

The First Reactor

DISCLAIMER

This report was prepared as an account of work sponsored by an agency of the United States Government. Neither the United States Government nor any agency thereof, nor any of their employees, make any warranty, express or implied, or assumes any legal liability or responsibility for the accuracy, completeness, or usefulness of any information, apparatus, product, or process disclosed, or represents that its use would not infringe privately owned rights. Reference herein to any specific commercial product, process, or service by trade name, trademark, manufacturer, or otherwise does not necessarily constitute or imply its endorsement, recommendation, or favoring by the United States Government or any agency thereof. The views and opinions of authors expressed herein do not necessarily state or reflect those of the United States Government or any agency thereof.

DISCLAIMER

Portions of this document may be illegible in electronic image products. Images are produced from the best available original document.



The First Reactor



U.S. Department of Energy

Assistant Secretary for Nuclear Energy
and Assistant Secretary, Management
and Administration
Washington, D.C. 20585

December 1982



This report has been reproduced directly from the best available copy.

Available from the National Technical Information Service, U.S. Department of Commerce, Springfield, Virginia 22161.

Price: Printed Copy A03
Microfiche A01

Codes are used for pricing all publications. The code is determined by the number of pages in the publication. Information pertaining to the pricing codes can be found in the current issues of the following publications, which are generally available in most libraries: *Energy Research Abstracts, (ERA)*; *Government Reports Announcements and Index (GRA and I)*; *Scientific and Technical Abstract Reports (STAR)*; and publication, NTIS-PR-360 available from (NTIS) at the above address.



The First Reactor / Contents

PREFACE	v
INTRODUCTION	vii
THE FIRST PILE	1
<i>By Corbin Allardice and Edward R. Trapnell</i>	
Years of Preliminary Research	3
Bohr's Trip to America	5
The Cubical Lattice Concept	7
The Manhattan District Formed	9
Computations Forecast Success	12
Assembly for the Test	14
Time Out for Lunch	16
The Curve is Exponential	18
FERMI'S OWN STORY	21
<i>By Enrico Fermi</i>	
The Discovery of Fission	22
The Gathering on the Balcony	24
OF SECRECY AND THE PILE	27
<i>By Laura Fermi</i>	
The Fermi's Party	28
A Homemaker's Schedule	29
Sinking an Admiral	30
FINAL CHAPTERS	34
EPILOGUE	36
SUGGESTED REFERENCES	38

United States Department of Energy

Assistant Secretary

for Nuclear Energy

and

Assistant Secretary, Management and Administration

Office of the Executive Secretary

History Division

Washington, D.C. 20585

PREFACE

On December 2, 1942, in a racquets court underneath the West Stands of Stagg Field at the University of Chicago, a team of scientists led by Enrico Fermi created man's first controlled, self-sustaining nuclear chain reaction.

Since 1946 the story of this remarkable scientific and technological achievement has been periodically commemorated by those involved. It is now a well known and significant benchmark in the history of nuclear energy technology.

This updated and revised story of the first reactor, or "pile," is based on the firsthand accounts of the participants as told to Corbin Allardice and Edward R. Trapnell. It also includes the postwar recollections of Enrico and Laura Fermi. The text of the three accounts remains largely unchanged.

Forty years after the event, this pamphlet still serves to provide the public with a brief and readable account of a significant moment in American history of nuclear energy.

Fall 1982

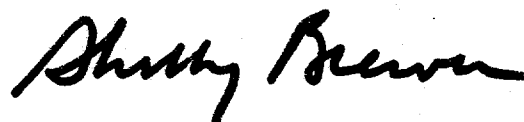

Shelby T. Brewer
Assistant Secretary for Nuclear Energy

INTRODUCTION

This new edition of an old story of man's first self-sustaining nuclear chain reaction is itself a document of historical interest and significance.

Because of the extraordinary secrecy that surrounded the Manhattan Engineer District, America's \$2 billion project to harness atomic energy, the postwar public was largely ignorant of its history.

The original essay on "The First Pile" was written in the fall of 1946 because nowhere in the extensive records of the Manhattan Project was there a narrative history of the first self-sustaining nuclear chain reaction. Prepared for a press release by the Manhattan Engineer District, the report included background material which was part of the final report on a significant experiment.

The original authors of "The First Pile" were Corbin Allardice and Edward R. Trapnell, two public information officers for the Atomic Energy Commission, the agency that succeeded the Manhattan Project on January 1, 1947. Allardice later served in various public information posts for the Atomic Energy Commission and Trapnell became Special Assistant to the AEC General Manager with responsibilities for congressional relations.

Trapnell and Allardice felt that the story of the experiment which was successfully completed on December 2, 1942, was of such significance that it should be written down while still relatively fresh in the minds of those who took part. Their essay is based on postwar interviews with more than a dozen of the 43 scientists present at the Stagg Field on December 2nd. Another valuable source was the tape on which was traced the neutron intensity within the first pile.

In addition, *The First Reactor* contains the firsthand reminiscences of Enrico Fermi, the Nobel prize-winning project director, and his wife, Laura. Written in the 1950's, they provide valuable insights into the human and technical challenges of a secret enterprise conducted by American and European refugee scientists.

The appended list of those present was obtained from the label of a bottle in which Dr. E. P. Wigner had brought Chianti wine to toast the experiment's success. Most of those present had signed the wine bottle's label and given it to Dr. A. Wattenberg as a memento. This was the only written record of who had taken part in the experiment. Each of the scientists listed on the bottle was asked if he recalled any others who might have been present, and the resulting list of 43 names was accepted as complete.

The two drawings of the first pile were prepared by Melvin A. Miller of the Argonne National Laboratory staff in the fall of 1946. They are based on descriptions given Miller by the scientists who built the first "pile."

In the years since 1946 more literature on nuclear energy history has become available, including the memoirs and autobiographies of many scientists involved in the Manhattan Project, the official but unpublished multi-volume history of the Project (declassified in 1976), and scholarly monographs. To reflect this new information and perspective forty years after the event, we have added an epilogue and updated the bibliography of recommended readings.

We are grateful to Professor Robert C. Williams of Washington University in St. Louis, and to History Associates Incorporated, for assistance in the revising and updating of this brief but important history.

Jack M. Holl
Chief Historian

THE FIRST PILE

By Corbin Allardice and Edward R. Trapnell

On December 2, 1942, man first initiated a self-sustaining nuclear chain reaction, and controlled it.

Beneath the West Stands of Stagg Field,¹ Chicago, late in the afternoon of that day, a small group of scientists witnessed the advent of a new era in science. History was made in what had been a squash-rackets court.

Precisely at 3:25 p.m.,² Chicago time, scientist George Weil withdrew the cadmium-plated control rod and by his action man unleashed and controlled the energy of the atom.

As those who witnessed the experiment became aware of what had happened, smiles spread over their faces and a quiet ripple of applause could be heard. It was a tribute to Enrico Fermi, Nobel Prize winner, to whom, more than to any other person, the success of the experiment was due.

Fermi, born in Rome, Italy, on September 29, 1901, had been working with uranium for many years. In 1934 he bombarded uranium with neutrons and produced what appeared to be element 93 (uranium is element 92) and element 94. However, after closer examination it seemed as if nature had gone wild; several other elements were present, but none could be fitted into the periodic table near uranium—where Fermi knew they should have fitted if they had been the transuranic elements 93 and 94. It was not until five years later that anyone, Fermi included, realized he had actually caused fission of the uranium and that these unexplained elements belonged back in the middle part of the periodic table.

Fermi was awarded the Nobel Prize in 1938 for his work on transuranic elements. He and his family went to Sweden to receive the prize. The Italian Fascist press severely criticized him for not wearing a Fascist uniform and failing to give the Fascist salute when he received the award. The Fermis never returned to Italy.

From Sweden, having taken most of his personal possessions with him, Fermi proceeded to London and thence to America where he has remained ever since.³

The modern Italian explorer of the unknown was in Chicago that cold December day in 1942. An outsider looking into the squash court where Fermi was working would have been greeted by a strange sight. In the center

¹The University of Chicago athletic stadium.

²Dr. Herbert Anderson has pointed out that the time was 3:36, which is now the accepted official time.

³Dr. Fermi died in Chicago, Illinois, November 28, 1954.

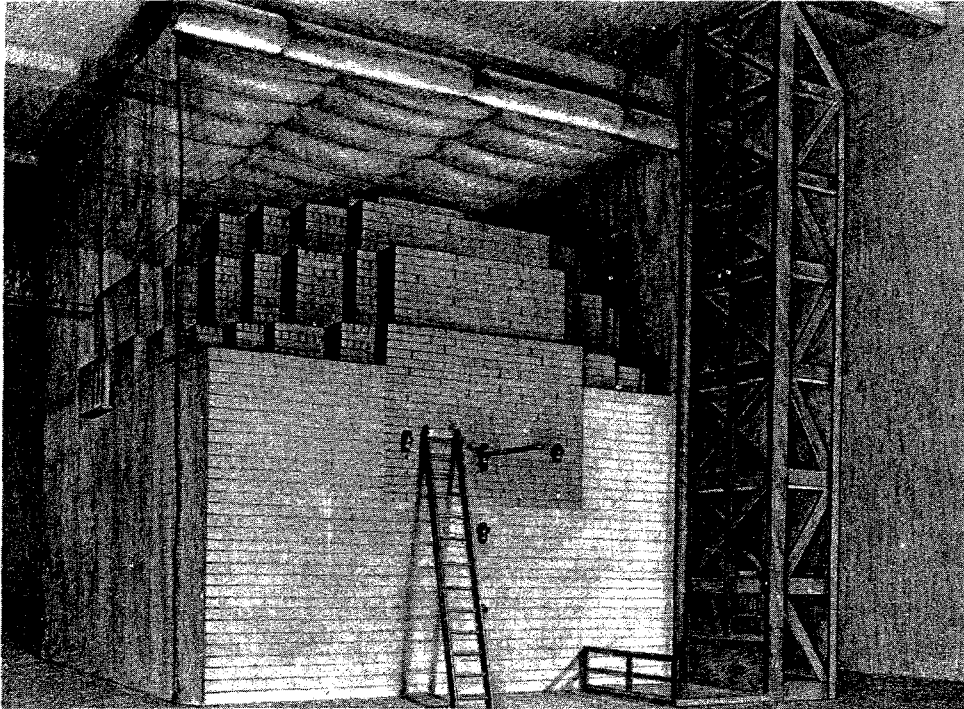

Sketch of the first pile. Around it is a tent of balloon cloth fabric, prepared so that the reactor could be sealed to minimize nonproductive loss of neutrons if necessary; the tent was never used.

of the 30- by 60-foot room, shrouded on all but one side by a gray balloon cloth envelope, was a pile of black bricks and wooden timbers, square at the bottom and a flattened sphere on top. Up to half of its height, its sides were straight. The top half was domed, like a beehive. During the construction of this crude appearing but complex pile (the name which has since been applied to all such devices)⁴ the standing joke among the scientists working on it was: "If people could see what we're doing with a million-and-a-half of their dollars, they'd think we are crazy. If they knew why we are doing it, they'd be sure we are."

In relation to the fabulous atomic bomb program, of which the Chicago Pile experiment was a key part, the successful result reported on December 2nd formed one more piece for the jigsaw puzzle which was atomic energy. Confirmation of the chain reactor studies was an inspiration to the leaders of the bomb project, and reassuring at the same time, because the Army's Manhattan Engineer District had moved ahead on many fronts. Contract negotiations were under way to build production-scale nuclear chain reactors,

⁴The term "pile," in use for the first few years of the atomic age, gradually gave way to "reactor" to identify the key device that controls the nuclear fission reaction.

land had been acquired at Oak Ridge, Tennessee, and millions of dollars had been obligated.

Three years before the December 2nd experiment, it had been discovered that when an atom of uranium was bombarded by neutrons, the uranium atom sometimes was split, or fissioned. Later, it had been found that when an atom of uranium fissioned, additional neutrons were emitted and became available for further reaction with other uranium atoms. These facts implied the possibility of a chain reaction, similar in certain respects to the reaction which is the source of the sun's energy. The facts further indicated that if a sufficient quantity of uranium could be brought together under the proper conditions, a self-sustaining chain reaction would result. This quantity of uranium necessary for a chain reaction under given conditions is known as the critical mass, or more commonly, the "critical size" of the particular pile.

For three years the problem of a self-sustaining chain reaction had been assiduously studied. Nearly a year after Pearl Harbor,⁵ a pile of critical size was finally constructed. It worked. A self-sustaining nuclear chain reaction was a reality

Years of Preliminary Research

Years of scientific effort and study lay behind this demonstration of the first self-sustaining nuclear chain reaction. The story goes back at least to the fall of 1938 when two German scientists, Otto Hahn and Fritz Strassman, working at the Kaiser Wilhelm Institute in Berlin, found barium in the residue material from an experiment in which they had bombarded uranium with neutrons from a radium-beryllium source. This discovery caused tremendous excitement in the laboratory because of the difference in atomic mass between the barium and the uranium. Previously, in residue material from similar experiments, elements other than uranium had been found, but they differed from the uranium by only one or two units of mass. The barium differed by approximately 98 units of mass. The question was, where did this element come from? It appeared that the uranium atom when bombarded by a neutron had split into two different elements, each of approximately half the mass of the uranium.

Before publishing their work in the German scientific journal *Die Naturwissenschaften*, Hahn and Strassman communicated with Lise Meitner

⁵The Japanese attacked the American naval base at Pearl Harbor, Hawaiian Islands, December 7, 1941; this attack brought the United States into World War II.



Lise Meitner and Otto Hahn in their laboratory in the 1930s.

who, having fled the Nazi-controlled Reich,⁶ was working with Niels Bohr in Copenhagen, Denmark.

Miss Meitner was very much interested in this phenomenon and immediately attempted to analyze mathematically the results of the experiment. She reasoned that the barium and the other residual elements were the result of a fission, or breaking, of the uranium atom. But when she added the atomic masses of the residual elements, she found this total was less than the atomic mass of uranium.

There was but one explanation: The uranium fissioned or split, forming two elements each of approximately half of its original mass, but not exactly half. Some of the mass of the uranium had disappeared. Miss Meitner and her nephew O. R. Frisch suggested that the mass which disappeared was converted into energy. According to the theory advanced in 1905 by Albert Einstein in which the relationship of mass to energy was stated by the equation $E = mc^2$ (energy is equal to mass times the square of the speed of light), this energy release would be of the order of 200,000,000 electron volts for each atom fissioned.

⁶Germany under Adolf Hitler's Nazi Party rule was known as the "Third Reich" (Third Realm).

Bohr's Trip to America



*Niels Bohr,
Danish physicist*

Einstein himself, nearly thirty-five years before, had said this theory might be proved by further study of radioactive elements. Bohr was planning a trip to America to discuss other problems with Einstein who had found a haven at Princeton's Institute for Advanced Studies. Bohr came to America, but the principal item he discussed with Einstein was the report of Meitner and Frisch. Bohr arrived at Princeton on January 16, 1939. He talked to Einstein and J. A. Wheeler who had once been his student. From Princeton the news spread by word of mouth to neighboring physicists, including Enrico Fermi at Columbia. Fermi and his associates immediately began work to find the heavy pulse of ionization which could be expected from the fission and consequent release of energy.

Before the experiments could be completed, however, Fermi left Columbia to attend a conference on theoretical physics at George Washington University in Washington, D.C. Here Fermi and Bohr exchanged information and discussed the problem of fission. Fermi mentioned the possibility that neutrons might be emitted in the process. In this conversation, their ideas of the possibility of a chain reaction began to crystallize.

Before the meeting was over, experimental confirmation of Meitner and Frisch's deduction was obtained from four laboratories in the United States (Carnegie Institution of Washington, Columbia, Johns Hopkins, and the University of California). Later it was learned that similar confirmatory experiments had been made by Frisch and Meitner on January 15th. Frederic Joliot-Curie in France, too, confirmed the results and published them in the January 30th issue of the French scientific journal, *Comptes rendus*.

On February 27, 1939, the Canadian-born Walter H. Zinn and Leo Szilard, a Hungarian, both working at Columbia University, began their experiments to find the number of neutrons emitted by the fissioning uranium. At the same time, Fermi and his associates, Herbert L. Anderson and H. B. Hanstein, commenced their investigation of the same problem. The results of these experiments were published side-by-side in the April edition of the *Physical Review* and showed that a chain reaction might be possible since the uranium emitted additional neutrons when it fissioned.

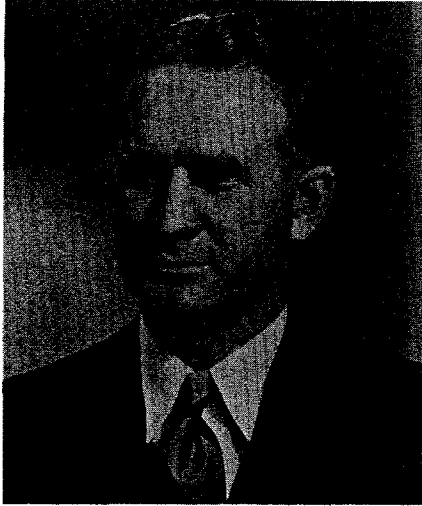

Walter H. Zinn



Leo Szilard

These measurements of neutron emission by Fermi, Zinn, Szilard, Anderson, and Hanstein were highly significant steps toward a chain reaction.

Further impetus to the work on a uranium reactor was given by the discovery of plutonium at the Radiation Laboratory,⁷ Berkeley, California, in March, 1940. This element, unknown in nature, was formed by uranium-238 capturing a neutron, and thence undergoing two successive changes in atomic structure with the emission of beta particles. Plutonium, it was believed, would undergo fission as did the rare isotope of uranium, U²³⁵.

Meanwhile, at Columbia, Fermi and Zinn and their associates were working to determine operationally possible designs of a uranium chain reactor. Among other things, they had to find a suitable moderating material to slow down the neutrons traveling at relatively high velocities. In July, 1941, experiments with uranium were started to obtain measurements of the reproduction factor (called "k"), which was the key to the problem of a chain reaction. If this factor could be made sufficiently greater than 1, a chain reaction could be made to take place in a mass of material of practical dimensions. If it were less than 1, no chain reaction could occur.

Since impurities in the uranium and in the moderator would capture neutrons and make them unavailable for further reactions, and since neutrons would escape from the pile without encountering uranium-235 atoms, it

⁷Now the Lawrence Berkeley Radiation Laboratory, operated for the U.S. Department of Energy by the University of California.

was not known whether a value for "k" greater than unity could ever be obtained.

Fortunate it was that the obtaining of a reproduction factor greater than 1 was a complex and difficult problem. If Hitler's scientists had discovered the secret of controlling the neutrons and had obtained a working value of "k," they would have been well on the way toward producing an atomic bomb for the Nazis.

The Cubical Lattice Concept

One of the first things that had to be determined was how best to place the uranium in the reactor. Fermi and Szilard suggested placing the uranium in a matrix of the moderating material, thus forming a cubical lattice of uranium. This placement appeared to offer the best opportunity for a neutron to encounter a uranium atom. Of all the materials which possessed the proper moderating qualities, graphite was the only one which could be obtained in sufficient quantity of the desired degree of purity.

The study of graphite-uranium lattice reactors was started at Columbia in July, 1941, but after reorganization of the uranium project in December, 1941, Arthur H. Compton was placed in charge of this phase of the work, under the Office of Scientific Research and Development, and it was decided that the chain reactor program should be concentrated at the University of Chicago. Consequently, early in 1942 the Columbia and Princeton groups

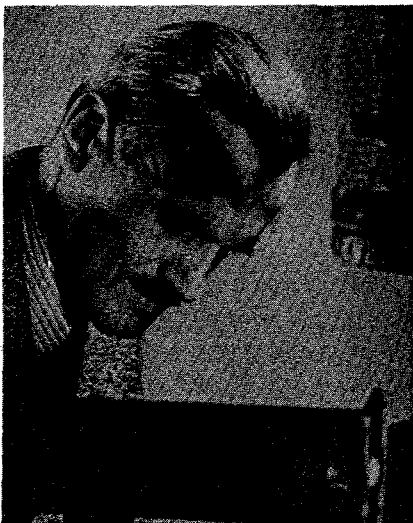

*Arthur Holly Compton, Director of the
"Chicago Metallurgical Project," 1942-1945.*

were transferred to Chicago where the Metallurgical Laboratory⁸ was established.

In a general way, the experimental nuclear physics group under Fermi was primarily concerned with getting a chain reaction going; the chemistry division organized by F. H. Spedding (later in turn under S. K. Allison, J. Franck, W. C. Johnson, and T. Hogness) with the chemistry of plutonium and with separation methods, and the theoretical group under E. P. Wigner with designing production piles. However, the problems were intertwined and the various scientific and technical aspects of the fission process were studied in whatever group seemed best equipped for the particular task.

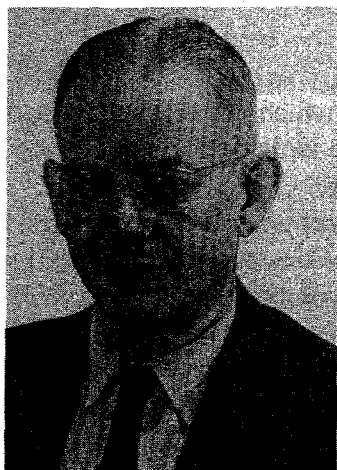

Norman Hilberry headed procurement efforts at the secret "Metallurgical Laboratory."

At Chicago, the work on subcritical size piles was continued. By July, 1942, the measurements obtained from these experimental piles had gone far enough to permit a choice of design for a test pile of critical size. At that time, the dies for the pressing of the uranium oxides were designed by Zinn and ordered made. It was a fateful step, since the entire construction of the pile depended upon the shape and size of the uranium pieces.

It was necessary to use uranium oxides because metallic uranium of the desired degree of purity did not exist. Although several manufacturers were attempting to produce the uranium metal, it was not until November, that any appreciable amount was available. By mid-November, Westinghouse Electric and Manufacturing Company, Metal Hydrides Company, and F. H.

⁸The Metallurgical Laboratory was the predecessor of Argonne National Laboratory, which is operated for the U.S. Department of Energy by the University of Chicago and Argonne Universities Association.

Spedding, who was working at Iowa State College at Ames, Iowa, had delivered several tons of the highly purified metal which was placed in the pile, as close to the center as possible. The procurement program for moderating material and uranium oxides had been handled by Norman Hilberry. R. L. Doan headed the procurement program for pure uranium metal.

Although the dies for the pressing of the uranium oxides were designed in July, additional measurements were necessary to obtain information about controlling the reaction, to revise estimates as to the final critical size of the pile, and to develop other data. Thirty experimental subcritical piles were constructed before the final pile was completed.

The Manhattan District Formed

Meantime, in Washington, Vannevar Bush, Director of the Office of Scientific Research and Development, had recommended to President Roosevelt that a special Army Engineer organization be established to take full responsibility for the development of the atomic bomb. During the summer, the Manhattan Engineer District⁹ was created, and in September, 1942, Major General L. R. Groves assumed command.



General Leslie R. Groves, U.S. Army Corps of Engineers, directed the "Manhattan Engineer District," 1942-1946.

⁹The Atomic Energy Commission (AEC), a civilian agency, succeeded the Manhattan Engineer District as the governmental organization to control atomic energy on January 1, 1947. On October 11, 1974, President Gerald Ford signed the bill that abolished the AEC. The research and development portions of the AEC were absorbed into the U.S. Energy Research and Development Administration (ERDA); the regulatory portions of the AEC were absorbed into the Nuclear Regulatory Commission (NRC). On October 1, 1977, the Energy Research and Development Administration became part of the newly created Department of Energy.

Construction of the main pile at Chicago started in November. The project gained momentum, with machining of the graphite blocks, pressing of the uranium oxide pellets, and the design of instruments. Fermi's two "construction" crews, one under Zinn and the other under Anderson, worked almost around the clock. V. C. Wilson headed up the instrument work.

Original estimates as to the critical size of the pile were pessimistic. As a further precaution, it was decided to enclose the pile in a balloon cloth bag which could be evacuated to remove the neutron-capturing air.

This balloon cloth bag was constructed by Goodyear Tire and Rubber Company. Specialists in designing gasbags for lighter-than-air craft, the company's engineers were a bit puzzled about the aerodynamics of a square balloon. Security regulations forbade informing Goodyear of the purpose of the envelope and so the Army's new square balloon was the butt of much joking.

The bag was hung with one side left open; in the center of the floor a circular layer of graphite bricks was placed. This and each succeeding layer of the pile was braced by a wooden frame. Alternate layers contained the uranium. By this layer-on-layer construction a roughly spherical pile of uranium and graphite was formed.

Facilities for the machining of graphite bricks were installed in the West Stands. Week after week this shop turned out graphite bricks. This work was done under the direction of Zinn's group, by skilled mechanics led by millwright August Knuth. In October, Anderson and his associates joined Zinn's men.

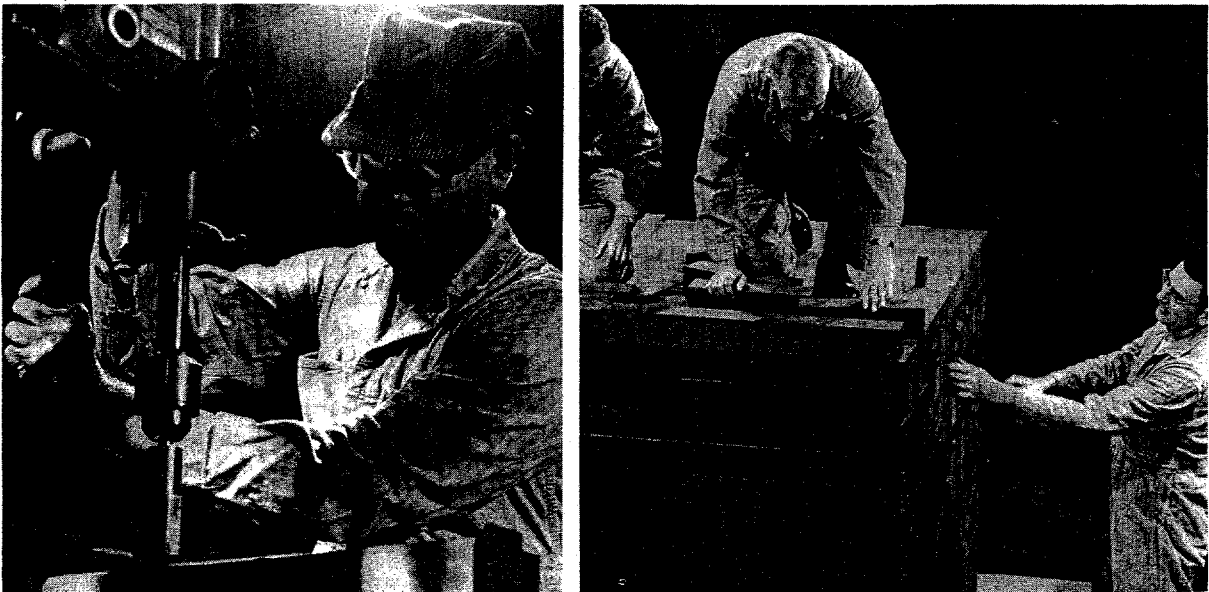

Construction of the Pile

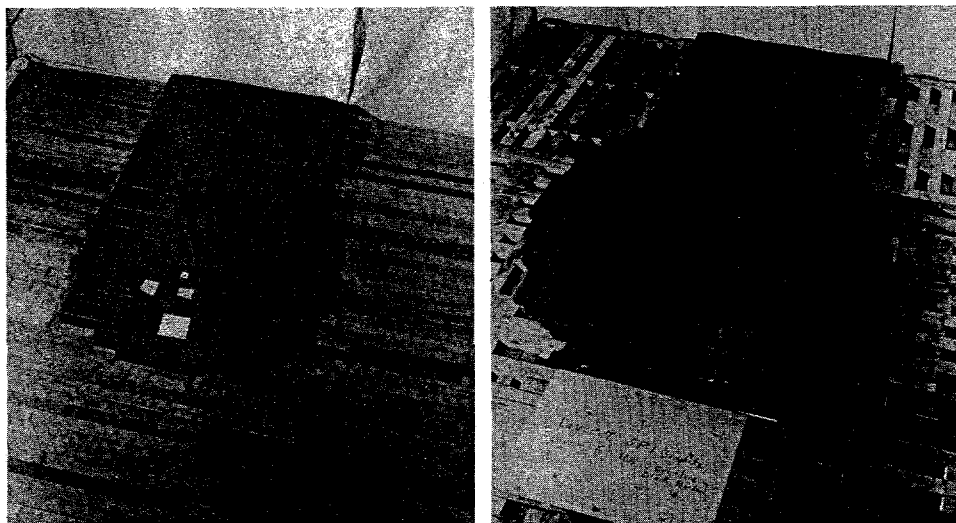

Graphite layers form the base of the pile, left. On the right is the 7th layer of graphite and edges of 6th layer containing 3/4-inch pseudospheres of black uranium oxide. Beginning with layer 6, alternate courses of graphite containing uranium metal and/or uranium oxide fuel were separated by layers of solid graphite blocks.

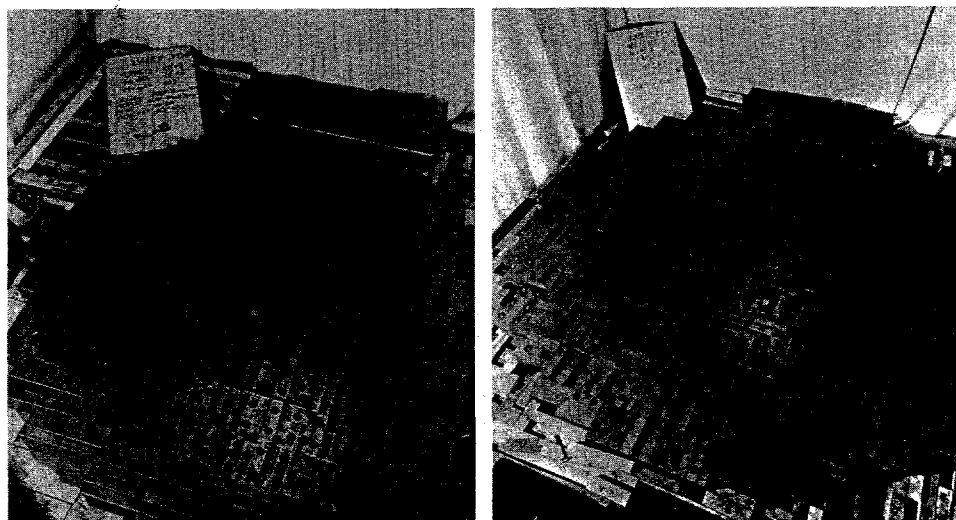

Tenth layer of graphite blocks containing pseudospheres of black and brown uranium oxide. The brown briquets, slightly richer in uranium, were concentrated in the central area. In the foreground and on either side are cavities filled with graphite, now presumed to have been an expedient measure dictated by shortage of fuel and, possibly, a last minute change in the lattice arrangement. On the right is the 19th layer of graphite covering layer 18 containing slugs of uranium oxide.

Describing this phase of the work, Albert Wattenberg, one of Zinn's group, said: "We found out how coal miners feel. After eight hours of machining graphite, we looked as if we were made up for a minstrel. One shower would remove only the surface graphite dust. About a half-hour after the first shower the dust in the pores of your skin would start oozing. Walking around the room where we cut the graphite was like walking on a dance floor. Graphite is a dry lubricant, you know, and the cement floor covered with graphite dust was slippery."

Before the structure was half complete, measurements indicated that the critical size at which the pile would become self-sustaining was somewhat less than had been anticipated in the design.

Computations Forecast Success

Day after day the pile grew toward its final shape. And as the size of the pile increased, so did the nervous tension of the men working on it. Logically and scientifically they knew this pile would become self-sustaining. It had to. All the measurements indicated that it would. But still the demonstration had to be made. As the eagerly awaited moment drew nearer, the scientists gave greater and greater attention to details, the accuracy of measurements, and exactness of their construction work.

Guiding the entire pile construction and design was the nimble-brained Fermi, whose associates described him as "completely self-confident but wholly without conceit."

So exact were Fermi's calculations, based on the measurements taken from the partially finished pile, that days before its completion and demonstration on December 2nd, he was able to predict almost to the exact brick the point at which the reactor would become self-sustaining.

But with all their care and confidence, few in the group knew the extent of the heavy bets being placed on their success. In Washington, the Manhattan District had proceeded with negotiations with E. I. duPont de Nemours and Company to design, build, and operate a plant based on the principles of the then unproved Chicago pile. The \$350,000,000 Hanford Engineer Works¹⁰ at Pasco, Washington, was to be the result.

At Chicago during the early afternoon of December 1st, tests indicated that critical size was rapidly being approached. At 4:00 p.m. Zinn's group was relieved by the men working under Anderson. Shortly afterwards, the

¹⁰Later the Hanford Atomic Products Operation—Hanford Laboratories, operated by the General Electric Co., for the AEC. Since 1965 Hanford facilities have been operated by 5 contractors.

Cutaway model of the first pile in the Stagg Field racquets court. The mechanism to withdraw and insert the emergency control rod "Zip" is at center right in the picture.

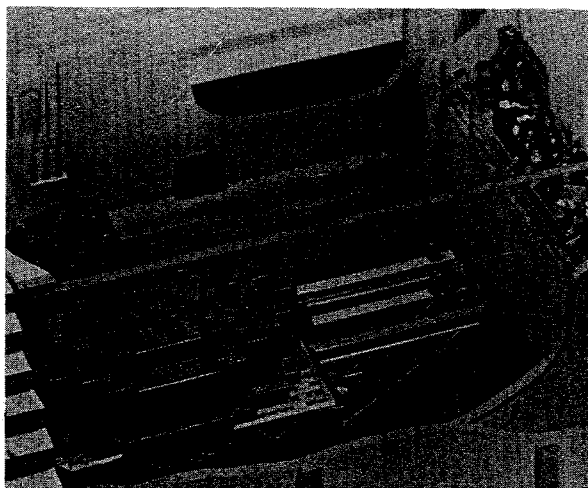

The West Stands of Stagg Field in Chicago.

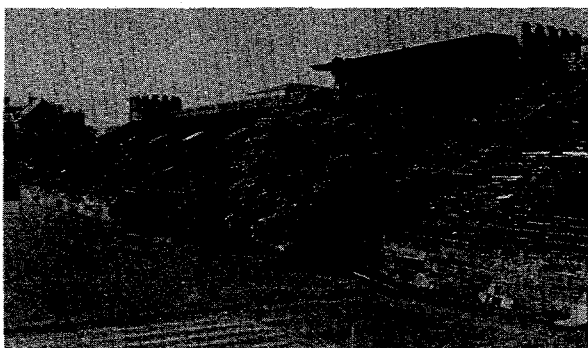

last layer of graphite and uranium bricks was placed on the pile. Zinn, who remained, and Anderson made several measurements of the activity within the pile. They were certain that when the control rods were withdrawn, the pile would become self-sustaining. Both had agreed, however, that should measurements indicate the reaction would become self-sustaining when the rods were withdrawn, they would not start the pile operating until Fermi and the rest of the group could be present. Consequently, the control rods were locked and further work was postponed until the following day.

That night the word was passed to the men who had worked on the pile that the trial run was due the next morning.

Assembly for the Test

About 8:30 on the morning of Wednesday, December 2nd, the group began to assemble in the squash court.

At the north end of the squash court was a balcony about ten feet above the floor of the court. Fermi, Zinn, Anderson, and Compton were grouped around instruments at the east end of the balcony. The remainder of the observers crowded the little balcony. R. G. Nobles, one of the young scientists who worked on the pile, put it this way: "The control cabinet was surrounded by the 'big wheels'; the 'little wheels' had to stand back."

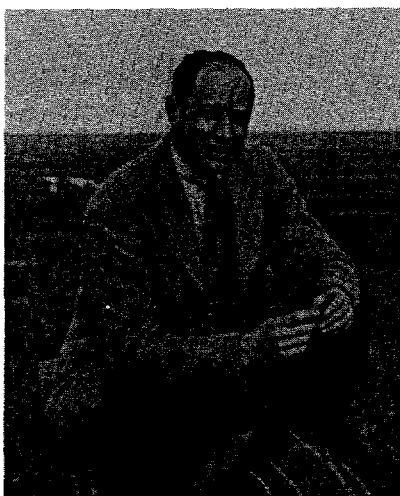

George Weil

On the floor of the squash court, just beneath the balcony, stood George Weil, whose duty it was to handle the final control rods. In the pile were three sets of control rods. One set was automatic and could be controlled from the balcony. Another was an emergency safety rod. Attached to one end of this rod was a rope running through the pile and weighted heavily on the opposite end. The rod was withdrawn from the pile and tied by another rope to the balcony. Hilberry was ready to cut this rope with an axe should something unexpected happen, or in case the automatic safety rods failed. The third rod,

operated by Weil, was the one which actually held the reaction in check until withdrawn the proper distance.

Since this demonstration was new and different from anything ever done before, complete reliance was not placed on mechanically operated control rods. Therefore, a "liquid-control squad," composed of Harold Lichtenberger, W. Nyer, and A. C. Graves, stood on a platform above the pile. They were prepared to flood the pile with cadmium-salt solution in case of mechanical failure of the control rods.

Each group rehearsed its part of the experiment.

At 9:45 Fermi ordered the electrically operated control rods withdrawn. The man at the controls threw the switch to withdraw them. A small motor whined. All eyes watched the lights which indicated the rods' position.

But quickly, the balcony group turned to watch the counters, whose clicking stepped up after the rods were out. The indicators of these counters



resembled the face of a clock, with "hands" to indicate neutron count. Nearby was a recorder, whose quivering pen traced the neutron activity within the pile.

Shortly after ten o'clock, Fermi ordered the emergency rod, called "Zip," pulled out and tied.

"Zip out," said Fermi. Zinn withdrew "Zip" by hand and tied it to the balcony rail. Weil stood ready by the "vernier" control rod which was marked to show the number of feet and inches which remained within the pile.

At 10:37 Fermi, without taking his eyes off the instruments, said quietly:

"Pull it to 13 feet, George." The counters clicked faster. The graph pen moved up. All the instruments were studied, and computations were made.

"This is not it," said Fermi. "The trace will go to this point and level off." He indicated a spot on the graph. In a few minutes the pen came to the indicated point and did not go above that point. Seven minutes later Fermi ordered the rod out another foot.

Again the counters stepped up their clicking, the graph pen edged upwards. But the clicking was irregular. Soon it leveled off, as did the thin line of the pen. The pile was not self-sustaining—yet.

At eleven o'clock, the rod came out another six inches; the result was the same: an increase in rate, followed by the leveling off.

Fifteen minutes later, the rod was further withdrawn and at 11:25 was moved again. Each time the counters speeded up, the pen climbed a few points. Fermi predicted correctly every movement of the indicators. He knew the time was near. He wanted to check everything again. The automatic con-

trol rod was reinserted without waiting for its automatic feature to operate. The graph line took a drop, the counters slowed abruptly.

At 11:35, the automatic safety rod was withdrawn and set. The control rod was adjusted and "Zip" was withdrawn. Up went the counters, clicking, clicking, faster and faster. It was the clickety-click of a fast train over the rails. The graph pen started to climb. Tensely, the little group watched, and waited, entranced by the climbing needle.

Whrrump! As if by a thunder clap, the spell was broken. Every man froze—then breathed a sigh of relief when he realized the automatic rod had slammed home. The safety point at which the rod operated automatically had been set too low.

"I'm hungry," said Fermi. "Let's go to lunch."

Time Out for Lunch

Perhaps, like a great coach, Fermi knew when his men needed a "break."

It was a strange "between halves" respite. They got no pep talk. They talked about everything else but the "game." The redoubtable Fermi, who never says much, had even less to say. But he appeared supremely confident. His "team" was back on the squash court at 2:00 p.m. Twenty minutes later, the automatic rod was reset and Weil stood ready at the control rod.

"All right, George," called Fermi, and Weil moved the rod to a pre-determined point. The spectators resumed their watching and waiting, watching the counters spin, watching the graph, waiting for the settling down and computing the rate of rise of reaction from the indicators.

At 2:50 the control rod came out another foot. The counters nearly jammed, the pen headed off the graph paper. But this was not it. Counting ratios and the graph scale had to be changed.

"Move it six inches," said Fermi at 3:20. Again the change—but again the leveling off. Five minutes later, Fermi called: "Pull it out another foot."

Weil withdrew the rod.

"This is going to do it," Fermi said to Compton, standing at his side. "Now it will become self-sustaining. The trace will climb and continue to climb. It will not level off."

Fermi computed the rate of rise of the neutron counts over a minute period. He silently, grim-faced, ran through some calculations on his slide rule.



First pile scientists at the University of Chicago on December 2, 1946, the fourth anniversary of their success. Back row, left to right, Norman Hilberry, Samuel Allison, Thomas Brill, Robert G. Nobles, Warren Nyer, and Marvin Wilkening. Middle row, Harold Agnew, William Sturm, Harold Lichtenberger, Leona W. Marshall, and Leo Szilard. Front row, Enrico Fermi, Walter H. Zinn, Albert Wattenberg, and Herbert L. Anderson.

In about a minute he again computed the rate of rise. If the rate was constant and remained so, he would know the reaction was self-sustaining. His fingers operated the slide rule with lightning speed. Characteristically, he turned the rule over and jotted down some figures on its ivory back.

Three minutes later he again computed the rate of rise in neutron count. The group on the balcony had by now crowded in to get an eye on the instruments, those behind craning their necks to be sure they would know the very instant history was made. In the background could be heard Wilcox Overbeck calling out the neutron count over an annunciator system. Leona Marshall (the only girl present), Anderson, and William Sturm were recording the readings from the instruments. By this time the click of the counters was too fast for the human ear. The clickety-click was now a steady brrrrr. Fermi, unmoved, unruffled, continued his computations.

The Curve is Exponential

"I couldn't see the instruments," said Weil. "I had to watch Fermi every second, waiting for orders. His face was motionless. His eyes darted from one dial to another. His expression was so calm it was hard. But suddenly, his whole face broke into a broad smile."

Fermi closed his slide rule—

"The reaction is self-sustaining," he announced quietly, happily. "The curve is exponential."

The group tensely watched for twenty-eight minutes while the world's first nuclear chain reactor operated.

The upward movement of the pen was leaving a straight line. There was no change to indicate a leveling off. This was it.

"O.K., 'Zip' in," called Fermi to Zinn who controlled that rod. The time was 3:53 p.m. Abruptly, the counters slowed down, the pen slid down across the paper. It was all over.

Man had initiated a self-sustaining nuclear reaction—and then stopped it. He had released the energy of the atom's nucleus and controlled that energy.

DEC. 2 1942 START-UP
OF
FIRST SELF-SUSTAINING CHAIN REACTION
NEUTRON INTENSITY IN THE PILE AS RECORDED BY A GALVANOMETER

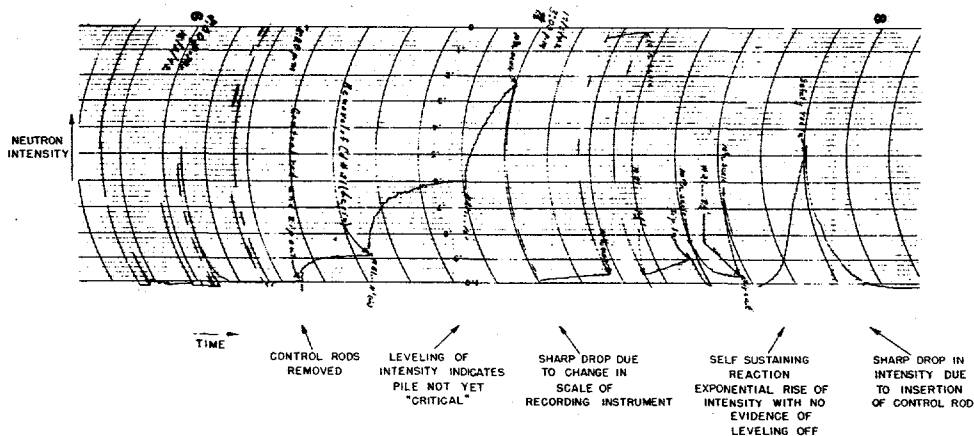

The "birth certificate" of the Atomic Age. The galvanometer chart that indicated the rise in neutron intensity associated with the first controlled chain reaction.

Right after Fermi ordered the reaction stopped, the Hungarian-born theoretical physicist Eugene Wigner presented him with a bottle of Chianti wine. All through the experiment Wigner had kept this wine hidden behind his back.

Fermi uncorked the wine bottle and sent out for paper cups so all could drink. He poured a little wine in all the cups, and silently, solemnly, without toasts, the scientists raised the cups to their lips—the Canadian Zinn, the Hungarians Szilard and Wigner, the Italian Fermi, the Americans Compton, Anderson, Hilberry, and a score of others. They drank to success—and to the hope they were the first to succeed.

A small crew was left to straighten up, lock controls, and check all apparatus. As the group filed from the West Stands, one of the guards asked Zinn:

"What's going on, Doctor, something happen in there?"

The guard did not hear the message which Arthur Compton was giving James B. Conant at Harvard, by long-distance telephone. Their code was not prearranged.

"The Italian navigator has landed in the New World," said Compton.

"How were the natives?" asked Conant.

"Very friendly."

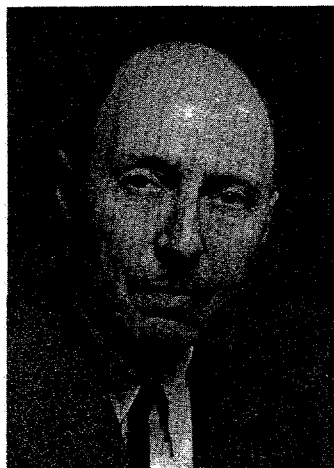

Eugene P. Wigner

The Chianti bottle purchased by Eugene Wigner to help celebrate the first self-sustaining, controlled chain reaction. Many of the participants, including Enrico Fermi, autographed the basket.



**List of Those Present at
CHICAGO PILE EXPERIMENT
December 2, 1942**

Enrico Fermi

H. M. Agnew	G. Monk, Jr.
S. K. Allison	R. G. Nobles
H. L. Anderson	W. E. Nyer
W. Arnold	W. P. Overbeck
H. M. Barton	H. J. Parsons
T. Brill	G. S. Pawlicki
R. F. Christy	L. Sayvetz
A. H. Compton	L. Seren
R. J. Fox	L. A. Slotin
S. A. Fox	F. H. Spedding
D. K. Froman	W. J. Sturm
A. C. Graves	Leo Szilard
C. H. Greenewalt	A. Wattenberg
N. Hilberry	R. J. Watts
D. L. Hill	G. L. Weil
W. H. Hinch	E. P. Wigner
W. R. Kanne	M. Wilkening
P. G. Koontz	V. C. Wilson
H. E. Kubitschek	E. O. Wollan
H. V. Lichtenberger	Miss L. Woods
G. Miller	W. H. Zinn

FERMI'S OWN STORY¹¹

By Enrico Fermi

It is ten years since man first achieved a self-sustaining atomic reaction.

Many people link this event only with the development of the atomic bomb and the subsequent efforts to develop the hydrogen bomb, reference to which has been made in the last few days by the Atomic Energy Commission.

The history of the first self-sustaining nuclear chain reaction, like that of all scientific achievements, begins with man's first philosophical speculations about the nature of the universe. Its ultimate consequences are still unpredictable.

The sequence of discoveries leading to the atomic chain reaction was part of the search of science for a fuller explanation of nature and the world around us. No one had any idea or intent in the beginning of contributing to a major industrial or military development.

A partial list of the main stepping-stones to this development indicates many countries contributed to it.

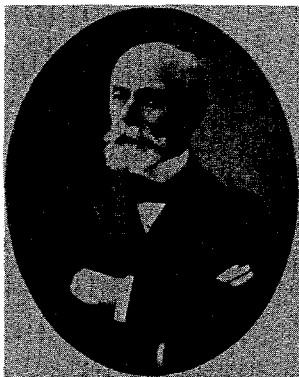

A. H. Becquerel

The story begins in Paris in 1896 when Antoine Henri Becquerel discovered the existence of radioactive elements; that is, elements which spontaneously emit invisible, penetrating rays. Two years later, also in Paris, Pierre and Marie Curie discovered radium, for many years the best known of the radioactive elements.

In Zurich, Switzerland, in 1905, Albert Einstein announced his belief that mass was equivalent to energy. This led to speculation that one could be transformed into the other.

A most important discovery came in 1912 when Ernest Rutherford discovered the minute but heavy nucleus which forms the core of the atom. In ordinary elements this core is stable; in radioactive elements it is unstable.

Shortly after World War I, the same Rutherford achieved for the first time the artificial disintegration of the nucleus at the center of the nitrogen atom.

¹¹Written by Dr. Fermi and published in the *Chicago Sun-Times*, November 23, 1952, in observance of the tenth anniversary of Fermi's successful "First Pile" experiment. Copyright by the *Chicago Sun-Times*. Reprinted by permission.

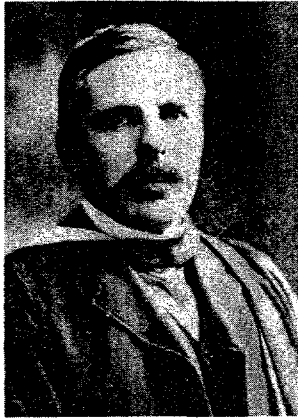

Ernest Rutherford

During the next decade, research progressed steadily, if unspectacularly. Then, in 1932, came a series of three discoveries by scientists working in three different countries which led to the next great advance.

Walter Bothe in Germany, and Frederic Joliot-Curie in Paris prepared the ground work that led James Chadwick of England to the discovery of the neutron. The neutron is an electrically neutral building block of the nuclear structure. The other building block is the positively charged proton.

The next step was taken in Rome in 1934. In experiments in which I was concerned it was shown that these neutrons could disintegrate many atoms, including those of uranium. This discovery was to be directly applied in the first atomic chain reaction eight years later.

The Discovery of Fission

The final stepping-stone was put in place in Berlin when Otto Hahn, working with Fritz Strassman, discovered fission or splitting of the uranium atom. When Hahn achieved fission, it occurred to many scientists that this fact opened the possibility of a form of nuclear (atomic) energy.

The year was 1939. A world war was about to start. The new possibilities appeared likely to be important, not only for peace but also for war.

A group of physicists in the United States—including Leo Szilard, Walter Zinn, now director of Argonne National Laboratory, Herbert Anderson, and myself—agreed privately to delay further publications of findings in this field.

We were afraid these findings might help the Nazis. Our action, of course, represented a break with scientific tradition and was not taken lightly. Subsequently, when the government became interested in the atom bomb project, secrecy became compulsory.

Here it may be well to define what is meant by the "chain reaction" which was to constitute our next objective in the search for a method of utilizing atomic energy.

An atomic chain reaction may be compared to the burning of a rubbish pile from spontaneous combustion. In such a fire, minute parts of the pile start to burn and in turn ignite other tiny fragments. When sufficient numbers

of these fractional parts are heated to the kindling points, the entire heap bursts into flames.

A similar process takes place in an atomic pile such as was constructed under the West Stands of Stagg Field at the University of Chicago in 1942.

The pile itself was constructed of uranium, a material that is embedded in a matrix of graphite. With sufficient uranium in the pile, the few neutrons emitted in a single fission that may accidentally occur strike neighboring atoms, which in turn undergo fission and produce more neutrons.

These bombard other atoms and so on at an increasing rate until the atomic "fire" is going full blast.

The atomic pile is controlled and prevented from burning itself to complete destruction by cadmium rods which absorb neutrons and stop the bombardment process. The same effect might be achieved by running a pipe of cold water through a rubbish heap; by keeping the temperature low the pipe would prevent the spontaneous burning.

The first atomic chain reaction experiment was designed to proceed at a slow rate. In this sense it differed from the atomic bomb, which was designed

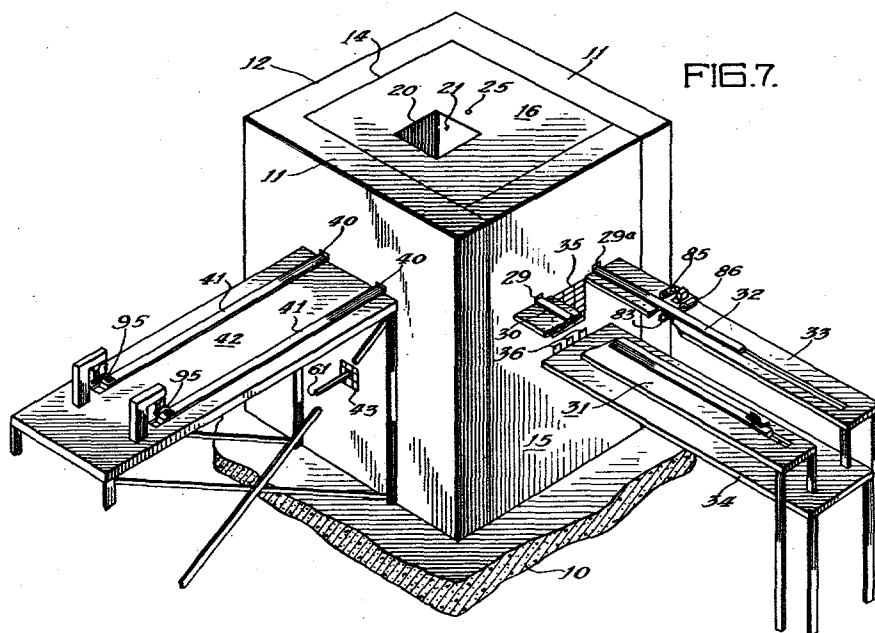

Patent Number 2,708,656 was issued on May 18, 1955, to Enrico Fermi and Leo Szilard. The invention it covered included the first nuclear reactor, Chicago Pile No. 1 (CP-1). Although the patent was applied for in December 1944, it could not be issued until years later when all the secret information it contained had been declassified. This drawing was part of the patent application.

to proceed at as fast a rate as was possible. Otherwise, the basic process is similar to that of the atomic bomb.

The atomic chain reaction was the result of hard work by many hands and many heads. Arthur H. Compton, Walter Zinn, Herbert Anderson, Leo Szilard, Eugene Wigner and many others worked directly on the problems at the University of Chicago. Very many experiments and calculations had to be performed. Finally a plan was decided upon.

Thirty "piles" of less than the size necessary to establish a chain reaction were built and tested. Then the plans were made for the final test of a full-sized pile.

The scene of this test at the University of Chicago would have been confusing to an outsider—if he could have eluded the security guards and gained admittance.

He would have seen only what appeared to be a crude pile of black bricks and wooden timbers. All but one side of the pile was obscured by a balloon cloth envelope.

As the pile grew toward its final shape during the days of preparation, the measurement performed many times a day indicated everything was going, if anything, a little bit better than predicted by calculations.

The Gathering on the Balcony

Finally, the day came when we were ready to run the experiment. We gathered on a balcony about 10 feet above the floor of the large room in which the structure had been erected.

Beneath us was a young scientist, George Weil, whose duty it was to handle the last control rod that was holding the reaction in check.

Every precaution had been taken against an accident. There were three sets of control rods in the pile. One set was automatic. Another consisted of a heavily weighted emergency safety held by a rope. Walter Zinn was holding the rope ready to release it at the least sign of trouble.

The last rod left in the pile, which acted as starter, accelerator and brake for the reaction, was the one handled by Weil.

Since the experiment had never been tried before, a "liquid control squad" stood ready to flood the pile with cadmium salt solution in case the control rods failed. Before we began, we rehearsed the safety precautions carefully.

Finally, it was time to remove the control rods. Slowly, Weil started to withdraw the main control rod. On the balcony, we watched the indicators which measured the neutron count and told us how rapidly the disintegra-

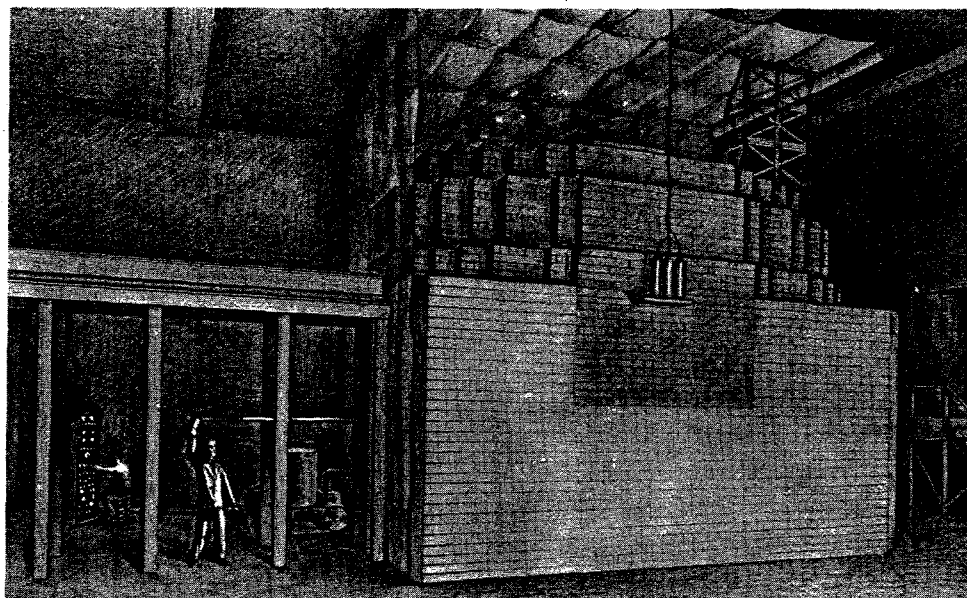

tion of the uranium atoms under their neutron bombardment was proceeding.

At 11:35 a.m., the counters were clicking rapidly. Then, with a loud clap, the automatic control rods slammed home. The safety point had been set too low.

It seemed a good time to eat lunch.

During lunch everyone was thinking about the experiment but nobody talked much about it.

At 2:30, Weil pulled out the control rod in a series of measured adjustments.

Shortly after, the intensity shown by the indicators began to rise at a slow but ever-increasing rate. At this moment we knew that the self-sustaining reaction was under way.

The event was not spectacular, no fuses burned, no lights flashed. But to us it meant that release of atomic energy on a large scale would be only a matter of time.

The further development of atomic energy during the next three years of the war was, of course, focused on the main objective of producing an effective weapon.

At the same time we all hoped that with the end of the war emphasis would be shifted decidedly from the weapon to the peaceful aspects of atomic energy.

We hoped that perhaps the building of power plants, production of radioactive elements for science and medicine would become the paramount objectives.

Unfortunately, the end of the war did not bring brotherly love among nations. The fabrication of weapons still is and must be the primary concern of the Atomic Energy Commission.

Secrecy that we thought was an unwelcome necessity of the war still appears to be an unwelcome necessity. The peaceful objectives must come second, although very considerable progress has been made also along those lines.

The problems posed by this world situation are not for the scientist alone but for all people to resolve. Perhaps a time will come when all scientific and technical progress will be hailed for the advantages that it may bring to man, and never feared on account of its destructive possibilities.

OF SECRECY AND THE PILE¹²

By Laura Fermi

The period of great secrecy in our life started when we moved to Chicago. Enrico walked to work every morning. Not to the physics building, nor simply to the "lab," but to the "Met. Lab," the Metallurgical Laboratory. Everything was top secret there. I was told one single secret: there were no metallurgists at the Metallurgical Laboratory. Even this piece of information was not to be divulged. As a matter of fact, the less I talked, the better; the fewer people I saw outside the group working at the Met. Lab., the wiser I would be.

In the fall, Mr. and Mrs. Arthur H. Compton—I was to learn later that he was in charge of the Metallurgical Project—gave a series of parties for newcomers at the Metallurgical Laboratory. Newcomers were by then so numerous that not even in Ida Noyes Hall, the students' recreation hall, was there a room large enough to seat them all at once; so they were invited in shifts. At each of these parties the English film *Next of Kin* was shown. It depicted in dark tones the consequences of negligence and carelessness. A briefcase laid down on the floor in a public place is stolen by a spy. English military plans become known to the enemy. Bombardments, destruction of civilian homes, and an unnecessary high toll of lives on the fighting front are the result.

After the film there was no need for words.

Willingly we accepted the hint and confined our social activities to the group of "metallurgists." Its always expanding size provided ample possibilities of choice; besides, most of them were congenial, as was to be expected, for they were scientists.

The nonworking wives wished, quite understandably, to do something for the war effort. One of the possible activities along this line was to help entertain the armed forces at the USO. I preferred to sew for the Red Cross or to work as a volunteer in the hospital of the university, and to save my social capacities for the people at the Met. Lab., who had not the benefit of the USO.

¹²From *Atoms in the Family*, Laura Fermi, University of Chicago Press, Chicago, Illinois, 1954. Copyright by the University of Chicago Press. Reprinted by permission.



Laura and Enrico Fermi

The Fermis' Party

Thus, early in December 1942, I gave a large party for the metallurgists who worked with Enrico and for their wives. As the first bell rang shortly after eight in the evening, Enrico went to open the door, and I kept a few steps behind him in the hall. Walter Zinn and his wife Jean walked in, bringing along the icy-cold air that clung to their clothes. Their teeth chattered. They shook the snow from their shoulders and stamped their feet heavily on the floor to reactivate the circulation in limbs made numb by the subzero weather. Walter extended his hand to Enrico and said:

"Congratulations."

"Congratulations?" I asked, puzzled, "What for?" Nobody took any notice of me.

Enrico was busy hanging Jean's coat in the closet, and both the Zinns were fumbling at their snow boots with sluggish fingers.

"Nasty weather," Jean said, getting up from her bent position to put her boots in a corner. Walter again stamped his feet noisily on the floor.

"Won't you come into the living room?" Enrico asked. Before we had time to sit down, the bell rang again; again Enrico went to open the door, and amid repeated stamping of feet and complaints about the extraordinarily cold weather I again heard a man's voice:

"Congratulations."

It went on this same way until all our guests had arrived. Every single man congratulated Enrico. He accepted the congratulations readily, with no embarrassment or show of modesty, with no words, but with a steady grin on his face.

My inquiries received either no answer at all or such evasive replies as: "Ask your husband," or: "Nothing special. He is a smart guy. That's all," or: "Don't get excited. You'll find out sometime."

I had nothing to help me guess. Enrico had mentioned nothing worthy of notice, and nothing unusual had happened, except, of course, the preparations for the party. And those did not involve Enrico and provided no ground for congratulating.

I had cleaned house all morning; I had polished silver. I had picked up the electric train in Giulio's room and the books in Nella's. If there is a formula to teach order to children, I have not found it. I had run the vacuum, dusted, and sighed. All along I was making calculations in my mind:

"Half an hour to set the table. Half an hour to spread sandwiches. Half an hour to collect juices for the punch. . . . I must remember to make tea for my punch soon, so that it will have time to cool. . . . And if people start coming by eight, we'll have to start dressing by seven-thirty, and eating dinner by" So I had calculated my afternoon schedule backward from the time the company would arrive up to when I should set myself to work.

A Homemaker's Schedule

My schedule was upset, as schedules will be. While I was baking cookies in the kitchen, the house had gone surprisingly quiet, too quiet to contain Giulio and his two girl friends who had come to play. Where were they? Into what sort of mischief had they got themselves? I found them on the third-floor porch. The three angelic-looking little children were mixing snow with the soil in the flower pots and throwing balls at our neighbor's recently washed windows. Precious time was spent in scolding and punishing, in seeing what could be done to placate our neighbor.

So at dinner time Enrico found me hurrying through the last preparations, absorbed in my task and even less than usually inclined to ask questions

of him. We rushed through dinner, and then I realized we had no cigarettes. It was not unusual: we don't smoke, and I always forget to buy them.

"Enrico, wouldn't you run to the drugstore for cigarettes?" I asked. The answer was what I expected, what it had been on other such occasions:

"I don't know how to buy them."

"We can't do without cigarettes for our guests," I insisted, as I always did; "it isn't done."

"We'll set the habit, then. Besides, the less our company smokes, the better. Not so much foul smell in the house tomorrow."

This little act was almost a ritual performed before each party. There was nothing unusual in it, nor in Enrico's behavior. Then why the congratulations?

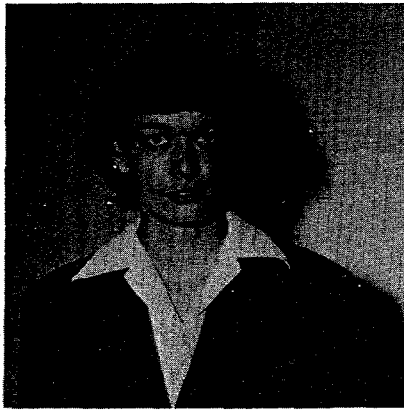

Leona Woods

I went up to Leona Woods, a tall young girl built like an athlete, who could do a man's job and do it well. She was the only woman physicist in Enrico's group. At that time her mother, who was also endowed with inexhaustible energy, was running a small farm near Chicago almost by herself. To relieve Mrs. Woods of some work, Leona divided her time and her allegiance between atoms and potatoes. Because I refused either to smash atoms or to dig potatoes, she looked down on me. I had been at the

Woods's farm, however, and had helped with picking apples. Leona, I thought, owed me some friendliness.

"Leona, be kind. Tell me what Enrico did to earn these congratulations."

Sinking an Admiral

Leona bent her head, covered with short, deep-black hair, toward me, and from her lips came a whisper:

"He has sunk a Japanese admiral."

"You are making fun of me," I protested.



Herbert L. Anderson

But Herbert Anderson came to join forces with Leona. Herbert, the boy who had been a graduate student at Columbia University when we arrived in the United States, had taken his Ph.D. work with Enrico and was still working with him. He had come to Chicago a few months before I did.

"Do you think anything is impossible for Enrico?" he asked me with an earnest, almost chiding, face.

No matter how firmly the logical part of my mind did disbelieve, there still was another, way back, almost in the subconscious, that was fighting for acceptance of Leona's and Herbert's words. Herbert was Enrico's mentor. Leona, who was young enough to have submitted to intelligence tests in her recent school days, was said to have a spectacular I.Q. They should know. To sink a ship in the Pacific from Chicago . . . perhaps power rays were discovered. . . .

When a struggle between two parts of one's mind is not promptly resolved with clear outcome, doubt results. My doubt was to last a long time.

That evening no more was said about admirals. The party proceeded as most parties do, with a great deal of small talk around the punch bowl in the dining room; with comments on the war in the living room; with games of pingpong and shuffleboard on the third floor, because Enrico has always enjoyed playing games, and most of our guests were young.

In the days that followed I made vain efforts to clear my doubts.

"Enrico, did you really sink a Japanese admiral?"

"Did I?" Enrico would answer with a candid expression.

"So you did not sink a Japanese admiral!"

"Didn't I?" His expression would not change.

Two years and a half elapsed. One evening, shortly after the end of the war in Japan, Enrico brought home a mimeographed, paperbound volume.

"It may interest you to see the Smyth Report,¹³ he said. "It contains all declassified information on atomic energy. It was just released for publication, and this is an advance copy."

¹³This classic document, *A General Account of the Development of Methods of Using Atomic Energy for Military Purposes*, written by Henry D. Smyth, who directed research at the Metallurgical Laboratory, was released by the War Department on August 12, 1945. (It later was published, with a shorter title, by Princeton University Press. See Suggested References.)

It was not easy reading. I struggled with its technical language and its difficult content until slowly, painfully, I worked my way through it. When I reached the middle of the book, I found the reason for the congratulations Enrico had received at our party. On the afternoon of that day, December 2, 1942, the first chain reaction was achieved and the first atomic pile operated successfully, under Enrico's direction. Young Leona Woods had considered this feat equivalent to the sinking of an admiral's ship with the admiral inside. The atomic bomb still lay in the womb of the future, and Leona could not foresee Hiroshima.

The "Council Tree" beneath which scientists held a highly secret discussion in April 1942 that was vital to the success of the first pile. It stands in front of Eckhart Hall on the University of Chicago campus. The meeting was held outdoors so the scientists could talk freely without being overheard.



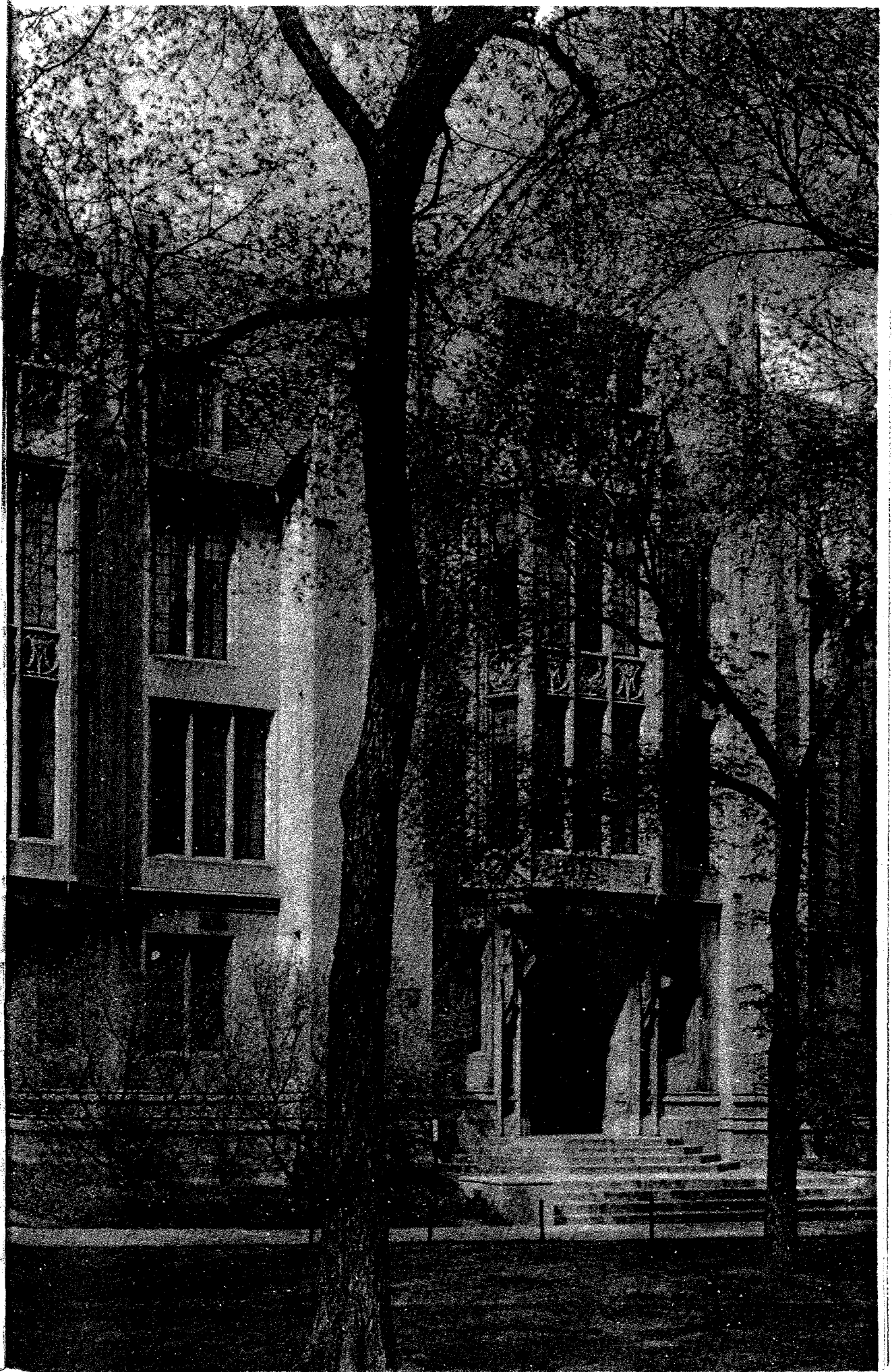

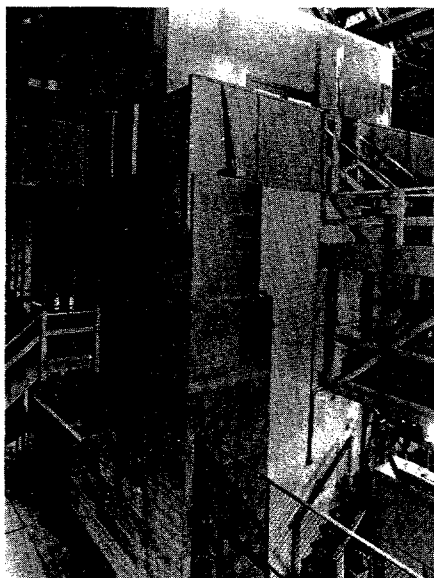

FINAL

The first pile was disassembled early in 1943 and rebuilt with certain refinements and modifications near the present site of the Argonne National Laboratory. It was renamed Chicago Pile No. 2 (CP-2).

Unveiling the plaque on the West Stands of Stagg Field on the fifth anniversary, December 2, 1947. Left to right are AEC Commissioners William W. Waymack and Robert F. Bacher, Farrington Daniels, Walter H. Zinn, Enrico Fermi, and R. M. Hutchins, Chancellor of the University of Chicago. The West Stands were demolished in 1957, but the plaque remains.

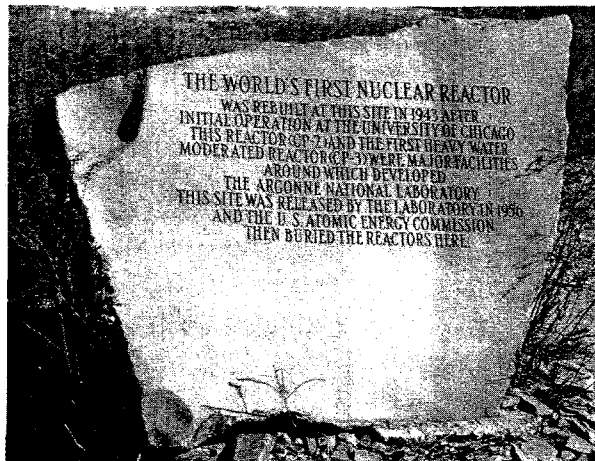

The first heavy water moderated reactor (CP-3) was built near CP-2 at Argonne. In 1956 the uranium, graphite, and heavy water from the two reactors were removed and the remaining shells buried beneath this marker.

CHAPTERS

PERSONS PRESENT AT CP-1 EXPERIMENT

Achievement of First Self-Sustained Nuclear Chain Reaction

December 2, 1942

- | | | | |
|-------------------------------|--------------------------------|------------------------|---------------------------------|
| Dr. Harold M. Agnew* | <i>Harold M. Agnew</i> | <i>Leona Marshall</i> | Dr. Leona Woods Marshall (Mrs.) |
| Professor Samuel K. Allison* | <i>Samuel K. Allison</i> | Anthony J. Matz | Anthony J. Matz |
| Professor Herbert L. Anderson | <i>Herbert L. Anderson</i> | George Miller* | George Miller* |
| Wayne Arnold† | <i>Wayne Arnold</i> | George D. Monk | George D. Monk |
| Hugh M. Barton, Jr.* | <i>Hugh M. Barton, Jr.</i> | Henry W. Natanson | Henry W. Natanson |
| Thomas Brill* | <i>Thomas Brill</i> | Robert G. Nobles* | Robert G. Nobles* |
| Dr. R. F. Christy | <i>R. F. Christy</i> | Warren E. Nyer* | Warren E. Nyer* |
| Arthur H. Compton† | <i>Arthur H. Compton</i> | Wilcox P. Overbeck* | Wilcox P. Overbeck* |
| Enrico Fermi† | <i>Enrico Fermi</i> | Howard Parsons* | Howard Parsons* |
| Richard J. Fox* | <i>Richard J. Fox</i> | Dr. Gerard S. Pawlida* | Dr. Gerard S. Pawlida* |
| Stewart Fox* | <i>Stewart Fox</i> | Theodore Petry* | Theodore Petry* |
| Dr. Carl C. Gahrtsfelder* | <i>Carl C. Gahrtsfelder</i> | David R. Rudolph | David R. Rudolph |
| Dr. Alvin C. Graves* | <i>Alvin C. Graves</i> | Leon Sayvetz* | Leon Sayvetz* |
| Dr. Crawford Greenewald | <i>Crawford Greenewald</i> | Dr. Leo Seren | Dr. Leo Seren |
| Dr. David L. Hill* | <i>David L. Hill</i> | Louis Slotin† | Louis Slotin† |
| Dr. Norman Hilberry* | <i>Norman Hilberry</i> | Dr. Frank H. Spedding | Dr. Frank H. Spedding |
| William H. Hinch* | <i>William H. Hinch</i> | Dr. William J. Sturm* | Dr. William J. Sturm* |
| Robert E. Johnson* | <i>Robert E. Johnson</i> | Dr. Leo Szilard | Dr. Leo Szilard |
| W. R. Kanne* | <i>W. R. Kanne</i> | Dr. Albert Wattenberg | Dr. Albert Wattenberg |
| August C. Knuth | <i>August C. Knuth</i> | R. J. Watts* | R. J. Watts* |
| P. G. Koontz* | <i>P. G. Koontz</i> | George L. Weil* | George L. Weil* |
| Dr. Herbert E. Kubitschek | <i>Herbert E. Kubitschek</i> | Dr. Eugene P. Wigner | Dr. Eugene P. Wigner |
| Harold V. Lichtenberger | <i>Harold V. Lichtenberger</i> | Dr. Marvin H. Wilk | Dr. Marvin H. Wilk |
| George M. Maronder | <i>George M. Maronder</i> | Volney C. Wilson* | Volney C. Wilson* |
| | <i>Walter H. Zinn</i> | Walter H. Zinn* | Walter H. Zinn* |

Signatures obtained during 20th anniversary programs at the American Nuclear Society-Atomic Industrial Forum Meeting, Washington, D.C., November 27, 1962, and at the University of Chicago, December 1, 1962.

* Present this Evening
† Deceased

Model of a work of sculpture by Henry Moore, who was commissioned by the Trustees of the Art Institute of Chicago to create a work to commemorate the "Birth of the Atomic Age". The sculpture was unveiled at the University of Chicago site on the 25th anniversary of the first pile.



EPILOGUE

The 1942 CP-1 chain reaction experiment marked the culmination of a process of European scientific discovery and American technical development in nuclear physics research that dated back to 1934, when Enrico Fermi split the atom without realizing it.

In this sense, the final success of the Metallurgical Laboratory was almost anticlimactic. The legendary bottle of Chianti produced by Eugene Wigner and signed by all the participants was actually purchased a year before the successful experiment was completed.

Nor was the success of CP-1 especially decisive in pushing the Manhattan Project forward. A visiting committee of scientists and engineers had already recommended continuing the pile project before they arrived in Chicago on December 2, and a day earlier General Leslie Groves, director of the Army project, had written the du Pont Company a letter authorizing design and construction of the massive Hanford, Washington, plant to produce plutonium, using the pile project as a prototype.

In this context, the famous telephone call from Compton to Conant takes on a different meaning. Conant, an enthusiast of Ernest Lawrence's project to separate electromagnetically U^{235} from U^{238} as the quickest route to the bomb, remained skeptical of the pile approach, and criticized the visiting Lewis committee report for pushing the pile project toward a full-scale plant. In telephoning Conant, Compton was not only conveying a secret message, but advocating a particular route to the new weapon.

On December 28, 1942, President Roosevelt approved the report from Vannevar Bush of the Office of Scientific Research and Development calling for an all-out effort to build an atomic bomb with private industry working under Army supervision. In this crucial decision CP-1 had played an important part. For it had transformed scientific theory into technological reality, and demonstrated that an awesome new form of energy had been harnessed to man's purposes.

In early 1943, following the success of CP-1, work on the production piles shifted to new plants springing up at Oak Ridge, Tennessee, and Hanford, Washington. The scientists of Chicago gave way to the engineers of du Pont, and the major work of the Manhattan Project moved away from that city.

In February 1943, Groves ordered Fermi's pile moved from Stagg Field to Site A, a 20-acre area of the Argonne Forest Preserve south of Chicago, where it was reassembled as CP-2. CP-2 was considerably larger than CP-1, and had a five-foot concrete shield build around it to avoid radiation exposure to staff.

CP-2 was followed in 1943 by CP-3, a heavy-water reactor designed by Eugene Wigner and built by Walter Zinn.

In 1944, the modest collection of cinderblock and corrugated iron buildings at Argonne became the Argonne Laboratory, directed by Fermi. Its function now became basic research on nuclear fission, rather than weapons development, with consequent shortages of both funding and personnel until after 1945.

In January 1947, the Atomic Energy Commission purchased a new site near LaMont, Illinois, southwest of Chicago for the Argonne National Laboratory. At the new laboratory the wartime reactors became peacetime centers of research into neutron diffraction, the effects of radiation, and applied mathematics. The pile of graphite and uranium known as CP-1 thus spawned a full-scale nuclear research laboratory. Its work no longer was used to study plutonium production, but the broader ramifications of nuclear fission—biological and medical research, basic physics, reactor analysis, and nuclear power.

In the end, the various offspring of CP-1, the first reactor, continued its original mission: to push back and explore the frontiers of science in the never-ending quest for knowledge of the universe in which we live.

SUGGESTED REFERENCES

Books

Compton, Arthur H., *Atomic Quest*, New York: Oxford University Press, 1956.

Fermi, Laura, *Atoms in the Family*, Chicago: University of Chicago Press, 1954.

Groueff, Stephane, *Manhattan Project*, Boston, Massachusetts: Little, Brown and Company, 1967.

Groves, Leslie R., *Now it Can Be Told: The Story of the Manhattan Project*, New York: Harper and Row, 1961.

Hawkins, David, *Manhattan District History, Project Y, The Los Alamos Project (LAMS-2532)*, Volume 1—Inception until August 1945, Springfield, Virginia: Technical Information Center, 1961.

Hewlett, Richard G., and Anderson, Oscar E., Jr., *The New World, 1939/1946, Volume 1, A History of the United States Atomic Energy Commission*. University Park, Pennsylvania: The Pennsylvania State University Press, 1962.

Kevles, Daniel J., *The Physicists; The History of a Scientific Community in Modern America*, New York: Alfred Knopf, 1977.

Lamont, Lansing, *Day of Trinity*, New York: Atheneum Publishers, 1965.

Latil, Pierre de, *Enrico Fermi; The Man and His Theories*, New York: Paul S. Eriksson, Inc., 1966.

Libby, Leona Marshall, *The Uranium People*, New York: Scribner's, 1979.

Purcell, John, *The Best-Kept Secret*, New York: The Vanguard Press, 1963.

Segre, Emilio, *The Collected Papers of Enrico Fermi*, Chicago, Illinois: University of Chicago Press, 1965.

Smyth, Henry D., *Atomic Energy for Military Purposes*, Princeton, New Jersey: Princeton University Press, 1945.

Strauss, Lewis L., *Men and Decisions*, New York: Doubleday and Company, Inc., 1962.

Wigner, Eugne P., *Symmetrics and Reflections*, Bloomington, Indiana: Indiana University Press, 1967.

Wilson, Jane, ed., *All in Our Time; The Reminiscences of Twelve Nuclear Pioneers*, Chicago, Illinois: Bulletin of the Atomic Scientists, 1975.

Articles

Anderson, Herbert L., et. al., "The Fission of Uranium," *Physical Review*, 33:511 (March 1, 1939).

Anderson, Herbert L., Fermi, E., and Hanstein, H. B., "Production of Neutrons in Uranium Bombarded by Neutrons," *Physical Review*, 34:797 (April 15, 1939).

Argonne National Laboratory News Bulletin, Anniversary Issue, Vol. 4 (December 1962).

Fermi, Enrico, "Elementary Theory of the Chain-Reacting Pile," *Science*, 105:27 (January 10, 1947).

Fermi, Enrico, "Development of the First Chain Reacting Pile," *Proceedings of the American Philosophical Society*, Vol. 22 (January 29, 1946).

Hahn, Otto, "The Discovery of Fission," *Scientific American*, 198:76 (February 1958).

International Atomic Energy Agency Bulletin, Special number to mark the 20th anniversary of the world's first nuclear reactor (December 2, 1962).

Laurence, William L., "The Birth of the Atomic Age, December 2, 1942," *New York Times Magazine*, VI; 11 (December 1, 1946).

Szilard, Leo, and Zinn, W. H., "Instantaneous Emission of Fast Neutrons in the Interaction of Slow Neutrons with Uranium," *Physical Review*, 34:799 (April 15, 1939).

"Zip out: World's First Uranium Pile," *Time*, 48:67 (December 9, 1946).

Motion Picture

The Day Tomorrow Began, 30 minutes, color, 1967. This film tells (via historical film strips, photographs, interviews, and paintings) the exciting story of the construction of the first nuclear reactor. The story is highlighted by interviews with members of the research team and those closely associated with it, such as Glenn Seaborg, Mrs. Enrico Fermi, Leslie Groves, Walter Zinn, Herbert Anderson, and Mrs. Leona Libby.

PHOTO CREDITS

Cover courtesy Chicago Historical Society

All other photographs from the Argonne National Laboratory except the following:

Page

4	Addison-Wesley Publishing Company
5	Nobel Institute
6	Louise Barker (left); Ike Verne
7	Stephen Deutsch; Washington University Archives
9	Oak Ridge Operations Office
15	<i>Chicago Tribune</i>
19	Nobel Institute (bottom)
21	Mary Elvira Weeks, <i>Discovery of the Elements</i> , Journal of Chemical Education
22	Nobel Institute
35	University of Chicago

This document is printed as a special edition to commemorate the 40th anniversary of the Chicago Pile, a landmark in the development of nuclear energy. For additional information on nuclear energy, contact the Department of Energy, Office of the Assistant Secretary for Nuclear Energy, Forrestal Building, 1000 Independence Avenue, Washington, D.C. 20585.

DOE/NE-0046

