

LANL Sustainable Design Guide

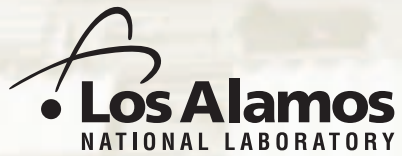

LANL Sustainable Design Guide

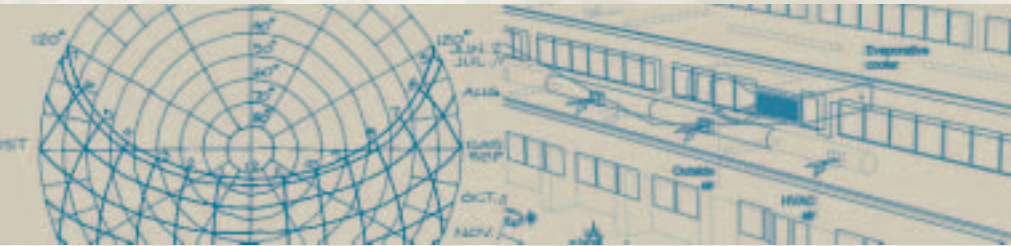
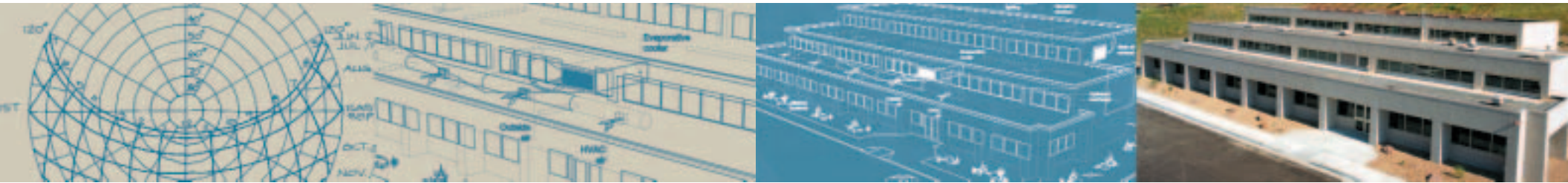

Produced under the direction of
the Site Planning and Construction
Committee

by the

Site and Project Planning
Group, PM-1

December 2002
LA-UR 02-6914

Acknowledgments

The *LANL Sustainable Design Guide* is the result of the dedicated efforts of many individuals and organizations. We gratefully acknowledge and thank the following for their commitment to the success of this resource guide.

LANL Site Planning and Construction Committee

Jim Holt, Chair, Associate Director, Operations

John Bretzke, Acting PM Division Director

Denise Derkacs, Weapons, Engineering, and Manufacturing Directorate

Sharon Eklund, University of California, Office of the President

Cliff Giles, Threat Reduction Directorate

Herman Ledoux, DOE-OLASO

Beverly Ramsey, PRES Division Leader

Tony Stanford, FWO Division Leader

Buck Thompson, Weapons Physics Directorate

Christopher Webster, Strategic Research Directorate

Carolyn Zerkle, IFC

Associate Director Operations – Office of Infrastructure, Facilities and Construction

Carolyn Zerkle, Director

Randy Parks, Program Manager

PM-1, Site and Project Planning Group

William H. Jones, PE, Group Leader

Kirt Anderson, AICP, ASLA, Senior Planner

Brooke Davis, PE, Engineer

Aleene Jenkins, Project Management Specialist

James Mork, Planning Technician

Scott Richardson, Architect

Sarah Salazar, Senior Planner

Don Sandstrom, Senior Management Liaison

Joan Stockum, GIS Mapping Technician

Rae Anne Tate, AICP, Planner

Ken Towery, Architect

Mona Valencia, GIS Mapping Technician

Risk Reduction and Environmental Stewardship – Prevention Program

Tom Starke, Program Manager

IM-4 Information Management

Guadalupe D. Archuleta, Printing Coordinator

Authors

National Renewable Energy Laboratory

Sara Farrar-Nagy

Sheila J. Hayter, P.E., Project Leader

Amber Larson

Paul A. Torcellini, Ph.D., P.E.

Otto Van Geet, P.E.

Other Authors

Nadav Malin, Building Green, Inc.

Alex Wilson, Building Green, Inc.

Thomas R. Wood, Architect, Montana State University

National Renewable Energy Laboratory editorial and production staff

Sara Boddy, copy editor

William Gillies, art director

Molly Miller, editor

Mark Swisher, designer

Contributing authors

J. Douglas Balcomb, Ph.D., National Renewable Energy Laboratory

Ron Judkoff, National Renewable Energy Laboratory

Jack Mizner, the Shaw Group

Terra Berning, S-4, LANL

William Talbert, National Renewable Energy Laboratory

Douglas Vetter, the Shaw Group

Architectural sketches

Thomas R Wood, Architect, Montana State University

Foreword

The principle of sustainability provides us with a path to balance protecting the environment with our other mission responsibilities. We should feel confidence and pride in our use of land, space, energy, and renewable and sustainable resources.

This year the Department of Energy formally embraced sustainable design in DOE Order 430.2A. The Order provides us the direction to engineer and build sustainable facilities. Successful private-sector and government facility projects committed to sustainable principles can be observed throughout the country. The numerous examples assure us that success in this endeavor is achievable and desirable.

This *LANL Sustainable Design Guide* enhances our ability to inform the design and construction community about the added value that sustainable design can provide in architecture, facility construction, operation, and maintenance. I feel you will find this guide to be a valuable tool for improving the way we manage our Laboratory's natural and built environment.



James L. Holt
Associate Director for Operations
Los Alamos National Laboratory



Preface

By Dr. J. Douglas Balcomb, Research Fellow, National Renewable Energy Laboratory

These guidelines, focused on the issues and design process for energy-efficient buildings at the Los Alamos National Laboratory (LANL), provide a powerful overview of important ways that LANL can make a difference in the future sustainability of the Laboratory and the nation. As a 27-year staff member of LANL, I urge the Laboratory to heed them wisely.

Energy efficiency has historically and rightfully been considered the most important attribute of a sustainable building. Although the impact on the environment from constructing the building can be significant, the accumulated environmental impact of energy consumption, which repeats year after year throughout the lifetime of the building, usually adds up to several times the consequences of its initial construction. These impacts include on-site emissions that result from burning fuel and off-site emissions at the power plant as a consequence of generating the electricity used in the building. Furthermore, there is more at stake than just saving energy and reducing emissions – good design can improve the productivity of staff who work in Lab facilities, improve creativity, and increase health.

Los Alamos is a uniquely suitable facility for instituting sustainable design for several reasons. The climate is particularly conducive to climate-sensitive design, sometimes called passive solar design. The potential for energy saved per square foot ranks as one of the highest in the nation. The Los Alamos climate is favorable to passive solar strategies, such as daylighting, natural cooling, and solar heating. Lighting is often the single most expensive energy load of a commercial building. Using natural light instead of electric lighting systems in LANL buildings is an attractive solution to save energy costs.

Although there may be a few hot days, summer daytime temperatures are usually in the comfort range and all evenings are cool. With good attention to solar gain control, minimizing internal heat gains by effectively using daylighting, and perhaps some pre-cooling of the building using cool night air, most of the cooling load can be avoided.

Few locations in the United States exhibit the combination of high heating loads resulting from the cold winter temperatures and the presence of ample winter sun that Los Alamos experiences. Daytime temperatures on sunny winter days are often pleasant, but plummet at night. In an office building with typical daytime internal gains, little if any heat is needed on winter days. This means that those considering passive solar designs should look to indirect system approaches to augment daytime direct gain – thermal storage walls and sunspaces in particular. These designs carry over heat from day to night effectively.

Another way that Los Alamos is unique is the low utility rates paid for natural gas, negotiated from the beginning years of the Lab. Unfortunately, this can make it difficult to justify any added expense to save energy. This picture changes if we take a national perspective – domestic natural gas is a limited resource that has passed its peak production rate. Sustainability must be viewed from a wider perspective than the Pajarito Plateau.

Many of the recommendations in this guide, particularly about passive solar design, stem from work that actually began at LANL. Jim Hedstrom, Stan Moore, Bob MacFarland, and I started the Los Alamos passive solar group. The work the solar group completed between 1974 and 1984 was the foundation for tools and documents that have become universally standard references for passive solar building design. I have continued to work to advance state-of-the-art climate sensitive building design through my work at the National Renewable Energy Laboratory.

One of the most important findings of our experience is that applying a whole-building design process to design and construct sustainable buildings results in buildings that cost no more to construct, yet use much less energy to operate. Significantly, peak electrical loads are also reduced. One needs to look at the final design as a package, comparing the end product with a fair reference case, rather than try to take it apart piece by piece, trying to justify each individual step along the way. The whole is greater than the sum of the parts.

It has been a distinct pleasure to help in the preparation of this *Sustainable Design Guide*. This guide is uniquely tailored to LANL's site, climate, and mission. I am heartened to see LANL continue to be a leader in sustainable design. So many buildings, and so many people, have already benefited from the work in this field that began there. As we come full circle, so many more will benefit from the Laboratory's willingness to implement the evolving design strategies we have recommended in this guide. It couldn't possibly be more appropriate for the Laboratory charged to protect the nation's security to lead the way in setting a precedent for energy-efficient building design.

A handwritten signature in blue ink that reads "J Douglas Palcomb". The signature is fluid and cursive, with a long horizontal stroke extending to the right.

Table of Contents



1

Chapter One: Sustainable Development – What and Why?

- 1** Mission Impact
- 3** Vision for Sustainable Development
- 5** Sustainable Development at LANL
- 6** Purpose of the *LANL Sustainable Design Guide*
- 6** Organization of the *LANL Sustainable Design Guide*



2

Chapter Two: Whole-Building Design

- 11** Whole-Building Design – the What and How
- 12** Articulating and Communicating a Vision
- 13** Creating an Integrated Project Team
- 14** Developing Project Goals
- 15** Design and Execution Phases
- 17** Decision-Making Process
- 20** Writing Sustainable F&OR Documents
- 23** Specific Sustainable Elements of F&OR Documents
- 26** Fitting Into the LANL Design Process



3

Chapter Three: Building Siting

- 35** Site Issues at LANL
- 38** Site Inventory and Analysis
- 42** Site Design
- 44** Transportation and Parking



4

Chapter Four: The Building Architectural Design

- 49** Schematic Design
- 53** Designing Using Computer Simulations
- 56** Designing High Performance Features and Systems
- 61** Designing for Daylighting
- 69** Passive and Active Solar Systems
- 77** Accommodating Recycling Activities



5

Chapter Five: Lighting, HVAC, and Plumbing

- 81** High Performance Engineering Design
- 83** Lighting System Design
- 90** Mechanical System Design
- 102** Central Plant Systems
- 109** Plumbing and Water Use
- 115** Building Control System



6

Chapter Six: Materials

- 123** Material Selection
- 127** Sustainable Building Materials
- 143** System Integration Issues



7

Chapter Seven: Landscape Design and Management

- 147** Landscape Issues at LANL
- 149** Stormwater Management
- 154** Using Water Outdoors
- 157** Landscape Vegetation
- 158** Exterior Lighting



8

Chapter Eight: Constructing the Building

- 163** Developing a Construction Plan
- 165** Writing Effective Construction Documents
- 167** Safeguarding Design Goals During Construction
- 168** Protecting the Site
- 170** Low-Impact Construction Processes
- 170** Protecting Indoor Air Quality
- 171** Managing Construction Waste



9

Chapter Nine: Commissioning the Building

- 177** Commissioning Process Overview
- 182** Commissioning Activities and Documentation



10

Chapter Ten: Education, Training and Operation

- 189** Building Occupant and Operator Roles
- 190** Information for Facilities Managers
- 191** Information for Building Users
- 193** Post Occupancy Evaluation



A-H

Appendices

- 197** *Appendix A:* Best Practice, Orders, Regulations, and Laws
- 201** *Appendix B:* Climate Charts
- 210** *Appendix C:* Green Building Adviser
- 224** *Appendix D:* Site-Wide Metering Program at LANL
- 226** *Appendix E:* LEED Checklist
- 235** *Appendix F:* Building Simulations
- 241** *Appendix G:* Sun Path Diagrams
- 249** *Appendix H:* Reduce, Reuse, Recycle Options

An aerial photograph of a mountainous region, likely the Los Alamos National Laboratory site. The foreground shows a large, organized complex of buildings and roads. The middle ground features rolling hills and valleys with sparse vegetation. The background consists of more rugged, forested mountains under a clear sky. The entire image has a blue color overlay.

Chapter 1: Sustainable Development – What and Why?

- ❖ *Mission Impact*
- ❖ *Vision for Sustainable Development*
- ❖ *Sustainable Development at LANL*
- ❖ *Purpose of the LANL Sustainable Design Guide*
- ❖ *Organization of the LANL Sustainable Design Guide*

Chapter 1

Sustainable Development – What and Why?

*“It is not what we have that
will make us a great nation; it is
the way in which we use it.”*

– Theodore Roosevelt

Mission Impact

As the nation increases its emphasis on security, the Los Alamos National Laboratory (LANL) stands as a center of excellence, bringing forth unique facilities and capabilities on issues of national significance. LANL’s infrastructure and most facilities were constructed during a period that extended from 1943 to the early 1960s. These facilities are now being targeted for replacement. In addition, new mission assignments are demanding state-of-the-art facilities to extend capabilities for the next 50 years. LANL’s population is also aging, creating the need for significant recruitment in response to increasing retirements. Such factors present LANL with a unique opportunity to form and foster an exceptional work

environment that supports its mission and attracts and retains the people most qualified to fulfill that mission.

What is an “exceptional work environment?” This work environment includes and must consider the:

- Individual laboratory and/or office space.
- Tools and equipment used by an individual and the ease of the human/machine interface.
- Surrounding structure or building and its created climate.



*Sustainable development is
“...developing the built environment
while considering environmental
responsiveness, resource efficiency,
and community sensitivity.”*

– Sustainable Design Report for the Los Alamos
National Laboratory Strategic Computing Complex,
LANL document LA-UR-01-5547.

- Interstitial or common space that facilitates population massing and encourages cross communication.
- Transportation (pedestrian and vehicular) options that provide ease of access.
- Natural environment in which the work environment is established.

An exceptional work environment supports and encourages interconnectedness among these elements contributing to efficiencies and productivity. The process of Sustainable Development will be a key element to establishing LANL’s exceptional work environment.

The sustainable development concept encompasses the materials to build and maintain a building, the energy and water needed to operate the building, and the ability to provide a healthy and productive environment for occupants of the building. Often, sustainable development has been referred to as climate-sensitive design, whole-building design, or high-performance buildings. Much of the original work in this field was done under the auspices of passive solar design – for which LANL was a national and international leader.



LANL

OCT./FEB. 21

NOV./JAN. 21

Vision for Sustainable Development

In furthering its commitment to a safe and comfortable working environment that meets its program requirements and is responsive to environmental issues, LANL has established a vision for sustainable development.

Sustainable design of LANL facilities is one of the most cost-effective strategies available for ensuring the high level of research output from the Laboratory upon which our nation depends. Buildings in the United States consume 37 percent of the nation's primary

energy. With advanced design strategies, a 50 percent reduction in energy consumption can become the standard practice for a new generation of buildings.

Leading-edge federal buildings demonstrate that far greater reductions in energy consumption – 50 percent or more – are both possible and cost-effective. Buildings that consume fewer resources to construct and operate will have lower environmental impact than today's conventional buildings. This lower impact leads to less air and water pollution, reduced water consumption, improved human comfort, and higher creativity, productivity, and job satisfaction for employees.

LANL vision for sustainable design

As a leader in sustainable development, Los Alamos National Laboratory commits to employing design and construction approaches that maximize productivity within the built environment, minimize impact to the natural environment, and assure good stewardship of public funds and resources.

“The vision for the physical development of the Laboratory is to create an exceptional work environment that supports the mission, and attracts and retains the quality personnel needed to meet the mission.”

– Site and Architectural Design Principles



LANL

Case Study Thermal Test Facility

Project Details:

- **Project funding:** GPP
- **Project description:** Research and Office Building
- **Size:** One story with high-ceiling bays, 10,000 square feet
- **Location:** Golden, Colorado
- **Heating degree-days:** 6020
- **Cooling-degree days:** 679
- **Construction cost:** \$1,127,000
- **Date completed:** June 1996
- **Energy cost savings:** \$3,475 per year
- **Energy cost savings:** 63% over base-case building

The National Renewable Energy Laboratory's Thermal Test Facility (TTF) is an open-plan laboratory/office building designed using a high-performance, whole-building approach. The building is a showcase for integrated energy-efficiency features that significantly reduce energy costs, and it is a good example of how it pays to incorporate sustainable design features. Additional costs for the sustainability design features increased construction costs by only 4%. The energy costs for the TTF are 63% less than a building built to the Federal Energy Code

(10CFR435). The energy cost saving includes a 50% reduction in energy consumption and a 30% peak power reduction. Approximately 75% of the lighting needs are met by daylighting. The main design features that made the TTF such an efficient building are:

Energy-Efficient Features:

- Building orientation
- Energy-efficient lighting (T-8 fluorescent) with daylighting controls
- Energy management system
- Daylighting
- Overhangs and side fins to block summer sun
- Direct/indirect evaporative cooling (two-stage evaporative cooling)
- Low-e window glazings
- Separate fresh air system with air-to-air heat recovery



“Sustainability is basically a concept about the interconnectedness of the environment, the economy, and social equity. It is a journey – a path forward – through which we demonstrate responsibility for our future legacy. It is a vision – an aspiration – for a better life for our children and our children’s children.”

– Statement of Unity, Federal Network for Sustainability, a project of the Federal Energy Management Program, Earth Day April 22, 2002



Robb Williamson

Why build sustainable buildings?

- Lower cost to maintain
- Reduced energy to operate
- Lower air pollution release
- Healthier and more productive occupants
- Greater stability of national energy supplies
- Less material usage
- Longer building life

Sustainable Development at LANL

This document provides insight and guidance for making LANL's sustainable principles and goals a reality. LANL embraces the following principles and goals to achieve its vision for sustainable development.

Principles –

- Maximize use of natural resources in the created building environment.
- Minimize energy and water use and the environmental effect of buildings.
- Ensure processes to validate building system functions and capabilities for proper maintenance and operations.

Goals –

- Integrate Sustainable Design into project development and execution processes.
- Construct sustainable high-performance buildings that are productive, inexpensive to operate, easy to reconfigure, sparing on their use of natural resources, and inherently protective of the natural environment.
- Provide LANL with sustainable buildings that offer a safe and secure work environment.
- Provide LANL with sustainable buildings that link together to form a sustainable campus.

The *LANL Sustainable Design Guide* describes the process of developing leading-edge energy and environmentally sensitive buildings. Prepared by the National Renewable Energy Laboratory (NREL) in conjunction with LANL, the *LANL Sustainable Design Guide* demonstrates how to design and construct new-generation buildings. The goals of the earlier *LANL Site and Architectural Design Principles* are a springboard for specific guidance for sustainable building design.

Sustainable design can minimize the environmental impact of new buildings and other facilities on the LANL campus and help retain the Laboratory's most important asset: the LANL staff. Sustainable buildings can improve the overall health, comfort, and productivity of building occupants. Improving human comfort in staff workspaces allows LANL to attract and retain the best and brightest workforce required to meet the Laboratory's core missions.

What are high-performance buildings?

High-performance buildings are designed and built to minimize resource consumption, to reduce life cycle costs, and to maximize health and environmental performance across a wide range of measures – from indoor air quality to habitat protection. For example, high-performance buildings can:

- Achieve energy savings in excess of 50% compared with conventional buildings
- Achieve higher employee productivity and longer job retention
- Reduce water consumption, maintenance and repair costs, capital costs in many cases, and overall environmental impacts.

Purpose of the LANL Sustainable Design Guide

The purpose of the *LANL Sustainable Design Guide* is to:

- Set forth a specific planning and design process for creating and meeting LANL sustainability goals, including energy reduction, indoor environmental quality, water quality, and site preservation.
- Guide the planners, designers, contractors, and groups responsible for the physical development of the Laboratory.
- Provide a tangible process for evaluating progress toward sustainability in the long-range physical development of the Laboratory.
- Provide leadership to the DOE laboratory system, as well as to the nation, for maintaining energy security and economic growth through sustainable design principles and practices.

The scope of the *LANL Sustainable Design Guide* includes the building envelope, interior functions, and building design. For example, site or material selection can affect the building's overall environmental impact and should be considered in a broader sense. (The guidance provided in this document covers the entire design and construction processes, from the early planning phases to the operation and maintenance phase.)

The *LANL Sustainable Design Guide* is one of a series of planning documents that guide project development and site improvements at the Laboratory. It is a companion document to the *Site and Architectural Design Principles*. (As shorthand, the *LANL Sustainable Design Guide* refers to the *Site and Architectural Design Principles* as the *Design Principles*.) The *Design Principles* establish broad planning principles and guidelines for site and architectural development at the project scale.

The *LANL Sustainable Design Guide* provides specific guidance regarding the “how-to” in implementing building sustainability goals defined in the *Design Principles*. The *LANL Sustainable Design Guide* provides detailed information required to design, construct, commission, and operate buildings and it charts the course for meeting most of the “architectural character” principles outlined in the *Design Principles*.

The primary audience for this document is the architectural and engineering design teams who are contracted to design and construct new LANL buildings. The *LANL Sustainable Design Guide* is also a valuable reference for members of the LANL Project Management Division and the building owners, operators, managers, and tenants.

Organization of the LANL Sustainable Design Guide

The *LANL Sustainable Design Guide* parallels the LANL design process. It provides guidance for integrating sustainability at all levels of the current LANL building design and construction process, beginning with the planning phases and continuing through the operations phase.

Why is sustainable design important?

Buildings consume more than two-thirds of the total electricity consumed annually in the U.S.

No matter what the source, using energy carries a burden. This burden can be from mining and extraction of fossil fuels, air pollutants released in the burning of these fuels, or the production and disposal of nuclear materials. Saving energy minimizes a wide range of environmental impacts and potential health risks. Sometimes the price is political. Our need for energy resources has caused political turmoil in the past, and ensuring continued access to these resources will long continue to carry strong economic consequences.

Sustainable buildings have benefits far beyond reducing our national dependence on fossil fuels. Occupants of sustainable buildings are more productive, more creative, and in general, healthier. These benefits contribute to LANL's ability to attract and retain the caliber of employees required to better meet its mission.



DOE Public Affairs

Spencer Abraham,
Secretary of Energy

“With respect to the pursuit of efficiency and the use of renewable resources, we have a responsibility to lead by example... We as a nation have to keep in mind how essential conservation and energy efficiency are to meeting what is projected to be a huge increase in energy demand over the next two decades.”

– Secretary of Energy Spencer Abraham
13th Annual Energy Efficiency Forum, National Press Club, Washington, DC, June 12, 2002

Summary of Topics Presented in the LANL Sustainable Design Guide

Chapter 1: Sustainable Development – What and Why?	Why is sustainable building design important to LANL?
Chapter 2: The Whole-Building Design Process	How does sustainability fit into the LANL building design, construction, and operation processes and what are the first steps the architectural and engineering design team take in a sustainable design process for LANL buildings?
Chapter 3: Building Siting	What siting issues relate to LANL building design?
Chapter 4: Building Architectural Design	What are the architectural guidelines for sustainable buildings at LANL?
Chapter 5: Lighting, HVAC, and Plumbing Systems Design	What are the engineering guidelines for sustainable buildings at LANL?
Chapter 6: Materials	What material issues should designers consider for sustainable buildings at LANL?
Chapter 7: Exterior Landscape Design and Management	How can LANL building sites be more responsibly landscaped and managed?
Chapter 8: Constructing the Building	What can LANL do to ensure that sustainability objectives are followed during construction?
Chapter 9: Commissioning the Building	Why and how should LANL buildings be commissioned to ensure optimal performance?
Chapter 10: Education, Training, and Operation	Why and how should the users and operators be educated about LANL sustainable buildings?

Designing for Productivity

Why don't more architectural teams design specifically to increase the productivity of building occupants? There are two reasons. One is that they are rightly concerned about keeping initial costs down. Design methods to increase occupant health, comfort, and productivity – such as increasing natural lighting and indoor air quality – do indeed often add initial costs to the design. Second, even if a design team is aware that productivity increases – and other benefits such as energy savings from better lighting – can offset these initial costs, human productivity can be a hard thing to measure. Employees who work in buildings with abundant daylight may say they have a better attitude at work, but how does that really affect the bottom line? Meaningful productivity increases can be measured in increases in output, lower absenteeism, fewer errors, and fewer workers compensation claims. Increasingly, companies interested in capturing savings and increases in profitability have begun to make the connection between increased employee productivity and high-performance building design.

Here are a few examples of private companies who feel their bottom line benefited from incorporating more expensive building designs that aimed to increase the health and comfort of the building occupants. These examples are provided by the non-profit Center for Energy and Climate. For more detailed information and examples of correlations between productivity and design, see the book *Cool Companies* by California Energy Commission analyst, Joseph Romm (Island Press, 1999). A recent study funded by Pacific Gas & Electric and carried out by the Heschong Mahone Group correlating daylighting with higher test scores in middle school students is available for downloading at www.h-m-g.com/.

- Mail sorters at the main U.S. Post Office in Reno, Nevada became the most productive and error-free in the western half of the U.S. after a major

energy and lighting upgrade in their building. A main feature of the overhaul was a new ceiling and lighting system. Before completing the \$300,000 renovation, managers installed the new system above one of their two sorting machines. In five months, productivity on that machine rose almost 10 percent, while the other showed no change. A year later the increase stabilized at about six percent. Working in a quieter and better lit area, employees did their jobs better and faster. The error rate by machine operators in the renovated area dropped to only one mistake per thousand letters. Energy savings projected for the whole building come to about \$22,400 a year. The new ceiling also saved \$30,000 a year in maintenance costs. Combined energy and maintenance savings came to \$50,000 a year, a six-year payback. But the productivity gains were worth \$400,000 to \$500,000 annually, paying for the renovation in less than 12 months.

- Hyde Tools is a Southbridge, Massachusetts, manufacturer of industrial cutting blades. Recently, the company did a \$98,000 lighting upgrade from old fluorescents to new high-pressure sodium-vapor and metal-halide lighting fixtures (with \$48,000 paid for by the local utility). Estimated annual energy savings are \$48,000, for a payback of one



Robb Williamson

A daylit classroom at Oberlin College's Adam Joseph Lewis Center for Environmental Studies in Oberlin, Ohio.

year. But with the new lighting, workers were able to see small particles that were causing defects in their high-precision blades. Hyde Tools estimates the improved product quality is worth another \$25,000 a year. Hyde says every dollar saved on the shop floor is worth \$10 in direct sales, meaning the quality improvements were worth the equivalent of \$250,000 in added sales.

- VeriFone, a subsidiary of Hewlett-Packard in Costa Mesa, California, renovated a building housing offices, a warehouse, and light manufacturing. The renovation beat California's strict Title 24 building code by 60% with a 7.5-year payback. Verifone experienced a 45% drop in absenteeism following the renovation.

References

Energy Information Agency, www.eia.doe.gov

High-Performance Commercial Buildings, a Technology Roadmap, www.eren.doe.gov/buildings/commercial_roadmap

Site+Architectural Design Principles, www.lanl.gov/orgs/ff6/pubf6stds/engrman/4arch/htmls/site_arch.htm

Cool Companies, Center for Energy and Climate, www.cool-companies.org

Additional Resources

“Building Sustainability Position Statement,” American Society of Heating, Refrigerating, and Air-Conditioning Engineers, www.ashrae.org

High-Performance Buildings Research Initiative, www.highperformancebuildings.gov

LEED™ Reference Guide. U.S. Green Building Council. Version 2.0, 2001, www.usgbc.org

Sustainable Design Report for Los Alamos National Laboratory’s Strategic Computing Complex, http://lemeso.lanl.gov/useful_info/publications/SCC_SD.pdf

“Guiding Principles of Sustainable Design,” U.S. Department of Interior, National Park Service. GPO, 1993. www.nps.gov/dsc/dsgncnstr/gpsd

Whole Building Design Guidelines, www.wbdg.org
Department of Energy – Energy Efficiency and Renewable Energy Network, www.eren.doe.gov

Center of Excellence for Sustainable Development, www.sustainable.doe.gov

“Sustainable Federal Facilities: A Guide to Integrating Value Engineering, Life-Cycle Costing, and Sustainable Development,” Federal Facilities Council Technical Report No. 142, National Academy Press, 2001.

The Practice of Sustainable Development. Urban Land Institute, 2000, www.uli.org

GSA Real Property Sustainable Development Guide, www.gsa.gov/realpropertypolicy



The Los Alamos Canyon Bridge opened the way for LANL growth onto the South Mesa.



Chapter 2:
Whole-Building Design

- ❑ *Whole-Building Design – the What and How*
- ❑ *Articulating and Communicating a Vision*
- ❑ *Creating an Integrated Project Team*
- ❑ *Developing Project Goals*
- ❑ *Design and Execution Phases*
- ❑ *Decision-Making Process*
- ❑ *Writing Sustainable F&OR Documents*
- ❑ *Specific Sustainable Elements of F&OR Documents*
- ❑ *Fitting into the LANL Design Process*

Chapter 2

Whole-Building Design

Creating a Sustainable Building requires a well-thought-out, participatory process.

Whole-Building Design – the What and How

Sustainable design can most easily be achieved through a *whole-building design* process.

The whole-building design process is a multi-disciplinary strategy that effectively integrates all aspects of site development, building design, construction, and operations and maintenance to minimize resource consumption and environmental impacts. Think of all the pieces of a building design as a single system, from the onset of the conceptual design through completion of the commissioning process. An integrated design can save money in energy and operating costs, cut down on expensive repairs over the lifetime of the building, and reduce the building's total environmental impact.

Process is key. Ensuring that a LANL building will be designed and built in a manner that minimizes environmental impacts while maximizing employee health and productivity should begin with *process* – how you will go about planning, designing, and building it.

Sustainable design is most effective when applied at the earliest stages of a design. This philosophy of creating a good building must be maintained throughout design and construction.

The first steps for a sustainable and high-performance building design include:

- Creating a vision for the project and setting design performance goals.
- Forming a strong, all-inclusive project team.
- Outlining important first steps to take in achieving a sustainable design.
- Realizing sustainable design within the LANL established design process.



Since this photo of LANL was taken in 1956, the campus has expanded to occupy more than 2,000 buildings on 43 square miles of land.

Articulating and Communicating a Vision

Functional, Operational, and Performance Requirements

A successful building begins with a vision outlining the proposed building function and anticipated long-term uses. A vision for sustainability must also be developed and incorporated into the Functional and Operational Requirement (F&OR) and request for proposal (RFP) documents.

An integrated RFP ensures that energy efficiency and sustainability will be important components of the design process. The selected design-build or design-bid-build contractor begins the conceptual design according to specifications stated in the RFP and assembles an integrated team to carry out the vision.

Setting a vision for sustainable building projects

It is important to create a measurable vision for sustainable building projects. The vision will be a guiding component in the RFP used to solicit the project team. A vision might be to design, construct, and commission a building that achieves a certain U.S. Green Building Council Leadership in Energy & Environmental Design™ (LEED™) rating, obtains New Mexico Green Zia Environmental Excellence Program Recognition, complies with guidance given by the Laboratories for the 21st Century Program, or costs less to operate than similar LANL buildings.

Why require building simulation models in the RFP?

During the building design phase, the team must ensure that the sustainable design strategies are integrated holistically into the building design. Effectively integrating the building envelope and systems can only be accomplished by relying on building energy simulation tools to guide design decisions. Simulation results provide insight into how the building is expected to perform. Therefore, it is recommended that the RFP states that the contracted project team is required to use computer simulations throughout the design process.



Central and Southwest Services

A design team discusses a proposed building project. Communication between team members early in the design process increases the opportunities for incorporating sustainable design strategies in the building project.



Berkeley National Laboratory



Paul Torcellini

Constant communication between team members during the entire design and construction process ensures that the building's sustainable design goals will be met.

Creating an Integrated Project Team

The key to achieving a sustainable building is to assemble a project team with both the experience and the desire to employ a systematic, integrated design. It is important to take a team-oriented, multi-disciplinary approach in which all members of the project team recognize and commit to the steps and actions necessary to achieve the project vision.

Assemble the project team very early in the design process. The project team comprises contracted experts as well as the LANL project team, including project managers, building owners and/or tenants, energy consultants, inspectors, and facility managers.

The entire project team collaborates to translate the initial project vision into specific design goals. Giving all those who can influence building design an opportunity to develop the design goals will ensure that issues such as life-safety, security, initial budgets, and code compliance are balanced with the energy-efficiency and sustainability features. The goals often reflect the current state-of-the-art of building design.

The LANL project team must agree with the vision that has been established for the project. Input and agreement from everyone is important at this early stage, for it sets the framework for future project success. The team also must be committed to meeting the performance goals they set for the project.



Developing Project Goals

The project team refines the articulated project vision into a set of specific goals and initial design concepts. These goals ensure that the building meets program needs, is cost-effective to operate and maintain, and provides a superior environment to maximize employee productivity.

A “design charrette” is a useful tool for communicating the project vision to members of the project team, brainstorming design goals and specific conceptual solutions to meet these goals, and beginning to incorporate sustainability into the planning and execution

phases. The design charrette occurs between the planning and conceptual design phases of the LANL project development process. Conduct a second charrette as soon as an architect is selected. (Criteria for selecting a firm include a requirement that the firm’s design proposals demonstrate a commitment to and a vision for sustainability.)

Sample Goals:

- Provide a design that will achieve a 50% reduction in energy use compared to an ASHRAE 90.1-compliant building.
- Provide daylighting to offset electrical lighting loads wherever possible (includes lighting controls).
- Obtain a LEED-Silver rating for the building.
- Design a building that costs the same (or no more than 5% greater) than a conventional building without sustainable features.
- Create a healthy indoor environment that will result in reduced absenteeism while boosting productivity.
- Follow a maintenance plan to ensure efficient operations, including energy management and waste recovery (recycling).
- Follow sustainable construction processes as outlined in Chapter 8.



A LANL project team engages in a design charrette.

LANL

Just What is a Design Charrette?

The team “Charrette” is widely used today to refer to an intensive workshop in which various stakeholders and experts are brought together to address a particular design issue. The term comes to us from the French word for “cart.” French architecture schools used a cart to collect final studio presentations. As with most students, they often weren’t quite finished and would continue working their presentations on the cart as the presentations were collected. The “charrette” became an intense time for putting ideas on paper. Often, the charrette process happens early in the design phase of building projects. Ideas are exchanged, goals established, and consensus is built among those involved with the design process.

Design charrettes are a good mechanism to start the communication process among the project team, building users, and project management staff. A facilitated discussion allows the team to brainstorm solutions meeting the building user’s requests and the sustainability vision for the building design. By the time the charrette concludes, the participants should have identified performance goals in the context of validating the program needs. The result of design charrettes is the foundation for good communication among project team members and the development of unified goals for everyone to work toward.



LANL

Design and Execution Phases

Discussions at the conceptual design phase extend beyond design and construction to include a process for ensuring that the building operates as designed and that occupant work environment goals are satisfied. Commissioning is a process for achieving, verifying, and documenting that the performance of a building and its various systems meet the design intent and the owner’s requirements. The process ideally extends through all phases of a project, from concept to occupancy and operation (see Chapter 9). Plans for commissioning activities and budget are developed during the conceptual design phase.

Also during the conceptual design phase, the project team plans a means for monitoring the building performance. Monitoring performance helps operators quickly identify when the building is not performing as expected, and verify that the building design vision and goals are met. Satisfied occupants are likely to be healthier, more productive, and more creative, so it is of utmost importance to ensure that the building is meeting the users’ needs. Conduct post-occupancy surveys to collect information for improving occupant



Paul Torcellini

Design team members confer on strategies for meeting the building performance goals.

satisfaction, if necessary, and to document design strategies that should (or should not) be replicated in future LANL buildings.

By the time the preliminary design is completed, the project team membership has grown to include the contracted architectural/engineering or design/build firm. It is important to conduct a second design charrette at this point to include the entire project team. Input from the expanded project team solidifies space and functional requirements, proposes solutions to code issues, identifies all safety and security needs, and sets clear energy goals.

Designing for good indoor environmental quality

Designing buildings to maximize the potential for good indoor environmental quality (IEQ) often leads to the same solutions for designs that maximize building energy performance. Indoor environmental quality represents the overall condition of the interior space. Factors affecting IEQ include space temperatures, lighting levels, relative humidity levels, noise levels, odor levels, ventilation air rates, perceivable air movement, color contrast, and any other factor that affects human comfort. Using the whole-building design approach, energy-efficiency and passive-solar design strategies can often improve IEQ, if they are incorporated properly into the building design. It is important to consider both the building's energy performance and IEQ when evaluating incorporation of design solutions into the whole-building design.



Interior of the Solar Energy Research Facility at the National Renewable Energy Laboratory in Golden, Colorado.

Caution

If whole-building and passive-solar design strategies are not properly incorporated into the building design, they can adversely affect the building's IEQ. For example,

- A daylighting system is ineffective if inadequate light levels are provided to meet the occupants' needs or if glare is a problem on the work surfaces.
- An improperly designed natural ventilation cooling system could introduce outdoor contaminants to the indoor space or pose a security risk.

Warren Gretz



Decision-Making Process

All phases of design – from the earliest goal setting through final design and creation of construction documents – involve making decisions. Of critical importance is knowing when to make which decisions. If certain decisions are not made during the planning phases, the project team will have to expend time and money later in the process correcting conflicting design decisions, or the project will be deemed to be unsuccessful for not achieving the stated goals. In design and construction, it is always quicker, easier, and cheaper to change things on paper than in steel or concrete. One of the standard adages of the built environment is, “There is never enough time or money to do it right

the first time, but always enough to correct the problem when it is detected or to pay for the added costs of energy, maintenance, and repair over the life of the building.” A requirement for *cost-effective*, sustainable design is to do the right thing at the right time the first time.

While conventional economic tools have a place in evaluating sustainability features, do not be limited to such analysis. Many costs and associated benefits are not easy to predict or quantify. Energy benefits of sustainable design are relatively easy to measure; many other



Decision making is a team effort.

Balancing sustainability with financial constraints

An overriding consideration in decision-making during building design is the “cost-effectiveness” of features. Typically, an economic ranking is applied for prioritizing strategies in a building design that save energy. Traditional economic methods for evaluating criteria are first cost, simple payback, life-cycle cost, or one of the following cash flow analysis methods: discounted payback, discounted cash flow, net benefits or savings, savings-to-investment ratio, or return-on-investment.

Because it is rarely possible to vary the first cost with LANL projects – even if doing so would make good long-term economic sense – this sort of economic analysis is generally limited to evaluation of specific features being considered within an overall design package. For example, eliminating a stormwater detention pond and storm sewers by using a more sustainable strategy of infiltrating stormwater on-site (see Chapter 7) saves a lot of money. The savings can be applied to other aspects of the project to avoid exceeding the overall budget.

benefits are much less quantifiable, so are not well suited to economic analysis. The LANL and contracted project team members need to understand all the obvious and subtle values that will affect decisions about whether or not to include various design strategies. Once these values are understood, the project team can creatively respond to supporting them in producing a sustainable building.

When Values Affect Building Design

LANL strives to apply the best science and technology to make the world a better and safer place. It is important that the LANL facilities provide a comfortable, productive working environment to attract and retain the highest caliber people to achieve this mission. Corporate image, productivity, creativity, health, and environmental quality are examples of values placed on new building projects that can attract and retain LANL employees, while providing superior service to the client, the U.S. Department of Energy and the American public.

Consider the time and money expended to make a new building architecturally pleasing, both outside and inside. In many cases, architectural decisions are not questioned and do not undergo the scrutiny of economic analysis, because achieving an aesthetically appealing design is considered very important. Ideally, values such as optimal energy performance and minimal environmental impact should be equally weighted with the desire for an architecturally appealing building. When this is done, architectural decisions serve a dual role – they achieve an artful building design, and they make a building more sustainable. For example, window overhangs can give a building a unique look as well as reduce summer cooling loads. The project team should collaborate to make the building form enhance the building performance.



The architectural facade recesses surrounding the south-facing windows also serve as window overhangs to shade the windows and minimize direct solar gains. Placing the windows at the top of these recesses further enhances the effectiveness of these overhangs.

LANL

Sustainable Buildings Look to the Past

Often, architecture from the past demonstrates how to effectively integrate form and function. The Old Pension Building in Washington, D.C., (now the National Building Museum) is a classic example. The atrium was designed to give the building a certain feel, but it also was strategically designed to provide light and ventilation to the building's entire interior. The height and size of the openings between the atrium and the interior spaces provided essential qualities to the building, including a healthy and comfortable environment. This building was constructed in

the 1800s, long before electric lighting and central air-conditioning systems were introduced. The design maximizes the use of daylighting and promotes natural ventilation throughout the building to help occupants stay comfortable during the hot Washington summers. Many of the strategies that were design necessities in times gone by, such as daylighting and natural ventilation cooling, are again being integrated into building envelopes to create low-energy, sustainable buildings for the future.



Maxwell Mackensie

Houchlander Davis
Photography

When the old Pension Building (now the National Building Museum) in Washington, D.C., was constructed, the occupants relied on daylighting and natural ventilation for lighting and comfort. These and other sustainable building design features were nearly forgotten when electric lighting and central cooling systems became available.

Writing Sustainable F&OR Documents

In the whole-building design process, a well-written F&OR document is the first concrete step toward achieving a sustainable building. The LANL project team first develops the initial vision for a building project. This process continues with the design charrette, in which the entire project team develops project design goals. The F&OR document is a refinement of those goals.

Typically, the F&OR document includes building requirements based on the site and type of building. Considerations in the selection of a particular site are planning

and code requirements that must be followed; climatic, geologic, and topographic conditions that affect the building form; and safety and security issues. It is the project team's ingenuity that effectively melds these factors into a building design that satisfies the owner's criteria and the needs of the occupants.

The F&OR document addresses design elements that will establish the energy performance of the building. Differences in minimum ceiling heights, levels of illumination, temperature requirements, acceptable humidity ranges, air quality levels, ventilation needs, equipment types and operating schedules, building usage patterns,

occupant densities, and occupancy schedules create opportunities for different strategies that could improve the overall performance of the building. Defining these differences and understanding their importance relative to established criteria enable the project team to select the best combination of design alternatives that will satisfy the owner and occupants.

Sample questions to ask in developing an F&OR document:

- Why is the building needed?
- What are the performance goals for the building?
- What are the first-cost or life-cycle cost issues?
- What process will be used to design and construct the building? Is a design/build or a design/bid/build process planned?
- Can the established design and construction process successfully meet the project goals? If not, what should be changed and how should it be changed?
- How will the project team verify that all design decisions will help meet the design goals? What design tools will be used (e.g., computer simulation tools for energy and daylighting)?
- How will the project team ensure that the building performs as it was designed (e.g., building commissioning, operation, and maintenance)?
- What safety and security issues must be considered?



Getty Images

By considering basic design criteria early in the design process, it is much easier to create a building that will meet all of its functional needs while ensuring health and safety of its occupants and minimizing energy consumption and negative environmental impacts.

F&OR Document Includes:

- **Building Function:** How is the building to be used? Define the uses that relate directly to why LANL needs the building. For example, will the building be an office building, a laboratory building, or a combination office/laboratory building? If laboratories are in the building, what kind of laboratories will they be?
- **Ancillary Space Requirements:** What other functions will the building house? Besides spaces to meet the primary needs of the building, most building requirements include circulation space, storage, and restrooms. LANL buildings may also require meeting spaces, break rooms, and other specialty-use spaces.
- **Code Compliance:** Even though this is a federal facility, LANL follows the 1997 New Mexico Building Code and the 1997 Uniform Building Code.
- **Safety and Security:** Identify all building-specific safety and security issues in the F&OR document to streamline integration of safety and security design solutions into the whole-building design. Addressing these issues later in the process may compromise the building's sustainable design strategies.
- **Energy and Environmental Goals:** Clearly state the energy and environmental goals of the project in the F&OR document.



The Cambria Office Building, which houses Pennsylvania's Department of Environmental Protection, is a high-performance office building that incorporates energy efficiency and renewable energy design strategies.

Jim Schafer



Corbis

Examine assumptions carefully

Good F&OR documents address all underlying assumptions. These assumptions need to be challenged and well documented. Conventional design assumptions applied to conditioning computer rooms is a good example of why this is true. Often, temperature limits established during the 1980s are still used today. However, current computer equipment can handle a much wider range of temperatures. The result is that space conditions in computer rooms no longer need to be as tightly controlled, which lowers the first-cost of space conditioning equipment and long-term operating costs.

Deciding on energy targets

The energy target is the easiest to quantify as a goal, but requires the most integration in the design process to achieve. For typical LANL buildings, the energy-performance target can readily be established from existing operating data (with whatever goal of reduction is assumed). If the building or occupancy type is unique, then an energy-performance target must be created from scratch. This target could be based on simulated energy performance of a conceptual building that is designed to typical local standards, that meets applicable energy codes, or that meets a national standard. The target should be based on the percentage reduction in energy consumption

or cost of energy that was identified in the project goals.

Another consideration in establishing the energy-performance target is to determine the metrics (the method of measuring energy consumption) by which the design will be judged. Creating a theoretical base-case building that meets programmatic requirements with the ultimate goal defined with respect to minimum standards of Federal Regulation 10CFR434 (based on ASHRAE/IESNA Standard 90.1) is a common approach for federal buildings. A recommended goal for LANL office/laboratory buildings is 40 kBtu/ft²/yr or less.

A tube of plans arrives at my office via an overnight delivery carrier. I usually stand them up behind my door waiting for the phone to ring. Everyone knows that overnight packages arrive by 10 am. Shortly thereafter the phone rings. "Hello." The voice on the other end of the phone says, "Did you get my plans?" "Yes – they are sitting right here." The voice continues, "We are going out to bid with these tomorrow and we need you to make this an energy-efficient building."

Energy efficiency is often an afterthought, not truly integrated into the building. In this example, it is too late in the process to make any significant changes that will improve the building's energy efficiency. It is never too early to think about energy efficiency and sustainable design.

– Paul Torcellini, Ph.D, PE, National Renewable Energy Laboratory

Specific Sustainable Elements of F&OR Documents

When creating the F&OR document, it is important to address specific solutions for integrating energy efficiency into the building design. At LANL, one of the most important of these will be daylighting. The F&OR document addresses how daylighting relates to such considerations as comfort and temperature constraints and occupancy patterns.

What is daylighting?

Daylighting uses sunlight to offset electrical lighting loads. Daylighting design provides the same or better quality light than electrical light equivalents with no glare or other distracting qualities.

Daylighting helps achieve the building's energy goals by reducing electrical loads – but only if it is properly harvested. Daylighting systems only realize energy savings if the electric lights are dimmed or turned off when sufficient daylighting is available.

Daylighting also can fit in with the goals of creating a healthy, productive space when focus is on optimizing the *quality* of the daylighting design, not just maximizing the *quantity* of daylighting. The design should provide even lighting levels throughout the workspace. High contrast (significant differences between the brightest and darkest areas in a particular area) can cause eyestrain to the occupants of that area. Consider the inherent brightness of surfaces (walls, ceilings, floors, and work surfaces) when deciding on ways to control daylighting through shading or glazing.

Daylighting

Daylighting is one of the best opportunities for reducing energy loads in LANL buildings. Solar irradiance measurements show that Los Alamos receives more than 75 percent of possible sunshine annually. (Possible sunshine is defined as the amount received when the sky is cloud-free, see Appendix B.) In daylit buildings, project teams carefully design the building envelope and consider characteristics of the fenestration to provide high-quality, natural lighting to the interior spaces. In the end, daylighting should substantially reduce electrical lighting loads and simultaneously reduce cooling loads.

Most spaces can be daylit, including offices, laboratories, conference rooms, corridors, and restrooms. Only those spaces that are completely or intermittently dark (e.g., laboratories for light-sensitive research, photography dark rooms, janitorial closets, or utility spaces) should not be daylit. The F&OR documents identify spaces that are not to be daylit and specify that daylighting should be considered in all other spaces. Chapters 4 and 5 discuss daylighting design in more detail.



Robb Williamson

Elements of whole-building design: operable windows for natural ventilation, daylighting, and reflective lighting in Pennsylvania's Department of Environmental Protection, Cambria Office Building.

Comfort and Temperature Constraints

According to ASHRAE Standard 55, it is acceptable for temperatures to vary in normal working spaces. Typically, the allowable range is between 68° and 78°F, but most building operators maintain temperatures of 70° to 74°F.

Specify space temperatures for electronic closets, server rooms, and other utility spaces according to the manufacturers' specifications of the equipment housed in those rooms. Tight temperature constraints lead to higher energy use (see Chapter 5).

Use temperature constraints in the F&OR document to calculate building loads and to size mechanical and electrical equipment. Spaces within buildings can typically be categorized into the following groups:

- **Occupied spaces**, or spaces in which people are working all the time (comply with the space comfort criteria described in ASHRAE Standard 55). Tightly control space temperatures in these spaces.
- **Transitional spaces**, such as corridors, entryways, and stairwells. Allow the space temperature to vary in these spaces.

- **Unoccupied or sporadically occupied spaces**, such as janitorial closets, computer closets, telephone switching rooms, and equipment rooms. These spaces can tolerate large temperature variations (depending on the equipment housed there). Note that computer closets were traditionally kept cool because older computer equipment could not tolerate varying space conditions; most modern computer equipment can withstand larger temperature swings.



The atrium at Oberlin College's Adam Joseph Lewis Environmental Center in Oberlin, Ohio.

Ed Hancock



An "outdoor room" saves space at the Zion National Park Visitor Center.

Robb Williamson

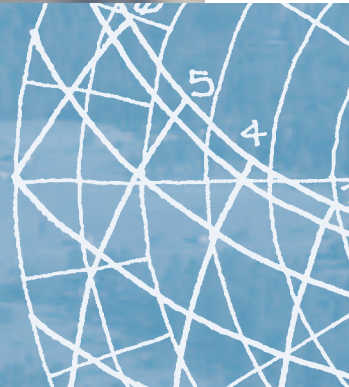

Occupancy Patterns

Understanding occupancy patterns of the various spaces in the building will help determine which spaces to daylight to minimize building energy loads. Daylight spaces that are occupied all the time and place sporadically occupied spaces in the building core where daylighting is not available. Equip sporadically occupied spaces with systems to turn off the lights when the space is not occupied, thereby reducing energy consumption. Note that spaces such as restrooms and corridors typically have high occupancy rates and can tolerate larger variations in temperature.

A merely code-compliant building is not an energy-efficient building. In fact, a code-compliant building is the worst building that can be built without breaking the law. An objective with sustainable design at LANL is to exceed the code, not just squeak by. The difference is mediocrity versus high-performance. A national laboratory should have high-performance buildings to create high-performance research from the world's best scientists and engineers.

Ancillary spaces are often the easiest to integrate with the energy-efficient design. Conference and meeting areas can be designed to be daylit. An often overlooked goal is to provide a creative environment for people to think and work in. One method to address this need is to design small meeting alcoves to provide havens for people to think creatively about problems or hold informal meetings.

The Los Alamos climate provides an opportunity to create and use outdoor spaces where employees can work or hold meetings. This amenity can boost productivity and unleash creative energy. Examples of these

“rooms” are transitional spaces, such as covered (protection from direct sun and rain) breezeways between buildings, and plazas or patios. An outdoor space can also be a covered extension of a cafeteria or conference room with tables and access to telephone and Local Area Network (LAN) ports to facilitate meetings and efficient work. The cost of creating these spaces is a fraction of building construction costs.



This roof garden on the Otowi Building provides a quiet outdoor space for LANL staff to hold informal meetings. Examples of outdoor “rooms” are covered breezeways between buildings, cafeteria and conference room extensions, plazas and patios, preferably with access to telephones and LAN ports. It is important to consider accessibility when designing outdoor spaces.

Fitting Into the LANL Design Process

Several LANL documents detail requirements for design and construction processes. The guiding document is the *Laboratory Implementation Requirement (LIR) 220-03-01*. This LIR directs the Facilities and Waste Operations (FWO) division to publish and maintain the *LANL Engineering Manual (LEM)*. Essentially, the LEM implements the LIR. The LEM, arranged by discipline-specific engineering requirements, provides site-specific engineering requirements and guidance for LANL facilities.

Two other documents support the guidance and requirements of the LEM: the *LANL Construction Specifications Manual (LCSM)* and the *Facility Drafting Manual*. The LCSM provides templates for preparation of project-specific construction specifications at LANL.

The *LANL Drafting Manual* provides drafting requirements for use when creating construction drawings. These documents are referenced throughout the LEM.

Two companion documents, the *Design Principles* and this *LANL Sustainable Design Guide*, are intended to augment the guidance and requirements provided in LIR, LEM, LCSM, and the *LANL Drafting Manual*. While not required documents, they present guidance and methods to help achieve LANL design and construction goals. Use these tools and methods to guide the integrated design process.

The LEM defines the regulatory basis and LANL requirements during the design stages. The LCSM is the basis for writing specifications that guide building construction.

The *LANL Sustainable Design Guide* and the *Design Principles* have applicability throughout the design and construction processes; LANL and A/E firm should use these resources as tools to assist in the following functions:

- Develop project vision and goals.
- Develop programming documents.
- Prepare and issue Request for Proposal.
- Evaluate site development plans for preparing the site for construction, treatment of the site during construction, and management of the site after construction with a sustainable landscaping and water management plan.

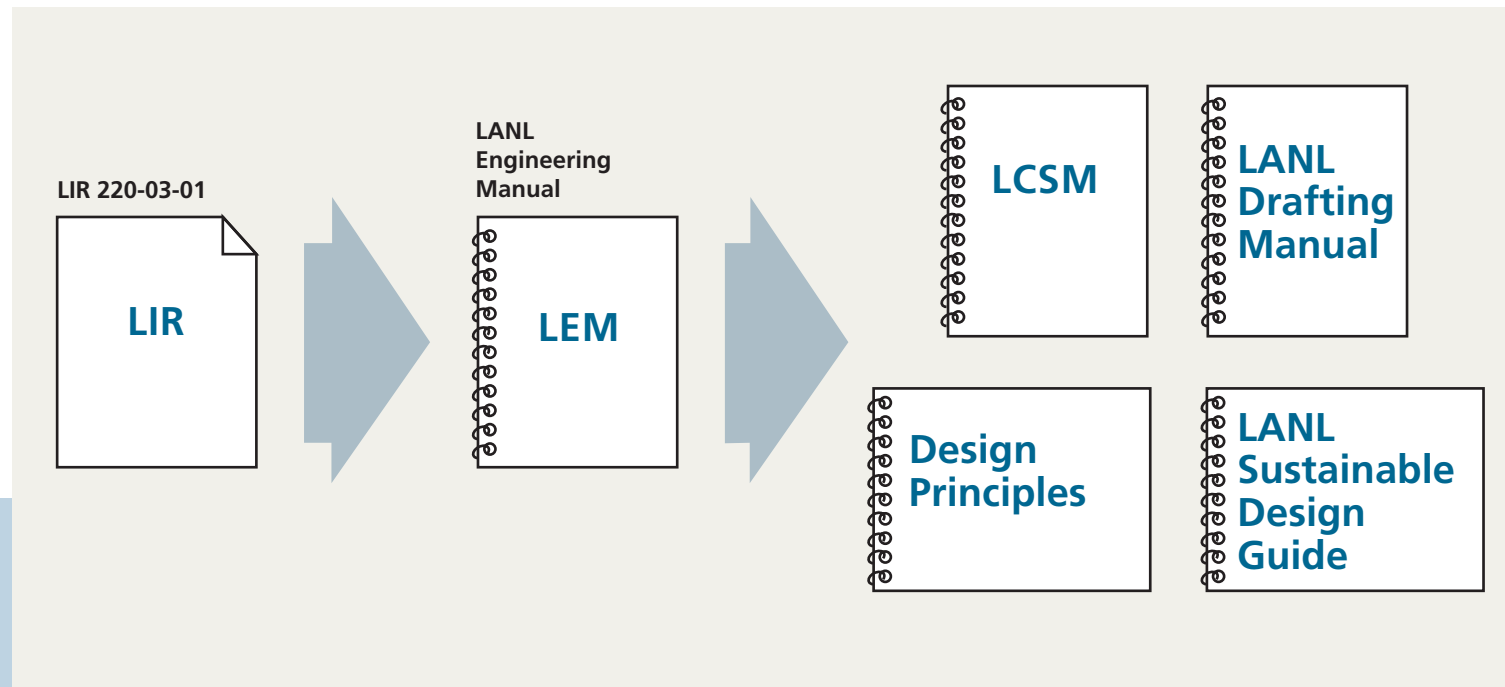

- Develop and evaluate design solutions.
- Evaluate site development plans before, during, and after construction.
- Develop commissioning and building operation plans.
- Evaluate and prepare change orders during construction.
- Educate the building operators on expected building performance and how to identify when the building is not performing as it should.

Without major changes, the whole-building sustainable design process can merge with the current LANL process for designing and constructing buildings. The only additions are to:

- Involve all LANL players (the project management team, the user, and the LANL decision makers) during the planning phases for all buildings, regardless of size.
- Foster strong communication links between members of the entire project team (e.g., architects, engineers, interior designers, landscape architects, planners, construction contractors, and commissioning agents) from the pre-conceptual phase through the execution phase.

- Follow up after the building is constructed and occupied to commission the building, survey the occupant's satisfaction with the building, and evaluate the building's actual performance to ensure that the original design goals are met.

The following chart recommends how to integrate the whole-building design process into the established LANL project development process. Note that elements of the whole-building design process appear throughout this chart, beginning with the planning phase and continuing through the operations phase.

**How LANL documents work together
(Example: Integrated lighting)**

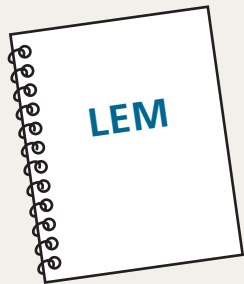

- Specifies interior lighting levels and states a preference for daylight areas and connection to the outdoors.

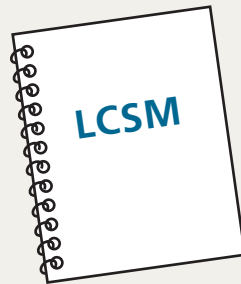

- Provides minimum requirements for window insulation and glazing type.
- Provides minimum requirements for electric lighting and controls.



- Recommends daylighting and presents strategies and design considerations for good daylighting design.

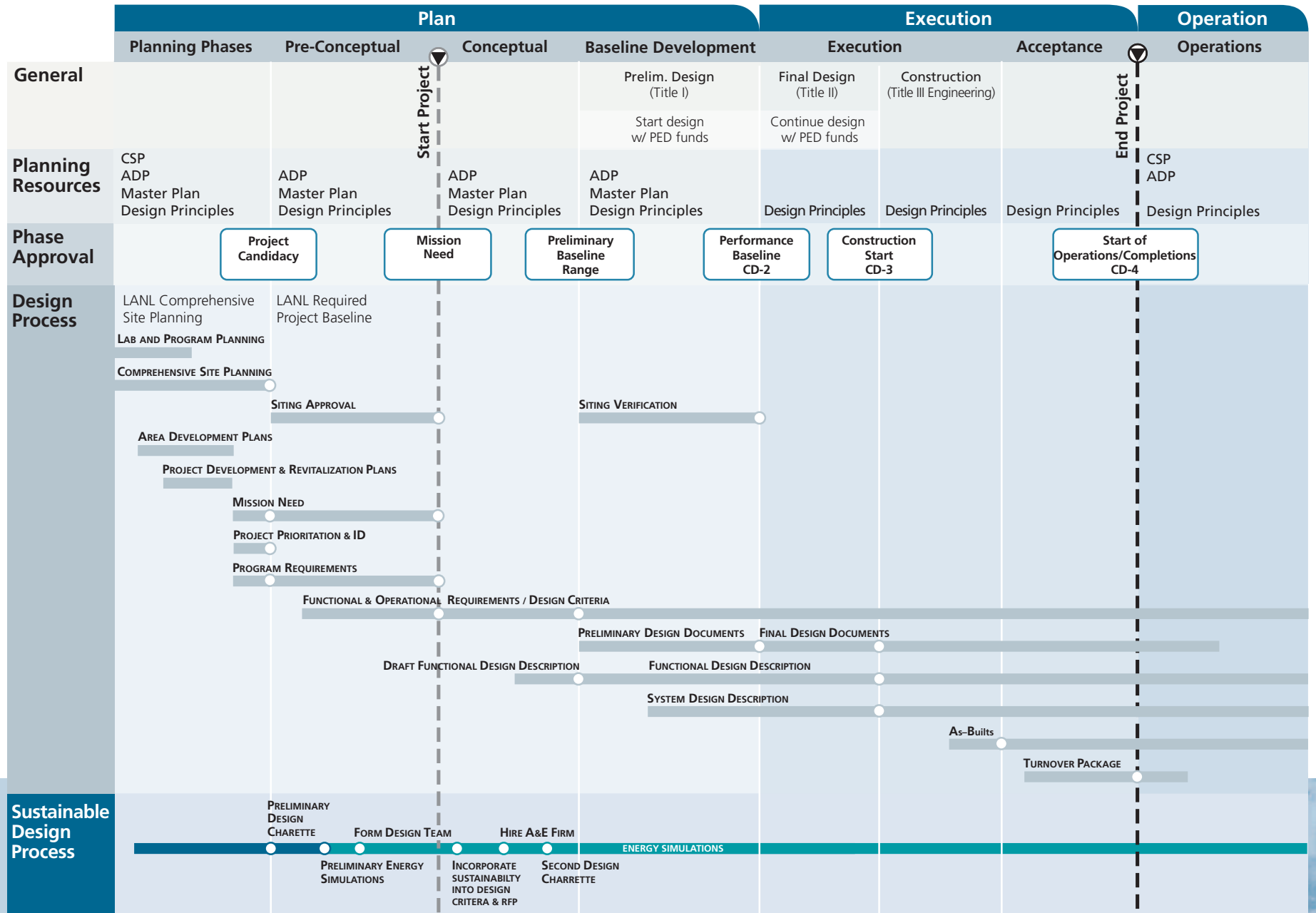

The project development process with the whole-building design process integrated into it (see page 6 of the Design Principles).

Up-front building and design costs may represent only a fraction of the building's life-cycle costs. When just 1% of a project's up-front costs are spent, up to 70% of its life cycle costs may already be committed; when 7% of project costs are spent, up to 85% of life-cycle costs have been committed.

– Joseph Romm, *Lean and Clean Management: How to Boost Profits and Productivity by Reducing Pollution* (Kodansha International, 1994)

Federal Regulations Overview

Federal laws, Executive Orders, and Executive Memoranda direct federal government facility managers to reduce the energy and environmental impacts of the buildings they manage. In addition, DOE issues Orders that apply to DOE facilities. These laws and regulations require facility managers to be proactive in their efforts to reduce resource consumption, to reuse and recycle materials, and to dramatically reduce the impacts of federal government activities on the environment. More information about laws, orders, and regulations is provided in Appendix A.

Laws, Executive Orders, DOE Orders, and other Regulations all provide a facility manager with the foundation, justification, and mandate to conduct projects designed to improve the energy and environmental performance of their facilities.

- **Laws** are the will of the American people expressed through their elected representatives.
- **Executive Orders** are the President's directives to the agencies.
- **DOE Orders** are issued by DOE and apply only to DOE facilities.

- **Regulations** establish procedures and criteria by which decisions shall be made and actions carried out.

All LANL facilities must comply with the Code of Federal Regulations 10CFR434, "Energy Conservation Voluntary Performance Standards for New Buildings; Mandatory for Federal Buildings." This code establishes the minimum performance standards to be used in the design of new federal commercial and multifamily high-rise buildings. Federal buildings constructed to comply with but not do better than 10CFR434 are the least efficient buildings that can legally be constructed. Sustainable building performance should far exceed that of buildings constructed only to comply with 10CFR434.

DOE Order 430.2A, "Departmental Energy and Utilities Management," establishes requirements for incorporating sustainable design principles in new buildings of 10,000 gross square feet or larger. An energy-efficiency/sustainability design report is required for new buildings at the completion of Title II design. The minimum elements of the report are energy-efficiency compliance with 10CFR434, site responsiveness, water conservation, materials sensitivity, healthiness, and environmental releases.

Important Points to Consider

✓ Project Vision and Design Goals

- Complete site analysis to determine the minimum environmental impact.
- Use computer simulations to direct design decisions.
- Complete a base-case building analysis to understand design strategies that will have the greatest impact on the building design for the particular building function.
- Evaluate adjacencies for building functions and how the building interacts with the site.
- Evaluate use of renewable energy technologies and how they can be incorporated into the building design, either now or in the future.

✓ Schematic Design

- Integrate the architectural design with the building's energy design. (The building's form should improve the building's performance.)
- Evaluate all building materials for environmental preference.
- Reduce building mechanical and electrical systems by incorporating passive solar technologies to help meet space loads and lighting loads. Use computer simulations to guide design decisions to achieve this strategy.
- Engineer building systems to ensure that their operation does not override benefits of the architectural design (e.g., electric lights should not operate when sufficient daylighting is available).

✓ Design Development

- Re-evaluate all suggested design changes using computer simulations to ensure that the changes will not detract from meeting the building sustainability goals.

✓ Construction Documents

- Write specifications clearly to eliminate confusion and on-site interpretation during construction
- Clearly depict high-performance design strategies in construction drawing details. Comprehensive details result in fewer errors from on-site interpretation of drawings during construction.
- If design changes are proposed during construction, use computer simulations to evaluate the impacts on building performance and to determine if the changes should be implemented.

✓ Occupancy

- Commission all building systems prior to occupancy.

✓ Post-Occupancy

- Check that all systems are operating as intended to meet sustainability goals.
- Educate building operators so they can ensure that the building continues to perform optimally.

Best Practices in high-performance building design

The worst building that can legally be built is one that just meets the requirements of 10CFR434. However, building minimally code-compliant buildings will not move LANL toward energy efficiency and sustainable design. Generally, buildings fall into one of three performance categories below:

Standard practice/code-compliant buildings:

Buildings that meet the requirements of 10CFR434

Better performance buildings: Buildings with an energy cost reduction of 20%, compared to a base-case building meeting the requirements of 10CFR434

High performance for sustainability: Buildings with an energy cost reduction of greater than 50% compared to a base-case building meeting the requirements of 10CFR434.

Design teams create high-performance buildings by following "best practices." For example, applying performance path ASHRAE standards can result in a building that is 50% more efficient than a building designed to merely comply with the prescriptive ASHRAE standards.

Criteria for Sustainable Success			
	✓ <i>Standard Practice/ Code-Compliant</i>	✓ <i>Better Performance</i>	✓ <i>High Performance for Sustainability</i>
Selecting the Project Team	<input type="radio"/> Sustainability vision not included in the RFP	<input type="radio"/> Sustainability vision included in the RFP	<input type="radio"/> Sustainability vision important part of the RFP
	<input type="radio"/> Team initially consists only of the LANL project team, A/E firm joins the team after Title I and pre-design	<input type="radio"/> Team consists of the LANL project team and the A/E firm	<input type="radio"/> Better performance plus additional team members representing LANL, ES&H, O&M, and custodial personnel
	<input type="radio"/> No goals set	<input type="radio"/> Team sets design goals during the conceptual design phase	<input type="radio"/> All team members involved in setting project design goals during conceptual design
Sustainable Design (SD) Report	<input type="radio"/> Required as Title II submittal per DOE Order 430.2A	<input type="radio"/> Specific requirements of SD Report detailed in the F&OR document and RFP	<input type="radio"/> Submittals of SD report during Title I and II with final report due at end of Title III
Project Evaluation	<input type="radio"/> No post occupancy evaluation conducted	<input type="radio"/> Conduct a post-occupancy survey of occupant satisfaction	<input type="radio"/> Conduct a post-occupancy survey of occupant satisfaction
	<input type="radio"/> No monitoring of energy performance	<input type="radio"/> Building level meter installed	<input type="radio"/> Monitor building's energy performance to determine how well the project vision was met and for early detection of performance problems, including lighting, HVAC, and plug loads
Environmental Goals	<input type="radio"/> No rating goals	<input type="radio"/> LEED-certifiable	<input type="radio"/> LEED Gold equivalent or higher

Table continues >

Criteria for Sustainable Success			
	✓ <i>Standard Practice/ Code-Compliant</i>	✓ <i>Better Performance</i>	✓ <i>High Performance for Sustainability</i>
Daylighting	<input type="radio"/> None specified	<input type="radio"/> Identified as a possibility in 50% of the area of the building	<input type="radio"/> Identified as a possibility in 80% of the area of the building
Space Conditioning	<input type="radio"/> All spaces conditioned equally	<input type="radio"/> Broad categories of spaces are defined and conditioned separately	<input type="radio"/> Temperatures are specified on each space with broad tolerances for equipment rooms and hallways
Design/Build Contract Documents	<input type="radio"/> Sustainability goals not mentioned	<input type="radio"/> Documents mention that sustainability is a goal, but no specific objectives are included to support this goal	<input type="radio"/> Energy and environmental goals and objectives are clearly identified in contract documents
Energy Consultant	<input type="radio"/> None involved	<input type="radio"/> A member of the project team oversees sustainable design strategies in addition to his/her other duties	<input type="radio"/> Person contracted to provide energy simulations to help guide the envelope design. Environmental consultation for material selection.



References

Code of Federal Regulations 10CFR434, "Energy Conservation Voluntary Performance Standards for New Buildings; Mandatory for Federal Buildings," www.access.gpo.gov/nara/cfr/waisidx_02/10cfr434_02.html

Construction Project Management (Implementing LIR), Laboratory Implementing Requirements LIR 220-01-01.4

DOE Order 430.2A, "Departmental Energy and Utilities Management," www.eren.doe.gov/femp/aboutfemp/pdfs/doeo430_2a.pdf

The Green Zia Environmental Excellence Program, www.nmenv.state.nm.us/Green_Zia_website/index.html

Laboratories for the 21st Century, www.epa.gov/labs21century

LANL Engineering Manual (LEM), OST-220-03-01-EM, www.lanl.gov/f6stds/pubf6stds/xternhome.html

LANL Construction Specifications Manual (LCSM), www.lanl.gov/f6stds/pubf6stds/xternhome.html

LANL Drafting Manual (FDM), OST-220-03-01-DM, www.lanl.gov/f6stds/pubf6stds/xternhome.html

Site and Architectural Design Principles, www.lanl.gov/f6stds/pubf6stds/engrman/4arch/html/site_arch.htm

U.S. Green Buildings Council LEED Program, www.usgbc.org

Additional Resources

Charrettes for High Performance Design, www.nrel.gov/buildings/highperformance

FEMP Resources: Regulations and Legislative Activities, www.eren.doe.gov/femp/resources/legislation.html

High-Performance Buildings Research Initiative Web site, www.highperformancebuildings.gov

Los Alamos National Laboratory, www.lanl.gov

Whole Building Design Guide, www.wbdg.org

FEMP Federal Greening Toolkit, www.eren.doe.gov/femp/techassist/greening_toolkit

Environmental Design Charrette Workbook, American Institute of Architects, Washington, D.C., 1996



Chapter 3: Building Siting

- ❑ *Site Issues at LANL*
- ❑ *Site Inventory and Analysis*
- ❑ *Site Design*
- ❑ *Transportation and Parking*

Chapter 3

Building Siting

Site Issues at LANL

Laboratory site-wide issues include transportation and travel distances for building occupants, impacts on wildlife corridors and hydrology, and energy supply and distribution limitations. Decisions made during site selection and planning impact the surrounding natural habitat, architectural design integration, building energy consumption, occupant comfort, and occupant productivity.

Significant opportunities for creating greener facilities arise during the site selection and site planning stages of design. Because LANL development zones are pre-determined, identify the various factors affecting development within the selected property and design the site to harmonize with adjacent development and the surrounding environment. Address site planning and building siting as part of the whole-building design process.

Definitions and related documents

Site selection refers to the choice of a site, and is covered by Laboratory master planning activities in the *10-Year Comprehensive Site Plan, Area Development Plans, Area Master Plans, and Facility Strategic Plans*. **Site planning** refers to laying out proposed uses within property boundaries and is the responsibility of LANL Project Management (PM) Division and the Site and Project Planning Group (PM-1). The **siting** of structures on a particular property is the focus of this section. Site design guidelines are presented in the *Design Principles*, a publication referred to throughout this chapter.

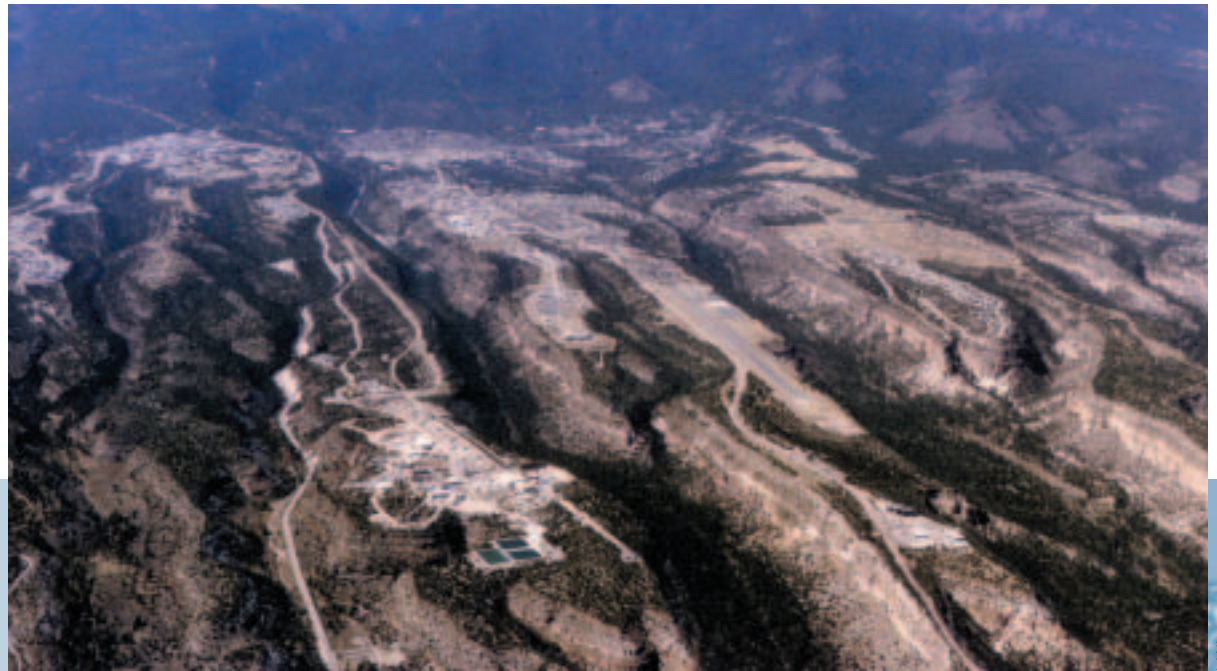

This aerial photo of portions of LANL, the Los Alamos town site, and the surrounding areas shows the diverse topography with the canyon and mesa erosion patterns of geological formations created 1.1 million years ago.

To promote sustainable land use, it is better to build on previously developed sites while improving or restoring natural site features, rather than develop natural undisturbed land. The Laboratory campus has both undisturbed (undeveloped) and disturbed (previously developed) sites that are targeted for new building projects. Approximately 2.5 percent of the 43 square miles that comprise the Laboratory campus has been developed. The remainder is preserved in its natural vegetative form: forest, prairie, and numerous streams. However, due to human traffic and barriers, much of the undeveloped land is not truly left alone.

When planning site design for a previously disturbed site, consider allocating funds saved from reuse of existing infrastructure to restore natural landscapes and historic features.

Sustainable and whole-building design practices assess both the site and the building program to determine a site's capacity to support the project without degrading vital systems or requiring extraordinary development expenditures. To enhance the sustainability of the environment while meeting the mission of the Laboratory, an integrated team approach is required throughout all aspects of Laboratory operations.



The existing site of the Admin/Badge building...



...and the proposed new building on the same site in TA-03.

Sustainable Site Planning and Design Opportunities

Good siting practices should:

- Integrate the building architecturally into the natural context of the site, which minimizes the appearance
- Minimize site-clearing to reduce costs
- Take advantage of natural site features, such as topography, sunlight, shade, and prevailing breezes, to promote energy conservation
- Preserve existing vegetation, which can reduce landscape maintenance costs
- Mitigate erosion to reduce topsoil loss and protect surface water quality
- Avoid the need for supplemental irrigation and fertilizer, to minimize groundwater and surface water pollution
- Manage for snow and snow melt run-off to reduce maintenance costs

Preserving mature stands of native vegetation can:

- Add character to the site
- Provide energy-conserving shade and wind protection

- Eliminate the waiting period for expensive new plantings to mature to provide the potential benefits of preserved vegetation

Carefully planned building placement should:

- Maximize benefits for site occupants
- Minimize stormwater runoff
- Minimize natural habitat disturbance
- Protect open space
- Reduce the risk of fire and erosion
- Save energy by providing for solar energy utilization, daylighting, shading, and natural ventilation

Maximize factors that contribute to the health and productivity of employees, such as:

- Thermal comfort
- Access to fresh air
- Acoustic privacy
- Aesthetic views
- Functional outdoor space

In the end, our society will be defined not only by what we create, but by what we refuse to destroy.

– John Sawhill, President
The Nature Conservancy 1990-2000

Case Study: Limiting Environmental Disturbance

In spite of its significant size, no undeveloped land was broken for construction of the Nicholas C. Metropolis Modeling and Simulation Center at the Strategic Computing Complex (SCC). It was built at TA-3 on a site that previously held a gas station and parking lot. Removal of those structures and site remediation was completed in 1999. During deconstruction, some materials were stockpiled for reuse through the Waste

Minimization/Pollution Prevention Program of LANL's support services subcontractor.

Given the prior history of development on the site, there were no new concerns with regard to ecological disturbance caused by construction of the new SCC building. In fact, the vegetative cover of today's site is better than that of the previous site. Where there had been less than 10% vegetative cover, native vegetation now covers 25 to 30%.

Site Inventory and Analysis

The site inventory and analysis process takes the form of drawings and written documentation. This assessment is used to identify existing features and constraints of a site, including drainage patterns, infrastructure, notable topography, vegetation, existing structures, and microclimates. The natural and existing characteristics of a site influence the feasibility and cost of site and building design elements, including:

- Building shape
- Architectural massing
- Building materials
- Surface-to-volume ratio and building footprint size
- Structural systems



The site of an old gas station and parking lot in TA-03 was deconstructed...



...and redeveloped for the Nicholas C. Metropolis Modeling and Simulation Center.

- Mechanical systems
- Site/building access and service
- Solar orientation
- Provisions for security and fire safety
- Wildfire protection
- Stormwater management

Use the Site Inventory and Design Impacts table on the next page to optimize sustainability opportunities as part of the pre-design phase. This table references site analysis issues from the *Design Principles* (p. 21) and identifies design elements affected by specific site characteristics. Inventory the existing boundaries and site features of both disturbed and undisturbed

portions of a previously developed site. These features include existing vegetation, drainage patterns, topography, views, adjacent land uses, existing and proposed infrastructure, and easements.

Once the site inventory is complete, it will be much easier to integrate development with the physical and ecological site and any specific site constraints. Follow the site analysis mapping approach described in the *Design Principles* to carry out this process. Although the project team performs most of the site inventory and analysis, it is important for the design team to understand the specific results of the site analysis before developing the building design.

Wind is a microclimate-specific element of site analysis. Each LANL building site experiences unique prevailing winds because of the varied terrain on the campus (see Design Principles, p. 17). Become familiar with the wind patterns on the building site. Situate building entrances on the protected side of the building, and position berms and landscaping to block winter winds and prevent snow build-up near the building. Also, locate outdoor meeting spaces, proximity of parking to operable windows, and placement of air inlets and exhaust ports to take advantage of prevailing winds.



Site planning for the TA-03 area of LANL. The cream color denotes existing buildings, tan represents building projects in progress, and purple identifies buildings in the 10-year plan.

This table lists building and site design elements that are affected by specific findings of the site inventory and analysis. These impacts can be complex. Individual site characteristics may point to certain design solutions that, taken as a group, result in conflicts. For example, minimizing excavation costs and stormwater runoff for the given topography of a site may require a building to have an elongated north-south axis. Maximum energy efficiency is achieved with an elongated east-west axis. A building configuration that fits with this site topography and provides energy-efficient design opportunities may be an L-shape. A full understanding of the site characteristics will be necessary to find synergies and select trade-offs that result in a design with optimized cost-effectiveness and minimized environmental impact.



Site Inventory and Design Impacts		
Site Inventory Characteristic	Building Design Elements	Site Design Elements
Topography, Slope, and Adjacent Landforms	Building proportions	Natural features for diverting and detaining stormwater runoff
	Structural wind loading	Gravity-fed sewer-line corridors
	Architectural elevations	Fire risk-reduction strategies
	Drainage away from structure	
Soil Types, Textures, and Load-Bearing Capacity	Foundation location and engineering	Site-grading procedures that minimize erosion or damage by machinery
		Plant selections appropriate to soil type
Vegetative Cover and Existing Native Plant Populations	Solar load access and avoidance	Vegetation susceptible to damage during construction
	Maintenance and operation strategies	Long-term maintenance requirements
	Construction boundaries and site drainage	Clearing for fire management setback zone
Wildlife Migration and Nesting Patterns		Erosion mitigation and biofiltration through existing vegetation
	Footprint location and proximity to wildlife	Location of game trails and established nesting sites
Geologic and Seismic Data	Foundation type	Structural requirements for constructed landscape features (e.g., retaining walls)
	Structural specifications	
	Location relative to faults	
Parcel Shape and Access with Adjacent Land Uses, Buildings, and Structures	Capacity to accommodate a proposed building size	Access points (should not burden lower-density or less compatible adjacent land use)



Site Inventory and Design Impacts		
<i>Site Inventory Characteristic</i>	<i>Building Design Elements</i>	<i>Site Design Elements</i>
Utility Easements or Corridors	Footprint location options	Integration with site layout options
Utility Lines and Sizes	Location of building tie-in	Vegetation disturbance (ground cover and tree root systems)
Road System and Networks for Parking, Pedestrians, Bicycles, and Transit	Walking distance and orientation to other pedestrian destinations	Parking capacity for all vehicle types
		Total impervious area
		Pedestrian interface with alternative modes of transportation
		Access to natural areas
Legacy Contamination	Footprint location	Location of potential release sites (PRS) and site drainage patterns
Security and Safety Improvements	Building access points for people, utilities, and fresh air	Location of barriers, gates, fences, walkways, roads, parking areas, and exterior lighting
	Fire protection	Fire control measures and management strategies
Microclimate Factors (e.g., solar and wind loads)	Layout for solar orientation	Paved area location and snow/ice removal strategy
	Location of entrances, windows, and loading docks	Vegetation strategy for aesthetics and biofiltration
	Location of air inlets and exhaust	Landscape elements as windbreaks
Proposed Future Development	Design changes for efficiency of campus interconnectivity	Design changes for efficiency of the campus infrastructure

When is the best time to think about site issues?

Maximize sustainability opportunities as early as possible in the site selection and site planning process – even before pre-design – to integrate site issues into the design process. Some opportunities continue through design development and, to a more limited extent, through facility and landscape construction. The earlier site issues are addressed, the better.

Site Design

After completing the site inventory and analysis, evaluate the overall project compatibility with the site. Identify alternative site design concepts to minimize resource costs and site disruption. Refine and adjust the proposed building footprint to optimize site opportunities. Follow these guidelines when developing the schematic design:

Natural Site Features

- **Preserve natural drainage systems.** Locate buildings, roadways, and parking areas so that water flowing off the developed site during extreme storm events will not cause environmental damage and result in excessive contamination of the watershed

from silt, oils, automobile fluids, and other pollutants. Also, consider how site development and construction will affect on-site and off-site drainage systems. Avoid sites where impacts will be excessive.

- **Locate driveways, parking, entrances, and loading docks on the south side of buildings.**

Desirable locations of driveways and parking are generally on the south-facing slopes or the south sides of buildings. This helps avoid snow and ice build-up. Balance these needs with other priorities for infrastructure and landscaping.

- **Orient the building with the long side on the east-west axis.** This orientation allows for the greatest winter solar gains and least summer solar gains. Mitigate excessive summer solar heat gain and

minimize cooling loads through optimal orientation. It is possible to efficiently manage solar gains on buildings oriented up to 15 degrees off true south.

- **Minimize ground-level wind loads.** Snow build-up, especially at doors and loading docks, requires significant effort and energy for snow removal. Control ground-level wind with vegetation, walls, and fences acting as windbreaks. An area exposed to wind can also be protected through berming and earth sheltering. Optimize wind patterns for dispersal of stack-released aerosols and other chemicals.



LANL



LANL

Examples of techniques to manage and direct stormwater without soil erosion.

Vegetation

- ❖ **Minimize native vegetation disruption.** Locate and size facilities to avoid cutting mature vegetation and minimize disruption to, or disassociation with, other natural features. Balance this strategy with the fire risk-reduction guidelines described in the *Design Principles*.
- ❖ **Minimize visual impacts.** Use natural vegetation and adjust the building plan and elevation to diminish the visual impact of facilities and minimize impacts on the cultural and natural viewshed.

Hydrology

- ❖ **Minimize erosion.** Locate and design facilities to minimize erosion and impacts on natural hydrological systems.
- ❖ **Avoid hydrological system contamination.** Safeguard the hydrological system from contamination by construction activities and building operation.
- ❖ **Minimize runoff.** Avoid large, impervious surfaces and building footprints that concentrate stormwater runoff into channels, which can carry soil away from the site (see Chapter 7). Manage the stormwater so that it irrigates site vegetation.
- ❖ **Allow precipitation to naturally recharge groundwater.** Use swales and dry retention ponds to maximize infiltration and minimize runoff.

Geology/Soils

- ❖ **Minimize excavation.** Site the long axis of a building or a parking lot with the natural topography to minimize site disturbance and excavation.
- ❖ **Minimize disturbance to groundcover.** Protect and plant groundcover that prevents soil loss to wind and stormwater erosion.
- ❖ **Avoid soil compression.** Locate construction vehicle parking and materials storage in proposed development areas such as future parking lots. Avoid locations designated as future landscaped or natural areas.



A burned area undergoing restoration with soil erosion prevention strategies.

LANL

Transportation and Parking

It is estimated that LANL employees commute an average of 20 miles one-way to work. This commuting adds up to a total of 98 million miles each year. Also, employees must often drive to meetings within the LANL campus. In fiscal year 2001, there were 10,000 employees working at the Laboratory, and, according to the LANL report, "The Laboratory's Footprint: Our Environmental Impacts," an employee traveled an average of 10 miles per day within the facility for 225 workdays per year. This distance equals 22.5 million miles, or 900 trips around the world.

Reducing the use of single-occupancy vehicles driving to and from the Laboratory and circulating within the campus will:

- Save energy
- Reduce pollution
- Improve employee health (to the extent that walking or bicycling is encouraged)

Parking is often a significant user of land. Reducing the area devoted to parking results in:

- Reduction of polluted surface runoff (stormwater)
- Greater groundwater recharge
- Reduced heat island effect and glare
- Opportunities for creating more natural landscaping and pedestrian-friendly environments
- Improved air quality



Note in this aerial photo of the Core Area of LANL the amount of land used for automobile parking and circulation.



An example of a large impervious parking surface near the MSL building...

Strive to decrease land area devoted to automobiles and increase land area devoted to natural ecosystems and pedestrians. However, to successfully reduce the demand for parking spaces, alternative transportation options and incentives must be available to Laboratory employees.

- Encourage the use of bicycles by providing safe bicycle paths throughout the LANL site.
- Provide secure and protected bicycle storage near building entrances. Bicycle parking spaces for at least 5 percent of the building population is a reasonable initial guideline for sizing the bicycle parking area.

- Provide places to change clothes and shower for those interested in biking, walking, or jogging to work or exercising mid-day.
- Provide a safe and convenient commuter waiting area to serve those using public transit or the on-site shuttle service.
- Provide visible and safe pedestrian access from commuter waiting areas to primary building access points.
- Provide preferential parking for carpool vehicles. Consider incentives for carpooling and reducing the need for paved parking.

- Provide only the minimum required number of paved parking stalls as dictated by design standards. If a significant parking area must be included on the building site, then design bioretention swales into the parking lot landscaping as part of the exterior water management and shading strategies (see Chapter 7).
- Use landscaping materials and appropriate signage to create comfortable and safe pedestrian environments. (Refer to *Design Principles* for more detailed guidelines.)

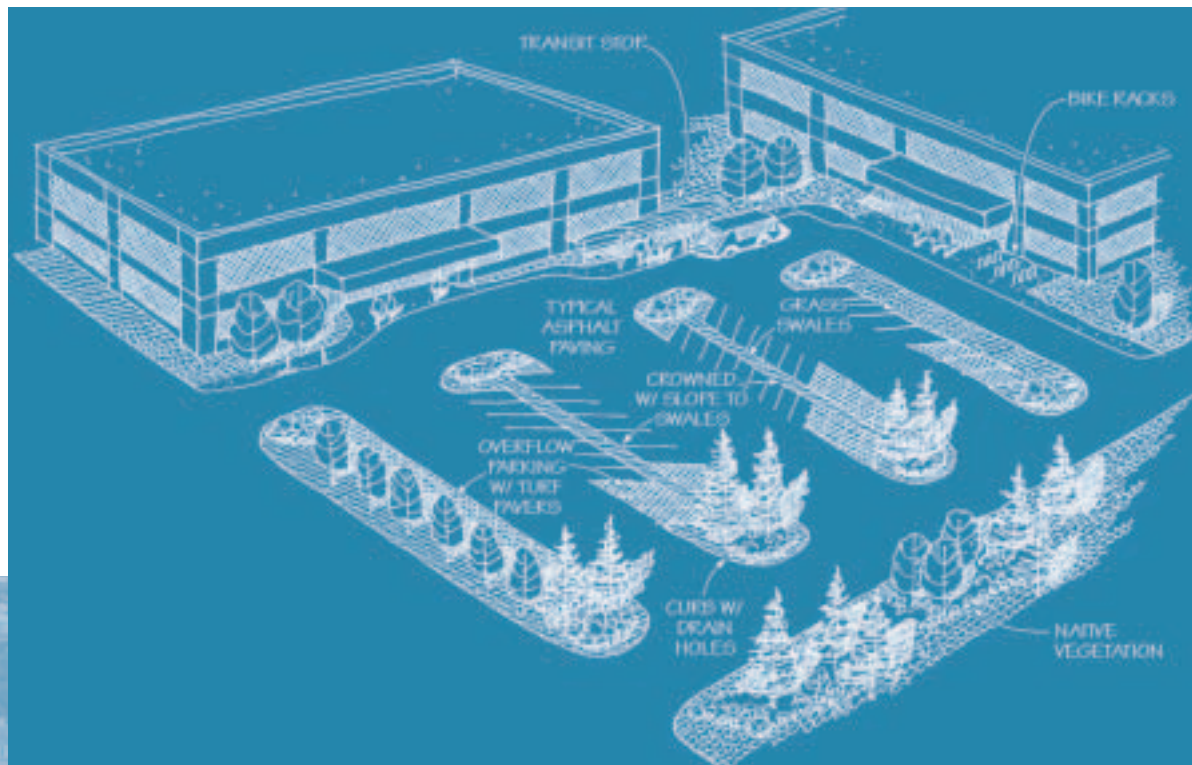

...and several solutions for reducing parking lot impervious surface area.

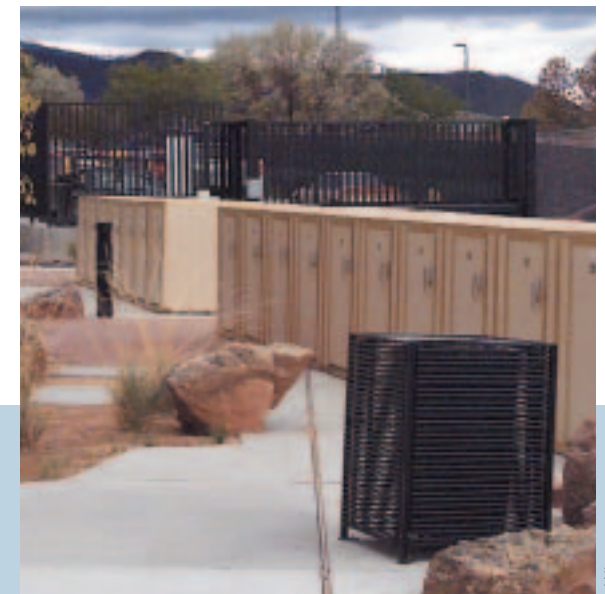

Secure and weather-protected bicycle storage lockers.

Criteria for Sustainable Success			
	✓ <i>Standard Practice/ Code Compliant</i>	✓ <i>Better Performance</i>	✓ <i>High Performance for Sustainability</i>
Site Disturbance – undisturbed sites	<ul style="list-style-type: none"> ○ Federal and local codes 	<ul style="list-style-type: none"> ○ Identify native plant populations and document preservation strategy (see also Chapter 8) 	<p><i>PLUS:</i></p> <ul style="list-style-type: none"> ○ Limit earthwork site disturbance to the Zone 1 fire management boundary and to 5 ft. beyond infrastructure requirements. Clearly delineate construction and disturbance boundaries with laydown, recycling, and disposal areas and contractual penalties for violation
Site Disturbance – previously developed sites	<ul style="list-style-type: none"> ○ Federal and local codes 	<ul style="list-style-type: none"> ○ Do not exceed existing development boundaries for building footprint, parking, and construction 	<ul style="list-style-type: none"> ○ Restore open area within Zone 2 and 3 fire management boundaries by planting native or adapted vegetation
Parking Area	<ul style="list-style-type: none"> ○ Federal and local codes (note: consider referencing the Institute of Transportation Engineers or City of Albuquerque) 	<ul style="list-style-type: none"> ○ The <i>Design Principles: Parking system</i> principles (p. 44) 	<ul style="list-style-type: none"> ○ Multiple alternative transportation choices and incentives
	<ul style="list-style-type: none"> ○ Typical office buildings: <i>minimum</i> of 1 standard car space per 200 gross square feet (gsf) of floor area 	<ul style="list-style-type: none"> ○ <i>Maximum</i> of 1 space per 375 ft² of building area dedicated to office/administration purposes and 1 space per 1,000 ft² of building area dedicated to laboratory purposes 	<ul style="list-style-type: none"> ○ Convenient parking spaces only for mass transit, carpools, bicycles, accessibility, delivery, maintenance, security, and emergency vehicles (maximum 2 spaces per 100 gsf)
Site Impact Analysis	<ul style="list-style-type: none"> ○ No site impact study completed 	<ul style="list-style-type: none"> ○ Independent site assessment completed with no design solutions 	<ul style="list-style-type: none"> ○ Develop a site impact study that can be used to guide the design process



✓ Systems Integration Issues

- Select building siting, configuration, and massing to optimize sustainable low-energy building design relative to the anticipated space needs.
- Evaluate building siting options for solar access and effective use of landscaping elements, especially for harvesting daylight, avoiding glare, reducing summer cooling loads, and gaining passive solar heat in the winter months.
- Select building site, orientation, and form simultaneously with defining functional requirements of the building and before integrating load-reduction strategies into the building mechanical and lighting designs.
- Minimize earthwork by aligning long buildings and parking lots with land contours.
- Reduce paved areas to lessen heat buildup around the building that will add to cooling loads in the building.

References

- Low-Energy Building Design Guidelines.* DOE/EE-0249, July 2001.
- Sustainable Building Technical Manual.* Public Technology, Inc., 1996.
- “Low-Energy, Sustainable Building Design for Federal Managers.” Sustainable Buildings Industry Council, 2000.
- “The Laboratory’s Footprint: Our Environmental Impacts.” Los Alamos National Laboratory. LA-UR-02-1971, April 2002.
- “Sustainable Design Report for Los Alamos National Laboratory’s Strategic Computing Complex.” Los Alamos National Laboratory. LA-UR-01-5547, 2001.

Additional Resources

- Site and Architectural Design Principles.* LA-UR 01-5383, January 2002.
- “Best Development Practices.” American Planning Association, 1996.
- Greenways: A Guide to Planning, Design, and Development.* Island Press, 1996.
- Greening Federal Facilities: An Energy, Environmental, and Economic Resource Guide for Federal Facility Managers and Designers.* DOE/EE Federal Energy Management Program, 2001. www.eren.doe.gov/fempltechassist/green_fed_facilities.html
- Parking Spaces: A Design, Implementation, and Use Manual for Architects, Planners, and Engineers.* McGraw-Hill, 1999.



Chapter 4: The Building Architectural Design

- ❑ Schematic Design*
- ❑ Designing Using Computer Simulations*
- ❑ Design of High Performance Features and Systems*
- ❑ Designing for Daylighting*
- ❑ Passive and Active Solar Systems*
- ❑ Accommodating Recycling Activities*

Chapter 4

The Building Architectural Design

Schematic Design

Achieving a sustainable building requires a commitment from developing the initial F&OR documents through construction detailing and commissioning. Initial decisions, such as the building's location, general massing, and configuration profoundly affect the building's environmental impact and energy performance. Well-defined sustainable goals will guide the entire spectrum of decision-making throughout the design and construction process (see Chapter 2).

In a sustainable building, the architecture itself is expected to provide comfort for the occupants.

Architectural programming establishes the needs and requirements for all of the functions in the building and their relationship to one another. Wise programming maximizes energy savings by placing spaces in the most advantageous position for daylighting, thermal control, and solar integration. It may also uncover opportunities for multiple functions to share space, thus reducing the gross square footage of the building.

Architectural programming involves an analysis of the required spaces to meet the functional and operational needs of the facility. With an eye toward sustainability



The long east/west axis, undulating Trombe wall providing passive solar heating and daylighting, and the horizontal architectural elements shading the Trombe wall in summer are sustainable building design features of the National Renewable Energy Laboratory Visitor's Center in Golden, Colorado.

and energy-efficiency targets, the individual spaces should be clearly described in terms of their:

- Primary functions
- Occupancy and time of use
- Daylight potential and electric light requirements
- Indoor environmental quality standards
- Equipment and plug loads
- Acoustic quality

■ Safety and security

Similar functions, thermal zoning (see Chapter 5), need for daylight or connection to outdoors, need for privacy or security, or other relevant criteria can then be used to cluster spaces.

After completing the F&OR document, careful conceptual design should strive for a building that:

- Has properly sized daylight apertures to avoid glare and maintain proper contrast ratios for visual comfort.

- Utilizes passive solar gain when the building is in heating mode.
- Minimizes solar gain when the building is in cooling mode through orientation, shading, and glazing selection.
- Facilitates natural ventilation where appropriate.
- Has good solar access if use of solar thermal or photovoltaic (PV) systems is anticipated.

*We shape our buildings,
and afterwards our buildings
shape us.*

– Winston S. Churchill, 1943



Thomas Wood

Daylighting, natural ventilation cooling, downdraft cooltowers (evaporative cooling), Trombe wall (passive heating), and a roof-mounted photovoltaic (PV) system are important components of the whole-building design strategy that reduced energy costs by more than 70% in the Zion National Park Visitors Center in Springdale, Utah.

Siting the Building for Solar Accessibility

Careful site selection and building placement are essential for optimal daylight and solar utilization.

- Does the building site receive unobstructed solar radiation between the hours of 9 a.m. to 5 p.m.?
- Are there major sky obstructions such as geologic features, trees, or adjacent buildings?
- Does the site allow for an elongated east-west configuration? If not, then manipulate the building shape to increase the potential for daylighting and solar load control.

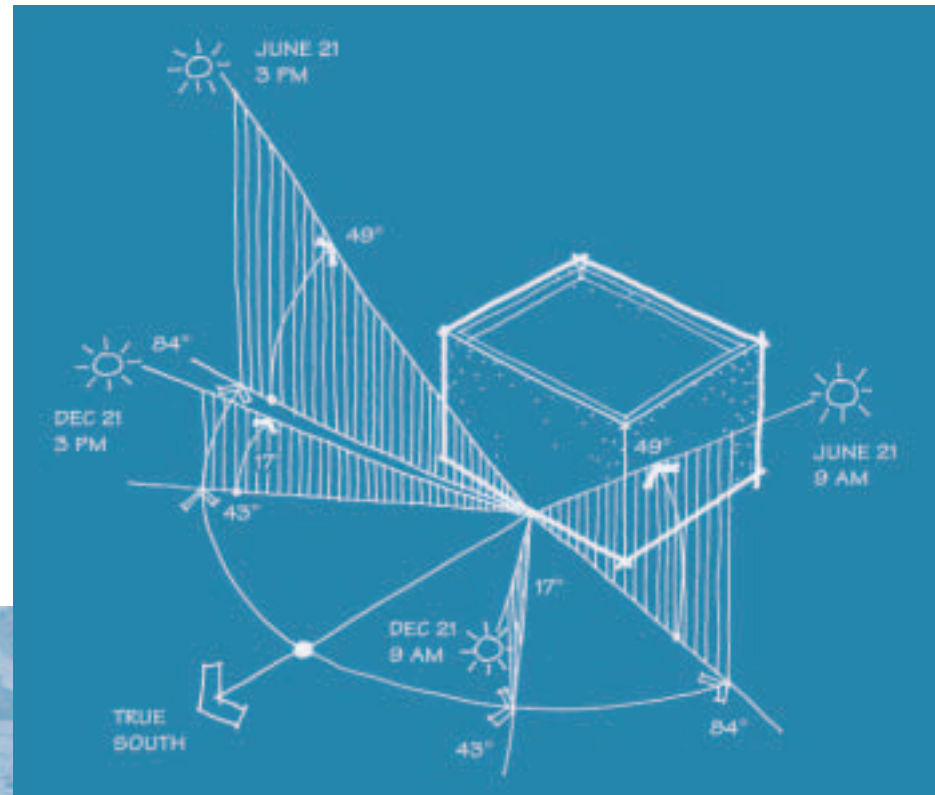

Solar access is extremely important where use of solar thermal or PV systems is anticipated or for passive solar heating in small buildings with minimal internal gains. This chart shows solar access angles for buildings in Los Alamos.



Warren Gretz

Plan early

In the conceptual design phase, site planning and building configuration and massing must involve all members of the design team. For example, the decision to daylight the building will influence the architectural design, the interior design, the HVAC design, and the electric lighting design. Use shading device tools and computer simulations to assess how building massing and orientation resulting from particular design decisions will affect overall building performance.

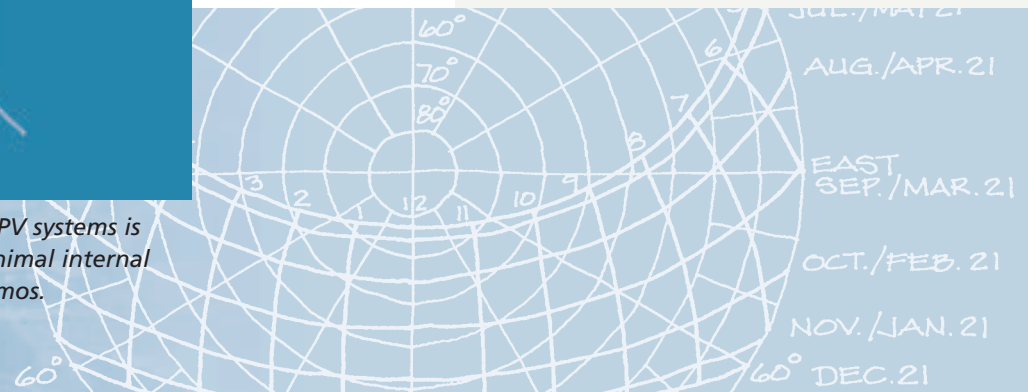

Building Massing and Orientation

There is a trade-off between a compact form that minimizes conductive heat transfer through the envelope and a form that facilitates daylighting, solar gain, and natural ventilation. The most compact building would be in the shape of a cube and would have the least losses and gains through the building skin. However, except in very small buildings, much of the floor area in a square building is far from the perimeter daylighting.

Another energy-related massing and orientation consideration is the seasonal wind pattern. Breezes can enhance natural ventilation, but they can also increase heating loads in cold weather.

A building that optimizes daylighting and natural ventilation would be shaped so that more of the floor area is close to the perimeter. While a narrow shape may appear to compromise the thermal performance of the

building, the electrical load and cooling load savings achieved by a well-designed daylighting system will more than compensate for the increased skin losses.

Effective daylighting depends on apertures of appropriate size and orientation, with interior or exterior shading devices to control unwanted direct sunlight. Computer simulations done during early design stages can measure the degree of this trade-off between skin exposure and daylighting benefits.

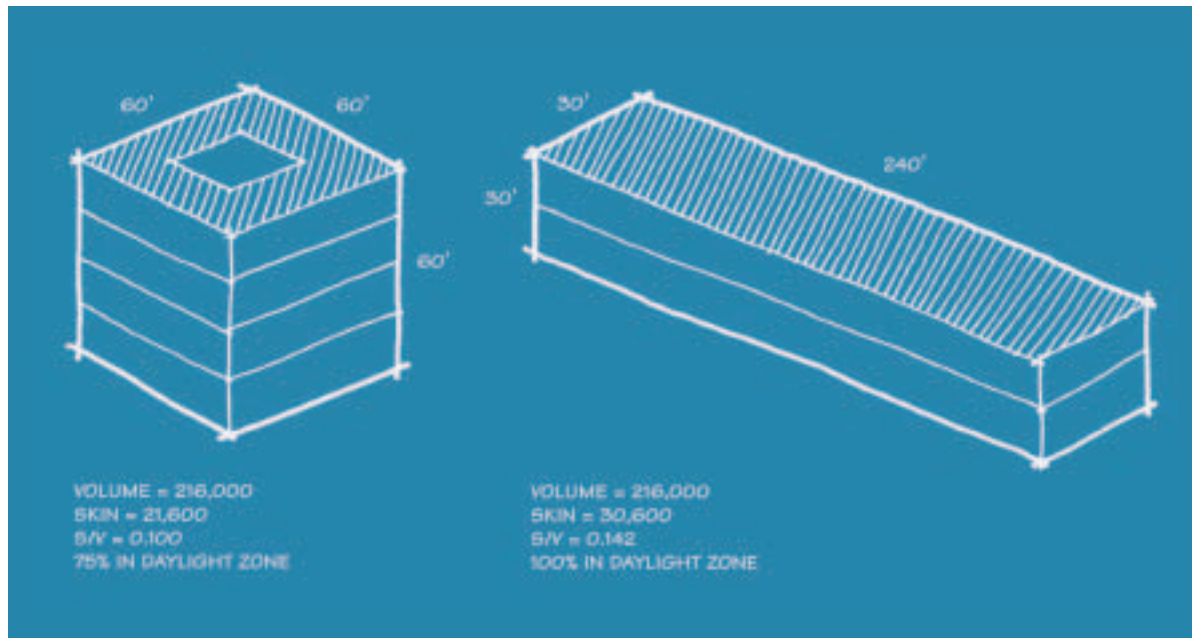

The skin-to-volume ratio is the exposed surface area compared to the building volume.

Designing Using Computer Simulations

The thermal performance of any building entails complex interactions between the exterior environment and the internal loads that must be mediated by the building envelope and mechanical systems. The difficulty is that these various external and internal load conditions and associated utility loads are constantly changing from hour to hour and season to season. Also, the number of potential interacting design alternatives and

possible trade-offs is extremely large. Computer simulations are the only practical way to predict the dynamic energy and energy cost performance for a large number of design solutions.

Accurate energy code-compliant base-case computer models give the design team typical energy and energy cost profiles for a building of similar type, size, and location to the one they are about to design. The

design team uses this information to develop a design concept to minimize these energy loads and energy costs from the very outset. At this stage, the design team can manipulate the building massing, zoning, siting, orientation, internal organization, and appearance of the facades without adding significantly to the cost of design.



Sheila Hayter

Building energy simulation tools help designers understand the complex interactions between design solutions.

Simplified peak load calculations versus hourly load simulations

Steady-state heat loss and gain calculations have commonly been used to determine heating and cooling peak loads and equipment sizes, but they give only a brief snapshot of the thermal performance under design load conditions in the summer and winter. They do not indicate the overall energy performance of the building, nor do they adequately treat daylighting, solar loads, and thermal capacitance effects. Only through dynamic hour-by-hour (or shorter time-step) computer simulations over a typical climate year will the complete picture of energy, energy cost, peak load, and comfort performance be revealed. Computer modeling early in the design process can pinpoint areas of particular concern and highlight areas of potentially significant energy savings. Updates of the model as the design progresses ensure that energy-efficiency goals are being met.

Annual Energy Use

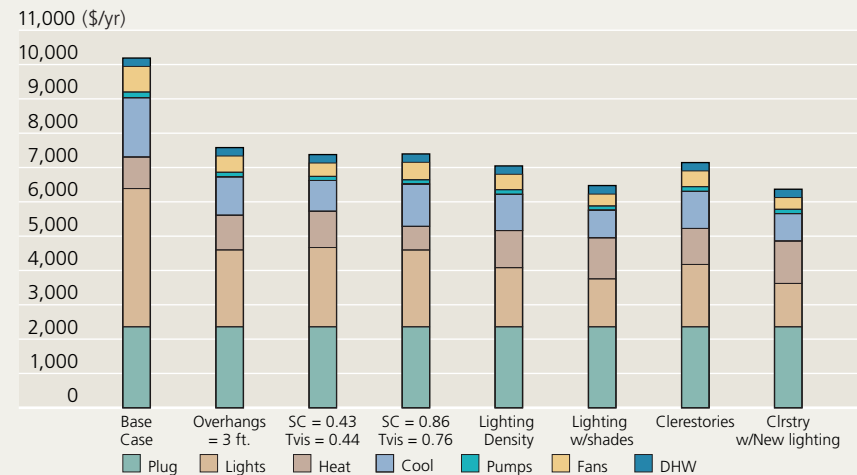

Daylighting strategy analysis for a typical LANL office/laboratory building.

As the design progresses, the design team compares the simulations of the proposed design alternatives to each other and to the base-case building simulation to understand the energy use, energy cost, and peak load implications of alternatives.

Building thermal simulation software tools that provide hour-by-hour analysis have been in use for more than 30 years. These software tools rely on an annual weather file for the site that provides the external hourly climate data. While several weather data for-

mat are available, the Typical Meteorological Year (TMY2) format is commonly used. Appendix B describes typical weather conditions for Los Alamos.

To simulate a building using these tools, describe building parameters, such as assembly construction, volumes, and number of floors, along with their respective orientations. Account for the hourly variations in internal load conditions, such as occupant, lighting, and equipment loads, using hourly schedules. Also, enter HVAC equipment and operation schedules and lighting schedules.

The simulation analyzes the conditions at the beginning hour and then the results are passed along to the next hour and so on throughout the simulation period. This process allows for the inclusion of thermal capacitance (mass) effects and solar impacts over time. The output of the simulation typically includes annual energy and cost data as well as hourly performance reports of the various building components.

Start early to simulate building energy performance

A detailed load analysis through computer simulation can identify energy-saving opportunities early in the design process. Unfortunately, most detailed computer simulations, if they are used at all, are applied late in the process as a way to verify performance. At this point in the process, it is too late to change the major form, orientation, or fenestration of the building. With a baseline energy model created at the outset of the project, the energy performance can be monitored throughout the design process. Changes in the design should be entered into the model to assess the energy impact.

Glazing Area – Economic Analysis

90 (Thousands of \$/year)

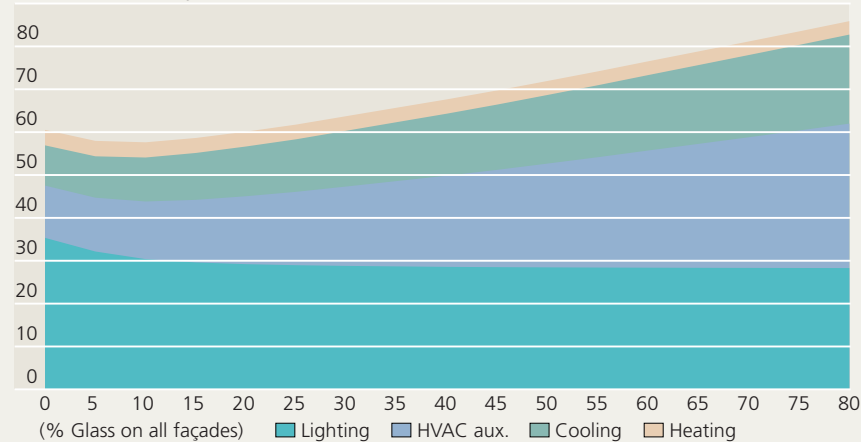

Robb Williamson

Operable clerestory windows automatically open when natural ventilation is appropriate for cooling the Lewis Center for Environmental Studies at Oberlin College in Oberlin, Ohio.

The computer energy simulation provides a method to test the integration of various design solutions to verify that they are meeting design goals. Decisions about building form, materials, and systems can be tested and adjusted to improve performance. Appendix F gives an example of how simulations were used to make design decisions throughout the design process for a laboratory/office building.

When should the design team use computer simulations?

Begin initiating computer simulations early in the design process for maximum effectiveness.

- **Pre-design** – Simulation helps identify and prioritize potential envelope-based energy-efficiency strategies.
- **Schematic design phase** – Add the building massing, fenestration, and envelope constructions to the model to determine if energy targets are still being met.
- **Design development** – Test the performance of the full building together with the HVAC systems.
- **Construction** – Evaluate how design changes proposed during construction will affect the building performance before implementing the change.
- **Commissioning** – Run a simulation of the as-built construction to provide a baseline building performance that can be used for actual performance comparisons.
- **Post-Occupancy** – Periodically update the simulation after the building is occupied to reflect variations in operations, use patterns, and unique climate conditions. These conditions may dramatically affect the actual performance of the building.

The “Energy Design Process”

The steps design teams take when following the energy design process are:

- Create a geometrically simple computer model of a code-compliant base-case building. This can be done in pre-design as soon as preliminary architectural requirements for the building have been defined in the F&OR document. A rule set for creating the base case is generally given in the performance path chapter of the applicable energy code. The code is usually 10CFR434 for federal buildings.
- Perform dynamic hourly annual simulations of the base-case building to determine annual energy loads, annual energy costs, peak loads, demand charges, hourly profiles for typical days representative of the climatic seasons, and occupant comfort. In addition to total energy loads, the software can identify the composition of the loads by end use (heating, cooling, ventilation, lighting, plug) and by source (window solar heat gains, envelope conduction, waste heat from lights and plug loads, etc.).
- Use the end-load disaggregation of building energy costs to understand energy issues associated with major functional spaces in the base-case building. This understanding can help generate potential architectural solutions to the energy loads. After optimizing the envelope design, use mechanical concepts and strategies to continue minimizing the energy costs without compromising the building’s functional and comfort requirements.
- Simulate the design alternatives and trade-offs to measure their impact on energy performance and comfort compared to the base-case building and to each other.
- Conduct cost/benefit analyses of the various alternatives and trade-offs to understand what gives the most “bang for the buck.”
- Reiterate through this process from pre-design through construction, commissioning, and occupancy.

Design of High-Performance Features and Systems

The warm summers of Los Alamos coupled with the intense high-altitude sunshine make solar control of all fenestration one of the important design considerations. Uncontrolled solar gain results in high cooling loads, excessive illumination, and glare. The first strategy in passive cooling is solar heat gain avoidance, which can be achieved primarily through shading and glazing selection.

Use solar angle charts for the Los Alamos latitude (36° N) to design shading devices that block unwanted solar gain at specific dates and times (see Appendix G). Glazing selection is also an important consideration in window design as it determines the visual, thermal, and optical performance of the window.

Defining passive solar design

A passive solar building is designed to maximize the use of natural systems to maintain thermal comfort for the occupants. A passive solar building successfully integrates the site, the local climate and microclimate, the Sun, and local materials in order to minimize dependence on external energy sources. The term “passive” implies a conceptually simple approach that uses few, if any, moving parts or input energy, requires little maintenance or user control, and results in no harmful pollution or waste by-products. Because of the inclusive nature of passive solar design, considerations for passive solar design permeate the entire design process and become critical architectural elements.



Warren Gretz

Solar Shading

The most effective solar shading devices are exterior to the building envelope. Shades and blinds located inside the building may be effective at controlling glare, but are not effective in reducing the solar gain entering the space. Consider light-colored surfaces on shading devices such as overhangs, louvers, or light shelves. These light surfaces can help bounce diffuse sunlight into the building. Diffuse daylight is ideal for providing lighting without glare.

Consider a deep exterior wall section that can be used to self-shade the window surfaces with overhangs

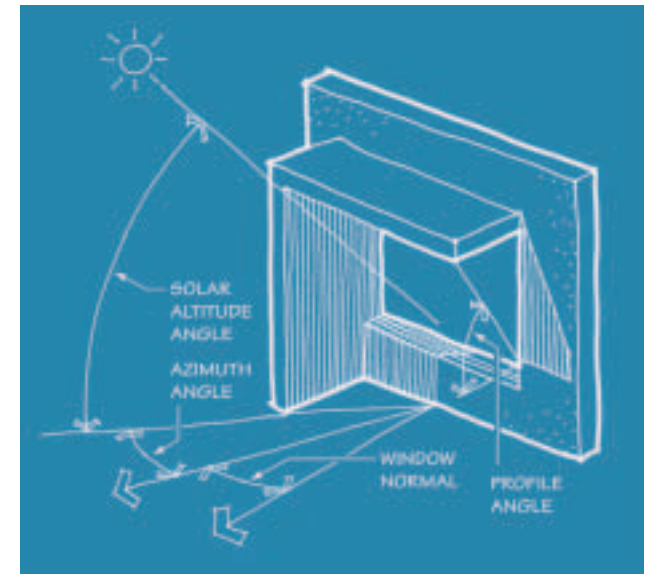

Shading angles for a south elevation. Diagrams like this are used to determine the optimal size and location of shading devices. Depending on the building type and interior space, the goal may be to prevent solar gain in summer while allowing it in the winter, or to prevent direct solar gain year round.



Warren Gretz

Overhangs and vertical fins on the lower windows and the overhangs on the clerestory windows provide shade to maximize daylighting and minimize summer solar gains to the Thermal Test Facility, National Renewable Energy Laboratory, Golden, Colorado.

and vertical fins. Move the plane of the glass toward the interior plane of the wall to get free shading from the wall thickness.

Solar shading is most easily and effectively handled on south and north elevations. One method of describing the horizontal overhang is the ratio of the horizontal projection (x) to the height of the window (y) below the horizontal projection (see Appendix B). Horizontal overhangs can adequately shade south-facing windows. North-facing windows receive predominately diffuse solar radiation and indirect daylight, and therefore do not need overhangs.

East- and west-facing windows are the most difficult to shade. Early morning and late afternoon sun rays are approaching perpendicular to these windows, causing excessive heat gain and visual glare. Minimize use of east- and west-facing windows. When these windows cannot be avoided, carefully size and place them for daylighting and view purposes only. Use a combination of horizontal louvers and vertical fins to shade these windows as much as possible.

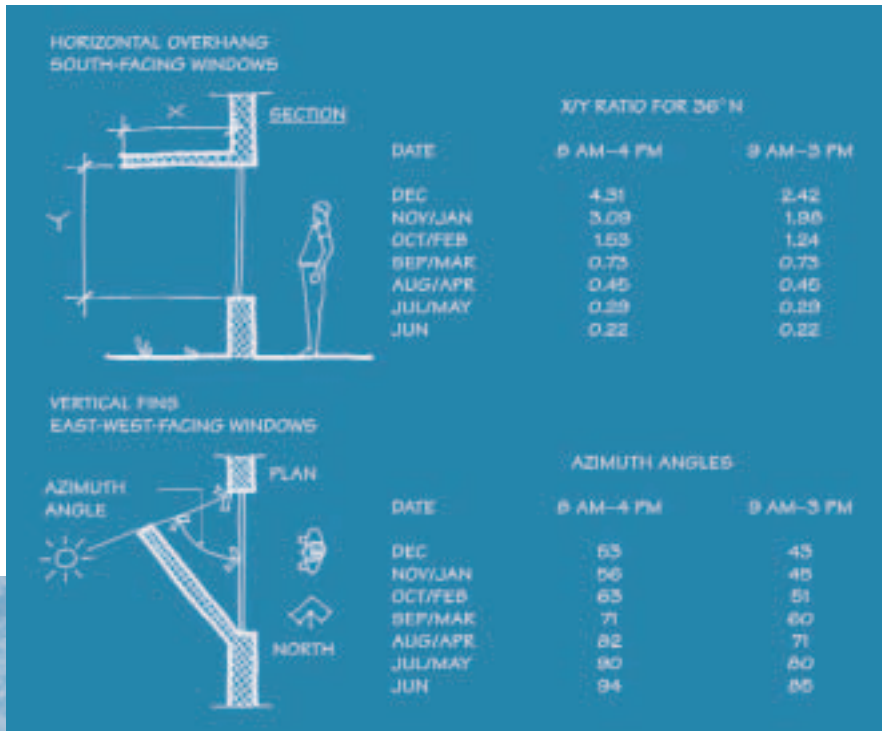

Horizontal and vertical shading ratios. This figure lists the appropriate x/y ratios for completely shading a south-facing window for various months at two different time ranges. Use the lower portion of this figure to determine the appropriate azimuth angle for shading an east- or west-facing window at various dates and times.

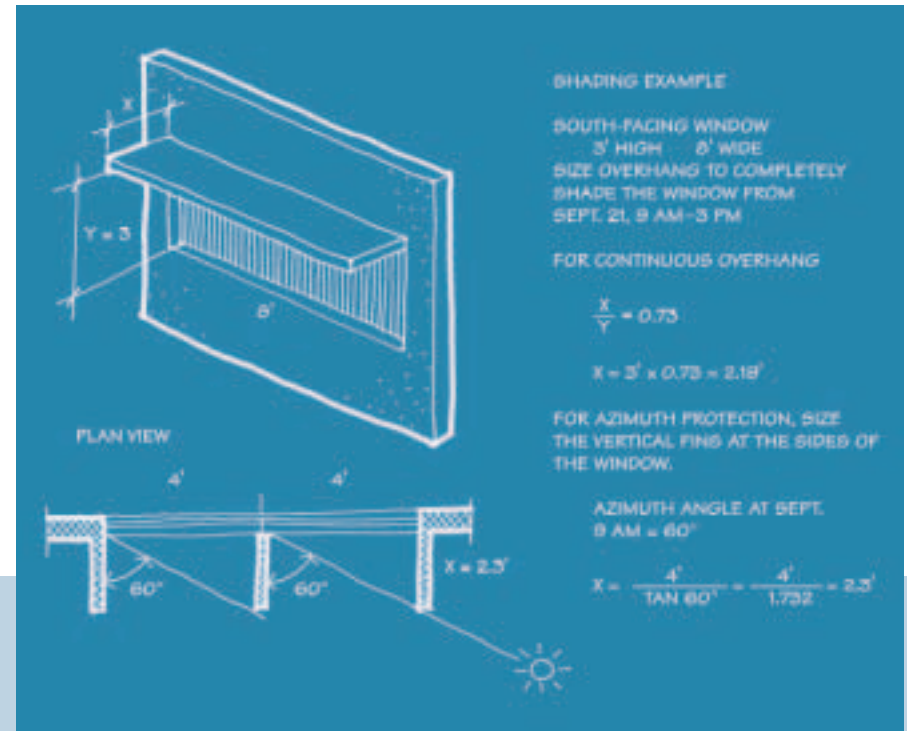

Shading angle example. This figure demonstrates how to apply the horizontal and vertical shading ratio in sizing the horizontal overhang that will shade a south-facing window from 9 a.m. to 3 p.m., March 21 through September 21.

Shading Strategies

Glare control is another function of shading. Limit or protect the views of extremely bright exterior surfaces, such as parked cars and large paving or sand areas. The reflected glare from these surfaces can be visually uncomfortable.

Interior shading devices have limited solar control potential and they often depend on user control to function properly. More likely an occupant will set the shading device once and leave it in position for the remainder of the day. This is often the case on east- and west-facing windows where louvers or shades are drawn to

keep out direct solar gain. When using an interior shade, select a light-color shade to minimize heat gain.

To maintain an exterior view while shading the window, consider fine mesh roll screens that reduce illumination and glare while allowing contact with the view. Another option is to use screens or louvers that operate upward from the window sill. This provides shade near the bottom of the window where it is often first needed while allowing an effective clerestory for daylighting.



South facade, horizontal architectural elements to shade the atrium windows of the Process and Environmental Technology Laboratory, Sandia National Laboratories, Albuquerque, New Mexico. Exterior shading devices and light shelves can often be designed as prominent aesthetic architectural features.

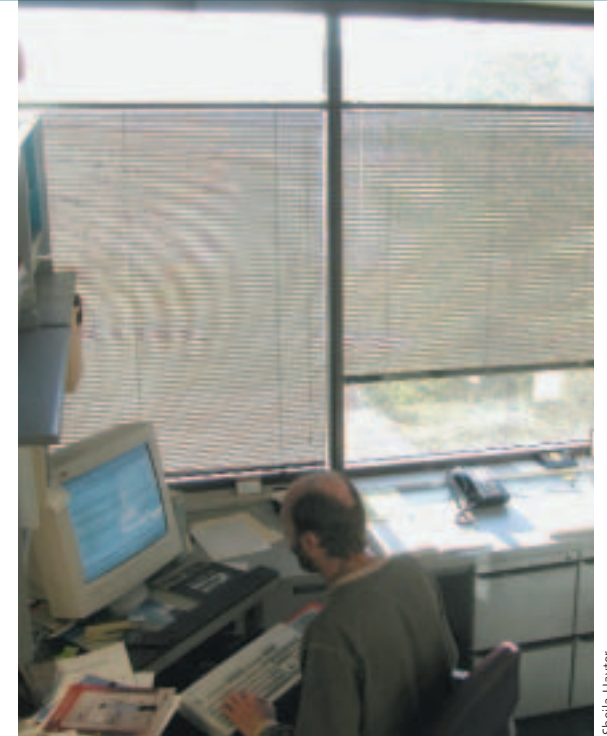

Sheila Hayter

Mounting the shade below the top of this west-facing office window allows the occupant to close the blinds to control glare on the work surface while still permitting daylight to enter the space. This strategy also works well when controlling glare from extremely bright exterior surfaces, such as from a nearby parking lot. Light-colored shades are preferred over the dark shades shown in this photo.

Sandia National Laboratories

Glazing Selection

Select insulated low-e glazing units to reduce thermal loads and provide better comfort in perimeter zones. Low-emissivity (low-e) coatings and argon between the panes can dramatically increase thermal performance. Low-e coatings also can be specified to shade a higher fraction of the heat-carrying infrared radiation, while permitting more visible light to pass through.

In general, spaces dominated by cooling loads should have glass with a low solar heat gain coefficient (SHGC), possibly with a reflective outer surface. Use glass with a higher SHGC in spaces dominated by heating loads to take advantage of passive solar heating. Always protect occupants of daylit spaces from glare and direct beam. Glazing optical properties, shading devices, glass area, and orientation are all highly interactive in terms of their effects on heating, cooling, and lighting loads. Simulation-based sensitivity studies are the best way to balance these effects.

Be aware that spaces having good daylighting designs are likely to become heating-dominated spaces; whereas without daylighting, they would be cooling-dominated spaces. Also, it may be necessary to vary the glazing visual transmittance, depending on the window orientation, space lighting conditions, and occupant lighting needs.

Guidelines for Good Window Design

1. Size all windows to provide the best daylighting.
2. Add additional windows for view glass. Frame views without overglazing the space.
3. Specify glazing properties to minimize heating and cooling loads, and maximize visual comfort.
4. Place external overhangs on south-facing windows to prevent glare and summer solar gains. Depending on simulation results, some south-facing windows may be unshaded to allow for good daylighting.
5. Use interior shade devices to provide user control of glare. Windows intended to provide daylighting should have been designed to prevent glare. Do not use shading devices on these windows.

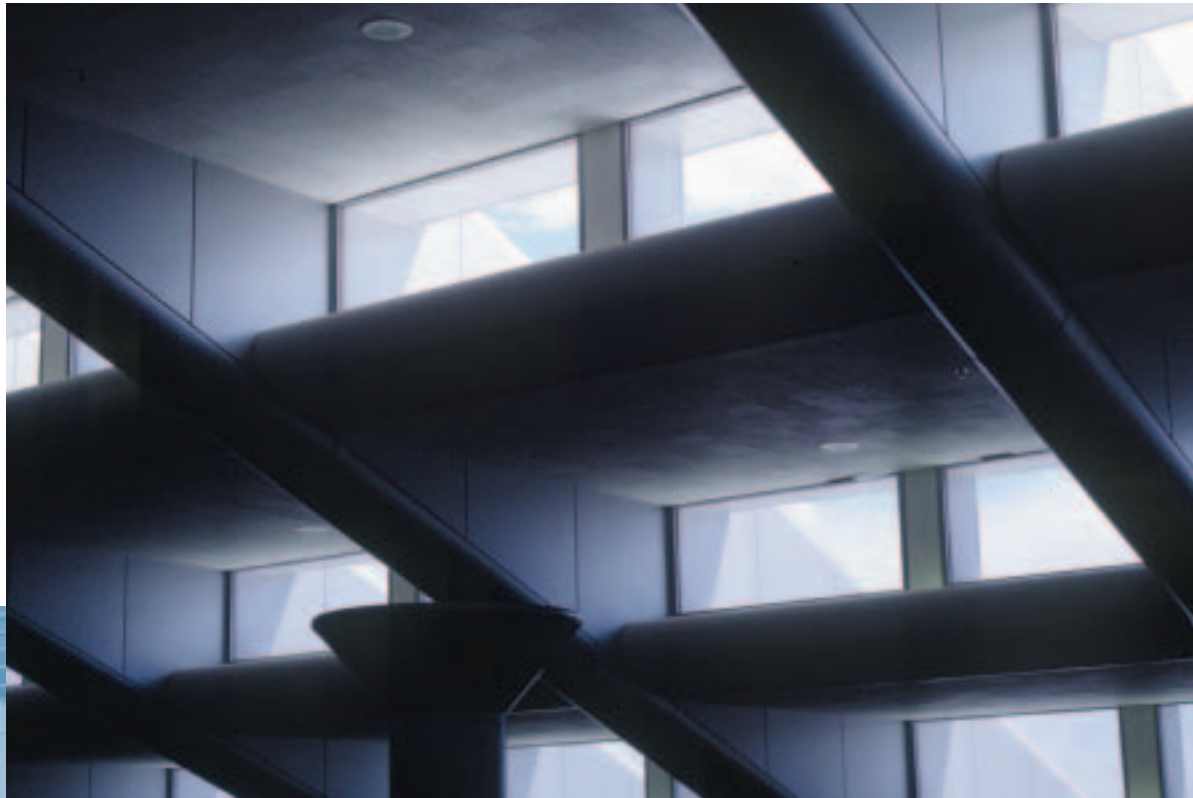

Designers carefully selected glazing with a low solar heat gain coefficient to maximize daylighting and minimize solar gains for the Solar Energy Research Facility at the National Renewable Energy Laboratory in Golden, Colorado.

Sun angle calculators, graphical shading software, and sun charts are helpful in establishing proper shading angles for different orientations and for various dates and times. See Appendix G for detailed instructions on making and using sun path diagrams. Physical daylight models and dedicated daylighting software (usually involving ray-tracing) are useful in assessing glare.

Glazing Properties

The choice of glazing materials for the various window orientations and functions is critical for both thermal and visual comfort. Consider these glazing properties when specifying windows.

- **Visible Transmittance (VT or Tvis):** percent of the visible spectrum striking the glazing that passes through the glazing. This value changes with angle of incidence. While it may seem desirable to maximize the visible transmittance for daylighting, doing so often results in exces-

- **Solar Heat Gain Coefficient (SHGC):** ratio of total transmitted solar heat to incident solar energy. A value of 1.0 indicates that 100% of the solar gain enters the building. A value of 0.0 indicates no solar gain is entering the space. In Los Alamos, a low SHGC is desired on east and west facades (less than 0.35). Windows shaded by overhangs on the south facade should have high SHGC (0.70 or greater). North-facing windows can typically have high SHGC values.

- **Shading Coefficient (SC):** ratio of solar gain of a particular glazing compared to the solar gain of clear single and double pane glazing and many tinted single pane glazing windows (term found in some older documentation). The lower the number, the less solar gain is admitted. $SC = SHGC \times 1.15$.

- **Visible and Solar Reflectance:** percent visible light or solar energy that is reflected from the glazing.

- **UV Transmittance:** percent transmittance of ultraviolet-wavelength solar energy (0.30 to 0.38 microns). High UV penetration will fade fabrics and can damage sensitive artwork.

- **U-Value:** measure of the rate of conductive heat transfer through the glazing due to a temperature change between inside and outside surfaces. Often given in a winter night U-value and a summer day U-value format. The lower the U-value, the better the thermal resistance of the window. Current window U-values are a composite of three heat transfer components of a window: the center of glass, the edge of glass, and the window frame. The total window U-value should be less than 0.35 for LANL buildings. U-value is the inverse of R-value ($U = 1/R$).

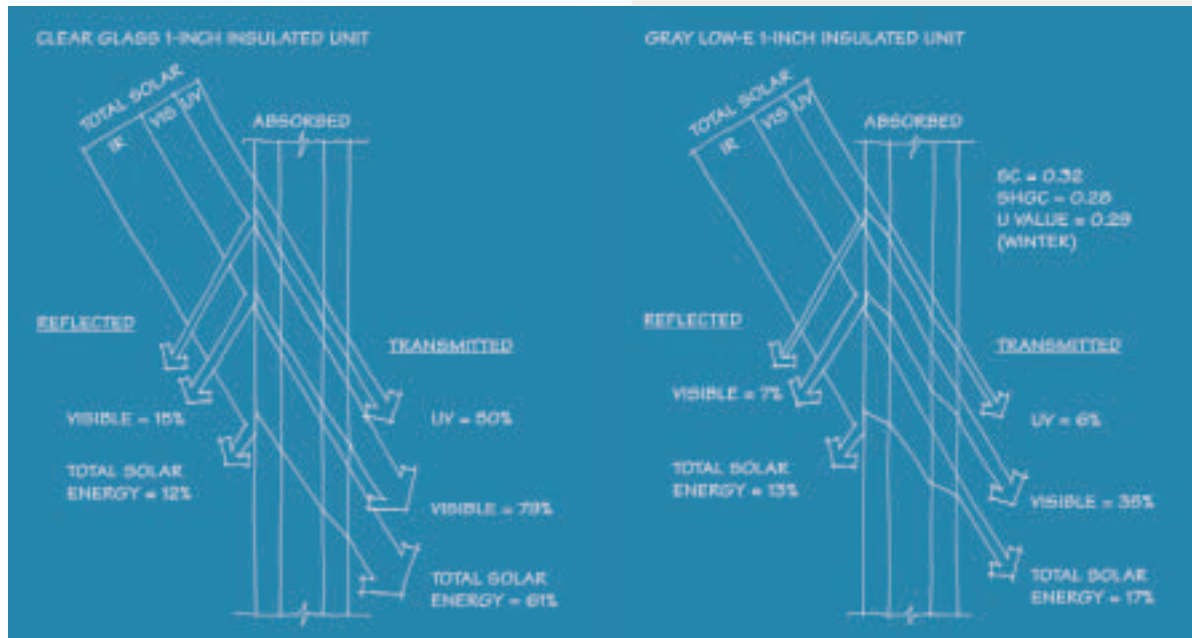

Glazing effects on transmitted solar energy.

sive window brightness. In the clear, intense sunshine of Los Alamos, a reduced visible transmittance will often be the better option to maintain visual comfort in the daylit space. Lower transmittance glazing will also typically result in better distribution of daylight at a more appropriate illumination level.

Designing for Daylighting

When properly designed and effectively integrated with the electric lighting system, daylighting can offer significant energy savings by offsetting a portion of the electric lighting load. A related benefit is the reduction in cooling system capacity because the electric lighting operates less, lowering a significant component of internal gains. In addition to energy savings, daylighting generally improves occupant satisfaction and comfort. Recent studies show improvements in productivity and health in daylit schools and offices. Windows also provide visual relief, contact with nature, time orientation, the possibility of ventilation, and emergency egress.

Refer to the F&OR document to recall which spaces will most benefit from daylight. Consider daylighting possibilities for every space *unless* a strong programmatic function does not allow daylight.

- Within the spaces that can use daylight, place the most critical visual tasks in positions near the window.
- Try to group tasks by similar lighting requirements and occupancy patterns.
- Carefully place the window in relation to the occupant to avoid extreme contrast and glare.

- When possible, locate computer monitors so that they are facing a window.
- Consider interior glazing that allows light from one space to be shared with another. This can be achieved with transom lights, vision glass, or translucent panels if privacy is required. Hallways can often be lit entirely by shared light.



Daylight entering the space through clerestory windows is reflected off the bright white ceiling to provide diffuse daylight throughout the ACE Hardware Store at the BigHorn Center in Silverthorne, Colorado.

Jim Yost

Window Design Considerations

A standard window typically provides daylight illumination to a depth of about 1.5 times the distance between the floor and the top of the window. Light shelves (see p. 64) or other reflector systems can increase this distance two or more times. As a general rule of thumb, the higher the window is placed on the wall, the deeper the daylight penetration. In most cases, daylighting designs are most effective within the first 25 feet from the window.

Daylight within a space comes from three sources:

1. The exterior reflected component includes ground surfaces, pavement, adjacent buildings, wide

window sills, and objects. Remember that excessive exterior reflectance can result in glare.

2. The direct sun/sky component is typically blocked from occupied spaces because of heat gain, glare, and ultraviolet (UV) degradation issues. Direct sun/sky is acceptable only when using patterned glass to diffuse the light.

3. The internal reflected component is the daylight reflected off the surrounding wall, ceiling, and floor surfaces. Surfaces that are reflective but not specular reflectors will bounce the daylight around the room without creating uncomfortable bright spots.

Window frame materials should be light-colored to reduce contrast with the view, and should have a non-specular finish to eliminate glare. The window jambs and sills can be beneficial light reflectors. Deep jambs should be splayed (angled to open toward the interior) to reduce the contrast around the perimeter of the window.

The most important interior light-reflecting surface is the ceiling. High reflectance paints and ceiling tiles are now available with 0.90 or higher reflectance values. Tilting the ceiling plane toward the daylight source creates a “bright” ceiling and improves the feeling of “brightness” in the space.



The ceiling, walls, floor, and tables are bright white or a light color to reflect the daylight within this classroom in the Lewis Center for Environmental Studies at Oberlin College in Oberlin, Ohio.

Ed Hancock

In small rooms, the rear wall is the next most important surface because it is directly facing the window. The rear wall should have a high-reflectance matte finish. The side walls, followed by the floor, have less impact on the reflected daylight in the space.

Major room furnishings such as office cubicles or partitions can have a significant impact on reflected light. Light-colored materials are important on those components as well.

The proportions of the room are more important than the dimensions. A room that has a high ceiling relative to its depth will have deeper penetration of daylight whether from sidelighting (windows) or toplighting (skylights and clerestories). Raising the window head height will also result in deeper penetration and more even illumination in the room.

Suggested room surface reflectances

- Ceilings: > 90%
- Floors: 20-40%
- Walls: 50-70%
- Furnishings: 25-45%

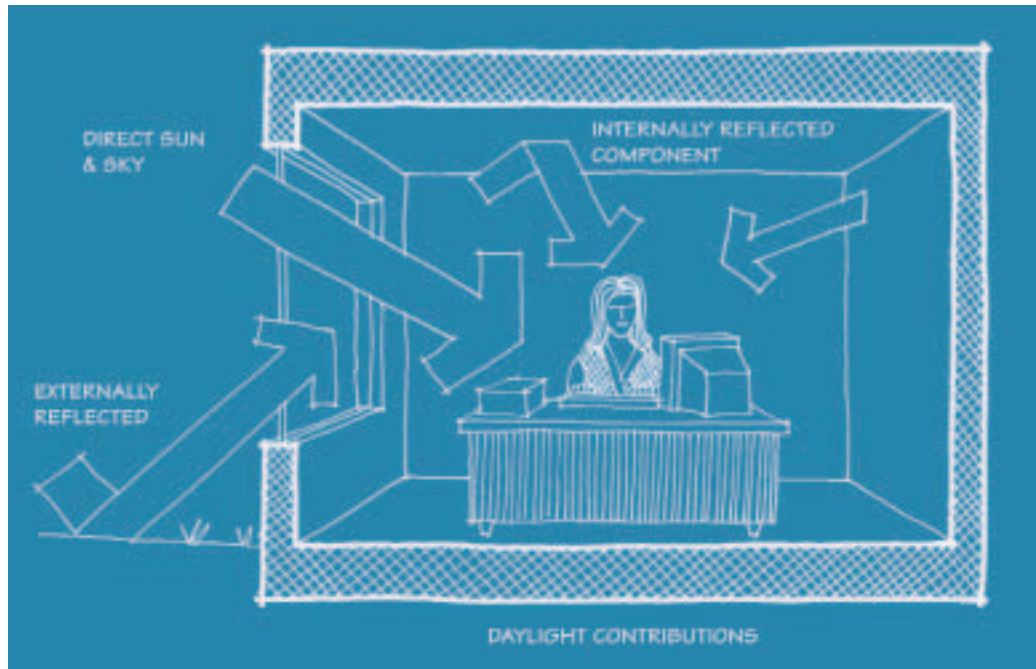

Sources of daylight contributions.



Thomas Wood

Effective Aperture

One method of assessing the relationship between visible light and the size of the window is the effective aperture method. The effective aperture (EA) is the product of the visible transmittance and the window-to-wall ratio. The window-to-wall ratio (WWR) is the proportion of window area compared with the total area of the wall in which the window is located. For a given EA number, a higher WWR (larger window) requires less visible transmittance.

Light Shelves

A light shelf is a horizontal light-reflecting overhang placed above eye-level with a transom window placed above it. This design, which is most effective on southern orientations, improves daylight penetration, creates shading near the window, and helps reduce window glare.

Exterior shelves are more effective shading devices, and actually increase the amount of light through the daylight aperture as compared to interior shelves. A combination of exterior and interior shelves will work best in providing an even illumination gradient.



Robb Williamson

Light shelves on this buildings bounce light onto the ceiling for deeper daylight penetration.

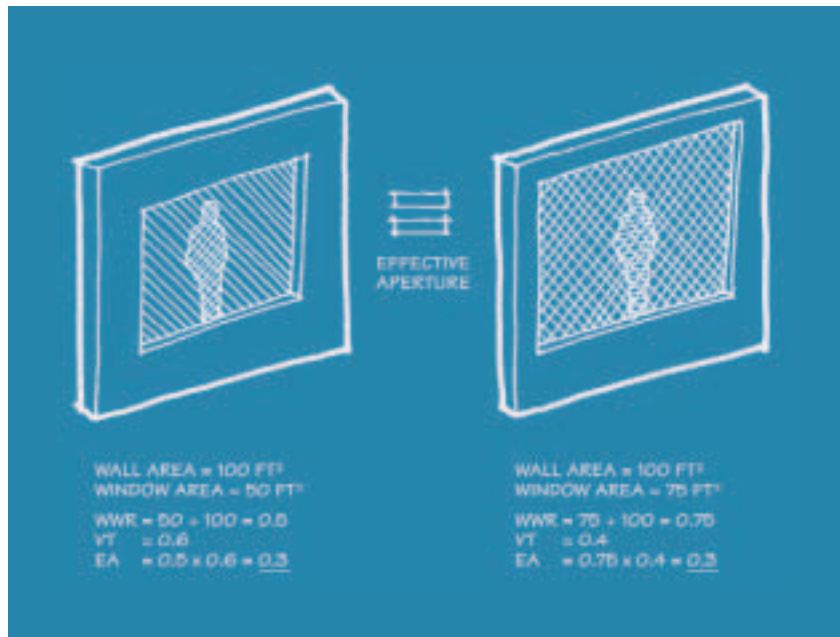

Effective aperture example. Adjust the visual transmittance to maintain equal effective apertures for windows of different sizes.

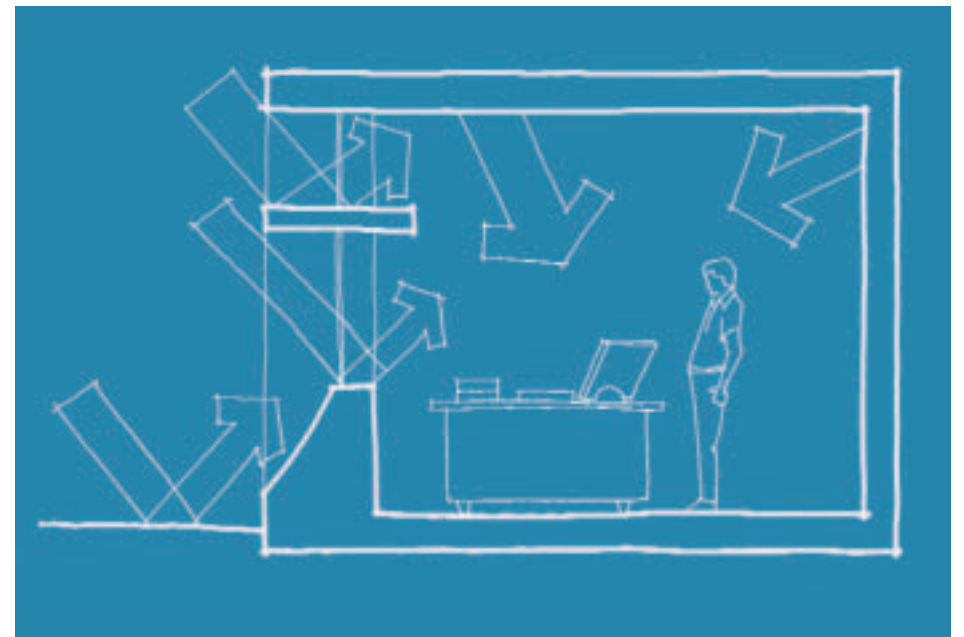

Separating the view aperture from the daylight aperture with a light shelf can improve the daylighting effectiveness by bouncing light deep into the room while at the same time maintaining comfortable luminance ratios through the view aperture.

Toplighting Strategies

Large single-level floor areas and the top floors of multi-story buildings can benefit from toplighting. The general types of toplighting include skylights, clerestories, monitors, and sawtooth roofs.

Horizontal skylights are an energy problem because they receive maximum solar gain in summer at the peak of the day. Their daylight contribution also peaks at midday and falls off severely in the morning and afternoon.

High-performance skylight designs address these problems by incorporating translucent insulating material, reflectors, or prismatic lenses to reduce the peak daylight and heat gain while increasing early and late afternoon daylight contributions.

Another option is lightpipes, in which a high-reflectance duct channels the light from a skylight down to a diffusing lens in the room. These may be advantageous in deep roof constructions.

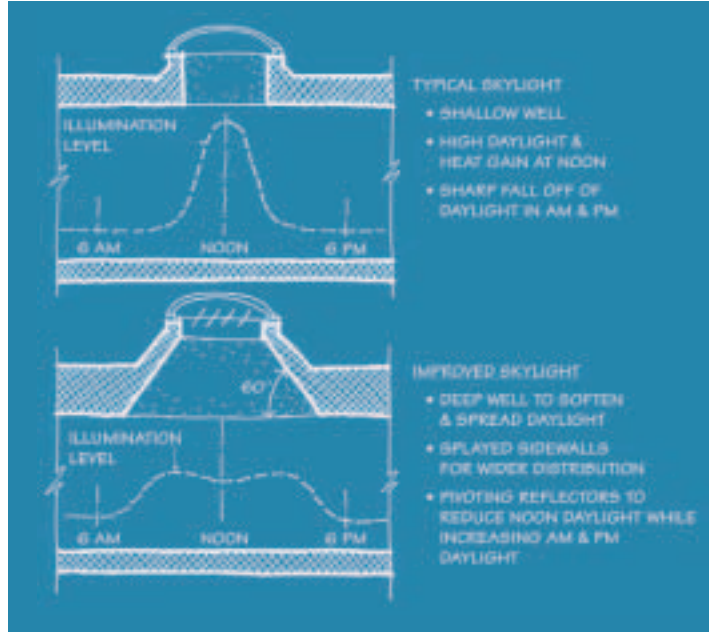

Skylight performance.

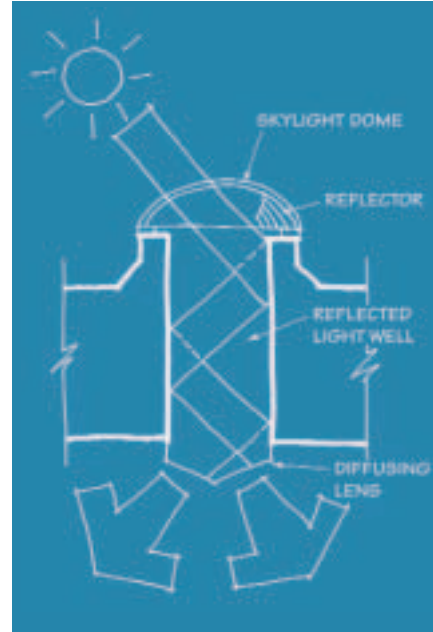

Lightpipe cross-section.



Jim Yost

Translucent insulating skylight panels help to offset more than 75% of the electric lighting load in BigHorn Home Improvement Center's warehouse in Silverthorne, Colorado, without significantly impacting the building's heating and cooling loads.

A clerestory window is vertical glazing located high overhead. A properly designed horizontal overhang can effectively shade south-facing clerestories from direct sunlight. It is best to slope the interior north clerestory wall to reflect the light down into the room. Use light-colored overhangs and adjacent roof surfaces to improve the reflected component.

If calculations show that direct winter sun on work surfaces is a problem, use a lightly patterned glass in the clerestory windows to diffuse the light. Another

solution to control this glare is to install interior vertical baffles at the clerestory windows.

North-facing clerestory windows do not need overhangs. Direct gain through these windows is rarely a problem. East- and west-facing clerestory windows are problematic because of glare issues and excessive solar gain. Use simulations to determine if east- and west-facing clerestories are beneficial.

A roof monitor consists of a flat roof section raised above the adjacent roof with vertical glazing on one or more sides. This design often results in excessive glazing area when glazed on all sides, which leads to higher heat losses and gains than a clerestory design. The multiple orientations of the glazing can also create shading problems.

A sawtooth roof is an old design often seen in industrial buildings. Typically one sloped surface is opaque and the other is glazed. A contemporary sawtooth roof

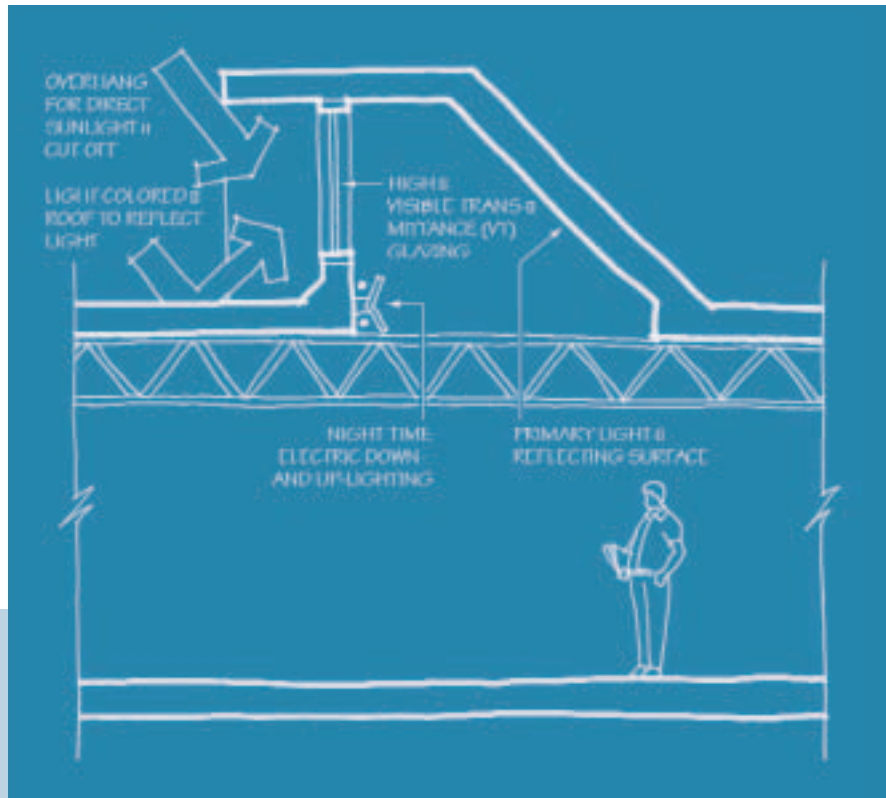

Clerestory section shown with structure passing through and supplemental night time lighting.

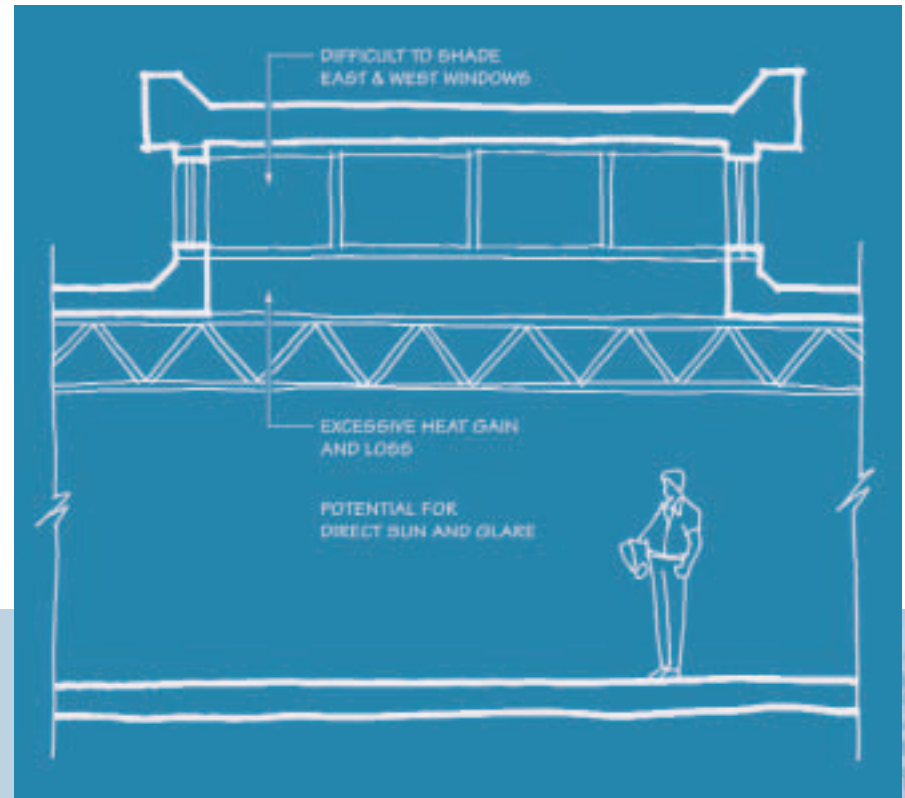

Roof monitor section shown with structure passing through and vertical glazing.

may have solar-thermal or solar-electric (photovoltaic) panels on the south-facing slope and north-facing daylight glazing. Unprotected glazing on the south-, east-, or west-facing sawtooth surface results in high heat gains.

In general, designs accommodating vertical glazing are preferred. Vertical glazing minimizes unwanted solar gains and reduce, the potential for maintenance problems.

Daylighting Integration Issues

A daylit building without an integrated electric lighting system will be a net energy loser resulting from heat losses and gains through the windows and the electric lighting system operating more than needed. An integrated lighting system has energy-efficient lighting fixtures that operate only to supplement the available daylight. The savings from reducing the electric lighting load will offset – and exceed – the added thermal loads. See Chapter 5 for lighting control strategies.

Coordinating the electrical lighting system design with the daylighting design is critical for the success of the

system. The layout and circuiting of the lighting should correspond to the daylight aperture. In a typical sidelighting design with windows along one wall, it is best to place the luminaires in rows parallel to the window wall, circuited so that the row nearest the windows will be the first to dim or switch off, followed by successive rows.

To maintain the designed performance of the daylighting system, the person responsible for interior finishes and furnishings must be aware of the desired reflectance values. Dark interior finishes can compromise an otherwise good daylighting design.

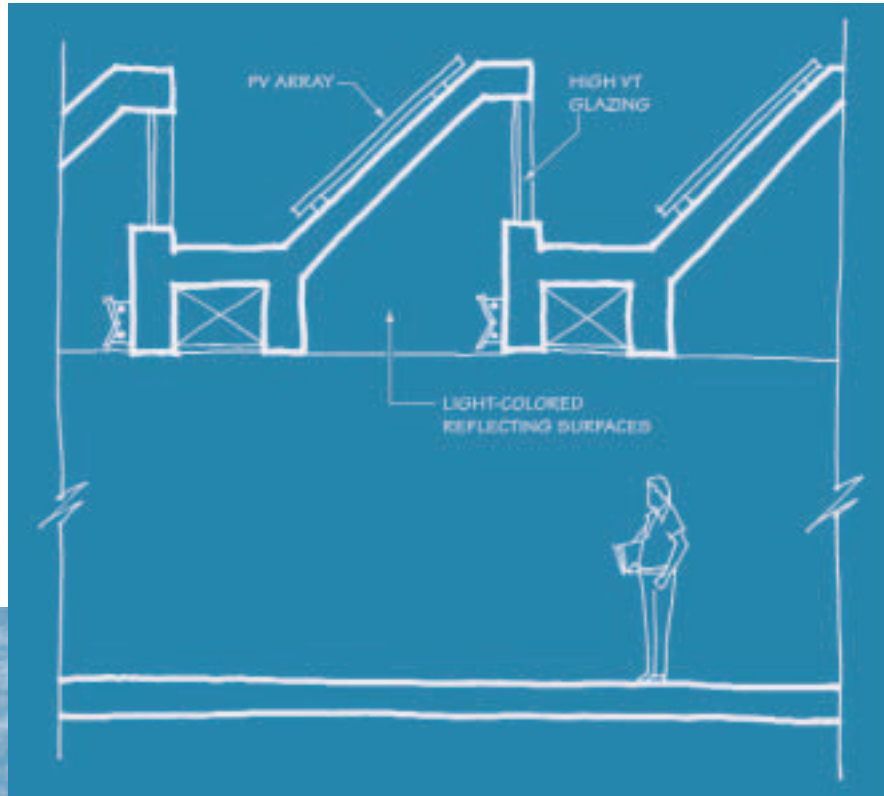

Sawtooth section shown with vertical north-facing glazing, supplemental night time lighting, and roof-mounted solar panels.



Photo sensors control the dimmable electric lighting to supplement the available daylight and maintain constant illuminance levels within the Harmony Library in Fort Collins, Colorado.

Douglas Batcomb

Daylighting Resources

Physical models are an effective way to analyze daylighting performance. Even simple models can begin to inform the designer of how daylight will behave in the building. For more detailed studies, the model should be at least 1" = 1' scale. This size model allows easy viewing to assess the daylight contribution and potential glare sources. The daylight apertures must be accurately modeled and the model must include the reflectance values of the surface materials. The model can then be tested on the actual site or under artificial sky conditions in a daylighting laboratory. A sundial for 36° north latitude (Los Alamos) attached to the model base allows the designer to simulate various dates and times of the year.

Computer analysis is another method of testing daylighting solutions. Several lighting programs such as *Lumen-Micro*,[™] *Radiance*,[™] and *Lightscape*[™] have daylighting calculations. Typically, a three-dimensional digital model is constructed using computer-aided design software that is then imported into the lighting software. The programs then require the operator to define all surface characteristics, sky conditions, location, date and time. *Lumen-Micro* and *Radiance* can produce photo-realistic renderings of the proposed design, while *Lightscape* is useful for less detailed analyses early in the design process.

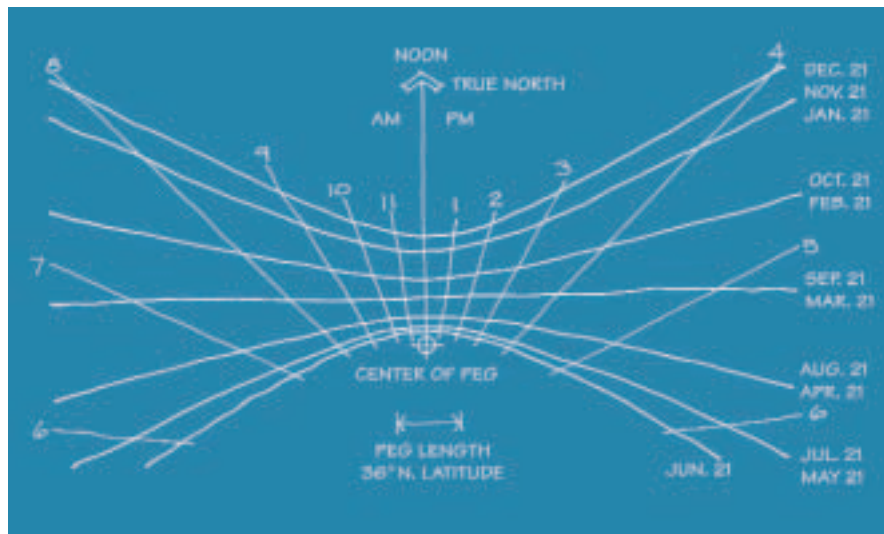

Sundial for use with a physical model.

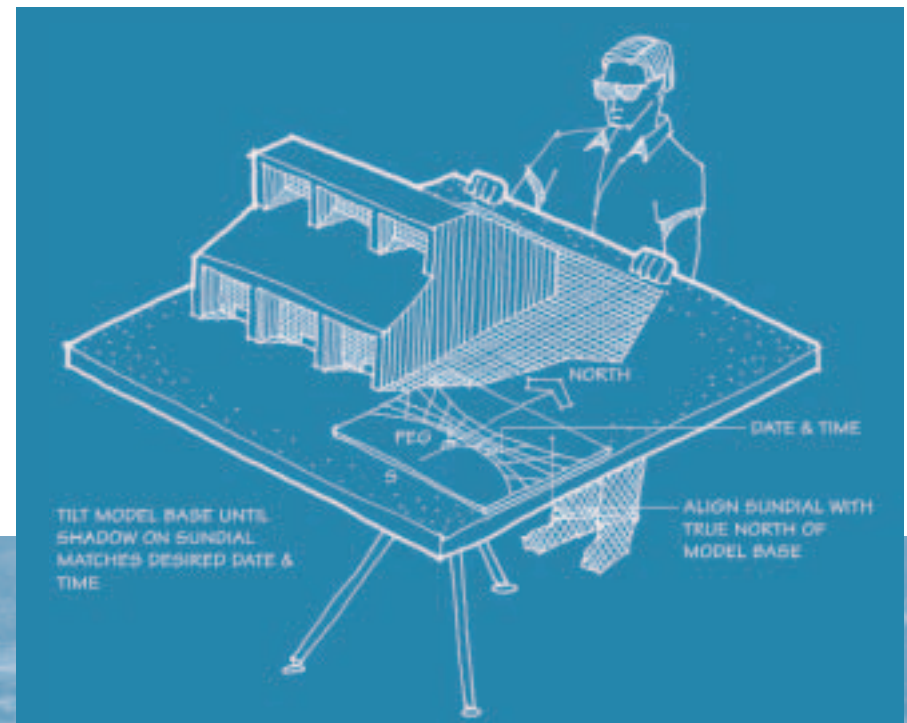

Illustration of how to use a sundial with a physical model.

Passive and Active Solar Systems

Passive and active solar systems provide sustainable methods of heating, cooling, and powering the buildings at LANL. Based on a careful analysis of the loads and the energy needs across the seasons, these systems can be used to supplant, or at least augment, off-site energy sources.

The Los Alamos high-altitude, dry and sunny climate offers great solar opportunities (see Appendix B). Passive systems can be incorporated into the design in a way that not only saves resources but celebrates the process as well. Always consider the potential benefits of energy efficiency and passive solar strategies early in the design process using computer simulation tools.

Thermal Storage

Internal thermal mass has the ability to help moderate the interior temperature swings of the building in spite of variable internal loads and fluctuating exterior temperatures. It can also be used as a heat storage component in a passive heating and cooling system. In a heating mode, the mass will absorb solar heat and internal gains during a sunny day and then reradiate that heat later when it is needed. As a summer cooling strategy, the mass can be cooled with night air so that it is ready to absorb heat during the following day. Closing the pre-cooled building during the day will allow internal gains to be absorbed by the mass until it is flushed again later that evening.

There are two types of thermal mass. One type is the solar-heated mass that is in direct contact with sunlight, such as floors and thermal storage walls. The other type is the distributed mass of the entire building.

Providing internal mass is counter to most standard building practices that strive for lightweight construction. Mass is typically available in the building's structure, in concrete floor slabs and exterior wall construction. To absorb and release heat on a daily cycle, the mass must be exposed to the interior space, and not covered with carpets, wall-coverings, or fire-proofing. One of the largest sources of heat loss in



Warren Gretz

This Trombe wall design incorporates windows to provide daylighting. Horizontal elements in front of the Trombe wall shade it during summer.



Judy Niemeyer

Installing rigid insulation under a floor slab minimizes conductive losses to the ground. Ground losses in well-designed buildings without slab insulation can be the greatest source of heat loss in these buildings.

buildings today is through the floor slab. Rigid insulation under a floor slab is important to minimize conductive losses to the ground and allow the slab to better moderate the interior thermal conditions. Insulate massive exterior walls on the *outside* surface of the mass to decouple the mass from the external environment and improve thermal performance of the wall.

Water is a very effective thermal storage medium because of the high thermal capacity, and high effective diffusivity. Detail water storage systems carefully to avoid leakage.

Trombe Wall

A Trombe wall, or thermal storage wall, is a mass wall, with an airspace and an exterior glazing surface. The wall gathers solar heat through the glazing and a black or selective coating absorbs the heat. The heat moves slowly through the wall to help heat the interior several hours later. In Los Alamos, the Trombe wall should be adequately shaded from summer sun. Trombe walls are appropriate for providing supplemental heat and for building spaces with low levels of thermal control such as warehouses, loading docks, or storage areas.

Passive Cooling Strategies

The first step in passive cooling is to minimize the cooling load by providing effective external window shading and not oversizing the windows. Glazing selection is also important in reducing the solar loads on the building. In addition, turn off or dim electric lighting systems to take full advantage of the daylighting entering the building while at the same time reducing cooling loads. Finally, minimizing plug and equipment loads will also help the cooling loads (see Chapter 5). Movable awnings, roll-down shades, or shutters can also shade building surfaces.



Paul Torcellini

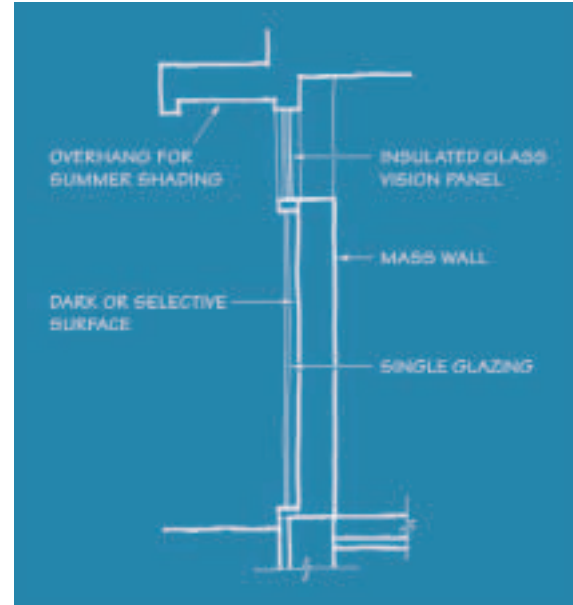

Trombe walls absorb heat during the day and release it into the space at night. An overhang shades this Trombe wall in summer when passive heating is not needed. View glass above this Trombe wall provides daylight to the interior space.

Trombe wall cross section with daylighting aperture.

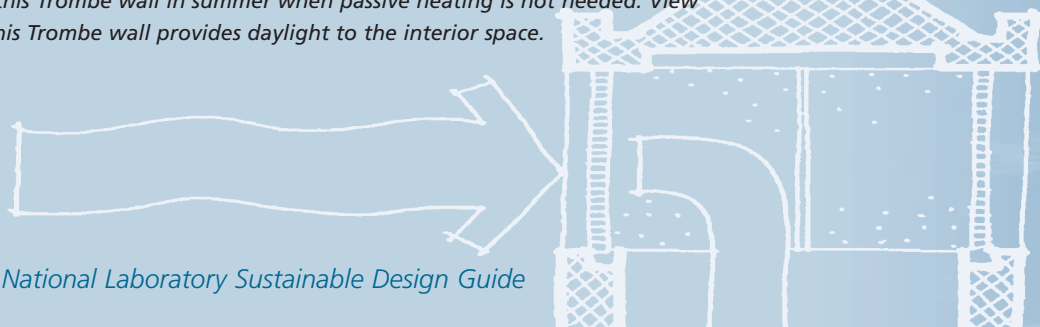

Landscaping can help reduce cooling loads. However, the building design should not rely on landscaping for shade because it takes years for new landscaping to mature, and then mature landscaping may die or be damaged. Low-fire-hazard landscape materials that shade building surfaces can help reduce the solar impact on the building envelope. Plantings may also be beneficial in blocking winter wind or channeling summer breezes. Chapter 7 contains more information on climate-sensitive landscaping.

Natural Ventilation

Los Alamos has many days when favorable outside temperatures can help condition the building. Take advantage of these conditions and use natural ventilation to reduce mechanical cooling loads. Natural ventilation systems work well whenever a traditional economizer cycle is a good design decision.

The building architecture will impact the success of a natural ventilation design. Operable windows located high in spaces can release hot air. Operable clerestory windows can easily provide all the ventilation requirements of a space, especially in high-bay areas. Tall

ceilings produce a “stack effect” by inducing air movement as the warm air is drawn out through the high windows. Carefully coordinate the automatic control of these high, operable windows with the mechanical system design. Turn off the mechanical system when windows are open.

Under certain conditions, natural ventilation can be augmented with air movement from ceiling fans or outdoor breezes.



Robb Williamson

Window actuators automatically open these clerestory windows for natural ventilation cooling. Warm air is drawn out the high windows because of the stack effect. Natural ventilation is most appropriate in dry climates having large diurnal temperature swings.

Evaporative Cooling

Evaporative cooling is an adiabatic process in which warm dry air takes on moisture, lowering its temperature in the process (direct evaporative cooling). Indirect evaporative cooling can lower the air temperature without adding moisture to the building air by using a heat exchanger between the evaporatively cooled air (which is then purged to the outside) and the building supply air. A combined indirect/direct evaporative cooler extends the design conditions under which evaporative cooling can sufficiently meet space conditioning requirements.

Most evaporative cooling systems are “active” in the sense that blowers are used (see Chapter 5). A passive alternative is the “cooltower” approach. This strategy

involves integrating with the building architecture a tower with wetted surfaces exposed to the air. As the air hits the wet pads, it takes on moisture and cools. Because this moist air is denser than the surrounding air, it falls down the tower and into the building and generates a self-perpetuating air current, a form of natural ventilation.

The Los Alamos water supply has a high mineral content that can quickly clog evaporative pads. Check the water supply properties before using evaporative cooling.

Passive Solar Heating Strategies

The Los Alamos climate provides good opportunities for passive solar heating. The basic passive solar heating systems are direct gain systems (sunlight entering a window), indirect gain systems (sunspaces or atria), and thermal storage walls (Trombe walls). In warehouses or storage areas with only periodic occupancy, passive solar heating may be sufficient for all the space heating needs.

Glare can often be problematic in direct passive solar heating designs. Areas such as break rooms, hallways, and entries can tolerate direct solar gains for supplemental heating because glare is not a big issue in these spaces.

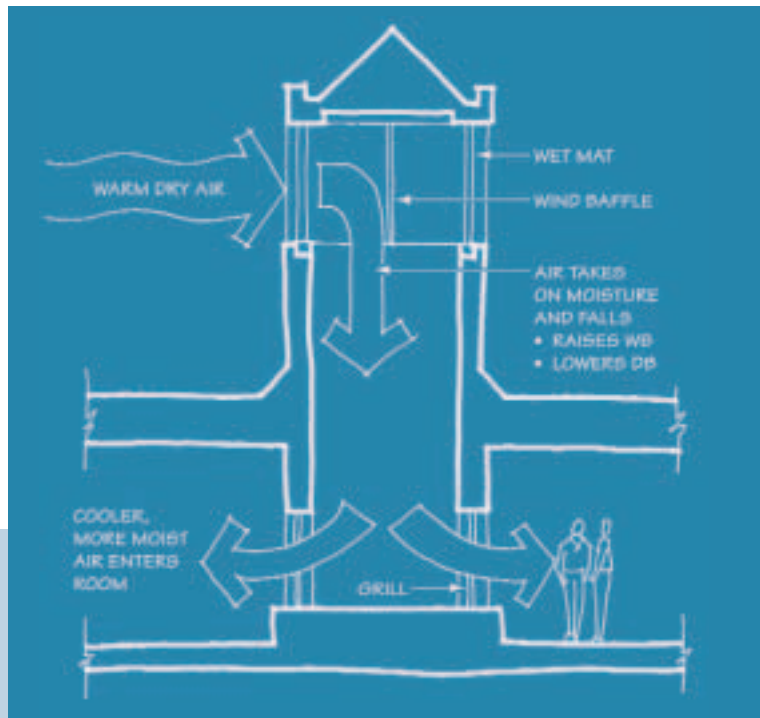

Cool moist air generated by air flowing through a wet medium at the top of the cooltower “drops” through large openings at the tower base to cool the space.



Robb Williamson

Downdraft cooltower at the Zion National Park Visitors Center, Springdale, Utah.



Use computer simulations to evaluate the effect of more glazing on the annual energy loads before increasing the amount of glazing on the building for more winter solar gains. Some spaces having high internal loads may not need additional heating, even in the winter. In these spaces, size the glazing to only provide the desired amount of daylight. Overhangs must be properly sized to avoid overheating of the space during the summer. If incorporating passive solar heating strategies, then select glazings having a high SHGC to maximize the passive solar potential.

Active Solar Heating Systems

Typical applications of active solar heating include domestic hot water heating, space heating (air or water), and ventilation air preheating. Of these, ventilation air preheat tends to be the most economical.

First, determine that the building use is appropriate for an active solar application. Determine the feasibility of using active solar systems in conjunction with the overall mechanical system design (see Chapter 5).

Solar hot water system collectors can be either mounted directly on the building or rack-mounted near the building. Installation is usually simpler and the collectors are more attractive if they are integrated into a roof surface or installed flush with it. Even if solar collectors are not

part of the initial design, it may make sense to design roof surfaces with future solar installations in mind.

A general rule of thumb is that the vertical tilt angle of the south-facing collector should equal the latitude angle (36° for Los Alamos) for year-round use such as domestic hot water heating. A solar space heating system would benefit from a steeper tilt angle (about 50°) to maximize solar gain in the winter, when the sun is lower in the sky. The collectors should have an unobstructed view of the sun path from at least 9:00 a.m. to 3:00 p.m. throughout the year. Beware of light reflecting off the glass-covered collectors as it can create uncomfortable glare in nearby buildings.

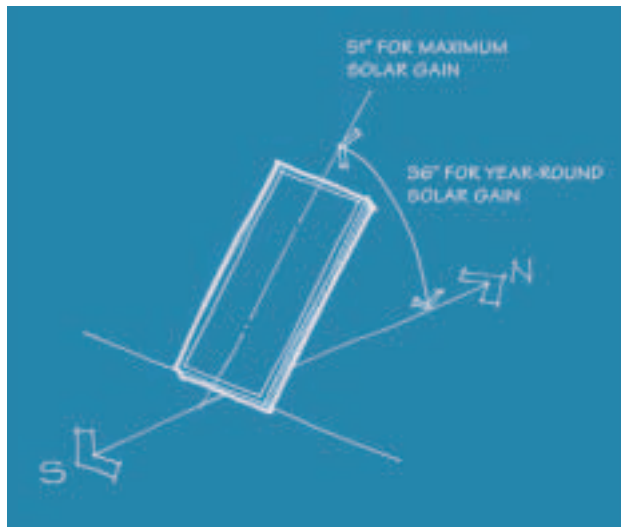

The tilt angle is measured from horizontal upward, facing true south.



The solar domestic hot water system for the LANL Otowi Building is mounted flush with the roof.

LANL

Transpired Solar Collector

A transpired collector is a simple, efficient method of heating ventilation air. The system consists of a dark, south-facing, perforated, metal surface that also acts as the building's exterior protective skin. The sun heats the dark perforated wall. A centrally located fan at the top of the wall draws air through the perforations. The air is heated as it travels up behind the heated wall. The fan then distributes the warm air into the interior space.

Transpired solar collectors are particularly effective in areas requiring large amounts of heated ventilation air during the daytime hours, such as warehouses or garages. On the other hand, spaces with large heated ventilation air requirements on a 24-hours-per-day basis may be better served by a system that transfers heat between the exhaust and ventilation air (see Chapter 5).



Warren Gretz

The transpired solar collector is the only heating system for this small waste handling facility at the National Renewable Energy Laboratory in Golden, Colorado.

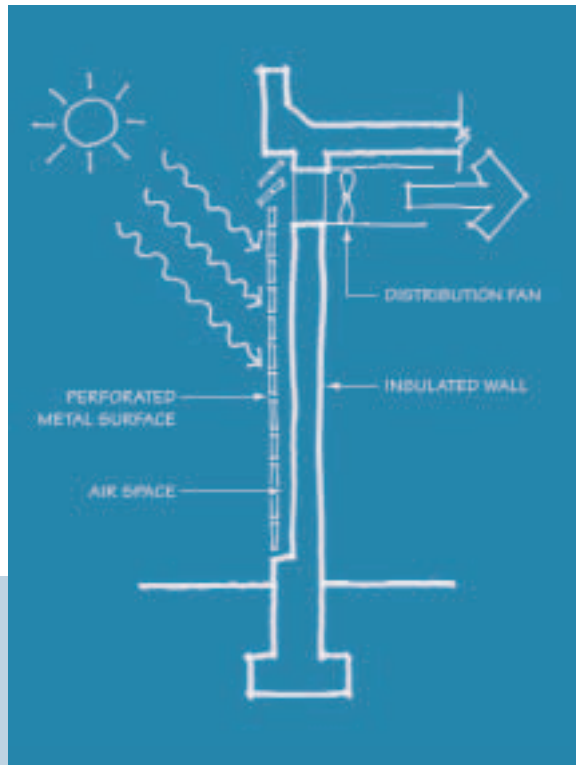

Transpired solar collectors are the most efficient active solar heating systems, having efficiencies exceeding 60%.



Warren Gretz

Red transpired solar collector installed as a retrofit on the entire south wall of the Federal Express building in Englewood, Colorado. Almost any dark color can be used for the perforated wall, giving some architectural flexibility. Choosing colors other than black has only a small effect on the system performance.

Solar Electric Systems

Solar electric systems (also known as PV systems) use the direct conversion of sunlight to direct current (DC) electricity. The four major types of PV cells in order of highest to lowest performance and cost are single crystal, polycrystalline, thin film, and amorphous silicon cells. The cells have a long life and are almost maintenance free. The cells are assembled into modules and the modules are connected into arrays. The type of cell connection determines the voltage and current of the array.

The power generated by a PV array is instantaneous direct current while the sun shines. Most systems include alternating current (AC) inverters and some include batteries for storage.

PV systems may be stand-alone or utility-grid-integrated. A stand-alone system is applicable to remote locations that are at least one-quarter mile from utility connections. For stand-alone systems, a fuel generator and/or batteries may be used to provide electricity during periods of insufficient solar radiation. A grid-integrated system supplements utility power. In buildings having an uninterruptible power supply (UPS) system, the PV

system can charge the UPS battery bank and supply supplemental power to the building.

Like active solar collectors, PV arrays may be mounted directly on the building or on nearby racks. Building-integrated PV modules are available as roofing tiles, shingles, standing seam metal roofing, spandrel panels, or as partially transparent shading elements. The building site might incorporate PV arrays as shading devices for parking areas, pedestrian walkways, or outdoor gathering spaces.



Jim Yost

PV modules integrated as a part of the standing seam metal roof system.



Paul Torcellini

The method for installing a PV-integrated standing seam metal roof is the same for a similar type roof without PV.

PV systems are still quite expensive when grid power is available, but improvements in efficiencies, manufacturing, and storage systems promise to reduce the total system cost of future PV installations. It may be desirable to plan building surfaces with proper solar access and wiring access points for a future PV system. PV systems sometimes make economic sense when very high-quality, uninterruptible power is needed.



Robb Williamson

60-kW roof-mounted PV system offsets 50% of the annual electrical load of the Lewis Center for Environmental Studies at Oberlin College in Oberlin, Ohio.

Design for Building Safety and Security

The building design must consider the safety of the occupants, protection of the building, and preservation of building functions as top priorities. LANL operational and facility safety and security is another top priority. Specific design requirements for elements including, but not limited to, exterior lighting, security fencing, vaults, vault-type rooms, computer networks, interior and exterior intrusion alarms, monitoring alarms, access control systems, and facility-wide administration requirements are contained in the LANL document “General Security, Laboratory Implementation Requirements LIR 406-00-01.0” (Attachments 2 and 8).

Most strategies that improve energy efficiency and building performance will tend to enhance building security by promoting independence in

building energy use. A building less dependent on electric lighting and mechanical cooling can provide functioning space in times of power outages. A building that uses significantly less fossil fuel is less impacted by foreign shortages or embargoes. A standby power system operated by PV may allow the building to function well into an extended power outage.

Other safety threats affect high-performance buildings just as they would affect any building. Building controls and air distribution systems must be protected from sabotage. At a minimum, the ventilation or make-up air intakes should be protected from possible contamination or tampering.

Accommodating Recycling Activities

It is estimated that the typical office building generates approximately one pound of waste per day for every occupant. Design features encouraging recycling help divert waste from over-burdened landfills. They also save virgin materials and a large component of the energy necessary to process materials into final products. For example, recycling aluminum can save up to 95 percent of the energy used to first produce the aluminum.

Identify the potential waste streams that the facility will produce (Chapter 2). Formulate plans to handle the separation, collection, and storage of common recyclable materials such as paper, glass, plastics, and

metals. Make the collection points easily accessible to occupants. For example, separate chutes in a multi-story building may be dedicated for the various recyclables. In low-rise buildings, provide at least one collection point on each floor level. Design the loading dock or dumpster area for easy central collection. Identify all recycling needs and facilities during the design phase and incorporate them into the building plans. Making these decisions early can save floor space by avoiding later placement of recycling collection centers after the building is occupied.



Typical makeshift recycling collection center in office spaces can be avoided if recycling activities are anticipated and accounted for during the design phase.

Sheila Hayter



Waste haulers typically remove recyclables from central collection areas. Employees can be encouraged to bring recyclables from home to increase the volume for more frequent pickups by the waste hauler.

Greg Oaklief

Criteria for Sustainable Success			
	✓ <i>Standard Practice/ Code-Compliant</i>	✓ <i>Better Performance</i>	✓ <i>High Performance for Sustainability</i>
Relationships of Interior Spaces	<input type="radio"/> No attention to daylight or energy issues	<input type="radio"/> Highly occupied spaces located near perimeter	<input type="radio"/> Highly occupied spaces on south and north sides, spaces grouped for optimal energy zone configuration
Siting the Building	<input type="radio"/> No attention to solar access or prevailing winds	<input type="radio"/> Site review for adequate solar access at fenestrations and solar collectors	<input type="radio"/> Site review includes attention to impact of the project on neighboring buildings, potential future threats to solar access
Building Orientation	<input type="radio"/> No attention to sun paths or wind directions	<input type="radio"/> Facades with most fenestrations oriented to the south and north	<input type="radio"/> Roof slopes oriented for solar collection
Massing	<input type="radio"/> No attention to energy or daylighting	<input type="radio"/> Building shape slightly elongated to increase perimeter zone for daylighting	<input type="radio"/> Elongated or finger-plan shape with most occupied spaces along north or south walls
Energy Simulations	<input type="radio"/> Only done to comply with DOE Order 430.2A Title II reporting requirements	<input type="radio"/> Used during design development to evaluate energy-related details	<input type="radio"/> Used throughout the design process to inform key decisions
Glazing Selection	<input type="radio"/> Double-glazed insulated units throughout, possibly tinted	<input type="radio"/> Low-solar-gain, low-e glazing used throughout	<input type="radio"/> Glazing U-value, visible transmittance, and solar heat gain coefficient optimized for each elevation and application
Daylighting	<input type="radio"/> Perimeter spaces receive some daylight through view glazing	<input type="radio"/> High windows, skylights, and increased perimeter extends the usefulness of the daylighting	<input type="radio"/> Light shelves, overhead glazing, and electric light integration designed using daylight design software and/or physical models to maximize daylighting and the resulting energy savings
Thermal Storage	<input type="radio"/> Not considered	<input type="radio"/> Some exposed mass provided in the building to moderate temperature swings	<input type="radio"/> Extensive exposed mass linked to night-flushing to reduce cooling loads
Natural Ventilation	<input type="radio"/> Not provided	<input type="radio"/> Operable windows enhance occupant satisfaction, but lack building control integration	<input type="radio"/> Operable windows linked to building control system for optimal energy benefits and occupant satisfaction. Building designed to maximize air flow patterns and stack effect.
Solar Electricity (PV)	<input type="radio"/> Not considered	<input type="radio"/> Building designed for future PV, including electrical conduit and power panel availability	<input type="radio"/> Building-integrated PV panels generate electricity and contribute architecturally

Additional Resources

Daylighting for Commercial, Institutional, and Industrial Buildings, Consumer Energy Information, EREC Reference Briefs. www.eren.doe.gov/consumerinfo/refbriefs/cb4.html

Tips for Daylighting with Windows: The Integrated Approach, Lawrence Berkeley National Laboratory. <http://windows.lbl.gov/pub/designguide/designguide.html>

Sun, Wind & Light, Second Edition. G. Z. Brown and Mark DeKay, John Wiley and Sons, New York, NY, 2000

General Security, Laboratory Implementation Requirements. LANL document LIR 406-00-01.0 (Attachments 2 and 8)

IES Lighting Handbook, Ninth Edition. Illuminating Engineering Society of North America, New York, NY, www.iesna.org

Advanced Building Guidelines, 2001 Edition. New Buildings Institute, White Salmon, WA.: www.newbuildings.org

Daylighting Performance and Design. Gregg D. Ander, AIA, Van Nostrand Reinhold, New York, NY, 1995.

Architectural Lighting, Second Edition. M. David Egan and Victor Olgay, McGraw-Hill, New York, NY, 2002.

Concepts and Practice of Architectural Daylighting. Fuller Moore, Van Nostrand Reinhold, New York, NY, 1985.

Daylighting Design and Analysis. Claude L. Robbins, Van Nostrand Reinhold, New York, NY, 1986.

The Passive Solar Energy Book. Edward Mazria, Rodale Press, Emmaus, PA, 1979.

International Energy Agency Building Simulations Test (IEA BESTEST) and Diagnostic Method. R. Judkoff, J. Neymark, NREL/TP-472-6231, National Renewable Energy Laboratory, Golden, CO, 1995.

Lumen-Micro by Lighting Technologies, www.lighting-technologies.com/

Radiance <http://radsite.lbl.gov/radiance/HOME.html>

Lightscape by Autodesk, <http://usa.autodesk.com/adsk/section/0,,775058-123112,00.html>

Building Energy Software Tools Directory, www.eren.doe.gov/buildings/tools_directory/subject.html

FEMP Federal Technology Alert, Transpired Collectors (Solar Preheaters for Outdoor Ventilation Air), www.eren.doe.gov/femp/prodtech/transfta.html

FEMP Low-Energy Building Design Guidelines, www.eren.doe.gov/femp/prodtech/low-e_bldgs.html

FEMP Technology Profile: Transpired Collectors, www.pnl.gov/techguide/36.htm

Zion National Park Visitor Center: Significant Energy Savings Achieved through a Whole-Building Design Process, www.nrel.gov/docs/fy02osti/32157.pdf

Sustainable Building Technical Manual, www.sustainable.doe.gov/pdf/sbt.pdf



Chapter 5: Lighting, HVAC, and Plumbing

- ⌘ High-Performance Engineering Design*
- ⌘ Lighting System Design*
- ⌘ Mechanical System Design*
- ⌘ Central Plant Systems*
- ⌘ Plumbing and Water Use*
- ⌘ Building Control Systems*
- ⌘ Electrical Power Systems*
- ⌘ Metering*

Chapter 5

Lighting, HVAC, and Plumbing

High-Performance Engineering Design

By now, the building envelope serves multiple roles. It protects the occupants from changing weather conditions and it plays a key part in meeting the occupants' comfort needs. The heating, ventilating, air-conditioning, and lighting (HVAC&L) systems complement the architectural design, govern the building's operation and maintenance costs, and shape the building's long-term environmental impact.

Designers of high-performance buildings depend on building energy simulation tools to understand the complicated interactions between the HVAC&L systems and the building envelope (see Appendix F). These tools also prove invaluable to the designer when comparing HVAC&L strategies and selecting the best systems to meet the building's lighting and space conditioning requirements. High-performance buildings cannot be designed using only rules of thumb or conventional wisdom.

The architectural design maximizes the potential for a high-performance building, but it is the engineering design that actually makes the building a high-performance building.



The LANL Ion Beam Facility mechanical room.

Lighting System Design

The single largest operating cost of commercial buildings in the U.S. is lighting. Lighting systems represent one-third or more of the total electrical energy costs of a commercial building. They also introduce heat into the space and increase building cooling loads. Because lighting systems significantly impact a building's operating cost and energy performance, evaluate options for the lighting systems before considering strategies for a low-energy HVAC system. Also, take advantage of daylighting opportunities whenever possible.

Building Heat Gains from Different Sources of Light

(Watts per 1000 lumens)

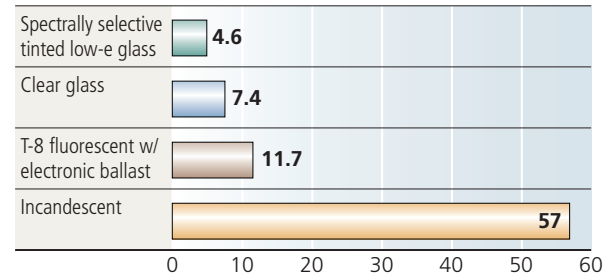

The solar heat gains from a good daylighting system can be less than half of the heat gains from the most efficient current electric lighting system technologies, to achieve equal lighting levels in a space.

Lighting systems constitute 30% to 50% of the total annual electrical energy consumption in U.S. office buildings. In the Federal sector, lighting accounts for 25% of the total electricity consumed annually.

A building designed to take advantage of daylighting will have electric lighting system controls that turn the electric lights off or dim them when sufficient daylighting is available. The electric lights operate only to maintain set lighting conditions that the daylighting cannot meet. Less waste heat from the electric lighting system is then introduced to the space, which in turn reduces the building's cooling loads.

Characteristics of a well-engineered lighting design

- Saves energy costs and decreases polluting power plant effluents.
- Responds to the varying daylight levels throughout the day.
- Improves indoor environmental quality making occupants more comfortable and productive.
- Tailors to individual's lighting needs throughout the building.
- Decreases building cooling loads resulting in smaller, less expensive space cooling equipment.

HVAC System Design

Space conditioning loads are a close second to lighting systems in terms of the most costly components to operate in commercial buildings in the U.S. Through good architectural design resulting from the engineer participating in the architectural design process, the building will have daylighting, solar gain avoidance, and other energy-efficient architectural strategies. In other words, the envelope will minimize heating, cooling, and lighting energy loads. It is the engineer's responsibility to design the HVAC systems to complement the architectural design.

Remember to account for the benefits of good lighting design – primarily reduced cooling loads – when sizing the HVAC system.

Consider advanced engineering design strategies early in the design process to allow time for making modifications to the architectural design to accommodate these strategies. Use computer simulation tools to evaluate the effect of the advanced architectural strategies when calculating HVAC system loads (see Appendix F). Also, be familiar with the intended building activities and the resulting impact on internal loads.



The LANL Ion Beam Facility mechanical room.

LANL

Just a reminder...

A well-thought-out building envelope design for the Los Alamos climate will reduce the building's primary lighting, heating, and cooling loads. The engineered systems within the building envelope will meet those additional lighting, heating, and cooling loads that the envelope *cannot* offset. Designing the envelope to be compatible with the climate and designing the engineered systems to truly work with the envelope is a non-traditional method of building design. This method offers considerable potential for achieving high-performance buildings in the uniquely suitable Los Alamos climate.

Plug and process loads impact the HVAC system design, especially in buildings housing energy-intensive laboratory and research activities. Recommend energy-saving equipment options for minimizing these loads. Reducing plug and process loads will decrease internal heat gains from this equipment, reduce building cooling loads, and decrease production of effluents from burning fossil fuels to produce electricity to operate this equipment.

Finally, develop a controls strategy that will operate the HVAC&L systems with the maximum comfort to the occupants at the minimum cost. Metering and evaluation is also important for providing continuous feedback for improvement.

Lighting System Design

The architectural design of a high-performance building maximizes the use of daylighting in the building. The engineering design integrates the electric lighting system design with the architectural design to supplement the changing daylighting levels and maintain constant prescribed lighting levels in the space, using the most efficient lighting technologies and control strategies available.

Always design the lighting system before designing the HVAC system.

The first step in lighting design is to determine the visual needs of the space and identify what type of lighting to use. Lighting types are divided into four categories:

1. **Ambient lighting** – typically used for circulation and general lighting to give a “sense of space.”

Fluorescent Lighting

Fluorescent lighting is the best type of lighting for most applications at LANL (usually linear fluorescent lamps). It can be easily controlled and integrated with the daylighting design.

Linear fluorescent lamps are classified by tube diameter, wattage, color rendering index (CRI), and color temperature, where:

- **Tube diameter** is measured in 1/8" increments (e.g., the diameter of T-8 lamps is 1" and the diameter of T-5 lamps is 5/8").
- **Wattage** is the power required to operate the lamp. The wattage is usually stamped on the lamp itself or on the package in which the lamp

is shipped. Note that the lamp wattage is different from the system wattage, which includes auxiliary equipment such as the ballasts.

2. **Task lighting** – used where clearly defined lighting levels are required to complete detailed work, such as paperwork, reading, or bench-top experiments.
3. **Accent lighting** – used for architectural purposes to add emphasis or focus to a space or to highlight a display.
4. **Emergency or egress lighting** – used to provide a pathway for exiting a building if an emergency arises.

is shipped. Note that the lamp wattage is different from the system wattage, which includes auxiliary equipment such as the ballasts.

- **CRI** is the ratio of the light source to a standard reference source. A CRI of over 80 for a fluorescent lamp is considered very good color rendering, while some high-pressure sodium (HPS) lamps have CRIs in the 20s.
- **Color temperature** gives a general idea of the visual color of the lamp (warm – more red – 2000 to 3000 K, or cool – more blue – 4000 K and above), while color rendering is how accurately a lamp renders colors in the environment.

Ambient Lighting

Ambient lighting systems can be easily integrated with the available daylighting. In a well-designed building, daylighting can offset most or all of the daytime ambient lighting loads. Use the following four steps to design ambient lighting systems.

1. Define the daylighting zones. Evaluate the location of the windows. Align the daylighting zones parallel to the windows with breaks at 5 feet, 10 feet, and 20 feet away from the windows. Place zone separations at corners where windows change orientation. Also, carefully evaluate the daylighting penetration into private offices or other small, enclosed rooms. Light levels measured in daylighting zones will determine how much electric lighting is needed to supplement the daylighting.

2. Define the occupancy zones. The occupancy zones do not necessarily have to match the daylighting zones. The occupancy zone is typically a room, such as a private office or a group of open offices. The sensors located in the occupancy zones turn the electric lights on when the daylighting is not sufficient to meet the prescribed luminance level if there are people in the zone.

Caution

A common lighting design error is to supply too much electric light to an area. Proper lighting levels lead to less energy-intensive electric lighting systems and introduce less waste heat into the space, which in turn decreases the space cooling loads.

3. Determine the minimum ambient lighting levels. Design a lighting system to complement the available daylighting in each occupancy zone. The space use will determine how much ambient light is needed (refer to the Illuminating Engineering Society of North America (IESNA) guidelines for detailed lighting level recommendations). The ambient lighting level in good daylighting designs may be less, but provides an equivalent feeling of brightness, than the level conventionally specified for a non-daylit space. Strive to design for less than 0.7 W/ft² for ambient lighting system power densities. Guidelines for determining ambient lighting levels are:

- Provide lower ambient lighting levels in private offices and other areas where the occupants rely on task lighting to complete most of their work.

The key is light, and light illuminates shapes, and shapes have an emotional power.

– Le Corbusier



Douglas Balcomb

Daylighting is the primary source of ambient light within the Harmony Library in Fort Collins, Colorado.

- Provide higher ambient lighting levels in densely occupied work areas. Distribute the ambient light uniformly in these spaces from directions that will minimize glare and reflections on the work surface. For example, position workstations between the rows of ceiling-mounted luminaires. Light coming from the sides of rather than directly in line with the viewing direction will reduce veiling reflection potential.
 - Plan for fluctuating lighting levels in daylit circulation spaces, as long as the minimum lighting levels allow for safe movement when there are people in the space. All circulation spaces can have sensors to turn the electric lights off when daylight is available or when the space is not occupied.
- 4. Select lighting fixtures.** Fixture designs can provide high lighting efficiency while also meeting the

other lighting objectives of the installation. Use efficient fixtures with appropriate distribution, glare control, and visual characteristics for the lowest possible power input. Work with the architectural designers to select fixtures that achieve the desired ambient quality while minimizing lighting energy requirements. Also, select fixtures that are capable of dimming the light output so they only supply the light needed to supplement available daylight.

- Direct, ceiling-recessed fixtures are commonly used in office and laboratory spaces; however, their use is discouraged because of poor lighting quality. If these fixtures must be used with a ceiling plenum-type return air stream, select fixtures with heat removal capabilities. The light output of fluorescent lamps decreases when operating at temperatures

higher than room temperature. Ventilated fixtures help keep the lamps at a lower temperature, thereby allowing the lighting equipment to operate more efficiently by directing some of the heat from the lamps into the return air stream instead of into the space.

- Indirect lighting fixtures provide very uniform light levels, eliminate excessive reflections on the task, and minimize shadows (especially from the head and hands). They provide good flexibility for future space rearrangements because of the uniform light level. Indirect lighting fixtures use about 15 percent more energy than direct fixtures to achieve a given lighting level because the light must bounce off the ceiling. However, indirect lighting fixtures provide a better quality of light, so the lighting levels and power densities can be reduced.

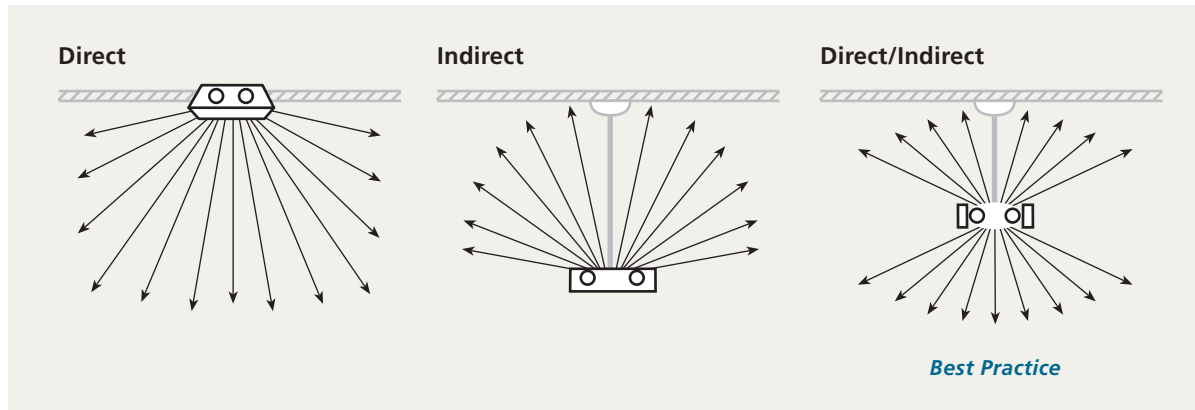

Direct/indirect lighting fixtures, recommended for ambient lighting systems, require the fixture to be mounted about 18 inches below the ceiling to provide uniform luminance. Increased ceiling height may be needed.



Indirect lighting fixtures with T-5 lamps in the LANL PM Division offices reduces glare and provides more uniform ambient light.

L. Brooke Davis

- The recommended lighting fixture for most LANL applications combines the direct and indirect approaches. These fixtures provide both upward and downward light. Their efficiency is about equal to a

Standard HID lamps do not work well with daylight or occupancy controls because of the long starting and restrike times. Consider HID lighting in high bay areas with no daylight that need to be continuously illuminated, and for exterior applications.

good direct lighting fixture with the uniformity and glare control of indirect lighting. The direct portion can provide some brightness and adequate shielding to provide good visual comfort and avoid glare. Ideally, the indirect portion does not create hot spots or excessive luminance on the ceiling. Typically, the best direct portion is 20 percent to 50 percent of the light, while the remainder is indirect.

Select direct/indirect fixtures that allow airflow through the fixture past the bulbs to minimize dirt accumulation. Note that not all direct/indirect fixtures are designed to resist dirt accumulation.

Task Lighting

Task lighting provides additional illumination to areas where individuals perform difficult visual tasks, such as working at a desk or completing detailed laboratory activities. Steps to designing good task lighting systems are:

1. **Determine where task lighting is needed.** To achieve the most energy savings, use separate lighting fixtures to provide additional task lighting only where the building occupants need it instead of



Robb Williamson

Direct/indirect lighting fixtures supplement daylighting to maintain constant luminance levels in this classroom within the Lewis Center for Environmental Studies at Oberlin College in Oberlin, Ohio.

depending on the ambient lighting system to provide enough light to complete detailed tasks.

- 2. Balance task and ambient lighting levels.** To help maintain visual comfort, the task illumination must not be more than three times that of the ambient illumination.
- 3. Provide automatic and manual controls.** Task lighting is best controlled with occupancy sensors and manual user controls.

Accent Lighting

Accent lighting highlights aesthetic features in the space or give the space a certain desired “feel.” Accent lighting system design guidelines are:

- 1. Limit the amount of accent lighting.** For the amount of useful light it provides, accent lighting often consumes more power than ambient or task lighting systems.
- 2. Use occupancy sensors to control accent lighting.** Ensure that the accent lighting is on only when there are people in the space.
- 3. Select low-energy fixtures.** Select the lowest-wattage fixtures possible to achieve the desired effect for all accent lighting.
- 4. Balance accent and ambient lighting levels.** Reduce the ambient lighting levels near accent lighting to improve contrast.

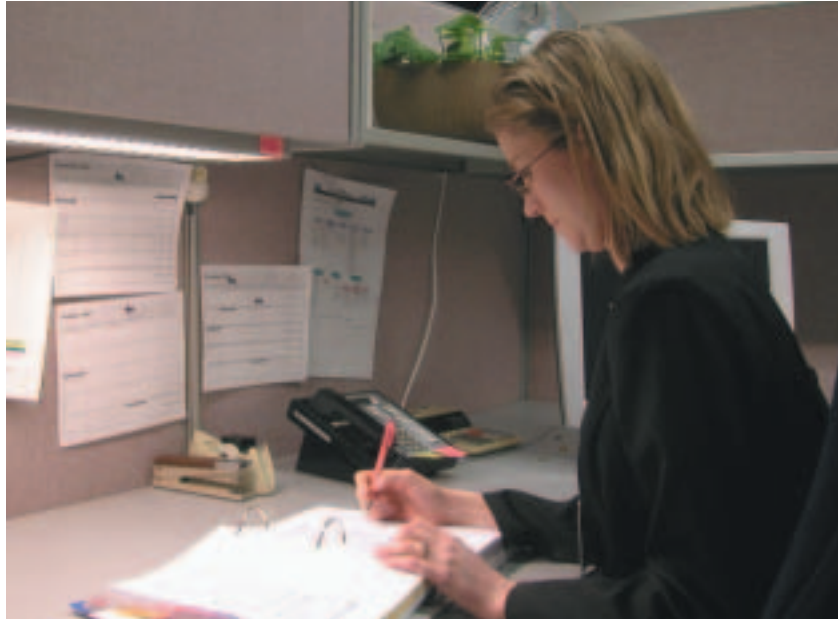

Sheila Hayter

Control task lighting with occupancy sensors so that the lighting is on only when additional light is needed to complete detailed work.



Robb Williamson

Carefully select accent lighting fixtures and controls so that the lighting provides the desired aesthetic value and energy efficiency.

Safety Lighting

Safety lighting (sometimes called “emergency lighting”) allows people to enter a space, occupy it, and move through or exit it without endangering their physical well-being. Building codes require that potential hazards, circulation areas, entrances, and exits must be illuminated. Guidelines for designing safety lighting systems are:

- 1. Select low-energy safety lighting fixtures.** Use high-efficacy lamps in efficient fixtures and provide safety lighting only to the required lighting level.
- 2. Operate safety lighting only when needed.** Use occupancy sensors and photo sensors to control safety lighting.
- 3. Place all safety lighting on separate lighting circuits.** Separating circuits leads to the ability to turn off the safety lighting when it is not needed.



Warren Gretz

Exit signs operate 24 hours per day every day of the year. Because buildings will have many exit signs, it is best if each sign consumes 2 watts or less. The LED exit sign shown here is an example of a 2-watt sign.

The Thermal Test Facility at the National Renewable Energy Laboratory has no 24-hour safety lighting. Instead, the interior lights turn on when the occupancy sensors detect motion within the building; otherwise the building is totally dark. Approximately 2,630 kWh/year are saved by not operating 10% of the electric lighting 24 hours per day, the typical percentage of lighting dedicated to security lighting in commercial buildings. The security lighting controls also save the security personnel time when patrolling the site after dark. The security personnel do not need to enter the building during routine patrols unless the lights are on, indicating to them that someone has entered the building.

Lighting Controls

Lighting controls match the light output to the occupancy schedule and illumination requirements. The controls minimize the actual energy consumption without compromising the quality of lighting in the space. There are two types of controls:

- ❑ **Manual controls** are appropriate for spaces that have lamps with long starting and restrike times, such as high-intensity discharge (HID) lamps. They may also be appropriate for spaces that require occupant light control, such as equipment rooms and laser laboratories; however, manual controls are usually not recommended.
- ❑ **Automatic controls** are more appropriate for spaces where daylighting is the primary lighting source and spaces having differing occupancy schedules, such as offices, break rooms, and restrooms.

On-off or step-function lighting controls are best suited for spaces where occupants are in the space for a short period or when sudden shifts in lighting levels will not

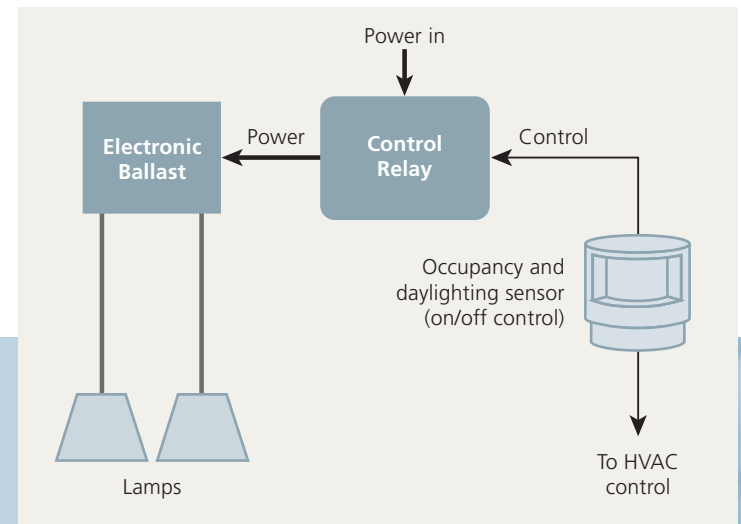

On/off with daylighting control: Motion and daylight trigger the lighting control. This type of control is ideal for common areas and hallways.

disturb the occupants. Circulation areas, restrooms, interior laboratories, and service rooms are good candidates for on-off or step-function lighting controls. These lighting control functions can be either manual or automatic.

Dimming function lighting controls are best suited for blending electrically generated light with daylight to provide the designed illumination level. Conference rooms and interior private offices with no daylighting are examples of the few places where manual dimming is appropriate. In these special cases, an occupancy sensor turns the electric lights on and off and the occupants may have manual dimming controls to set the lighting at the appropriate level.

The best dimming controls are automatic and continuous. Continuous dimming avoids instantaneous jumps in lighting levels that can be distracting to the occupant. Ideally, the lighting control system is capable of dimming the lights based on lighting level, and turning off the lights if the space is unoccupied.

Steps for Effective Lighting System Design

1. Review the F&OR document for the space use description.
2. Define the reason for the lighting.
 - Ambient- circulation and general lighting
 - Task- areas where detailed work is done
 - Accent- architectural use only (minimal)
 - Safety or emergency egress lighting
3. Design the ambient lighting system.
 - Define daylighting zones
 - Define occupancy sensor zones
 - Determine minimum ambient lighting levels
 - Select lighting fixtures
4. Design the task lighting system.
 - Determine where task lighting is needed
 - Balance task and ambient lighting levels
 - Provide automatic and manual controls
5. Design the accent lighting system.
 - Limit the amount of accent lighting
 - Use occupancy sensors to control accent lighting
 - Select low-energy fixtures
 - Reduce ambient light levels when there is accent lighting
6. Design the safety lighting system.
 - Select low-energy safety lighting fixtures
 - Operate safety lighting only when needed
 - Place all safety lighting on separate lighting circuits
7. Design the lighting control system, using automatic and dimmable controls.
8. Verify the design by evaluating lighting power densities W/ft².

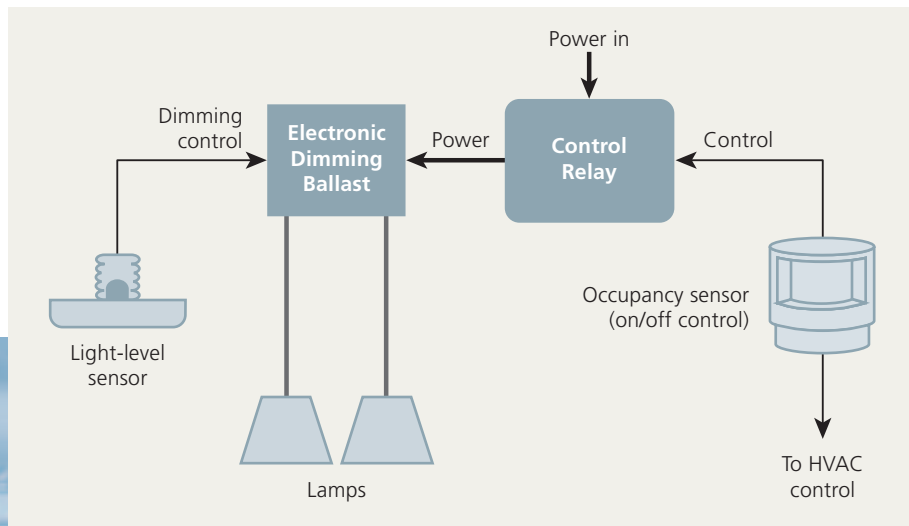

Dimming control: Lighting controls incorporating an occupancy sensor to turn lights on/off and a light-level sensor to dim the lights based on available daylight.

Mechanical System Design

The HVAC systems maintain a comfortable and healthy indoor environment by responding to the loads imposed by the building's envelope design, lighting system design, and occupant activities. Proper design of the control schemes for the systems that heat and cool the interior spaces, provide fresh air for the occupants, and remove contaminants from the building will ensure that the HVAC system operation complements the architectural and lighting designs and minimizes building energy consumption.

HVAC System Zones

Determine the minimum conditions, such as temperature and humidity requirements, for all spaces in the buildings. Group spaces having similar space conditioning requirements into one zone, then separate the HVAC systems into zones based on these expected loads. When identifying HVAC system zones:

- Separate systems serving office areas from those serving laboratory or process areas.
- Separate areas with relatively constant and weather-independent loads (e.g., interior offices or interior light laboratory spaces) from perimeter spaces.

- Separate areas with special temperature or humidity requirements (e.g., computer rooms) from those areas that require comfort heating and cooling.

Identify the space loads to determine the capacity of the HVAC equipment for each zone. Typically, envelope loads dominate the heating and cooling loads of perimeter zones and equipment loads dominate the interior zone loads.

Carefully calculate the HVAC system loads using computer simulation tools (see Appendix F). Especially in high-performance buildings, it is difficult to accurately estimate system loads using "rules of thumb," such as sizing an air-conditioning unit's capacity assuming that so many tons of cooling are needed per square foot of building floor area. It is important to use computer simulation tools to assist with making engineering design decisions.

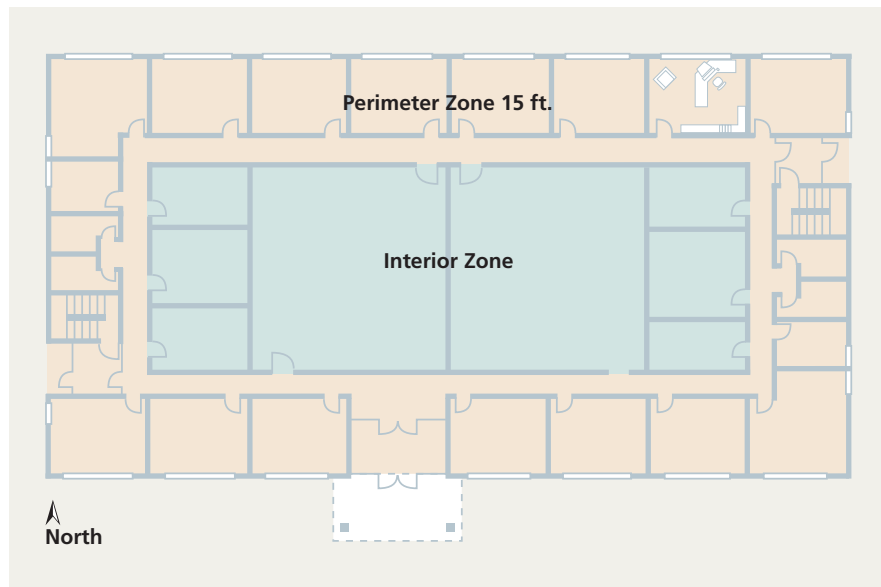

Typical HVAC zone design for a building with perimeter offices. Perimeter zones can extend from the exterior wall to the first interior wall, or for open floor plans, up to 15 feet from the exterior wall.

Peak Load Analysis

Evaluate the predicted peak loads when completing the heating and cooling loads calculation – when and why they occur. A thorough analysis of the peak loads often leads to design solutions that further decrease building energy loads. The following points exemplify why peak load analysis is important.

- When using daylighting to offset lighting loads, the peak cooling month will often shift from a summer month (such as for a conventional building) to October. This non-intuitive peak loading occurs because the sun is low in the sky during October so that overhangs no longer shade the building, yet the daytime outdoor temperatures are still high enough that cooling will be needed. One solution to this late-season cooling load is to use outside air to cool the building, by means of an economizer, natural ventilation, or precooling the building by night flushing.
- A winter morning peak load may occur during the building warm-up period. One solution is to design a heating system to accommodate this peak load, but this system will then operate at part load for most of the time. Another

solution is to downsize the heating system so that it is operating near full capacity during a typical heating day. Begin the morning warm-up period earlier in the day to decrease the system peak load to that which the system can handle. The system then has a longer time to heat the building before the occupants arrive. Compare the lifetime operating costs of these and other scenarios before determining the best solution.

- A peak load analysis may show the largest cooling loads occurring late in the afternoon because of solar gains through west-facing windows. It may be that changing the specified glass characteristics (to those that reduce the amount of solar gains entering a space, see Chapter 4) of these windows will help reduce the cooling load. Another solution could be to shade the windows from the outside with an architectural screen. Or, the solution may be to reduce the glazing area on the west facade.

Perimeter Zones

The wall, roof, and floor insulation and the heat transfer characteristics of the window glass will affect the perimeter zone heating and cooling loads. In a well-designed building, the architectural features of the envelope will shade the building to minimize direct solar gains and reduce perimeter-zone cooling loads.

It is likely that daylighting will be available in the perimeter zones. Interior zones may have daylighting if clerestories, roof monitors, light tubes, or other strategies are used to bring daylighting to the space (see Chapter 4). Remember to accurately evaluate how daylighting will affect the zone loads. A good daylighting design will decrease the internal heat gains from operating electric lighting systems and introduce little or no adverse solar gains. Reducing the internal and solar heat gains decreases cooling loads and potentially increases heating loads.



Placing the windows deep in the south-facing wall helps to shade the window to minimize direct solar gains and reduce perimeter cooling loads.

LANL

Interior Zones

Internal loads from people occupying the space and waste heat from operating electric lighting systems and equipment in the space typically determine the interior-zone heating and cooling loads. Reduce internal loads as much as possible by reducing the lighting loads. Use efficient lighting fixtures and control the lighting to operate only to provide the lighting level needed when

the space is occupied. Also, select energy-efficient equipment (e.g., office or process equipment), or recommend specific energy-efficient equipment for the user to purchase.

Plug loads are loads from the individual pieces of electrical equipment that can be removed from the building and powered through electrical wall outlets. Process loads are the loads produced by the process equipment in a space. When operating, both plug and process loads introduce heat to the space and increases load on the building's cooling system. The first step to reducing plug and process loads is to ensure that the equipment is turned off or set to a "sleep" mode when not in use. For example, always enable the power saving features for computer equipment. In addition, it is best that all new equipment be ENERGY STAR® rated or of the highest available efficiency.

Internal Loads and Supply Air Flow

3.5 Supply air flow (cfm/ft²)

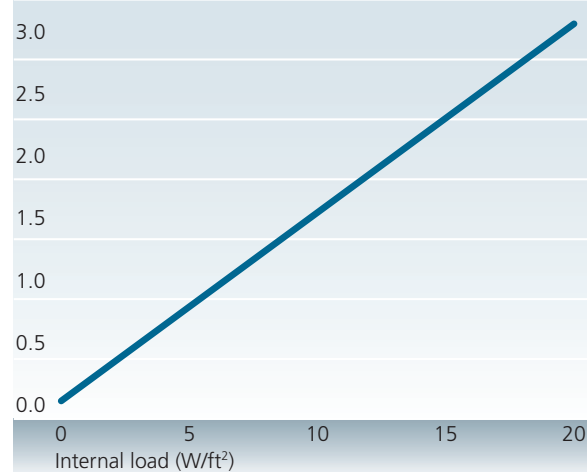

Quantity of 55°F supply air required to offset internal loads.

Be sure to accurately calculate the magnitude of plug and process loads. Consider the average instead of the peak energy use for this equipment when determining the maximum internal gains, unless all the equipment will be simultaneously operating at peak power draws. If the equipment to be used in a new building is similar to equipment in an existing building, base the estimated loads on the measured average energy use of that existing equipment.

Flat screen monitors save energy

Flat screen computer monitors use a fraction of the energy of traditional monitors, which means they introduce less waste heat to the space. They also reduce the incidences of complaints about glare, making them the better option in spaces where occupant workstations may be rearranged without regard to the locations of entering daylight or electric lighting fixtures.



Sheila Hayter

Ventilation Systems for Zones

Ventilation air requirements often vary between zones. Ventilation is the use of outdoor air for controlling containment concentration by dilution or sweeping the contaminants from their source. Ventilation should meet the recommended values of ANSI/ASHRAE Standard 62-1999, 15 to 20 cubic feet per minute (cfm) per person, or the performance criteria described in the Standard using demand-control ventilation systems.

Demand-controlled ventilation reduces outside air requirements to the minimum needed for the actual zone occupancy when the zone would not benefit from economizer operation. Demand-controlled ventilation can greatly reduce the heating and cooling required for

treating outside air. Carbon dioxide sensors are a useful indicator of the concentration of human bioeffluents and work well for regulating ventilation air rates. Use multiple sensors to ensure proper ventilation in densely versus lightly occupied spaces. As a general rule, place one sensor for the return air stream of the air handling unit and one sensor for each densely occupied space to ensure proper ventilation per minimum requirements and provide opportunities for increased energy savings.

Use higher levels of ventilation (e.g., economizers) as a substitute for mechanical cooling when ambient conditions allow for this “free” cooling. During the heating season, continue to use cool outdoor air to offset cooling loads that occur in interior zones. For the zones that require heating, reduce the ventilation air rates to

the lowest volume possible and still maintain adequate indoor air quality to minimize the amount of cold air that must be heated before delivering it to the space.

It is common for separate zones within a building to experience opposite loads during the same period. For example, an interior zone may call for cooling while a perimeter zone requires heating, or an office zone may require very different conditions than a laboratory zone. To satisfy the space conditioning requirements of all spaces using the least amount of energy, separate the HVAC systems to serve zones with dissimilar heating and cooling patterns. Also, keep control zones small, especially when expecting a large difference in internal loads.

According to ANSI/ASHRAE Standard 62-1999, “Where peak occupancy of less than three hours duration occurs, the outdoor air flow rate may be determined on the basis of average occupancy for buildings for the duration of operation of the system, provided the average occupancy used is not less than one-half the maximum.” Spaces having intermittent or variable occupancy may then have lower ventilation rates than would be required if the peak occupancy were used to determine the amount of ventilation (e.g., a conference room). It is better to use CO₂ sensing to control the amount of ventilation air needed during any particular period versus supplying 15–20 cfm per person for the average expected occupancy. Changing the ventilation rates with the changing occupancy will result in lower energy consumption and improved occupant comfort.

Energy Usage of Modeled LANL Building with and without an Economizer

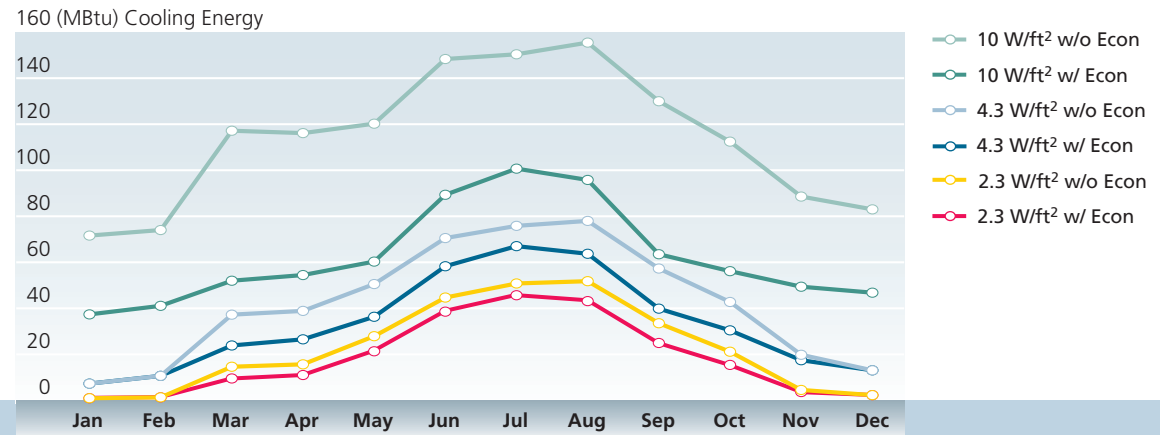

Energy use of a simulated LANL office laboratory building with and without an economizer. The chart shows the results of three simulations: the building with internal loads set to 2.3 W/ft², 4.3 W/ft², and 10 W/ft². The annual energy savings from using an economizer for the building with internal loads set to 2.3 W/ft² is 51.7 MBtu, which corresponds to a 20% energy savings.

HVAC System Selection

Select the system type after completing a thorough analysis of the heating and cooling loads and the varying ventilation requirements of each zone. Evaluate several types of HVAC system options to identify the system that will satisfy the zone's temperature and humidity requirements using the least amount of energy.

VAV Systems

VAV systems moderate space conditions by varying the amount of air delivered to the space. For most LANL buildings, variable-air-volume (VAV) systems will best meet space conditioning requirements of each zone. This is true for both office spaces and laboratory spaces. For example, occupants of each office or group of offices may have varying temperature demands

compared to their neighbors. Also, one laboratory may call for high levels of exhaust air flow, while a neighboring laboratory may be unoccupied and require very little exhaust airflow.

Use induction VAV units for interior zones and fan-powered VAV units with hot-water reheat coils for perimeter zones. Be sure to select a reheat coil rated for low-airside and low-waterside flow resistances. In addition, recommended perimeter zone VAV units are "parallel flow" fan-powered (the VAV box fan is only on during the heating mode and is off during the cooling mode). Control the perimeter heating system operation so that it can maintain minimum space conditions during unoccupied hours without requiring the main air-handling unit (AHU) fan to also operate.

Dedicated hot water heating systems are often used in perimeter zones of LANL buildings to offset the heat losses through the building envelope.

The diverse requirements for laboratory spaces also hold for internal loads. This is another important reason to use lab VAV systems. The VAV system can control the amount of "economizer" that is required to meet loads.

...the underlying purpose of the building is neither to save nor use energy. Rather, the building is there to serve the occupants and their activities.

– FEMP Low-Energy Building Design Guidelines

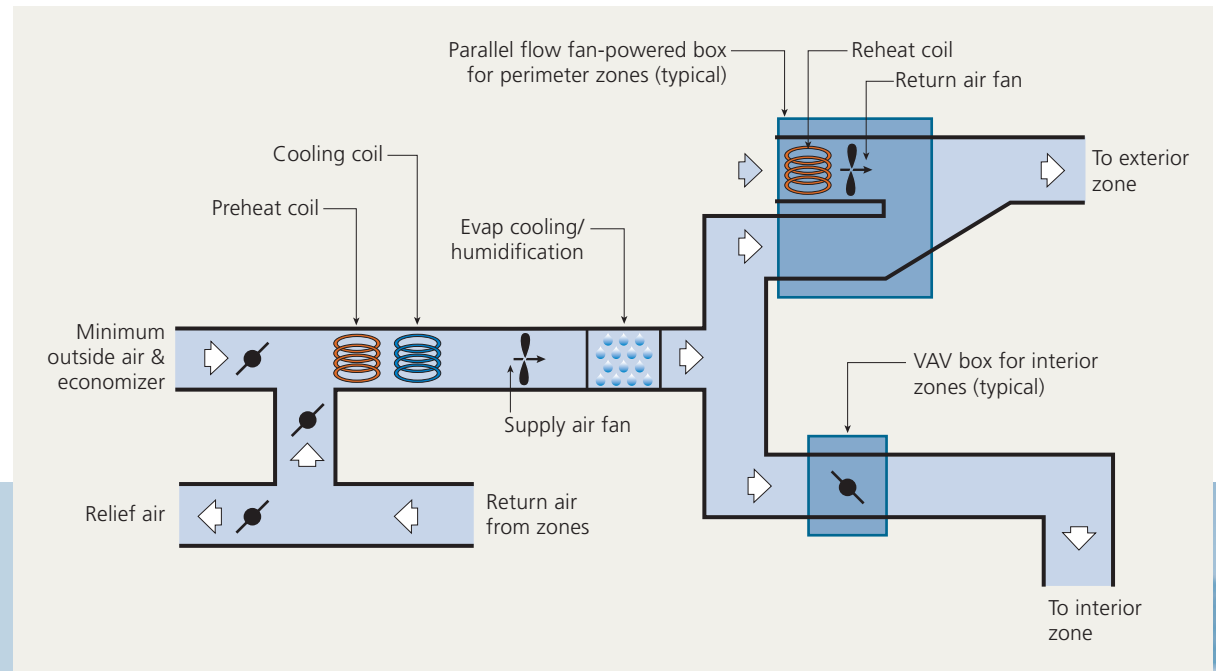

Use variable air volume induction units to condition interior zones and fan-powered perimeter reheat VAV units to condition perimeter zones.

Air-Handling Unit (AHU) Design Guidelines

- **Fan selection** – In most cases, vane-axial and backward-curved centrifugal fans are the most efficient AHU fan choice. Consider the rated acoustical properties, space limitations, inlet and outlet conditions, and air quantities/pressure requirements of the fan before identifying the best fan for the application.
- **Coil and filter selection** – Select AHU coils for low airside and waterside flow resistance, low water flow rates, and operation at warmer chilled water or cooler hot water temperatures. Specify coil control strategies that will minimize water flow and maximize heat transfer. Pay special attention to the pressure drop of coils and filters. Limit face velocity to 450 feet per minute (fpm) for VAV systems and 400 fpm for constant air volume systems.
- **Hot and chilled water piping systems** – Increasing the system pipe diameters and specifying low-friction valves reduces flow resistance through the piping and coils and decreases the system pumping energy.
- **Air distribution systems** – Select air distribution components that offer the lowest pressure drop through the system. Large duct sizes provide low pressure drop and future flexibility if increased airflow is required. Try to minimize fittings such as elbows and transitions, since they have large pressure drops.

Air Distribution Systems

The two types of air distribution systems that are likely to be considered for most LANL buildings are overhead and under-floor air distribution systems.

- **Overhead air distribution systems** deliver conditioned air through ducts above the ceiling and then to the space through overhead diffusers. These conventional distribution systems typically deliver 50°F to 55°F supply air. They rely on the properties of the diffuser to throw the conditioned air to mix with the room air and maintain comfort at the occupant's level (e.g., at desk level in a typical office space).

Well-designed overhead air distribution systems have little variance in the floor-to-ceiling space temperatures.

- **Under-floor air distribution systems** use a plenum under a raised floor to distribute air to a space. The systems typically deliver 60°F to 65°F supply air through diffusers in the floor. The systems then rely on stratification to move the warm air above the occupant's level to be replaced by the cooler conditioned air. There is typically a large temperature variance between the conditioned air temperature at the floor and the warmer air temperature at the ceiling. Under-floor air distribution systems can be installed with little or no first-cost penalty, and operational savings will occur over the life of the systems.

Fan Energy (76% efficiency)

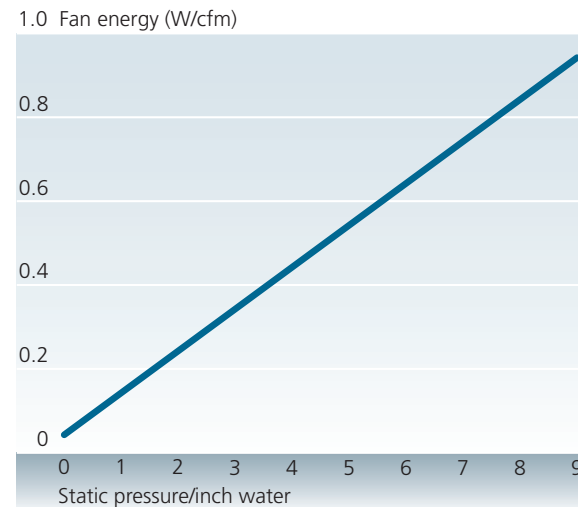

Fan energy increases with higher pressure drops through the air distribution system. Understand how fan properties will affect system energy consumption before selecting fans.

Under-floor air distribution systems can lead to improved thermal comfort, improved indoor air quality, reduced HVAC system energy use, and increased flexibility of the office space.

- Increased personnel comfort is possible because personal control of airflow can be relatively easily incorporated into the system design.
- HVAC system energy savings result from reduced ventilation air rates. Cleaner air can be delivered directly to the occupants without dilution with existing room air (displacement ventilation), compared to

overhead systems that deliver air at the ceiling and then mix with room air.

- The higher supply air temperatures of under-floor air distribution systems allow more hours of economizer operation, increase chiller plant efficiency, and decrease the run-time of mechanical cooling equipment.
- The under-floor air distribution plenum often doubles as a wire management corridor, increasing the space reconfiguration flexibility.

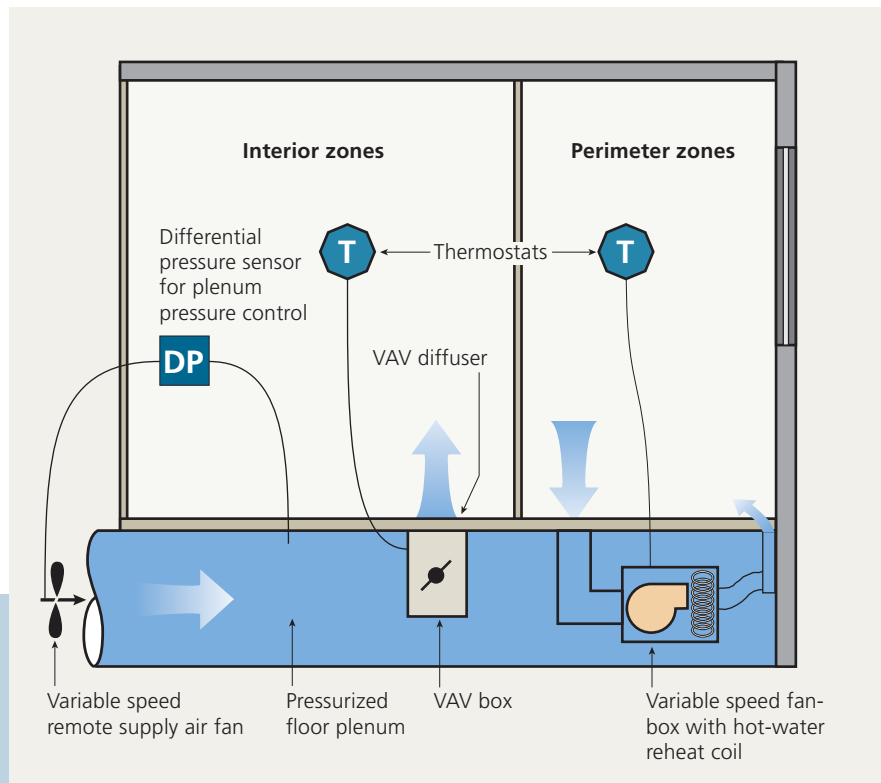

VAV under-floor distribution system with plenum pressure control and perimeter fan-powered heating unit. Under-floor air distribution systems are more flexible, provide greater occupant control, and use less energy compared to overhead air distribution systems.

Under-Floor Air Distribution System Design Guidelines

- Evaluate under-floor air distribution systems early in the design process during the conceptual design phase.
- Consider under-floor air distribution systems for spaces having a high density of information technology equipment, office spaces, or spaces that are expected to undergo frequent reconfigurations.
- Minimize pressurized plenum air leakage by sealing all plenum penetrations and specifying low-air-leakage (tight) raised floor systems.
- Use VAV controls for all under-floor air systems to control plenum pressure.
- Use variable speed fan units and reheat in the perimeter zones if additional heat is needed in these zones.
- Deliver adequate supply air quantities to meet the loads. Supply air quantities do not differ greatly between conventional overhead and under-floor air distribution systems.

“Free” Cooling Systems

The high diurnal temperature swings and low humidity levels prevalent at Los Alamos are ideal conditions for “free” cooling (see Appendix B). Free cooling is accomplished by delivering outdoor air to cool buildings instead of relying on mechanical cooling systems. These systems can significantly decrease compressor, cooling tower, and condenser water pump energy requirements as well as tower makeup water use and the related water treatment. Free cooling has the added benefit of providing a high level of ventilation air to a space, often resulting in improved indoor air quality.

- ❖ **Air-side economizer systems** – A mixing box capable of handling 100 percent outside air integrated with the HVAC system is an economizer system. The amount of outside air brought in to the building through these systems is limited by the outside air conditions (usually just temperature in Los Alamos) or requirements for ventilation air (based on indoor CO₂ levels). Note that laboratories requiring 100 percent outside air are always in “economizer” mode.

- ❖ **Nighttime precooling (night purge) systems** – Use of nighttime precooling (night purge) reduces daytime mechanical cooling requirements. Flushing

the building at night with outside air cools the building mass, which will stay cool through the beginning hours of building occupancy. When operating a night purge system, let the building temperature float during the first part of the night then run the system fans for the few hours prior to occupancy to precool the building to the desired temperature.

- ❖ **Natural ventilation systems** – Natural ventilation relies on the air movement through the space without the use of fans to cool the building. Consider natural ventilation early in the design process to ensure that the architectural design incorporates strategically placed, operable windows to accommodate natural ventilation systems. Many times, operable windows are automatically controlled to promote natural ventilation only when the outdoor conditions are suitable and to ensure that all operable windows close if fire or smoke are detected in the building. Using natural ventilation whenever an economizer is operating would also be appropriate.

Evaporative Cooling Systems

In evaporative cooling, the sensible heat in an air stream is exchanged for the latent heat of water. Most buildings at LANL could be cooled by evaporative cooling methods alone.

Direct evaporative coolers (also known as swamp coolers) introduce some moisture to the air stream, subsequently reducing the dry bulb temperature of the outside air to within 5°F to 10°F of the wet bulb temperature. *Indirect evaporative coolers* provide sensible cooling only. Air cooled by water sprayed on the backside of a heat exchanger is separate from the air delivered to the occupied space.

Indirect/direct evaporative cooling systems pass air through an indirect evaporative cooling system heat exchanger to provide sensible cooling to the air stream

Evaporative cooling has been somewhat limited at LANL because of hard (high silica) water. Evaporative cooling systems are practical at LANL if a water treatment technology that cost-effectively removes the silica from the water is employed. If water treatment is to be installed for research purposes, then consider increasing the capacity of this treatment system to also provide water for evaporative cooling.



before it reaches the direct evaporative cooling section of the unit. These systems are often sized so that small to medium cooling loads can be met with the indirect section operating alone. The indirect/direct sections operate together to meet larger cooling loads.

Both direct and indirect evaporative cooling systems can be modified to improve the performance of other cooling systems. Direct evaporative cooling systems can extend the range of economizer cycles by pre-cooling the air stream. An adaptation of indirect evaporative cooling systems is to circulate cooling tower water through a coil installed in an AHU to provide sensible cooling. This type of indirect system is often augmented with a chiller to provide enough cooling capacity to meet peak loads.

Ventilation and Exhaust Systems

Rooms with exhaust air systems, such as kitchens and restrooms, can draw air from adjacent occupied spaces to replace the exhausted air. This approach has two benefits:

1. Rooms where odors may be an issue are kept at lower pressure than surrounding spaces, minimizing the potential for odors to spread.

Space Heating at LANL

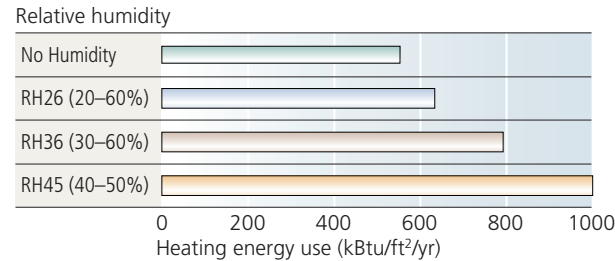

Tight control of humidity levels in a lab building at LANL with a high ventilation rate has a huge heating energy penalty. Assuming an average flow rate of 2 cfm/ft² and no heat recovery, the heating energy use almost doubles if humidity is controlled to between 40% and 50% relative humidity (RH) (RH45) compared to not controlling humidity (No Humidity). Controlling between 30% and 60% (RH36) and between 20% and 60% (RH26) has a lower, but still significant, energy penalty.

2. Ventilation air is distributed to occupied spaces before being exhausted, thereby reducing the required ventilation air.

Laboratory buildings having hazardous materials may need large quantities of exhaust and makeup air for safety reasons. Conditioning and moving large quantities of air will dominate the energy use in laboratory buildings.

Because of the diversity of laboratory spaces, it is recommended that each space have a fan coil for heating and cooling (if high internal loads are expected). A fan coil is preferred over a reheat coil located in the makeup air duct. A fan coil configuration does not require circulation of a large volume of air through a reheat coil, which results in an air system pressure drop, 365 days a year.

Consider potential contamination sources when locating outside air intakes for building ventilation air. Exhaust fan discharge, plumbing vents, cooling towers, and combustion products from vehicles and equipment (e.g., boilers and generators) are examples of contami-

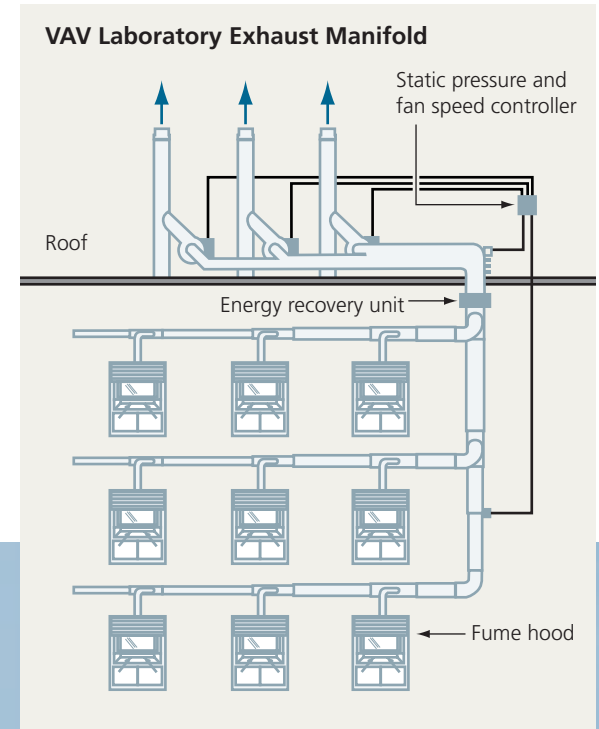

VAV Exhaust System Controls

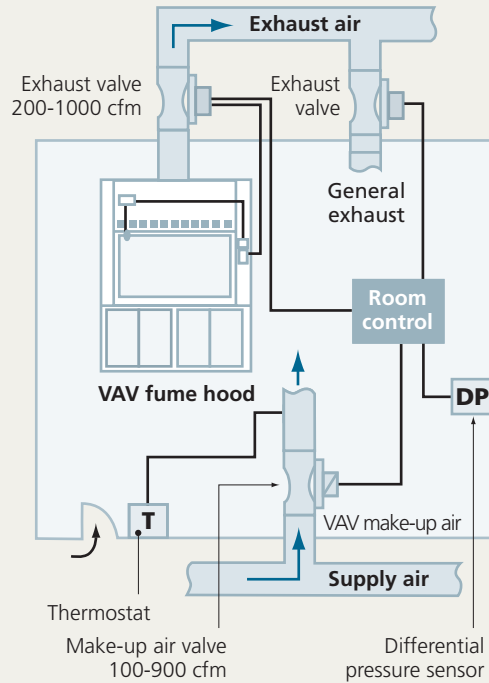

nation sources. Perform effluent plume models using wind tunnels or Computational Fluid Dynamics (CFD) software programs to predict plume paths and help locate air intakes and exhausts.

Design laboratory exhaust systems as a “manifold” exhaust. Manifold exhaust systems provide substantial energy and first-cost savings. This system offers opportunities for centralized energy recovery, and better dilu-

Fume hood design guidelines

Store and use hazardous materials only in exhausted enclosures such as chemical storage cabinets and fume hoods. It takes less energy to remove a contaminant at the source than to condition and supply enough ventilation air to dilute the contaminant. As a rule of thumb, control concentrated contaminant sources at the source by containment, local exhaust systems, or both. In many laboratory cases, this containment and local exhaust is accomplished by using fume hoods.

The fume-hood-exhausted enclosures only need to draw enough exhaust air to maintain a negative pressure when not in use; however, when in use the exhaust rate typically increases. For example, a fume hood sash that remains closed when not in use could draw about 40 cfm per linear foot. When the fume hood sash is open, the flow must be enough to meet ASHRAE Standard 110 containment requirements, typically about



Labconco

60 fpm for new low-flow fume hoods. Use VAV supply and exhaust systems to minimize the quantity of air flowing through the fume hood and other exhaust devices.

tion. Use multiple exhaust fans and stacks with the laboratory VAV system for redundancy and to maintain a constant stack discharge velocity as system volume varies. Constant stack discharge velocity is maintained by operating only the required number of fans to match the current exhaust system load.

Air-to-Air Energy Recovery Systems

Air-to-air energy recovery opportunities exist at LANL in buildings with high ventilation loads. In air-to-air energy recovery systems, exhaust air and outdoor air both pass through a heat exchanger where the exhaust air preconditions the outdoor air entering the building. These systems reduce the heating and cooling peak energy demands and can reduce the heating energy consumption of buildings by 30 percent to 50 percent.

Effective use of energy recovery devices results in decreased loads on the heating and cooling mechanical equipment. Equipment with reduced capacities can then be purchased. The savings gained from purchasing smaller equipment often exceeds the first cost of the energy recovery devices.

Air-to-air heat exchangers increase the fan power needed to supply the outside air to the building and to discharge the exhaust or relief air from the building. Even though the fan energy increases, the total energy use of the system decreases because the overall heating and cooling system energy use decreases. Including a bypass damper to redirect the air around the recovery device when the outdoor conditions do not warrant energy recovery improves the performance of these energy recovery systems.

Locate the outside air intake riser and the exhaust or relief air riser in close proximity to one another to further improve the performance of energy recovery systems. To do this, it is important to coordinate plans for energy recovery systems early in the design process.

There are two typical types of air-to-air energy recovery: sensible and total. Sensible energy recovery systems transfer only sensible heat. Total energy recovery systems transfer sensible and latent heat. Because of the dry Los Alamos climate, latent heat recovery is typically not important unless the building requires a minimum humidity level.

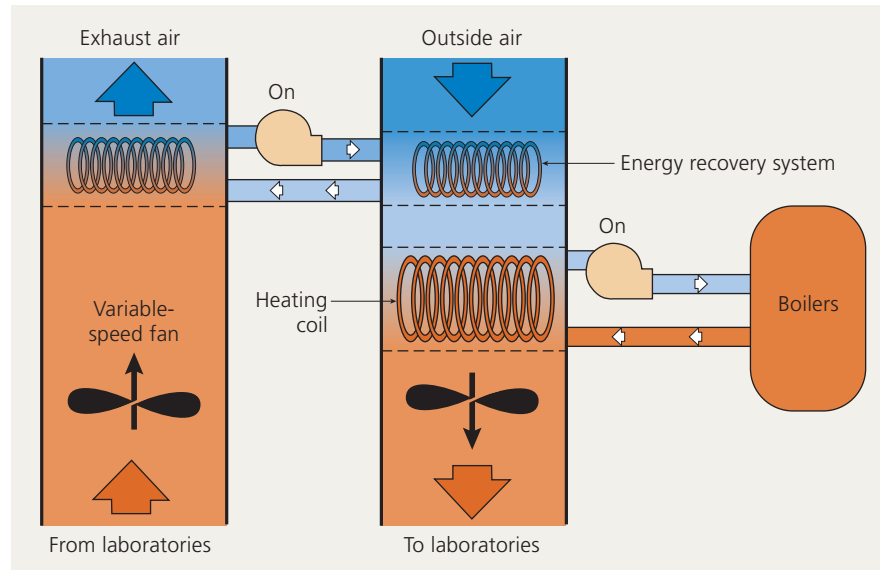

Air-to-air sensible energy recovery system using run-around coils.



Energy Recovery Devices Comparison

Name	Description
Run-Around Systems	<p>A simple piping loop connecting a finned-tube coil in the exhaust plenum with a finned-tube coil in the make-up air plenum or AHU.</p> <p>Does not require supply and exhaust air ducts to be adjacent and does not require a bypass air damper. Requires pump and piping.</p>
Heat Pipe Devices	<p>A heat source boils a heat transfer fluid within a pipe, and a heat sink condenses the fluid back to its liquid state, liberating the energy transferred from the fluid's change of phase.</p> <p>Requires supply and exhaust to be adjacent. Requires a bypass damper and/or tilting controls.</p>
Fixed-Plate Air-to-Air Devices	<p>Typically, coated air-to-air aluminum heat exchangers.</p> <p>May have to be quite large to perform effectively.</p> <p>Requires supply and exhaust to be adjacent. Requires a bypass damper.</p>
Rotary Air-to-Air Energy Exchangers	<p>Recovers latent and sensible heat – highest effectiveness and lowest pressure drop.</p> <p>Previously not recommended because of potential carryover of contaminants from the exhaust to the supply air stream. Purge sectors and good seals minimize cross-leakage.</p> <p>Recent development of a molecular sieve, desiccant-based heat wheel technology that will not absorb large molecules.</p> <p>Requires supply and exhaust to be adjacent. A bypass damper reduces pressure drop when not in use.</p>

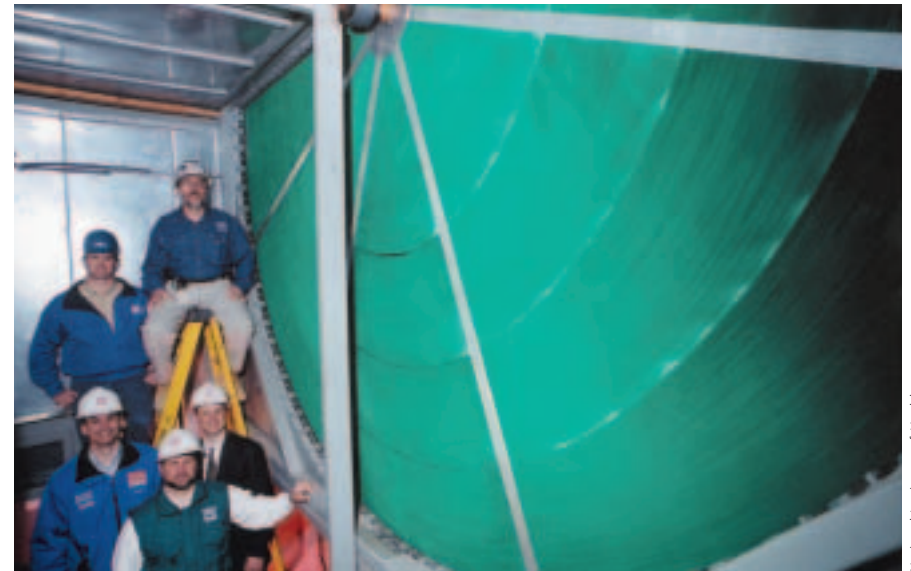

National Institutes of Health

Molecular sieve desiccant energy recover wheel at the National Institutes of Health, Louis Stokes Laboratories in Bethesda, Maryland.

Laboratories for the 21st Century

Laboratory buildings typically consume 5 to 10 times more energy per square foot than office buildings. This high use suggests great opportunities for energy savings. The U.S. EPA and DOE established a program called “Laboratories for the 21st Century” (www.epa.gov/labs21century) to promote and assist in the design, construction, and operation of high-performance, low-energy laboratories.



LABORATORIES FOR THE 21ST CENTURY

Central Plant Systems

Central plant systems comprise the mechanical equipment that heat and cool water (boilers and chillers) to provide heating or cooling to a single or group of buildings. Distribution systems circulate the heated or cooled water through heat exchangers to condition air or meet process loads.

Begin considering the central plant design and obtaining input from other design team members about the building loads, space conditioning requirements,

Advantages of central plants versus dedicated mechanical systems

Central plants –

- Allow for diversity of equipment capacity for multiple buildings.
- Provide future flexibility for increased loads on the system (remember to allow space and accessibility for future expansion).
- Lower maintenance costs because all major equipment is in one location.
- Increase system efficiency because multiple chillers, boilers, and cooling towers can be staged so that they operate near their maximum efficiency and provide useful redundancy. Waterside economizers can also be easily incorporated.
- Reduce amount of space dedicated to mechanical equipment in a building.
- Reduce the noise and vibrations associated with operating combustion- and refrigeration-based equipment by removing this equipment from the building.
- Increase the potential for combined heat and power (CHP) systems.

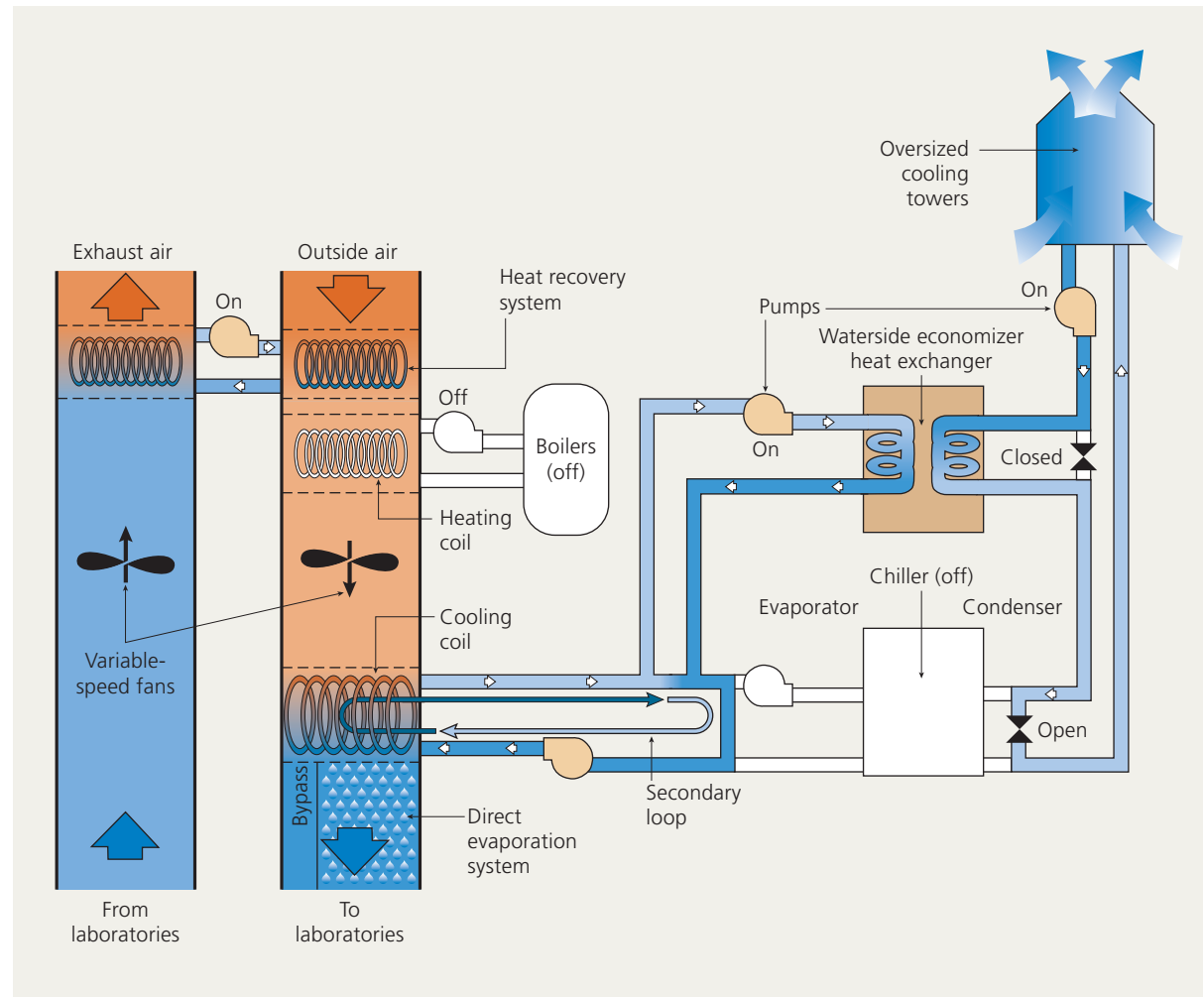

Laboratory space conditioning system operating in the cooling mode using a heat exchanger for a waterside economizer. A cooling tower provides indirect evaporative cooling. A direct evaporative cooling section with a bypass for humidity control further conditions the air before it is delivered to the laboratories.

and process loads early in the design process. Participate in the architectural design activities to minimize building loads, then design the central plant and distribution systems to meet these loads while using the least amount of energy.

Water-side economizers

The low wet-bulb temperatures in Los Alamos are especially suitable for water-side economizer systems. Select chiller systems designed to operate at as low a condenser (tower) water temperature as possible, down to about 50°F. When the CWS temperature is this low, a water-side economizer system can offset the entire chilled water load. Water-side economizer systems are particularly applicable for meeting large cooling water loads such as that which may be required by some laboratory activities. Provide a chiller bypass when using a water-side economizer.

Chillers

Anticipate the actual operating conditions of the chiller and select accordingly. Most chillers operate between 40 percent and 70 percent of capacity a majority of the time and rarely operate at full load. Select chillers with a high-integrated part-load value (IPLV) rating so that they operate efficiently under full and part load conditions.

Consider selecting multiple chillers of different capacities to provide flexibility in meeting varying loads in addition to selecting chillers with high IPLV ratings. It is better to operate chillers near full capacity and start up additional chillers as needed than it is to operate large chillers at part load most of the time.

The energy use of central plant and distribution systems can vary by a factor of two or more based on the system design and operation. For example, an air-cooled chiller operating in Los Alamos will have an energy use of 1 kW/ton or more; whereas, the same sized water-cooled chiller with a cooling tower can have an energy use of less than 0.5 kW/ton.

Achieve improved compressor part-load kW/ton ratings by installing a variable-speed-drive (VSD) on the compressor. The VSD allows the compressor to run at lower speed under part-load conditions.

Refrigerant Options

Criteria	HCFC-123	HCFC-22	HFC-134a	Ammonia
Ozone-Depletion Potential	0.016	0.05	0	0
Global Warming Potential (relative to CO₂)	85	1500	1200	0
Phase Out Date	2030	2020	N/A	N/A
Occupational Risk	Low	Low	Low	Low
Flammable	No	No	No	Yes

Select refrigerants with a zero-ozone-depletion factor whenever possible, especially when the chiller efficiency is not significantly affected by the type of refrigerant.

Operating chillers to provide higher chiller water supply (CHWS) temperatures increases the efficiency and provides greater cooling capacity (tons) for a given chiller size and constant condenser water supply (CWS) temperature. Keep this in mind when selecting coils for the chilled water system. Select coils using a 50°F or higher CHWS temperature. The larger face area of these coils reduces the air velocity and pressure drop across them. Also, designing for warm chilled water temperatures increases the number of hours of potential “free” cooling using a waterside economizer.

Variable Speed Drives

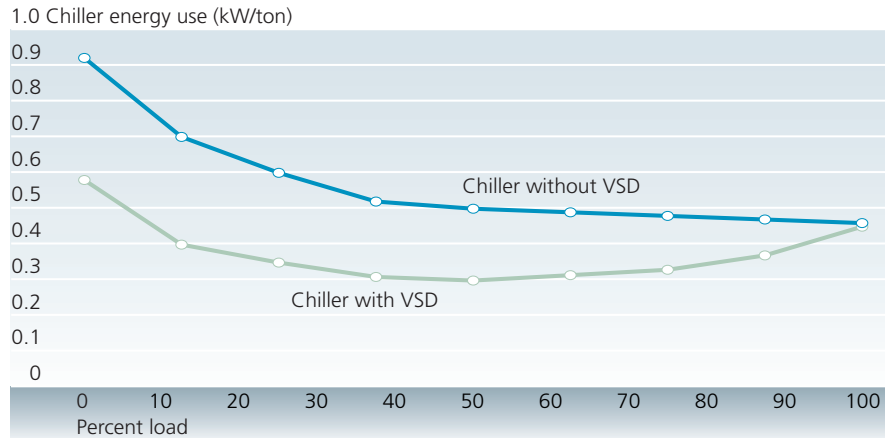

Comparison of the performance of a standard chiller and a chiller using a VSD.

Low- vs. Medium-Temperature Chillers

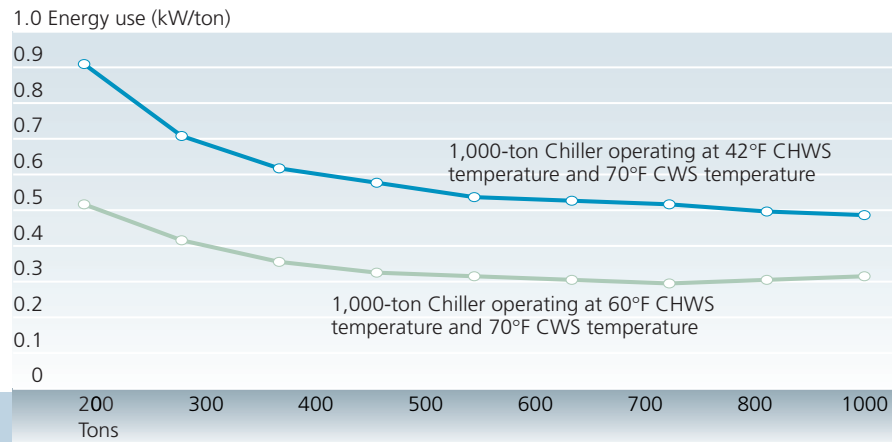

Operating chillers to provide higher CHWS temperatures decreases the chiller energy consumption.



Provide variable-speed-drive (VSD) fans on all new cooling towers. A direct-drive propeller axial cooling tower is usually more efficient than a centrifugal-fan cooling tower. Over-sizing the cooling tower enables condenser water to return to the chiller at a temperature close to the wet bulb temperature, maximizing system efficiency.

LANL



Modular boiler system provides good part-load efficiency and redundancy.

Boilers

Select boilers based on the lowest life cycle cost. In most cases, it is best to purchase high-efficiency condensing boilers. But, if the heating load is small (so the boiler would not be operating very many hours per year), the added cost of these efficient boilers may not be justified. Discuss the various capital costs and full-load and part-load efficiencies with the project team as well as with the boiler manufacturers to determine the right boiler for a particular load.

Consider selecting multiple boilers of different capacities to provide flexibility in meeting varying loads. It is better to operate boilers near full capacity and start up additional boilers as needed than it is to operate large boilers at part load most of the time. Systems relying on multiple hot water boilers are more flexible and result in better peak and part-load performance.



Consider gas-fired radiant heating systems for areas with high ceilings, spot heating, and other applications where radiant heating may be more energy efficient than convective or all-air heating systems.

Condensing Boiler Operating Efficiency

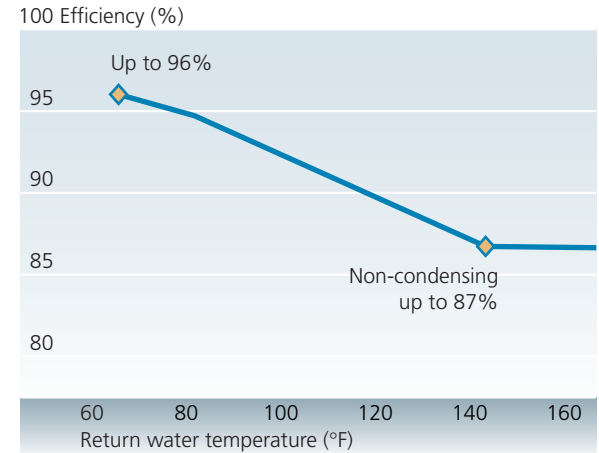

Condensing boilers operate at their highest efficiencies when the return water temperature is below 120°F.

Avoid selecting steam boilers for heating LANL buildings. Steam systems are not recommended because of their typical high maintenance and poor efficiency. Should a steam boiler system be included in the design, consult an experienced boiler manufacturer regarding the boiler, heating surfaces, valves, combustion, condensate, condensate return, flashing, automatic temperature control, steam traps, pressure reduction, and steam metering.

Combined Heat and Power (CHP)

Combined heat and power systems generate both electricity and heat. Consider using CHP systems where the heat can be used for space heating, powering an absorption cooling system, or providing heat for a particular research activity. Size the CHP system so that all the waste heat is used most of the time. One appropriate application of CHP systems is to provide standby (emergency) power instead of installing an emergency generator for a building with a process heat load.

The low cost and high thermal-to-electrical efficiency (23 percent to 27 percent) of micro-turbines are making CHP systems viable in sizes of 30 kW and larger. CHP systems are also developing the reputation of being low-maintenance systems.

Remember to derate the capacity of all combustion devices (e.g., boilers and turbines) at LANL for altitude.

CHP systems reduce peak electrical demands of buildings. If CHP systems are considered for all new LANL buildings, then installing these systems may help delay construction of new high-voltage feeds to the LANL campus. This can be an important factor where available electrical power is limited.

Heating Systems

The primary heating energy categories are –

- Outside air preconditioning
- Space reheat
- Overcoming envelope heat loss
- Heating domestic hot water and process water.

Precondition ventilation air for freeze protection by using exhaust air heat recovery systems, natural-gas-fired furnaces, or hot water coils. Natural-gas-fired furnaces located in the preconditioning unit can be direct-fired (combustion products go into the airstream) or indirect-fired (combustion products go out a flue). Direct-fired furnaces are more efficient, but only if used in systems needing 100% outdoor air. Use modulation controls with good turndown for all gas-fired units.

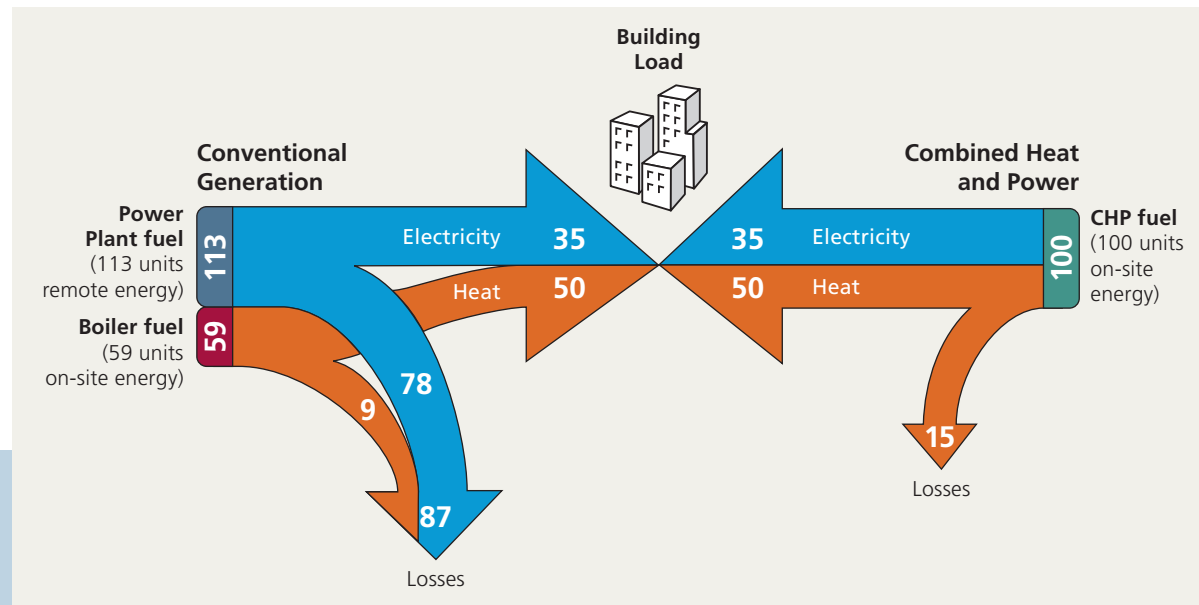

The efficiency of CHP is approximately 85%, compared to about 30% for a typical central power plant. This diagram assumes operation of 1-MW or larger gas turbines or fuel cells.



Smaller solar hot water systems, such as the system installed at the Chesapeake Bay Foundation's Philip Merrill Environmental Center in Annapolis, Maryland, are more common than larger systems, such as that found on the LANL Otowi Building.

Robb Williamson

Minimize space reheat requirements by supplying air to the space at a temperature appropriate to the loads in that space. Minimize laboratory space conditioning system energy consumption by supplying air as warm as possible to the space when it is warm outside and as cool as possible when it is cold outside.

Guidelines for Laboratory Supply Air Temperatures

A common design error is to condition all air to 55°F before distributing that air to any part of the building. This is an appropriate strategy when supplying air to spaces with low ventilation loads and constant space loads, such as office spaces. Laboratories have high ventilation loads and varying space loads, depending on the activities occurring within the laboratory. Supplying 55°F air to a laboratory with a high ventilation load but a low space load requires that this air be reheated before it enters the space. Cooling the air to 55°F then reheating it wastes energy. Alternatively, supplying 62°F air to a laboratory with high ventilation and space loads requires that that air be cooled before it enters the space. Heating the air to 62°F then recooling it wastes energy.

Suggested Reset Supply Air Temperature Schedule for Laboratories

Outside Air Temperature (°F)	Supply Air Temperature (°F)
< 55	55
56–62	Floats within the dead band; supply air temperature equals outside air temperature
>62	62

Work closely with the architectural design team members during the early design phases to ensure inclusion of a good thermal envelope for the building. Reducing building loads minimize, the need to provide heating system equipment to overcome heat losses through the envelope (see Chapter 4).

There are many variations in hot water system requirements at LANL, from very light domestic hot water (DHW) loads to process-level loads. Typically, the DHW loads are quite small in most LANL buildings. In all buildings, minimize the DHW demand as much as possible by specifying low-flow sink and shower fixtures.

Design the DHW system to meet the anticipated loads (DHW systems are often oversized in commercial buildings). Consider point-of-use hot water systems in buildings with light DHW loads (also known as instantaneous hot water heaters). These systems avoid the

Electricity costs about four times as much as natural gas at LANL. If renewable energy systems cannot be used to provide space and water heating, then select natural gas as the primary fuel source for heating systems.

central hot water storage tank and system circulator pumps found with centralized systems. They save energy by eliminating thermal losses through the storage tank and eliminating the pump loads.

Central gas-fired hot water systems are typically a more efficient solution as the DHW loads increase and to meet process loads. For these systems, be sure to schedule circulator pump operation based on use patterns.



Solar hot water system on the LANL Otowi Building. The excellent solar resources in Los Alamos make solar hot water systems a viable solution for meeting DHW loads and preheating water for process and space heating loads. These systems have a high first cost, but very low operating costs. A year-round water heating load, such as for cafeteria, locker room facilities, and process loads, is required to make solar hot water systems cost-effective.

Distribution Systems

Properly engineered distribution system design, good specifications, and accurate installation result in system that efficiently deliver heated and cooled air or water from the point where it is generated to the point where it is used. In addition to the chillers, boilers, air handling units, and other components discussed so far in Chapter 5, good distribution system design includes effective insulation, condensation control, and minimized air leakage.

The two most common and efficient types of water distribution systems within a building are primary/secondary and variable flow primary pumping systems.

Specify all motors controlled by variable speed drives as “inverter duty.”

Primary/secondary systems provide energy-saving opportunities through variable flow (only pumps the water actually needed to meet the required loads) and

elevated return-water temperature. The cost of variable speed drives has decreased significantly in recent years, resulting in an extremely cost-effective approach to reducing wasted pumping energy. Two-way valves cost less to buy and install than three-way valves.

Issues such as the minimum, maximum, and acceptable change of flow rate through the boilers or chillers, and the installation of a bypass to satisfy the minimum flow through the chiller will affect the design of variable flow primary pumping systems. These systems cost less to purchase and operate than the primary/secondary systems because there are fewer pumps in the system.

Provide controls that automatically reset supply water temperatures by representative temperature changes responding to changes in building loads or by outside air temperatures. It is best if fluid temperatures for heating equipment devices are as low as practical and as high as a practical for cooling equipment, while meeting loads and minimizing flow quantities.

Guidelines for Water Distribution System Design

- Design systems for the maximum temperature differential to improve equipment efficiency and reduce pumping energy
- Vary the flow quantity with the load, using two-way control valves and variable speed pumps
- Design for the lowest practical pressure drop
- Provide operating and idle control modes
- Identify the critical pressure path and size the pipe runs for minimum practical pressure drop when locating equipment
- Specify high-efficiency pumps with high-efficiency (NEMA Premium) motors

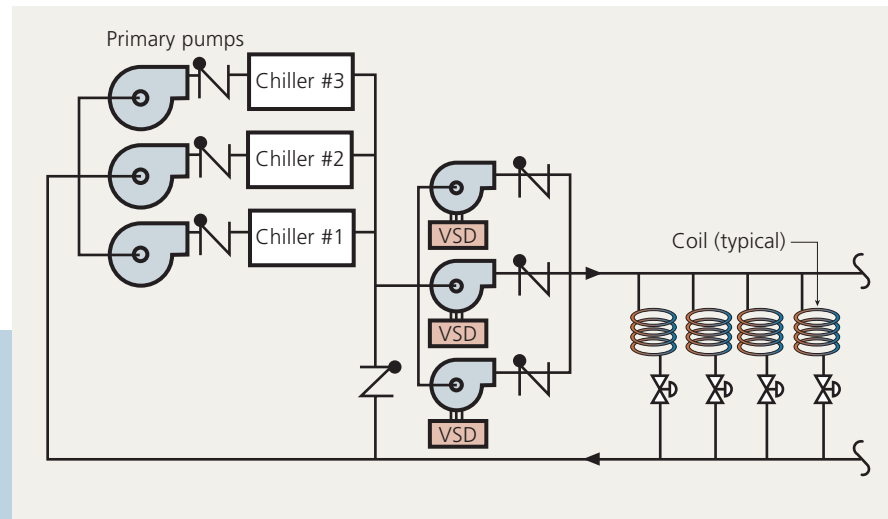

Primary/secondary pumping strategies provide constant water flow through the boiler(s) or chiller(s) and vary the flow through the system with variable speed drives on the secondary pump motors and two-way valves throughout.

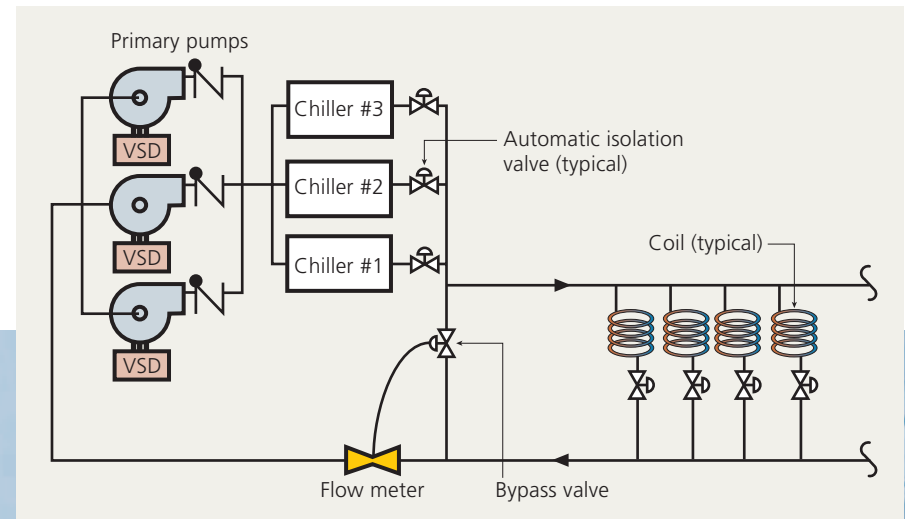

Variable flow primary pumping varies the flow through the boiler(s) or chiller(s) and the coils at the air-handling units, relying on fewer pumps than the primary/secondary strategy.

Plumbing and Water Use

Los Alamos County supplies water to LANL from a series of deep wells drawing water from a regional aquifer that discharges into the Rio Grande river valley. Approximately 88 percent of the discharged water is regulated by the National-Pollution-Discharge-Elimination-System (NPDES) and groundwater (GW) permits. Most discharged water is treated by the sanitary waste system plant or in specialized treatment systems, such as the High Explosives Wastewater Treatment Plant. Non-regulated discharges primarily result from construction activities and landscaping.

Water conservation procedures currently being implemented at LANL decrease maintenance and life cycle costs for building operations and help achieve the water conservation goals of the Laboratory. In addition, facilities that use water efficiently reduce overall costs to LANL by lowering water use fees from Los Alamos County, volumes of sewage to treat, energy and chemical use, and capacity charges and limits.



Sensors that automatically shut off faucets and flush toilets improve hygiene, comply with Americans with Disabilities Act (ADA) requirements, and save water.

LANL Water Consumption

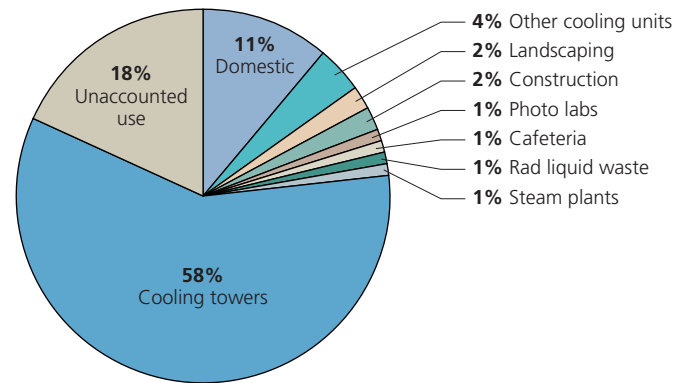

Cooling towers are the largest water consumers on the LANL campus, accounting for 58% of the LANL campus water consumption.

Warren Gretz

Indoor Plumbing Fixtures

Federal law mandates that all plumbing fixtures meet or exceed the minimum Energy Policy Act of 1992 (EPACT) requirements. Specify fixtures that exceed the EPACT requirements, including dry fixture and control technologies, in all new LANL buildings.



Sheila Hayter

Waterless urinals represent the most water-efficient urinal option.

EPACT 1992 Standards for Indoor Plumbing Fixtures

Fixture	EPACT Requirement	Comments
Toilets	1.6 gallons per flush (gpf)	<p>Flush-valve toilets are typically used in commercial applications because they offer durability and less maintenance compared to gravity tank toilet fixtures.</p> <p>Devices sensing motion (ultrasound) and heat (infrared) and timers help avoid double flushing and flushing during unoccupied times, eliminate handling of fixture controls, improve hygiene, and meet ADA requirements.</p> <p>It is recommended not to pursue water use reduction beyond 1.6 gpf for toilets.</p>
Urinals	1.0 gpf	<p>Waterless urinals provide first-cost savings (e.g., eliminating the need to provide a water line and flush valve) and less maintenance (e.g., leaks, valve repairs, water overflows, etc.) over conventional urinals.</p> <p>Waterless urinals require the use and periodic replacement of a strainer cartridge and sealant fluid.</p>
Showerheads	2.5 gallons per minute (gpm) at 80 pounds per inch ² (psi)	<p>Metering shower systems are typically used for high-use applications such as health clubs.</p> <p>When specifying low-flow showerheads, be sure to select those that will supply water at a pressure that is satisfactory to the user.</p>
Faucets	2.5 gpm at 80 psi	<p>Metering and self-closing faucets (faucets that automatically shut off after a certain period of time or when the user moves away) provide water savings by preventing faucets from being left on (or not completely shut off) and preventing overuse.</p>
Metering Faucets	0.25 gallons per cycle (gpc)	<p>Microprocessor-controlled sensor (motion or infrared-sensing devices) valves can be custom programmed to stay on for predefined lengths of time for water conserving needs.</p> <p>Sensor-operated faucets improve hygiene, are ADA-compliant, and save water.</p> <p>Sensor control devices are usually battery-operated for retrofit installations and hardwired for new construction. They require an electrician in addition to a plumber when maintenance problems occur.</p>

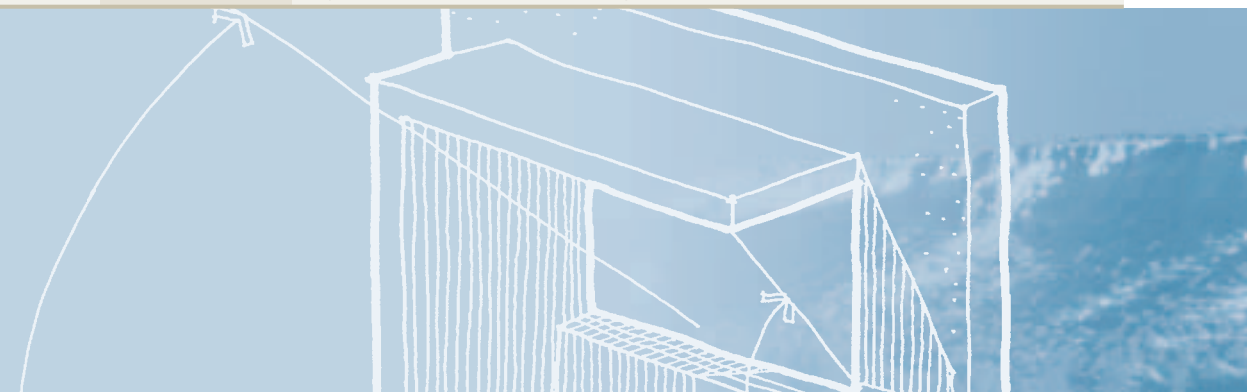

EPACT 1992 Standards for Indoor Plumbing Fixtures

Fixture	EPACT Requirement	Comments
Drinking water fixtures	N/A	<p>Bottled water coolers offer the highest potential for water conservation because dispensed water must be directed into a container such as a glass or bottle.</p> <p>From an overall sustainability point of view, bottled water uses more resources than a drinking fountain because the bottles must be cleaned, filled, and delivered, and must be retrieved when empty.</p> <p>Energy savings can be achieved by either not providing chilled water for drinking, or by ensuring that chillers and heaters for drinking water are energy-efficient and do not operate during unoccupied times (e.g., timers are a low cost means of preventing such chillers from operating continuously).</p> <p>Use only Energy Star qualified bottled water coolers in LANL buildings with bottled water.</p>

Water-efficiency measures in buildings can easily reduce water usage by 30% or more. In a typical 100,000-ft² office building, low-flow fixtures and equipment can save 1,000,000 gallons of water per year or more, based on 650 building occupants each using an average of 20 gallons per day.

Cost Comparisons for Plumbing Fixtures

Fixture	Standard (EPACT)	Better Performance	High Performance for Sustainability
Toilets	1.6 gpf	Same as baseline (1.6 gpf)	Same as baseline (1.6 gpf)
Urinals	1.0 gpf	2x to 3x (for 0.5 gpf)	0.5x to 1x (waterless)
Showerheads	2.5 gpm	No cost increase (for 2.0 gpm)	No cost increase (for 1.5 gpm)
Kitchen Faucets	2.5 gpm	No cost increase (for 1.5 gpm)	No cost increase (for 0.5 gpm)
Lavatory Faucets	2.5 gpm	No cost increase (for 0.5 gpm)	1.5x to 3x (for metering, adjustable cycle, and flow)

Wastewater recycling/reuse (downcycling)

Common uses of recycled/reused wastewater include: landscape irrigation, toilet and urinal flush water, space heating and cooling, and other water-consuming processes or equipment that do not require potable water. Wastewater recycling/reuse and treatment systems provide significant water savings, reduce the costs associated with purchasing and discharging facility water, and reduce site stormwater runoff (see Chapter 7). Consider the following questions when assessing wastewater recycling/reuse systems:

- What are the water reuse opportunities?
- What is the minimum water quality needed for the reuse opportunities?
- How much wastewater will the facility generate?
- What are the wastewater sources that satisfy the water quality requirements?
- How much wastewater should be recycled?
- How extensive a treatment system is needed?
- Where will the treatment system be built?
- What are the implementation costs?
- What are the operational and maintenance costs?
- Will the ultimate savings from reduced water consumption and discharge costs outweigh the cost of the system?
- What is the payback period?



Water-Consuming Mechanical Systems

Cooling towers are the most common type of cooling system for large cooling loads. Make-up water must be added to cooling towers to replace the water lost by evaporation, bleed-off, and drift. Operate cooling towers at the highest possible cycles of concentration to save water.

Sources of make-up water for cooling towers can be once-through cooling system, process wastewater, and treated municipal wastewater effluent. The most water-intensive cooling method is once-through cooling, in which water contacts and lowers the temperature of a heat source and then is discharged. Eliminate once-through systems when possible. If it is not possible to eliminate these systems, then integrate shut-off devices to prevent the water from running when the once-through unit is not operating. Also consider converting once-through systems to recirculating systems by connecting them to cooling towers or chilled water systems.

The New Mexico Environment Department

The New Mexico Environment Department (NMED) encourages the recycling/reusing of wastewater that has not come in contact with food or human waste (typically referred to as greywater). Some level of treatment may be required before waste can be recycled/reused. Contact the NMED (800-219-6157) for wastewater recycling/reuse assistance, such as answering questions, reviewing designs, and obtaining a NMED permit (that may be required for modifying plumbing or disconnecting plumbing from the sewer system).

Robb Williamson

Steam boilers require make-up water to replace blow-down water (periodically released from the boiler to remove accumulated solids and sediments), or to compensate for uncollected condensate (in steam generator systems). The following water conservation and recycling/reuse options are applicable for boiler and steam generator applications:

- Consider a condensate return (recycle/reuse) system that enables otherwise uncollected condensate to be returned as boiler feed or cooling tower make-up water.
- Employ an expansion tank to collect boiler blow-down water and permit cooling (rather than mixing cold water) for recycling/reuse. Consider use of a heat exchanger to preheat boiler feedwater and cool blow-down.

- Depending on water quality considerations, condensate and blow-down may be used for other non-potable-water-consuming applications.

Consider the reuse of once-used deionized water for a different application because deionized water is often more pure after its initial use than municipal. Also consider using reject water from reverse osmosis (RO) systems.

First minimize the quantity of wastewater generated, then implement recycling/reuse of the unavoidably generated wastewater. Consider the following water-efficiency with features and techniques when selecting HVAC equipment and other industrial processes and equipment:

- Avoid single-pass or “once-through” process cooling systems. Consider multi-pass, recirculation, or cooling tower systems.

- Consider connecting equipment to a closed-loop system rather than using a potable water source.
- Adjust overflows from recirculation systems by controlling the rate at which make-up water is added: install float-controlled valves on the make-up lines, close filling lines during operation, and provide surge tanks for each system to avoid overflow.
- Install high-pressure, low-volume nozzles on spray washers.
- Avoid high-volume hoses with high-pressure. Consider low-volume cleaning systems.

Proper operation and maintenance of water-consuming mechanical equipment is another important component to the overall water conservation effort. Keep in mind ease of operation and maintenance of mechanical systems when designing new LANL buildings.



The LANL Nicholas C. Metropolis Modeling and Simulation Center currently uses treated wastewater from the LANL complex for cooling tower application.

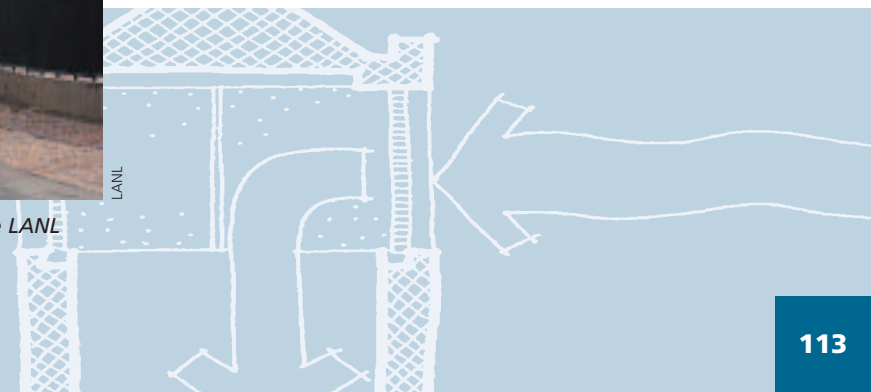

Rainwater Harvesting Systems

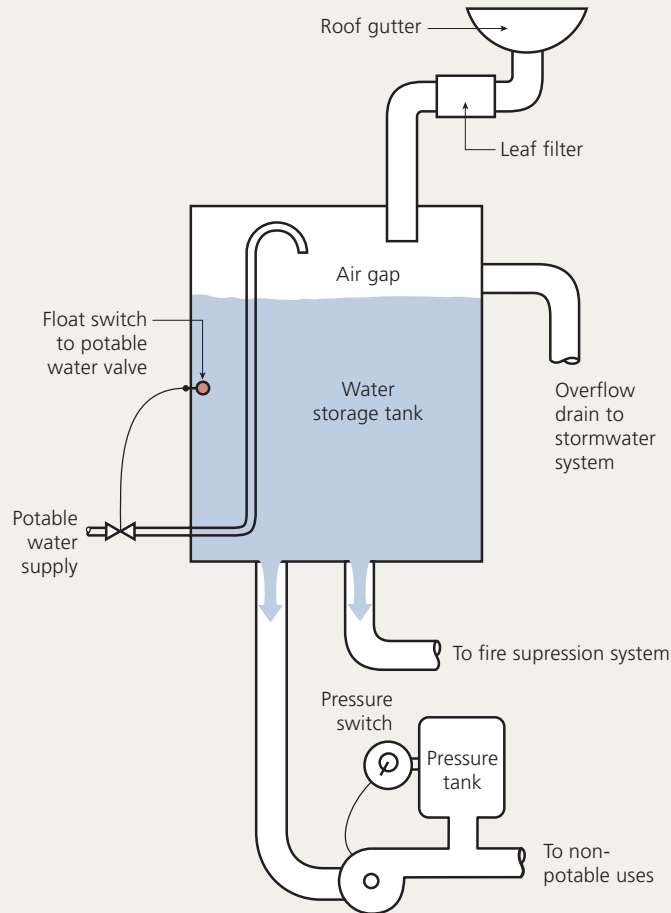

Rainwater harvesting systems collect rainwater runoff from a building roof and store the water in a cistern (water storage tank). A pump transfers water from the cistern to a pressure tank to be used by evaporative cooling systems, toilets, landscape irrigation, and other non-potable water loads. Plan for freeze protection when designing these systems. Capturing and using rainwater reduces that amount of water that needs to be pumped from wells and reduces stormwater runoff. The average historical moisture at LANL is about 18 inches per year. The annual amount of rainwater available for each square foot of roof area at LANL is about 11 gallons. Size the rainwater storage tank for the maximum normal rain-fall event (e.g., 90% of the area's storms, not the 100-year events).



Robb Williamson

A rainwater harvesting system on the Chesapeake Bay Foundation's Philip Merrill Environmental Center in Annapolis, Maryland, captures rainwater for use in fire suppression and in the building's sinks.

Building Control Systems

Building energy management control systems (EMCS) control operation of a building's mechanical and electrical systems. A good EMCS design takes advantage of advanced control strategies to meet the building's original sustainable design intent. After commissioning (see Chapter 9), the building operator guarantees the building continues to perform sustainably by adjusting the EMCS to accommodate changes in occupant requests and building functions. Poor building operation will reduce the energy saving benefits of an otherwise good design.

An EMCS is an integrated network of sensors, controllers, actuators, and software. When programming an EMCS, designers typically specify use of reset schedules for supply air discharge temperatures, hot-deck and cold-deck temperatures, mixed air temperatures, variable volume duct pressure and flow, heating water tempera-

ture, condenser water temperature, secondary chilled water loop pressure, and chiller and boiler staging. A good EMCS sequence avoids conflicts between these schedules so that savings achieved by one component are not offset by losses at another component. Evaluate each component control strategy on an individual basis and then determine the cumulative effects of various configurations. Consult with a controls representative to assist in identifying where interferences may occur.

An EMCS saves energy and money by:

- Optimizing the equipment start and stop times (e.g., turning fans off during unoccupied hours).
- Operating the equipment at the minimum capacity necessary (e.g., running the fans in a VAV system at the minimum speed needed).

Load shedding means that non-essential equipment is turned down or off when the building is approaching the set demand limit. Sequential startup of equipment reduces spikes in electrical loads by not allowing simultaneous startup of major electric equipment. Both ensure that the electrical demand for the building or a specific piece of equipment within the building does not exceed a predetermined maximum.

- Limiting peak electric demand.

Direct digital control (DDC) systems, the preferred method of controlling buildings at LANL, use electronic signals to actuate, control, and send/receive input and feedback to/from equipment. Centralized DDC systems monitor the building systems as a whole instead of controlling individual equipment separately, reflecting the basis for designing and operating energy-efficient buildings. Central systems also provide opportunities for remote access through modems or networks and can record historical data about equipment operation that can later be used for troubleshooting and diagnostics.

Design an easy-to-use EMCS

The most important consideration when selecting and specifying an EMCS is ease of use. Standardizing the EMCS to one or two manufacturers who have an open-protocol system will help the LANL facilities personnel become better acquainted with the systems on site and avoid having to learn about multiple types of systems. To further the facility managers' flexibility to monitor and control all LANL buildings, interconnect the EMCS through a network to allow for central monitoring.



Robb Williamson

Guidelines for Designing EMCSs

- Specify and install EMCSs in all new LANS buildings. If a building is very small, such as a transportable office, install programmable thermostats.
- Require a detailed sequence of operation for all systems controlled by an EMCS. The sequence must describe all modes of operation of the system and how they are accomplished.
- Commission EMCSs and periodically check calibration of critical sensors (see Chapter 9).
- Allow as wide a “dead band” as possible for temperature and humidity set points, and increase the dead band during unoccupied hours. Thermostatic controls for office areas can be programmed for a cooling set point of 75°F and heating set point of 72°F. Plan for an adjustable dead band of at least 6°F ($\pm 3^\circ\text{F}$) to reduce the cycling of the heating and cooling equipment and to prevent switching back and forth between the two systems. Having different set point temperatures for heating and cooling seasons increases personnel comfort because people tend to dress according to the season (e.g., warmer in the winter). Also, the temperature and humidity of unoccupied spaces can float (drift beyond the levels required when the space is unoccupied) until the space becomes occupied again or when the space gets too cold (below 55°F).
- Integrate economizer controls with the mechanical cooling (leaving air temperature controls) so that mechanical cooling is only operated when necessary and to avoid over-cooling the supply air.
- Design the systems and controls so that operating the economizer does not increase heating energy use.
- Control VAV systems to have a reset temperature such that one box is always fully open. This strategy reduces the supply duct static pressure.
- Use a sensor for multiple purposes, if possible. For example, a current transducer (CT) may be used to verify that a pump is operating properly and to calculate and record pump energy use. Also, tie occupancy sensors that control the lighting to the VAV boxes serving the same space to control temperature and the amount of outside air (e.g., only condition and supply outside air to the space when it is occupied).
- Provide controls that automatically reset supply water temperatures (heated and/or chilled water) by representative temperature changes responding to changes in building loads or by outside air temperatures.
- Use lockouts based on time of year or outside temperatures to prevent simultaneous operation of the heating and cooling systems.

Electrical Power Systems

The cumulative pollution burden of producing electricity is three times that of a building's electrical load at the building site. Ensuring efficient transfer and consumption of electricity within a building will save money, because less electricity is needed, and will reduce the amount of pollutants emitted at the power plant to produce the electricity that the building consumes. Improve the efficiency of building electrical power systems by:

- Using higher voltage power distribution systems in buildings, such as 480/277 volts where electric codes allow. High-voltage distribution systems can result in better economics, smaller conductor sizes, and less energy consumed in the system due to lower line losses.
- Sizing transformers as close as possible to the actual anticipated load to avoid oversizing and to minimize fixed thermal losses. When possible, distribute electric power at the highest practical voltage and power factor consistent with safety.

Green certificates

Purchasing “green power” is one way to minimize the environmental burden of using electricity generated using fossil fuels. Purchasing green certificates (also known as green tags, renewable energy certificates, or tradable renewable certificates [TRC]) represent the environmental attributes of power generated from renewable electric plants. Several organizations offer TRCs. The approximate cost of TRCs is 2¢/kWh. These certificates support power generation from newly developed power generation facilities that use renewable energy technologies (power from the sun, wind, geothermal, low-impact hydropower, or biofuels). For more information see: www.green-e.org/your_e_choices/trcs.html.



Electricity for LANL is generated mostly from burning fossil fuels (primarily coal). Only about one-third of the energy of the source fuel is delivered to the end user as electricity. The rest is lost in inefficiencies in generation and distribution (see diagram on page 106).

- Comply with the National Energy Managers Association (NEMA) criteria for premium transformers to reduce the no-load (core) losses and the coil (winding) losses during transformer operation. The resulting energy savings will range from about 30 percent at no-load to about 10 percent at full load. Always specify ENERGY STAR transformers.
- Specify higher-efficiency, liquid-filled transformers. These transformers typically use oil as a combination coolant and insulating medium and they are most frequently installed outdoors.
- Select energy-efficient electrical motors to reduce building electricity consumption. It is best if all motors one horsepower and larger are three-phase and “NEMA Premium.”

Los Alamos experiences excellent solar resources. For this reason, consider integrating solar electric systems (PV), into the design of new buildings. PV panels produce DC electricity from sunlight. If AC power is required, an inverter converts the DC electricity to AC.

Uninterruptible Power Supply Systems

Uninterruptible power supply (UPS) systems provide electricity when grid power fails. UPS systems consist of rectifiers, battery storage, inverters, and controls to convert AC electricity to DC for the storage batteries, and back to AC for the load. The batteries are typically sized to meet the load for 10 to 15 minutes. All UPS systems consume energy to maintain a charge in the batteries. Avoid UPS systems unless the mission requires them.

Two types of UPS systems exist: on-line UPS and standby UPS. An on-line UPS feeds the entire load through a rectifier to a DC bus that serves the batteries. The DC power is converted to AC power to serve the load. This design eliminates grid disturbance; however, it is less efficient than the standby design because the entire load passes through a rectifier and an inverter.

If an on-line UPS system is chosen, it can be augmented with solar electric (PV), power at the DC bus voltage. This arrangement saves the inverter cost in a grid-tied PV system. It also provides a

longer run time for the UPS system if the power failure occurs during the daytime because the PV system will feed part of the load.

A standby UPS system exposes the load to utility power during normal operation, if utility power fails a switch transfers the load to the UPS system until the utility power becomes available. A standby type UPS cannot readily accept PV augmentation because the load is not normally served by the UPS.



Ryan Ault

A PVIUPS system provides backup power for the Site Entrance Building at the National Renewable Energy Laboratory (NREL) in Golden, Colorado. The generator's 600-watt PV array charges a storage system of eight rechargeable batteries and enables NREL's security staff to maintain critical functions during power failures.

Avoid imbalanced supply circuits

Use three-phase equipment when possible. If single-phase loads exist, such as single-phase motors and plug loads, distribute these loads evenly among the three phases.

PV electricity is not currently cost-effective for most applications at LANL because of the low cost of grid electricity. These systems can be cost-effective for applications where the power grid location is more than ¼ mile away from the building site and when trenching would otherwise be required to bring power to signs or outdoor lighting.

The lifetime operating cost of PV systems is low and these systems can help protect LANL from future electricity shortages.

Metering

Monitor the actual performance of individual LANL buildings through metering. In new buildings, metering verifies that sustainable design and operational goals are met or detect when the buildings are not performing as designed. Metering also helps identify opportunities for improving performance in existing buildings.

Record both electrical consumption (kWh) and electrical demand (kW) to determine building performance. Electrical demand is the time average value over a sliding 15-minute time frame. The LANL automated meter reading system is capable of recording consumption and demand (see Appendix D).

The Federal Energy Code 10CFR434 (see Appendix A) requires buildings with a connected service of over 250 kVA to have provisions (sufficient space to attach portable or permanent metering) for submetering the electrical consumption of HVAC&L systems and large equipment loads. According to the 10CFR434 guidance, the following is recommended for LANL:

Metering alone cannot save energy; however, regularly collecting and recording meter data and looking for unexplained changes can be a tool for assessing and identifying performance problems.

- Install submetering equipment for measuring lighting loads, HVAC system loads, and equipment loads of more than 20 kW.
- Further subdivide the HVAC system metering to separately measure ventilation fan use and cooling plant use for large buildings with complex HVAC systems, such as laboratory buildings.
- Install gas meters in all LANL buildings having gas service, preferably connected to the automated meter reading system. Separately sub meter large process gas loads, if they exist.
- Install water meters in all LANL buildings with water service, preferably connected to the automated meter reading system. Separately sub meter large water use systems, such as a cooling tower.

LANL site-wide metering program

LANL has established a site-wide metering program for recording electricity, gas, and water use data via the local area network (see Appendix D). All new LANL buildings can install meters and connect to this system.



The skylighted entryway at the Thoreau Center for Sustainability at Presidio National Park, San Francisco, California, uses photovoltaic cells that are laminated to the skylight glass to produce electricity as well as to shade and daylight.

Lawrence Berkeley Laboratory

Criteria for Sustainable Success			
	✓ <i>Standard Practice/ Code-Compliant</i>	✓ <i>Better Performance</i>	✓ <i>High Performance for Sustainability</i>
Zoning	<input type="radio"/> Zoning only by floor	<input type="radio"/> Zoning by function of laboratory and office	<input type="radio"/> Zoning by load analysis that includes envelope analysis and function analysis
System Design	<input type="radio"/> Aggregation of zones into systems	<input type="radio"/> Multiple systems used	<input type="radio"/> Multiple systems used with zones arranged by function
System Sizing	<input type="radio"/> Rules-of-thumb and base-line sizing tools used	<input type="radio"/> Equipment sizes reduced to account for daylighting contribution (no lights on)	<input type="radio"/> Hourly simulations on each zone with good diversification factors; daylighting and overhangs incorporated into simulations
System Selection – Labs	<input type="radio"/> VAV with no outside air control	<input type="radio"/> VAV supply and exhaust	<input type="radio"/> VAV plus energy recovery
System Selection – Offices	<input type="radio"/> VAV with no outside air control	<input type="radio"/> VAV with CO ₂ monitoring for outside air	<input type="radio"/> Displacement ventilation with CO ₂ outside air control and VAV supply
Ventilation Flow Rate	<input type="radio"/> Constant-volume system	<input type="radio"/> Flow rate less than 1.5 cfm/ft ²	<input type="radio"/> 1 cfm/ft ² net lab area, less than 0.5 cfm/ft ² when unoccupied
Exhaust Stack Design	<input type="radio"/> Fixed-speed exhaust for each device	<input type="radio"/> Multiple fans on central manifold	<input type="radio"/> Multiple stacks with variable-speed exhaust fans
Chillers	<input type="radio"/> Air-cooled DX with evaporator in air handler	<input type="radio"/> Air-cooled chiller producing chilled water, cooling coil in air handler	<input type="radio"/> High-efficiency (less than 0.5 kW/ton) full-load and part-load chiller with cooling tower; set total delivered cooling energy performance including tower, chiller, and pumps to less than 0.55 kW/ton; water-side economizer
Heating	<input type="radio"/> Gas-fired boiler with on-off controls	<input type="radio"/> Modular boilers	<input type="radio"/> Modular condensing boilers with low return water temperature; gas-fired radiant heating for areas with high ceilings; direct-fired modulating natural gas furnaces in 100% outside air units

Criteria for Sustainable Success			
	✓ <i>Standard Practice/ Code-Compliant</i>	✓ <i>Better Performance</i>	✓ <i>High Performance for Sustainability</i>
Combined Heat and Power	<input type="radio"/> Not considered	<input type="radio"/> Limited capacity installed	<input type="radio"/> Used in conjunction with emergency power loads and base-line power production when heating is required
Water Distribution	<input type="radio"/> Constant flow	<input type="radio"/> Primary/secondary with variable-flow and variable-speed drives on secondary pumps	<input type="radio"/> Variable-flow primary pumping with variable-speed drives
Metering	<input type="radio"/> No building-level metering	<input type="radio"/> Building-level metering of gas, water, and electric; tie to central metering system	<input type="radio"/> Submetering for plug loads, process loads, lighting, chillers, ventilation loads
Controls	<input type="radio"/> Programmable thermostats	<input type="radio"/> Stand-alone DDC	<input type="radio"/> Networked EMCS, standardized on one or two vendors, EMCS commissioned and periodically checked for calibration of critical sensors, wide deadband for temperature and humidity levels.
Electrical Distribution System	<input type="radio"/> No alternative electrical energy resource used	<input type="radio"/> High-efficiency equipment	<input type="radio"/> 5% green power, PV power meeting 1% of building load. 10% green power, highest efficiency equipment available, PV power meeting 5% of building load



References

Energy Information Agency (EIA), www.eia.doe.gov

ENERGY STAR Commercial and Industrial Transformers, http://yosemite1.epa.gov/Estar/consumers.nsf/content/comm_indust_transformers.htm

FEMP: "How to Buy a Premium Energy-Efficient Motor," www.eren.doe.gov/femp/procurement/pdfs/motor.pdf

Sustainable Building Technical Manual, www.sustainable.doe.gov/pdfs/sbt.pdf

American Society of Heating, Refrigerating, and Air-Conditioning Engineers, www.ashrae.org

Illuminating Engineering Society of North America, www.iesna.org

Laboratories for the 21st Century, www.epa.gov/labs21century

ENERGY STAR Purchasing, www.epa.gov/nrgystar/purchasing

FEMP: *Greening Federal Facilities*, www.eren.doe.gov/femp/techassist/green_fed_facilities.html

"UFEMP Resources: "Regulations and Legislative Activities," www.eren.doe.gov/femp/resources/legislation.html

"Underfloor Air Distribution: Lessons Learned." Allan Daly, ASHRAE Journal, vol. 44, no. 5, May 2002.

EPA's National Pollutant Discharge Elimination Systems (NPDES), <http://cfpub.epa.gov/npdes>

Americans with Disabilities Act, www.usdoj.gov/crt/ada/adahom1.htm

New Mexico Environment Department, www.nmenv.state.nm.us

NEMA TP-1, Guide for Determining Energy Efficiency for Distribution Transformers. National Electrical Manufacturer's Association (NEMA), www.nema.org

Additional Resources

Building Energy Software Tools Directory, www.eren.doe.gov/buildings/tools_directory/subject.html

2002 Buildings Energy Databook. U.S. Department of Energy, <http://buildingsdatabook.eren.doe.gov>

"Buying Energy Efficient Products, Federal Energy Management Program (FEMP)," www.eren.doe.gov/femp/procurement

Federal Energy Management Program, www.eren.doe.gov/femp

The background of the slide is a photograph of a stone wall with several wooden beams protruding from it. The image is overlaid with a semi-transparent blue filter. The stone wall is made of irregular, light-colored stones, and the wooden beams are dark and run diagonally across the frame.

Chapter 6: Materials

- ❑ *Material Selection*
- ❑ *Sustainable Building Materials*
- ❑ *System Integration Issues*

Chapter 6

Materials

Material Selection

The use of durable, attractive, and environmentally responsible building materials is a key element of any high-performance building effort. The use of natural and healthy materials contributes to the well-being of the occupants and to a feeling of connection with the bounty of the natural world.

Many construction materials have significant environmental impacts from pollutant releases, habitat destruction, and depletion of natural resources. This can occur during extraction and acquisition of raw materials, production and manufacturing processes, and transportation. In addition, some construction materials can harm human health by exposing workers and building occu-

pants to toxic and hazardous substances. As a result, identification and selection of environmentally preferable materials for use in construction activities at LANL provide an opportunity to limit such environmental and human health impacts.

Selecting environmentally attractive materials with reduced environmental impacts is primarily achieved through the practice of resource conservation and selection of non-toxic materials. The resources used to manufacture construction materials affect the environment by depleting natural resources, using energy, and releasing pollutants to the land, water, and

“Then I say the Earth belongs to each generation. During its course, fully and in its own right, no generation can contract debts greater than may be paid during the course of its own existence.”

– Thomas Jefferson, 1789



Unfinished pressed fiberboard and the lack of interior finishes and fixtures reduce resource use and indoor air pollutants in the Chesapeake Bay Foundation's Phillip Merrill Environmental Center in Annapolis, Maryland.

Robb Williamson

atmosphere. Materials that contain irritating, odorous, hazardous, or toxic components adversely affect human health through out-gassing of volatile components or direct contact.

Ideally, materials choices would be made based on a rigorous assessment of environmental burdens throughout the entire of the product or material. This practice, known as *environmental life cycle assessment*, is rarely feasible for most building procurement decisions. It is possible, however, to use *life cycle thinking* to compare what is known about the environmental performance of products and make informed choices. Materials that



Craig Miller, DOE

Engineered wood products conserve wood and generate less waste.

Sample Characteristics of Environmentally Preferable (EP) Materials

Category	Characteristic
Material Cost	Relative cost to equivalent products that do not possess sustainable characteristics.
Life Cycle Cost Impact (LCI)	Relative impact on life cycle cost of building operations (not to be confused with environmental life cycle assessment, which measures environmental burdens, not financial impact).
Energy Efficiency (EE)	Construction materials that directly influence building energy use.
Water Efficiency (WE)	Construction materials that directly influence building water use.
Locally Manufactured (LM)	Construction materials that are manufactured within a defined radius (500 miles for the LEED Rating System) of Los Alamos, New Mexico. LANL strongly encourages the use of construction materials manufactured in northern New Mexico.
Material Reduction (MR)	Products or materials that serve a defined function using less material than is typically used.
Locally Derived Raw Materials (LRM)	Construction materials that are locally manufactured using raw materials obtained within a defined radius of Los Alamos, New Mexico. LANL strongly encourages the use of construction materials manufactured using raw materials derived from northern New Mexico.
Non-Toxic (NT)	Construction materials that release relatively low levels of emissions of odorous, irritating, toxic, or hazardous substances. Volatile organic compounds (VOCs), formaldehydes, and particulates and fibers are examples of substances emitted from construction materials that can adversely impact human health (allergens, carcinogens, irritants).
Recycled Content (RC)	Amount of reprocessed material contained within a construction product that originated from post-consumer use and/or post-industrial processes that would otherwise have been disposed of in a landfill.
Salvaged (S)	Construction materials that are reused as-is (or with minor refurbishing) without having undergone any type of reprocessing to change the intended use. This includes the reuse of existing building structures, equipment, and furnishings at LANL.
Rapidly Renewable (RR)	Construction materials that replenish themselves faster (within 10 years) than traditional extraction demand; and do not result in adverse environmental impacts.
Certified Wood (CW)	Construction materials manufactured all or in part from wood that has been certified to the standards of the Forest Stewardship Council as originating from a well-managed forest.

have a reduced environmental impact are known as environmentally preferable (EP) materials.

Environmentally preferable building materials have a reduced adverse effect on human health and the environment when compared with competing products for the same application. The selection of EP construction materials should always be based on functional performance, environmental performance, and economic costs. First costs and life cycle costs for building materials must be taken into consideration to ensure a balance between functional and environmental performance.

“We shall require a substantially new manner of thinking if mankind is to survive.”

– Albert Einstein

Sustainable Design Evaluations for Materials and Resources

Material	Material cost	Life cycle cost impact	Energy efficiency	Water efficiency	Material reduction	Locally manufactured	Locally derived raw materials	Non-toxic	Recycled content	Rapidly renewable	Certified wood	Salvaged
Ceiling tiles	= +	-						●				
Carpet	=	=		●			●	●				
Fabrics (wall/furniture)	= +	= -					●	●				
Resilient flooring	= +	= -					●	●	●			
Interior/exterior paints	=	=					●	●				
Sealants and adhesives	=	=					●					
Steel	=	=		●				●				
Cement/concrete	=	=	●	●	●	●		●				
Insulation	=	-	●		●	○	●	●				
Bathroom partitions	=	=						●				
Wood products	= +	=		●			●		●	●		
Gypsum wallboard	=	=			●	●		●				●
Furniture	= +	=						●	●	●		
Brick/CMU	=	=			●	●						
Roofing	=	=	●					●				
Windows	+	-	●									
Doors	= +	-	●					●		●		
Ceramic tile	=	=					●		●	●	○	
Insulating concrete forms	+	-	●					●				
Structural insulated panels	+	-	●					●				
Aerated autoclave concrete	+	-						●				
Exterior finishes					●	○						
Permeable paving	+	-	●					●				

○ Potentially applicable Material & Resource issue, research ongoing
 ● Applicable Material & Resource issue
 (=) Equivalent, (-) Generally less expensive, or (+) Generally more expensive

Environmentally preferable construction materials may possess any one or more of the characteristics described previously, and they may possess these characteristics in varying degrees. A product may contain more or less recycled content, for example, or be better or worse in terms of indoor air emissions. The more EP characteristics a construction material possesses, and the greater the degree to which it possesses them, the better. Materials can also have environmental drawbacks, and these must be weighed against the EP characteristics when making a selection. Finally, the

performance of a product must be assessed not only in the abstract, but also in the context of the specific application in the building.

The following internet Web sites identify manufacturers that offer products meeting one or more EP criteria for each material type:

- www.epa.gov/cpg/database.htm
- www.epa.gov/nrgystar/purchasing/2d_products.html
- www.oikos.com

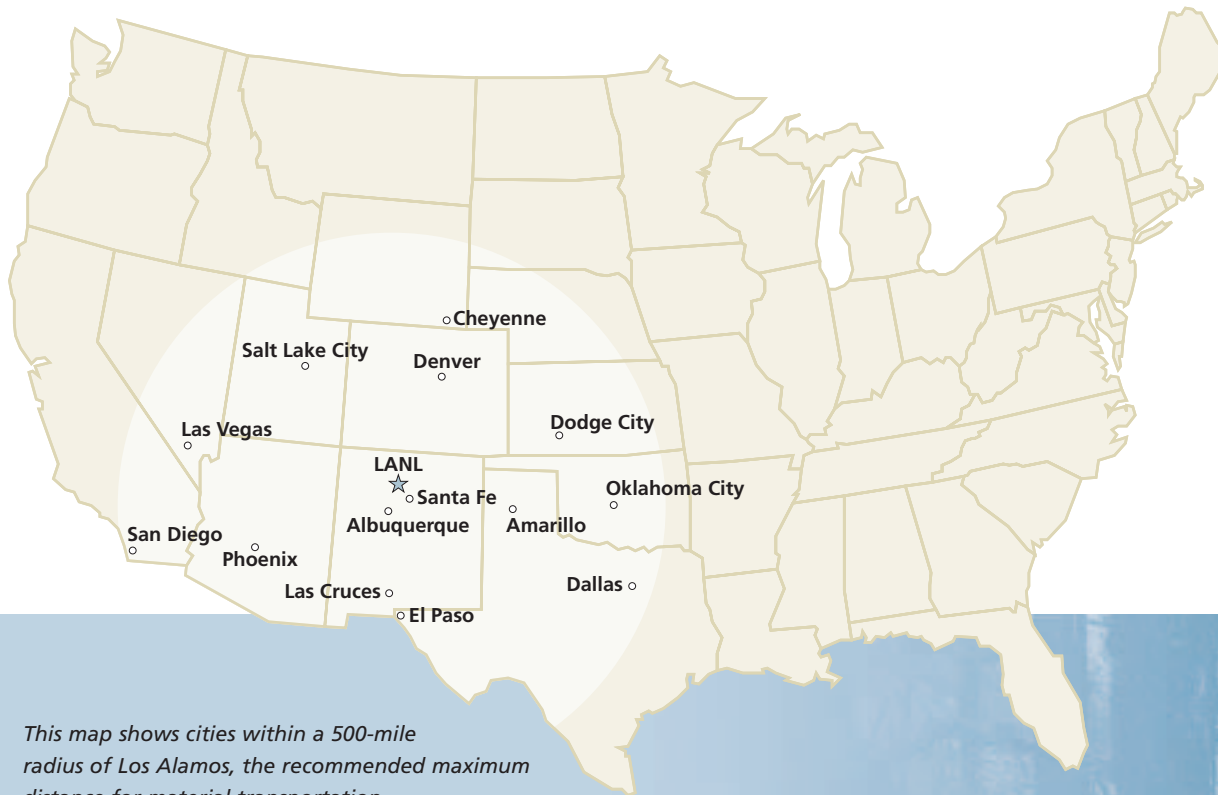

This map shows cities within a 500-mile radius of Los Alamos, the recommended maximum distance for material transportation.

Recycled-Content Products

Under the Resource Conservation and Recovery Act (RCRA), EPA established the Affirmative Procurement (AP) Program to promote procurement of products with recycled content. Executive Order 13101 was issued to improve federal use of recycled content products and environmentally preferable products and services. EPA's Comprehensive Procurement Guidelines (CPG) identifies such products along with minimum recycled content requirements for federal agency procurement. Fifty-one such items are currently designated as EPA CPG compliant items with new products and categories added each year. The product categories currently include:

- Paper and Paper Products, including sanitary tissue, printing and writing paper, newsprint, paperboard and packaging, and paper office supplies (e.g., file folders, hanging files).
- Non-Paper Office Products, including binders, recycling and trash containers, plastic desk-top accessories, plastic envelopes, trash bags, printer ribbons and toner cartridges, report covers, plastic file folders, and plastic clipboards.
- Construction Products, including insulation, carpet, cement and concrete, latex paint, floor tiles, patio blocks, shower and restroom dividers, structural fiberboard, and laminated paperboard.
- Transportation Products, including channelizers, delineators, parking stops, barricades, and cones.
- Landscaping Products, including garden and soaker hoses, mulch, edging, and compost.
- Miscellaneous Products, including pallets, mats, awards, and plaques.

Sustainable Building Materials

Ceiling Tile

Ceiling tiles are manufactured from a variety of different materials, including mineral fibers (mineral wool and cellulose fiber), fiberglass, gypsum, and polystyrene. Ceiling tiles are available with recycled content up to 95 percent. Slag wool from the steel industry, newspaper, glass, and sugar cane fiber are examples of recovered materials used in the manufacture of ceiling tiles. Ceiling tiles are also recyclable when replaced or discarded. Most major ceiling tile manufacturers have become environmentally conscious and resource-efficient through raw materials acquisition, manufacturing plant operations, and waste management.

Light reflectance is also an important part of a ceiling. The light reflectance (LR) characteristic of ceiling tiles enhances the efficiency of indirect lighting, which can reduce light requirements and energy costs. Highly reflective ceiling tiles have an LR of 0.85 or greater and should be specified with indirect, high-efficiency lighting, and can be incorporated as part of a daylighting strategy.

Recycled-content ceiling tiles are readily available at no increased cost. Additional first costs are incurred for high-LR ceiling tiles. However, the life cycle costs are lower when considering the operating cost savings associated with reduced lighting requirements for an indirect, high-efficiency lighting system.

Carpet

Nylon and polyester are common carpet fabrics. Such carpets have been identified under the CPG program to be available with recycled content of up to 100 percent for polyester and nylon carpet face fiber and up to 70 percent for nylon carpet backing. Carpet backing, such as vinyl, is also available with recycled content up to 100 percent. Reconditioned carpets are considered to be 100 percent recycled content. In addition, carpet cushion is available with recycled content ranging from 15 to 50 percent for bonded polyurethane, 40 percent for jute, 100 percent for synthetic fibers, and 60 to 90 percent for rubber. Some carpet manufacturers have buyback programs for used carpet. Most major carpet



LANL new construction uses a variety of regionally available building materials.

Recycled Content for Carpet		
Carpet Components		Recycled Content
Carpet Face Fiber	Polyester	Up to 70%
	Nylon	Up to 100%
Carpet Backing	Vinyl	Up to 100%
	Nylon	Up to 70%
Carpet Cushion	Bonded Polyurethane	Up to 50%
	Jute	Up to 40%
	Synthetic Fibers	Up to 100%
	Rubber	Up to 90%

manufacturers are increasingly environmentally conscious regarding raw materials acquisition, operation of manufacturing plants, and waste management.

Carpet can be a detriment to indoor air quality. Once installed, carpets can trap pollutants from the air and from people's shoes, and they can be difficult to clean thoroughly. If they get wet, carpets with accumulated dirt can become a breeding grounds for mold. In addition, VOCs are released from the carpet, cushion, and adhesives, especially in the period immediately following installation. The Carpet and Rug Institute (CRI) has

Volatile Organic Compound (VOC) Limits for Carpet

Carpet Components	VOC Limits
Carpet	< 0.5 mg/m ² /hr
Cushion	< 1.0 mg/m ² /hr
Adhesive	< 10.0 mg/m ² /hr

an indoor air quality (IAQ) test program that limits VOC emissions from carpet products. Carpet installed at LANL facilities should comply with the CRI IAQ test program.

Recycled content carpet complying with the CRI IAQ test program is readily available at no added cost.

Fabrics (Wall/Furniture)

Fabric materials are common components of furniture (including partitions) and sound absorbing products. Major manufacturers of these products have recycled content fabric options available. IAQ issues associated with emissions from such fabric materials as well as installation requirements (such as use of adhesives) should be considered. Materials specifiers must always consider manufacturing location and transportation requirements. Cost for recycled content fabrics can vary, but in most cases will not impact cost.



C&A Floor Coverings

LANL specs recommend recycled-content carpeting.

Requirements for recycled products

LANL, including construction contractors for LANL, are required to purchase products with recycled content, as long as recycled content versions of the products meet the applicable performance specifications, are available at a competitive price, and are available within a timeframe that doesn't delay schedules. Descriptions of CPG products and recycled content requirements are available at www.epa.gov/epaoswer/non-hw/procure/index.htm.

Resilient Flooring (Linoleum, Cork, Bamboo)

Common types of resilient flooring materials include vinyl composition tile (VCT), vinyl (PVC) tile and sheet, rubber tile and sheet, linoleum tile and sheet, and cork tile and planks. The CPG program requires 90 to 100 percent recycled content for rubber flooring. Vinyl and PVC plastic can be recycled for use in the manufacturing of vinyl flooring. Similarly, recycled rubber and tires can be used to manufacture rubber flooring. Natural linoleum is made from cork, linseed oil, wood flour, and pine rosin. Cork used in linoleum and cork tile/planks is sustainably harvested from the bark of cork oak.

Similar to carpet floor coverings, IAQ is a sustainability issue for resilient flooring. Emissions associated with the flooring material selected as well as the adhesives used for installation are potential contributors to poor IAQ. Low or no-VOC adhesives should be used for all resilient flooring installation. Vinyl-based resilient flooring (VCT and PVC) should generally be avoided due to the use of hazardous and toxic substances in the production process. Off-gassing from rubber flooring as well as odors from linseed oil in linoleum may cause problems for chemically sensitive people. Light reflectance is another IAQ issue that should be considered when selecting resilient flooring to ensure adequate

performance as part of the lighting (and daylighting) design efforts.

While recycled-content resilient flooring is readily available, cost varies widely depending on the resilient flooring material selected. Consider maintenance issues when selecting resilient flooring materials. Those requiring frequent maintenance or harsh chemicals for cleaning, waxing, and stripping should be avoided. The majority of cork and linoleum flooring is produced in Europe, resulting in significant transportation impacts.



Forbo Industries

Natural linoleum is a low-VOC flooring.



Robb Williamson

Bamboo is a rapidly renewable substitute for hardwood.

Interior/Exterior Paints

Latex paints are available with recycled content. Reprocessed latex paints in white, off-white, and pastel colors are available with up to 20 percent recycled content. Reprocessed latex paints in gray, brown, earth tones, and other dark colors are available with up to 99 percent recycled content. Consolidated latex paint (no color designation) composed of 100 percent recycled content is available for use as an undercoat or for exterior applications where color is not of concern.

Paint is a potential contributor to poor IAQ. Regardless of the types of paints used, VOC emissions from paints should be minimized. Green Seal (GS), an independent nonprofit organization that certifies products following the ISO 14024 environmental labeling standards, has developed a standard (GS-11: Paints) to limit VOC



Low and zero-VOC paints protect indoor air quality.

VOC Limits for Paint		
Paint Applications		VOC Content Limit* (grams of VOC per liter)
Interior Coatings (GS-11)	Flat	< 150
	Non-Flat	< 50
Exterior Coatings (GS-11)	Flat	< 200
	Non-Flat	< 100
Anti-Corrosive (GS-03)	Gloss	< 250
	Semi-Gloss	< 250
	Flat	< 250

*Excluding water and tinting added at the point of sale.

emissions and prohibit the use of specific toxic chemicals in paints. Interior and exterior paints used at LANL should comply with the GS standard. Although not all paints meet the GS standard, all major paint manufacturers produce GS-compliant paints (though very few of them are certified by Green Seal).

There is little or no cost increase associated with GS-compliant paints. Although recycled-content paints are available, inventories vary with the quantities being recycled. Recycled paints are typically less expensive than new “virgin” paints.

Sealants and Adhesives

IAQ considerations are the most important sustainability characteristics associated with sealants and adhesives. These products can contain toxic chemicals that are released during construction as well as during building occupancy. Due to air quality laws enacted in the state of California, all major sealant and adhesive manufacturers now offer products that limit VOC emissions and prohibit the use of specific toxic chemicals. Green Seal has also developed a standard (GS-36: Commercial Adhesives) to limit VOC emissions and prohibit the use of specific toxic chemicals. California-and/or GS-compliant adhesives should be required for construction at LANL.

No-VOC and low-VOC sealants and adhesives are readily available and are becoming the industry standard. As a result, such non-emitting or low-emitting sealants and adhesives can be used at no additional cost.

VOC Limits for Sealants	
Sealant Applications	VOC Content Limit* (grams of VOC per liter)
Architectural	250
Roadways	250
Single-Ply Roof Material Installation/Repair	450
Non-Membrane Roof Installation/Repair	300
Other	420
Sealant Primer Applications	VOC Content Limit* (grams of VOC per liter)
Architectural – Nonporous	250
Architectural – Porous	775
Other	750

*Water; acetone; parachlorobenzotrifluoride (PCBTF); cyclic, branched or linear, fully methylated siloxanes (VMS); and difluoroethane (HFC-152a) are not considered part of the product.

Source: California South Coast Air Quality District

Source: California Bay Area Air Quality Management District

VOC Limits for Adhesives			
Adhesive Applications	VOC Content Limit* (grams of VOC per liter)	Adhesive Applications	VOC Content Limit* (grams of VOC per liter)
Architectural		Specialty	
Indoor carpet	50	PVC welding	285
Carpet pad	50	CPVC welding	270
Outdoor carpet	150	ABS welding	400
Wood flooring	100	Plastic cement welding	250
Rubber flooring	60	Adhesive primer for plastic	250
Subfloor	50	Contact adhesive	80
Ceramic tile	65	Special purpose contact adhesive	250
VCT and asphalt tile	50	Adhesive for traffic marking tape	150
Dry wall and panel	50	Structural wood member adhesive	140
Cove base	50	Sheet-applied rubber lining operations	850
Multipurpose construction	70	Substrate-Specific	
Structural glazing	100	Metal to metal	30
Single-ply roof membrane	250	Plastic foams	50
*Water; acetone; parachlorobenzotrifluoride (PCBTF); cyclic, branched or linear, fully methylated siloxanes (VMS); and difluoroethane (HFC-152a) are not considered part of the product.		Porous material (except wood)	50
		Wood	30
		Fiberglass	80

Steel

All steel manufactured in the United States contains recycled content. Recycled content varies based on the type of furnace used for processing. Steel from a Basic Oxygen Furnace (BOF) contains approximately 30 percent recycled content on average. Steel from an Electric Arc Furnace (EAF) contains nearly 100 percent recycled content. Structural shapes (such as I-beams) are typically manufactured using the EAF, while historically, other steel products such as plates, sheets, and tubing components have been manufactured using the BOF. As EAF plants get more sophisticated, however, more and more profiles are available from those facilities. Although local manufacturers of structural steel may be difficult to identify, local fabricators of structural steel are readily available.



Pennsylvania Department of Environmental Protection

The headquarters of the Pennsylvania Department of Environmental Protection was constructed from sustainable resources, such as wheatstraw, cork, recycled glass, and steel.

Structures should be designed to use the least amount of steel adequate to do the job. At a minimum, steel surfaces generally require a protective primer coat to prevent rust and corrosion. Depending on the visibility of the particular material, paint may also be applied. Such coatings have potential to degrade air quality by emitting toxic VOCs. No- or low-VOC paints and primers should be applied to steel surfaces when such coatings are required. In addition, application of paints and primers at the manufacturing facility is always preferable due to better process emission controls.

No additional costs are associated with recycled-content steel products due to the inherent recycling in all U.S. steel manufacturing processes. Although some products manufactured using foreign steel may actually be less expensive, the recycled content in foreign steel may be unknown. Foreign steel products are not recommended due to the environmental cost associated with energy and natural resources expended for transportation.

Cement/Concrete

The manufacturing of cement has significant environmental impacts, including energy consumption, natural resource depletion, and greenhouse-gas emissions. The manufacturing of cement is the most significant contributor to these emissions. The amount of cement used in concrete can be reduced by replacing a portion of the cement with coal fly ash and/or ground granulated blast furnace (GGBF) slag. The level of fly ash in concrete typically ranges from 15 to 35 percent of total cementitious material, but can reach 70 percent for use in massive walls, girders, road bases, and dams. The level of GGBF slag usually ranges from 25 to 50 per-

cent. The amount of fly ash and/or GGBF slag used in cement or concrete constitutes the recycled content. Cement and concrete containing such additives should be readily available at no increased cost. An additional EP feature of concrete is its potential to contribute to energy efficiency by providing thermal mass to a building envelope that slows heat transfer. Fly ash often contains elevated concentrations of natural radioisotopes. Radioanalytic laboratories should evaluate the potential impact of the residual radioactivity.



Coal fly ash is a byproduct of coal burning at electric utility plants, while slag is a byproduct of iron blast furnaces. Both can replace cement in concrete. The walls of this building are constructed with concrete made from coal fly ash and insulated with an Exterior Insulating Finishing System (EIFS). The additional thermal mass provided by the insulated concrete walls combined with the other passive solar design features reduce the annual energy costs by more than 60%.

Sheila Hayter

Insulation

Insulation is a critical component of an energy-efficient building. Energy (or thermal) performance associated with insulation is based on the thickness needed to achieve a specified or desired thermal resistance (such as R-19 walls and R-30 roof). In addition to the energy (or thermal) characteristics of insulation, recycled content and toxicity (to both human health and the environment) of insulation must be considered. Although some manufacturers now offer formaldehyde-free fiberglass insulation, phenol formaldehyde is widely used to bond the fibers in fiberglass batts. In addition to formaldehyde concerns, airborne fiberglass particulates are considered an inhalation irritant. Such fibers can become airborne when installing insulation, and if allowed to enter the HVAC system can be distributed throughout a building. However, insulation manufacturers can control the release of particulate fibers by encapsulating the batts in a thin plastic film.

The optimal amount of insulation in the building envelope should be determined based on computer models of the building's overall thermal performance (see Chapter 5). Insulation containing recycled-content material is readily available from all major insulation manufacturers at no increased cost. Formaldehyde-free fiberglass insulation, however, is relatively new, and not universally available.



Bob Hendron

CPG-Required Recycled Content Levels for Building Insulation

Insulation Type	Recycled Content
Rock Wool	At least 75%
Fiberglass	At least 25%
Cellulose	At least 75%
Plastic Rigid Foam (polyisocyanurate and polyurethane)	At least 10%

Bathroom Partitions

Restroom and shower partitions/dividers are constructed primarily of steel or plastic, although partitions/dividers can also be made of wood or marble. Such partitions/dividers are available with recycled contents ranging from 20 to 100 percent for plastic and from 30 to 100 percent for steel. Steel partitions/dividers are typically painted to prevent rust or corrosion. Factory-applied paint should always be required to minimize VOC emissions following installation.

No cost increase is incurred by using restroom and shower partitions/dividers constructed of recycled-content plastic or steel when compared to non-recycled-content plastic and steel. It should be noted that recycled-content steel does not include stainless steel. Partitions/dividers constructed of stainless steel, or marble, are significantly more expensive than painted steel or plastic.



Wood Products

Wood is a versatile construction material that can be used for both structural and non-structural applications. However, due to degradation from exposure to sun and weather and the corresponding maintenance required, wood is not recommended for exterior surface finishes.

Wood may be salvaged, certified, and low in toxicity. Wood products are often composed of wood composites, fibers, or chips. Particleboard and medium-density fiberboard are often made using shavings from milling operations, but these are not considered a “recycled”

material as they have not historically been landfilled. Wood chips or particles that are adhered together using a bonding resin may emit toxic substances, most notably formaldehydes. Wood finishes such as paints, stains, and varnishes are also potential sources of toxic emissions. However, non-toxic finishes such as water-based paints and stains, as well as curing processes that accelerate the emission of any volatile toxins, are readily available.

The cost of wood construction materials can vary depending on market demand and availability. Wood products (or components) that are certified as originat-

ing from sustainably managed forests will generally add to initial costs. To ensure Forest-Stewardship-Council-compliant certification, the invoices from the supplier must include a chain-of-custody certificate number. The availability of salvaged wood is dependent on supply and generally adds to up-front cost. Many wood product manufacturers are replacing formaldehyde-based bonding resins with non-toxic substitutes. Cost impacts for such non-formaldehyde wood products can vary.



Robb Williamson

The Chesapeake Bay Foundation's Phillip Merrill Environmental Center in Annapolis, Maryland, made plentiful use of salvaged and recycled-content wood.

Gypsum Wallboard

Drywall is generally composed of 92 percent gypsum and 7 percent paper, with the remaining 1 percent being a combination of impurities in the gypsum rock and additives. The primary component of drywall, gypsum, can be obtained from natural resources or synthetically produced from byproducts of power plant operations. The synthetic gypsum represents a 100-percent post-industrial recycled-content product. Gypsum wallboard composed of synthetic gypsum and recycled-content paper facing and backing is available at no cost increase; however, synthetic gypsum wallboard is not currently manufactured within 500 miles of Los Alamos.

We are 'doomed to achieve sustainability' one way or another, at some level of comfort or discomfort, by choice or by nature's decisive hand.

– Alan Atkisson,
author of *Believing Cassandra*

Furniture

Furniture is typically constructed using a combination of different materials (steel, wood, plastic, adhesives, fabric, etc.), and offers many sustainability opportunities. Recycled-content materials can be used for a variety of furniture components. Wood components in furniture can be derived from rapidly renewable or sustainably certified sources. Furniture is also available as a salvaged material that is refurbished for reuse. An important EP characteristic of furniture involves VOC emissions. The potential for emissions from furniture can result from fabric material, adhesives, finishes on wood and metal components, and formaldehyde in wood components.

Furniture costs are highly variable depending on style, ergonomic characteristics, functional requirements, and other optional features that may be required. The impact of EP characteristics on furniture costs is also variable.



Ecowork office furniture is made from 98% recycled materials.

Studio eg

Brick/Concrete Masonry Units (CMU)

Brick provides thermal mass that adds to energy efficiency by slowing heat transfer through the wall. Brick is also very durable, requiring essentially no maintenance because it never needs to be painted and never rots, fades, warps, burns, dents, tears, or becomes brittle. Salvaged brick may be available depending on local vendor supplies. New brick can be matched to salvaged brick as necessary. Although brick containing recycled content has not been identified, locally manufactured brick is available.

Brick wall construction is generally less expensive (both first cost and life cycle cost) than pre-cast concrete

panel, metal panel, and exterior insulation finish system walls. Salvaged brick can actually cost more than new brick due to the labor required to refurbish used brick for resale. CMUs or concrete block are less expensive than brick and may be available with recycled content. CMUs with finished faces can provide both the structure and either the interior or exterior surface of a wall, thereby replacing whole layers of additional material. For energy efficiency and comfort, it is best to locate the CMU on the inside and insulation on the outside of the wall (e.g., CMU with an exterior finish insulating system [EFIS], see p. 141).

Roofing

Dark, non-reflective roofing surfaces create heat island effects by absorbing energy from the sun and radiating it as heat. This “black body” effect causes ambient temperatures to rise, which increases cooling requirements in the summer, requires larger HVAC equipment, and increases building energy consumption. A roof system with light colors can reflect heat instead of absorbing it, reducing HVAC equipment and energy use. The U.S. Environmental Protection Agency’s ENERGY STAR program has established solar reflectance and thermal emissivity requirements for roofs. Product manufacturers must comply with these requirements to



CMU construction for the LANL Emergency Operations Center provides a durable exterior wall. A second CMU interior wall provides mass to improve interior thermal comfort.



ENERGY STAR-compliant roof materials include metal and are applicable to both low-slope and steep-slope roof configurations.

LANL

LANL

receive an ENERGY STAR label. ENERGY STAR-compliant roof systems are required for all new LANL facilities as part of the overall energy-efficiency strategy for the project.

Depending on the roofing system selected, there is potential for roofing materials to contain recycled content and low-emitting materials. ENERGY STAR-compliant roof construction does not increase building cost. The roofing materials required to comply with ENERGY STAR provisions are becoming standard in the industry.

Ecologically conscious design is less about what the individual knows or thinks he knows, and more about approaching the design with a totally new consciousness and the willingness to rely on the collaborative energy of all of the participants.

– Bob Berkebile, Founding Chair,
AIA's Committee on the Environment

Windows

Windows are a critical component for an energy-efficient building. Not only do windows affect the thermal performance of a building (in the same manner as insulation), they provide natural daylight, reducing the electric lighting requirements of a building.

High-performance windows should be considered for all new LANL facilities as part of the overall energy-efficiency strategy for the project. See Chapter 4 for details on optimizing the energy performance of windows and glazing systems. Select frame materials that have recycled content, are durable, and are compatible with the LANL climate and weather characteristics

(to conserve resources and reduce maintenance). High-performance windows used for LANL facilities should be constructed at a local window fabricator that uses insulating glass units from a major glass manufacturer. High-performance windows cost more than standard windows. However, reduced lighting requirements and superior thermal efficiency can recover any cost increase in a relatively short period of time. In addition, high-performance windows lead to improved occupant comfort



Robb Williamson

High-performance windows increase thermal resistance, reduce solar heat gain (for internal-load-dominated buildings), and provide daylighting.

Doors

Exterior doors (and frames) should be constructed of recycled-content steel and contain insulating core material that does not contribute to ozone depletion. Rigid foam plastics and fiberglass are typically used as insulating cores. In the case of foam plastics, expanded polystyrene (EPS) is preferable to extruded polystyrene and polyurethane. Fiberglass core materials should also contain recycled content. Finishes on steel doors should be applied at the factory (where process emission controls are in place) and consist of a no- or low-VOC paint that is cured (or baked) to eliminate VOC emissions after installation. Weather-stripping along the top, jams, and bottom sweeps will minimize air infiltration around exterior doors.

Interior doors do not separate conditioned space from unconditioned space and do not require good thermal performance characteristics. Interior doors are typically constructed of wood products (veneers, core materials, rails, and styles) and synthetic wood products (plastics). Steel frames are also commonly used for interior doors for durability and reduced maintenance. Interior doors provide an opportunity for using recycled-content material (plastics and steel) and certified wood (as applicable), and in some cases salvaged materials (complete doors or components). Urea formaldehyde is a commonly used binding agent in wood door construction that should be avoided in favor of significantly less volatile binders such as phenol formaldehyde. Factory-applied finishing is preferred to site-applied finishing based on control of VOC emissions.

The costs for EP interior and exterior doors may be higher than for conventional doors. However, such cost increases are dependent on the sustainable features specified. For example, no- and low-VOC finishing techniques are readily available for both wood and steel at no additional cost; however, certified wood components will generally increase cost. Non-ozone-depleting insulation material such as expanded polystyrene does not increase cost relative to other door insulation materials; although highly insulated doors (low-temperature applications) cost more than non-insulated or marginally insulated doors (moderate-temperature applications). Additional first costs are generally offset by reduced operating costs.



Select certified wood or salvaged doors when using wood doors.



Ceramic Tile

Ceramic tile is durable and low-maintenance. Up to 100 percent recycled content is available in ceramic tile. Glass and feldspar mine wastes are the primary materials of the recycled content. Reuse of salvaged ceramic tile may also be an option. Although ceramic tile is an inert material, to prevent adverse air quality impacts, the adhesives used for tile placement should be non-toxic and/or non-VOC-emitting. Tile cost varies depending on the characteristics and features selected. No additional cost results from recycled-content material or non-toxic adhesives.

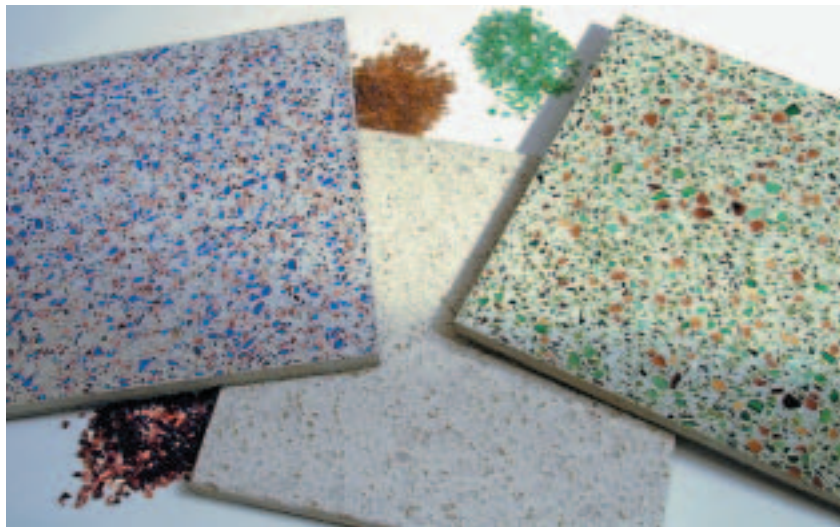

Weusau Tile

These terrazzo tiles, 60 percent recycled glass by weight, are stronger and more water-resistant than most stone-based terrazzo tile.

Insulating Concrete Forms (ICF)

The thermal efficiency of ICF construction is attributable to the insulation properties of the form material, temperature stability from the thermal mass of concrete, and reduced air infiltration. ICF walls can have thermal resistance (or R-value) of approximately R-15. Both the insulation material of the forms and the concrete used in ICF construction could contain recycled-content material, as noted previously in the discussions on insulation and cement/concrete materials. The potential for toxic emissions from ICF walls is low based on the materials used for construction. Expanded polystyrene is the most common insulation material used in ICF construction, and along with concrete, these materials generally have no emissions.

The relative cost for ICF construction is nearly equivalent to poured concrete or concrete block construction. ICF construction is marginally more expensive when compared to wood or steel-frame construction. However, the energy savings resulting from ICF construction may result in a lower overall life cycle cost compared to conventional wall construction techniques.



Craig Miller, DOE

ICF construction provides superior energy efficiency (high R-value, low air infiltration, and high thermal mass), and is strong and durable.

Structural Insulated Panels (SIP)

Facing materials in SIP construction are commonly dry-wall and structural wood sheathing (such as plywood and oriented strand board). These facing materials could contain certified wood, although no SIP manufacturers offer certified wood facings as a standard product. Similar to ICFs, the foam insulation used as core center should be EPS (which is most commonly used) to eliminate potential contributions to ozone depletion. Structural wood sheathing and adhesives used in the construction of SIPs have the potential to release toxic emissions, such as formaldehyde and VOCs.

The cost for SIP construction is equivalent to poured concrete or concrete block, and marginally higher than conventional frame and insulation package construction. However, life cycle considerations indicate reduced overall costs due to the substantially increased energy efficiency over conventional construction techniques.

Aerated Autoclave Concrete (AAC)

AAC is considered a highly sustainable building material. Features of AAC include low energy and raw material consumption during manufacturing, good thermal performance, structural-use capabilities, non-toxicity, and durability. AAC can be used as an insulating and structural material, reducing the overall construction materials needed. AAC is considered to be fairly friable and must be protected from weather by an exterior finish or coating. Any number of interior finishes can cover the interior surface. AAC was incorporated throughout the Metropolis Center (MC) facility recently completed at LANL.

The first cost for AAC construction is marginally higher compared to conventional concrete construction techniques. However, the use of AAC in place of structural steel at the MC facility resulted in savings of approximately \$2.5 million. Life cycle energy savings may also offset initial cost increases.



Michael Bacchler

SIPs can be faced with wood sheathing made from certified wood.

Exterior Finishes

In addition to aesthetics, exterior finishes prevent water and air infiltration. The moisture barrier provided by an exterior finish protects the interior wall materials, such as wood, steel, and insulation, from degradation caused by contact with water. Newer manufactured sidings have been engineered to require far less maintenance than traditional wood.

Toxicity is generally not a concern for exterior finish materials (with the exception of painted surfaces). To be durable and withstand the effects of sun and weather, the material will likely be inert. Recycled-content materials that are locally manufactured (and preferably locally harvested) should be considered. High-mainte-

nance materials (such as wood) should be avoided to reduce repair, replacement, and upkeep costs (such as repainting). Brick, concrete, stucco, steel, aluminum, and fiber-cement offer superior longevity. These materials resist cracking and other deterioration. Only the exterior finishes known to be applicable to the LANL climate and weather characteristics should be considered.

Exterior Insulation Finishing Systems (EIFS) refers to a specific category of exterior finishes. EIFSs are multi-layered exterior wall systems consisting of the following components: insulation board secured to the exterior wall surface with a specially formulated adhesive and/or mechanical attachment; a durable, water-resistant base coat applied on top of the insulation and reinforced with fiber glass mesh; and a durable finish coat. By

applying insulation outside the structure, EIFS reduces air infiltration and reduces energy consumption. Traditional “between-the-studs” insulation leaves thermal breaks caused by gaps where heat and cold pass more freely between the outdoors and the interior conditioned space. EIFS can reduce air infiltration by as much as 55 percent compared to standard brick or wood construction. Experienced, skilled applicators are required for proper installation.

Cost comparisons for the different exterior finish options will primarily be determined during the design phase based on functional and architectural considerations.



Jim Schaefer

The siding on the Cambria Office Building in Harrisburg, Pennsylvania, is made from untreated hemlock. It will gray with age to match the area's century-old barns.

Permeable Paving

Permeable (or porous) paving can be used to control surface water runoff by allowing stormwater to infiltrate the soil and return to the watershed (see Chapter 7). Permeable paving includes methods for using porous materials in locations that would otherwise be covered with impermeable materials (parking areas, walkways, and patio areas). These methods and materials include:

- **Permeable pavers** – Paving stones placed in an interlocking fashion over pedestrian surfaces (such as walkways and patios).
- **Gravel/crusher fines** – Loose aggregate material used to cover pedestrian surfaces.
- **Open cell pavers** – Concrete or plastic grids with voids that are filled with a reinforced vegetative turf or an aggregate material (sand, gravel, crusher fines). These are applicable to limited-vehicle-use areas.
- **Porous asphalt (bituminous concrete)** – A porous asphalt layer constructed with “open-graded” aggregate (small fines removed), which leaves voids between the large particles unfilled by smaller fine particles. An open-graded stone base holds water until it filters through into the underlying soil. This is applicable to general-vehicle-use areas.
- **Porous concrete** – A concrete mix without the fine aggregate, and with special additives for strength.

Permeable paving is not intended to replace standard impervious paving, but to limit the use of impermeable paving to heavy traffic areas. The availability of recycled content, salvaged materials, and locally manufactured products depends on the specific techniques implemented. Impacts from snow removal and control (salting) may affect durability.

Permeable paving surfaces generally cost more than conventional impervious surfaces. However, life cycle savings include reduced cost for stormwater management facilities and equipment and reduced operation and maintenance for infrastructure repairs. Permeable paving can potentially eliminate the need for stormwater collection drains, subsurface piping, and discharge structures.



Limiting the use of impermeable paving helps control runoff and protects the watershed.

LANL

System Integration Issues

Materials are in every physical aspect of a building. Therefore, the integration of material considerations into all components of building systems is a necessity. The following integration issues relate to material considerations:

- Low-energy building design involves integration of building envelope materials (insulation, windows, doors, and structural mass components) into the overall thermal load. Material characteristics should be included in the energy simulations (see Chapter 4).
- Indoor environmental quality involves integration with materials considerations to ensure workers and occupants are not subject to odorous, irritating, toxic, or hazardous substances and emissions.
- Daylighting design involves integration with materials considerations for windows as well as reflectance characteristics of interior finishes (such as ceiling tiles and paint).
- Stormwater design involves integration with materials considerations for perviousness of exterior surface structures (sidewalks, roadways, and parking lots) to promote infiltration into the ground surface.
- Roofing design involves integration with materials considerations to achieve ENERGY STAR compliance for reflectance and emissivity.
- Operation and maintenance requirements must be considered when selecting materials to ensure future sustainability when cleaning, repair, and replacement are required.



Robb Williamson

Criteria for Sustainable Success			
	✓ <i>Standard Practice/ Code-Compliant</i>	✓ <i>Better Performance</i>	✓ <i>High Performance for Sustainability</i>
Materials Reduction	<input type="radio"/> Typical material use	<input type="radio"/> Alternate low-mass, low volume materials	<input type="radio"/> Materials that serve multiple functions, and allow for omission of layers
Locally Manufactured	<input type="radio"/> 10% of building materials	<input type="radio"/> 20% of building materials	<input type="radio"/> 30% of building materials
Locally Derived Raw Materials	<input type="radio"/> 5% of building materials	<input type="radio"/> 10% of building materials	<input type="radio"/> 15% of building materials
Non-Toxic	<input type="radio"/> CRI-compliant	<input type="radio"/> CRI-compliant carpet and GS-compliant paint	<input type="radio"/> CRI-compliant carpet, GS-compliant paint, California AQMD-compliant adhesives and sealants
Recycled Content	<input type="radio"/> Meet EPA Comprehensive Procurement Guideline requirements	<input type="radio"/> 10% of building materials by weighted average	<input type="radio"/> 20% of building materials by weighted average
Salvaged – Material	<input type="radio"/> None	<input type="radio"/> 5% of building materials	<input type="radio"/> 10% of building materials
Salvaged – Building Reuse (if applicable)	<input type="radio"/> Maintain 75% of existing building structure and shell	<input type="radio"/> Maintain 100% of existing building and shell	<input type="radio"/> Maintain 100% of existing structure and shell AND 50% of non-shell (walls, floor coverings, ceiling systems)
Rapidly Renewable	<input type="radio"/> None	<input type="radio"/> 5% of building materials	<input type="radio"/> 10% of building materials
Certified Wood	<input type="radio"/> None	<input type="radio"/> 50% of wood-based materials	<input type="radio"/> 75% of wood-based materials



Additional Resources

ENERGY STAR – A voluntary labeling program sponsored by the U.S. EPA and DOE designed to identify and promote energy-efficient products, www.energystar.gov

Federal Energy Management Program (FEMP) – FEMP is a U.S. DOE program that promotes water and energy efficiency. FEMP issues “Product Energy-Efficiency Recommendations” for products, www.eren.doe.gov/femp/

Environmentally Preferable Purchasing (EPP) – EPP is a U.S. EPA program that encourages and assists in the purchasing of environmentally preferable products and services, www.epa.gov/opptintr/lepp/

Comprehensive Procurement Guidelines (CPG) – CPG is a U.S. EPA program established to promote the use of recycled products by designating products and establishing recycled-content recommendations, www.epa.gov/cpg/

A Guide to Implementing Executive Order 13101, www.eren.doe.gov/femp/resources/greengovintro.html

Resource Conservation and Recovery Act Online, www.epa.gov/rcaonline

GreenSpec – A product directory listing building products selected by the publishers of Environmental Building News, www.greenspec.com

GREENGUARD™ – A certification and labeling program for low-emitting interior products and building materials, www.greenguard.org

Carpet and Rug Institute – Manages a testing program that verifies adherence to minimum standards for pollution emissions from carpets, cushions, and adhesives, www.carpet-rug.org

WaterWiser – A resource for water-efficient products, www.waterwiser.org

Green Seal – A nonprofit organization that develops consensus standards for environmentally preferable materials and products, www.greenseal.org

OIKOS Green Building Source – A resource for construction products, materials, and techniques that promote sustainable design and construction, www.oikos.com

Certified Forest Products Council – Provides a database of wood products certified to the standards of the international Forest Stewardship Council, www.certifiedwood.org

Architectural Record/Green Architect – Provides a guide to green building products and materials, www.archrecord.com/green/green/asp

“Rule 1168 Adhesive and Sealant Applications.” California South Coast Air Quality District, September 15, 2000.

“Regulation 8, Organic Compounds, Rule 51, Adhesive and Sealant Products.” California Bay Area Air Quality Management District, May 2, 2001.

“Anti-Corrosive Paints,” Second Edition. GC-03, January 7, 1997. “Paints,” First Edition. GS-11, May 20, 1993. “Commercial Adhesives.” GS-36, October 19, 2000. Green Seal Inc., 1001 Connecticut, NW Suite 837, Washington, D.C., 20036-5525

Steel Recycling Institute (SRI), Fact Sheet, www.recycle-steel.org/index2.html.

The resources listed above are not intended to be comprehensive and LANL encourages identification and use of other resources to support procurement of EP building materials.



Chapter 7: Landscape Design and Management

- ❑ *Landscape Issues at LANL*
- ❑ *Stormwater Management*
- ❑ *Using Water Outdoors*
- ❑ *Parking Pavement*
- ❑ *Landscape Vegetation*
- ❑ *Exterior Lighting*

Chapter 7

Landscape Design and Management

Landscape Issues at LANL

Once the site analysis has been completed, design scheme alternatives have been developed and evaluated, and the building footprint and placement have been determined, design and specifications can be refined for the landscape surrounding the building.

Several key elements of the landscape design are addressed in this section:

- Stormwater management
- Using water outdoors
- Parking pavement
- Landscape vegetation
- Exterior lighting

The first four of these elements are linked by their impacts on water. The Laboratory is located in an area

where water resources are limited and local hydrology is driven by evaporation. The source of water for the Laboratory is a series of deep wells that draw water from the regional aquifer. If the Laboratory draws too much water from the aquifer, the Rio Grande will not be sufficiently recharged – which is particularly important downstream. Under current operations, water is consumed for purposes such as cooling tower use, temperature control, domestic use, and landscape irrigation. In FY 2000, the Laboratory used approximately 446 million gallons of water for its operation.

Other sustainability priorities addressed in this chapter include keeping pollutants out of the Rio Grande watershed, saving exterior lighting energy, and minimizing light pollution.



An example of a historical water management technique.

Opportunities

Sustainable landscape design can help protect the regional watershed while enhancing the sustainability of the site. Specific opportunities include:

- Minimizing costs and resource impacts of ongoing landscape management
- Reducing fire risk and promoting recovery from past fire damage
- Protecting soil and topography features on the site
- Minimizing pollutant loading of groundwater and surface waters
- Avoiding depletion of the regional aquifer

Additional benefits of sustainable site/landscape design include:

- Reducing energy use in buildings and for lighting around buildings
- Protecting the night skies through light pollution control
- Increasing durability of building foundations through water management
- Protecting and enhancing the natural beauty and ecological value of the site
- Interpreting the value of sustainable landscape management to employees and visitors
- Creating markets for recycled landscape construction materials



LANL

Stormwater management and landscape water efficiency have impacts on the Rio Grande watershed.

Stormwater Management

Stormwater is precipitation that does not soak into the ground or evaporate but flows along the surface of the ground as runoff. Conventional practice for stormwater management – concentrating runoff and carrying it off a site as quickly as possible through storm sewers – causes various environmental problems, including erosion, downstream flooding, pollution loading of surface waters, and reduced groundwater recharge.

There are two basic principles of sustainable stormwater management:

- **Drainage and flood control** is based on managing the quantity of stormwater runoff potentially generated during a design-basis storm event (a storm event likely to occur only once in a specified time period). Major contributors to stormwater runoff are impervious surfaces such as rooftops, parking lots, and roadways.
- **Water quality control** is based on managing on-site sources of pollutants in stormwater and, if needed, treating the stormwater to remove these pollutants. Pollutants enter stormwater primarily by erosion of soil (sediment loading) or by being picked up from impervious surfaces. Rooftop surfaces typically

accumulate pollutants that are deposited from the atmosphere or blown on during adverse weather. Parking lot surfaces collect a variety of pollutants leaked from vehicles.

The primary goal of sustainable stormwater management should be to generate no additional runoff from the existing site compared with pre-development conditions. The intent of this design goal is to use an integrated approach that minimizes generation of stormwater runoff and maximizes infiltration of the generated stormwater into the ground. This approach limits runoff (and potential pollutants) from leaving the site.

An integrated design approach involves configuring the location and placement of impervious surfaces, avoiding contiguous impervious surfaces where feasible, specifying land-based structural practices for stormwater detention and treatment, and providing proprietary stormwater pollutant removal devices where significant pollutant sources occur.

Green roofs

A green (vegetated) roof can serve as a very effective stormwater management system. This practice is gaining wide attention for stormwater control and pollutant filtration systems. Such a roof will typically absorb the first half-inch or more of a rain event, detaining the runoff from that storm.

I recognize the right and duty of this generation to develop and use the natural resources of our land; but I do not recognize the right to waste them, or to rob, by wasteful use, the generations that come after us.

– Theodore Roosevelt, 1910

Stormwater Management

Investigate the feasibility of applying stormwater management strategies to detain and treat stormwater on the site. Note that stormwater detention areas at the Laboratory should be designed to be “dry” most of the year, unless they are also serving as fire control ponds. Wet detention ponds (sometimes called stormwater retention ponds) are appropriate in other areas, but not

appropriate for the Laboratory because development of wetlands or breeding areas presents operational risks. Each of the following stormwater structural practices described and illustrated requires specific periodic maintenance practices for proper operation.

Infiltration Basin

- Best applied to drainage areas of less than 10 acres.
- Soil infiltration rate should range between 0.5 and 3 inches per hour.
- Can be optimized for seasonal operation and to accommodate snow melt.

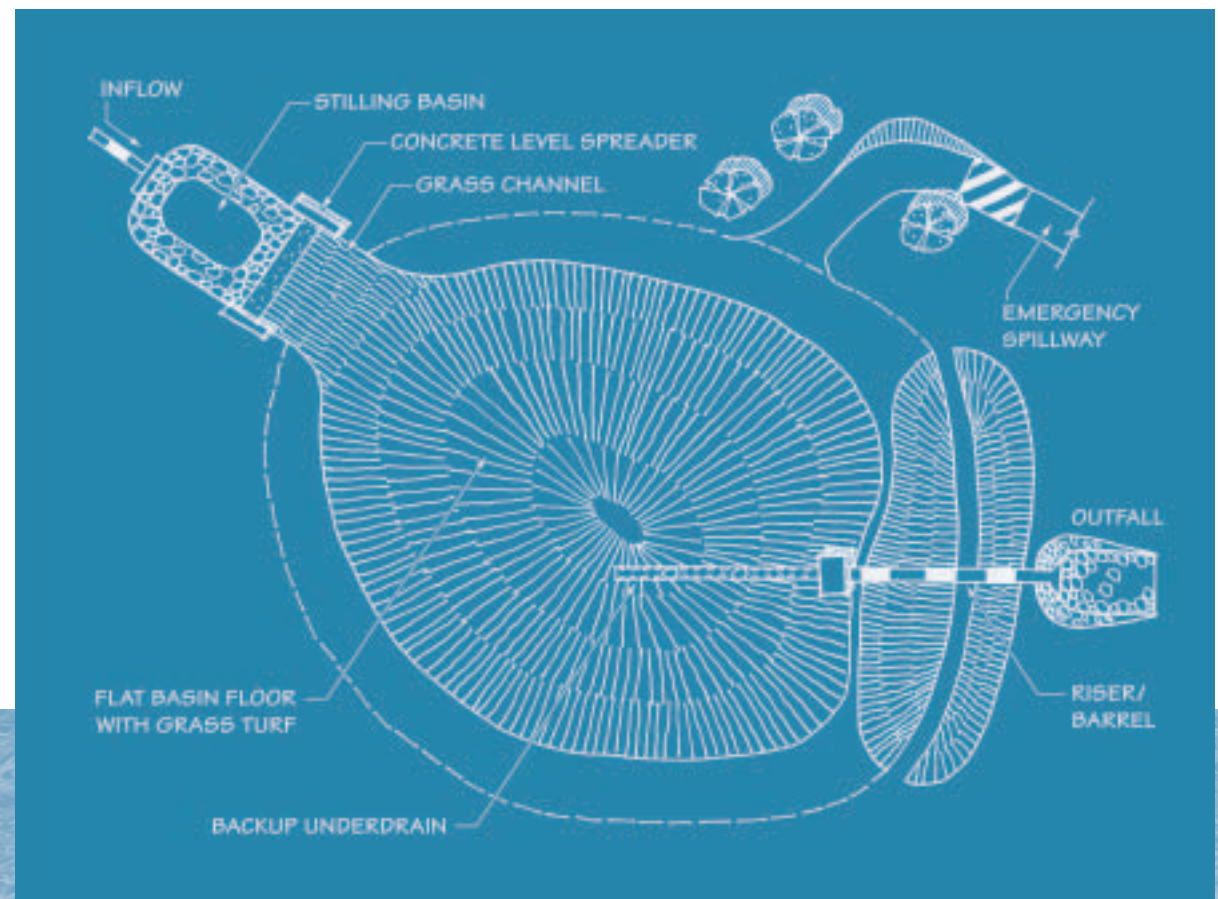

An infiltration basin is a shallow impoundment designed to infiltrate stormwater into the ground. Design elements direct stormwater to flow through a stilling basin, concrete level spreader, grass channel, and a flat basin floor with a backup underdrain and an emergency spillway.

Bioretention Swales

- Landscaping features can be adapted to treat and infiltrate stormwater runoff.
- Surface runoff is directed into shallow, landscaped depressions with ecologically engineered layers to facilitate pollutant removal.

- Typically, some portion of the filtered runoff is infiltrated through the bioretention system into the ground beneath; additional stormwater is carried away to a secondary detention or infiltration area.

- Parking lot biofiltration swales should be sized to equal 5 to 10 percent of the area being drained.
- These bioretention areas can be designed to hold plowed snow.

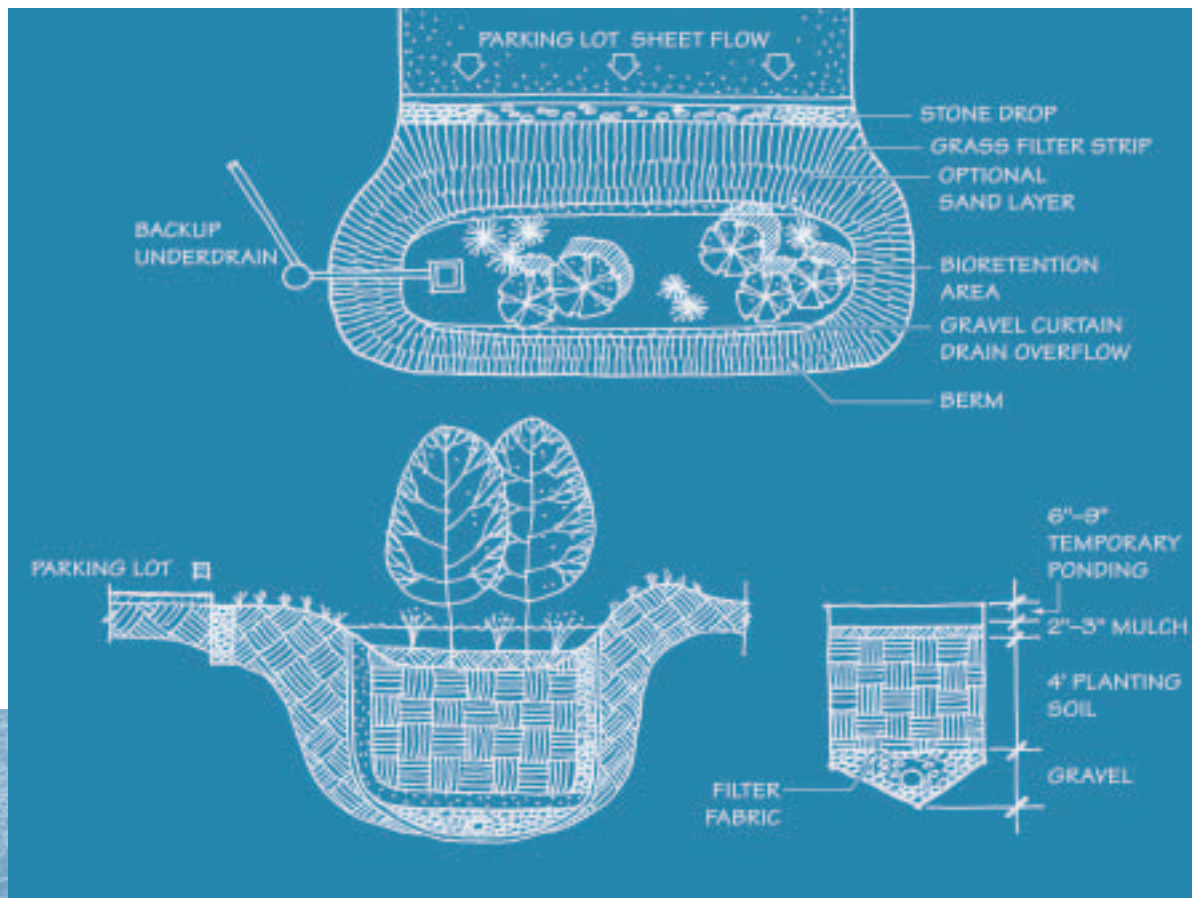

Example pedestrian area swale near the Nicholas C. Metropolis Modeling and Simulation Center.

Bioretention swales direct water across a stone drop and grass filter strip to collect and filter through the mulch, prepared soil, or aggregate mix. Filtered runoff not absorbed into the ground is typically collected in a perforated underdrain.

Dry Extended Detention Pond

- Vegetated, open-channel management practice.
- May be an option as a snow storage facility to promote treatment of plowed snow.
- Recommended for sites with a minimum drainage of 10 acres.
- Least expensive stormwater treatment practice, on a cost-per-area treated basis.
- Best long-term performance track record (fewest clogging problems).

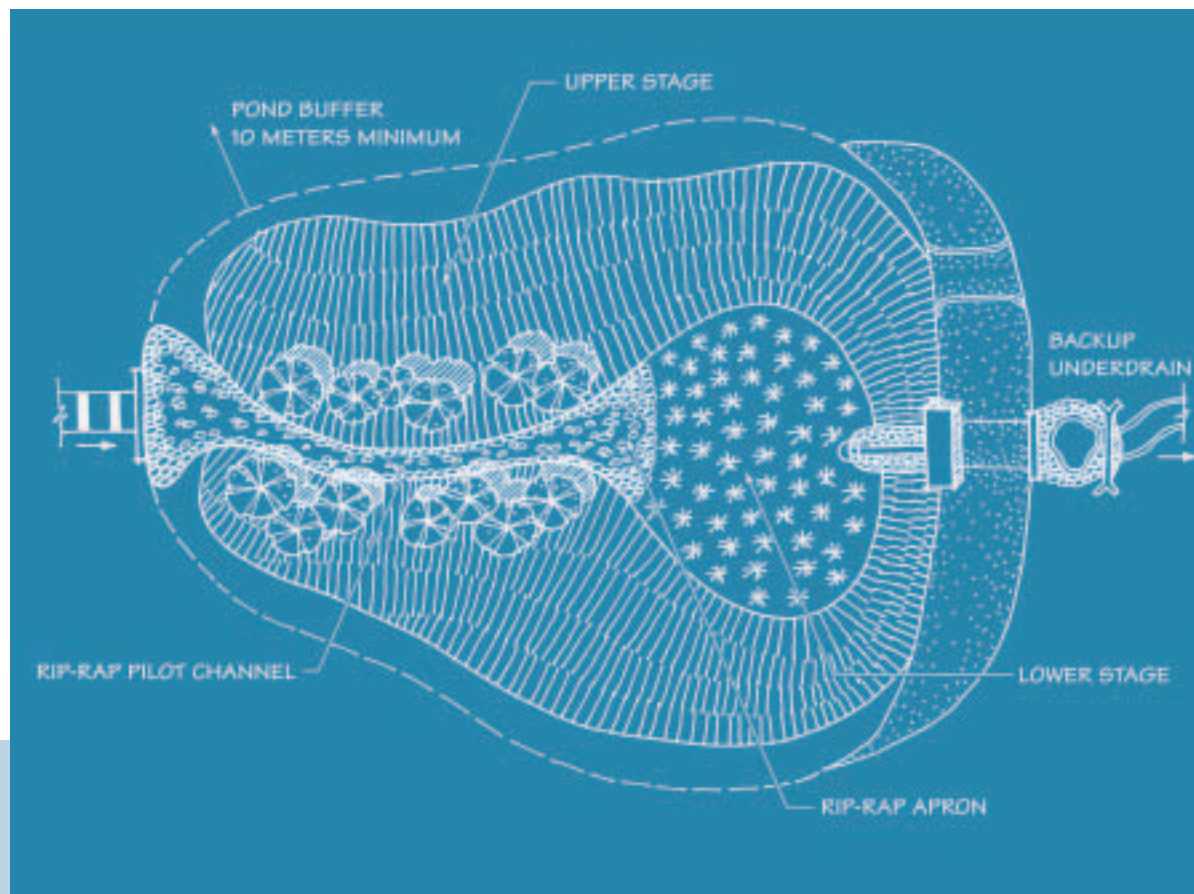

Dry extended detention ponds are basins with outlets designed to detain the stormwater runoff from a storm event to allow particles and associated pollutants to settle. Design elements direct stormwater to flow in a rip-rap pilot channel through an upper stage meadow to a lower stage basin with an underdrain and a spillway.



Proprietary Systems for Stormwater Pollutant Removal

The longest-lasting and lowest-maintenance stormwater management systems are features designed into the landscape (structural practices). However, these structural practices can be aided by proprietary stormwater products in areas that generate high levels of pollutants. Proprietary stormwater products are manufactured systems – often precast concrete with specialized filtration systems – used to capture pollutants from maintenance garages, parking lots, fuel-storage zones, and other areas where fuel or chemical spills are likely. Often referred to as “oil/grit filters,” these systems require regular maintenance to remain effective, so they should not be installed unless there is a long-term commitment to maintenance.

There are approximately two dozen manufacturers of proprietary stormwater treatment systems currently on the market. They are becoming an important component of permitting under the National Pollutant Discharge Elimination System (NPDES). Most are designed to replace or fit into the storm-drain inlets of storm sewer systems. They may include floatation chambers to capture hydrocarbons that float on the surface of the water and sophisticated filters to capture silt and other pollutants. Listings and descriptions of these proprietary products can be found on the U.S. EPA Web site and in references listed at the end of this chapter.

Keeping Pollutants Out of Stormwater

While management of stormwater is a high priority, it makes sense to also implement policies designed to keep pollutants out of stormwater in the first place. Such measures could include regular vehicle inspections of Laboratory vehicles and equipment, strong policies regulating the transport of chemicals and fuels on the LANL campus, limitations on fertilizer and pesticide use, restrictions on road salt use, and regular street and parking lot cleaning. Keeping pollutants out of stormwater is almost always cheaper and more effective than trying to remove them.

Stormwater Pollutants

A wide range of pollutants are found in stormwater, including:

- **Suspended solids.** Soil particles and other materials deposited by wind or erosion.
- **Nutrients.** Primarily nitrogen and phosphorus from fertilizers. These cause excessive algae growth in surface waters.
- **Organic carbon.** Commonly referred to as biochemical oxygen demand (BOD), organic matter washed into surface waters robs the water of oxygen as it breaks down.
- **Bacteria.** Fecal coliform and other bacteria are regularly found in stormwater and can result in the closing of public swimming areas.
- **Hydrocarbons.** Engine oil, gasoline and diesel fuels, and other hydrocarbons are leaked onto parking lots and roadways; they are often toxic to aquatic organisms.
- **Trace metals.** Lead, zinc, copper, and mercury are found in stormwater. The leading source of lead in stormwater today is from automobile tire weights that get ground to dust on roadways.
- **Pesticides.** While safer than the persistent pesticides used several decades ago, today’s pesticides can be toxic to aquatic organisms.
- **Chlorides.** Calcium chloride is commonly applied to roadways and parking lots for snow and ice control/removal.
- **Trash and debris.** Primarily a visual pollutant, trash also can be contaminated with toxics.
- **Thermal pollution.** Stormwater washed off parking lots and roadways in summer thunderstorms can be warmed by the pavement and raise the temperature of streams – sometimes harming cold-water fish species, such as trout.

Using Water Outdoors

Strategies for Reducing Water Use Associated with Landscaping

Water efficiency is the planned management of potable water to prevent waste, overuse, and exploitation of the resource. Effective water-efficiency planning seeks to “do more with less,” without sacrificing performance. Irrigation water can be reduced by applying the following strategies:

- Preserve, encourage, or reintroduce native, drought-tolerant vegetation that is already optimized for Los Alamos precipitation levels.
- If plants are desired that need water, group them by similar watering and soil type needs.
- Where irrigation is needed, use efficient practices:
 - Use ultra-low-volume distribution devices such as drip irrigation systems.
- Irrigate after on-site inspection or electronic sensing of moisture requirements, rather than just by a timeclock. Automatic irrigation controllers should have rain switches that override the “on” signal when sufficient rain has fallen or soils are moist.
- Water requirements vary greatly by season, and as the landscape matures, less irrigation should be required (assuming native, drought-tolerant plantings).



This xeriscape area at TA-48 RC-1 has been tended by employees for a couple of years. Xeriscaping creates an aesthetically pleasing landscape with native, drought-tolerant plants and low maintenance requirements.

LANL

Rainwater Harvesting

Rainwater harvesting is the practice of collecting rainwater off roof surfaces and storing that water for later use. While collected water can be filtered and treated for potable uses, such systems are fairly complex (see Chapter 5 for additional details). Using collected rainwater for landscape irrigation is more easily accomplished. The basic elements of a rainwater harvesting system are:

- Construct the building roof of materials that will not contaminate rainwater falling on it (avoid asphaltic membranes).

- Channel rainwater into an above-ground or buried cistern. Above-ground cisterns should be covered to keep people and animals out and to block sunlight so that algae doesn't grow; freeze-protection may be required if the cisterns aren't drained in the winter months.
- Provide a gravity-fed outlet or pump system to extract water from the cistern for irrigation.



A small cistern stores rainwater for landscape irrigation at the Chesapeake Bay Foundation's Phillip Merrill Environmental Center in Annapolis, Maryland.

Recycled Water

Recycled water is either reclaimed wastewater or untreated greywater – two other possible sources for irrigation water.

Reclaimed wastewater, sometimes called irrigation quality or IQ water, is water from a wastewater treatment plant that has been treated and can be used for nonpotable uses such as landscape irrigation, cooling towers, industrial processes, toilet flushing, and fire-protection. The New Mexico Environment Department is currently reviewing its guidance for the use of reclaimed wastewater.

Greywater is untreated wastewater generated within the facility from showers, laundry, and bathroom sinks (not from toilets, urinals, kitchen sinks, or dishwashers). Greywater can be used for below-ground irrigation, but it is not recommended for use above-ground. Due to organic matter, greywater should be used right away and not stored. If greywater is stored too long, the oxygen will be used up and anaerobic conditions will result in unpleasant odors. The New Mexico Environment Department regulates treatment and use of greywater.

Reclaimed wastewater systems must be scrupulously isolated from potable water distribution, and all IQ hose bibs must be clearly marked as "nonpotable."

Parking Pavement

If large parking areas must be included on the building site, then design bioretention areas into the parking lot landscaping as part of the exterior water management strategy. Bioretention areas or swales can include trees for shade as well as understory plantings. Provide infiltration swales along roadways (with no curbs, so that sheet-flow can distribute water thinly during storm events). Permeable pavement surfaces can reduce runoff (see sidebar).

To minimize the heat island effect (a localized warming that occurs around built-up and urban areas), paving material for parking lots should have a high reflectance to minimize absorption of solar heat. However, be aware that light-colored parking lots can reflect light onto adjacent buildings, increasing cooling loads and causing visual glare. Abate this glare by screening or shading the parking lot with vegetation, such as drought-tolerant groundcover and canopy trees.

Permeable Paving

Permeable paving is a powerful tool for maintaining and restoring natural hydrological cycles on developed sites by allowing water infiltration rather than concentrating rainwater into runoff. A permeable paving system is a pavement surface that contains voids, allowing water to infiltrate through. The pavement surface can be pervious concrete, porous asphalt, or hard unit pavers that allow water to infiltrate between the units or through hollow cores. A stone reservoir beneath the pervious pavement surface temporarily stores surface runoff before infiltrating into the subsoil.

Permeable pavement systems have been used successfully in cold climates with the base of the stone reservoir extending below the frost line to reduce the risk of frost heave. Snow will melt faster because of accelerated drainage below the surface.

However, permeable pavement is not recommended for surfaces receiving snow and ice treatments. Sand will clog the permeable surface and chlorides from road salt may migrate into the groundwater. If a paved area is treated for snow removal only by plowing (no salt, sand, or chemicals), then permeable pavement is viable with proper maintenance, including periodic cleaning (power washing or vacuum sweeping) to prevent clogging.

Alternative paving surfaces are appropriate for vehicle and pedestrian areas that do not receive snow and ice removal treatments. These surfaces can reduce the runoff from paved areas but typically do not incorporate the reservoir for temporary storage below the pavement (see Chapter 6). Soft paving strategies provide stable load support rated for accessible pedestrian surfaces and low-volume vehicle traffic (such as emergency and utility vehicles or overflow parking).

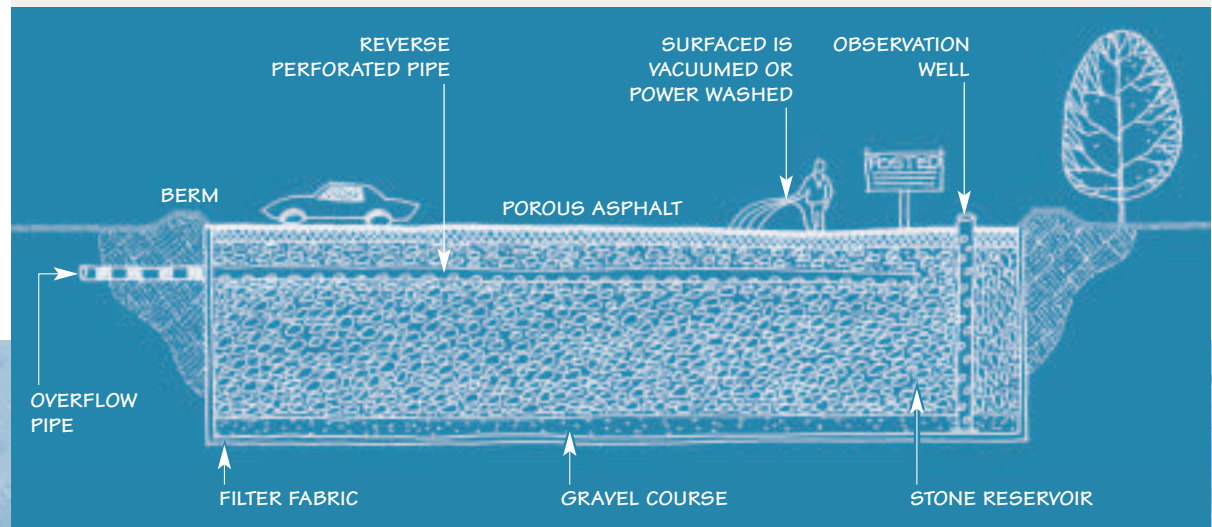

Porous pavement is a permeable pavement surface with an underlying stone reservoir to temporarily store surface runoff before it infiltrates into the subsoil. Design elements include fabric lining to prevent underground sediment entry and a sign posted to prevent resurfacing, sand treatment, and use of abrasives.

Landscape Vegetation

Landscaping is key to the relationship of the building and the site. Functional aspects of landscaping should be incorporated into the site design. Landscaping is an integral component of any sustainable design and must be integrated with all aspects of the building design, construction, and operation. The landscape functions as a system that supports the overall sustainability goals of the project. Specific functional uses of plants are given on page 87 of the *Design Principles*.

Native landscape on the LANL campus ranges from wooded areas to grasslands and alluvial water environ-

ments. Native forests include piñon and ponderosa pines, aspen, and gamble oak. Forested areas often have a rich understory of shrubs and flowering plants. The native flora has evolved to flourish within specific regional conditions, is self-propagating, and requires no additional water, nutrients, or maintenance. Native plants also have natural controls, so they will not become invasive as many non-native, introduced plants have become. A wide array of trees, shrubs, groundcovers and grasses that are indigenous, hardy, and drought-resistant can be incorporated into the landscape design using xeriscape principles. A listing of approved plants is given in Appendix B of the *Design Principles*.

Natural vegetation in many areas has been damaged by development, erosion, wildlife, and introduction of non-native, invasive plants. An important component of landscape design can be ecological restoration. Through ecological restoration and careful siting of buildings on a degraded site, it is possible for a post-development site to support greater biodiversity than prior to development.

Be sure to follow the guidance for fire management zones, general fire risk reduction, landscape fire risk reduction, and defensible space as given on pages 24–26 of the *Design Principles*.

Examples of regional native plants.



Blue Fescue, *Festuca ovina*



Sideoats Grama, *Bouteloua curtipendula*



Blue Grama, *Bouteloua gracilis*



Creeping Red Fescue, *Festuca rubra*



Buffalo Grass, *Bichloe dactyloides*

Illustrations courtesy of Texas A&M University.

Exterior Lighting

Exterior lighting improves security, enhances safety, and directs pedestrians and vehicles. A wide selection of new lamps, ballasts, fixtures, and controls is available to lighting designers to replace traditional inefficient exterior lighting systems. With any exterior lighting design, control of light pollution and light trespass should be a high priority. *Light pollution* is the upward transmission of light into the night sky. *Light trespass* is the transmission of direct-beam light off the premises (glare

that is obnoxious to neighbors or passing drivers). Careful luminaire and lamp selection can minimize or eliminate these problems.

Light pollution can disrupt biological cycles in plants and animals, including humans. Glare increases hazards by creating stark contrasts and making areas outside the light even less visible. Light pollution often hinders effective stargazing and astronomical research by over-illuminating the night sky. The State of New Mexico has legislated against light pollution with the New Mexico

Night Sky Protection Act. Specifically, fixtures greater than 150 Watts must be shielded or turned-off between 11 p.m. and sunrise. Also, mercury vapor lamps can no longer be sold or installed.

Remember that lighting design should be for the actual site usage patterns, safety and security requirements, not just for footcandles. Here is a checklist of suggested practices for outdoor lighting.



Solar Outdoor Lighting, Inc.

Solar lights are self-contained, stand alone, and useful in a variety of outdoor lighting applications. This parking lot lighting example has a shoebox fixture with a full-cutoff lens and an 8-ft. arm.

✓ Exterior Lighting Checklist

Light the minimum area for the minimum time.

- Limit all-night illumination to areas with actual all-night use or specific security concerns. Simple timers and photocells can turn lights on and off at seasonally appropriate times. For security lighting, motion or infrared sensors can spotlight intruders without beaming constantly glaring lights.
- Use full cut-off fixtures, shades or highly focused lamps to avoid spillover. Linear “tube lights,” fiber-optics, and electro-luminescent fixtures can light the way for pedestrians without over-illuminating a much larger area.
- Question the “brighter is better” myth, especially for security and advertisement. Avoiding areas of high contrast is better than increasing lumen levels for security lighting.

Clearly identify the actual purpose of lighting to determine minimum acceptable levels.

- Hazard lighting is usually focused on the hazard, bright enough to warn, identify, and allow judgment of distance. Area lighting, seldom as bright or focused, allows a user to choose a safe route.

Use energy-efficient lamps and ballasts.

- The most efficient new lamps produce 10 times as many lumens per watt of power as a conven-

tional incandescent bulb. Operating-cost savings (including deferred bulb replacement, labor, and equipment rental for inefficient, hard-to-reach parking-lot lamps) quickly recover the cost of re-lamping. High-pressure sodium (HPS) lamps are a common choice for an energy-efficient outdoor light source. New fixtures are often miniaturized, allowing design flexibility. Low-temperature-starting compact fluorescent lamps are suitable for some outdoor applications, such as bollard lighting, lamp posts, and exterior wall sconces.

Optimize uniformity and minimize shadows.

- Design the placement of exterior lighting systems to provide good uniformity ratios and minimal glare. Locate luminaires to minimize shadow effects of trees and other fixed objects such as large signs or security-building walls.

Use renewable energy sources for lighting and other outdoor power applications.

- Photovoltaic (PV) power is generally cost-effective for light fixture sites over 200 yards from the utility grid and is an attractive alternative to power lines. With the right specifications, PV-powered fixtures are low-maintenance and very reliable. Manufacturers offer solar path-lights, streetlights, and security lights.

Case Study:

Reducing Light Pollution at the Nicholas C. Metropolis Modeling and Simulation Center at the Strategic Computing Complex (SCC)

The outdoor lighting at the SCC includes bollards with downward angled louvers, wall-mounted sconces with adjustable shields, and a variety of emergency lighting fixtures. Timers control all outdoor lighting through a programmable dimming system.

Security lighting must be designed for the people and the equipment involved in the security plan and for the security of the property at issue. High-efficacy light sources (light source efficiency expressed in lumens per watt) with inferior color rendering properties may be used for security lighting when motion rather than identification is the prime security concern. Avoid bright “glare bomb” fixtures that can actually decrease security by inhibiting vision and creating shadowed spaces. New infrared and motion-sensing security

systems with remote alarms may reduce the need for security lighting, depending on the security objectives. Placement of vegetation and other landscape features (walls, etc.) also can have a significant impact on security. In parking lots, for example, planting tall trees with exposed trunks rather than shrubbery may provide longer views and increase safety.

✓ Landscaping Integration Issues

- Provide capacity in the building control system for exterior lighting if not already using campus-based energy management control system
- Integrate the landscaping plan with the design of “exterior space” (see Chapter 4)
- Reduce/avoid parking lot glare that can conflict with daylighting
- Balance preserving natural vegetation and new landscape plantings with fire risk reduction guidelines
- Coordinate building design strategy with landscaping decisions
- Avoid placing either vehicle idling areas or plants that produce allergens near building air intakes
- Landscape designs must be coordinated with LANL Civil Grading Standards



Mists over the San Ildefonso Pueblo.

Criteria for Sustainable Success			
	✓ Standard Practical/ Code-Compliant	✓ Better Performance	✓ High Performance for Sustainability
Exterior Water Management			
Stormwater	<ul style="list-style-type: none"> ○ Federal and local codes 	<ul style="list-style-type: none"> ○ Site grading and erosion control according to the <i>Design Principles</i> (p. 19, 28) and the <i>LEM</i> civil design standards, using surface and channel treatments from the <i>Storm Water/Surface Water Pollution Prevention Best Management Practices Guidance Document</i> 	<p><i>PLUS:</i></p> <ul style="list-style-type: none"> ○ No net increase in the rate or quantity of stormwater runoff from undisturbed to developed conditions by implementing structural practices for groundwater recharge and biologically-based features for pollutant load reduction
Landscape water use	<ul style="list-style-type: none"> ○ Federal and local codes (note: the town of Los Alamos uses reclaimed wastewater above ground, but local regulations are under review) 	<ul style="list-style-type: none"> ○ Xeriscape, water conservation, and rainwater harvest guidelines as given in the <i>Design Principles</i> (p. 84–86) 	<ul style="list-style-type: none"> ○ Acceptable aesthetics with native plants, no irrigation, and low maintenance (i.e., only following landscape fire risk reduction guidelines)
	<ul style="list-style-type: none"> ○ Conventional turf irrigation practices with potable water 	<ul style="list-style-type: none"> ○ Reliable, low-flow, water-efficient irrigation systems to establish plants in initial years 	<ul style="list-style-type: none"> ○ Cistern-harvested rainwater or recycled water for landscape irrigation
Parking lot landscaping	<ul style="list-style-type: none"> ○ Federal and local codes 	<ul style="list-style-type: none"> ○ Parking design guidelines in the <i>Design Principles</i> (p. 44–49) including bioretention areas (or parking lot water harvesting swales) 	<p><i>PLUS:</i></p> <ul style="list-style-type: none"> ○ Use permeable paving materials in overflow, or low volume parking areas as well as bicycle and pedestrian trails
Exterior Lighting			
General specifications (walkway, plazas, parking areas)	<ul style="list-style-type: none"> ○ New Mexico Night Sky Protection Act 	<ul style="list-style-type: none"> ○ Exterior lighting guidelines in the <i>Design Principles</i> (p. 75–77) with shielded fixtures (full-cutoff luminaires) 	<p><i>PLUS:</i></p> <ul style="list-style-type: none"> ○ Clearly identify lighting purpose to optimize light fixture density, lighting intensity, and light uniformity
	<ul style="list-style-type: none"> ○ Federal and local codes 	<ul style="list-style-type: none"> ○ High-efficacy lamps and fixtures with timer or photocell control 	<ul style="list-style-type: none"> ○ High-efficacy lamps and fixtures with motion or IR sensor control so that they're only lit when site staff are present at night OR non-grid tied fixtures (with PV and battery system)
Security	<ul style="list-style-type: none"> ○ DOE and LANL S-1 requirements 	<ul style="list-style-type: none"> ○ <i>Design Principles</i>: Security lighting guidelines (p. 77) 	<ul style="list-style-type: none"> ○ Renewable energy powered fixtures (i.e., photovoltaics)

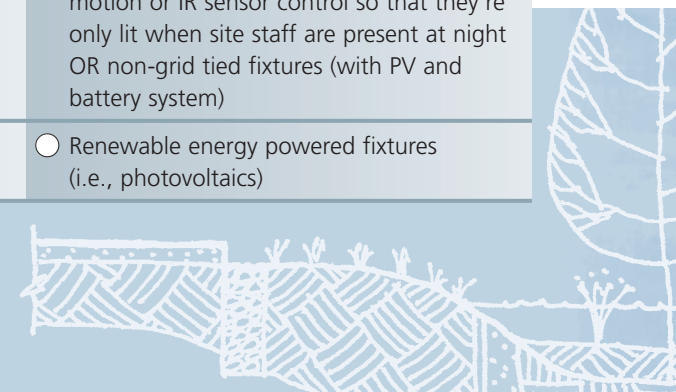

References

"Greening Federal Facilities: An Energy, Environmental, and Economic Resource Guide for Federal Facility Managers and Designers." DOE/EE Federal Energy Management Program, 2001.

"Sustainable Building Technical Manual." Public Technology, Inc., 1996.

Center for Watershed Protection, www.stormwatercenter.net

New Mexico Environment Department www.nmenv.state.nm.us

"The Laboratory's Footprint: Our Environmental Impacts." LA-UR-02-1971, April 2002.

Environmental Building News, www.buildinggreen.com

- "Cleaning Up Stormwater: Understanding Pollutant Removal from Runoff," Vol. 11, No. 2, February 2002.
- "Development and Nature: Enhancing Ecosystems Where We Build," Vol. 10, No. 2, February 2001.
- "Light Pollution: Efforts to Bring Back the Night Sky," Vol. 7, No. 8, September 1998.

Additional Resources

"Site and Architectural Design Principles." LA-UR 01-5383, January 2002.

"Storm Water/Surface Water Pollution Prevention Best Management Practices Guidance Document" (LANL, Revision 1.0 August 1998)

DOE-OEM Fact Sheets at http://emeso.lanl.gov/useful_info/success_stories/success_stories.html

- "Recycling Construction and Landscaping Materials"
- "Dust Suppression with Less Water"
- "Asphalt Recycling"

National Stormwater Best Management Practices (BMP) Database www.bmpdatabase.org.

New Mexico Night Sky Protection Act, www.rld.state.nm.us/cid/news.htm

IESNA Recommended Practices Manuals:

- Lighting for Parking Facilities, RP-20-98
- Lighting for Exterior Environments, RP-33-99
- Selection of Photocontrols for Outdoor Lighting Applications, D6-13-99

Whole Building Design Guidelines, www.wbdg.org

ASTM Standard E-50.06.08, A guide for green landscaping, xeriscaping, and pollution prevention.

EPA's Storm Water Management of Construction Activities, Chapter 3, EPA Document No. EPA 832-R-92-005

"Greenways: A Guide to Planning, Design, and Development." Island Press, 1996.

"Parking Spaces: A Design Implementation, and Use Manual for Architects, Planners, and Engineers." McGraw-Hill, 1999.

"GreenSpec: Product Directory with Guideline Specifications." 3rd Edition, October 2002. BuildingGreen, Inc. www.buildinggreen.com

Society for Ecological Restoration, www.ser.org

American Society of Landscape Architects, publisher of Landscape Architecture, www.asla.org

International Dark Sky Association, www.darksky.org

EPA's National Pollutant Discharge Elimination System (NPDES), <http://cfpub.epa.gov/npdes>

An aerial photograph of a large-scale construction project, possibly a school or institutional building, set in a wooded area. The site is filled with earth, concrete foundations, and various construction materials. The entire image is overlaid with a semi-transparent blue filter. The text is positioned in the upper left corner.

Chapter 8: Constructing the Building

- ❑ *Developing a Construction Plan*
- ❑ *Writing Effective Construction Documents*
- ❑ *Safeguarding Design Goals During Construction*
- ❑ *Protecting the Site*
- ❑ *Low-Impact Construction Processes*
- ❑ *Protecting Indoor Air Quality*
- ❑ *Managing Construction Waste*

Chapter 8

Constructing the Building

Developing a Construction Plan

A high-performance design is a great achievement, but it doesn't mean much if the building isn't then built as intended. Getting from design to a completed project happens in two stages: 1) development of construction documents and 2) actual construction. To successfully implement a sustainable design, the construction documents must accurately convey the specifics that determine building performance, and they have to set up systems for informing and training contractors and sub-contractors about unfamiliar materials and methods. The task during construction is also two-fold: 1) construct the building so it will perform as intended and 2) protect the environment as much as possible throughout the process.

Ideally, the general contractor will have been an active participant in the design process, suggesting materials and construction methods to achieve the project's goals in an efficient and cost-effective manner. He or she will already be familiar with those goals, and will be well-equipped to ensure that they are promoted and supported during construction. Often, additional decisions with energy and environmental impacts are made during construction. It is essential to evaluate how these decisions can affect the ability to meet the original project design goals before implementing changes to the project design.



The LANL Emergency Operations Center under construction.

Regardless of whether the contractor has been involved throughout the design process, the contractor and principal subcontractors should participate in setting guidelines to ensure that construction meets project design goals and that it is carried out in an energy- and environmentally sensitive manner. Creating the guidelines as a team is helpful for educating contractors about sustainability issues and getting their buy-in to the sustainability goals. Also, including the contractors in the process will ensure that the guidelines can be realistically implemented during construction. Environmental guidelines for the construction process should include

construction practices, site protection, erosion control, indoor air quality, and specific measures for reducing energy and water use.

The integrated nature of high-performance buildings means that each building element may serve multiple functions. Coordinating the specifications and construction of these elements requires excellent communication throughout the process.

When developing and implementing construction documents, specification writers, general contractors, tradesmen, and others can add value by understanding the goals and intended uses of the building, and

ensuring that everything they do fully supports those goals. As each person on the team is the expert within his or her profession or trade, he or she should be encouraged to suggest alternative ways to meet those goals, especially if those alternatives can improve quality, enhance performance, or reduce costs. But any changes must be reviewed by team members who are knowledgeable about all aspects of the building's performance to ensure that the proposed changes do not inadvertently undermine key performance goals.

Benefits Resulting from Good Construction Guidelines

- **Building performance** – Attention to process issues during construction is critical to creation of a high-performance building.
- **Reduced environmental compliance costs** – A proactive approach to environmental issues can reduce the time and effort needed to document compliance with environmental regulations and guidelines.
- **Safer construction site** – Attention to environmental issues during construction leads to a safer and healthier work site.
- **Reduced construction costs** – Working with natural landscape features is often less expensive than clearing a site and then reestablishing landscaping and stormwater management functions.
- **Professional development** – Given the increasing demand for green buildings, knowledge of the skills needed to deliver these buildings will serve everyone well in the future.



LANL

Reviewing construction documents for the LANL Medical Facility.

Writing Effective Construction Documents

Construction documents must accurately document the design, including all features and details needed for the building's sustainable goals. They also must set up mechanisms to ensure that everyone who will participate in implementing the design is apprised of the environmental goals and knowledgeable about the materials and techniques that will be used to meet those goals. Spell out this information in Division 1 of the specifications, typically in Section 01350 – Special Procedures. Also, insert the information throughout the drawing and specifications wherever special conditions or requirements exist.

Construction documents spell out the design and make the design team informed of and accountable to the sustainability goals of the building.

Verify that the construction specifications and drawings support the design intent. Ideally, a commissioning agent will already be on-board to perform such a review at the end of the design process. The team member(s) responsible for reviewing the construction documents should follow these five steps when completing this review.

1. Verify that HVAC equipment has specified efficiencies, air-delivery volumes, and temperatures. Consult Chapter 5 to ensure that equipment has been designed for the building and sizing was not based just on rules-of-thumb.

2. Specify materials and products by name and include a performance specification to accommodate alternative products. For example,

- Specify insulation by thermal resistance (R-value), permeability, and recycled content, not by thickness.
- Specify interior paints based on durability, cleanability, aesthetics, and VOC emissions.



Warren Gretz

Accurately document the sustainable design intent in construction drawings and specifications to avoid confusion during construction.

3. Evaluate the plan's thermal integrity:

- Check for continuity of insulation to avoid thermal bridging. Potential trouble spots to focus on include: steel framing members, the building slab, door thresholds, and window frames.
- Check for potential air leakage at construction seams and joints.

4. Temporary materials purchased for construction must meet the same environmental guidelines as other materials in the project, unless other criteria have been explicitly chosen for these applications. See Chapter 6 for specifics. For example:

- Construction wood (forms, bracing, etc.) may need to be certified.
 - Temporary materials should be local in origin when possible.
 - Temporary materials, such as wood frames, bracing, and temporary fencing should contain recycled content when possible.
5. Create a written system for evaluating and monitoring how the contractor is meeting sustainability requirements.

What makes good construction documents?

- Requiring pre-installation conferences to discuss installation procedures for a product or assembly that might be unfamiliar to the local contractors or might need to be handled in a specific way. This conference allows for face-to-face communication that should clarify ambiguities and prevent costly misunderstandings.
- Clearly stating in the specifications that all substitutions shall be approved before the substitution is made. The specifications should avoid the term "or equal," and use "or approved equal" instead. That way, material or equipment selections can be considered for potential alternative products. The submission instructions must clearly explain information required to evaluate substitution requests, and the criteria to be used. In particular, it should be noted that, in addition to the usual product performance criteria (strength, durability, appearance), environmental factors will be considered.



An organized, well-managed construction site promotes safety.

LANL



Safeguarding Design Goals During Construction

Building contractors are typically under a lot of pressure to meet the required schedule and budget for construction. Often, even with ample lead time, it can be difficult to ensure that specialty construction materials will be delivered when they are needed. When this happens, alternative materials and methods may be proposed to maintain the construction schedule.

Establish a plan for identifying critical design elements and component attributes that have the potential to affect other systems. Such attributes include: HVAC design, efficiency of heating and cooling equipment, glazing type (both visible and solar spectra, thermal performance of window frames, insulation R-values, and lighting layout. When changes are identified, determine alternatives with similar characteristics. Run energy simulations to determine impacts of alternatives.

Possible Consequences of Construction Substitutions

Material substitutions can result in a building that does not perform as intended. Recovering from construction errors also can compromise the original design intent. For example:

- If window glass was specified with specific visible transmittance and solar heat gain characteristics, but is replaced with glass having different characteristics, the daylighting may not work as designed, and the building may have higher heating or cooling loads than expected. Such a change would also require redesign of the mechanical and electrical systems and the final result would be higher construction costs and much higher operational costs. Energy and environmental goals would not be met.
- If the building foundation were back-filled prior to proper installation of insulation, the consequence would be additional heat loss through the slab and higher heating costs. More important, it would adversely affect thermal comfort and require maintaining higher air temperature in the space to compensate for the reduced radiant temperature of the slab. The ripple effect is usually not acceptable from a human productivity or a long-term energy cost point-of-view.

When such errors occur, it is important not to assume that their effect will be negligible. Instead, they should be brought to the attention of design team members who can determine what effect they might have on the project goals and how any adverse effect can be mitigated.



David Parsons

Examining a desiccant wheel upon delivery to the construction site.

Protecting the Site

The final site plan for the building should minimize site disturbance zones based on the current state of the site (see Chapter 3). A plan should be written that protects as much of the site as possible, including vegetation, land contours, and drainages.

The plan should indicate areas of the site to be used, including staging areas, storage areas (for materials and excavated materials), and the building site. Consider any site clearing that may be necessary to meet fire risk reduction guidelines as described in the *Design Principles*. Elements to protect should be clearly

marked. All materials entering the site should have a designated site storage destination prior to their arrival. Often, materials entering the site are “dropped” at a point that looks open. The more materials are moved, the greater the possibility for damage to the materials and the site and the potential for wasted funds.

Avoid damaging existing vegetation, especially to mature stands of trees. Damage to trees, both above and below ground, can occur during construction activities. The following guidelines help preserve existing trees:

- Install fences around trees to protect them from construction activities.
- Avoid trenching and digging near roots. (Roots can grow at distances one to three times the height of the tree.)
- If trenching cannot be avoided, then place the trench directly under the tree, as this damages the fewest roots and does not unbalance the tree. (If major roots from one side of a tree are severed, the tree could fall or blow over.)
- Avoid compacting soils containing tree roots to prevent decreasing the soil oxygen level, which inhibits root growth.



A silt fence is used to control erosion.

LANL



The LANL Non-Proliferation and International Security Center (NISC) was constructed on a previously distributed site.

LANL

- Avoid placing additional soil on the ground or changing the surface grade over the tree root systems, as that can smother the roots.
- Carefully choose which trees to remove, for removal of tall neighboring trees can expose remaining sun- and wind-sensitive trees to the elements and cause damage such as sunscald to trunks and branches.

Consider relocating and planting trees, shrubs, and other flora that could be restored as landscaping on this project or another project (see Chapter 7). Be sure to select plants that are able to tolerate transplanting; and become familiar with the best method for transplanting and care of the species chosen.

Preserve vegetation whenever possible, especially in low areas, to minimize runoff erosion and help water infiltrate during and after construction.



LANL

Checklist for Protecting the Site:

- | | |
|---|---|
| <ul style="list-style-type: none"> <input type="checkbox"/> Protect designated areas (trees, drainages, etc.) with temporary fencing. <input type="checkbox"/> Locate all construction trailers and parking areas for construction equipment and employees where they will cause the least damage to the site. <input type="checkbox"/> Specify areas in which to receive materials. <input type="checkbox"/> Identify locations for recycling and waste bins. <input type="checkbox"/> Identify access paths for construction vehicles and general public access. If possible, these paths should correspond to areas that will eventually be paved or covered with other hard surfaces. <input type="checkbox"/> Consider laying down preliminary paving in areas that will be permanently paved later. This will | <ul style="list-style-type: none"> reduce dust and erosion from construction activities and traffic. <input type="checkbox"/> When preparing the site, consider reusing site debris, including plant material, stone, gravel, and soil. Chip wood and use it on LANL grounds for mulch. Some of the material can be used as erosion and mud protection on the site. Scrape all topsoil to the construction limits and stockpile it for later use. <input type="checkbox"/> Use best management practices for stormwater and silt management. Consider creating stormwater management practices, such as piping systems, retention ponds, or tanks, which can be carried over after the building is complete (see Chapter 3). |
|---|---|

Low-Impact Construction Processes

Construction of a building uses a lot of energy, water, and other resources, beyond those that end up in the building itself. By paying attention to these resource flows, contractors can adopt procedures that are more efficient and less polluting. Here are some examples.

- Monitor energy and water use for construction. Provide incentives or place the utility and water bills in the contractor's name to encourage conservation.
- Use lighting during construction only in active areas of the site. This saves energy and protects the night sky from light pollution.
- Turn all lights off when work is at a halt. Operate security lighting on motion sensors.

- Use energy-efficient lamps, such as compact fluorescents, for temporary and permanent lighting schemes.
- Use renewable energy technologies or green power, if locally available, to power equipment.
- Consider using low-sulfur diesel or biodiesel fuel to minimize pollution from construction equipment and vehicles.
- Consider maintaining a natural-gas or electric pick-up truck on site for errands and other local use.
- Use low-flow fixtures for water siphons installed for construction.
- Use rainwater or reuse greywater from the construction site.



Appropriate construction equipment selection reduces site environmental impacts.

Protecting Indoor Air Quality

During construction, dust, VOCs, and emissions from equipment permeate the building site and the building itself. Poor indoor air quality (IAQ) can damage the health of workers and occupants of nearby buildings. It is important to take specific measures to protect IAQ on the site during and after construction.

Create a written plan for the contractor to use in managing air quality on the construction site that includes the following:

- Put up barriers to keep noise and pollutants from migrating.
- During pollution-generating activities in enclosed spaces, ventilate those spaces directly to the outdoors whenever possible.
- Once it is installed, ventilate the building through the HVAC system with appropriate temporary filtration to prevent the system from becoming contaminated.
- Cover and seal exposed openings of any ducts or equipment during construction.
- Increase the amount of outside air coming into the building during construction to reduce pollutants.
- Create controls, such as scheduling construction activities at the end of the day, to ventilate overnight while site and surroundings are unoccupied.

LANL

- Be aware of air quality throughout the project, not just during times of activities that create high amounts of airborne pollutants and emissions.
- Monitor IAQ regularly with tests and inspections and adjust the ventilation and scheduling if necessary to improve IAQ.
- Prevent poor IAQ by selecting materials and products designed for less offgassing, such as low-VOC paints and sealants and formaldehyde-free particle board (see Chapter 6).
- Keep the site and interiors clean and free of debris to keep dust down. Store polluting materials in a specified storage area to protect the building from pollutants.
- Meet or exceed the minimum requirements of the Sheet Metal and Air Conditioning National Contractors Association (SMACNA) IAQ Guideline for Occupied Buildings under Construction, 1995.

- Protect stored on-site or installed absorptive materials from moisture damage. Avoid installing any materials that might absorb moisture until they can be protected adequately.
- Replace all filtration immediately prior to occupancy. Filtration should have a Minimum Efficiency Reporting Value (MERV) of 13 as determined by ASHRAE 55-1992, Addendum-1995.
- Check for dirt and contamination in ducts and plenums, and clean them, if necessary, before occupancy.
- If an under-floor air distribution system is to be installed, keep the floors clean because they will become part of the air supply passages.
- Conduct a minimum two-week building flush-out with new filtration media at 100 percent outside air after construction ends and before occupancy.

Managing Construction Waste

Construction activities generate significant quantities of solid waste. The primary intent of sustainable construction waste management practices is to conserve resources by minimizing the amount of material disposed of in landfills. Always conduct construction waste management on the basis of the three- “Rs” hierarchy: reduce, reuse, and recycle. Although recycling is an important aspect of construction waste management, it is last in the hierarchy.

- Reduce waste generation by following the waste reduction measures developed during the design phase.

Typical Construction and Demolition Waste Streams

(Waste percent by volume)

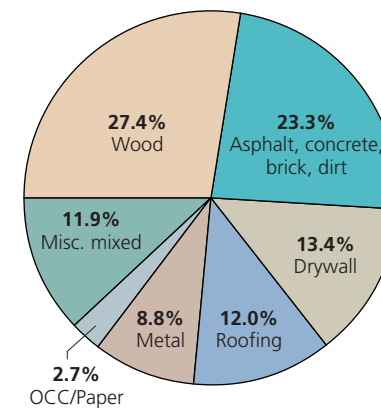

Reference: USGBC LEED Reference Guide, Version 2.0, August 2000



National Institutes of Health

- Reuse materials on the project or offer materials for reuse or resale by others (e.g., return unused materials to vendors for credit or donate unused materials to organizations such as Habitat for Humanity).
- Recycle construction waste materials as the last opportunity to reduce the amount of waste destined for the landfill.

Generally, recycling construction waste also offers cost savings in the form of reduced disposal costs. However, such savings can be offset by the extra labor required to prepare the materials (e.g., source separation) and the additional hauling expense. Evaluate these factors for each project because they will vary with project size and market conditions.

Guidelines for Implementing Successful Construction Waste Management Practices

Identify recyclable materials

It is important to identify which materials can be recycled in the vicinity of LANL. Contact LANL Pollution Prevention for recycling options. The local solid waste authority or Home Builders Association may provide additional recycling options. Other sources of information include: New Mexico Environment Department, New Mexico Energy, Minerals and Natural Resources Department, waste haulers, and demolition contractors.

Determine the cost and savings of recycling

To determine if recycling is cost-effective on a construction project, compare the cost of normal waste disposal practices with the cost of recycling. Generally, recycling offers cost savings in the form of avoided disposal costs. Unfortunately, savings can sometimes be offset by the extra labor it may take to prepare materials to meet the recycler's specifications or the additional hauling expense to take the materials to the recycler.

Specifications

Develop specification language to address waste reduction, reuse, and recycling during construction. Sample specification sections are included in the references at the end of this chapter.

Waste Management Plan

A waste management plan is an effective planning document for projects generating large quantities of waste. The waste management plan does not need to be lengthy or complicated to be effective, but a successful plan should contain all of the following information:

- Waste management goals
- An analysis of project waste
- Identification of what materials will be recycled
- Disposal methods
- Material handling procedures
- Identification of who will be responsible for implementing and monitoring waste disposal and recycling
- Instructions for the crew and subcontractors.

Specifications in Subcontractor Agreements

In addition to a general waste management plan, it may also be helpful to specify the waste management goals in subcontractor agreements. This ensures that expectations and procedures are clearly communicated to everyone. The following is a sample specification in a subcontractor agreement:

"The subcontractor will make a good faith effort to reduce the amount of waste generated on the job-site and recycle material per the contractor's Waste Management Plan. The subcontractor will follow the designated handling procedures for each type of waste generated on-site and provide documentation to verify material reuse, recycling, and disposal as indicated in the waste management plan."

Managing the Program

Implementing a successful waste management plan requires leadership. An individual or team should be responsible for educating crew and subcontractors, setting up the site, and

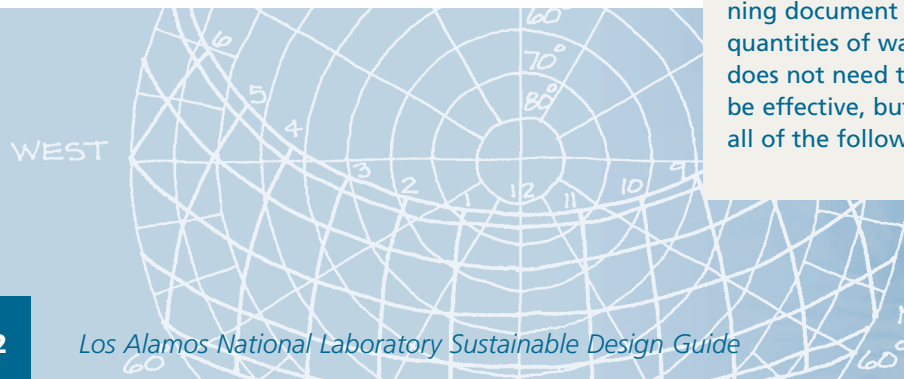

OCT./FEB. 21

NOV./JAN. 21

60° DEC. 21

Guidelines for Implementing Successful Construction Waste Management Practices (continued)

coordinating and supervising recycling efforts to prevent contamination of recycling loads. On small-scale projects, the contractor, site supervisor, or crew chief can manage recycling activities. For larger projects, form a waste management team consisting of key people such as the owner, designer, project manager, and site supervisor.

Involving Subcontractors

Take steps to ensure that subcontractors will participate in the successful implementation of the waste management plan. Require subcontractors to use the recycling and disposal bins on-site. In doing so, be sure to provide recycling for the variety of wastes that subcontractors generate. Alternatively, the subcontractors could recycle their waste on their own, but documentation of their efforts would be required.

Source Reduction

Source reduction at the job site prevents waste generation. This includes minimizing contributors to waste such as over-packing, improper storage, ordering errors, poor planning, breakage, mishandling, and contamination.

Reuse Options

There are some new approaches to reusing materials to lower disposal costs. “Clean” wood and drywall waste can be used on site. Chipped wood can be used as mulch and pulverized drywall can be used as a soil amendment. In addition, reuse centers accept and then resell salvaged materials and misordered or slightly damaged new materials. Many reuse operations are not-for-profit organizations, such as Habitat for Humanity, the Salvation

Army, and Wemagination. All reuse options considered must be coordinated through LANL.

Finding Appropriate Space

Recycling and reuse efforts require space. Set aside an area of the job site to store salvaged building materials and to house recycling bins (for either commingled or source-separated loads). The following are helpful hints for finding space on the job site:

- Use smaller bins and more frequent collection.
- Ask recycling service providers about single dumpsters with multiple compartments.
- Rent a trailer for the major portion of recyclable material generated in the first phase of construction and haul it directly to the recycler when full.
- Use smaller containers that are collected at the end of the day and dumped into a larger container for pickup.
- If self-hauling, build custom containers to fit the space requirements using scrap or damaged plywood, concrete forms, or barrier fencing.
- If space is too limited on the job site to accommodate separation of materials, seek a waste hauler who will take comingled waste and sort it off-site for recycling and disposal.

Promotion and Education

Once space for recycling and disposal activities has been designated, communicate the plan to the crew and subcontractors. Everyone will need to know how materials should be separated, where materials should go, and how often the materials will be collected and delivered to appropriate facilities. Tips for educating the project team are:

- Include waste handling requirements in all project documents. This makes it clear from the beginning that waste prevention and recycling is expected from all crew members and subcontractors.
- Let the crew and subcontractors know how effective they have been by regularly posting the volumes of material reused or recycled.
- Include everyone in the process.
- Encourage suggestions for more efficient recycling methods, or additional materials that can be recycled.

Preventing Contamination

Project recycling efforts may be in vain if recycling loads get mixed or become contaminated with non-recyclable garbage. Haulers and recyclers generally won't take contaminated materials, which can then cost extra disposal fees. The following tips can help prevent contamination of recyclables:

- Post information describing the recycling program in visible locations.
- Clearly label recycling bins. Post lists of materials that are and are not recyclable.
- Place recycling and trash bins near each other so that trash is not thrown into the recycling bins.
- Conduct regular site visits to verify that bins are not contaminated. Give feedback to subcontractors and the crew on the results of their efforts.
- Consider locating bins in a locked or supervised area.

Criteria for Sustainable Success			
	✓ <i>Standard Practice/ Code-Compliant</i>	✓ <i>Better Performance</i>	✓ <i>High Performance for Sustainability</i>
Specifications	<input type="radio"/> Standard specs based on office master or generic master specifications, modified to fit project	<input type="radio"/> Specifications with green goals and requirements spelled out in Division 1 and all relevant technical sections	<input type="radio"/> Preinstallation conferences with contractors and subcontractors to ensure good communication
Changes During Construction	<input type="radio"/> Accepted with minimal review in most cases	<input type="radio"/> Reviewed by generalist who is supervising construction	<input type="radio"/> Reviewed by design team members who are qualified to determine the effect of the change on the project goals
Sitework	<input type="radio"/> Staging areas and traffic flows not well coordinated	<input type="radio"/> Areas designated for staging and traffic with consideration for protection of environmentally sensitive areas	<input type="radio"/> Any areas not specifically designated for staging or traffic protected with temporary fencing and penalties for damage
	<input type="radio"/> Existing vegetation scraped off for convenience of construction activities	<input type="radio"/> Areas to be protected fenced off and irrigated as appropriate	<input type="radio"/> Existing vegetation protected during construction, including relocating existing plants for reuse
Construction Processes	<input type="radio"/> Minimal attention to energy and water usage	<input type="radio"/> Efforts made to improve efficiency of the most energy- and water-intensive processes	<input type="radio"/> Comprehensive effort to document energy and water usage and avoid waste
Construction Waste	<input type="radio"/> Segregation and disposal	<input type="radio"/> Recycling	<input type="radio"/> Comprehensive plan implemented for material and waste reduction
Construction IAQ	<input type="radio"/> No special attention to indoor air quality effects of construction	<input type="radio"/> Increased ventilation during polluting activities	<input type="radio"/> Comprehensive plan implemented for protecting IAQ during construction and preventing actions that could jeopardize IAQ afterwards



Additional Resources

American Society of Heating, Refrigerating, and Air-Conditioning Engineers (ASHRAE), www.ashrae.org

“Construction IAQ Management: Job-site Strategies for Ensuring a Healthy Building” *Environmental Building News*, Vol. 11, No. 5 (May 2002).

EPA Comprehensive Procurement Guidelines, www.epa.gov/epaoswer/non-hw/procure/products.htm

“Greening Your Business” *Environmental Building News*, Vol. 9, No. 10 (October 2000)

Green Seal, www.greenseal.org

“Getting from Design to Construction: Writing Specifications for Green Projects” *Environmental Building News*, Vol. 11, No. 7 (July-August 2002)

Green Building Materials: A Guide to Product Selection and Specification, Ross Spiegel and Dru Meadows, John Wiley & Sons, 1999.

“Construction Specifications” by Donald Baerman, in *Time-Saver Standards for Architectural Design Data*, 7th edition (McGraw-Hill, 1997)

Reference Specifications for Energy and Resource Efficiency, California Energy Commission: www.eley.com/specs/

GreenSpec Product Directory with Guideline Specifications, BuildingGreen, Inc., 2002
International Society of Arboriculture, www.isa-arbor.com

Sheet Metal and Air Conditioning National Contractors Association (SMACNA), www.smacna.org

“Transplanting Trees and Shrubs,” North Dakota State University, NDSU Extension Service, www.ext.nodak.edu/extpubs/plantsciltrees/f1147w.htm

WasteSpec: Model Specifications for Construction Waste Reduction, Reuse, and Recycling, Triangle J Council of Governments, www.tjcog.dst.nc.us/cdwaste.htm

Habitat for Humanity, Espanola, New Mexico:
Phone: (505)747-2690

LANL Pollution Prevention, <http://emeso.lanl.gov>

New Mexico Environment Department, www.nmenv.state.nm.us

New Mexico Energy, Minerals, and Natural Resources Department, www.emnrd.state.nm.us

Home Builder’s Association for Central New Mexico, www.hbacnm.com



*Chapter 9:
Commissioning the Building*

- ❏ *Commissioning Process Overview*
- ❏ *Commissioning Activities and Documentation*

Chapter 9

Commissioning the Building

Commissioning Process Overview

Commissioning is a process – a systematic process of ensuring that a building performs in accordance with the design intent, contract documents, and the owner’s operational needs. Commissioning is fundamental to the success of the whole-building design process. Due to the sophistication of building designs and the complexity of building systems constructed today, commissioning is necessary, but not automatically included as part of the typical design and contracting process.

Commissioning is critical for ensuring that the building design is successfully constructed and operated.

Any type of building will benefit from a commissioning effort. Commissioning is even more important in energy-efficient buildings to ensure that they perform as intended to maintain comfort. Also, HVAC equipment in better-performing buildings may require advanced control strategies. But commissioning goes beyond the traditional HVAC elements. More and more buildings rely on the integrity of the envelope to ensure comfort.

Commissioning can also evaluate claims about the construction materials such as durability and VOC emission content. It can improve power quality for the overall building by verifying that electrical building support and



Rooftop cooling equipment inspection with building owner representative, facility engineer, and installer.

Warren Gretz

Building Commissioning

Building commissioning:

- Is a systematic and designed process coordinated by a commissioning authority or team.
- Includes documentation, verification procedures, functional performance tests, validation, and training.
- Is performed specifically to ensure building operation in accordance with design intent and construction documents.
- Starts with the conceptual phase and continues through design and construction to a minimum of one year after construction completion.

Building commissioning implementation:

- Begins early in the design process.
- Necessitates special bidding requirements during contractor selection.
- Coordinates the static and dynamic testing that acceptance is based on.
- Finishes with staff training and warranty monitoring.

Building systems to be commissioned include:

- Mechanical (heating, ventilating, air-conditioning, and refrigeration)
- Electrical
- Lighting
- Life safety
- Plumbing
- Building envelope and interior finish materials
- Laboratory-specific processes

Building commissioning is more than:

- Construction observation (punch list)
- Start-up
- Testing, adjusting, and balancing (TAB)
- Final punch-out and acceptance
- Post-occupancy re-tuning

These activities are among the individual steps in the systematic process of commissioning, but by themselves these activities cannot meet the goals of building commissioning.

laboratory equipment performs as specified. It is important that the products specified for the building meet the manufacturer's claims and are appropriate for the project.

While commissioning is critical before and during initial occupancy, use and changes over time require that systems be evaluated on an ongoing basis. *Continuous commissioning*, or recommissioning at planned inter-



Robb Williamson

Checking air flow in a displacement ventilation system diffuser. Dirty or clogged air filters are a common commissioning finding. Not only do dirty filters reduce air handler efficiency, they also can affect occupant comfort and health.

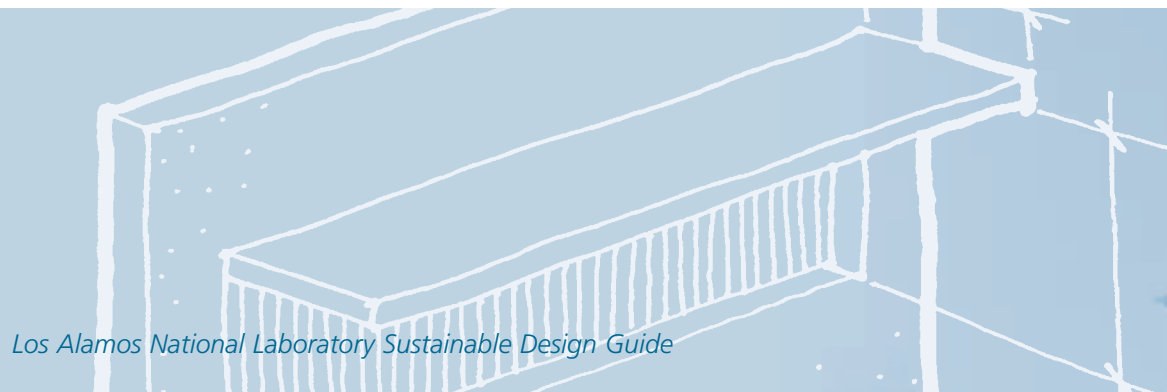

vals, ensures that the building operates as efficiently as possible while meeting comfort and functional needs throughout the life of the building. Continuous commissioning goes beyond traditional building operation and maintenance just as initial commissioning differs from testing, adjusting, and balancing. Continuous commissioning involves scheduled and rigorous retesting of building systems to ensure that they continue to operate optimally.

Building commissioning has emerged as the preferred method of ensuring that building systems are installed and operated to provide the performance envisioned by the designer.

– *Continuous Commissioning Guidebook, U.S. Department of Energy*

Benefits of building commissioning include:

- Energy savings and persistence of savings
- Improved thermal comfort with proper environmental control
- Improved indoor air quality
- Improved operation and maintenance with documentation
- Improved system function that eases building turn-over from contractor to owner
- Consistent system function when the building turns over from one operator to another

The Laboratory already uses project documentation relevant to commissioning including:

- Quality Assurance Project Plans
- Construction Management Plans
- Test and Inspection Plans
- Acceptance Test Procedures
- O&M Manuals

Building commissioning coordinates these plans and manuals and leverages their benefits through a systematic and integrated process.

The Cost of Commissioning

Energy, water, productivity, and operational savings resulting from commissioning offsets the cost of implementing a building commissioning process. Recent studies indicate that on average, operating costs of a commissioned building range from 8–20% below that of a non-commissioned building. The one-time investment in commissioning at the beginning of a project results in reduced operating costs that will last the life of the building. In general, the cost of commissioning is less than the cost of NOT commissioning. Continuous commissioning is an enhancement to O&M that typically makes facility operations and management more efficient.

The cost of commissioning is dependent upon many factors, including a building’s size and complexity, and whether the project consists of new construction or building renovation. In general,

the cost of commissioning a new building ranges from 0.5–1.5% of the total construction cost. For an existing building, never before commissioned, the cost of retro-commissioning can range from 3–5% of total operating cost.

Costs of Commissioning, New Construction

Commissioning Scope	Estimated Cost
Entire building (HVAC, Controls, Electrical, Mechanical)	0.5–1.5% of total construction cost
HVAC and Automated Control System	1.5–2.5% of mechanical system cost
Electrical Systems	1.0–1.5% of electrical system cost
Energy Efficiency Measures	\$0.23–0.28 per square foot

Source: Building Commissioning Guide, Version 2.2, 1998. DOE/GSA.

Commissioning Process Flow Chart Across the LANL Project Development Process

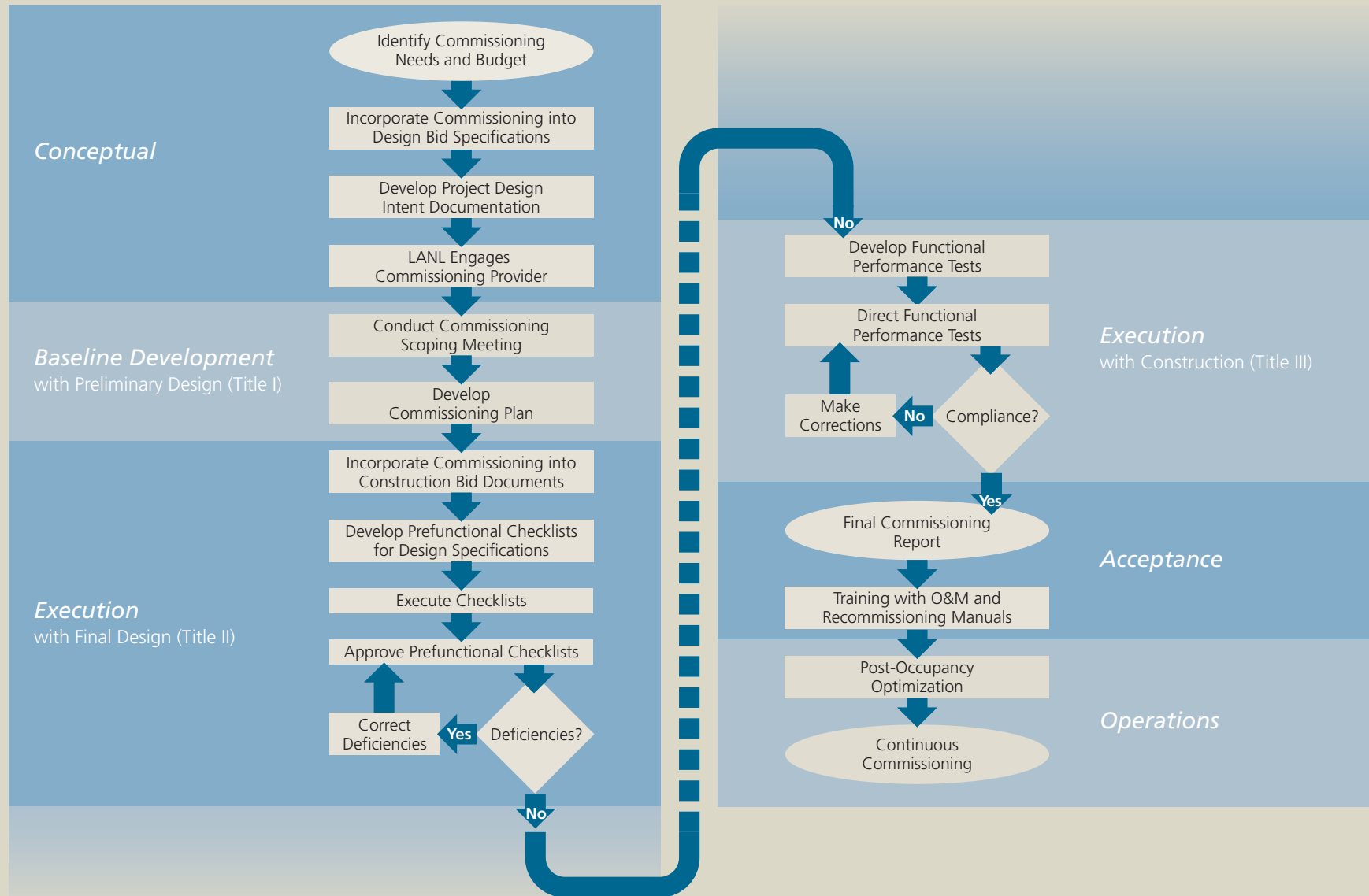

Commissioning ideally occurs through all phases of a building project (see figure on the opposing page). The process begins by identifying commissioning needs in the conceptual design phase and then designating a commissioning provider. While it is beneficial to have a third-party commissioning authority for more comprehensive design and construction review, it is acceptable for a project to use a qualified member of the design team as the commissioning agent.

The commissioning provider serves as an objective advocate of the owner, directs the commissioning process, and presents final recommendations to the

owner regarding the design and performance of commissioned building systems. The commissioning provider introduces standards and strategies early in the design process and then ensures implementation of selected measures by clearly stating target requirements in construction documents. The commissioning provider then verifies that the minimum performance targets have been met after construction completion. In addition, the commissioning provider should provide guidance on how to operate the building at peak efficiency as part of a continuous commissioning manual.



End-use metering provides a good indication of how sub-systems are operating in a building. Sub-meters are recommended for HVAC, lighting, and plug loads. Recording and tracking this information is useful for evaluating the start-up and efficiencies of sub-metered systems.



Temperature sensors must be calibrated against known standards to ensure that monitoring results and actual comfort conditions match.

Commissioning Activities and Documentation

- **Owner's Requirements.** List and describe the owner's requirements and basis of design intent with performance criteria and goals.
- **Commissioning Plan.** Create the commissioning plan as early in the design phase as possible, including the management strategy and list of all features and systems to be commissioned.
- **Design Review.** Review plans at designated points in the design process to verify that the design is consistent with the owner's intent and goals.
- **Bid Documents.** Integrate commissioning requirements in the construction bid and contract documents. Designate the Construction Specifications Institute (CSI) Construction Specification Section 01810 in Division 1 for general commissioning requirements. Use the unassigned Sections 01811 through 01819 to address requirements specific to individual systems. Notify mechanical and electrical subcontractors of Division 15 and 16 commissioning requirements in Sections 15995 and 16995.
- **Prefunctional Checklists.** Develop prefunctional checklists for specifications of each piece of equipment identified in the commissioning plan.
- **Functional Performance Test Procedures and Checklists.** Develop functional performance test procedures or performance criteria verification checklists for each of the systems identified in the commissioning plan.
- **Commissioning Report.** Complete a commissioning report for each identified component, equipment, system, or feature, including results of prefunctional checklists, installation observation, start-up and checkout, operation sampling, functional performance testing, and performance criteria verification.
- **Training.** Assemble written verification that training was conducted for appropriate personnel on all commissioned features and systems.

Examples of Components and Systems to Target for Functional Performance Testing:

Mechanical and Electrical

- Central building automation systems, including linkages to remote monitoring and control sites
- Air supply and exhaust systems and controls
- Fume hoods and laboratory air pressurization
- Central plant systems (boilers, chillers, pumps, cooling towers, controls, etc.)
- All equipment of the heating, ventilating and air conditioning (HVAC) systems, including test and balance (TAB) procedures and ductwork testing and cleaning
- Lighting systems and controls
- Electrical power systems including emergency power, electrical grounding, and possible faults

Building Envelope

- Interior and exterior light and shade management devices
- Window glazing
- Infiltration air leakage

Laboratory

- Life-safety systems and toxic-gas monitoring systems (verify that HVAC systems are interlocked and operate per code under emergency situations)
- Process and specialty gas distribution systems, including hazardous production materials
- Process cooling water systems, including deionized water

- **Operation and Maintenance Manuals.** Review operation and maintenance manuals for completeness, including instructions for installation, maintenance schedules and procedures, replacement, and start-up; replacement sources; parts lists; special tools; performance data; and warranty details.
- **Recommissioning Management Manual.** Develop an indexed recommissioning management manual with components such as guidelines for establishing and tracking benchmarks for whole building energy use and equipment efficiencies, recommendations

for recalibration frequency of sensors, list of all user adjustable set-points and reset schedules, and list of diagnostic tools.

- **Post-Occupancy Optimization Report.** Complete a commissioning report at the close of the warranty period verifying that the identified systems and features of the building are performing as intended through the heating, cooling, and swing seasons. Identify any issues with recommended resolutions.

Examples of Functional Performance Test Activities:

- Verify all pieces of equipment perform according to manufacturers' specifications.
- Measure temperatures and flow rates from all HVAC devices and compare to specifications.
- Calibrate all sensors to a known standard.
- Review the sequence of start-up operations.
- Verify controls are providing the correct interaction between equipment and systems.
- Determine energy efficiency of major systems and equipment relative to design specifications and at variable loads.



Mike Ketcham

Light sensors must be calibrated and control sequences validated properly to dim and shut-off light fixtures when adequate natural light is available.



Robb Williamson

A National Park Service staff member verifies the operation of an Energy Management Control System. Calibration of sensors and verification of program sequencing is essential to creating a building that operates properly.

Building flush-out

Consider a building flush-out period after construction completion and prior to occupancy to reduce possible indoor air quality contamination. This involves running the mechanical system with tempered 100% outside air for an extended period of time (two weeks). Flushing out the building may be particularly important when high VOC- and particle-emitting construction materials, furnishings, interior finishes, and cleaning agents have been applied. Change all ventilation air filters as a final step of building flush-out.



Craig Miller, DOE

Visual inspection can provide clues for diagnosing HVAC system performance problems. For example, filters full of construction dust and water on the floor of a mechanical room indicate issues that need to be corrected.

Case Study:

Commissioning at the Nicholas C. Metropolis Modeling and Simulation Center at the Strategic Computing Complex

The Metropolis Center general contractor, Hensel Phelps, retained a third-party commissioning agent, Testmark Associates of Golden, Colorado. Testmark participated in the general review. They reviewed and had some input into plans for chilled water schematics and sequences and mechanical/electrical systems.

Subsequently, there were bimonthly commissioning meetings to address issues as they arose during construction, to plan coordination for building start-up, and to review safety procedures. Testmark placed two full-time staff on site to carry out standard testing procedures during construction. These tests were ongoing through-

out summer months. Commissioned systems included chilled water, heating water, ventilation systems (including air handlers, variable air volumes, and exhaust fans), main switches, building substations, power panels, lighting controls, electrical receptacles, i.e. all mechanical/electrical systems and equipment. Before Testmark completed its contract, it conducted a 24-hour baseline analysis during winter months to ensure that systems were functioning within the expected design and operating parameters. Testmark's contract did not call for revisits. Due to security concerns, it is necessary for LANL to carry out all future testing and recommissioning procedures. Testmark provided a comprehensive procedure manual with manufacturer specifications for that purpose.

✓ Systems Integration Issues

- The commissioning process is a mechanism to ensure that the interface between the trades is working properly. It affects all dynamically operated components, equipment, systems, and features, as well as the environmental performance aspects of selected static materials and systems.
- Additional commissioning supplements fundamental commissioning and focuses on review of the building design and construction documents to identify areas for improvement as well as re-commissioning of building systems after occupancy.
- Address the commissioning process during pre-bid or pre-construction conferences as well as at design and construction meetings.
- The construction contractor should understand that a third-party will be evaluating their work for compliance with the specifications. If design review is included within the commissioning scope, the design team also will be asked to provide plans and specifications and to respond to questions and concerns. These expectations must be made clear early in the process so that the designers and contractors are prepared to assist and provide appropriate documentation.
- Coordinate functional performance test measurement devices with those required as part of the energy management control system and any long-term continuous measurement and verification objectives to either double check instrument readings or to reduce redundancy of equipment.

The bottom line is that commissioning improves a building's value... Systems that function properly use less energy, experience less down time, and require less maintenance, thereby saving money for building owners.

– Building Commissioning: The Key to Quality Assurance, U.S. Department of Energy



Perform functional tests at design, intermediate, and minimum flow conditions on variable frequency drive motors controlling variable flow hydronic systems.

Warren Gretz



Criteria for Sustainable Success			
	✓ <i>Standard Practice/ Code-Compliant</i>	✓ <i>Better Performance</i>	✓ <i>High Performance for Sustainability</i>
Commissioning Activities	<input type="radio"/> Federal and local codes for quality assurance	<i>PLUS:</i> <input type="radio"/> Commissioning plan, functional performance testing, and commissioning report	<i>PLUS:</i> <input type="radio"/> Comprehensive review of design and contractor submittals throughout the entire construction process
Commissioning Provider	<input type="radio"/> None	<input type="radio"/> Contract for commissioning agent as part of design or construction team	<input type="radio"/> Contract for third-party commissioning authority
Operation Documentation	<input type="radio"/> Construction as-built drawings and warranty documentation	<i>PLUS:</i> <input type="radio"/> Comprehensive O&M manual and preventive maintenance plan	<i>PLUS:</i> <input type="radio"/> Recommissioning management manual
Last Construction Process Step	<input type="radio"/> Final contractor punch-out	<input type="radio"/> Final commissioning report after staff training and building flush-out	<input type="radio"/> Near-warranty end or post-occupancy review (i.e., 10 months into 12-month warranty period)
Continuous Commissioning	<input type="radio"/> Reactive approach: examination of systems only when problems are reported	<input type="radio"/> Active approach: effective maintenance with performance testing as resources allow	<input type="radio"/> Proactive approach: scheduled recommissioning of all systems on a periodic basis



References

"Building Commissioning Guide." Version 2.2. 1998. DOE/GSA. www.eren.doe.gov/fempl/techassist/bldgcomgd.html

"ASHRAE Guideline 1-1996: The HVAC Commissioning Process." American Society of Heating, Refrigerating, and Air-Conditioning Engineers (ASHRAE), 1996.

"An Integrated Approach to Building Commissioning – Professional Development Seminar." ASHRAE, 1999.

"What Can Commissioning Do For Your Building?" PECl. www.peci.org/cx/overviews.html

"Commissioning to Meet Green Expectations." PECl. www.peci.org/cx/CxGreen.pdf

Proceedings of the Annual National Conference on Building Commissioning. 1993–2002. PECl. www.peci.org/ncbc/proceed.html

"Leadership in Energy & Environmental Design Reference Guide." Version 2.0. U.S. Green Building Council, 2001.

"Sustainable Building Technical Manual." Public Technology, Inc., 1996.

"Sustainable Design Report for Los Alamos National Laboratory's Strategic Computing Complex." LA-UR-01-5547. http://emeso.lanl.gov/useful_info/publications/SCC_SD.pdf

Additional Resources

"Model Commissioning Plan and Guide Specifications." Version 2.05. www.eren.doe.gov/fempl/techassist/bldgcomgd.html

"Commissioning for Energy Efficiency." DOE Office of Energy Efficiency and Renewable Energy. www.eren.doe.gov/buildings/comm_energyeff.html

E-design Online Commissioning Archives 1996-2000. www.state.fl.us/fdiledesign/news/main/commiss.htm

Diagnostics for Building Commissioning and Operation <http://leed.lbl.gov/EAIIT/diag>

"Building Commissioning; The Key to Buildings that Work." *Environmental Building News*. Vol. 9, No. 2 (February 2000).

Oregon State Energy Office www.energy.state.or.us/bus/comm/bldgcx.htm

Building Commissioning Association www.bcxa.org



**Chapter 10: Education,
Training, and Operation**

- ❑ *Building Occupant and Operator Roles*
- ❑ *Information for Facilities Managers and Maintenance Staff*
- ❑ *Information for Building Users*
- ❑ *Post-Occupancy Evaluation*

Nicholas C. Metropolis Center
For Modeling & Simulation

Chapter 10

Education, Training, and Operation

Building Occupant and Operator Roles

The success of a high-performance building depends how it is designed, built, and managed. Many of the most important sustainable design goals relate to resource use and pollution from building operations. If the facility managers are not well-informed and actively supporting these goals, they may inadvertently undermine them. Depending on how the building systems are designed, cooperation from building occupants may also be essential to success.

Communicating the building's sustainability vision and features can imbue its managers and users with a sense of pride that can reinforce the commitment to low-impact, high-performance operations. The hand-off from the building delivery team to the ones who will run and use it is a critical point at which much can be gained or lost, depending on the effectiveness of the communication.



David Parsons

Information for Facilities Managers and Maintenance Staff

Unless they are told otherwise, the people who will manage and maintain a new high-performance building are likely to expect this building to work like any other building. Anything out-of-the-ordinary or unusual in the new building must be identified and explained if it is to be operated and maintained properly. Hopefully, key facility managers will have participated in the design process, and had an opportunity to gain some comfort with the systems that are being used, and warn against the use of systems that might be problematic.

If high-tech mechanical systems and building controls are used in a setting where they are not yet standard, special training may be needed. Such training might be

available, either on- or off-site, from the manufacturers of the systems or from third party trainers.

Often the commissioning process is an ideal opportunity for building staff to learn about the systems they are inheriting. A commissioning agent must be well-versed in the systems and controls. As he or she takes the building through its paces, others can follow along, ask questions, and assist in the process, thereby learning both how the systems were designed to work and how they are performing as installed. It is even advisable to video this process. Personnel who cannot participate or who join the staff later can learn by watching video.



Kenneth Shipp

User Manual for Building Operation

At a minimum, the commissioning report can become the basis for a “user manual,” as it explains the design intent and the documented performance of the various systems. This information can be supplemented with protocols and resources for dealing with regular maintenance and unexpected events.

It is common practice for the design team and/or construction contractor to supply a binder full of user guides for all equipment in the building. It is not standard practice for this binder to include big picture information about the design intent and guidance about how the building should be operated as a whole system. Yet that additional information is essential for a building to achieve a high level of performance in operation.

More specifically, include information about any systems that required research on the part of the design team in the user manual – it is fair to assume that if the designers were not experienced with those systems, the building operators will not be either. Also, review the “Criteria for Sustainable Success” tables throughout this guide and include documentation for the facility managers from the areas with “Better” or “High” performance.



Warren Gretz

Information for Building Users

There are two distinct design philosophies regarding the relationship between a high-performance building and its occupants. The first is that the users want to actively participate in controlling their environment. This design philosophy tends to result in buildings that depend on this occupant participation for optimal performance. Occupants may be empowered, for example, to open windows when conditions permit,

Well-labeled mechanical system components greatly improve the building operators ability to manage and maintain all systems as the sustainable design intended.

to manually control blinds and louvers, and to learn something about their building and how it differs from a typical building.

The second design approach argues that most users would rather not be bothered with learning about the building in which they work, and any non-standard systems should be automated and managed in a way that makes them transparent. This approach places the optimal performance of the building before the education of occupants in terms of priorities, and tends to depend heavily on automated control systems rather than human intervention.

Either philosophy may be appropriate as an underlying strategy for designing a high-performance building. They differ greatly, however, in terms of the information that must be communicated to the occupants. If the occupants are to be engaged and participate in running the building properly, it is up to the designers to create the systems that teach the occupants what they must do. These systems might include strategically placed informational signs and placards, brochures, even interactive kiosks displaying the building's performance in real time. If the building is to perform independently of the occupants, the designers must focus on robust control systems and a well-trained building staff to keep things working well.



Warren Gretz

Features that May Benefit from Interpretive Signage

Light switches – Placards encouraging users to turn off unneeded lights OR explaining the principles of automated controls so users understand when and how it is appropriate to override those controls.

Window blinds – Placards explaining how the blinds are best used to control glare while introducing daylight.

Task lights – Information at workstations explaining the benefits of lighting based on indirect ambient light combined with direct task lighting, and suggestions for adjusting the task lighting for various activities.

Building energy performance (especially if renewable energy systems are included) – Informational kiosk displaying and interpreting energy performance in real time. Ideally this information would also be available at workstations via the Internet.

Operable windows – Placards describing when it is appropriate to open them (ideally based on real-time guidance from building management) or why they are locked at certain times to maintain air-flow integrity for the mechanical system.

Underfloor air distribution – Information at workstations explaining how users can adjust the air-flow in their vicinity using the round diffusers.



Warren Gretz

Entryway track-off system – Sign explaining the benefits of trapping dirt to improve building maintenance and indoor air quality.

Dual-flush toilets – Placards explaining the two levels of flushing action and when each is appropriate.

No-flush urinals – Placards explaining how they work.

Foot-pedal faucet controls – Placards explaining how they work.



Robb Williamson

The design response may be to engage the occupants and educate them about the effect of daylighting and the energy savings in order to discourage them from manually overriding the lighting controls and turning on the lights. Or, it can involve the installation of fully dimmable ballasts and calibrated controls that keep the lights on at very low levels, even when the daylight is sufficient. These controls can even be set to allow users to turn the lights up, while limiting their range of control to a reasonable level.

Regardless of the design philosophy, it is important to provide general information on the benefits of the high-performance building so that building occupants and LANL administrators can take pride in what they have. This information may be in the form of attractive brochures illustrating the building's features, and can be made available to visitors as well as staff. These brochures can be published both on paper and electronically via the Internet, and should focus on how these features contribute to a more comfortable and productive workplace and how they protect and enhance the global environment.

Post-Occupancy Evaluation

Once the building is occupied, it becomes a valuable source of information to be mined and analyzed when planning maintenance, modifications, and future projects. Information extracted through periodic or ongoing commissioning provide critical information about how building systems perform over time. Survey the building users for information on how they feel about the building in terms of thermal, visual, and acoustical comfort, indoor environmental quality, and responsiveness to problems.



Criteria for Sustainable Success			
	✓ <i>Standard Practice/ Code-Compliant</i>	✓ <i>Better Performance</i>	✓ <i>High Performance for Sustainability</i>
Information transfer to building staff	<ul style="list-style-type: none"> ○ Binder with manuals for installed equipment 	<ul style="list-style-type: none"> ○ As-built drawings, notes about the design intent, and guidance on operating the building as a whole system 	<p><i>PLUS:</i></p> <ul style="list-style-type: none"> ○ Hands-on training, including performance targets, (may be linked to the commissioning process) documented on video
Information transfer to building users	<ul style="list-style-type: none"> ○ Emergency response and evacuation procedures 	<ul style="list-style-type: none"> ○ Brochures or signage explaining the building's benefits to users and the environment 	<ul style="list-style-type: none"> ○ Interpretive signs, literature, and other materials explaining the building's high-performance features and how users can maximize the benefits of those features
Post-occupancy evaluation	<ul style="list-style-type: none"> ○ Not done 	<ul style="list-style-type: none"> ○ Occasional, limited-scope investigations in reaction to problems 	<ul style="list-style-type: none"> ○ Comprehensive plan for periodic commissioning of building systems and surveying of occupants, with the results used to identify modifications and other projects.



Additional Resources

Vital Signs, <http://arch.ced.berkeley.edu/research/>

Building Use Studies, www.usablebuildings.co.uk



NYSERDA

Appendices

- ⌘ *Appendix A: Best Practices, Orders, Regulations, and Laws*
- ⌘ *Appendix B: Climate Charts*
- ⌘ *Appendix C: Green Building Adviser*
- ⌘ *Appendix D: Site-Wide Metering Program at LANL*
- ⌘ *Appendix E: LEED Checklist*
- ⌘ *Appendix F: Building Simulations*
- ⌘ *Appendix G: Sun Path Diagram*
- ⌘ *Appendix H: Reduce, Reuse, and Recycle Options*

Appendix A

Best Practices, Orders, Regulations, and Laws

All facilities must comply with the Code of Federal Regulations 10CFR434, “Energy Conservation Voluntary Performance Standards for New Buildings; Mandatory for Federal Buildings.” This code establishes performance standards to be used in the design of new federal commercial and multifamily high-rise buildings. Some of the guidelines are relevant to retrofits. 10CFR434 establishes the “base case” for a building, such as defining insulation levels and lighting requirements. This code is based on ASHRAE/IESNA Standard 90.1-1989.

Following ASHRAE Standards is considered good practice. The three ASHRAE Standards that are most often used in building design and operations are Standards 90.1, 62, and 55. There are two methods for complying with the recommendations of these Standards: a *prescriptive method* and a *performance method*. When using the prescriptive method, the designer strictly follows the guidelines laid out in the Standard, such as complying with a recommended constant level of ventilation air provided to a space. When using the performance method, the designer makes certain that the overall building performance meets the intent of the Standard. For example, a designer using the performance method may specify more or less ventilation air to a space than that recommended in the prescription portion of the Standard to account for variable occu-

pancy. Complying with the intent of the Standards using the performance method often results in buildings that consume less energy and still maintain comfortable indoor conditions.

■ **ASHRAE/IESNA Standard 90.1**, “Energy Standard for Buildings Except Low-Rise Residential Buildings.” Standard 90.1-1989 is the basis for the Federal Energy Code 10CFR434, the energy conservation standard for federal buildings. Standard 90.1-2001 is the revised version of Standard 90.1-1989. Revisions include considerably more stringent lighting requirements and an alternative method for comparing energy-efficiency design strategies. DOE is developing another update to 10CFR434 using the new ASHRAE/IESNA Standard 90.1-2001 as the model. Standard 90.1-2001 is more aggressive than 90.1-1989 or 10CFR434 for laboratory buildings with fume hoods having a total exhaust rate greater than 15,000 CFM because it requires variable air volume (VAV) supply and exhaust systems or heat recovery.

■ **ANSI/ASHRAE Standard 62-1999**, “Ventilation for Acceptable Indoor Air Quality.” This Standard specifies minimum ventilation rates and indoor air quality that will be acceptable to human occupants. Limiting contaminants in indoor air and providing adequate quantity of outdoor air should achieve acceptable IAQ. The Standard specifies alternative procedures to obtain acceptable air quality: the ventilation rate procedure and the indoor air quality procedure.

■ **Ventilation Rate Procedure:** Acceptable air quality is achieved by providing ventilation of the specified quantity to the space. For example, 20 CFM/person is required for the AVERAGE (not peak) occupancy in offices.

■ **Indoor Air Quality Procedure:** Acceptable air quality is achieved by controlling known contaminants to the space. This procedure incorporates both quantitative and subjective evaluation of contaminants. Indoor carbon dioxide (CO₂) levels are often used as an indicator of the concentration of human bioeffluents with this procedure. An indoor-to-outdoor differential concentration not greater than 700 ppm of CO₂ indicates that the comfort (odor) criteria related to human bioeffluents are likely to be satisfied.

■ **ASHRAE Standard 55-1992 Addendum –1995**, “Thermal Environmental Conditions for Human Occupancy.” The purpose of this Standard is to specify the combination of indoor space environmental and personal factors that will produce thermal environmental conditions acceptable to 80 percent or more of the occupants within the space.

The Laws, Executive Orders, DOE Orders, and regulations in the following sections all encourage energy efficiency and sustainable design.

Best Practices, Orders, Regulations, and Laws Overview

Federal laws, Executive Orders (EO), and Executive Memoranda direct federal government facility managers to reduce the energy and environmental impacts of the buildings they manage. In addition, DOE issues Orders that apply to DOE facilities. These laws and regulations require facility managers to be proactive in their efforts to reduce resource consumption, to reuse and recycle materials, and to dramatically reduce the impacts of federal government activities on the environment.

- **Best Practices** result in a building that costs at least 50 percent less to operate than a code compliant building
- **DOE Orders** are issued by DOE and apply only to DOE facilities.
- **Executive Orders** are the president’s directives to the agencies.
- **Regulations** establish procedures and criteria by which decisions shall be made and actions carried out.

■ **Laws** are the will of the American people expressed through their elected representatives.

DOE Orders, Executive Orders, Regulations, and Federal Laws all provide a facility manager with the foundation, justification, and mandate to conduct projects designed to improve the energy and environmental performance of their facilities.

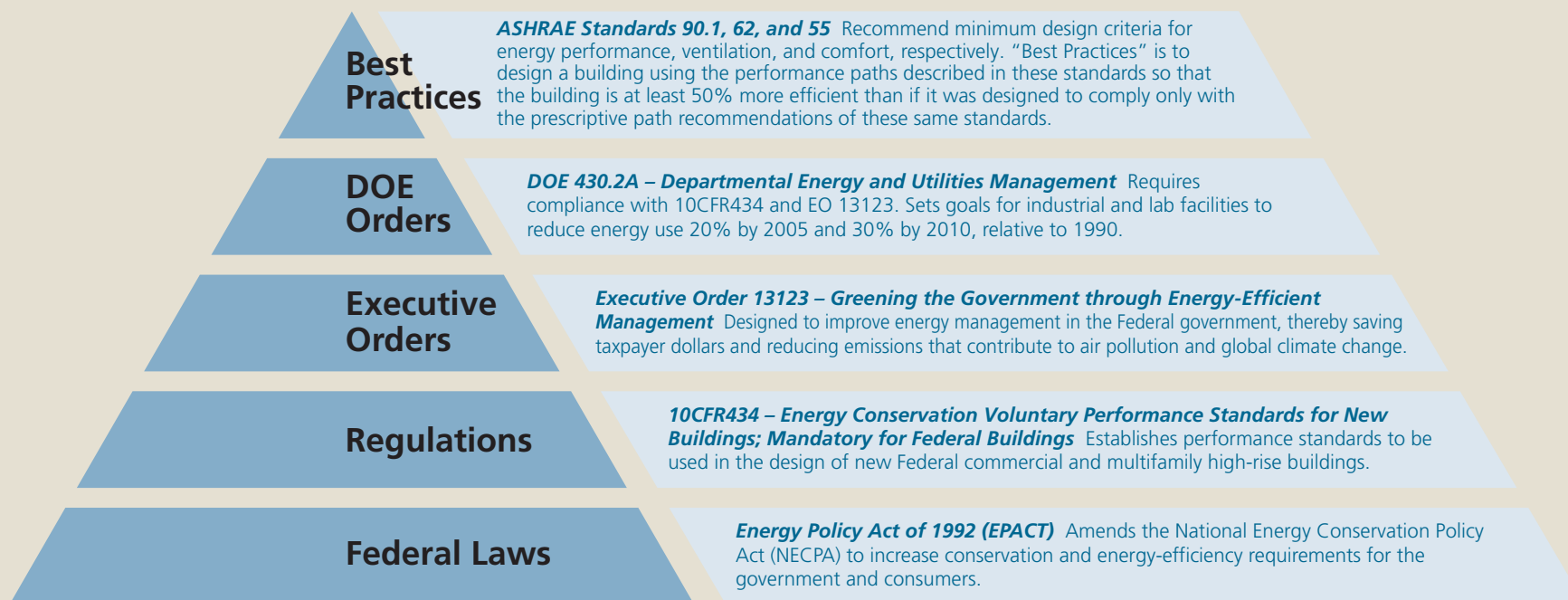

Codes: LANL is on federal land, but it is considered good practice to follow local and state codes. The following codes currently apply in New Mexico: 1997 New Mexico Building Code, 1997 Uniform Building Code (UBC), 1997 New Mexico Plumbing and Mechanical Code, 1997 New Mexico Uniform Mechanical Code, 1997 New Mexico Uniform Plumbing Code, 1999 New Mexico Electrical Code.

DOE Orders

DOE 430.2A – Departmental Energy and Utilities Management requires following 10CFR434 and Executive Order (EO) 13123. Sets goals for industrial and lab facilities to reduce energy use 20 percent by 2005 and 30 percent by 2010, relative to 1990. Sets goals for other buildings to reduce energy use 40 percent by 2005 and 45 percent by 2010, relative to 1985. 430.2A requires DOE facilities to have a documented Energy Management Program and an Energy Management Plan, to report energy cost and consumption to the Energy Management System 4 (EMS4), and to submit a energy efficiency/sustainable design report for all new buildings of 10,000 gross square feet or more, or with an estimated energy use of 500 million BTU/yr.

DOE 413.3- Program and Project Management for the Acquisition of Capital Assets “Sustainable Building Design.” New federal buildings must meet or exceed energy-efficiency standards established under EPACK PL Section 101 (10CFR434). Sustainable building design principles must be applied to the siting, design, and construction of new facilities.”

Executive Orders

Executive Order 13221, “Energy-Efficient Standby Power Devices,” July 31, 2001. This Order requires a federal agency, when it purchases products that use external standby power devices, or devices that contain an internal standby power function, to purchase products that use no more than one watt in their standby power-consuming mode.

Executive Order 13148, “Greening the Government through Leadership in Environmental Management,” April 21, 2000. This Order includes requirements for federal agencies to integrate environmental management into decision making, conduct compliance audits, emphasize pollution prevention, reduce use and releases of toxic chemicals, reduce use of ozone-depleting substances, and use environmentally sound landscaping techniques. It authorized agencies to participate in utility incentive programs; it required federal agencies to train and use energy managers; it directed the Office of Management and Budget to issue guidelines for accurate assessment of energy consumption by federal buildings; and it directed GSA to report annually on estimated energy costs for leased space.

Executive Order 13123, “Greening the Government through Energy-Efficient Management,” June 3, 1999. This Order is to improve energy management in the federal government, thereby saving taxpayer dollars and reducing emissions that contribute to air pollution and global climate change. Specific requirements include a 30 percent reduction of greenhouse gas emissions from facility energy use by 2010 compared to 1990 levels; a 30 percent reduction of energy use per gross square foot by 2005 and a 35 percent reduction by 2010 compared to 1985 levels for general use buildings (including office buildings); a 20 percent reduction of energy use per gross square foot by 2005 and a 25 percent reduction by 2010 compared to 1985 levels for industrial and laboratory buildings; use of renewable energy and support for the Million Solar Roofs Initiative; Applying sustainable design principles to the siting, design, and construction of new facilities; conducting energy and water audits for 10 percent of their facilities each year; purchasing ENERGY STAR and other efficient products; and water conservation. EO13123 requires an annual energy report to the president.

Best Practices in High-Performance Building Design

The worst building that can legally be built is one that just meets the requirements of 10CFR434. However, building minimally code compliant buildings will not move LANL toward energy efficiency and sustainable design. Generally, buildings fall into one of the three categories below:

Standard practice/code compliant buildings: Buildings that meet the requirements of 10CFR434

Better performance buildings: Buildings with an energy cost reduction of 20 percent, compared to a base-case building meeting the requirements of 10CFR434

High performance for sustainability: Buildings with an energy cost reduction of greater than 50 percent compared to a base-case building meeting the requirements of 10CFR434

Design teams create high performance buildings by following “best practices.” For example, applying performance path ASHRAE standards to a building design can result in a building that is 50 percent more efficient than a building designed to be merely compliant with the prescriptive ASHRAE standards.

Executive Order 13101, “Greening the Government through Waste Prevention, Recycling, and Federal Acquisition,” September 14, 1998. Requires acquisition of environmentally preferable products and services, recycling, and waste prevention. This order created a Steering Committee and a Federal Environmental Executive. It requires EPA to update the *Comprehensive Procurement Guideline* and publish *Recovered Materials Advisory Notices*; develop guidance on environmentally preferable purchasing; and assist agencies in conducting pilot projects using these guidelines. It requires the USDA to prepare a list of biobased products and encourages Federal agencies to consider purchasing these products.

Executive Order 12902, “Energy Efficiency and Water Conservation at Federal Facilities,” March 8, 1994. This Order has been superseded by Executive Order 13123.

Code of Federal Regulations

10CFR434, “Energy Conservation Voluntary Performance Standards for New Buildings; Mandatory for Federal Buildings,” establishes performance standards to be used in the design of new federal commercial and multifamily high-rise buildings. Some of the guidelines are relevant to retrofits. 10CFR434 establishes maximum energy consumption for new buildings, including insulation levels, lighting requirements, and HVAC system efficiencies. 10CFR434 is based on an ASHRAE/ IESNA Standard 90.1-1989. This code has a number of differences from Standard 90.1-1989, such as more stringent lighting requirements. DOE also is initiating another update of the federal commercial code, using the new ASHRAE/IESNA Standard 90.1-2001 as the model. Note that the ASHRAE/IESNA Standard 90.1-2001 is more stringent and is recommended to be followed as the minimum code.

10CFR436, “Federal Energy Management and Planning Programs,” establishes procedures for determining the life cycle cost-effectiveness of energy-conservation measures, and for setting priorities for energy conservation measures in retrofits of existing federal buildings. Subpart B establishes an ESPC program to accelerate investment in cost-effective energy conservation measures in federal buildings.

Federal Laws

Energy Policy Act of 1992 (EPACT). By amending the National Energy Conservation Policy Act (NECPA), this Act increased conservation and energy-efficiency requirements for the government and consumers. Specifically, it requires federal agencies to reduce per-square-foot energy consumption 20 percent by 2000 compared to a 1985 baseline; it provided authorization for DOE to issue rules and guidance on Energy Savings Performance Contracts (ESPCs) for federal agencies; it authorized agencies to participate in utility incentive programs; it required federal agencies to train and utilize energy managers; it directed the Office of Management and Budget to issue guidelines for accurate assessment of energy consumption by federal buildings; and it directed GSA to report annually on estimated energy costs for leased space.

National Energy Conservation Policy Act (NECPA) of 1978. NECPA specified the use of a life-cycle costing methodology as the basis for energy procurement policy and specified the rate for retrofit of federal buildings with cost-effective energy measures. Title V of NECPA was codified as the *Federal Energy Initiative*.

Resource Conservation and Recovery Act (RCRA) of 1976. RCRA 6002 established a federal mandate to “Buy Recycled.” RCRA 1008 and 6004 require all federal agencies generating solid waste to take action to recover it.

Energy Policy and Conservation Act (EPCA) of 1975. EPCA was the first major piece of legislation to address federal energy management. This law directed the president to develop a comprehensive energy management plan. EPCA has largely been superseded by later legislation.

References

American Society of Heating, Refrigerating, and Air-Conditioning Engineers (ASHRAE), www.ashrae.org

FEMP Resources: Regulations and Legislative Activities, www.eren.doe.gov/femp/resources/legislation.html

Additional Resources

Illuminating Engineering Society of North America (IESNA), www.iesna.org

Institute of Electrical and Electronics Engineers (IEEE), <http://standards.ieee.org/index.html>

Million Solar Roofs, www.millionsolarroofs.org

Appendix B

Climate Charts

This appendix gives an overview of the weather at Los Alamos. Using 30-year historical weather data collected at Los Alamos, a typical meteorological year (TMY) weather file was created for Los Alamos. The graphs in this appendix summarize this TMY data and show weather parameters, such as temperature, wet bulb temperature, heating degree days, and cooling degree days. In addition to the graphs, the appendix provides monthly averages for many key weather variables.

Dry Bulb Temperatures

(°F)

100 (Hours)

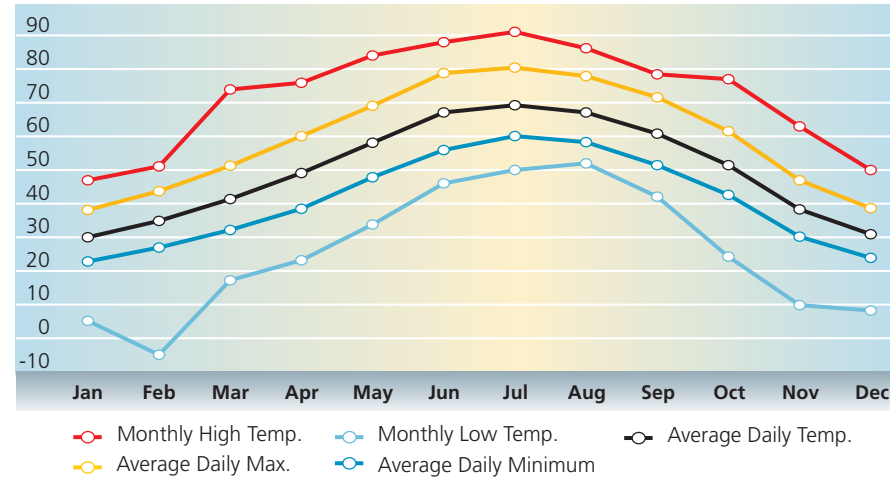

Dry Bulb Temperatures

This graph shows the minimum, maximum, and average monthly dry bulb temperatures. The Los Alamos annual dry bulb temperatures are ideal for climate-sensitive building design and operation.

Dry Bulb Temperature Bins

(5°F Bins)

1200 (Hours)

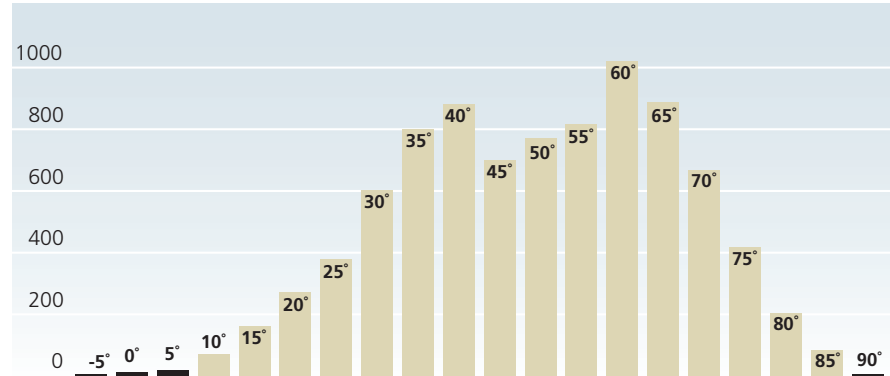

Average dry bulb bin temperature (°F)

Dry Bulb Temperature Bins

This graph separates the number of hours per year that the dry bulb temperature is in certain temperature ranges. The ranges, or bins, include temperatures that are $\pm 2.5^\circ\text{F}$ of the temperatures shown for each bin (e.g., the temperature in the 55°F bins ranges between 52.5°F and 57.5°F). The graph indicates that there are only 700 hours when the dry bulb temperature exceeds 75°F, signifying low annual cooling loads. Minimizing lighting loads (by using daylighting), equipment loads, and solar gains will further reduce the cooling loads.

Wet Bulb Temperature

(Range of 5°F)

1200 (hours)

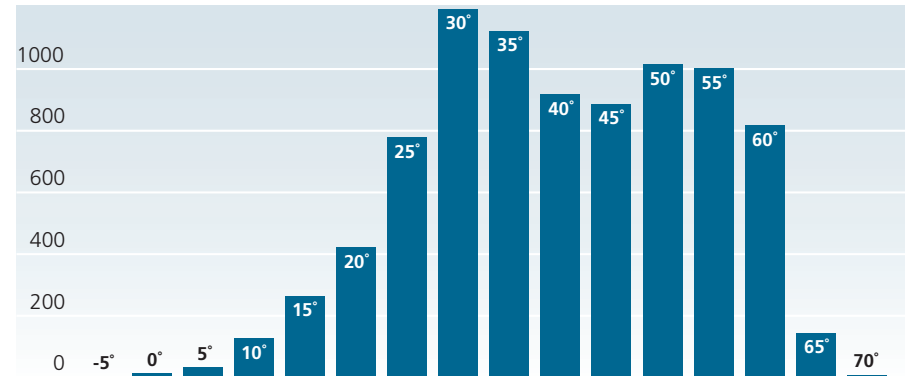

Average wet bulb temperature (°F)

Wet Bulb Temperature Bins

This graph shows the number of hours per year that the web bulb temperature is in certain temperature ranges. The ranges, or bins, include temperatures that are $\pm 2.5^\circ\text{F}$ of the temperatures shown for each bin (e.g., the temperature in the 35°F bins ranges between 32.5°F and 37.5°F). The graph shows that the wet bulb temperature is less than 40°F during 4500 hours per year, indicating that 55°F chilled water can be achieved by using cooling towers and heat exchangers for most of the year. Because the wet bulb temperature is less than 65°F most of the year, economizers are a good solution for meeting cooling loads at a low cost. Evaporative cooling systems may also be a good cooling solution, except during the approximately 150 hours per year when the wet bulb temperature exceeds 65°F.

Heating and Cooling Degree Days

(Base 65°F)

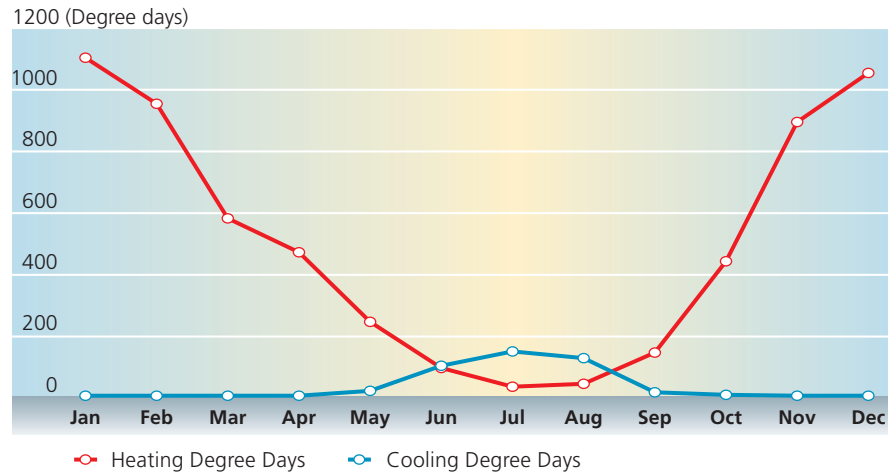

Heating and Cooling Degree Days

This graph shows the monthly heating and cooling degree days (base 65°F). The heating and cooling degree days indicate building heating and cooling loads for this climate. The data show that there are 3,198 heating and 259 cooling degree days. Buildings are heating-dominated. Ensure that the building cooling loads are small by minimizing lighting loads (by using daylighting), equipment loads, and solar gains.

Global Solar Radiation

8.0 (Solar radiation [kWh/m²/day])

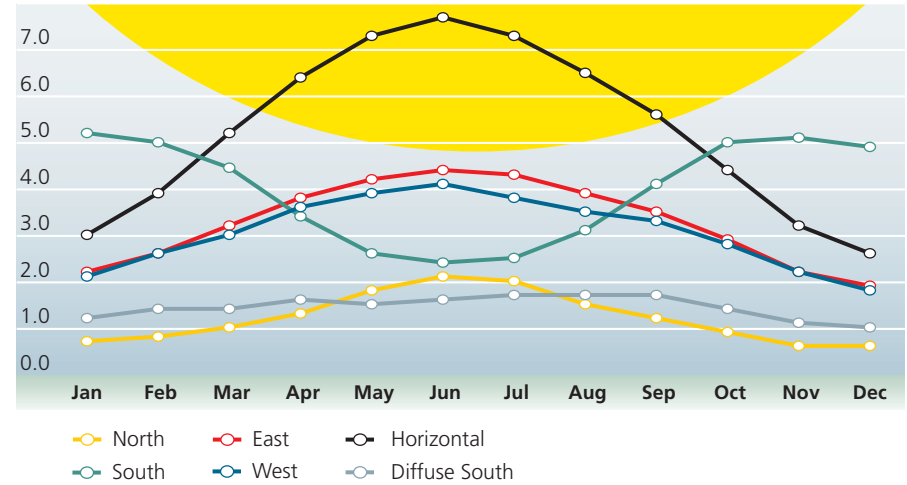

Global Solar Radiation and South Diffuse Radiation

This graph shows the daily average global solar radiation on a horizontal surface and on vertical surfaces facing each of the cardinal directions. It also shows diffuse solar radiation on a south-facing surface. The Los Alamos solar resources are excellent for photovoltaic (solar electric) and solar thermal systems. East- and west-facing surfaces receive a large amount of solar energy during the summer months, indicating that east- and west-facing window areas should be minimized to minimize local overheating (increased cooling loads) and glare (uneven and uncomfortable lighting conditions). Horizontal skylights should be avoided because of the large solar heat gains during summer. This climate is excellent for daylighting buildings, particularly using south- and north-facing windows with solar load control (e.g., overhangs). The diffuse radiation data for a south-facing surface exemplify how overhangs completely shading south-facing windows can significantly reduce the annual solar gains through those windows.

Interpreting the Climate Table

Station Description

Information at the top of the table describes the location (or station) described by the data in the table.

Solar Radiation

Incident solar radiation. The table gives the monthly and yearly average global radiation, clear-day global radiation, and diffuse radiation for windows on five surfaces: a horizontal window and vertical windows facing north, east, south, and west.

Global radiation is the total radiation received by the window and is the sum of the direct-beam radiation, sky radiation, and radiation reflected from the ground in front of the surface. Clear-day global radiation represents the global radiation obtainable under clear skies.

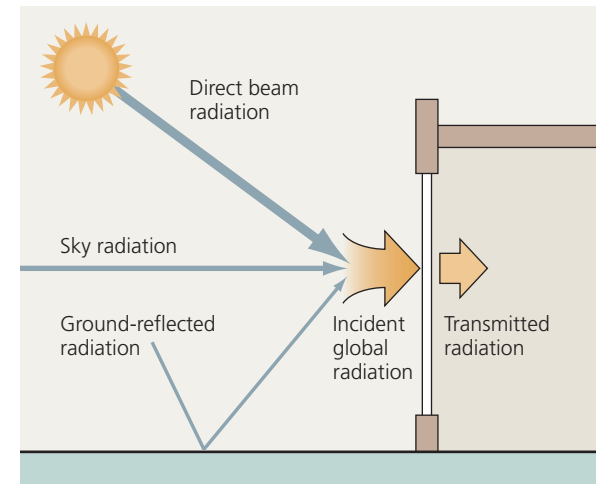

Incident global solar radiation includes direct-beam, sky, and ground-reflected radiation.

Average Precipitation

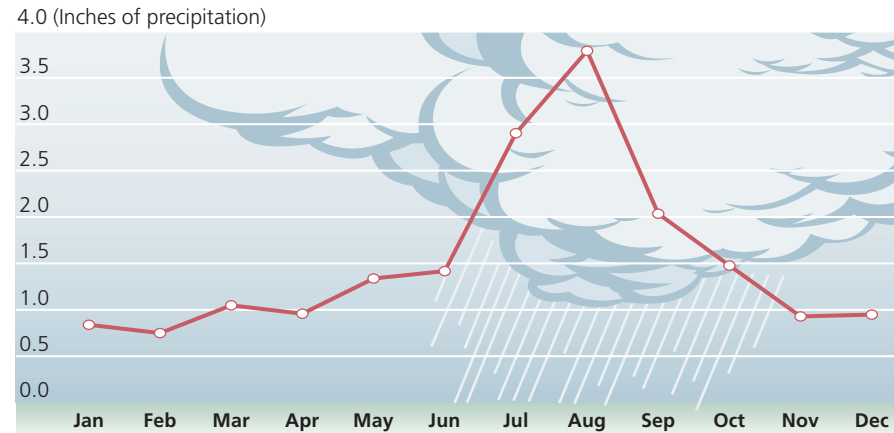

Average Precipitation

This graph shows the average inches of precipitation per month. The average annual rainfall is 18 inches. Note that most of the rainfall occurs in July, August, and September, which also are the warmest months of the year and the time of the year when water is most needed for other purposes such as landscaping. Rainwater provides an excellent source of soft water for uses such as cooling tower make-up water and irrigation if a rainwater capture system is used. The data in this graph are average monthly precipitation data between 1937 and 1997 as reported on the National Climatic Data Center Web site (<http://lwf.ncdc.noaa.gov/oa/climate/online/coop-precip.html>).

The diffuse radiation data do not include the direct beam radiation component. Diffuse radiation is the sum of sky radiation and radiation reflected from the ground in front of the surface. The ground-reflected radiation was calculated using monthly averages of ground reflectivity or albedo.

Transmitted solar radiation. The solar radiation transmitted into an occupied space is less than the radiation that strikes the outside of a window because of reflections and losses by the glass. The data are for windows with conventional, clear, double glazing and a glass thickness of 0.125 in. (3.18 mm).

The table contains values for unshaded and shaded vertical windows on five surfaces: a horizontal window and vertical windows facing north, east, south, and west. Unshaded values are for windows with no external shading. Shaded values are for windows shaded by the roof overhang. The shading geometry, shown with the table, is not applicable for the horizontal surface; consequently, shaded transmitted solar radiation values for a horizontal surface are not included.

The shading geometry is generally a function of the latitude, but consideration also is given to heating and cooling requirements. For south-facing windows, the shading geometry provides guidance for the appropriate dimensions of roof overhangs. However, situations may require a different geometry, depending on the balance between heating and cooling loads for the particular building and factors such as required window sizes and building practices. For east- and west-facing windows, overhangs are not particularly effective in preventing unwanted heat gain. Additional shading strategies such as vertical louvers may be needed.

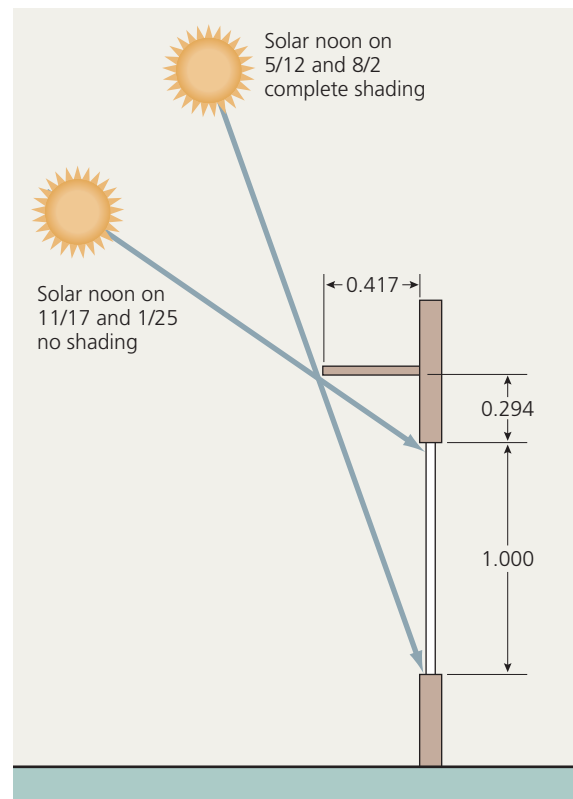

Shading geometry (in dimensionless units) and sun positions for south-facing windows at 36° north latitude.

Climatic Conditions

The following tables contain average climatic condition information listed monthly and yearly.

Degree days indicate heating and cooling requirements of buildings. They are defined as the difference between the average temperature for the day and a base temperature. If the average for the day (calculated by averaging the minimum and maximum temperature for the day) is less than the base value, then the difference

is designated as heating degree days. If the average is greater than the base value, the difference is designated as cooling degree days.

The clearness index (K_t) is the global horizontal solar radiation divided by its extraterrestrial horizontal radiation. Clouds decrease the amount of solar radiation reaching the Earth, which lower the K_t values. Lower K_t values indicate more cloud cover than higher K_t values.

Illuminance

The illuminance table contains diurnal profiles of the average illuminance incident on five surfaces (a horizontal window and vertical windows facing north, east, south, and west) for four months of the year and consists of two data values. The first value is the average illuminance for mostly clear conditions (total cloud cover less than 50 percent), and the second value after the slash is the average illuminance for mostly cloudy conditions (total cloud cover equal to or greater than 50 percent).

The last line in the illuminance table indicates the percentage of time during the hour that the location is mostly clear (M. Clear). These values, along with the illuminance values, can be used to determine the average hourly illuminance:

$$\text{Average illuminance} = [(M. \text{ Clear}) \times (\text{illuminance for mostly clear}) + (100 - M. \text{ Clear}) \times (\text{illuminance for mostly cloudy})] \div 100$$

The illuminance data represent the illuminance received during the preceding hour. For example, data for 3 p.m. include the illuminance received from 2 p.m. to 3 p.m. local standard time. (To convert to daylight savings time, add 1 hour.)

English Unit Climate Tables

Station Description

Location:	Los Alamos, NM
Station number:	723654
Latitude (N):	35.9
Longitude (W):	106.3
Elevation (ft):	7149

Shading Geometry in Dimensionless Units

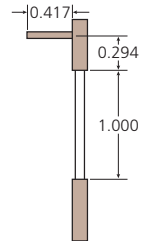

Average Incident Solar Radiation (BTU/ft ² /day)														
		Jan	Feb	Mar	Apr	May	Jun	Jul	Aug	Sep	Oct	Nov	Dec	Year
Horiz.	<i>Global</i>	951	1236	1648	2029	2314	2441	2314	2060	1775	1395	1014	824	1680
	<i>Diffuse</i>	254	349	444	571	602	634	666	666	507	349	254	222	475
	<i>Clear-day Global</i>	1173	1522	1997	2473	2758	2853	2758	2473	2092	1617	1205	1046	1997
North	<i>Global</i>	222	254	317	412	571	666	634	475	380	285	190	190	380
	<i>Diffuse</i>	222	254	317	412	444	507	507	444	380	285	190	190	349
	<i>Clear-day Global</i>	190	222	254	380	571	729	666	444	349	254	190	158	380
East	<i>Global</i>	697	824	1014	1205	1331	1395	1363	1236	1109	919	697	602	1046
	<i>Diffuse</i>	254	349	412	507	539	602	602	571	475	349	254	222	444
	<i>Clear-day Global</i>	856	1046	1236	1458	1553	1585	1553	1458	1331	1078	856	761	1236
South	<i>Global</i>	1648	1585	1395	1078	824	761	792	983	1300	1585	1617	1553	1268
	<i>Diffuse</i>	380	444	444	507	475	507	539	539	539	444	349	317	444
	<i>Clear-day Global</i>	2187	2124	1775	1300	888	761	824	1109	1617	1997	2124	2124	1553
West	<i>Global</i>	666	824	951	1141	1236	1300	1205	1109	1046	888	697	571	983
	<i>Diffuse</i>	285	349	412	507	571	602	602	571	507	349	254	222	444
	<i>Clear-day Global</i>	856	1046	1268	1458	1553	1585	1553	1458	1331	1078	856	761	1236

Average Transmitted Solar Radiation for Double Glazing (BTU/ft²/day)

		Jan	Feb	Mar	Apr	May	Jun	Jul	Aug	Sep	Oct	Nov	Dec	Year
Horiz.	<i>Unshaded</i>	634	856	1173	1490	1680	1807	1680	1490	1268	983	697	539	1205
North	<i>Unshaded</i>	158	190	222	285	349	412	380	317	254	190	127	127	254
	<i>Shaded</i>	127	158	190	254	317	380	349	285	254	190	127	127	222
East	<i>Unshaded</i>	475	602	729	856	951	1014	983	888	792	666	475	412	729
	<i>Shaded</i>	444	539	666	792	856	888	888	824	729	602	444	380	666
South	<i>Unshaded</i>	1236	1141	951	666	475	412	444	602	856	1141	1205	1173	856
	<i>Shaded</i>	1236	1078	761	444	317	349	349	380	666	1014	1205	1173	729
West	<i>Unshaded</i>	475	571	697	824	888	919	856	792	761	634	475	412	697
	<i>Shaded</i>	444	539	634	729	792	824	761	697	666	571	444	380	634

Average Climatic Conditions

Element	Jan	Feb	Mar	Apr	May	Jun	Jul	Aug	Sep	Oct	Nov	Dec	Year
Temp. (deg F)	30.0	34.9	41.4	49.1	58.1	67.1	69.3	67.1	60.8	51.4	38.3	30.9	50.0
Daily Min (deg F)	22.8	27.0	32.2	38.5	47.8	55.9	60.1	58.3	51.4	42.6	30.2	23.9	41.0
Daily Max (deg F)	38.1	43.7	51.3	60.1	69.1	78.8	80.4	77.9	71.6	61.5	46.9	38.7	59.9
HDD, base = 65°F	594	461	400	260	124	27	5	12	74	222	439	580	3198
CDD, base = 65°F	0	0	0	0	12	69	97	65	16	0	0	0	259
Hum Ratio (#w/#day)	0.0022	0.0025	0.0028	0.0034	0.0048	0.0059	0.0081	0.0087	0.0065	0.0044	0.0029	0.0023	0.0045
Wind Spd. (mph)	3.1	4.3	5.6	6.5	6.1	5.6	4.9	4.0	4.7	4.7	3.8	3.4	4.7
Clearness Index K_t	0.61	0.61	0.63	0.64	0.65	0.66	0.64	0.63	0.63	0.64	0.61	0.58	0.63

Average Incident Illuminance for Mostly Clear/Mostly Cloudy Conditions (klux-hr)

	March					June					Sept					Dec				
	9am	11am	1pm	3pm	5pm	9am	11am	1pm	3pm	5pm	9am	11am	1pm	3pm	5pm	9am	11am	1pm	3pm	5pm
Horiz.	44/32	78/59	88/70	70/55	31/23	69/57	97/84	105/92	88/73	51/42	52/39	83/66	88/73	69/57	29/22	20/13	49/34	55/39	37/26	4/3
North	9/9	12/13	13/14	12/13	7/7	13/15	15/17	15/17	15/17	19/18	11/12	15/17	15/17	14/15	8/8	6/5	9/9	10/10	8/8	2/2
East	81/49	57/43	13/14	12/13	7/7	83/65	54/50	15/17	15/17	11/12	81/51	54/43	15/17	14/15	8/8	52/24	43/27	10/10	8/8	2/2
South	39/26	68/51	77/61	61/46	27/18	13/15	34/32	39/37	27/26	11/12	39/28	66/52	72/58	55/43	21/14	47/22	86/51	93/57	72/41	15/6
West	9/9	12/13	20/20	67/50	73/43	13/15	15/17	26/26	70/59	81/60	11/12	15/17	29/27	72/55	69/39	6/5	9/9	22/17	56/33	22/9
M.Clear (% hrs)	57	52	45	40	41	72	66	49	43	42	63	57	49	42	48	58	54	51	50	50

Metric Unit Climate Tables

Station Description

Location:	Los Alamos, NM
Station number:	723654
Latitude (N):	35.9
Longitude (W):	106.3
Elevation (m):	2179

Shading Geometry in Dimensionless Units

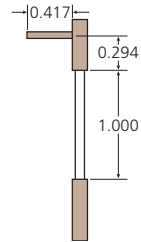

Average Incident Solar Radiation (kWh/m ² /day)		Jan	Feb	Mar	Apr	May	Jun	Jul	Aug	Sep	Oct	Nov	Dec	Year
Horiz.	<i>Global</i>	3	3.9	5.2	6.4	7.3	7.7	7.3	6.5	5.6	4.4	3.2	2.6	5.3
	<i>Diffuse</i>	0.8	1.1	1.4	1.8	1.9	2	2.1	2.1	1.6	1.1	0.8	0.7	1.5
	<i>Clear-day Global</i>	3.7	4.8	6.3	7.8	8.7	9	8.7	7.8	6.6	5.1	3.8	3.3	6.3
North	<i>Global</i>	0.7	0.8	1	1.3	1.8	2.1	2	1.5	1.2	0.9	0.6	0.6	1.2
	<i>Diffuse</i>	0.7	0.8	1	1.3	1.4	1.6	1.6	1.4	1.2	0.9	0.6	0.6	1.1
	<i>Clear-day Global</i>	0.6	0.7	0.8	1.2	1.8	2.3	2.1	1.4	1.1	0.8	0.6	0.5	1.2
East	<i>Global</i>	2.2	2.6	3.2	3.8	4.2	4.4	4.3	3.9	3.5	2.9	2.2	1.9	3.3
	<i>Diffuse</i>	0.8	1.1	1.3	1.6	1.7	1.9	1.9	1.8	1.5	1.1	0.8	0.7	1.4
	<i>Clear-day Global</i>	2.7	3.3	3.9	4.6	4.9	5	4.9	4.6	4.2	3.4	2.7	2.4	3.9
South	<i>Global</i>	5.2	5	4.4	3.4	2.6	2.4	2.5	3.1	4.1	5	5.1	4.9	4
	<i>Diffuse</i>	1.2	1.4	1.4	1.6	1.5	1.6	1.7	1.7	1.7	1.4	1.1	1	1.4
	<i>Clear-day Global</i>	6.9	6.7	5.6	4.1	2.8	2.4	2.6	3.5	5.1	6.3	6.7	6.7	4.9
West	<i>Global</i>	2.1	2.6	3	3.6	3.9	4.1	3.8	3.5	3.3	2.8	2.2	1.8	3.1
	<i>Diffuse</i>	0.9	1.1	1.3	1.6	1.8	1.9	1.9	1.8	1.6	1.1	0.8	0.7	1.4
	<i>Clear-day Global</i>	2.7	3.3	4	4.6	4.9	5	4.9	4.6	4.2	3.4	2.7	2.4	3.9

Average Transmitted Solar Radiation for Double Glazing (kWh/m²/day)

		Jan	Feb	Mar	Apr	May	Jun	Jul	Aug	Sep	Oct	Nov	Dec	Year
Horiz.	<i>Unshaded</i>	2.0	2.7	3.7	4.7	5.3	5.7	5.3	4.7	4.0	3.1	2.2	1.7	3.8
North	<i>Unshaded</i>	0.5	0.6	0.7	0.9	1.1	1.3	1.2	1.0	0.8	0.6	0.4	0.4	0.8
	<i>Shaded</i>	0.4	0.5	0.6	0.8	1.0	1.2	1.1	0.9	0.8	0.6	0.4	0.4	0.7
East	<i>Unshaded</i>	1.5	1.9	2.3	2.7	3.0	3.2	3.1	2.8	2.5	2.1	1.5	1.3	2.3
	<i>Shaded</i>	1.4	1.7	2.1	2.5	2.7	2.8	2.8	2.6	2.3	1.9	1.4	1.2	2.1
South	<i>Unshaded</i>	3.9	3.6	3.0	2.1	1.5	1.3	1.4	1.9	2.7	3.6	3.8	3.7	2.7
	<i>Shaded</i>	3.9	3.4	2.4	1.4	1.0	1.1	1.1	1.2	2.1	3.2	3.8	3.7	2.3
West	<i>Unshaded</i>	1.5	1.8	2.2	2.6	2.8	2.9	2.7	2.5	2.4	2.0	1.5	1.3	2.2
	<i>Shaded</i>	1.4	1.7	2.0	2.3	2.5	2.6	2.4	2.2	2.1	1.8	1.4	1.2	2.0

Average Climatic Conditions

Element	Jan	Feb	Mar	Apr	May	Jun	Jul	Aug	Sep	Oct	Nov	Dec	Year
Temp. (deg C)	-1.1	1.6	5.2	9.5	14.5	19.5	20.7	19.5	16	10.8	3.5	-0.6	10
Daily Min (deg C)	-5.1	-2.8	0.1	3.6	8.8	13.3	15.6	14.6	10.8	5.9	-1.0	-4.5	5.0
Daily Max (deg C)	3.4	6.5	10.7	15.6	20.6	26.0	26.9	25.5	22	16.4	8.3	3.7	15.5
HDD, base = 18.3°C	594	461	400	260	124	27	5	12	74	222	439	580	3198
CDD, base = 18.3°C	0	0	0	0	12	69	97	65	16	0	0	0	259
Hum Ratio g/kg	2.2	2.5	2.8	3.4	4.8	5.9	8.1	8.7	6.5	4.4	2.9	2.3	4.5
Wind Spd. (m/s)	1.4	1.9	2.5	2.9	2.7	2.5	2.2	1.8	2.1	2.1	1.7	1.5	2.1
Clearness Index K_t	0.61	0.61	0.63	0.64	0.65	0.66	0.64	0.63	0.63	0.64	0.61	0.58	0.63

Average Incident Illuminance for Mostly Clear/Mostly Cloudy Conditions (klux-hr)

	March					June					Sept					Dec				
	9am	11am	1pm	3pm	5pm	9am	11am	1pm	3pm	5pm	9am	11am	1pm	3pm	5pm	9am	11am	1pm	3pm	5pm
Horiz.	44/32	78/59	88/70	70/55	31/23	69/57	97/84	105/92	88/73	51/42	52/39	83/66	88/73	69/57	29/22	20/13	49/34	55/39	37/26	4/3
North	9/9	12/13	13/14	12/13	7/7	13/15	15/17	15/17	15/17	19/18	11/12	15/17	15/17	14/15	8/8	6/5	9/9	10/10	8/8	2/2
East	81/49	57/43	13/14	12/13	7/7	83/65	54/50	15/17	15/17	11/12	81/51	54/43	15/17	14/15	8/8	52/24	43/27	10/10	8/8	2/2
South	39/26	68/51	77/61	61/46	27/18	13/15	34/32	39/37	27/26	11/12	39/28	66/52	72/58	55/43	21/14	47/22	86/51	93/57	72/41	15/6
West	9/9	12/13	20/20	67/50	73/43	13/15	15/17	26/26	70/59	81/60	11/12	15/17	29/27	72/55	69/39	6/5	9/9	22/17	56/33	22/9
M.Clear (% hrs)	57	52	45	40	41	72	66	49	43	42	63	57	49	42	48	58	54	51	50	50

Appendix C

Green Building Adviser

This appendix contains a list of strategies generated by the *Green Building Adviser* (GBA), a software tool used in brainstorming and learning about sustainable design solutions. GBA solicits a limited set of inputs about a project and uses those inputs to query its database of green building strategies for those most likely to be relevant to the project.

A user of GBA can then click on any strategy in the list to learn more about that strategy. The information available about each strategy might include:

- A detailed explanation;
- Links to case studies of projects in which the strategy was implemented;
- Links to potentially synergistic and/or conflicting strategies;
- Listings and links to resources for more information;
- Links to listings of products that might be used to implement the strategy; and
- Other specifics about the strategy.

The following report was exported from GBA. It includes the inputs that describe the prototype LANL building, the climate data provided for Los Alamos, and an edited version of the list of strategies generated by the program. The strategies are organized under five major topic areas (similar to the structure of the LEED™ Rating System): Site & Ecosystems, Energy Use, Water Use, Materials & Resources, and Indoor Environmental Quality. Within each topic area, the strategies are

organized into subtopics and headings. Within each subtopic, the strategies and headings also are grouped into relevance categories: “Strongly recommended” and “Moderately recommended.”

GBA is available from BuildingGreen, Inc. More information about the program is available online at www.GreenBuildingAdvisor.com.

Green Building Adviser Project Report

Project Information

Prototype Office Building at LANL for Sustainable Design Guide

Project Data

- Site location: (NM) Los Alamos
- Project type: New
- Scope of work: Whole building
- Building type: Commercial office
- Size of site: 1–3 acres
- Building footprint: 20–50% of site
- Status of site: Greenfield
- Community density: Suburban/rural
- Building size: 12,000 - 50,000 square feet
- Number of floors: 2
- Type of construction: Steel
- Foundation: Slab on grade
- Window coverage: Typical number of windows

Location Climate Data (customized for Los Alamos)

- Average low temp for coldest month of year [F]: 22.7
- Average high temp for warmest month of year [F]: 78.9
- Average daily temp for entire year [F]: 49.9
- HDD [65 F base]: 6017
- CDD [65 F base]: 345
- Annual days of freezing: 115
- Annual precipitation [inches]: 18
- Annual days of precipitation: 92
- Average windspeed [mph]: 4.7
- Average relative humidity [%]: 60
- Annual sunshine [hours]: 5496.9
- Elevation [feet]: 7149
- Latitude: 35.88
- Longitude: -106.28

Recommended Ecosystem Strategies

Site Selection and Ecosystems

Strongly Recommended

Comparing properties prior to purchase

- Hire a landscape architect or other specialist to evaluate prospective properties
- Assess property for integration with local community and regional transportation corridors

Avoiding properties with excessive impacts

- Avoid contributing to sprawl
- Reevaluate greenfield development
- Avoid properties that interfere with wildlife corridors
- Avoid building on flood-prone properties
- Avoid properties where damage to fragile ecosystems cannot be avoided
- Avoid properties with excessive slopes
- Avoid non-sewered sites if environmentally responsible on-site system is not feasible
- Avoid properties that would require excessively long and excessively damaging access roads

Selecting a property with opportunities for minimal environmental impacts

- Look for opportunities for infill development
- Select brownfield sites for development
- Select already-developed sites for new development
- Look for a property where infrastructure needs can be combined

Assessment of site for building and infrastructure placement

- Assess regional climatic conditions
- Investigate microclimate (specific variations from regional climatic conditions)

- Create a map of physical elements on the site (structures, topography, soils, hydrology)
- Create a map of vegetation on site, including notation of significant specimens
- Create a wildlife/habitat survey, including links to offsite habitat corridors
- Carry out a careful wetlands survey
- Identify most degraded or ecologically damaged areas of a site

Avoiding building sites with excessive impacts

- Avoid building on or degrading wetlands
- Avoid damaging significant historic or prehistoric sites
- Avoid sites with excessive slopes

Siting buildings and infrastructure on a property to minimize environmental impacts

- Select an already-developed portion of a site for new development
- Locate the building(s) on the most degraded part of the site
- Site access roads or driveways to help maintain identifiable edges on the property
- Look for opportunities to combine needs with infrastructure
- Select building sites that make use of existing infrastructure
- Choose building sites to minimize impact of on-site wastewater system
- Site development carefully to protect significant ecosystems
- Avoid building in flood-prone areas

Siting buildings and infrastructure for other benefits

- Follow natural contours with roadways, utility lines, etc.

- Protect and celebrate a site's uniqueness
- Site buildings to help occupants celebrate the natural beauty
- Site building(s) where existing vegetation can reduce energy use
- Provide for solar access

Moderately Recommended

Comparing properties prior to purchase

- Investigate property for possible contaminants (e.g., toxic or hazardous wastes, dumps)

Assessment of site for building and infrastructure placement

- Hire a landscape architect to help with siting of buildings and infrastructure
- Research past human uses of the site

Siting buildings and infrastructure on a property to minimize environmental impacts

- Site buildings where lowest biodiversity is present
- Site buildings to minimize access road length

Siting buildings and infrastructure for other benefits

- Site buildings to minimize visual impacts, including from roadways and neighboring buildings

Land Development and Ecosystems

Strongly Recommended

Confining development impact

- Minimize development impact area
- Minimize building footprint
- Restrict vehicle access during construction to reduce damage to vegetation
- Fence off a wide area around trees to be protected

- Avoid storage of building materials or soil in areas where tree roots could be damaged
- Limit parking area

Construction impacts

- Establish long-term relationship with responsible excavation and sitework contractor
- Institute a reward or penalty system to provide incentive for contractor to protect the site
- Designate appropriate staging areas for construction-related activities
- Schedule construction carefully to minimize damage to vegetation and ecosystems
- Minimize soil erosion from construction activities
- Disperse parking to avoid flattening large areas
- Use the smallest excavation and sitework machinery that will do the job
- Stockpile topsoil during excavation and sitework
- Avoid grade change around trees
- Provide terracing or large-diameter wells to protect tree roots from grade change
- Tunnel under trees for utility lines
- Before concrete pours, designate a location for cleaning out concrete trucks

Integration with site resources and limitations

- Celebrate and enhance existing landscape features
- Integrate on-site wastewater treatment system with landscape design

Moderately Recommended

Confining development impact

- Cluster buildings to preserve open space and protect habitat

Integration with site resources and limitations

- Install composting toilets

Avoiding need for chemical treatment

- Avoid burying woody debris near building(s)
- Design buildings to provide easy visual inspection for above-ground termite tubes
- Use the least toxic treatment methods and materials for pest control around new buildings
- Prevent termite access to structure
- Use bait system for termite control

Stormwater and Ecosystems

Strongly Recommended

Reducing impervious surfaces

- Minimize width and length of roadways
- Use planted swales instead of curbs and gutters
- Avoid contiguous impermeable surfaces
- Use modular block paving

Managing stormwater

- Contour slopes for reduced runoff

Moderately Recommended

Reducing impervious surfaces

- Use dispersed parking
- Design a green roof system
- Consider porous turf-paving systems on low-traffic parking and driveway areas
- Install gravel paving in a matrix to retain permeability
- Install porous asphalt or concrete

Managing stormwater

- Utilize sheet flow
- Incorporate surface infiltration basins in landscapes
- Use subsurface infiltration basins
- Design a constructed wetland for pollutant removal from stormwater

Landscaping and Ecosystems

Strongly Recommended

Ecosystem restoration

- Convert turf areas to native desert, prairie, or woodland ecosystem
- Remove ecologically damaging non-native (invasive) species
- Install landscape buffers along streams with native vegetation
- Use bioengineering practices for erosion control along waterways

Landscape plantings

- Salvage native plants during construction
- Landscape with indigenous vegetation
- Landscape with plants that provide wildlife forage or habitat
- Use plantings to stabilize soils and control erosion
- Plant trees to shade parked vehicles
- Minimize turf area

Moderately Recommended

Landscape plantings

- Landscape with edible plants

Regional Integration and Ecosystems

Strongly Recommended

Protection of global ecosystem

- Minimize ozone-depletion potential of refrigerants in cooling systems
- Avoid rigid or blown foam insulation made with an HCFC blowing agent

Responsible planning

- Ensure that development fits within a responsible local and regional planning framework

Support for appropriate transportation

- Provide showers and changing areas for bicycle and pedestrian commuters
- Provide access to public transportation
- Provide vehicle access to support car and vanpooling
- Provide incentives for non-automobile commuting options

Moderately Recommended

Protection of global ecosystem

- Avoid carpet cushion made with HCFC blowing agents

Responsible planning

- Carry out mixed-use development

Support for appropriate transportation

- Design development to have pedestrian emphasis rather than automobile emphasis
- Provide safe access for bicyclers and pedestrians
- Provide storage area for bicycles
- Incorporate traffic-calming measures
- Provide for electric vehicle charging

Recommended Energy Strategies

Building Envelope Energy Use

Strongly Recommended

Walls

- Minimize wall area through proper building massing
- Achieve a whole-wall R-value greater than 25

Foundations

- Use slab perimeter insulation with an insulating value of R-7 or greater
- Use sub-slab insulation with a minimum insulating value of R-5

Windows and doors

- Use exterior doors with rated R-values of R-4 or greater
- Use windows with a whole-unit U-factor less than 0.32 (greater than R-3.0)
- Avoid divided-lite windows to reduce edge losses

Infiltration

- Use continuous air barriers
- Keep all mechanical, electrical, and plumbing systems within the air and vapor barriers
- Minimize plumbing, electrical, and other penetrations through the building envelope
- Use air lock entries
- Seal all penetrations through the building envelope
- Seal all joints with caulks or gaskets
- Use appropriate caulks and sealants for different applications
- Use windows with infiltration rates no greater than 0.03 cfm/ft

- Minimize pressure difference between the building and the outside
- Pressure-test the building envelope using the mechanical system
- Perform duct leakage testing

Roofs

- Achieve a whole-roof R-value greater than R-35
- Design roof system with consistent thermal integrity
- Design roof system with raised rafters or trusses to avoid cold corners

Heating, Cooling, and Ventilation Energy Use

Strongly Recommended

Minimize solar heat gain

- Orient the building properly
- Utilize heliodon studies to optimize shading strategies

Minimize non-solar cooling loads

- Provide high-low openings to remove unwanted heat by stack ventilation
- Provide an open floor plan and openings located to catch prevailing breezes
- Use operable windows
- Reduce internal heat gains by improving lighting and appliance efficiency

Cooling systems

- Use chillers with high-efficiency screw compressors or scroll compressors
- Specify low-pressure-drop cooling coils
- Use an air-side economizer
- Use water-cooled mechanical cooling equipment
- Site condensing units in areas with adequate ventilation

- Locate cooling systems in areas accessible for maintenance and service
- Keep cooling equipment, especially air handlers and coils, in conditioned space
- Commission the HVAC system

Minimize heating load

- Site the building for southern exposure

Heating systems

- Use high-efficiency, condensing oil or gas boilers and furnaces
- Size heating systems appropriately
- Use modulating burners in boilers
- Keep heating equipment in conditioned space
- Design heating distribution systems for a large temperature drop
- Use hot water heat distribution
- Use modular boilers that can be staged to meet varying loads
- Locate heating equipment in an accessible place for maintenance and service

Ventilation systems

- Draw supply air from favorable microclimates around the building
- Use solar ventilation air preheat
- Use enthalpic heat-recovery ventilation
- Use air distribution strategies with high-ventilation effectiveness

Distribution systems

- Consider using an access floor system
- Seal ducts
- Size ducts for low-pressure drop
- Size pipes for low-pressure drop

- Specify turning vanes or large radius bends in duct work
- Keep duct work out of unconditioned space
- Insulate duct work located in unconditioned space
- Minimize bends in duct work
- Use variable frequency drives for fans
- Increase area/specify low-face-velocity filters
- Use high-efficiency pumps and motors
- Use high-efficiency fans and motors
- Size fans and pumps properly to meet the loads

Controls and zoning

- Provide sufficient sensors and control logic
- Use thermostats with night setback
- Locate thermostats in a central area out of the direct sun
- Use direct digital control (DDC) systems
- Use occupancy-based conditioning controls
- Create zones that unite spaces with similar thermal requirements
- Locate spaces used after normal occupancy hours near one another
- Provide separate HVAC systems for spaces with distinct heating and cooling loads

Moderately Recommended

Cooling systems

- Use accurate simulation tools to design cooling system
- Use AC systems with a high efficiency rating
- Use low-temperature cooling air distribution
- Design chilled-water loops for a large temperature rise

Heating systems

- Use sunspace passive solar heating
- Use roof-pond passive solar heating
- Preheat intake combustion air with exhaust products

Ventilation Systems

- Use displacement ventilation
- Use demand-controlled ventilation

Controls and zoning

- Use variable-volume air distribution systems
- Zone the building for modular HVAC control

Lighting Energy Use

Strongly Recommended

Daylighting

- Use south-facing windows for daylighting
- Do not shade the south side of the building with trees
- Orient the floor plan on an east-west axis for best use of daylighting
- Locate frequently used areas on the south side of the building
- Design an open floor plan to allow exterior daylighting to penetrate the interior
- Use low partitions near the exterior glazing to promote daylight penetration
- Use large exterior windows and high ceilings to increase daylighting
- Use large interior windows to increase daylighting penetration
- Use north/south roof monitors and/or clerestories for daylighting
- Use light pipes and/or active tracking skylights for daylighting

Interior design

- Use light colors for surfaces and finishes

Light levels

- Design for no more than 1.0 watts/square foot
- Use light levels appropriate for different tasks
- Use different task and ambient lighting
- Minimize outdoor lighting

Light sources

- Specify ENERGY STAR-rated lighting equipment
- Use LED or other super-efficient exit signs
- Use high-efficacy T8 fluorescent lamps
- Use high-efficacy T-5 fluorescent lamps
- Use high-pressure sodium lamps for area lighting when color rendition is not important
- Use solar-powered pathway lights

Ballasts

- Use high-efficiency electronic fluorescent lamp ballasts
- Use automatic-dimming electronic fluorescent lamp ballasts in conjunction with daylighting
- Tandem wire ballasts to control two luminaires

Luminaires

- Use high-efficiency luminaires
- Use the luminaire efficiency rating (LER) to compare different styles and models
- Use luminaires that accommodate high-intensity discharge lamps
- With outdoor lighting, specify luminaires that direct light downward

Controls

- Use on/off photoelectric daylight sensors
- Use modulating photoelectric daylight sensors
- Use occupancy sensors
- Use timers to control lighting
- Use door-impact switches in closets
- Use small-scale switching zones
- Use switches with 1, 2, 3 lamp operation

Moderately Recommended**Daylighting**

- Use building elements to redirect daylight and control glare
- Use skylights for daylighting
- Locate floor openings under top-lighting to increase daylighting penetration

Interior design

- Use the lowest ceiling height that permits proper use of the space
- Use reflective suspended ceilings

Light sources

- Use halogen infrared reflector lamps for track lighting where necessary

Ballasts

- Use linear reactor ballasts with metal halide lamps

Luminaires

- Illuminate signs from above only

Controls

- Put outdoor lighting on motion-detector controls or timers
- Use dimming switches

Appliances and Equipment Energy Use**Strongly Recommended****Motors**

- Use computer software to assist in motor selection
- Use adjustable-speed drives (ASDs)
- Align motor and shaft as precisely as possible
- Correct for low power factor
- Use high-efficiency belts

Computers and office equipment

- Use ENERGY STAR copiers and fax machines
- Use ENERGY STAR computer equipment
- Use laptop computers
- Use an occupancy sensor to turn off computer peripherals when the office is unoccupied

Refrigerators and freezers

- Allow sufficient airflow around refrigerator and freezer condenser coils
- Don't set refrigerator and freezer temperatures lower than necessary

Elevators and escalators

- Use variable-frequency drives and high-efficiency motors for elevators and escalators
- Use control systems that de-energize cabs during low-use periods

Vending machines

- Use energy-efficient vending machines

Moderately Recommended**Motors**

- Use energy-efficient motors
- Use two-speed motors
- Size motors appropriately
- Size electrical cables for motors appropriately

Water Heating Energy Use

Strongly Recommended**Minimize hot water load**

- Use water-efficient faucets

Water heaters

- Use water heaters with energy efficiency ratings in the top 20 percent
- Use solar water heaters
- Use a boiler to heat water
- Use waste heat from mechanical systems to heat water

Standby heat loss

- Minimize the length of hot water piping
- Insulate hot water piping
- Use heat trap valves
- Provide different water temperatures for general and sanitary uses

Moderately Recommended**Water heaters**

- Use heat-pump water heaters
- Use demand water heaters

Energy Sources Energy Use

Strongly Recommended**Photovoltaics**

- Use a photovoltaic (PV) system to generate electricity on-site
- Use building-integrated photovoltaics (PV) to generate electricity on-site
- Arrange for sale of excess electricity into the grid
- Design roof surfaces to accommodate future PV installations

Moderately Recommended**Ground-coupled systems**

- Use earth sheltering
- Use earth tubes to preheat or pre-cool ventilation air
- Use ground-source heat pumps as a source for heating and cooling
- Use surface water as a sink for direct cooling
- Use deep well water as a sink for direct cooling
- Use surface water as a sink for mechanical cooling

Other alternative sources

- Develop or take advantage of district heating

Recommended Water Strategies

Landscaping and Water Use

Strongly Recommended**Xeriscaping—planting for low water use**

- Convert turf areas to native ecosystem
- Select plants for drought tolerance
- Arrange plantings in groups according to water needs
- Improve soil quality to increase water retention
- Use mulch to improve water retention
- Utilize non-plant landscaping

Irrigation

- Recycle greywater for landscape irrigation
- Use water-efficient irrigation fixtures

Moderately recommended**Irrigation**

- Use appropriate grading to retain irrigation and reduce runoff
- Use automatic controls to improve efficiency and effectiveness of irrigation system
- Use a moisture meter to control outdoor irrigation

Plumbing/Fixtures and Water Use

Strongly Recommended**Keeping waste separate from water**

- Use composting toilets
- Specify waterless urinals

Low-water-use fixtures

- Use low-flow toilets
- Use foot-pedal faucet controls
- Install faucet aerator on kitchen faucet
- Use automatic faucet controls for lavatories

Hot water delivery to fixtures

- Design floorplan to minimize length of hot water piping
- Insulate hot water pipes to reduce water waste during warm-up
- Size water supply pipes appropriately, assuming use of water-efficient fixtures

Moderately Recommended

Wastewater and greywater recycling

- Design buildings to use treated wastewater for non-potable uses

Hot water delivery to fixtures

- Specify on-demand hot-water recirculation system to avoid water waste
- Install point-of-use hot water heaters

General Water Uses

Strongly Recommended

Education

- Educate building management and employees about water conservation

Rainwater collection

- Collect and store rainwater for landscape irrigation

Controlling leaks

- Reduce excessive water delivery pressure

Moderately Recommended

Financial incentives

- Check for rebates on water-conserving fixtures and landscaping
- Check for rebates on water-conserving appliances

Controlling leaks

- Carry out careful water leakage audit and fix any leaks

Recommended Resources & Materials Strategies

Resource Efficiency and Resources & Materials

Strongly Recommended

Reduce material use

- Design and build for phased construction
- Determine whether varying functions can be accommodated in shared spaces
- Group or stack bathrooms and other water-using spaces
- Minimize space devoted exclusively to circulation
- Consider the use of structural materials that do not require application of finish layers

Longevity

- Provide to contractors (or require from designers) detailed and complete plans and specs
- Provide anchoring in exterior walls for future addition of intermediate stories
- Use materials and systems with low maintenance requirements
- Keep materials dry during construction
- Use landscaping and grading to divert water from the building
- Design and build components with constituent parts of equivalent longevity

Transporting materials

- Prefer materials that are sourced and manufactured within the local area
- Have materials transported by the most efficient means available

Moderately Recommended**Longevity**

- Use an access floor to facilitate reconfiguring of spaces and cabling systems
- Implement or request of contractors a total quality management program such as ISO 9000
- Seek to engage subcontractors who are certified by recognized organizations

C&D waste management and Resources & Materials**Strongly Recommended****Job site recycling**

- Investigate local infrastructure for recycling
- Seek a waste hauler who can separate recyclables out of commingled waste
- Require a waste management plan from the contractor
- Before concrete pours, designate locations or uses for excess concrete

Moderately Recommended**Job site recycling**

- Designate a recycling coordinator
- Require weekly job-site recycling training
- Set up labeled bins to keep recyclable materials separate
- Require that subcontractors keep their wastes separate

Future Waste Minimization and Resources & Materials**Strongly Recommended****Reusable components**

- Design for disassembly at end of life
- Build with reusable modular units
- Use materials with integral finish

Recyclable materials

- Facilitate recycling by avoiding materials with toxic components
- Use biodegradable materials

Recycling by occupants

- Specify recycling receptacles that are accessible to the occupants

Moderately Recommended**Reusable components**

- Design with refinishable components

Recyclable materials

- Avoid composite materials to facilitate recycling
- Select products that manufacturers will take back for recycling
- Consider green leasing of materials and furnishings

Recycling by occupants

- Design a physical in-house composting system

Materials by CSI Division and Resources & Materials**Strongly Recommended****Division 2 – Sitework**

- Enhance existing features in landscaping
- Use natural-fiber erosion-control mats
- Use geotextiles with high levels of recycled content
- Use retaining wall systems with high levels of recycled content
- Use porous pavement systems with high levels of recycled content

Division 2 – Site furnishings

- Use living fencing
- Avoid conventional preservative-treated wood
- Use recycled-plastic benches or picnic tables
- Use recycled-plastic wheel stops and speed bumps
- Specify tree grates with high recycled content

Division 2 – Landscaping

- Use organic compost
- Specify mulch made from post-consumer waste
- Specify landscape ties, headers, edgers of recycled plastic
- Specify recycled-content pipe for irrigation

Division 3 – Concrete

- Use reusable forms
- Replace up to 30% of the cement in concrete with flyash
- Specify vegetable-based form-release oil

Division 4 – Unit masonry

- Use clay brick made from contaminated soil or industrial waste products

Division 5 – Metals

- Specify aluminum products made from high levels of recycled scrap
- Use the most efficient section to optimize material use
- Specify heavy steel framing with highest recycled content
- Design to avoid thermal bridging when using light-gauge steel for building shell

Division 6 – Wood

- Choose naturally rot-resistant wood species for exposed applications
- Avoid endangered wood species and species from sensitive habitats
- Use wood products from independently certified, well-managed forests for rough carpentry
- Use salvaged wood for rough carpentry
- Use trusses for roofs and floors
- Use wood products from independently certified, well-managed forests for finish carpentry
- Use salvaged wood for finish carpentry
- Avoid wood products made with urea-formaldehyde binder
- Use agricultural-waste-fiber panels for millwork and interior finish

Division 6 – Plastics

- Specify recycled wood-plastic composite lumber to substitute for preservative-treated wood
- Specify recycled-plastic lumber as a substitute for preservative-treated wood

Division 7 – Insulation

- Avoid rigid foam insulation made with HCFCs
- Avoid sprayed-in foam insulation made with HCFCs
- Protect workers from exposure to glass fibers

Division 7 – Roofing & Siding

- Prefer the most durable roofing material
- Ensure that flashing details are as durable as the roofing
- Select a roofing system that allows the membrane to be replaced without replacing insulation

Division 8 – Windows

- Optimize energy performance of glazing systems
- Choose frame and sash materials with low thermal conductivity
- Select durable window assemblies
- Use pan flashing under all windows

Division 8 – Doors

- Select insulated doors for optimal thermal performance

Division 9 – Flooring & floor coverings

- Specify wood flooring from independently certified forestry operations
- Specify salvaged flooring or flooring from salvaged wood
- Ensure that concrete slabs are dry before installing flooring
- Use a solvent-free, water-resistant adhesive recommended by manufacturer
- Avoid carpet in areas that are susceptible to moisture intrusion
- Avoid urea-formaldehyde-based underlayment
- Avoid lauan plywood underlayment
- Specify carpet made with recycled-content face fiber
- Specify carpet tiles made with recycled-content backing

- Specify carpet tiles that can be resurfaced for reuse
- Use only very-low-VOC carpet adhesives
- Use hook-and-loop tape rather than adhesives

Division 9 – Paints & Coatings

- Specify zero-VOC interior latex paints
- Specify recycled paint
- Maximize direct-to-outdoors ventilation when applying paint

Division 10 – Specialties

- Use plastic toilet partitions made from recycled plastic

Division 16 – Electrical

- Size electrical cables appropriately
- Specify only low-mercury fluorescent lamps

Moderately Recommended**Division 2 – Sitework**

- Minimize width of roadways

Division 2 – Landscaping

- Use imported fill or topsoil from nearest available source
- Specify mulch made from materials removed during sitework

Division 3 – Concrete

- Save lumber from forms for reuse in framing and sheathing
- Use precast structural concrete components
- Use recycled materials as aggregate in the concrete

Division 5 – Metals

- Seek alternatives to aluminum
- Use salvaged steel members
- Use light-gauge steel for interior partitions

Division 6 – Wood

- Use wood treated with less-toxic preservatives than the standard CCA or ACZA
- Use engineered wood products for rough carpentry
- Use engineered wood products for finish carpentry
- Seal all surfaces of composite woodwork made with urea-formaldehyde-based binders

Division 7 – Insulation

- Prefer formaldehyde-free batt insulation
- Prefer insulation with high recycled content

Division 7 – Roofing & Siding

- Prefer roofing materials with high levels of recycled content
- Prefer recyclable roofing materials
- Consider using hardboard siding

Division 7 – Sealants

- Use dry adhesive tape instead of wet sealants where feasible

Division 8 – Windows

- Choose frame and sash materials made from recycled materials

Division 9 – Wall & ceiling finishes

- Use wallboard from manufacturers that utilize gypsum from job-site scraps
- Use gypsum board made with higher percentages of synthetic gypsum
- Specify gypsum wallboard from suppliers that take back scrap for recycling
- Use site-mixed rather than premixed joint compounds

Division 9 – Flooring & floor coverings

- Specify prefinished wood or bamboo flooring
- Specify bamboo flooring instead of hardwood
- Specify floor tiles with recycled content
- Use true linoleum flooring
- Use natural cork flooring
- Use recycled-content vinyl flooring
- Avoid adhering carpet directly to concrete floor
- Wait three or more days after painting to install carpet
- Specify natural fiber carpets
- Specify carpet from manufacturers who will recycle used carpet

Division 9 – Paints & Coatings

- Specify paints made from plants and minimally processed minerals

Division 15 – Mechanical

- Run air ducts only to interior of each room, not to building perimeter

Recommended Indoor Environmental Quality Strategies

Control of Outdoor Pollution and Indoor Environmental Quality

Strongly Recommended

Avoiding pollution sources

- Locate building away from sources of pollution
- Research previous uses of the site
- Use least-toxic pest-control before and during construction

Preventing entry of pollutants

- Locate outdoor air intakes away from pollution sources
- Seal openings in building envelope and interstitial spaces to control migration of contaminants
- Design so that it is easy to prevent soil gas entry
- Check for and minimize radon within the structure
- Design entry to facilitate removal of dirt before entering building
- Avoid carpet and other hard-to-clean floor surfaces near entry

Comfort and Indoor Environmental Quality

Strongly Recommended

Thermal comfort

- Use glazing with a low Solar Heat Gain Coefficient
- Maintain relative humidity levels between 30% and 60%
- Provide occupants with the means to control temperature in their area

Visual comfort – building envelope features

- Orient the floor plan on an east-west axis for best control of daylighting
- Use large exterior windows and high ceilings to increase daylighting
- Use skylights and/or clerestories for daylighting
- Incorporate light shelves on the south facade

Visual comfort – interior features

- Design open floor plans to allow exterior daylight to penetrate to the interior
- Use low partitions near the exterior glazing to promote daylight penetration
- Install large interior windows to allow for the transmission of daylight
- Locate floor openings under skylights to increase daylight penetration
- Place primarily unoccupied spaces away from daylight sources

Visual comfort – Internal light sources

- Use electronic ballasts with fluorescent lighting
- Provide occupants with control of light in their area
- Provide illumination sensors

Acoustical comfort – Managing occupant noise

- Specify acoustically absorbent materials to lower reflected noise levels
- Use moving water to create a pleasant acoustic environment

Acoustical comfort – Managing mechanical system noise

- Select and install mechanical equipment based on specific (low) sound level targets
- Use transfer grills only when acoustic transmission is not an issue
- Seal air passages in partitions and ceilings, and around doors

Moderately Recommended**Thermal comfort**

- Use glazing with a minimum U-value of 0.33 when occupants will be adjacent to windows

Visual comfort – building envelope features

- Choose interior and exterior glazing to maximize daylight transmission

Visual comfort – interior features

- Select only white to midrange finishes to maximize reflectance of light
- Maintain a ratio no greater than 10 to 1 between brightest and darkest visible surfaces

Acoustical comfort – Controlling outdoor noise

- Install acoustical glazing to reduce sound transmission
- Consider exterior noise when designing for operable windows

Acoustical comfort – Managing occupant noise

- Minimize sound transmission between rooms with appropriate detailing and material densities

Acoustical comfort – Managing mechanical system noise

- Control noise with large-volume, low-velocity air systems instead of lined ducts

Ventilation and Air Distribution and Indoor Environmental Quality**Strongly Recommended****Ventilation and filtration systems**

- Provide occupants with access to operable windows
- Design for optimum cross-ventilation through window placement

- Specify ventilation rates that meet or exceed ASHRAE Standard 62-1999
- Locate airflow monitoring devices on the outdoor air side of air handling units

Managing pressure relationships

- Ensure that exhaust fans and air handlers do not depressurize building cavities or the soil
- Keep negative pressure in attached garages
- Avoid backdrafting by using sealed-combustion or power-vented combustion devices
- Enclose gas-fired HVAC/hot water systems and vent them to the exterior

Distribution systems

- Use duct mastic instead of duct tape
- Keep air supply and return vents clear of obstruction
- Specify external duct insulation rather than internal

Direct exhaust from high-source locations

- Provide local exhaust ventilation for rooms with high-emitting sources
- Designate a separate, well-exhausted smoking lounge if smoking is to be allowed

Moderately Recommended**Ventilation and filtration systems**

- Provide heat-recovery ventilation
- Design ventilation system to exchange both heat and humidity between incoming and outgoing air

Distribution systems

- Use hard-surface acoustic controls in ducts

Direct exhaust from high-source locations

- Install a quiet, effective fan in bathrooms
- Use special equipment for ventilating locations with high heat loads

Moisture Control and Indoor Environmental Quality

Strongly Recommended

Foundations – rainwater and groundwater

- Use foundation perimeter rainwater collection system to divert water from the building
- Prevent water migration from beneath slab-on-grade or below-grade floors
- Use landscaping and grading to divert water from the building

Foundations – humidity, condensation and water vapor

- Avoid use of linoleum and vinyl flooring over uncured concrete and below-grade slabs

Walls, roofs, doors, and windows – rainwater and groundwater

- Keep insulation and other construction materials dry
- Seal exterior walls and provide overhangs to prevent bulk water (rain) penetration

Walls, roofs, doors, and windows – humidity, condensation

- Design building envelope to avoid thermal bridging
- Use windows that provide R-2 or better over their entire surface
- Provide special envelope and mechanical detailing for high-moisture-source spaces
- Locate vapor retarding layers toward the interior or near the thermal center of the wall

Mechanical systems

- Design ductwork to allow access for cleaning
- Seal any ductwork running through unconditioned space with mastic
- Provide easy access to coils, filters, and drain pans
- Insulate outdoor air ducts in conditioned space

Moderately Recommended

Foundations – rainwater and groundwater

- Use drainage to lower the water table around the building

Pollution from Materials and Indoor Environmental Quality

Strongly Recommended

Identification

- Review the Material Safety Data Sheet when evaluating construction materials

Elimination

- Specify low-mercury fluorescent lamps
- Avoid products that may release mineral fibers
- Use finishes that are easy to clean using mild surfactants and water
- Use only non-solvent-based adhesives
- Use water-based wood finishes
- Avoid the use of adhesives when installing gypsum board

Reduction

- Avoid urea formaldehyde particleboard
- Use only very low or no-VOC paints
- Use only solvent-free floor finishes for wood and stone

Moderately Recommended

Identification

- Procure green-label-certified carpet
- Test carpets for VOC emissions or procure test results

Elimination

- Specify vegetable-based form-release oil for concrete forms

Reduction

- Apply a sealer to any panel products made with urea-formaldehyde

Construction, Commissioning, and Operations and Indoor Environmental Quality

Strongly Recommended

Absorption of pollutants

- Minimize exposure of textiles and uncoated paper to high VOC concentrations

Pollutant migration

- Ensure that materials containing mineral or glass fibers are properly installed and contained

Ventilation during construction

- Use adequate ventilation during installation and curing of thermal insulation
- Ensure good ventilation during high-VOC-source applications

- Provide adequate ventilation whenever construction activities are occurring in confined space
- Provide temporary filters on any permanent air-handling devices used during construction
- Purge the building of VOCs during furniture installation prior to move-in

Commissioning

- Commission the mechanical and electrical systems prior to occupancy

Maintenance

- When using water for cleaning, ensure that materials can dry quickly
- Avoid air handler designs that provide convenient but inappropriate storage space
- Design for easy access to HVAC components
- Specify routine maintenance for HVAC system and check performance of system
- Specify use of only nontoxic cleaning products
- Design isolated storage closet for cleaning and maintenance products

Facility policies

- Establish a problem reporting and resolution process
- Establish specific construction or renovation protocols for preventing future IAQ problems
- Use least-toxic pest-control strategies

Moderately Recommended

Absorption of pollutants

- Store gypsum board during construction in a well-ventilated area
- Warehouse carpet unrolled to allow airing
- Wait three or more days to install carpet and other furnishings after painting

Pollutant migration

- Minimize the generation of airborne particulates during construction

Facility policies

- Recommend a non-smoking policy for the building

Green Building Adviser is a trademark of Building-Green, Inc. and Design Harmony, Inc.

Appendix D

Site-Wide Metering Program at LANL

The main objective of the Site-Wide Metering Program is to measure electric, gas, water, steam, and other fuel commodities usages at the Laboratory. The guiding principles are:

- If we can measure it, we can manage it.
- If we can show the customers how much energy they are consuming and how much they are paying for it, they will have incentive to save energy.

The goal of the Site-Wide Metering program is to automate all meter readings; use the latest technology meters that will read and process electric, gas, and water meter data in the same meter; and transmit data via the local area network. As a by-product, the same real time energy use data and other technical data can be transmitted to the customers for their own use to manage their loads and to look at power quality.

FWO-UI is currently developing and evaluating installed metering systems from two competing manufacturers. The type of meters and network communications system will be similar to the type of meters and system that have been on the market for at least six to ten years and are currently being used in other facilities like Sandia National Laboratory, Intel, and Hewlett-Packard. The system will be completely automated, thus eliminating the need for meter readers, and minimize data transfer and handling. An automated utility billing system will be developed.

The meters and network system will be self-diagnostic and will not require maintenance except direct replacement of defective meters. No site calibration is required. The meters will have I/O modules for analog and digital inputs for metering of water, gas, and steam in the future.

The following is FWO-UI's plan to implement a site-wide metering program:

Strategy

1. Completely develop and evaluate working metering network systems in three different size and system configurations from two competing manufacturers. Utilize the meter manufacturer's Engineering Product and Technical Support to develop and design additional systems specific to applications at LANL.

Funds will be used directly to purchase and install meters. Planning and supervision will be done by the Energy Manager/Electrical Engineer under FWO-UI's Energy Management Program.
2. Duplicate the systems developed in other priority areas starting with big energy users.
3. Network each system via local area network for remote readout, alarms, and controls by building groups and FM units. The LEDA project at TA-53, Material Science Bldg at TA-3, TA-48 Bldg.1, and TA-3-261 Otowi Building electric meters are now networked via local area network.
4. Develop the network system Lab-wide with two main client/server computer stations with options for any group user to install a client computer station for readout only and/or controls for load manage-

ment or voluntary load shedding. (A client/server computer station is now installed at Utilities Group Bldg 481 and at the Power Plant.)

5. Develop a Web page for all customers to see their real time and historical energy use.
6. Develop customized automatic (programmed) utility billing system for all FMs.

Funding Plan

1. Budget \$250K from special projects funds each year to purchase and install meters for a five-year metering program. Larger allocations will shorten the program to 3 or 4 years.
2. Utilize Utility's Capital Re-investment Funds savings from Energy Savings Retrofit Projects and ESPC projects.
3. Share part of the meter installation costs with the using groups.
4. Allocate a small percentage of the utility tax increase for metering.

Procurement Plan

1. Purchase meters through GSA pricing procurement.
2. Purchase start-up, training, and special installations directly from meter manufacturers.

Installation Plan

1. Meter installation will be done as part of the meter procurement by factory-authorized technicians and by the support services subcontractor under Special Projects' Work Orders. Installations will be done by buildings or group of buildings in coordination with the Facility Manager's staff.
2. Perform a few meter installations utilizing factory-authorized service technicians with the support services subcontractor support. The support services subcontractor will use this opportunity for on-the-job training on meter installations. A dedicated crew of two support services subcontractor electricians will be sent for meter installation training at the manufacturer's plant. After training, all meter installations will be done by this dedicated crew.
3. Installations of the communication wires, local area network gateway or telephone modems, and connection to the local area network bus will be done by the support services subcontractor in coordination with the Facility's Network Administrator.

Operations

1. FWO-UI's Energy Manager and Budget/Billing Staff will oversee the metering program functions.
 - Develop and test the metering program system configuration
 - Procure meters and issue work orders or purchase requests for installation
 - Provide technical support and field verification of meter locations and spaces being metered
 - Provide technical customer support for load management and energy savings
 - Provide temporary power profile metering and verify readings
 - Provide trending historical energy use data to the customers
2. FWO-UI's FM Implementation Team will perform the utility rate structuring and utility billing functions in coordination with BUS-3.
 - Support and interface with LANL accounting system
 - Analyze the existing utility metering data
 - Develop the billing recharge system for implementation by accounting (BUS-3)
 - Provide customer service to ensure that customers are being billed correctly, accurately, and billing allocations are reasonable and fair.
 - Ensure that correct and accurate data are delivered to the accounting systems in a timely manner

3. The Support Services Subcontractor will:

- Implement and maintain the meter reading database
- Ensure accuracy of all meter readings and timeliness of reporting
- Respond to meter malfunction alarms
- Inspect and verify meter installations and calibrations
- Install new meters and temporary power profile metering, and replace old or defective meters
- Maintain a record of all meter locations and the buildings or spaces being metered

4. Meter Standard

The following are the LANL-approved electric meters:

- PowerLogic Circuit Monitor SQ D Model No. 3020CM2350
- IQ Analyzer Cutler-Hammer Model No. 6230

Appendix E

LANL GPP Building Example

LEED Checklist

Use this worksheet as a tool for determining the potential LEED score for a project. The points below are based on the score a typical LANL GPP Building might receive. For new projects, photocopy this sheet for

planning discussions, and write over the top of the grayed out points. Points that end up in the question mark category can be moved in either direction when making a final decision about whether to pursue them.

Yes	?	No	LEED Criteria	Actions/Comments	Reference Chapter
X			Sustaining Sites		
			Site Prerequisite: Erosion & Sedimentation Control		4, 9
			Meet EPA-BMP or local soil erosion standards with a sediment and erosion control plan, meeting the following objectives: prevent loss of soil during construction and prevent sedimentation of storm sewer or receiving streams and/or air pollution with dust and particulate matter.		
1			Site Credit 1: Site Selection		4
			Do not locate facility: 1. On prime farmland, 2. On land whose elevation is lower than 5 ft. above 100 year flood, 3. Land which provides habitat for species on the Federal/State threatened or endangered list, 4. Within 100 ft. of any wetland, or 5. On land which was public parkland without trade.		
		1	Site Credit 2: Urban Redevelopment		-
			Increase localized density to conform to existing or desired density goals by utilizing sites that are located within an existing minimum development density of 60,000 sf/acre (2 story downtown development).	Not applicable to LANL sites.	
		1	Site Credit 3: Brownfield Redevelopment		-
			Develop on a site classified as a Brownfield and provide remediation as required by EPA's Sustainable Redevelopment of Brownfields program requirements.	Not applicable to most LANL sites.	
		1	Site Credit 4.1: Alternative Transportation, Public Transportation Access		4, 5
			Locate building within ½ mile of a commuter rail, light rail, or subway station or ¼ mile of 2 or more bus lines.	Currently, only one bus line is available.	
1			Site Credit 4.2: Alternative Transportation, Bicycle Storage & Changing Rooms		
			Provide suitable means for securing bicycles, with convenient changing/shower facilities for use by cyclists, for 5% or more of building occupants.		
		1	Site Credit 4.3: Alternative Transportation, Alternative Fuel Refueling Stations		
			Install alternative-fuel refueling station(s) for 3% of the total vehicle parking capacity of the site. Liquid or gaseous fueling facilities must be separately ventilated or located outdoors.		
1			Site Credit 4.4: Alternative Transportation, Parking Capacity		
			Size parking capacity not to exceed minimum local zoning requirements AND provide preferred parking for carpools or van pools capable of serving 5% of the building occupants, OR, add no new parking for rehabilitation projects AND provide preferred parking for carpools or vanpools capable of serving 5% of the building occupants.		

			LEED Criteria	Actions/Comments	Reference Chapter
Yes	?	No	Sustaining Sites, continued		
	1		Site Credit 5.1: Reduced Site Disturbance, Protect or Restore Open Space		4, 9
			Limit site disturbance including earthwork and clearing of vegetation to: a) 40 ft. beyond the building perimeter b) 5 ft. beyond primary roadway curbs, primary walkways, and utility trenches c) 25 ft. beyond pervious paving areas that require additional staging areas to limit compaction in the paved area; OR, on previously developed sites, restore a minimum of 50% of the remaining open area by planting native or adapted vegetation.	Standard construction practices would have to be changed.	
1			Site Credit 5.2: Reduced Site Disturbance, Development Footprint		
			Reduce the development footprint (including building, utilities, access roads and parking) to exceed the local zoning's open space requirements for the site by 25%.	No local zoning requirements.	
	1		Site Credit 6.1: Storm Water Management, Rate or Quantity		8
			Implement a stormwater management plan that results in: No net increase in the rate and quantity of stormwater runoff from existing to developed conditions; OR, if existing imperviousness is greater than 50%, implement a stormwater management plan that results in a 25% decrease in the rate and quantity of stormwater runoff.		
		1	Site Credit 6.2: Stormwater Management, Treatment		
			Treatment systems designed to remove 80% of the average annual post development total suspended solids (TSS), and 40% of the average annual post development total phosphorous (TP), by implementing EPA-BMPs.		
	1		Site Credit 7.1: Landscape & Exterior Design to Reduce Heat Islands, Non-roof		4, 5, 7, 8
			Provide shade (within 5 years) on at least 30% of non-roof impervious surface on the site, including parking lots, walkways, plazas, etc., OR, use light-colored/high-albedo materials (reflectance of at least 0.3) for 30% of the site's non-roof impervious surfaces, OR, place a minimum of 50% of parking space underground OR use open-grid pavement system (net impervious area of less than 50%) for a minimum of 50% of the parking lot area.		
1			Site Credit 7.2: Landscape & Exterior Design to Reduce Heat Islands, Roof		
			Use ENERGY STAR Roof-compliant, high-reflectance AND high emissivity roofing (initial reflectance of at least .65, 3-year-aged reflectance of at least .5, and emissivity of at least 0.9) for a minimum of 75% of the roof surface; OR, install a "green" (vegetated) roof for at least 50% of the roof area.	LANL roof specifications already meet these requirements.	
1			Site Credit 8: Light Pollution Reduction		D, F
			Do not exceed IESNA foot-candle level requirements as stated in the Recommended Practice Manual: Lighting for Exterior Environments, AND design interior and exterior lighting such that zero direct-beam illumination leaves the building site.	Already comply with New Mexico Night Sky Protection Act.	
5	4	5	SUBTOTAL FOR SUSTAINABLE SITES		

			LEED Criteria	Actions/Comments	Reference Chapter
			Water Efficiency		
1			Water Credit 1.1: Water Efficient Landscaping, Reduce by 50%		8
			Use high efficiency irrigation technology, OR, use captured rain or recycled site water, to reduce potable water consumption for irrigation by 50% over conventional means.	Can install landscaping without a permanent irrigation system	
1			Water Credit 1.2: Water Efficient Landscaping, No Potable Use or No Irrigation		
			Use only captured rain or recycled site water for an additional 50% reduction (100% total reduction) of potable water for site irrigation needs, OR, do not install permanent landscape irrigation systems.		
		1	Water Credit 2: Innovative Wastewater Technologies		–
			Reduce the use of municipally provided potable water for building sewage conveyance by a minimum of 50%, OR treat 100% of wastewater on site to tertiary standards.		
	1		Water Credit 3.1: Water Use Reduction, 20% Reduction		6
			Employ strategies that in aggregate use 20% less water than the water use baseline calculated for the building (not including irrigation) after meeting Energy Policy Act of 1992 fixture performance requirements.	This is easily achievable with waterless urinals and/or low flow faucets.	
	1		Water Credit 3.2: Water Use Reduction, 30% Reduction		
			Exceed the potable water use reduction by an additional 10% (30% total efficiency increase).		
2	2	1	SUBTOTAL FOR WATER EFFICIENCY		
			Energy and Atmosphere		
X			Energy Prerequisite 1: Fundamental Building Systems Commissioning		10
			Implement all of the following fundamental best practice commissioning procedures: <ul style="list-style-type: none"> ▪ Engage a commissioning authority. ▪ Document design intent and the basis of design documentation ▪ Include commissioning requirements in the construction documents. ▪ Develop and utilize a commissioning plan. ▪ Verify installation, functional performance, training and documentation. ▪ Complete a commissioning report. 		
X			Energy Prerequisite 2: Minimum Energy Performance		6
			Design to meet building energy efficiency and performance as required by ASHRAE 90.1-1999 or the local energy code, which ever is the more stringent.		
X			Energy Prerequisite 3: CFC Reduction in HVAC&R Equipment		6
			Zero use of CFC-based refrigerants in new building HVAC&R base building systems. When reusing existing base building HVAC equipment, complete a comprehensive CFC phase-out conversion.		

LEED Criteria			Actions/Comments	Reference Chapter	
Energy and Atmosphere, continued					
Energy Credit 1: Optimize Energy Performance				6	
Reduce design energy cost compared to the energy cost budget for regulated energy components described in the requirements of ASHRAE Standard 90.1-1999, as demonstrated by a whole building simulation using the Energy Cost Budget Method:			LANL standard GPP building already exceeds ASHRAE 90.1-1999. 30% and perhaps higher is achievable.		
	Level	New			Existing
2	1	20%			10%
2	2	30%			20%
2	3	40%			30%
2	4	50%			40%
	2	5	60%	50%	
Energy Credit 2: Renewable Energy				6	
Supply a net fraction of the building's total energy load (as expressed as a fraction of annual energy cost) through the use of on-site renewable energy systems.					
	Level	Fraction			
1	1	5%			
1	2	10%			
1	3	20%			
1	Energy Credit 3: Additional Commissioning			10	
In addition to the Fundamental Building Commissioning prerequisite, implement the following: 1) Conduct a focused review of design prior to the construction documents phase 2) Conduct a focused review of the construction documents when close to completion 3) Conduct a selective review of contractor submittals of commissioned equipment 4) Develop a re-commissioning management manual 5) Have a contract in place for a near-warranty end or post occupancy review Items 1, 2, and 3 must be performed by a firm other than the designer.					
1	Energy Credit 4: Ozone Depletion			6	
Install building HVAC and refrigeration equipment and fire suppression systems that do not contain HCFC's or Halon.			Can specify chillers with R134a or 407C.		

			LEED Criteria	Actions/Comments	Reference Chapter
Yes ? No			Energy and Atmosphere, continued		
	1		Energy Credit 5: Measurement and Verification		6, 10
			Comply with the long term continuous measurement of performance as stated in Option B: Methods by Technology of the U.S. DOE's International Performance Measurement and Verification Protocol (IPMVP) for the following: <ul style="list-style-type: none"> ▪ Lighting systems and controls ▪ Constant and variable motor loads ▪ Variable frequency drive (VFD) operation ▪ Chiller efficiency at variable loads (kW/ton) ▪ Cooling load ▪ Air and water economizer and heat recovery cycles ▪ Air distribution static pressures and ventilation air volumes ▪ Boiler efficiencies ▪ Building specific process energy efficiency systems and equipment ▪ Indoor water risers and outdoor watering systems. 		
		1	Energy Credit 6: Green Power		–
			Engage in a two-year contract to purchase power generated from renewable sources that meets the Center for Resource Solutions (CRS) Green-e products certification requirements.	Green power is not available.	
5	7	5	SUBTOTAL OF ENERGY AND ATMOSPHERE		
Materials and Resources					
X			Materials Prerequisite 1: Storage & Collection of Recyclables		5
			Provide an easily accessible area that serves the entire building and is dedicated to the separation, collection and storage of materials for recycling including (at a minimum) paper, glass, plastics, and metals.		
		1	Materials Credit 1.1: Building Reuse, Maintain 75% of Existing Shell		–
			Reuse large portions of existing structures during renovation or redevelopment projects. Maintain at least 75% of existing building structure and shell (exterior skin, excluding window assemblies and framing).	Does not apply to most new construction projects.	
		1	Materials Credit 1.2: Building Reuse, Maintain 100% of Shell		
			Maintain an additional 25% (100% total) of existing building structure and shell.		
		1	Materials Credit 1.3: Building Reuse, Maintain 100% Shell & 50% Non-Shell		
			Maintain 100% of existing building structure and shell AND 50% of non-shell (walls, floor coverings, and ceiling systems).		
1			Materials Credit 2.1: Construction Waste Management, Divert 50%		9
			Develop and implement a waste management plan, quantifying material diversion by weight. Recycle and/or salvage at least 50% (by weight) of construction, demolition, and land clearing waste.	LANL is already doing this. Need to extend to contractors through contract language.	

			LEED Criteria	Actions/Comments	Reference Chapter
			Materials and Resources, continued		
1			Materials Credit 2.2: Construction Waste Management, Divert 75%		9
			Recycle and/or salvage an additional 25% (75% total by weight) of the construction, demolition, and land clearing debris.	LANL is already doing this. Need to extend to contractors through contract language.	
1			Materials Credit 3.1: Resource Reuse, Specify 5%		5, 7
			Specify salvaged or refurbished materials for 5% of total building materials.		
		1	Materials Credit 3.2: Resource Reuse, Specify 10%		
			Specify salvaged or refurbished materials for 10% of total building materials.		
1			Materials Credit 4.1: Recycled Content, Specify 25%		5, 7
			Specify a minimum of 25% of building materials that contain in aggregate a minimum weighted average of 20% post-consumer recycled content material, OR, a minimum weighted average of 40% post-industrial recycled content material.	Achievable and required by Executive Order 13101.	
	1		Materials Credit 4.2: Recycled Content, Specify 50%		
			Specify an additional 25% (50% total) of total building materials that contain in aggregate, a minimum weighted average of 20% post-consumer recycled content material, OR, a minimum weighted average of 40% post-industrial recycled content material.		
1			Materials Credit 5.1: Local/Regional Materials, 20% Manufactured Locally		5, 7
			Specify a minimum of 20% of building materials that are manufactured regionally within a radius of 500 miles.	This is consistent with LANL directive for business development in northern New Mexico.	
		1	Materials Credit 5.2: Local/Regional Materials, of 20% Above, 50% Harvested Locally		
			Of these regionally manufactured materials, specify a minimum of 50% that are extracted, harvested, or recovered within 500 miles.		
		1	Materials Credit 6: Rapidly Renewable Materials		–
			Specify rapidly renewable building materials for 5% of total building materials.		
1			Materials Credit 7: Certified Wood		5, 7
			Use a minimum of 50% of wood-based materials certified in accordance with the Forest Stewardship Council guidelines for wood building components including, but not limited to framing, flooring, finishes, furnishings, and non-rented temporary construction applications such as bracing, concrete form work and pedestrian barriers.	Achievable and required by Executive Order 13101.	
6	1	6	SUBTOTAL OF MATERIALS AND RESOURCES		

			LEED Criteria	Actions/Comments	Reference Chapter
Yes	?	No	Indoor Environmental Quality		
X			IEQ Prerequisite 1: Minimum Indoor Air Quality (IAQ) Performance		6
			Meet the minimum requirements of voluntary consensus standard ASHRAE 62-1999, Ventilation for Acceptable Indoor Air Quality and approved Addenda.		
X			IEQ Prerequisite 2: Environmental Tobacco Smoke (ETS) Control		6
			Zero exposure of nonsmokers to ETS by prohibition of smoking in the building, OR, by providing a designated smoking room designed to effectively contain, capture and remove ETS from the building.		
1			IEQ Credit 1: Carbon Dioxide (CO₂) Monitoring Control		6
			Install a permanent carbon dioxide (CO ₂) monitoring system that provides feedback on space ventilation performance in a form that affords operational adjustments, AND specify initial operational set point parameters that maintain indoor carbon dioxide levels no higher than outdoor levels by more than 530 parts per million at any time.	Direct Digital Controls (DDC) are already required. Incorporating CO ₂ monitoring and feedback should not be difficult.	
1			IEQ Credit 2: Increase Ventilation Effectiveness		6
			For mechanically ventilated buildings, design ventilation systems that result in an air change effectiveness (E) greater than or equal to 0.9 as determined by ASHRAE 129-1997. For naturally ventilated spaces demonstrate a distribution and laminar flow pattern that involves at least 90% of the room or zone area in the direction of air flow for at least 95% of hours of occupancy.		
			IEQ Credit 3: Construction IAQ Management Plan		6, 9, 10,
			Develop and implement an Indoor Air Quality (IAQ) Management Plan for the construction and pre-occupancy phases of the building as follows:		
1			IEQ Credit 3.1: Construction IAQ Management Plan, During Construction		
			During construction, meet or exceed minimum requirements of the SMACNA IAQ Guideline for Occupied Buildings under Construction, AND protect stored on-site or installed absorptive materials from moisture damage, AND replace all filtration media immediately prior to occupancy. Filtration media shall have a MERV of 13.		
	1		IEQ Credit 3.2: Construction IAQ Management Plan, Before Occupancy		
			Conduct a minimum two-week building flush-out with new filtration media at 100% outside air after construction ends and prior to occupancy, OR conduct a baseline indoor air quality testing procedure consistent with current EPA protocols.	Scheduling prior to occupancy may make this difficult to achieve.	

		LEED Criteria	Actions/Comments	Reference Chapter
Yes ? No		Indoor Environmental Quality, continued		
		IEQ Credit 4: Low-Emitting Materials		5, 7
		Meet or exceed VOC limits for adhesives, sealants, paints, composite wood products, and carpet systems as follows:		
1		IEQ Credit 4.1: Low-Emitting Materials, Adhesives & Sealants		
		Adhesives must meet or exceed the VOC limits of South Coast Air Quality Management District Rule #1168, AND all sealants used as a filler must meet or exceed Bay Area Air Quality Management District Reg. 8, Rule 51.		
1		IEQ Credit 4.2: Low-Emitting Materials, Paints		
		Paints and coatings must meet or exceed the VOC and chemical component limits of Green Seal requirements.		
1		IEQ Credit 4.3: Low-Emitting Materials, Carpet		
		Carpet systems must meet or exceed the Carpet and Rug Institute Green Label Indoor Air Quality Test Program.		
	1	IEQ Credit 4.4: Low-Emitting Materials, Composite Wood		
		Composite wood or agrifiber products must contain no added urea-formaldehyde resins.		
1		IEQ Credit 5: Indoor Chemical Pollutant Source Control		5, 6
		Design to minimize cross-contamination of regularly occupied areas by chemical pollutants: Employ permanent entryway systems (grills, grates, etc.) to capture dirt, particulates, etc. from entering the building at all high volume entryways, AND provide areas with structural deck to deck partitions with separate outside exhausting, no air recirculation and negative pressure where chemical use occurs (including housekeeping areas and copying/print rooms), AND provide drains plumbed for appropriate disposal of liquid waste in spaces where water and chemical concentrate mixing occurs.		
	1	IEQ Credit 6.1: Controllability of Systems, Perimeter		5, 6
		Provide a minimum of one operable window and one lighting control zone per 200 sf for all occupied areas within 15 ft. of the perimeter wall.	Operable windows are not specified for LANL buildings.	
	1	IEQ Credit 6.2: Controllability of Systems, Non-Perimeter		
		Provide controls for each individual for airflow, temperature, and lighting for 50% of the non-perimeter, regularly occupied areas.	Thermostats are typically provided for small numbers of offices (4-10), but not individually.	
1		IEQ Credit 7.1: Thermal Comfort, Comply with ASHRAE 55-1992		6
		Comply with ASHRAE Standard 55-1992, Addenda 1995 for thermal comfort standards including humidity control within established ranges per climate zone.		

LEED Criteria			Actions/Comments	Reference Chapter
Yes	?	No	<i>Indoor Environmental Quality, continued</i>	
	1		IEQ Credit 7.2: Permanent Monitoring System 6	
			Install a permanent temperature and humidity monitoring system configured to provide operators control over thermal comfort performance and effectiveness of humidification and/or dehumidification systems in the building.	
1			IEQ Credit 8.1: Daylight and Views, Daylight 75% of Spaces 5	
			Achieve a minimum Daylight Factor of 2% (excluding all direct sunlight penetration) in 75% of all space occupied for critical visual tasks, not including copy rooms, storage areas, mechanical, laundry, and other low occupancy support areas. Exceptions include those spaces where tasks would be hindered by the use of daylight or where accomplishing the specific tasks within a space would be enhanced by the direct penetration of sunlight.	
	1		"IEQ Credit 8.2: Daylight and Views, View for 90% of Spaces	
			Direct line of sight to vision glazing while seated from 90% of all regularly occupied spaces, not including copy rooms, storage areas, mechanical, laundry, and other low occupancy support areas.	
9	5	1	SUBTOTAL OF IEQ	
<i>Design Process and Innovation Points</i>				
	4		Innovation in Design Credit 1.1 - 1.4:	
			Up to four points available.	
			Example: Give trailers to contractor in value for clearing utilities.	
1			Innovation Credit 2: LEED Accredited Professional	
			At least one principal participant of the project team that has successfully completed the LEED exam.	
1	4	0	SUBTOTAL OF DESIGN PROCESS & INNOVATION	
28	23	18	TOTAL LEED SCORE	
<div style="display: flex; justify-content: space-between;"> <div style="width: 30%; background-color: #e0e0e0; padding: 10px;"> <p>Platinum = 52+ points</p> <p>Gold = 39-51 points</p> <p>Silver = 33-38 points</p> <p>Certified = 26-32 points</p> </div> <div style="width: 65%; background-color: #e0e0e0; padding: 10px;"> <p>For additional details, please refer to the following resources on http://www.usgbc.org</p> <ul style="list-style-type: none"> ■ LEED Green Building Rating System ■ LEED Credit Checklist ■ LEED Documentation Requirements ■ LEED Reference Package </div> </div>				

Appendix F

Building Simulations

Using Computerized Energy Simulations to Design Buildings

Computer simulation tools are an essential component of the whole-building design process. Designers depend on these tools to understand factors affecting the performance of the particular building they are designing, assist with decisions relating to building massing and adjacencies, determine the optimal combination of design solutions, predict the actual building performance, and identify performance problems after

construction and commissioning are completed. To achieve these benefits, designers should begin depending on computer simulations of the proposed building early in the design process.

This discussion presents an example where a simulation-based energy design process (see Chapter 4) was applied beginning with the conceptual and schematic design for the Solar Energy Research Facility (SERF), a laboratory and office building located at the National Renewable Energy Laboratory in Golden, Colorado.

During pre-design, little if anything is known about the building geometry. As a result, designers simulated a very simple shape for the base-case building. To simulate the base-case building, designers only need to know the typical information available after preliminary

architectural programming (see Chapter 2). Such information includes building type, size, location, utility rate structure, height constraints, square footage for different functions, special needs associated with various functions such as vibration, ventilation, and environmental control requirements for labs, types of equipment and processes to be housed in the various spaces, and so on. In this example, the base-case building is modeled as two zones—an office zone and a lab zone—to evaluate the very different load profiles for those major functions. Later in design, when more is known about building geometry, it will be necessary to model using more zones to ensure energy performance and comfort in all major spaces in the building.



Warren Gretz

The Solar Energy Research Facility, a 115,000-sq.ft. laboratory and office building at the National Renewable Energy Laboratory in Golden, Colorado.

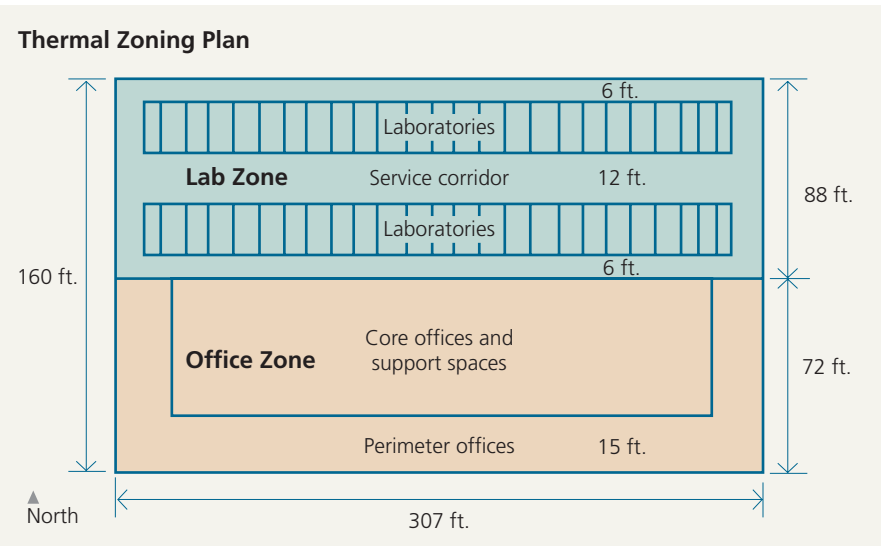

Simple base-case building schematic of the SERF. Designers described two zones, an office zone and a lab zone, to evaluate the very different load profiles for those major functions.

The annual predicted area normalized energy cost for the energy code compliant base-case building representing the SERF shows that in the office spaces, lighting, equipment, and cooling are the dominant loads. In the lab spaces, heating and lab equipment are the dominant loads. Also, it is noteworthy that total energy costs in the lab spaces are about six times those in the office spaces. It is evident from these data that the energy issues are very different for the offices and labs, and that there will be profound energy implications associated with various architectural strategies. Thus, an architectural concept that organizes office and lab space together in close proximity (often the prefer-

ence of the scientists) will require much more energy than a concept that divides these functions into separate zones.

In addition, zoning the labs separately from the offices offers opportunities to further address the very different energy issues of these spaces through both architectural and mechanical interventions. Once a detailed hourly annual simulation is completed for the base-case building, it is possible to explore hourly patterns on typical seasonal days and evaluate summer and winter peak energy loads. It is also possible to disaggregate the loads into component loads such as ventilation loads, solar loads through windows, heat transfer through envelope elements, latent and sensible loads, etc.

Charting the results of the base-case simulation analysis is a good starting point to show where to investigate further for additional design solutions. A deeper look at the simulation results for the SERF base-case building reveals that the major reason for the large heating loads is the large outside air requirement for air quality safety in the labs. Also, the hourly data indicate that the bulk of these heating loads occur on winter nights, thus ruling out simple passive or air-based solar heating strategies.

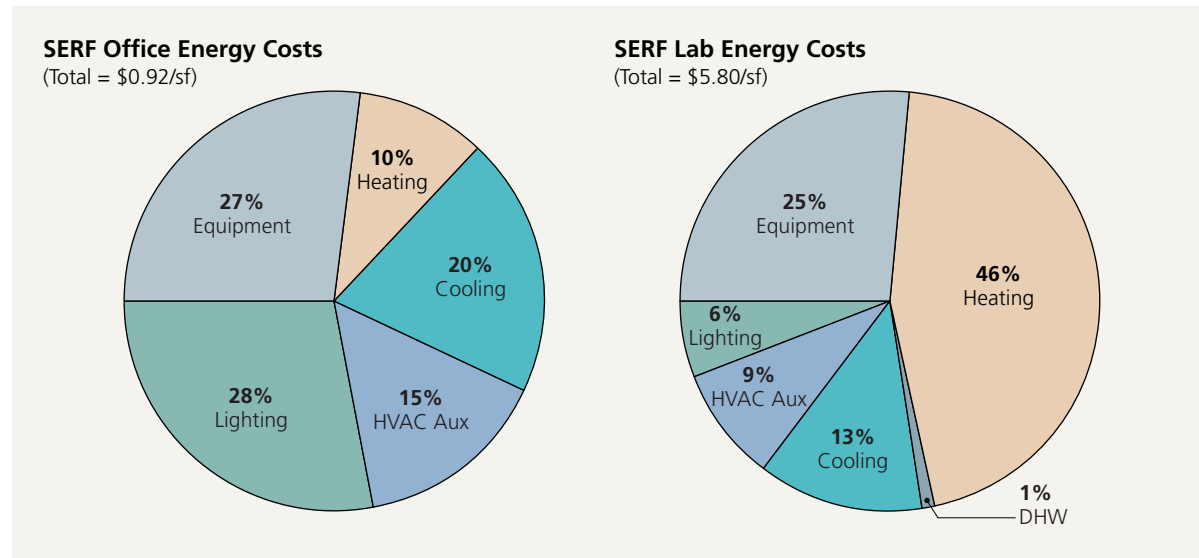

Annual predicted area normalized energy cost for SERF base-case building.

Potential strategies to consider suggested by the results of the base-case building simulation analysis

Office Spaces

- Daylighting to reduce electrical lighting and cooling loads.
- High-efficiency electric lighting where extensive daylighting is not possible.
- Architectural facade features, such as light shelves, to avoid direct-beam sunlight and maintain acceptable contrast ratios for visual comfort.
- Solar heat gain avoidance, such as properly sized external window shading devices and proper selection of glass optical and thermal properties. (Shading devices may be combined with light shelves where appropriate.)
- Occupancy and photo sensors to turn lights off when not needed.
- High-efficiency office equipment, such as flat-screen monitors and laptops with docking stations instead of desktop computers.
- Indirect/direct evaporative cooling.

Laboratory Spaces

- Exhaust air heat recovery because of the large outside air requirements (up to 12 air changes per hour in some labs).
- High-efficiency motors and variable speed motors because of the large pumping and fan power requirements.
- High-efficiency electric lights and occupancy sensors.
- Indirect evaporatively cooled water for removal of process heat from lab equipment and machines (provided by oversized cooling towers).
- High-efficiency chillers.
- Short direct duct runs to minimize pressure drop and fan power.
- Large diameter, low pressure ducts to minimize fan power.

One of the biggest benefits of an energy simulation is the ability to test various parameters on the overall building performance to see where the major savings may occur. If elimination of a load has little effect on the annual energy cost of the base-case building, then it is not worth trying to reduce that load in the design. For example, one parameter such as wall insulation can be set to an extremely high value to see if it would have a significant impact on the annual performance. The designer may determine that perhaps reducing the window solar heat gain coefficient might be more advantageous than doubling the wall insulation.

Annual Energy Cost (\$/ft²)

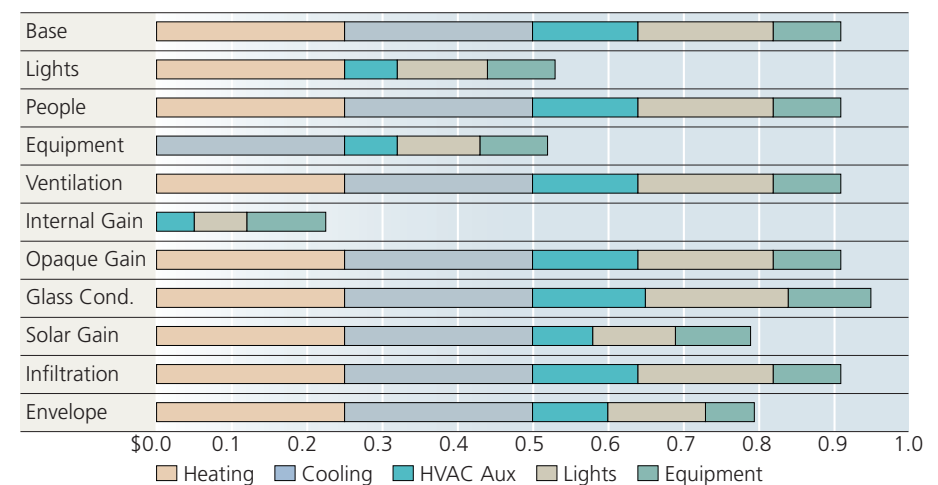

Elimination parametric study for the SERF office space. The first bar at the top shows the disaggregated annual energy costs of the base-case building. Each successive bar represents just one parametric change from the base-case building (except the bars labeled Internal Gain and Envelope) and shows the annual energy costs after eliminating the load indicated by the labels on the y-axis. The bars labeled Internal Gain and Envelope represent the cumulative effect of eliminating all internal gain, and all envelope loads respectively.

The parametric analysis for the SERF showed that eliminating ventilation loads has very little effect on the office base-case building, while eliminating lighting loads and equipment loads has a pronounced effect. Eliminating solar gains also has an important effect, indicating the value of designing in to reduce solar gain. A similar chart for the labs would show different sensitivities as one might expect.

It is also helpful to use the simulation to explore comfort, as well as energy cost and energy use. The parametric analysis indicated that reducing glass conduction does not help annual energy cost. However, such a strategy may have a beneficial comfort effect for those people stationed near windows on the perimeter.

With this kind of information, it is possible for the design team to propose and test concepts for siting, orientation, massing, and overall architectural organization that hold promise for minimizing energy costs, loads, and peaks while maintaining comfort. Each alternative should be simulated as the geometry becomes more defined. In this way, the quantitative energy implications of the design decisions are known and can be used to select among alternatives.

Even though much of the overall architecture is now defined, many questions remain to be answered such as how much glass, what glass properties, and what geometry and size for shading devices and light shelves? Here again, the simulation assists in answering such questions quantitatively. For example, past a cer-

tain point when comparing building energy costs to total glass area, the decrease in lighting cost is offset by the increase in cooling and cooling fan costs. There is an optimum, and that optimum is frequently less than the glass area seen in many conventional buildings. Many architects are surprised at how little glass area it takes to daylight a building. This example does not tell the whole story. A number of such simulation runs would be needed to explore the interactions between orientation, glass area, glass type, shading device geometry, and light shelf geometry.

As the design progresses, the cost of construction versus the reduction in energy cost needs to be considered. The exact economic analysis approach depends

Glazing Area – Economic Analysis

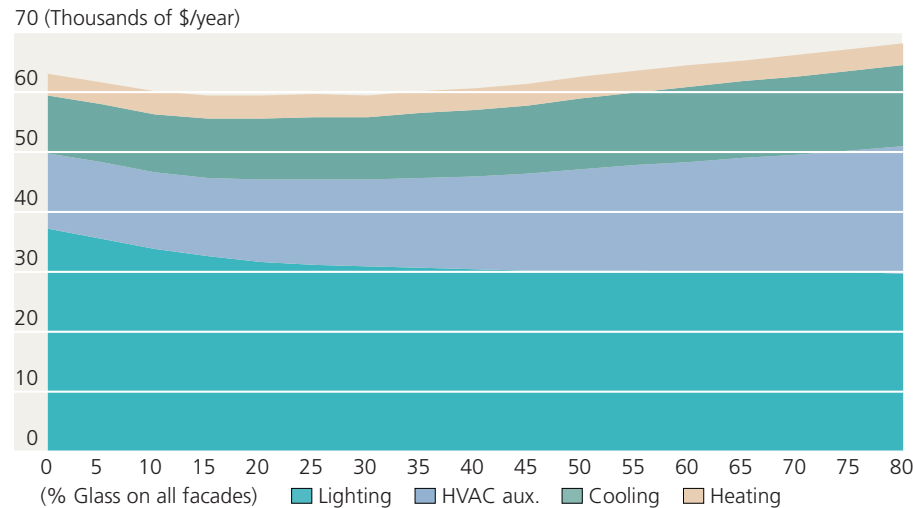

Simulation results showing effect of glass area on annual energy costs. The figure shows the sum of annual heating, cooling, ventilation, and lighting costs on the y-axis as a function of the percent of glass area on all facades using low E-glass on the x-axis. Past about 15% to 30% glass, the decrease in lighting cost is offset by the increase in cooling and cooling fan costs.

SERF Added Costs, Annual Energy Savings, and Simple Payback

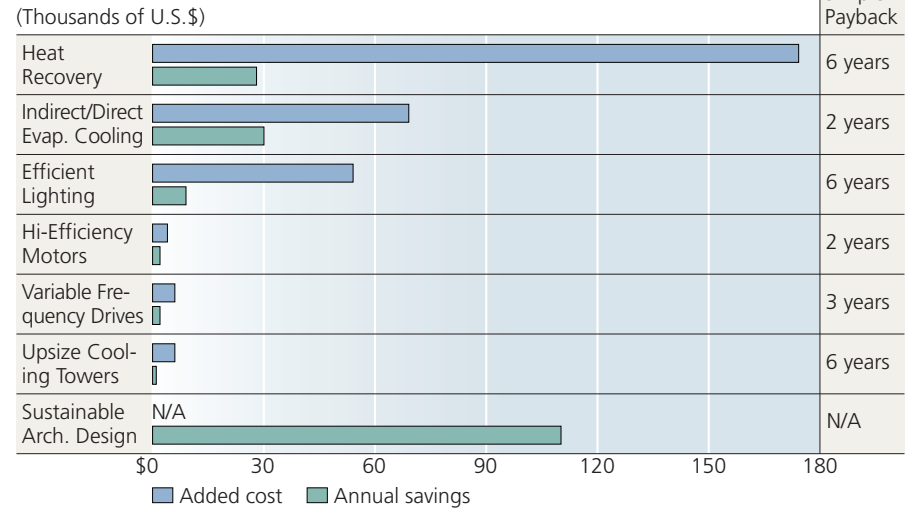

Partial economic analysis for energy-efficiency strategies included in the SERF design

on the client and may vary from simple payback to more sophisticated net present value or life-cycle cost analysis. If budgetary constraints become severe, such an analysis will help to determine which strategies deliver the most “bang for the buck.”

With this kind of simulation-based quantitative approach to the energy design of buildings, it is possible to reduce energy cost and use far below that of typical code-compliant buildings. In the SERF example, actual savings compared to if the building had merely met code, are close to \$2,000,000 from the time the building was first occupied. Predictions slightly underestimated the actual measured savings.

Customize utility rate structures in the hourly computer building simulations

The computer analysis should respond to the local utility rate structures and compare results based upon energy cost. Basing the analysis on energy units does not reflect variations in pricing such as time-of-use charges, demand charges, ratchet clauses, and other creative pricing structures developed by the utilities. While LANL currently benefits from a flat rate structure for electricity, this situation may change in the future. Another benefit of a full-year energy simulation is that it can be used to verify energy code compliance.

Building Energy Simulation Tools

A number of sophisticated computer simulation tools that can be used to design and analyze high-performance buildings. Several of these tools are discussed in this appendix.

Energy Plus

Energy Plus is the newest and most comprehensive of the public-domain building energy simulation programs under development by the U.S. DOE. The program combines the best aspects of DOE2 (described below) and BLAST in a flexible, object-oriented programming environment. As of this writing, the program does not have a friendly user interface; however, a number of private software houses are working on interfaces. The program combines calculation of loads, systems, plant, and controls in each time step thereby facilitating more accurate and flexible simulation of energy fluxes, temperatures, and control strategies.

DOE2

The DOE2 program is a large, detailed, public-domain energy-analysis program. It is available on a range of platforms from mainframes to desktop computers. The program can handle complex variables such as the orientation of surfaces, the order of materials in construction, thermal storage, ventilation effects, the intermittent operation of HVAC equipment, daylighting, and internal and external shading to name just a few. Hourly energy use and costs can be generated for an entire year or for partial year periods. It requires an hourly weather file and can accept a variety of weather data file formats. The main problem with DOE2, however, is the complex input language known as Building

SERF Annual Energy Costs and Savings

(Thousands of US\$)

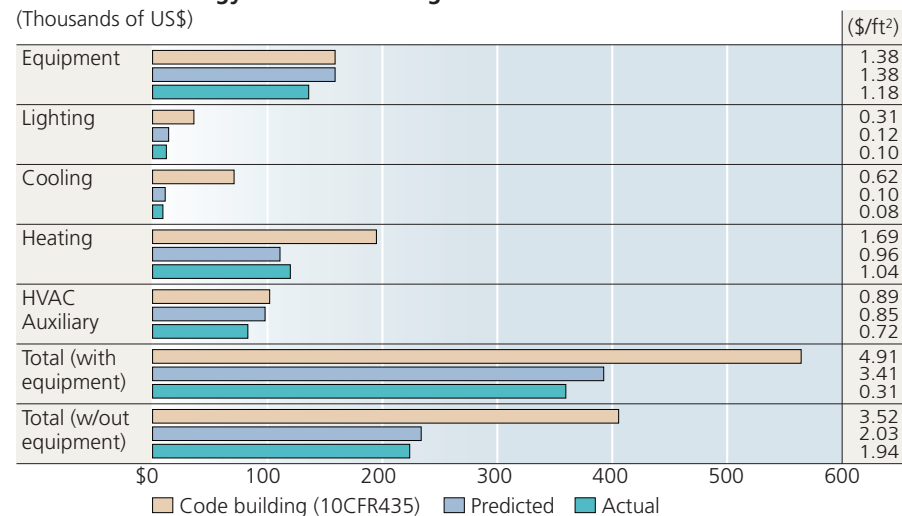

Annual energy cost comparison of the SERF between the simulated base-case building, the building design, and the actual building after almost 10 years of operation. The energy cost savings compared to the base-case building are 36% and 45% when including and excluding the equipment loads, respectively.

Description Language (BDL). This cryptic input structure will take some time to master! Many private software vendors have developed friendlier user interfaces that simplify input by avoiding BDL but one still needs to know the fundamentals of DOE2 to understand what it is doing and how to read the input and output files. A number of private energy consultants specialize in energy modeling with DOE2 and other programs. It is advisable to require the use of such an energy consultant in the solicitation documents used to obtain architectural and engineering services at LANL.

DOE2 is structured in four components. The first component calculates the loads in the building loads. Detailed building description and location information is entered into the Loads component. The loads module then produces an hourly file of all building loads, which is then passed to the System section. "Systems" describes the thermal zones, controls, and HVAC systems, and calculates the response of the mechanical systems to the load along with zone temperatures and loads-not-met conditions. The third component is the Plant section, which defines the central equipment such as boilers and chillers. The final component is the Economic section, where utility and equipment cost information is defined. Each section has a wide range of structured output reports to track the energy performance of the building. The main advantage of DOE2 is that it has an extensive library of mechanical systems and can be used to model multi-zone buildings with complex mechanical systems and control strategies.

Energy-10

The Energy-10 software program was developed to meet energy-analysis needs of designers in the early stages of a project where critical decisions are made. The Windows-based program is appropriate for small to medium-sized building up to 10,000 square feet with one or two thermal zones. The companion manual "Designing Low-Energy Buildings," is a useful guide to using the program and provides a good overview of basic energy-saving strategies. The emphasis is on passive solar design techniques. The program can compare 16 energy-efficient strategies ranging from daylighting, thermal mass, and high-efficiency HVAC to evaporative cooling. It uses a local climate file and local utility information. The goal of the program is to provide the designer with a fast tool for comparing energy strategies early in the design process. The trade-off for speed and ease of use is a lack of flexibility for modeling more complex buildings and mechanical systems.

The basic structure of the program is to first create a predesign reference building using minimal inputs. The basic inputs include building location (weather file), utility rates, building use, HVAC system type, floor area, and number of floors. From this basic information, the program creates two buildings: one reference case and one low-energy case that includes selected energy-efficiency strategies. Graphical output shows the difference in thermal performance. While many defaults are applied in these early models, the user can adjust all defaults. The various passive solar strategies can then be applied to the low-energy case and a rank order of benefit can be produced. This helps to direct the designer's efforts to those strategies that will produce the greatest benefit. Design revisions can be applied to the model as refinements are made during the design process.

References

Building Energy Software Tools Directory,
www.eren.doe.gov/buildings/tools_directory

DOE-2.1E, <http://SimulationResearch.lbl.gov>

Energy Plus, www.eren.doe.gov/buildings/energy_tools/energyplus

Energy-10, www.SBICouncil.org

Appendix G

Sun Path Diagram

A *sun path diagram* (or sun chart) is a two-dimensional representation of the three-dimensional movement of the sun across the sky for a particular latitude (see Figure 1). Sun charts can be used in conjunction with tools like a *profile-angle protractor* (Figure 5) to evaluate when a building or other feature will be shaded at different times during the year.

This appendix will explain how sun path diagrams and profile-angle protractors work, and will walk you through an example showing how these two tools can be used. Note that the sun path diagram will change depending on your latitude. This sun path diagram can be used for 36°N, which is the latitude of Los Alamos National Laboratory.

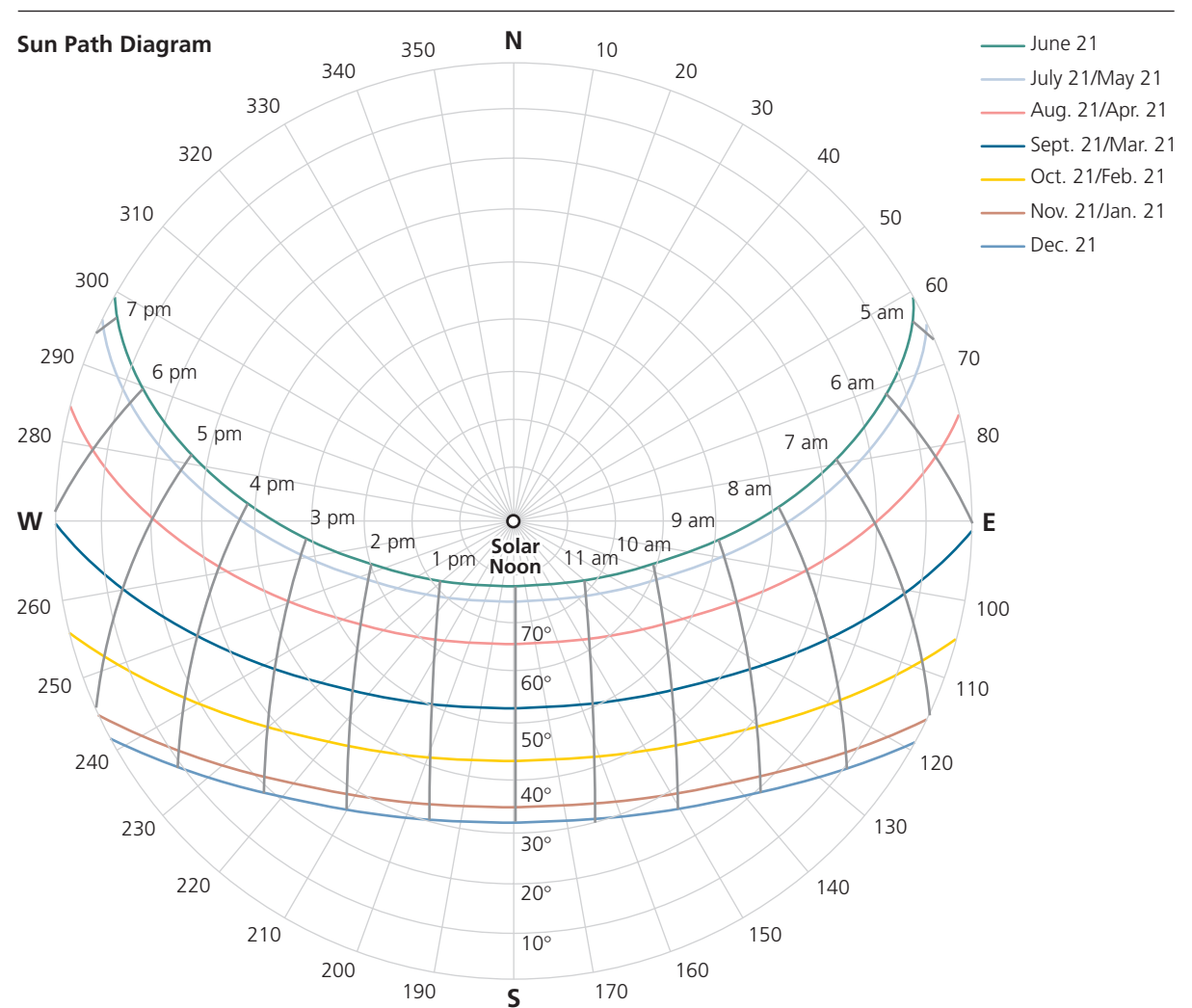

Figure 1 – Sun Path Diagram for 36° N (Latitude of LANL)

The three-dimensional diagram below can help you visualize the sun's path across the sky, and how that path is translated into two-dimensional space on a sun path diagram.

Picture yourself standing in a place with an unobstructed view of the horizon in all directions. The sky is a dome overhead, through which the sun arcs – and the angle that the arc makes with the horizon changes with the seasons. The horizon that you see is represented by the brown circle on the three-dimensional diagram; the sun's path is represented by the gray arcs. Note how the position of the sun's path changes through the year. The dashed brown lines are the projection of the gray arcs onto the two-dimensional space of the brown circle. Thus, the brown circle and the dashed lines form the sun path diagram – a two-dimensional, visual representation of the three-dimensional sky dome (Figure 1).

Note that the numbers on the gray arcs represent the sun's position at that particular time of day. θ is the vertical angle between the horizon and the sun (the solar altitude); θ here is shown for 2 p.m. on the Equinox. If you draw a vertical line from the sun's position at 2 p.m. on the Equinox, you can see how this sun position would plot on the sun path diagram. The angle β represents the solar azimuth as measured clockwise from south; the angle α is the solar azimuth as measured clockwise from north.

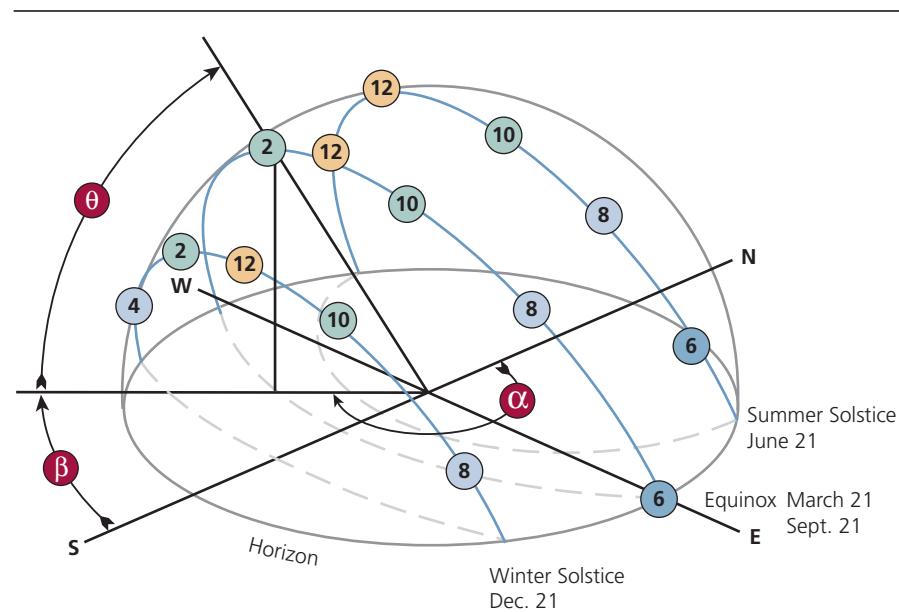

Figure 2 – 3-Dimensional Diagram of the Sun's Path where
 α = solar azimuth, an angle between 0° and 360° measured from the north in a clockwise direction to the vertical plane of the sun
 β = solar azimuth, an angle between 0° and 360° measured from the south in a clockwise direction to the vertical plane of the sun
 θ = solar altitude angle, the vertical angle between the horizon and the sun. The concentric circles inside the Sun Path Diagram represent the angle θ (see Figure 1).
 ② = sun's position at the time of day indicated within the circle

Now let's look at the way the sun moves across the sky, both daily and seasonally. You can see that trace of the sun's path is characterized by two types of motion on the diagram – horizontal and vertical. The vertical lines in Figure 3a show the seasonally changing position of the sun at a fixed time of day, while the horizontal lines

in Figure 3b show the sun's daily movement through the sky at a fixed time of year. Thus, sun locations are plotted using the intersection of the horizontal and vertical arcs (i.e. at a particular time, at a particular time of year).

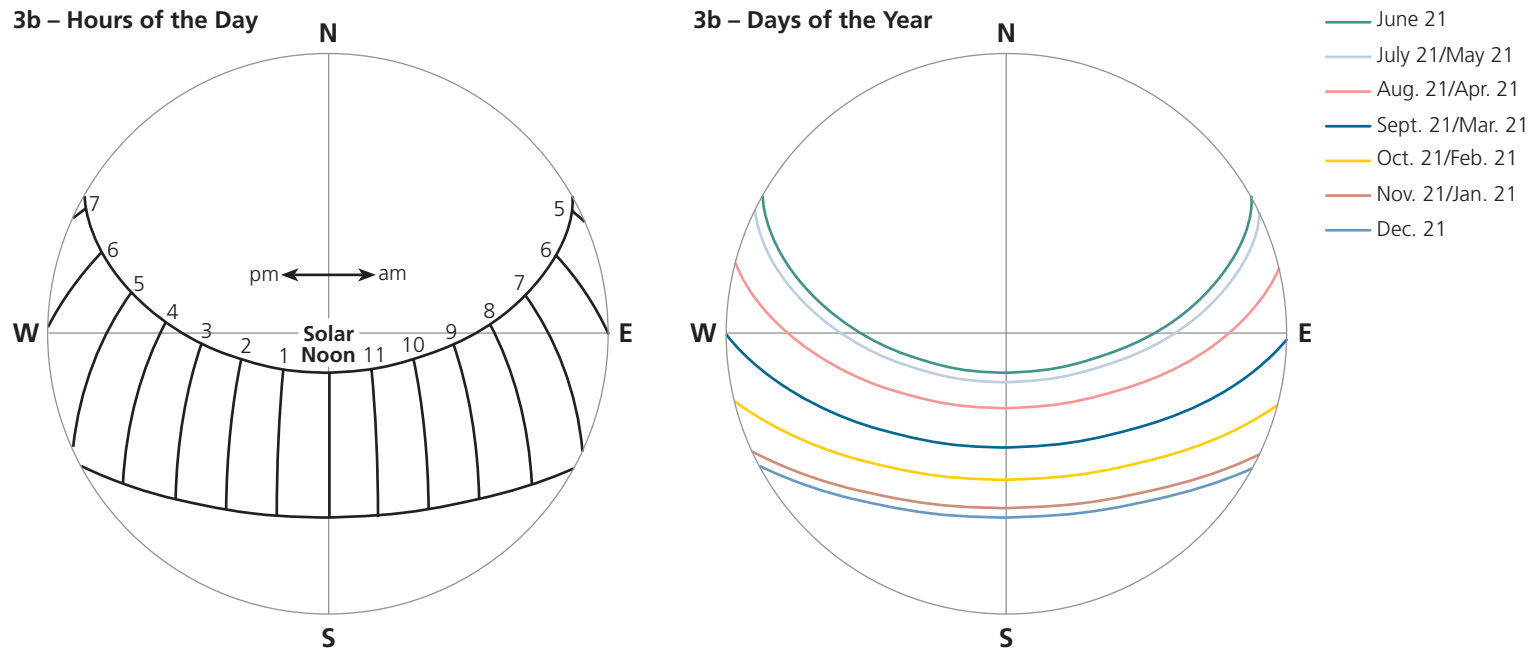
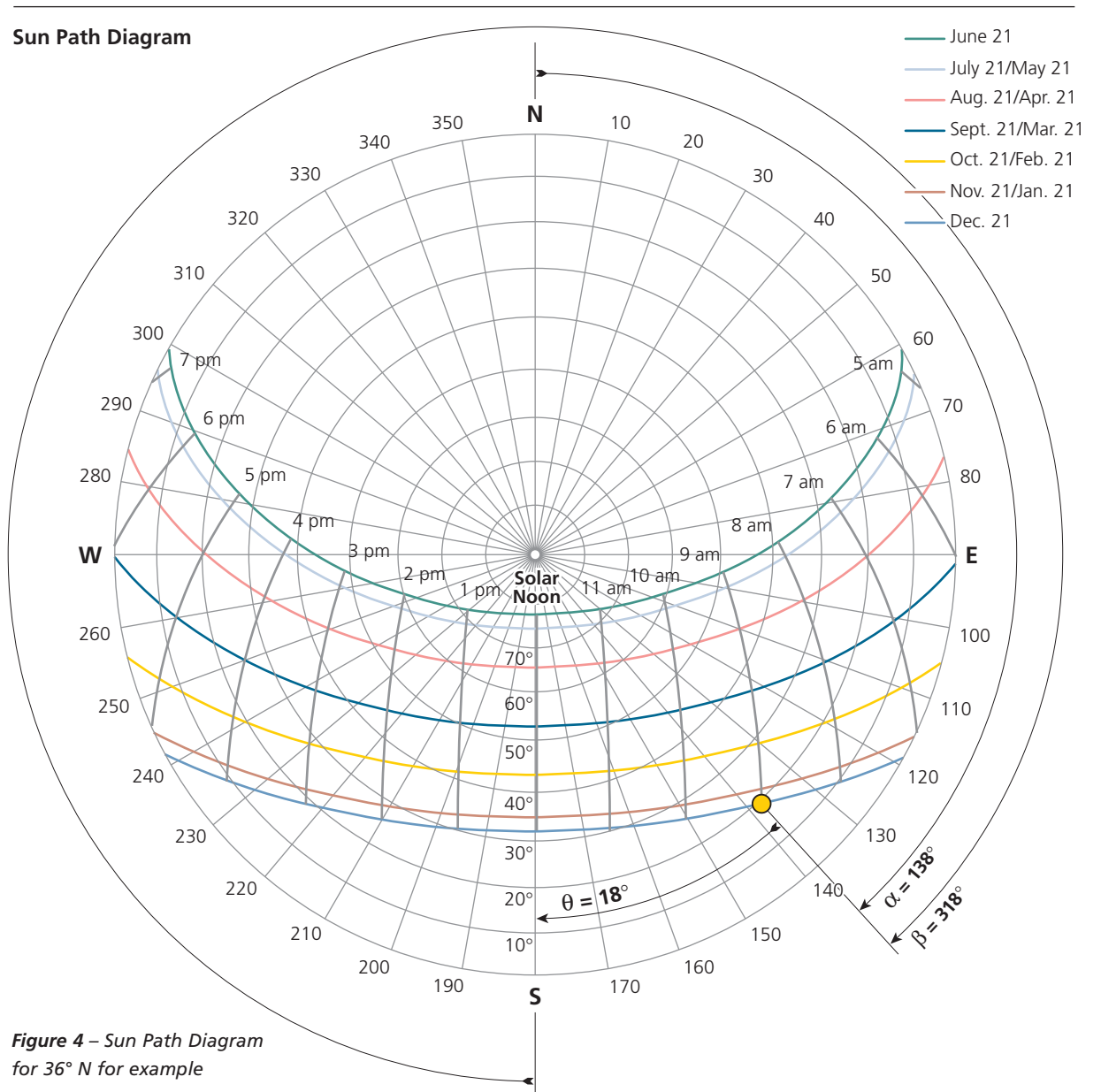

Figure 3a, 3b – Sun Path on the Sun Path Diagram for 36° N (Latitude of LANL)

Now you can apply the information from Figures 1-3 to figure out where the sun would be at a specific date and time for this latitude (36°N). As an example, use the sun path diagram in Figure 4 to determine where the sun would be on December 21 at 9 a.m.; then find the compass location, the solar altitude angle θ , the solar azimuth angle α (measured from north), and the solar azimuth angle β (measured from south) for that sun position. To figure out where the sun would be, first locate the gray, horizontal arc representing the sun's path for December 21. Trace the path until it intersects the vertical line for "9 a.m." Now that your sun position is plotted (yellow dot), you can read the rest of the data directly off the chart. Your compass location is southeast; the solar altitude angle is about 18°; the solar azimuth angle α is about 138°; and solar azimuth angle β is about 318°.



To figure out the shading on a building from another building, overhang, or other obstacles, you can use the sun path diagram in conjunction with a second tool – a profile-angle protractor (Figure 5). The profile-angle protractor overlays the sun path diagram by matching the diagram centers; the profile-angle protractor can then rotate on top of the sun path diagram.

Profile-Angle Protractor

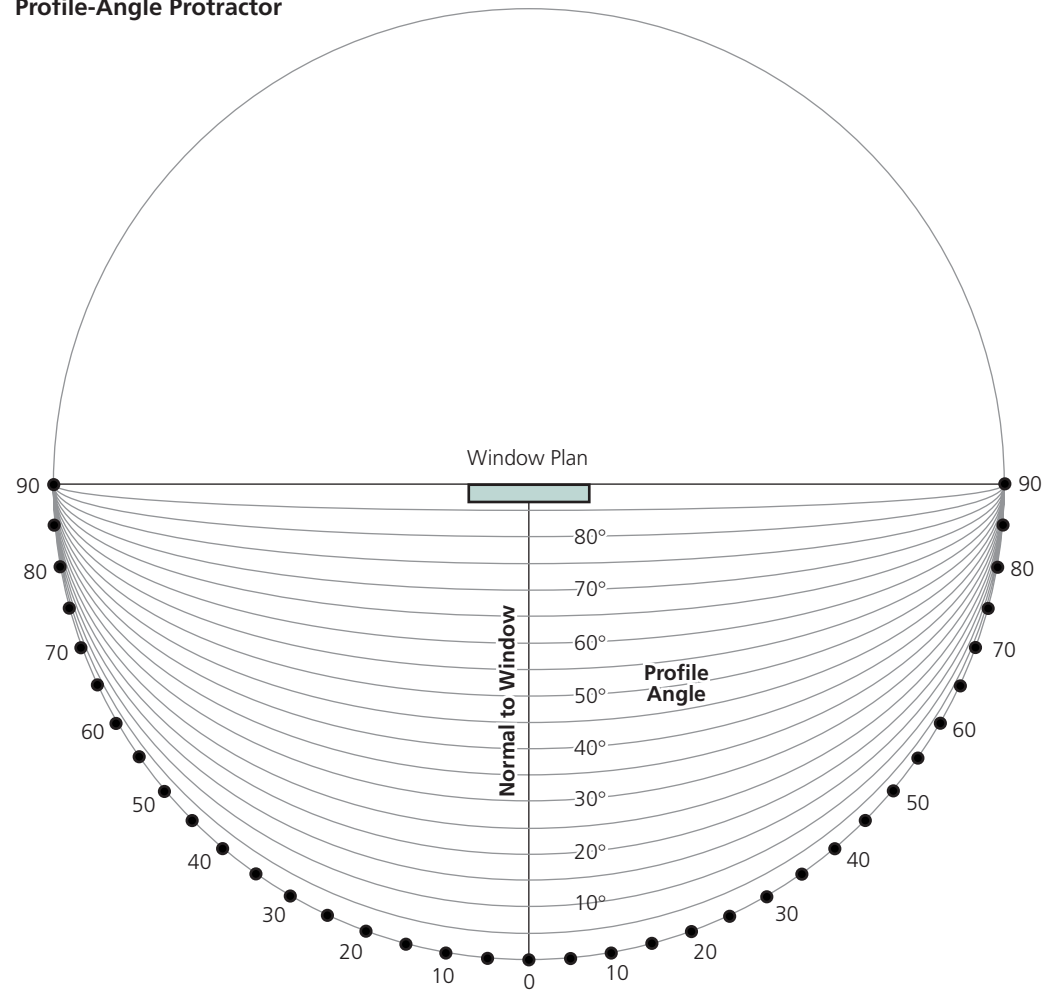

Figure 5 – Profile-Angle Protractor

Figures 6-8 provide an example of how to use a profile-angle protractor and a sun path diagram to determine when the wall below a window on one building is shaded by an adjacent building. Note that while the sun path diagram is specific to a particular latitude, the profile-angle protractor can be used for any latitude.

The window on building 1, which is located at 36°N latitude, faces 20° west of true south. We will determine the shading below point A, which is at the center bottom of the window. The plan and elevation views for both buildings are shown in Figure 6.

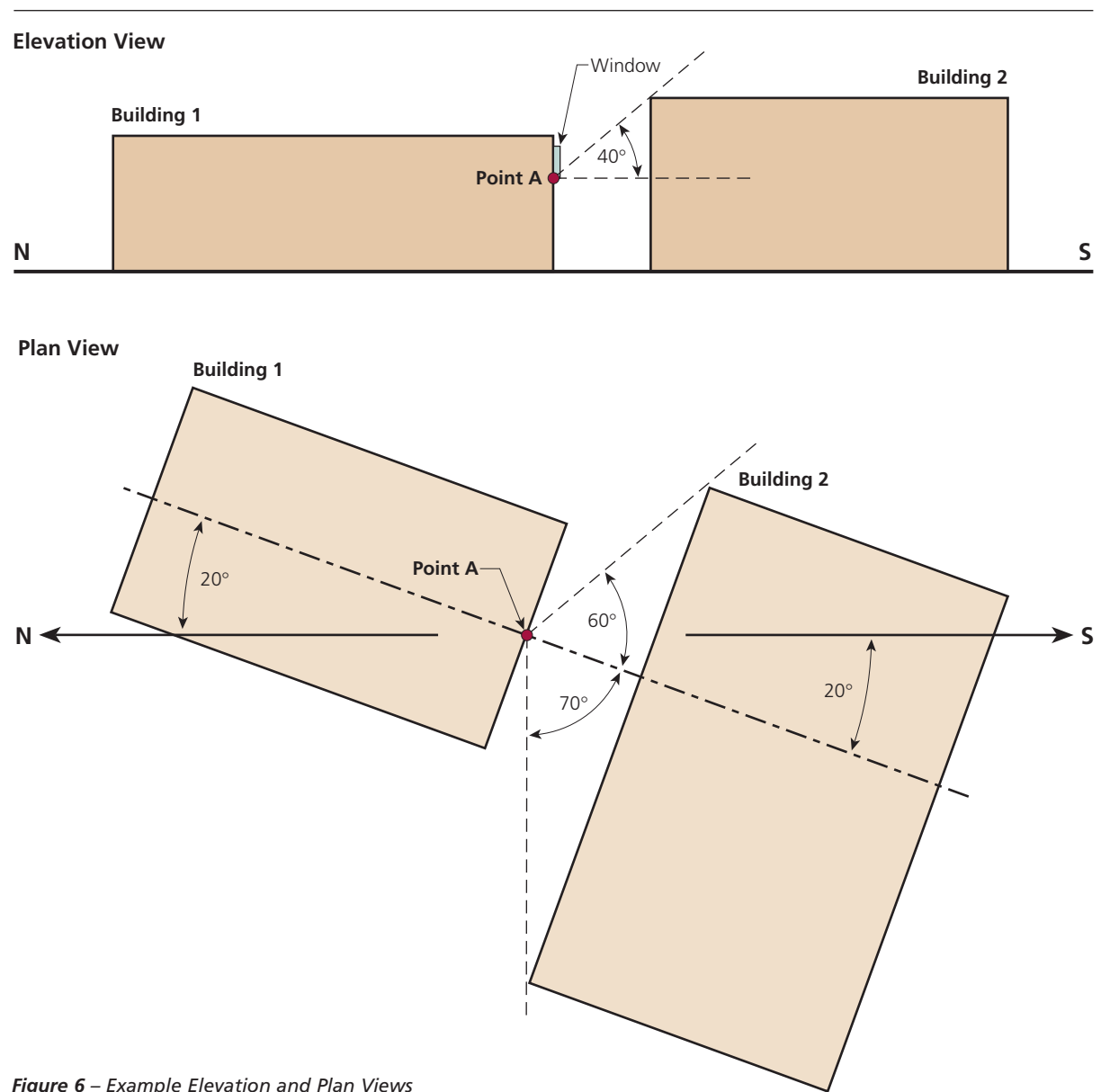

Figure 6 – Example Elevation and Plan Views

To prepare a map of the shading below point A (Figure 6), begin by drawing the window on the profile-angle protractor. Next, find the 40° line (which is the angle between point A and the top of building 2) on the protractor and darken it. Using a ruler, draw in the angles from point A to the corners of building 2. The angle on the right (east) will be 60° from the line that is normal to the window; the angle on the left (west) will be 70° from the line that is normal to the window. Building 2 will shade the wall below point A on building 1 when the profile angle is greater than 40°. Knowing this, you can now shade in the protractor (Figure 7).

Profile-Angle Protractor

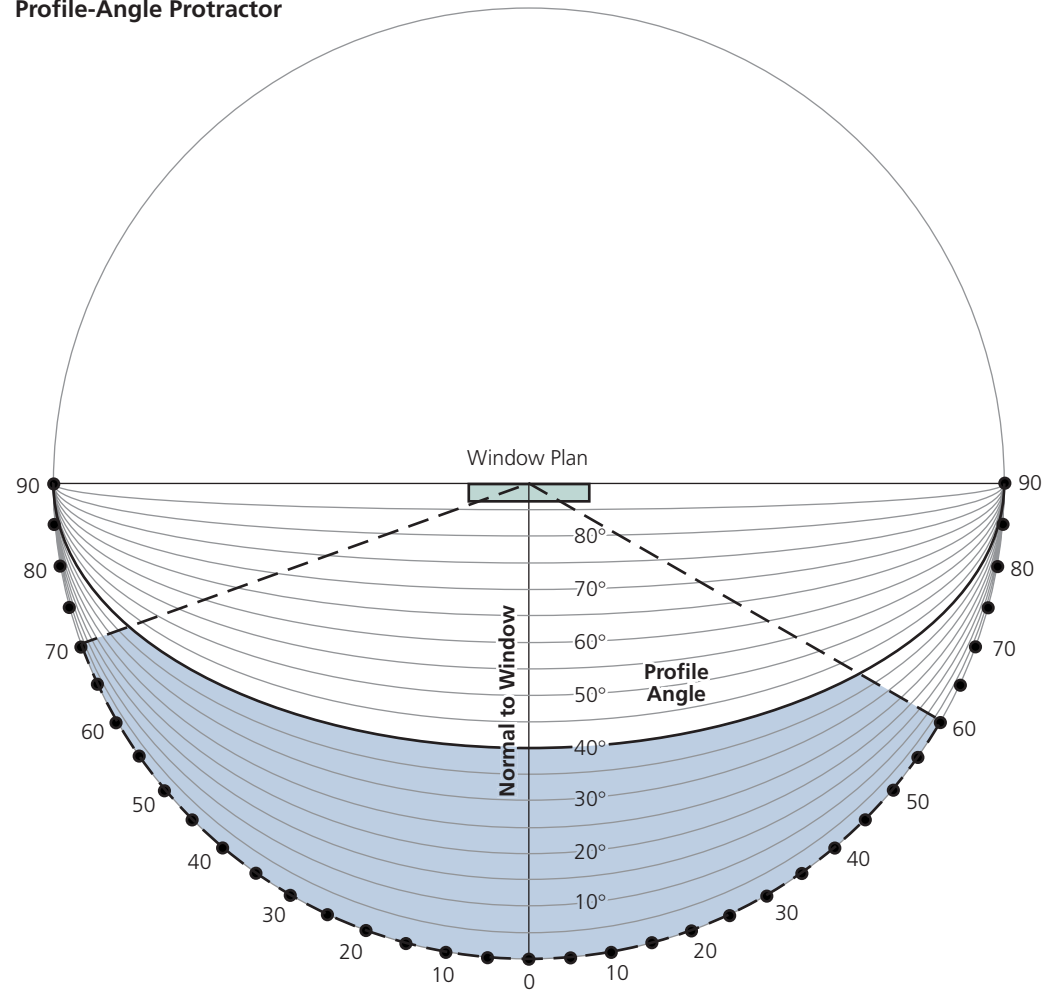

Figure 7 – Shaded Profile-Angle Protractor

We can now lay the profile-angle protractor developed in Figure 7 over the sun path diagram to determine the months of the year and hours of the day during which the wall below point A (Figure 6) will be shaded by building 2. First, align the protractor on top of the sun path diagrams by matching the center points of both circles. Second, rotate the profile-angle protractor so that the line that is normal to the window is aligned with the 200° line on the sun path diagram. The profile-angle protractor is rotated 20° west of south because the orientation of point A on the window of building 1 is 20° west of south. When the colored arcs (which represent sun paths for different times of the year) enter the shaded area, the building below point A will be in the shade (Figure 8).

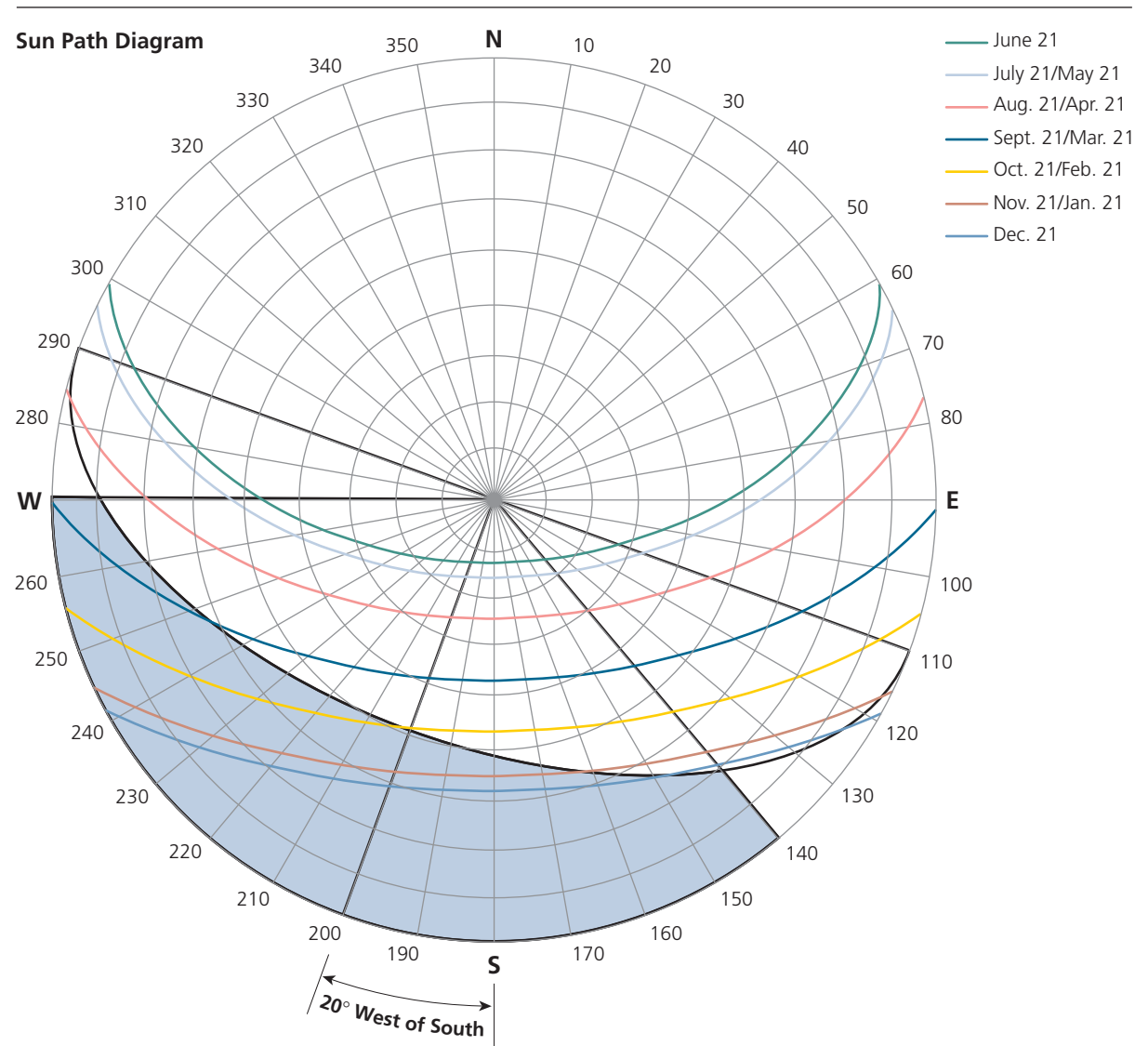

Figure 8 – Profile-Angle Protractor Overlaid on a Sun Path Diagram (36° N)

Appendix H

Reduce, Reuse, and Recycle Options

Reduce, Reuse, and Recycle Options for LANL Construction Waste			
Potential Waste Materials	Segregate and Dispose	Reuse/Recycle	Waste Minimization
Asphalt	Stockpile in a designated area on-site. If known or suspected to be contaminated: <ul style="list-style-type: none"> ■ Segregate, label, and store hazardous waste in a <90 day storage area. ■ Segregate and label radioactive waste. 	FWO-SWO Recycling Program	Saw cut minimum perimeter of asphalt to be removed per construction drawings. Remove and segregate contaminated asphalt (if any) from recyclable (uncontaminated) asphalt.
	Uncontaminated disposal at LA County Landfill or Rio Rancho Landfill (industrial waste).	Nambe Recycling Facility	
	Radioactive waste disposal TA-54 Area G.	LA County Recycling Center LANL FWO- Utilities and Infrastructure (may accept crushed asphalt to meet its needs) Uncontaminated asphalt may be crushed and utilized as base course material.	
Concrete	Stockpile in a designated area on-site. If known or suspected to be contaminated: <ul style="list-style-type: none"> ■ Segregate, label, and store hazardous waste in a <90 day storage area. ■ Segregate and label radioactive waste. 	FWO-SWO Recycling Program	Remove only those areas indicated on the construction drawings. Remove and segregate contaminated concrete (if any) from recyclable (uncontaminated) concrete. Procure concrete in quantities consistent with the construction drawings and EPA Affirmative Procurement specifications.
	Uncontaminated disposal at LA County Landfill or Rio Rancho Landfill (industrial waste).	Nambe Recycling Facility	
	Radioactive waste disposal TA-54 Area G.	LANL FWO- Utilities and Infrastructure (may accept crushed asphalt to meet its needs) Uncontaminated concrete may be crushed and utilized as base course materiel	
Soil	Stockpile in a designated area on-site. If known or suspected to be contaminated: <ul style="list-style-type: none"> ■ Segregate, label, and store hazardous waste in a <90 day storage area. ■ Segregate and label radioactive waste. 	Use uncontaminated soil as fill at the construction site.	Remove per elevations indicated by the construction drawings. Remove and segregate contaminated soils (if any).
	Uncontaminated disposal at LA County Landfill or Rio Rancho Landfill (industrial waste).	FWO-SWO Recycling Program	
	Hazardous waste disposal at a Subpart C RCRA landfill.	Nambe Recycling Facility	
	Radioactive waste disposal TA-54 Area G.		

Table continues >

Reduce, Reuse, and Recycle Options for LANL Construction Waste			
Potential Waste Materials	Segregate and Dispose	Reuse/Recycle	Reduce
Electrical Conduit/Wire/Equipment	Stockpile in a designated area on-site. If known or suspected to be contaminated: <ul style="list-style-type: none"> ■ Segregate, label, and store hazardous waste in a <90 day storage area. ■ Segregate and label radioactive waste. 	LANL Equipment Salvage Program (BUS, Property Management).	Remove and segregate reusable conduit and wire from equipment.
	Uncontaminated disposal at LA County Landfill or Rio Rancho Landfill (industrial waste).	FWO-SWO Recycling Program	
	Radioactive waste disposal TA-54 Area G		
Wood	Stockpile in a designated area on-site and disposal at LA County Landfill.	FWO-SWO Recycling Program	Avoid use of wooden pallets for storage of construction materials.
		LA County Landfill – to be chipped.	Minimize use of wooden framing and forming materials.
Paper Products (cardboard and paper)	Stockpile in a designated area on-site and dispose of at the LA County Landfill.	FWO-SWO Recycling Program	Procure construction materials and equipment in bulk to minimize packaging. Remove all possible packaging materials before entering controlled area to prevent generation of radiological waste.
		Nambe Recycling Facility	
		LA County Recycling Program	
Plastic (numbered containers, bags, and sheeting)	Stockpile in a designated area on-site and dispose of at LA County Landfill.	FWO-SWO Recycling Program	Procure construction materials and equipment in bulk to minimize packaging. Remove all possible packaging materials before entering controlled area to prevent generation of radiological waste.
		Nambe Recycling Facility	
		TEWA technology Corporation	
Metal (sheeting, ducting, fence, pipe, valves)^a	Stockpile in a designated area on-site. If known or suspected to be contaminated: <ul style="list-style-type: none"> ■ Segregate, label, and store hazardous waste in a <90 day storage area. ■ Segregate and label radioactive waste. 	LANL Metal Recovery Program: <ul style="list-style-type: none"> ■ Uncontaminated scrap lead, silver, cadmium, copper, tin, iron, brass, aluminum, stainless steel, mixed steel 	Remove hazardous constituents from recyclable metals (e.g., remove lead-soldered wires from metal equipment).
		FWO-SWO Recycling Program	
		Reuse pipe and valves at appropriate facilities.	
		Uncontaminated disposal at LA County Landfill or Rio Rancho Landfill (industrial waste).	
	Radioactive waste disposal TA-54 Area G.		

^aNote that metal debris released from radiological areas must comply with the metal recycling moratorium requirements contained in ESH Notice 0052.

Table continues >

Reduce, Reuse, and Recycle Options for LANL Construction Waste			
Potential Waste Materials	Segregate and Dispose	Reuse/Recycle	Reduce
Paints, Stains, Solvents, and Sealant	Stockpile in a designated area on-site. If known or suspected to be contaminated: <ul style="list-style-type: none"> ■ Segregate, label, and store hazardous waste in a <90 day storage area. ■ Segregate and label radioactive waste. 	Contractor should check with FWO waste management coordinators to see if excess materials may be used at the facility.	Procure non-hazardous substitutes to traditional solvents, paints, stains, and sealant (see “green seal” products at www.green.seal.org).
	Untaminated disposal at LA County Landfill or Rio Rancho Landfill (industrial waste).		Procure only the materials that are needed (just-in-time purchasing).
	Radioactive waste disposal TA-54 Area G.		Sequence work to minimize waste generation through material use on successive tasks.
Equipment (pumps, instrumentation, fans)	Stockpile in a designated area on-site. If known or suspected to be contaminated: <ul style="list-style-type: none"> ■ Segregate, label, and store hazardous waste in a <90 day storage area. ■ Segregate and label radioactive waste. 	LANL Equipment Salvage Program (BUS, Property Management). FWO-SWO Recycling Program	
	Untaminated disposal at LA County Landfill or Rio Rancho Landfill (industrial waste).		
	Radioactive waste disposal TA-54 Area G.		



Printed on recycled paper.

