



CERT Basic Training

Instructor Guide



FEMA



HISTORY OF THE CERT BASIC TRAINING

The Community Emergency Response Team (CERT) program is a nationally supported, locally implemented initiative that teaches people how to better prepare themselves for hazards that may affect their communities. CERT trains them in basic disaster response skills such as team organization, disaster medical operations, fire safety, and light search and rescue. Local CERT programs train and organize teams of volunteers to assist their families, neighbors, co-workers, and other community members during emergencies when professional responders may not be immediately available to provide assistance. Before, during, and after disasters, CERT volunteer teams perform basic response activities, including checking in on neighbors, distributing information to the public, supporting emergency operations centers, and helping to manage traffic and crowds. The ability for CERT volunteers to perform these activities frees up professional responders to focus their efforts on more complex, essential, and critical tasks. CERT volunteers also support their communities by organizing, promoting, and participating in emergency preparedness events, activities, and projects.

The Los Angeles Fire Department (LAFD) developed the CERT program after examining the civilian response to disasters in Mexico and Japan in 1985. The LAFD recognized that citizens are likely to be on their own during the early stages of disaster. Under these circumstances, family members, co-workers, and neighbors will often spontaneously come to the aid of each other. While untrained volunteers can be very effective in aiding others, their lack of training puts them at risk for injury or death. For example, during the response to the 1985 Mexico City earthquake that claimed more than 10,000 lives, untrained volunteers saved 700 lives, but unfortunately, 100 volunteers died in the process.

In response, the LAFD decided to develop and offer disaster response training to Los Angeles residents so that during and after future disasters volunteers would be able to assist in a safe, responsible, and effective manner. The LAFD piloted the first CERT training in 1986. In turn, other fire departments around the country, including communities where the major threat is hurricanes rather than earthquakes, adopted the LAFD's training model. Building on this development, the Federal Emergency Management Agency (FEMA) expanded the CERT materials in 1994 to make them applicable to all hazards and made the program available to communities nationwide. Since that time, thousands of dedicated trainers, organizations, and citizens have embraced the responsibility to learn new skills and become prepared to execute safe and effective emergency response capabilities.

The National CERT Program Office would like to thank the regional, state, and local partners and subject matter experts who contributed to the 2019 CERT Basic Training update.

A MODEL FOR COMMUNITY PREPAREDNESS

The CERT program is critical in the effort to engage everyone in the United States in making their communities safer, more prepared, and more resilient when incidents occur.

Community-based preparedness planning allows us all to prepare for and respond to anticipated disruptions and potential hazards following a disaster. As individuals, we can prepare our homes and families to cope during that critical period. Through pre-event planning, neighborhoods, and worksites can also work together to help reduce injuries, loss of lives, and property damage. Neighborhood preparedness will enhance the ability of individuals and communities to reduce their emergency needs and to manage their existing resources until professional assistance becomes available.

Studies of behavior following disasters have shown that groups working together in the disaster period perform more effectively if there has been prior planning and training for disaster response. These studies also show that organized grassroots efforts may be more successful if they are woven into the social and political fabric of the community—neighborhood associations, schools, workplaces, places of worship, and other existing organizations.

Effective response, therefore, requires comprehensive planning and coordination of all who will be involved—government, volunteer groups, private businesses, schools, and community organizations. With training and information, individuals and community groups can be prepared to serve as a crucial resource capable of performing many of the emergency functions needed in the immediate post-disaster period. The CERT program trains individuals to be assets to help communities prepare for effective disaster response.

When Disaster Strikes

The damage caused by natural disasters, such as earthquakes, hurricanes, tornadoes, and floods, or from manmade/technological events such as explosions or hazardous materials accidents can affect all aspects of a community, from government services to private enterprise to civic activities. These events:

- Severely restrict or overwhelm our response resources, communications, transportation, and utilities; and
- Leave many individuals and neighborhoods cut off from outside support.

Damaged roads and disrupted communications systems may restrict the access of emergency response agencies into critically affected areas. Thus, for the initial period immediately following a disaster—often up to three days or longer—individuals, households, and neighborhoods may need to rely on their own resources for:

- Food;
- Water; and
- Shelter.

Individual preparedness, planning, survival skills, and mutual aid within neighborhoods and worksites during this initial period are essential measures in managing the

aftermath of a disaster. What you do today will have a critical impact on the quality of your survival and your ability to help others safely and effectively. You will be more resilient to a potentially disruptive event by learning about the likely hazards in your community and your community's plans and protocols, understanding hazard-specific protective actions and response skills, assembling important emergency supplies, and mitigating potential hazards in your home. Subsequently, you will be an important asset to your family, neighbors, and other members of your community.

How CERTS Operate

As each CERT is organized and trained in accordance with standard operating procedures developed by the sponsoring agency, members identify potential meeting locations or staging areas to be used in the event of a disaster.

The staging area is where the fire department and other services will interact with CERTs. Having a centralized contact point makes it possible to communicate damage assessments and allocate volunteer resources more effectively. This is true for all CERTs, whether active in a neighborhood, workplace, school, college/university campus, or other venue.

Damage from disasters may vary considerably from one location to another. In an actual disaster, communities will deploy CERTs as needs dictate. Volunteers should assess their own needs and the priorities of those in their immediate environment first.

CERT volunteers who do not encounter a need in their immediate area should then report to their staging area, and the first volunteer to arrive will become the initial Team Leader (TL) for the disaster response. The TL may pass leadership to someone else as other volunteers arrive. Volunteers who find themselves in a heavily impacted location should send runners to staging areas to get assistance from available resources. Volunteers may use ham radios or similar technologies to increase communication capabilities and coordination.

CERTs provide an effective first-response capability. Acting as individuals first, then as team members, trained CERT volunteers can fan-out within their assigned areas, extinguish small fires, turn off natural gas at damaged homes, perform light search and rescue, and render basic medical treatment. CERTs also act as effective "eyes and ears" for uniformed emergency responders. Trained volunteers also offer an important potential workforce to service organizations in non-hazardous functions such as shelter support, crowd control, and evacuation.

About the CERT Basic Training

If available, emergency services personnel are the best trained and equipped to handle emergencies. Following a catastrophic disaster, however, you and your community may be isolated for an extended period for a myriad of reasons, including the size of the area affected, inoperable communications systems, or unpassable roads.

CERT Basic Training prepares you to help yourself and help others in the event of a catastrophic disaster. Because emergency services personnel will not be able to help everyone immediately, you can make a difference by using your CERT training to save lives and protect property.

This training covers basic skills that are important to know in a disaster when emergency services are not available. With training and practice, and by working as a team, you will be able to protect yourself and maximize your capability to help for the greatest number of people after a disaster.

COURSE AGENDA

The agenda for this course is outlined below (**Table 1: Course Agenda**). Please note that some adjustments to the agenda may be required to allow discussion of hazards specific to a community and—depending on class size—to allow all participants to take part in the exercise portions of this course.

Table 1: Course Agenda

Unit	Topics
1	Disaster Preparedness <ul style="list-style-type: none"> • Unit Overview • Community Preparedness: Roles and Responsibilities • Hazards and Their Potential Impact • Home and Workplace Preparedness • Reducing the Impact of Hazards Through Mitigation • CERT Disaster Response • Additional Training for CERT Volunteers • Unit Summary
2	CERT Organization <ul style="list-style-type: none"> • Unit Overview • CERT Organization • CERT Mobilization • Documentation • Unit Summary
3	Disaster Medical Operations — Part 1 <ul style="list-style-type: none"> • Unit Overview • Treating Life – Threatening Conditions • Basic First Aid Care • Unit Summary
4	Disaster Medical Operations — Part 2 <ul style="list-style-type: none"> • Unit Overview • Mass Casualty Incidents • Functions of Disaster Medical Operations • Establishing Medical Treatment Areas • Conducting Head-to-Toe Assessments • Public Health Considerations • Unit Summary
5	Disaster Psychology <ul style="list-style-type: none"> • Unit Overview • Disaster Reactions • Self-Care and Team Well-Being • Working with Survivors' Emotional Responses • Unit Summary

Unit	Topics
6	Fire Safety and Utility Controls <ul style="list-style-type: none">• Unit Overview• Fire Chemistry• Fire Size-up Considerations• Firefighting Resources• Fire Suppression Safety• Fire and Utility Hazards• Hazardous Materials• Unit Summary
7	Light Search and Rescue Operations <ul style="list-style-type: none">• Unit Overview• Safety During Search and Rescue Operations• Conducting Interior and Exterior Search Operations• Conducting Rescue Operations• Unit Summary
8	CERT and Terrorism <ul style="list-style-type: none">• Unit Overview• Terrorist Goals and Tactics• Preparing Your Community• Active Shooter Situations• Until Help Arrives• Hazmat and CBRNE• Unit Summary
9	Course Review, Final Exam, and Disaster Simulation <ul style="list-style-type: none">• Unit Overview• Course Review• Final Exam• Disaster Simulation• Exercise Critique and Summary

AFTER CERT BASIC TRAINING

Upon completion of the CERT Basic Training course, participants will receive a certificate. Your community may also provide additional documents that will identify each participant as an emergency response team volunteer during disaster response. CERT volunteers should maintain their own CERT safety equipment, such as goggles, gloves, and basic first-aid supplies, and have them available for use during a disaster. Training in disaster response should not be a one-time event. Volunteers should reinforce their skills through follow-up training and repeated practice to maintain the edge necessary for effective response to a disaster.

To maintain their skill level and continually improve performance, CERT volunteers should continue to participate in supplemental training when offered in your area. Working through practice disaster scenarios with other teams will provide opportunities not only for extended practice, but also for valuable networking with teams in the local area.

INSTRUCTOR RESPONSIBILITIES

Instructor Qualifications

The local sponsoring agency will recruit and select instructors to conduct this course based on potential instructors' working knowledge of the content and skills required for each session. The NCPO recommends that at least two instructors jointly conduct each session. Because Sessions 3 and 4 address disaster medical operations, the NCPO recommends these sessions be led by licensed or certified:

- Paramedics or Emergency Medical Technicians; and/or
- Nurses.

Further, it is recommended that all other sessions be conducted by skilled fire and rescue instructors who have completed the CERT Train-the-Trainer course. Instructors should also be knowledgeable about:

- The CERT model
- The types of hazards (natural, technological and accidental, terrorism, pandemics, and house fires) that present the greatest risk to the community;
- Local building structures that present the greatest hazard in the event of a disaster; and
- The community's emergency operation plan

Preparing To Train

The preparation and conduct of the instructor has a strong impact on the effectiveness of the training. This introductory section provides guidelines for preparing for this course.

1. Thoroughly read both the Instructor Guide and the Participant Manual.
2. Conduct a walk-through of all exercises and be prepared to answer any questions that the participants ask while completing the exercises themselves.
3. Tailor each session to your local community. Wherever possible, use local photographs of common fire hazards, local buildings, etc. Using local information will add a personal meaning for the participants and will help them to "buy into" the CERT concept.
4. Draft your own notes in the white space around the margins of this book. Include information that is specific to the community. Indicate points where you want to include additional local photographs.
5. Identify sessions that require you to prepare information or materials that relate specifically to your community (see "Preparation" at the beginning of each unit). Prepare these items in advance of the session.
6. Be certain you are aware of any cultural sensitivities for the community in which you will be training. It is important to understand how to deliver the content to the participants in the most effective and engaging manner. Because of the differences in individual cultures, it is essential to work with influential and

knowledgeable members of your community who can help you understand any topics in the training that may be culturally sensitive to specific cultural groups.

7. In advance of the training, meet with community representatives involved in emergency preparedness to discuss the different topics covered in the training. Together, try to identify any culturally sensitive issues, such as physical contact, medical response, or disaster psychology. Discuss how to present these topics in the most appropriate way for the participants.
8. During the training, do not pretend to be an expert on cultural issues but do invite participants to discuss culturally relevant topics. If possible, a member of the community in which you are training should co-teach the class.
9. Bear in mind several points regarding communities and cultures. First, when entering a new community, community members of that community may not accept you immediately. This is one reason to request information and seek the guidance and advice of community representatives regarding cultural issues. Additionally, remember that not all members of a community may have the same cultural background. Avoid making assumptions about the beliefs or attitudes of the participants.
10. Draft or copy any supplemental materials from which you feel the participants will benefit. Many supplemental materials may be available from local emergency management personnel or from such Federal agencies as the National Fire Academy, Emergency Management Institute, or National Severe Weather Center. If you use copyrighted materials, be sure to obtain copyright releases.
11. Instructors are encouraged to add pertinent information to the course, but they should not delete topics.

Preparing a Classroom

As an instructor, you are responsible for the room arrangement. This is your choice and, depending on the number of participants, you may opt for different arrangements. Regardless of the room arrangement you select, the training room must be large enough to accommodate the exercises for each session.

Equipment and Resources

For each session, you will need:

- A computer with PowerPoint software (PowerPoint 97 or more recent)
- A computer projector and screen
- Chart paper, easel, and markers
- Masking tape
- Pens and pencils

See below for session-specific equipment and materials notes for each unit (**Table 2: Equipment and Resource Checklist**).

Table 2: Equipment and Resource Checklist

Unit 1	Equipment/Supply Checklist
1	<p>Disaster Preparedness</p> <ul style="list-style-type: none"> • Scissors (1 for every 5 participants) • Tape (1 roll for every 5 participants) • Two pieces of cardboard, approximately 8 by 10 inches (1 set for every 5 participants) • Forty pieces of construction paper, 8.5 by 11 inches (1 set for every 5 participants)
2	<p>CERT Organization</p>
3	<p>Disaster Medical Operations — Part 1</p> <ul style="list-style-type: none"> • One mannequin (optional) • 1-liter bottle • Tourniquet if available (preferably one for every two students) • Non-latex examination gloves (one pair per participant) • 4- by 4-inch dressings (one for each participant) • One triangular bandage per participant • Splinting material (e.g., cardboard, magazines, pieces of lath, pillows, towels) • Note cards • Duct tape
4	<p>Disaster Medical Operations — Part 2</p> <ul style="list-style-type: none"> • One mannequin (optional) • 1-liter bottle • Tourniquet if available (preferably one for every two students) • Non-latex examination gloves (one pair per participant) • 4- by 4-inch dressings (one for each participant) • One triangular bandage per participant • Splinting material (e.g., cardboard, magazines, pieces of lath, pillows, towels) • Note cards • Duct tape
5	<p>Disaster Psychology</p>
6	<p>Fire Safety and Utility Controls</p> <ul style="list-style-type: none"> • One mannequin (optional) • 1-liter bottle • Tourniquet if available (preferably one for every two students)

Unit 1	Equipment/Supply Checklist
	<ul style="list-style-type: none"> • Non-latex examination gloves (one pair per participant) • 4- by 4-inch dressings (one for each participant) • One triangular bandage per participant • Splinting material (e.g., cardboard, magazines, pieces of lath, pillows, towels) • Note cards • Duct tape
7	<p>Light Search and Rescue Operations</p> <ul style="list-style-type: none"> • One mannequin (optional) • 1-liter bottle • Tourniquet if available (preferably one for every two students) • Non-latex examination gloves (one pair per participant) • 4- by 4-inch dressings (one for each participant) • One triangular bandage per participant • Splinting material (e.g., cardboard, magazines, pieces of lath, pillows, towels) • Note cards • Duct tape
8	Terrorism and CERT
9	Course Review, Final Exam, and Disaster Simulation

Evaluation Plan

There are three primary methods for evaluation during the delivery of this course.

1. Instructors will conduct learning assessment throughout the course delivery through checks for learning and understanding, discussion questions, and opportunities for feedback.
2. Students will demonstrate their proficiency in applying knowledge and/or skills learned by completing a multiple-choice test. A proficiency of 75 percent is required to pass this course. There will also be an opportunity for individual evaluation during the course activities and exercises to determine whether individual students demonstrate proficiency in the required functions.
3. Course providers will use an evaluation form to document participant feedback on overall quality of content, instruction, and facilities. The evaluation uses a 1–5 rating system, with five being the highest. At the conclusion of the course, the course provider will collect the evaluations and return them to the course manager for review.

[This page intentional left blank]



CERT Unit 1: Disaster Preparedness

Instructor Guide



FEMA



[This page intentional left blank]



CERT Unit: Disaster Preparedness

In this unit, participants will learn about:

- **Roles and Responsibilities for Community Preparedness:** How everyone in a community has a role in disaster preparedness.
- **Role of CERTs:** CERT organization, disaster and non-disaster roles, and laws that protect disaster workers from liability.
- **Elements of Disasters and Their Impact on the Infrastructure:** The potential effects of extreme emergencies and disasters on; electrical service; emergency services; telephone communication; transportation; and availability of food, water, shelter, and fuel.

[This page intentional left blank]

CERT Unit 1 Table of Contents

<i>SECTION 1: UNIT OVERVIEW</i>	<i>1-1</i>
Setting the Stage	1-1
Course Preview	1-2
Unit Objectives	1-3
Exercise 1.1: Building a Tower	1-3
<i>SECTION 2: COMMUNITY PREPAREDNESS: ROLES AND RESPONSIBILITIES</i>	<i>1-5</i>
Government.....	1-5
Emergency Operations Plan (EOP).....	1-6
Community Leaders	1-6
The Public	1-7
Engaging the Whole Community	1-7
Get Involved	1-8
<i>SECTION 3: HAZARDS AND THEIR POTENTIAL IMPACT</i>	<i>1-9</i>
Types of Disasters.....	1-9
Key Elements of Disasters.....	1-9
Understanding Local Hazard Vulnerability	1-9
Impact on Infrastructure.....	1-10
Consequences of Damage to Infrastructure.....	1-11
Damage Related to Structure Type.....	1-12
Multiple-Use Buildings	1-13
Non-Structural Hazards	1-14
<i>SECTION 4: HOME AND WORKPLACE PREPAREDNESS</i>	<i>1-15</i>
Preparing for a Disaster	1-15
Family Disaster Plan.....	1-17
Creating a Family Disaster Plan	1-17
Assembling and Storing Disaster Supplies	1-19
To Prepare Your Disaster Supply Kit	1-19
Notes Regarding the Disaster Supply Kit.....	1-20
Escape Planning.....	1-25
Exercise 1.2: Evacuate!.....	1-26
Protective Actions.....	1-26
Sheltering	1-28
<i>SECTION 5: REDUCING THE IMPACT OF HAZARDS THROUGH MITIGATION.....</i>	<i>1-29</i>

Mitigation	1-29
Fortifying Your Home	1-31
SECTION 6: CERT DISASTER RESPONSE	1-32
CERT Organization	1-33
Personal Protective Equipment	1-33
CERT in Action	1-34
CERT in Non-Disaster Roles	1-34
Protection for Disaster Workers	1-34
SECTION 7: ADDITIONAL TRAINING FOR CERT VOLUNTEERS	1-36
UNIT SUMMARY	1-37
Homework Assignment	1-38
CERT UNIT 1: ADDITIONAL MATERIALS	1-42

[This page intentional left blank]

UNIT OBJECTIVES

At the conclusion of this unit, participants will be able to:

1. Describe the functions of CERT, discuss their role as CERT volunteers, and explain how CERT fits into their community's emergency preparedness structure.
2. Describe the types of hazards most likely to affect their communities and the potential impact those hazards have on people, health, and infrastructure.
3. Prepare themselves and their families for potential disasters their communities may face, including learning to create a family disaster plan and emergency preparedness kit.

ESTIMATED COMPLETION TIME

The following timetable (**Table 1: Estimated Completion Times**) is suggested for this module.

Table 1: Estimated Completion Times

Unit	Estimated Time
Introductions and Overview	20 minutes
Community Preparedness: Roles and Responsibilities	10 minutes
Hazards and Their Potential Impact	10 minutes
Impact on the Infrastructure	30 minutes
Home and Workplace Preparedness	30 minutes
Reducing the Impact of Hazards Through Mitigation	15 minutes
CERT Disaster Response	15 minutes
Protection for Disaster Workers	10 minutes
Additional Training for CERTS	5 minutes
Unit Summary	5 minutes
Total	2 hours, 30 minutes

RESOURCES REQUIRED

- Community Emergency Response Team Instructor Guide
- Community Emergency Response Team Participant Manual
- PowerPoint Slides 1-0 through 1-38
- PowerPoint Slides from hazard modules selected

EQUIPMENT

The following equipment is required for this unit:

- A computer with PowerPoint software;
- A computer projector and screen;
- Scissors (1 for every 5 participants);
- Tape (1 roll for every 5 participants);
- Two pieces of cardboard, approximately 8 by 10 inches (1 set for every 5 participants); and
- Forty pieces of construction paper, 8.5 by 11 inches (1 set for every 5 participants).

PREPARATION

1. Prepare information on state and local laws that protect CERT volunteers in your area. Enter the information in the table on page 31 of the Participant Manual before making copies.
2. Carefully review this unit and the hazard modules that are included as annexes to this unit. Select the hazards that present the greatest threat to your community and incorporate them into the unit. If possible, tailor the hazard materials by including local examples and photographs.
3. Working with a representative of the community in which you will be conducting training, identify any potentially culturally or community sensitive topics in this module. Develop strategies for presenting any such topics in ways that will be engaging and appropriate for the participants.
 - a. For example, some cultures dislike the term “disaster preparedness,” because it can imply an invitation to disaster. In this case, an alternate concept such as “community readiness” could be helpful.

INSTRUCTOR REMARKS

This unit includes information on a variety of hazards, some but not all, may affect the community in which you are teaching. Review this unit and the additional materials carefully **before** training to identify hazards that pose a threat to the local community.

After determining which hazard presentations you wish to include, you will want to add the PowerPoint slides into the main file for Unit 1. Complete the following steps to merge the slide presentations.

1. Open the PowerPoint file for Unit 1.
2. Open the PowerPoint file for the hazard you wish to include
3. While in the hazard presentation, click “Slide Sorter View” (☐) at the bottom left corner of the screen.
4. Click “Edit” at the top of the screen.
5. Click “Select All” from the edit pull-down menu.
6. Click “Window” at the top of the screen and select the Unit 1 presentation.
7. Click “Slide Sorter View” (☐).

8. Place the cursor where the hazard insert should be by clicking between the slides at the appropriate place in the Unit 1 presentation.
9. Right click and select "Paste" to pull in the hazard slides.
10. Repeat Steps 2 through 8 for each hazard presentation that you wish to include in this unit.

SECTION 1: UNIT OVERVIEW



Welcome

Welcome the participants to Community Emergency Response Team (CERT) Basic Training.

As the participants are arriving, develop a class roster by passing around a sheet of paper, or ask them to sign-in on the class roster if one already exists. Ask the participants to confirm their name, address, phone number, and e-mail address.

Introduce yourself and any additional trainers. Provide some background information about your experiences in emergency response.

Ask each participant to introduce himself or herself and provide a brief description of:

- Why he or she is attending the course; and
- Where he or she lives or works in the community.

Following the introductions, review the collective distribution of participants and facilitate a brief discussion of how the skills demonstrated in class might be useful in the immediate aftermath of a disaster.

Make any necessary administrative announcements at this time. Include information about:

- The times for this and future sessions;
- Materials required;
- Emergency exits and safety information;
- Restroom locations, smoking policy, etc.;
- Course completion requirements; and
- Classroom ground rules.

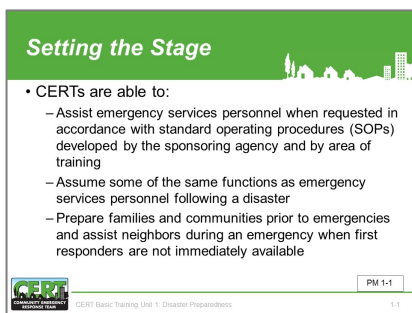

Setting the Stage

Open by telling participants that the damage caused by natural disasters and manmade events can be extensive.

While emergency services personnel are best trained and equipped to handle emergencies, they may not be immediately available in large or catastrophic disasters. In such situations, members of the community may be on their own for several days or longer. They may have to rely on their own resources for food, water, first-aid, and shelter, and neighbors or coworkers may have to provide immediate assistance to those who are hurt or need help.

Point out that CERTs respond in the period immediately after a disaster when response resources are overwhelmed or delayed.

Explain that CERTs:

- Assist first responders when requested in accordance with standard operating procedures developed by the sponsoring agency and by area of training;
- May assume some of the same functions as response personnel following a disaster;
- Are activated by first responders and should not self-deploy; and
- Prepare families and communities prior to emergencies and assist neighbors during an emergency when first responders are not immediately available.

Instructors should be aware of the policies that are in place for CERT deployment for their jurisdiction or the jurisdiction in which they are teaching. It is best to confer with local emergency management or first responder organization leadership to determine the correct response to provide course participants.

Point out that while CERTs are a valuable asset in emergency response, CERTs are not trained to perform all of the functions or respond to the same degree as professional responders. CERTs are a bridge to professional responders until they are able to arrive.

Let participants know that this training covers basic skills that are important to know in a disaster when emergency services are not immediately available. By learning how to work as a team, neighbors and coworkers will be able to do the greatest good for the greatest number after a disaster. Beyond what they will learn in this class, take this as an opportunity to review their own personal and family preparedness. They should prepare and take care of their own household before they perform their duties as a volunteer of CERT.

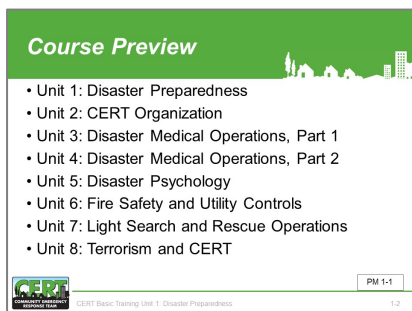

Course Preview

Explain that this unit will provide an overview of the course by establishing a context for CERTs within the specific hazards faced by the community.

Tell the group that later units will cover:

- CERT organization;
- Disaster medical operations;
- Disaster psychology;
- Fire safety;
- Light search and rescue; and
- CERT and terrorism.

Unit 1 objectives

1. Describe the functions of CERT, discuss your role as a CERT volunteer, and explain how CERT fits into your community's emergency preparedness structure
2. Describe the types of hazards most likely to affect your communities and their potential impact on people, health, and infrastructure
3. Prepare yourself and your family for potential disasters your community may face, including learning to create a family disaster plan and emergency preparedness kit

PM 1-1

Unit Objectives

At the end of this unit, participants should be able to:

1. Describe the functions of CERT, discuss their role as CERT volunteers, and explain how CERT fits into their community's emergency preparedness structure.
2. Describe the types of hazards most likely to affect their communities and the potential impact those hazards have on people, health, and infrastructure.
3. Prepare themselves and their families for potential disasters their communities may face, including learning to create a family disaster plan and emergency preparedness kit.

Exercise 1.1

- Work in groups of five to design and construct a free-standing tower that stands at least 5 feet tall from the bottom of the structure to the top
- You will have a total of 10 minutes. Spend the first 5 minutes planning and designing the tower as a group. While you are planning, you should not touch any of the materials
- Wait to be told when to begin construction and you will have 5 minutes from that point to complete the tower

PM 1-2

Exercise 1.1: Building a Tower

Purpose: Introduce the exercise to the participants by explaining that they will now work in small groups. Each group will work together to accomplish the same task – building a tower.

Instructions: Follow the steps below to conduct this exercise:

Step 1: Assign the participants to groups of five

Step 2: Distribute the following materials to each group:

- One pair of scissors;
- One roll of scotch tape;
- Two pieces of cardboard (approximately 8 by 10 inches); and
- Forty pieces of construction paper (8.5 by 11 inches).

Step 3: Tell the groups to spend 10 minutes planning and designing a freestanding tower that stands at least 5 feet tall from the bottom of the structure to the top.

If desired, provide the participants with a different activity that highlights similar skills: the ability to work together successfully with limited resources and under time pressure.

Step 4: Emphasize that the first 5 minutes is for planning only and they should not touch the materials during that time.

Step 5: Inform them that they will then have 5 minutes to construct the tower.

Step 6: Tell the groups when to begin, then at the 5-minute mark tell them to start constructing, and finally, at the 10-minute mark tell them to end construction.

Step 7: At the end of the allotted time, facilitate a group discussion going over what they have learned through the exercise. Be sure to emphasize that to achieve a common goal, unfamiliar people can:

- Work on an unfamiliar problem;
- Use unfamiliar tools;
- In unfamiliar surroundings; and
- In a time-compressed environment.

Step 8: Stress that the skills and abilities that the groups used during the exercise are the same skills that they will use as CERT volunteers.

Does anyone have any questions about anything covered so far?



Check for understanding.

Community Preparedness Roles

- Preparedness is important for communities of all sizes across the Nation
 - Key priority in lessening the impact of disasters
 - Critical that all community members take steps to prepare
 - Effective when addresses unique attributes of community and engages whole community

 PM 1-3
CERT Basic Training Unit 1: Disaster Preparedness 1.5

SECTION 2: COMMUNITY PREPAREDNESS: ROLES AND RESPONSIBILITIES

Community preparedness is a key priority in lessening the impact of disasters. It is critical that all community members take steps to prepare prior to an event.

Effective community preparedness addresses the unique attributes of the community:

- The threat and hazards profile and vulnerabilities of the area;
- The existing infrastructure;
- Resources and skills within the community; and
- The population composition of the community.

Effective community preparedness also engages the whole community, which includes:

- Government leaders and the public sector;
- Community leaders from the private and civic sectors; and
- The public.

Government

- Government has responsibility to:
 - Develop, test, and refine emergency plans
 - Ensure emergency responders have adequate skills and resources
 - Provide services to protect and assist citizens

 PM 1-3
CERT Basic Training Unit 1: Disaster Preparedness 1.6

Government

Government has the responsibility to develop, test, and refine emergency operations plans, ensure emergency responders have adequate skills and resources, and provide services to protect and assist its citizens.

To meet these challenges, government should involve the community in the planning process to:

- Incorporate community resources in the plans;
- Provide reliable, actionable information; and
- Encourage training, practicing, and volunteer programs.

Inform participants that government emergency service providers include professionals from the following:

- Emergency management;
- Emergency medical services;
- Fire and rescue;
- Human services;
- Law enforcement;
- Public health services; and
- Public works.

Emergency Operations Plan (EOP)

- All government agencies with a role in disaster response work to organize and coordinate their agencies' activities before an emergency or disaster using EOP's:
 - Assigns responsibility to organizations and individuals
 - Sets forth lines of authority
 - Describes how people and property will be protected
 - Identifies personnel, equipment, facilities, supplies, and other resources

PM 1-3

Emergency Operations Plan (EOP)

All government agencies with a role in disaster response work to organize and coordinate their agencies' activities before an emergency or disaster. The product of their work is the Emergency Operations Plan or "EOP" for that community. The agency responsible for the EOP may vary between jurisdictions. Some have emergency management offices, while others place the responsibility with local fire or law enforcement.

Explain that the EOP is a document that:

- Assigns responsibility to organizations and individuals for carrying out specific actions at projected times and places in an emergency that exceeds the capability or routine responsibility of any one agency (e.g., the fire department);
- Sets forth lines of authority and organizational relationships and shows how all actions will be coordinated;
- Describes how to protect people and property in emergencies and disasters; and
- Identifies personnel, equipment, facilities, supplies, and other resources available —within the jurisdiction or by agreement with other jurisdictions — for use during response and recovery operations.

In short, the EOP describes how the community will function in an emergency.

Your local agency may use a different term for its Emergency Operations Plan (EOP). Use the term used in your jurisdiction.

Know what agency is responsible for your local EOP.

Depending on where you live, there may also be a hazard mitigation plan and/or evacuation plan. Briefly describe these if applicable.

Community Leaders

Community leaders from the private and civic sectors have a responsibility to participate in community preparedness. Their responsibilities include:

- Participating on the local collaborative planning council to provide insights and perspectives reflecting their industry or the constituency they service, for example, people with access and functional needs, local schools, communities with language or cultural differences, small businesses, the economically disadvantaged, and communities of faith;
- Identifying and integrating appropriate resources into government plans; and

Community Leaders

- Have a responsibility to participate in community preparedness:
 - Participate on local collaborative planning council
 - Identify and integrate appropriate resources into government plans
 - Ensure facilities, staff, and customers served are prepared

PM 1-4

- Ensuring facilities, staff, and customers or population served are prepared, trained, and practiced in preparedness actions.

The Public

- Learn about community alerts, warnings, and evacuation routes
- Take training
- Practice skills and personal plans
- Network and help others
- Provide feedback to community
- Report suspicious activity
- Volunteer

PM 1-4

The Public

The public also has a responsibility for preparedness. All members of the community should:

- Learn about community alerts and warnings, evacuation routes, and how to obtain critical information;
- Take training in preparedness, first-aid, and response skills;
- Practice skills and personal plans through periodic drills in multiple settings;
- Network and be able to help others;
- Participate in community feedback opportunities;
- Report suspicious activity; and
- Volunteer.

Engaging the Whole Community

- Whole Community approach to emergency preparedness seeks to engage the full capacity of society
- Relationships and social connections are the foundation for a more resilient community that can bounce back after a disaster
- Community coalitions strengthen relationships and provide a framework for organizing community preparedness efforts

PM 1-4

Engaging the Whole Community

FEMA’s Whole Community approach to emergency management seeks to engage the full capacity of society in a dialogue to increase disaster preparedness and resilience. The full capacity of society is a reference to all of the partners within a community who should engage in community preparedness, including government entities, non-governmental organizations, faith-based organizations, schools, non-profit groups, and private sector entities. Partners at the grass roots level include individuals, families, local communities, and social networks.

Explain to participants that some communities may have a Citizen Corps Council (CCC) or other entity such as a Local Emergency Planning Committee (LEPC) that acts as a CCC and that both of these types of organizations serve as models for community coalitions that promote preparedness efforts.

Community coalitions, such as Citizen Corps, are, organized collaborative bodies within a community that help to foster and strengthen relationships throughout the community. Relationships are the fabric that makes a community stronger and more resilient after disasters. Social capital is the value we place on our relationships with one another. Studies have shown that communities that possess a high amount of social capital bounce back much more efficiently after a disaster and tend to rely less on outside resources to return to normal.

Despite advances in technology, a functioning community is based on complex and interdependent systems driven by human forces. Community coalitions bring government and community leaders together to ensure

Check for understanding.

Get Involved

- Preparedness requires active participation from all
 - Talk to friends and family about hazards
 - Ask about emergency planning outside the home
 - Make sure those in charge have a plan
- Training provides skills needed to help others and keeps skills current
 - CERT program provides training, practice, and connection to others
 - Participate in drills and exercises
 - Talk to friends and family about volunteering

 CERT Basic Training Unit 1: Disaster Preparedness PM 1-8

emergency plans more effectively reflect the community's needs, challenges, capabilities, and resources.

Do you have any questions about the roles and responsibilities of community preparedness?

Get Involved

Preparedness requires active participation from all. Inform participants about ways that the public can get involved.

- Start the process by talking to your friends and family about the hazards in your area and discuss what steps – large or small –you all need to take to be able to help each other in a crisis.
- Ask about emergency planning at your workplace, schools, places of worship, and other social settings.
- Make sure those individuals in charge have a plan and are connected to community authorities on emergency management and planning.

Take training to acquire the skills needed to help others and keep your skills current through refresher training and practice.

- Participate in the CERT Program to provide training, practice, and the connection with others to develop teams.
- Plan to participate in drills and exercises with your family and neighbors and at your workplace, school, place of worship, and community-organized events. The more you practice, the better prepared you will be to take effective action when a disaster happens.
- Talk to your friends and family about volunteering, too. Volunteering to help your community through CERT and other activities is a great experience to share!

SECTION 3: HAZARDS AND THEIR POTENTIAL IMPACT

Types of Disasters

Type of Disasters

- **Natural** (e.g., earthquakes, wildfires, floods, extreme heat, hurricanes, landslides, thunderstorms, tornadoes, tsunamis, volcanic eruptions, winter storms)
- **Technological & Accidental** (e.g., hazardous material spill, nuclear power plant accident)
- **Terrorism** (e.g., chemical, biological, radiological, nuclear, explosive weapons)

CERT Basic Training Unit 1: Disaster Preparedness 1-12

Tell the group that disasters can be:

- Natural (e.g., earthquakes, wildfires, floods, extreme heat, hurricanes, landslides, thunderstorms, tornadoes, tsunamis, volcanic eruptions, winter storms);
- Technological and Accidental (e.g., hazardous material spill, nuclear power plant accident); or
- Terrorism (chemical, biological, radiological, nuclear, or explosive weapons);
- Pandemics; and/or
- Home fires.

Explain that CERT volunteers will generally respond to large-scale events in their communities. The scope of this CERT training does not cover pandemics. While home fires are not always community events, Unit 6: Fire Safety and Utility Controls discusses them in further detail. For the purposes of this training, most of the hazards discussed will be natural, technological/accidental, or terrorist related.

Key Disaster Elements

- They are relatively unexpected
- Emergency personnel may be overwhelmed
- Lives, health, and the environment are endangered

CERT Basic Training Unit 1: Disaster Preparedness 1-13

Key Elements of Disasters

Regardless of the event, disasters have several key elements in common:

- They are relatively unexpected, with little or no warning or opportunity to prepare.
- Increased demands for resources may initially overwhelm available response personnel and emergency services.
- They endanger lives, health, and the environment.

Stress that in the immediate aftermath of a disaster, needs are often greater than professional emergency services personnel can provide. In these instances, CERTs become a vital link in the emergency service chain.

Understanding Local Hazard Vulnerability

Local Hazard Vulnerability

- Identify most common disasters that occur
- Identify possible hazards with most severe impact
- Consider recent or historical impacts
- Identify susceptible locations in the community for specific hazards
- Consider what to expect from disruption of services

CERT Basic Training Unit 1: Disaster Preparedness 1-14

Assessing your community's vulnerability to hazards allows the community to prioritize preparedness measures and to target effective actions for the

appropriate hazard. To assess your community’s vulnerability to hazards, it is useful to:

- Identify the most common disasters that occur;
- Identify possible hazards with most severe impact;
- Consider recent and/or historical impacts;
- Identify susceptible locations in the community for specific hazards - people, buildings, and infrastructure; and
- Consider what to expect for disruption of services and length of restoration.

Open a group discussion.

Keep a close eye on the clock. Try to limit the discussion to between 10 and 15 minutes.

Impact on the Infrastructure

How many of you have been caught in a(n) [insert the type of event that is most common for your area]?

What types of problems did you experience with such things as utilities and transportation?

Refer the participants to **Table 1.1: Examples of Possible Impact on Infrastructure** in their Participant Manuals. Summarize the participants’ responses to the discussion question by listing some of the effects on the infrastructure.

Table 1.1: Examples of Possible Impact on Infrastructure

Infrastructure at Risk	Possible Impacts
Transportation	<ul style="list-style-type: none"> • Roads are closed and/or impassable • Responders may be delayed in reaching areas of need • Flow of needed supplies (e.g., food, water) is interrupted
Structures	<ul style="list-style-type: none"> • Damaged critical facilities (e.g., hospitals, fire stations, police precincts, airports) unable to function • Increased risk of damage from falling debris
Communications Systems	<ul style="list-style-type: none"> • Survivors unable to phone for help or reach service providers • Coordination of services is hampered

Infrastructure at Risk	Possible Impacts
	<ul style="list-style-type: none"> Families and friends cannot communicate
Utilities	<ul style="list-style-type: none"> Loss of service Increased risk of fire or electrical shock Limited access to fuel (e.g., pumps that may not work)
Water Service	<ul style="list-style-type: none"> Medical facilities hampered Inadequate water flow, which results in notice to boil water and hampered firefighting capabilities Increased risk to public health
Fuel Supplies	<ul style="list-style-type: none"> Increased risk of fire or explosion from fuel line rupture Flow of fuel is interrupted by impassable roads
Financial Services	<ul style="list-style-type: none"> ATMs do not work Credit card systems inoperable

Infrastructure Damage

- Resources will be applied to the highest priority need:
 - Police will address incidences of grave public safety
 - Firefighters will suppress major fires
 - EMS personnel will handle life-threatening injuries

PM 1-7
CERT Basic Training Unit 1: Disaster Preparedness 1-15

Consequences of Damage to the Infrastructure

Draw the correlation that each instance of damage to the infrastructure may severely restrict the abilities of police, fire, and emergency medical services in that disaster.

Because emergency services personnel are likely to have inadequate resources to meet the public’s needs during a major disaster, they will only apply those resources according to the highest priority need.

Use the hospital emergency room analogy: in the emergency room, hospital personnel prioritize resources based on the severity of each injury. Similarly, emergency services personnel are likely to have inadequate resources to meet the public’s needs in the immediate aftermath of a disaster, and they too will need to prioritize resources.

For emergency room personnel, life-threatening injuries take the highest priority and they treat them first. In the same way, during or after a disaster, emergency services

personnel must prioritize emergency services resources according to the highest-priority need:

- Police will address incidents of grave public safety;
- Firefighters will suppress major fires; and
- EMS personnel will handle life-threatening injuries, but stress that CERT volunteers may also handle life-threatening injuries until EMS units become available.

Lower-priority needs will be met in other ways.

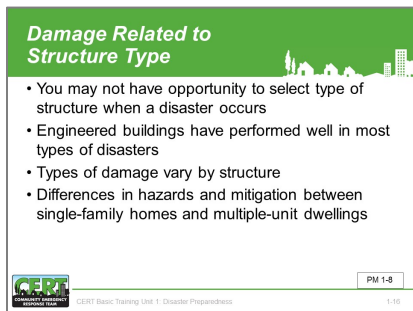

Damage Related to Structure Type

Remind the participants that they might not have an opportunity to select the type of structure that they are in when a disaster occurs. It is important to know what type of damage to expect from the main types of structures in the community.

Tell the participants that engineered buildings, such as most high-rise buildings, have generally performed well in most types of disasters.

Stress that, during earthquakes and high-wind events (e.g., tornadoes, hurricanes), older high-rise buildings, however, are more susceptible to damage from:

- Broken glass;
- Falling panels; and
- Collapsing walkways and stairways.

How many of you live in single-family homes?

Do you know what types of damage to expect to your home in the event of a disaster?

If not mentioned by the group, tell them that age, type of construction, and type of disaster are major factors in potential damage to detached homes and garages.

- In general, homes built prior to 1940 were not originally bolted to the foundation, making them subject to being shaken, blown, or floated off their foundations.
- Older homes constructed of non-reinforced brick are less stable than newer construction.

Remind the participants that:

- Tornado and hurricane damage to single-family homes can range from broken windows to total destruction;

Check for knowledge.

- When an event damages a structure, there is a threat of additional damage, such as fire from ruptured gas lines, following the event; and
- Volunteers should be aware that they may encounter multiple-unit dwellings in response to a disaster. They should approach such dwellings in a different manner than a single-family home. Unit 6 will cover utility control in more depth.

Check for knowledge.

How many of you live in manufactured, or mobile, homes?

Do you know what type of damage you can expect if a high-risk hazard occurs?

If not mentioned by the group, stress that mobile homes are most susceptible to damage because they could be displaced. When displacement occurs, structural integrity becomes questionable and utility connections may be damaged, increasing the risk of fire and electric shock.

How many of you live in multiple-unit dwellings?

Do you understand how the hazards and mitigation approaches differ from those of single-family homes?

Point out to participants that others in the building may be affected even if it appears that there is limited visible damage.

It is important to remind participants that utility shutoffs are often arranged differently in multiple-unit dwellings than in typical single-family homes. There is often a main utility shutoff for the entire building, as well as a shutoff located within each individual unit. Depending on the situation at hand, they may need to use one or both of them. Stress to be mindful of the effects and consequences of using each.

Multiple-Use Buildings

Explain to the group that buildings with oversized roof-spans pose particular hazards in a disaster.

- Airports
- Malls and Strip Malls
- Places of Worship
- Sports Arenas
- Warehouse-type Structures (e.g., “big box” stores)

Check for knowledge.

Check for knowledge.

How many of you are aware of non-structural hazards in your own neighborhoods, homes, or workplaces?

Non-Structural Hazards

Stress that everyone has non-structural hazards in their neighborhood, homes, or workplaces. Fixtures and other items within a home, garage, or workplace can pose a hazard during or after a disaster, including:

- Gas line ruptures from water heaters or ranges displaced by shaking, water, or wind;
- Damage from falling books, dishes, or other cabinet contents;
- Risk of injury or electric shock from displaced appliances and office equipment;
- Fire from faulty wiring, overloaded plugs, or frayed electrical cords.

Emphasize the importance of reducing hazards as part of personal preparedness. It is also important to know how and when to turn off utilities safely. Unit 6 – Fire Safety and Utility Control will cover utility shutoffs.

Does anyone have any questions about hazards and their potential impacts?

Check for understanding.

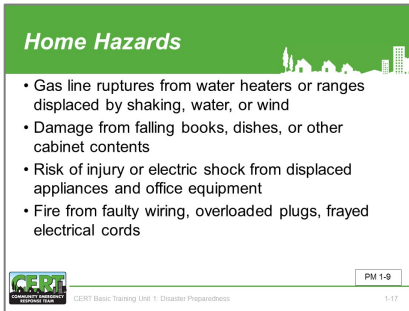

Home Hazards

- Gas line ruptures from water heaters or ranges displaced by shaking, water, or wind
- Damage from falling books, dishes, or other cabinet contents
- Risk of injury or electric shock from displaced appliances and office equipment
- Fire from faulty wiring, overloaded plugs, frayed electrical cords

PM 1-8

CERT Basic Training Unit 1: Disaster Preparedness 1-17

SECTION 4: HOME AND WORKPLACE PREPAREDNESS

Inform the group that FEMA is committed to social and physical science as the foundation for increasing individual and community preparedness, and that the agency has conducted national household surveys to assess the public's knowledge, attitudes, and behaviors on preparing for a range of hazards since 2007. The 2015 National Household Survey details key findings on individual preparedness and the general preparedness concepts relayed throughout the CERT Basic Training.

- 68 percent of respondents reported having enough supplies to get through three days.
- 63 percent of respondents reported having taken steps to safeguard critical documents.
- 39 percent of respondents reported having sought preparedness information within the past year.
- 27 percent of respondents reported having talked to others about getting prepared within the past year.
- 18 percent of respondents reported having attended a preparedness meeting/training within the past year.

Preparing for a Disaster

- Know local hazards, alerts, warning systems, evacuation routes, and sheltering plans
- Consider important elements of disaster preparedness
- Address specific needs for yourself and people you know

CERT CERTIFIED VOLUNTEER PREPAREDNESS PM 1-10
CERT Basic Training Unit 1: Disaster Preparedness 1-18

Preparing for a Disaster

Many preparedness actions are useful in any type of emergency, and some are specific to a particular type of disaster. A critical first step of preparedness is to understand which hazards are most relevant to each community. Next, it is important to learn about local alerts and warning systems, evacuation routes, and sheltering plans. It is also important for CERT volunteers to familiarize themselves with hazards in other areas, given that they may experience a type of hazard for which they are not as familiar when they are traveling.

Remind participants that regardless of the type of disaster, important elements of disaster preparedness include:

- Having the skills to evaluate the situation quickly and to take effective action to protect yourself;
- Having a family disaster plan and practicing the plan with drills;
- Assembling supplies in multiple locations;

Preparing for a Disaster

- Have the skills to evaluate the situation quickly and take effective action to protect yourself
- Have a family disaster plan and practice the plan with drills
- Assemble supplies in multiple locations
- Reduce the impact of hazards through mitigation practices
- Get involved by participating in training and volunteer programs





CERT CERTIFIED VOLUNTEER PREPAREDNESS PM 1-10
CERT Basic Training Unit 1: Disaster Preparedness 1-18

- Reducing the impact of hazards through mitigation practices; and
- Getting involved by participating in training and volunteer programs.

Emphasize to participants that it is always important to address specific needs, including any access and functional needs, considerations for pets and service animals, and transportation requirements for themselves and their family and friends. Additionally, as preparedness leaders in their community, CERT volunteers should ensure they are doing their best to meet these elements of preparedness in their home.

More information on preparedness is available online. Direct the participants to **Table 1.2: Preparedness Websites** in their Participant Manual.

Table 1.2: Preparedness Websites

Organization	URL	Description
	https://www.ready.gov/community-emergency-response-team	Resources, trainings, and information about the CERT program.
	www.ready.gov/	FEMA’s national website for disaster preparedness. Provides excellent, general advice and is a good place to start.
	www.community.fema.gov	Prepareathon is a grassroots campaign to increase community preparedness and resilience.
	www.redcross.org	The American Red Cross website is full of excellent tips and information related to most of the natural disasters that occur, including a few topics not covered at FEMA’s Ready.gov website.
	www.pandemicflu.gov	The Centers for Disease Control and Prevention (CDC) established this website as a hub for national information on pandemic influenza.

Family Disaster Plan

- Where will you meet family members?
- Who is your out-of-state “check-in” contact?
- Will you have an extended stay? Shelter in place? Evacuate?
- How will you escape your home? Workplace? School? Place of worship?
- What route (and several alternates) will you use to evacuate your neighborhood?
- Do you have transportation?
- Did you practice your plan?

PM 1-12

CERT Basic Training Unit 1: Disaster Preparedness 1.05

Explain that the answers to these questions may be different depending on the hazard and the participants probably will not be able to plan for every event that could happen. But stress that, by playing “What if?” with high-risk hazards, they will be better prepared for any hazard that might strike.

Remind the participants to see www.ready.gov for additional information.

Family Disaster Plan

In addition to knowing immediate protective actions that participants may need to take, they should also create a family disaster plan. These plans can mean the difference between life and death in a disaster.

Important considerations for your family disaster plan include:

- Where will you meet family members? You should have a location outside the house and another location outside the neighborhood.
- Identify an out-of-state “check-in contact.”
- Plan for all possibilities: extended stay, sheltering in place, or evacuation.
- How will you escape buildings where you spend time: your home, workplace, school, place of worship?
- What route (and several alternatives) will you use to evacuate? Do you have transportation?

Remind participants that family safety is the most important factor when disaster strikes. To make the most informed decision regarding their family’s safety, participants should first consider what option is best, given the situation. Practicing their plan with their family — evacuating the home and contacting all family members using their “check-in contact” — is essential.

Emphasize to participants that practicing their plans now will improve their preparedness level when it matters most.

As a part of the family disaster plan, families should also create a family communications plan. This plan outlines how family members should communicate during an emergency, and steps for family reunification should they be separated. Participants can download a template for a family communications plan at www.ready.gov.

Creating a Family Disaster Plan

To create a Family Disaster Plan

Step 1: Contact your local emergency management office and local chapter of the American Red Cross to:

- Find out which disasters are most likely to happen in the community;

- Ask how to receive warnings about the event; and
- Find out how to prepare for each type of disaster.

Step 2: Meet with your family to:

- Discuss the types of disasters that could occur;
- Explain how to prepare and respond;
- Discuss what to do if advised to evacuate; and
- Practice what has been discussed.

Step 3: Plan how family will stay in contact if separated by disaster by:

- Picking two meeting places –a location in a safe distance from the home in case of fire, and a place outside of your neighborhood in case you cannot return home;
- Choose an out-of-state friend as a “check-in contact” for everyone to call;
- Make sure the person selected understands that they are the family out-of-state contact in case of emergency and know what is expected of them should such an emergency arise;
- Give the “check-in contact” a list of pertinent people to contact – be sure to include phone numbers; and
- Periodically practice using local and out-of-state contacts as if it were an emergency.

Step 4: Prepare a business-card sized list of family and friends’ phone numbers and print one for each family member:

- FEMA developed the Family Communications Plan to consolidate important contact information for emergencies;
- The two-page plan includes double-sided card printouts for this purpose; and
- As a security measure, do not specify relationships.

Step 5: Ensure that the following steps are accounted for:

- Post emergency telephone numbers by every home phone and save in every cell phone;
- Show responsible family members how and when to shut off water, gas, and electricity at main switches; and
- Install a smoke alarm on each level of the home, especially near bedrooms. Test them monthly and change the batteries when clocks are changed in the spring and fall.

To reinforce your level of individual and community preparedness:

- Contact your local fire department to learn about home fire hazards.
- Learn first-aid and CPR. Contact your local hospital, fire department, health department, or local American Red Cross chapter for information and training.
- Meet with your neighbors.
- Plan how the neighborhood could work together after a disaster. Know your neighbors' skills (e.g., medical, technical).
- Consider how you could help neighbors, including the elderly or individuals who have access or functional needs.
- Make plans for childcare in case parents cannot get home.

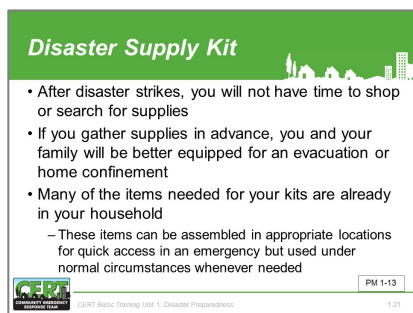

Assembling and Storing Disaster Supplies

Inform participants they can cope best by preparing for disaster before it strikes. One way to prepare is by assembling a Disaster Supply Kit. After disaster strikes, they may not have time to shop or search for supplies. By gathering supplies in advance, they and their family can endure an evacuation or home confinement.

Refer participants to **Table 1.4: Disaster Supply Items** in their Participant Manuals. Tell the group that the list includes all disaster supplies recommended by FEMA. Review the following items about preparing their kit.

To Prepare Your Disaster Supply Kit

- Review the checklist on the next few pages.
- Gather the supplies from the list. Remember that many of the items needed for the kits are likely already in many households. These items can be

assembled in appropriate locations for quick access in an emergency but used under normal circumstances whenever needed. For example, keep a wrench in the kit to shut off gas at the meter in an emergency, but use the wrench for everyday tasks, too. Just be sure to return it to the emergency kit.

- Place the supplies needed for an evacuation in an easy-to-carry container.

These supplies are listed with an asterisk (*).

Notes Regarding the Disaster Supply Kit:

Water

- Store water in plastic containers, such as soft drink bottles.
- Look for the triangular recycling symbol with a number 1 on the bottom of the bottle, as those are best for water storage. Avoid using containers that will degrade or break, such as milk jugs or glass bottles.
- Wash the bottle with soap and warm water, fill with water from the tap, and store in a cool, dark area away from direct sunlight.
- Replace your emergency water every six months, as all plastic degrades over time.
- Keep in mind that a normally active person needs to drink at least 3 quarts of water each day. Hot environments and intense physical activity can double that requirement. Children, nursing mothers, and ill people will need more.
- Store at least 1 gallon of water per person, per day (3 quarts for drinking, 1 quart for food preparation and sanitation) *.
- Keep at least a three-day supply of water for each person in the household.

If the quality of the water is questionable, purify it before drinking. Heat water to a rolling boil for 1 minute or use commercial purification tablets to purify the water. Regular household liquid chlorine bleach, if it is pure 5.25 – 6.0 percent sodium hypochlorite, also purifies the water. (Do not use perfumed bleach!) After adding bleach, shake or stir the water container and let it stand for 30 minutes before drinking.

Use **Table 1.3: Ratios for Purifying Water with Bleach** as a guide:

Table 1.3: Ratios for Purifying Water with Bleach

Water Quantity	Bleach Added
1 quart	4 drops
1 gallon	8 drops
4 gallons	1/3 teaspoon

Note: If the water is cloudy, double the recommended amount of bleach.

Food Kitchen Items

Store at least a three-day supply of nonperishable food. Select foods that require do not require refrigeration, preparation, or cooking with little to no water. If heating food is necessary, pack a can of chafing fuel. Select food items that are compact and lightweight. Avoid salty foods if possible as they increase thirst. Check expiration dates biannually.

First-Aid Kit*

Assemble a first-aid kit for the home and one for each car. (Note: This kit should not supplement or replace a CERT volunteer supply kit!)

Special Items

Remember to include items for family members with special needs, such as infants, the elderly, or anyone with access and functional needs.

General

Supplies marked with an asterisk (*) can also be used for evacuation.

Table 1.4: Disaster Supply Items

Food Items	
<ul style="list-style-type: none"> • Ready-to-eat canned meats, fruits, and vegetables • Canned, juices, milk, soup (if powdered, store extra water) • Sugar, salt, pepper 	<ul style="list-style-type: none"> • High-energy foods (Peanut butter, jelly, crackers, granola bars, trail mix) • Foods for infants, elderly persons, or persons on special diets • Comfort and stress foods (Cookies, hard candy, sweetened cereals, lollipops, instant coffee, tea bags)
Kitchen Items	
<ul style="list-style-type: none"> • Manual can opener • Mess kits or paper cups, plates, and plastic utensils • All-purpose knife • Small cooking stove and a can of cooking fuel 	<ul style="list-style-type: none"> • Trash bags • Household liquid bleach to treat drinking water • Aluminum foil and plastic wrap
Disaster Kit First Aid Items	
<ul style="list-style-type: none"> • First aid manual • Two-inch sterile gauze pads (4-6) • Hypoallergenic adhesive tape • Needle • Antibacterial ointment • Tongue depressors (2) • Assorted sizes of safety pins • Non-latex exam gloves (2 pairs) 	<ul style="list-style-type: none"> • Four-inch sterile gauze pads (4-6) • Triangular bandages (3) • Moistened towelettes • Thermometer • Tube of petroleum jelly or other lubricant • Cleaning agent/soap • Cotton balls • Three-inch sterile roller bandages (3 rolls)

<ul style="list-style-type: none"> • Four-inch sterile roller bandages (3 rolls) • Sunscreen • Tweezers • Aspirin or non-aspirin pain reliever • Antacid (for upset stomach) • Laxative • Sterile adhesive bandages in assorted sizes 	<ul style="list-style-type: none"> • Scissors • Hot and cold compress • Anti-diarrhea medication • Allergy medication and, if necessary, epinephrine • Activated charcoal
Disaster Kit Tools	
<ul style="list-style-type: none"> • Emergency preparedness manual* • Battery-operated weather radio and extra batteries • Tube tent • Duct tape • Matches in a waterproof container • Plastic storage containers • Paper, pencil* • Work gloves • Flashlight and extra batteries* • Fuel for vehicle and generator • Plastic sheeting 	<ul style="list-style-type: none"> • Non-sparking shutoff wrench to turn off household gas and water • Pliers • Compass* • Fire extinguisher (small canister, ABC type) • Signal flare(s)* • Needles, thread • Medicine dropper • Whistle • Landline telephone

Personal Sanitation Items	
<ul style="list-style-type: none"> • Toilet paper, towelettes* • Feminine supplies* • Household chlorine bleach • Disinfectant • Plastic garbage bags, ties 	<ul style="list-style-type: none"> • Soap, liquid detergent* • Personal hygiene items* • Plastic bucket with tight lid • Liquid hand sanitizer
Pet Items	
<ul style="list-style-type: none"> • Medication and medical records (stored in a waterproof container) • Current photos of your pet in case they get lost • The name and number of your veterinarian in case you have to foster or board your pets • Sturdy leashes, harnesses, and/or carriers to transport pets safely and ensure that your animals can't escape 	<ul style="list-style-type: none"> • Food, potable water, bowls, cat litter, pan, can opener • Pet beds and toys, if easily transportable • Information on feeding schedules, medical conditions, and behavior problems • Pet first aid kit
Clothing and Bedding Supplies	
<ul style="list-style-type: none"> • Sturdy shoes or boots* • Blankets or sleeping bags* • Thermal underwear • One complete change of clothing and footwear per person 	<ul style="list-style-type: none"> • Rain gear* • Hats and gloves* • Sunglasses* • Remember to cycle clothing for different seasons

Consider asking participants to take one or two steps (that you define) in assembling their household kit.

Check for understanding.

Check for experience.

Point out that the disaster supplies included on this list are mostly complete. Suggest that participants determine the supplies that they will need for evacuation, to shelter in place, and supplies they may need for both.

The disaster supply kit is located in the Appendix in checklist form.

Remind the participants that there are considerations for those with access and functional needs, as well as children and pets.

Do you have any questions about home and workplace preparations?

Escape Planning

Escape Planning

- Consider needs of children and individuals with access and functional needs
- Inform all family members or office coworkers of the plan
- Run practice escape drills

PM 1-17

How many of you have developed escape plans for your homes or workplaces?

Emphasize the importance of having an escape plan that includes escape from every room of the house or every area of the workplace. Refer participants to **Image 1.1: Escape Plan** in their Participant Manuals.

Image 1.1: Escape Plan

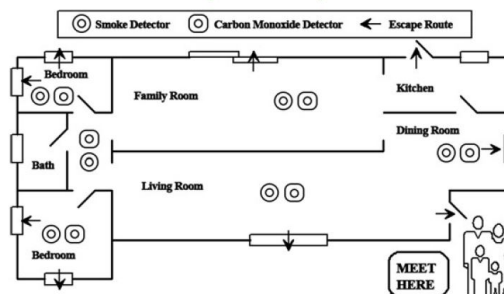

Sample family escape plan with arrows showing an escape route from every room in the home and a family meeting place outside the home.

Urge the participants to practice their plans after developing them. Suggest that they conduct family fire drills, follow the local evacuation routes, and locate the nearest shelter to ensure that, when a disaster occurs, they know what to do.

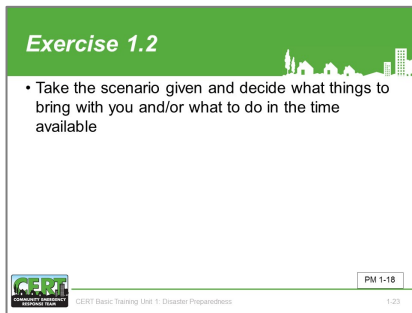

Exercise 1.2

- Take the scenario given and decide what things to bring with you and/or what to do in the time available

CERT Basic Training Unit 1: Disaster Preparedness PM 1-18 1-23

Exercise 1.2: Evacuate!

Instructions: Follow the steps below to conduct this exercise.

- Describe a disaster (e.g., hurricane or earthquake) and instruct the participants that they have 5 minutes to evacuate their homes in this disaster scenario.
- Ask participants to come up with a list of items they would bring with them and/or what they would do in that window of time.
- For added urgency, end the exercise after 4 minutes.
- Ask volunteers to share their information and explain their choices.

Debrief by explaining that the answer to this question may be different depending on the hazard. Participants probably will not be able to plan for every event that could happen.

Stress that, by asking “What if?” for high-risk hazards, they will be better prepared for any hazard that might strike.

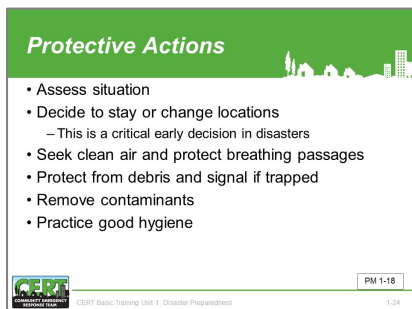

Protective Actions

- Assess situation
- Decide to stay or change locations
 - This is a critical early decision in disasters
- Seek clean air and protect breathing passages
- Protect from debris and signal if trapped
- Remove contaminants
- Practice good hygiene

CERT Basic Training Unit 1: Disaster Preparedness PM 1-18 1-24

Protective Actions

Because many disasters occur with little or no warning, individuals need to have the knowledge and skills to take immediate protective actions in the first critical moments after a disaster has occurred – before they receive instruction from authorities. While the specific actions to take are based on a number of variables (e.g., disaster type, amount of warning, amount of training, location), the following list provides an overview of the protective actions for which individuals should be familiar. These should be their objectives in assessing their post-event environment:

- **Assess the situation.** When something occurs without notice, it is important to take a few seconds to assess the situation to determine the most effective next steps, including identifying the type of event and determining whether the event has compromised air quality or a building structure.
- **Decide to stay or change locations.** In some cases, individuals should stay where they are, for example, if they are inside and an event has

occurred outside. In other cases, individuals should change location, for example, if they are inside and the event is outside. All disasters have unique attributes, so it is important to realize they may need to evaluate the circumstances to determine the best course of action.

- **Staying or changing location is a critical early decision in disasters.** If not in immediate danger, individuals should stay where they are and get more information before taking their next steps. Thinking through the likely hazards in their community and where they might be when an event occurs may help participants visualize their response. While they may need to make the first, immediate decision (i.e., to stay inside or go outside), or to shelter in place by sealing a room without authoritative instruction, it is important to listen to local authorities once they are able to provide information. If experts advise citizens to evacuate from their location, LEAVE!
- **Seek clean air and protect breathing passages.** Regardless of the type of disaster, clean air is a critical need. Actions to protect breathing passages and seek clean air may include covering mouths with a cloth or mask, vacating the building, or sheltering in place by sealing an internal room while the airborne contaminant dissipates.
- **Protect from debris and signal rescuers if trapped.** Protecting yourself from falling or precarious debris is a critical protective action. If trapped, individuals should protect their airways, bang on an object, or blow a whistle. Yelling should be a last resort.
- **Remove contaminants.** If contaminants have been released into the area, or if you have come in contact with liquid or solid contaminants, quickly remove contaminated clothing before washing yourself with soap and water, starting at the head and working toward the feet.
- **Practice good hygiene.** Good hygiene is a preventive measure for spreading disease, and it is important to be mindful of hygiene in a post-disaster environment. Clean drinking water and sanitation are important protective actions.

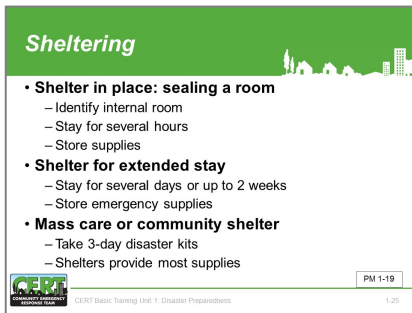

Sheltering

- **Shelter in place: sealing a room**
 - Identify internal room
 - Stay for several hours
 - Store supplies
- **Shelter for extended stay**
 - Stay for several days or up to 2 weeks
 - Store emergency supplies
- **Mass care or community shelter**
 - Take 3-day disaster kits
 - Shelters provide most supplies

 PM 1-19
CERT Basic Training Unit 1: Disaster Preparedness 1.25

Sheltering

There are different types of sheltering that are appropriate for different disasters.

- **Shelter in place:** Sealing a room is a way to protect themselves from contaminants in the air for a short period until the contaminants dissipate. They should identify an internal room in their home, at work, or other locations where they spend a great deal of time. If they are required to shelter-in-place, they will be in this room for only a few hours, but it is important that they seal the room quickly. Storing specific items in the room is helpful. They should have snacks and water, a battery-operated radio, a flashlight, and pre-cut plastic sheeting and duct tape to seal off vents and door and window openings.
- **Shelter for an extended stay:** Sheltering for an extended stay means they would shelter in place for several days. In the case of a pandemic, authorities may ask them to limit their time outside the home for up to two weeks. It is important to store emergency supplies for these possibilities.
- **Mass care/community shelter:** These shelters often provide water, food, medicine, and basic sanitary facilities but, if possible, they should take their 3-day disaster supplies kit with them so that they will be sure to have the supplies they require.

Check for understanding.

Before we move on to hazard mitigation, does anyone have any questions about assembling and storing a disaster supply kit, escape planning, or sheltering?

SECTION 5: REDUCING THE IMPACT OF HAZARDS THROUGH MITIGATION

Mitigation

Mitigation

- Mitigation is the reduction of loss of life and property by lessening the impact of disasters and includes any activity that prevents an emergency or reduces effects of hazards
- CERT members should have adequate homeowners coverage
 - Add flood insurance if in a flood hazard area

CERT Basic Training Unit 1: Disaster Preparedness
PM 1-20

Assembling disaster supplies and having a family disaster plan will help lessen the impact that a disaster may have on a person and their family. Mitigation is another approach a person can take. Mitigation is the reduction of loss of life and property by lessening the impact of disasters. This includes any activities that prevent an emergency, reduce the likelihood of occurrence, or reduce the damaging effects of unavoidable hazards, such as taking non-structural measures, making structural changes, and purchasing appropriate insurance.

CERT members should ensure their homeowner’s policy provides adequate coverage and covers appropriate hazards in their area. Homeowner’s insurance does not cover damage caused by flooding, so it is important to know whether they are in a flood hazard area and to purchase flood insurance if they are. Visit the National Flood Insurance Program Web site, www.floodsmart.gov, to learn more.

Explain that while some mitigation measures require a bigger investment to address structural changes to reduce the impact of disasters, other non-structural mitigation measures may include relatively simple actions to prevent home furnishings and appliances from causing damage or injuries during any event that might cause them to shift.

Refer the participants to **Table 1.5: Home Mitigation Measures** in the Participant Manual.

Table 1.5: Home Mitigation Measures

Type of Hazard	Sample Precautions
Structural	<ul style="list-style-type: none"> • Bolt older houses to the foundation • Install trusses or hurricane straps to reinforce the roof • Strap propane tanks and chimneys • Strap mobile homes to their concrete pads

Structural Mitigation Measures

- Bolt houses to foundations
- Install trusses or hurricane straps to reinforce roof
- Strap propane tanks and chimneys
- Strap mobile homes to their slabs
- Raise utilities
- Build a safe room

CERT Basic Training Unit 1: Disaster Preparedness
PM 1-20

Research the types of structural hazards in your area, and modify these hazard mitigation measures to make them appropriate to your area.

Non-Structural Hazard Mitigation

- Anchor heavy furniture
- Secure appliances and office equipment
- Childproof cabinet doors
- Locate and label gas, electricity, and water shutoffs
- Secure water heaters and have flexible gas lines installed
- Install hurricane storm shutters

CERT Basic Training Unit 1: Disaster Preparedness PM 1-20

Pay particular attention to the precautions that are common and necessary in your locality. Whenever possible, bring in samples of materials used (e.g., industrial-strength hook and loop fasteners), and demonstrate their use.

Type of Hazard	Sample Precautions
	<ul style="list-style-type: none"> • Raise utilities (above the level of flood risk) • Ask a professional to check the foundation, roof connectors, chimney, etc.
Non-Structural	<ul style="list-style-type: none"> • Anchor furniture (e.g., bookshelves, hutches, grandfather clocks) to the wall • Secure appliances and office equipment in place with industrial strength hook and loop fasteners • Secure cabinet doors with childproof fasteners • Locate and label shutoffs for gas, electricity, and water before disasters occur. After a disaster, shut off the utilities as needed to prevent fires and other risks • Teach all home occupants, including children who are old enough to handle the responsibility, when and how to shut off the important utilities • Secure water heaters to the wall to safeguard against ruptured gas line or loose electrical wires • Install hurricane storm shutters to protect windows

Emphasize that a safe room is NOT the same as a shelter-in-place location. A safe room requires significant fortification in order for the room to provide protection against extremely high winds. More information is available at www.fema.gov/plan/prevent/saferoom/index.shtm.

Tell participants that sheltering-in-place protects against contaminants in the air. To shelter in place, they do not need to alter the structure of the room. Participants are simply sealing the room with plastic sheeting and duct tape for a short period while the contaminants in the air dissipate.

Fortifying Your Home

Remind the group that different non-structural hazards pose different threats, depending on the disaster, as evidenced by the following examples:

- Home Fires. Make sure burglar bars and locks on outside window entries are easy to open from the inside.
- Landslides and Mudslides. Install flexible pipefittings to avoid gas or water leaks. Flexible fittings are more resistant to breakage.
- Wildfires. Avoid using wooden shakes and shingles for roofing. Clear all flammable vegetation at least 30 feet from the home. Remove vines from the walls of the home. Place propane tanks at least 30 feet from the home or other structures. Stack firewood at least 30 feet away and uphill from the home.

For more information: “Learn About the Different Types of Disasters and Hazards” at

www.fema.gov/hazard/index.shtm.



Check for understanding.

Do you have any questions about hazard mitigation and the steps you can take to prepare your home?



SECTION 6: CERT DISASTER RESPONSE

Explain that, as described earlier in this unit, CERTs respond in the period immediately after a disaster when response resources are overwhelmed or delayed.

CERTs assist emergency response personnel when requested in accordance with standard operating procedures developed by the sponsoring agency. Working as a team, volunteers assume some of the same functions as emergency response personnel.

Remind participants that, while CERTs are valuable assets in emergency response,

CERTs are not trained to perform all of the functions or respond to the same degree as professional responders. CERTs are a bridge to professional responders until they are able to arrive.

CERTs respond after a disaster by:

- Treating life-threatening injuries until professional assistance is available;
- Helping disaster survivors cope with their emotional stressors;
- Locating and turning off utilities, if safe to do so;
- Extinguishing small fires; and
- Conducting light search and rescue operations.

There is a distinction between how an individual CERT volunteer responds to a disaster, and how that volunteer responds as part of a team. In all instances, it is critical for CERT volunteers to stay within the limits of their training when providing disaster relief.

A CERT volunteer's first responsibility is personal and family safety. Only after CERT volunteers have secured their personal and family safety is it possible and pertinent to respond in a group capacity and do what is necessary for the community. For many participants, that is the central reason for attending this training.

In this way, CERT volunteers can provide first for their own well-being and that of their family and, once appropriate, serve as part of the CERT responding to the disaster in the community.

The sponsoring agency orchestrates its group response. In general, the team members select a leader (and

alternate) and define the meeting location, or staging area, they will use in the event of disaster.

CERT volunteers gather at the pre-established staging area to organize and receive tasking assignments. Leaders may identify “runners” to serve as a communication link between the staging area and CERT volunteers working in the field.

In some cases, CERT volunteers also provide a well-trained workforce for such duties as shelter support, crowd and traffic management, and evacuation.

CERT Organization

Refer the participants to the *Image 1.2 CERT Organization* in the Participant Manual. Point out that they will learn more about the major CERT functional areas in Unit 2.

Emphasize that, no matter which function CERT volunteers perform, effective CERTs require teamwork.

Tell the group that there are checklists in the Additional Materials section at the back of Unit 1 in the *Participant Manual* that will help in:

- Planning and organizing a CERT; and
- Assembling equipment and supplies for a CERT.

Emphasize that many details included in the checklists for Team Organization will be discussed in later units of the training.

Do you have any questions about community preparations?

Personal Protective Equipment

Emphasize that, at all times, a CERT volunteer’s first job is to stay safe.

Remind the participants of the central importance of wearing the appropriate personal protective equipment (PPE). CERT volunteers are required to wear:

- Helmet;
- Goggles;
- N95 Mask*;
- Gloves (work and non-latex exam); and
- Sturdy shoes or boots.

*Also referred to as a surgical mask, these single-use masks filter at least 95 percent of airborne particles.

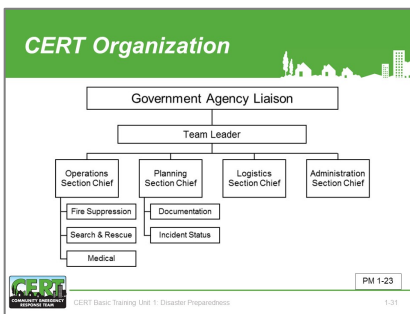

Clearly explain to whom CERTs report in your area.

Explain also that this is a snapshot of how CERTs operate. CERT organization and operation will be covered in detail Unit 2.

Check for understanding.



Briefly demonstrate the proper equipment by putting on your own PPE.



CERT in Action

Across the country, CERTs continue to be activated in a wide range of disaster and emergency support operations. For these efforts, CERT volunteers and teams are receiving Federal, state, and local recognition for their response assistance.

For brief profiles of how CERTs have assisted in actual emergencies all over the country, visit: www.ready.gov/community-emergency-response-team.



CERT in Non-Disaster Roles

CERT volunteers are a potential volunteer pool for the community. They can help with projects such as:

- Identifying and aiding neighbors and coworkers who might need assistance during an emergency or disaster;
- Distributing preparedness materials and doing preparedness demonstrations;
- Staffing parades, health fairs, county fairs, and other special events;
- Assisting with the installation of smoke alarms for seniors and special-needs households; and
- Traffic and crowd management at community events.

Describe non-emergency volunteer opportunities for CERTs in your community.

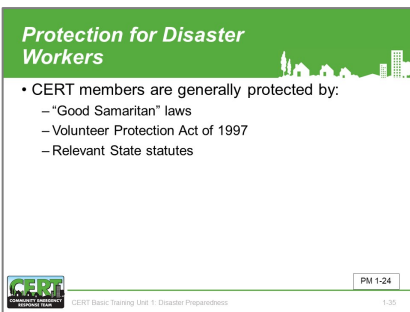

Protection for Disaster Workers

Inform the group that “Good Samaritan” laws generally protect CERT volunteers who provide care in a prudent and reasonable manner.

State that during a disaster, the Volunteer Protection Act of 1997, a Federal law that protects volunteers from liability as long as they are acting in accordance with the training that they have received, also protect CERT volunteers.

Add that CERT volunteers may also have protection under relevant state statutes where they live. Remind participants that these laws vary from state to state and emphasize the laws that apply in their area. Refer participants to **Table 1.6: Local Laws in Your Area** in their Participant Manuals to record these laws.

Please remember to cover all state laws that apply to both rescuers and survivors. If pertinent information has been entered on the page, tell participants to turn to page 38 in their Participant Manuals for applicable laws. Direct participants to the following website for additional information: <https://www.nonprofitrisk.org/app/uploads/2017/01/state-liability-laws.pdf>

Table 1.6: Local Laws in Your Area

Applicable Laws and Key Points	
Applicable Laws	Key Points

Check for understanding.

Does anyone have any questions about CERT disaster response?

SECTION 7: ADDITIONAL TRAINING FOR CERT VOLUNTEERS

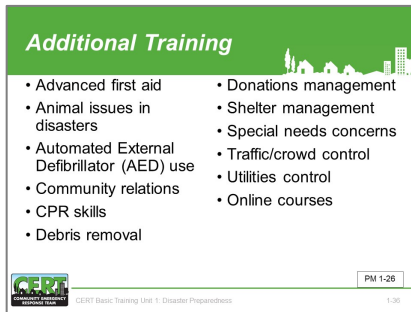

Indicate that these are some examples and specify any additional training that your program offers to CERT members.

Recommend the CERT Web site for online training for a range of topics:
www.fema.gov/cert

Let the group know that after completing CERT Basic Training, many CERT volunteers seek to expand and improve their skills — through continuing CERT modules offered locally, courses offered through the American Red Cross or programs from other sources. Some CERT volunteers have sought additional training opportunities in:

- Advanced first-aid;
- Animal issues in disasters;
- Automated External Defibrillator (AED) use;
- Community relations;
- CPR skills;
- Debris removal;
- Donations management;
- Shelter management;
- Special needs concerns;
- Traffic and crowd control; and
- Utilities control.

There are also Independent Study (IS) courses available online from FEMA, that may be of interest to CERT volunteers. Some of these include:

- IS-100 Introduction to Incident Command System (ICS);
- IS-200 ICS for Single Resources and Initial Action Incidents;
- IS-700 National Incident Management System; (NIMS), An Introduction; and
- IS-800 National Response Framework, An Introduction.

For a complete listing and access to FEMA IS courses, visit www.training.fema.gov/IS/. Click on the “IS Course List” link.

Does anyone have any questions about additional training?

Check for understanding.

UNIT SUMMARY

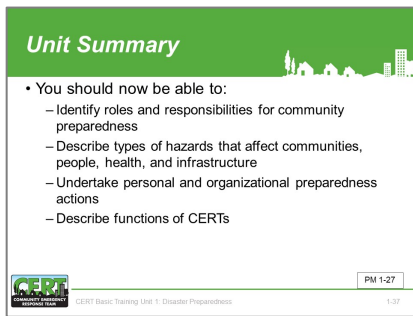

Unit Summary

- You should now be able to:
 - Identify roles and responsibilities for community preparedness
 - Describe types of hazards that affect communities, people, health, and infrastructure
 - Undertake personal and organizational preparedness actions
 - Describe functions of CERTs

CERT
Community Emergency Response Team

CERT Basic Training Unit 1: Disaster Preparedness

PM 1-27

Summarize the unit by reviewing the following points:

- Everyone in the community has the ability and the responsibility to prepare for disasters.
- Engaging the Whole Community can increase collective preparedness and disaster resilience.
- Government leaders have the responsibility to engage the whole community in the process of community planning, and in testing and evaluating community plans.
- Community leaders have the responsibility to ensure their employees and constituent groups are prepared to participate on coordinating planning councils.
- The public has the responsibility to learn about community hazards and plans, as well as how to prepare, train, practice, and volunteer.
- There are five types of disasters: natural, technological and accidental, terrorist, pandemics, and home fires. Most hazards occur with little or no notice, may cause emergency personnel to be overwhelmed, and are a danger to lives, health, and the environment.
- Personal preparedness should be tailored to the hazards in your community:
 - Learning about community alerts, warnings, and plans;
 - Learning about appropriate protective actions;
 - Developing household plans and conducting drills to practice;
 - Assembling disaster supplies in multiple locations;
 - Reducing hazards in the home; and
 - Encouraging others to prepare and volunteer to help your community.
- CERTs are among a variety of agencies and personnel who cooperate to provide assistance in the aftermath of a disaster. The keys to CERT effectiveness are:
 - Familiarity with the types of events that are high risk for the area and the types of damage that can occur as a result;

- Adequate preparation for each event and its aftermath;
- Training in the functional areas to which CERTs are assigned; and
- Practice through refreshers and simulations.

CERTs have proven themselves invaluable in the areas in which they were tested. They can be invaluable in this community as well.

Do you have any questions about anything covered in this unit?

Check for understanding.

Homework Assignment

- Review the detailed information in Unit 1 of the Participant Manual
- Read and familiarize yourself with Unit 2: CERT Organization in the Participant Manual
- Discuss preparedness with family and friends and make a communications plan, including an out-of-state "check-in contact "
- Begin to assemble supplies in multiple locations
- Examine your home for hazards and identify ways to prevent potential injury



CERT Basic Training Unit 1: Disaster Preparedness

PM 1-27

1-39

Note: For courses, completed in 3 days, disregard the homework assignment. If the schedule permits, allow students a moment to review the material in Unit 2: CERT Organization before moving on.

Homework Assignment

Tell the group that the next unit will cover CERT organization. Then remind the group that, before the next session, they should:

- Review the detailed information in Unit 1 of the Participant Manual.
- Read and familiarize themselves with Unit 2: *CERT Organization in the Participant Manual*.
- Discuss preparedness with family and friends and make a communications plan that includes establishing an out-of-state "check-in contact."
- Begin to assemble supplies in multiple locations.
- Examine their homes for hazards and identify ways to prevent potential injury.

Thank the participants for attending this session.

[This page intentional left blank]



CERT Unit 1: Additional Materials

- Community Emergency Response Team Checklist
- Recommended PPE
- Recommended CERT Equipment and Supplies

[This page intentional left blank]

COMMUNITY EMERGENCY RESPONSE TEAM CHECKLIST

Instructions: This checklist will help guide you in the setup of your CERT as well as emergency preparedness at home.

Team Organization	Check if Completed	Date Checked
Personal Preparedness		
Food	<input type="checkbox"/>	
Water	<input type="checkbox"/>	
Out-of-State Check-In Contact	<input type="checkbox"/>	
Mitigation Measure: Water heater	<input type="checkbox"/>	
Mitigation Measure: Utilities	<input type="checkbox"/>	
Mitigation Measure: Cabinets, etc.	<input type="checkbox"/>	
Other: _____	<input type="checkbox"/>	
Team Organization: Leadership		
Incident Commander/Team Leader	<input type="checkbox"/>	
Group leaders	<input type="checkbox"/>	
Team Organization: Membership		
Roster	<input type="checkbox"/>	
Phone list	<input type="checkbox"/>	
Skills inventory	<input type="checkbox"/>	
Team Organization: Communications		
Telephone tree	<input type="checkbox"/>	
Newsletter	<input type="checkbox"/>	
Amateur radio	<input type="checkbox"/>	

Team Organization	Check if Completed	Date Checked
Runners	<input type="checkbox"/>	
Team Organization: Resources		
Personnel	<input type="checkbox"/>	
Equipment	<input type="checkbox"/>	
Supplies	<input type="checkbox"/>	
Personal CERT Kit	<input type="checkbox"/>	
Team Organization: Area Surveys and Locations		
Evacuation plans	<input type="checkbox"/>	
Staging area/command post	<input type="checkbox"/>	
Medical treatment area	<input type="checkbox"/>	
Specific hazard areas	<input type="checkbox"/>	
Area maps	<input type="checkbox"/>	
Team Organization: Response Plan		
Response criteria	<input type="checkbox"/>	
Communications and notifications	<input type="checkbox"/>	
Staging area/command post	<input type="checkbox"/>	
Team Organization: Teamwork		
Meetings	<input type="checkbox"/>	
Drills and exercises	<input type="checkbox"/>	
Training: First-aid	<input type="checkbox"/>	
Training: CPR	<input type="checkbox"/>	
Other: _____	<input type="checkbox"/>	

RECOMMENDED PERSONAL PROTECTION EQUIPMENT (PPE)

The following items are required safety equipment for all CERT volunteers.

- Hard hat
- Protective eyewear (safety goggles)
- Leather work gloves
- Long-sleeved shirt
- N-95 mask
- Reflective vest
- Sturdy shoes or boots
- Long pants

RECOMMENDED CERT EQUIPMENT AND SUPPLIES

The following equipment and supplies are recommended as minimum kit items for each CERT volunteer. These guidelines are recommended in addition to team supplies.

Equipment and Supplies	Date Obtained	Quantity	Date Checked
• Nylon or canvas bag with shoulder strap			
• Water (two canteens or bottles per search and rescue team)			
• Dehydrated foods			
• Water purification tablets			
• Work gloves (leather)			
• Non-latex exam gloves (10 pair min.)			
• Goggles			
• N95 masks			
• Flashlight or miner's lamp			
• Batteries and extra bulbs			
• Secondary flashlight			

Equipment and Supplies	Date Obtained	Quantity	Date Checked
<ul style="list-style-type: none"> • Cyalume sticks (12-hour omni glow) 			
<ul style="list-style-type: none"> • Voltage tick meter 			
<ul style="list-style-type: none"> • Pea-less whistle 			
<ul style="list-style-type: none"> • Utility knife 			
<ul style="list-style-type: none"> • Markers: <ul style="list-style-type: none"> – Thin-point – Thick-point 			
<ul style="list-style-type: none"> • Pens 			
<ul style="list-style-type: none"> • Duct tape 			
<ul style="list-style-type: none"> • Masking tape (2-inch) 			
<ul style="list-style-type: none"> • Scissors (EMT shears) 			
<ul style="list-style-type: none"> • Non-sparking crescent wrench 			
<ul style="list-style-type: none"> • First-aid pouch containing: <ul style="list-style-type: none"> – 4 by 4-inch gauze dressings (6) – Abdominal pads (4) – Triangular bandages (4) – Band-Aids – Roller bandage – Any personal medications that a CERT member may need during deployment 			

[This page intentional left blank]



CERT Unit 2: CERT Organization

Instructor Guide



FEMA

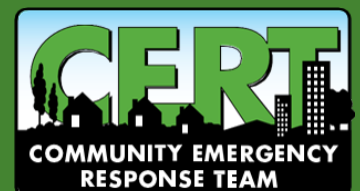

[This page intentional left blank]



CERT Unit 2: CERT Organization

In this unit, participants will learn about:

- ❑ **CERT Organization:** How to organize and deploy CERT resources according to CERT organizational principles.
- ❑ **CERT Size-up:** How to conduct the continual data-gathering and evaluation process at the scene of a disaster or emergency.
- ❑ **Rescuer Safety:** How to protect your own safety and your buddy's during search and rescue.
- ❑ **Documentation:** Strategies for documenting situation and resource status.

[This page intentional left blank]

CERT Unit 2 Table of Contents

SECTION 1: UNIT OVERVIEW	2-1
Unit Objectives	2-1
SECTION 2: CERT ORGANIZATION	2-2
Principles of On-Scene Management	2-2
CERT Application of On-Scene Management	2-2
Objectives for CERT On-Scene Management	2-3
Incident Command System	2-3
CERT Operations	2-6
Dealing with the Media	2-7
NIMS Implementation	2-7
Exercise 2.1 ICS Functions	2-8
SECTION 3: CERT MOBILIZATION	2-10
CERT On-Scene Size-up	2-10
Rescuer Safety	2-13
SECTION 4: DOCUMENTATION	2-16
Documentation Forms	2-17
Documentation Flow	2-20
UNIT SUMMARY	2-31
Homework Assignment	2-31
CERT UNIT 2: ADDITIONAL MATERIALS	2-34
CERT Damage Assessment Form	2-34
CERT Personnel Resources Check-In Form	2-35
CERT Assignment Tracking Log	2-36
CERT Briefing Assignment Form	2-37
CERT Team Action Log	2-38
CERT Victim Treatment Area Record	2-39
CERT Communications Log	2-40
CERT Equipment Inventory Log	2-41
CERT General Message Form	2-42

[This page intentional left blank]

UNIT OBJECTIVES

At the conclusion of this unit, participants will be able to:

1. Describe the CERT organizational structure;
2. Explain the Incident Command System (ICS) and how CERT operates within this structure;
3. Describe the 9-step on-scene size-up process; and
4. Describe how to use CERT standard documents.

SCOPE

The topics that will be discussed in this unit are:

- Introduction and Unit Overview;
- CERT Organization;
- CERT Mobilization;
- On-Scene Size-up;
- Documentation;
- Activity: ICS Functions;
- Tabletop Exercise; and
- Unit Summary.

ESTIMATED COMPLETION TIME

The following timetable (**Table 2: Estimated Completion Times**) is suggested for this module.

Table 2: Estimated Completion Times

Unit	Estimated Time
Introductions and Overview	5 minutes
CERT Organization	20 minutes
Exercise: ICS Functions	10 minutes
CERT Mobilization	10 minutes
CERT On-Scene Size-up	5 minutes
Documentation	10 minutes
Unit Summary	5 minutes
Total	1 hour, 5 minutes

RESOURCES REQUIRED

- Community Emergency Response Team Instructor Guide

- Community Emergency Response Team Participant Manual
- PowerPoint Slides 2-0 through 2-22

EQUIPMENT

The following additional equipment is required for this unit:

- A computer with PowerPoint software; and
- A computer projector and screen.

PREPARATION

- Consider whether you want to include basic crime scene protocols in this unit. If so, arrange for that information to be delivered.
- A set of CERT documentation forms is included in the Instructor Guide and in the Participant Manual. Other options may also be used. If your local program decides to use any of the forms listed below before conducting this unit, replace the forms in this unit of the Instructor Guide and the Participant Manual. It is useful to include a blank form and an example of the same form with information filled in.
 - Some local CERT programs develop their own CERT documentation forms and/or adapt forms used by the agency that sponsors the CERT program.
 - Other CERT programs use forms that the Los Angeles CERT Program developed originally. These samples and other forms are available at www.cert-la.com/cert-programs-information/cert-forms/. The forms should be adapted to fit your program needs.
 - The National Incident Management System (NIMS) requires adoption of the ICS. If your department's NIMS compliance plan includes the use of ICS forms, some of these forms could be considered for CERT as well. All of the ICS forms are available [here](#).
- Working with a representative of the community in which you will be teaching, identify any potentially culturally sensitive topics in this module. Develop strategies for presenting any such topics in ways that will engage, rather than offend, participants.
 - Consider how participants may react to discussions of leadership and other ICS roles. Some audiences may find the chain-of-command structure to be rigid and uncomfortable. Be sure to explain the critical importance of all ICS roles, and point out that the incident commander role is not more or less important than any other role. Focus on the concept of teamwork and the importance of team structure in a disaster.



SECTION 1: UNIT OVERVIEW

Welcome

Welcome the participants to Unit 2 of the CERT Basic Training.

Introduce the instructors for this unit and ask any new instructors to briefly describe their experience with CERT organization.

In this session, participants will learn how CERT operates in a team environment. Later in the training, participants will be asked to use teamwork during medical assessment and search and rescue operations. Point out that team organization concepts can help them both operationally and psychologically. Working together and looking out for each other are important aspects of successful teams.

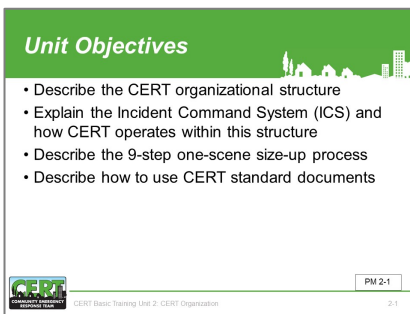

Unit Objectives

Tell the participants that at the end of this unit, they should be able to:

1. Describe the CERT organizational structure;
2. Explain the ICS and how CERT operates within this structure;
3. Describe the 9-step on-scene size-up process; and
4. Describe how to use CERT standard documents

Note that effective CERT operations, like all aspects of emergency response, rely on effective communication.

Ask the group to note how frequently effective communication underlies the operational guidance to be covered in this unit.

Principles of On-Scene Management

- Maintain the safety of disaster workers
- Provide clear leadership and organizational structure
- Improve effectiveness of rescue efforts

CERT
CERT Basic Training Unit 2: CERT Organization

PM 2-2 2.2

SECTION 2: CERT ORGANIZATION

Principles of On-Scene Management

Point out that the CERT organization is based on the ICS, which is a proven management system used by emergency responders across the country. On-scene management in a disaster situation follows these principles:

- Maintain the safety of disaster workers. The CERT Team Leader (TL) must continually prioritize response activities based on the team's capability and training and the principle that rescuer safety is the number one concern. CERT functional leadership assigns activities and accounts for team volunteers. CERT volunteers work in the buddy system and respond based on their size-up of the situations that they encounter.
- Provide clear leadership and organizational structure by developing a chain of command and roles that are known by all team volunteers. Each CERT member has only one person that he or she takes direction from and responds to.
- Improve the effectiveness of rescue efforts. Disaster information is collected, and responses are prioritized based on rescuer safety and doing the greatest good for the greatest number according to the team's capabilities and training.

CERT On-Scene Management

- Well-defined management structure
- Manageable span of control
- Common terminology
- Effective communication
- Consolidated action plans
- Comprehensive resource management
- Accountability

CERT
CERT Basic Training Unit 2: CERT Organization

PM 2-2 2.3

CERT Application of On-Scene Management

The specific CERT organizational structure and protocols provide:

- A well-defined management structure (e.g., leadership, functional areas, reporting chain, working in teams);
- A manageable span of control that provides for a desirable rescuer-to-supervisor ratio of between three and seven rescuers per supervisor;
- Common terminology that contributes to effective communication and shared understanding;
- Effective communication among team volunteers and with professional responders, including the use of radios;
- Consolidated action plans that coordinate strategic goals, tactical objectives, and support activities;

- Comprehensive resource management that facilitates application of available resources to the incident in a timely manner; and
- Accountability.

Objectives for On-Scene Management

- Identify scope of incident
- Determine overall strategy
- Deploy resources
- Document actions and results

PM 2-2

Objectives for CERT On-Scene Management

In a disaster situation, the CERT Team Leader:

- Identifies the scope of the incident (i.e., What is the problem?);
- Determines an overall strategy (i.e., What can we do, and how will we do it?);
- Deploys teams and resources (i.e., Who is going to do what?); and
- Documents actions and results.

Stress that disasters create a dynamic, continuously changing environment. The CERT organizational framework is flexible, so it can expand or contract depending on the ongoing assessment priorities determined by the CERT Team Leader (TL), and people and resources available. This expansion and contraction helps ensure:

- Rescuer safety;
- Doing the greatest good for the greatest number;
- A manageable span of control; and
- Accountability of CERT volunteers.

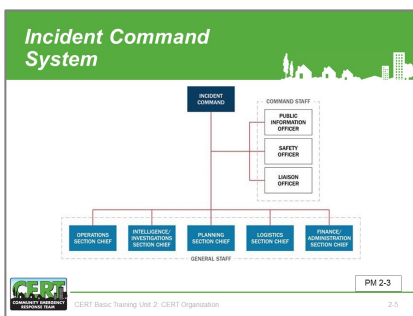

Incident Command System

As noted, the ICS is the system used by emergency response agencies to manage emergency operations. When CERTs activate, they become part of that system.

Explain that the basic ICS structure for CERT is established by the person who arrives first on the scene. This person becomes the TL. Initially, the TL may handle all of the command positions of ICS but, as the incident evolves, he or she may assign personnel as needed to the ICS Command Functions:

5. Operations Section Chief;
6. Intelligence/Investigations Section Chief;
7. Logistics Section Chief;
8. Planning Section Chief; and
9. Finance/Administration Section Chief.

Emphasize to participants that through an effective ICS, all CERT volunteers report through a chain of command

to the TL. The TL reports to the first fire or law enforcement official at their location and takes direction from that person until otherwise directed, or until the CERT is relieved.

Refer the participants to **Image 2.1: ICS Command Function Organization Chart** in the Participant Manuals.

Image 2.1: ICS Command Function Organization Chart

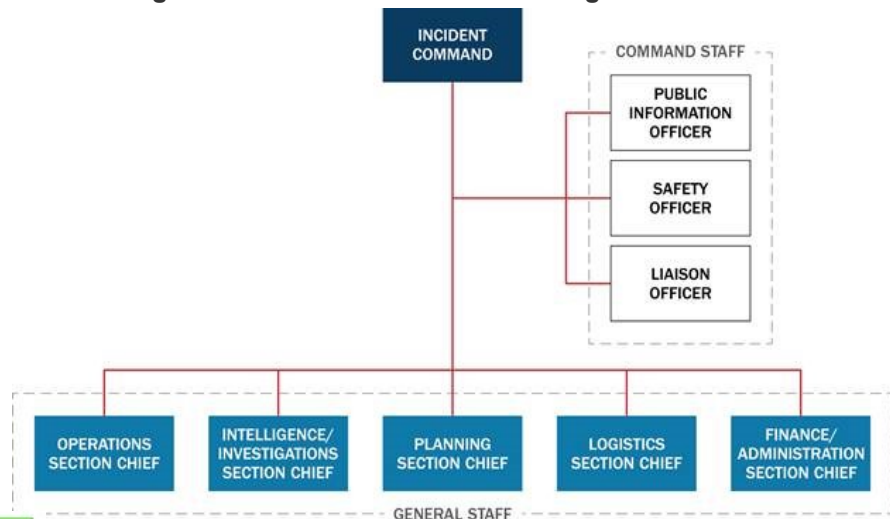

Emphasize this point.

Emphasize that CERTs will typically require the Operations, Planning, and Logistics functions. The CERT TL is responsible for handling or delegating each function.

Explain that, as the incident expands, it may be necessary to assign other personnel in each section to handle specific aspects of the response while maintaining an effective span of control.

Explain the responsibilities of each standard ICS function. Be sure to emphasize that, though there are a number of detailed responsibilities under each ICS function, the system itself is straightforward.

CERT Team Leader:

- Provides overall leadership for incident response;
- Ensures incident safety;
- Establishes incident objectives;
- Is responsible for all functions until delegated;
- Delegates authority to others;
- Provides information to internal and external parties;

- Establishes and maintains liaison with other responders (e.g., fire, law enforcement, public works, other CERTs); and
- Takes direction from an agency official.

Operations Section:

- Directs and coordinates all incident tactical operations;
- Is typically one of the first functions to be assigned;
- Supports medical operations;
- Participates in search and rescue operations; and
- Manages traffic.

Intelligence/Investigations Section:

- Prevents and deters potential unlawful activity, incidents, and/or attacks;
- Collects, processes, analyzes, secures, and appropriately disseminates information and intelligence;
- Conducts investigations; and
- Informs and supports life safety operations.

Explain that the Intelligence/Investigations section is a function in the formal ICS. CERTS, however, will have a very limited involvement (if any) with this function.

Planning Section:

- Tracks resource status (e. g., number of CERT volunteers who have “reported for duty”);
- Tracks situation status;
- Prepares the Team’s action plan;
- Develops alternative strategies; and
- Provides documentation services.

Logistics Section:

- Provides communications;
- Provides food and medical support to team volunteers; and
- Manages supplies and facilities.

Finance and Administration Section:

- Contract negotiation and monitoring;
- Timekeeping;
- Cost analysis; and
- Compensation for injury or damage to property.

Explain that Finance and Administration is a function in the formal ICS; however, CERTs will have very limited involvement, if any, with this function.

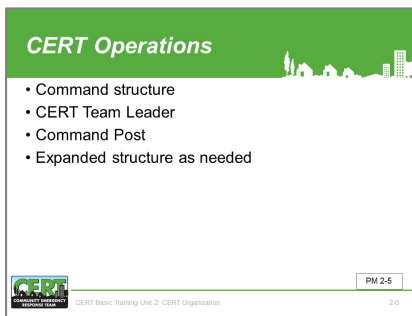

CERT Operations

Explain the following points about the principles of ICS and how CERTs follow these protocols:

- Each CERT must establish a command structure.
- The CERT TL directs team activities. During activation for a disaster, the first person at a predesignated staging area assumes this responsibility. The initial TL may hand off this role to a predesignated leader when that person arrives.
- The location established by the CERT TL as the central point for command and control of the incident is called the Command Post for the CERT. The TL stays in the Command Post. If the TL has to leave, the responsibility of TL must be delegated to someone in the Command Post.

Using the ICS structure, CERT volunteers are assigned to assist with a range of functions:

- **Logistics.** Managing resources, services, and supplies;
- **Planning/Intelligence.** Collecting and displaying information; collecting and compiling documentation; and
- **Operations.** Conducting fire suppression, medical operations, search and rescue.

In all situations, each unit assigned must have an identified leader to supervise tasks being performed, to account for team volunteers, and to report information to his or her designated leader. In all situations, a manageable span of control is three to seven team volunteers reporting to their designated leader.

Refer the participants to **Image 2.2: Expanded CERT Operations Structure** in the Participant Manual.

Image 2.2: Expanded CERT Operations Structure

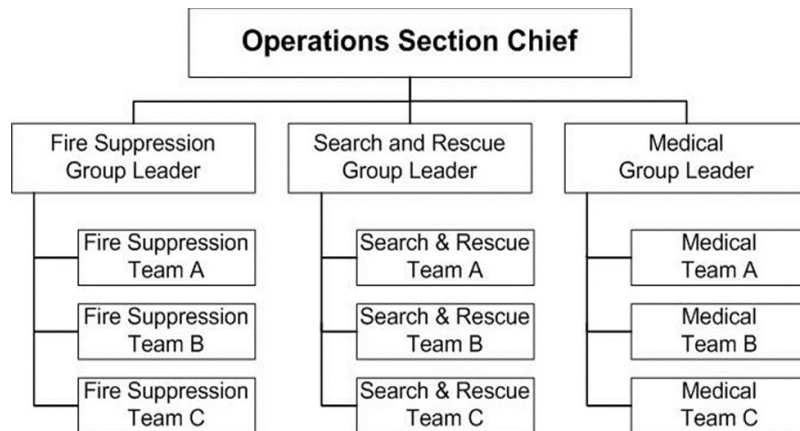

CERT operations section structure, showing the Operations Section Chief at the top and the three Group Leaders underneath

Dealing with the Media

Dealing with the Media

- Refer media inquiries to CERT Incident Commander/Team Leader
- Do not let media inhibit CERT goals
- Be careful about information released



PM 2-6

Explain that CERT volunteers should refer any media inquiries to the CERT TL. The TL should then refer the media inquiries to the Public Information Officer of the CERT’s sponsoring organization.

If the Public Information Officer of the sponsoring organization refers media to the CERT TL or otherwise authorizes them to speak with the media, the TL should:

- Refrain from addressing the media. Doing so will no longer inhibit or delay the team’s ability to do the greatest good for the greatest number in the shortest amount of time;
- Establish an area for briefing the media if necessary;
- Be careful about releasing information, by making sure it is both accurate and approved for release, while also keeping in mind survivors’ right to privacy; and
- Not feel compelled to answer every question asked.

If your CERT has basic protocols for how to handle a crime scene, discuss those here.

Check for understanding.

Does anyone have any questions about CERT structure or ICS?

NIMS Implementation

- Ability to work together
- IS-100: Introduction to ICS
– <https://emilms.fema.gov/IS100/curriculum/1.html>
- IS-700: Introduction to NIMS
– <https://emilms.fema.gov/IS700b/curriculum/1.html>



PM 2-6

NIMS Implementation

Conclude the discussion by noting that the ICS is part of the National Incident Management System (NIMS). NIMS provides a consistent, comprehensive approach to incident management. It applies to all jurisdictional levels and across all emergency management functions and types of incidents.

Explain that NIMS was established so that first responders, including CERT volunteers, from different jurisdictions and disciplines can work together to better respond to disasters and emergencies.

To meet NIMS standards, CERT volunteers must complete both the IS-100.a (*Introduction to Incident Command System*) and IS-700.b

(*Introduction to National Incident Management System [NIMS]*) courses.

Encourage participants to complete both IS-100 and IS-700. Remind them if your program requires CERT participants to complete IS-100 or 700 before they are considered official CERT volunteers.

Exercise 2.1

- Using your knowledge about the ICS functions, decide under which function the following CERT activities would fall. Some activities may involve more than one function to be completed
- Use the following key to fill in the blanks before each activity:
 - Team Leader = TL
 - Operations = O
 - Planning = P
 - Logistics = L

PM 2-6

CERT Basic Training Unit 2: CERT Organization 2-9

- Both independent study courses are available online from FEMA at <http://training.fema.gov/IS/NIMS.asp>.

Exercise 2.1: ICS Functions

Purpose: This activity will give the participants an opportunity to relate the ICS functions to specific situations.

Instructions:

- Assign the participants to small table groups.
- Explain how this exercise will provide the group with the opportunity to decide under which ICS functions the listed activities will fall.
- Tell the group to review the list of activities and use the initials, “TL,” “O,” “P,” or “L” to indicate which ICS function would cover each activity.
- When the groups have finished, ask a spokesperson from each group to provide the group’s answers to the class.

Remind participants that while Finance/Administration is part of ICS, it is generally not used by CERTs. Refer participants to **Table 2.1: ICS Activities** in their Participant Manuals.

Table 2.1: ICS Activities

Scenario	ICS Function
It’s dark, all the lights are out, and you need additional flashlights to continue your response.	
The designated first-aid site has a downed power line.	
A neighbor reports the smell of gas in his house, but he cannot shut off the gas at the meter.	
The batteries for the portable radio are dead.	
The city wants to know the overall status of your neighborhood.	
Several of your neighbors have minor injuries and need first-aid.	
Fire from another neighborhood is moving toward your neighborhood.	
There is a pit bull-type dog seen wandering near the first-aid station.	

Scenario	ICS Function
A news crew has arrived with a camera to film your activities.	
Two hysterical neighbors are demanding help. One cannot find her adolescent child who was playing outside when the disaster struck. The other wants help moving a bookcase off of his wife. He says she's bleeding from a wound on the head.	
It's starting to rain. Your command post and the first-aid area are not under shelter.	
Too many people are coming to the Team Leader to ask questions. The Team Leader asks for someone to act as a "gatekeeper."	
There is a great increase of car and foot traffic through your neighborhood because other roadways are blocked.	
The Team Leader is very tired and is going to hand over responsibilities to someone else. He or she wants a report on the status of the neighborhood before doing so.	
Many neighborhood residents have come to volunteer their help.	
Reports have come in of damage and injuries in the next block. Teams must be assigned to assess the situation.	
A professional responder has arrived at the scene and would like a briefing on situation status.	

Tell the participants the next topic will explain CERT mobilization. Explain that some of the information will be a preview of topics covered in Unit 7: *Light Search and Rescue Operations*.

CERT Mobilization

- CERTs take care of themselves, their families, their homes, their neighbors
- Proceed to predesignated staging area
- TL is established, organizes the group
- TL prioritizes actions
- Organization is flexible and evolves based on new information

PM 2-8

This description provides an explanation for CERT deployment based on the concept of a response to a catastrophic disaster. Each community needs to develop its unique standard operating procedure for CERT.

SECTION 3: CERT MOBILIZATION

Introduce CERT mobilization by pointing out how CERTs mobilize when an incident occurs. Immediately following the incident, CERT volunteers take care of themselves, their families, homes, and neighbors.

- If the standard operating procedure
- (SOP) calls for self-activation, CERT volunteers proceed to the predesignated staging area with their disaster supplies. Along the way, they make damage assessments that would be helpful for the CERT TL’s decision-making.
- The first CERT member at the staging area becomes the initial TL for the response. As other CERT volunteers arrive, the CERT TL may pass leadership to someone else. The CERT TL establishes operations to ensure effective communication, maintain span of control, maintain accountability, and to do the greatest good for the greatest number without endangering CERT volunteers.
- One of the CERT TL’s first decisions will be to locate the team’s command post. The staging area may become the command post. However, the command post should be set in another location if it is safer or otherwise better.
- As intelligence is collected and assessed, the TL must prioritize actions and work with the Section Chiefs or leaders. The CERT organization is flexible and evolves based on new information.

Remind the group that, following an incident, information — and, therefore, priorities — may be changing rapidly. Communication between the CERT TL and response teams ensures that CERTs do not overextend their resources or supplies.

On-Scene Size-up

1. Gather Facts
2. Assess and Communicate Damage
3. Consider Probabilities
4. Assess Your Own Situation
5. Establish Priorities
6. Make Decisions
7. Develop Plan of Action
8. Take Action
9. Evaluate Progress

PM 2-9

CERT On-Scene Size-up

On-Scene size-up should be conducted upon CERT mobilization. Size-up is a continual process that enables professional responders to make decisions and respond appropriately in the areas of greatest need. CERT size-up consists of nine steps and should be used in any emergency situation.

Refer the participants to Table 2.2 CERT On-Scene Size-up Worksheet in the Participant Manual. Point out that,

although the checklist is not exhaustive, it does include many of the questions that CERT volunteers should ask when sizing up an emergency situation.

Refer the participants to **Table 2.2: CERT On-Scene Size-Up Worksheet** in the Participant Manual. Point out that, although the checklist is not exhaustive, it does include many of the questions that CERT volunteers should ask when sizing up an emergency situation.

CERT Size-up Steps

The nine steps of CERT size-up are:

Step 1: Gather facts. What has happened? How many people appear to be involved? What is the current situation?

Step 2: Assess and communicate the damage. Try to determine what has happened, what is happening now, and how severe situations can really get.

Step 3: Consider probabilities. What is likely to happen? What could happen through cascading events?

Step 4: Assess your own situation. Are you in immediate danger? Have you been trained to handle the situation? Do you have the equipment that you need?

Step 5: Establish priorities. Are lives at risk? Can you help? Remember, life safety is the first priority!

Step 6: Make decisions. Base your decisions on the answers to Steps 1 through 5 in accordance with the priorities that you established.

Step 7: Develop a plan of action. Develop a plan to help you accomplish your priorities. Simple plans may be verbal, but more complex plans should always be written.

Step 8: Take action. Execute your plan, documenting deviations and status changes so that you can report the situation accurately to first responders.

Step 9: Evaluate progress. At intervals, evaluate your progress in accomplishing the objectives in the plan of action to determine what is working, and what changes you may have to make to stabilize the situation.

Point out that, while size-up is a fire department term, the process has been tailored for CERTs and will be used again in other areas of CERT responsibility.

Provide several examples to illustrate the differences between fire department size-up and CERT size-up.

Unit 2 describes CERT size-up as it is used to respond to any emergency situation. Unit 6 describe the steps associated with fire size-up.

Table 2.2: CERT On-Scene Size-Up Worksheet

Step 1: Gather Facts		
Time		
Does the time of day or week affect response efforts? How?	Yes	No
Weather		
Are there weather conditions that affect your safety? If yes, how will your safety be affected?	Yes	No
Will weather conditions affect the situation? If yes, how will the situation be affected?	Yes	No
Type of Construction		
What type(s) of structure(s) is (are) involved?		
What type(s) of construction is (are) involved?		
Occupancy		
Are the structures occupied? If yes, how many people are likely to be affected?	Yes	No
Are there special considerations (e.g. children, elderly, pets, people with access and functional needs)?	Yes	No
Hazards		
Are hazardous materials evident?	Yes	No
Are any other types of hazards involved? If yes, what other hazards?	Yes	No
Step 2: Assess and Communicate the Damage		
Survey all sides of the scene. Is the danger beyond the CERT's capability?	Yes	No
Have the facts and the initial damage assessment been communicated to the appropriate person(s)?	Yes	No
Step 3: Consider Possibilities		
Life Hazards		
Are there potentially life-threatening hazards? If yes, what are the hazards?	Yes	No
Additional Damage		
Is there a high potential for more disaster activity that will impact personal safety? If yes, what are the known risks?	Yes	No

Step 4: Assess Your Own Situation		
What equipment is available to support response efforts?		
What other resources are available?		
Can response be safely attempted by CERT volunteers? <i>If not, do not attempt response activities.</i>	Yes	No
Step 5: Establish Priorities		
Are there any other more pressing needs now? If yes, list.	Yes	No
Step 6: Make Decisions		
Where will resources do the most good while maintaining an adequate margin of safety?		
Step 7: Develop Plan of Action		
Determine how personnel and other resources should be used.		
Step 8: Take Action		
Put the plan into effect.		
Step 9: Evaluate Progress		
Continually size up the situation to identify changes in the scope of the problem, safety risks, and resources availability.		
Adjust strategies as required.		

Emphasize that size-up is a continuous process.

Evaluation of progress — Step 9 — may require you to go back and gather more facts.

Does anyone have any questions about CERT On-Scene Size-up?

Rescuer Safety

Introduce rescuer safety by telling the participants that effective emergency scene management requires the formulation and communication of strategic goals, as well as tactical objectives to do the greatest good for the greatest number while maintaining the safety of rescue personnel.

Remind the group that **rescuer safety is paramount**. The first question to ask is, “Is it safe for the CERT volunteers to attempt the rescue?”

The identification of rescuer safety issues should be identified during the initial on-scene size-up.

Emphasize that the answer to this question is based mainly on the degree of damage:

- **If the damage is heavy:** No rescue should be attempted. Use tape around the area or mark the area as heavy damage. CERT volunteers do not have any legal authority to stop or restrict someone who wants to enter an area. At best, CERT volunteers can warn others about the danger and inform the CERT TL immediately if it is known that people are in the building.
- **If the damage is moderate:** Locate, assess (quickly evaluate, and treat for airway obstruction, bleeding, and low body temperature), and immediately evacuate survivors to a safe area while minimizing both the number of rescuers inside the building and the amount of time that they remain inside.
- **If the damage is light:** Locate, assess, continue size-up, and document.

Refer the participants to **Table 2.3: CERT Rescue Efforts Based on Degree of Damage** in the Participant Manual and on the following page in the Instructor Guide. Specific strategies are identified for rescue efforts based on degree of damage. Review the strategies listed in the chart.

Explain to the group that the extent of involvement for the various CERT functional teams varies depending on the level of damage encountered.

Table 2.3: CERT Rescue Efforts Based on Degree of Damage

Degree of Damage	Should Rescue be Attempted
Heavy	No, it is too dangerous to enter. Warn people to stay away. Inform the CERT TL immediately if it is known that people are in the building.
Moderate	Yes, but perform only quick and safe removals; limit onsite medical care to checking for breathing, stopping major bleeding, and maintaining body temperature. Minimize the number of rescuers inside the building.

Degree of Damage	Should Rescue be Attempted
Light	Yes, locate, assess, continue size-up, and document.

Image 2.3: CERT Tasks Based on Damage Level

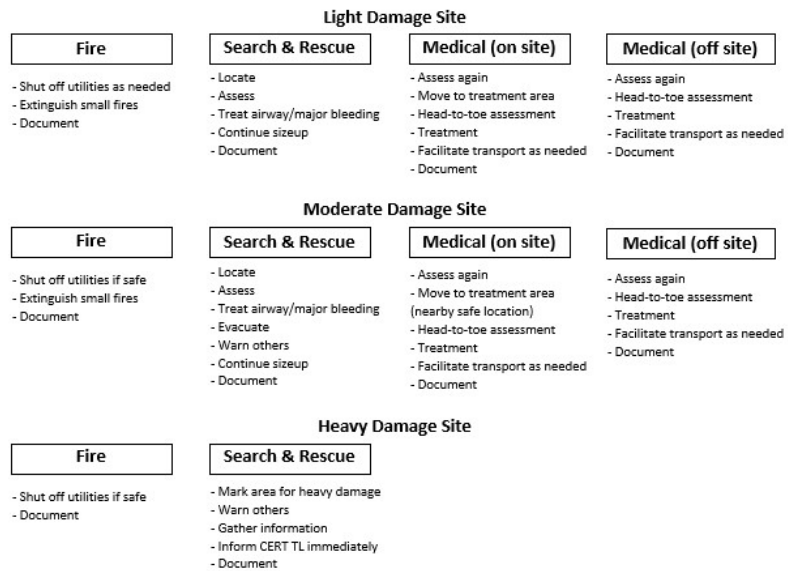

Tasks required of Fire, Search and Rescue, Medical, and Treatment Area teams based on the degree of damage to the structure.

Refer the participants to **Image 2.3: CERT Tasks Based on Damage Level** in the Participant Manual and on the following page in the Instructor Guide.

Describe several hypothetical rescue situations, including the type of disaster, type of structure, and visible or probable damage. After each situation, use the following two questions to get the participants to identify rescue strategies that are appropriate.

Check for understanding.

What is your primary mission?

How would you respond, and why?

Does anyone have any questions about how the CERT’s mission and strategies are affected by the severity of damage?

Tell the group that the next topic covered will be documentation requirements for CERT volunteers.

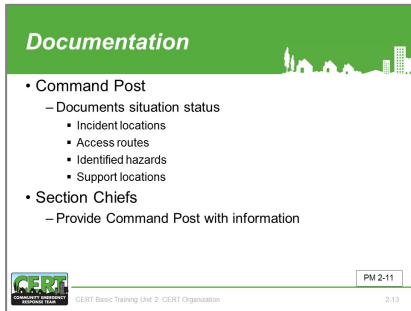

SECTION 4: DOCUMENTATION

Introduce the need to document by emphasizing the importance of documentation and communication about the disaster situation and resource status.

Stress that efficient flow of information makes it possible for resources to be deployed effectively and for professional emergency services to be applied appropriately.

Why do you need to document what happens in an incident?

Recap the discussion by explaining that documentation can serve several purposes:

Introduce the need to document by emphasizing the importance of documentation and communication about the disaster situation and resource status.

Stress that efficient flow of information makes it possible for resources to be deployed effectively and for professional emergency services to be applied appropriately.

Why do you need to document what happens in an incident?

Recap the discussion by explaining that documentation can serve several purposes:

- The CERT TL will know what is happening throughout the incident.
- The CERT TL will have written information to pass on to the professional responders when they arrive.
- The CERT will be able to show how many volunteer hours it provided to the sponsoring agency or entity.
- Communication will be improved between functional areas and shifts.
- Liability exposure will be documented.

Explain that, under the CERT structure, each level of organization has documentation responsibilities:

- Section Chiefs are responsible for providing the Command Post with ongoing information about damage assessment, group status, and ongoing needs.

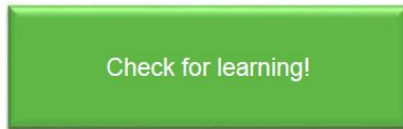

- The Command Post is responsible for documenting the situation status, including:
 - Incident locations;
 - Access routes;
 - Identified hazards; and
 - Support locations.

Note that support locations include:

- A staging area;
- A medical treatment and assessment area; and
- A morgue, if there are fatalities.



Stress that this information is vital for tracking the overall situation, and that the CERT TL must be ready to provide the documentation to the first professional responders on the scene.

Explain that the most important thing to do is to write down what happened. The information can be written down on the sample forms provided in this unit or on a piece of paper.

Say that every entity, such as a functional team or staging location, must have a scribe to record everything. The TL typically designates the scribe and provides some simple instructions.



Documentation Forms

Explain that there are eight standard forms that can be used to facilitate documentation and information flow. The forms are functionally consistent with ICS forms and are designed to follow NIMS protocols.

The CERT forms are:

- Damage Assessment;
- Personnel Resources Sign-In;
- CERT Assignment Tracking Log;
- Briefing Assignment;
- Treatment Area Record;
- Communications Log;
- Equipment Inventory; and
- General Message

Reinforce that scribes can produce useful, high-quality documentation without using the forms as long as they take detailed notes of all activities.

Refer the participants to **Table 2.4: Forms Used for Response Documentation** in the Participant Manual and on the following pages of the Instructor Guide for example.

Table 2.4: Forms Used for Response Documentation

Form	Purpose
Damage Assessment [CERT Form #1]	Completed by CERT volunteers as they travel through the area to the CERT's staging location, then given to the CERT Team Leader; provides a summary of overall hazards in selected areas, including: <ul style="list-style-type: none"> • Fires; • Utility hazards; • Structural damage; • Injuries and deaths; • Available access; and • Essential for prioritizing and formulating action plans.
Personnel Resources Check-In [CERT Form #2]	Used to sign in CERT volunteers as they arrive at the staging location; provides information about: <ul style="list-style-type: none"> • Who is on site; • When they arrived; • When they were assigned; • Their special skills; and • Used by staging personnel to track personnel availability.
CERT Assignment Tracking Log [CERT Form #3]	Used by the Command Post for keeping awareness of situation status; contains essential information for tracking the overall situation.
Briefing Assignment [CERT Form #4 a, b]	Used by the Command Post to provide instructions to functional teams; used by teams to log their actions and report new damage assessment information.
Treatment Area Record [CERT Form #5]	Completed by medical treatment area personnel to record survivors entering the treatment area, their condition, and their status.
Communications Log [CERT Form #6 (based on ICS 309)]	Completed by the radio operator; used to log incoming and outgoing transmissions.
Equipment Inventory [CERT Form #7 (based on ICS 303)]	Used to check out and check in CERT-managed equipment.
General Message [CERT Form #8 (ICS 213)]	Used for sending messages between command levels and groups; messages should be clear and concise and should focus on such key issues as: <ul style="list-style-type: none"> • Assignment completion; • Additional resources required; • Special information; and • Status update.

Displaying the next slides in sequence will allow you to “build” a diagram that demonstrates who owns which document and how that document is used in an event.

Documentation Flow

Explain how a CERT would use these standard documents within the context of an event. Remind participants that, even if the forms are not used, this should give them an idea of the preferred information that needs to be collected and communicated between groups.

- CERT volunteers complete the **Damage Assessment Form** that provides a summary of the overall hazards as they travel through the area to the CERT’s staging location. The form is then given to the CERT TL and is used for prioritizing and formulating activities. This is a valuable tool to use during the on-scene size-up.
- The CERT TL assembles teams and makes assignments based on the damage assessment information. This person keeps the **CERT Assignment Tracking Log**, which is the most important tool for recording the activities of the functional teams and overall situation status.
- A scribe at the staging location signs in each volunteer using the **Personnel Resources Check-In Form**, noting any preferred team assignments or skills. This information needs to be passed on to the Command Post.
- The Command Post and the functional team share the **Briefing Assignment Form**. The CERT TL uses the front side of the form to communicate instructions (e.g., address, incident type, and team objectives) about the incident. The scribe of the functional team uses the back side (blank) of the form to log team actions. The form is returned to the Command Post when the team checks in.
- The **Treatment Area Record** is used to document each person brought into the treatment area and his or her condition.
- The **Communications Log** is used to log incoming and outgoing transmissions; it is typically kept by the radio operator.
- The **Equipment Inventory** is kept in the area or vehicle in which equipment is stored.
- The **General Message** form is used for sending messages between any command levels and groups. The messages must be clear and concise.

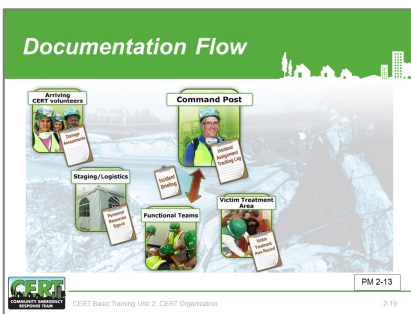
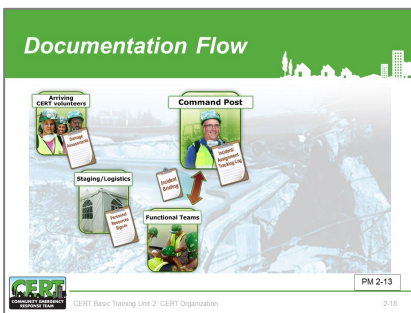
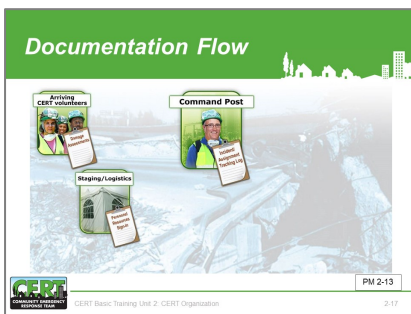

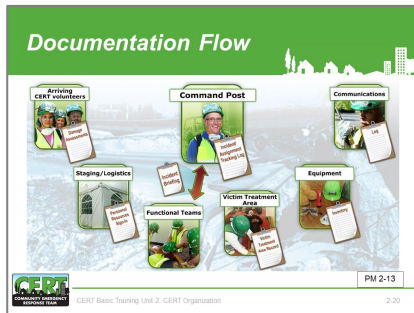

Emphasize this point.

Review each form briefly and describe the types of information that each should include.

Explain to the participants that the forms will assist them in collecting and organizing critical information during CERT operations. However, information needs to be recorded even if the correct form is not available. That is one reason why all volunteers need a small notebook and a pen in their personal CERT kit.

Note that area maps, site maps, and building plans are also very useful for tracking response activities.

Check for understanding.

Does anyone have any questions about how the CERT's mission and strategies are affected by the severity of damage?

Form 2.1: CERT Damage Assessment Form

<p>DAMAGE ASSESSMENT FORM</p>	<p>CERT WILSONVILLE</p>	<p>DATE ## / ## / ##</p>
<p>LOCATION SE CORNER 16TH AND OAK ROAD UP TO THE SCHOOL IS CLEAR.</p>		
<p>CERT MEMBER SUSAN ADAMS</p>		<p>PAGE <u>1</u> OF <u>1</u></p>

CERT FORM #1

Form 2.3: CERT Assignment Tracking Log

ASSIGNMENT TRACKING LOG		CERT		WILSONVILLE		DATE		## / ## / ##	
ASSIGNMENT	Structural damage-Tornado	ASSIGNMENT		ASSIGNMENT		ASSIGNMENT		ASSIGNMENT	
LOCATION	SE Corner 16th and Oak	LOCATION		LOCATION		LOCATION		LOCATION	
TEAM	SAR-1	TEAM		TEAM		TEAM		TEAM	
TEAM LEADER/CONTACT #	Marlene Shaw (212) 522-2222	TEAM LEADER/CONTACT #		TEAM LEADER/CONTACT #		TEAM LEADER/CONTACT #		TEAM LEADER/CONTACT #	
START TIME	9:37AM	END TIME	10:22 AM	START TIME		END TIME		START TIME	
1	Taejin Kim	2	Ring Jah	3	Bur Manning	4	Alison McKittredge	5	
OBJECTIVES	To conduct a search and rescue of damaged high school gym	OBJECTIVES		OBJECTIVES		OBJECTIVES		OBJECTIVES	
RESULTS	No victims located. Gym lightly damaged. Saw heavy damage to west wing of school.	RESULTS		RESULTS		RESULTS		RESULTS	
CERT LEADER/ INCIDENT COMMANDER	Elizabeth King	CERT LEADER/ INCIDENT COMMANDER	Elizabeth King						
SCRIBE(S)	Billy Rogers, Jorge Garcia								PAGE 1 OF 2

CERT FORM #3

Form 2.4a - CERT Briefing Assignment Form

BRIEFING ASSIGNMENT		CERT WILSONVILLE			DATE ## / ## / ##										
COMMAND POST CONTACT # (212) 555-1212				TIME OUT 9:50 AM		TIME BACK 10:36 AM									
INSTRUCTIONS TO TEAM															
TEAM NAME Medical 2			LOCATION Delmonico's Italian Restaurant, 810 King Street												
OBJECTIVES To conduct medical sizeup of any victims found.															
EQUIPMENT ALLOCATED															
REPORT FROM RESPONSE TEAM															
FIRES		HAZARDS			STRUCTURE		PEOPLE		ROADS		ANIMALS				
BURNING	OUT	GAS LEAK	H2O LEAK	ELECTRIC	CHEMICAL	DAMAGED	COLLAPSED	INJURED	TRAPPED	DEAD	ACCESS	NO ACCESS	INJURED	TRAPPED	ROAMING
								W			✓				

CERT FORM #4.a

Form 2.4b – CERT Team Action Log

TEAM ACTION LOG (time stamp each action; draw map if needed)	
<p>10:52 Team arrived at the restaurant. Made our way through the debris to victim #1, Bill Baker. Conscious and in pain. Ankle was trapped under a heavy bookcase. Extricated him. Two team members carried him to treatment area.</p> <p>10:54 Victim #2, Carol Loughney. Bleeding on head from falling ceiling. Walked her to treatment area.</p> <p>10:55 Victim # 3. Found in kitchen. Unconscious but breathing. May have broken leg. Splinted leg. Moved by stretcher to treatment area.</p>	
<p>SCRIBE</p> <p style="padding-left: 40px;"><i>Sam Arton</i></p>	

CERT FORM #4.b

Form 2.5: CERT Treatment Area Record

VICTIM TREATMENT AREA RECORD		CERT	DATE	## / ## / ##
TREATMENT AREA LOCATION		WILSONVILLE RIDGEWAY PARK		
TIME IN	NAME OR DESCRIPTION	CONDITION/TREATMENT (update as needed)	MOVED TO	TIME OUT
10-24 AM	Stephen Edmondson, 35 Yo, very tall	10:30 Heavy bleeding from cut at right temple—bandaged 10:45 Complained of dizziness and nausea	Sibley Hospital	12:15 PM
SCRIBE(S)		REGGIE OSBORN		PAGE <u>2</u> OF <u>2</u>

CERT FORM #5

Form 2.6 – CERT Communications Log

COMMUNICATIONS LOG		CERT	DATE
		RADIO OPERATOR NAME	
LOG			
TIME	FROM	TO	MESSAGE
			PAGE ____ OF ____

CERT FORM #6 (Based on ICS 309)

Form 2.8: CERT General Message Form

GENERAL MESSAGE			
TO	POSITION		
FROM	POSITION		
SUBJECT	DATE	TIME	
MESSAGE			
SIGNATURE		POSITION	
REPLY			
DATE	TIME	SIGNATURE/POSITION	

CERT FORM #8 (ICS 213)

GENERAL MESSAGE			
TO	POSITION		
FROM	POSITION		
SUBJECT	DATE	TIME	
MESSAGE			
SIGNATURE		POSITION	
REPLY			
DATE	TIME	SIGNATURE/POSITION	

CERT FORM #8 (ICS 213)

Unit Summary

- ICS provides flexible means of organization
- Ask "Is it safe to attempt the rescue?"
- Document and communicate information to all CERT levels
- Provide Command Post with ongoing information about damage assessment, group status, and needs
- Command Post documents and tracks situation status



CERT Basic Training Unit 2: CERT Organization

PM 2-25

2.21

UNIT SUMMARY

Summarize the key points from this unit:

- Emergency response agencies and CERT use the ICS to manage emergency operations. ICS provides a flexible means of managing personnel, facilities, equipment, and communication that can be expanded as necessary.
- The key question CERT Team Leaders must always ask is: "Is it safe for CERT volunteers to attempt the rescue?" Whether or not to attempt a rescue depends on the degree of damage to the structure involved. Remind the participants that their safety is the top priority.
- It is vital to document and communicate information about situation and resource status to all CERT levels.
- Sections, Groups, and Teams must provide the Command Post with ongoing information about damage assessment, incident status, and ongoing needs.
- The Command Post must document the situation status, so the overall disaster situation can be tracked and reported to emergency response agencies.

Check for understanding.

Does anyone have any questions about anything covered in this unit?

Homework Assignment

- Read unit to be covered in next session
- Bring necessary supplies to next session
- Wear appropriate clothes to next session



CERT Basic Training Unit 2: CERT Organization

PM 2-25

2.22

Homework Assignment

Ask the group to read and become familiar with the unit that will be covered in the next session.

Thank the participants for attending the session. Remind them of the time and location of the next session, if necessary.

[This page intentional left blank]



CERT Unit 2: Additional Materials

- Damage Assessment Form
- Personnel Resources Check-In Form
- CERT Assignment Tracking Log
- Briefing Assignment Form
- Team Action Log
- Treatment Area Record
- Communications Log
- Equipment Inventory
- General Message

[This page intentional left blank]

CERT Damage Assessment Form

Form 2.9: CERT Damage Assessment Form

DAMAGE ASSESSMENT FORM		CERT					DATE								
LOCATION															
SIZE UP (check if applicable)															
FIRES		HAZARDS			STRUCTURE		PEOPLE			ROADS		ANIMALS			
BURNING	OUT	GAS LEAK	H2O LEAK	ELECTRIC	CHEMICAL	DAMAGED	COLLAPSED	INJURED	TRAPPED	DEAD	ACCESS	NO ACCESS	INJURED	TRAPPED	ROAMING
OBSERVATIONS															

CERT Personnel Resources Check-In Form

Form 2.10: CERT Personnel Resources Check-In Form

PERSONNEL RESOURCES CHECK-IN			CERT				DATE			
CHECK IN TIME	CHECK OUT TIME	NAME	ID # (CERT badge or other)	CONTACT (cell # or radio)	PREFERRED ASSIGNMENT			SKILLS	TEAM ASSIGNMENT	TIME ASSIGNED
					FIRE	MEDICAL	SAR			

CERT Assignment Tracking Log

Form 2.11: CERT Assignment Tracking Log

ASSIGNMENT TRACKING LOG		CERT				DATE	
ASSIGNMENT		ASSIGNMENT		ASSIGNMENT		ASSIGNMENT	
LOCATION		LOCATION		LOCATION		LOCATION	
TEAM		TEAM		TEAM		TEAM	
TEAM LEADER/CONTACT #		TEAM LEADER/CONTACT #		TEAM LEADER/CONTACT #		TEAM LEADER/CONTACT #	
START TIME	END TIME	START TIME	END TIME	START TIME	END TIME	START TIME	END TIME
1		1		1		1	
2		2		2		2	
3		3		3		3	
4		4		4		4	
5		5		5		5	
OBJECTIVES		OBJECTIVES		OBJECTIVES		OBJECTIVES	
RESULTS		RESULTS		RESULTS		RESULTS	
CERT LEADER						PAGE ___ OF ___	
SCRIBE(S)							

CERT Briefing Assignment Form

Form 2.12: CERT Briefing Assignment Form

BRIEFING ASSIGNMENT		CERT				DATE									
COMMAND POST CONTACT #						TIME OUT		TIME BACK							
INSTRUCTIONS TO TEAM															
TEAM NAME			LOCATION												
OBJECTIVES															
EQUIPMENT ALLOCATED															
REPORT FROM RESPONSE TEAM															
FIRES		HAZARDS			STRUCTURE		PEOPLE		ROADS		ANIMALS				
BURNING	OUT	GAS LEAK	H2O LEAK	ELECTRIC	CHEMICAL	DAMAGED	COLLAPSED	INJURED	TRAPPED	DEAD	ACCESS	NO ACCESS	INJURED	TRAPPED	ROAMING

CERT Team Action Log

Form 2.13: CERT Team Action Log

TEAM ACTION LOG (time stamp each action; draw map if needed)

CERT Victim Treatment Area Record

Form 2.14: CERT Victim Treatment Area Record

VICTIM TREATMENT AREA RECORD		CERT	DATE	
TREATMENT AREA LOCATION				
TIME IN	NAME OR DESCRIPTION	CONDITION/TREATMENT (update as needed)	MOVED TO	TIME OUT
SCRIBE(S)			PAGE ___ OF ___	

CERT Communications Log

Form 2.15: CERT Communications Log

Communications Log		CERT	DATE
		RADIO OPERATOR NAME	
LOG			
TIME	FROM	TO	MESSAGE

CERT Equipment Inventory Form

Form 2.16: CERT Equipment Inventory Log

EQUIPMENT INVENTORY		CERT				DATE		
ASSET #	ITEM DESCRIPTION	OWNER	ISSUED TO		QTY	TIME	INITIALS	COMMENTS
				ISSUED				
				RETURNED				
				ISSUED				
				RETURNED				
				ISSUED				
				RETURNED				
				ISSUED				
				RETURNED				
				ISSUED				
				RETURNED				
				ISSUED				
				RETURNED				
				ISSUED				
				RETURNED				
				ISSUED				
				RETURNED				
SCRIBE(S)						PAGE ___ OF ___		

CERT General Message Form

Form 2.17: CERT General Message Form

GENERAL MESSAGE		
TO	POSITION	
FROM	POSITION	
SUBJECT	DATE	TIME
MESSAGE		
SIGNATURE	POSITION	
REPLY		

[This page intentional left blank]



CERT Unit 3: Disaster Medical Operations – Part 1

Instructor Guide



FEMA

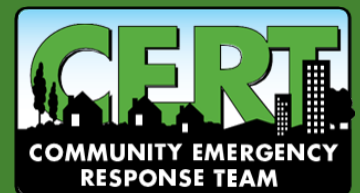

[This page intentional left blank]



CERT Unit 3: Disaster Medical Operations – Part 1

In this unit, participants will learn about:

- **Assisting Disaster Medical Operations:** How to assist by controlling bleeding, maintaining normal body temperature, opening an airway, providing comfort to patients, and applying basic first-aid care for numerous types of injuries.

[This page intentional left blank]

CERT Unit 3 Table of Contents

SECTION 1: UNIT OVERVIEW	3-1
SECTION 2: TREATING LIFE-THREATENING CONDITIONS	3-4
Approaching the Patient	3-4
Controlling the Bleeding.....	3-5
Maintaining Body Temperature.....	3-9
Exercise 3.1: Controlling the Bleeding	3-10
Opening the Airway	3-10
Exercise 3.2: Recovery Position	3-13
Providing Comfort.....	3-13
SECTION 3: BASIC FIRST-AID CARE	3-15
Treating Burns.....	3-15
Wound Care	3-18
Amputations	3-19
Impaled Objects.....	3-19
Treating Fractures, Dislocations, Sprains, and Strains	3-20
Splinting	3-22
Exercise 3.3: Splinting	3-23
Treating Cold-Related Injuries	3-24
Treating Heat-Related Injuries.....	3-26
Insect Bites and Stings	3-28
Unit Summary.....	3-29
Homework Assignment.....	3-29

[This page intentional left blank]

UNIT OBJECTIVES

At the conclusion of this unit, the participants will be able to:

1. Identify life-threatening conditions resulting from trauma including severe bleeding, low body temperature, and airway blockage;
2. Apply correct potentially life-saving techniques; and
3. Provide basic first-aid care for non-fatal injuries.

SCOPE

The topics that will be discussed in this unit are:

- Introduction and Unit Overview;
- Treating Life-Threatening Conditions;
- Basic First-Aid Care; and
- Unit Summary.

ESTIMATED COMPLETION TIME

The following timetable (**Table 3: Estimated Completion Times**) is suggested for this module.

Table 3: Estimated Completion Times

Unit	Estimated Time
Introductions and Overview	10 minutes
Treating Life-Threatening Conditions	45 minutes
Treating Burns	20 minutes
Wound Care	20 minutes
Treating Fractures, Dislocations, Sprains, and Strains	35 minutes
Treating Cold-Related Injuries	5 minutes
Treating Heat-Related Injuries	5 minutes
Insect Bites and Stings	5 minutes
Unit Summary	5 minutes
Total	2 hours, 30 minutes

RESOURCES REQUIRED

- Community Emergency Response Team Instructor Guide
- Community Emergency Response Team Participant Manual

- PowerPoint Slides 3-0 through 3-50

OTHER RESOURCES

If time permits, the 23-minute video, CERT Triage: Handling Mass Casualty Situations, is recommended for this unit. The video portrays sample assessment procedures and treatment of obstructed airway, uncontrolled bleeding, and shock, as well as size-up and rescuer safety. The video is available for download at the national CERT website: www.fema.gov/cert.

EQUIPMENT

The following equipment is required for this unit:

- A computer with PowerPoint software;
- A computer projector and screen;
- One mannequin (optional);
- 1-liter bottle;
- Tourniquet (if available) (preferably one for every two students);
- Non-latex examination gloves (one pair per participant);
- 4- by 4-inch dressings (one for each participant);
- One triangular bandage per participant;
- Splinting material (e.g., cardboard, magazines, pieces of lath, pillows, towels);
- Note cards; and
- Duct tape.

SECTION 1: UNIT OVERVIEW



Welcome

Introduce the new instructors for this unit and ask each to describe briefly his or her experience in disaster medical operations or providing basic first-aid care.

Introduce this unit by welcoming the participants to Unit 3 of the CERT Basic Training.

Briefly review the CERT organization lesson by posing the following questions to the class:

Question: The CERT organization is based on a proven management system used by emergency responders. What is the name of this system?

Correct response: The Incident Command System (ICS)

Question: Who becomes the CERT Team Leader (TL)? What does that person do?

Correct response:

- The first person to arrive on the scene and establishes the basic ICS structure for the incident.

Question: What is name of the place where the TL is located?

Correct response: The Command Post.

Question: What is the key question that CERT Team Leaders must always ask?

Correct response: Is it safe for CERT members to attempt this rescue?

Question: Documentation is an essential part of the CERT's job. What kinds of information should a CERT document?

Correct responses:

- Damage assessment
- Status of personnel resources
- Communications between command levels and groups
- Incident status
- Survivor treatment provided

Answer any questions the students may have about CERT organization, then continue with the session.

Check for learning!

Check for learning!

Check for learning!

Check for learning!

Check for learning!

Explain that understanding the potential disaster medical operations environment is crucial to CERT's success in assisting emergency responders. Units 3 and 4, Disaster Medical Operations Part I and II, teach life-saving steps CERT volunteers can take immediately following trauma and provide an overview of how emergency responders apply and organize disaster medical care in the event of a large-scale disaster. CERT volunteer's assistance with disaster medical operations can play a vital role in limiting deaths from trauma.

Tell participants that units 3 and 4 do not provide an absolute way of how to manage disaster medical operations. Many localities will handle disaster medical operations differently, and there is no concrete way to teach this material. Instead, the goal of Units 3 and 4 is to provide a high-level overview about the immediate medical interventions that CERT volunteers can take to save lives, and how disaster medical operations may operate.

Explain that in some disaster, there may be more survivors than rescuers, and assistance from medical professionals may not be immediately available. While emergency medical responders are quick to arrive, any delay between injury and the initiation of care can result in death. Those nearest to someone with life-threatening injuries are best positioned to provide the first care, which should focus on the most essential actions, including moving someone away from ongoing danger, stopping life-threatening bleeding, positioning the injured so they can breathe, keeping them warm, and providing comfort.

CERT volunteers are trained to take part of disaster medical operations and to assist in providing treatment for life-threatening conditions. Remember, the mission of CERT is to provide the greatest good for the greatest number of people. In a disaster with many survivors, time will be critical. CERT volunteers must work quickly and efficiently to help as many survivors as possible.

Let participants know that they are encouraged to take basic first-aid and CPR training. However, even if they have taken first-aid courses in the past, they will need to understand CERT covers basic medical interventions for life-threatening (traumatic) injuries where time is critical and/or there are many injured. Inform the participants that this course does not teach CPR, and participants can search their local chapters of the American Red

Cross and American Heart Association to find a nearby CPR course.

Unit Objectives

Tell the group that at the end of this unit, they will be able to:

1. Identify life-threatening conditions resulting from trauma including severe bleeding, low body temperature, and airway blockage;
2. Apply correct life saving techniques; and
3. Provide basic first-aid care for non-life-threatening injuries.

Add that, throughout the unit, they will have opportunities to practice the treatment techniques.

Unit Objectives

1. Identify life-threatening conditions resulting from trauma including severe bleeding, low body temperature, and airway blockage
2. Apply correct life saving techniques
3. Provide basic first-aid care for non-life-threatening injuries

CERT
CERT Basic Training Unit 3: Disaster Medical Operations – Part 1

PM 3-1

3-1

SECTION 2: TREATING LIFE-THREATENING CONDITIONS

Treating Life-Threatening Conditions

- Without treatment, severe bleeding and airway obstruction can quickly lead to death
- The first priority of CERT volunteers assisting in disaster medical operations is to attend to these conditions by controlling bleeding and positioning a patient so they can breathe

 CERT Basic Training Unit 3: Disaster Medical Operations – Part 1 PM 3-2
3-2

Without treatment, severe bleeding and airway obstruction can quickly lead to death. CERT volunteers' first priority in assisting disaster medical operations is to attend to these conditions, by controlling bleeding and positioning a patient so they can breathe.

Explain that this section will train the group to recognize these potentially life-threatening conditions, as well as how to maintain normal body temperatures in patients and how to recognize patients who may be in shock.

Safety Considerations

- Prior to treatment, ensure that both the patient and rescuer are in a safe environment to administer care
- Some questions CERT volunteers to consider
 - Do I feel safe at this spot?
 - Should I leave and move to a safer location, or am I able to stay and start providing care immediately?
 - If I leave, can I take anyone with me?

 CERT Basic Training Unit 3: Disaster Medical Operations – Part 1 PM 3-2
3-3

Prior to treatment, it is critical to ensure that both the survivor and rescuer are in a safe environment to administer care. CERT volunteers should use their best judgement to determine if the situation is safe enough to help a survivor properly.

Some questions CERT volunteers can consider are:

- Do I feel safe at this spot?
- Should I move to a safer location, or am I able to stay and start providing care immediately?
- If I leave, can I take anyone with me?

Whatever the decision is, the goal is to get help to the people who need it as soon as possible.

Approaching the Patient

- Be sure patient can see you
- Identify yourself
 - Your name and name of your organization
- Request permission to treat, if possible
- Respect cultural differences
- Protect patient privacy

 CERT Basic Training Unit 3: Disaster Medical Operations – Part 1 PM 3-2
3-4

Approaching the Patient

When able, CERT volunteers should first ensure they are wearing the appropriate and proper personal protective equipment (PPE). For a detailed list of PPE, please reference Unit 1.

There are several steps to take when approaching a patient.

Step 1: If the patient is conscious, be sure he or she can see you.

Step 2: Identify yourself by giving your name and indicating the organization with which you are affiliated.

Step 3: Always request permission to treat an individual. If the individual is unconscious,

“implied consent” is assumed, and you may treat him or her. Ask a parent or guardian for permission to treat a child, if possible.

Step 4: Whenever possible, respect cultural differences.

Step 5: Remember, all medical patients are legally entitled to confidentiality (HIPAA). When dealing with patients, always be mindful and respectful of the privacy of their medical condition.

Controlling Bleeding

The average adult has about five liters of blood. Severe blood loss can result in irreversible shock. If someone loses half of their body’s blood supply, no matter what actions are taken to save them, death is unavoidable.

Emphasize that it is important to get bleeding under control as soon as possible.

Indications of life-threatening bleeding include:

- Spurting/steady bleeding;
- Blood is pooling;
- Blood is soaking through overlying clothes;
- Blood is soaking through bandages; and
- Amputation.

Life-threatening decreases in blood pressure often are associated with a state of shock. There are typically four stages of excessive bleeding. Refer the group to **Table 3.1: Stages of Severe Bleeding**.

Stage	Blood Loss	Heart Rate	Blood Pressure	Breath Rate	Patient
I	Less than 15%	Normal (<100 bpm)	Normal	14-20	Patient appears normal
II	15%-40%	Fast (>100 bpm)	Slightly Low	20-30	Patient may feel anxious
III	30%-40%	Very Fast (>120 bpm)	Low	30-40	Patient feels confused
IV	Greater than 40%	Critical (>140 bpm)	Critical	>35	Patient feels lethargic

PM 3-3

Stage 1: Loss of <15% of blood volume. Patient appears normal with a slightly increased heart rate.

Stage 2: Loss of 15%-30% of blood volume. Patient’s body is able to compensate for the loss of blood but may appear agitated or anxious as vital signs rise.

Stage 3: Loss of 30%-40% of blood volume. Patient becomes unable to compensate and condition worsens. If left untreated will proceed to irreversible shock. Patient appears confused.

Stage 4: Loss of >40% of blood volume. Patient enters irreversible shock. Patient appears lethargic and death will occur within minutes because of overwhelming and irreversible damage to vital organs.

Table 3.1: Stages of Severe Bleeding

Stage	Blood Loss	Heart Rate	Blood Pressure	Breath Rate	Patient
I	Less than 15%	Normal (<100 bpm)	Normal	14-20	Patient appears normal
II	15%-40%	Fast (>100 bpm)	Slightly Low	20-30	Patient may feel anxious
III	30%-40%	Very Fast (>120 bpm)	Low	30-40	Patient feels confused
IV	Greater than 40%	Critical (>140 bpm)	Critical	>35	Patient feels lethargic

Types of Bleeding

- **Arterial bleeding:** Arteries transport blood under high pressure
– Blood coming from an artery will spurt
- **Venous bleeding:** Veins transport blood under low pressure
– Blood coming from a vein will flow
- **Capillary bleeding:** Capillaries also carry blood under low pressure
– Blood coming from capillaries will ooze

PM 3-3

Explain to the group the three types of bleeding, characterized by the speed of the blood flow.

1. **Arterial bleeding:** Arteries transport blood under high pressure. Blood coming from an artery will spurt.
2. **Venous bleeding:** Veins transport blood under low pressure. Blood coming from a vein will flow.
3. **Capillary bleeding:** Capillaries also carry blood under low pressure. Blood coming from capillaries will ooze.

Types of Bleeding



PM 3-3

Direct Pressure

The first way to try to control excessive bleeding is through applying direct pressure. To control and stop bleeding through direct pressure, follow these steps:

- Step 1:** Find the source(s) of bleeding.
- Step 2:** If you have something (e.g., gloves, a cloth, a plastic bag) to put in between the blood and your hands, use it.
- Step 3:** Apply firm, steady pressure directly on the source of the bleeding. Push hard to stop or slow bleeding – even if it is painful to the injured!
- Step 4:** Keep pressure applied until EMS takes over care or bleeding has stopped. If you are unsure if bleeding has stopped, continue applying pressure and wait for EMS.

Controlling Bleeding: Direct Pressure

- Step 1: Find the source(s)
- Step 2: Cover the source
- Step 3: Apply pressure
- Step 4: Maintain pressure until bleeding has stopped

PM 3-3

Review some considerations for CERT members to keep in mind when applying direct pressure:

- Try to provide a barrier against the blood, if possible. (Gloves are best.)

- Do not use the same gloves or barrier on more than one person.
- If your barrier becomes blood soaked, replace it, but do not layer more things on top of it.
- Do not place bulky layers in between your hands and the source of the wound because it decreases the effectiveness of the pressure.
- Correctly applied pressure may not be comfortable for the injured. Do not let up; hold pressure until EMS arrives.

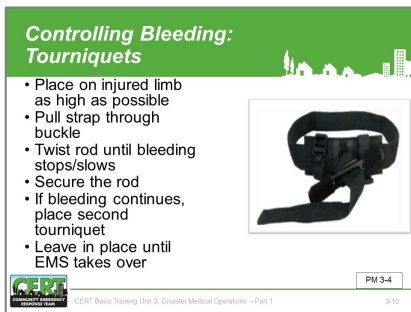

Tourniquets

Tell participants that if they cannot stop the bleeding by applying direct pressure and EMS professionals are delayed in responding, a tourniquet may be a viable option to save a person from bleeding to death. A tourniquet is a tight bandage, which when placed around a limb and tightened, cuts off the blood supply to the part of the limb beyond it.

Tourniquets have been used effectively in combat to control bleeding in a wounded soldier's extremities (arms or legs) and are increasingly being used by uniformed responders in civilian emergencies. Tourniquets are safe and effective when applied appropriately; you are more likely to save a life than cause the loss of a limb if you use a tourniquet.

If a commercial tourniquet is not readily available, you can try to create one yourself using something that is broad, flexible, strong, and able to be twisted, tightened, and secured, such as a webbed belt or luggage strap or material. Improvised tourniquets often fail, but you can attempt to use them as a last resort to at least slow the bleeding.

How to use a tourniquet:

Step 1: Place tourniquet as high as possible on the injured limb – closest to the torso. (You can place it over clothing.)

Step 2: Pull the strap through the buckle.

Step 3: Twist the rod tightly until bleeding stops/slow significantly. (May be very painful.)

Step 4: Secure the rod.

Step 5: If bleeding does not stop, place a second tourniquet.

Step 6: Leave in place until EMS takes over care.

Recognizing shock

Shock

- Shock is often difficult to diagnose
- Main signs of shock:
 - Rapid and shallow breathing
 - Capillary refill of greater than two seconds
 - Failure to follow simple commands, such as “squeeze my hand”
- Symptoms of shock are easily missed. Pay careful attention to your patient



CERT Basic Training Unit 3: Disaster Medical Operations – Part 1
PM 3-5

Remind participants that the body will initially compensate for blood loss and mask the symptoms of shock; therefore, shock is often difficult to diagnose. It is possible — and, in fact, common — for an individual suffering from shock to be fully coherent and not complaining of pain. Pay attention to subtle clues, as failure to recognize shock will have serious consequences.

The main signs of shock that CERT volunteers should look for are:

- Rapid and shallow breathing;
- Capillary refill of greater than two seconds; and
- Failure to follow simple commands, such as “squeeze my hand.”

The instructor should use the following demonstrations to help students understand the different ways to recognize shock.

Evaluate Breathing

To demonstrate rapid, shallow breathing, ask two participants to come to the front of the room. Tell one to breathe normally. Tell the other to “pant” (i.e., 30 or more breaths per minute). Point out the audible difference to the class. Make sure that the participant who is “panting” is sitting during the demonstration.

Evaluate Circulation

Demonstrate the capillary refill test, which monitors dehydration and the amount of blood flow to tissues. Tell the group this is referred to as the “blanch test.” A good place to do this is on the palm of the hand. The nail beds are sometimes used.

Explain that the blanch test is not valid in the case of a child, and that mental status should be used as the main indicator instead.

Ask the participants to check their own capillary refill by pushing down on the palm of their hand and then releasing. Tell them to watch what happens. Ask one of the participants to explain.

Emphasize that capillary refill (and pink color) should occur within two seconds after pressure is removed.

Explain that another way to check for circulation is the radial pulse test, which is an alternative to the blanch test and can be used in the dark or where it is cold.

Demonstrate how to find a radial pulse.

Ask participants to perform a radial pulse test by placing middle and ring finger over the interior of their wrist where the thumb meets the arm

Note that a normal pulse rate is 60-100 beats per minute.

Evaluate Mental Status

Explain that there are several ways to evaluate mental status.

- Ask, “Are you okay?”
- Give a simple command such as “Squeeze my hand.”

If they are concerned that there might be a language barrier or hearing impairment, reach out with both hands and squeeze one of the patient’s hands. The person will squeeze back if they can.

When a patient is in shock, avoid rough or excessive handling. It is also important to maintain the patient’s body temperature.

Does anyone have a question about the signs or treatment of shock?



Maintaining Body Temperature

Place a blanket or other material under and/or over the patient to provide protection from extreme ground temperatures (hot or cold). People with very serious injuries are more susceptible to hypothermia, or abnormally low body temperature. Because hypothermia increases the risk of death in survivors with serious injuries, it is important that CERT members maintain normal body temperatures in patients as much as possible.

To keep a person warm, you should:

- Remove wet clothing;
- Place something between the injured person and the ground (e.g., cardboard, jacket, blanket, or anything that provides physical separation);
- Wrap the injured person with dry layers (e.g., coat, blanket, or Mylar emergency blanket); and

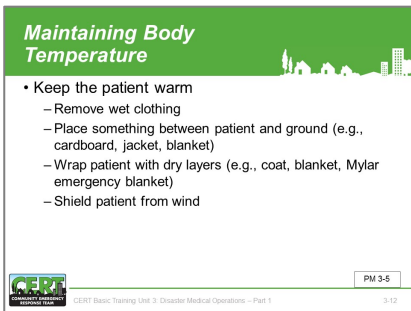

- Shield the injured person from the wind with your body or surrounding objects.

Tell participants that hypothermia and other cold-related injuries will be discussed in greater detail later in this unit.

Exercise 3.1

1. After breaking into pairs, identify one person to take the role of the patient and one to take the role of the rescuer
2. Respond as if the patient has an injury on the right forearm, just below the elbow
3. Apply a pressure bandage or tourniquet (if available)
4. Repeat the process twice
5. Swap roles and have the new rescuer complete the above steps

CERT Basic Training Unit 3: Disaster Medical Operations – Part 1 PM 3-6 3-13

Exercise 3.1: Controlling Bleeding

Purpose: Explain that this exercise allows the participants to practice the techniques for controlling bleeding with each other.

Divide the participants into pairs. Each member of the pair will practice applying a pressure bandage and a tourniquet (if available).

Instructions: Follow the steps below to conduct this exercise:

Step 1: After breaking into pairs, identify one person to take the role of the patient and the other as the rescuer.

Step 2: Ask the patient to lie down with their back to the floor and close their eyes.

Step 3: The rescuer should respond as if the patient has an injury on the right forearm, just below the elbow.

Step 4: Apply a pressure bandage or tourniquet (if available).

Step 5: Repeat the process twice. Swap roles and have the new rescuer complete the above steps.

Observe each group and correct any improper techniques.

Does anyone have any questions about controlling excessive bleeding?

Check for understanding.

Opening the Airway

Opening the Airway

CERT Basic Training Unit 3: Disaster Medical Operations – Part 1 PM 3-6 3-14

Positioning an injured patient to keep their airway open and clear is critical to saving their life. The best position for the body is one that allows the chest to expand fully and making sure the airway is not at risk of being obstructed. In other words, the best position is one in which the tongue cannot flop back into the individual's throat and one in which blood or fluid does not end up in the lungs (aspirated), particularly in the case with someone with facial trauma.

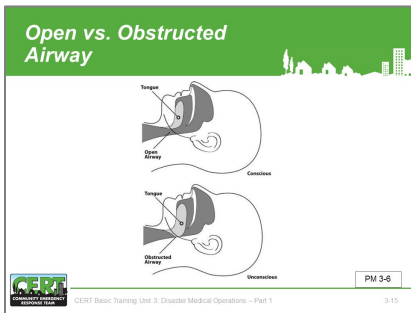

Check for knowledge.

The respiratory system includes the following components:

- Lung;
- Bronchus;
- Larynx;
- Pharynx;
- Nasal Cavity; and
- Trachea.

Does anyone know what the most common airway obstruction is?

The most common airway obstruction is the tongue.

There are different ways to position a patient to keep their airway open depending on whether they are conscious or unconscious.

Positioning a Conscious Patient

Point out to the class that someone who is awake will naturally assume the position that is best for them given their injuries. Despite how it looks to you, let them self-manage their airway by positioning their own body. Assist if needed.

The tripod position is a natural way to open your airway – think of catching your breath after sprinting. In the tripod position, the lungs and ribcage are able to expand to the fullest extent.

- **When sitting on a raised platform** (e.g., chair, bench): Legs shoulder width apart, elbows or hands on knees, and leaning forward slightly.
- **When standing:** Legs shoulder width apart, hands on knees arms straight, and leaning forward with flat back.

Positioning an Unconscious Patient

Inform the group that if an individual is unconscious, you can help by turning the person on his or her side, so their chest can expand, tilting the head to drain fluid away from the airway. Direct their attention to **Image 3.1: Positioning an Unconscious Patient**.

Image 3.1: Positioning an Unconscious Patient

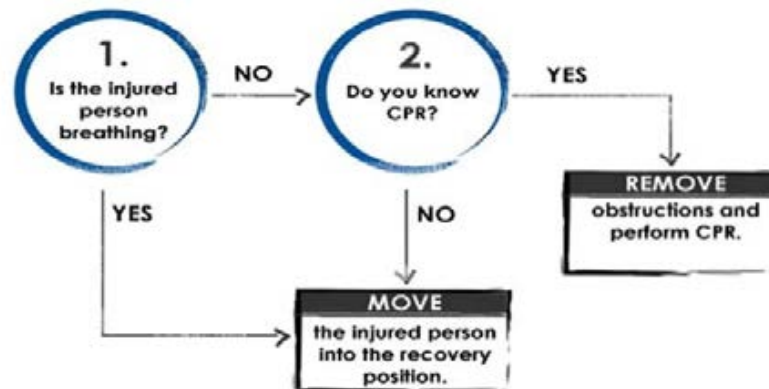

Recovery Position

Explain how to move a patient into the recovery position:

- **Body:** Laid on its side;
- **Bottom Arm:** Reached outward;
- **Top Arm:** Rest hand on bicep of bottom arm;
- **Head:** Rest on hand;
- **Legs:** Bent slightly;
- **Chin:** Raised forward; and
- **Mouth:** Pointed downward.

Although the risk is very small, it is possible that moving someone into the recovery position could cause harm to the person's spine. To prevent this:

- Try to support the head and neck when rolling them onto their side; and
- Do not move them more than necessary.

Jaw-thrust Maneuver

If a patient is unconscious and CERT members suspect there is an airway obstruction, they should clear the airway using the jaw-thrust maneuver. To perform this maneuver on an adult, kneel above the patient's head and:

- Put one hand on each side of the patient's head with the thumbs near the corners of the mouth pointed toward the chin, using the elbows for support;
- Slide the fingers into position under the angles of the patient's jawbone without moving the head or neck; and
- Thrust the jaw upward without moving the head or neck to lift the jaw and open the airway.

Check for understanding.

Exercise 3.2

1. Break into pairs and have one person play the rescuer and one person play the patient
2. Assume that the unconscious injured individual is breathing
3. Place them into the recovery position using the technique you just learned

CERT Basic Training Unit 3: Disaster Medical Operations – Part 1 3-20

Does anyone have any questions about recognizing and clearing airway obstructions?

Exercise 3.2: Recovery Position

Purpose: Explain that this exercise allows participants in pairs to practice using the techniques for moving a patient into the recovery position.

Instructions: Follow the steps below to conduct this exercise:

Step 1: Assign the group to work in pairs.

Step 2: Ask the person on the right to be the patient and the person on the left to be the rescuer.

Step 3: Ask the patients to lie on the floor on their backs and close their eyes.

Step 4: Tell the rescuer to assume that the unconscious injured individual is breathing. **Step 5:** The rescuer should then place the patient into the recovery position using the technique reviewed.

Observe each pair and correct improper technique.

After all participants have had the opportunity to practice as the rescuer, discuss any problems or incorrect techniques you observed. Explain how to avoid these problems in the future.

Check for understanding.

Providing Comfort

- What can you do?
 - Keep them warm
 - Offer a hand to hold
 - Maintain eye contact
 - Be patient and understanding
 - If you have to move on to provide aid to another person, let them know

CERT Basic Training Unit 3: Disaster Medical Operations – Part 1 3-21

Does anyone have any questions about performing the recovery position for clearing airway obstructions?

Providing Comfort

Point out that CERT volunteers can be of great value to injured and emotional patients simply by offering comfort and support. No special skills are needed, just a calm and reassuring presence. Unit 5 will discuss disaster psychology in greater depth; however, it is important to note that providing comfort is part of the immediate care CERT volunteers can provide.

Providing comfort can be as basic as asking some simple questions such as:

- How can I help?
- What do you need?
- What happened?

You can also provide comfort to the patient by providing information about:

- What you currently know about what happened without speculating;
- What is being done to assist them; and
- What is going to happen next.

What can you do?

- Keep them warm;
- Offer a hand to hold;
- Maintain eye contact;
- Be patient and understanding; and
- If you have to move on to provide aid to another person, let him or her know.



Check for understanding.

Does anyone have any questions about treating life-threatening conditions?

SECTION 3: BASIC FIRST-AID CARE

The following section reviews a number of treatments for non-life-threatening injuries that CERT volunteers may perform while assisting disaster medical operations. As with the previous section, CERT volunteers should not attempt to provide assistance beyond their comfort level, training, or abilities.

Explain that in the next section, the participants will learn to treat other injuries that are common after disasters:

- Burns;
- Lacerations;
- Amputations and impaled objects;
- Fractures, dislocations, sprains, and strains;
- Cold-related injuries;
- Heat-related injuries; and
- Insect bites/stings.

Treating Burns

- Prevent hypothermia
- Manage pain
- Reduce risk of infection

PM 3-9
CERT Basic Training Unit 3: Disaster Medical Operations – Part 1
3/23

Treating Burns

The first step in treating burns is to conduct a thorough size-up. A few examples of burn-related size-up questions to ask are:

- What caused the burn?
- Is the danger still present?
- When did the burning cease?

The objectives of first-aid treatment for burns are to:

- Prevent hypothermia;
- Manage pain; and
- Reduce the risk of infection.

Explain that heat, chemicals, electrical current, or radiation may cause burns. The severity of a burn depends on the:

- Temperature of the burning agent;
- Period of time the patient was exposed;
- Area of the body that was affected;
- Size of the area burned; and
- Depth of the burn.

Tell the group to exercise extreme caution around patients who appear to have burns when there is no obvious cause for the burns. These burns may indicate chemical burns, which present a risk to the rescuer.

Burn Severity

- Factors that affect burn severity:
 - Temperature of burning agent
 - Period of time survivor exposed
 - Area of body affected
 - Size of area burned
 - Depth of burn



PM 3-9
CERT Basic Training Unit 3: Disaster Medical Operations – Part 1
3/23

Burn Classifications

- **Superficial:** epidermis
- **Partial Thickness:** dermis and epidermis
- **Full Thickness:** subcutaneous layer and all layers above

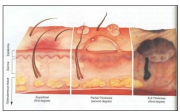

CERT
CERT Basic Training Unit 3: Disaster Medical Operations – Part 1
PM 3-9
3-24

Burn Classifications

Explain that depending on the severity, burns may affect all three layers of skin.

1. The epidermis, or outer layer of skin, contains nerve endings and is penetrated by hairs.
2. The dermis, or middle layer of skin, contains blood vessels, oil glands, hair follicles, and sweat glands.
3. The subcutaneous layer, or innermost layer, contains blood vessels and overlies the muscles.

Refer the participants to **Table 3.2: Burn Classification**, in the Participant Manual. Tell the group that burns are classified depending on their severity as superficial, partial thickness, and full thickness.

Table 3.2: Burn Classification

Classification	Skin Layers Affected	Signs
Superficial	<ul style="list-style-type: none"> • Epidermis 	<ul style="list-style-type: none"> • Reddened, dry skin • Pain • Swelling (possible)
Partial Thickness	<ul style="list-style-type: none"> • Epidermis • Partial destruction of dermis 	<ul style="list-style-type: none"> • Reddened, blistered skin • Wet appearance • Pain • Swelling (possible)
Full Thickness	<ul style="list-style-type: none"> • Complete destruction of epidermis and dermis • Possible subcutaneous damage (destroys all layers of skin and some or all underlying structures) 	<ul style="list-style-type: none"> • Whitened, leathery, or charred (brown or black) • Painful or relatively painless

Guidelines for Treating Heat-related

Cool the burn:

- Remove the patient from the burning source. Put out any flames and remove smoldering clothing unless it is stuck to the skin.
- Cool skin or clothing, if they are still hot, by immersing them in cool water for no longer than one minute or cover with clean compresses that have been soaked in cool water and wrung out. Note that rapid temperature changes can cause shock in the patient, so it is important to assess the size and severity of the burn prior to attempting to cool the skin to prevent a drop in body temperature.
- Cooling sources include water from the bathroom or kitchen; garden hose; and soaked towels, sheets, or other cloths.
- Do not use ice. Ice causes vessel constriction.

Dress the burn:

- Cover loosely with dry, sterile dressings to keep air out, reduce pain, and prevent infection.
- Wrap fingers and toes loosely and individually when treating severe burns to the hands and feet.
- Loosen clothing near the affected area. Remove jewelry if necessary, taking care to document what you removed, when, and to whom you gave it to.
- Do not apply antiseptics, ointments, or other remedies.
- Do not remove shreds of tissue, break blisters, or remove adhered particles of clothing. Cut burned-in clothing around the burn.

Guidelines for Treating Chemical Burns

Point out to the class that, unlike more traditional burns, chemical burns do not result from extreme heat, and therefore treatment differs greatly (e.g., decontamination procedures). If they suspect a chemical burn, it is best to defer treatment to trained medical professionals.

Stress that chemical burns are not always obvious. Consider chemical burns as a possibility if the patient's skin is burning and there is no sign of a fire. If they suspect a chemical burn:

- Protect yourself from contact with the substance. Use your protective gear, especially goggles, mask, and gloves;
- Be sure to remove any affected clothing or jewelry;
- If the irritant is dry, gently brush away as much as possible. Always brush away from the eyes and away from the patient and yourself;
- Use lots of cool running water to flush the chemical from the skin for at least 10 minutes. The running water will dilute the chemical fast enough to prevent the injury from getting worse;
- Apply a cool, wet compress to relieve pain; and
- Cover the wound very loosely with a dry, sterile, or clean cloth so that the cloth will not stick to the wound.

Check for understanding.

Does anyone have a question about the treatment for burns?

Wound Care

Wound Care

- Main treatment for wounds:
 - Control bleeding
 - Apply dressing and bandage
- Apply dressing and bandage:
 - Apply dressing directly to wound
 - Bandage holds dressing in place



PM 3-11 3/20

CERT Basic Training Unit 3: Disaster Medical Operations – Part 1

This section will focus on cleaning and bandaging wounds to control infection. The main treatment for wounds includes:

- Controlling bleeding; and
- Applying dressing and bandage.

Remind participants that treatment for controlling bleeding was covered earlier in this unit. Explain that the focus of this section is on bandaging, which will help to prevent secondary infection.

Bandaging Wounds

Tell the group once they have controlled the bleeding, they will need to apply a dressing and bandage to help maintain the clot and prevent infection.

Explain the difference between a dressing and a bandage.

- Apply dressing directly to the wound. Whenever possible, a dressing should be sterile.
- A bandage holds the dressing in place.

Demonstrate the correct procedure for dressing and bandaging a wound.

Demonstrate some techniques for tying a bandage if no tape is available.

Point out that, if a wound is still bleeding, the bandage should place enough pressure on the wound to help control bleeding without interfering with circulation.

Rules of Dressing

- If active bleeding:
 - Redress OVER existing dressing
- If no active bleeding:
 - Maintain the pressure and keep wound bandaged until further treatment by a medical professional

CERT Basic Training Unit 3: Disaster Medical Operations – Part 1 PM 3-11 3-27

Rules of Dressing

Explain to the participants that they should follow these rules:

- If there is active bleeding (i.e., if the dressing is soaked with blood), redress over the existing dressing and maintain pressure to control bleeding; and
- In the absence of active bleeding, maintain the pressure and keep the wound bandaged until further treatment by a medical professional.

Signs of Infection

- Signs of possible infection:
 - Swelling around wound site
 - Discoloration
 - Discharge from wound
 - Red striations from wound site



CERT Basic Training Unit 3: Disaster Medical Operations – Part 1 PM 3-11 3-28

Signs of possible infection include:

- Swelling around the wound site;
- Discoloration;
- Discharge from the wound; and
- Red striations from the wound site.

Amputations

- If amputated body part is found:
 - Save tissue parts, wrapped in clean material and placed in plastic bag
 - Keep tissue parts cool, but NOT directly on ice
 - Keep severed part with survivor

CERT Basic Training Unit 3: Disaster Medical Operations – Part 1 PM 3-11 3-29

Amputations

If CERT volunteers are assisting a patient with a severed body part, there are a few guidelines to follow. Stress that when the severed body part can be located, CERT members should:

- Save tissue parts, wrapped in clean material and placed in a plastic bag, if available. Label them with the date, time, and patient’s name;
- Keep the tissue parts cool, but NOT in direct contact with ice; and
- Keep the severed body part with the patient.

Emphasize that CERT volunteers should never amputate a body part.

Impaled Objects

- When foreign object is impaled in patient’s body:
 - Immobilize affected body part
 - Do not attempt to move or remove
 - Try to control bleeding at entrance wound
 - Clean and dress wound, making sure to stabilize impaled object

CERT Basic Training Unit 3: Disaster Medical Operations – Part 1 PM 3-12 3-30

Impaled Objects

Tell the group they may also encounter some patients who have foreign objects lodged in their bodies, usually as the result of flying debris during the disaster.

This situation is usually outside of the scope of the volunteer’s CERT training. The best course of action is to find trained medical personnel (EMS) to care for a patient with an impaled object. However, in the event that EMS

is still a long way from the scene or otherwise unavailable, there are a few steps you can take to provide care.

When a foreign object impales a patient, the volunteers should:

- Immobilize the affected body part;
- Not attempt to move or remove the object, unless it is obstructing the airway;
- Try to control bleeding at the entrance wound without placing undue pressure on the foreign object;
- Clean and dress the wound making sure to stabilize the impaled object; and
- Wrap bulky dressings around the object to keep it from moving.

Does anyone have questions about wound care?

Tell the participants that the next topic will address treatment for fractures, dislocations, sprains, and strains.

Treating Fractures, Dislocations, Sprains, and Strains

The objective when treating a suspected fracture, sprain, or strain is to immobilize the injury and the joints immediately above and below the injury site.

Point out that because it is difficult to distinguish among fractures, sprains, or strains, if uncertain of the type of injury, CERT members should treat the injury as a fracture.

Fractures

Introduce this section by explaining that a fracture is a complete break, a chip, or a crack in a bone. There are several types of fractures (refer the participants to the illustrations *Image 3.3 Open and Closed Fractures* in the Participant Manual):

- An **open fracture** is a broken bone with some kind of wound that allows contaminants to enter into or around the fracture site.
- A **closed fracture** is a broken bone with no associated wound. First-aid treatment for closed fractures may only require splinting.

Refer the participants to *Image 3.4 - Displaced and Nondisplaced Fractures* in the Participant Manual.

Check for understanding.

Fractures, Dislocations, Sprains, Strains

- Immobilize injury and joints immediately above and below injury site
- If uncertain of injury type, treat as fracture

CERT Basic Training Unit 3: Disaster Medical Operations – Part 1 PM 3-12 3-31

Types of Fractures

Open Fracture
Open fracture in which the bone protrudes through the skin.

Closed Fracture
Closed fracture in which the fracture does not puncture the skin.

CERT Basic Training Unit 3: Disaster Medical Operations – Part 1 PM 3-12 3-32

Types of Fractures

Displaced Fracture
Displaced fracture in which the broken bone is no longer aligned.

Nondisplaced Fracture
Nondisplaced fracture in which the broken bone remains aligned.

CERT Basic Training Unit 3: Disaster Medical Operations – Part 1 PM 3-13 3-33

- Explain that if the limb is angled, then there is a **displaced fracture**, which can be described by the degree of displacement of the bone fragments.
- Explain that **nondisplaced fractures** are difficult to identify, with the main signs being pain and swelling. Stress that the participants should treat a suspected fracture as a fracture until professional treatment is available.

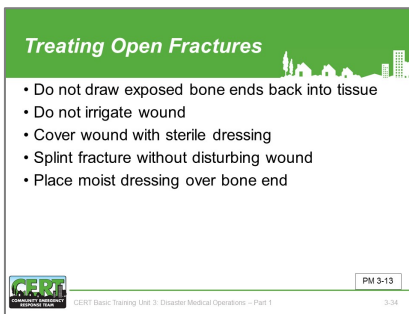

Treating an Open Fracture

Closed fractures are generally treated with splinting, but open fractures are more dangerous than closed fractures because they pose a significant risk of severe bleeding and infection. Therefore, they are a higher priority and volunteers should check them more frequently.

Stress that when treating an open fracture:

- Do not draw the exposed bone ends back into the tissue; and
- Do not irrigate the wound.

Continue by telling the group that they should:

- Cover the wound with a sterile dressing;
- Splint the fracture without disturbing the wound; and
- Place a moist 4 by 4-inch dressing over the bone end to keep it from drying out.

Tell the group that they will cover splinting procedures later in this unit.

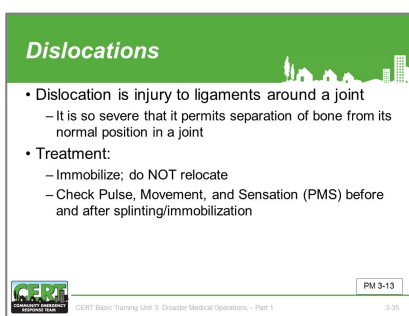

Dislocations

Introduce this section by telling the group that dislocations are another common injury in emergencies.

Explain that a dislocation is an injury to the ligaments around a joint that is so severe that it permits a separation of the bone from its normal position in a joint.

Tell the participants that the signs of a dislocation are similar to those of a fracture and that they should treat a suspected dislocation like a fracture.

Stress that the participants should not try to relocate a suspected dislocation. Instead, they should immobilize the joint until professional medical assistance is available.



Sprains and Strains

Introduce this section by explaining that a sprain is an injury that involves a stretching or tearing of ligaments at a joint. Typically, stretching or extending the joint beyond its normal limits causes the sprain.

Point out that a sprain is considered a partial dislocation, although the bone either remains in place or is able to fall back into place after the injury. Whether an injury is a strain, sprain, or fracture, treat it as if it is a fracture.

Tell the group that the most common signs of a sprain are:

- Tenderness at the site of the injury;
- Swelling and/or bruising; and
- Restricted use or loss of use.

Does anyone have any questions about fractures, dislocations, sprains, or strains?

Check for understanding.



Splinting

Introduce this topic by explaining that splinting is the most common procedure for immobilizing an injury.

Point out that cardboard is typically used for makeshift splints, but volunteers can use a variety of materials including:

- **Soft materials** including towels, blankets, or pillows, tied with bandaging materials or soft cloths; or
- **Rigid materials** including boards, metal strips, folded magazines or newspapers, or other rigid items.

Add that volunteers can create anatomical splints by securing a fractured bone to an adjacent un-fractured bone. Usually, anatomical splints are reserved for fingers and toes, but in an emergency, volunteers may splint legs together.

Use soft materials to fill the gap between the splinting material and the body part.

Remind participants to be creative when looking for splinting materials. For example, consider using the patient's t-shirt as a makeshift sling. To do so:

- Remove the shirt and cut the lower portion of the shirt from armpit to armpit; and

- Use the remaining band of fabric as a sling by placing one end under the injured arm and the other end over the patient’s head.

Given that there will be swelling with this type of injury, inform participants that they should remove restrictive clothing, including shoes and jewelry when necessary to prevent these items from acting as unintended tourniquets.

Refer the participants to the pages titled *Splint Illustrations* in the Participant Manual.

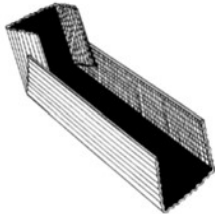

Cardboard Splint

To create a cardboard splint, turn up the edges of the cardboard to form a “mold” in which the injured limb can rest.

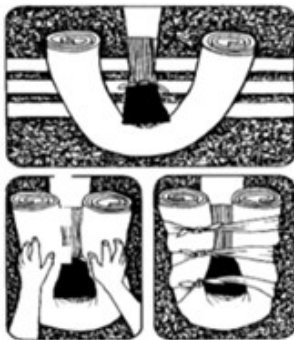

Splint Using a Towel

To splint using a towel, roll up the towel and wrap it around the limb, then tie it in place.



Pillow Splint

For a pillow splint, wrap and tie the pillow around the limb.

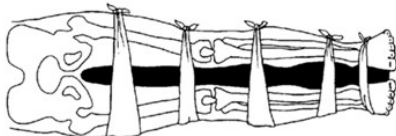

Anatomical Splint

For an anatomical splint, tie the injured leg at intervals to the non-injured leg, while using a blanket as padding between the legs.

Exercise 3.3: Splinting

Purpose: This exercise allows the participants to practice the procedures for splinting on each other. Use cardboard, duct tape, gauze, and other splinting material.

Instructions: Follow the steps below to facilitate this exercise:

Step 1: Assign the group to work in pairs. Ask participants to switch partners from the previous exercise.

Step 2: Ask one person to be the patient and one person to be the rescuer.

Step 3: Ask the patient to lie on the floor on their backs or sit in a chair.

Step 4: Ask the rescuer to apply a splint on the patient's upper arm using the procedure demonstrated earlier. Then, ask the rescuers to apply a splint to the patient's lower leg.

Step 5: After the rescuer has made several observed attempts at splinting, ask the patient and the rescuer to change roles.

Step 6: Allow each new rescuer at least one observed attempt to apply the splint.

Observe each group and correct improper technique. Be sure to check for bandages that are either too tight or too loose.

After the participants have had the opportunity to practice as the rescuer, discuss any problems or incorrect techniques you observed. Explain how to avoid the problems in emergencies.

Does anyone have any questions about correct procedures for splinting?

Tell the group that the next section will address treatment for cold-related injuries.

Check for understanding.

Cold-Related Injuries

- Hypothermia:
 - Occurs when body's temperature drops below normal
- Frostbite:
 - Occurs when extreme cold shuts down blood flow to extremities, causing tissue death



CERT Basic Training Unit 3: Disaster Medical Operations – Part 1

PM 3-16

3-35

Treating Cold-Related Injuries

Introduce this topic by explaining that cold-related injuries include:

- Hypothermia, which is a condition that occurs when the body's temperature drops below 95° F (37° C); and
- Frostbite, which occurs when extreme cold shuts down blood flow to extremities, causing tissue death.

Symptoms of Hypothermia

- Body temperature of 95°F or lower
- Redness or blueness of skin
- Numbness and shivering
- Slurred speech
- Unpredictable behavior
- Listlessness



CERT
CERT Basic Training Unit 3: Disaster Medical Operations – Part 1
PM 3-16
3-39

Hypothermia

Hypothermia may be caused by exposure to cold or by trauma.

The primary signs and symptoms of hypothermia are:

- A body temperature of 95° F (37° C) or lower;
- Redness or blueness of the skin; and
- Numbness accompanied by shivering.

In later stages, hypothermia will be accompanied by:

- Slurred speech;
- Unpredictable behavior; and
- Listlessness.

Explain that hypothermia can set in within only a few minutes, and therefore participants should treat patients rescued from cold air or water environments first by taking the following actions:

- Removing wet clothing;
- Placing something between the injured person and the ground (e.g., cardboard, jacket, blanket, or anything that provides physical separation);
- Wrapping the injured person with dry layers (e.g., coat, blanket, or Mylar emergency blanket);
- Shielding the injured person from the wind with your body or surrounding objects; and
- Placing an unconscious patient in the recovery position.
- Do NOT use massaging techniques
- to warm affected body parts

Hypothermia Treatment

- Remove wet clothing
- Put something under the patient
- Keep them sheltered and/or covered
- Do not attempt to use massage
- Place in the recovery position if unconscious

CERT
CERT Basic Training Unit 3: Disaster Medical Operations – Part 1
PM 3-16
3-40

Symptoms of Frostbite

- Skin discoloration
- Burning or tingling sensation
- Partial or complete numbness



CERT
CERT Basic Training Unit 3: Disaster Medical Operations – Part 1
PM 3-16
3-41

Frostbite

Explain to the group that blood vessels constrict in cold weather in an effort to preserve body heat. In extreme cold, the body will further constrict blood vessels in the extremities in an effort to shunt blood toward the core organs (e.g., heart, lungs, intestines,). The combination of inadequate circulation and extreme temperatures will cause tissue in these extremities to freeze, and in some cases, resulting in tissue death. Frostbite is most common in the nose, ears, hands, and feet.

Tell the participants that there are several key signs and symptoms of frostbite:

- Skin discoloration (red, white, purple, black);

- Burning or tingling sensation, at times not localized to the injury site; and
- Partial or complete numbness.

Explain to participants that you must warm a patient suffering from frostbite slowly! Thawing the frozen extremity too rapidly can cause chilled blood to flow to the heart, shocking it and potentially stopping it.

Frostbite Treatment

- Immerse injured area in warm (NOT hot) water
 - Warm slowly!
- Do not allow part to re-freeze
- Do not attempt to use massage
- Wrap affected body parts in dry, sterile dressing



CERT Basic Training Unit 3: Disaster Medical Operations – Part 1 PM 3-16 3-42

- Immerse injured area in warm (NOT hot) water, at approximately 107.6° F.
- Do NOT allow the body part to re-freeze, as this will exacerbate the injury.
- Do NOT use massaging techniques to warm affected body parts.

Tell the participants to wrap affected body parts in dry, sterile dressing. Again, it is vital to complete this task carefully. Frostbite results in the formation of ice crystals in the tissue; rubbing could potentially cause a great deal of damage.

Check for understanding.

Does anyone have any questions about cold-related injuries?

Explain that the next section will discuss heat-related injuries.

Heat-Related Injuries

- **Heat cramps**
 - Muscle spasms brought on by over-exertion in extreme heat
- **Heat exhaustion**
 - Occurs when exercising or working in extreme heat results in loss of body fluids
- **Heat stroke**
 - Survivor's temperature control system shuts down
 - Body temperature rises so high that brain damage and death may result



CERT Basic Training Unit 3: Disaster Medical Operations – Part 1 PM 3-17 3-43

Treating Heat-Related Injuries

CERT volunteers may encounter several types of heat-related injuries during a disaster, including the following:

- **Heat cramps:** muscle spasms brought on by over-exertion in extreme heat.
- **Heat exhaustion:** occurs when an individual works or exercises in extreme heat, resulting in loss of body fluids through heavy sweating. Blood flow to the skin increases, causing blood flow to decrease to the vital organs. This results in a mild form of shock.
- **Heat stroke:** life-threatening condition that occurs when the patient's temperature control system shuts down, and the body temperature rising so high that brain damage and death may result.

Symptoms of Heat Exhaustion

- Cool, moist, pale or flushed skin
- Heavy sweating
- Headache
- Nausea or vomiting
- Dizziness
- Exhaustion



CERT Basic Training Unit 3: Disaster Medical Operations – Part 1 PM 3-17 3-44

Heat Exhaustion

Explain to the group that the following are symptoms of heat exhaustion:

- Cool, moist, pale, or flushed skin;

- Heavy sweating;
- Headache;
- Nausea or vomiting;
- Dizziness; and/or
- Exhaustion.

A patient suffering heat exhaustion will have a near normal body temperature. If left untreated, heat exhaustion will develop into heat stroke.

Symptoms of Heat Stroke

- Hot, red skin
- Lack of perspiration
- Changes in consciousness
- Rapid, weak pulse and rapid, shallow breathing

PM 3-17

Heat Stroke

Inform the participants some or all of the following symptoms that characterize heat stroke:

- Hot, red skin;
- Lack of perspiration;
- Changes in consciousness; and/or
- Rapid, weak pulse and rapid, shallow breathing.

In a heat stroke patient, body temperature can be very high (105° F). If an individual suffering from heat stroke is not treated, death can result.

Treatment of Heat-Related Injuries

- Remove from heat to cool environment
- Cool body slowly
- Have the heat exhaustion patient drink water, SLOWLY
- Do not provide food or drink to the patient if he or she is experiencing vomiting, cramping, or is losing consciousness

PM 3-18

Treatment

Explain that treatment is similar for both heat exhaustion and heat stroke.

4. Take the patient out of the heat and place into a cool environment.
5. Cool the body slowly with chilled, wet towels or sheets. If possible, put the patient in a cool bath.
6. Have a heat exhaustion patient SLOWLY drink water, at the rate of approximately half a glass of water every 15 minutes. Consuming too much water too quickly will cause nausea and vomiting in a patient of heat sickness.
7. If the patient is experiencing vomiting, cramping, or loss of consciousness, DO NOT administer food or drink. Alert a medical professional as soon as possible and keep a close watch on the individual until professional help is available.

Check for understanding.

Does anyone have any questions about any of the heat-related injuries covered in this section?

Treatment for Bites/Stings

- If bite or sting is suspected, and situation is non-emergency:
 - Remove stinger if still present by scraping edge of credit card or other stiff, straight-edged object across stinger
 - Wash site thoroughly with soap and water
 - Place ice on site for 10 minutes on and 10 minutes off

 CERT Basic Training Unit 3: Disaster Medical Operations – Part 1 PM 3-18 3-47

Insect Bites and Stings

Remind participants that in a disaster environment, insect bites and stings may be more common than is typical as these creatures, like people, are under additional stress.

The specific symptoms vary depending on the type of creature, but generally, bites and stings can result in redness and itching, tingling or burning, and oftentimes a welt on the skin at the site of the injury.

Discuss insects and/or animals that pose a particular threat to your locality.

Explain that, in general, treatment for insect bites and stings follows the steps below.

Step 1: Remove the stinger, if still present, by scraping the edge of a credit card or another stiff straight-edged object across the stinger. Do not use tweezers; these may squeeze the venom sac and increase the amount of venom released.

Step 2: Wash the site thoroughly with soap and water.

Step 3: Place ice (wrapped in a washcloth) on the site of the sting for 10 minutes and then off for 10 minutes. Repeat this process.

Anaphylaxis

- Calm the individual
- If possible, find and help administer a patient's Epi-pen
 - Many severe allergy sufferers carry one at all times
- Do not administer medicine aside from the Epi-pen
 - This includes pain relievers, allergy medicine, etc.



 CERT Basic Training Unit 3: Disaster Medical Operations – Part 1 PM 3-18 3-48

Allergic Reactions to Bites and Stings

Tell the participants that the greatest concern with any insect bite or sting is a severe allergic reaction, or anaphylaxis. Anaphylaxis occurs when an allergic reaction becomes so severe that it compromises the airway. If you suspect anaphylaxis:

- Calm the individual;
- If possible, find and help administer a patient's Epi-pen. (Many severe allergy sufferers carry one at all times); and
- DO NOT administer medicine aside from the Epi-pen. This includes pain relievers, allergy medicine, etc.

Demonstrate how to administer an Epi-pen. If possible, pass one around the room to familiarize the group with it.

Emphasize that CERT members do not administer medications, including over-the-counter products, such as aspirin. CERT members can assist patients in administering their own medications (e.g., Epi-pen).

Check for understanding.

Unit Summary

- Life-saving measures CERT volunteers can take:
 - Control bleeding using direct pressure and/or a tourniquet
 - Maintain normal body temperature
 - Open airway and position patient correctly
- Other injuries that are common after disasters:
 - Burns
 - Wounds
 - Amputations and impaled objects
 - Fractures, dislocations, sprains, and strains
 - Cold-related injuries
 - Heat-related injuries
 - Insect bites/stings

CERT Basic Training Unit 3: Disaster Medical Operations – Part 1 3-49

Remind the participants to keep a close watch on the individual's airway and breathing. Seek professional medical help as soon as possible.

Are there any questions about any of the injuries covered in this section?

UNIT SUMMARY

Summarize the key points from this unit:

- CERT volunteers' ability to enact initial live-saving measures can be critical during a disaster.
- Life-saving measures CERT volunteers can take, include:
 - Controlling severe bleeding using direct pressure and/or a tourniquet;
 - Maintaining normal body temperature; and
 - Opening airways and positioning patients correctly.
- CERT volunteers can be of great value to injured and emotional patients simply by offering comfort and support. No special skills are needed — just a calm and reassuring presence.
- In addition to critical live-saving measures, CERT volunteers can also administer basic first-aid and care to injured patients.
- Other injuries that are common after disasters:
 - Burns;
 - Wounds;
 - Amputations and impaled objects;
 - Fractures, dislocations, sprains, and strains;
 - Cold-related injuries;
 - Heat-related injuries; and
 - Insect bites/stings.

Does anyone have any questions about anything covered in this unit?

Check for understanding.

Homework Assignment

- Read unit to be covered in next session
- Wear appropriate clothes for next session

CERT Basic Training Unit 3: Disaster Medical Operations – Part 1 3-50

Homework Assignment

Ask participants to read and become familiar with Unit 4: Disaster Medical Operations — Part 2 before the next session. Thank everyone for attending this session.

[This page intentional left blank]



CERT Unit 4: Disaster Medical Operations – Part 2

Instructor Guide



FEMA

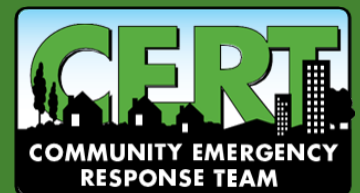

[This page intentional left blank]



CERT Unit 4: Disaster Medical Operations – Part 2

In this unit participants will learn about:

- ❑ **Mass Casualty Incidents:** How to assist first responders in responding to mass casualty incidents.
- ❑ **Functions of Disaster Medical Operations:** Major functions of disaster medical operations.
- ❑ **Disaster Medical Treatment Areas:** Types of medical treatment areas.
- ❑ **Head-to-Toe Assessment:** How to perform a head-to-toe assessment to identify and treat injuries.
- ❑ **Public Health Considerations:** How to maintain hygiene and sanitation.

[This page intentional left blank]

CERT Unit 4 Table of Contents

<i>SECTION 1: UNIT OVERVIEW</i>	<i>4-1</i>
<i>SECTION 2: MASS CASUALTY INCIDENTS</i>	<i>4-3</i>
Role of CERT Volunteers During Mass Casualty Incidents	4-3
<i>SECTION 3: FUNCTIONS OF DISASTER MEDICAL OPERATIONS</i>	<i>4-5</i>
<i>SECTION 4: ESTABLISHING MEDICAL TREATMENT AREAS</i>	<i>4-7</i>
Safety for Rescuers and Survivors	4-8
<i>SECTION 5: CONDUCTING HEAD-TO-TOE ASSESSMENTS</i>	<i>4-9</i>
Objectives of Head-to-Toe Assessments	4-9
What to Look for in Head-to-Toe Assessments	4-9
How to Conduct Head-to-Toe Assessments	4-10
Closed-Head, Neck, and Spinal Injuries	4-11
Stabilizing the Head	4-12
Demonstrate Head-to-Toe Assessments	4-12
Exercise 4.1: Conducting Head-to-Toe Assessments	4-13
<i>SECTION 6: Public Health Considerations</i>	<i>4-14</i>
Maintaining Hygiene	4-14
Maintaining Sanitation	4-15
Water Purification	4-15
<i>Unit Summary</i>	<i>4-16</i>
Homework Assignment	4-17

[This page intentional left blank]

UNIT OBJECTIVES

At the conclusion of this unit, the participants should be able to:

1. Explain the role of the CERT volunteer during a mass casualty incident.
2. Describe the functions of disaster medical operations.
3. Describe how to set up survivor treatment areas.
4. Perform head-to-toe patient assessments.
5. Take appropriate sanitation and hygiene measures to protect public health.

SCOPE

The scope of this unit will include:

- Introductions and Unit Overview;
- Mass Casualty Incidents;
- Functions of Disaster Medical Operations;
- Establishing Medical Treatment Areas;
- Conducting Head-to-Toe Assessments;
- Public Health Considerations; and
- Unit Summary.

ESTIMATED COMPLETION TIME

The following timetable (Table 4: Estimated Completion Times) is suggested for this module.

Table 4: Estimated Completion Times

Unit	Estimated Time
Introductions and Overview	15 minutes
Mass Casualty Incidents	10 minutes
Functions of Disaster Medical Operations	5 minutes
Establishing Medical Treatment Areas	5 minutes
Conducting Head-to-Toe Assessments	25 minutes
Public Health Considerations	10 minutes
Unit Summary	5 minutes
Total	1 hour, 15 minutes

RESOURCES REQUIRED

- Community Emergency Response Team Instructor Guide
- Community Emergency Response Team Participant Manual

- PowerPoint slides 4-0 through 4-22

EQUIPMENT

In addition to the equipment listed at the front of this Instructor Guide, you will need the following equipment for this unit:

- A computer with PowerPoint software; and
- A computer projector and screen.

PREPARATION

Working with a local community representative, identify any potentially culturally sensitive topics in this module. Develop strategies for presenting such topics in ways that will be engaging and appropriate for the participants. For example, in some cultures, discussing death is off-limits. With the head-to-toe assessment activity, physical contact is another potentially sensitive topic participants will encounter in this module. Prepare participants by always introducing these and other potentially sensitive topics gradually, with an awareness of the sensitivity of the audience. Avoid making jokes or being dismissive regarding these types of topics and individual's sensitivities toward them.

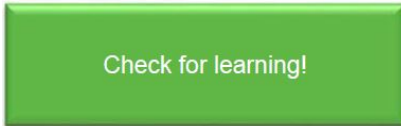
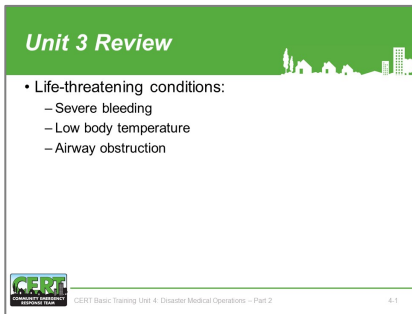

SECTION 1: UNIT OVERVIEW

Welcome

Introduce this unit by welcoming the participants to Unit 4 of the CERT Basic Training.

Introduce the instructors for this session and ask new instructors to describe their experience in medical operations briefly.

Review the main points from Unit 3:

Severe bleeding, airway obstruction, and low body temperature can be life-threatening conditions. Survivors with signs of these conditions must receive immediate treatment.

Question: What techniques are available to aid in the control of bleeding?

Correct responses:

- Direct pressure; and
- Tourniquet.

Question: What is the first action to take when approaching a survivor?

Correct response:

- Survey the area.

Question: When approaching a survivor, you should always do three things before treatment. What should you do?

Correct responses:

- Introduce yourself;
- Name your affiliation; and
- Ask permission to treat.

Question: How should you position an unconscious person to keep their airway clear?

Correct response:

- The recovery position.

CERT Size-up

- Gather Facts
- Assess Damage
- Consider Probabilities
- Assess Your Situation
- Establish Priorities
- Make Decisions
- Develop Plan of Action
- Take Action
- Evaluate Progress

REMEMBER: CERT SIZE-UP IS A CONTINUAL PROCESS

PM 2-8

CERT Basic Training Unit 4: Disaster Medical Operations – Part 2

Remind the participants that, as always, size-up is a critical component of any disaster operation and should be used during disaster medical operations. The size-up process consists of the following nine steps:

- Step 1:** Gather Facts;
- Step 2:** Assess and Communicate;
- Step 3:** Consider Probabilities;
- Step 4:** Assess Your Own Situation;
- Step 5:** Establish Priorities;
- Step 6:** Make Decisions;
- Step 7:** Develop Plan of Action;
- Step 8:** Take Action; and
- Step 9:** Evaluate Progress.

Does anyone have questions about the information presented in the previous unit?



Unit Objectives

Unit Objectives

- Explain the role of the CERT volunteer during a mass casualty incident
- Describe the functions of disaster medical operations
- Describe how to set up survivor treatment areas
- Perform head-to-toe patient assessments
- Take appropriate sanitation and hygiene measures to protect public health

PM 4-1

CERT Basic Training Unit 4: Disaster Medical Operations – Part 2

Tell the group that at the end of this unit, they should be able to:

1. Explain the role of the CERT volunteer during a mass casualty incident.
2. Describe the functions of disaster medical operations.
3. Describe how to set up survivor treatment areas.
4. Perform head-to-toe patient assessments.
5. Take appropriate sanitation and hygiene measures to protect public health.

SECTION 2: MASSCASUALTY INCIDENTS

Mass Casualty Incidents

- Incidents in which the number of casualties overwhelms the local resources
 - Commuter train derailment
 - Multi-car accident
 - Bus accident
 - Building collapse
 - Natural disasters (e.g., tornadoes)

 PM 4-2
CERT Basic Training Unit 4: Disaster Medical Operations – Part 2 4.4

Inform participants that mass casualty incidents are incidents in which the number of casualties overwhelms local resources. While these incidents are infrequent, CERT volunteers can play an important role by supporting local resources in responding to the incident.

Give the following examples of mass casualty incidents:

- Commuter train derailment;
- Multi-car accident;
- Bus accident;
- Building collapse; and
- Natural disasters (e.g., tornadoes).

Role of First Responder Personnel

- During mass casualty events, first responder personnel will:
 - Establish command and control of the incident area
 - Conduct a scene size-up and set-up
 - Send survivors with relatively minor injuries to a holding area to await treatment
 - Identify survivors who require life-saving interventions and treat them immediately

 PM 4-2
CERT Basic Training Unit 4: Disaster Medical Operations – Part 2 4.5

Explain that, in mass casualty incidents, first responder personnel:

- Establish command and control of the incident area;
- Conduct a scene size-up and set-up;
- Send survivors with relatively minor injuries to a holding area to await treatment;
- Identify survivors who require life-saving interventions and treat them immediately;
- Identify deceased victims as well as survivors too severely injured to save;
- Manage medical transportation for survivors who require additional treatment;
- Secure the area to protect first responders, survivors, and evidence for law enforcement investigations; and
- Remove debris and other safety or health threats.

Role of First Responder Personnel

- During mass casualty events, first responder personnel will also:
 - Identify deceased victims as well as survivors too severely injured to save
 - Manage medical transportation for survivors who require additional treatment
 - Secure the area to protect first responders, survivors, and evidence for law enforcement investigations
 - Remove debris and other safety or health threats

 PM 4-2
CERT Basic Training Unit 4: Disaster Medical Operations – Part 2 4.6

In addition to providing critical life-saving interventions, first responders must organize a likely chaotic situation when they arrive on scene. To support first responders, CERT volunteers must understand their role during mass casualty incidents.

Role of CERT Volunteers

- Put on PPE and any CERT affiliated gear
- Locate the nearest first responder and identify yourself/give them your local agency affiliation
- If a first responder is not available, assess the situation and determine whether you can provide life-saving interventions

 PM 4-2
CERT Basic Training Unit 4: Disaster Medical Operations – Part 2 4.7

Role of CERT Volunteers during Mass Casualty Incidents

Tell participants the first task of a CERT volunteer is to conduct a scene size-up, whether dispatched to the scene or located nearby out of coincidence. Take a moment to look around the scene and determine the appropriate course of action. After dialing 9-1-1, CERT volunteers should take the following actions:

- Put on their personal protective equipment (PPE), and any CERT affiliated gear, such as a hat, vest, or shirt;
- Locate the nearest first responder and identify themselves as a CERT volunteer;
- Communicate their CERT affiliation to first responder personnel. For their safety, first responders may ask them to leave the area. After leaving, report the incident and their role to the CERT Team Leader and/or local agency CERT affiliation.
- If a first responder is not available, assess the situation and determine whether they can provide life-saving interventions, such as controlling bleeding or opening an airway; and
- Once responders have arrived, provide them with detailed information from their size-up, and ask how they can help.

Communication is key for supporting first responders. CERT volunteers can provide valuable information to support an effective response.



Check for understanding.

Does anyone have questions about the role of CERT volunteers in a Mass Casualty Incident?

SECTION 3: FUNCTIONS OF DISASTER MEDICAL OPERATIONS



Explain that, disaster medical operations are the tasks associated with survivor treatment and support during a mass casualty incident. Tell participants there are five major functions of disaster medical operations:

1. **Triage/Assessment:** The initial assessment and sorting of survivors for treatment based on the severity of their injuries.
2. **Treatment:** The medical services provided to survivors.
3. **Transport:** The movement of survivors from the scene to the treatment area or medical facility.
4. **Morgue:** The temporary holding area for patients who died at the scene or the treatment area.
5. **Supply:** The hub for getting and distributing supplies.

Refer the participants to the **Image 4.1: Disaster Medical Operations Organization** in the *Participant Manual*.

Image 4.1: Disaster Medical Operations Organization

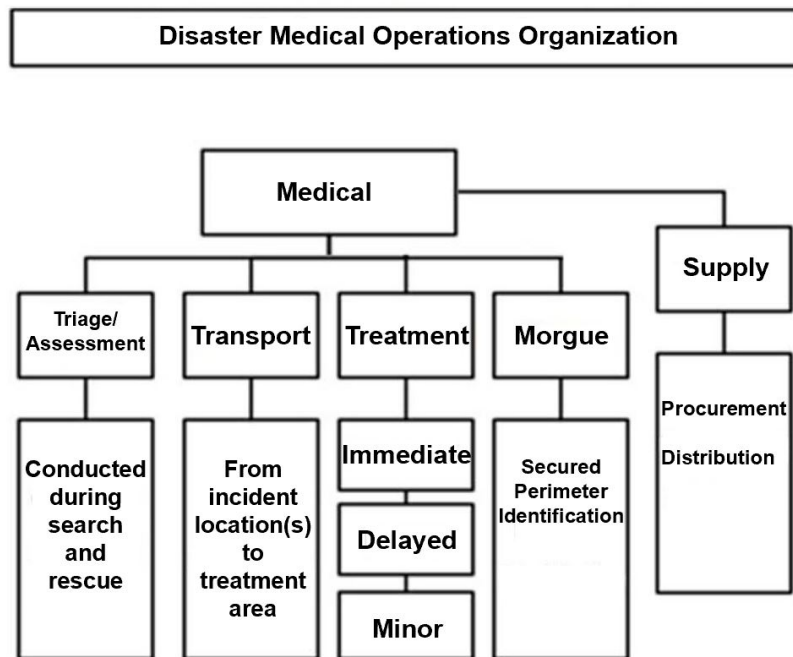

Disaster Medical Operations Organization showing the functions of disaster medical operations: Triage/Assessment, Transport, Treatment, Morgue, and Supply

Explain that triage/assessment and transport are functions of both search and rescue operations and medical operations.

Check for understanding.

Does anyone have questions regarding CERT organization?

Establish a Medical Treatment Area

- Select site and set up treatment area as soon as injured survivors are confirmed
- When determining best location(s) for treatment area, consider:
 - Safety of rescuers and survivors
 - Ease of access to resources



CERT
CERT Basic Training Unit 4: Disaster Medical Operations – Part 2

PM 4-5

Medical Treatment Areas

- To help meet the challenge of limited resources, CERT may need to establish:
 - Decentralized Treatment Areas (more than one location)
 - Centralized Treatment Areas (one location)

CERT
CERT Basic Training Unit 4: Disaster Medical Operations – Part 2

PM 4-5

SECTION 4: ESTABLISHING MEDICAL TREATMENT AREAS

Tell participants that as soon as injured survivors are confirmed, first responders will begin to set up a treatment area. The treatment area should consider safety for rescuers and survivors, and ease of access to resources (e.g., medical supplies, transport areas). First responders may call on CERT volunteers to help establish treatment areas or supply needs.

Decentralized Treatment Areas: It is sometimes necessary to set up more than one medical treatment location. The severity of the damage, number of injuries and casualties, and the safety of the immediate environment determine where the initial treatment area(s) should be located. Having multiple treatment areas can provide life-saving interventions when a central treatment location is too far away from the initial treatment area.

- A medical treatment location should be set up close to, but a safe distance from, each of the damage sites. Each of the treatment locations should include areas for survivors as well as a morgue.
- Survivors remain under treatment at the location until first responders can transport them to a location for professional medical care.

Centralized Treatment Areas: In an event with few injured survivors at multiple different sites, the first responders may need to establish one central medical treatment location. A centralized location may need to be set up even when there are decentralized sites established.

- The location should include treatment areas and a morgue.
- Move survivors to the treatment area from where they were initially rescued, assessed, and treated. They should remain under treatment there until first responders can transport them to a location for professional medical treatment.
- A central medical treatment area facilitates the effective use of resources since a limited number of medical operation personnel in one location can take care of a greater number of survivors.

- First responders and other medical professionals will generally be able to transport the injured more efficiently from one central location than from multiple decentralized locations.
- Move the deceased to the morgue, which should be physically separated from the survivor treatment area, in the centralized treatment area.

Whether a treatment area is centralized or is one in a number of decentralized areas, locations selected should be:

- Accessible by transportation vehicles (ambulances, trucks, helicopters, etc.); and
- Expandable.

Safety for Rescuers and Survivors

- In structures with light damage:
 - Assess survivors as they are found
 - Further medical treatment is performed in a safe location inside the designated treatment area
- In structures with moderate damage:
 - Assess survivors as they are found
 - Survivors are sent to a medical treatment area a safe distance from the incident

Individual safety is the number one priority



CERT Basic Training Unit 4: Disaster Medical Operations – Part 2

PM 4-5

Safety for Rescuers and Survivors

CERT volunteers may play a role in light search and rescue operations. Explain that as survivors are located, rescued, and assessed, they are moved to a location where medical personnel can treat them. As a reminder, the severity of the damage, number of injuries and casualties, and the safety of the immediate environment determine where the initial treatment area(s) should be located. Remind participants that in all cases their individual safety is the number one priority.

- In structures with light damage, CERT members assess the survivors as they find them. Further medical treatment is performed in a safe location inside the designated treatment areas.
- In structures with moderate damage, CERT members assess the survivors as they find them. Survivors are sent to a medical treatment area a safe distance from the incident.
- CERT members are not to enter a building with heavy damage under any circumstances.

Tell participants that CERT volunteers should never declare or attempt to move a patient who has died. If a CERT volunteer finds a deceased person (or a suspected deceased person), CERT volunteers should document the location and notify medical personnel.

Does anyone have questions about establishing treatment areas?



SECTION 5: CONDUCTING HEAD-TO-TOE ASSESSMENTS

Conducting assessments and providing rapid treatment are the first steps CERT volunteers take when working with a patient.

Remind the group that during an assessment, they should look for:

- Severe bleeding;
- Low body temperature; and
- Airway obstruction.

Stress that a head-to-toe assessment goes beyond the immediate life-threatening injuries to try to determine the nature of the patient’s injury. Perform the entire assessment before initiating treatment.

The instructor should stress not to conduct an assessment if a patient requires immediate care to prevent serious injury or death. In these cases, CERT volunteers should administer the necessary treatment before they follow up with an assessment.

Objectives of Head-to-Toe Assessments

Explain that the objectives of a head-to-toe assessment are to:

- Determine the extent of injuries as clearly as possible;
- Determine what type of treatment the patient needs; and
- Document the patient’s injuries.

Stress the importance of wearing PPE when conducting head-to-toe assessments.

If you wish, suggest that if the medical team runs out of non-latex exam gloves to reduce the risk of cross contamination, they can use rubber gloves if they clean them in a bucket of bleach-and-water solution (1-part bleach to 10 parts water) in between treating survivors.

What to Look for in Head-to-Toe Assessments

The medical community uses the acronym DCAP-BTLS to remember what to look for when conducting a rapid assessment. DCAP-BTLS stands for the following:

- Deformities;

Head-to-Toe Assessment

- Objectives of head-to-toe assessment:
 - Determine extent of injuries
 - Determine type of treatment needed
 - Document injuries

PM 4-7

DCAP-BTLS

- Deformities
- Contusions
- Abrasions
- Punctures
- Burns
- Tenderness
- Lacerations
- Swelling

PM 4-8

- Contusions (bruising);
- Abrasions;
- Punctures;
- Burns;
- Tenderness;
- Lacerations; and
- Swelling.

Explain that when conducting a head-to-toe assessment, CERT members should look for DCAP-BTLS in all parts of the body.

Remind the participants to provide IMMEDIATE treatment for life-threatening injuries.

Emphasize to the participants that they should pay careful attention to how people have been hurt (i.e., what caused the harm) because it provides insight to probable injuries suffered.

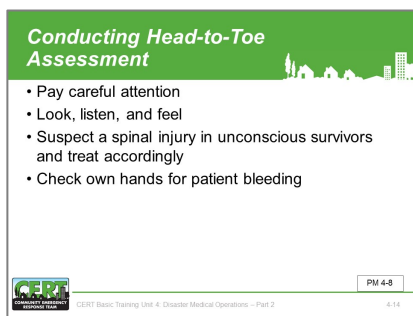

How to Conduct a Head-to-Toe Assessment

Whenever possible, CERT volunteers should ask the person about any injuries, pain, bleeding, or other symptoms. Stress that, if the patient is conscious, CERT members should always ask permission to conduct the assessment. The patient has the right to refuse treatment.

Emphasize the importance of talking with the conscious patient to reduce anxiety.

Explain that head-to-toe assessments should be:

- Conducted on all survivors, even those who seem all right;
- Verbal (if the patient is able to speak); and
- Hands-on. Do not be afraid to remove clothing to look.

Stress the need to conduct each head-to-toe assessment the same way; doing so will make the procedure quicker and more accurate with each assessment. Remember to:

- Pay careful attention;
- Look, listen, and feel for anything unusual;
- Suspect a spinal injury in all unconscious survivors and treat accordingly; and
- Check your own hands for patient bleeding as they perform the head-to-toe assessment.

Order of Assessment

1. Head
2. Neck
3. Shoulders
4. Chest
5. Arms
6. Abdomen
7. Pelvis
8. Legs



CERT
COMMUNITY EMERGENCY RESPONSE TEAM PM 4-8
CERT Basic Training Unit 4: Disaster Medical Operations – Part 2 4-15

Check (DCAP-BTLS) body parts from the head to toe for fractured bones and soft tissue injuries in the following order:

1. Head;
2. Neck;
3. Shoulders;
4. Chest;
5. Arms;
6. Abdomen;
7. Pelvis; and
8. Legs.

Tell participants that while conducting a head-to-toe assessment, CERT members should always check for:

- Pulse, Movement, Sensation (PMS) in all extremities.
- Medical ID emblems on bracelet or necklace.

Closed-Head, Neck, Spinal Injuries

- If injuries to the head or spine are suspected, **do no harm**
 - Minimize movement of head and neck while treating life-threatening conditions
- If survivors exhibit signs or are found under heavy debris, treat them as having a closed-head, neck, or spinal injury

CERT
COMMUNITY EMERGENCY RESPONSE TEAM PM 4-8
CERT Basic Training Unit 4: Disaster Medical Operations – Part 2 4-15

Closed-Head, Neck, and Spinal Injuries

When conducting head-to-toe assessments, rescuers may find survivors who have or may have suffered closed-head, neck, or spinal injuries.

Inform the participants that a closed-head injury is a concussion-type injury as opposed to a laceration or tear wound, although, lacerations can indicate that the survivor has suffered a closed-head injury.

Tell the group that the main objective when CERT members encounter suspected injuries to the head or spine is to **do no harm**. They should minimize movement of the head and spine while treating any life-threatening conditions.

The signs of a closed-head, neck, or spinal injury most often include:

- Change in consciousness;
- Inability to move one or more body parts;
- Severe pain or pressure in head, neck, or back;
- Tingling or numbness in extremities;
- Difficulty breathing or seeing;
- Heavy bleeding, bruising, or deformity of the head or spine;
- Blood or fluid in the ears or nose;
- Bruising behind the ear;
- “Raccoon” eyes (bruising around eyes);
- “Uneven” pupils;

- Seizures; and
- Nausea or vomiting.

Stress that if survivors are exhibiting any of these signs, or if the survivor is found under collapsed building material or heavy debris, you should treat them as having a closed-head, neck, or spinal injury.

Stabilizing the Head

Explain that during a disaster, ideal equipment is rarely available. CERT members may need to be creative by:

- Looking for materials — a door, desktop, building materials — to use as a backboard; and
- Looking for items — towels, draperies, or clothing — to stabilize the head on the board by tucking them snugly on either side of the head to immobilize it.

Only move survivors to increase the safety of both the rescuer and the survivor, or when professional help is delayed, and a medical treatment area is established to care for multiple survivors.

- Note that moving patients with suspected head, neck, or spinal injury require sufficient patient stabilization. However, if the rescuer or patient is in immediate danger, safety is more important than any potential spinal injury, and the rescuer should move the patient from the area as quickly as possible.

Note that Unit 7: Light Search and Rescue will cover techniques for moving survivors.

Introduce the head-to-toe assessment demonstration.

Demonstrate Head-to-Toe Assessment

Ask the group if someone would volunteer to be the “survivor” in your demonstration of a head-to-toe assessment. Another instructor could also be the “survivor.”

Demonstrate the head-to-toe assessment procedure, explaining each step to the class. Describe what the rescuer should look for at each step and explain how and where the rescuer should place his or her hands in each step to best identify injuries.

Does anyone have any questions about the head-to-toe assessment?

Demonstrate “creative” in-line stabilization, using a table and towels.

Ask the participants to brainstorm about materials in the classroom or in their vehicles that they might use to stabilize a head on a board.

Check for understanding.

Tell the group that they will now practice the procedure.

Exercise 4.1: Conducting Head-to-Toe Assessments

Purpose: This exercise allows the participants to practice performing head-to-toe assessments on each other.

Complete this exercise as many times as possible with different “patients.”

Instructions: Follow the steps below to facilitate this exercise:

Step 1: Assign the group to work in pairs. Attempt to partner each participant with someone with whom he or she is relatively unfamiliar. This helps to simulate a head-to-toe assessment in a disaster environment.

Step 2: Ask the person on the right to be the patient and the person on the left to be the rescuer.

Step 3: Ask the patients to lie on the floor on their backs and close their eyes.

Step 4: Ask the rescuers to conduct a head-to-toe assessment on the patients, following the procedure demonstrated earlier. Have the rescuer repeat the head-to-toe assessment.

Step 5: After the rescuer has made at least two observed head-to-toe assessments, ask the patient and rescuer to change roles.

Step 6: Allow each new rescuer to perform at least two observed head-to-toe assessments.

Step 7: After the participants have had the opportunity to be the rescuer, discuss any problems or incorrect techniques that they demonstrated. Explain how to avoid the problems during emergencies.

Does anyone have any additional questions about conducting head-to-toe assessments?

Tell the group that the remainder of this unit will deal with public health considerations associated with disaster medical operations.

Observe each pair and correct improper techniques.

Check for understanding.

SECTION 6: PUBLIC HEALTH CONSIDERATIONS

Public Health Considerations

- Maintaining proper hygiene
- Maintaining proper sanitation
- Purifying water (if necessary)
- Preventing spread of disease



CERT Basic Training Unit 4: Disaster Medical Operations – Part 2 PM 4-11

Introduce this topic by reminding the group that when disaster survivors are sheltered together for treatment, public health becomes a concern. CERT members and programs should take measures to avoid the spread of disease.

Explain that the primary public health measures include:

- Maintaining proper hygiene;
- Maintaining proper sanitation;
- Purifying water (if necessary); and
- Preventing the spread of disease.

Maintaining Hygiene

The maintenance of proper personal hygiene is critical, even under makeshift conditions.

Inform the group of the following actions they should take to maintain personal hygiene:

Maintaining Hygiene

- Wash hands frequently
 - Or use alcohol-based hand sanitizer
- Wear non-latex exam gloves
- Keep dressings sterile
- Wash areas that come in contact with body fluids



CERT Basic Training Unit 4: Disaster Medical Operations – Part 2 PM 4-11

- **Wash hands frequently using soap and water.** Hand washing should be thorough (at least 15 to 20 seconds of vigorous rubbing on all surfaces of the hand). Alcohol-based hand sanitizers, which do not require water, are a good alternative to hand washing. The U.S. Centers for Disease Control (CDC) recommends products that are at least 60 percent alcohol. To use an alcohol-based hand sanitizer, apply about half a teaspoon of the product to the palm of your hand. Rub your hands together, covering all surfaces, until hands are dry.
- **Wear non-latex exam gloves at all times.** Change or disinfect gloves after examining and/or treating each patient. As explained earlier, under field conditions, individuals can use rubber gloves if sterilized between treating survivors using bleach and water (one-part bleach to 10 parts water).
- **Keep dressings sterile.** Do not remove the wrapping from dressings until use. After opening, use the entire package of dressing, if possible.
- **Wash surface areas with soap and water or diluted bleach that come in contact with bodily fluid.**

Stress the importance of practicing proper hygiene techniques even during exercises.



Maintaining Sanitation

Introduce proper sanitation by cautioning the group that poor sanitation is a major cause of infection.

Explain that CERT medical operations personnel can maintain sanitary conditions by:

- Controlling the disposal of bacterial sources (e.g., soiled exam gloves, dressings);
- Putting waste products in plastic bags, tying off the bags, and marking them as medical waste. Keep medical waste separate from other trash and dispose of it as hazardous waste; and
- Burying human waste. Select a burial site away from the operations area and mark the burial site for later cleanup.

Again, stress the need to practice proper sanitation, even during exercises.

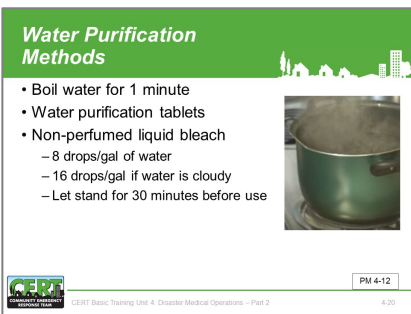

Water Purification

Introduce water purification by pointing out to the group that potable water supplies are often in short supply during a disaster. Remind the group to purify water for drinking, cooking, and medical use by heating it to a rolling boil for 1 minute, or by using water purification tablets or non-perfumed liquid bleach.

The bleach to water ratios are:

- 8 drops of bleach per gallon of water; and
- 16 drops per gallon if the water is cloudy or dirty.

Let the bleach and water solution stand for 30 minutes. Note: if the solution does not smell of bleach, add another six drops of bleach and let the solution stand for 15 minutes.

Explain to the participants that rescuers should not put anything on wounds other than purified water. The use of other solutions (e.g., hydrogen peroxide) on wounds must be a decision made by trained medical personnel.

Does anyone have any questions about the public health considerations related to disaster medical operations?

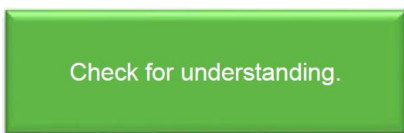

Unit Summary

- During a mass casualty incident, CERT volunteers should:
 - Identify self as CERT volunteer and give agency affiliation
 - Assess and provide life-saving interventions
 - Provide responders with detailed information
Communication is key
- First responders may establish a central treatment location or multiple at different incident sites
Treatment areas will take into consideration safety and access to resources

 CERT Basic Training Unit 4: Disaster Medical Operations – Part 2 PM 4-13 4-21

UNIT SUMMARY

Begin the summary by congratulating the group on completing the disaster medical operations sessions. Remind them that they have learned a large amount of information about how to recognize and treat life-threatening disaster-related injuries. Further, thank the participants for proving their knowledge and skills in high-pressure exercises.

Summarize the key points of this unit:

- During a mass casualty incident, where the number of injured and dead overwhelms local resources, CERT volunteers should:
 - Identify yourself as a CERT volunteer and your local agency affiliation;
 - Assess the situation and provide life-saving interventions if a first responder is not available;
 - Provide responders with detailed information from your size-up when they arrive on scene; and
 - Remember that communication is key for supporting first responders.
- Disaster medical operations include these major functions:
 - Triage/Assessment;
 - Treatment; Transport;
 - Morgue; and
 - Supply.
- Treatment areas will take into consideration safety for rescuers and survivors and proximity to resources.
- Depending on the circumstances, a first responder may establish a central medical treatment location and/or treatment locations at multiple incident sites with many injured survivors.
- Head-to-toe assessments should be hands-on and verbal. Always conduct head-to-toe assessments in the same way — beginning with the head and moving toward the feet. If you suspect injuries to the head, neck, or spine, the main objective is to not cause additional injury. Use in-line stabilization and a backboard if you must move the survivor.

Unit Summary Cont'd

- Head-to-toe assessments should be:
 - Hands-on and verbal
 - Conducted in the same way each time
- To safeguard public health, maintain proper hygiene and sanitation, and purify water

 CERT Basic Training Unit 4: Disaster Medical Operations – Part 2 PM 4-13 4-21

- To safeguard public health, take measures to maintain proper hygiene and sanitation, and purify water if necessary. In advance, plan all public health measures and practice during exercises.

Remind the group that there is much more to learn about medical operations than could possibly be presented in a couple 2 to 3-hour sessions. Recommend strongly that the participants attend additional training offered by the American Red Cross, or through community colleges.

Remind the group also that disaster medical operations is a team effort and that, like all teams, they must practice together so they can function as a team under pressure. Encourage the participants to attend exercise simulations whenever offered locally.

Check for understanding.

Does anyone have any questions about anything covered in this unit?

Homework Assignment

Homework Assignment

- Read unit to be covered in next session
- Practice complete head-to-toe assessment on friend or family member

CERT
Community Emergency Response Team

PM 4-13

CERT Basic Training Unit 4: Disaster Medical Operations – Part 2

4-22

Ask the group to read and become familiar with the unit to be covered in the next session.

Tell them to try practicing a rapid head-to-toe assessment on a friend or family member. Do not forget to document!

Thank all of the participants for attending the session and remind the group of the date and time of the next session, if necessary.

[This page intentional left blank]



CERT Unit 5: Disaster Psychology

Instructor Guide



FEMA

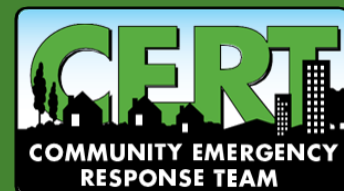

[This page intentional left blank]



CERT Unit 5: Disaster Psychology

In this unit, participants will learn about:

- **Disaster Psychology:** The psychological impact a disaster has on rescuers and survivors, and lessons on providing components of “psychological first-aid.”
- **Caring for Yourself and Survivors:** Steps volunteers can take individually and as part of a CERT before, following, and after a disaster.

[This page intentional left blank]

CERT Unit 5 Table of Contents

<i>SECTION 1: UNIT OVERVIEW</i>	<i>5-1</i>
How were you impacted?	5-2
<i>SECTION 2: DISASTER REACTIONS</i>	<i>5-3</i>
The Five Fs Are	5-3
Possible Psychological Symptoms	5-4
Possible Physical Symptoms	5-4
<i>SECTION 3: SELF-CARE AND TEAM WELL-BEING</i>	<i>5-6</i>
How You Reduce Stress.....	5-6
Exercise 5.1: Self-Care Toolbox	5-7
How Team Leaders Reduce Stress During the Incident.....	5-8
<i>SECTION 4: WORKING WITH SURVIVORS' EMOTIONAL RESPONSES</i>	<i>5-10</i>
Traumatic Crisis.....	5-12
Mediating Factors	5-13
Stabilizing Survivors	5-13
Listen, Protect, Connect	5-14
Being an Empathetic Listener	5-15
What Not to Say	5-16
Say This Instead.....	5-17
Managing the Death Scene	5-17
<i>UNIT SUMMARY</i>	<i>5-17</i>
Homework Assignment	5-18

[This page intentional left blank]

UNIT OBJECTIVES

At the conclusion of this unit, the participants should be able to:

1. Understand disaster trauma for survivors and rescuers, including CERT volunteers.
2. List steps to take for personal and team well-being.
3. Demonstrate key steps to apply when aiding someone with survivor's trauma.

SCOPE

The topics that will be discussed in this unit are:

- Introduction and Unit Overview;
- Disaster Reactions;
- Self-Care and Team Well-Being;
- Working with Survivors' Emotional Responses; and
- Unit Summary.

ESTIMATED COMPLETION TIME

The following timetable (**Table 5: Estimated Completion Times**) is suggested for this module.

Table 5: Estimated Completion Times

Unit	Estimated Time
Introductions and Overview	10 minutes
Disaster Reactions	15 minutes
Self-Care and Team Well-Being	15 minutes
Activity: Self-Care Toolbox	20 minutes
Working with Survivors' Emotional Responses	30 minutes
Unit Summary	5 minutes
Total	1 hour 35 minutes (2 hours 20 minutes with video)

RESOURCES REQUIRED

- Community Emergency Response Team Instructor Guide
- Community Emergency Response Team Participant Manual
- PowerPoint Slides 5-0 through 5-22

OTHER RESOURCES

If time permits, instructors are encouraged to show the class all or portions of the 43-minute video CERT Training: Disaster Psychology for this unit. The video describes the physical, emotional, and psychological reactions to a disaster and techniques for CERT volunteers to take care of themselves and assist others in coping with the stress. The video is available for download at the national CERT Web site: www.fema.gov/cert.

EQUIPMENT

The following equipment is required for this unit:

- A computer with PowerPoint software; and
- A computer projector and screen.

PREPARATION

Working with a representative of the community in which you will be teaching, identify any potentially culturally sensitive topics in this module. Develop strategies for presenting any such topics in ways that will be engaging and appropriate for participants.

It is particularly important in this unit to be aware of how your target audience may feel about topics such as trauma or coping with stressors. Encourage participants to discuss ways that people within their community may cope with psychological trauma. Avoid forcing your own coping mechanisms onto others.

In particular, look closely at the topic on What Not to Say. Make specific note of phrases that might be culturally inappropriate to the target audience. In the topic, Managing a Death Scene, ensure you understand culturally appropriate ways of dealing with death. Treat this topic with reverence and respect participants' cultural backgrounds.

All instructors are encouraged to complete FEMA Independent Study course IS-505: Religious and Cultural Literacy and Competency in Disaster on the FEMA EMI website (<http://training.fema.gov>). This course provides a background on how to engage different religious and cultural groups in the community.



SECTION 1: UNIT OVERVIEW

Welcome

Introduce the instructors for this unit.

Ask any new instructors to briefly describe their experience with disaster psychology.

Briefly review Units 3 and 4: Disaster Medical Operations.

What are you looking for in a head-to-toe assessment?

Correct Responses:

- Deformities
- Contusions (bruising)
- Abrasions
- Punctures
- Burns
- Tenderness
- Lacerations
- Swelling

Check for learning!

What are your objectives when treating burns?

Correct responses:

- Cool the burned area.
- Cover with a sterile cloth to reduce the risk of infection (to keep the fluids in and germs out).

Check for learning!

How do you dress a wound when there is active bleeding?

Correct response:

- Redress over the existing dressing and maintain pressure and elevation to control bleeding.

Check for learning!

If you are not sure whether it is a fracture or a sprain, what should you do?

Correct response:

- Immobilize the affected area using a splint.

Explain that CERT volunteers will likely encounter things during a disaster that are unpleasant and uncomfortable to witness and talk about.

In response to both natural disasters and acts of violence, CERT volunteers must be prepared to deal with



Open a group discussion.

the psychological effects of the trauma, including fear, anger, intense sadness, frustration, and traumatic grief. Survivors and CERT volunteers alike are at risk for experiencing these psychological effects.

Has anyone ever been involved in a large-scale emergency or disaster?

How Were You Impacted?

Discuss the participants' responses. Ask students for examples of physical and emotional reactions they may have encountered themselves or witnessed in other survivors.

Instructors should be aware of and considerate of the fact that this question may prompt emotional responses from the students. If students do not wish to share, instructors should provide examples of fictitious or real-world incidents from which the students can draw comparisons.

Stress the need for CERT volunteers to prepare for their role during and following a disaster by learning about the possible impact of disasters on themselves and on others, both emotionally and physically. This knowledge will help CERT volunteers understand and manage their reactions to the event, enabling them to work better with others.

Reminding the group about the course's earlier discussion of team organization, highlight the fact that team organization concepts can help them both operationally and psychologically. Working together and looking out for each other are important aspects of successful teams. This unit will address basic techniques for providing psychological first-aid.

Remind participants that psychological first-aid is not therapy; rather, it is a set of techniques to provide emotional intervention during field operations. This unit will cover techniques to help manage one's personal situation, so that participants can meet the needs of all survivors, including fellow CERT volunteers. Should CERT volunteers feel uncomfortable or incapable of conducting this type of intervention in the field during an emergency, they should be encouraged to ask for assistance.

Unit Objectives

1. Understand disaster trauma for survivors and rescuers, including CERT volunteers
2. List steps to take for personal and team well-being
3. Demonstrate key steps to apply when providing aid to someone with survivor's trauma

 CERT Basic Training Unit 5: Disaster Psychology PM 5-1

Unit Objectives

At the end of this unit, students should be able to:

5. Understand disaster trauma for survivors and rescuers, including CERT volunteers.
6. List steps to take for personal and team well-being.
7. Demonstrate key steps to apply when aiding someone with survivor's trauma.

SECTION 2: DISASTER REACTIONS

Inform the group that during a disaster, CERT volunteers may encounter extremely unpleasant circumstances. Reactions to psychological trauma can result from:

- Dealing with your own personal losses;
- Working in your neighborhood;
- Assisting neighbors, friends, coworkers who have been injured; and
- Feeling unsafe and insecure.

Explain to participants how they might experience "vicarious trauma," which is a common occupational hazard for disaster response volunteers. Vicarious trauma – also referred to as compassion fatigue, secondary victimization, or secondary traumatic stress – is a natural reaction of an individual exposed to a survivor's trauma. A person who identifies too strongly with a survivor may take on that survivor's feelings.

Caution participants against over-identifying with survivors, as taking on survivors' feelings as their own can affect their ability to do their job as rescuers. Taking ownership of others' problems will compound their own stress and impact the CERT's overall effectiveness.

Explain that CERT volunteers need to be aware of signs of disaster trauma in themselves, as well as in survivors, so they can take steps to alleviate stress. Explain that the term "burnout" is quite different from trauma. Typically, individuals suffering from burnout can overcome it by distancing themselves from their work for a period.

Causes of Disaster Reactions

- Dealing with your own personal losses
- Working in your neighborhood
- Assisting neighbors, friends, or coworkers who have also been injured
- Feeling unsafe and insecure

 CERT Basic Training Unit 5: Disaster Psychology PM 5-2

The Five Fs

- **Freeze:** "Stop, look, and listen," or be on guard and watchful
- **Flight:** Flee
- **Fight:** Attempt to combat the threat
- **Fright:** Tonic immobility when in contact with a predator, or playing dead
- **Faint:** Fear-induced fainting

 CERT Basic Training Unit 5: Disaster Psychology PM 5-2

The Five Fs are:

Humans typically have five primary responses to stress – we refer to those as the "Five Fs," which are: 1) freeze, 2) flight, 3) fight, 4) fright, and 5) faint. Our bodies have both physical and psychological responses to stressful events.

Recognizing examples of each of these responses in both CERT volunteers and survivors can assist you in determining how best to provide support.

8. Freeze: “Stop, look, and listen,” or be on guard and watchful.
9. Flight: Flee.
10. Fight: Attempt to combat the threat.
11. Fright: Tonic immobility when in contact with a predator or playing dead.
12. Faint: Fear-induced fainting.

Possible Psychological Symptoms

Here are examples of the types of disaster-related psychological and physiological responses volunteers may experience or observe others experience.

Emotional: nervousness; helplessness; shock; numbness; inability to feel love or joy; feelings of abandonment; agitation; feelings of detachment; exhilaration as a result of surviving; unreal feelings; feelings of being out of control; instances of denial; feelings of being overwhelmed; and feelings of fragility.

Cognitive: difficulty making decisions; reoccurrence of disturbing dreams; memories and flashbacks; feelings of always being on guard or on constant alert; feelings of dissociation; distortion of time and space; rumination or racing thoughts; or repeatedly replaying the traumatic event.

Spiritual: loss of hope; limited expectations about life, intense use of prayer; loss of self-efficacy; feelings of despair and disillusionment; questioning (“Why Me?”); redefining meaning and importance of life.

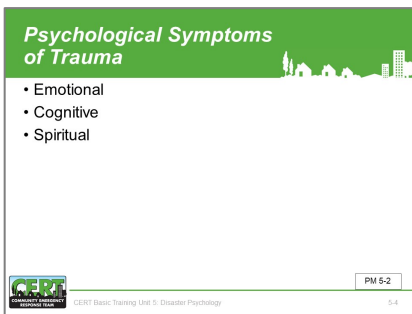

Possible Physical Symptoms

- Loss of appetite;
- Headaches or chest pain;
- Diarrhea, stomach pain, or nausea;
- Hyperactivity;
- Increase in alcohol or drug consumption;
- Nightmares;
- The inability to sleep; and
- Fatigue or low energy

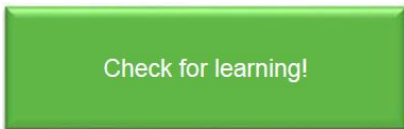
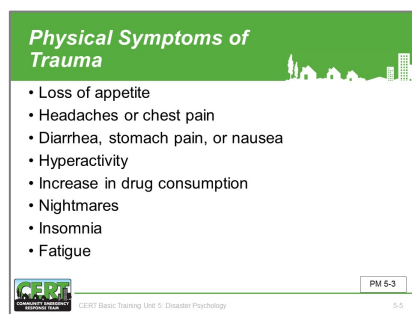

Look at these lists of symptoms above. Which of these symptoms can we categorize into each of the Five Fs?

- **Freeze:** “Stop, look, and listen,” or to be on guard and watchful;
- **Flight:** Flee;
- **Fight:** Attempt to combat the threat;
- **Fright:** Tonic immobility when in contact with a predator, or playing dead; and
- **Faint:** Fear-induced fainting.



Check for understanding.

Does anyone have any questions about disaster reactions?

SECTION 3: SELF-CARE AND TEAM WELL-BEING

Team Well-Being

- Actions can be taken before, during, and after an incident to help manage emotional impact of disaster response work
- Knowing possible psychological and physiological symptoms of disaster trauma helps manage impact
- Learn to manage stress:
 - CERT volunteers for themselves
 - CERT leaders during response

 CERT Basic Training Unit 5: Disaster Psychology PM 5-4 5-6

Volunteers can take a range of actions before, during, and after an incident to help manage the emotional impact of disaster response work.

Knowing in advance the possible psychological and physiological symptoms of disaster trauma covered in this unit is one-step in managing the impact.

Some other aspects of stress management for CERT volunteers include actions they can take for themselves, and actions that CERT leaders can take during a response.

How to Reduce Stress

- Get enough sleep
- Exercise regularly
- Eat a balanced diet
- Balance work, play, and rest
- Allow yourself to receive as well as give
- Connect with others
- Use spiritual resources

 CERT Basic Training Unit 5: Disaster Psychology PM 5-4 5-7

How You Reduce Stress

Remind participants they should think about ways to reduce stress personally. Emphasize to them that only they know how to reduce their own personal stress, and that spending the effort stress reducers is worthwhile before an incident occurs.

Remind the participants that they can take the following preventive actions in their everyday lives.

- Get enough sleep;
- Exercise regularly;
- Eat a balanced diet;
- Balance work, play, and rest;
- Allow themselves to receive as well as give;
- Remember that their identity is broader than that of a helper;
- Connect with others; and
- Use spiritual resources.

Take Care of Yourself

- Be aware of trauma that can follow a disaster
- Explain to family members and friends what you need:
 - Listen when you want to talk
 - Don't force yourself to talk until you are ready

 CERT Basic Training Unit 5: Disaster Psychology PM 5-4 5-8

In addition to preventive steps, participants should also be aware of trauma that can follow a disaster. They should explain how to support their family, volunteers, and friends when they return from a disaster area.

- Listen when you want to talk.
- Do not force you to talk if you are not ready.

Participants might also want to share with their loved ones and friends the information on possible disaster-related psychological and physiological symptoms this unit discussed earlier.

Point out that experienced rescue workers find these steps helpful in controlling their stress levels, but that, in some cases, it might be necessary to seek help from mental health professionals.

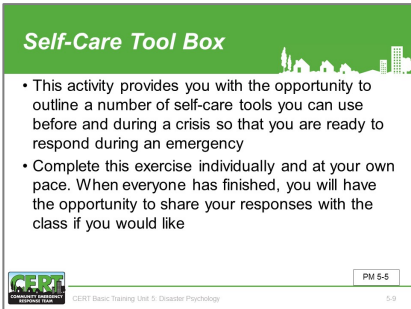

Exercise 5.1: Self-Care Toolbox

Purpose: This activity gives participants the opportunity to outline the self-care tools they can use before and during a crisis, so that they are ready to respond during an emergency.

Instructions: Participants should complete the Self-Care Toolkit (pages 5-5 to 5-6) individually. **Image 5.1: Self Care Toolkit** and **Image 5.2: Self Care Toolkit (cont.)** are displayed below.

Explain how this exercise will provide them with the opportunity to outline a number of self-care tools they can use to help them cope with stress.

When everyone in the class has finished, ask if anyone would like to share any of their responses with the class.

Image 5.1: Self Care Toolkit

<p>What is likely to be your greatest challenge? List out in rank order, what kinds of events may be most difficult for you. Examples of events that are difficult for lots of people: events involving pets, animals, children, or the elderly; contagious disease, intentional human-to-human harm.</p> <p>What skills do you have that may come in handy during a crisis?</p> <p>How do you know that you are feeling stressed? List symptoms that characterize you when you are feeling stressed (e.g., thoughts, feelings, body sensations, or behaviors).</p> <p>Make a list of things that help you relax (e.g., listening to music, taking a walk, reading a book, laughing, and talking with a loved one).</p> <p>Make a list of things you need to avoid (and that you would likely do without consideration) that will only add to your stress (e.g., drinking too much caffeine, overindulging in media, sitting for the whole day/shift, and taking on someone else's tasks).</p> <p>We all need to talk about our experiences from time to time. Who are the top five people you can go talk to during or after a crisis?</p> <p>What things can others do for you when you are feeling stressed?</p>	
---	--

Image 5.2: Self Care Toolkit (cont.)

How can you tell others what you need? How will you tell them?

The following areas are daily things that we either do or do not do that affect our ability to respond to emergencies. Following each one, rank how well you do in that area (1 = very poor, 10 = excellent) and then write down one action you can take to improve that area by one point.

Nutrition	1	2	3	4	5	6	7	8	9	10
What can you do:										
Sleep	1	2	3	4	5	6	7	8	9	10
What can you do:										
Manage Workload	1	2	3	4	5	6	7	8	9	10
What can you do:										
Balanced Lifestyle	1	2	3	4	5	6	7	8	9	10
What can you do:										
Stress Management	1	2	3	4	5	6	7	8	9	10
What can you do:										
Having fun	1	2	3	4	5	6	7	8	9	10
What can you do:										
Social network	1	2	3	4	5	6	7	8	9	10
What can you do:										
Exercise (30 min/day)	1	2	3	4	5	6	7	8	9	10
What can you do:										

How Team Leaders Reduce Stress

- Brief CERT personnel beforehand
- Remember CERT is a team
- Rest and regroup
- Take breaks away from the incident site
- Establish a culture of acceptance
- Eat properly, stay hydrated
- Be aware of changes in teammates
- Rotate teams and duties
- Phase out workers gradually
- Defuse after shift

CERT Basic Training Unit 5: Disaster Psychology PM 5-7 5-10

How Team Leaders Reduce Stress During the Incident

Explain the steps CERT TLs can take to reduce the stress on their team volunteers before, during, and after an incident:

- Brief CERT personnel before the effort begins on what they can expect to see and what they can expect in terms of emotional response in the survivors and themselves.

- Emphasize the team aspect of CERT. Sharing the workload and emotional stress can help defuse pent-up emotions.
- Encourage rescuers to rest and regroup to avoid becoming overtired. Physical wellness can have a tremendous impact on psychological well-being.
- Advise rescuers to take breaks away from the incident area for relief from the stress of the effort.
- Establish a culture of acceptance amongst the team. Encourage volunteers to verbalize their experiences and normalize open communication.
- Encourage rescuers to eat properly and maintain fluid intake during the operation. Encourage them to drink water or other electrolyte-replacing fluids, avoiding drinks with caffeine or refined sugar.
- Encourage team volunteers to be aware of changes in their teammates that may indicate personal stress and the need for a break or change of assignment.
- Rotate teams for breaks or new duties (e.g., from high-stress to low-stress jobs). Encourage team volunteers to talk with each other about their experiences to promote psychological health.
- Do not send home volunteers who just completed a high-stress operation; instead, assign them to a low-stress responsibility so they can decompress gradually.
- Conduct a brief discussion with rescue workers after their shift during which they can describe what they encountered and express their feelings about it.

Check for understanding.

Do you have any questions about self-care or team well-being?

SECTION 4: WORKING WITH SURVIVORS' EMOTIONAL RESPONSES

Emotional Phases of a Crisis

- Pre-Disaster
- Impact
- Heroic
- Honeymoon
- Disillusionment
- Reconstruction



CERT
COMMUNITY EMERGENCY RESPONSE TEAM

CERT Basic Training Unit 5: Disaster Psychology

PM 5-8

5-11

Identify the emotional phases a crisis survivor is likely to experience and discuss who and what rescuers might encounter during each phase. Collectively, communities can go through the stages listed below, and survivors can experience them individually as well.

Explain that conditions associated with evacuation and relocation have psychological significance. When there are physical hazards or family separations during the evacuation process, survivors often experience post-traumatic reactions. When the family unit is not together due to shelter requirements or other factors, anxiety regarding the welfare of those not present may detract from the attention necessary for immediate problem solving.

Pre-Disaster Phase: Communities will have varying degrees of warning depending on the type of disaster. For example, earthquakes typically hit without warning, whereas hurricanes and floods typically strike within days (or even hours) of a warning.

When there is no warning, survivors may feel more vulnerable, unsafe, and fearful of future unpredicted tragedies. The perception of having no control over protecting themselves or their loved ones can be deeply distressing.

Meanwhile, when people do not heed warnings and suffer losses as a result, they may experience guilt and self-blame. While they may have specific plans for how they might protect themselves in the future, survivors often feel guilty or responsible for what has occurred.

Impact Phase: The impact phase of a disaster can vary from the slow, low-threat buildup associated with some types of floods to the violent, dangerous, and destructive outcomes associated with tornadoes and explosions. The greater the scope, community destruction, and personal losses associated with the disaster, the greater the psychosocial effects.

Depending on the characteristics of the incident, people's reactions may range from constricted, stunned, or shock, to the less common overt expressions of panic and hysteria. Most typically, people respond initially with confusion and disbelief and focus on the survival and

physical well-being of themselves and their loved ones. When families are in different geographic locations during the impact of a disaster (e.g., children at school, adults at work), survivors will experience considerable anxiety until reunification.

Heroic Phase: In the immediate aftermath of a disaster, survival, rescuing others, and promoting safety are priorities. Evacuation to shelters, motels, or other homes may be necessary. For some, post-impact disorientation gives way to adrenaline-induced rescue behavior to save lives and protect property. While activity level may be high, actual productivity is often low. The capacity to assess risk may be impaired, and injuries can result. Altruism is prominent among both survivors and emergency responders.

Honeymoon Phase: In the weeks and months following a disaster, formal governmental and volunteer assistance may be readily available. Community bonding occurs from the shared experience of surviving a catastrophic experience and the giving and receiving of community support. Survivors may experience a short-lived sense of optimism of the help they will receive will make them “whole” again. When disaster behavioral health workers are visible and perceived as helpful during this phase, they are more readily accepted and have a foundation from which to provide assistance in the difficult phases ahead.

Disillusionment Phase: Disappointment in a slower-than-expected pace of recovery can trigger this phase. Disillusionment typically occurs in the second half of the year immediately following a disaster, and after the disaster’s first anniversary.

Reconstruction Phase: The reconstruction of physical property and recovery of emotional well-being may continue for years following a disaster. At this point, survivors realized that they will need to solve the problems of rebuilding their own homes, businesses, and lives largely by themselves and have gradually assumed the responsibility for doing so.

With the construction of new residences, buildings, and roads comes another level of loss recognition. Survivors face the need to readjust and integrate to new surroundings as they continue to grieve losses. Emotional resources within the family may be exhausted,

and social support from friends and family may have worn thin.

When people come to see meaning, personal growth, and opportunity from their disaster experience despite their losses and pain, they are well on the road to recovery. While disasters may bring profound life-changing losses, they also bring the opportunity to recognize personal strengths and reexamine life priorities.

Individuals and communities progress through these phases at different rates, depending on the type of disaster and the degree and nature of disaster exposure. This progression may not be linear or sequential, as each person and community brings unique elements to the recovery process. Individual variables, such as psychological resilience, social support, and financial resources, influence a survivor's capacity to move through the phases. While there is always a risk of aligning expectations too rigidly with a developmental sequence, having an appreciation of the unfolding of psychosocial reactions to disaster is valuable.

Tell the participants to expect that survivors will show psychological effects from the disaster — and that they should expect that some of the reaction will be directed toward them.

Traumatic Crisis

- A traumatic crisis is an event experienced or witnessed in which people's ability to cope is overwhelmed by:
 - Actual or potential death or injury to self or others
 - Serious injury
 - Destruction of their homes, neighborhood, or value possessions
 - Loss of contact with family or close friends

CERT Basic Training Unit 5: Disaster Psychology PM 5-9 5-12

Traumatic Crisis

A traumatic crisis is an event experienced or witnessed in which people's ability to cope is overwhelmed. The following factors can constitute, or contribute to, a traumatic crisis:

- Death, potential of death, or injury to self or others;
- Serious injury;
- Destruction of their homes, neighborhood, or valued possessions; and/or
- Loss of contact with family volunteers or close friends.

Traumatic stress may affect:

- **Cognitive function** - Those who have suffered traumatic stress may act irrationally, in ways out of character for them, and they may have difficulty making decisions. Additionally, they may have difficulty sharing or retrieving memories.

Effects of Traumatic Stress

- Traumatic stress may affect:
 - Cognitive functioning
 - Physical health
 - Interpersonal relationships

CERT Basic Training Unit 5: Disaster Psychology PM 5-9 5-13

- **Physical health** - Traumatic stress can cause physical symptoms and health problems.
- **Interpersonal relationships** - Survivors of traumatic stress may undergo temporary or long-term personality changes that make interpersonal relationships difficult.

Mediating Factors

- Prior experience with a similar event
- Intensity of disruption
- Individual feelings about event
- Emotional strength of individual
- Length of time since event

CERT
Community Emergency Response Team

CERT Basic Training Unit 5: Disaster Psychology

PM 5-9

5-14

Mediating Factors

Explain that the strength and type of personal reaction to trauma vary depending on a combination of the following factors:

- A person's prior experience with the same or similar event. The emotional effect of multiple events can be cumulative, leading to greater stress reactions.
- Intensity of the disruption in the survivors' lives. The more the survivors' lives are disrupted, the greater their psychological and physiological reactions may become.
- The meaning of the event to the individual, the more catastrophic the survivor perceives the event to be to him or her personally, the more intense his or her stress reaction will be.
- The emotional well-being of the individual and the resources (especially social) that he or she can use to help cope with stress. People who have had other recent traumas may not cope well with additional stresses.
- The length of time that has elapsed between the event's occurrence and the present, as the reality of the event usually takes time to "sink in."

CERT volunteers cannot know — and should never assume to know — what someone is thinking or feeling.

Caution the group not to take the survivors' surface attitudes personally. Rescuers should expect to see a range of responses that will vary from person to person, but the responses they see will be part of the psychological impact of the event — and probably will not relate to anything that the CERTs have or have not done.

Stabilizing Survivors

- Assess survivors for injury or shock
- Get uninjured people to help
- Provide support by listening and empathizing
- Help survivors connect with natural support systems

CERT
Community Emergency Response Team

CERT Basic Training Unit 5: Disaster Psychology

PM 5-10

5-15

Stabilizing Survivors

Explain that the goal of on-scene psychological intervention on the part of CERT volunteers should be to calm the incident scene by stabilizing individuals.

Address any medical needs then use the methods below to psychologically stabilize individuals.

- Observe survivors to determine their level of responsiveness and decide whether they pose a danger to themselves or to others.
- Get uninjured people involved in helping. Engaging survivors in focused activity helps them cope. Give them constructive jobs to do such as organizing supplies. This strategy is especially effective for survivors who are being disruptive.
- Provide support by:
 - **Listening:** Let them talk about their feelings and their physical needs. Survivors often need to talk about what they have been through — and they want someone to listen to them.
 - **Empathizing:** Caring responses show survivors that someone else shares their feelings of pain and grief.
- Help survivors connect to natural support systems, such as family, friends, or clergy.

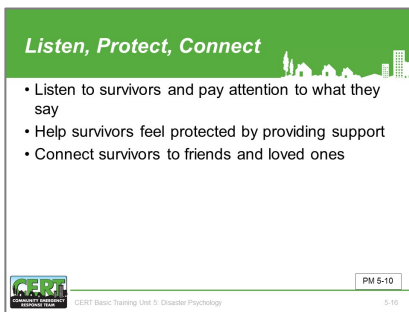

Listen, Protect, Connect

Psychological First-Aid (PFA) is an evidence-informed approach to assist children, adolescents, adults, and families in a disaster’s aftermath. Just as you learned basic first-aid in Units 3 and 4 to support the physical needs of survivors, PFA provides the initial support for survivors’ psychological well-being. “Listen, Protect, Connect” is one method of PFA that can assist survivors in taking steps to bounce back more quickly.

Listen. The first important step to help your survivors after an event is to listen and pay attention to what they say (and how they say it), how they act, and what they need right now. We talked previously about the many ways in which people may react after experiencing a traumatic event. Remember that not all reactions are verbal or can be seen.

Let the survivor(s) know you are willing to listen and talk about the event if and when they would like to. Understand that sometimes survivors are not ready to talk or do not want to talk and that is okay. Check back with them on a regular basis to see if their reactions or needs have changed.

Say to participants that although “listen” is the first step, you will continue to listen through all steps of PFA.

Protect – This step helps survivors feel protected and allows you to protect them from added stress. This step helps survivors feel better by taking actions to provide support, encouragement, and reassurance. The listening step should have provided you with enough information to make informed decisions about each survivor’s needs.

- Provide information or resources.
- Answer questions simply and honestly, clearing up any confusion they may have.
- Empathize and let them know they are not alone in their reactions to the event.
- Provide opportunities for them to communicate, but do not force them.
- Talk to them about what is being done to keep everyone safe from harm.
- Watch for anything in the environment that could re-traumatize them such as sights, smells, or sounds, and help them reduce contact with those elements.
- Help them decide what their basic needs are and how to get access to them (e.g., encouraging healthy behaviors such as eating and resting).

Connect – Connecting survivors to their friends, loved ones, and other resources has a positive impact on their recovery.

- Assist survivors in reconnecting with friends or loved ones after a disaster.
- Ensure you are connecting with them on a regular basis.
- Help them find access to resources that can offer support.

Check for understanding.

Do you have any questions about psychological first-aid or “Listen, Protect, Connect”?

Being an Empathetic Listener

Explain that being an empathetic listener requires the listener to listen and let the survivor talk. Good listeners will:

- Put the listener in the speaker’s shoes to understand their point of view more profoundly. Draw upon experiences or try to imagine how the

speaker is feeling. To limit the effects of vicarious trauma, be careful not to completely take on the speaker's feelings.

- Listen for meaning, not just words, and pay close attention to the speaker's nonverbal communication, such as body language, facial expressions, and tone of voice.
- Paraphrase the speaker periodically to make sure he or she fully understood what the speaker said and to indicate to the speaker that he or she is listening. This reinforces the communication process.

To learn more about being an empathetic listener, Dr. Brené Brown has a short video on how to create an emphatic connection available at: www.youtube.com/watch?v=1Evvgu369Jw.

Stress that survivors can show evidence of being suicidal, psychotic, or unable to care for themselves. Be sure to refer these cases to EMS and/or mental health professionals as soon as possible.

What Not to Say

Tell participants that, when providing support, they should avoid saying the following phrases. On the surface, these phrases may be meant to comfort the survivors. That said, for various reasons, the following may not always be well received:

- **"I understand."** In most situations, we cannot understand unless we have had the same experience.
- **"Don't feel bad."** The survivor has a right to feel bad and will need time to feel differently.
- **"You're strong"** or **"You'll get through this."** Many survivors do not feel strong and question if they will recover from the loss.
- **"Don't cry."** It is okay to cry.
- **"It's God's will."** With a person you do not know, giving religious meaning to an event may insult or anger the person.
- **"It could be worse,"** at least you still have...", or **"Everything will be okay."** It is up to the individual to decide whether things could be worse or if everything can be okay.

Emphasize that these types of responses, rather than providing comfort, can elicit a strong **negative** response or distance the survivor from the listener.

Point out that it is okay to apologize if the survivor reacts negatively to something you said.

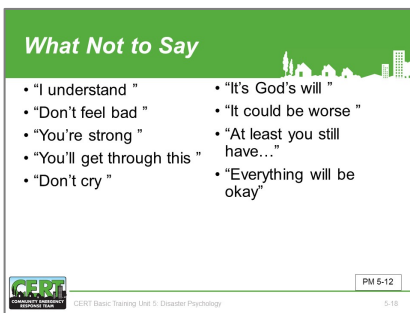

Learn to be comfortable with silence. Do not say something just to alleviate your own discomfort.

Say This Instead

Say This Instead

- "I'm sorry for your pain "
- "I'm so sorry this has happened "
- "Is it all right if I help you with...?"
- "I can't imagine what this is like for you "
- "What do you need?"

PM 5-12

Always ask permission to enter their space, provide help, or interact with them.

Allow people to say what they need. Normalize what they are feeling and thinking using phrases similar to the ones below:

- "I'm sorry for your pain."
- "I'm so sorry this has happened."
- "Is it all right if I help you with...?"
- "I can't imagine what this is like for you."
- "What do you need?"

Managing the Death Scene

Managing the Death Scene

- Cover the body; treat it with respect
- Follow local laws and protocols
- Talk with local authorities

PM 5-12

Explain that one unpleasant task that CERT volunteers may face is dealing with a victim who dies while under the team's care. CERT volunteers should never pronounce nor assume the death of a victim. The guidelines for dealing with this situation are listed below:

- Cover the body; treat it with respect.
- Follow local laws and protocols for handling the deceased.
- Talk with local authorities to determine the plan.

Check for understanding.

Are there any questions about the types of emotional and physiological responses you can expect to see during and following a disaster?

After answering all of the participants' questions, pose some "What would you do if ..." questions to ensure they understand the concepts of this section.

For example, ask the participants, "What would you do if you were attempting to rescue a survivor and the survivor became hysterical?"

UNIT SUMMARY

Unit Summary

- Prepare yourself, as rescues may be unpleasant and uncomfortable
- Know the psychological and physiological symptoms of trauma
- Understand the six emotional phases of a disaster
- Take steps to reduce stress, which affects cognition, health, and interactions
- Stabilize individuals
- Listen, protect, and connect to support survivors
- Be an empathetic listener

PM 5-13

Summarize the unit by making the following points:

- A disaster may expose rescuers to extremely unpleasant or uncomfortable situations. These experiences will often be stressful and may be traumatic.
- Over-identifying with survivors may subject rescuers to vicarious trauma.

- Survivors and rescuers may experience psychological and physiological symptoms of trauma after a disaster.
- CERT leaders can take steps to reduce stress on rescue workers before, during, and after an incident.
- CERT volunteers can take steps to reduce stress on themselves.
- Psychological First-Aid (PFA) is an evidence-informed approach for
 - assisting children, adolescents, adults, and families in the aftermath of disaster.
- The steps listen, protect, and connect can provide actions associated with supporting survivors after a disaster.
- Research shows that survivors go through the below distinct emotional phases following a disaster:
 - Pre-Disaster;
 - Impact;
 - Heroic;
 - Honeymoon;
 - Disillusionment; and
 - Reconstruction.
- Traumatic stress may affect cognitive functioning, physical health, and interpersonal reactions.
- People react differently to traumatic stress based on a variety of mediating factors.
- A traumatic crisis occurs when a person's ability to cope is overwhelmed.
- The goal of on-scene psychological intervention is to stabilize the incident by stabilizing individuals.
- Provide support for survivors by being an empathetic listener.

Check for understanding.

Does anyone have any questions about anything covered in this unit?

Homework Assignment

Ask the group to familiarize themselves by reading the next unit that will be covered in the next session.

Thank the participants for attending the session. Remind them of the time and location of the next session, if necessary.

Homework Assignment

- Read unit to be covered in next session
- Bring necessary supplies to next session
- Wear appropriate clothes to next session



CERT Basic Training Unit 5: Disaster Psychology

PM 5-13 1/22

[This page intentional left blank]



CERT Unit 6: Fire Safety and Utility Controls

Instructor Guide



FEMA

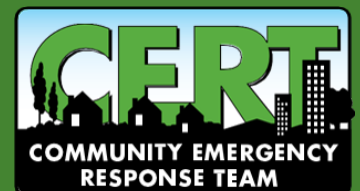

[This page intentional left blank]



CERT Unit 6: Fire Safety and Utility Controls

In this unit, participants will learn about:

- ❑ **Fire Chemistry:** How fire occurs, classes of fire, and choosing the correct means to extinguish each type of fire.
- ❑ **Fire Size-up Considerations:** How to evaluate fires, assess firefighting resources, and determine a course of action.
- ❑ **Portable Fire Extinguishers:** How to identify types of portable fire extinguishers and how to operate them.
- ❑ **Fire Suppression Safety:** How to decide if they should attempt to extinguish a fire; how to approach and extinguish a fire safely.
- ❑ **Hazardous Materials:** How to identify potentially dangerous materials in storage, in transit, and in their home.
- ❑ **Fire and Utility Hazards:** Potential fire and utility hazards in the home and workplace; how to implement successful fire prevention strategies.

[This page intentional left blank]

CERT Unit 6 Table of Contents

<i>SECTION 1: UNIT OVERVIEW</i>	<i>6-1</i>
Role of CERTs	6-1
CERT Priorities.....	6-2
<i>SECTION 2: FIRE CHEMISTRY</i>	<i>6-3</i>
The Fire Triangle	6-3
Demonstrating the Fire Triangle	6-3
Classes of Fire	6-4
<i>SECTION 3: FIRE SIZE-UP CONSIDERATIONS</i>	<i>6-5</i>
<i>SECTION 4: FIREFIGHTING RESOURCES</i>	<i>6-8</i>
Fire Extinguishers.....	6-8
Types of Fire Extinguishers	6-8
Extinguisher Rating and Labeling	6-9
Water Extinguishers	6-10
Chemical Extinguishers	6-10
Deciding to Use a Fire Extinguisher.....	6-11
Operating a Fire Extinguisher	6-12
P.A.S.S.....	6-13
Interior Wet Standpipes	6-14
Confinement.....	6-14
<i>SECTION 5: FIRE SUPPRESSION SAFETY</i>	<i>6-15</i>
Fire Suppression Safety Rules	6-15
Proper Fire Suppression Procedures.....	6-16
<i>SECTION 6: FIRE AND UTILITY HAZARDS</i>	<i>6-18</i>
Electrical Hazards.....	6-18
Natural Gas Hazards	6-20
Flammable Liquid Hazards	6-22
<i>SECTION 7: HAZARDOUS MATERIALS</i>	<i>6-23</i>
Identifying Hazardous Materials Locations.....	6-23
Location and Type of Occupancy	6-23
Placards	6-24
Identifying Hazardous Materials in Transit	6-26
Emergency Response Guidebook	6-28
Sights, Sounds, and Smells.....	6-28

Exercise 6.1: Suppressing Small Fires6-28

UNIT SUMMARY**6-30**

Homework Assignment6-31

[This page intentional left blank]

UNIT OBJECTIVES

At the conclusion of this unit, the participants should be able to:

1. Explain the role CERTs play in fire safety and response, including the fire size-up process and minimum safety precautions.
2. Extinguish a small fire using a fire extinguisher.
3. Identify and reduce potential fire, utility, and hazardous materials at home and in the community.

SCOPE

The topics that will be discussed in this unit are:

- Introduction and Unit Overview;
- Fire Chemistry;
- Fire Size-up Considerations;
- Firefighting Resources;
- Fire Suppression Safety;
- Fire and Utility Hazards;
- Hazardous Materials;
- Exercise: Suppressing Small Fires; and
- Unit Summary.

ESTIMATED COMPLETION TIME

The following timetable (**Table 6: Estimated Completion Times**) is suggested for this module.

Table 6: Estimated Completion Times

Unit	Estimated Time
Introductions and Overview	10 minutes
Fire Chemistry	10 minutes
Fire Size-up Considerations	10 minutes
Firefighting Resources	20 minutes
Fire Suppression Safety	15 minutes
Fire and Utility Hazards	15 minutes
Hazardous Materials	10 minutes
Exercise: Suppressing Small Fires	60 minutes
Unit Summary	5 minutes

Unit	Estimated Time
Total	2 hours, 50 minutes with video

RESOURCES REQUIRED

- Community Emergency Response Team Instructor Guide
- Community Emergency Response Team Participant Manual
- PowerPoint Slides 6-0 through 6-32

OTHER RESOURCES

If time permits, showing the 18-minute video Fire Safety: The CERT Member's Role is recommended for this unit. The video provides information on how to size-up the fire and select the right extinguisher, as well as how to use extinguishers correctly. The video is available for download at the national CERT Web site, www.fema.gov/cert.

EQUIPMENT

The following equipment is required for this unit:

- A computer with PowerPoint software;
- A computer projector and screen;
- Samples of NFPA 704 Diamond and other hazardous materials placards, if possible;
- One roll of cotton swabbing;
- One Pyrex® jar with lid;
- One box of wooden kitchen matches;
- One water fire extinguisher;
- One dry chemical fire extinguisher;
- Portable Class A:B:C fire extinguishers (one for every five participants);
- Fire Pan; and
- Road flares and a long pole.

EXERCISE REMARKS

Most fire extinguisher service companies will provide Class A:B:C portable extinguishers for the final activity in this unit. Contact local companies for support.

One method for setting up this exercise is shown below in **Image 6: Exercise Set Up**. Consult your local fire department for any additional assistance required in building and operating the fire pan. Check with your state fire marshal about guidelines for open burning.

Image 6: Exercise Set Up

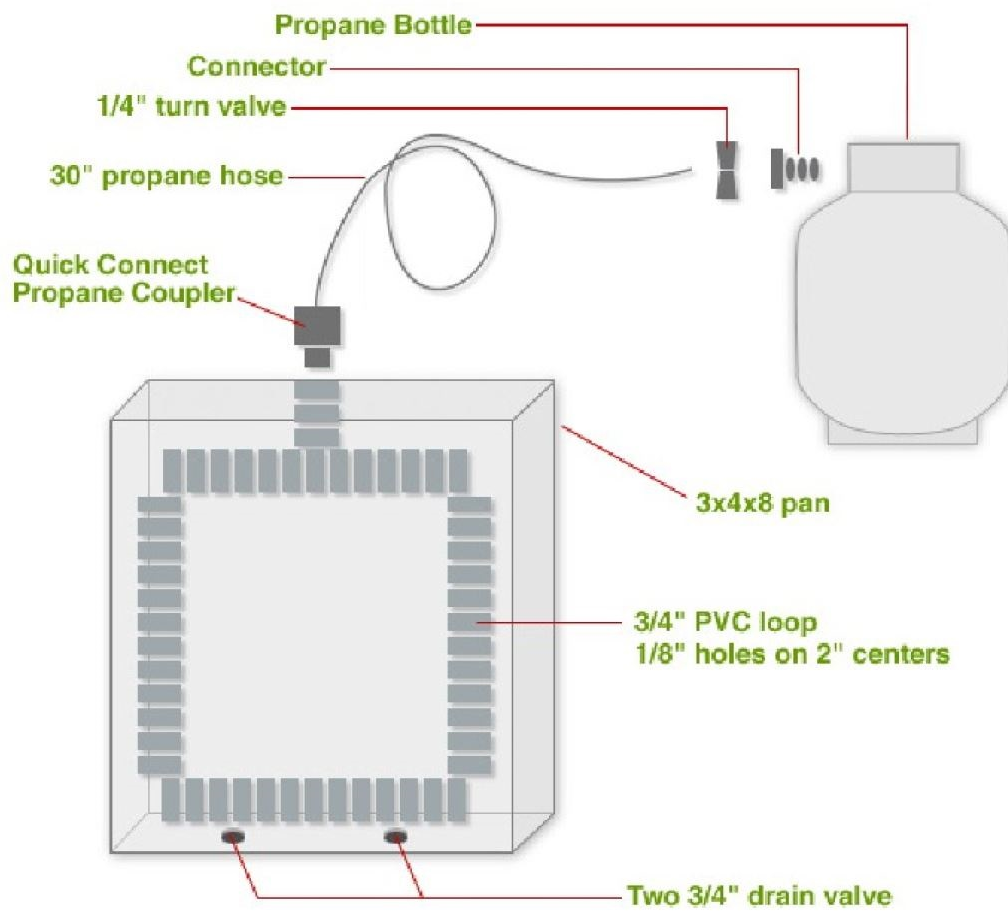



SECTION 1: UNIT OVERVIEW

Welcome

Introduce this unit by welcoming participants to Unit 6 of the CERT Basic Training.

Introduce any new instructors who will be assisting with this session.

Recall concepts and topics from Unit 5 for review.

Introduce fire and utility safety by telling participants that during, and immediately following a severe emergency, the first priorities of professional fire services are life safety, incident stabilization, and property conservation.

Limited access to roads, weather conditions, inadequate water supply, and limited resources may hamper and slow the response time of responders.

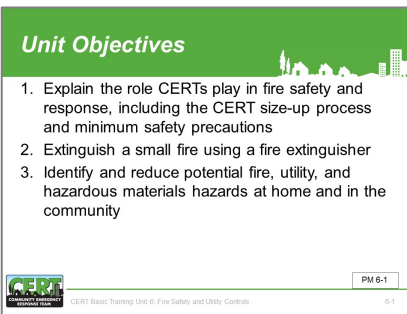

Unit Objectives

At the end of this unit, students should be able to:

- 13. Explain the role CERTs play in fire safety and response, including the fire size-up process and minimum safety precautions.
- 14. Extinguish a small fire using a fire extinguisher.
- 15. Identify and reduce potential fire, utility, and hazardous materials hazards at home and in the community.

Tell the group that, at the end of the unit, they will have an opportunity to use a portable extinguisher to put out a fire.

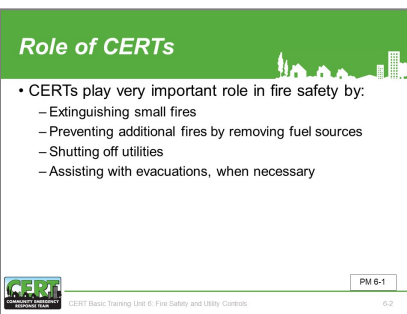

Role of CERTs

Emphasize that CERTs play a very important role in fire and utility safety by supporting the following actions:

- Extinguishing small fires before they become major fires. This unit will provide training on how to use an extinguisher to put out small fires and how to recognize when a fire is too big to handle. As a rule, if they cannot put out a fire in five seconds, it is already too big to handle, and they should leave the premises immediately.
- Preventing additional fires by removing fuel sources. This unit will describe how to perform an "overhaul," the process to ensure they extinguish a fire completely and permanently.

Although CERTs assist with evacuations, the procedures for conducting evacuations are not covered in this course. It is recommended that evacuation be covered in supplemental training.

- Shutting off utilities when necessary and safe to do so. This unit will review utility shutoff procedures taught in Unit 1.
- Assisting with evacuations where necessary. When a fire is beyond the ability of CERTs to extinguish, CERT volunteers need to protect lives by evacuating the area and establishing a perimeter while also notifying fire services of the situation.

CERT Priorities

- Rescuer safety is number one priority
 - Always work with a buddy
 - Always wear safety equipment

CERT Goal:
Do the greatest good for the greatest number

PM 6-1

CERT Basic Training Unit 6: Fire Safety and Utility Controls 6-3

CERT Priorities

CERTs play an important role in neighborhood and workplace fire and utility safety. CERT volunteers help in fire- and utility-related emergencies before professional responders arrive. When responding, CERT volunteers should keep in mind the following CERT standards:

- Rescuer safety is always the number one priority. Therefore, CERT volunteers should always:
 - Use the buddy system. Buddies serve an important purpose –protecting each other’s safety. Do not ever try to fight a fire alone. Stick together at all times.
 - Wear safety equipment (gloves, helmet, goggles, N95 mask, and sturdy shoes or boots). Unless otherwise stated, this equipment is generally not fire resistant personal protective equipment.
- CERT’s goal is to do the greatest good for the greatest number.

Check for understanding.

Does anyone have any questions regarding CERT roles or priorities regarding fire safety and utility controls?

Check for knowledge.

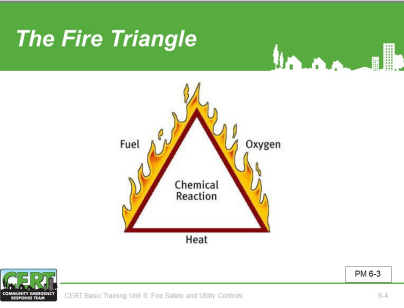

SECTION 2: FIRE CHEMISTRY

Does anyone know what it takes for a fire to burn?

The Fire Triangle

Fire requires three elements to exist:

16. **Heat:** Heat is required to elevate the temperature of a material to its ignition point.
17. **Fuel:** The fuel for a fire may be a solid, liquid, or gas. The type and quantity of the fuel will determine which method they should use to extinguish the fire.
18. **Oxygen:** Most fires will burn vigorously in any atmosphere of at least 20 percent oxygen. Without oxygen, most fuels could be heated until entirely consumed yet they would not burn.

Explain that working together, these three elements, called the fire triangle, create a chemical exothermic reaction, which is fire.

Refer the participants to **Image 6.1: Fire Triangle** in the Participant Manual.

A new fire will not ignite, and an existing fire will extinguish if any of these three elements is missing or is taken away.

Image 6.1: Fire Triangle

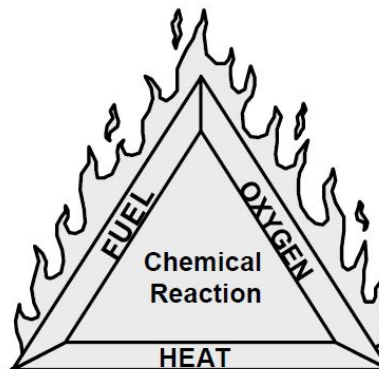

Fire Triangle: Fuel, oxygen, and heat create a chemical reaction, which causes fire.

Demonstrating the Fire Triangle

Tell the group you will now demonstrate the concept of the fire triangle by removing the oxygen from burning cotton by completing the following steps:

Step 1: Ignite a rolled-up piece of cotton, place it inside a Pyrex® jar, and cover it tightly.

Step 2: Wait until the flame goes out.

Step 3: Remove the material from the jar and blow on it to demonstrate that, unless the fire is completely out and overhauled, adding oxygen may complete the fire triangle and rekindle the fire.

Emphasize the need to ensure they have extinguished every piece of burning material completely. Tell the participants to think of Smokey the Bear and campfires to remember this point.

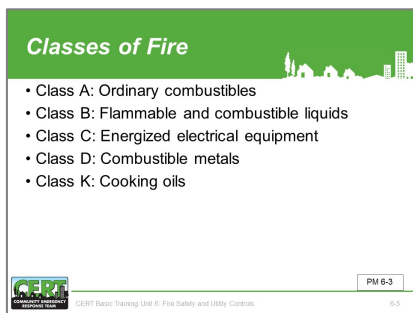

Classes of Fire

To aid in distinguishing types of fires, there are five classes based on the type of fuel that is burning.

- **Class A Fires:** Ordinary combustibles, such as paper, cloth, wood, rubber, and many plastics.
- **Class B Fires:** Flammable liquids, including oils and gasoline, as well as combustible liquids such as charcoal lighter fluid and kerosene. Only the vapor burns when ignited.
- **Class C Fires:** Energized electrical equipment, such as wires and motors. When the electricity is turned off, the fire becomes a Class A fire.
- **Class D Fires:** Combustible metals, including aluminum, magnesium, and titanium.
- **Class K Fires:** Cooking oils, such as vegetable oils, animal oils, and fats.

Stress that it is extremely important to identify the type of fuel feeding the fire to select the correct method and agent for extinguishing the fire.

Does anyone have any questions about fire chemistry?

Reemphasize the need to overhaul Class A fires (i.e., ensure that every piece of burning material is completely extinguished).

Check for understanding.

SECTION 3: FIRE SIZE-UP CONSIDERATIONS

CERT Fire Size-up

- Helps CERT volunteers decide:
 - Whether to attempt to suppress a fire
 - A plan of action
- Answers these questions:
 - Do my buddy and I have the right equipment?
 - Are there other hazards?
 - Is the building structurally damaged?
 - Can my buddy and I escape?
 - Can my buddy and I fight the fire safely?

Remember: The safety of individual CERT volunteers is always the top priority

CERT Basic Training Unit 6: Fire Safety and Utility Controls
PM 6-4

Point out that, while size-up is a fire department term, the process has been tailored for CERTs and is used in other areas of CERT responsibility.

Provide several examples to illustrate the differences between fire department size-up and CERT size-up.

As introduced in Unit 2, size-up is a continual process that enables professional responders to make decisions and respond appropriately in the areas of greatest need. CERT size-up consists of nine steps and should be used in any emergency, including during fire situations.

Refer the participants to **Table 6.1: CERT Fire Size-up** beginning on page 6-5 in the Participant Manual. Point out that, although the checklist is not exhaustive, it does include many of the questions that CERT volunteers should ask when sizing up a fire situation.

Explain that a size-up of a situation involving a fire will dictate whether to attempt fire suppression and will help them plan for extinguishing the fire.

Emphasize that the safety of individual CERT volunteers is always the top priority. Inform the group that an effective fire size-up will allow them to answer all of the following questions:

- Do my buddy and I have the right equipment?
- Are there other hazards?
- Is the building structurally damaged?
- Can my buddy and I escape?
- Can my buddy and I fight the fire safely?

Explain that you will now discuss fire size-up considerations and review the checklist with the group.

Table 6.1: CERT Fire Size-up

Step 1: Gather Facts		
Time		
Does the time of day or week affect fire suppression efforts? How?	Yes	No
Weather		
Are there weather conditions that affect your safety? If yes, how will your safety be affected?	Yes	No
Will weather conditions affect the situation? If yes, how will the situation be affected?	Yes	No
Type of Construction		
What type(s) of structure(s) is (are) involved?		
What type(s) of construction is (are) involved?		

Step 1: Gather Facts		
Occupancy		
Are the structures occupied? If yes, how many people are likely to be affected?	Yes	No
Are there special considerations (e.g. children, elderly, pets, people with access and functional needs)?	Yes	No
Hazards		
Are hazardous materials evident?	Yes	No
Are any other types of hazards involved? If yes, what other hazards?	Yes	No
Step 2: Assess and Communicate the Damage		
Survey all sides of the scene. Is the danger beyond the CERT's capability?	Yes	No
Have the facts and the initial damage assessment been communicated to the appropriate person(s)?	Yes	No
Step 3: Consider Possibilities		
Life Hazards		
Are there potentially life-threatening hazards? If yes, what are the hazards?	Yes	No
Path of Fire		
Does the path of the fire jeopardize other areas? If yes, what other areas may be in jeopardy?	Yes	No
Additional Damage		
Is there a high potential for more disaster activity that will impact personal safety? If yes, what are the known risks?	Yes	No
Step 4: Assess Your Own Situation		
What equipment is available to help suppress the fire?		
What other resources are available?		
Can CERT volunteers <i>safely</i> attempt to suppress the fire? <i>If not, do not attempt suppression.</i>	Yes	No
Step 5: Establish Priorities		
Are there any other more pressing needs now? If yes, list.	Yes	No

Step 6: Make Decisions
Where will resources do the most good while maintaining an adequate margin of safety?
Step 7: Develop Plan of Action
Determine how personnel and other resources should be used.
Step 8: Take Action
Put the plan into effect.
Step 9: Evaluate Progress
Continually size up the situation to identify changes in the scope of the problem, safety risks, and resources availability.
Adjust strategies as required.

Emphasize that size-up is a continuous process.

Evaluation of progress — Step 9 — may require them to go back and gather additional facts.

Remind participants that the safety of individual CERT volunteers is always the top priority.

Does anyone have any questions about CERT fire size-up?

Check for understanding.

SECTION 4: FIREFIGHTING RESOURCES

Check for knowledge.

What comes to mind when you think about firefighting resources?

If not mentioned, tell the group that the most common firefighting resources are:

- Local fire departments;
- Fire alarm systems;
- Sprinkler systems;
- Portable fire extinguishers; and
- Interior wet standpipes (water hoses found in commercial or residential buildings, not for public use).

Firefighting Resources

- Local fire department
- Fire alarm system
- Sprinkler systems
- Portable fire extinguishers
- Interior wet standpipes



PM 6-7

Fire Extinguishers

Portable fire extinguishers are invaluable for putting out small fires. A well-prepared home should have multiple portable fire extinguishers (possible locations could include kitchen, garage, workshop space, and basement). Workplaces are governed by regulation or fire code and should have the appropriate number of fire extinguishers as defined by regulation or fire code.

Emphasize that the type of fuel that is burning will determine which resources to select to fight a fire.

Fire Extinguishers

- Water
- Dry chemical
- Carbon dioxide
- Specialized



PM 6-7

Types of Fire Extinguishers





There are four types of extinguishers:

19. Water;
20. Dry chemical;
21. Carbon dioxide; and
22. Specialized.

Refer the participants to **Table 6.2: Fire Types, Extinguishing Agents, and Methods** on page 6-7 in the Participant Manual for an overview of this information.

Table 6.2: Fire Types, Extinguishing Agents, and Methods

Fire Type	Extinguishing Agent	Extinguishing Method
Ordinary Solid Materials 	<ul style="list-style-type: none"> • Water • Foam • Dry chemical 	<ul style="list-style-type: none"> • Removes heat • Removes air and heat • Breaks chain reaction

Fire Type	Extinguishing Agent	Extinguishing Method
Flammable Liquids 	<ul style="list-style-type: none"> • Foam • CO2 • Dry chemical 	<ul style="list-style-type: none"> • Removes air • Breaks chain reaction
Electrical Equipment 	<ul style="list-style-type: none"> • CO2 • Dry chemical 	<ul style="list-style-type: none"> • Removes air • Breaks chain reaction
Combustible Metals 	<ul style="list-style-type: none"> • Special agents 	<ul style="list-style-type: none"> • Usually removes air
Kitchen Oils 	<ul style="list-style-type: none"> • Chemical 	<ul style="list-style-type: none"> • Usually removes air

Extinguisher Rating/Labeling

- Labels show types of fires for which that extinguisher is used
 - Class A fire ratings: 1A to 40A
 - Class B fire ratings: 1B to 640B
- Higher number on label = greater amount of extinguishing agent

CERT Basic Training Unit 6: Fire Safety and Utility Controls PM 6-9 6-9

Extinguisher Rating and Labeling

The State Fire Marshal and Underwriters Laboratories (an organization that sets safety standards for manufactured goods) rates and approves all portable fire extinguishers. Extinguishers are rated according to their effectiveness on the different classes of fire. Manufacturers must label the strength and capability for each extinguisher, as well.

Explain that the label contains vital information about the type(s) of fire for which the extinguisher is appropriate. Extinguishers appropriate for Class A fires have a rating from 1A to 40A, with a higher number indicating a higher volume of extinguishing agent. Extinguishers appropriate for Class B fires have a rating from 1B to 640B. No number accompanies an extinguisher rated Class C, D, or K. The C on the label indicates only that the extinguisher is safe to use on electrical fires.

Manufacturers label extinguishers for Class D fires to match the type of metal that is burning and with a list detailing the metals that match the unit’s extinguishing agent. The extinguishers for Class K fires supplement fire suppression systems in commercial kitchens. They spray

an alkaline mixture that, when combined with the fatty acid of the burning cooking oil or fat, creates soapy foam to hold in the vapors and extinguish the fire.

Describe some of the different types of fire extinguisher labels that participants might encounter.

Refer the participants to **Image 6.2: Manufacturer’s Label** on page 6-12 in the Participant Manual.



Image 6.2: Manufacturer’s Label

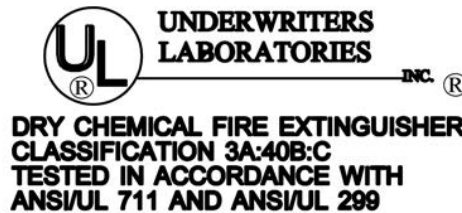

NO.

**MARINE TYPE U.S.C.G. TYPE A SIZE II TYPE B:C SIZE I
U.S.C.G. APPROVAL NO. 162.028/EX-2480
VALID ONLY WITH BRACKET NO. A-6**

Sample manufacturer’s label for a fire extinguisher, showing the Underwriters Laboratories symbol at the top, the type and classification of fire extinguisher, testing procedures used, and serial number. At the bottom of the label is marine information, including the U.S. Coast Guard approval number.

Review the types of fires and appropriate extinguishing methods with the group, noting the capacity, range, and pressure of each type of extinguisher.

Display a water extinguisher.

Water Extinguishers

Common characteristics of water extinguishers include:

- **Capacity:** Standard size is 2.5 gallons.
- **Range:** Standard range is 30-40 feet.
- **Pressure:** Standard pressure is 110 pounds per square inch (psi).

Display a chemical extinguisher.

Chemical Extinguishers

Dry chemical extinguishers are most common.

- Dry chemical extinguishers have a sodium bicarbonate base and are effective on Class B and C fires.
- Multipurpose dry chemical extinguishers have a monoammonium phosphate base and are effective for Class A, B, and C fires.

If discussing or demonstrating how to use a carbon dioxide extinguisher indoors, note the need for caution, as these extinguishers remove oxygen from the room.

Common characteristics of dry chemical extinguishers include:

- **Capacity:** Approximately 10-20 seconds discharge time.
- **Range:** Standard range is 8-12 feet.
- **Pressure:** Standard pressure is 175-250 psi.

Explain that, while still in use, carbon dioxide and other specialized extinguishers are becoming less common.

Deciding to Use a Fire Extinguisher

There is a series of questions volunteers should ask themselves before attempting to fight a fire with an extinguisher. Remind the group that the first priority for them and their buddy is personal safety.

Refer the group to **Image 6.3: Deciding to Use a Fire Extinguisher** on page 6-14 in the Participant Manual, and review the following questions and decisions with the group:

- Are there two ways to exit the area quickly and safely if I attempt to extinguish the fire?
- Do I have the right type of extinguisher for the fire?
- Is the extinguisher large enough for the fire?
- Is the area free from other dangers, such as hazardous materials and falling debris?
- Am I experienced or trained in the use of a fire extinguisher?

Stress that if the participants answer “NO” to any of these questions, or if they have been unable to put out the fire in five seconds using the extinguisher, they should:

- Leave the building immediately (activate fire alarm system if it is safe to do so);
- While leaving, shut all doors to slow the spread of the fire; and
- Contact local fire department.

Tell the participants that if they answer “YES” to all of these questions, they may attempt to extinguish the fire. Emphasize that, even if they answer

“YES” to all of the questions but feel unable to extinguish the fire, they should leave immediately. Reemphasize the five-second rule.

Explain that, if the fire is extinguished in five seconds and the area is safe, CERT volunteers should stay and

overhaul the fire. Overhauling is the process of searching a fire scene for hidden fire or sparks in an effort to prevent the fire from rekindling. Tell the participants how to overhaul a fire by remembering to “cool, soak, and separate.”

Let the participants know it is always a good idea to contact their local fire department even if they were able to extinguish a small fire. Fire department personnel will be able to assist with properly overhauling and ensuring the fire was extinguished completely. In addition, insurance companies or workplace management (depending on their location) may want a report to have

Image 6.3: Deciding to Use a Fire Extinguisher

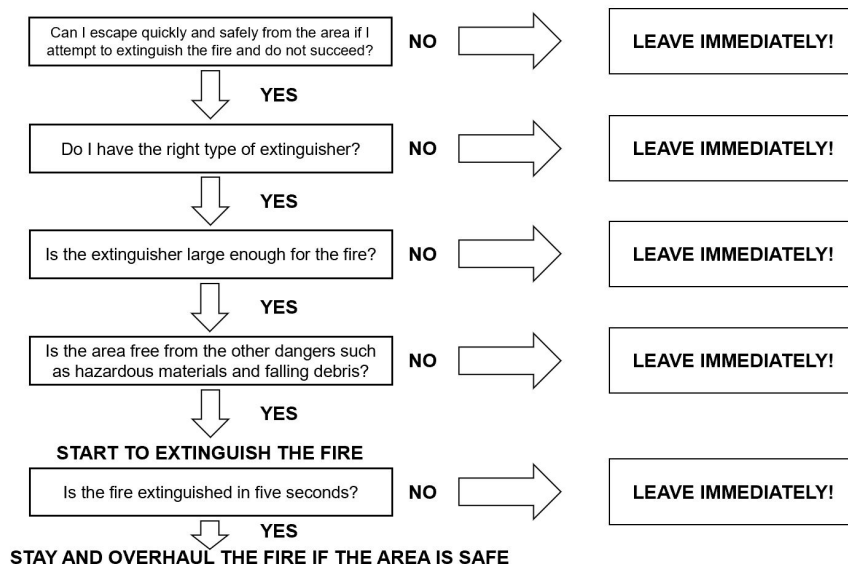

on file regarding the incident, especially if there is any damage.

Does anyone have any questions about how to use the decision-making flowchart?

Operating a Fire Extinguisher

How many of you have operated a portable fire extinguisher?

After a show of hands, ask a few participants to share their results. Use their comments to elaborate on the topic.

Demonstrate how to use a portable fire extinguisher.

Refer participants to **Image 6.4: Components of a Portable Fire Extinguisher** on page 6-10 in the

Check for experience.

Demonstrate how to use a portable extinguisher.

Participant Manual. Explain that a portable fire extinguisher includes four components:

- A pressure gauge;
- A hose;
- A cylinder; and
- A carrying handle with trigger.

Image 6.4: Components of a Portable Fire Extinguisher

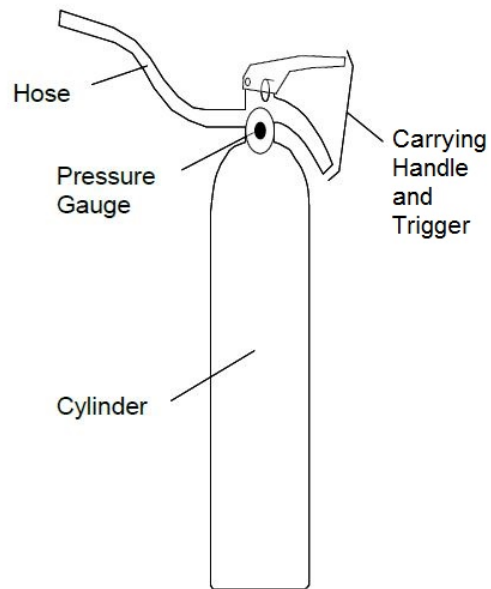

Components of a portable fire extinguisher: hose, carrying handle and trigger, pressure gauge, and cylinder.

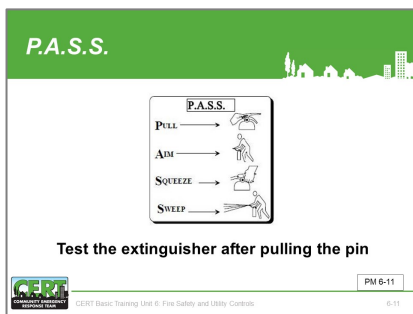

P.A.S.S.

Explain that the acronym for operating a fire extinguisher is P.A.S.S.:

- Pull (test the extinguisher after pulling the pin.);
- Aim;
- Squeeze; and
- Sweep.

To ensure the extinguisher is working properly, test it before approaching any fire.

Refer the participants to **Image 6.5: P.A.S.S.** in the Participant Manual.

Image 6.5: P.A.S.S.

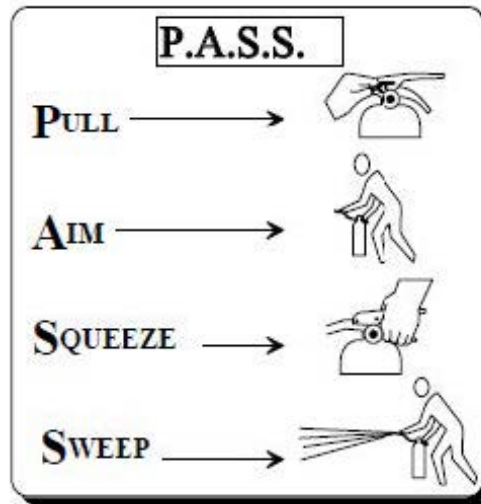

Emphasize the need to aim at the base of the fire; it is important to extinguish the fuel, not the flames.

Explain that each participant will have the opportunity to practice this technique near the end of the session.

Does anyone have any questions about portable fire extinguishers or their operation?

Check for understanding.

Interior Wet Standpipes

Explain that interior wet standpipes are usually in commercial and apartment buildings and consist of 100 feet of 1.5-inch jacketed hose with an adjustable spray nozzle. They deliver at least 100 gallons of water per minute.

Because of the size of the hose and the volume of water discharged, interior wet standpipes can be difficult to manage. Therefore, CERT volunteers should never operate interior wet standpipes.

Confinement

For interior spaces, it is possible to *confine* a fire and restrict the spread of smoke and heat by closing interior and exterior doors.

Does anyone have any questions about portable firefighting resources?

Check for understanding.

Interior Wet Standpipes

- Usually found in commercial buildings or apartments
- CERT volunteers should not operate



PM 6-11

CERT Basic Training Unit 6: Fire Safety and Utility Controls 6-12

SECTION 5: FIRE SUPPRESSION SAFETY



Small fire suppression may be one of the roles of CERT volunteers. Emphasize that even following a disaster, personal safety must always be volunteers' number one concern. Stress that they will be unable to help anyone if they injure themselves through a careless size-up or performing unsafe acts.

Refer the group to the list of *Fire Suppression Safety Rules* in the Participant Manual.

Fire Suppression Safety Rules

Stress the importance to the volunteers that they should follow **all** rules regarding fire suppression safety.

- Use safety equipment at all times. Wear helmet, goggles, dust mask, leather gloves, and sturdy shoes or boots. If not equipped to protect personal safety, leave the building.
- Work with a buddy. Buddies serve an important purpose. They protect their buddy's safety. Do not ever try to fight a fire alone. Stick together at all times.
- Have a backup team, whenever possible. A backup team can support fire suppression efforts and can provide help if needed.
- Always have two ways to exit the fire area. Fires spread much faster than one might think. Always have a backup escape plan in case the main escape route becomes blocked.
- Look at the door. If air is being sucked under the door or smoke is seeping out the top of the door, do not touch or open the door.
- Feel closed doors with the back of the hand, working from the bottom of the door up, including the space between the door and its frame. Do not touch the door handle before feeling the door. If the door is hot, there is fire behind it. Do not enter! Opening the door will feed additional oxygen to the fire.
- Confine the fire whenever possible, by closing doors and keeping them closed.
- Stay low to the ground. Smoke inhalation is the leading cause of fire-related deaths. Smoke will naturally rise and keeping low to the ground will provide fresher air to breathe.

- Maintain a safe distance. Remember the effective range of the fire extinguisher. Do not get closer than necessary to extinguish the fire.
- Never turn their back on a fire when backing out.
- Overhaul the extinguished fire to be sure that it stays extinguished.

Stress to your volunteers that what CERTs **should not** do when suppressing fires, is just as important as what they should do.

Fire Suppression Don't's

- Don't get too close
- Don't try to fight a fire alone
- Don't try to suppress large fires
- Don't enter smoke-filled areas



PM 6-12

CERT Basic Training Unit 6: Fire Safety and Utility Controls 6-14

- DO NOT get too close. Stay near the outer range of the extinguisher. If they feel the heat, they are too close.
- DO NOT try to fight a fire alone. Remember the CERT volunteer's first priority is personal safety. Do not put it at risk.
- DO NOT try to suppress large fires. Learn the capability of the equipment, and do not try to suppress a fire that is clearly too large for the equipment at hand (i.e., a fire that is larger than the combined ratings of available fire extinguishers).
- DO NOT enter smoke-filled areas. Suppressing fires in smoke-filled areas requires equipment that CERT volunteers do not have.

Explain that a small fire, unlike a large fire:

- Is about the size of a wastepaper can.
- Can be extinguished with one fire extinguisher.

Remind the group of the earlier demonstration (using burning cotton in the Pyrex® jar) to stress the need for overhauling.

Proper Fire Suppression Procedures

Describe and demonstrate the six-step process for proper fire suppression outlined below.

Remember that volunteers should use the “buddy system” in all cases. Briefly explain the responsibilities of each buddy. The job of Team Member 1 is to put out a fire with an extinguisher. Meanwhile, the job of Team Member 2 needs to complete the following steps to watch for hazards and ensure the safety of both team members.

Step 1: Assume ready position. With the pin pulled, Team Member 1 holds the extinguisher aimed and upright, approximately 20 to 25 feet from the fire for small fires.

Step 2: When ready to approach the fire, Team Member 1 should say, “Ready.” Team Member 2 should repeat, “Ready.”

Step 3: As Team Member 1 begins to move forward, he or she should say, “Going in.” Team Member 2

Ask a volunteer to assist you in demonstrating this technique.

should repeat the command and stay within reach of Team Member 1.

Step 4: Both team members should walk toward the fire. Team Member 1 should watch the fire and Team Member 2 should stay close to Team Member 1, keeping his or her hand on Team Member 1's shoulder. Team Member 2's job is to protect Team Member 1.

After reviewing the fire suppression procedure, show the video *Fire Safety: The CERT Member's Role*.

Step 5: When Team Member 1 is exiting the fire area, he or she should say, "Backing out." Team Member 2 should repeat the command.

Step 6: Team Member 2 should guide Team Member 1 from the area with his or her hands as Team Member 1 continues facing the fire and looking for other hazards. Team Member 1 must never turn his or her back on the fire scene.

Check for understanding.

Does anyone have any questions about fire suppression safety?

Tell the volunteers that they are going to learn about identifying fire and utility hazards in the next section.

SECTION 6: FIRE AND UTILITY HAZARDS

Explain that this section will deal with identifying and preventing fires and utility hazards in the home and workplace.

Open a group discussion.

What are potential fire and utility hazards in homes or workplaces?

Allow the group time to respond. Provide suggestions of additional potential fire and utility hazards.

Check for experience.

What measures have you taken to mitigate or prevent the hazards?

Use the participants' responses to make the following points. Each of us has some type of fire or utility hazard in our home and workplace. Most of these hazards fall into three categories:

- 23. Electrical;
- 24. Natural gas; or
- 25. Flammable or combustible liquids.

Point out that homes and workplaces can and do have other hazards, including incompatible materials stored in close proximity to each other, such as flammables, combustibles, corrosives, compressed gases, and explosives. Explain that simple fire prevention measures will help reduce the likelihood of fires:

- First, locate potential sources of ignition; then
- Do what they can to reduce or eliminate the hazards.

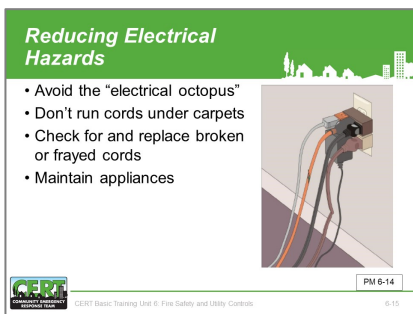

Electrical Hazards

Provide the group with examples of common electrical hazards and simple ways that the volunteers can reduce or eliminate them, such as:

- Avoid the “electrical octopus.” Eliminate tangles of electrical cords;
- Do not overload electrical outlets;
- Do not plug power strips into other power strips;
- Do not run electrical cords under carpets;
- Check for and replace broken or frayed cords immediately; and
- Maintain electrical appliances properly. Repair or replace malfunctioning appliances.

Electrical Emergencies

- Know where power shutoffs are
 - Appliances
 - Circuit breakers
 - Fuses
- Post shutoff directions next to all utilities
- Know procedures for turning power back on after the fire

PM 6-14

Responding to Electrical Emergencies

Point out that electrical emergencies sometimes occur despite our best efforts. Every member of the household should be aware of the following procedures in the event of an electrical emergency:

- Locate the circuit breakers or fuses and know how to shut off the power. Post shutoff instructions next to the breaker box or fuse box.
- Unscrew individual fuses or switch off smaller breakers first, then pull the main switch or breaker.
- When turning the power back on, turn on the main switch or breaker first, then screw in the fuses or switch on the smaller breakers, one at a time.

Check with a representative from the local utility company regarding local utility protocols. Obtain or develop training models of fuse and breaker boxes to allow demonstrations and hands-on practice.

Depending on your location, you may also choose to cover propane gas shutoffs.

Inform participants to notify a licensed electrician and/or utility company in the event of an electrical emergency or fire. In addition, participants should notify a licensed electrician and/or utility company before turning on the power after an electrical emergency or fire.

Shutoff Procedures

- Circuit box with shutoff
- Fuse box with shutoff

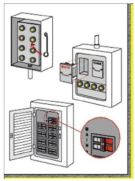

PM 6-14

Stress that the participants should NOT enter a flooded basement or wade into standing water to shut off the electrical supply, since water is a conductor of electricity.

Image 6.6: Circuit Box and Fuse Box

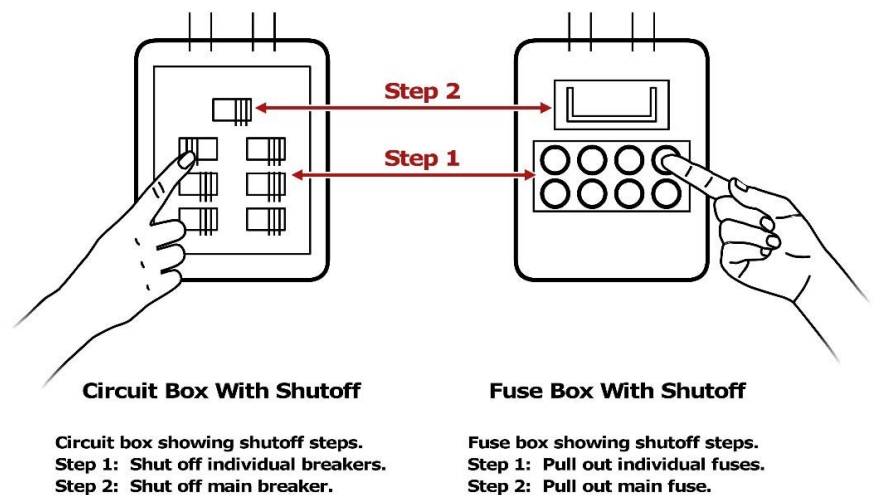

Refer the participants to **Image 6.6: Circuit Box and Fuse Box** on page 6-15 in the Participant Manual.

Natural Gas Hazards

- Asphyxiant
 - Displaces oxygen in the body
- Explosive
 - Can readily ignite under the right conditions

 PM 6-15
CERT Basic Training Unit 6: Fire Safety and Utility Controls 6-15

Natural Gas Hazards

Explain that natural gas presents two types of hazards:

- Asphyxiant – Displaces oxygen in the body; and
- Flammable – can readily ignite under the right conditions.

Stress the importance of recognizing that natural gas is lighter than air and know they will likely not be able to feel the gas in the event of a leak. Therefore, they should place natural gas detectors as they would smoke alarms, strategically on every level of their home. Common areas to place natural gas detectors are near the furnace, hot water tank, and other gas appliances such as a clothes dryer. Test the detector monthly to ensure it works.

Natural Gas Hazard Awareness

- Install natural gas detector
- Install carbon monoxide detector in home
- Test batteries for natural gas and carbon monoxide detectors every month
 - Change batteries every six months
- Locate and label gas shutoffs
 - Have proper non-sparking tool

 PM 6-15
CERT Basic Training Unit 6: Fire Safety and Utility Controls 6-15

Carbon Monoxide

Explain that carbon monoxide (CO) is a deadly, colorless, odorless, and poisonous gas that, like natural gas, is lighter than air. The incomplete burning of various fuels, including natural gas, is responsible for producing CO. Malfunctioning fuel- burning appliances such as furnaces, ranges, water heaters and room heaters; engine-powered equipment such as portable generators; fireplaces; and charcoal that is burned in homes and other enclosed areas are at risk for producing CO.

Natural Gas Hazard Awareness

- Install natural gas detector
- Install carbon monoxide detector in home
- Test batteries for natural gas and carbon monoxide detectors every month
 - Change batteries every six months
- Locate and label gas shutoffs
 - Have proper non-sparking tool

 PM 6-15
CERT Basic Training Unit 6: Fire Safety and Utility Controls 6-15

To prevent CO poisoning, participants should install carbon monoxide detectors, which meet the current safety standards, near all separate sleeping areas. They should install additional detectors on every level of the home and in every bedroom. Do not place detectors within 15 feet of heating or cooking appliances, or in or near very humid areas, such as bathrooms. Test the detector monthly to make sure it works.

Gas Shutoff

- Locate and label gas shutoff valves
- If not automatic, know procedures for shutting off gas



 PM 6-16
CERT Basic Training Unit 6: Fire Safety and Utility Controls 6-20

Natural Gas Shutoff

Tell participants to locate and clearly label the gas shutoff valve(s). There may be multiple valves inside a home in addition to the main shutoff. Emphasize that they should know how to shut off the gas and have the proper non-sparking tool for shutting off the gas. If they are unsure of how to shut off the gas properly and safely, they should never attempt to do so. Tell them to contact their local gas company for assistance.

Image 6.7: Natural Gas Meter with Shutoff

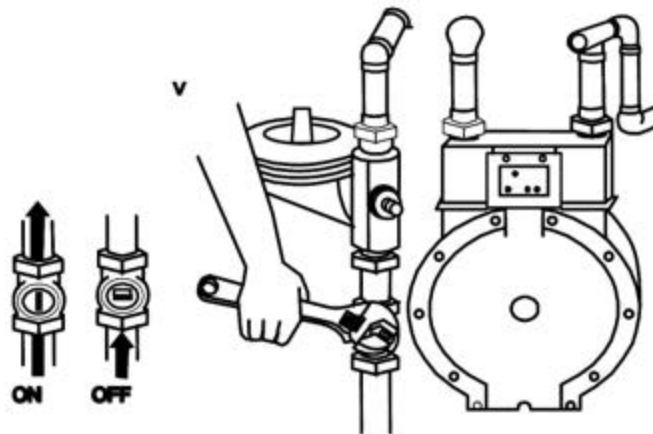

Refer the participants to **Image 6.7: Natural Gas Meter with Shutoff** on page 6-16 in the Participant Manual.

The gas meter shutoff diagram indicates the shutoff valve location on the pipe that comes out of the ground. To turn off the valve, use a non-sparking wrench to turn the valve clockwise one-quarter turn. Remember that in all cases, only a licensed technician should turn on natural gas flow.

Please note: Some gas meters have automatic shutoff valves that restrict the flow of gas during an earthquake or other emergency. A licensed plumber installs these downstream of the utility point of delivery. If unsure whether the home has this shutoff device, contact the gas service company. If this shutoff device is closed, only a qualified professional should restore it.

Gas meter inside the home

Explain that if the gas meter is located inside the home, participants should only shut off the gas flow when instructed to by local authorities. Emphasize that if they smell gas or see the dials on their meter showing gas is flowing even though their appliances are off, they should evacuate the premises and call 911. Tell them they should not attempt to shut off the gas from inside the building if gas may be in the air.

Gas meter outside the home

Tell participants to turn off the meter from outside the building if they smell gas or see dials on the meter showing gas is flowing, even if their appliances are off. If there is a fire they cannot extinguish, they should call 9-1-1 and turn off the gas only if it is safe to do so.

Consult with a local utility representative to determine protocols and, if possible, create a model gas meter to demonstrate and allow practice with the procedure for shutting off the gas.

Warn the participants never to enter the basement of a structure that is on fire to turn off any utility. Stress that they should use a flashlight, not a candle, if they need an additional light source to locate and shut off the gas valve.

Explain that if participants are unsure of the proper procedures, they should not attempt to turn the utilities on again by themselves, particularly in multiple-unit dwellings. They should always follow the local fire department’s guidelines. Stress that after the gas flow has been turned off, only a trained technician can restore it. Inappropriate or abrupt engagement of gas service may cause gas leaks inside the house.

L.I.E.S.

- Always read labels
- Use L.I.E.S. storage procedures
 - (Limit, Isolate, Eliminate, Separate)



PII 6-17

CERT Basic Training Unit 6: Fire Safety and Utility Controls 6-21

L.I.E.S. stands for Limit, Isolate, Eliminate, and Separate.

Provide the group with information about safe disposal of hazardous materials in your area.

Check for understanding.

Flammable Liquid Hazards

Provide examples for reducing hazards from flammable liquids:

- Read labels to identify flammable products; and
- Store them properly, using the L.I.E.S. method (Limit, Isolate, Eliminate, Separate).

Stress that if participants need to use a fire extinguisher, they should only extinguish a flammable liquid using a portable fire extinguisher rated for Class B fires.

Does anyone have any questions about fire and utility hazards?

SECTION 7: HAZARDOUS MATERIALS

Open a group discussion.

How do you know if a material is hazardous?

Materials are considered hazardous if they have any of the characteristics listed on the slide:

- Corrodes other materials;
- Explodes or are easily ignited;
- Reacts strongly with water;
- Unstable when exposed to heat or shock; and
- Are otherwise toxic to humans, animals, or the environment through absorption, inhalation, injection, or ingestion.

Explain that hazardous materials include, but are not limited to:

- Explosives;
- Flammable gases and liquids;
- Poisons and poisonous gases;
- Corrosives;
- Nonflammable gases;
- Oxidizers; and
- Radioactive materials.

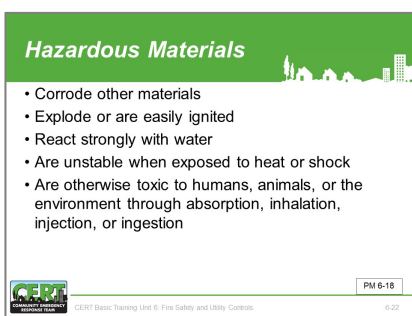

Check for knowledge.

Why is it important to know if hazardous materials are present?

If not mentioned by the group, explain how the knowledge of hazardous materials helps to protect CERT volunteers' safety and serves as valuable size-up information for all first responders.

Identifying Hazardous Materials Locations

There are several ways to identify locations where hazardous materials are stored, used, or in transit:

- Location and type of occupancy;
- Placards and labels; and
- Sights, sounds, and smells.

Location and Type of Occupancy

Hazardous materials are commonplace throughout every community. Many commercial processes rely on hazardous materials and many retail outlets sell them. Despite protections in place, accidents and disasters can occur, causing these materials to release into the environment.

Provide some common locations in the community:

- Industrial locations, such as warehouses, rail yards, shipyards;
- Household locations, including under kitchen/bathroom sinks, workshop cabinets, garages, basements;
- Dry cleaner;
- Funeral home;
- Home supply store;
- Big box store; and
- Delivery van, such as overnight delivery services.

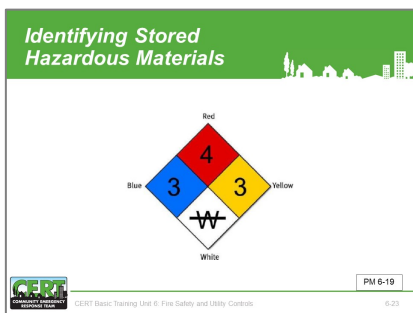

Placards

Warning placards are required whenever large amounts of hazardous materials are being stored, used, or transported. These placards act as an immediate warning system for emergency responders, helping them identify the kinds of materials present and the dangers they pose.

CERT volunteers should consider these placards a “stop sign.”

National Fire Protection Association

Has anyone ever seen the symbol in the slide or one similar to it? Does anyone know what it is or what it means?

If not mentioned by the group, explain that the placard is an **NFPA 704 Diamond**, which is the identification system instituted by the National Fire Protection Association (NFPA). The NFPA 704 Diamond is a concise system for identifying the hazards associated with specific materials. Volunteers would find this type of placard on a fixed facility. Refer participants to **Image 6.8: NFPA 704 Diamond** in the Participant Manuals.

Tell the participants that the diamond is divided into four colored quadrants, each with a rating number inside of it. The number indicates the degree of risk associated with the material. Numbers range from 0 to 4. The higher the number, the higher the risk!

Explain that:

- The **red** quadrant describes the material’s **flammability**.
- The **blue** quadrant indicates **health hazard**.
- The **yellow** quadrant indicates **reactivity**.

Check for experience.

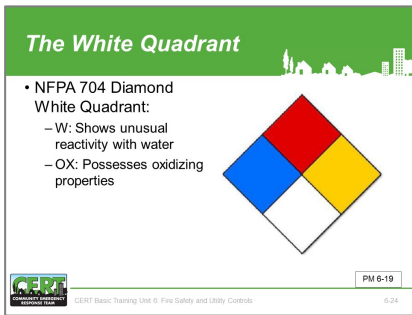

Point out that the **white** quadrant indicates **special precautions**. There are two symbols specified in the National Fire Codes, section 704.

- W indicates a material that displays unusual reactivity with water (i.e., should never be mixed with water or have water sprayed on it). **Magnesium metal** is an example of a material that is reactive to water.
- OX indicates a material that possesses oxidizing properties. **Ammonium nitrate** is an example of a material with oxidizing properties.

Explain that materials that are oxidizers increase the potential for explosion or fire.

In addition to the above symbols that are specified under the National Fire Codes, some NFPA 704 Diamonds will include additional symbols:

- ACID indicates that the material is an acid.
- ALK indicates that the material is a base.
- COR indicates that the material is corrosive.
- ☸ indicates that the material is radioactive.



Stress that the numbers within the NFPA 704 Diamond are used to assist professional firefighters in responding to accidents or fires and CERT volunteers should consider them a “stop sign.”

The only action CERT volunteers should take is to evacuate persons who are downwind, as necessary, to an uphill or upwind location. Do not enter the building in an attempt to evacuate persons inside.

Image 6.8: NFPA 704 Diamond

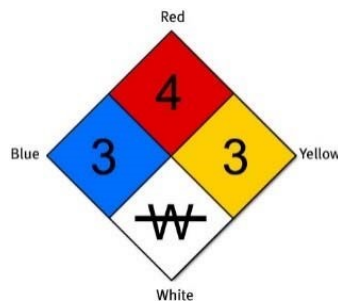

Global Harmonized System

The Globally Harmonized System of Classification and Labeling of Chemicals (GHS) is a system developed by the United Nations as a voluntary international system for



chemical hazard communication. The GHS includes methods for classifying all hazardous chemical substances and mixtures. Refer participants to **Image 6.8: GHS Pictograms** in their Participant Manuals.

Review the three standard elements to a GHS safety label.

- Symbols use pictograms to communicate physical, health, and environmental hazard information.
- Signal Words indicate the severity of the hazard. “Danger” is used for severe hazards and “Warning” is used for less severe hazards. For lower level hazards, a signal word is not used.
- Hazard Statements are standardized phrases that describe each hazard presented by a chemical substance or mixture.

GHS labels also include the following additional elements:

- Precautionary Statements and Pictograms to provide information to minimize or prevent the effects from a hazard;
- Product Identifiers, or the name or number used on a product’s safety data sheet;
- Supplier Identification includes the name, address, and telephone number of the product’s manufacturer or supplier; and
- Supplemental Information is additional, non-harmonized information that is not required or specified under the GHS.

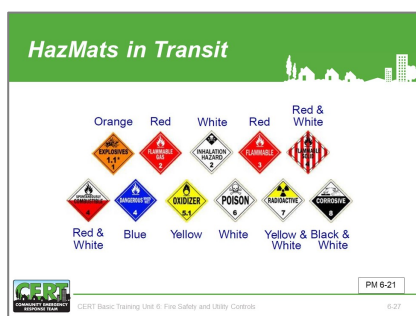
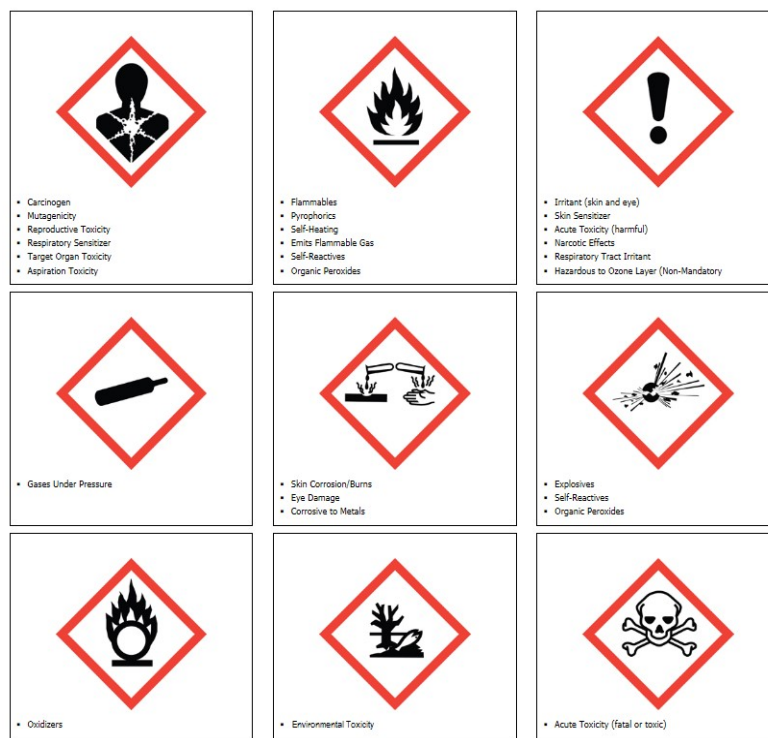

Image 6.9: GHS Pictograms



Identifying Hazardous Materials in Transit

Does anyone recognize the placards in the slide?

If not mentioned by the group, explain that they are U.S. Department of Transportation (DOT) placards. Refer participants to **Image 6.10: DOT Placard Warning** in their Participant Manuals.

The DOT placard is one of three ways that hazardous materials are marked and identified while in transit. The other two ways are:

- The United Nations (UN) system; and
- The North American (NA) warning placards

Point out that these placards can be on any vehicle, not only tankers. Also, emphasize that:

- No placard is required for less than 1,000 pounds of many hazardous materials;
- Certain hazardous materials (e.g., anhydrous ammonia) are placarded as a nonflammable gas for domestic transport but as a flammable gas for international transport. (Anhydrous ammonia is a flammable gas!); and

The NA placarding system is being phased out but is still occasionally used, usually on hazardous materials being transported from Canada.

If anyone asks, hazardous materials that require placarding in any quantity include poisonous gases that present an inhalation hazard (DOT Class 2.3), poisonous liquids that present an inhalation hazard (DOT Class 6.1), and radioactive materials (DOT Class 7).

- Sometimes drivers forget to change the placard when they change their cargo. CERT volunteers should use extreme caution when approaching any vehicle in an accident.

Refer the participants to the DOT Placard Warning illustrations in the Participant Manual.

This slide shows examples of the UN and NA systems. The UN and NA systems are displayed mainly on tank cars, cargo tanks, rail cars, and portable tanks.

Explain that, like the NFPA 704 Diamond, the DOT, UN, and NA placards should be a “stop sign” for CERT volunteers. They should always err on the side of safety. They should NOT assume that because there is no placard, no hazardous materials are present. Treat any unknown situation as a hazardous materials incident.

As a general rule of thumb, if they see a number in the NFPA 704 Diamond that is greater than one, stay away.

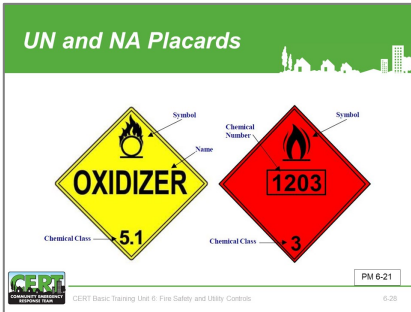

Image 6.10: DOT Placard Warning



Emergency Response Guidebook

For more information on the ERG, students should visit <http://www.phmsa.dot.gov/staticfiles/PHMSA/DownloadableFiles/Files/Hazmat/ERG2016.pdf>

First responders use the Emergency Response Guidebook (ERG) for a transportation (i.e., highway or railway) emergency involving hazardous materials. The guide provides responders with information on how to identify the hazards quickly, and details how to protect themselves and the public from issues related to the hazards. Also included in the guide are the recommended evacuation distances for common hazards.

Sights, Sounds, and Smells

Explain that hazardous materials are all around us and may be present regardless of the location, or whether there are placards or other posted warnings. While hazardous materials often smell, sound, or look unusual, participants may not be able recognize something toxic. Participants should stay away from any unidentifiable substances and alert building managers or authorities.

Does anyone have any questions about hazardous materials or determining how to identify them in storage or transport?

Check for understanding.

Exercise 6.1

- Practice using a portable fire extinguisher to suppress a small fire
- Apply teamwork to fire suppression

PM 6-22
CERT Basic Training Unit 6: Fire Safety and Utility Controls 6-30

Exercise 6.1: Suppressing Small Fires

Purpose: This exercise will provide the participants with experience in two key areas of fire suppression:

- Using a portable fire extinguisher to suppress a small fire; and
- Applying teamwork to fire suppression.

Ensure all participants are dressed properly and wear safety equipment for this exercise. Dress for this exercise may be casual. However, do not permit shorts and open-toed shoes.

Prepare a propane gas fire source outside in an area with at least 40 feet of open space upwind of the fire source. Provide Class A:B:C portable extinguishers. This exercise requires two instructors:

- Instructor 1 will lead the exercise; and
- Instructor 2 will observe and serve as the exercise Safety Officer.

Instructions: Follow the nine steps below to conduct this exercise. Coach the participants through the exercise using the instructions shown in **bold type**.

It is advisable to demonstrate critical steps (e.g., the "ready" position) before allowing the participants to complete this exercise.

Assign participants to two-person teams. Stress that participants must communicate with each other, emphasizing safety and teamwork.

Provide each team member with a portable fire extinguisher, taking one team at a time.

Instructor 2 will light the fire using a road flare mounted on a long pole, while Instructor 1 indicates that the participants are ready to begin the exercise.

Before allowing the participants to begin this exercise, Instructor 1 should ask them:

- What are the exit routes?
- From which direction is the wind blowing?
- Is the fire spreading, and where will it be in the next 30 seconds?

Follow the instructions to conduct the exercise:

Step 1: Ask Team Member 1 to assume the “ready” position. With pin pulled and extinguisher aimed and upright, volunteers should position themselves approximately 20 to 25 feet from the fire.

Step 2: When ready to approach the fire, Team Member 1 should say, “ready.” Team Member 2 repeats this command.

Step 3: As Team Member 1 begins to move forward, he or she should say, “going in.” Team Member 2 should repeat the command and place his or her hand on Team Member 1’s shoulder and stay within reach of Team Member 1.

Step 4: Ask Team Member 2 to act as backup, assuming the “ready” position at an arm’s distance from Team Member 1. Position Instructor 1 between the participants and the fire at all times.

Step 5: Both team members should walk toward the fire. Team Member 1 should watch the fire and Team Member 2 should stay close to Team Member 1, keeping his or her hand on Team Member 1’s shoulder. Remember that Team Member 2’s job is to protect Team Member 1.

Step 6: Ask Team Member 1 to approach the fire from the windward side (i.e., with the wind to the participant’s back). When approximately 10 feet from the fire, Team Member 1 should begin to discharge the extinguisher at the base of the fire, continuing the

approach until the range for the extinguisher is optimal. Make sure to sweep the base of the fire until it has been extinguished completely.

Step 7: When Team Member 1 is ready to exit the fire area, he or she should say, “Backing out.” Team Member 2 should repeat the command. Team Member 2 should guide Team Member 1 from the area with his or her hands as Team Member 1 continues facing the fire and looking for other hazards.

After extinguishing the fire, ask participants to trade positions and repeat the exercise. If time permits, allow each participant to use the extinguisher twice, to provide added practice.

Repeat this exercise with the other teams until all participants have had the opportunity to extinguish the fire.

Unit Summary

- You should know:
 - Keys to effective fire suppression
 - Classes of fire and types of fire extinguishers
 - P.A.S.S.
 - How to identify hazardous materials

Always follow the safety rules established for CERTs. Personal safety comes first!

CERT Basic Training Unit 6: Fire Safety and Utility Controls
PM 6-23

UNIT SUMMARY

Summarize the key points of this unit:

- Effective fire suppression depends on understanding:
 - The elements required for fire to exist;
 - The type of fuel involved;
 - The class of fire;
 - The resources required and available to extinguish each type of fire; and
 - Effective fire suppression techniques.
- Fire requires heat, fuel, and oxygen to exist. There are five types, or classes, of fire:
 - Class A: Ordinary combustibles;
 - Class B: Flammable liquids;
 - Class C: Energized electrical equipment;
 - Class D: Combustible metals; and
 - Class K: Cooking oils.
- It is extremely important to identify the class of fire to use the proper extinguisher for the class.
- Portable fire extinguishers are frequently used to suppress small fires. Their labels tell the types of fires for which they are effective and the area that they can suppress.

- When using portable fire extinguishers, remember P.A.S.S.: Pull, Aim, Squeeze, and Sweep. Always test the extinguisher after pulling the pin.
- When suppressing a fire, always follow the safety rules established for CERTs.
- There are several methods of placarding hazardous materials being stored or transported, including NFPA, DOT, UN, and NA placards, to help volunteers understand the types of materials found at a specific location. When faced with accidents involving hazardous or unknown materials, volunteers should keep away and call for professional help immediately.

Check for understanding.

Does anyone have any questions about anything we have covered in this unit?

Homework Assignment

Remind the participants that, before the next session, they should review the unit to be covered.

Homework Assignment

- Read unit to be covered in next session
- Bring necessary supplies to next session
- Wear appropriate clothes to next session

 CERT Basic Training Unit 6: Fire Safety and Utility Controls PM 6-23
6-32

[This page intentional left blank]



CERT Unit 7: Light Search and Rescue Operations

Instructor Guide



FEMA

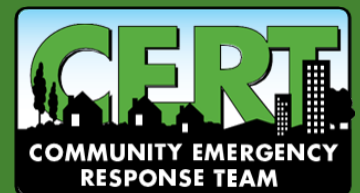

[This page intentional left blank]



CERT Unit 7: Light Search and Rescue Operations

In this unit, participants will learn about:

- **Search and Rescue Size-up:** How to size up the situation in which the search and rescue teams will operation.
- **Conducting Interior and Exterior Search Operations:** How to search systematically for disaster survivors.
- **Conducting Rescue Operations:** Safe techniques for lifting, leveraging, cribbing, and survivor removal.

[This page intentional left blank]

CERT Unit 7 Table of Contents

<i>SECTION 1: UNIT OVERVIEW</i>	<i>7-1</i>
Deciding to Attempt Rescue	7-2
Goals of Search and Rescue	7-2
Effective Search and Rescue	7-3
<i>SECTION 2: SAFETY DURING SEARCH AND RESCUE OPERATIONS</i>	<i>7-4</i>
CERT Search and Rescue Size-up.....	7-4
Step 1: Gather Facts	7-7
Exercise 7.1: Gathering Facts.....	7-8
Step 2: Assess and Communicate Damage.....	7-9
Step 3: Consider Probabilities.....	7-13
Step 4: Assess Your Situation	7-14
Step 5: Establish Priorities	7-16
Step 6: Make Decisions	7-17
Step 7: Develop Plan of Action	7-17
Step 8: Take Action	7-17
Step 9: Evaluate Progress	7-17
Specific Safety Considerations	7-18
Exercise 7.2: Search and Rescue Size-up.....	7-19
<i>SECTION 3: CONDUCTING INTERIOR AND EXTERIOR SEARCH OPERATIONS</i>	<i>7-20</i>
Locating Potential Survivors in a Structure	7-20
Search Methodology.....	7-22
Exterior Search.....	7-24
<i>SECTION 4: FIREFIGHTING RESCUE OPERATIONS</i>	<i>7-26</i>
Creating a Safe Environment.....	7-26
Precautions to Minimize Risk.....	7-26
Leveraging and Cribbing.....	7-27
Removing Survivors	7-31
Exercise 7.3: Survivor Carries	7-37
Exercise 7.4: Survivor Extrication	7-38
<i>UNIT SUMMARY</i>	<i>7-39</i>
Homework Assignment	7-40

UNIT OBJECTIVES

At the conclusion of this unit, the participants should be able to:

1. Identify and apply CERT size-up requirements for potential search and rescue situations.
2. Demonstrate common techniques for light search and rescue.
3. Demonstrate safe techniques for debris removal and survivor extraction during search and rescue operations.

SCOPE

The topics that will be discussed in this unit are:

- Unit Overview;
- Safety During Search and Rescue Operations;
- Conducting Interior and Exterior Search Operations;
- Conducting Rescue Operations; and
- Unit Summary.

ESTIMATED COMPLETION TIME

The following timetable (**Table 7: Estimated Completion Times**) is suggested for this module:

Table 7: Estimated Completion Times

Unit	Estimated Time
Introductions and Overview	5 minutes
Safety During Search and Rescue Operations	45 minutes
Conducting Interior and Exterior Search Operations	35 minutes
Conducting Rescue Operations	60 minutes
Unit Summary	5 minutes
Total	2 hours, 30 minutes

RESOURCES REQUIRED

- Community Emergency Response Team Instructor Guide
- Community Emergency Response Team Participant Manual
- PowerPoint slides 7-0 through 7-51

OTHER RESOURCES

If time permits, it is recommended that the instructor show all or portions of the 32-minute video CERT Training: Safety in the Post-Disaster Environment. The video

provides an overview of safety considerations for CERT responders and is available for download at the national CERT website: www.fema.gov/cert.

EQUIPMENT

In addition to the equipment listed at the front of this Instructor Guide, you will need the following equipment for this session. The number of each item needed for practicing survivor extrication and carries will depend on the number of groups practicing these skills at the same time.

- A computer with PowerPoint software;
- A computer projector and screen;
- Mannequin(s) or rescue dummy(ies) for extrication;
- Blankets for survivor carries;
- Appropriate chairs for survivor carries;
- Large, flat objects (e.g., table) and pieces of wood for leveraging and cribbing; and
- Pry bars or long 2" x 4" pieces of lumber.

PREPARATION

The "Gathering Facts" exercise scenario appears in the Participant Manual and on page 7-5 in the Instructor Guide. You should feel free to alter the scenario to reflect the community's needs.

The "Search and Rescue Size-up" exercise requires the preparation of scenarios that are realistic for your community. This exercise appears in the Participant Manual on page 7-12. Be sure to prepare the scenarios in advance of the session and have copies for each participant. Include the following types of information in the scenarios:

- Type of event;
- Intensity, severity, and duration;
- Occupancy affected;
- Current and forecast weather conditions;
- Time of day and week; and
- Other factors that may affect search and rescue operations.

Information provided about assessment of probable damage in relation to types of construction focuses primarily on earthquake damage. For other types of disasters (e.g., tornadoes, hurricanes, or floods) likely to occur in your area, obtain and add information about their probable impact on various types of construction.

NOTES

Remember as you work through this unit with the group to stress the role of CERT in search and rescue. The participants must take away from the training an understanding of their limitations and the attitude that their personal safety is paramount, even above that of the survivors.

For the purposes of time and comprehension, you may divide this unit into two separate units and teach them separately. Should you choose to do this, you are advised to

teach through “Conducting Interior and Exterior Search Operations” in the first session and resume with “Conducting Rescue Operations” in the second session.

REMARKS

Search and rescue size-up is based on the model introduced in Unit 2: CERT Organization and reviewed in Unit 6: Fire Safety and Utility Controls. Review the size-up section carefully and develop examples of damage levels based on the hazards faced and the types of structures common to your community. Provide these examples at appropriate points in the instruction to illustrate important learning points.



SECTION 1: UNIT OVERVIEW

Welcome

Introduce this session by welcoming the participants to Unit 7 of the CERT Basic Training.

Introduce the instructors for this session and ask any new instructors to describe briefly their experience with search and rescue operations.

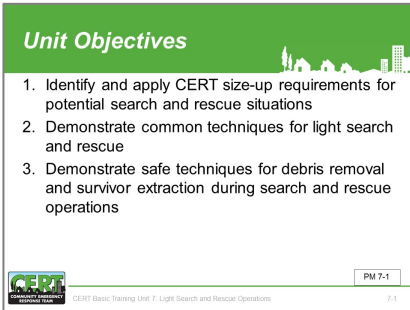

Unit Objectives

1. Identify and apply CERT size-up requirements for potential search and rescue situations.
2. Demonstrate common techniques for light search and rescue.
3. Demonstrate safe techniques for debris removal and survivor extraction during search and rescue operations.

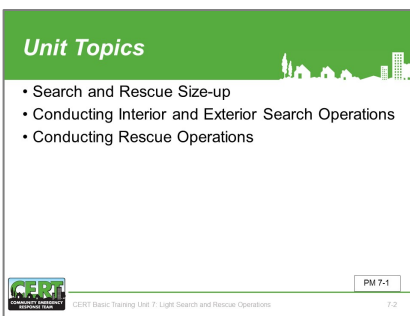

Unit Overview

Search and rescue consists of:

1. Size-up - involves assessing the situation and determining a safe action plan (using the 9-step size-up model outlined in Unit 2);
2. Search - involves locating survivors and documenting their location; and
3. Rescue - involves the procedures and methods required to extricate the survivors.



Point out that previous disasters have shown that the immediate first response to trapped survivors is by spontaneous, untrained, and well-intentioned persons who rush to the site of a collapse in an attempt to free the survivors.

This is an important time to reiterate how the participants should use the skills they learned in Units 2, 3, 4, and 6 during light search and rescue.

- Unit 2: Use the 9-step size-up process to assess the scene.
- Units 3 and 4: During rescue operations, participants may need to treat life-threatening conditions.
- Unit 6: Fire safety skills should be used during the size-up.

Emphasize that more often than not, these spontaneous rescue efforts result in serious injuries and compounded problems. Should participants find themselves in a similar situation, they should not try to attempt efforts that exceed their level of training or expertise.

Always plan and practice rescue efforts in advance. People, including rescuers, have died when the rescuers were neither prepared nor properly trained.

Use the example from the earthquake in Mexico City, where spontaneous efforts saved 700 lives — but cost the lives of more than 100 people — to add emphasis to this discussion.

Point out that the Mexico City example is not isolated but is part of a larger pattern of behavior in emergencies, ranging from accidental drowning in which the would-be rescuer also drowns, to the massive influx of untrained volunteers following major disasters.

Deciding to Attempt Rescue

- Rescue attempt decisions are based on three factors
 - Risks involved for the rescuer and survivor
 - Greatest good for the greatest number
 - Resources and manpower available



CERT
CERT Basic Training Unit 7: Light Search and Rescue Operations

PM 7-1
7.4

Deciding to Attempt Rescue

The decision to attempt a rescue should be based on three factors:

- Risks involved to both the rescuer and the survivor.
 - Ensure if they are going to attempt a rescue that they not exacerbate the injuries of the survivor including those injuries that may not be visible.
- Doing the greatest good for the greatest number of people.
- Availability of resources and labor.

Goals of Search and Rescue

- Rescue greatest number in shortest amount of time
- Get walking wounded out first
- Rescue lightly trapped survivors next
- Keep the rescuers and survivors safe

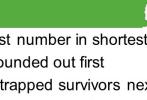

CERT
CERT Basic Training Unit 7: Light Search and Rescue Operations

PM 7-1
7.5

Goals of Search and Rescue

The goals of search and rescue operations are to:

- Rescue the greatest number of people in the shortest amount of time;
- Get the walking wounded and ambulatory survivors out first;
- Rescue lightly trapped survivors next; and
- Keep the rescuers and survivors safe.

Effective Search and Rescue

Depends on:

- Effective size-up
- Rescuer safety
- Survivor safety



 PM 7-1

CERT Basic Training Unit 7: Light Search and Rescue Operations 7-6

Effective Search and Rescue

Effective search and rescue operations hinge on:

- Effective size-up;
- Rescuer safety; and
- Survivor safety.

Inform the participants that this unit will focus on the components of an effective search and rescue operation — size-up, search, and rescue — and the methods and techniques that rescuers can use to locate and safely remove survivors.

Does anyone have any questions about what will or will not be covered in this unit?

Check for understanding.

SECTION 2: SAFETY DURING SEARCH AND RESCUE OPERATIONS

Introduce search and rescue techniques by re-emphasizing the importance of CERT safety measures, including appropriate PPE, use of the buddy system, and knowing their limitations.

CERT Search and Rescue Size-up

Remind the participants that, like every other CERT operation, search and rescue requires size-up at the beginning of the operation and continually as long as the operation continues.

Review the nine steps of the continual size-up process presented in Unit 2:

- Gather facts;
- Assess damage;
- Consider probabilities;
- Assess the situation;
- Establish priorities;
- Make decisions;
- Develop a plan of action;
- Take action; and
- Evaluate progress.

Stress the need for designating a Safety Officer if the decision is made to take action.

Refer the participants to **Table 7.1: CERT Search and Rescue Size-up Checklist** on page 7-3 in the Participant Manual and review the steps briefly.

Tell the group that this section will focus on size-up as it relates to both interior and exterior search and rescue operations.

If you have not yet taught Unit 2, you will have to explain the 9 steps of size-up in more depth now.

CERT Size-up

1. Gather Facts
2. Assess Damage
3. Consider Probabilities
4. Assess Your Situation
5. Establish Priorities
6. Make Decisions
7. Develop Plan of Action
8. Take Action
9. Evaluate Progress

REMEMBER: CERT SIZE-UP IS A CONTINUAL PROCESS

PM 7-3

CERT Basic Training Unit 7: Light Search and Rescue Operations 7.7

Table 7.1: CERT Search and Rescue Size-up Checklist

Step 1: Gather Facts		
Time		
Does the time of day or week affect search and rescue efforts? How?	Yes	No
Type of Construction		
What type(s) of structure(s) is (are) involved?		
What type(s) of construction is (are) involved?		
What type(s) of terrain is (are) involved?		
Occupancy		
Are the structures occupied? If yes, how many people are likely to be affected?	Yes	No
Are there special considerations (e.g. children, elderly, pets, people with access and functional needs)? If yes, what are the special considerations?	Yes	No
Weather		
Will weather conditions affect your safety? If yes, how will your safety be affected?	Yes	No
Will weather conditions affect the search and rescue situation? If yes, how will the search and rescue situation be affected?	Yes	No
Hazards		
Are hazardous materials involved? If yes, at what location?	Yes	No
Are any other types of hazards involved? If yes, what other hazards?	Yes	No
Step 2: Assess and Communicate the Damage		
For structural searches, take a lap around the building. Is the damage beyond the CERT's capability? If yes, what special requirements or specifications are required?	Yes	No
Have you communicated the facts and the initial damage assessment to the appropriate person(s)?	Yes	No
Step 3: Consider Possibilities		
Is the situation stable?	Yes	No
Is there a great risk or potential for more disaster activity that will affect personal safety? If yes, what are the known risks?	Yes	No
What else could go wrong?	Yes	No

Step 4: Assess Your Own Situation		
What available resources do you have to attempt the search and rescue?		
What equipment is available?		
Step 5: Establish Priorities		
Can CERT volunteers attempt a search and rescue <i>safely</i> ? If no, do not attempt a search and rescue.	Yes	No
Are there any other more pressing needs now? If yes, list.	Yes	No
Step 6: Make Decisions		
Where will deployment of available resources do the most good while maintaining an adequate margin of safety?		
Step 7: Develop Plan of Action		
Determine how best to deploy personnel and other resources.		
Step 8: Take Action		
Put the plan into effect.		
Step 9: Evaluate Progress		
Continually size up the situation to identify changes in the scope of the problem, safety risks, and resources availability.		

Size-up Step 1

• Gather Facts:

- Time of event and day of the week
- Construction type/terrain
- Occupancy
- Weather
- Hazards
- Search subject profile



CERT
COMMUNITY EMERGENCY RESPONSE TEAM

CERT Basic Training Unit 7: Light Search and Rescue Operations

PM 7-5

7.5

Provide and discuss locally relevant examples of planning factors to develop an understanding of the effects of each factor.

Mention that the amount of damage likely to be found in different types of construction will be covered in a few minutes.

Step 1: Gather Facts

Introduce Step 1 by telling the group that the facts of the situation must guide their search and rescue efforts.

When gathering facts, CERT volunteers need to consider:

- The time of the event and day of the week.
 - At night, more people will be in their homes, so the greatest need for search and rescue will be in residential settings. Conversely during the day, people will be at work, so the need will be in commercial buildings. The locations of people in their homes and the amount of daylight available may also affect search and rescue operations.
- Construction type and terrain.
 - Some types of construction are more susceptible to damage and the type of terrain will affect how best to conduct the search.
- • Occupancy.
 - The design purpose of the structure may indicate the likely number of victims, survivors and their location.
- Weather
 - Severe weather will have an effect on survivors and rescuers alike and will certainly hamper rescue efforts. Consider forecasts of severe weather as a limiting factor on the period during which search and rescue can occur.
- Hazards.
 - Knowledge of other potential hazards in the general and immediate areas is important to search and rescue efforts. For example, if a gas leak is suspected, taking the time to locate and shut off the gas can have a big impact in terms of loss of life.
- Search subject profile, if known.
 - If they know who they are looking for, they can focus search efforts based on habits and last known locations.

Refer the group to Scenario on page 7-5 in the Participant Manual and introduce the *Gathering Facts* exercise.

Exercise 7.1

- Brainstorm the following questions:
 - What does this scenario tell you about the probable density for the affected area?
 - What does this scenario tell you about the facts that must be gathered?
 - What impact could these facts have on search and rescue operations?
 - What kinds of search and rescue operations are probable?
 - What, if any, are the constraints that search and rescue personnel may face in this scenario?
 - Can these constraints be overcome within the established CERT mission? If so, how?



CERT Basic Training Unit 7: Light Search and Rescue Operations

PM 7-5

7/9

Use the following steps to facilitate this exercise, keeping in mind that this scenario is only an example and may be changed to fit your community's needs.

Exercise 7.1: Gathering Facts

Purpose: Explain how this exercise is an interactive activity to give the participants the opportunity to consider some of the facts that CERT search and rescue teams will need to gather during size-up.

Instructions:

1. Refer the participants to Scenario in the Participant Manual.
2. Ask the group to brainstorm the following questions:
 - What does this scenario tell you about the probable density for the affected area?
 - What does this scenario tell you about the facts that volunteers must gather?
 - What impact could these facts have on search and rescue operations?
 - What kinds of search and rescue operations are probable?
 - What, if any, are the constraints that search and rescue personnel may face in this scenario?
 - Can volunteers overcome constraints within the established CERT mission? If so, how?
3. Record the group's responses on chart paper.
4. Discuss the group's responses and provide feedback regarding strengths and possible improvements in their planning.

Scenario for Exercise 7.1

At 2:30 p.m. on Tuesday, August 9, a squall line passed through your town. Because of the difference in barometric pressure on either side of the front, a “gust front” with straight-line winds of more than 70 miles per hour preceded the squall line. Continued strong winds and extremely heavy rain followed the gust front. The town loses electricity.

You activate in accordance with your CERT program's Standard Operating Procedures

(SOPs). On the way to the staging area at the local high school, you notice considerable damage, including felled trees and utility lines. Many streets are impassable, causing you take a roundabout route to the high school. As you make your way to the staging area, you see that

the roof has blown off of a large portion of a local strip shopping center, and that the exterior wall on the west end of the structure has collapsed.

After reaching the staging area, you check-in with the Logistics Team Leader, who assigns you to Search and Rescue Team 2. Although CERT volunteers cannot venture into the section of the shopping center that has collapsed, Search and Rescue Team 2 will be searching near the collapsed area to see if there are survivors in that area.

Step 2: Assess and Communicate Damage

Introduce Step 2 by pointing out general guidelines for assessing damage in interior and exterior searches. When in doubt about the condition of a building, CERT volunteers should always use the more cautious assessment. If unsure about whether a building is damaged moderately or heavily, CERT volunteers should assume heavy damage.

Emphasize that the CERT mission changes depending on the amount of structural damage.

The following information on probable damage and the table titled Probable Severity and Type of Earthquake Damage Based on Construction Type on page 7-8 in the Participant Manual relate to earthquakes.

If other types of disasters (e.g., tornadoes, hurricanes, or floods) are likely in your area, add information about the probable impact on various types of construction and the definition of light, moderate, and heavy damage.

CERT Mission and Types of Damage

Explain how the CERT mission for interior searches changes if:

Damage is Light

The CERT mission is to locate; assess; treat airway, major bleeding, and low body temperature; continue size-up; and document.

Light damage includes:

- Superficial damage;
- Broken windows;
- Superficial cracks or breaks in the wall surface, for example, fallen or cracked plaster; and
- Minor damage to the interior contents.

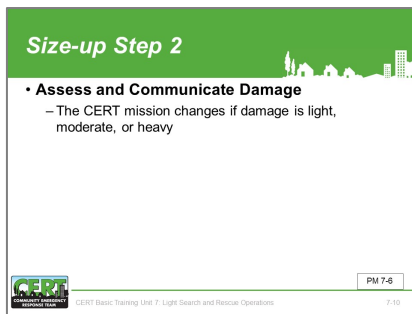

Moderate Damage

- Visible signs of damage
- Decorative work damaged or fallen
- Many visible cracks or breaks in wall
- Major damage to interior contents
- Building still on foundation
- **Enter only to save lives**



PM 7-6

CERT Basic Training Unit 7: Light Search and Rescue Operations 7-12

Damage is Moderate

The CERT mission is to locate; treat airway, major bleeding, and low body temperature; evacuate; warn others; continue size-up while minimizing the number of rescuers and time spent inside the structure.

Moderate damage includes:

- Visible signs of damage;
- Decorative work damaged or fallen;
- Many visible cracks or breaks in the wall surface;
- Major damage to interior contents; and
- Building still on foundation.

Heavy Damage

- Partial or total collapse
- Tilting
- Obvious structural instability
- Building off foundation
- Smoke, fire, gas leaks, or hazardous material
- Rising water
- **Do not enter a building with heavy damage under any circumstances!**



PM 7-7

CERT Basic Training Unit 7: Light Search and Rescue Operations 7-13

Damage is Heavy

The CERT mission is to secure the building perimeter and warn others of the dangers in entering the building.

Heavy damage includes:

- Partial or total collapse;
- Tilting;
- Obvious structural instability;
- Building off foundation;
- Heavy smoke or fire;
- Gas leaks/hazardous materials inside; and
- Rising or moving water.

Mention that, later in this session, the participants will learn more about formulating rescue strategies based on the damage assessment.

Reemphasize that CERT volunteers must not enter a building with heavy damage **under any circumstances**.

Assessing Damage

Explain that assessing damage of a building or structure will require an examination from all sides. Urge participants to do an initial "lap around" the building.

Explain that, in assessing damage, CERT personnel must consider probable levels of damage based on the type and age of construction. In addition to a visual assessment, rescuers should also "listen" to damaged structures. If a building is creaking or "groaning," it is unstable, and volunteers should not enter it.

Refer the participants to **Table 7.2: Earthquake Severity Based on Construction Type** on page 7-8 in the Participant Manual.

Tell the participants that, in some instances, an exterior search is required and that they should employ a grid search.

More detailed search methodology will be discussed later in this unit.

Communicating Damage

Tell participants to describe different locations within and around the structure by using the ABCD standard, with A corresponding to the front of the building, and B, C, and D representing the sides of the building, moving clockwise from A.

Using this system, volunteers can break down the area inside of a structure by quadrants to facilitate communication. For instance, a hazard or survivor located closest to the A and B sides of the structure is in the A/B quadrant.

Stress that participants must communicate their findings to the CERT command post or responding agencies.

Table 7.2: Earthquake Severity Based on Construction Type

Construction Type	Description	Probable Damage Areas	Severity
Single-Family Dwelling	<ul style="list-style-type: none"> • Wood frame 	<ul style="list-style-type: none"> • Masonry chimney • Utilities 	Light
	<ul style="list-style-type: none"> • Pre-1933 	<ul style="list-style-type: none"> • Foundation movement • Utilities • Porches 	Moderate
	<ul style="list-style-type: none"> • Hillside 	<ul style="list-style-type: none"> • Unique hazards • Ground failure 	Heavy
Multi-Family Dwelling	<ul style="list-style-type: none"> • Up-and-down and/or side-by side living units 	<ul style="list-style-type: none"> • Soft first floor • Utilities 	Moderate
Unreinforced Brick	<ul style="list-style-type: none"> • Pre-1933 construction • Lime or sand mortar • “King Row” or • “Soldier Row” (bricks turned on end every 5-7 rows) • Reinforcing plates • Arched windows and doors • Recessed windows and doors 	<ul style="list-style-type: none"> • Walls collapse, then roof 	Heavy
Tilt-up	<ul style="list-style-type: none"> • Large warehouses and plants • Concrete slabs lifted into place • Walls in set approximately 6-8 inches • Lightweight roof construction 	<ul style="list-style-type: none"> • Roof collapses, then walls 	Heavy
High-Rise	<ul style="list-style-type: none"> • Steel reinforced 	<ul style="list-style-type: none"> • Broken glass • Content movement • Exterior trim and fascia 	Light

Size-up Step 3

• **Consider Probabilities:**

- How stable is the situation?
- What secondary factors should be considered?
- What else could go wrong?
- What does it mean for the search and rescue?

 PM 7-8

CERT Basic Training Unit 7: Light Search and Rescue Operations 7-14

Step 3: Consider Probabilities

Stress that, because CERT volunteers will be working in such close proximity to the dangerous situation, considering what will probably happen and what could happen are of critical importance. Urge the participants to identify potentially life-threatening hazards and ask:

- How stable is the situation?
 - Even within a structure that appears from the outside to have only minimal or moderate damage, nonstructural damage or instability inside the structure can pose real danger to the rescue team. CERT volunteers should think about what they already know about the structure that has been damaged. Are lawn chemicals, paints, or other potentially hazardous materials stored within the structure? How are they stored? Where are they? It will not take CERT volunteers much time to answer these types of questions, but the answers could make a huge difference in how they approach the search.
- What secondary factors should CERT volunteers consider?
 - Take a moment to look around and assess the situation outside of the immediate area. What is the weather doing? Is the wind changing? Is a storm moving in that would affect the response? Is there a crowd growing? Are there very few people around? Do they hear first responders in the distance, or is everything quiet?
- What else could go wrong?
 - Based on the information gathered during Steps 1 and 2 of the size-up, CERT volunteers should take a few moments to play “What if?” to try to identify additional risks that they may face. What happens if the power goes out during the search? What if a wall that appears stable shifts and collapses? Applying “Murphy’s Law” to the situation could save CERT volunteers’ lives.
- What does it all mean for the search and rescue?

- Based on the probabilities, CERTs should think about what they can do to reduce the risks associated with the probabilities that they have identified. Is a spotter necessary to look for movement that could indicate a possible collapse and warn the rescue team? Is some remedial action required to stabilize nonstructural hazards before beginning the search? CERT search and rescue teams must remember that their own safety is the first priority.

Check for learning!

Are there any questions before moving on to Step 4?

Step 4: Assess Your Situation

Remind the participants that size-up is a continuous process, with each step building upon the previous steps until the decision is made to begin the search and rescue operation or that the situation is not safe to begin. You need to draw on everything you have already learned from Steps 1 through 3 to assess your situation to determine:

- Whether the situation is safe enough to continue;
- The risks that rescuers will face if they continue; and
- The available resources volunteers will need to conduct the operation safely.

Point out that assessing resources is extremely important to search and rescue operations.

When you talk about “resources,” to what are you referring?

Acknowledge the group’s responses. If not mentioned by the participants, say that search and rescue resources include personnel, tools, and equipment. Refer the participants to **Table 7.3: Search and Rescue Resource Planning Questions** on page 7-10 in the Participant Manual.

Size-up Step 4

• **Assess Your Situation:**

- Is the situation safe enough to continue?
- What risks will rescuers face?
- What resources are needed?
- What resources are available?

PM 7-9

Instructors should stress that participants consider their personal safety when assessing the situation. If they are not equipped to take action they should wait until first responders arrive.

Open a group discussion.

Table 7.3: Search and Rescue Resource Planning Questions

Resource	Planning Questions
Personnel	<ul style="list-style-type: none"> • How many trained CERT volunteers are available for this operation? • Who lives and/or works in the area? • During what hours are these people most likely to be available? • What skills or hobbies do they have that might be useful in search and rescue operations? • What might be the most effective means of mobilizing their efforts? • Do all team members have everyone else’s cell number?
Equipment	<ul style="list-style-type: none"> • What equipment is available locally that might be useful for search and rescue? • Where is it located? • How can volunteers access it? • On which structures (or types of structures) might it be most effective?
Tools	<ul style="list-style-type: none"> • What tools are available that might be useful to lift, move, or cut disaster debris? • What tools are available that will aid communication?

Rescue Resources

- Personnel:
 - Firefighters
 - Police officers
 - Doctors, Nurses
 - Contractors
- Tools:
 - Crowbars
 - Auto jacks
 - Chainsaws
- Equipment



CERT Basic Training Unit 7: Light Search and Rescue Operations PM 7-9

Rescue Resources

Search and rescue resources include personnel, equipment, and tools. Below are questions that volunteers should ask regarding the availability of these types of resources.

Personnel

- How many CERT volunteers are available for this operation?
- In addition, who lives and/or works in the area?
- When are they likely to be available?
- Do they have skills that might be useful in search and rescue operations?
- How can volunteers mobilize their efforts?

Drawing on personnel resources that may be available can make search and rescue operations more efficient. For example, having CERT volunteers monitor the situation can free resources for tasks requiring specialized training.

Equipment

- What equipment is available that might be useful for search and rescue?
- Where is it located?

Provide the participants with examples of tools and equipment that they might need for search and rescue operations.

- How can volunteers access it?
- On which structures (or types of structures) might it be most effective?

Tools

- What tools are available that might be useful to lift, move, or cut debris?

Often times the key to successful light search and rescue is flexibility and the ability to improvise.

Mention that they may not always have the required resources they need at their disposal. There may be time when CERT volunteers will need to improvise with the resources available to them. For example, they may need a sheet or blanket to lay someone on top of to move them; however, they only have a large piece of cardboard.

Point out that considering each of these questions will facilitate action planning.

Size-up Step 5

- **Establish Priorities:**
 - What should be done?
 - In what order?
 - How do you rescue the greatest number in the shortest amount of time?





CERT Basic Training Unit 7: Light Search and Rescue Operations

PM 7-10

Step 5: Establish Priorities

After evaluating the situation and keeping in mind that the safety of the CERT volunteer is always the top priority, the next step is to determine:

- What should be done; and
- In what order?

For example, volunteers must complete the task of removing or mitigating known hazards before teams begin to search. Urge the participants to think through the situation logically to determine how they should approach the operation.

Priority determinations are based on:

- The safety of CERT volunteers;
- Life safety for survivors and others;
- Protection of the environment; and
- Protection of property.

Remind participants of the goal: rescue the greatest number in the shortest amount of time, but not at the expense of their own safety.

Size-up Step 6

- **Make Decisions:**
 - Keep in mind:
 - Safety of CERT members
 - Life safety for survivors and others
 - Protection of the environment
 - Protection of property

 PM 7-10
CERT Basic Training Unit 7: Light Search and Rescue Operations 7-17

Step 6: Make Decisions

Explain that this is the point during the size-up where they will make decisions about where to deploy their resources to do the most good while maintaining an adequate margin of safety. Stress that they will base many of their decisions on the priorities established during Step 5.

Remind the group that the CERT mission priorities in search and rescue operations change depending on the amount of structural damage.

Size-up Step 7

- **Develop Plan of Action:**
 - Focus operation on established priorities and decisions
 - Provide documentation to give to responding agencies
 - Provide documentation to become part of CERT records

 PM 7-11
CERT Basic Training Unit 7: Light Search and Rescue Operations 7-17

Step 7: Develop Plan of Action

Step 7 is where all the information they have regarding the situation comes together. During Step 7, the CERT Team Leader (TL) will decide specifically how the team will conduct its operation, considering the highest priority tasks first.

Remind the participants that they do not have to write down an action plan, but suggest that, when search and rescue operations are required, the situation is probably complex enough that a written plan of some type will be important. Point out that a plan should:

- Help focus the operation on established priorities and decisions.
- Provide for documentation to give to responding agencies when they arrive on scene.
- Provide for documentation that will become part of the record of the CERT's overall operation.

Size-up Step 8

- **Take Action:**
 - Base action on plan developed during Step 7



 PM 7-11
CERT Basic Training Unit 7: Light Search and Rescue Operations 7-20

Step 8: Take Action

Urge the participants to keep a notebook for jotting notes when developing an action plan. Volunteers should also document any changes made to the initial plan based on new information that emerges.

Size-up Step 9

- **Evaluate Progress:**
 - Most critical step
 - Monitor plan's effectiveness and safety



 PM 7-11
CERT Basic Training Unit 7: Light Search and Rescue Operations 7-21

Step 9: Evaluate Progress

Emphasize that Step 9: Evaluate Progress, is the most critical, not only in terms of evaluating whether the plan works, but also from a safety standpoint.

Remind the group that size-up is ongoing and that information gained during Step 9 needs to be fed back

Check for understanding.

into the decision-making process for possible revision of priorities and updated action planning.

Are there any questions about the 9-step size-up process for light search and rescue?

Specific Safety Considerations

Point out that regardless of the severity of structural damage, rescuer safety must be the primary concern. The most frequent causes of rescuer deaths are disorientation and secondary collapse.

Be prepared and make rescuer safety the top priority.

Refer the participants to *Specific Safety Considerations* in the Participant Manual. Caution the participants that they must follow these guidelines during all search and rescue operations:

- Use the buddy system.
 - Successful search and rescue depends on teamwork.
- Be alert for hazards (e.g., power lines, natural gas leaks, hazardous materials, sharp objects, overhead objects that could fall).
 - Never attempt to search an area where water is rising.
- Use safety equipment.
 - Wearing gloves and a helmet will protect a rescuer's hands and head. Kneepads, coveralls, and thick-soled boots will protect a rescuer from glass and other sharp objects found on the ground following many natural disasters.

Also, tell the group that the primary cause of rescuer problems after working in a structural collapse is breathing dust, so an N95 mask is essential.

Tell the group that dust masks will not filter chemicals or biological agents. Stress that, if CERT volunteers suspect the use of chemical or biological agents, they must evacuate to an upwind location and notify professional responders.

Have backup teams available to allow rotation of teams, prevent fatigue, and ensure help if a team gets into

Emphasize this point.

trouble. Have teams drink fluids and eat to keep themselves fresh.

Use the following steps to facilitate this exercise. The exercise is based on several different types of **local** buildings (one for each small group) for the most probable type of disaster that the community will face.

Exercise 7.2: Search and Rescue Size-up

Purpose: Explain that this exercise is an interactive activity to give the participants an opportunity to practice some of the thinking processes involved in planning and search and rescue size-up.

The brainstorming required will help participants begin to assess their neighborhoods or workplaces in terms of building structures, hazardous materials, and any necessary safety precautions.

Instructions:

1. Assign participants to groups of four or five.
2. Provide each group with a local scenario (with slides, if possible) describing a local building in a disaster event that is realistic for the community.
3. Ask the groups to designate a recorder and, given the disaster and the specific building, answer the following questions:
 - What are the pertinent facts that the group must gather?
 - What kind of prediction can you make regarding damage, based on the incident and the building construction?
 - What specific safety considerations can you identify?

Ask each group to select a spokesperson to present the group's responses to the class.

Discuss each group's responses and provide feedback about how their search and rescue size-up might be improved.

Does anyone have any questions about anything covered to this point?

Explain that the next section will deal with how to conduct search operations.

Check for understanding.

Exercise 7.2

- Given the disaster and the specific building, answer the following questions
 - What are the pertinent facts that must be gathered?
 - What kind of prediction can you make regarding damage, based on the incident and the building construction?
 - What probable search and rescue problems can you identify?
 - What specific safety considerations can you identify?



CERT Basic Training Unit 7: Light Search and Rescue Operations

PM 7-12

7-22

SECTION 3: CONDUCTING INTERIOR AND EXTERIOR SEARCH OPERATIONS

During light search and rescue operations, CERT volunteers will inspect the area assigned by the CERT Team Leader (TL).

Emphasize the concept of survivor accountability, as this is a key skill that incident command will require of CERT. This is where CERTs conduct searches and account for survivors but not actually take action to relocate or extricate them. Floods are a great example of how this is used. CERT team volunteers would go door to door to see who was sheltering in place, provide people with information (stay here with no electricity or go to the shelter), and mark the dwelling. This allows first responders to more safely and efficiently extract survivors. Place emphasis on survivor accountability.

Explain that the search operation involves two processes:

1. Employing search techniques based on the size-up; and
2. Locating survivors.

Point out that by using these processes, search operations will be more efficient, thorough, and safe. They will also facilitate later rescue operations. Explain that although the processes are related, this section will address them one at a time. Interior search operations are the most common, and the unit will discuss them first. Exterior search operations will be discussed later in this unit.

Locating Potential Survivors in a Structure

Tell the participants that the first step in locating potential survivors in a structure is to conduct a size-up of the interior of the building to gather precise information about damage, and to develop priorities and plans.

Explain this by saying that the data gathered will provide more information about possible areas of entrapment — or voids.

Provide examples of how to use the information gathered to find out more information about areas of entrapment.

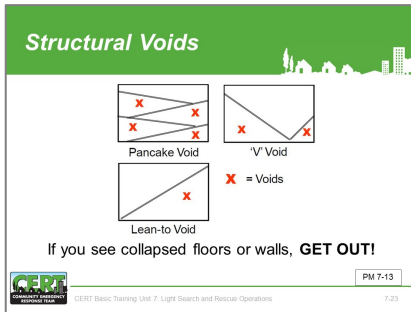

Structural Voids

Point out that there are several types of voids, including a pancake void, lean-to void, and a “V” void.

Survivors may be trapped in a structural void. If they hear any signs of life coming from a structural void, report it to the TL immediately and make appropriate markings to direct professional rescuers, but do not attempt the rescue. Attempting to rescue a person from a structural void without proper equipment may result in completing the collapse and harming the trapped person and volunteer.

Emphasize that if CERT volunteers see collapsed floors or walls, they should leave the premises immediately.

Does anyone have any questions about the types of structural voids?

Check for understanding.

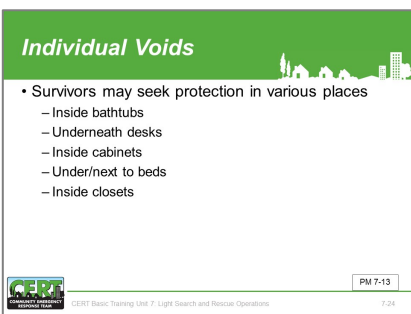

Individual Voids

Explain that individual voids are spaces into which the survivor may have crawled for protection. Examples of individual voids include bathtubs and the space underneath desks. Children may seek shelter in smaller places like cabinets.

Tell the group that, after identifying the possible areas of entrapment, CERT volunteers must:

- Determine the potential number of survivors; and
- Identify the most probable areas of entrapment.

While assessment may highlight some of this information, CERT volunteers may need to get some information by talking to bystanders or those who are familiar with the structure.

Explain that CERT volunteers should ask questions when talking with these individuals, including:

- How many people live (or work) in the building?
- Where would they be at this time?
- What is the building layout?
- What have you seen or heard?
- Has anyone come out?
- What are the normal exit routes from the building?

Caution the group that the event may confuse bystanders. They may tend to exaggerate potential numbers or may not even remember the event accurately. Tell the group to gather as much information as they can, because it will be useful for planning out search priorities and implementing the search.

Search Methodology

Introduce this section by telling the group that an effective search methodology:

- Indicates rescuer location;
- Locates survivors as quickly and safely as possible; and
- Prevents duplication of effort.

Search Markings

- Upon entering search area:
 - Make a slash
 - Enter info
- Upon leaving search area:
 - Complete 'X'
 - Enter info

PM 7-14

Search Markings

Inform the group that CERTs will use the same system that experienced search and rescue personnel use. This will save time for fellow CERT volunteers and other responders during the continual search and size-up of the structure.

Explain that upon entering a search area, they will make a mark next to the door to indicate that they are entering. Do not make the mark on the door or on the wall where the door swings. Make a single slash and write the agency or group ID at the “9 o’clock” position. Then write the date and “time in” at the “12 o’clock” position.

Upon exiting the search area, make another slash to form an “X” (the agency or group ID will be in the left quadrant). Enter the search “time out” in the top quadrant.

Search Markings

• What information do you mark?

PM 7-14

- **Right quadrant:** Enter the areas of the structure searched and any specific information about hazards.
- **Lower quadrant:** Enter information about the survivors found in the search area. “L” represents living survivors, while “D” represents dead. The search marking on the front of a structure or building should contain the total number of survivors, whereas search markings inside the structure or building will include survivor totals for specific search areas. Indicate where survivors were taken.

Search Markings

Sample

PM 7-14

Review the example of the completed search marking, quadrant by quadrant.

Explain what type(s) of markers the CERTs should use (e.g., lumber crayons, chalk) and suggest where to purchase markers if they are not provided.

Does anyone have any questions about search markings?

Search Methodology

- Use the buddy system.
 - Remain within arm’s reach of at least one other CERT volunteer at all times when conducting an interior search. This is to enable assistance in the event of a slip or a fall and to be able to push or pull one another out of harm's way.
- Upon entering each space or room, call out to survivors.
 - Shout something like, "If anyone can hear my voice, come here." If any survivors come to you, ask them for any information they may have about the building or others who may be trapped, then give them further directions such as, "Stay here" or "Wait outside" (depending on the condition of the building).

Remind the group that even those who are able to get to them may be in shock and confused. When giving directions to survivors, CERT volunteers should look directly at the survivors, speak in short sentences, and keep their directions simple.

Explain that it may be best to search interior rooms with a partner. When doing so, ensure that both are using the same search methodology and remain in contact with one another. It is important that partners never lose sight of each other. In dark rooms, this may mean maintaining physical contact throughout the search.

Use a systematic search pattern. Ensure that all areas of the building are covered. Examples of systematic search patterns to use include:

- Bottom-up/top-down
- Right wall/left wall



Search Methodology

- Remain within arm’s reach of one other CERT member
- Call out to survivors, "If anyone can hear my voice, come here"
- Ask any survivors who do respond for more information about the building or others who may be trapped
- Survivors might be in shock or confused

PM 7-14

Search Methodology

- Bottom-up/top-down for a multi-story building
- Right wall/left wall for a single floor
- Stop frequently to listen

PM 7-15

Emphasize that every interior space has six sides, including the floor and ceiling. Emphasize that rescuers must check all six sides to locate hazards such as fixtures that may be hanging from the ceiling.

Search Methodology

- Stop frequently to listen for:
 - Tapping
 - Movement
 - Voices



PM 7-15

CERT Basic Training Unit 7: Light Search and Rescue Operations 7-30

Stop frequently to listen. Listen for tapping, movement, or voices.

Triangulate. Use triangulation when a potential survivor’s location is obscured. If access permits, three rescuers, guided by survivor sounds, form a triangle around the area and direct flashlights into the area. The light shining from different directions will eliminate shadows that could otherwise hide survivors.

Search Methodology

- Triangulation allows rescuers to view a location from several perspectives

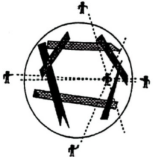

PM 7-15

CERT Basic Training Unit 7: Light Search and Rescue Operations 7-31

1. Emphasize that triangulation should not be used as an initial search method.
2. Following this review of search methods, the instructor(s) should demonstrate how to conduct a search in a room, including search patterns (e.g., right wall/left wall) and marking next to doors. You can do the demonstration in any room. You can use tables, chairs, and other items to simulate debris.
3. Report results. Keep complete records of survivors removed and survivors who remain trapped or dead. Report this information to emergency services personnel when they reach the scene.

Search Methodology

- Keep records of rescued survivors and of those who remain trapped or who are dead
- Report information to emergency services personnel

PM 7-15

CERT Basic Training Unit 7: Light Search and Rescue Operations 7-32

Exterior Search

- Set up a grid search:
 - Set distance between searchers according to visibility and debris
 - Overlap patterns for full coverage
 - Search in as straight a line as possible
 - Mark areas that have been searched

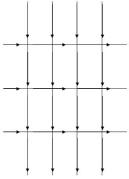

PM 7-15

CERT Basic Training Unit 7: Light Search and Rescue Operations 7-33

Exterior Search

In addition to searching inside a structure, CERT volunteers may need to search open areas outside of buildings.

Conducting an effective search in open areas requires that searchers work methodically and follow standard procedures established by those in charge of the search operation.

If searchers are needed, they should assemble in a central staging area and sign in. Authorities will brief the searchers on what they will be looking for, what areas

they are responsible for searching, the pattern of the search, and what they should do if they discover the missing person, evidence, or related information.

Exterior search patterns include grid, line, quadrant or zone, and spiral. Typically, a grid pattern is used in large open areas, or small areas when a hands-and-knees search is conducted.

Grid is one of the most commonly used types of search patterns. Keep in mind the guidelines below when conducting a grid search:

- View the search area as a grid, with searchers initially positioned at one side of the grid.
- The distance between the searchers should be set according to visibility and debris. In all cases, searchers must remain within line of sight and voice contact with searchers on either side of them.
- It is critical that the area assigned to each searcher overlaps that of the searchers on either side of them.
- The searchers proceed, maintaining as straight a line as possible across the entire search area. As each searcher moves across the area, they conduct a thorough search for survivors within their designated row of the grid.
- To ensure full coverage, CERTs must record each area searched.

Explain that a grid search might be particularly useful following a tornado or hurricane.

Check for understanding.

Are there questions about planning and conducting search operations or the methods involved in an effective search?

Inform the participants that the next section will deal with conducting rescue operations.

SECTION 4: CONDUCTING RESCUE OPERATIONS

Rescue Operations

- Remove objects and debris to free survivors and create safe rescue environment
- Assess survivors
- Remove survivors



CERT Basic Training Unit 7: Light Search and Rescue Operations 7:24

When discussing “assessing survivors,” remind participants of the skills covered in Units 3 and 4.

Creating a Safe Environment

- Maintain rescuer safety
- Assess survivors in lightly and moderately damaged buildings
- Evacuate survivors as quickly as possible

CERT Basic Training Unit 7: Light Search and Rescue Operations 7:30

Precautions to Minimize Risk

- Know your limitations
- Follow safety procedures
- Remove debris by leveraging and cribbing

CERT Basic Training Unit 7: Light Search and Rescue Operations 7:36

Rescues involve three primary functions:

1. Moving objects and debris to create a safe rescue environment and to free survivors.
2. Assessing survivors, checking for life-threatening conditions such as airway obstruction, severe bleeding, and low body temperature.
3. Removing survivors as safely and quickly as possible.

Stress that rescuer safety is always the top priority.

Explain that the unit will address the three primary functions of rescue separately.

Creating a Safe Environment

There are three safety considerations for all rescue operations:

1. Maintaining rescuer safety;
2. Assessing survivors in lightly and moderately damaged buildings; and
3. Evacuating survivors as quickly as possible from moderately damaged buildings while minimizing additional injury.

Emphasize that CERTs cannot achieve these considerations without creating as safe an environment as possible before attempting rescue. Therefore, there are certain precautions that rescuers must take to minimize risk.

Precautions to Minimize Risk

Stress that there are certain precautions that rescuers must take to minimize risk and increase their chances of achieving their rescue goals.

- **Know your limitations.** Many volunteers have been injured or killed during rescue operations because they did not pay attention to their own physical and mental limitations. CERT rescuers should take the time to drink fluids, eat, relax, and rest so that they can return with a clear mind and improved energy.

- **Follow safety procedures.** CERT volunteers should always use the proper safety equipment required for the situation and follow established procedures, including:
 - Work in pairs;
 - Assess and treat only in lightly damaged buildings;
 - In moderately damaged buildings, assess only and remove survivors as quickly as possible;
 - Never enter an unstable structure;
 - Lift by bending the knees, keeping the back straight, and pushing up with the legs;
 - Carry the load close to the body; and
 - Lift and carry no more than is reasonable.

- **Remove debris.** Remove debris as needed to minimize risk to rescuers and to free entrapped survivors.

Refer the participants to **Image 7.1: Proper Body Positions for Lifting** on page 7-18 in the Participant Manual.

Image 7.1: Proper Body Positions for Lifting

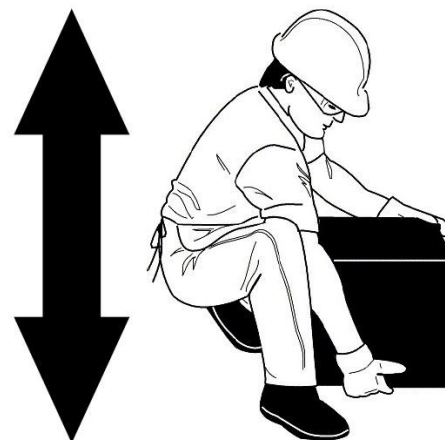
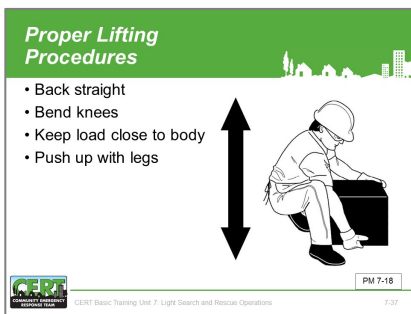

Leveraging and Cribbing

Tell participants they may encounter situations in which debris needs to be moved to free survivors. In these situations, CERT rescuers should consider “leveraging” and “cribbing” to move and stabilize the debris until the rescue is complete.

- **Leveraging** is accomplished by wedging a lever under the object that needs to be moved, with a stationary object underneath it to act as a fulcrum. When the lever is forced down over the fulcrum, the far end of the lever will lift the object.
- A **crib** is a wooden framework used for support or strengthening an object.
- **Box cribbing** means arranging pairs of wood pieces alternately to form a stable rectangle.

Refer the participants to the section titled *Leveraging* and *Cribbing* beginning on page 7-19 in the Participant Manual, for a description and illustration of a leveraging and cribbing operation.

Demonstrate leveraging and cribbing for the group. Show box cribbing and "unboxed" cribbing.

Volunteers may use leveraging and cribbing together by alternately lifting the object and placing cribbing materials underneath the lifted edge to stabilize it.

Safety is number one: "Lift an inch; crib an inch." Caution that leveraging and cribbing should be gradual for stability, safety, and efficiency.

It may also be necessary to use leveraging and cribbing at more than one location (e.g., front and back) to ensure stability. NEVER leverage and crib at opposite ends at the same time because doing so will increase the instability of the debris. If leveraging is required at both ends, suggest that the participants lift and crib at one end, then repeat the process at the other end.

Explain that positioning the lever and the fulcrum correctly is critical for safe operations. The fulcrum and pry tool must be perpendicular (90 degrees) to the edge of the object being lifted. Attempting to leverage a heavy object using too sharp of an angle is inefficient and can result in back injury.

Caution the group that box cribbing is stable but requires pieces of cribbing material of relatively uniform size. When such material is not available, "unboxed" cribbing can also work effectively to support and stabilize the heavy object.

Tell participants that they may use a variety of cribbing materials for these procedures and provide suggestions (e.g., tires or structural debris). Emphasize the importance of improvising, and encourage them not to put form over function.

Warn the participants that when they are able to achieve sufficient lift, they should remove the survivor and reverse the leveraging and cribbing procedure to lower the object. Stress that they should never leave an unsafe condition, unless the event has left the structure or building obviously compromised.

Tell the group that when they must remove debris to locate survivors, they should set up a human chain and pass the debris from one person to the next. Caution them to set up the chain in a position that will not interfere with rescue operations.

Remind them to wear their PPE to protect themselves at all times. Note that kneepads can be an important addition to their PPE during rescue operations.

Ask the group several "What would you do if?" questions to ensure that they understand the material.

Does anyone have any questions about safety precautions and leveraging and cribbing during rescue operations?

When it is clear that the participants understand the concepts, tell them that the next section will cover moving survivors.

Check for learning!

When asking the questions, set up a brief scenario and ask what the participants would do in that situation.

Leveraging and Cribbing Steps

Step 1: Conduct a size-up of the scene: Gather facts, identify hazards, and establish priorities.

Step 2: Have one person in charge and formulate a plan of action based on the information you have received, to identify how and where to lift and crib to determine how you will remove the survivor from underneath the debris.

Step 3: Gather necessary materials for lifting/cribbing operations: lever, fulcrum, cribbing blocks, spacers/wedges. During an actual emergency, you may have to use creative, substitute materials.

Step 4: Use cribbing materials to stabilize the object prior to lifting.

Step 5: Distribute cribbing materials as necessary to be readily accessible during the lifting operation.

Step 6: Prepare to lift the object: Assemble the lever and fulcrum at the previously identified location.

Step 7: Assign a person to monitor and be ready to remove the survivor as soon as possible.

Step 8: Initiate the lift, using the lever and fulcrum for mechanical advantage.

Step 9: As the object is lifted, add cribbing as needed one layer at a time.

Step 10: Once the object is adequately supported, remove the lever and fulcrum. You may then remove the survivor.

Step 11: Unless the event has left the structure obviously compromised requiring you to evacuate immediately, reinitiate the lift and begin removing cribbing materials, reversing the process by which you built the crib.

Step 12: Progressively lower the object to the ground. Always return the heavy object to a stable position unless you have to evacuate immediately.

Step 13: Before you leave, remember to collect the lifting/cribbing supplies to be available for additional operations.

Image 7.2: Leveraging and Cribbing

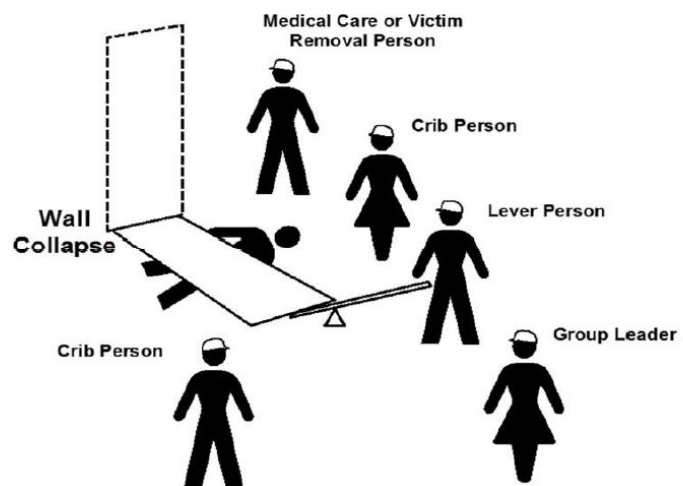
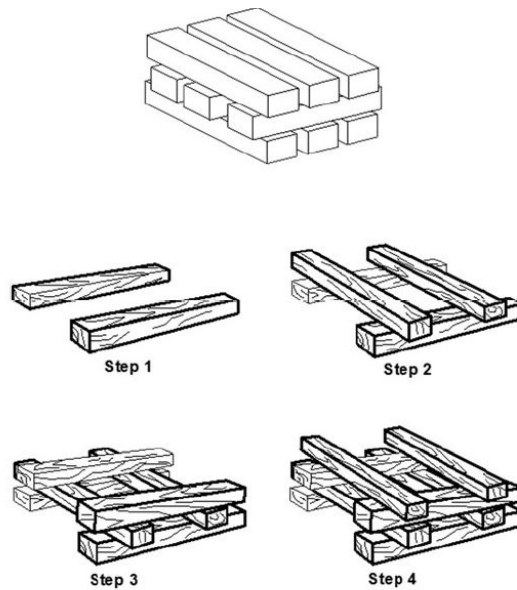

Image 7.2: Leveraging and Cribbing displays team organization for leveraging/cribbing operation, showing the survivor underneath a collapsed wall and the CERT volunteers at the following locations:

- **Group Leader:** In front of the collapse, positioned so that he or she can view the entire operation while remaining out of the rescuers' way;

- **Lever Person:** At the front edge of the collapsed wall and positioned so that he or she can position a fulcrum and lever under the wall;
- **Crib Persons:** On either side of the collapsed wall and positioned to enable the placement of cribbing as the wall is raised with the lever; and
- **Medical Care/Survivor Removal Person:** Next to the Crib Person who is closest to the survivor's head

Image 7.3: Box Cribbing



Four Steps to Box Building

Refer participants to **Image 7.3: Box Cribbing** in their Participant Manuals. Steps for building box cribbing:

Step 1: Position two pieces of wood parallel to each other on either side of the collapse.

Step 2: Place two pieces of wood perpendicularly across the base pieces.

Steps 3 and 4: Add additional layers of wood, with each being perpendicular to the previous level.

Removing Survivors

Introduce this section by explaining that the basic types of survivor removal:

- Self-removal or assist; and
- Lifts and drags.

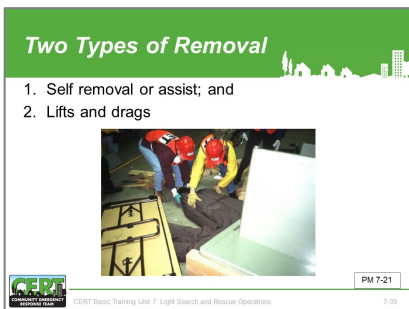

Explain that it is usually best to allow an ambulatory survivor to extricate him or herself.

Caution the group that ambulatory survivors are not always as strong and free of injury as they believe. When survivors are freed, they may need assistance to exit the structure.

Which Extrication Method?

- Extraction method depends on a number of criteria
 - General stability of the immediate environment
 - Number of rescuers available
 - Strength and ability of the rescuers
 - Condition of survivor



PM 7-21

CERT Basic Training Unit 7: Light Search and Rescue Operations 7-40

Extrication Method

Explain that the type of extrication method selected should depend on the:

- General stability of the immediate environment;
- Number of rescuers available;
- Strength and ability of the rescuers; and
- Condition of the survivor.

Explain that participants will learn the basic types of survivor removal and will have the opportunity to practice some of the techniques.

Caution participants that, if safety and time permit, they should not use lifts and drags to remove survivors when rescuers suspect closed-head or spinal injuries. In such cases, stabilize the spine using a backboard. Rescuers can use doors, tables, and similar materials as improvised backboards. Stress that the backboard must be able to carry the person and remind volunteers to use proper lifting techniques. The unit will cover the log rolling technique later in this section.

When moving survivors, rescuers must use teamwork and communication and keep the survivor's spine in a straight line. Remember, rescuer safety and the condition of the building will dictate the approach.

Point out that there are several types of lifts and carries. Refer the participants to the illustrations titled *Types of Lifts and Carries* beginning on page 7-22 in the Participant Manual.

Demonstrate these carries. Then, have all participants who are physically able pair up and practice the carries themselves. Give permission for participants to opt out of any carry with which they do not feel comfortable. Remind participants that CERT volunteers' safety is the number one priority.

Review the symptoms of head and spinal injury if necessary.

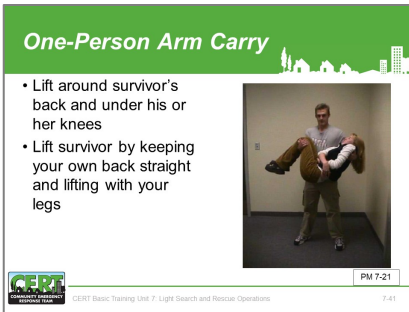

One-Person Arm Carry

For example, if some participants are physically able and the survivor is small, they may use the one-person arm carry to lift and carry the survivor themselves by following the steps below:

Step 1: Reaching around the survivor's back and under the knees; and

Step 2: Lifting the survivor while keeping their own back straight and lifting with their legs.

Consider the size of the survivor and the distance in which the volunteer will need to carry him or her before using this carry.

Refer participants to **Image 7.4: One-Person Arm Carry** in their Participants Manuals.

Image 7.4: One-Person Arm Carry



Pack-Strap Carry

Tell the participants that another way for a single rescuer to lift a survivor safely is by using the one-person pack-strap carry. Using this method, the rescuer should:

Step 1: Stand with his or her back to the survivor.

Step 2: Place the survivor's arms over the rescuer's shoulders and grab the hands in front of the rescuer's chest.

Step 3: Hoist the survivor by bending forward slightly, until the survivor's feet just clear the floor.

Note: The pack-strap carry is most effective for quick removal of a survivor over a short distance.

Refer participants to **Image 7.5: Pack-Strap Carry** in their Participant Manuals.

Image 7.5: Pack-Strap Carry



Two-Person Carry

Explain that the survivor’s upper body will weigh more than his or her lower body; therefore, rescuers with greater body strength should be positioned at the survivor’s upper body.

Explain that survivor removal is easier when multiple rescuers are available. Two rescuers can remove a survivor using a two-person carry, by following these instructions:

Demonstrate this lift using a participant volunteer as the survivor. Allow all participants who are physically able to practice the lift. Assign the participants into groups of three (two rescuers and one survivor), and rotate roles so that each person has a chance to try the two rescuer positions.

- **Rescuer 1:** Squat at the survivor's head and grasp the survivor from behind around the midsection. Reach under the arms and grasp the survivor's left wrist with rescuer's right hand, and vice versa. Crossing the wrists creates a more secure hold on the survivor, pulling their arms and elbows closer to their body. This will be particularly helpful if rescuers need to carry the survivor through any narrow passages.
- **Rescuer 2:** Squat between the survivor's knees, facing either toward or away from the survivor. Note that if the rescuers carry the survivor over uneven areas such as stairs, the rescuers will need to face each other. Grasp the outside of the survivor's legs at the knees.
- **Both rescuers:** Rise to a standing position simultaneously, keeping backs straight and lifting with the legs. Walk the survivor to safety.

Refer participants to **Image 7.6: Two-Person Carry** in their Participant Manuals.

Image 7.6: Two-Person Carry



Chair Carry

Demonstrate that two rescuers can also remove a survivor by seating him or her on a chair:

- **Rescuer 1:** Cross the survivor’s arms in his or her lap. Facing the back of the chair, grasp the back upright.
- **Rescuer 2:** Grasp the two front legs of the chair.
- **Both rescuers:** Tilt the chair back, lift simultaneously, and walk out.

Using a sturdy, non-swivel chair, demonstrate this carry using two instructors as rescuers and a volunteer participant as a survivor.

Then, have all participants who are physically able practice the carry, working in the same three-person groups.

Explain that it is best to use a sturdy, non-swivel chair for this lift.

Note that, if rescuers will need to carry the survivor over uneven surfaces such as stairs, the rescuers must face each other.

Refer participants to **Image 7.7: Chair Carry** in the Participant Manuals.

Image 7.7: Chair Carry



Blanket Carry

Inform participants they can use the blanket carry for survivors for whom you cannot remove by other means. Caution the participants that the blanket carry requires

four to six rescuers to ensure stability for the survivor and that one rescuer must be designated the lead person:

Step 1: Position a blanket next to the survivor, ensuring that the blanket will extend under the survivor's head.

Step 2: Tuck the blanket under the survivor, and assist the survivor in moving to the center of the blanket. If necessary, use the log rolling technique to position them on the blanket.

Step 3: With three rescuers squatting on each side, roll up the edges of the blanket against the survivor to grasp a "handle." The lead person checks the team for even weight distribution and correct lifting position.

Step 4: The lead person calls out, "Ready to lift on the count of three: One, two, three, lift."

Step 5: Keeping the survivor level, the team lifts and stands in unison, carrying the survivor feet first.

Point out that the team must also lower the survivor together, using the following steps:

Step 1: The lead person calls out, "Ready to lower on the count of three: One, two, three, lower."

Step 2: The team lowers the survivor in unison, exercising caution to keep the survivor level.

Explain that you can use a variety of materials such as blankets, carpets, and folded tables, as improvised stretchers.

Refer participants to **Image 7. 8: Correct Drag Technique** in their Participant Manuals.

Image 7. 8: Correct Drag Technique

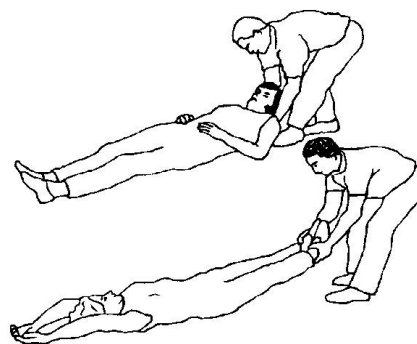

Ask participants to volunteer to demonstrate log rolling and the blanket carry. Make sure that all participants have an opportunity to practice using the carry.

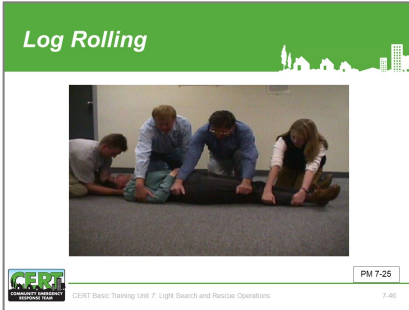

Log Rolling

Explain that rescuers should use “log rolling” to move survivors with a suspected or confirmed cervical spine injury. If the survivor is unconscious, assume he or she has a cervical spine injury. The rescuer at a survivor’s head should give commands as fellow rescuers roll the survivor as a single unit onto the blanket, backboard, or other support.

Rescuers can also drag a survivor out of a confined area by grasping either under the arms or feet and pulling across the floor. Refer the participants to the diagram titled *Image 7.8: Correct Drag Techniques*, on page 7-25 in the Participant Manual for an illustration. Caution the participants, however, that unless there is no other way to remove the survivor and the survivor's removal is time critical, they should not use this drag when debris may cause additional injury.

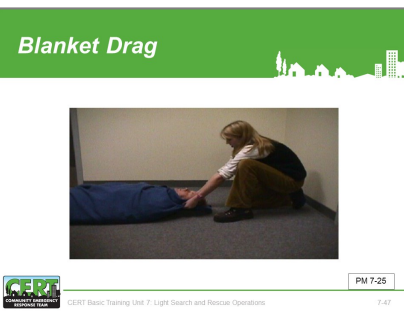

Blanket Drag

Explain that when necessary, one rescuer can use the blanket drag by following these steps:

- Step 1:** Wrap the survivor in a blanket.
- Step 2:** Squat down and grasp an edge of the blanket.
- Step 3:** Drag the survivor across the floor.

Refer participants to **Image 7.9: Blanket Drag** in their Participant Manuals.

Does anyone have any questions about rescue operations or survivor removal?

Explain that the participants will now have an opportunity to practice some of the survivor removal techniques.

Image 7.9: Blanket Drag

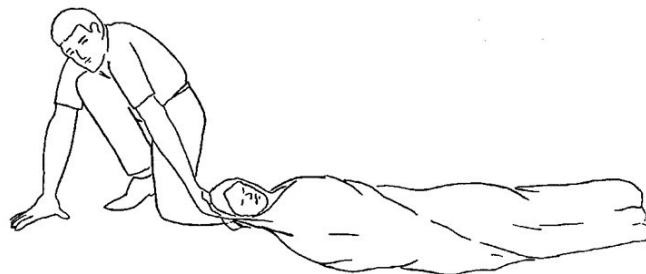

Check for understanding.

Exercise 7.3

- Break into teams of seven
- Members of your team will volunteer to be "victims" that other team members will move using the drags and carries demonstrated in the class
- Use chairs and other items as needed to perform the drags and carries
- Trade off "victim" and "rescuer" roles so that everyone on your team has a chance to practice the drags and carries
- Know your limits! Do not attempt any lift or carry that will not be safe for you and the victim

PM 7-26

CERT Basic Training Unit 7: Light Search and Rescue Operations 7-48

Instructor(s) should move from team to team and offer coaching as needed.

Ask the teams to stay together for the next activity of the class, the Survivor Extrication exercise.

This exercise is best conducted by two instructors. Instructors should provide guidance to each team as they perform their extrication.

You can create a more realistic scenario by using two or three rooms simultaneously, so that there are several "rescues" occurring at once.

Use mannequins or rescue dummies as the entrapped survivors at the "collapse sites," allowing all members of the group to practice as rescuers.

If there are more groups of seven than there are "collapse sites," have one group observe while another conducts extrication at one site. When groups rotate, observers and rescuers will switch.

Instructors should observe each group and correct errors that they see.

Exercise 7.3: Survivor Carries

Purpose: Explain that this exercise will provide participants with an opportunity to practice different drags and carries to move survivors to safety.

Instructions:

1. Break the class into teams of seven.
2. Tell all teams to practice each of the carries.
3. Tell class that members of each team will volunteer to be "survivors."
4. Explain that the "survivors" and "rescuers" must trade off roles so that everyone on the team has an opportunity to practice the drags and carries as a "rescuer."
5. Emphasize that each person must recognize his or her own limitations. Each person should attempt only those drags or carries that will be safe for them to perform.
6. Provide blankets, chairs, and backboards if available, and encourage students to use each item as they practice performing drags and carries.
7. Make sure teams trade "survivor" and "rescuer" roles so that everyone on each team has a chance to practice the drags and carries
8. Emphasize that participants know their own limits! Tell participants not to attempt any lift or carry that will not be safe for the rescuer and the survivor.

Exercise 7.4: Survivor Extrication

Purpose: This exercise will provide the participants with an opportunity to practice the removal of entrapped survivors from a damage site, using leveraging/cribbing and drags and carries. Assign participants to groups to do a room search, locate survivors, and remove survivors.

Instructions:

1. Assign the participants to groups of seven.
2. Arrange the survivors at the "collapse site(s)," using desks, shelves, etc., to represent debris. Place other items haphazardly around the survivors. Make sure that there are items available that can serve as levers (e.g., 2 by 4s), fulcrums, and cribbing material.
3. Instruct the groups to:

- Enter their respective "collapse site" rooms;
- Do a room search; and
- Locate the survivors and use leveraging and cribbing procedures to free them.

Use appropriate lifts and drags to remove the survivors from the room (and, if possible, from the building).

4. Rearrange the survivors and "debris," and repeat the exercise until each participant has had an opportunity to practice being a rescuer, and each team has practiced at two "collapse sites."
5. Discuss the exercise with the entire group, focusing on any differences between the teams' techniques and experiences.

UNIT SUMMARY

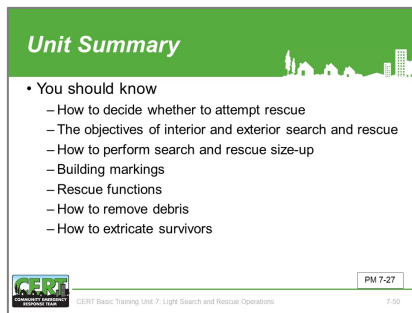

Unit Summary

- You should know
 - How to decide whether to attempt rescue
 - The objectives of interior and exterior search and rescue
 - How to perform search and rescue size-up
 - Building markings
 - Rescue functions
 - How to remove debris
 - How to extricate survivors

CERT PM 7-27

CERT Basic Training Unit 7: Light Search and Rescue Operations 7.50

Summarize the key points in this unit:

- Base the decision to attempt a rescue on:
 - Risks involved; and
 - Achievement of the overall goal of doing the greatest good for the greatest number.
- The objectives of interior and exterior search and rescue are to:
 - Maintain rescuer safety at all times;
 - Rescue the greatest number of people in the shortest amount of time;
 - Get the walking, wounded, and ambulatory survivors out first; and
 - Rescue lightly trapped survivors next.
- Remind participants that CERTs are restricted to light search and rescue. Their mission when dealing with heavily damaged structures or situations that are clearly unsafe (e.g., rising or swiftly moving water) is to warn others.
- Search and rescue size-up follows the same process as other CERT size-up operations. Size-up continues throughout search and rescue efforts and provides information about how to proceed. Remember that the CERT mission is to ensure safety and organization during the evacuation. Therefore, if the size-up indicates that evacuation of the team is necessary, do so immediately.
- When the decision to begin search operations is made, CERT searchers must:
 - Remember that the first priority is volunteer safety;
 - Employ appropriate search techniques; and
 - Locate any survivors and check for life-threatening injuries.
- Locating survivors means completing a size-up of the building interior to identify areas of entrapment, then conducting a search that:
 - Is systematic and thorough;
 - Avoids unnecessary duplication of effort; and
 - Documents results.

- Rescue involves these main functions:
 - Moving objects and debris to create a safe environment and free survivors;
 - Assessing or stabilizing survivors by checking for life-threatening conditions (airway obstruction, severe bleeding, and low body temperature); and
 - Removing survivors as safely and as quickly as possible based on the size-up.
- Rescue operations hinge on maintaining rescuer safety, which requires CERT volunteers to recognize their own limitations. CERT volunteers should *never* attempt anything that exceeds their limitations *at that point in time*.
- Rescuers may use leveraging and cribbing to lift heavy debris and give access to trapped survivors.
- Rescuers can remove survivors in a number of ways, depending on:
 - Survivor condition;
 - The number of rescuers available;
 - The strength and ability of the rescuers; and
 - The stability of the environment.
- Remind the participants of the lifts and drags that they found easier to accomplish, and then suggest they use those drags and carries when circumstances permit.
- Stabilize survivors with suspected head or spinal injuries on some type of backboard before being removed. When possible, defer these removals to trained EMS personnel.

Does anyone have any questions about anything covered in this unit?

Homework Assignment

Ask the group to read and become familiar with the next unit in the course.

Thank the participants for attending the session. Remind them of the time and location of the next session, if necessary.

Check for understanding.

Homework Assignment

1. Read unit to be covered in next session
2. Bring necessary supplies to next session
3. Wear appropriate clothes to next session



CERT Basic Training Unit 7: Light Search and Rescue Operations

PM 7-27

[This page intentional left blank]



CERT Unit 8: Terrorism and CERT

Instructor Guide



FEMA

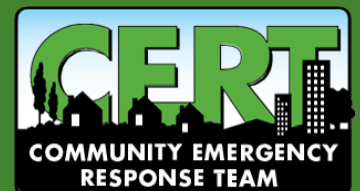

[This page intentional left blank]



CERT Unit 8: Terrorism and CERT

In this unit, participants will learn about:

- **Terrorism:** Defining terrorism, including the goals and tactics of some terrorist groups, and detailing how to respond when an active shooter is in the vicinity.
- **Eight Signs of Terrorism:** The eight signs of terrorism and how to report suspicious activity.
- **Preparing for Your Neighborhood:** Steps to take to be prepared at home, work, and in the neighborhood.
- **Hazmat and CBRNE:** Identifying some basic guidelines during a Hazmat or CBRNE event.

[This page intentional left blank]

CERT Unit 8 Table of Contents

<i>SECTION 1: UNIT OVERVIEW</i>	<i>8-1</i>
Unit Objectives	8-1
<i>SECTION 2: TERRORIST GOALS AND TATICS</i>	<i>8-2</i>
Terrorist Goals.....	8-2
New Tactics.....	8-2
<i>SECTION 3: PREPARING YOUR COMMUNITY</i>	<i>8-6</i>
Potential Indicators	8-6
Exercise 8.1: Preparing for a Terrorism-Related Event.....	8-7
<i>SECTION 4: DOCUMENTATION</i>	<i>8-9</i>
How to Respond When an Active Shooter is in Your Area.....	8-9
How to Respond When Law Enforcement Arrives	8-10
<i>SECTION 5: UNTIL HELP ARRIVES</i>	<i>8-12</i>
Treating Others	8-12
Recognizing Stress.....	8-14
Physical Impact	8-14
Secondary Attacks.....	8-15
What Professional Responders Will Do	8-15
<i>SECTION 6: HAZMAT AND CBRNE</i>	<i>8-17</i>
Basic HAZMAT Decontamination Procedures	8-17
CBRNE.....	8-18
Nuclear Attack	8-19
Shelter in Place	8-20
<i>UNIT SUMMARY</i>	<i>8-22</i>
Homework Assignment.....	8-23

[This page intentional left blank]

UNIT OBJECTIVES

At the end of this unit, participants should be able to:

1. Define terrorism.
2. List the eight signs of terrorism and describe how to report suspicious activity.
3. Explain the role of a CERT volunteer during a terrorist incident.
4. Describe activities to prepare for a terrorist incident at home, at work, and in the community.

SCOPE

The topics that will be discussed in this unit are:

- Introduction and Unit Overview;
- Terrorist Goals and Tactics;
- Preparing Your Community;
- Active Shooter Situations;
- Until Help Arrives;
- Hazmat and CBRNE;
- Exercise; and
- Unit Summary.

ESTIMATED COMPLETION TIME

The following timetable (**Table 8: Estimated Completion Times**) is suggested for this module:

Table 8: Estimated Completion Times

Unit	Estimated Time
Introductions and Overview	10 minutes
Terrorist Goals and Tactics	10 minutes
Preparing Your Community	10 minutes
Active Shooter Situations	10 minutes
Until Help Arrives	10 minutes
Hazmat and CBRNE	5 minutes
Exercise	10 minutes
Unit Summary	5 minutes
Total	1 hour, 10 minutes

RESOURCES REQUIRED

None.

EQUIPMENT

The following additional equipment is required for this unit:

- A computer with PowerPoint software; and
- A computer projector and screen.

INSTRUCTOR REMARKS

During this unit, be sure to emphasize the role of the CERT volunteer during a terrorism related event. They should be encouraged to report suspicious activity identified within their community to the appropriate authorities. Terrorism related events require a great deal of law enforcement involvement; CERT volunteers should attempt to keep themselves and those around them as safe as possible without interfering with the response operations of trained first responders. Should volunteers find themselves as survivors or bystanders during a terrorism-related event, this course has provided them with the foundation to support the physical and mental well-being of those around them, anything beyond those activities should be left to official response personnel.

SECTION 1: UNIT OVERVIEW

Welcome

Introduce yourself and welcome the participants to this session, Terrorism and CERT.

Introduce the instructors for this unit and ask any new instructors to briefly describe their experience with terrorism planning.

Briefly review Unit 7: Disaster Psychology.

Unit Objectives

At the end of this unit, participants should be able to:

1. Define terrorism.
2. List the eight signs of terrorism and describe how to report suspicious activity.
3. Explain the role of a CERT volunteer during a terrorist incident.
4. Describe activities to prepare for a terrorist incident at home, at work, and in the community.

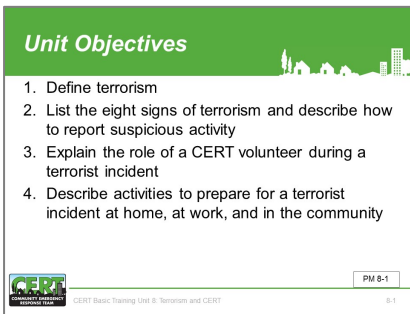

SECTION 2: TERRORIST GOALS AND TACTICS

What Is Terrorism?

- The unlawful use of force or violence against persons or property to intimidate or coerce a government, the civilian population, or any segment thereof, in furtherance of political or social objectives

 CERT Basic Training Unit 8: Terrorism and CERT PM 8-2

Introduce this topic by providing the U.S. Department of Justice's definition of *terrorism*:

“The unlawful use of force or violence against persons or property to intimidate or coerce a government, the civilian population, or any segment thereof, in furtherance of political or social objectives.”

Stress that terrorism may be perpetuated by both foreign and domestic individuals or by groups, and although the results are similar, these groups may select different targets and use different tactics to achieve their goals.

Terrorist Goals

- Influence government policy and to achieve specific objectives
- Undermine the public's sense of safety and their confidence in the government
- Portray the government as ineffective, weak and/or otherwise incapable

 CERT Basic Training Unit 8: Terrorism and CERT PM 8-2

Terrorist Goals

Tell participants that terrorists use violence as a means to influence government policy and to achieve specific objectives for their cause. Attacks are intended to undermine the public's sense of safety and their confidence in the government. Attackers seek to portray the government as ineffective, weak, and/or otherwise incapable.

Terrorist attacks are often perpetrated by ideological extremists who are prepared to die in what they consider a symbolic sacrifice or act of martyrdom. Attackers frequently exploit social media seeking to spread misinformation and broadcast their actions to audiences around the globe, with the desire of increasing fear while simultaneously bolstering their credibility and legitimacy with like-minded supporters.

New Tactics

- Active Shooter
- Improvised Explosive Devices (IEDs)
- Complex Coordinated Terrorist Attacks
- Cyber Attacks

 CERT Basic Training Unit 8: Terrorism and CERT PM 8-2

New Tactics

Explain that recently, terrorist attacks have trended away from large resource intensive plots such as the September 11 attacks to more decentralized, less sophisticated attacks like those in Paris, France in 2016. Attackers have favored smaller, less centrally controlled networks, using more simplistic and accessible means such as guns and homemade improvised explosive devices (IED). These components are easier to acquire, control, and conceal than large high-yield explosives, biological, radiological, or nuclear devices. Although there is always some risk from CBRNE type incidents and the United States remains vigilant against these

threats, it is relatively difficult to obtain and deploy these types of weapons.

Active Shooter

Tell participants that an active shooter is an individual actively engaged in killing or attempting to kill people in a confined or populated area and in most cases, active shooters use firearms with no pattern or method to their selection of targets. Active shooter situations are unpredictable and evolve quickly. Typically, the immediate deployment of law enforcement is required to stop the shooting and mitigate harm to survivors.

Point out that many recent terrorist attacks have included armed individuals with some training, indiscriminately shooting civilians. Although the motivations are different than a single active shooter, the results are similar, rapidly accumulating casualties in a relatively contained space.









Improvised Explosive Device (IED)

Tell participants that an IED attack is the use of a “homemade” bomb and/or destructive device to destroy, incapacitate, harass, or distract. Because they are improvised, IEDs can come in many forms, ranging from a small pipe bomb to a sophisticated device capable of causing massive damage and loss of life.

Tell participants that terrorist networks both domestic and abroad have published numerous sets of instructions on how to make homemade explosives. IEDs consist of a variety of components that include an initiator, switch, main charge, power source, and a container. IEDs can be worn (e.g., belts, vests), carried (e.g., bags, backpacks, containers of all sizes/types), transported in a vehicle, placed or thrown by a person, delivered in a package, or concealed on the roadside.

Refer participants to **Image 8.1: IED Impact** in their Participant Manuals. It illustrates the damage radius caused by various sizes and types of IEDs. Note that as the volume weight and size of the IEDs increase, so does their capacity to inflict damage.

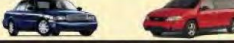
Image 8.1: IED Impact

Threat	Threat Description	Explosive Capacity	Building Evacuation Distance	Outdoor Evacuation Distance
	Small Package/letter	1 lb	40 ft	900 ft
	Pipe Bomb	5 lb	70 ft	1,200 ft
	FedEx Package	10 lb	90 ft	1,080 ft
	Vest/Container Bombs	20 lb	110 ft	1,700 ft
	Parcel Package	50 lb	150 ft	1,850 ft
	Compact Car	500 lb	320 ft	1,900 ft
	Full Size Car/Minivan	1,000 lb	400 ft	2,400 ft
	Van/SUV/Pickup Truck	4,000 lb	640 ft	3,800 ft
	Delivery Truck	10,000 lb	860 ft	5,100 ft

IEDs may be surrounded by or packed with additional materials or “enhancements,” such as nails, glass, or metal fragments designed to increase the amount of shrapnel propelled by the explosion to maximize casualties. Enhancements may also include other elements such as hazardous materials. An IED can be initiated by a variety of methods depending on the intended target.

Complex Coordinated Terrorist Attacks

The definition of a complex coordinated terrorist attack is as follows: a synchronized attack, conducted by two or more semi-independent teams at multiple locations in close succession, initiated with little or no warning, using well trained attackers and employing one or more of the following: fire arms, explosives and fire as a weapon. Point out that, as seen in Paris, France in 2016, attackers have coordinated their actions to hit multiple targets nearly simultaneously. When conducting these attacks, there may be pre-planned coordination as well as real-time coordination between attackers. These attacks can be extremely lethal in a relatively short period of time.

Cyber Attacks

Explain that another type of terrorist weapon is deliberate, large-scale disruption of computer networks. This is known as cyberterrorism. To help guard against cyberterrorism, it is important that computer users implement appropriate security measures.

Tell the participants that cybersecurity involves protecting infrastructure by preventing, detecting, and responding to cyber incidents. Unlike physical threats that prompt immediate action such as

“stop, drop, and roll” in the event of a fire, cyber threats are often difficult to identify and comprehend.

Among these dangers are viruses erasing entire systems, intruders breaking into systems and altering files, intruders using your computer or device to attack others, or intruders stealing confidential information. The spectrum of cyber risks is limitless, as threats, some more serious and sophisticated than others, can have wide-ranging effects at the individual, community, organizational, and national level. These risks include:

- Organized cybercrime, state-sponsored hackers, and cyber espionage can pose national security risks to our country.
- Transportation, power, and other services may be disrupted by large-scale cyber incidents. The extent of the disruption is highly uncertain as it will be determined by many unknown factors such as the target and size of the incident.
- Vulnerability to data breach and loss increases if an organization’s network is compromised. Information about a company, its employees, and its customers can be at risk.
- Individually-owned devices such as computers, tablets, mobile phones, and gaming systems that connect to the Internet are vulnerable to intrusion. Personal information may be at risk without proper security.

SECTION 3: PREPARING YOUR COMMUNITY

Potential Indicators

Potential Indicators

- If you see something, say something!
- Understand the signs of terrorist activity
- Contact local law enforcement
- Use the FBI Suspicious Activity Reporting Tip Line

 CERT Basic Training Unit 8: Terrorism and CERT PM 8-5

Tell participants that we all have a responsibility to play an active role in keeping the country safe. The phrase, “If you see something, say something” took on additional power after the foiled Times Square bomb plot in New York City. On May 1, 2010, street vendors in Times Square noticed a smoking SUV with its blinkers on, engine running, and no one inside. They decided to say something to a police officer. Thousands of people were cleared from the area while the bomb was dismantled.

Eight Signs of Terrorism

Eight Signs of Terrorism

1. Surveillance
2. Elicitation
3. Tests of security
4. Funding
5. Acquiring supplies
6. Impersonation or suspicious people
7. Rehearsals and dry runs
8. Deployment



 CERT Basic Training Unit 8: Terrorism and CERT PM 8-5

The presence of even a few of these signs may indicate the possibility of a terrorist attack. It is important to understand what these signs may look like as they are executed so volunteers are able to identify them within their communities. If a volunteer recognizes one of these signs being executed, it is important for them to contact their local law enforcement and effectively communicate the suspicious activity that they have identified. The FBI’s Suspicious Activity Reporting (SAR) tip line is an avenue CERT volunteers can use to report suspicious activities. These signs are exhibited by potential terrorists (often in this order) and include:

1. **Surveillance:** The targeted area is being watched and studied carefully. This may include recording or monitoring activities.
2. **Elicitation:** Information is gathered that is specific to the intended target. This may be by mail, phone, or in person.
3. **Tests of security:** Local security measures are tested and analyzed, including measuring reaction times to security breaches or attempts to penetrate security.
4. **Funding:** Raising, transferring, spending money, which may include selling drugs or stolen merchandise, human trafficking, and funneling money through businesses or charities.
5. **Acquiring supplies:** Necessary supplies are gathered to prepare the attack, including weapons/weapon components, transportation, and

communications. Supplies may be purchased with cash only.

6. **Impersonation or suspicious people who do not belong:** People impersonating roles to gain access or information and people who don't fit in or don't seem to belong in the location.
7. **Rehearsal and dry runs:** Groups or individuals will often times map out routes, determine traffic flow and timing ahead of time and can also operate test runs before the actual attack.
8. **Deployment:** The final and most urgent phase when terrorists are deploying assets and getting into position. Attack is imminent.

Tell the group that, although it is not the mission of CERT volunteers to keep constant watch for these eight signs, everyone should be alert to changes in their environment as a clue to a possible terrorist attack and report suspicious activities to appropriate authorities.

Potential Targets

- **Soft Targets** include schools, parks, large gathering spaces, cafes, and concert halls
- **Less Secure Targets** include malls, movie theaters, and universities

CERT Basic Training Unit 8: Terrorism and CERT PM 8-6 8/7

Potential Targets in Your Community

Point out that terrorists have frequently selected soft targets like schools, parks, large gathering spaces, cafés, and concert halls. Although differently motivated, active shooters in the United States have also selected less secure targets, like malls, movie theatres, and universities. While hardened targets, such as government buildings, military installations, and infrastructure including power grids and dams remain viable targets for certain groups, attacks have trended towards easier, less secure targets. Smaller, less involved plots still generate high casualties and allow the attackers to achieve their objectives with fewer resources.

Exercise 8.1

- **Purpose:** As with all types of disasters and emergencies, preparation is key to planning for a terrorism related event. Although it is often difficult to predict when such an event may occur, there are a number of steps you can take today to be prepared
- **Instructions:**
 1. Break into small table groups
 2. As a group, create a list of activities that CERT volunteers can do at home or work to better prepare for a terrorism related emergency. Be prepared to share your list with the rest of the class

CERT Basic Training Unit 8: Terrorism and CERT PM 8-6 8/7

Exercise 8.1: Preparing for a Terrorism-Related Event

Purpose: As with all types of disasters and emergency, preparation is key to planning for a terrorism-related event. Although it is often difficult to predict when such an event may occur, there are a number of steps that CERT volunteers can take today to be prepared.

Instructions:

1. Break the participants into small table groups.
2. As a group, ask each table to create a list of activities that CERT volunteers can do at home or

work to better prepare for a terrorism related emergency.

3. After convening the group, ask each table to share their list.

Some example activities include:

- Have a Family/Work Emergency Plan, including a Communication Plan.
- Map out evacuation routes from areas you frequent including multiple routes from work to home.
- Know routes to hospitals in the area.
- Take a first-aid or active bystander course.
- Have an emergency supply kit ready.
- Create a list of important numbers including local law enforcement and the FBI to report suspicious activity.
- Conduct research to learn about threats in your area.

SECTION 4: ACTIVESHOOTER SITUATIONS

As introduced in Section 1, active shooter situations are unpredictable and evolve quickly.

How to Respond When an Active Shooter is in Your Vicinity

Stress that participants must quickly determine the most reasonable way to protect their own lives. Remind them that customers and clients are likely to follow the lead of employees and managers during an active shooter situation. Below are the following actions participants must take in an active shooter situation:

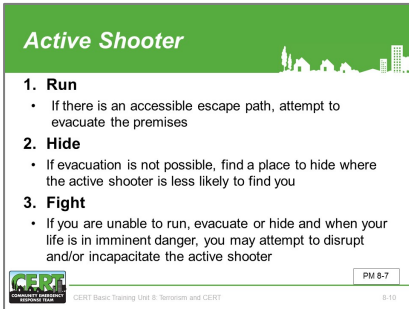

- **RUN.** If there is an accessible escape path, attempt to evacuate the premises. Be sure to:
 - Have an escape route and plan in mind ahead of time.
 - Evacuate regardless of whether others agree to follow.
 - Leave your belongings behind.
 - Help others escape, if possible.
 - Prevent individuals from entering an area where the active shooter may be, if possible.
 - Keep your hands visible.
 - Follow the instructions of any police officers.
 - Call 9-1-1 when you are safe.
- **HIDE.** If evacuation is not possible, find a place to hide where the active shooter is less likely to find you. Your hiding place should:
 - Be out of the active shooter's view;
 - Provide protection if shots are fired in your direction (e.g., an office with a closed and locked door); and Not trap you or restrict your options for movement.

To prevent an active shooter from entering your hiding place:

 - Lock the door; and
 - Blockade the door with heavy furniture.

If the active shooter is nearby:

- Lock the door;
- Silence your cell phone and/or pager;
- Turn off any source of noise (e.g., radios, televisions);
- Hide behind large items (e.g., cabinets, desks); and
- Remain quiet.

If evacuation and hiding out are not possible:

- Remain calm;
- Dial 9-1-1, if possible, to alert police to the active shooter's location; and
- If you cannot speak, leave the line open and allow the dispatcher to listen.

- **FIGHT.** If you are unable to run, evacuate, or hide and when your life is in imminent danger, you may attempt to disrupt and/or incapacitate the active shooter by:
 - Taking decisive action;
 - Acting as aggressively as possible against him/her;
 - Throwing items and improvising weapons;
 - Yelling; and
 - Committing to your actions.

How to Respond When Law Enforcement Arrives

Explain to participants that law enforcement's purpose is to stop the active shooter as soon as possible. Officers will proceed directly to the shooting without stopping to render aid to the survivors.

- Officers may arrive in teams.
- Officers may wear street clothes, regular patrol uniforms, or external bulletproof vests, Kevlar helmets, and other tactical equipment.
- Officers may be armed with rifles, shotguns, and/or handguns.
- Officers may shout commands and may push individuals to the ground for their safety.

How to react when law enforcement arrives:

- Try to remain calm.
- Follow officers' instructions.

- Put down any items in your hands (e.g., bags, jackets).
- Immediately raise hands and spread fingers.
- Keep hands visible at all times.
- Avoid making quick movements toward officers such as holding on to them.
- Avoid pointing, screaming, and/or yelling.
- Do not stop to ask officers for help or direction when evacuating, just proceed in the direction from which officers are entering the premises.

Information to provide to law enforcement or 9-1-1 operator:

- Location of the active shooter(s);
- Number of shooters, if more than one;
- Physical description of shooter(s);
- Number and type of weapons held by the shooter(s); and
- Number of people at the location.

Inform participants that the first officers to arrive to the scene will not stop to help injured persons. They should expect rescue teams comprised of additional officers and emergency medical personnel to follow the initial officers. These rescue teams will treat and remove any injured persons. They may also call upon able-bodied individuals to assist in removing the wounded from the premises.

Explain that once they have reached a safe location or an assembly point, they will likely be held in that area by law enforcement until the situation is under control, and all witnesses have been identified and questioned. Do not leave until law enforcement authorities have instructed you to do so.

SECTION 5: UNTIL HELP ARRIVES



Terrorist attacks frequently occur without warning; however, being alert, reporting suspicious activities, and taking general preparedness steps, such as having a plan to communicate with loved ones, will help you if one does occur. Remind participants that if they believe a terrorist attack is *imminent*, they should call 9-1-1 and follow the instructions provided.

It is essential to emphasize the point that CERT volunteers are NOT equipped or trained to respond to terrorist incidents. CERT volunteers should in no way activate or respond to an incident in their community.

However, while highly unlikely, it is possible that volunteers may find themselves in a situation they believe to be a terrorist attack. In this rare circumstance, CERT volunteers have developed a skillset through this training to provide care until help arrives.

Like in any other situation, CERT volunteers should follow the direction of law enforcement and first responders. CERT volunteers should be mindful of their limits and recognize that their safety is their top priority. They should not put themselves at risk but save lives if they can.

If CERT volunteers are willing and able to assist, they should recall the most important life-saving interventions, recognize what the stress of the situation can do to them, and understand the physical impact of being in a potential terrorist situation.

Treating Others

If you believe you are able to help those around you, focus on the most lifesaving interventions that were covered in Unit 3:

1. **Safe Place:** Prior to treating others, ensure that both the survivor and rescuer are in a safe environment to administer care. CERT volunteers should use their best judgement to determine if the situation is safe enough to properly help a survivor. For more information, please refer to page 3-2 of the Unit 3 Participant Manual.
2. **Stop Bleeding:** The average person has approximately five liters of blood. Severe blood loss can result in irreversible shock. This means

that if you lose about half of your body's blood supply, no matter what anyone does to try to save you, death is unavoidable. You must get bleeding under control as soon as possible. The first way to control excessive bleeding is through applying direct pressure. For more information on controlling bleeding, please refer to page 3-3 of the Unit 3 Participant Manual.

3. **Maintaining Body Temperature:** It is important to maintain the patient's body temperature. If necessary, place a blanket or other material under and/or over the patient to provide protection from extreme ground temperatures (hot or cold). People with very serious injuries are more susceptible to hypothermia, and it can increase the risk of death. For more information on maintaining body temperature, please refer to page 3-5 of the Unit 3 Participant Manual.
4. **Opening the Airway:** Positioning an injured patient to keep their airway open and clear is critical to saving their life. The best position for the body is one in which the chest can expand fully, and the airway is not at risk of being obstructed. In other words, the best position is one in which the tongue cannot flop back into the individual's throat and one in which blood or fluid does not end up in the lungs (aspirated), particularly in the case with someone with facial trauma. There are different ways to position an injured patient to keep their airway open depending on if the patient is conscious or unconscious. For more information on opening the airway, please refer to page 6 of the Unit 3 Participant Manual.
5. **Providing Comfort:** CERT volunteers can be of great value to an injured and emotional patient simply by offering comfort and support. No special skills are needed, just a calm and reassuring presence. For more information on providing comfort, please refer to page 3-8 of the Unit 3 Participant Manual.

Emphasize that CERT volunteers must make the best decisions possible with the information that they have at hand. Even if an incident turns out not to be terrorist related, they have made the right decision if they have done the most good for the greatest number and have not been injured.

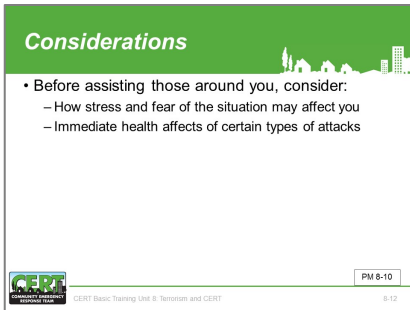

Considerations

- Before assisting those around you, consider:
 - How stress and fear of the situation may affect you
 - Immediate health affects of certain types of attacks

CERT
Community Emergency Response Team

CERT Basic Training Unit 8: Terrorism and CERT

PM 8-10

8-12

Recognizing Stress

Stress that before CERT volunteers step forward to help, it is important to recognize how the stress of the situation may affect them. In any life-threatening situation, they will feel fear and this fear will impact their mind and body. It is important for them to be aware of what may happen, so they can recognize these responses as a normal part of their body's response to stress. It is normal to experience certain physical and psychological changes such as those on the slide. Recognize that fear:

- Is typically at its peak once we comprehend the danger of the situation;
- Has profound effects on the mind and body; and
- Can influence action.

Physical Impact

Inform the participants that explosions create a high-pressure blast that sends debris flying and lifts people off the ground. The type of injuries and the number of people wounded will vary depending on the physical environment and the size of the blast, the amount of shielding between people and the blast, fires, structural damage that result from the explosion, and whether the explosion occurs in a closed space or an open area. Explain that injuries common to explosions include:

- Overpressure damage to the lungs, ears, abdomen, and other pressure-sensitive organs. Blast lung injury, a condition caused by the extreme pressure of an explosion, is the leading cause of illness and death for initial survivors of an explosion.
- Fragmentation injuries caused by projectiles thrown by the blast – material from the bomb, shrapnel, or flying debris that penetrates the body and causes damage.
- Impact injuries are caused when the blast throws a person into another object, causing serious injuries, including fractures, amputation, and trauma to the head and neck.
- Thermal injuries caused by burns to the skin, mouth, sinus, and lungs.
- Other injuries including exposure to toxic substances, crush injuries, and aggravation of pre-

existing conditions (e.g., asthma, congestive heart failure).

Secondary Attacks

Inform participants that terrorist attacks, especially those involving explosives, may include a secondary wave targeting those who are providing care to the injured. CERT volunteers should be highly aware of their surroundings and move away from danger as soon as they are able. If you can do so, take others with you.

The explosion of a bomb can cause secondary explosions if gasoline, natural gas, or other flammable material is ignited. Secondary hazards that result can include fire with possibly toxic smoke, disruption of electric power, ruptured natural gas lines and water mains, and debris. There can be loss of traffic control in the area of the blast with possible traffic accidents involving fleeing citizens.

What Professional Responders Will Do

Tell the group that there are several measures that they can expect professional responders to take when they arrive at the scene of a terrorist incident.

Size-up

Explain that the first step that professional responders will take when they arrive at the scene is to conduct a thorough size-up. They will follow steps that are very similar to those that CERTs take to determine:

- What is going on.
- How bad the situation is and how much worse it could get.
- What measures can be taken to control the incident safely.
- What resources will be needed.

Establish Zones

CERTs can expect professional responders to treat some terrorist incidents the same as hazardous materials incidents.

As such, the next step that they will take is to establish three incident zones.

1. **The Hot Zone** is typically referred to as the incident scene and the contaminated area around the scene.

Secondary Attacks

- Be prepared for a secondary attack
- Be aware of your surroundings
- Move away from danger as soon as you are able
- Move others to safety if you are able

CERT Basic Training Unit 8: Terrorism and CERT
PM 8-11

What Professional Responders Will Do

- Follow size-up steps
 - What is going on?
 - How bad is the situation and how much worse could it get?
 - What measures can be taken to control the incident safely?
 - What resources will be needed?

CERT Basic Training Unit 8: Terrorism and CERT
PM 8-12

2. **The Warm Zone** in a decontamination situation would be upwind (and upstream if the contaminant is waterborne) from the Hot Zone and is used to isolate survivors during decontamination. In a non-decontamination situation, such as a terrorist attack, the warm zone will be the area immediately outside of the incident scene.
3. **The Cold Zone** is located beyond the Warm Zone. Survivors will be evacuated to the Cold Zone and kept there until professional responders authorize them to leave.

SECTION 6: HAZMAT AND CBRNE

Inform participants that it is highly unlikely that they will be working within a Hazmat or CBRNE incident. However, there are some basic guidelines that can be noted for these types of incidents.

Basic HAZMAT Decontamination Procedures

The objective of decontamination is to remove harmful chemicals or particles of radioactive dirt or dust that came in contact with the skin or clothes.

- Leave the contaminated area immediately. Depending on the circumstances, go inside, outside, or go upwind, uphill, or upstream away from the contaminant. (Seek a distance of at least 1,000 to 1,500 feet.)
- Take decontamination action. Seconds count! The goal is to limit the time that the agent is in contact with the skin.
- Remove everything from the body including jewelry. Cut off clothing that would normally be removed over the head to reduce the probability of inhaling or ingesting the agent. Seal your clothes in a plastic bag.
- Wash hands before using them to shower. If no shower is available, improvise with water from faucets or bottled water.
- Flush the entire body, including the eyes, underarms, and groin area, with copious amounts of cool water. Hot water opens the pores of the skin and can promote absorption of the contaminant. Using copious amounts of water is important because some chemicals react to small amounts of water.
- If soap is immediately available, mix the soap with water for decontamination. Avoid scrubbing with soap because scrubbing can rub the chemical into the skin rather than remove it.
- Wash hair with soap or shampoo or rinse with water if soap is not available. Do not use conditioner as that can bind radioactive materials to your hair and make it difficult to remove.
- If hosing someone else off or pouring water from a container, avoid both physical contact with the person and with the runoff.

Basic Decontamination Procedures

- Leave the contaminated area
- Take decontamination action
 - Remove everything
 - Wash hands
 - Flush the entire body
 - Blot dry
- Report for decontamination



CERT
CERT Basic Training Unit 8: Terrorism and CERT

PM 8-13

8-13

- The water used for decontamination must be contained and covered or drained outside of the shelter area to avoid shelter contamination.
 - Blot dry using an absorbent cloth. Do not rub the skin! Put on clean clothes.

As soon as possible, emergency responders will set up mass decontamination capabilities. For radiological events, stations for radiation monitoring and blood tests will also be set up to determine levels of exposure and what next steps to take to protect health.

CBRNE

Explain that CBRNE stands for chemical, biological, radiological, nuclear, and high-yield explosive. These events have the capability to cause mass casualties and cause great public unrest. The anthrax letter attacks in 2001 are an example of how effective and disrupting a CBRNE attack could be.

A CBRNE incident differs from a hazardous material incident in both scope (i.e., CBRNE can be a mass casualty situation) and intent. CBRNE incidents are responded to under the assumption that they are intentional and malicious.

CBRNE Indicators

Stress the need to be alert to changes in the environment as a clue to a possible terrorist attack.

Explain that while bombs and explosions have obvious immediate effects, biological or chemical attacks may not be as immediately noticeable. Indicators that a biological or chemical attack has occurred or is underway could include:

- Vapor clouds or mists that are unusual for the area or for the time of day; and
- Out of place and unattended packages, boxes, or vehicles. Items that are out of place and unattended could signal a possible terrorist attack. This could include chemical or biological agents as well as explosives.

If you observe any of these indicators of a terrorist incident, you should:

- Not touch it;
- Move away from the object or area; and

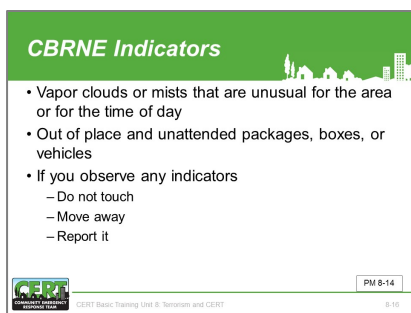

- Report it to authorities immediately.

Nuclear Attack

A nuclear weapon is an explosive device that derives its destructive force from nuclear reaction. All nuclear devices cause deadly effects when detonated, including blinding light, intense heat, initial nuclear radiation, blast, fires started by the heat pulse, secondary fires caused by the destruction, and widespread radioactive material that can contaminate the air, water, and ground surfaces for miles around.

A nuclear device can range from a weapon carried by an intercontinental ballistic missile launched by a hostile nation or terrorist organization, to a small portable nuclear device transported by an individual.

Tell the participants that in the very unlikely event you believe you are in a nuclear attack or exposed to radiation, there are three factors that significantly affect your safety after the incident: time, distance, shielding. A critical protective action in a radiological or nuclear event is to get inside as quickly as possible, stay inside, and stay tuned to local radio or television stations for further guidance.

- **Stay Inside (time):** Limiting the amount of time in the area of an incident is important to limit exposure to radioactive fallout resulting from the explosion. Remain inside until you receive notification from authorities that it is safe to leave the building. In most cases, be prepared to shelter inside for a few days. However, sheltering may be necessary for as long as a month.
- **Go Deep Inside (distance/shielding):** It is important to find adequate shelter quickly to avoid radioactive fallout resulting from the explosion. Get inside as soon as possible and go to the farthest interior room or to a basement. Flat roofs collect fallout particles, so the top floor is not a good choice, nor is a floor adjacent to a neighboring flat roof. The more distance between you and the fallout particles, the better.

If you are outside when the event occurs, do not look at the flash or fire ball. It can blind you. Take cover behind anything that will offer protection, lie flat, and cover your head. If the explosion is some distance away, it could

Nuclear Weapons

- Derives destructive force from nuclear reaction
- Affected area is larger as contaminated objects spread
- Potential for casualties extends beyond initial attack
- Long-term effects difficult to monitor and track

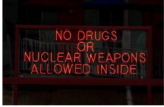

CERT Basic Training Unit 8: Terrorism and CERT 8-17

take 30 seconds or more for the blast wave to hit. Get inside as soon as you can.

Shelter in Place

Tell participants they may receive direction from law enforcement to shelter in place. Depending on the nature of the threat (if it is chemical or biological), this may involve sealing yourself into a room. Procedures for sheltering in place during a chemical or biological attack include:

- Shut off the ventilation system and latch all doors and windows to reduce airflow from the outside.
- Go to your shelter-in-place room (where your precut plastic, duct tape, radio, and other supplies should be stored).
- Use precut plastic sheeting to cover openings where air can enter the room, including doors, windows, vents, electrical outlets, and telephone outlets. When cut, the sheeting should extend several inches beyond the dimensions of the door or window to allow room to duct tape the sheeting to the walls and floor.
- Tape the plastic sheeting around all doors and windows using duct tape to ensure a good seal.
- Seal other areas with duct tape where air can come in, such as under doors and areas where pipes enter the home. Air can be blocked by placing towels or other soft objects in areas where air could enter, then securing them with duct tape.
- Listen to a battery-powered radio for the “all clear.” Chemicals used in an attack will be carried on the wind and will dissipate over time. You will generally not need to stay in a sealed room for more than a few hours. Listen to Emergency Alert System broadcasts to know when it is safe to leave the safe room.
- After contaminants have cleared, open windows and vents and turn on fans to provide ventilation.

To be able to execute these procedures during an actual event requires that you:

- Store precut plastic sheeting in your identified shelter-in-place room.
- Assemble and store food, water, and a battery-operated radio in the shelter-in-place room.
- Practice sealing the room.

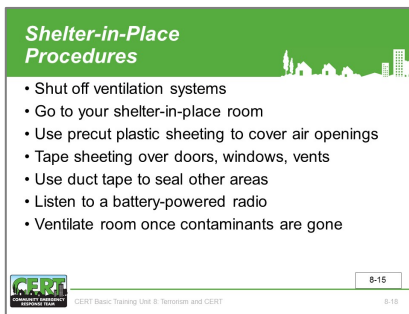

- Establish shelter-in-place procedures wherever you spend significant amounts of time at home, at work, at school.

As a rule of thumb, 10 square feet of floor space per person will provide sufficient air to prevent carbon dioxide buildup for up to 5 hours, assuming a normal breathing rate while resting.

Explain that if the threat is a violent individual(s), shelter in place may be referred to as a lockout, and you may be asked to lock yourself into a safe space by doing the following:

- Lock exterior doors;
- Clear hallways, restrooms, and other rooms that cannot be secured;
- Move all persons away from windows. Secure and cover windows, if able;
- Make only essential communications and avoid any broadcasts about the movement, location, or status of law enforcement in the area; and
- Once the threat has subsided, law enforcement announces the “all clear” and operations can return to normal.

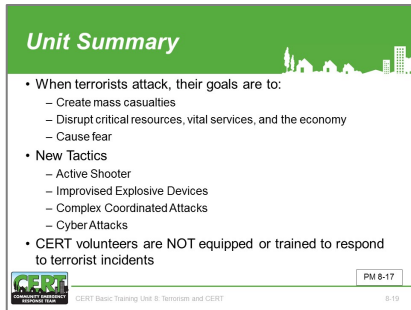

Unit Summary

- When terrorists attack, their goals are to:
 - Create mass casualties
 - Disrupt critical resources, vital services, and the economy
 - Cause fear
- New Tactics
 - Active Shooter
 - Improvised Explosive Devices
 - Complex Coordinated Attacks
 - Cyber Attacks
- CERT volunteers are NOT equipped or trained to respond to terrorist incidents

PM 8-17

CERT Basic Training Unit 8: Terrorism and CERT

UNIT SUMMARY

Summarize this unit by making the points below:

- The definition of terrorism, as defined by the Department of Justice, is the “unlawful use of force or violence against persons or property to intimidate or coerce a government, the civilian population, or any segment thereof, in furtherance of political or social objectives.” Terrorism may be perpetrated by foreign or domestic individuals or groups
- When terrorists attack, their goals are to:
 - Create mass casualties;
 - Disrupt critical resources, vital services, and the economy; and
 - Cause fear.
- Terrorists have moved away from large, resource-intensive plots to decentralized, less sophisticated attacks like the attacks in Paris, France in 2016.
- New tactics include active shooter events and detonating improvised explosive devices, sometimes occurring simultaneously in coordinated attacks. In addition, an evolving terrorist tactic is cyberterrorism.
- An active shooter is an individual actively engaged in killing or attempting to kill people in a confined and populated area; in most cases, active shooters use firearms(s) and there is no pattern or method to their selection of targets. Active shooter situations are unpredictable and evolve quickly. Typically, the immediate deployment of law enforcement is required to stop the shooting and mitigate harm to survivors.
- Run, Hide, Fight is the best way to respond if an active shooter is in your vicinity.
- An improvised explosive device (IED) attack is the use of a “homemade” bomb and/or destructive device to destroy, incapacitate, harass, or distract. IEDs are used by criminals, vandals, terrorists, suicide bombers, and insurgents. Because they are improvised, IEDs can come in many forms, ranging from a small pipe bomb to a sophisticated device capable of causing massive damage and loss of life.

- CERT volunteers, along with the general public, play a critical role in identifying suspicious activities occurring within the community. There are typically eight signs of terrorism that signal potential terrorist activity. If identified and communicated correctly to local law enforcement, suspicious activities surrounding the potential possibility of a terrorist attack can be stopped. The eight signs of terrorism are:
 1. Surveillance;
 2. Elicitation;
 3. Tests of security;
 4. Funding;
 5. Acquiring supplies;
 6. Impersonation or suspicious people who don't belong;
 7. Rehearsal and dry runs; and
 8. Deployment.
- Terrorist attacks frequently occur without warning. However, being alert, reporting suspicious activities, and taking general preparedness steps, such as having a plan to communicate with loved ones, will help you if one does occur. If you believe a terrorist attack is imminent, call 9-1-1 and follow the instructions provided.
- CERT volunteers are NOT equipped or trained to respond to terrorist incidents. CERT volunteers should in no way activate or respond to an incident in their community.
- While highly unlikely, it is possible that you may find yourself in a situation that you believe is a terrorist attack. As with any situation, be mindful of your limits and recognize that your safety is the top priority. Stay safe. Do not put yourself at risk but save lives if you can.

Homework Assignment

- Review the materials for the next session
- Wear appropriate clothing for next session



CERT Basic Training Unit 8: Terrorism and CERT

PM 8-18

Homework Assignment

Review the materials to be presented in the next unit.

[This page intentional left blank]



CERT Unit 9: Course Review, Final Exam, and Disaster Simulation

Instructor Guide



FEMA

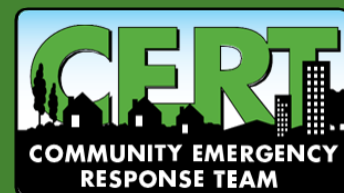

[This page intentional left blank]



CERT Unit 9: Course Review, Final Exam, and Disaster Simulation

This unit includes:

- A Review of Key Points from the Course**
- A Final Exam**
- A Final Exercise**

[This page intentional left blank]

CERT Unit 9 Table of Contents

<i>SECTION 1: INTRODUCTION AND OVERVIEW</i>	<i>9-1</i>
Course Review	9-1
<i>SECTION 2: FINAL EXAM</i>	<i>9-4</i>
<i>CERT BASIC TRAINING FINAL EXAM</i>	<i>9-5</i>
Unit 1: Disaster Preparedness	9-5
Unit 2: CERT Organization	9-6
Unit 3: Disaster Medical Operations — Part 1.....	9-7
Unit 4: Disaster Medical Operations — Part 2.....	9-8
Unit 5: Disaster Psychology	9-9
Unit 6: Fire Safety and Utility Controls	9-10
Unit 7: Light Search and Rescue Operations	9-11
Unit 8: Terrorism and CERT	9-12
<i>SECTION 3: DISASTER SIMULATION</i>	<i>9-14</i>
<i>SECTION 4: EXERCISE CRITIQUE AND CONCLUSION</i>	<i>9-16</i>
<i>SECTION 5: GRADUATION</i>	<i>9-16</i>

[This page intentional left blank]

UNIT OBJECTIVES

At the conclusion of this unit, the participants should be able to apply the skills and knowledge learned in Units 1 through 8 to a simulated disaster situation.

SCOPE

The topics of this unit will include:

- Introduction and Unit Overview;
- Course Review;
- Final Exam;
- Disaster Simulation; and
- Exercise Critique and Summary.

ESTIMATED COMPLETION TIME

The following timetable (**Table 9: Estimated Completion Times**) is suggested for this module.

Table 9: Estimated Completion Times

Unit	Estimated Time
Introductions and Overview	5 minutes
Course Review	15 minutes
Final Exam	15 minutes
Disaster Simulation	90 minutes
Exercise Critique and Summary	25 minutes
Total	2 hours, 30 minutes

RESOURCES REQUIRED

- Community Emergency Response Team Instructor Guide
- Community Emergency Response Team Participant Manual
- Certificate of Completion (to be developed locally)

OTHER RESOURCES

“Survivors” will be needed for the triage and treatment simulation and for the survivor extrication simulation. Live “survivors” are recommended for the triage and treatment simulation.

EQUIPMENT

The following equipment is required for this unit:

- A computer with PowerPoint software;
- A computer projector and screen;
- Safety equipment;
- Pieces of wood, furniture, or other items to simulate debris;
- Two or more poles;
- Moulage (used to simulate injuries); and
- Other equipment items, which may be available from earlier units that may add to the realism of the simulation.

GENERAL PREPARATION

If you believe a PowerPoint presentation will be helpful to the participants, you may pull slides from the presentations that accompany the previous units.

The final exam is included in the Participant Manual. Within this unit is a copy of the exam with the correct responses.

You will need to make a copy of your agency's CERT Certificate of Completion for each participant who will complete the training.

1. **Develop a disaster scenario.** Before the session begins, develop a scenario based on a potential disaster in your community. A sample disaster scenario is included on pages 9-5 and 9-6, so that you can see the type of exercise that will be required. Note: Participant Manual includes a copy of the map for the sample disaster scenario on PM 9-17.
2. **Identify four areas**, three indoors and one outdoors (weather permitting), to serve as exercise stations. At Station 1, the participants will receive the disaster simulation scenario. Based on that scenario, the participants will:
 - Determine the extent of damage;
 - Establish team priorities;
 - Determine the resources needed; and
 - Identify potential hazards

The participants will also select a CERT leader who will establish a CERT organization based on resources available and established priorities. To ensure that as many participants as possible have the opportunity to serve as team leader during the exercise, each group will select a different CERT leader at Station 1, Station 3, and Station 4.

- At Station 2, the participants will be required to:
 - Evaluate a fire situation
 - Select the proper extinguisher
 - Extinguish a fire

NOTE: Each participant will extinguish the fire.

- At Station 3, the participants will be required to conduct triage and treat survivors with the medical supplies available.
- At Station 4, the participants will perform leveraging and cribbing to extricate survivors who are trapped by debris.

3. Select four assistant instructors to help with the disaster simulation. The instructors will serve at the following stations:
 - Two assistants at Station 2 to conduct the fire suppression exercise
 - One assistant at Station 3 to monitor survivor triage and treatment
 - One assistant at Station 4 to monitor survivor extrication
4. Set up the four exercise stations.

The instructors at each station will oversee the station setup, monitor safety during the exercise, provide feedback to the participants, and oversee station teardown. Setup for each station is as follows:

Station 1 should include one table with chairs. Place one copy of the disaster scenario on the table at each chair.

Station 2 should be set up in the same manner as the fire suppression exercise in Unit 2. Provide multiple types and sizes of extinguishers so that participants must select the proper type of extinguisher for the fire.

Station 3 instructors will apply moulage to the “survivors” to simulate injuries that would be common for the disaster scenario. Before the session begins, identify several types of injuries that would be common as a result of the disaster described in the simulation. They should then place the “survivors” in sitting or lying positions around the station. It may be desirable to not have all “survivors” in clear view or easy reach of the participants.

Station 4 simulates debris using pieces of wood, furniture, or other items to “trap” the survivors. Provide additional materials that can be used in a leverage and cribbing operation, as well as blankets and other items that could be used if necessary to lift or otherwise move the survivor from his or her place of entrapment.

Sample Disaster Scenario

Apple Valley is a rural community with a population of 13,000. Located in Apple County, the town is located between Dawson and Sparkville.

South Lawn Retirement Home is a privately-owned geriatric facility, located at the end of 7th Street (see the map on the next page). Although a new access road is under construction, 7th Street is currently the only access route to South Lawn. Because South Lawn is located across the main line of the Southeast Railroad from the remainder of Apple Valley and could be isolated in the event of a major incident, the South Lawn administrator jumped at the opportunity to organize a CERT. CERT training ended just 2 weeks ago.

You are an employee at the retirement home and a CERT volunteer.

It has been a hot, muggy June day — the kind of day that usually spawns thunderstorms. Earlier in the day, the National Weather Service issued a severe thunderstorm watch for the afternoon and early evening hours. As the afternoon continued, the temperature rose into the high 80s. Building storms were very visible to the southwest.

While on your dinner break, you turned on the Weather Channel™ to check the latest forecast. It didn't surprise you to see that the National Weather Service had upgraded the watch to a warning for your county. After finishing your dinner, you went back to work on the second floor of the nursing home. As you work, you hear thunder off in the distance.

A while later, you hear the outdoor warning siren begin to sound. Although you immediately begin following the home's established procedures for a tornado warning, there is just no time. Before you can get even the first patient wheeled toward the hallway, you hear glass breaking at the other end of the hallway. The tornado (which would later be determined to be an F-3) struck the northwest corner of the building, tearing away the roof, throwing glass everywhere, and causing a partial collapse at that corner.

As the tornado passes, you realize that you and the residents assigned to you are safe. But you can tell from a quick look down the hall and the screams coming from that area that there have been injuries. Although the situation is confused, you also think you can smell smoke.

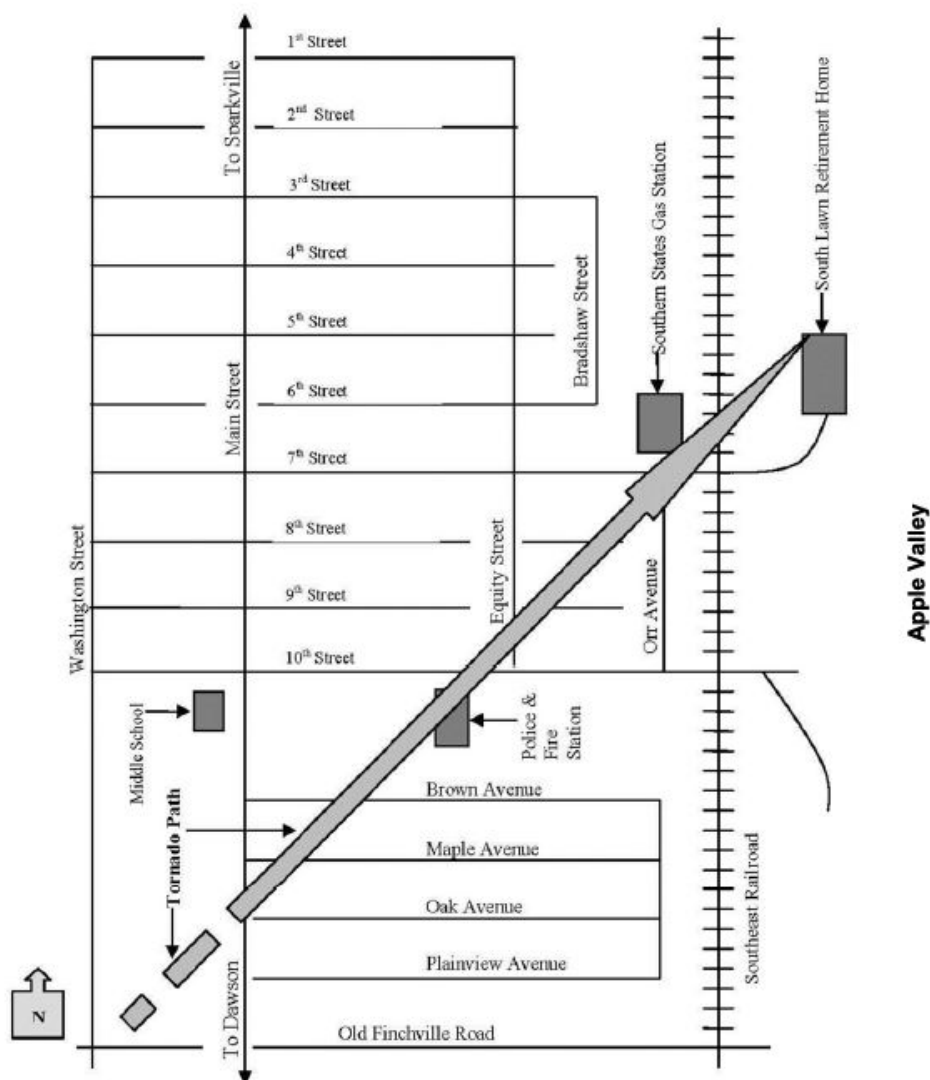

SECTION 1: INTRODUCTION AND OVERVIEW

Welcome the participants to Unit 9 of the CERT Basic Training course. Introduce the instructors for this session.

Begin by telling the participants that this unit is the culmination of all that they have learned throughout the course. Inform them that, after a brief review of the key points of the course, they will take a final exam. They will then use their skills and knowledge of CERT organization and operations in a simulated disaster exercise.

Make any administrative announcements that may be required at this time (e.g., make-up classes).

Spend 2-3 minutes reviewing the key points from each unit.

Course Review

Cover the following points from the disaster preparedness unit:

- Home and workplace preparedness:
 - Assembling a disaster supply kit;
 - Developing a disaster plan;
 - Developing a safe room; and
 - Evacuation versus sheltering-in-place.
- Specific preparedness measures for local high-risk hazards (including terrorism).

Cover the following points from the CERT organization unit:

- Organizational structure:
 - Well-defined management structure;
 - Effective communications among agency personnel; and
 - Accountability.
- Command objectives:
 - Identify the scope of the incident through damage assessment;
 - Determine an overall strategy and logistical requirements; and
 - Deploy resources efficiently but safely.

Cover the following points for disaster medical operations (two units):

- Life-threatening conditions.
- Methods for controlling bleeding:

- Direct pressure
- Tourniquets
- Recognizing shock
- Maintaining body temperature
- Opening the airway:
 - Positioning
 - Jaw-thrust maneuver
- Wound care
- Special considerations when head, neck, or spinal injuries are suspected
- Treatment area considerations
- Splinting and bandaging
- Basic treatment for various injuries
- Establishing a treatment area
- Conducting triage
- Head-to-toe assessments

Cover the following points for disaster psychology:

- In the aftermath of disasters, survivors and disaster workers can experience psychological and physiological symptoms of stress;
- The steps CERT leaders should take to reduce stress on team members;
- The steps CERT volunteers can take to reduce their own stress levels; and
- Strategies for helping survivors work through their trauma.

Cover the following points for fire safety and utility controls:

- Fire chemistry
 - The fire triangle
 - Classes of fire
- Fire size-up considerations, including size-up of a situation involving a fire and the additional fire considerations
- Firefighting resources:
 - General resources available; and
 - Portable fire extinguishers, their capabilities and limitations
- Fire suppression safety:
 - Safety equipment must be used at all times;

- CERT volunteers must always use the buddy system; and
- Fire suppression group leaders should always have a backup team available.
- Fire and utility hazards:
 - Electrical
 - Natural gas
 - Flammable liquids
- Hazardous materials:
 - Identification
 - Defensive strategies

Cover the following points for light search and rescue:

- Search and rescue are really two functions with the same goal:
 - Rescuing the greatest number of people in the shortest amount of time; and
 - Rescuing the lightly trapped survivors first.
- Size-up:
 - Construction types
 - Related hazards
- Structural damage:
 - Light damage
 - Moderate damage
 - Heavy damage
- Search techniques:
 - Be systematic and thorough
 - Mark areas searched
 - Document search results
- Rescue techniques:
 - Survivor carries
 - Leverage and cribbing
 - Lifts and drags

Cover the following points for terrorism:

- Active shooter tactics
- CBRNE indicators
- CERT protocols for terrorist incidents
- Protective actions following a terrorist incident

SECTION 2: FINAL EXAM

The instructor's copy of the final exam is on the following pages of the Instructor Guide. The response in bold is the correct response.

Tell participants that they will now take the final exam for CERT Basic Training.

The final exam is on pp. 9-4 through 9-17 in the Participant Manual.

CERT BASIC TRAINING FINAL EXAM ANSWER KEY

Unit 1: Disaster Preparedness

1. When a disaster occurs, a CERT member's first responsibility is to:
 - A. Join the CERT in disaster response efforts
 - B. Help professional responders
 - C. Ensure personal and family safety**
 - D. Do the greatest good for the greatest number of people
2. CERT members volunteer to fill non-disaster roles. An example of a non-disaster function of CERTs is:
 - A. Staffing parades, health fairs, and other special events**
 - B. Monitoring the news for potential disaster threats
 - C. Petitioning local officials for more local emergency response funding
 - D. Distributing political pamphlets and other materials
3. There are five types of disasters. They are natural, terrorist, home fires, pandemic and _____.
 - A. Mechanical
 - B. Biological
 - C. Chemical
 - D. Technological and Accidental**
4. Which of the following is NOT a hazard associated with home fixtures?
 - A. Gas line ruptures
 - B. Hazardous material spill**
 - C. Injury or electric shock
 - D. Fire from faulty wiring
5. One of the steps in preparing for a disaster is to develop a disaster supply kit. Where should you keep separate disaster supply kits?
 - A. Home and work
 - B. Every room in the house
 - C. Vehicle
 - D. Home, work, and vehicle**

Unit 2: CERT Organization

Following an earthquake, you and your fellow CERT members mobilize and meet at a disaster scene, where fire and law enforcement officials have already arrived. Before taking action, you work with the professional responders to get organized.

1. What is the name of the system used by emergency response agencies to manage emergency responses?
 - A. Incident Command System (ICS)**
 - B. Strategic Planning Unit (SPU)
 - C. Search and Rescue System (SRS)
 - D. Rescue Command System (RCS)
2. In the CERT command structure, how is the CERT leader established?
 - A. By being the first person to arrive on the scene**
 - B. By seniority
 - C. By department
 - D. By the local police chief

You are the CERT Team Leader and therefore responsible for directing team activities. You establish a Command Post for your CERT.

3. What should you do if you have to leave the command post for whatever reason?
 - A. Ask a law enforcement official to take over while you're gone
 - B. Designate CERT Team Leader status to someone else in the Command Post**
 - C. Leave without delegating any of your Team Leader responsibilities
 - D. You may never leave the Command Post under any circumstances
4. CERT members should always be assigned to teams of at least how many people?
 - A. Six
 - B. Three**
 - C. Two
 - D. Four
5. A woman comes up to a disaster scene that you have determined is unsafe to enter. What should you do?
 - A. Warn her that the situation is unsafe**
 - B. Threaten to call the police if she attempts to enter
 - C. Physically restrain her from entering
 - D. Nothing; you should let her be
6. To whom should you give documentation?
 - A. The first professional responders on the scene**
 - B. Your local CERT leader
 - C. Keep it for your own records
 - D. The National CERT Program Office

7. Which of the following forms contains essential information for tracking the overall situation?
- A. Survivor Treatment Area Record
 - B. CERT Assignment Tracking Log**
 - C. Message form
 - D. Equipment Resources form

Unit 3: Disaster Medical Operations — Part 1

In the aftermath of a magnitude 7.7 earthquake, you have ensured your safety and your family's safety, and you grab your CERT kit and PPE. As you are making your way to your CERT's established meeting point, you come across a woman lying by the side of the road. You call out your name and affiliation and ask, "Are you okay?" There is no response.

1. Based on what you know thus far, how should you proceed?
- A. Assume the woman is dead and continue to the CERT meeting point
 - B. Call 9-1-1 on your cell phone immediately
 - C. Assess for airway obstruction, excessive bleeding, and low body temperature**
 - D. Make a note of the woman's location and go for help

You move closer to the survivor. Once again, you ask, "Can you hear me? Are you okay?" As you approach, you hear a very faint "help me," and now that you are closer, you notice that the survivor is bleeding heavily from a wound on her thigh. You immediately attempt to call 9-1-1 on your cell phone but the system is down.

2. You know this woman is seriously injured. How would you help her?
- A. Assess for life-threatening conditions systematically, starting with the airway
 - B. Focus immediately on the most critical threat, the heavy bleeding**
 - C. Get blankets from your supply kit because this woman is clearly in shock
 - D. Keep the woman company until more help arrives
3. You notice that the blood is spurting from the wound on the survivor's inner thigh. What type of bleeding is this?
- A. Arterial**
 - B. Venous
 - C. Capillary
 - D. Mortal
4. What is the first thing you do to stop the bleeding?
- A. Apply a tourniquet
 - B. Wrap the wound with the first piece of cloth you can find
 - C. Elevate the survivor's heart above the wound by having the woman sit up
 - D. Using the sterile dressings in your supply kit, apply pressure directly to the wound**

After a few moments, the bleeding slows considerably. You ask the woman, “Are you okay? Squeeze my hand if you can hear me.” She is only able to groan unintelligibly in response. You notice that her fingers are cold — despite soaring temperatures — when she tries to squeeze your hand.

5. The signs and symptoms that you witness tell you that this woman is suffering from what?
 - A. Low blood sugar
 - B. Shock due to inadequate blood flow**
 - C. Malnourishment
 - D. Shock due to the extreme stress of the situation
6. How would you treat the woman based on your findings?
 - A. Wrap her in something warm**
 - B. Tell her to go to sleep
 - C. Ask her to hold the dressing in place while you search for help
 - D. Give her food and water

You arrive at the meeting point and your CERT Team Leader assigns you to help with the survivors. A woman runs into the treatment area holding a little boy and frantically calling out, “Someone please help my son, he’s turning blue! I don’t think he can breathe!” You turn and run to help the woman. You ask her to put her son down, so you can help.

7. What is the first thing that you should do?
 - A. Conduct a head-to-toe assessment
 - B. Have another volunteer lead the mother away
 - C. Assess for airway, bleeding, and low body temperature**
 - D. Perform CPR

While listening for lung sounds, you notice that the boy is wheezing, and his lips are blue. You cannot find anything obvious obstructing his airway. As you glance down quickly at the rest of the boy’s body, you notice an angry red welt on his inner arm.

8. You have reason to suspect that this boy is suffering from:
 - A. Anaphylaxis**
 - B. An unknown blood-borne disease
 - C. Hypertension
 - D. Hypothermia

Unit 4: Disaster Medical Operations — Part 2

A Category 4 hurricane has just struck your town. You are assigned by your Team Leader to the treatment area. You are directed to help with the survivors. A fellow team member asks you to get some clean water to wash soiled gloves. You know the supply team is on its way but could be several hours away. Grabbing a bucket, you run to a nearby stream for water.

1. What should you do to sterilize the water for medical use?
 - A. Mix 1-part bleach and 10 parts water**
 - B. Mix in 8 drops of non-perfumed chlorine bleach per gallon of water and wait for 30 minutes

- C. Take the bucket and find a place to boil the water, since you assume that one of the buildings must have a functional kitchen
- D. Mix in 8 tablespoons of non-perfumed chlorine bleach and wait for 30 seconds

Once you arrive back at the treatment area with the water, the team leader explains that a survivor has died. The team leader puts you in charge of establishing the morgue.

- 2. How and where will you set up the morgue?
 - A. Near the treatment area
 - B. Inside the treatment area
 - C. Away from the treatment areas**
 - D. None of the above

A few hours later, you return to the treatment area and ask your Team Leader for a new assignment. She quickly explains that the area is overflowing with survivors and asks you to help perform rapid head-to-toe assessments.

- 3. What acronym does the medical community use to remember what to look for when conducting a rapid assessment?
 - A. DCAP-PMS
 - B. SALT
 - C. DCAP-BTLS**
 - D. IDMD-SALT

While performing your first assessment on a young adult male, you notice bruising around the eyes and blood in the nose. The survivor says his hands feel numb and he is unable to move them.

- 4. While it is impossible to be sure out in the field, you should assume that:
 - A. The survivor is in shock
 - B. The survivor will die unless you find a medical professional
 - C. The survivor is bleeding internally
 - D. The survivor has a closed-head, neck, or spinal injury**

Unit 5: Disaster Psychology

You and your fellow CERT members arrive at a neighboring community following a devastating tornado. Survivors have been sifting through debris and have found six bodies. They tell you about what it was like to find the bodies. One of your fellow CERT members starts feeling nauseated. He is obviously overwhelmed.

- 1. Which of the following is not an example of a physiological symptom of trauma?
 - A. Hyperactivity
 - B. Denial**
 - C. Headaches
 - D. Loss of appetite

Some of the survivors you rescue exhibit signs of trauma, and you've warned your team ahead of time that they should expect some of the psychological effects will be directed toward them. In order to help your team better understand what the survivors are going through, you've also explained the six phases of a crisis following a disaster.

2. During which phase do survivors attempt to assess the damage and locate other survivors?
 - A. Pre-disaster phase
 - B. Impact phase
 - C. Honeymoon phase
 - D. Heroic phase**

The goal of on-scene psychological intervention by CERT members is to stabilize the incident scene by stabilizing individuals. You come across a man who is in shock and bleeding from his chest.

3. What should you do first?
 - A. Listen empathetically
 - B. Attempt to locate the man's family or friends to provide natural support
 - C. Say, "You'll get through this"
 - D. Address the man's medical needs**
4. Which of the following is not a step that your team's members should take in the future to personally reduce stress?
 - A. Eat a balanced diet
 - B. Get enough sleep
 - C. Take antidepressants**
 - D. Connect with others

Unit 6: Fire Safety and Utility Controls

While searching a lightly damaged structure following a destructive storm, you and fellow CERT members locate a fire.

1. As you conduct your fire size-up, which of the following is the least important question to consider:
 - A. Can my buddy and I fight the fire safely?
 - B. Do my buddy and I have the right equipment?
 - C. How many people are in the building?**
 - D. Can my buddy and I escape?

From your size-up, you determine that the fire can be put out with a portable fire extinguisher. You and your buddy quickly retrieve a portable fire extinguisher, which you have determined is the right type of extinguisher to fight this fire.

2. What should you do before approaching the fire?
 - A. Test the extinguisher after pulling the pin**
 - B. Wait for the fire department to arrive
 - C. Tell your buddy to wait at the door for you
 - D. Make sure the house's water supply is shut off

Following the correct CERT procedure (P.A.S.S.), you discharge the extinguisher.

3. What should you do if the fire continues to burn 5 seconds after you start to extinguish it?
 - A. Check the label on the extinguisher
 - B. Look for creative resources to fight the fire
 - C. Leave immediately**

- D. Back out and signal for your buddy to attempt to suppress the fire
4. The fire has spread to other areas by the time the fire department arrives. What's your next course of action?
- A. Attempt to suppress the fire again with a new extinguisher
 - B. Communicate what you know to one of the firefighters**
 - C. Overhaul the fire
 - D. Send in a backup team to fight the fire
5. If the chief officer asks you and your fellow CERT members to remain outside at a safe distance, how should you respond?
- A. Continue to conduct a size-up from a safe distance outside of the building**
 - B. Leave the premises
 - C. Enter the house after the firefighters
 - D. Call in more CERT members for backup

While the fire department manages to suppress most of the fire inside the building, a small fire has started to spread through the yard. You notice a nearby shed is posted with an NFPA 704 Diamond featuring the numbers 1, 1, and 2.

6. What should you do?
- A. Suppress and overhaul the fire because the numbers in the Diamond are small and indicate that little risk is present
 - B. Leave the area and communicate the information to one of the professional firefighters on the scene if they are accessible**
 - C. Suppress and overhaul the fire only if the number in the blue quadrant is less than 2
 - D. Make sure you are using the correct type of fire extinguisher

Unit 7: Light Search and Rescue Operations

After a tornado ravages a nearby community, you and your fellow CERT members volunteer to help with the search and rescue operations. You arrive on the scene to discover collapsed houses, cars swept up into trees, and various debris strewn everywhere.

1. As you begin the CERT size-up process, what is the first thing you should do?
- A. Gather facts**
 - B. Assess and communicate damage
 - C. Establish priorities
 - D. Consider probabilities

You and three other CERT members begin searching the local library, a large brick building where many people in the community were instructed to take cover before the storm. A size-up of the building reveals superficial damage, including broken windows and cracked plaster.

2. How would you classify the damage to the building?
- A. Heavy damage
 - B. Moderate damage
 - C. Light damage**

D. Slight damage

As you continue your search of the library, you make a single slash next to the doorway of the first room you enter.

3. What information do you write in what will become the left quadrant of this search marking?
 - A. Information about hazards and collapses
 - B. The number of survivors in the room
 - C. Your agency or group ID**
 - D. The room number

While stopping frequently to listen, you hear a faint cry for help from the corner of the room. You walk over to find a young boy who has glass shards in his leg and is unable to walk.

4. Keeping in mind that you are searching the room with only two other CERT members, which of the following is not a recommended way of moving the boy?
 - A. Blanket carry**
 - B. Pack-strap carry
 - C. Chair carry
 - D. One-person arm carry

Upon completing your search and rescue in the library, you enter a house where the second floor has collapsed, creating a lean-to void.

5. How should you proceed?
 - A. Leave the premises immediately and mark the structure as unsound**
 - B. Quickly search the ground floor
 - C. Use an axe or similar tool to knock down the floor and clear the void
 - D. Call for backup

Unit 8: Terrorism and CERT

You are having a business lunch downtown when you hear a loud explosion. You follow others outside to find what caused the noise. In the distance you can see heavy smoke rising from the electrical plant, the very same electrical plant used to power your town and several major cities in the area and that you saw on the news last night cited as a potential target for a recently uncovered terrorist plot. All around you, people are speculating that the plot was successful.

1. What is the first thing you should do?
 - A. Gather your CERT equipment and report for duty
 - B. Locate your family and evacuate to safety
 - C. Call the Federal Government to alert it about a terrorist attack
 - D. Initially monitor the situation from a safe place**

You remember from the news report that the potential plot was uncovered when an electrical plant security guard noticed the same black van parked outside for over a week. Worried that someone was watching the building, he alerted local authorities.

2. Which of the eight signs of a terrorist attack did the security guard notice?

- A. **Surveillance**
- B. Tests of security
- C. Acquiring supplies
- D. Dry runs

A friend runs over to you, a little frantic, and asks why you are not headed to the disaster site to help. After all, he says, you are a trained CERT member.

3. How do you respond to your friend?

- A. "Yes. You're right. I'm heading in that direction now."
- B. "I am a CERT member, but I have to wait for an official to declare a disaster before I can activate."
- C. "I'm not part of the Terrorist Response Team."
- D. **"You're right. I am a CERT member, but CERT members must not respond to a potential terrorist incident."**

SECTION 3: DISASTER SIMULATION

Conduct the simulated disaster exercise. Participants will find instructions for the simulation in the Participant Manual.

1. Assign the participants to four groups.
2. Explain that the simulation will provide each group with the opportunity to apply many of the skills that they learned during the earlier sessions.
3. Elaborate by informing the participants that the disaster simulation will be conducted at four stations.
4. At Station 1, each group will receive the disaster simulation. Based on that scenario, the participants will:
 - Determine the extent of damage;
 - Establish team priorities;
 - Determine the resources needed; and
 - Identify potential hazards.

Explain that, while at Station 1, the participants will select a CERT Team Leader who will establish a CERT organization based on resources available and established priorities.

Note that the map for the sample disaster scenario is on PM p. 9-17.

5. At Station 2, the participants will be required to:
 - Evaluate a fire situation;
 - Select the proper extinguisher for the situation; and
 - Extinguish the fire.

Inform the participants that each of them will be required to extinguish the fire.

6. At Station 3, the participants will be required to treat survivors with the medical supplies available.
7. At Station 4, the participants will perform leveraging and cribbing to extricate survivors who are trapped by debris.
8. Explain that the participants will have approximately 15 minutes at each station. After 10 minutes, the instructors will provide feedback.
9. Point out that at the end of the exercise, all of the groups will meet for feedback and a question-and-answer session.

Ask the participants to assemble in their four teams.

Give each team a number and explain that each team will begin the rotation at the station that has the same number as the team.

Instruct all of the teams to select a different person to act as leader at Station 3 and Station 4.

Ask if there are any questions before the teams proceed to their initial stations.

SECTION 4: EXERCISE CRITIQUE AND CONCLUSION

At the end of the exercise, conduct an interactive discussion on the points learned and the difficulties encountered during the exercise.

Provide the participants with feedback on their performance, including:

- Overall operations;
- Communications;
- Safety; and
- Teamwork.

Answer any comments or questions about the exercise.

Stress the importance of continuing education and training to maintain and improve the participants' skills and knowledge. Suggest that the participants attend:

- Periodic refresher training that is offered locally;
- Standard and advanced first-aid courses that are offered through organizations such as the American Red Cross;
- Cardiopulmonary resuscitation classes that are offered through the American Red Cross or the American Heart Association; and
- Independent Study (IS) courses available online from FEMA at www.training.fema.gov/IS/.

Thank all of the participants for attending the CERT training.

SECTION 5: GRADUATION

Distribute a certificate of completion to each participant and thank each personally for attending the course.

If you have any refresher or supplemental training scheduled for CERT volunteers, provide the details.

[This page intentional left blank]