



President's Council on Integrity and Efficiency
Executive Council on Integrity and Efficiency



Oversight of Gulf Coast Hurricane Recovery A Semiannual Report to Congress

April 30, 2006



**PRESIDENT'S COUNCIL on INTEGRITY & EFFICIENCY
EXECUTIVE COUNCIL on INTEGRITY & EFFICIENCY**



April 30, 2006

The Honorable Ed Whitfield
Subcommittee on Oversight and Investigations
Committee on Energy and Commerce
U.S. House of Representatives
2125 Rayburn House Office Building
Washington, D.C. 20515

Dear Chairman Whitfield:

This report is the first of what will be a series of semiannual reports on Gulf Coast hurricane recovery oversight. The report will be sequenced with each Inspector General's regular semiannual report to Congress to streamline the reporting process.

Gulf Coast hurricane recovery oversight is truly a significant effort by the federal Inspectors General community. Coordinated through the President's Council on Integrity and Efficiency (PCIE) and the Executive Council on Integrity and Efficiency (ECIE), the Inspectors General community is ensuring that the audit and investigative efforts and resources are focused on disaster-related issues, ensuring accountability and the prevention of crimes and mismanagement. Today, approximately 600 personnel are working on recovery oversight.

The PCIE and ECIE activities are being coordinated by Richard L. Skinner, the chair of the PCIE's Homeland Security Roundtable and the Inspector General of the Department of Homeland Security. Under Mr. Skinner's leadership, federal Inspector General (IG) staff have been working tirelessly to ensure that: (1) agency internal controls are in place to prevent fraud, waste, and abuse; (2) IG investigative activities are coordinated with the Department of Justice's Hurricane Katrina Fraud Task Force; (3) agency stewardship plans for hurricane relief activities are in place and operating as intended; and, (4) the IG community is executing its hurricane relief oversight efforts in a coordinated fashion so that its resources are utilized as efficiently and effectively as possible.

Mr. Chairman, in our judgment, the result of the Inspectors General community's efforts will greatly benefit the Federal government's hurricane relief activities. In pursuing this task, we have received notable support from many members of the Congress and, specifically, from committee staff both in the Senate and House of Representatives. Further, we have had the cooperation of agency officials with direct responsibility for the hurricane relief effort.

Finally, we have received excellent support from the Chairman of the PCIE and ECIE, Clay Johnson, the Deputy Director of the Office of Management and Budget. He took an active role in ensuring a robust Inspector General oversight program.

It is a privilege for us to represent the efforts of the hundreds of dedicated Inspector General professionals on the frontline of disaster response and recovery.

Sincerely,



Gregory H. Friedman
Inspector General
Department of Energy
Vice Chair, PCIE



Richard L. Skinner
Inspector General
Department of Homeland Security
Chair, PCIE/ECIE
Homeland Security Roundtable



Barry R. Snyder
Inspector General
Federal Reserve Board
Vice Chair, ECIE

TABLE OF CONTENTS

SECTION 1	Executive Summary	1
SECTION 2	Highlights of Oversight Activities	7
	Post-Disaster Stewardship Plan	9
	Contract Actions	11
	Role of the Federal Inspectors General	13
	Monitoring and Technical Advice	14
	Recommendations for Preparedness	15
	Significant Oversight Highlights	17
SECTION 3	Gulf Coast Recovery Funding	41
	U.S. Emergency Supplemental Appropriations	43
	Recent Appropriations Activity	49
	Private Donations for Hurricane Recovery	49
	Selected Activities	51
SECTION 4	Audits and Other Reviews	55
	Management and Performance Reviews	57
	Contract Reviews	59
	Department Agency Summaries	60
SECTION 5	Investigations	107
	The Hurricane Katrina Fraud Task Force	109
	Crime Trends and Enforcement Actions	110
	PCIE/ECIE Katrina Fraud Hotline	110
	Case Summaries	112
	Training	117
SECTION 6	Inspections	119
	Department of Homeland Security	121
	Department of Health and Human Services	138

APPENDICES	Appendix A Compendium of OIG Hurricane Oversight in the Gulf States	A1-A22
	Appendix B Hurricane Recovery Funding – The 1 st Emergency Supplemental (2005)	B1-B2
	Appendix C Hurricane Recovery Funding – The 2 nd Emergency Supplemental (2005)	C1-C2
	Appendix D Hurricane Recovery Funding – The 3 rd Emergency Supplemental (FY 2006)	D1-D2
	Appendix E Private Donations for Hurricane Katrina Victims	E1-E8
	Appendix F Hurricane Declaration by Program Area	F1-F4
	Appendix G Useful Website Links	G1-G3
	Appendix H PCIE / ECIE Contributing Members	H1-H6
	Appendix I OIG Congressional Activities	I1-I2
	Appendix J PCIE / ECIE Oversight Audit and Investigative Models	J1-J3
	Appendix K Acronyms and Glossary	K1-K10

EXECUTIVE SUMMARY

1



New Orleans, LA, 4-22-06 -- U.S. Army Corps of Engineers lift a 75 ton Gate Jacket Structure into place for the interim Flood Gate closer structures at the 17th St Canal. FEMA is building the interim flood gate by June 1st under its Public Assistance program till a better Flood Gate and Levee system can be completed to better protect New Orleans residents and property. Marvin Nauman/FEMA photo

OVERSIGHT OF GULF COAST HURRICANE RECOVERY

Executive Summary

Six months after Hurricane Katrina swept through three Gulf States, and Hurricanes Wilma and Rita added to the devastation in the Gulf States, federal recovery and repair efforts are underway on an unprecedented scale. Record amounts of federal funds have been spent on these initiatives, and with them come closer inspections than ever before about how funds are being spent. Ongoing oversight of post-hurricane expenditures by the Inspector General (IG) community provides valuable “lessons learned” as various agencies plan for the upcoming hurricane season.

The federal government has dedicated billions of dollars to address the widespread devastation, upheaval and dislocation. With such a massive commitment of government resources, the federal IGs became the logical choice for oversight and stewardship of federal spending. Overall, the Inspectors General (IGs) for 22 departments and agencies have committed approximately 600 personnel to recovery oversight.

Before Hurricane Katrina, the President’s Council on Integrity and Efficiency (PCIE) and the Executive Council on Integrity and Efficiency (ECIE) had established a Homeland Security Roundtable, building on collective experience after the 9/11 attacks. This roundtable became the natural vehicle to manage hurricane recovery oversight, under the direction of Richard L. Skinner, the Department of Homeland Security (DHS) Inspector General.

Key oversight accomplishments since the Roundtable’s first 90-day report on hurricane recovery oversight was issued on December 30, 2005, include:

- A landmark performance review of FEMA’s response to the hurricane with 38 recommendations for improvements
- The discovery of over-purchasing and poor planning surrounding transitional housing for evacuees. The DHS OIG reported that 10,777 mobile homes, costing \$301.7 million, were sitting unused in Hope, Arkansas
- As of March 31, 2006, the number of arrests have increased from 36 to 152; the number of indictments went up from 44 to 174, and the number of convictions went up from 3 to 48

EMERGENCY FEDERAL FUNDING

During 2005, Congress approved three emergency supplemental appropriations totaling \$67.5 billion for recovery effort, of which \$28.6 billion has been designated for economic development, federal facility restoration and tax relief. Of this funding, the largest recent appropriations were:

- \$11.5 billion to Housing and Urban Development (HUD) to assist five Gulf Coast states with restoration and recovery, and \$390 million for housing vouchers
- \$8.65 billion to the Department of Defense (DoD), which included \$2.9 billion for the U.S. Army Corps of Engineers for levee and floodwall repairs

State and local governments receive federal funding through federal grant programs. In addition, other federal agencies received funding under mission assignments from the Federal Emergency Management Agency’s (FEMA’s) Disaster Relief Fund. This funding is distributed by FEMA to federal agencies under mission assignments. As of March 31, 2006, there were more than \$6.98 billion for Katrina; \$1.15 billion for Rita and more than \$366 million for Wilma.

The President has requested a fourth emergency supplemental spending bill for an additional \$19.76 billion for relief and recovery, which at the time of the publication of this report, had been recommended for an increase of \$7.36 billion by the Senate Appropriations Committee.

OVERSIGHT OF FEDERAL CONTRACTING

Audits and other reviews monitor how much and how funds are spent. As of March 31, 2006, agencies issued a total of at least 6,665 contracts, totaling \$9.69 billion; DHS alone awarded 3,456 contracts worth about \$5.4 billion, of which 770 were worth \$500,000 or more, but more than half were awarded under full competition; and the IGs have completed 246 contract reviews and have 289 reviews still in progress.

Looking to future oversight activities, the DHS OIG is reviewing the amounts distributed to the five DHS components that received the largest mission assignments and is assisting other OIGs in similar reviews.

Auditing in Real Time

Ongoing reviews offer retrospective, but they can sometimes influence change in a timely fashion.

Examples of reviews that produced immediate corrective action, and savings, are:

- A building maintenance contract review disclosed that many service categories were extremely high priced. FEMA canceled the contract, generating a potential savings of about \$3.1 million
- Two-thirds of the \$100 million that foreign governments contributed to assist in the recovery was designated for case management services. A review of the \$66 million FEMA grant disclosed that interest could be earned if the money were properly invested by FEMA. This was done and provided an additional \$2.5 million for case management

Investigations Result in Arrests, Recouped Funds

As of March 31, 2006, members of the PCIE/ECIE have reported:

- 785 open cases of potential crimes, involving theft, fraud, wrongful claims and over-billing
- 174 indictments handed down
- 152 arrests
- 48 convictions for hurricane-related allegations and crimes
- 2,284 individuals have returned checks to FEMA totaling \$6.3 million

The Federal Government's Obligations

In his Senate testimony on April 21, 2006, DHS Inspector General Skinner concluded that "The devastation caused by Hurricane Katrina is still being assessed. In the aftermath of a major disaster such as this, the federal government is obligated to ensure that roads are cleared of debris to allow emergency workers access to affected areas; it is obligated to ensure that immediate steps are taken to shelter and protect the lives of its citizens; and, it is obligated to take measures to mitigate further damage or harm to homes and dwellings.

"It is also critical that the federal government provide these services quickly and at a reasonable cost. The federal government, in particular FEMA, has received widespread criticism for a slow and ineffective response. Unfortunately, much of the criticism is warranted. These findings are not only emerging from our work, but from that of other federal agencies," he said.

HIGHLIGHTS

2



Belle Chasse, LA, 3-27-06 – Students at Belle Chasse Primary School share in the excitement of 6 additional modular classrooms provided by FEMA that are being dedicated today in a ribbon cutting ceremony. Robert Kaufmann/FEMA

Highlights of Oversight Activities

The *Performance Review of FEMA's Disaster Management Activities in Response to Hurricane Katrina* evaluates the adequacy of the laws, regulations, policies, procedures, plans, guidelines, and resources that the Federal Emergency Management Agency (FEMA) followed after the storm to provide relief and initiate recovery. In this sweeping review of FEMA's performance, 38 recommendations to improve emergency management capabilities were made: 24 recommendations produced agreement from FEMA, and 13 recommendations were already being implemented in one form or another, and one recommendation produced disagreement with FEMA management.

The President's Council on Integrity and Efficiency's (PCIE's) Homeland Security Roundtable has gathered input from 22 federal agencies that continue to engage in the oversight of recovery efforts resulting from the 2005 hurricane damage in addition to the myriad other responsibilities belonging to these departments and agencies. Major highlights of this combined federal, state, and local oversight effort include the centerpiece performance review that was released in late March 2006 and many other notable inspections, audits, and investigative efforts.

Just two weeks after Hurricane Katrina subsided, the Office of Management and Budget (OMB) and the Department of Homeland Security (DHS) started tracking key vulnerability areas for the federal Inspectors General (IGs), as a means to stem hemorrhaging of funds, stop uncontrolled spending, and establish a strong anti-fraud message for companies that were awarded contracts in the first several weeks.

On March 31, 2006, the federal IGs issued their updated consolidated oversight plan in the Compendium of OIG Hurricane Oversight in the Gulf States (see Appendix A) to ensure accountability; prevent duplication; and focus heavily on fraud prevention to include reviewing internal controls, auditing major contracts, and advising department officials on precedent-setting decisions and procurement vehicles and methods before they are finalized. This plan included a matrix of planned oversight activities on multi- and single-agency bases.

Since September 2005, many auditors, inspectors, and investigators have been on the ground in the region. Their visible presence alone is a deterrent to fraud, waste and abuse. As of March 31, 2006, there is a total of approximately 600 personnel on site.

POST-DISASTER STEWARDSHIP PLAN

Just prior to Hurricane Katrina, the PCIE and the Executive Council on Integrity and Efficiency (ECIE) had established a Homeland Security Roundtable to deal with government-wide homeland security-related issues.

After Hurricane Katrina, the Roundtable has served as the forum for the IG community to plan and discuss hurricane recovery oversight. The Roundtable members each provide oversight of federal dollars for their respective agencies, whether the funding is from a direct appropriation or through a mission assignment from FEMA. Thus, no one agency is responsible for all oversight and stewardship activities. The benefit of this

organizational approach is that each OIG is able to audit and investigate its respective agency's recovery programs and operations. As a result, greater oversight is taking place and oversight efforts are not being duplicated. In addition, the PCIE/ECIE established a central hotline to handle reports of fraud, waste, and abuse throughout the Gulf Coast.

The Federal Acquisition Regulation (FAR) requires agencies to perform acquisition planning and conduct market research for all acquisitions to obtain competition among potential contractors to the maximum extent practicable. According to the Homeland Security Acquisition Manual and the FAR, formal acquisition plans are not required for emergency acquisitions; that is, when the need for the supplies and services is of such an unusual and compelling urgency that the government would be seriously injured if the needed supplies or services were not immediately acquired.

FEMA's core mission is to respond to emergencies and procure emergency supplies and equipment, such as travel trailers, mobile homes, base camps, food, and ice, on a recurring basis. Thus planning for these procurements represents sound business practice for FEMA. Because of the unpredictable nature of emergency operations, such planning cannot always be used to select specific sources in advance of a disaster. However, for each major type of procurement, whether it is for travel trailers, mobile homes, base camps, or some other procurement, pre-disaster planning should include the following processes:

- Identify prospective sources of supplies and/or services, including sources identifiable through government-wide and industry association databases using market survey approaches
- Delineate how to seek, promote, and sustain competition during emergency operations
- Describe how to meet Stafford Act requirements for preferences of firms affected by the disaster
- Layout source-selection procedures for each type of procurement
- Establish communications systems and processes and publicize them to ensure prospective sources know how to contact FEMA procurement personnel

Although every disaster is unique, many of the response requirements are the same. Pre-disaster planning must include establishing standby or call contracts with vendors to provide essential goods and services required to facilitate immediate response operations or to meet the needs of disaster victims.

Call contracts for ice, water, food, tarps, transportation, travel trailers, and other items commonly procured shortly after disasters strike should be in place and ready to execute on short notice. A call contract allows for costs, specifications, terms, and conditions to be negotiated in advance, negating the need for intensive contract negotiations during a crisis. This is a common business practice in other federal agencies, including the U.S. Army Corps of Engineers (USACE) and the Forest Service.

Because the above pre-disaster planning process did not take place prior to Hurricane Katrina, FEMA found itself in an untenable position and hastily entered into contracts with little to no contract competition for disaster commodities.



Baker, LA December 25, 2005 – Evacuee children waste no time enjoying their Christmas presents at the FEMA trailer park where they have been living since Hurricane Katrina forced them from their New Orleans homes. Over 600 families moved to Baker after the disaster and are living in a FEMA park. Photo by Greg Henshall / FEMA

CONTRACT ACTIONS

In the immediate aftermath of Katrina, government agencies expedited contracting methods, as authorized under the Federal Acquisition Regulation (FAR). There were many contingency contracts already in place, and these contracts were activated for significant initial relief requirements, as well as many contracts adhering to otherwise routine procurement parameters, limiting the higher risk associated with the aforementioned “good faith” agreements. Many of the contract actions have long-term value.

The job of the IGs involved in hurricane oversight, then, becomes as an arbiter in contract review and management and a real-time deterrent in their field offices along the Gulf Coast against those contractors who might have improperly discharged their contracts during the crisis. Contract actions, over time, are expected to include more and more measures of full and open competition.

As can be seen in Table 2-1, the total number of contracts awarded as of March 31, 2006, is 6,665, a significant increase from the 4,700 total contracts that had been awarded as of November 30, 2005. These 6,665 contracts had a total dollar value of approximately \$9.69 billion. Of the total number of contracts, 1,203 contracts had values that exceeded \$500,000 in value.

Competitive Contracting and Oversight

Although expedited contracting is an acceptable practice immediately after a disaster, once the emergency period is over, it is reasonable to expect that the government may recompute some contractual requirements in order to introduce competition into the process and ensure that the government is getting a fair price. This practice was not consistently followed in the post-Katrina environment.

The issue was raised in a number of recent congressional hearings and relates to the federal government’s ability to make necessary purchases in response to a disaster in a timely manner and for a fair price as well as plan effectively, contract, and subsequently monitor disaster contracts. There were many weaknesses observed in the federal government’s pre-disaster planning and contract management efforts.

In its contracting reviews, the OIGs have noted problems with inadequate contract files. Often there is little or no information on how “price reasonableness” was determined, whether specifications were

CONTRACT ACTIONS, BY AGENCY

Agency	Total Contracts	< \$500K	> \$500K	Contracts > \$500K by Competition Type				Value of Contracts (in thousands of dollars)		
				Full and Open	Limited	Sole Source	Other	< \$500K	> \$500K	Total
DHS	3,456	2,686	770	144	1	420	205	\$227,203	\$5,151,589	\$5,378,792
DOC	-	-	-	-	-	-	-	\$5,300	\$1,200	\$6,500
DoD (1)	-	-	-	-	-	-	-	-	\$2,774,623	\$2,774,623
DOE	-	-	-	-	-	-	-	-	-	-
DOI	569	560	9	5	-	2	2	\$7,328	\$10,854	\$18,182
DOJ	50	46	4	-	-	3	1	\$1,874	\$7,335	\$9,209
DOL	6	4	2	-	-	2	-	\$2,712	\$2,048	\$4,760
DOT	71	56	15	7	2	6	-	\$7,080	\$327,836	\$334,916
ED	-	-	-	-	-	-	-	-	-	-
EPA	257	170	87	74	-	13	-	\$12,946	\$222,467	\$235,413
GSA	1,637	1,418	219	42	19	147	11	\$80,464	\$554,108	\$634,572
HHS	183	155	28	22	-	6	-	\$13,225	\$77,011	\$90,236
HUD	21	11	10	-	4	3	3	\$1,260	\$16,690	\$17,950
NASA	33	26	7	5	-	2	-	\$4,596	\$84,564	\$89,160
SBA	-	-	-	-	-	-	-	-	-	-
SSA	13	12	1	1	-	-	-	\$1,083	\$600	\$1,683
TIGTA	16	16	-	-	-	-	-	\$318	\$0	\$318
USDA	324	278	46	46	-	-	-	\$28,798	\$63,205	\$92,003
USPS	29	24	5	2	-	3	-	\$2,176	\$6,173	\$8,349
VA	-	-	-	-	-	-	-	-	-	-
Total	6,665	5,462	1,203	348	26	607	222	\$396,363	\$9,300,303	\$9,696,666

Source: 9th PCIE Hurricane Katrina Report (as of March 31, 2006)

Note 1: The total dollar value of contracts was based on data provided by OSD AT&L and is current as of 11/09/05. DOD reported that the number of contracts data have not been determined.

Table 2-1

included, and whether there was supervisory review. Specifications were especially poor for travel trailers purchased off the lot and for base camps set up to house evacuees, workers, and volunteers.

Sole-Source Contracts

Within days of the 2005 storms subsiding, contracts worth hundreds of million of dollars were awarded, some of which were awarded on a sole source basis, some on a limited-competition basis, and some were awarded using free and open competition. In instances where timing is critical to saving lives and property, sole source contracts are often used by program managers. As the emergency subsides, the number of sole source contracts is usually expected to decrease over time. In the case of the 2005 hurricane recovery contracts, this was the case as can be seen in Table 2-2.

SOLE SOURCE CONTRACTS, BY AGENCY

Agency	As of November 30, 2005			As of March 31, 2006		
	Contracts >\$500k	Sole Source ²	Percentage	Contracts > \$500K	Sole Source	Percentage
DHS	554	355	64.1%	770	420	54.6%
DOC	2	-	0%	-	-	-
DOD (1)	-	-	-	-	-	-
DOE	-	-	-	-	-	-
DOI	1	1	100%	9	2	22.2%
DOJ	1	1	100%	4	3	75%
DOL	2	-	0%	2	2	100%
DOT	17	7	41.2%	15	6	40%
ED	-	-	-	-	-	-
EPA	27	7	25.9%	87	13	14.9%
GSA	146	82	56.2%	219	147	67.1%
HHS	17	3	17.6%	28	6	21.4%
HUD	6	1	16.7%	10	3	30%
NASA	7	2	28.6%	7	2	28.6%
SBA	-	-	-	-	-	-
SSA	1	-	0%	1	-	0%
TIGTA	-	-	-	-	-	-
USDA	-	-	-	46	-	0%
USPS	1	1	100%	5	3	60%
VA	-	-	0%	-	-	0%
Total	782	460	58.8%	1203	607	50.5%

Source: 9th PCIE Hurricane Katrina Report (as of March 31, 2006)

Note 1 : As of December 2, 2005, DoD reported 104 contracts with values greater than \$500,000. DOD subsequently reported that the number of contracts data have not been determined.

Note 2: Data from *PCIE Bi-Weekly Report* (as of December 2, 2005)

Table 2-2

ROLE OF THE FEDERAL INSPECTORS GENERAL

In the wake of Hurricane Katrina and due to the large sums of money made available for the recovery effort, the need for oversight was unprecedented. The federal IGs, through the PCIE/ECIE, offered the capacity needed for consistent reporting and the preventive interaction to oversee the spending of billions of dollars for the recovery effort. The federal IG community was a natural fit for oversight and stewardship of the recovery funding effort.

Central to this arrangement of cooperating federal IGs, the Homeland Security Roundtable serves as the forum to plan and discuss hurricane recovery oversight. The Roundtable members meet regularly to share information and collaborate. Each participating IG provides oversight of federal dollars for their respective agencies, whether the funding was from a direct appropriation or through a mission assignment from FEMA.

As a result, greater oversight is taking place and oversight efforts are not being duplicated. In addition, the PCIE/ECIE established a central hotline to handle reports of fraud, waste, and abuse throughout the Gulf Coast.

MONITORING AND TECHNICAL ADVICE

Initial Strategic Initiatives

The PCIE/ECIE Homeland Security Roundtable took immediate action after the storm, forming two strategic building blocks: (1) Framework and Planning and (2) Outreach and Reporting. Together, these two cornerstones feature nine initiatives.

Framework and Planning

1. Initially, the IGs from the agencies with the majority of funds allocated to mission-relief efforts were mobilized to create the framework of oversight. These included IGs from DHS, Department of Commerce (DOC), Department of Defense (DoD), Department of Justice (DOJ), Department of Interior (DOI), Environmental Protection Agency (EPA), General Services Administration (GSA), Health and Human Services (HHS), Housing and Urban Development (HUD), U.S. Department of Agriculture (USDA) and the U.S. Postal Service (USPS). Others later joined, bringing the total number of agencies involved, as of March 31, 2006, to 22.
2. The DHS OIG established the Office for Gulf Coast Hurricane Recovery. This office is dedicated to preventing problems through a proactive program of assessing controls; advising management on issues, policies, and approaches as they arise; and conducting contract and grant audits to ensure disaster assistance funds are being spent wisely. OIG personnel (inspectors, auditors, and investigators) have been assigned to the Joint Field Offices in the five states affected by the storms and are working throughout the coastal region. The visible OIG presence throughout the response and recovery zone is designed to reduce fraud, waste, and abuse at the local level.
3. The DOJ created the Hurricane Katrina Fraud Task Force. The PCIE/ECIE interagency group joined this DOJ task force to investigate and prosecute fraud and public corruption cases directly related to hurricane response and recovery efforts. Aside from prevention, the initial emphasis has been on prompt law enforcement responses to charity fraud, identity theft, insurance fraud, and procurement and government-benefit fraud. Since the task force was established, the U.S. Attorney's Offices and a variety of investigative agencies, including the Federal Bureau of Investigation (FBI), the Postal Inspection Service, the U.S. Secret Service, and the federal IGs, have pursued a significant number of prosecutions stemming from Hurricanes Katrina and Rita that spanned federal districts from Oregon to Florida.
4. The OIGs have established a Hurricane Katrina Contract Audit Task Force to coordinate IG efforts. Contract audit experts have developed a methodology to evaluate the risks presented by large dollar contracts awarded without competition or definitive requirements and consequently identify contracts that will require more detailed review or investigation.

5. The PCIE/ECIE subgroup for Individual Assistance/Housing was established to ensure efficient and effective use of relief resources allocated to those individuals and households receiving various federal benefits. It reviews the implementation of individual assistance initiatives and, where appropriate, provides technical advice to disaster recovery program managers.
6. A common work plan, called the PCIE Compendium of Hurricane Oversight in the Gulf States, was developed for the IGs to use in relief oversight. (For more information, see Appendix A or <http://www.ignet.gov>.)

Outreach and Reporting

The three outreach and reporting initiatives are the employment of a large oversight staff, the regular reporting of oversight efforts, and the fraud hotline.

7. As of March 31, 2006, approximately 600 full-time personnel have been committed to hurricane oversight. This includes auditors, investigators, inspectors, managers, and administrative personnel dedicated to Katrina oversight operations.
8. Publication of the PCIE/ECIE Bi-weekly Homeland Security Roundtable reports on Hurricane Katrina Oversight was initiated on October 28, 2005, to update administration officials and Congress. Effective January 2006, the reports were published monthly and effective April 2006, the reports will be published quarterly.
9. On October 4, 2005, the Katrina Fraud Hotline was established. As of March 31, 2006, the Hotline had 9,664 contacts, while contacts made directly to departmental hotlines totaled 4,721. Concerned individuals may notify the government of fraud, waste, abuse, or allegations of mismanagement by calling, faxing, e-mailing, or writing as indicated on the back cover of this report.

RECOMMENDATIONS FOR PREPAREDNESS

Many key recommendations on how better to prepare for the next hurricane season are found in the DHS OIG's report, *A Performance Review of FEMA's Disaster Management Activities in Response to Hurricane Katrina*.

Many congressional committees have held and continue to hold hearings on the federal government's response to the 2005 hurricanes and the devastation produced by the storms. Since the storms subsided last year, there have been 67 reports issued by the Senate or the House of Representatives regarding the hurricanes and their after effects, according to the Library of Congress Web site.

The Department of Labor, the Small Business Administration, and the General Services Administration offered additional recommendations for their respective agencies that can be found below in the departmental section of the *Highlights*.

While private economists debate the short- and long-term effects of the storms on the U.S. economy, it is generally agreed that the energy and export sectors were the hardest hit. But as Ben Bernanke, chairman of the White House Council of Economic Advisers said after Hurricane Katrina hit, the storm “will have a strong effect on economies of Louisiana, Mississippi, Alabama and Florida. But the entire economy will suffer much less.”

So while those debates continue, last fall the federal government had begun the long process of self-examination. DHS’s OIG’s performance review recommendations of the federal government’s response to the storms are summarized below and more detail on the entire report can be found in Section 6, Inspections.

The FEMA Performance Report Recommendations

DHS’ OIG recommended, among other things, that DHS headquarters and FEMA:

- Establish measurable expectations of FEMA’s response
- Provide the necessary financial, technical, and staff support to meet them
- Assess FEMA’s readiness

Also, DHS OIG made recommendations to (1) clarify how DHS headquarters, FEMA, and other DHS components will implement aspects of the National Response Plan (NRP) and (2) address improvements to FEMA’s infrastructure for resource ordering and tracking, personnel deployment, disaster communications, and disaster application handling.



Biloxi, Miss., April 1, 2006 – Mississippi Emergency Management Agency (MEMA) and FEMA staff actively participate in today’s “All-Hands Meeting” at the Biloxi Joint Field Office (JFO). MEMA and FEMA are partners in providing a unified response to the thousands of Mississippians affected by Hurricane Katrina. George Armstrong/FEMA

To improve disaster preparedness, the OIG recommended that FEMA do the following:

- Complete catastrophic, surge, and workforce plans
- Add training
- Strengthen its remedial action program
- Build relationships with the States in concert with the Preparedness Directorate and DHS Public Affairs

DHS OIG also recommended several modifications to how FEMA manages disaster assistance.

The FEMA performance review findings are summarized below, and in more detail in Section 6, *Inspections*.

SIGNIFICANT OVERSIGHT HIGHLIGHTS

In addition to its own activities related to hurricane relief efforts in the Gulf Coast region, FEMA tasked other federal departments and agencies to assist in response efforts through mission assignments. Departments use funds provided by FEMA to award contracts or provide direct support for response efforts. In addition, some departments and agencies received direct appropriations for hurricane relief activities. As of March 31, 2006, contracts valued at more than \$9.6 billion have been awarded. Federal IGs will be responsible for the review and oversight of these contract actions.

Because of the nature of disaster operations, acquisition planning should be sufficiently flexible to address the impact of the disaster on production capabilities and available on-site inventory. However, pre-disaster acquisition planning can balance the capabilities of distributors, wholesalers, retailers, and manufacturers, and maximize the use of licensed manufacturers and dealers.

Department of Homeland Security

The DHS Office of Inspector General (OIG) issued 29 management advisory reports, some of which are summarized in Section 4 of this report. DHS OIG investigators reported 4,533 hotline complaints, 466 cases opened, 117 arrests, 140 indictments, and 40 convictions as of March 31, 2006.

As detailed in Section 6, the DHS OIG's Office of Inspection and Special Reviews (DHS-ISP) undertook a performance review of FEMA's disaster management activities in response to Hurricane Katrina. The review examined whether FEMA's authorities, plans, procedures, organizational structure, and resources were adequate and effective. As a result of this review, the DHS OIG made 38 recommendations to FEMA and other DHS components to improve emergency management capabilities.

A Performance Review of FEMA's Disaster Management Activities in Response to Hurricane Katrina

DHS OIG examined whether FEMA's organizational structure enhanced or hindered its emergency management capabilities. In its March 31, 2006 report, the DHS OIG made 38 recommendations, including that DHS headquarters and FEMA establish measurable expectations of FEMA's response; provide the

necessary financial, technical, and staff support to meet them; and assess FEMA's readiness.

In addition, DHS OIG made recommendations aimed at clarifying how DHS headquarters, FEMA, and other DHS components will implement aspects of the NRP, and address improvements to FEMA's infrastructure for resource ordering and tracking; personnel deployment; disaster communications; and disaster application handling.

To improve disaster preparedness, the DHS OIG recommended that FEMA complete catastrophic, surge, and workforce plans; add training; strengthen its remedial action program; and build relationships with the States in concert with the Preparedness Directorate and DHS Public Affairs. Finally, the DHS OIG recommended several modifications to improve how FEMA manages disaster assistance.

While management reviews are still ongoing, the DHS OIG disclosed the following information:

- Because FEMA's requirements planning prior to Katrina was inadequate, FEMA either purchased insufficient supplies, commodities, equipment, and other resources to support emergency and disaster response efforts or FEMA over-purchased commodities
- The government, in many instances, did not pay reasonable prices for goods and services because competition was limited or non-existent
- Costs and prices were not always controlled because the government's contract oversight and monitoring was inadequate

The one "non-concur" response to one of the 38 recommendations related to FEMA management's position that there is no duplication between the Interagency Incident Management Group (IIMG) and the Homeland Security Operations Center (HSOC).

The IIMG oversees incident management functions to execute prevention, protection, preparedness, response, and recovery strategies by combining existing FEMA-coordinated emergency support functions with other incident management groups and agencies, such as counterterrorism, law enforcement, border, maritime and transportation security, and other related activities.

The HSOC is the primary conduit for situation awareness to the White House Situation Room, DHS leadership, and federal incident management organizations. (At the time of this writing, all of the recommendations, which are covered in detail in Section 6, are still open for continued management input and discussion.)

Manufactured Homes and Trailers

As of March 31, 2006, there was little evidence of either formal or informal acquisition planning processes in the majority of FEMA procurements awarded for transitional housing, including travel trailers and mobile homes.

Many contract files did not contain any source-selection information, and there was no apparent source-selection process for the contract awards. For example, while some large contracts were awarded to firms that were well-established leaders in the industry, other large contracts were awarded to firms with

little or no industry experience for the product procured. In its effort to provide travel trailers to victims quickly, FEMA purchased more than 27,000 travel trailers “off the lot” from 300 local firms. In this case, the immediate need for housing likely overshadowed the need for planning, but nonetheless, FEMA risked receiving unusable trailers when it did not include any specifications in the contract.

Additionally, FEMA did not use standard templates for contract specifications for many of the products or services being procured despite the fact that they were procured on a regular basis. For example, DHS OIG reviewed a number of procurements for off-the-lot purchases of travel trailers, and there were no minimum government requirements listed in the contract, only the travel trailer vehicle identification number. Because no minimum government requirements were listed, the contractors did not have any requirement to provide trailers in working order. Therefore, vendors could submit trailers with significantly different levels of amenities, that is, trailers or mobile homes with or without bathroom, beds, dinettes, refrigeration, electrical outlets, water heaters, ranges, etc., that may or may not meet the government’s minimum needs or standards.

FEMA purchased 24,967 manufactured homes at a cost of \$862.7 million and 1,755 modular homes at a cost of \$52.4 million in response to the need for transitional housing to assist displaced evacuees from Hurricanes Katrina and Rita. Due to the large number of homes purchased and the need to prepare sites before distributing the homes, FEMA granted a mission assignment to the U.S. Department of Agriculture (USDA) Forest Service to set up eight emergency housing storage sites, including one in Hope, Arkansas, and one at Red River Army Depot in Texarkana, Texas. Most importantly, FEMA had no plans for how the homes would be used before they were purchased. Subsequently, there are currently 17,055 mobile homes



Hope, Arkansas -- Mobile homes ordered but unused as temporary housing remain in this field in Arkansas and in another location in Texas. A total of 17,055 of these units remain unused.

and 5,707 travel trailers staged at eight emergency housing sites waiting to be used.

The Government Accountability Office (GAO) reported that, in November, FEMA's contracts for installing temporary housing in four states had only 17 of the 27 required monitors. Even now, FEMA staff in New Orleans have told DHS auditors that there is inadequate monitoring of the Technical Assistance Contractors (TACs) because there are (1) too few Contracting Officer Technical Representatives (COTRs), (2) COTR rotation periods do not overlap, so the arriving COTR has not been sufficiently briefed by the departing COTR, and (3) many of the COTRs have been "borrowed" from other agencies and are not familiar with FEMA temporary housing contracts. Some FEMA staff allege that the TACs are "running the show."

The OIG is conducting a comprehensive review of the four TACs and plans to issue a report on their performance later this year. The OIG also found that FEMA's Housing Area Command (HAC), which is responsible for coordinating temporary housing throughout the affected area, worked independently of other FEMA field organizations and contributed to FEMA problems with contract oversight. The HAC did not communicate its activities and requested contractors to perform additional work without coordinating or receiving approval from the COTR. Consequently, the COTRs were not afforded the opportunity to effectively document and oversee the TACs' work. One of the OIG's concerns is the rejected sites for placing travel trailers for evacuees. The OIG is reviewing nine sites that were rejected, for various reasons, after an estimated total of \$8.5 million was spent preparing the sites.

Debris Removal

Under the Stafford Act, states have the option of using either the U.S. Army Corps of Engineers (USACE) to provide debris removal or entering into direct contracts. When using USACE, FEMA will pay the full cost of debris removal during the response period, usually the first 72 hours after the disaster declaration, but often extended during a catastrophic event. For example, the response period in Louisiana has been extended to June 30, 2006. FEMA will pay 100 percent of all debris removal costs performed by the USACE through the end of June.

After June, if the response date is not extended or state matching requirements are not waived, the state will be expected to pay a matching share of the costs. If a state decides to contract directly, it will be reimbursed by FEMA under a public assistance grant, but the state must pay a matching share unless it is waived. In Louisiana, about half of the parishes are using the USACE; the other parishes are contracting for debris removal work to be reimbursed by FEMA. The OIG is in the process of auditing debris removal grants awarded to the states.

In the past, the OIG has waited until most or all the work was completed before starting the audit. The amount of destruction and resulting debris from Hurricanes Katrina, Rita, and Wilma created unprecedented debris removal operations estimated at several billion dollars.

As a result of this massive effort, the OIG initiated audits of a number of debris removal grants with the goal of identifying and preventing problems before they occur. Specifically, the OIG is looking at the reasonableness of debris removal contracts, the types of awards, and the terms and conditions. In the past, the OIG reported cases of price gouging, inappropriate transactions, bribery, and false or padded billings.

New Orleans, LA, 4-9-06 – FEMA Debris Specialist for Private Property Debris Removal, Phillip Jones, takes a GPS reading to identify and record the location and debris type on this property in 9th Ward. FEMA is identifying, marking, and documenting what is on every lot in 9th Ward as part of the demolition process. Marvin Nauman/FEMA photo



Some of the OIG's work resulted in arrests and convictions. Other work identified significant ineligible or questioned costs that required reimbursement to the government.

The Blue Roof Program

The Blue Roof program provides roof tarps for homes that sustained some, but not major, roof damage. The tarps are a short-term preventive measure to mitigate further home damage until permanent repairs can be made. In most cases, it allows victims to return to their homes shortly after the disaster, thereby decreasing the need for temporary housing or shelters.

Traditionally, FEMA tasks the USACE to install the blue roofs through mission assignments under a Presidential disaster declaration. FEMA purchases and stockpiles the tarps in specific grades and quality. The USACE is responsible for hiring crews for tarp installation.

A number of manufacturers provide tarps that meet FEMA specifications. A sufficient inventory of the tarps was readily available after Hurricane Katrina and the prices that were paid were consistent with prices paid after other disasters. The OIG plans to continue to audit the blue tarp purchases during the recovery efforts.

Acquisition Lessons Learned

Through its oversight efforts, DHS OIG has learned the following about requirements planning and contract actions:

- Because requirements planning prior to Katrina was inadequate, FEMA scrambled to purchase supplies, commodities, equipment, and other resources from numerous vendors to support emergency and disaster response efforts
- Call or standby contracts with pre-negotiated prices, quantities, terms and conditions, and specifications could have greatly facilitated post-disaster procurement operations

- In some instances, the government did not pay a reasonable price for its purchases because competition was limited
- The government's contract oversight and monitoring was inadequate, resulting in cost and price variations

The DHS OIG plans to issue a contract management report later this year.

Department of Commerce

DOC hurricane response activities thus far include those conducted by the National Oceanic and Atmospheric Administration (NOAA), the National Institute of Standards and Technology (NIST), the Economic Development Administration (EDA), the National Telecommunications and Information Administration (NTIA), the Minority Business Development Agency (MBDA), and other efforts.

National Oceanic and Atmospheric Administration (NOAA)

NOAA awarded a total of \$6.4 million in contracts and procurements, broken down as follows: 57 contracts or procurements with values greater than \$10,000, 19 contracts or procurements with values greater than \$100,000, and two contracts with values greater than \$500,000. DOC OIG auditors visited the NOAA Procurement Office in Silver Spring, Maryland, and the Central Region Acquisition Office in Kansas City, Missouri, and obtained copies of all contracts for review. The Kansas City acquisition office handled approximately \$4.3 million of the contract awards. The contracts used preexisting agreements wherever possible, and small, local businesses in the hurricane-stricken areas received some of the contracts. Most contracts or procurements were fixed price. There were only two time-and-materials contracts. There were no verbal contracts and no unlimited ceiling cost contracts; nor were there any no-bid contracts to large firms such as Bechtel, CH2M Hill, Halliburton, Fluor Federal, or Shaw Group.

A contracting officer from NOAA's Kansas City office was sent to Pascagoula, Mississippi, to handle on-site procurements for emergency clean-up and building repairs at two NOAA sites (the National Marine Fisheries Lab and the National Seafood Inspection Lab). Department auditors visited the two NOAA sites to observe repairs and to inventory replacement equipment. NOAA's director of acquisitions is reviewing and tracking every hurricane-related procurement and reviewing transactions that appear questionable.

National Institute of Standards and Technology (NIST)

NIST awarded one time-and-materials contract for \$300,000 to assess damage to structures and make recommendations for additional studies of structural damage.

Economic Development Administration (EDA)

EDA awarded four grants totaling \$8.8 million to the States of Louisiana, Mississippi, and Alabama for technical assistance and economic recovery planning. The grants may not be used for construction or infrastructure activities. EDA waived requirements (such as Comprehensive Economic Development Strategies

and matching shares), modified general processing procedures, and designated the three States as Special Impact Areas to award the grants.

National Telecommunications and Information Administration (NTIA)

NTIA awarded one grant following applicable regulations for \$378,000 to repair transmission equipment of the Louisiana Public Broadcasting System.

Minority Business Development Agency (MBDA)

MBDA awarded one grant for \$300,000 to the Houston, Texas, Minority Business Development Center to assist minority businesses in Louisiana and Texas. MBDA waived the cost-sharing requirement of the grant.

Other DOC Efforts

DOC OIG auditors also visited the DOC Hurricane Contracting Information Center in Washington, D.C. Secretary Gutierrez opened the center on October 11, 2005, as a one-stop shop for small and disadvantaged businesses to learn about contracting and subcontracting opportunities. Contracting professionals from 12 federal agencies are staffing the center. In its first weeks, the center received 250 to 300 calls a day. It currently receives 100 to 150 calls a day.

DOC OIG Office of Investigations met with members of the Hurricane Katrina Fraud Task Force at its command center in Baton Rouge, Louisiana. The OIG will coordinate with this Task Force on any hurricane investigations that may arise.

Department of Defense

DoD contract actions include many with high visibility, such as debris removal, levee and floodwall repairs, and emergency water supplies.

Preparedness for Oversight

Specifically within DoD, the Office of Inspector General (DoD OIG), the Army Audit Agency (AAA), the Naval Audit Service (NAS), the Air Force Audit Agency (AFAA), the Defense Contract Audit Agency (DCAA), the Defense Criminal Investigative Service (DCIS), and the Army Criminal Investigation Command have employed a cadre of about 150 auditors, investigators, and inspectors who have provided professional oversight of contracts and operations related to Hurricane Katrina relief and recovery efforts. The OIG leveraged resources by coordinating among the DoD OIG, Service audit agencies, and other federal agencies to avoid possible duplication of efforts and to ensure broad audit coverage. The OIG deferred other audit work to ensure resources are available for this important effort. Hurricane Katrina audit efforts were given priority and took precedence over planned audit work that was not congressionally requested or mandated.

Audit Activities

DoD OIG Audit currently has 11 ongoing audits related to Hurricane Katrina efforts. Three audits were congressional requests, one audit was requested by DoD, and the remaining seven were self-initiated. The audits cover contracts on ice, water, Operation Blue Roof, subsistence, and construction capabilities; expanded micro-purchase authority for purchase card transactions; the effects on information technology resources in affected areas; accounting and oversight of obligations and expenditures related to DoD Hurricane Katrina efforts; and the use of DoD resources supporting the Hurricane Katrina relief and recovery.

DCAA is supporting both the FEMA and the USACE in their Hurricane Katrina recovery efforts. Further, AAA, NAS, and AFAA have each provided audit oversight. These audit agencies currently have 14 ongoing audit projects that cover the areas of contracting, financial accounting and reporting, contract data reporting, and purchase cards.

Investigative Activities

DCIS has received 21 criminal allegations related to Hurricane Katrina. As of March 31, 2006, DCIS has opened six cases dealing with bribery, kickbacks, and possible product substitution. Regarding coordination and oversight, DCIS conducted 34 mission or fraud awareness briefings. Currently, DCIS is working joint investigations with the U.S. Army Criminal Investigation Command and the FBI. In addition, DCIS is supporting the Hurricane Katrina Fraud Task Force Command Center in Baton Rouge, the joint law enforcement and U.S. Attorneys' Offices working group in Louisiana, and the Joint Criminal Investigative Task Force in Mississippi.

Vision for Future Recovery Oversight

DoD OIG Audit and the Service Audit Agencies have 24 ongoing audits and plans for future audits in the areas of contractor pricing and levels of subcontractors used, demolition contracts, contracts to enhance flood protection system, and reconstitution efforts at Keesler Air Force Base. Additional audit effort will be assessed based on the need and risk.

Katrina Fraud Hotline Effort

In support of the DHS and the PCIE community, the DoD OIG established the Katrina Fraud Hotline on October 4, 2005. The Hotline functions as a channel for logging, relaying, and tracking incoming complaints and allegations of wrongdoing. These complaints come to the Hotline through calls to an established toll-free telephone number or via fax, regular mail service, or e-mail. Initially, staff from the DoD OIG and detailees from the following federal agencies operated the Hotline:

- Department of Defense (NAS, DoD OIG)
- Department of Homeland Security
- Department of Justice
- Department of Labor

- Department of Transportation
- Department of Treasury
- Environmental Protection Agency
- U.S. Postal Service

Between October 5, 2005, and March 31, 2006, the Katrina Fraud Hotline reported 9,664 total DoD contacts, which includes calls, e-mail messages, letters, and faxes. Of those total contacts, 5,017 cases were opened and forwarded to the DHS for further review.

On March 20, 2006, control of the Katrina Fraud Hotline passed from the DoD OIG to the Hurricane Katrina Fraud Task Force Command Center in Baton Rouge, Louisiana.

Monitoring and Technical Advice

The DCAA is supporting both FEMA and the USACE in their Hurricane Katrina recovery efforts.

DCAA's support to FEMA is focused on FEMA's four largest reconstruction contractors: Bechtel, CH2M Hill, Fluor Federal, and Shaw Environmental. The audit effort has included forward pricing reviews, reviews of costs billed under government contracts, and pre-award accounting system surveys, as well as support of Source Selection Evaluation Boards.

DCAA has also provided direct support to the USACE emergency response mission. DCAA provides professional advice on accounting and financial matters to assist in contract negotiation, award, administration, re-pricing, and settlement. DCAA has been primarily involved in USACE missions related to the installation of plastic roofing (Roofing Mission) and debris removal (Debris Mission). This effort involves verifying contractor compliance with the terms and conditions of the contract. DCAA conducts audit steps such as on-site visits, physical observations, and verification of contractor records to ensure compliance with contractor policies and contract terms.

Department of Education

The Hurricane Education Recovery Act (HERA), signed by President Bush on December 30, 2005, authorized three new grant programs to assist school districts and schools in meeting the educational needs of students displaced by Hurricanes Katrina and Rita and to help schools closed as a result of the hurricanes to reopen as quickly and effectively as possible. These programs are (1) the Immediate Aid to Restart School Operations (Restart) program (\$750 million), (2) the Assistance for Homeless Youth (Homeless Youth) program (\$5 million), and (3) the Temporary Emergency Impact Aid for Displaced Students (Emergency Impact Aid) program (\$645 million).

The HERA also funded three initiatives for students attending institutions of higher education in areas affected by Hurricanes Katrina and Rita. These initiatives are (1) Emergency Assistance for Higher Education to the Louisiana Board of Regents (\$95 million), (2) Payments to Institutions of Higher Education to Defray Unexpected Expenses of Displaced Students (\$10 million), and (3) Assistance for Higher Education



New Orleans, LA 1-23-06 – Southern University at New Orleans officials review classroom plans during a walk through of phase A inspection of the Facility FEMA is providing for them. FEMA is providing the Southern University at New Orleans (S.U.N.O.) with 45 Modular Buildings to provide instructional Classrooms, Offices, Cafeteria, and facilities staffed for student education. MARVIN NAUMAN/FEMA photo

to the Mississippi Institutes of Higher Learning (\$95 million).

Department of Education OIG staff members are working closely with the DHS to help ensure that HERA funds are expended in accordance with the terms of the grants and applicable laws, regulations, policies, and procedures. The OIG has nine audits underway and one additional audit is planned to begin in April 2006. The OIG also was an active participant in creating a new section of the OMB Circular A-133 Compliance Supplement to cover the new HERA programs. This addition to the Compliance Supplement will be used nationwide in conjunction with the 2006 Single Audits.

Department of Energy

The Department of Energy IG has conducted one audit entitled “Special Report on the Department of Energy’s Response to Hurricanes Katrina and Rita” (IG-0707, November 9, 2005) and reported one ongoing audit, “The Department of Energy Strategic Petroleum Reserve.”

Department of Health and Human Services

In the months after Hurricanes Katrina and Rita hit the Gulf Coast, the HHS OIG launched an aggressive coordinated oversight effort. OIG is working to ensure that federal response and recovery funds are spent appropriately; those individuals attempting to defraud the government are brought to justice; and the individuals responsible for the relief efforts are wise stewards in their work, assisting those impacted by the hurricanes and their aftermath. In addition, more than 2,500 HHS staff and volunteers have been sent to the Gulf States in response to the hurricane disasters.

OIG is working with federal, State, and local partners in this effort, including participating as a member of the PCIE Homeland Security Roundtable, which is coordinating the oversight activities of the various IGs. In addition, along with other members of the IG community, HHS is a member of the Hurricane Katrina Fraud Task Force and Command Center in Baton Rouge. This task force is designed to investigate al-

legations of fraud related to federal outlays in connection with Hurricane Katrina. Separate from this, OIG is conducting several investigations jointly with the Medicaid Fraud Control Unit in the State of Louisiana in connection with allegations of poor quality of care and patient abuse and neglect that occurred during Hurricane Katrina and its aftermath.

Department of Housing and Urban Development

HUD has taken a number of actions to address the more immediate housing assistance issues and challenges, including the following:

- Establishing a Hurricane Recovery and Response Center (HRRC), an emergency management division chaired by the Assistant Secretary for Housing-Federal Housing Commissioner that serves as the HUD Headquarters command post and reports directly to the Secretary
- Establishing a field operations office in Baton Rouge and dispatching HUD specialists with expertise on manufactured housing, reconstruction, and community planning
- Working with the United States Conference of Mayors and the National Association of Counties to coordinate the identification of housing opportunities nationwide
- Identifying vacant public housing units and available vouchers nationwide
- Temporarily waiving numerous program requirements to make it easier for disaster-displaced individuals who previously received housing assistance to obtain housing assistance in their new locations
- Modifying or awarding contracts to provide various contractor services to address the housing assistance needs of the displaced hurricane victims
- Identifying about 6,000 HUD-owned properties within a 500-mile radius of the disaster region and authorizing management and marketing contractors to rehabilitate the properties to make them available for housing

HUD OIG investigators have initiated or participated in a number of significant investigation activities, including the following:

- Review of State Action Plans—Office of Investigation senior management met with the States of Louisiana and Mississippi to coordinate fraud prevention efforts
- FEMA Disaster Relief Centers—the Office of Investigation coordinated with HUD officials at these FEMA centers to brief staff of Katrina Disaster Housing Assistance Program (KDHAP) on application fraud by evacuees
- Damage Assessment Survey—special agents photographed and documented hurricane-related damage to all HUD public housing and multifamily projects in Louisiana and Mississippi
- Outreach Program—the Office of Investigation addressed the National Affordable Housing Managers Association in Jackson, Mississippi, regarding multifamily development and associated fraud opportunities
- Training—HUD OIG is working with the Louisiana Recovery Authority and the Mississippi Develop-

ment Authority to train staff, property appraisers, and homeowner service center employees on fraud awareness

- Liaison—the Office of Investigation met with the Mortgage Bankers Association to establish fraud prevention training and fraud-reporting protocols for disaster-related matters

Department of Interior

The DOI OIG is continuing its audit effort to ensure the Department is making the best use of funds and to confirm the appropriateness of current and future contracts. Identifying all costs associated with hurricane relief and assessing the adequacy of the controls used to collect and report the costs is currently the primary focus. Although the OIG has had a limited number of investigative cases associated with Hurricane Katrina, the OIG will actively pursue any additional complaints. The Hurricane Katrina Fraud Task Force has been able to assist the agency's investigators by running names of companies suspected of criminal wrongdoing through law enforcement information systems.

Department of Justice

Contract Actions

The Federal Bureau of Prisons (BOP) awarded a \$5.2 million sole source contract for roof repairs at the Beaumont, Texas, Federal Correctional Complex. The DOJ OIG is currently conducting an audit of this contract to determine whether: (1) the BOP had adequate justification for awarding a sole source contract, (2) the cost of the repairs was reasonable, and (3) the contract was awarded appropriately.

Highlights of Grants Management

Following the Hurricane Katrina disaster, the Office of Justice Programs, Bureau of Justice Assistance (BJA), awarded 33 Hurricane Katrina disaster relief grants for \$5,000,003. The DOJ OIG conducted an audit that examined whether BJA implemented appropriate internal controls and procedures for the 33 grants. The purpose of these grants is to assist State and local criminal justice agencies by providing funding for items such as additional personnel, equipment, supplies, training, and technical assistance. The OIG found that while BJA was proactive in providing additional grant funding to grantees in the Hurricane Katrina affected areas, it had no assurance that funding was going to the areas of greatest need. The DOJ OIG will also conduct audits of 5 of the 33 criminal justice agencies that received one of these grants to determine whether costs claimed under the grants are reasonable, allocable, allowable, and in accordance with applicable laws, regulations, and the terms and conditions of the grants.

Purchase Card Transactions

As of December 31, 2005, DOJ components purchased approximately \$8.6 million of goods and services using government purchase cards. Of that amount, the BOP accounted for expenditures totaling approximately \$4.8 million, which appear to be related to relocating and housing prisoners. The majority of the

purchase card expenditures for all DOJ components appears to be for food, supplies, building equipment, and safety equipment needed for law enforcement functions. The DOJ OIG is currently performing an audit of hurricane-related purchase card transactions.

Department of Labor

The OIG's first task was to assess risks and identify vulnerabilities that might hinder the effective delivery of services and benefits to eligible individuals. Through early and frequent discussions with the Department's leadership, the OIG drew on its past experience with DOL programs to communicate and provide advice on how to mitigate potential risks. For example, the OIG noticed a significant vulnerability in the unemployment insurance (UI) program: evacuees receiving unemployment benefits from a disaster state would obtain employment in another state without reporting it, thereby improperly continuing to draw unemployment benefits.

The OIG recommended the Department work with Louisiana and the other affected States to obtain or accelerate access to the National Directory of New Hires (NDNH). This national database was originally created to collect information on individuals who have obtained employment for child support enforcement purposes, but it has also proven useful to identify UI claimants who went to work in other states.

One product of these early efforts was an OIG *Risk Alert* to provide information on and identify vulnerabilities associated with DOL programs involved in the Hurricane response. The *Risk Alert* was disseminated to the State Auditors of all States and territories. DOL OIG also posted on its Web site current information on the OIG's hurricane-related audit and investigative results, links to the *Risk Alert* and Katrina Fraud Hotline, and information on the OIG community's hurricane oversight efforts.

Its second task was to develop a coordinated audit and investigative approach to DOL's hurricane response. With more than 30 auditors and investigators assigned to hurricane-related activities, communication and data-sharing were critical for an effective OIG response. Working with State officials, OIG staff set out to perform data mining and other techniques on UI and Disaster Unemployment Assistance (DUA) data files to identify potentially fraudulent overpayments and initiated investigations as appropriate.

Highlights of Grants Management

The OIG initiated reviews of National Emergency Grant (NEG) programs in Louisiana, Mississippi, Texas, and Alabama to quickly identify and communicate to the Department issues that needed policy decisions, monitoring, or other action. The OIG issued management letters to convey preliminary results to the Department, in this case, the Employment and Training Administration (ETA). The management letters were an interim reporting mechanism intended to be used with the understanding that more detailed, subsequent reviews may be performed.

Recommendations for Preparedness

The Department of Labor should take action to do the following:

- Accelerate States' access to the National Directory of New Hires (NDNH)
- Develop guidance on compensating back-end controls that must be in place when existing controls are suspended
- Evaluate and mitigate risks associated with putting technology to new uses in times of crisis, such as paying unemployment claims via debit cards
- Develop guidance on the allowable and appropriate uses of National Emergency Grants

The NDNH is a national database originally created for child support enforcement purposes that collects information on individuals who have obtained employment. This could help reconcile and identify unemployment insurance claimants who went to work in other States.

Department of Transportation

At the request of the DOT's Assistant Secretary for Budget and Programs/Chief Financial Officer, the OIG assisted in developing a detailed Hurricane Financial Stewardship Control Plan outlining existing and additional internal controls needed to safeguard the expenditure of taxpayer funds in support of hurricane relief and recovery activities. For example, the OIG provided input regarding (1) possible financial management risks identified in prior audit reports and congressional testimonies and (2) specific actions the OIG planned to take to oversee DOT departmental and operating administration hurricane-related spending. This plan represented DOT's initial construct for the oversight of expenditures related to Hurricanes Katrina and Rita and was submitted to the Office of Management and Budget (OMB).

A recent DOT OIG audit led to the recovery of \$32 million on the Department's emergency transportation services contract, because the actual number of buses used to evacuate flood victims from New Orleans was far less than initial estimates. This audit also identified opportunities for improving how the contract is administered during future emergencies. The Department implemented OIG recommendations to obtain better information for evaluating contractor price quotes and documentation of goods and services received (Report #AV-2006-032, dated January 20, 2006).

Department of the Treasury

The Department of Treasury OIG has two ongoing audits, specifically:

- Office of the Comptroller of the Currency's Response to Hurricanes Katrina and Rita (Project Number: A-BK-06-001)
- Office of Thrift Supervision's Response to Hurricanes Katrina and Rita (Project Number: A-BK-06-002)

Also, Treasury OIG investigators agents participated in staffing the Katrina Fraud Hotline to combat fraud and other crimes related to this natural disaster and responded to more than 800 Hotline calls.

Department of Veterans Affairs

Hurricane Katrina produced significant damage to VA facilities along the Mississippi Gulf Coast and New Orleans. The VA Regional Office in New Orleans; the Biloxi National Cemetery; and the VA Medical Centers at New Orleans, Gulfport, and Biloxi received major damage, causing the facilities to be closed in some instances. Hurricane Rita created significant disruptions in service and ongoing repairs, but it did not further devastate the VA's infrastructure in that region.

The Department produced two final audits, including:

- Audit of Alleged Mismanagement of VA's Permanent Change of Station Travel Program (2006-00785-R9-0080)
- Audit of the Department of Veterans Affairs' Response and Recovery Efforts Related to Gulf Coast Hurricanes (2006-00595-R9-0057)

Environmental Protection Agency

EPA's Stewardship Plan requires all EPA offices involved in current and future acquisitions related to support of hurricane rescue, recovery, and reconstruction operations to ensure prudent stewardship of taxpayer funds used for these acquisitions.

Significant acquisitions awarded immediately following Hurricane Katrina and prior to the effective date of the Stewardship Plan (September 26, 2005) are being reviewed by a control board that is composed of the EPA Office of Acquisition Management Division Directors and one representative each from the Office of General Counsel, the Office of the Chief Financial Officer, and the Office of the Chief Information Officer.

The EPA Board's review is intended to determine whether significant acquisitions were placed appropriately, and whether adequate controls are in place to ensure performance and accountability. The EPA OIG has participated in the control board's reviews in an advisory capacity, providing guidance and technical advice.

Contract Actions

EPA executed 257 contract actions with a total value of \$235,413,000. EPA's contracting effort in response to the hurricane disaster has primarily focused on using its existing Superfund Technical Assessment and Response Team/Emergency and Rapid Response Services (START/ERRS) contracts. These contracts provide for 24/7/365-response capability for natural disasters as well as nuclear, biological, chemical, and radiological events. The START/ERRS contractors are providing labor and equipment to support the EPA's relief and recovery efforts. Specifically, the contractors are providing services for sampling; field detection/monitoring; quality assurance/quality control support; data management; technical advice; and assistance with the coordination and communication among federal, State, and local responding agencies and the public.

The EPA OIG review is primarily focused on examining contractor invoices submitted under the START/ERRS contracts to determine whether the amounts billed are allowable and allocable. The OIG is also examining the Agency's oversight of these contracts, including billing review procedures and contract administration.

The OIG determined that EPA Region 4 had been conducting limited reviews of contractor invoices. In most cases, Region 4 relied on field operators rather than contracting personnel to review costs, and these personnel had limited time and resources to perform the reviews. This approach is more likely to produce errors and unallowable costs may not be identified as a result. Indeed, the OIG noted several instances of contractors billing incorrect labor rates, using incorrect indirect rates, and double billing. After raising these concerns, Region 4 provided more contracting personnel to review contracting invoices.

EPA had been leasing command post space at a school as well as accommodations in 78 trailers, and the Agency had been planning to extend the contracts for 6 months. The OIG noted concerns with the current costs being charged, particularly for the trailers and their related services. Because of its concerns, EPA issued a request for information to determine whether there were other options for housing and the command post. The Agency received more than 80 inquiries in response to this request. EPA then issued a request for quotations, and awarded a new contract on March 20, 2006. Awarding follow-on contracts competitively should produce cost savings.

For the large volume of new equipment purchased in support of the Hurricane Katrina response, EPA did not place the needed decals on the equipment and did not record the equipment in its property system. This occurred because much of the equipment was shipped directly to field locations so that it could quickly be put into use. However, lack of decals and recording can make equipment difficult to locate and leaves it susceptible to theft. EPA Regions 4 and 6 began identifying, tagging, and recording the equipment after the OIG made them aware of the situation.

Purchase Card Transactions

EPA used purchase cards to acquire air and water sampling equipment, supplies, computer equipment, and software. EPA's most significant purchase card transactions were for leasing recreational vehicles to use as temporary housing for EPA personnel working on hurricane relief activities. Subsequently, EPA leased additional housing using purchase orders.

The OIG selected a sample of approximately 30 percent of the purchase card transactions concentrating on expensive pilferable items, such as digital cameras, cell phones, and portable desk accessories (PDAs). The OIG is awaiting supporting documentation to verify the approval, receipt, and entry of these items into an EPA equipment management system. EPA has made \$1.48 million in purchase card transactions.

Coordination

EPA's follow-up reviews for all significant acquisitions made after September 26, 2005, are required no later than 60 days after the award (contracts or purchase and delivery orders) or the transaction date (pur-

chase card transactions). These reviews are being performed by EPA's Office of Acquisition Management, which is responsible for oversight of contract operations. The oversight reviews include an examination of a sample of significant acquisition files to verify compliance with regulations and established policy. The EPA OIG has coordinated its efforts with Agency managers to ensure that no duplicate reviews are performed. While OIG auditors have selected their own transactions to review, they are also working closely with EPA employees to ensure consistency among transaction reviews. OIG auditors are also working closely with Agency personnel to resolve issues of concern, such as temporary housing and equipment accountability.

Since September 2005, the Office of Investigations has deployed six Special Agents on several missions to the affected Gulf States to meet with EPA officials, government contractors, federal prosecutors, and local and State law enforcement officials. Special Agents are participating at the Hurricane Katrina Fraud Task Force Joint Command Center, where they have access to task force databases, intelligence, and staff for operational support during investigations conducted in the affected Gulf States. In addition, they are engaged in periodic meetings with task force members to discuss investigative operations and have conducted a variety of investigative steps to address allegations of fraud against EPA and EPA-funded programs.

Federal Communications Commission

The Commission has announced that it would use \$211 million from the FCC's Universal Service Fund (USF) funds to assist with recovery in the Gulf Coast area. This includes \$51 million in USF assistance from the Low Income Program. Persons eligible for FEMA disaster assistance who are without telephone service will receive support for wireless handsets and a package of 300 free calling minutes for evacuees and people in the affected area without telephone service. Persons eligible for FEMA disaster assistance may receive support to pay the costs of reconnecting consumers to the network as the disaster-struck area is rebuilt. The OIG will conduct an audit to identify areas of risk, potential vulnerabilities, and compliance with program requirements and regulations as outlined by the Commission's Katrina relief proposals.

Federal Deposit Insurance Corporation

Over the last six months, the FDIC OIG monitored the Corporation's response to the impact of Gulf Coast hurricanes on the financial services industry. The OIG also coordinated with other interested parties regarding possible joint oversight efforts and is prepared to conduct FDIC-specific audit, evaluation, and investigative work as circumstances warrant.

Just days after Hurricane Katrina struck the Gulf Coast, the FDIC formed its own fraud task force to meet and discuss FDIC efforts, as well as those of financial regulators, and disaster recovery groups to deal with the aftermath of the 2005 hurricanes.

As a member of the DOJ's Hurricane Katrina Fraud Task Force, the FDIC OIG also established a page on its website to provide information on its hotline and guidance for possible victims. Any FDIC-regulated financial institution that believed it had been the victim of fraud, or any individuals who believe that they were victims of bank-related consumer fraud, could contact the OIG for assistance through its hotline.

The OIG anticipates bank fraud to be a long-term significant problem and will continue to monitor hotline activities.

In October 2005, the FDIC OIG arranged for representatives of the OIGs of the federal banking regulators—Federal Reserve, Treasury (which oversees the Office of the Comptroller of the Currency and Office of Thrift Supervision), National Credit Union Administration, and FDIC—to discuss ongoing or planned audit efforts in response to the Gulf Coast hurricanes. The various representatives indicated that there were no immediate plans for audit work to avoid interfering with ongoing recovery operations and the representatives agreed to stay informed of future audit work related to these disasters.

General Services Administration

GSA's role in emergencies, such as Hurricane Katrina, is twofold. First, under the 2004 National Response Plan, GSA serves a central role in procuring equipment and services used by FEMA. GSA has awarded approximately \$1 billion in contracts on FEMA's behalf. In these procurements, FEMA uses GSA contracting professionals to award contracts for which FEMA has identified the procurement requirement, and FEMA is billed directly.

Second, GSA has responsibilities as the landlord to federal agencies in the affected area to locate or repair space so that the agencies may continue their missions. Initially, 84 facilities in four States were affected. GSA incurred expenses as a result of hurricane damage to federal buildings, and \$38 million in supplemental funding was provided to the Federal Buildings Fund to facilitate repairs to these damaged buildings.

Recommendations for Preparedness

The General Services Administration (GSA) needs to discuss pre-qualified contractors (in addition to the Multiple Award Schedules) as well as additional sources of certain staples. The demand for meals ready-to-eat was so great, that it depleted the Defense Logistics Agency supplies.

Additionally, training is needed in both emergencies and FEMA procedures to ensure that coordination among agencies goes more smoothly. There are aspects of the National Response Plan itself that may need to be revisited. For example, security has been the responsibility of the Department of Homeland Security since 2003, but it is also still identified as part of GSA's responsibilities.

The government must be able to do a better job of tracking its expenditures related to disasters. The mission assignment process needs to improve to facilitate the reconciliation at the end of the assignment and, while the Federal Procurement Data System exists, to facilitate accurate, up-to-date contract reporting.

National Aeronautics and Space Administration

The National Aeronautics and Space Administration (NASA) reported that it has awarded 33 contracts, with a value of nearly \$89 million, to support Hurricane Katrina recovery efforts. The NASA OIG is re-

viewing internal controls to manage its recovery efforts; specifically, it is evaluating NASA's estimation and execution of Hurricane Katrina funds and the processes used to ensure that those funds are used for their intended purposes.

Small Business Administration

As of March 31, 2006, the Small Business Administration (SBA) approved more than \$7 billion in loans to homeowners, renters, and businesses in the Gulf Coast area. SBA OIG has also begun a series of audits on selected aspects of loan processing, including the use of the newly implemented Disaster Credit Management System (DCMS) and its interface with FEMA's National Emergency Management Information System (NEMIS). SBA OIG has planned a number of audits to be conducted throughout the loan cycle, to include loan origination, disbursement, use of proceeds, servicing, and liquidation.

In addition, SBA OIG has drafted and circulated for comments a review guide for other agencies to use to assess small business contracting activities. SBA OIG has also coordinated with GAO on its recently initiated review of small business procurement in the Gulf Coast region.

SBA OIG continues to coordinate with other law enforcement agencies and the Hurricane Katrina Fraud Task Force and participate in meetings on joint data mining and fraud-detection efforts. SBA OIG also continues to monitor the task force's investigative activity for patterns of fraud being committed by organized groups against SBA.



Waveland, MS – Small Business Administration workers help resident of Waveland, MS apply for SBA program support from their tented disaster assistance center

Monitoring and Technical Advice

The SBA OIG provided fraud awareness information packets to more than 700 Office of Disaster Assistance employees at SBA's Fort Worth Disaster Center, and anti-fraud hotline posters were disseminated throughout SBA field disaster centers in the Gulf States.

As part of its review of the DCMS, the SBA OIG identified that SBA employees had unrestricted access to an Internal Revenue Service (IRS) Tracking Report that contained pending loan applicants' names, addresses, and social security numbers. The potential Privacy Act violation was reported to the SBA Privacy Officer and the unrestricted access was disabled. As a result, access was restricted to necessary personnel.

The SBA OIG assisted SBA in preparing an October 21, 2005, news release urging hurricane survivors to be aware of scam artists posing as federal officials offering help, while trying to take advantage of those facing the daunting challenge of rebuilding their lives. The OIG also issued an information notice to all SBA employees announcing the Katrina Fraud Hotline. The OIG asked SBA employees to increase their awareness of fraudulent activities as they receive and process disaster-related loans and provide other disaster-related assistance and report any fraudulent activities to the hotline.

Significant Oversight Highlights

The SBA OIG's Office of Security Operations is conducting name checks and FBI fingerprint checks on borrowers whose disaster loan applications indicate a criminal history. The results of these checks are reported to SBA program officials for character eligibility determinations.

On February 23, 2006, SBA OIG issued a letter to the Ranking Member of the House Committee on Homeland Security concerning three contractors that received small business contracts that appeared to be large businesses. SBA OIG found that two of the contractors had not certified to the procuring agency that they were small businesses. The procuring agencies misclassified these businesses when reporting the procurements. The third contractor, however, had appropriately certified it was a small business at the time the contract was awarded.

Recommendations for Preparedness

The Small Business Administration Office of the Inspector General (SBA OIG) reports—especially those relating to the interface between FEMA's NEMIS and SBA's Disaster Credit Management System (DCMS)—need to be corrected before next hurricane season to ensure timely and efficient disaster assistance to individuals and businesses.

Further, while SBA OIG has not completed its review of the DCMS upgrade, the DCMS has limitations on the number of users that can access the system at one time. SBA is implementing an upgrade that is designed to double user capacity. This upgrade is essential to process loan applications in a timely manner.

Social Security Administration

The Social Security Administration (SSA) OIG reported one audit in process: Service Delivery to Individu-

als and Beneficiaries Affected by Hurricanes Katrina and Rita (A-06-06-26072).

The objective of this audit is to determine and report on the status of the SSA's service delivery to individuals and beneficiaries affected by Hurricanes Katrina and Rita and assess the Administration's plans to ensure payments made under emergency procedures were appropriate and properly safeguarded.

SSA OIG has received a total of 42 allegations of potential fraud relating to Hurricanes Katrina and Rita. Of those, most fall into the category of social security number (SSN) misuse, which includes identity theft and false claims, among other violations.

Treasury Inspector General for Tax Administration

IRS Response to 2005 Gulf Coast Hurricanes

The 2005 Gulf Coast hurricanes presented an unprecedented need for government assistance to more than 11 million taxpayers who lived in the affected areas of the Gulf Coast, as well as to others who may have been adversely impacted by these storms. New tax law provisions were included in the Katrina Emergency Tax Relief Act of 2005,¹ the Gulf Opportunity Zone Act of 2005,² and in provisions in the Working Families Tax Relief Act of 2004³ and the American Jobs Creation Act of 2004,⁴ all of which became effective in 2005. The most recent legislation, the Gulf Opportunity Zone Act of 2005, was signed into law on December 21, 2005.

The Senate Finance Committee requested that the Treasury Inspector General for Tax Administration (TIGTA) review IRS activity to ensure the IRS was prepared to effectively respond to the taxpayer needs. In response, the TIGTA assigned more than 50 auditors and investigators. To date, the auditors have accomplished the following:

- Initiated 10 non-contract reviews of key tax administration customer service, tax returns processing, compliance, and, taxpayer data and employee security programs undertaken by the IRS for response and recovery activities
- Opened two investigations, and made one arrest and one indictment on another investigation related to hurricane relief tax administration issues
- Monitored 16 contracts totaling \$318,000 that the IRS awarded and made \$74,000 in purchase card transactions that IRS used to address Hurricane relief efforts

The TIGTA believes that, overall, the IRS was adequately prepared for and responded appropriately in addressing the majority of hurricane-related tax relief issues.

¹ Pub. L. No.109-73, 119 Stat. 2016 (to be codified in scattered sections of 26 U.S.C.).

² Pub. L. No.109-135, 119 Stat. 2577 (2005).

³ Pub. L. No.108-311, 118 Stat. 1166 (2004).

⁴ Pub. L. No.108-357, 118 Stat. 1418 (2004).

Customer Service Program Reviews

Three Customer Service Program reviews were conducted to address the impact of hurricane activity on IRS' preparation for the 2006 tax filing season (the period from January through mid-April when most individual income tax returns are filed). These reviews addressed the following issues:

- The level of staff accuracy in addressing tax law questions related to the Katrina Emergency Tax Relief Act of 2005
- The operation of the toll-free telephone system
- The operation of taxpayer Field Assistance offices

Tax Return Processing Program Reviews

Three Tax Return Processing Program reviews were conducted to verify whether the IRS could accurately deal with tax filing in the post-Katrina environment:

- Accurately update tax products and computer programming for tax law changes affecting the processing of individual income tax returns during the 2006 filing season
- Accurately process individual tax forms that incorporated relevant new tax legislation in a timely manner
- Correctly identify hurricane impacted taxpayers and accurately place disaster indicators on their accounts and suppress applicable notices during the disaster relief period

Compliance Monitoring Program Reviews

Three Compliance Monitoring Program reviews were conducted to determine whether the IRS could perform the following:

- The Exempt Organization function to ensure that new tax-exempt organizations, established to provide assistance to individuals affected by Hurricane Katrina, were properly approved and that referrals of potentially abusive charitable organizations were given priority treatment
- The examination and collection functions received appropriate compliance actions on open cases in designated Hurricane Tax Relief areas
- Automated Underreporter Program ensured that compliance actions were suspended for hurricane-impacted taxpayers

TIGTA also initiated a security program review (for data and employees) to evaluate actions taken. This review examined how the IRS protected taxpayer data and accounted for employees in damaged offices both prior to the hurricanes' arrival and actions taken in the aftermath. This review also evaluated business resumption plans in various locations to determine whether the IRS is prepared for future disasters.

Department of Agriculture

As of March 31, 2006, the Department OIG has ten audits in process and six more audits planned. The OIG reported that many of its investigations originated from referrals by the U.S. Attorney's Offices in Mississippi and Louisiana. The cases involve government-benefit fraud originating from individuals who have submitted false claims or made false statements to obtain benefits to which they are not entitled.

U.S. Postal Service

The Postal Service has issued seven draft or final audits related to hurricane recovery. The Service has three audits in process and one additional audit on supply management is planned.

FUNDING

3



New Orleans, LA, February 24, 2006 – Dismantling of the barge grounded at the levee break in the lower 9th ward has begun as FEMA continues debris removal in this area. Robert Kaufmann/FEMA

OVERSIGHT OF GULF COAST HURRICANE RECOVERY

Gulf Coast Recovery Funding

Federal response and recovery efforts have been extensive, and the rebuilding in the Gulf Coast continues. Congress has appropriated \$67.5 billion to meet the needs of reconstruction. The \$67.5 billion accounts for the amounts made available under three emergency supplemental acts passed in 2005, two of them in September and one in December 2005.

Private funding totaling \$3.57 billion has been donated to Gulf Coast recovery efforts in cash and in-kind gifts, as of February 20, 2006, according to the University of Indiana's Center on Philanthropy. In addition, various foreign governments donated approximately \$100 million to assist hurricane victims.

EMERGENCY SUPPLEMENTAL APPROPRIATIONS

The three emergency supplemental appropriation bills signed into law in response to Hurricane Katrina are

- Public Law (P.L.) 109-61, Emergency Supplemental Appropriations Act to Meet Immediate Needs Arising From the Consequences of Hurricane Katrina, 2005, September 2, 2005
- P.L. 109-62, Second Emergency Supplemental Appropriations Act to Meet Immediate Needs Arising From the Consequences of Hurricane Katrina, 2005, September 8, 2005
- P.L. 109-148, Department of Defense, Emergency Supplemental Appropriations to Address Hurricanes in the Gulf of Mexico, and Pandemic Influenza Act, 2006, December 30, 2005

The President's Council on Integrity and Efficiency/Executive Council on Integrity and Efficiency (PCIE/ECIE) 90-Day Progress Report to Congress on Oversight of Gulf Coast Hurricane Recovery issued on December 30, 2005, reported that Congress had passed, in December 2005, a hurricane relief bill (P.L. 109-148) that redirected \$29 billion of the previously approved \$62.3 billion in appropriations towards economic development, federal facility restoration, and tax relief. Eventually, that figure was reduced to \$28.6 billion.

Although P.L. 109-148 initially appropriated \$28.6 billion, \$23.4 billion was rescinded by decreasing the Disaster Relief Fund, which is managed by the Department of Homeland Security's (DHS's) Federal Emergency Management Agency (FEMA). Thus the "net" appropriation then for P.L. 109-148 was \$5.2 billion; the cumulative total over three supplemental acts is \$67.5 billion.

The first two supplemental acts, P.L. 109-61 and P.L. 109-62, appropriated \$60 billion (or 96 percent of the total appropriation amount of \$62.3 billion in these two acts) to the Disaster Relief Fund. Subsequently, FEMA provided funding to other federal agencies by Mission Assignments (MAs). The \$23.4 billion was a rescission against the \$49.98 billion appropriated to the Disaster Relief Fund in the Second Emergency Supplemental Appropriations Act (P.L. 109-62) of September 8, 2005.

EMERGENCY SUPPLEMENTAL FUNDING PROFILE (in millions of dollars)

Department/Agency	P.L. 109-61	P.L. 109-62	P.L. 109-148	Subtotals
DHS (FEMA Disaster Relief Fund)	\$10,000	\$49,985	-\$23,409	\$36,576
DHS (Other)	-	\$15	\$285	\$300
Dept. of Commerce	-	-	\$404	\$404
DoD/USACE	\$500	\$1,800	\$8,653	\$10,953
Dept. of Education	-	-	\$1,600	\$1,600
Dept. of Interior	-	-	\$70	\$70
Dept. of Health and Human Services	-	-	\$640	\$640
Dept. of Housing and Urban Development	-	-	\$11,890	\$11,890
Dept. of Justice	-	-	\$229	\$229
Dept. of Labor	-	-	\$125	\$125
Dept. of Transportation	-	-	\$2,798	\$2,798
Dept. of Veterans Affairs	-	-	\$593	\$593
Small Business Administration	-	-	\$446	\$446
Dept. of Agriculture	-	-	\$779	\$779
Other Agencies	-	-	\$130	\$130
Totals	\$10,500	\$51,800	\$5,233	\$67,533

Source: Public Law 109-61, 109-62, 109-148

Note 1: This table does not reflect the increases in FEMA's National Flood Insurance borrowing authority:

(a) Pub. L. No. 109-65, increased borrowing authority from \$1.5 billion to \$3.5 billion

(b) Pub. L. No. 109-106 increased borrowing authority from \$3.5 billion to \$18.5 billion

(c) Pub. L. No. 109-208 increased borrowing authority from \$18.5 billion to \$20.8 billion

Table 3-1

The Third Emergency Supplemental Act

Under P.L. 109-148, which became law on December 30, 2005, Congress directed \$28.6 billion across a large number of federal agencies. Figure 3-1 provides the amounts appropriated to the departments and agencies. The Department of Housing and Urban Development was appropriated the largest amount of funding of all agencies. HUD's \$11.9 billion appropriation includes the following:

- \$11.5 billion for the Community Development Fund to assist five Gulf Coast States with expenses related to disaster relief, long-term recovery, and restoration of infrastructure
- \$390 million for housing vouchers for households within the area declared a major disaster

The \$11.5 billion was distributed as follows: \$6.21 billion to Louisiana, \$5.06 billion to Mississippi, \$83 million to Florida, \$75 million to Texas, and \$74 million to Alabama. The governors of these States have identified the appropriate State agency to receive the funds and are submitting plans to HUD detailing how the block grant funds will be used.

The Katrina Disaster Housing Assistance Program (KDHAP) was previously funded at \$79 million to relocate 102,000 families in the disaster area.

Other appropriations from the third supplemental can be found in Figure 3-1 and include the following:

- \$8.65 billion to the Department of Defense for construction; military personnel expenses; operations and maintenance; emergency procurement requirements; replacement of damaged or destroyed naval vessels and equipment; and other general expenses (this amount includes \$2.9 billion for U.S. Army

HURRICANE RECOVERY: THIRD SUPPLEMENTAL APPROPRIATIONS

(in millions of dollars)

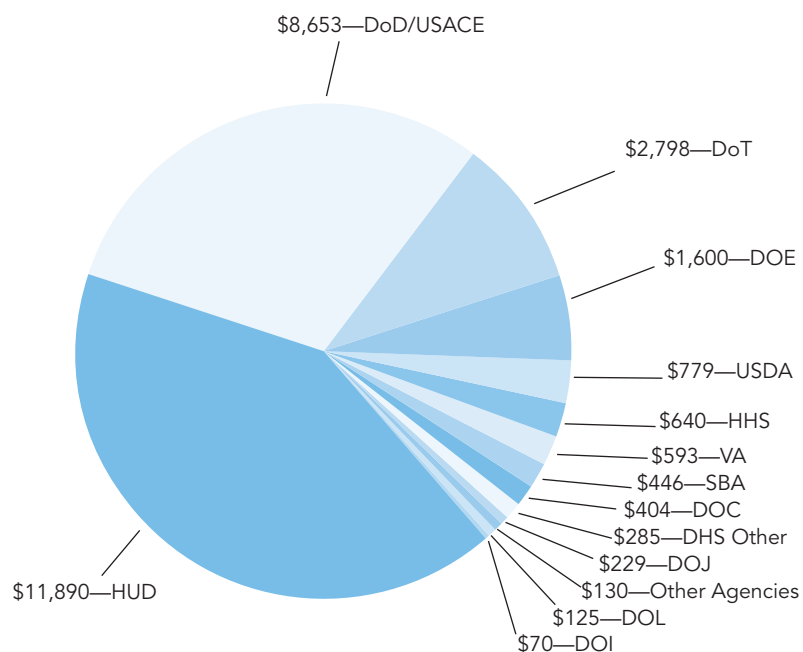

Source: Public Law 109-61, 109-62, 109-148

Note 1: Does not include \$23.4 billion rescinded from the Disaster Relief Fund.

Figure 3-1

Corps of Engineers (USACE) to repair levee and floodwalls (flood control) and study flood and storm damage, construction, and other general expenses)

- \$2.79 billion to the Department of Transportation, including \$2.75 billion for the Federal Highway Administration’s Emergency Relief Program for repair and reconstruction of bridges, highways, roads, and trails, and \$40 million for Federal Aviation Administration facilities and equipment
- \$1.6 billion to the Department of Education, including \$750 million for immediate aid to restart school operations; \$645 million for temporary emergency impact aid for displaced students; and \$95 million for emergency assistance for higher education to the Louisiana Board of Regents
- \$779 million to the Department of Agriculture including, \$300 million for the Emergency Watershed Protection Program; \$200 million for the Emergency Conservation Program; \$65 million for rural housing service; \$58 million for rural utilities service; and \$57 million for Forest Service state and private forestry, national forest system, and capital improvement and maintenance
- \$640 million to the Department of Health and Human Services including, \$550 million for health services (including mental health services) and for repair, renovations, and construction of health facilities, and \$90 million for Children and Families Services programs, to include covering the costs of renovating Head Start facilities affected by the hurricanes
- \$593 million to the Department of Veterans Affairs for medical services, National Cemetery administration, major and minor construction projects, and general operating expenses
- \$446 million to the Small Business Administration including, \$264.5 million for the Disaster Loans



Empire, New Orleans, LA, 4-14-06
 – U.S. Army Corps of Engineer Herbie Petit and Plaquemines Parrish Flood Gate Operator John Machella point to some pumps used to pump water out from between a temporary coffer dam and the Flood Gate so repairs can be made. FEMA is helping the Parrish government repair the Flood Gate that was damaged by Hurricane Katrina under its Public Assistance Program. Marvin Nauman/FEMA photo

Program Account; \$176.5 million for administrative expenses; and \$5 million for the Office of Inspector General

- \$404 million to the Department of Commerce including, \$349.8 million for exploration capabilities
- \$285 million to the Department of Homeland Security including, \$206.5 million for U.S. Coast Guard operating expenses and acquisition, construction, and improvements; \$34.5 million for Customs and Border Protection salaries and expenses and construction; \$17.2 million for FEMA administrative and regional operations; \$13 million for Immigration and Customs Enforcement salaries and expenses; \$10.3 million for Office for Domestic Preparedness State and local programs; and \$3.6 million for U.S. Secret Service salaries and expenses
- \$229 million to the Department of Justice including, \$125 million for State and local law enforcement assistance; \$45 million for Federal Bureau of Investigation salaries and expenses; \$20 million for Bureau of Alcohol, Tobacco, Firearms, and Explosives (ATF) salaries and expenses; \$11 million for ATF buildings and facilities of the federal prison system; \$10 million for Drug Enforcement Agency salaries and expenses; \$9 million for U.S. Marshals Service salaries and expenses; and \$9 million for legal activities
- \$125 million to the Department of Labor for training and employment services
- \$70 million to the Department of the Interior including, \$30 million to the U.S. Fish and Wildlife Service for cleanup, recovery, repair, and reconstruction expenses; \$19 million to the National Park Service for cleanup, recovery, repair, and reconstruction expenses; \$16 million to the Minerals Management Service for royalty and offshore minerals; \$5 million to the U.S. Geological Survey for surveys, investigations, and research
- \$66 million to the Armed Forces Retirement Home for necessary expenses related to the consequences of Hurricane Katrina
- \$38 million to the General Services Administration federal buildings fund
- \$18 million to the Courts of Appeals, District Courts, and other Judicial Services for salaries and expenses

- \$8 million to the Environmental Protection Agency’s (EPA) Leaking Underground Storage Tank Program (EPA has ongoing and planned work in this program)

FEMA’s Disaster Relief Fund

The FEMA Disaster Relief Fund is the major source of federal disaster recovery assistance for State and local governments when a disaster occurs.

The supplemental appropriations made to Disaster Relief Fund remain available until expended. Since the storms ended, \$36.6 billion was provided for Gulf Coast Hurricane Recovery in response to Hurricanes Katrina, Rita, and Wilma. The \$36.6 billion amount reflects the rescission of the \$23.4 billion mandated in P.L. 109-148.

Figure 3-2 presents the status of Disaster Relief Fund allocations (planned spending), obligations and expenditures for all three hurricane-related supplemental appropriations acts, as of March 31, 2006. The chart shows that of the \$36.6 billion appropriated to FEMA that \$32.9 billion has been allocated. As of March 31, 2006, \$30.2 billion has been obligated for goods of which \$16.1 billion has been expended. As of the first 90 days, \$23.1 billion was obligated, of which \$8.1 was expended.

STATUS OF THE 2005 HURRICANE-RELATED DISASTER RELIEF FUND (in billions of dollars)

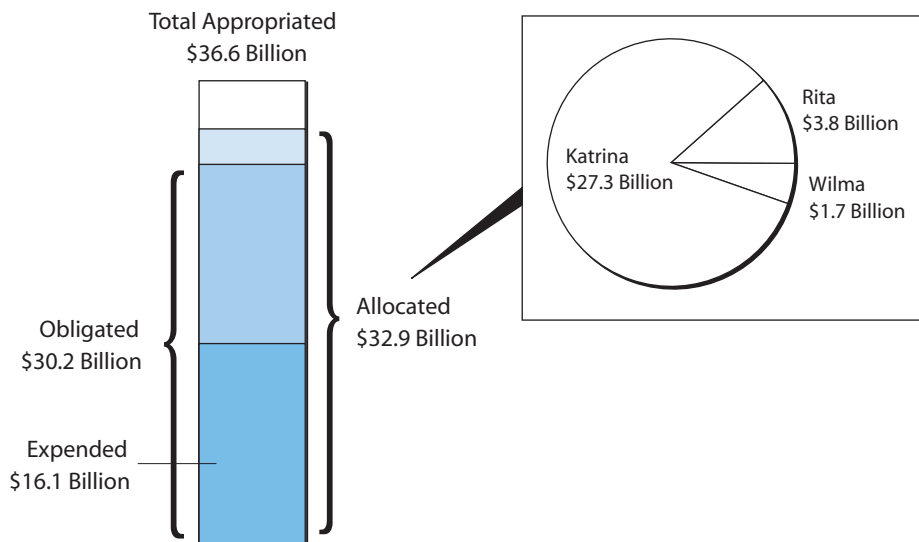

Source: FEMA

Note 1: This information is current as of March 31, 2006.

Figure 3-2

Mission Assignments

For the 2005 hurricane recovery funds, the Disaster Relief Fund issues mission assignments (MAs) to other federal agencies involved in Gulf Coast recovery. Table 3-2 provides the mission assignments made for hurricane recovery as of March 31, 2006.

Disaster Relief Fund mission assignments are identified by three categories:

- Technical assistance—federal agencies provide expertise to States. The cost is 100 percent federally funded; there is no State cost share.
- Direct federal assistance—the State requests Disaster Relief Fund funds; goods and services are provided to the State to save lives and protect property; this type of assistance is subject to State cost share, unless waived by FEMA.
- Federal operations support—Disaster Relief Fund coordinates agreements with federal agencies to perform services, such as providing search and rescue operations; health and medical support; assistance with disease prevention and control; transportation of disaster victims; and delivery of food, water, and other essential commodities to disaster victims. This type of assistance is 100 percent federally funded; there is no State cost share.

FEMA HURRICANE RECOVERY MISSION ASSIGNMENTS, BY AGENCY

Department / Agency	Katrina Mission Assignments	Rita Mission Assignments	Wilma Mission Assignments	Total Mission Assignments
USACE	\$3,983,830,516	\$650,115,000	\$293,772,000	\$4,927,717,516
DoD	\$1,123,593,889	\$48,480,000	\$3,550,000	\$1,175,623,889
DHS	\$466,830,726	\$56,820,685	\$30,681,512	\$554,332,923
DOT	\$426,169,213	\$62,022,000	\$20,083,000	\$508,274,213
EPA	\$321,886,200	\$44,545,000	\$440,000	\$366,871,200
USFS	\$178,545,288	\$180,905,000	\$5,580,000	\$365,030,288
HHS	\$161,637,800	\$83,290,000	\$9,395,000	\$254,322,800
HUD	\$82,945,000	\$120,000	-	\$83,065,000
GSA	\$77,988,268	\$540,000	\$130,000	\$78,658,268
DOJ	\$55,629,600	-	\$45,000	\$55,674,600
Other	\$104,639,088	\$24,836,600	\$2,380,884	\$131,856,572
Total	\$6,983,695,588	\$1,151,674,285	\$366,057,396	\$8,501,427,269

Source: FEMA *Weekly Disaster Relief Finance Report*, as of April 5, 2006

Note 1: Agencies are arranged by the top ten Mission Assigned agencies based on Hurricane Katrina assignments by FEMA

Table 3-2

The Disaster Relief Fund balance fluctuates continually as funds are obligated. FEMA is required by the House and Senate Appropriations Committees to report weekly on the Fund's status. The reports are intended to enable the Congress to better monitor the availability of funds and allow for the timely preparation of requests for supplemental funds. The reports provide a snapshot of the funds available, obligations to date, remaining costs from past disasters, and the anticipated costs of disasters that might occur in the remaining months of the fiscal year.

RECENT APPROPRIATIONS ACTIVITY

The President has requested an additional \$19.76 billion for further hurricane disaster relief and recovery. In April 2006, the U.S. Senate Committee on Appropriations recommended that amount be increased by \$7.36 billion, reaching an adjusted total of \$27.1 billion. Because this bill has not been signed into law, any existing notional breakdown of funding by agency would be premature and immaterial.

Furthermore, the Bush Administration has begun working with Congress to address additional funding, estimated at \$2.5 billion, beyond what the Administration has already requested for levee work in the New Orleans area. On April 12, 2006, the U.S. Army Corps of Engineers released revised cost estimates to certify and further enhance the levees in New Orleans and the majority of the surrounding area. The \$2.5 billion will be spent in two ways:

- To allow the Army Corps of Engineers to raise levee heights, in some cases as much as 7 feet, and complete other levee work, at a cost of \$900 million
- To upgrade or replace existing flood I-walls with T-walls. The estimated cost of replacing I-walls outside of lower Plaquemines Parish is \$1.6 billion

PRIVATE DONATIONS FOR HURRICANE RECOVERY

According to the University of Indiana's Center for Philanthropy, total donations by individuals, foundations, and corporations totaled \$3.57 billion as of February 20, 2006, for the victims of Hurricanes Katrina and Rita. Of the total \$3.57 billion, \$3.12 billion was received in the first 90 days following the storms, and another \$450 million was received in the second 90-day period, ending February 20, 2006.

The largest five private donors, as of February 20, 2006, were the following:

- American Red Cross, \$2.12 billion
- The Salvation Army, \$325 million
- Catholic Charities, \$154 million
- Bush-Clinton Katrina Fund, \$110 million
- Habitat for Humanity, \$95 million

TOTAL PRIVATE DONATIONS AS OF FEBRUARY 20, 2006
PRIVATE DONATIONS FOR HURRICANES KATRINA AND RITA
(INDIVIDUALS, FOUNDATIONS, AND CORPORATIONS)

Total Cash Donations (Katrina only, or combined Katrina & Rita)	\$3,378,185,879
Total In-Kind	\$166,624,000
Total from Reserves	\$26,381,150
Total Pledges Outstanding	\$2,840,000
Total cash and in-kind gifts to date	\$3,574,031,029

Source: The University of Indiana Center for Philanthropy

Table 3-3

Table 3-3 outlines the type of donations that have been pledged or delivered in cash or in-kind donations from private sources.



Houston, TX, October 26, 2005 – Workers for Habitat for Humanity team up with major league baseball to build houses in the shadow of the George R. Brown Convention Center. These houses will be transported to Louisiana for victims of Hurricanes Katrina and Rita. FEMA coordinates many kinds of volunteer efforts. Photo by Ed Edahl/FEMA

SELECTED ACTIVITIES

Agency Purchase Card Transactions

As of December 31, 2005, Department of Justice (DOJ) components purchased approximately \$8.6 million in goods and services using government purchase cards. Of that amount, the Federal Bureau of Prisons accounted for expenditures totaling approximately \$4.8 million, which appear to be related to relocating and housing prisoners. The majority of the purchase card expenditures for all DOJ components appear to be for food, supplies, building equipment, and safety equipment needed for law enforcement functions. The DOJ Office of Inspector General (OIG) is currently performing an audit of hurricane-related purchase card transactions.

EPA used purchase cards to buy air and water sampling equipment, supplies, computer equipment, and software, totaling \$1,480,000. EPA's most significant purchase card transactions were for leasing recreational vehicles to use as temporary housing for EPA personnel working on hurricane relief activities. Subsequently, EPA leased additional housing using purchase orders.

Grant Activities

Department of Commerce

- The Economic Development Administration (EDA) awarded four grants totaling \$8.8 million to the States of Louisiana, Mississippi, and Alabama for technical assistance and economic recovery planning. The grants may not be used for construction or infrastructure activities. EDA waived requirements such as Comprehensive Economic Development Strategies and matching shares, and modified general processing procedures and designated the three States as Special Impact Areas to award the grants.
- The National Telecommunications and Information Administration (NTIA) awarded one grant following applicable regulations for \$378,000 to repair transmission equipment of the Louisiana Public Broadcasting system.
- The Minority Business Development Agency (MBDA) awarded one grant for \$300,000 to the Houston, Texas, Minority Business Development Center to assist minority businesses in Louisiana and Texas. MBDA waived the cost-sharing requirement of the grant.

Department of Housing and Urban Development

The Housing Authority of New Orleans received a \$21.8 million grant from the Public Housing Capital Fund reserve for the cost and repair of its public housing inventory before a full assessment could be performed. HUD's Office of Community Development (CDP) plans to reprogram existing funds of \$380 million for the disaster areas. To expedite the process, CPD issued numerous waivers to streamline its grant programs, including HOME (Home Ownership Made Easy), Emergency Shelter Grants, and Community Development Block Grants.

Department of Justice

Following Hurricane Katrina, the Office of Justice Programs, Bureau of Justice Assistance (BJA), awarded 33 Hurricane Katrina disaster relief grants for \$5,000,003. The DOJ OIG conducted an audit that examined whether BJA implemented appropriate internal controls and procedures for the 33 grants. The purpose of these grants is to assist State and local criminal justice agencies by providing funding for items such as additional personnel, equipment, supplies, training, and technical assistance. The OIG found that while BJA was proactive in providing additional grant funding to grantees in areas affected by Hurricane Katrina, it had no assurance that funding was going to the areas of greatest need.

The DOJ OIG will also conduct audits of five of the 33 criminal justice agencies that received one of these grants to determine whether costs claimed under the grants are reasonable, allocable, allowable, and in accordance with applicable laws, regulations, and terms and conditions of the grants.

Department of Labor

Grants totaling \$267 million were awarded as follows:

- National Emergency Grants, \$191 million
- Grants to four disaster States to help these States process unemployment insurance (UI) and disaster unemployment assistance (DUA) claims, \$30 million
- Occupational Safety and Health Administration Worker Safety and Health Annex (FEMA mission assignment), \$21 million
- Reintegration Counselor Grants, \$13 million
- High-Growth Job Training Grants, \$12 million

The Worker Safety and Health Annex provides for the coordination of Federal safety and health assets for proactive consideration of all potential hazards; ensures availability and management of all safety resources needed by responders.

AUDITS

4



Empire, LA, 4-14-06 – EPA Contractor Terrell Barrett points to a gas tank that the Hurricane Katrina levee flood waters left on the roof of a house while EPA Contractor Alison Fogle takes a GPS reading of the location. The EPA is trying to remove hazardous materials to an approved collection site for proper disposal. Marvin Nauman/FEMA photo

OVERSIGHT OF GULF COAST HURRICANE RECOVERY

Audits and Other Reviews

The Inspectors General (IGs) for 22 federal departments and agencies involved in the auditing of Gulf Coast hurricane relief efforts have coordinated their oversight activities through the President's Council on Integrity and Efficiency (PCIE) and the Executive Council on Integrity and Efficiency (ECIE). The overall effort is coordinated with the Government Accountability Office (GAO).

The scope of hurricane relief projects to be studied by the auditors has been formidable. As of March 31, 2006, agencies under review by the IGs had issued a total of at least 6,665 contracts with a total value over \$9.69 billion. More than half those contracts (3,456), with a total value of \$5.38 billion, were under the Department of Homeland Security (DHS). With the costs of recovery so high and so many government agencies involved in the work, the necessity for oversight is unprecedented.

Accordingly, since the initial PCIE/ECIE 90-day progress report was issued in December 2005, IGs for many of the departments and agencies involved in hurricane relief have significantly expanded their activities.

As of March 31, 2006, approximately 465 government auditors were devoted to the various reviews, with Department of Defense (DoD) having the largest contingent of 135 auditors. Each auditor involved is a skilled professional whose work is guided by U.S. government auditing standards. Due to the urgency of the situation, some audits and other reviews were not conducted according to generally accepted government audit (Yellow Book) standards.

MANAGEMENT AND PERFORMANCE REVIEWS

Table 4-1 on the next page provides the number of non-contract reviews, purchase card reviews, and other oversight activities reported by the federal agencies involved in the recovery effort.



Empire, LA, February 4, 2006 – Grounded fishing fleets in Plaquemines Parish are prepared for salvage or stabilized for their return to the water. Hurricane Katrina has adversely affected the area's fishing industry which is beginning to recover with the help of FEMA, state and parish officials. Robert Kaufmann/FEMA

MANAGEMENT AND PERFORMANCE REVIEWS, BY AGENCY

Agency	Purchase Cards		Non-Contract Reviews ¹					
	Transactions (in thousands)	Transactions Reviewed (%)	Grants		Mission Assignments		Other	
			In Process	Complete	In Process	Complete	In Process	Complete
DHS	\$22,687	29	21	7	2	-	16	6
DOC	\$289	-	1	-	-	-	-	-
DoD ²	-	-	-	-	3	-	11	-
DOE	-	-	-	-	-	-	1	1
DOI	\$22,323	-	-	-	-	-	1	-
DOJ	\$8,967	-	-	1	-	-	-	-
DOL	\$540	-	3	4	-	-	4	3
DOT	\$821	-	5	-	4	2	1	1
ED	-	-	9	-	-	-	-	-
EPA	\$1,480	50	-	-	3	-	-	-
GSA	\$107	-	-	-	1	-	1	-
HHS	\$2,175	-	1	-	-	-	3	-
HUD	-	-	-	-	-	-	-	-
NASA	\$135	99	-	-	2	-	-	-
SBA	-	-	-	-	-	-	2	3
SSA	\$224	-	-	-	1	-	-	-
TIGTA	\$74	-	-	-	-	-	7	3
USDA	\$20,061	-	1	-	3	4	-	-
USPS	\$1,917	100	-	-	-	1	3	4
VA	-	-	-	-	-	-	1	-
TOTAL	\$81,800	-	41	12	19	7	51	21
Compared to first 90 days ³	\$41,044	-	31	3	14	0	60	7

Source: 9th PCIE Hurricane Katrina Report (as of March 31, 2006)

Note 1: Data is not provided for comparison purposes. Some reviews represent audits of multiple grants, mission assignments, and other non-contract vehicles. Some reviews are Yellow Book audits.

Note 2: A total universe cannot be derived for purchase card transactions related to Hurricane Katrina.

Note 3: Data as of December 2, 2005 PCIE Bi-Weekly Report

Table 4-1

CONTRACT REVIEWS

Table 4-2 below captures the number of contract reviews in process and completed as well as the value of these contracts. A sizable body of final audits has emerged, and the IGs reported that many of their recommendations already were being implemented by the time this reporting period closed on March 31, 2006. Many of these recommendations are designed not just to address errors or shortcomings in the federal response to the 2005 hurricanes, but also to set the stage for more efficient and cost-effective responses to future disasters anywhere in the United States.

CONTRACT REVIEWS, BY AGENCY¹

Agency	Number of Reviews			Value of Reviews (in thousands of dollars)		
	Total	In Process	Completed	Total	In Process	Completed
DHS	159	65	94	\$3,572,418	\$2,377,075	\$1,195,343
DOC	1	1	-	\$6,500	\$6,500	-
DoD	9	8	1	\$2,738,707	\$2,489,707	\$249,000
DOE	-	-	-	-	-	-
DOI	-	-	-	-	-	-
DOJ	1	1	-	\$5,180	\$5,180	-
DOL	6	6	-	\$4,760	\$4,760	-
DOT	1	1	-	\$210,421	\$210,421	-
ED	-	-	-	-	-	-
EPA	127	1	126	\$220,081	\$981	\$219,100
GSA	182	182	-	\$542,549	\$542,549	-
HHS	10	10	-	\$35,136	\$35,136	-
HUD	2	2	-	\$19,000	\$19,000	-
NASA	33	11	22	\$89,160	\$11,243	\$77,917
SBA	-	-	-	-	-	-
SSA	-	-	-	-	-	-
TIGTA	-	-	-	-	-	-
USDA	-	-	-	-	-	-
USPS	3	1	2	\$349	-	\$8,349
VA	1	-	1	\$709,440	-	\$709,440
Total	535	289	246	\$8,161,701	\$5,702,552	\$2,459,149
Compared to first 90 days ²	211	164	47			

Source: 9th PCIE Hurricane Katrina Report (as of March 31, 2006)

Note 1: Data is not provided for comparison purposes. Some reviews represent audits of multiple contracts. Some reviews are Yellow Book audits.

Note 2: Data as of December 2, 2005, from PCIE Bi-Weekly Report

Table 4-2

As was the case in December's 90-day report, this report on audits and reviews of hurricane relief oversight focuses heavily on prevention, with auditors performing the following work:

- Reviewing controls
- Monitoring and advising department officials on contracts, grants, and purchase transactions before they are approved
- Meeting with applicants, contractors, and grantees to advise them of the requirements and to assess their capability to account for the funds

There also are aggressive and ongoing audit efforts designed to identify and address fraud, waste, and abuse as early as possible.

Both Hurricanes Katrina and Rita are recent memories for most Americans. The damage inflicted by these natural disasters on the millions living along the Gulf Coast should not be compounded by those whose business practices include fraud, waste, or abuse of federal dollars. The auditors of the PCIE/ECIE providing hurricane oversight are dedicated to protecting the interests of those Americans who are only beginning to address the disruptions to their lives.

DEPARTMENT /AGENCY SUMMARIES

This section provides the summaries from federal departments and agencies involved in the rebuilding of the Gulf Coast region.

Department of Homeland Security

Final Management Advisory Reports

Review of the Proposed Interagency Housing Agreement with the Department of Veteran Affairs

Auditors found that, as of October 13, 2005, the Baton Rouge Joint Field Office (JFO) Contracting Officer had not executed a proposed \$28.4 million interagency housing agreement between the Department of Veterans Affairs (VA) and Federal Emergency Management Agency (FEMA). However, while FEMA Headquarters reviewed whether it was appropriate under the Stafford Act, the VA had already incurred costs for preparation of 35 housing units and had lost potential sales proceeds for more than 2,800 properties that were off the market to make them available for evacuees.

To ensure effective expenditure of disaster relief funds, auditors recommended that the Principal Federal Officer for Hurricane Katrina direct the JFO Contracting Officer to have the VA cease work or continue work at the agency's own risk. [GC-LA-06-02, October 2005, GC (formerly DD-01-06)]

Changes in State of Louisiana Compensation Policies

Within three weeks after Hurricane Katrina, Louisiana made two changes in its compensation policies for State employees performing Katrina-related work. The increased costs are not eligible for FEMA reimbursement under the Office of Management and Budget's (OMB's) criteria for cost principles that require consistency in compensation between federally funded and nonfederally funded activities. Auditors recom-

mended that the Deputy Federal Coordinating Officer for Hurricane Katrina in Louisiana notify FEMA and State personnel that increased costs resulting from Louisiana's new policies are not eligible for reimbursement. [GC-LA-06-04, October 2005, GC (formerly DD-03-06)]

Clearbrook LLC Billing Errors under Contract Number HSFE-06-05-F-6232

Clearbrook LLC provides food and base camp lodging services to disaster responders at seven base camps in Louisiana. As of September 28, 2005, Clearbrook billed and FEMA paid \$34 million of the \$80 million contract.

Auditors identified several problems with the contract and its billings:

- The initial \$4.9 million payment was for work before the contract's effective date.
- Contractor billings were mathematically inaccurate, indicating more than \$3 million in overcharges.
- Billings were based on a time-and-materials plus fixed per diem rate, when the contract appeared to be an \$80 million fixed-price contract.
- The contract had few terms, conditions, or prices; the scope of work contained no details, and there was a lack of documentation supporting price reasonableness.

Auditors recommended that the Principal Federal Officer for Hurricane Katrina direct the Joint Field Office (JFO) FEMA Contracting Officer to suspend payments on the contract until FEMA contracting officials resolved these issues. [GC-LA-06-07, November 2005, GC (formerly DD-04-06)]

Management Advisory Report on Invoices Submitted under Order HSFEHQ-06-F-0047 by Corporate Lodging Consultants, Inc.

FEMA awarded a task order under a Basic Purchasing Agreement (BPA) with Corporate Lodging Consultants, Inc. (CLC) for emergency lodging for evacuees. The task order was for 4 million room nights and, according to the BPA, CLC would be paid \$2.48 per room night. Actual lodging costs were to be paid separately.

Auditors looked at whether FEMA used effective contract management processes to award and administer this task order. The BPA provided fixed rates per room night for CLC's services with lodging costs priced separately at cost. The BPA did not provide any mechanisms to control lodging costs. The task order contained an estimate of \$60 per room night. However, it was not a mandatory cap. Review of a sample of three invoices submitted by CLC showed the average room rate for 126,000 rooms was nearly \$70—more than \$10 over the \$60 task order estimate.

Some room rates were excessive compared to the contract's estimated cost, but they were consistent with the hotel's published price. For example, CLC paid the Millennium Hilton in New York City its published rate of \$438 per night. The Panama City Beachfront Condominiums charged \$330 to \$375 per night for beachfront condominiums in Panama City, Florida. The Residence Inn in downtown Chicago charged up to \$399 per night. As late as December 7, 2005, FEMA was still paying relatively high prices—up to \$364 per night at the Hilton Gas Lamp Quarter in San Diego and up to \$339 per night at the Intercontinental in New Orleans.

Auditors recommended that FEMA do the following:

- Require that the contractor continue to obtain appropriate credits to hotel billings where room charges were higher than published room rates plus applicable taxes
- Request that the General Services Administration (GSA) modify the contract to provide incentives for meeting contract cost estimates and/or penalties for failing to meet contract cost estimates
- Work with the CLC and/or the American Red Cross to revise the process for selecting hotels to prevent excessive per-night room charges (GC-HQ-06-09, February 2006, GC)

Strengthening Registration Intake Controls

Auditors evaluated the effectiveness of procedures governing the process that applicants use to register for individual disaster assistance. Eligibility verification controls were weakened because employees often times overrode established registration intake processes. For example, some reviewing employees had approved applications for payment without thoroughly verifying that the information was correct and that there was no duplication.

Auditors recognized that some controls were eased to expedite assistance to as many applicants as possible. However, because the majority of victims had been registered, they recommended FEMA reinstate its established internal controls for registering applicants. (GC-HQ-06-10, February 2006, GC)

Management Advisory Report on the Acquisition of Cruise Ships for Hurricane Katrina Evacuees

Auditors reviewed FEMA's leasing of four cruise ships to provide immediate housing for hurricane evacuees, with an eye toward the reasonableness of leasing the ships and of the major contract requirements. They also performed a limited analysis of the cost efficiency of using the cruise ships for temporary housing.

As of November 2005, the weekly GSA per diem rate per person in the New Orleans area was about \$1,282, and about \$770 in Alabama and Mississippi. The average weekly cost per person on the cruise ships, at full occupancy, was \$1,177.

Using this analysis, the overall occupancy rate for the cruise ships would have to be more than 95 percent to be more cost effective than the per diem rates. During the first 30 days, when the average occupancy for the ships was about 35 percent, FEMA paid \$3,300 per evacuee per week—three times the average per diem rate. Subsequently, the average occupancy for the cruise ships ranged from 82 to 92 percent.

Auditors concluded FEMA's leasing of the ships reasonable under the circumstances, although FEMA might have been wise to lease the ships for three months rather than six. The limited analysis of cost efficiency indicated that the ships might be cost-efficient for a high-cost area like New Orleans as long as a high occupancy rate is maintained. Unfortunately, several problems kept occupancy low in the first weeks after the disaster. Cruise ships are high-cost options in Mississippi and Alabama where costs are low.

Auditors recommended that FEMA not renew the contracts for the cruise ship *Holiday*. (GC-HQ-06-11, February 2006, GC)



New Orleans, LA, 2-1-05 – Hurricane Katrina disaster victims talk with SBA Disaster Loan officers about what loans may be available to them. This “DRC” Disaster Recovery Center was just opened to assist in the disaster victims still needing to register for assistance. MARVIN NAUMAN/FEMA photo

Mobile Homes and Modular Homes at Hope and Red River

Auditors reviewed FEMA’s procedures for accepting and maintaining manufactured and modular homes staged at Hope, Arkansas, and Red River Army Depot in Texarkana, Texas, to determine whether there were reasonable requirements for those units and to evaluate storage arrangements.

Minor damage to some units (incurred during delivery) was noted at Hope. Other homes were sinking in the mud from heavy rainfall. Frames of some larger units were beginning to warp from being stored on wheeled trailers without adequate support. FEMA did not have a plan for how the homes would be used before they purchased them.

Auditors recommended that FEMA:

- Develop a comprehensive plan for the most cost-effective way to use or dispose of manufactured and modular homes
- Continue to monitor storage sites to ensure proper maintenance and mitigate deterioration, and inventory units that might already be damaged and make necessary repairs
- Recoup from the manufacturers repair costs for damages caused by the manufacturer during delivery
- For future disasters, develop written policies, procedures, and plans to govern the acquisition and use of mobile and modular homes. These policies should prohibit the procurement of oversized mobile homes that do not meet FEMA’s specifications. Also, FEMA should work with State and local governments to identify prearranged sites for mobile homes. Furthermore and most disturbing, FEMA should not wait for a disaster to identify possible sites for the homes (GC-HQ-06-12, February 2006, GC)

Investing Funds Associated with Grant EMW-2006-GR-0056

In Katrina’s aftermath, a number of foreign governments and international entities donated more than \$100 million to assist Hurricane Katrina victims. From these funds, DHS/FEMA awarded a \$66 million grant to the National Case Management Consortium for case management services for displaced persons.

Because the vast majority of the grant would be disbursed over an extended period for expenses, the funds held by FEMA could average more than \$30 million per day over the life of the grant. Auditors recommended that the funds be invested in public debt securities, with the \$2.5 million interest income used to further assistance. (GC-HQ-06-13, February 2006, GC)

Management Advisory Report on Armed Guard Services Provided by Blackwater Security Consulting, LLC, Under Contract HSCEFC-05-J-F00002

Shortly after Hurricane Katrina hit New Orleans, FEMA requested guard services from the Federal Protective Service (FPS) for FEMA facilities, disaster-response centers, disaster medical-assistance teams, and the New Orleans and Louisiana field offices. FPS contracted with Blackwater Security Consulting, LLC, for armed guard services. Auditors reviewed the Blackwater contract and related correspondence to determine whether the contract was appropriate and costs were reasonable.

FPS officials said that they customarily use contract services for static guard posts at FEMA facilities during disaster operations so that FPS and other police officers can respond to requests for law enforcement assistance.

FPS solicited offers from two companies on the GSA's Federal Supply Schedule (FSS) to provide armed guard services. Blackwater offered services at \$950 per staff-day—a 5 percent discount from its FSS rate and lower than the rate from the other solicited vendor. FPS officials considered this the best value and believed Blackwater's past performance under other contracts and current performance under contracts with the Department of State demonstrated its capability to perform under the conditions of this contract.

Under the circumstances, there was not sufficient time for FPS to conduct a comprehensive needs assessment, issue an invitation for bids, and conduct an open competition. The FPS action, obtaining already approved offers from FSS listings, was acceptable and generally superior to the often-used option of a sole source contract. Moreover, FPS obtained a negotiated rate lower than Blackwater's FSS rate. The contracting methodology and price were appropriate under these urgent circumstances.

However, there may now be opportunities to reduce guard service costs. FEMA expects that guard services will be required for two to five years for some facilities. Armed guards at all locations may not be required. Security requirements may be met by a mix of armed and unarmed guards. Unarmed guards generally cost less than armed guards. It is possible that lower-cost guard services can be obtained via full and open competition.

The audit team recommended that FEMA conduct a needs assessment of guard services, including the need for armed and unarmed guards. Auditors also recommended that FEMA conduct a full and open competition to meet all long-term requirements for armed and unarmed guard services. (GC-HQ-06-17, March 2006, GC)

Indirect Costs under Grant Agreement Number EMW-2006-GR-0056 with UMCOR/Emergency Services International

This review of FEMA's grant to the National Case Management Consortium for case management services for displaced persons questioned whether the approved budget might result in duplicative payments for rent, executive salaries, and a variety of administrative functions. Auditors recommended amending the grant to eliminate \$580,925 in indirect charges, with a budget increase for actual direct charges that were previously included in the indirect costs rate. Any remaining funds should become available for program operations. This amendment was considered fair and equitable by all parties. (GC-HQ-06-19, March 2006, GC)

FEMA Trailers at Pontchartrain Guest House

Auditors reviewed an allegation that 16 travel trailers, provided by FEMA to a Louisiana nursing facility to house its workers, were not being used. The trailers were provided to Gulf South Medical Enterprise, which operates the Pontchartrain Guest House, a nursing facility in Mandeville, Louisiana. The trailers were to house staffs that were also Hurricane Katrina evacuees. Auditors determined that 15 vacant FEMA travel trailers located behind the Pontchartrain Guest House, not 16 as stated in the allegation, were not hooked up to power, water, or sewer sources, and have never been used.

The audit team recommended that FEMA recover the vacant trailers and place them back in FEMA's inventory. (GC-HQ-06-23, March 2006, GC)

Review of Hurricane Katrina Activities, City of Biloxi, Mississippi, FEMA Disaster

The City of Biloxi received an award of \$41.4 million for emergency protective measures and the removal of debris necessitated by Hurricane Katrina. The City was properly accounting for grant funds. However, the FEMA award and City records reflected \$1.9 million for debris removal from Federal aid roads, which are the responsibility of the Federal Highway Administration. Additionally, the City earned \$23,874 of interest earned on FEMA funds that were provided as an advance to the city. Pursuant to federal regulations, these funds must be returned to the federal treasury.

The audit team recommended that the Federal Coordinating Officer disallow the \$1.9 million of ineligible debris removal costs and obtain the \$23,874 of interest earned on the FEMA advance. (GC-MS-HQ-25, February 2006, GC)

Ongoing Audits

Review of Contracting and Micro-Purchases

Auditors have been reviewing and doing risk analysis of major contracts awarded by FEMA and the JFOs to ensure that contracts personnel are adhering to federal acquisition regulations and that expenditures are necessary and reasonable. Auditors have reviewed 42 contracts over \$500,000 awarded by FEMA headquarters. In general auditors found such problems as: contracts awarded without adequate competition, no assurance of reasonable prices, inadequate statements of work, and inadequate documentation in the con-

tract files. Auditors have reviewed 53 of the largest contracts awarded by the JFOs and found similar problems. Auditors are continuing our contract reviews, but are now beginning to focus on contract management – how well FEMA is monitoring contract performance to ensure that it is getting what it contracted for and that prices are reasonable. Auditors have one contractor performing a detailed review of FEMA's four technical assistance contractors, and another contractor reviewing contractor billings for hotels and motels that housed evacuees. Auditors are also performing, in cooperation with GAO, a data mining review of FEMA's use of purchase cards.

Oversight of Public Assistance Projects

Auditors continue to review public assistance projects as they are being prepared at the JFOs. In addition, auditors are reviewing the major grant recipients to determine whether or not they have financial management systems that are adequate for managing the grants. Auditors have also begun interim audits of grant recipients to ensure that they are documenting their costs and that the costs they claim are eligible for FEMA reimbursement.

Mission Assignments

Auditors are reviewing FEMA mission assignments (MAs) to the five DHS components that received the largest MAs: Federal Protective Service, U.S. Coast Guard, U.S. Customs and Border Protection, U.S. Immigration and Customs Enforcement, and National Communication System. These reviews will ensure that mission assignments were managed to satisfy mission requirements, funds were spent effectively and accurately accounted for, contracting followed proper procurement procedures, adequate documentation was maintained, and that purchased property was managed according to governing laws and regulations. Also, working through the PCIE, auditors are assisting other Offices of Inspector General (OIGs) that are reviewing their agencies' mission assignments.

Review of FEMA Sheltering and Transitional Housing for Evacuees

Hurricanes Katrina and Rita produced more than one million evacuees. Many are still living in transitional housing. Auditors are reviewing FEMA's planning for sheltering evacuees and implementation of transitional housing that included hotels and motels, apartments, travel trailers and manufactured homes, cruise ships, and fixed facilities. Auditors will include FEMA's coordination with state and local governments and voluntary agencies, and assess how well evacuee needs were met. The review will identify the actions FEMA is taking to be better prepared to provide housing to evacuees of future catastrophic disasters and recommend ways to prevent problems that occurred during the response to Hurricane Katrina.

Review of FEMA's Property Management

Disaster assistance operations involve numerous acquisitions of personal property by FEMA as well as other agencies. Our auditors will perform oversight of FEMA's management of personal property and will evaluate internal controls in place to ensure that personal property purchased during disaster operations is

properly accounted for and managed. Auditors will evaluate how personal property is acquired, received, issued, disposed of, controlled, and tracked by the JFOs, Agency Logistics Centers, Territory Logistics Centers, and Remote Storage Sites. Personal property received through international donations also will be monitored as part of this effort.

Review of Potential Duplication Among Federal Disaster Assistance Programs

Auditors are preparing an inventory of federal disaster assistance programs and assessing their potential for duplication of benefits. This is a high-level review rather than an effort to identify specific incidents of duplication. Auditors plan to use case studies to demonstrate the importance of applying safeguards to these programs to prevent both intentional and inadvertent duplication of benefits. Some instances of overlapping programs have already surfaced, such as individuals receiving both cash for rental assistance and travel trailers provided by federal agencies.

Review of Potential for Improved Intergovernmental Coordination and Data Sharing Among Federal Agencies

Auditors are reviewing interagency data sharing processes and procedures to determine how data sharing might improve the effectiveness of disaster response and recovery. A variety of federal agencies collect data that might benefit FEMA in activities such as determining eligibility of individuals for assistance and preventing duplicate assistance payments. Similarly, FEMA collects data that might be useful to other agencies. For example, FEMA data might include information on the post-disaster location of missing children or persons being sought by law enforcement agencies.

Review of UMCOR Case Management Grant

After Hurricane Katrina, various foreign governments donated approximately \$100 million to assist hurricane victims. Using \$66 million of those funds, FEMA awarded a grant to the United Methodist Committee on Relief (UMCOR) to provide case management services for the hurricane victims. Auditors are reviewing the grant to determine whether the grant is being managed according to laws and regulations, to assess whether the program is being operated in an economical and efficient manner, and to determine whether the program is delivering the needed assistance.

Review of Selected Components of FEMA's Individual and Households Program

Several components of FEMA's Individual Assistance grant program provide non-housing assistance for disaster victims. For example, victims may be able to get reimbursement for generators, chain saws, medical and dental cost, lost personal property, and a variety of other disaster related costs. This review will evaluate how FEMA determines what costs will be paid and ensures applicant eligibility, how efficiently and accurately claims are processed, and how FEMA ensures recoupment of overpayments, duplicate payments, and payments to ineligible recipients.

Review of FEMA State Management Grants for Louisiana and Mississippi

FEMA provides grants to reimburse states for management administrative costs. There is potential for these grants to be duplicative of other federal funding for similar purposes. Auditors will identify such grants in Louisiana and Mississippi and determine whether costs incurred under those grants are appropriate and eligible. The objective of the review is to determine whether FEMA's procedures and practices for awarding grants for state management costs limits funding for only those costs that are reasonable and necessary for state grantees to maintain effective and efficient oversight of grant program operations.

Planned Audits*Review of FEMA's National Flood Insurance Program*

FEMA manages the National Flood Insurance Program (NFIP). In addition to providing insurance for flooded property, the NFIP helps ensure that communities are less vulnerable to flooding disasters. One way that is accomplished is by establishing policies to guide state and local officials in rebuilding after a disaster. FEMA is now assessing elevation policies for Mississippi and Louisiana communities to provide the most accurate data possible on elevation of structures necessary to mitigate future flood damage. The objective of this review will be to assess how effectively FEMA managed flood insurance in the wake of Hurricane Katrina, and to determine the effect of FEMA's elevation determinations on affected communities.

Review of FEMA's Mitigation Grant Programs

FEMA provides grants for mitigation activities through its Public Assistance Grant Program, Hazard Mitigation Grant Program, Pre-Disaster Mitigation Grant Program, and the Flood Mitigation Assistance Program. Auditors will review FEMA's implementation of these grant programs in response to Hurricane Katrina.

Department of Commerce**Planned Audits**

The Department of Commerce (DOC) OIG does not plan additional Katrina audit work due to the small dollar value of reimbursable FEMA mission assignments.

Department of Defense**Final Audit Products**

To date, one Department of Defense (DoD) audit has been completed by the Naval Audit Service.

NAVAL AUDIT SERVICE

Chartered Cruise Ships

(Report No. N2006-0015, February 16, 2006)

The Naval Audit Service verified that Military Sealift Command's (MSC) contract awards for time-chartered cruise ships requested by FEMA complied with Federal Acquisition Regulations (FAR) and DoD and



New Orleans, LA, 03-2-06– The Carnival Cruise Ship Sensation prepares to leave port at sunrise after completing her FEMA Contract to house and feed disaster victims. The departure of the ships marks another step forward in the region's recovery. Marvin Nauman/FEMA photo

Department of the Navy (DON) policies.

The limited review of the contract process used to award and administer four chartered cruise ship contracts showed that MSC met the requirements of the FAR as well as DoD and DON policies. Auditors did not find any material control weaknesses. However, the audit did disclose opportunities to improve methods in which MSC administers vessel preoccupancy inspections and invoice certification. MSC took actions to improve its methods in these areas during the audit.

Ongoing Audits

DOD OFFICE OF INSPECTOR GENERAL

Audit of DoD Contract Support for the Hurricane Katrina Recovery Effort

(Project No. D2005-D000CH-0309.000, September 15, 2005)

The audit's overall objective is to review the award and administration of DoD contracts used to support Hurricane Katrina recovery efforts.

Audit of the Effects of Hurricane Katrina on DoD Information Technology Resources in Affected Areas

(Project No. D2005-D000AS-0310.000, September 15, 2005)

This audit will determine the effects of Hurricane Katrina on DoD information technology resources.

Audit of the Use of DoD Resources Supporting the Hurricane Katrina Disaster

(Project No. D2006-D000LA-0009.000, September 19, 2005)

Auditors are examining the use of DoD resources in providing hurricane relief.

Audit of Accounting and Oversight of Obligations and Expenditures Related to the Department of Defense Hurricane Katrina Reconstruction Effort

(Project No. D2006-D000FE-0010.000, September 19, 2005)

The overall objective of this audit will be to determine whether DoD obligations and expenditures related to the Hurricane Katrina reconstruction effort are timely and efficiently executed and in accordance with applicable laws and regulations.

Audit of Expanded Micro-Purchase Authority for Purchase Card Transactions Related to Hurricane Katrina
(Project No. D2006-D000CK-0019.000, September 23, 2005)

The objective is to determine whether DoD purchase card transactions in support of Hurricane Katrina rescue-and-relief operations were reasonable, appropriate, and consistent with DoD purchase card policies and procedures.

Audit of the International American Products, Worldwide Services, Ice Delivery Contract for the Army Corps of Engineers
(Project No. D2006-D000CG-0075.000, November 8, 2005)

This audit addresses congressional concerns regarding the award and administration of the ice delivery contract between the U.S. Army Corps of Engineers (USACE) and International American Products, Worldwide Services.

Audit of the Army Corps of Engineers "Operation Blue Roof" Project in Response to Hurricane Katrina
(Project No. D2006-D000CG-0081.000, November 9, 2005)

This audit addresses congressional concerns regarding the award and administration of "Operation Blue Roof" contracts for the hurricane relief effort.

Audit of the USACE's "Emergency Water" Contractor
(Project No. D2006-D000FE-0091.000, November 17, 2005)

This audit responds to congressional concerns about the selection of Lipsey Mountain Spring Water Company as the sole source for emergency water supplies. Auditors are reviewing the selection and contracting processes and examining the contractor's capability to function as the sole source water supplier for domestic emergencies.

Costs Incurred Under the CONCAP Contract Task Orders for Hurricane Relief Efforts
(Project No. D2006-D000CH-0110.000, January 9, 2006)

The audit focuses on whether costs incurred on task orders for relief efforts after Hurricanes Ivan and Katrina were reasonable. Auditors are reviewing the Navy's methods and procedures for ensuring it paid fair and reasonable prices for labor and material used to support the hurricane relief efforts.

Audit of Defense Logistics Agency Subsistence Contracts Used for the Hurricane Katrina Recovery Efforts
(Project No. D2006-D000CG-0121.000, January 23, 2006)

The overall audit objective is to review the award and administration of Defense Logistics Agency contracts

used for Hurricane Katrina recovery efforts.

*Audit of Disaster Recovery Efforts Related to Hurricane Katrina on Army Information Technology Resources
(Project No. D2006-D000AS-0135.000, February 13, 2006)*

Auditors are determining whether adequate disaster recovery controls and plans were in place to safeguard Army information technology resources.

ARMY AUDIT AGENCY

*Audit of Army Fund Accountability for Hurricane Relief Efforts
(Project No. A-2006-FFD-0216.000, October 7, 2005)*

This audit assesses whether the Army established and implemented appropriate procedures and processes to account for funds received and costs incurred and to obtain reimbursements for allowable expenses for Hurricane Katrina relief efforts.

Audit of Debris Removal Contracts

(Project No. A-2006-FFD-232.000, October 12, 2005)

The audit's objective is to assess whether USACE appropriately awarded and has adequately monitored its debris removal contracts.

Audit of Contracts for Hurricane Protection System

(Project No. A-2006-FFD-0238.000, October 12, 2005)

Auditors are determining whether the USACE appropriately awarded and has adequately monitored levee repair contracts.

Audit of the Contract Data Reporting for Hurricane Operations

(Project No. A-2006-FFD-0250.000, December 12, 2005)

The USACE process for accurately reporting contract information for hurricane relief is being examined. Auditors are evaluating data for contracts awarded in support of Hurricanes Katrina, Rita, and Wilma.

Audit of Quality Assurance Service Contracts for Hurricane Operations

(Project No. A-2006-FFD-0354.000, December 12, 2005)

The audit assesses the contract requirements to determine whether they were valid and monitored. Auditors also are assessing the acquisition strategies used to determine whether they helped assure the best value to the government.

NAVAL AUDIT SERVICE

Audit of Hurricane Katrina Relief Funds

(Project No. N2006-NFA000-0009.000, September 30, 2005)

The audit will address design and implementation of internal controls in the following areas: alloca-

tion, use, and tracking of Katrina Relief funds; accounting and reporting of costs and benefits; use of the Government Purchase Card; contract requirements generation, award, administration, deliverables, and payment; Disbursing Officer cash accountability; management of reimbursable arrangements; controls and accountability over medical equipment; adequacy of support to DON personnel and families; and other matters that emerge as work progresses.

Audit of Department of the Navy's Use of Hurricane Katrina Relief Funds
(Project No. N2006-NFA000-0009.003, September 30, 2005)

The audit focuses on whether the Navy allocated, used, tracked, and reported the use of Katrina relief funds in accordance with relevant laws and regulations.

Audit of Cash Accountability of Department of Navy Disbursing Officers for Hurricane Katrina Relief Funds
(Project No. N2006-NFA000-0009.004, September 30, 2005)

Auditors are verifying that Disbursing Officer cash is accounted for in accordance with established guidance for Hurricane Katrina relief funds, and that internal controls have been implemented to prevent and detect irregularities and acts of fraud, waste, and abuse.

Audit of Government Commercial Purchase Cards Used for Hurricane Katrina Relief Efforts
(Project No. N2006-NFA000.0009.002, October 3, 2005)

Auditors want to verify that commercial purchase cards have been used properly—with goods and services adequately accounted for—and that the program's internal controls are adequate to prevent or promptly detect errors, irregularities, fraud, waste, and abuse.

Audit of Controls and Accountability over Medical Supplies and Equipment for Hurricane Relief Efforts
(Project No. N2006-NFA000-0009.005, October 17, 2005)

The audit objective is to determine whether management controls over medical supplies and equipment used in Hurricane relief efforts were effective.

Audit of Contractor Support Services in Support of Hurricane Relief Efforts
(Project No. N2006-NFA000-0009.006, October 17, 2005)

The audit objective is to determine whether management controls over service contracts were adequate to ensure the following:

- a. Contract services were properly justified, provided services of value to the Navy, and met government requirements concerning authorized use of service contracts.
- b. Contract deliverables were clearly defined and adequately measured in terms of results, quality and timeliness.
- c. Contract deliverables met contract requirements in terms of results, quality, and timeliness.
- d. The appropriate contract type was used to provide services at the lowest cost and least risk to the gov-

ernment.

AIR FORCE AUDIT AGENCY

Audit Planning, Hurricane Katrina Relief Efforts

(Project No. F2006-FB1000-0124.000, October 5, 2005)

The overall objective is to formulate audit objectives related to financial management, aviation fuel reimbursements, and reconstruction planning efforts.

Hurricane Katrina FEMA Reimbursements

(Project No. F2006-FB1000-0173.000, November 1, 2005)

The overall objective of the audit is to determine whether Air Force personnel effectively managed FEMA reimbursements. Specifically, the audit will determine whether personnel established adequate accountability over the funds; used funds for valid Hurricane Katrina relief efforts; and accurately reported those costs.

Hurricane Katrina Supplemental Funds Management

(Project No. 2006-FD1000-0210.000, November 21, 2005)

The overall objective is to determine whether Air Force personnel effectively managed Hurricane Katrina supplemental funds. Superficially the audit will determine whether supplemental funds were used for valid Hurricane Katrina efforts and if personnel maintained adequate accountability of the supplemental funds.

Planned Audits

The DoD OIG, Army Audit Agency, and Air Force Audit Agency have additional audits planned as well.

DOD OIG

In response to concerns raised by the public and Congress, specifically related to subcontracting and contract pricing for temporary roofs, DoD OIG plans to initiate an audit in June 2006. It will focus on contractors' costs used to establish pricing, the percentage of contract cost for overhead, and how many layers of subcontractors were used.

ARMY AUDIT AGENCY

Audit of Demolition Contracts (not yet announced)

Auditors will assess whether the USACE established appropriate acquisition strategies and means to monitor new contracts for demolition and debris removal.

Audit of Contracts to Enhance Flood Protection System (not yet announced)

The audit is to assess whether the USACE established appropriate acquisition strategies and means to

monitor new contracts to enhance the flood protection system for New Orleans.

AIR FORCE AUDIT AGENCY

A series of audits is planned related to the reconstitution of Keesler Air Force Base, Mississippi. Specific objectives will be discussed with management as part of the annual audit planning process in June 2006.

Department of Education

Final Audit Products

The Department of Education OIG did not issue any final audit products during the reporting period ending on March 31, 2006.

Ongoing Audits

Department Controls Over Hurricane Education Recovery Funding

(Audit No. A19G0003)

Auditors are assessing the adequacy of Department controls over funding for the Restart, Emergency Impact Aid, and Homeless Youth programs. Specifically, they are evaluating controls over the Department's process for awarding funds to grantees and assuring that funds are properly spent.

Texas State Education Agency (SEA) and Local Education Agency (LEA) Controls Over HERA Funding

(Audit No. A06G0009)

This audit assesses the adequacy of Texas SEA and LEA controls over funding for the Restart, Emergency Impact Aid, and Homeless Youth programs. This includes tests for adequate controls and criteria for allocations and for measures to assure that expenditures meet applicable laws and regulations.

Louisiana SEA and LEA Controls Over Funding

(Audit No. A06G0010)

The adequacy of Louisiana SEA and LEA controls over funding for the Restart, Emergency Impact Aid, and Homeless Youth programs is the subject of this audit.

Mississippi SEA and LEA Controls Over Funding

(Audit Nos. A04G0012 and A04G0013)

These audits assess the adequacy of Mississippi SEA and LEA controls over funding for the Restart, Emergency Impact Aid, and Homeless Youth programs, both before and after allocations are made.

Alabama SEA and LEA Controls Over Funding

(Audit Nos. A05G0020 and A05G0021)

These audits focus on the adequacy of Alabama SEA and LEA controls over funding for the Restart, Emergency Impact Aid, and Homeless Youth programs. In both cases, controls and criteria for the allocations are

being examined.

Controls Over Hurricane Assistance Provided to the Louisiana Board of Regents
(Audit No. A06G0011)

This audit will determine how the Louisiana Board of Regents allocated and used the \$95 million provided for postsecondary institutions of higher education. The funds are to be used for student financial assistance, faculty and staff salaries, equipment, and instruments.

Controls Over Hurricane Assistance Provided to the Mississippi Institutes of Higher Learning (IHL)
(Audit No. A04G0014)

The purpose of this audit is to determine how the Mississippi IHL allocated and used the \$95 million provided for student financial assistance. Recipients do not have to comply with any requirements relating to matching, federal share, reservation of funds, or maintenance of effort.

Planned Audits

The Department of Education OIG plans an audit in Georgia similar to those already launched in Texas, Louisiana, Mississippi, and Alabama. In Georgia, the focus will be on the adequacy of controls over funding for the Emergency Impact Aid and Homeless Youth programs. Future audit work also will evaluate any waivers to program regulations that are granted by the Department.

Department of Energy

Final Audit Products

Department of Energy (DOE) Response to Hurricanes Katrina and Rita
(Project No. IG-0707, November 9, 2005)

Auditors found that the Department met its responsibilities under the National Response Plan as the lead federal agency for Emergency Support Function-12 (ESF-12), which addresses restoration of energy systems after a natural disaster. Specifically, the Department did the following:

- Initiated policy and regulatory actions to assist energy recovery efforts and mitigate hurricane impacts
- Coordinated with the energy industry and with other government agencies to identify supporting resources and facilitate restoration of energy systems
- Continuously monitored the status of energy systems damage and repair work

The audit identified certain actions that could enhance future ESF-12 missions, including the following:

- Improved communications with private and government bodies
- Improved DOE's ability to identify emergency response assets before disasters
- Augmented the staffing of ESF-12 emergency response teams

Ongoing Audits

DOE Strategic Petroleum Reserve

The audit will determine whether the Strategic Petroleum Reserve effectively met energy security requirements as a part of its response to Hurricanes Katrina and Rita.

Planned Audits/Reviews

No additional audits or reviews were planned by the DOE OIG as of March 31, 2006.

Department of Interior

Final Audit Products

The Department of the Interior (DOI) OIG did not issue any final audit products for the 120-day period ending March 31, 2006.

Ongoing Audits

As of March 31, 2006, the DOI OIG has one ongoing audit focused on ensuring that the Department makes the best use of funds intended for hurricane relief and recovery and confirming the appropriateness of expenditures.

Planned Audits

The DOI OIG has no other planned audits scheduled at this time. DOI has requested \$213 million under the fourth supplemental appropriation (H.R. 4939). Should that funding become available, the OIG will evaluate the need for a follow-on audit effort to ensure appropriate use of the funds.

Department of Health and Human Services

Ongoing Audits

Department of Health and Human Services (HHS) Tasks Requested by FEMA

Auditors will determine whether HHS is appropriately accounting for the \$396.3 million of hurricane-related spending under MAs from FEMA.

Transporting Medically Needy Evacuees

HHS OIG is evaluating the performance of a contractor in charge of returning all of the approximately 6,000 Texas, Louisiana, and Mississippi evacuees who require en-route medical care and therefore cannot travel via commercial air or without medical assistance. The contractor was awarded \$21 million for Texas evacuees. An additional \$20 million may be awarded when Louisiana's recovery permits the return of evacuees to their respective medical facilities.

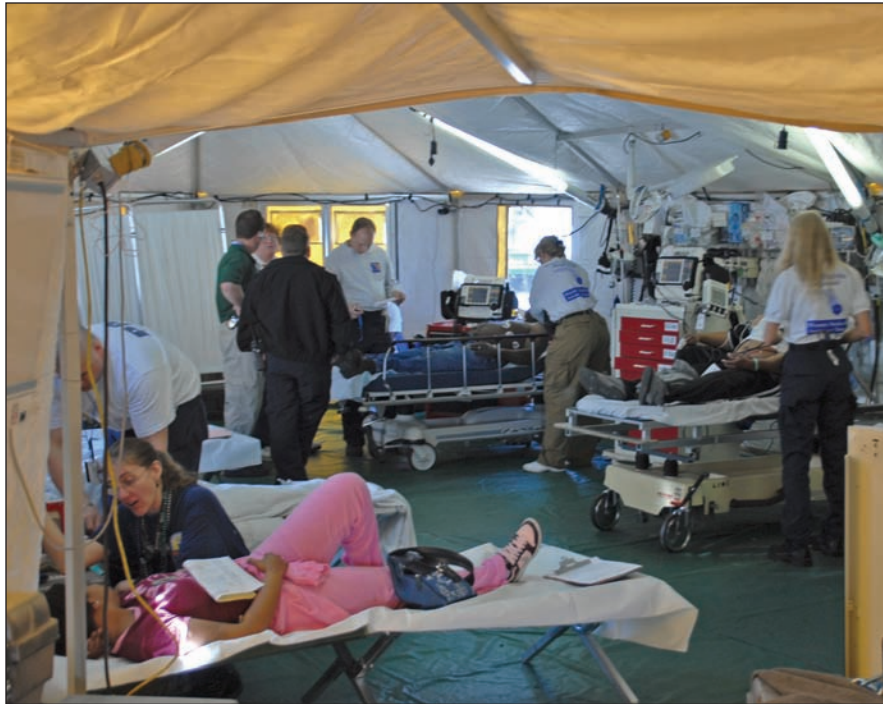

New Orleans LA 2-27-06 – Disaster Medical Assistance Team (DMAT) members tend to patients being treated in this acute care tent that is equipped to handle most medical emergencies. This DMAT site on Canal Street is equipped to do Resuscitation, Minor Surgery, Intensive Care, Observation Recovery, Acute Care, and has 2 Pharmacies and is a part of FEMA's assistance to those injured by Hurricane Katrina. Marvin Nauman/FEMA photo

Auditing Vulnerable Hurricane-Related Procurements

Auditors are reviewing hurricane-related contractual procurements over \$100,000 and a sample of contracts under \$100,000. The first stage assesses the risk of fraud, waste, or abuse. OIG then uses those assessments to select the most vulnerable procurements for in-depth audit, examining procurement methods, costs, and quantity/quality/timeliness of deliverables. Ten audits were in progress as of March 31, 2006.

Use of Purchase Cards in Response to Hurricane Katrina

OIG is analyzing purchase card use by HHS personnel deployed in response to Hurricane Katrina. This review builds on OIG's March 2003 report, *International Merchant Purchase Authorization Card Program: Review of Calendar Year 2001 Transactions*, which found 44 percent of transactions sampled did not fully comply with requirements for using IMPAC cards.

Implementation of National Response Plan Responsibilities

Auditors are examining HHS's handling of FEMA-requested work under the National Response Plan, specifically Emergency Support Function #8: Public Health and Medical Services. Results will help improve the Department's response in future emergencies.

Use of Emergency Preparedness Grants in Selected Gulf Coast States

OIG will determine whether the funding provided annually by the Centers for Disease Control and Prevention and the Health Resources and Services Administration has been utilized for approved purposes and whether items funded by these grants were effective in the hurricane response and recovery efforts. Re-

views are being performed in Florida, Alabama, Louisiana, Texas, and Mississippi.

Claims for Services Not Rendered in Medicare and Medicaid Programs

OIG auditors will review services performed during the months immediately following Hurricane Katrina by providers in disaster-area ZIP codes. The results will be analyzed to determine whether any providers that were not in operation continued to bill the Medicare and/or Medicaid programs.

Identification of Aberrant Providers in Medicare and Medicaid Programs

Auditors will identify providers who submitted claims to Medicare and/or Medicaid for services provided to evacuees that greatly exceeded the number of claims submitted by other providers in the peer group. These claims will then be selectively reviewed to determine whether they are legitimate and medically necessary.

Duplicate Medicaid Payments to Providers in Medicaid

Auditors will determine whether providers submitted claims and were paid by multiple State Medicaid agencies for the same service for the same evacuee. They will determine whether providers received Medicaid payments from both the evacuee's home State and the host State in which the evacuee is residing, or whether they received Medicaid payments for services paid by FEMA.

Establishment of Claims Identifiers in Medicare

In "Consolidated HHS Response to OMB Data Call: Katrina Stewardship," the Centers for Medicare and Medicaid Services (CMS) presented a risk assessment for Hurricane Katrina-related activities. As noted in this document, OIG auditors plan to determine if the following occurred:

- Whether CMS established the necessary claims identifiers (called "special claims condition codes and modifiers"), and CMS contractors implemented those claims identifiers
- Whether the claims identifiers accurately represent the numbers, dollars, and nature of disaster-related claims

Hurricane Katrina-Related Medical Review Contract

Auditors will determine whether payments to providers were appropriate under the expanded coverage provided under certain programs, including Medicaid, to certain HHS beneficiaries who were evacuated from the Gulf Coast region.

Department of Housing and Urban Development

Ongoing Audits

Real Estate Owned (REO) Properties

Auditors are reviewing the Department of Housing and Urban Development's (HUD's) use of REO properties to house disaster evacuees, including management and marketing contractors' rehabilitation cost billings.

Management and Marketing Contracts

OIG is reviewing two management and marketing contractors in two States.

Public Housing Authority (PHA) Draw Downs

Auditors are identifying and analyzing all fund draw downs (usage) by PHAs in the disaster areas, for audit and investigation follow-up

Katrina Disaster Housing Assistance Program (KDHAP) Vouchers

Auditors have identified PHAs providing KDHAP vouchers. An audit is planned of the KDHAP voucher process/matching review.

HUD Waivers

All HUD waivers have been reviewed to assure that statutory requirements are not waived.

HUD Contracting

Auditors are reviewing HUD contracting related to disaster recovery efforts as part of the PCIE Contract Oversight Task Force.

FEMA Data

OIG auditors and legal counsel are working to gain access to FEMA data for matching purposes.

HUD Contracting

This is an internal audit of the HUD contracting process relating to disaster recovery.

Department of Justice

Final Audit Products

*Oversight of Department of Justice (DOJ) Expenditures Related to Hurricane Katrina
(Project No. 06-11, February 23, 2006)*

Following the Hurricane Katrina disaster, the Office of Justice Programs, Bureau of Justice Assistance (BJA), awarded 33 Hurricane Katrina disaster relief grants with a total value of \$5,000,003. Auditors found that while BJA was proactive in providing additional funding to 33 grantees in the Hurricane Katrina affected areas, it had no assurance that funding was going to the areas of greatest need.

Recommendation: That, for future disaster relief funding, the BJA should ensure that funding is provided to those with the greatest need.

Ongoing Audits

Oversight of Department of Justice Expenditures Related to Hurricane Rita – Beaumont Federal Correctional Complex Roof Repair

(Assignment No. 01-8-06-001)

An audit of the Federal Bureau of Prisons (BOP) \$5.2 million sole source contract for roof repairs at the Beaumont, Texas, Federal Correctional Complex will determine whether the BOP had adequate justification for awarding a sole source contract and whether the contract was awarded on an arm's-length basis with reasonable costs.

Department of Justice Hurricane-Related Purchase Card Transactions

(Assignment No. 01-3-06-003)

The audit is intended to determine whether:

- DOJ components minimized the misuse of purchase cards for hurricane-related expenditures by utilizing effective and appropriate internal controls
- Purchase card transactions were authorized and allowable
- Purchased goods and services were received. (Auditors are examining credit card purchases for the period September 1, 2005, through December 31, 2005, totaling approximately \$8.6 million.)

Planned Audits

The DOJ OIG will conduct audits of five grantees that received hurricane relief grants from the Bureau of Justice Assistance. This will determine whether:

- Costs claimed under the grant are reasonable, allocable, allowable and in accordance with applicable laws, regulations, and the grant's terms and conditions
- Administrative and financial controls are adequate to provide accurate and reliable operating and financial information

The DOJ OIG also will review DOJ expenditures for hurricane-related emergency electrical repairs at the Beaumont Federal Correctional Complex. The objectives of this audit are to determine whether BOP had adequate justification for awarding the \$500,000 sole source contract and whether the contract was awarded on an arm's-length basis and with reasonable costs.

Department of Labor

Final Audit Products

Items to Consider for Effective Implementation of the National Emergency Grant (NEG) Awarded to the Texas Workforce Commission for Hurricanes Katrina and Rita Relief

(Report No. 06-06-001-03-390, December 20, 2005)

Auditors determined that delivery of services was hampered by the following:

- A lack of contact information with relocated evacuees and restricted by limits set for individuals hired

in temporary positions

- Reluctance to provide needs-related payments without information on other financial assistance
- A need to set priorities for serving victims
- Difficulty in enforcing certain grant requirements because of allowable public service employment (PSE) activities expanding to any PSE

Recommendation: That the Employment and Training Administration (ETA) Assistant Secretary evaluate these issues and determine how they might be addressed by ETA and/or state officials. In response, a Katrina Team was organized by the Office of National Response to help impacted states resolve questions and to monitor the states' activities.

Grant Implementation Issues NEG No. EM-15067-05-60 Issued to the Louisiana DOL for Hurricane Katrina Relief

(Report Number 06-06-003-03-390, December 20, 2005)

Auditors found that local officials need guidance on allowable temporary employment and were concerned about:

- Transitioning clients to regular Workforce Incentive Act (WIA) activities
- The lack of long-range planning and NEG funds distribution
- Indications that participants may have continued to receive Disaster Unemployment Assistance (DUA) payments after starting PSE positions under the NEG

Recommendation: That the ETA Assistant Secretary evaluate issues raised in the Management Letter to determine how they might be addressed by ETA and/or State officials. In response, a Katrina Team was organized by the Office of National Response to help affected States resolve questions and to help monitor the States' activities.

Grant Implementation Issues NEG No. EM-15066-05-60 Issued to the Mississippi Department of Employment Security (MDES) for Hurricane Katrina Relief (Report No. 04-06-004-03-390, February 27, 2006)

Auditors found that a contractor underpaid workers by paying wages at the federal minimum wage rate and overcharged the grant by billing based on an agreed-upon wage rate rather than the lower, actual wage rate. They also found that the State overestimated the number of PSE positions needed and that two individuals hired at one worksite were not eligible for their PSE positions.

Recommendation: That the ETA Assistant Secretary evaluate issues in the Management Letter to determine how they might be addressed by ETA and/or State officials. In response, a Katrina Team was organized by the Office of National Response and charged with helping affected States resolve questions and to help monitor the States' activities.

Grant Implementation Issues NEG No. EM-15065-05-60 Issued to the Alabama Department of Economic and Community Affairs for Hurricane Katrina Relief (Report No. 04-06-003-03-390, February 28, 2006)

Auditors identified the following problems under the NEG Implementation Plan:

- Temporary jobs were not clearly identified
- Participant placement lists were not accurate
- Participants were ineligible or performed work outside the grant scope
- Timecards were either not reconcilable or unavailable for review

Recommendation: That the ETA Assistant Secretary evaluate issues in the Management Letter to determine how they might be addressed by ETA and/or State officials. In response, a Katrina Team was organized by the Office of National Response to help affected States resolve questions and participate in monitoring the States' activities.

Claimants with Unemployment Claims in Both Mississippi and Louisiana Related to Hurricane Katrina (Report No. 06-06-004-03-315, December 20, 2005)

This audit's objective was to help the States ensure that only legitimate unemployment insurance (UI) and DUA claims are paid and that fraudulent claims are terminated; this would reduce the drain on the States' unemployment trust funds and on the federal FEMA funds used to pay DUA.

Auditors initially identified 238 claims (revised in a subsequent review to 233) where the same social security number (SSN) was used to file claims in two States and where benefits were paid in both states for the same week-ending dates.

Recommendation: That ETA encourages the Regional ETA offices to assist states with their case reviews to help identify fraudulent claims. ETA now has staff on site in both States to provide technical assistance, review each claim, and take action to stop and recover improper payments. ETA also will continue to work with the States to cross-match one State's DUA claims against those of bordering states to identify potentially fraudulent claims.

One Individual in Possession of Multiple Hurricane Katrina Disaster Unemployment Assistance Claims in Louisiana (Report No. 06-06-005-03-315, March 3, 2006)

The audit's purpose was to help Louisiana officials ensure that only legitimate DUA claims are paid and that fraudulent claims are terminated to reduce the drain on the FEMA funds used to pay DUA. It was determined that one individual possessed eight DUA debit cards issued under different names and Montana addresses that totaled more than \$15,000 for the weeks ending September 10, 2005, through January 21, 2006.

Recommendation: That the ETA Assistant Secretary follow up with the State to ensure these claims

have been stopped and collection procedures have been established. The Louisiana Department of Labor has since determined the payments made on these claims were improper and has established collection procedures.

Follow-up on Claimants with Unemployment Claims in Both Mississippi and Louisiana Related to Hurricane Katrina

(Report No. 06-06-008-03-315, March 20, 2006)

Auditors sought to help the States ensure that only legitimate UI and DUA claims are paid and that fraudulent claims are terminated as soon as possible to reduce the drain on the States' Unemployment Trust Funds and the FEMA funds used to pay DUA. Auditors found the following during their review:

- 125 claimants received both Louisiana DUA payments and Mississippi UI payments
- 22 claimants received both Mississippi DUA payments and Louisiana UI payments
- 66 claimants received DUA payments from both Mississippi and Louisiana
- 17 SSNs were on both Mississippi's and Louisiana's claimant files, but the claimants' names were different for each State
- three claimants received UI payments from both Mississippi and Louisiana

Recommendation: That the ETA Assistant Secretary continue helping the States identify and collect the \$239,648 of DUA overpayments in accordance with federal regulations. ETA did not provide comments for this Management Letter because, in a final response to Management Letter 06-06-004-03-315, the Assistant Secretary reported that the States had completed investigation of 126 of the 238 claims that DOL auditors had initially identified as potentially fraudulent.

Ongoing Audits

Legitimacy of Hurricane Katrina-Related UI/DUA Claims in Mississippi

(Report No. 04-A06-010-03-390)

The audit is designed to help MDES ensure that only legitimate UI and DUA claims are paid and that fraudulent claims are terminated as soon as possible to reduce the drain on the States' unemployment trust funds and the federal FEMA funds used to pay DUA. A Management Letter for this project was in process as of March 31, 2006.

Individuals Who Received Unemployment Benefits in Louisiana While Receiving PSE Wages in Texas

(Report No. 06-A06-008-03-315)

Auditors will determine whether individuals received unemployment benefits for the same weeks they received wages while enrolled in the State's NEG PSE program and whether the State's management information system properly reflected the enrollment status of its PSE participants. This project was undergoing internal review as of March 31, 2006.

Individuals Who Received Unemployment Benefits in Louisiana While Receiving PSE Wages in Louisiana
(Report No. 06-A06-007-03-315)

The audit will determine whether individuals received unemployment benefits for the same weeks they received wages while enrolled in the Louisiana's NEG PSE program and whether the State's management information system properly reflected the enrollment status of its PSE participants. This project was under internal review as of March 31, 2006.

Individuals Who Received DUA in Louisiana While Receiving Unemployment Benefits in Mississippi
(Report No. 06-A06-006-03-315)

Auditors will determine whether individuals received DUA payments from either Louisiana or Mississippi while receiving unemployment compensation in the other State.

Individuals Who Received DUA in Both Louisiana and Mississippi
(Report No. 06-A06-011-03-315)

The audit will determine whether individuals received Hurricane Katrina-related DUA benefits in both Louisiana and Mississippi.

Louisiana DUA Debit Card Assessment (Project No. 06-A06-005-03-315)

Auditors will determine the monetary impact on the federal government of Louisiana's automatic pay system for debit cards that were never activated or were not delivered to claimants.

Analysis of Louisiana's National Directory of New Hires (NDNH) Database Match Outcomes
(Project No. 06-A06-016-03-315)

Auditors will determine the monetary impact on State and federal funds of individuals continuing to collect unemployment benefits in Louisiana after becoming employed in another State.

Planned Audits

Review of DUA

Auditors will determine the monetary impact on federal funds as a result of the following:

- Claimants who were initially eligible for UI but were paid DUA instead
- Louisiana not redetermining DUA claimants' eligibility for UI benefits between October 1, 2005, and January 1, 2006
- The Mississippi governor's decision to pay every claimant the maximum weekly benefit amount of DUA benefits
- DUA ineligibility determined from tests of other claimant populations for both Mississippi and

Louisiana and possibly Texas

- DUA claimants in Louisiana and Mississippi having wages in the third quarter of 2005 with the employer they claimed laid them off on August 29, 2005

Department of Transportation

Final Audit Products

Accounting and Financial Reporting of Hurricane Costs

(Controlled Correspondence No. 2006-001, October 12, 2005)

Auditors found that the operating administrations were working to implement the Assistant Secretary for Budget and Programs/Chief Financial Officer's direction that they establish procedures to track and report all costs; however, there were areas where the operating administrations did not yet have procedures to track all administrative costs related to Hurricanes Katrina, Ophelia, and Rita. Office of the Secretary of officials agreed to address these issues promptly.

Internal Controls Over the Emergency Disaster Relief Transportation Services Contract

(Report No. AV-2006-032, January 20, 2006)

OIG found that the FAA Southern Region and the contractor provided an unprecedented response to the crisis as it unfolded. Auditors also cited the following administration improvements needed to address future emergencies:

- Better procedures for evaluating contractor price quotes
- Better documentation of the actual amount of goods or services provided was needed before authorizing invoices for payment

FAA Southern Region management took immediate corrective action, including the recovery of \$32 million.

Internal Controls Over Maritime Administration (MARAD) Contracts for Operating Ready Reserve Fleet and Training Ships During Hurricane Disaster Relief and Recovery (Briefing on January 18, 2006)

OIG verified that the ships were used, as intended, to deliver urgently needed supplies, water, electricity generation, oil spill cleanup assistance, and food and shelter for rescue and recovery workers. OIG also verified that MARAD exercised oversight controls under existing contracting structures.

As a follow-up, OIG also participated in a conference panel on Hurricane Katrina Maritime Disaster Response where lessons learned for future disaster planning were shared with MARAD and U.S. Coast Guard officials, members of the maritime industry, and representatives of various State and local disaster response groups.

Ongoing Audits

Emergency Disaster Relief Transportation Services Contract Controls

Auditors will determine whether FAA Southern Region's internal controls over the contract have been sufficient to ensure that the government received the goods and services it paid for.

Opportunities to Free Up Unneeded Funds in States Affected by Hurricanes Katrina and Rita and Use Those Funds on Recovery Efforts

Auditors are looking at whether the affected States (Alabama, Florida, Louisiana, Mississippi, and Texas) have Department of Transportation funds dedicated to congressionally directed highway projects that are no longer needed and, if so, whether the funds can be redirected for hurricane reconstruction projects.

Mississippi DOT Katrina Emergency Repair Contracts

Auditors will determine whether oversight of selected emergency repair contracts awarded through the Mississippi DOT resulted in fair and reasonable prices, considering the emergency circumstances of their issuance.

Design and Administration of the Emergency Disaster Relief Transportation Services Contract

The audit will examine emergency disaster relief transportation services contract provisions for calculating administrative overhead and profit to make sure they are fair and reasonable and to determine whether the contract was adequately designed to protect the government's interest.

FTA Controls More Than \$47 Million Mission Assignment and Related Contracts to Provide Bus Services in New Orleans and Baton Rouge

Auditors are reviewing the reasonableness of the \$47 million contract for bus service in New Orleans and Baton Rouge and assessing the adequacy of controls over contract performance.

Planned Audits

DOT OIG is considering studies of the following:

- The risks associated with contracts for repairing air traffic facilities
- Ways to ensure that FHA emergency relief funds are spent in accordance with program guidelines
- Award criteria and grantee oversight for significant infrastructure construction projects

Department of Treasury

Ongoing Audits

Office of the Comptroller of the Currency's Response to Hurricanes Katrina and Rita (Project No. A-BK-06-001)

Auditors are looking at the agency's preparedness for and responsiveness to the needs of national banks, thrifts, savings and loans, and their customers during and after the hurricanes. They also are reviewing the

agency's plans and abilities to assess and manage increased risks resulting from the hurricanes' impact on regulated institutions as well as the risks from relaxation of certain operational, compliance, and reporting requirements.

Office of Thrift Supervisor's (OTS's) Response to Hurricanes Katrina and Rita (Project No. A-BK-06-002)

The Treasury OIG is reviewing OTS preparedness for and responsiveness to the needs of national banks, thrifts, savings and loans, and their customers during and after the hurricanes, including the adequacy and effectiveness of Continuity of Operations Plans. Auditors are reviewing the OTS plans and abilities to assess and manage increased risks resulting from the hurricanes' impact on regulated institutions as well as the risks from relaxation of certain operational, compliance, and reporting requirements.

Department of Veterans Affairs

Final Audit Products

Audit of Alleged Mismanagement of VA's Permanent Change-of-Station (PCS) Travel Program (Assignment No. 2006-00785-R9-0080)

An allegation was made that the Department of Veterans Affairs did not adequately explore outsourcing PCS services for the more than 600 transferring employees who required relocation as a result of Hurricane Katrina.

Auditors determined that the Department did not adhere to the FAR, Part 8, which requires that, except under limited circumstances, agencies must provide Request for Quotations (RFQs) to at least three Federal Supply Schedule (FSS) contractors that can meet agency needs.

Auditors recommended that the Assistant Secretary for Management ensure that VA competes the requirement for entitlement counseling and voucher services for those affected by Hurricane Katrina under the provisions in the FAR, Part 8.

Ongoing Audits

Audit of the Department of Veterans Affairs' Response and Recovery Efforts Related to Gulf Coast Hurricanes (Assignment No. 2006-00595-R9-0057)

The VA OIG is conducting an audit of hurricane-related activities to assess the following:

- Management controls over contract and procurement activities
- Controls to reestablish healthcare and benefit delivery to veterans
- Quality-of-care issues resulting from the evacuation

Audit of Alleged Mismanagement of VA's PCS Travel Program (Assignment No. 2006-00785-R9-0080)

Auditors are reviewing allegations of mismanagement of the VA's PCS travel program, administered by the Financial Services Center in Austin, Texas. This audit includes the review of a contract issued in support of the Gulf Coast hurricane recovery effort.

Planned Audits/Reviews

As of March 31, 2006, no additional audits were planned by the VA OIG.

Environmental Protection Agency

Final Audit Products

EPA's and Mississippi's Efforts to Assess and Restore Public Drinking Water Supplies after Hurricane Katrina (Report No. 2006-P-00011, February 14, 2006)

Auditors found that Mississippi State officials gave the public timely and accurate information about the safety and proper treatment of drinking water following Hurricane Katrina, issuing a boil water notice less than 48 hours after Katrina's landfall. Mississippi's analysis systems were adequate to support the decisions. Region 4 of the Environmental Protection Agency (EPA) provided both technical and logistical support to the State in making these determinations.

While significant progress has been made, challenges remain to restoring the water system to pre-storm conditions. Mississippi officials estimate replacement and repairs will cost approximately \$235 million.

Auditors found no conditions requiring corrective actions and made no recommendations.

EPA's and Louisiana's Efforts to Assess and Restore Public Drinking Water Systems after Hurricane Katrina (Report No. 2006-P-00014, March 7, 2006)

Louisiana's process for determining the safety of drinking water appeared adequate. EPA Region 6 provided critical assistance, including assessing water systems, collecting and analyzing drinking water samples, and providing information to the public about drinking water quality.

EPA and the State and local water system operators had not identified or heard of any occurrences of waterborne illnesses or diseases from drinking contaminated water in the two months following Hurricane Katrina.

While considerable progress has been made, substantial work remains to restore the drinking water infrastructure to pre-Katrina conditions. The most recent public water system recovery estimates for Hurricane Katrina are about \$380 million.

Auditors found no conditions requiring corrective actions and made no recommendations.

EPA Provided Quality and Timely Information Regarding Wastewater After Hurricane Katrina (Report No. 2006-P-00018, March 28, 2006)

Auditors found that Katrina damaged approximately 208 wastewater treatment facilities and collection systems, creating a potentially critical health concern. Affected States used information from the EPA to determine how to protect rescue workers and the public.

Auditors found no conditions requiring corrective actions and made no recommendations.

Ongoing Audits

EPA's Katrina Expenditure Oversight (Assignment No. 2005-001709)

This is a review of EPA's Hurricane Katrina-related expenditures to prevent and detect fraud, waste, and abuse, and to ensure that the EPA is safeguarding assets to prevent or minimize loss or theft. (The review of contract actions and purchase card transactions is discussed under *Final Audit Products*.)

EPA's Katrina Land Project

(Assignment No. 2005-001751)

Auditors are determining whether EPA is providing quality and timely information relative to the safety of individuals and the environment and whether the information is being considered by the States and other



New Orleans, LA, 1-13-06 – Workers from the EPA were on the scene helping the New Orleans Fire Department when a fire broke out at this Hurricane Katrina debris processing plant. The EPA, funded by FEMA, are working to identify, monitor, and clean up any hazards. MARVIN NAUMAN/FEMA photo

regulatory agencies in their responses. Auditors are reviewing the following:

- EPA's role in determining the nature, magnitude, and impact of oil spills, fuel releases, sediment contamination, and other hazardous material or substance releases
- EPA's process for distinguishing between hazardous and non-hazardous hurricane debris and waste and whether those distinctions are consistent across the region.

Planned Audits

The agency expects to conduct audits of contractor invoices and on the management of hurricane debris.

Federal Communications Commission

Final Audit Products

As of March 31, 2006, the Federal Communications Commission's (FCC's) OIG had not conducted any audits, inspections, or investigations related to hurricane oversight.

Planned Audits

The FCC OIG plans one audit, which will be conducted later in this fiscal year. It will examine a \$211 million recovery assistance program for the Gulf Coast that is funded by the Universal Service Fund (USF). The program includes funds for wireless handsets and 300 free minutes for evacuees and people in the area who lack telephone service. The OIG will look for areas of risk, potential vulnerabilities, and evidence of compliance with program requirements and regulations as outlined by the Commission's Katrina relief proposals.

General Services Administration

Ongoing Audits

The GSA OIG has initiated an audit of the effectiveness of GSA's response to Hurricane Katrina, in which GSA has had a central role in procuring approximately \$1 billion in equipment and services used by FEMA. GSA also serves as the landlord to federal agencies in the affected area to locate or repair space so that the agencies may continue their missions.

Auditors already have shared with agency management certain observations, including a need for GSA to have more consistent and up-to-date policies and guidance.

National Aeronautics and Space Administration

Final Audit Products

The National Aeronautics and Space Administration (NASA) did not issue any final audit products during the period October 1, 2005, to March 31, 2006.

Ongoing Audits

Audit of NASA's Hurricane Katrina Recovery Efforts

(Assignment No. A-05-030-00)

NASA auditors will determine whether the agency has established the necessary internal controls to manage Hurricane Katrina recovery and reconstruction efforts. Specifically, NASA OIG is evaluating NASA's estimation and execution of Hurricane Katrina funds and the processes used to ensure that those funds were used for their intended purposes. The audit covers the following:

- NASA's processes for cost estimating and accounting for the rebuilding of facilities at the Michoud Assembly Facility and the Stennis Space Center, and for providing employee family assistance
- Supplemental funding requests by NASA for Hurricane Katrina reconstruction costs
- How NASA and its centers specifically identified, designated, and tracked supplemental funds received from Congress for accounting purposes
- NASA's processes for procurements (such as contracts, purchase orders, purchase card purchases) related to rebuilding the Michoud Assembly Facility and the Stennis Space Center
- Compliance with the Emergency Procurement Authority requirements, as defined by NASA's Procurement Information Circular, for contract awards related to Hurricane Katrina efforts
- The degree of competition to help ensure fair and reasonable price to the government to avoid the potential abuse of sole-source determinations
- NASA's internal controls, specifically implementation of OMB guidance and Executive Orders, revising micro-purchase thresholds and waivers to the Davis Bacon Act

Planned Audits

No additional audits are planned by the NASA as of March 31, 2006.

Small Business Administration

Final Audit Products

Audit of the Small Business Administrations (SBA's) FY 2005 Financial Statements

(Report No. 06-04, November 15, 2005)

Auditors found that improvement was needed in the management of express mail expenses and employee time and attendance. Auditors found that the Atlanta Disaster Area Office (DAO) had inadequate controls over the approval of time and attendance for approximately 2,300 temporary personnel working in remote locations of disaster sites and that inadequate controls were in place regarding the use and reconciliation of Federal Express shipping vouchers. The rapid increase of temporary personnel to administer disaster loans increases the importance of controls over these areas because these processes are inherently high risk for abuse, which may result in improper payments or misuse of funds or assets.

Audit of SBA's Information Systems Controls for Fiscal Year 2005

(Report No. 06-08, December 22, 2005)

Auditors determined that controls in the Disaster Credit Management System (DCMS) were inadequate

for management to determine which activities and files were sensitive and required logging. They recommended an independent management review of database and application logs to ensure potential security violations are investigated and. Auditors also recommended reducing the number of individuals granted “SuperUser” access to the minimum number possible and establishing procedures granting access according to responsibilities and duties.

Problems with Processing a Number of Disaster Loan Application Declines within the Disaster Credit Management System

(Report No. 06-11 – Assignment No.6001) February 2, 2006

Based on applicant complaints to both the FEMA and the SBA that disaster loan rejection notices referenced incorrect addresses, SBA’s Office of Disaster Assistance (ODA) identified 646 disaster loan applications with potentially erroneous address information either contained within the applications themselves or entered into DCMS incorrectly. The applications had been processed as declines by DCMS and uploaded to FEMA’s National Emergency Management Information System (NEMIS).

Auditors identified a lack of timely resolution and correction of these disaster loan applications. As a result, there may have been delays in applicants’ obtaining available benefits from either SBA or FEMA. OIG recommended the following:

- ODA continue its analysis of loan application decline issues and implement corrective measures for loan applications that were processed incorrectly
- In the future, SBA representatives contact applicants where address errors were identified before assigning a decline status in DCMS to determine if the addresses are correct in the DCMS

ODA generally agreed with the finding and recommendations.

Disaster Application Referrals with “\$0 Income” from FEMA Online Registration Have Increased Costs and the Demand for SBA Resources

(Report No. 06-12, Assignment No.6001, February 17, 2006)

OIG noted a problem with FEMA’s Individual Assistance Center Online Registration referrals: potential applicants for SBA disaster loans cited either “\$0 Income” in the income field or left this field blank. Auditors determined that the lack of a screening process or qualifying criteria in this field needlessly increased the volume of FEMA referrals of applicants to the SBA disaster assistance program. Moreover, the disaster applicants were delayed from consideration for FEMA Other Needs Assistance grants until a determination was made on the outstanding loan application submitted to SBA.

SBA agreed with recommendations that it improve its loan screening processes relating to “\$0 Income” referrals and work with FEMA to reduce unnecessary online referrals.

Improvement Is Needed in Interface Error Correction Between SBA’s DCMS and FEMA’s NEMIS

(Report No. 06-20, Assignment No.6001, March 31, 2006)

Auditors concluded there was need for improved error correction procedures when processing disaster victim updates between SBA's DCMS and FEMA's NEMIS. Delays in correcting errors resulted in disaster victims not always receiving needed assistance in a timely manner. SBA estimated that 83,000 errors required correction during system updates relating to the Gulf hurricane relief effort.

SBA OIG recommended that SBA do the following:

- Coordinate with FEMA to establish a Configuration Change Control Board and update NEMIS-Individuals & Households & SBA Interface Requirements Specifications with defined responsibilities for data element ownership, data administration, and data correction responsibilities within both SBA's DCMS and FEMA's NEMIS for all records transmitted between SBA and FEMA
- Coordinate with FEMA to identify the conditions that will cause records to abort status update processing, design appropriate program edits to prevent and report these conditions, and update the interface documentation to include these conditions
- Coordinate with FEMA to develop a formalized error-resolution process with trouble tickets and mechanisms to identify specific aborted record processing

Central Contractor Registration Needs Large Business and Small Business Designation Improvements (Report No. 06-18, Assignment No.6002, March 21, 2006)

SBA OIG received a congressional request to review whether a Gulf hurricane-related contract was appropriately coded as "small business" in the Federal Procurement Data System – Next Generation (FPDS-NG). In the review, auditors noted that the Central Contractor Registration (CCR) allowed contradictory information on a contractor's size to be included in the system. This contradictory information could cause contracting officials and others relying on the CCR database to incorrectly identify contractors as small businesses. OIG recommended that CCR be modified to correct the reported problem.

Ongoing Audits

Project 6300: Review of Disaster Loans Approval/Disbursement Process

Auditors are reviewing a sample of loans and assessing whether there are any loan closing impediments that hinder timely disbursement. They will also investigate any external impediments, such as local governments and other federal agency requirements, which may have a negative impact on the timely delivery of disaster loan funds that prevent home and business borrowers from beginning the rebuilding process.

Project 6302: Review of the Disaster Credit Management System Upgrade Project

Auditors will determine whether the SBA is in compliance with applicable requirements, including the agency's System Development Methodology for mission-critical systems development and maintenance. Additionally, the review will determine whether SBA is in a position to achieve identified goals and requirements to increase DCMS processing capacity.

Planned Audits

SBA OIG plans a host of audits focused on the complete cycle of hurricane-related disaster loans, including SBA's loan origination, closing and disbursement, borrower use of proceeds, and agency loan servicing, as well as, after loan default, SBA's efforts to recover the debt through liquidation. Because payments by disaster loan borrowers have been deferred for one year after the loan is disbursed, the loan cycle will necessarily extend for many years; however, OIG's initial focus is on the crucial period of the next four years.

Processing reviews will focus on whether SBA has proper controls to provide reasonable assurance that loans go to eligible recipients and that proceeds are used for their intended purposes. Heightened scrutiny will be given to loans that go into default quickly, after the first payment becomes due, as early defaults often indicate origination and servicing problems by the agency or possible borrower fraud. Other reviews will ensure that SBA is devoting adequate resources and has established sufficient controls to maximize recovery of taxpayer dollars through the liquidation process.

Social Security Administration

Final Audit Products

As of March 31, 2006, the Social Security Administration (SSA) OIG had not issued any final audit products.

Ongoing Audits

SSA's Service Delivery to Individuals and Beneficiaries Affected by Hurricanes Katrina and Rita (A-06-06-26072)

Under review is the status of the SSA's service delivery to individuals and beneficiaries affected by Hurricanes Katrina and Rita. Auditors also are assessing the agency's plans to ensure payments made under emergency procedures were appropriate and properly safeguarded.

Planned Audits

As of March 31, 2006, no additional audits were planned.

Treasury Inspector General for Tax Administration

Final Audit Products

Planning for the 2006 Filing Season Is on Course, but Challenges Exist for the Toll-Free Telephone Operations

(Audit No. 200540041; Report No. 2006-40-053, February 27, 2006)

Auditors sought to determine whether the Internal Revenue Service (IRS) adequately prepared its toll-free telephone system for the 2006 filing season (January through mid-April) and adequately considered and accounted for the effects of Hurricanes Katrina and Rita in their filing season preparations.

The IRS Customer Account Services (CAS) function appeared to have an effective planning process



Cameron, LA, 11-10-05 – A Free phone call can be made from this FEMA sponsored MCI phone/communication trailer. The FEMA sponsored MCI communication van provides phone and internet service for the whole community which is totally without service. MARVIN NAUMAN/FEMA photo

for the 2006 filing season that, if properly implemented, would allow taxpayers who call the IRS toll-free telephone lines for assistance to receive effective customer service. CAS function management established goals and objectives and, based on budget and data from prior years, planned for the upcoming fiscal year to ensure staffing, training, and equipment were sufficient for toll-free telephone operations.

However, it was clear that the 2006 filing season could present unique challenges. The Treasury Inspector General for Tax Administration (TIGTA) believed more taxpayers than the number estimated by the IRS could call the Special Services Applications telephone lines for disaster-related issues. Also, the CAS function was to have about 400 fewer resources for toll-free telephone operations than it had in 2005 due to IRS plans to reduce operating hours from 15 to 12 hours per day in 2006.

Congress and the National Treasury Employees Union expressed concern about the cutback in toll-free telephone service. A new law enacted in November 2005 requires the IRS to consult with stakeholder organizations, including the TIGTA, about any proposal or plan to terminate or reduce significantly taxpayer service, including any limiting of available hours for telephone assistance below the daily, weekly, and monthly levels in effect in October 2005. As a result, in fiscal year 2006, the TIGTA is conducting an audit to evaluate IRS plans to reduce operating hours for the toll-free telephone lines. The IRS postponed its plans to reduce the toll-free hours of operation pending the results of this audit.

The TIGTA made no recommendations in this audit report but has continued to monitor the toll-free

telephone operations during the 2006 filing season.

IRS Successfully Accounted for Employees and Restored Computer Operations After Hurricanes Katrina and Rita

(Audit No. 200620036, Report No. 2006-20-068, March 30, 2006)

Auditors found that by adequately planning for and taking aggressive actions after Hurricanes Katrina and Rita, the IRS located all its employees and restored its computer operations in the Gulf Coast area. The IRS took actions immediately prior to the hurricanes to enhance post-hurricane employee communications, ensure continued salary payments, and minimize computer damage in affected offices. Because seven computers remained missing from two offices, the TIGTA was unable to state definitively that taxpayer data were protected in the wake of the Hurricanes. However, none of the missing computers were used to access the IRS computer network after the hurricanes, so any loss of data would have been limited to data on the seven computers.

IRS officials agreed to establish procedures for a rapid evaluation of damaged offices to mitigate physical losses and to re-establish control over its impacted computer inventory.

Field Assistance Office Has Taken Appropriate Actions to Plan for the 2006 Filing Season, but Challenges Remain for the Taxpayer Assistance Center Program

(Audit No. 200540037, Report No. 2006-40-067, March 31, 2006)

Auditors found that the IRS appropriately considered Hurricanes Katrina and Rita issues when planning for the 2006 filing season. Services were added for the 2006 filing season to help lessen taxpayer burden.

Taxpayers affected by Hurricanes Katrina and Rita were considered to meet extreme hardship criteria. This allows them to receive transcripts of prior year tax returns instead of having to order them and wait for delivery. The scope of tax law topics in which assistors are trained was expanded to provide assistance for taxpayers with questions about casualty losses. Taxpayers affected by the hurricanes also could have current and prior year tax returns prepared even if their income levels exceeded the income requirement. All IRS employees affected by the hurricanes had been accounted for, alternate space for offices in affected areas had been obtained, and all Taxpayer Assistance Centers (TACs) in affected areas were open and operational.

However, challenges remained for the IRS for the 2006 filing season: As of December 1, 2005, 47 TACs had critical staffing shortages, including five staff vacancies in TACs located in hurricane-affected areas. In addition to not knowing the overall impact of staff shortages, the Field Assistance Office had insufficient management information to determine which TACs were not offering standard services or standard hours of operation.

The IRS agreed to better publicize TAC hours of operation and services, and the Field Assistance Office is working on a new management information system.

Ongoing Audits*Exempt Organization (EO) Function's Oversight of Tax Exempt Organizations Involved with Hurricane Katrina Relief**(Assignment No. 20060900.H04)*

The audit assesses the adequacy of the EO function's efforts to ensure that new tax-exempt organizations providing assistance to individuals affected by Hurricane Katrina have been properly approved and that referrals of potentially abusive charitable organizations are given priority treatment.

*Review of Hurricane Tax Relief Efforts for Compliance Activities**(Assignment No. 200630006)*

Auditors will look at the IRS's Examination and Collection functions and determine whether compliance action was taken on open taxpayer cases within designated hurricane tax relief areas. Specifically, they will analyze Examination and Collection field cases to identify any inappropriate contacts with taxpayers, such as filing levies and liens, issuing statutory notices of deficiency, and assessing additional tax.

*Identifying and Handling Disaster-Related Cases in the Wage and Investment Division's Automated Underreporter Program**(Assignment No. 200640003)*

The audit will determine whether the IRS's Automated Underreporter Program ensured that compliance actions were suspended for individual taxpayers affected by the recent hurricane disasters.

*Review of Disaster Relief Codes and Associated Freezes**(Assignment No. 200640026)*

The audit examines whether the IRS correctly identified taxpayers (individual and business) affected by Hurricanes Katrina and Rita, determines whether disaster indicators were accurately placed on their accounts, and ascertains whether applicable notices were suppressed on these accounts during the disaster relief period.

Preliminary audit results indicate that the IRS correctly identified affected taxpayers and accurately placed disaster indicators on their accounts. Disaster indicators properly suppressed balance-due notices to affected taxpayers. More than 99 percent of the disaster indicators were systemically placed on taxpayer's accounts using ZIP codes.

Less than 1 percent of disaster indicators were manually placed on taxpayer accounts by IRS personnel based on contact with taxpayers. Although these inputs were relatively small in number, the TIGTA identified the following two issues that adversely affected some taxpayers:

- Disaster indicator relief dates entered by IRS personnel had high error rates attributable to human error and misleading procedures
- The IRS did not properly update the ending dates, meaning some taxpayers did not receive relief for the

time period intended

Implementing Tax Law Changes for the Processing of Individual Income Tax Returns During the 2006 Filing Season

(Assignment No. 200640015)

Auditors will review whether the IRS accurately updated tax products and computer programming for tax law changes that will affect the processing of individual income tax returns during the 2006 filing season. They also will assess whether the IRS completely and accurately initiated changes to the tax forms, instructions, and publications and initiated computer system change requests necessary to implement new or expiring tax law provisions that affect the processing of individual income tax returns.

2006 Filing Season Implementation

(Assignment No. 200640016)

This audit will evaluate whether the IRS timely and accurately processed individual paper and electronic tax returns during the 2006 filing season. Specifically, auditors will determine whether the IRS did the following:

- Correctly implemented new tax legislation that could affect the processing of individual taxpayer returns during the 2006 filing season
- Adequately monitored and documented that individual returns are being processed in a timely and accurate manner
- Took corrective actions in response to the prior TIGTA filing season report to resolve identified issues

Taxpayer Assistance Center (TAC) Filing Season 2006

(Assignment No. 200640027)

During the 2006 filing season, auditors planned anonymous visits to approximately 12 TACs each month, visiting 50 TACs in 16 states. They sought to determine the following:

- Whether taxpayers were receiving quality service
- Whether employees were professional and courteous
- Whether wait times for service were appropriate
- Whether customer survey comment cards were provided
- Whether correct addresses and office hours were provided

Preliminary results from visits made during January and February 2006 to 13 TACs in Georgia, Florida, Louisiana, Mississippi, Tennessee, and Texas showed the accuracy rates were as follows:

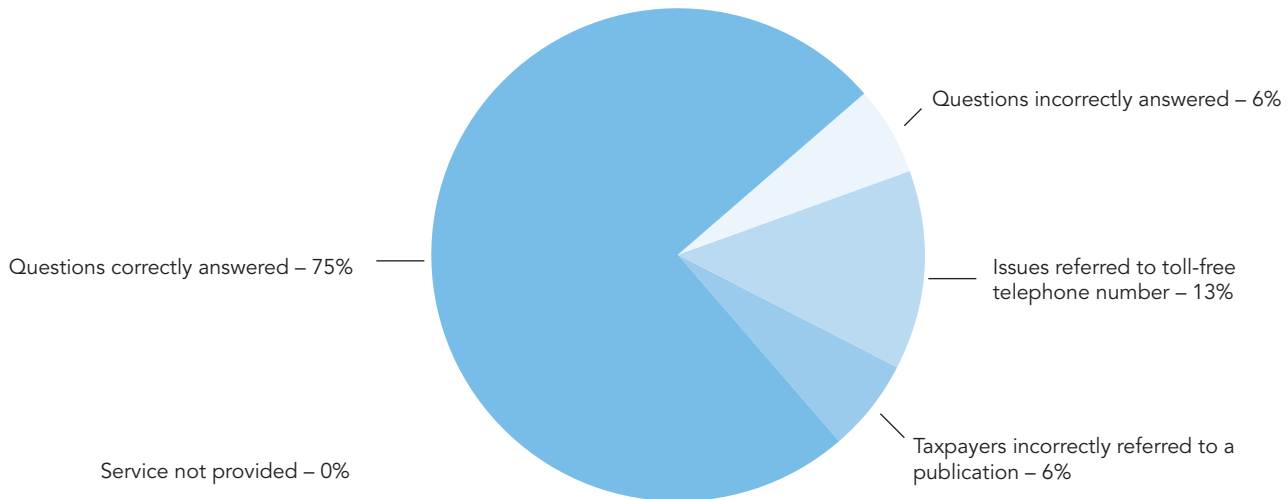

Observations from these interviews include the following:

- IRS employees answered questions without using any of the available tools as required in 14 (27 percent) of the 52 questions asked
- IRS employees answered questions and did not follow the publication method as required in 15 (29 percent) of the 52 questions asked. The publication method requires employees to use a publication to explain the tax law to taxpayers. Employees should also highlight the appropriate sections discussed and provide a copy to the taxpayer to take home
- IRS employees were professional and courteous for 24 (92 percent) of the 26 visits
- Wait time was 30 minutes or less for 14 (54 percent) of the 26 visits

United States Department of Agriculture

Ongoing Audits

Hurricane Relief Initiatives: Barge Movement and Transportation Differential Agreements
(Audit # 03601-21-KC)

Auditors will determine whether Commodity Credit Corporation (CCC) payments made for barge movement, barge unloading, and transportation differential agreements were effective in removing barges from the New Orleans area, and thereby reducing transportation demands for these barges on the upper Mississippi River.

Hurricane Relief Initiatives: Emergency and Alternative Grain Storage
(Audit No. 03601-22-KC)

The audit will determine whether costs associated with CCC's alternative and emergency warehouse grain storage initiatives were reasonable and if the initiatives were effective in alleviating grain movement and storage problems.

Controls Over Housing Funds Provided for Hurricane Relief Efforts
(Audit No. 04601-13-CH)

The audit ensures the accountability of housing assistance (multi- and single-family) provided by the United States Department of Agriculture (USDA) to disaster victims.

Risk Management Agency 2005 Emergency Hurricane Relief Efforts in Florida
(Audit No. 05099-28-AT)

Auditors are assessing the adequacy of controls over hurricane relief efforts.

Forest Service (FS) Hurricane Relief Efforts
(Audit No. 08601-46-SF)

The Forest Service's existing internal controls are being assessed to ensure disaster relief funds are spent wisely and to identify any waste, fraud, and abuse.

Food and Nutrition Services (FNS) Disaster Food Stamp Program for Hurricanes Katrina, Rita, and Wilma in Texas
(Audit No. 27099-46-TE)

Auditors will determine whether FNS Regional Offices are adequately overseeing the Disaster Food Stamp Program (DFSP) operations and if State agencies are operating the DFSP in accordance with the waivers approved by the FNS Administrator. Auditors also will evaluate the effectiveness of controls to prevent program abuse, such as the prevention of duplicate payments.

FNS Disaster Food Stamp Program (DFSP) for Hurricanes Katrina, Rita, and Wilma in Mississippi
(Audit No. 27099-47-TE)

The audit will determine whether FNS Regional Offices are adequately overseeing DFSP operations and whether State agencies are operating the DFSP in accordance with the waivers approved by the FNS Administrator. Auditors also will evaluate the effectiveness of controls to prevent program abuse, such as the prevention of duplicate payments.

FNS Hurricane Relief Effort in Alabama
(Audit No. 27099-61-AT)

The review will determine whether FNS Regional Offices are adequately overseeing DFSP operations and whether State agencies are operating the DFSP in accordance with the waivers approved by the FNS Administrator. Auditors also will evaluate the effectiveness of controls to prevent abuse, such as preventing duplicate payments.

FNS Hurricane Relief Effort in Florida
(Audit No. 27099-62-AT)

The audit will determine whether FNS Regional Offices are adequately overseeing DFSP operations and if State agencies are operating the DFSP in accordance with the waivers approved by the FNS Administrator. Auditors also will evaluate the effectiveness of controls to prevent program abuse, such as the prevention of duplicate payments.

Hurricane Relief Initiatives: Natural Resources Conservation Services (NRCS) Emergency Watershed Protection Program (EWP) and Dead Animal Debris Disposal Project and FSA Emergency Conservation Program (ECP)
(Audit No. 50601-12-KC)

Auditors will monitor funding levels to evaluate the adequacy of management controls and to review the reasonableness of reimbursements under EWP and ECP. They also will assess waivers or revise procedures applicable to EWP and ECP and review NRCS's efforts to assist agricultural producers in the disposal of dead animal debris.

Planned Audits

Review of Management Controls for Crop Insurance Emergency Loss

Auditors will assess the adequacy of management controls over this program.

Review of Acquisitions Made in Response to the Hurricanes

The objective is to assess whether acquisitions were made in accordance with regulations and if USDA received best value.

Review of Crop Disaster, Livestock, Tree Hurricane, Feed, and Indemnity Programs

Auditors will assess USDA implementation and controls over the Hurricane Indemnity Program, Livestock Indemnity Program, Feed Indemnity Program and Aquaculture Block Grant Program

Review of Emergency Watershed, Forestry Reserve, and Conservation Program

This will be an assessment of implementation and controls over the programs.

Review Rural Community Advancement Program Hurricane Disaster Grants

The audit will determine whether the agency administered the grant funds for water, waste disposal, and wastewater facilities in accordance with the rural community advancement program regulations.

Review Loans for Telecommunications and Electrical Assistance

Auditors will determine whether the Rural Utilities Service administered Direct Rural Telecommunications loans in accordance with regulations and if funds were used for approved purposes.

United States Postal Service

Final Audit Products

Postal Service Actions to Safeguard Employees from Hurricane Katrina
(Report No. HM-AR-06-002, February 2006)

Auditors concluded that the Postal Service took appropriate actions under the Integrated Emergency Management Plans (IEMPs) and supplemental hurricane plans related to effective notification to employees prior to Katrina's landfall. Postal Service employees were safeguarded, and there were no reported injuries to employees prior to Katrina's landfall. The OIG offered no recommendations.

Mail Processing Operations in the Wake of Hurricane Katrina and Rita
(Report No. NO-MA-06-002, March 1, 2006)

The Postal Service successfully reestablished mail processing in the aftermath of the hurricanes, auditors found, by implementing emergency management plans to move the mail, assessing damage to the mail-processing network, and quickly reestablishing mail-processing operations in the Gulf Coast region.

The OIG recommended that management revise, validate, and utilize a communications plan, assess existing mail processing contingency sites, and assess electrical requirements to improve future disaster response. Management agreed to these changes.

National Change of Address (COA) Emergency Preparedness (Report No. IS-AR-06-005, March 30, 2006)

The OIG concluded that Postal Service management responded diligently to Hurricane Katrina by creating new procedures to redirect mail to affected customers under extremely tight time constraints. However, auditors also recommended that the Postal Service establish and consolidate essential COA emergency procedures. Management stated that processes and committees were in place to address this and offered alternative actions.

*Postal Service's Emergency Purchasing in Response to Hurricanes Katrina and Rita
(Report No. CA-MA-06-001, March 7, 2006)*

The OIG concluded that the Postal Service quickly responded to Hurricanes Katrina and Rita by using existing contracts and containing costs when new contracts were needed. No recommendations were made.

Ongoing Audits

Review of Postal Service's Replacement and Repair of Facilities Affected by Hurricane Katrina (Report No. FA-MA-06-DRAFT, March 2006)

Auditors found that Postal Service facilities quickly and successfully responded to Hurricane Katrina and resumed regular operations quickly and that the Postal Service suspended rent payments for leased facilities deemed unusable after the storm. The report recommended that the Postal Service improve accessibility to facilities and take additional steps to enhance its response to future disasters. Management's com-

Cameron, LA, 11-10-05 – A Free phone call can be made from this FEMA sponsored MCI phone/communication trailer. The FEMA sponsored MCI communication van provides phone and internet service for the whole community which is totally without service. MARVIN NAUMAN/FEMA photo



ments were due in April 2006.

Postal Inspection Service's Procurement Transactions Related to Hurricane Katrina Response, Recovery, and Reconstruct Efforts (Report No. SA-AR-06-DRAFT, March 2006)

The OIG concluded that, overall, the Postal Service and the Postal Inspection Service had effective controls over procurement transactions related to Katrina recovery efforts. Procurement transactions were valid, authorized, and supported by the appropriate documentation. However, the OIG recommended that management strengthen controls to ensure that International Merchant Purchase Authorization Card cardholders review, sign, and date U.S. bank statements within five days of receipt as required. Management comments were due in April 2006.

Postal Inspection Service Emergency Preparedness for Hurricane Katrina (Report No. SA-AR-06-DRAFT, March 2006)

Auditors found that the Postal Inspection Service responded to Hurricane Katrina rapidly and successfully under very difficult and unprecedented circumstances and that it implemented actions consistent with the IEMPs. Further, the Postal Inspection Service initiated an educational campaign to prevent fraud schemes related to Katrina relief efforts.

Postal Service Emergency Preparedness for Hurricanes Katrina and Rita (Report No. SA-AR-06-DRAFT)

While the Postal Service took noteworthy actions in responding to the hurricanes, auditors to date have found several opportunities to enhance emergency preparedness planning and responses:

- Aligning the framework of the IEMP to the National Response Plan
- Completing and approving the IEMPs
- Using the Postal Emergency Management Systems or an alternative system to manage incidents more effectively
- Revising performance measures to address all hazards
- Establishing mandatory training for responsible personnel

Hurricane Katrina—The Effectiveness of the Postal Service Transportation and Logistics Network

In an ongoing audit of the effectiveness of the Postal Service Transportation and Logistics Network, the OIG has tentatively concluded that the Postal Service's proactive anticipation of Hurricane Katrina and rapid response to the storm's impact on the Gulf Coast preserved Postal Service funds and other resources and facilitated the task of reconstituting the Postal Service network.

Audit of the Postal Service Actions to Locate Employees After Hurricane Katrina

Postal Service actions after Katrina's landfall are being analyzed to determine the effectiveness of the efforts to locate employees and track their locations as they changed addresses in the ensuing days and months.

Planned Audits

Supply Management and Incurred Cost Audits of Hurricane Katrina

The OIG will audit costs charged to Postal Service contracts to ensure they are allocable, allowable, reasonable, and in accordance with the terms of the contracts and Postal Service regulations.

INVESTIGATIONS

5



New Orleans, La, August 31, 2005 -- A sheriff's deputy helps an elderly man, too weak to lift his bottle of water, take a drink. Many elderly people were affected by Hurricane Katrina which struck the area on August 29. New Orleans is being evacuated following hurricane Katrina and rising flood waters. Photo by Win Henderson/FEMA photo.

OVERSIGHT OF GULF COAST HURRICANE RECOVERY

Investigations

Each of the federal Inspectors General (IGs) investigates potential violations of law related to hurricane recovery efforts in the Gulf Coast region. Where concerns arise, criminal investigators are assigned to determine whether there has been a violation of law, statute, or regulation. Members of the President's Council on Integrity and Efficiency (PCIE) and Executive Council on Integrity and Efficiency (ECIE) submit monthly reports listing the key details about their investigations.

Since the hurricane relief and recovery process was initiated, through March 31, 2006, 174 indictments, 152 arrests, and 48 convictions have been reported by the IG investigative community.

Investigative teams have been deployed to each of the IG Joint Field Offices in Alabama, Mississippi, Louisiana, Texas, and Florida to provide technical assistance to Federal Emergency Management Agency (FEMA), State, and local officials. The investigators are coordinating with their respective federal, State, and local law enforcement agencies and prosecutors as part of their "fraud awareness" initiatives. They have also initiated a series of investigations of allegations received through the Katrina Fraud Hotline and other sources.

"Due to our efforts, along with the highly publicized work of the U.S. Attorney's Office, approximately 2,484 individuals have returned checks to FEMA for a total of \$6.3 million," said Richard L. Skinner, Inspector General for the Department of Homeland Security (DHS), when he testified before the Senate Committee on Homeland Security and Government Affairs on February 13, 2006.

THE HURRICANE KATRINA FRAUD TASK FORCE

The task force, established on September 8, 2005, by the U.S. Attorney General, works to deter, investigate, and prosecute hurricane-related fraud. The Department of Justice's (DOJ) Criminal Division heads the task force, whose members include the U.S. Attorney's Offices, the Federal Bureau of Investigation (FBI), the federal IGs, the U.S. Secret Service, and the U.S. Postal Inspection Service, among others. It works closely with other federal and State partners. The task force focuses on specific areas of fraud common in post-disaster environments, including the following:

- Fraudulent charities—cases in which individuals falsely present themselves as agents of a legitimate charity or create a "charity" that is in fact a sham



New Orleans, LA--September 16, 2005 – Members of the FEMA Urban Search and Rescue task forces meet with local police to discuss operations in areas that are impacted by Hurricane Katrina. Jocelyn Augustino/FEMA

- Identity theft—cases in which the identities of innocent victims are stolen and assumed by criminals who convert the funds of, or otherwise defraud, the victims
- Disaster relief benefit fraud—cases in which persons misrepresent their status as hurricane victims to receive private or public disaster relief benefits
- Government-contract and procurement fraud and public corruption—cases in which individuals and companies engage in fraud and public corruption relating to federal funds provided for the repair and restoration of infrastructure, businesses, and government agencies in the affected region
- Insurance fraud—cases in which false or inflated insurance claims are filed

CRIME TRENDS AND ENFORCEMENT ACTIONS

To identify criminal trends in the hurricane recovery process, the federal IGs have collected agency-level statistics. As of March 31, 2006, members of the PCIE/ECIE have reported 785 open cases of potential criminal activity.

As shown in Table 5-1, most of the cases were reported through the DHS, with 466 cases opened. In general, most of these cases involved fraudulently seeking or receiving disaster relief funds.

The Department of Labor (DOL) reported the second highest number of cases, with 206 opened. Most of its investigations involve potential unemployment insurance and/or disaster unemployment insurance fraud.

The number of open cases reported by other contributing departments and agencies include six by the Department of Defense (DoD), one by the Department of the Interior (DOI), 17 by the Department of Health and Human Services (HHS), 18 by the Department of Housing and Urban Development (HUD), six by the Department of Justice (DOJ), ten by the Department of Transportation (DOT), six by the Environmental Protection Agency (EPA), two by the General Services Administration (GSA), 11 by the National Aeronautics and Space Administration (NASA), three by the Small Business Administration (SBA), 17 by the Social Security Administration (SSA), two by the Treasury Inspector General for Tax Administration (TIGTA), 11 by the U.S. Department of Agriculture (USDA) and three by the United States Postal Service (USPS).

Compared to the number of investigations reported in the first 90 days following the storms, after 180 days, there are more than three times the numbers of cases opened, more than four times the numbers of arrests made, nearly four times the numbers of indictments, and more than 14 times the numbers of convictions handed down.

PCIE/ECIE KATRINA FRAUD HOTLINE

Between October 5, 2005, and March 19, 2006, the Hotline operated as the PCIE/ECIE Katrina Fraud Hotline. The Department of Defense Office of Inspector General (DoD OIG) managed the hotline on behalf of the federal IGs involved in hurricane recovery oversight. Each of the Inspectors General also has a separate hotline for receiving complaints.

INVESTIGATIVE STATISTICS, BY AGENCY

Agency	Cases Opened	Cases Opened	Arrests	Arrests	Indictments	Indictments	Convictions	Convictions	Hotline ¹ Contacts	Hotline ¹ Contacts
	1st 180 days	1st 90 days ²	1st 180 days	1st 90 days ²	1st 180 days	1st 90 days ²	1st 180 days	1st 90 days ²	1st 180 days	1st 90 days ²
DHS	466	188	117	29	140	41	40	3	4,533	1,590
DOC	-	-	-	-	-	-	-	-	1	-
DoD	6	3	1	-	-	-	2	-	9,664	3,777
DOE	-	-	-	-	-	-	-	-	2	-
DOI	1	-	-	-	-	-	-	-	-	-
DOJ	6	-	-	-	-	-	-	-	-	-
DOL	206	4	14	-	13	-	1	-	10	-
DOT	10	1	2	-	3	-	1	-	1	3
ED	-	-	-	-	-	-	-	-	-	-
EPA	6	3	-	-	-	-	-	-	6	1
GSA	2	1	-	-	-	-	-	-	-	-
HHS	17	11	-	-	-	-	-	-	2	-
HUD	18	7	6	-	5	-	2	-	81	41
NASA	11	1	5	5	1	1	-	-	-	-
SBA	3	-	-	-	-	-	-	-	12	2
SSA	17	8	4	1	9	1	1	-	22	20
TIGTA	2	2	1	1	1	1	-	-	-	-
USDA	11	1	2	-	2	-	1	-	1	-
USPS	3	-	-	-	-	-	-	-	50	34
VA	-	-	-	-	-	-	-	-	-	-
TOTAL	785	230	152	36	174	44	48	3	14,385	5,468

Source: 9th PCIE Hurricane Katrina Report (as of March 31, 2006)

Note 1: DoD hotline numbers represent the Katrina Fraud Hotline. All other agency numbers represent their individual hotline operation.

Note 2: Data from PCIE *Weekly Report*, as of December 2, 2005

Table 5-1

On March 20, 2006, control of the Katrina Fraud Hotline passed from DoD OIG to the Hurricane Katrina Fraud Task Force Joint Command Center in Baton Rouge, Louisiana. This office manages the hotline on behalf of the federal IGs involved in hurricane recovery oversight. The consolidated hotline facilitates reporting, logging, relaying, and tracking of calls about fraud, waste, and abuse by contractors, government employees, and the public in Gulf Coast recovery activities.

CASE SUMMARIES

The following case summaries represent claims and investigations reported by the federal IGs involved in hurricane recovery oversight.

Department of Homeland Security

DHS has opened 466 investigations, resulting in 117 arrests, 140 indictments, and 40 convictions.

The following ten cases represent more than \$1.42 million in theft or attempts to defraud the federal government of funds earmarked for hurricane disaster recovery efforts or relief. Additional cases with smaller dollar figures are also being pursued.

- In a joint investigation with the FBI and U.S. Postal Inspection Service, eleven suspects were indicted and arrested for theft of government property, totaling \$470,406 in fraudulent Katrina claims with FEMA.
- The executive director of a private nonprofit organization was identified by the Internal Revenue Service (IRS) Criminal Investigation Division as a suspect in the theft of federal program funds and submitting false documents to FEMA. A 21-count indictment was returned against the suspect, who was charged with theft of federal program funds, money laundering, and filing false tax returns of more than \$350,000. As of March 31, the trial was scheduled for April 6.
- A hotel owner was charged with defrauding FEMA of \$232,000. An arrest was made as a result of a joint investigation with the U.S. Secret Service. A 39-count indictment was filed against the owner for wire fraud and filing false claims through FEMA's Public Assistance Program disaster relief lodging programs for hurricane evacuees. The owner was arrested and released on a \$75,000 bond.
- A group of Dallas residents has been arrested for stealing more than \$80,000 in FEMA funds by filing false claims. The arrests came after a joint investigation with the DOL OIG, the U.S. Postal Service, and the Louisiana Department of Labor. The civilian who devised a scheme to impersonate hurricane evacuees and defraud FEMA using false identities with a group of co-conspirators failed to appear for arraignment; a warrant has been issued for this civilian. Ten Dallas, Texas, and Jackson, Mississippi area residents have been indicted for their role in the scheme.
- A person was arrested on charges of committing \$70,000 in Disaster Unemployment Assistance (DUA) program fraud. This action came as a result of a joint investigation with the DOL OIG.
- An individual fraudulently filed multiple disaster claims on behalf of local homeless people. The claims amounted to \$47,000. He pleaded guilty and is awaiting sentencing. The subject was identified in a joint investigation with the U.S. Secret Service.

- After a joint investigation with the U.S. Secret Service, four suspects were indicted and then arrested for devising a scheme to defraud FEMA by misrepresenting themselves as Hurricane Katrina victims. (Because of their false statements, FEMA had paid them \$20,425.)
- Two temporary FEMA employees were arrested for soliciting a \$20,000 bribe in return for inflating a catering contract. This is the first case of FEMA employees being arrested on fraud charges during the Katrina recovery effort.

Three other investigations center on government employees: a former IRS employee who was charged with falsely claiming to be a hurricane victim, two FEMA inspectors were indicted for soliciting and accepting bribes, and a FEMA inspector was indicted for making false statements.

Other investigations undertaken by DHS for attempting to defraud FEMA include: a subject who also threatened a witness; a couple indicted for hurricane relief fraud; false disaster assistance claims based on wrong addresses; a subject who falsified government documents and received a \$2,000 housing emergency check; one fugitive and a Houston woman who pleaded guilty to charges and one parolee arrested; and three Oklahoma residents indicted for conspiring to defraud FEMA.

Department of Defense

As of March 31, 2006, the Defense Criminal Investigative Service (DCIS) received 21 criminal allegations related to Hurricane Katrina. These involved theft, false claims, bribery, kickbacks, product substitution, procurement fraud, and selling Meals Ready to Eat on eBay.

Of the 21 allegations, eight were unfounded; three were referred to other federal agencies; three were declined for prosecution; one allegation is still being examined; and six resulted in opened cases. The opened cases deal with bribery, kickbacks, and possible product substitution. The allegations have originated from the Government Accountability Office, the U.S. Army Criminal Investigation Command, the U.S. Army Corps of Engineers, the FBI, subcontractors, and private citizens.

Two defendants were successfully convicted in one of the open cases. They pleaded guilty to a single count of criminal information charging conspiracy to commit bribery. The defendants are scheduled for sentencing on June 8, 2006.

DCIS is working joint investigations with the U.S. Army Criminal Investigation Command and the FBI. In addition, DCIS is providing support to the following organizations:

- The Hurricane Katrina Fraud Task Force Joint Command Center, which consists of senior law enforcement and U.S. Attorney's Office personnel.
- The joint law enforcement and U.S. Attorney's Offices working group, headquartered in Covington, Louisiana, and the Joint Criminal Investigative Task Force, headquartered in Mississippi.

Department of Health and Human Services

The Department's OIG is currently investigating 15 quality-of-care cases in the Gulf area. The treatment of certain beneficiaries residing in health care facilities during the disaster is being investigated based on allegations of euthanasia, gross negligence, and poor quality of care.

The Senate Special Committee on Aging requested that OIG conduct a study of facility evacuation planning and execution. This study will respond to the Committee's request and continues the OIG's ongoing work to monitor the health and safety of nursing home residents. Specifically, OIG will determine whether these nursing homes complied with federal requirements to develop and practice emergency preparedness plans and whether the plans included evacuation of residents. The report will also examine to what extent plans were executed for facilities that evacuated, or considered evacuation, during recent disasters. Additionally, it will identify lessons learned from these facilities regarding the development and execution of emergency preparedness plans.

Department of Housing and Urban Development

The Department's OIG opened 18 cases during the period ending March 31, 2006, which resulted in six indictments, six arrests, and two convictions. HUD OIG combined forces with DOJ and the FBI to address allegations of fraud and public corruption.

Examples of HUD investigations include the following:

- Three Louisiana individuals who have been arrested for falsely representing themselves as hurricane evacuees displaced from public housing
- Two individuals indicted in Pennsylvania for making false statements when applying to a public housing authority
- A California man arrested for mail fraud, then subsequently being charged with wire fraud and making false statements that he was a Hurricane Katrina victim, receiving monetary and lodging aid from charitable organizations

Department of Justice

The Department's OIG Investigation Division has six ongoing investigations related to fraudulent claims for hurricane relief benefits. Five of these investigations were initiated after January 1, 2006.

Department of Labor

As of March 31, 2006, the DOL OIG initiated 188 investigations, mainly involving potential Unemployment Insurance and/or Disaster Unemployment Assistance fraud. Cases are being worked jointly with other agencies. Several cases are in the grand jury phase.

Department of Transportation

DOT investigators working on the Hurricane Katrina Fraud Task Force and the Public Corruption Task Force have reviewed allegations of over-billings on highway debris-removal contracts, an alleged improper



HUD OIG Special Agents assessing damage in New Orleans, LA

award of a large-dollar emergency repair service contract in the Gulf Region, and a possible employee conflict of interest with administration of the DOT's emergency transportation services contract.

In addition, DOT is working with the Federal Aviation Administration (FAA) to ensure proper disposition of wind- and flood-damaged aircraft considered un-airworthy. For example, the crash of a Cessna 152 aircraft in Florida Bay off the coast of Key Largo was investigated, and an individual was arrested for flying without a pilot's license. Subsequently, investigators learned that he was ferrying an aircraft damaged by Hurricane Wilma, allegedly for resale to an unsuspecting buyer.

FAA officials were notified, and the DOT helped devise a strategy to identify and track hurricane-damaged aircraft and publicly disseminate information about this important safety concern. The FAA Safety Team has sent a special notice to all registered airmen (approximately 250,000) concerning this issue; placed information about hurricane-damaged aircraft on its Web site, www.faasafety.gov; and began working with insurance companies to obtain listings of damaged aircraft for follow-up attention, as appropriate.

Department of the Treasury

The Department's OIG currently has a significant ongoing criminal investigation involving multiple defendants. The investigation concerns illegally received Hurricane Katrina relief benefits proceeds.

Environmental Protection Agency

The EPA OIG Office of Investigations currently has six open investigations, and one investigation has been closed with an administrative action during this reporting period. The case that was closed concerned allegations of potential false statements by a contractor, who purported that he had received approval from an EPA on-scene coordinator to commence clean-up and rescue operations in New Orleans. He used the approval only to enter designated disaster areas. No EPA funding was paid to him. A cease and desist letter was issued to the contractor by the EPA OIG, and the case was declined for prosecution by federal and State prosecutors.

General Services Administration

Two GSA investigators participate in the DOJ Hurricane Katrina Fraud Task Force, conducting criminal investigations related to hurricane relief efforts. Currently, the GSA has reported two open cases.

National Aeronautics and Space Administration

NASA conducted and assisted in many criminal investigations during and immediately after the Hurricane Katrina evacuation. Stennis Space Center served as an evacuation refuge for displaced citizens. The NASA OIG dealt with cases involving illegal drugs, illegal solicitation, alleged assaults, breaking and entering, theft, diversion of FEMA supplies, and an unattended death case of an elderly evacuee.

More recently, NASA OIG conducted a joint investigation into the use of illegal immigrants on critical infrastructure projects. Five illegal immigrants were arrested and one was later indicted.

Small Business Administration

The Small Business Administration's (SBA's) OIG is investigating allegations including claims for property damage that never occurred or for property not owned by the borrower during the disaster; false statements about prior criminal records; misuse of SBA loan funds for unauthorized purposes; and overstatement of financial loss. Of these, four cases have been opened and referred for criminal prosecution.

Instances of fraud are expected to increase significantly as more loan disbursements are made to borrowers and after the 12-month deferment of principal and interest payments for many disaster loans comes to an end.

The SBA OIG is also initiating several proactive projects. One is designed to identify borrowers who submit false statements on their SBA applications for disaster assistance business loans and who may have past criminal records. The OIG will conduct criminal history checks on a statistical sample of loans, to ensure compliance with the SBA's policy of preventing assistance to those of poor character.

Another proactive project is a joint effort with the DHS OIG and other OIGs to identify applicants for disaster assistance loans who did not reside in the affected areas during the Gulf hurricanes.

The third project is early fraud detection for hurricane-related disaster assistance loans. Data mining and analysis of disaster data will be used to identify potential fraud indicators in disaster loans. Where indicated, further review and investigation will follow.

Social Security Administration

The SSA OIG Office of Investigations (OI) has received 42 allegations of potential fraud relating to Hurricanes Katrina and Rita. Most fall into the category of social security number (SSN) misuse, which includes identity theft and false claims, among other allegations.

To date, OI has opened 17 investigations; two of these have been closed. Fourteen of the 18 relate to misuse of an SSN, and the other four relate to disability program fraud. Three specific cases are described in the SSA OIG's report. In one case, a woman pleaded guilty to two counts in a seven-count indictment and has been ordered to pay restitution of \$4,000 to FEMA, in addition to paying a \$2,000 fine and a \$200



New Orleans, St. Bernard, LA, 03-1-06 – Security guards John Oleaga and Lol Madrigal check a truck driver for proper access to the dock and Cruise Ships that house disaster victims. The housing afforded by the cruise ship allowed police officers, fire fighters, emergency medical personnel and city workers to keep the city functioning. Marvin Nauman/FEMA photo

special assessment and being sentenced to home confinement and probation. Another woman pleaded guilty to illegal use of an SSN and was sentenced to probation and a \$100 special assessment fee. The third case involves an individual charged with wire fraud and SSN misuse. He was arrested in December and indicted on January 19, 2006.

United States Department of Agriculture

In January 2006, an individual pleaded guilty to making false statements on the food stamp application he submitted. He listed a New Orleans address as his residence and received \$447 in disaster food stamp assistance from September through November 2005. The department's investigation found that he was not entitled to this assistance since he did not live in the affected area. Sentencing is pending.

United States Postal Service

The U.S. Postal Service (USPS) OIG is working with DOL OIG to use proactive analytical techniques investigating possible hurricane-related fraud. Two investigations are underway.

TRAINING

As part of the federal government's effort to prevent fraud, waste, and abuse in the Gulf Coast region, agency IGs have launched training programs to increase fraud awareness. These programs are part of an effort to educate and train personnel involved in the contracting and procurement process.

For example, DCIS conducted 34 mission/fraud awareness briefings. DOT OIG special agents have conducted nearly 50 fraud awareness briefings to various oversight providers, Federal Highway Administration and State transportation department personnel, and trade association officials. The presentations addressed fraud risks and indicators. The presentations focused on fraud schemes the OIG has historically identified on highway and bridge projects, including false claims, product substitution, bid rigging, Disadvantaged Business Enterprise fraud, and kickback and bribery schemes. The presentations resulted in the identification of several allegations of criminal activity.

DOL OIG anticipates working with the U.S. Attorney's Offices in the disaster region to present fraud awareness briefings on Katrina-related construction fraud and the Davis Bacon Act.

INSPECTIONS

6



9th Ward, New Orleans, LA, 3-15-06 – Search & Rescue dog Ranger searches for human remains in tight confining areas faster and better than humans can. All homes being demolished in 9th Ward are searched by a search and recovery team that includes special search recovery dogs so that no human remains are left in houses that are being demolished. Marvin Nauman/FEMA photo

OVERSIGHT OF GULF COAST HURRICANE RECOVERY

Inspections

After addressing immediate emergency needs post-Katrina, the Offices of Inspector General (OIGs) for two agencies—the Department of Homeland Security (DHS) and the Department of Health and Human Services (HHS)—began to inspect their departments' performance in the wake of the disaster. On March 31, 2006, the DHS OIG released a 218-page report reviewing FEMA's response to Hurricane Katrina, proposing 38 recommendations for improvement.

In addition, the HHS OIG plans to evaluate deployment of the U.S. Public Health Service Commissioned Corps. In testimony before the Senate Homeland Security and Governmental Affairs (HSGA) Committee on March 8, 2006, DHS Inspector General Richard L. Skinner highlighted six areas where critical improvements are needed:

1. Clarifying command and control
2. Coordinating other federal agencies' responses
3. Gaining visibility of assets flowing to the disaster area
4. Ensuring reliable communication of disaster information
5. Incorporating the media in public information efforts
6. Turning "lessons learned" into "problems solved"

While time frames for addressing these critical areas were not the subject of his testimony, it is commonly understood that these improvements would increase DHS' readiness, response, efficiency, and effectiveness in meeting the challenges of future incidents of national significance.

DEPARTMENT OF HOMELAND SECURITY

A Performance Review of FEMA's Disaster Management Activities in Response to Hurricane Katrina⁵

"The federal government, in particular the Federal Emergency Management Agency (FEMA), received widespread criticism for a slow and ineffective response to Hurricane Katrina. Much of the criticism is warranted," according to the DHS OIG.

Although FEMA and other agencies deployed emergency responders and resources in advance of the storm and supported state efforts to evacuate people and conduct other final preparations, most were overwhelmed the first week after landfall. The response highlighted severe deficiencies and multiple areas where FEMA and DHS headquarters must make adjustments to the National Response Plan (NRP), such as the use of incident designations, the role of the Principal Federal Official, and the responsibilities of Emergency Support Function (ESF) coordinators. A lack of visibility in the resource ordering process, difficulty deploying sufficient numbers of trained personnel, unreliable communication systems, and insufficient management controls for some assistance programs demonstrate a need for improved response support capabilities and more effective delivery mechanisms for assistance.

FEMA's efforts to support State emergency management and to prepare for federal response and recovery in natural disasters were insufficient for an event of Hurricane Katrina's magnitude, and directly correlate with weaknesses in FEMA's grant programs, staffing, training, catastrophic planning, and remediation of issues identified during previous disasters and exercises.

As FEMA's role in administering grants and conducting exercises for natural disasters preparedness has diminished, DHS must ensure that all four phases of emergency management—preparedness, response, recovery, and mitigation—are managed throughout the department on an all-hazards basis. Coordination and consultation among DHS components and with the States are essential to guide, advise, develop, and monitor all-hazards capability and responder effectiveness, according to the report.

⁵*A Performance Review of FEMA's Disaster Management Activities in Response to Hurricane Katrina*, OIG-06-32, Department of Homeland Security Office of Inspections and Special Reviews.



New Orleans, LA, March 8, 2006 – This house in Gentilly is in the process of being elevated above the base flood elevation adopted by the community in result of flooding from Hurricane Katrina. The homeowner will raise the house a total of 11' and has received the Increased Cost of Compliance (ICC) benefit included with his National Flood Insurance Program (NFIP) policy because of his compliance to the community's floodplain management ordinance. Robert Kaufmann/FEMA

The review covered FEMA's responsibilities for three of the four major phases of disaster management—preparedness, response, and recovery—during the first five weeks of the federal response. Beyond that, the report evaluated FEMA's preparedness and readiness efforts over the past 10 years to determine its organizational capability and posture before Katrina.

DHS OIG recommended, among other things, that DHS headquarters and FEMA do the following:

- Establish measurable expectations of FEMA's response
- Provide the necessary financial, technical, and staff support to meet them
- Assess FEMA's readiness

In addition, DHS OIG made recommendations to (1) clarify how DHS headquarters, FEMA, and other DHS components will implement aspects of the NRP and (2) address improvements to FEMA's infrastructure for resource ordering and tracking, personnel deployment, disaster communications, and disaster application handling.

To improve disaster preparedness, the OIG recommended that FEMA:

- Complete catastrophic, surge, and workforce plans
- Add training
- Strengthen its remedial action program
- Build relationships with the States in concert with the Preparedness Directorate and DHS Public Affairs

DHS OIG also recommended several modifications to how FEMA manages disaster assistance. By the end of the semi-annual reporting period, DHS OIG had not received DHS' management comments in response to these recommendations. As a result, all recommendations are considered unresolved and open. There are no other ongoing or planned inspections or reviews. However, the DHS OIG will be work-

ing closely with FEMA and other DHS components highlighted in this report to ensure steps are taken to fully address open recommendations.

While management reviews are still ongoing, the DHS OIG review thus far has disclosed the following general problems:

- Requirements planning for relief and recovery prior to Hurricane Katrina were inadequate. FEMA either purchased supplies, commodities, equipment, and other resources to support emergency and disaster response efforts in insufficient quantities or over purchased commodities.
- Because competition was limited or nonexistent, the government, in many instances, did not pay reasonable prices for goods and services. Costs and prices were not always controlled because the government's contract oversight and monitoring was inadequate.

Three Categories of Recommended Actions

Thirty-eight recommendations, grouped into three general categories, were proposed in the report.

Better Defined Roles

In the first category of recommendations, 15 actions require that roles, responsibilities, and expectations be defined, clarified, or reviewed. In instances where roles, responsibilities, and expectations are defined, the DHS OIG recommends that agencies and offices be held accountable for adhering to their responsibilities and meeting expectations. The nature of these recommendations suggest that most should be able to be addressed prior to this upcoming hurricane season and within existing resources and funding levels.

Better Efficiency

In the second category, 20 actions related to the development, refinement, or completion of program systems, processes, plans, procedures, and initiatives to make response and recovery activities more efficient and effective. These recommendations may require additional time, beyond the start of hurricane season, to be fully addressed. Many recommendations will require an initial and sustained funding commitment by DHS and Congress to be fully implemented.

More Training

In the third category, seven actions related to training deficiencies need to be addressed. Again, these recommendations may require additional time, beyond the start of hurricane season, to be fully addressed.

Issues Surrounding the FEMA Hurricane Katrina Response

This section summarizes the DHS OIG report that led to the development of the 38 recommendations.

Duplication of Effort

An overlap existed between the Interagency Incident Management Group (IIMG) and the Homeland Security Operations Center (HSOC). This created some duplication of efforts in information gathering. IIMG

provided information to DHS leadership and the White House. HSOC's primary role is to collect operational and situational information for DHS headquarters.

Principal Federal Official Role Issues

The National Response Plan describes several key leadership positions during a disaster response:

- DHS Secretary
- Federal Coordinating Officer (FCO)
- Principal Federal Official (PFO)
- Federal Resource Coordinator (FRC)
- Disaster Recovery Manager (DRM)

The response to Hurricane Katrina was the first operational use of the PFO. Initially, the designated PFO, who was the Under Secretary of Emergency Preparedness and Response, performed non-directive coordination duties as described in the NRP. When the DHS Secretary appointed Vice Admiral Thad Allen as PFO on September 9, 2005, the PFO took a greater role in directing the federal response. New lines of command and authority created some confusion. Effective September 21, 2005, the PFO was designated as FCO for the States of Alabama, Mississippi, and Louisiana. Several officials commented that the blending of authorities suggests an unnecessary division in the NRP.

Information and Reporting Problems

Despite multiple levels of reporting, critical, timely, and accurate information did not consistently reach FEMA and DHS leadership. For example, the DHS Secretary and key FEMA officials said they did not learn of the first breach of the New Orleans levees until almost 24 hours after it occurred.

Coordination Efforts with Other Governmental and Nongovernmental Organization Partners

While FEMA made major efforts to coordinate with other agencies and improve its ability to provide housing resources in its response to Hurricane Katrina, some of its efforts were more effective than others. For example, FEMA and the Red Cross found it difficult to identify the number and location of evacuees.

Efforts to Identify and Establish Housing Resources

In response to Hurricane Katrina, there was little evidence of either formal or informal acquisition planning processes in the majority of FEMA procurements awarded for transitional housing, including travel trailers and mobile homes.

FEMA purchased 24,967 manufactured homes at a cost of \$862.7 million and 1,755 modular homes at a cost of \$52.4 million in response to the need for transitional housing to assist displaced evacuees from Hurricanes Katrina and Rita. FEMA also purchased 27,000 travel trailers "off the lot" from 300 local firms, according to the report, as of March 31, 2006. Most importantly, FEMA had no plans for how the homes

New Orleans, LA, 4-9-06 -- Keith Anthony Craft cuts the grass behind his temporary home, he is the first person in 9th Ward to get a FEMA Travel Trailer. He is repairing his Hurricane Katrina damaged home. The FEMA Travel Trailer program puts temporary housing on the homeowner's property to help make rebuilding quicker and help keep the family under one roof. Marvin Nauman/FEMA photo



would be used before they were purchased. Subsequently, there are currently 17,055 mobile homes and 5,707 travel trailers staged at eight emergency housing sites waiting to be used.

Because FEMA was slow to identify and establish its direct housing mission, alternative housing resources—such as cruise ships—were used initially. During the first 30 days after the disaster, all four ships were only about 35 percent occupied, costing FEMA about \$3,363 per evacuee per week. As of October 31, 2005, ship occupancy had increased to 74 to 90 percent, significantly reducing the cost per evacuee.

Inspection Services

When people apply for FEMA assistance, the information is entered into the National Emergency Management Information System (NEMIS). Should an inspection be required to process the application, the system will generate an inspection request, which is then issued to one of FEMA's contract inspection service providers to verify the personal and real property losses and damages of the applicant. Inspectors visit the homes of applicants to verify disaster-related damages. After the inspection is completed, inspectors upload (or return) their findings to FEMA's processing system so eligibility can be determined.

By September 28, 2005, there were 2,099 inspectors in the field. By that same date, 1,011,087 inspections were issued, of which 20 percent were returned. Several FEMA officials said there were not enough contract inspectors available to perform inspections.

Disaster Area Recovery Centers

Disaster Area Recovery Centers are intended to provide "one-stop" access to federal, State, local, and volunteer assistance programs. FEMA officials reported having inadequate numbers of trained staff in these centers.

Urban Search and Rescue Coordination

FEMA Urban Search and Rescue (US&R) task forces—in conjunction with the U.S. Coast Guard, State and local first responders, and volunteers—rescued an estimated 50,000 victims stranded from Hurricane Katrina. Increased water rescue capabilities and improved urban search and rescue coordination are needed for FEMA to be more responsive to future catastrophic events that involve large-scale flooding and the mass evacuation of stranded persons.

External Affairs Structure and Coordination

External affairs serves as the primary means of sharing information and developing a unified message for the government, disaster victims, and the public. When Katrina made landfall, problems with the communications infrastructure along the Gulf Coast region and staffing shortages hampered external affairs operations on the ground. This was true for many FEMA, State, and local responders. Confusion over the hierarchy and information flow and difficulty establishing a coordinated message with the State of Louisiana also surfaced. State coordination is needed to establish a unified message.

National Guard and Active Duty Troops Support and Coordination

At its peak, approximately 50,000 National Guard troops and more than 22,000 active-duty military troops were supporting response efforts in Mississippi and Louisiana. Joint Task Force Katrina, activated by Department of Defense (DoD), Northern Command, coordinated the federal military response beginning August 30, 2005. Active-duty troops with the joint task force arrived in New Orleans on September 1 to support evacuation from the Superdome. Several FEMA officials said they had no knowledge of the task force's presence in the affected area until troops began arriving. Initially, troops appeared to act independently, sometimes leading to duplication of efforts.

FEMA Delivery Structure

A lack of asset visibility in the resource ordering process, inexperienced and untrained personnel, unreliable communications, and insufficient internal management controls demonstrate a continued need for improvement in how FEMA supports its response activities and delivery of assistance.

Visibility and Improvements Needed For Resource Ordering and Delivery

On a day-to-day basis, FEMA headquarters operates seven logistics centers nationwide and one Disaster Information Systems Clearinghouse facility in Virginia. In 2004, FEMA Logistics received approval to pilot an asset visibility system, which involved placing tracking equipment on selected trucks to monitor their movement. Between 25 and 33 percent of the trucks were equipped with tracking units when Katrina made landfall. Due to software limitations in the tracking equipment, FEMA was unable to determine whether a truck had been offloaded or had changed cargo once it left its point of origin.

FEMA Logistics Performance Measures

Historically, FEMA has established a 72-hour time period as the maximum amount of time for emergency response teams to arrive on scene. What is clear is that a 72-hour response time does not meet public expectations, as was vividly demonstrated by media accounts within 24 hours after landfall. To meet aggressive timelines, FEMA Logistics officials said they need to do the following:

- Obtain more FEMA-owned transportation resources
- Secure additional, strategically located warehouses to stockpile resources
- Address what quantities of on-hand equipment, supplies, and commodities should be immediately available

“Ironically, some FEMA and State field personnel suggested they had to order twice as much to get half of what they needed, primarily because they had no confidence in a system that had no asset visibility,” according to the report.

Resource Ordering System Needs Improvement, Standardization and Automation

DHS OIG tested FEMA’s resource ordering process for ice, water, and food commodities by sampling 57 action request forms for all three affected States. Of these action request forms, only three requests could be tracked through the established process.

Based on interviews and a review of FEMA tracking logs, steps taken to ensure that an action request was completed or resolved were either performed as time permitted or not performed at all. (FEMA records indicate a lack of logistics procedures as long ago as the aftermath of Hurricane George in 1998 and the terrorist attacks of September 11, 2001.) Without performing this critical step, there is no assurance that a requested activity was completed or that resources were provided. Beyond that, no data exist to measure the efficiency with which actions were taken or performed.

Mission Assignment and Emergency Management Compact Activity

FEMA initiated more than 68 actions before landfall to activate federal agencies and pre-position teams, commodities, and equipment in an effort to establish readiness in anticipation of Hurricane Katrina’s arrival. In all, 438 separate mission assignments were issued, involving 57 different federal departments, agencies, and other organizations. Because FEMA did not consistently track mission assignments, the OISR was unable to determine the status of these mission assignments.

Unreliable Disaster Communications During the Initial Response

Emergency responders at some sites did not have sufficient communications during the first critical days after the storm. FEMA needs to strengthen its capabilities to provide communications support during the initial disaster response, when the infrastructure is most weakened and emergency responder teams are still establishing operations.

Inability to Meet Human Capital Needs for Catastrophic Disasters

FEMA was unable to dedicate its full staffing strength to Hurricane Katrina. First, it had to maintain response operations for other disasters. On August 31, 2005, FEMA had personnel assigned to the Hurricane Katrina response and 38 other disasters. Second, an average of 30 percent of FEMA Disaster Assistance Employees reported they were unavailable to respond to Hurricane Katrina or any other disaster during the August 24-September 30, 2005, time frame. More than 1,000 DHS employees deployed to support the response—as did 4,000 firefighters and personnel from other agencies like the SBA and U.S. Postal Service.

Ultimately, FEMA's additional efforts to identify and track deployments resulted in just 85 to 90 percent visibility of its disaster workforce during Hurricane Katrina. An automated system to track all disaster personnel would improve FEMA's resource visibility.

Surge Capacity Training During Disasters

FEMA needs to strengthen its ability to provide training for surge reservists activated during large-scale disasters. Only 24 of 47 training staff were deployed for surge training post-Katrina, and there was confusion about how many people would attend training sessions, when they would arrive, and what they would do once training was completed. Hundreds of new hires attended classes, rather than the usual 50.

Disaster Support Initiatives Could Enhance Temporary Disaster Work Force System

Since 1992, FEMA amassed 12 studies on disaster workforce management without developing a final plan. Before Hurricane Katrina, FEMA recognized deficiencies in its reserve cadre size, automated deployment and tracking systems, and surge training. FEMA began two projects to remediate the deficiencies. First, FEMA halted hiring Disaster Assistance Employees (DAEs) from April to July 2005 to remove inactive personnel from its roster and establish a baseline level for its DAEs. This temporary hiring freeze was ill-timed, affecting FEMA's ability to increase staff for hurricane season. Second, FEMA staff proposed a Disaster Support Initiative to enhance the temporary disaster workforce system. FEMA is currently revising the initiative for resubmission to the Office of Management and Budget for funding approval.

Individual Assistance

In April 2003, FEMA's Recovery Division prepared a narrative justification for what it termed "over target" requests for additional funding in FY 2005. This request for \$3.9 million above baseline funding would allow FEMA to enhance its capacity to provide assistance to disaster victims. "The failure to provide funding to ensure scalable recovery capability will result in a crisis of unimaginable proportions not only for individual victims and their communities and States, but also for the country as a whole," FEMA's narrative foreshadowed. However, no additional funding was provided to FEMA in FY 2005 or FY 2006 to enhance its Recovery Division's existing capability.

FEMA's Efforts to Augment Staff and Call Center Capacity

Given the scale of this disaster and the sheer number of applicants seeking assistance from FEMA, initial efforts to augment call center sites and registration intake agents were admirable. But FEMA staff and resources need to be positioned to succeed. Additional investment is necessary to establish basic case management capabilities that can respond to applicants' needs. A total of 19 call centers handled inquiries. From August 24, 2005, to September 30, 2005, approximately 5,320,578 registration intake and helpline calls reached FEMA's call centers. Of these, FEMA answered 3,124,112 (59 percent) of the calls; 1,524,423 (29 percent) were deflected; and 672,043 (12 percent) hung up. Deflected calls are calls that reach a call center, but are not answered because the waiting queue is full.

Online Registration

Applicants can apply for assistance on-line via www.FEMA.gov. Internet applications accounted for more than 40 percent of initial registrations received as of September 19, 2005. By September 30, 2005, 704,086 online registrations were made, compared to 853,851 through registration intake. However, for several weeks after the major disaster was declared, many applicants experienced difficulty applying online. The system would "lock up" or "time out" during the application process, and applicants could not tell whether their applications were completed, sent, or received by FEMA. Some registered repeatedly, causing duplicate applications.

Aware that its information technology infrastructure was overwhelmed by the sheer volume of online applicants, FEMA doubled the online user capacity as of September 15, 2005. FEMA also developed a script, based on unique social security numbers, to reduce the number of duplicate applications.

Housing Area Command: Initial Implementation Lacked Coordination with Oversight and Operational Elements

A Housing Area Command (HAC) concept was established in 2005 to respond to large-scale disasters where housing needs were significant and spread over multiple States. The HAC would coordinate and oversee housing solutions throughout the affected area where several Joint Field Offices (JFOs) had been established. However, the HAC would not be an operational element, as the housing operation functions remain within the JFO. The Technical Assistance Contractor would be involved in staffing housing operations and implementing housing solutions, such as emergency group shelters, manufactured housing, travel trailers, and modular construction.

Before Katrina's landfall, FEMA's HAC began planning contingencies for potential shortfalls in sheltering and housing. FEMA activated four technical assistance contractors to support its temporary housing mission. The agency purchased 20,000 manufactured housing units and planned to purchase more than 100,000 units. Eighteen days after landfall, only 910 units were occupied by disaster victims. As of October 1, 2005, 4,128 units were occupied.

Significant communication impediments resulted from having all technical assistance contractors report only to the HAC without appropriate coordination and input from field operational elements, such as the JFOs. Some FEMA officials viewed the HAC as becoming an operational element working parallel to JFO operations, while others viewed it as working in disregard of housing resource needs and identified requirements set or requested by other FEMA components.

FEMA's Individuals and Households Program (IHP)

Realizing it would be an extended period before many disaster victims could return to their homes, FEMA attempted to devise new methods to expedite financial assistance and technology to verify need. However, it was difficult for FEMA to maintain internal controls as modifications were made to eligibility criteria, and the use of technology to verify damage, occupancy, and ownership was less reliable than initially anticipated. Duplication of applications became a concern.

Expedited assistance is used only for extraordinary disaster events. It allows for pre-inspection disbursement of funds. FEMA determined that this was warranted due to the severity of damage and nationwide relocation. It provided an equal amount of assistance (\$2,000) to all eligible households.

Debit Cards for Delivery of Expedited Assistance

For applicants who had no access to an existing bank account or mailing address, a debit card system was used to distribute the \$2,000 expedited assistance. FEMA began providing funds without any assurance of need and with no way of verifying that people who received the cards were actually eligible for assistance. In two days, more than \$22 million was provided to persons, some of whom may or may not have been eligible for assistance.

Eligibility Modifications

To qualify for assistance, the primary residence was to have sustained damage. However, some people who had evacuated before the hurricane answered "no" or "do not know" when asked that particular question. Although this initially rendered these applicants as ineligible, FEMA changed the processing script, granting eligibility to those applicants.

FEMA also determined the \$2,000 would not be considered a duplication of housing assistance program benefits, and therefore was not subject to recoupment. For applicants with insurance, the understanding was that the \$2,000 was to be treated as an advance on the applicant's insurance settlement. Federal regulation, however, prohibits FEMA from funding applicants who can meet their needs in other ways.

Originally, only one payment of \$2,000 per household was authorized. Reports of families separated during evacuation prompted FEMA to provide expedited assistance to separated household members, including minor children housed with extended family or guardians.

Ultimately, FEMA awarded \$1.6 billion to 803,088 applicants in three States during the first 30 days

after declaration. This compares to a total of \$51 million to 94,993 applicants during the four hurricanes that hit Florida in 2004.

IHP Housing Assistance Component

In less affected areas, FEMA implemented its traditional housing assistance and other needs assistance components of the IHP. Home inspections were performed to verify damage and assess need. When insurance or SBA loans did not address needs, FEMA provided temporary housing in the form of rental assistance or housing units, such as travel trailers or mobile homes. It also provided homeowners with funds to repair a damaged home that could be made safe, sanitary, and functional or for replacement when homes were destroyed. More than \$2.4 billion was awarded in the three States between August 28 and September 30, 2005, under this component.

Other Needs Assistance

When insurance and SBA loans did not address these needs, grants to repair personal property or to cover disaster-related necessary expenses for hardships related to the hurricane were also made. Medical and dental costs, funeral and burial costs, clothing, household items, tools required for employment, educational materials, generators, cleaning items, and damage to vehicles were expenses eligible for reimbursement. The maximum amount of assistance for housing and other needs combined could not exceed \$26,200. In all States, more than \$68 million was awarded for other needs assistance between August 28 and September 30, 2005.

Verifying Eligibility without an Inspection

To verify occupancy eligibility, FEMA used satellite imagery and geospatial maps to identify the degree of damage to homes, combined with information supplied by a FEMA contractor on consumer information to verify occupancy. The contractor used tax records, census data, public utilities, and other public records to verify the occupants of individual homes and their status as an owner or renter. However, the contractor was unable to provide FEMA with verification data as early as expected, and FEMA had no contingencies for incomplete or untimely information. When verification could not be established, applicants were referred to the Department of Housing and Urban Development (HUD) for assistance under the Hurricane Katrina Housing Assistance Program.

Delay in Providing Additional Housing Assistance in Most Affected Areas

The initial method FEMA developed to provide expedited transitional housing assistance was thought to be an unreliable method for use in awarding additional IHP housing assistance. Concerns were raised within FEMA and DHS that additional data and analysis would be required to validate the method before additional housing assistance could be provided.

The implication of this decision was that eligible applicants in the most affected areas were provided only expedited assistance (\$2,000) and transitional housing assistance (\$2,358) to address their housing needs, while applicants in other areas where inspections were conducted were potentially eligible for up to \$26,200 in IHP assistance.

By October 28, 2005, FEMA program officials had completed additional analysis and provided data to support the extent of damage caused by different water levels (four to six feet) in a variety of homes that ranged in size, style, and foundation type. FEMA proposed that homes that had two feet or more of standing water be deemed destroyed, and uninsured homeowners be eligible for the maximum real property replacement grant of \$10,500.

Homes with standing water levels between one and two feet were deemed as having major damage, and uninsured homeowners were eligible for the maximum real property repair grant of \$5,200. Homes with one foot or less would be considered as having sustained moderate damage, and uninsured homeowners were eligible for a real property repair grant of \$2,600.

FEMA's initial efforts to verify damages and determine occupancy through alternative means were creative and demonstrated an effort to provide assistance as expeditiously as possible. However, FEMA's initial assumptions about the data's accuracy, reliability, and timeliness were not realized, which cast doubt upon its effectiveness for use as a basis for awarding additional assistance.

FEMA's Public Assistance Program

The Public Assistance Program was an integral part of FEMA's ability to assist States with funding to shelter evacuees throughout the United States. Program modifications were made to expedite the processing of project worksheets, removing debris from private property, and funding 100 percent of eligible costs for emergency protective measures and debris removal for 60 days. Some practices demonstrated a unique interpretation of statutory authority, while others provided an unprecedented level of federal assistance.

Given the amount of debris and immediate threats to life and health, the decision to reimburse 100 percent of eligible costs for emergency protective measures and debris removal for an initial 60-day period, seemed prudent. However, with the exception of the World Trade Center recovery after September 11, 2001, this decision was unprecedented. Historically, these costs are shared by the federal government, the State, and the applicant, and the time period allowed for reimbursement of emergency activities is more closely aligned with the initial response period of a disaster, that is, activities within a 72-hour period.

As of October 1, 2005, FEMA had received a total of 430 project worksheets requesting Public Assistance program funds and obligated more than \$962 million.

Use of Stafford Act, Section 403

To supplement State and local government efforts to shelter and care for Hurricane Katrina evacuees, FEMA used Section 403, Essential Assistance, of the Stafford Act. On September 2, 2005, the President began issuing emergency declarations authorizing reimbursement of 100 percent of eligible costs incurred by States providing shelter and care to evacuees.

Before Hurricane Katrina, such authority had not been used to reimburse States for the costs associated with sheltering disaster victims from other States. By September 30, 2005, 45 emergency declarations had been made and more than \$72 million obligated to five States.

FEMA planned to use Section 403 funding until it could develop a longer term strategy for implementing its Individual Assistance programs, which have statutory assistance limitations of 18 months and a maximum of \$26,200. On September 9, 2005, FEMA provided guidance on eligible costs for emergency sheltering and determined States could be reimbursed for such costs under Section 403 for up to 12 months. As a result, several States engaged in contracts to support their short-term and interim sheltering operations. Further, the subsequent announcement to move all evacuees out of shelters and into longer term housing by October 1, 2005, left States uncertain as to what costs FEMA would reimburse and for how long.

The decision to use Section 403 to address longer-term housing needs of disaster victims demonstrates a fundamental lack of planning by FEMA and other federal and nongovernmental partners to address contingencies for the loss of housing resources presented by catastrophic disasters. FEMA should also reevaluate using emergency declarations as a delivery mechanism for Section 403 assistance, as each declaration required staff-intensive resources to process and administer this assistance by individual States.

FEMA Needs to Improve Readiness

The response to Hurricane Katrina showed that FEMA was inadequately prepared for a catastrophic event in terms of staffing, training, planning, exercises, and the remediation of “lessons learned” from previous events. FEMA’s efforts in these areas from 1995 to 2005 were surveyed, including grants to improve State readiness to evaluate FEMA’s overall posture for catastrophic events.

FEMA’s poor workforce management and frequent reorganizations have not provided sufficient trained staff for catastrophic surges or day-to-day operations. FEMA’s involvement in State efforts through federal emergency management grants has diminished significantly, reducing opportunities to build relationships between federal and State responders. FEMA needs a stronger mechanism for readdressing issues identified in previous disasters and exercises.

Grant Program Changes Contributed to Weakened State Relationships

Over the past 10 years, a number of changes to the administration of grants for natural hazards preparedness diminished FEMA’s involvement in how States conduct emergency training planning exercises and other functions. Even though there were reporting requirements and accountability mechanisms for Emergency Management Performance Grants (EMPG), FEMA was limited in its ability to prioritize or direct state activities.

Additionally, according to FEMA headquarters and regional officials, EMPG reporting mechanisms were inconsistent and lacked quantitative performance measures. FEMA has limited visibility and no required evaluation for the States’ overall preparedness goals or their day-to-day activities. There is no formal mechanism for FEMA regional personnel to provide feedback on both the development of EMPG guidance

and the use of EMPG funds, which distances FEMA from State activities.

Even though federal funding for all hazards preparedness has not decreased, there is a perception among States that DHS favors terrorism preparedness because of the less prescriptive grant mechanisms; FEMA's discontinued administration of these grants, and the expansion of terrorism preparedness grants.

In Figure 6-1, FEMA's grant funding priorities for 2005 are presented.

MOST FY 2005 DHS GRANT FUNDING FOR FIRST RESPONDERS FOCUSES ON TERRORISM

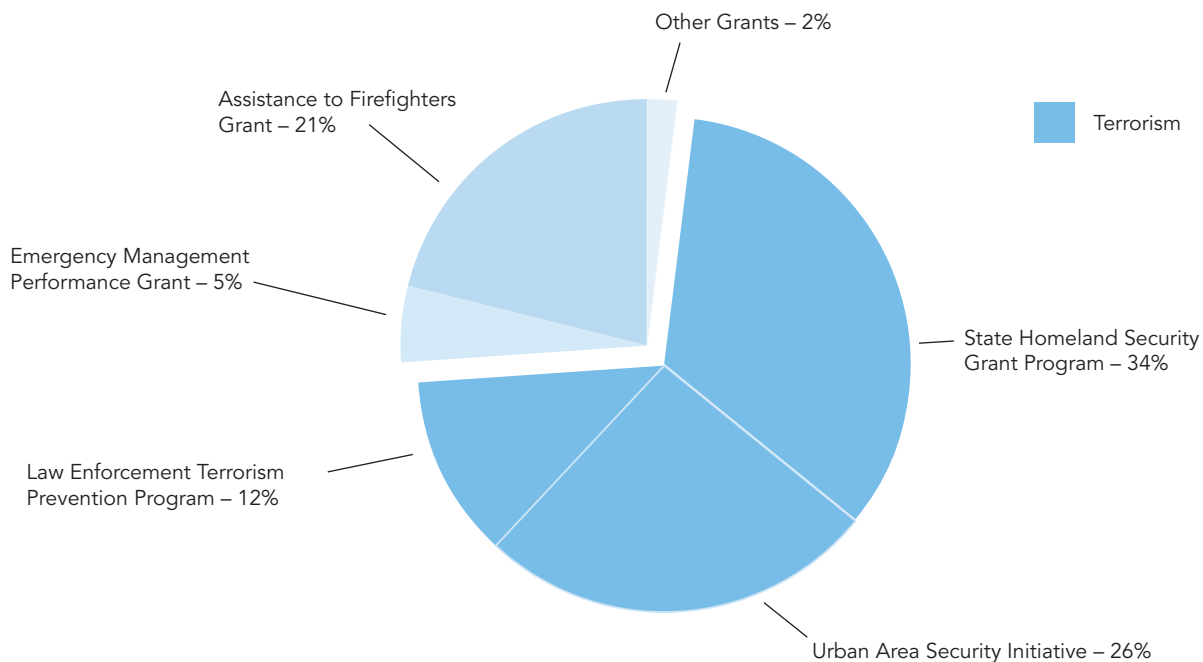

Source: DHS' Efforts to Enhance First Responders' All-Hazard Capabilities Continue to Evolve, GAO-05-652, July 2005

Figure 6-1

Organizational Staffing Requires Better Management

While Hurricane Katrina highlighted weaknesses in FEMA's ability to staff catastrophic events, FEMA confronts staffing challenges on a day-to-day basis. Frequent reorganizations, chronic vacancies, the use of temporary staff in permanent positions, and fragmented human resources management limit FEMA's ability to hire and retain sufficient staff. FEMA has reorganized its divisions and offices more than five times since 1995. Though some divisions within FEMA have created organizational charts, FEMA has not created a chart for its current organization.

Negative effects from FEMA's understaffing include decreased morale and inadequate succession planning. The remaining FEMA staff is overworked, often performing multiple duties and working with a few days off during disaster responses. The annual Office of Personnel Management reports on morale indicate that FEMA has one of the lowest levels of morale in the federal government.

FEMA Training Delivery and Requirements

FEMA provides regular training for emergency responders at the federal, State, and local levels; manages the training and development of FEMA employees; and internally provides disaster-specific training through the disaster field training operation cadre. However, employee development lacks the resources and organizational alignment to improve performance.

Several FEMA staff reported that insufficient employee development led to a shortage of qualified staff for key positions responding to Hurricane Katrina. FEMA does not have individual development plans, despite attempts to institute such plans in the past. FEMA has no centralized and comprehensive information on employee training.

Incomplete and Insufficient Planning Efforts

Other than evacuation plans created under the National Hurricane Program, this review demonstrated no FEMA efforts to conduct planning specifically for catastrophic natural disasters and little awareness of the need for preparing for them prior to 2001. Beyond the overarching strategy compiled in the catastrophic incident supplement to the NRP, FEMA has not developed final, incident-specific catastrophic plans for functional responses to disasters.

The National Hurricane Program, which has several components, is FEMA's most comprehensive hurricane preparedness tool. The current National Hurricane Program budget is \$2.9 million, with \$1.8 million set aside for the Hurricane Evacuation Study Program. FEMA, along with USACE and NOAA, developed the Hurricane Evacuation Study, which includes analyses of hazards, vulnerability, behavior, shelter, and transportation for a given State.

As the U.S. Army Corps of Engineers' budget for the Hurricane Evacuation Study Program is decreasing, the National Hurricane Program has had a steady budget for the study program. As such, the Hurricane Evacuation Study Program is required to do more with the funding that FEMA provides for it. In 2003, several catastrophic planning projects within FEMA as well as among coordinating agencies were

either underway or had been proposed. The Southeast Louisiana Catastrophic Hurricane Plan, which included 15 specific areas of focus, was a major output of these planning sessions. Beyond the four sessions for Hurricane Pam, however, no catastrophic planning events reached fruition. According to FEMA, the major challenge in conducting catastrophic planning was a lack of funding. There were three follow-up planning sessions after the initial event, which focused on sheltering, temporary housing, and temporary medical issues. The last one was held in August 2005.

Long-Term Deterioration in FEMA's Exercise Program

Emergency management exercises are developed to test and validate existing programs, policies, plans, and procedures to address a wide range of disasters to which FEMA must respond. There are numerous types of exercises, ranging from tabletop exercises where participants discuss actions and responses, to command post exercises where specific aspects of a situation are exercised, to large-scale exercises involving multiple entities and a significant planned event with activation of personnel and resources.

FEMA participates in exercises administered by other agencies, including DHS Office of Disaster Preparedness (ODP) and the Department of Defense, but these exercises limit FEMA's ability to choose which plans, objectives, and relationships to test.

Currently, the All Hazards Exercise Section in FEMA's Preparedness Division has one staff member working on exercise planning and development. Compounding the decline in staff over the past 10 years, FEMA's exercise budget decreased by more than 90 percent to less than \$200,000. This funding leaves FEMA unable to conduct a large-scale catastrophic event exercise, which costs between \$500,000 and \$1 million.

The decline in budget highlights the diminished focus on exercises in particular and natural hazard preparedness in general. Further, there is now no clear "owner" within FEMA who has the authority to plan and implement exercises and induce the participation of the other FEMA divisions.

FEMA No Longer Conducts Catastrophic Natural Disaster Exercises on a National Level

Exercise is one component of preparedness that has been allowed to atrophy over the past decade. Between 1995 and 1998, FEMA conducted several large-scale natural event exercises, targeting different areas threatened by natural disasters, such as hurricanes, earthquakes, and floods. In 1998, FEMA leadership determined that FEMA exercises would focus on tabletop rather than full-scale exercises. Staff in the Response Division questioned the need for expensive full-scale exercises and instead believed that small-scale exercises with fewer participants and objectives would be more useful. Now that FEMA does not conduct its own catastrophic natural disaster exercises, it partners with exercise conductors.

The difficulty with FEMA's "piggybacking" exercise strategy is that FEMA must wrap its objectives around an exercise that it is able to participate in as opposed to creating an exercise around the objectives it seeks to test.

FEMA Should Strengthen Remediation Measures for Lessons Learned

Some of the difficulties that FEMA encountered after Hurricane Katrina were first experienced during previous disasters and exercises. After additional reports, facilitators led discussions (hot washes) and third-party reviews, which resulted in recommendations and lessons learned.

In 2003, Hurricane Isabel demonstrated that FEMA needed a better understanding of State capability to respond to a disaster. During the Top Officials 2 exercise in 2003, States affected by a simulated biological attack requested major disaster declarations under the Stafford Act, but FEMA interpreted the biological attack not to be within the scope of the act and ineligible for assistance. The 2004 hurricanes highlighted that FEMA had insufficient methods to track logistics assets.

Future Considerations on Prioritization

The integration of FEMA, natural hazards preparedness, and disaster response and recovery into DHS requires additional work and a level of support not currently demonstrated. After the September 11, 2001, terrorist attacks, terrorism prevention and preparedness overshadowed preparedness for natural hazards, both in perception and application. This has occurred even though natural disasters are more frequent and cannot be prevented.

Working Toward All-Hazards Preparedness

The response to Hurricane Katrina demonstrated that DHS efforts to protect and prepare the nation for terrorist events and natural disasters have not yet translated into preparedness for all hazards. Federal awareness of when an individual State will become overwhelmed and require federal support enables preparation, and this awareness is essential to a prepared and seamless response. Differences in State and local capabilities translate into differences in the federal responses. FEMA has never had an effective system for assessing state readiness or determining a standard to which a state must be prepared.

DHS Culture and Emergency Management Responsibilities

Emergency management refers to the comprehensive approach to preparing for, responding to, recovering from, and mitigating the effects of emergencies and disasters. With the creation of DHS, what had been traditionally the responsibility for one agency has evolved into a Department-wide responsibility. It is critical that DHS develop a culture that maximizes the capabilities of its components, personnel, and resources; establishes performance expectations; and adequately funds department priorities.

Stafford Act Authorities and Long-Term Recovery Issues

In general, OIG determined the authorities of the Stafford Act are adequate to deliver the necessary supplemental assistance required after such a catastrophic event, subject to funding caps, cost shares, and time limitations. However, in events where entire communities are affected and the vast majority of housing stock destroyed, there is no other current mechanism, aside from FEMA's IHP, for the federal government to address individual needs for persons without insurance or persons unable to obtain a loan. Con-

gressional consideration may be warranted to better position the federal government to address widespread physical catastrophic damages and economic loss issues of individuals affected by disasters.

Management Comments and OIG Analysis

The Department did not provide its official comments to the earlier report until after the report was signed on March 31, 2006. The DHS OIG has requested that the Department to advise within 90 days what actions it has taken or plans to implement based on the recommendations contained in the report. At this writing, all 38 recommendations are considered unresolved and open.

DEPARTMENT OF HEALTH AND HUMAN SERVICES

The Department of Health and Human Services OIG will evaluate whether the U.S. Public Health Service Commissioned Corps has achieved its goal to be 100 percent deployable to effectively mobilize and respond to public health emergencies by the end of 2005. The review will focus on recent deployments associated with Hurricanes Katrina and Rita. In the weeks following Katrina, more than 1,400 officers worked with State, local, and private agencies in seven Gulf States. After one month, more than 700 officers remained in the Gulf States and evacuee areas to provide relief services.

APPENDIX

The President's Council on Integrity and Efficiency Homeland Security Roundtable

"Compendium of OIG Hurricane Oversight in the Gulf States"

A

DHS-OIG compiled this compendium of federal inspectors general activities in the oversight of hurricane disaster response and recovery in the U.S. Gulf Coast region.

D A T E D M A R C H 3 1 , 2 0 0 6

President's Council on Integrity and Efficiency Homeland Security Roundtable

Compendium of OIG Hurricane Oversight in the Gulf States



March 31, 2006



On August 29, 2005, Hurricane Katrina dealt unprecedented amounts of damage to Louisiana, Mississippi, and Alabama. Congress quickly appropriated more than \$62 billion to the Department of Homeland Security (DHS) and Department of Defense (DoD) for an immediate relief effort. Many of these funds were, in turn, tasked to other federal departments and agencies. Also, some departments have initiated separate programs addressing their particular areas of responsibility.

On December 30, 2005, Public Law 109-148, the Department of Defense Emergency Supplemental Appropriations to Address Hurricanes in the Gulf of Mexico, and Pandemic Influenza Act, 2006, included an additional \$28.6 billion to allow recovery efforts to continue through March 2006. Of this amount, \$23.4 billion was offset by a reallocation from the DHS's Disaster Relief Fund.

In February 2006, to further our efforts to respond to the significant needs of hurricane-affected States and proceed uninterrupted with recovery and reconstruction activities underway, the President submitted a proposal for \$19.8 billion to Congress.

Congress is concerned that such emergency circumstances provide the opportunity for fraud and mismanagement that would deprive the affected individuals the full benefit of the funds to be spent on the recovery and will rely upon the Inspectors General (IGs) as a principal line of defense against such fraud and abuse. Congress and the IGs recognize that coordination of efforts is critical to effectiveness, especially when the work is to be performed in a short time frame under complex conditions.

In early 2005, the President's Council on Integrity and Efficiency (PCIE) had already established a special working group to address homeland security audit and investigative issues chaired by the DHS IG. It was natural for this group to take the lead in coordinating support and oversight for billions of dollars of efforts being undertaken by their departments.

The attached compendium presents an updated overview of the audit and investigation efforts being undertaken by the participating Offices of Inspector General (OIGs) and also presents a brief description of each OIG's plan as envisioned by its executives.

On behalf of the Inspector General community, DHS-OIG is pleased to have compiled this compendium of collective OIG's activities, as of March 31 2006 in the oversight of hurricane disaster response and recovery in the Gulf Coast region and appreciates the efforts of all involved.

Richard L. Skinner
DHS Inspector General

Table of Contents/Abbreviations/Acronyms

Introduction and Background	3
Objective, Scope, and Methodology	4
Summary of OIG Oversight Plans	4
Acknowledgements	10
Individual OIG Oversight Plans	Appendix A

Abbreviations

DHS	Department of Homeland Security
DISA	Defense Information Systems Agency
DOC	Department of Commerce
DoD	Department of Defense
DOE	Department of Energy
DOI	Department of Interior
DOJ	Department of Justice
DOL	Department of Labor
DOT	Department of Transportation
ED	Department of Education
EPA	Environmental Protection Agency
FEMA	Federal Emergency Management Agency
GAO	Government Accountability Office
GSA	General Services Administration
HHS	Department of Health and Human Services
HUD	Department of Housing and Urban Development
IRS	Internal Revenue Service
NASA	National Aeronautics and Space Administration
OSHA	Occupational Safety and Health Administration
SBA	Small Business Administration
SSA	Social Security Administration
TIGTA	Treasury Inspector General for Tax Administration
TOIG	Treasury Office of Inspector General
TREAS	Department of the Treasury
USDA	United States Department of Agriculture
USPS	United States Postal Service
VA	Department of Veterans Affairs

Acronyms

DCMS	Disaster Credit Management System
DUA	Disaster Unemployment Assistance
ECIE	Executive Council on Integrity and Efficiency
EOC	Emergency Operations Center
HERA	Higher Education Recovery Act
JFO	Joint Field Office
NEMIS	National Emergency Management Information System
OCC	Office of the Comptroller of the Currency
OIG	Office of Inspector General
OMB	Office of Management and Budget
OTS	Office of Thrift Supervision
PCIE	President's Council on Integrity and Efficiency
SIG	Special Inspector General
UI	Unemployment Insurance
WIA NEG	Workforce Investment Act National Emergency Grant

Introduction and Background

The purpose of this compendium is to summarize the ongoing and planned activities of the IGs community in their oversight of response and recovery efforts related to Hurricane Katrina. The compendium includes the activities of those OIGs whose Departments were part of the initial response phase or have received significant mission assignments from FEMA. Additional OIG offices may be included in the compendium in the recovery phase.

In many cases, reviews conducted by OIG staff have subsequently expanded to provide oversight of response and recovery efforts related to Hurricanes Rita and Wilma. In such cases, summaries of these broader scoped efforts are also included in this compendium.

In response to Hurricane Katrina, FEMA made mission assignments totaling approximately \$7 billion. In the first 180 days after the storms, more than \$16.1 billion overall spent on recovery efforts for Hurricane Katrina, Rita and Wilma and federal agencies have entered into contracts totaling more than \$9.6 billion. In addition, as of March 31, 2006, SBA had approved more than \$7 billion in disaster loans to more than 107,000 homeowners, renters, and businesses in Louisiana, Mississippi, Alabama, Texas, and Florida. SBA disaster loans are intended primarily for long-term rebuilding and reconstruction of damaged homes and businesses.

To answer the call for OIG oversight of these massive and complex activities, the OIGs whose departments and agencies are involved in the various efforts have designated extensive staff resources to a variety of assignments. As of March 31, 2006, the federal OIGs have committed approximately 600 oversight personnel to providing immediate oversight of contracts, grants, and operations related to hurricane recovery efforts. Other OIGs and the Government Accounting Office(GAO) also have staff involved in the conduct of oversight and investigative activities related to the response and recovery efforts on-site and in headquarters units. DHS-OIG has already assigned 99 auditors, investigators, and inspectors to Hurricane Katrina related work, as well as four contractor firms hired to assist the DHS OIG in its oversight efforts. Many of DHS-OIG's personnel are already on the ground at FEMA headquarters and at the Joint Field Offices (JFOs) in Louisiana, Mississippi, and Alabama. DHS-OIG will leverage its efforts with those of the state and local audit organizations in the affected States.

The oversight activities of the various organizations involved will need to be closely coordinated to maximize the scope and effectiveness of the work performed and minimize disruptions to the response and recovery efforts. The IGs involved in these efforts have coordinated their oversight activities through the PCIE Homeland Security Roundtable and the overall effort is being coordinated with the GAO.

Objective, Scope, and Methodology

The overriding objective of the OIGs' oversight plans is to ensure accountability and prevent problems from occurring. Our plans focus heavily on prevention, including reviewing internal controls; monitoring and advising department officials on precedent-setting decisions, contracts, grants, loans, and purchase transactions before they are finalized; and meeting with applicants, contractors, and grantees to advise them of their fiduciary responsibilities and assess their capability to account for the funds. The plans also encompass an aggressive and ongoing audit and investigative effort designed to ensure that disaster relief funds are being spent wisely and to identify fraud, waste, and abuse as early as possible.

We will evaluate internal controls over program and grant management, lending practices, contract and procurement, and property and equipment management to ensure accountability of funds expended and the safeguarding of assets. We will also assess management controls over purchase card transactions and micro-purchase transactions. We will verify the validity of these transactions through selective testing.

We will investigate allegations of fraud, waste, and abuse and monitor Hotline Complaints, prioritize them, and assess their validity.

Our OIG oversight also incorporates conducting special reviews of areas that are unique to certain agencies, such as the reconstruction of NASA space facilities.

Summary of OIG Oversight Plans

The matrix beginning on page 5 summarizes the audit, investigative, and inspection oversight efforts that are planned by OIGs at multiple agencies as well as significant efforts that are unique to individual agencies.

AREAS OF EXAMINATION	PLAN OBJECTIVES	D H S	D O C	D O D	D O E	D O I	D O J	D O L	D O T	E D	E P A	G S A	H S	H U D	N A S A	S B A	S S A	T I G T A	T R E A S	U S D A	U S P S	V A	
MULTI-AGENCY REVIEWS																							
Contract Actions	Assess whether contracting actions comply with appropriate procurement standards and pricing guidelines as well as agency policies and procedures.	X	X	X		X	X	X	X		X	X	X	X	X						X	X	X
Purchase Card Transactions	Determine whether purchase card activities are consistent with the government-wide requirements and OMB guidance on increased micro-purchase threshold.	X		X		X	X	X	X		X	X	X	X	X						X	X	X
Grant Mgmt	Determine if grants were used for their intended purposes.	X	X			X	X	X	X	X			X	X									
Reviewing Internal Controls	Assess and evaluate management controls in the following areas: contracts or procurement, purchase card transactions, grants or financial management, program management, and property and equipment management.	X	X	X		X	X	X	X	X	X	X	X	X	X	X	X				X		X
Program Mgmt	Test the effectiveness of overall program management and controls.	X		X	X				X	X	X	X	X	X	X	X					X		X
Monitoring/ Technical Advice	Test and monitor existing controls and/or provide technical advice to ensure that management controls are operating effectively.	X		X		X		X	X	X	X	X	X	X	X	X					X		
Fraud Awareness Initiatives	Coordinate with federal, state, and local law enforcement agencies and prosecutors as part of fraud awareness.	X		X				X	X	X	X		X		X	X					X		
FEMA/SBA Interface	Review system processing controls impacting disaster victims, update benefits coordination between the SBA's Disaster Credit Management System and FEMA's NEMIS	X														X							
Hotline Complaints	Assess allegations of fraud, waste, and abuse within programs and operations.	X	X	X	X	X	X	X	X	X	X	X	X	X	X	X	X	X	X	X	X	X	X

AREAS OF EXAMINATION	PLAN OBJECTIVES	D	D	D	D	D	D	D	D	D	E	E	G	H	H	N	S	S	T	T	U	U	V
		H	C	O	O	O	O	O	O	O	D	P	S	H	U	A	B	S	I	R	S	S	A
		S	C	D	E	I	J	L	T		A	A	S	D	S	A	A	A	G	E	D	P	A
SINGLE-AGENCY REVIEWS																							
DHS/FEMA –Property Management	Review DHS/FEMA property management to ensure they were acquired for use at the JFOs and were adequately safeguarded against loss and pilferage.	X																					
DHS/FEMA –Disaster Management	Evaluate how FEMA carried out its disaster management responsibilities in response to Katrina.	X																					
DoD –Information Systems	Review the contingency operations and associated plans for affected information technology resources, and review the effects the disasters had on the DoD’s DISA.			X																			
DoD –Accountability over Medical Supplies and Equipment	Determine the effectiveness of controls over medical supplies and equipment for hurricane relief efforts.			X																			
Use of DoD Resources	Evaluate the use of Title 10 and Title 32 military forces, DoD civilian personnel supporting hurricane relief efforts, and the impact on the readiness and logistic support provided by DoD.			X																			
DoD –Obligations and Expenditures	Determine whether DoD’s obligations and expenditures related to reconstruction are timely and efficient.			X																			
DOE – National Response Activities	Review DOE’s response to Hurricanes Katrina and Rita, specifically to assess whether the Department’s actions fulfilled its obligations as outlined in the DHS National Response Plan.				X																		
DOE – Strategic Petroleum Reserve	Examine Strategic Petroleum Reserve’s activities to ensure that the activities meet Energy Security Agreements’ requirements.				X																		

AREAS OF EXAMINATION	PLAN OBJECTIVES	D H S	D C C	D O D	D O E	D O I	D O J	D O L	D O T	E D	E P A	G S A	H H S	H U D	N A S A	S B A	S S A	T I G T A S	T R E A S	U S D A	U S P S	V A
DOT – Mission Assignment	Review large or high-risk mission assignments to ensure required tasks were effective and related payments to DOT were supported.								X													
DOT – Federal Highway Administration Funding in Recovery Area	Determine whether the affected States have congressionally designated federal aid funds (both obligated and unobligated) that could be redirected to pay for hurricane recovery.								X													
DOT – Road and Bridge Repair	(1) Review oversight of selected contracts in Mississippi to ensure that fair prices were obtained. (2) Determine whether bridge contracts were awarded IAW Federal Highway Administration guidelines and if value engineering studies were performed.								X													
DOT – Airport Improvement Grants	Assess the internal controls for awarding and overseeing Airport Improvement Program grants for hurricane related reconstruction.								X													
DOT – FAA Capital Contracts	Plans to assess risks associated with capital contracts for repairing air traffic facilities.								X													
ED – Higher Education Recovery Act (HERA)	Assess the adequacy of ED, State Education Agency, and Local Education Agency controls over HERA funding for the Restart, Emergency Impact Aid, and Homeless Youth pgms and the ED’s allocation of funding to the Louisiana Board of Regents and Mississippi Institutes of Higher Learning.									X												
EPA – Health and Environmental Protection	Evaluate the effectiveness of EPA’s role in protecting the public health and the environment focusing on drinking water, wastewater, oil spills, Superfund sites, other hazardous materials, and management of debris-										X											

AREAS OF EXAMINATION	PLAN OBJECTIVES	D H S	D C C	D O D	D O E	D O I	D O J	D O L	D O T	E D	E P A	G S A	H H S	H U D	N A S A	S B A	S S A	T I G T A	T R E A S	U S D A	U S P S	V A	
GSA Properties	Assess GSA response to the hurricanes as the landlord of the affected properties.											X											
HHS – Mission Assignment	Review large or high-risk mission assignments to ensure required tasks were achieved effectively and related payments to HHS were supported.												X										
HUD – Community Rebuilding	Evaluate HUD’s proposed plans for rebuilding the residential communities and reducing regulatory requirements in the affected areas.													X									
HUD – Property Assessments	Conduct property assessments for HUD’s long-term disaster response.													X									
NASA –Recovery and Reconstruction	Assess NASA’s recovery and reconstruction efforts for Michoud Assembly Facility in Louisiana and the Stennis Space Center in Mississippi.														X								
SBA – Disaster Credit Management System	Review planning and project controls related to systems upgrades designed to accommodate up to 10,000 users.															X							
SBA – Disaster Loan Processing	Review revised loan guidelines to determine whether loan decisions were appropriate.															X							
SBA – Disaster Loan Disbursement	Review approved loans to determine whether loan disbursements are processed timely and in accordance with loan policies.															X							
SBA – Disaster Loan Servicing and Liquidation	Review loan servicing and liquidation cycles.															X							
TIGTA – Tax Relief Issues	Assess relaxation of tax enforcement and oversight of tax-exempt organizations involved in hurricane relief. Determine how the IRS Underreporter Program handled tax relief cases and whether tax relief codes were input and maintained for affected taxpayers.																	X					

AREAS OF EXAMINATION	PLAN OBJECTIVES	D H S	D C C	D O D	D O E	D O I	D O J	D O L	D O T	E D	E P A	G S A	H H S	H U D	N A S A	S B A	S S A	T I G T A	T R E A S	U S D A	U S P S	V A	
TIGTA – Taxpayer Data	Determine if taxpayer data was adequately protected.																		X				
TIGTA – Tax Returns	Evaluate whether the IRS has addressed hurricane relief issues in updates to forms, publications, computer systems, and in its other tax filing season preparations																		X				
Treasury Department –Office of the Comptroller of the Currency (OCC)	Determine the preparedness for and responsiveness of the Office of the OCC with respect to addressing the needs of national banks and their customers and determine OCC’s abilities to assess and manage increased risks.																			X			
Treasury Department –Office of Thrift Supervision (OTS)	Determine the preparedness for and responsiveness of OTS with respect to addressing the needs of thrifts, savings and loan companies, and their customers and determine OTS’ abilities to assess and manage increased risks.																		X				
USDA –Disaster Food Stamp Program	Review the effectiveness of controls to prevent improper program payments in disaster and evacuee States.																				X		
USDA –Housing Assistance	Ensure accountability of housing assistance (multi and single-family) provided by USDA to disaster victims.																				X		
USDA –Hurricane Disaster Programs	Assess implementation and controls over Hurricane Indemnity Pgm, Livestock Indemnity Pgm, Feed Indemnity Pgm, and Tree Indemnity Pgm.																				X		
Locating USPS Employees	Assess USPS’ progress in locating affected employees.																					X	
USPS – Asset Management	Assess the overall damage to USPS’ assets (facilities, vehicles, and equipment), and determine the impact.																					X	
USPS Mail Handling	Assess USPS interim facilities for processing, delivery, and transportation of U.S. mail.																					X	

Acknowledgements

The DHS OIG appreciates all those who contributed to this Compendium. We had the opportunity to work with OIGs from the following departments and agencies:

Department of Commerce
Department of Defense
Department of Education
Department of Energy
Department of Interior
Department of Health and Human Services
Department of Housing and Urban Development
Department of Justice
Department of Labor
Department of Transportation
Department of the Treasury
Department of Veterans Affairs
Environmental Protection Agency
General Services Administration
National Aeronautics and Space Administration
Small Business Administration
Social Security Administration
Treasury Inspector General for Tax Administration
United States Department of Agriculture
United States Postal Service

We also appreciate the participation of the Executive Council on Integrity and Efficiency and the Government Accountability Office in coordinating communications and other efforts among the various federal OIGs.

Individual Oversight Plans (Appendix A)

DHS

A Special Inspector General (SIG) for Gulf Coast Hurricane Recovery manages the overall effort on a full-time basis for the Department. The SIG is supported by a core group of DHS auditors, investigators, and inspectors with FEMA experience who are well positioned and prepared to provide immediate and continuing oversight of contracts, grants, and operations related to hurricane relief efforts.

Auditors are monitoring operations at the FEMA Emergency Operations Center (EOC), staying current on all disaster relief operations and providing on-the-spot advice. Our objective in this effort is to help DHS officials appropriately consider internal controls and the potential ramifications of their precedent setting decisions as emergency response and recovery activities continue. Specific oversight activities include the following:

- Review of major contract awards and micro-purchases
- Audits public assistance projects
- Performance review of FEMA's disaster management activities in response to Hurricane Katrina
- Review of FEMA's property management
- Review of FEMA's transitional housing and Individuals and Households Program
- Review of contracts management
- Reviews of mission assignments
- Contractor reviews of public assistance sub-grantees
- Review of intergovernmental coordination and data sharing
- Review of potential duplication in federal disaster assistance programs
- Investigate fraud and other crimes, in cooperation with DOJ Katrina Fraud Task Force

DOC

The DOC OIG's overall objectives in its audit plan are to:

- Verify that transactions are authorized and valid
- Verify whether the Department receives goods or services under contract
- Ensure problems are prevented (versus problems are uncovered)

DoD

The DoD OIG's overall objectives are to:

- Review the internal controls, procurement controls, and oversight of the DoD contracts used for the Hurricane Katrina recovery effort
- Review DoD purchase card transactions authorized by Section 101 of the Second Emergency Supplemental Appropriations Act
- Evaluate the use of Title 10 and Title 32 military forces, DoD civilian personnel supporting the relief efforts, and the impact on the readiness and logistics support provided by DoD
- Determine the effectiveness of internal controls over medical supplies and equipment used in hurricane relief efforts
- Determine the effects of Katrina on DoD information technology resources
- Determine whether DoD obligations and expenditures related to the Hurricane Katrina reconstruction effort are timely and efficiently executed and in accordance with applicable laws and regulations
- Investigate fraud abuse, corruption, and other crimes associated with the expenditure of DoD funds for response and recovery efforts related to Hurricane Katrina
- Conduct mission and fraud awareness briefings

DOE

The DOE OIG's overall objectives are to:

- Determine whether DOE's response to Hurricanes Katrina and Rita fulfilled its responsibilities under the DHS' National Response Plan
- Determine whether the Strategic Petroleum Reserve effectively met the Energy Security requirements during the response to Hurricanes Katrina and Rita
- Ensure that appropriated funds are used for their intended purposes and comply with applicable procurement standards
- Investigate allegations of fraud involving DOE-funded projects

DOI

The DOI OIG's overall objectives within its audit plans are to:

- Review the award and administration of major DOI funded contracts and DOI's implementation of expanded micro-purchase authority to ensure that appropriate federal acquisition regulations are being adhered to, and expenditures are necessary and reasonable
- Provide oversight of DOI's control environment, financial and operational processes, and the effectiveness of internal controls to identify financial reporting issues early. We will identify, document, and test internal controls for operating effectiveness

DOJ

The DOJ OIG's overall objectives in its oversight plan are to:

- Determine whether DOJ components implement appropriate internal controls over hurricane related expenditures
- Verify that transactions are authorized, valid, and comply with appropriate procurement regulations
- Verify the Department receives the good or services under contract
- Review selected grants to ensure expenditures are appropriate, allowable, and allocable
- Investigate allegations of fraud

DOL

The DOL received \$21.2 million from FEMA to support the Occupational Safety and Health Administration's responsibilities for one annex of the National Emergency Response Plan. In addition, the Department has two major forms of assistance to help hurricane victims: (1) The Federal-State Unemployment Insurance (UI) and Disaster Unemployment Assistance (DUA) programs, which provide income maintenance for eligible unemployed workers, and (2) the Workforce Investment Act National Emergency Grant (WIA NEG) program, which provides temporary employment and other services to eligible individuals during times of major economic dislocations, including natural disasters. UI and DUA have paid out hundreds of millions of dollars in benefits to workers whose employment was lost or interrupted as a result of the hurricanes. Additionally, the Department awarded \$206 million in WIA NEG funds to affected states to provide more than 20,000 temporary jobs and other assistance to workers dislocated by the hurricanes.

In October 2005, DOL OIG disseminated a *Risk Alert* to inform state and local auditors of vulnerabilities associated with DOL programs to assist hurricane victims. We initiated reviews of WIA NEG programs in Louisiana, Mississippi, Texas, and Alabama to quickly identify and communicate to the Department issues that needed policy decisions, monitoring, or other action. At the same time, working with State officials, DOL OIG staff performed data mining and other techniques on UI and DUA data files to identify potentially fraudulent overpayments, and initiated investigations as appropriate. As a result of these and other efforts, to date we have made 14 arrests and obtained 13 indictments and one conviction.

DOL OIG continues to work with other Federal OIGs to ensure coordination with the combined Federal response. Our primary emphasis is to minimize overpayments through early detection, and aggressively audit and investigate allegations of waste, fraud, and abuse.

DOT

The DOT OIG's overall objective in its oversight plan is to prevent fraud, waste, and abuse and detect and prosecute fraud. In addition, the OIG plans to confirm the effectiveness of increased Departmental and State Departments of Transportation oversight and apprise the Secretary and Congress of its findings. Specifically, the OIG will:

- Verify whether expenditures of Federal funds on transportation services and programs are being appropriately tracked by the Operating Administrations, as required by the Assistant Secretary for Budget and Programs and Chief Financial Officer
- Proactively ensure that Operating Administrations and State Departments of Transportation exercise adequate oversight of Department expenditures and put systems in place to make certain funds are appropriately spent;
- Audit selected projects, grants, and contracts
- Conduct fraud awareness and prevention activities to alert Federal, state, and local government agencies
- Investigate allegations of fraud involving transportation-funded projects, to include presenting cases to the Department of Justice for prosecution, participating in resulting prosecutions, and ensuring that the Operating Administrations and states take appropriate suspension and debarment actions

EDUCATION

The ED OIG is reviewing multiple aspects of the \$1.6 billion appropriated under the Higher Education Recovery Act (HERA):

- Department of Education Internal Audit – Evaluate controls over the Department's process for awarding funds to grantees, and once authorized, the Department's controls to ensure that funds are expended in accordance with the terms of the grants and applicable laws, regulations, policies, and procedures
- Immediate Aid to Restart School Operations Program – Determine if the State Education Agency (SEA) has adequate controls and criteria to make accurate allocations to Local Education Agencies (LEA) and if SEA and LEA expenditures were allowed by the terms of the grant and applicable laws and regulations
- Temporary Emergency Impact Aid for Displaced Students and Assistance for Homeless Youth Programs – Determine if the SEA and LEAs: (1) have internal controls in place to ensure accurate displaced and homeless student count data; (2) have adequate controls and criteria to make accurate allocations of funds; and (3) made expenditures that were allowed by the terms of the grant and applicable laws and regulations
- Emergency Assistance for Higher Education to the Louisiana Board of Regents and Assistance for Higher Education to the Mississippi Institutes of Higher Learning – Objectives are: (1) assess the allocation methodology in distributing hurricane assistance

funding and evaluate the adequacy of the information provided by postsecondary institutions; and (2) identify and assess the controls over accounting for funds and compliance with laws and regulations

EPA

The EPA OIG's overall objectives in this area are to determine whether EPA:

- Adequately designed and effectively implemented controls for authorizing, awarding, documenting, and approving expenditures
- Paid a reasonable price for goods and services obtained
- Adequately safeguarded purchased assets
- Provided quality and timely information relative to the safety of individuals and the environment; and whether and how the information is being used by affected states and other regulatory agencies in their response efforts. This work will focus in the areas of drinking water, wastewater, oil spills, Superfund sites, other hazardous materials, and management of hurricane debris

Additionally, EPA OIG investigators will coordinate with the respective Federal, state, and local law enforcement agencies.

GSA

The GSA OIG's overall objective is to determine how effectively GSA responded to Hurricane Katrina. It is reviewing how the agency assisted FEMA in providing timely relief to the victims of the hurricane. Additionally, the OIG will assess the agency's performance as the landlord for the Federal agencies in the affected areas. More specifically, the OIG is assessing whether:

- Proper management controls were implemented, and how well these management controls are operating to protect against fraud, waste, and abuse
- Transactions were authorized, valid, reasonably priced, and complied with appropriate regulations
- GSA adequately responded to safeguard physical assets and tenant agencies' needs

Additionally, OIG investigators participate on the DOJ Hurricane Katrina Fraud Task Force and coordinate with the respective Federal, state, and local law enforcement agencies.

HHS

Immediately after Hurricanes Katrina and Rita hit the Gulf Coast, the HHS OIG launched an aggressive coordinated oversight effort to oversee HHS recovery efforts. The overall objectives of HHS OIG's oversight plan are to: examine hurricane deployment and recovery activities occurring under the auspices of the Department's public health, human services,

and health care programs (i.e., Medicare and Medicaid) and related contracting activities to identify needed improvements related to ongoing and future disaster preparedness, deployment, and recovery activities; assess various management controls and the associated risk of potential fraud, waste and/or abuse in Departmental procurements; and conduct an in-depth assessment of the effectiveness of the Department's overall programmatic response to the hurricanes.

Specifically, HHS OIG is working to:

- Ensure that response and recovery funds are spent appropriately for valid and authorized transactions that comply with appropriate procurement standards
- Bring individuals and entities attempting to defraud the Government to justice
- Ensure the individuals and entities responsible for the relief efforts are wise stewards in their work assisting those impacted by the hurricanes and their aftermath
- Verify if the goods and services procured were delivered
- Ensure that problems were prevented rather than identified after the fact

HUD

The HUD OIG's overall objectives in its audit plans are to:

- Conduct a risk assessment of the overall financial and procurement controls prior to implementation to ensure the necessary controls are built into the process
- Evaluate the selected organization's control process for distributing funding to the various Community Development Block Grant grantees, Public Housing Agencies, and housing vouchers
- Evaluate the proposed plan to reduce regulatory requirements for HUD administered programs that already allocate or expect to allocate funds to the affected areas
- Perform a risk analysis of the rebuilding and revitalization plan for the affected areas
- Assess, evaluate, and make recommendations for the proposed development corporation structure

NASA

NASA's overall objectives are to:

- Determine whether NASA has established the necessary internal controls to manage Hurricane Katrina recovery and reconstruction efforts
- Evaluate NASA's estimating and execution of Hurricane Katrina funds and the processes, i.e., controls, used to ensure that those funds were used for their intended purposes

SBA

The SBA OIG's overall objectives in its oversight plans are to:

- Determine if SBA's Disaster Credit Management System (DCMS) is performing in accordance with its business process design criteria and other requirements established in SBA policies, applicable laws, and regulations
- Assess DCMS conversion plans and tests to ensure all new disaster loans are properly recorded and accounted for and identify any loan processing bottlenecks hampering the effective and timely delivery of services
- Evaluate SBA's disaster loan making and servicing processes and assess whether loan proceeds are used for relief to victims who are eligible to receive small business and home loans
- Review a selected sample of loans to determine the effectiveness of the processes for originating, servicing, and liquidating disaster assistance loans in accordance with applicable laws and regulations
- Identify potential operational issues hampering the effective delivery of services, internal controls, and loan processing
- Coordinate with other agencies on small business procurement issues; and
- Deter and detect frauds related to the SBA disaster loan program including proactive measures to: (1) identify entities wrongfully receiving payments; (2) identify potential fraud through review of loan data; and (3) identify fraudulent representations to SBA through random sampling of criminal background information of loan recipients

SSA

The SSA OIG Office of Audit has initiated a review to report on the status of SSA service delivery to individuals affected by Hurricanes Katrina and Rita. As part of this review we will assess SSA's plans to ensure that payments made under emergency procedures were appropriate and properly safeguarded.

SSA's service delivery to recipients and beneficiaries is vital to the region's recovery. As part of its immediate response to the disaster, SSA temporarily changed or eliminated several control procedures to ensure continued benefit payments in the affected area. We

will assess SSA's plans to ensure that payments made are proper and that controls are sufficient to safeguard against fraud, waste, and mismanagement.

TIGTA

The Treasury Inspector General for Tax Administration's (TIGTA) audit objectives are to:

- Verify whether the IRS: accurately updated tax products and computer programming for tax law changes affecting the processing of individual income tax returns during the 2006 Filing Season, timely and accurately processed individual tax forms which incorporated relevant new tax legislation, and, correctly identified hurricane impacted taxpayers and accurately placed disaster indicators on their accounts, and suppressed applicable notices and collection during the disaster relief period;
- Verify whether the IRS' Exempt Organization function ensured that new tax exempt organizations, established to provide assistance to individuals affected by Hurricane Katrina, were properly approved and that referrals of potentially abusive charitable organizations were given priority treatment; and
- Evaluate actions taken to protect taxpayer data, account for employees in damaged offices, and, to evaluate business resumption plans.

TREASURY

The Department of the Treasury Office of Inspector General (TOIG) is conducting audits of the OCC's and the OTS' responses to Hurricanes Katrina and Rita.

The objectives of the OCC and OTS audits are twofold: first, to determine the preparedness for, and responsiveness of, the OCC and OTS with respect to addressing the needs of national banks, thrifts, and savings and loans and their customers during the recent hurricanes; second, to determine OCC's and OTS' plans and abilities to assess and manage increased risks resulting from (a) the hurricanes' impact to their regulated institutions and (b) the relaxation of certain operational, compliance, and reporting requirements. The TOIG is focusing on the adequacy and effectiveness of OCC's and OTS' Continuity of Operations Plans as well as their abilities to respond and monitor the national banks, thrifts and savings and loans in the days and weeks following the hurricanes.

TOIG special agents participated in staffing the Katrina Fraud Hotline to combat fraud and other crimes related to this natural disaster, and responded to more than 800 hotline calls. TOIG currently has a significant ongoing multiple defendant criminal investigation concerning illegally received Hurricane Katrina relief benefits proceeds.

USDA

The USDA OIG has developed a coordinated plan, utilizing audits, investigations, and special reviews to prevent and address fraud, waste, and abuse in hurricane response and recovery efforts. Short, intermediate, and long-term objectives have been established. Areas of emphasis include reviewing controls; monitoring and advising department officials on

contracts, grants, and purchase transactions; and responding aggressively when fraud or abuse is discovered. Efforts underway include:

- Assessing Forest Service controls over the delivery of hurricane relief assistance (FEMA mission assignments) to ensure that the contracting and delivery of disaster relief assistance is safeguarded from fraud, waste, and abuse
- Reviewing the effectiveness of controls to prevent improper Disaster Food Stamp program payments in disaster and evacuee States to include:
 - Identifying and evaluating controls to prevent duplicate payments both within States and across States
 - Reviewing States' controls to prevent possible employee fraud and collusion to obtain improper benefits
 - Identifying and evaluating controls over the replacement of Electronic Benefit Transfer terminals
- Determining whether payments made for barge movement, barge unloading, and transportation differential agreements were effective in removing barges from the New Orleans area
- Determining whether costs associated with alternative and emergency warehouse grain storage were reasonable
- Ensuring accountability of housing assistance (multi and single-family) provided by USDA to disaster victims
- Evaluate the adequacy of management controls and reasonableness of reimbursements under Emergency Watershed Protection Program and Emergency Conservation Program
- Assess implementation and controls over Hurricane Indemnity Program, Livestock Indemnity Program, Feed Indemnity Program, and Tree Indemnity Program

USPS

The USPS OIG's overall objectives in its audit plans are to:

- Assess whether transactions were authorized and valid
- Verify if contracts were appropriate
- Ascertain if assets were safeguarded and secure
- Ascertain if the U.S. Mail was processed, transported, and delivered, and issues were identified and corrected

VA

The VA OIG will conduct an audit of planning, response, and recovery efforts for the Gulf Coast Hurricanes Katrina and Rita by the Veterans Health Administration, Veterans Benefits Administration, and the National Cemetery Administration. The purpose of the audit is to assess:

- Management controls over contract and procurement activities
- Controls to reestablish healthcare and benefit delivery to veterans
- Quality of care issues resulting from the evacuation

APPENDIX

Hurricane Recovery Funding— The 1st Emergency Supplemental (2005)

B

Appendix B provides copies of a public law, which made emergency funding available to meet immediate needs arising from the consequences of Hurricane Katrina. This was an emergency supplemental appropriations act, for the Fiscal Year ending September 30, 2005.

1. HR 3645 BECAME PUBLIC LAW 109 61 ON SEPTEMBER 2, 2005.

H. R. 3645

One Hundred Ninth Congress
of the
United States of America

AT THE FIRST SESSION

*Begun and held at the City of Washington on Tuesday,
the fourth day of January, two thousand and five*

An Act

Making emergency supplemental appropriations to meet immediate needs arising from the consequences of Hurricane Katrina, for the fiscal year ending September 30, 2005, and for other purposes.

Be it enacted by the Senate and House of Representatives of the United States of America in Congress assembled, That the following sums are appropriated, out of any money in the Treasury not otherwise appropriated, for the fiscal year ending September 30, 2005, namely:

DEPARTMENT OF HOMELAND SECURITY

EMERGENCY PREPAREDNESS AND RESPONSE

DISASTER RELIEF

For an additional amount for “Disaster Relief”, \$10,000,000,000, to remain available until expended: *Provided*, That the amount provided herein is designated as an emergency requirement pursuant to section 402 of H. Con. Res. 95 (109th Congress).

DEPARTMENT OF DEFENSE

OPERATION AND MAINTENANCE

OPERATION AND MAINTENANCE, DEFENSE-WIDE

(INCLUDING TRANSFER OF FUNDS)

For an additional amount for “Operation and Maintenance, Defense-Wide”, \$500,000,000 for emergency hurricane expenses, to support costs of evacuation, emergency repairs, deployment of personnel, and other costs resulting from immediate relief efforts, to remain available until September 30, 2006: *Provided*, That the Secretary of Defense may transfer these funds to appropriations for military personnel, operation and maintenance, procurement, family housing, Defense Health Program, and working capital funds: *Provided further*, That funds transferred shall be merged with and be available for the same purposes and for the same time period as the appropriation or fund to which transferred: *Provided further*, That this transfer authority is in addition to any other transfer authority available to the Department of Defense: *Provided further*, That upon a determination that all or part of the funds transferred from this appropriation are not necessary for the purposes provided herein, such amounts may be transferred back to this appropriation: *Provided further*, That the Secretary of Defense

H. R. 3645—2

shall, not more than 5 days after making transfers from this appropriation, notify the congressional defense committees in writing of any such transfer: *Provided further*, That the amount provided herein is designated as an emergency requirement pursuant to section 402 of H. Con. Res. 95 (109th Congress).

This Act may be cited as the “Emergency Supplemental Appropriations Act to Meet Immediate Needs Arising From the Consequences of Hurricane Katrina, 2005”.

Speaker of the House of Representatives.

*Vice President of the United States and
President of the Senate.*

APPENDIX

Hurricane Recovery Funding— The 2nd Emergency Supplemental (2005)

C

Appendix C provides copies of a public law, which made emergency funding available to meet immediate needs arising from the consequences of Hurricane Katrina. This was an emergency supplemental appropriations act, for the Fiscal Year ending September 30, 2005.

1. HR 3673 BECAME PUBLIC LAW 109 62 ON SEPTEMBER 8, 2005.

H. R. 3673

One Hundred Ninth Congress of the United States of America

AT THE FIRST SESSION

*Begun and held at the City of Washington on Tuesday,
the fourth day of January, two thousand and five*

An Act

Making further emergency supplemental appropriations to meet immediate needs arising from the consequences of Hurricane Katrina, for the fiscal year ending September 30, 2005, and for other purposes.

Be it enacted by the Senate and House of Representatives of the United States of America in Congress assembled, That the following sums are appropriated, out of any money in the Treasury not otherwise appropriated, for the fiscal year ending September 30, 2005, namely:

DEPARTMENT OF DEFENSE—MILITARY

OPERATION AND MAINTENANCE

OPERATION AND MAINTENANCE, DEFENSE-WIDE

(INCLUDING TRANSFERS OF FUNDS)

For an additional amount for “Operation and Maintenance, Defense-Wide”, \$1,400,000,000 for emergency hurricane expenses, to support costs of evacuation, emergency repairs, deployment of personnel, and other costs resulting from immediate relief efforts, to remain available until September 30, 2006: *Provided*, That the Secretary of Defense may transfer these funds to appropriations for military personnel, operation and maintenance, procurement, family housing, Defense Health Program, and working capital funds: *Provided further*, That not to exceed \$6,000,000 may be transferred to “Armed Forces Retirement Home” for emergency hurricane expenses: *Provided further*, That funds transferred shall be merged with and be available for the same purposes and for the same time period as the appropriation or fund to which transferred: *Provided further*, That this transfer authority is in addition to any other transfer authority available to the Department of Defense: *Provided further*, That upon a determination that all or part of the funds transferred from this appropriation are not necessary for the purposes provided herein, such amounts may be transferred back to this appropriation: *Provided further*, That the Secretary of Defense shall, not more than 5 days after making transfers from this appropriation, notify the Committees on Appropriations in writing of any such transfer: *Provided further*, That the amounts provided herein are designated as an emergency requirement pursuant to section 402 of H. Con. Res. 95 (109th Congress).

H. R. 3673—2

DEPARTMENT OF DEFENSE—CIVIL

DEPARTMENT OF THE ARMY

CORPS OF ENGINEERS—CIVIL

OPERATION AND MAINTENANCE

For an additional amount for “Operation and Maintenance” for emergency expenses for repair of storm damage to authorized projects in the Gulf states affected by Hurricane Katrina, \$200,000,000, to remain available until expended: *Provided*, That the Chief of Engineers, acting through the Assistant Secretary of the Army for Civil Works, shall provide, at a minimum, a weekly report to the Committees on Appropriations detailing the allocation and obligation of these funds, beginning not later than September 15, 2005: *Provided further*, That the amount provided herein is designated as an emergency requirement pursuant to section 402 of H. Con. Res. 95 (109th Congress).

FLOOD CONTROL AND COASTAL EMERGENCIES

For an additional amount for “Flood Control and Coastal Emergencies”, as authorized by section 5 of the Flood Control Act of August 16, 1941 (33 U.S.C. 701), for emergency expenses for repair of damage to flood control and hurricane shore protection projects in the Gulf states caused by Hurricane Katrina, \$200,000,000, to remain available until expended: *Provided*, That the Chief of Engineers, acting through the Assistant Secretary of the Army for Civil Works, shall provide, at a minimum, a weekly report to the Committees on Appropriations detailing the allocation and obligation of these funds, beginning not later than September 15, 2005: *Provided further*, That the amount provided herein is designated as an emergency requirement pursuant to section 402 of H. Con. Res. 95 (109th Congress).

DEPARTMENT OF HOMELAND SECURITY

EMERGENCY PREPAREDNESS AND RESPONSE

DISASTER RELIEF

(INCLUDING TRANSFERS OF FUNDS)

For an additional amount for “Disaster Relief”, \$50,000,000,000, to remain available until expended: *Provided*, That up to \$100,000,000 may be transferred to and merged with “Emergency Preparedness and Response, Public Health Programs” for the National Disaster Medical System to support medical care as authorized by the Public Health Security and Bioterrorism Preparedness and Response Act of 2002 (42 U.S.C. 300hh–11): *Provided further*, That \$15,000,000 shall be transferred to and merged with “Departmental Management and Operations, Office of Inspector General” for necessary expenses of the Office of Inspector General for audits and investigations as authorized by law for Hurricane Katrina response and recovery activities: *Provided further*, That the Secretary of Homeland Security shall provide, at a minimum, a weekly report to the Committees on Appropriations detailing the allocation and obligation of these funds,

H. R. 3673—3

beginning not later than September 15, 2005: *Provided further*, That the amounts provided herein are designated as an emergency requirement pursuant to section 402 of H. Con. Res. 95 (109th Congress).

GENERAL PROVISION

SEC. 101. For procurements of property or services determined by the head of an executive agency to be used in support of Hurricane Katrina rescue and relief operations—

(1) the emergency procurement authority in subsection 32A(c) of the Office of Federal Procurement Policy Act (41 U.S.C. 428a(c)) may be used; and

(2) the amount specified in subsections (c), (d), and (f) of section 32 of the Office of Federal Procurement Policy Act (41 U.S.C. 428) shall be \$250,000.

This Act may be cited as the “Second Emergency Supplemental Appropriations Act to Meet Immediate Needs Arising From the Consequences of Hurricane Katrina, 2005”.

Speaker of the House of Representatives.

*Vice President of the United States and
President of the Senate.*

APPENDIX

Hurricane Recovery Funding— The 3rd Emergency Supplemental (FY 2006)

D

Appendix D provides a link to a public law, which made emergency funding available to meet immediate needs arising from the consequences of the 2005 hurricanes. This was an emergency supplemental appropriations act for the Fiscal Year ending September 30, 2006.

To review Supplemental 3, link to:
http://frwebgate.access.gpo.gov/cgi-bin/getdoc.cgi?dbname=109_cong_public_laws&docid=f:publ148.109
and scroll to Page 119.

1. HR 2863 BECAME PUBLIC LAW 109 148 ON DECEMBER 30, 2005.

APPENDIX

Private Donations for Hurricane Katrina Victims

E

This appendix provides information, as of February 20, 2006, on private donations from individuals, foundations, and corporations for Hurricanes Katrina and Rita relief and recovery.

U.S. Organizations Providing Hurricane Relief Efforts =									
Source: The Center on Philanthropy at Indiana University									
Includes funds or in-kind contributions made from reserves from some agencies and new donations received and committed for Hurricane Katrina Relief									
Based on publicly reported data except as noted; Does not include every organization accepting contributions or providing relief services=									
Recipient Org/Entity	Emergency Response	Rebuilding from Reserves	Cash only or cash + pledges (depending on how the organization reports)	Pledges outstanding	Goal/Estimate of need	In-Kind value	In-Kind desc.	As of (date)	Source of info. =
Total Gulf Coast Hurricane Relief Donations As Of: 2/20/2006									
Private Donations (Individuals, Foundations, & Corporations) for the Gulf Coast Hurricanes									
Total Cash Donation (Katrina only, or combined Katrina & Rita)		3,376,185,879							
Total In-Kind		166,624,000							
Total From Reserves		26,381,150							
Total Pledges Outstanding		2,840,000							
		\$3,574,031,029							
Adventist Development and Relief Agency (ADRA) =	X =	1,100,000 =				1,200,000	food & clothing =	10/10/2005	http://press.armyvetnet.com/notforprofit/article.php/700146.html
Aidmatrix Foundation									
Air Compassion America =	X =								
Alley Cat Allies									
Alley Cat Rescue									
Alzheimer's Association									
America Continental 2000 =	X =								Network for Good
America Responds with Love =									Network for Good
American Cancer Society									
American Federation of Musicians =			100,000 =					2/8/2006 =	
American Forests Katrina ReLeaf Fund =			500,000 =					11/18/2005	http://www.americanforests.org/news/display.php?id=146
American Friends Service Committee =	X =	2,065,000 =						9/22/2005	afsc.org
American Humane Society									
American Humanists Association									
American Jewish Committee =	X =		900,000 =					10/10/2005	http://www.ajc.org/site/c.jjT12PH
American Kennel Club Companion Animal Recovery =			250,000 =					9/23/2005	KoG/b.685761/k.C697/Home.htm
American Kidney Fund =			200,000 =						their site
American Lung Association									Network for Good
American Public Schools Endowments									
American Red Cross =	X =		2,120,000,000 =			2,000,000,000 =		12/19/2005	redcross.org
American Refugee Committee =		10,000 =						9/7 and 10 =	archqt.org =
American Society for the Prevention of Cruelty to Animals =									
AmeriCares =	X =		1,000,000 =	2,500,000 =				9/23/2005	their site
America's Second Harvest =	X =		15,000,000 =					2/23/2006	Chronicle =
Ananda Margia Universal Relief Teams =	X =								http://www.secondharvest.org/+
Angel Flight =	X =		29,590,000 =			87,800,000	food =	2/20/2006	Chronicle =
Angel Flight America =	X =								Network for Good
Angels in Care									
Animal Defense League									
Architecture for Humanity =			10,000 =					9/1/2005	archrecord.construction.com
Associated Black Charities =	X =		600,000 =					11/14/2005	USA Today
Associated Colleges of the South =			500,000 =						Mellon Foundation
Association of Community Organizations for Relief									
Association of Gospel Rescue Missions =	X =		80,000 =					11/15/2005	a.html
BAPS Care International =	X =		10,000 =					11/17/2005	enter/announcements/2005/hurric
Baptist Child & Family Services =	X =	75,000 =						9/7/2005	Network for Good
Baptist World Alliance =	X =							2/23/2006	Chronicle
Baton Rouge Area foundation =			34,000,000 =						Network for Good
Best Friends Animal Society =	X =							11/18/2005	Network for Good
Big Brothers Big Sisters of America =	X =		1,106,002 =					10/28/2005	bnalbrith.org
Bhai B'rith International =			925,845 =			43,834 =		11/11/2005	email confirmation
Boys & Girls Clubs =									

Recipient Org/Entity	Emergency Response	Rebuilding	from Reserves	Cash only or cash + pledges (depending on how the organization reports)	Pledges outstanding	Goal/Estimate of need	In-Kind value	In-Kind desc. and other efforts by troops-specific ones =	As of (date)	Source of info. =
Boys Scouts of American Hurricane Relief Fund =				50,000 =					11/2/2005	http://www.sportys.com/press.html?display=press.cfm?id=258 =
Brother's Brother Foundation =	X =	X =		720,000 =		6,000,000 =	5,500,000 =	medicine, and equipment =	12/19/2005	http://www.brothersbrother.org/katrinaupdate.htm
Brown University =				5,000,000 =					9/12/2005	Chronicle; Sidney Frank
Bush-Clinton Katrina Fund =		X =		110,000,000 =					2/23/2006	Chronicle =
Catholic Charities =	X =			154,500,000 =					2/23/2006	Chronicle =
CDC Foundation =			2,000,000 =	1,000,000 =					1/18/2005	Philanthropy News Digest; Additional \$1 million RWJF; Chronicle \$2million.
Charity Hospital (in New Orleans)									9/27/2005 =	
CHF International =				1,000,000 =					12/1/2005	http://www.nbc5.com/politics/643#3399/detail.html
Chicago Helps Fund =		X =							9/12/2005	Chronicle
Child Welfare League of America Katrina Kids Fund										
Children's Health Fund =										
Children's Miracle Network										
Children's Network International										
Christian Children's Fund				5,000 =					9/2/2005	Chronicle
Christian Disaster Response =				3,200,000 =		5,000,000 =			10/4/2005	cnwrc.org
Christian Reformed World Relief Committee =				300,000 =			1,200,000 =	supplies =	10/4/2005	churchworldservices.org
Church World Services =		X =								
CinChouse Operation Homefront										
CitiHope International =	X =		1,000,000 =				1,974,000 =	medical supplies =	11/18/2005	http://www.citihope.org/index.php?id=59 =
CityTeam Ministries =	X =								11/18/2005	
Coast Guard Foundation =	X =									
Communities in Schools National Katrina Fund										
Community Foundation of Southern Alabama =				200,000 =					11/11/2005	Wachovia =
Convoy of Hope =	X =			100,000 =				20 million pounds of relief supplies =	10/4/2005	convoyofhope.org; Benny Hinn Ministries; Nascar
Cornell University School of Veterinary Medicine =				15,000 =					11/11/2005	Triad Foundation
Corporation for National and Community Service Disaster Relief Fund =				480,866 =				12301 volunteers =	11/14/2005	website
Counterpart International, Inc.										
Cystic-Fibrosis Foundation										
Days End Farm Horse Rescue										
Desire Street Ministries =	X =			800,000 =						Network for Good Mellon Foundation =
Dillard University =										
Direct Relief International =	X =			3,880,000 =			20,120,000 =	medical inventory =	12/15/2005	directrelief.org & Chronicle
Dogs for Deaf and Disabled Americans										
Dream Center =	X =			50,000 =				2 homes =	9/12/2005	Dr. Phil
Easter Seals										
Emergency Fund =		X =		70,000 =					11/14/2005	email confirmation =
Episcopal Relief & Development =	X =			10,000,000 =					10/10/2005	http://www.er-d.org/newsroom_68407_ENG_H.html
Evangelical Lutheran Church in America =	X =			23,000,000 =					2/23/2006	Chronicle =
Farm Aid, Inc. =		X =	49,500 =					14,000 lb of food =	10/20/2005	farmaid.org
Federal Employees Education and Assistance Fund										
Feed the Children =				1,000 =				juice, food and supplies, office equipment =	11/11/2005	old orchard (\$65,000 in-kind); Mitsubishi Electric America Foundation (\$1,000 cash); Archer Daniels Midland (\$1.2 mil in-kind); Office Depot (\$13mil supplies) =
First Book =							14,265,000 =			Network for Good =
Florida Hurricane Relief Fund =		X =		50,000 =					11/11/2005	Blue Cross and Blue Shield Florida =

Recipient Org/Entity	Emergency Response	Rebuilding	from Reserves	Cash only or cash + pledges (depending on how the organization reports)	Pledges outstanding	Goal/Estimate of need	In-Kind value	In-Kind desc.	As of (date)	Source of info. =
Food for the Poor =								200 trailers of food =	11/2/2005	http://www.foodforthe poor.org/sit e/c.dn/GKNINsFmG/b.1046533/k 1F60/91505_Hurricane_Katrina.htm
Foundations for the Mid-South =				11,600,000 =					2/23/2006	Chronicle
Foundations for Recovery =		X =		17,100,000 =					10/20/2005	their site
Friedkin Disaster Relief Fund =			2,000,000 =						9/12/2005	Chronicle
Gifts in Kind International =	X =									Network for Good
Giving Children Hope										Network for Good
Global Lifeguards Inc. =		X =								Network for Good
Goodness Outreach Depot =	X =			50,000 =					11/11/2005	From Meadows Foundation
Goodwill Industries of Dallas =										
Grant Committee of the Hurricane Katrina Relief Fund, established by The Community Foundation of South Alabama, United Way of Southwest Alabama and WKRG-TV5 =				271,920 =					11/2/2005	http://www.al.com/news/mobilee gster/index.ssf?base/news/1130 826820182280.xml&coll=3
Greater New Orleans Foundation =			1,300,000 =						9/12/2005 =	
Gulf Coast Community Foundation of Mississippi =				800,000 =					11/11/2005	Wachovia
Habitat for Humanity =		X =		95,000,000 =					2/23/2006	Chronicle
Hands on Humanity										
Hare Krishna Food for Life Global =	X =			2,180,000 =					9/22/2005	PR Newswire
Harrah's Employees Recovery Fund =				1,000,000 =					11/11/2005	Health Net (CA)
HCA Hope Fund =				2,500,000 =					10/20/2005	http://biz.yahoo.com/bw/0510107 65855.html?_v=1
Healing Hands =			1,000,000 =	15,000,000 =					11/11/2005	Starkey (MN)
Hear Now Project =	X =			25,000 =					11/11/2005	Polk Bros. Foundation
Heart to Heart International =										
Heartland Alliance for Human Needs and Human Rights =										
Hearst United for Animals										
Hearst with Hands =	X =			280,000 =						lexisnexis =
Hebrew Immigration Aid Society				25,000,000 =					11/11/2005	Starkey (MN)
Help America Hear Project =				2,800,000 =					2/8/2006 =	
Higher Ground Hurricane Relief Fund (musicians) =				3,000,000 =					11/18/2005	http://www.homeaid.org/howhelp
HomeAid America =		X =								AGCRF.html
Hoshea Feed the Hungry and Homeless =	X =			100,000 =					9/12/2002	Corp. list of Chronicle
Houston Food Bank =				25,000,000 =					2/23/2006	Chronicle =
Humane Society of the US =				100,000 =					10/28/2005	email confirmation
Humanity First USA =	X =			250,000 =						www.lcnarelieff.org
Huntington's Disease Society of America										
ICNA =										
In Defense of Animals										
Independent Charities of America Hurricane Katrina Fund										
Independent Insurance Agents and Brokers Association =				25,000 =					11/11/2005	Safeco Insurance
Institute of International Education =		X =					100,000 =			
Interchurch Medical Assistance =	X =			3,300,000 =			15,000,000 supplies =		11/2/2005	email confirmation
International Aid =	X =									Network for Good
International Association for Human Values =	X =									Network for Good
International Fund for Animal Welfare										Network for Good
International Medical Corp =										Network for Good =
International Orthodox Christian Charities =	X =									Network for Good =
International Relief and Development =		X =					100,000 medical supplies =			ird-dc.org =
International Relief Friendship Foundation =	X =									Network for Good
International Relief Teams =	X =						35,000 =			Network for Good
International Rescue Committee =	X =								9/27/2005	http://www.irc.org/katrina/
Islamic Relief =				2,000,000 =						Network for Good
Kids Acquiring Real-life education =										
Kids in Distressed Situations										
Kiwanis International =				500,000 =					2/5/2006 =	
Knights of Columbus Katrina Relief Fund =				2,500,000 =						
Korean American Sharing Movement										
Lakewood Church (Houston) =			1,000,000 =						9/19/2005	christianitytoday.com
Latter Day Saints Humanitarian Services										
Life for Relief and Development (LIFE) =			1,000,000 =							

Recipient Org/Entity	Emergency Response	Rebuilding	from Reserves	Cash only or cash + pledges (depending on how the organization reports)	Pledges outstanding	Goal/Estimate of need	In-Kind value	In-Kind desc.	As of (date)	Source of info. =
Lions Club International Foundation =	X =			250,000 =					11/11/2005	GlaxoSmithKline
Lott Carey Baptist Foreign Mission Society, Inc. =	X =			200,000 =					9/14/2005	http://www.leanweb.org/hurricanekatrina/ = Mellon Foundation =
Louisiana Disaster Recovery Fund =										
Louisiana Environmental Action Network =										
Louisiana Philharmonic Orchestra =										
Louisiana Society for the Prevention of Cruelty to Animals										
Love Our Children USA (Kids of Katrina Fund) =										
Lutheran Disaster Response =				125,000 =			50,000	Supplies =	11/11/2005	email confirmation
MADRE Inc. =	X =			1,232,412 =					19/2006	http://www.iss.org/disaster/new_s_financialoverview.htm
MAP (Medical Assistance Programs) International =										
March of Dimes =										
MAP (Medical Assistance Programs) International =										
Masonic Services Association of America =										
Massachusetts Society for the Prevention of Cruelty to Animals =										
MAZON										
Mennonite Disaster Service =	X =			20,000 =					9/8/2005	Chronicle
Mercy Corps =	X =			350,000 =					9/12/2005	Chronicle
Mercy Medical Airlift =	X =			10,000,000 =					12/15/2005	Chronicle
Mercy USA for Aid and Development =	X =									
Mississippi Animal Rescue League										
Mississippi Food Network =										
Mississippi Hurricane Fund =				250,000 =					9/14/2005 =	http://www.marchofdimes.com/a
Missouri Foundation for Health =										http://www.marchofdimes.com/a
Modest Needs Foundation =										http://www.marchofdimes.com/a
Mr. Holland's Opus Foundation Emergency Fund										http://www.marchofdimes.com/a
Muslim Hurricane Relief Task Force (Islamic Relief, Muslim American Society, Kind Hearts) =	X =			10,000,000 =						http://www.marchofdimes.com/a
National Academy Foundation Educational Partnerships for America's Youth										
National Association for the Advancement of Colored People =										
National Fuel Funds Network =										
National Heritage Foundation US Troop Support =										
National Kidney Foundation										
National Trust for Historic Preservation =										
National Voluntary Organizations Active in Disaster										
Nazaréne Disaster Response =										
Neighbors Helping Neighbors Campaign =	X =			2,000,000 =						
Next of Kin Registry =	X =			6,500,000 =						
Noah's Wish =										
North Shore Animal League America =										
North Texas Food Bank =										
Northwest Medical Teams International =				25,000 =						
Ochsner Clinic Foundation =				4,900,000 =						
Operation Blessing =	X =			100,000 =						
Operation Compassion =										
Operation USA =										
Oxfam America =	X =			1,669,750 =						
Pan American Health and Education Foundation =	X =									
Paralyzed Veterans of America										
PEETA										
PetsMart Charities =										
Pittsburgh Foundation										
Points of Light Foundation =										

Recipient Org/Entity	Emergency Response	Rebuilding from Reserves	Cash only or cash + pledges (depending on how the organization reports)	Pledges outstanding	Goal/Estimate of need	In-Kind value	In-Kind desc.	As of (date)	Source of info. =
Presbyterian Disaster Assistance =		500,000 =			10,000,000 =				FEMA list =
Project HALO =	X =								
ProLiberacy Katrina Fund									
Reach Our America =	X =								
Rebuilding Together =	X =		500,000 =					11/11/2005	Countrywide Financial Corporation =
Robert Wood Johnson Foundation (Long-Term Recovery Grants) =		10,000,000 =							RWJF letter dated 10.28.05; above initial grants to ARC,
Salvation Army =	X =		325,000,000 =					11/9/2005	6DC. & Salvation Army
Samaritan's Purse =	X =		36,890,000 =					1/27/2006	phone conversation
Save the Children USA =			5,000,000 =					2/23/2006	Chronicle
Scholarship America Disaster Relief Fund								12/15/2005	Chronicle
Society for the Prevention of Cruelty to Animals Los Angeles									
Society of St. Vincent de Paul =	X =								
Southern Arts Federation =	X =		300 =					9/8/2005	Chronicle
Southern Baptist Convention Disaster Relief =	X =		20,100,000 =					2/23/2006	Chronicle =
Southern Education Foundation =			2,800,000 =						Mellon Foundation
Spina Bifida Association									
St. Jude Children's Research Hospital									
Starlight Children's Foundation									
Texas Children's Hospital =			160,000 =					9/8/2005	Chronicle
The Leukemia and Lymphoma Society									
Think on These Things Ministries Intl =	X =								
Tides Rapid Response Fund									
Time Dollar Institute =	X =								
Trickle Up Program, Inc. =	X =								
UUA - Federation of New York =	X =		3,000,000 =					9/23/2005	Chronicle
UJC/the Federations of North America and their partners =	X =		28,500,000 =					2/23/2006	Chronicle
Union for Reform Judaism =			3,100,000 =			2,000,000	materials =	10/27/2005	Email Confirmation
Unitarian Universalist Service Committee =			3,146,705 =					12/19/2005	www.UUSC.org
United Animals Nations =			1,000,000 =					10/28/2005	Email Confirmation
United Cerebral Palsy									
United Methodist Committee Relief =	X =		62,370,000 =					2/23/2006	Chronicle
United Way of America =	X =		45,800,000 =					2/23/2006	Chronicle
University of Louisiana =			1,200,000 =						Mellon Foundation
Urban League of Greater New Orleans =		1,000,000 =						9/12/2005	Chronicle
US Committee for Refugees and Immigrants									
US Fund for Unicef =									
Veterans of Foreign Wars =	X =		2,300,000 =					12/15/2005	Chronicle
Volunteers of America =	X =	115,000 =						9/13/2005	vfw.org
Water Missions International =	X =			250,000 =		500,000 =		9/13/2005	watermissions.org
Women's Hospital Foundation									
World Concern =			250,000 =					10/12/2005	seatlept.com
World Hope International =	X =	100,000 =						9/13/2005	website
World Relief =								2/23/2006	Chronicle
World Vision =	X =		10,900,000 =			8,700,000 =		11/11/2005	Triad Foundation
YMCA, Tampa Metropolitan Area =			10,000 =						
Youth Matter, Inc. =									

Recipient Org/Entity Direct Corporate or Foundation Support =	Emergency Response	Rebuilding	from Reserves	Cash only or cash + pledges (depending on how the organization reports)	Pledges outstanding	Goal/Estimate of need	In-Kind value	In-Kind desc.	As of (date)	Source of info.
AEP (OH) TX and LA schools =				100,000 =				Rental Cars and Trucks and Hotel Rooms to DHS & FEMA =	11/11/2005	To Texas and Louisiana Schools Foundation Center =
Cedant =				350,000 = 150,000 =					11/11/2005	Foundation Center http://www.cleco.com/site380.ppt =
Cleco EmpPowers Fund = Deloitte & Touche Disaster Fund =								Administered by Team Leaders; smaller grants given to affected areas where DuPont is located - matching corporate Fund =	11/11/2005	Foundation Center =
DuPont Disaster Assistance Fund = Ernst & Young Disaster Relief Fund =				1,000,000 = 1,000,000 =					11/11/2005	http://www2.dupont.com/Media_Center/en_US/news_releases/2005/article20050909b.html
Fannie Mae Foundation (long-term housing grants) =				500,000 =					8/31/2005	http://www.fanniemae.com/foundation.org/news/pr/2005sum/083105_tlu http://www.fanniemae.com/foundation.org/news/pr/2005sum/083105_tlu
Federal Home Loan Bank of Cincinnati =		X =		15,000,000 =				A fund to provide housing assistance to victims of Hurricane Katrina and Rita =	10/24/2005	Website =
Federal Home Loan Bank of Dallas =		X =		5,000,000 =				A fund to provide housing assistance to victims of Hurricane Katrina and Rita =	11/14/2005	http://www.fhfb.com/press/2005/p #_20060921.htm =
Ford = Ford Foundation (Rebuilding Gulf Coast) =		X =		9,000,000 =			4,350,000	275 Used vehicles to Louisiana & Mississippi; mobile command center to St. Bernard Parish sheriff's office =	11/11/2005	Foundation Center Foundation Center
John D. and Catherine T. MacArthur Foundation = KPMG Disaster Relief Fund =		X =		6,000,000 = 910,000 =					9/22/2005	http://www.fdncenter.org/pnd/ne http://www.fdncenter.org/pnd/ne #s/story.html?id=117100009
MusiCares Foundation =				1,000,000 =					11/11/2005	Foundation Center = Foundation Center; to assist musicians affected by the hurricane =
Office Depot = Textron =							4,000,000 8 helicopters =	Contents of 5 stores =	11/11/2005	Foundation Center = Foundation Center =
W. K. Kellogg =	X =			12,000,000 =					9/12/2005	http://www.wkkf.org/Pubs/Katrina AdRelease 00439_03818.pdf =

Recipient Org/Entity	Emergency Response	Rebuilding	from Reserves	Cash only or cash + pledges (depending on how the organization reports)	Pledges outstanding	Goal/Estimate of need	In-Kind value	In-Kind desc.	As of (date)	Source of info.
Washington Square Health Foundation Hurricane Katrina Disaster Capacity Health Care Grant Fund				35,000					11/14/2005	Foundation Center
TOTAL DIRECT CORPORATE DONATIONS				38,410,000			4,350,000			
Totals			\$26,381,150	\$3,378,185,879	\$2,840,000		166,624,000			

APPENDIX

Hurricane Declaration by Program Area

F

This appendix provides the Federal Emergency Management Agency's declaration by program area, for each of three storms, Katrina, Rita and Wilma, respectively.

**HURRICANE KATRINA DECLARATION
BY PROGRAM AREA (as of 3/31/06)**

PROGRAM AREA	PROGRAM NAME	ALLOCATIONS	UN-OBLIGATED COMMITMENTS	OBLIGATIONS	UN-OBLIGATED ALLOCATIONS(C)	UN-LIQUIDATED OBLIGATIONS	EXPENDITURES	ALLOCATION AVAILABLE
1-HUMAN SERVICES	2503-UNEMPLOYMENT	386,870,659		328,939,802	57,930,857	4,923,284	324,016,518	57,930,857
	2504-CRISIS							
	COUNSELING-NIMH	46,515,418		21,048,736	25,466,682	1,667,835	19,380,901	25,466,682
	2576-LEGAL SERVICES	123,275	87,000	79,767	43,508	75,892	3,875	(43,492)
	2592-INSPECTIONS	179,709,004	35,052,221	144,651,634	35,057,370	39,898,189	104,753,445	5,150
	4149-OTHER NEEDS ASSISTANCE	1,612,920,823		1,612,920,823		50,934,939	1,561,985,883	
	414X-HOUSING ASSISTANCE	3,991,963,937	60,000	3,991,963,849	89	89,360,539	3,902,603,309	(59,911)
1-HUMAN SERVICES Total	4152-CRISIS COUNSELING-SCC MANUFACTURED HOUSING	34,673,087		31,292,647	3,380,440	18,203,493	13,089,153	3,380,440
		6,397,831,507	1,844,741,181	4,522,211,975	1,875,619,532	1,088,465,920	3,433,746,055	30,878,350
		12,650,607,710	1,879,940,402	10,653,109,232	1,997,498,478	1,293,530,091	9,359,579,140	117,558,076
2-INFRASTRUCTURE	2594-INSPECTIONS	290,028,500	5,734,100	282,052,800	7,975,700	205,314,414	76,738,386	2,241,600
	416X-PUBLIC ASSISTANCE	3,756,745,515		3,691,756,388	64,989,127	2,058,417,312	1,633,339,076	64,989,128
2-INFRASTRUCTURE Total		4,046,774,015	5,734,100	3,973,809,188	72,964,827	2,263,731,727	1,710,077,461	67,230,728
3-MITIGATION	2593-INSPECTIONS	26,643,721	5,418,311	14,449,410	12,194,311	9,751,964	4,697,446	6,776,000
	4173-HAZARD MITIGATION	16,169,604		16,169,604		15,926,098	243,506	
3-MITIGATION Total		42,813,325	5,418,311	30,619,014	12,194,311	25,678,062	4,940,952	6,776,000
4-OPERATIONS	2507-MISSIONS-TA	41,925,756		24,457,556	17,468,200	23,966,930	490,626	17,468,200
	2508-MISSIONS-DFA	4,646,132,155		4,631,632,153	14,500,002	4,323,418,489	308,213,664	14,500,002
4-OPERATIONS Total		4,688,057,911		4,656,089,709	31,968,202	4,347,385,419	308,704,290	31,968,202
5-ADMINISTRATION	11XX-SALARIES & BENEFITS	272,082,391		282,442,431	(10,360,040)		282,442,431	(10,360,040)
	21XX-TRAVEL	208,380,017	9,095,873	191,878,631	16,501,386	32,515,759	159,362,873	7,405,513
	22XX-TRANSPORTATION	45,842,671	27,291	41,419,523	4,423,149	13,162,547	28,256,976	4,395,857
	23XX-RENT, COMM, UTILITIES	264,309,781	50,512,623	210,831,820	53,477,961	81,896,530	128,935,291	2,965,338
	24XX-PRINT & REPRO	6,112,588	493,391	4,275,519	1,837,069	2,975,400	1,300,119	1,343,678
	2501-MISSIONS-FOS	2,333,952,304		2,330,278,379	3,673,925	2,037,286,397	292,991,982	3,673,925
	25XX-OTHER SERVICES	1,850,659,458	326,981,468	1,526,411,622	324,247,836	681,403,571	845,008,052	(2,733,632)
	26XX-SUPPLIES & MATERIALS	540,387,864	34,287,880	501,960,880	38,426,983	246,599,587	255,361,293	4,139,104
	31XX-EQUIPMENT	206,697,299	31,307,338	174,450,886	32,246,413	37,089,045	137,361,840	939,076
	32XX-LAND & STRUCTURES	9,861,466	2,051,604	7,450,977	2,410,489	5,375,261	2,075,716	358,885
4101-URBAN SEARCH & RESCUE	75,195,470	1	75,195,469	1	57,508,865	17,686,604	(0)	
5-ADMINISTRATION Total		5,813,481,310	454,757,469	5,346,596,138	466,885,172	3,195,812,962	2,150,783,176	12,127,702
GRANTS	411X-SUPERFUND							
	41XX-GRANTS							
GRANTS Total								
Grand Total		27,241,734,271	2,345,850,282	24,660,223,281	2,581,510,990	11,126,138,260	13,534,085,020	235,660,707

**HURRICANE RITA DECLARATION
BY PROGRAM AREA (as of 3/31/06)**

PROGRAM AREA	PROGRAM NAME	ALLOCATIONS	UN-OBLIGATED COMMITMENTS	OBLIGATIONS	UN-OBLIGATED ALLOCATIONS(c)	UN-LIQUIDATED OBLIGATIONS	EXPENDITURES	ALLOCATION AVAILABLE
1-HUMAN SERVICES	2503-UNEMPLOYMENT	18,291,421		17,838,942	452,479		17,838,942	452,479
	2504-CRISIS COUNSELING-NIMH			1,546,988	(1,546,988)	1,546,988		(1,546,988)
	2576-LEGAL SERVICES	5,000			5,000			5,000
	2592-INSPECTIONS	65,198,750	30,808	65,166,747	32,003	19,428,906	45,737,841	1,194
	4149-OTHER NEEDS ASSISTANCE	96,150,000		96,150,000		2,376,215	93,773,785	
	414X-HOUSING ASSISTANCE	1,036,301,568		1,036,300,669	899	140,039,684	896,260,985	899
	4152-CRISIS COUNSELING-SCC	1,557,215		650,742	906,473	650,742		906,473
	4154-OTHER NEEDS ASSISTANCE	68,880,000		68,880,000		5,085,935	63,794,065	
	MANUFACTURED HOUSING	241,797,400	118,126,081	108,189,001	133,608,399	22,065,492	86,123,509	15,482,319
	1-HUMAN SERVICES Total		1,528,181,354	118,156,889	1,394,723,089	133,458,265	191,193,962	1,203,529,127
2-INFRASTRUCTURE	2594-INSPECTIONS	18,395,900	2,550,000	15,782,400	2,613,500	11,941,371	3,841,029	63,500
	416X-PUBLIC ASSISTANCE	397,947,097		377,565,794	20,381,303	192,674,508	184,891,286	20,381,303
2-INFRASTRUCTURE Total		416,342,997	2,550,000	393,348,194	22,994,803	204,615,878	188,732,315	20,444,803
3-MITIGATION	2593-INSPECTIONS	16,244,974	4,870,040	6,799,934	9,445,040	4,979,004	1,820,930	4,575,000
	4173-HAZARD MITIGATION	1,897,681		1,897,681		1,897,681		
3-MITIGATION Total		18,142,655	4,870,040	8,697,615	9,445,040	6,876,685	1,820,930	4,575,000
4-OPERATIONS	2507-MISSIONS-TA	1,100,000		1,100,000		1,035,443	64,557	
	2508-MISSIONS-DEA	763,196,000		760,513,600	2,682,400	709,252,576	51,261,024	2,682,400
4-OPERATIONS Total		764,296,000		761,613,600	2,682,400	710,288,020	51,325,580	2,682,400
5-ADMINISTRATION	11XX-SALARIES & BENEFITS	44,840,560		45,039,038	(198,478)		45,039,038	(198,478)
	21XX-TRAVEL	30,010,288	31,829	29,320,478	689,810	2,845,563	26,474,915	657,981
	22XX-TRANSPORTATION	3,761,000	1,174,125	472,000	3,289,000	336,085	135,915	2,114,875
	23XX-RENT, COMM, UTILITIES	21,097,325	3,278,080	16,523,223	4,574,102	7,677,801	8,845,421	1,296,022
	24XX-PRINT & REPRO	1,143,000	177,100	811,586	331,414	557,738	253,848	154,314
	2501-MISSIONS-FOS	406,339,685		404,559,685	1,780,000	399,401,823	5,157,862	1,780,000
	25XX-OTHER SERVICES	520,315,374	107,449,011	410,501,432	109,813,942	193,414,364	217,087,068	2,364,932
	26XX-SUPPLIES & MATERIALS	50,080,975	6,517,254	42,639,037	7,441,938	11,666,329	30,972,708	924,684
	31XX-EQUIPMENT	11,255,983	4,724,863	7,678,557	3,577,426	2,343,846	5,334,711	(1,147,437)
	32XX-LAND & STRUCTURES	2,100,000	2,100,000					
4101-URBAN SEARCH & RESCUE	22,400,226	120,000	22,280,226	120,000	18,430,111	3,850,115		
5-ADMINISTRATION Total		1,113,344,416	125,572,262	979,825,262	133,519,154	636,673,661	343,151,601	7,946,892
GRANTS	41XX-GRANTS							
GRANTS Total								
Grand Total		3,840,307,422	251,149,192	3,538,207,759	302,099,663	1,749,648,205	1,788,559,554	50,950,471

**HURRICANE WILMA DECLARATION
BY PROGRAM AREA (as of 3/31/06)**

PROGRAM AREA	PROGRAM NAME	ALLOCATION S	UN- OBLIGATED COMMIT- MENTS	OBLIGATION S	UN-OBLIGATED ALLOCATIONS(c)	LIQUIDATED OBLIGATION S	EXPENDITUR ES	ALLOCATION AVAILABLE
1-HUMAN SERVICES	2503-UNEMPLOYMENT	5,770,125		5,770,125			5,770,125	
	2504-CRISIS COUNSELING-NIMH	3,246,808		3,246,808			3,246,808	
	2576-LEGAL SERVICES	5,000		5,000		5,000		
	2592-INSPECTIONS	42,429,400		42,429,256	144	6,094,237	36,335,019	144
	4149-OTHER NEEDS ASSISTANCE	148,000,000		148,000,000		6,333,618	141,666,382	
	414X-HOUSING ASSISTANCE	156,715,000		156,695,000	20,000	18,034,949	138,660,051	20,000
1-HUMAN SERVICES Total	4152-CRISIS COUNSELING-SCC	2,628,148		1,164,961	1,463,187		1,164,961	1,463,187
	MANUFACTURED HOUSING	89,013,000	8,822,656	76,555,508	12,457,492	14,531,512	62,023,996	3,634,836
		447,807,481	8,822,656	433,866,659	13,940,822	44,999,316	388,867,342	5,118,167
2-INFRASTRUCTURE	2594-INSPECTIONS	44,126,700	16,016,400	28,110,300	16,016,400	23,823,994	4,286,306	
	416X-PUBLIC ASSISTANCE	712,050,000		708,883,294	3,166,706	502,421,667	206,461,627	3,166,706
2-INFRASTRUCTURE Total		756,176,700	16,016,400	736,993,594	19,183,106	526,245,662	210,747,933	3,166,706
3-MITIGATION	2593-INSPECTIONS	1,000,000	335,100	599,900	400,100	478,019	121,881	65,000
3-MITIGATION Total		1,000,000	335,100	599,900	400,100	478,019	121,881	65,000
4-OPERATIONS	2507-MISSIONS-TA	700,000		700,000		686,205	13,795	
	2508-MISSIONS-DFA	233,328,384		233,328,384		232,595,129	733,254	
4-OPERATIONS Total		234,028,384		234,028,384		233,281,334	747,050	
5-ADMINISTRATION	11XX-SALARIES & BENEFITS	32,973,330		30,425,036	2,548,294		30,425,036	2,548,294
	21XX-TRAVEL	13,059,700	167,200	12,745,158	314,542	1,382,388	11,362,770	147,342
	22XX-TRANSPORTION	12,725,440	410,000	10,225,440	2,500,000	8,118,943	2,106,497	2,090,000
	23XX-RENT, COMM, UTILITIES	5,871,000	2,476,426	3,417,760	2,453,240	1,789,182	1,628,578	(23,186)
	24XX-PRINT & REPRO	323,500	39,928	265,870	57,630	151,954	113,916	17,702
	2501-MISSIONS-FOS	132,029,012		132,029,012		125,394,264	6,634,748	
	25XX-OTHER SERVICES	18,150,000	6,251,686	12,779,276	5,370,724	10,803,566	1,975,710	(880,963)
	26XX-SUPPLIES & MATERIALS	91,470,000	16,087,313	74,646,543	16,823,457	73,740,808	905,735	736,144
	31XX-EQUIPMENT	2,310,000	1,669,338	494,884	1,815,116	129,842	365,043	145,778
	32XX-LAND & STRUCTURES	74,225	4,932	69,293	4,932	51,001	18,292	
4101-URBAN SEARCH & RESCUE	6,216,000		5,985,681	230,319	5,457,151	528,529	230,319	
5-ADMINISTRATION Total		315,202,207	27,106,823	283,083,953	32,118,254	227,019,098	56,064,855	5,011,431
GRANTS	41XX-GRANTS							
GRANTS Total								
Grand Total		1,754,214,772	52,280,979	1,688,572,490	65,642,282	1,032,023,429	656,549,061	13,361,303

APPENDIX

Useful Website Links

G

This appendix provides useful website links, related to hurricane relief and recovery activities mentioned in this report.

Useful Links for Hurricane Recovery and Oversight:

Hurricane Contracting Information Center (Dept. of Commerce)

<http://www.rebuildingthegulfcoast.gov/>

Department of Education – Hurricane Help for Schools

<http://hurricanehelpforschools.gov/index.html>

Department of Homeland Security (OIG) Katrina Oversight Page:

[http://www.dhs.gov/dhspublic/interapp/editorial/Copy_\(2\)_of_editorial_0602.xml](http://www.dhs.gov/dhspublic/interapp/editorial/Copy_(2)_of_editorial_0602.xml)

Department of Homeland Security (Emergency and Disasters):

<http://www.dhs.gov/interweb/assetlibrary/katrina.htm>

Department of Justice Katrina Fraud Task Force:

http://www.usdoj.gov/katrina/Katrina_Fraud/

FBI Katrina/Rita Information Page:

<http://www.fbi.gov/katrina.htm#vgn-hurricane-katrina-fraud-task-force-vgn>

Department of Transportation: Status of Transportation-Related Recovery Efforts

<http://www.nhtsa.dot.gov/USDOTReliefSite>

Roadway Information Related to Hurricanes Rita and Katrina (DOT)

<http://www.fhwa.dot.gov/trafficinfo/katrina.htm>

Environmental Protection Agency - Disaster Response

<http://www.epa.gov/katrina/index.html>

PCIE/ECIE:

<http://www.ignet.gov/pande/hsr/oigplanoverview.pdf>

PCIE/ECIE: Hurricane Relief Oversight

<http://www.ignet.gov/pande/hsr1.html#relief>

Small Business Administration: Disaster Recovery

http://www.sba.gov/disaster_recov/index.html

SBA Office of Inspector General (e.g., to obtain copies of reports mentioned in the SAR)

<http://www.sba.gov/ig>

White House: Hurricane Recovery, Rebuilding the Gulf Coast Region

<http://www.whitehouse.gov/infocus/hurricane>

NON-FEDERAL SITES

Center for Philanthropy, Indiana University (Katrina and Rita private donations)

http://www.philanthropy.iupui.edu/Hurricane_Katrina.html

Alabama: Department of Economic and Community Affairs

<http://www.adeca.alabama.gov/default.aspx>

Florida: Department of Community Affairs

<http://www.floridacommunitydevelopment.org>

State of Louisiana: Hurricane Information

<http://katrina.louisiana.gov/>

State of Louisiana: Office of Community Development, Disaster Recovery Unit

<http://www.state.la.us/cdbg/drhome.htm>

LouisianaRebuilds: Louisiana Non-Partisan Public-Private Partnership for Louisiana residents affected by Hurricanes Katrina and Rita

<http://www.louisianarebuilds.info/>

Louisiana Recovery Authority: Louisiana Long-Term Recovery Planning

<http://www.louisianaspeaks.org>

Louisiana Disaster Recovery Unit

<http://www.state.la.us/cdbg/drhome.htm>

Mississippi: Hurricane Katrina Homeowner's Grant Program

<http://www.mshomehelp.gov>

Texas: Department of Housing and Community Affairs

<http://www.tdhca.state.tx.us>

APPENDIX

PCIE/ECIE Contributing Members

H

This appendix provides the contact information for all PCIE/ECIE members who contributed to this semiannual report.

PCIE/ECIE Contributors to the Semi-annual Report

DEPARTMENT OF AGRICULTURE (USDA)

Phyllis K. Fong, Inspector General
1400 Independence Avenue, SW
Room 117-W, Jamie L. Whitten Building
Washington, DC 20250
(202) 720-8001
Website: <http://www.usda.gov/oig>
Hotlines: (202) 690-1622 (800) 424-9121
Hearing impaired: (202) 690-1202

DEPARTMENT OF COMMERCE (DOC)

Johnnie E. Frazier, Inspector General
14TH and Constitution Avenue, NW
HCHB 7898-C
Washington, DC 20230
(202) 482-4661
Website: <http://www.oig.doc.gov/oig>
Hotlines: (202) 482-2495 (800) 424-5197
Hearing impaired: (800) 854-8407

DEPARTMENT OF DEFENSE (DOD)

Thomas S. Gimble, Acting Inspector General
400 Army Navy Drive
Arlington, VA 22202
(703) 604-8300
Website: <http://www.dodig.mil>
Hotlines: (703) 604-8569 (800) 424-9098
Hotline website: www.dodig.mil/HOTLINE/fwa-compl.htm

DEPARTMENT OF EDUCATION (ED)

John P. Higgins, Jr., Inspector General
400 Maryland Avenue, SW
Washington, DC 20024
(202) 245-6900
Website: <http://www.ed.gov/about/offices/list/oig>
Hotline: 800-MIS-USED
Hotline E-mail: oig hotline@ed.gov

DEPARTMENT OF ENERGY (DOE)

Gregory H. Friedman, Inspector General
1000 Independence Avenue, S.W.
Washington, DC 20585
(202)586-4393
Website: <http://www.ig.doe.gov>
Hotline: (202) 586-4073 1(800) 541-1625
Hotline email: ig hotline@hq.doe.gov

DEPARTMENT OF HEALTH AND HUMAN SERVICES (HHS)

Daniel Levinson, Inspector General
330 Independence Avenue, SW, Room 5250
Washington, DC 20201
(202) 619-3148
Website: <http://oig.hhs.gov>
Hotline: (800) 447-8477
Hotline E-mail: Hotline@oig.hhs.gov

DEPARTMENT OF HOMELAND SECURITY (DHS)

Richard L. Skinner, Inspector General
245 Murray Drive, SW
Building 410
Washington, D.C. 20528
(202) 254-4100
Website: http://www.dhs.gov/dhspublic/interapp/editorial/editorial_0330.xml
Hotline: (800) 323-8603

DEPARTMENT OF HOUSING AND URBAN DEVELOPMENT (HUD)

Kenneth M. Donohue, Inspector General
451 Seventh Street, SW
Washington, DC 20410
(202) 708-0430
Website: <http://www.hud.gov/offices/oig>
Hotline: (800) 347-3735

DEPARTMENT OF THE INTERIOR (DOI)

Earl E. Devaney, Inspector General
1849 C Street, NW
Washington, DC 20240
(202) 208-5745
Website: <http://www.oig.doi.gov>
Hotline: (800) 424-5081

DEPARTMENT OF JUSTICE (DOJ)

Glenn A. Fine, Inspector General
950 Pennsylvania Avenue, NW, Room 4706
Washington, DC 20530
(202) 514-3435
Website: <http://www.usdoj.gov/oig>
Hotline: (800) 869-4499
Hotline E-mail: oig.hotline@usdoj.gov

DEPARTMENT OF LABOR (DOL)

Gordon S. Heddell, Inspector General
200 Constitution Avenue, NW, Room S5502
Washington, DC 20210
(202) 693-5100
Website: <http://www.oig.dol.gov>
Hotlines: (202) 693-6999 (800) 347-3756

DEPARTMENT OF TRANSPORTATION (DOT)

Todd J. Zinser, Acting Inspector General
400 7TH Street, SW, Room 9210
Washington, DC 20590
(202) 366-1959
Website: <http://www.oig.dot.gov>
Hotlines: (202) 366-1461 (800) 424-9071

DEPARTMENT OF VETERANS AFFAIRS (VA)

George Opfer, Inspector General
810 Vermont Avenue, NW
Washington, DC 20420
(202) 565-8620
Website: <http://www.va.gov/oig>
Hotline: (800) 488-8244
Hotline E-mail: VAOIGHOTLINE@VA.GOV

ENVIRONMENTAL PROTECTION AGENCY (EPA)

Bill A. Roderick, Acting Inspector General
1200 Pennsylvania Avenue, NW
Mailcode 2410T
Washington, DC 20460
(202) 566-0847
Website: <http://www.epa.gov/oig>
Hotlines: (202) 566-2476 (888) 546-8740
Hotline E-mail: OIG_hotline@epa.gov

FEDERAL COMMUNICATIONS COMMISSION (FCC)

Kent R. Nilsson
Acting Inspector General
Federal Communications Commission
445 12th Street, S.W., Room 2-C762
Washington, D.C. 20554
Phone: (202) 418-0476
Fax: (202) 418-2811
E-Mail: Kent.Nilsson@fcc.gov

FEDERAL DEPOSIT INSURANCE CORPORATION (FDIC)

Patricia M. Black, Acting Inspector General
801 17TH Street, NW
Washington, DC 20434
(202) 416-2026
Website: <http://www.fdic.gov>
Hotline: (800) 964-3342
Hotline E-mail: ighotline@fdic.gov

GENERAL SERVICES ADMINISTRATION (GSA)

Brian D. Miller, Inspector General
18th and F Streets, NW
Washington, DC 20405
(202) 501-0450
Website: <http://oig.gsa.gov>
Hotlines: (202) 501-1780 (800) 424-5210

NATIONAL AERONAUTICS AND SPACE ADMINISTRATION (NASA)

Robert W. Cobb, Inspector General
300 E Street, NW, Room 8U70
Washington, DC 20546
(202) 358-1220
Website: <http://oig.nasa.gov>
Hotline: (800) 424-9183
Hotline Website: <http://oig.nasa.gov/cyberhotline.html>

SMALL BUSINESS ADMINISTRATION (SBA)

Eric M. Thorson, Inspector General
409 Third Street, SW
Washington, DC 20416
(202) 205-6586
Website: <http://www.sba.gov/IG>
Hotline: (800) 767-0385

SOCIAL SECURITY ADMINISTRATION (SSA)

Patrick P. O'Carroll, Jr., Inspector General
Room 300, Altmeyer Building
6401 Security Boulevard
Baltimore, MD 21235
(410) 966-8385
Website: <http://www.ssa.gov/oig>
Hotline: (800) 269-0271

TREASURY INSPECTOR GENERAL FOR TAX ADMINISTRATION (TIGTA)

J. Russell George, Inspector General
1125 15th Street, NW
Washington, DC 20005
(202) 622-6500
Website: <http://www.treas.gov/tigta>
Hotline: (800) 366-4484

U.S. POSTAL SERVICE (USPS)

Dave Williams, Inspector General
1735 North Lynn Street
Arlington, VA 22209-2005
(703) 248-2300
Website: <http://www.uspsoig.gov>
Hotline: (888) 877-7644

*To date, some Offices of Inspector General and their Departments and Agencies have not received any hurricane relief-related funding or only a small portion of the funds; therefore, future efforts of these OIGs will depend on the amount of money received and how those funds are used.

APPENDIX

OIG Congressional Activities

This appendix provides a list of hurricane recovery PCIE/ECIE OIG congressional activities.

AS OF MARCH 31, 2006

Hurricane Recovery OIG Congressional Activities (as of March 31, 2006)

Date	Committee / Subcommittee	Type	Subject	Dept
3/30/06	Senate Special Committee on Aging	Study Assigned	Evacuating Nursing Homes During a Disaster	HHS
3/22/06	Senate Homeland Security and Governmental Affairs Committee	Staff Briefing	OIG's Performance Review of FEMA's Disaster Management Activities in Response to Katrina	DHS
3/8/06	Senate Homeland Security and Governmental Affairs Committee	Hearing	Improving the Nation's Disaster Response System	Sen. Mikulski DHS GAO
3/8/06	Senate Appropriations Committee	Hearing	Additional \$4.2 billion in Community Development Block Grant funds for Louisiana. Additional \$202 million for the Disaster Voucher Program.	HUD
2/15/06	Senate Committee on Banking, Housing, and Urban Affairs	Hearing	Mortgage Assistance, Community Development Block Grants, Rental & Fair Housing Assistance	HUD FEMA FDIC SBA FED COORD
2/13/06	Senate Committee on Homeland Security and Government Affairs	Hearing	Hurricane Katrina: Waste, Fraud, and Abuse Worsen the Disaster	DHS DOJ GAO
11/2/05	House Select Bipartisan Cmte. to Investigate Preparations for and Response to Hurricane Katrina	Hearing	The role of Federal agency contracting in disaster preparedness and response.	DHS FEMA USACE GAO
10/6/05	House Appropriations Subcommittee on Homeland Security	Hearing	Katrina Oversight	DHS
10/6/05	House Transportation and Infrastructure Subcommittee on Economic Development, Public buildings and Emergency Management	Hearing	Recovering After Katrina: Ensuring that FEMA is up to the Task	DHS
9/28/05	House Committee on Energy and Commerce - Subcommittee on Oversight and Investigations	Hearing	OIG Oversight Plans Regarding Hurricane Katrina Relief and Recovery	DHS DOC DOD DOE EPA FCC GAO HHS

Source: PCIE/ECIE 3/31/2006 Semiannual Data Call and Agency Web sites

APPENDIX

PCIE/ECIE Oversight Audit and Investigative Models

J

This appendix contains the audit model provided to federal agencies in October 2005 to help coordinate oversight work, using a program-by-program focus based on post-disaster time phasing.

Also, in this appendix is the investigations coordination model provided to federal agencies in October 2005 to help coordinate oversight federal, state and local law enforcement actions and provide information sharing among all agencies.

**PCIE / ECIE
Hurricane Oversight Audit Model**

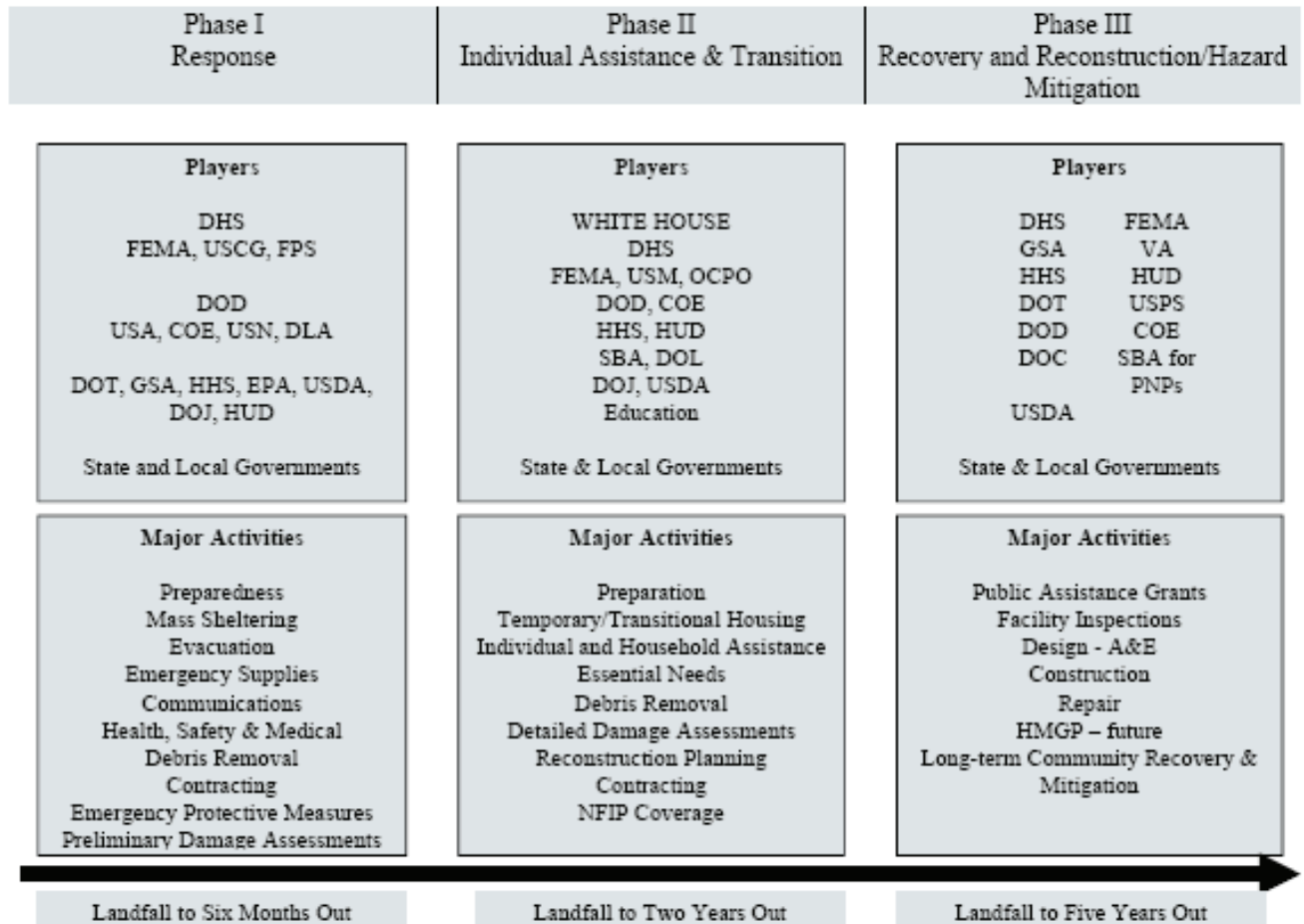

PCIE / ECIE Hurricane Relief Investigation Coordination Model

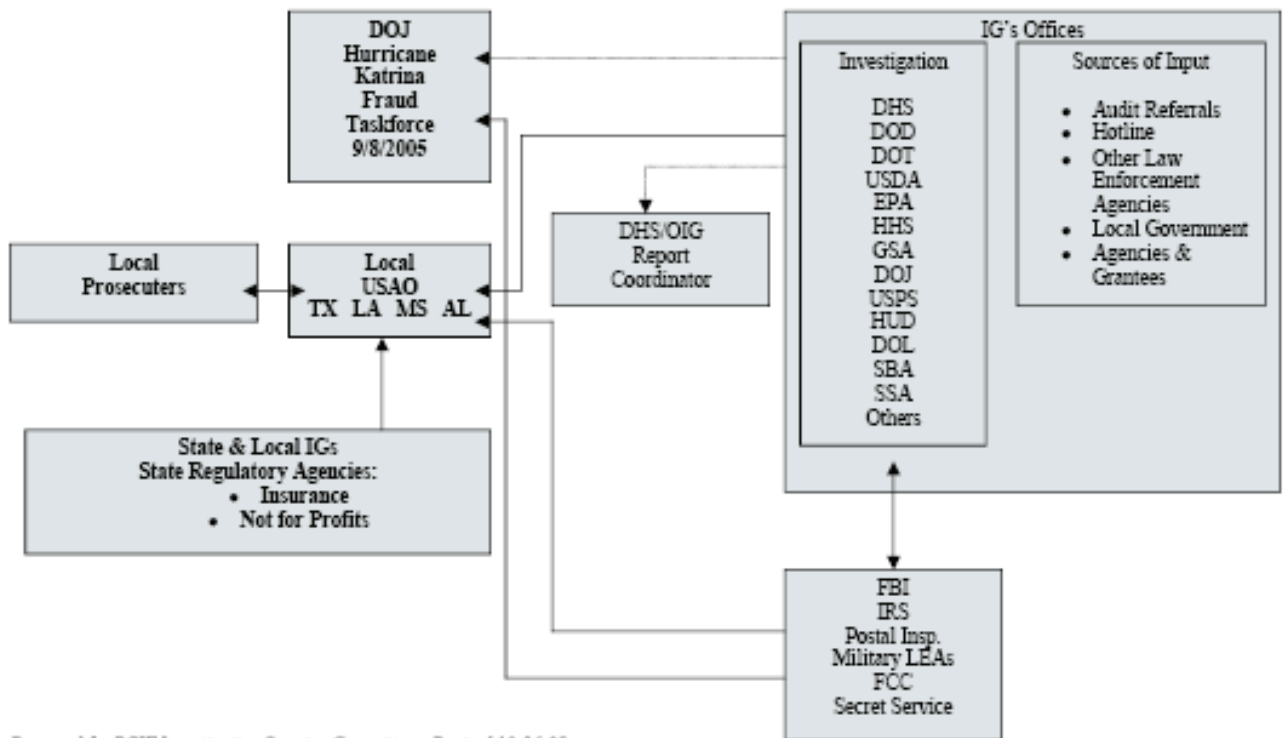

Prepared for PCIE Investigation Steering Committee – Revised 10-26-05

APPENDIX

Acronyms and Definitions

K

Acronyms

ORGANIZATIONS

Acronym	Definition
AFAA	Air Force Audit Agency
AAA	Army Audit Agency
ARC	Appalachian Regional Commission
CIA	Central Intelligence Agency
CNCS	Corporation for National and Community Service
DCAA	Defense Contract Audit Agency
DCIS	Defense Criminal Investigative Service
DHS	Department of Homeland Security
DHS JFO	DHS Joint Field Office
DHS OIG	DHS Office of Inspector General
DHS OIG ISP	DHS OIG – Office of Inspection and Special Reviews
DHS HSOC	DHS Homeland Security Operations Center
DISA	Defense Information Systems Agency
DOC	Department of Commerce
DOC EDA	DOC Economic Development Authority
DOC HCIC	DOC Hurricane Contracting Information Center
DOC MBDA	DOC Minority Business Development Agency
DoD	Department of Defense
DoDIG	Department of Defense Inspector General
DOE	Department of Energy
DOED	Department of Education
DOI	Department of Interior
DOI BIA	DOI Bureau of Indian Affairs
DOI BuRec	DOI Bureau of Reclamation
DOJ	Department of Justice
DOJ BJA	DOJ Bureau of Justice Assistance
DOJ BOP	DOJ Bureau of Prisons
DOJ OJP	Office of Justice Programs
DOL	Department of Labor
DOL ETA	DOL Employment and Training Administration
DOL MBDA	DOL Minority Business Development Agency
DOS	Department of State
DOT	Department of Transportation
DOT FAA	DOT Federal Aviation Administration
DOT FHA	DOT Federal Highway Administration

Acronym	Definition
DOT FRA	DOT Federal Railroad Administration
DOT FTA	DOT Federal Transit Administration
DOT MARAD	DOT Maritime Administration
ECIE	Executive Council on Integrity and Efficiency
EDA	Economic Development Administration
EEOC	Equal Employment Opportunity Commission
EOC	Emergency Operations Center
EPA	Environmental Protection Agency
ETA	Employment and Training Administration
FBI	Federal Bureau of Investigation
FCC	Federal Communications Commission
FCSIC	Farm Credit System Insurance Corporation.
FDIC	Federal Deposit Insurance Corporation
FEMA	Federal Emergency Management Agency
FMSHRC	Federal Mine Safety and Health Review Commission
FPS	Federal Protective Service
GAO	Government Accountability Office
GSA	General Services Administration
HAC	Housing Area Command
HANO	Housing Authority of New Orleans
HHS	Department of Health and Human Services
HHS AoA	HHS Administration on Aging
HHS ACF	HHS Administration for Children and Families
HHS CCB	HHS Child Care Bureau
HHS CDCP	HHS Centers for Disease Control and Prevention
HHS CMS	HHS Centers for Medicare and Medicaid Services
HHS HSB	HHS Head Start Bureau
HHS HSRA	HHS Health Services Resource Administration
HHS SAMHSA	HHS Substance Abuse and Mental Health Services Administration
HHS OPHEP	HHS Office of Public Health Emergency Preparedness
HKFTF	Hurricane Katrina Fraud Task Force
HKFTFCC	Hurricane Katrina Fraud Task Force Command Center
HRRC	Hurricane Recovery and Response Center
HUD	Department of Housing and Urban Development
HUD PHA	HUD Public Housing Agency
IRS	Internal Revenue Service
IRS TAC	IRS Taxpayer Assistance Center

Acronym	Definition
LOLA	Louisiana Office of the Legislative Auditor
MDES	Mississippi Department of Employment Security
MSC	Military Sealift Command
MSPB	Merit Systems Protection Board
NAR	National Association of Realtors
NASA	National Aeronautics and Space Administration
NAS	Naval Audit Service
NCUA	National Credit Union Administration
NIST	National Institute of Standards and Technology
NLRB	National Labor Relations Board
NOAA	National Oceanographic and Atmospheric Administration
NRCS	Natural Resource Conservation Services
NTIA	National Telecommunications and Information Administration
OI	Office of Investigations
OIG	Office of Inspector General
OMB	Office of Management and Budget
OPM	Office of Personnel Management
OSHA	Occupational Safety and Health Administration
OTS	Office of Thrift Supervision
PCIE	President's Council on Integrity and Efficiency
PCIE HSR	PCIE Homeland Security Roundtable
SBA	Small Business Administration
SBA DAPDC	SBA Disaster Assistance Processing and Disbursement Center
SIG	Special Inspector General
SSA	Social Security Administration
TIGTA	Treasury Inspector General for Tax Administration
TREAS	U.S. Treasury Department
TVA	Tennessee Valley Authority
USA	U.S. Army
USAF	U.S. Air Force
USACE	U.S. Army Corps of Engineers
USDA	United States Department of Agriculture
USDA APHIS	USDA Animal and Plant Health Inspection Service
USDA DFSP	USDA Disaster Food Stamp Program
USDA ECP	USDA Emergency Conservation Program
USDA EWP	USDA Emergency Watershed Protection Program
USDA FNS	USDA Food and Nutrition Service
USDA FS	USDA Forest Service

Acronym	Definition
USDA FSA	USDA Farm Service Agency
USDA NRCS	USDA Natural Resources Conservation Service
USDA NRCE DADDP	USDA NRCS Dead Animal Debris Disposal Program
USDA RHS	USDA Rural Housing Service
USDA RMA	USDA Risk Management Agency
USMC	U.S. Marine Corps
USN	U.S. Navy
USPHS	U.S. Public Health Service
USPS	United States Postal Service
VA	Department of Veterans Affairs
VA-NPSC	Virginia National Processing Service Center

Programs / Other	Definition
BPA	Basic Purchasing Agreement
CAS	Customer Account Services
CCC	Commodity Credit Corporation
CCR	Central Contractor Registration
CDBG	Community Development Block Grant
CDP	Office of Community Development
COOP	Continuity of Operations Plan (USPS)
COTR	Contracting Officer Technical Representative
DAO	Disaster Area Office (SBA)
DBA	Davis-Bacon Act
DCMS	Disaster Credit Management System (SBA)
DFA	Direct Federal Assistance
DRC	Disaster Relief Codes (TIGTA)
DRF	Disaster Relief Fund
DUA	Disaster Unemployment Assistance
ECP	Emergency Conservation Program
EO	Exempt Organization (TIGTA)
ERG	Economic Recovery Grants
ESF	Emergency Support Function
EWP	Emergency Watershed Protection Program
FAA AIG	FAA Airport Improvement Grant
FAG	Family Assistance Grant
FAR	Federal Acquisition Regulation
FISCAM	Federal Information System Controls Audit Manual
FPDS NG	Federal Procurement Data System – Next Generation
FSS	Federal Supply Schedule
GAGAS	Generally Accepted Government Auditing Standards
FOS	Federal Operations Support
GCHR	Gulf Coast Hurricane Recovery
HERA	Hurricane Education Recovery Act
HGJTG	High-Growth Job Training Grants
HKFTF	Hurricane Katrina Fraud Task Force
HOME	Home Ownership Made Easy
HSWG	Homeland Security Working Group
HTR	Hurricane Tax Relief (TIGTA)
IEMP	Integrated Emergency Management Plan (USPS)
IG	Inspector General
IH	Individuals and Household

Programs / Other	Definition
IHL	Institutes of Higher Learning
IIMG	Interagency Incident Management Group
IMPAC	International Merchant Purchase Authorization Card
JAG	Edward Byrne Memorial Justice Assistance Grants (DOJ)
KDHAP	Katrina Disaster Housing Assistance Program
LEA	Local Education Agency
LIHEAP	Low Income Home Energy Assistance Program (HHS)
MA	Mission Assignments
NDNH	National Directory of New Hires
NEG	National Emergency Grant
NEMIS	National Emergency Management Information System
NFIP	National Flood Insurance Program
NRF	National Relief Fund
NRP	National Response Plan
ODA	Office of Disaster Assistance (SBA)
ONA	Other Needs Assistance
PHA	Public House Agency
PSE	Public Service Employment
RCG	Reintegration Counselor Grants
REO	Real Estate Owned
RFQ	Request for Quotation
SEA	State Education Agency
SSN	Social Security Number
START/ERRS	Superfund Technical Assessment and Response Team/ Emergency and Rapid Response Services (EPA)
TA	Technical Assistance
TAC	Technical Assistance Contractor
UI	Unemployment Insurance
USF	Universal Service Fund
WIA NEG	Workforce Investment Act - National Emergency Grant

Glossary

DIRECT /SUPPORT

Direct disaster programs provide resources to specifically address the short-, medium-, and long-term consequences of an event on both individuals and communities for declared disasters, emergencies, and fire management assistance grants. Direct disaster programs include pre-declaration activity (e.g., pre-positioning equipment and people, before a hurricane strikes). Disaster support programs allow the Federal Emergency Management Agency (FEMA) to maintain critical, ongoing disaster operations and support infrastructure that supports the timely delivery of all of FEMA's disaster assistance programs. These resources provide for disaster-related support activities, which encompass ongoing operational capabilities that are not readily attributable to any one specific declared disaster.

ALLOCATIONS

Funds set aside for declarations based on estimated needs for the next 30 days or less.

APPROPRIATIONS

Funding authority approved by the Congress and signed by the President to expend a given amount of funds to carry out federal programs. The appropriations act specifies an amount of funding in each appropriation (fund) account of an agency. Types of appropriations include the following:

- One-year – available for incurring obligations only during a specified fiscal year
- Multiple-year – available for incurring obligations for a definite period in excess of one fiscal year
- No-year – available for incurring obligations for an indefinite period of time until the objectives have been accomplished
- Unexpired – available for incurring obligations during the current fiscal year and which authority has not expired
- Expired – no longer available for obligation, but is still available for disbursement to pay existing obligations
- Definite – the amount stated in the Appropriations Act as a specific sum of money.
- Indefinite – the amount of which is not stated in the Appropriations Act as a specific sum of money, but is determinable only at some future date, such as an appropriation of the receipts from a certain source
- Permanent – automatically made each year over a period of time by virtue of standing legislation, without annual action by Congress. “Operation and Maintenance of Quarters” are two examples.
- Current – requires periodic action by Congress, usually annually, in or immediately preceding the fiscal year.

APPORTIONMENT

A distribution made by OMB of amounts available for obligation in an appropriation or fund account. Apportionments divide amounts available by specific time periods (usually quarters; now tri-annum) activities, projects, objects, or a combination thereof. The amounts so apportioned are a large limitation on the amount of obligations that may be incurred. The apportionment process is intended to prevent obligation of funds in a manner that would require supplemental or deficiency appropriations and to achieve the most effective and economical use of amounts made available for obligation.

AUTHORIZING LEGISLATION

Legislation enacted by Congress that establishes or continues the legal operation of a federal program or agency, either indefinitely or for a specific period of time, or sanctions a particular type of obligation or expenditure within a program. Sometimes referred to as substantive legislation.

Authorizing legislation is normally a prerequisite for appropriations. It may place a limit on the amount of budget authority to be included in appropriations acts, or it may authorize the appropriation of “such sums as may be necessary.” In some instances, authorizing legislation may provide authority to incur debts or to mandate payment to particular persons or political subdivisions of the country.

BUDGET AUTHORITY

The amount of money that the law allows an agency to commit to be spent in current or future years. An agency may choose not to spend its total budget authority in a fiscal year, but it may not exceed it. Budget authority is what permits a department to expend funds or commit the government to a contract..

CASE DISPOSITION

The term “resolved” generally means that the component agrees with the recommendation and the OIG agrees with the planned corrective action. The term “closed” generally means that the action the component has taken adequately addresses the recommendation.

COMMITMENTS

Funds reserved in the financial system based on specific requisitions in anticipation of their obligation.

EXPENDED

Goods and services purchased by the federal government.

OBLIGATIONS

Amounts of orders placed, contracts awarded, services received, and similar transactions during a given period that will require payment during the same or a future period. Such amounts will include outlays for which obligations had not been previously recorded and will reflect adjustments for differences between obligations previously recorded and actual outlays to liquidate those obligations.]

MISSION ASSIGNMENTS

Through Mission Assignments, FEMA tasks and reimburses other federal agencies (OFAs) for providing services under the Stafford Act. These Mission Assignments fall into three categories:

- Technical Assistance (TA). OFAs provide expertise to States. 100% Federally funded. No State cost share
- Direct Federal Assistance (DFA). Requested by State; subject to State cost share (Unless waived in response timeframe); goods and services provided to the State to save lives and protect property
- Federal Operations Support (FOS). 100% federally funded; No State cost share; Fed-to-Fed field operations support. This category reflects agreements with Federal agencies to perform services such as providing search and rescue operations, health and medical support, assisting with disease prevention and control, transportation of disaster victims, and delivery of food, water and other essential commodities to disaster victims.

HUMAN SERVICES CATEGORIES

- **Unemployment.** Disaster Unemployment Assistance for individuals who are unemployed as a result of a President-declared disaster and are not covered by any other unemployment compensation.
- **Crisis Counseling.** Professional counseling services, including financial assistance to State or local agencies or private mental health organizations to provide such services or training of disaster workers, to victims of major disasters in order to relieve mental health problems caused or aggravated by such major disaster or its aftermath. From the Stafford Act – Provides immediate, short-term crisis counseling services to victims of Presidentially declared disasters.
- **Legal Services.** See Stafford Act – Legal advice for low-income individuals regarding cases that will not produce a fee, provided by The Young Lawyers Division of the American Bar Association, through an agreement with FEMA.
- **Inspections.** Inspections to assess disaster damage.
- **Other Needs Assistance.** Medical, dental, funeral, personal property, transportation, moving and storage, Group Flood Insurance, and other disaster-related needs within a total cap for Individual Assistance of \$26,200 per applicant. Funding is on a Federal/State cost-share basis with 75% FEMA and 25% State. Some ONA assistance is dependent upon an applicant's loan-repayment ability.
- **Housing Assistance.** Lodging expenses reimbursement (for a hotel or motel), rental assistance, home repair cash grant (up to \$5,200.00) and home replacement cash grants up to \$10,500, within a total cap for Individual Assistance of \$26,200 per applicant. When rental properties are not available, direct assistance in the form of a government provided housing unit can be provided.

MITIGATION

Hazard Mitigation. Long-term hazard mitigation measures after a major disaster declaration. The purpose of the program is to reduce the loss of life and property due to natural disasters and to enable mitigation measures to be implemented during the immediate recovery from a disaster.

STAFFORD ACT

The Robert T. Stafford Disaster Relief and Emergency Assistance Act (the Stafford Act) authorizes the President to issue a major disaster declaration to speed a wide range of federal aid to states determined to be overwhelmed by hurricanes or other catastrophes. Financing for the aid is appropriated to the Disaster Relief Fund (DRF), administered by the Department of Homeland Security (DHS). Funds appropriated to the DRF remain available until expended (a "no-year" account). The Stafford Act authorizes temporary housing, grants for immediate needs of families and individuals, the repair of public infrastructure, emergency communications systems, and other forms of assistance.

The Stafford Act provides the President with permanent authority to direct federal aid to stricken states. Congress appropriated over \$10 billion to the DRF in FY2005, largely in response to the four hurricanes that struck Florida in the fall of 2004. The appropriations legislation for FY2006 includes roughly \$2 billion for the DRF in both the House and Senate versions of H.R. 2360 in conference at the time Hurricane Katrina struck. Congress can elect to consider supplemental appropriations should additional money be required to meet the requests for assistance.

ADDITIONAL INFORMATION AND COPIES

To obtain additional copies of this report, call the Department of Homeland Security Office of Inspector General (OIG) at (202) 254-4100, fax your request to (202) 254-4285, or visit the Department of Homeland Security OIG web site at www.dhs.gov/oig or the President's Council on Integrity and Efficiency and the Executive Council on Integrity and Efficiency Homeland Security Roundtable web site at <http://ignet.gov/pande/hsr1.html#relief>.

HURRICANE FRAUD HOTLINE

If you have knowledge of fraud, waste, abuse, or allegations of mismanagement involving hurricane operations, you can:

- **CALL** the Hurricane Fraud Hotline at (866) 720-5721
- **FAX** the Hurricane Fraud Hotline at (225) 334-4707
- **EMAIL:** HKFTF@leo.gov
- **OR WRITE:** Hurricane Fraud Task Force, Baton Rouge, LA 70821-4909

Calls can be made anonymously and confidentially