



**U.S. DEPARTMENT OF TRANSPORTATION  
FEDERAL AVIATION ADMINISTRATION**

**ORDER  
8260.46E**

National Policy

Effective Date:  
05/30/2014

**SUBJ:** Departure Procedure (DP) Program

---

This order provides the policy, guidance, and standardization for initiating, developing, processing, and managing the Departure Procedure (DP) Program. The original order combined into a single product textual instrument flight rules (IFR) departure procedures and graphical Standard Instrument Departures (SIDs). It made no distinction between area navigation (RNAV) DPs: those developed solely for obstruction clearance and those developed for system enhancement. This document defines two separate types of DPs: SIDs developed for system enhancement and Obstacle Departure Procedure (ODPs) developed solely for obstruction clearance.

A handwritten signature in cursive script that reads "John S. Duncan".

John S. Duncan  
Director, Flight Standards Service

**Table of Contents**

<b>Chapter 1. General Information.....</b>	<b>5</b>
<i>Section 1-1. Basic .....</i>	<i>5</i>
1-1-1. Purpose of this order.....	5
1-1-2. Audience .....	5
1-1-3. Where you can find this order .....	5
1-1-4. What this order cancels.....	5
1-1-5. Effective Date .....	5
1-1-6. Explanation of Changes.....	5
<b>Chapter 2. Responsibilities .....</b>	<b>11</b>
<i>Section 2-1. ....</i>	<i>11</i>
2-1-1. Departure Procedure (DP) Guidelines .....	11
2-1-2. Responsibilities.....	26
2-1-3. Accuracy Verification and Responsibilities .....	31
2-1-4. Military Departure Procedures (DPs).....	31
2-1-5. FAA 8260-15 Series Forms (see appendices D through G) .....	32
2-1-6. Procedure Amendments.....	33
<b>Chapter 3. Guidelines for the Design of Graphic Instrument Departure Procedures (DPs).....</b>	<b>37</b>
<i>Section 3-1. ....</i>	<i>37</i>
3-1-1. General.....	37
3-1-2. Naming of DPs (see examples at the end of this chapter) .....	38
3-1-3. Transition Naming.....	39
3-1-4. Computer Identification Codes.....	39
3-1-5. RNAV DPs .....	39
3-1-6. Examples of Various Graphic Departure Scenarios.....	42
<b>Appendix A. Administrative Information.....</b>	<b>47</b>
1. Distribution.....	47
2. Background.....	47
3. Definitions .....	47
4. Related Publications .....	50
5. Forms and Reports.....	51
6. Information Update.....	51
<b>Appendix B. Instructions for Completing Graphic Departure Procedure (DP) Requirements Worksheet.....</b>	<b>53</b>
<b>Appendix C. Instructions for Completing FAA Form 8260-2, Data Worksheet .....</b>	<b>61</b>
<b>Appendix D. ....</b>	<b>63</b>

*Section 1. Instructions for Completing FAA Form 8260-15A, Takeoff Minimums and Obstacle Departure Procedures (ODP) and Sample Forms..... 63*

*Section 2. Instructions for Completing FAA Form 8260-15B, Graphic Departure Procedure (DP) [Non-RNAV Departure Procedures] and Sample Forms..... 79*

**Appendix E. .... 91**

*Section 1. Instructions for Completing FAA Form 8260-15B, Graphic Departure Procedures (DP) [RNAV Departure Procedures] and Sample Forms..... 91*

*Section 2. Instructions for Completing FAA Form 8260-15C, Departure (Data Record) and Sample Forms..... 111*

*Section 3. Instructions for Completing FAA Form 8260-15E, RNAV Departure Procedure Attention All users Page (AAUP) [RNAV Departure Procedure] and Sample Form..... 123*

**Appendix F. Helicopter RNAV Departure Procedures..... 129**

**Appendix G. Instructions for Completing FAA Form 8260-15D. .... 141**

THIS PAGE IS INTENTIONALLY LEFT BLANK

## Chapter 1. General Information

### Section 1-1. Basic

**1-1-1. Purpose of this order.** This order provides policy, guidance, and standardization for initiating, developing, processing, and managing the DP program.

**1-1-2. Audience.** The primary audience for this order is the Air Traffic Organization (ATO) Mission Support Services (MSS) and all service providers (as defined in appendix A) who have the responsibility to develop instrument departure procedures. The secondary audience includes all other Air Traffic Organizations (ATO), Flight Standards headquarters, and regional office Divisions/Branches who have responsibilities related to instrument departure procedures.

**1-1-3. Where you can find this order.** You can find this order on the Directives Management System (DMS) website [https://employees.faa.gov/tools\\_resources/orders\\_notices](https://employees.faa.gov/tools_resources/orders_notices). This order is available to the public at [http://www.faa.gov/regulations\\_policies/orders\\_notices](http://www.faa.gov/regulations_policies/orders_notices).

**1-1-4. What this order cancels.**

**a. Order 8260.46D,** Departure Procedure (DP) Program, dated August 20, 2009 and all associated changes.

**b. AFS-400 memorandum** dated April 18, 2013, “Clarification to Order 8260.46D, Departure Procedure (DP) Program – Takeoff Obstacle Notes for Helicopter Departure Procedures.”

**c. AFS-400 memorandum** dated May 7, 2013, “Clarification to Order 8260.46D, Departure Procedure (DP) Program – Cancellation of FAA 8260-15 Series Form.”

**1-1-5. Effective Date.** This order and subsequent changes are effective on the dates shown in the upper left corner of each page. Implementation of changes must commence no later than 24 months from the published effective date. Use previous editions until implementation has commenced, not to exceed 24 months from the new effective date.

**1-1-6. Explanation of Changes.**

**a. Chapter 1.** Added reference to audience refers to appendix A of “service providers.”

**b. Chapter 2.**

(1) Paragraph 2-1-1b. Added guidance on the application of newly added figures 2-1-1, 2-1-2, and 2-1-3.

(2) Paragraph 2-1-1b(6). Editorial and revised text, replacing “route” with “method” to clarify that the primary emphasis when developing an ODP is to use the least onerous “method” available. A “route” departure is one of those methods.

(3) Paragraph 2-1-1b(7). Revised text for clarity.

- (4) Paragraph 2-1-1b(10). Editorial.
- (5) Paragraph 2-1-1b(12). Editorial.
- (6) Added figures 2-1-1, 2-1-2, and 2-1-3.
- (7) Paragraph 2-2-1c(1). Editorial.
- (8) Paragraph 2-2-1c(2). Added reference to “course to be flown” to support use of an FM leg type.
- (9) Paragraph 2-1-1d(2). Editorial and deleted “whether for obstacle clearance or air traffic control restrictions.”
- (10) Paragraph 2-1-1d(2) Note. Editorial.
- (11) Paragraph 2-1-1d(3). Editorial and removed references to ATC speed restrictions.
- (12) Paragraph 2-1-1d(7). Added guidance to clarify that this limitation applies to both lateral and vertical portions of the departure procedure and it applies to the end of the SID.
- (13) Paragraph 2-1-1e(1)(b) Note. Added note to remind procedure developers to consider aircraft performance limitations when establishing fix crossing altitudes to support ATC requests.
- (14) Paragraph 2-1-1e(2). Revised “climb gradient” application to provide climb gradients in excess of 200 ft per NM for supporting obstacle clearance and/or RNAV engagement altitude. Added Note information regarding helicopter climb gradients.
- (15) Paragraph 2-1-1e(3)(b). Expanded guidance on how to document a speed restriction.
- (16) Paragraph 2-1-1e(3)(c). Deleted paragraph.
- (17) Paragraph 2-1-1g(1). Editorial.
- (18) Paragraph 2-1-1i. Added paragraph to expand guidance regarding publication of Attention All Users Page (AAUP).
- (19) Paragraph 2-1-2a(4). Added paragraph at the ATO’s request regarding their Safety Risk Management (SRM) responsibilities.
- (20) Paragraph 2-1-2c(11). Changed reference for AAUP guidance.
- (21) Paragraph 2-1-2d. At the request of the ATO, moved paragraphs 2-1-2c(4) and (5) (ATC responsibilities) to become the responsibility of the Service Area Operations Support Groups. Also at the request of the ATO, added paragraph requiring Service Area Operations Support Groups to comply with their Safety Risk Management (SRM) requirements.

(22) Paragraph 2-1-2e(7). Deleted; “proposed” instrument procedures are no longer permitted under Order 8260.26F. Paragraphs re-numbered accordingly.

(23) Paragraph 2-1-2e(7). Revised to reflect actual processing steps.

(24) Paragraph 2-1-2e(9). New (remaining paragraphs renumbered). Moved effective date and Transmittal Letter processing from the National Flight Data Center (NFDC) responsibilities to AeroNav Products responsibilities. Also clarified that both textual and graphic ODPs will be incorporated into the Transmittal Letter and that SIDs and Diverse Vector Areas (DVA) will be submitted to NFDC for incorporation into the National Flight Data Digest (NFDD).

(25) Paragraph 2-1-2e(10). New (remaining paragraphs renumbered). Moved responsibility from NFDC to AeroNav Products.

(26) Paragraph 2-1-2e(11). New (remaining paragraphs renumbered). Added guidance to ensure completed airspace action prior to assigning an effective date.

(27) Paragraph 2-1-2e(12). New (remaining paragraphs renumbered). Added requirement to ensure “routine” procedures are flight inspected prior to incorporating the procedure into the Transmittal Letter.

(28) Paragraph 2-1-2g(2). Revised paragraph to support transfer of NFDC Transmittal Letter responsibilities to AeroNav Products; see paragraphs 7 thru 10, above. Added requirement to publish DVA in NFDD.

(29) Paragraphs 2-1-2g(3) thru (6) removed, paragraph numbering updated accordingly.

(30) Paragraph 2-1-2g. Updated guidance regarding AAUP.

(31) Paragraph 2-1-3. Revised paragraph to support AeroNav Products and NFDC responsibilities changes; re-lettered paragraph accordingly.

(32) Paragraph 2-1-4a. Editorial change, moving the Note guidance to the main body of the paragraph and converted what was in the main body to a Note.

(33) Paragraph 2-1-5a(5). Changed reference for AAUP guidance to a new paragraph.

(34) Paragraph 2-1-5d(2). Editorial change for consistency with instrument approach procedure cancellation process.

(35) Paragraph 2-1-6. Editorial change for clarity.

(36) Paragraph 2-1-6b(4)(k) Added. Added the ability to make heading/course/track number changes to support magnetic variation changes with abbreviated amendments.

(37) Paragraph 2-1-6c (New). Added guidance to address a DVA amendment.

**c. Chapter 3.**

- (1) The former appendix A is now chapter 3.
- (2) Paragraph 3-1-1a. Editorial.
- (3) Paragraph 3-1-1i. Revised to tie more closely to the SID definition in the Pilot/Controller Glossary.
- (4) Paragraph 3-1-1j (new). Added guidance on Transitions and clarified that multiple Transitions may contain a common segment prior to branching off.
- (5) Paragraph 3-1-1m. Removed reference to crossing altitudes.
- (6) Paragraph 3-1-2d. Revised paragraph to return RNAV procedure naming to previous methods; i.e., “(RNAV)” adjacent to procedure name.
- (7) Paragraph 3-1-4b. Clarified that a CID is optional for radar vector SIDs.
- (8) Table 3-1-1, footnote 2. Added option for VA-VM-DF leg type combination.
- (9) Table 3-1-1, footnote 9. Added regarding FM Legs.
- (10) Paragraph 3-1-5d. Revised paragraphs to return RNAV procedure naming and chart notes to previous methods; i.e., Chart: “RNAV-1” or “RNP-1” as applicable.
- (11) Paragraph 3-1-6. Broke examples out into separate paragraph and made editorial changes to match requirements specified throughout the order.

**d. Appendix A.**

- (1) Appendix A is now “Administrative Information”; former appendix A is now chapter 3.
- (2) Distribution requirements changed to “electronically only.”
- (3) Added definition of “Service Providers.”
- (4) Changed “Service Center” to “Service Area.”
- (5) Paragraph 3p. Changed to “Least Onerous Method” and revised definition accordingly.

**e. Appendix C.** Updated instructions and data worksheet to match Order 8260.19 instructions.

**f. Appendix D.**

- (1) Section 1, paragraph 9b. Expanded guidance on describing low, close-in obstacles.
- (2) Section 1, paragraph 11.



(3) Section 1, paragraph 18a. Editorial; “proposed” instrument procedures are no longer permitted under Order 8260.26F.

(4) Section 2, paragraph 2. Added requirement to enter “Special” if applicable.

(5) Section 2, paragraph 6b. Expanded guidance on describing low, close-in obstacles.

(6) Section 2, paragraph 9b. Added requirement to document reference magnetic variation to be consistent with the existing requirement in appendix E for RNAV departure procedures.

(7) Section 2, paragraph 20a. Editorial; “proposed” instrument procedures are no longer permitted under Order 8260.26F.

(8) Updated sample forms to correspond to various changes for documentation.

**g. Appendix E.**

(1) Section 1, paragraph 2. Added requirement to enter “Special” if applicable.

(2) Section 1, table E-1 Footnote\*. Added guidance on turn direction application for DF legs after the first leg.

(3) Section 1, paragraph 3e Examples. Added guidance to support VA-VM-DF leg type combination.

(4) Section 1, paragraph 6. Expanded guidance on describing low, close-in obstacles.

(5) Section 1, paragraph 7. Added unique guidance regarding documenting controlling obstacles helicopter procedures.

(6) Section 1, paragraph 13. Broke into sub-paragraphs and added guidance for a chart note that directs the user to the AAUP.

(7) Section 1, paragraph 20a. Editorial; “proposed” instrument procedures are no longer permitted under Order 8260.26F.

(8) Updated sample forms to correspond to various changes for documentation.

(9) Section 2, paragraph 1j. Added requirement to document reference NAVAID for CF Legs.

(10) Section 3. Updated AAUP guidance.

**h. Appendix F.**

(1) Paragraph 3a(5) Added. Added requirement to insert “COPTER” in the “Type” line to indicate that these procedures are for helicopter operations only.

(2) Paragraph 3a(7)(a) and (b) Added. Added guidance for documenting Takeoff Obstacle notes for helicopter procedures that contains either a “visual segment” or a “VFR segment.”

(3) Paragraph 3a(8)(a) Added. Added requirement to chart a note to inform the pilot to use a specific altimeter source.

(4) Paragraph 3a(8)(c). Added, “CDI may be reset to 1.0 NM after (Fix Name).”

(5) Updated sample forms to correspond to various changes for documentation.

**i. Appendix G.**

(1) Paragraph 1e. Added new paragraph to provide guidance on charting the DVA to include required climb gradients where necessary and provided examples.

(2) Paragraph 1f. Formerly paragraph 1e; changed paragraph identification from “DVA” to read “For ATC Use Only.”

(3) Paragraph 1h. Added requirement to provide facility contact information in the event immediate changes need to be passed on immediately.

## Chapter 2. Responsibilities

### Section 2-1.

#### 2-1-1. Departure Procedure (DP) Guidelines.

**a. General.** There are two types of DPs; those developed to assist pilots in obstruction avoidance [referred to as Obstacle Departure Procedure (ODP)] and those developed to communicate air traffic control (ATC) clearances [referred to as Standard Instrument Departure (SID)].

(1) Conduct a diverse departure assessment for those airports with approved instrument approach procedures. ODPs are developed by AeroNav Products at locations where they have instrument procedure development responsibility.

(2) ODPs may also be required at private airports where the FAA does not have instrument procedure development responsibility. It is the responsibility of non-FAA proponents to ensure a Terminal Instrument Procedures (TERPS) Diverse Departure obstacle assessment is accomplished and an ODP developed, where applicable.

**b. Obstacle Departure Procedures.** Develop an ODP and/or non-standard takeoff minimums when obstructions penetrate the 40:1 departure obstacle clearance surface (OCS) as described in Order 8260.3, U.S. Standard for Terminal Instrument Procedures (TERPS), volume 4. Use table 2-1-1 as a guide to determine each situation and the required action. Use figures 2-1-1, 2-1-2, or 2-1-3 as an aid when applying the scenarios listed in table 2-1-1. The following rules apply to ODPs:

(1) The primary goal in ODP development is to retain standard takeoff minimums with standard climb gradient to the extent possible. See table 2-1-1 and associated figures that follow for recommended ODP development combinations and figure footnotes containing ODP text examples.

(2) Establish only one ODP for a Runway. This will be considered the default instrument flight rule (IFR) departure procedure for a given runway and is intended for pilot awareness and use in the absence of ATC radar vectors or SID assignment. Do not publish text that allows an option to use a SID or alternate maneuver assigned by ATC; e.g., "Climb runway heading to 1200 before turning or use Manchester Departure" or "Turn right, climb direct ABC VOR or as assigned by ATC."

(3) When using table 2-1-1, apply "before rounding" values to each situation to determine required action.

(4) Depict an ODP either textually or graphically within the following guidelines.

(a) Textual ODP. A relatively simple ODP may be published textually unless a graphical depiction is required for clarity. Textual ODP instructions that exceed a maximum of one turn, one altitude change, and one climb gradient must be published graphically.

(b) Graphic ODP. Complex ODPs are those that require a visual presentation to clearly communicate the departure instructions and desired flight paths. If the ODP is depicted graphically, it must be clearly stated on FAA Form 8260-15A, Takeoff Minimums and Textual Departure Procedures (DP), in the Departure Procedure section; e.g., “USE JONES DEPARTURE.” The decision to graphically publish ODPs rests within AeroNav Products. When determining the need for a graphic DP, AeroNav Products must, in addition to the textual DP restrictions noted in paragraph 2-1-1b(4)(a), consider:

1. The number of ground-based navigational aids (NAVAIDs) and fixes.
2. Whether graphical depiction will enhance pilot comprehension of the procedure.
3. The proximity and effect of precipitous or significant terrain.

(5) A graphic ODP may serve one or more runways at a single airport; e.g., a graphic departure may contain initial departure instructions for both Runways 9 and 27 on the same chart.

(6) Develop ODPs with primary emphasis given to using the least onerous method (see appendix A) to get the aircraft to the en route structure or at an altitude that will allow random (diverse) IFR flight, while accommodating commonly used routings out of each airport to the maximum extent practicable. Procedure designers must consider the impact on local ATC operations when using the phrases “before turning” or “before proceeding on course.” ODPs must be coordinated with ATC to ensure flight safety and compatibility with the local operating environment and the en route structure.

(7) ODPs may include a climb gradient when required for obstruction avoidance; however, climb gradients, speed and/or altitude restrictions solely for ATC purposes are not allowed.

(8) Naming conventions and computer code assignments for graphic ODPs must follow the guidance specified for SIDs in chapter 3 to ensure controller awareness of route flown.

(9) Transition Routes are not permitted on ODPs.

(10) When applicable, develop ODPs using ground based NAVAIDs, area navigation (RNAV), or dead reckoning guidance wherever possible. Do not specify radar vectors for navigation guidance in ODP development. At those locations served by RNAV approaches exclusively, every effort must first be made to develop an ODP that accommodates conventional (preferably VOR) navigation systems. If this effort fails, develop an RNAV ODP.

(11) When a Visual Climb Over Airport (VCOA) has been established, publish a note that requires the pilot to obtain approval from ATC with their IFR clearance when executing the VCOA. See appendix D, section 1, paragraph 8.

(12) Do not establish a VCOA maneuver in conjunction with an RNAV ODP.

(13) The VCOA requirement in table 2-1-1 is mandatory. However, ATC may submit a justification request to Flight Procedure Implementation and Oversight Branch (AFS-460) for Flight Standards Service (AFS) approval to opt-out of publishing a VCOA. This “opt-out” option is intended for use at major metropolitan airports that experience a high volume of traffic (e.g., Los Angeles, San Francisco, New York, etc.) where permission to use a VCOA is impractical and/or impossible. ATC must consider user needs as well as the operational impact upon low performance aircraft that must depart IFR from mountainous/obstacle encumbered airports when deciding to submit a request to not establish a VCOA.

(14) Textual ODPs designed specifying a route must terminate at a fix/NAVAID located within the IFR en route structure and/or at an altitude that will allow random (diverse) IFR flight.

(15) Design graphic ODPs to terminate at a fix/NAVAID located within the IFR en route structure.

**Table 2-1-1. ODP Development Combinations**

SITUATION	ACTION
1) TERPS diverse departure obstacle assessment does not identify any obstacle penetrations.	Complete Form 8260-15A documenting standard takeoff minimums apply.
2) TERPS diverse departure obstacle assessment identifies obstacles within the initial climb area (ICA) that require a Climb Gradient (CG) greater than 200 ft/NM to an altitude of 200 feet or less, above Departure End of Runway (DER) (commonly referred to as “low, close-in obstacles”).	Establish a DP that provides the pilot a NOTE identifying the obstacle(s) type, location relative to DER, height (AGL), and elevation (MSL). See appendix D for recommended publication text available.
3) TERPS diverse departure obstacle assessment identifies obstacles that require a CG greater than 200 ft/NM, to an altitude greater than 200 feet above DER.	<p>A) Obstacles located within the ICA [extended] 3 SM or less from DER: Establish a DP using one of the following options (listed in order of preference):</p> <p>1) Publish a textual or graphic route/sector to avoid the obstacle(s) with standard takeoff minimums and standard CG, OR</p> <p>2) Publish a ceiling and visibility to see and avoid the obstacle(s) with the option of standard takeoff minimums with a minimum CG to a specified fix or altitude that provides obstacle clearance with a standard CG, AND;</p> <p>a) Provide a NOTE identifying the obstacle(s), which specifies the obstacle description, location relative to the DER, height (AGL), and elevation (MSL), AND</p> <p>b) For obstacles that penetrate the 40:1 OCS by 35 feet or less, provide an option to reduce takeoff runway length to accommodate the most penetrating obstacle based on a standard 200 ft/NM climb gradient, OR</p> <p>3) A combination of options 1) and 2) above.</p>

	<p>B) All Other Obstacles: Establish a DP using one of the following options (listed in order of preference):</p> <ol style="list-style-type: none"> <li>1) Publish a graphic or textual route/sector to avoid the obstacle with standard takeoff minimums and standard climb, OR</li> <li>2) Publish standard takeoff minimums with a minimum CG to a specified fix or altitude that provides obstacle clearance with a standard CG, AND             <ol style="list-style-type: none"> <li>a) For obstacles that penetrate the 40:1 OCS by 35 feet or less, provide an option to reduce takeoff runway length to accommodate the most penetrating obstacle based on a standard 200 ft/NM CG, AND/OR</li> <li>b) Provide a ceiling and visibility sufficient to allow a visual climb over the airport (VCOA) to an altitude that will provide obstacle clearance [see paragraph 2-1b(11) and (12)], OR</li> </ol> </li> <li>3) A combination of options 1 and 2 above.</li> </ol> <p>C) Both Action A) and B) Obstacles:</p> <ol style="list-style-type: none"> <li>1) If the DP highest CG is based on an obstacle <math>\leq 3</math> SM from DER (Action A), establish a DP using one of the following options (listed in order of preference):             <ol style="list-style-type: none"> <li>a) Publish a graphic or textual route/sector to avoid the obstacle with standard takeoff minimums and standard climb, OR</li> <li>b) Publish standard takeoff minimums and the minimum CG required to clear the <math>\leq 3</math> SM obstacle to a specified fix or altitude that will provide subsequent obstacle clearance above all DP obstacles based on a standard 200 ft/NM CG, AND                 <ol style="list-style-type: none"> <li>1 Provide a ceiling and visibility to see and avoid the <math>\leq 3</math> SM obstacle and the minimum CG required to clear all other obstacles outside the ICA (extended) to a specified fix or altitude that provides obstacle clearance, AND</li> <li>2 For obstacles that penetrate the 40:1 OCS by 35 feet or less, provide an option to reduce takeoff runway length to accommodate the most penetrating obstacle based on a standard 200 ft/NM climb gradient, AND/OR</li> <li>3 Provide a ceiling and visibility sufficient to allow a VCOA to an altitude that will provide obstacle clearance [see paragraphs 2-1b(11) and (12)],</li> </ol> </li> </ol> </li> <li>2) If the DP highest CG is based on all other obstacles (Action B), then Action B above applies.</li> </ol> <p>Note: Where a graphic route/sector is published, include on the chart: takeoff minimums, required CGs, and applicable obstacle data for each runway using the DP.</p> <p>D) If none of the above actions are feasible, an IFR departure must not be authorized.</p>
<p>4) TERPS diverse departure obstacle assessment identifies obstacles requiring a CG to 200 feet or less above DER and additional obstacles that require a CG to an altitude greater than 200 feet above DER.</p>	<p>Apply a combination of action items from situations 2) and 3).</p>

**Figure 2-1-1. Situation 3, Action A and Situation 2/4 (as applicable)  
Penetrating obstacles located within the 3 SM ICA**

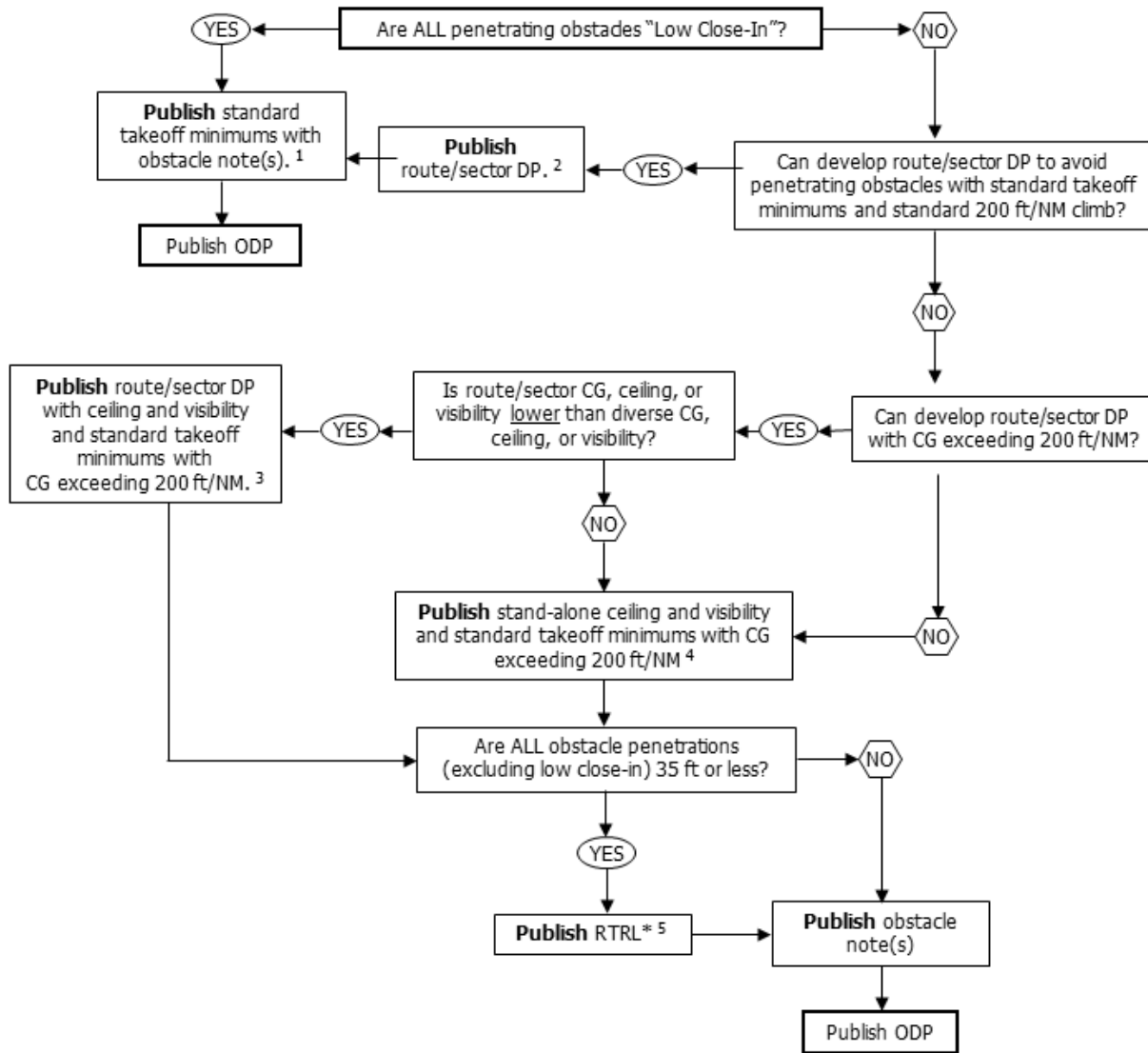

\*RTRL: Reduced Takeoff Runway Length

**Figure 2-1-1 Footnotes:**

1. TAKEOFF MINIMUMS: “RWY 11, Standard.”  
TEXTUAL DEPARTURE PROCEDURE: (Leave blank)  
TAKEOFF OBSTACLE NOTES: “NOTE: RWY 11: (Enter obstacle notes)”
2. TAKEOFF MINIMUMS: “RWY 23, Standard.”  
TEXTUAL DEPARTURE PROCEDURE: “RWY 23 - Climbing right turn direct ABC VORTAC, continue climb in ABC holding pattern (hold east, left turns, 252.17 inbound) to cross ABC VORTAC at or above MEA for route of flight.”  
TAKEOFF OBSTACLE NOTES: “NOTE: RWY 23: (Enter obstacle notes)”
3. TAKEOFF MINIMUMS: “RWY 23, 300-1 ¼ or standard with minimum climb of 415 ft per NM to 2800.”  
TEXTUAL DEPARTURE PROCEDURE: “RWY 23 - Climbing right turn direct ABC VORTAC, continue climb in ABC holding pattern (hold east, left turns, 252.17 inbound) to cross ABC VORTAC at or above MEA for route of flight.”  
TAKEOFF OBSTACLE NOTES: “NOTE: RWY 23: (Enter obstacle notes)”
4. TAKEOFF MINIMUMS: “RWY 27, 300-1 or standard with minimum climb of 275 ft per NM to 2100.”  
TEXTUAL DEPARTURE PROCEDURE: (Leave blank)  
TAKEOFF OBSTACLE NOTES: “NOTE: RWY 27: (Enter obstacle notes)”
5. TAKEOFF MINIMUMS: “RWY 36, 300-2 or standard with minimum climb of 225 ft per NM to 600, or alternatively with standard takeoff minimums and a normal 200 ft per NM climb gradient, takeoff must occur no later than 1800 ft prior to DER.”  
TEXTUAL DEPARTURE PROCEDURE: “RWY 36 - (Specify departure procedure or leave blank for diverse)”  
TAKEOFF OBSTACLE NOTES: “NOTE: RWY 36: (Enter obstacle notes)”

**Graphic ODP in lieu of Textual ODP**

TAKEOFF MINIMUMS: (Blank)

TEXTUAL DEPARTURE PROCEDURE: “RWY 23 - Use ALPHA departure.”

TAKEOFF OBSTACLE NOTES: (Blank)



**Figure 2-1-2. Situation 3, Action B**  
**Penetrating obstacles located outside the 3 SM ICA**

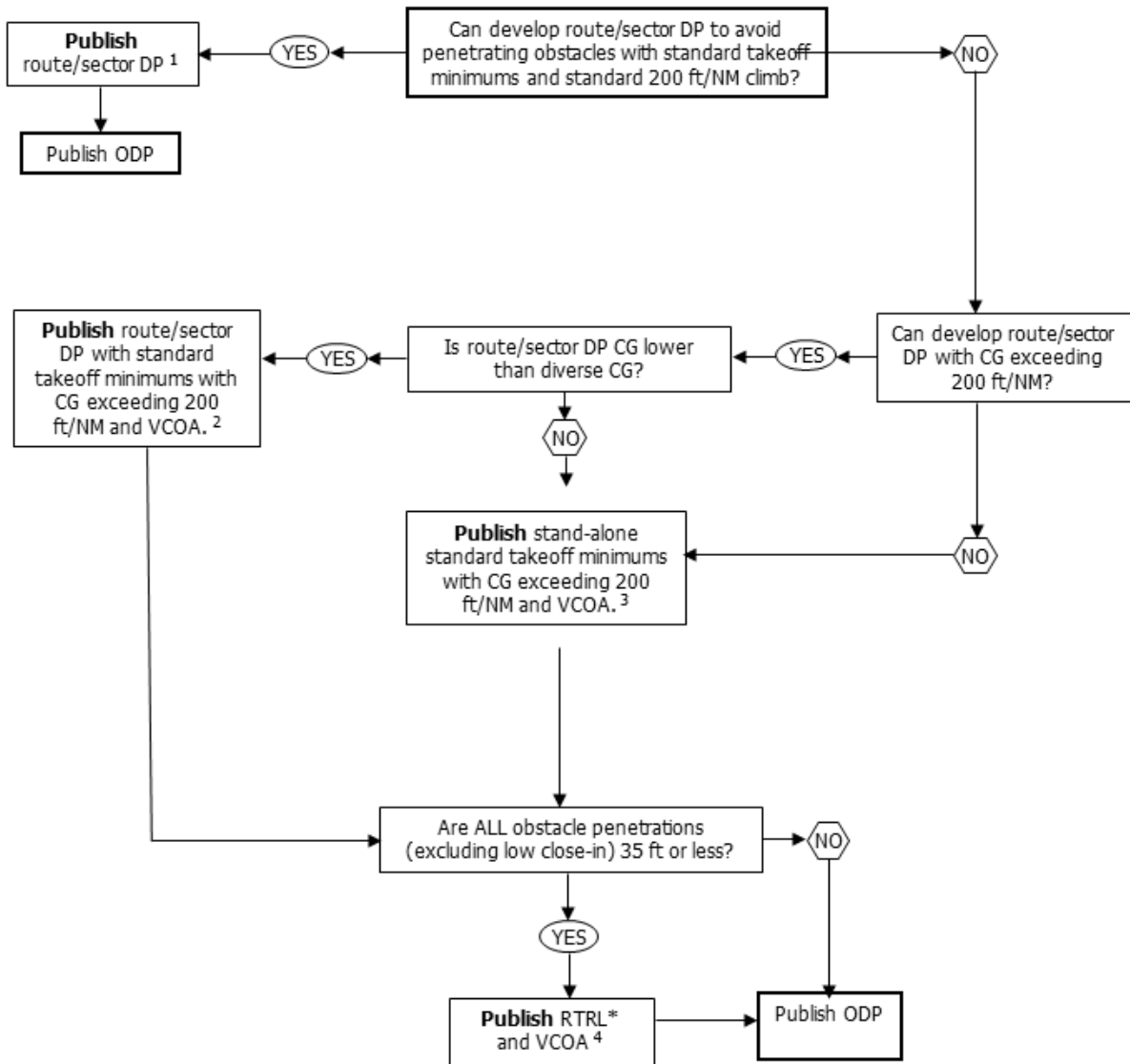

\*RTRL: Reduced Takeoff Runway Length

**Figure 2-1-2 Footnotes:**

1. TAKEOFF MINIMUMS: "RWY 36, Standard."  
TEXTUAL DEPARTURE PROCEDURE: "RWY 36 - Climb on heading 357.11 to 2800 before turning right."
2. TAKEOFF MINIMUMS: "RWY 8, Standard with minimum climb of 390 ft per NM to 11800, or 5300-3 for VCOA."  
TEXTUAL DEPARTURE PROCEDURE: "RWY 8 - Climb on XYZ VOR/DME R-081 TO ALPHA, then climbing left turn direct XYZ VOR/DME, continue climb in XYZ holding pattern (hold east, right turns, 263.57 inbound) to cross XYZ VOR/DME at or above MEA for route of flight.  
VISUAL CLIMB OVER AIRPORT: Obtain ATC approval for VCOA when requesting IFR clearance. Climb in visual conditions to cross Metro Airport at or above 10800 before proceeding on course."
3. TAKEOFF MINIMUMS: "RWY 36, Standard with minimum climb of 355 ft per NM to 7700, or 3800-3 for VCOA."  
VISUAL CLIMB OVER AIRPORT: "RWY 36 – Obtain ATC approval for VCOA when requesting IFR clearance. Climb in visual conditions to cross Downtown Airport at or above 9200 before proceeding on course."
4. TAKEOFF MINIMUMS: "RWY 8, Standard with minimum climb of 220 ft per NM to 10700 or alternatively, with standard takeoff minimums and a normal 200' per NM climb gradient, takeoff must occur no later than 1600' prior to DER or 5300-3 for VCOA."  
TEXTUAL DEPARTURE PROCEDURE: "RWY 8 - (Specify departure procedure, OR for diverse, leave blank)"  
VISUAL CLIMB OVER AIRPORT: Obtain ATC approval for VCOA when requesting IFR clearance. Climb in visual conditions to cross (instructions as required based on decision above) before proceeding on course."

**Graphic ODP in lieu of Textual ODP**

TAKEOFF MINIMUMS: (Blank)

TEXTUAL DEPARTURE PROCEDURE: "RWY 23 - Use ALPHA departure."

TAKEOFF OBSTACLE NOTES: (Blank)

**Figure 2-1-3. Situation 3, Action C and Situation 4  
Penetrating obstacles located within AND outside the 3 SM ICA  
that require a non-standard climb gradient (Diverse & Route/Sector)**

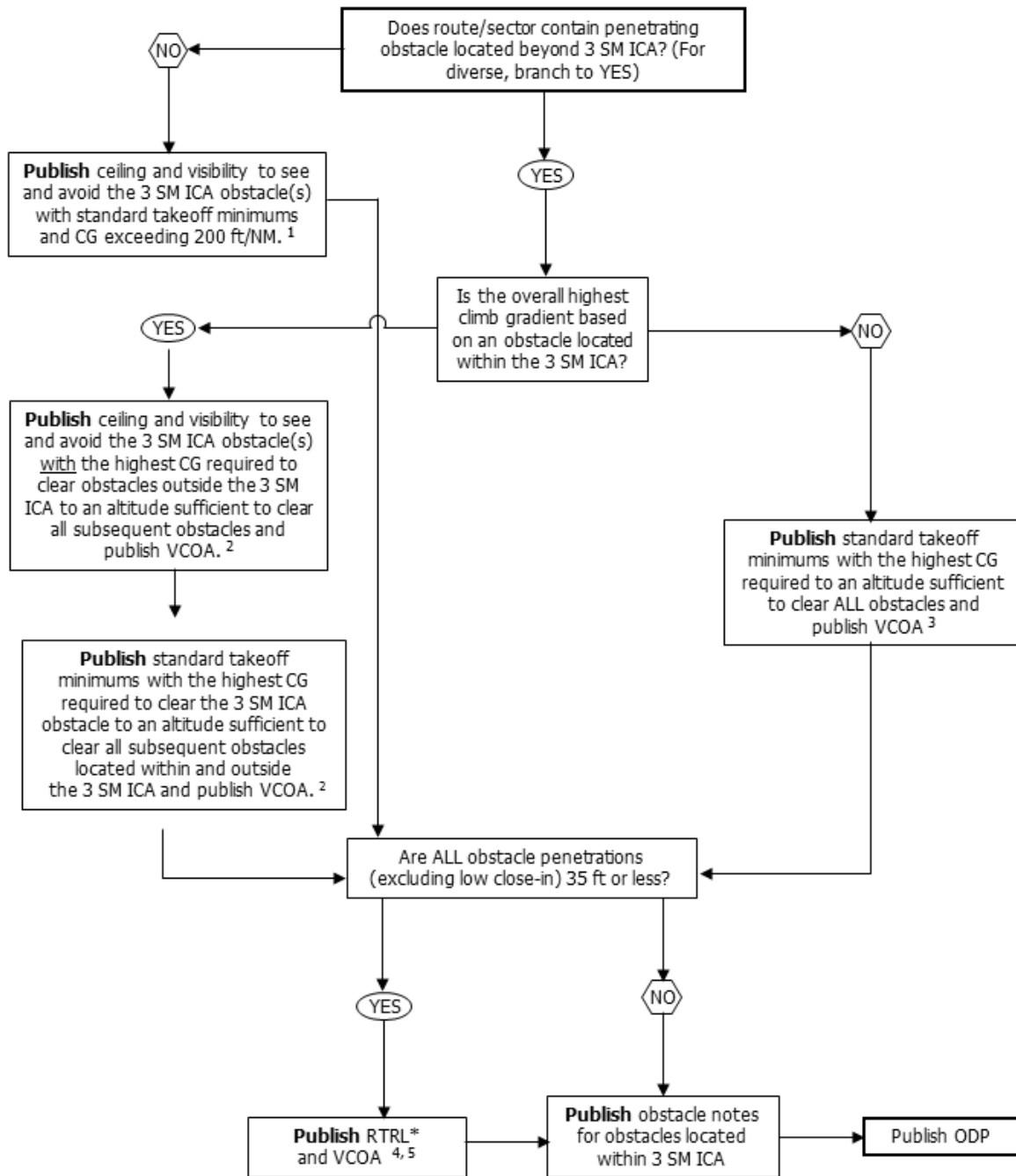

\*RTRL: Reduced Takeoff Runway Length

**Figure 2-1-3 Footnotes:**

1. TAKEOFF MINIMUMS: "RWY 11, 400-2 or standard with minimum climb of 250 ft per NM to 3000."  
TEXTUAL DEPARTURE PROCEDURE: "RWY 11 - Climb on heading 112.90 to 3700 before turning right."  
TAKEOFF OBSTACLE NOTES: "NOTE: RWY 11: (Enter notes for obstacles located within the 3 SM ICA)"
  
2. TAKEOFF MINIMUMS: "RWY 5, 300-1¼ with minimum climb of 350 ft per NM to 6000 or standard with minimum climb of 500' per NM to 5000 or 2100-3 for climb in visual conditions."  
TEXTUAL DEPARTURE PROCEDURE: "RWY 5 - (Specify departure procedure, OR for diverse, leave blank)"  
VISUAL CLIMB OVER AIRPORT: Obtain ATC approval for VCOA when requesting IFR clearance. Climb in visual conditions to cross (instructions as required based on decision above) before proceeding on course.  
TAKEOFF OBSTACLE NOTES: "NOTE: RWY 5: (Enter notes for obstacles located within the 3 SM ICA)"
  
3. TAKEOFF MINIMUMS: "RWY 5, Standard with minimum climb of 425 ft per NM to 5400 or 2100-3 for climb in visual conditions."  
TEXTUAL DEPARTURE PROCEDURE: "RWY 5 - (Specify departure procedure, OR for diverse, leave blank)"  
VISUAL CLIMB OVER AIRPORT: Obtain ATC approval for VCOA when requesting IFR clearance. Climb in visual conditions to cross (instructions as required based on decision above) before proceeding on course.  
TAKEOFF OBSTACLE NOTES: "NOTE: RWY 5: (Enter notes for obstacles located within the 3 SM ICA)"
  
4. TAKEOFF MINIMUMS: "RWY 11, 400-2 or standard with minimum climb of 220 ft per NM to 3400 or alternatively, with standard takeoff minimums and a normal 200 ft per NM climb gradient, takeoff must occur no later than 1200 ft prior to DER."  
TEXTUAL DEPARTURE PROCEDURE: "RWY 11 - Climb on heading 115.90 to 3700 before turning right."  
TAKEOFF OBSTACLE NOTES: "NOTE: RWY 11: (Enter notes for obstacles located within the 3 SM ICA)"
  
5. TAKEOFF MINIMUMS: "RWY 5, 300-2 with minimum climb of 210 ft per NM to 5100 or standard with minimum climb of 225 ft per NM to 4200 or alternatively with standard takeoff minimums and a normal 200 ft per NM climb gradient, takeoff must occur no later than 1500 ft prior to DER or 1700-2 for VCOA."  
TEXTUAL DEPARTURE PROCEDURE: "RWY 5 - (Specify departure procedure, OR for diverse, leave blank)"  
VISUAL CLIMB OVER AIRPORT: Obtain ATC approval for VCOA when requesting IFR clearance. Climb in visual conditions to cross (instructions as required based on decision above) before proceeding on course.  
TAKEOFF OBSTACLE NOTES: "NOTE: RWY 5: (Enter notes for obstacles located within the 3 SM ICA)"

**Graphic ODP in lieu of Textual ODP**

TAKEOFF MINIMUMS: (Blank)

TEXTUAL DEPARTURE PROCEDURE: "RWY 23 - Use ALPHA departure."

TAKEOFF OBSTACLE NOTES: (Blank)

**c. Standard Instrument Departures (SIDs).** Develop SIDs to assist in meeting environmental, capacity, and air traffic control requirements. SIDs may be requested by specific ATC facilities, the military services, or other proponents to enhance operations. A SID also provides protection from obstacles and depict graphically; however, it will not contain the “(OBSTACLE)” designation following the procedure title on the chart, and may not be flown unless approved by ATC. The following rules apply to SIDs:

(1) Design SIDs to terminate at a fix/NAVAID depicted on an IFR en route chart, at an altitude that will allow random IFR flight, or at a position and altitude where ATC radar service is provided.

(2) When a SID is designed to incorporate radar vectors or a course to be flown at the termination point, provide a heading/course for charting and incorporation into the avionics database in the event ATC instructions are not received prior to or at the termination fix.

**d. Design Constraints.** The following design constraints apply to all ODPs and SIDs:

(1) DPs must not require a turn prior to reaching 400 feet above the departure end of runway (DER) elevation. See Order 8260.3, volume 4, and Order 8260.58, United States Standard for Performance Based Navigation (PBN) Instrument Procedure Design, when a turn is required within two nautical miles (NM) of departure end runway (DER).

(2) Flight Standards Service or appropriate Department of Defense (DoD) authority must approve DPs requiring a climb gradient (CG) in excess of 500 ft/NM (600 ft/NM for helicopters). Approval requests will be assessed by the FAA Flight Technologies and Procedures Division (AFS-400), Procedures Review Board (PRB).

**Note:** Base consideration for approval on, but not limited to, potential users/aircraft capability of meeting such a CG, and location of the obstruction along the projected flight track that is causing the CG.

(a) Requests for approval of CGs in excess of 500 ft/NM (600 ft/NM for helicopters) must include documentation showing the calculations used to derive the climb gradient values.

(b) When AFS will not approve a CG in excess of 500 ft/NM (600 ft/NM for helicopters) and all of the obstacles forcing such a CG are located inside the ICA (extended) 3 statute miles (SM) or less from DER, a ceiling and visibility may be applied to see and avoid the obstruction(s) as the only option available.

(c) When AFS will not approve a CG in excess of 500 ft/NM (600 ft/NM for helicopters) and any of the obstacles forcing such a CG are located outside the ICA (extended) greater than 3 SM from DER; a stand-alone VCOA procedure may be used as the only option available for obstacle avoidance.

(3) Specify speed restrictions only when necessary to ensure obstacle clearance, airspace efficiency during turns, or when necessary to achieve an operational advantage. Refer to applicable DP criteria directives.

(a) Speed restrictions to support ATC requirements are only allowed in SID design and must not be included in ODPs.

(b) Limit speed restrictions [except as noted in paragraph 2-1-1d(3)(c)] to one restriction per fix/waypoint. In this instance, a minimum altitude based on the minimum required climb gradient must also be specified at the fix/waypoint.

(c) Avoid using multiple speed restrictions at the same fix for different aircraft types, insofar as possible; e.g., “Turbo-props do not exceed 160 KIAS until passing GARVY; Turbo-jets do not exceed 230 KIAS until passing GARVY.”

(4) Do not use fan markers as a fix to designate a turning point on a SID or ODP.

(5) Do not establish VCOA procedures in conjunction with a SID.

(6) Except for departures that use Radar vectors to join RNAV routes, RNAV departure procedures must only serve one airport.

(7) Do not establish DPs containing more than one initial departure route (lateral or vertical) from the end of a runway to the end of the DP, to support different types of aircraft (i.e., jet, turbo-prop, etc.) or different equipment requirements [distance measuring equipment (DME), non DME]. Where this is necessary, develop separate procedures.

**e. Charting Constraints.** The following charting constraints apply:

(1) Charting Altitudes. Document altitudes for charting as follows:

(a) Graphic departure procedures may require depiction of a minimum altitude at a fix established along the departure route. SIDs may require altitudes to support ATC requirements; however, do not depict ATC required altitudes on ODPs.

(b) When ATC requests a minimum “at or above” altitude restriction at a fix in an initial SID routing (prior to reaching the SID termination fix) that is higher than the required procedure design minimum altitude at the same fix, the higher requested ATC altitude then becomes the minimum altitude at that fix. This altitude must support all procedure design and criteria requirements [i.e., obstacle clearance/procedure design constraints/navigation solution and the ATC requirement(s)].

**Note:** When establishing crossing altitudes for other than meeting obstacle clearance and/or lateral navigation (LNAV) engagement altitude requirements, stakeholders should give consideration to aircraft performance limitations based on the type of aircraft expected to be using the SID and whether those aircraft will be capable of meeting these altitude restrictions. This may require consultation with “lead carriers,” local operators, and/or industry associations that could be impacted.

(c) When an ATC has requested an “at or below” altitude restriction at a fix, ensure that the requested altitude meets all obstacle clearance (ROC) requirements as well as other criteria design standards. ATC may also have a need to establish an “at or above” altitude

in conjunction with the “at or below” altitude at the same fix making this either a “mandatory” or “block” fix crossing altitude. See note in paragraph 2-1-1e(1)(b).

(d) When ATC requests an altitude restriction for a fix located on a transition route, it must be at or above the specified minimum en route altitude (MEA) for the route. See note in paragraph 2-1-1e(1)(b).

(e) Enter altitudes to be charted on the appropriate 8260-15 series form (see appendix D or E). Government and civil charting organizations will chart/depict these altitudes according to their individual specifications.

(2) Charting a Minimum Climb Gradient. Establish a single minimum CG exceeding 200 ft/NM [400 ft/NM for helicopters beginning at the initial departure fix (IDF)] whenever required for obstruction clearance and include the altitude to which the gradient is required in the Takeoff Minimums note; e.g., “(Takeoff minimums) with minimum climb of 300 ft/NM to 4300.” Do not establish CGs for crossing altitudes used to support airspace, environmental, or ATC operational limitations. When a CG is required to support an LNAV engagement altitude (e.g., 500 ft/NM to 1300) before turning, a reduced, second CG may be established in this situation only (i.e., a maximum of two CGs). See applicable 8260-series orders for the appropriate criteria to use when establishing a minimum CG. Enter minimum CG and associated termination altitude for charting on the appropriate 8260-15 series form (see appendix D, E, or F).

**Note:** Helicopter Point in Space IFR departures depart VFR (or may depart visually for approved Special procedures) from a heliport/departure surface, to the IDF. The departure is considered as beginning at the IDF for departures that *do not* contain a “visual segment” (see appendix F, paragraph 2). The climb gradient for helicopter departures is normally much greater to the IDF after which the CG is reduced to (typically) the standard CG of 400 ft/NM in the 20:1 area.

(3) Charting Speed Restrictions. Identify required speed restrictions per Interagency Air Cartographic Committee (IACC) specifications.

(a) Speed restrictions for textual ODPs will follow the departure instructions; e.g., “...climbing right turn direct XXX VOR. Do not exceed 200 KIAS until XXX VOR.”

(b) Annotate speed restrictions for graphic ODPs and SIDs on the chart at the restriction point; in the Additional Flight Data block of Form 8260-15B, document the speed restriction as follows: CHART SPEED ICON (Maximum/Minimum/Mandatory) SPEED (value) KIAS AT (Fix Name). State speed restrictions not associated with a fix in the form of a chart note; e.g., “Chart Note: Do not exceed 210 KIAS until established direct ABC VOR.”

(4) ODPs depicted graphically must have the term “(OBSTACLE)” printed on the graphic (see appendix D or E). Indicate the word “OBSTACLE” adjacent to the “Type” line on Form 8260-15B, Graphic Departure Procedure. U.S. Government charts will include this immediately following the procedure title; e.g., TETON ONE DEPARTURE (OBSTACLE).

(5) ODPs developed for RNAV use must have the terms (OBSTACLE) and (RNAV) printed on the graphic. Indicated by the words “OBSTACLE” and “RNAV” adjacent to the “Type” line on Form 8260-15B. U.S. Government charts will include this immediately following the procedure title; e.g., LASCH ONE DEPARTURE (OBSTACLE) (RNAV).

(6) All Graphic DPs must include applicable takeoff minimums, climb gradients, obstacle data (see table 2-1-1), on the graphic chart, even if redundant to information published textually.

(7) A Radar Vector Area (RVA) used in conjunction with an RNAV SID may be published on the same chart with an RNAV route departure from a different runway; however, both must contain the same common segment prior to reaching the end of the departure (see appendix E, section 2 for unique database coding requirements).

**f. Equipment Requirements.** DPs are also categorized by equipment requirements as follows:

(1) Non-RNAV DP. A DP established for aircraft equipped with conventional avionics using ground-based NAVAIDs; e.g., nondirectional beacon (NDB), very high frequency omni-directional range (VOR), very high frequency omni-directional range/tactical air navigation (VORTAC), localizer (LOC), etc. These DPs may also be designed using dead reckoning navigation.

(2) RNAV DP. A DP established for aircraft equipped with RNAV avionics; e.g., global positioning system (GPS), flight management system (FMS), etc. Do not require automated vertical navigation.

(3) Radar SID. A SID established when ATC has a need to vector aircraft on departure to a particular ATS Route, NAVAID, or fix. Radar vectors may also be used to join conventional or RNAV navigation SIDs. Annotate SIDs requiring radar vectors with “RADAR REQUIRED.”

**g. Terminology.** The following terminology applies for initial climb instructions:

(1) When required, departure instructions must specify the actual heading to be flown after takeoff. Example: “Climb heading 350.10...” Some existing procedures specify, “Climb runway heading.” Procedure developers will update these procedures during the periodic review process, changing the terminology to specify the actual heading to be flown.

**Note:** For database coding, heading/track/course values must be in hundredths of a degree. For charting purposes, these heading/track/course values will be rounded to the nearest whole degree (hundredths of a degree are not used in ATC communications).

(2) If departure instructions require ATC to assign a heading, use: “Climb on assigned heading for radar vectors to (name of fix/airway, etc.).”

(3) If departure instructions require a specific altitude to climb to after takeoff, do not use the terminology “Climb to (altitude) ...” without including a heading to fly. Example: “Climb heading 310.25 to 1500 ...”



(4) Do not use the terminology “Climb straight ahead...” or “Maintain runway track...” as there is no guidance or reference definition of this phraseology for the pilot to apply.

(5) Ensure initial departure instructions that require altitude restrictions are written clearly and in order to be flown to lessen the possibility of pilot deviations. For example, “Climb heading 240.15 to 1500, cross TEB 4.5 DME at 1500, then climb and maintain 2000, thence...” or, “Climb heading 195.47 to 900, then climbing right turn to heading 280, maintain 2000, thence...”

(6) A departure procedure requiring a turn does not require an initial climb heading to be specified. For example, “Climbing right turn direct XYZ VOR...” Direction of turn must be specified when turn exceeds 15 degrees.

(7) Do not use the word “immediate/immediately” in any type of departure instructions; e.g., turning instruction or speed restrictions. Old “early turn” departure procedures may contain instructions to “Turn left (right) as soon as practicable.” This terminology is used on non-standard departure procedures approved by Flight Standards or the appropriate military authority.

**h. Diverse Vector Area (DVA).** An ATC facility may request a DVA to permit vectoring of aircraft on departure, below the Minimum Vectoring Altitude (MVA) or Minimum IFR Altitude (MIA) under the provisions in Order JO 7210.3, paragraph 3-8-5, Establishing Diverse Vector Areas. Order 8260.3, contains the criteria used for development. See appendix G of this order for documenting the development of a DVA.

**i. Attention All Users Page.** For simultaneous RNAV departures, an AAUP must be published. The AAUP provides the flight crew with procedures that must be used when conducting these operations, in a form that may be reviewed prior to conducting the procedure.

**Note:** The flight crew will be notified when an AAUP is published. The note will appear on the narrative page immediately beneath the Departure Route Description title. See appendix E, section 1, paragraph 13d.

(1) Site Implementation Team (SIT). A SIT is normally established to address issues related to establishing the procedures. If no team is established, the FAA facility that provides ATC services for the airport at which the operations are to be conducted is responsible for the AAUP. The SIT is:

(a) Comprised of FAA and industry members with the team leadership designated by ATO.

(b) Responsible for the development, among other things, of an AAUP.

(2) AAUP Preparation. The AAUP must present the step-by-step procedures used to conduct the procedure. Develop the AAUP using Form 8260-15E and the guidance provided in appendix E, section 3.

**Note:** An AAUP example is provided in appendix E and may not be the most current or not necessarily applicable to other locations. This example should be used as a developmental

guideline. AAUPs must reflect the requirements of the specific procedure and airport for which they are developed.

(3) **AAUP Processing.** The SIT (or applicable ATC facility) submits the draft AAUP through channels as applicable (that is, Service Areas may have a coordination process unique to their area). Also, submit the procedure to AJV-14 for comment. When completed, submit the procedure to the Flight Technologies and Procedures Division (AFS-400) for approval. Also, provide a copy to Flight Standards' Flight Operations Branch (AFS-410) and the Performance-Based Flight Operations Branch (AFS-470). AFS-400 submits the AAUP and requested effective date to the National Flight Data Center (NFDC).

(4) **AAUP Publication.** The originating organization will determine the required publication date; coordinate with AeroNav Products and NFDC as necessary. After receiving the AAUP from AFS-400, NFDC will:

(a) Verify the applicability of the publication date and assign that date for publication.

(b) Coordinate with AFS-400 who will, in turn, contact the originating organization and AeroNav Products should a change in the previously agreed upon date be required.

**Note:** When publishing a new AAUP in conjunction with a new or revised procedure, it is important that the AAUP be coordinated jointly between the originating organization, NFDC, AeroNav Products, and AFS-400 to ensure its publication is concurrent with the procedure(s) for which the AAUP was developed.

(c) Publish the AAUP in the National Flight Data Digest (NFDD).

**Note:** The NFDD is the source for AAUP information for publication by all chart producers.

## **2-1-2. Responsibilities.**

**a. General.** The following guidance outlines procedures for DP requests, processing, and cancellation.

(1) **Procedure Requests.** SIDs are normally requested by the ATC facility responsible for departure control at the airport where the procedure is proposed, or by another proponent. Process all requests for new or amended SIDs through the Service Area Operations Support Group, Flight Procedures Team (OSG-FPT) and will forward to the appropriate Regional Airspace and Procedures Team (RAPT) in accordance with Order 8260.43, Flight Procedures Management Program.

(2) **Requirements.** ATC must provide the OSG-FPT, detailed operational requirements and restrictions for inclusion in the SID design. AeroNav Products must make every effort to meet ATC identified operational requirements and constraints using current criteria and policy. When current criteria and policy will not support a design to meet ATC requirements, AeroNav

Products, Flight Procedure Standards Branch (AFS-420), and other ATO organizations/involved parties must work together to find an acceptable solution.

(3) Cancellation. The RAPT must approve all proposed SID cancellations. AeroNav Products has sole responsibility for canceling ODPs. AeroNav Products cancels a DVA by notifying the ATC Facility Manager and Support Specialist by phone/e-mail, followed by a memorandum to indicate the previously approved Form 8260-15D, Diverse Vector Area, is no longer valid.

**b. Proponent.** A proponent's request to develop a DP must include the information in appendices B and C. Complete and forward this information to the ATC facility providing departure control service to the airport for acceptance, prior to development. The DP request package must include the following:

- (1) An outline of the type of procedure and expected benefits.
- (2) A proposed ground track, including associated fixes and any proposed altitude or speed restrictions.
- (3) A request (if required) for development assistance from the servicing ATC facility.
- (4) The Air Traffic Organization (ATO) is responsible for satisfying the requirements for FAA Order 1100.161 paragraph 3-2, Air Traffic Safety Oversight, Safety Risk Management Program for changes to the National Airspace System (NAS).

**c. ATC.** When assisting a proponent or requesting a SID, the ATC facility providing departure control service must:

- (1) Evaluate the proponent's request to ascertain preliminary operational feasibility and to determine/verify that significant benefits (see appendix B) will be derived.
- (2) Assist in designing the procedure by providing the proponent with information pertaining to traffic flow and operational constraints; e.g., routes, minimum IFR altitudes, facility/sector lateral and vertical airspace boundaries, special use airspace, etc.

**Note:** When an ATC facility proposes SID development from an airport served primarily by air carriers, it may attempt to solicit the assistance of a "lead carrier" in the design and flyability of the proposed procedure.

- (3) Coordinate with other ATC facilities affected by the procedure.
- (4) Coordinate with the servicing Air Route Traffic Control Center (ARTCC) to obtain a 5-letter pronounceable name for all fixes in the graphic DP. Complete Form 8260-2, Radio Fix and Holding Data Record, for each fix being established, modified, or canceled (see appendix C). Include the worksheet(s) as part of the graphic DP request package. Existing fixes/NAVAIDs should be used where conveniently located.

(5) Coordinate with the servicing ARTCC to obtain a name and computer code for the SID as specified in chapter 3.

(6) Complete the DP requirements data worksheet (see appendix B), when applicable.

(7) Forward the requested package to the applicable Service Area Operations Support Group. The package must contain worksheets for all fixes, the DP requirements data worksheet, and a sketch of procedures requiring graphic publication (see appendix D or E).

(8) Review SIDs at least biennially for continued need. Coordinate requested changes through the applicable Service Area Operations Support Group, Flight Procedures Team.

(9) Collaborate with Performance Based Flight Systems Branch (AFS-470) when the development of an Attention All Users Page (AAUP) is necessary for RNAV departure procedures. See paragraph 2-1-1i for additional guidance.

**d. Service Area Operations Support Group.** The Service Area Operations Support Group, Flight Procedures Team must:

(1) Review the DP package for completeness.

(2) Review DPs for impact based on Facilities and Equipment changes, National Change Proposal (NCP), or other applicable projects.

**Note:** The point-of-contact (POC) and telephone number for the ATC facility is listed on the Graphic DP requirements worksheet. The FPT must contact the POC to resolve any problems in developing the requested procedure and provide appropriate alternatives. The POC must be responsible for additional coordination of changes required for development. The FPT should coordinate with the Regional NextGen Branch (RNGB) for assistance where necessary.

(3) Act as the focal point for all ATC coordination and provide appropriate assistance in resolving any problems identified during the development process.

(4) Ensure that a DME/DME screening model has been run on RNAV SIDs to determine if the procedure is useable by suitably equipped aircraft, prior to submission.

**Note:** The DME/DME assessment process is contained in Order JO 7470.1, DME/DME Infrastructure Evaluation for Area Navigation (RNAV) Routes and Procedures.

(5) Facilitate discussion of the procedure at the RAPT.

(6) Forward the DP package to AeroNav Products.

(7) Provide one copy of each FAA 8260-2 and 8260-15 series form(s) to all affected ATC facilities.

(8) The OSG-FPT notifies the requesting ATC facility of the anticipated publication date and any delay in the publication and cause.

(9) The OSG-FPT must ensure that changes to the National Airspace System (NAS) comply with FAA Order 1100.161, paragraph 3-2, Safety Risk Management Program.

**e. AeroNav Products.** AeroNav Products must:

(1) Develop and process textual ODPs on Form 8260-15A, Takeoff Minimums and Obstacle Departure Procedures, under applicable directives.

(2) Develop and process graphic ODPs and SIDs on Form 8260-15B, Graphic Departure Procedure.

(3) Develop and process a Form 8260-15C, Departure Data Record, for all RNAV DPs.

(4) Develop and process a Form 8260-15D, Diverse Vector Area, for all DVAs.

(5) Ensure that a DME/DME screening model has been run on RNAV “obstacle” departures (the Service Area OSG is responsible for DME/DME screening of SIDs) to determine if the procedure is useable by suitably equipped aircraft, prior to submission for flight inspection.

**Note:** The DME/DME assessment process is contained in separate guidance.

(6) Submit DPs to Flight Inspection Operations Division, AJW-391, for necessary action.

(7) After satisfactory flight inspection, forward the original Form(s) 8260-2 and original 8260-15 series forms to NFDC. Copies are available for distribution [see paragraph 2-1-2d(5)].

(8) Develop, review, track, and cancel Notices to Airmen (NOTAMs) relating to ODPs and SIDs.

(9) Assign an effective date for all ODPs and SIDs. Publish both textual and graphic ODPs in the Transmittal Letter (TL) authorizing charting agencies to publish the procedure(s). Submit SIDs and DVAs to the NFDC for incorporation into the National Flight Data Digest (NFDD).

(10) Monitor and track the status of concurrent instrument approach procedure (IAP) packages to ensure that the entire package is published with the same effective date.

(11) Ensure related controlled airspace actions as required by Order JO 7400.2, Procedures for Handling Airspace Matters, have been completed prior to assigning an effective date.

(12) Ensure “routine” procedures have been flight inspected prior to incorporation in the TL.

(13) Review ODPs periodically for continued need, obstacle clearance, and compliance with current criteria and policy; and coordinate proposed changes with the appropriate ATC

facility. When application of new criteria or a new obstacle affects an ODP/SID that requires adjustment to an obstacle-driven CG, all DPs must be evaluated to determine if other CGs require adjustment. If CG adjustments are required, they must be updated simultaneously in the same charting cycle.

(14) When a location currently has standard takeoff minimums and circumstances now require non-standard takeoff minimums and/or an ODP development, amend the current Form 8260-15A for the airport accordingly.

(15) When it is necessary to cancel a DP, process the appropriate Form 8260-15 as directed in paragraph 2-1-5d.

(16) Add the “T” symbol to the IAP and SID charts whenever the Form 8260-15A indicates any data entries other than Standard Takeoff Minimums.

**Note:** The “T” symbol will not be placed on graphic ODPs.

(17) Delete the “T” symbol from the IAP charts based on receipt of a Form 8260-15A that has “Standard” in the “Takeoff Minimums” and it applies to all runways. This symbol deletion applies when a Textual ODP is not published or when removal of textual ODP information is necessary based on a revised Form 8260-15A.

**Note:** The basic rule is that if an ODP is published (Text or Graphic), the “T” symbol is required on all approach charts to that airport. If an ODP is not published, a “T” symbol will not appear on approach charts.

(18) Issue P-NOTAMs to correct U.S. Government charting discrepancies and compilation errors required (see Order 8260.19).

**f. Flight Inspection Services.** Flight Inspection Services must:

(1) Coordinate and execute Flight Validation and Flight Inspection for FAA developed procedures and under a reimbursable agreement with other instrument flight procedure (IFP) providers,

(2) Provide flight inspection results and archived reports upon request, and

(3) Verify DME/DME coverage when applicable.

**g. National Flight Data Center (NFDC).** The NFDC must:

(1) Conduct a review of submitted forms to ensure compatibility with the National Airspace System Resources, National Database, and compliance with applicable directives relative to form entries.

(2) Publish SIDs, associated fixes, AAUPs, and DVAs in the daily NFDD authorizing charting agencies to publish these procedures. See paragraph 2-1-1i(4) for more specific AAUP responsibilities.

- (3) Resolve data conflicts, form discrepancies, etc., with AeroNav Products.
- (4) File and maintain the original signed copy of the forms.

**2-1-3. Accuracy Verification and Responsibilities.** Any ATC facility, DoD, proponent, charting agency, procedure user, concerned individual, organization, or office must:

**a. Notify AeroNav Products of published errors** (including omissions) that affect safety of flight by the fastest means available. AeroNav Products must take appropriate NOTAM action under Order 8260.19.

**b. Notify AeroNav products whenever pre-publication errors** are discovered in the TL. AeroNav Products will coordinate necessary corrective actions with the NFDC and promulgate corrected data/forms.

**c. Notify the NFDC whenever pre-publication errors** are discovered in the NFDD. The NFDC will coordinate necessary corrective actions with AeroNav Products and promulgate corrected data/forms.

**d. Notify AeroNav Products whenever charting discrepancies/compilation errors** are detected in United States government published aeronautical products. AeroNav Products will coordinate corrective actions with NFDC.

**2-1-4. Military Departure Procedures (DPs).**

**a. Military DPs.** Name and number all military DPs in accordance with the criteria outlined in this order.

**Note:** Military DPs are not handled or published in the same manner as civil DPs. Approval authority for DPs at military airports rests with the military. The FAA develops United States Army DPs under Order 8260.15, United States Army Terminal Instrument Procedures Service. The FAA develops United States Air Force DPs at domestic civil airports under Order 8260.32, United States Air Force Terminal Instrument Procedures Service. The National Geospatial-Intelligence Agency (NGA) publishes all military DPs.

**b. The FAA requires that all military DPs** be coordinated with FAA ATC facilities or regions when such DPs affect the National Airspace System (NAS). The Air Traffic Facility providing the departure service must assist the military in coordinating the procedures and in obtaining computer codes to ensure that the procedures are properly interfaced with the NAS. United States Air Force and Navy procedures are NOT sent to NFDC.

**c. When military DPs affect airspace** under the jurisdiction of FAA facilities, those affected ATC facilities/ARTCCs must maintain copies of the applicable military or FAA procedure approval forms.

**d. When a military DP has a climb gradient** established to clear obstruction(s) that uses the “DoD Option” provision (see Order 8260.3), the procedure must be annotated “NOT FOR CIVIL USE.”

**2-1-5. FAA 8260-15 Series Forms (see appendices D through G).**

**a. The 8260-15 series forms document** standard takeoff minimums and facilitate transmittal of nonstandard takeoff minimums and/or departure procedures. These forms will be the basis for charting agencies to publish non-standard takeoff minimums, departure procedures, and/or to add/delete charting icons used to denote that other than standard takeoff minimums and/or specific obstacle departure procedures are published.

- (1) Use Form 8260-15A to document:
  - (a) Standard takeoff minimums.
  - (b) Nonstandard takeoff minimums and/or higher than standard climb gradients for a runway.
  - (c) Textual ODPs.
  - (d) That the ODP for a runway is published graphically.
  - (e) Other pertinent textual data for publication; e.g., obstacle data notes, VCOA data, etc.
- (2) Use Form 8260-15B to document:
  - (a) Graphically depicted complex ODPs and all SIDs.
  - (b) Other pertinent procedural data; e.g., fixes, NAVAIDs, routes, vectoring areas, altitudes, etc. required for charting database development on RNAV DPs.
- (3) Use Form 8260-15C to document RNAV DPs in a manner consistent with and which aids in charting and database coding. Specifically use 8260-15C to document:
  - (a) The RNAV route of flight in terms of a series of segments defined by fix name, positions, waypoint type, leg types, course, and distance.
  - (b) Altitude and airspeed restrictions associated with fixes.
- (4) Use Form 8260-15D to document a Diverse Vector Area (DVA).
- (5) Use Form 8260-15E to document RNAV Departure Procedure AAUPs for locations where it has been determined that detailed departure information is necessary. See paragraph 2-1-1i for AAUP guidance.

**b. Use Form 8260-15A/B to deny lower** than standard takeoff minimums. When touchdown and rollout runway visual range (RVR) are available on runways with centerline lights and either RVR is installed on a baseline greater than 250 feet, deny takeoff minimums lower than RVR 1200 by adding the following example standard note on Form 8260-15:

“RWY 27R, Air Carrier reduction below RVR 1200 NA.”



**c. Administratively process the 8260-15 series forms** as specified in Order 8260.19, chapter 8. Additionally, when submitting procedures for waiver and/or Flight Standards approvals, include supporting documentation; e.g., for excessive climb gradient approval, submit documentation showing calculations.

**d. Cancellation of Form 8260-15(s).** Cancel specific takeoff minimums for an airport or cancel any textual or graphical DP(s) no longer required, as follows:

(1) Enter the current information from the top line of page 1 of Form 8260-15A/B and into the corresponding blocks on blank Forms 8260-15A and/or B. Additionally, on Form 8260-15B; complete the “Airports Served” section.

(2) Enter/Overprint “Procedure Canceled Effective” in the “Takeoff Minimums” section on Form 8260-15A and/or “DP Route Description” section of Form 8260-15B (a stamp may be used for this purpose).

**2-1-6. Procedure Amendments.** Amend all departure procedures using either the full amendment or an abbreviated amendment process as specified below. A full amendment must ensure that periodic review requirements have been met for the procedures documented on the specific form being completed. A full amendment requires a complete procedure package (i.e., all necessary forms, maps, and supporting documentation) be developed and submitted for processing. An abbreviated amendment only requires submission of the Forms 8260-15A/B as applicable (and 8260-15C, if an RNAV procedure) for processing (see note 2). All departure procedures, regardless of the amendment process used, are to be submitted to Flight Inspection for a determination of what action they must take, based on what is being amended. Submit departure procedures not developed and/or not flight inspected by the FAA are to AFS-460 to determine flight validation requirements.

**Note 1:** Flight Inspection (AFS-460 for procedures not developed and/or flight inspected by the FAA) may establish unique/specific policy guidelines with individual procedure development authorities, addressing specific situations that do not require submission for flight inspection/validation. Specify this exception (or exceptions) in either an FAA directive or policy memorandum controlled by the flight inspection/validation authority. Provide AFS-460 a copy of all policy memorandums between flight inspection and procedure developers.

**Note 2:** When the abbreviated amendment process is used, take steps to ensure all supporting documentation, e.g., maps, waiver/approval letters, etc., remain on file in the abbreviated amendment procedure package.

**a. Textual ODPs.**

(1) When completing a full amendment, advance the amendment number in the “AMDT No.” item of Form 8260-15A; e.g., “AMDT 1,” “AMDT 4.” When the “abbreviated amendment” process is used, an alphabetical suffix is added/advanced whenever the procedure is revised; for example “ORIG-A,” “AMDT 5C.” The circumstances dictating the need for revision determine whether an amendment or abbreviated amendment may be made or whether the existing procedure must be canceled and an original established.

(2) Use P-NOTAMs to act as an “abbreviated amendment” for Textual ODPs to effect changes immediately and will generate a publication change, creating a letter suffix as noted in the above paragraph (also see Order 8260.19).

**b. Graphic ODPs and SIDs.**

(1) Whenever changing the “DP Name” in the title line of the Form 8260-15B, or changing the procedure “Type,” cancel the procedure and develop a new procedure.

(2) Both the full and the abbreviated amendment processes require the number in the procedure title to be increased; e.g., “SHEMP 2” increases to “SHEMP 3.” (See paragraph 3-1-2f.)

(3) Require a full amendment whenever a change is made to the items listed below as specified on Form 8260-15B:

(a) DP Route Description (pertains to entire route charted to include leg lengths when applicable).

(b) Transition Routes (adding/revising).

(c) Airports Served (Only when airports are added).

(4) Use an abbreviated amendment whenever a change is made to the items listed below as specified on Form 8260-15B. Do not use a P-NOTAM to effect an abbreviated amendment for graphic ODPs and SIDs.

(a) Transition Routes (only when removing).

(b) Procedural Data Notes/Takeoff Minimums.

(c) Takeoff Obstacle Notes.

(d) Lost Comm Procedures.

(e) Additional Flight Data.

(f) Airports Served (only when airports are deleted).

(g) Communications.

(h) Fixes and/or NAVAIDs (only those requested for charting purposes, but are not included in the textual description of the departure or entered in the transition route data).

(i) Remarks (that will require a change to what will be charted on the procedure).

(j) Altitude changes (RNAV procedures require RNAV-PRO assessment when altitude changes are made).

(k) Heading/course/track number changes made to support a magnetic variation update that does not alter the ground track of the existing procedure.

(5) An amendment is not required for changes made to the items listed below as specified on Form 8260-15B.

(a) Controlling Obstacle (that does not require a change to what will be charted on the procedure; note the change in the procedure package historical information and retain until a future amendment/abbreviated amendment Form reflects this new controlling obstacle).

(b) Remarks (that do not require a change to what will be charted on the procedure).

**c. DVA.** Any change to a DVA is considered an amendment and requires a new Form 8260-15D to be generated, establishing a new amendment number.

THIS PAGE INTENTIONALLY LEFT BLANK

## Chapter 3. Guidelines for the Design of Graphic Instrument Departure Procedures (DPs)

### Section 3-1.

#### 3-1-1. General.

- a. **DPs must be designed** so that they provide obstacle clearance, least onerous routing (where possible), and can be confidently and consistently flown by all aircraft expected to use the procedure.
- b. **A DP must be relatively simple** and easily understood. To avoid chart complexity and human factors concerns, limit the number of airports and/or runways from which a particular DP may be used to only those necessary to support operations.
- c. **A DP should use only the minimum** number of fixes, turns, or altitude changes necessary to depict the route.
- d. **A DP should be developed to accommodate** as many different types of aircraft as possible.
- e. **A DP should avoid** the use of DME arcs.
- f. **Graphic ODPs must be designed** to terminate at a fix/NAVAID located within the IFR en route structure or at an altitude that will allow random IFR flight.
- g. **A SID must provide** for a significant user/system benefit.
- h. **A SID must reduce** pilot/controller communications and workload.
- i. **A SID must be designed** to terminate at a fix/NAVAID located within the IFR en route structure, at an altitude that will allow random IFR flight, or at a position where ATC radar service is provided.
- j. **A Transition may be developed** from the end of a SID to support a need to take aircraft to additional fixes/NAVAIDs depicted on an IFR en route chart. A SID may contain multiple transitions and may share a common segment prior to branching off into multiple directions.
- k. **Avoid Speed Restrictions Whenever Possible.** See paragraphs 2-1-1d(3) and 2-1-1e(3) for specific guidance.
- l. **Altitude.**
  - (1) Limit the number of altitude requirements to the minimum necessary. ATC operational restrictions are not permitted on ODPs.
  - (2) Minimum and maximum “block” altitudes for the same fix/waypoint are permitted. See paragraph 2-1-1e(1) for specific guidance and charting constraints.

(3) Do not use multiple altitude restrictions at the same fix for different aircraft types or departure runways; e.g., “Turbo-props cross GRAVY at-or-below 5000, Turbo-jets cross GRAVY at-or-above 6000” or “RWY 9: Cross XRRAY at 9000; RWY 27: Cross XRRAY at 11000.”

(4) Define crossing altitude restrictions as “at,” “at-or-above,” “at-or-below,” or “expect.” Avoid “at” and “at-or-below” altitudes whenever possible.

**Note:** “Expect” altitude restrictions will not be coded.

(5) Procedure designers must use good judgment and common sense, coupled with operational input where available, to restrict procedural altitudes due to precipitous terrain.

**m. Climb Gradient.** DPs are designed assuming a minimum standard CG of 200 ft/NM (400 ft/NM for helicopters) to ensure required obstacle clearance is achieved. Higher CGs must be published when required for obstruction clearance and/or LNAV engagement altitude [see paragraphs 2-1-1d(2) and 2-1-1e(2) for specific guidance].

### **3-1-2. Naming of DPs (see examples at the end of this chapter).**

**a. Textual ODPs are not named,** while all graphic ODPs and SIDs must be named as described in this section.

**b. SIDs, designed using radar vectors** as the only navigation source to the en route environment, are normally named to correspond with the terminal control facility name. For example, the SID from Tampa International Airport is named the TAMPA THREE; the SID from Greater Cincinnati Airport is named the CINCINNATI EIGHT. If the terminal control facility name is already in use, use a fix, city, airport, or geographical area name in that order.

**c. SIDs designed using a diverse vector area** and radar vectors to a common specified route must be named to correspond to the fix/NAVAID/waypoint where the specified route ends. For example, the SID uses a diverse vector area and radar vectors to a fix/NAVAID/waypoint that begins a specified route to COTEE; the SID is named the COTEE ONE.

**d. DPs designed using conventional, RNAV, or RNP guidance** must be named to correspond with the en route fix/NAVAID name where the DP ends. For example, a conventional DP from Altoona-Blair County Airport that ends at the TATES fix is named the TATES TWO DEPARTURE. If the DP is an RNAV procedure, the “(RNAV)” must be included in the name; for example, TATES TWO DEPARTURE (RNAV). See appendix E to see how this will be documented for RNAV procedures.

**e. If two or more DPs end at the same fix/NAVAID,** the second and subsequent procedures must be named for the city, airport, or geographical area in that order. For example, a SID from Greater Cincinnati Airport that ends at the REDSS fix is named the REDSS FOUR DEPARTURE. A SID from Cincinnati-Lunken Airport that also ends at the REDSS fix is called the LUNKEN SEVEN DEPARTURE.

**f. Number Each Original Graphic DP “ONE.”** Number subsequent amendments in numerical sequence through NINE and then start over with ONE (see paragraph 2-1-6b for the amendment process).

**3-1-3. Transition Naming.** DP transition names must always correspond with the fix/NAVAID where the transition ends. For example, the FORT LAUDERDALE SEVEN DEPARTURE termination fix is the Fort Lauderdale VORTAC (FLL) and it has a transition to the ZAPPA intersection; the transition name is ZAPPA. The REDSS FOUR DEPARTURE terminates at the REDSS fix and it has a transition to the Johnstown VORTAC (JST); the transition name is JOHNSTOWN.

**3-1-4. Computer Identification Codes.** See pages appendix B for examples.

**a. Textual ODPs.** Textual ODPs will not receive a computer identification code.

**b. Graphic ODPs and SIDs.** Computer identification codes are assigned to graphic DPs by using the abbreviated name of the DP; e.g., a NAVAID or airport 3-letter NAVAID or airport identifier, a 4-letter geographical abbreviation, or a 5-letter fix/waypoint name, or other 5-letter code, followed by the current DP number, then a dot, followed by the fix/NAVAID identifier where the DP ends. For example, the CINCINNATI EIGHT DEPARTURE in paragraph 3-1-2d is coded “CVG8.CVG”; the FORT LAUDERDALE SEVEN DEPARTURE in paragraph 3-1-3 is coded “FLL7.FLL”; and the “TATES TWO DEPARTURE in paragraph 3-1-2d is coded “TATES2.TATES.” A computer identification code is not required and; therefore, optional for radar vector SIDs that do not contain a specified or common route published as part of the SID; i.e., a SID based solely on radar vectors to the en route structure.

**Note:** In order to determine if a Computer Identification Code is to be established for a new (or can be removed from an existing) radar vector SID, the applicable ATC facility must be contacted to “confirm” what action is desired.

**c. SID Transition.** SID transition computer codes are assigned by using the SID identifier and number as noted in paragraph 3-1-4b, followed by a dot, followed by the identifier of the en route fix where the transition ends. Using the Fort Lauderdale example in paragraph 3-1-3, the ZAPPA transition is coded “FLL7.ZAPPA.” Using the REDSS example in paragraph 3-1-3, the Johnstown transition is coded “REDSS4.JST.

**3-1-5. RNAV DPs.** The following general criteria and guidelines apply only to DPs designed for exclusive use by certain RNAV equipped aircraft. See the latest edition of Order 8260.58 for specific guidance and criteria.

**a. Waypoints.** Specify all waypoints as either fly-by or fly-over.

- (1) Use fly-by waypoints whenever possible.
- (2) Use fly-over waypoints only when operationally necessary or for obstacle clearance.
- (3) Design procedures using the fewest number of waypoints.

**b. Leg Types.** Table 3-1-1 shows permissible leg types for use with RNAV DPs. See Order 8260.58 for leg type definitions and examples.

**Table 3-1-1. Permissible Leg Types**

FROM	VIA (leg type)	TO
AER	VI <sup>1</sup>	See <sup>1</sup>
AER	VA <sup>2</sup>	ALT
AER	VM <sup>8</sup>	HDG
AER	CF <sup>3</sup> , DF <sup>4</sup>	FB/FO
ALT	CF <sup>3</sup> , DF <sup>4</sup>	FB/FO
ALT	VM <sup>2</sup>	ALT
FB	TF <sup>5</sup>	FB/FO
FO	DF <sup>4</sup> , TF <sup>5</sup>	FB/FO
IF <sup>7</sup>	DF <sup>4</sup> , TF <sup>5</sup>	FB/FO
FB	RF <sup>6</sup>	FB
FO	VM <sup>8</sup>	HDG
FO	FM <sup>9</sup>	Course

<sup>1</sup> VI (Heading-to-intercept) may only be used as the first leg of a departure and must be followed by a course-to-fix (CF) leg.

<sup>2</sup> VA (Heading-to-an-altitude) may only be used as the first leg of a departure and must be followed by a direct-to-fix (DF) leg or a heading-to-manual termination (VM) to DF leg. The altitude must be an at-or-above altitude; a mandatory (i.e., “at”) altitude must not be used at the first fix.

<sup>3</sup> CF (Course-to-fix) may only be used as the first leg of a departure or as the leg following a departure VI leg.

<sup>4</sup> DF (Direct-to-fix) may be used as the first leg of a departure, the leg following a departure VA leg, and for any leg thereafter preceded by a fly-over (FO) waypoint (WP) only.

<sup>5</sup> TF (Track-to-fix) is not used as the first leg of a departure. TF is the preferred leg after the first leg of a departure.

<sup>6</sup> RF (Constant radius arc) may only be used when necessary because some users do not have RF capability. An RF leg may only be used after a TF, CF, or another RF leg.

<sup>7</sup> IF (Initial fix) is used to designate the first fix of a departure transition, i.e., the IF is coincident with the DP termination fix. IF is also used to designate the point at which RNAV begins when used in conjunction with radar vectors.



<sup>8</sup> VM (Heading-to-manual termination) legs are only to be used in conjunction with ATC radar vectoring.

<sup>9</sup> FM (Course from a fix-to-manual termination) legs are used when requested by ATC and can only be placed at the end of a SID and must be at an altitude at or above the minimum vectoring altitude or minimum IFR altitude for direction of flight.

**Note:** AER – approach end of runway, ALT – altitude, FB/FO – fly-by fix/fly-over fix.

### c. Leg Length.

(1) Use the Longest Legs possible. The designer must consider speed and course changes when determining minimum leg length. See Order 8260.58 for specific minima.

(2) There is no maximum leg length for straight-line paths. **Exception:** Do not develop leg lengths in the en route environment exceeding 260 miles to ensure the geodesic path does not exceed the protected airspace for a great circle path.

### d. Chart Annotation.

(1) “RNAV-1” will be the default designation for RNAV DPs. Annotate procedures with a standard note: “RNAV-1” on FAA Form 8260-15B (see appendix E).

(2) “RNP-1” (in-lieu-of RNAV-1) will be used when a DP that contains an RF leg or when surveillance (Radar) monitoring is not desired for when DME/DME/IRU will be used. Annotate the procedure with a standard note: “RNP-1” on FAA Form 8260-15B (see appendix E).

(3) All RNAV DPs will contain a note that describes the equipment sensor limitations. Notes, as appropriate, are as follows:

**Note 1:** DME/DME/IRU or GPS Required.

**Note 2:** GPS Required.

(4) A note may be required to address the need for specific DME facilities to be operational. These are referred to as “critical DME facilities.”

### Example:

**Note:** For Non-GPS Equipped aircraft, ABC, JKL, and XYZ DMEs Must Be Operational.

(5) Except as required by paragraph 2-1-1f(3), all “RNAV 1” DPs that are annotated “DME/DME/IRU or GPS REQUIRED” must be annotated with the note: “RADAR REQUIRED FOR NON-GPS EQUIPPED AIRCRAFT.”

(6) When an “RNP 1” DP contains a radius-to-fix (RF) leg or all transitions require an RF leg, annotate the procedure with the standard note “RF REQUIRED” (see note 1, below). If

the RNP DP does not require an RF leg, but at least one transition requires an RF leg, define affected transitions as “RF REQUIRED” (see note 2, below).

**Note 1:** RF Required.

**Note 2:** (Name) Transition, RF Required.

**3-1-6. Examples of Various Graphic Departure Scenarios.**

**EXAMPLES:**

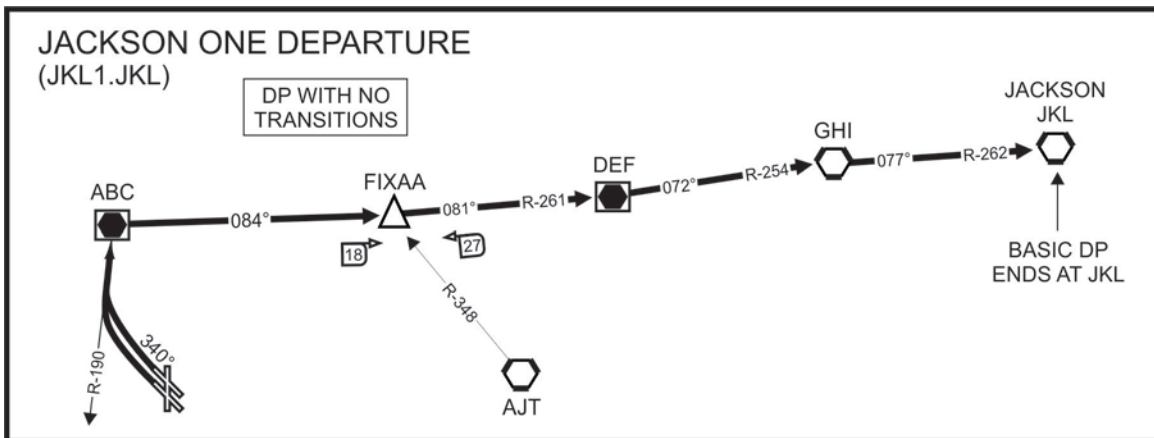
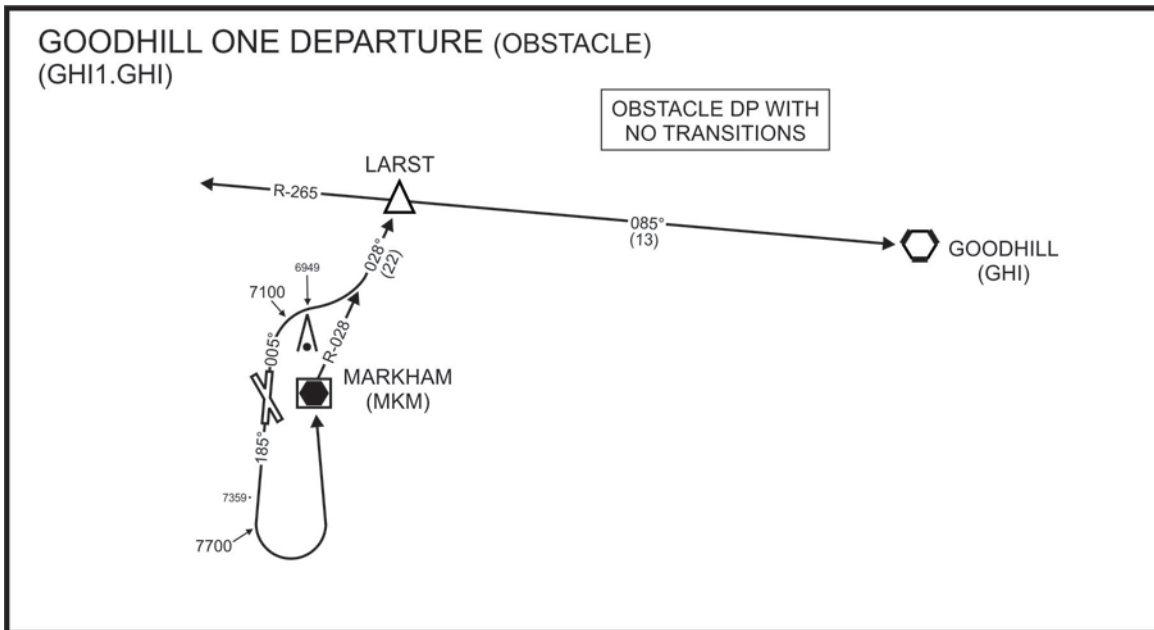

**EXAMPLES (Continued):**

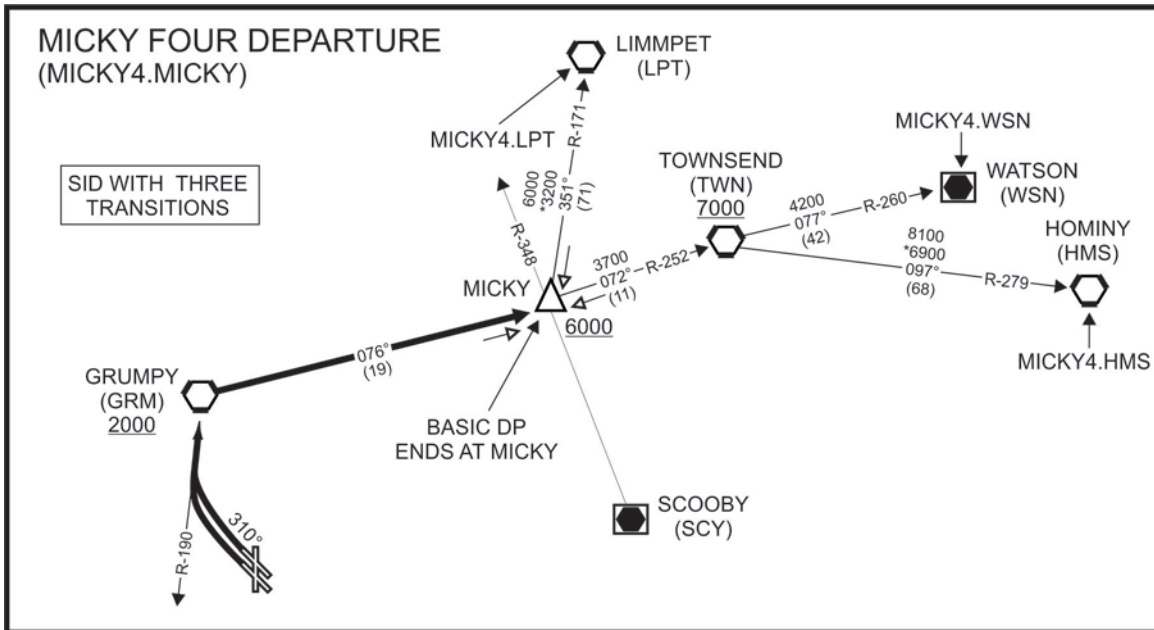
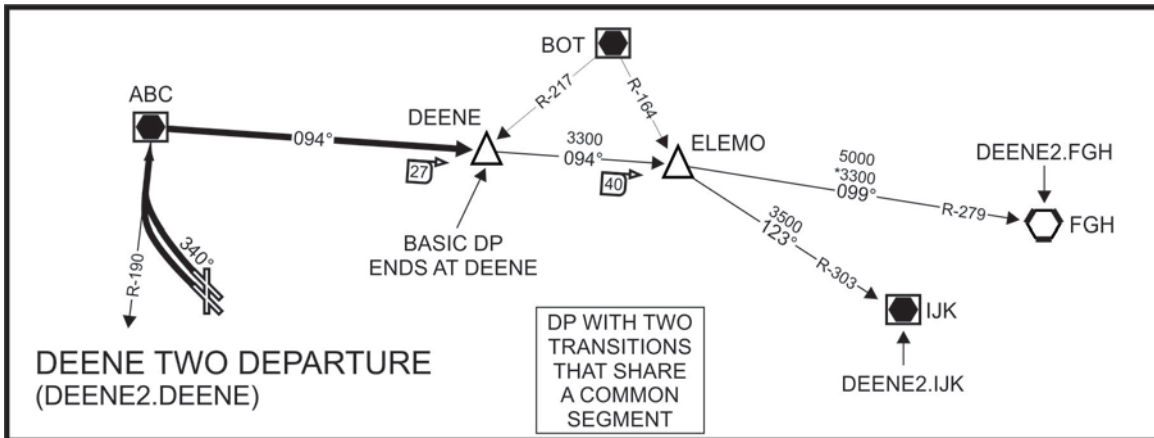

**EXAMPLES (Continued):**

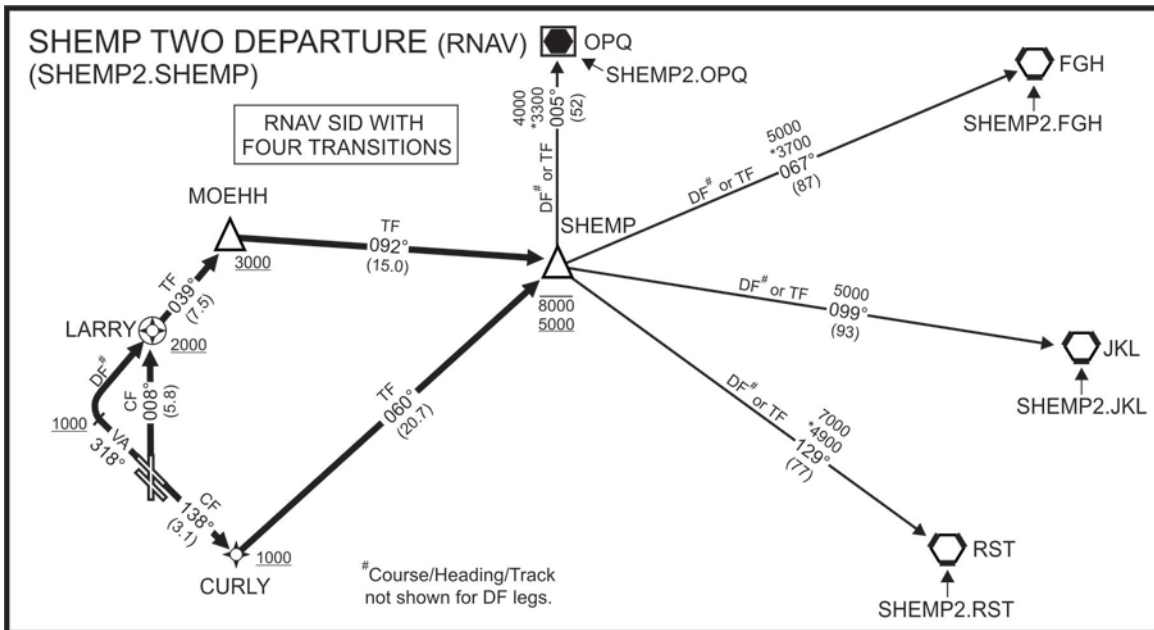
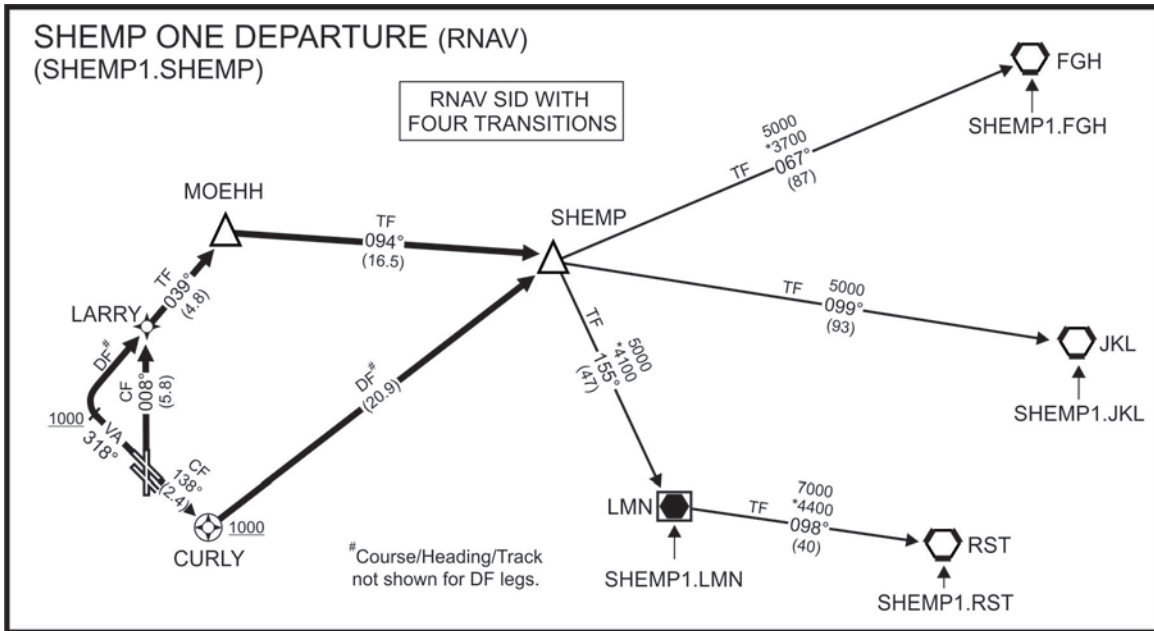

EXAMPLES (Continued):

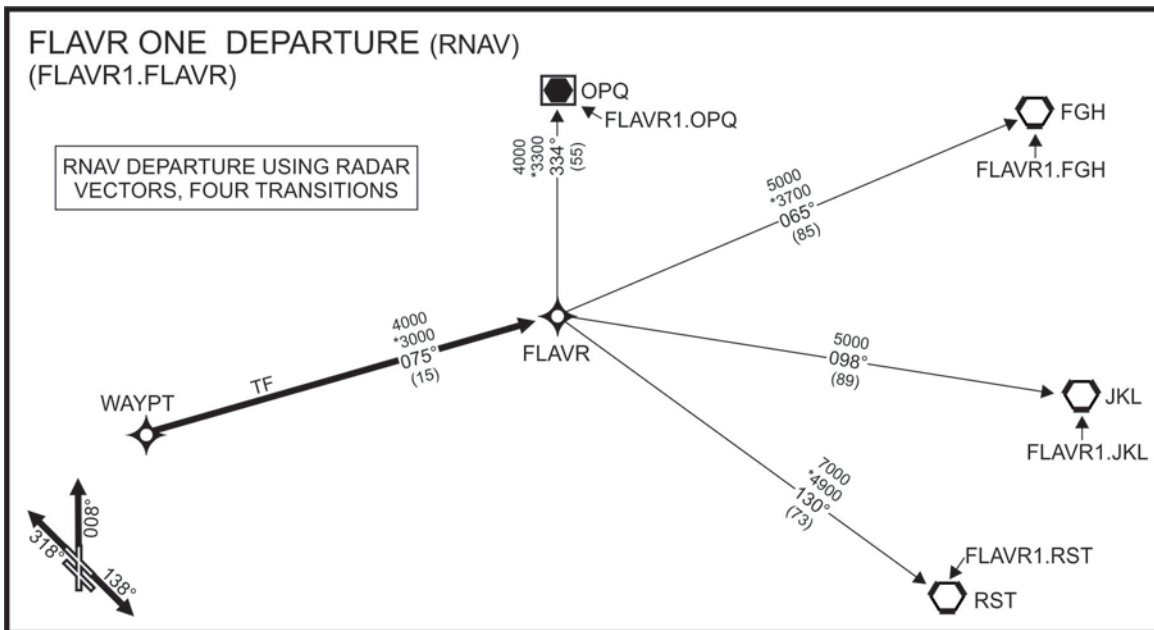
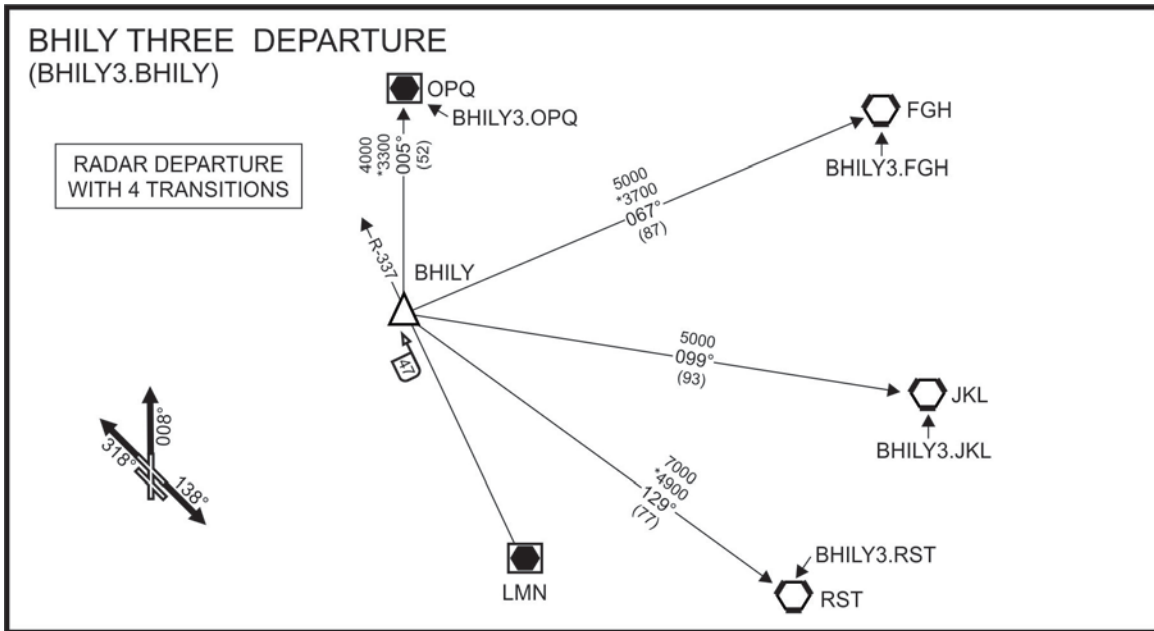

THIS PAGE IS INTENTIONALLY LEFT BLANK

## Appendix A. Administrative Information

**1. Distribution.** This order is distributed electronically only.

**2. Background.** The original order combined into a single product, textual instrument flight rule (IFR) departure procedures that were developed by the AeroNav Products under the guidance of the Flight Standards Service (AFS), and graphic standard instrument departures (SIDs) that were designed and produced under the direction of the Air Traffic Organization (ATO) into a single product. This combined product introduced the new acronym, Departure Procedures (DP), to the pilot/controller community and the aforementioned terms of “IFR departure procedure,” and “SID” were eliminated. The original order also provided for the graphic publication of IFR departure procedures (DP) to facilitate pilot understanding of the procedure as well as all area navigation (RNAV) and required navigation performance (RNP) DPs, both those developed solely for obstruction clearance and those developed for system enhancement. Elimination of the term “SID” created undue confusion in both the domestic and international aviation communities. Therefore, in the interest of international harmonization, the FAA reintroduced the term “SID” in Order 8260.46B while also using the term “Obstacle Departure Procedures (ODPs)” to describe certain procedures. This order defines two separate types of DPs: SIDs and ODPs and provides policy guidance for the development and documentation of each.

**3. Definitions.** As used in this order shall or must mean compliance is mandatory. All references to related Orders and Publications apply to the latest edition. A glossary of additional terms, abbreviations, and acronyms used in this order:

**a. Approach End of Runway (AER).** The first portion of the runway available for landing. If the runway threshold is displaced, use the displaced threshold Lat/Long as the AER.

**b. Area Navigation (RNAV).** A system of enhanced navigational capability that can compute aircraft position, actual track and ground speed, and then provide meaningful information relative to the route of flight selected by the pilot.

**c. Climb Gradient (CG).** A climb requirement expressed in feet per NM (gradient greater than 200 ft/NM).

**d. Controller Chart.** An aeronautical chart developed for internal air traffic controller reference in specific ATC facilities. These charts may also be used to design instrument procedures to support ATC operations.

**e. Departure End of Runway (DER).** The end of the runway that is opposite the landing threshold. It is sometimes referred to as the stop end of the runway.

**f. Departure Procedure (DP).** A preplanned IFR departure procedure published for pilot use, in graphic or textual format, that provides obstruction clearance from the terminal area to the en route structure. There are two types of DPs - Obstacle Departure Procedures (ODP) printed either textually or graphically, and Standard Instrument Departure (SID), which is always printed graphically.

**g. Diverse Vector Area (DVA).** An area in a radar environment established at the request of Air Traffic, and jointly developed with the FPT, that meets TERPS criteria for diverse departures, obstacles and terrain avoidance in which random radar vectors below the MVA/MIA may be issued to departing aircraft.

**h. Electronic Transmission.** Transmittal via electronic mail (e-mail) or facsimile (fax).

**i. Fix.** A generic term used to define a predetermined geographical position used for route definition. A fix may be a ground-based NAVAID, a waypoint, or defined by reference to one or more radio NAVAIDs.

**j. Flight Procedures Team (FPT).** An element of Mission Support Services, geographically located in each Air Traffic Service Area.

**k. Fly-By Waypoint.** A fly-by waypoint requires the use of turn anticipation to avoid overshoot of the next flight segment.

**l. Fly-Over Waypoint.** A fly-over waypoint precludes any turn until the waypoint is overflown and is followed either by an intercept maneuver of the next flight segment or direct flight to the next waypoint.

**m. Initial Climb Area (ICA).** An area beginning at the departure end of runway (DER) to provide unrestricted climb to at least 400 feet above DER elevation.

**n. Initial Departure Fix (IDF).** The first published fix/waypoint used for the departure. The IDF denotes the beginning of the RNAV portion of the SID.

**Note:** “IF” is used for coding (per ARINC 424) of the IDF. “IF” or “IDF” will not be placed on a departure chart in order to prevent confusion. The “IF” acronym is also used in conjunction with the intermediate fix of an instrument approach procedure.

**o. Lead Carrier.** An air carrier or operator that has agreed to serve as the focal point for the development of DPs at a specific airport. The lead carrier agrees to help develop the DP and conducts initial flyability evaluations by all RNAV-equipped aircraft expected to use the DP.

**p. Least Onerous Method.** The use of obstacle DP criteria standards to clear terrain or other obstacles that will result in the lowest possible climb gradient for that runway.

**q. National Flight Data Center (NFDC).** The FAA office responsible for the collection, validation, and dissemination of all aeronautical information relating to the NAS.

**r. National Flight Data Digest (NFDD).** A daily publication, prepared by the NFDC to promulgate non-regulatory changes to the NAS.

**s. Navigational Aid (NAVAID).** See Aeronautical Information Manual (AIM). Any visual or electronics device airborne or on the surface which provides point-to-point guidance information or position data to aircraft in flight.



**t. Non-RNAV DP.** A DP whose ground track is based on ground-based NAVAIDs and/or dead reckoning navigation.

**u. Obstacle Clearance Surface (OCS).** An inclined surface associated with a defined area for obstruction evaluation.

**v. Obstacle Departure Procedure (ODP).** A preplanned IFR departure procedure printed for pilot use in textual or graphic form to provide obstruction clearance via the least onerous route from the terminal area to the appropriate en route structure. ODPs provide obstruction clearance and may be flown without ATC clearance unless an alternate departure procedure (SID or radar vector) has been specifically assigned by ATC.

**w. Proponent.** The originator of a DP requirement. This may include an individual user group, ATC, AeroNav Services, or other appropriate government agency.

**x. Radar SID.** A SID established when ATC has a need to vector aircraft on departure to a particular ATS Route, NAVAID, or fix.

**y. Regional Airspace and Procedures Team (RAPT).** A team established for the purpose of coordinating and processing requests for new or modified flight procedures and related airspace matters (see Order 8260.43).

**z. RNAV DP.** A DP developed for RNAV-equipped aircraft whose ground track is based on satellite or distance measuring equipment (DME)/DME navigation systems.

**aa. Required Navigation Performance (RNP).** A statement of the navigational performance accuracy necessary for operation within defined airspace. See the AIM for current definition.

**bb. Runway Heading.** The magnetic direction that corresponds with the runway centerline extended, not the painted runway numbers on the runway. Pilots cleared to “fly or maintain runway heading” are expected to fly or maintain the published heading that corresponds with the extended centerline of the departure runway (until otherwise instructed by ATC), and are not to apply drift correction; e.g., RWY 4, actual magnetic heading of the runway centerline 044.22 degrees, fly 044 degrees.

**cc. Service Providers.** Any organization, company, or person who develops Instrument Procedures.

**dd. SID Transition.** A published segment used to connect the SID to one or several en route airways/jet routes.

**ee. Significant Benefits.** Tangible or intangible advantages resulting from the implementation of a DP such as fuel savings from reduced flight tracks and time, reduced inter-/intra-facility coordination, reduced communications between ATC and pilots, increased flexibility of airspace management and sectorization due to more predictable ground tracks, or other similar benefits to users or providers.

**ff. Standard Instrument Departure (SID).** A preplanned IFR ATC departure procedure printed in graphic form for pilot/controller use to provide obstacle clearance and a transition from the terminal area to the appropriate en route structure. SIDs are primarily designed for system enhancement to expedite traffic flow and to reduce pilot/controller workload. ATC clearance must be received prior to flying a SID.

**gg. Terminal Area Route Generation Evaluation and Traffic Simulation (TARGETS).** An air traffic tool for RNAV DP design.

**hh. Transmittal Letter (TL).** A biweekly publication, prepared by the NFDC, used as the medium to promulgate instrument approach procedures and textual ODPs and their effective dates for publication.

**ii. Visual Climb Over Airport (VCOA).** A departure option for an IFR aircraft, operating in visual meteorological conditions equal to or greater than the specified visibility and ceiling, to visually conduct climbing turns over the airport to the published “climb-to” altitude from which to proceed with the instrument portion of the departure. VCOA procedures are developed to avoid obstacles greater than 3 statute miles (SM) from the departure end of the runway as an alternative to complying with climb gradients greater than 200 ft/NM. These procedures are published in the ‘Takeoff Minimums and (Obstacle) Departure Procedures’ section of the Terminal Procedures Publications or as an option on a Graphic ODP.

**jj. Waypoint (WP).** A predetermined geographical position used for route definition and/or progress reporting purposes defined by latitude/longitude and may include elevation.

#### **4. Related Publications.**

##### **a. FAA Orders and Advisory Circulars.**

- (1) Advisory Circular 90-100, United States Terminal and En route Area Navigation (RNAV) Operations.
- (2) Advisory Circular 90-105, Approval Guidance for RNP Operations and Barometric Vertical Navigation in the U.S. National Airspace System.
- (3) Order 1100.161, Air Traffic Safety Oversight.
- (4) Order 7100.9, Standard Terminal Arrival Program and Procedures.
- (5) Order 7210.3, Facility Operation and Administration.
- (6) Order 7400.2, Procedures for Handling Airspace Matters.
- (7) Order JO 7470.1, DME/DME Infrastructure Evaluation for Area Navigation (RNAV) Routes and Procedures.
- (8) Order 8260.3, United States Standard for Terminal Instrument Procedures.

- (9) Order 8260.19, Flight Procedures and Airspace.
- (10) Order 8260.26, Establishing and Scheduling Standard Instrument Procedure Effective Dates.
- (11) Order 8260.42, United States Standard for Helicopter Area Navigation.
- (12) Order 8260.43, Flight Procedures Management Program.
- (13) Order 8260.53, Standard Instrument Departures that Use Radar Vectors to Join RNAV Routes.
- (14) Order 8260.58, United States Standard for Performance Based Navigation (PBN) Instrument Procedure Design.

**b. Other Documents.**

- (1) ARINC Specification 424, Navigation System Data Base.
- (2) IACC No. 4, Interagency Air Cartographic Committee Chart Specification for Low Altitude Instrument Approach Procedures.
- (3) IACC No. 7, Interagency Air Cartographic Committee Chart Specification for Standard Instrument Departure Charts.
- (4) IACC No. 17, Interagency Air Cartographic Committee Chart Specification for Terminal Procedures Publications.
- (5) RTCA DO-187, Minimum Operational Performance Standards for Airborne Area Navigation Equipment Using Multi-Sensor Inputs.

**5. Forms and Reports.** Appendices B, C, D, E, F, and G contain requirements data, applicable forms, and associated instructions.

**6. Information Update.** For your convenience, FAA Form 1320-19, Directive Feedback Information, is included at the end of this order to note any deficiencies found, clarifications needed, or suggested improvements regarding the contents of this order. When forwarding your comments to the originating office for consideration, please provide a complete explanation of why the suggested change is necessary.

THIS PAGE IS INTENTIONALLY LEFT BLANK

## Appendix B. Instructions for Completing Graphic Departure Procedure (DP) Requirements Worksheet

Instructions for completing the graphic departure procedure requirements worksheet by other than AeroNav Products personnel.

**Note:** Proponents with the capability may use electronically generated 8260-15 series forms (with graphic depiction included) instead of the Graphic DP Requirements Worksheet.

This worksheet may be used to process changes to existing DPs. In such cases, only complete those Lines needed to convey the request/recommendation.

- 1. Line 1.** Airport(s). Enter the name(s) of the airport(s) and the ICAO identifier(s) of each.
- 2. Line 2.** City and State. Self-explanatory.
- 3. Line 3.** DP Name and Computer Codes. Enter the proposed name of the DP and computer code. Use the naming and computer code conventions as outlined in chapter 3. Coordinate the proposed name(s) and code(s) with the servicing ARTCC to ensure there are no duplications.
- 4. Line 4.** Action Required. Indicate whether a new procedure is being established or modifying an existing DP.
- 5. Line 5.** Communications. Indicate the communications functions to be charted; e.g., ATIS, AWOS/ASOS, CTAF, CLNC DEL, DEP CON, etc. List specific frequency(ies) only when multiple frequencies are available at a facility and there may be confusion as to which should be assigned to the procedure, or if the frequency(ies) are unique to the procedure. Coordinate with ATC as necessary.
- 6. Line 6.** Route.
  - a. Line 6.1.** Runway(s)/Helipads/Vertiports. Indicate the runway number(s) or helipads/vertiports the DP will serve.
  - b. Line 6.2.** Initial Route from Runway. Indicate the desired initial route(s) that is required. If known, specify the single heading/course, or range of headings for each runway authorized for the SID.
  - c. Line 6.3.** ATC Requested Routing/Operational Parameters. Enter any information that would assist the procedure developer by providing flexibility in ground tracks. For example, if ATC needs the departure track to go generally south and join a route at a specified point and the exact ground track is not important, so state. Conversely, if there is flexibility to the east but there is an operational constraint to the west, that information must be provided. In extraordinary cases, when exact ground track is the primary concern in RNAV DPs, specify desired routing. ATC should specify the routing based on ATC needs.
  - d. Line 6.4.** Fix(es). Enter each fix in the order flown. For the Departure IF, either indicate a specific point or at least describe the factors constraining the placement of the fix. Enter

coordinates to the nearest 0.01 arc second when known. The TARGETS distribution package will satisfy this requirement. If used, enter the statement "See attached (DP name) TARGETS distribution package dated (date)."

**Note:** If an existing fix/NAVAID is used, enter only the fix name/facility type and ID, and any altitude restriction at the fix.

**e. Line 6.5.** ATC Required Altitudes. Enter any altitude restrictions associated with each fix.

**7. Line 7.** Transitions. [NA for Obstacle Departure Procedures (ODPs)]

**a. Line 7.1.** Identification. Enter the proposed name and computer code of each transition (see Block 3).

**b. Line 7.2.** Transition Fix(es). See Block 6.4.

**c. Line 7.3.** ATC Required Altitudes. See Block 6.5.

**d. Line 7.4.** ATC Operational Parameters. See Block 6.3.

**8. Line 8.** Lost Communications. List specific lost communications instructions if other than 14 CFR Part 91.185 (standard).

**9. Line 9.** Graphic Depiction. Provide a basic sketch of the procedure. The sketch may be hand drawn, computer generated, or overlaid on the appropriate portion of a controller chart. It is not necessary for the sketch to be to an exact scale. The intent here is to provide the procedure developer with a visual correlation of the textual route description.

**10. Line 10.** Requested Publication Date or Airspace Docket Number. Enter the desired effective date that coincides with the charting cycle. If the DP effective date is to be concurrent with an airspace action, enter the docket number, which may be obtained from the applicable ATO Service Area. See Order 8260.26, appendix A for chart dates and lead-time for submission.

**11. Line 11.** Remarks.

**a. Indicate that the environmental review** under Order 1050.1 (latest edition) and the noise screening have been accomplished.

**Note:** Notice 7210.360, Noise Screening Criteria for Certain Air Traffic Actions Above 3000 Feet, has expired; however, the noise screening is still required. The requirement will be re-established in a proposed Air Traffic environment order.

**b. Enter appropriate information to clarify** a data entry; e.g., airspeed restriction for air traffic, maximum altitude for aircraft performance, etc.

**c. If the proposed DP does not meet the criteria** requirements in chapter 2, paragraph 2-1-1, a statement of justification is necessary to explain why a DP is required. Avoid publication of unnecessary DPs.

**12. Line 12.** Point of Contact (POC). Self-explanatory.

THIS PAGE INTENTIONALLY LEFT BLANK



**Graphic Departure Procedure (DP)  
Requirements Worksheet**

1. **Airport(s)** \_\_\_\_\_

2. **City and State** \_\_\_\_\_

3. **DP Name** \_\_\_\_\_ **Computer Code** \_\_\_\_\_

4. **Action Required: Establish** \_\_\_\_\_ **Amend** \_\_\_\_\_

5. **Communications:** Enter an X in the space provided next to the communications function listed. Enter specific frequency(ies) only when multiple frequencies are available at a facility and there may be confusion as to which should be assigned to the procedure, or if the frequency is unique to the procedure.

**ATIS** \_\_\_\_\_ **AWOS/ASOS** \_\_\_\_\_ **CLEARANCE DELIVERY** \_\_\_\_\_ **GROUND** \_\_\_\_\_

**TOWER** \_\_\_\_\_ **CTAF** \_\_\_\_\_ **DEPARTURE CONTROL** \_\_\_\_\_ **ARTCC** \_\_\_\_\_

6. **Route:**

6.1. **Runway(s)** \_\_\_\_\_ **Helipads/Vertiports** \_\_\_\_\_

6.2. **Initial Route From Runway** \_\_\_\_\_

6.3. **ATC Requested Routing/Operational Parameters** \_\_\_\_\_

6.4. **Fix(es):**

**NAME** \_\_\_\_\_ **NAVAID** \_\_\_\_\_ **LAT/LONG** \_\_\_\_\_ **ALT** \_\_\_\_\_

**NAME** \_\_\_\_\_ **NAVAID** \_\_\_\_\_ **LAT/LONG** \_\_\_\_\_ **ALT** \_\_\_\_\_

**NAME** \_\_\_\_\_ **NAVAID** \_\_\_\_\_ **LAT/LONG** \_\_\_\_\_ **ALT** \_\_\_\_\_

**NAME** \_\_\_\_\_ **NAVAID** \_\_\_\_\_ **LAT/LONG** \_\_\_\_\_ **ALT** \_\_\_\_\_

**NAME** \_\_\_\_\_ **NAVAID** \_\_\_\_\_ **LAT/LONG** \_\_\_\_\_ **ALT** \_\_\_\_\_

**NAME** \_\_\_\_\_ **NAVAID** \_\_\_\_\_ **LAT/LONG** \_\_\_\_\_ **ALT** \_\_\_\_\_

**NAME** \_\_\_\_\_ **NAVAID** \_\_\_\_\_ **LAT/LONG** \_\_\_\_\_ **ALT** \_\_\_\_\_

6.5. **ATC Required Altitudes:** \_\_\_\_\_

**Graphic Departure Procedure (DP)  
Requirements Worksheet (Continued)**

**7. Transitions:** [Not allowed for graphic Obstacle Departure Procedures (ODPs)]

**7.1 Identification:**

NAME \_\_\_\_\_ COMPUTER CODE \_\_\_\_\_

NAME \_\_\_\_\_ COMPUTER CODE \_\_\_\_\_

NAME \_\_\_\_\_ COMPUTER CODE \_\_\_\_\_

NAME \_\_\_\_\_ COMPUTER CODE \_\_\_\_\_

NAME \_\_\_\_\_ COMPUTER CODE \_\_\_\_\_

**7.2 Transition Fix(es):**

**Note:** If fix/NAVAID is currently published on an en route chart, enter only the fix name and/or facility ID, and required altitude.

NAME \_\_\_\_\_ NAV AID \_\_\_\_\_ LAT/LONG \_\_\_\_\_ ALT \_\_\_\_\_

NAME \_\_\_\_\_ NAV AID \_\_\_\_\_ LAT/LONG \_\_\_\_\_ ALT \_\_\_\_\_

NAME \_\_\_\_\_ NAV AID \_\_\_\_\_ LAT/LONG \_\_\_\_\_ ALT \_\_\_\_\_

NAME \_\_\_\_\_ NAV AID \_\_\_\_\_ LAT/LONG \_\_\_\_\_ ALT \_\_\_\_\_

NAME \_\_\_\_\_ NAV AID \_\_\_\_\_ LAT/LONG \_\_\_\_\_ ALT \_\_\_\_\_

NAME \_\_\_\_\_ NAV AID \_\_\_\_\_ LAT/LONG \_\_\_\_\_ ALT \_\_\_\_\_

NAME \_\_\_\_\_ NAV AID \_\_\_\_\_ LAT/LONG \_\_\_\_\_ ALT \_\_\_\_\_

**7.3. ATC Required Altitudes:** \_\_\_\_\_

**7.4. ATC Operational Parameters:** \_\_\_\_\_

**8. Lost Communications:** \_\_\_\_\_

**Graphic Departure Procedure (DP)  
Requirements Worksheet (Continued)**

**9. Graphic Depiction:**

**Note:** Depiction must clearly portray intended routing, fixes, NAVAIDs, and altitudes to be used in the DP. A separate sheet may be used.

**10. Request Publication Date or Airspace Docket Number**

**11. Remarks:**

**12. Point-of-Contact:**

**ATC Facility Name.**

**POC's Name.**

**Telephone Number.**

**Fax Number.**

**E-Mail Address.**

THIS PAGE INTENTIONALLY LEFT BLANK

**Appendix C. Instructions for Completing FAA Form 8260-2, Data Worksheet**

Instructions for completing 8260-2, Data Worksheet, (see figure C-1) for requesting modification of fixes (including “Fix Use” updates) and/or holding patterns associated with existing 14 CFR Part 95 routes, 14 CFR Part 97 approaches, Special instrument procedures, SID or STARs.

Complete this worksheet with as much information as possible and explain the addition or deletion in Block 10, Remarks. Submit this worksheet to the Office of Primary Responsibility (OPR) identified on the Form 8260-2 for proper action to be taken. For those fixes/holding patterns documented on older versions of Form 8260-2 that do not contain an OPR listed, contact the National Flight Data Center (NFDC), for a determination on where to submit this request.

**Block 1. Requested Publication Date.** Enter the desired effective date that coincides with the charting cycle (see Order 8260.26, appendix A). If the Form 8260-2 request is to be in conjunction with an airspace action, obtain the docket number from the Western, Central, or Eastern Service Area for En Route Operations, Airspace Group. For Form 8260-2 requests, allow at least 20 weeks lead-time from the desired effective date.

**Block 2. Fix Name.** Enter the 5-character pronounceable name obtained from ARTCC. Do not include “WP” as part of the name. If requesting holding at a navigational aid, enter the name and type of navigational aid.

**Block 3. Fix Type.** List the type(s) of fix, e.g., RADAR, WP, DME, INT (made up of crossing radials, bearings, or combinations of both).

**Block 4. STATE.** Enter the state in which the fix is located.

**Block 5. ICAO Region Code.** Enter the ICAO Region code in which the fix is located.

**Block 6. Location.** Latitude and longitude accurate to the hundredth of a second; e.g., 09.25 sec. List all navigational aids used for the fix makeup. Provide radials or bearings, DME, and distance values to the hundredth value; e.g., 347.23°; 08.37NM.

**Block 7. Type of Action Required.** Check applicable box to establish, modify, or cancel the fix. If there is no change to the fix, check “no change.”

**Block 8. Holding.** Describe holding patterns required at fix. When climb-in-holding is required, provide detailed holding instructions including maximum altitude and maximum speed (if other than standard).

**Block 9. Charting.** Indicate required charting; i.e., terminal, SIDs, STARs, or en route charts.

**Block 10. Remarks.** List all procedures which use the fix and other uses of the fix; e.g., reporting points, etc. Include any other information that may assist in developing the fix. Justify the requirement for other than routine processing and charting.

**13. Block 11. Point-of-Contact (POC).** Self explanatory.



**Appendix D.****Section 1. Instructions for Completing  
FAA Form 8260-15A, Takeoff Minimums and  
Obstacle Departure Procedures (ODP) and Sample Forms**

- 1. Develop a separate Form 8260-15A for each airport with approved instrument procedures.** If all runways are standard (e.g., no ODP required), then state “Standard.” The form must encompass all runways for that airport. Use table 2-1-1 as a guide to initiate the required “Action” to support the “Situation” for a specific airport.
- 2. City and State.** Complete this section with the same location data as on the associated approach procedure(s).
- 3. Airport.** Complete this section with the same airport name data as on the associated approach procedure(s).
- 4. Effective Date.** Leave blank. The National Flight Data Center (NFDC) will normally add the effective date. Enter an effective date only when a specific effective date is required; e.g., Magnetic Variation (MagVar) rotation. If the procedure is a “Special,” the Regional Flight Standards Division, NextGen Branch (RNGB), will enter the effective date.
- 5. AMDT No.** Enter standard entry as on Standard Instrument Approach Procedures (SIAP).
- 6. Takeoff Minimums.** Enter takeoff minimums as directed below; however, do not list Takeoff Minimums for the runway(s) served by a graphic ODP - see appendix D, paragraph 7a(6).
  - a. List the runway(s) that are not authorized** for IFR departures. If none of the actions listed in table 2-1-1 are feasible, or if another reason(s) precludes ODP development (noise abatement, environmental, etc.), an IFR departure must not be authorized.

**Examples:**

RWY 27: NA - Obstacles.  
 RWY 35: NA - Environmental.  
 RWY 17: NA - Obstacles and noise abatement.

Followed by:

- b. List the runway(s) authorized standard takeoff minimums.**

**Example:**

RWY 9, 31: Standard.

Followed by:

**c. List the runway(s) that have any deviations** from standard minimums and/or restrictions.

**Example:**

TAKEOFF MINIMUMS: RWY 13, 400-2 or standard with minimum climb of 310 ft per NM to 900, or alternatively, with standard takeoff minimums and a normal 200 ft/NM climb gradient, takeoff must occur no later than 1800 feet prior to DER.

(1) When obstacles in the initial climb area (ICA) cause a climb gradient to an altitude 200 feet or less above DER, before rounding, do not publish takeoff minimums or a climb gradient. Instead, identify the obstacle data by note for publication in the “Takeoff Obstacle Notes” section.

(2) When obstacles 3 SM or less from DER preclude standard takeoff minimums:

**Note:** The obstacle may be within the ICA or ICA extended to 3 SM.

(a) Provide a Note identifying the obstacle(s) in the “Takeoff Obstacle Notes” section.

(b) Provide higher than standard takeoff minimums followed by the alternative of standard minimums with a specified climb gradient.

(c) Identify the obstacle(s) on which the published ceiling and visibility is based in the Controlling Obstacles section.

(3) When obstacles beyond 3 SM of DER preclude standard takeoff minimums:

(a) Provide standard takeoff minimums with minimum climb gradient requirements.

(b) Provide higher than standard takeoff minimums to allow a visual climb over the airport (VCOA). Use standard Note in the following format: RWY XX, (CIG/VSBY) for VCOA.

**Example:**

TAKEOFF MINIMUMS: RWY 9, Standard with minimum climb of 310 ft per NM to 1400 or alternatively, with standard takeoff minimums and a normal 200 ft per NM climb gradient, takeoff must occur no later than 1800 feet prior to DER or 1100-2½ for VCOA.

**7. TEXTUAL Departure Procedure.**

**a. When a specific departure route is necessary,** provide the complete text, by runway, for required DPs.



(1) When a climb to an altitude is necessary before turning, define the limitation as clear and simple as possible when limiting the initiation of a turn; e.g., “RWY 36: CLIMB HEADING 350.11 TO 2800 BEFORE TURNING LEFT.”

**Note:** Procedure designers must consider the impact on local ATC operations when using such phrases as “before turning” or “before proceeding on course”; therefore, coordinate these actions with ATC to ensure compatibility with the local operating environment.

(2) When a DP routing is required and VOR or TACAN is used to define the route, use the format: RWY 9: CLIMBING LEFT TURN TO INTERCEPT ABC VORTAC R-310 TO 6000 BEFORE PROCEEDING ON COURSE.

(3) When a DP routing is required and NDB is used to define the route, use course to or bearing from the NDB; e.g., RWY 35: CLIMB HEADING 350..., THEN CLIMBING RIGHT TURN TO INTERCEPT BEARING 020 FROM ABC NDB TO 6000 BEFORE PROCEEDING ON COURSE; or RWY 35: CLIMB HEADING 030..., THEN ON COURSE 015 TO ABC NDB TO 4000 BEFORE PROCEEDING ON COURSE.

(4) When a ODP routing permits a climb within a sector, define the courses to remain within in a clockwise fashion; e.g., “RWY 12: CLIMB ON A HEADING BETWEEN 061 CW TO 228 FROM DEPARTURE END OF RUNWAY, OR MINIMUM CLIMB OF 260 FEET PER NM TO 8700 FOR HEADINGS 229 THROUGH 300.”

(5) When a DP routing is required and a localizer course is used to define the route, use magnetic direction of localizer course to be flown; e.g., “RWY 5: CLIMB ON I-XXX LOCALIZER NE COURSE TO 3000 BEFORE TURNING.”

(6) When the departure instructions must be graphically depicted, inform the pilot of the name of the default Obstacle DP, and submit an accompanying Form 8260-15B; e.g., Use standard Note: “USE JONES DEPARTURE” when the graphic obstacle DP serves all runways or use “RWY 27: USE SMITH DEPARTURE” when the graphic obstacle DP serves only a specific runway.

**b. It is not appropriate to use the wording** “Comply with ODP or....” This could be confusing and cause the pilot to use a different routing than was expected by ATC.

**c. Do not use the phrase** “...or comply with ATC instructions.” The pilot is aware that ATC instructions are to be complied with, when possible, and safety of flight is not compromised.

**d. Specify a single obstacle DP.** Do not provide an option to use a SID as the default ODP. For example, do not use “Climb runway heading to 1200 before turning or use Manchester Departure.”

## **8. Visual Climb Over Airport.**

**a. When a VCOA has been established,** include instructions to climb in visual conditions to cross a specified airport, NAVAID, or fix at or above a specified altitude before proceeding on course.

**b. The statement** “Obtain ATC approval for VCOA when requesting IFR clearance” must be included at the beginning of the VCOA instructions.

**Examples:**

RWY 19: OBTAIN ATC APPROVAL FOR VCOA WHEN REQUESTING IFR CLEARANCE. Climb in Visual Conditions TO CROSS Hickory Regional Airport at or above 1200 before proceeding on course.

ALL RUNWAYS : OBTAIN ATC APPROVAL FOR VCOA WHEN REQUESTING IFR CLEARANCE. Climb in Visual Conditions TO Cross XYZ VOR southeast bound at or above 4200, then proceed on XYZ R-150 to HAMET.

**9. Takeoff Obstacle Notes.**

**a. Enter a Note regarding obstacles found** as a result of applying table 2-1-1, Situation 2 action, and Situation 3, action “A.” See appendix D. Do not list Takeoff Obstacle Notes for the runway(s) served by a graphic default Obstacle DP as described in appendix D.

**Note:** Do not identify/publish an adverse assumption obstacle (AAO) as a “takeoff obstacle” because pilots are not familiar with the AAO concept. However, publishing a ceiling and visibility will allow for those situations where the CG cannot be achieved and still afford the pilot the opportunity to visually acquire and avoid any obstruction that could have been built without notice to the FAA.

**b. The note must include the runway affected** and inform the pilot of the obstacle(s) type and location relative to the DER and height [AGL/elevation (MSL)]. When there are obstacles on both sides of the runway centerline extended, note the most significant obstacles left and right of the runway centerline. Phrases such as “multiple antennas, numerous trees, etc.” are acceptable. Also, when identifying these obstacles, be as descriptive as reasonably possible so as to provide the pilot a clear understanding of what to prepare and/or look for; e.g., instead of just saying “power poles,” it would be more helpful to use the descriptor of “power lines” in some instances. Another example would be instead of just saying “terrain,” if applicable; use of “ridgeline” or “bluff” would provide a clearer picture. Specify distances 1 NM or greater to the nearest whole and tenth of a NM (e.g., 2.1 NM FROM DER). Specify distances less than 1 NM in feet (e.g., 1280 FEET FROM DER).

**Examples:**

**Note:** RWY 35: Trees 1280 feet from DER, 120 feet left of centerline, 50 feet AGL/ 1527 feet MSL.

**Note:** RWY 35: Building 2.1 NM from DER, 160 feet left of centerline, 350 feet AGL/1927 feet MSL.

**Note:** RWY 17: Multiple buildings 500 feet from DER, 350 feet right of centerline, 50 feet AGL/1107 feet MSL. Antenna 6000 feet from DER, 1235 feet left of centerline, 200 feet AGL/1257 feet MSL.

**Note:** RWY 27: Multiple trees and antennas beginning 500 feet from DER, 350 feet right of centerline, up to 110 feet AGL/1307 feet MSL.

**c. Charting agents.** Charting agents must publish these obstacle notes.

## 10. Controlling Obstacles.

**a. Document the controlling obstacle(s)** found as a result of applying table 2-1-1, Situation 3 and/or Situation 4. See appendix D, paragraph 6c(2). When there is more than one controlling obstacle to be documented, following the coordinates, include what entity it applies too; i.e., “(Ceiling),” “(Visibility),” “(Climb Gradient),” or “(Climb-To Altitude).” Do not list Controlling Obstacles for the runway(s) served by a graphic default ODP as described in appendix D.

**Note:** For all DPs, the controlling obstacle is that obstacle which, having penetrated the 40:1 Obstacle Clearance Surface (OCS) causes the most adverse climb gradient, climb-to altitude, and/or ceiling and visibility to be published.

**b. Use the following format to list the runway affected,** elevation, and type of obstacle, the coordinates to the nearest 0.01 second; e.g., “RWY 32: 2049 FEET MSL ANTENNA 341548.01N/ 0862101.05W” or “RWY 32: 2049 FEET MSL ANTENNA 341548.01N/ 0862101.05W.”

**c. Document the obstacle(s) that mandated development** of a specific textual ODP route. These obstacles are not considered the “controlling obstacles” because they are not a factor to the specified route being flown. Do not chart this information on the procedure. Document these obstacles as follows:

“OBSTACLES MANDATING ODP ROUTE DEVELOPMENT: RWY 36: 2049 FEET MSL Antenna 341658.01N/ 0863108.05W.”

**11. Remarks.** List information/data that is not normally charted; e.g., administrative data or notes for controller information (requested by ATC). However, if something does need to be charted, precede the text with the “Chart Note:” annotation. See Order 8260.19, for a chart note that is required if the ODP is a Special. General chart notes (not Takeoff Minimums or Departure Instructions Notes) need to include instructions to the chart organization to place the note at the bottom of the entry. Use the following format: “Chart Note at bottom of entry...” Document as the first entry, “Special Use Procedure,” if the ODP is at a private airport and *will not* be published under Title 14 CFR Part 97.

**12. Flight Inspected By.** Enter the name of the pilot who conducted the flight inspection/validation, and the date.

**13. Developed By.** Enter the name of the FAA procedure specialist and organizational routing code. If developed under an Other Transactional Authority, enter the procedure developer's name and organization.

**14. Approved By.** Enter the name of AeroNav Products Manager, or his/her delegated representative. For procedures developed under an Other Transactional Authority, enter the name of the organization's manager or his/her delegated representative. This individual must sign in the "approved by" space, and enter the date signed. If the procedure is a "Special," this line will contain the name of and be signed by the manager, AFS-400.

**15. Coordinated With.** Specify the offices/organizations the procedure was coordinated. DP coordination must be identical with the approach procedure coordination as outlined in Order 8260.19, Flight Procedures and Airspace, (latest edition), chapter 8.

**16. Changes.** List changes relating to data entries on page one.

**17. Reasons.** List reasons for changes relating to data entries on page one. Additionally, when a VCOA cannot be established, an explanation must be provided; e.g., "VCOA not established at ATC request due to (Reason)."

**18. Required Effective Date.**

**a. Enter the effective date as noted** in Order 8260.19 (latest edition), chapter 8. Optimally, submit as routine. En route submission cutoff dates apply to graphic DPs.

**b. If the Form 8260-15A** represents a concurrent action, enter "CONCURRENT" followed by the necessary information; e.g., Airport ID, IAP name and amendment number; airspace action, or other event.

**c. When documenting Standard Takeoff Minimums** where all runways have a clear 40:1 Obstacle Clearance Surface (i.e., No ODP or obstacle notes required), enter "N/A."

**Figure D-1.**

U.S. DEPARTMENT of TRANSPORTATION - FEDERAL AVIATION ADMINISTRATION

**TAKEOFF MINIMUMS AND OBSTACLE DEPARTURE PROCEDURES (ODP)**

Bearings, headings, courses, tracks, and radials are magnetic. Elevations and altitudes are in feet, MSL. Altitudes are minimum altitudes unless otherwise indicated. Ceilings are in feet above airport elevation. Distances are in nautical miles. Visibilities are in statute miles or feet RVR unless otherwise indicated.

City, State	Airport	Effective Date	Amdt No.
MILES CITY, MT	MILES CITY/FRANK WILEY FIELD		ORIG

**TAKEOFF MINIMUMS:**

STANDARD

**TEXTUAL DEPARTURE PROCEDURE:**

**VISUAL CLIMB OVER AIRPORT:**

**TAKEOFF OBSTACLE NOTES:**

**CONTROLLING OBSTACLES:**

**REMARKS:**

**FLIGHT INSPECTED BY:**

JON P. DOE

FIOG

03/13/2013

**REQUIRED EFFECTIVE DATE:**

N/A

**DEVELOPED BY:**

JOE DEVELOPER

AJV-352

02/18/2013

**APPROVED BY:**

JOE MANAGER

AJV-352

03/14/2013

**COORDINATED WITH:**

APA, ALPA, AOPA, NBAA, ARPT MGR, ZNY, ZDC

**CHANGES:**

**REASONS:**

THIS PAGE IS INTENTIONALLY LEFT BLANK

**Figure D-2.**

U.S. DEPARTMENT of TRANSPORTATION - FEDERAL AVIATION ADMINISTRATION

**TAKEOFF MINIMUMS AND OBSTACLE DEPARTURE PROCEDURES (ODP)**

Bearings, headings, courses, tracks, and radials are magnetic. Elevations and altitudes are in feet, MSL. Altitudes are minimum altitudes unless otherwise indicated. Ceilings are in feet above airport elevation. Distances are in nautical miles. Visibilities are in statute miles or feet RVR unless otherwise indicated.

City, State	Airport	Effective Date	Amdt No.
DANVILLE, TX	HICKORY REGIONAL		ORIG

**TAKEOFF MINIMUMS:**

RWY 1: NA - OBSTACLES  
RWY 32: STANDARD  
RWY 14: 500 - 2 1/2 OR STANDARD WITH MINIMUM CLIMB OF 330 FT PER NM TO 1200.  
RWY 19: STANDARD WITH MINIMUM CLIMB OF 214 FT PER NM TO 1100, OR ALTERNATIVELY, WITH STANDARD TAKEOFF MINIMUMS AND A NORMAL 200 FT PER NM CLIMB GRADIENT, TAKEOFF MUST OCCUR NO LATER THAN 2000 FT PRIOR TO DER OR 1000 - 2 FOR VCOA.

**TEXTUAL DEPARTURE PROCEDURE:**

RWY 32: CLIMB HEADING 317.66 TO 2200 BEFORE TURNING LEFT.

**VISUAL CLIMB OVER AIRPORT:**

RWY 19: OBTAIN ATC APPROVAL FOR VCOA WHEN REQUESTING IFR CLEARANCE. CLIMB IN VISUAL CONDITIONS TO CROSS HICKORY REGIONAL AIRPORT AT OR ABOVE 1300 BEFORE PROCEEDING ON COURSE.

**TAKEOFF OBSTACLE NOTES:**

NOTE: RWY 14, BUILDING 1.96 NM FROM DER, ON RWY CENTERLINE, 478 FT AGL/974 FT MSL.  
NOTE: RWY 32, TREES 143 FT LEFT OF DER, 21 FT AGL/498 FT MSL.

**CONTROLLING OBSTACLES:**

RWY 14: 974 FT MSL BUILDING, 324911.09N/0964838.62W  
RWY 19: 922 FT MSL TOWER, 324748.00N/0965137.00W  
RWY 32: 1049 FT MSL TOWER, 325216.19N/0965523.02W  
RWY 19 (VCOA): 974 FT MSL BUILDING, 324911.09N/0964838.62W

OBSTACLES MANDATING ROUTE DEVELOPMENT: RWY 32 – 1538 FT MSL TOWER, 325249.09N-0965639.66W

**REMARKS:**

**FLIGHT INSPECTED BY:**

JON P. DOE FIOG 02/12/2013

**REQUIRED EFFECTIVE DATE:**

CONCURRENT WITH KHCK RNAV (GPS) RWY 14, ORIG

**DEVELOPED BY:**

JOE SPECIALIST AJV-352 01/30/2013

**APPROVED BY:**

JOE MANAGER AJV-352 02/15/2013

**COORDINATED WITH:**

APA, ALPA, AOPA, NBAA, ARPT MGR, FCR ATCT, ZFW

**CHANGES:**

**REASONS:**

THIS PAGE IS INTENTIONALLY LEFT BLANK



Figure D-3.

U.S. DEPARTMENT of TRANSPORTATION - FEDERAL AVIATION ADMINISTRATION

**TAKEOFF MINIMUMS AND OBSTACLE DEPARTURE PROCEDURES (ODP)**

Bearings, headings, courses, tracks, and radials are magnetic. Elevations and altitudes are in feet, MSL. Altitudes are minimum altitudes unless otherwise indicated. Ceilings are in feet above airport elevation. Distances are in nautical miles. Visibilities are in statute miles or feet RVR unless otherwise indicated.

City, State	Airport	Effective Date	Amdt No.
LASKY, WY	LASKY REGIONAL		ORIG

**TAKEOFF MINIMUMS:**

RWY 16, 34: NA - OBSTACLES

**TEXTUAL DEPARTURE PROCEDURE:**

RWY 18, 36: USE GOODHILL DEPARTURE.

**VISUAL CLIMB OVER AIRPORT:**

**TAKEOFF OBSTACLE NOTES:**

**CONTROLLING OBSTACLES:**

**REMARKS:**

**FLIGHT INSPECTED BY:**

JON P. DOE

FIOG

03/12/2013

**REQUIRED EFFECTIVE DATE:**

Routine

**DEVELOPED BY:**

JOE DEVELOPER  
(JOHN TRAINEE)

AJV-352

02/20/2013

**APPROVED BY:**

JOE MANAGER

AJV-352

03/20/2013

**COORDINATED WITH:**

APA, ALPA, AOPA, NBAA, ARPT MGR, LSK ATCT, LSK APP CON, ZLC, ZOB

**CHANGES:**

**REASONS:**

THIS PAGE IS INTENTIONALLY LEFT BLANK

Figure D-4.

U.S. DEPARTMENT of TRANSPORTATION - FEDERAL AVIATION ADMINISTRATION

**TAKEOFF MINIMUMS AND OBSTACLE DEPARTURE PROCEDURES (ODP)**

Bearings, headings, courses, tracks, and radials are magnetic. Elevations and altitudes are in feet, MSL. Altitudes are minimum altitudes unless otherwise indicated. Ceilings are in feet above airport elevation. Distances are in nautical miles. Visibilities are in statute miles or feet RVR unless otherwise indicated.

City, State	Airport	Effective Date	Amdt No.
LASKY, WY	LASKY REGIONAL	04/18/2002	4

**TAKEOFF MINIMUMS:**

PROCEDURE CANCELLED EFFECTIVE \_\_\_\_\_.

**TEXTUAL DEPARTURE PROCEDURE:**

**VISUAL CLIMB OVER AIRPORT:**

**TAKEOFF OBSTACLE NOTES:**

**CONTROLLING OBSTACLES:**

**REMARKS:**

**FLIGHT INSPECTED BY:**

FIOG

**REQUIRED EFFECTIVE DATE:**

Routine

**DEVELOPED BY:**

JOE DEVELOPER AJV-352 02/20/2013

**APPROVED BY:**

JOE MANAGER AJV-352 02/27/2013

**COORDINATED WITH:**

APA, ALPA, AOPA, NBAA, ARPT MGR, LSK ATCT, LSK APP CON, ZLC, ZOB

**CHANGES:**

**REASONS:**

OBSTACLE DATA REVIEW - ODP NO LONGER REQUIRED

THIS PAGE IS INTENTIONALLY LEFT BLANK

## Figure D-5.

U.S. DEPARTMENT of TRANSPORTATION - FEDERAL AVIATION ADMINISTRATION

**TAKEOFF MINIMUMS AND OBSTACLE DEPARTURE PROCEDURES (ODP)**

Bearings, headings, courses, tracks, and radials are magnetic. Elevations and altitudes are in feet, MSL. Altitudes are minimum altitudes unless otherwise indicated. Ceilings are in feet above airport elevation. Distances are in nautical miles. Visibilities are in statute miles or feet RVR unless otherwise indicated.

City, State	Airport	Effective Date	Amdt No.
PITTSBURGH, PA	PITTSBURGH INTERNATIONAL		4

**TAKEOFF MINIMUMS:**

RWY 10L, 10C, 10R, 28L, 28C, 28R, 14: STANDARD.  
RWY 32: 200 - 1 1/2 OR STANDARD WITH MINIMUM CLIMB OF 240 FT PER NM TO 1500, OR ALTERNATIVELY, WITH STANDARD TAKEOFF MINIMUMS AND A NORMAL 200 FT PER NM CLIMB GRADIENT, TAKEOFF MUST OCCUR NO LATER THAN 2100 FT PRIOR TO DER.

**TEXTUAL DEPARTURE PROCEDURE:****VISUAL CLIMB OVER AIRPORT:****TAKEOFF OBSTACLE NOTES:**

NOTE: RWY 10L: TREE 1387 FT FROM DER, 733 FT LEFT OF CENTERLINE, 59 FT AGL/1233 FT MSL. ROD ON OL TOWER, 4168 FT FROM DER, 910 FT LEFT OF CENTERLINE, 112 FT AGL/1282 FT MSL. TOWER 4175 FT FROM DER, 864 FT LEFT OF CENTERLINE, 112 FT AGL/1282 FT MSL. TREE 1463 FT FROM DER, 672 FT LEFT OF CENTERLINE, 38 FT AGL/1212 FT MSL.  
NOTE: RWY 10C: MULTIPLE TREES BEGINNING 3207 FT FROM DER, 461 FT LEFT OF CENTERLINE, UP TO 29 FT AGL/1263 FT MSL.  
NOTE: RWY 10R: MULTIPLE TREES BEGINNING 1082 FT FROM DER, 102 FT RIGHT OF CENTERLINE, UP TO 66 FT AGL/1265 FT MSL. OL ON MONITOR POLE 4590 FT FROM DER, 1124 FT LEFT OF CENTERLINE, 55 FT AGL/1241 FT MSL. POLE 4610 FT FROM DER, 1138 FT LEFT OF CENTERLINE, 55 FT AGL/1241 FT MSL.  
NOTE: RWY 28L: TREE 2272 FT FROM DER, 1109 FT LEFT OF CENTERLINE, 64 FT AGL/1223 FT MSL. TREE 39 FT FROM DER, 498 FT LEFT OF CENTERLINE, 55 FT AGL/1144 FT MSL.  
NOTE: RWY 28R: TREE 1810 FT FROM DER, 912 FT RIGHT OF CENTERLINE, 34 FT AGL/1273 FT MSL. BUSH 73 FT FROM DER, 477 FT LEFT OF CENTERLINE, 12 FT AGL/1215 FT MSL. POLE 645 FT FROM DER, 663 FT LEFT OF CENTERLINE, 20 FT AGL/1223 FT MSL.  
NOTE: RWY 14: TREE 968 FT FROM DER, 516 FT RIGHT OF CENTERLINE, 44 FT AGL/1158 FT MSL.  
NOTE: RWY 32: ANT ON OL TOWER, 1.1 NM FROM DER, 435 FT LEFT OF CENTERLINE, 105 FT AGL/1354 FT MSL. TOWER 6812 FT FROM DER, 497 FT LEFT OF CENTERLINE, 96 FT AGL/1342 FT MSL. LT ON POLE 454 FT FROM DER, 515 FT RIGHT OF CENTERLINE, 25 FT AGL/1173 FT MSL. MULTIPLE TREES BEGINNING 1717 FT FROM DER, 1108 FT RIGHT OF CENTERLINE, UP TO 61 FT AGL/1321 FT MSL. TREE 6074 FT FROM DER, 1272 FT RIGHT OF CENTERLINE, 61 FT AGL/1321 FT MSL. TREE 2577 FT FROM DER, 1108 FT RIGHT OF CENTERLINE, 74 FT AGL/1233 FT MSL. TREE 2480 FT FROM DER, 1118 FT RIGHT OF CENTERLINE, 33 FT AGL/1212 FT MSL.

**CONTROLLING OBSTACLES:**

RWY 32: 1354 FT MSL TOWER 403032.06N/0801435.23W

**REMARKS:****FLIGHT INSPECTED BY:**

JOHN P. DOE FIOG 08/08/2013

**REQUIRED EFFECTIVE DATE:**

09/23/2010

**DEVELOPED BY:**

JOE DEVELOPER  
(JIM TRAINEE) AJV-352 05/02/2013

**APPROVED BY:**

JOE MANAGER AJV-352 09/25/2013

**COORDINATED WITH:**

APA ALPA, AOPA, NBAA, ARPT MGR, PIT APP CON, ZOB

**CHANGES:**

1. RWY 32 ADDED CLIMB GRADIENT AND CEILING/VISIBILITY.
2. DELETED DEPARTURE PROCEDURES.

**REASONS:**

1. NEW CONTROLLING OBSTACLE REQUIRED A CLIMB GRADIENT.
2. DIVERSE DEPARTURE AUTHORIZED.

THIS PAGE IS INTENTIONALLY LEFT BLANK

**Section 2. Instructions for Completing  
FAA Form 8260-15B, Graphic Departure Procedure (DP)  
[Non-RNAV Departure Procedures] and Sample Forms**

**1. Title Line:** The Title Line consists of the six following elements and will be filled in as noted.

**a. DP Name.** Enter name of departure procedure. For example, the CATHEDRAL SEVEN DEPARTURE is entered as CATHEDRAL.

**b. Number.** Enter departure procedure number (spelled out); e.g., EIGHT.

**c. DP Computer Code.** Enter computer identification code as coordinated with by ATC (see chapter 3).

**d. Superseded Number.** Departure procedure number (spelled out) superseded by this procedure. Enter “None” for a new procedure.

**e. Dated.** Date of superseded procedure. Format: DD MMM YY.

**f. Effective Date.** Leave blank. The effective date will normally be added by NFDC. Enter an effective date only when a specific effective date is required; e.g., MagVar rotation. If the procedure is a “Special,” the Regional Flight Standards Division, NextGen Branch (RNGB), will enter the effective date.

**2. Type:** Specify whether the procedure is a default obstacle departure procedure (see paragraph 2-1-1b) by placing “Obstacle” on this line or specify that the procedure is a “SID” when the procedure is initiated by ATC (see paragraph 2-1-1c). Additionally, if this is a Special procedure, enter “Special” following “Obstacle” or “SID.”

**Note:** Attach an up-to-date, clear graphic depiction of the procedure. DO NOT include a textual description of transitions or departure route text.

**3. DP Route Description.** Provide the initial climb out instructions for each runway and a textual description of the departure route(s) to the DP termination fix. Include only information pertinent to the departure procedure. Where the initial climb out instructions from multiple runways join and share a common route/instructions prior to the DP termination fix, end each instruction with “..., thence...” followed by a paragraph containing the common information (see figure D-6). If the DP route can be clearly understood from a graphic depiction, a complete textual description is not necessary. Simply state, “...then on depicted route.” Define crossing altitudes at fixes as follows:

**a. Document crossing altitude restrictions** in plain text; e.g., “Cross GRM VORTAC at or above (altitude)”; “CROSS BRADY AT OR BELOW (altitude)”; “Cross SHEMP at or above (altitude), AT OR BELOW (altitude)”; “CROSS EDDIE AT (altitude).”

**b. Altitude Restrictions Requested** by ATC (not authorized for ODPs).

(1) See Order 8260.3, volume 4, and/or other 8260-series directives, as applicable, for the criteria to use when establishing fix crossing altitude restrictions requested by ATC.

(2) See paragraph 2-1-1e(1) for altitude charting constraints.

#### 4. Transition Routes. (Not Authorized for ODPs)

**a. Transition Name.** Name each transition according to the name of the fix at the transition termination point entered in appendix D, paragraph 4d. Do not include the word “Transition.”

**b. Transition Computer Codes.** Enter computer code as coordinated with ATC (see chapter 3).

**c. From FIX/NAVAID.** Fix/NAVAID where the basic DP ends; e.g., DANNY INT, BICKR.

**d. To FIX/NAVAID.** En route fix/NAVAID where each transition ends; e.g., DANNY, BICKR. If a transition has multiple segments, enter one line for each segment.

**e. Course.** Specify the course for each transition segment. Enter the actual magnetic course to the hundredth of a degree (see Order 8260.19, chapter 8). When documenting the course between facilities, provide this information for both facilities.

#### Example:

076.56 & 080.47 (TWN R-077 & WSN R-260)

**Note:** AeroNav Products will round for publication.

**f. Distance.** Specify the distance for each transition segment. Enter the distance to the hundredth of a mile (see Order 8260.19, chapter 8). When documenting the course/distance between facilities, provide this information for both facilities.

#### Example:

41.61

**Note:** AeroNav Products will round for publication.

**g. MEA.** Enter MEA along transition route. By definition, the MEA also encompasses the MRA. If transitions share a common segment, make sure the MEA for that segment is the same for each transition.

**h. MOCA.** Enter MOCA along transition route. To reduce chart clutter, do not publish MOCAs less than 500 feet below MEAs.



**i. Crossing Altitudes/Fixes.** When a SID Transition(s) must accommodate an ATC required altitude at a specified fix, only document the ATC altitude; e.g., “BECKY at/above 9000.” No secondary altitude is required on transition routes since an MEA is specified that will provide obstacle clearance and ensure design constraints are met. The ATC altitude must not be lower than the MEA.

## **5. Procedural Data Notes/Takeoff Minimums.**

**a. List any procedural data information** that is to appear in note form on the graphic depiction; e.g., DME required minimum climb rate information, etc. Also, depict all restrictions and performance requirements to fly the procedure. See Order 8260.19, for a chart note that is required if the SID/Graphic ODP is a Special.

Followed by:

**b. List the runway(s) that are not authorized** for IFR departures. If none of the actions listed in table 3-1-1 are feasible, or if another reason(s) precludes DP development (noise abatement, environmental, etc.), an IFR departure must not be authorized.

### **Examples:**

RWY 27: NA - Obstacles.

RWY 35: NA - Environmental.

RWY 17: NA - Obstacles and noise abatement.

Followed by:

**c. List the runway(s) authorized** standard takeoff minimums.

### **Example:**

RWY 9, 31 Standard.

Followed by:

**d. List the runway(s) that have any deviations** from standard minimums and/or restrictions.

### **Examples:**

(1) TAKEOFF MINIMUMS: RWY 13: 400-2 or standard with minimum climb of 310 ft per NM to 900, or alternatively, with standard takeoff minimums and normal 200 ft per NM climb gradient, takeoff must occur no later than 1800 feet prior to DER.

(2) TAKEOFF MINIMUMS: RWY 27: Standard with minimum climb of 280 ft per NM to 2500, or alternatively, with standard takeoff minimums and normal 200 ft per NM climb gradient, takeoff must occur no later than 1800 feet prior to DER.

## 6. Takeoff Obstacle Notes.

**a. Enter a note regarding obstacles** found as a result of applying table 2-1-1; Situation 2 action and Situation 3, action “A” (see Form 8260-15A, Takeoff Obstacle Notes).

**Note:** An adverse assumption obstacle (AAO) must not be identified/published as a “takeoff obstacle” because pilots are not familiar with the AAO concept. However, publishing a ceiling and visibility will allow for those situations where the CG cannot be achieved and still afford the pilot the opportunity to visually acquire and avoid any obstruction that could have been built without notice to the FAA.

**b. The note must include the runway affected** and inform the pilot of the obstacle(s) type and location relative to the DER, and height [AGL/elevation (MSL)]. When there are obstacles on both sides of the runway centerline extended, note the most significant obstacles left and right of the runway centerline. Phrases such as “multiple antennas, numerous trees, etc.” are acceptable. Also, when identifying these obstacles, be as descriptive as reasonably possible so as to provide the pilot a clear understanding of what to prepare and/or look for; e.g., instead of just saying “power poles,” it would be more helpful to use the descriptor of “power lines” in some instances. Another example would be instead of just saying “terrain,” if applicable; use of “ridgeline” or “bluff” would provide a clearer picture. Specify distances one NM or greater to the nearest whole and tenth of a NM (e.g., 2.1 NM from DER). Specify distances less than one NM in feet (e.g., 1280 feet from DER).

### Examples:

**Note:** RWY 35: Trees 1280 feet from DER, 120 feet left of centerline, 50 feet AGL/ 1527 feet MSL.

**Note:** RWY 35: Building 2.1 NM from DER, 160 feet left of centerline, 350 feet AGL/ 1927 feet MSL.

**Note:** RWY 17: Multiple buildings 500 feet from DER 350 feet right of centerline, 50 feet AGL/ 1107 feet MSL. Antenna 6000 feet from DER, 1235 feet left of centerline, 200 feet AGL/ 1257 feet MSL.

**Note:** RWY 27: Multiple trees and antennas beginning 500 feet from DER, 350 feet right of centerline, up to 110 feet AGL/1307 feet MSL.

**c. Charting agents.** Charting agents must publish these obstacle notes.

## 7. Controlling Obstacles.

**a. Document the controlling obstacle(s)** found as a result of applying table 2-1-1, Situation 3 and/or Situation 4. When there is more than one controlling obstacle to be documented, following the coordinates, include what entity it applies to; i.e., “(Ceiling),” “(Visibility),” “(Climb Gradient),” or “(Climb-To Altitude).”

**Note:** For all DPs, the controlling obstacle is that obstacle which, having penetrated the 40:1 Obstacle Clearance Surface (OCS) causes the most adverse climb gradient, climb-to altitude, and/or ceiling and visibility to be published.

**b. Use the following format to list the runway affected,** elevation and type of obstacle, the coordinates to the nearest 0.01-second; e.g., “RWY 32: 2049 FEET MSL ANTENNA 341548.01N/ 0862101.05W.”

**c. Document the obstacle(s) that mandated development** of a specific graphic ODP route. These obstacles are not considered the “controlling obstacles” because they are not a factor to the specified route being flown. Do not chart this information on the procedure. Document these obstacles as follows:

“OBSTACLES MANDATING ODP ROUTE DEVELOPMENT: RWY 36: 2049 FEET MSL ANTENNA 341658.01N/ 0863108.05W.”

**8. Lost Communications Procedures.** Air Traffic Control (ATC) is responsible for determining the need and content of lost communications instructions. Leave blank when procedures are the same as in 14 CFR Part 91.185 (standard).

**9. Additional Flight Data.** List any additional charting instructions, items essential to clarify charting or information a specialist has determined needs charting as other than a note. Examples of data may include:

**a. Terrain features, airports, Special Use Airspace (SUA), holding patterns, or takeoff and departure obstacles;** e.g., CHART: \_\_\_\_\_ MOA; CHART: HOLDING PATTERN AT ICT VORTAC, HOLD NE, RT, 222.03 INBOUND (Include Leg Length for RNAV or DME Holding, when applicable and speed, if other than standard). Ensure that the accompanying Form 8260-2 contains the appropriate documentation for holding patterns supporting the departure procedure.

**b. Place the reference (departure airport) magnetic variation of record used to develop the procedure in this section.** Include the point of reference and the epoch year. Example: “REFERENCE MAG VAR: KFCR 2W EPOCH YR: 2000”

**10. Airports Served.** List the official airport name(s), city, and 2-letter state code served by the departure procedure.

**Note:** An obstacle DP may only serve one airport.

**11. Communications.** Enter name of radio communications to be charted; e.g., ATIS, AWOS/ASOS, CTAF, CLNC DEL, DEP CON, etc. Specify frequency(ies) only when multiple frequencies are available at a facility (such as the multiple DEP CON freqs at MIA) and there may be confusion as to which should be assigned to the procedure, or if the frequency(ies) are unique to the procedure.

**12. Fixes and/or NAVAIDs.** Enter only the fixes and/or NAVAIDs for which charting is requested but are not included in the textual description of the departure or entered in the transition route data.

**13. Remarks.** List information/data that is not to be charted; e.g., administrative data or notes for controller information (requested by ATC). However, if something does need to be charted, precede the text with the “Chart Note:” annotation. See Order 8260.19 for a chart note that is required if the SID/Graphic ODP is a Special. General chart notes (not Takeoff Minimums or Departure Instructions Notes) need to include instructions to the chart organization to place the note at the bottom of the entry. Use the following format: “Chart Note at bottom of entry...”

**14. Flight Inspected By.** Enter the name of the pilot who conducted the flight inspection/validation, and the date.

**15. Developed By.** Enter the name of the FAA procedure specialist and organizational routing code. If developed under an Other Transactional Authority, enter the procedure developer's name and organization.

**16. Approved By.** Enter the name of AeroNav Products Manager, or his/her delegated representative. For procedures developed under an Other Transactional Authority, enter the name of the organization's manager or his/her delegated representative. This individual must sign in the “approved by” space and enter the date signed. If the procedure is a “Special,” this line will contain the name of and be signed by the manager, AFS-400.

**17. Coordinated With.** Specify the offices/organizations the procedure was coordinated. Departure procedure coordination must be identical with the approach procedure coordination as outlined in Order 8260.19 (latest edition), chapter 8.

**18. Changes.** List changes relating to data entries.

**19. Reasons.** List reasons for changes relating to data entries.

**20. Required Effective Date.**

**a. Enter the effective date as noted** in Order 8260.19 (latest edition), chapter 8. Optimally, submit as routine. En route submission cutoff dates apply to graphic DPs.

**b. If the Form 8260-15B represents** a concurrent action, enter “CONCURRENT” followed by the necessary information; e.g., Airport ID, IAP name and amendment number; airspace action, or other event.

Figure D-6.

U.S. DEPARTMENT OF TRANSPORTATION - FEDERAL AVIATION ADMINISTRATION  
**GRAPHIC DEPARTURE PROCEDURE (DP)**

Bearings, headings, courses, tracks, and radials are magnetic. Elevations and altitudes are in feet, MSL. Altitudes are minimum altitudes unless otherwise indicated. Ceilings are in feet above airport elevation. Distances are in nautical miles (NM). Visibilities are in statute miles (SM) or feet RVR unless otherwise indicated. Graphic depiction attached.

DP Name	Number	DP Computer Code	Superseded Number	Dated	Effective Date
GOODHILL	ONE	GHI1.GHI	NONE		

**TYPE:** Obstacle

**DP ROUTE DESCRIPTION:**

TAKEOFF RWY 18: CLIMB HEADING 185 22 TO 7700, THEN CLIMBING LEFT TURN DIRECT MKM VOR/DME, THEN ON MKM R-028 TO LARST, THENCE...  
TAKEOFF RWY 36: CLIMB HEADING 005 22 TO 7100, THEN CLIMBING RIGHT TURN TO INTERCEPT MKM R-028 TO LARST, THENCE...

... RIGHT TURN TO INTERCEPT GHI R-285 TO GHI VORTAC. CROSS GHI VORTAC AT OR ABOVE MEAMCA FOR ASSIGNED ROUTE OF FLIGHT.

VCOA ALL RUNWAYS: OBTAIN ATC APPROVAL FOR VCOA WHEN REQUESTING IFR CLEARANCE. CLIMB IN VISUAL CONDITIONS TO CROSS MKM VOR/DME NORTHEASTBOUND AT OR ABOVE 8100, THEN ON MKM R-028 TO LARST, THENCE...

... RIGHT TURN TO INTERCEPT GHI R-285 TO GHI VORTAC. CROSS GHI VORTAC AT OR ABOVE MEAMCA FOR ASSIGNED ROUTE OF FLIGHT.

**TRANSITION ROUTES (GRAPHIC DEPICTION ONLY):**

Transition Name	Computer Codes	From	To	Distance	MEA	MOCA	Crossing Altitudes/Fixes
		FIX/NAVAID	TO FIX/NAVAID				

**PROCEDURAL DATA NOTES/TAKEOFF MINIMUMS:**

TAKEOFF MINIMUMS: RWY 16.34 NA - OBSTACLES, RWY 36 STANDARD, RWY 18 STANDARD WITH MINIMUM CLIMB OF 380 FT PER NM TO 7700 OR 1800-3 FOR VCOA.

**TAKEOFF OBSTACLE NOTES:**

**CONTROLLING OBSTACLES:**

RWY 18: 7359 FT MSL TREES, 433303.44N/1104648.03W.  
RWY 18 (VCOA): 7751 FT MSL TREES, 433807.67N/1104133.89W.  
RWY 36: 6949 FT MSL TOWER, 433801.40N/1104220.06W.

**LOST COMMUNICATIONS PROCEDURES:**

U.S. DEPARTMENT OF TRANSPORTATION - FEDERAL AVIATION ADMINISTRATION  
**GRAPHIC DEPARTURE PROCEDURE (DP)**

Bearings, headings, courses, tracks, and radials are magnetic. Elevations and altitudes are in feet, MSL. Altitudes are minimum altitudes unless otherwise indicated. Ceilings are in feet above airport elevation. Distances are in nautical miles (NM). Visibilities are in statute miles (SM) or feet RVR unless otherwise indicated. Graphic depiction attached.

DP Name	Number	DP Computer Code	Superseded Number	Dated	Effective Date
GOODHILL	ONE	GHI1.GHI	NONE		

**ADDITIONAL FLIGHT DATA:**

**AIRPORTS SERVED:**  
LASKY REGIONAL, LASKY, WY

**COMMUNICATIONS:**  
ATIS, GND CON, TWR, ZLC

**FIXES AND/OR NAVAID'S:**

**REMARKS:**

**FLIGHT INSPECTED BY:**  
Johnathan P. Doe

**DEVELOPED BY:**  
Timothy S. Wisenheimer  
(John Q. Public)

**APPROVED BY:**  
David P. Specialist

**COORDINATED WITH:**  
A4A, ALPA, AOPA, AOPA, NBAA, ARPT MGR, LSK ATCT, ZLC

**CHANGES:**

**REASONS:**

**REQUIRED EFFECTIVE DATE:**  
Routine

4/15/2011

FIOG

2/13/2011

AJV-352

6/12/2011

AJV-352

Figure D-7.

U.S. DEPARTMENT OF TRANSPORTATION - FEDERAL AVIATION ADMINISTRATION  
**GRAPHIC DEPARTURE PROCEDURE (DP)**

Bearings, headings, courses, tracks, and radials are magnetic. Elevations and altitudes are in feet, MSL. Altitudes are minimum altitudes unless otherwise indicated. Ceilings are in feet above airport elevation. Distances are in nautical miles (NM). Visibilities are in statute miles (SM) or feet RVR unless otherwise indicated. Graphic depiction attached.

DP Name	DP Computer Code	Superseded Number	Dated	Effective Date
MICKY	MICKY4.MICKY	THREE		

Type: SID

**DP ROUTE DESCRIPTION:**

TAKEOFF RWY 31L/R: CLIMB ON HEADING 309.71 AND GRM R-190 TO CROSS GRM VORTAC AT OR ABOVE 2000, THEN RIGHT TURN TO INTERCEPT GRM R-076 TO CROSS MICKY AT OR ABOVE 6000, MAINTAIN 9000, EXPECT CLEARANCE TO FILED ALTITUDE AT MICKY.

**TRANSITION ROUTES (GRAPHIC DEPICTION ONLY):**

Transition Name	Computer Codes	FIX/NAVAID	To	From	Course	Distance	MEA	MOCA	Crossing Altitudes/Fixes
HOMINY	MICKY4.HMS	MICKY	TWN VORTAC	TWN VORTAC	71.64 (TWN R-072)	10.89	3700		TWN AT/ABOVE 7000
			TWN VORTAC	HMS VORTAC	097.22 & 098.54	68.47	8100	6900	
					(TWN R-097.7 HMS R-279)				
LIMPET	MICKY4.LPT	MICKY	LPT VORTAC	LPT VORTAC	351.19 (LPT R-171)	70.98	6000	3200	
WATSON	MICKY4.WSN	MICKY	TWN VORTAC	TWN VORTAC	071.64 (TWN R-072)	10.89	3700		TWN AT/ABOVE 7000
			TWN VORTAC	WSN VORTAC	076.56 & 080.47	41.61	4200		

**PROCEDURAL DATA NOTES/TAKEOFF MINIMUMS:**

NOTE: THIS SID TO BE USED ONLY UPON ASSIGNMENT BY METRO TOWER. NORMALLY BETWEEN THE HOURS OF 2100-0600 LOCAL TIME.  
TAKEOFF MINIMUMS: RWY 13L-13R 18.36 NA FOR THIS SID - NOISE ABATEMENT. RWY 31L: MINIMUM CLIMB OF 310 FT PER NM TO 2000.  
RWY 31R: 300-1 3/4 OR STANDARD WITH MINIMUM CLIMB OF 310 FT PER NM TO 2000 OR ALTERNATIVELY, WITH STANDARD TAKEOFF MINIMUMS AND A NORMAL 200 FT PER NM CLIMB GRADIENT. TAKEOFF MUST OCCUR NO LATER THAN 2100 FT PRIOR TO DER.

**TAKEOFF OBSTACLE NOTES:**

**CONTROLLING OBSTACLES:**  
RWY 31L: 1049 FT MSL TOWER, 325304.00N/0965428.00W.  
RWY 31R: 739 FT MSL BUILDING, 325245.67N/0965221.00W.

**LOST COMMUNICATIONS PROCEDURES:**

U.S. DEPARTMENT OF TRANSPORTATION - FEDERAL AVIATION ADMINISTRATION  
**GRAPHIC DEPARTURE PROCEDURE (DP)**

Bearings, headings, courses, tracks, and radials are magnetic. Elevations and altitudes are in feet, MSL. Altitudes are minimum altitudes unless otherwise indicated. Ceilings are in feet above airport elevation. Distances are in nautical miles (NM). Visibilities are in statute miles (SM) or feet RVR unless otherwise indicated. Graphic depiction attached.

DP Name	Number	DP Computer Code	Superseded Number	Dated	Effective Date
MICKY	FOUR	MICKY4.MICKY	THREE		

**ADDITIONAL FLIGHT DATA:**

**AIRPORTS SERVED:**  
METRO JETPORT, DALLAS, TX

**COMMUNICATIONS:**  
ATIS, CLNC DEL, GND CON, TWR, DEP CON

**FIXES AND/OR NAVAIDS:**  
SCY VOR/DME  
**REMARKS:**

**FLIGHT INSPECTED BY:**  
Johnathan P. Doe  
**REQUIRED EFFECTIVE DATE:**  
CONCURRENT WITH AIRSPACE DOCKET 10-ASW-28

**DEVELOPED BY:**  
Timothy S. Wisenheimer  
(John Q. Public)

**APPROVED BY:**  
David P. Specialist

**COORDINATED WITH:**  
A4A, ALPA, APA, AOPA, NBAA, ARPT MGR, MET ATCT, REG ATCT, ZFW

**CHANGES:**  
ADDED HMS TRANSITION

**REASONS:**  
RAPT REQUEST



Figure D-8.

U.S. DEPARTMENT OF TRANSPORTATION - FEDERAL AVIATION ADMINISTRATION  
**GRAPHIC DEPARTURE PROCEDURE (DP)**

Bearings, headings, courses, tracks, and radials are magnetic. Elevations and altitudes are in feet, MSL. Altitudes are minimum altitudes unless otherwise indicated. Ceilings are in feet above airport elevation. Distances are in nautical miles (NM). Visibilities are in statute miles (SM) or feet RVR unless otherwise indicated. Graphic depiction attached.

DP Name: **GOODHILL**      Number: **ONE**      DP Computer Code: **GHI1,GHI**      Superseded Number: **NONE**      Dated:      Effective Date:

Type:

DP ROUTE DESCRIPTION:

PROCEDURE CANCELLED EFFECTIVE \_\_\_\_\_

TRANSITION ROUTES (GRAPHIC DEPICTION ONLY):

Transition Computer Codes	From Transition Computer Codes	To FIX/NAVAID	Course	Distance	MEA	MOCA	Crossing Altitudes/Fixes

PROCEDURAL DATA NOTES/TAKEOFF MINIMUMS:

TAKEOFF OBSTACLE NOTES:

CONTROLLING OBSTACLES:

LOST COMMUNICATIONS PROCEDURES:

ADDITIONAL FLIGHT DATA:

AIRPORTS SERVED:

COMMUNICATIONS:

FIXES AND/OR NAVAIID'S:

U.S. DEPARTMENT OF TRANSPORTATION - FEDERAL AVIATION ADMINISTRATION  
**GRAPHIC DEPARTURE PROCEDURE (DP)**

Bearings, headings, courses, tracks, and radials are magnetic. Elevations and altitudes are in feet, MSL. Altitudes are minimum altitudes unless otherwise indicated. Ceilings are in feet above airport elevation. Distances are in nautical miles (NM). Visibilities are in statute miles (SM) or feet RVR unless otherwise indicated. Graphic depiction attached.

DP Name	Number	DP Computer Code	Superseded Number	Dated	Effective Date
GOODHILL	ONE	GH11.GHI	NONE		

REMARKS:

FLIGHT INSPECTED BY:

REQUIRED EFFECTIVE DATE:  
Routine

DEVELOPED BY:

Timothy S. Wisenheimer  
(John Q. Public)

AJV-352 2/13/2011

APPROVED BY:

David P. Specialist

AJV-352 6/12/2011

COORDINATED WITH:

CHANGES:

PROCEDURE CANCELED.

REASONS:

OBSTACLE DATA REVIEW - ODP NO LONGER REQUIRED.

\*CONCURRENT WITH CANCELATION OF KLSK TAKEOFF MINIMUMS AND (OBSTACLE) DEPARTURE PROCEDURES, ORIG.

**Appendix E.****Section 1. Instructions for Completing  
FAA Form 8260-15B, Graphic Departure Procedures (DP)  
[RNAV Departure Procedures] and Sample Forms**

**1. Title Line.** The title line consists of the following six elements and will be filled in as noted.

**a. DP Name.** Enter name of departure procedure. For example, the CATHEDRAL SEVEN DEPARTURE is entered as CATHEDRAL.

**b. Number.** Enter departure procedure number (spelled out); e.g., EIGHT.

**c. DP Computer Code.** Enter computer identification code coordinated with ATC (see chapter 3).

**d. Superseded Number.** Departure procedure number (spelled out) superseded by this procedure. Enter “None” for a new procedure.

**e. Dated.** Date of superseded procedure. Format: DD MMM YY.

**f. Effective Date.** Leave blank. The effective date will normally be added by NFDC. Enter an effective date only when a specific effective date is required; e.g., MagVar rotation. If the procedure is a “Special,” the Regional Flight Standards Division, NextGen Branch (RNGB), will enter the effective date.

**2. Type.** Specify “RNAV” on this line to indicate that this is an RNAV departure. Additionally, specify “OBSTACLE” when the procedure is the default obstacle departure procedure (see paragraph 2-1-1b), or specify “SID” when the procedure is initiated by ATC (see paragraph 2-1-1c). If this is a Special procedure, also enter “Special” following “Obstacle” or “SID.”

**Note:** Attach an up-to-date, clear graphic depiction of the procedure. Do not include a textual description of transitions or departure route text.

**3. DP Route Description.** Provide the initial climb out instructions for each runway and a textual description of the departure route(s) to the DP termination fix. Include only information pertinent to the departure procedure. Where the initial climb out instructions from multiple runways join and share a common route/instructions prior to the DP termination fix, end each instruction with “..., thence...” followed by a paragraph containing the common information (see figure E-2). If the DP route can be clearly understood from a graphic depiction, a complete textual description is not necessary. Simply state, “...then on depicted route.” Define crossing altitudes at fixes as follows:

**a. Document crossing altitude restrictions** in plain text; e.g., “CROSS GRM VORTAC AT OR ABOVE (altitude)”; “CROSS BRADY AT OR BELOW (altitude)”; “CROSS SHEMA AT OR ABOVE (altitude), AT OR BELOW (altitude)”; “CROSS EDDIE AT (altitude).”

**b. Altitude Restrictions requested by ATC** (not authorized for ODPs).

(1) See Order 8260.3, volume 4, and/or other 8260-series directives, as applicable, for the criteria to use when establishing fix crossing altitude restrictions requested by ATC.

(2) See paragraph 2-1-1e(1) for altitude charting constraints.

**Note:** Information in this section must match the corresponding information in the Altitude column of the Form 8260-15C.

**c. See table E-1 for specific wording** and required information. Specify the turn direction as either “Left/Right” as follows:

(1) DF legs. For all course changes exceeding 15 degrees.

(2) CF and TF legs. For all course changes exceeding 90 degrees.

**Note:** If the DP route becomes a series of consecutive TF legs with turns less than or equal to 90 degrees, a complete textual description from that point is not necessary. Simply state, “...then on depicted route.” (See example, “TAKEOFF RWY 1”)

**d. Document all courses, headings, tracks,** and distances to the nearest hundredth unit of measurement.

**Note:** Fix/NAVAID column entries will be published verbatim on the AeroNav Products chart, with the exception of courses, headings, and tracks, which will be rounded by AeroNav Products to the nearest whole degree.

**e. When using a VA, VI, or VM leg,** specify the actual heading to be flown (e.g., do not use “climb on runway heading”). Ensure courses, tracks, headings, and distances entered on Form 8260-15B match the equivalent true values and distances entered on Form 8260-15C as appropriate.

**Table E-1. Leg Type Wording and Required Information**

8260-15C Leg Type	8260-15B Wording	8260-15B Required Information
VI	"heading"	heading
VA	"heading"	heading/altitude
DF	"direct"	turn direction*/distance**
CF	"course"	course/distance/turn direction***
TF	"track"	course/distance/turn direction***
VM	"heading"	Heading/altitude

\* Do not specify turn direction when a DF leg is used as the first leg of a DP. For subsequent legs, only specify turn direction for DF legs when amount of turn exceeds 15 degrees.

\*\* Do not specify distance when part of a VA-DF leg combination.

\*\*\* Only specify turn direction for CF or TF legs when amount of turn exceeds 90 degrees.

### **Examples:**

**VI leg followed by CF leg** – “TAKEOFF RWY 32R: CLIMB HEADING 317.66 TO INTERCEPT COURSE 041.20 TO LARRY.”

**VA leg followed by DF leg** – “TAKEOFF RWY 32R: CLIMB HEADING 317.66 TO 1000, THEN RIGHT TURN DIRECT LARRY.”

**VA leg followed by VM leg, followed by DF leg** – “TAKEOFF RWY 32R: CLIMB HEADING 317.66 TO 1000, THEN EXPECT VECTORS TO LARRY.”

**Note:** This leg type combination is used for “Radar Vectors to Join RNAV Routes” (see Order 8260.53) departure procedures where ATC wants the aircraft to climb on a specified heading to an altitude prior to initiating radar vectors. Following the vectoring sequence, ATC is expected to issue a clearance direct to the IDF.

**CF leg** - “TAKEOFF RWY 1: CLIMB ON COURSE 007.52 TO LARRY, THENCE...”

**DF leg** - “TAKEOFF RWY 14L: CLIMB DIRECT CURLY, THENCE...”

**CF leg followed by TF legs (less than 90-degree course changes)** – “TAKEOFF RWY 1: CLIMB ON COURSE 007.52 TO LARRY, THEN ON DEPICTED ROUTE TO SHEMP, THENCE...”

**CF leg followed by DF leg** – “TAKEOFF RWY 14L: CLIMB ON COURSE 137.64 TO CROSS CURLY AT OR ABOVE 1000, THEN LEFT TURN DIRECT SHEMP, THENCE...”

VM leg – “Takeoff RWY 35C: Climb heading 350.11 or as assigned by ATC to 3000, expect vectors to AIMEE, thence...”

**4. Transition Routes.** (Not Authorized for ODPs.)

**a. Transition Name.** Name each transition according to the name of the fix at the transition termination point entered in appendix E, paragraph 4d. Do not include the word “TRANSITION.”

**b. Transition Computer Codes.** Enter computer code as coordinated with ATC (see chapter 3).

**c. From FIX/NAVAID.** Fix/NAVAID where each transition begins (normally, the en route fix where the DP ends); e.g., DANNY, BICKR.

**d. To FIX/NAVAID.** En route fix/NAVAID where each transition ends; e.g., DANNY, BICKR. If a transition has multiple segments, enter one line for each segment.

**e. Course.** Specify the course for each transition segment. Enter the actual magnetic course to the hundredth of a degree (see Order 8260.19, chapter 8). When documenting the course between facilities, provide this information for both facilities.

**Examples:**

**DF leg** – “DIRECT,” “RIGHT TURN DIRECT,” OR “LEFT TURN DIRECT”

**CF leg** – Not used for transition routing.

**TF leg** – “TRACK 067.11” or “RIGHT TURN, TRACK 054.94”

076.56 & 080.47 (TWN R-077 & WSN R-260)

**Note 1:** The VA or VI leg, when used, will be used only on the first leg of a departure and as such, a VA/VI leg should not appear in the transition route.

**Note 2:** AeroNav Services will round for publication.

**f. Distance.** Specify the distance for each transition segment. Enter the distance to the hundredth of a mile (see Order 8260.19, chapter 8). When documenting the course/distance between facilities, provide this information for both facilities.

**Example:** 41.61 **Note:** AeroNav Services will round for publication.

**g. MEA.** Enter MEA along transition route. By definition, the MEA also encompasses the MRA. If transitions share a common segment, make sure the MEA for that segment is the same for each transition.

**h. MOCA.** Enter MOCA along transition route. To reduce chart clutter, do not publish MOCAs less than 500 below MEAs.

**i. Crossing Altitudes/Fixes.** When a SID Transition(s) must accommodate an ATC required altitude at a specified fix, only document the ATC altitude; e.g., “BECKY AT/ABOVE 9000.” No secondary altitude is required on transition routes since an MEA is specified that will provide obstacle clearance and ensure design constraints are met. The ATC altitude must not be lower than the MEA.

## 5. Procedural Data Notes/Takeoff Minimums.

**a. List any procedural data information** that is to appear in note form on the graphic depiction; e.g., minimum climb rate information, etc. Also, depict all restrictions and performance requirements to fly the procedure. See paragraph 3-1-5d, for specific information that must be charted and entered in this section. See Order 8260.19 for a chart note that is required if the SID/Graphic ODP is a Special.

Followed by:

**b. List the runway(s) that are not authorized** for IFR departures. If none of the actions listed in table E-1 are feasible, or if another reason(s) precludes DP development (noise abatement, environmental, etc.), an IFR departure must not be authorized.

### Examples:

RWY 27: NA - OBSTACLES.  
RWY 35: NA - ENVIRONMENTAL.  
RWY 17: NA - OBSTACLES AND NOISE ABATEMENT.

Followed by:

**c. List the runway(s) authorized** standard takeoff minimums.

### Example:

RWY 9, 31: STANDARD.

Followed by:

**d. List the runway(s) that have any deviations** from standard minimums and/or restrictions.

### Examples:

**TAKEOFF MINIMUMS:** RWY 13: 400-2 OR STANDARD WITH MINIMUM CLIMB OF 310 FEET PER NM TO 900, OR ALTERNATIVELY, WITH STANDARD TAKEOFF

MINIMUMS AND A NORMAL 200 FEET PER NM CLIMB GRADIENT, TAKEOFF MUST OCCUR NO LATER THAN 1800 FEET PRIOR TO DER.

**TAKEOFF MINIMUMS:** RWY 27: STANDARD WITH MINIMUM CLIMB OF 280 FEET PER NM TO 2500, OR ALTERNATIVELY, WITH STANDARD TAKEOFF MINIMUMS AND A NORMAL 200 FEET PER NM CLIMB GRADIENT, TAKEOFF MUST OCCUR NO LATER THAN 1800 FEET PRIOR TO DER.

## 6. Takeoff Obstacle Notes.

**a. Enter a note regarding obstacles** found as a result of applying table 2-1-1, Situation 2 action, and Situation 3, action “A.”

**Note:** An adverse assumption obstacle (AAO) must not be identified/published as a “takeoff obstacle” because pilots are not familiar with the AAO concept. However, publishing a ceiling and visibility will allow for those situations where the CG cannot be achieved and still afford the pilot the opportunity to visually acquire and avoid any obstruction that could have been built without notice to the FAA.

**b. The note must include the runway** affected and inform the pilot of the obstacle(s) type and location relative to the DER, and height (AGL/elevation [MSL]). When there are obstacles on both sides of the runway centerline extended, note the most significant obstacles left and right of the runway centerline. Phrases such as “multiple antennas, numerous trees, etc.” are acceptable. Specify distances one NM or greater to the nearest whole and tenth of a NM (e.g., 2.1 NM from DER). Also, when identifying these obstacles, be as descriptive as reasonably possible so as to provide the pilot a clear understanding of what to prepare and/or look for; e.g., instead of just saying “power poles,” it would be more helpful to use the descriptor of “power lines” in some instances. Another example would be instead of just saying “terrain,” if applicable; use of “ridgeline” or “bluff” would provide a clearer picture. Specify distances less than one NM in feet (e.g., 1280 feet from DER).

### Examples:

**NOTE:** RWY 35: TREES 1280 FEET FROM DER, 120 FEET LEFT OF CENTERLINE, 50 FEET AGL/1527 FEET MSL.

**NOTE:** RWY 35: BUILDING 2.1 NM FROM DER, 160 FEET LEFT OF CENTERLINE, 350 FEET AGL/1927 FEET MSL.

**NOTE:** RWY 17: MULTIPLE BUILDINGS 500 FEET FROM DER, 350 FEET RIGHT OF CENTERLINE, 50 FEET AGL/1107 FEET MSL. ANTENNA 6000 FEET FROM DER, 1235 FEET LEFT OF CENTERLINE, 200 FEET AGL/1257 FEET MSL.

**NOTE:** RWY 27: MULTIPLE TREES AND ANTENNAS BEGINNING 500 FEET FROM DER, 350 FEET RIGHT OF CENTERLINE, UP TO 110 FEET AGL/1307 FEET MSL.



- c. **Charting agents.** Charting agents must publish these obstacle notes.

## 7. Controlling Obstacles.

a. **Document the controlling obstacle(s)** found as a result of applying table 2-1-1, Situation 3 and/or Situation 4. When there is more than one controlling obstacle to be documented, following the coordinates, include what entity it applies too; i.e., “(Ceiling),” “(Visibility),” “(Climb Gradient),” or “(Climb-To Altitude).”

**Note:** For all DPs, the controlling obstacle is that obstacle which, having penetrated the 40:1 Obstacle Clearance Surface (OCS) causes the most adverse climb gradient, climb-to altitude, and/or ceiling and/or visibility to be published.

b. **Use the following format to list the runway affected,** elevation and type of obstacle, the coordinates to the nearest 0.01 second, and if applicable, OCS height above DER elevation; e.g., “RWY 32: 2049 FEET MSL ANTENNA 341548.01N/0862101.05W.”

c. **Document the obstacle(s) that mandated development** of a specific RNAV ODP route. These obstacles are not considered the “controlling obstacles” because they are not a factor to the specified route being flown. Do not chart this information on the procedure. Document these obstacles as follows:

**“OBSTACLES MANDATING ODP ROUTE DEVELOPMENT: RWY 36 - 2049 FEET MSL ANTENNA 341658.01N/ 0863108.05W.”**

**8. Lost Communications Procedures.** ATC is responsible for determining the need and content of lost communications instructions. Leave blank when procedures are the same as in 14 CFR Part 91.185 (standard).

**9. Additional Flight Data.** List any additional charting instructions, items essential to clarify charting or information a specialist has determined needs charting as other than a note. Examples of data may include:

a. **Terrain features, airports,** military operating areas (MOA), holding patterns, or takeoff and departure obstacles; e.g., CHART: \_\_\_\_\_ MOA; CHART: HOLDING PATTERN AT ICT VORTAC, HOLD NE, RT, 222.03 INBOUND (Include Leg Length for RNAV or DME Holding, when applicable and speed, if other than standard). Ensure that the accompanying Form 8260-2 contains the appropriate documentation for holding patterns supporting the departure procedure.

b. **Document the MEA/MOCA** for the segment between the IF and Basic DP fix on RNAV Radar departure procedures as follows: CHART: MEA/MOCA FROM (RNAV IF) TO (BASIC DP FIX), (Altitude).

**c. Place the reference (departure airport) magnetic variation of record used to develop the procedure in this section. Include the point of reference and the epoch year. Example:**  
“REFERENCE MAG VAR: KFCR 2W EPOCH YR: 2000”

**d. DME Assessment.** Enter one of the following:

(1) “DME/DME ASSESSMENT: SAT (RNP 1.0 OR 2.0 AS APPROPRIATE).”  
Indicates a successful assessment to the RNP value specified.

(2) “DME/DME ASSESSMENT: UNSAT (RNP 1.0), SAT (RNP 2.0).” Indicates an unsuccessful assessment to RNP 1.0, but returned a successful assessment to RNP 2.0.

(3) “DME/DME ASSESSMENT: UNSAT.” Indicates an unsuccessful assessment to RNP 2.0.

(4) “DME/DME Assessment: NOT CONDUCTED.”

**Note 1:** If the DME/DME assessment indicates “UNSAT” or “NOT CONDUCTED,” the note “GPS Required” must be entered in the Procedural Data Notes/Takeoff Minimums section.

**Note 2:** The DME/DME assessment process is covered in separate guidance.

**e. Use this section to describe the Pilot Navigation Area (PNA) for RNAV Radar departures. The description will be in the following manner:**

PILOT NAVIGATION AREA:

7 NM ARC CENTERED ON WAYPT (IF), CW  
FROM: POINT A (BEARING 015 DEGREES TO WAYPT)  
TO: POINT B (BEARING 105 DEGREES TO WAYPT)  
MINIMUM ALTITUDE - 4000

**Note:** The illustration in figure E-1 is provided as an example of what this text is describing. An illustration may be provided but is not required on the form.

Figure E-1.

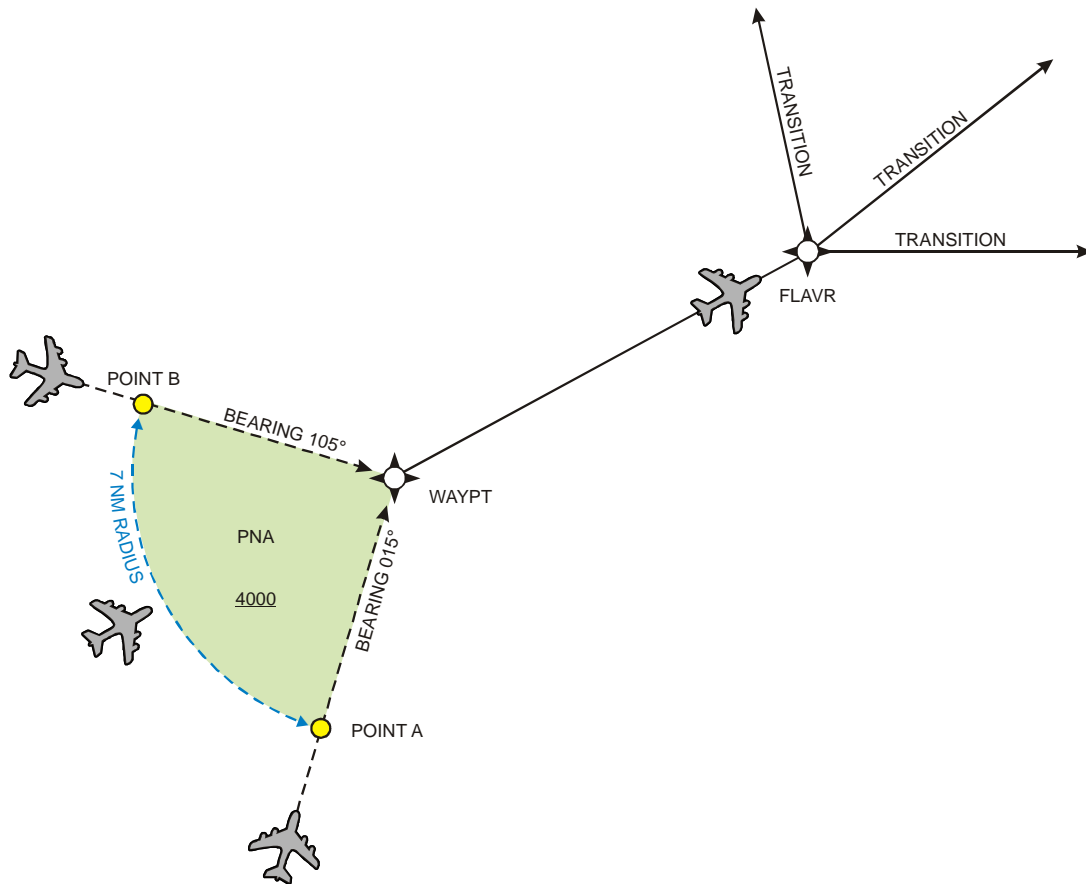

**10. Airports Served.** Except for departures that use Radar vectors to join RNAV routes, RNAV DPs must only serve one airport. List the airport, city, and 2-letter state code served by the departure procedure.

**11. Communications.** Enter name of radio communications to be charted; e.g., ATIS, AWOS/ASOS, CTAF, CLNC DEL, DEP CON, etc. Specify frequency(ies) only when multiple frequencies are available at a facility (such as the multiple DEP CON freqs at MIA) and there may be confusion as to which should be assigned to the procedure, or if the frequency(ies) are unique to the procedure.

**12. Fixes and/or NAVAIDs.** Enter only those fixes and/or NAVAIDs for which charting is requested but are not included in the textual description of the departure or entered in the transition route data.

**13. Remarks.**

**a. List information/data, which is not to be charted;** e.g., administrative data or notes for controller information (requested by ATC). However, if something does need to be charted, precede the text with the “Chart Note:” annotation.

**b. See Order 8260.19 for a chart note** that is required if the SID/Graphic ODP is a Special. General chart notes (not Takeoff Minimums or Departure Instructions Notes) need to include instructions to the chart organization to place the note at the bottom of the entry. Use the following format: “Chart Note at bottom of entry...”

**c. Document when a climb gradient** has been established to support RNAV or RNP operational requirements (e.g., RNAV-Pro DME/DME/IRU limitations), etc.

**d. When an AAUP has been established** [see paragraph 2-1-2c(11)], a chart note must be established as follows: “CHART NOTE: SEE ADDITIONAL REQUIREMENTS ON AAUP.”

**14. Flight Inspected By.** Enter the name of the pilot who conducted the flight inspection/validation, and the date.

**15. Developed By.** Enter the name of the FAA procedure specialist and organizational routing code. If developed under an Other Transactional Authority, enter the procedure developer's name and organization.

**16. Approved By.** Enter the name of the AeroNav Services' Manager, or his/her delegated representative. For procedures developed under an Other Transactional Authority, enter the name of the organization's manager or his/her delegated representative. This individual must sign in the “approved by” space and enter the date signed. If the procedure is a “Special,” this line will contain the name of and be signed by the manager, AFS-400.

**17. Coordinated With.** Specify the offices/organizations the procedure was coordinated. Departure procedure coordination must be identical with the approach procedure coordination as outlined in Order 8260.19 (latest edition), chapter 8.

**18. Changes.** List changes relating to data entries.

**19. Reasons.** List reasons for changes relating to data entries.

**20. Required Effective Date.**

**a. Enter the effective date as noted** in Order 8260.19 (latest edition), chapter 8. Optimally, submit as routine. En route submission cutoff dates apply to graphic DPs.

**b. If the Form 8260-15B represents a concurrent action,** enter “CONCURRENT” followed by the necessary information; e.g., Airport ID, IAP name and amendment number, airspace action, or other event.

Figure E-2.

U.S. DEPARTMENT of TRANSPORTATION - FEDERAL AVIATION ADMINISTRATION  
**GRAPHIC DEPARTURE PROCEDURE (DP)**

Bearings, headings, courses, tracks, and radials are magnetic. Elevations and altitudes are in feet, MSL. Altitudes are minimum altitudes unless otherwise indicated. Ceilings are in feet above airport elevation. Distances are in nautical miles (NM). Visibilities are in statute miles (SM) or feet RVR unless otherwise indicated. Graphic depiction attached.

DP Name <b>SHEMP</b>	Number <b>ONE</b>	DP Computer Code <b>SHEMP1,SHEMP</b>	Superseded Number <b>NONE</b>	Dated	Effective Date
-------------------------	----------------------	---	----------------------------------	-------	----------------

**Type:** RNAV SID

**DP ROUTE DESCRIPTION:**

TAKEOFF RWY 1: CLIMB ON COURSE 007.52 TO LARRY, THEN ON DEPICTED ROUTE TO SHEMP, THENCE...  
TAKEOFF RWY 14L: CLIMB ON COURSE 137.64 TO CROSS CURLY AT OR ABOVE 1000, THEN CLIMBING LEFT TURN DIRECT SHEMP, THENCE...  
TAKEOFF RWY 32R: CLIMB ON 317.66 HEADING TO AT OR ABOVE 1000, THEN TURN RIGHT DIRECT TO LARRY, THEN ON DEPICTED ROUTE TO SHEMP, THENCE...  
... (TRANSITION). MAINTAIN 5000, EXPECT FILED ALTITUDE 10 MINUTES AFTER DEPARTURE.

**TRANSITION ROUTES (GRAPHIC DEPICTION ONLY):**

Transition Name	Computer Codes	FIX/NAVAID	To FIX/NAVAID	Course	Distance	MEA	MOCA	Crossing Altitudes/Fixes
FOGART	SHEMP1.FGH	SHEMP	FGH VORTAC	TRACK 087.11	87.24	5000	3700	
JENKO	SHEMP1.JKL	SHEMP	JKL VORTAC	TRACK 096.77	92.51	5000		
LAYMAN	SHEMP1.LMN	SHEMP	LMN VOR/DME	RIGHT TURN TRACK 154.94	47.23	5000	4100	
ROOSTER	SHEMP1.RST	SHEMP	LMN VOR/DME	RIGHT TURN TRACK 154.94	47.23	5000	4100	
			RST VORTAC	TRACK 098.38	39.79	7000	4400	

**PROCEDURAL DATA NOTES/TAKEOFF MINIMUMS:**

TAKEOFF MINIMUMS: RWY 14R: 19. 32L NA - AIR TRAFFIC. RWY 1, 32R STANDARD. RWY 14L 500-2 1/2 OR STANDARD WITH MINIMUM CLIMB OF 330 FT PER NM TO 1200.  
NOTE: DME/DME/IRU OR GPS REQUIRED  
NOTE: RADAR REQUIRED FOR NON-GPS EQUIPPED AIRCRAFT  
NOTE: RNAV-1

**TAKEOFF OBSTACLE NOTES:**

NOTE: RWY 1, OBSTRUCTION LIGHT 1022 FT FROM DER, 672 FT RIGHT OF CENTERLINE, 73 FT AGL/643 FT MSL.  
NOTE: RWY 14L, BUILDING 1.96 NM FROM DER, 575 FT RIGHT OF CENTERLINE, 478 FT AGL/974 FT MSL.  
NOTE: RWY 32R, TREES 143 FT LEFT OF DER, 21 FT AGL/498 FT MSL.

**CONTROLLING OBSTACLES:**

RWY 1: 543 FT MSL OBSTRUCTION LIGHT, 325141.44N/0965102.87W.  
RWY 14L: 974 FT MSL BUILDING, 324911.09N/0964838.62W.  
RWY 32R: 1049 FT MSL TOWER, 325216.19N/0965523.02W, 498 FT MSL TREES, 325125.20N/0965125.68W.

**LOST COMMUNICATIONS PROCEDURES:**

U.S. DEPARTMENT of TRANSPORTATION - FEDERAL AVIATION ADMINISTRATION  
**GRAPHIC DEPARTURE PROCEDURE (DP)**

Bearings, headings, courses, tracks, and radials are magnetic. Elevations and altitudes are in feet, MSL. Altitudes are minimum altitudes unless otherwise indicated. Ceilings are in feet above airport elevation. Distances are in nautical miles (NM). Visibilities are in statute miles (SM) or feet RVR unless otherwise indicated. Graphic depiction attached.

DP Name	Number	DP Computer Code	Superseded Number	Dated	Effective Date
<b>SHEMP</b>	<b>ONE</b>	<b>SHEMP1.SHEMP</b>	<b>NONE</b>		

**ADDITIONAL FLIGHT DATA:**

REFERENCE MAG VAR: KFOR 2W EPOCH YR: 00  
DME/DME ASSESSMENT: UNSAT

**AIRPORTS SERVED:**

FOUR CLOWNS REGIONAL, VICTORVILLE, TX

**COMMUNICATIONS:**

ATIS, CLNC DEL, GND CON, FCR ATCT, ARCON DEP CON

**FIXES AND/OR NAVAID'S:**

**REMARKS:**

**FLIGHT INSPECTED BY:**

Johnathan P. Doe

**DEVELOPED BY:**

Timothy S. Wisenheimer  
(John Q. Public)

**APPROVED BY:**

David P. Specialist

**COORDINATED WITH:**

AAA, ALPA, AFA, AOPA, NBAA, ARPT MGR, FCR ATCT, ZFW

**CHANGES:**

**REASONS:**

**REQUIRED EFFECTIVE DATE:**

ROUTINE

4/15/2011

FIOG

2/13/2011

AJV-352

6/12/2011

AJV-352

Figure E-3.

U.S. DEPARTMENT of TRANSPORTATION - FEDERAL AVIATION ADMINISTRATION  
**GRAPHIC DEPARTURE PROCEDURE (DP)**

Bearings, headings, courses, tracks, and radiata are magnetic. Elevations and altitudes are in feet, MSL. Altitudes are minimum altitudes unless otherwise indicated. Ceilings are in feet above airport elevation. Distances are in nautical miles (NM). Visibilities are in statute miles (SM) or feet RVR unless otherwise indicated. Graphic depiction attached.

DP Name	DP Computer Code	Superseded Number	Dated	Effective Date
SHEMP	TWO SHEMP2:SHEMP	ONE	18-Apr-02	

Type: RNAV SID

**DP ROUTE DESCRIPTION:**

TAKEOFF RWY 1: CLIMB ON COURSE 007.52 TO CROSS LARRY AT OR ABOVE 2000, THEN ON TRACK 038.92 TO CROSS MOEHH AT OR ABOVE 3000, THEN ON TRACK 091.64 TO CROSS SHEMP AT OR ABOVE 5000, AT OR BELOW 8000, THENCE...  
 TAKEOFF RWY 14L: CLIMB ON COURSE 137.64 TO CROSS CURLY AT OR ABOVE 1000, THEN TURN LEFT ON TRACK 059.62 TO CROSS SHEMP AT OR ABOVE 5000, AT OR BELOW 8000, THENCE...  
 TAKEOFF RWY 32R: CLIMB ON HEADING 317.66 TO AT OR ABOVE 1000, THEN TURN RIGHT DIRECT TO CROSS LARRY AT OR ABOVE 2000, THEN ON TRACK 038.92 TO CROSS MOEHH AT OR ABOVE 3000, THEN ON TRACK 091.64 TO CROSS SHEMP AT OR ABOVE 5000, AT OR BELOW 8000, THENCE...  
 ... (TRANSITION). MAINTAIN 5000. EXPECT FILED ALTITUDE 10 MINUTES AFTER DEPARTURE.

**TRANSITION ROUTES (GRAPHIC DEPICTION ONLY):**

Transition Name	Computer Codes	FIX/NAVAID	To	Course	Distance	MEA	MOCA	Crossing Altitudes/Fixes
FOGART	SHEMP2:FGH	SHEMP	FGH VORTAC	TRACK 065.11	87.24	5000	3700	
JENKO	SHEMP2:JKL	SHEMP	JKL VORTAC	TRACK 096.77	92.51	5000		
OPAKE	SHEMP2:OPQ	SHEMP	OPQ	LEFT TURN	52.21	4000	3300	
ROOSTER	SHEMP2:RST	SHEMP	VOR/DME	TRACK 003.19				
			RST VORTAC	TRACK 098.38	39.79	7000	4900	

**PROCEDURAL DATA NOTES/TAKEOFF MINIMUMS:**

TAKEOFF MINIMUMS: RWY 14R, 19, 32L NA - AIR TRAFFIC. RWY 1, 32R STANDARD. RWY 14L 500-2 1/2 OR STANDARD WITH MINIMUM CLIMB OF 330 FT PER NM TO 1200.  
 NOTE: GPS REQUIRED.  
 NOTE: RNAV-1

**TAKEOFF OBSTACLE NOTES:**

NOTE: RWY 1: OBSTRUCTION LIGHT 1022 FT FROM DER, 672 FT RIGHT OF CENTERLINE, 73 FT AGL/543 FT  
 NOTE: RWY 14L, BUILDING 1.96 NM FROM DER, 575 FT RIGHT OF CENTERLINE, 478 FT AGL/974 FT MSL.  
 NOTE: RWY 32R, TREES 143 FT LEFT OF DER, 21 FT AGL/498 FT MSL.

**CONTROLLING OBSTACLES:**

RWY 1: 543 FT MSL OBSTRUCTION LIGHT, 325141.44N/0966102.87W.  
 RWY 14L: 974 FT MSL BUILDING, 324911.09N/0964838.62W.  
 RWY 32R: 1049 FT MSL TOWER, 325216.19N/0965523.02W, 498 FT MSL TREES, 325125.20N/0965125.66W.

**LOST COMMUNICATIONS PROCEDURES:**

U.S. DEPARTMENT of TRANSPORTATION - FEDERAL AVIATION ADMINISTRATION  
**GRAPHIC DEPARTURE PROCEDURE (DP)**

Bearings, headings, courses, tracks, and radials are magnetic. Elevations and altitudes are in feet, MSL. Altitudes are minimum altitudes unless otherwise indicated. Ceilings are in feet above airport elevation. Distances are in nautical miles (NM). Visibilities are in statute miles (SM) or feet RVR unless otherwise indicated. Graphic depiction attached.

DP Name **SHEMP** Number **TWO** DP Computer Code **SHEMP2.SHEMP** Superseded Number **ONE** Dated **18-Apr-02** Effective Date

**ADDITIONAL FLIGHT DATA:**

REFERENCE MAG VAR: KFCR 2W EPOCH YR: 00  
DME/DME ASSESSMENT: UNSAT  
CHART SPEED ICON: MAXIMUM SPEED 230 KIAS AT MOEHH.

**AIRPORTS SERVED:**

FOUR CLOWNS REGIONAL, VICTORVILLE, TX

**COMMUNICATIONS:**

ATIS, CLNC DEL, GND CON, FCR ATCT, ARCON DEP CON

**FIXES AND/OR NAVAID'S:**

**REMARKS:**

**FLIGHT INSPECTED BY:**

Johnathan P. Doe

FIOG 4/15/2011

**REQUIRED EFFECTIVE DATE:**

ROUTINE

**DEVELOPED BY:**

Timothy S. Wisenheimer  
(John Q. Public)

AJV-352 2/13/2011

**APPROVED BY:**

David P. Specialist

AJV-352 6/12/2011

**COORDINATED WITH:**

A4A, ALPA, APA, AOPA, NBAA, ARPT MGR, FCR ATCT, ZFW

**CHANGES:**

1. ADDED OPO TRANSITION.
2. REMOVED LMN VOR/DME FROM RST TRANSITION
3. RELOCATED MOEHH
4. DELETED AUTHORIZATION TO USE DME/DME/IRU
5. DELETED NOTE: RADAR REQUIRED FOR NON-GPS EQUIPPED AIRCRAFT

**REASONS:**

- 1-3. RAPT REQUEST.
- 4-5. ABILITY TO USE DME/DME/IRU NO LONGER AVAILABLE



Figure E-4.

U.S. DEPARTMENT of TRANSPORTATION - FEDERAL AVIATION ADMINISTRATION  
**GRAPHIC DEPARTURE PROCEDURE (DP)**

Bearings, headings, courses, tracks, and radials are magnetic. Elevations and altitudes are in feet, MSL. Altitudes are minimum altitudes unless otherwise indicated. Ceilings are in feet above airport elevation. Distances are in nautical miles (NM). Visibilities are in statute miles (SM) or feet RVR unless otherwise indicated. Graphic depiction attached.

DP Name	DP Computer Code	Superseded Number	Dated	Effective Date
ARKE5	ONE	ARKE51.ARKE5	NONE	

**TYPE:** RNAV SID

**DP ROUTE DESCRIPTION:**

TAKEOFF RWY 9L: CLIMB HEADING 093.36 TO 520. THEN DIRECT JUMAR, THEN LEFT TURN ON TRACK 351.15 TO HAPOR, THEN ON DEPICTED ROUTE, THENCE...  
 TAKEOFF RWY 9R: CLIMB HEADING 093.36 TO 520. THEN LEFT TURN DIRECT JUMAR, THEN LEFT TURN ON TRACK 351.15 TO HAPOR, THEN ON DEPICTED ROUTE, THENCE...  
 TAKEOFF RWY 13: CLIMB HEADING 138.36 TO 520. THEN LEFT TURN DIRECT JUMAR, THEN LEFT TURN ON TRACK 351.15 TO HAPOR, THEN ON DEPICTED ROUTE, THENCE...  
 TAKEOFF RWY 27L: CLIMB HEADING 273.39 TO 520. THEN RIGHT TURN DIRECT NOVAE, THEN ON DEPICTED ROUTE, THENCE...  
 TAKEOFF RWY 27R: CLIMB HEADING 273.36 TO 520. THEN DIRECT NOVAE, THEN ON DEPICTED ROUTE, THENCE...  
 TAKEOFF RWY 31: CLIMB HEADING 318.37 TO 520. THEN DIRECT NOVAE, THEN ON DEPICTED ROUTE, THENCE...

... MAINTAIN 3000 OR AS ASSIGNED BY ATC. EXPECT CLEARANCE TO FILED ALTITUDE 10 MINUTES AFTER DEPARTURE.

**TRANSITION ROUTES (GRAPHIC DEPICTION ONLY):**

Transition Name	Computer Codes	FIX/NAVAID	To FIX/NAVAID	Course	Distance	MEA	MOCA	Crossing Altitudes/Fixes
-----------------	----------------	------------	---------------	--------	----------	-----	------	--------------------------

**PROCEDURAL DATA NOTES/TAKEOFF MINIMUMS:**

TAKEOFF MINIMUMS: RWY 9L, 9R STANDARD. RWY 13, 27L, 27R, 31 STANDARD WITH CLIMB OF 500 FT PER NM TO 520.  
 NOTE: DME/DME/IRU OR GPS REQUIRED.  
 NOTE: RADAR REQUIRED FOR NON-GPS EQUIPPED AIRCRAFT  
 NOTE: TURBOJET AIRCRAFT ACCELERATE TO 250 KIAS WITHIN 7 NM OF DEPARTURE, IF UNABLE, ADVISE ATC.  
 NOTE: RNAV-1

**TAKEOFF OBSTACLE NOTES:**

NOTE: RWY 9L, RAILROAD, LIGHT POLE, AND ANTENNA ON BUILDING BEGINNING 469' FT FROM DER, 379' FT LEFT OF CENTERLINE, UP TO 43 FT AGL/47 FT MSL. LIGHT POLE 1332 FT FROM DER, 634 FT RIGHT OF CENTERLINE, 42 FT AGL/46 FT MSL. TREE 1977 FT FROM DER, 272 FT RIGHT OF CENTERLINE, 55 FT AGL/59 FT MSL.  
 NOTE: RWY 9R, LIGHT POLE 545 FT FROM DER, 335 FT LEFT OF CENTERLINE, 27 FT AGL/41 FT MSL. TREE 783 FT FROM DER, 396 FT LEFT OF CENTERLINE, 30 FT AGL/44 FT MSL. ANTENNA ON BUILDING, FENCE, LIGHT POLE, AND MULTIPLE TREES BEGINNING 254 FT FROM DER, 133 FT RIGHT OF CENTERLINE, UP TO 56 FT AGL/70 FT MSL.  
 NOTE: RWY 13, MULTIPLE TREES BEGINNING 844 FT FROM DER, 206 FT LEFT OF CENTERLINE, UP TO 76 FT AGL/80 FT MSL. ANTENNA ON BUILDING 534 FT FROM DER, 431 FT LEFT OF CENTERLINE, 11 FT AGL/20 FT MSL. POLE 910 FT FROM DER, ON CENTERLINE, 30 FT AGL/39 FT MSL. RAILROAD CROSSING ARM 1104 FT FROM DER, 14 FT RIGHT OF CENTERLINE, 42 FT AGL/56 FT MSL. MULTIPLE TREES AND LIGHT POLES BEGINNING 563 FT FROM DER, 53 FT RIGHT OF CENTERLINE, UP TO 81 FT AGL/95 FT MSL.  
 NOTE: RWY 27L, FENCE 154 FT FROM DER, 120 FT LEFT OF CENTERLINE, 5 FT AGL/13 FT MSL. ROAD 212 FT FROM DER, 80 FT LEFT OF CENTERLINE, 11 FT AGL/20 FT MSL. MULTIPLE BUILDINGS, POLES, AND TREES BEGINNING 622 FT FROM DER, 227 FT LEFT OF CENTERLINE, UP TO 97 FT AGL/106 FT MSL. BUSH, MULTIPLE LIGHT POLES, TREES, AND TOWERS BEGINNING 221 FT FROM DER, 41 FT RIGHT OF CENTERLINE, UP TO 105 FT AGL/114 FT MSL.  
 NOTE: RWY 27R, ANTENNA ON BUILDING, ROAD, RAILROAD, AND SIGN BEGINNING 262 FT FROM DER, 6 FT LEFT OF CENTERLINE, UP TO 37 FT AGL/46 FT MSL. MULTIPLE TREES BEGINNING 1206 FT FROM DER, 279 FT LEFT OF CENTERLINE, UP TO 93 FT AGL/97 FT MSL. ROAD 584 FT FROM DER, 557 FT RIGHT OF CENTERLINE, 24 FT AGL/33 FT MSL. MULTIPLE TREES BEGINNING 2288 FT FROM DER, 848 FT RIGHT OF CENTERLINE, UP TO 103 FT AGL/112 FT MSL.

U.S. DEPARTMENT OF TRANSPORTATION - FEDERAL AVIATION ADMINISTRATION  
**GRAPHIC DEPARTURE PROCEDURE (DP)**

Bearings, headings, courses, tracks, and radials are magnetic. Elevations and altitudes are in feet, MSL. Altitudes are minimum altitudes unless otherwise indicated. Ceilings are in feet above airport elevation. Distances are in nautical miles (NM). Visibilities are in statute miles (SM) or feet RVR unless otherwise indicated. Graphic depiction attached.

DP Name	Number	DP Computer Code	Superseded Number	Dated	Effective Date
ARKES	ONE	ARKES1	ARKES		NONE

**TAKEOFF OBSTACLE NOTES (CONTINUED):**

NOTE: RWY 31: ROD ON TOWER 299 FT FROM DER, 382 FT LEFT OF CENTERLINE, 14 FT AGL/23 FT MSL. TREE 1332 FT FROM DER, 488 FT LEFT OF CENTERLINE, 34 FT AGL/43 FT MSL. ROAD 3384 FT FROM DER, 711 FT LEFT OF CENTERLINE, 84 FT AGL/94 FT MSL. MULTIPLE TREES AND POLES BEGINNING 1180 FT FROM DER, 405 FT RIGHT OF CENTERLINE, UP TO 111 FT AGL/116 FT MSL.

**CONTROLLING OBSTACLES:**

RWY 9L: 362 FT MSL STACKS 260509.00N/0800730.00W.  
RWY 13: 1049 FT MSL TOWER 255935.28N/0801026.00W.  
RWY 27L: 1049 FT MSL TOWER 255935.28N/0801026.00W.  
RWY 27R: 1049 FT MSL TOWER 255935.28N/0801026.00W.

**LOST COMMUNICATIONS PROCEDURES:**

**ADDITIONAL FLIGHT DATA:**

REFERENCE MAG VAR: KELL 3W EPOCH YR: 85. DME/DME/IRU ASSESSMENT: SAT (RNP 2.0).

**AIRPORTS SERVED:**

FORT LAUDERDALE/HOLLYWOOD INTL, FORT LAUDERDALE, FL

**COMMUNICATIONS:**

ATIS, CLNC DEL, GND CON, FLL ATCT, DEP CON 126.05

**FIXES AND/OR NAVAIDS:**

**REMARKS:**

RWY 13, 27L, 27R, 31 CLIMB GRADIENT OF 500 FEET PER NM DRIVEN BY AC 90-100 OPERATIONAL REQUIREMENT TO ENGAGE LNAV NO LATER THAN 500 FEET ABOVE AIRPORT ELEVATION.

**FLIGHT INSPECTED BY:**

Johnathan P. Doe FIOG 2/13/2011 ROUTINE

**DEVELOPED BY:**

Timothy S. Wisenheimer AJV-352 2/13/2011

**APPROVED BY:**

David P. Specialist AJV-352 2/13/2011

**REQUIRED EFFECTIVE DATE:**

ROUTINE

U.S. DEPARTMENT OF TRANSPORTATION - FEDERAL AVIATION ADMINISTRATION  
**GRAPHIC DEPARTURE PROCEDURE (DP)**

Bearings, headings, courses, tracks, and radials are magnetic. Elevations and altitudes are in feet, MSL. Altitudes are minimum altitudes unless otherwise indicated. Ceilings are in feet above airport elevation. Distances are in nautical miles (NM). Visibilities are in statute miles (SM) or feet RVR unless otherwise indicated. Graphic depiction attached.

DP Name ARKE5 DP Computer Code ARKE51.ARKE5 Superseded Number NONE Effective Date

COORDINATED WITH:

AAA, ALPA, APA, AOPA, NBAA, ZMA, MIA APP CON

CHANGES:

REASONS:

THIS PAGE IS INTENTIONALLY LEFT BLANK

Figure E-5.

U.S. DEPARTMENT OF TRANSPORTATION - FEDERAL AVIATION ADMINISTRATION  
**GRAPHIC DEPARTURE PROCEDURE (DP)**

Bearings, headings, courses, tracks, and radials are magnetic. Elevations and altitudes are in feet, MSL. Altitudes are minimum altitudes unless otherwise indicated. Ceilings are in feet above airport elevation. Distances are in nautical miles (NM). Visibilities are in statute miles (SM) or feet RVR unless otherwise indicated. Graphic depiction attached.

DP Name	DP Computer Code	Superseded Number	Dated	Effective Date
FLAVR	FLAVR1.FLAVR	ONE		

Type: RNAV SID

**DP ROUTE DESCRIPTION:**

TAKEOFF RWY 1, 14L, 32R: CLIMB ON ASSIGNED HEADING FOR RADAR VECTORS TO WAYPT, THEN ON TRACK 075.33 TO FLAVR, THENCE...

... (TRANSITION), MAINTAIN 5000, EXPECT FILED ALTITUDE 10 MINUTES AFTER DEPARTURE.

**TRANSITION ROUTES (GRAPHIC DEPICTION ONLY):**

Transition Name	Computer Codes	FLX/NAVAID	To	FIX/NAVAID	Course	Distance	MEA	MOCA	Crossing Altitudes/Fixes
FOGART	FLAVR1.FGH	FLAVR	FGH	VORTAC	TRACK 065.11	84.74	5000	3700	
JENKO	FLAVR1.JKL	FLAVR	JKL	VORTAC	TRACK 098.06	88.8	5000		
OPAKE	FLAVR1.OPQ	FLAVR	OPQ	VOR/DME	LEFT TURN TRACK 333.87	55.23	4000	3300	
ROOSTER	FLAVR1.RST	FLAVR	RST	VORTAC	TRACK 129.92	72.85	7000	4900	

**PROCEDURAL DATA NOTES/TAKEOFF MINIMUMS:**

TAKEOFF MINIMUMS: RWY 14R, 19, 32L NA - AIR TRAFFIC. RWY 1, 32R STANDARD. RWY 14L 500-2 1/2 OR STANDARD WITH MINIMUM CLIMB OF 330 FT PER NM TO 1200.  
NOTE: DME/DME/IRU OR GPS REQUIRED.  
NOTE: RADAR REQUIRED  
NOTE: RNAV-1

**TAKEOFF OBSTACLE NOTES:**

NOTE: RWY 1, OBSTRUCTION LIGHT 1022 FT FROM DER, 672 FT RIGHT OF CENTERLINE, 73 FT AGL/543 FT MSL.  
NOTE: RWY 14L, BUILDING 1.96 NM FROM DER, 575 FT RIGHT OF CENTERLINE, 478 FT AGL/974 FT MSL.  
NOTE: RWY 32R, TREES 143 FT LEFT OF DER, 21 FT AGL/498 FT MSL.

**CONTROLLING OBSTACLES:**

RWY 1: 543 FT MSL OBSTRUCTION LIGHT, 325141.44N/0965102.87W.  
RWY 14L: 974 FT MSL BUILDING, 324911.09N/0964838.62W.  
RWY 32R: 1049 FT MSL TOWER, 325216.19N/0965523.02W, 498 FT MSL TREES, 325125.20N/0965125.68W.

**LOST COMMUNICATIONS PROCEDURES:**

U.S. DEPARTMENT OF TRANSPORTATION - FEDERAL AVIATION ADMINISTRATION  
**GRAPHIC DEPARTURE PROCEDURE (DP)**

Bearings, headings, courses, tracks, and radials are magnetic. Elevations and altitudes are in feet, MSL. Altitudes are minimum altitudes unless otherwise indicated. Ceilings are in feet above airport elevation. Distances are in nautical miles (NM). Visibilities are in statute miles (SM) or feet RVR unless otherwise indicated. Graphic depiction attached.

DP Name: **FLAVR**      Number: **ONE**      DP Computer Code: **FLAVR1.FLAVR**      Superseded Number:      Dated:      Effective Date:

**ADDITIONAL FLIGHT DATA:**

REFERENCE MAG VAR: KFCR 2W EPOCH YR: 00  
DME/DME ASSESSMENT: SAT  
CHART: MEA/MOCA FROM WAYPT TO FLAVR, 4000/3000

**AIRPORTS SERVED:**

FOUR CLOWNS REGIONAL, VICTORVILLE, TX

**COMMUNICATIONS:**

ATIS, CLNC DEL, GND CON, FCR ATCT, ARCON DEP CON

**FIXES AND/OR NAVAIDS:**

**REMARKS:**

**FLIGHT INSPECTED BY:**

Johnathan P. Doe

4/15/2011

FOG

**REQUIRED EFFECTIVE DATE:**

09/23/2011

**DEVELOPED BY:**

Timothy S. Wisenheimer  
(John G. Public)

2/13/2011

AJV-352

**APPROVED BY:**

David P. Specialist

6/12/2011

AJV-352

**COORDINATED WITH:**

AAA, ALPA, APA, AOPA, NBAA, ARPT MGR, FCR ATCT, ZFW

**CHANGES:**

**REASONS:**

## Section 2. Instructions for Completing FAA Form 8260-15C, Departure (Data Record) and Sample Forms

**1. Basic instructions for completing Form 8260-15C.** Detailed instructions are contained in appendix E, paragraphs 2 through 5. Enter a dash (e.g., “-”) in the FO/FB, Leg Type, TC (True Course), and Distance columns when they are intentionally left blank.

**a. Fix/NAVAID.** Enter the name of the fix/NAVAID in one of the following formats: (5-letter pronounceable name; (NAVAID) 3-letter facility ID and type (e.g., ABC VORTAC).

**b. Lat/Long.** Enter the latitude and longitude, separated by a “slant(/)” to the nearest hundredth of a second.

**c. C (Chart).** Enter a Y (yes) if a fix is to be charted. Enter an N (no) if a fix does not require charting. Any fix where a change in altitude, course, or speed, including WPs where turns or transitions begin and end, require charting.

**d. FO/FB.** Enter the FO (Fly-over) or FB (Fly-by) as appropriate to indicate desired use. FB is the normal designation. Determination is based on operational or obstacle requirements.

**e. Leg Type.** Enter the two-letter ARINC-24 code for leg-type; e.g., IF, TF, RF, etc.

**f. TC.** Enter the true course (TC) to the nearest hundredth of a degree. The charting agency will apply magnetic variation, if necessary, and round for publication.

**g. Dist.** Enter the distance to the nearest hundredth of a NM. The charting agency will round for publication.

**h. Altitude.** Enter the minimum, mandatory, or maximum altitude in 100-foot increments (or Flight Levels in 1000-foot increments) and label each altitude/flight level as “at/above,” “at,” or “at/below.” Enter “block altitudes” with a “B” between the altitude values; e.g., 5000B8000.

**i. Speed.** Enter the minimum, mandatory, or maximum airspeed(s) in KIAS. Optionally, the airspeed may be entered as ground speed (GS). Label airspeed restrictions as “at/above,” “at,” or “at/below,” as appropriate. Following the numerical value, add “K” for KIAS or “G” for ground speed. Enter restrictions only where necessary for procedural containment, or for traffic flow requirements.

**j. Remarks.** Enter any pertinent information that would clarify a data entry; e.g., airspeed restriction for turn radius. Additionally, such items as CG restrictions, displaced threshold information, transition computer code, reference NAVAID for CF legs (see Order 8260.19, chapter 2, section 2-5), etc., are also placed in this column.

**2. The departure routing from each authorized runway to the DP fix (i.e., the DP termination fix) is documented first, followed by the routing from the DP fix to each transition fix as appropriate.**

**3. Departure Routing to DP Fix (see examples).** The initial departure routing represents the most complex portion of documenting the RNAV or RNP DP. The first three lines of Form 8260-15C are typically the most problematic, largely due to the variables associated with permissible leg types and waypoint sequencing. The following line-by-line explanation used in conjunction with guidance in paragraph 3-1-5b, outlines the departure sequence element (i.e., from AER to DP fix) beginning at the AER\*, with each succeeding line representing a permissible option until reaching the DP fix. Fix/NAVAIDs, Lat/Long, “C” (chart), FO/FB, Leg Type, TC (True Course), and Distance columns are required entries except as noted. Altitude and Speed columns enter restrictions associated with the Fix/NAVAID column as appropriate.

**\*Note:** WP placement is computed from DER as outlined in Order 8260.58 (latest edition); AER is a required coding element used for course/heading and distance computations.

**4. For each authorized runway:**

**a. First line of each element.**

- (1) In the Fix/NAVAID column, enter the AER. Example: “RW14L (AER).”
- (2) In the Lat/Long column, enter the AER Lat/long. If the runway threshold is displaced, enter the displaced AER Lat/long and note the amount of displacement in Remarks column. Example: “RW 14L (AER)\*, 325117.19N/0965114.05W\*, \*DISPL THLD (1273 FEET).”
- (3) In the “C” column, enter “N.”
- (4) Remaining columns leave blank.

**Note:** For procedures that are strictly Radar Vectors to RNAV, an AER entry is not necessary (i.e., the first entry will be an IF). For procedures that incorporate Radar Vectors to RNAV for one or more runways on the same chart that contains an RNAV route departure off other runways, the runway(s) that use Radar Vectors to RNAV will require an “AER” entry prior to defining the IF.

**b. Second line options.**

- (1) CF leg from AER to FB/FO: True Course and Distance columns enter true course/distance from AER to the next fix (see example SHEMP ONE, RW01).
- (2) DF leg from AER to FB/FO: True Course column, leave blank. Distance column, enter distance from AER to the next fix (see example SHEMP TWO, RW01).
- (3) VI to CF leg (See third line options for required CF entries): Fix/NAVAID column, leave blank. Lat/Long column, enter the computed Lat/long of the VI/CF intersect point. C columns leave blank. True Course column, enter the true heading to be flown as computed from AER to VI/CF intersect point. Distance column, enter distance from AER to VI/CF intersect point. Speed and Altitude columns: Leave blank.



(4) VA to DF leg (See third line options for required DF entries): Fix/NAVAID column, enter the climb-to MSL altitude. Lat/Long, C, and FO/FB columns, leave blank. True Course column, enter the true azimuth of the takeoff runway. Distance, Altitude, and Speed columns, leave blank. (See example for SHEMP TWO, RW32R.)

**c. Third line options.** If required; third line required for VA combinations:

(1) DF leg (preceded by FO WP): True Course column, leave blank. Distance column, enter the distance between the plotted positions of fixes. Remarks column, specify turn direction as either “Left/Right Turn” when required (see example SHEMP ONE, RW14L).

(2) TF leg: True Course and Distance columns, enter the true course and distance between the plotted positions of fixes. Remarks Column, specify turn direction as described above only if course change exceeds 90 degrees.

(3) CF leg (VI/CF combination): True Course and Distance columns, enter the true course and distance from the VI/CF intersect point to the next fix (CF termination fix). Remarks column, specify turn direction as described above only if course change exceeds 90 degrees (see example SHEMP ONE, RW32R).

(4) DF leg (VA/DF combination): True Course and Distance columns leave blank. Remarks column, specify turn direction as either “Left/Right Turn” when required (see example SHEMP TWO, RW32R).

**d. Fourth and subsequent lines (DF or TF only).** Same as third line (1) & (2) entries.

**e. The DP routing concludes** with the DP fix data entered on the last line of each routing element. Repeat this process until all authorized runways have been entered.

## 5. Transition Routing (see examples). For each transition:

**a. First line of each element.**

- (1) Fix/NAVAID and Lat/Long columns: Enter the DP fix name and Lat/long.
- (2) “C” (chart) column: Enter “Y.”
- (3) FO/FB column: Leave blank.
- (4) Leg Type column: Enter “IF.”
- (5) True Course, Distance, Altitude, and Speed columns: Leave blank.
- (6) Remarks column: Enter the transition computer code.

**b. Second and subsequent lines (DF or TF only).** Same as departure routing element third line (1) and (2) entries. Enter the transition fix data on the last line of the transition routing element.

THIS PAGE IS INTENTIONALLY LEFT BLANK

Figure E-6.

DEPARTURE (DATA RECORD)

DP Name	Number	DP Computer Code	Superseded Number	Dated	Effective Date				
SHEMP	ONE	SHEMP1.SHEMP	NONE						
FIXNAVAID	LAT/LONG	C	FO/FE	LEG	TC	DIST	ALTITUDE	SPEED	REMARKS
RW01 (AER)	325030.65N/0965118.52W	N	-	-	-	-	-	-	
LARRY	325615.86N/0965038.96W	Y	FB	CF	005.52	5.77			
MOEHH	330002.41N/0964701.80W	Y	FB	TF	038.92	4.84			
SHEMP	325932.61N/0962728.24W	Y	FB	TF	091.64	16.46			
RWY14L (AER)*	325117.19N/0965114.05W*	N	-	-	-	-	-	-	*DISPL THLD (1273 FT)
CURLY	324935.46N/0964916.24W	Y	FO	CF	135.64	2.37	AT/ABOVE 1000		CG 330 FT PER NM TO 1200
SHEMP	325932.61N/0962728.24W	Y	FB	DF		20.87			LEFT TURN
RW32R (AER)	325031.35N/0965020.95W	N	-	-	-	-	-	-	
1000 MSL	-	-	-	VA	315.66	3.84			
LARRY	325615.86N/0965038.96W	Y	FO	DF					RIGHT TURN
MOEHH	330002.41N/0964701.80W	Y	FO	TF	038.92	4.84			
SHEMP	325932.61N/0962728.24W	Y	FO	TF	091.64	16.46			
SHEMP	325932.61N/0962728.24W	Y	-	IF	-	-	-	-	SHEMP1.FGH
FGH VORTAC	333543.94N/0945243.79W	Y	FB	TF	065.11	87.24			
SHEMP	325932.61N/0962728.24W	Y	-	IF	-	-	-	-	SHEMP1.JKL
JKL VORTAC	324749.41N/0943828.97W	Y	FB	TF	096.77	92.52			
SHEMP	325932.61N/0962728.24W	Y	-	IF	-	-	-	-	SHEMP1.LMN
LMN VOR/DME	321721.40N/0960207.46W	Y	FB	TF	152.94	47.23			
SHEMP	325932.61N/0962728.24W	Y	-	IF	-	-	-	-	SHEMP1.RST
LMN VOR/DME	321721.40N/0960207.46W	Y	FB	TF	152.94	47.23			
RST VORTAC	321246.96N/0951530.88W	Y	FB	TF	096.38	39.79			

THIS PAGE INTENTIONALLY LEFT BLANK

Figure E-7.

DEPARTURE (DATA RECORD)

DP Name	Number	DP Computer Code	Superseded Number	Dated	Effective Date				
<b>SHEMP</b>	<b>TWO</b>	<b>SHEMP2:SHEMP</b>	<b>ONE</b>	<b>18 Apr 02</b>					
<b>FIX/NAVAID</b>	<b>LAT/LONG</b>	<b>C</b>	<b>FO/IB</b>	<b>TYPE</b>	<b>TC</b>	<b>DIST</b>	<b>ALTITUDE</b>	<b>SPEED</b>	<b>REMARKS</b>
RW01 (AER)	325030.65N/0965118.52W	N	-	-	-	-	-	-	-
LARRY	326615.86N/0965038.96W	Y	FO	DF	-	-	AT/ABOVE 2000	-	-
MOEHH	330205.91N/0964502.64W	Y	FO	TF	038.97	7.49	AT/ABOVE 3000	AT/BELOW 220K	-
SHEMP	325932.61N/0962728.24W	Y	FO	TF	098.71	15.00	5000B8000	-	-
RWY14L (AER)*	325117.19N/0965114.05W	N	-	-	-	-	-	-	*DISPL THLD (1273 FT)
CURLY	324905.36N/0964841.41W	Y	FB	DF	-	3.07	AT/ABOVE 1000	-	CG 330 FT PER NM TO 1200
SHEMP	325932.61N/0962728.24W	Y	FO	TF	059.62	20.69	5000B8000	-	-
RW32R (AER)	325031.35N/0965020.95W	N	-	-	-	-	-	-	-
1000 MSL	-	-	-	VA	315.66	-	AT/ABOVE 1000	-	-
LARRY	326615.86N/0965038.96W	Y	FO	DF	-	-	AT/ABOVE 2000	-	RIGHT TURN
MOEHH	330205.91N/0964502.64W	Y	FO	TF	038.97	7.49	AT/ABOVE 3000	AT/BELOW 220K	-
SHEMP	325932.61N/0962728.24W	Y	FO	TF	098.71	15.00	5000B8000	-	-
SHEMP	325932.61N/0962728.24W	Y	-	IF	-	-	-	-	SHEMP2:FGH
FGH VORTAC	333543.94N/0945243.79W	Y	FB	TF	065.11	87.24	-	-	RIGHT TURN
SHEMP	325932.61N/0962728.24W	Y	-	IF	-	-	-	-	SHEMP2:JKL
JKL VORTAC	324749.41N/0943828.97W	Y	FB	TF	096.77	92.51	-	-	RIGHT TURN
SHEMP	325932.61N/0962728.24W	Y	-	IF	-	-	-	-	SHEMP2:OPQ
OPQ VOR/DME	334641.06N/0965429.57W	Y	FB	TF	003.19	52.21	-	-	LEFT TURN
SHEMP	325932.61N/0962728.24W	Y	-	IF	-	-	-	-	SHEMP2:RST
RST VORTAC	321246.96N/0951530.88W	Y	FB	TF	127.19	76.63	-	-	RIGHT TURN

THIS PAGE INTENTIONALLY LEFT BLANK

Figure E-8.

DEPARTURE (DATA RECORD)

DP Name	Number	DP Computer Code	Superseded Number	Dated	Effective Date					
ARKES	ONE	ARKES1-ARKES	NONE							
FIX/NAVAID	LAT/LONG	C	FO/FB	TYPE	TC	LEG	DIST	ALTIUDE	SPEED	REMARKS
RW09L (AER)*	360436.98N/0800953.20W	N	-	-	-	VA	090.36	-	-	*DISPL THLD (577 FT)
520 MSL	-	-	-	-	-	VA	090.36	-	-	
JUMAR	260431.29N/0795501.17W	Y	FB	DF	-	-	-	-	-	
HAPOR	261243.07N/0795655.56W	Y	FB	TF	348.15	8.35	-	-	-	LEFT TURN
SECOR	261427.18N/0801120.40W	Y	FB	TF	277.66	13.08	-	-	-	
ATONE	262312.14N/0802123.68W	Y	FB	TF	314.03	12.56	-	-	-	
ARKES	263437.73N/0802503.60W	Y	FB	TF	343.91	11.86	-	-	-	
RW09R (AER)*	360357.49N/0800933.63W	N	-	-	-	VA	090.36	-	-	*DISPL THLD (320 FT)
520 MSL	-	-	-	-	-	VA	090.36	-	-	
JUMAR	260431.29N/0795501.17W	Y	FB	DF	-	-	-	-	-	LEFT TURN
HAPOR	261243.07N/0795655.56W	Y	FB	TF	348.15	8.35	-	-	-	LEFT TURN
SECOR	261427.18N/0801120.40W	Y	FB	TF	277.66	13.08	-	-	-	
ATONE	262312.14N/0802123.68W	Y	FB	TF	314.03	12.56	-	-	-	
ARKES	263437.73N/0802503.60W	Y	FB	TF	343.91	11.86	-	-	-	
RW13 (AER)	260444.05N/0800937.40W	N	-	-	-	VA	135.36	-	-	CG 500 FT PER NM TO 520
520 MSL	-	-	-	-	-	VA	135.36	-	-	LEFT TURN
JUMAR	260431.29N/0795501.17W	Y	FB	DF	-	-	-	-	-	LEFT TURN
HAPOR	261243.07N/0795655.56W	Y	FB	TF	348.15	8.35	-	-	-	LEFT TURN
SECOR	261427.18N/0801120.40W	Y	FB	TF	277.66	13.08	-	-	-	
ATONE	262312.14N/0802123.68W	Y	FB	TF	314.03	12.56	-	-	-	
ARKES	263437.73N/0802503.60W	Y	FB	TF	343.91	11.86	-	-	-	
RW27L (AER)*	360357.17N/0800840.84W	N	-	-	-	VA	270.39	-	-	*DISPL THLD (142 FT)
520 MSL	-	-	-	-	-	VA	270.39	-	-	CG 500 FT PER NM TO 520
NOVAE	260438.90N/0801553.29W	Y	FB	DF	-	-	-	-	-	RIGHT TURN
KRMIT	261322.00N/0801816.69W	Y	FB	TF	346.11	8.95	-	-	-	
ATONE	262312.14N/0802123.68W	Y	FB	TF	344.07	10.20	-	-	-	
ARKES	263437.73N/0802503.60W	Y	FB	TF	343.91	11.86	-	-	-	
RW27R (AER)*	360436.49N/0800827.45W	N	-	-	-	VA	270.36	-	-	*DISPL THLD (604 FT)
520 MSL	-	-	-	-	-	VA	270.36	-	-	CG 500 FT PER NM TO 520
NOVAE	260438.90N/0801553.29W	Y	FB	DF	-	-	-	-	-	
KRMIT	261322.00N/0801816.69W	Y	FB	TF	346.11	8.95	-	-	-	
ATONE	262312.14N/0802123.68W	Y	FB	TF	344.07	10.20	-	-	-	
ARKES	263437.73N/0802503.60W	Y	FB	TF	343.91	11.86	-	-	-	

**DEPARTURE (DATA RECORD)**

DP Name	Number	DP Computer Code	Superseded Number	Dated	Effective Date						
ARKES	ONE	ARKES1,ARKES	NONE								
FIX/NAVAID		LAT/LONG	C	FO/FB	TYPE	TC	LEG	DIST	ALTIITUDE	SPEED	REMARKS
RW31 (AER)*		360355.70N0800844.54W	N	-	-	-	-	-	-	-	*DISPL THLD (70 FT)
520 MSL		-	-	-	-	-	-	-	-	-	CG 500 FT PER NM TO 520
NOVAE		260438.90N0801553.29W	Y	FB	DF	-	-	-	-	-	LEFT TURN
KRMIT		261322.00N0801816.69W	Y	FB	TF	346.11	8.95	-	-	-	
ATONE		262312.14N0802123.68W	Y	FB	TF	344.07	10.20	-	-	-	
ARKES		263437.73N0802503.60W	Y	FB	TF	343.91	11.86	-	-	-	





THIS PAGE IS INTENTIONALLY LEFT BLANK

**Section 3. Instructions for Completing FAA Form 8260-15E,  
RNAV Departure Procedure Attention All users Page (AAUP)  
[RNAV Departure Procedure] and Sample Form**

**1. General.** This section provides procedural guidance for developing AAUPs utilized when conducting simultaneous RNAV departure operations from two or more runways. For implementing this section, consider simultaneous operations to be those when RNAV departures can be independently conducted by air traffic.

**a. This guidance applies to simultaneous RNAV departure procedures** that use published SIDs with tracks that utilize a standard track divergence angle of 15 degrees or more, as well as those that use reduced track divergence angles.

**b. Use Form 8260-15E, RNAV Departure Procedure Attention All Users Page,** to document an RNAV Departure Procedure AAUP. If an AAUP for a departure procedure using navigation other than RNAV is proposed, collaborate with Flight Standards (primary contact is AFS-470) for the development of the AAUP.

**2. Title Line.** The title line consists of the following three headings and will be filled in as noted (for a sample, see figure E-10).

**a. City, State.** Enter name of city and state abbreviation; e.g., ATLANTA, GA.

**b. Airport Name and Airport ID.** Enter airport name and ID, e.g., ATLANTA/HARTSFIELD-JACKSON ATLANTA INTL (ATL).

**Note:** NFDC, as the official source of airport IDs, will verify that the ID is correct.

**c. Effective Date.** The originating organization determines the desired effective date after coordination with AeroNav Products, NFDC, and AFS-400 and then entered on the AAUP form.

**3. General Information.** This section consists of the following four elements and will be filled out as noted (see figure E-10).

**a. Preflight.** Upon assignment of an RNAV SID, crosscheck the charted RNAV SID with the aircraft navigation system. Consider the following crosscheck items:

- (1) Departure Runway if known;
- (2) Waypoint sequencing on the RNAV SID;
- (3) En Route Transition;
- (4) Any specific aircraft navigation operating procedures or limitations,
- (5) Do not modify or manually construct waypoints on the SID.

**b. Before Takeoff.** Verify any modification to the navigation system, including runway changes, against the charted RNAV SID. Advise ATC if unable to verify correct loading of the runway and/or procedure or if unable to comply with the RNAV SID. Ensure a runway position update is accomplished prior to takeoff, if required.

**c. Line Up/Takeoff.** Expect a takeoff clearance to include, “RNAV track to the first fix/waypoint” or an assigned heading. Consider the following:

- (1) If assigned a heading do not delete the RNAV SID from the navigation system.
- (2) An RNAV takeoff clearance will be issued with “RNAV to” phraseology. For example, “(Callsign) 123, RNAV to MPASS, Runway 26L, Cleared for Takeoff.” The expected pilot response is “(Callsign) 123, RNAV to MPASS, Runway 26L, Cleared for Takeoff.”
- (3) Verify the departure clearance takeoff runway and cleared to fix/waypoint is displayed in the aircraft navigation system. If a discrepancy exists, request an initial heading for takeoff from tower or refuse the takeoff clearance until the discrepancy is resolved.
- (4) Verify lateral mode to be used on departure.
- (5) Fly the published procedure issued in the IFR clearance if no additional instructions are received with the take-off clearance.

**d. After Takeoff.** RNAV to fix/waypoint. Fly runway heading, engage lateral navigation flight guidance when appropriate, and fly the cleared departure procedure. Strict compliance with the lateral track, charted altitude and any speed restrictions is imperative. Parallel RNAV departures must not encroach on the airspace between extended parallel runway centerlines without specific ATC clearance. Manually intervene, if required, to remain on track to avoid deviating in the direction of a parallel runway, track, or aircraft. If unable to comply with the SID profile, either laterally or vertically, immediately notify ATC. Assigned Heading: Fly assigned heading until otherwise cleared.

**4. Additional Airport Information.** This section will contain information specific to the airport and may contain both textual instructions and graphical depictions; i.e., (Airport Name) SPECIFIC INFORMATION: (Airport ID) e.g., ATL, followed by instructions (see figure E-10).

**5. Administrative Information.** Items below are for informational and administrative purposes only. These items are to be completed on the forms and not to be published on the AAUP. A blank FAA Form 8260-XX is available on the FAA website.

**a. Developed By.** Enter the name of the person responsible for producing the AAUP. This individual must sign in the “developed by” space, and enter the date signed. Enter the office or function of the person responsible, such as ATL TRACON or ATL SIT.

**b. Coordinated With.** Specify the offices/organizations the AAUP was coordinated.

- c. Changes (for revised AAUPs).** List changes relating to AAUP entries.
- d. Reasons (for initial or revised AAUPs).** List reasons for changes relating to AAUP entries.

THIS PAGE IS INTENTIONALLY LEFT BLANK

**Figure E-10. Sample of Completed FAA Form 8260-15E**U.S. DEPARTMENT of TRANSPORTATION –  
FEDERAL AVIATION ADMINISTRATION**RNAV DEPARTURE PROCEDURE  
ATTENTION ALL USERS PAGE (AAUP)**

City, State	Airport	Effective Date
<b>ATLANTA, GA</b>	<b>ATLANTA/HARTSFIELD-JACKSON ATLANTA INTL (ATL)</b>	

1. **PREFLIGHT:** Upon assignment of an RNAV SID, crosscheck the charted RNAV SID with the aircraft navigation system. Consider the following crosscheck items:
  - a. Departure Runway if known,
  - b. Waypoint sequencing on the RNAV SID,
  - c. En Route Transition,
  - d. Any specific aircraft navigation operating procedures or limitations, and
  - e. Do not modify or manually construct waypoints on the SID.
2. **BEFORE TAKEOFF:** Verify any modification to the navigation system, including runway changes, against the charted RNAV SID. Advise ATC if unable to verify correct loading of the runway and/or procedure if unable for any reason to comply with the RNAV SID. Ensure a runway position update is accomplished prior to takeoff, if required.
3. **LINE UP/TAKEOFF:** Expect a takeoff clearance to include the “RNAV track to the first fix/waypoint” or an assigned heading. Consider the following:
  - a. If assigned a heading do not delete the RNAV SID from the navigation system.
  - b. An RNAV takeoff clearance will be issued with “RNAV to phraseology,” for example “(Callsign) 123, RNAV to MPASS, Runway 26L, Cleared for Takeoff.” The expected pilot response is to read back the clearance, for example “(Callsign) 123, RNAV to MPASS Runway 26L, Cleared to Takeoff.”
  - c. Verify the departure clearance takeoff runway and cleared to “fix/waypoint” is displayed in the aircraft navigation system. If a discrepancy exists, request an initial heading from tower or refuse the takeoff clearance until the discrepancy is resolved.
  - d. Verify lateral mode to be used on departure.
  - e. Fly the published procedure issued on the IFR clearance if no additional instructions are received with the takeoff clearance.
4. **AFTER TAKEOFF: RNAV to fix/waypoint:** Fly runway heading, engage lateral navigation flight guidance when appropriate, and fly the cleared departure procedure. Strict compliance with the lateral track charted altitude and any speed restrictions are imperative. Parallel RNAV departures must not encroach on the airspace between extended parallel runway centerlines without specific ATC clearance. Manually intervene, if required, to remain on track to avoid deviating in the direction of a parallel runway, track, or aircraft. If unable to comply with the SID profile, either laterally or vertically, immediately notify ATC. **Assigned Heading:** Fly assigned headings until otherwise cleared.

U.S. DEPARTMENT of TRANSPORTATION –  
FEDERAL AVIATION ADMINISTRATION

**RNAV DEPARTURE PROCEDURE  
ATTENTION ALL USERS PAGE (AAUP)**

City, State	Airport	Effective Date
<b>ATLANTA, GA</b>	<b>ATLANTA/HARTSFIELD-JACKSON ATLANTA INTL (ATL)</b>	

5. **ATLANTA (ATL) SPECIFIC INFORMATION:** Runway assignment will be issued on initial contact with Atlanta Ground Control at the Ramp exit spot. During dual runway simultaneous departure operations, expect an RNAV departure clearance.

Atlanta Departure RNAV SIDs and Associated Departure Directions

North	East	South	West
CADIT	DAWGS	BRAVS	JOGOR(WEST 1)
COKEM	DOOLY	PNUTT	JCKTS(WEST 1)
SUMMT	MUNSN	THRSR	GEETK(WEST 2)
NUGGT	UGAAA	NOVSS	RMBLN(WEST 2)

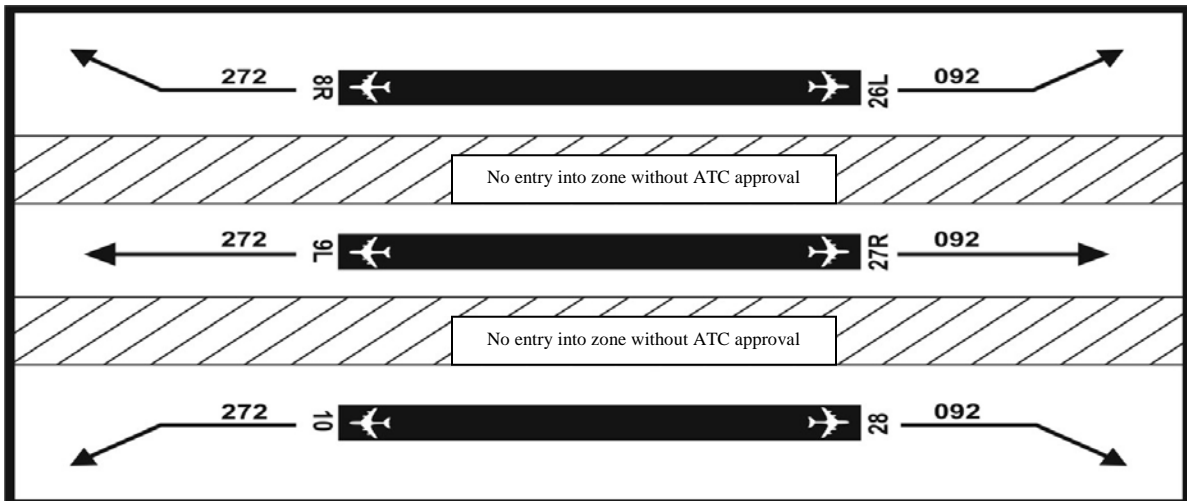

**ADMINISTRATIVE INFORMATION (DO NOT PUBLISH):**

**DEVELOPED BY:** [signature and date]  
John Q Doe  
ATL TRACON

**COORDINATED WITH:** RAPT, AJV, Delta Air Lines, and AFS-400

**CHANGES:** N/A (Original)

**REASONS:** New operation with multiple parallel RNAV departure procedures.



## Appendix F. Helicopter RNAV Departure Procedures

### Section 1.

#### 1. General.

**a. Obstacle Departure Procedures (ODPs).** Currently for heliport operations, ODPs cannot be developed to accommodate IFR diverse departures because diverse departure criteria do not exist. However, a Form 8260-15A will still be required and must indicate the name of the IFR departure procedure (i.e., SID) that is to be used. Since this will be a SID, it will not contain “Obstacle” in parenthesis on the chart. See Order 8260.42, United States Standard for Helicopter Area Navigation (RNAV), for criteria used to develop helicopter departure procedures. Other criteria approved by AFS-400 may be used for development of “Special” departure procedures; i.e., SIDs and/or graphic or textual ODPs.

**b. All IFR helicopter departure procedures** will consist of a “visual” or “VFR” segment to the Initial Departure Fix (IDF), thence via a defined route that is published/charted in graphic form as a SID. The procedure must comply with design and documentation guidelines specified in chapters 2 and 3, appendices C, D, and E to the maximum extent possible with exceptions as noted throughout this directive.

**c. Point-in-space departures may be established** to support multiple departure locations. When this condition exists, use a single Form 8260-15A and identify all heliports that can use the departure in the “Airport” section of the form. A point-in-space graphic SID may serve more than one departure location.

**d. Form 8260-15C, Departure Data Record,** must accompany all Form 8260-15B submissions.

#### 2. Departure Procedure.

**a. Departure from a location with a Visual Segment** will be conducted by crossing the IDF outbound at-or-above the altitude depicted. The helicopter will initially establish a hover at or above the Heliport Crossing Height (HCH). If required, specify a minimum hover height in the instructions on the chart to avoid obstacles. The helicopter will leave the departure location on the outbound heading/course specified, climbing at-or-above 400 ft/NM, crossing at-or-above the IDF altitude specified, prior to proceeding outbound on the procedure.

**b. Departure from a location with a VFR Segment** will be conducted by crossing the IDF outbound at the altitude depicted. Departure procedures that support multiple departure locations will have a VFR segment leading to the IDF. The helicopter will leave the departure location via pilot navigation in order to align with the departure route and comply with the altitude specified at the IDF.

**c. Proceed out the described route as specified,** crossing each consecutive fix at or above the indicated altitude(s) until reaching the end of the departure.

**3. Documentation.** Comply with this order, except as noted below:

**a. Document all items as prescribed** in Order 8260.42, chapter 6; e.g., takeoff weather minimums, etc.

**b. Table 2-1-1, ODP Development Combinations**, does not apply to helicopter departure procedures.

**c. Appendix D, Section 1, paragraph 1.** Use Form 8260-15A for a single departure procedure that serves multiple departure locations.

**d. Appendix D, Section 1, paragraph 7a(6).** Place the name of the SID that will be used in the “Textual Departure Procedure” section of the Form 8260-15A.

**e. Appendix E, Section 1, paragraph 2, insert “COPTER”** prior to “RNAV” to indicate that this procedure supports helicopter operations only.

**f. Appendix E, Section 1, paragraph 3, DP Route Description.** This item will consist of two independent sets of instructions. The “VISUAL SEGMENT” or “VFR SEGMENT” and the “IFR SEGMENT.”

(1) Special helicopter procedures with a “Visual Segment” will include a hover height (AGL) and contain a specified route to the IDF. Example: “Hover at 15 feet/AGL, then climb on track 275.21 to cross JONES at or above 900.

(2) Helicopter procedures with a “VFR Segment” will contain instructions to conduct a VFR climb to the IDF. Example: “VFR Climb to SOSNO, Cross SOSNO at or above 800.”

**g. Appendix E, Section 1, paragraph 6, Takeoff Obstacle Notes.**

(1) Helicopter procedures that contain a “visual segment” from the heliport to the Initial Departure Fix (IDF) that require obstacles to be identified in the Takeoff Obstacle Notes section of Form 8260-15B must have the obstacle(s) defined by the distance [to the nearest tenth of a nautical mile (NM), or feet if the distance is less than 0.5 NM from the heliport] and bearing (magnetic) from the heliport. Also, include the type of obstacle and MSL elevation; e.g., Antenna, 1.3 NM bearing 221°, 166 MSL.

(2) Helicopter procedures that contain a “VFR segment” from one or multiple heliports to the IDF must not contain Takeoff Obstacle Notes. Leave this section of Form 8260-15B blank. Controlling Obstacles will be documented per appendix E, Section 1, paragraph 7, consisting of the MSL elevation, description, and coordinates.

**h. Appendix E, Section 1, paragraph 7, Controlling Obstacles.** Document the controlling obstacle(s) on Form 8260-15B in the “Controlling Obstacles” section as follows:

(1) The controlling obstacle within the IDF flat surface area and which the IDF crossing altitude is based upon will be documented and preceded by “IDF Altitude Controlling Obstacle” and will provide the height (MSL), obstacle type (Tower, AAO, etc.), height (MSL), and geographical coordinates:

**Example:** “IDF ALTITUDE CONTROLLING OBSTACLE: 2290 FT MSL, ANTENNA, 370549.22N/0802934.16W”

(2) The controlling obstacle within the 20:1 sloping area will be preceded by “IFR Segment Controlling Obstacle” and will provide the height (MSL), obstacle type (Tower, AAO, etc.), height (MSL), and geographical coordinates:

**Example:** “SEGMENT ALTITUDE CONTROLLING OBSTACLE: 3325 FT MSL, BUILDING, 370648.22N/0803133.15W”

**h. Procedures will contain** the following chart notes as applicable:

(1) Document the altimeter source to be used when departing, use: “**NOTE: USE (location name) ALTIMETER SETTING.**”

(2) Standard helicopter speed used in procedure design is 140 KIAS. If a speed less than 140 KIAS are used, place a chart note in the plan view that states “**NOTE: LIMIT TO (number) KIAS ON DEPARTURE TO (name of end fix).**” If a speed less than 140 KIAS is required for a specific segment of a departure, use: “**NOTE: LIMIT TO (number) KIAS FROM (name of start fix) TO (name of end fix).**”

(3) For all Special procedures: “**NOTE: PILOT MUST ENSURE CDI SENSITIVITY IS SET TO 0.3 NM. CDI MAY BE RESET TO 1.0 NM AFTER (Fix Name).**”

THIS PAGE IS INTENTIONALLY LEFT BLANK

Figure F-1.

**U.S. DEPARTMENT OF TRANSPORTATION – FEDERAL AVIATION ADMINISTRATION  
TAKEOFF MINIMUMS AND OBSTACLE DEPARTURE PROCEDURES (ODP)**

Bearings, headings, courses, tracks and radials are magnetic. Elevation and altitudes are in feet MSL. Altitudes are minimum altitudes unless otherwise indicated.  
Ceilings are in feet above airport elevation. Distances are in nautical miles. Visibilities are in statute miles or feet RVR unless otherwise indicated.

<b>City, State</b>	<b>Airport</b>	<b>Effective Date</b>	<b>Amdt. No.</b>
ANYTOWN, CA	ANY HOSPITAL HELIPORT		ORIG

**TAKEOFF MINIMUMS:**

**TEXTUAL DEPARTURE PROCEDURES:**

USE GARYS DEPARTURE

**VISUAL CLIMB OVER AIRPORT:**

**TAKEOFF OBSTACLE NOTES:**

**CONTROLLING OBSTACLES:**

**REMARKS:**

**FLIGHT INSPECTED BY:**

JOE INSPECTOR                      AJW-XXX                      12/14/2013

**REQUIRED EFFECTIVE DATE:**

**DEVELOPED BY:**

JAMES DEVELOPER                      AJV-XXX                      12/09/2013

**APPROVED BY:**

**COORDINATED WITH:**

**CHANGES:**

**REASONS:**

THIS PAGE IS INTENTIONALLY LEFT BLANK

Figure F-2.

**U.S. DEPARTMENT OF TRANSPORTATION – FEDERAL AVIATION ADMINISTRATION  
TAKEOFF MINIMUMS AND OBSTACLE DEPARTURE PROCEDURES (ODP)**

Bearings, headings, courses, tracks and radials are magnetic. Elevation and altitudes are in feet MSL. Altitudes are minimum altitudes unless otherwise indicated.  
Ceilings are in feet above airport elevation. Distances are in nautical miles. Visibilities are in statute miles or feet RVR unless otherwise indicated.

<b>City, State</b>	<b>Airport</b>	<b>Effective Date</b>	<b>Amdt. No.</b>
ANYTOWN, CA	MULTIPLE HELIPORTS: W HELIPORT; X HELIPORT; Y HELIPORT; Z HELIPORT		ORIG

**TAKEOFF MINIMUMS:**

**TEXTUAL DEPARTURE PROCEDURES:**

USE XRRAY DEPARTURE

**VISUAL CLIMB OVER AIRPORT:**

**TAKEOFF OBSTACLE NOTES:**

**CONTROLLING OBSTACLES:**

**REMARKS:**

**FLIGHT INSPECTED BY:**

JOE INSPECTOR                      AJW-XXX                      2/14/2013

**REQUIRED EFFECTIVE DATE:**

**DEVELOPED BY:**

JAMES DEVELOPER                      AJV-XXX                      2/09/2013

**APPROVED BY:**

**COORDINATED WITH:**

**CHANGES:**

**REASONS:**

THIS PAGE IS INTENTIONALLY LEFT BLANK



Figure F-3.

**U.S. DEPARTMENT OF TRANSPORTATION – FEDERAL AVIATION ADMINISTRATION  
GRAPHIC DEPARTURE PROCEDURE (DP)**

Bearings, headings, courses, tracks, and radials are magnetic. Elevation and altitudes are in feet MSL. Altitudes are minimum altitudes unless otherwise indicated. Callings are in feet above airport elevation. Distances are in nautical miles. Visibilities are in statute miles or feet PVR, unless otherwise indicated. Graphic depictions attached.

DP Name	Number	DP Computer Code	Superseded Number	Dated	Effective Date
GARYS	ONE	GARYS1 GARYS	NONE		

**TYPE:** COPTER RNAV SID SPECIAL

**DP ROUTE DESCRIPTION:**

**VISUAL SEGMENT:** HOVER AT 15 FT/AGL, THEN CLIMB ON TRACK 270.31 TO CROSS FSTFX IDF AT OR ABOVE 500.

**IFR SEGMENT:** CLIMB ON COURSE 270.31 TO CROSS SECFX AT OR ABOVE 2000, THEN TRACK 180.21 TO CROSS THDFX AT OR ABOVE 3000, THEN TRACK 245.33 TO CROSS FOREFX AT OR ABOVE 4000, THEN TRACK 180.21 TO CROSS GARYSAT 4500.

**TRANSITION ROUTES (GRAPHIC DEPICTION ONLY):**

Transition Name	Transition Computer Codes	From	To	FIX/NAVAID	Course	Distance	MEA	MOCA	Crossing Altitudes/Fixes
				FIX/NAVAID					

**PROCEDURAL DATA NOTES/TAKEOFF MINIMUMS:**

TAKE OFF MINIMUMS: 600- 3/4 OR STANDARD WITH MINIMUM CLIMB OF 600FT PER NM TO 3500.

NOTE: GPS REQUIRED

NOTE: RNAV-1

NOTE: USE TILLAMOOK ALTIMETER SETTING

NOTE: LIMIT TO 120 KIAS ON DEPARTURE TO GARYS.

NOTE: PILOT MUST ENSURE CDI SENSITIVITY IS SET TO 0.3 NM.

NOTE: PROCEDURE NA AT NIGHT.

**TAKEOFF OBSTACLES NOTES:**

ANTENNA 1.3 NM BEARING 221° 166 MSL

**CONTROLLING OBSTACLES:**

IDF ALTITUDE CONTROLLING OBSTACLE: 166 FT MSL, ANTENNA 452646.70N/1235252.30W  
SEGMENT ALTITUDE CONTROLLING OBSTACLE: 652 FT MSL, POWER LINES, 452730.60N/1235354.20W

**LOST COMMUNICATIONS PROCEDURES:**

PROCEED TO ANYFX WAYPOINT THEN EXECUTE THE COPTER RNAV (GPS) 128 APPROACH

**ADDITIONAL FLIGHT DATA:**

REFERENCE MAG VAR: 17W EPOCH YR: 2015

**U.S. DEPARTMENT OF TRANSPORTATION – FEDERAL AVIATION ADMINISTRATION  
GRAPHIC DEPARTURE PROCEDURE (DP)**

Bearings, headings, courses, tracks, and radials are magnetic. Elevation and altitudes are in feet MSL. Altitudes are minimum altitudes unless otherwise indicated. Ceilings are in feet above airport elevation. Distances are in nautical miles. Visibilities are in statute miles or feet FVR unless otherwise indicated. Graphic depictions attached.

DP Name	Number	DP Computer Code	Superseded Number	Dated	Effective Date
GARYS	ONE	GARYS1.GARYS	NONE		

**AIRPORTS SERVED:**

XXXX, ANY HOSPITAL HELIPORT; ANYTWN, OR

**COMMUNICATIONS:**

LOS ANGELES CENTER 124.2, TILLAMOOK AWOS-3 120.00

**FIXES AND/OR NAVAIDS:**

**REMARKS:**

**FLIGHT INSPECTED BY:**

JOE INSPECTOR

AJW-XXX

12/14/2011

**REQUIRED EFFECTIVE DATE:**

**DEVELOPED BY:**

JAMES DEVELOPER

AJW-XXX

12/09/2009

**APPROVED BY:**

**COORDINATED WITH:**

**CHANGES:**

**REASONS:**

Figure F-4.

**U.S. DEPARTMENT OF TRANSPORTATION – FEDERAL AVIATION ADMINISTRATION  
GRAPHIC DEPARTURE PROCEDURE (DP)**

Bearings, headings, courses, tracks, and radials are magnetic. Elevations and altitudes are in feet MSL. Altitudes are minimum altitudes unless otherwise indicated. Crossings are in feet above airport elevation. Distances are in nautical miles. Visibility are in statute miles or feet (VR) unless otherwise indicated. Graphic depictions attached.

DP Name OHANA	Number ONE	DP Computer Code OHANA1.OHANA	Superseded Number	Dated	Effective Date
------------------	---------------	----------------------------------	-------------------	-------	----------------

**TYPE:** COPTER RNAV SID

**DP ROUTE DESCRIPTION:**

**VFR SEGMENT:** VFR CLIMB TO ALOHA, CROSS ALOHA AT OR ABOVE 800.

**IFR SEGMENT:** TRACK 040.30 TO CROSS PEARL AT OR ABOVE 1600, THEN TRACK 040.44 TO CROSS HARBR AT OR ABOVE 3300, THEN TRACK 129.41 TO CROSS MOSES AT OR ABOVE 3500, THEN TRACK 086.11 TO CROSS OHANA AT OR ABOVE 3700.

**TRANSITION ROUTES (GRAPHIC DEPICTION ONLY):**

Transition Name	Transition Computer Codes	From FIX/NAVAID	To FIX/NAVAID	Course	Distance	MEA	MOCA	Crossing Altitudes/Fixes
-----------------	---------------------------	--------------------	------------------	--------	----------	-----	------	--------------------------

**PROCEDURAL DATA NOTES/TAKEOFF MINIMUMS:**

TAKE OFF MINIMUMS: FROM ALOHA IDF, MINIMUM CLIMB OF 580 FT PER NM TO 3300  
NOTE: RNAV-1  
NOTE: USE HONOLULU ALTIMETER SETTING  
NOTE: GPS REQUIRED

**TAKEOFF OBSTACLES NOTES:**

**CONTROLLING OBSTACLES:**

IDF ALTITUDE CONTROLLING OBSTACLE: 985 MSL, TERRAIN, 212350.00N/1574553.00W  
SEGMENT CONTROLLING OBSTACLE: 1049 MSL, ANTENNA, 212410.20N/1574630.20W

**LOST COMMUNICATIONS PROCEDURES:**

PROCEED TO AKANA WAYPOINT THEN EXECUTE THE COPTER RNAV (GPS) 220 APPROACH

**ADDITIONAL FLIGHT DATA:**

REFERENCE MAG VAR: 9W EPOCH YR: 2015

**AIRPORTS SERVED:**

KAMEHAMEHA MEDICAL CENTER HELIPORT

**U.S. DEPARTMENT OF TRANSPORTATION – FEDERAL AVIATION ADMINISTRATION  
GRAPHIC DEPARTURE PROCEDURE (DP)**

Bearings, headings, courses, tracks, and radials are magnetic. Elevation and altitudes are in feet MSL. Altitudes are minimum altitudes unless otherwise indicated. Ceilings are in feet above airport elevation. Distances are in nautical miles. Visibilities are in statute miles or feet FVR unless otherwise indicated. Graphic depictions attached.

DP Name	Number	DP Computer Code	Superseded Number	Dated	Effective Date
OHANA	ONE	OHANA1.OHANA			

**COMMUNICATIONS:**

HCF APP / CON 118.3, AMOS-3 135.775

**FIXES AND/OR NAVAIDS:**

**REMARKS:**

**FLIGHT INSPECTED BY:**

JOE INSPECTOR

AJW-XXX

**DEVELOPED BY:**

JAMES DEVELOPER

AJV-3XX

**APPROVED BY:**

03/26/2012

**REQUIRED EFFECTIVE DATE:**

**COORDINATED WITH:**

**CHANGES:**

**REASONS:**

**Appendix G. Instructions for Completing FAA Form 8260-15D.****Section 1.**

**1. Documentation.** Complete a single Form 8260-15D (or applicable military form) for each airport where a Diverse Vector Area (DVA) has been developed and forward to the requesting ATC facility. The information on the form will be used by the facility to establish the DVA procedure. See figure G-1.

**Note:** For a complex DVA, consider providing a graphic depiction of the area to the facility in addition to the Form 8260-15D.

**a. City and State.** Complete this section with the same location data as on the associated Form 8260-15A.

**b. Airport.** Complete this section with the same airport name data as on the associated Form 8260-15A.

**c. Effective Date.** The effective date is the date of approval.

**d. Amendment Number.** Enter the amendment number as applicable. When the Form 8260-15D is an original, enter "ORIG."

**e. Chart – Diverse Vector Area (Radar Vectors).** List each runway to be charted followed by "Heading as assigned by ATC." When applicable, include climb gradient information.

**Example:**

RWY 21: HEADING AS ASSIGNED BY ATC; REQUIRES MINIMUM CLIMB OF 215 FT PER NM TO 4000.

RWY 4, 22, 30L/30R: HEADING AS ASSIGNED BY ATC.

RWY 17: HEADING AS ASSIGNED BY ATC; REQUIRES MINIMUM CLIMB OF 215 FT PER NM TO 1500.

**f. For ATC Use Only.** List each runway assessed for a DVA followed by a description of the area. Do not include the buffer areas within the description since these descriptions may be used by ATC facilities to develop radar video maps of the DVA.

(1) Isolation Area. Include the latitude/longitude of the DRP and a distance from DRP determined by the diverse departure evaluation distance (25/46 NM) minus 5 NM. Describe in detail the isolation area(s) that must be avoided.

**Example:**

RWY 31: ALL AREA WITHIN 20 NM OF 352336.01N/0973607.80W

(DEPARTURE REFERENCE POINT) EXCEPT FOR THE FOLLOWING AREAS: 1) WITHIN 3 NM RADIUS OF 352557.45N/0974109.53W AND 2) WITHIN 3 NM RADIUS OF 353405.64N/0972920.85W.

(2) Range of Authorized Headings. Describe the authorized range of headings (corresponding to the lateral sector boundaries) beginning with the extreme left heading, clockwise to the extreme right heading as would be viewed from the departure runway in the direction of the departure, as well as the distance from the DRP to which the DVA is applicable. Also, provide a detailed point-to-point description of the area to assist in the creation of a video map.

**Example:**

RWY 6: AUTHORIZED HEADINGS 270 CLOCKWISE TO 150 WITHIN 20 NM OF 384457.07N/0902229.98W (DEPARTURE REFERENCE POINT).

INCLUDES ALL AREA WITHIN 384457.07N/0902229.98W TO 384454.27N/0904803.87W THEN VIA 20 MILE ARC CENTERED ON 384457.07N/0902229.98W TO 382736.10N/0900946.11W TO 384457.07N/0902229.98W.

(3) Climb to Initial MVA/MIA. Describe the authorized range of headings beginning with the extreme left heading, clockwise to the extreme right heading as would be viewed from the departure runway in the direction of the departure. The DVA description must state it is applicable only within those areas where the MVA/MIA sector altitude is equal to or less than the initial MVA/MIA.

**Example:**

RWY 36: AUTHORIZED HEADINGS 310 CLOCKWISE TO 050 TO 3500 WITHIN ANY MVA SECTOR WITH A MINIMUM ALTITUDE OF 3500 OR LESS.

(4) Defined Area (DoD Option). Use latitude/longitude points, lines, arcs, and arc center points (as applicable) to describe the area.

**Example:**

RWY 21L: WITHIN THE AREA BOUNDED BY A SERIES OF LINES FROM  
381458.00N/1215805.00W TO  
381014.00N/1220922.00W TO  
380200.00N/1215823.00W TO  
381831.00N/1213839.00W TO  
382207.00N/1214546.00W TO  
381458.00N/1215805.00W.

**g. Obstacle Evaluation Area.** This area is used to document and describe the OEA (including buffer areas where utilized) of the DVA and will primarily be used for identifying and evaluating the aeronautical effect of proposed obstacles. Enter a description of each OEA (using

as necessary latitude/longitudes, bearings, arcs, radii, etc.) for which a DVA has been established.

**h. Authorized Facility.** Specify the ATC facility which requested the DVA and for which the DVA is applicable. Do not specify more than one facility on the same form. Include facility contact information, i.e., phone number.

**i. Form 7210-9 Date.** For a DVA based on a climb to an initial MVA/MIA, enter the date of the Form 7210-9 that was used to evaluate the DVA. Leave blank for other DVA types.

**Note:** A DVA does not require a flight inspection; therefore, no additional signatures are required.

**j. Developed By.** Enter the name of the FAA procedure specialist and organizational routing code.

**k. Approved By.** Enter the name of the Aeronautical Navigation Products manager, or the delegated representative. This individual must sign in the “approved by” space and enter the date signed.

**l. Changes.** List changes from the Form 8260-15D, which immediately preceded the current version. Leave blank for an original.

**m. Reasons.** List reasons for any changes annotated on the form.

THIS PAGE INTENTIONALLY LEFT BLANK



**Figure G-1.**

U.S. DEPARTMENT of TRANSPORTATION - FEDERAL AVIATION ADMINISTRATION

**DIVERSE VECTOR AREA (DVA)**

Bearings, headings, courses, tracks, and radials are magnetic. Elevations and altitudes are in feet, MSL. Distances are in nautical miles.

City, State	Airport	Effective Date	Amdt No.
SANTA MONICA, CA	SANTA MONICA MUNI	12/13/2013	ORIG

**CHART - DIVERSE VECTOR AREA (Radar Vectors):**

RWY 21: HEADING AS ASSIGNED BY ATC; REQUIRES MINIMUM CLIMB OF 215 FT PER NM TO 4000.

**FOR ATC USE ONLY:**

RWY 21: AUTHORIZED HEADINGS 165 CLOCKWISE TO 255 WITHIN 20 NM OF 340100.39N/1182700.64W (DEPARTURE REFERENCE POINT). INCLUDES ALL AREA WITHIN 340100.39N/1182700.64W TO 334058.22N/1182700.64W. THEN VIA 20 MILE CLOCKWISE ARC CENTERED ON 340100.39N/1182700.64W TO 335729.36N/1185041.37W, TO 340100.39N/1182700.64W

**OBSTACLE EVALUATION AREA (not for video mapping use):**

RWY 21: FROM 340100.39N/1182700.64W TO 334210.45N/1181848.69W, THEN VIA 20 NM CLOCKWISE ARC CENTERED ON 340100.39N/1182700.64W TO 334114.51N/1182324.59W, THEN VIA 3 NM CLOCKWISE ARC CENTERED ON 334058.22N/1182700.64W TO 333757.89N/1182700.64W, THEN VIA 23 NM CLOCKWISE ARC TO 335657.31N/1185414.31W, THEN VIA 3 NM CLOCKWISE ARC CENTERED ON 335729.36N/1185041.37W TO 340028.62N/1185105.74W, THEN VIA 20 NM CLOCKWISE ARC CENTERED ON 340100.39N/1182700.64W TO 340426.85N/1185043.31W, TO 340100.39N/1182700.64W

**AUTHORIZED FACILITY:**

SCT APP CON PHONE: (858) 537-5800

**FAA FORM 7210-9 DATE:**

**DEVELOPED BY:**

*Joe Developer* AJV-35 07/31/2013

**APPROVED BY:**

*Jolene Manager* AJV-35 07/31/2013

**CHANGES:**

**REASONS:**

THIS PAGE INTENTIONALLY LEFT BLANK