

The Effects of Nuclear Weapons

Compiled and edited by
Samuel Glasstone *and* Philip J. Dolan

Third Edition

Prepared and published by the
UNITED STATES DEPARTMENT OF DEFENSE
and the
UNITED STATES DEPARTMENT OF ENERGY



1977

PREFACE

When "The Effects of Atomic Weapons" was published in 1950, the explosive energy yields of the fission bombs available at that time were equivalent to some thousands of tons (i.e., kilotons) of TNT. With the development of thermonuclear (fusion) weapons, having energy yields in the range of millions of tons (i.e., megatons) of TNT, a new presentation, entitled "The Effects of Nuclear Weapons," was issued in 1957. A completely revised edition was published in 1962 and this was reprinted with a few changes early in 1964.

Since the last version of "The Effects of Nuclear Weapons" was prepared, much new information has become available concerning nuclear weapons effects. This has come in part from the series of atmospheric tests, including several at very high altitudes, conducted in the Pacific Ocean area in 1962. In addition, laboratory studies, theoretical calculations, and computer simulations have provided a better understanding of the various effects. Within the limits imposed by security requirements, the new information has been incorporated in the present edition. In particular, attention may be called to a new chapter on the electromagnetic pulse.

We should emphasize, as has been done in the earlier editions, that numerical values given in this book are not—and cannot be—exact. They must inevitably include a substantial margin of error. Apart from the difficulties in making measurements of weapons effects, the results are often dependent upon circumstances which could not be predicted in the event of a nuclear attack. Furthermore, two weapons of different design may have the same explosive energy yield, but the effects could be markedly different. Where such possibilities exist, attention is called in the text to the limitations of the data presented; these limitations should not be overlooked.

The material is arranged in a manner that should permit the general reader to obtain a good understanding of the various topics without having to cope with the more technical details. Most chapters are thus in two parts: the first part is written at a fairly low technical level whereas the second treats some of the more technical and mathematical aspects. The presentation allows the reader to omit any or all of the latter sections without loss of continuity.

The choice of units for expressing numerical data presented us with a dilemma. The exclusive use of international (SI) or metric units would have placed a burden on many readers not familiar with these units, whereas the inclusion of both SI and common units would have complicated many figures, especially those with logarithmic scales. As a compromise, we have retained the older units and added an explanation of the SI system and a table of appropriate conversion factors.

Preface

Many organizations and individuals contributed in one way or another to this revision of "The Effects of Nuclear Weapons," and their cooperation is gratefully acknowledged. In particular, we wish to express our appreciation of the help given us by L. J. Deal and W. W. Schroebel of the Energy Research and Development Administration and by Cmdr. H. L. Hoppe of the Department of Defense.

Samuel Glasstone

Philip J. Dolan

ACKNOWLEDGEMENTS

Preparation of this revision of "The Effects of Nuclear Weapons" was made possible by the assistance and cooperation of members of the organizations listed below.

Department of Defense

Headquarters, Defense Nuclear Agency
Defense Civil Preparedness Agency
Armed Forces Radiobiology Research Institute
U.S. Army Aberdeen Research and Development Center, Ballistic Research Laboratories
U.S. Army Engineer Waterways Experiment Station
Naval Surface Weapons Center

Department of Defense Contractors

Stanford Research Institute
General Electric, TEMPO
Mission Research Corporation

Department of Commerce

National Oceanic and Atmospheric Administration

Atomic Energy Commission/ Energy Research and Development Administration

Headquarters Divisions and the laboratories:

Brookhaven National Laboratory
Health and Safety Laboratory
Lawrence Livermore Laboratory
Los Alamos Scientific Laboratory
Lovelace Biomedical and Environmental Research Laboratories
Oak Ridge National Laboratory
Sandia Laboratories

CONTENTS

	Page
CHAPTER I—General Principles of Nuclear Explosions	1
Characteristics of Nuclear Explosions	1
Scientific Basis of Nuclear Explosions	12
CHAPTER II—Descriptions of Nuclear Explosions	26
Introduction	26
Description of Air and Surface Bursts	27
Description of High-Altitude Bursts	45
Description of Underwater Bursts	48
Description of Underground Bursts	58
Scientific Aspects of Nuclear Explosion Phenomena	63
CHAPTER III—Air Blast Phenomena in Air and Surface Bursts	80
Characteristics of the Blast Wave in Air	80
Reflection of Blast Wave at a Surface	86
Modification of Air Blast Phenomena	92
Technical Aspects of Blast Wave Phenomena	96
CHAPTER IV—Air Blast Loading	127
Interaction of Blast Wave with Structures	127
Interaction of Objects with Air Blast	132
CHAPTER V—Structural Damage from Air Blast	154
Introduction	154
Factors Affecting Response	156
Commercial and Administrative Structures	158
Industrial Structures	165
Residential Structures	175
Transportation	189
Utilities	195
Miscellaneous Targets	206
Analysis of Damage from Air Blast	212
CHAPTER VI—Shock Effects of Surface and Subsurface Bursts	231
Characteristics of Surface and Shallow Underground Bursts	231
Deep Underground Bursts	238
Damage to Structures	241
Characteristics of Underwater Bursts	244

Technical Aspects of Surface and Underground Bursts	253
Technical Aspects of Deep Underground Bursts	260
Loading on Buried Structures	263
Damage from Ground Shock	265
Technical Aspects of Underwater Bursts	268
CHAPTER VII—Thermal Radiation and Its Effects	276
Radiation from the Fireball	276
Thermal Radiation Effects	282
Incendiary Effects	296
Incendiary Effects in Japan	300
Technical Aspects of Thermal Radiation	305
Radiant Exposure—Distance Relationships	316
CHAPTER VIII—Initial Nuclear Radiation	324
Nature of Nuclear Radiations	324
Gamma Rays	326
Neutrons	340
Transient-Radiation Effects on Electronics (TREE)	349
Technical Aspects of Initial Nuclear Radiation	353
CHAPTER IX—Residual Nuclear Radiation and Fallout	387
Sources of Residual Radiation	387
Radioactive Contamination from Nuclear Explosions	409
Fallout Distribution in Land Surface Bursts	414
Fallout Predictions for Land Surface Bursts	422
Attenuation of Residual Nuclear Radiation	439
Delayed Fallout	442
Technical Aspects of Residual Nuclear Radiation	450
CHAPTER X—Radio and Radar Effects	461
Introduction	461
Atmospheric Ionization Phenomena	462
Ionization Produced by Nuclear Explosions	466
Effects on Radio and Radar Signals	479
Technical Aspects of Radio and Radar Effects	489
CHAPTER XI—The Electromagnetic Pulse and its Effects	514
Origin and Nature of the EMP	514
EMP Damage and Protection	523
Theory of the EMP	532
CHAPTER XII—Biological Effects	541
Introduction	541
Blast Injuries	548
Burn Injuries	560
Nuclear Radiation Injury	575

Characteristics of Acute Whole-Body Radiation Injury	583
Combined Injuries	588
Late Effects of Ionizing Radiation	589
Effects of Early Fallout	594
Long-Term Hazard from Delayed Fallout	604
Genetic Effects of Nuclear Radiation	609
Pathology of Acute Radiation Injury	614
Blast-Related Effects	618
Effects on Farm Animals and Plants	618
Glossary	629
Guide to SI Units	642
Index	644

CHAPTER I

GENERAL PRINCIPLES OF NUCLEAR EXPLOSIONS

CHARACTERISTICS OF NUCLEAR EXPLOSIONS

INTRODUCTION

1.01 An explosion, in general, results from the very rapid release of a large amount of energy within a limited space. This is true for a conventional "high explosive," such as TNT, as well as for a nuclear (or atomic) explosion,¹ although the energy is produced in quite different ways (§ 1.11). The sudden liberation of energy causes a considerable increase of temperature and pressure, so that all the materials present are converted into hot, compressed gases. Since these gases are at very high temperatures and pressures, they expand rapidly and thus initiate a pressure wave, called a "shock wave," in the surrounding medium—air, water, or earth. The characteristic of a shock wave is that there is (ideally) a sudden increase of pressure at the front, with a gradual decrease behind it, as shown in Fig. 1.01. A shock wave in air is generally referred to as a "blast wave" because it resembles and is accompanied by a very strong wind. In water or in

the ground, however, the term "shock" is used, because the effect is like that of a sudden impact.

1.02 Nuclear weapons are similar to those of more conventional types insofar as their destructive action is due mainly to blast or shock. On the other hand, there are several basic differences between nuclear and high-explosive weapons. In the first place, nuclear explosions can be many thousands (or millions) of times more powerful than the largest conventional detonations. Second, for the release of a given amount of energy, the mass of a nuclear explosive would be much less than that of a conventional high explosive. Consequently, in the former case, there is a much smaller amount of material available in the weapon itself that is converted into the hot, compressed gases mentioned above. This results in somewhat different mechanisms for the initiation of the blast wave. Third, the temperatures reached in a nuclear explosion are very much higher than in a

¹The terms "nuclear" and "atomic" may be used interchangeably so far as weapons, explosions, and energy are concerned, but "nuclear" is preferred for the reason given in § 1.11.

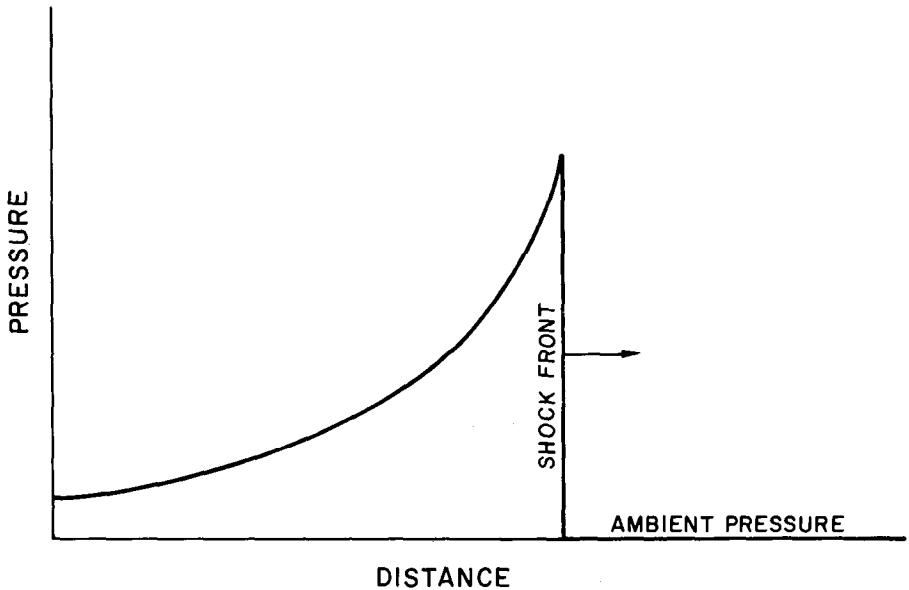

Figure 1.01. Variation of pressure (in excess of ambient) with distance in an ideal shock wave.

conventional explosion, and a fairly large proportion of the energy in a nuclear explosion is emitted in the form of light and heat, generally referred to as "thermal radiation." This is capable of causing skin burns and of starting fires at considerable distances. Fourth, the nuclear explosion is accompanied by highly-penetrating and harmful invisible rays, called the "initial nuclear radiation." Finally the substances remaining after a nuclear explosion are radioactive, emitting similar radiations over an extended period of time. This is known as the "residual nuclear radiation" or "residual radioactivity" (Fig. 1.02).

1.03 It is because of these fundamental differences between a nuclear and a conventional explosion, including the tremendously greater power of the former, that the effects of nuclear weapons require special consideration. In this connection, a knowledge and

understanding of the mechanical and the various radiation phenomena associated with a nuclear explosion are of vital importance.

1.04 The purpose of this book is to describe the different forms in which the energy of a nuclear explosion are released, to explain how they are propagated, and to show how they may affect people (and other living organisms) and materials. Where numerical values are given for specific observed effects, it should be kept in mind that there are inevitable uncertainties associated with the data, for at least two reasons. In the first place, there are inherent difficulties in making exact measurements of weapons effects. The results are often dependent on circumstances which are difficult, if not impossible, to control, even in a test and certainly cannot be predicted in the event of an attack. Furthermore, two weapons producing the

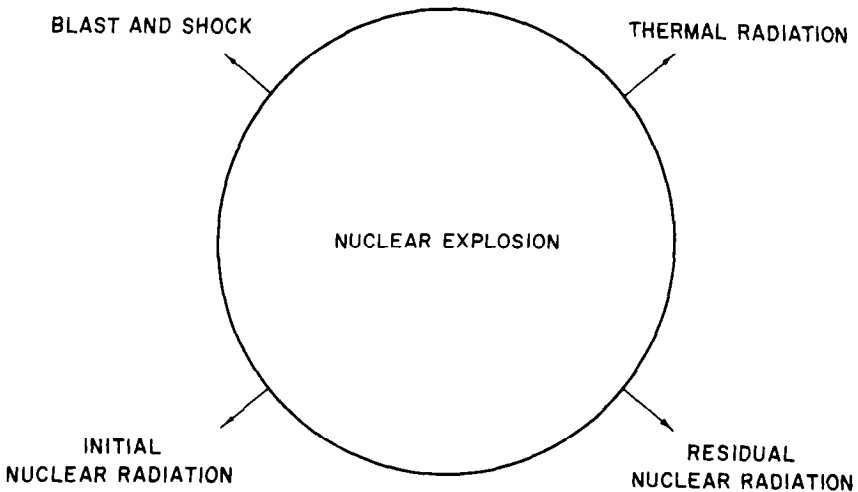

Figure 1.02. Effects of a nuclear explosion.

same amount of explosive energy may have different quantitative effects because of differences in composition and design.

1.05 It is hoped, nevertheless, that the information contained in this volume, which is the best available, may be of assistance to those responsible for defense planning and in making preparations to deal with the emergencies that may arise from nuclear warfare. In addition, architects and engineers may be able to utilize the data in the design of structures having increased resistance to damage by blast, shock, and fire, and which provide shielding against nuclear radiations.

ATOMIC STRUCTURE AND ISOTOPES

1.06 All substances are made up from one or more of about 90 different kinds of simple materials known as "elements." Among the common elements are the gases hydrogen, oxygen, and nitrogen; the solid nonmetals carbon, sulfur, and phosphorus; and

various metals, such as iron, copper, and zinc. A less familiar element, which has attained prominence in recent years because of its use as a source of nuclear energy, is uranium, normally a solid metal.

1.07 The smallest part of any element that can exist, while still retaining the characteristics of the element, is called an "atom" of that element. Thus, there are atoms of hydrogen, of iron, of uranium, and so on, for all the elements. The hydrogen atom is the lightest of all atoms, whereas the atoms of uranium are the heaviest of those found on earth. Heavier atoms, such as those of plutonium, also important for the release of nuclear energy, have been made artificially (§ 1.14). Frequently, two or more atoms of the same or of different elements join together to form a "molecule."

1.08 Every atom consists of a relatively heavy central region or "nucleus," surrounded by a number of very light particles known as "electrons." Further, the atomic nucleus is itself

made up of a definite number of fundamental particles, referred to as "protons" and "neutrons." These two particles have almost the same mass, but they differ in the respect that the proton carries a unit charge of positive electricity whereas the neutron, as its name implies, is uncharged electrically, i.e., it is neutral. Because of the protons present in the nucleus, the latter has a positive electrical charge, but in the normal atom this is exactly balanced by the negative charge carried by the electrons surrounding the nucleus.

1.09 The essential difference between atoms of different elements lies in the number of protons (or positive charges) in the nucleus; this is called the "atomic number" of the element. Hydrogen atoms, for example, contain only one proton, helium atoms have two protons, uranium atoms have 92 protons, and plutonium atoms 94 protons. Although all the nuclei of a given element contain the same number of protons, they may have different numbers of neutrons. The resulting atomic species, which have identical atomic numbers but which differ in their masses, are called "isotopes" of the particular element. All but about 20 of the elements occur in nature in two or more isotopic forms, and many other isotopes, which are unstable, i.e., radioactive, have been obtained in various ways.

1.10 Each isotope of a given element is identified by its "mass number," which is the sum of the numbers of protons and neutrons in the nucleus. For example, the element uranium, as found in nature, consists mainly of two isotopes with mass numbers of 235 and 238; they are con-

sequently referred to as uranium-235 and uranium-238, respectively. The nuclei of both isotopes contain 92 protons—as do the nuclei of all uranium isotopes—but the former have in addition 143 neutrons and the latter 146 neutrons. The general term "nuclide" is used to describe any atomic species distinguished by the composition of its nucleus, i.e., by the number of protons and the number of neutrons. Isotopes of a given element are nuclides having the same number of protons but different numbers of neutrons in their nuclei.

1.11 In a conventional explosion, the energy released arises from chemical reactions; these involve a rearrangement among the atoms, e.g., of hydrogen, carbon, oxygen, and nitrogen, present in the chemical high-explosive material. In a nuclear explosion, on the other hand, the energy is produced as a result of the formation of different atomic nuclei by the redistribution of the protons and neutrons within the interacting nuclei. What is sometimes referred to as atomic energy is thus actually nuclear energy, since it results from particular nuclear interactions. It is for the same reason, too, that atomic weapons are preferably called "nuclear weapons." The forces between the protons and neutrons within atomic nuclei are tremendously greater than those between the atoms; consequently, nuclear energy is of a much higher order of magnitude than conventional (or chemical) energy when equal masses are considered.

1.12 Many nuclear processes are known, but not all are accompanied by the release of energy. There is a definite equivalence between mass and energy, and when a decrease of mass occurs in a nuclear reaction there is an accompany-

ing release of a certain amount of energy related to the decrease in mass. These mass changes are really a reflection of the difference in the internal forces in the various nuclei. It is a basic law of nature that the conversion of any system in which the constituents are held together by weaker forces into one in which the forces are stronger must be accompanied by the release of energy, and a corresponding decrease in mass.

1.13 In addition to the necessity for the nuclear process to be one in which there is a net decrease in mass, the release of nuclear energy in amounts sufficient to cause an explosion requires that the reaction should be able to reproduce itself once it has been started. Two kinds of nuclear interactions can satisfy the conditions for the production of large amounts of energy in a short time. They are known as "fission" (splitting) and "fusion" (joining together). The former process takes place with some of the heaviest (high atomic number) nuclei; whereas the latter, at the other extreme, involves some of the lightest (low atomic number) nuclei.

1.14 The materials used to produce nuclear explosions by fission are certain isotopes of the elements uranium and plutonium. As noted above, uranium in nature consists mainly of two isotopes, namely, uranium-235 (about 0.7 percent), and uranium-238 (about 99.3 percent). The less abundant of these isotopes, i.e., uranium-235, is the readily fissionable species that is commonly used in nuclear weapons. Another isotope, uranium-233, does not occur naturally, but it is also readily fissionable and it can be made artificially starting with thorium-232. Since only insignificant amounts of the element plutonium

are found in nature, the fissionable isotope used in nuclear weapons, plutonium-239, is made artificially from uranium-238.

1.15 When a free (or unattached) neutron enters the nucleus of a fissionable atom, it can cause the nucleus to split into two smaller parts. This is the fission process, which is accompanied by the release of a large amount of energy. The smaller (or lighter) nuclei which result are called the "fission products." The complete fission of 1 pound of uranium or plutonium releases as much explosive energy as does the explosion of about 8,000 (short) tons of TNT.

1.16 In nuclear fusion, a pair of light nuclei unite (or fuse) together to form a nucleus of a heavier atom. An example is the fusion of the hydrogen isotope known as deuterium or "heavy hydrogen." Under suitable conditions, two deuterium nuclei may combine to form the nucleus of a heavier element, helium, with the release of energy. Other fusion reactions are described in § 1.69.

1.17 Nuclear fusion reactions can be brought about by means of very high temperatures, and they are thus referred to as "thermonuclear processes." The actual quantity of energy liberated, for a given mass of material, depends on the particular isotope (or isotopes) involved in the nuclear fusion reaction. As an example, the fusion of all the nuclei present in 1 pound of the hydrogen isotope deuterium would release roughly the same amount of energy as the explosion of 26,000 tons of TNT.

1.18 In certain fusion processes, between nuclei of the hydrogen isotopes, neutrons of high energy are lib-

erated (see § 1.72). These can cause fission in the most abundant isotope (uranium-238) in ordinary uranium as well as in uranium-235 and plutonium-239. Consequently, association of the appropriate fusion reactions with natural uranium can result in an extensive utilization of the latter for the release of energy. A device in which fission and fusion (thermonuclear) reactions are combined can therefore produce an explosion of great power. Such weapons might typically release about equal amounts of explosive energy from fission and from fusion.

1.19 A distinction has sometimes been made between atomic weapons, in which the energy arises from fission, on the one hand, and hydrogen (or thermonuclear) weapons, involving fusion, on the other hand. In each case, however, the explosive energy results from nuclear reactions, so that they are both correctly described as nuclear weapons. In this book, therefore, the general terms "nuclear bomb" and "nuclear weapon" will be used, irrespective of the type of nuclear reaction producing the energy of the explosion.

ENERGY YIELD OF A NUCLEAR EXPLOSION

1.20 The "yield" of a nuclear weapon is a measure of the amount of explosive energy it can produce. It is the usual practice to state the yield in terms of the quantity of TNT that would generate the same amount of energy when it explodes. Thus, a 1-kiloton nuclear weapon is one which produces the same amount of energy in an explosion as does 1 kiloton (or 1,000 tons) of TNT. Similarly, a 1-megaton weapon would

have the energy equivalent of 1 million tons (or 1,000 kilotons) of TNT. The earliest nuclear bombs, such as were dropped over Japan in 1945 and used in the tests at Bikini in 1946, released very roughly the same quantity of energy as 20,000 tons (or 20 kilotons) of TNT (see, however, § 2.24). Since that time, much more powerful weapons, with energy yields in the megaton range, have been developed.

1.21 From the statement in § 1.15 that the fission of 1 pound of uranium or plutonium will release the same amount of explosive energy as about 8,000 tons of TNT, it is evident that in a 20-kiloton nuclear weapon 2.5 pounds of material undergo fission. However, the actual weight of uranium or plutonium in such a weapon is greater than this amount. In other words, in a fission weapon, only part of the nuclear material suffers fission. The efficiency is thus said to be less than 100 percent. The material that has not undergone fission remains in the weapon residues after the explosion.

DISTRIBUTION OF ENERGY IN NUCLEAR EXPLOSIONS

1.22 It has been mentioned that one important difference between nuclear and conventional (or chemical) explosions is the appearance of an appreciable proportion of the energy as thermal radiation in the former case. The basic reason for this difference is that, weight for weight, the energy produced by a nuclear explosive is millions of times as great as that produced by a chemical explosive. Consequently, the temperatures reached in the former case are very much higher than in the latter, namely, tens of millions of degrees in a nuclear

explosion compared with a few thousands in a conventional explosion. As a result of this great difference in temperature, the distribution of the explosion energy is quite different in the two cases.

1.23 Broadly speaking, the energy may be divided into three categories: kinetic (or external) energy, i.e., energy of motion of electrons, atoms, and molecules as a whole; internal energy of these particles; and thermal radiation energy. The proportion of thermal radiation energy increases rapidly with increasing temperature. At the moderate temperatures attained in a chemical explosion, the amount of thermal radiation is comparatively small, and so essentially all the energy released at the time of the explosion appears as kinetic and internal energy. This is almost entirely converted into blast and shock, in the manner described in § 1.01. Because of the very much higher temperatures in a nuclear explosion, however, a considerable proportion of the energy is released as thermal radiation. The manner in which this takes place is described later (§ 1.77 *et seq.*).

1.24 The fraction of the explosion energy received at a distance from the burst point in each of the forms depicted in Fig. 1.02 depends on the nature and yield of the weapon and particularly on the environment of the explosion. For a nuclear detonation in the atmosphere below an altitude of about 100,000 feet, from 35 to 45 percent of the explosion energy is received as thermal energy in the visible and infrared portions of the spectrum (see Fig. 1.74). In addition, below an altitude of about 40,000 feet, about 50 percent of the explosive energy is used in the production of air shock. At

somewhat higher altitudes, where there is less air with which the energy of the exploding nuclear weapon can interact, the proportion of energy converted into shock is decreased whereas that emitted as thermal radiation is correspondingly increased (§ 1.36).

1.25 The exact distribution of energy between air shock and thermal radiation is related in a complex manner to the explosive energy yield, the burst altitude, and, to some extent, to the weapon design, as will be seen in this and later chapters. However, an approximate rule of thumb for a fission weapon exploded in the air at an altitude of less than about 40,000 feet is that 35 percent of the explosion energy is in the form of thermal radiation and 50 percent produces air shock. Thus, for a burst at moderately low altitudes, the air shock energy from a fission weapon will be about half of that from a conventional high explosive with the same total energy release; in the latter, essentially all of the explosive energy is in the form of air blast. This means that if a 20-kiloton fission weapon, for example, is exploded in the air below 40,000 feet or so, the energy used in the production of blast would be roughly equivalent to that from 10 kilotons of TNT.

1.26 Regardless of the height of burst, approximately 85 percent of the explosive energy of a nuclear fission weapon produces air blast (and shock), thermal radiation, and heat. The remaining 15 percent of the energy is released as various nuclear radiations. Of this, 5 percent constitutes the initial nuclear radiation, defined as that produced within a minute or so of the explosion (§ 2.42). The final 10 percent of the total fission energy represents that

of the residual (or delayed) nuclear radiation which is emitted over a period of time. This is largely due to the radioactivity of the fission products present in the weapon residues (or debris) after the explosion. In a thermonuclear device, in which only about half of the total energy arises from fission (§ 1.18), the residual nuclear radiation carries only 5 percent of the energy released in the explosion. It should be noted that there are no nuclear radiations from a conventional explosion since the nuclei are unaffected in the chemical reactions which take place.

1.27 Because about 10 percent of the total fission energy is released in the form of residual nuclear radiation some time after the detonation, this is not included when the energy yield of a nuclear explosion is stated, e.g., in terms of the TNT equivalent as in § 1.20. Hence, in a pure fission weapon the explosion energy is about 90 percent of the total fission energy, and in a thermonuclear device it is, on the average, about 95 percent of the total energy of the fission and fusion reactions. This common convention will be adhered to in subsequent chapters. For example, when the yield of a nuclear weapon is quoted or used in equations, figures, etc., it will represent that portion of the energy delivered within a minute or so, and will exclude the contribution of the residual nuclear radiation.

1.28 The initial nuclear radiation consists mainly of "gamma rays," which are electromagnetic radiations of high energy (see § 1.73) originating in atomic nuclei, and neutrons. These radiations, especially gamma rays, can

travel great distances through air and can penetrate considerable thicknesses of material. Although they can neither be seen nor felt by human beings, except at very high intensities which cause a tingling sensation, gamma rays and neutrons can produce harmful effects even at a distance from their source. Consequently, the initial nuclear radiation is an important aspect of nuclear explosions.

1.29 The delayed nuclear radiation arises mainly from the fission products which, in the course of their radioactive decay, emit gamma rays and another type of nuclear radiation called "beta particles." The latter are electrons, i.e., particles carrying a negative electric charge, moving with high speed; they are formed by a change (neutron \rightarrow proton + electron) within the nuclei of the radioactive atoms. Beta particles, which are also invisible, are much less penetrating than gamma rays, but like the latter they represent a potential hazard.

1.30 The spontaneous emission of beta particles and gamma rays from radioactive substances, i.e., a radioactive nuclide (or radionuclide), such as the fission products, is a gradual process. It takes place over a period of time, at a rate depending upon the nature of the material and upon the amount present. Because of the continuous decay, the quantity of the radionuclide and the rate of emission of radiation decrease steadily. This means that the residual nuclear radiation, due mainly to the fission products, is most intense soon after the explosion but diminishes in the course of time.

TYPES OF NUCLEAR EXPLOSIONS

1.31 The immediate phenomena associated with a nuclear explosion, as well as the effects of shock and blast and of thermal and nuclear radiations, vary with the location of the point of burst in relation to the surface of the earth. For descriptive purposes five types of burst are distinguished, although many variations and intermediate situations can arise in practice. The main types, which will be defined below, are (1) air burst, (2) high-altitude burst, (3) underwater burst, (4) underground burst, and (5) surface burst.

1.32 Provided the nuclear explosion takes place at an altitude where there is still an appreciable atmosphere, e.g., below about 100,000 feet, the weapon residues almost immediately incorporate material from the surrounding medium and form an intensely hot and luminous mass, roughly spherical in shape, called the "fireball." An "air burst" is defined as one in which the weapon is exploded in the air at an altitude below 100,000 feet, but at such a height that the fireball (at roughly maximum brilliance in its later stages) does not touch the surface of the earth. For example, in the explosion of a 1-megaton weapon the fireball may grow until it is nearly 5,700 feet (1.1 mile) across at maximum brilliance. This means that, in this particular case, the explosion must occur at least 2,850 feet above the earth's surface if it is to be called an air burst.

1.33 The quantitative aspects of an air burst will be dependent upon its energy yield, but the general phenomena are much the same in all cases. Nearly all of the shock energy that

leaves the fireball appears as air blast, although some is generally also transmitted into the ground. The thermal radiation will travel long distances through the air and may be of sufficient intensity to cause moderately severe burns of exposed skin as far away as 12 miles from a 1-megaton explosion, on a fairly clear day. For air bursts of higher energy yields, the corresponding distances will, of course, be greater. The thermal radiation is largely stopped by ordinary opaque materials; hence, buildings and clothing can provide protection.

1.34 The initial nuclear radiation from an air burst will also penetrate a long way in air, although the intensity falls off fairly rapidly at increasing distances from the explosion. The interactions with matter that result in the absorption of energy from gamma rays and from neutrons are quite different, as will be seen in Chapter VIII. Different materials are thus required for the most efficient removal of these radiations; but concrete, especially if it incorporates a heavy element, such as iron or barium, represents a reasonable practical compromise for reducing the intensities of both gamma rays and neutrons. A thickness of about 4 feet of ordinary concrete would probably provide adequate protection from the effects of the initial nuclear radiation for people at a distance of about 1 mile from an air burst of a 1-megaton nuclear weapon. However, at this distance the blast effect would be so great that only specially designed blast-resistant structures would survive.

1.35 In the event of a moderately high (or high) air burst, the fission products remaining after the nuclear ex-

plosion will be dispersed in the atmosphere. The residual nuclear radiation arising from these products will be of minor immediate consequence on the ground. On the other hand, if the burst occurs nearer the earth's surface, the fission products may fuse with particles of earth, part of which will soon fall to the ground at points close to the explosion. This dirt and other debris will be contaminated with radioactive material and will, consequently, represent a possible danger to living things.

1.36 A "high-altitude burst" is defined as one in which the explosion takes place at an altitude in excess of 100,000 feet. Above this level, the air density is so low that the interaction of the weapon energy with the surroundings is markedly different from that at lower altitudes and, moreover, varies with the altitude. The absence of relatively dense air causes the fireball characteristics in a high-altitude explosion to differ from those of an air burst. For example, the fraction of the energy converted into blast and shock is less and decreases with increasing altitude. Two factors affect the thermal energy radiated at high altitude. First, since a shock wave does not form so readily in the less dense air, the fireball is able to radiate thermal energy that would, at lower altitudes, have been used in the production of air blast. Second, the less dense air allows energy from the exploding weapon to travel much farther than at lower altitudes. Some of this energy simply warms the air at a distance from the fireball and it does not contribute to the energy that can be radiated within a short time (§ 1.79). In general, the first of these factors is effective between 100,000 and 140,000 feet, and a larger

proportion of the explosion energy is released in the form of thermal radiation than at lower altitudes. For explosions above about 140,000 feet, the second factor becomes the more important, and the fraction of the energy that appears as thermal radiation at the time of the explosion becomes smaller.

1.37 The fraction of the explosion energy emitted from a weapon as nuclear radiations is independent of the height of burst. However, the partition of that energy between gamma rays and neutrons received at a distance will vary since a significant fraction of the gamma rays result from interactions of neutrons with nitrogen atoms in the air at low altitudes. Furthermore, the attenuation of the initial nuclear radiation with increasing distance from the explosion is determined by the total amount of air through which the radiation travels. This means that, for a given explosion energy yield, more initial nuclear radiation will be received at the same slant range on the earth's surface from a high-altitude detonation than from a moderately high air burst. In both cases the residual radiation from the fission products and other weapon residues will not be significant on the ground (§ 1.35).

1.38 Both the initial and the residual nuclear radiations from high-altitude bursts will interact with the constituents of the atmosphere to expel electrons from the atoms and molecules. Since the electron carries a negative electrical charge, the residual part of the atom (or molecule) is positively charged, i.e., it is a positive ion. This process is referred to as "ionization," and the separated electrons and positive ions are called "ion pairs." The existence of large

numbers of electrons and ions at high altitudes may have seriously degrading effects on the propagation of radio and radar signals (see Chapter X). The free electrons resulting from gamma-ray ionization of the air in a high-altitude explosion may also interact with the earth's magnetic field to generate strong electromagnetic fields capable of causing damage to unprotected electrical or electronic equipment located in an extensive area below the burst. The phenomenon known as the "electromagnetic pulse" (or EMP) is described in Chapter XI. The EMP can also be produced in surface and low air bursts, but a much smaller area around the detonation point is affected.

1.39 If a nuclear explosion occurs under such conditions that its center is beneath the ground or under the surface of water, the situation is described as an "underground burst" or an "underwater burst," respectively. Since some of the effects of these two types of explosions are similar, they will be considered here together as subsurface bursts. In a subsurface burst, most of the shock energy of the explosion appears as underground or underwater shock, but a certain proportion, which is less the greater the depth of the burst, escapes and produces air blast. Much of the thermal radiation and of the initial nuclear radiation will be absorbed within a short distance of the explosion. The energy of the absorbed radiations will merely contribute to the heating of the ground or body of water. Depending upon the depth of the explosion, some of the thermal and nuclear radiations will escape, but the intensities will gen-

erally be less than for an air burst. However, the residual nuclear radiation, i.e., the radiation emitted after the first minute, now becomes of considerable significance, since large quantities of earth or water in the vicinity of the explosion will be contaminated with radioactive fission products.

1.40 A "surface burst" is regarded as one which occurs either at or slightly above the actual surface of the land or water. Provided the distance above the surface is not great, the phenomena are essentially the same as for a burst occurring on the surface. As the height of burst increases up to a point where the fireball (at maximum brilliance in its later stages) no longer touches the land or water, there is a transition zone in which the behavior is intermediate between that of a true surface burst and of an air burst. In surface bursts, the air blast and ground (or water) shock are produced in varying proportions depending on the energy of the explosion and the height of burst.

1.41 Although the five types of burst have been considered as being fairly distinct, there is actually no clear line of demarcation between them. It will be apparent that, as the height of the explosion is decreased, a high-altitude burst will become an air burst, and an air burst will become a surface burst. Similarly, a surface burst merges into a subsurface explosion at a shallow depth, when part of the fireball actually breaks through the surface of the land or water. It is nevertheless a matter of convenience, as will be seen in later chapters, to divide nuclear explosions into the five general types defined above.

SCIENTIFIC BASIS OF NUCLEAR EXPLOSIONS²

FISSION ENERGY

1.42 The significant point about the fission of a uranium (or plutonium) nucleus by means of a neutron, in addition to the release of a large quantity of energy, is that the process is accompanied by the instantaneous emission of two or more neutrons; thus,

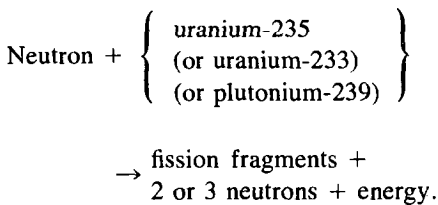

The neutrons liberated in this manner are able to induce fission of additional uranium (or plutonium) nuclei, each such process resulting in the emission of more neutrons which can produce further fission, and so on. Thus, in principle, a single neutron could start off a chain of nuclear fissions, the number of nuclei suffering fission, and the energy liberated, increasing at a tremendous rate, as will be seen shortly.

1.43 There are many different ways in which the nuclei of a given fissionable species can split up into two fission fragments (initial fission products), but the total amount of energy liberated per fission does not vary greatly. A satisfactory average value of this energy is 200 million electron volts. The million electron volt (or 1 MeV) unit has been found convenient for expressing the energy released in nuclear reactions; it is

equivalent to 1.6×10^{-6} erg or 1.6×10^{-13} joule. The manner in which this energy is distributed among the fission fragments and the various radiations associated with fission is shown in Table 1.43.

Table 1.43**DISTRIBUTION OF FISSION ENERGY**

	MeV
Kinetic energy of fission fragments	165 ± 5
Instantaneous gamma-ray energy	7 ± 1
Kinetic energy of fission neutrons	5 ± 0.5
Beta particles from fission products	7 ± 1
Gamma rays from fission products	6 ± 1
Neutrinos from fission products	10
<hr/>	
Total energy per fission	200 ± 6

1.44 The results in the table may be taken as being approximately applicable to either uranium-233, uranium-235, or plutonium-239. These are the only three known substances, which are reasonably stable so that they can be stored without appreciable decay, that are capable of undergoing fission by neutrons of all energies. Hence, they are the only materials that can be used to sustain a fission chain. Uranium-238, the most abundant isotope in natural uranium (§ 1.14), and thorium-232 will suffer fission by neutrons of high energy only, but not by those of lower energy. For this reason these substances cannot sustain a chain reaction. However, when fission does occur in these elements, the energy distribution is quite similar to that shown in the table.

1.45 Only part of the fission energy

²The remaining (more technical) sections of this chapter may be omitted without loss of continuity.

is immediately available in a nuclear explosion; this includes the kinetic energy of the fission fragments, most of the energy of the instantaneous gamma rays, which is converted into other forms of energy within the exploding weapon, and also most of the neutron kinetic energy, but only a small fraction of the decay energy of the fission products. There is some compensation from energy released in reactions in which neutrons are captured by the weapon debris, and so it is usually accepted that about 180 MeV of energy are immediately available per fission. There are 6.02×10^{23} nuclei in 235 grams of uranium-235 (or 239 grams of plutonium-239), and by making use of familiar conversion factors (cf. § 1.43) the results quoted in Table 1.45 may be obtained for the energy (and other) equivalents of 1 kiloton of TNT. The calculations are based on an accepted, although somewhat arbitrary, figure of 10^{12} calories as the energy released in the explosion of this amount of TNT.³

Table 1.45

EQUIVALENTS OF 1 KILOTON OF TNT

Complete fission of 0.057 kg (57 grams or 2 ounces) fissionable material
Fission of 1.45×10^{23} nuclei
10^{12} calories
2.6×10^{25} million electron volts
4.18×10^{19} ergs (4.18×10^{12} joules)
1.16×10^6 kilowatt-hours
3.97×10^9 British thermal units

CRITICAL MASS FOR A FISSION CHAIN

1.46 Although two to three neutrons are produced in the fission reaction for every nucleus that undergoes fission, not all of these neutrons are available for causing further fissions. Some of the fission neutrons are lost by escape, whereas others are lost in various non-fission reactions. In order to sustain a fission chain reaction, with continuous release of energy, at least one fission neutron must be available to cause further fission for each neutron previously absorbed in fission. If the conditions are such that the neutrons are lost at a faster rate than they are formed by fission, the chain reaction would not be self-sustaining. Some energy would be produced, but the amount would not be large enough, and the rate of liberation would not be sufficiently fast, to cause an effective explosion. It is necessary, therefore, in order to achieve a nuclear explosion, to establish conditions under which the loss of neutrons is minimized. In this connection, it is especially important to consider the neutrons which escape from the substance undergoing fission.

1.47 The escape of neutrons occurs at the exterior of the uranium (or plutonium) material. The rate of loss by escape will thus be determined by the surface area. On the other hand, the fission process, which results in the formation of more neutrons, takes place

³The majority of the experimental and theoretical values of the explosive energy released by TNT range from 900 to 1,100 calories per gram. At one time, there was some uncertainty as to whether the term "kiloton" of TNT referred to a short kiloton (2×10^6 pounds), a metric kiloton (2.205×10^6 pounds), or a long kiloton (2.24×10^6 pounds). In order to avoid ambiguity, it was agreed that the term "kiloton" would refer to the release of 10^{12} calories of explosive energy. This is equivalent to 1 short kiloton of TNT if the energy release is 1,102 calories per gram or to 1 long kiloton if the energy is 984 calories per gram of TNT.

throughout the whole of the material and its rate is, therefore, dependent upon the mass. By increasing the mass of the fissionable material, at constant density, the ratio of the surface area to the mass is decreased; consequently, the loss of neutrons by escape relative to their formation by fission is decreased. The same result can also be achieved by having a constant mass but compressing it to a smaller volume (higher density), so that the surface area is decreased.

1.48 The situation may be understood by reference to Fig. 1.48 showing two spherical masses, one larger than the other, of fissionable material of the same density. Fission is initiated by a neutron represented by a dot within a small circle. It is supposed that in each act of fission three neutrons are emitted; in other words, one neutron is captured and three are expelled. The removal of a

neutron from the system is indicated by the head of an arrow. Thus, an arrowhead within the sphere means that fission has occurred and extra neutrons are produced, whereas an arrowhead outside the sphere implies the loss of a neutron. It is evident from Fig. 1.48 that a much greater fraction of the neutrons is lost from the smaller than from the larger mass.

1.49 If the quantity of a fissionable isotope of uranium (or plutonium) is such that the ratio of the surface area to the mass is large, the proportion of neutrons lost by escape will be so great that the propagation of a nuclear fission chain, and hence the production of an explosion, will not be possible. Such a quantity of material is said to be "sub-critical." But as the mass of the piece of uranium (or plutonium) is increased (or the volume is decreased by compress-

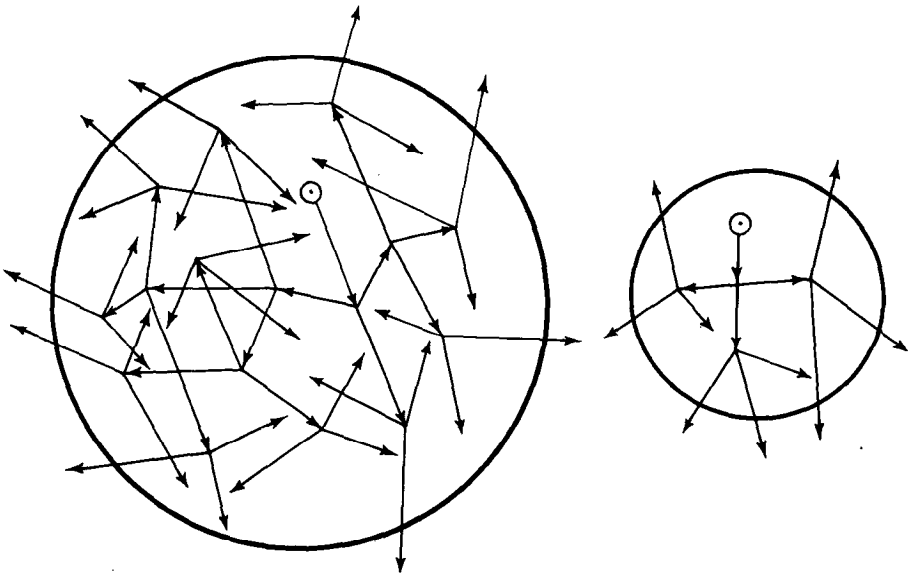

Figure 1.48. Effect of increased mass of fissionable material in reducing the proportion of neutrons lost by escape.

sion) and the relative loss of neutrons is thereby decreased, a point is reached at which the chain reaction can become self-sustaining. This is referred to as the "critical mass" of the fissionable material under the existing conditions.

1.50 For a nuclear explosion to take place, the weapon must thus contain a sufficient amount of a fissionable uranium (or plutonium) isotope for the critical mass to be exceeded. Actually, the critical mass depends, among other things, on the shape of the material, its composition and density (or compression), and the presence of impurities which can remove neutrons in nonfission reactions. By surrounding the fissionable material with a suitable neutron "reflector," the loss of neutrons by escape can be reduced, and the critical mass can thus be decreased. Moreover, elements of high density, which make good reflectors for neutrons of high energy, provide inertia, thereby delaying expansion of the exploding material. The action of the reflector is then like the familiar tamping in blasting operations. As a consequence of its neutron reflecting and inertial properties, the "tamper" permits the fissionable material in a nuclear weapon to be used more efficiently.

ATTAINMENT OF CRITICAL MASS IN A WEAPON

1.51 Because of the presence of stray neutrons in the atmosphere or the possibility of their being generated in various ways, a quantity of a suitable isotope of uranium (or plutonium) exceeding the critical mass would be likely to melt or possibly explode. It is necessary, therefore, that before detonation, a nuclear weapon should contain no piece of fissionable material that is as large as the critical mass for the given conditions. In order to produce an explosion, the material must then be made "supercritical," i.e., larger than the critical mass, in a time so short as to preclude a subexplosive change in the configuration, such as by melting.

1.52 Two general methods have been described for bringing about a nuclear explosion, that is to say, for quickly converting a subcritical system into a supercritical one. In the first method, two or more pieces of fissionable material, each less than a critical mass, are brought together very rapidly in order to form one piece that exceeds the critical mass (Fig. 1.52). This may be achieved in some kind of gun-barrel device, in which an explosive propellant

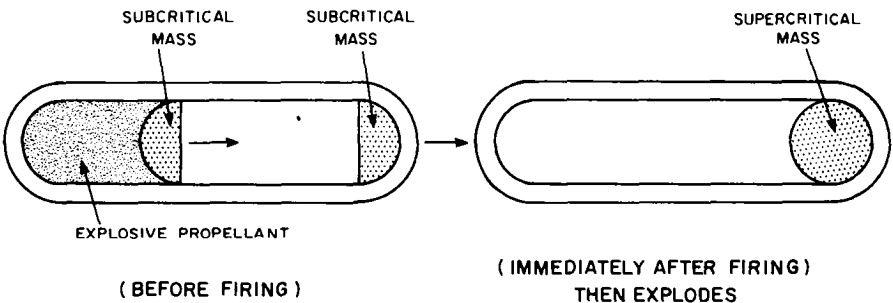

Figure 1.52. Principle of a gun-assembly nuclear device.

is used to blow one subcritical piece of fissionable material from the breech end of the gun into another subcritical piece firmly held in the muzzle end.

1.53 The second method makes use of the fact that when a subcritical quantity of an appropriate isotope of uranium (or plutonium) is strongly compressed, it can become critical or supercritical as indicated above. The compression may be achieved by means of a spherical arrangement of specially fabricated shapes (lenses) of ordinary high explosive. In a hole in the center of this system is placed a subcritical sphere of fissionable material. When the high-explosive lens system is set off, by means of a detonator on the outside of each lens, an inwardly-directed spherical "implosion" wave is produced. A similar wave can be realized without lenses by detonating a large number of points distributed over a spherical surface. When the implosion wave reaches the sphere of uranium (or plutonium), it causes the latter to be compressed and become supercritical (Fig. 1.53). The introduction of neutrons from a suitable

source can then initiate a chain reaction leading to an explosion.

TIME SCALE OF A FISSION EXPLOSION

1.54 An interesting insight into the rate at which the energy is released in a fission explosion can be obtained by treating the fission chain as a series of "generations." Suppose that a certain number of neutrons are present initially and that these are captured by fissionable nuclei; then, in the fission process other neutrons are released. These neutrons, are, in turn, captured by fissionable nuclei and produce more neutrons, and so on. Each stage of the fission chain is regarded as a generation, and the "generation time" is the average time interval between successive generations. The time required for the actual fission of a nucleus is extremely short and most of the neutrons are emitted promptly. Consequently, the generation time is essentially equal to the average time elapsing between the release of a neutron and its subsequent capture by a

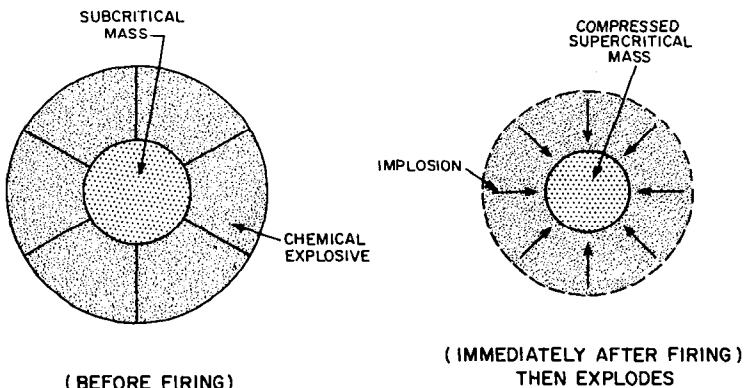

Figure 1.53. Principle of an implosion-type nuclear device.

fissionable nucleus. This time depends, among other things, on the energy (or speed) of the neutron, and if most of the neutrons are of fairly high energy, usually referred to as "fast neutrons," the generation time is about a one-hundred-millionth part (10^{-8}) of a second, i.e., 0.01 microsecond.⁴

1.55 It was mentioned earlier that not all the fission neutrons are available for maintaining the fission chain because some are lost by escape and by removal in nonfission reactions. Suppose that when a nucleus captures a neutron and suffers fission f neutrons are released; let l be the average number of neutrons lost, in one way or another, for each fission. There will thus be $f - l$ neutrons available to carry on the fission chain. If there are N neutrons present at any instant, then as a result of their capture by fissionable nuclei $N(f - l)$ neutrons will be produced at the end of one generation; hence, the increase in the number of neutrons per generation is $N(f - l) - N$ or $N(f - l - 1)$. For convenience, the quantity $f - l - 1$, that is, the increase in neutrons per fission, will be represented by x . If g is the generation time, then the rate at which the number of neutrons increases is given by

Rate of neutron increase

$$dN/dt = Nx/g.$$

The solution of this equation is

$$N = N_0 e^{xt/g},$$

where N_0 is the number of neutrons present initially and N is the number at a time t later. The fraction t/g is the number of generations which have

elapsed during the time t , and if this is represented by n , it follows that

$$N = N_0 e^{xn}. \quad (1.55.1)$$

1.56 If the value of x is known, equation (1.55.1) can be used to calculate either the neutron population after any prescribed number of generations in the fission chain, or, alternatively, the generations required to attain a particular number of neutrons. For uranium-235, f is about 2.5, l may be taken to be roughly 0.5, so that x , which is equal to $f - l - 1$, is close to unity; hence, equation (1.55.1) may be written as

$$N \approx N_0 e^n \text{ or } N \approx N_0 10^{n/2.3}. \quad (1.56.1)$$

1.57 According to the data in Table 1.45, it would need 1.45×10^{22} fissions, and hence the same number of neutrons, to produce 0.1 kiloton equivalent of energy. If the fission chain is initiated by one neutron, so that N_0 is 1, it follows from equation (1.56.1) that it would take approximately 51 generations to produce the necessary number of neutrons. Similarly, to release 100 kilotons of energy would require 1.45×10^{25} neutrons and this number would be attained in about 58 generations. It is seen, therefore, that 99.9 percent of the energy of a 100-kiloton fission explosion is released during the last 7 generations, that is, in a period of roughly 0.07 microsecond. Clearly, most of the fission energy is released in an extremely short time period. The same conclusion is reached for any value of the fission explosion energy.

1.58 In 50 generations or so, i.e., roughly half microsecond, after the ini-

⁴A microsecond is a one-millionth part of a second, i.e., 10^{-6} second; a hundredth of a microsecond, i.e., 10^{-8} second, is often called a "shake." The generation time in fission by fast neutrons is thus roughly 1 shake.

tiation of the fission chain, so much energy will have been released—about 10^{11} calories—that extremely high temperatures will be attained. Consequently, in spite of the restraining effect of the tamper (§ 1.50) and the weapon casing, the mass of fissionable material will begin to expand rapidly. The time at which this expansion commences is called the “explosion time.” Since the expansion permits neutrons to escape more readily, the mass becomes subcritical and the self-sustaining chain reaction soon ends. An appreciable proportion of the fissionable material remains unchanged and some fissions will continue as a result of neutron capture, but the amount of energy released at this stage is relatively small.

1.59 To summarize the foregoing discussion, it may be stated that because the fission process is accompanied by the instantaneous liberation of neutrons, it is possible, in principle to produce a self-sustaining chain reaction accompanied by the rapid release of large amounts of energy. As a result, a few pounds of fissionable material can be made to liberate, within a very small fraction of a second, as much energy as the explosion of many thousands of tons of TNT. This is the basic principle of nuclear fission weapons.

FISSION PRODUCTS

1.60 Many different, initial fission product nuclei, i.e., fission fragments, are formed when uranium or plutonium nuclei capture neutrons and suffer fission. There are 40 or so different ways in which the nuclei can split up when fission occurs; hence about 80 different

fragments are produced. The nature and proportions of the fission fragment nuclei vary to some extent, depending on the particular substance undergoing fission and on the energy of the neutrons causing fission. For example, when uranium-238 undergoes fission as a result of the capture of neutrons of very high energy released in certain fusion reactions (§ 1.72), the products are somewhat different, especially in their relative amounts, from those formed from uranium-235 by ordinary fission neutrons.

1.61 Regardless of their origin, most, if not all, of the approximately 80 fission fragments are the nuclei of radioactive forms (radioisotopes) of well-known, lighter elements. The radioactivity is usually manifested by the emission of negatively charged beta particles (§ 1.29). This is frequently, although not always, accompanied by gamma radiation, which serves to carry off excess energy. In a few special cases, gamma radiation only is emitted.

1.62 As a result of the expulsion of a beta particle, the nucleus of a radioactive substance is changed into that of another element, sometimes called the “decay product.” In the case of the fission fragments, the decay products are generally also radioactive, and these in turn may decay with the emission of beta particles and gamma rays. On the average there are about four stages of radioactivity for each fission fragment before a stable (nonradioactive) nucleus is formed. Because of the large number of different ways in which fission can occur and the several stages of decay involved, the fission product mixture

becomes very complex.⁵ More than 300 different isotopes of 36 light elements, from zinc to terbium, have been identified among the fission products.

1.63 The rate of radioactive change, i.e., the rate of emission of beta particles and gamma radiation, is usually expressed by means of the "half-life" of the radionuclide (§ 1.30) involved. This is defined as the time required for the radioactivity of a given quantity of a particular nuclide to decrease (or decay) to half of its original value. Each individual radionuclide has a definite half-life which is independent of its state or its amount. The half-lives of the fission products have been found to range from a small fraction of a second to something like a million years.

1.64 Although every radionuclide present among the fission products is known to have a definite half-life, the mixture formed after a nuclear explosion is so complex that it is not possible to represent the decay as a whole in terms of a half-life. Nevertheless, it has been found that the decrease in the total radiation intensity from the fission products can be calculated approximately by means of a fairly simple formula. This will be given and discussed in Chapter IX, but the general nature of the decay rate of fission products, based on this formula, will be apparent from Fig. 1.64. The residual radioactivity from the fission products at 1 hour after a nuclear detonation is taken as 100 and the subsequent decrease with time is indicated by the curve. It is seen that at 7 hours after the explosion, the fission product activity will have decreased to

about one-tenth (10 percent) of its amount at 1 hour. Within approximately 2 days, the activity will have decreased to 1 percent of the 1-hour value.

1.65 In addition to the beta-particle and gamma-ray activity due to the fission products, there is another kind of residual radioactivity that should be mentioned. This is the activity of the fissionable material, part of which, as noted in § 1.58, remains after the explosion. The fissionable uranium and plutonium isotopes are radioactive, and their activity consists in the emission of what are called "alpha particles." These are a form of nuclear radiation, since they are expelled from atomic nuclei; but they differ from the beta particles arising from the fission products in being much heavier and carrying a positive electrical charge. Alpha particles are, in fact, identical with the nuclei of helium atoms.

1.66 Because of their greater mass and charge, alpha particles are much less penetrating than beta particles or gamma rays of the same energy. Thus, very few alpha particles from radioactive sources can travel more than 1 to 3 inches in air before being stopped. It is doubtful that these particles can get through the unbroken skin, and they certainly cannot penetrate clothing. Consequently, the uranium (or plutonium) present in the weapon residues does not constitute a hazard if the latter are outside the body. However, if plutonium enters the body by ingestion, through skin abrasions, or particularly through inhalation, the effects may be serious.

⁵The general term "fission products" is used to describe this complex mixture.

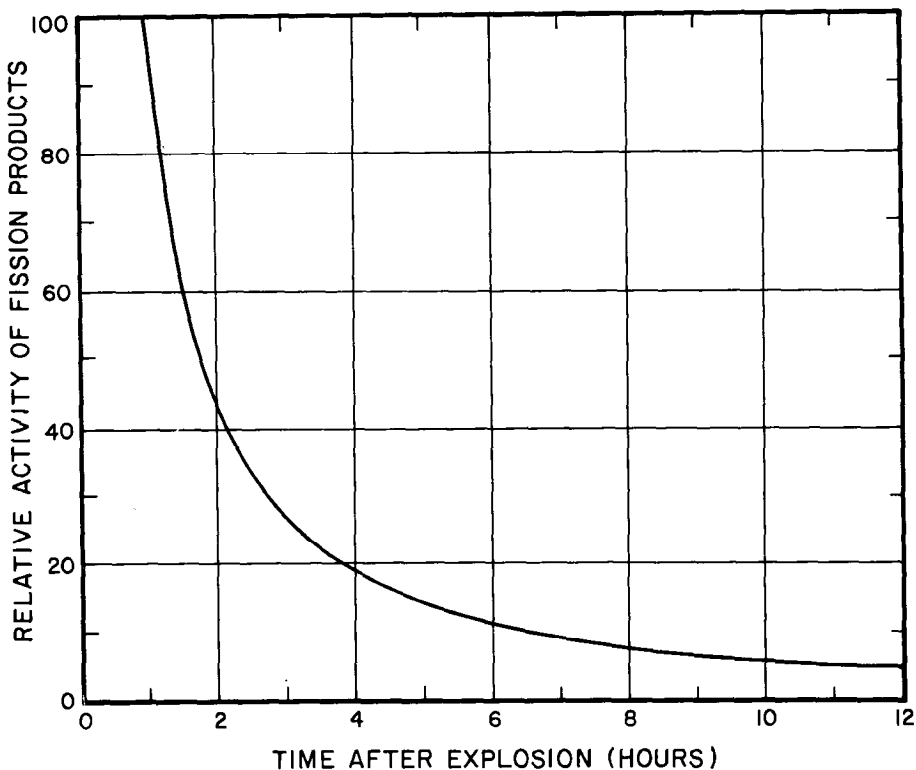

Figure 1.64. Rate of Decay of fission products after a nuclear explosion (activity is taken as 100 at 1 hour after the detonation).

FUSION (THERMONUCLEAR) REACTIONS

1.67 Energy production in the sun and stars is undoubtedly due to fusion reactions involving the nuclei of various light (low atomic weight) atoms. From experiments made in laboratories with charged-particle accelerators, it was concluded that the fusion of isotopes of hydrogen was possible. This element is known to exist in three isotopic forms, in which the nuclei have mass numbers (§ 1.10) of 1, 2, and 3, respectively. These are generally referred to as hydrogen (^1H), deuterium (^2H or D), and

tritium (^3H or T). All the nuclei carry a single positive charge, i.e., they all contain one proton, but they differ in the number of neutrons. The lightest (^1H) nuclei (or protons) contain no neutrons; deuterium (D) nuclei contain one neutron, and tritium (T) nuclei contain two neutrons.

1.68 Several different fusion reactions have been observed between the nuclei of the three hydrogen isotopes, involving either two similar or two different nuclei. In order to make these reactions occur to an appreciable extent, the nuclei must have high energies. One way in which this energy can be sup-

plied is to raise the temperature to very high levels. In these circumstances the fusion processes are referred to as "thermonuclear reactions," as mentioned in § 1.17.

1.69 Four thermonuclear fusion reactions appear to be of interest for the production of energy because they are expected to occur sufficiently rapidly at realizable temperatures; these are:

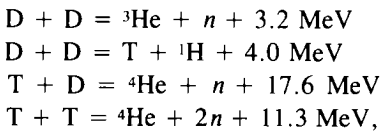

where He is the symbol for helium and n (mass = 1) represents a neutron. The energy liberated in each case is given in million electron volt (MeV) units. The first two of these reactions occur with almost equal probability at the temperatures associated with nuclear explosions (several tens of million degrees Kelvin), whereas the third reaction has a much higher probability and the fourth a much lower probability. Thus, a valid comparison of the energy released in fusion reactions with that produced in fission can be made by noting that, as a result of the first three reactions given above, five deuterium nuclei, with a total mass of 10 units, will liberate 24.8 MeV upon fusion. On the other hand, in the fission process, e.g., of uranium-235, a mass of 235 units will produce a total of about 200 MeV of energy (§ 1.43). Weight for weight, therefore, the fusion of deuterium nuclei would produce nearly three times as much energy as the fission of uranium or plutonium.

1.70 Another reaction of thermonuclear weapons interest, with tritium as a product, is

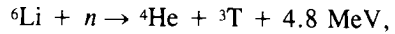

where ${}^6\text{Li}$ represents the lithium-6 isotope, which makes up about 7.4 percent of natural lithium. Other reactions can occur with lithium-6 or the more abundant isotope lithium-7 and various particles produced in the weapon. However, the reaction shown above is of most interest for two reasons: (1) it has a high probability of occurrence and (2) if the lithium is placed in the weapon in the form of the compound lithium deuteride (LiD), the tritium formed in the reaction has a high probability of interacting with the deuterium. Large amounts of energy are thus released by the third reaction in § 1.69, and additional neutrons are produced to react with lithium-6.

1.71 In order to make the nuclear fusion reactions take place at the required rate, temperatures of the order of several tens of million degrees are necessary. The only practical way in which such temperatures can be obtained on earth is by means of a fission explosion. Consequently, by combining a quantity of deuterium or lithium deuteride (or a mixture of deuterium and tritium) with a fission device, it should be possible to initiate one or more of the thermonuclear fusion reactions given above. If these reactions, accompanied by energy evolution, can be propagated rapidly through a volume of the hydrogen isotope (or isotopes) a thermonuclear explosion may be realized.

1.72 It will be observed that in three of the fusion reactions given in § 1.69, neutrons are produced. Because of their small mass, these neutrons carry off most of the reaction energy; consequently, they have sufficient energy to

cause fission of uranium-238 nuclei. As stated earlier, this process requires neutrons of high energy. It is possible, therefore, to make use of the thermonuclear neutrons by surrounding the fusion weapon with a blanket of ordinary uranium. The high-energy neutrons are then captured by uranium-238 nuclei; the latter undergo fission, thereby contributing to the overall energy yield of the explosion, and also to the residual nuclear radiation arising from the fission products. On the average, the energy released in the explosion of a thermonuclear weapon originates in roughly equal amounts from fission and fusion processes, although there may be variations in individual cases. In "boosted" fission weapons, thermonuclear neutrons serve to enhance the fission process; energy released in the thermonuclear reaction is then a small fraction of the total energy yield.

THERMAL RADIATION

1.73 The observed phenomena associated with a nuclear explosion and the effects on people and materials are largely determined by the thermal radiation and its interaction with the surroundings. It is desirable, therefore, to consider the nature of these radiations somewhat further. Thermal radiations belong in the broad category of what are known as "electromagnetic radiations." These are a kind of wave motion resulting from oscillating electric charges and their associated magnetic fields. Ordinary visible light is the most familiar kind of electromagnetic radiation, and all such radiations travel through the air (or, more exactly, a vacuum) at the same velocity, namely,

the velocity of light, 186,000 miles per second. Electromagnetic radiations range from the very short wavelength (or very high frequency) gamma rays (§ 1.28) and X rays, through the invisible ultraviolet to the visible region, and then to the infrared and radar and radio waves of relatively long wavelength (and low frequency).

1.74 The approximate wavelength and frequency regions occupied by the different kinds of electromagnetic radiations are indicated in Fig. 1.74. The wavelength λ in centimeters and the frequency ν in hertz, i.e., in waves (or cycles) per second, are related by $\lambda\nu = c$, where c is the velocity of light, 3.00×10^{10} cm per second. According to Planck's theory, the energy of the corresponding "quantum" (or unit) of energy, carried by the "photon," i.e., the postulated particle (or atom) of radiation, is given by

$$E \text{ (ergs)} = h\nu = \frac{hc}{\lambda} \\ = \frac{1.99 \times 10^{-16}}{\lambda(\text{cm})}, \quad (1.74.1)$$

where h is a universal constant equal to 6.62×10^{-27} erg-second. The energy quantum values for the various electromagnetic radiations are included in Fig. 1.74; the results are expressed either in MeV, i.e., million electron volt, in keV, i.e., kilo (or thousand) electron volt, or in eV, i.e., electron volt, units. These are obtained from equation (1.74.1) by writing it in the form

$$E \text{ (MeV)} = \frac{1.24 \times 10^{-10}}{\lambda(\text{cm})} \quad (1.74.2)$$

It is seen that the energy of the radiations decreases from left to right in the

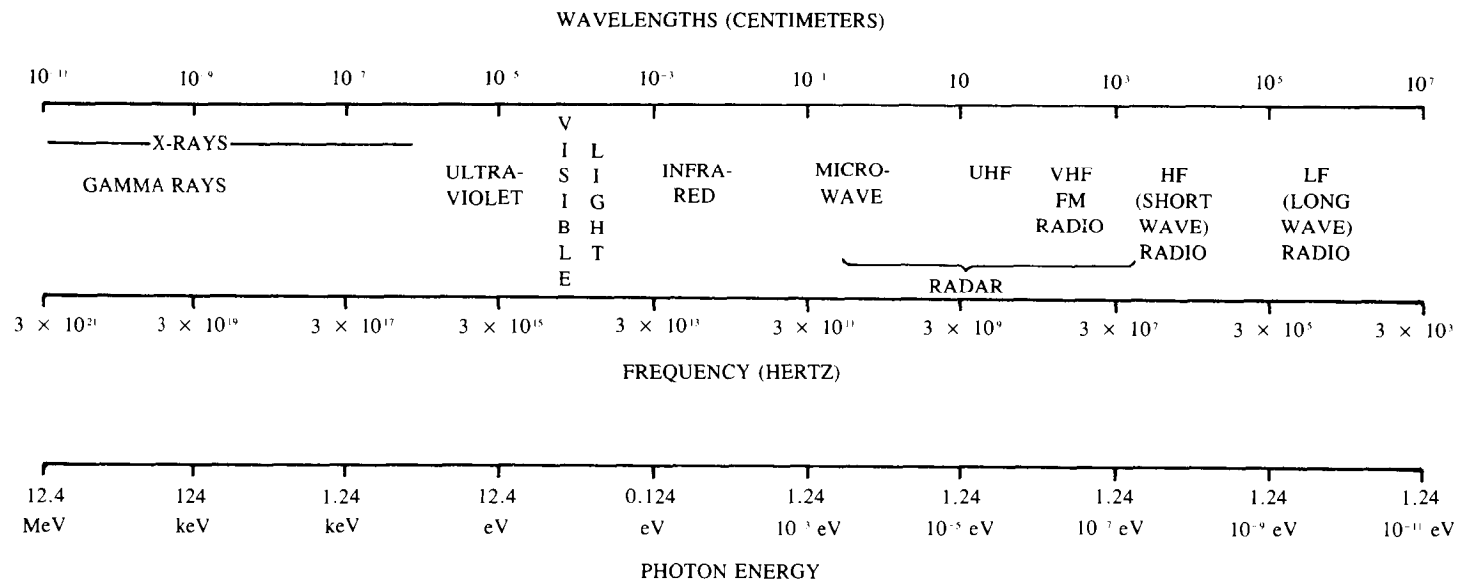

Figure 1.74. Wavelengths, frequencies, and photon energies of electromagnetic radiations.

figure, i.e., as the wavelength increases and the frequency decreases.

1.75 The (thermal) radiation energy density for matter in temperature equilibrium is given by

$$E \text{ (radiation)} = 7.6 \times 10^{-15} T^4 \text{ ergs/cm}^3,$$

where T is the temperature in degrees Kelvin. At the temperature of a conventional chemical explosion, e.g., 5,000°K, the radiation energy density is then less than 1 erg/cm³, compared with roughly 10⁸ ergs/cm³ for the material energy, i.e., kinetic energy and internal (electronic, vibrational, and rotational) energy. Hence, as indicated in § 1.23, the radiation energy is a very small proportion of the total energy. In a nuclear explosion, on the other hand, where temperatures of several tens of million degrees are reached, the radiation energy density will be of the order of 10¹⁶ ergs/cm³, whereas the material energy is in the range of 10¹⁴ to 10¹⁵ ergs/cm³. It has been estimated that in a nuclear explosion some 80 percent of the total energy may be present initially as thermal radiation energy.

1.76 Not only does the radiation energy density increase with temperature but the rate of its emission as thermal radiation increases correspondingly. For materials at temperatures of a few thousand degrees Kelvin, the energy is radiated slowly, with the greatest part in the ultraviolet, visible, and infrared regions of the electromagnetic spectrum (Fig. 1.74). At the temperatures of a nuclear explosion, however, not only is the radiation energy emitted very rapidly, but most of this energy is

in the spectral region with wavelengths shorter than the ultraviolet.

1.77 When a nuclear weapon explodes, temperature equilibrium is rapidly established in the residual material. Within about one microsecond after the explosion, some 70 to 80 percent of the explosion energy, as defined in § 1.27, is emitted as primary thermal radiation, most of which consists of soft X rays.⁶ Almost all of the rest of the energy is in the form of kinetic energy of the weapon debris at this time. The interaction of the primary thermal radiation and the debris particles with the surroundings will vary with the altitude of burst and will determine the ultimate partition of energy between the thermal radiation received at a distance and shock.

1.78 When a nuclear detonation occurs in the air, where the atmospheric pressure (and density) is near to sea-level conditions, the soft X rays in the primary thermal radiation are completely absorbed within a distance of a few feet. Some of the radiations are degraded to lower energies, e.g., into the ultraviolet region, but most of the energy of the primary thermal radiation serves to heat the air immediately surrounding the nuclear burst. It is in this manner that the fireball is formed. Part of the energy is then reradiated at a lower temperature from the fireball and the remainder is converted into shock (or blast) energy (see Chapter II). This explains why only about 35 to 45 percent of the fission energy from an air burst is received as thermal radiation energy at a distance, although the primary thermal radiation may constitute

⁶X rays are frequently distinguished as "hard" or "soft." The latter have longer wavelengths and lower energies, and they are more easily absorbed than hard X rays. They are, nevertheless, radiations of high energy compared with ultraviolet or visible light.

as much as 70 to 80 percent of the total. Furthermore, because the secondary thermal radiation is emitted at a lower temperature, it lies mainly in the region of the spectrum with longer wavelengths (lower photon energies), i.e., ultraviolet, visible, and infrared⁷ (see Chapter VII).

1.79 In the event of a burst at high altitudes, where the air density is low, the soft X rays travel long distances before they are degraded and absorbed. At this stage, the available energy is spread throughout such a large volume (and mass) that most of the atoms and molecules in the air cannot get very hot.

Although the total energy emitted as thermal radiation in a high-altitude explosion is greater than for an air burst closer to sea level, about half is reradiated so slowly by the heated air that it has no great significance as a cause of damage. The remainder, however, is radiated very much more rapidly, i.e., in a shorter time interval, than is the case at lower altitudes. A shock wave is generated from a high-altitude burst, but at distances of normal practical interest it produces a smaller pressure increase than from an air burst of the same yield. These matters are treated more fully in Chapter II.

BIBLIOGRAPHY

BRODE, H. L., "Review of Nuclear Weapons Effects," *Annual Review of Nuclear Science*, **18**, 153 (1968).
 CROCKER, G. R., "Fission Product Decay Chains: Schematics with Branching Fractions, Half-Lives, and Literature References," U.S. Naval Radiological Defense Laboratory, June 1967, USNRDL-TR-67-111.
 DOLAN, P. J., "Calculated Abundances and Activities of the Products of High Energy Neutron Fission of Uranium-238," Defense Atomic Support Agency, May 1959, DASA 525.
 GLASSTONE, S., "Sourcebook on Atomic Energy," D. Van Nostrand Co., Inc., Third Edition, 1967.

HOISINGTON, D. B., "Nucleonics Fundamentals," McGraw-Hill Book Co., Inc., 1959, Chapter 14.
 LAURENCE, W. L., "Men and Atoms," Simon and Schuster, Inc., 1959.
 SELDON, R. W., "An Introduction to Fission Explosions," University of California, Lawrence Radiation Laboratory, Livermore, July 1969, UCID-15554.
 SMYTH, H. DeW., "Atomic Energy for Military Purposes," Princeton University Press, 1945.
 WEAVER, L. E., P. O. STROM, and P. A. KILLEEN, "Estimated Total Chain and Independent Fission Yields for Several Neutron-Induced Fission Processes," U.S. Naval Radiological Defense Laboratory, March 1963, USNRDL-TR-633.

⁷It is sometimes referred to as the "prompt thermal radiation" because only that which is received within a few seconds of the explosion is significant as a hazard.

CHAPTER II

DESCRIPTIONS OF NUCLEAR EXPLOSIONS

INTRODUCTION

2.01 A number of characteristic phenomena, some of which are visible whereas others are not directly apparent, are associated with nuclear explosions. Certain aspects of these phenomena will depend on the type of burst, i.e., air, high-altitude, surface, or subsurface, as indicated in Chapter I. This dependence arises from direct and secondary interactions of the output of the exploding weapon with its environment, and leads to variations in the distribution of the energy released, particularly among blast, shock, and thermal radiation. In addition, the design of the weapon can also affect the energy distribution. Finally, meteorological conditions, such as temperature, humidity, wind, precipitation, and atmospheric pressure, and even the nature of the terrain over which the explosion occurs, may influence some of the observed effects. Nevertheless, the gross phenomena associated with a particular type of nuclear explosion, namely, high-altitude, air, surface, underwater, or underground, remain unchanged. It is such phenomena that are described in this chapter.

2.02 The descriptions of explosions at very high altitudes as well as those in the air nearer to the ground refer mainly to nuclear devices with energies in the vicinity of 1-megaton TNT equivalent. For underwater bursts, the information is based on the detonations of a few weapons with roughly 20 to 30 kilotons of TNT energy in shallow and moderately deep, and deep water. Indications will be given of the results to be expected for explosions of other yields. As a general rule, however, the basic phenomena for a burst in a particular environment are not greatly dependent upon the energy of the explosion. In the following discussion it will be supposed, first, that a typical air burst takes place at such a height that the fireball, even at its maximum, is well above the surface of the earth. The modifications, as well as the special effects, resulting from a surface burst and for one at very high altitude will be included. In addition, some of the characteristic phenomena associated with underwater and underground nuclear explosions will be described.

DESCRIPTION OF AIR AND SURFACE BURSTS

THE FIREBALL

2.03 As already seen, the fission of uranium (or plutonium) or the fusion of the isotopes of hydrogen in a nuclear weapon leads to the liberation of a large amount of energy in a very small period of time within a limited quantity of matter. As a result, the fission products, bomb casing, and other weapon parts are raised to extremely high temperatures, similar to those in the center of the sun. The maximum temperature attained by the fission weapon residues is several tens of million degrees, which may be compared with a maximum of 5,000°C (or 9,000°F) in a conventional high-explosive weapon. Because of the great heat produced by the nuclear explosion, all the materials are converted into the gaseous form. Since the gases, at the instant of explosion, are restricted to the region occupied by the original constituents in the weapon, tremendous pressures will be produced. These pressures are probably over a million times the atmospheric pressure, i.e., of the order of many millions of pounds per square inch.

2.04 Within less than a millionth of a second of the detonation of the weapon, the extremely hot weapon residues radiate large amounts of energy, mainly as invisible X rays, which are absorbed within a few feet in the surrounding (sea-level) atmosphere (§ 1.78). This leads to the formation of an extremely hot and highly luminous (incandescent) spherical mass of air and gaseous weapon residues which is the

fireball referred to in § 1.32; a typical fireball accompanying an air burst is shown in Fig. 2.04. The surface brightness decreases with time, but after about a millisecond,¹ the fireball from a 1-megaton nuclear weapon would appear to an observer 50 miles away to be many times more brilliant than the sun at noon. In several of the nuclear tests made in the atmosphere at low altitudes at the Nevada Test Site, in all of which the energy yields were less than 100 kilotons, the glare in the sky, in the early hours of the dawn, was visible 400 (or more) miles away. This was not the result of direct (line-of-sight) transmission, but rather of scattering and diffraction, i.e., bending, of the light rays by particles of dust and possibly by moisture in the atmosphere. However, high-altitude bursts in the megaton range have been seen directly as far as 700 miles away.

2.05 The surface temperatures of the fireball, upon which the brightness (or luminance) depends, do not vary greatly with the total energy yield of the weapon. Consequently, the observed brightness of the fireball in an air burst is roughly the same, regardless of the amount of energy released in the explosion. Immediately after its formation, the fireball begins to grow in size, engulfing the surrounding air. This growth is accompanied by a decrease in temperature because of the accompanying increase in mass. At the same time, the fireball rises, like a hot-air balloon. Within seven-tenths of a millisecond

¹A millisecond is a one-thousandth part of a second.

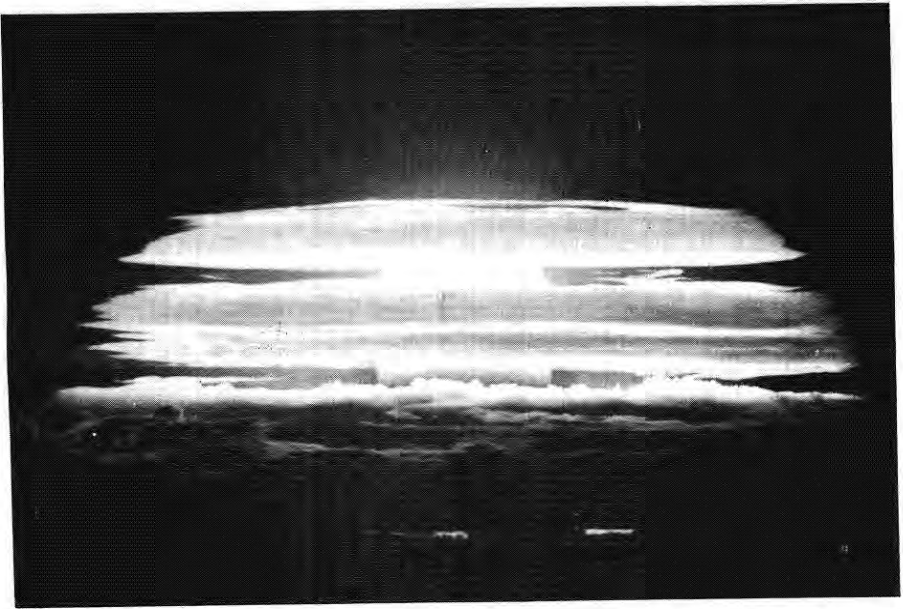

Figure 2.04. Fireball from an air burst in the megaton energy range, photographed from an altitude of 12,000 feet at a distance of about 50 miles. The fireball is partially surrounded by the condensation cloud (see § 2.48).

from the detonation, the fireball from a 1-megaton weapon is about 440 feet across, and this increases to a maximum value of about 5,700 feet in 10 seconds. It is then rising at a rate of 250 to 350 feet per second. After a minute, the fireball has cooled to such an extent that it no longer emits visible radiation. It has then risen roughly 4.5 miles from the point of burst.

THE RADIOACTIVE CLOUD

2.06 While the fireball is still luminous, the temperature, in the interior at least, is so high that all the weapon materials are in the form of vapor. This includes the radioactive fission products, uranium (or plutonium) that has escaped fission, and the weapon casing (and other) materials. As the fireball

increases in size and cools, the vapors condense to form a cloud containing solid particles of the weapon debris, as well as many small drops of water derived from the air sucked into the rising fireball.

2.07. Quite early in the ascent of the fireball, cooling of the outside by radiation and the drag of the air through which it rises frequently bring about a change in shape. The roughly spherical form becomes a toroid (or doughnut), although this shape and its associated motion are often soon hidden by the radioactive cloud and debris. As it ascends, the toroid undergoes a violent, internal circulatory motion as shown in Fig. 2.07a. The formation of the toroid is usually observed in the lower part of the visible cloud, as may be seen in the lighter, i.e., more luminous, portion of

Fig. 2.07b. The circulation entrains more air through the bottom of the toroid, thereby cooling the cloud and dissipating the energy contained in the fireball. As a result, the toroidal motion slows and may stop completely as the cloud rises toward its maximum height.

2.08 The color of the radioactive cloud is initially red or reddish brown, due to the presence of various colored compounds (nitrous acid and oxides of nitrogen) at the surface of the fireball. These result from chemical interaction of nitrogen, oxygen, and water vapor in the air at the existing high temperatures and under the influence of the nuclear

radiations. As the fireball cools and condensation occurs, the color of the cloud changes to white, mainly due to the water droplets as in an ordinary cloud.

2.09 Depending on the height of burst of the nuclear weapon and the nature of the terrain below, a strong updraft with inflowing winds, called "afterwinds," is produced in the immediate vicinity. These afterwinds can cause varying amounts of dirt and debris to be sucked up from the earth's surface into the radioactive cloud (Fig. 2.07b).

2.10 In an air burst with a moderate (or small) amount of dirt and debris

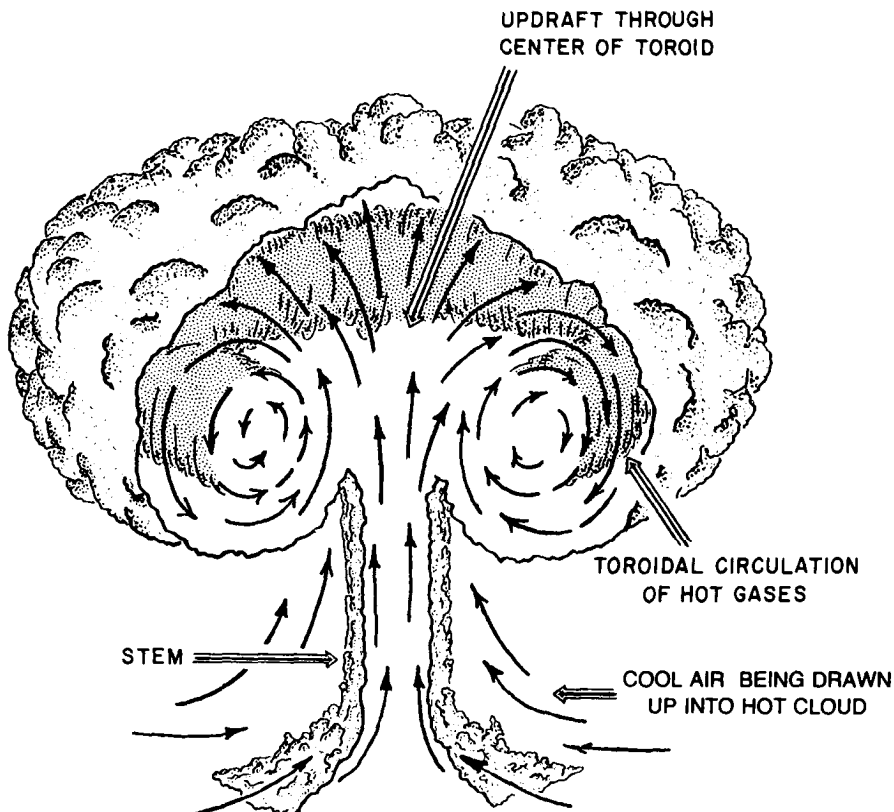

Figure 2.07a. Cutaway showing artist's conception of toroidal circulation within the radioactive cloud from a nuclear explosion.

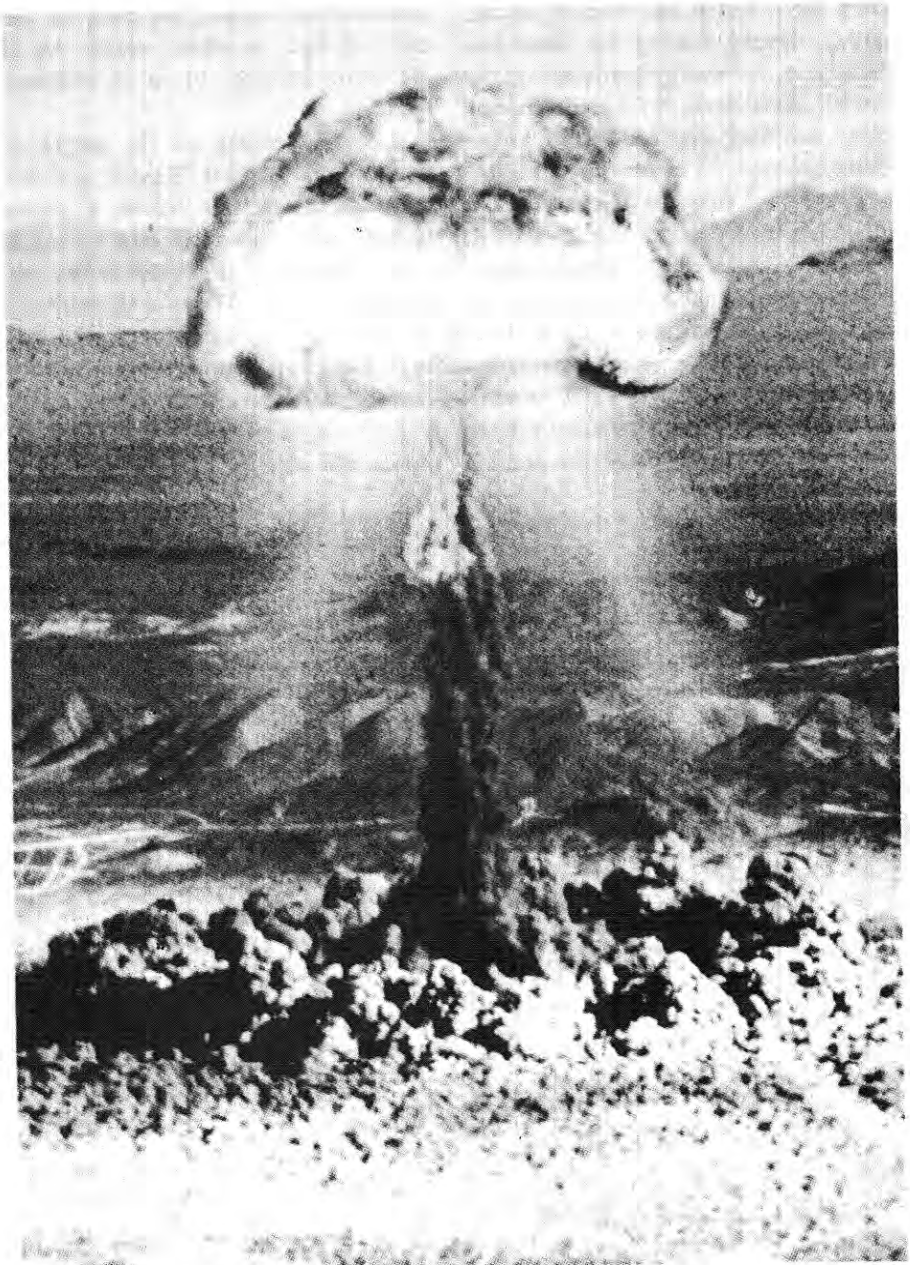

Figure 2.07b. Low air burst showing toroidal fireball and dirt cloud.

drawn up into the cloud, only a relatively small proportion of the dirt particles become contaminated with radioactivity. This is because the particles do not mix intimately with the weapon residues in the cloud at the time when the fission products are still vaporized and about to condense. For a burst near the land surface, however, large quantities of dirt and other debris are drawn into the cloud at early times. Good mixing then occurs during the initial phases of cloud formation and growth. Consequently, when the vaporized fission products condense they do so on the foreign matter, thus forming highly radioactive particles (§ 2.23).

2.11 At first the rising mass of weapon residues carries the particles upward, but after a time they begin to fall slowly under the influence of gravity, at rates dependent upon their size. Consequently, a lengthening (and widening) column of cloud (or smoke) is produced. This cloud consists chiefly of very small particles of radioactive fission products and weapon residues, water droplets, and larger particles of dirt and debris carried up by the afterwinds.

2.12 The speed with which the top of the radioactive cloud continues to ascend depends on the meteorological conditions as well as on the energy yield of the weapon. An approximate indication of the rate of rise of the cloud from a 1-megaton explosion is given by the results in Table 2.12 and the curve in Fig. 2.12. Thus, in general, the cloud will have attained a height of 3 miles in 30 seconds and 5 miles in about a min-

Table 2.12
RATE OF RISE OF RADIOACTIVE CLOUD
FROM A 1-MEGATON AIR BURST

Height (miles)	Time (minutes)	Rate of Rise (miles per hour)
2	0.3	330
4	0.7	270
6	1.1	220
10	2.5	140
12	3.8	27

ute. The average rate of rise during the first minute or so is nearly 300 miles per hour (440 feet per second). These values should be regarded as rough averages only, and large deviations may be expected in different circumstances (see also Figs. 10.158a, b, c).

2.13 The eventual height reached by the radioactive cloud depends upon the heat energy of the weapon, and upon the atmospheric conditions, e.g., moisture content and stability. The greater the amount of heat generated the greater will be the upward thrust due to buoyancy and so the greater will be the distance the cloud ascends. The maximum height attained by the radioactive cloud is strongly influenced by the tropopause, i.e., the boundary between the troposphere below and the stratosphere above, assuming that the cloud attains the height of the troposphere.²

2.14 When the cloud reaches the tropopause, there is a tendency for it to spread out laterally, i.e., sideways. But if sufficient energy remains in the radioactive cloud at this height, a portion of it will penetrate the tropopause and ascend into the more stable air of the stratosphere.

²The tropopause is the boundary between the troposphere and the relatively stable air of the stratosphere. It varies with season and latitude, ranging from 25,000 feet near the poles to about 55,000 feet in equatorial regions (§ 9.128).

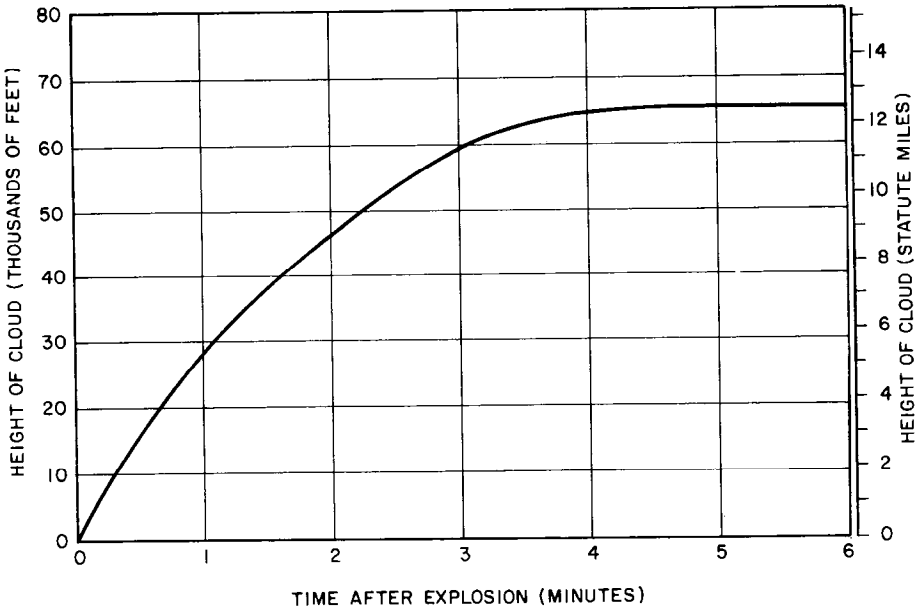

Figure 2.12. Height of cloud top above burst height at various times after a 1-megaton explosion for a moderately low air burst.

2.15 The cloud attains its maximum height after about 10 minutes and is then said to be "stabilized." It continues to grow laterally, however, to produce the characteristic mushroom shape (Fig. 2.15). The cloud may continue to be visible for about an hour or more before being dispersed by the winds into the surrounding atmosphere where it merges with natural clouds in the sky.

2.16 The dimensions of the stabilized cloud formed in a nuclear explosion depend on the meteorological conditions, which vary with time and place. Approximate average values of cloud height and radius (at about 10 minutes after the explosion), attained in land surface or low air bursts, for conditions most likely to be encountered in the continental United States, are given in Fig. 2.16 as a function of the energy yield of the explosion. The flattening of

the height curve in the range of about 20- to 100-kilotons TNT equivalent is due to the effect of the tropopause in slowing down the cloud rise. For yields below about 15 kilotons the heights indicated are distances above the burst point but for higher yields the values are above sea level. For land surface bursts, the maximum cloud height is somewhat less than given by Fig. 2.16 because of the mass of dirt and debris carried aloft by the explosion.

2.17 For yields below about 20 kilotons, the radius of the stem of the mushroom cloud is about half the cloud radius. With increasing yield, however, the ratio of these dimensions decreases, and for yields in the megaton range the stem may be only one-fifth to one-tenth as wide as the cloud. For clouds which do not penetrate the tropopause the base of the mushroom head is, very roughly,

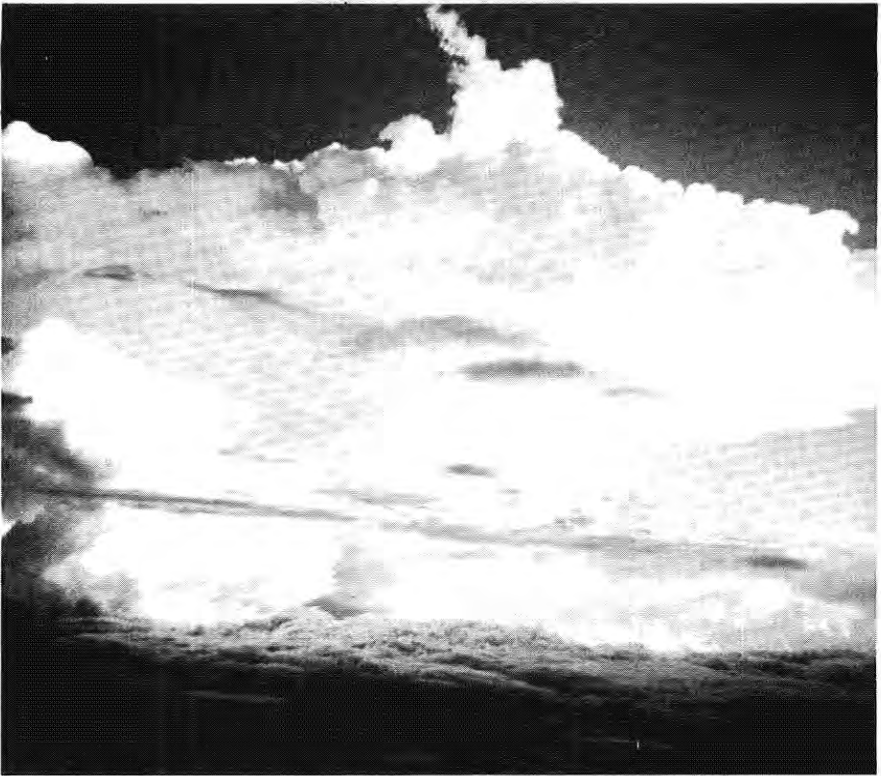

Figure 2.15. The mushroom cloud formed in a nuclear explosion in the megaton energy range, photographed from an altitude of 12,000 feet at a distance of about 50 miles.

at about one-half the altitude of the top. For higher yields, the broad base will probably be in the vicinity of the tropopause. There is a change in cloud shape in going from the kiloton to the megaton range. A typical cloud from a 10-kiloton air burst would reach a height of 19,000 feet with the base at about 10,000 feet; the horizontal extent would also be roughly 10,000 feet. For an explosion in the megaton range, however, the horizontal dimensions are greater than the total height (cf. Fig. 2.16).

CHARACTERISTICS OF A SURFACE BURST

2.18 Since many of the phenomena and effects of a nuclear explosion occurring on or near the earth's surface are similar to those associated with an air burst, it is convenient before proceeding further to refer to some of the special characteristics of a surface burst. In such a burst, the fireball in its rapid initial growth, abuts (or touches) the surface of the earth (Fig. 2.18a). Be-

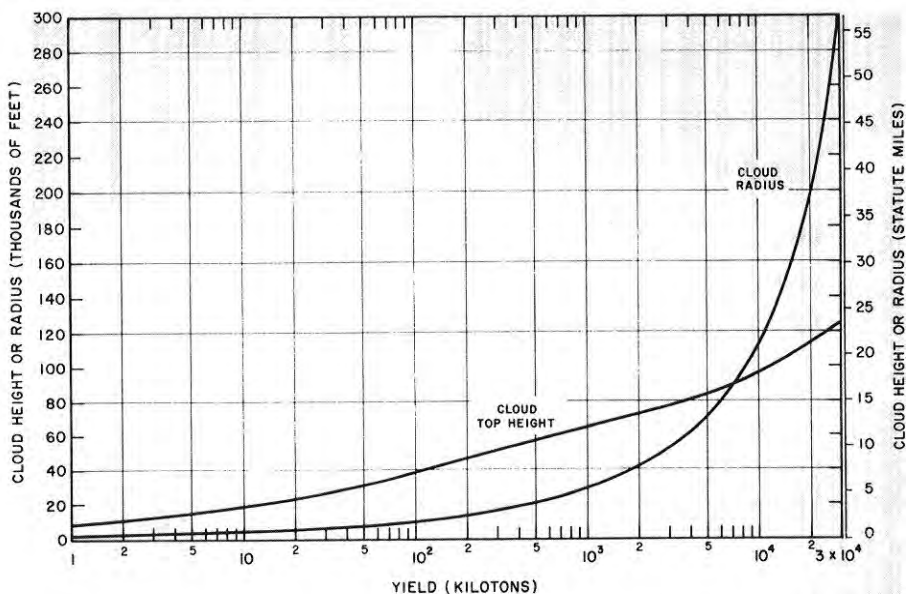

Figure 2.16. Approximate values of stabilized cloud height and radius as a function of explosion yield for land surface or low air bursts.



Figure 2.18a. Fireball formed by a nuclear explosion in the megaton energy range near the earth's surface. The maximum diameter of the fireball was $3\frac{1}{4}$ miles.



Figure 2.18b. Formation of dirt cloud in surface burst.

cause of the intense heat, some of the rock, soil, and other material in the area is vaporized and taken into the fireball. Additional material is melted, either completely or on its surface, and the strong afterwinds cause large amounts of dirt, dust, and other particles to be sucked up as the fireball rises (Fig. 2.18b).

2.19 An important difference between a surface burst and an air burst is, consequently, that in the surface burst the radioactive cloud is much more heavily loaded with debris. This con-

sists of particles ranging in size from the very small ones produced by condensation as the fireball cools to the much larger debris particles which have been raised by the afterwinds. The exact composition of the cloud will, of course, depend on the nature of the surface materials and the extent of their contact with the fireball.

2.20 For a surface burst associated with a moderate amount of debris, such as has been the case in several test explosions in which the weapons were detonated near the ground, the rate of

rise of the cloud is much the same as given earlier for an air burst (Table 2.12). The radioactive cloud reaches a height of several miles before spreading out abruptly into a mushroom shape.

2.21 When the fireball touches the earth's surface, a crater is formed as a result of the vaporization of dirt and other material and the removal of soil, etc., by the blast wave and winds accompanying the explosion. The size of the crater will vary with the height above the surface at which the weapon is exploded and with the character of the soil, as well as with the energy of the explosion. It is believed that for a 1-megaton weapon there would be no appreciable crater formation unless detonation occurs at an altitude of 450 feet or less.

2.22 If a nuclear weapon is exploded near a water surface, large amounts of water are vaporized and carried up into the radioactive cloud. When the cloud reaches high altitudes the vapor condenses to form water droplets, similar to those in an ordinary atmospheric cloud.

THE FALLOUT

2.23 In a surface burst, large quantities of earth or water enter the fireball at an early stage and are fused or vaporized. When sufficient cooling has occurred, the fission products and other radioactive residues become incorporated with the earth particles as a result of the condensation of vaporized fission products into fused particles of earth, etc. A small proportion of the

solid particles formed upon further cooling are contaminated fairly uniformly throughout with the radioactive fission products and other weapon residues,³ but as a general rule the contamination is found mainly in a thin shell near the surface of the particles (§ 9.50). In water droplets, the small fission product particles occur at discrete points within the drops. As the violent disturbance due to the explosion subsides, the contaminated particles and droplets gradually descend to earth. This phenomenon is referred to as "fallout," and the same name is applied to the particles themselves when they reach the ground. It is the fallout, with its associated radioactivity which decays over a long period of time, that is the main source of the residual nuclear radiation referred to in the preceding chapter.

2.24 The extent and nature of the fallout can range between wide extremes. The actual situation is determined by a combination of circumstances associated with the energy yield and design of the weapon, the height of the explosion, the nature of the surface beneath the point of burst, and the meteorological conditions. In an air burst, for example, occurring at an appreciable distance above the earth's surface, so that no large amounts of surface materials are sucked into the cloud, the contaminated particles become widely dispersed. The magnitude of the hazard from fallout will then be far less than if the explosion were a surface burst. Thus at Hiroshima (height of burst 1670 feet, yield about 12.5 kilotons) and Nagasaki

³These residues include radioactive species formed at the time of the explosion by neutron capture in various materials (§ 9.31).

(height of burst 1640 feet, yield about 22 kilotons) injuries due to fallout were completely absent.

2.25 On the other hand, a nuclear explosion occurring at or near the earth's surface can result in severe contamination by the radioactive fallout. From the 15-megaton thermonuclear device tested at Bikini Atoll on March 1, 1954—the BRAVO shot of Operation CASTLE—the fallout caused substantial contamination over an area of more than 7,000 square miles. The contaminated region was roughly cigar-shaped and extended more than 20 statute miles upwind and over 350 miles downwind. The width in the crosswind direction was variable, the maximum being over 60 miles (§ 9.104).

2.26 The meteorological conditions which determine the shape, extent, and location of the fallout pattern from a nuclear explosion are the height of the tropopause, atmospheric winds, and the occurrence of precipitation. For a given explosion energy yield, type of burst, and tropopause height, the fallout pattern is affected mainly by the directions and speeds of the winds over the fallout area, from the earth's surface to the top of the stabilized cloud, which may be as high as 100,000 feet. Furthermore, variations in the winds, from the time of burst until the particles reach the ground, perhaps several hours later, affect the fallout pattern following a nuclear explosion (see Chapter IX).

2.27 It should be understood that fallout is a gradual phenomenon extending over a period of time. In the BRAVO explosion, for example, about

10 hours elapsed before the contaminated particles began to fall at the extremities of the 7,000 square mile area. By that time, the radioactive cloud had thinned out to such an extent that it was no longer visible. This brings up the important fact that fallout can occur even when the cloud cannot be seen. Nevertheless, the area of contamination which presents the most serious hazard generally results from the fallout of visible particles. The sizes of these particles range from that of fine sand, i.e., approximately 100 micrometers⁴ in diameter, or smaller, in the more distant portions of the fallout area, to pieces about the size of a marble, i.e., roughly 1 cm (0.4 inch) in diameter, and even larger close to the burst point.

2.28 Particles in this size range arrive on the ground within one day after the explosion, and will not have traveled too far, e.g., up to a few hundred miles, from the region of the shot, depending on the wind. Thus, the fallout pattern from particles of visible size is established within about 24 hours after the burst. This is referred to as "early" fallout, also sometimes called "local" or "close-in" fallout. In addition, there is the deposition of very small particles which descend very slowly over large areas of the earth's surface. This is the "delayed" (or "worldwide") fallout, to which residues from nuclear explosions of various types—air, high-altitude, surface, and shallow subsurface—may contribute (see Chapter IX).

2.29 Although the test of March 1, 1954 produced the most extensive early fallout yet recorded, it should be pointed

⁴A micrometer (also called a micron) is a one-millionth part of a meter, i.e., 10^{-6} meter, or about 0.00004 (or 4×10^{-5}) inch.

out that the phenomenon was not necessarily characteristic of (nor restricted to) thermonuclear explosions. It is very probable that if the same device had been detonated at an appreciable distance above the coral island, so that the large fireball did not touch the surface of the ground, the early fallout would have been of insignificant proportions.

2.30 The general term "scavenging" is used to describe various processes resulting in the removal of radioactivity from the cloud and its deposition on the earth. One of these processes arises from the entrainment in the cloud of quantities of dirt and debris sucked up in a surface (or near-surface) nuclear burst. The condensation of the fission-product and other radioactive vapors on the particles and their subsequent relatively rapid fall to earth leads to a certain degree of scavenging.

2.31 Another scavenging process, which can occur at any time in the history of the radioactive cloud, is that due to rain falling through the weapon debris and carrying contaminated particles down with it. This is one mechanism for the production of "hot spots," i.e., areas on the ground of much higher activity than the surroundings, in both early and delayed fallout patterns. Since rains (other than thundershowers) generally originate from atmospheric clouds whose tops are between about 10,000 and 30,000 feet altitude, it is only below this region that scavenging by rain is likely to take place. Another effect that rain may have if it occurs either during or after the deposition of the fallout is to wash radioactive debris over the surface of the ground. This may result in cleansing some areas and reducing their activity while causing hot spots in other (lower) areas.

THE BLAST WAVE

2.32 At a fraction of a second after a nuclear explosion, a high-pressure wave develops and moves outward from the fireball (Fig. 2.32). This is the shock wave or blast wave, mentioned in § 1.01 and to be considered subsequently in more detail, which is the cause of much destruction accompanying an air burst. The front of the blast wave, i.e., the shock front, travels rapidly away from the fireball, behaving like a moving wall of highly compressed air. After the lapse of 10 seconds, when the fireball of a 1-megaton nuclear weapon has attained its maximum size (5,700 feet across), the shock front is some 3 miles farther ahead. At 50 seconds after the explosion, when the fireball is no longer visible, the blast wave has traveled about 12 miles. It is then moving at about 1,150 feet per second, which is slightly faster than the speed of sound at sea level.

2.33 When the blast wave strikes the surface of the earth, it is reflected back, similar to a sound wave producing an echo. This reflected blast wave, like the original (or direct) wave, is also capable of causing material damage. At a certain region on the surface, the position of which depends chiefly on the height of the burst and the energy of the explosion, the direct and reflected wave fronts merge. This merging phenomenon is called the "Mach effect." The "overpressure," i.e., the pressure in excess of the normal atmospheric value, at the front of the Mach wave is generally about twice as great as that at the direct blast wave front.

2.34 For an air burst of a 1-megaton nuclear weapon at an altitude of 6,500 feet, the Mach effect will begin approx-

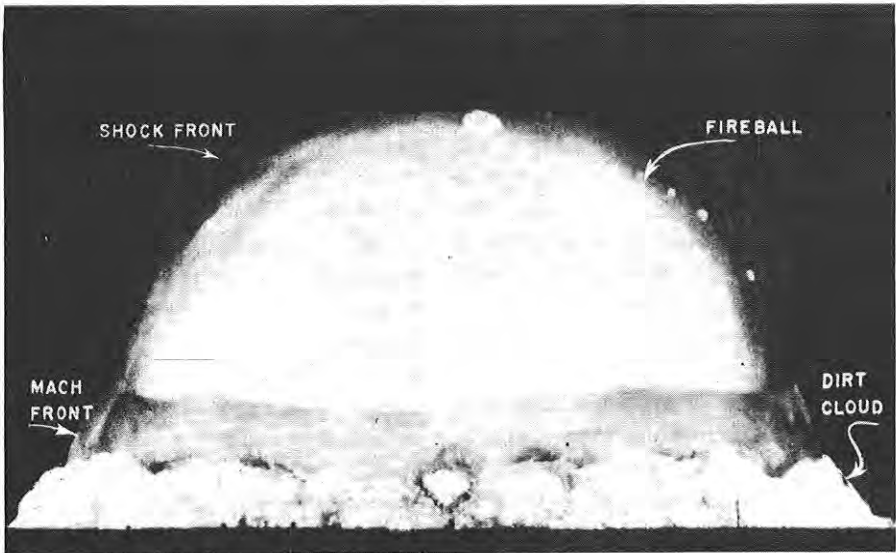

Figure 2.32. The faintly luminous shock front seen just ahead of the fireball soon after breakaway (see § 2.120).

imately 4.5 seconds after the explosion, in a rough circle at a radius of 1.3 miles from ground zero.⁵ The overpressure on the ground at the blast wave front at this time is about 20 pounds per square inch, so that the total air pressure is more than double the normal atmospheric pressure.⁶

2.35 At first the height of the Mach front is small, but as the blast wave front continues to move outward, the height increases steadily. At the same time, however, the overpressure, like that in the original (or direct) wave, decreases correspondingly because of the continuous loss of energy and the ever-increasing area of the advancing front. After the lapse of about 40 seconds, when the Mach front from a 1-megaton nuclear

weapon is 10 miles from ground zero, the overpressure will have decreased to roughly 1 pound per square inch.

2.36 The distance from ground zero at which the Mach effect commences varies with the height of burst. Thus, as seen in Fig. 2.32, in the low-altitude (100 feet) detonation at the TRINITY (Alamogordo) test, the Mach front was apparent when the direct shock front had advanced a short distance from the fireball. At the other extreme, in a very high air burst there might be no detectable Mach effect. (The TRINITY test, conducted on July 16, 1945 near Alamogordo, New Mexico, was the first test of a nuclear (implosion) weapon; the yield was estimated to be about 19 kilotons.)

⁵The term "ground zero" refers to the point on the earth's surface immediately below (or above) the point of detonation. For a burst over (or under) water, the corresponding point is generally called "surface zero." The term "surface zero" or "surface ground zero" is also commonly used for ground surface and underground explosions. In some publications, ground (or surface) zero is called the "hypocenter" of the explosion.

⁶The normal atmospheric pressure at sea level is 14.7 pounds per square inch.

2.37 Strong transient winds are associated with the passage of the shock (and Mach) front. These blast winds (§ 3.07) are very much stronger than the ground wind (or afterwind) due to the updraft caused by the rising fireball (§ 2.09) which occurs at a later time. The blast winds may have peak velocities of several hundred miles an hour fairly near to ground zero; even at more than 6 miles from the explosion of a 1-megaton nuclear weapon, the peak velocity will be greater than 70 miles per hour. It is evident that such strong winds can contribute greatly to the blast damage resulting from the explosion of a nuclear weapon.

THERMAL RADIATION FROM AN AIR BURST

2.38 Immediately after the explosion, the weapon residues emit the primary thermal radiation (§ 1.77). Because of the very high temperature, much of this is in the form of X rays which are absorbed within a layer of a few feet of air; the energy is then re-emitted from the fireball as (secondary) thermal radiation of longer wavelength, consisting of ultraviolet, visible, and infrared rays. Because of certain phenomena occurring in the fireball (see § 2.106 *et seq.*), the surface temperature undergoes a curious change. The temperature of the interior falls steadily, but the apparent surface temperature of the fireball decreases more rapidly for a small fraction of a second. Then, the apparent surface temperature increases again for a somewhat longer time, after which it falls continuously (see Fig. 2.123). In other words, there are effectively two surface-temperature pulses;

the first is of very short duration, whereas the second lasts for a much longer time. The behavior is quite general for air (and surface) bursts, although the duration times of the pulses increase with the energy yield of the explosion.

2.39 Corresponding to the two surface-temperature pulses, there are two pulses of emission of thermal radiation from the fireball (Fig. 2.39). In the first pulse, which lasts about a tenth of a second for a 1-megaton explosion, the surface temperatures are mostly very high. As a result, much of the radiation emitted by the fireball during this pulse is in the ultraviolet region. Although ultraviolet radiation can cause skin burns, in most circumstances following an ordinary air burst the first pulse of thermal radiation is not a significant hazard in this respect, for several reasons. In the first place, only about 1 percent of the thermal radiation appears in the initial pulse because of its short duration. Second, the ultraviolet rays are readily attenuated by the intervening air, so that the dose delivered at a distance from the explosion may be comparatively small. Furthermore, it appears that the ultraviolet radiation from the first pulse could cause significant effects on the human skin only within ranges at which other thermal radiation effects are much more serious. It should be mentioned, however, that although the first radiation pulse may be disregarded as a source of skin burns, it is capable of producing permanent or temporary effects on the eyes, especially of individuals who happen to be looking in the direction of the explosion.

2.40 In contrast to the first pulse, the second radiation pulse may last for

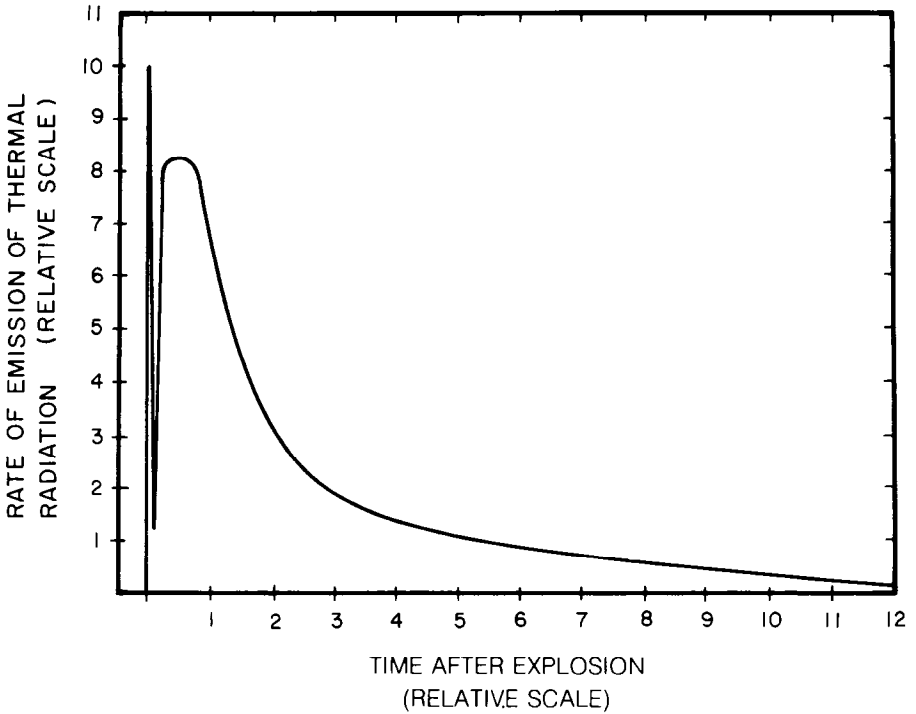

Figure 2.39. Emission of thermal radiation in two pulses in an air burst.

several seconds, e.g., about 10 seconds for a 1-megaton explosion; it carries about 99 percent of the total thermal radiation energy. Since the temperatures are lower than in the first pulse, most of the rays reaching the earth consist of visible and infrared (invisible) light. It is this radiation which is the main cause of skin burns of various degrees suffered by exposed individuals up to 12 miles or more, and of eye effects at even greater distances, from the explosion of a 1-megaton weapon. For weapons of higher energy, the effective damage range is greater, as will be explained in Chapter VII. The radiation from the second pulse can also cause fires to start under suitable conditions.

INITIAL NUCLEAR RADIATION FROM AN AIR BURST

2.41 As stated in Chapter I, the explosion of a nuclear weapon is associated with the emission of various nuclear radiations, consisting of neutrons, gamma rays, and alpha and beta particles. Essentially all the neutrons and part of the gamma rays are emitted in the actual fission process. These are referred to as the "prompt nuclear radiations" because they are produced simultaneously with the nuclear explosion. Some of the neutrons liberated in fission are immediately captured and others undergo "scattering collisions" with various nuclei present in the

weapon. These processes are frequently accompanied by the instantaneous emission of gamma rays. In addition, many of the escaping neutrons undergo similar interactions with atomic nuclei of the air, thus forming an extended source of gamma rays around the burst point. The remainder of the gamma rays and the beta particles are liberated over a period of time as the fission products undergo radioactive decay. The alpha particles are expelled, in an analogous manner, as a result of the decay of the uranium (or plutonium) which has escaped fission in the weapon.

2.42 The initial nuclear radiation is generally defined as that emitted from both the fireball and the radioactive cloud within the first minute after the explosion. It includes neutrons and gamma rays given off almost instantaneously, as well as the gamma rays emitted by the fission products and other radioactive species in the rising cloud. It should be noted that the alpha and beta particles present in the initial radiation have not been considered. This is because they are so easily absorbed that they will not reach more than a few yards, at most, from the radioactive cloud.

2.43 The somewhat arbitrary time period of 1 minute for the duration of the initial nuclear radiations was originally based upon the following considerations. As a consequence of attenuation by the air, the effective range of the fission gamma rays and of those from the fission products from a 20-kiloton explosion is very roughly 2 miles. In other words, gamma rays originating from such a source at an altitude of over 2 miles can be ignored, as far as their effect at the earth's surface is con-

cerned. Thus, when the radioactive cloud has reached a height of 2 miles, the effects of the initial nuclear radiations are no longer significant. Since it takes roughly a minute for the cloud to rise this distance, the initial nuclear radiation was defined as that emitted in the first minute after the explosion.

2.44 The foregoing arguments are based on the characteristics of a 20-kiloton nuclear weapon. For a detonation of higher energy, the maximum distance over which the gamma rays are effective will be larger than given above. However, at the same time, there is an increase in the rate at which the cloud rises. Similarly for a weapon of lower energy, the effective distance is less, but so also is the rate of ascent of the cloud. The period over which the initial nuclear radiation extends may consequently be taken to be approximately the same, namely, 1 minute, irrespective of the energy release of the explosion.

2.45 Neutrons are the only significant nuclear radiations produced directly in the thermonuclear reactions mentioned in § 1.69. Alpha particles (helium nuclei) are also formed, but they do not travel very far from the explosion. Some of the neutrons will escape but others will be captured by the various nuclei present in the exploding weapon. Those neutrons absorbed by fissionable species may lead to the liberation of more neutrons as well as to the emission of gamma rays. In addition, the capture of neutrons in nonfission reactions is usually accompanied by gamma rays. It is seen, therefore, that the initial radiations from an explosion in which both fission and fusion (thermonuclear) processes occur consist

essentially of neutrons and gamma rays. The relative proportions of these two radiations may be somewhat different than for a weapon in which all the energy release is due to fission, but for present purposes the difference may be disregarded.

THE ELECTROMAGNETIC PULSE

2.46 If a detonation occurs at or near the earth's surface, the EMP phenomenon referred to in § 1.38 produces intense electric and magnetic fields which may extend to distances up to several miles, depending on the weapon yield. The close-in region near the burst point is highly ionized and large electric currents flow in the air and the ground, producing a pulse of electromagnetic radiation. Beyond this close-in region the electromagnetic field strength, as measured on (or near) the ground, drops sharply and then more slowly with increasing distance from the explosion. The intense fields may damage unprotected electrical and electronic equipment at distances exceeding those at which significant air blast damage may occur, especially for weapons of low yield (see Chapter XI).

OTHER NUCLEAR EXPLOSION PHENOMENA

2.47 There are a number of interesting phenomena associated with a nuclear air burst that are worth mentioning although they have no connection with the destructive or other harmful effects of the explosion. Soon after the detonation, a violet-colored glow may be observed, particularly at night or in dim daylight, at some distance from the

fireball. This glow may persist for an appreciable length of time, being distinctly visible near the head of the radioactive cloud. It is believed to be the ultimate result of a complex series of processes initiated by the action of the various radiations on the nitrogen and oxygen of the air.

2.48 Another early phenomenon following a nuclear explosion in certain circumstances is the formation of a "condensation cloud." This is sometimes called the Wilson cloud (or cloud-chamber effect) because it is the result of conditions analogous to those utilized by scientists in the Wilson cloud chamber. It will be seen in Chapter III that the passage of a high-pressure shock front in air is followed by a rarefaction (or suction) wave. During the compression (or blast) phase, the temperature of the air rises and during the decompression (or suction) phase it falls. For moderately low blast pressures, the temperature can drop below its original, preshock value, so that if the air contains a fair amount of water vapor, condensation accompanied by cloud formation will occur.

2.49 The condensation cloud which was observed in the ABLE Test at Bikini in 1946 is shown in Fig. 2.49. Since the device was detonated just above the surface of the lagoon, the air was nearly saturated with water vapor and the conditions were suitable for the production of a Wilson cloud. It can be seen from the photograph that the cloud formed some way ahead of the fireball. The reason is that the shock front must travel a considerable distance before the blast pressure has fallen sufficiently for a low temperature to be attained in the subsequent decompression phase. At the

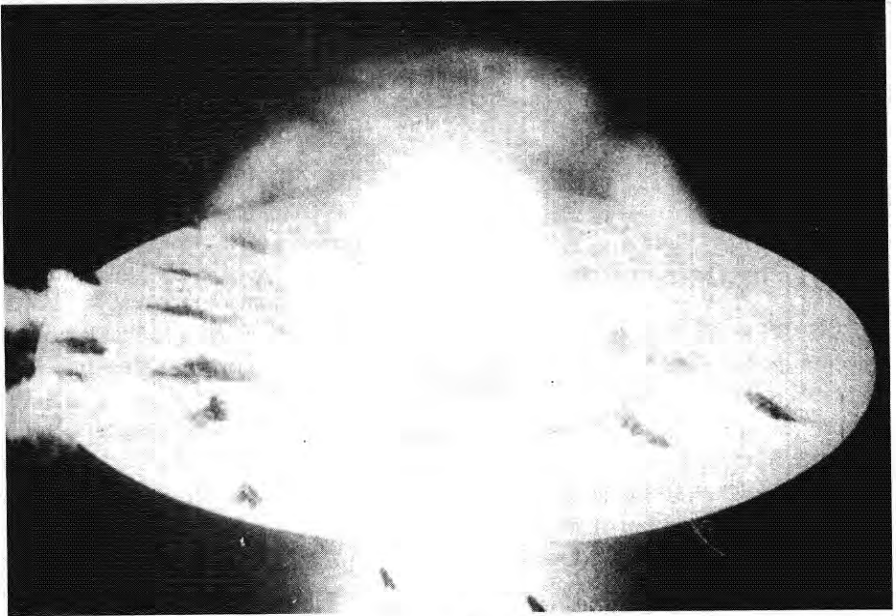

Figure 2.49. Condensation cloud formed in an air burst over water.



Figure 2.50. Late stage of the condensation cloud in an air burst over water.

time the temperature has dropped to that required for condensation to occur, the blast wave front has moved still farther away, as is apparent in Fig. 2.49, where the disk-like formation on the surface of the water indicates the passage of the shock wave.

2.50 The relatively high humidity of the air makes the conditions for the formation of the condensation cloud most favorable in nuclear explosions occurring over (or under) water, as in the Bikini tests in 1946. The cloud commenced to form 1 to 2 seconds after the detonation, and it had dispersed completely within another second or so,

as the air warmed up and the water droplets evaporated. The original dome-like cloud first changed to a ring shape, as seen in Fig. 2.50, and then disappeared.

2.51 Since the Wilson condensation cloud forms after the fireball has emitted most of its thermal radiation, it has little influence on this radiation. It is true that fairly thick clouds, especially smoke clouds, can attenuate the thermal radiation reaching the earth from the fireball. However, apart from being formed at too late a stage, the condensation cloud is too tenuous to have any appreciable effect in this connection.

DESCRIPTION OF HIGH-ALTITUDE BURSTS

INTRODUCTION

2.52 Nuclear devices were exploded at high altitudes during the summer of 1958 as part of the HARDTACK test series in the Pacific Ocean and the ARGUS operation in the South Atlantic Ocean. Additional high-altitude nuclear tests were conducted during the FISHBOWL test series in 1962. In the HARDTACK series, two high-altitude bursts, with energy yields in the megaton range, were set off in the vicinity of Johnston Island, 700 miles southwest of Hawaii. The first device, named TEAK, was detonated on August 1, 1958 (Greenwich Civil Time) at an altitude of 252,000 feet, i.e., nearly 48 miles. The second, called ORANGE, was exploded at an altitude of 141,000 feet, i.e., nearly 27 miles, on August 12, 1958 (GCT). During the FISHBOWL series, a megaton and three submegaton devices were detonated at high altitudes in

the vicinity of Johnston Island. The STARFISH PRIME device, with a yield of 1.4 megatons, was exploded at an altitude of about 248 miles on July 9, 1962 (GCT). The three submegaton devices, CHECKMATE, BLUEGILL TRIPLE PRIME, and KINGFISH, were detonated at altitudes of tens of miles on October 20, 1962, October 26, 1962, and November 1, 1962 (GCT), respectively.

2.53 The ARGUS operation was not intended as a test of nuclear weapons or their destructive effects. It was an experiment designed to provide information on the trapping of electrically charged particles in the earth's magnetic field (§ 2.145). The operation consisted of three high-altitude nuclear detonations, each having a yield from 1 to 2 kilotons TNT equivalent. The burst altitudes were from about 125 to 300 miles.

HIGH-ALTITUDE BURST PHENOMENA

2.54 If a burst occurs in the altitude regime of roughly 10 to 50 miles, the explosion energy radiated as X rays will be deposited in the burst region, although over a much larger volume of air than at lower altitudes. In this manner, the ORANGE shot created a large fireball almost spherical in shape. In general, the fireball behavior was in agreement with the expected interactions of the various radiations and kinetic energy of the expanding weapon debris with the ambient air (§ 2.130 *et seq.*).

2.55 The mechanism of fireball formation changes appreciably at still higher burst altitude, since the X rays are able to penetrate to greater distances in the low-density air. Starting at an explosion altitude of about 50 miles, the interaction of the weapon debris energy with the atmosphere becomes the dominant mechanism for producing a fireball. Because the debris is highly ionized (§ 1.38), the earth's magnetic field, i.e., the geomagnetic field, will influence the location and distribution of the late-time fireball from bursts above about 50 miles altitude.

2.56 The TEAK explosion was accompanied by a sharp and bright flash of light which was visible above the horizon from Hawaii, over 700 miles away. Because of the long range of the X rays in the low-density atmosphere in the immediate vicinity of the burst, the fireball grew very rapidly in size. In 0.3 second, its diameter was already 11 miles and it increased to 18 miles in 3.5 seconds. The fireball also ascended with great rapidity, the initial rate of rise being about a mile per second. Surrounding the fireball was a very large

red luminous spherical wave, arising apparently from electronically excited oxygen atoms produced by a shock wave passing through the low-density air (Fig. 2.56).

2.57 At about a minute or so after the detonation, the TEAK fireball had risen to a height of over 90 miles, and it was then directly (line-of-sight) visible from Hawaii. The rate of rise of the fireball was estimated to be some 3,300 feet per second and it was expanding horizontally at a rate of about 1,000 feet per second. The large red luminous sphere was observed for a few minutes; at roughly 6 minutes after the explosion it was nearly 600 miles in diameter.

2.58 The formation and growth of the fireball changes even more drastically as the explosion altitude increases above 65 miles. Because X rays can penetrate the low-density atmosphere to great distances before being absorbed, there is no local fireball. Below about 190 miles (depending on weapon yield), the energy initially appearing as the rapid outward motion of debris particles will still be deposited relatively locally, resulting in a highly heated and ionized region. The geomagnetic field plays an increasingly important role in controlling debris motion as the detonation altitude increases. Above about 200 miles, where the air density is very low, the geomagnetic field is the dominant factor in slowing the expansion of the ionized debris across the field lines. Upward and downward motion along the field lines, however, is not greatly affected (§ 10.64). When the debris is stopped by the atmosphere, at about 75 miles altitude, it may heat and ionize the air sufficiently to cause a visible region which will subsequently rise and ex-



Figure 2.56. Fireball and red luminous spherical wave formed after the TEAK high-altitude shot. (The photograph was taken from Hawaii, 780 miles from the explosion.)

pand. Such a phenomenon was observed following the STARFISH PRIME event.

2.59 A special feature of explosions at altitudes between about 20 and 50 miles is the extreme brightness of the fireball. It is visible at distances of several hundred miles and is capable of producing injury to the eyes over large areas (§ 12.79 *et seq.*).

2.60 Additional important effects that result from high-altitude bursts are the widespread ionization and other disturbances of the portion of the upper atmosphere known as the ionosphere. These disturbances affect the propagation of radio and radar waves, sometimes over extended areas (see Chapter X). Following the TEAK event, propagation of high-frequency (HF) radio communications (Table 10.91) was de-

graded over a region of several thousand miles in diameter for a period lasting from shortly after midnight until sunrise. Some very-high-frequency (VHF) communications circuits in the Pacific area were unable to function for about 30 seconds after the STARFISH PRIME event.

2.61 Detonations above about 19 miles can produce EMP effects (§ 2.46) on the ground over large areas, increasing with the yield of the explosion and the height of burst. For fairly large yields and burst heights, the EMP fields may be significant at nearly all points within the line of sight, i.e., to the horizon, from the burst point. Although these fields are weaker than those in the close-in region surrounding a surface burst, they are of sufficient magnitude to damage some unprotected electrical and

electronic equipment. The mechanism of formation and the effects of the EMP are treated in Chapter XI.

2.62 An interesting visible effect of high-altitude nuclear explosions is the creation of an "artificial aurora." Within a second or two after burst time of the TEAK shot a brilliant aurora appeared from the bottom of the fireball and purple streamers were seen to spread toward the north. Less than a second later, an aurora was observed at Apia, in the Samoan Islands, more than 2,000 miles from the point of burst, although at no time was the fireball in direct view. The formation of the aurora

is attributed to the motion along the lines of the earth's magnetic field of beta particles (electrons), emitted by the radioactive fission fragments. Because of the natural cloud cover over Johnston Island at the time of burst, direct observation of the ORANGE fireball was not possible from the ground. However, such observations were made from aircraft flying above the low clouds. The auroras were less marked than from the TEAK shot, but an aurora lasting 17 minutes was again seen from Apia. Similar auroral effects were observed after the other high-altitude explosions mentioned in § 2.52.

DESCRIPTION OF UNDERWATER BURSTS

SHALLOW UNDERWATER EXPLOSION PHENOMENA

2.63 Certain characteristic phenomena are associated with an underwater nuclear explosion, but the details vary with the energy yield of the weapon, the distance below the surface at which the detonation occurs, and the depth and area of the body of water. The description given here is based mainly on the observations made at the BAKER test at Bikini in July 1946. In this test, a nuclear weapon of approximately 20-kilotons yield was detonated well below the surface of the lagoon which was about 200 feet deep. These conditions may be regarded as corresponding to a shallow underwater explosion.

2.64 In an underwater nuclear detonation, a fireball is formed, but it is smaller than for an air burst. At the BAKER test the water in the vicinity of

the explosion was illuminated by the fireball. The distortion caused by the water waves on the surface of the lagoon prevented a clear view of the fireball, and the general effect was similar to that of light seen through a ground-glass screen. The luminosity persisted for a few thousandths of a second, but it disappeared as soon as the bubble of hot, high-pressure gases (or vapors) and steam constituting the fireball reached the water surface. At this time, the gases were expelled and cooled, so that the fireball was no longer visible.

2.65 In the course of its rapid expansion, the hot gas bubble, while still underwater, initiates a shock wave. Intersection of the shock wave with the surface produces an effect which, viewed from above, appears to be a rapidly expanding ring of darkened water. This is often called the "slick" because of its resemblance to an oil

slick. Following closely behind the dark region is a white circular patch called the "crack," probably caused by reflection of the water shock wave at the surface.

2.66 Immediately after the appearance of the crack, and prior to the formation of the Wilson cloud (§ 2.48), a mound or column of broken water and spray, called the "spray dome," is thrown up over the point of burst (Fig. 2.66). This dome is caused by the velocity imparted to the water near the surface by the reflection of the shock wave and to the subsequent breakup of the surface layer into drops of spray. The initial upward velocity of the water

is proportional to the pressure of the direct shock wave, and so it is greatest directly above the detonation point. Consequently, the water in the center rises more rapidly (and for a longer time) than water farther away. As a result, the sides of the spray dome become steeper as the water rises. The upward motion is terminated by the downward pull of gravity and the resistance of the air. The total time of rise and the maximum height depend upon the energy of the explosion, and upon its depth below the water surface. Additional slick, crack, and spray-dome phenomena may result if the shock wave reflected from the water bottom and compression waves produced by the gas

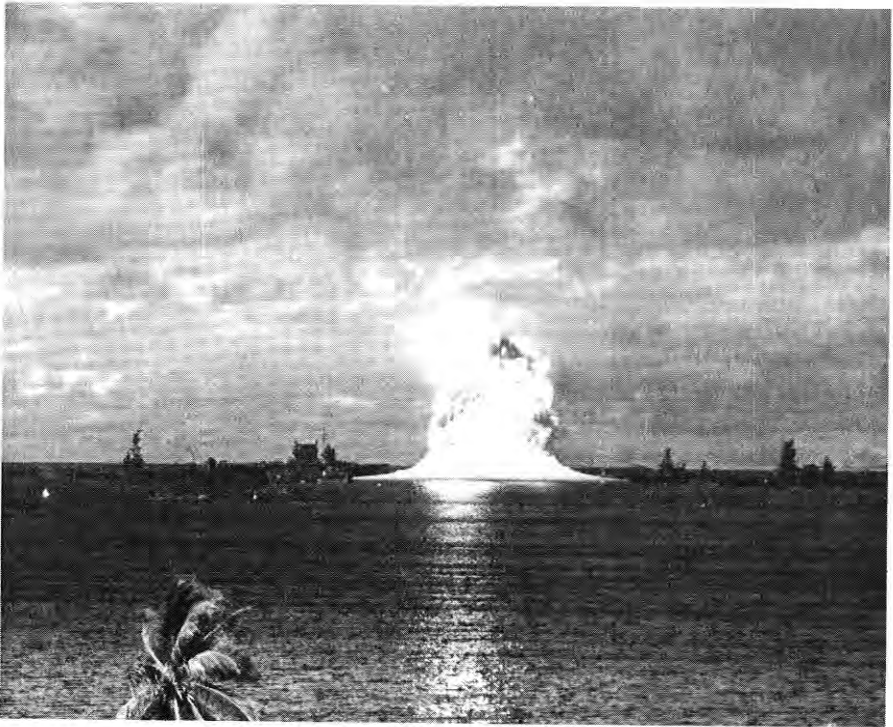

Figure 2.66. The "spray dome" formed over the point of burst in a shallow underwater explosion.

bubble (§ 2.86 *et seq.*) reach the surface with sufficient intensity.

2.67 If the depth of burst is not too great, the bubble remains essentially intact until it rises to the surface of the water. At this point the steam, fission gases, and debris are expelled into the atmosphere. Part of the shock wave passes through the surface into the air, and because of the high humidity the conditions are suitable for the formation of a condensation cloud (Fig. 2.67a). As the pressure of the bubble is released, water rushes into the cavity, and the resultant complex phenomena cause the water to be thrown up as a hollow cylinder or chimney of spray called the "column" or "plume." The radioac-

tive contents of the bubble are vented through this hollow column and may form a cauliflower-shaped cloud at the top (Fig. 2.67b.)

2.68 In the shallow underwater (BAKER) burst at Bikini, the spray dome began to form at about 4 milliseconds after the explosion. Its initial rate of rise was roughly 2,500 feet per second, but this was rapidly diminished by air resistance and gravity. A few milliseconds later, the hot gas bubble reached the surface of the lagoon and the column began to form, quickly overtaking the spray dome. The maximum height attained by the hollow column, through which the gases vented, could not be estimated exactly

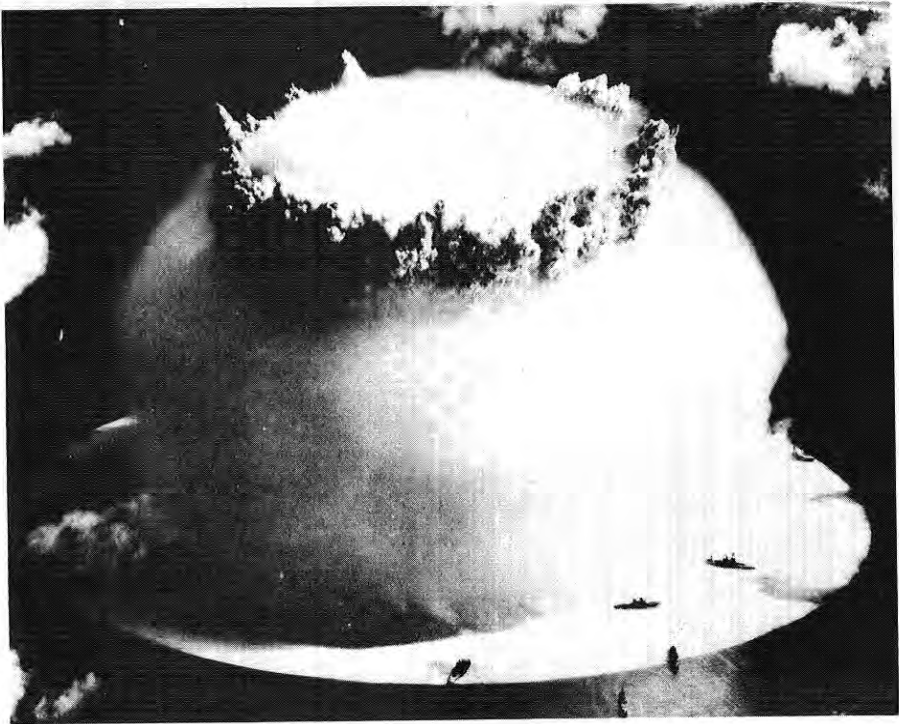

Figure 2.67a. The condensation cloud formed after a shallow underwater explosion. (The "crack" due to the shock wave can be seen on the water surface.)

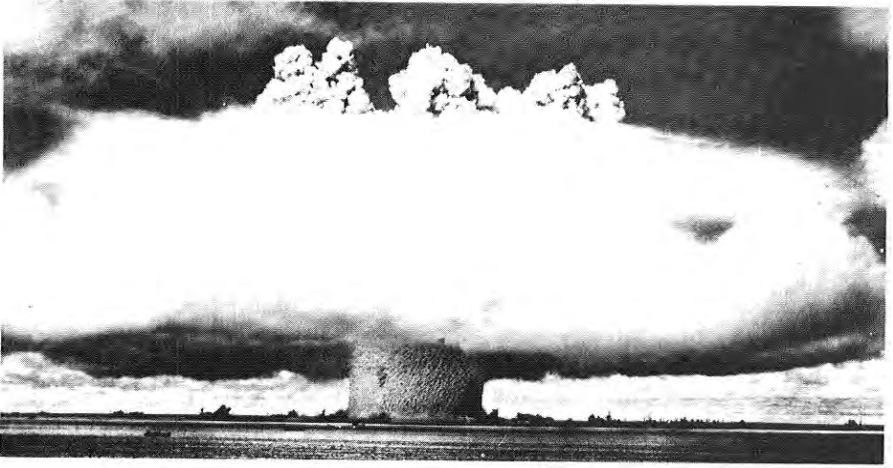

Figure 2.67b. Formation of the hollow column in a shallow underwater explosion; the top is surrounded by a late stage of the condensation cloud.

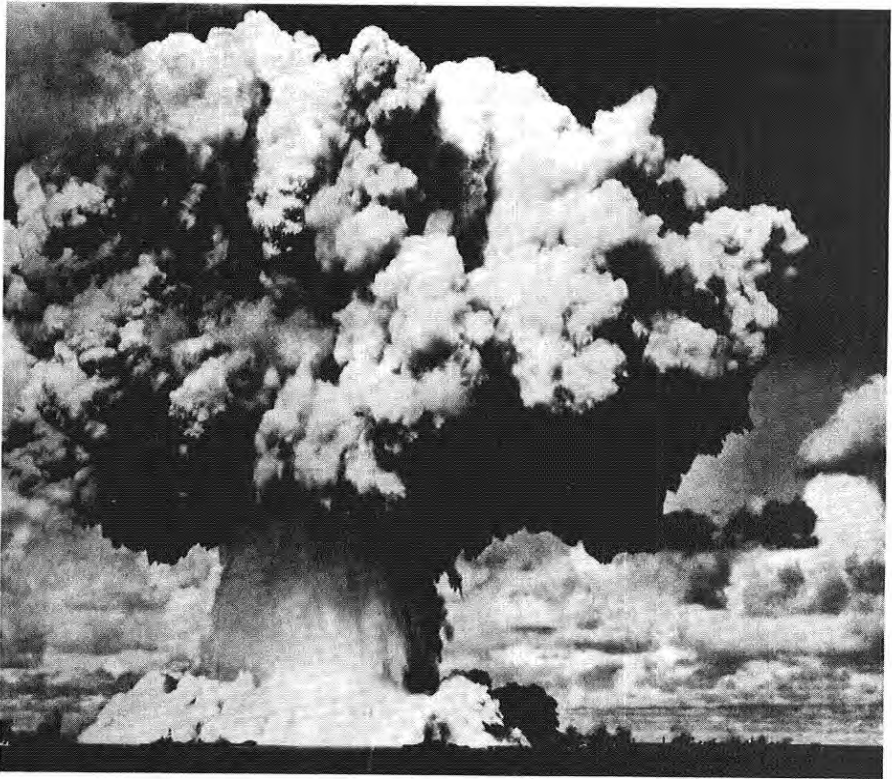

Figure 2.68. The radioactive cloud and first stages of the base surge following a shallow underwater burst. Water is beginning to fall back from the column into the lagoon.

because the upper part was surrounded by the radioactive cloud (Fig. 2.68). The column was probably some 6,000 feet high and the maximum diameter was about 2,000 feet. The walls were probably 300 feet thick, and approximately a million tons of water were raised in the column.

2.69 The cauliflower-shaped cloud, which concealed part of the upper portion of the column, contained some of the fission products and other weapon residues, as well as a large quantity of water in small droplet form. In addition, there is evidence that material sucked up from the bottom of the lagoon was also present, for a calcareous (or chalky) sediment, which must have dropped from this cloud, was found on the decks of ships some distance from the burst. The cloud was roughly 6,000 feet across

and ultimately rose to a height of nearly 10,000 feet before being dispersed. This is considerably less than the height attained by the radioactive cloud in an air burst.

2.70 The disturbance created by the underwater burst caused a series of waves to move outward from the center of the explosion across the surface of Bikini lagoon. At 11 seconds after the detonation, the first wave had a maximum height of 94 feet and was about 1,000 feet from surface zero. This moved outward at high speed and was followed by a series of other waves. At 22,000 feet from surface zero, the ninth wave in the series was the highest with a height of 6 feet.

2.71 It has been observed that certain underwater and water surface bursts have caused unexpectedly serious

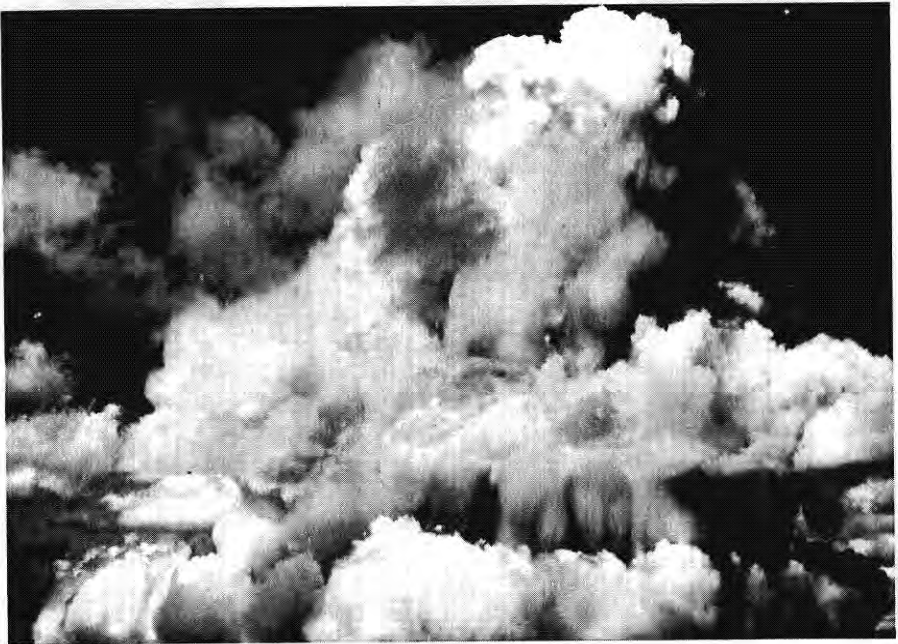

Figure 2.73. The development of the base surge following a shallow underwater explosion.

flooding of nearby beach areas, the depth of inundation being sometimes twice as high as the approaching water wave. The extent of inundation is related in a complex manner to a number of factors which include the energy yield of the explosion, the depth of burst, the depth of the water, the composition and contour of the bottom, and the angle the approaching wave makes with the shoreline.

THE VISIBLE BASE SURGE

2.72 As the column (or plume) of water and spray fell back into the lagoon in the BAKER test, there developed a gigantic wave (or cloud) of mist completely surrounding the column at its base (Fig. 2.68). This doughnut-shaped cloud, moving rapidly outward from the column, is called the "base surge." It is essentially a dense cloud of small water droplets, much like the spray at the base of Niagara Falls (or other high waterfalls), but having the property of flowing almost as if it were a homogeneous fluid.

2.73 The base surge at Bikini commenced to form at 10 or 12 seconds after the detonation. The surge cloud, billowing upward, rapidly attained a height of 900 feet, and moved outward at an initial rate of more than a mile a minute. Within 4 minutes the outer radius of the cloud, growing rapidly at first and then more slowly, was nearly $3\frac{1}{2}$ miles across and its height had then increased to 1,800 feet. At this stage, the base surge gradually rose from the surface of the water and began to merge with the radioactive cloud and other clouds in the sky (Fig. 2.73).

2.74 After about 5 minutes, the

base surge had the appearance of a mass of stratocumulus clouds which eventually reached a thickness of several thousand feet (Fig. 2.74). A moderate to heavy rainfall, moving with the wind and lasting for nearly an hour, developed from the cloud mass. In its early stages the rain was augmented by the small water droplets still descending from the radioactive cloud.

2.75 In the few instances in which base surge formation has been observed over water, the visible configuration has been quite irregular. Nevertheless, to a good approximation, the base surge can be represented as a hollow cylinder with the inner diameter about two-thirds of the outer diameter. The heights of the visible base surge clouds have generally ranged between 1,000 and 2,000 feet.

2.76 The necessary conditions for the formation of a base surge have not been definitely established, although it is reasonably certain that no base surge would accompany bursts at great depths. The underwater test shots upon which the present analysis is based have all created both a visible and an invisible (§ 2.77) base surge. The only marked difference between the phenomena at the various tests is that at Bikini BAKER there was an airborne cloud, evidently composed of fission debris and steam. The other shots, which were at somewhat greater depths, produced no such cloud. The whole of the plume fell back into the surface of the water where the low-lying base surge cloud was formed.

THE RADIOACTIVE BASE SURGE

2.77 From the weapons effects standpoint, the importance of the base



Figure 2.74. Final stage in the development of the base surge.

surge lies in the fact that it is likely to be highly radioactive because of the fission (and other) residues present either at its inception, or dropped into it from the radioactive cloud. Because of its radioactivity, it may represent a hazard for a distance of several miles, especially in the downwind direction. The fission debris is suspended in the form of very small particles that occupy the same volume as the visible base surge at early times, that is, within the first 3 or 4 minutes. However, when the small water droplets which make the base surge visible evaporate and disappear, the radioactive particles and gases remain in the air and continue to move outwards as an invisible radioactive base surge. There may well be some

fallout or rainout on to the surface of the water (or ship or shore station) from the radioactive base surge, but in many cases it is expected to pass over without depositing any debris. Thus, according to circumstances, there may or may not be radioactive contamination on the surfaces of objects in the vicinity of a shallow underwater nuclear burst.

2.78 The radioactive base surge continues to expand in the same manner as would have been expected had it remained visible. It drifts downwind either as an invisible, doughnut-shaped cloud or as several such possibly concentric clouds that approximate a low-lying disc with no hole in the center. The latter shape is more probable for deeper bursts. The length of time this

base surge remains radioactive will depend on the energy yield of the explosion, the burst depth, and the nearness of the sea bottom to the point of burst. In addition, weather conditions will control depletion of debris due to rain-out and diffusion by atmospheric winds. As a general rule, it is expected that there will be a considerable hazard from the radioactive base surge within the first 5 to 10 minutes after an underwater explosion and a decreasing hazard for half an hour or more.

2.79 The proportion of the residual nuclear radiation that remains in the water or that is trapped by the falling plume and returns immediately to the surface is determined by the location of the burst and the depth of the water, and perhaps also by the nature of the bottom material. Although as much as 90 percent of the fission product and other radioactivity could be left behind in the water, the base surge, both visible and invisible, could still be extremely radioactive in its early stages.

THERMAL AND NUCLEAR RADIATIONS IN UNDERWATER BURST

2.80 Essentially all the thermal radiation emitted by the fireball while it is still submerged is absorbed by the surrounding water. When the hot steam and gases reach the surface and expand, the cooling is so rapid that the temperature drops almost immediately to a point where there is no further appreciable emission of thermal radiation. It follows, therefore, that in an underwater nuclear explosion the thermal radiation can be ignored, as far as its effects on

people and as a source of fire are concerned.

2.81 It is probable, too, that most of the neutrons and gamma rays liberated within a short time of the initiation of the explosion will also be absorbed by the water. But, when the fireball reaches the surface and vents, the gamma rays (and beta particles) from the fission products will represent a form of initial nuclear radiation. In addition, the radiation from the radioactive residues present in the column, cloud, and base surge, all three of which are formed within a few seconds of the burst, will contribute to the initial effects.

2.82 However, the water fallout (or rainout) from the cloud and the base surge are also responsible for the residual nuclear radiation, as described above. For an underwater burst, it is thus less meaningful to make a sharp distinction between initial and residual radiations, such as is done in the case of an air burst. The initial nuclear radiations merge continuously into those which are produced over a period of time following the nuclear explosion.

DEEP UNDERWATER EXPLOSION PHENOMENA

2.83 Because the effects of a deep underwater nuclear explosion are largely of military interest, the phenomena will be described in general terms and in less detail than for a shallow underwater burst. The following discussion is based largely on observations made at the WAHOO shot in 1958, when a nuclear weapon was detonated at a depth of 500 feet in deep water. The generation of large-scale

water waves in deep underwater bursts will be considered in Chapter VI.

2.84 The spray dome formed by the WAHOO explosion rose to a height of 900 feet above the surface of the water (Fig. 2.84a). Shortly after the maximum height was attained, the hot gas and steam bubble burst through the dome, throwing out a plume with jets in all directions; the highest jets reached an elevation of 1,700 feet (Fig. 2.84b). There was no airborne radioactive cloud, such as was observed in the shallow underwater BAKER shot. The collapse of the plume created a visible base surge extending out to a distance of over $2\frac{1}{2}$ miles downwind and reaching a maximum height of about 1,000 feet (Fig. 2.84c). This base surge traveled outward at an initial speed of nearly 75 miles per hour, but decreased within 10 seconds to less than 20 miles per hour.

2.85 There was little evidence of the fireball in the WAHOO shot, because of the depth of the burst, and only a small amount of thermal radiation escaped. The initial nuclear radiation was similar to that from a shallow underwater burst, but there was no lingering airborne radioactive cloud from which fallout could occur. The radioactivity was associated with the base surge while it was visible and also after the water droplets had evaporated. The invisible, radioactive base surge continued to expand while moving in the downwind direction. However, very little radioactivity was found on the surface of the water.

2.86 The hot gas bubble formed by a deep underwater nuclear explosion rises through the water and continues to expand at a decreasing rate until a max-

imum size is reached. If it is not too near the surface or the bottom at this time, the bubble remains nearly spherical. As a result of the outward momentum of the water surrounding the bubble, the latter actually overexpands; that is to say, when it attains its maximum size its contents are at a pressure well below the ambient water pressure. The higher pressure outside the bubble then causes it to contract, resulting in an increase of the pressure within the bubble and condensation of some of the steam. Since the hydrostatic (water) pressure is larger at the bottom of the bubble than at the top, the bubble does not remain spherical during the contraction phase. The bottom moves upward faster than the top (which may even remain stationary) and reaches the top to form a toroidal bubble as viewed from above. This causes turbulence and mixing of the bubble contents with the surrounding water.

2.87 The momentum of the water set in motion by contraction of the bubble causes it to overcontract, and its internal pressure once more becomes higher than the ambient water pressure. A second compression (shock) wave in the water commences after the bubble reaches its minimum volume. This compression wave has a lower peak overpressure but a longer duration than the initial shock wave in the water. A second cycle of bubble expansion and contraction then begins.

2.88 If the detonation occurs far enough below the surface, as in the WIGWAM test in 1955 at a depth of about 2,000 feet, the bubble continues to pulsate and rise, although after three complete cycles enough steam will have condensed to make additional pulsations

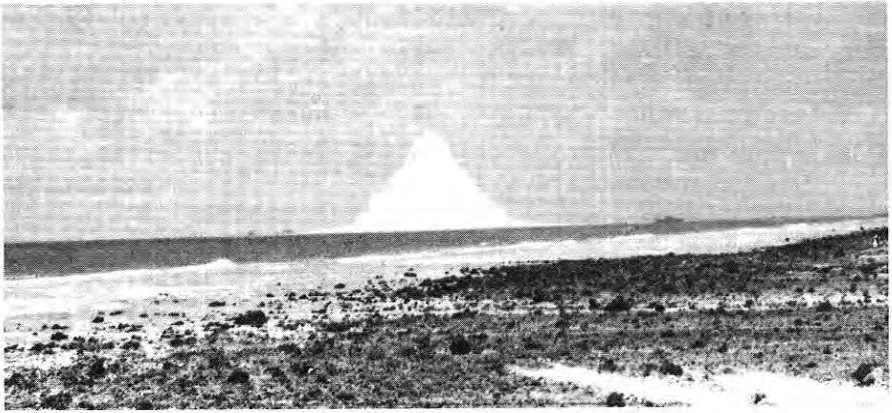

Figure 2.84a. Spray dome observed 5.3 seconds after explosion in deep water.



Figure 2.84b. Plume observed 11.7 seconds after explosion in deep water.



Figure 2.84c. Formation of base surge at 45 seconds after explosion in deep water.

unlikely. During the pulsation and upward motion of the bubble, the water surrounding the bubble acquires considerable upward momentum and eventually breaks through the surface with a high velocity, e.g., 200 miles per hour in the WIGWAM event, thereby creating a large plume. If water surface breakthrough occurs while the bubble pressure is below ambient, a phenomenon called "blowin" occurs. The plume is then likely to resemble a vertical col-

umn which may break up into jets that disintegrate into spray as they travel through the air.

2.89 The activity levels of the radioactive base surge will be affected by the phase of the bubble when it breaks through the water surface. Hence, these levels may be expected to vary widely, and although the initial radiation intensities may be very high, their duration is expected to be short.

DESCRIPTION OF UNDERGROUND BURSTS

SHALLOW UNDERGROUND EXPLOSION PHENOMENA

2.90 For the present purpose, a shallow underground explosion may be regarded as one which produces a substantial crater resulting from the throwout of earth and rock. There is an optimum depth of burst, dependent on the energy yield of the detonation and the nature of the rock medium, which gives a crater of maximum size. The mechanism of the formation of such throwout (or excavation) craters will be considered here. For shallower depths of burst, the behavior approaches that of a surface burst (§§ 2.18, 6.03 *et seq.*), whereas for explosions at greater depths the phenomena tend toward those of a deep underground detonation (§ 2.101 *et seq.*).

2.91 When a nuclear weapon is exploded under the ground, a sphere of extremely hot, high-pressure gases, including vaporized weapon residues and rock, is formed. This is the equivalent of the fireball in an air or surface burst.

The rapid expansion of the gas bubble initiates a ground shock wave which travels in all directions away from the burst point. When the upwardly directed shock (compression) wave reaches the earth's surface, it is reflected back as a rarefaction (or tension) wave. If the tension exceeds the tensile strength of the surface material, the upper layers of the ground will spall, i.e., split off into more-or-less horizontal layers. Then, as a result of the momentum imparted by the incident shock wave, these layers move upward at a speed which may be about 150 (or more) feet per second.

2.92 When it is reflected back from the surface, the rarefaction wave travels into the ground toward the expanding gas sphere (or cavity) produced by the explosion. If the detonation is not at too great a depth, this wave may reach the top of the cavity while it is still growing. The resistance of the ground to the upward growth of the cavity is thus decreased and the cavity expands rapidly in the upward direction. The expanding

gases and vapors can thus supply additional energy to the spalled layers, so that their upward motion is sustained for a time or even increased. This effect is referred to as "gas acceleration."

2.93 The ground surface moving upward first assumes the shape of a dome. As the dome continues to increase in height, cracks form through which the cavity gases vent to the atmosphere. The mound then disintegrates completely and the rock fragments are thrown upward and outward (Fig. 2.93). Subsequently, much of the ejected material collapses and falls back, partly into the newly formed crater and partly onto the surrounding "lip." The material that falls back immediately into the crater is called the "fallback," whereas that descending on the lip is called the "ejecta." The size of the remaining (or "apparent")

crater depends on the energy yield of the detonation and on the nature of the excavated medium. In general, for equivalent conditions, the volume of the crater is roughly proportional to the yield of the explosion.

2.94 The relative extents to which spalling and gas acceleration contribute to the formation of a throwout crater depend to large extent on the moisture content of the rock medium. In rock containing a moderately large proportion of water, the cavity pressure is greatly increased by the presence of water vapor. Gas acceleration then plays an important role in crater formation. In dry rock, however, the contribution of gas acceleration to the upward motion of the ground is generally small and may be unobservable.

2.95 As in an underwater burst, part of the energy released by the weapon in

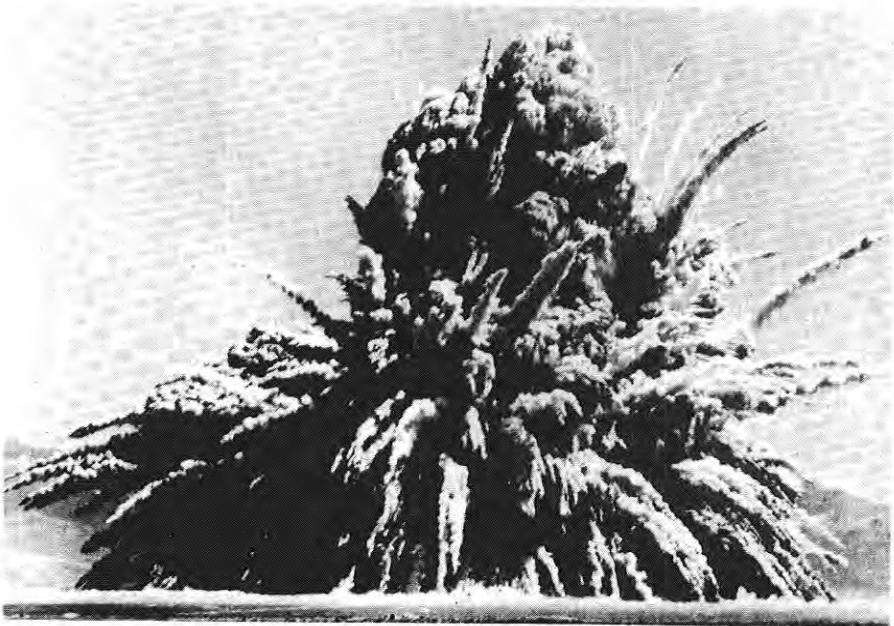

Figure 2.93. Shallow underground burst.

a shallow underground explosion appears as an air blast wave. The fraction of the energy imparted to the air in the form of blast depends primarily on the depth of burst for the given total energy yield. The greater the depth of burst, the smaller, in general, will be the proportion of shock energy that escapes into the air. For a sufficiently deep explosion, there is, of course, no blast wave.

BASE SURGE AND MAIN CLOUD

2.96 When the fallback from a shallow underground detonation descends to the ground, it entrains air and fine dust particles which are carried downward. The dust-laden air upon reaching the ground moves outward as a result of its momentum and density, thereby producing a base surge, similar to that observed in shallow underwater explosions. The base surge of dirt particles moves outward from the center of the explosion and is subsequently carried downwind. Eventually the particles settle out and produce radioactive con-

tamination over a large area, the extent of which depends upon the depth of burst, the nature of the soil, and the atmospheric conditions, as well as upon the energy yield of the explosion. A dry sandy terrain would be particularly conducive to base surge formation in an underground burst.

2.97 Throwout crater formation is apparently always accompanied by a base surge. If gas acceleration occurs, however, a cloud consisting of particles of various sizes and the hot gases escaping from the explosion cavity generally also forms and rises to a height of thousands of feet. This is usually referred to as the "main cloud," to distinguish it from the base surge cloud. The latter surrounds the base of the main cloud and spreads out initially to a greater distance. The main cloud and base surge formed in the SEDAN test (100 kilotons yield, depth of burial 635 feet in alluvium containing 7 percent of water) are shown in the photograph in Fig. 2.97, taken six minutes after the explosion.

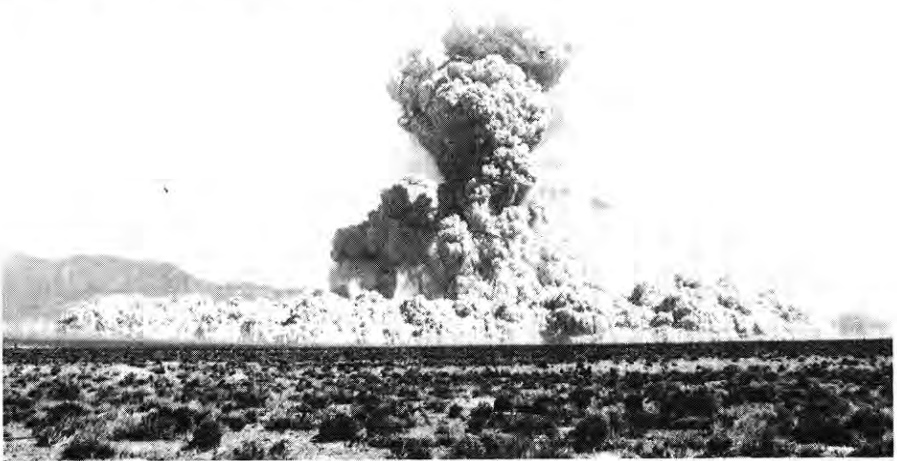

Figure 2.97. Main cloud and base surge 6 minutes after the SEDAN underground burst.

2.98 Both the base surge and the main cloud are contaminated with radioactivity, and the particles present contribute to the fallout. The larger pieces are the first to reach the earth and so they are deposited near the location of the burst. But the smaller particles remain suspended in the air some time and may be carried great distances by the wind before they eventually settle out.

THERMAL AND NUCLEAR RADIATIONS IN UNDERGROUND BURSTS

2.99 The situations as regards thermal and nuclear radiations from an underground burst are quite similar to those described above in connection with an underwater explosion. As a general rule, the thermal radiation is almost completely absorbed by the ground material, so that it does not represent a significant hazard. Most of the neutrons and early gamma rays are also removed, although the capture of the neutrons may cause a considerable amount of induced radioactivity in various materials present in the soil (§ 9.35). This will constitute a small part of the residual nuclear radiation, of importance only in the close vicinity of the point of burst. The remainder of the residual radiation will be due to the contaminated base surge and fallout.

2.100 For the reasons given in § 2.82 for an underwater burst, the initial and residual radiations from an underground burst tend to merge into one another. The distinction which is made in the case of air and surface bursts is consequently less significant in a subsurface explosion.

DEEP UNDERGROUND EXPLOSION PHENOMENA

2.101 A deep underground explosion is one occurring at such a depth that the effects are essentially fully contained. The surface above the detonation point may be disturbed, e.g., by the formation of a shallow subsidence crater or a mound, and ground tremors may be detected at a distance. There is no significant venting of the weapon residues to the atmosphere, although some of the noncondensable gases present may seep out gradually through the surface. The United States has conducted many deep underground tests, especially since September 1961. Almost all of the explosion energy has been contained in the ground, and, except in the few cases of accidental venting or seepage of a small fraction of the residues, the radioactivity from these explosions has also been confined. The phenomena of deep underground detonations can be described best in terms of four phases having markedly different time scales.

2.102 First, the explosion energy is released in less than one-millionth part of a second, i.e., less than one microsecond (§ 1.54 footnote). As a result, the pressure in the hot gas bubble formed will rise to several million atmospheres and the temperature will reach about a million degrees within a few microseconds. In the second (hydrodynamic) stage, which generally is of a few tenths of a second duration, the high pressure of the hot gases initiates a strong shock wave which breaks away and expands in all directions with a velocity equal to or greater than the speed of sound in the rock medium. During the hydrodynamic phase, the hot gases continue to expand, although

more slowly than initially, and form a cavity of substantial size. At the end of this phase the cavity will have attained its maximum diameter and its walls will be lined with molten rock. The shock wave will have reached a distance of some hundreds of feet ahead of the cavity and it will have crushed or fractured much of the rock in the region it has traversed. The shock wave will continue to expand and decrease in strength eventually becoming the "head" (or leading) wave of a train of seismic waves (§ 6.19). During the third stage, the cavity will cool and the molten rock material will collect and solidify at the bottom of the cavity.

2.103 Finally, the gas pressure in the cavity decreases to the point when it can no longer support the overburden. Then, in a matter of seconds to hours, the roof falls in and this is followed by progressive collapse of the overlying rocks. A tall cylinder, commonly referred to as a "chimney," filled with broken rock or rubble is thus formed (Fig. 2.103). If the top of the chimney does not reach the ground surface, an empty space, roughly equivalent to the cavity volume, will remain at the top of the chimney. However, if the collapse of the chimney material should reach the surface, the ground will sink into to the empty space thereby forming a subsidence crater (see Fig. 6.06f). The collapse of the roof and the formation of the chimney represented the fourth (and last) phase of the underground explosion.

2.104 The effects of the RAINIER event of Operation Plumbbob in 1957 will provide an example of the extent to which the surrounding medium may be affected by a deep underground detona-

tion. RAINIER was a 1.7-kiloton nuclear device detonated in a chamber $6 \times 6 \times 7$ feet in size, at a depth of 790 feet below the surface in a compacted volcanic-ash medium referred to geologically as "tuff." During the hydrodynamic stage the chamber expanded to form a spherical cavity 62 feet in radius, which was lined with molten rock about 4 inches thick. The shock from the explosion crushed the surrounding medium to a radius of 130 feet and fractured it to 180 feet. Seismic signals were detected out to distances of several hundred miles and a weak signal was recorded in Alaska. The chimney extended upward for about 400 feet from the burst point. Further information on cavity and chimney dimensions is given in Chapter VI.

2.105 Deep underground nuclear detonations, especially those of high yield, are followed by a number of minor seismic tremors called "aftershocks," the term that is used to describe the secondary tremors that gener-

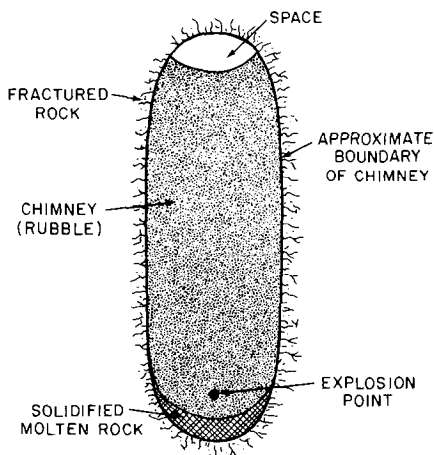

Figure 2.103. The rubble chimney formed after collapse of the cavity in a deep underground nuclear detonation.

ally occur after the main shock of a large earthquake. In tests made in Nevada and on Amchitka Island in the Aleutians, the aftershocks have not constituted a danger to people or to structures off the

test sites. No correlation has been found between underground nuclear detonations and the occurrence of natural earthquakes in the vicinity (§ 6.24 *et seq.*).

SCIENTIFIC ASPECTS OF NUCLEAR EXPLOSION PHENOMENA⁷

INTRODUCTION

2.106 The events which follow the very large and extremely rapid energy release in a nuclear explosion are mainly the consequences of the interaction of the kinetic energy of the fission fragments and the thermal radiations with the medium surrounding the explosion. The exact nature of these interactions, and hence the directly observable and indirect effects they produce, that is to say, the nuclear explosion phenomena, are dependent on such properties of the medium as its temperature, pressure, density, and composition. It is the variations in these factors in the environment of the nuclear detonation that account for the different types of response associated with air, high-altitude, surface, and subsurface bursts, as described earlier in this chapter.

2.107 Immediately after the explosion time, the temperature of the weapon material is several tens of million degrees and the pressures are estimated to be many million atmospheres. As a result of numerous inelastic collisions, part of the kinetic energy of the fission fragments is converted into

internal and radiation energy. Some of the electrons are removed entirely from the atoms, thus causing ionization, whereas others are raised to higher energy (or excited) states while still remaining attached to the nuclei. Within an extremely short time, perhaps a hundredth of a microsecond or so, the weapon residues consist essentially of completely and partially stripped (ionized) atoms, many of the latter being in excited states, together with the corresponding free electrons. The system then immediately emits electromagnetic (thermal) radiation, the nature of which is determined by the temperature. Since this is of the order of several times 10^7 degrees, most of the energy emitted within a microsecond or so is in the soft X-ray region (§ 1.77, see also § 7.75).

2.108 The primary thermal radiation leaving the exploding weapon is absorbed by the atoms and molecules of the surrounding medium. The medium is thus heated and the resulting fireball re-radiates part of its energy as the secondary thermal radiation of longer wavelengths (§ 2.38). The remainder of the energy contributes to the shock wave formed in the surrounding medium. Ul-

⁷The remaining (more technical) sections of this chapter may be omitted without loss of continuity.

timately, essentially all the thermal radiation (and shock wave energy) is absorbed and appears as heat, although it may be spread over a large volume. In a dense medium such as earth or water, the degradation and absorption occur within a short distance from the explosion, but in air both the shock wave and the thermal radiation may travel considerable distances. The actual behavior depends on the air density, as will be seen later.

2.109 It is apparent that the kinetic energy of the fission fragments, constituting some 85 percent of the total energy released, will distribute itself between thermal radiation, on the one hand, and shock and blast, on the other hand, in proportions determined largely by the nature of the ambient medium. The higher the density of the latter, the greater the extent of the coupling between it and the energy from the exploding nuclear weapon. Consequently, when a burst takes place in a medium of high density, e.g., water or earth, a larger percentage of the kinetic energy of the fission fragments is converted into shock and blast energy than is the case in a less dense medium, e.g., air. At very high altitudes, on the other hand, where the air pressure is extremely low, there is no true fireball and the kinetic energy of the fission fragments is dissipated over a very large volume. In any event, the form and amount in which the thermal radiation is received at a distance from the explosion will depend on the nature of the intervening medium.

DEVELOPMENT OF THE FIREBALL IN AN AIR BURST

2.110 As seen above, most of the initial (or primary) thermal radiation

from a nuclear explosion is in the soft X-ray region of the spectrum. If the burst occurs in the lower part of the atmosphere where the air density is appreciable, the X rays are absorbed in the immediate vicinity of the burst, and they heat the air to high temperatures. This sphere of hot air is sometimes referred to as the "X-ray fireball." The volume of air involved, resultant air temperatures, and ensuing behavior of this fireball are all determined by the burst conditions. At moderate and low altitudes (below about 100,000 feet), the X rays are absorbed within some yards of the burst point, and the relatively small volume of air involved is heated to a very high temperature.

2.111 The energies (or wavelengths) of the X rays, as determined by the temperature of the weapon debris, cover a wide range (§ 7.73 *et seq.*), and a small proportion of the photons (§ 1.74) have energies considerably in excess of the average. These high-energy photons are not easily absorbed and so they move ahead of the fireball front. As a result of interaction with the atmospheric molecules, the X rays so alter the chemistry and radiation absorption properties of the air that, in the air burst at low and moderate altitudes, a veil of opaque air is generated that obscures the early growth of the fireball. Several microseconds elapse before the fireball front emerges from the opaque X-ray veil.

2.112 The X-ray fireball grows in size as a result of the transfer of radiation from the very hot interior where the explosion has occurred to the cooler exterior. During this "radiative growth" phase, most of the energy transfer in the hot gas takes place in the

following manner. First, an atom, molecule, ion, or electron absorbs a photon of radiation and is thereby converted into an excited state. The atom or other particle remains in this state for a short time and then emits a photon, usually of lower energy. The residual energy is retained by the particle either as kinetic energy or as internal energy. The emitted photon moves off in a random direction with the velocity of light, and it may then be absorbed once again to form another excited particle. The latter will then re-emit a photon, and so on. The radiation energy is thus transmitted from one point to another within the gas; at the same time, the average photon energy (and radiation frequency) decreases. The energy lost by the photons serves largely to heat the gas through which the photons travel.

2.113 If the mean free path of the radiation, i.e., the average distance a photon travels between interactions, is large in comparison with the dimensions of the gaseous volume, the transfer of energy from the hot interior to the cooler exterior of the fireball will occur more rapidly than if the mean free path is short. This is because, in their outward motion through the gas, the photons with short mean free paths will be absorbed and re-emitted several times. At each re-emission the photon moves away in a random direction, and so the effective rate of transfer of energy in the outward direction will be less than for a photon of long mean free path which undergoes little or no absorption and re-emission in the hot gas.

2.114 In the radiative growth phase, the photon mean free paths in the hot fireball are of the order of (or longer than) the fireball diameter because at the

very high temperatures the photons are not readily absorbed. As a result, the energy distribution and temperature are fairly uniform throughout the volume of hot gas. The fireball at this stage is consequently referred to as the "isothermal sphere." The name is something of a misnomer, since temperature gradients do exist, particularly near the advancing radiation front.

2.115 As the fireball cools, the transfer of energy by radiation and radiative growth become less rapid because of the decreasing mean free path of the photons. When the average temperature of the isothermal sphere has dropped to about 300,000°C, the expansion velocity will have decreased to a value comparable to the local acoustic (sound) velocity. At this point, a shock wave develops at the fireball front and the subsequent growth of the fireball is dominated by the shock and associated hydrodynamic expansion. The phenomenon of shock formation is sometimes called "hydrodynamic separation." For a 20-kiloton burst it occurs at about a tenth of a millisecond after the explosion when the fireball radius is roughly 40 feet.

2.116 At very early times, beginning in less than a microsecond, an "inner" shock wave forms driven by the expanding bomb debris. This shock expands outward within the isothermal sphere at a velocity exceeding the local acoustic velocity. The inner shock overtakes and merges with the outer shock at the fireball front shortly after hydrodynamic separation. The relative importance of the debris shock wave depends on the ratio of the yield to the mass of the exploding device and on the altitude of the explosion (§ 2.136). The

debris shock front is a strong source of ultraviolet radiation, and for weapons of small yield-to-mass ratio it may replace the X-ray fireball as the dominant energy source for the radiative growth.

2.117 As the (combined) shock front from a normal air burst moves ahead of the isothermal sphere it causes a tremendous compression of the ambient air and the temperature is thereby increased to an extent sufficient to render the air incandescent. The luminous shell thus formed constitutes the advancing visible fireball during this "hydrodynamic phase" of fireball growth. The fireball now consists of two concentric regions. The inner (hotter) region is the isothermal sphere of uniform temperature, and it is surrounded by a layer of luminous, shock-heated air at a somewhat lower, but still high, temperature. Because hot (over 8,000°C) air is effectively opaque to visible radiation, the isothermal sphere is not visible through the outer shocked air.

2.118 Some of the phenomena described above are represented schematically in Fig. 2.118; qualitative temperature profiles are shown at the left and pressure profiles at the right of a series of photographs of the fireball at various intervals after the detonation of a 20-kiloton weapon. In the first picture, at 0.1 millisecond, the temperature is shown to be uniform within the fireball and to drop abruptly at the exterior, so that the condition is that of the isothermal sphere. Subsequently, as the shock front begins to move ahead of the isothermal sphere, the temperature is no longer uniform, as indicated by the more gradual fall near the outside of the fireball. Eventually, two separate tem-

perature regions form. The outer region absorbs the radiation from the isothermal sphere in the center and so the latter cannot be seen. The photographs, therefore, show only the exterior surface of the fireball.

2.119 From the shapes of the curves at the right of Fig. 2.118 the nature of the pressure changes in the fireball can be understood. In the isothermal stage the pressure is uniform throughout and drops sharply at the outside, but after a short time, when the shock front has separated from the isothermal sphere, the pressure near the surface is greater than in the interior of the fireball. Within less than 1 millisecond the steep-fronted shock wave has traveled some distance ahead of the isothermal region. The rise of the pressure in the fireball to a peak, which is characteristic of a shock wave, followed by a sharp drop at the external surface, implies that the latter is identical with the shock front. It will be noted, incidentally, from the photographs, that the surface of the fireball, which has hitherto been somewhat uneven, has now become sharply defined.

2.120 For some time the fireball continues to grow in size at a rate determined by the propagation of the shock front in the surrounding air. During this period the temperature of the shocked air decreases steadily so that it becomes less opaque. Eventually, it is transparent enough to permit the much hotter and still incandescent interior of the fireball, i.e., the isothermal sphere, to be seen through the faintly visible shock front (see Fig. 2.32). The onset of this condition at about 15 milliseconds (0.015 second) after the detonation of a 20-kiloton weapon, for example, is referred to as the "breakaway."

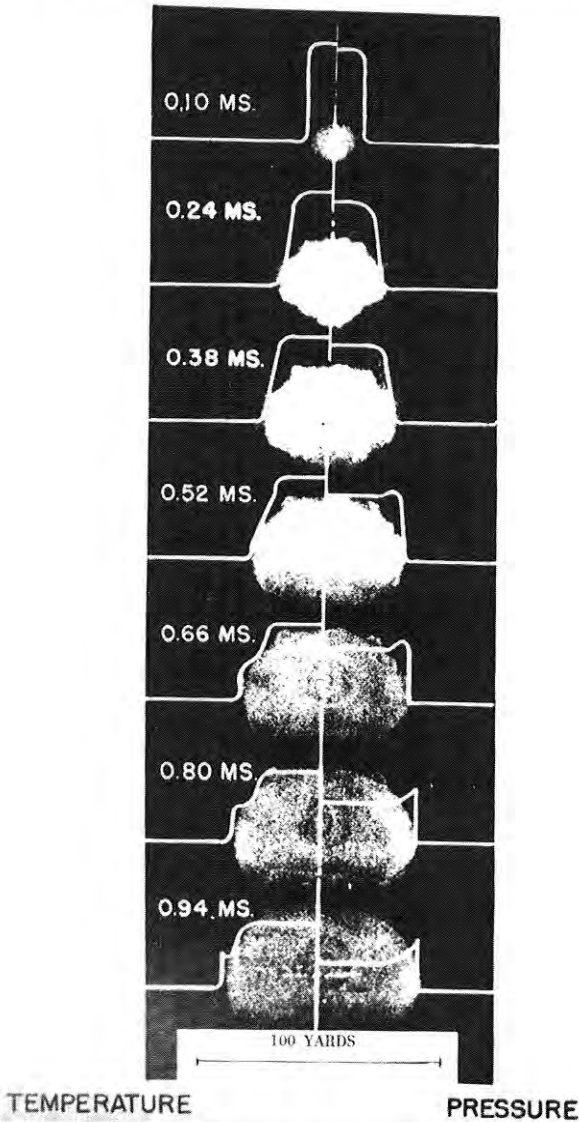

Figure 2.118. Variation of temperature and pressure in the fireball. (Times and dimensions apply to a 20-kiloton air burst.)

2.121 Following the breakaway, the visible fireball continues to increase in size at a slower rate than before, the maximum dimensions being attained after about a second or so. The manner

in which the radius increases with time, in the period from roughly 0.1 millisecond to 1 second after the detonation of a 20-kiloton nuclear weapon, is shown in Figure 2.121. Attention should be called

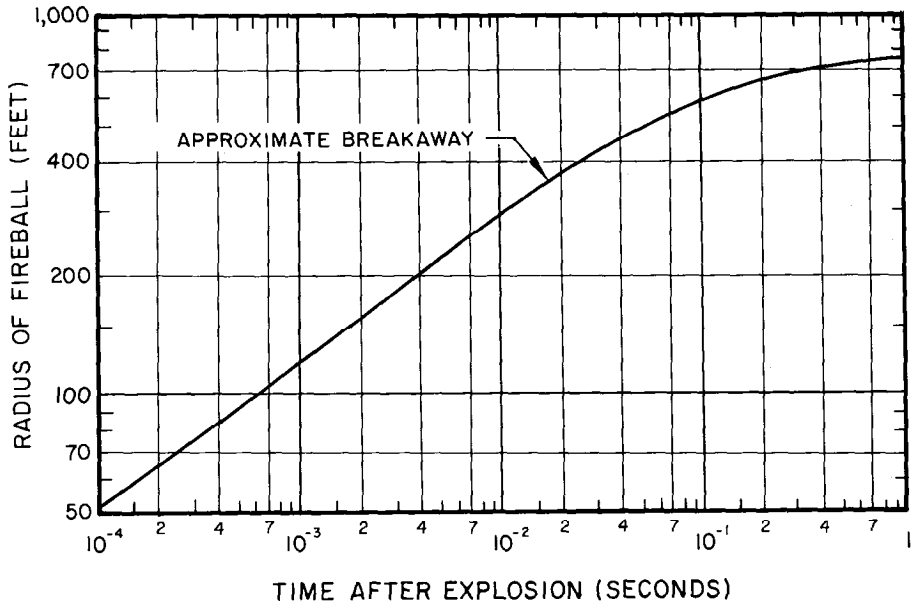

Figure 2.121. Variation of radius of luminous fireball with time in a 20-kiloton air burst.

to the fact that both scales are logarithmic, so that the lower portion of the curve (at the left) does not represent a constant rate of growth, but rather one that falls off with time. Nevertheless, the marked decrease in the rate at which the fireball grows after breakaway is apparent from the subsequent flattening of the curve.

TEMPERATURE OF THE FIREBALL

2.122 As indicated earlier, the interior temperature of the fireball decreases steadily, but the apparent surface temperature, which influences the emission of thermal radiation, decreases to a minimum and then increases to a maximum before the final steady decline. This behavior is related to the fact that at high temperatures air both absorbs and emits thermal radiation very readily, but

as the temperature falls below a few thousand degrees, the ability to absorb and radiate decreases.

2.123 From about the time the fireball temperature has fallen to $300,000^{\circ}\text{C}$, when the shock front begins to move ahead of the isothermal sphere, until close to the time of the first temperature minimum (§ 2.38), the expansion of the fireball is governed by the laws of hydrodynamics. It is then possible to calculate the temperature of the shocked air from the measured shock velocity, i.e., the rate of growth of the fireball. The variation of the temperature of the shock front with time, obtained in this manner, is shown by the full line from 10^{-4} to 10^{-2} second in Fig. 2.123, for a 20-kiloton explosion. But photographic and spectroscopic observations of the surface brightness of the advancing shock front, made from a distance,

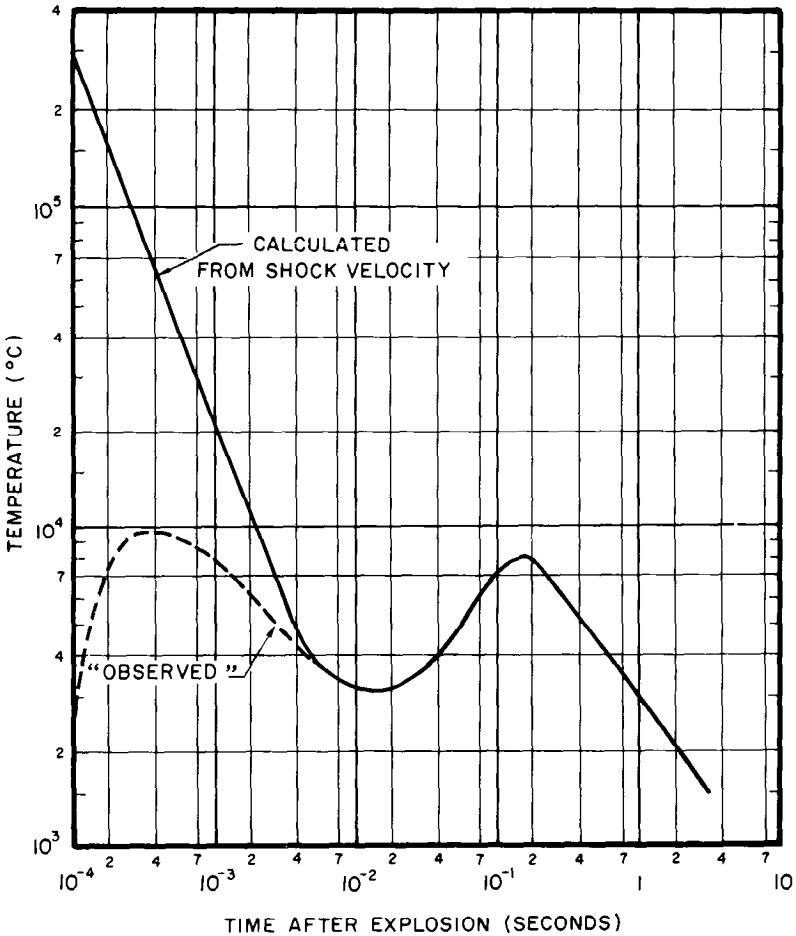

Figure 2.123. Variation of apparent fireball surface temperature with time in a 20-kiloton air burst.

indicate the much lower temperatures represented by the broken curve in the figure. The reason for this discrepancy is that both the nuclear and thermal radiations emitted in the earliest stages of the detonation interact in depth with the gases of the atmosphere ahead of the shock front to produce ozone, nitrogen dioxide, nitrous acid, etc. These substances are strong absorbers of radiation coming from the fireball, so that the brightness observed some distance away

corresponds to a temperature considerably lower than that of the shock front.

2.124 Provided the temperature of the air at the shock front is sufficiently high, the isothermal sphere is invisible (§ 2.117). The rate at which the shock front emits (and absorbs) radiation is determined by its temperature and radius. The temperature at this time is considerably lower than that of the isothermal sphere but the radius is larger. However, as the temperature of

the shocked air approaches 3,000°C (5,400°F) it absorbs (and radiates) less readily. Thus the shock front becomes increasingly transparent to the radiation from the isothermal sphere and there is a gradual unmasking of the still hot isothermal sphere, representing breakaway (§ 2.120).

2.125 As a result of this unmasking of the isothermal sphere, the apparent surface temperature (or brightness) of the fireball increases (Fig. 2.123), after passing through the temperature minimum of about 3,000°C attributed to the shock front. This minimum, representing the end of the first thermal pulse, occurs at about 11 milliseconds (0.011 second) after the explosion time for a 20-kiloton weapon. Subsequently, as the brightness continues to increase from the minimum, radiation from the fireball is emitted directly from the hot interior (or isothermal sphere), largely unimpeded by the cooled air in the shock wave ahead of it; energy is then radiated more rapidly than before. The apparent surface temperature increases to a maximum of about 7,700°C (14,000°F), and this is followed by a steady decrease over a period of seconds as the fireball cools by the emission of radiation and mixing with air. It is during the second pulse that the major part of the thermal radiation is emitted in an air burst (§ 2.38 *et seq.*). In such a burst, the rate of emission of radiation is greatest when the surface temperature is at the maximum.

2.126 The curves in Figs. 2.121 and 2.123 apply to a 20-kiloton nuclear burst, but similar results are obtained for

explosions of other energy yields. The minimum temperature of the radiating surface and the subsequent temperature maximum are essentially independent of the yield of the explosion. But the times at which these temperatures occur for an air burst increase approximately as the 0.4 power of the yield (Chapter VII). The time of breakaway is generally very soon after the thermal minimum is attained.

SIZE OF THE FIREBALL

2.127 The size of the fireball increases with the energy yield of the explosion. Because of the complex interaction of hydrodynamic and radiation factors, the radius of the fireball at the thermal minimum is not very different for air and surface bursts of the same yield. The relationship between the average radius and the yield is then given approximately by

$$R \text{ (at thermal minimum)} \approx 90 W^{0.4},$$

where R is the fireball radius in feet and W is the explosion yield in kilotons TNT equivalent. The breakaway phenomenon, on the other hand, is determined almost entirely by hydrodynamic considerations, so that a distinction should be made between air and surface bursts. For an air burst the radius of the fireball is given by

$$R \text{ (at breakaway) for} \\ \text{air burst} \approx 110 W^{0.4}, \quad (2.127.1)$$

For a contact surface burst, i.e., in which the exploding weapon is actually on the surface,⁸ blast wave energy is

⁸For most purposes, a contact surface burst may be defined as one for which the burst point is not more than $5 W^{0.3}$ feet above or below the surface.

reflected back from the surface into the fireball (§ 3.34) and W in equation (2.127.1) should probably be replaced by $2W$, where W is the actual yield. Hence, for a contact surface burst,

$$R \text{ (at breakaway) for contact surface burst} \approx 145 W^{0.4}. \quad (2.127.2)$$

For surface bursts in the transition range between air bursts and contact bursts, the radius of the fireball at breakaway is somewhere between the values given by equations (2.127.1) and (2.127.2). The size of the fireball is not well defined in its later stages, but as a rough approximation the maximum radius may be taken to be about twice that at the time of breakaway (cf. Fig. 2.121).

2.128 Related to the fireball size is the question of the height of burst at which early (or local) fallout ceases to be a serious problem. As a guide, it may be stated that this is very roughly related to the weapon yield by

$$H \text{ (maximum for local fallout)} \approx 180 W^{0.4}, \quad (2.128.1)$$

where H feet is the maximum value of the height of burst for which there will be appreciable local fallout. This expression is plotted in Fig. 2.128. For an explosion of 1,000 kilotons, i.e., 1 megaton yield, it can be found from Fig. 2.128 or equation (2.128.1) that significant local fallout is probable for heights of burst less than about 2,900 feet. It should be emphasized that the heights of burst estimated in this manner are approximations only, with probable errors of ± 30 percent. Furthermore, it must not be assumed that if the burst height exceeds the value given by equation (2.128.1) there will definitely be no local fallout. The amount, if any, may

be expected, however, to be small enough to be tolerable under emergency conditions.

2.129 Other aspects of fireball size are determined by the conditions under which the fireball rises. If the fireball is small compared with an atmospheric scale height, which is about 4.3 miles at altitudes of interest (§ 10.123), the late fireball rise is caused by buoyant forces similar to those acting on a bubble rising in shallow water. This is called "buoyant" rise. The fireball is then essentially in pressure equilibrium with the surrounding air as it rises. If the initial fireball radius is comparable to or greater than a scale height, the atmospheric pressure on the bottom of the fireball is much larger than the pressure on the top. This causes a very rapid acceleration of the fireball, referred to as "ballistic" rise. The rise velocity becomes so great compared to the expansion rate that the fireball ascends almost like a solid projectile. "Overshoot" then occurs, in which a parcel of dense air is carried to high altitudes where the ambient air has a lower density. The dense "bubble" will subsequently expand, thereby decreasing its density, and will fall back until it is in a region of comparable density.

HIGH-ALTITUDE BURSTS

2.130 For nuclear detonations at heights up to about 100,000 feet (19 miles), the distribution of explosion energy between thermal radiation and blast varies only to a small extent with yield and detonation altitude (§ 1.24). But at burst altitudes above 100,000 feet, the distribution begins to change more noticeably with increasing height of burst

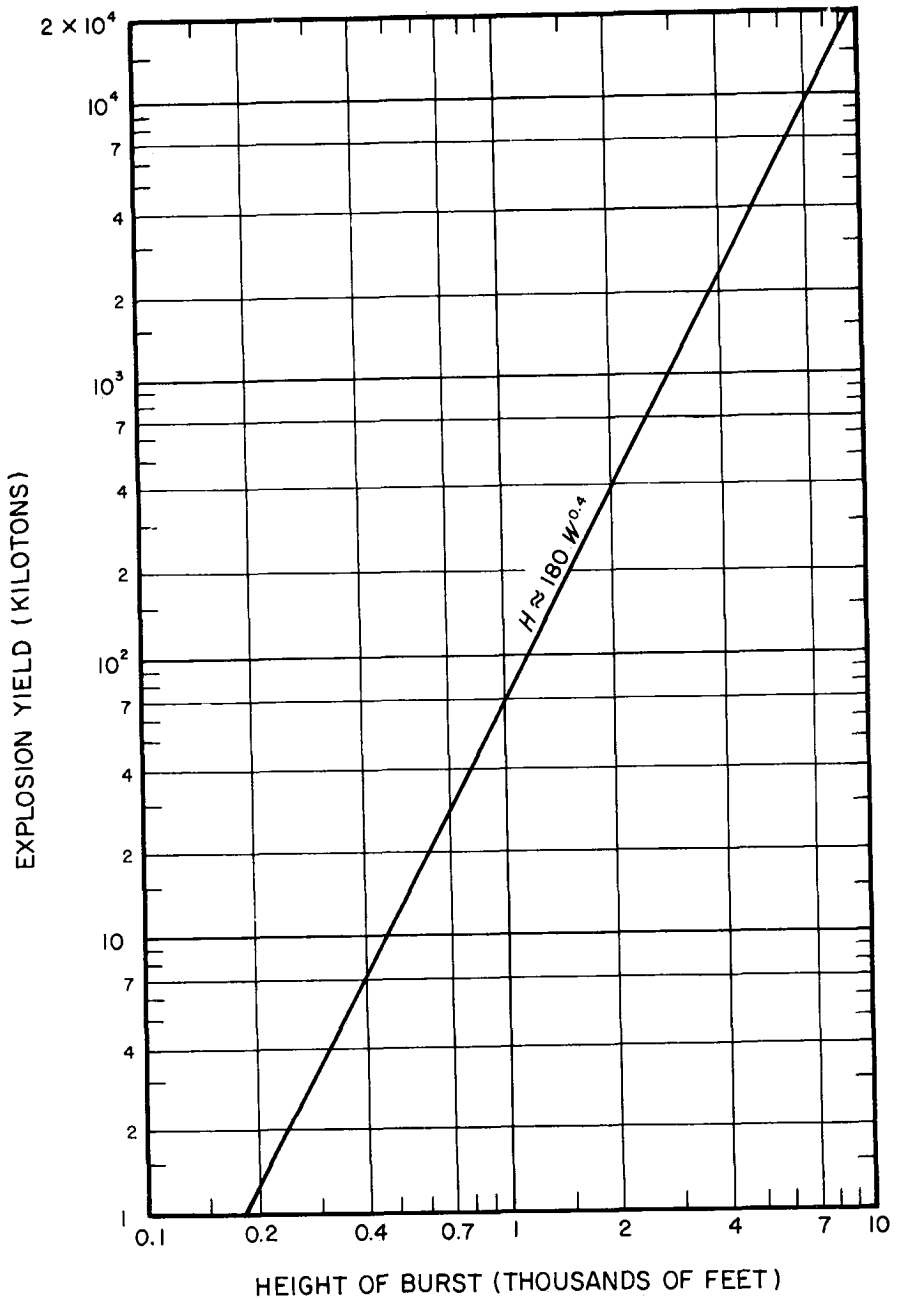

Figure 2.128. Approximate maximum height of burst for appreciable local fallout.

(see Chapter VII). It is for this reason that the level of 100,000 feet has been chosen for distinguishing between air bursts and high-altitude bursts. There is, of course, no sharp change in behavior at this elevation, and so the definition of a high-altitude burst as being at a height above 100,000 feet is somewhat arbitrary. There is a progressive decline in the blast energy with increasing height of burst above 100,000 feet, but the proportion of the explosion energy received as effective thermal radiation on the ground at first increases only slightly with altitude. Subsequently, as the burst altitude increases, the effective thermal radiation received on the ground decreases and becomes less than at an equal distance from an air burst of the same total yield (§ 7.102).

2.131 For nuclear explosions at altitudes between 100,000 and about 270,000 feet (51 miles) the fireball phenomena are affected by the low density of the air. The probability of interaction of the primary thermal radiation, i.e., the thermal X rays, with atoms and molecules in the air is markedly decreased, so that the photons have long mean free paths and travel greater distances, on the average, before they are absorbed or degraded into heat and into radiations of longer wavelength (smaller photon energy). The volume of the atmosphere in which the energy of the radiation is deposited, over a period of a millisecond or so, may extend for several miles, the dimensions increasing with the burst altitude. The interaction of the air molecules with the prompt gamma rays, neutrons, and high-energy component of the X rays produces a strong flash of fluorescence radiation (§ 2.140), but there is less tendency for

the X-ray veil to form than in an air burst (§ 2.111).

2.132 Because the primary thermal radiation energy in a high-altitude burst is deposited in a much larger volume of air, the energy per unit volume available for the development of the shock front is less than in an air burst. The outer shock wave (§ 2.116) is slow to form and radiative expansion predominates in the growth of the fireball. The air at the shock front does not become hot enough to be opaque at times sufficiently early to mask the radiation front and the fireball radiates most of its energy very rapidly. There is no apparent temperature minimum as is the case for an air burst. Thus, with increasing height, a series of changes take place in the thermal-pulse phenomena; the surface temperature minimum becomes less pronounced and eventually disappears, so that the thermal radiation is emitted in a single pulse of fairly short duration. In the absence of the obscuring opaque shock front, the fireball surface is visible throughout the period of radiative growth and the temperature is higher than for a low-altitude fireball. Both of these effects contribute to the increase in the thermal radiation emission.

2.133 A qualitative comparison of the rate of arrival of thermal radiation energy at a distance from the burst point as a function of time for a megaton-range explosion at high altitude and in a sea-level atmosphere is shown in Fig. 2.133. In a low (or moderately low) air burst, the thermal radiation is emitted in two pulses, but in a high-altitude burst there is only a single pulse in which most of the radiation is emitted in a relatively short time. Furthermore, the thermal pulse from a high-altitude ex-

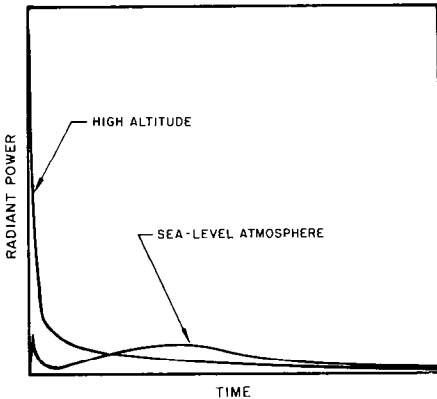

Figure 2.133. Qualitative comparison of rates of arrival of thermal radiation at a given distance from high-altitude and sea-level bursts.

losion is richer in ultraviolet radiation than is the main (second) pulse from an air burst. The reason is that formation of ozone, oxides of nitrogen, and nitrous acid (§ 2.123), which absorb strongly in this spectral region, is decreased.

2.134 For burst altitudes above about 270,000 feet, there is virtually no absorption of the X rays emitted in upward directions. The downward directed X rays are mostly absorbed in a layer of air, called the "X-ray pancake," which becomes incandescent as a result of energy deposition. The so-called pancake is more like the frustum of a cone, pointing upward, with a thickness of roughly 30,000 feet (or more) and a mean altitude of around 270,000 feet; the radius at this altitude is approximately equal to the height of burst minus 270,000 feet. The height and dimensions of the pancake are determined largely by the emission temperature for the primary X rays, which depends on the weapon yield and design, but the values given here are regarded as being reasonable averages. Because of the

very large volume and mass of air in the X-ray pancake, the temperatures reached in the layer are much lower than those in the fireballs from bursts in the normal atmosphere. Various excited atoms and ions are formed and the radiations of lower energy (longer wavelength) re-emitted by these species represent the thermal radiation observed at a distance.

2.135 For heights of burst up to about 270,000 feet, the early fireball is approximately spherical, although at the higher altitudes it begins to elongate vertically. The weapon debris and the incandescent air heated by the X rays roughly coincide. Above 270,000 feet, however, the debris tends to be separate from the X-ray pancake. The debris can rise to great altitudes, depending on the explosion yield and the burst height; its behavior and ionization effects are described in detail in Chapter X. The incandescent (X-ray pancake) region, on the other hand, remains at an essentially constant altitude regardless of the height of burst. From this region the thermal radiation is emitted as a single pulse containing a substantially smaller proportion of the total explosion energy but of somewhat longer duration than for detonations below roughly 270,000 feet (see § 7.89 *et seq.*).

2.136 Although the energy density in the atmosphere as the result of a high-altitude burst is small compared with that from an air burst of the same yield, a shock wave is ultimately produced by the weapon debris (§ 2.116), at least for bursts up to about 400,000 feet (75 miles) altitude. For example, disturbance of the ionosphere in the vicinity of Hawaii after the TEAK shot (at 252,000 feet altitude) indicated that a

shock wave was being propagated at that time at an average speed of about 4,200 feet per second. The formation of the large red, luminous sphere, several hundred miles in diameter, surrounding the fireball, has been attributed to the electronic excitation of oxygen atoms by the energy of the shock wave. Soon after excitation, the excess energy was emitted as visible radiation toward the red end of the spectrum (6,300 and 6,364 Å).

2.137 For bursts above about 400,000 feet, the earth's magnetic field plays an increasingly important role in controlling weapon debris motion, and it becomes the dominant factor for explosions above 200 miles or so (Chapter X). At these altitudes, the shock waves are probably magnetohydrodynamic (rather than purely hydrodynamic) in character. The amount of primary thermal radiation produced by these shock waves is quite small.

AIR FLUORESCENCE PHENOMENA

2.138 Various transient fluorescent effects, that is, the emission of visible and ultraviolet radiations for very short periods of time, accompany nuclear explosions in the atmosphere and at high altitudes. These effects arise from electronic excitation (and ionization) of atoms and molecules in the air resulting from interactions with high-energy X rays from the fireball, or with gamma rays, neutrons, beta particles, or other charged particles of sufficient energy. The excess energy of the excited atoms, molecules, and ions is then rapidly emitted as fluorescence radiation.

2.139 In a conventional air burst, i.e., at an altitude below about 100,000

feet, the first brief fluorescence that can be detected, within a microsecond or so of the explosion time, is called the "Teller light." The excited particles are produced initially by the prompt (or instantaneous) gamma rays that accompany the fission process and in the later stages by the interaction of fast neutrons with nuclei in the air (§ 8.53).

2.140 For bursts above 100,000 feet, the gamma rays and neutrons tend to be absorbed, with an emission of fluorescence, in a region at an altitude of about 15 miles (80,000 feet), since at higher altitudes the mean free paths in the low-density air are too long for appreciable local absorption (§ 10.29). The fluorescence is emitted over a relatively long period of time because of time-of-flight delays resulting from the distances traveled by the photons and neutrons before they are absorbed. An appreciable fraction of the high-energy X rays escaping from the explosion region are deposited outside the fireball and also produce fluorescence. The relative importance of the X-ray fluorescence increases with the altitude of the burst point.

2.141 High-energy beta particles associated with bursts at sufficiently high altitudes can also cause air fluorescence. For explosions above about 40 miles, the beta particles emitted by the weapon residues in the downward direction are absorbed in the air roughly at this altitude, their outward spread being restricted by the geomagnetic field lines (§ 10.63 *et seq.*). A region of air fluorescence, called a "beta patch," may then be formed. If the burst is at a sufficiently high altitude, the weapon debris ions can themselves produce fluorescence. A fraction of these ions can

be channeled by the geomagnetic field to an altitude of about 70 miles where they are stopped by the atmosphere (§ 10.29) and cause the air to fluoresce. Under suitable conditions, as will be explained below, fluorescence due to beta particles and debris ions can also appear in the atmosphere in the opposite hemisphere of earth to the one in which the nuclear explosion occurred.

AURORAL PHENOMENA

2.142 The auroral phenomena associated with high-altitude explosions (§ 2.62) are caused by the beta particles emitted by the radioactive weapon residues and, to a varying extent, by the debris ions. Interaction of these charged particles with the atmosphere produces excited molecules, atoms, and ions which emit their excess energy in the form of visible radiations characteristic of natural auroras. In this respect, there is a resemblance to the production of the air fluorescence described above. However, auroras are produced by charged particles of lower energy and they persist for a much longer time, namely,

several minutes compared with fractions of a second for air fluorescence. Furthermore, the radiations have somewhat different wavelength characteristics since they are emitted, as a general rule, by a different distribution of excited species.

2.143 The geomagnetic field exerts forces on charged particles, i.e., beta particles (electrons) and debris ions, so that these particles are constrained to travel in helical (spiral) paths along the field lines. Since the earth behaves like a magnetic dipole, and has north and south poles, the field lines reach the earth at two points, called "conjugate points," one north of the magnetic equator and the other south of it. Hence, the charged particles spiraling about the geomagnetic field lines will enter the atmosphere in corresponding conjugate regions. It is in these regions that the auroras may be expected to form (Fig. 2.143).

2.144 For the high-altitude tests conducted in 1958 and 1962 in the vicinity of Johnston Island (§ 2.52), the charged particles entered the atmosphere in the northern hemisphere be-

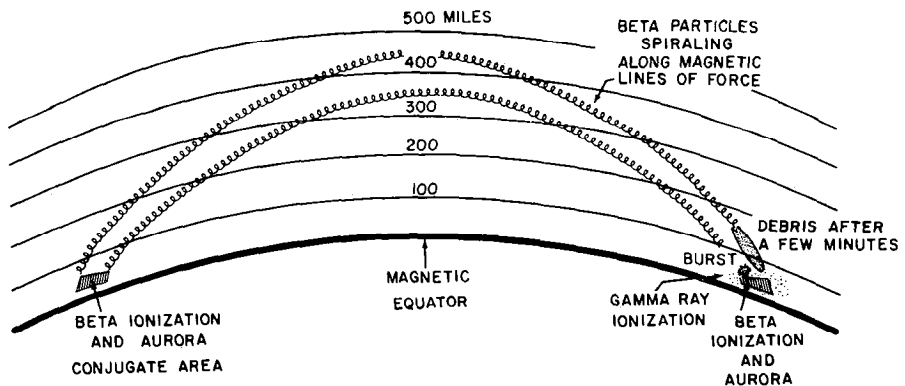

Figure 2.143. Phenomena associated with high-altitude explosions.

tween Johnston Island and the main Hawaiian Islands, whereas the conjugate region in the southern hemisphere was in the vicinity of the Samoan, Fiji, and Tonga Islands. It is in these areas that auroras were actually observed, in addition to those in the areas of the nuclear explosions.

2.145 Because the beta particles have high velocities, the beta auroras in the remote (southern) hemisphere appeared within a fraction of a second of those in the hemisphere where the bursts had occurred. The debris ions, however, travel more slowly and so the debris aurora in the remote hemisphere, if it is formed, appears at a somewhat later time. The beta auroras are generally most intense at an altitude of 30 to 60 miles, whereas the intensity of the debris auroras is greatest in the 60 to 125 miles range. Remote conjugate beta auroras can occur if the detonation is above 25 miles, whereas debris auroras appear only if the detonation altitude is in excess of some 200 miles.

THE ARGUS EFFECT

2.146 For bursts at sufficiently high altitudes, the debris ions, moving along the earth's magnetic field lines, are mostly brought to rest at altitudes of about 70 miles near the conjugate points. There they continue to decay and so act as a stationary source of beta particles which spiral about the geomagnetic lines of force. When the particles enter a region where the strength of the earth's magnetic field increases significantly, as it does in the vicinity of the conjugate points, some of the beta particles are turned back (or reflected). Consequently, they may travel back and

forth, from one conjugate region to the other, a number of times before they are eventually captured in the atmosphere. (More will be said in Chapter X about the interactions of the geomagnetic field with the charged particles and radiations produced by a nuclear explosion.)

2.147 In addition to the motion of the charged particles along the field lines, there is a tendency for them to move across the lines wherever the magnetic field strength is not uniform. This results in an eastward (longitudinal) drift around the earth superimposed on the back-and-forth spiral motion between regions near the conjugate points. Within a few hours after a high-altitude nuclear detonation, the beta particles form a shell completely around the earth. In the ARGUS experiment (§ 2.53), in which the bursts occurred at altitudes of 125 to 300 miles, well-defined shells of about 60 miles thickness, with measurable electron densities, were established and remained for several days. This has become known as the "ARGUS effect." Similar phenomena were observed after the STARFISH PRIME (§ 2.52) and other high-altitude nuclear explosions.

EFFECT ON THE OZONE LAYER

2.148 Ozone (O_3) is formed in the upper atmosphere, mainly in the stratosphere (see Fig. 9.126) in the altitude range of approximately 50,000 to 100,000 feet (roughly 10 to 20 miles), by the action of solar radiation on molecular oxygen (O_2). The accumulation of ozone is limited by its decomposition, partly by the absorption of solar ultraviolet radiation in the wavelength range from about 2,100 to 3,000 Å and

partly by chemical reaction with traces of nitrogen oxides (and other chemical species) present in the atmosphere. The chemical decomposition occurs by way of a complex series of chain reactions whereby small quantities of nitrogen oxides can cause considerable breakdown of the ozone. The equilibrium (or steady-state) concentration of ozone at any time represents a balance between the rates of formation and decomposition; hence, it is significantly dependent on the amount of nitrogen oxides present. Solar radiation is, of course, another determining factor; the normal concentration of ozone varies, consequently, with the latitude, season of the year, time of day, the stage in the solar (sunspot) cycle, and perhaps with other factors not yet defined.

2.149 Although the equilibrium amount in the atmosphere is small, rarely exceeding 10 parts by weight per million parts of air, ozone has an important bearing on life on earth. If it were not for the absorption of much of the solar ultraviolet radiation by the ozone, life as currently known could not exist except possibly in the ocean. A significant reduction in the ozone concentration, e.g., as a result of an increase in the amount of nitrogen oxides, would be expected to cause an increased incidence of skin cancer and to have

adverse effects on plant and animal life.

2.150 As seen in §§ 2.08 and 2.123, nuclear explosions are accompanied by the formation of oxides of nitrogen. An air burst, for example, is estimated to produce about 10^{32} molecules of nitrogen oxides per megaton TNT equivalent. For nuclear explosions of intermediate and moderately high yield in the air or near the surface, the cloud reaches into the altitude range of 50,000 to 100,000 feet (Fig. 2.16); hence, the nitrogen oxides from such explosions would be expected to enhance mechanisms which tend to decrease the ozone concentration. Routine monitoring of the atmosphere during and following periods of major nuclear testing have shown no significant change in the ozone concentration in the sense of marked, long-lasting perturbations. However, the large natural variations in the ozone layer and uncertainties in the measurements do not allow an unambiguous conclusion to be reached. Theoretical calculations indicate that extensive use of nuclear weapons in warfare could cause a substantial decrease in the atmospheric ozone concentration, accompanied by an increase in adverse biological effects due to ultraviolet radiation. The ozone layer should eventually recover, but this might take up to 25 years.

BIBLIOGRAPHY

BAUER, E., and F. R. GILMORE, "The Effect of Atmospheric Nuclear Explosions on Total Ozone," Institute for Defense Analyses, January 1975, Paper P-1076, IDA Log. No. HQ 74-16726.

*BETHE, H. A., *et al.*, "Blast Wave," University of California, Los Alamos Scientific Laboratory, March, 1958, LA-2000.

BOQUIST, W. P., and J. W. SNYDER, "Conjugate Auroral Measurements from the 1962 U.S. High Altitude Nuclear Test Series," in "Aurora and Airglow," B. M. McCormac, Ed., Reinhold Publishing Corp., 1967.

BRICKWEDDE, F. G., "Temperature in Atomic Explosions," in "Temperature, Its Measurement and Control in Science and Industry,"

- Reinhold Publishing Corp., 1955, Vol. II, p. 395.
- BRODE, H. L., "Review of Nuclear Weapons Effects," *Ann Rev. Nuclear Science*, **18**, 153 (1968).
- CHRISTOFILOS, N. C., "The Argus Experiment," *J. Geophys. Res.*, **64**, 869 (1959).
- FOLEY, N. M., and M. A. RUDERMAN, "Stratospheric Nitric Oxide Production from Past Nuclear Explosions and Its Relevance to Projected SST Pollution," Institute for Defense Analyses, August 1972, Paper P-894, IDA Log. No. HQ 72-14452.
- GILMORE, F. R., "The Production of Nitrogen Oxides by Low Altitude Nuclear Explosions," Institute for Defense Analyses, July 1974, Paper P-986, IDA Log. No. HQ 73-15738.
- GLASSTONE, S., "Public Safety and Underground Nuclear Detonations," U.S. Atomic Energy Commission, June 1971, TID-25708.
- HESS, W. N., Ed., "Collected Papers on the Artificial Radiation Belt from the July 9, 1962 Nuclear Detonation," *J. Geophys. Res.*, **68**, 605 *et seq.* (1963).
- *HOERLIN, H., "United States High-Altitude Test Experiences," University of California, Los Alamos Scientific Laboratory, October 1976, LA-6405.
- *JOHNSON, G. W., and C. E. VIOLET, "Phenomenology of Contained Nuclear Explosions," University of California, Lawrence Radiation Laboratory, Livermore, December 1958, UCRL 5124 Rev. 1.
- *JOHNSON, G. W., *et al.*, "Underground Nuclear Detonations," University of California, Lawrence Radiation Laboratory, Livermore, July 1959, UCRL 5626.
- MATSUSHITA, S., "On Artificial Geomagnetic and Ionospheric Storms Associated with High Altitude Explosions," *J. Geophys. Res.*, **64**, 1149 (1959).
- NELSON, D. B., "EMP Impact on U.S. Defense," *Survive*, 2, No. 6, 2 (1969).
- *"Proceedings of the Third Plowshare Symposium, Engineering with Nuclear Explosives," April 1966, University of California, Lawrence Radiation Laboratory, Livermore, TID-695.
- "Proceedings of the Symposium on Engineering with Nuclear Explosives," Las Vegas, Nevada, January 1970, American Nuclear Society and U.S. Atomic Energy Commission, CONF-700101, Vols. 1 and 2.
- "Proceedings for the Symposium on Public Health Aspects of Peaceful Uses of Nuclear Explosives," Las Vegas, Nevada, April 1969, Southwestern Radiological Health Laboratory, SWRHL-82.
- "Proceedings of the Special Session on Nuclear Excavation," *Nuclear Applications and Technology*, 7, 188 *et seq.* (1969).
- SNAY, H. G., and R. C. TIPTON, "Charts for the Parameters of Migrating Explosion Bubbles," U.S. Naval Ordnance Laboratory, 1962, NOLTR 62-184.
- STEIGER, W. R., and S. MATSUSHITA, "Photographs of the High Altitude Nuclear Explosion TEAK," *J. Geophys. Res.*, **65**, 545 (1960).
- STRANGE, J. N., and L. MILLER, "Blast Phenomena from Explosions and an Air-Water Interface," U.S. Army Engineer Waterways Experiment Station, 1966, Report 1, Misc. Paper 1-814.
- TELLER, E., *et al.*, "The Constructive Uses of Nuclear Explosives," McGraw-Hill Book Company, 1968.
- VAN DORN, W. G., B. LE MÉHAUTÉ, and L. HWANG, "Handbook of Explosion-Generated Water Waves, Vol. I—State of the Art," Tetra Tech, Inc., Pasadena, California, October 1968, Report No. TC-130.

CHAPTER III

AIR BLAST PHENOMENA IN AIR AND SURFACE BURSTS

CHARACTERISTICS OF THE BLAST WAVE IN AIR

DEVELOPMENT OF THE BLAST WAVE

3.01 Most of the material damage caused by a nuclear explosion at the surface or at a low or moderate altitude in the air is due—directly or indirectly—to the shock (or blast) wave which accompanies the explosion. Many structures will suffer some damage from air blast when the overpressure in the blast wave, i.e., the excess over the atmospheric pressure (14.7 pounds per square inch at standard sea level conditions), is about one-half pound per square inch or more. The distance to which this overpressure level will extend depends primarily on the energy yield (§ 1.20) of the explosion, and on the height of the burst. It is consequently desirable to consider in some detail the phenomena associated with the passage of a blast wave through the air.

3.02 A difference in the air pressure acting on separate surfaces of a structure produces a force on the structure. In considering the destructive effect of a blast wave, one of its important characteristics is the overpressure. The varia-

tion in the overpressure with time and distance will be described in succeeding sections. The maximum value, i.e., at the blast wave (or shock) front, is called the “peak overpressure.” Other characteristics of the blast wave, such as dynamic pressure, duration, and time of arrival will also be discussed.

3.03 As stated in Chapter II, the expansion of the intensely hot gases at extremely high pressures in the fireball causes a shock wave to form, moving outward at high velocity. The main characteristic of this wave is that the pressure rises very sharply at the moving front and falls off toward the interior region of the explosion. In the very early stages, for example, the variation of the pressure with distance from the center of the fireball, at a given instant, is somewhat as illustrated in Fig. 3.03 for an ideal (instantaneously rising) shock front. It is seen that, prior to breakaway (§ 2.120), pressures at the shock front are two or three times as large as the already very high pressures in the interior of the fireball.

3.04 As the blast wave travels in the air away from its source, the overpressure at the front steadily decreases, and

the pressure behind the front falls off in a regular manner. After a short time, when the shock front has traveled a certain distance from the fireball, the pressure behind the front drops below that of the surrounding atmosphere and

a so-called "negative phase" of the blast wave forms. This development is seen in Fig. 3.04, which shows the overpressures at six successive times, indicated by the numbers 1, 2, 3, 4, 5, and 6. In the curves marked t_1 through t_5

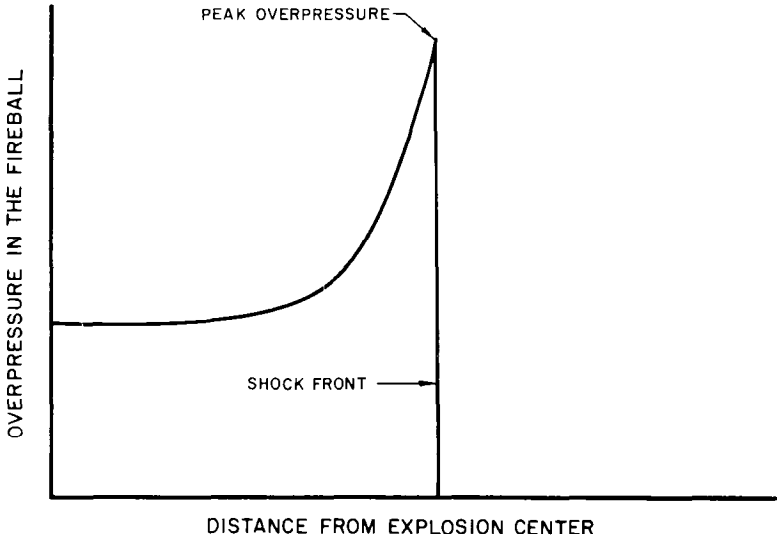

Figure 3.03. Variation of overpressure with distance in the fireball.

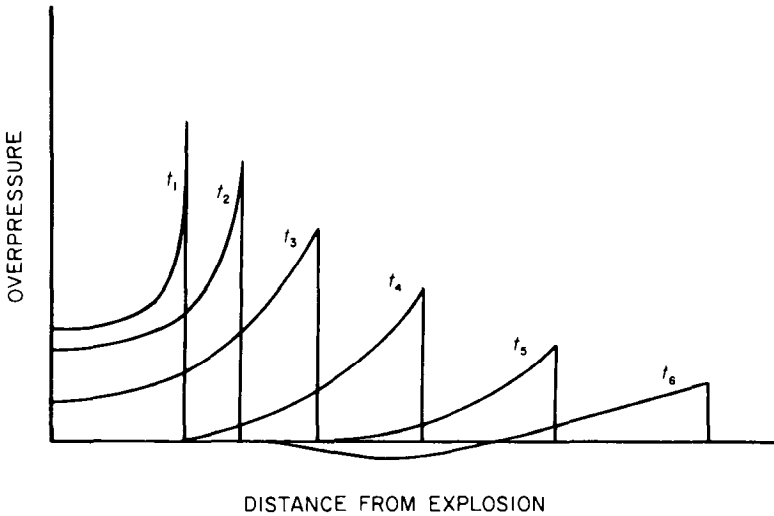

Figure 3.04. Variation of overpressure in air with distance at successive times.

the pressure in the blast wave has not fallen below atmospheric, but in the curve marked t_0 it is seen that at some distance behind the shock front the overpressure has a negative value. In this region the air pressure is below that of the original (or ambient) atmosphere, so that an "underpressure" rather than an overpressure exists.

3.05 During the negative (rarefaction or suction) phase, a partial vacuum is produced and the air is sucked in, instead of being pushed away from the explosion as it is when the overpressure is positive. At the end of the negative phase, which is somewhat longer than the positive phase, the pressure has essentially returned to ambient. The peak (or maximum) values of the underpressure are usually small compared with the peak positive overpressures; the former are generally not more than about 4 pounds per square inch below the ambient pressure whereas the positive overpressure may be much larger. With increasing distance from the explosion, both peak values decrease, the positive more rapidly than the negative,

and they approach equality when the peak pressures have decayed to a very low level.

THE DYNAMIC PRESSURE

3.06 The destructive effects of the blast wave are frequently related to values of the peak overpressure, but there is another important quantity called the "dynamic pressure." For a great variety of building types, the degree of blast damage depends largely on the drag force associated with the strong winds accompanying the passage of the blast wave. The drag force is influenced by certain characteristics—primarily the shape and size—of the structure, but this force also depends on the peak value of the dynamic pressure and its duration at a given location.

3.07 The dynamic pressure is proportional to the square of the wind velocity and to the density of the air behind the shock front. Both of these quantities may be related to the overpressure under ideal conditions at the wave front by certain equations, which will be given later (see § 3.55). For very

Table 3.07

PEAK OVERPRESSURE AND DYNAMIC PRESSURE AND MAXIMUM WIND VELOCITY IN AIR AT SEA LEVEL CALCULATED FOR AN IDEAL SHOCK FRONT

Peak overpressure (pounds per square inch)	Peak dynamic pressure (pounds per square inch)	Maximum wind velocity (miles per hour)
200	330	2,078
150	222	1,777
100	123	1,415
72	74	1,168
50	41	934
30	17	669
20	8.1	502
10	2.2	294
5	0.6	163
2	0.1	70

strong shocks the peak dynamic pressure is larger than the peak overpressure, but below 70 pounds per square inch overpressure at sea level the dynamic pressure is the smaller. Like the peak shock overpressure, the peak dynamic pressure generally decreases with increasing distance from the explosion center, although at a different rate. Some peak dynamic pressures and maximum blast wind velocities corresponding to various peak overpressures, as calculated for an ideal shock front in air at sea level (§ 3.53 *et seq.*) are given in Table 3.07. The results are based on 1,116 feet per second (761 miles per hour) as the velocity of sound in air (see Table 3.66).

3.08 The winds referred to above, which determine the dynamic pressure in the shock wave, are a direct consequence of the air blast. More will be said about these winds shortly. There are also other winds associated with nuclear explosions. These include the afterwinds mentioned in § 2.09, and the firestorms which will be described in Chapter VII.

CHANGES IN THE BLAST WAVE WITH TIME

3.09 From the practical standpoint, it is of interest to examine the changes of overpressure and dynamic pressure with time at a fixed location (or observation point). For a short interval after the detonation, there will be no change in the ambient pressure because it takes some time for the blast wave to travel from the point of the explosion to the given location. This time interval (or arrival time) depends upon the energy yield of the explosion and the slant

range. For example, at a distance of 1 mile from a 20-kiloton explosion in the air the arrival time would be about 3 seconds, whereas at 2 miles it would be about 7.5 seconds. The corresponding times for a 1-megaton burst would be roughly 1.4 and 4.5 seconds, respectively.

3.10 It is evident that the blast wave from an explosion of higher yield will arrive at a given point sooner than one for a lower yield. The higher the overpressure at the shock front, the greater is the velocity of the shock wave (see Figure. 3.55). Initially, this velocity may be quite high, several times the speed of sound in air (about 1,100 feet per second at sea level). As the blast wave progresses outward, the pressure at the front decreases and the velocity falls off accordingly. At long ranges, when the overpressure has decreased to less than about 1 pound per square inch, the velocity of the blast wave approaches the ambient speed of sound.

3.11 When the (ideal) shock front arrives at the observation point, the overpressure will increase sharply from zero to its maximum (or peak) value. Subsequently the overpressure decreases, as indicated by the upper curve in Fig. 3.11. The overpressure drops to zero in a short time, and this marks the end of the positive (or compression) phase of the overpressure at the given location. The duration of the overpressure positive phase increases with the energy yield and the distance from the explosion. For a 20-kiloton air burst, for example, this phase lasts roughly 1 second to 1.4 seconds at slant ranges of 1 to 2 miles; for a 1-megaton explosion, the respective durations would be approximately 1.4 to 2.3 seconds.

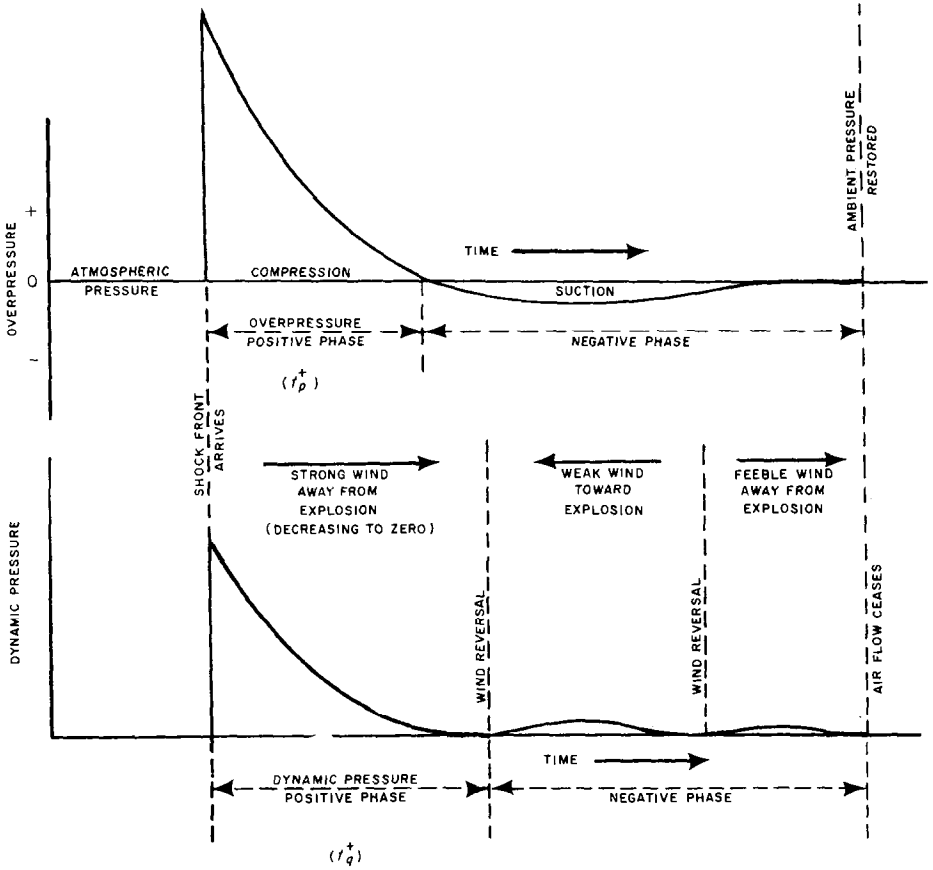

Figure 3.11. Variation of overpressure and dynamic pressure with time at a fixed location.

3.12 Provided the observation point is at a sufficient distance from the explosion, the overpressure will continue to decrease after it falls to zero so that it becomes negative. During this negative (or suction) phase, the pressure in the shock wave is less than the ambient atmospheric pressure. However, as seen in § 3.05, the underpressure is never very large. After decreasing gradually to a minimum value, the pressure starts to increase until it becomes equal to the normal atmospheric pressure, and the overpressure is zero again. The negative phase of the blast wave is usually longer

than the positive phase and it may last for several seconds. When this phase is ended, the blast wave will have passed the given observation point.

3.13 Changes in the wind and in the associated dynamic pressure accompany the changes with time of the overpressure. With the arrival of the shock front at a given location, a strong wind commences, blowing away from the explosion point. This blast wind is often referred to as a “transient wind” because its velocity decreases rapidly with time. The maximum velocity of the transient wind can be quite high, as indicated by

the values corresponding to various peak overpressures given in Table 3.07. The wind velocity decreases as the overpressure decreases, but it continues to blow for a time after the end of the positive overpressure phase (see Fig. 3.11). The reason is that the momentum of the air in motion behind the shock front keeps the wind blowing in the same direction even after the overpressure has dropped to zero and has started to become negative.

3.14 Since the dynamic pressure is related to the square of the wind velocity, the changes in the dynamic pressure with time will correspond to the changes in the wind just described. The dynamic pressure increases suddenly when the (ideal) shock front arrives at the observation point. Then it decreases, but drops to zero some time later than the overpressure, as shown by the lower curve in Fig. 3.11. The dynamic pressure positive phase is thus longer than the overpressure positive phase. The ratio of the dynamic pressure and overpressure positive phase durations depends on the pressure levels involved. When the peak pressures are high, the positive phase of the dynamic pressure may be more than twice as long as for the overpressure. At low peak pressures, on the other hand, the difference is only a few percent.

3.15 As a general rule, the peak overpressure and the peak dynamic pressure behind the shock front are quite different (see Table 3.07). Furthermore, the dynamic pressure takes somewhat longer than the overpressure to drop to zero during the positive phase. Consequently, it is evident that the overpressure and dynamic pressure at a given location change at different rates with

time. This matter will be discussed more fully later in this chapter (§ 3.57 *et seq.*).

3.16 By the time the wind ceases blowing away from the explosion, the overpressure is definitely negative (see Fig. 3.11); that is to say, the pressure in the blast wave is less than the ambient atmospheric pressure. Hence, air is drawn in from outside and, as a result, the wind starts to blow in the opposite direction, i.e., toward the explosion, but with a relatively small velocity. A short time after the overpressure minimum is passed, the wind again reverses direction and blows, once more, away from the explosion point. The feeble wind apparently results from expansion of the air due to an increase of temperature that occur at this stage.

3.17 The changes in the dynamic pressure corresponding to the foregoing wind changes after the end of the dynamic pressure positive phase are indicated in Fig. 3.11. The dynamic pressure finally decreases to zero when the ambient atmospheric pressure is restored and the blast wave has passed the observation point.

3.18 It should be noted that the dynamic pressure remains positive (or zero) even when the overpressure is negative. Since the overpressure is the difference between the actual blast wave pressure and the ambient atmospheric pressure, a negative overpressure merely implies that the actual pressure is less than the atmospheric pressure. The dynamic pressure, on the other hand, is an actual pressure without reference to any other pressure. It is a measure of the kinetic energy, i.e., energy of motion, of a certain volume of air behind the shock front (§ 3.55). The dynamic

pressure is consequently positive if the air is moving or zero if it is not; the direction in which the pressure acts depends on the direction of motion, i.e., the wind direction (see Fig. 3.11).

3.19 Nearly all the direct damage caused by both overpressure and dynamic pressure occurs during the positive overpressure phase of the blast wave. Although the dynamic pressure persists for a longer time, its magnitude during this additional time is usually so low that the destructive effects are not very significant. The damage referred to here is that caused directly by the blast wave. This will be largely terminated by the end of the overpressure positive phase, but the indirect destructive ef-

fects, e.g., due to fire (see Chapter VII), may continue long after the blast wave has passed.

3.20 There may be some direct damage to structures during the negative phase of the overpressure; for example, large windows which are poorly held against outward motion, brick veneer, and plaster walls may be dislodged by trapped air at normal pressure. But the maximum underpressure (and corresponding dynamic pressure) is generally quite small in comparison with the peak pressures at the shock front; hence, there is usually much less direct damage in the negative than in the positive overpressure phase of the blast wave.

REFLECTION OF BLAST WAVE AT A SURFACE

INCIDENT AND REFLECTED WAVES

3.21 When the incident blast wave from an explosion in air strikes a more dense medium such as the earth's surface, e.g., either land or water, it is reflected. The formation of the reflected wave in these circumstances is represented in Fig. 3.21. This figure shows four stages in the outward motion of the spherical blast wave originating from an air burst. In the first stage the wave front has not reached the ground; the second stage is somewhat later in time, and in the third stage, which is still later, a reflected wave, indicated by the dashed line, has been produced.

3.22 When such reflection occurs, an individual or object precisely at the

surface will experience a single pressure increase, since the reflected wave is formed instantaneously. Consequently, the overpressure at the surface is generally considered to be entirely a reflected pressure. For a smooth (or ideal) surface, the total reflected overpressure in the region near ground zero will be more than twice the value of the peak overpressure of the incident blast wave. The exact value of the peak reflected pressure will depend on the strength of the incident wave (§ 3.56) and the angle at which it strikes the surface (§ 3.78). The nature of the surface also has an important effect (§ 3.47), but for the present the surface is assumed to be smooth so that it acts as an ideal reflector. The variation in overpressure with time, as observed at a point actually on

the surface not too far from ground zero,¹ such as A in Fig. 3.21, is depicted in Fig. 3.22 for an ideal shock front. The point A may be considered as lying

within the region of "regular" reflection, i.e., where the incident and reflected waves do not merge except on the surface.

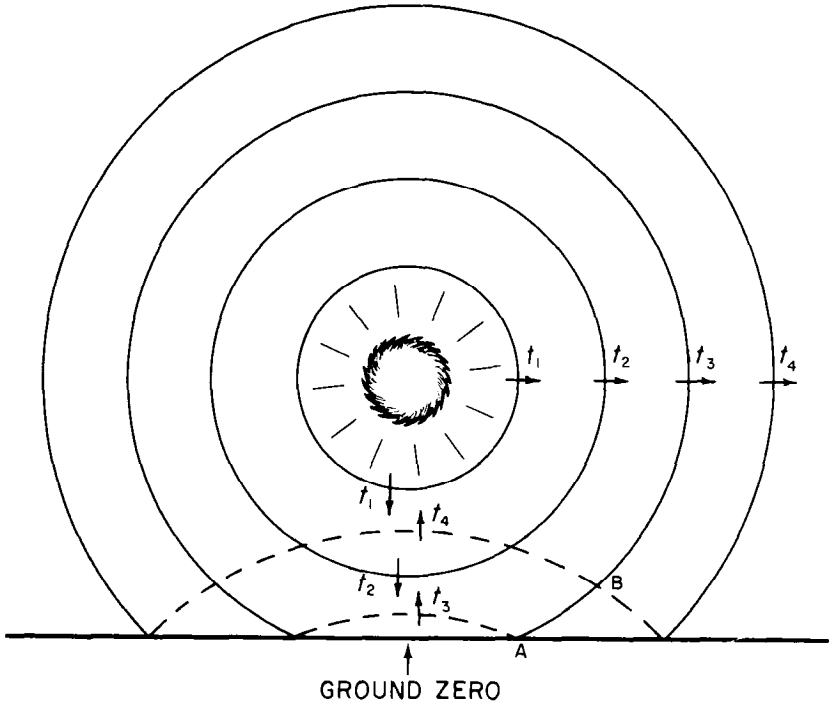

Figure 3.21. Reflection of blast wave at the earth's surface in an air burst; t_1 to t_4 represent successive times.

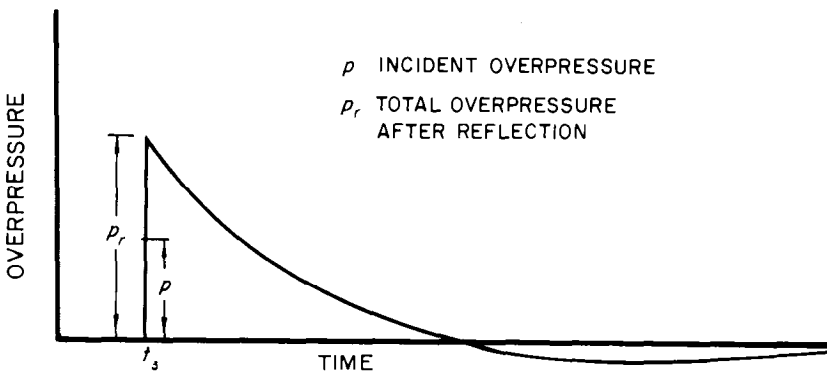

Figure 3.22. Variation of overpressure with time at a point on the surface in the region of regular reflection.

¹For an explanation of the term "ground zero," see § 2.34.

3.23 At any location somewhat above the surface in this region, two separate shocks will be felt, the first being due to the incident blast wave and the second to the reflected wave, which arrives a short time later (Fig. 3.23). This situation can be illustrated by considering the point B in Fig. 3.21, also in the regular reflection region. When the incident wave front reaches this point, at time t_3 , the reflected wave is still some distance away. There will, consequently, be a short interval before the reflected wave reaches the point above the surface at time t_4 . Between t_3 and t_4 , the reflected wave has spread out to some extent, so that its peak overpressure will be less than the value obtained at surface level. In determining the effects of air blast on structures in the regular reflection region, it may be necessary to consider the magnitude and also the directions of motion of both the incident and reflected waves. After passage of the reflected wave, the transient wind direction near the surface becomes essentially horizontal.

3.24 The following discussion concerning the delay between the arrival of the incident and reflected wave fronts at

a point above the surface, such as B in Fig. 3.21, is based on the tacit assumption that the two waves travel with approximately equal velocities. This assumption is reasonably justified in the early stages, when the wave front is not far from ground zero. However, it will be evident that the reflected wave always travels through air that has been heated and compressed by the passage of the incident wave. As a result, the reflected wave front moves faster than the incident wave and, under certain conditions, eventually overtakes it so that the two wave fronts merge to produce a single front. This process of wave interaction is called "Mach" or "irregular" reflection. The region in which the two waves have merged is therefore called the Mach (or irregular) region in contrast to the regular region where they have not merged.

3.25 The merging of the incident and reflected waves is indicated schematically in Fig. 3.25, which shows a portion of the profile of the blast wave close to the surface. The situation at a point fairly close to ground zero, such as A in Fig. 3.21, is represented in Fig. 3.25a. At a later stage, farther from

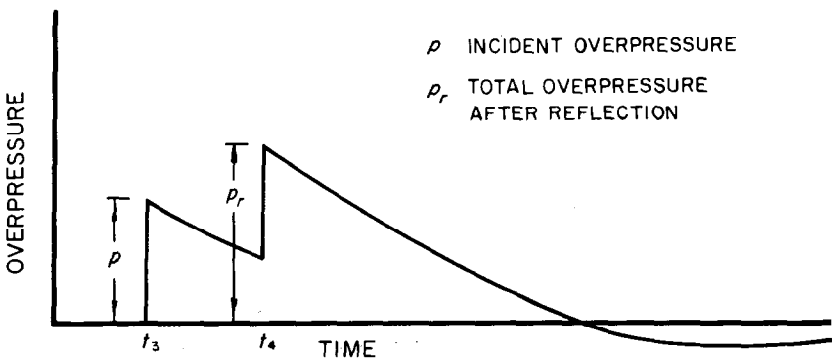

Figure 3.23. Variation of overpressure with time at a point above the surface in the region of regular reflection.

ground zero, as in Fig. 3.25b, the steeper front of the reflected wave shows that it is traveling faster than, and is overtaking, the incident wave. At the stage represented by Fig. 3.25c, the reflected wave near the ground has overtaken and merged with the incident wave to form a single front called the "Mach stem." The point at which the incident wave, reflected wave, and Mach fronts meet is referred to as the "triple point."² The configuration of

the three shock fronts has been called the "Mach Y."

3.26 As the reflected wave continues to overtake the incident wave, the triple point rises and the height of the Mach stem increases (Fig. 3.26). Any object located either at or above the ground, within the Mach region and below the triple point path, will experience a single shock. The behavior of this merged (or Mach) wave is the same as that previously described for blast

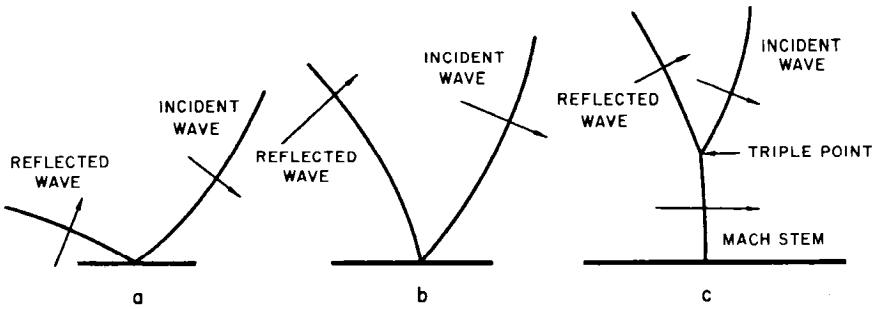

Figure 3.25. Merging of incident and reflected waves and formation of Mach Y configuration of shock fronts.

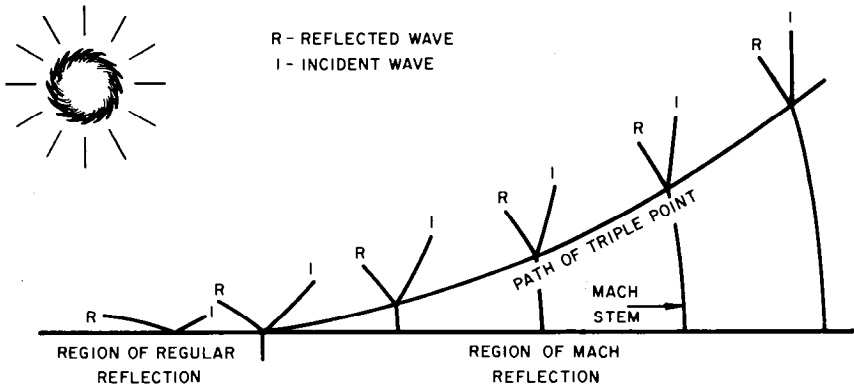

Figure 3.26. Outward motion of the blast wave near the surface in the Mach region.

²At any instant the so-called "triple point" is not really a point, but a horizontal circle with its center on the vertical line through the burst point; it appears as a point on a sectional (or profile) drawing, such as Fig. 3.25c.

waves in general. The overpressure at a particular location will fall off with time and the positive (compression) phase will be followed by a negative (suction) phase in the usual manner.

3.27 At points in the air above the triple point path, such as at an aircraft or at the top of a high building, two pressure increases will be felt. The first will be due to the incident blast wave and the second, a short time later, to the reflected wave. When a weapon is detonated at the surface, i.e., in a contact surface burst (§ 2.127 footnote), only a single merged wave develops. Consequently, only one pressure increase will be observed either on or above the ground.

3.28 As far as the destructive action of the air blast is concerned, there are at least two important aspects of the reflection process to which attention should be drawn. First, only a single pressure increase is experienced in the Mach region below the triple point as compared to the separate incident and reflected waves in the region of regular reflection. Second, since the Mach stem is nearly vertical, the accompanying blast wave is traveling in a horizontal direction at the surface, and the transient winds are approximately parallel to the ground (Fig. 3.25). Thus, in the Mach region, the blast forces on aboveground structures and other objects are directed nearly horizontally, so that vertical surfaces are loaded more intensely than horizontal surfaces.

3.29 The distance from ground zero at which the Mach stem begins to form depends primarily upon the yield of the detonation and the height of the burst above the ground. Provided the height of burst is not too great, the Mach stem forms at increasing distances from

ground zero as the height of burst increases for a given yield, and also as the yield decreases at a specified height of burst. For moderate heights of burst, Mach merging of direct and reflected waves occurs at a distance from ground zero approximately equal to the burst height. As the height of burst is increased, the distance from ground zero at which the Mach effect commences exceeds the burst height by larger and larger amounts.

HEIGHT OF BURST AND BLAST DAMAGE

3.30 The height of burst and energy yield of the nuclear explosion are important factors in determining the extent of damage at the surface. These two quantities generally define the variation of pressure with distance from ground zero and other associated blast wave characteristics, such as the distance from ground zero at which the Mach stem begins to form. As the height of burst for an explosion of given energy yield is decreased, or as the energy yield for a given height of burst increases, the consequences are as follows: (1) Mach reflection commences nearer to ground zero, and (2) the overpressure at the surface near ground zero becomes larger. An actual contact surface burst leads to the highest possible overpressures near ground zero. In addition, cratering and ground shock phenomena are observed, as will be described in Chapter VI.

3.31 Because of the relation between height of burst and energy of the explosion, the air blast phenomena to be expected on the ground from a weapon of large yield detonated at a height of a few thousand feet will approach those of

a near surface burst. On the other hand, explosions of weapons of smaller energy yields at these same or even lower levels will have the characteristics of air bursts. A typical example of the latter situation is found in the nuclear explosion which occurred over Nagasaki, Japan, in World War II when a weapon having a yield of approximately 22 kilotons of TNT equivalent was detonated at a height of about 1,640 feet. By means of certain rules, called "scaling laws," which are described in the technical section of this chapter (§ 3.60 *et seq.*), it is found that to produce similar blast phenomena at ground distances proportional to the heights of burst, for a 1-kiloton weapon the height of burst would have to be roughly 585 feet and for a 1-megaton explosion about 5,850 feet. In these three cases, the Mach stem formation would occur at distances from ground zero that are not very different from the respective heights of burst.

3.32 It should be noted that there is no single optimum height of burst, with regard to blast effects, for any specified explosion yield because the chosen burst height will be determined by the nature of the target. As a rule, strong (or hard) targets will require the equivalent of a low air burst or a surface burst. For weaker targets, which are destroyed or damaged at relatively low overpressures or dynamic pressures, the height of burst may be raised to increase the damage areas, since the required pressures will extend to a larger range than for a low air or surface burst.

3.33 The variation of blast characteristics with distance from ground zero for air bursts occurring at different heights are most conveniently represented by what are called "height of

burst" curves. Such curves have been prepared for various blast wave properties, e.g., peak overpressure, peak dynamic pressure, time of arrival, and positive phase duration, and will be presented and discussed later (§ 3.69 *et seq.*). Values of these (and other) properties can be determined from the curves, by application of appropriate scaling factors, for any explosion yield and height of burst.

CONTACT SURFACE BURST

3.34 The general air blast phenomena resulting from a contact surface burst are somewhat different from those for an air burst as described above. In a surface explosion the incident and reflected shock waves merge instantly, as seen in § 3.27, and there is no region of regular reflection. All objects and structures on the surface, even close to ground zero, are thus subjected to air blast similar to that in the Mach region below the triple point for an air burst. For an ideal (absolutely rigid) reflecting surface the shock wave characteristics, i.e., overpressure, dynamic pressure, etc., at the shock front would correspond to that for a "free air" burst, i.e., in the absence of a surface, with twice the energy yield. Behind the front, the various pressures would decay in the same manner as for an air burst. Because of the immediate merging of the incident and reflected air blast waves, there is a single shock front which is hemispherical in form, as shown at successive times, t_1 through t_4 , in Figure 3.34. Near the surface, the wave front is essentially vertical and the transient winds behind the front will blow in a horizontal direction.

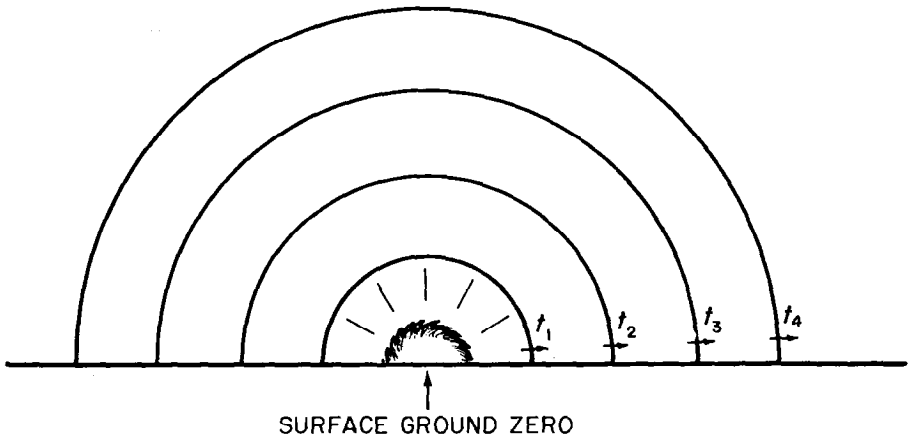

Figure 3.34. Blast wave from a contact surface burst; incident and reflected waves coincide.

MODIFICATION OF AIR BLAST PHENOMENA

TERRAIN EFFECTS

3.35 Large hilly land masses tend to increase air blast effects in some areas and to decrease them in others. The change in peak overpressure appears to depend on the slope angle and on the actual value of the pressure. The increase (or "spike") in peak overpressure which occurs at the base of a hill is attributable to the reflection of the blast wave by the front slope. This spike tends to broaden or lengthen with time as the wave travels up the hill. However, a reduction in peak overpressure occurs as the blast wave moves over the crest and down the back slope. The pressure at the wave front does not rise instantaneously, as in an ideal shock wave (see Fig. 3.11), but somewhat more gradually, although the behavior soon becomes normal as the blast wave proceeds down the hill. In general, the

variation in peak overpressure at any point on a hill from that expected if the hill were not present depends on the dimensions of the hill with respect to the energy yield and location of the explosion. Since the time interval in which the pressure increase or decrease occurs is short compared to the length of the positive phase, the effects of terrain on the blast wave are not expected to be significant for a large variety of structural types.

3.36 It is important to emphasize, in particular, that shielding from blast effects behind the brow of a large hill is not dependent upon line-of-sight considerations. In other words, the fact that the point of the explosion cannot be seen from behind the hill by no means implies that the blast effects will not be felt. It will be shown in Chapter IV that blast waves can easily bend (or diffract) around apparent obstructions.

3.37 Although prominent terrain features may shield a particular target from thermal radiation, and perhaps also to some extent from the initial nuclear radiation, little reduction in blast damage to structures may be expected, except in very special circumstances. Nevertheless, considerable protection from debris and other missiles (§ 3.50) and drag forces may be achieved for such movable objects as heavy construction equipment by placing them below the surface of the ground in open excavations or deep trenches or behind steep earth mounds.

3.38 The departure from idealized or flat terrain presented by a city complex may be considered as an aspect of topography. It is to be expected that the presence of many buildings close together will cause local changes in the blast wave, especially in the dynamic pressure. Some shielding may result from intervening objects and structures; however, in other areas multiple reflections between buildings and the channeling caused by streets may increase the overpressure and dynamic pressure.

METEOROLOGICAL CONDITIONS

3.39 The presence of large amounts of moisture in the atmosphere may affect the properties of a blast wave in the low overpressure region. But the probability of encountering significant concentrations of atmospheric liquid water that would influence damage is considered to be small. Meteorological conditions, however, can sometimes either enlarge or contract the area over which light structural damage would normally be expected. For example, window breakage and noise have been experi-

enced hundreds of miles from the burst point. Such phenomena, which have been observed with large TNT detonations as well as with nuclear explosions, are caused by the bending back to the earth of the blast wave by the atmosphere.

3.40 Four general conditions which can lead to this effect are known. The first is a temperature "inversion" near the earth's surface. Normally, the air temperature in the lower atmosphere (troposphere) decreases with increasing altitude in the daytime. In some cases, however, the temperature near the surface increases instead of decreasing with altitude; this is called a temperature inversion. It can arise either from nighttime cooling of the ground surface by the radiation of heat or from a mass of warm air moving over a relatively cold surface. The result of an inversion is that the overpressure on the ground at a distance from the explosion may be higher than would otherwise be expected. Conversely, when unstable conditions prevail, and the temperature near the earth's surface decreases rapidly with altitude, as in the afternoon or in tropical climates, the blast wave is bent away from the ground. The overpressure then decays with distance faster than expected.

3.41 The second situation exists when there are high-speed winds aloft. If the normal decrease in the temperature of the air with increasing altitude is combined with an upper wind whose speed exceeds 3 miles per hour for each 1,000 feet of altitude, the blast wave will be refracted (or bent) back to the ground. This usually occurs with jet-stream winds, where maximum velocities are found between 25,000- and

50,000-foot altitudes. These conditions may cause several "rays" to converge into a sharp focus at one location on the ground, and the concentration of blast energy there will greatly exceed the value that would otherwise occur at that distance. The first (or direct striking) focus from a jet stream duct may be at 20 to 50 miles from the explosion. Since the blast energy is reflected from the ground and is again bent back by the atmosphere, the focus may be repeated at regularly spaced distances. In an explosion of a 20-kiloton weapon in the air at the Nevada Test Site, this effect caused windows to break 75 to 100 miles away.

3.42 Bending of blast waves in the downwind direction can also be produced by a layer of relatively warm air at a height of 20 to 30 miles in the lower mesosphere (see Fig. 9.126). In these levels winds blow from the west in winter and from east in summer, enhancing blast pressures and noise at downwind distances from 70 to 150 miles (first direct strike). Reflections from the ground, and subsequent refractions by the lower mesosphere, cause the usual repeat focus pattern. Focusing of this type has resulted in the breakage of windows on the second ground strike at 285 miles downwind from a 17-kiloton nuclear air burst. Large explosions have been distinctly heard at even greater distances.³

3.43 The fourth condition is brought about by the very high temperatures in the thermosphere, the region of the atmosphere above an altitude of about 60 miles (Fig. 9.126). Blast waves are ducted in the thermosphere so

that they reach the ground at distances beyond 100 miles from the burst, generally in the opposite direction from the principal mesospheric signals, i.e., in the upwind direction. Most of the blast wave energy is absorbed in the low-density air at high altitudes, and no structural damage has been reported from thermospheric ducting. However, sharp pops and crackles have been heard when the waves from large explosions reach the ground.

EFFECT OF ALTITUDE

3.44 The relations between overpressure, distance, and time that describe the propagation of a blast wave in air depend upon the ambient atmospheric conditions, and these vary with the altitude. In reviewing the effects of elevation on blast phenomena, two cases will be considered; one in which the point of burst and the target are essentially at the same altitude, but not necessarily at sea level, and the second, when the burst and target are at different altitudes.

3.45 For an air burst, the peak overpressure at a given distance from the explosion will depend on the ambient atmospheric pressure and this will vary with the burst altitude. There are a number of simple correction factors, which will be given later (§ 3.65 *et seq.*), that can be used to allow for differences in the ambient conditions, but for the present it will be sufficient to state the general conclusions. With increasing altitude of both target and burst point, the overpressure at a given distance from an explosion of specified

³The situations described here and in § 3.43 could also be considered as temperature inversions.

yield will generally decrease. Correspondingly, an increase may usually be expected in both the arrival time of the shock front and in the duration of the positive phase of the blast wave. For elevations of less than 5,000 feet or so above sea level, the changes are small, and since most surface targets are at lower altitudes, it is rarely necessary to make the corrections.

3.46 The effect when the burst and target are at different elevations, such as for a high air burst, is somewhat more complex. Since the blast wave is influenced by changes in air temperature and pressure in the atmosphere through which it travels, some variations in the pressure-distance relationship at the surface might be expected. Within the range of significant damaging overpressures, these differences are small for weapons of low energy yield. For weapons of high yield, where the blast wave travels over appreciably longer distances, local variations, such as temperature inversions and refraction, may be expected. Consequently, a detailed knowledge of the atmosphere on a particular day would be necessary in order to make precise calculations. For planning purposes, however, when the target is at an appreciable elevation above sea level the ambient conditions at the target altitude are used to evaluate the correction factors referred to above.

SURFACE EFFECTS

3.47 For a given height of burst and explosion energy yield, some variation in blast wave characteristics may be expected over different surfaces. These variations are determined primarily by the type and extent of the surface over

which the blast wave passes. In considering the effects of the surface, a distinction is made between ideal (or nearly ideal) and nonideal surface conditions. An "ideal" surface is defined as a perfectly flat surface that reflects all (and absorbs none) of the energy, both thermal (heat) and blast, that strikes it. No area of the earth's surface is ideal in this sense, but some surfaces behave almost like ideal surfaces and they are classified as "nearly ideal." For an ideal (or nearly ideal) surface the properties of the blast wave are essentially free of mechanical and thermal effects. If the surface is such that these effects are significant, it is said to be "nonideal."

3.48 The terrain phenomena described in § 3.35 *et seq.* are examples of mechanical factors that can change the characteristics of the blast wave. In general, the nature of the reflecting surface can affect the peak overpressure and the formation and growth of the Mach stem. Absorption of some of the blast energy in the ground, which will be considered in § 3.51, is to be regarded as another type of mechanical effect on the blast wave due to a nonideal surface.

3.49 Many surfaces, especially when the explosion can raise a cloud of dust, are nonideal because they absorb substantial amounts of heat energy. In these circumstances, the properties of the blast wave may be modified by the formation of an auxiliary wave, called a "precursor," that precedes the main incident wave. The characteristics of the blast wave will then be quite different from those that would be observed on an ideal (or nearly ideal) surface. Precursor phenomena, which are complex, are discussed more fully in § 3.79 *et seq.*

3.50 Somewhat related to the condition of the surface are the effects of objects and material picked up by the blast wave. Damage may be caused by missiles such as rocks, boulders, and pebbles, as well as by smaller particles such as sand and dust. This particulate matter carried along by the blast wave does not necessarily affect the overpressures at the shock front. In dusty areas, however, the blast wave may pick up enough dust to increase the dynamic pressure over the values corresponding to the overpressure in an ideal blast wave. There may also be an increase in the velocity of air particles in the wave due to precursor action. Consequently, the effect on structures which are damaged mainly by dynamic pressure will be correspondingly increased, especially in regions where the precursor is strong.

GROUND SHOCK FROM AIR BLAST

3.51 Another aspect of the blast wave problem is the possible effect of an air burst on underground structures as a result of the transfer of some of the blast wave energy into the ground. A minor oscillation of the surface is experienced and a ground shock is produced. The strength of this shock at any point is determined by the overpressure in the

blast wave immediately above it. For large overpressures with long positive-phase duration, the shock will penetrate some distance into the ground, but blast waves which are weaker and of shorter duration are attenuated more rapidly. The major principal stress in the soil will be nearly vertical and about equal in magnitude to the air blast overpressure. These matters will be treated in more detail in Chapter VI.

3.52 For a high air burst, the blast overpressures are expected to be relatively small at ground level; the effects of ground shock induced by air blast will then be negligible. But if the overpressure at the surface is large, there may be damage to buried structures. However, even if the structure is strong enough to withstand the effect of the ground shock, the sharp jolt resulting from the impact of the shock wave can cause injury to occupants and damage to loose equipment. In areas where the air blast pressure is high, certain public utilities, such as sewer pipes and drains made of relatively rigid materials and located at shallow depths, may be damaged by earth movement, but relatively flexible metal pipe will not normally be affected. For a surface burst in which cratering occurs, the situation is quite different, as will be seen in Chapter VI.

TECHNICAL ASPECTS OF BLAST WAVE PHENOMENA⁴

PROPERTIES OF THE IDEAL BLAST WAVE

3.53 The characteristics of the blast wave have been discussed in a qualitative manner in the earlier parts of this

chapter, and the remaining sections will be devoted mainly to a consideration of some of the quantitative aspects of blast wave phenomena in air. The basic relationships among the properties of a blast wave having a sharp front at which there

⁴The remaining sections of this chapter may be omitted without loss of continuity.

is a sudden pressure discontinuity, i.e., a true (or ideal) shock front, are derived from the Rankine-Hugoniot conditions based on the conservation of mass, energy, and momentum at the shock front. These conditions, together with the equation of state for air, permit the derivation of the required relations involving the shock velocity, the particle (or wind) velocity, the overpressure, the dynamic pressure, and the density of the air behind the ideal shock front.

3.54 The blast wave properties in the region of regular reflection are somewhat complex and depend on the angle of incidence of the wave with the ground and the overpressure. For a contact surface burst, when there is but a single hemispherical (merged) wave, as stated in § 3.34, and in the Mach region below the triple point path for an air burst, the various blast wave characteristics at the shock front are uniquely related by the Rankine-Hugoniot equations. It is for these conditions, in which there is a single shock front, that the following results are applicable.

3.55 The shock velocity, U , is expressed by

$$U = c_0 \left(1 + \frac{\gamma + 1}{2\gamma} \cdot \frac{p}{P_0} \right)^{1/2},$$

where c_0 is the ambient speed of sound (ahead of the shock front), p is the peak overpressure (behind the shock front), P_0 is the ambient pressure (ahead of the shock), and γ is the ratio of the specific heats of the medium, i.e., air. If γ is taken as 1.4, which is the value at moderate temperatures, the equation for the shock velocity becomes

$$U = c_0 \left(1 + \frac{6p}{7P_0} \right)^{1/2}.$$

The particle velocity (or peak wind velocity behind the shock front), u , is given by

$$u = \frac{c_0 p}{\gamma P_0} \left(1 + \frac{\gamma + 1}{2\gamma} \cdot \frac{p}{P_0} \right)^{-1/2}$$

so that for air

$$u = \frac{5p}{7P_0} \cdot \frac{c_0}{(1 + 6p/7P_0)^{1/2}}.$$

The density, ρ , of the air behind the shock front is related to the ambient density, ρ_0 , by

$$\begin{aligned} \frac{\rho}{\rho_0} &= \frac{2\gamma P_0 + (\gamma + 1)p}{2\gamma P_0 + (\gamma - 1)p} \\ &= \frac{7 + 6p/P_0}{7 + p/P_0}. \end{aligned}$$

The dynamic pressure, q , is defined by

$$q = \frac{1}{2} \rho u^2,$$

so that it is actually the kinetic energy per unit volume of air immediately behind the shock front; this quantity has the same dimensions as pressure. Introduction of the Rankine-Hugoniot equations for ρ and u given above leads to the relation

$$\begin{aligned} q &= \frac{p^2}{2\gamma P_0 + (\gamma - 1)p} \\ &= \frac{5}{2} \cdot \frac{p^2}{7P_0 + p} \quad (3.55.1) \end{aligned}$$

between the peak dynamic pressure in air and the peak overpressure and ambient pressure. The variations of shock velocity, particle (or peak wind) velocity, and peak dynamic pressure with the peak overpressure at sea level, as derived from the foregoing equations, are shown graphically in Fig. 3.55.

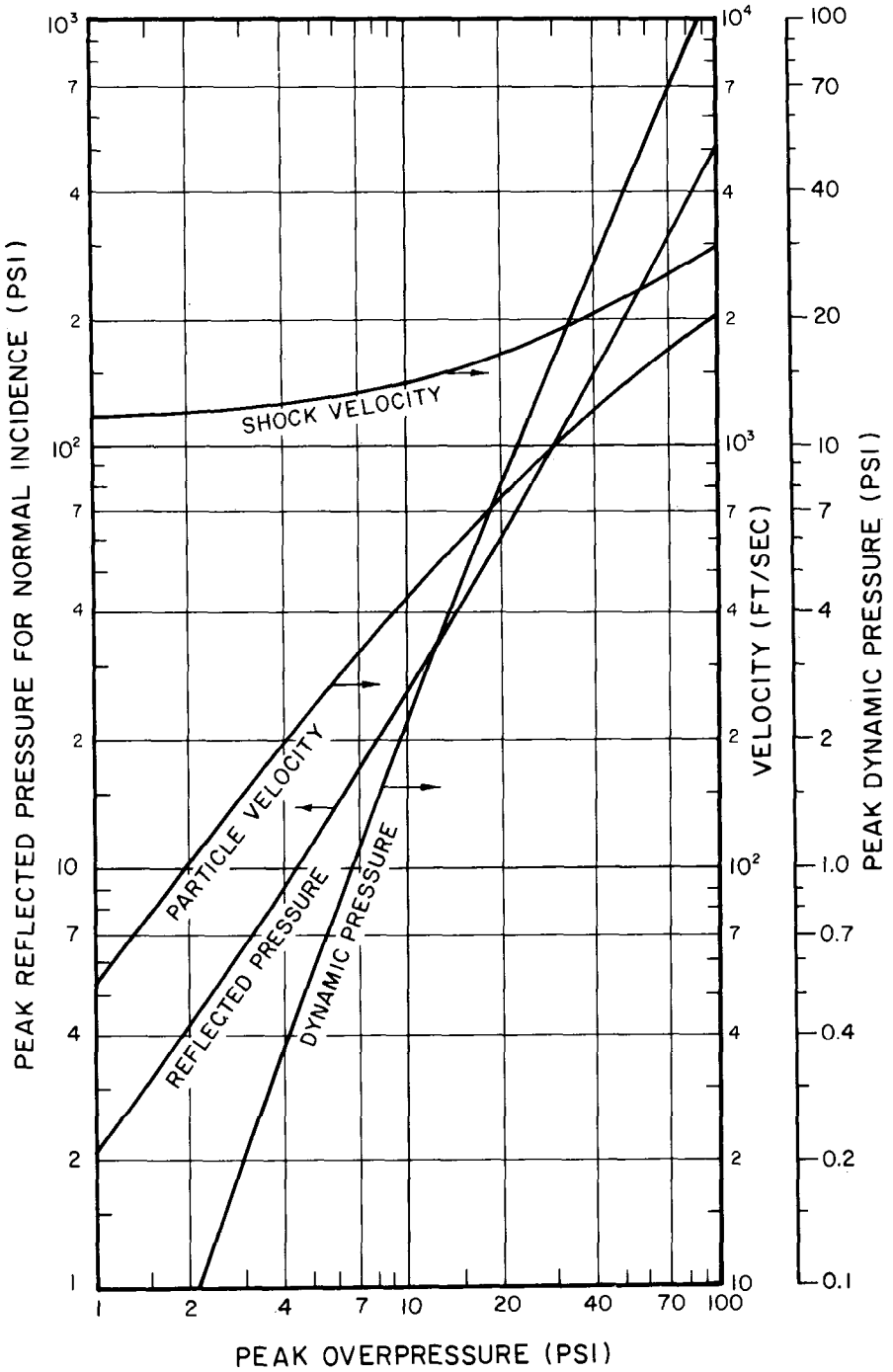

Figure 3.55. Relation of ideal blast wave characteristics at the shock front to peak overpressure.

3.56 When the blast wave strikes a flat surface, such as that of a structure, at normal incidence, i.e., head on, the instantaneous (peak) value of the reflected overpressure, p_r , is given by

$$p_r = 2p + (\gamma + 1)q. \tag{3.56.1}$$

Upon using equation (3.55.1) for air, this becomes

$$p_r = 2p \frac{7P_0 + 4p}{7P_0 + p}. \tag{3.56.2}$$

It can be seen from equation (3.56.2) that the value of p_r approaches $8p$ for very large values of the incident overpressure and dynamic pressure (strong shocks), and tends toward $2p$ for small overpressures and small dynamic pressures (weak shocks). It is evident from equation (3.56.1) that the increase in the reflected overpressure above the expected value of twice the incident value, i.e., $2p$, is due to the dynamic (or wind) pressure. The reflected overpressure arises from the change of momentum when the moving air changes direction as a result of striking the surface. A curve showing the variation of the instantaneous (peak) reflected pressure, with the peak incident overpressure, for normal incidence on a flat surface, is included in Fig. 3.55.

3.57 The equations in § 3.55 give the peak values of the various blast parameters at the shock front. The variation of the overpressure at a given point with time after its arrival at that point has been obtained by numerical integration of the equations of motion and the results are represented in Fig. 3.57. In these curves the "normalized" overpressure, defined by $p(t)/p$, where $p(t)$ is the overpressure at time t after the ar-

rival of the shock front and p is the peak overpressure, is given as a function of the "normalized" time, t/t_p^+ , where t_p^+ is the duration of the overpressure positive phase. The parameter indicated on each curve is the peak overpressure to which that curve refers. It is seen, therefore, that the variation of the normalized (and actual) overpressure with time depends on the peak overpressure. Values of t_p^+ for various burst conditions are given in Fig. 3.76.

3.58 Similarly, the variation of the normalized dynamic pressure, $q(t)/q$, with the normalized time, t/t_q^+ , where t_q^+ is the duration of the dynamic pressure positive phase, depends on the peak value of the dynamic pressure. This is shown by the curves in Fig. 3.58 for several indicated values of the peak dynamic pressure; values of t_q^+ required for use with this figure will be found in Fig. 3.76. It should be noted that, since the duration of the dynamic pressure positive phase is somewhat longer than that for the overpressure, i.e., t_q^+ is longer than t_p^+ , Figs. 3.57 and 3.58 do not have a common time base.

3.59 Another important blast damage parameter is the "impulse," which takes into account the duration of the positive phase and the variation of the overpressure during that time. Impulse (per unit area) may be defined as the total area under the curve for the variation of overpressure with time. The positive phase overpressure impulse (per unit area), I_p^+ , may then be represented mathematically by

$$I_p^+ = \int_0^{t_p^+} p(t)dt,$$

where $p(t)$ is obtained from Fig. 3.57 for any overpressure between 3 and 3,000

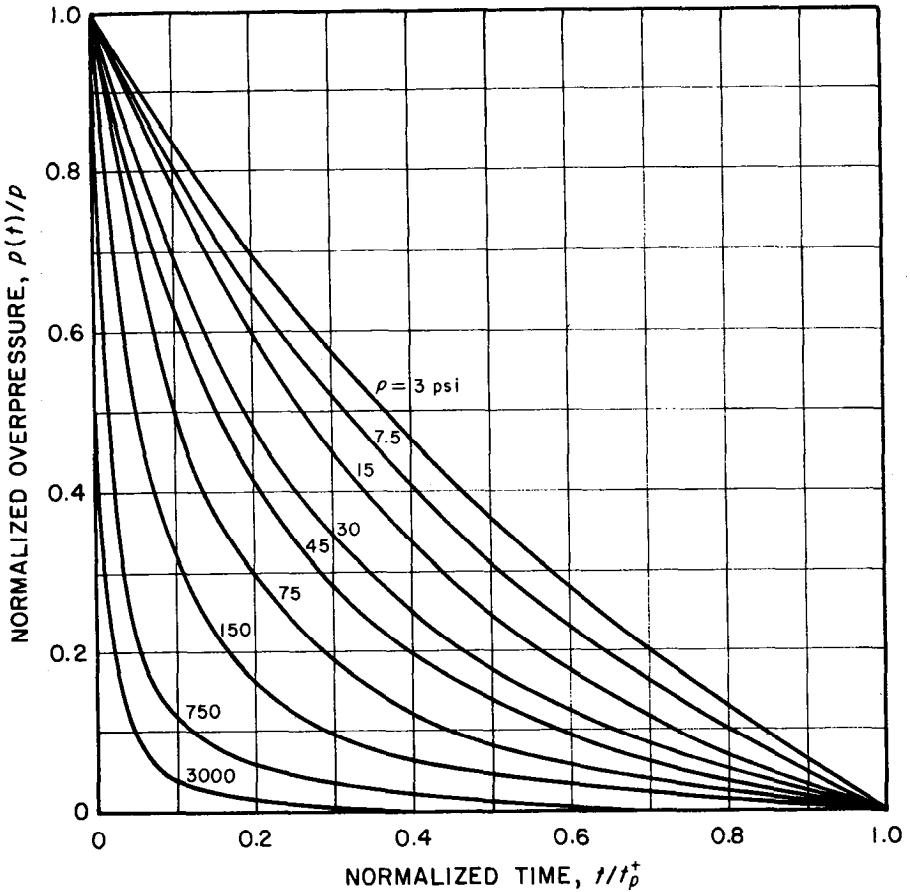

Fig. 3.57. Rate of decay of overpressure with time for several values of the peak overpressure.

psi. The positive phase dynamic impulse is defined by a similar expression in which $q(t)$ and t_q^+ replace $p(t)$ and t_p^+ , respectively.

SCALING LAWS

3.60 In order to calculate the characteristic properties of the blast wave from an explosion of any given energy if those for another energy are known, appropriate scaling laws are applied. With the aid of such laws it is possible to express the data for a large

range of energies in a simple form. One way of doing this, which will be illustrated below, is to draw curves showing how the various properties of the blast wave at the surface change with increasing distance from the detonation in the case of a 1-kiloton nuclear explosion. Then, with the aid of the scaling laws, the values for an explosion of any specified energy can be readily determined for a particular height of burst.

3.61 Theoretically, a given pressure will occur at a distance from an explosion that is proportional to the cube root

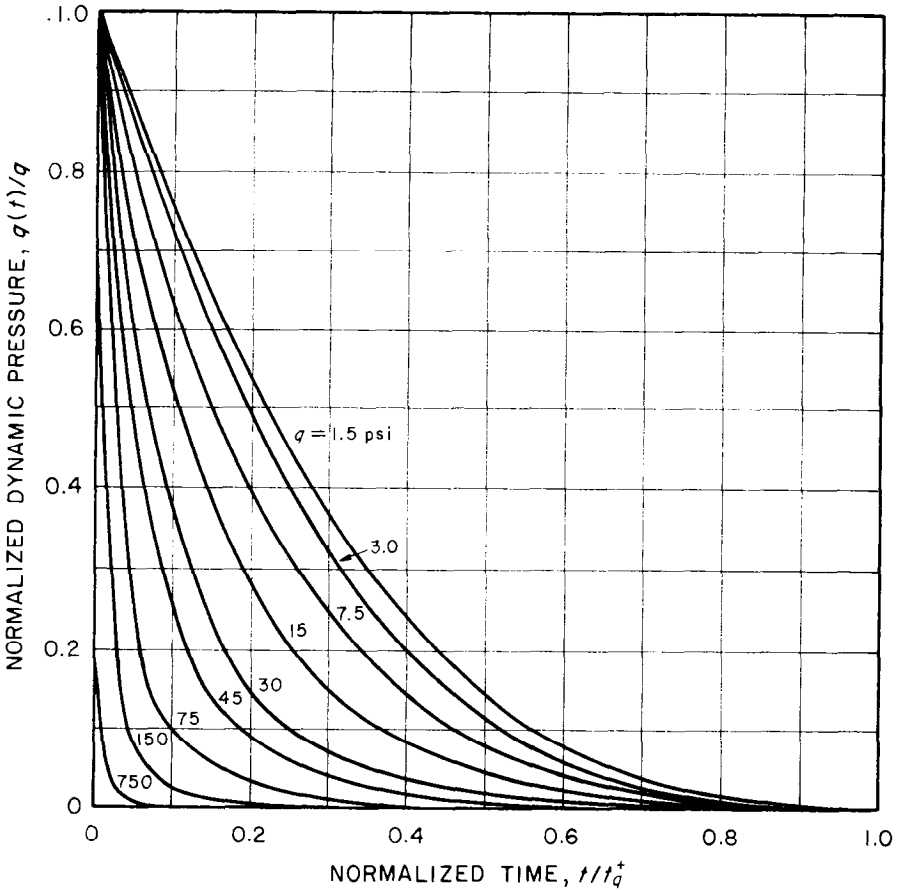

Fig. 3.58. Rate of decay of dynamic pressure with time for several values of the dynamic pressure.

of the energy yield. Full-scale tests have shown this relationship between distance and energy yield to hold for yields up to (and including) the megaton range. Thus, cube root scaling may be applied with confidence over a wide range of explosion energies. According to this law, if D_1 is the distance (or slant range) from a reference explosion of W_1 kilotons at which a certain overpressure or dynamic pressure is attained, then for any explosion of W kilotons energy these same pressures will occur at a distance D given by

$$\frac{D}{D_1} = \left(\frac{W}{W_1} \right)^{1/3} \quad (3.61.1)$$

As stated above, the reference explosion is conveniently chosen as having an energy yield of 1 kiloton, so that $W_1 = 1$. It follows, therefore, from equation (3.61.1) that

$$D = D_1 \times W^{1/3}, \quad (3.61.2)$$

where D_1 refers to the slant range from a 1-kiloton explosion. Consequently, if the distance D is specified, then the value of the explosion energy, W , re-

quired to produce a certain effect, e.g., a given peak overpressure, can be calculated. Alternatively, if the energy, W , is specified, the appropriate range, D , can be evaluated from equation (3.61.2).

3.62 When comparing air bursts having different energy yields, it is convenient to introduce a scaled height of burst, defined as

$$\text{Scaled height of burst} = \frac{\text{Actual height of burst}}{W^{1/3}}$$

For explosions of different energies having *the same scaled height of burst*, the cube root scaling law may be applied to distances from ground zero, as well as to distances from the explosion. Thus, if d_1 is the distance from ground zero at which a particular overpressure or dynamic pressure occurs for a 1-kiloton explosion, then for an explosion of W kilotons energy the same pressures will be observed at a distance d determined by the relationship

$$d = d_1 \times W^{1/3}. \quad (3.62.1)$$

This expression can be used for calculations of the type referred to in the preceding paragraph, except that the distances involved are from ground zero instead of from the explosion (slant ranges).⁵

3.63 Cube root scaling can also be applied to arrival time of the shock front, positive phase duration, and positive phase impulse, with the understanding that the distances concerned are themselves scaled according to the cube root law. The relationships (for

bursts with the same scaled height) may be expressed in the form

$$\frac{t}{t_1} = \frac{d}{d_1} = \left(\frac{W}{W_1} \right)^{1/3}$$

and

$$\frac{I}{I_1} = \frac{d}{d_1} = \left(\frac{W}{W_1} \right)^{1/3},$$

where t_1 represents arrival time or positive phase duration and I_1 is the positive phase impulse for a reference explosion of energy W_1 , and t and I refer to any explosion of energy W ; as before, d_1 and d are distances from ground zero. If W_1 is taken as 1 kiloton, then the various quantities are related as follows:

$$t = t_1 \times W^{1/3} \text{ at a distance } d = d_1 \times W^{1/3}$$

and

$$I = I_1 \times W^{1/3} \text{ at a distance } d = d_1 \times W^{1/3}.$$

Examples of the use of the equations developed above will be given later.

ALTITUDE CORRECTIONS

3.64 The data presented (§ 3.55 *et seq.*) for the characteristic properties of a blast wave are strictly applicable to a homogeneous (or uniform) atmosphere at sea level. At altitudes below about 5,000 feet, the temperatures and pressures in the atmosphere do not change very much from the sea-level values. Consequently, up to this altitude, it is a reasonably good approximation to treat the atmosphere as being homogeneous with sea-level properties. The equations given above may thus be used without

⁵The symbol d is used for the distance from ground zero, whereas D refers to the slant range, i.e., the distance from the actual burst.

correction if the burst and target are both at altitudes up to 5,000 feet. If it is required to determine the air blast parameters at altitudes where the ambient conditions are appreciably different from those at sea level, appropriate correction factors must be applied.

3.65 The general relationships which take into account the fact that the absolute temperature T and ambient pressure P are not the same as T_0 and P_0 respectively, in the reference (1-kiloton) explosion in a sea-level atmosphere, are as follows. For the overpressure

$$p = p_1 \frac{P}{P_0}, \quad (3.65.1)$$

where p is the overpressure at altitude and p_1 is that at sea level. The corrected value of the distance from ground zero for the new overpressure level is then given by

$$d = d_1 W^{1/3} \left(\frac{P}{P_0} \right)^{1/3}. \quad (3.65.2)$$

A similar expression is applicable to the slant range, D . The arrival time of positive phase duration at this new distance is

$$t = t_1 W^{1/3} \left(\frac{P}{P_0} \right)^{1/3} \left(\frac{T_0}{T} \right)^{1/2}. \quad (3.65.3)$$

The factor $(T_0/T)^{1/2}$ appears in this expression because the speed of sound is proportional to the square root of the absolute temperature. For impulse at altitude, the appropriate relationship is

$$I = I_1 W^{1/3} \left(\frac{P}{P_0} \right)^{2/3} \left(\frac{T_0}{T} \right)^{1/2}. \quad (3.65.4)$$

The foregoing equations are applicable when the target and burst point are at roughly the same altitude. If the altitude difference is less than a few thousand

feet, the temperature and pressure at a mean altitude may be used. But if the altitude difference is considerable, a good approximation is to apply the correction at the target altitude (§ 3.46). For bursts above about 40,000 feet, an allowance must be made for changes in the explosion energy partition (§ 3.67.)

3.66 In order to facilitate calculations based on the equations in the preceding paragraph, the following factors have been defined and tabulated (Table 3.66):

$$S_p = \frac{P}{P_0}$$

$$S_d = \left(\frac{P}{P_0} \right)^{1/3}$$

$$S_t = \left(\frac{P}{P_0} \right)^{1/3} \left(\frac{T_0}{T} \right)^{1/2},$$

so that

$$p = p_1 S_p \quad (3.66.1)$$

$$D = D_1 W^{1/3} S_d \text{ and} \\ d = d_1 W^{1/3} S_d. \quad (3.66.2)$$

$$t = t_1 W^{1/3} S_t \quad (3.66.3)$$

$$I = I_1 W^{1/3} S_p S_t. \quad (3.66.4)$$

The reference values P_0 and T_0 are for a standard sea-level atmosphere. The atmospheric pressure P_0 is 14.7 pounds per square inch and the temperature is 59°F or 15°C, so that T_0 is 519° Rankine or 288° Kelvin. In a strictly homogeneous atmosphere the altitude scaling factors S_p , S_d , and S_t would all be unity and equations (3.66.1), etc., would reduce to those in § 3.65. Below an altitude of about 5,000 feet the scaling factors do not differ greatly from unity and the approximation of a homogeneous (sea-level) atmosphere is not seriously in error, as mentioned above.

Table 3.66

AVERAGE ATMOSPHERIC DATA FOR MID-LATITUDES

Altitude (feet)	Temperature (degrees Kelvin)	Pressure (psi)	Altitude Scaling Factors			Speed of Sound (ft/sec)
			S_p	S_d	S_t	
0	288	14.70	1.00	1.00	1.00	1,116
1,000	286	14.17	0.96	1.01	1.02	1,113
2,000	284	13.66	0.93	1.03	1.03	1,109
3,000	282	13.17	0.90	1.04	1.05	1,105
4,000	280	12.69	0.86	1.05	1.07	1,101
5,000	278	12.23	0.83	1.06	1.08	1,097
10,000	268	10.11	0.69	1.13	1.17	1,077
15,000	258	8.30	0.56	1.21	1.28	1,057
20,000	249	6.76	0.46	1.30	1.39	1,037
25,000	239	5.46	0.37	1.39	1.53	1,016
30,000	229	4.37	0.30	1.50	1.68	995
35,000	219	3.47	0.24	1.62	1.86	973
40,000	217	2.73	0.19	1.75	2.02	968
45,000	217	2.15	0.15	1.90	2.19	968
50,000	217	1.69	0.12	2.06	2.37	968
55,000	217	1.33	0.091	2.23	2.57	968
60,000	217	1.05	0.071	2.41	2.78	968
65,000	217	0.83	0.056	2.61	3.01	968
70,000	218	0.65	0.044	2.83	3.25	971
75,000	219	0.51	0.035	3.06	3.50	974
80,000	221	0.41	0.028	3.31	3.78	978
85,000	222	0.32	0.022	3.57	4.07	981
90,000	224	0.25	0.017	3.86	4.38	984
95,000	225	0.20	0.014	4.17	4.71	988
100,000	227	0.16	0.011	4.50	5.07	991
110,000	232	0.10	0.0070	5.23	5.82	1,003
120,000	241	0.067	0.0045	6.04	6.61	1,021
130,000	249	0.044	0.0030	6.95	7.47	1,038
140,000	258	0.029	0.0020	7.95	8.41	1,056
150,000	266	0.020	0.0013	9.06	9.43	1,073

3.67 The correction factors in § 3.66 are applicable for burst altitudes up to about 40,000 feet (about 7.6 miles). Nearly all of the energy from nuclear explosions below this altitude is absorbed by air molecules near the burst. Deviations from the scaling laws described in the preceding paragraphs are caused principally by differences in

the partitioning of the energy components when the burst occurs above 40,000 feet. At such altitudes, part of the energy that would have contributed to the blast wave at lower altitudes is emitted as thermal radiation.

3.68 To allow for the smaller fraction of the yield that appears as blast energy at higher altitudes, the actual

yield is multiplied by a "blast efficiency factor" to obtain an effective blast yield. There is no simple way to formulate the blast efficiency factor as a function of altitude since, at high altitudes, overpressure varies with distance in such a manner that the effective blast yield is different at different distances. It is possible, however, to specify upper and lower limits on the blast efficiency factor, as shown in Table 3.68 for several altitudes. By using this factor, together with the ambient pressure P and the absolute temperature T at the observation point (or target) in the equations in § 3.65 (or § 3.66), an estimate can be made of the upper and lower limits of the blast parameters. An example of such an estimate will be given later.

Table 3.68

BLAST EFFICIENCY FACTORS FOR HIGH-ALTITUDE BURSTS

Burst Altitude (feet)	Blast Efficiency Factor	
	Upper Limit	Lower Limit
40,000	1.0	0.9
60,000	1.0	0.8
90,000	0.9	0.6
120,000	0.7	0.4
150,000	0.4	0.2

STANDARD CURVES AND CALCULATIONS OF BLAST WAVE PROPERTIES

3.69 In order to estimate the damage which might be expected to occur at a particular range from a given explosion, it is necessary to define the characteristics of the blast wave as they vary with time and distance. Consequently, standard "height of burst" curves of the various air blast wave properties are given here to supplement

the general discussion already presented. These curves show the variation of peak overpressure, peak dynamic pressure, arrival time, and positive phase duration with distance from ground zero for various heights of burst over a nearly ideal surface. Similar curves may also be constructed for other blast wave parameters, but the ones presented here are generally considered to be the most useful. They apply to urban targets as well as to a wide variety of other approximately ideal situations.

3.70 From the curves given below the values of the blast wave properties can be determined for a free air burst or as observed at the surface for an air burst at a particular height or for a contact surface burst (zero height). The peak overpressures, dynamic pressures, and positive phase duration times obtained in this manner are the basic data to be used in determining the blast loading and response of a target to a nuclear explosion under specified conditions. The procedures for evaluating the blast damage to be expected are discussed in Chapters IV and V.

3.71 The standard curves give the blast wave properties for a 1-kiloton TNT equivalent explosion in a sea-level atmosphere. By means of these curves and the scaling laws already presented, the corresponding properties can be calculated for an explosion of W -kilotons energy yield. Examples of the use of the curves are given on the pages facing the figures. It should be borne in mind that the data have been computed for nearly ideal conditions and that significant deviations may occur in practice.

3.72 The variation of peak overpressure with distance from a 1-kiloton TNT equivalent free air burst, i.e., a

burst in a homogeneous atmosphere where no boundaries or surfaces are present, for a standard sea-level atmosphere is shown in Fig. 3.72. This curve, together with the scaling laws and altitude corrections described above, may be used to predict incident overpressures from air bursts for those cases in which the blast wave arrives at the target without having been reflected from any surface. Other blast wave characteristics may be obtained from the Rankine-Hugoniot equations (§ 3.55 *et seq.*).

3.73 The curves in Fig. 3.73a (high-pressure range), Fig. 3.73b (intermediate-pressure range), and Fig. 3.73c (low-pressure range) show the variation with distance from ground zero of the peak overpressure at points near the ground surface for a 1-kiloton air burst as a function of the height of burst. The corresponding data for other explosion energy yields may be obtained by use of the scaling laws. The curves are applicable to a standard sea-level atmosphere and to nearly ideal surface conditions. Deviations from these conditions will affect the results, as explained in previous sections (cf. § 3.35 *et seq.*, also § 3.79 *et seq.*). It is seen from the figures, especially for overpressures of 30 pounds per square inch or less, that the curves show a pronounced "knee." Consequently, for any specified overpressure, there is a burst height that will result in a maximum surface distance from ground zero to which that overpressure extends. This is called the "optimum" height of burst for the given overpressure.

3.74 The variation of peak overpressure with distance from ground zero for an air burst at any given height can be readily derived from the curves in

Figs. 3.73a, b, and c. A horizontal line is drawn at the desired height of burst and then the ground distances for specific values of the peak overpressure can be read off. These curves differ from the one in Fig. 3.72 for a free air burst because they include the effect of reflection of the blast wave at the earth's surface. A curve for peak overpressure versus distance from ground zero for a contact surface burst can be obtained by taking the height of burst in Figs. 3.73a, b, and c to be zero.

3.75 The curves in Fig. 3.75 indicate the variation of the peak dynamic pressure along the surface with distance from ground zero and height of burst for a 1-kiloton air burst in a standard sea-level atmosphere for nearly ideal surface conditions. Since height-of-burst charts indicate conditions after the blast wave has been reflected from the surface, the curves do not represent the dynamic pressure of the incident wave. At ground zero the wind in the incident blast wave is stopped by the ground surface, and all of the incident dynamic pressure is transformed to static overpressure. Thus, the height-of-burst curves show that the dynamic pressure is zero at ground zero. At other locations, reflection of the incident blast wave produces winds that at the surface must blow parallel to the surface. The dynamic pressures associated with these winds produce horizontal forces. It is this horizontal component of the dynamic pressure that is given in Fig. 3.75.

3.76 The dependence of the positive phase duration of the overpressure and of the dynamic pressure on the distance from ground zero and on the height of burst is shown by the curves in

Fig. 3.76; the values for the dynamic pressure duration are in parentheses. As in the other cases, the results apply to a 1-kiloton explosion in a standard sea-level atmosphere for a nearly ideal surface. It will be noted, as mentioned earlier, that for a given detonation and location, the duration of the positive phase of the dynamic pressure is longer than that of the overpressure.

3.77 The curves in Figs. 3.77a and b give the time of arrival of the shock front on the ground at various distances from ground zero as a function of the height of burst for a 1-kiloton explosion under the usual conditions of a sea-level atmosphere and nearly ideal surface.

3.78 The peak overpressures in Figs. 3.74a, b, and c, which allow for reflection at the ground surface, are considered to be the side-on overpres-

ures (§ 4.06 footnote) to be used in determining target loading and response. However, further reflection is possible at the front face of a structure when it is struck by the blast wave. The magnitude of the reflected pressure $p_r(\alpha)$ depends on the side-on pressure p and the angle, α , between blast wave front and the struck surface (Fig. 3.78a). The values of the ratio $p_r(\alpha)/p$ as a function of angle of incidence for various indicated side-on pressures are given in Fig. 3.78b. It is seen that for normal incidence, i.e., when $\alpha = 0^\circ$, the ratio $p_r(\alpha)/p$ is approximately 2 at low overpressures and increases with the overpressure (§ 3.56). The curves in Fig. 3.78b are particularly applicable in the Mach region where an essentially vertical shock front moving radially strikes a reflecting surface such as the front wall of a structure (see Fig. 4.07).

(Text continued on page 124.)

The curve in Fig. 3.72 shows the variation of peak overpressure with distance for a 1 KT free air burst in a standard sea-level atmosphere.

Scaling. For targets below 5,000 feet and for burst altitudes below 40,000 feet, the range to which a given peak overpressure extends for yields other than 1 KT scales as the cube root of the yield, i.e.,

$$D = D_1 \times W^{1/3},$$

where, for a given peak overpressure, D_1 is the distance (slant range) from the explosion for 1 KT, and D is the distance from the explosion for W KT. (For higher target or burst altitudes, see § 3.64 *et seq.*)

Example

Given: A 2 MT burst at an altitude of 100,000 feet.

Find: The highest value of peak overpressure that reasonably may be expected to be incident on a target (an aircraft or missile) at an altitude of 60,000 feet.

Solution: The blast efficiency factor is based on the burst altitude, but the altitude scaling factors are based on target altitude (§ 3.64). The highest value of peak overpressure will occur with the upper limit of the blast efficiency factor.

From Table 3.68, this upper limit for a burst at an altitude of 100,000 feet is somewhat less than 0.9. Hence, the effective yield is approximately

$$\begin{aligned} 0.9W &= 0.9 \times 2 \\ &= 1.8 \text{ MT} = 1,800 \text{ KT}. \end{aligned}$$

The shortest distance from burst point to target, i.e., where the overpressure would be largest, is

$$D = 100,000 - 60,000 = 40,000 \text{ feet.}$$

From equation (3.66.2), the corresponding distance from a 1 KT burst for sea-level conditions is

$$D_1 = \frac{D}{W^{1/3}} \cdot \frac{1}{S_d}.$$

From Table 3.66, S_d at the target altitude of 60,000 feet is 2.41; hence;

$$\begin{aligned} D_1 &= \frac{40,000}{(1,800)^{1/3}} \cdot \frac{1}{2.41} \\ &= 1,360 \text{ feet.} \end{aligned}$$

From Fig. 3.72, the peak overpressure at a distance of 1,360 feet from a 1 KT free air burst at sea-level conditions is 4.2 psi. The corresponding overpressure at an altitude of 60,000 feet is obtained from equation (3.66.1) and Table 3.66; thus

$$\begin{aligned} p &= p_1 S_p = 4.2 \times 0.071 \\ &= 0.30 \text{ psi.} \\ &\text{Answer} \end{aligned}$$

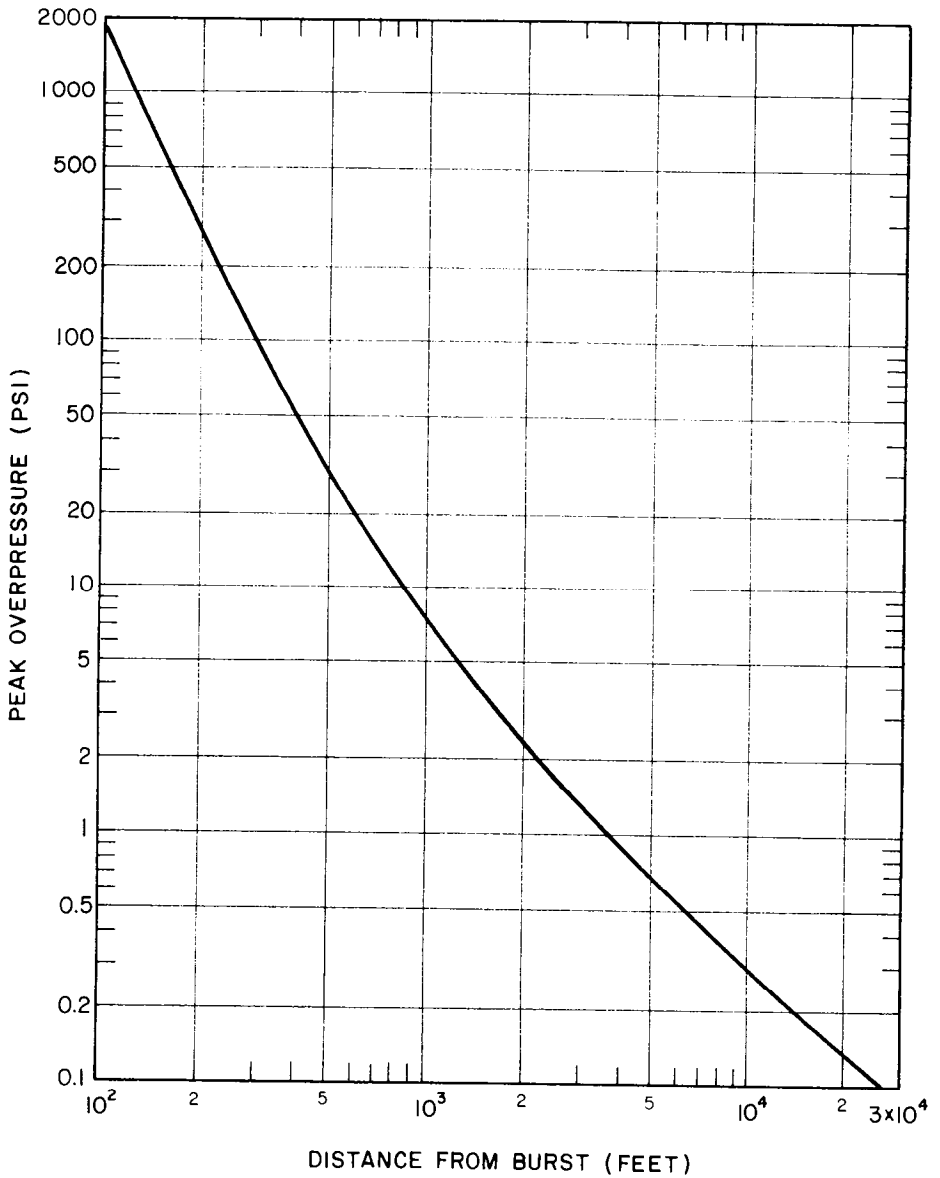

Figure 3.72. Peak overpressure from a 1-kiloton free air burst for sea-level ambient conditions.

The curves in Fig. 3.73a show peak overpressures on the ground in the high-pressure range as a function of distance from ground zero and height of burst for a 1 KT burst in a standard sea-level atmosphere. The broken line separates the regular reflection region from the Mach region and indicates where the triple point is formed (§ 3.24 *et seq.*). The data are considered appropriate to nearly ideal surface conditions. (For terrain, surface, and meteorological effects, see §§ 3.35–3.43, §§ 3.47–3.49, and § 3.79 *et seq.*)

Scaling. The height of burst and distance from ground zero to which a given overpressure extends scale as the cube root of the yield, i.e.,

$$\frac{d}{d_1} = \frac{h}{h_1} = W^{1/3},$$

where, for a given peak overpressure, d_1 and h_1 are distance from ground zero and height of burst for 1 KT, and d and h are the corresponding distance and height of burst for W KT. For a height of burst of 5,000 feet or less, a homogeneous sea-level atmosphere may be assumed.

Example

Given: An 80 KT detonation at a height of 860 feet.

Find: The distance from ground zero to which 1,000 psi overpressure extends.

Solution: The corresponding height of burst for 1 KT, i.e., the scaled height, is

$$h_1 = \frac{h}{W^{1/3}} = \frac{860}{(80)^{1/3}} = 200 \text{ feet.}$$

$$d = d_1 W^{1/3} =$$

$$110 \times (80)^{1/3} = 475 \text{ feet.}$$

Answer.

From Fig. 3.73a, an overpressure of 1,000 psi extends 110 feet from ground zero for a 200-foot burst height for a 1 KT weapon. The corresponding distance for 80 KT is

$$d = d_1 W^{1/3} =$$

$$110 \times (80)^{1/3} = 475 \text{ feet.}$$

Answer.

The procedure described above is applicable to similar problems for the curves in Figs. 3.73b and c.

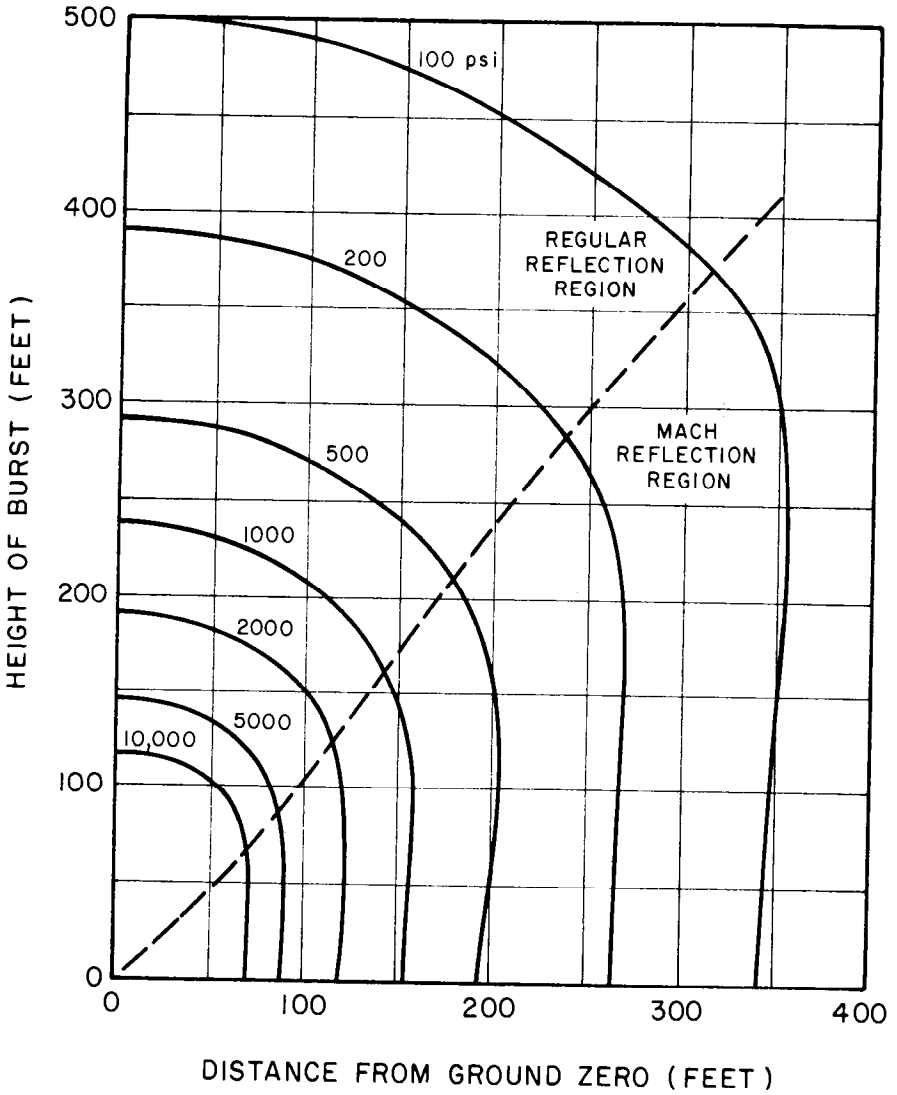

Figure 3.73a. Peak overpressures on the ground for a 1-kiloton burst (high-pressure range).

The curves in Fig. 3.73b show peak overpressures on the ground in the intermediate-pressure range as a function of distance from ground zero and height of burst for a 1 KT burst in a standard sea-level atmosphere. The broken line separates the regular reflection region from the Mach region and indicates where the triple point is formed (§ 3.24 *et seq.*). The data are considered appropriate for nearly ideal surface conditions. (For terrain, surface, and meteorological effects, see (§ 3.35–3.43, § 3.47–3.49, and § 3.79 *et seq.*).

Scaling. The height of burst and the distance from ground zero to which a given peak overpressure extends scale as the cube root of the yield, i.e.,

$$\frac{d}{d_1} = \frac{h}{h_1} = W^{1/3},$$

where, for a given peak overpressure, d_1 and h_1 are distance from ground zero and height of burst for 1 KT, and d and h are the corresponding distance and height of burst for W KT. For a height of burst of 5,000 feet or less, a homogeneous sea-level atmosphere may be assumed.

Example

Given: A 100 KT detonation at a height of 2,320 feet.

Find: The peak overpressure at 1,860 feet from ground zero.

Solution: The corresponding height of burst for 1 KT is

$$h_1 = \frac{h}{W^{1/3}} = \frac{2,320}{(100)^{1/3}} = 500 \text{ feet.}$$

and the ground distance is

$$d_1 = \frac{d}{W^{1/3}} = \frac{1,860}{(100)^{1/3}} = 400 \text{ feet.}$$

From Fig. 3.73b, at a ground distance of 400 feet and a burst height of 500 feet, the peak overpressure is 50 psi. *Answer.*

The procedure described above is applicable to similar problems for the curves in Figs. 3.73a and c.

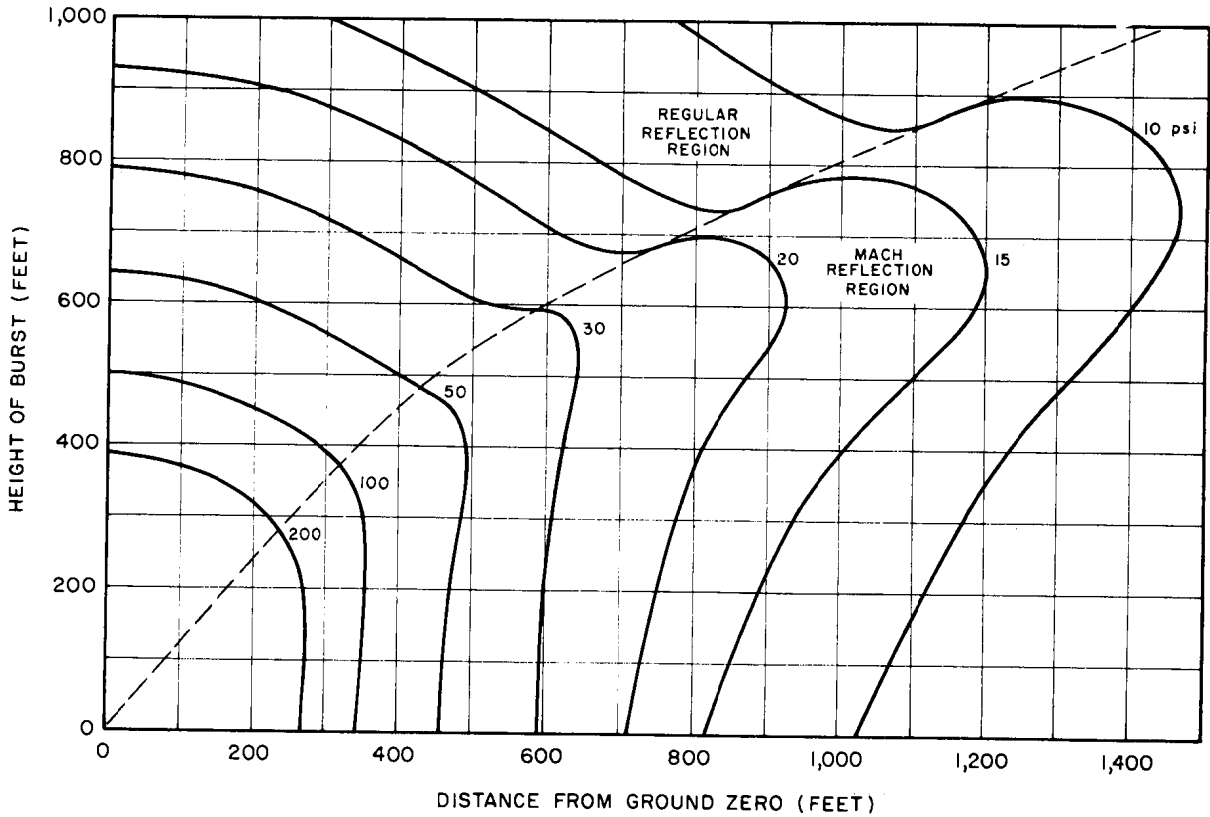

Figure 3.73b. Peak overpressures on the ground for a 1-kiloton burst (intermediate-pressure range).

The curves in Fig. 3.73c show peak overpressures on the ground in the low-pressure range as a function of distance from ground zero and height of burst for a 1 KT burst in a standard sea-level atmosphere. The broken line separates the regular reflection region from the Mach region and indicates where the triple point is formed (§ 3.24 *et seq.*). The data are considered appropriate for nearly ideal surface conditions. (For terrain, surface, and meteorological effects, see §§ 3.35–3.43, §§ 3.47–3.49, and § 3.79 *et seq.*)

Scaling. The height of burst and the distance from ground zero to which a given peak overpressure extends scale as the cube root of the yield, i.e.,

$$\frac{d}{d_1} = \frac{h}{h_1} = W^{1/3},$$

where, for a given peak overpressure, d_1 and h_1 are the distance from ground zero and height of burst for 1 KT, and d and h are the corresponding distance and height of burst for W KT. For a height of burst of 5,000 feet or less, a homogeneous sea-level atmosphere may be assumed.

Example

Given: A 125 KT detonation.

Find: The maximum distance from ground zero to which 4 psi extends, and the height of burst at which 4 psi extends to this distance.

Solution: From Fig. 3.73c, the maximum ground distance to which 4 psi extends for a 1 KT weapon is 2,600 feet. This occurs for a burst height of approximately 1,100 feet. Hence, for a 125 KT detonation, the required burst height is

$$\begin{aligned} h &= h_1 W^{1/3} = 1,100 \times (125)^{1/3} \\ &= 5,500 \text{ feet.} \end{aligned}$$

This is sufficiently close to 5,000 feet for a homogeneous atmosphere to be assumed. The distance from ground zero is then

$$\begin{aligned} d &= d_1 W^{1/3} = 2,600 \times (125)^{1/3} \\ &= 13,000 \text{ feet. } \textit{Answer.} \end{aligned}$$

The procedure described above is applicable to similar problems for the curves in Figs. 3.73a and b.

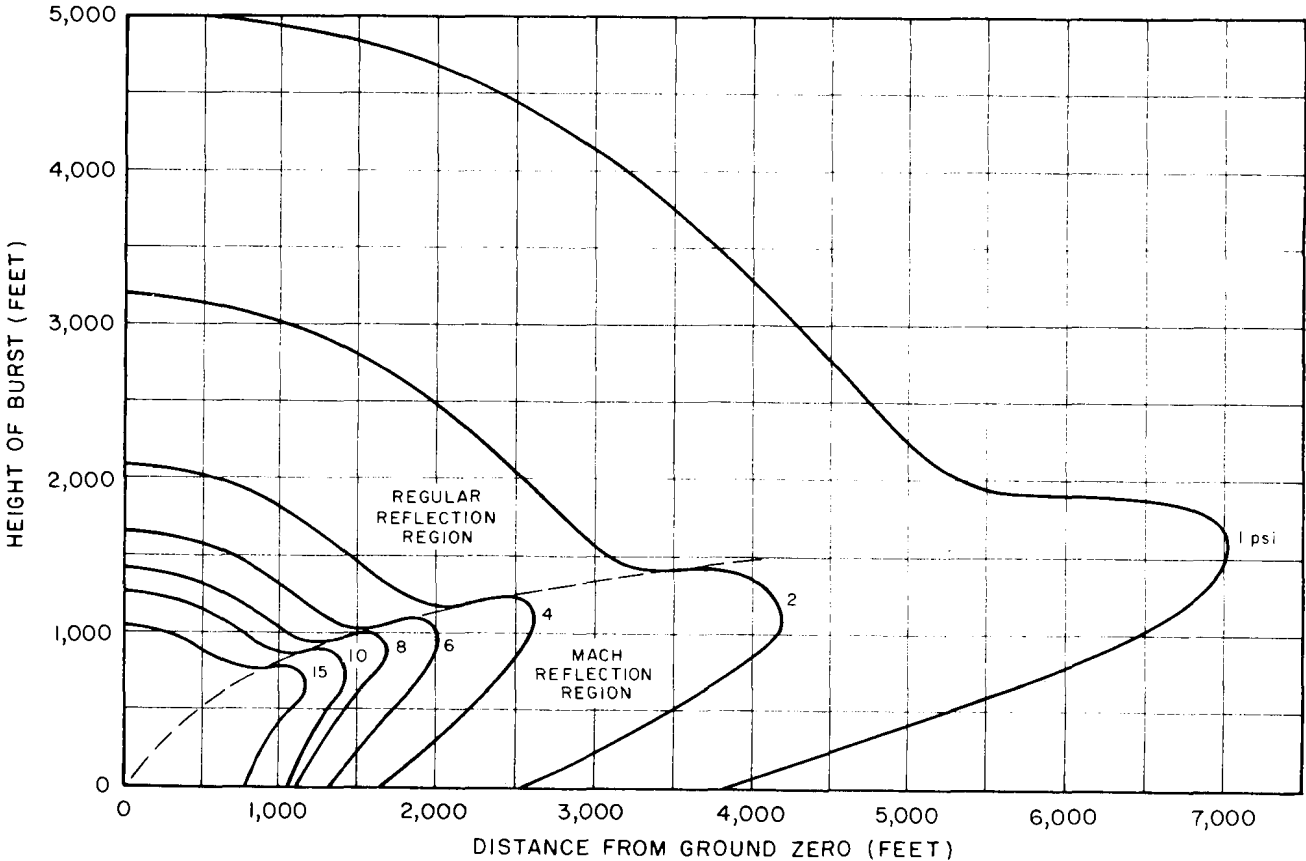

Figure 3.73c. Peak overpressures on the ground for 1-kiloton burst (low-pressure range).

The curves in Fig. 3.75 show the horizontal component of peak dynamic pressure on the ground as a function of distance from ground zero and height of burst for a 1 KT burst in a standard sea-level atmosphere. The data are considered appropriate for nearly ideal surface conditions. (For terrain, surface, and meteorological effects, see §§ 3.35–3.43, §§ 3.47–3.49, and § 3.79 *et seq.*)

Scaling. The height of burst and distance from ground zero to which a given peak dynamic pressure value extends scale as the cube root of the yield, i.e.,

$$\frac{d}{d_1} = \frac{h}{h_1} = W^{1/3},$$

where, for a given peak dynamic pressure, h_1 and d_1 are the height of burst and distance from ground zero for 1 KT, and h and d are the corresponding height of burst and distance for W KT. For a height of burst of 5,000 feet or less, a homogeneous sea-level atmosphere may be assumed.

Example

Given: A 160 KT burst at a height of 3,000 feet.

Find: The horizontal component of peak dynamic pressure on the surface at 6,000 feet from ground zero.

Solution: The corresponding height of burst for 1 KT is

$$h_1 = \frac{h}{W^{1/3}} = \frac{3,000}{(160)^{1/3}} = 550 \text{ feet.}$$

The corresponding distance for 1 KT is

$$d_1 = \frac{d}{W^{1/3}} = \frac{6,000}{(160)^{1/3}} = 1,110 \text{ feet.}$$

From Fig. 3.75, at a distance of 1,110 feet from ground zero and a burst height of 550 feet, the horizontal component of the peak dynamic pressure is approximately 3 psi. *Answer.*

Calculations similar to those described in connection with Figs. 3.74a and c may be made for the horizontal component of the peak dynamic pressure (instead of the peak overpressure) by using Fig. 3.75.

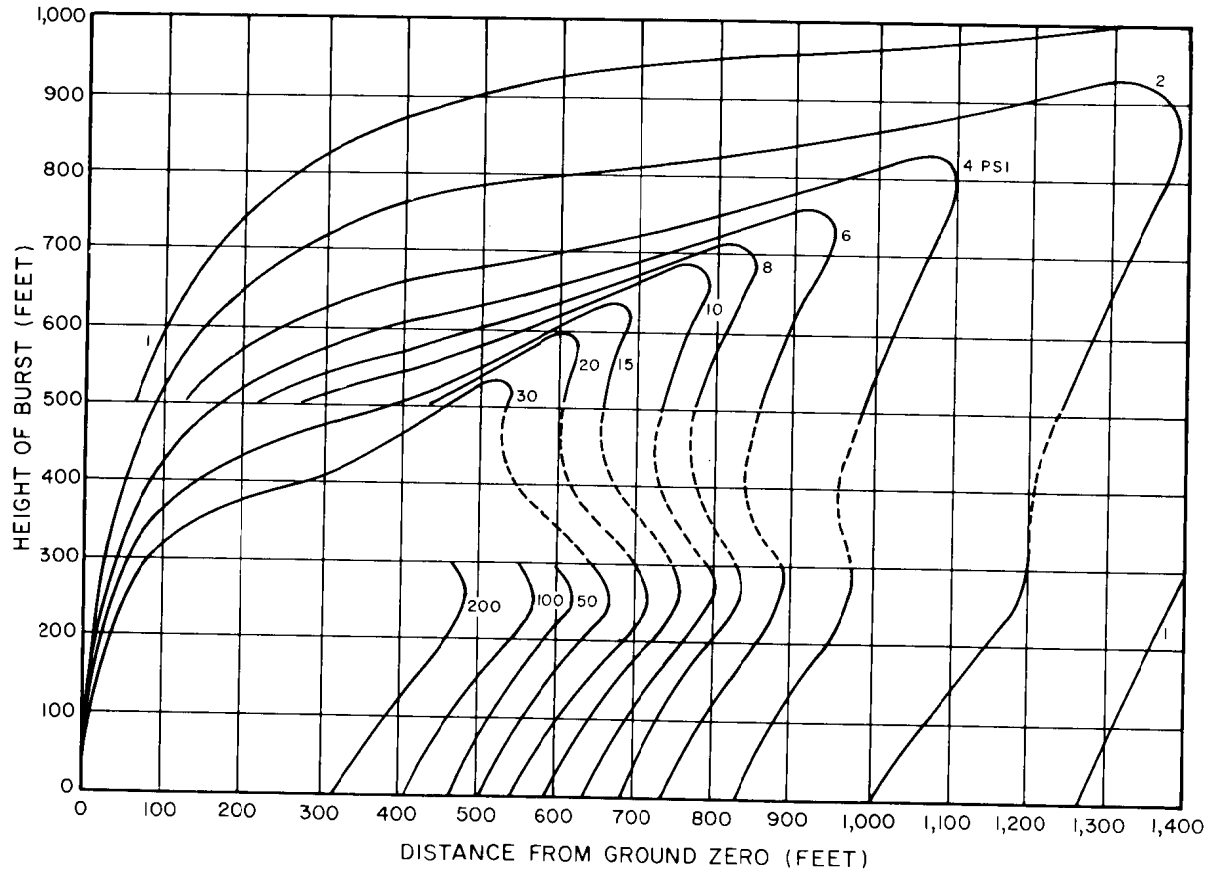

Figure 3.75. Horizontal component of peak dynamic pressure for 1-kiloton burst.

The curves in Fig. 3.76 show the duration on the ground of the positive phase of the overpressure and of the dynamic pressure (in parentheses) as a function of distance from ground zero and height of burst for a 1 KT burst in a standard sea-level atmosphere. The curves are considered appropriate for nearly ideal surface conditions.

Scaling. The required relationships are

$$\frac{d}{d_1} = \frac{h}{h_1} = \frac{t}{t_1} = W^{1/3},$$

where d_1 , h_1 , and t_1 are the distance from ground zero, the height of burst, and duration, respectively, for 1 KT; and d , h , and t are the corresponding distance, height of burst, and duration for W KT. For a height of burst of 5,000 feet or less, a homogeneous sea-level atmosphere may be assumed.

Example

Given: A 160 KT explosion at a height of 3,000 feet.

Find: The positive phase duration on the ground of (a) the overpressure, (b) the dynamic pressure at 4,000 feet from ground zero.

Solution: The corresponding height of burst for 1 KT is

$$h_1 = \frac{h}{W^{1/3}} = \frac{3,000}{(160)^{1/3}} = 550 \text{ feet,}$$

and the corresponding distance from ground zero is

$$d_1 = \frac{d}{W^{1/3}} = \frac{4,000}{(160)^{1/3}} = 740 \text{ feet.}$$

(a) From Fig. 3.76, the positive phase duration of the overpressure for a 1 KT at 740 feet from ground zero and a burst height of 550 feet is 0.18 second. The corresponding duration of the overpressure positive phase for 160 KT is, therefore,

$$\begin{aligned} t &= t_1 W^{1/3} = 0.18 \times (160)^{1/3} \\ &= 1.0 \text{ second. } \textit{Answer.} \end{aligned}$$

(b) From Fig. 3.76, the positive phase duration of the dynamic pressure for 1 KT at 740 feet from ground zero and a burst height of 550 feet is 0.34 second. The corresponding duration of the dynamic pressure positive phase for 160 KT is, therefore,

$$\begin{aligned} t &= t_1 W^{1/3} = 0.34 \times (160)^{1/3} \\ &= 1.8 \text{ second. } \textit{Answer.} \end{aligned}$$

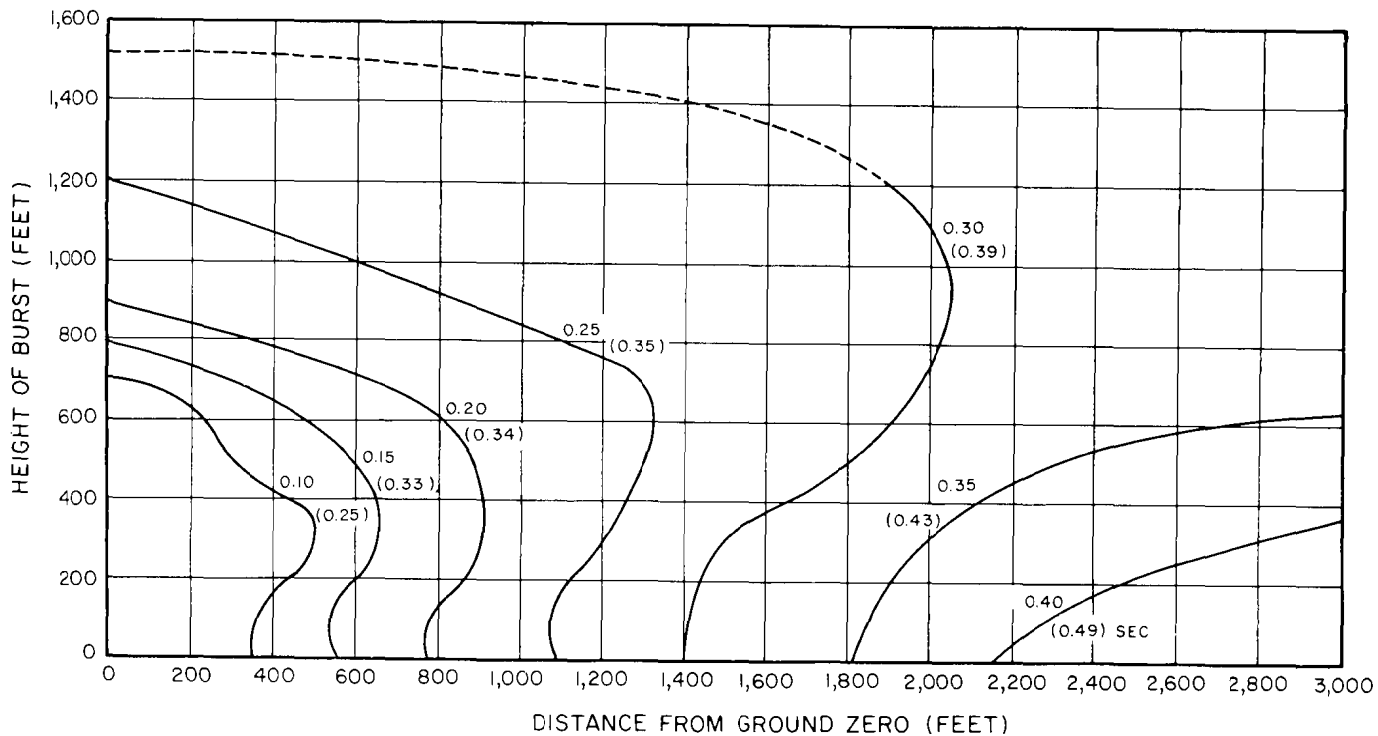

Figure 3.76. Positive phase duration on the ground of overpressure and dynamic pressure (in parentheses) for 1-kiloton burst.

The curves in Figs. 3.77a and b give the time of arrival in seconds of the blast wave on the ground as a function of distance from ground zero and height of burst for a 1 KT burst in a standard sea-level atmosphere. The curves are considered appropriate for nearly ideal surface conditions.

Scaling. The required relationships are

$$\frac{d}{d_1} = \frac{h}{h_1} = \frac{t}{t_1} = W^{1/3},$$

where d_1 , h_1 , and t_1 are the distance from ground zero, height of burst, and time of arrival, respectively, for 1 KT; and d , h , and t are the corresponding distance, height of burst, and time for W KT. For a height of burst of 5,000 feet or less, a homogeneous sea-level atmosphere may be assumed.

Example

Given: A 1 MT explosion at a height of 5,000 feet.

Find: The time of arrival of the blast wave at a distance of 10 miles from ground zero.

Solution: The corresponding burst height for 1 KT is

$$h_1 = \frac{h}{W^{1/3}} = \frac{5,000}{(1,000)^{1/3}} = 500 \text{ feet.}$$

The corresponding distance from ground zero for 1 KT is

$$d_1 = \frac{D}{W^{1/3}} = \frac{5,280 \times 10}{(1,000)^{1/3}} = 5,280 \text{ feet.}$$

From Fig. 3.77b, at a height of burst of 500 feet and a distance of 5,280 feet from ground zero, the arrival time is 4.0 seconds for 1 KT. The corresponding arrival time for 1 MT is

$$\begin{aligned} t &= t_1 W^{1/3} = 4.0 \times (1,000)^{1/3} \\ &= 40 \text{ seconds. } \textit{Answer.} \end{aligned}$$

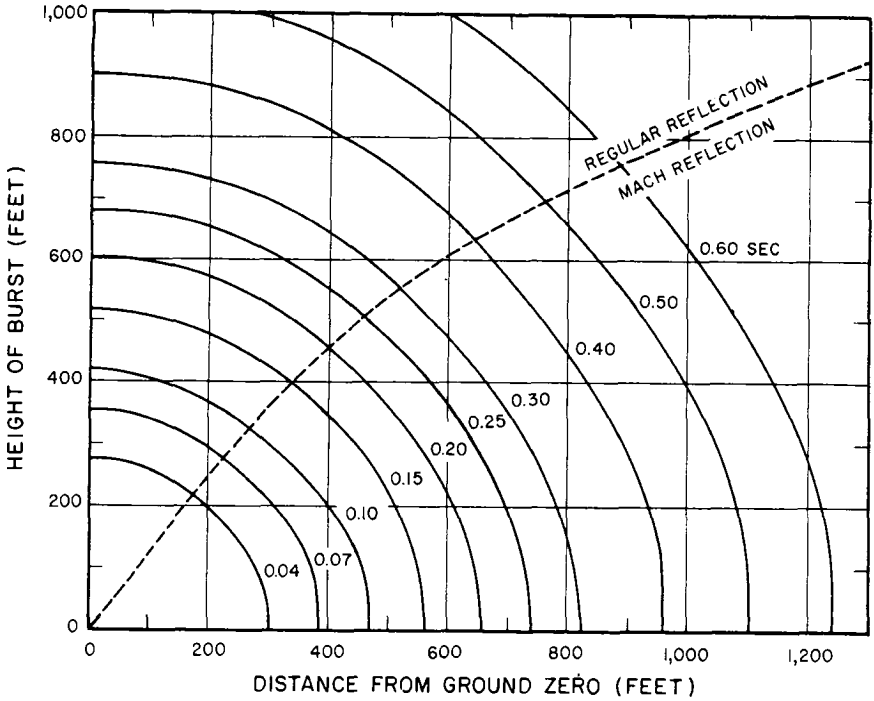

Figure 3.77a. Arrival times on the ground of blast wave for 1-kiloton burst (early times).

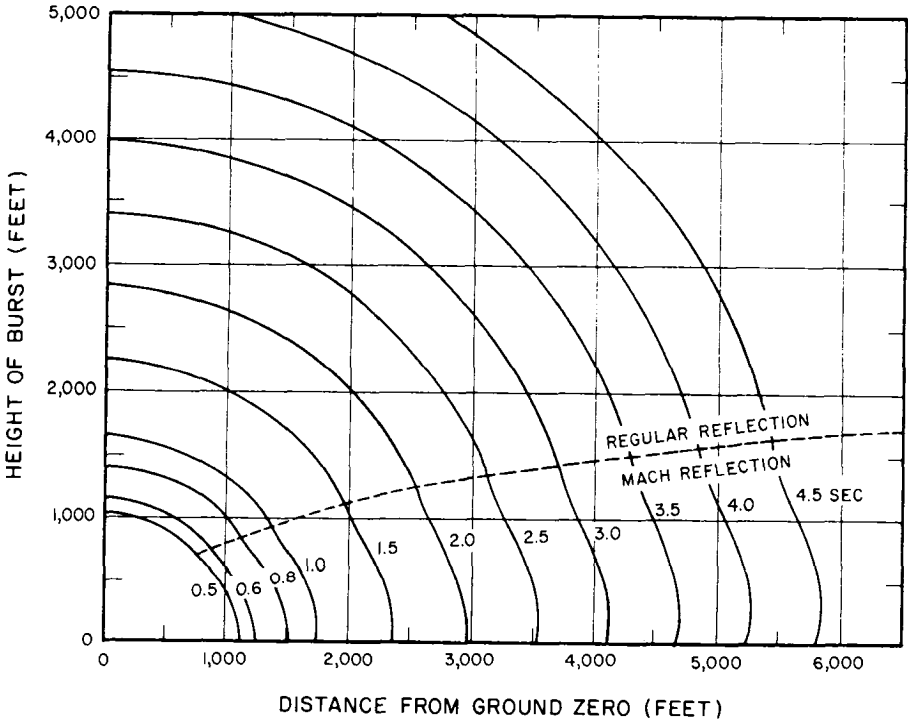

Figure 3.77b. Arrival times on the ground of blast wave for 1-kiloton burst (late times).

The reflected overpressure ratio $p_{r(\alpha)}/p$ is plotted in Fig. 3.78b as a function of the angle of incidence of the blast wave front for various values of the peak (side-on) overpressure. The curves apply to a wave front striking a reflecting surface, such as a wall of a structure.

- $p_{r(\alpha)}$ = reflected blast wave overpressure for any given angle of incidence (psi).
 p = initial peak incident overpressure (psi).
 α = angle between the blast wave front and the reflecting surface (degrees).

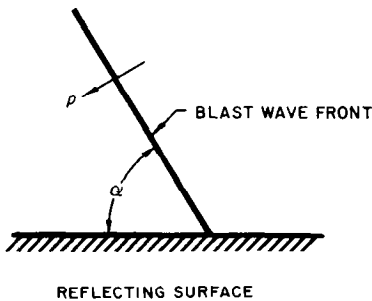

Figure 3.78a. Angle of incidence (α) of blast wave front with reflecting surface.

Example

Given: A shock wave of 50 psi initial peak overpressure striking a surface at an angle of 35° .

Find: The reflected shock wave overpressure.

Solution: From Fig. 3.78b, the reflected overpressure ratio, $p_{r(\alpha)}/p$, for 50 psi and an angle of incidence of 35° is 3.6; hence,

$$\begin{aligned} p_{r(35^\circ)} &= 3.6p = 3.6 \times 50 \\ &= 180 \text{ psi. Answer.} \end{aligned}$$

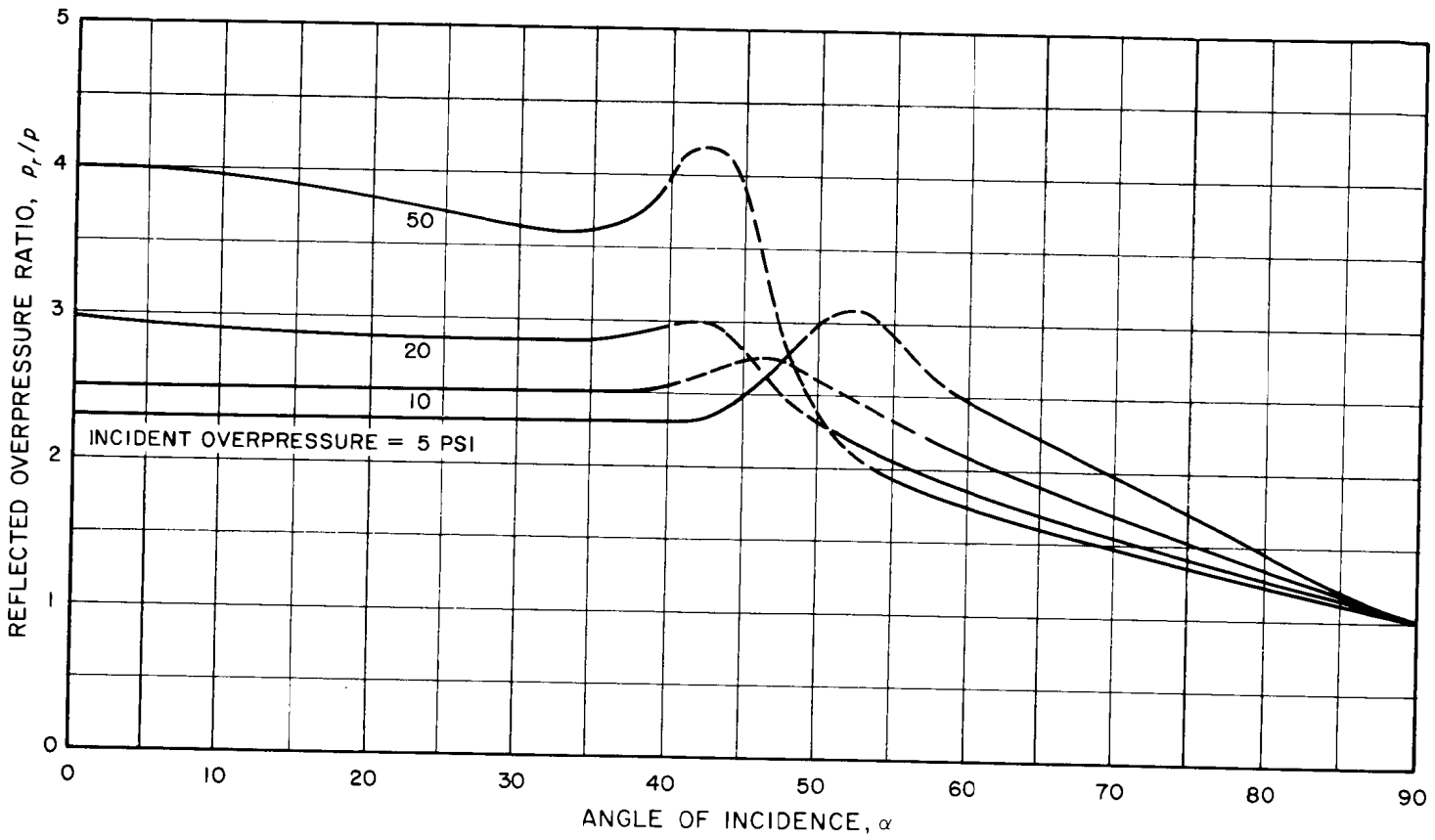

Figure 3.78b. Reflected overpressure ratio as a function of angle of incidence for various side-on overpressures.

(Text continued from page 107.)

THE PRECURSOR

3.79 The foregoing results have referred to blast wave conditions near the surfaces that are ideal or nearly ideal (§ 3.47), so that the Rankine-Hugoniot equations are applicable. When the surface is nonideal, there may be mechanical or thermal effects (or both) on the blast wave. Some of the phenomena associated with mechanical effects were mentioned in § 3.48. As a consequence of thermal nonideal behavior, the overpressure and dynamic pressure patterns can be distorted. Severe thermal effects are associated with the formation of a precursor (§ 3.49) which produces significant changes in the parameters of the blast wave.

3.80 When a nuclear weapon is detonated over a thermally nonideal (heat-absorbing) surface, radiation from the fireball produces a hot layer of air, referred to as a "thermal layer," near the surface. This layer, which often includes smoke, dust, and other particulate matter, forms before the arrival of the blast wave from an air burst. It is thus referred to as the preshock thermal layer. Interaction of the blast wave with the hot air layer may affect the reflection process to a considerable extent. For appropriate combinations of explosion energy yield, burst height, and heat-absorbing surfaces, an auxiliary (or secondary) blast wave, the precursor, will form and will move ahead of the main incident wave for some distance. It is called precursor because it precedes the main blast wave.

3.81 After the precursor forms, the main shock front usually no longer ex-

tends to the ground; if it does, the lower portion is so weakened and distorted that it is not easily recognized. Between the ground and the bottom edge of the main shock wave is a gap, probably not sharply defined, through which the energy that feeds the precursor may flow. Ahead of the main shock front, the blast energy in the precursor is free not only to follow the rapidly moving shock front in the thermal layer, but also to propagate upward into the undisturbed air ahead of the main shock front. This diverging flow pattern within the precursor tends to weaken it, while the energy which is continually fed into the precursor from the main blast wave tends to strengthen the precursor shock front. The foregoing description of what happens within a precursor explains some of the characteristics shown in Fig. 3.81. Only that portion of the precursor shock front that is in the preshock thermal layer travels faster than the main shock front; the energy diverging upward, out of this layer, causes the upper portion to lose some of its forward speed. The interaction of the precursor and the main shock front indicates that the main shock is continually overtaking this upward-traveling energy. Dust, which may billow to heights of more than 100 feet, shows the upward flow of air in the precursor.

3.82 Considerable modification of the usual blast wave characteristics may occur within the precursor region. The overpressure wave form shows a rounded leading edge and a slow rise to its peak amplitude. In highly disturbed waveforms, the pressure jump at the leading edge may be completely absent. (An example of a measured overpressure waveform in the precursor region is

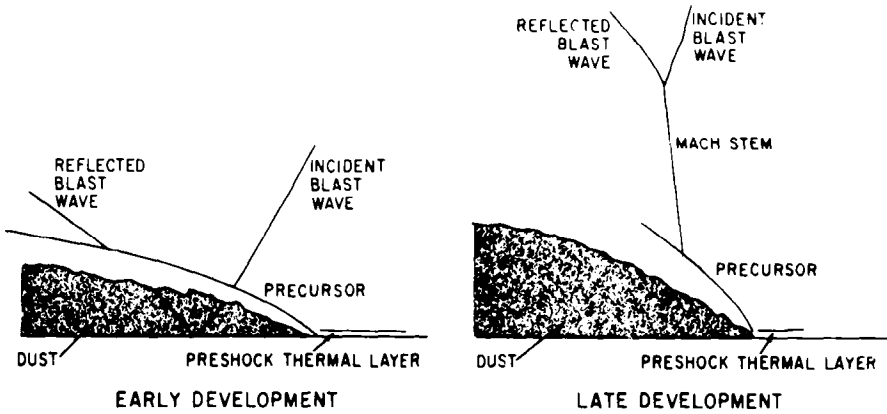

Figure 3.81. Precursor characteristics.

given in Fig. 4.67a.) Dynamic pressure waveforms often have high-frequency oscillations that indicate severe turbulence. Peak amplitudes of the precursor waveforms show that the overpressure has a lower peak value and the dynamic pressure a higher peak value than over a surface that did not permit a precursor to form. The higher peak value of the dynamic pressure is primarily attributable to the increased density of the moving medium as a result of the dust loading in the air. Furthermore, the normal Rankine-Hugoniot relations at the shock front no longer apply.

3.83 Examples of surfaces which are considered thermally nearly ideal (unlikely to produce significant precursor effects) and thermally nonideal (expected to produce a precursor for suitable combinations of burst height and ground distance) are given in Table 3.83. Under many conditions, e.g., for scaled heights of burst in excess of 800 feet or at large ground distances (where the peak overpressure is less than about 6 psi), precursors are not expected to occur regardless of yield and type of

surface. Thermal effects on the blast wave are also expected to be small for contact surface bursts; consequently, it is believed that in many situations, especially in urban areas, nearly ideal blast wave conditions would prevail.

3.84 For this reason, the curves for various air blast parameters presented earlier, which apply to nearly ideal surface conditions, are considered to be

Table 3.83
EXAMPLES OF
THERMALLY NEARLY IDEAL AND
THERMALLY NONIDEAL SURFACES

Thermally Nearly Ideal (precursor unlikely)	Thermally Nonideal (precursor may occur for low air bursts)
Water	Desert sand
Ground covered by white smoke	Coral
Heat-reflecting concrete	Asphalt
Ice	Surface with thick low vegetation
Packed snow	Surface covered by dark smoke
Moist soil with sparse vegetation	Most agricultural areas
Commercial and industrial areas	Dry soil with sparse vegetation

most representative for general use. It should be noted, however, that blast phenomena and damage observed in the precursor region for low air bursts at the Nevada Test Site may have resulted from nonideal behavior of the surface. Under such conditions, the overpressure waveform may be irregular and may show a slow rise to a peak value somewhat less than that expected for nearly ideal conditions (§ 3.82). Consequently, the peak value of reflected pressure on the front face of an object struck by the blast wave may not exceed the peak value of the incident pressure by more than a factor of two instead of

the much higher theoretical factor for an ideal shock front as given by equation (3.56.2).

3.85 Similarly, the dynamic pressure waveform will probably be irregular (§ 3.82), but the peak value may be several times that computed from the peak overpressure by the Rankine-Hugoniot relations. Damage to and displacement of targets which are affected by dynamic pressure may thus be considerably greater in the nonideal precursor region for a given value of peak overpressure than under nearly ideal conditions.

BIBLIOGRAPHY

- *BANISTER, J. R., and L. J. VORTMAN, "Effects of a Precursor Shock Wave on Blast Loading of a Structure," Sandia Corporation, Albuquerque, New Mexico, October 1960, WT-1472.
- *BETHE, H. A., *et al.*, "Blast Wave," University of California, Los Alamos Scientific Laboratory, March 1958, LA-2000.
- BRINKLEY, S. R., JR., and J. G. KIRKWOOD, "Theory of the Propagation of Shock Waves," *Phys. Rev.*, **71**, 606 (1947); **72**, 1109 (1947).
- BRODE, H. L., "Numerical Solution of Spherical Blast Waves," *J. Appl. Phys.* **26**, 766 (1955).
- BRODE, H. L., "Review of Nuclear Weapons Effects," *Ann. Rev. Nuclear Science*, **18**, 153 (1968).
- BRODE, H. L., "Height of Burst Effects at High Overpressures," Rand Corporation, Santa Monica, California, July 1970, RM-6301-DASA, DASA 2506.
- COURANT, R., and K. O. FRIEDRICH, "Supersonic Flow and Shock Waves," Interscience Publishers, Inc., 1948.
- GOLDSTINE, H. H., and J. VON NEUMANN, "Blast Wave Calculations," *Comm. on Pure and Appl. Math.* **8**, 327 (1955).
- LETHO, D. L. and R. A. LARSON, "Long Range Propagation of Spherical Shockwaves from Explosions in Air," U.S. Naval Ordnance Laboratory, July 1969, NOLTR 69-88.
- LIEPMANN, H. W., and A. E. PUCKETT, "Aerodynamics of a Compressible Fluid," John Wiley and Sons, Inc., 1947.
- PENNEY, W. G., D. E. J. SAMUELS, and G. C. SCORGIE, "The Nuclear Explosive Yields at Hiroshima and Nagasaki," *Phil. Trans. Roy. Soc., A* **266**, 357 (1970).
- REED, J. W., "Airblast from Plowshare Projects," in Proceedings of the Symposium on Public Health Aspects of Peaceful Uses of Nuclear Explosives, Southwestern Radiological Health Laboratory, April 1969, SWRHL-82, p. 309.
- TAYLOR, G. I., "The Formation of a Blast Wave by a Very Intense Explosion," *Proc. Roy. Soc., A* **201**, 159, 175 (1950).
- *U.S. Standard Atmosphere, U.S. Government Printing Office, Washington, D.C., 1962, Supplements, 1966.

*These documents may be purchased from the National Technical Information Service, U.S. Department of Commerce, Arlington, Virginia 22161.

CHAPTER IV

AIR BLAST LOADING

INTERACTION OF BLAST WAVE WITH STRUCTURES

INTRODUCTION

4.01 The phenomena associated with the blast wave in air from a nuclear explosion have been treated in the preceding chapter. The behavior of an object or structure exposed to such a wave may be considered under two main headings. The first, called the "loading," i.e., the forces which result from the action of the blast pressure, is the subject of this chapter. The second, the "response" or distortion of the structure due to the particular loading, is treated in the next chapter.

4.02 For an air burst, the direction of propagation of the incident blast wave will be toward the ground at ground zero. In the regular reflection region, where the direction of propagation of the blast wave is not parallel to the horizontal axis of the structure, the forces exerted upon structures will also have a considerable downward component (prior to passage of the reflected wave) due to the reflected pressure buildup on the horizontal surfaces. Consequently, in addition to the horizontal loading, as in the Mach region (§ 3.24 *et seq.*), there will also be initially an appreciable downward force.

This tends to cause crushing toward the ground, e.g., dished-in roofs, in addition to distortion due to translational motion.

4.03 The discussion of air blast loading for aboveground structures in the Mach region in the sections that follow emphasizes the situation where the reflecting surface is nearly ideal (§ 3.47) and the blast wave behaves normally, in accordance with theoretical considerations. A brief description of blast wave loading in the precursor region (§ 3.79 *et seq.*) is also given. For convenience, the treatment will be somewhat arbitrarily divided into two parts: one deals with "diffraction loading," which is determined mainly by the peak overpressure in the blast wave, and the other with "drag loading," in which the dynamic pressure is the significant property. It is important to remember, however, that all structures are subjected simultaneously to both types of loading, since the overpressure and dynamic pressure cannot be separated, although for certain structures one may be more important than the other.

4.04 Details of the interaction of a blast wave with any structure are quite

complicated, particularly if the geometry of the structure is complex. However, it is frequently possible to consider equivalent simplified geometries, and blast loadings of several such geometries are discussed later in this chapter.

DIFFRACTION LOADING

4.05 When the front of an air blast wave strikes the face of a structure, reflection occurs. As a result the overpressure builds up rapidly to at least twice (and generally several times) that in the incident wave front. The actual pressure attained is determined by various factors, such as the peak overpressure of the incident blast wave and the angle between the direction of motion of the wave and the face of the structure (§ 3.78). The pressure increase is due to the conversion of the kinetic energy of the air behind the shock front into internal energy as the rapidly moving air behind the shock front is decelerated at the face of the structure. The reflected shock front propagates back into the air in all directions. The high pressure region expands outward towards the surrounding regions of lower pressure.

4.06 As the wave front moves forward, the reflected overpressure on the face of the structure drops rapidly to that produced by the blast wave without reflection,¹ plus an added drag force due to the wind (dynamic) pressure. At the same time, the air pressure wave bends or "diffracts" around the structure, so that the structure is eventually engulfed by the blast, and approximately the

same pressure is exerted on the sides and the roof. The front face, however, is still subjected to wind pressure, although the back face is shielded from it.

4.07 The developments described above are illustrated in a simplified form in Figs. 4.07a, b, c, d, e;² this shows, in plan, successive stages of a structure without openings which is being struck by an air blast wave moving in a horizontal direction. In Fig. 4.07a the wave front is seen approaching the structure with the direction of motion perpendicular to the face of the structure exposed to the blast. In Fig. 4.07b the wave has just reached the front face, producing a high reflected overpressure. In Fig. 4.07c the blast wave has proceeded about halfway along the structure and in Fig. 4.07d the wave front has just passed the rear of the structure. The pressure on the front face has dropped to some extent while the pressure is building up on the back face as the blast wave diffracts around the structure. Finally, when the wave front has passed completely, as in Fig. 4.07e, approximately equal air pressures are exerted on the sides and top of the structure. A pressure difference between front and back faces, due to the wind forces, will persist, however, during the whole positive phase of the blast wave. If the structure is oriented at an angle to the blast wave, the pressure would immediately be exerted on two faces, instead of one, but the general characteristics of the blast loading would be similar to that just described (Figs. 4.07f, g, h, and i).

4.08 The pressure differential between the front and back faces will have

¹This is often referred to as the "side-on overpressure," since it is the same as that experienced by the side of the structure, where there is no appreciable reflection.

²A more detailed treatment is given later in this chapter.

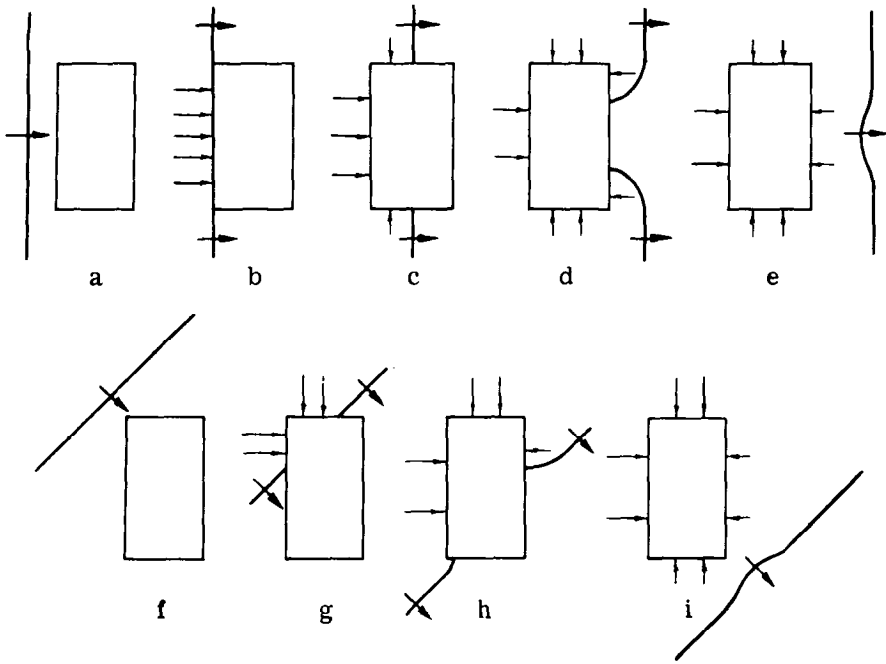

Figure 4.07. Stages in the diffraction of a blast wave by a structure without openings (plan view).

its maximum value when the blast wave has not yet completely surrounded the structure, as in Figs. 4.07b, c, and d or g and h. Such a pressure differential will produce a lateral (or translational) force tending to cause the structure to deflect and thus move bodily, usually in the same direction as the blast wave. This force is known as the "diffraction loading" because it operates while the blast wave is being diffracted around the structure. The extent and nature of the response will depend upon the size, shape, and weight of the structure and how firmly it is attached to the ground. Other characteristics of the structure are also important in determining the response, as will be seen later.

4.09 When the blast wave has en-

gulfed the structure (Fig. 4.07e or 4.07i), the pressure differential is small, and the loading is due almost entirely to the drag pressure³ exerted on the front face. The actual pressures on all faces of the structure are in excess of the ambient atmospheric pressure and will remain so, although decreasing steadily, until the positive phase of the blast wave has ended. Hence, the diffraction loading on a structure without openings is eventually replaced by an inwardly directed pressure, i.e., a compression or squeezing action, combined with the dynamic pressure of the blast wave. In a structure with no openings, the loading will cease only when the overpressure drops to zero.

4.10 The damage caused during the

³The drag pressure is the product of the dynamic pressure and the drag coefficient (§ 4.29).

diffraction stage will be determined by the magnitude of the loading and by its duration. The loading is related to the peak overpressure in the blast wave and this is consequently an important factor. If the structure under consideration has no openings, as has been assumed so far, the duration of the diffraction loading will be very roughly the time required for the wave front to move from the front to the back of the building, although wind loading will continue for a longer period. The size of the structure will thus affect the diffraction loading. For a structure 75 feet long, the diffraction loading will operate for a period of about one-tenth of a second, but the squeezing and the wind loading will persist for a longer time (§ 4.13). For thin structures, e.g., telegraph or utility poles and smokestacks, the diffraction period is so short that the corresponding loading is negligible.

4.11 If the building exposed to the blast wave has openings, or if it has windows, panels, light siding, or doors which fail in a very short space of time, there will be a rapid equalization of pressure between the inside and outside of the structure. This will tend to reduce the pressure differential while diffraction is occurring. The diffraction loading on the structure as a whole will thus be decreased, although the loading on interior walls and partitions will be greater than for an essentially closed structure, i.e., one with few openings. Furthermore, if the building has many openings, the squeezing (crushing) action, due to the pressure being higher outside than inside after the diffraction stage, will not occur.

DRAG (DYNAMIC PRESSURE) LOADING

4.12 During the whole of the overpressure positive phase (and for a short time thereafter) a structure will be subjected to the dynamic pressure (or drag) loading caused by the transient winds behind the blast wave front. Under nonideal (precursor) conditions, a dynamic pressure loading of varying strength may exist prior to the maximum overpressure (diffraction) loading. Like the diffraction loading, the drag loading, especially in the Mach region, is equivalent to a lateral (or translational) force acting upon the structure or object exposed to the blast.

4.13 Except at high blast overpressures, the dynamic pressures at the face of a structure are much less than the peak overpressures due to the blast wave and its reflection (Table 3.07). However, the drag loading on a structure persists for a longer period of time, compared to the diffraction loading. For example, the duration of the positive phase of the dynamic pressure on the ground at a slant range of 1 mile from a 1-megaton nuclear explosion in the air is almost 3 seconds. On the other hand, the diffraction loading is effective only for a small fraction of a second, even for a large structure, as seen above.

4.14 It is the effect of the duration of the drag loading on structures which constitutes an important difference between nuclear and high-explosive detonations. For the same peak overpressure in the blast wave, a nuclear weapon will prove to be more destructive than a conventional one, especially for buildings which respond to drag loading.

This is because the blast wave is of much shorter duration for a high-explosive weapon, e.g., a few hundredths of a second. As a consequence of the longer duration of the positive phase of the blast wave from weapons of high energy yield, such devices cause more damage to drag-sensitive structures (§ 4.18) than might be expected from the peak overpressures alone.

STRUCTURAL CHARACTERISTICS AND AIR BLAST LOADING

4.15 In analyzing the response to blast loading, as will be done more fully in Chapter V, it is convenient to consider structures in two categories, i.e., diffraction-type structures and drag-type structures. As these names imply, in a nuclear explosion the former would be affected mainly by diffraction loading and the latter by drag loading. It should be emphasized, however, that the distinction is made in order to simplify the treatment of real situations which are, in fact, very complex. Although it is true that some structures will respond mainly to diffraction forces and others mainly to drag forces, actually all buildings will respond to both types of loading. The relative importance of each type of loading in causing damage will depend upon the type of structure as well as on the characteristics of the blast wave. These facts should be borne in mind in connection with the ensuing discussion.

4.16 Large buildings having a moderately small window and door area and fairly strong exterior walls respond mainly to diffraction loading. This is because it takes an appreciable time for the blast wave to engulf the building, and the pressure differential between

front and rear exists during the whole of this period. Examples of structures which respond mainly to diffraction loading are multistory, reinforced-concrete buildings with small window area, large wall-bearing structures such as apartment houses, and wood-frame buildings such as dwelling houses.

4.17 Because, even with large structures, the diffraction loading will generally be operative for a fraction of a second only, the duration of the blast wave positive phase, which is usually much longer, will not be significant. In other words, the length of the blast wave positive phase will not materially affect the net translational loading (or the resulting damage) during the diffraction stage. A diffraction-type structure is, therefore, primarily sensitive to the peak overpressure in the blast wave to which it is exposed. Actually it is the associated reflected overpressure on the structure that largely determines the diffraction loading, and this may be several times the incident blast overpressure (§ 3.78).

4.18 When the pressures on different areas of a structure (or structural element) are quickly equalized, either because of its small size, the characteristics of the structure (or element), or the rapid formation of numerous openings by action of the blast, the diffraction forces operate for a very short time. The response of the structure is then mainly due to the dynamic pressure (or drag force) of the blast wind. Typical drag-type structures are smokestacks, telephone poles, radio and television transmitter towers, electric transmission towers, and truss bridges. In all these cases the diffraction of the blast wave around the structure or its component

elements requires such a very short time that the diffraction processes are negligible, but the drag loading may be considerable.

4.19 The drag loading on a structure is determined not only by the dynamic pressure, but also by the shape of the structure (or structural element). The shape factor (or drag coefficient) is less for rounded or streamlined objects than for irregular or sharp-edged structures or elements. For example, for a unit of projected area, the loading on a telephone pole or a smokestack will be less than on an I-beam. Furthermore, the drag coefficient can be either positive or negative, according to circumstances (§ 4.29).

4.20 Steel (or reinforced-concrete) frame buildings with light walls made of asbestos cement, aluminum, or corrugated steel, quickly become drag-sensitive because of the failure of the walls at low overpressures. This failure, accompanied by pressure equalization, occurs

very soon after the blast wave strikes the structure, so that the frame is subject to a relatively small diffraction loading. The distortion, or other damage, subsequently experienced by the frame, as well as by narrow elements of the structure, e.g., columns, beams, and trusses, is then caused by the drag forces.

4.21 For structures which are fundamentally of the drag type, or which rapidly become so because of loss of siding, the response of the structure or of its components is determined by both the drag loading and its duration. Thus, the damage is dependent on the duration of the positive phase of the blast wave as well as on the peak dynamic pressure. Consequently, for a given peak dynamic pressure, an explosion of high energy yield will cause more damage to a drag-type structure than will one of lower yield because of the longer duration of the positive phase in the former case (see § 5.48 *et seq.*).

INTERACTION OF OBJECTS WITH AIR BLAST⁴

DEVELOPMENT OF BLAST LOADING

4.22 The usual procedure for predicting blast damage is by an analysis, supported by such laboratory and full-scale observations as may be available. The analysis is done in two stages: first the air blast loading on the particular structure is determined; and second, an evaluation is made of the response of the structure to this loading. The first stage of the analysis for a number of idealized targets of simple shape is discussed in

the following sections. The second stage is treated in Chapter V.

4.23 The blast loading on an object is a function of both the incident blast wave characteristics, i.e., the peak overpressure, dynamic pressure, decay, and duration, as described in Chapter III, and the size, shape, orientation, and response of the object. The interaction of the incident blast wave with an object is a complicated process, for which a theory, supported primarily by experimental data from shock tubes and wind

⁴The remaining (more technical) sections of this chapter may be omitted without loss of continuity.

tunnels, has been developed. To reduce the complex problem of blast loading to reasonable terms, it will be assumed, for the present purpose, that (1) the overpressures of interest are less than 50 pounds per square inch (dynamic pressures less than about 40 pounds per square inch), and (2) the object being loaded is in the region of Mach reflection.

4.24 To obtain a general idea of the blast loading process, a simple object, namely, a cube with one side facing toward the explosion, will be selected as an example. It will be postulated, further, that the cube is rigidly attached to the ground surface and remains motionless when subjected to the loading. The blast wave (or shock) front is taken to be of such size compared to the cube that it can be considered to be a plane wave striking the cube. The pressures referred to below are the average pressures on a particular face. Since the object is in the region of Mach reflection, the blast front is perpendicular to the surface of the ground. The front of the cube, i.e., the side facing toward the explosion, is normal to the direction of propagation of the blast wave (Fig. 4.24).

4.25 When the blast wave strikes the front of the cube, reflection occurs producing reflected pressures which

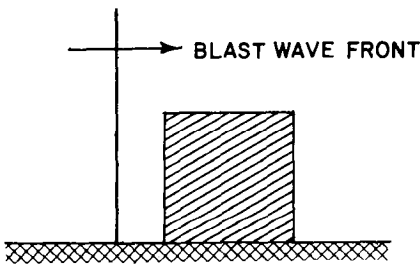

Figure 4.24. Blast wave approaching cube rigidly attached to ground.

may be from two to eight times as great as the incident overpressure (§ 3.56). The blast wave then bends (or diffracts) around the cube exerting pressures on the sides and top of the object, and finally on its back face. The object is thus engulfed in the high pressure of the blast wave and this decays with time, eventually returning to ambient conditions. Because the reflected pressure on the front face is greater than the pressure in the blast wave above and to the sides, the reflected pressure cannot be maintained and it soon decays to a "stagnation pressure," which is the sum of the incident overpressure and the dynamic (drag) pressure. The decay time is roughly that required for a rarefaction wave to sweep from the edges of the front face to the center of this face and back to the edges.

4.26 The pressures on the sides and top of the cube build up to the incident overpressure when the blast front arrives at the points in question. This is followed by a short period of low pressure caused by a vortex formed at the front edge during the diffraction process and which travels along or near the surface behind the wave front (Fig. 4.26). After the vortex has passed, the pressure returns essentially to that in the incident blast wave which decays with time. The air flow causes some reduction in the loading to the sides and top, because, as will be seen in § 4.43, the drag pressure here has a negative value.

4.27 When the blast wave reaches the rear of the cube, it diffracts around the edges, and travels down the back surface (Fig. 4.27). The pressure takes a certain time ("rise time") to reach a more-or-less steady state value equal to the algebraic sum of the overpressure

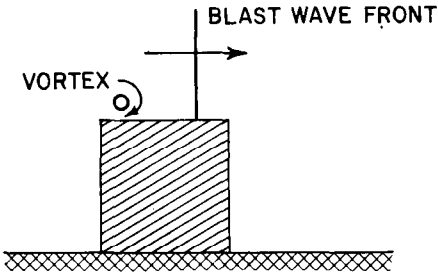

Figure 4.26. Blast wave moving over sides and top of cube.

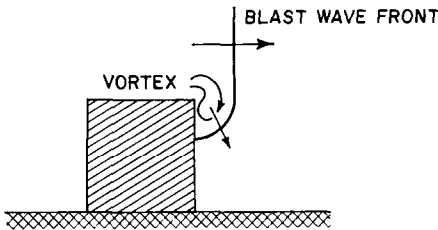

Figure 4.27. Blast wave moving down rear of cube.

and the drag pressure, the latter having a negative value in this case also (§ 4.44). The finite rise time results from a weakening of the blast wave front as it diffracts around the back edges, accompanied by a temporary vortex action, and the time of transit of the blast wave from the edges to the center of the back face.

4.28 When the overpressure at the rear of the cube attains the value of the overpressure in the blast wave, the diffraction process may be considered to have terminated. Subsequently, essentially steady state conditions may be assumed to exist until the pressures have returned to the ambient value prevailing prior to the arrival of the blast wave.

4.29 The total loading on any given face of the cube is equal to the algebraic sum of the respective overpressure, $p(t)$,

and the drag pressure. The latter is related to the dynamic pressure, $q(t)$, by the expression

$$\text{Drag pressure} = C_d q(t),$$

where C_d is the drag coefficient. The value of C_d depends on the orientation of the particular face to the blast wave front and may be positive or negative. The drag pressures (or loading) may thus be correspondingly positive or negative. The quantities $p(t)$ and $q(t)$ represent the overpressure and dynamic pressure, respectively, at any time, t , after the arrival of the wave front (§ 3.57 *et seq.*).

4.30 The foregoing discussion has referred to the loading on the various surfaces in a general manner. For a particular point on a surface, the loading depends also on the distance from the point to the edges and a more detailed treatment is necessary. It should be noted that only the gross characteristics of the development of the loading have been described here. There are, in actual fact, several cycles of reflected and rarefaction waves traveling across the surfaces before damping out, but these fluctuations are considered to be of minor significance as far as damage to the structure is concerned.

EFFECT OF SIZE ON LOADING DEVELOPMENT

4.31 The loading on each surface may not be as important as the net horizontal loading on the entire object. Hence, it is necessary to study the net loading, i.e., the loading on the front face minus that on the back face of the cube. The net horizontal loading during the diffraction process is high because

the pressure on the front face is initially the reflected pressure and no loading has reached the rear face.

4.32 When the diffraction process is completed, the overpressure loadings on the front and back faces are essentially equal. The net horizontal loading is then relatively small. At this time the net loading consists primarily of the difference between front and back loadings resulting from the dynamic pressure loading. Because the time required for the completion of the diffraction process depends on the size of the object, rather than on the positive phase duration of the incident blast wave, the diffraction loading impulse per unit area (§ 3.59) is greater for long objects than for short ones.

4.33 The magnitude of the dynamic pressure (or drag) loading, on the other hand, is affected by the shape of the object and the duration of the dynamic pressure. It is the latter, and not the size of the object, which determines the application time (and impulse per unit area) of the drag loading.

4.34 It may be concluded, therefore, that, for large objects struck by blast waves of short duration, the net horizontal loading during the diffraction process is more important than the dynamic pressure loading. As the object becomes smaller, or as the dynamic pressure duration becomes longer, e.g., with weapons of larger yield, the drag loading becomes increasingly important. For classification purposes, objects are often described as "diffraction targets" or "drag targets," as mentioned earlier, to indicate the loading mainly responsible for damage. Actually, all objects are damaged by the total loading, which is a combination of over-

pressure and dynamic pressure loadings, rather than by any one component of the blast loading.

EFFECT OF SHAPE ON LOADING DEVELOPMENT

4.35 The description given above for the interaction of a blast wave with a cube may be generalized to apply to the loading on a structure of any other shape. The reflection coefficient, i.e., the ratio of the (instantaneous) reflected overpressure to the incident overpressure at the blast front, depends on the angle at which the blast wave strikes the structure. For a curved structure, e.g., a sphere or a cylinder (or part of a sphere or cylinder), the reflection varies from point to point on the front surface. The time of decay from reflected to stagnation pressure then depends on the size of the structure and the location of the point in question on the front surface.

4.36 The drag coefficient, i.e., the ratio of the drag pressure to the dynamic pressure (§ 4.29), varies with the shape of the structure. In many cases an overall (or average) drag coefficient is given, so that the net force on the surface can be determined. In other instances, local coefficients are necessary to evaluate the pressures at various points on the surfaces. The time of buildup (or rise time) of the average pressure on the back surface depends on the size and also, to some extent, on the shape of the structure.

4.37 Some structures have frangible portions that are easily blown out by the initial impact of the blast wave, thus altering the shape of the object and the subsequent loading. When windows are blown out of an ordinary building, the

blast wave enters and tends to equalize the interior and exterior pressures. In fact, a structure may be designed to have certain parts frangible to lessen damage to all other portions of the structure. Thus, the response of certain elements in such cases influences the blast loading on the structure as a whole. In general, the movement of a structural element is not considered to influence the blast loading on that element itself. However, an exception to this rule arises in the case of an aircraft in flight when struck by a blast wave.

BLAST LOADING-TIME CURVES

4.38 The procedures whereby curves showing the air blast loading as a function of time may be derived are given below. The methods presented are for the following five relatively simple shapes: (1) closed box-like structure; (2) partially open box-like structure; (3) open frame structure; (4) cylindrical structure; and (5) semicircular arched structure. These methods can be altered somewhat for objects having similar characteristics. For very irregularly shaped structures, however, the proce-

dures described may provide no more than a rough estimate of the blast loading to be expected.

4.39 As a general rule, the loading analysis of a diffraction-type structure is extended only until the positive phase overpressure falls to zero at the surface under consideration. Although the dynamic pressure persists after this time, the value is so small that the drag force can be neglected. However, for drag-type structures, the analysis is continued until the dynamic pressure is zero. During the negative overpressure phase, both overpressure and dynamic pressure are too small to have any significant effect on structures (§ 3.11 *et seq.*).

4.40 The blast wave characteristics which need to be known for the loading analysis and their symbols are summarized in Table 4.40. The locations in Chapter III where the data may be obtained, at a specified distance from ground zero for an explosion of given energy yield and height of burst, are also indicated.

4.41 A closed box-like structure may be represented simply by a parallelepiped, as in Fig. 4.41, having a length L , height H , and breadth B . Structures

Table 4.40

BLAST WAVE CHARACTERISTICS FOR DETERMINATION OF LOADING

Property	Symbol	Source
Peak overpressure	p	Figs. 3.73a, b, and c
Time variation of overpressure	$p(t)$	Fig. 3.57
Peak dynamic pressure	q	Fig. 3.75
Time variation of dynamic pressure	$q(t)$	Fig. 3.58
Reflected overpressure	p_r	Fig. 3.78b
Duration of positive phase of overpressure	t_p^*	Fig. 3.76
Duration of positive phase of dynamic pressure	t_q^*	Fig. 3.76
Blast front (shock) velocity	U	Fig. 3.55

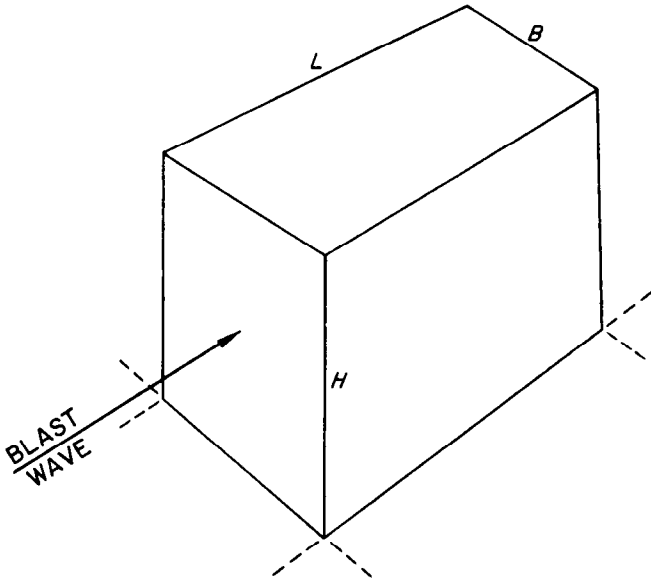

Figure 4.41. Representation of closed box-like structure.

with a flat roof and walls of approximately the same blast resistance as the frame will fall into this category. The walls have either no openings (doors and windows), or a small number of such openings up to about 5 percent of the total area. The pressures on the interior of the structure then remain near the ambient value existing before the arrival of the blast wave, while the outside is subjected to blast loading. To simplify the treatment, it will be supposed that one side of the structure faces toward the explosion and is perpendicular to the direction of propagation of the blast wave. This side is called the front face. The loading diagrams are computed below for (a) the front face, (b) the side and top, and (c) the back face. By combining the data for (a) and (c), the net horizontal loading is obtained in (d).

Front Face.—The first step is to determine the reflected pressure, p_r ; this gives the pressure at the time $t = 0$, when the blast wave front strikes the front face (Fig. 4.42). Next, the time, t_s , is calculated at which the stagnation pressure, p_s , is first attained. It has been found from laboratory studies that, for peak overpressures being considered (50 pounds per square inch or less), t_s can be represented, to a good approximation, by

$$t_s = \frac{3S}{U},$$

where S is equal to H or $B/2$, whichever is less, and U is the blast front (shock) velocity. The drag coefficient for the front face is unity, so that the drag pressure is here equal to the dynamic pressure. The stagnation pressure is thus

4.42 (a) Average Loading on

$$p_s = p(t_s) + q(t_s),$$

where $p(t_s)$ and $q(t_s)$ are the overpressure and dynamic pressure at the time t_s . The average pressure subsequently decays with time, so that,

$$\text{Pressure at time } t = p(t) + q(t),$$

where t is any time between t_s and t_p^+ . The pressure-time curve for the front face can thus be determined, as in Fig. 4.42.

4.43 (b) Average Loading on Sides and Top.—Although loading commences immediately after the blast wave strikes the front face, i.e., at $t = 0$, the sides and top are not fully loaded until the wave has traveled the distance L , i.e., at times $t = L/U$. The average pressure, p_a , at this time is considered to be the overpressure plus the drag load-

ing at the distance $L/2$ from the front of the structure, so that

$$p_a = p\left(\frac{L}{2U}\right) + C_d q\left(\frac{L}{2U}\right)$$

The drag coefficient on the sides and top of the structure is approximately -0.4 for the blast pressure range under consideration (§ 4.23). The loading increases from zero at $t = 0$ to the value p_a at the time L/U , as shown in Fig. 4.43. Subsequently, the average pressure at any time t is given by

$$\begin{aligned} \text{Pressure at time } t = & p\left(t - \frac{L}{2U}\right) \\ & + C_d q\left(t - \frac{L}{2U}\right), \end{aligned}$$

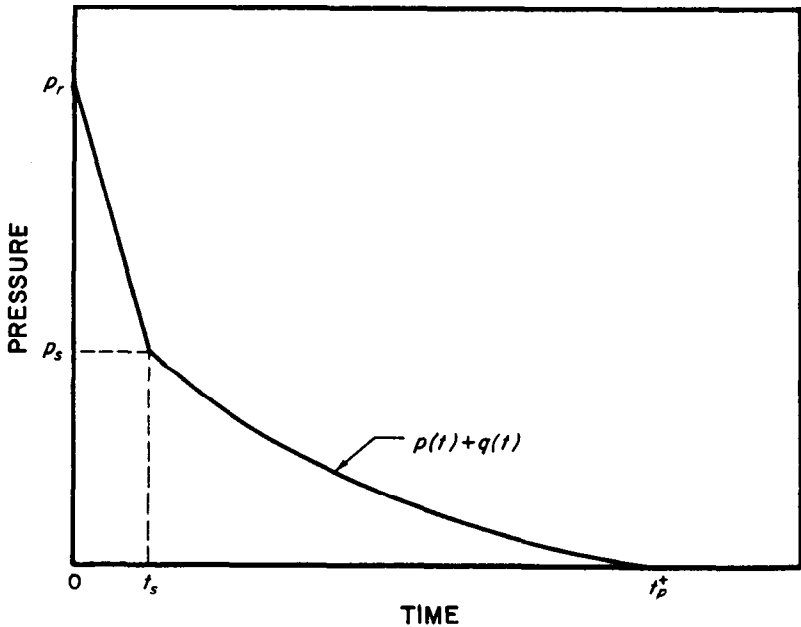

Figure 4.42. Average front face loading of closed box-like structure.

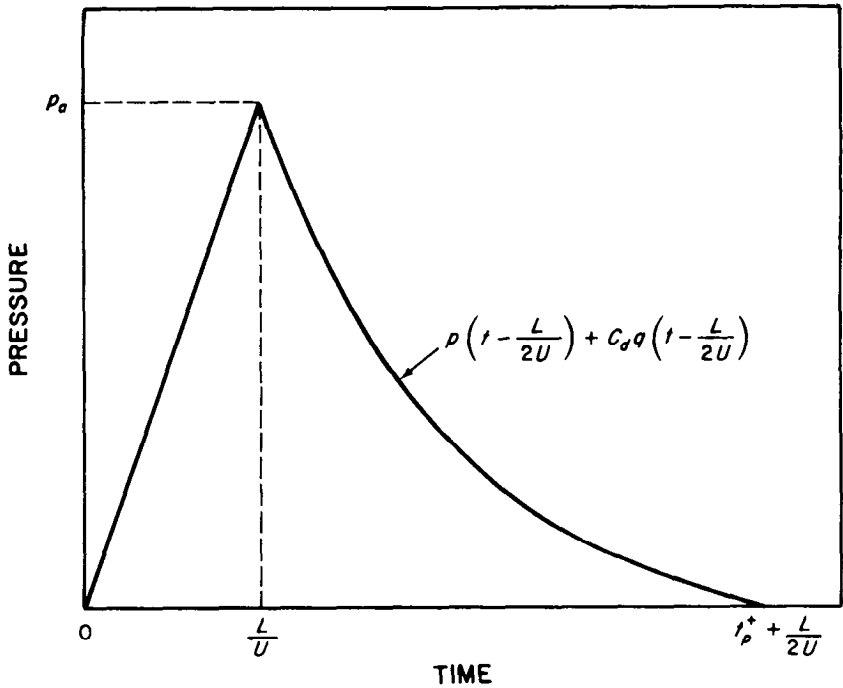

Figure 4.43. Average side and top loading of closed box-like structure.

where t lies between L/U and $t_p^* + L/2U$, as seen in Fig. 4.43. The overpressure and dynamic pressure, respectively, are the values at the time $t - L/2U$. Hence, the overpressure on the sides and top becomes zero at time $t_p^* + L/2U$.

4.44 (c) Average Loading on Back Face.—The shock front arrives at the back face at time L/U , but it requires an additional time, $4S/U$, for the average pressure to build up to the value p_b (Fig. 4.44), where p_b is given approximately by

$$p_b = p \left(\frac{L+4S}{U} \right) + C_d q \left(\frac{L+4S}{U} \right).$$

Here, as before, S is equal to H or $B/2$ whichever is the smaller. The drag coefficient on the back face is about -0.3

for the postulated blast pressure range. The average pressure at any time t after the attainment of p_b is represented by

Pressure at time $t =$

$$p \left(t - \frac{L}{U} \right) + C_d q \left(t - \frac{L}{U} \right),$$

where t lies between $(L + 4S)/U$ and $t_p^* + L/U$, as seen in Fig. 4.44.

4.45 (d) Net Horizontal Loading.—The net loading is equal to the front loading minus the back loading. This subtraction is best performed graphically, as shown in Fig. 4.45. The left-hand diagram gives the individual front and back loading curves, as derived from Figs. 4.42 and 4.44, respectively. The difference indicated by the shaded region is then transferred to

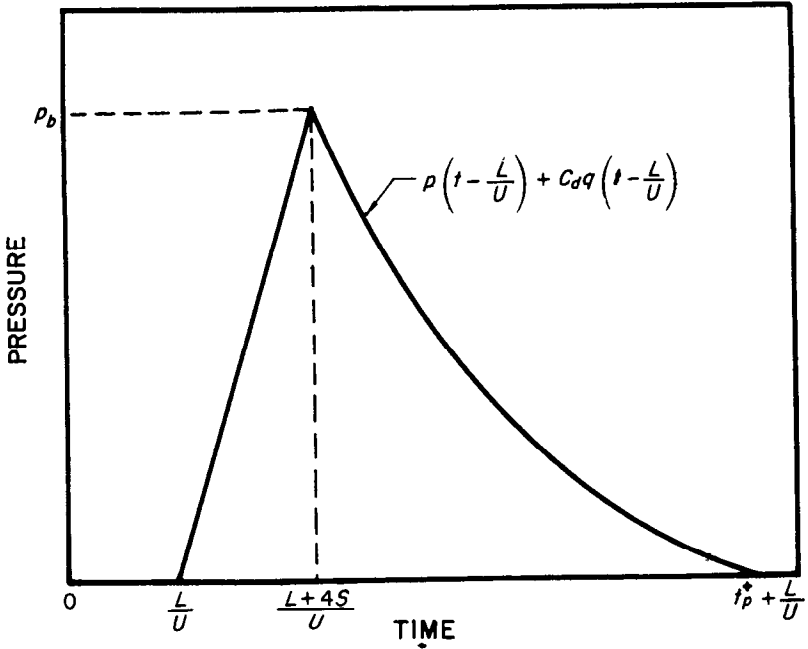

Figure 4.44. Average back face loading of closed box-like structure.

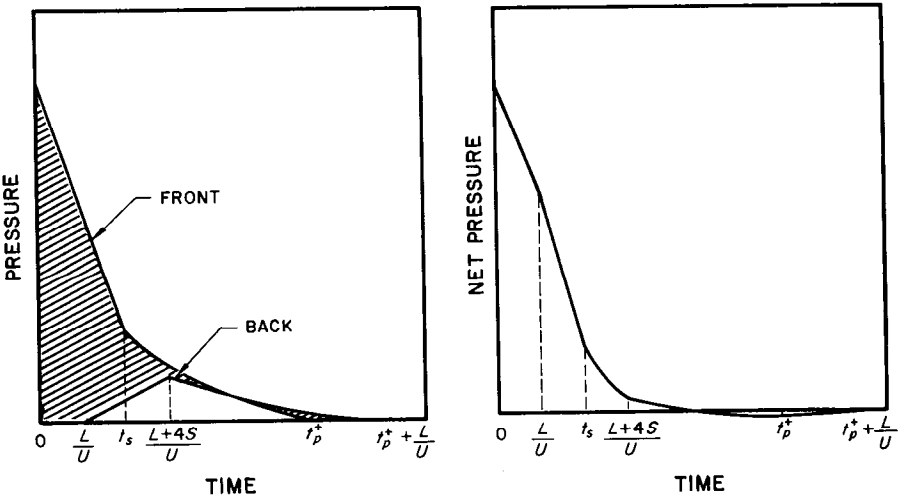

Figure 4.45. Net horizontal loading of closed box-like structure.

the right-hand diagram to give the net pressure. The net loading is necessary for determining the frame response, whereas the wall actions are governed primarily by the loadings on the individual faces.

PARTIALLY OPEN BOX-LIKE STRUCTURES

4.46 A partially open box-like structure is one in which the front and back walls have about 30 percent of openings or window area and no interior partitions to influence the passage of the blast wave. As in the previous case, the loading is derived for (a) the front face, (b) the sides and roof, (c) the back face, and (d) the net horizontal loading. Because the blast wave can now enter the inside of the structure, the loading-time curves must be considered for both the exterior and interior of the structure.

4.47 (a) Average Loading on Front Face.—The outside loading is computed in the same manner as that used for a closed structure, except that S is replaced by S' . The quantity S' is the average distance (for the entire front face) from the center of a wall section to an open edge of the wall. It represents the average distance which rarefaction waves must travel on the front face to reduce the reflected pressures to the stagnation pressure.

4.48 The pressure on the inside of the front face starts rising at zero time, because the blast wave immediately enters through the openings, but it takes a time $2L/U$ to reach the blast wave overpressure value. Subsequently, the inside pressure at any time t is given by $p(t)$. The dynamic pressures are assumed to be negligible on the interior of the structure. The variations of the in-

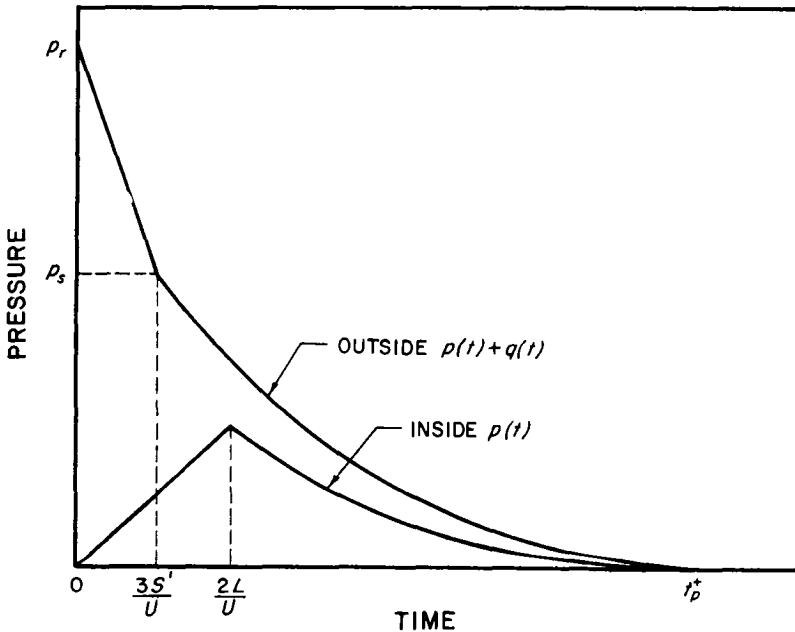

Figure 4.48. Average front face loading of partially open box-like structure.

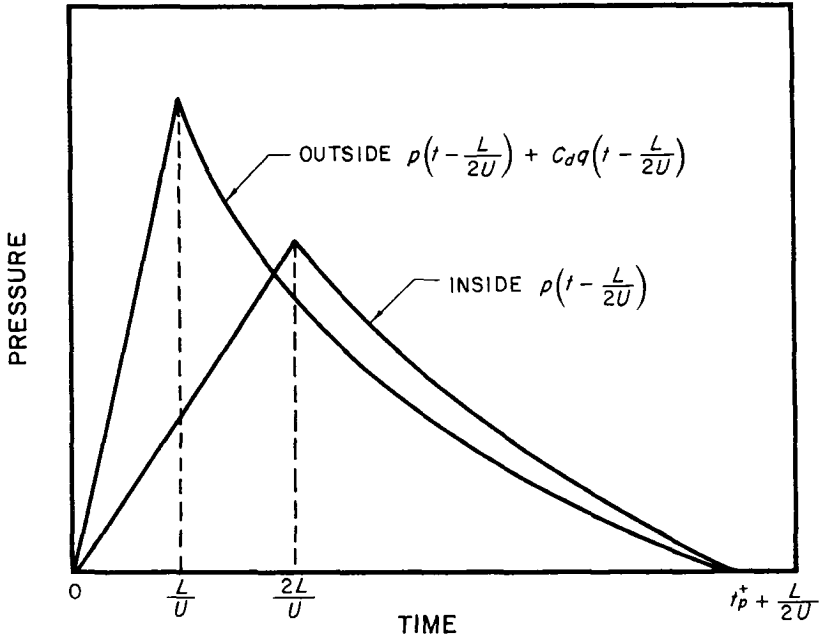

Figure 4.49 Average side and top loading of partially open box-like structure.

side and the outside pressures with time are as represented in Fig. 4.48.

4.49 (b) Average Loading on Sides and Top.—The outside pressures are obtained as for a closed structure (§ 4.43), but the inside pressures, as for the front face, require a time $2L/U$ to attain the overpressure in the blast wave. Here also, the dynamic pressures on the interior are neglected, and side wall openings are ignored because their effect on the loading is uncertain. The loading curves are depicted in Fig. 4.49.

4.50 (c) Average Loading on Back Face.—The outside pressures are the same as for a closed structure, with the exception that S is replaced by S' , as described above. The inside pressure, reflected from the inside of the back face, reaches the same value as the blast overpressure at a time L/U and then decays as $p(t - L/U)$; as before, the

dynamic pressure is regarded as being negligible (Fig. 4.50).

4.51 (d) Net Horizontal Loading.—The net horizontal loading is equal to the net front loading, i.e., outside minus inside, minus the net back face loading.

OPEN FRAME STRUCTURE

4.52 A structure in which small separate elements are exposed to a blast wave, e.g., a truss bridge, may be regarded as an open frame structure. Steel-frame office buildings with a majority of the wall area of glass, and industrial buildings with asbestos, light steel, or aluminum panels quickly become open frame structures after the initial impact of the blast wave.

4.53 It is difficult to determine the magnitude of the loading that the frang-

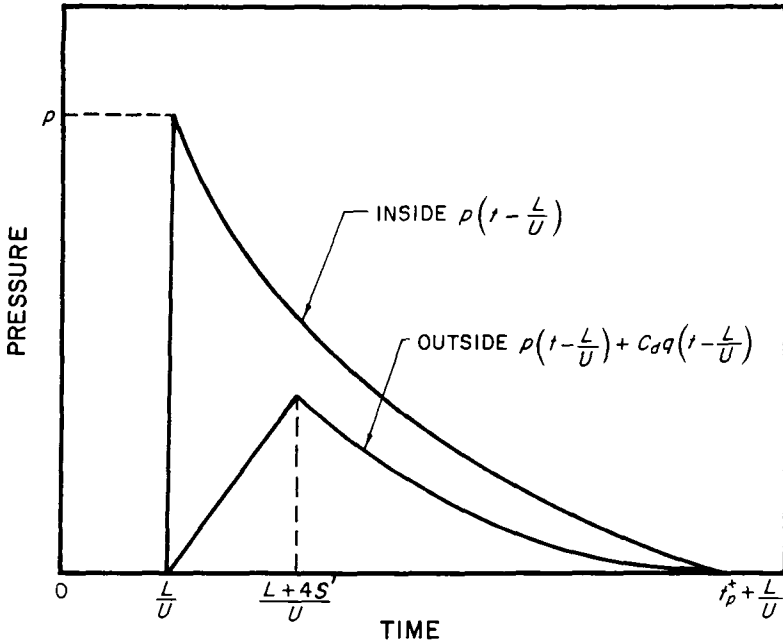

Figure 4.50. Average back face loading of partially open box-like structure.

ible wall material transmits to the frame before failing. For glass, the load transmitted is assumed to be negligible if the loading is sufficient to fracture the glass. For asbestos, transite, corrugated steel, or aluminum paneling, an approximate value of the load transmitted to the frame is an impulse of 0.04 pound-second per square inch. Depending on the span lengths and panel strength, the panels are not likely to fail when the peak overpressure is less than about 2 pounds per square inch. In this event, the full blast load is transmitted to the frame.

4.54 Another difficulty in the treatment of open frame structures arises in the computations of the overpressure loading on each individual member during the diffraction process. Because this process occurs at different times for various members and is affected by

shielding of one member by adjacent members, the problem must be simplified. A recommended simplification is to treat the loading as an impulse, the value of which is obtained in the following manner. The overpressure loading impulse is determined for an average member treated as a closed structure and this is multiplied by the number of members. The resulting impulse is considered as being delivered at the time the shock front first strikes the structure, or it can be separated into two impulses for front and back faces where the majority of the elements are located, as shown below in Fig. 4.56.

4.55 The major portion of the loading on an open frame structure consists of the drag loading. For an individual member in the open, the drag coefficient for I-beams, channels, angles, and for members with rectangular cross section

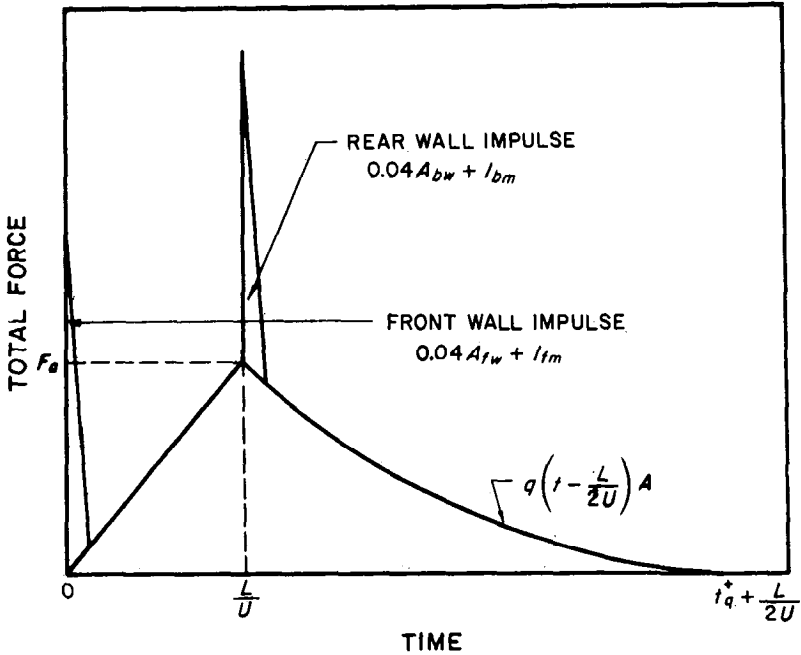

Figure 4.56. Net horizontal loading of an open frame structure.

is approximately 1.5. However, because in a frame the various members shield one another to some extent from the full blast loading, the average drag coefficient when the whole frame is considered is reduced to 1.0. The force F , i.e., pressure multiplied by area, on an individual member is thus given by

$$F(\text{member}) = C_d q(t) A_i,$$

where C_d is 1.5 and A_i is the member area projected perpendicular to the direction of blast propagation. For the loading on the frame, however, the force is

$$F(\text{frame}) = C_d q(t) \Sigma A_i,$$

where C_d is 1.0 and ΣA_i is the sum of the projected areas of all the members.

The result may thus be written in the form

$$F(\text{frame}) = q(t) A,$$

where $A = \Sigma A_i$.

4.56 The loading (force) versus time for a frame of length L , having major areas in the planes of the front and rear faces, is shown in Fig. 4.56. The symbols A_{fw} and A_{bw} represent the areas of the front and back faces, respectively, which transmit loads before failure, and I_{fm} and I_{bm} are the overpressure loading impulses on front and back members, respectively. Although drag loading commences immediately after the blast wave strikes the front face, i.e., at $t = 0$, the back face is not fully loaded until the wave has traveled the distance L , i.e., at time $t = L/U$. The

average drag loading, q_a , on the entire structure at this time is considered to be that which would occur at the distance $L/2$ from the front of the structure, so that

$$q_a = C_d q \left(\frac{L}{2U} \right),$$

and the average force on the frame, F_a (frame), is

$$F_a \text{ (frame)} = q \left(\frac{L}{2U} \right) A,$$

where C_d is 1.0, as above. After this time, the average drag force on the frame at any time t is given by

$$F_a \text{ (frame) at time } t = q \left(t - \frac{L}{2U} \right) A,$$

where t lies between L/U and $t_q^* + L/2U$, as seen in Fig. 4.56.

CYLINDRICAL STRUCTURE

4.57 The following treatment is applicable to structures with a circular cross section, such as telephone poles and smokestacks, for which the diame-

ters are small compared to the lengths. The discussion presented here provides methods for determining average pressures on projected areas of cylindrical structures with the direction of propagation of the blast perpendicular to the axis of the cylinder. A more detailed method for determining the pressure-time curves for points on cylinders is provided in the discussion of the loading on arched structures in § 4.62 *et seq.* The general situation for a blast wave approaching a cylindrical structure is represented in section in Fig. 4.57.

4.58 (a) Average Loading on Front Surface.—When an ideal blast wave impinges on a flat surface of a structure, the pressure rises instantaneously to the reflected value and then it soon drops to the stagnation pressure (§ 4.25). On the curved surface of a cylinder the interaction of the blast wave with the front face is much more complex in detail. However, in terms of the average pressure, the load appears as a force that increases with time from zero when the blast front arrives to a maximum when the blast wave has propagated one radius. This occurs at a time $D/2U$, where D is the diameter of the cylinder. For the blast

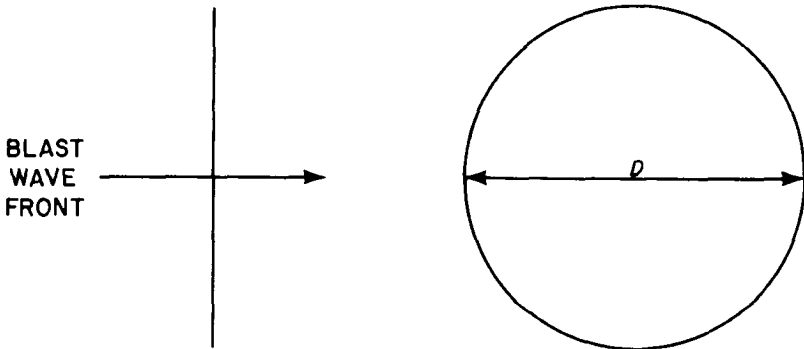

Figure 4.57. Representation of a cylindrical structure.

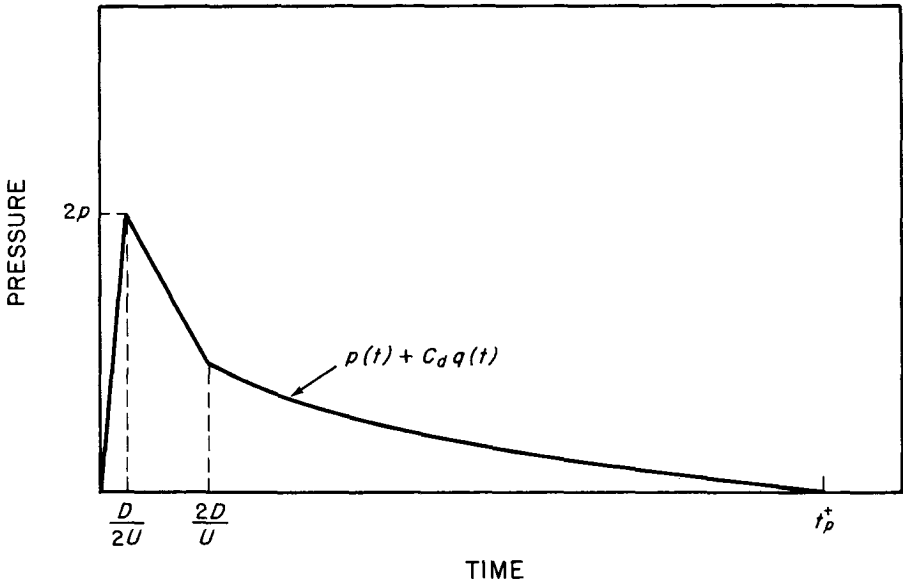

Figure 4.58. Average pressure variation on the front face of a cylinder.

pressure range being considered, the maximum average pressure reaches a value of about $2p$ as depicted in Fig. 4.58. The load on the front surface then decays in an approximately linear manner to the value it would have at about time $t = 2D/U$. Subsequently, the average pressure decreases as shown. The drag coefficient for the front surface of the cylinder is 0.8.

4.59 (b) Average Loading on the Sides.—Loading of the sides commences immediately after the blast wave strikes the front surface but, as with the closed box discussed in § 4.41 *et seq.*, the sides are not fully loaded until the wave has traveled the distance D , i.e., at time $t = D/U$. The average pressure on the sides at this time is indicated by p_{s1} , given approximately by

$$p_{s1} = p \left(\frac{D}{U} \right)$$

Complex vortex formation then causes the average pressure to drop to a minimum, p_{s2} , at the time $t = 3D/2U$; the value of p_{s2} is about half the maximum overpressure at this time, i.e.,

$$p_{s2} \approx \frac{1}{2} p \left(\frac{3D}{2U} \right)$$

The average pressure on the side then rises until time $9D/2U$ and subsequently decays as shown in Fig. 4.59. The drag coefficient for the side face is 0.9.

4.60 (c) Average Loading on Back Surface.—The blast wave begins to affect the back surface of the cylinder at time $D/2U$ and the average pressure gradually builds up to p_{b1} (Fig. 4.60) at a time of about $4D/U$. The value of p_{b1} is given by

$$p_{b1} = \frac{1}{2} p \left(\frac{4D}{U} \right)$$

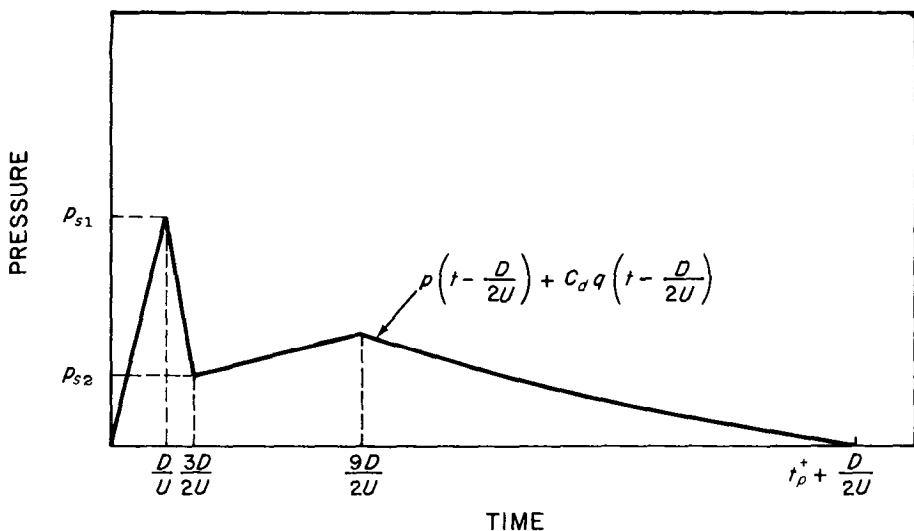

Figure 4.59. Average pressure variation on the side face of a cylinder.

The average pressure continues to rise until it reaches a maximum, p_{b2} , at a time of about $20D/U$, where

$$p_{b2} = p\left(\frac{20D}{U}\right) + C_d q\left(\frac{20D}{U}\right)$$

The average pressure at any time t after the maximum is represented by

$$\begin{aligned} \text{Pressure at time } t = & p\left(t - \frac{D}{2U}\right) \\ & + C_d q\left(t - \frac{D}{2U}\right) \end{aligned}$$

where t lies between $20D/U$ and $t_p^* + D/2U$. The drag coefficient for the back surface is -0.2 .

4.61 The preceding discussion has been concerned with average values of the loads on the various surfaces of a cylinder, whereas the actual pressures vary continuously from point to point.

Consequently, the net horizontal loading cannot be determined accurately by the simple process of subtracting the back loading from the front loading. A rough approximation of the net load may be obtained by procedures similar to those described for a closed box-like structure (§ 4.45), but a better approximation is given by the method referred to in § 4.65 *et seq.*

ARCHED STRUCTURES

4.62 The following treatment is applicable to arched structures, such as ground huts, and, as a rough approximation, to dome shaped or spherical structures. The discussion presented here is for a semicylindrical structure with the direction of propagation of the blast perpendicular to the axis of the cylinder. The results can be applied to a cylindrical structure, such as discussed above, since it consists of two such semicylinders with identical loadings on

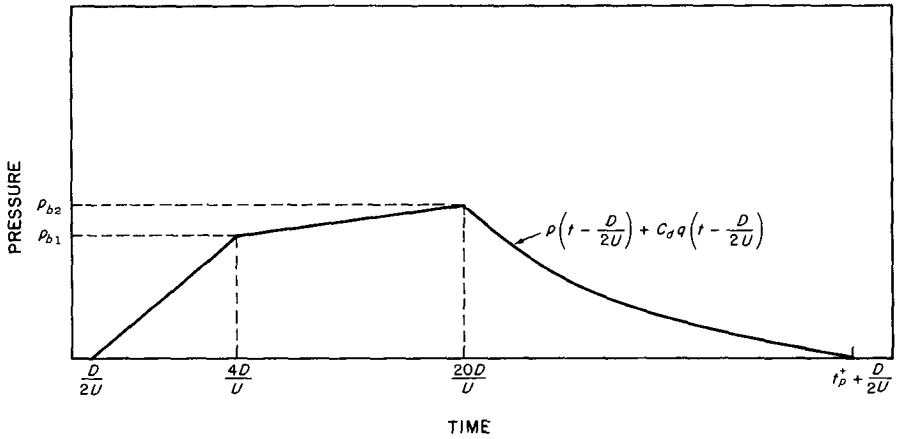

Figure 4.60. Average pressure variation on the back face of a cylinder.

each half. Whereas the preceding treatment referred to the average loads on the various faces of the cylinder (§ 4.57 *et seq.*), the present discussion describes the loads at each point. The general situation is depicted in Fig. 4.62; H is the height of the arch (or the radius of the cylinder) and z represents any point on the surface. The angle between the horizontal (or springing line) and the line joining z to the center of curvature of the semicircle is indicated by α ; and X , equal to $H(1 - \cos \alpha)$, is the hori-

zontal distance, in the direction of propagation of the blast wave, between the bottom of the arch and the arbitrary point z .

4.63 When an ideal blast wave impinges on a curved surface, vortex formation occurs just after reflection, so that there may be a temporary sharp pressure drop before the stagnation pressure is reached. A generalized representation of the variation of the pressure with time at any point, z , is shown in Fig. 4.63. The blast wave

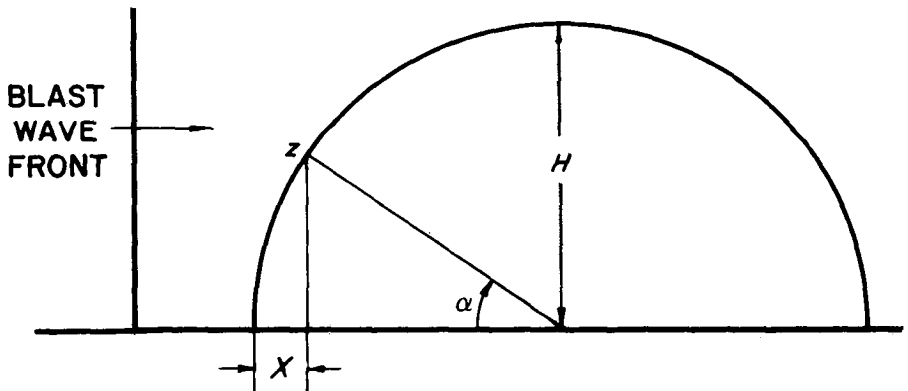

Figure 4.62. Representation of a typical semicircular arched structure.

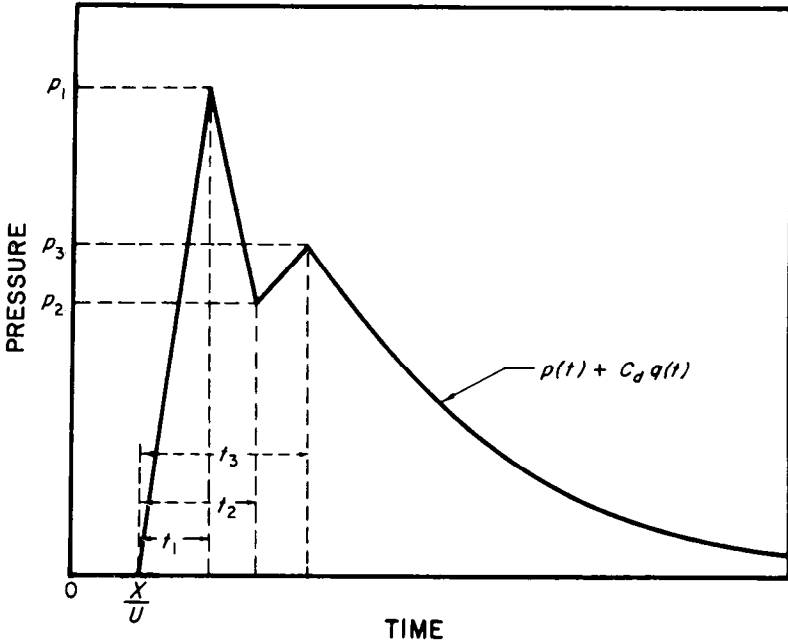

Figure 4.63. Typical pressure variation at a point on an arched structure subjected to a blast wave.

front strikes the base of the arch at time $t = 0$ and the time of arrival at the point z , regardless of whether it is on the front or back half, is X/U . The overpressure then rises sharply, in the time interval t_1 , to the reflected value, p_1 , so that t_1 is the rise time. Vortex formation causes the pressure to drop to p_2 , and this is followed by an increase to p_3 , the stagnation pressure; subsequently, the pressure, which is equal to $p(t) + C_d q(t)$, where C_d is the appropriate drag coefficient, decays in the normal manner.

4.64 The dependence of the pressures p_1 and p_2 and the drag coefficient C_d on the angle α is represented in Fig. 4.64; the pressure values are expressed as the ratios to p_r , where p_r is the ideal reflected pressure for a flat surface. When α is zero, i.e., at the base of the arch, p_1 is identical with p_r , but for

larger angles it is less. The rise time t and the time intervals t_2 and t_3 , corresponding to vortex formation and attainment of the stagnation pressure, respectively, after the blast wave reaches the base of the arch, are also given in Fig. 4.64, in terms of the time unit H/U . The rise time is seen to be zero for the front half of the arch, i.e., for α between 0° and 90° , but it is finite and increases with α on the back half, i.e., for a α between 90° and 180° . The times t_2 and t_3 are independent of the angle α .

4.65 Since the procedures described above give the loads normal to the surface at any arbitrary point z , the net horizontal loading is not determined by the simple process of subtracting the back loading from that on the front. To obtain the net horizontal loading, it is necessary to sum the horizontal compo-

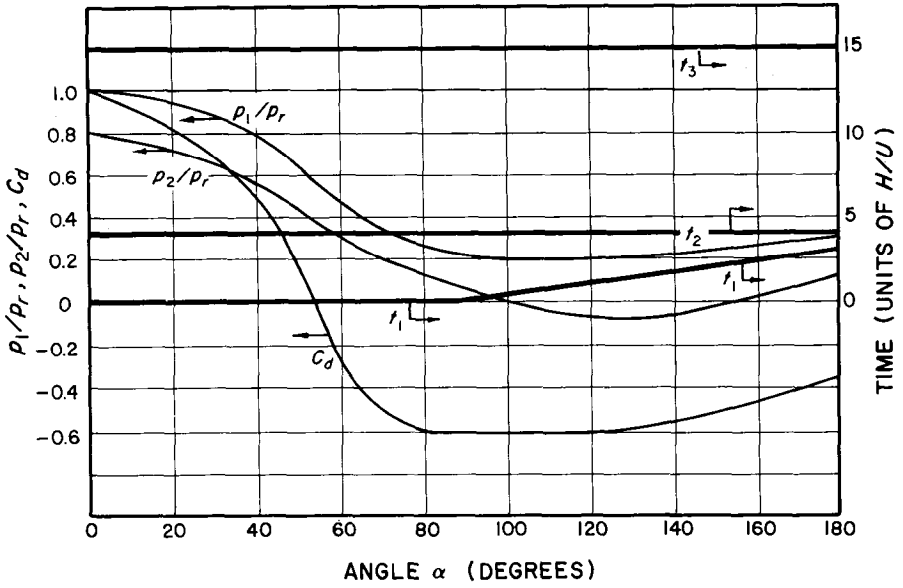

Figure 4.64. Variation of pressure ratios, drag coefficient, and time intervals for an arched structure.

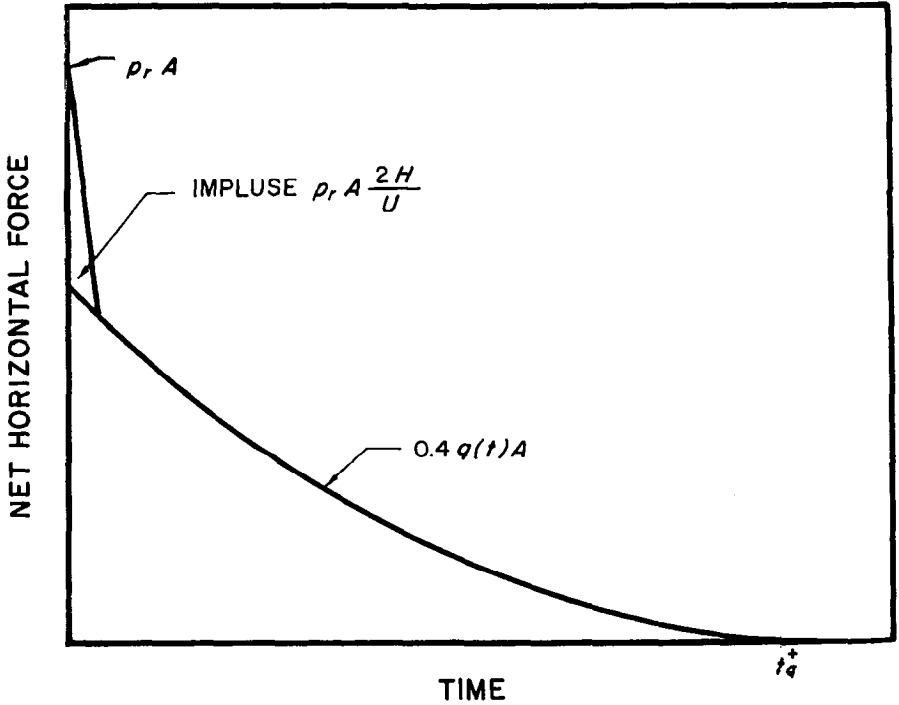

Figure 4.66. Approximate equivalent net horizontal force loading on semicylindrical structure.

nents of the loads over the two areas and then subtract them. In practice, an approximation may be used to obtain the required result in such cases where the net horizontal loading is considered to be important. It may be pointed out that, in certain instances, especially for large structures, it is the local loading, rather than the net loading, which is the significant criterion of damage.

4.66 In the approximate procedure for determining the net loading, the overpressure loading during the diffraction stage is considered to be equivalent to an initial impulse equal to $p_r A(2H/U)$, where A is the projected area normal to the direction of the blast propagation. It will be noted that $2H/U$ is the time taken for the blast front to traverse the structure. The net drag coefficient for a single cylinder is about 0.4 in the blast pres-

sure range of interest (§ 4.23). Hence, in addition to the initial impulse, the remainder of the net horizontal loading may be represented by the force $0.4 q(t)A$, as seen in Fig. 4.66, which applies to a single structure. When a frame is made up of a number of circular elements, the methods used are similar to those for an open frame structure (§ 4.55) with C_d equal to 0.2.

NONIDEAL BLAST WAVE LOADING

4.67 The preceding discussions have dealt with loading caused by blast waves reflected from nearly ideal ground surfaces (§ 3.47). In practice, however, the wave form will not always be ideal. In particular, if a precursor wave is formed (§ 3.79 *et seq.*), the loadings may depart radically from

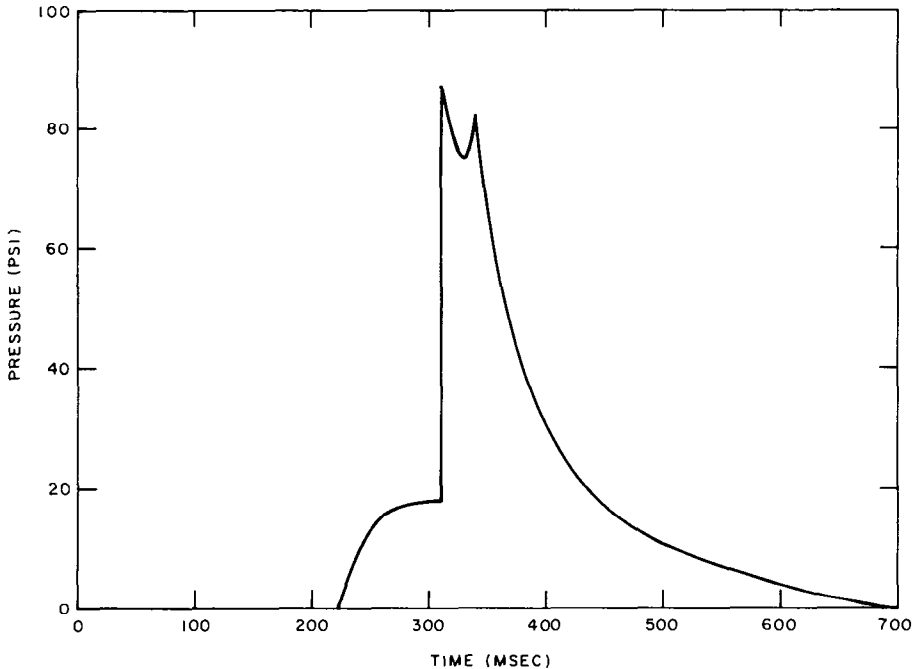
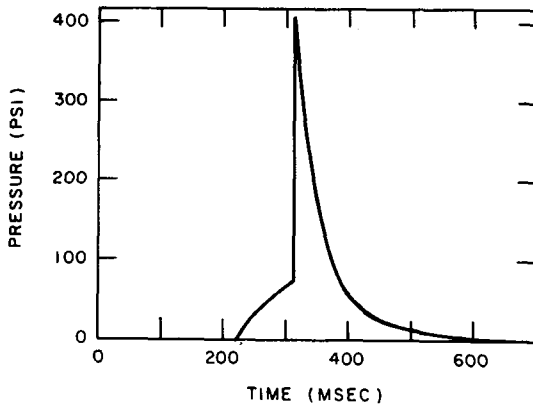
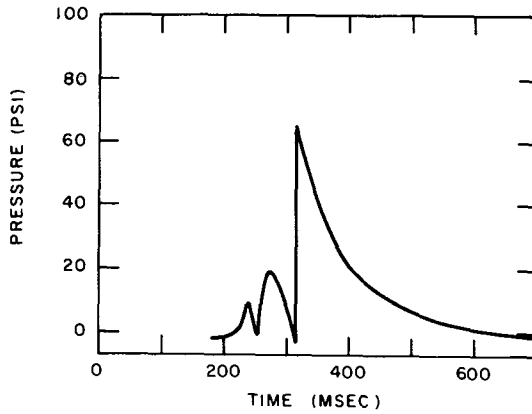

Figure 4.67a. Nonideal incident air blast (shock) wave.



b.



c.

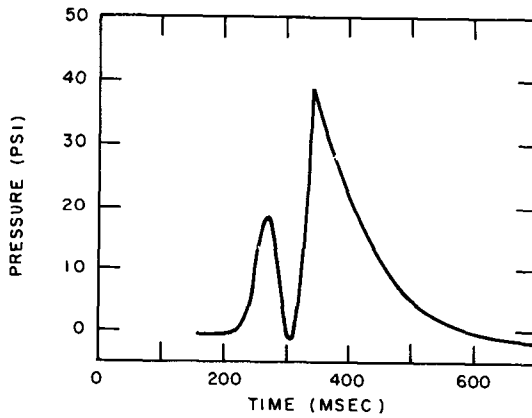

d.

Figure 4.67b, c, d. Loading pattern on the front, top, and back, respectively, on a rectangular block from nonideal blast wave.

those described above. Although it is beyond the scope of the present treatment to provide a detailed discussion of nonideal loading, one qualitative example is given here. Figure 4.67a shows a nonideal incident air blast (shock) wave and Figs. 4.67b, c, and d give the loading patterns on the front, top, and back, respectively, of a rectangular block as observed at a nuclear weapon test.

Comparison of Figs. 4.67b, c, and d with the corresponding Figs. 4.42, 4.43, and 4.44 indicates the departures from ideal loadings that may be encountered in certain circumstances. The net loading on this structure was significantly less than it would have been under ideal conditions, but this would not necessarily always be the case.

BIBLIOGRAPHY

- *AMERICAN SOCIETY OF CIVIL ENGINEERS, "Design of Structures to Resist Nuclear Weapons Effects," ASCE Manual of Engineering Practice No. 42, 1961.
- *ARMOUR RESEARCH FOUNDATION, "A Simple Method of Evaluating Blast Effects on Buildings," Armour Research Foundation, Chicago, Illinois, 1954.
- *BANISTER, J. R., and L. J. VORTMAN, "Effect of a Precursor Shock Wave on Blast Loading of a Structure," Sandia Corporation, Albuquerque, New Mexico, October 1960, WT-1472.
- JACOBSEN, L. S. and R. S. AYRE, "Engineering Vibrations," McGraw-Hill Book Co., Inc., New York, 1958.
- KAPLAN, K. and C. WIEHLE, "Air Blast Loading in the High Shock Strength Region," URS Corporation, Burlingame, California, 1965, URS 633-3 (DASA 1460-1), Part II.
- *MITCHELL, J. H., "Nuclear Explosion Effects on Structures and Protective Construction—A Selected Bibliography," U.S. Atomic Energy Commission, April 1961, TID-3092.
- PICKERING, E. E., and J. L. BOCKHOLT, "Probabilistic Air Blast Failure Criteria for Urban Structures," Stanford Research Institute, Menlo Park, California, November 1971.
- WILLOUGHBY, A. B., *et al.*, "A Study of Loading, Structural Response, and Debris Characteristics of Wall Panels," URS Research Co., Burlingame, California, July 1969.
- WILTON, C., *et al.*, "Final Report Summary, Structural Response and Loading of Wall Panels," URS Research Co., Burlingame, California, July 1971.

*These documents may be purchased from the National Technical Information Service, U.S. Department of Commerce, Springfield, Virginia 22161.

CHAPTER V

STRUCTURAL DAMAGE FROM AIR BLAST

INTRODUCTION

GENERAL OBSERVATIONS

5.01 The two preceding chapters have dealt with general principles of air blast and the loads on structures produced by the action of the air blast wave. In the present chapter, the actual damage to buildings of various types, bridges, utilities, and vehicles caused by nuclear explosions will be considered. In addition, criteria of damage to various targets will be discussed and quantitative relationships will be given between the damage and the distances over which such damage may be expected from nuclear weapons of different yields.

5.02 Direct damage to structures attributable to air blast can take various forms. For example, the blast may deflect structural steel frames, collapse roofs, dish-in walls, shatter panels, and break windows. In general, the damage results from some type of displacement (or distortion) and the manner in which such displacement can arise as the result of a nuclear explosion will be examined.

5.03 Attention may be called to an important difference between the blast effects of a nuclear weapon and those due to a conventional high-explosive

bomb. In the former case, the combination of high peak overpressure, high wind (or dynamic) pressure, and longer duration of the positive (compression) phase of the blast wave results in "mass distortion" of buildings, similar to that produced by earthquakes and hurricanes. An ordinary explosion will usually damage only part of a large structure, but the blast from a nuclear weapon can surround and destroy whole buildings in addition to causing localized structural damage.

5.04 An examination of the areas in Japan affected by nuclear explosions (§ 2.24) shows that small masonry buildings were engulfed by the oncoming pressure wave and collapsed completely. Light structures and residences were totally demolished by blast and subsequently destroyed by fire. Industrial buildings of steel construction were denuded of roofing and siding, and only twisted frames remained. Nearly everything at close range, except structures and smokestacks of strong reinforced concrete, was destroyed. Some buildings leaned away from ground zero as though struck by a wind of stupendous proportions. Telephone poles were

snapped off at ground level, as in a hurricane, carrying the wires down with them. Large gas holders were ruptured and collapsed by the crushing action of the blast wave.

5.05 Many buildings, which at a distance appeared to be sound, were found on close inspection to be damaged and gutted by fire. This was frequently an indirect result of blast action. In some instances the thermal radiation may have been responsible for the initiation of fires, but in many other cases fires were started by overturned stoves and furnaces and by the rupture of gas lines. The loss of water pressure by the breaking of pipes, mainly due to the collapse of buildings, and other circumstances arising from the explosions, contributed greatly to the additional destruction by fire (Chapter VII).

5.06 A highly important consequence of the tremendous power of the nuclear explosions was the formation of

enormous numbers of flying missiles consisting of bricks (and other masonry), glass, pieces of wood and metal, etc. These caused considerable amounts of secondary damage to structures and utilities, and numerous casualties even in the lightly damaged areas. In addition, the large quantities of debris resulted in the blockage of streets, thus making rescue and fire-fighting operations extremely difficult (Fig. 5.06).

5.07 Many structures in Japan were designed to be earthquake resistant, which probably made them stronger than most of their counterparts in the United States. On the other hand, some construction was undoubtedly lighter than in this country. However, contrary to popular belief concerning the flimsy character of Japanese residences, it was the considered opinion of a group of architects and engineers, who surveyed the nuclear bomb damage, that the resistance to blast of American residences



Figure 5.06. Debris after the nuclear explosion at Hiroshima.

in general would not be markedly different from that of the houses in Hiroshima and Nagasaki. This has been

borne out by the observations on experimental structures exposed to air blast at nuclear weapons tests in Nevada.

FACTORS AFFECTING RESPONSE

STRENGTH AND MASS

5.08 There are numerous factors associated with the characteristics of a structure which influence the response to the blast wave accompanying a nuclear explosion. Those considered below include various aspects of the strength and mass of the structure, general structural design, and ductility (§ 5.14) of the component materials and members.

5.09 The basic criterion for determining the response of a structure to blast is its strength. As used in this connection, "strength" is a general term, for it is a property influenced by many factors some of which are obvious and others are not. The most obvious indication of strength is, of course, massiveness of construction, but this is modified greatly by other factors not immediately visible to the eye, e.g., resilience and ductility of the frame, the strength of the beam and column connections, the redundancy of supports, and the amount of diagonal bracing in the structure. Some of these factors will be examined subsequently. If the building does not have the same strength along both axes, then orientation with respect to the burst should also be considered.

5.10 The strongest structures are heavily framed steel and reinforced-concrete buildings, particularly those designed to be earthquake resistant, whereas the weakest are probably certain shed-type industrial structures hav-

ing light frames and long beam spans. Some kinds of lightly built and open frame construction also fall into the latter category, but well-constructed frame houses have greater strength than these sheds.

5.11 The resistance to blast of structures having load-bearing, masonry walls (brick or concrete block), without reinforcement, is not very good. This is due to the lack of resilience and to the moderate strength of the connections which are put under stress when the blast load is applied laterally to the building. The use of steel reinforcement with structures of this type greatly increases their strength.

STRUCTURAL DESIGN

5.12 Except for those regions in which fairly strong earthquake shocks may be expected, most structures in the United States are designed to withstand only the lateral (sideways) loadings produced by moderately strong winds. For design purposes, such loading is assumed to be static (or stationary) in character because natural winds build up relatively slowly and remain fairly steady. The blast from a nuclear explosion, however, causes a lateral dynamic (rather than static) loading; the load is applied extremely rapidly and it lasts for a second or more with continuously decreasing strength. The inertia, as measured by the mass of the structure or

member, is an important factor in determining response to a dynamic lateral load, although it is not significant for static loading.

5.13 Of existing structures, those intended to be earthquake resistant and capable of withstanding a lateral load equal to about 10 percent of the weight, will probably be damaged least by blast. Such structures, often stiffened by diaphragm walls and having continuity of joints to provide additional rigidity, may be expected to withstand appreciable lateral forces without serious damage.

DUCTILITY

5.14 The term ductility refers to the ability of a material or structure to absorb energy inelastically without failure; in other words, the greater the ductility, the greater the resistance to failure. Materials which are brittle have poor ductility and fail suddenly after passing their elastic (yield) loading.

5.15 There are two main aspects of ductility to be considered. When a force (or load) is applied to a material so as to deform it, as is the case in a nuclear explosion, for example, the initial deformation is said to be "elastic." Provided it is still in the elastic range, the material will recover its original form when the loading is removed. However, if the "stress" (or internal force) produced by the load is sufficiently great, the material passes into the "plastic" range. In this state the material does not recover completely after removal of the load; that is to say, some deformation is permanent, but there is no failure. Only when the stress reaches the "ultimate strength" does failure occur.

5.16 Ideally, a structure which is to suffer little damage from blast should

have as much ductility as possible. Unfortunately, structural materials are generally not able to absorb much energy in the elastic range, although many common materials can take up large amounts of energy in the plastic range before they fail. One of the problems in blast-resistant design, therefore, is to decide how much permanent (plastic) deformation can be accepted before a particular structure is rendered useless. This will, of course, vary with the nature and purpose of the structure. Although deformation to the point of collapse is definitely undesirable, some lesser deformation may not seriously interfere with the continued use of the structure.

5.17 It is evident that ductility is a desirable property of structural materials required to resist blast. Structural steel and steel reinforcement have this property to a considerable extent. They are able to absorb large amounts of energy, e.g., from a blast wave, without failure and thus reduce the chances of collapse of the structure in which they are used. Structural steel has the further advantage of a higher yield point (or elastic limit) under dynamic than under static loading; the increase is quite large for some steels.

5.18 Although concrete alone is not ductile, when steel and concrete are used together properly, as in reinforced-concrete structures, the ductile behavior of the steel will usually predominate. The structure will then have considerable ductility and, consequently, the ability to absorb energy. Without reinforcement, masonry walls are completely lacking in ductility and readily suffer brittle failure, as stated above.

COMMERCIAL AND ADMINISTRATIVE STRUCTURES

INTRODUCTION

5.19 In this and several subsequent sections, the actual damage to various types of structures caused by the air blast from nuclear explosions will be described. First, commercial, administrative, and similar buildings will be considered. These buildings are of substantial construction and include banks, offices, hospitals, hotels, and large apartment houses. Essentially all the empirical information concerning the effects of air blast on such multistory structures has been obtained from observations made at Hiroshima and Nagasaki. The descriptions given below are for three general types, namely, reinforced-concrete frame buildings, steel-frame buildings, and buildings with load-bearing walls. As is to be expected from the preceding discussion, buildings of the first two types are more blast resistant than those of the third type; however, even light to moderate damage (see Table 5.139a) to frame-supported buildings can result in casualties to people in these buildings.

MULTISTORY,
REINFORCED-CONCRETE FRAME
BUILDINGS

5.20 There were many multistory, reinforced-concrete frame buildings of several types in Hiroshima and a smaller number in Nagasaki. They varied in resistance to blast according to design and construction, but they generally suffered remarkably little damage externally. Close to ground zero, however, there was considerable destruction of

the interior and contents due to the entry of blast through doors and window openings and to subsequent fires. An exceptionally strong structure of earthquake-resistant (aseismic) design, located some 640 feet from ground zero in Hiroshima, is seen in Fig. 5.20a. Although the exterior walls were hardly damaged, the roof was depressed and the interior was destroyed. More typical of reinforced-concrete frame construction in the United States was the building shown in Fig. 5.20b at about the same distance from ground zero. This suffered more severely than the one of aseismic design.

5.21 A factor contributing to the blast resistance of many reinforced-concrete buildings in Japan was the construction code established after the severe earthquake of 1923. The height of new buildings was limited to 100 feet and they were designed to withstand a lateral force equal to 10 percent of the vertical load. In addition, the recognized principles of stiffening by diaphragms and improved framing to provide continuity were specified. The more important buildings were well designed and constructed according to the code. However, some were built without regard to the earthquake-resistant requirements and these were less able to withstand the blast wave from the nuclear explosion.

5.22 Close to ground zero the vertical component of the blast was more significant and so greater damage to the roof resulted from the downward force (Fig. 5.22a) than appeared farther away. Depending upon its strength, the roof



Figure 5.20a. Upper photo: Reinforced-concrete, aseismic structure; window fire shutters were blown in by blast and the interior gutted by fire (0.12 mile from ground zero at Hiroshima). Lower photo: Burned out interior of similar structure.

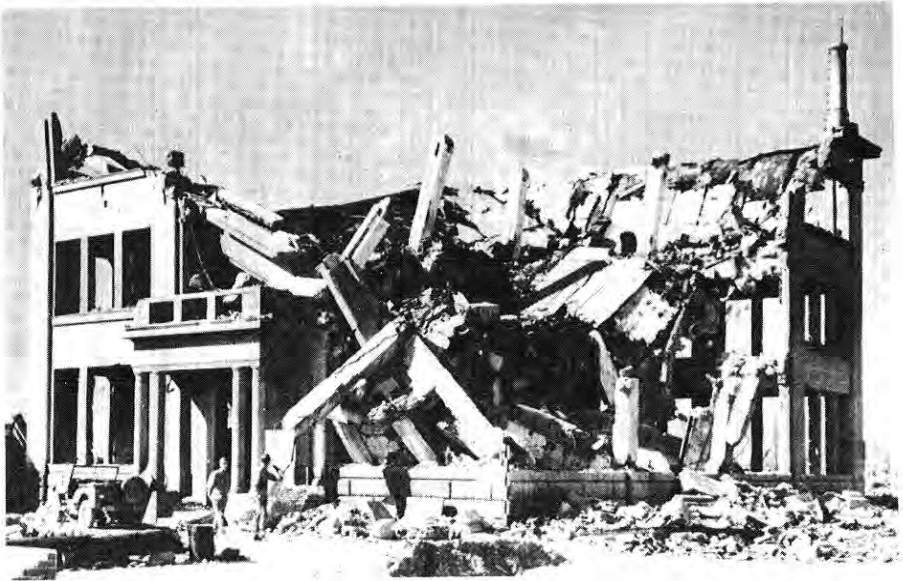

Figure 5.20b. Three-story, reinforced-concrete frame building; walls were 13-inch thick brick panel with large window openings (0.13 mile from ground zero at Hiroshima).

was pushed down and left sagging or it failed completely. The remainder of the structure was less damaged than similar buildings farther from the explosion because of the smaller horizontal (lateral) forces. At greater distances, from ground zero, especially in the region of Mach reflection, the consequences of horizontal loading were apparent (Fig. 5.22b).

5.23 In addition to the failure of roof slabs and the lateral displacement of walls, numerous other blast effects were observed. These included bending and fracture of beams, failure of columns, crushing of exterior wall panels, and failure of floor slabs (Fig. 5.23). Heavy damage to false ceilings, plaster, and partitions occurred as far out as 9,000 feet (1.7 miles) from ground zero, and glass windows were generally bro-

ken out to a distance of $3\frac{3}{4}$ miles and in a few instances out to 8 miles.

5.24 The various effects just described have referred especially to reinforced-concrete structures. This is because the buildings as a whole did not collapse, so that other consequences of the blast loading could be observed. It should be pointed out, however, that damage of a similar nature also occurred in structures of the other types described below.

MULTISTORY, STEEL-FRAME BUILDINGS

5.25 There was apparently only one steel-frame structure having more than two stories in the Japanese cities exposed to nuclear explosions. This was a five-story structure in Nagasaki at a distance of 4,500 feet (0.85 mile) from

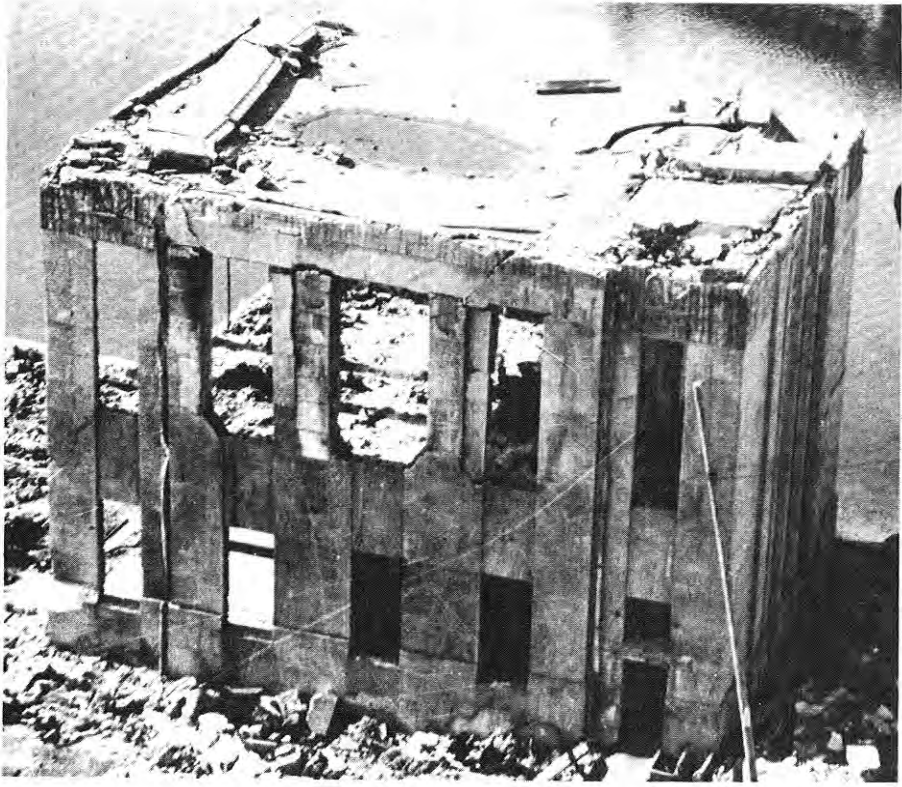

Figure 5.22a. Depressed roof of reinforced-concrete building (0.10 mile from ground zero at Hiroshima).

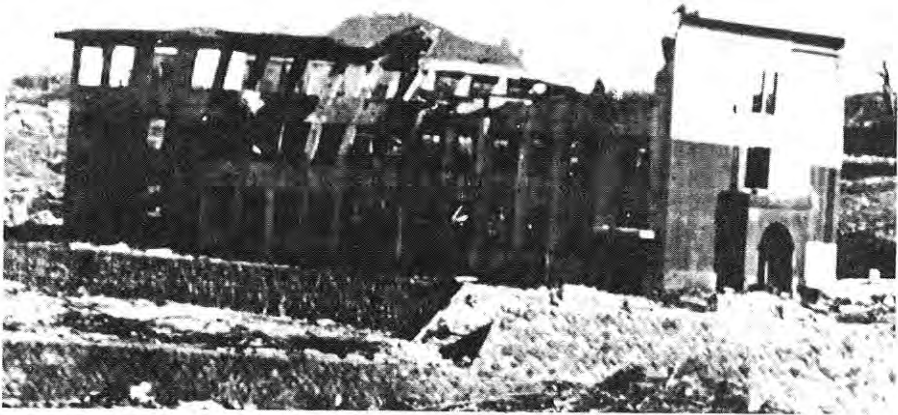

Figure 5.22b. Effects of horizontal loading on wall facing explosion (0.4 mile from ground zero at Nagasaki).



Figure 5.23. Reinforced-concrete building showing collapsed roof and floor slabs (0.10 mile from ground zero at Nagasaki).

ground zero (Fig. 5.25). The only part of the building that was not regarded as being of heavy construction was the roof, which was of 4-inch thick reinforced concrete supported by unusually light steel trusses. The downward failure of the roof, which was dished 3 feet, was the only important structural damage suffered.

5.26 Reinforced-concrete frame buildings at the same distance from the explosion were also undamaged, and so there is insufficient evidence to permit any conclusions to be drawn as to the relative resistance of the two types of construction. An example of damage to a two-story, steel-frame structure is

shown in Fig. 5.26. The heavy walls of the structure transmitted their loads to the steel frame, the columns of which collapsed. Weakening of unprotected steel by fire could have contributed significantly to the damage to steel-frame structures (§ 5.31).

BUILDING WITH LOAD-BEARING WALLS

5.27 Small structures with light load-bearing walls offered little resistance to the nuclear blast and, in general, collapsed completely. Large buildings of the same type, but with cross walls and of somewhat heavier

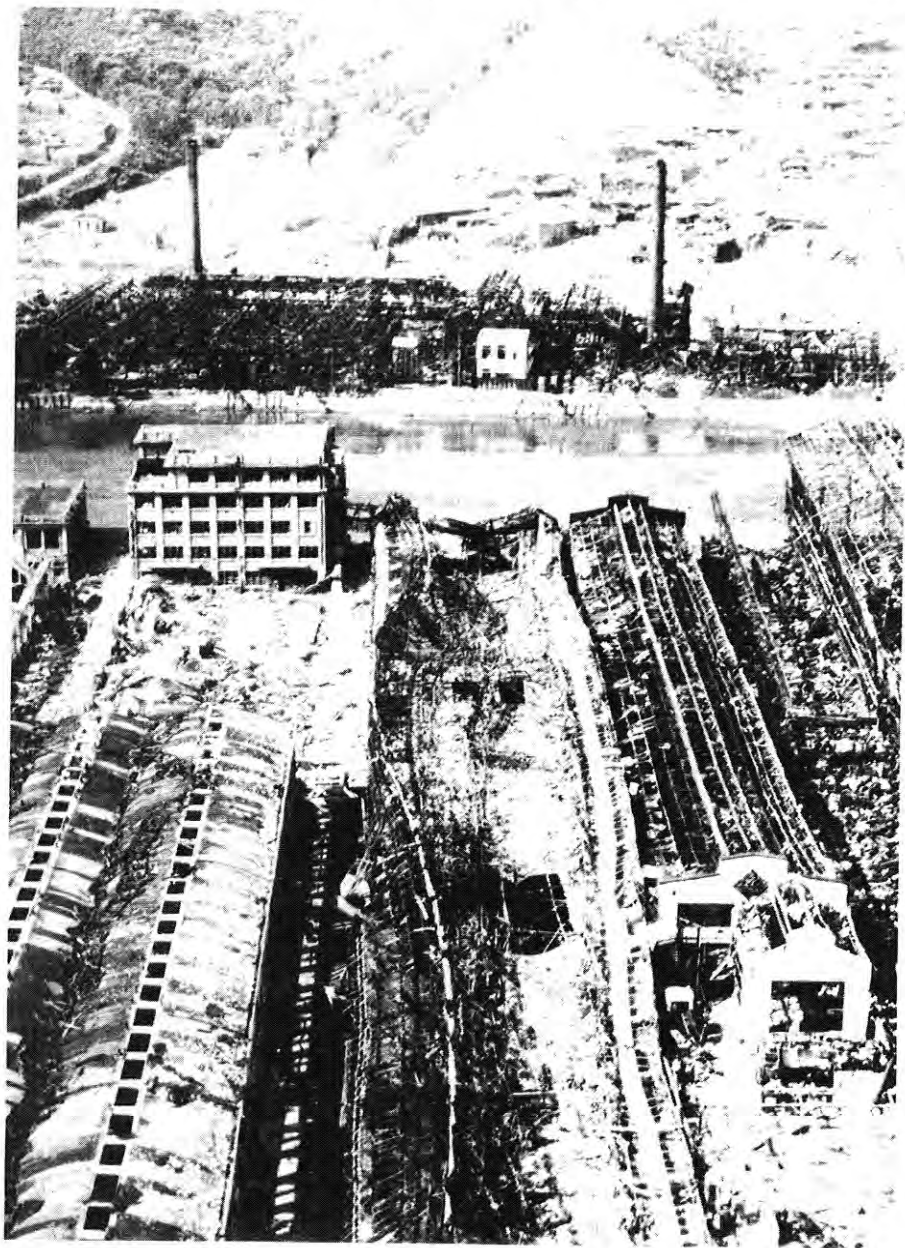

Figure 5.25. At left and back of center is a multistory, steel-frame building (0.85 mile from ground zero at Nagasaki).



Figure 5.26. Two-story, steel-frame building with 7-inch reinforced-concrete wall panels (0.40 mile from ground zero at Hiroshima). The first story columns buckled away from ground zero dropping the second story to the ground.

construction, were more resistant but failed at distances up to 6,300 feet (1.2 miles) from ground zero. Cracks were observed at the junctions of cross walls and sidewalls when the building re-

mained standing. It is apparent that structures with load-bearing walls possess few of the characteristics that would make them resistant to collapse when subjected to large lateral loads.

INDUSTRIAL STRUCTURES

JAPANESE EXPERIENCE

5.28 In Nagasaki there were many buildings of the familiar type used for industrial purposes, consisting of a steel frame with roof and siding of corrugated sheet metal or of asbestos cement. In some cases, there were rails for gantry cranes, but the cranes were usually of low capacity. In general, construction of industrial-type buildings was comparable to that in the United States.

5.29 Severe damage of these structures occurred up to a distance of about 6,000 feet (1.14 miles) from ground zero. Moderately close to ground zero, the buildings were pushed over bodily, and at greater distances they were generally left leaning away from the source of the blast (Fig. 5.29). The columns being long and slender offered little resistance to the lateral loading. Sometimes columns failed due to a lateral

force causing flexure, combined with a simultaneous small increase in the downward load coming from the impact of the blast on the roof. This caused buckling and, in some instances, complete collapse. Roof trusses were buckled by compression resulting from lateral blast loading on the side of the building facing the explosion.

5.30 A difference was noted in the effect on the frame depending upon whether a frangible material, like asbestos cement, or a material of high tensile strength, such as corrugated sheet-iron, was used for roof and siding. Asbestos cement broke up more readily permitting more rapid equalization of pressure and, consequently, less structural damage to the frame.

5.31 Fire caused heavy damage to unprotected steel members, so that it was impossible to tell exactly what the



Figure 5.29. Single-story, light steel-frame building (0.80 mile from ground zero at Hiroshima); partially damaged by blast and further collapsed by subsequent fire.

blast effect had been. In general, steel frames were badly distorted and would have been of little use, even if siding and roofing material had been available for repairs.

5.32 In some industrial buildings wood trusses were used to support the roof. These were more vulnerable to blast because of poor framing and connections, and were readily burned out by fire. Concrete columns were employed in some cases with steel roof trusses; such columns appeared to be more resistant to buckling than steel, possibly because the strength of concrete is decreased to a lesser extent by fire than is that of steel.

5.33 Damage to machine tools was caused by debris, resulting from the collapse of roof and siding, by fire in wood-frame structures, and by dislocation and overturning as a result of damage to the building. In many instances the machine tools were belt-driven, so that the distortion of the building pulled the machine tool off its base, damaging or overturning it.

5.34 Smokestacks, especially those of reinforced concrete, proved to have considerable blast resistance (Fig. 5.34a). Because of their shape, they are subjected essentially to drag loading only and, if sufficiently strong, their long period of vibration makes them less sensitive to blast than many other structures. An example of extreme damage to a reinforced-concrete stack is shown in Fig. 5.34b. Steel smokestacks performed reasonably well, but being lighter in weight and subject to crushing were not comparable to reinforced concrete. On the whole, well-constructed masonry stacks withstood the blast

somewhat better than did those made of steel.

NEVADA TESTS

5.35 A considerable amount of information on the blast response of structures of several different kinds was obtained in the studies made at the Nevada Test Site in 1953 and in 1955. The nuclear device employed in the test of March 17, 1953, was detonated at the top of a 300-foot tower; the energy yield was about 16 kilotons. In the test of May 5, 1955, the explosion took place on a 500-foot tower and the yield was close to 29 kilotons. In each case, air pressure measurements made possible a correlation, where it was justified, between the blast damage and the peak overpressure.

5.36 Three types of metal buildings of standard construction, such as are used for various commercial and industrial purposes, were exposed at peak overpressures of 3.1 and 1.3 pounds per square inch. The main objectives of the tests, made in 1955, were to determine the blast pressures at which such structures would survive, in the sense that they could still be used after moderate repairs, and to provide information upon which could be based improvements in design to resist blast.

STEEL FRAME WITH ALUMINUM PANELS

5.37 The first industrial type building had a conventional rigid steel frame, which is familiar to structural engineers, with aluminum-sheet panels for roofing and siding (Fig. 5.37a). At a blast overpressure of 3.1 pounds per square inch this building was severely damaged. The welded and bolted steel frame

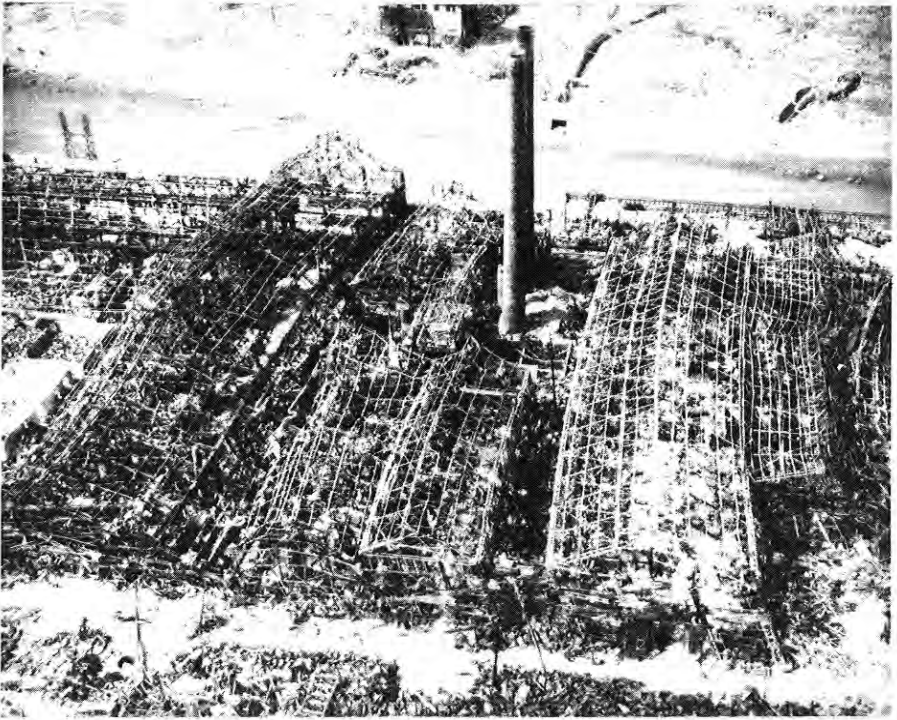

Figure 5.34a. Destroyed industrial area showing smokestacks still standing (0.51 mile from ground zero at Nagasaki).

remained standing, but was badly distorted and pulled away from the concrete footings. On the side facing the explosion the deflection was about 1 foot at the eaves (Fig. 5.37b).

5.38 At a peak overpressure of 1.3 pounds per square inch the main steel frame suffered only slight distortion. The aluminum roofing and siding were not blown off, although the panels were disengaged from the bolt fasteners on the front face of the steel columns and girts (horizontal connecting members). Wall and roof panels facing the explosion were dished inward. The center girts were torn loose from their attachments to the columns in the front of the

building. The aluminum panels on the side walls were dished inward slightly, but on the rear wall and rear slope of the roof, the sheeting was almost undisturbed.

5.39 As presently designed, structures of this type may be regarded as being repairable, provided they are not exposed to blast pressures exceeding 1 pound per square inch. Increased blast resistance would probably result from improvement in the design of girts and purlins (horizontal members supporting rafters), in particular. Better fastening between sill and wall footing and increased resistance to transverse loading would also be beneficial.



Figure 5.34b. A circular, 60 feet high, reinforced-concrete stack (0.34 mile from ground zero at Hiroshima). The failure caused by the blast wave occurred 15 feet above the base.

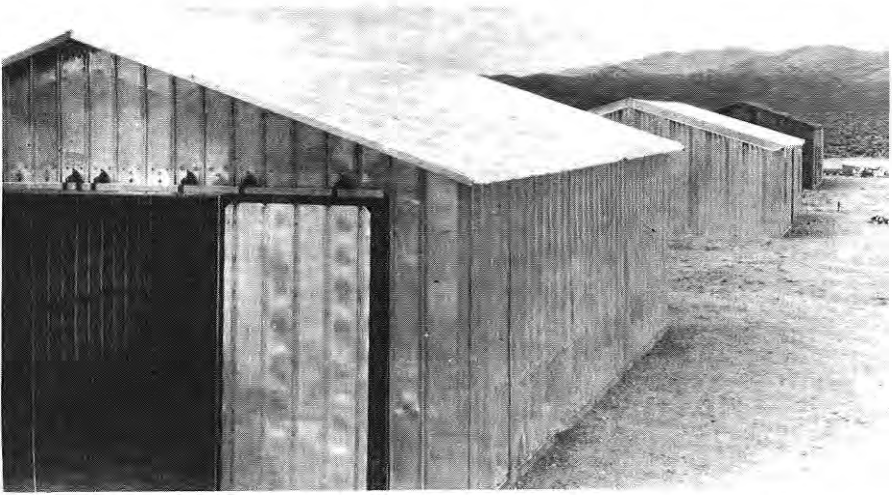

Figure 5.37a. Rigid steel-frame building before a nuclear explosion, Nevada Test Site.

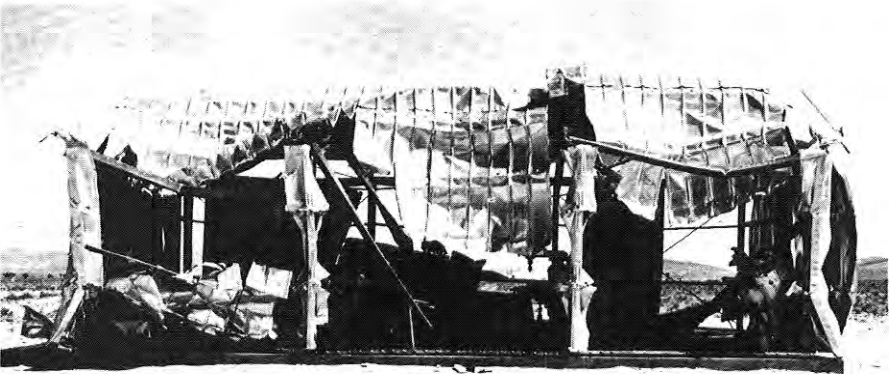

Figure 5.37b. Rigid steel-frame building after a nuclear explosion (3.1 psi peak overpressure).

SELF-FRAMING WITH STEEL PANELS

5.40 A frameless structure with self-supporting walls and roof of light, channel-shaped, interlocking, steel panels (16 inches wide) represented the second standard type of industrial building (Fig. 5.40a). The one subjected to 3.1 pounds per square inch peak overpressure (and a dynamic pressure of

0.2 pound per square inch) was completely demolished (Fig. 5.40b). One or two segments of wall were blown as far as 50 feet away, but, in general, the bent and twisted segments of the building remained approximately in their original locations. Most of the wall sections were still attached to their foundation bolts on the side and rear walls of the

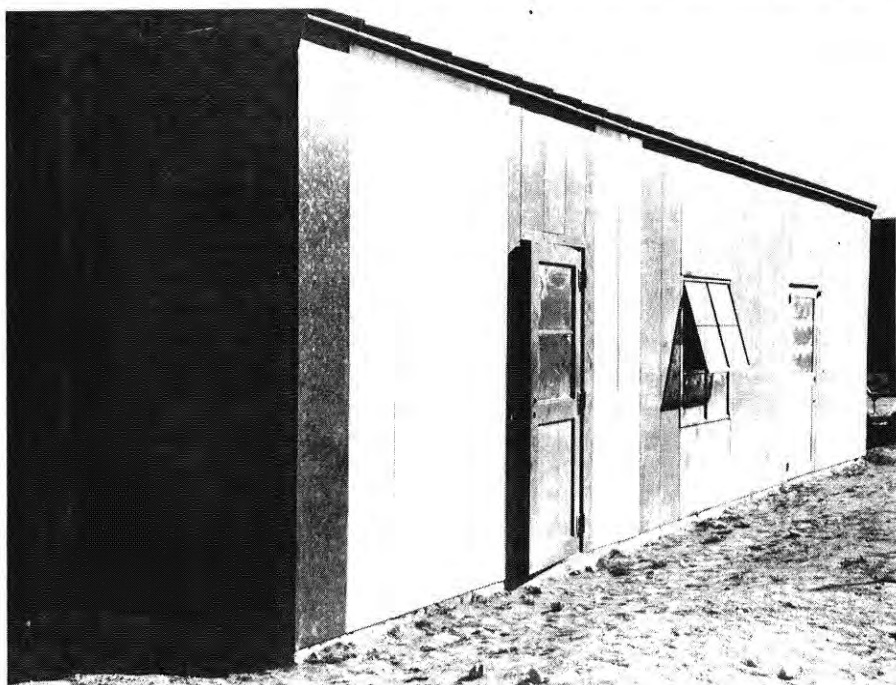

Figure 5.40a. Exterior of self-framing steel panel building before a nuclear explosion, Nevada Test Site.



Figure 5.40b. Self-framing steel panel building after a nuclear explosion (3.1 psi peak overpressure).

building. The roof had collapsed completely and was resting on the machinery in the interior.

5.41 Although damage at 1.3 pounds per square inch peak overpressure was much less, it was still considerable in parts of the structure. The front wall panels were buckled inward from 1 to 2 feet at the center, but the rear wall and rear slope of the roof were undamaged. In general, the roof structure remained intact, except for some deflection near the center.

5.42 It appears that the steel panel type of structure is repairable if exposed to overpressures of not more than about $\frac{3}{4}$ to 1 pound per square inch. The buildings are simple to construct but they do not hold together well under

blast. Blast-resistant improvements would seem to be difficult to incorporate while maintaining the essential simplicity of design.

SELF-FRAMING WITH CORRUGATED STEEL PANELS

5.43 The third type of industrial building was a completely frameless structure made of strong, deeply-corrugated 43-inch wide panels of 16-gauge steel sheet. The panels were held together with large bolt fasteners at the sides and at the eaves and roof ridge. The wall panels were bolted to the concrete foundation. The entire structure was self-supporting, without frames, girts, or purlins (Fig. 5.43).

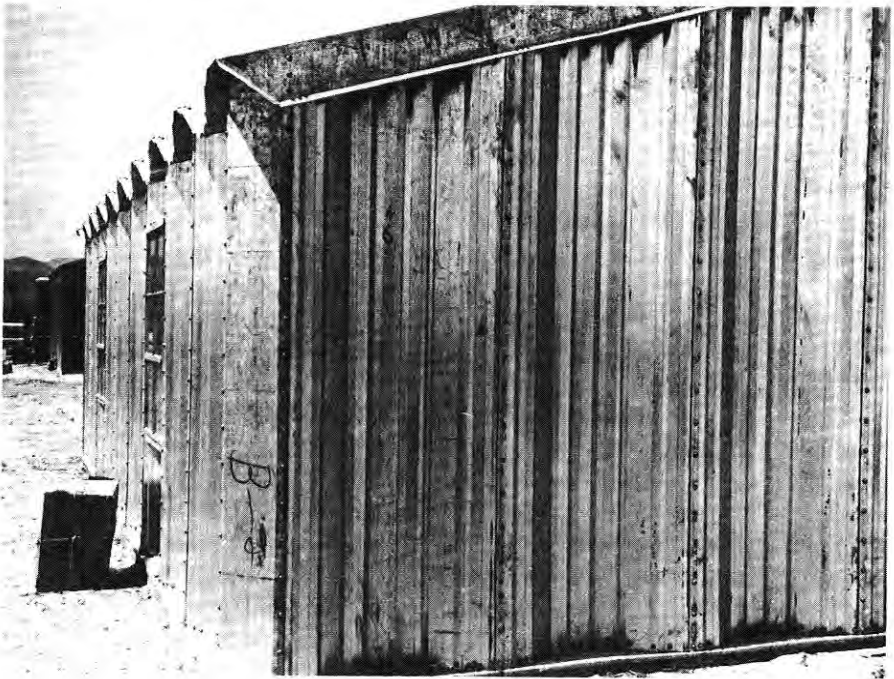

Figure 5.43. Self-framing corrugated steel panel building before a nuclear explosion, Nevada Test Site.

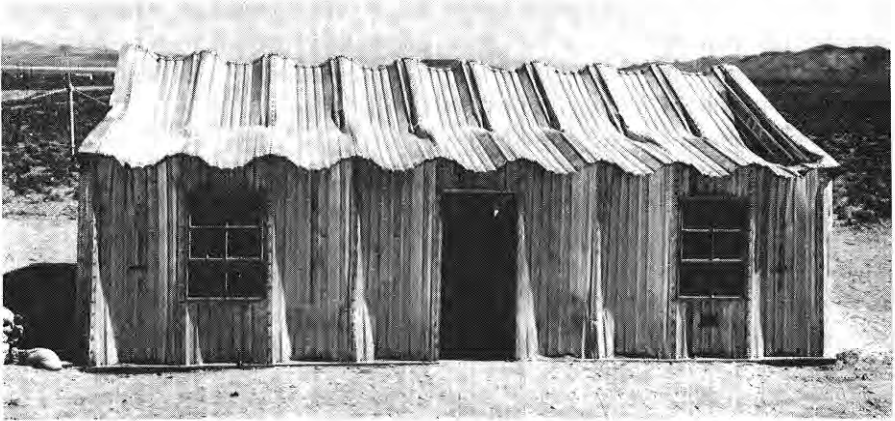

Figure 5.44. Self-framing corrugated steel panel building after a nuclear explosion (3.1 psi peak overpressure).

5.44 At a peak overpressure of 3.1 and a dynamic pressure of 0.2 pound per square inch a structure of this type was badly damaged, but all the pieces remained bolted together, so that the structure still provided good protection from the elements for its contents. The front slope of the roof was crushed downward, from 1 to 2 feet, at midsection, and the ridge line suffered moderate deflection. The rear slope of the roof appeared to be essentially undamaged (Fig. 5.44).

5.45 The front and side walls were buckled inward several inches, and the door in the front was broken off. All the windows were damaged to some extent, although a few panes in the rear remained in place.

5.46 Another building of this type, exposed to 1.3 pounds per square inch peak overpressure, experienced little structural damage. The roof along the ridge line showed indications of downward deflections of only 1 or 2 inches, and there was no apparent buckling of roof or wall panels. Most of the win-

dows were broken, cracked, or chipped. Replacement of the glass where necessary and some minor repairs would have rendered the building completely serviceable.

5.47 The corrugated steel, frameless structure proved to be the most blast-resistant of those tested. It is believed that, provided the overpressure did not exceed about 3 pounds per square inch, relatively minor repairs would make possible continued use of the building. Improvement in the design of doors and windows, so as to reduce the missile hazard from broken glass, would be advantageous.

POSITIVE PHASE DURATION TESTS

5.48 Tests were carried out at Nevada in 1955 and at Eniwetok Atoll in the Pacific in 1956 to investigate the effect of the duration of the positive overpressure phase of a blast wave on damage. Typical drag-type structures were exposed, at approximately the same overpressure, to nuclear detona-

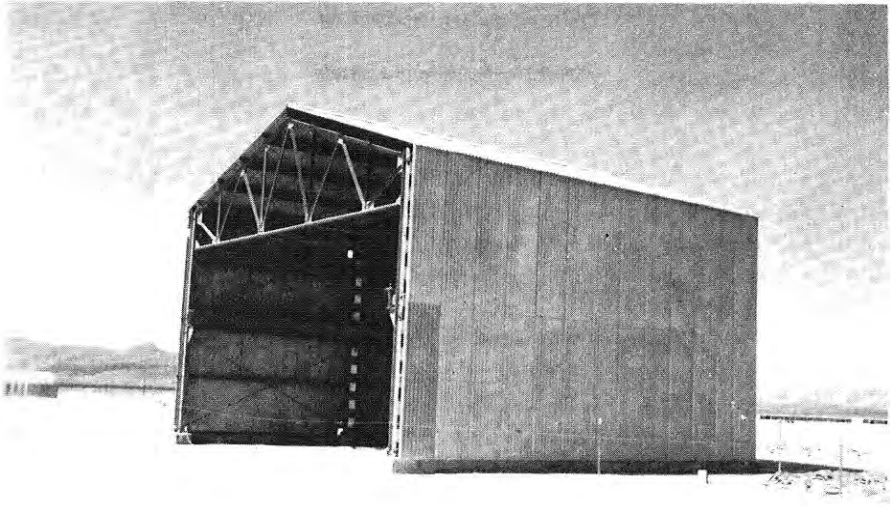

Figure 5.48a. Steel-frame building with siding and roof of frangible material.

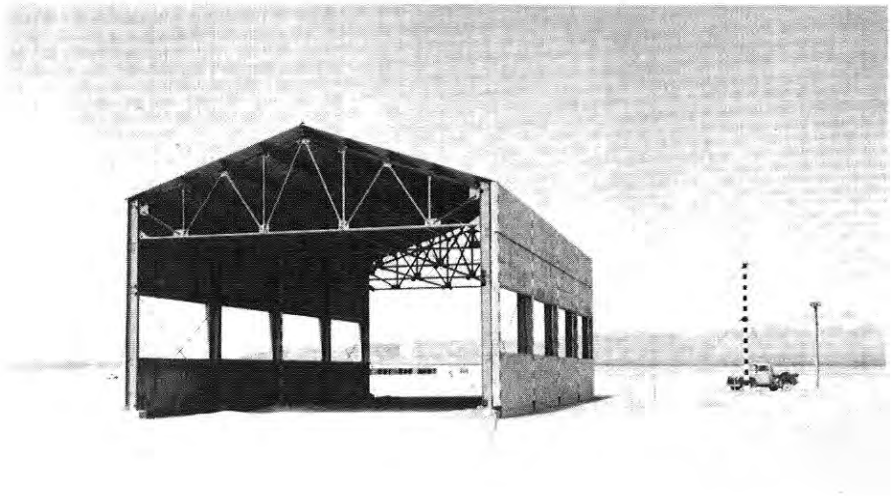

Figure 5.48b. Steel-frame building with concrete siding and window openings of 30 percent of the wall area.

tions in the kiloton and megaton ranges. Two representative types of small industrial buildings were chosen for these tests. One had a steel frame covered with siding and roofing of a frangible material and was considered to be a drag-type structure (Fig. 5.48a). The other had the same steel frame and roofing, but it had concrete siding with a window opening of about 30 percent of the wall area; this was regarded as a semidrag structure (Fig. 5.48b).

5.49 In the Nevada tests, with kiloton yield weapons, the first structure was subjected to a peak overpressure of about 6.5 and a dynamic pressure of 1.1 pounds per square inch; the positive phase duration of the blast wave was 0.9 second. A permanent horizontal deflection of about 15 inches occurred at the top of the columns. The column anchor

bolts failed, and yielding was found between the lower chord (horizontal member of the roof truss) and column connections. The girts on the windward side were severely damaged and all of the siding was completely blown off (Fig. 5.49).

5.50 The second building, with the stronger siding, was exposed in Nevada to a peak overpressure loading of about 3.5 and a dynamic pressure of 0.3 pounds per square inch, with a positive phase duration of 1 second. Damage to this structure was small (Fig. 5.50). Although almost the whole of the frangible roof was blown off, the only other damage observed was a small yielding at some connections and column bases.

5.51 Structures of the same type were subjected to similar pressures in the blast wave from a megaton range

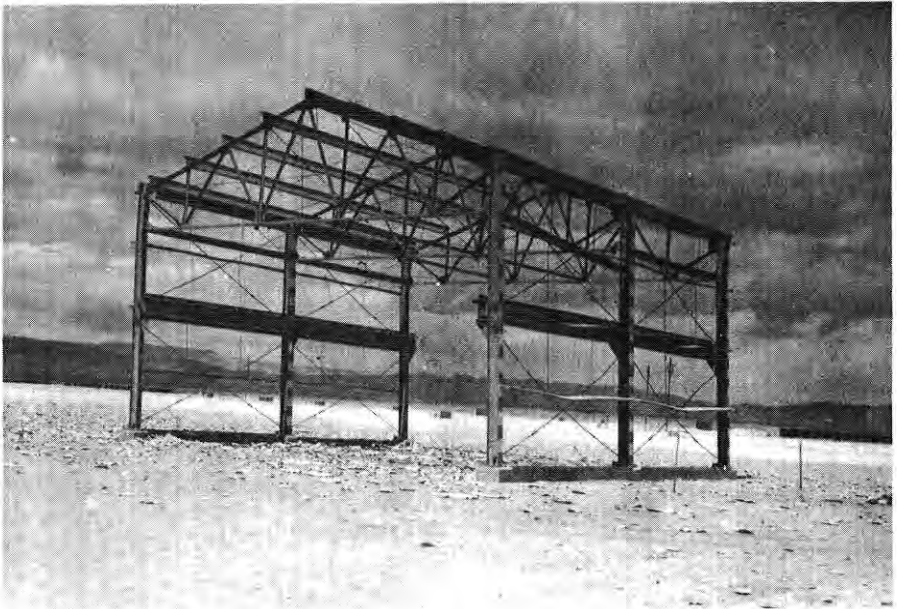

Figure 5.49. Structure in Figure 5.48a after exposure to 6.5 psi peak overpressure and 1.1 psi dynamic pressure; positive phase duration 0.9 second.



Figure 5.50. Structure in Figure 5.48b after exposure to 3.5 psi peak overpressure and 0.3 psi dynamic pressure; positive phase duration 1 second.

explosion at Eniwetok; namely, a peak overpressure of 6.1 and a dynamic pressure of 0.6 pounds per square inch for the drag-type building, and 5 and 0.5 pounds per square inch, respectively, for the semidrag structure. However, the positive phase now lasted several seconds as compared with about 1 second in the Nevada tests. Both structures

suffered complete collapse (Figs. 5.51a and b). Distortion and breakup occurred throughout, particularly of columns and connections. It was concluded, therefore, that damage to drag-sensitive structures can be enhanced, for a given peak overpressure value, if the duration of the positive phase of the blast wave is increased (cf. § 4.13).

RESIDENTIAL STRUCTURES

JAPANESE EXPERIENCE

5.52 There were many wood-framed residential structures with adobe walls in the Japanese cities which were subjected to nuclear attack, but such a large proportion were destroyed by fire that very little detailed information concerning blast damage was obtained. It

appeared that, although the quality of the workmanship in framing was usually high, little attention was paid to good engineering principles. On the whole, therefore, the construction was not well adapted to resist wracking action (distortion). For example, mortise and tenon joints were weak points in the

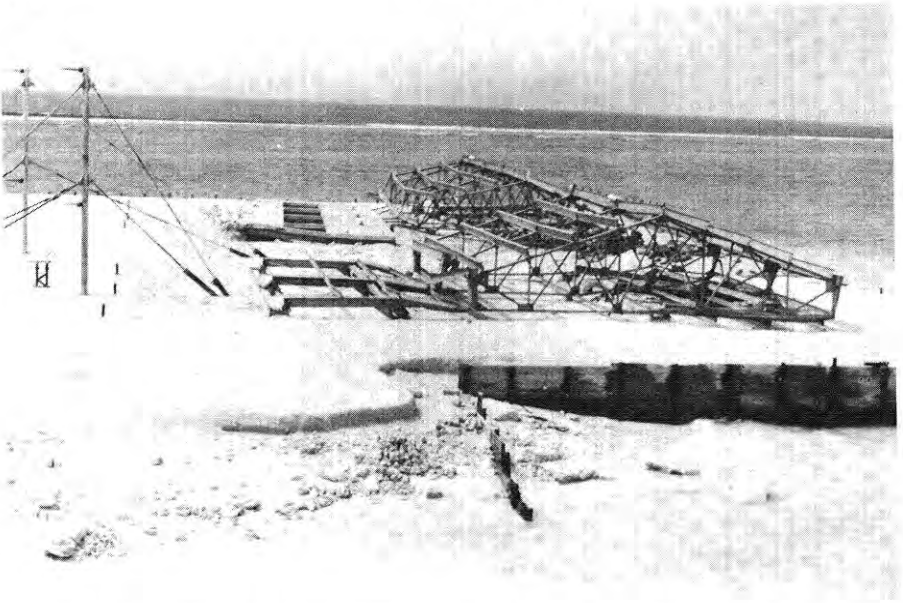

Figure 5.51a. Structure similar to Figure 5.48a after exposure to 6.1 psi peak overpressure and 0.6 psi dynamic pressure; positive phase duration several seconds.

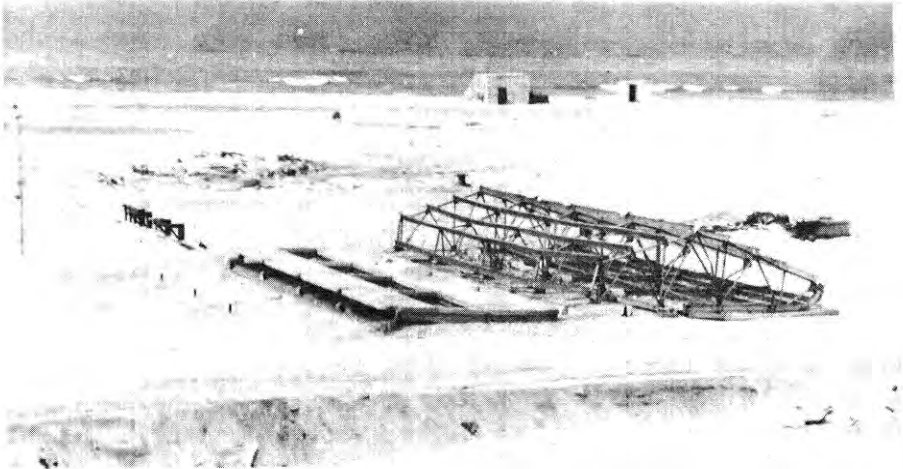

Figure 5.51b. Structure similar to Figure 5.48b after exposure to 5 psi peak overpressure and 0.5 psi dynamic pressure; positive phase duration several seconds.



Figure 5.52. Upper photo; Wood-frame building; 1.0 mile from ground zero at Hiroshima. Lower photo: Frame of residence under construction, showing small tenons.

structure and connections were in general poor. Timbers were often dapped

(cut into) more than was necessary or slices put in improper locations, result-

ing in an overall weakening (Fig. 5.52).

5.53 In Nagasaki, dwellings collapsed at distances up to 7,500 feet (1.4 miles) from ground zero, where the peak overpressure was estimated to be about 3 pounds per square inch, and there was severe structural damage up to 8,500 feet (1.6 miles). Roofs, wall panels, and partitions were damaged out to 9,000 feet (1.7 miles), where the overpressure was approximately 2 pounds per square inch, but the buildings would probably have been habitable with moderate repairs.

NEVADA TESTS

5.54 The main objectives of the tests made in Nevada in 1953 and 1955 (§ 5.35) on residential structures were as follows: (1) to determine the elements most susceptible to blast damage and consequently to devise methods for strengthening structures of various types; (2) to provide information concerning the amount of damage to residences that might be expected as a result of a nuclear explosion and to what extent these structures would be subsequently rendered habitable without major repairs; and (3) to determine how persons remaining in their houses during a nuclear attack might be protected from the effects of blast and radiations. Only the first two of these aspects of the tests will be considered here, since the present chapter deals primarily with blast effects.

TWO-STORY, WOOD-FRAME HOUSE: 1953 TEST

5.55 In the 1953 test, two essentially identical houses, of a type common in the United States, were placed at

different locations. They were of typical wood-frame construction, with two stories, basement, and brick chimney (Fig. 5.55). The interiors were plastered but not painted. Since the tests were intended for studying the effects of blast, precautions were taken to prevent the houses from burning. The exteriors were consequently painted white (except for the shutters), to reflect the thermal radiation. For the same purpose, the windows facing the explosion were equipped with metal venetian blinds having an aluminum finish. In addition, the houses were roofed with light-gray shingles; these were of asbestos cement for the house nearer to the explosion where the chances of fire were greater, whereas asphalt shingles were used for the other house. There were no utilities of any kind.

5.56 One of the two houses was located in the region of Mach reflection where the peak incident overpressure was close to 5 pounds per square inch. It was expected, from the effects in Japan, that this house would be almost completely destroyed—as indeed it was—but the chief purpose was to see what protection might be obtained by persons in the basement.

5.57 Some indication of the blast damage suffered by this dwelling can be obtained from Fig. 5.57. It is apparent that the house was ruined beyond repair. The first story was completely demolished and the second story, which was very badly damaged, dropped down on the first floor debris. The roof was blown off in several sections which landed at both front and back of the house. The gable end walls were blown apart and outward, and the brick chimney was broken into several pieces.



Figure 5.55. Wood-frame house before a nuclear explosion, Nevada Test Site.



Figure 5.57. Wood-frame house after a nuclear explosion (5 psi peak overpressure).



Figure 5.59. Wood-frame house after a nuclear explosion (1.7 psi peak overpressure).

5.58 The basement walls suffered some damage above grade, mostly in the rear, i.e., away from the explosion. The front basement wall was pushed in slightly, but was not cracked except at the ends. The joists supporting the first floor were forced downward probably because of the air pressure differential between the first floor and the largely enclosed basement, and the supporting pipe columns were inclined to the rear. However, only in limited areas did a complete breakthrough from first floor to basement occur. The rest of the basement was comparatively clear and the shelters located there were unaffected.

5.59 The second house, exposed to an incident peak overpressure of 1.7 pounds per square inch, was badly damaged both internally and externally, but it remained standing (Fig. 5.59).

People in the main and upper floors would have suffered injuries ranging from minor cuts from glass fragments to possible fatal injuries from flying debris or as a result of translational displacement of the body as a whole. Some damage would also result to the furnishings and other contents of the house. Although complete restoration would have been very costly, it is believed that, with the window and door openings covered, and shoring in the basement, the house would have been habitable under emergency conditions.

5.60 The most obvious damage was suffered by doors and windows, including sash and frames. The front door was broken into pieces and the kitchen and basement entrance doors were torn off their hinges. Damage to interior doors varied; those which were open before



Figure 5.64. Strengthened wood-frame house after a nuclear explosion (4 psi peak overpressure).

the explosion suffered least. Window glass throughout the house was broken into fragments, and the force on the sash, especially in the front of the house, dislodged the frames.

5.61 Principal damage to the first-floor system consisted of broken joists. The second-story system suffered relatively little in structural respects, although windows were broken and plaster cracked. Damage to the roof consisted mainly of broken rafters (2×6 inches with 16-inch spacing).

5.62 The basement showed no signs of damage except to the windows, and the entry door and frame. The shelters in the basement were intact.

TWO-STORY, WOOD-FRAME HOUSE: 1955 TEST

5.63 Based upon the results described above, certain improvements in design were incorporated in two similar wood-frame houses used in the 1955 test. The following changes, which increased the estimated cost of the houses

some 10 percent above that for normal construction, were made: (1) improved connection between exterior walls and foundations; (2) reinforced-concrete shear walls to replace the pipe columns in the basement; (3) increase in size and strengthening of connections of first-floor joists; (4) substitution of plywood for lath and plaster; (5) increase in size of rafters (to 2×8 inches) and wall studs; and (6) stronger nailing of window frames in wall openings.

5.64 Even with these improvements, it was expected that almost complete destruction would occur at 5 pounds per square inch peak overpressure, and so one of the houses was located where the overpressure at the Mach front would be 4 pounds per square inch. Partly because of the increased strength and partly because of the lower air blast pressure the house did not collapse (Fig. 5.64). But the superstructure was so badly damaged that it could not have been occupied without expensive repair which would not have been economically advisable.

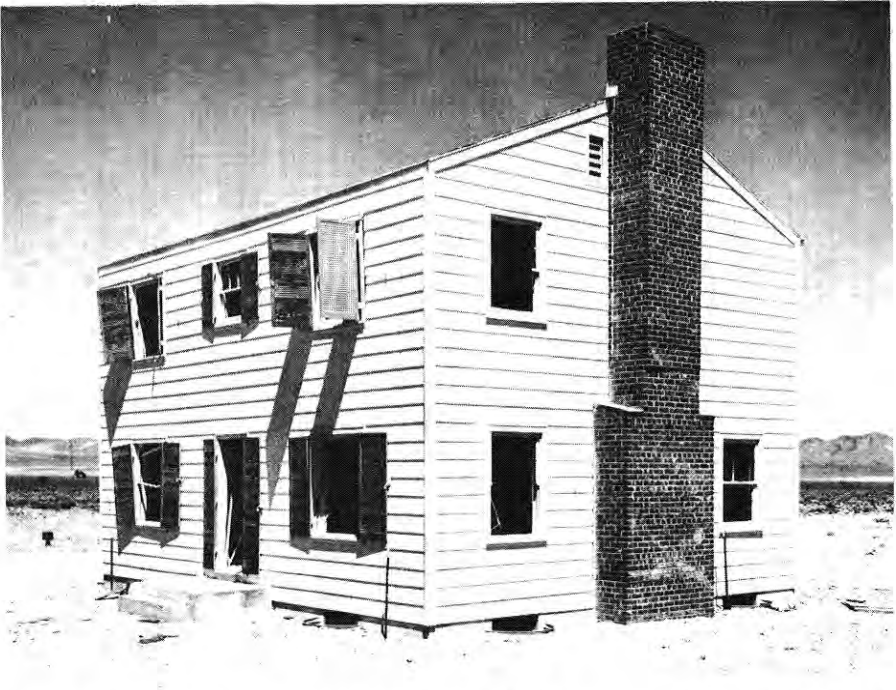

Figure 5.65. Strengthened wood-frame house after a nuclear explosion (2.6 psi peak overpressure).

5.65 The other strengthened two-story frame house was in a location where the incident peak overpressure was about 2.6 pounds per square inch; this was appreciably greater than the lower overpressure of the 1953 test. Relatively heavy damage was experienced, but the condition of the house was such that it could be made available for emergency shelter by shoring and not too expensive repairs (Fig. 5.65). Although there were differences in detail, the overall damage was much the same degree as that suffered by the corresponding house without the improved features at an overpressure of 1.7 pounds per square inch.

TWO-STORY, BRICK-WALL-BEARING HOUSE: 1955 TEST

5.66 For comparison with the tests on the two-story, wood-frame structures made in Nevada in 1953, two brick-wall-bearing houses of conventional construction, similar in size and layout, were exposed to 5 and 1.7 pounds per square inch peak overpressure, respectively, in the 1955 tests (Fig. 5.66). The exterior walls were of brick veneer and cinder block and the foundation walls of cinder block; the floors, partitions, and roof were wood-framed.

5.67 At an incident peak overpressure of 5 pounds per square inch, the brick-wall house was damaged beyond

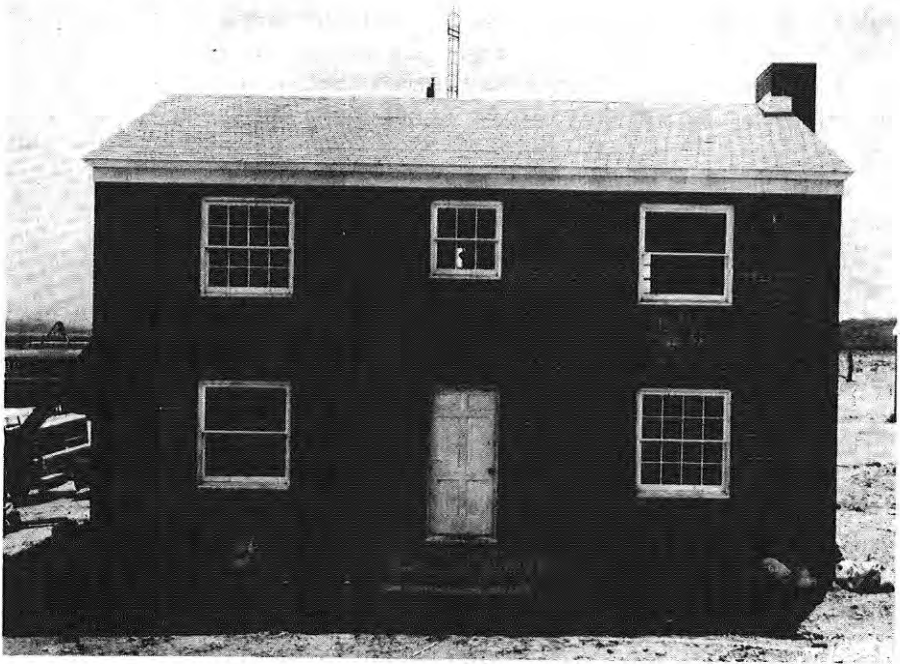

Figure 5.66. Unreinforced brick house before a nuclear explosion, Nevada Test Site.



Figure 5.67. Unreinforced brick house after a nuclear explosion (5 psi peak overpressure).

repair (Fig. 5.67). The side and back walls failed outward. The front wall failed initially inward, but its subsequent behavior was obscured by dust. The final location of the debris from the front wall is therefore uncertain, but very little fell on the floor framing. The roof was demolished and blown off, the rear part landing 50 feet behind the house. The first floor had partially collapsed into the basement as a result of fracturing of the floor joists at the center of the spans and the load of the second floor which fell upon it. The chimney was broken into several large sections.

5.68 Farther from the explosion, where the peak overpressure was 1.7 pounds per square inch, the corresponding structure was damaged to a

considerable extent. Nevertheless, its condition was such that it could be made available for habitation by shoring and some fairly inexpensive repairs (Fig. 5.68).

ONE-STORY, WOOD-FRAME
(RAMBLER TYPE) HOUSE: 1955 TEST

5.69 A pair of the so-called "rambler" type, single-story, wood-frame houses were erected at the Nevada Test Site on concrete slabs poured in place at grade. They were of conventional design except that each contained a shelter, above ground, consisting of the bathroom walls, floor, and ceiling of reinforced concrete with blast door and shutter (Fig. 5.69).



Figure 5.68. Unreinforced brick house after a nuclear explosion (1.7 psi peak overpressure).

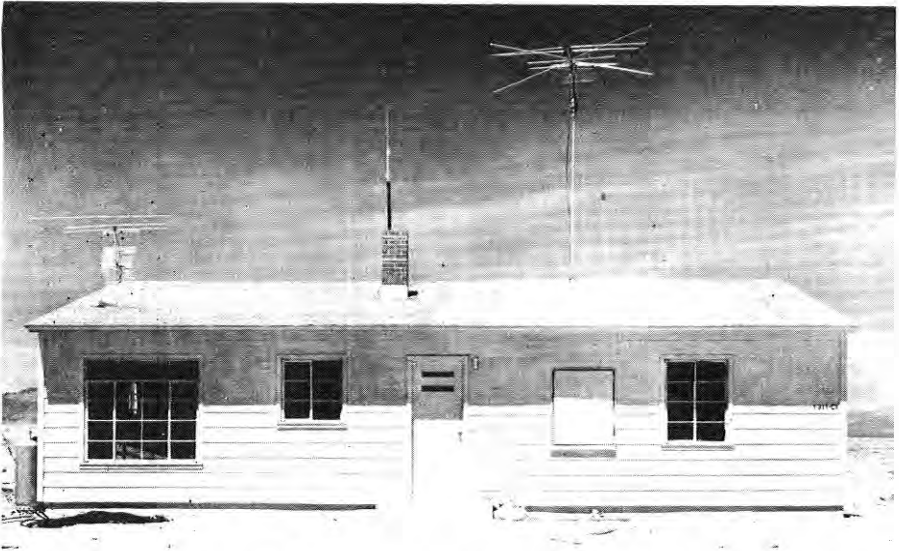

Figure 5.69. Rambler-type house before a nuclear explosion, Nevada Test Site. (Note blast door over bathroom window at right.)

5.70 When exposed to an incident peak overpressure of about 5 pounds per square inch, one of these houses was demolished beyond repair. However, the bathroom shelter was not damaged at all. Although the latch bolt on the blast shutter failed, leaving the shutter unfastened, the window was still intact. The roof was blown off and the rafters were split and broken. The side walls at gable ends were blown outward, and fell to the ground. A portion of the front wall remained standing, although it was leaning away from the direction of the explosion (Fig. 5.70).

5.71 The other house of the same type, subjected to a peak overpressure of 1.7 pounds per square inch, did not suffer too badly and it could easily have been made habitable. Windows were broken, doors blown off their hinges, and plaster-board walls and ceilings were badly damaged. The main struc-

tural damage was a broken midspan rafter beam and distortion of the frame. In addition, the porch roof was lifted 6 inches off its supports.

ONE-STORY, PRECAST CONCRETE HOUSE: 1955 TEST

5.72 Another residential type of construction tested in Nevada in 1955 was a single-story house made of precast, lightweight (expanded shale aggregate) concrete wall and partition panels, joined by welded matching steel lugs. Similar roof panels were anchored to the walls by special countersunk and grouted connections. The walls were supported on concrete piers and a concrete floor slab, poured in place on a tamped fill after the walls were erected. The floor was anchored securely to the walls by means of perimeter reinforcing rods held by hook bolts screwed into



Figure 5.70. Rambler-type house after a nuclear explosion (5 psi peak overpressure).

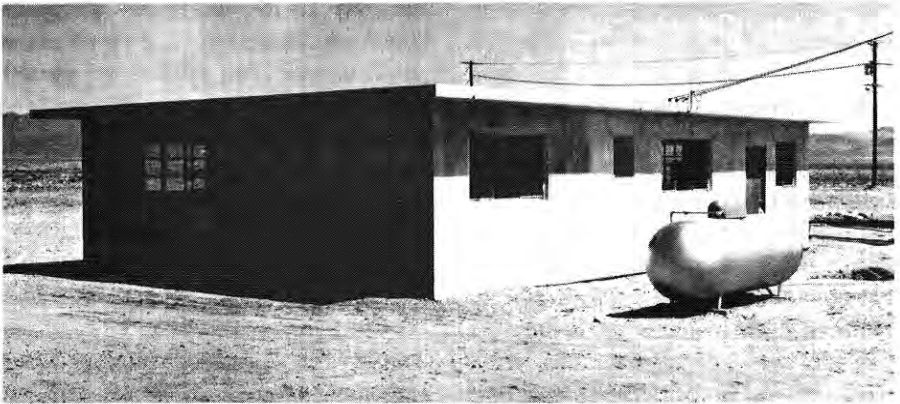

Figure 5.72. Reinforced precast concrete house before a nuclear explosion, Nevada Test Site.

inserts in the wall panels. The overall design was such as to comply with the California code for earthquake-resistant construction (Fig. 5.72).

5.73 This house stood up well, even at a peak overpressure of 5 pounds per square inch. By replacement of demolished or badly damaged doors and windows, it could have been made available for occupancy (Fig. 5.73).

5.74 There was some indication that the roof slabs at the front of the house were lifted slightly from their supports, but this was not sufficient to break any connections. Some of the walls were cracked slightly and others showed indications of minor movement. In certain areas the concrete around the slab connections was spalled, so that the connectors were exposed. The steel

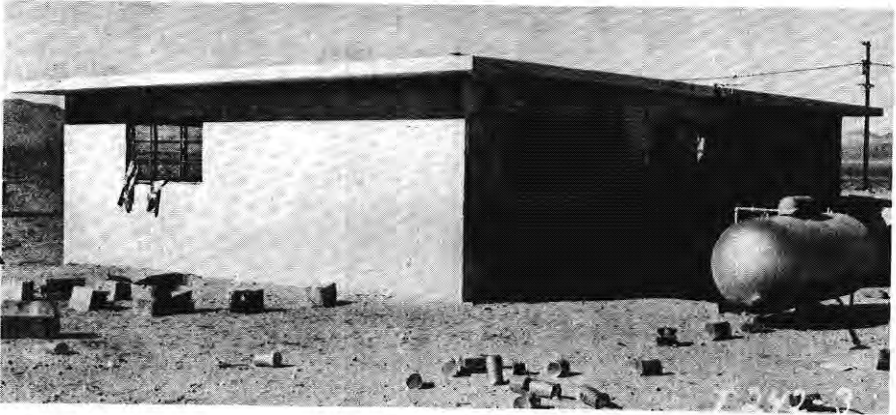

Figure 5.73. Reinforced precast concrete house after a nuclear explosion (5 psi peak overpressure). The LP-gas tank, sheltered by the house, is essentially undamaged.

window-sash was somewhat distorted, but it remained in place.

5.75 At a peak overpressure of 1.7 pounds per square inch, the precast concrete-slab house suffered relatively minor damage. Glass was broken extensively, and doors were blown off their hinges and demolished, as in other houses exposed to the same air pressure. But, apart from this and distortion of the steel window-sash, the only important damage was spalling of the concrete at the lug connections, i.e., where the sash projected into the concrete.

ONE-STORY, REINFORCED-MASONRY HOUSE: 1955 TEST

5.76 The last type of house subjected to test in 1955 was also of earthquake-resistant design. The floor was a concrete slab, poured in place at grade. The walls and partitions were built of lightweight (expanded shale aggregate) 8-inch masonry blocks, reinforced with vertical steel rods anchored into the floor slab. The walls were also reinforced with horizontal steel rods at two

levels, and openings were spanned by reinforced lintel courses. The roof was made of precast, lightweight concrete slabs, similar to those used in the precast concrete houses described above (Fig. 5.76).

5.77 At a peak overpressure of about 5 pounds per square inch, windows were destroyed and doors blown in the demolished. The steel window-sash was distorted, but nearly all remained in place. The house suffered only minor structural damage and could have been made habitable at relatively small cost (Fig. 5.77).

5.78 There was some evidence that the roof slabs had been moved, but not sufficiently to break any connections. The masonry wall under the large window (see Fig. 5.77) was pushed in about 4 inches on the concrete floor slab; this appeared to be due to the omission of dowels between the walls and the floor beneath window openings. Some cracks developed in the wall above the same window, probably as a result of improper installation of the reinforced lintel course and the substitution of a pipe

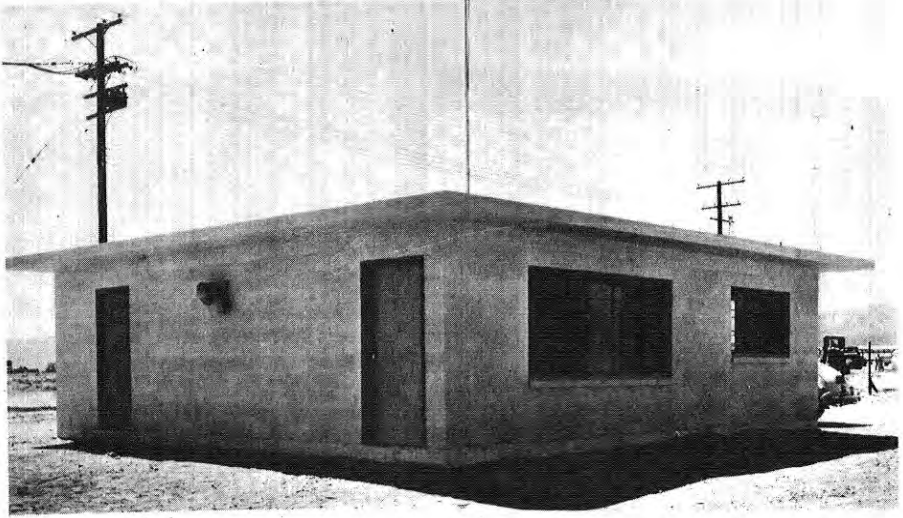

Figure 5.76. Reinforced masonry-block house before a nuclear explosion, Nevada Test Site.

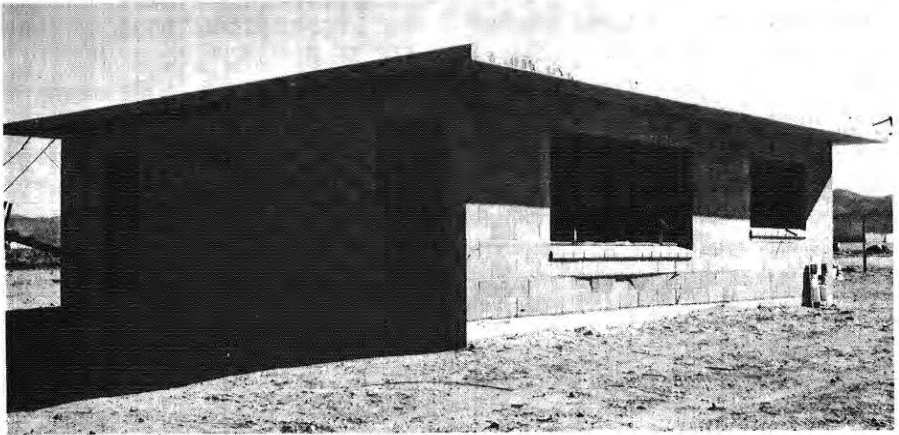

Figure 5.77. Reinforced masonry-block house after a nuclear explosion (5 psi peak overpressure).

column in the center span of the window.

5.79 A house of the same type exposed to the blast at a peak overpressure of 1.7 pounds per square inch suffered little more than the usual destruction of doors and windows. The steel window-

sash remained in place but was distorted, and some spalling of the concrete around lug connections was noted. On the whole, the damage to the house was of a minor character and it could readily have been repaired.

**TRAILER-COACH MOBILE HOMES:
1955 TEST**

5.80 Sixteen trailer-coaches of various makes, intended for use as mobile homes, were subjected to blast in the 1955 test in Nevada. Nine were located where the peak blast overpressure was 1.7 pounds per square inch, and the other seven where the peak overpressure was about 1 pound per square inch. They were parked at various angles with respect to the direction of travel of the blast wave.

5.81 At the higher overpressure two of the mobile homes were tipped over by the explosion. One of these was originally broadside to the blast, whereas the second, at an angle of about 45°, was of much lighter weight. All the others at both locations remained standing. On the whole, the damage sustained was not of a serious character.

5.82 From the exterior, many of the mobile homes showed some dents in walls or roof, and a certain amount of distortion. There were, however, relatively few ruptures. Most windows were broken, but there was little or no glass in

the interior, especially in those coaches having screens fitted on the inside. Where there were no screens or venetian blinds, and particularly where there were large picture windows, glass was found inside.

5.83 The interiors of the mobile homes were usually in a state of disorder due to ruptured panels, broken and upset furniture, and cupboards, cabinets, and wardrobes which had been torn loose and damaged. Stoves, refrigerators, and heaters were not displaced, and the floors were apparently unharmed. The plumbing was, in general, still operable after the explosion. Consequently, by rearranging the displaced furniture, repairing cabinets, improvising window coverings, and cleaning up the debris, all trailer-coaches could have been made habitable for emergency use.

5.84 At the 1 pound per square inch overpressure location some windows were broken, but no major damage was sustained. The principal repairs required to make the mobile homes available for occupancy would be window replacement or improvised window covering.

TRANSPORTATION**LIGHT LAND TRANSPORTATION
EQUIPMENT**

5.85 In Japan, trolley-car equipment was heavily damaged by both blast and fire, although the poles were frequently left standing. Buses and automobiles generally were rendered inoperable by blast and fire as well as by damage caused by flying debris. However, the damage decreased rapidly with

distance. An American made automobile was badly damaged and burned at 3,000 feet (0.57 mile) from ground zero, but a similar vehicle at 6,000 feet (1.14 miles) suffered only minor damage.

5.86 Automobiles and buses have been exposed to several of the nuclear test explosions in Nevada, where the conditions, especially as regards dam-



Figure 5.87a. Damage to automobile originally located behind wood-frame house (5 psi peak overpressure); the front of this car can be seen in Figure 5.57. Although badly damaged, the car could still be driven after the explosion.



Figure 5.87b. Typical public bus damaged by a nuclear explosion, Nevada Test Site; this bus, like the one in the left background, was overturned, coming to rest as shown after a displacement of 50 feet.

age by fire and missiles, were somewhat different from those in Japan. In the descriptions that follow, distance is related to peak overpressure. In most cases, however, it was not primarily overpressure, but drag forces, which produced the damage. In addition, allowance must be made for the effect of the blast wave precursor (§ 3.79 *et seq.*). Hence, the damage radii cannot be determined from overpressure alone.

5.87 Some illustrations of the effects of a nuclear explosion on motorized vehicles are shown in Figs. 5.87a and b. At a peak overpressure of 5 pounds per square inch motor vehicles were badly battered, with their tops and sides pushed in, windows broken, and hoods blown open. But the engines were still operable and the vehicles could be driven away after the explosion. Even at higher blast pressures, when the overall damage was greater, the motors appeared to be intact.

5.88 During the 1955 tests in Nevada, studies were made to determine the extent to which various emergency vehicles and their equipment would be available for use immediately following a nuclear attack. The vehicles included a rescue truck, gas and electric utility service or repair trucks, telephone service trucks, and fire pumpers and ladder trucks. One vehicle was exposed to a peak overpressure of about 30 pounds per square inch, two at 5 pounds per square inch, two at 1.7 pounds per square inch, and six at about 1 pound per square inch. It should be emphasized, however, that, for vehicles in general, overpressure is not usually the sole or even the primary damage mechanism.

5.89 The rescue truck at the 30

pounds per square inch location was completely destroyed, and only one wheel and part of the axle were found after the blast. At 5 pounds per square inch peak overpressure a truck, with an earth-boring machine bolted to the bed, was broadside to the blast. This truck was overturned and somewhat damaged, but still operable (Fig. 5.89). The earth-boring machine was knocked loose and was on its side leaking gasoline and water. At the same location, shown to the left of the overturned truck in Fig. 5.89, was a heavy-duty electric utility truck, facing head-on to the blast. It had the windshield shattered, both doors and cab dished in, the hood partly blown off, and one tool-compartment door dished. There was, however, no damage to tools or equipment and the truck was driven away without any repairs being required.

5.90 At the 1.7 pounds per square inch location, a light-duty electric utility truck and a fire department 75-foot aerial ladder truck sustained minor exterior damage, such as broken windows and dished-in panels. There was no damage to equipment in either case, and both vehicles would have been available for immediate use after an attack. Two telephone trucks, two gas utility trucks, a fire department pumper, and a Jeep firetruck, exposed to a peak overpressure of 1 pound per square inch, were largely unharmed.

5.91 It may be concluded that vehicles designed for disaster and emergency operation are substantially constructed, so that they can withstand a peak overpressure of about 5 pounds per square inch and the associated dynamic pressure and still be capable of operation. Tools and equipment are protected



Figure 5.89. Truck broadside to the blast wave (5 psi peak overpressure) overturned; electric utility truck in background head-on to blast was damaged but remained standing.

from the blast by the design of the truck body or when housed in compartments with strong doors.

RAILROAD EQUIPMENT

5.92 Railroad equipment suffered blast damage in Japan and also in tests in Nevada. Like motor vehicles, these targets are primarily drag sensitive and damage cannot be directly related to overpressure. At a peak overpressure of 2 pounds per square inch from a kiloton-range weapon, an empty wooden boxcar may be expected to receive relatively minor damage. At 4 pounds per square inch overpressure, the damage to a loaded wooden boxcar would be more severe (Fig. 5.92a). At a peak overpressure of 6 pounds per square inch the

body of an empty wooden boxcar, weighing about 20 tons, was lifted off the trucks, i.e., the wheels, axles, etc., carrying the body, and landed about 6 feet away. The trucks themselves were pulled off the rails, apparently by the brake rods connecting them to the car body. A similar boxcar, at the same location, loaded with 30 tons of sandbags remained upright (Fig. 5.92b). Although the sides were badly damaged and the roof demolished, the car was capable of being moved on its own wheels. At 7.5 pounds per square inch peak overpressure, a loaded boxcar of the same type was overturned, and at 9 pounds per square inch it was completely demolished.

5.93 A Diesel locomotive weighing 46 tons was exposed to a peak over-

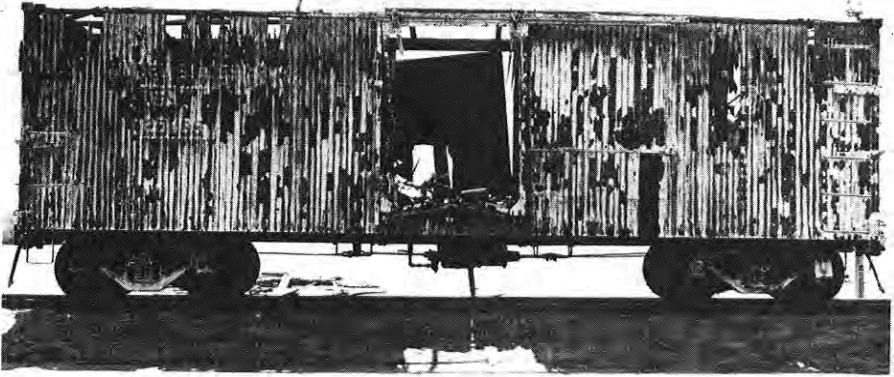

Figure 5.92a. Loaded wooden boxcar after a nuclear explosion (4 psi peak overpressure).

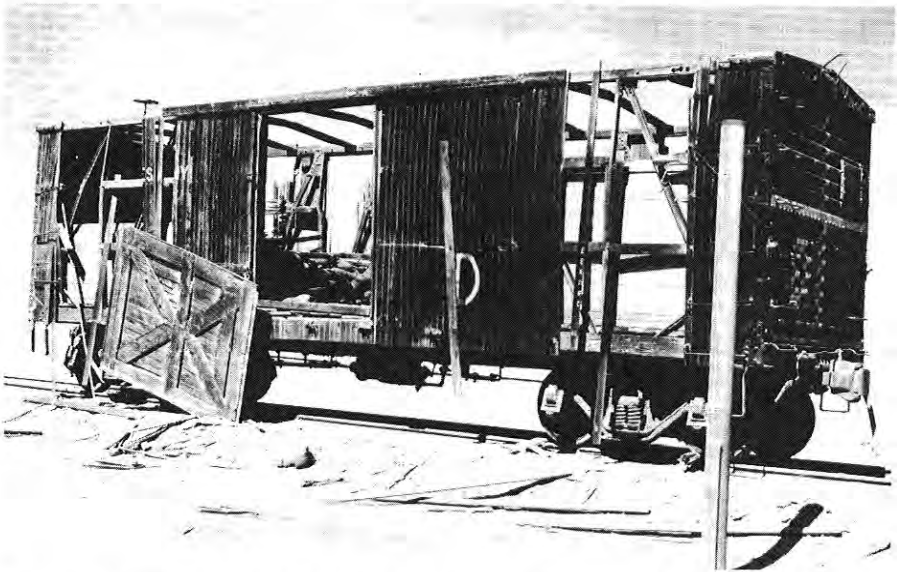

Figure 5.92b. Loaded wooden boxcar after a nuclear explosion (6 psi peak overpressure).

pressure of 6 pounds per square inch while the engine was running. It continued to operate normally after the blast, in spite of damage to windows

and compartment doors and panels. There was no damage to the railroad track at this point.

AIRCRAFT

5.94 Aircraft are damaged by blast effects at levels of peak overpressure as low as 1 to 2 pounds per square inch. Complete destruction or damage beyond economical repair may be expected at peak overpressures of 4 to 10 pounds per square inch. Within this range, the peak overpressure appears to be the main criterion of damage. However, tests indicate that, at a given overpressure, damage to an aircraft oriented with the nose toward the burst will be less than damage to one with the tail or a side directed toward the explosion.

5.95 Damage to an aircraft exposed with its left side to the blast at a peak overpressure of 3.6 pounds per square inch is shown in Fig. 5.95a. The fuselage of this aircraft failed completely just aft of the wing. The skin of the fuselage, stabilizers, and engine cowling was severely buckled. Figure 5.95b shows damage to an aircraft oriented with its tail toward the burst and exposed to 2.4 pounds per square inch peak overpressure. Skin was dished in on the vertical stabilizer, horizontal stabilizers, wing surface above the flaps, and outboard wing sections. Vertical stabilizer bulkheads and the fuselage frame near the cockpit were buckled.

SHIPPING

5.96 Damage to ships from an air or surface burst is due primarily to the air blast, since little pressure is transmitted

through the water. At closer ranges, air blast can cause hull rupture resulting in flooding and sinking. Such rupture appears likely to begin near the waterline on the side facing the burst. Since the main hull generally is stronger than the superstructure, structures and equipment exposed above the waterline may be damaged at ranges well beyond that at which hull rupture might occur. Masts, spars, radar antennas, stacks, electrical equipment, and other light objects are especially sensitive to air blast. Damage to masts and stacks is apparent in Fig. 5.96; the ship was approximately 0.47 mile from surface zero at the ABLE test (about 20-kiloton air burst) at Bikini in 1946. Air blast may also roll and possibly capsize the ship; this effect would be most pronounced for the air blast wave from a large weapon striking the ship broadside.

5.97 Blast pressures penetrating through openings of ventilation systems and stack-uptake systems can cause damage to interior equipment and compartments, and also to boilers. Damage to the latter may result in immobilization of the ship. The distortion of weather bulkheads may render useless interior equipment mounted on or near them. Similarly, the suddenly applied blast loading induces rapid motion of the structures which may cause shock damage to interior equipment. Equipment in the superstructure is most susceptible to this type of damage, although shock motions may be felt throughout the ship.

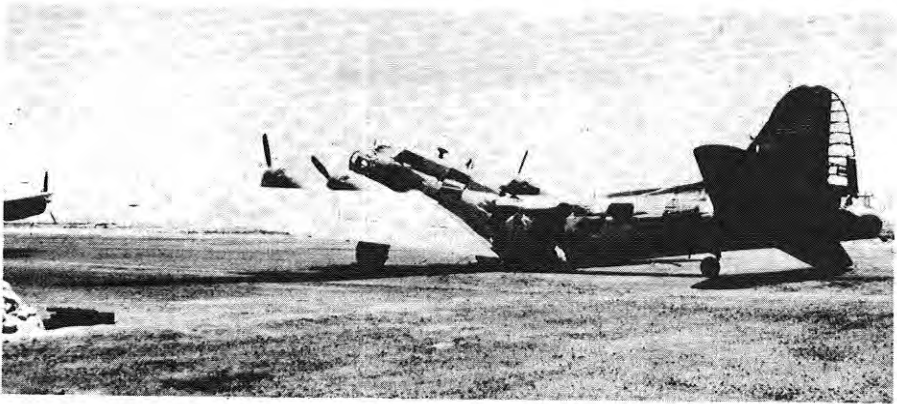

Figure 5.95a. Aircraft after side exposed to a nuclear explosion (3.6 psi peak overpressure).



Figure 5.95b. Aircraft after tail exposed to a nuclear explosion (2.4 psi peak overpressure).

UTILITIES

ELECTRICAL DISTRIBUTION SYSTEMS

5.98 Because of the extensive damage caused by the nuclear explosions to the cities in Japan, the electrical distri-

bution systems suffered severely. Utility poles were destroyed by blast or fire, and overhead lines were heavily damaged at distances up to 9,000 feet (1.7 miles) from ground zero (Fig. 5.98).

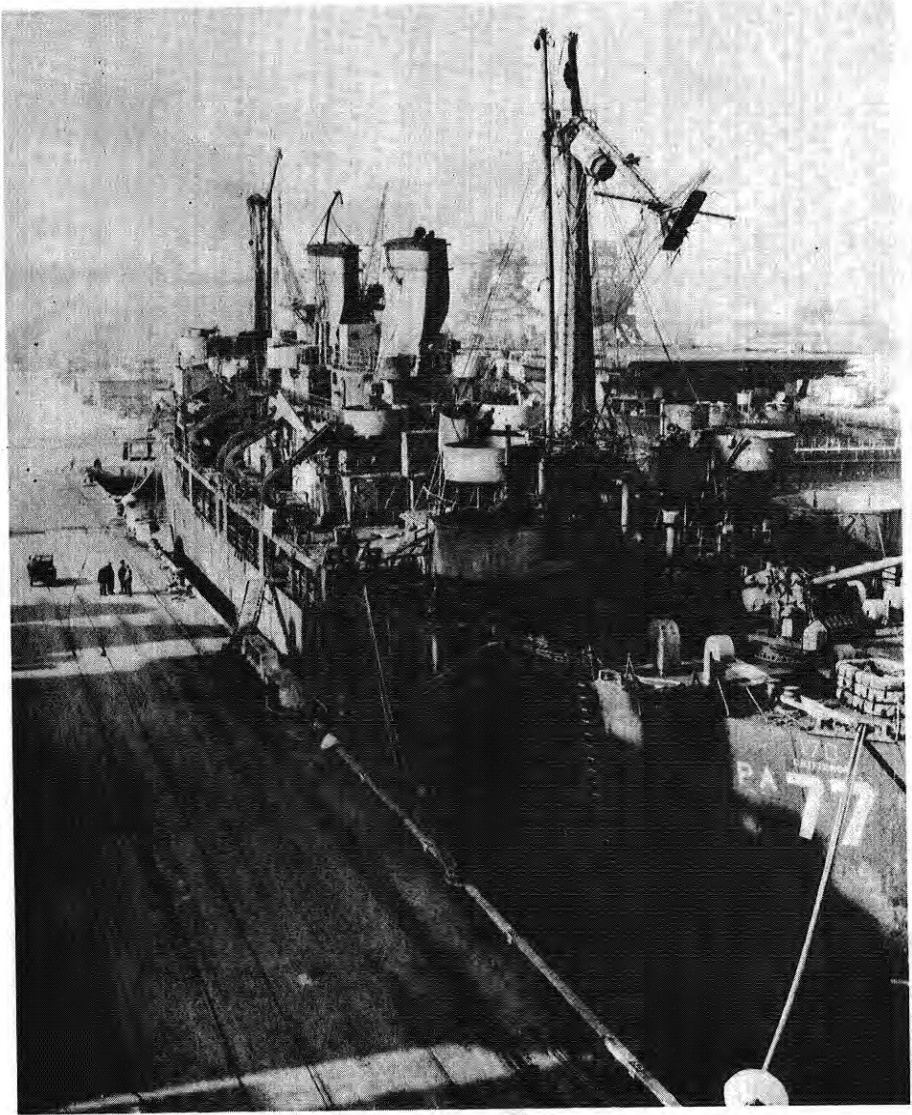

Figure 5.96. The U.S.S. Crittenden after ABLE test; damage resulting was generally serious (0.47 mile from surface zero).

Underground electrical circuits were, however, little affected. Switchgear and transformers were not damaged so much directly by blast as by secondary effects, such as collapse of the structure in which they were located or by debris.

Motors and generators were damaged by fire.

5.99 A fairly extensive study of the effects of a nuclear explosion on electric utilities was made in the Nevada tests in 1955. Among the purposes of these tests



Figure 5.98. Damage to utility pole (0.80 mile from ground zero at Hiroshima).

were the following: (1) to determine the blast pressure at which standard electrical equipment might be expected to

suffer little or no damage; (2) to study the extent and character of the damage that might be sustained in a nuclear

attack; and (3) to determine the nature of the repairs that would be needed to restore electrical service in those areas where homes and factories would survive sufficiently to permit their use after some repair. With these objectives in mind, two identical power systems were erected; one to be subjected to a peak overpressure of about 5 and a dynamic pressure of 0.6 pounds per square inch and the other to 1.7 and 0.1 pounds per square inch, respectively. It will be recalled that, at the lower overpressure, typical American residences would not be damaged beyond the possibility of further use.

5.100 Each power system consisted of a high-voltage (69-kV) transmission line on steel towers connected to a conventional, outdoor transformer substation. From this proceeded typical overhead distribution lines on 15 wood poles; the latter were each 45 feet long and were set 6 feet in the ground. Service drops from the overhead lines supplied electricity to equipment placed in some of the houses used in the tests described earlier. These installations were typical of those serving an urban community. In addition, the 69-kV transmission line, the 69-kV switch rack with oil circuit-breakers, and power transformer represented equipment of the kind that might supply electricity to large industrial plants.

5.101 At a peak overpressure of 5 and a dynamic pressure of 0.6 pounds per square inch the power system suffered to some extent, but it was not seriously harmed. The type of damage appeared, on the whole, to be similar to that caused by severe wind storms. In addition to the direct effect of blast, some destruction was due to missiles.

5.102 The only damage suffered by the high-voltage transmission line was the collapse of the suspension tower, bringing down the distribution line with it (Fig. 5.102a). It may be noted that the dead-end tower, which was much stronger and heavier, and another suspension tower of somewhat stronger design were only slightly affected (Fig. 5.102b). In some parts of the United States, the suspension towers are of similar heavy construction. Structures of this type are sensitive to drag forces which are related to dynamic pressure and positive phase duration, so that the overpressure is not the important criterion of damage.

5.103 The transformer substation survived the blast with relatively minor damage to the essential components. The metal cubicle, which housed the meters, batteries, and relays, suffered badly, but this substation and its contents were not essential to the emergency operation of the power system. The 4 kV regulators had been shifted on the concrete pad, resulting in separation of the electrical connections to the bus. The glass cells of the batteries were broken and most of the plates were beyond repair. But relays, meters, and other instruments were undamaged, except for broken glass. The substation as a whole was in sufficiently sound condition to permit operation on a nonautomatic (manual) basis. By replacing the batteries, automatic operation could have been restored.

5.104 Of the 15 wood poles used to carry the lines from the substation to the houses, four were blown down completely and broken, and two others were extensively damaged. The collapse of the poles was attributed partly to the

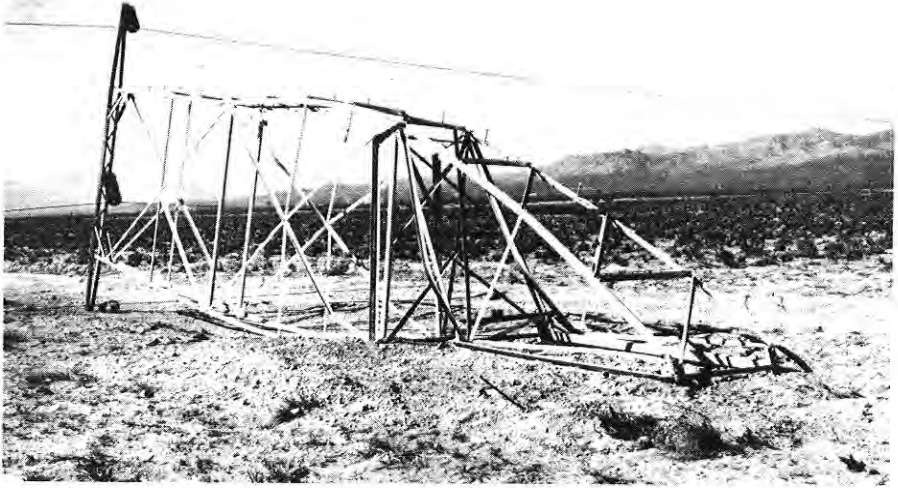

Figure 5.102a. Collapsed suspension tower (5 psi peak overpressure, 0.6 psi dynamic pressure from 30-kiloton explosion), Nevada Test Site.

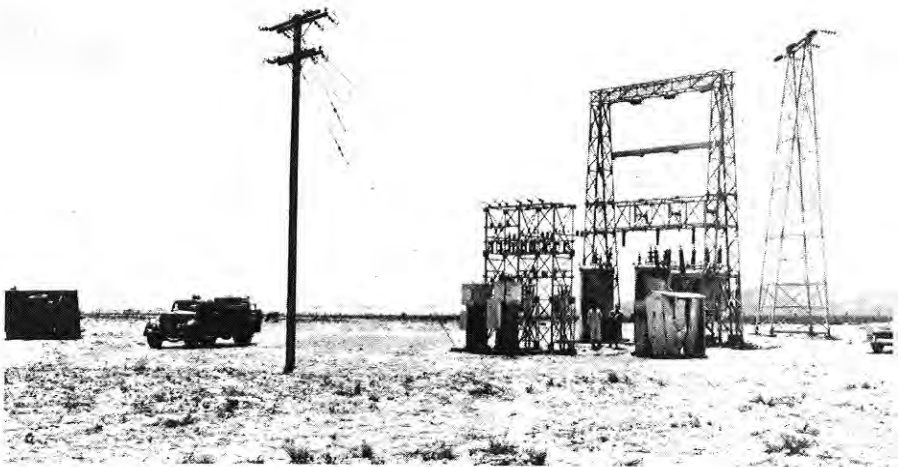

Figure 5.102b. Dead-end tower, suspension tower, and transformers (5 psi peak overpressure, 0.6 psi dynamic pressure from 30-kiloton explosion), Nevada Test Site. The trucks at the left of the photograph are those in Figure 5.89.

weight and resistance of the aerial cable (Fig. 5.104). Other damage was believed to be caused by missiles.

5.105 Several distributor transformers had fallen from the poles and

secondary wires and service drops were down (Fig. 5.105). Nevertheless the transformers, pot heads, arresters, cut-outs, primary conductors of both aluminum and copper, and the aerial cables

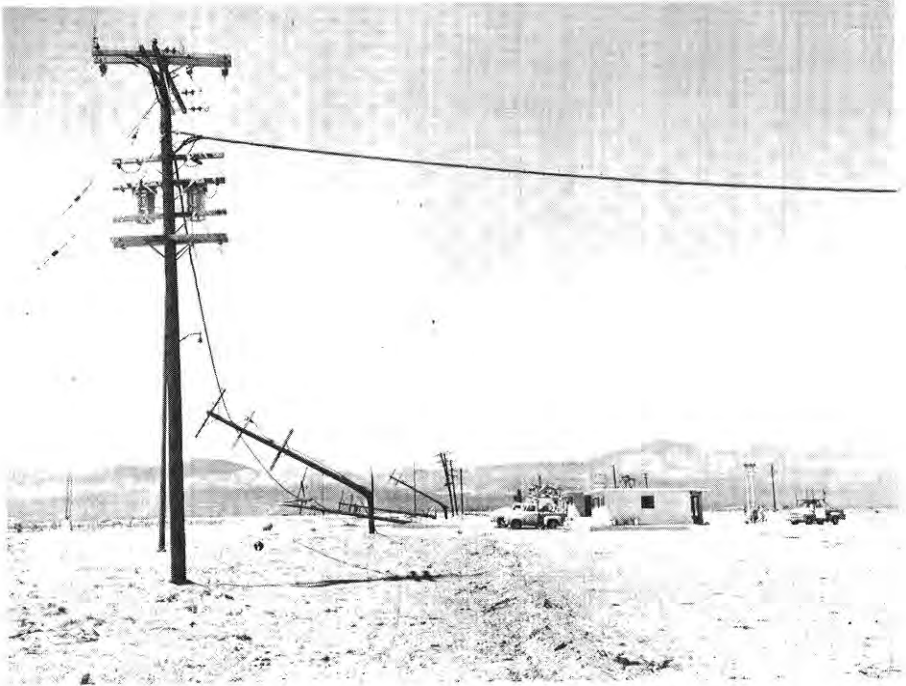

Figure 5.104. Collapse of utility poles on line (5 psi peak overpressure, 0.6 psi dynamic pressure from 30-kiloton explosion), Nevada Test Site.

were unharmed. Although the pole line would have required some rebuilding, the general damage was such that it could have been repaired within a day or so with materials normally carried in stock by electric utility companies.

GAS, WATER, AND SEWERAGE SYSTEMS

5.106 The public utility system in Nagasaki was similar to that of a somewhat smaller town in the United States, except that open sewers were used. The most significant damage was suffered by the water supply system, so that it became almost impossible to extinguish fires. Except for a special case, described below, loss of water pressure

resulted from breakage of pipes inside and at entrances to buildings or on structures, rather than from the disruption of underground mains (Figs. 5.106a and b). The exceptional case was one in which the 12-inch cast iron water pipes were 3 feet below grade in a filled-in area. A number of depressions, up to 1 foot in depth, were produced in the fill, and these caused failure of the underground pipes, presumably due to unequal displacements.

5.107 There was no appreciable damage to reservoirs and water-treatment plants in Japan. As is generally the case, these were located outside the cities, and so were at too great a distance from the explosions to be damaged in any way.



Figure 5.105. Transformer fallen from collapsed utility pole (5 psi peak overpressure), Nevada Test Site.

5.108 Gas holders suffered heavily from blast up to 6,000 feet (1.1 miles) from ground zero and the escaping gas was ignited, but there was no explosion. Underground gas mains appear to have been little affected by the blast.

NATURAL AND MANUFACTURED GAS INSTALLATIONS

5.109 One of the objectives of the

tests made in Nevada in 1955 was to determine the extent to which natural and manufactured gas utility installations might be disrupted by a nuclear explosion. The test was intended, in particular, to provide information concerning the effect of blast on critical underground units of a typical gas distribution system.



Figure 5.106a. Four-inch gate valve in water main broken by debris from brick wall (0.23 mile from ground zero at Hiroshima).



Figure 5.106b. Broken portion of 16-inch water main carried on bridge (0.23 mile from ground zero at Hiroshima).

5.110 The installations tested were of two kinds, each in duplicate. The first represented a typical underground gas-

transmission and distribution main of 6-inch steel and cast iron pipe, at a depth of 3 feet, with its associated ser-

vice pipes and attachments. Valve pits of either brick or concrete blocks contained 6-inch valves with piping and protective casings. A street regulator-vault held a 6-inch, low-pressure, pilot-loaded regulator, attached to steel piping projecting through the walls. One of these underground systems was installed where the blast overpressure was about 30 pounds per square inch and the other at 5 pounds per square inch. No domestic or ordinary industrial structures at the surface would have survived the higher of these pressures.

5.111 The second type of installation consisted of typical service lines of steel, copper, and plastic materials connected to 20-foot lengths of 6-inch steel main. Each service pipe rose out of the ground at the side of a house, and was joined to a pressure regulator and meter. The pipe then entered the wall of the house about 2 feet above floor level. The copper and plastic services terminated inside the wall, so that they would be subject to strain if the house moved on its foundation. The steel service line similarly terminated inside the wall, but it was also attached outside to piping that ran around the back of the house at ground level to connect to the house piping. This latter connection was made with flexible seamless bronze tubing, passing through a sleeve in the wall of the building. Typical domestic gas appliances, some attached to the interior piping, were located in several houses. Duplicate installations were located at peak overpressures of 5 and 1.7 pounds per square inch, respectively.

5.112 Neither of the underground installations was greatly affected by the blast. At the 30 pounds per square inch

peak overpressure location a 1½-inch pipe pressure-test riser was bent to the ground, and the valve handle, stem, and bonnet had blown off. At the same place two 4-inch ventilating pipes of the street regulator-vaults were sheared off just below ground level. A few minor leaks developed in jute and lead caulked cast iron bell and spigot joints because of ground motion, presumably due to ground shock induced by air blast. Otherwise the blast effects were negligible.

5.113 At the peak overpressure of 1.7 pounds per square inch, where the houses did not suffer severe damage, (§ 5.59), the service piping both inside and outside the houses was unharmed, as also were pressure regulators and meters. In the two-story, brick house at 5 pounds per square inch peak overpressure, which was demolished beyond repair (§ 5.57), the piping in the basement was displaced and bent as a result of the collapse of the first floor. The meter also became detached from the fittings and fell to the ground, but the meter itself and the regulator were undamaged and still operable. All other service piping and equipment were essentially intact.

5.114 Domestic gas appliances, such as refrigerators, ranges, room heaters, clothes dryers, and water heaters suffered to a moderate extent only. There was some displacement of the appliances and connections which was related to the damage suffered by the house. However, even in the collapsed two-story, brick house (§ 5.67), the upset refrigerator and range were probably still usable, although largely buried in debris. The general conclusion is, therefore, that domestic gas (and also electric) appliances would be operable

in all houses that did not suffer major structural damage.

LIQUID PETROLEUM (LP) GAS INSTALLATIONS

5.115 Various LP-gas installations have been exposed to air blast from nuclear tests in Nevada to determine the effects of typical gas containers and supply systems such as are found at suburban and farm homes and at storage, industrial, and utility plants. In addition, it was of interest to see what reliance might be placed upon LP-gas as an emergency fuel after a nuclear attack.

5.116 Two kinds of typical home (or small commercial) LP-gas installations were tested: (1) a system consisting of two replaceable ICC-approved cylinders each of 100-pound capacity; and (2) a 500-gallon bulk storage type system filled from a tank truck. Some of these installations were in the open and others were attached, in the usual manner, by means of either copper tubing or steel pipe service line, to the houses exposed to peak overpressures of 5 and 1.7 pounds per square inch. Others were located where the peak overpressures were about 25 and 10 pounds per square inch. In these cases, piping from the gas containers passed through a concrete wall simulating the wall of a house.

5.117 In addition to the foregoing, a complete bulk storage plant was erected at a point where the peak overpressure was 5 pounds per square inch. This consisted of an 18,000-gallon tank (containing 15,400 gallons of propane), pump compressor, cylinder-filling building, cylinder dock, and all necessary valves, fittings, hose, accessories, and interconnecting piping.

5.118 The dual-cylinder installation, exposed to 25 pounds per square inch peak overpressure, suffered most; the regulators were torn loose from their mountings and the cylinders displaced. One cylinder came to rest about 2,000 feet from its original position; it was badly dented, but was still usable. At both 25 and 10 pounds per square inch peak overpressure the components, although often separated, could generally be salvaged and used again. The cylinder installations at 5 pounds per square inch peak overpressure were mostly damaged by missiles and falling debris from the houses to which they were attached. The component parts, except for the copper tubing, suffered little and were usable. At 1.7 pounds per square inch, there was neither damage to nor dislocation of LP-gas cylinders. Of those tested, only one cylinder developed a leak, and this was a small puncture resulting from impact with a sharp object.

5.119 The 500-gallon bulk gas tanks also proved very durable and experienced little damage. The tank closest to the explosion was bounced end-over-end for a distance of some 700 feet; nevertheless, it suffered only superficially and its strength and serviceability were not impaired. The filler valve was damaged, but the internal check valve prevented escape of the contents. The tank exposed at 10 pounds per square inch peak overpressure was moved about 5 feet, but it sustained little or no damage. All the other tanks, at 5 or 1.7 pounds per square inch, including those at houses piped for service, were unmoved and undamaged (Fig. 5.73).

5.120 The equipment of the



Figure 5.120. Upper photo: LP-gas bulk storage and filling plant before a nuclear explosion. Lower photo: The plant after the explosion (5 psi peak overpressure).

18,000-gallon bulk storage and filling plant received only superficial damage from the blast at 5 pounds per square inch peak overpressure. The cylinder-filling building was completely demolished; the scale used for weighing the cylinders was wrecked, and a filling line was broken at the point where it entered the building (Fig. 5.120). The major operating services of the plant would, however, not be affected because the transfer facilities were outside and undamaged. All valves and nearly all piping in the plant were intact and there

was no leakage of gas. The plant could have been readily put back into operation if power, from electricity or a gasoline engine, were restored. If not, liquid propane in the storage tank could have been made available by taking advantage of gravity flow in conjunction with the inherent pressure of the gas in the tank.

5.121 The general conclusion to be drawn from the tests is that standard LP-gas equipment is very rugged, except for copper tubing connections. Disruption of the service as a result of a

nuclear attack would probably be localized and perhaps negligible, so that LP-gas might prove to be a very useful emergency fuel. Where LP-gas is used

mainly for domestic purposes, it appears that the gas supply would not be affected under such conditions that the house remains habitable.

MISCELLANEOUS TARGETS

COMMUNICATIONS EQUIPMENT

5.122 The importance of having communications equipment in operating condition after a nuclear attack is evident and so a variety of such equipment has been tested in Nevada. Among the items exposed to air blast were mobile radio-communication systems and units, a standard broadcasting transmitter, antenna towers, home radio and television receivers, telephone equipment (including a small telephone exchange), public address sound systems, and sirens. Some of these were located where the peak overpressure was 5 pounds per square inch, and in most cases there were duplicates at 1.7 pounds per square inch. The damage at the latter location was of such a minor character that it need not be considered here.

5.123 At the higher overpressure region, where typical houses were damaged beyond repair, the communications equipment proved to be very resistant to blast. This equipment is drag sensitive and so the peak overpressure does not determine the extent of damage. Standard broadcast and television receivers, and mobile radio base stations were found to be in working condition, even though they were covered with debris and had, in some cases, been damaged by missiles, or by being thrown or dropped several feet. No

vacuum or picture tubes were broken. The only mobile radio station to be seriously affected was one in an automobile which was completely crushed by a falling chimney.

5.124 A guyed 150-foot antenna tower was unharmed, but an unguyed 120-foot tower, of lighter construction, close by, broke off at a height of about 40 feet and fell to the ground (Fig. 5.124): This represented the only serious damage to any of the equipment tested.

5.125 The base station antennas, which were on the towers, appeared to withstand blast reasonably well, although those attached to the unguyed tower, referred to above, suffered when the tower collapsed. As would have been expected from their lighter construction, television antennas for home receivers were more easily damaged. Several were bent both by the blast and the collapse of the houses upon which they were mounted. Since the houses were generally damaged beyond repair at a peak overpressure of 5 pounds per square inch, the failure of the television antennas is not of great significance.

5.126 Some items, such as power lines and telephone service equipment, were frequently attached to utility-line poles. When the poles failed, as they did in some cases (§ 5.104), the communi-



Figure 5.124. Unguyed lightweight 120-foot antenna tower (5 psi peak overpressure, 0.6 psi dynamic pressure from 30-kiloton explosion), Nevada Test Site.

cations systems suffered accordingly. Although the equipment operated satisfactorily after repairs were made to the wire line, it appears that the power supply represents a weak link in the communications chain.

BRIDGES

5.127 There were a number of different kinds of bridges exposed to the nuclear explosions in Hiroshima and

Nagasaki. Those of wood were burned in most cases, but steel-girder bridges suffered relatively little destruction (Figs. 5.127a and b). One bridge, only 270 feet from ground zero, i.e., about 2,100 feet from the burst point, which was of a girder type with a reinforced-concrete deck, showed no sign of any structural damage. It had, apparently, been deflected downward by the blast force and had rebounded, causing only a slight net displacement. Other bridges,



Figure 5.127a. Bridge with deck of reinforced concrete on steel-plate girders; outer girder had concrete facing (270 feet from ground zero at Hiroshima). The railing was blown down but the deck received little damage so that traffic continued.

at greater distances from ground zero, suffered more lateral shifting. A reinforced-concrete deck was lifted from the supporting steel girder of one bridge, apparently as a result of reflection of the blast wave from the surface of the water below.

HEAVY-DUTY MACHINE TOOLS

5.128 The vulnerability of heavy-duty machine tools and their components to air blast from a nuclear explosion was studied at the Nevada Test Site to supplement the information from Nagasaki (§ 5.33). A number of machine tools were anchored on a reinforced-

concrete slab in such a manner as to duplicate good industrial practice. Two engine lathes (weighing approximately 7,000 and 12,000 pounds, respectively), and two horizontal milling machines (7,000 and 10,000 pounds, respectively) were exposed to a peak overpressure of 10 pounds per square inch. A concrete-block wall, 8 inches thick and 64 inches high, was constructed immediately in front of the machines, i.e., between the machines and ground zero (Fig. 5.128). The purpose of this wall was to simulate the exterior wall of the average industrial plant and to provide debris and missiles.

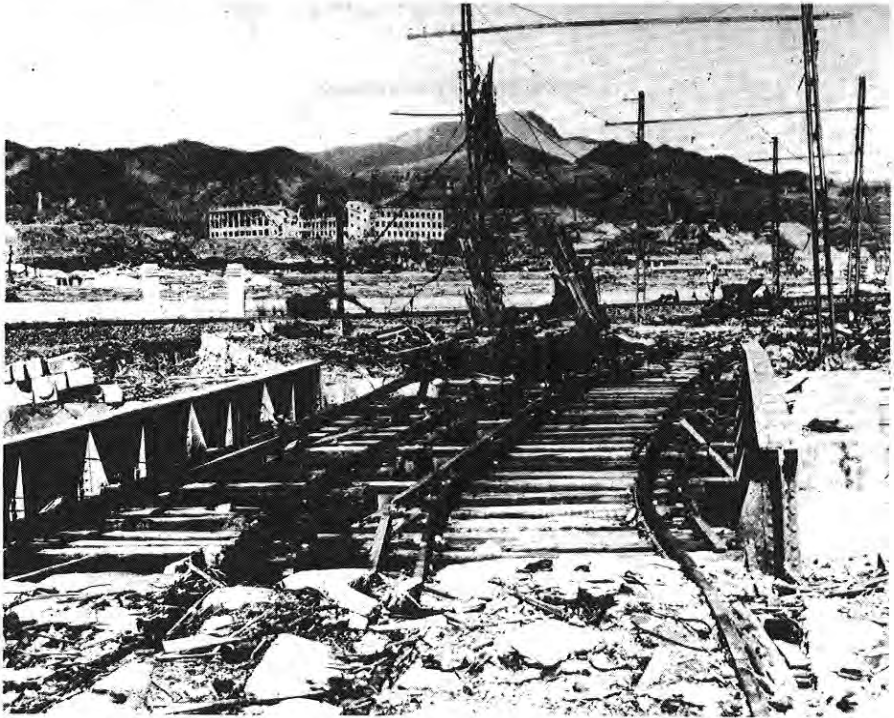

Figure 5.127b. A steel-plate girder, double-track railway bridge (0.16 mile from ground zero at Nagasaki). The plate girders were moved about 3 feet by the blast; the railroad track was bent out of shape and trolley cars were demolished, but the poles were left standing.

5.129 Of the four machines, the three lighter ones were moved from their foundations and damaged quite badly (Fig. 5.129a). The fourth, weighing 12,000 pounds, which was considered as the only one to be actually of the heavy-duty type, survived (Fig. 5.129b). From the observations it was concluded that a properly anchored machine tool of the true heavy-duty type would be able to withstand peak overpressures of 10 pounds per square inch or more without substantial damage.

5.130 In addition to the direct effects of blast, considerable destruction was caused by debris and missiles,

much of which resulted from the expected complete demolition of the concrete-block wall. Delicate mechanisms and appendages, which are usually on the exterior and unprotected, suffered especially severely. Gears and gear cases were damaged, hand valves and control levers were broken off, and drive belts were broken. It appears, however, that most of the missile damage could be easily repaired if replacement parts were available, since major dismantling would not be required.

5.131 Behind the two-story brick house in the peak overpressure region of 5 pounds per square inch (§ 5.67), a

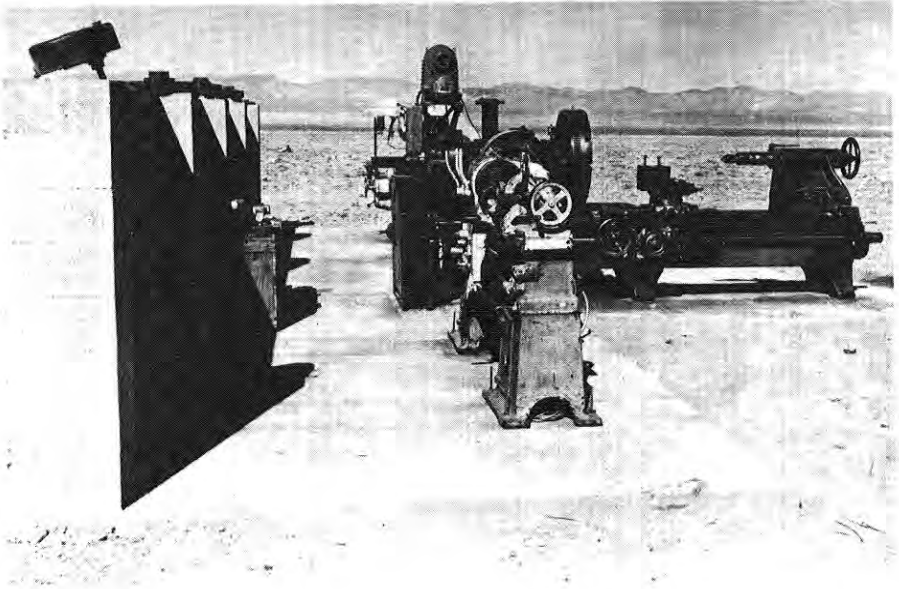

Figure 5.128. Machine tools behind masonry wall before a nuclear explosion, Nevada Test Site.

200-ton capacity hydraulic press weighing some 49,000 pounds was erected. The location was chosen as being the best to simulate actual factory conditions. This unusually tall (19 feet high) and slim piece of equipment showed little evidence of blast damage, even though the brick house was demolished. It was probable that the house provided some shielding from the blast wave. Moreover, at the existing blast pressure, missiles did not have high velocities. Such minor damage as was suffered by the machine was probably due to debris falling from the house.

5.132 At the 3-pounds per square inch peak overpressure location, there were two light, industrial buildings of standard type. In each of these was placed a vertical milling machine weighing about 3,000 pounds, a 50-gallon capacity, stainless-steel, pressure

vessel weighing roughly 4,100 pounds, and a steel steam oven approximately 2½ feet wide, 5 feet high, and 9 feet long. Both buildings suffered extensively from blast, but the equipment experienced little or no operational damage. In one case, the collapsing structure fell on and broke off an exposed part of the milling machine.

5.133 The damage sustained by machine tools in the Nevada tests was probably less than that suffered in Japan at the same blast pressures (§ 5.33). Certain destructive factors, present in the latter case, were absent in the tests. First, the conditions were such that there was no damage by fire; and, second, there was no exposure to the elements after the explosion. In addition, the total amount of debris and missiles produced in the tests was probably less than in the industrial buildings in Japan.



Figure 5.129a. Machine tools after a nuclear explosion (10 psi peak overpressure).



Figure 5.129b. Heavy-duty lathe after a nuclear explosion (10 psi peak overpressure).

ANALYSIS OF DAMAGE FROM AIR BLAST

INTRODUCTION

5.134 The remainder of this chapter is concerned with descriptions of air-blast damage criteria for various types of targets and with the development of damage-distance relationships for predicting the distances at which damage may be expected from nuclear explosions of different energy yields. The nature of any target complex, such as a city, is such, however, that exact predictions are not possible. Nevertheless, by application of proper judgment to the available information, results of practical value can be obtained. The conclusions given here are considered to be applicable to average situations that might be encountered in an actual target complex.

5.135 Damage to structures and objects is generally classified in three categories: severe, moderate, and light. In several of the cases discussed below, the specific nature of each type of damage is described, but the following broad definitions are a useful guide.

Severe Damage

A degree of damage that precludes further use of the structure or object for its intended purpose without essentially complete reconstruction. For a structure or building, collapse is generally implied.

Moderate Damage

A degree of damage to principal members that precludes effective

use of the structure or object for its intended purpose unless major repairs are made.

Light Damage

A degree of damage to buildings resulting in broken windows, slight damage to roofing and siding, blowing down of light interior partitions, and slight cracking of curtain walls in buildings. Minor repairs are sufficient to permit use of the structure or object for its intended purpose.

5.136 For a number of types of targets, the distances out to which different degrees of damage may be expected from nuclear explosions of various yields have been represented by diagrams, such as Figs. 5.140 and 5.146. These are based on observations made in Japan and at various nuclear tests, on experiments conducted in shock tubes in laboratories and with high-explosives in field tests, and on theoretical analyses of the loading and response of structures (see Chapter IV). As a result of these studies, it is possible to make reasonably accurate predictions of the response of interior as well as exterior wall panels and complete structures to the air-blast wave. These predictions, however, must take into account constructional details of each individual structure. Moreover, observations made during laboratory tests have indicated a large scatter in failure loadings as a result of statistical variations among wall and material properties. The data in Figs. 5.140 and 5.146 are intended, however,

to provide only gross estimates for the categories of structures given in Tables 5.139a and b. The response of a particular structure may thus deviate from that shown for its class in the figures.

5.137 For structures that are damaged primarily by diffraction loading (§ 4.03), the peak overpressure is the important factor in determining the response to blast. In some instances, where detailed analyses have not been performed, peak overpressures are given for various kinds of damage. Approximate damage–distance relationships can then be derived by using peak overpressure–distance curves and scaling laws from Chapter III. For equal scaled heights of burst, as defined in § 3.62, the range for a specified damage to a diffraction-sensitive structure increases in proportion to the cube root, and the damage area in proportion to the two-thirds power, of the energy of the explosion. This means, for example, that a thousand-fold increase in the energy will increase the range for a particular kind of diffraction-type damage by a factor of roughly ten; the area over which the damage occurs will be increased by a factor of about a hundred, for a given scaled burst height.

5.138 Where the response depends mainly on drag (or wind) loading, the peak overpressure is no longer a useful criterion of damage. The response of a drag-sensitive structure is determined by the length of the blast wave positive phase as well as by the peak dynamic pressure (§ 4.12 *et seq.*). The greater the energy of the weapon, the farther will be the distance from the explosion at which the peak dynamic pressure has a specific value and the longer will be the duration of the positive phase. Since

there is increased drag damage with increased duration at a given pressure, the same damage will extend to lower dynamic pressure levels. Structures which are sensitive to drag loading will therefore be damaged over a range that is larger than is given by the cube root rule for diffraction-type structures. In other words, as the result of a thousand-fold increase in the energy of the explosion, the range for a specified damage to a drag-sensitive structure will be increased by a factor of more than ten, and the area by more than a hundred.

ABOVE-GROUND BUILDINGS AND BRIDGES

5.139 The detailed nature of the damage in the severe, moderate, and light categories to above-ground structures of various types are given in Tables 5.139a and b. For convenience, the information is divided into two groups. Table 5.139a is concerned with structures of the type that are primarily affected by the blast wave during the diffraction phase, whereas the structures in Table 5.139b are drag sensitive.

5.140 The ranges for severe and moderate damage to the structures in Tables 5.139a and b are presented in Fig. 5.140, based on actual observations and theoretical analysis. The numbers (1 to 21) in the figure identify the target types as given in the first column of the tables. The data refer to air bursts with the height of burst chosen so as to maximize the radius of damage for the particular target being considered and is not necessarily the same for different targets. For a surface burst, the respective ranges are to be multiplied by three-fourths. An example illustrating the use of the diagram is given.

(Text continued on page 220.)

Table 5.139a

**DAMAGE CRITERIA FOR STRUCTURES PRIMARILY AFFECTED BY DIFFRACTION
LOADING**

Structural Type	Description of Structure	Description of Damage		
		Severe	Moderate	Light
1	Multistory reinforced concrete building with reinforced concrete walls, blast resistant design for 30 psi Mach region pressure from 1 MT, no windows.	Walls shattered, severe frame distortion, incipient collapse.	Walls breached or on the point of being so, frame distorted, entranceways damaged, doors blown in or jammed, extensive spalling of concrete.	Some cracking of concrete walls and frame.
2	Multistory reinforced concrete building with concrete walls, small window area, three to eight stories.	Walls shattered, severe frame distortion, incipient collapse.	Exterior walls severely cracked. Interior partitions severely cracked or blown down. Structural frame permanently distorted, extensive spalling of concrete.	Windows and doors blown in, interior partitions cracked.
3	Multistory wall-bearing building, brick apartment house type, up to three stories.	Collapse of bearing walls, resulting in total collapse of structure.	Exterior walls severely cracked, interior partitions severely cracked or blown down.	Windows and doors blown in, interior partitions cracked.
4	Multistory wall-bearing building, monumental type, up to four stories.	Collapse of bearing walls, resulting in collapse of structure supported by these walls. Some bearing walls may be shielded by intervening walls so that part of the structure may receive only moderate damage.	Exterior walls facing blast severely cracked, interior partitions severely cracked with damage toward far end of building possibly less intense.	Windows and doors blown in, interior partitions cracked.
5	Wood frame building, house type, one or two stories.	Frame shattered resulting in almost complete collapse.	Wall framing cracked. Roof severely damaged, interior partitions blown down.	Windows and doors blown in, interior partitions cracked.

Table 5.139b

DAMAGE CRITERIA FOR STRUCTURES PRIMARILY AFFECTED BY DRAG LOADING

Structural Type	Description of Structure	Description of Damage		
		Severe	Moderate	Light
6	Light steel frame industrial building, single story, with up to 5-ton crane capacity; low strength walls which fail quickly.	Severe distortion or collapse of frame.	Minor to major distortion of frame; cranes, if any, not operable until repairs made.	Windows and doors blown in, light siding ripped off.
7	Heavy steel-frame industrial building, single story, with 25 to 50-ton crane capacity; lightweight, low strength walls which fail quickly.	Severe distortion or collapse of frame.	Some distortion to frame; cranes not operable until repairs made.	Windows and doors blown in, light siding ripped off.
8	Heavy steel frame industrial building, single story, with 60 to 100-ton crane capacity; lightweight low strength walls which fail quickly.	Severe distortion or collapse of frame.	Some distortion or frame; cranes not operable until repairs made.	Windows and doors blown in, light siding ripped off.
9	Multistorey steel-frame office-type building, 3 to 10 stories. Lightweight low strength walls which fail quickly, earthquake resistant construction.	Severe frame distortion, incipient collapse.	Frame distorted moderately, interior partitions blown down.	Windows and doors blown in, light siding ripped off, interior partitions cracked.
10	Multistorey steel-frame office-type building, 3 to 10 stories. Lightweight low strength walls which fail quickly, non-earthquake resistant construction.	Severe frame distortion, incipient collapse.	Frame distorted moderately, interior partitions blown down.	Windows and doors blown in, light siding ripped off, interior partitions cracked.

Table 5.139b (continued)

Structural Type	Description of Structure	Description of Damage		
		Severe	Moderate	Light
11	Multistory reinforced concrete frame office-type building, 3 to 10 stories; lightweight low strength walls which fail quickly, earthquake resistant construction.	Severe frame distortion, incipient collapse.	Frame distorted moderately, interior partitions blown down, some spalling of concrete.	Windows and doors blown in, light siding ripped off, interior partitions cracked.
12	Multistory reinforced concrete frame office type building, 3 to 10 stories; lightweight low strength walls which fail quickly, non-earthquake resistant construction.	Severe frame distortion, incipient collapse.	Frame distorted moderately, interior partitions blown down, some spalling of concrete.	Windows and doors blown in, light siding ripped off, interior partitions cracked.
13	Highway truss bridges, 4-lane, spans 200 to 400 ft; railroad truss bridges, double track ballast floor, spans 200 to 400 ft.	Total failure of lateral bracing or anchorage, collapse of bridge.	Substantial distortion of lateral bracing or slippage on supports, significant reduction in capacity of bridge.	Capacity of bridge not significantly reduced, slight distortion of some bridge components.
14	Highway truss bridges, 2-lane, spans 200 to 400 ft; railroad truss bridges, single track ballast or double track open floors, spans 200 to 400 ft; railroad truss bridges, single track open floor, span 400 ft.	(Ditto)	(Ditto)	(Ditto)
15	Railroad truss bridges, single track open floor, span 200 ft.	(Ditto)	(Ditto)	(Ditto)
16	Highway girder bridges, 4-lane through, span 75 ft.	(Ditto)	(Ditto)	(Ditto)

Table 5.139b (concluded)

Structural Type	Description of Structure	Description of Damage		
		Severe	Moderate	Light
17	Highway girder bridges, 2-lane deck, 2-lane through, 4-lane deck, span 75 ft; railroad girder bridges, double-track deck, open or ballast floor, span 75 ft; railroad girder bridges, single or double track through, ballast floors, span 75 ft.	(Ditto)	(Ditto)	(Ditto)
18	Railroad girder bridges, single track deck, open or ballast floors, span 75 ft; railroad girder bridges, single or double track through, open floors, span 75 ft.	(Ditto)	(Ditto)	(Ditto)
19	Highway girder bridges, 2-lane through, 4-lane deck or through, span 200 ft; railroad girder bridges, double track deck or through, ballast floor, span 200 ft.	(Ditto)	(Ditto)	(Ditto)
20	Highway girder bridges, 2-lane deck, span 200 ft; railroad girder bridges, single track deck or through, ballast floors, span 200 ft; railroad girder bridges, double track deck or through, open floors, span 200 ft.	(Ditto)	(Ditto)	(Ditto)
21	Railroad girder bridges, single track deck or through, open floors, span 200 ft.	(Ditto)	(Ditto)	(Ditto)

The various above-ground structures in Fig. 5.140 are identified (Items 1 through 21) and the different types of damage are described in Tables 5.139a and b. The "fan" from each point indicates the range of yields for which the diagram may be used. For a surface burst multiply the damage distances obtained from the diagram by three-fourths. The results are estimated to be accurate within ± 20 percent for the average target conditions specified in § 5.141.

Example

Given: Wood-frame building (Type 5). A 1 MT weapon is burst (a) at optimum height, (b) at the surface.

Find: The distances from ground zero to which severe and moderate damage extend.

Solution: (a) From the point 5 (at the right) draw a straight line to 1 MT (1000 KT) on the severe damage scale and another to 1 MT (1000 KT) on the moderate damage scale. The intersections of these lines with the distance scale give the required solutions for the optimum burst height; thus,

Distance for severe damage =
29,000 feet. *Answer.*

Distance for moderate damage =
33,000 feet. *Answer.*

(b) For a surface burst the respective distances are three-fourths those obtained above; hence,

Distance for severe damage =
22,000 feet. *Answer.*

Distance for moderate damage =
25,000 feet. *Answer.*

(The values have been rounded off to two significant figures, since greater precision is not warranted.)

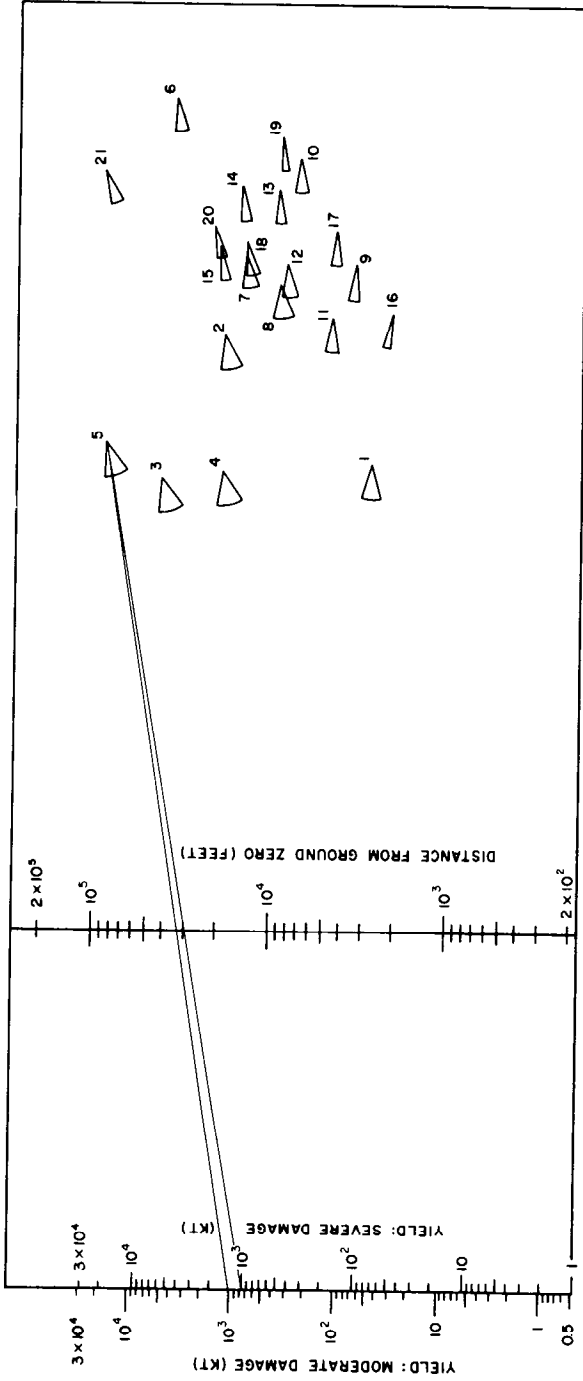

Figure 5.140. Damage-distance relationships for above ground structures.

5.141 The data in Fig. 5.140 are for certain average target conditions. These are that (1) the target is at sea level (no correction is necessary if the target altitude is less than 5,000 feet); (2) the terrain is fairly flat (rugged terrain would provide some local shielding and protection in certain areas and local enhancement of damage in others); and (3) the structures have average characteristics (that is, they are of average size and strength and that orientation of the target with respect to the burst is no problem, i.e., that the ratio of loading to resistance is relatively the same in all directions from the target).

5.142 The "fan" from each point in the figure designating a target type delineates the range of yields over which theoretical analyses have been made. For yields falling within this range, the diagram is estimated to be accurate within ± 20 percent for the average conditions discussed above. The significance of results obtained by applying the diagram to conditions that depart appreciably from the average or to yields outside the limits of the fans must be left to the judgment of the analyst.

5.143 Figure 5.140 gives the distances from ground zero for severe and moderate damage. Light damage to all targets except blast-resistant structures and bridges can be expected at the range at which the overpressure is 1 pound per square inch. For the blast-resistant structure (Type 1) described in Table 5.139a, a peak overpressure of 10 pounds per square inch should be used to estimate the distance for light damage. Light damage to bridges can be expected at the range at which 0.6

pound per square inch dynamic pressure occurs.

5.144 The foregoing results do not take into consideration the possibility of fire. Generally speaking, the direct effects of thermal radiation on the structures and other targets under consideration are inconsequential. However, thermal radiation may initiate fires, and in structures with severe or moderate damage fires may start because of disrupted gas and electric utilities. In some cases, as in Hiroshima (§ 7.71), the individual fires may develop into a mass fire which may exist throughout a city, even beyond the range of significant blast damage. The spread of such a fire depends to a great extent on local weather and other conditions and is therefore difficult to predict. This limitation must be kept in mind when Fig. 5.140 is used to estimate the damage to a particular city or target area.

STRUCTURAL ELEMENTS

5.145 For certain structural elements, with short periods of vibration (up to about 0.05 second) and small plastic deformation at failure, the conditions for failure can be expressed as a peak overpressure without considering the duration of the blast wave. The failure conditions for elements of this type are given in Table 5.145. Some of these elements fail in a brittle fashion, and thus there is only a small difference between the pressures that cause no damage and those that produce complete failure. Other elements may fail in a moderately ductile manner, but still with little difference between the pressures for light damage and complete failure. The pressures are side-on blast overpressures for panels that face

Table 5.145

CONDITIONS OF FAILURE OF OVERPRESSURE-SENSITIVE ELEMENTS

Structural element	Failure	Approximate side-on peak overpressure (psi)
Glass windows, large and small.	Shattering usually, occasional frame failure.	0.5- 1.0
Corrugated asbestos siding.	Shattering.	1.0- 2.0
Corrugated steel or aluminum paneling.	Connection failure followed by buckling.	1.0- 2.0
Brick wall panel, 8 in. or 12 in. thick (not reinforced).	Shearing and flexure failures.	3.0-10.0
Wood siding panels, standard house construction.	Usually failure occurs at the main connections allowing a whole panel to be blown in.	1.0- 2.0
Concrete or cinder-block wall panels, 8 in. or 12 in. thick (not reinforced).	Shattering of the wall.	1.5- 5.5

ground zero. For panels that are oriented so that there are no reflected pressures thereon, the side-on pressures must be doubled. The fraction of the area of a panel wall that contains windows will influence the overpressure required to damage the panel. Such damage is a function of the net load, which may be reduced considerably if the windows fail early. This allows the pressure to become equalized on the two sides of the wall before panel failure occurs.

DRAG-SENSITIVE TARGETS

5.146 A diagram of damage-distance relationships for various targets which are largely affected by drag forces is given in Fig. 5.146. The conditions under which it is applicable and the

limits of accuracy are similar to those in § 5.141 and § 5.142, respectively; the possibility of fire mentioned in § 5.144 must also be kept in mind. The targets (Items 1 to 13) in the figure are enumerated on the page facing Fig. 5.146 and the different types of damage are described in the following paragraphs.

Transportation Equipment

5.147 The damage criteria for various types of land transportation equipment, including civilian motor-driven vehicles and earth-moving equipment, and railroad rolling stock are given in Table 5.147a. The various types of damage to merchant shipping from air blast are described in Table 5.147b.

(Text continued on page 225.)

The drag-sensitive targets in Fig. 5.146 are identified as follows:

1. Truck mounted engineering equipment (unprotected).
2. Earth moving engineering equipment (unprotected).
3. Transportation vehicles.
4. Unloaded railroad cars.
5. Loaded boxcars, flatcars, full tank cars, and gondola cars (side-on orientation).
6. Locomotives (side-on orientation).
7. Telephone lines (radial).
8. Telephone lines (transverse).
9. Unimproved coniferous forest stand.
10. Average deciduous forest stand.
11. Loaded boxcars, flatcars, full tank cars, and gondola cars (end-on orientation).
12. Locomotives (end-on orientation).
13. Merchant shipping.

Subscript "m" refers to moderate damage and subscript "s" refers to severe damage.

For a surface burst multiply the distance by three-fourths for Items 1 through 8 and by one-half for Items 9 and 10. For Items 11 through 13, the distances are the same for a surface burst as for the optimum burst height. Estimated accuracy ± 20 percent for average targets.

Example

Given: A transportation type vehicle (Item 3). A 10 KT weapon is burst at (a) the optimum height, (b) at the surface.

Find: The distances from ground zero to which severe and moderate damage extend.

Solution: (a) Draw straight lines from the points 3_s and 3_m , at the right, to 10 KT on the yield scale at the left. The intersections of these lines with the distance scale give the solutions for severe and moderate damage, respectively, for the optimum burst height; thus,

Distance for severe damage =
1,400 feet. *Answer.*

Distance for moderate damage =
1,600 feet. *Answer.*

(b) For a surface burst the distances in this case are three-fourths those obtained above; thus,

Distance for severe damage =
1,000 feet. *Answer.*

Distance for moderate damage =
1,200 feet. *Answer.*

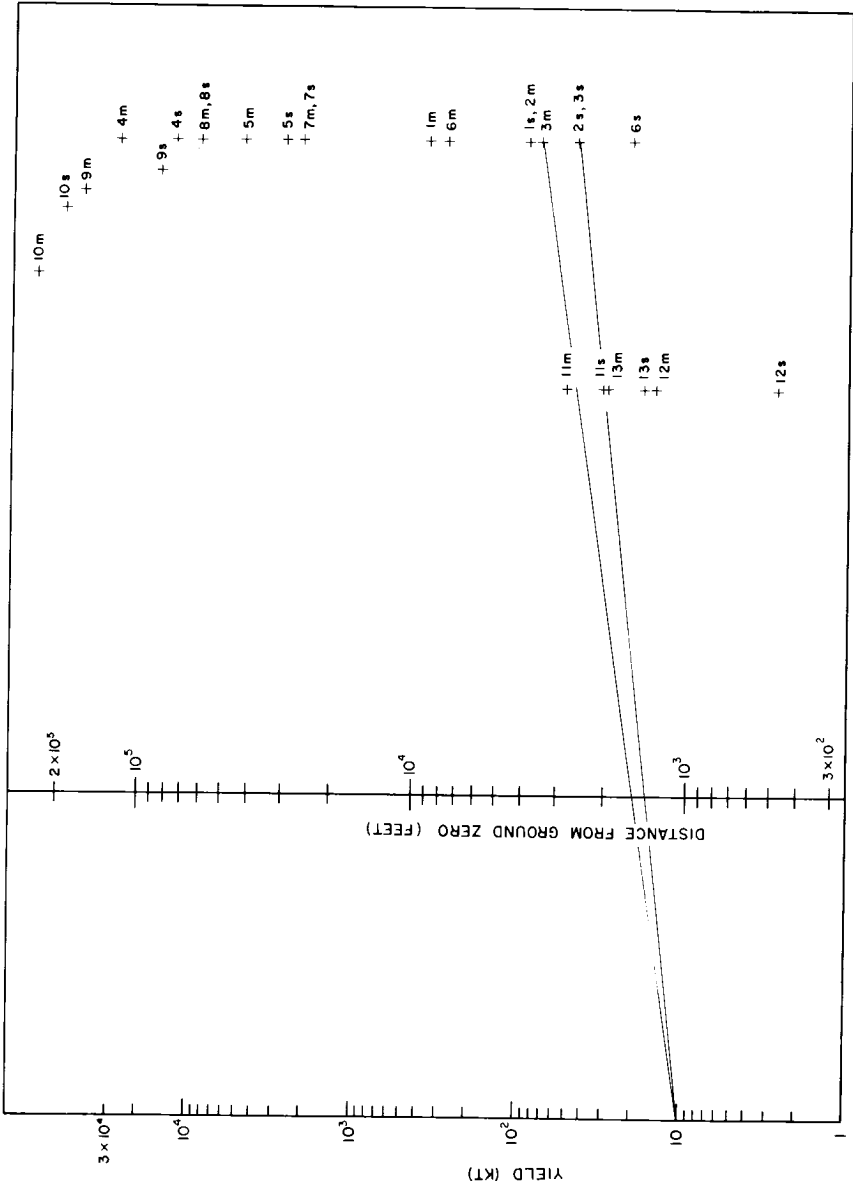

Figure 5.146. Damage-distance relationships for drag-sensitive targets.

Table 5.147a**DAMAGE CRITERIA FOR LAND TRANSPORTATION EQUIPMENT**

Description of equipment	Damage	Nature of damage
Motor equipment (cars and trucks).	Severe	Gross distortion of frame, large displacements, outside appurtenances (doors and hoods) torn off, need rebuilding before use.
	Moderate	Turned over and displaced, badly dented, frames sprung, need major repairs.
	Light	Glass broken, dents in body, possibly turned over, immediately usable.
Railroad rolling stock (box, flat, tank, and gondola cars).	Severe	Car blown from track and badly smashed, extensive distortion, some parts usable.
	Moderate	Doors demolished, body damaged, frame distorted, could possibly roll to repair shop.
	Light	Some door and body damage, car can continue in use.
Railroad locomotives (Diesel or steam).	Severe	Overturned, parts blown off, sprung and twisted, major overhaul required.
	Moderate	Probably overturned, can be towed to repair shop after being righted, need major repairs.
	Light	Glass breakage and minor damage to parts, immediately usable.
Construction equipment (bulldozers and graders).	Severe	Extensive distortion of frame and crushing of sheet metal, extensive damage to caterpillar tracks and wheels.
	Moderate	Some frame distortion, overturning, track and wheel damage.
	Light	Slight damage to cabs and housing, glass breakage.

Table 5.147b**DAMAGE CRITERIA FOR SHIPPING FROM AIR BLAST**

Damage type	Nature of damage
Severe	The ship is either sunk, capsized, or damaged to the extent of requiring rebuilding.
Moderate	The ship is immobilized and requires extensive repairs, especially to shock-sensitive components or their foundations, e.g., propulsive machinery, boilers, and interior equipment.
Light	The ship may still be able to operate, although there will be damage to electronic, electrical, and mechanical equipment.

Communication and Power Lines

5.148 Damage to telephone, telegraph, and utility power lines is generally either severe or light. Such damage depends on whether the poles supporting the lines are damaged or not. If the poles are blown down, damage to the lines will be severe and extensive repairs will be required. On the other hand, if the poles remain standing, the lines will suffer only light damage and will need little repair. In general, lines extending radially from ground zero are less susceptible to damage than are those running at right angles to this direction.

Forests

5.149 The detailed characteristics of the damage to forest stands resulting from a nuclear explosion will depend on a variety of conditions, e.g., deciduous or coniferous trees, degree of foliage of the trees, natural or planted stands, and favorable or unfavorable growing

conditions. A general classification of forest damage, applicable in most cases, is given in Table 5.149. Trees are primarily sensitive to the drag forces from a blast wave and so it is of interest that the damage in an explosion is similar to that resulting from a strong, steady wind; the velocities of such winds that would produce comparable damage are included in the table.

5.150 The damage-distance results derived from Fig. 5.146 apply in particular to unimproved coniferous forests which have developed under unfavorable growing conditions and to most deciduous forests in the temperate zone when foliage is present. Improved coniferous forests, with trees of uniform height and a smaller average tree density per acre, are more resistant to blast than are unimproved forests which have grown under unfavorable conditions. A forest of defoliated deciduous trees is also somewhat more blast resistant than is implied by the data in Fig. 5.146.

Table 5.149**DAMAGE CRITERIA FOR FORESTS**

Damage type	Nature of damage	Equivalent steady wind velocity (miles per hour)
Severe	Up to 90 percent of trees blown down; remainder denuded of branches and leaves. (Area impassable to vehicles and very difficult on foot.)	130-140
Moderate	About 30 percent of trees blown down; remainder have some branches and leaves blown off. (Area passable to vehicles only after extensive clearing.)	90-100
Light	Only applies to deciduous forest stands. Very few trees blown down; some leaves and branches blown off. (Area passable to vehicles.)	60-80

PARKED AIRCRAFT

5.151 Aircraft are relatively vulnerable to air blast effects associated with nuclear detonations. The forces developed by peak overpressures of 1 to 2 pounds per square inch are sufficient to dish in panels and buckle stiffeners and stringers. At higher overpressures, the drag forces due to wind (dynamic) pressure tend to rotate, translate, overturn, or lift a parked aircraft, so that damage may then result from collision with other aircraft, structures, or the ground. Aircraft are also very susceptible to damage from flying debris carried by the blast wave.

5.152 Several factors influence the degree of damage that may be expected for an aircraft of a given type at a specified range from a nuclear detonation. Aircraft that are parked with the

nose pointed toward the burst will suffer less damage than those with the tail or either side directed toward the oncoming blast wave (§ 5.94). Shielding of one aircraft by another or by structures or terrain features may reduce damage, especially that caused by flying debris. Standard tiedown of aircraft, as used when high winds are expected, will also minimize the extent of damage at ranges where destruction might otherwise occur.

5.153 The various damage categories for parked transport airplanes, light liaison airplanes, and helicopters are outlined in Table 5.153 together with the approximate peak overpressures at which the damage may be expected to occur. The aircraft are considered to be parked in the open at random orientation with respect to the point of burst. The

Table 5.153

DAMAGE CRITERIA FOR PARKED AIRCRAFT

Damage type	Nature of damage		Overpressure (psi)
Severe	Major (or depot level) maintenance required to restore aircraft to operational status.	Transport airplanes	3
		Light liaison craft	2
		Helicopters	3
Moderate	Field maintenance required to restore aircraft to operational status.	Transport airplanes	2
		Light liaison craft	1
		Helicopters	1.5
Light	Flight of the aircraft not prevented, although performance may be restricted.	Transport airplanes	1.0
		Light liaison craft	0.75
		Helicopters	1.0

data in the table are based on tests in which aircraft were exposed to detonations with yields in the kiloton range. For megaton yields, the longer duration of the positive phase of the blast wave may result in some increase in damage over that estimated from small-yield explosions at the same overpressure level. This increase is likely to be significant at pressures producing severe damage, but will probably be less important for moderate and light damage conditions.

5.154 Aircraft with exposed ignitable materials may, under certain conditions, be damaged by thermal radiation at distances beyond those at which equivalent damage would result from blast effects. The vulnerability to thermal radiation may be decreased by protecting ignitable materials from exposure to direct radiation or by painting them with protective (light colored) coatings which reflect, rather than absorb, most of the thermal radiation (see Chapter VII).

POL STORAGE TANKS

5.155 The chief cause of failure of POL (petroleum, oil, lubricant) storage tanks exposed to the blast wave appears to be the lifting of the tank from its foundation. This results in plastic deformation and yielding of the joint between the side and bottom so that leakage can occur. Severe damage is regarded as that damage which is associated with loss of the contents of the tank by leakage. Furthermore, the leakage can lead to secondary effects, such as the development of fires. If failure by lifting does not occur, it is expected that there will be little, if any, loss of liquid

from the tank as a consequence of sloshing. There is apparently no clear-cut overall structural collapse which initially limits the usefulness of the tank. Peak overpressures required for severe damage to POL tanks of diameter D may be obtained from Figs. 5.155a and b. Figure 5.155a is applicable to nuclear explosions with energy yields from 1 to 500 kilotons and Fig. 5.155b to yields over 500 kilotons. For yields less than 1 kiloton, the peak overpressure for severe damage may be taken to be 1 pound per square inch.

LIGHTWEIGHT, EARTH COVERED AND BURIED STRUCTURES

5.156 Air blast is the controlling factor for damage to lightweight earth covered structures and shallow buried underground structures. The earth cover provides surface structures with substantial protection against air blast and also some protection against flying debris. The depth of earth cover above the structure would usually be determined by the degree of protection from nuclear radiation required at the design overpressure or dynamic pressure (see Chapter VIII).

5.157 The usual method of providing earth cover for surface or "cut-and-cover" semiburied structures is to build an earth mound over the portion of the structure that is above the normal ground level. If the slope of the earth cover is chosen properly, the blast reflection factor is reduced and the aerodynamic shape of the structure is improved. This results in a considerable reduction in the applied translational forces. An additional benefit of the earth cover is the stiffening or resistance to

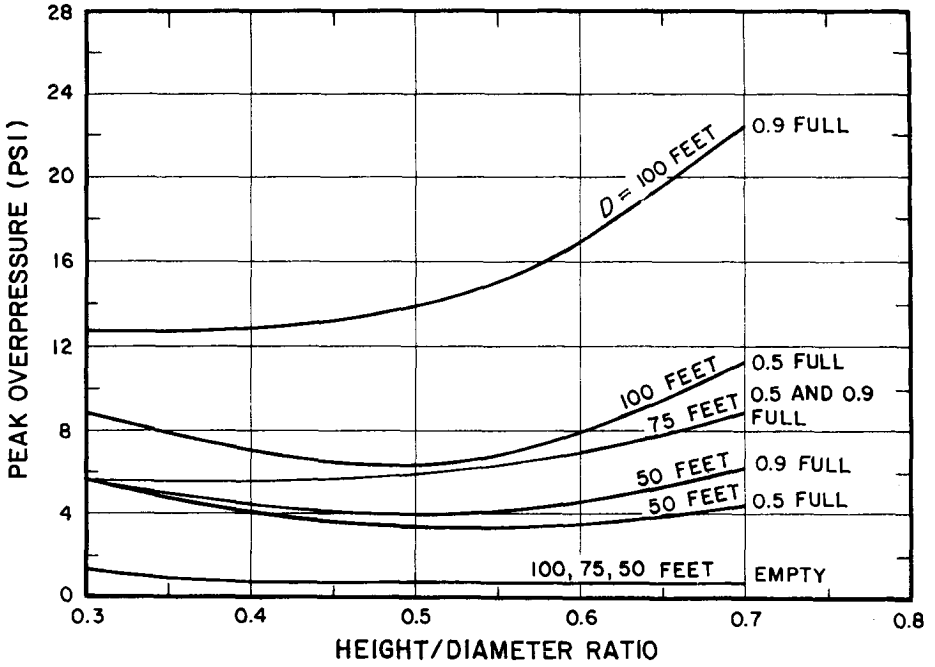

Figure 5.155a. Peak overpressures for severe blast damage to floating- or conical-roof tanks of diameter D for explosions from 1 to 500 kilotons.

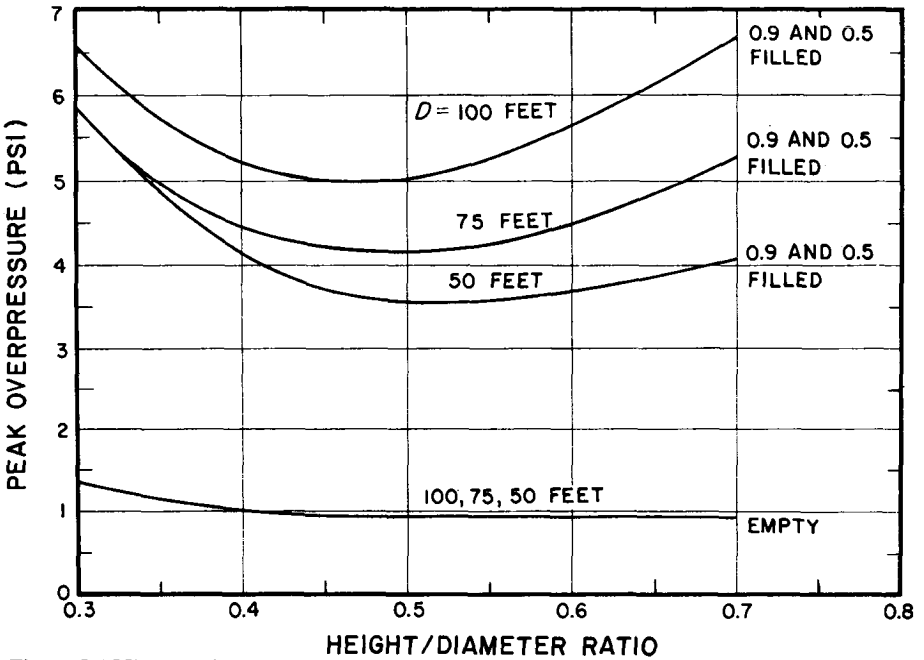

Figure 5.155b. Peak overpressures for severe blast damage to floating- or conical-roof tanks of diameter D from explosions of 500 kilotons or more.

deformation that the earth provides to flexible structures by the buttressing action of the soil.

5.158 For lightweight, shallow buried underground structures the top of the earth cover is at least flush with the original grade but the depth of cover is not more than 6 percent of the span. Such structures are not sufficiently deep for the ratio of the depth of burial to the span to be large enough to obtain the benefits described in § 5.161. The soil provides little attenuation of the air blast pressure applied to the top surface of a shallow buried underground structure. Observations made at full-scale nuclear tests indicate that there is apparently no increase in pressure on the structure as a result of ground shock reflection at the

interface between the earth and the top of the structure.

5.159 The lateral blast pressures exerted on the vertical faces of a shallow buried structure have been found to be as low as 15 percent of the blast pressure on the roof in dry, well-compacted, silty soils. For most soils, however, this lateral blast pressure is likely to be somewhat higher and may approach 100 percent of the roof blast pressure in porous saturated soil. The pressures on the bottom of a buried structure, in which the bottom slab is a structural unit integral with the walls, may range from 75 to 100 percent of the pressure exerted on the roof.

5.160 The damage that might be suffered by a shallow buried structure

Table 5.160

DAMAGE CRITERIA FOR SHALLOW BURIED STRUCTURES

Type of structure	Damage type	Peak over-pressure (psi)	Nature of damage
Light, corrugated steel arch, surface structure (10-gage corrugated steel with a span of 20–25 ft), central angle of 180°; 5 ft of earth cover at the crown.*	Severe	45– 60	Collapse
	Moderate	50– 50	Large deformations of end walls and arch, also major entrance door damage.
	Light	30– 40	Damage to ventilation and entrance door.
Buried concrete arch 8-in. thick with a 16 ft span and central angle of 180°; 4 ft of earth cover at the crown.	Severe	220–280	Collapse.
	Moderate	100–220	Large deformations with considerable cracking and spalling.
	Light	120–160	Cracking of panels, possible entrance door damage.

*For arched structures reinforced with ribs, the collapse pressure is higher depending on the number of ribs.

will depend on a number of variables, including the structural characteristics, the nature of the soil, the depth of burial, and the downward pressure, i.e., the peak overpressure and direction of the blast wave. In Table 5.160 are given the limiting values of the peak overpressure required to cause various degrees of damage to two types of shallow buried structures. The range of pressures is intended to allow for differences in structural design, soil conditions, shape of earth mound, and orientation

with respect to the blast wave.

5.161 Underground structures, buried at such a depth that the ratio of the burial depth to the span approaches (or exceeds) a value of 3.0, will obtain some benefit from the attenuation with depth of the pressure induced by air blast, and from the arching of the load from more deformable areas to less deformable ones. Limited experience at nuclear tests suggests that the arching action of the soil effectively reduces the loading on flexible structures.

BIBLIOGRAPHY

- JACOBSEN, L. S. and R. S. AYRE, "Engineering Vibrations," McGraw-Hill Book Co., Inc., 1958.
- *JOHNSTON, B. G., "Damage to Commercial and Industrial Buildings Exposed to Nuclear Effects," Federal Civil Defense Administration, February 1956, WT-1189.
- *MITCHELL, J. H., "Nuclear Explosion Effects on Structures and Protective Construction—A Selected Bibliography," U.S. Atomic Energy Commission, April 1961, TID-3092.
- NEWMARK, N. M., "An Engineering Approach to Blast Resistant Design," *Trans. Amer. Soc. of Civil Engineers*, **121**, 45 (1956).
- NORRIS, C. H., *et al.*, "Structural Design for Dynamic Loads," McGraw-Hill Book Co., Inc., 1959.
- PICKERING, E. E., and J. L. BOCKHOLT, "Probabilistic Air Blast Failure Criteria for Urban Structures," Stanford Research Institute, Menlo Park, California, November 1971.
- *RANDALL, P. A., "Damage to Conventional and Special Types of Residences Exposed to Nuclear Effects," OCDM, FHA, and HHFA, March 1961, WT-1194.
- RODGERS, G. L., "Dynamics of Framed Structures," John Wiley and Sons, Inc., 1959.
- *SHAW, E. R. and F. P. MCNEA, "Exposure of Mobile Homes and Emergency Vehicles to Nuclear Explosions," Federal Civil Defense Administration, July 1957, WT-1181.
- *SPARKS, L. N., "Nuclear Effects on Machine Tools," U.S. Atomic Energy Commission, December 1956, WT-1184.
- *TAYLOR, B. C., "Blast Effects of Atomic Weapons Upon Curtain Walls and Partitions of Masonry and Other Materials," Federal Civil Defense Administration, August 1956, WT-741.
- *TUCKER, P. W. and G. R. WEBSTER, "Effects of a Nuclear Explosion on Typical Liquefied Petroleum Gas (LP-Gas) Installations and Facilities," Liquefied Petroleum Gas Association, December 1956, WT-1175.
- TUNG, T. P. and N. M. NEWMARK, "A Review of Numerical Integration Methods for Dynamic Response of Structures," University of Illinois Structural Research Series No. 69, 1954.
- *WILLIAMSON, R. H., "Effects of a Nuclear Explosion on Commercial Communications Equipment," Federal Civil Defense Administration, May 1955, ITR-1193.
- WILLOUGHBY, A. B., *et al.*, "A Study of Loading, Structural Response, and Debris Characteristics of Wall Panels," URS Research Co., Burlingame, California, July 1969.
- WILTON, C., *et al.*, "Final Report Summary, Structural Response and Loading of Wall Panels," URS Research Co., Burlingame, California, July 1971.

*These publications may be purchased from the National Technical Information Service, U.S. Department of Commerce, Springfield, Virginia, 22161.

CHAPTER VI

SHOCK EFFECTS OF SURFACE AND SUBSURFACE BURSTS

CHARACTERISTICS OF SURFACE AND SHALLOW UNDERGROUND BURSTS

INTRODUCTION

6.01 Surface and shallow underground bursts are defined as those in which either the fireball or the hot, high-pressure gases generated by the explosion intersect or break through the earth's surface. In explosions of this type, part of the energy released is spent in producing a surface crater, whereas much of the remainder appears as air blast and ground shock. The greater the depth of the burst point below the surface, the smaller is the energy expended as air blast. The dimensions of the crater increase at first with increasing depth of burial of the weapon, pass through a maximum, and then decrease virtually to zero at still greater depths.

AIR BLAST

6.02 In a contact surface burst (§ 2.127 footnote) the incident and reflected air blast waves coincide immediately, forming a hemispherical shock front as shown in Fig. 3.34. The characteristics of the blast wave accompanying a reference (1 kiloton) explo-

sion, as functions of the distance from ground (surface) zero (§ 2.34 footnote), can then be obtained from the curves given at the end of Chapter III. The cube root scaling law described there can be used to calculate the blast wave properties from a contact surface burst of any specified energy yield. When the burst occurs below the surface, the air blast arises partly from the ground shock transmitted through the surface into the air and partly from the release of the high-pressure gases produced in the explosion. At shallow burst depths the latter effect predominates but with increasing depth of burial it contributes less and less to the air blast. Furthermore, as the depth of burst is increased, the higher overpressures closer to surface zero fall off more rapidly than do the lower overpressures at greater distances. More information concerning the air blast from shallow underground explosions and the effect of yield and burst depth on the spatial distribution of the overpressure is given in § 6.80 *et seq.*

CRATER FORMATION

6.03 The mechanism of crater formation depends on the height or depth of the burst. For an explosion well above the surface but in which the fireball intersects the ground (§ 6.08), a depression crater is formed as a result of the vaporization of considerable quantities of earth material. This material is sucked upward by ascending air currents resulting from the rising fireball and it eventually appears as fallout (Chapter IX). For bursts at or near (above or below) the surface, air blast plays a part in crater formation, in addition to vaporization. Surface material is then removed by being pushed, thrown, and scoured out. Some of this material falls back into the crater and most of the remainder is deposited around the edges to form the lip of the crater or is scattered as loose ejecta beyond the crater.

6.04 When the burst is at such a depth that surface vaporization and scouring by air blast are not significant, several other processes may contribute to the formation of a "throwout" crater. One is the crushing and fracture of the ground material by the expanding compressional (shock) wave. Another important mechanism is spalling, i.e., the separation of earth layers at the surface (§ 2.91). The spalled layers will fly upward and be deposited as ejecta beyond the crater or on the lip, or, for moderately deep burials, they will fall back into the crater itself. If the hot, high-pressure gases formed by the explosion are not vented during the crushing and spalling phases, the expanding gases may force the confining earth upward; thus gas acceleration can contribute to crater formation, as described in § 2.92.

6.05 Finally, deeply buried explo-

sions may lead to a subsidence crater, to a raised mound above the detonation point, or to no permanent displacement of the surface at all. If the collapse of the chimney containing broken and crushed material should reach the surface, a subsidence crater may be formed (§ 2.103). In strong earth material, such as hard rock, the chimney top may not reach the surface; surface displacement may then be only temporary. If bulking of the broken rock occurs, a surface mound may be formed above the chimney (Fig. 6.05).

6.06 The variations in the character of the crater as a result of the changes in the predominant mechanism of crater formation as the depth of burst (DOB) increases are illustrated in Figs. 6.06a through f. The depression crater in Fig. 6.06a is formed mainly by vaporization, with most of the removed material being carried away. In a contact (or near surface) burst, represented in Fig. 6.06b, scouring, etc., by an air blast also contributes to crater formation and some of the material removed falls back into and around the crater. At greater depths (Fig. 6.06c), spallation and gas acceleration become increasingly important and the dimensions of the crater increase. The crater reaches its largest size when gas acceleration is the predominant mechanism of formation, but even then a large quantity of material falls back (Fig. 6.06d). Finally, Figs. 6.06e and f show examples of bulking and subsidence, respectively, for deeper underground explosions.

6.07 Two more-or-less distinct zones in the earth surrounding the crater may be distinguished (see Fig. 6.70). First is the "rupture zone" in which stresses develop innumerable radial



Figure 6.05. SULKY event; mound created by the bulking of rock material in a 0.087-kiloton nuclear detonation at a depth of 90 feet.

cracks of various sizes. Beyond the rupture zone is the "plastic zone" in which the stress level has declined to such an extent that there is no visible rupture, although the soil is permanently deformed and compressed to a higher density. Plastic deformation and distortion of soil around the edges of the crater contribute to the production of the crater lip. The thicknesses of the rupture and plastic zones depend on the nature of the soil, as well as upon the energy yield of the explosion and location of the burst point. If the earth below the burst consists of rock, then there will be a rupture zone but little or no plastic zone.

CRATER DIMENSIONS

6.08 For an explosion above the earth's surface, appreciable formation of a vaporization (depression) crater will commence when the height of burst is less than about a tenth of the maximum fireball radius (§ 2.127). With decreasing distance from the surface, the dimensions of the crater vary in a complex manner, especially as the ground is approached, because of the change in the mechanism of crater formation. In general, however, the depth of the depression increases rapidly with decreasing burst height and the ratio of the depth to radius also increases. The dimensions of the crater increase with the explosion

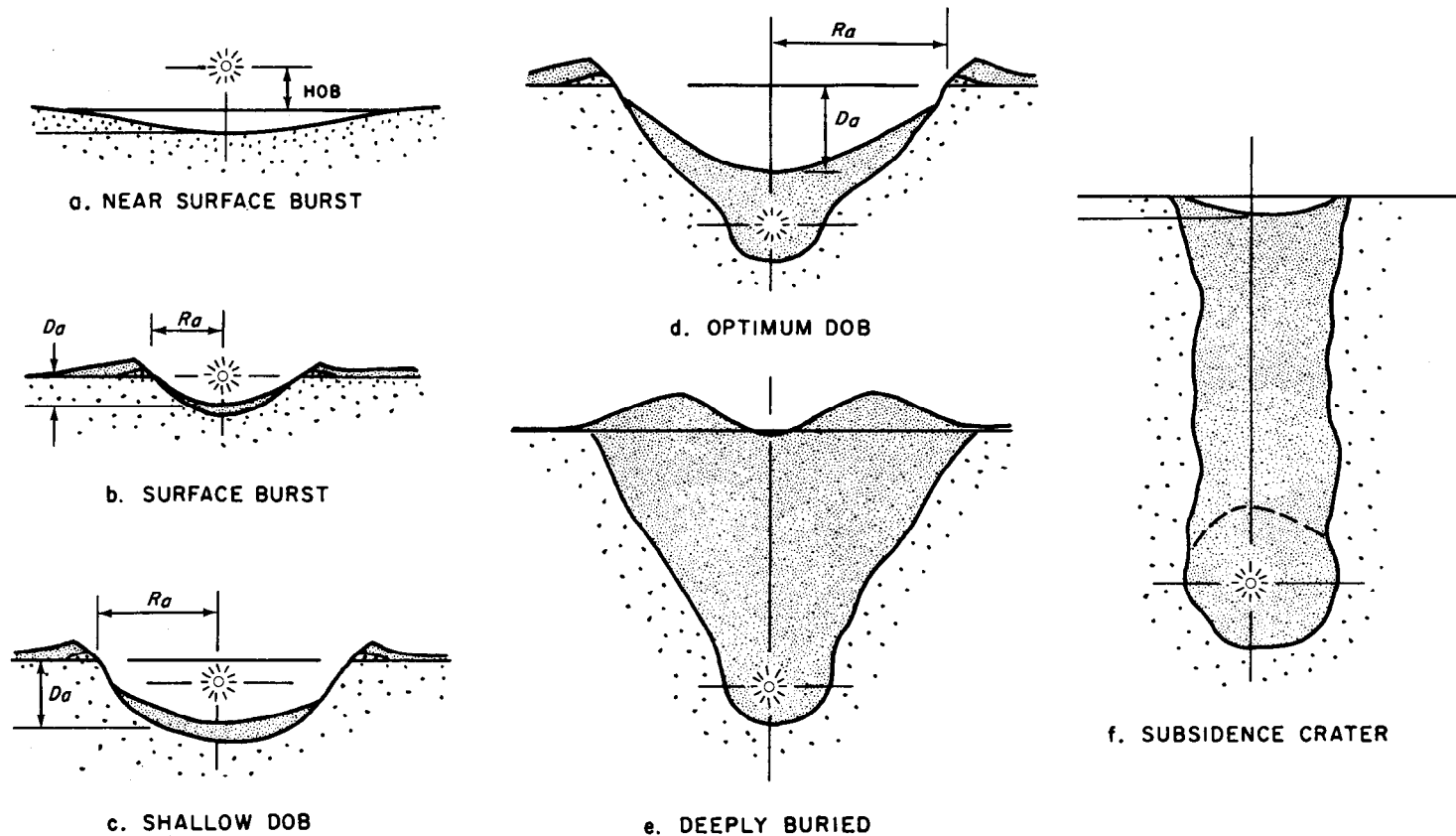

Figure 6.06. Relative crater sizes and shapes resulting from various burst depths; R_a and D_a are the apparent radius and depth, respectively, of the crater (see Figure 6.70).



Figure 6.10. SEDAN event; crater formed by a 100-kiloton explosion in alluvial soil at the optimum depth of burst (635 feet) for cratering. The crater radius is 611 feet, the depth 323 feet, and the volume 179 million cubic feet.

yield but the actual values depend on the soil characteristics.

6.09 For contact surface bursts, approximate values of the crater dimensions can be given. For a 1-kiloton nuclear explosion at the surface, the apparent radius of the crater in dry soil or dry soft rock is estimated to be about 60 feet. The radius at the crest of the lip will be 15 feet or so greater. The apparent depth of the crater is expected to be about 30 feet. In hard rock, consisting of granite or sandstone, the dimensions will be somewhat less. The radius will be appreciably greater in soil saturated with water, and so also will be the initial depth, to which structural damage is related. The final depth, however, will be shallower because of "hydraulic fill," i.e., slumping back of wet material and the seepage of water carrying loose soil. All crater dimensions resulting from a surface burst of yield W

kilotons are related approximately to those given above for a yield of 1-kiloton by the factor $W^{0.3}$. For example, for a 100-kiloton explosion on the surface of dry soil, the radius of the crater may be expected to be roughly $60 \times (100)^{0.3} = 240$ feet, and the depth about $30 \times (100)^{0.3} = 120$ feet. Further information on crater dimensions will be found in § 6.72 *et seq.*

6.10 As the depth of burial is increased, the radius and depth of the crater also increase until maxima are reached; deeper burial then results in progressively smaller craters. These maximum values of radius and depth for a given yield are termed "optimum" (Fig. 6.06d) and depths of burial for optimum crater radius and for optimum crater depth are roughly equal. A photograph of a crater formed at the optimum burst depth is shown in Fig. 6.10. For a 1-kiloton weapon, the

deepest crater possible, namely, 100 feet, is produced when the burst point is 120 feet below the surface; the radius of the crater at that depth will also be near its optimum, namely about 160 feet. Optimum values, like all crater dimensions, are approximately proportional to $W^{0.3}$. Curves showing the variations of crater radius and depth with depth of burial in various media appear later in this chapter (§ 6.70 *et seq.*).

6.11 If the soil is saturated and the high water table is maintained after the detonation, the crater dimensions will change with time. Slumping of the crater sides will continue until a stable condition exists for the material. It can be expected that the sides of very large craters will ultimately slump until their slopes decrease to 10 to 15 degrees. As a result, the craters will become shallower and broader. In weak saturated soil with a very high water table, slumping occurs immediately. If the soil is stronger and the water table not too high, there is a time lag in the slumping which may be a matter of hours in sands and months in clay soils. Examination of craters in coral from high-yield bursts at the Eniwetok Proving Grounds has shown that the inward rush of water carries material which would normally constitute the crater lip into the bottom of the crater.

GROUND SHOCK

6.12 A nuclear explosion on or near the surface produces a ground shock in two primary ways, each of which sets the earth in motion; they are (1) by direct coupling of explosive energy to the ground in the neighborhood of the crater, and (2) by pressure of the air

blast wave as it runs over the earth's surface. A random type disturbance is often superimposed on the ground motion resulting from these shocks (§ 6.82) but only the latter will be considered here. Each kind of ground shock (or pressure) is transmitted through the earth downward and outward. The direct ground shock contributes to the formation of the crater and the fracture and plastic zones immediately around it. The air blast pressure, called "airslap," is the source of most of the stress on underground structures beyond the crater area when the burst point is not too deep.

6.13 Although shock waves transmitted through the earth may be greatly complicated and distorted by the presence of geological inhomogeneities, certain regularities tend to be found. Airslap, for example, almost always results in a single movement downward followed by a slower, partial relaxation upward; in some soils residual permanent compression after airslap is measurable and significant. The amount of earth motion depends on the air blast overpressure, the positive phase duration, and the character of the soil. Close to the surface, airslap motion is initially abrupt, similar to the rise of pressure in the air shock, but it becomes more gradual with increasing depth.

6.14 In those regions where the air blast wave front is ahead of the direct ground shock front at the surface, the situation is described as being "super-seismic;" that is to say, the air blast wave is traveling at a speed greater than the speed of sound (or seismic velocity) in the earth. The ground motion near the surface is vertically downward, but it becomes increasingly outward, i.e., ra-

dial, from the burst point at greater depths below the surface.

6.15 On the other hand, when the air blast front lags behind the shock front transmitted directly through the ground, the ground wave is said to "outrun" the air blast. The airslap then causes the ground surface at locations ahead of it to undergo a characteristic outrunning motion, generally consisting of two or three cycles of a damped, i.e., decreasing, undulation with the first motion usually upward. Since the air blast overpressure decreases with increasing distance from surface zero, so also does the outrunning motion. If the air blast wave reaches the observation point while the outrunning surface motion is still underway, the airslap motion will be superimposed on the undulations.

6.16 At locations close to the burst, the air blast usually travels faster than the direct ground shock. The superseismic condition then prevails and the first ground motion is determined essentially by the airslap. At greater distances, the air blast weakens and its velocity decreases significantly, but the ground shock velocity, which is approximately the same as the seismic velocity, does not decrease very much. Hence, the ground shock front moves ahead and outrunning becomes the dominant factor in ground motion. At still greater distances from surface zero, the effect of airslap disappears or it is so weak that it merges with the direct ground shock without causing any outrunning motion. The phenomena described above are strongly influenced by the seismic velo-

cities in the ground down to considerable depths.

6.17 The strength of the shock wave in the ground decreases with increasing distance from the explosion, and at large distances it becomes similar to an acoustic (or seismic) wave. In this region the effects of underground shock produced by a nuclear explosion are somewhat similar to those of an earthquake of low intensity. However, the evidence to date indicates that underground explosions do not cause earthquakes, except for minor aftershocks within a few miles of the burst point (§ 6.20 *et seq.*).

6.18 The effect of ground shock pressure on an underground structure is somewhat different in character from that of air blast on a structure above the ground. In the latter case, as explained in Chapter IV, the structure experiences something like a sudden blow, followed by drag due to the blast wind. This type of behavior is not associated with underground shock. Because of the similarity in density of the medium through which a ground shock wave travels and that of the underground structure, the response of the ground and the structure are closely related. In other words, the movement (acceleration, velocity, and displacement) of the underground structure by the shock wave is largely determined by the motion and containing action of the ground itself. This fact has an important influence on the structural damage associated with both surface and underground explosions. Damage criteria are outlined in § 6.28 *et seq.* and are discussed more fully in § 6.90 *et seq.*

GROUND SHOCK

6.19 In a fully-contained deep underground explosion there would be little or no air blast. Much of the energy is expended in forming the cavity around the burst point and in melting the rock (§ 2.102), and the remainder appears in the form of a ground shock wave. As this shock wave moves outward it first produces a zone of crushed and compressed rock, somewhat similar to the rupture zone associated with crater formation (Fig. 6.70). Farther out, where the shock wave is weaker, the ground may become permanently distorted in the plastic (deformation) zone. Finally, at considerable distances from the burst point, the weak shock wave (carrying less than 5 percent of the explosion energy) becomes the leading wave of a series of seismic waves. A seismic wave produces a temporary (elastic) displacement or disturbance of the ground; recovery of the original position, following the displacement, is generally achieved after a series of vibrations and undulations, up and down, to and fro, and side to side, such as are typical of earthquake motion.

AFTERSHOCKS AND FAULT
DISPLACEMENTS

6.20 Many of the aftershocks associated with a deep underground explo-

sion appear to be directly related to the postdetonation phenomena of cavity collapse and chimney growth (§ 2.103). Some aftershocks, however, originate a few miles beyond the region involved in the development of the chimney. These aftershocks are generally considered to result from small movements along pre-existing fault planes² and to represent the release of natural strain (deformation) energy. For explosions of high energy yields aftershocks may continue, although at a reduced rate, for many days after the chimney has formed.

6.21 The 1.1-megaton BENHAM test was conducted at a depth of 4,600 feet in tuff (§ 2.104) at the Nevada Test Site on December 19, 1968. During the period of six weeks following the detonation, some 10,000 weak aftershocks were detected, nearly all within 8 miles of the explosion point. Of these, 640 aftershocks were chosen for detailed study and their locations are shown by the small crosses in Fig. 6.21. The thin lines indicate positions of known faults and the thick lines show approximately where fault displacements were observed at the surface. It is apparent that a large number of the aftershocks occurred along a north-south line, which is the general direction of the known faults. Many of these aftershocks presumably occurred along hidden faults or other geological discontinuities parallel to the faults.

¹The phenomena and effects of deep (fully contained) underground explosions are of primary interest for nuclear weapons tests. For a more detailed nontechnical discussion see "Public Safety and Underground Nuclear Detonations," U.S. Atomic Energy Commission, June 1971, TID-25708.

²A geological "fault" is a fracture in the ground at which adjacent rock surfaces are displaced with respect to each other. The presence of a fault can sometimes be detected by a fault line on the surface, but hidden faults cannot be observed in this way.

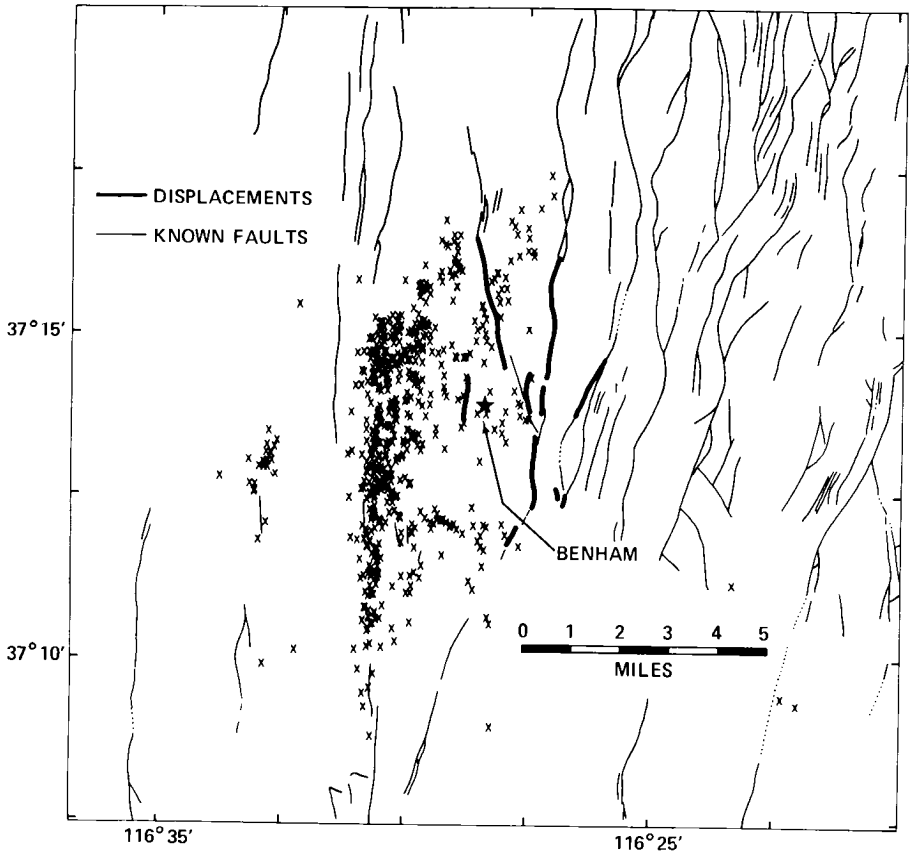

Figure 6.21. Locations of 640 aftershocks and fault displacements from the BENHAM 1.1-megaton test.

6.22 As may be seen from Fig. 6.21, most of the ground displacements in the vicinity of the BENHAM explosion occurred along or near pre-existing fault lines. The maximum vertical displacement was 1.5 feet, at locations 1.5 and 2.5 miles north of the burst point. Larger displacements have occurred in some instances, but vertical displacements of the surface along or near fault lines have been mostly less than a foot. These displacements, although not continuous, may extend for a distance of several miles. For the same (or similar) conditions, the linear extent of dis-

placement is roughly proportional to the yield of the explosion.

6.23 A rough rule of thumb has been developed from observations at the Nevada Test Site. According to this rule, displacement along a fault line may occur only if the distance (in feet) from surface zero is less than about 1000 times the cube root of the energy expressed in kilotons of TNT equivalent. Thus, for a 1-megaton (1000-kiloton) detonation, displacement would be expected only if the fault lines were within a distance of roughly $1000 \times (1000)^{1/3} = 1000 \times 10 = 10,000$ feet

(about 2 miles). In other words, fault lines that are nowhere closer than 2 miles from a 1-megaton deeply buried explosion would not be significantly affected. However, if any part of the fault line is within 2 miles of the detonation site, the actual displacement may be observed along that fault line at a greater distance.

UNDERGROUND EXPLOSIONS AND EARTHQUAKES

6.24 Fear has been expressed that deep underground nuclear explosions of high energy might stimulate natural earthquakes, but there is no evidence that such is the case. The "hypocenter" or "focus" of an aftershock or an earthquake is the point below the surface where motion, e.g., slippage at a fault, responsible for the observed disturbance originated. The focal depths, i.e., the depths of the hypocenters below the earth's surface, of the aftershocks that follow deep underground tests in Nevada have ranged from zero to roughly 4 miles, with most depths being between 0.6 and 3 miles. Natural earthquakes in the same area, however, have considerably greater focal depths. Hence, it seems unlikely that a nuclear explosion would stimulate a natural earthquake.

6.25 A statistical study has been made of the occurrence of earthquakes in a circular region of 535 miles radius around the Nevada Test Site to determine the possible effects of underground explosions. During a period of 104 hours preceding September 15, 1961, when an extensive series of underground tests was initiated at the Nevada Test Site, 620 earthquakes were recorded. After December 19, 1968, the

date of the high-yield BENHAM event, by which time 235 underground tests had been conducted, 616 earthquakes were observed in a 104-hour period. There thus appears to be no indication that underground tests have resulted in any significant change in the occurrence of earthquakes in the Nevada area.

6.26 Two high-yield underground nuclear explosions on Amchitka Island, in the Aleutian Island chain, are of special interest because the island is located in one of the earth's most seismically active regions. The MILROW device, with a yield of about 1 megaton TNT equivalent, was detonated on October 2, 1969 at a depth of 4,000 feet. The explosion was followed by a few hundred small, separate aftershocks which were apparently related to deterioration of the explosion cavity. This aftershock activity decreased at first but later increased sharply and then terminated within a few minutes of a larger, complex multiple event at 37 hours after the burst. The simultaneous formation of a surface subsidence indicated that complete collapse of the cavity occurred at this time. Subsequently, 12 small aftershocks of a different type, ten of which were detected within 41 days of the explosion, were observed during a period of 13 months. Two of these events were close to the explosion region and most of the others originated at or near the Rifle Range Fault, some 2 or 3 miles away. They were attributed to underground structural adjustments following the explosion.

6.27 A more stringent test was provided by the CANNIKIN event on November 6, 1971 when a nuclear weapon with a yield described as being "less than 5 megatons" was exploded at a

depth of 5,875 feet below the surface of Amchitka Island. The number of initial, small aftershocks arising from cavity deterioration was larger than after the MILROW test, but otherwise the phenomena were similar. Cavity collapse, immediately preceded by considerable activity, occurred 38 hours after the explosion. During the next 23 days, 21 earth tremors were detected and one more occurred more than 2 months later, but there were no others during the next year. Of these disturbances, five

were not clearly related to the explosion cavity or to known faults. The hypocenters, as well as those of the tremors following MILROW, were all less than 4.5 miles deep, compared with depths exceeding 12 miles for essentially all natural earthquakes in the area. Furthermore, there was no evidence of any increase in the frequency of such earthquakes in the sensitive Aleutian Islands region following the MILROW and CANNIKIN events.

DAMAGE TO STRUCTURES

SURFACE AND SHALLOW UNDERGROUND BURSTS

6.28 For a nuclear burst at a moderate height above the ground the crater or depression formed will not be very deep, although it may cover a large area. Shallow buried and semiburied structures near ground zero will be damaged by this depression of the earth. For deep underground structures, ground shock may be the primary factor causing damage, but its effects are principally important to people and equipment within the structures. As far as structures above ground are concerned, the range of damage will depend upon the characteristics of the blast wave in air, just as for an air burst (see Chapter V). The area affected by air blast will greatly exceed that in which damage is caused by both direct and induced shock waves in the ground. In the event of a contact or near-surface burst, the situation is similar to that in a shallow underground burst, as described below.

6.29 The damage criteria associated

with shallow underground (and contact surface) bursts, especially in connection with buried structures, are difficult to define. A simple and practical approach is to consider three regions around surface zero. The first region is that of the true crater, which is larger than the apparent (or observable) crater (§ 6.70). Within this region there is practically complete destruction. The depth at which underground structures directly beneath the crater will remain undamaged cannot be clearly defined. This depth is dependent upon the attenuation of pressure and ground motion in the material.

6.30 The second region, which includes the rupture and plastic deformation zones, extends roughly out as far as the major displacement of the ground. In some materials the radius of this region may be about two and one-half times the radius of the (apparent) crater. Damage to underground structures is caused by a combination of direct ground shock and shock induced in the

ground by air blast. Damage to doors, air intakes, and other exposed elements may be expected from direct air blast. The actual mechanism of damage from these causes depends upon several more-or-less independent factors, such as size, shape, and flexibility of the structure, its orientation with respect to the explosion, and the soil characteristics (§ 6.90 *et seq.*).

6.31 Along with underground structures, mention may be made of buried utility pipes and tunnels and subways. Long pipes are damaged primarily as a result of differential motion at the joints and at points where the lines enter a building. Failure is especially likely to occur if the utility connections are made of brittle material and are rigidly attached to the structure. Although tunnels and subways would probably be destroyed within the crater region and would suffer some damage in the plastic zone, it appears that these structures, particularly when bored through solid rock and lined to minimize spalling, are very resistant to underground shock.

6.32 In the third region, beyond the plastic zone, the effects of ground shock are relatively unimportant and then air blast loading becomes the significant criterion of structural damage. Strong or deeply buried underground structures will not be greatly affected, but damage to moderately light, shallow buried structures and some utility pipes will be determined, to a great extent, by the downward pressure, on the ground, i.e., by the peak overpressure of the air blast accompanying the surface or subsurface burst. Structures which are partly above and partly below ground will, of course, also be affected by the direct air blast.

DEEP UNDERGROUND BURSTS

6.33 The ground shock wave from a deep (or moderately deep) underground nuclear explosion weakens into a train of seismic waves which can cause appreciable ground motion at considerable distances from surface zero. The response of aboveground structures of various types to this motion can be predicted with a considerable degree of certainty. The procedures for making these predictions will not be described here (see § 6.90 *et seq.*), but some of the general conclusions are of interest.

6.34 It is natural for buildings, bridges, and other structures to vibrate or oscillate to some extent. Apart from earthquakes and underground detonations, these vibrations can result from high winds, from sonic booms, and even from vehicles on a nearby street or subway. Every structure and indeed every element (or component) of a structure has many natural periods of vibration. For the majority of common structures, the most important of these periods is usually the longest one. This is generally a second or two for a tall building (10 to 20 stories) and a fraction of a second for a short one. Unless the structure has previously suffered significant damage, the natural periods of vibration do not change very much regardless of the source of the disturbance that starts the vibration.

6.35 The ground motion caused by a distant underground explosion (or an earthquake) contains vibrations of many different periods (or frequencies) and widely varying amplitudes. The waves of shorter periods (higher frequencies) tend to be absorbed by the ground more readily than those of longer periods (lower frequencies). Consequently, the

greater the distance from the explosion, the larger is the fraction of seismic energy in ground vibrations with longer periods.

6.36 As a result of the effect called "resonance," a structure tends to respond, e.g., vibrate, most readily to ground motion when the period of the latter is equal or close to one of the natural periods of vibration, especially the principal (longest) period, of the structure. Because the ground motion from an underground burst (or an earthquake) is so complex, at least one of the natural periods of the structure will be near to a period in the ground motion. All structures may thus be expected to respond to some extent to the ground motion from a distant underground explosion. If the response is more than the structure is designed to accept, some damage may occur.

6.37 With increasing distance from an explosion of specified yield, the seismic energy decreases, but a larger fraction of the available energy is present in the ground vibrations with longer periods. Furthermore, as already seen, tall buildings have longer vibration periods than shorter ones. As a result of these factors, the response of any structure decreases with increasing distance from an underground explosion, but the decrease is relatively less for the longer vibration periods, i.e., for tall buildings, than for the shorter periods, i.e., short buildings.

6.38 As might be expected, the response of any structure at a given distance from the burst point increases with the explosion energy yield. However, the increase is greater for longer than shorter vibration periods. Consequently, with increasing energy yield, the re-

sponse of a tall building will increase more than that of a short building at the same distance from the explosion.

6.39 The foregoing generalizations, based on Nevada Test Site experience, imply that at greater distances from underground explosions of high energy yield there should be a tendency for a larger proportion of the seismic energy to appear in ground motion of longer periods. As a consequence, the responses of high-rise buildings, e.g., nine or more stories, with their longer vibration periods, are of special interest at greater distances from underground nuclear explosions of high yield. At shorter distances, where more seismic energy is available, both tall and short buildings could exhibit a significant response.

6.40 Tall buildings in Las Vegas, Nevada, more than 100 miles from the area where high-yield nuclear tests were conducted, have been known to sway in response to the ground motion produced by underground explosions, just as they do during mild earthquakes or strong winds. No damage, which could be definitely attributed to such explosions, however, was recorded in these structures prior to the HANDLEY event, with a yield somewhat greater than 1 megaton, on March 26, 1970. There was no structural damage in Las Vegas on this occasion, but nonstructural damage was reported as disturbance of ornamental blocks on one building and a cracked window in another, which could be readily repaired. There are no tall structures closer to the Nevada Test Site than those in Las Vegas, but low-rise buildings nearer to the test area have experienced minor nonstructural damage, as was to be expected.

CHARACTERISTICS OF UNDERWATER BURSTS

SHOCK WAVE IN WATER

6.41 The rapid expansion of the hot gas bubble formed by a nuclear explosion under water (§ 2.86) results in a shock wave being sent out through the water in all directions. The shock wave is similar in general form to the blast wave in air, although it differs in detail. Just as in air, there is a sharp rise in overpressure at the shock front. In water, however, the peak overpressure does not fall off as rapidly with distance as it does in air. Hence, the peak values in water are much higher than at the same distance from an equal explosion in air. For example, the peak overpressure at 3,000 feet from a 100-kiloton burst in deep water is about 2,700 pounds per square inch, compared with a few pounds per square inch for an air burst. On the other hand, the duration of the shock wave in water is shorter than in air. In water it is of the order of a few hundredths of a second, compared with something like a second or so in air.

6.42 The velocity of sound in water under normal conditions is nearly a mile per second, almost five times as great as in air. When the peak pressure is high, the velocity of the shock wave is greater than the normal velocity of sound. The shock front velocity becomes less at lower overpressures and ultimately approaches that of sound, just as it does in air.

6.43 When the shock wave in water strikes a rigid, submerged surface, such as the hull of a ship or a firm sea bottom, positive (compression) reflection occurs as in air (§ 3.78). However, when the water shock wave reaches the upper

(air) surface, an entirely different reflection phenomenon occurs. At this surface the shock wave meets a much less rigid medium, namely the air. As a result a reflected wave is sent back into the water, but this is a rarefaction or tension, i.e., negative pressure, wave. At a point below the surface the combination of the negative reflected wave with the direct positive wave produces a decrease in the water shock pressure. This is referred to as the "surface cut-off."

6.44 The idealized variation at a given location (or target) of the shock overpressure with time after the explosion at a point under water, in the absence of bottom reflections (§ 6.49), is shown in Fig. 6.44. The representation applies to what is called the "acoustic approximation" in which the initial shock wave and the negative reflected wave are assumed to travel at the same speed. After the lapse of a short interval, which is the time required for the shock wave to travel from the explosion to the given target, the overpressure rises suddenly due to the arrival of the shock front. Then, for a period of time, the pressure decreases steadily, as in air. Soon thereafter, the arrival of the reflected negative wave from the air-water surface causes the pressure to drop sharply, possibly below the normal (hydrostatic) pressure of the water. This negative pressure phase is of short duration.

6.45 The time interval between the arrival of the direct shock wave at a particular target in the water and that of the cutoff, signaling the arrival of the

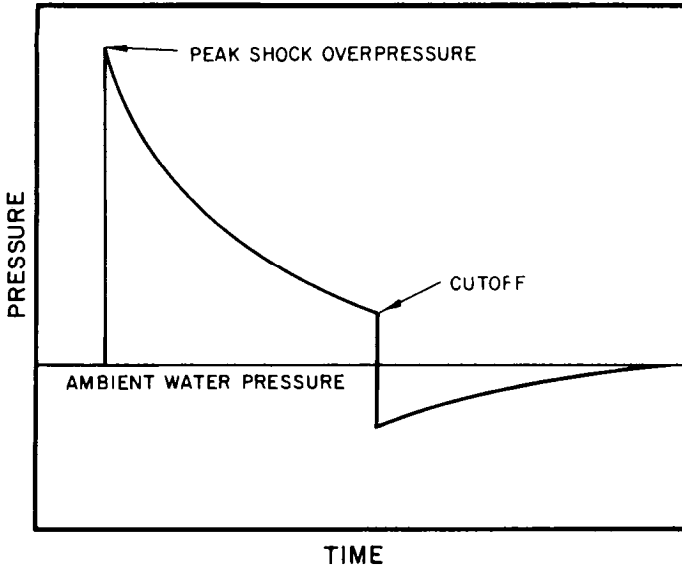

Figure 6.44. Idealized (acoustic approximation) variation of water pressure with time in an underwater explosion at a point near the air surface in the absence of bottom reflections.

reflected negative wave, depends on the shock velocity and on the depth of burst, the depth of the target, and the distance from the burst point to the target. These three distances determine the lengths of the paths traveled by the direct (positive) and reflected (negative) shock waves in reaching the underwater target. If the latter is close to the surface, e.g., a shallow ship bottom, then the time elapsing between the arrival of the two shock fronts will be small and the cutoff will occur soon after the arrival of the shock front. A surface ship may then suffer less damage than a deeper submerged target at the same distance from the explosion.

6.46 The idealized wave shape in Fig. 6.44 for the acoustic approximation is modified in practice, as illustrated in Fig. 6.46. When the shock intensity is strong, the reflection tends to overtake the shock wave because the shock wave

sets in motion the water through which the following reflection (rarefaction) wave travels. Within a region near the air-water surface—the anomalous region—the initial shock wave may be strongly attenuated by overtaking rarefactions, as shown at point A. At deeper levels (points B, C, D) differences in the paths traveled by primary and reflected waves may be too great to allow significant overtaking. Nevertheless, passage of the reflected wave through the disturbed water results in a less sharp surface cutoff than for the ideal acoustic approximation.

6.47 In deep water, when bottom (and other positive) reflections are not significant, the initial shock wave and the negative surface reflection are the most generally important features of the pressure disturbance arising from an underwater detonation. There are, however, several other effects which may be

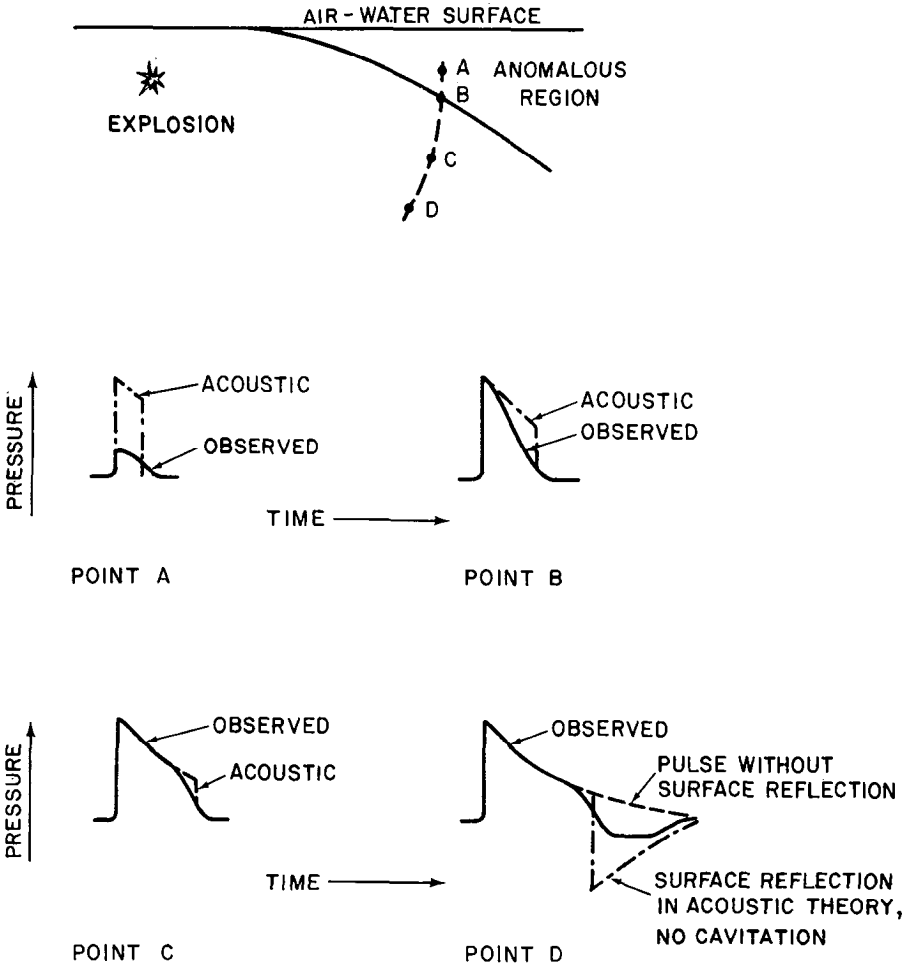

Figure 6.46. Typical pressure pulses affected by air-water surface reflection in the absence of bottom reflections.

significant in some circumstances.

6.48 One group of such effects is associated with inhomogeneities of density, temperature, and salinity. Because shock wave speed depends on these nonuniform properties of the medium, underwater shock waves are often refracted, i.e., changed in direction, as well as reflected. This means that in some cases shock energy will be turned away from certain regions and will ar-

rive at a target attenuated in strength. In other cases energy may be channeled or even focused into one part of the medium to produce a stronger than expected shock wave at some point remote from the detonation. Thus, in many areas the expected reduction of shock pressure by surface cutoff may be replaced by enhancement due to focusing.

6.49 Certain effects connected with the bottom may be important, particu-

larly in shallow water. One of these is the bottom reflection of the primary shock wave. Unlike the reflection from the air, the bottom reflection is a compression wave and increases the pressure in regions it traverses. The pressure on the target now includes a positive reflected pressure in addition to the initial shock pressure and the negative (air-surface) reflected pressure. The characteristics of the overall pressure pulse, and hence the effect on an underwater target, will be dependent on the magnitudes and signs of the various pressures and the times of arrival at the target of the two reflected pressures. These quantities are determined by the three distances mentioned in § 6.45 and the water depth, as well as by the explosion yield and the nature of the bottom material.

6.50 When the bottom is rock or other hard material and the burst point is not too far above it, the bottom may contribute two compression waves; the first a simple reflection of the primary water shock, considered above, and the second a reradiation of energy transmitted a distance through the bottom material. The latter wave may become prominent if it can run ahead of the primary shock and then radiate energy back into the water. In this case the first motion observed at a remote station will be due to this bottom-induced wave.

6.51 In deep underwater nuclear explosions, the associated gas bubble may undergo two or three cycles of expansion and contraction before it collapses (§ 2.86 *et seq.*). Each cycle leads to distinct compression and rarefaction waves, called bubble pulses, which move outward through the water initially from the burst point and subse-

quently from the rising gas bubble.

6.52 Secondary underwater pressure pulses may be a consequence of the action of the reflected (negative) wave at the air-water surface. This wave moving downward can cause the temporary upward separation of water masses in a manner analogous to spalling in an underground burst (§ 2.91). When these water masses are brought together again by the action of gravity, the impact may set in motion a train of waves. The separation of water masses in this way is called spalling if the separated water flies into the air to produce a spray dome (§ 2.66) or "cavitation" if an underwater void (or cavity) forms.

AIR BLAST FROM UNDERWATER EXPLOSIONS

6.53 Although the particular mechanism will depend on yield and depth of burst, one or more air blast waves will generally follow an underwater nuclear detonation. In the first place, some energy of the primary shock wave in the water is transmitted across the water-air interface. This air shock remains attached to the water shock as it spreads out from the burst point. Second, if the scaled depth of burst, i.e., the actual depth of burst in feet divided by the cube root of the weapon yield W in kilotons, is less than about 35 feet/kilotons^{1/3}, the bubble vents directly into the atmosphere during its first expansion phase, thereby causing an air shock. Third, although deeper bursts will not vent, the spall or spray dome pushing rapidly upward into the air can cause an air shock. Beyond a scaled depth of approximately 150 feet/kilotons^{1/3}, however, the spray dome rises too

slowly to cause an appreciable air shock. The second and third mechanisms produce air blast waves that lag far behind the primary water shock, but they can be identified underwater by airslap compression, similar to the airslap effect of explosions at or near the ground surface (§ 6.12). Thus, an underwater target will always receive the primary water shock before the airslap, if any. Regardless of the generating mechanism, however, attenuation of air blast pressure with depth of burst below the water surface is rapid and follows a pattern similar to that shown in Fig. 6.81 for underground explosions.

SURFACE WAVES FROM UNDERWATER EXPLOSIONS

6.54 Underwater explosions generate relatively slow, outward-moving surface waves, which have certain recognizable characteristics. These waves, originating in the oscillations of the gas bubble as it breaks the surface, eventually form a train spreading in widening circles of steadily diminishing intensity around surface zero. The first surface wave near the burst is generally too steep to be sustained; consequently, it breaks into turbulent motion, consuming a large part of the original energy that would otherwise be available to the surface wave. Subsequently the train travels over deep water almost without further energy loss. The energy in this surface motion has been estimated to be between 2 and 5 percent of the weapon yield.

6.55 Certain characteristics of surface waves become more pronounced when the detonation occurs in shallow water rather than in deep water. Obser-

vation of the waves in the BAKER test (approximately 20-kilotons yield) at Bikini (§ 2.70) indicated that the first wave behaved differently from the succeeding ones; it was apparently a long, solitary wave, generated directly by the explosion, receiving its initial energy from the high-velocity outward motion of the water accompanying the expansion of the gas bubble. The subsequent waves were probably formed by the venting of the gas bubble and refilling of the void created in the water. A photograph of the surface train approaching the beach from the Bikini BAKER test is reproduced in Fig. 6.55. Later tests have shown that the initial, solitary wave is characteristic of explosions in shallow water. Detonations in deep water generate a train of waves in which the number of crests and troughs increases as the train propagates outward from the center of the explosion.

6.56 Near the BAKER explosion the first crest was somewhat higher than the succeeding ones, both above the undisturbed water level and in total height above the following trough. At greater distances from the burst point the highest wave was usually one of those in the succeeding train. The maximum height in this train appeared to pass backward to later and later waves as the distance from the center increased. This recession of the maximum wave height has also been observed in explosions in deep water.

6.57 The maximum heights and arrival times (not always of the first wave), at various distances from surface zero, of the water waves accompanying a 20-kiloton shallow underwater explosion are given in Table 6.57. These results are based on observations made



Figure 6.55. Waves from the BAKER underwater explosion reaching the beach at Bikini, 11 miles from surface zero.

Table 6.57

MAXIMUM HEIGHTS (CREST TO TROUGH) AND ARRIVAL TIMES OF WATER WAVES AT BIKINI BAKER TEST

Distance (yards)	330	660	1,330	2,000	2,700	3,300	4,000
Wave height (feet)	94	47	24	16	13	11	9
Time (seconds)	11	23	48	74	101	127	154

at the Bikini BAKER test. A more generalized treatment of wave heights, which can be adapted to underwater explosions of any specified energy, is given in § 6.119 *et seq.*

6.58 For the conditions that existed in the BAKER test, water wave damage

is possible to ships that are moderately near to surface zero. There was evidence for such damage to the carrier U.S.S. Saratoga, anchored in Bikini lagoon almost broadside on to the explosion with its stern 400 yards from surface zero. The "island" structure was



Figure 6.58. The aircraft carrier U.S.S. Saratoga after the BAKER explosion.

not affected by the air blast, but later the central part of the structure was observed to be folded down on the deck of the carrier (Fig. 6.58). Shortly after rising on the first wave crest, when the stern was over 43 feet above its previous position, the Saratoga fell into the succeeding trough. It appears probable that the vessel was then struck by the second wave crest which caused the damage to the island structure.

6.59 Water waves generated by an underwater detonation can cause damage in harbors or near the shoreline, both by the force of the waves and by inundation. The waves will increase in height as they move into shallower water, and inundation, similar to that observed with tidal waves, can occur to

an extent depending on the beach slope and wave height and steepness (§ 2.71).

UNDERWATER CRATERING

6.60 For a nuclear explosion in (or even just above) a body of water, a significant crater forms in the bottom material if the gaseous bubble or a cavity in the water (§ 6.52) formed by the explosion makes contact with the bottom. Such an underwater crater is similar to a crater on land formed by an explosion near the ground surface since both are characterized by a dish-shaped depression, wider than it is deep, and surrounded by a lip raised above the undisturbed surface (see Fig. 6.70). For most underwater craters, however, the

observed ratio of crater radius to depth is larger and the lip height is smaller than for craters from comparable bursts in similar materials on land. These differences are caused by water displaced by the explosion washing back over the crater. This flow increases the crater radius by as much as 10 percent and decreases the depth by up to 30 percent. An exception to this general rule occurs when the water layer is so shallow that the lip formed by the initial cratering extends above the surface of the water. Such craters, termed "unwashed craters," approach surface craters in appearance, with higher lips and smaller radius-to-depth ratios than washed craters.

6.61 The Bikini BAKER explosion resulted in a measurable increase in depth of the bottom of the lagoon over an area roughly 2,000 feet across. The greatest apparent change in depth was 32 feet, but this represented the removal of an elevated region rather than an excavation in a previously flat surface. Before the test, samples of sediment collected from the bottom of the lagoon consisted of coarse-grained algal debris mixed with less than 10 percent of sand and mud. Samples taken after the explosion were, however, quite different. Instead of algal debris, layers of mud, up to 10 feet thick, were found on the bottom near the burst point.

UNDERWATER SHOCK DAMAGE: GENERAL CHARACTERISTICS

6.62 The impact of a shock wave on a ship or structure, such as a breakwater or dam, is comparable to a sudden blow. Shocks of this kind have been experienced in connection with underwater

detonations of TNT and other chemical explosives. However, because of the smaller yields, the shock damage from such explosions is localized, whereas the shock wave from a high-yield nuclear explosion can engulf an entire ship and cause damage over a large area.

6.63 The effects of an underwater nuclear burst on a ship may be expected to be of two general types. First, there will be the direct effect of the shock on the vessel's hull; and second, the indirect effects resulting from components within the ship being set in motion by the shock. An underwater shock acting on the hull of a ship tends to cause distortion of the hull below the water line and rupture of the shell plating, thus producing leaks as well as severely stressing the ship's framing. The underwater shock also leads to a rapid movement in both horizontal and vertical directions. This motion causes damage by shock to components and equipment within the ship.

6.64 Main feed lines, main steam lines, shafting, and boiler brickwork within the ship are especially sensitive to shock. Because of the effects of inertia, the supporting members or foundations of heavy components, such as engines and boilers, are likely to collapse or become distorted. Lighter or inadequately fastened articles will be thrown about with great violence, causing damage to themselves, to bulkheads, and to other equipment. Electronic, fire control, and guided missile equipment is likely to be rendered inoperative, at least temporarily, by shock effects. However, equipment which has been properly designed to be shock resistant will suffer less seriously (cf. § 6.112 *et seq.*). In general, it appears that the

damage to shipboard equipment is dependent on the peak velocity imparted to the particular article by the shock wave.

6.65 The damage to the hull of a ship is related to the energy per unit area of the shock wave, evaluated up to a time corresponding to the surface cutoff time at a characteristic depth. Damage to the gate structure of canal locks and drydock caissons is dependent mainly on the peak pressure of the underwater shock wave. Within the range of very high pressures at the shock front, such structures may be expected to sustain appreciable damage. On the other hand, damage to large, massive subsurface structures, such as harbor installations, is more nearly dependent upon the shock wave impulse. The impulse is dependent upon the duration of the shock wave as well as its pressure (§ 3.59).

UNDERWATER SHOCK: BIKINI EXPERIENCE

6.66 In the shallow, underwater BAKER test, some 70 ships of various types were anchored around the point of burst. From the observations made after the shot, certain general conclusions were drawn, and these will be outlined here. It should be noted, however, that the nature and extent of the damage sustained by a surface vessel from underwater shock will depend upon the depth of the burst, yield, depth of water, range, the ship type, whether it is operating or riding at anchor, and its orientation with respect to the explosion.

6.67 In a shallow underwater burst,

boilers and main propulsive machinery suffer heavy damage due to motion caused by the water shock at close-in locations. As the range is increased, auxiliary machinery associated with propulsion of the ship does not suffer as severely, but light interior equipment, especially electronic equipment, is affected to ranges considerably beyond the limit of hull damage. In vessels underway, machinery will probably suffer somewhat more damage than those at anchor.

6.68 Although the major portion of the shock energy from a shallow underwater explosion is propagated through the water, a considerable amount is transmitted through the surface as a shock (or blast) wave in air. Air blast undoubtedly caused some damage to the superstructures of the ships at the Bikini BAKER test, but this was insignificant in comparison to the damage done by the underwater shock. Air blast could also cause some damage to ships by capsizing them. The main effect of the air blast wave, however, would probably be to targets on land, if the explosion occurred not too far from shore. The damage criteria are then the same as for a surface burst over land, at the appropriate overpressures and dynamic pressures.

6.69 As the depth of burst increases, the proportion of the explosion energy going into air blast diminishes, in a manner similar to that in a burst beneath the earth's surface. Consequently, the range for a given overpressure decreases, with the close-in higher pressures decreasing more rapidly than lower pressures at longer ranges.

TECHNICAL ASPECTS OF SURFACE AND UNDERGROUND BURSTS³

CRATER DIMENSIONS

6.70 In addition to the rupture and plastic zones (§ 6.07), two other features of a crater may be defined; these are the "apparent crater" and the "true crater." The apparent crater, which has a radius R_a and a depth D_a , as shown in Fig. 6.70, is the depression or hole left in the ground after the explosion. The true crater, on the other hand, extends beyond the apparent crater to the distance at which definite shear has occurred. The volume of the (apparent) crater, assumed to be roughly paraboloid, is given approximately by

$$\text{Volume of crater} \approx \frac{1}{2} \pi R_a^2 D_a.$$

6.71 Values of other crater parameters indicated in Fig. 6.70 can be estimated with respect to the apparent crater radius and the apparent crater depth by the following relations. The radius to the crater lip crest, R_{al} , is

$$R_{al} \approx 1.25 R_a.$$

The height of the lip crest, D_{al} , is

$$D_{al} \approx 1.25 D_a.$$

The height of the apparent lip above the original ground surface, H_{al} , is

$$H_{al} \approx 0.25 D_a.$$

Thus, if R_a and D_a are known, the

quantities given above (and others defined in § 6.74 *et seq.*) can be estimated.

6.72 Crater dimensions depend upon the depth of burst (or burial), the explosion energy yield, and the characteristics of the soil. The apparent crater radius and depth, as functions of the depth of burst, are given in Figs. 6.72a and b for a 1-kiloton explosion in four media. For bursts just above the surface, the heights of burst are treated as negative depths of burst. Because of the rapid change in crater dimensions as the depth of bursts passes through zero, the values for a contact surface burst are shown explicitly on the figures. The best empirical fit to crater data indicates that, for a given scaled depth of burst, i.e., actual depth divided by $W^{0.3}$, both the radius and depth vary approximately as $W^{0.3}$, where W is the weapon yield. The procedure for calculating the dimensions of the apparent crater for any specified depth of burst and yield by means of these scaling rules is illustrated in the example facing Fig. 6.72a. The maxima in the curves indicate the so-called optimum depths of burst. It is evident that a change in the moisture content of a soil or rock medium can have a significant influence on the size of a crater; a higher moisture content increases the crater size by increasing the plasticity of a soil medium, weakening a rock medium, and providing a better coupling of the explosive energy to both soil and rock media.

(Text continued on page 255.)

³The remaining sections of this chapter may be omitted without loss of continuity.

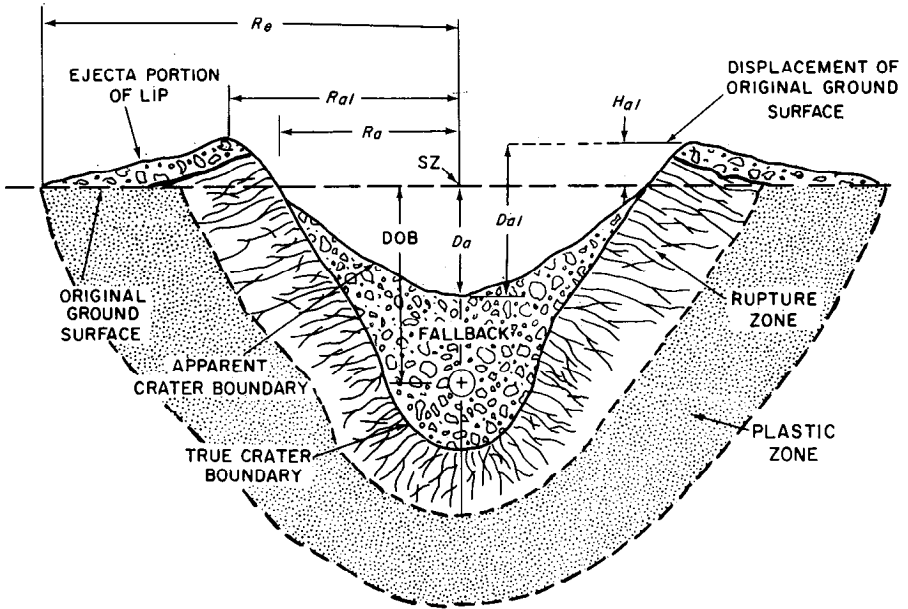

Figure 6.70. Cross section of a crater from a subsurface nuclear detonation.

The curves in Figs. 6.72a and b give the approximate apparent crater radius and depth, respectively, as a function of depth of burst (DOB) in wet hard rock, dry hard rock, wet soil or wet soft rock, and dry soil or dry hard rock. Heights of burst (up to 20 feet) are treated as negative depths of burst.

Scaling. To determine the apparent crater radius and depth for a W KT yield, the actual burst depth is first divided by $W^{0.3}$ to obtain the scaled depth. The radius and depth of a crater for 1 KT at this depth are obtained from Figs. 6.72a and b, respectively. The results are then multiplied by $W^{0.3}$ to obtain the required dimensions.

Example

Given: A 20 KT explosion at a depth of 270 feet in dry hard rock.

Find: Apparent crater radius and depth.

Solution: The scaled burst depth is

$$\begin{aligned} \text{DOB}/W^{0.3} &= 270/20^{0.3} \\ &= 270/2.46 = 110 \text{ feet.} \end{aligned}$$

From Fig. 6.72a the apparent crater radius for a 1 KT explosion at this depth in dry hard rock is 150 feet (curve 4) and from Fig. 6.72b the corresponding crater depth is 87 feet (curve 4). Hence, the apparent crater radius and depth for a 20 KT burst at a depth of 270 feet in dry hard rock are given approximately as follows:

$$\begin{aligned} \text{Crater radius } (R_a) &\approx 150 \times 20^{0.3} \\ &= 150 \times 2.46 = 368 \text{ feet.} \end{aligned}$$

$$\begin{aligned} \text{Crater depth } (D_a) &\approx 87 \times 20^{0.3} \\ &= 87 \times 2.46 = 214 \text{ feet.} \end{aligned}$$

Answer. (With R_a and D_a known, other crater (and lip) dimensions can be obtained from the approximate relations in §§ 6.71, 6.74, and 6.75.)

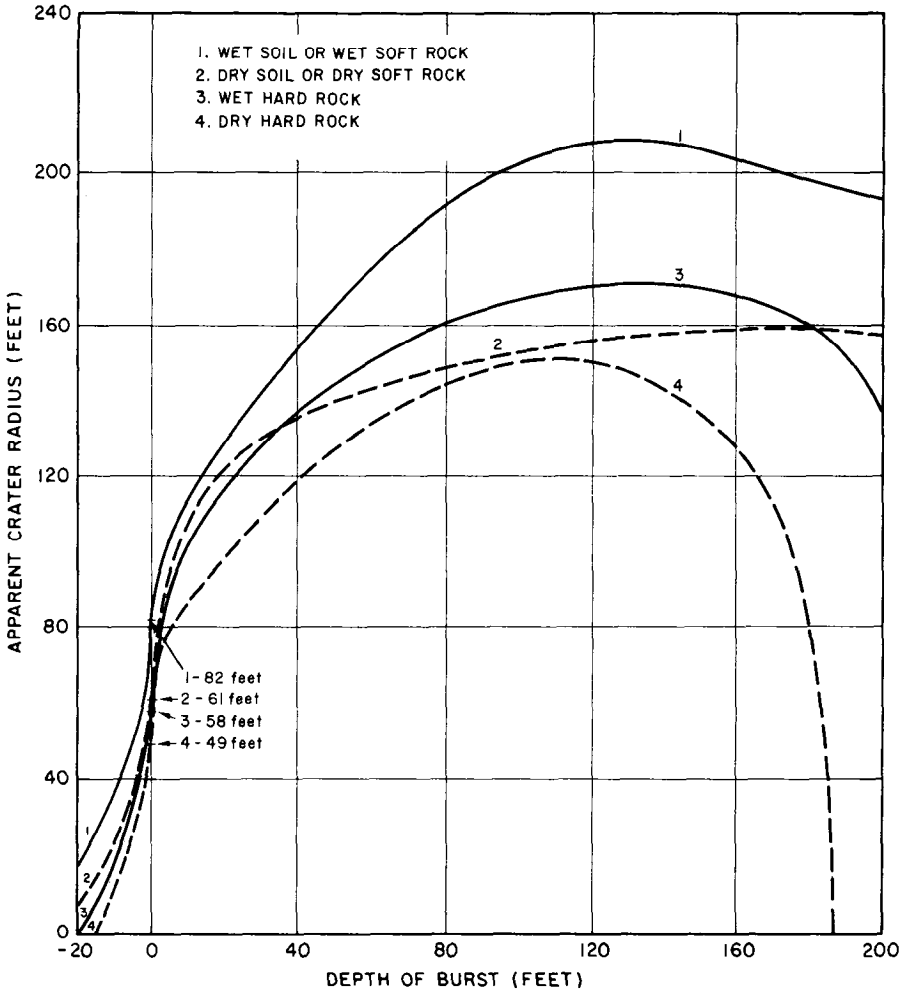

Figure 6.72a. Apparent crater radius as a function of depth of burst for a 1-kiloton explosion in (or above) various media.

CRATER EJECTA

6.73 Crater ejecta consist of soil or rock debris that is thrown beyond the boundaries of the apparent crater. Together with the fallback, which lies between the true and apparent crater boundaries, ejecta comprise all material completely disassociated from the parent medium by the explosion. The

ejecta field is divided into two zones: (1) the crater lip including the continuous ejecta surrounding the apparent crater (Fig. 6.70), and (2) the discontinuous ejecta, comprising the discrete missiles that fall beyond the limit of the continuous ejecta.

6.74 The amount and extent of the continuous ejecta in the crater lip are

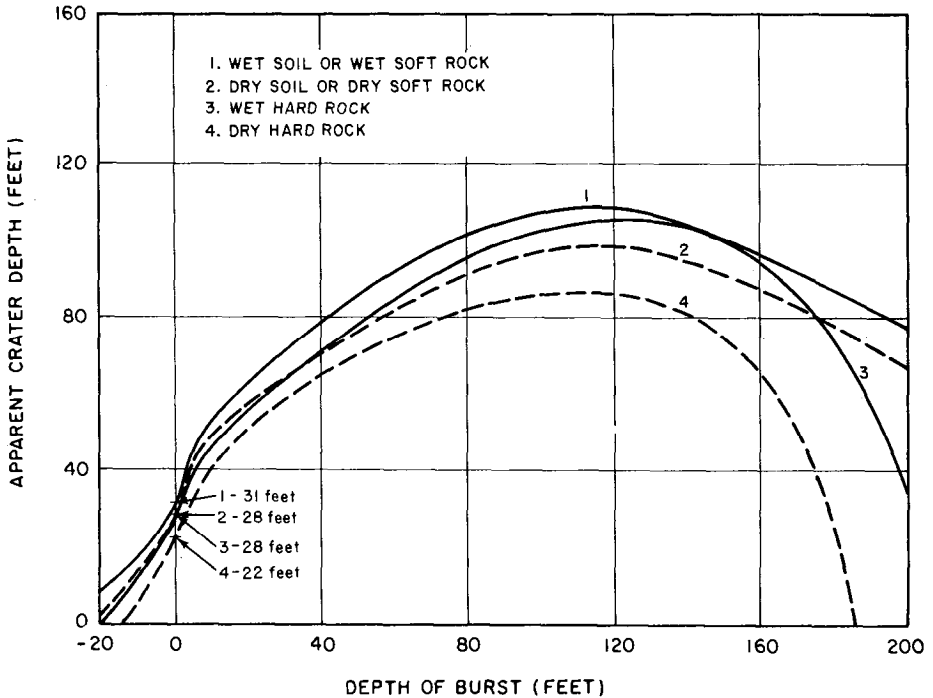

Figure 6.72b. Apparent crater depth as a function of depth of burst for a 1-kiloton explosion in (or above) various media.

determined primarily by the explosion yield and the location of the burst point, although the characteristics of the medium have some effect. The radial limit of the continuous ejecta, which is the outer edge of the lip, will usually vary from two to three times the apparent crater radius. In most cases, a satisfactory approximation to the radius of the continuous ejecta, R_e (Fig. 6.70), is

$$R_e \approx 2.15 R_a$$

6.75 The depth of the ejecta decreases rapidly in an exponential manner as the distance from surface zero increases. In general, about 80 to 90 percent of the entire ejecta volume is deposited within the area of the continuous ejecta. Analysis of data for craters formed by nuclear bursts in soil indi-

cates that ejecta mass represents approximately 55 percent of the apparent crater mass (the remainder being found in fallback, compaction, and the dust cloud which is blown away). For an explosion of given yield, the ejecta mass increases significantly with the depth of burst until the optimum depth is reached. Ejecta thickness can be estimated for soil in terms of the apparent radius and diameter; thus:

$$t_e \approx 0.9 D_a \left(\frac{R_a}{R} \right)^{3.86}, \text{ for } R > 1.8 R_a, \quad (6.75.1)$$

where t_e is the ejecta thickness and R is the distance from surface zero to the point of interest. In equation (6.75.1), it is assumed that the ejecta mass density is approximately equal to the original in-situ density of the medium, which

could be considered valid for a soil medium. However, the bulking inherent in disturbed rock media would result in ejecta thicknesses about 30 percent greater than predicted by equation (6.75.1).

GEOLOGIC FACTORS

6.76 In addition to the nature and water content of the soil, certain other geologic factors may influence crater size and shape. Terrain slopes of about 5° or more will affect the geometry of a crater formed by either surface or buried explosions, with the influence of the slope being more evident as burst depth increases. The surface slope will cause much of the debris ejected by the explosion to fall on the downslope side of the crater, often resulting in rockslides below the crater area. In addition, the upslope rupture zone may collapse into the crater, resulting in an asymmetric crater shape.

6.77 In rock, the dip of bedding planes will influence energy propagation, causing the maximum crater depth to be offset in the down-dip direction. Little overall effect is noted in regard to crater radius, but differences in ejecta angles cause the maximum lip height and ejecta radius to occur in the down-dip direction.

6.78 A subsurface groundwater table in a soil medium will begin to influence the size and shape of the crater when the water table is above the detonation point. Its effect is to flatten and widen the crater. The influence of a bedrock layer below a soil medium is similar to that of a water table, although somewhat less pronounced. For explosions at or near the surface, the bedrock

layer has little effect on the crater radius, but may decrease the final depth considerably.

6.79 For relatively low-yield explosions at or very near the surface, the bedding or jointing planes in rock can alter significantly the shape of the crater and the direction of the ejection. The crater shape will tend to follow the direction of the predominant joints; the crater radius will increase in the direction parallel to the joints and decrease normal to the joints.

AIR BLAST PRESSURE

6.80 Several different mechanisms may operate to transfer part of the energy released in an underground explosion into the air and thereby produce air blast. For explosions at moderate depths, such that the fireball does not break through the surface, the predominant mechanisms may be described as follows. A shock wave propagated through the ground arrives at the surface and imparts an upward velocity to the air (air particles) at the air-ground interface, thus initiating an air pulse. At the same time, there may be spalling and upward motion of the surface layers, as explained in § 2.91. Meanwhile, the underground explosion gases expand, pushing the earth upward so that the spall merges into a dome at surface zero. The piston-like action of the spall and the rising dome increase the duration of the initial air pulse. The air blast sustained in this manner appears on pressure-time records as a single pulse, termed the air-transmitted, ground-shock-induced pulse. Somewhat later, the explosion gases puncture the dome and escape, creating a second air

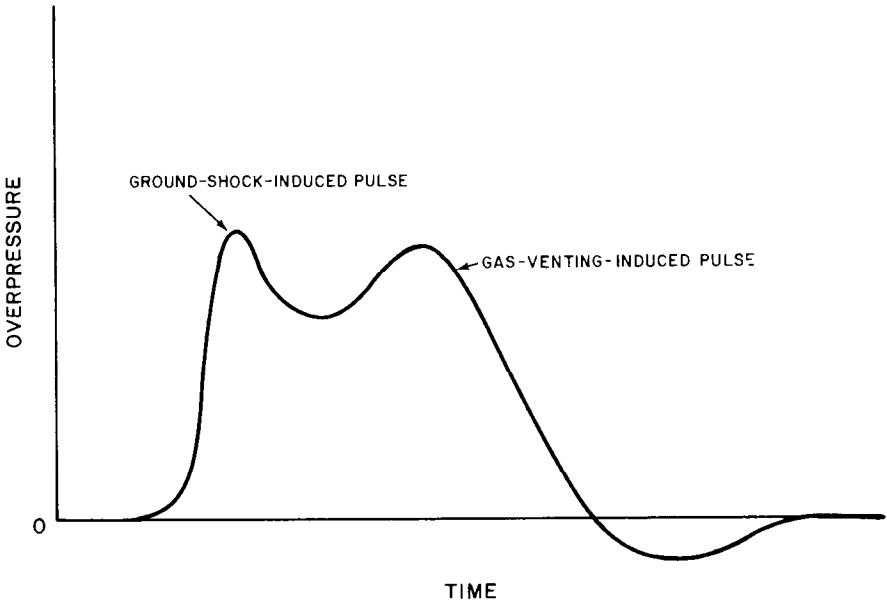

Figure 6.80. Air blast overpressure from underground explosions of moderate depth. With increasing burst depth, the relative contribution of gas venting decreases and the time between the pulses increases.

pulse called the gas-venting-induced pulse (Fig. 6.80).

6.81 With increasing depth of burst, the relative contribution of gas venting decreases and the time between the two pulses increases. Although the mechanisms that generate the air pulses change with depth in a complex manner, a procedure has been developed for predicting peak overpressures in the air near the surface as a function of distance from surface zero over a reasonable range of burial depths; the results are shown in Fig. 6.81. The value of \bar{x} may be obtained from the following relations:

$$\bar{x} = \lambda_x e^{\rho \lambda_d / 126},$$

$$\lambda_x = x/W^{1/3} \text{ and } \lambda_d = d/W^{1/3},$$

where x = ground distance in feet, d = depth of the explosion in feet, W = explosion yield in kilotons, and ρ = specific gravity of the ground medium. The curve in Fig. 6.81 may be used with the relations given above for scaled depths of burst, λ_d , less than 252 feet/KT^{1/3}. Typical values of specific gravities are 1.6 for alluvium, 1.9 for tuff, and 2.7 for granite.

GROUND MOTION

6.82 Earth shock motion at or near the surface accompanying a shallow or moderately deep underground burst may be regarded as consisting of systemic and random effects. The systemic effects are those associated with air blast and the shock wave transmitted directly

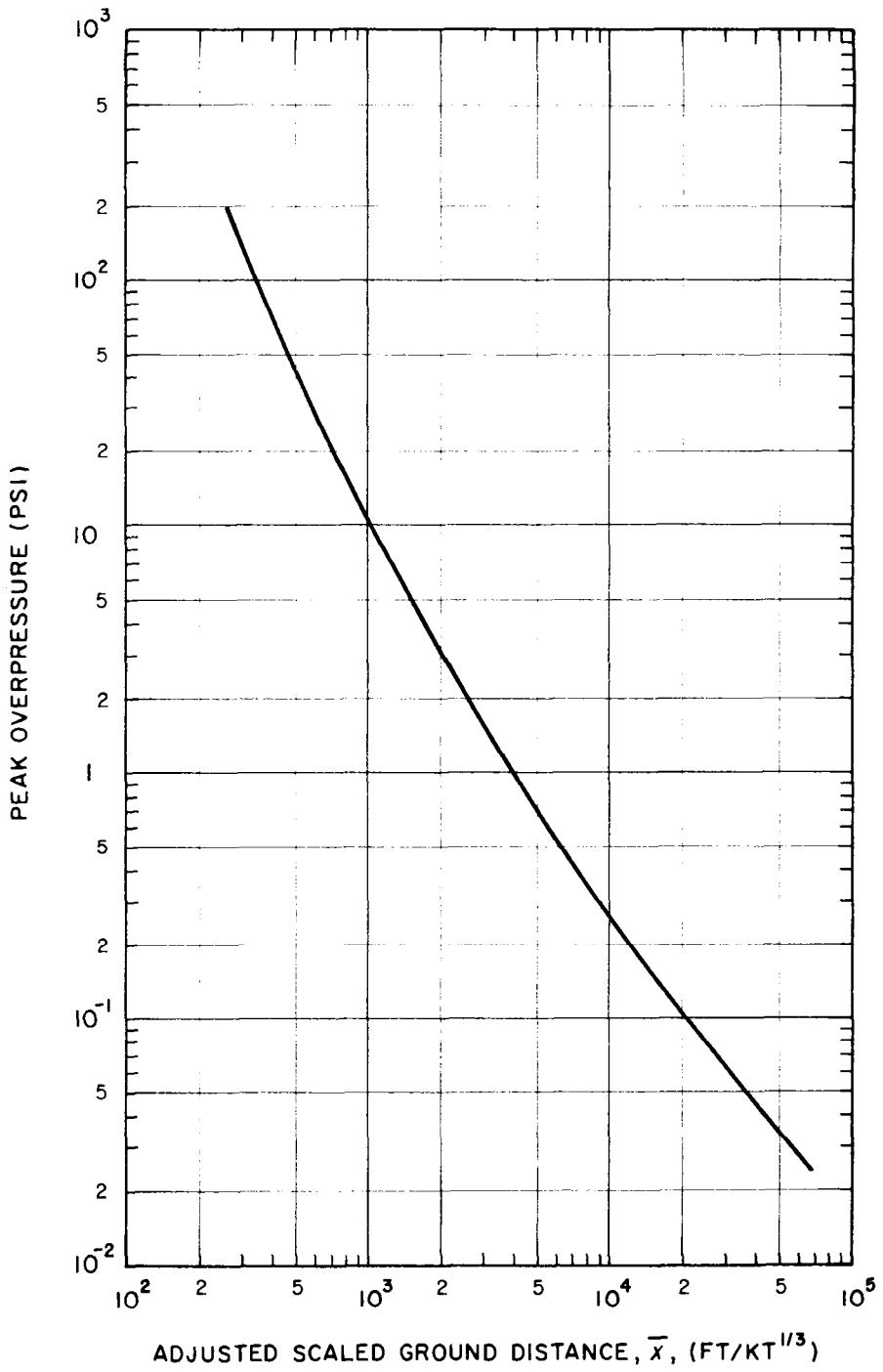

Figure 6.81. Peak overpressure of air blast from an underground explosion as a function of adjusted scaled ground distance from a buried 1-kiloton explosion.

through the ground from the detonation (§ 6.12 *et seq.*). Random effects include high-frequency shock waves in the ground, surface wave effects, reflections, refractions, etc. They depend on such factors as the explosion yield, distance from surface zero, depth of the observation point, and, in particular, the local geologic conditions. The following discussion will be concerned mainly with the systemic effects.

6.83 In the superseismic situation, the downward acceleration of the ground due to the air blast is large compared with the subsequent upward acceleration caused by the direct ground shock. The record of ground acceleration (or velocity) versus time obtained on a gage mounted near the surface is similar in shape to the air overpressure-time pulse, at least in the early stages. When the direct ground shock wave outruns the air blast, there is a slower increase in the acceleration and the direction may be upward rather than downward. The acceleration-time pulse may then last for a longer time than the

duration of the positive air overpressure pulse. The overall motion record is characterized by a considerable degree of oscillation. When precursors (§§ 3.49, 3.79) are present, the records may exhibit components of higher frequency and a more random type of oscillation.

6.84 By using data obtained during various nuclear tests, expressions have been derived from which peak ground acceleration, velocity, and displacement (transient and permanent), both at the surface and down to moderate depths, in the superseismic condition can be estimated from the peak air overpressure as evaluated in § 6.81. No simple method is presently available for calculating the effects of outrunning ground motion. As far as the effects of the direct shock wave are concerned, the expected results are inferred mainly from data obtained at deep underground tests in which the air blast is negligible. The response of structures to seismic (or elastic) waves generated at a distance from the burst point by the ground shock wave is considered in § 6.90 *et seq.*

TECHNICAL ASPECTS OF DEEP UNDERGROUND BURSTS

CAVITY AND CHIMNEY DIMENSIONS

6.85 The dimensions of the gas cavity and the chimney formed in a deep underground explosion depend on the energy yield, on the nature of the medium in which the explosion occurs, on that in which the chimney develops, and to some extent on the depth of burial. Because of the variability of the conditions, it is not possible to state a relationship among the factors involved.

The purpose of the following treatment is only to give some rough indications of cavity and chimney dimensions and it should not be taken as providing definitive information.

6.86 As a rough approximation, the volume of the cavity in a given medium and fixed depth of burial may be taken to be proportional to the explosion energy. Hence, if the cavity is assumed to be spherical, its radius should be propor-

tional to $W^{1/3}$, where W is the energy yield. Measurements indicate that this relationship is very roughly true, so that $R_c/W^{1/3}$, where R_c is the cavity radius, is approximately constant for a given medium and burst depth. For moderately deep, contained explosions the effect of burst depth is small and the following values have been found for $R_c/W^{1/3}$ in two types of media:

- Dense silicate rocks
(e.g., granite).35 feet/KT^{1/3}
- Dense carbonate rocks
(e.g., dolomite, limestone)
.25 feet/KT^{1/3}

These expressions are applicable approximately for burst depths below about 2,000 feet.

6.87 At greater burst depths, the pressure of the overburden, which must be overcome in forming the gas cavity, has some effect on the cavity radius. On the basis of adiabatic compression of the overburden material, the cavity radius would be expected to be inversely proportional to $(\rho h)^{0.25}$, where ρ is the density and h is the height of the overburden. Limited observations, however, indicate that the exponent may differ significantly from 0.25. It appears, therefore, that a number of factors, which are not well understood, affect the relationship between the cavity radius and the overburden pressure at depths exceeding 2,000 feet.

6.88 If the roof of the gas cavity collapses upon cooling, as it generally (but not always) does, the dimensions of the chimney are highly dependent upon the characteristics of the medium in which it is formed. As a general rule, the radius of the chimney is from 10 to 20 percent greater than that of the cavity. Furthermore, the height of the

chimney may be from about four to six times the cavity radius. The higher factor appears to apply to completely bulked granite and the lower to dolomite, shale, and incompletely bulked granite.

6.89 From the foregoing rough data, it appears that for an underground explosion in which the top of the chimney does not reach the earth's surface the scaled depth of burial, i.e., $d/W^{1/3}$, must be greater than about 300 feet/KT^{1/3}. If the top of the chimney is fairly close to the surface, however, some of the radioactive gases formed in the nuclear detonation could seep through the ground into the atmosphere. In conducting underground tests, the escape of these gases must be prevented. The scaled depth of burial is consequently not less than 400 feet/KT^{1/3}. For explosions of low yield, when the actual depth of burial would be relatively small, and in media with a substantial water content, the scaled depths of burial are increased even more in order to achieve containment of radioactive gases.

STRUCTURAL RESPONSE TO GROUND MOTION

6.90 A semiempirical method for studying (and predicting) the response of structures to ground motion caused by the seismic wave from an underground explosion makes use of the "response spectrum." A linear oscillator with a single mode of vibration, which may be thought of as a simple idealized structure, is considered. It is assumed to be subjected to the entire history of the ground motion as actually recorded on a seismic instrument at a given location.

By utilizing the laws of mechanics, the peak response of the idealized structure to the ground motion can then be calculated. For an elastic oscillator, this response depends only on the natural vibration period (or frequency) of the oscillator and the damping ratio. A particular damping ratio is selected, e.g., 0.05, and the peak structural response is calculated for one specified vibration period by means of the procedure just described. The calculation is repeated for a range of vibration periods, generally from about 0.05 to 10 seconds. The results are plotted on a special logarithmic paper to give the response spectrum corresponding to the specified damping ratio and observed ground motion. Because the peak acceleration, velocity, and displacement are related mathematically, a single curve gives the variation of these quantities with the vibration period of the idealized structure.

6.91 From the response spectrum at a given location it is possible to determine the relative amounts of ground motion energy, from an explosion of specified yield, that would cause vibration of structures with different natural vibration periods. The general conclusions stated in § 6.37 *et seq.*, concerning the response of structures to the seismic motion accompanying underground nuclear explosions, were reached from a study of response spectra derived from many ground motion records obtained at various locations in the vicinity of the Nevada Test Site.

6.92 The response spectrum is calculated from the actual ground motion, which depends primarily on the yield of the explosion, the depth of burst, and

the distance from the burst point. In addition, however, the nature of the medium through which the seismic wave is propagated and of the ground upon which the structure stands have an important influence. Because of the large amount of information accumulated in underground explosions at the Nevada Test Site, reasonably good predictions can be made of the ground motions and hence of the response spectra in the general area of the site. For underground explosions in other areas, the results from Nevada are used as the basis for preliminary calculations of response spectra. Modifications are then made for differences in geology.

6.93 If the characteristics of a structure are known, an engineer experienced in such matters can predict from the response spectrum whether the structure will be damaged or not by a specified underground nuclear explosion at a given distance. In making these predictions, it must be recalled that a response spectrum applies to a range of linear, elastic oscillators, each with a single vibration period and an assumed damping ratio. Such an oscillator may be identified approximately with a simple, idealized structure having the same respective vibration period and damping ratio. In real-life situations, however, buildings do not behave as ideal structures with a single vibration period and, moreover, the damping ratios vary, although 0.05 is a reasonable average value. Consequently, in making damage estimates, allowances must be made for several variables, including structural details, different vibration periods, and the type, age, and condition of the structure.

LOADING ON BURIED STRUCTURES

GENERAL CONSIDERATIONS

6.94 Of the ground motions resulting from a nuclear burst at or near the surface (§ 6.12 *et. seq.*) two types (airslap and outrunning) are traceable to the pressure of the airblast wave on the ground surface. Only in the immediate neighborhood of the crater will directly coupled ground motion be a significant damage mechanism. For example, a 1-kiloton explosion on the surface leaves a crater approximately 49 to 82 feet radius (Fig. 6.72a). Yet the free-field peak air blast overpressure, i.e., the overpressure in the absence of structures, at a distance of two crater radii from surface zero is several thousand pounds per square inch (Fig. 3.73a) and remains above 100 pounds per square inch up to a distance of five or six crater radii. Outrunning ground motion generally occurs so far from surface zero that it is relatively small. Therefore, unless a structure is extremely deeply buried, i.e., its distance from the surface is similar to its distance from surface zero, the major threat to it is most likely to arise from airslap. For shallow-buried structures, the air blast overpressure may consequently be taken as the effective load. For deeply-buried structures, attenuation of the shock must be considered.

6.95 For the purposes of making loading estimates for buried structures, the medium may be described as soil or rock. In soil, the structure must resist most of the load, whereas in rock, the medium itself may carry a large part of the load.

ARCHING EFFECT

6.96 If the deformability of a buried structure is the same as that of the surrounding displaced soil, the loads produced on the structure by the air blast from a nuclear detonation will be determined by the free-field pressures induced in the soil by the blast wave. If the deformability of the structure is greater or less than that of the soil, the pressures on the structure will be less or greater, respectively, than those in the soil.

6.97 Results of tests have indicated that there is no significant buildup of pressure due to reflection at the interface between the soil and a buried structure. It may be assumed, therefore, that structures are at least as deformable as soils and that the free-field pressure, regardless of its direction, can be taken as an upper limit of the pressure acting on the structure. If the structure is much more deformable than the surrounding soil, the pressure on the buried structure will be considerably lower than the free-field pressure at the given depth. In this case, as the free-field pressure is exerted initially, the structure deflects away from the soil and a situation is created in which the "arching effect" within the soil serves to transmit part of the blast-induced pressure around the structure rather than through it. Arching, properly speaking, belongs to the loading process, but it may also be treated as a factor that enhances the resistance of the structure.

6.98 In soil, the load carrying ability of the medium is a form of arching.

The degree of arching is determined by (1) the structural shape and (2) the ratio of the roof span to depth of burial. Shells, such as arches and domes, develop significant arching resistance in soils; rectangular structures generally do so to a lesser extent.

6.99 The weight of the overburden on a buried structure represents a force that must be overcome. Hence, the structural strength remaining to oppose the shock decreases as the depth of burial is increased. This effect of increasing overburden on a structure is countered to some extent by the opposite effect of arching.

LOADING ON BURIED RECTANGULAR STRUCTURES

6.100 The treatment of the air-blast-induced loads on shallow-buried rectangular (or box-type) structures resulting from surface or shallow underground bursts is similar to the treatment of loads on buried structures from air bursts. Thus, the procedures described in § 5.156 *et seq.* are applicable, except that the overpressure at the surface should be obtained by the method described in § 6.81. For a column-supported slab, capitals between the columns and the slab may greatly increase the structural resistance.

LOADING ON BURIED ARCHES AND DOMES

6.101 On buried arches and domes the actual loading is considerably more complex because of the constantly changing attitude of the surface of the structure with respect to a horizontal plane and also because, at very shallow

depths, the initial nonuniformity of load cannot be neglected. As a blast wave passes over a buried arch or dome, the side closest to the explosion is loaded earlier than the farther side and, consequently, an unsymmetrical flexural (or bending) mode of response is excited. Furthermore, after the structure is completely engulfed by the blast wave, the radial (inwardly directed) loading will be very nearly symmetrical, although not uniform. The pressure at the crown, corresponding to the free-field vertical pressure close to the ground surface, is then the maximum. Beyond the crown, the radial pressure decreases in intensity to a minimum at the springing line where, if the arch or dome has a 180° central angle, the pressure will correspond to the free-field lateral (sideways) pressure at the depth of the footings. This symmetrical nonuniform loading tends to excite a symmetrical flexural mode of response. In addition to these two flexural modes, the structures will also respond in a direct compression mode.

6.102 For the flexural modes to be significant, deformations corresponding to these modes must be possible. For such deformations to occur, the passive resistance of the surrounding soil must be overcome and a wedge of the soil must be displaced by the deforming structure. Thus, the passive resistance of the soil will tend to limit these deformations and prevent the flexural modes from being significant. Although the flexural modes may be important with shallow buried structures, they decrease in importance very rapidly with depth since the passive resistance of the soil increases quite rapidly at the same time.

6.103 In the foregoing discussion it

is assumed that the footings do not move with respect to the soil adjacent to them. If the footings do penetrate into the

underlying material, the radial pressures on the arch or dome may be reduced slightly.

DAMAGE FROM GROUND SHOCK

UNDERGROUND STRUCTURES

6.104 The damage to an underground structure itself, as distinct from the effects of ground shock on its contents (§ 6.112), can be readily defined in terms of inelastic deformation or collapse. For fully buried arches and domes, severe damage corresponds to collapse either by elastic or, more frequently, inelastic buckling. If very near the ground surface, the deformations may be primarily flexural. Light damage has little or no meaning unless it refers to partial impairment of operational capability of personnel and equipment. Moderate structural damage for concrete structures can be defined as deformation accompanied by significant spalling. Such deformation would correspond to stress levels in the concrete slightly above the yield point, i.e., a ductility factor of about 1.3. This presumes that failure is by inelastic deformation rather than by elastic buckling, as would be the case in a properly designed blast-resistant structure. If failure is by elastic buckling, moderate damage cannot be realized.

6.105 For steel arches and domes, moderate structural damage can also be defined in terms of a reduced ductility factor, although the nature of such damage for steel structures is not as clearly evident as in the spalling of concrete. For underground, blast-resis-

tant, box-type structures, the several degrees of damage to arches and domes are also applicable, but the mechanism of deformation may be different. In a box structure, primary response may be in flexure of the walls, roof, or base slabs or in direct stress or buckling of the walls or columns. However, severe damage is still characterized by excessive deformation or collapse through any of these mechanisms; moderate damage corresponds to deformations of any of the elements associated with spalling of concrete and small permanent deflections; and light damage is virtually meaningless except in terms of shock effects on personnel and equipment.

6.106 For very low yield weapons, it is difficult to produce significant damage to a buried structure unless it is within the rupture zone around the crater (Fig. 6.70). With the exception of a number of special structural types, e.g., pipelines and small highly resistant reinforced-concrete fortifications, soil pressures produced by air blast pressures on the ground surface constitute the primary source of damage to buried structures.

6.107 It is expected that underground structures whose span closely matches one-half the wave length of the shock will "roll with the blow." This expectation has been borne out by actual

experience. The movement of the structure is intimately connected with the movement of the soil as the shock wave passes. In other words, if the particle acceleration in the soil has certain peak horizontal and vertical components, then the small underground structure may be expected to have almost the same peak acceleration components.

6.108 Shock damage to underground structures is most frequently calculated with computer codes. Graphs and tables suitable for hand calculations have been developed, but such calculations are time consuming, and the results are approximations at best. There is evidence that the degrees of damage from shallow (and moderately shallow) explosions can be related to the apparent crater radius. Some examples of this relationship are given in Table 6.108 for moderately deep underground structures, defined as structures for which the ratio of the depth of cover at the crown to the span is somewhat greater than unity. Crater radii, and hence the damage distances, will vary with soil type (§ 6.72). Deeply buried structures, with a ratio of depth of cover to span much greater than unity, would suffer less damage.

6.109 Although tunnels and subways would be destroyed within the crater region and would suffer damage outside this area, these structures, especially when bored through solid rock and lined to minimize spalling, are very resistant to ground shock. The rock, being an elastic medium, will transmit the pressure (compression) wave very well, and when this wave strikes the wall of the tunnel, a tension (negative

pressure) wave is reflected from the rock-air interface.⁵ Even in a soil medium, tunnels and subways could survive; flexible structures would resist damage by taking advantage of the tremendous passive earth pressure. However, construction in soil should be above the water table, if possible.

6.110 Under certain circumstances, failure of the rock at the tunnel wall will result in spalling when the reflected tensile stress exceeds the tensile strength of the rock. The thickness of spalling is dependent upon the magnitude, duration, and shape of the pressure wave, upon the size and shape of the tunnel, and upon the physical properties of the rock.

6.111 A structure may extend above the grade level but be protected by earth piled or mounded around it (Fig. 6.111). The idealized surface is the surface of constant slope which is equivalent to the actual (curved) surface. If the slope of the idealized surface is less than 14° , the structure may be treated as buried, and the foregoing discussion of buried arches and domes is applicable. If the slope is more than 14° , or if the structure is located well beyond the plastic zone, the overall damage is determined by air blast, and is in accordance with the discussion in Chapters IV and V.

VULNERABILITY OF EQUIPMENT

6.112 Although a structure may suffer little or no damage from ground motion, its contents, e.g., machinery or other equipment, may be rendered in-

⁵The formation of a negative pressure wave upon reflection of a compression wave at the surface of a less dense medium (air) is discussed more fully in the treatment of shock waves in water (§ 6.43 *et seq.*).

Table 6.108

DAMAGE CRITERIA FOR MODERATELY DEEP UNDERGROUND STRUCTURES

Structural Type	Damage Type	Distance from Surface Zero	Nature of Damage
Relatively small, heavy, well-designed, underground structures.	Severe	1¼ apparent crater radii	Collapse.
	Light	2½ apparent crater radii	Slight cracking, severance of brittle external connections.
Relatively long, flexible structures, e.g., buried pipelines, tanks, etc.	Severe	1½ apparent crater radii	Deformation and rupture.
	Moderate	2 apparent crater radii	Slight deformation and rupture.
	Light	2½ to 3 apparent crater radii	Failure of connections.

operative by the shock. Such equipment may be made less vulnerable by suitable shock mounting. Shock mounts (or shock isolators) are commonly made of an elastic material like rubber or they may consist of springs. The material absorbs much of the energy delivered very rapidly by the shock and releases it more slowly, thereby protecting the mounted equipment.

6.113 By shaking, vibrating, or dropping pieces of equipment, engineers can often estimate the vulnerabil-

ity of that equipment to all kinds of motion. The results are commonly expressed as the natural vibration frequency at which the equipment is most vulnerable and the maximum acceleration tolerable at that frequency for 50 percent probability of severe damage. Some examples of the values of these parameters for four classes of equipment, without and with shock mounting, are quoted in Table 6.113. It is seen that the shock mounting serves to decrease the most sensitive natural fre-



Figure 6.111. Configuration of mounded arch.

Table 6.113

FREQUENCY AND VULNERABILITY ACCELERATION OF TYPICAL EQUIPMENT ITEMS

Class	Item	Shock Mounted	Typical Value of	
			Natural frequency (cps)	Vulnerability acceleration (g)
A	Heavy machinery—motors, generators, transformers, etc. (>4000 lb).	No	10	20
		Yes	3	40
B	Medium and light machinery—pumps, condensers, air conditioning, fans, small motors (<1000 lb).	No	20	40
		Yes	5	80
C	Communication equipment, relays, rotating magnetic drum units of electronic equipment, etc.	No	25	7
		Yes	6	60
D	Storage batteries, piping and duct work.	No	20	70
		Yes	5	150

quency, i.e., increase the period, and to increase the acceleration for 50 percent probability of severe damage at that frequency.

6.114 Whether or not a specified piece of equipment is likely to be damaged by a particular ground motion can be estimated from the data in Table 6.113 in conjunction with the response spectrum (§ 6.90) for that ground mo-

tion. If the peak acceleration on the response spectrum corresponding to the equipment frequency is less than the vulnerability acceleration, then the equipment will probably be undamaged by the particular ground motion. On the other hand, if the response spectrum indicates that the equipment may be damaged, shock mounting should be added or improved.

TECHNICAL ASPECTS OF UNDERWATER BURSTS

SHOCK WAVE PROPERTIES

6.115 By combining a theoretical treatment with measurements made in connection with detonations of high-explosive charges under water, some characteristic properties of the underwater shock wave from a nuclear ex-

plosion have been calculated. The peak pressure of the shock wave in water for various energy yields is shown in Fig. 6.115 as a function of slant range, R , for pressures less than 3,000 pounds per square inch and (in the top right corner) as a function of the scaled slant range,

$R/W^{1/3}$, for higher pressures. The data refer to "isovelocity" water, i.e., water in which there are no reflections or refractions.

6.116 The decrease of the water pressure with time can be obtained from Figs. 6.116a and b. The former gives the time constant, θ , in terms of the slant range for various yields, and the latter shows the variation of $p(t)/p$, where $p(t)$ is the pressure at time t after the arrival of the shock front at the observation point and p is the peak pressure at that point, with the reduced time t/θ . The time constant is the time at which the shock pressure has decayed to $1/e$, i.e., about 37 percent, of its peak value. (The use of a time constant defined in this manner must not be taken to imply that the pressure decreases exponentially; it does not do so except at early times.) The longer the time constant, the more slowly does the water shock pressure decay; it is apparent, therefore, from Fig. 6.116a that the duration of the shock wave increases with the energy yield and the distance from the explosion point. The data in Figs. 6.116a and b may be used to construct a curve showing the decrease with time of the pressure at a specified slant range from an underwater explosion of given yield. The area under the curve gives the pressure impulse of the water shock wave, analogous to the air overpressure impulse defined in § 3.59.

6.117 In shallow water and in certain circumstances in deep water, the primary underwater shock pulse will be modified by surface and bottom effects (§ 6.41 *et seq.*). Water is much less compressible than air, and positive reflection phenomena (§ 6.49) are less well understood than reflections of air

shocks from the ground and other surfaces. Bottom reflections in water are frequently more nearly acoustic than air blast reflections. Consequently, under appropriate conditions, the influence of the bottom can be treated ideally by replacing the bottom surface with an image explosion of the same yield as the actual explosion located a distance below the bottom equal to the distance of the actual explosion above it.

6.118 In practice, the character of the bottom, e.g., mud, loose or packed sand, or hard rock, has a marked effect on the magnitude of the reflected pressure. The distances traveled by the primary shock and reflected waves to the target also influence the pressures. When the explosion and the target are both near the bottom, the reflected pressure received at the target may be greater than, equal to, or less than the primary pressure. When the burst point and the target are both remote from the bottom, the reflected pressure is generally much smaller because of the greater travel distance. In each case, of course, the negative pressure reflected from the air-water interface must not be overlooked. The times of arrival of the reflected pressures, after the primary shock, may be estimated from the respective travel distances by assuming that the pulses travel with the speed of sound in the water.

(Text continued on page 272.)

The curves in Figs. 6.115 and 6.116a and b give the parameters for the primary shock wave from an underwater explosion in deep isovelocity water. Figure 6.115 shows the peak pressure p as a function of slant range R for various yields, where the peak pressure is lower than 3,000 psi, and as a function of scaled slant range $(R/W^{1/3})$ for peak pressures above 3,000 psi. Values of the time constant θ as a function of slant range for various yields are given in Fig. 6.116a, and Fig. 6.116b shows the reduced (or normalized) pressure $p(t)/p$, where $p(t)$ is the shock pressure at time t , as a function of the reduced time t/θ .

Scaling. For yields other than those shown in the figures, use linear interpolation between appropriate curves.

Example

Given: A 50 KT burst in deep water.

Find: (a) The peak shock pressure p and (b) the pressure $p(t)$ at 0.1 second after arrival of the shock wave at a distance of 4,000 yards from the burst point.

Solution: (a) From Fig. 6.115, the peak shock pressure p at a slant range of 4,000 yards from a 50 KT burst in deep water is found to be approximately 470 psi. *Answer.*

(b) From Fig. 6.116a, the time constant θ is 50 millisecc, i.e., 0.050 sec. Hence $t/\theta = 0.1/0.050 = 2$. From Fig. 6.116b, the value of $p(t)/p$ for $t/\theta = 2$ is about 0.15; hence

$$p(t) \approx 470 \times 0.15 = 70 \text{ psi. } \textit{Answer.}$$

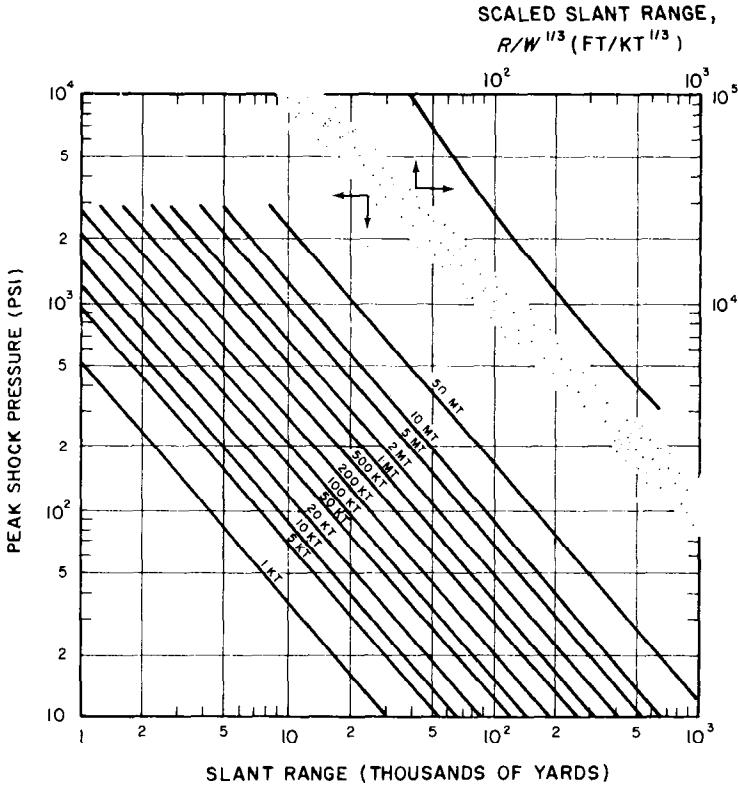

Figure 6.115. Shock wave peak pressure in deep isovelocity water as a function of slant range.

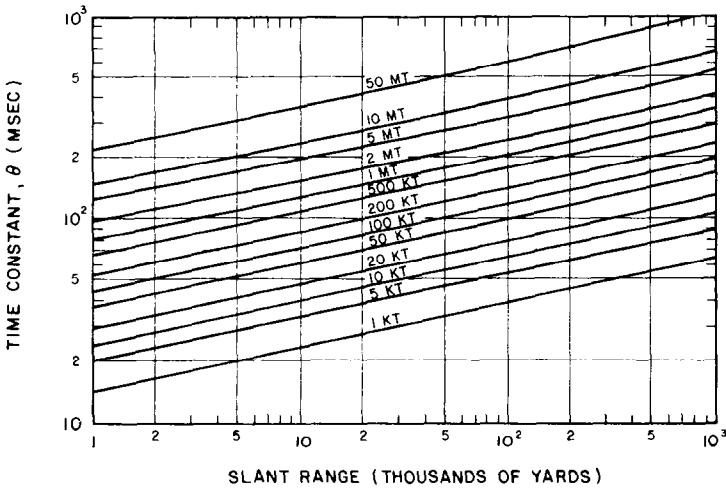

Figure 6.116a. Shock wave time constant in deep isovelocity water as a function of slant range.

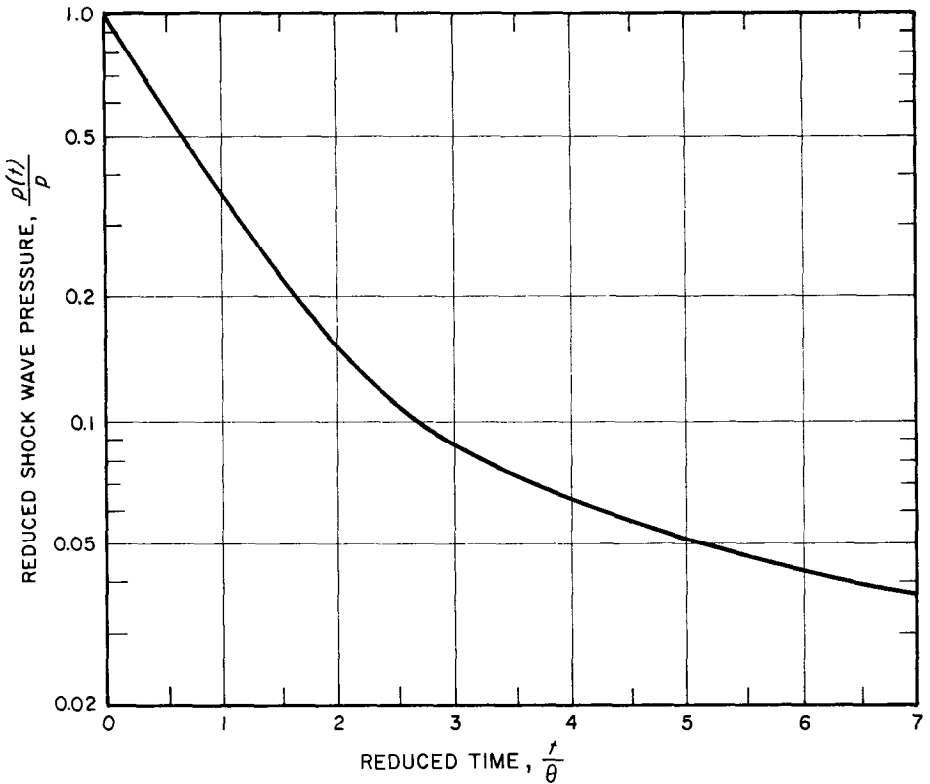

Figure 6.116b. Pressure-time relationship for water shock waves from nuclear explosion in deep isovelocity water; p is the peak pressure and $p(t)$ is the value at time t after arrival of the shock front.

SURFACE WAVES

6.119 When observed at a point remote from surface zero, the idealized surface displacement associated with the train of waves referred to in § 6.54 is shown in Fig. 6.119. In deep water, the wave intensity is represented by the peak-to-peak height H of the wave envelope. The manner in which this height diminishes with distance (or radius) R from surface zero can be expressed to an accuracy of about 35 percent by the relationship

$$H \approx 40,500 \frac{W^{0.54}}{R}, \quad (6.119.1)$$

with both H and R in feet, and the yield

W in kilotons TNT equivalent. This expression holds provided the depth, d_w feet, of the water in which the surface waves are produced is in the range $850 W^{0.25} \geq d_w \geq 256 W^{0.25}$, where the lower limit is the maximum diameter of the gas bubble (§ 2.86). The relation is valid for any depth of burst within the water. Other parameters characterizing surface waves are the length L and period T of the peak wave. Extrapolation of deep water chemical explosions indicate these quantities are given approximately by

$$L \approx 1010 W^{0.288} \text{ feet}$$

$$T \approx 14.1 W^{0.144} \text{ seconds}$$

where W is in kilotons.

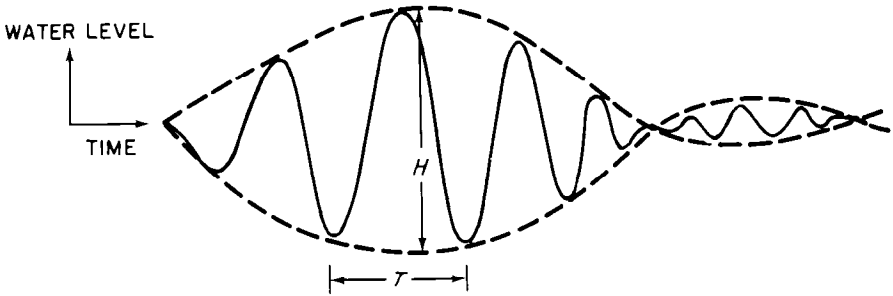

Figure 6.119. An explosion-generated wave train as observed at a given distance from surface zero.

6.120 The length is a critical factor in determining the changes taking place in a wave train running into shoal water (§ 6.59). If water depth becomes less than approximately $L/3$, successive waves in the train bunch up while wave speed increases. The period T remains the same. Of equal or greater importance is the fact that, after an initial small decrease, the height H increases as the water through which the wave is running becomes more shoal. The increase in height of a wave relative to its length (steepening) continues as the wave shoals until it becomes unstable and breaks, unless the bottom slope is so shallow that bottom friction dissipates the wave before it breaks.

6.121 A burst in shallow water, such as Bikini BAKER, delivers less energy to the water than a burst of the same yield in deep water; consequently the constant of proportionality in equation (6.119.1) becomes less as water depth decreases. An approximate relationship between wave height H and distance R from surface zero for a shallow burst ($d_w \leq 100 W^{0.25}$) is

$$H \approx 150 d_w \frac{W^{0.25}}{R}$$

with H and R in feet.

DAMAGE TO HYDRAULIC STRUCTURES

6.122 As is the case with air blast, it is to be expected that the damage to an underwater structure resulting from water shock will depend upon the dimensions of the structure and certain characteristic times. The particular times which appear to be significant are, on the one hand, the time constant of the shock wave (§ 6.116) and, on the other hand, the natural (or elastic) response time and the diffraction time of the structure, i.e., the time required for the shock wave to be propagated distances of the order of magnitude of the dimensions of the structure. In the event that the underwater structure is near the surface, the cutoff time (§ 6.43) would be significant in certain cases.

6.123 If the time constant of the pressure wave and the cutoff time are large compared to the times which are characteristic of the structure, that is to say, if the water shock wave is one of relatively long duration, the effect of the shock is similar to that of a steady (or static) pressure applied suddenly. In these circumstances, the peak pressure is the appropriate criterion of damage. Such would be the case for small, rigid

underwater structures, since they can be expected to have short characteristic times.

6.124 For large, rigid underwater structures, where the duration of the shock wave is short in comparison with the characteristic times of the structure, the impulse of the shock wave will be significant in determining the damage. It should be remembered, in this connection, that the magnitude of the impulse and damage will be greatly decreased if the negative reflected wave from the

air-water surface reaches the target and causes cutoff soon after the arrival of the primary shock wave.

6.125 If the large underwater structure can accept a substantial amount of permanent (plastic) deformation as a result of impact with the shock front, it appears that the damage depends essentially on the energy of the shock wave. If the structure is near the surface, the cutoff effect will decrease the amount of shock energy available for causing damage.

BIBLIOGRAPHY

- BARASH, R. M., and J. A. GOERTNER, "Refraction of Underwater Explosion Shock Waves: Pressure Histories Measured at Caustics in a Flooded Quarry," U.S. Naval Ordnance Laboratory, April 1967, NOLTR-67-9.
- CARLSON, R. H., and W. A. ROBERTS, "Project SEDAN, Mass Distribution and Throwout Studies," The Boeing Company, Seattle, Washington, August 1963, PNE-217E.
- CIRCEO, L. J., and M. D. NORDYKE, "Nuclear Cratering Experience at the Pacific Proving Grounds," University of California, Lawrence Radiation Laboratory, November 1964, UCRL-12172.
- COLE, R. H., "Underwater Explosions," Dover Publications, Inc., 1965. (Reprint of 1948 edition, Princeton University Press.)
- DAVIS, L. K., "MINE SHAFT Series, Events MINE UNDER and MINE ORE, Subtask, N121, Crater Investigations," U.S. Army Engineer Waterways Experiment Station, March 1970, Technical Report N-70-8.
- ENGD AHL, E. R., "Seismic Effects of the MILROW and CANNIKIN Nuclear Explosions," *Bull. Seismol. Soc. America*, **62**, 1411 (1972).
- FITCHETT, D. J., "MIDDLE COURSE I Cratering Series," U.S. Army Engineer Nuclear Cratering Group, June 1971, Technical Report 35.
- FRANSDEN, A. D., "Project CABRIOLET, Engineering Properties Investigations of the CABRIOLET Crater," U.S. Army Engineer Nuclear Cratering Group, March 1970, PNE-957.
- *GLASSTONE, S., "Public Safety and Underground Nuclear Detonations," U.S. Atomic Energy Commission, June 1971, TID-25708.
- HEALY, J. H., and P. A. MARSHALL, "Nuclear Explosions and Distant Earthquakes: A Search for Correlations," *Science*, **169**, 176 (1970).
- KOT, C. A., "Hydra Program: Theoretical Study of Bubble Behavior in Underwater Explosions," U.S. Naval Radiological Defense Laboratory, April 1964, USNRDL-TR-747.
- MALME, C. I., J. R. CARBONELL, and I. DYER, "Mechanisms in the Generation of Airblast by Underwater Explosions," U.S. Naval Ordnance Laboratory, September 1966, Bolt, Beranek and Newman Report No. 1434, NOLTR-66-88.
- NEWMARK, N. M., and W. J. HALL, "Preliminary Design Methods for Underground Protective Structures," University of Illinois, June 1962, AFSWC-TDR-62-6.
- NEWMARK, N. M., "Notes on Shock Isolation Concepts," Vibration and Civil Engineering Proceedings of Symposium of British National Section International Association for Earthquake Engineering, p. 71, Butterworths, London, 1966.
- PHILLIPS, D. E., and T. B. HEATHCOTE, "Underwater Explosion Tests of Two Steam Producing Explosives, I. Small Charge Tests," U.S. Naval Ordnance Laboratory, May 1966, NOLTR-66-79.
- **Proceedings of the Second Plowshare Symposium," Part I, Phenomenology of Underground Nuclear Explosions," University of California, Lawrence Radiation Laboratory, Livermore, May 1959, UCRL-5677.
- **Proceedings of the Third Plowshare Symposium, Engineering with Nuclear Explosives," April 1964, University of California, Lawrence Radiation Laboratory, Livermore, TID-7695.
- **Proceedings of the Symposium on Engineering with Nuclear Explosives," Las Vegas, Nevada, January 1970, American Nuclear Society and U.S. Atomic Energy Commission, CONF-700101, Vols. 1 and 2.

- *RODEAN, H. C., "Nuclear Explosion Seismology," AEC Critical Review Series, U.S. Atomic Energy Commission, September 1971, TID-25572.
- ROOKE, A. D., JR., and L. K. DAVIS, "FERRIS WHEEL Series, FLAT TOP Event, Crater Measurements," U.S. Army Engineer Waterways Experiment Station, August 1966, POR-3008.
- SNAY, H. G., "Hydrodynamic Concepts, Selected Topics for Underwater Nuclear Explosions," U.S. Naval Ordnance Laboratory, September 1966, NOLTR-65-52.
- Special Papers on Underground Nuclear Explosions at the Nevada Test Site, *Bull. Seismol. Soc. America*, **59**, 2167 *et seq.* (1969).
- Special Papers on the CANNIKIN Nuclear Explosion, *Bull. Seismol. Soc. America*, **62**, 1365 *et seq.* (1972).
- VAN DORN, W. G., B. LE MÉHAUTÉ, and L. HWANG, "Handbook of Explosion-Generated Water Waves Vol. I—State of the Art," Tetra Tech, Inc., Pasadena, California, October 1968, Report No. TC-130.
- VAN DORN, W. G., and W. S. MONTGOMERY, "Water Waves from 10,000-lb High-Explosive Charges," Final Report Operation HYDRA II-A, Scripps Institution of Oceanography, La Jolla, California, June 1963, S1063-20.
- VELETSOS, A. S., and N. M. NEWMARK, "Effect of Inelastic Behavior on the Response of Simple Systems to Earthquake Motions," University of Illinois, 1960, III. U.SRS 219.
- VELETSOS, A. S., and N. M. NEWMARK, "Response Spectra Approach to Behavior of Shock Isolation Systems," Vol. 2, Newmark, Hansen and Associates, Urbana, Illinois, June 1963.
- VORTMAN, L. J., "Craters from Surface Explosions and Scaling Laws," *J. Geophys. Res.*, **73**, 4621 (1968).

CHAPTER VII

THERMAL RADIATION AND ITS EFFECTS

RADIATION FROM THE FIREBALL

GENERAL CHARACTERISTICS OF THERMAL RADIATION

7.01 One of the important differences between a nuclear and a conventional high-explosive weapon is the large proportion of the energy of a nuclear explosion which is released in the form of thermal (or heat) radiation. Because of the enormous amount of energy liberated per unit mass in a nuclear weapon, very high temperatures are attained. These are estimated to be several tens of million degrees, compared with a few thousand degrees in the case of a conventional explosion. As a consequence of these high temperatures, about 70 to 80 percent of the total energy (excluding the energy of the residual radiation) is released in the form of electromagnetic radiation of short wavelength. Initially, the (primary) thermal radiations are mainly in the soft X-ray region of the spectrum but, for nuclear explosions below about 50 miles, the X rays are absorbed in air in the general vicinity of the burst, thereby heating it to high temperatures. Most of the remaining 20 to 30 percent of the

energy is initially in the form of kinetic energy of the weapon debris. This kinetic energy is also absorbed by the air at a slightly later time (§ 2.109) and serves to further heat the air. The heated air, which constitutes the fireball, in turn radiates in a spectral region roughly similar to that of sunlight near the earth's surface. It is the radiation (ultraviolet, visible, and infrared) from the fireball, traveling with the velocity of light, which constitutes the thermal radiation at distances from the explosion. The time elapsing, therefore, between the emission of this (secondary) thermal radiation from the fireball and its arrival at a target miles away, is quite insignificant.

7.02 It is desirable to state specifically what is meant by the term "thermal radiation" as it is used in the present chapter. Actually, all the energy released by a nuclear detonation, including the residual radiation from the weapon debris, is ultimately degraded to thermal energy, i.e., heat. But only part of it is regarded as constituting the thermal radiation of interest which can cause fire damage and personal injury at

or near the earth's surface. Some of the thermal radiations emitted by the fireball in the very early stages, particularly in the ultraviolet region, are selectively absorbed by various atomic and molecular species in the heated air, which slowly re-emits this energy in a degraded, i.e., longer wavelength, form. The delay in reaching the target, and the slower rate at which they are delivered, lowers the damaging effectiveness of these radiations. Consequently they are not considered as a part of the thermal radiation for present purposes. It is convenient, therefore, to define the effective (or prompt) thermal radiation as that emitted from the heated air of the fireball within the first minute (or less) following the explosion.

7.03 For an air burst at altitudes below about 100,000 feet (roughly 19 miles), the thermal radiation is emitted from the fireball in two pulses, as described in Chapter II. The first, which is quite short, carries roughly 1 percent of the total radiant energy (§ 2.39); the second pulse is the more significant and is of longer duration. The total length of the effective thermal pulse increases with the energy yield of the explosion. Thus the duration of the effective pulse from a 1-kiloton air burst is about 0.4 second, whereas from a 10-megaton explosion it is more than 20 seconds. With increasing altitude the character of the thermal radiation pulse changes (§ 2.130 *et seq.*). At altitudes above about 100,000 feet, there is only a single thermal pulse and its effective duration, which depends on the height of burst and the energy yield of the explosion, is of the order of a second or less for weapons in the megaton range. For explosions above about 270,000 feet (51

miles), the pulse length is somewhat longer.

7.04 In an ordinary air burst, i.e., at altitudes up to some 100,000 feet, roughly 35 to 45 percent of the total energy yield of the explosion is emitted as effective thermal radiation. The actual fraction of the energy that appears as such radiation depends on the height of burst and the total yield, as well as on the weapon characteristics; estimates of this fraction for various yields and burst altitudes will be given later (Table 7.88). For simplicity, however, it is often assumed that 35 percent of the total energy yield of an air burst is emitted as thermal radiation energy. This means that for every 1 kiloton TNT equivalent of energy release, about 0.35 kiloton, i.e., 3.5×10^{11} calories or about 410,000 kilowatt-hours, is in the form of thermal radiation. The proportion of this energy that reaches the surface depends on the distance from the burst point and on the state of the atmosphere.

7.05 A nuclear air burst can cause considerable blast damage; however, thermal radiation can result in serious additional damage by igniting combustible materials, e.g., finely divided or thin fuels such as dried leaves and newspapers. Thus, fires may be started in buildings and forests and may spread rapidly to considerable distances. In addition, thermal radiation is capable of causing skin burns and eye injuries to exposed persons at distances at which thin fuels are not ignited. Thermal radiation can, in fact, be an important cause of injuries to people from both direct exposure and as the result of fires, even at greater distances than other weapons effects.

ATTENUATION OF THERMAL RADIATION

7.06 The extent of injury or damage caused by thermal radiation or the chance of igniting combustible material depends to a large extent upon the amount of thermal radiation energy received by a unit area of skin, fabric, or other exposed material within a short interval of time. The thermal energy falling upon a given area from a specified explosion will be less the farther from the explosion, for two reasons: (1) the spread of the radiation over an ever increasing area as it travels away from the fireball, and (2) attenuation of the radiation in its passage through the air. These factors will be considered in turn.

7.07 If the radiation is distributed evenly in all directions, then at a distance D from the explosion the same amount of energy will fall upon each unit area of the surface of a sphere of radius D . The total area of this sphere is $4\pi D^2$, and if E is the thermal radiation energy produced in the explosion, the energy received per unit area at a distance D would be $E/4\pi D^2$, provided there were no attenuation by the atmosphere. Obviously, this quantity varies inversely as the square of the distance from the explosion. At 2 miles, from a given explosion, for example, the thermal energy received per unit area would be one-fourth of that received at half the distance, i.e., at 1 mile, from the same explosion.

7.08 In order to estimate the amount of thermal energy actually reaching the unit area, allowance must also be made for the attenuation of the radiation by the atmosphere. This attenuation is due to two main causes,

namely, absorption and scattering. Atoms and molecules present in the air are capable of absorbing, and thus removing, certain portions of the thermal radiation. The absorption is most effective for the shorter wavelength (or ultraviolet) rays. In this connection, oxygen molecules, as well as ozone, nitrogen dioxide, and nitrous acid formed from the gases in the atmosphere (§ 2.123), play an important part.

7.09 Because of absorption, the thermal radiation, particularly that in the ultraviolet region, decreases markedly with increasing distance from the explosion. Some of the absorbed radiation is subsequently reradiated, but the emission occurs with equal probability in all directions, so that the quantity proceeding in the direction of a given target is substantially reduced. Consequently, at those distances where persons exposed to thermal radiation could survive the blast and initial nuclear radiation effects, the proportion of ultraviolet radiation is quite small. However, the ultraviolet is more effective in causing biological injury than visible and infrared rays, so that even the small amount present could, under some conditions, be important.

7.10 Attenuation as a result of scattering, i.e., by the random diversion of rays from their original paths, occurs with radiations of all wavelengths. Scattering can be caused by molecules, such as oxygen and nitrogen, present in the air. This is, however, not as important as scattering resulting from the reflection and diffraction (or bending) of light rays by particles, e.g., of dust, smoke, or fog, in the atmosphere. The diversion of the radiation as a result of scattering interactions leads to a some-

what diffuse, rather than a direct, transmission of the thermal radiation.

EFFECT OF ATMOSPHERIC CONDITIONS

7.11 The decrease in energy of thermal radiation due to scattering by particles in the air depends upon the atmospheric conditions, such as the concentration and size of the particles, and also upon the wavelength of the radiation. This means that radiations of different wavelengths, namely, ultraviolet, visible, and infrared, will suffer energy attenuation to different extents. For most practical purposes, however, it is more convenient and reasonably satisfactory, although less precise, to postulate a mean attenuation averaged over all the wavelengths present in the thermal radiation.

7.12 The extent to which the atmosphere attenuates thermal energy and limits visibility depends largely on the scattering of radiation. Therefore, the state of the atmosphere as far as scattering is concerned can be represented by what is known as the daylight "visibility range" or, in brief, as the "visibility."

This is defined as the horizontal distance at which a large dark object on the horizon has just enough contrast with the surrounding sky to be discernible in daylight. The international code for correlating the visibility with the condition of the atmosphere is given in Table 7.12.

7.13 At first thought, it would be expected that the decrease of thermal radiation energy with increasing distance from the explosion would be greater when the visibility is low than when it is high. But, for the reason given below, it has been found that, at distances less than about half the visibility, the degree of attenuation of the thermal radiation is relatively insensitive to atmospheric conditions if at least moderately clear (10 miles or more) visibility prevails. At greater distances, however, a larger proportion of the radiant energy is indeed lost as the atmospheric visibility decreases. As a rough approximation, the amount of thermal energy received at a given distance from a nuclear explosion may be assumed to be independent of the visibility. This leads to overestimates at distances greater than about half the

Table 7.12

VISIBILITY AND CONDITION OF THE ATMOSPHERE

Atmospheric Condition	Visibility	
	Kilometers	Miles
Exceptionally clear	280	170
Very clear	50	31
Clear	20	12
Light haze	10	6
Haze	4	2.5
Thin fog	2	1.2
Light to thick fog	1 or less	0.6 or less

visibility range, but from the standpoint of protection from thermal radiation such estimates would be preferable to those which err in being too low.

7.14 The thermal radiation received at a given distance from a nuclear explosion is made up of both directly transmitted (unscattered) and scattered radiations. If the air is clear, and there are very few suspended particles, the extent of scattering is small, and the radiation received is essentially only that which has been transmitted from the exploding weapon without scattering. If the air contains a moderately large number of particles, the amount of radiation transmitted directly will be less than in a clear atmosphere. But this decrease is largely compensated by an increase in the scattered radiation reaching the object (or area) under consideration. Multiple scattering, i.e., subsequent scattering of already scattered radiation, which is very probable when the concentration of particles is high, will result in the arrival of radiation at the target from many directions. An appreciable amount of thermal radiation will thus reach the given area indirectly, in addition to that transmitted directly. It is because of the partial compensation due to multiple scattering that the total amount of energy from a nuclear explosion falling upon unit area at a given distance may not be too greatly dependent upon the visibility range, within certain limits.

7.15 Under atmospheric conditions of rain, fog, or dense industrial haze, absorption due to the increase in water vapor and carbon dioxide content of the air will play a predominant role in the attenuation of thermal radiation. The loss in the directly transmitted radiation,

from scattering and absorption, cannot then be compensated by multiple scattering. Hence, less radiant energy is received at a specified distance from the explosion than for clear visibility conditions.

EFFECT OF SMOKE, FOG, AND CLOUDS

7.16 In the event of an air burst occurring above a layer of dense cloud, smoke, or fog, an appreciable portion of the thermal radiation will be scattered upward from the top of the layer. This scattered radiation may be regarded as lost, as far as a point on the ground is concerned. In addition, most of the radiation which penetrates the layer will be scattered, and very little will reach the given point by direct transmission. These two effects will result in a substantial decrease in the amount of thermal energy reaching a ground target covered by fog or smoke, from a nuclear explosion above the layer.

7.17 It is important to understand that the decrease in thermal radiation by fog and smoke will be realized only if the burst point is above or, to a lesser extent, within the fog (or similar) layer. If the explosion should occur in moderately clear air beneath a layer of cloud or fog, some of the radiation which would normally proceed outward into space will be scattered back to earth. As a result, there may be some cases in which the thermal energy received will actually be greater than for the same atmospheric transmission conditions without a cloud or fog cover. (A layer of snow on the ground will have much the same effect as a cloud layer above the burst (§ § 7.43, 7.100)).

EFFECT OF SHIELDING

7.18 Unless it is scattered, thermal radiation from a nuclear explosion, like ordinary light, travels in straight lines from the fireball. Any solid, opaque material, e.g., a wall, a hill, or a tree, between a given object and the fireball will act as a shield and provide protection from thermal radiation. Some instances of such shielding, many of which were observed after the nuclear explosions in Japan, will be described later. Transparent materials, on the other hand, such as glass or plastics, allow thermal radiation to pass through only slightly attenuated.

7.19 A shield which merely intervenes between a given target and the fireball but does not surround the target, may not be entirely effective under hazy atmospheric conditions. A large proportion of the thermal radiation received, especially at considerable distances from the explosion, has undergone multiple scattering and will arrive from all directions, not merely that from the point of burst. This situation should be borne in mind in connection with the problem of thermal radiation shielding.

TYPE OF BURST

7.20 The foregoing discussion has referred in particular to thermal radiation from a nuclear air burst. For other types of burst the general effects are the same, although they differ in degree. For a surface burst, in which the fireball actually touches the earth or water, the proportion of the explosion energy appearing at a distance as thermal radiation will be less than for an air burst. Some energy is utilized in melting or

evaporating surface material, but this is relatively small (about 1 or 2 percent) and has a minor effect on the thermal radiation emitted. As far as the energy received at a distance from the explosion is concerned, other factors are more significant. First, there will be a certain amount of shielding due to terrain irregularities and, second, some absorption of the radiation will occur in the low layer of dust or water vapor produced near the burst point in the early stages of the explosion. In addition, most of the thermal radiation reaching a given target on the ground will have traveled through the air near the earth's surface. In this part of the atmosphere there is considerable absorption by molecules of water vapor and of carbon dioxide and the extent of scattering by various particles is greater than at higher altitudes. Consequently, in a surface burst, the amount of thermal energy reaching a target at a specified distance from the explosion may be from half to three-fourths of that from an air burst of the same total energy yield. However, when viewed from above, e.g., from an aircraft, surface explosions exhibit the same thermal characteristics as air bursts.

7.21 In subsurface bursts, either in the earth or under water, nearly all the thermal radiation is absorbed, provided there is no appreciable penetration of the surface by the fireball. The thermal energy is then used up in heating and melting the soil or vaporizing the water, as the case may be. Normal thermal radiation effects, such as accompany an air burst, are thus absent.

7.22 When nuclear explosions occur at high altitudes, i.e., somewhat above 100,000 feet, the primary thermal

X rays from the extremely hot weapon residues are absorbed in a large volume (and mass) of air because of the low density, as explained in § 2.131 *et seq.* Consequently, the fireball temperatures are lower than for an air burst at lower

altitude (§ 7.81), with the result that, although about half of the absorbed energy is emitted as thermal radiation in less than a second, the remainder of the thermal energy is radiated so slowly that it can be ignored as a significant effect.

THERMAL RADIATION EFFECTS

ABSORPTION OF THERMAL RADIATION

7.23 The amount of thermal energy falling upon a unit area exposed to a nuclear explosion depends upon the total energy yield, the height of burst, the distance from the explosion, and, to some extent, the atmospheric conditions. The thermal radiation leaving the fireball covers a wide range of wavelengths, from the short ultraviolet, through the visible, to the infrared region. Much of the ultraviolet radiation is absorbed or scattered in its passage through the atmosphere with the result that at a target near the earth's surface less ultraviolet radiation is received than might be expected from the temperature of the fireball.¹

7.24 When thermal radiation falls upon any material or object, part may be reflected, part will be absorbed, and the remainder, if any, will pass through and ultimately fall upon other materials. It is the radiation absorbed by a particular material that produces heat and so determines the damage suffered by that

material. The extent or fraction of the incident radiation that is absorbed depends upon the nature and color of the material or object. Highly reflecting and transparent substances do not absorb much of the thermal radiation and so they are relatively resistant to its effects. A thin material will often transmit a large proportion of the radiation falling upon it and thus escape serious damage. A black fabric will absorb a much larger proportion of the incident thermal radiation than will the same fabric when white in color. The former will thus be more affected than the latter. A light-colored material will then not char as readily as a dark piece of the same material.

7.25 Essentially all of the thermal radiation absorbed serves to raise the temperature of the absorbing material and it is the high temperature attained which causes injury or damage, or even ignition of combustible materials. An important point about the thermal radiation from a nuclear explosion is not only that the amount of energy is consider-

¹It is known, from theoretical studies and experimental measurements, that the wavelength corresponding to the maximum energy density of radiation from an ideal (or "black body") radiator, to which the nuclear fireball is a good approximation, decreases with increasing temperature of the radiation. At temperatures above 7,500°K (13,000°F), this maximum lies in the ultraviolet and X-ray regions of the spectrum (§ 7.78).

able, but also that it is emitted in a very short time. This means that the intensity of the radiation, i.e., the rate at which it is incident upon a particular surface, is very high. Because of this high intensity, the heat accompanying the absorption of the thermal radiation is produced with great rapidity.

7.26 Since only a small proportion of the heat is dissipated by conduction in the short time during which the radiation falls upon the material—except perhaps in good heat conductors such as metals—the absorbed energy is largely confined to a shallow depth of the material. Consequently, very high temperatures are attained at the surface. It has been estimated, for example, that in the nuclear explosions in Japan (§ 2.24), solid materials on the ground immedi-

ately below the burst probably attained surface temperatures of 3,000 to 4,000°C (5,400 to 7,200°F). It is true that the temperatures fell off rapidly with increasing distance from the explosion, but there is some evidence that they reached 1,800°C (3,270°F) at 3,200 feet (0.61 mile) away (§ 7.47).

7.27 The most important physical effects of the high temperatures resulting from the absorption of thermal radiation are burning of the skin, and scorching, charring, and possibly ignition of combustible organic substances, e.g., wood, fabrics, and paper (Fig. 7.27). Thin or porous materials, such as lightweight fabrics, newspaper, dried grass and leaves, and dry rotted wood, may flame when exposed to thermal radiation. On the other hand, thick or-



Figure 7.27. Thermal radiation from a nuclear explosion ignited the upholstery and caused fire to spread in an automobile, Nevada Test Site.

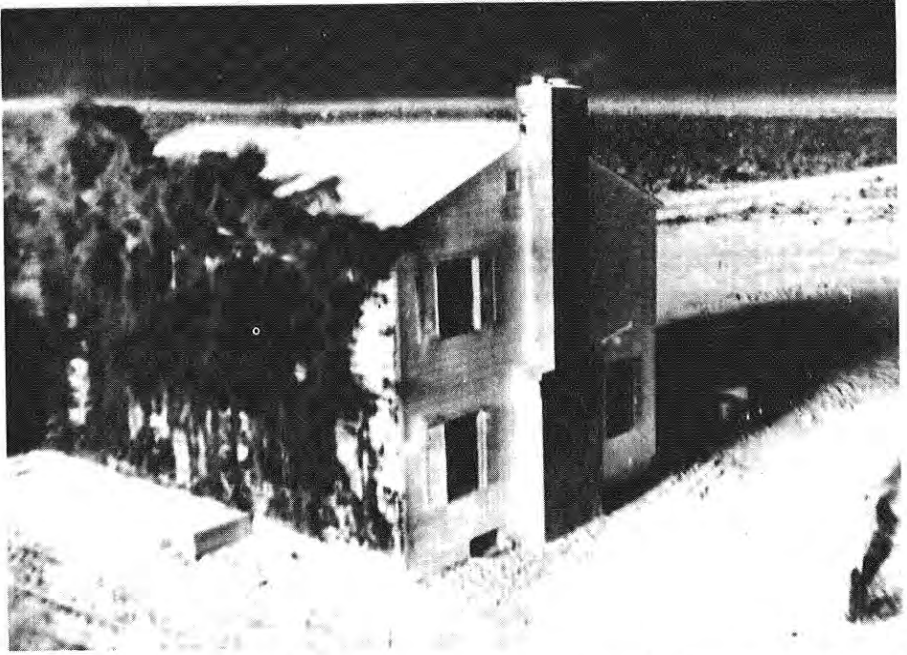

Figure 7.28a. Thermal effects on wood-frame house 1 second after explosion (about 25 cal/cm^2).

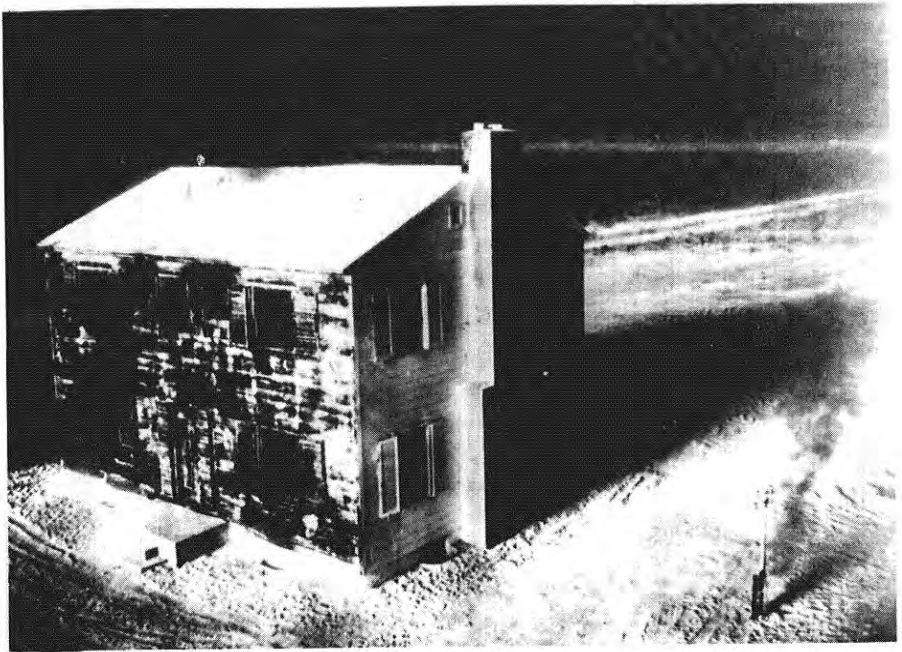

Figure 7.28b. Thermal effects on wood-frame house about $\frac{3}{4}$ second later.

ganic materials, for example, wood (more than $\frac{1}{2}$ inch thick), plastics, and heavy fabrics, char but do not burn. Dense smoke, and even jets of flame, may be emitted, but the material does not sustain ignition. If the material is light colored and blackens readily by charring in the initial stages of exposure to thermal radiation, it will absorb the subsequent thermal radiation more readily. However, smoke formed in the early stages will partially shield the underlying material from subsequent radiation.

7.28 This behavior is illustrated in the photographs taken of one of the wood-frame houses exposed in the 1953 Nevada tests. As mentioned in § 5.55, the houses were given a white exterior finish in order to reflect the thermal radiation and minimize the chances of fire. Virtually at the instant of the burst, the house front became covered with a thick black smoke, as shown in Fig. 7.28a. There was, however, no sign of flame. Very shortly thereafter, but before the arrival of the blast wave, i.e., within less than 2 seconds from the explosion, the smoke ceased, as is apparent from Fig. 7.28b. Ignition of the wood did not occur.

7.29 The ignition of materials by thermal radiation depends upon a number of factors, the two most important, apart from the nature of the material itself, being the thickness and the moisture content. A thin piece of a given material, for example, will ignite more easily than a thick one, and a dry

sample will be more readily damaged than one that is damp.

7.30 An important consideration in connection with charring and ignition of various materials and with the production of skin burns by thermal radiation is the rate at which the thermal energy is delivered. For a given total amount of thermal energy received by each unit area of exposed material, the damage will be greater if the energy is delivered rapidly than if it were delivered slowly. This means that, in order to produce the same thermal effect in a given material, the total amount of thermal energy (per unit area) received must be larger for a nuclear explosion of high yield than for one of the lower yield, because a given amount of energy is delivered over a longer period of time, i.e., more slowly, in the former case.

7.31 There is evidence that for thermal radiation pulses of very short duration, such as might arise from air bursts of low-yield weapons or from explosions of large yield at high altitudes, this trend is reversed. In other words, a given amount of energy may be less effective if delivered in a very short pulse, e.g., a fraction of second, than in one of moderate duration, e.g., one or two seconds. In some experiments in which certain materials were exposed to short pulses of thermal radiation, it was observed that the surfaces were rapidly degraded and vaporized. It appeared as if the surface had been "exploded" off the material, leaving the remainder with very little sign of

damage. The thermal energy incident upon the material was apparently dissipated in the kinetic energy of the "exploding" surface molecules before the radiation could penetrate into the depth of the material.

THERMAL RADIATION EFFECTS ON SKIN AND EYES

7.32 One of the serious consequences of the thermal radiation from a nuclear explosion is the production of "flash burns" resulting from the absorption of radiant energy by the skin of exposed individuals. In addition, because of the focusing action of the lens of the eye, thermal radiation can cause permanent damage to the eyes of persons who happen to be looking directly at the burst; however, such direct viewing will be fortuitous and rare. What is expected to be a more frequent occurrence, and therefore much more important to defensive action, is the temporary loss of visual acuity (flash blindness or dazzle) resulting from the extreme brightness, particularly at night when the eyes have been adapted to the dark. This may be experienced no matter what the direction in which the individual is facing. The various effects of thermal radiation on human beings will be considered more fully in Chapter XII.

THERMAL RADIATION DAMAGE TO FABRICS, WOOD, AND PLASTICS

7.33 Mention has already been made of the damage caused to fabrics by the high surface temperatures accompanying the absorption of thermal radiation. Natural fibers, e.g., cotton and wool, and some synthetic materials,

e.g., rayon, will scorch, char, and perhaps burn; nylon, on the other hand, melts when heated to a sufficient extent. The heat energy required to produce a particular change in a fabric depends on a variety of circumstances. The following generalizations, however, appear to hold in most instances.

7.34 Dark-colored fabrics absorb the radiation, and hence suffer damage more readily than do the same fabrics if light in color. Even in this connection there are variations according to the method of dyeing and the particular fiber involved. Wool is more resistant to radiant energy than cotton or rayon, and these are less easily affected than nylon. Orlon appears to be appreciably more resistant than nylon. Fabrics of light weight (for a given area) need less thermal energy to cause specific damage than do those of heavy weight. The energy required, for the same exposure time, is roughly proportional to the fabric weight per unit area. Fabric with a moderate moisture content behaves like dry fabric, but if the amount of moisture is fairly high, more thermal energy will be needed to produce damage.

7.35 Although extensive studies have been made of the effects of thermal radiation on a large number of individual fabrics, it is difficult to summarize the results because of the many variables that have a significant influence. Some attempt is nevertheless made in Table 7.35 to give an indication of the magnitude of the exposures required to ignite (or otherwise damage) various fabric materials by the absorption of thermal radiation. The values are expressed in terms of gram-calories of thermal energy incident upon a 1 square centimeter area of material, i.e.,

Table 7.35

APPROXIMATE RADIANT EXPOSURES FOR IGNITION OF FABRICS FOR LOW AIR BURSTS

Material	Weight (oz/yd ²)	Color	Effect on Material	Radiant Exposure* (cal/cm ²)		
				35 kilotons	1.4 megatons	20 megatons
CLOTHING FABRICS						
Cotton	8	White	Ignites	32	48	85
		Khaki	Tears on flexing	17	27	34
		Khaki	Ignites	20	30	39
		Olive	Tears on flexing	9	14	21
		Olive	Ignites	14	19	21
		Dark blue	Tears on flexing	11	14	17
		Dark blue	Ignites	14	19	21
Cotton corduroy	8	Brown	Ignites	11	16	22
Cotton denim, new	10	Blue	Ignites	12	27	44
Cotton shirting	3	Khaki	Ignites	14	21	28
Cotton-nylon mixture	5	Olive	Tears on flexing	8	15	17
		Olive	Ignites	12	28	53
Wool	8	White	Tears on flexing	14	25	38
		Khaki	Tears on flexing	14	24	34
		Olive	Tears on flexing	9	13	19
		Dark blue	Tears on flexing	8	12	18
Rainwear (double neo- prene-coated nylon twill)	20	Dark blue	Tears on flexing	14	20	26
		9	Olive	Begins to melt	5	9
		Olive	Tears on flexing	8	14	22
DRAPERY FABRICS						
Rayon gabardine	6	Black	Ignites	9	20	26
Rayon-acetate drapery	5	Wine	Ignites	9	22	28
Rayon gabardine	7	Gold	Ignites	**	24†	28†
Rayon twill lining	3	Black	Ignites	7	17	25
Rayon twill lining	3	Beige	Ignites	13	20	28
Acetate-shantung	3	Black	Ignites	10†	22†	35†
Cotton heavy draperies	13	Dark				
		colors	Ignites	15	18	34
TENT FABRICS						
Canvas (cotton)	12	White	Ignites	13	28	51
Canvas	12	Olive				
		drab	Ignites	12	18	28
OTHER FABRICS						
Cotton chenille bedspread		Light blue	Ignites	**	11†	15†
Cotton venetian blind tape, dirty		White	Ignites	10	18	22
		White	Ignites	13†	27†	31†
Cotton muslin window shade	8	Green	Ignites	7	13	19

*Radiant exposures for the indicated responses (except where marked †) are estimated to be valid to $\pm 25\%$ under standard laboratory conditions. Under typical field conditions the values are estimated to be valid within $\pm 50\%$ with a greater likelihood of higher rather than lower values. For materials marked †, ignition levels are estimated to be valid within $\pm 50\%$ under laboratory conditions and within $\pm 100\%$ under field conditions.

cal/cm², generally referred to as the "radiant exposure." Results are presented for low air bursts with arbitrary energy yields of 35 kilotons, 1.4 megatons, and 20 megatons. It will be noted that, for the reasons given in § 7.30, the radiant exposure required to produce a particular effect increases with the yield.

7.36 Since the shape and duration of the thermal pulse depend on the actual burst altitude, as well as on the yield, the radiant exposures given in Table 7.35 for "low air bursts" are somewhat approximate. In general, however, the radiant exposures in the three columns would apply to nuclear explosions below 100,000 feet altitude for which the times to the second maximum in the fireball temperature are 0.2, 1.0, and 3.2 seconds, respectively (§ 7.85).

7.37 Wood is charred by exposure to thermal radiation, the depth of the char being closely proportional to the radiant exposure. For sufficiently large amounts of energy per unit area, wood in some massive forms may exhibit transient flaming but persistent ignition is improbable under the conditions of a nuclear explosion. However, the transitory flame may ignite adjacent combustible material which is not directly exposed to the radiation. In a more-or-less finely divided form, such as sawdust, shavings, or excelsior, or in a decayed, spongy (punk) state, wood can be ignited fairly readily by the thermal radiation from a nuclear explosion, as will be seen below.

7.38 Roughly speaking, something

like 10 to 15 calories per square centimeter of thermal energy are required to produce visible charring of unpainted and unstained pine, douglas fir, redwood, and maple. Dark staining increases the tendency of the wood to char, but light-colored paints and hard varnishes provide protection.²

7.39 Glass is highly resistant to heat, but as it is very brittle it is sometimes replaced by transparent or translucent plastic materials or combined with layers of plastic, as in automobile windshields, to make it shatterproof. These plastics are organic compounds and so are subject to decomposition by heat. Nevertheless, many plastic materials, such as Bakelite, cellulose acetate, Lucite, Plexiglas, polyethylene, and Teflon, have been found to withstand thermal radiation remarkably well. At least 60 to 70 cal/cm² of thermal energy are required to produce surface melting or darkening.

RADIANT EXPOSURES FOR IGNITION OF VARIOUS MATERIALS

7.40 Studies have been made in laboratories and at nuclear tests of the radiant exposures required for the ignition of various common household items and other materials of interest. The results for low air bursts with three arbitrary yields are presented in Table 7.40; the conditions and limitations noted in § 7.36 also hold here. The radiant exposures given would be applicable to explosions at altitudes below 100,000 feet.

²The thermal radiation energy incident on the front of the house referred to in § 7.28 was about 25 cal/cm².

Table 7.40
APPROXIMATE RADIANT EXPOSURES FOR IGNITION OF VARIOUS MATERIALS
FOR LOW AIR BURSTS

Material	Weight (oz/yd ²)	Color	Effect on Material	Radiant Exposure* (cal/cm ²)		
				35 kilotons	1.4 megatons	20 megatons
HOUSEHOLD TINDER MATERIALS						
Newspaper, shredded	2		Ignites	4	6	11
Newspaper, dark picture area	2		Ignites	5	7	12
Newspaper, printed text area	2		Ignites	6	8	15
Crepe paper	1	Green	Ignites	6	9	16
Kraft paper	3	Tan	Ignites	10	13	20
Bristol board, 3 ply	10	Dark	Ignites	16	20	40
Kraft paper carton, used (flat side)	16	Brown	Ignites	16	20	40
New bond typing paper	2	White	Ignites	24+	30+	50+
Cotton rags		Black	Ignites	10	15	20
Rayon rags		Black	Ignites	9	14	21
Cotton string scrubbing mop (used)		Gray	Ignites	10†	15+	21+
Cotton string scrubbing mop (weathered)		Cream	Ignites	10+	19+	26+
Paper book matches, blue head exposed			Ignites	11+	14+	20+
Excelsior, ponderosa pine	2 lb/ft ³	Light yellow	Ignites	**	23+	23+
OUTDOOR TINDER MATERIALS***						
Dry rotted wood punk (fir)			Ignites	4†	6†	8†
Deciduous leaves (beech)			Ignites	4	6	8
Fine grass (cheat)			Ignites	5	8	10
Coarse grass (sedge)			Ignites	6	9	11
Pine needles, brown (ponderosa)			Ignites	10	16	21
CONSTRUCTION MATERIALS						
Roll roofing, mineral surface			Ignites	**	>34	>116
Roll roofing, smooth surface			Ignites	**	30	77
Plywood, douglas fir			Flaming during exposure	9	16	20
Rubber, pale latex			Ignites	50	80	110
Rubber, black			Ignites	10	20	25
OTHER MATERIALS						
Aluminum aircraft skin (0.020 in. thick) coated with 0.002 in. of standard white aircraft paint			Blisters	15	30	40
Cotton canvas sandbags, dry filled			Failure	10	18	32
Coral sand			Explodes (popcorning)	15	27	47
Siliceous sand			Explodes (popcorning)	11	19	35

*Radiant exposures for the indicated responses (except where marked †) are estimated to be valid to $\pm 25\%$ under standard laboratory conditions. Under typical field conditions, the values are estimated to be valid within $\pm 50\%$ with a greater likelihood of higher rather than lower values. For materials marked †, ignition levels are estimated to be valid within $\pm 50\%$ under laboratory conditions and within $\pm 100\%$ under field conditions.

**Data not available or appropriate scaling not known.

***Radiant exposures for ignition of these substances are highly dependent on the moisture content.

RADIANT EXPOSURE AND SLANT RANGE

7.41 In order to utilize the data in Tables 7.35 and 7.40 to determine how far from the burst point, for an explosion of given energy yield, ignition of a particular material would be observed, it is required to know how the thermal energy varies with distance. For a specific explosion yield, the variation of radiation exposure with distance from the point of burst depends upon a number of factors, including the height of burst and the condition (or clarity) of the atmosphere. As seen earlier, the proportion of the total yield that appears as thermal energy and the character and duration of the thermal pulse vary with the height of burst. Furthermore, the height of burst and the atmospheric visibility determine the fraction of the thermal energy that can penetrate the atmosphere.

7.42 The variation of radiant exposure on the ground with slant range from the explosion for a particular set of conditions can be conveniently represented in the form of Fig. 7.42. These curves were calculated for burst heights of $200 W^{0.4}$ feet, where W is the explosion yield in kilotons (see § 7.99), but they provide reasonably good predictions of radiant exposures from air bursts at altitudes up to about 15,000 feet, for a visibility of 12 miles. This visibility represents the conditions for typical urban areas on a clear day. For air bursts at altitudes above 15,000 feet, Fig. 7.42 is not satisfactory and the procedures described in § 7.93 *et seq.* should be used. For bursts at low altitudes, e.g., less than $180 W^{0.4}$ feet,

which are essentially surface bursts (cf. § 2.128), radiant exposures should be calculated by using the procedures in § 7.101 *et seq.*

7.43 The application of Fig. 7.42 may be illustrated by estimating the range over which ignition may occur in newspaper as a result of exposure to a 1000-kiloton (1-megaton) air burst under the conditions specified above. According to Table 7.40, the radiant exposure for the ignition of newspaper is about 8 cal/cm^2 in a 1-megaton explosion. Fig. 7.42 is entered at the point on the yield scale corresponding to 1 megaton (10^3 kilotons); the perpendicular line is then followed until it intersects the curve marked 8 cal/cm^2 of radiant exposure. The intersection is seen to correspond to a slant range of about 7 miles from the explosion. This is the range at which the thermal radiation from a 1-megaton air burst (below 15,000 feet altitude) could cause ignition in newspaper when the visibility is 12 miles. Under hazy conditions, such as often exist in large cities, the visibility would be less and the ignition range might be smaller. Similarly, a layer of dense cloud or smoke between the target and the burst point will decrease the distance over which a specified ignition may occur. However, if the explosion were to take place between a cloud layer and the target or if the ground surface is highly reflective, as when covered with snow, the distance would be greater than indicated by Fig. 7.42.

THERMAL EFFECTS ON MATERIALS IN JAPAN³

7.44 Apart from the actual ignition of combustible materials resulting in

³The effects of thermal radiations on people in Japan are described in Chapter XII.

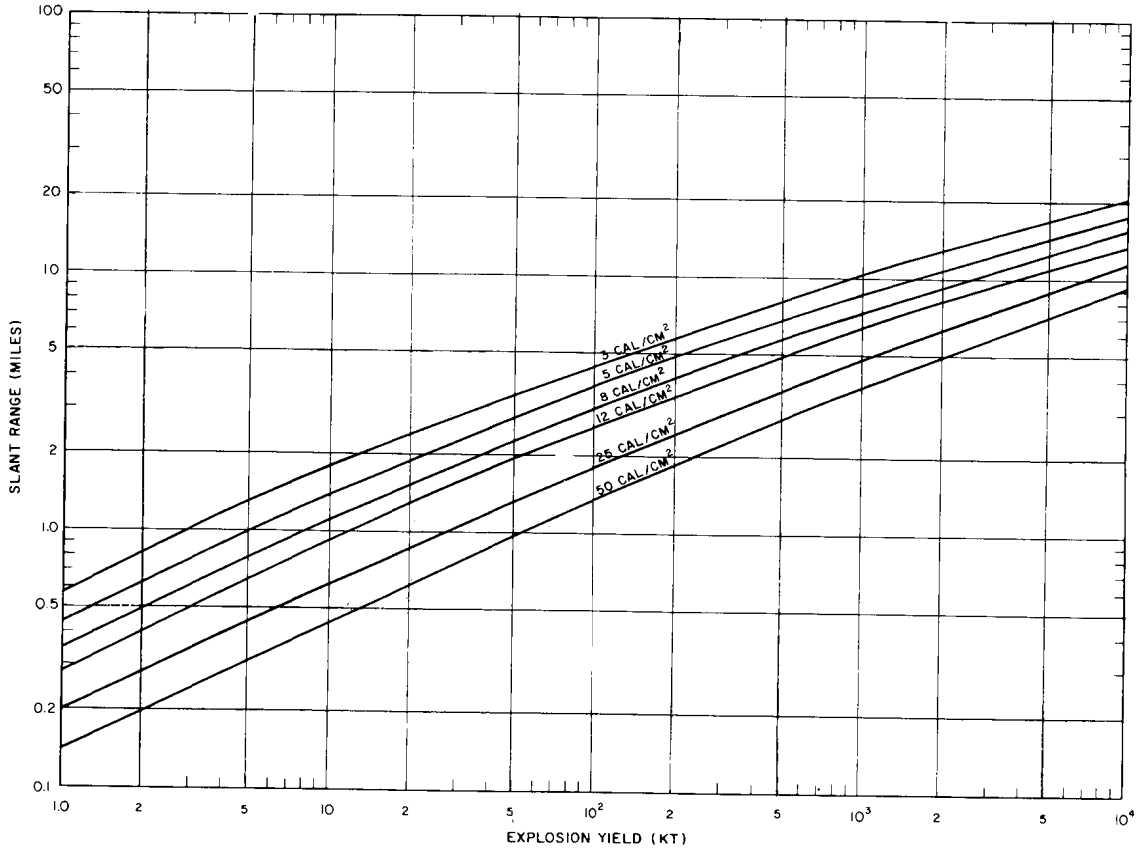

Figure 7.42. Slant ranges for specified radiant exposures on the ground as a function of energy yield of air bursts at altitudes up to 15,000 feet for a 12-mile visibility.

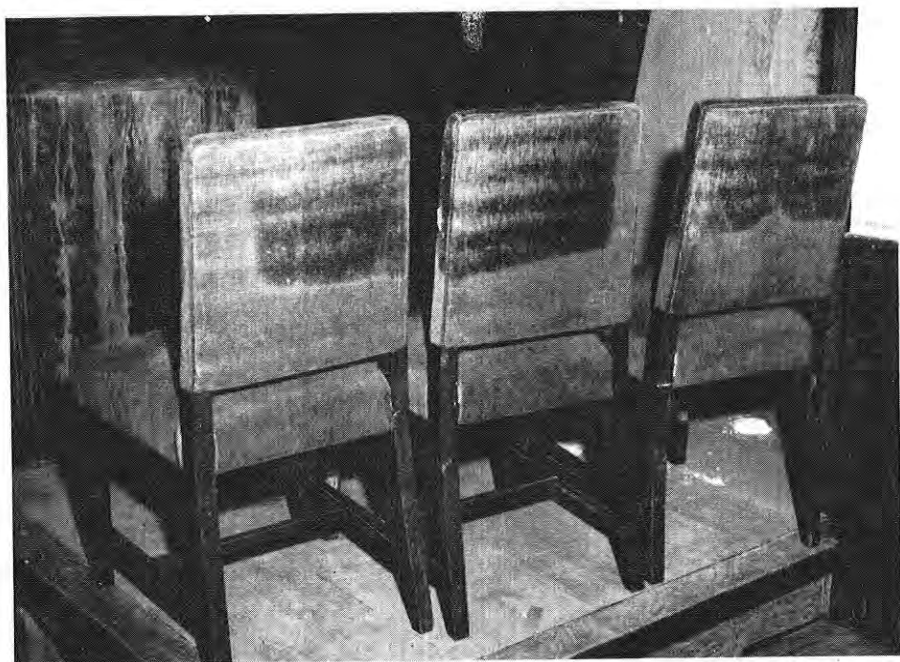

Figure 7.44a. Flash burns on upholstery of chairs exposed to bomb flash at window (1 mile from ground zero at Hiroshima, 8 to 9 cal/cm²).

fires being started, which will be referred to later, a number of other phenomena observed in Japan testified to the intense heat due to the absorption of thermal radiation. Fabrics (Fig. 7.44a), utility poles (Fig. 7.44b), trees, and wooden posts, up to a radius of 11,000 feet (2.1 miles) from ground zero to Nagasaki (estimated 3.4 cal/cm² radiant exposure) and 9,000 feet (1.7 miles) at Hiroshima (estimated 3 cal/cm²), if not destroyed in the general conflagration, were charred and blackened, but only on the side facing the point of burst. Where there was protection by buildings, walls, hills, and other objects there was no evidence of thermal radiation effects. An interesting case of shadowing of this kind was recorded at Nagasaki. The tops and upper parts of a row of wooden

posts were heavily charred, but the charred area was sharply limited by the shadow of a wall. The wall was, however, completely demolished by the blast wave which arrived after the thermal radiation. This radiation travels with the speed of light, whereas the blast wave advances much more slowly (§ 3.09).

7.45 From observations of the shadows left by intervening objects where they shielded otherwise exposed surfaces (Figs. 7.45a and b), the direction of the center of the explosion was located with considerable accuracy. Furthermore, by examining the shadow effects at various places around the explosion, a good indication was obtained of the height of burst. Occasionally, a distinct penumbra was found, and from

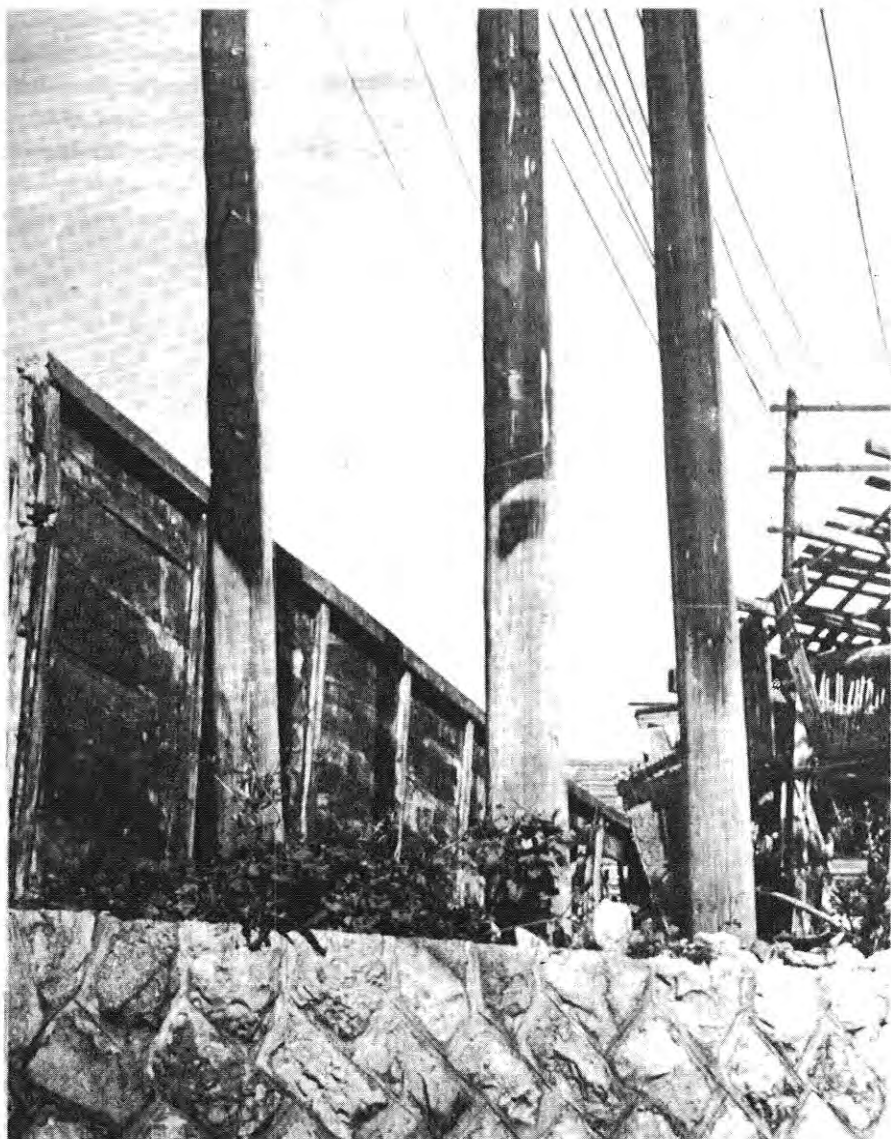

Figure 7.44b. Flash burns on wooden poles (1.17 miles from ground zero at Nagasaki, 5 to 6 cal/cm²). The uncharred portions were protected from thermal radiation by a fence.



Figure 7.45a. Flash marks produced by thermal radiation on asphalt of bridge in Hiroshima. Where the railings served as a protection from the radiation, there were no marks; the length and direction of the "shadows" indicate the point of the bomb explosion.

this it was possible to calculate the diameter of the fireball at the time the thermal radiation intensity was at a maximum.

7.46 One of the striking effects of the thermal radiation was the roughening of the surface of polished granite where there was direct exposure. This roughening was attributed to the unequal expansion of the constituent crys-

tals of the stone, and it is estimated that a temperature of at least 600°C ($1,100^{\circ}\text{F}$) was necessary to produce the observed effects. From the depth of the roughening and ultimate flaking of the granite surface, the depth to which this temperature was attained could be determined. These observations were used to calculate the maximum ground temperatures at the time of the explosion.

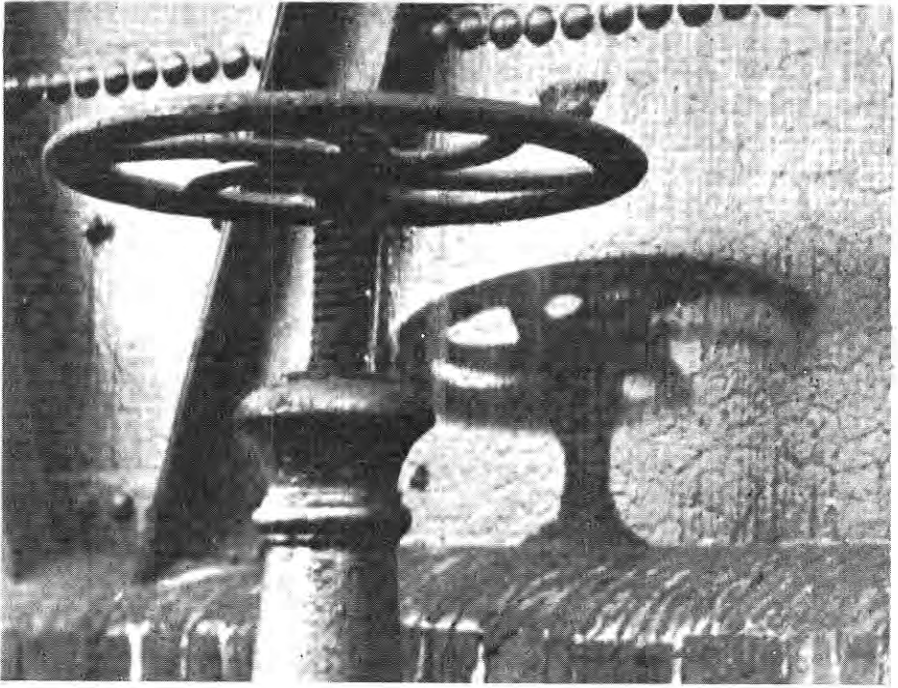

Figure 7.45b. Paint on gas holder scorched by the thermal radiation, except where protected by the valve (1.33 miles from ground zero at Hiroshima).

As mentioned in § 7.26, they were extremely high, especially near ground zero.

7.47 Another thermal effect, which proved to be valuable in subsequent studies, was the bubbling or blistering of the dark green (almost black) tile with a porous surface widely used for roofing in Japan (Fig. 7.47). The phenomenon was reported as far as 3,200 feet (0.61 mile) from ground zero at Hiroshima, where the radiant exposure was estimated to have been 45 cal/cm^2 . The size of the bubbles and their extent increased with proximity to ground zero, and also with the directness with which the tile itself faced the explosion. In a laboratory test, using undamaged tile of the

same kind, it was found that similar blistering could be obtained by heating to $1,800^\circ\text{C}$ ($3,270^\circ\text{F}$) for a period of 4 seconds, although the effect extended deeper into the tile than it did in Japan. From this result, it was concluded that in the nuclear explosion the tile attained a surface temperature of more than $1,800^\circ\text{C}$ for a period of less than 4 seconds.

7.48 The difference in behavior of light and dark fabrics exposed to thermal radiation in Japan is also of considerable interest. Light-colored fabrics either reflect or transmit most of the thermal radiation and absorb very little. Consequently, they will not reach such a high temperature and will suffer less

damage than dark fabrics which absorb a large proportion of the radiation. In one case, a shirt with alternate narrow light and dark gray stripes had the dark stripes burned out by a radiant exposure of about 7 cal/cm^2 , whereas the light-

colored stripes were undamaged (Fig. 7.48). Similarly, a piece of paper which had received approximately 5 cal/cm^2 had the characters, written in black ink, burned out, but the rest of the paper was not greatly affected.

INCENDIARY EFFECTS

ORIGIN OF FIRES

7.49 There are two general ways in which fires can originate in a nuclear explosion. First, as a direct result of the absorption of thermal radiation, thin kindling fuels can be ignited. And second, as an indirect effect of the destruction caused by the blast wave, fires can be started by upset stoves, water heaters, and furnaces, electrical short cir-

cuits, and broken gas lines. No matter how the fire originates, its subsequent spread will be determined by the amount and distribution of combustible materials in the vicinity.

7.50 In urban areas kindling fuels which can be ignited by direct exposure to thermal radiation are located both indoors and out of doors. Interior igni-



Figure 7.47. Blistered surface of roof tile; left portion of the tile was shielded by an overlapping one (0.37 mile from ground zero at Hiroshima).

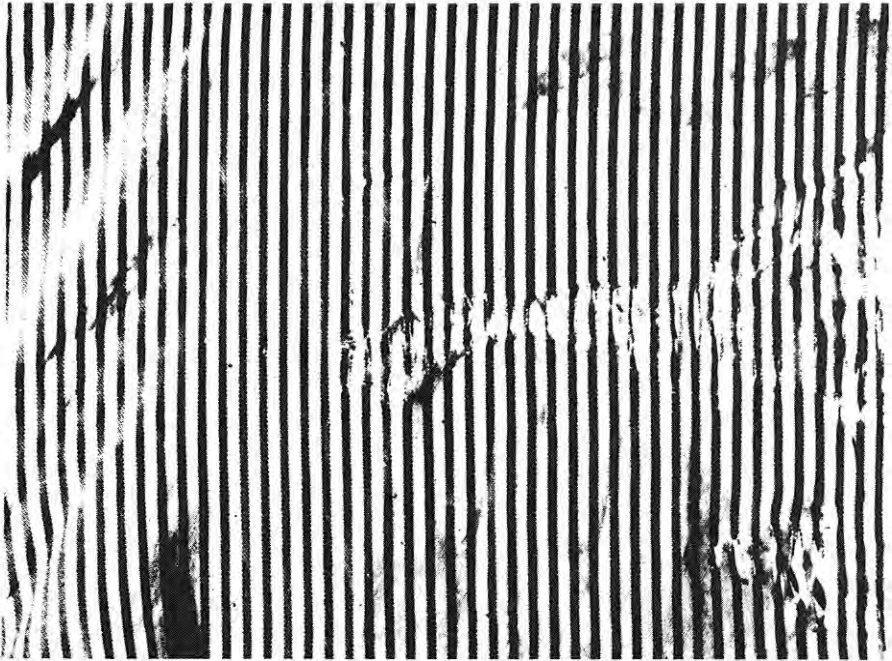

Figure 7.48. The light-colored portions of the material are intact, but some of the dark-colored stripes have been destroyed by the heat from the thermal radiation.

tion points could receive thermal radiation through a window or other opening. The thermal exposure at any interior point would be roughly proportional to the fraction of the fireball that would be visible at that point through the opening. If the thermal radiation should pass through a glass window, the amount entering a room would be about 80 percent of that falling on the exterior of the glass. The reduction is mainly due to reflection of the radiation, and so it is essentially independent of the thickness of the glass. A combination of a glass window and a screen will reduce the transmitted radiation energy to roughly 40 to 50 percent of the incident energy. In addition, the thermal radiation will be attenuated by window coverings, such

as shades, curtains, and drapes. Of course, if the window coverings are made of combustible materials, they will constitute internal ignition points, as also will upholstered furniture, bedding, carpets, papers, and fabrics. Exterior ignition points are paper, trash, awnings, dry grass, leaves, and dry shrubs. Interior ignitions are more likely to grow into self-sustaining fires than are exterior ignitions. Large amounts of kindling are required to maintain an ignition for a sufficient time to ignite a sound wooden structure, and the necessary fuel arrangements are much more common indoors than outdoors.

7.51 In order for an ignition to develop within a room, one or two substantial combustible furnishings, such as

an overstuffed chair or couch, a bed, or a wooden table, must be ignited and burn vigorously. Fires that become large enough to spread generally burn between 10 and 20 minutes before room "flashover." Flashover occurs when flames from a localized fire suddenly spread to fill the room. After room flashover, the fire becomes intense enough to penetrate interior partitions and to spread to other rooms. The blaze from a single fire in an average residence may be expected to reach peak intensity in about an hour.

7.52 In a typical urban area the density of interior ignition points is usually much greater than that of exterior points. Furthermore, as stated above, the probability of ignitions spreading to more substantial fuels is greater for interior than for exterior ignition points. Nevertheless, fires started outdoors can also result in significant damage. Ignitions of dead weeds or tall dry grass or brush may develop into fires sufficiently intense to ignite houses. The fuel contained in a pile of trash is often sufficient to ignite a structure with loose, weathered siding. Structures with very badly weathered and decayed siding or shingles may ignite directly from the incident thermal radiation.

7.53 Since most of the thermal radiation reaches a target before the blast wave, the subsequent arrival of the latter may affect the development of fires initiated by the thermal radiation. In particular, there is a possibility that such fires may be extinguished by the blast wind. Studies of the effects in Japan and at various nuclear and high-explosive tests have given contradictory results and they leave the matter unresolved. Laboratory experiments that simulate

blast loading of urban interiors show that the blast wave typically does extinguish flames but often leaves the material smoldering so that active flaming is revived at a later time. It is not certain, however, to what extent this behavior would apply to actual urban targets subjected to a nuclear explosion. Although some fires may be extinguished by the blast, many others will undoubtedly persist.

SPREAD OF FIRES

7.54 The spread of fires in a city, including the development of "mass fires," depends upon various conditions, e.g., weather, terrain, closeness and combustibility of buildings, and the amount of combustible material in a given area. The interaction of blast and fire, as described above, and the extent of blast damage are also important factors in determining fire spread. Some conclusions concerning the development and growth of fires from a large number of ignition points were drawn from the experiences of World War II incendiary raids and the two nuclear bomb attacks on Japan, but these experiences were not completely documented. More useful data have been obtained from full-scale and model tests conducted in recent years.

7.55 The spread of fire between buildings can result from the ignition of combustible materials heated by fires in adjacent buildings, ignition of heated combustible materials by contact with flames, sparks, embers, or brands, and the ignition of unheated combustible materials by contact with flames or burning brands. Spread by heating, due either to convection, i.e., to the flow of

hot gases, or to absorption of radiation, is a short-range effect, whereas spread by firebrands may be either short or long range. Hence, an important criterion of the probability of fire spread is the distance between buildings. The lower the building density, the less will be the probability that fire will spread from one structure to another. In an urban area, especially one fairly close to the explosion point, where substantial blast damage has occurred, the situation would be changed substantially. A deep, almost continuous layer of debris would cover the ground, thereby providing a medium for the ready spread of fires.

7.56 Combustible building surfaces exposed to a thermal radiation intensity of as low as 0.4 cal/cm^2 per second for extended periods of time will ultimately burst into flame. The radiating portions of a burning building emit about 4 cal/cm^2 per second. Consequently, radiation from a burning building may cause ignition of an adjacent building. Such ignition by radiation is probable for most structures if the dimensions of the burning structure are as large as, or larger than, the distance to the unburned structure. The convective plume of hot gases from a burning building would come into contact with another building which is farther away than the range for radiation fire spread only under conditions of extremely high wind. Therefore, fire spread by convective heat transfer is not expected to be a significant factor under normal terrain and weather conditions.

7.57 Fires can be spread between buildings by burning brands which are borne aloft by the hot gases and carried downwind for considerable distances. The fires can thus spread to distances

greater than those at which radiative and convective heating can have a significant effect. Long-range fire spread by brands could greatly extend the area of destruction by urban fires resulting from nuclear explosions; there is no single method for predicting the spread but computer models are being developed for this purpose.

MASS FIRES

7.58 Under some conditions the many individual fires created by a nuclear explosion can coalesce into mass fires. The types of mass fires of particular interest, because of their great potential for destruction, are "fire storms" and conflagrations. In a fire storm many fires merge to form a single convective column of hot gases rising from the burning area and strong, fire-induced, radial (inwardly directed) winds are associated with the convective column. Thus the fire front is essentially stationary and the outward spread of fire is prevented by the in-rushing wind; however, virtually everything combustible within the fire storm area is eventually destroyed. Apart from a description of the observed phenomena, there is as yet no generally accepted definition of a fire storm. Furthermore, the conditions, e.g., weather, ignition-point density, fuel density, etc., under which a fire storm may be expected are not known. Nevertheless, based on World War II experience with mass fires resulting from air raids on Germany and Japan, the minimum requirements for a fire storm to develop are considered by some authorities to be the following: (1) at least 8 pounds of combustibles per square foot of fire area, (2) at least half

of the structures in the area on fire simultaneously, (3) a wind of less than 8 miles per hour at the time, and (4) a minimum burning area of about half a square mile. High-rise buildings do not lend themselves to formation of fire storms because of the vertical dispersion of the combustible material and the baffle effects of the structures.

7.59 Conflagrations, as distinct from fire storms, have moving fire fronts which can be driven by the ambient wind. The fire can spread as long as there is sufficient fuel. Conflagrations can develop from a single ignition, whereas fire storms have been observed only where a large number of fires are burning simultaneously over a relatively large area.

7.60 Another aspect of fire spread is

the development of mass fires in a forest following primary ignition of dried leaves, grass, and rotten wood by the thermal radiation. Some of the factors which will influence the growth of such fires are the average density and moisture content of the trees, the ratio of open to tree-covered areas, topography, season of the year, and meteorological conditions. Low atmospheric humidity, strong winds, and steep terrain favor the development of forest fires. In general, a deciduous forest, particularly when in leaf, may be expected to burn less rapidly and with less intensity than a forest of coniferous trees. Green leaves and the trunks of trees would act as shields against thermal radiation, so that the number of points at which ignition occurs in a forest may well be less than would appear at first sight.

INCENDIARY EFFECTS IN JAPAN

THE NUCLEAR BOMB AS AN INCENDIARY WEAPON

7.61 The incendiary effects of a nuclear explosion do not present any especially characteristic features. In principle, the same overall result, as regards destruction by fire and blast, might be achieved by the use of conventional incendiary and high-explosive bombs. It has been estimated, for example, that the fire damage to buildings and other structures suffered at Hiroshima could have been produced by about 1,000 tons of incendiary bombs distributed over the city. It can be seen, however, that since this damage was caused by a single nuclear bomb of only

about 12.5 kilotons energy yield, nuclear weapons are capable of causing tremendous destruction by fire, as well as by blast.

7.62 Evidence was obtained from the nuclear explosions over Japan that the damage by fire is much more dependent upon local terrain and meteorological conditions than are blast effects. At both Hiroshima and Nagasaki the distances from ground zero at which particular types of blast damage were experienced were much the same. But the ranges of incendiary effects were quite different. In Hiroshima, for example, the total area severely damaged by fire, about 4.4 square miles, was

roughly four times as great as in Nagasaki. One contributory cause was the irregular layout of Nagasaki as compared with Hiroshima; also greater destruction could probably have been achieved by a change in the burst point. Nevertheless, an important factor was the difference in terrain, with its associated building density. Hiroshima was relatively flat and highly built up, whereas Nagasaki had hilly portions near ground zero that were bare of structures.

ORIGIN AND SPREAD OF FIRES IN JAPAN

7.63 Definite evidence was obtained from Japanese observers that the thermal radiation caused thin, dark cotton cloth, such as the blackout curtains that were in common use during the war, thin paper, and dry, rotted wood to catch fire at distances up to 3,500 feet (0.66 mile) from ground zero. It was reported that a cedar bark roof farther out was seen to burst into flame, apparently spontaneously, but this was not definitely confirmed. Abnormal enhanced amounts of radiation, due to reflection, scattering, and focusing effects, might have caused fires to originate at isolated points (Fig. 7.63).

7.64 From the evidence of charred wood found at both Hiroshima and Nagasaki, it was originally concluded that such wood had actually been ignited by thermal radiation and that the flames were subsequently extinguished by the blast. But it now seems more probable that, apart from some exceptional instances, there was no actual ignition of the wood. The absorption of the thermal radiation caused charring in sound wood

but the temperatures were generally not high enough for ignition to occur (§ 7.28). Rotted and checked (cracked) wood and excelsior, however, have been observed to burn completely, and the flame was not greatly affected by the blast wave.

7.65 It is not known to what extent thermal radiation contributed to the initiation of fires in the nuclear bombings in Japan. It is possible, that, up to a mile or so from ground zero, some fires may have originated from secondary causes, such as upsetting of stoves, electrical shortcircuits, broken gas lines, and so on, which were a direct effect of the blast wave. A number of fires in industrial plants were initiated by furnaces and boilers being overturned, and by the collapse of buildings on them.

7.66 Once the fires had started, there were several factors, directly related to the destruction caused by the nuclear explosion, that influenced their spreading. By breaking windows and blowing in or damaging fire shutters (Fig. 7.66), by stripping wall and roof sheathing, and collapsing walls and roofs, the blast made many buildings more vulnerable to fire. Noncombustible (fire-resistive) structures were often left in a condition favorable to the internal spread of fires by damage at stairways, elevators, and in firewall openings as well as by the rupture and collapse of floors and partitions (see Fig. 5.23).

7.67 On the other hand, when combustible frame buildings were blown down, they did not burn as rapidly as they would have done had they remained standing. Moreover, the noncombustible debris produced by the blast frequently covered and prevented the burning of combustible material.



Figure 7.63. The top of a wood pole was reported as being ignited by the thermal radiation (1.25 miles from ground zero at Hiroshima, 5 to 6 cal/cm²). Note the unburned surroundings; the nearest burned building was 360 feet away.



Figure 7.66. Fire shutters in building blown in or damaged by the blast; shutter at center probably blown outward by blast passing through building (0.57 mile from ground zero at Hiroshima).

There is some doubt, therefore, whether on the whole the effect of the blast was to facilitate or to hinder the development of fires at Hiroshima and Nagasaki.

7.68 Although there were firebreaks, both natural, e.g., rivers and open spaces, and artificial, e.g., roads and cleared areas, in the Japanese cities, they were not very effective in preventing the fires from spreading. The reason was that fires often started simultaneously on both sides of the firebreaks, so that they could not serve their intended purpose. In addition, combustible materials were frequently strewn by the blast across the firebreaks and open spaces, such as yards and street areas, so that they could not prevent the spread

of fires. Nevertheless, there were a few instances where firebreaks assisted in preventing the burnout of some fire-resistant buildings.

7.69 One of the important aspects of the nuclear attacks on Japan was that, in the large area that suffered simultaneous blast damage, the fire departments were completely overwhelmed. It is true that the fire-fighting services and equipment were poor by American standards, but it is doubtful if much could have been achieved, under the circumstances, by more efficient fire departments. At Hiroshima, for example, 70 percent of the firefighting equipment was crushed in the collapse of fire houses, and 80 percent of the personnel were unable to

respond. Even if men and machines had survived the blast, many fires would have been inaccessible because of the streets being blocked with debris. For this reason, and also because of the fear of being trapped, a fire company from an area which had escaped destruction was unable to approach closer than 6,600 feet (1.25 miles) from ground zero at Nagasaki.

7.70 Another contributory factor to the destruction by fire was the failure of the water supply in both Hiroshima and Nagasaki. The pumping stations were not largely affected, but serious damage was sustained by distribution pipes and mains, with a resulting leakage and drop in available water pressure. Most of the lines above ground were broken by collapsing buildings and by heat from the fires which melted the pipes. Some buried water mains were fractured and others were broken due to the collapse or distortion of bridges upon which they were supported (§ 5.106).

7.71 About 20 minutes after the detonation of the nuclear bomb at Hiroshima, a mass fire developed showing many characteristics usually associated with fire storms. A wind blew toward the burning area of the city from all directions, reaching a maximum velocity of 30 to 40 miles per hour about 2 to 3 hours after the explosion, decreasing to light or moderate and variable in direction about 6 hours after. The wind was accompanied by intermittent rain,

light over the center of the city and heavier about 3,500 to 5,000 feet (0.67 to 0.95 mile) to the north and west. Rain in these circumstances was apparently due to the condensation of moisture on particles from the fire when they reached a cooler area. The strong inward draft at ground level was a decisive factor in limiting the spread of fire beyond the initial ignited area. It accounts for the fact that the radius of the burned-out area was so uniform in Hiroshima and was not much greater than the range in which fires started soon after the explosion. However, virtually everything combustible within this region was destroyed.

7.72 No definite fire storm occurred at Nagasaki, although the velocity of the southwest wind blowing between the hills increased to 35 miles an hour when the conflagration had become well established, perhaps about 2 hours after the explosion. This wind tended to carry the fire up the valley in a direction where there was nothing to burn. Some 7 hours later, the wind had shifted to the east and its velocity had dropped to 10 to 15 miles per hour. These winds undoubtedly restricted the spread of fire in the respective directions from which they were blowing. The small number of dwellings exposed in the long narrow valley running through Nagasaki probably did not furnish sufficient fuel for the development of a fire storm as compared to the many buildings on the flat terrain at Hiroshima.

TECHNICAL ASPECTS OF THERMAL RADIATION⁴

DISTRIBUTION AND ABSORPTION OF ENERGY FROM THE FIREBALL

7.73 Spectroscopic studies made in the course of weapons tests have shown that the fireball does not behave exactly like a black body, i.e., as a perfect radiator. Generally, the proportion of radiations of longer wavelength (greater than 5,500 Å) corresponds to higher black body temperatures than does the shorter wave emission. The assumption of black body behavior for the fireball, however, serves as a reasonable approximation in interpreting the thermal radiation emission characteristics. For a black body, the distribution of radiant energy over the spectrum can be related to the surface temperature by Planck's radiation equation. If $E_\lambda d\lambda$ denotes the energy density, i.e., energy per unit volume, in the wavelength interval λ to $\lambda + d\lambda$, then,

$$E_\lambda = \frac{8\pi hc}{\lambda^5} \cdot \frac{1}{e^{hc/\lambda kT} - 1}, \tag{7.73.1}$$

where c is the velocity of light, h is Planck's quantum of action, k is Boltzmann's constant, i.e., the gas constant per molecule, and T is the absolute temperature. It will be noted that hc/λ is the energy of the photon of wavelength λ (§ 1.74).

7.74 From the Planck equation it is possible to calculate the rate of energy emission (or radiant power) of a black

body for a given wavelength, i.e., J_λ , as a function of wavelength for any specified temperature, since J_λ is related to E_λ by

$$J_\lambda = \frac{c}{4} E_\lambda, \tag{7.74.1}$$

where J_λ is in units of energy (ergs) per unit area (cm²) per unit time (sec) per unit wavelength (Å). The results of such calculations for temperatures ranging from 100 million (10⁸) degrees to 2,000°K are shown in Fig. 7.74. It is seen that the total radiant power, which is given by the area under each curve, decreases greatly as the temperature is decreased.

7.75 An important aspect of Fig. 7.74 is the change in location of the curves with temperature; in other words, the spectrum of the radiant energy varies with the temperature. At high temperatures, radiations of short wavelength predominate, but at low temperatures those of long wavelength make the major contribution. For example, in the exploding weapon, before the formation of the fireball, the temperature is several tens of million degrees Kelvin. Most of the (primary) thermal radiation is then in the wavelength range from about 0.1 to 100 Å, i.e., 120 to 0.12 kilo-electron volts (keV) energy, corresponding roughly to the soft X-ray region (Fig. 1.74). This is the basis of the statement made earlier that the primary thermal radiation from

⁴The remaining sections of this chapter may be omitted without loss of continuity.

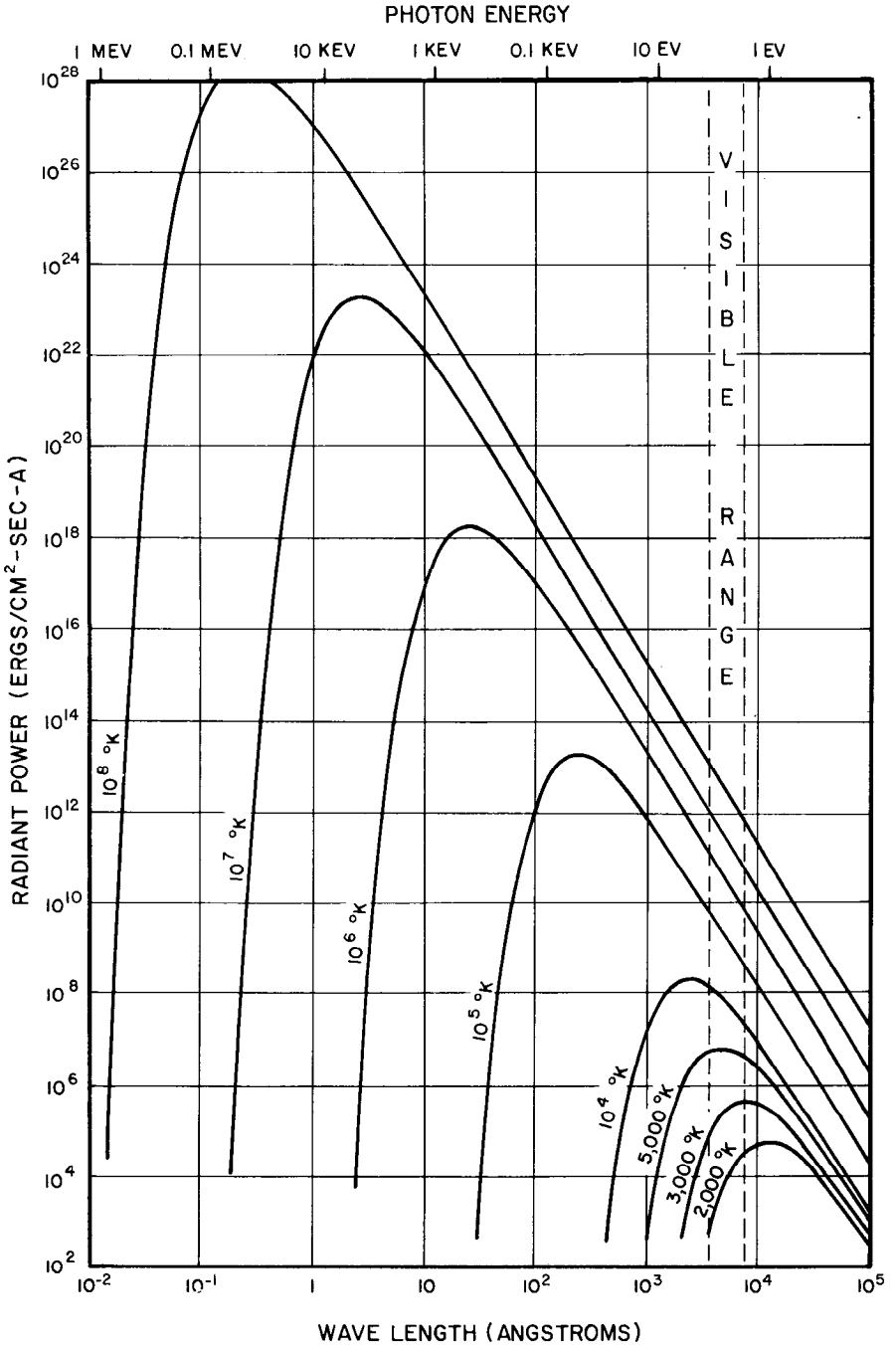

Figure 7.74. Radiant power of a black body as a function of wavelength at various temperatures.

a nuclear explosion consists largely of X rays. These radiations are absorbed by the surrounding air to form the fireball from which the effective thermal radiation of present interest is emitted in the ultraviolet, visible, and infrared regions of the spectrum. The dimensions of the fireball in which the thermal X rays are absorbed depends on the ambient air density, as will be seen shortly.

7.76 It will be recalled that the thermal radiation received at the earth's surface differs to some extent from that leaving the fireball. The reason is that the radiations of shorter wavelength, i.e., in the ultraviolet, are more readily absorbed than the others by the atmosphere between the burst point and the earth's surface. The thermal radiation received at a distance from a nuclear explosion is fairly characteristic of a black body at a temperature of about 6,000 to 7,000°K, although somewhat depleted in the ultraviolet and other shorter wavelengths. Even if the detonation occurs at very high altitudes, the thermal radiation from the low-density fireball must pass through the denser atmosphere before reaching the ground. The effective thermal radiation received on the earth's surface in this case is, therefore, also composed of the longer wavelengths.

7.77 An expression for the wavelength (λ_m) corresponding to the maximum in the radiant power as a function of the black body temperature can be obtained by differentiating equation (7.74.1) with respect to wavelength and equating the result to zero. It is then found that

$$\lambda_m = \frac{C}{T}, \quad (7.77.1)$$

where C is a constant, equal to 2.90×10^7 angstroms-degrees K. This expression is known as Wien's displacement law.

7.78 The temperature at which the maximum in the radiant power distribution from a black body should just fall into the visible spectrum, i.e., wavelength 3,850 Å, is found from equation (7.77.1) to be about 7,500°K. This happens to be very close to the maximum surface temperature of the fireball after the minimum, i.e., during the second radiation pulse (Fig. 2.39). Since the apparent surface temperature generally does not exceed 8,000°K and the average is considerably less, it is evident that the thermal energy emitted in the second pulse should consist mainly of visible and infrared rays, with a smaller proportion in the ultraviolet region of the spectrum. This has been found to be the case in actual tests, even though the fireball deviates appreciably from black body behavior at this stage.

7.79 The mean free path (§ 2.113) in cold air, at sea-level density, of X-ray photons with energies from about 0.5 to 15 keV is given by the approximate relationship

$$\text{Mean free path} \approx \frac{E^3}{5} \text{ cm}, \quad (7.79.1)$$

where E is the photon energy in keV. In order to make some order-of-magnitude calculations of the distances in which thermal X rays from a nuclear explosion are absorbed in air, a convenient round-number temperature of 10^7 degrees Kelvin will be used for simplicity. From equation (7.77.1), the wavelength at which the rate of emission of radiation

from a black body at this temperature is a maximum is found to be 2.9 A. According to equation (1.74.2) this corresponds to a photon energy of 4.3 keV, and from equation (7.79.1) the mean free path of these photons in normal air is about 15 cm. In traversing a distance of one mean free path the energy of the radiations decreases by a factor of e , i.e., approximately 2.7; hence 90 per cent of the energy will be deposited within a radius of 2.3 mean free paths. It is seen, therefore, that 4.3-keV radiation will be largely absorbed in a distance of about 35 cm, i.e., a little over 1 foot, in a sea-level atmosphere.

7.80 The primary thermal radiations from a nuclear explosion cover a wide range of wavelengths, as is evident from Fig. 7.74. But to obtain a rough indication of the initial size of the fireball, the wavelength (or energy) at which the radiant power from a black body is a maximum may be taken as typical. It follows, therefore, from the results given above that the thermal X rays from a nuclear explosion will be almost completely absorbed by about a foot of air at normal density. The oxygen and nitrogen in the air in the vicinity of the explosion are considerably ionized, and the ions do not absorb as effectively as do neutral molecules. Nevertheless, in a nuclear explosion in the atmosphere where the air density does not differ greatly from the sea-level value, most of the X rays, which constitute the primary thermal radiation, will be absorbed within a few feet of the explosion. It is in this manner that the initial fireball is formed in an air burst.

7.81 With increasing altitude, the air density decreases roughly by a factor of ten for every 10 miles (see § 10.124);

hence at 155,000 feet (approximately 30 miles), for example, the density is about 10^{-3} of the sea-level value. The mean free path of the photon varies inversely as the density, so that for nuclear explosions at an altitude of about 30 miles, the region of the air heated by X rays, which is equivalent to the fireball, extends over a radius of some thousands of feet. In spite of the lower density, the mass of heated air in this large volume is much greater than in the fireball associated with a nuclear explosion at lower altitudes, and so the temperature attained by the air is lower.

THERMAL POWER AND ENERGY FROM THE FIREBALL

7.82 According to the Stefan-Boltzmann law, the total amount of energy (of all wavelengths), J , radiated per square centimeter per second by a black body in all directions in one hemisphere is related to the absolute temperature, T , by the equation

$$J = \sigma T^4, \quad (7.82.1)$$

where σ is the Stefan-Boltzmann constant. The value of J can also be obtained by integration of equation (7.74.1) over all wavelengths from zero to infinity. It is then found that

$$\begin{aligned} \sigma &= 2\pi^5 k^4 / 15h^3 c^2 \\ &= 5.67 \times 10^{-5} \text{ erg cm}^{-2} \text{ sec}^{-1} \text{ deg}^{-4} \\ &= 1.36 \times 10^{-12} \text{ cal cm}^{-2} \text{ sec}^{-1} \\ &\quad \text{deg}^{-4}. \end{aligned}$$

With σ known, the total radiant energy intensity from the fireball behaving as a black body can be readily calculated for any required temperature.

7.83 In accordance with the definition of J , given above, it follows that the

total rate of emission of radiant energy from the fireball can be obtained upon multiplying the expression in equation (7.82.1) by the area. If R is the radius of the fireball, its area is $4\pi R^2$, so that the total rate of thermal energy emission (or total radiant power) is $\sigma T^4 \times 4\pi R^2$. Representing this quantity by the symbol P , it follows that

$$P = 4\pi\sigma T^4 R^2 = 1.71 \times 10^{-11} T^4 R^2 \text{ cal/sec,}$$

where T is in degrees Kelvin and R is in centimeters. Alternatively, if the radius, R , is expressed in feet, then

$$P = 1.59 \times 10^{-8} T^4 R^2 \text{ cal/sec.} \tag{7.83.1}$$

7.84 Complex interactions of hydrodynamic and radiation factors govern the variation of the apparent size and temperature of the fireball with time. Nevertheless, the fireball thermal power can be calculated as a function of time based upon theoretical considerations modified by experimental measurements. The results are conveniently expressed as the scaled power, i.e., P/P_{\max} , versus the scaled time, i.e., t/t_{\max} ; P is the thermal power at any time t after the explosion, and the P_{\max} is the maximum value of the thermal power at the time, t_{\max} , of the second temperature maximum (§ 2.125). The resulting (left scale) curve, shown in Fig. 7.84, is then of general applicability irrespective of the yield of the explosion. Changes in yield and altitude can affect the shape of the power pulse; however, the values in Fig. 7.84 are reasonably accurate for most air bursts below 100,000 feet. The zero of the scaled time axis is the time of the first maximum, but for all practical

purposes this may be taken as the explosion time.

THERMAL ENERGY FROM AN AIR BURST

7.85 In order to make the power-time curve specific for any particular explosion energy yield, it is necessary to know the appropriate values of P_{\max} and t_{\max} . Theoretically, these quantities should depend on the air density, but experimental evidence indicates that the dependence is small for air bursts at altitudes below 15,000 feet; in this altitude range, P_{\max} and t_{\max} are related approximately to the yield, W kilotons, in the following manner:

$$P_{\max} \approx 3.18 W^{0.56} \text{ kilotons/sec}$$

$$t_{\max} \approx 0.0417 W^{0.44} \text{ sec.}$$

For heights of burst above 15,000 feet the data are sparse. Theoretical calculations indicate that the corresponding relationships are as follows:

$$P_{\max} = \frac{3.56 W^{0.59}}{[\rho(h)/\rho_0]^{0.45}} \text{ kilotons/sec.}$$

$$t_{\max} = 0.038 W^{0.44} [\rho(h)/\rho_0]^{0.36} \text{ sec.}$$

In these expressions $\rho(h)$ is the ambient air density at the burst altitude and ρ_0 is the normal ambient air density at sea level (taken to be 1.225×10^{-3} gram/cm³). Values of $\rho(h)/\rho_0$ are given in Table 7.85 for several altitudes. Use of the preceding equations results in a discontinuity at 15,000 feet. For heights of burst at or near that altitude, values should be calculated by both sets of equations, and the appropriate result should be used depending on whether offensive or defensive conservatism is

(Text continued on page 312.)

The curves in Fig. 7.84 show the variation with the scaled time, t/t_{\max} , of the scaled fireball power, P/P_{\max} (left ordinate) and of the percent of the total thermal energy emitted, E/E_{tot} (right ordinate), in the thermal pulse of an air burst.

Scaling. In order to apply the data in Fig. 7.84 to an explosion of any yield, W kilotons, the following expressions are used for bursts below 15,000 feet:

$$P_{\max} \approx 3.18 W^{0.56} \text{ kilotons/sec.}$$

$$t_{\max} \approx 0.0417 W^{0.44} \text{ sec.}$$

For bursts above 15,000 feet, the following expressions are used:

$$P_{\max} = \frac{3.56 W^{0.59}}{[\rho(h)/\rho_0]^{0.45}} \text{ kilotons/sec.}$$

$$t_{\max} = 0.038 W^{0.44} [\rho(h)/\rho_0]^{0.36} \text{ sec.}$$

In all cases $E_{\text{tot}} = fW$.

In these expressions t_{\max} is the time after the explosion for the temperature maximum in the second thermal pulse, P_{\max} is the maximum rate (at t_{\max}) of emission of thermal energy from the fireball, E_{tot} is the total thermal energy emitted by the fireball, f is the thermal partition (Table 7.88), and $\rho(h)/\rho_0$ is ratio of the ambient air density at burst altitude to that at sea level (Table 7.85).

Example

Given: A 500 KT burst at 5,000 feet altitude

Find: (a) The rate of emission of thermal energy, (b) the total amount of thermal energy emitted, at 1 second after the explosion.

Solution: Since the explosion is below 15,000 feet,

$t_{\max} = 0.0417 \times (500)^{0.44} = 0.64$ sec, and the normalized time at 1 sec after the explosion is

$$\frac{t}{t_{\max}} = \frac{1}{0.64} = 1.56.$$

(a) From Fig. 7.84, the value of P/P_{\max} at this scaled time is 0.59, and since

$$P_{\max} = 3.18 \times (500)^{0.56} = 103 \text{ kilotons/sec,}$$

it follows that

$$P = 0.59 \times 103 = 60.8 \text{ kilotons/sec} \\ = 60.8 \times 10^{12} \text{ cal/sec. } \textit{Answer.}$$

(b) For a yield of 500 KT and a burst altitude of 5,000 feet, $f (= E_{\text{tot}}/W)$ is found from Table 7.88 to be about 0.35; hence,

$$E_{\text{tot}} = 500 \times 0.35 = 175 \text{ kilotons.}$$

At the scaled time of 1.56, the value of E/E_{tot} from Fig. 7.84 is 40 percent, i.e., 0.40, so that

$$E = 0.40 \times 175 = 70 \text{ kilotons} \\ = 70 \times 10^{12} \text{ cal. } \textit{Answer.}$$

Reliability: For bursts below 15,000 feet, the data in Table 7.88 together with the curves in Fig. 7.84 are accurate to within about ± 25 percent. For bursts between 15,000 and 100,000 feet, the accuracy is probably within ± 50 percent. Explosions above 100,000 feet are described in § 7.89 *et seq.*

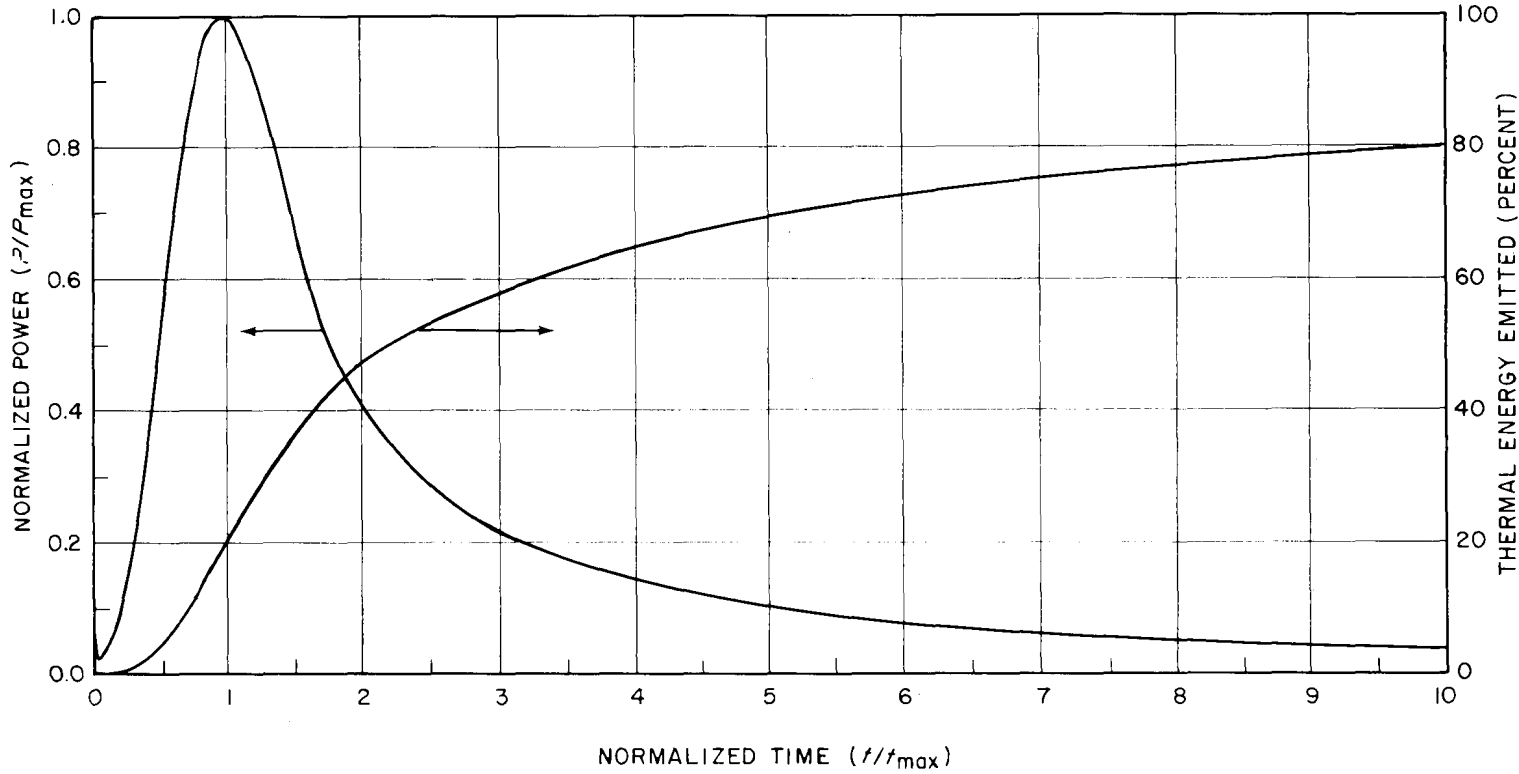

Figure 7.84. Scaled (or normalized) fireball power and fraction of thermal energy emitted versus scaled (or normalized) time in the thermal pulse of an air burst below 100,000 feet.

Table 7.85

ATMOSPHERIC DENSITY RATIOS

Altitude (feet)	Density Ratio, $\rho(h)/\rho_0$	Altitude (feet)	Density Ratio, $\rho(h)/\rho_0$
15,000	0.63	60,000	0.095
20,000	0.53	65,000	0.075
25,000	0.45	70,000	0.059
30,000	0.37	75,000	0.046
35,000	0.31	80,000	0.036
40,000	0.24	85,000	0.028
45,000	0.19	90,000	0.022
50,000	0.15	95,000	0.017
55,000	0.12	100,000	0.014

desired. For a contact surface burst (§ 2.127 footnote) the fireball develops in a manner approaching that for an air burst of twice the yield, because the blast wave energy is reflected back from the surface into the fireball (§ 3.34). Hence, t_{\max} may be expected to be larger than for an air burst of the same actual yield.

7.86 The thermal power curve in Fig. 7.84 (left scale) presents some features of special interest. As is to be expected, the thermal power (or rate of emission of radiant energy) of the fireball rises to a maximum, just as does the temperature in the second radiation pulse. However, since the thermal power is roughly proportional to T^4 , it increases and decreases much more rapidly than does the temperature. This accounts for the sharp rise to the maximum in the P/P_{\max} curve, followed by a somewhat less sharp drop which tapers off as the fireball approaches its final stages. The amount of thermal energy, E , emitted by the fireball in an air burst up to any specified time can be obtained from the area under the curve of P/P_{\max}

versus t/t_{\max} up to that time. The results, expressed as E/E_{tot} (percent) versus t/t_{\max} , are shown by the second curve (right scale) in Fig. 7.84, where E_{tot} is the total thermal energy emitted by the fireball. It is seen that at a time equal to $10 t_{\max}$ about 80 percent of the thermal energy will have been emitted; hence this time may be taken as a rough measure of the effective duration of the thermal pulse for an air burst. Since t_{\max} increases with the explosion energy yield, so also does the pulse length.

7.87 The fact that the thermal pulse length increases with the weapon yield has a bearing on the possibility of people taking evasive action against thermal radiation. Evasive action is expected to have greater relative effectiveness for explosions of higher than lower yield because of the longer thermal pulse duration. The situation is indicated in another way in Fig. 7.87, which shows the thermal energy emission as a function of actual time, rather than of t/t_{\max} , for four different explosion energy yields. The data were derived from the corresponding curve in Fig. 7.84 by using the

appropriate calculated value of t_{max} for each yield. At the lower energy yields the thermal radiation is emitted in such a short time that no evasive action is possible. At the higher yields, however, exposure to much of the thermal radiation could be avoided if evasive action were taken within a fraction of a second of the explosion time. It must be remembered, of course, that even during this short period a very considerable amount of thermal energy will have been emitted from an explosion of high yield.

by the symbol f . Estimated values of f are given in Table 7.88 for air bursts with yields in the range from 1 kiloton to 10 megatons at altitudes up to 100,000 feet (19 miles). The data for heights of burst up to 15,000 feet were obtained primarily from experimental results. For higher bursts altitudes, the values were obtained by calculations, various aspects of which were checked with experimental results. They are considered to be fairly reliable for yields between 1 kiloton and 1 megaton at altitudes up to 50,000 feet (9.5 miles). Outside this range of yields and altitudes, the data in Table 7.88 may be used with less confidence. Values of f for burst altitudes above 100,000 feet are given in § 7.90 (see also § 7.104).

7.88 The fraction of the explosion energy yield in the form of thermal radiation, i.e., E_{tot}/W , is called the "thermal partition" and is represented

Table 7.88

THERMAL PARTITION FOR VARIOUS EXPLOSION YIELDS AT DIFFERENT ALTITUDES

Height of Burst (kilofeet)	Thermal Partition, f				
	Total Yield (kilotons)				
	1	10	100	1,000	10,000
Up to 15	0.35	0.35	0.35	0.35	0.35
20	0.35	0.36	0.39	0.41	0.43
30	0.35	0.36	0.39	0.41	0.43
40	0.35	0.36	0.38	0.40	0.42
50	0.35	0.36	0.38	0.40	0.42
60	0.35	0.37	0.38	0.40	0.42
70	0.36	0.37	0.39	0.40	0.42
80	0.37	0.38	0.39	0.41	0.43
90	0.38	0.39	0.40	0.41	0.43
100	0.40	0.40	0.41	0.42	0.45

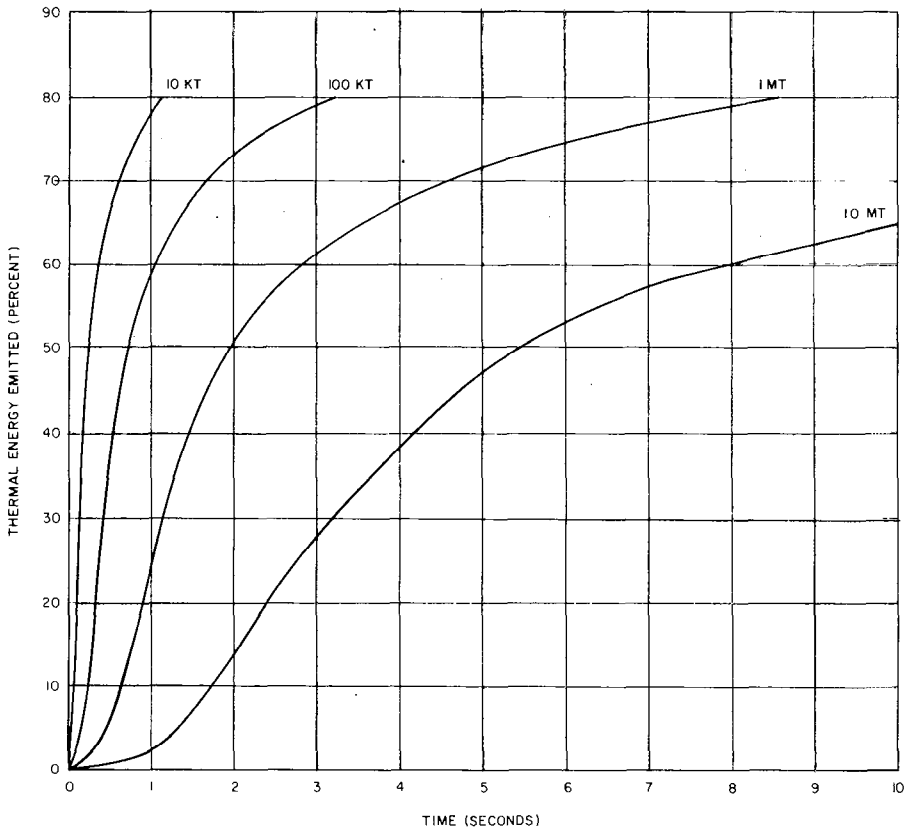

Figure 7.87. Percentage of thermal energy emitted as a function of time for air bursts of various yields.

THERMAL RADIATION IN HIGH-ALTITUDE EXPLOSIONS

7.89 The results described above are applicable to detonations at altitudes below about 100,000 feet (19 miles) where the density of the air is still appreciable. At higher altitudes, the fire-ball phenomena change, as described in Chapter II, and so also do the thermal pulse characteristics, such as shape and length, and the thermal partition. With increasing altitude, there is a tendency for the relative duration of the first pulse, i.e., up to the first temperature

minimum (§§ 2.39, 2.125), to increase and for the minimum to be less marked. Up to an altitude of about 100,000 feet, these changes are small and so also are those in the second thermal pulse. The normalized plot (Fig. 7.84) is thus a satisfactory representation in this altitude range. However, between 100,000 and 130,000 feet (25 miles), the pulse shape changes drastically. The first minimum observed at lower altitudes disappears and essentially all the thermal radiation is emitted as a single pulse (§ 2.132). The thermal emission rises to a maximum in an extremely short time

and then declines steadily, at first rapidly and later more slowly. For an explosion in the megaton range at an altitude of 250,000 feet (about 47 miles), the duration of the thermal pulse is less than a second compared with a few seconds for a similar burst below 100,000 feet (cf. Fig. 7.87). Scaling of the pulse length with respect to the explosion yield at high altitudes is very complex and depends on a variety of factors. However, the duration of the thermal pulse is probably not strongly dependent on the total yield. At altitudes above roughly 270,000 feet (51 miles), the pulse length increases because of the larger mass and lower temperature of the radiating region (§ 7.91).

7.90 At high altitudes shock waves form much less readily in the thinner air and consequently the fireball is able to radiate thermal energy that would, at lower altitudes, have been transformed to hydrodynamic energy of the blast wave. Furthermore, the thinner air allows the primary thermal radiation (X rays) from the explosion to travel much farther than at lower levels. Some of this radiation travels so far from the source that it makes no contribution to the energy in the fireball. Between about 100,000 and 160,000 feet (30 miles), the first factor is dominant and the proportion of energy in the blast wave decreases; consequently, the thermal energy increases. In this altitude range the thermal partition, f , is about 0.6, compared with 0.40 to 0.45 at 100,000 feet (Table 7.88). Above 160,000 feet, however, the second factor, i.e., escape of thermal X rays, becomes increasingly important; the thermal partition decreases to about 0.25 at 200,000 feet (38 miles) and remains at this value up to

roughly 260,000 feet (49 miles). At still higher altitudes there is a change in the fireball behavior (§ 2.135) and the thermal partition decreases very rapidly with increasing altitude of the explosion.

7.91 At heights of burst above about 270,000 feet, only the primary X rays traveling downward are absorbed and the energy deposition leads to the formation of the incandescent X-ray pancake described in Chapter II. This heated region then reradiates its energy at longer wavelengths over a period of several seconds. The altitude and dimensions of the pancake depend to some extent on the explosion yield but, as stated in § 2.134, reasonable average values are 30,000 feet for the thickness, 270,000 feet for the mean altitude, and the height of burst minus 270,000 feet for the radius at this altitude. The altitude and thickness of the reradiating region are essentially independent of the height of burst above 270,000 feet, but the mean radius increases with the burst height. The shape of the region thus approaches a thick disk (or frustum) centered at about 270,000 feet altitude.

7.92 Not more than one-fourth of the X-ray energy from the explosion is absorbed in the low-density air of the reradiating region, and only a small fraction, which decreases with increasing height of burst, is reradiated as secondary radiation. Consequently, only a few percent of the weapon energy is emitted as thermal radiation capable of causing damage at the earth's surface. In fact, for bursts at altitudes exceeding some 330,000 feet (63 miles), the thermal radiation from a nuclear explosion even in the megaton range is essentially ineffective so far as skin burns, ignition,

etc., are concerned. However, the early-time debris, which separates from the X-ray pancake (§ 2.135), is at a fairly high temperature and it emits a

very short pulse of thermal energy that can cause eye injury to individuals looking directly at the explosion (§ 12.79 *et seq.*).

RADIANT EXPOSURE-DISTANCE RELATIONSHIPS

AIR BURSTS

7.93 The following procedure is used to calculate the dependence of the radiant exposure of a target (§ 7.35) upon its distance from an air burst of specified yield. As seen earlier in this chapter, such information, which is given in Fig. 7.42, combined with the data in Tables 7.35 and 7.40, permits estimates to be made of the probable ranges for various thermal radiation effects.

7.94 If there is no atmospheric attenuation, then at a distance D from the explosion the thermal radiation energy, E_{tot} may be regarded as being spread uniformly over the surface of a sphere of area $4\pi D^2$. If the radiating fireball is treated as a point source, the energy received per unit area of the sphere would be $E_{\text{tot}}/4\pi D^2$. If attenuation were due only to absorption in a uniform atmosphere, e.g., for an air burst, this quantity would be multiplied by the factor $e^{-\kappa D}$, where κ is an absorption coefficient averaged over the whole spectrum of wavelengths. Hence in these circumstances, using the symbol Q to represent the radiant exposure, i.e.,

the energy received per unit area normal to the direction of propagation, at a distance D from the explosion, it follows that

$$Q = \frac{E_{\text{tot}}}{4\pi D^2} e^{-\kappa D}. \quad (7.94.1)$$

7.95 When scattering of the radiation occurs, in addition to absorption, the coefficient κ changes with distance and other variables. The simple exponential attenuation factor in equation (7.94.1) is then no longer adequate. A more useful (empirical) formulation is

$$Q = \frac{E_{\text{tot}}\tau}{4\pi D^2}, \quad (7.95.1)$$

where the transmittance, τ , i.e., the fraction of the radiation (direct and scattered) which is transmitted, is a complex function of the visibility (scattering), absorption, and distance.⁵

7.96 Since $E_{\text{tot}} = fW$, equation (7.95.1) for the radiant exposure from an air burst of yield W can be expressed as

$$Q = \frac{fW\tau}{4\pi D^2}. \quad (7.96.1)$$

⁵ Scattered radiation does not cause permanent damage to the retina of the eye. Hence, to determine the effective radiant exposure in this connection equation (7.94.1) should be used; κ is about 0.03 km^{-1} for a visibility of 80 km (50 miles), 0.1 km^{-1} for 40 km (25 miles) and 0.2 km^{-1} for 20 km (12.4 miles). Scattered radiation can, however, contribute to flashblindness, resulting from the dazzling effect of bright light (§ 12.83).

By utilizing the fact that 1 kiloton of TNT is equivalent to 10^{12} calories, equation (7.96.1) for an air burst becomes

$$Q \text{ (cal/cm}^2\text{)} = \frac{10^{12}fW\tau}{4\pi D^2}, \quad (7.96.2)$$

where D is in centimeters and W is in kilotons. If the distance, D , from the explosion to the target, i.e., the slant range, is expressed in kilofeet or miles, equation (7.96.2) reduces approximately to

$$D \text{ in kilofeet: } Q \text{ (cal/cm}^2\text{)} \approx \frac{85.6 fW\tau}{D^2} \quad (7.96.3)$$

$$D \text{ in miles: } Q \text{ (cal/cm}^2\text{)} \approx \frac{3.07 fW\tau}{D^2}. \quad (7.96.4)$$

7.97 In nuclear weapons tests, it is possible to measure Q and W , and since the distance D from the explosion is known the magnitude of the product $f\tau$ can be determined from the equations in § 7.96. Hence, to obtain f and τ individually, one of these two quantities must be determined independently of the other. The method used is to obtain f for different conditions from calculations checked by observations, as stated in § 7.88. The values of τ are then derived from measurements of $f\tau$ made at a large number of weapons tests.

7.98 The transmittance τ for any given atmospheric condition depends on the solid angle over which scattered radiation can reach a particular exposed object. For the present purpose it will be assumed that the target is such, e.g., an appreciable flat area, that scattered radiation is received from all directions above, in addition to the direct thermal

radiation from the source. Transmittance data for these conditions are presented in Fig. 7.98 in terms of burst altitude and distance of a surface target from ground zero for a cloudless atmosphere with a visibility of 12 miles. Since actual visibilities in cities are often less, the values in Fig. 7.98 are conservative.

7.99 The transmittance values in Fig. 7.98 were used, in conjunction with equation (7.96.4) and the thermal partitions from Table 7.88, to obtain the data from which the curves in Fig. 7.42 were constructed. If H is the height of burst and d is the distance from ground zero of a given point on the surface, the corresponding slant range for use in equation (7.96.4) is $D = (d^2 + H^2)^{1/2}$. A height of burst of $200 W^{0.4}$ feet, with W in kilotons, was used for the calculations, but the results in Fig. 7.42 are reasonably accurate for air bursts at any altitude up to some 15,000 feet.

7.100 Under unusual conditions and especially for cities at high-altitude locations, the visibility might be greater than at sea level and the transmittance would be larger than the values given in Fig. 7.98. The curves show that most attenuation of radiation occurs within a few thousand feet of the surface; thus, the much clearer air at higher altitudes has less effect. For bursts above about 150,000 feet (28 miles), the transmittance changes slowly with the altitude. Experimental data indicate that multiplying the transmittance by 1.5 corrects approximately for the effect of reflection from a cloud layer over the burst. The same correction may be made for a snow-covered ground surface. If the burst and target are both between a

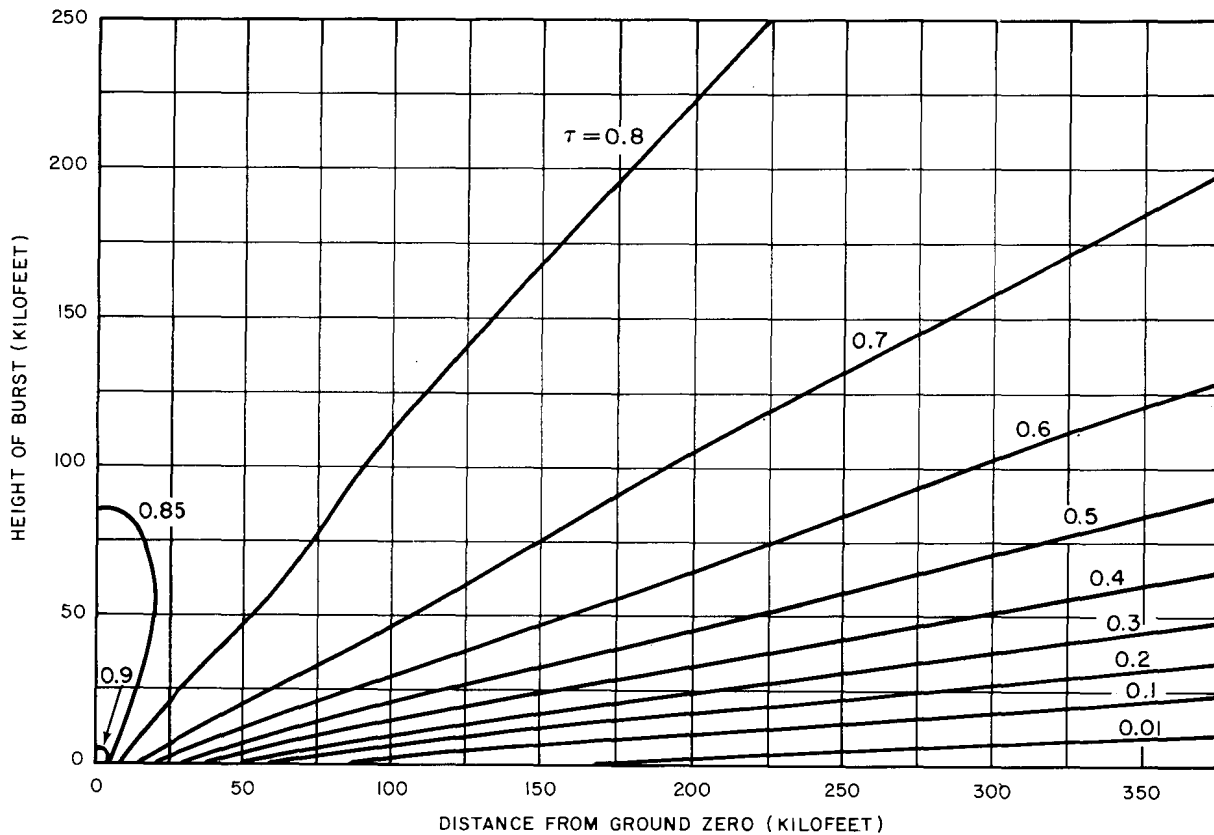

Figure 7.98. Transmittance, τ , to a target on the ground on a typical clear day (visibility = 12 miles).

cloud layer and a snow covered surface, the correction is $1.5 \times 1.5 = 2.25$.

SURFACE BURSTS

7.101 For a surface burst, the radiant exposures along the earth's surface will be less than for equal distances from an air burst of the same total yield. This difference arises partly, as indicated in § 7.20, from the decreased transmittance of the intervening low air layer due to dust and water vapor produced by the explosion. Furthermore, the normal atmosphere close to the earth's surface transmits less than at higher altitudes. In order to utilize the equations in § 7.96 to determine radiant exposure for surface bursts, the concept of an "effective thermal partition" is used, together with the normal transmittance, such as given in Fig. 7.98, for the existing atmospheric conditions.

Based upon experimental data, contact surface bursts can be represented fairly well by an effective thermal partition of 0.18. Values of the thermal partition for other surface bursts are shown in Table 7.101; they have been derived by assigning a thermal partition of 0.18 to a contact surface burst and interpolating between that value and the air burst thermal partition values in Table 7.88.

VERY-HIGH-ALTITUDE BURSTS

7.102 In the calculation of the thermal radiation exposure at the surface of the earth from very-high-altitude nuclear explosions, two altitude regions must be considered because of the change in the fireball behavior that occurs at altitudes in the vicinity of about 270,000 feet (§ 7.91). At burst heights from roughly 160,000 to 200,000 feet (30 to 38 miles), the ther-

Table 7.101

EFFECTIVE THERMAL PARTITION FOR SURFACE BURSTS

Height of Burst (feet)	Thermal Partition				
	Total Yield (kilotons)				
	1	10	100	1,000	10,000
20	0.19	*	*	*	*
40	0.21	0.19	*	*	*
70	0.23	0.21	0.19	*	*
100	0.26	0.22	0.20	*	*
200	0.35	0.25	0.21	0.19	*
400	**	0.33	0.25	0.21	0.19
700	**	**	0.28	0.24	0.21
1,000	**	**	0.34	0.26	0.22
2,000	**	**	**	0.34	0.26
4,000	**	**	**	**	0.33
7,000	**	**	**	**	0.35

*These may be treated as contact surface bursts, with $f = 0.18$.

**Air bursts; for values of f see Table 7.88.

mal energy capable of causing damage at the surface of the earth drops sharply from about 60 percent to about 25 percent, i.e., from $f = 0.60$ to $f = 0.25$. As the height of burst is increased above 200,000 feet, the thermal partition remains about 0.25 up to a height of burst of approximately 260,000 feet (49 miles). Since a nearly spherical fireball forms within this latter altitude region, equation (7.93.3) becomes

$$Q \text{ (cal/cm}^2\text{)} = \frac{21.4 W\tau}{D^2}, \quad (7.102.1)$$

where D is the slant range in kilofeet, and W is the yield in kilotons. A linear interpolation of the variation of thermal partition with burst altitude may be performed for bursts between 160,000 feet and 200,000 feet; however, in view of the uncertainties in high-altitude burst phenomenology, it may be desirable to use the high (0.60) or the low (0.25) value throughout this burst altitude region, depending on the degree of conservatism desired.

7.103 At burst altitudes of roughly 270,000 feet and above, the thermal radiation is emitted from the thick X-ray pancake at a mean altitude of about 270,000 feet, essentially independent of the actual height of burst (§ 7.91). In order to use the equations in § 7.96 to calculate radiant exposures at various distances from the burst, the approximation is made of replacing the disklike radiating region by an equivalent source point defined in the following manner. If the distance d from ground zero to the target position where Q is to be calculated is less than the height of burst, H , the source may be regarded as being located at the closest point on a circle

with the median radius at an altitude of 270,000 feet; this is indicated by the point S in Fig. 7.103. Hence, for the target point X, the appropriate slant range is given approximately by

$$D \text{ (kilofeet)} \approx \{(270)^2 + [\frac{1}{2}(H - 270) - d]^2\}^{1/2}, \quad (7.103.1)$$

with d and H in kilofeet. This expression holds even when d is greater than $\frac{1}{2}(H - 270)$; although the quantity in the square brackets is then negative, the square is positive. The slant range, D_0 , for ground zero is obtained by setting d in equation (7.103.1) equal to zero; thus,

$$D_0 \text{ (kilofeet)} \approx [(270)^2 + \frac{1}{2}(H - 270)^2]^{1/2}.$$

If the distance d is greater than the height of burst, the equivalent point source may be taken to be approximately at the center of the radiating disk at 270,00 feet altitude; then

$$D \text{ (kilofeet)} \approx [(270)^2 + d^2]^{1/2}.$$

7.104 For the heights of burst under consideration, it is assumed that the fraction 0.8 of the total yield is emitted as X-ray energy and that 0.25 of this energy is absorbed in the radiating disk region. Hence, $0.8 \times 0.25 = 0.2$ of the total yield is absorbed. For calculating the radiant exposure, the total yield W in the equations in § 7.96 is consequently replaced by $0.2W$. Furthermore, the equivalent of the thermal partition is called the "thermal efficiency," ϵ , defined as the effective fraction of the absorbed energy that is

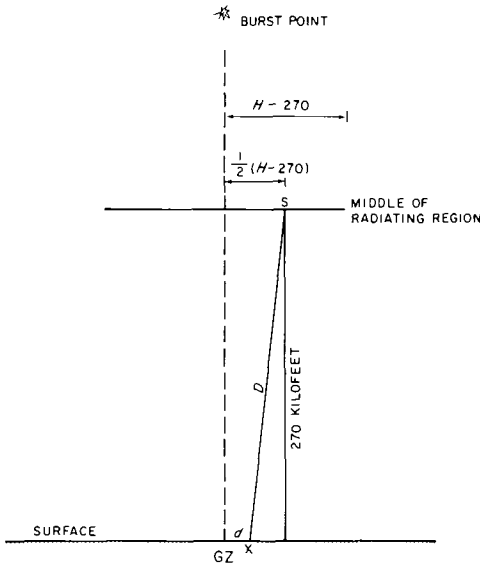

Figure 7.103. Equivalent point source at median radius when height of burst exceeds distance of the target, X , from ground zero.

reradiated. Hence equation (7.96.3), for example, becomes

$$Q \text{ (cal/cm}^2\text{)} = \frac{17.1 \epsilon W_T}{D^2} ,$$

where D in kilofeet is determined in accordance with the conditions described in the preceding paragraph. The values of ϵ given in Fig. 7.104 as a function of height of burst and yield were obtained by theoretical calculations.⁶ The transmittance may be estimated from Fig. 7.98 but no serious error would be involved by setting it equal to unity for the large burst heights involved.

7.105 With the information given above, it is possible to utilize the equations in § 7.96 to calculate the approximate radiant exposure, Q , for points on the earth's surface at a given distance, d , from ground zero, for a prescribed height of burst, H , for explosions of essentially all burst altitudes. If d and H are specified, the appropriate slant range can be determined. Tables 7.88 and 7.101 and Fig. 7.104 are used to obtain the required thermal partition or thermal efficiency, and the transmittance can be estimated from Fig. 7.98 for the known d and H . Suppose, however, it is required to reverse the calculations and to find the slant range to a surface target (or the corresponding distance from ground zero for a specified height of burst) at which a particular value of Q will be attained. The situation is then much more difficult because τ can be estimated only when the slant range or distance from ground zero is known. One approach would be to prepare figures like Fig. 7.42 for several heights of burst and to interpolate among them for any other burst height. Another possibility is to make use of an iteration procedure by guessing a value of τ , e.g., $\tau = 1$, to determine a first approximation to D . With this value of D and the known height of burst, an improved estimate of τ can be obtained from Fig. 7.98. This is then utilized to derive a better approximation to D , and so on until convergence is attained.

⁶The calculations are actually for the fraction of the absorbed X-ray energy reradiated within 10 seconds; for estimating effects on the ground, the subsequent reradiation can be neglected.

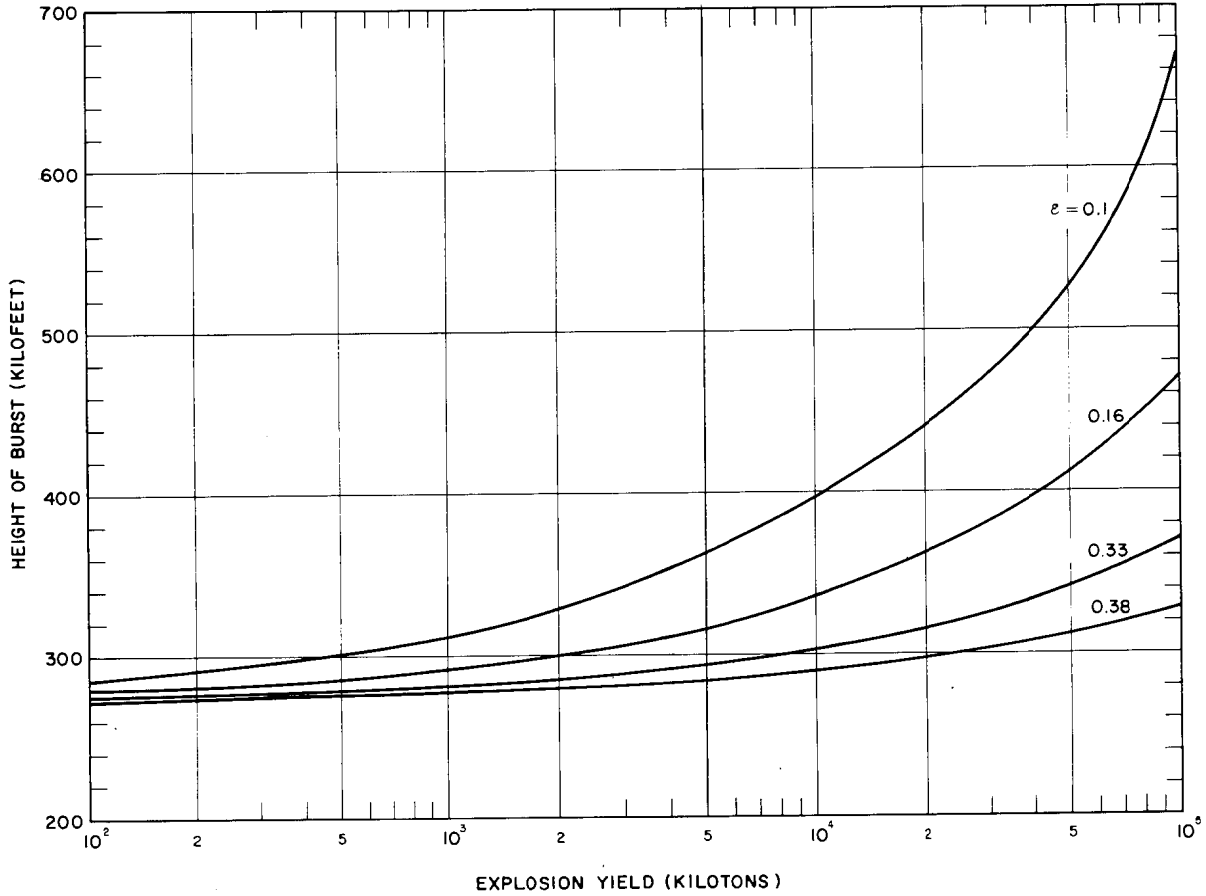

Figure 7.104. Fraction of absorbed X-ray energy reradiated from high-altitude bursts.

BIBLIOGRAPHY

- *BETHE, H. A., *et al.*, "Blast Wave," University of California, Los Alamos Scientific Laboratory, March 1958, LA-2000.
- BRODE, H. L., "Review of Nuclear Weapons Effects," *Ann. Rev. Nuclear Sci.*, **18**, 153(1968).
- CHANDLER, C. C., *et al.*, "Prediction of Fire Spread Following Nuclear Explosions," Pacific Southwest Forest and Range Experiment Station, Berkeley, California, 1963, U.S. Forest Service Paper PSW-5.
- GIBBONS, M. G., "Transmissivity of the Atmosphere for Thermal Radiation from Nuclear Weapons," U.S. Naval Radiological Laboratory, August 1966, USNRDL-TR-1060.
- GOODALE, T., "Effects of Air Blast on Urban Fires," URS Research Co., Burlingame, California, December 1970, OCD Work Unit 25341.
- **GUESS, A. W., and R. M. CHAPMAN, "Reflection of Point Source Radiation from a Lambert Plane onto a Plane Receiver," Air Force Cambridge Research Center, TR-57-253, Library of Congress, Washington, D.C., 1957.
- **HARDY, J. D., "Studies on Thermal Radiation," Cornell University Medical College, PB 154-803, Library of Congress, Washington, D.C., 1952.
- *LAUGHLIN, K. P., "Thermal Ignition and Response of Materials," Office of Civil Defense and Mobilization, 1957, WT-1198.
- MARTIN, S. B., "The Role of Fire in Nuclear Warfare: An Interpretative Review of the Current Technology for Evaluating the Incendiary Consequences of the Strategic and Tactical Uses of Nuclear Weapons," URS Research Co., San Mateo, California, August 1974, DNA 2692F.
- MIDDLETON, W. E., "Vision Through the Atmosphere," University of Toronto Press, 1958.
- PASSELL, T. O., and R. I. MILLER, "Radiative Transfer from Nuclear Detonations Above 50-Km Altitude," *Fire Research Abstracts and Reviews*, **6**, 99 (1964), National Academy of Sciences—National Research Council.
- *RANDALL, P. A., "Damage to Conventional and Special Types of Residences Exposed to Nuclear Effects," Office of Civil Defense and Mobilization, March 1961, WT-1194.
- *VISHKANTA, R., "Heat Transfer in Thermal Radiation Absorbing and Scattering Material," Argonne National Laboratory, May 1960, ANL 6170.
- WIERSMA, S. J., and S. B. MARTIN, "Evaluation of the Nuclear Fire Threat to Urban Areas," Stanford Research Institute, Menlo Park, California, September 1973, SRI PYU-8150.

*These documents may be purchased from the National Technical Information Service, Department of Commerce, Springfield, Virginia, 22161.

**These documents may be obtained from the Library of Congress, Washington, D.C. 20402.

CHAPTER VIII

INITIAL NUCLEAR RADIATION

NATURE OF NUCLEAR RADIATIONS

NEUTRONS AND GAMMA RAYS

8.01 As stated in Chapter I, one of the special features of a nuclear explosion is the emission of nuclear radiations. These radiations, which are quite different from the thermal radiation discussed in the preceding chapter, consist of gamma rays, neutrons, beta particles, and a small proportion of alpha particles. Most of the neutrons and part of the gamma rays are emitted in the fission and fusion reactions, i.e., simultaneously with the explosion. The remainder of the gamma rays are produced in various secondary nuclear processes, including decay of the fission products. The beta particles are also emitted as the fission products decay. Some of the alpha particles result from the normal radioactive decay of the uranium or plutonium which has escaped fission in the weapon, and others (helium nuclei) are formed in fusion reactions (§ 1.69).

8.02 Because of the nature of the phenomena associated with a nuclear explosion, either in the air or near the surface, it is convenient, for practical purposes, to consider the nuclear radiations as being divided into two categories,

namely, initial and residual (§ 1.02). The line of demarcation is somewhat arbitrary, but it may be taken as about 1 minute after the explosion, for the reasons given in § 2.43. The initial nuclear radiation, with which the present chapter will be concerned, consequently refers to the radiation emitted within 1 minute of the detonation. For underground or underwater explosions, it is less meaningful to separate the initial from the residual nuclear radiation (§ 2.82, 2.100), although the distinction may be made if desired.

8.03 The ranges of alpha and beta particles are comparatively short and they cannot reach the surface of the earth from an air burst. Even when the fireball touches the ground, the alpha and beta particles are not very important. The initial nuclear radiation may thus be regarded as consisting only of the gamma rays and neutrons produced during a period of 1 minute after the nuclear explosion. Both of these nuclear radiations, although different in character, can travel considerable distances through the air. Further, both gamma rays and neutrons can produce harmful effects in living organisms (see Chapter XII). It is the highly injurious nature of

these nuclear radiations, combined with their long range, that makes them such a significant aspect of nuclear explosions. The energy of the initial gamma rays and neutrons is only about 3 percent of the total explosion energy, compared with some 35 to 45 percent appearing as thermal radiation in an air burst, but the nuclear radiations can cause a considerable proportion of the casualties. Nuclear radiation can also damage certain electronic equipment, as will be seen later in this chapter.

8.04 Most of the gamma rays accompanying the actual fission process are absorbed by the weapon materials and are thereby converted into other forms of energy. Thus, only a small proportion (about 1 percent) of this gamma radiation succeeds in penetrating any distance from the exploding weapon, but there are several other sources of gamma radiation that contribute to the initial nuclear radiation. Similarly, many of the neutrons produced in fission and fusion reactions (§ 1.69) are reduced in energy and captured by the weapon residues or by the air through which they travel. Nevertheless, a sufficient number of high-energy neutrons escape from the explosion region to represent a significant hazard at considerable distances away.

COMPARISON OF NUCLEAR WEAPON RADIATIONS

8.05 Although shielding from thermal radiation at distances not too close to the point of the explosion of a nuclear weapon is a fairly simple matter, this is

not true for gamma rays and neutrons. For example, at a distance of 1 mile from a 1-megaton explosion, the initial nuclear radiation would probably prove fatal to a large proportion of exposed human beings even if surrounded by 24 inches of concrete; however, a much lighter shield would provide complete protection from thermal radiation at the same location. The problems of shielding from thermal and nuclear radiations are thus quite distinct.

8.06 The effective injury ranges of these two kinds of nuclear weapon radiations may also differ widely. For explosions of moderate and large energy yields, thermal radiation can have harmful consequences at appreciably greater distances than can the initial nuclear radiation. Beyond about 1¼ miles, the initial nuclear radiation from a 20-kiloton air burst, for instance, would not cause observable injury even without protective shielding. However, exposure to thermal radiation at this distance could produce serious skin burns. On the other hand, when the energy of the nuclear explosion is relatively small, e.g., a few kilotons, the initial nuclear radiation has the greater effective range.

8.07 In the discussion of the characteristics of the initial nuclear radiation, it is desirable to consider the neutrons and the gamma rays separately. Although their ultimate effects on living organisms are much the same, the two kinds of nuclear radiations differ in many respects. The subject of gamma rays will be considered in the section which follows, and neutrons will be discussed in § 8.49 *et seq.*

GAMMA RAYS

SOURCES OF GAMMA RAYS

8.08 In addition to the gamma rays that actually accompany the fission process, contributions to the initial nuclear radiations are made by gamma rays from other sources. Of the neutrons produced in fission, some serve to sustain the fission chain reaction, others escape, and a large number are inevitably captured by nonfissionable nuclei. Similar interactions occur for the neutrons produced by fusion. As a result of neutron capture, the nucleus is converted into a new species known as a "compound nucleus," which is in a high-energy (or excited) state. The excess energy may then be emitted, almost instantaneously, as gamma radiations. These are called "capture gamma rays," because they are the result of the capture of a neutron by a nucleus. The process is correspondingly referred to as "radiative capture."

8.09 The interaction of weapon neutrons with certain atomic nuclei provides another source of gamma rays. When a "fast" neutron, i.e., one having a large amount of kinetic energy, collides with such a nucleus, the neutron may transfer some of its energy to the nucleus, leaving the latter in an excited (high-energy) state. The excited nucleus can then return to its normal energy (or ground) state by the emission of the

excess energy as gamma rays. This type of interaction of a fast neutron with a nucleus is called "inelastic scattering" and the accompanying radiations are referred to as "inelastic scattering gamma rays."¹ The fast neutrons produced during the fission and fusion reactions can undergo inelastic scattering reactions with atomic nuclei in the air as well as with nuclei of weapon materials.

8.10 During the fission process, certain of the fission products and weapon products are formed as isomers.² Some of the isomers decay initially by emitting a gamma ray. This is generally followed by emission of a beta particle that may or may not be accompanied by additional gamma rays. The initial gamma rays emitted by such isomers may be considered an independent source of gamma rays. Those gamma rays that may be emitted subsequently are generally considered to be part of the fission product decay.

8.11 Neutrons produced during the fission and fusion processes can undergo radiative capture reactions with nuclei of nitrogen in the surrounding atmosphere as well as with nuclei of various materials present in the weapon. These reactions are accompanied by (secondary) gamma rays which form part of the initial nuclear radiation. The interaction with nitrogen nuclei is of particular importance, since some of the

¹The term "scattering" (cf. § 7.10) is used because, after interacting with the nucleus, the neutron of lower energy generally moves off in a direction different from that in which the original neutron was traveling before the collision.

²In an isomer of a particular nuclear species the nuclei are in a high-energy (or excited) state with an appreciable half-life. The isomers of interest here are those that decay rapidly, with a half-life of about one thousandth of a second or less, by the emission of the excess (or excitation) energy as gamma radiation.

gamma rays thereby produced have very high energies and are, consequently, much less readily attenuated than the other components of the initial gamma radiation.

8.12 The gamma rays produced during fission and as a result of neutron interactions with weapon materials form a pulse of extremely short duration, much less than a microsecond (§ 1.54 footnote). For this reason, the radiations from these sources are known as the "prompt" or "instantaneous" gamma rays.

8.13 The fission fragments and many of their decay products are radioactive species, i.e., radionuclides (§ 1.30), which emit gamma radiations (see Chapter I). The half-lives of these radioactive species range from a fraction of a second to many years. Nevertheless, since the decay of the fission fragments commences at the instant of fission and since, in fact, their rate of decay is greatest at the beginning, there will be an appreciable liberation of gamma radiation from these radionuclides during the first minute after the explosion. In other words, the gamma rays emitted by the fission products make a significant contribution to the initial nuclear radiation. However, since the radioactive decay process is a continuing (or gradual) one, spread over a period of time which is long compared to that in which the instantaneous radiation is produced, the resulting gamma radiations, together with part of the gamma radiations that arise from initial isomeric decays and interactions of neutrons with nuclei of the air, are referred to as "delayed" gamma rays.

8.14 The calculated time dependence of the gamma-ray output of a

hypothetical nuclear weapon is shown in Fig. 8.14. The energy rate is expressed in terms of million electron volts (§ 1.43) per second per kiloton of explosion energy. The gamma rays that result from neutron capture in nitrogen occur at late times relative to some of the other sources because the probability of capture is much greater for low-energy neutrons, i.e., those that have lost energy by multiple scattering reactions. The dashed lines in Fig. 8.14 show the gamma-ray source as it would exist in a vacuum, e.g., from an explosion above the normal atmosphere. The gamma rays that result from inelastic scattering of neutrons by nuclei of air atoms and capture in nitrogen would be absent from such an explosion.

8.15 The instantaneous gamma rays and the portion of the delayed gamma rays included in the initial radiation are produced in nearly equal amounts, but they are by no means equal fractions of the initial nuclear radiation escaping from the exploding weapon. The instantaneous gamma rays are produced almost entirely before the weapon has completely blown apart. They are, therefore, strongly absorbed by the dense weapon materials, and only a small proportion actually emerges. The delayed gamma rays, on the other hand, are mostly emitted at a later stage in the explosion, after the weapon materials have vaporized and expanded to form a tenuous gas. These radiations thus suffer little or no absorption before emerging into the air. The net result is that, at a distance from an air (or surface) burst, the delayed gamma rays, together with those produced by the radiative capture of neutrons by the nitrogen in the atmosphere, contribute about a hundred

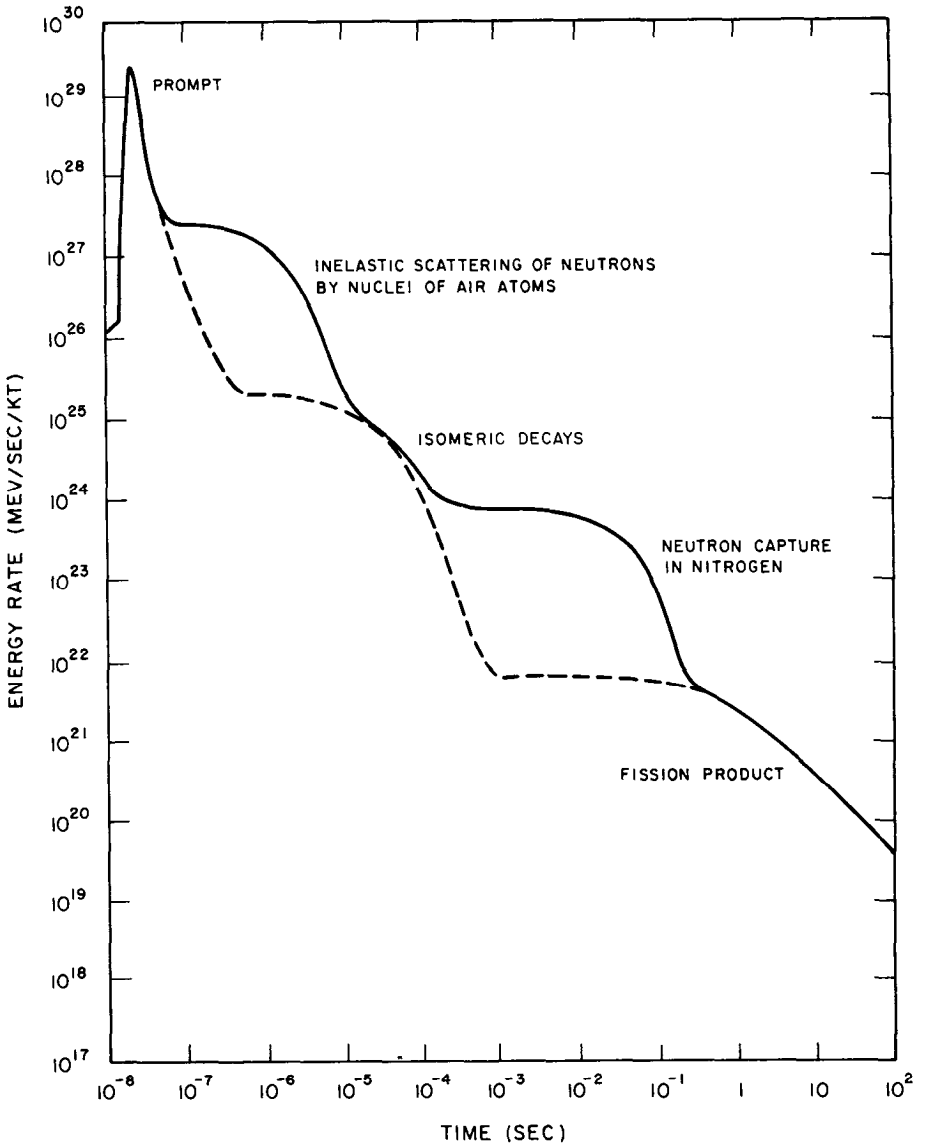

Figure 8.14. Calculated time dependence of the gamma-ray energy output per kiloton energy yield from a hypothetical nuclear explosion. The dashed line refers to an explosion at very high altitude.

times more energy than the prompt gamma rays to the total nuclear radiation received during the first minute after detonation (§ 8.47).

8.16 There is another possible source of gamma rays which may be mentioned. If a nuclear explosion occurs near the earth's surface, the emitted neutrons can cause what is called "induced radioactivity" in the materials present in the ground (or water). This may be accompanied by the emission of gamma rays which will commence at the time of the explosion and will continue thereafter. However, except near ground zero, where the intensity of gamma rays from other sources is very high in any event, the contribution of induced radioactivity to the initial gamma radiation is small. Consequently, the radioactivity induced in the earth's surface by neutrons will be treated in the next chapter as an aspect of the residual nuclear radiation (§ 9.31 *et. seq.*).

RADIATION DOSE AND DOSE RATE

8.17 Gamma rays are electromagnetic radiations analogous to X rays, but, generally of shorter wave length or higher photon energy (§ 1.74). A measurement unit that is used specifically for gamma rays (and X rays) is called the "roentgen." It is based on the ability of these radiations to cause ionization and produce ion pairs, i.e., separated electrons and positive ions, in their

passage through matter, as described in § 1.38. In simple terms, a roentgen is the quantity of gamma radiation (or X rays) that will give rise to the formation of 2.08×10^9 ion pairs per cubic centimeter of dry air at S.T.P., i.e., at standard temperature (0°C) and pressure (1 atmosphere). This is equivalent to the release of about 88 ergs of energy when 1 gram of dry air under S.T.P. conditions is exposed to 1 roentgen of gamma radiation.³

8.18 The roentgen is a measure of exposure to gamma rays (or X rays). The effect on a biological system, such as the whole body or a particular organ, or on a material, e.g., in electronic equipment, however, is related to the amount of energy absorbed as a result of exposure to radiation. The unit of energy absorption, which applies to all kinds of nuclear radiations, including alpha and beta particles and neutrons as well as gamma rays, is the "rad." The rad represents the deposition of 100 ergs of radiation energy per gram of the absorbing material. In stating the quantity (or dose) of a particular radiation in rads, the absorbing material must be specified since the extent of energy deposition depends on the nature of the material. In tissue at or near the surface of the body, the gamma (or X-ray) exposure of 1 roentgen results in an absorption of approximately 1 rad,⁴ but this rough equivalence does not necessarily apply to other materials. Furthermore, the relationship does not hold for

³According to the official definition, 1 roentgen produces electrons (in ion pairs) with a total charge of 2.58×10^{-4} coulomb in 1 kilogram of dry air.

⁴The rough equivalence between a gamma (or X-ray) exposure of 1 roentgen and the absorption in body tissue of 1 rad holds for photons of intermediate energies (0.3 to 3 MeV). For photon energies outside the range from 0.3 to 3 MeV, the exposure in roentgens is no longer simply related to the absorption in rads.

absorption in tissue in the interior of the body. However, in describing the biological effects of nuclear radiations in this book, the energy absorption (in rads) refers to that in tissue at (or close to) the body surface nearest to the explosion (§ 12.108).

8.19 There are two basic types of nuclear radiation measurement both of which are important for biological effects and damage to materials. One is the total "exposure" in roentgens of gamma rays or the total absorbed "dose" in rads of any radiation accumulated over a *period of time*. The other is the "exposure rate" or the "dose rate", respectively; the rate is the exposure or the absorbed dose received *per unit time*. Exposure rates may be expressed in roentgens per hour or, for lower rates, in milliroentgens per hour, where 1 milliroentgen is one thousandth part of a roentgen. Absorbed dose rates can be given correspondingly in rads per hour or millirads per hour. In connection with damage to electronic equipment, the exposure rates are generally stated in roentgens per second and the absorbed dose rates in rads per second.

MEASUREMENT OF GAMMA RADIATION

8.20 Thermal radiation from a nuclear explosion can be felt (as heat), and the portion in the visible region of the spectrum can be seen as light. The human senses, however, do not respond to nuclear radiations except at very high intensities (or dose rates), when itching and tingling of the skin are experienced. Special instrumental methods, based on the interaction of these radiations with matter, have therefore been developed

for the detection and measurement of various nuclear radiations. Some of the instruments described below respond to neutrons (to a certain extent) as well as to gamma rays. For gamma-ray measurement, the instrument would have to be shielded from neutrons. The basic operating principles of the instruments are described below and their use for determining either doses or dose rates is indicated in §§ 8.29, 8.30.

8.21 Normally a gas will not conduct electricity to any appreciable extent, but as a result of the formation of ion pairs, by the passage of nuclear (or ionizing) radiations, e.g., alpha particles, beta particles or gamma rays, the gas becomes a reasonably good conductor. Several types of *ionization instruments*, e.g., the Geiger counter and the pocket chamber (or dosimeter), for the measurement of gamma (and other) radiations, are based on the formation of electrically charged ion pairs in a gas and its consequent ability to conduct electricity.

8.22 *Semiconductor* (solid-state) *detectors* depend on ionization in a solid rather than in a gas. These detectors consist of three regions: one is the *n* (for negative) region, so called because it has an excess of electrons available for conducting electricity, the second is the *p* (for positive) region which has a deficiency of such electrons, and the third is neutral. In the detector, the neutral region is located between the *n* and *p* regions. A voltage from a battery is applied across the detector to balance the normal difference of potential between the outer regions and there is no net flow of current. When exposed to nuclear radiation, ionization occurs in the neutral region and there is a pulse of

current proportional to the radiation intensity. Semiconductor detectors for operation at normal temperature are made of silicon which is either pure (neutral region) or contains regulated amounts of impurities, e.g., arsenic or antimony (*n* region) or boron or aluminum (*p* region).

8.23 Another type of interaction of nuclear radiations with matter, either solid, liquid, or gas, called "excitation," is also used in radiation measurement. Instead of the electron being removed completely from an atom, as it is in ionization, it acquires an additional amount of energy. As a result, the atom is converted into a high-energy (or excited) electronic state. When an atom (or molecule) becomes electronically excited, it will generally give off the excess (or excitation) energy within about one-millionth of a second. Certain materials, usually in the solid or liquid state, are able to lose their electronic excitation energy in the form of visible flashes of light or scintillations. In *scintillation detectors*, the scintillations are counted by means of a photomultiplier tube and associated electronic devices.

8.24 In *radio-photoluminescent dosimeters*, irradiation produces stable fluorescence centers which can be stimulated by subsequent ultraviolet illumination to emit visible light. For example, after exposure to gamma (or X) rays, a silver metaphosphate glass rod or plate system emits a phosphorescent glow when subjected to ultraviolet light; the glow can be measured by means of a photoelectric detector. In *thermoluminescent dosimeters* metastable centers are produced by radiation, and these centers can be induced to emit light by heating the material. A thermoluminescent sub-

stance commonly used in radiation dosimeters is lithium fluoride containing a small quantity of manganese. The total light emission from radio-photoluminescent and thermoluminescent dosimeters is a measure of the absorbed dose in the sensitive material.

8.25 In most materials, the energy of the absorbed radiation ultimately appears in the form of heat. Thus, the heat generated by the passage of radiation is a measure of the absorbed dose. This fact is utilized in a special *calorimeter dosimeter* consisting of a thin sample of absorbing material. The energy deposited by the radiation can then be determined from the measured temperature rise and the known heat capacity of this material.

8.26 Indirect effects of nuclear radiations, notably chemical changes, have also been used for measurement purposes. One example is the blackening (or fogging) of photographic film which appears after it is developed. *Film badges* for the measurement of nuclear radiations generally contain two or three pieces of film, similar to those used by dentists for taking X rays. They are wrapped in paper (or other thin material) which is opaque to light but is readily penetrated by gamma rays. The films are developed and the degree of fogging observed is a measure of the gamma-ray exposure.

8.27 Other *optical density dosimeters* depend on the production by radiation of stable color centers which absorb light at a certain wavelength. An example is a device that measures radiation by a change in the transmission of light through a cobalt-glass chip. A lead borate glass containing bismuth has also been developed for the measurement of

high levels of radiation, specifically for use in mixed gamma-neutron environments. Other materials that are utilized in instruments for the measurement of radiation by color changes include dyed plastics, such as blue cellophane and "cinemoid" film, i.e., a celluloid-like film containing a red dye.

8.28 In practice, measuring instruments do not determine the exposure in roentgens or the absorbed dose in rads directly. One or other of several observable effects, such as current pulses produced by ionization, scintillations, changes in optical response, or temperature rise, serves as the basis for the actual determination. The instruments can indicate the exposure in roentgens or the dose in rads after being calibrated with a standard gamma-ray source, usually a known quantity of a radioactive material that emits a gamma ray of the appropriate energy at a known rate.

8.29 Some instruments can record both the total radiation dose (or exposure) and the dose (or exposure) rate, but most radiation measuring devices are designed to indicate either the total or the rate. Total radiation doses (or exposures) are measured by personnel dosimeters worn by individuals who may be exposed to unusual amounts of nuclear radiation in the course of their work. Examples of such instruments are pocket ion chambers, optical density devices (especially film badges), and photoluminescent, thermoluminescent, and color-change dosimeters. Calorimeters also measure total radiation doses. The charge collection time in semiconductor detectors is so short that these instruments lend themselves to the measurement of gamma-ray dose rates

in pulses of very short duration as well as of the total dose.

8.30 Dose (or exposure) rates are usually determined by what are called "survey meters." They may be ion chambers, Geiger-Mueller tubes, or scintillation detectors, together with associated electronic counting circuitry. In general, these survey meters are portable and battery powered. The dose-rate measurement may be converted into the total radiation dose by multiplying the properly averaged dose rate by the total time of exposure.

GAMMA-RAY DOSE DEPENDENCE ON YIELD AND DISTANCE

8.31 The biological effects of various gamma-radiation doses will be considered more fully in Chapter XII. However, in order to provide some indication of the significance of the numbers given below, it may be stated that a single absorbed dose of gamma rays of less than 25 rads (in body tissue) will produce no detectable clinical effects in humans. Larger doses have increasingly more serious consequences and whole-body doses of 1,000 rads would probably prove fatal in nearly all cases, although death would not occur until a few days later.

8.32 As is to be expected, the gamma-ray dose at a particular location, resulting from a nuclear explosion, is less the farther that location is from the point of burst. The relationship of the radiation dose to the distance is dependent upon two factors, analogous to those which apply to thermal radiation. There is, first, the general decrease due to the spread of the radiation over larger and larger areas as it travels away from

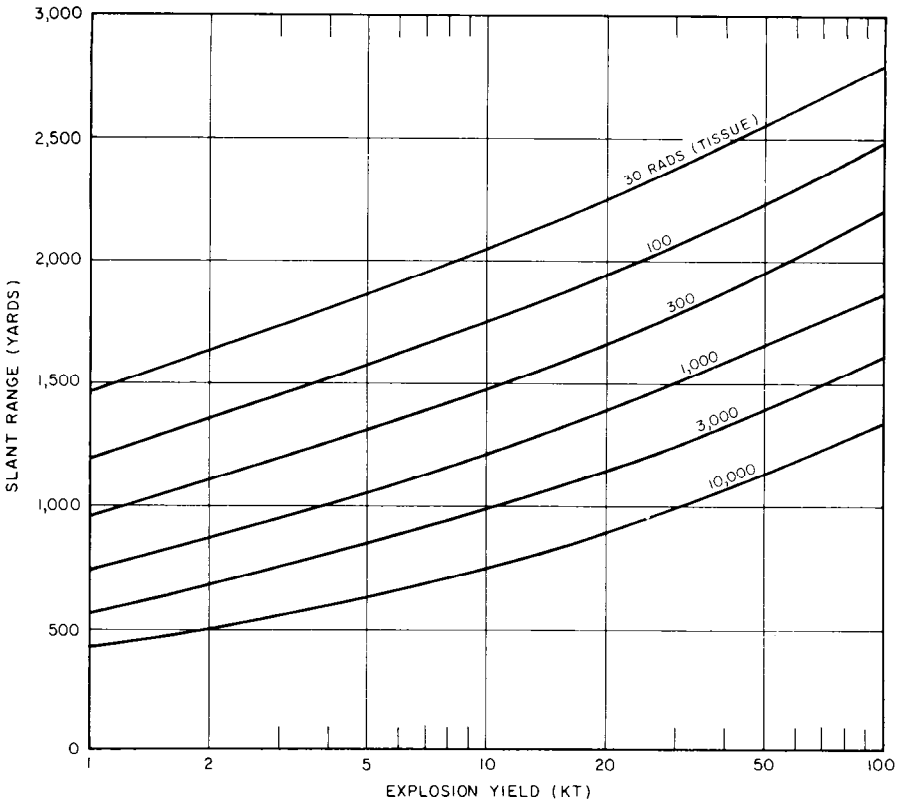

Figure 8.33a. Slant ranges for specified gamma-ray doses for targets near the ground as a function of energy yield of air-burst fission weapons, based on 0.9 sea-level air density. (Reliability factor from 0.5 to 2 for most fission weapons.)

the explosion center. As with thermal radiation (§ 7.07), the dose received is inversely proportional to the square of the distance from the burst point, so that it is said to be governed by the “inverse square” law. Second, there is an attenuation factor to allow for the decrease in intensity due to absorption and scattering of gamma rays by the intervening atmosphere.

8.33 The gamma-radiation doses at known distances from explosions of different energy yields have been measured at a number of nuclear weapons tests. Extensive computer calculations

have also been performed of the transport of gamma rays through the air. These calculations have been correlated with measurements of the gamma-ray transport from known sources and with observations made at nuclear explosions. The results obtained for air bursts are summarized in the form of two graphs: the first (Fig. 8.33a) shows the relation between yield and slant range for various absorbed gamma-ray doses (in tissue near the body surface, see § 8.18) for fission weapons; the second (Fig. 8.33b) gives similar information for thermonuclear weapons with 50

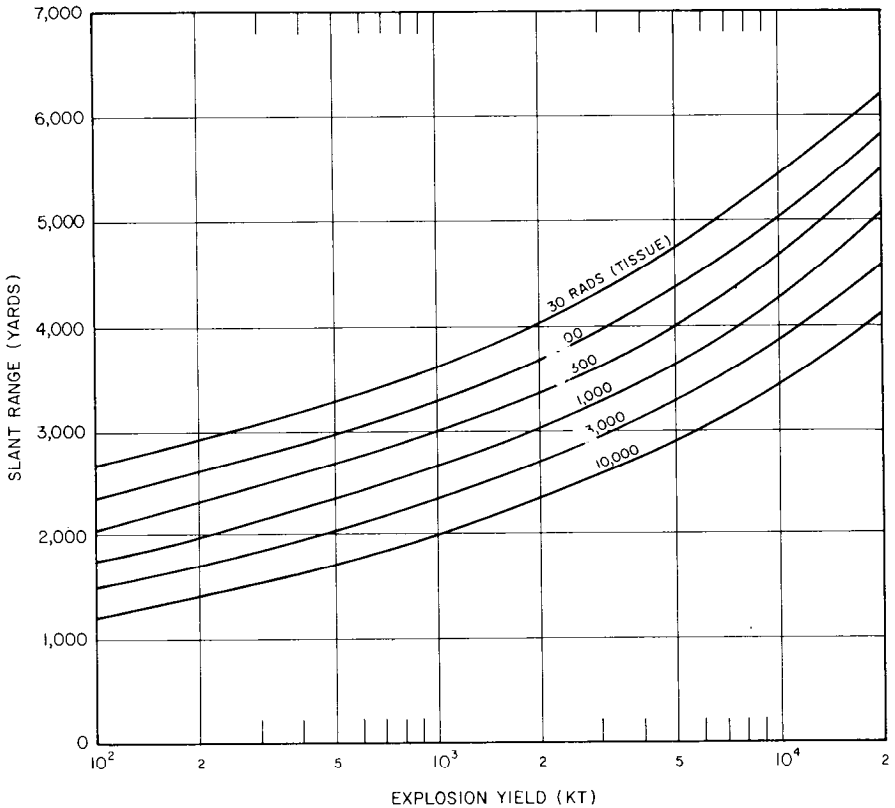

Figure 8.33b. Slant ranges for specified gamma-ray doses for targets near the ground as a function of energy yield of air-burst thermonuclear weapons with 50 percent fission yield, based on 0.9 sea-level air density. (Reliability factor from 0.25 to 1.5 for most thermonuclear weapons.)

percent of their yield from fission (§ 1.72). The data are based on an average density of the air in the transmission path between the burst point and the target of 0.9 of the normal sea-level density.⁵ Because of variations in weapon design and for other reasons (§ 8.127), the gamma-ray doses calculated from Figs. 8.33a and b are not exact for all situations that may arise. Figure 8.33a is considered to be reliable

within a factor of 0.5 to 2 for most fission weapons, whereas the reliability factor for Fig. 8.33b is from 0.25 to 1.5 for most thermonuclear weapons. Interpolation may be used for doses other than those shown on the figures.

8.34 The use of the gamma-ray dose curves may be illustrated by determining the absorbed dose received at a distance of 2,000 yards from a 50-kiloton low air burst of a fission weapon.

⁵The density referred to here (and subsequently) is that of the air before it is disturbed by the explosion (cf. § 8.36).

From Fig. 8.33a, the dose for the case specified is seen to be somewhat less than 300 rads. A reasonable interpolated value would appear to be about 250 rads.

8.35 The data in Figs. 8.33a and b are dependent upon the density of the air between the center of the explosion and the point on the ground at which the radiation is received. This is so because the air absorbs some of the gamma radiation in the course of its transmission; the dense air near the surface absorbs more than the less dense air at higher altitudes. If the actual average density is higher or lower than 0.9 of the normal sea-level value for which the curves were drawn, the gamma-ray dose will be decreased or increased, respectively.

8.36 It will be noted, especially in Fig. 8.33b, that for a specified dose, the slant range increases more rapidly in the higher explosion yield range, i.e., the slope of the curves becomes steeper. The cause is the sustained low air density following the passage of the positive phase of the shock wave (§ 3.04), particularly for explosions of high energy yield. The emission of gamma rays by the fission products is delayed (§ 8.13) and so these radiations do not

reach distant points until the shock wave has passed and the air density has decreased. There is consequently less attenuation of the fission product gamma rays by the air than at lower energy yields. This effect is known as the "hydrodynamic enhancement" of the gamma-ray dose.

8.37 The foregoing figures were calculated for heights of burst of $200W^{0.4}$ feet and the conclusions are reasonably applicable provided the height of burst exceeds about 300 feet, even though the fireball may touch the earth's surface. For a contact surface burst (§ 2.127 footnote) the dose for a specified explosion yield and range may be obtained upon multiplication of the corresponding dose in Fig. 8.33a or b by a factor which depends to some extent on both yield and range. The factors in Table 8.37 for some specific yields are averages which provide a fair approximation for distances of interest. The factors for intermediate yields may be obtained by interpolation. Interpolation between unity and the tabulated factor may also be used to obtain the appropriate factors for bursts between about 300 feet and the actual surface.

Table 8.37

CORRECTION FACTORS FOR CONTACT SURFACE BURSTS

Fig. 8.33a		Fig. 8.33b	
Yield	Factor	Yield	Factor
1 to 50 KT	$\frac{2}{3}$	100 KT	1
100 KT	1	300 KT	$1\frac{1}{4}$
		700 KT	$1\frac{1}{2}$
		2 MT	2
		5 to 20 MT	3

SHIELDING AGAINST GAMMA RAYS

8.38 Gamma rays are absorbed (or attenuated) to some extent in the course of their passage through any material. As a rough rule, the decrease in the radiation intensity is dependent upon the mass (per unit area) of material that intervenes between the source of the rays and the point of observation. This means that it would require a greater thickness of a substance of low density, e.g., water, than one of high density, e.g., iron, to attenuate the radiations by a specified amount. Strictly speaking, it is not possible to absorb gamma rays completely. Nevertheless, if a sufficient thickness of matter is interposed between the radiation source, such as an exploding nuclear weapon, and an individual, the dose received can be reduced to negligible proportions.

8.39 The simplest case of gamma-ray attenuation is that of a narrow beam of monoenergetic radiation, i.e., radiation having a single energy, passing through a relatively thin layer of shielding material. In these special (and hypothetical) circumstances, theoretical considerations lead to the concept of a "tenth-value" thickness as a measure of the effectiveness of the material in attenuating gamma rays of a given energy (cf. § 8.95 *et seq.*). A tenth-value thickness is defined as the thickness of the specified material which reduces the radiation dose (or dose rate) to one tenth of that falling upon it; in other words, one tenth-value thickness of the material would decrease the radiation by a factor of ten. Thus, if a person were in a

location where the tissue dose is 500 rads, e.g., of initial gamma radiation, with no shielding, the introduction of the appropriate tenth-value thickness of any substance would decrease the dose to (approximately) 50 rads. The addition of a second tenth-value thickness would result in another decrease by a factor of ten, so that the dose received would be (approximately) 5 rads. Each succeeding tenth-value thickness would bring about a further reduction by a factor of ten. Thus, one tenth-value thickness decreases the radiation dose by a factor of (approximately) 10; two tenth-value thicknesses by a factor of 10×10 , i.e., 100; three tenth-value thicknesses by a factor of $10 \times 10 \times 10$, i.e., 1,000; and so on.⁶

8.40 In shielding against gamma radiations from a nuclear explosion the conditions leading to the tenth-value thickness concept do not exist. In the first place, the gamma-ray energies cover a wide range, the radiations are spread over a large area, and thick shields are necessary in regions of interest. Evaluation of the effectiveness of a given shield material is then a complex problem, but calculations have been made with the aid of electronic computers. It has been found that, beyond the first few inches of a shielding material, the radiation attenuation can be expressed with fair accuracy in many cases in terms of an effective tenth-value thickness. This useful result apparently arises from the fortuitous cancellation of factors which have opposing effects on the simple situation considered in § 8.39. In the first few inches of the

⁶The "half-value thickness" is sometimes used; it is defined as the thickness of a given material which reduces the dose of impinging radiation to (approximately) one half. Two such thicknesses decrease the dose to one fourth; three thicknesses to one eighth, etc.

shield the attenuation is generally greater than indicated by the effective tenth-value thickness and so use of the latter would be conservative.

8.41 The effective tenth-value thicknesses of some materials of interest in radiation shielding are given in Table 8.41,⁷ for broad beams of gamma rays emitted by the fission products in the first minute after the detonation and for those (secondary gamma rays) accompanying the capture of neutrons by nitrogen in the air (§ 8.11). These particular radiations were chosen because they are representative of the main constituents of the initial gamma rays. The thickness of any material required to decrease the nitrogen capture (secondary) gamma rays to one-tenth is about 50 percent greater than for the fission product gamma rays; this is because the former have a considerably higher energy.

8.42 The second column for each type of gamma radiation, designated $D \times T$ (lb/sq ft), gives the product of the density, D , of the material (in lb/cu ft) and the tenth-value thickness, T (in feet). It will be noted that $D \times T$ is roughly constant for a given gamma radiation. This is the basis of the statement in § 8.38 that gamma-ray attenuation is determined approximately by the mass (per unit area) of the shielding material. If the tenth-value thickness for a particular material is not known, but the density is, a fair estimate can be made by assuming $D \times T$ to be 130 lb/sq ft for fission product gamma rays and 200 lb/sq ft for nitrogen capture gamma rays. To determine the effectiveness of a given shield as a protection against the initial radiation from a nuclear explosion, it is recommended that the higher of these values be employed. The result will indicate a smaller degree

Table 8.41

APPROXIMATE EFFECTIVE TENTH-VALUE THICKNESSES FOR FISSION PRODUCT AND NITROGEN CAPTURE GAMMA RAYS

Material	Density (lb/cu ft)	Fission Product		Nitrogen Capture	
		Tenth- Value Thickness (inches)	$D \times T$ (lb/sq ft)	Tenth- Value Thickness (inches)	$D \times T$ (lb/sq ft)
Steel (Iron)	490	3.3	135	4.3	176
Concrete	146	11	134	16	194
Earth	100	16	133	24	200
Water	62.4	24	125	39	201
Wood	40	38	127	63	210

⁷The tenth-value thicknesses are for gamma rays that are incident perpendicularly on the slab of material. If the rays make an angle θ with the perpendicular, the tenth-value thickness is obtained approximately by multiplying the values in the table by cosine θ , provided θ is less than 45° .

of protection than can actually be obtained, but it is better to be conservative in this respect than to overestimate the effectiveness of the shield.

8.43 A more accurate estimate of the protection that can be provided by a particular shield between the source of the radiation and the target, e.g., a person, can be made by taking a number of factors into consideration. These include the energy distribution of the gamma radiation falling on the shield, the angle of incidence of the radiation, and the geometry (or form) of the shielding material. Such considerations make it necessary to use computer methods to calculate the shielding provided by even simple structures. Estimates of the effectiveness of some common shelters in shielding from initial gamma radiation (and neutrons) are given in Table 8.72. (Data for these same structures for residual (fallout) gamma rays will be found in Table 9.120.)

8.44 In a vacuum, gamma rays travel in straight lines with the speed of light. However, in its passage through the atmosphere, gamma radiation, like thermal radiation, is scattered, especially by the oxygen and nitrogen in the air. Consequently, gamma rays will reach a particular target on the ground from many directions. Most of the dose received will come from the direction of the explosion, but a considerable amount of radiation will arrive from other directions. The gamma radiation reaching a target as a result of scattering in the air is called "skyshine."

8.45 The fact that gamma rays can reach a target from directions other than that of the burst point has an important bearing on the problem of shielding. A

person taking shelter behind a single wall, an embankment, or a hill will be shielded, to some extent, from the direct gamma rays, but will still be exposed to the scattered radiation (or skyshine), as shown by the broken lines in Fig. 8.45a. Adequate protection from gamma rays can be secured only if the shelter is one which surrounds the individual, so that he can be shielded from all directions (Fig. 8.45b). In this case, both direct and scattered radiations can be attenuated. The variation in the amounts of radiation received at a target from different directions is called the "angular distribution." It has been found that the angular distribution of the initial gamma radiation is relatively insensitive to the type of weapon and to the distance of the target from the explosion point.

RATE OF DELIVERY OF INITIAL GAMMA RAYS

8.46 Radiation dose calculations based on Figs. 8.33a and b involve the assumption that the exposure lasts for the whole minute which was somewhat arbitrarily set as the period in which the initial nuclear radiation is emitted. It is important to know, however, something about the rate at which the radiation is delivered from the exploding weapon. If this information is available, it is possible to obtain some idea of the dose that would be received if part of the radiation could be avoided, e.g., by taking shelter within a second or two of observing the luminous flash of the explosion.

8.47 The rate at which gamma-ray energy is released from a weapon is shown in Fig. 8.14. But the rate at which this energy is received at a distant target depends upon a number of fac-

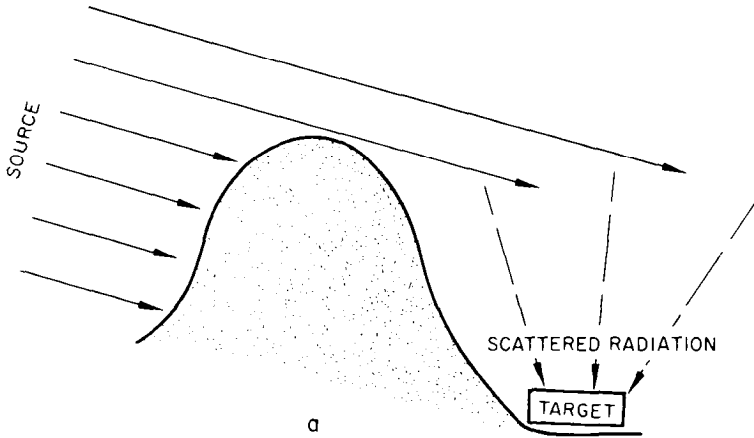

Figure 8.45a. Target exposed to scattered gamma radiation.

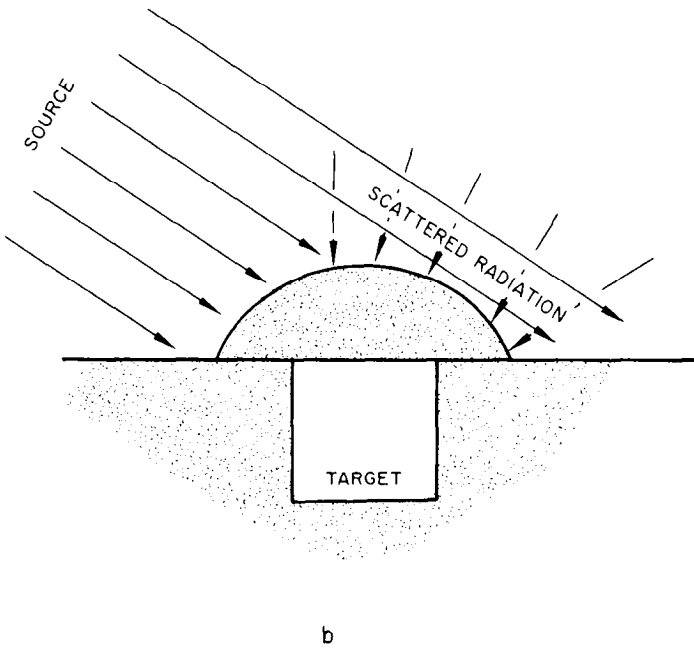

Figure 8.45b. Target shielded from scattered gamma radiation.

tors; the most significant are the energy yield of the explosion and the distance from the burst point. These two quantities affect the relative importance of the several components of the initial gamma radiation. The larger the yield and the greater the distance, the greater will be the hydrodynamic enhancement of the fission product gamma rays (§ 8.36). As this enhancement is increased, the relative importance of the fission product gamma rays is increased. Thus, for larger yields and greater distances, the fission product gamma rays, which are important at late times relative to the other components of the initial gamma radiation, provide a larger percentage of the total dose. The percentage of the total dose received up to various times for two different cases is shown in Fig.

8.47. One curve refers to a distance of 1,000 yards from a 20-kiloton air burst and the other to 2,500 yards from a 5-megaton explosion. It is seen that in the former case about 65 percent and in the latter case about 5 percent of the total initial gamma radiation dose is received during the first second after the detonation.

8.48 If some shelter could be obtained, e.g., by falling prone behind a substantial object, within a second of seeing the explosion flash, in certain circumstances it might make the difference between life and death. The curves in Fig. 8.47 show that avoidance of part of the initial gamma-ray dose would be more practicable for explosions of higher energy yields.

NEUTRONS

SOURCES OF NEUTRONS

8.49 Although neutrons are nuclear particles of appreciable mass, whereas gamma rays are electromagnetic waves (§ 8.17), their harmful effects on the body and their ability to damage certain materials are similar in character. Like gamma rays, only very large doses of neutrons may possibly be detected by the human senses. Neutrons can penetrate a considerable distance through the air and constitute a hazard that is greater than might be expected from the small fraction (about 1 percent) of the explosion energy which they carry.

8.50 Essentially all the neutrons accompanying a nuclear explosion are

released either in the fission or fusion process (§§ 1.42, 1.69). All of the neutrons from the latter source and over 99 percent of the fission neutrons are produced almost immediately, within less than a millionth of a second of the initiation of the explosion. These are referred to as the "prompt" neutrons. In addition, somewhat less than 1 percent of the fission neutrons, called the "delayed" neutrons, are emitted subsequently. The majority of these delayed neutrons are released within the first minute, and so constitute part of the initial nuclear radiation. At distances greater than about 2,000 yards from a multimegaton explosion, the dose from delayed neutrons can exceed that from

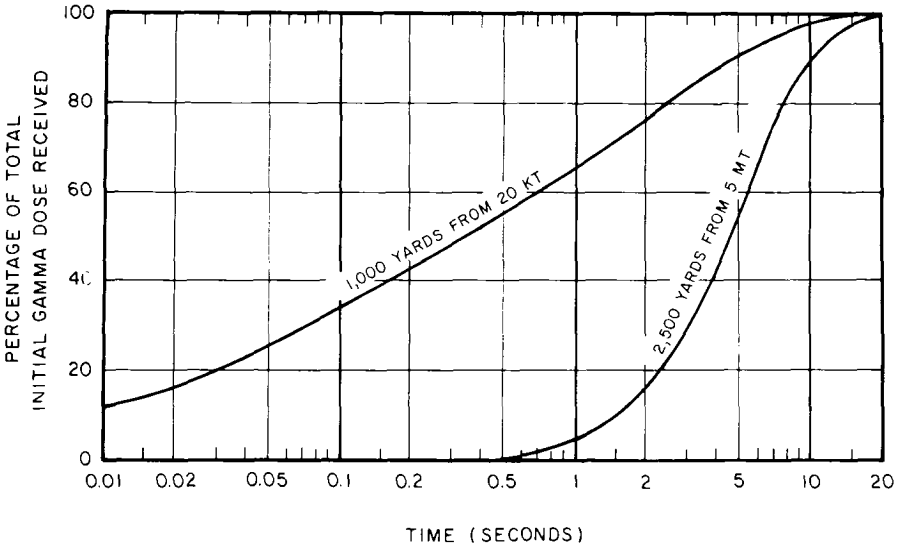

Figure 8.47. Percentage of initial gamma-radiation dose received as a function of time for 20-kiloton and 5-megaton air bursts.

prompt neutrons, because the delayed neutrons are subject to hydrodynamic enhancement (§ 8.36) whereas the prompt neutrons are not. Both doses are, however, much less than the gamma-ray dose for high-yield weapons. Neutrons are also produced by the action of high-energy gamma rays on the weapon materials, but their contribution is minor.

8.51 Despite their almost instantaneous release, the prompt fission neutrons are slightly delayed in escaping from the environment of the exploding weapon. This delay arises from the numerous scattering collisions suffered by the neutrons with the nuclei present in the weapon residues. As a result, the neutrons traverse a complex zigzag path before they finally emerge. However, they move so fast that the delay in the escape of the prompt neutrons is much less than a one-thousandth part of a

second. At distances from the burst where they represent a hazard, nearly all of the neutrons are received within a second of the explosion, that is, before the arrival of the fission product gamma rays. The evasive action described in § 8.48 for gamma rays thus has little effect on the neutron dose received.

8.52 The neutrons produced in the fission process have a range of energies, but they are virtually all in the region of high energy. Such high-energy neutrons are the fast neutrons referred to in § 8.09, their energy being kinetic in nature, i.e., energy of motion. In the course of scattering collisions with atomic nuclei, there is an exchange of energy between the fast neutrons and the nuclei. Within the weapon itself, where heavy nuclei, e.g., of uranium, are present, some of the neutrons lose energy as a result of inelastic scattering, the energy removed being emitted in the

form of gamma radiation (§ 8.09). In other collisions, especially with light nuclei, there is a simple transfer of kinetic energy from the fast neutron to the struck nucleus; these are "elastic collisions" and are not accompanied by gamma radiation. Because of the variety of collisions which occur with different nuclei, the neutrons leaving the region of the explosion have speeds (or energies) covering a wide range, from fast through intermediate to slow. The neutrons of lowest energy (or speed) are often called "thermal" neutrons because they are approximately in thermal (or temperature) equilibrium with their surroundings.

8.53 As a consequence of the various interactions described above, the neutrons that emerge from the region of the explosion have a very different energy distribution, i.e., "neutron energy spectrum," than when they were formed in the fission and fusion reactions. Furthermore, the energy spectrum may change as the neutrons travel through the air. For example, the neutrons leaving the weapon environment undergo scattering collisions with nuclei of nitrogen, oxygen, and other elements in the atmosphere. These collisions are less frequent than within the weapon because of the lower density and smaller concentration of nuclei. Nevertheless, the results of the collisions are important. In the first place, the fractional decrease in neutron energy per elastic scattering collision is, on the average, greatest for light nuclei. The nuclei of oxygen and nitrogen are relatively light, so that the neutrons are appreciably slowed down by elastic scattering collisions in the air. Some of the collisions with nitrogen result in inelastic scatter-

ing which removes energy from the neutrons and is a substantial source of gamma radiation (§ 8.09, Fig. 8.14). Inelastic scattering of high-energy neutrons by oxygen also results in energy removal and provides a less important source of gamma radiation (§ 8.107).

8.54 In some collisions, particularly with nitrogen nuclei, the neutrons can be captured (§ 8.11), so that they are completely removed. The probability of capture is greatest with the slow (low-energy) neutrons. Consequently, in their passage through the air, from the weapon to a location on the ground, for example, there are many interactions involving the neutrons. There is a tendency for the fast (high-energy) neutrons to lose some of their energy and to be slowed down. At the same time, the slower neutrons have a greater chance of being captured and eliminated, as such, from the nuclear radiation, although the capture usually leads to the emission of gamma rays.

8.55 It is important in connection with the measurement of nuclear weapon neutrons and the study of their biological effects to know something of the neutron energy spectrum and its variation with distance from the explosion. From measurements made during nuclear tests in the field, measurements with laboratory calibrated sources, and extensive computer calculations, it appears that the neutron energy spectrum for fission weapons remains essentially the same for a given weapon over the range of distances that are of biological interest. This condition is referred to as an "equilibrium spectrum."

8.56 The occurrence of an equilibrium spectrum is related to a combination of circumstances which arise during

passage of the neutrons through the air; the loss of the slower neutrons by capture, e.g., by nitrogen nuclei, is compensated by the slowing down of fast neutrons. Consequently, the proportion (or fraction) of neutrons present in any particular energy range appears to be essentially constant at all distances of interest. The total number of neutrons received per unit area, however, at a given location is less the farther that point is from the explosion, because, in addition to being spread over a large area (cf. § 8.32), some of the neutrons are removed by capture.

8.57 The thermonuclear reaction between deuterium and tritium results in the liberation of neutrons with energies of 14.1 MeV. This energy is considerably greater than that of essentially all the fission neutrons and is also much greater than the energy of the neutrons produced by the other thermonuclear reactions (§ 1.69). These neutrons of very high energy undergo reactions within the exploding weapon similar to those described in § 8.52. Consequently some of the high-energy neutrons are emitted from the region of the explosion with energies lower than 14.1 MeV. Nevertheless, sufficient quantities of energetic neutrons emerge from a thermonuclear weapon to cause a peak in the neutron spectrum at energies in the range of 12 to 14 MeV. This peak is in contrast to the continuous decrease in the number of neutrons with increasing neutron energy observed for fission weapons. The existence of the high-energy peak in the neutron energy spectrum from thermonuclear weapons pre-

vents the occurrence of an equilibrium spectrum until the neutrons have traveled long distances in air (§ 8.117 *et seq.*).

MEASUREMENT OF NEUTRON FLUX

8.58 Neutrons, being electrically neutral particles, do not produce ionization or excitation directly in their passage through matter. They can, however, cause these effects indirectly as a result of their interaction with certain light nuclei. When a fast neutron collides with the nucleus of a hydrogen atom, for example, the neutron may transfer a large part of its energy to that nucleus. As a result, the hydrogen nucleus is freed from its associated electron and moves off as a high-energy proton. Such a proton is capable of producing a considerable number of ion pairs in its passage through a gas or it can cause electronic excitation. Thus, the interaction of a fast neutron with hydrogen (or with any substance containing hydrogen) can cause ionization or excitation to occur indirectly.* The interaction of neutrons with hydrogen thus makes it possible to use both ionization and scintillation counters as neutron detectors. For example, if a hydrogenous material is impregnated with a substance that is capable of producing scintillations, protons released by neutrons interacting with hydrogen atoms cause the excitation of the scintillation material.

8.59 Neutrons in the slow and moderate speed ranges can produce ionization and excitation indirectly in

*The ionization and excitation resulting from the interaction of fast neutrons with hydrogen in tissue is considered to be the main cause of biological injury by neutrons.

other ways. When such neutrons are captured by the lighter isotope of boron (boron-10), two electrically charged particles—a helium nucleus (alpha particle) and a lithium nucleus—of high energy are formed. Neutrons also can be captured in the lighter isotope of lithium (lithium-6) to produce a tritium nucleus and an alpha particle (§ 1.70), or the neutrons can be captured by nitrogen nuclei and high-energy particles are emitted (§ 8.110). In each of these reactions, the resulting charged particles can produce ion pairs or excitation. Indirect ionization by neutrons can also result from the fission of plutonium or uranium isotopes. The fission fragments are electrically charged particles (ions) of high energy which leave considerable ionization in their paths.

8.60 All of the foregoing indirect ionization or excitation processes can be used to detect and measure neutron intensities. The quantity determined, either directly or indirectly, is called the "neutron flux"; it is the product of the neutron density, i.e., the number per unit volume, and the average velocity. The instruments employed for the measurement of neutron flux, such as boron counters and fission chambers, are somewhat similar, in general principle, to the dose rate (survey) meters commonly used for gamma radiations (§ 8.30). "Tissue equivalent" chambers have been developed in which the ionization produced indirectly by neutrons is related to the energy which would be taken up from these neutrons by animal tissue. Thus, the absorbed

dose in rads (tissue) can be determined in this manner.

8.61 In addition to the procedures described above, "foil activation" methods have been extensively used in the detection and measurement of neutrons in various energy ranges. These methods are based upon the fact that certain elements become radioactive as a result of the capture of neutrons (§ 8.16). Under appropriate conditions, the extent of the radioactivity, as measured by the rate of emission of radiation (beta or gamma or both), is related to the "integrated flux," or "fluence," of incident neutrons, i.e., the product of the flux and time, expressed as neutrons per square centimeter (neutrons/cm²). Hence, by the use of appropriate conversion factors, neutron fluence can be calculated.⁹ In practice the elements are used in the form of thin sheet or foil, so that they produce a minimum disturbance of the neutron field. The technique is referred to as "activation detection" and the materials employed are known as "activation detectors." An activation detector which has an appreciable probability of reaction only when the energy of the neutron exceeds a particular (threshold) value is called a "threshold detector." The procedure is then described as the "threshold detector technique" and is used to determine the number of neutrons with energies in excess of the threshold value.

8.62 The "fission foil" method, as its name implies, makes use of fission reactions. A thin layer of a fissionable material, such as an isotope of uranium

⁹The neutron fluence (at a given energy) is, in a sense, a measure of the neutron exposure (at that energy). The absorbed dose can be derived from the fluence by allowing for the energy deposited by the neutrons in a specified material.

or plutonium, is exposed to neutrons. The fission products formed are highly radioactive, emitting beta particles and gamma rays. By measuring the radioactivity produced in this manner, the amount of fission and, hence, the neutron fluence to which the fissionable material was exposed can be determined.

NEUTRON DOSE DEPENDENCE ON YIELD AND DISTANCE

8.63 A basic difficulty in expressing the relation between the neutron dose, yield, and the distance from a nuclear explosion is the fact that the results vary significantly with changes in the characteristics of the weapon. The materials, for example, have a considerable influence on the extent of neutron capture and, consequently, on the number and energy distribution of the fission neutrons that succeed in escaping into the air. Further, the thermonuclear reaction between deuterium and tritium is accompanied by the liberation of neutrons of high energy (§ 8.57). Hence, it is to be expected that, for an explosion in which part of the energy yield arises from thermonuclear (fusion) processes, there will be a larger proportion of high-energy (fast) neutrons than from a purely fission explosion.

8.64 In view of these considerations, it is evident that the actual number of neutrons emitted per kiloton of explosion energy yield, as well as their energy distribution, may differ not only for weapons of different types, i.e., fission and fusion, but also for weapons of the same kind. Hence, any curve which purports to indicate the variation of neutron dose with yield and distance

cannot be correct for all situations that might arise. It is with this limitation in mind that the curves in Figs. 8.64a and b are presented; the former is for fission weapons and the latter for thermonuclear weapons with 50 percent of their yield from fission. The estimated reliability factors are the same as given in § 8.33 for Figs 8.33a and b, respectively. The curves give absorbed neutron doses in tissue close to the surface of the body received near the ground for low air bursts. The data are based on an average air density in the transmission path of 0.9 of the normal sea-level density. If the actual average air density is higher or lower than this, the neutron dose will be decreased or increased, respectively.

8.65 When comparing or combining neutron doses with those from gamma rays (Figs. 8.33a and b), it should be noted that the biological effects of a certain number of rads of neutrons are often greater than for the same number of rads of gamma rays absorbed in a given tissue (§ 12.97). As for gamma rays, the neutron dose decreases with distance from the explosion as a result of the inverse square law and attenuation by absorption and scattering in the atmosphere. However, since the prompt neutrons are emitted during a short time (§ 8.51), and since those of major biological significance travel much faster than the blast wave, there is no hydrodynamic enhancement of the (prompt) neutrons dose as there is for fission product gamma rays. This is one reason why the gamma-ray dose increases more rapidly with the energy yield than does the neutron dose. The data in Figs. 8.64a and b may be regarded as applying to air bursts. For

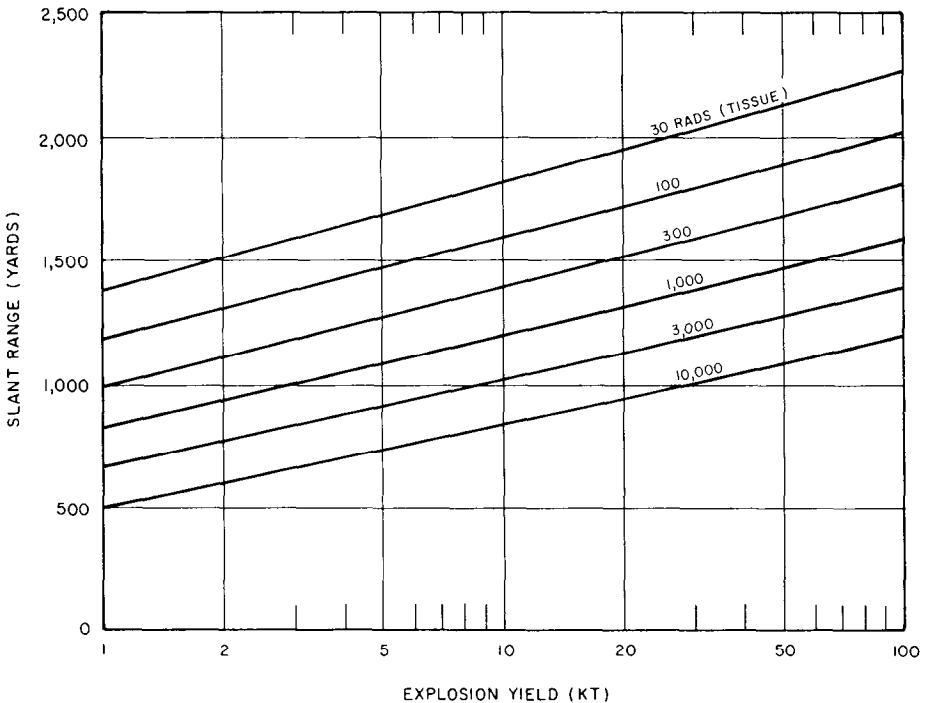

Figure 8.64a. Slant ranges for specified neutron doses for targets near the ground as a function of energy yield of air-burst fission weapons, based on 0.9 sea-level air density. (Reliability factor from 0.5 to 2 for most fission weapons.)

contact surface bursts, the prompt neutron dose may be taken as one-half the value for a corresponding air burst. For heights of burst below 300 feet, the dose may be estimated by interpolation between the values for an air burst and a contact surface burst.

SHIELDING AGAINST NEUTRONS

8.66 Neutron shielding is a different, and more difficult, problem than shielding against gamma rays. As far as the latter are concerned, it is merely a matter of interposing a sufficient mass of material between the source of gamma radiations and the recipient. Heavy metals, such as iron and lead, make

good gamma-ray shields because of their high density. These elements alone, however, are not quite as satisfactory for neutron shielding. An iron shield will attenuate weapon neutrons to some extent, but it is less effective than some of the types described below.

8.67 The attenuation of neutrons from a nuclear explosion involves several different phenomena. First, the very fast neutrons must be slowed down into the moderately fast range; this requires a suitable (inelastic) scattering material, such as one containing barium or iron. Then, the moderately fast neutrons have to be decelerated (by elastic scattering) into the slow range by means of an element of low atomic weight (or mass

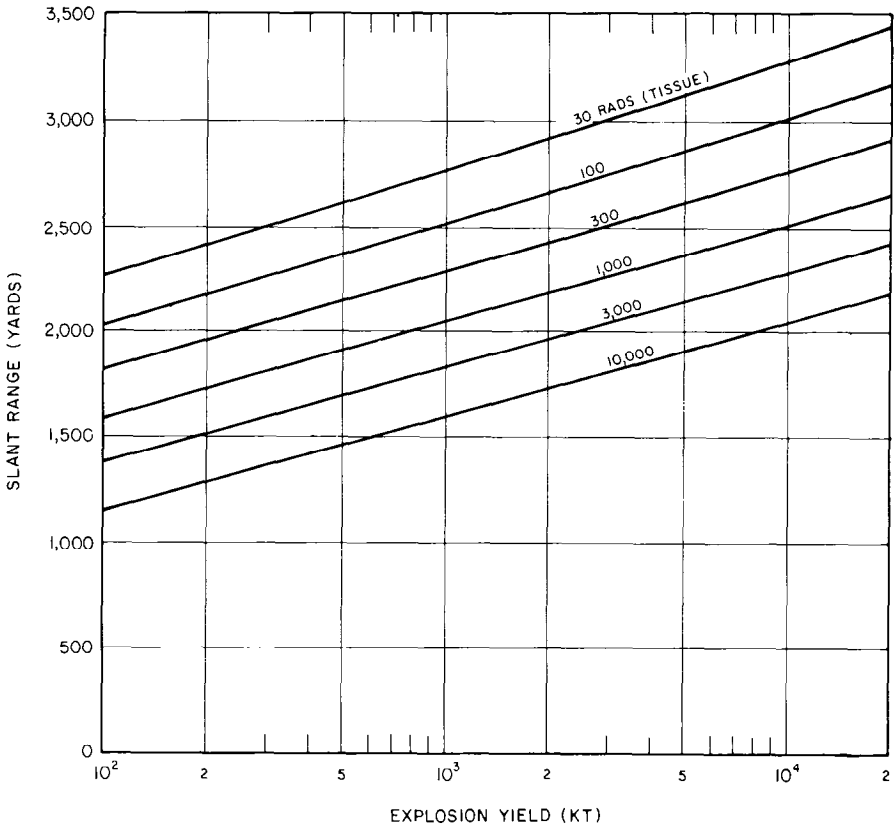

Figure 8.64b. Slant ranges for specified neutron doses for targets near the ground as a function of energy yield of air-burst thermonuclear weapons based on 0.9 sea-level air density. (Reliability factor 0.25 to 1.5 for most thermonuclear weapons.)

number). Water is very satisfactory in this respect, since its two constituent elements, i.e., hydrogen and oxygen, both have low atomic weights. The slow (thermal) neutrons must then be absorbed. This is not a difficult matter, since the hydrogen in water will serve the purpose. However, neutron inelastic scattering reactions and most neutron capture reactions are accompanied by the emission of gamma rays (§§ 8.53, 8.54). Consequently, sufficient gamma-attenuating material must be included to

minimize the escape of the gamma rays from the shield.

8.68 In general, concrete or damp earth would represent a fair compromise for neutron, as well as for gamma-ray shielding. Although these materials do not normally contain elements of high atomic weight, they do have a fairly large proportion of hydrogen to slow down and capture neutrons, as well as calcium, silicon, and oxygen to absorb the gamma radiations. A thickness of 12 inches of concrete, for example, will

decrease the neutron fluence from a thermonuclear weapon by a factor of about 10, and 24 inches by a factor of roughly 100. The high energy initial gamma radiation would be decreased to a somewhat lesser extent (see Table 8.41), but, in sufficient thickness, concrete could be used to provide shielding against both neutrons and gamma rays from a nuclear explosion. Damp earth may be expected to act in a similar manner, although about 50 percent greater thickness would be required.

8.69 An increase in the absorption of the nuclear radiations can be achieved by using a modified ("heavy") concrete made by adding a considerable proportion of an iron (oxide) ore, e.g., limonite, to the mix and incorporating small pieces of iron, such as steel punchings. Alternatively, the mineral barytes, which is a compound of barium, may be included in the concrete. The presence of a heavy element improves both the neutron and gamma-ray shielding properties of a given thickness (or volume) of the material. Attenuation of the neutron fluence from a thermonuclear weapon by a factor of 10 requires about 7 inches of this heavy concrete.

8.70 The presence of boron or a boron compound in neutron shields has certain advantages. The lighter (boron-10) isotope of the element captures slow neutrons very readily (§ 8.59), the process being accompanied by the emission of gamma rays of moderate energy (0.48 MeV) that are not difficult to attenuate. Thus, the mineral colemanite, which contains a large proportion of boron, can be incorporated into concrete in order to improve its ability to absorb neutrons.

8.71 It was pointed out in § 8.45

that, because of the scattering experienced by gamma rays, an adequate shield must provide protection from all directions. Somewhat the same situation applies to neutrons. As seen earlier, neutrons undergo extensive scattering in the air, so that, by the time they reach the ground, even at a moderate distance from the explosion, their directions of motion are almost randomly distributed. Partial protection from injury by neutrons may be obtained by means of an object or structure that provides shielding only from the direction of the explosion, although better protection, as in the case of gamma rays, would be given by a shelter which shields in all directions.

8.72 In addition to the complexities introduced by the arrival of neutrons at a target from many directions, the distribution in energy from each direction makes it impractical to calculate the shielding effectiveness of even simple structures without resort to complex computer codes. Estimates of the shielding afforded by various structures are given in Table 8.72 in terms of a "dose transmission factor"; this is defined as the ratio of the dose received behind the shield to the dose at the same location in the absence of shielding. Some of the transmission factors were obtained by measurements at weapons tests or are extrapolations from such measurements. Others were obtained by relatively detailed calculations, whereas still others are mere estimates. Ranges of values are given for the dose transmission factors for two reasons: uncertainties in the estimates themselves and variations in the degree of shielding that may be obtained at different locations within a structure.

Table 8.72

DOSE TRANSMISSION FACTORS FOR VARIOUS STRUCTURES

Structure	Initial	
	Gamma Rays	Neutrons
Three feet underground	0.002-0.004	0.002-0.01
Frame House	0.8-1.0	0.3-0.8
Basement	0.1-0.6	0.1-0.8
Multistory building (apartment type):		
Upper stories	0.8-0.9	0.9-1.0
Lower stories	0.3-0.6	0.3-0.8
Concrete blockhouse shelter:		
9-in. walls	0.1-0.2	0.3-0.5
12-in. walls	0.05-0.1	0.2-0.4
24-in. walls	0.007-0.02	0.1-0.2
Shelter, partly above grade:		
With 2 ft earth cover	0.03-0.07	0.02-0.08
With 3 ft earth cover	0.007-0.02	0.01-0.05

TRANSIENT-RADIATION EFFECTS ON ELECTRONICS (TREE)

GENERAL CHARACTERISTICS OF TREE

8.73 The initial nuclear radiation, specifically gamma rays and neutrons, can affect materials, such as those used in electronics systems, e.g., radio and radar sets, gyroscopes, inertial guidance devices, computers, etc. The response of such systems to radiation from a nuclear explosion depends on the nature of the radiation absorbed and also on the specific component and often on the operating state of the system. The actual effects are determined by the characteristics of the circuits contained in the electronics package, the exact components present in the circuits, and the specific construction techniques and materials used in making the components.

8.74 The name commonly applied to the class of effects under consideration is "transient-radiation effects on electronics," commonly abbreviated to the acronym TREE. In general, TREE means those effects occurring in an electronics system as a result of exposure to the transient initial radiation from a nuclear weapon explosion. The adjective "transient" applies to the radiation since it persists for a short time, i.e., less than 1 minute. The response, however, is not necessarily transient. In order to study the effects of nuclear radiations on electronics systems and components, the transient radiation from a weapon is simulated in the laboratory by means of controlled sources of both steady-state and transient radiations.

8.75 The term "electronics" as used in TREE may refer to any or all of the following: individual electronic component parts, component parts assembled into a circuit, and circuits combined to form a complete system. TREE studies may also include electro-mechanical components connected to the electronics, e.g., gyros, inertial instruments, etc. Purely mechanical or structural components are excluded since they are much less sensitive to radiation than are components or systems that depend on electrical currents (or voltages) for their operation.

8.76 Radiation effects on electronics may be temporary or more-or-less permanent. Even though the effects on a particular component, e.g., a transistor, may be temporary, these effects may result in permanent damage to some other part of a circuit. The component responses of short duration are usually the result of ionization caused by gamma radiation and are dependent upon the dose rate, e.g., in rads per second, rather than the dose. The more permanent effects are generally—but not always—due to the displacement of atoms in a crystal lattice by high-energy (fast) neutrons. In such cases the extent of damage is determined by the neutron fluence, expressed in neutrons/cm² (§ 8.61). When a permanent effect is produced in an electronic component by gamma radiation, the important quantity usually is the dose in rads. A brief description of the responses of some components of electronics systems are given below; the mechanisms of the interactions with nuclear radiations are explained later (§ 8.133 *et seq.*).

OBSERVED EFFECTS ON ELECTRONICS COMPONENTS

Solid-State Devices

8.77 Solid-state devices, such as diodes, transistors, and integrated circuits, are widely used in electronics systems. They consist of semiconductor materials that are quite sensitive to nuclear radiations. Temporary effects are the production of spurious current pulses caused by gamma rays absorbed in the solid. This phenomenon is turned to advantage in the semiconductor detectors of nuclear radiation (§ 8.22). The strength of the current pulse is proportional to the dose rate of the radiation and is much larger in a transistor than in a diode because the primary current resulting from ionization produces an amplified secondary current in the transistor.

8.78 Some of the changes caused by atomic displacements in a semiconductor disappear or "anneal" (§ 8.142) in a short time but others remain. Permanent changes in the physical properties of materials affect the operating characteristics of the diode or transistor. The latter are usually more sensitive to radiation and so the discussion here will be restricted to transistors. In most cases, degradation in the current amplification (or gain) of transistors is the critical factor in determining the usefulness of electronic systems containing solid-state components.

8.79 There is a wide variation in the response of transistors to radiation, even among electronic devices designed to perform similar functions. The decrease in gain may become unacceptable at

fast-neutron fluences as small as 10^{11} or as large as 10^{15} (or more) neutrons/cm². (Fast-neutron fluences referred to in this section are fission neutrons with energies exceeding 10 keV, i.e., 0.01 MeV).¹⁰ The structure of the device has an important influence on the radiation resistance of a transistor. As a general rule, a thin base, as in high-frequency devices, and a small junction area favor radiation resistance. For example, diffuse-junction transistors are significantly more resistant than alloy-junction devices because of the smaller junction area. Junction and especially thin-film field-effect transistors can be made that are quite resistant to radiation. Certain types of the latter have remained operational after exposure to a fast-neutron fluence of 10^{15} neutrons/cm².

8.80 Damage in MOS (metal-oxide semiconductor) field-effect transistors is caused primarily by gamma radiation rather than by neutrons; hence, the effects are reported in terms of the dose in rads (silicon). The most sensitive parameter to radiation in these devices is the threshold voltage, i.e., the value of the gate voltage for which current just starts to flow between the drain and the source. In general, gradual degradation, i.e., a shift of about 0.5 volt in the threshold voltage, begins at about 10^4 rads (silicon) and proceeds rapidly at higher doses. The sensitivity of MOS transistors to radiation is, however, dependent on the impurities in the gate oxide. With improvements in the technique for producing the oxide, the devices are expected to survive doses of 10^6 rads (silicon).

Vacuum Tubes and Thyratrons

8.81 The principal transient effect in vacuum tubes arises from the (Compton) electrons ejected by gamma rays (§ 8.89) from the structural parts of the tube into the evacuated region. These electrons are too energetic to be significantly influenced by the electric fields in the tube. However, their impact on the interior surfaces of the tube produces low-energy secondary electrons that can be affected by the existing electric fields, and as a result the operating characteristics of the tube can be altered temporarily. The grid is particularly sensitive to this phenomenon; if it suffers a net loss of electrons, its voltage will become more positive and there is a transient increase in the plate current. Large fluences of thermal neutrons, e.g., 10^{16} neutrons/cm², can cause permanent damage to vacuum tubes as a consequence of mechanical failure of the glass envelope. But at distances from a nuclear explosion at which such fluences might be experienced, blast and fire damage would be dominant.

8.82 Gas-filled tubes (thyratrons) exposed to gamma radiation exhibit a transient, spurious firing due to partial ionization of the gas, usually xenon. Additional ionization is caused by collisions between ions and neutral molecules in the gas. As with vacuum tubes, large fluences of thermal neutrons can cause thyratrons to become useless as a result of breakage of the glass envelope or failure of glass-to-metal seals.

¹⁰For the dependence of neutron fluences at various energies on the energy yield and distance from a nuclear explosion, see Figs. 8.117a and b.

Capacitors, Resistors, and Batteries

8.83 Nuclear radiation affects the electrical properties of capacitors to some extent. Changes in the capacitance value, dissipation factor, and leakage resistance have been observed as a consequence of exposure. The effects are generally not considered to be severe for fast-neutron fluences less than 10^{15} neutrons/cm². During a high-intensity pulse of nuclear radiation, the most pronounced effect in a capacitor is a transient change in the conductivity of the dielectric (insulating) material with a corresponding increase in the leakage currents through the capacitor.

8.84 Radiation effects in resistors are generally small compared with those in semiconductors and capacitors and are usually negligible. However, in circuits requiring high-precision carbon resistors transient effects may be significant at gamma-ray dose rates of 10^7 rads (carbon)/sec¹¹ and at fast-neutron fluences of 10^{14} neutrons/cm². The transient effects are generally attributed to gamma rays that interact with materials to produce electrons; however, energetic neutrons can also cause significant ionization by recoiling nuclei. The transient effects on resistors include (1) a change in the effective resistance due to leakage in the insulating material and the surrounding medium, and (2) induced current that is the result of the difference between the emission and absorption of secondary electrons by the resistor materials. The permanent effects are generally due to the displacement of atoms by neutrons, thereby

causing a change in the resistivity of the material.

8.85 Batteries are affected much less by radiation than other components. The effects of radiation on nickel-cadmium batteries appear to be insignificant at gamma-ray dose rates up to 10^7 rads (air)/sec. No radiation damage was apparent in a number of batteries and standard cells that were subjected to 10^{13} fast neutrons/cm². Mercury batteries can withstand fast neutron fluences up to 10^{16} neutrons/cm².

Cables and Wiring

8.86 It has been recognized for some time that intense pulses of radiation produce significant perturbation in electrical cables and wiring, including coaxial and triaxial signal cables. Even with no voltage applied to a cable, a signal is observed when the cable is exposed to a radiation pulse. The current associated with this signal is defined as a replacement current, since it is a current in an external circuit that is apparently necessary to replace electrons or other charged particles that are knocked out of their usual positions by the radiation. In addition there is a signal, attributed to what is called the conduction current, which varies with the voltage applied to the cable. It is ascribed to the conductivity induced in the insulating dielectric by the radiation. However, the conductivity current may also include substantial contributions from changes in the dielectric ma-

¹¹ In this and other cases, the damage is determined by the dose rate (rather than the dose) of gamma radiation.

terial. These can usually be identified by their gradual disappearance (saturation) after repeated exposures and by their reappearance after additional exposures in which there is a considerable change in the applied voltage, e.g., it is removed or reversed.

8.87 Nuclear radiation can have both temporary and permanent effects on the insulating material of cables. If ionization occurs in the material, the free electrons produced contribute to its conductivity. Hence, insulators are expected to have a temporary enhancement of conductivity in an ionizing radiation environment. Conduction in the insulator is frequently characterized by two components: (1) for very short radiation pulses, a prompt component whose magnitude is a function of only the instantaneous exposure rate, and (2) frequently at the end of the short radiation exposure, a delayed component having approximately exponential decay, i.e., rapid at first and then more and more slowly.

8.88 Permanent damage effects in cables and wiring are apparent as

changes in the electrical properties of the insulating materials. When such damage becomes appreciable, e.g., when the resistance is reduced severely, electrical characteristics may be affected. The extent of the damage to insulating materials increases with the neutron fluence (or gamma-ray dose), humidity, and irradiation temperature. Certain types of insulation are quite susceptible to permanent damage. For example, silicon rubber is severely cracked and powdered by a fluence of 2×10^{15} fast neutrons/cm². The approximate gamma-radiation damage thresholds for three common types of cable insulation are: polyethylene, 1×10^7 rads (carbon); Teflon TFE, 1×10^4 rads (carbon); and Teflon FEB, 2×10^6 rads (carbon). On the other hand, some irradiated polyolefins are capable of withstanding up to 5×10^9 rads (carbon). A considerable degree of recovery has been observed with respect to insulation resistance; this implies the possibility of adequate electrical serviceability after moderate physical damage.

TECHNICAL ASPECTS OF INITIAL NUCLEAR RADIATION¹²

INTERACTION OF GAMMA RAYS WITH MATTER

8.89 There are three important types of interaction of gamma rays with matter, as a result of which the photons (§ 1.74) are scattered or absorbed. The

first of these is called the "Compton effect." In this interaction, the gamma-ray (primary) photon collides with an electron and some of the energy of the photon is transferred to the electron. Another (secondary) photon, with less energy, then moves off in a new direc-

¹²The remaining sections of this chapter may be omitted without loss of continuity.

tion at an angle to the direction of motion of the primary photon. Consequently, Compton interaction results in a change of direction (or scattering) of the gamma-ray photon and a degradation in its energy. The electron which, after colliding with the primary photon, recoils in such a manner as to conserve energy and momentum is called a Compton (recoil) electron.

8.90 The total extent of Compton scattering per atom of the material with which the radiation interacts is proportional to the number of electrons in the atom, i.e., to the atomic number (§ 1.09). It is, consequently, greater per atom for an element of high atomic number than for one of low atomic number. The Compton scattering decreases with increasing energy of the gamma radiation for all materials, irrespective of the atomic number.

8.91 The second type of interaction of gamma rays and matter is by the "photoelectric effect." A photon, with energy somewhat greater than the binding energy of an electron in an atom, transfers all its energy to the electron which is consequently ejected from the atom. Since the photon involved in the photoelectric effect loses all of its energy, it ceases to exist. In this respect, it differs from the Compton effect, in which a photon still remains after the interaction, although with decreased energy. The magnitude of the photoelectric effect per atom, like that of the Compton effect, increases with the atomic number of the material through which the gamma rays pass, and decreases with increasing energy of the photon.

8.92 Gamma radiation can interact with matter in a third manner, called

"pair production." When a gamma-ray photon with energy in excess of 1.02 MeV passes near the nucleus of an atom, the photon may be converted into matter with the formation of a pair of particles, namely, a positive and a negative electron. As with the photoelectric effect, pair production results in the disappearance of the gamma-ray photon concerned. However, the positive electron soon interacts with a negative electron with the formation of two photons of lower energy than the original one. The occurrence of pair production per atom, as with the other interactions, increases with the atomic number of the material, but it also increases with the energy of the photon in excess of 1.02 MeV.

8.93 In reviewing the three types of interaction described above, it is seen that, in all cases, the magnitude per atom increases with increasing atomic number (or atomic weight) of the material through which the gamma rays pass. Each effect, too, is accompanied by either the complete removal of photons or a decrease in their energy. The net result is some attenuation of the gamma-ray intensity or dose rate. Since there is an approximate parallelism between atomic weight and density, the number of atoms per unit volume does not vary greatly from one substance to another. Hence, a given volume (or thickness) of a material containing elements of high atomic weight ("heavy elements") will be more effective as a gamma-ray shield than the same volume (or thickness) of one consisting only of elements of low atomic weight ("light elements"). An illustration of this difference in behavior will be given below.

8.94 Another important point is that

the probabilities of the Compton and photoelectric effects (per atom) both decrease with increasing energy of the gamma-ray photon. However, pair production, which starts at 1.02 MeV, increases with the energy beyond this value. Combination of the various attenuating effects, two of which decrease whereas one increases with increasing photon energy, means that, at some energy in excess of 1.02 MeV, the absorption of gamma radiation by a particular material should be a minimum. That such minima do exist will be seen shortly.

GAMMA-RAY ATTENUATION COEFFICIENTS

8.95 When a narrow (or collimated) beam of gamma rays passes through a material, photons are removed as a result of the Compton scattering interaction as well as by the photoelectric and pair-production interactions. In other words, the scattered photons are regarded as being lost from the beam, although only part of their energy will have been deposited in the material. If such a collimated beam of gamma rays of a specific energy, having an initial intensity (or flux) of I_0 photons per square centimeter per second, traverses a thickness of x of a given material, the intensity, I , of the rays which emerge

without having undergone any interactions can be represented by the equation

$$I = I_0 e^{-\mu x}, \quad (8.95.1)^{13}$$

where μ is called the "linear attenuation coefficient." The distance x is usually expressed in centimeters, so that the corresponding units for μ are reciprocal centimeters (cm^{-1}). It can be seen from the equation (8.95.1) that, for a given thickness x of material, the intensity I of the emerging gamma rays will be less the larger is the value of μ . In other words, the linear attenuation coefficient is a measure of the shielding ability of a definite thickness, e.g., 1 cm, 1 foot, or other thickness, or any material for a collimated beam of monoenergetic gamma rays.

8.96 The value of μ , under any given conditions, can be obtained with the aid of equation (8.95.1) by determining the gamma-ray intensity before (I_0) and after (I) passage through a known thickness, x , of material. Some of the data obtained in this manner, for monoenergetic gamma rays with energies ranging from 0.5 MeV to 10 MeV, are recorded in Table 8.96. The values given for concrete apply to the common form with a density of 2.3 grams per cubic centimeter (144 pounds per cubic foot). For special heavy concretes, containing iron, iron oxide, or barytes, the coefficients are increased roughly in proportion to the density.

¹³In this equation, the intensity is the *number* of (uncollided) photons per square centimeter per second. A similar equation, with the "linear energy absorption coefficient" replacing the linear attenuation coefficient, is applicable when the intensity is expressed in terms of the total *energy* of the photons per square centimeter per second.

Table 8.96
LINEAR ATTENUATION COEFFICIENTS FOR GAMMA RAYS

Gamma-ray Energy (MeV)	Linear Attenuation Coefficient (μ) in cm^{-1}				
	Air	Water	Concrete	Iron	Lead
0.5	1.11×10^{-4}	0.097	0.22	0.66	1.64
1.0	0.81×10^{-4}	0.071	0.15	0.47	0.80
2.0	0.57×10^{-4}	0.049	0.11	0.33	0.52
3.0	0.46×10^{-4}	0.040	0.088	0.28	0.47
4.0	0.41×10^{-4}	0.034	0.078	0.26	0.48
5.0	0.35×10^{-4}	0.030	0.071	0.25	0.52
10	0.26×10^{-4}	0.022	0.060	0.23	0.55

8.97 By suitable measurements and theoretical calculations, it is possible to determine the separate contributions of the Compton effect (μ_c), of the photoelectric effect (μ_{pe}), and of pair production (μ_{pp}) to the total linear attenuation coefficient as functions of the gamma-ray energy. The results for lead, a typical heavy element (high atomic number) with a large attenuation coefficient, are given in Fig. 8.97a and those for air, a mixture of light elements (low atomic number) with a small attenuation coefficient, in Fig. 8.97b. Except at extremely low energies, the photoelectric effect in air is negligible, and hence is not shown in the figure. At the lower gamma-ray energies, the linear attenuation coefficients in both lead and air decrease with increasing energy because of the decrease in the Compton and photoelectric effects. At energies in ex-

cess of 1.02 MeV, pair production begins to make an increasingly significant contribution. Therefore, at sufficiently high energies the attenuation coefficient begins to increase after passing through a minimum. This is apparent in Fig. 8.97a, as well as in the last column of Table 8.96, for lead. For elements of lower atomic weight, the increase does not set in until very high gamma-ray energies are attained, e.g., about 17 MeV for concrete and 50 MeV for water.

8.98 The fact that the attenuation coefficient decreases as the gamma-ray energy increases, and may pass through a minimum, has an important bearing on the problem of shielding. For example, a shield intended to attenuate gamma rays of 1 MeV energy will be much less effective for radiations of 10 MeV energy because of the lower value of the

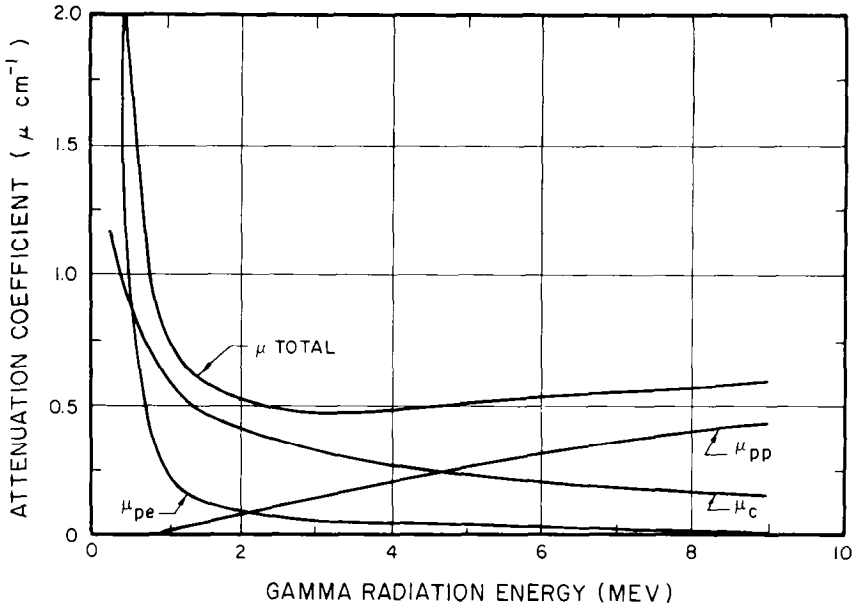

Figure 8.97a. Linear attenuation coefficient of lead as function of gamma-ray energy.

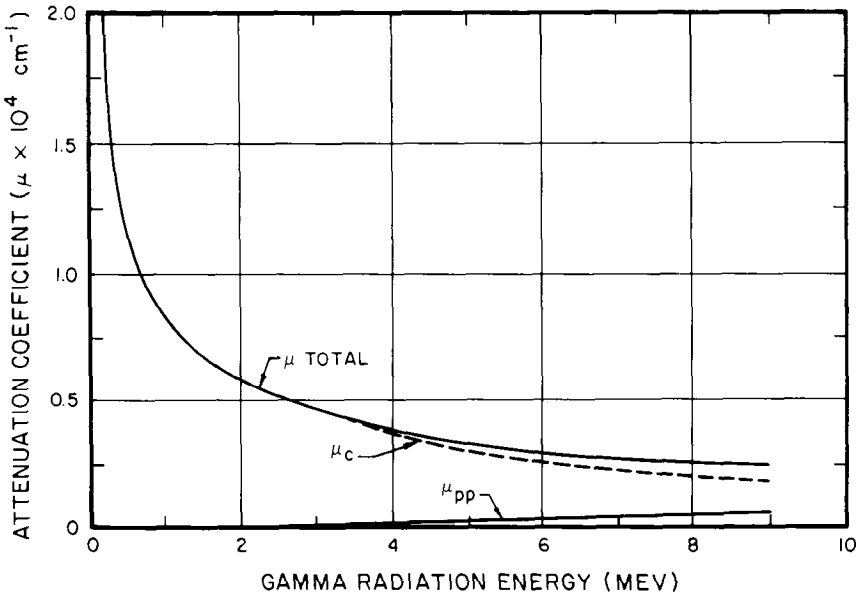

Figure 8.97b. Linear attenuation coefficient of air as function of gamma-ray energy.

attenuation coefficient, irrespective of the material of which the shield is composed.

8.99 An examination of Table 8.96 shows that, for any particular energy value, the linear attenuation coefficients increase from left to right, that is, with increasing density of the material. Thus, a given thickness of a denser substance will attenuate the gamma radiation more than the same thickness of a less dense material. This is in agreement with the qualitative concept that a small thickness of a substance of high density will make as effective a gamma-ray shield as a greater thickness of one of lower density (§ 8.38 *et seq.*).

MASS ATTENUATION COEFFICIENT

8.100 As a very rough approximation, it has been found that the linear attenuation coefficient for gamma rays of a particular energy is proportional to the density of the absorbing (shield) material. That is to say, the linear attenuation coefficient divided by the density, giving what is called the "mass attenuation coefficient," is approximately the same for all substances for a specified gamma-ray energy. This is especially true for elements of low and medium atomic weight, up to that of iron (about 56), where the Compton effect makes the major contribution to the attenuation coefficient for energies up to a few million electron volts (cf. Fig. 8.97b). For the initial gamma rays of higher energy, the effective mass attenuation coefficient (§ 8.104) is close to 0.023 for water, wood, concrete, and earth, with the densities expressed in grams per cubic centimeter. The value

for iron is about 0.027 in the same units (g/cm^2).

8.101 If the symbol ρ is used for the density of the shield material, then equation (8.95.1) can be rewritten in the form

$$I/I_0 = e^{-\mu x} = e^{-(\mu/\rho)(\rho x)}, \quad (8.101.1)$$

where I/I_0 is the transmission factor of the shield of thickness x cm, and μ/ρ is, by definition, the mass attenuation coefficient. Taking μ/ρ to be 0.023 g/cm^2 for initial gamma rays, it follows from equation (8.101.1) that

$$\begin{aligned} \text{Transmission factor} &\approx \\ e^{-0.023\rho x} &\approx 10^{-0.01\rho x}. \end{aligned} \quad (8.101.2)$$

In the absence of better information, this expression may be used to provide a rough idea of the dose transmission factor, as defined in § 8.72, of a thickness of x centimeters of any material (of known density) of low or moderate atomic weight.

8.102 The simple tenth-value thickness concept described in § 8.39 is based on equation (8.95.1). For such a thickness the transmission factor is 0.1 and if the thickness is represented by $x_{0.1}$, it follows that

$$0.1 = e^{-\mu x_{0.1}}$$

or

$$x_{0.1} = \frac{2.30}{\mu} \text{ cm.} \quad (8.102.1)$$

If μ/ρ is taken to be 0.023 g/cm^2 for the initial gamma radiation of higher energy then, as a "rule-of-thumb" approximation,

$$x_{0.1} \text{ (cm)} \approx \frac{100}{\rho(\text{g}/\text{cm}^3)}$$

or the equivalent

$$T(\text{ft}) \approx \frac{203}{D(\text{lb}/\text{ft}^3)} \quad (8.102.2)$$

where, as in § 8.42, T is the tenth-value thickness in feet and D is the density of the material in lb/ft^3 . It follows, therefore, that for the less-dense materials, for which μ/ρ is close to $0.023 \text{ g}/\text{cm}^2$, the product $D \times T$ should be equal to about $200 \text{ lb}/\text{ft}^2$ for gamma rays of higher energy. This is in agreement with the values in the last column of Table 8.41 for nitrogen capture (secondary) gamma rays. The $D \times T$ for iron (or steel) is smaller than for the other materials because μ/ρ is larger, namely about $0.027 \text{ g}/\text{cm}^2$, for the gamma rays of higher energy.

THICK SHIELDS: BUILDUP FACTOR

8.103 Equation (8.95.1) is strictly applicable only to cases in which the photons scattered in Compton interactions may be regarded as having been removed from the gamma-ray beam. This situation holds reasonably well for narrow beams or for shields of moderate thickness, but it fails for broad beams or thick shields. In the latter circumstances, the photon may be scattered several times before emerging from the shield. For broad radiation beams and thick shields, such as are of interest in shielding from nuclear explosions, the value of I , the intensity (or dose) of the emerging radiation, is larger than that given by equation (8.95.1). Allowance for the multiple scattering of the radiation is made by including a "buildup factor," represented by $B(x)$, the value of which depends upon the thickness x of the shield, the nature of the material,

and the energy of the impinging radiation; thus, equation (8.95.1) is now written as

$$I = I_0 B(x) e^{-\mu x}.$$

Values of the buildup factor for a variety of conditions have been calculated for a number of elements from a theoretical consideration of the scattering of photons by electrons. The fact that these values are frequently in the range from 10 to 100 shows that serious errors could arise if equation (8.95.1) is used to determine the attenuation of gamma rays by thick shields.

8.104 It will be apparent, therefore, that equation (8.95.1) and others derived from it, such as equations (8.101.2) and (8.102.1), as well as the simple tenth-value thickness concept, will apply only to monoenergetic radiations and thin shields, for which the buildup factor is unity. By taking the mass attenuation coefficient to be 0.023 for less dense materials (or 0.027 for iron), as given above, an approximate (empirical) allowance has been made for both the polyenergetic nature of the gamma radiations from a nuclear explosion and the buildup factors due to multiple scattering of the photons. The results are, at best, applicable only to shields with simple (slab) geometries. Furthermore, practical radiation shields must absorb neutrons as well as gamma rays, and the gamma radiation produced in the shield by inelastic scattering and radiative capture of the neutrons may produce a greater intensity inside the shield than the incident gamma radiation. Consequently, any problem involving gamma radiation shielding, especially in the presence of neutrons, is complex, even for relatively simple

structures; appropriate computer codes are thus necessary to obtain approximations of the attenuation. In the absence of better information, however, the effective tenth-value thicknesses, as given in Table 8.41 or derived from equation (8.102.2), can be used to provide a rough indication of gamma-ray shielding.

THE INITIAL GAMMA-RAY SPECTRUM

8.105 The major proportion of the initial gamma radiation received at a distance from a nuclear explosion arises from the interaction of neutrons with nuclei, especially nitrogen, in the atmosphere and from the fission products during the first minute after the burst. Gamma rays from inelastic scattering and neutron capture by nitrogen have effective energies ranging up to 7.5 MeV (or more) and those from the fission products are mainly in the 1 to 2 MeV range. After passage through a distance in air, some of the photons will have been removed by photoelectric and pair-production effects and others will have had their energies decreased as a result of successive Compton scatterings. There will consequently be a change in the gamma-ray energy distribution, i.e., in the spectrum.

8.106 Information concerning the gamma-ray spectrum of the initial radiation is important because the susceptibility of living organisms and of various electronics components, the attenuation properties of air and shielding materials, and the response of radiation detectors are dependent upon it. Although the interactions of both neutrons and gamma rays with the atmosphere, which

determine the gamma-ray spectrum, are complex, it is possible to calculate the spectrum at various distances from a nuclear explosion. Computations of this kind have been used to estimate gamma-ray doses, as will be seen later (§ 8.125 *et seq.*). As an example, Fig. 8.106 shows the spectrum of the initial gamma radiation received at a distance of 2,000 yards from the explosion of a fission weapon with an energy yield of 20 kilotons. At this range, some 70 percent of the gamma-ray photons have energies less than 0.75 MeV. It should be remembered, however, that the photons of high energy are the most hazardous and also are the most difficult to attenuate.

INTERACTIONS OF NEUTRONS WITH MATTER

8.107 The modes of interaction of neutrons with matter are quite different from those experienced by gamma-ray photons. Unlike photons, neutrons are little affected by electrons, but they do interact in various ways with the nuclei of atoms present in all forms of matter. These neutron-nucleus interactions are of two main types, namely, scattering and absorption. As already seen, scattering reactions can be either inelastic (§ 8.09) or elastic (§ 8.52). In inelastic scattering part of the kinetic energy of the neutron is converted into internal (or excitation) energy of the struck nucleus; this energy is then emitted as gamma radiation. For inelastic scattering to occur, the neutron must initially have sufficient energy to raise the nucleus to an excited state. The magnitude of this energy depends on the nature of the nucleus and varies greatly from one el-

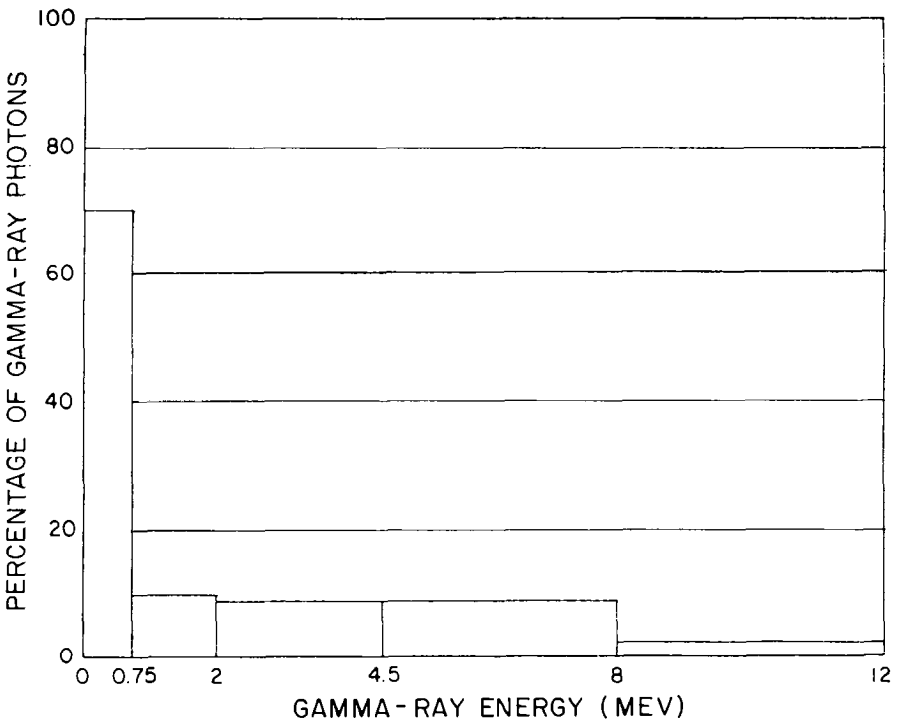

Figure 8.106. Spectrum of initial gamma radiation 2,000 yards from a 20-kiloton explosion.

ement to another. However, a rough general rule is that for many, but not all, heavy or moderately heavy nuclei, e.g., iron and uranium, inelastic scattering may occur for neutrons with energies ranging from a few tenths MeV to as low as a few tens of keV. For lighter nuclei, inelastic scattering is possible only when the neutrons have higher energies. Significant inelastic scattering occurs only for neutron energies above about 1.6 MeV for nitrogen and about 6 MeV for oxygen. Neutrons with energies below the appropriate threshold values for the nuclei present in the medium cannot undergo inelastic scattering.

8.108 When elastic scattering occurs, the interaction of the neutron

with a nucleus is equivalent to a collision between two billiard balls; kinetic energy is conserved and is merely transferred from one particle to the other. None of the neutron energy is transformed into excitation energy of the nucleus and there is no accompanying gamma radiation. In contrast with inelastic scattering, elastic scattering can take place with neutrons of all energies and any nucleus. For a given angle of impact, the fraction of the kinetic energy of the neutron that is transferred to the nucleus in a collision is dependent only on the mass of the latter. The smaller the mass of the nucleus the greater is the fraction of the neutron energy it can remove. Theoretically, the whole of the kinetic energy of a neutron

could be transferred to a hydrogen nucleus (proton) in a single head-on collision. In fact, hydrogen, the lightest element, offers the best means for rapidly degrading fast neutrons with energies less than about 0.5 MeV. It is for this reason that hydrogen, e.g., as water, is an important constituent of neutron shields (§ 8.67). For neutrons of higher energy than 0.5 MeV, it is better to take advantage of inelastic scattering to slow down the neutrons. The heavy element in the special concretes described in § 8.69 serves this purpose.

8.109 The second fundamental type of interaction of neutrons with matter involves complete removal of the neutron by capture. Radiative capture (§ 8.08) is the most common kind of capture reaction; it occurs to some extent, at least, with nearly all nuclei. The probability of capture is greater for slow neutrons than for those of high energy. Most light nuclei, e.g., carbon and oxygen, have little tendency to undergo the radiative capture reaction with neutrons. With nitrogen, however, the tendency is significant (§ 8.11), but not great. For other nuclei, especially some of medium or high mass, e.g., cadmium, the radiative capture reaction occurs very readily. In certain cases, the reaction product is radioactive (§ 8.61); this is of importance in some aspects of weapons effects, as will be seen in Chapter IX.

8.110 Another type of reaction is that in which the incident neutron enters the target nucleus and the compound nucleus so formed has enough excitation energy to permit the expulsion of another (charged) particle, e.g., a proton, deuteron, or alpha particle. The residual nucleus is often in an excited state and

emits the excess energy as a gamma-ray photon. This type of reaction usually occurs with light nuclei and fast neutrons, although there are a few instances, e.g., lithium-6 and boron-10, where it also takes place with slow neutrons. Nitrogen interacts with fast neutrons in at least two ways in which charged particles are emitted (§§ 9.34, 9.44); one leads to the formation of radioactive carbon-14 (plus a proton) and the other to tritium, the radioactive isotope of hydrogen (plus stable carbon-12).

8.111 Fission, is of course, also a form of interaction between neutrons and matter. But since it is restricted to a small number of nuclear species and has been considered in detail in Chapter I, it will not be discussed further here.

8.112 The rate of interaction of neutrons with nuclei can be described quantitatively in terms of the concept of nuclear "cross sections." The cross section may be regarded as the effective target area of a particular type of nucleus for a specific reaction and is a measure of the probability that this reaction will occur between a neutron, of given energy, and that nucleus. Thus, each nuclear species has a specific scattering cross section, a capture cross section, and so on, for a given neutron energy; the total cross section for that energy is the sum of the specific cross sections for the individual interactions. Both specific and total cross sections vary with the energy of the neutron, often in a very complex manner.

8.113 The nuclear cross sections for neutron-nucleus interactions are analogous to the linear attenuation coefficients (for gamma rays) divided by the number of nuclei in unit volume of the

medium. In fact, an expression similar to equation (8.95.1) can be employed to describe the attenuation of a narrow beam of monoenergetic neutrons in their passage through matter. However, because the neutrons in the initial nuclear radiation are far from monoenergetic and the cross sections are so highly dependent on the neutron energy, the equivalent of equation (8.95.1) must not be used to calculate neutron attenuation for shielding purposes. Shielding calculations can be made by utilizing cross sections, the neutron energy distribution in space and direction, and other data, but the calculations require the use of computer codes. Such calculations are too complicated to be described here.

THE NEUTRON ENERGY SPECTRUM

8.114 The energies of the neutrons received at some distance from a nuclear explosion cover a very wide range, from several millions down to a fraction of an electron volt. The determination of the complete energy spectrum (§ 8.53), either by experiment or by calculation, is very difficult. However, it is possible to divide the spectrum into a finite number of energy groups and to calculate the neutron flux in each energy group at various distances from the explosion point. These calculations can then be checked by measuring the variation of flux with distance from known neutron sources that are representative of each energy group.

8.115 Prior to the cessation of atmospheric testing of nuclear weapons, neither the extremely large and fast computers nor the sophisticated measurement instruments that are now available were in existence. Recourse

was, therefore, made to measurements of neutron flux within a few specified energy ranges; from the results a general idea of the spectrum was obtained. Measurements of this kind were made by the use of threshold detectors of activated foil or fission foil type (§§ 8.61, 8.62).

8.116 Neutrons are liberated during the fission and fusion processes, but the neutrons of interest here are those that escape from the exploding weapon. Both the total number of neutrons and their spectrum are altered during transit through the weapon materials. Output spectra that might be considered illustrative of fission and thermonuclear weapons are shown in Figs. 8.116a and b, respectively. As mentioned previously, the neutron source can be defined properly only by considering the actual design of a specific weapon. Hence, the spectra in these figures are presented only as examples and should not be taken to be generally applicable.

8.117 Passage of the neutrons through the air, from the exploding weapon to a distant point, is accompanied by interactions with nuclei that result in attenuation and energy changes. Hence, the neutron spectrum at a distance may differ from the output spectrum of the weapon. Extensive results of computer calculations of neutron fluences at (or near) the earth's surface are now available and these have been used to plot the curves in Figs. 8.117a and b, for fission and thermonuclear weapons, respectively. The figures show the neutron fluences per kiloton of energy release for a number of energy groups as a function of slant range. The uppermost curve in each case gives the total fluence (per kiloton) of neutrons

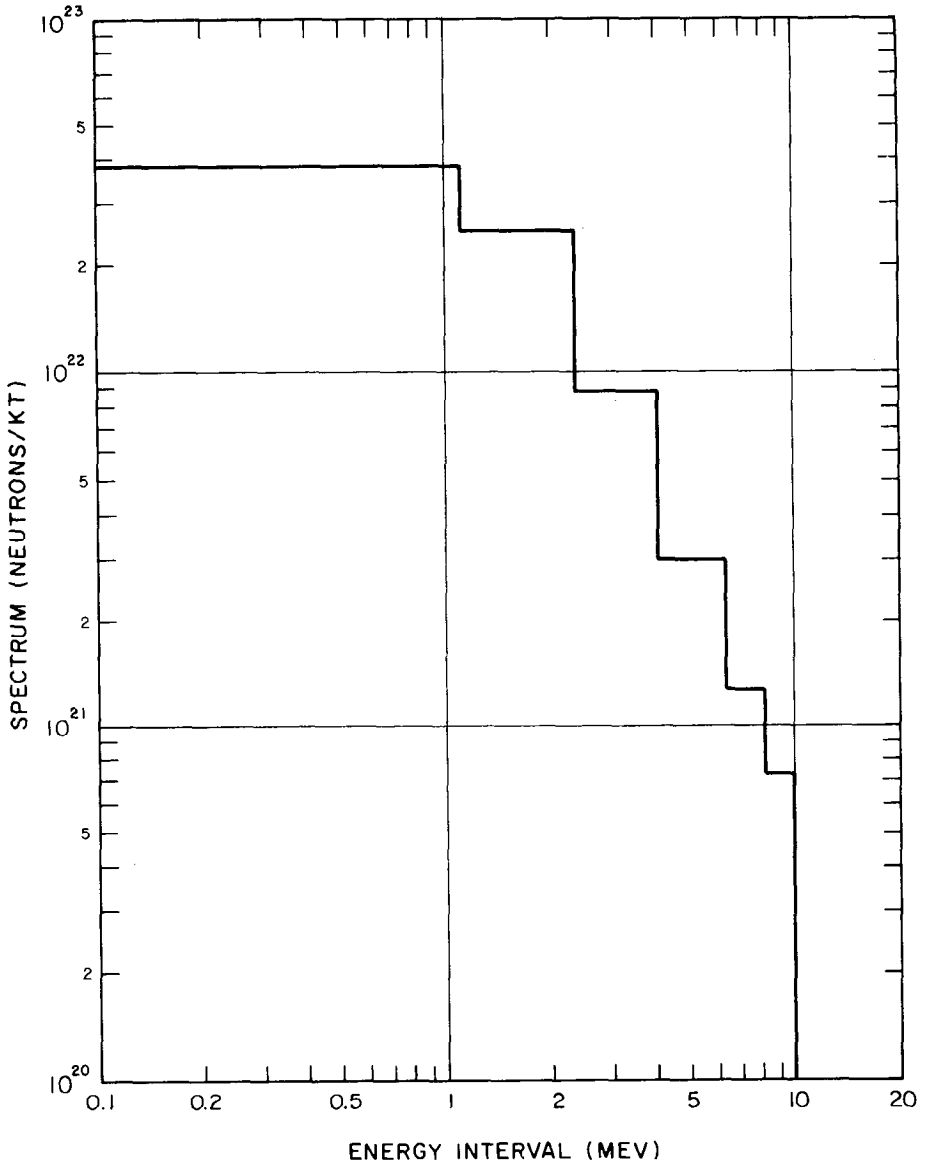

Figure 8.116a. Neutron spectrum for a fission weapon per kiloton total energy yield.

with energies greater than 0.0033 MeV, i.e., 3.3 keV.

8.118 It is apparent from Fig. 8.117a that for a fission weapon the curves for the different energy groups all have roughly the same slope. This

means that the fluence in each energy group decreases with increasing distance from the explosion, but the proportions in the various groups do not change very much; that is to say, the neutron spectrum does not vary signifi-

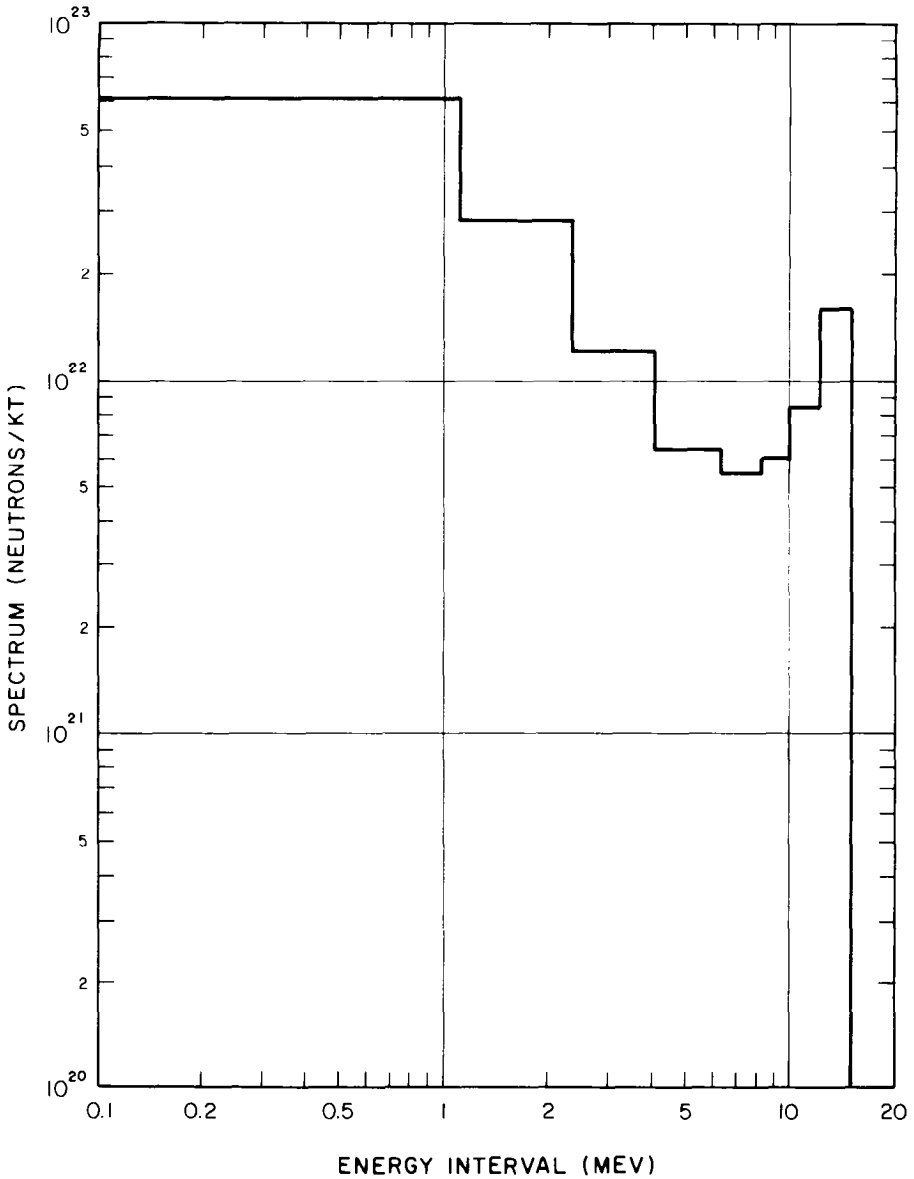

Figure 8.116b. Neutron spectrum for a thermonuclear weapon per kiloton total energy yield.

cantly with distance. Furthermore, although it is not immediately apparent from Fig. 8.117a, the spectrum is almost the same as the source spectrum in

Fig. 8.116a. This accounts for the equilibrium neutron spectrum from a fission explosion mentioned in § 8.55. The spectrum does change at much lower

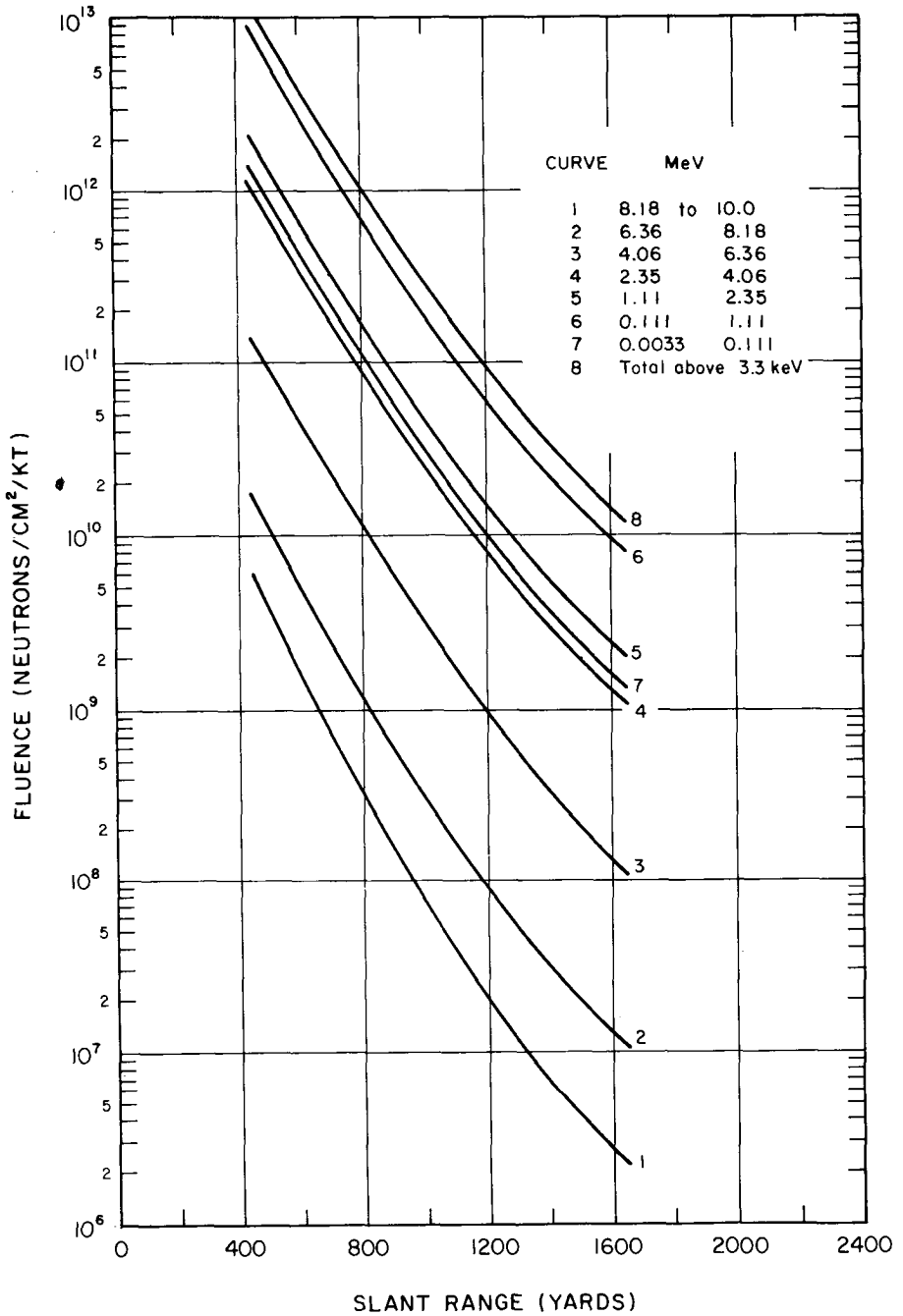

Figure 8.117a. Neutron fluence per kiloton energy yield incident on a target located on or near the earth's surface from the fission spectrum shown in Fig. 8.116a.

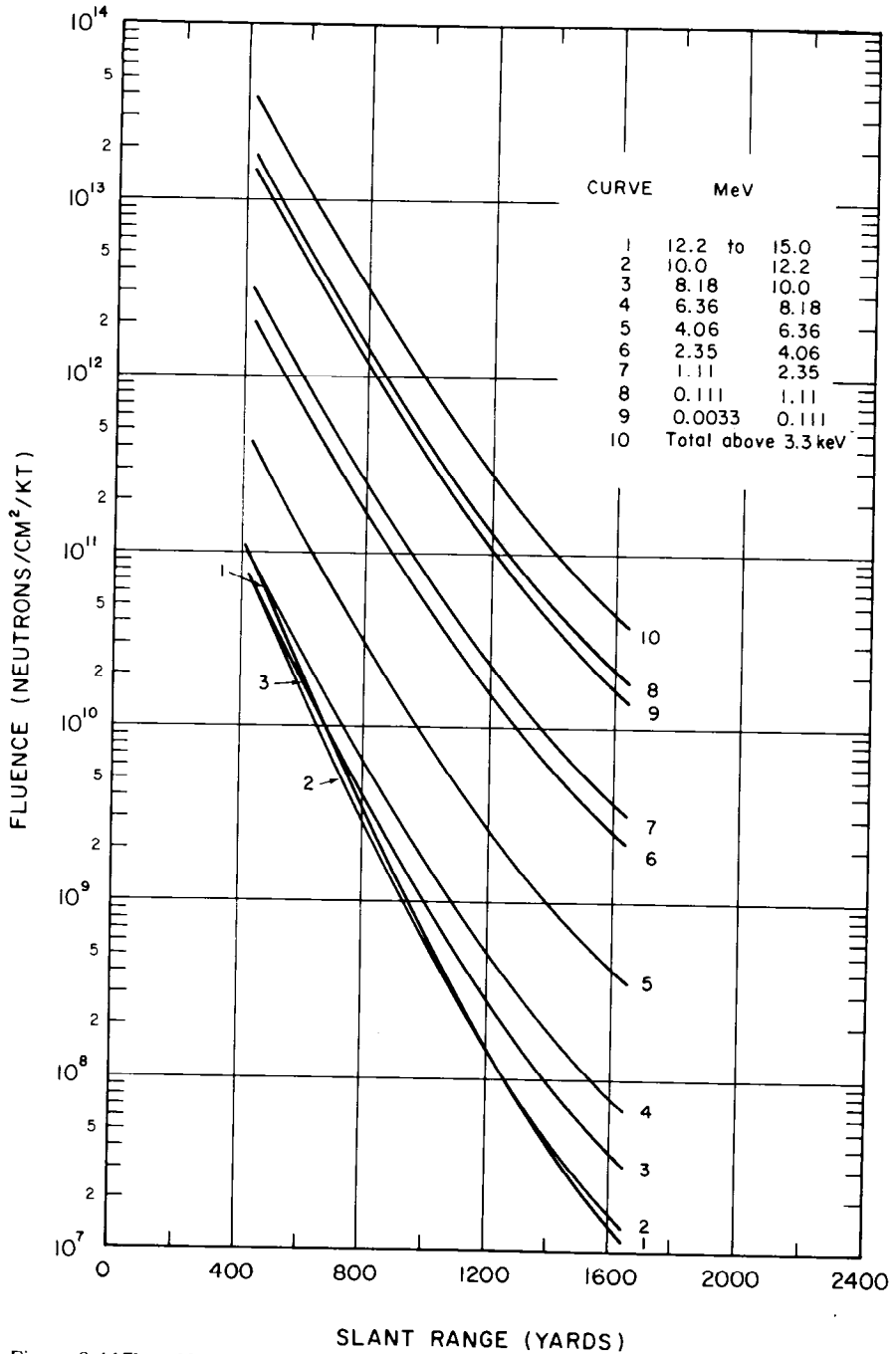

Figure 8.117b. Neutron fluence per kiloton energy yield incident on a target located on or near the earth's surface from the thermonuclear spectrum shown in Fig. 8.116b.

neutron energies, but this is not important.

8.119 Examination of Fig. 8.117b for thermonuclear weapons reveals a different behavior. Curves 5 through 9, i.e., for neutron energies from 0.0033 to 6.36 MeV, are almost parallel, so that in this range the spectrum does not change much with distance. But at higher energies, especially from 8.18 to 15 MeV, the slopes of the curves are quite different. Of the neutrons in groups 1, 2, and 3, those in group 1, which have the highest energies, predominate at a slant range of 400 yards, but they are present in the smallest proportion at 1,600 yards. During their passage through the air, the fastest neutrons are degraded in energy and their relative abundance is decreased whereas the proportions of the somewhat less energetic neutrons is increased. The neutron spectrum thus changes with distance, especially in the high-energy range. The peak that exists at 12 to 14 MeV of the source spectrum in Fig. 8.116b becomes lower and the valley between about 6 and 12 MeV disappears with increasing slant range. At very long ranges, when the high-energy neutrons have lost much of their energy, an equilibrium spectrum would be approached.

8.120 Figs. 8.117a and b provide estimates of neutron fluences and spectra from low air bursts for targets on or near the surface of the ground. As a result of reflections and absorption by the ground, an air-ground interface can increase or decrease the neutron fluences by as much as a factor of ten

compared to fluences at corresponding distances in an infinite air medium. For source-target separation distances less than about a relaxation length,¹⁴ localized reflection from the ground generally tends to increase the intensity of high-energy neutrons; however, at such short distances, the initial nuclear radiation is of interest only for very low yields, since for higher yields other weapon effects will normally be dominant (cf. § 8.06). At longer distances, the high-energy neutron intensity may be reduced by a factor of five or more compared to infinite air when both the source and the target are at or near the ground surface, e.g. a surface or near-surface burst. These effects have been included in the calculations from which the figures given above were derived.

INITIAL RADIATION DOSE IN TISSUE

8.121 Simplified, but reasonably accurate, methods have been developed to predict the initial radiation dose to persons located on or near the surface of the earth. These methods are described separately for neutrons, secondary gamma rays from radiative capture and inelastic scattering in the atmosphere (§ 8.11), and fission product gamma rays. The contribution of the primary gamma rays from fission to the radiation dose at a distance is small enough to neglect (§ 8.04). In all cases, the data are based on the assumption that the average density of the air in the transmission path, between the burst point and the target, is 0.9 of the normal sea-level density.

¹⁴A relaxation length may be taken as the distance in which the radiation intensity in a specified material is decreased by a factor of e , where e is the base of the natural logarithms (about 2.718). The relaxation length in a given material depends on the neutron energy and on whether the direct fluence only or the total (direct plus scattered) fluence is being considered.

Initial Neutron Absorbed Dose

8.122 With spectra such as those shown in Figs. 8.116a and b to serve as sources, a neutron transport computer code may be used to calculate the neutron dose resulting from a nuclear explosion in a specified geometry, i.e., burst height, target height, and air density. The latter is taken to be the average density of the air between the burst and the target before disturbance of the air by the blast wave, since the neutrons of interest depart from the region of the explosion before formation of the blast wave and are deposited at the target prior to its arrival.

8.123 Results of such calculations, which have been corroborated by test data, are given in Figs. 8.123a and b, for fission and thermonuclear weapons, respectively. In each case the absorbed neutron dose (in tissue) received by a target on or near the surface of the earth is shown as a function of slant range per kiloton energy yield for explosions at a height of about 300 feet or more. For convenience of representation, the curves are shown in two parts; the left ordinate scale is for shorter ranges and the right is for longer distances. For

fission weapons, there are two curves in each part; they do not necessarily represent the extremes in neutron dose that might result from different weapon designs, but the dose from most fission weapons should fall between the two curves. It is suggested that the upper curve of each pair in Fig. 8.123a be used to obtain a conservative estimate of the neutron dose from fission weapons for defensive purposes and that the lower curve be used for a conservative estimate for offensive purposes.

8.124 In order to determine the neutron dose received from an air burst of W kilotons energy yield, the dose for the given distance as obtained from Fig. 8.123a or b is multiplied by W . For a contact surface burst, the values from Figs. 8.123a and b should be multiplied by 0.5. For explosions above the surface but below about 300 feet, an approximate value of the neutron dose may be obtained by linear interpolation between the values for a contact surface burst and one at 300 feet or above. The "defense" curve of Fig. 8.123a was used to generate the data for Fig. 8.64a, and the curve in Fig. 8.123b was used for Fig. 8.64b.

(Text continued on page 373.)

The curves in Figs. 8.123a and b show the neutron dose in tissue per kiloton yield as a function of slant range from a burst at a height of 300 feet or more for fission weapons and thermonuclear weapons, respectively.

Scaling. In order to apply the data in Figs. 8.123a and b to an explosion of any energy, W kilotons, multiply the value for the given distance as obtained from Fig. 8.123a or b by W . For a contact surface burst, multiply the dose obtained from Fig. 8.123a or b by 0.5. For bursts between the surface and about 300 feet, an approximate value of the neutron dose may be obtained by linear interpolation between a surface burst and one at 300 feet or above.

Example

Given: A 10 KT fission weapon is exploded at a height of 300 feet.

Find: The neutron dose at a slant range of 1,500 yards that is conservative from the defensive standpoint.

Solution: Since the height of burst is 300 feet, no height correction is necessary. From the upper ("defense") curve in Fig. 8.123a, the neutron dose per kiloton yield at a slant range of 1,500 yards from an explosion is 16 rads. The corresponding dose, D_n , from a 10 KT explosion is

$$D_n = 10 \times 16 = 160 \text{ rads.} \quad \text{Answer}$$

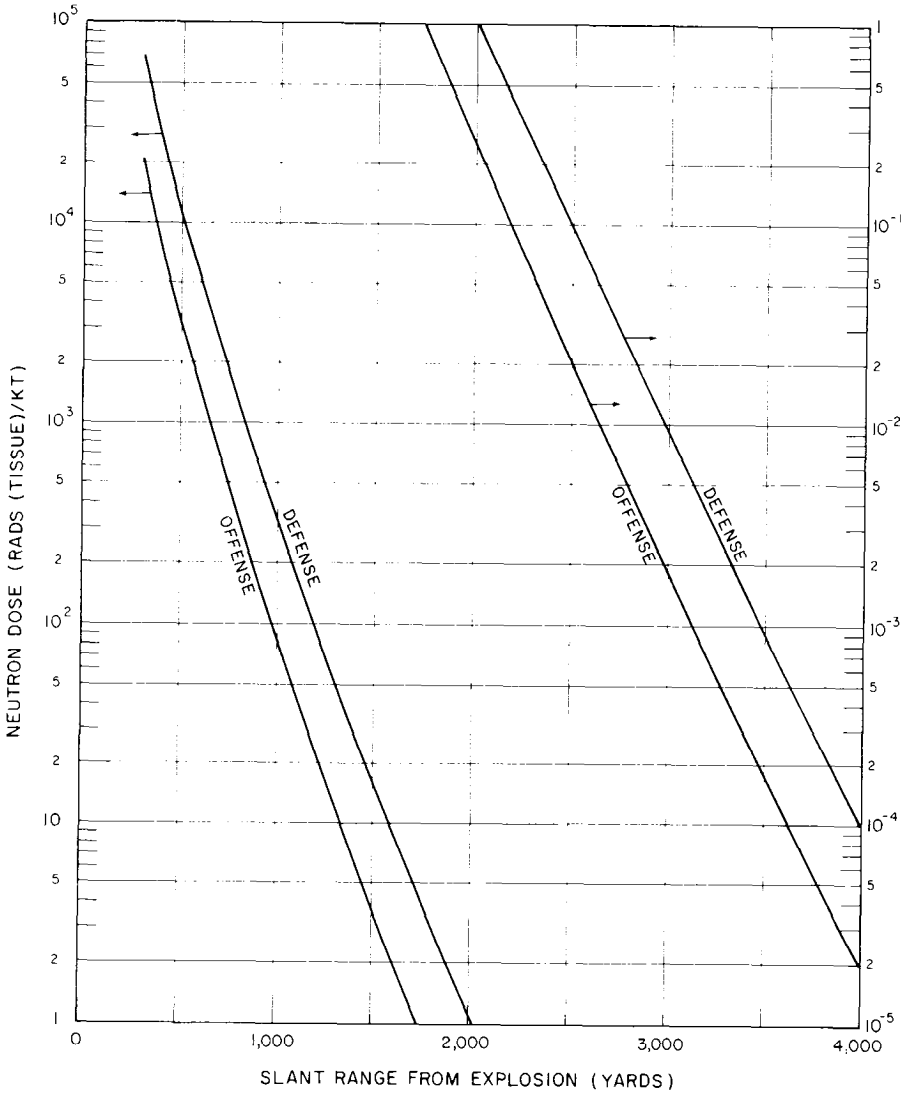

Figure 8.123a. Initial neutron dose per kiloton total yield as a function of slant range from fission weapon air bursts, based on 0.9 normal sea-level air density.

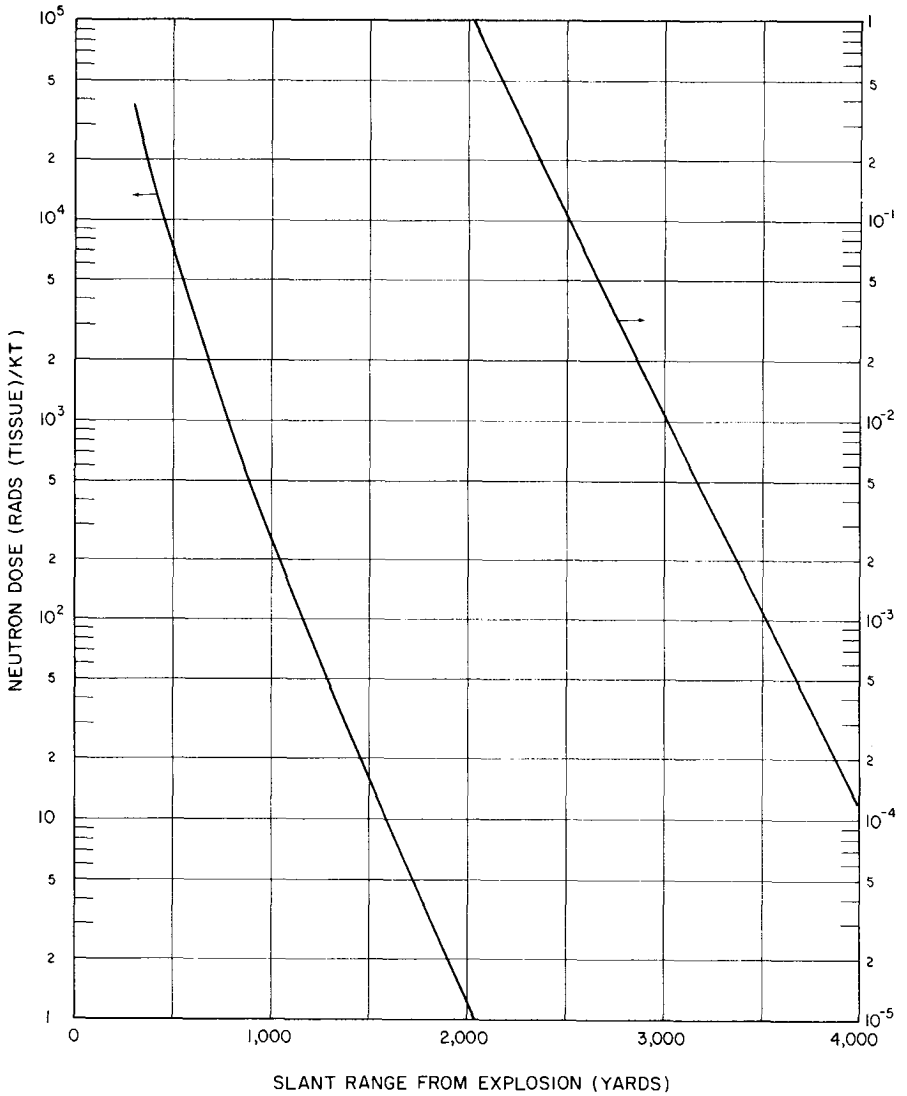

Figure 8.123b. Initial neutron dose per kiloton total yield as a function of slant range from thermonuclear weapon air bursts, based on 0.9 normal sea-level air density.

Secondary Gamma-Ray Absorbed Dose

8.125 The secondary (or air-secondary) gamma rays, i.e., the gamma rays produced by various interactions of neutrons with atmospheric nuclei, must be considered separately from the fission product gamma rays to provide a generalized prediction scheme since the relative importance of the two depends on several factors, including the total yield, the fraction of the total yield derived from fission, the height of burst, and the slant range from the explosion to the target. Since measurements at atmospheric tests have provided only the total gamma radiation dose as a function of distance from the source, computer calculations have been used to obtain the doses from the two individual gamma-ray sources. The results of the calculations of air-secondary gamma-ray doses (and the total doses) predicted by the calculations have been compared with measurements performed at nuclear weapon tests. For bursts in the lower atmosphere, the gamma rays from isomeric decay provide such a small fraction of the total gamma-ray energy that they can be neglected in the calculation of total dose in tissue.¹⁵

8.126 By using neutron spectra, such as those shown in Figs. 8.116a and b, the secondary gamma-ray source can be calculated. The latter is then utilized to compute the secondary gamma-ray dose resulting from a nuclear explosion in a specified geometry. As is the case for neutrons, the air density is taken to be the average density of the air between the burst and the target before disturbance of the air by the blast wave, since

the secondary gamma rays reach a distant target before the blast wave has traveled very far (see Fig. 8.14).

8.127 Some of the results of calculations of secondary absorbed gamma-ray doses (in tissue), obtained in the manner indicated above, are shown in Figs. 8.127a and b, which correspond to the neutron dose curves in Figs. 8.123a and b, respectively. The conditions of applicability of the figures, such as air burst or contact surface burst, target location, offensive or defensive use, etc., are the same as given in §§ 8.123, 8.124. In order to be consistent, if either the "offense" or "defense" curve in Fig. 8.123a is used to obtain the neutron dose for a given situation, the corresponding curve in Fig. 8.127a should be used for the secondary gamma-ray dose.

Fission Product Gamma-Ray Absorbed Dose

8.128 In order to estimate the gamma-ray dose from fission products, the radiation transport computer code must be supplemented with a code that describes the evolution and rise of the radioactive cloud containing the fission products. Since the fission product radiation is emitted over a sufficiently long period of time, the hydrodynamic effect (§ 8.36) of the blast wave on the average air density between the source and the target must be considered. The hydrodynamic enhancement becomes more important at high energy yields and also at greater ranges because of the larger volume of low-density air behind the shock front.

¹⁵It should be noted that the ordinates in Fig. 8.14 are the energy emission rates; the total energy would then be obtained by integration over the effective emission time. This time is very much shorter for isomeric decay gamma rays than for fission products.

The curves in Figs. 8.127a and b show the secondary gamma-ray dose in tissue per kiloton yield as a function of slant range from a burst at a height of 300 feet or more for fission weapons and thermonuclear weapons, respectively.

Scaling. In order to apply the data in Figs. 8.127a and b to an explosion of any energy, W kilotons, multiply the value for the given distance as obtained from Fig. 8.127a or b by W . In the case of a contact surface burst, multiply the dose obtained from Fig. 8.127a or b by 0.5. For bursts between the surface and about 300 feet, an approximate value of the secondary gamma-ray dose may be obtained by linear interpolation.

Example

Given: A 20 KT fission weapon is exploded on the surface.

Find: The secondary gamma-ray dose at a slant range of 1,000 yards that is conservative from the offensive standpoint.

Solution: Since this is a contact surface burst, a correction factor of 0.5 must be applied to the value obtained from Fig. 8.127a. From the lower ("offense") curve in Fig. 8.127a, the secondary gamma-ray dose per kiloton yield at a slant range of 1,000 yards from an explosion at or above 300 feet is 30 rads. The corresponding dose, D_{γ_s} , from a surface burst 20 KT explosion is

$$\begin{aligned} D_{\gamma_s} &= 20 \times 0.5 \times 30 \\ &= 300 \text{ rads. } \textit{Answer} \end{aligned}$$

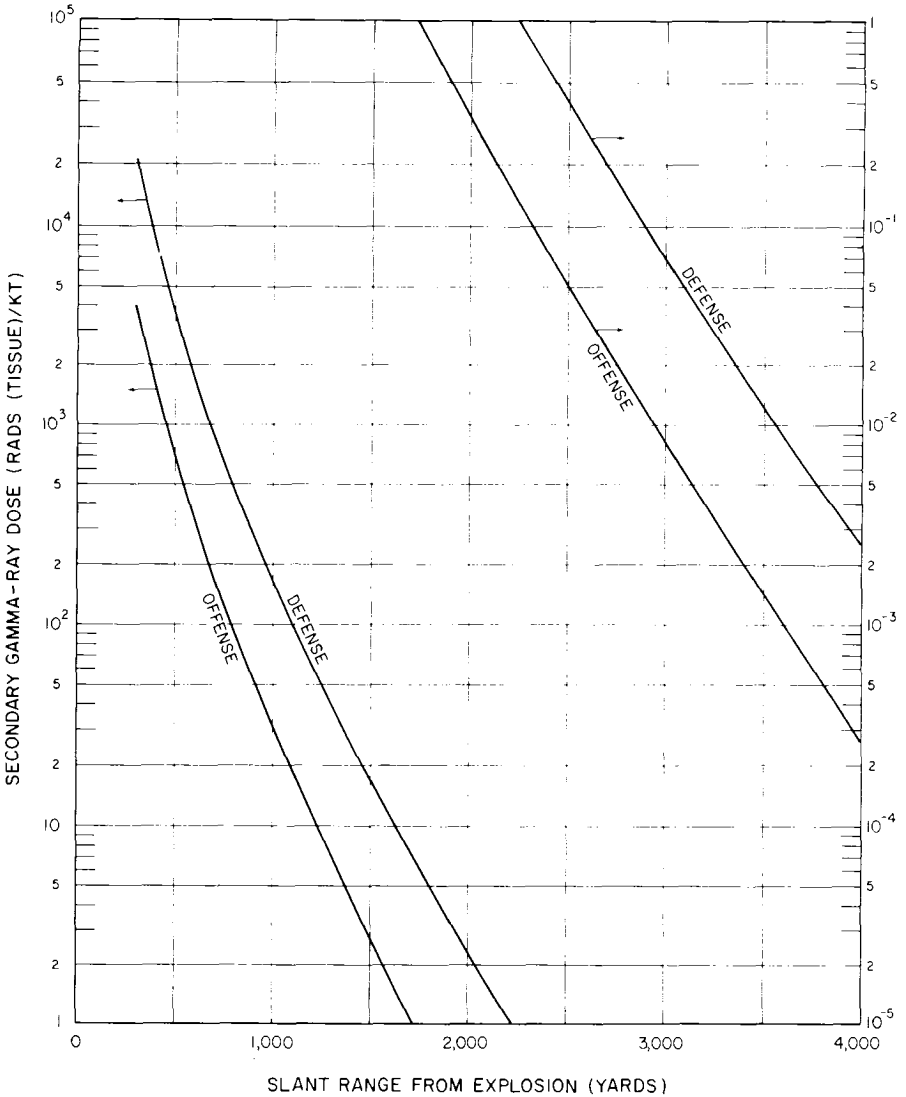

Figure 8.127a. Air-secondary gamma-ray component of the initial nuclear radiation dose per kiloton yield as a function of slant range from fission weapon air bursts, based on 0.9 normal sea-level air density.

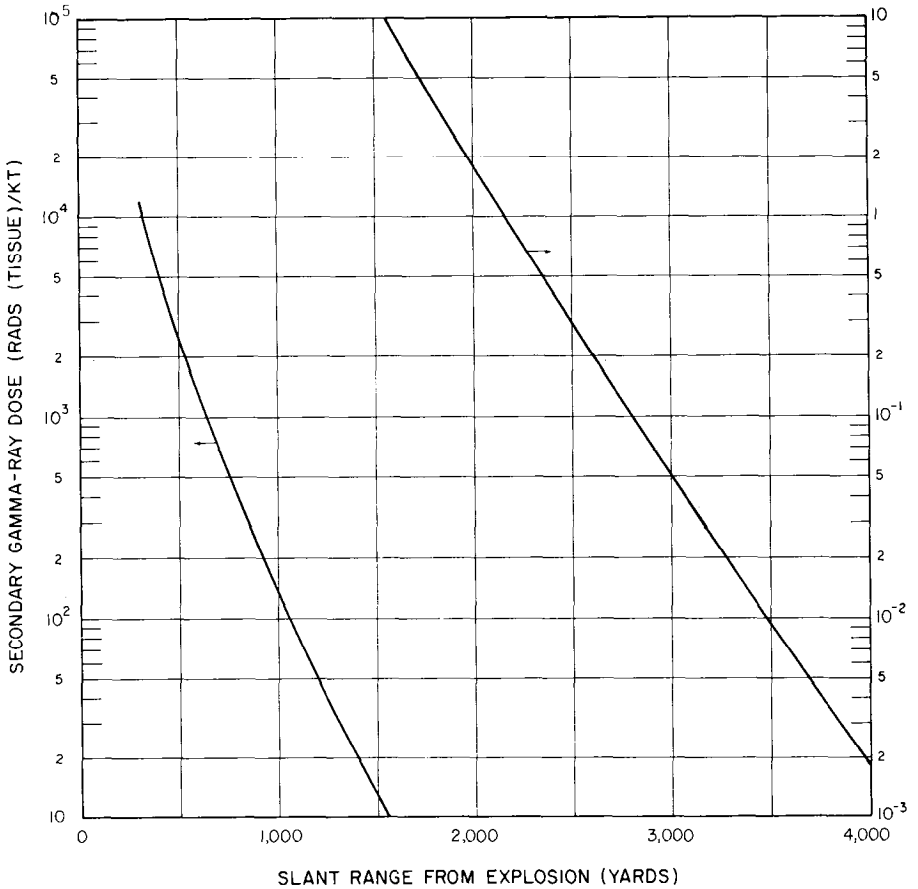

Figure 8.127b. Air-secondary gamma-ray component of the initial nuclear radiation dose per kiloton yield as a function of slant range from thermonuclear weapon air bursts, based on 0.9 normal sea-level air density.

8.129 With minimal hydrodynamic enhancement, as is the case for very low-yield weapons, the fission product gamma rays and the secondary gamma rays contribute approximately equal doses at slant ranges up to about 3,000 yards. However, the average energy of the former gamma rays is considerably less than that of the latter, and the angular distribution of the fission product gamma rays is diffused by the rise of the cloud. Each of these factors tends to

reduce the dose from fission product gamma rays relative to that from secondary gamma rays with increasing distance from low-yield explosions. For explosions of higher yield, however, hydrodynamic enhancement may cause the fission product gamma-ray dose to exceed the secondary gamma-ray dose, particularly at longer ranges.

8.130 The calculated fission product gamma-ray dose in tissue per kiloton of fission energy yield received by a

target on or near the surface of the earth as a function of slant range from a nuclear explosion is shown in Fig. 8.130a. In order to determine the fission product gamma-ray dose received in the initial radiation from an air burst of a fission weapon of W kilotons energy yield, the value for the given distance as obtained from Fig. 8.130a is multiplied by the "effective" yield, determined from Fig. 8.130b. The use of the effective yield instead of the actual yield provides the necessary corrections for the differences in cloud rise velocity and the hydrodynamic enhancement, each of which is a function of total energy yield.

8.131 For thermonuclear weapons, the dose for a given distance as obtained from Fig. 8.130a must be multiplied by the fraction of the total yield that results from fission, e.g., 0.5 for a weapon with 50 percent fission yield, prior to multiplying by the effective yield as obtained from Fig. 8.130b. It should be noted that Fig. 8.130b is always entered with the total energy yield of the weapon to obtain the effective yield, since the cloud rise velocity and the hydrodyn-

amic enhancement depend on the total energy release. Interpolation may be employed to obtain the effective yield for slant ranges that are not shown. The curves in Fig. 8.130b were calculated for a scaled height of burst of $200 W^{0.4}$ feet, where W is the total weapon energy yield in kilotons. For a given slant range the curve is terminated at the yield at which the height of burst is equal to that slant range.

8.132 The data for the effective yields in Fig. 8.132 are similar to those in Fig. 8.130b but are applicable to contact surface bursts. There is no simple method to interpolate or extrapolate these curves for fission-product gamma rays to other heights of burst; however, Fig. 8.130b may be taken to be reasonably accurate for most low air bursts, and Fig. 8.132 may be applied to near-surface as well as to contact surface bursts. The results presented in Fig. 8.33a are based on the upper curves in Fig. 8.127a (for secondary gamma rays) and the curves in Figs. 8.130a and b. The results in Fig. 8.33b are based correspondingly on the curves in Fig. 8.127b and those in Figs. 8.130a and b.

(Text continued on page 383.)

The curves in Fig. 8.130a show the initial radiation, fission product gamma-ray dose per kiloton fission yield as a function of slant range from a nuclear explosion.

Scaling. In order to apply the data in Fig. 8.130a to a fission explosion of any energy, W kilotons, multiply the value for the given distance as obtained from Fig. 8.130a by the effective yield, W_{eff} kilotons, from Fig. 8.130b for a low air burst or from Fig. 8.132 for a surface burst. For a thermonuclear weapon, the value obtained from Fig. 8.130a should be multiplied by the fraction of the yield that results from fission as well as by W_{eff} for the total yield.

Example 1

Given: A 20 KT fission weapon is exploded on the surface.

Find: The fission product gamma-ray dose at a slant range of 1,000 yards.

Solution: From Fig. 8.130a, the initial radiation, fission product gamma-ray dose per kiloton yield at a slant range of 1,000 yards is 75 rads. From Fig. 8.132, the effective yield at a slant range of 1,000 yards from a 20 KT explosion on the surface is 45 KT. The fission product gamma-ray dose for the desired conditions is therefore

$$D_{\gamma f} = 75 \times 45 = 3,375 \text{ rads. Answer}$$

(This is more than ten times the secondary gamma-ray dose determined previously for the same conditions, but the relative values will change with variations in total and fission yields and height of burst.)

Example 2

Given: A 1 MT thermonuclear weapon with 50 percent of its energy yield derived from fission is exploded at a height of 3,200 feet.

Find: The total initial nuclear radiation dose at a slant range of 4,000 yards.

Solution: The total initial nuclear radiation dose is the sum of the initial neutron dose, the secondary gamma-ray dose, and the fission product gamma-ray dose. From Fig. 8.123b, the neutron dose per kiloton yield, is 1.2×10^{-4} rad at a slant range of 4,000 yards from a low air burst. The corresponding dose from a 1 MT explosion is

$$D_n = 1.2 \times 10^{-4} \times 10^3 = 0.12 \text{ rad.}$$

From Fig. 8.127b, the secondary gamma-ray dose per kiloton yield is 1.8×10^{-3} rad at a slant range of 4,000 yards from a low air burst. The corresponding dose from a 1 MT explosion is

$$D_{\gamma s} = 1.8 \times 10^{-3} \times 10^3 = 1.8 \text{ rads.}$$

From Fig. 8.130a, the fission product gamma-ray dose per kiloton fission yield at a slant range of 4,000 yards from the explosion is 3.2×10^{-4} rad. The height of burst, 3,200 feet, is sufficiently close to the scaled height of $200 W^{0.4}$, i.e., 3,170 feet, that Fig. 8.130b should provide an accurate value of the effective yield. From Fig. 8.130b, the effective yield at a slant range of 4,000 yards from a low air burst 1 MT explosion is 4×10^4 KT (or 40 MT). Since only 50 percent of the total yield is derived from fission, a correction factor of 0.5 must be applied. The fission product gamma-ray dose is

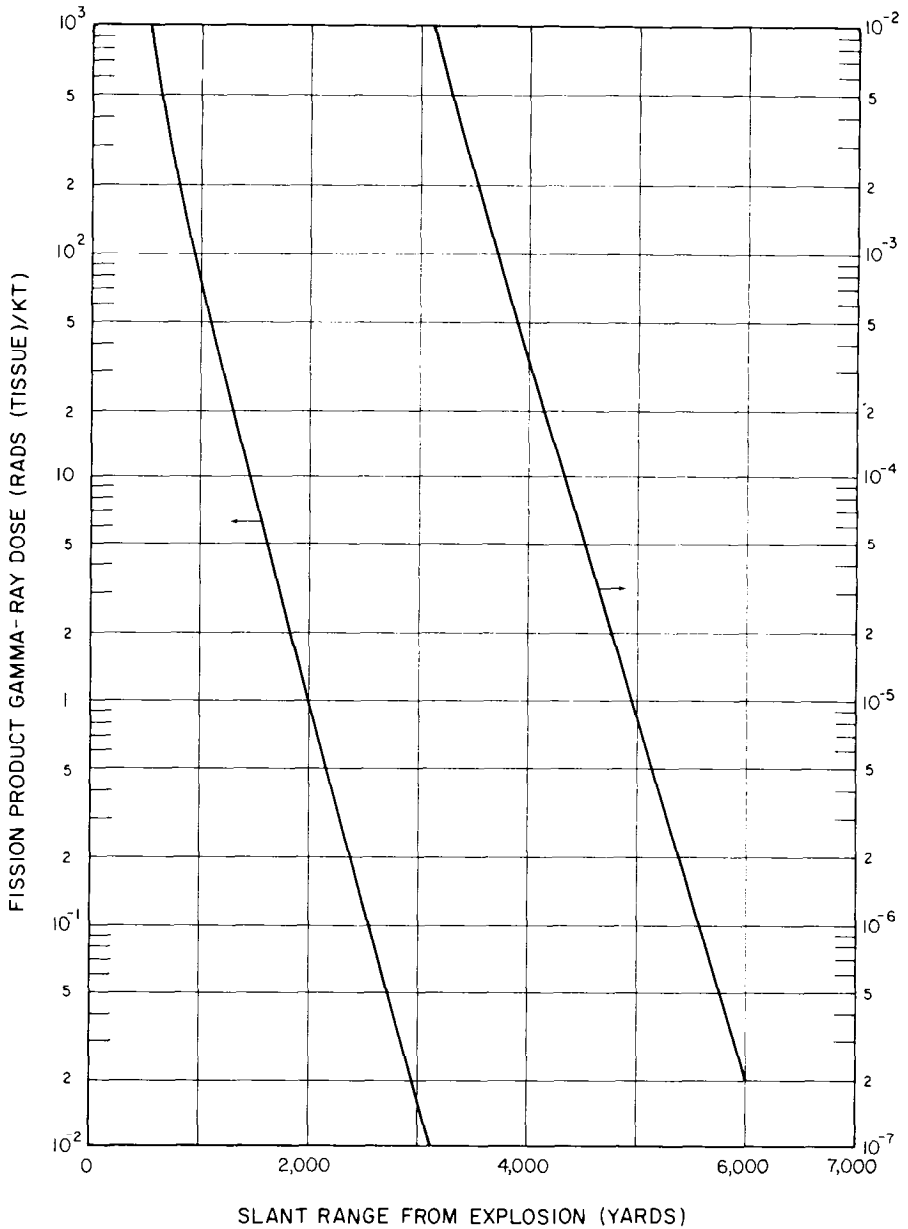

Figure 8.130a. Fission product gamma-ray component of the initial nuclear radiation dose per kiloton fission yield as a function of slant range from a nuclear explosion, based on 0.9 normal sea-level air density.

$$D_{\gamma f} = 0.5 \times 3.2 \times 10^{-4} \times 4 \times 10^4 \\ = 6.4 \text{ rads.}$$

The total initial nuclear radiation dose is

$$D = D_n + D_{\gamma s} + D_{\gamma f} \\ = 0.12 + 1.8 + 6.4 \\ = 8.3 \text{ rads. } \textit{Answer}$$

In adding the doses, it should be recalled that 1 rad of neutrons may not be biologically equivalent to 1 rad of gamma rays (§ 8.64).

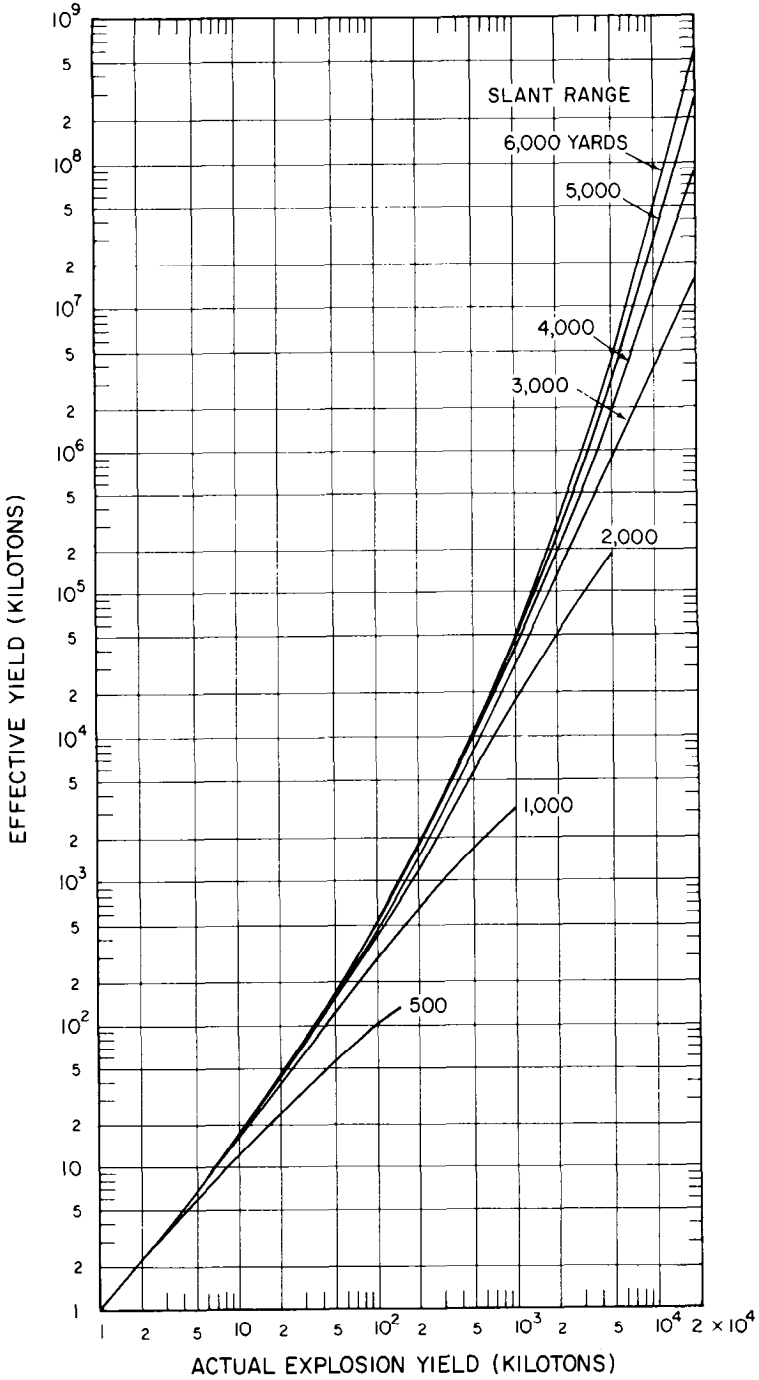

Figure 8.130b. Effective yield as a function of actual yield for the fission product gamma-ray dose from a low air burst, based on 0.9 normal sea-level air density.

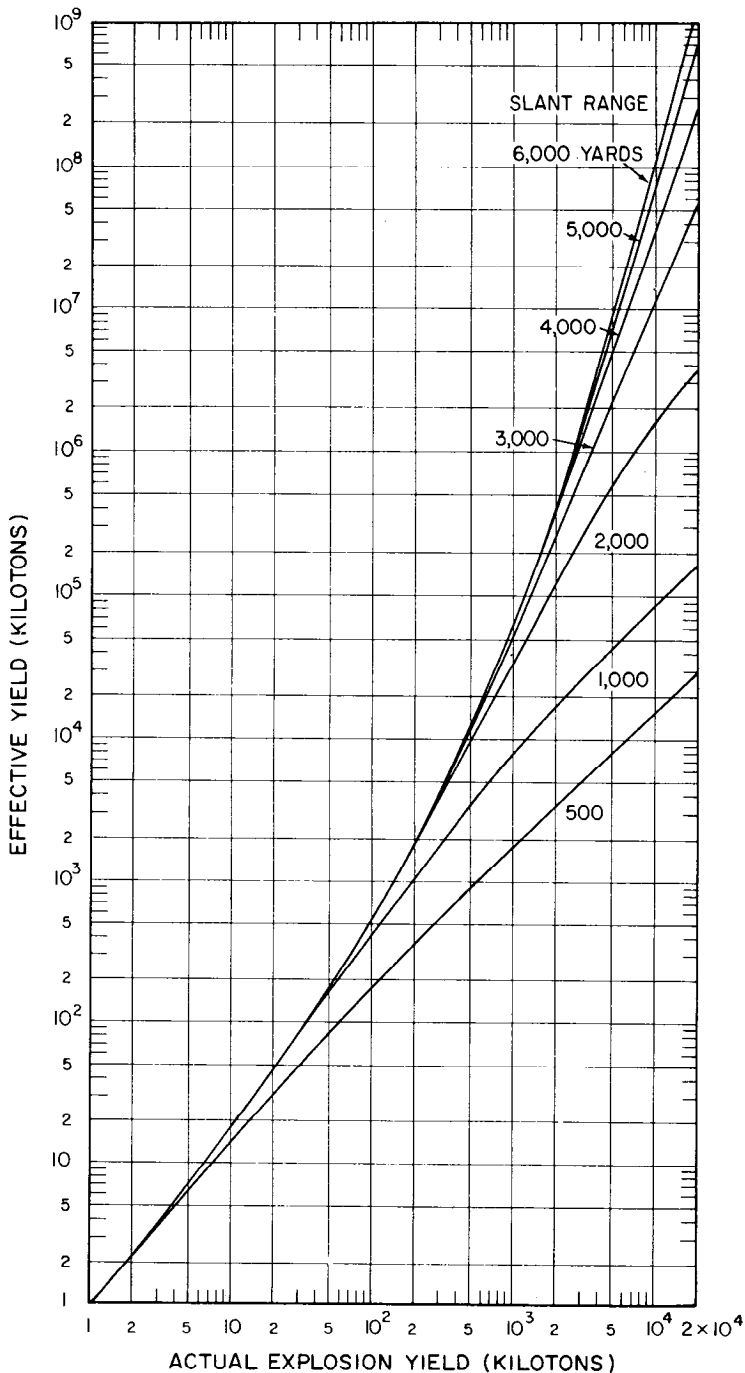

Figure 8.132. Effective yield as a function of actual yield for the fission product gamma-ray dose from a contact surface burst, based on 0.9 normal sea-level air density.

MECHANISMS IN TREE: IONIZATION

8.133 Two basic interactions of nuclear radiation with matter are important in connection with the transient-radiation effects on electronics (TREE); they are ionization and atomic displacement (§ 8.76). The charged particles, i.e., electrons and ions, produced by ionization eventually combine but the accompanying changes in materials may be more or less permanent. Some aspects of TREE depend on the relative durations of the radiation pulse and the recovery time. If the pulse duration is the longer, the effect is observed promptly. The magnitude of the effect is usually a function of the density of charged particles created by ionization and this is determined by the rate of energy absorption, i.e., by the dose rate. On the other hand, if the pulse length is short relative to the recovery time, the effect will be delayed. The amount of damage is then usually a function of the total energy absorbed, i.e., the dose. Thus, both absorbed dose and dose rate must be considered in assessing the effects of nuclear radiation on electronics; in many cases, the dose rate is the determining factor. The persistence of the effect is related, in general, to the recovery time.

8.134 The chief manifestations of ionization include (1) charge transfers, (2) bulk conductivity increase, (3) excess minority-carrier generation, (4) charge trapping, and (5) chemical change. These effects will be examined in turn in the following paragraphs.

8.135 Charge transfer results from the escape of some electrons produced by ionization from the surface of the ionized material. If the net flow of these electrons is from the ionized material to

an adjacent material, the former will acquire a positive charge and the latter a negative charge. Consequently, a difference of potential will exist between the two materials. The most obvious effect of this potential difference is a flow of current through an electrical circuit connecting the two materials, and this current will produce electric and magnetic fields. If there is matter in the space between the two materials, the charge transfer may cause ionization and hence conduction if there are local electric fields. Finally, if the charge either originates or embeds itself in an insulator, a long-lived local space charge may result. The effects of charge transfer may thus be temporary or semipermanent.

8.136 The free charge carriers produced during ionization respond to an applied electric field by causing a net drift current; there is consequently a transient increase in conductivity. This effect is particularly important for capacitors, since the ability to retain or restore electrical charge is dependent on the low conductivity of the dielectric. In an ionizing environment the increase in the bulk conductivity results in a decrease of the stored charge in a capacitor.

8.137 In semiconductor devices, such as transistors and diodes, there are both positive (holes) and negative (electron) charge carriers, either of which may be in the minority. The effect of ionization in producing additional minority carriers is of prime concern in many semiconductors and is usually the most important manifestation of ionization in TREE. Some of the characteristics of semiconductor devices depends upon the instantaneous con-

centration of minority carriers in various regions of the device. Since ionizing radiation creates large (and equal) numbers of positive and negative charge carriers, there is a large relative increase in the concentration of minority carriers. The electrical operation of the device may thus be seriously affected. The current pulse observed in a semiconductor detector (§ 8.22) when exposed to radiation is an example of the effect of excess minority carriers, although in this case it is turned to advantage.

8.138 When free charge carriers are created in insulating materials and are trapped at impurity sites, sometimes present in such materials, many may not undergo recombination with the oppositely charged carriers, which may be trapped elsewhere. In these cases, the properties of the material may be altered semipermanently, even though there is no net charge in the material. This ionization effect is known as charge trapping. Trapped charge can change the optical properties of some substances, e.g., F (color) centers in alkali halides and coloration of glasses. The trapped carriers may be released thermally, either at the temperature of irradiation or by increasing the temperature. In either case, the resultant creation of free carriers is manifested by an increase in conductivity and sometimes by the emission of light (§ 8.24).

8.139 As a result of the recombination of electrical charges, sufficient energy may be released to disrupt chemical bonds. The material may thus suffer a chemical change which persists long after the charged particles have disappeared. This chemical change may be accompanied by permanent changes in the electrical and other properties of the

material. However, the radiation dose required to produce a significant chemical effect is larger than would normally be encountered at a distance from a nuclear explosion where the equipment would survive blast and fire damage.

MECHANISMS IN TREE: ATOMIC DISPLACEMENT

8.140 Another potential damage mechanism of nuclear radiation in electronic systems involves the movement of electrically neutral atoms. Such displacement of atoms from their usual sites in a crystal lattice produces lattice defects. A common type of defect arises from the displacement of an atom from a normal lattice position to an "interstitial" position between two occupied normal positions. The displaced atom leaves behind an unoccupied normal lattice position (or "vacancy"), possibly some distance away. At least part of the damage to a crystalline material caused in this manner is permanent. Since many electronic devices contain crystalline semiconductor materials, usually silicon or germanium, displacement damage is of special concern for TREE.

8.141 Fast neutrons, in particular, are very effective in causing atomic displacement. The total number of defects (temporary and permanent) generated by a neutron depends on its energy. Thus, a 14-MeV neutron (from a thermonuclear weapon) produces about 2.5 times as many defects as a 1-MeV neutron (roughly the average energy from a fission weapon). For neutrons of a given energy (or energy spectrum) the number of defects is determined by the neutron fluence, and the changes in the proper-

ties of a semiconductor material are directly related to the total number of defects. Thus, the neutron fluence is an important consideration in assessing damage to a semiconductor caused by atomic displacement.

8.142 Some of the defects produced by the displacement process are permanent but others are temporary. The temporary defects are annihilated by recombination of the vacancy-interstitial pairs, i.e., by the movement of an interstitial atom into a vacancy, by combination with pre-existing lattice defects, or they may eventually escape from a free surface of the material. The gradual disappearance of some defects is called "annealing" and the rate of annealing can be increased by raising the temperature. The degree of displacement damage in a crystalline semiconductor increases rapidly with time, reaches a peak, and then decreases as annealing becomes increasingly effective. The annealing process may lead to either an improvement or further degradation of the irradiated material, because in some cases thermally stable defects may result. These defects may be more or less effective than the unstable ones in changing a particular property.

8.143 Annealing processes fall roughly into two time frames. Rapid (or short-term) annealing occurs in hundredths of a second, whereas long-term annealing continues for times of the order of tens of seconds. At ambient temperature, annealing of temporary damage will be essentially complete within about half an hour. The ratio of the damage observed at early times

(number of defects present) to the damage remaining after a long time is called the "annealing factor"; it depends on the observation time as well as on the temperature and the electrical condition of the material. The maximum number of defects created at early times following a fast-neutron burst is frequently important to the performance of electronics systems. The maximum annealing factor of a component indicates the peak damage that must be tolerated above the permanent damage if that component is to continue to function.

8.144 The lattice damage caused by atomic displacement degrades the electrical characteristics of semiconductors by increasing the number of centers for trapping, scattering, and recombination of charge carriers. The increase in trapping centers results in removal of charge carriers and thereby decreases the current flow. The additional scattering centers reduce the capability of the charge carriers to move through the semiconductor material. Finally, the additional recombination centers decrease the time during which the minority charge carriers are available for electrical conduction. The last effect, i.e., the reduced lifetime of the minority carriers, is the most important factor in determining the performance of a semiconductor device in an environment of radiation that can cause atomic displacement. The minority carrier lifetime is very roughly inversely proportional to the neutron fluence at large values of the fluence that are likely to cause damage to semiconductors. At sufficiently large fluences, the lifetime becomes too short for the semiconductor device to function properly.

BIBLIOGRAPHY

- ABBOTT, L. S., "Shielding Against Initial Radiations from Nuclear Explosions," Oak Ridge National Laboratory, July 1973, ORNL-RSIC-36.
- *AUXIER, J. A., *et al.*, "Nuclear Weapons Free-Field Environment Recommended for Initial Radiation Shielding Calculations," Oak Ridge National Laboratory, February 1972, ORNL-TM-3396.
- "Basic Radiation Protection Criteria," NCRP Report No. 39, National Council on Radiation Protection, Washington, D.C., 1971.
- ETHERINGTON, H. (Ed.), "Nuclear Engineering Handbook," McGraw-Hill Book Co., Inc., 1958.
- FRENCH, R. L., "A First-Last Collision Model of the Air/Ground Interface Effects on Fast-Neutron Distributions," *Nuclear Sci. and Eng.*, **19**, 151 (1964).
- FRENCH, R. L., and L. G. MOONEY, "Initial Radiation Exposure from Nuclear Weapons," Radiation Research Associates, Fort Worth, Texas, July 1972, RRA-T7201.
- *FRITZSCHE, A. E., N. E. LORIMIER, and Z. G. BURSON, "Measured Low-Altitude Neutron and Gamma Dose Distributions Due to a 14-MeV Neutron Source," E. G., and G., Inc., Las Vegas, Nevada, 1969, EGG 1183-1449.
- *FRITZSCHE, A. E., N. E. LORIMIER, and Z. G. BURSON, "Measured High-Altitude Neutron and Gamma Dose Distributions Due to a 14-MeV Neutron Source," E. G., and G., Inc., Las Vegas, Nevada, 1969, EGG 1183-1438.
- GWYN, C. W., D. L. SCHARFETTER, and J. L. WIRTH, "The Analysis of Radiation Effects in Semiconductor Junction Devices," Sandia Corporation, Albuquerque, New Mexico, July 1967, SC-R-67-1158.
- JONES, T. D., and F. F. HAYWOOD, "Transmission of Photons Through Common Shielding Media," Oak Ridge National Laboratory, October 1974, ORNL-TM-4728.
- *KEITH, J. R., and F. H. SHELTON, "Neutron Transport in Non-Uniform Air by Monte Carlo Calculations, Volume I," Kaman Nuclear, Colorado Springs, Colorado, January 1969, DASA 2236-I, KN-774-69-1.
- *KUKHTEVICH, V. I., *et al.*, "Protection from Penetrating Radiation of Nuclear Explosions," English translation, Joint Publications Research Service, U.S. Department of Commerce, July 1971, JPRS 53498.
- LARIN, F., "Radiation Effects in Semiconductor Devices," John Wiley and Sons, Inc., 1968.
- MARSHALL, J. D., and M. B. WELLS, "The Effects of Cut-Off Energy on Monte Carlo Calculated Gamma-Ray Dose Rates in Air," Radiation Research Associates, Fort Worth, Texas, 1966, RRA-M67.
- MOONEY, L. G., "Calculations of Weapon Radiation Doses in Single-Compartment Above-Ground Concrete Structures," Radiation Research Associates, Fort Worth, Texas, November 1969, RRA-M93.
- National Bureau of Standards, "Measurement of Absorbed Dose of Neutrons and Mixtures of Neutrons and Gamma Rays," NCRP Report No. 25, U.S. Government Printing Office, 1961, National Bureau of Standards Handbook 75.
- "Protection Against Neutron Radiation," NCRP Report No. 38, National Council on Radiation Protection, Washington, D. C., 1971.
- "Radiation Damage and Defects in Semiconductors," Conference Series, No. 16, July 1972. The Institute of Physics (London), 1973.
- "Recommended Techniques for the Measurement of Selected Nuclear Radiation Effects on Electronic Components," IBM Electronics Systems Center, Owego, New York, August 1967, DASA 627, Vol. II.
- *SCHAEFER, N. M. (Editor), "Reactor Shielding for Nuclear Engineers," U.S. AEC Report TID-25951, 1973.
- *STRAKER, E. A., "Time-Dependent Neutron and Secondary Gamma-Ray Transport in an Air-Over-Ground Geometry, Volume II. Tabulated Data," Oak Ridge National Laboratory, September 1968, ORNL 4289.
- *STRAKER, E. A., "Status of Neutron Transport in the Atmosphere," Oak Ridge National Laboratory, July 1970, ORNL-TM-3065.
- VOOK, F. L. (Editor), "Radiation Effects in Semiconductors," Proceedings of the Santa Fe Conference on Radiation Effects in Semiconductors, Plenum Press, 1968.

*These publications may be purchased from the National Technical Information Service, Department of Commerce, Springfield, Virginia, 22161.

CHAPTER IX

RESIDUAL NUCLEAR RADIATION AND FALLOUT

SOURCES OF RESIDUAL RADIATION

INTRODUCTION

9.01 The residual nuclear radiation is defined as that which is emitted later than 1 minute from the instant of the explosion (§ 8.02). The sources and characteristics of this radiation will vary in accordance with the relative extents to which fission and fusion reactions contribute to the energy of the weapon. The residual radiation from a fission weapon detonated in the air arises mainly from the weapon debris, that is, from the fission products and, to a lesser extent, from the uranium and plutonium which have escaped fission. In addition, the debris will usually contain some radioactive isotopes formed by neutron reactions, other than fission, in the weapon materials. Another source of residual radiation, especially for surface and subsurface bursts, is the radioactivity induced by the interaction of neutrons with various elements present in the earth, sea, air, or other substances in the explosion environment. The debris from a predominantly fusion weapon, on the other hand, will not contain the quantities of fission products associated with a fission weapon of the same energy yield. However, large numbers of

high-energy neutrons are produced (§ 1.72), so that the residual radiation from fusion weapons will arise mainly from neutron reactions in the weapon and its surroundings, if the fission yield is sufficiently low.

9.02 The primary hazard of the residual radiation results from the creation of fallout particles (§ 2.18 *et seq.*) which incorporate the radioactive weapon residues and the induced activity in the soil, water, and other materials in the vicinity of the explosion. These particles may be dispersed over large areas by the wind and their effects may be felt at distances well beyond the range of the other effects of a nuclear explosion (§ 9.113). A secondary hazard may arise from neutron induced activity on the earth's surface in the immediate neighborhood of the burst point (§ 8.16). Both the absolute and relative contributions of the fission product and induced radioactivity will depend on the total and fission yields of the weapon, the height of burst, the nature of the surface at the burst point, and the time after the explosion.

9.03 As mentioned in § 2.28, it is convenient to consider the fallout in two parts, namely, early and delayed. Early

(or local) fallout is defined as that which reaches the ground during the first 24 hours following a nuclear explosion. The early fallout from surface, subsurface, or low air bursts can produce radioactive contamination over large areas and can represent an immediate biological hazard. Delayed (or long range) fallout, which is that reaching the ground after the first day, consists of very fine, invisible particles which settle in low concentrations over a considerable portion of the earth's surface. The radiation from the fission products and other substances is greatly reduced as a result of radioactive decay during the relatively long time the delayed fallout remains suspended in the atmosphere. Consequently, the radiations from most of the delayed fallout pose no immediate danger to health, although there may be a long-term hazard. The biological effects on people, plants, and animals of the radiations from early and late fallout are described in Chapter XII.

9.04 In the case of an air burst, particularly when the fireball is well above the earth's surface, a fairly sharp distinction can be made between the initial nuclear radiation, considered in the preceding chapter, and the residual radiation. The reason is that, by the end of a minute, essentially all of the weapon residues, in the form of very small particles, will have risen to such a height that the nuclear radiations no longer reach the ground in significant amounts. Subsequently, the fine particles are widely dispersed in the atmosphere and descend to earth very slowly.

9.05 With surface and, especially, subsurface explosions, or low air bursts in weather involving precipitation (§ 9.67) the demarcation between initial

and residual nuclear radiations is not as definite. Some of the radiations from the weapon residues will be within range of the earth's surface at all times, so that the initial and residual categories merge continuously into one another (§§ 2.82, 2.100). For very deep underground and underwater bursts the initial gamma rays and neutrons produced in the fission or fusion process may be ignored since they are absorbed by the surrounding medium. The residual radiations, from fission products and from radioactive species produced by neutron interaction, are then the only kind of nuclear radiations that need be considered. In a surface burst, however, both initial and residual nuclear radiations must be taken into account.

EARLY FALLOUT

9.06 The radiological characteristics of the early fallout from a nuclear weapon are those of the fission products and any induced activity produced. The relative importance of these two sources of residual radiation depends upon the percentage of the total yield that is due to fission, and other factors mentioned in § 9.02. There are, however, two additional factors, namely, fractionation and salting, which may affect the activity of the early fallout; these will be described below.

9.07 As the fireball cools, the fission products and other vapors are gradually condensed on such soil and other particles as are sucked up from below while the fireball rises in the air. For detonations over land, where the particles consist mainly of soil minerals, the fission product vapors condense onto both solid and molten soil particles and

also onto other particles that may be present. In addition, the vapors of the fission products may condense with vapors of other substances to form mixed solid particles of small size. In the course of these processes, the composition of the fission products will change, apart from the direct effects of radioactive decay. This change in composition is called "fractionation." The occurrence of fractionation is shown, for example, by the fact that in a land surface burst the larger particles, which fall out of the fireball at early times and are found near ground zero, have different radiological properties from the smaller particles that leave the radioactive cloud at later times and reach the ground some distance downwind.

9.08 The details of the fractionation process are not completely understood, but models have been developed that represent the phenomena reasonably satisfactorily. Fractionation can occur, for example, when there is a change in physical state of the fission products. As a result of radioactive decay, the gases krypton and xenon form rubidium and cesium, respectively, which subsequently condense onto solid particles. Consequently, the first particles to fall out, near ground zero, will be depleted not only in krypton and xenon, but also in their various decay (or daughter) products. On the other hand, small particles that have remained in the cloud for some time will have rubidium and cesium, and their daughters, strontium and barium, condensed upon them. Hence, the more distant fallout will be relatively richer in those elements in which the close fallout is depleted.

9.09 An additional phenomenon which contributes to the fractionation

process is the separation of the fission product elements in the ascending fireball and cloud as they condense at different times, corresponding to their different condensation temperatures. Thus the refractory elements can condense at early times in the nuclear cloud, when the temperature is quite high, onto the relatively larger particles which are more abundant at these times. Conversely, volatile elements, with low condensation temperatures, cannot condense until later, when the cloud has cooled and when the larger particle sizes will be depleted. Refractory elements are expected to be relatively more abundant in the close-in early fallout, representing the larger particles, and to be relatively depleted in the more distant portion of the early fallout deposited by smaller particles. The reverse will be true for the more volatile elements. The particle size distribution in the nuclear cloud varies with the surface material and hence the latter will have an effect on fractionation.

9.10 For explosions of large energy yield at or near the surface of the sea, where the condensed particles consist of sea-water salts and water, fractionation is observed to a lesser degree than for a land surface burst. The reason is that the cloud must cool to 100°C (212°F) or less before the evaporated water condenses. The long cooling time and the presence of very small water droplets permit removal from the radioactive cloud of the daughters of the gaseous krypton and xenon along with the other fission products. In this event, there is little or no variation in composition of the radioactive fallout (or rainout) with distance from the explosion.

9.11 The composition of the fallout

can also be changed by "salting" the weapon to be detonated. This consists in the inclusion of significant quantities of certain elements, possibly enriched in specific isotopes, for the purpose of producing induced radioactivity. There are several reasons why a weapon might be salted. For example, salting has been used in some weapons tests to provide radioactive tracers for various purposes, such as the study of the paths and relative compositions of the early and delayed stages of fallout.

ACTIVITY AND DECAY OF EARLY FALLOUT

9.12 The fission products constitute a very complex mixture of more than 300 different forms (isotopes) of 36 elements (§ 1.62). Most of these isotopes are radioactive, decaying by the emission of beta particles, frequently accompanied by gamma radiation. About 3×10^{23} fission product atoms, weighing roughly 2 ounces, are formed per kiloton (or 125 pounds per megaton) of fission energy yield. The total radioactivity of the fission products initially is extremely large but it falls off at a fairly rapid rate as the result of radioactive decay.

9.13 At 1 minute after a nuclear explosion, when the residual nuclear radiation has been postulated as beginning, the radioactivity of the fission products from a 1-kiloton fission yield explosion is of the order of 10^{21} disinte-

grations per second, i.e., almost 3×10^{10} curies (§ 9.141). The level of activity even from an explosion of low yield is enormously greater than anything that had been encountered prior to the detonation of nuclear weapons. By the end of a day, the rate of beta-particle emission will have decreased by a factor of about 2,000 from its 1-minute value, and there will have been an even larger decrease in the gamma-ray energy emission rate. Nevertheless, the radioactivity of the fission products will still be very considerable.

9.14 It has been calculated (§ 9.159) that if fallout particles were spread uniformly over a smooth infinite plane surface, with the radioactivity equal to that of all the fission products from 1-kiloton fission energy yield for each square mile, the radiation dose rate at a height of 3 feet above the plane would be approximately 2,900 rads (in tissue)¹ per hour at 1 hour after the explosion.² In actual practice, a uniform distribution would be improbable, since a larger proportion of the fission products would be deposited near ground zero than at farther distances. Hence, the dose rate will greatly exceed the average at points near the explosion center, whereas at more remote locations it will usually be less. Moreover, the phenomenon of fractionation will cause a depletion of certain fission product isotopes in the local fallout; this will tend to lower the theoretically calculated dose rate. Finally, the actual

¹ The actual value depends on the nature of the fissionable material and other weapon variables, but the number quoted here is a reasonable average (§ 9.159).

² Fallout radiation measurements (and calculations) have commonly been made in terms of gamma-ray exposures (or rates) in roentgens. For consistency with other chapters, however, all data in this chapter are given as the equivalent doses (or rates) in rads absorbed in tissue near the surface of the body (cf. § 8.18). The qualification "in tissue" will be omitted subsequently since it applies throughout the chapter.

surface of the earth is not a smooth plane. As will be discussed subsequently (§ 9.95), the surface roughness will cause a further decrease in the dose rate calculated for an infinite smooth plane. In spite of these reductions, extremely high dose rates have been observed within the first few hours following surface bursts.

9.15 The early fallout consists of particles that are contaminated mainly, but not entirely, with fission products. An indication of the manner in which the dose rate from a fixed quantity of the actual mixture decreases with time may be obtained from the following approximate rule: for every sevenfold increase in time after the explosion, the dose rate decreases by a factor of ten. For example, if the radiation dose rate at 1 hour after the explosion is taken as a reference point, then at 7 hours after the explosion the dose rate will have decreased to one-tenth; at $7 \times 7 = 49$ hours (or roughly 2 days) it will be one-hundredth; and at $7 \times 7 \times 7 = 343$ hours (or roughly 2 weeks) the dose rate will be one-thousandth of that at 1 hour after the burst. Another aspect of the rule is that at the end of 1 week (7 days), the radiation dose rate will be about one-tenth of the value after 1 day. This rule is accurate to within about 25 percent up to 2 weeks or so and is applicable to within a factor of two up to roughly 6 months after the nuclear detonation. Subsequently, the dose rate decreases at a much more rapid rate than predicted by this rule. The complications introduced by fractionation and the presence

of induced activities make the approximate rule useful only for illustration and some planning purposes. Any change in the quantity of fallout, arising from the continuing descent or the removal of particles or from multiple detonations, would affect the dose rate. Hence, in any real fallout situation, it would be necessary to perform actual measurements repeated at suitable intervals to establish the level and the rate of decay of the radioactivity.

9.16 The decrease of dose rate from a given amount of the early fallout, consisting of fission products and some other weapon residues (§ 9.32), is indicated by the continuous curves in Figs. 9.16a and b, which were calculated in the manner described in § 9.146. In these figures the ratio of the approximate radiation dose rate (in rads per hour) at any time after the explosion to a convenient reference value, called the "unit-time reference dose rate," is plotted against time in hours.³ The use of the reference dose rate simplifies the representation of the results and the calculations based on them, as will be shown below. The following treatment refers only to external radiation exposures from gamma-ray sources outside the body. The possibility should be borne in mind, however, that some fallout could enter the body, by inhalation and ingestion, and so give rise to internal radiation exposures (§ 12.163 *et seq.*). The major hazard in this respect is probably radioactive iodine, which can readily enter the body by way of milk from cows that have eaten forage contami-

³The significance of the dashed lines, marked "t = 1," will be described in § 9.146 *et seq.*, where the physical meaning of the unit-time reference dose rate will be explained. For the present, the dashed lines may be ignored.

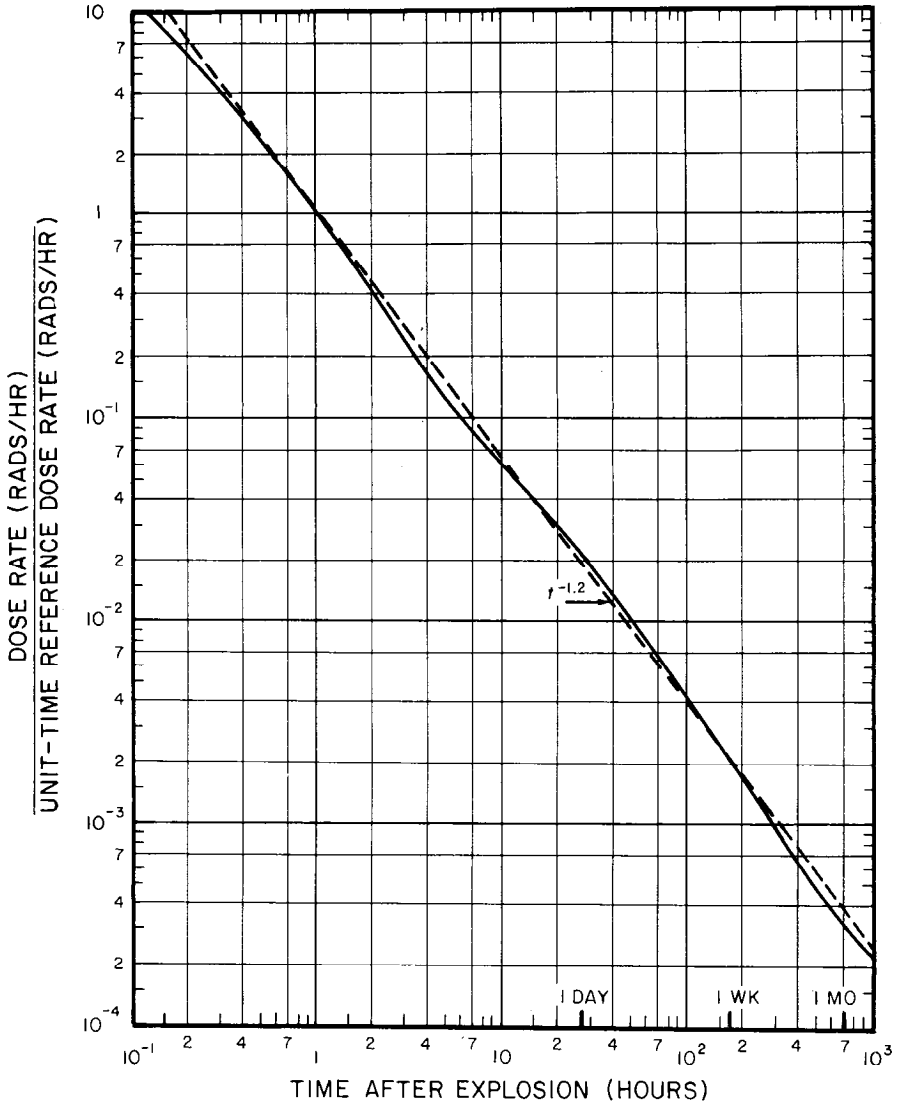

Figure 9.16a. Dependence of dose rate from early fallout upon time after explosion.

nated with fallout. Because the internal doses are highly dependent upon the circumstances, they are not predictable.

9.17 Suppose, for example, that at a given location, the fallout commences at 5 hours after the explosion, and that at 15 hours, when the fallout has ceased to descend, the observed (external) dose

rate is 4.0 rads per hour (rads/hr). From the curve in Fig. 9.16a (or the data in Table 9.19), it is seen that at 15 hours after the explosion, the ratio of the actual dose rate to the reference value is 0.040; hence, the reference dose rate must be $4.0/0.040=100$ rads/hr. By means of this reference value and the

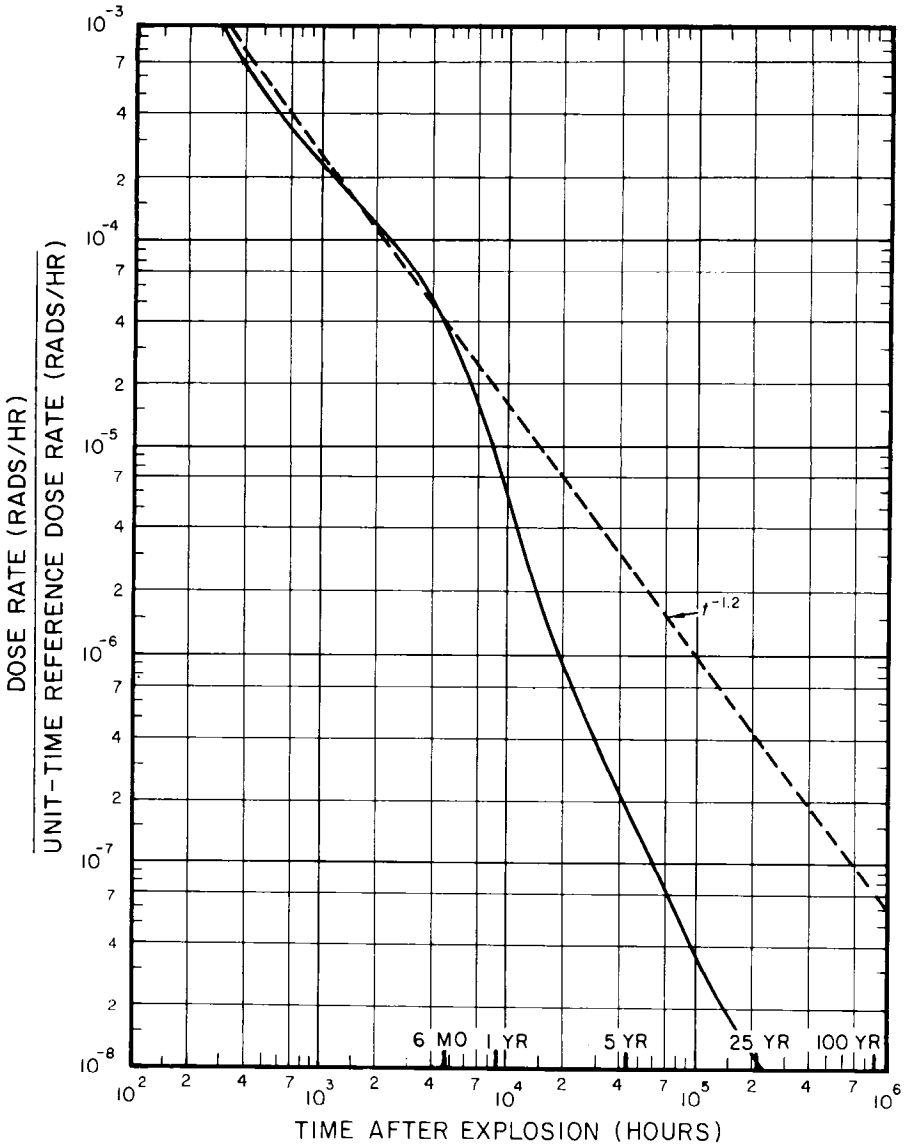

Figure 9.16b. Dependence of dose rate from early fallout upon time after explosion.

decay curves in Figs. 9.16a and b, it is possible to estimate the actual dose rate at the place under consideration at any time after fallout is complete. Thus, if the value is required at 24 hours after the explosion, Fig. 9.16a is entered at the point representing 24 hours on the hori-

zontal axis. Upon moving upward vertically until the plotted (continuous) line is reached, it is seen that the required dose rate is 0.023 multiplied by the unit-time reference dose rate, i.e., $0.023 \times 100 = 2.3$ rads/hr.

9.18 If the dose rate at any time is

Table 9.19

RELATIVE THEORETICAL DOSE RATES FROM EARLY FALLOUT AT VARIOUS TIMES AFTER A NUCLEAR EXPLOSION

Time (hours)	Relative dose rate	Time (hours)	Relative dose rate
1	1,000	36	15
1½	610	48	10
2	400	72	6.2
3	230	100	4.0
5	130	200	1.7
6	100	400	0.69
10	63	600	0.40
15	40	800	0.31
24	23	1,000	0.24

known, by actual measurement, the value at any other time can be estimated. All that is necessary is to compare the ratios (to the unit-time reference dose rate) for the two given times as obtained from Fig. 9.16a or Fig. 9.16b. For example, suppose the dose rate at 3 hours after the explosion is found to be 50 rads/hr; what would be the value at 18 hours? The respective ratios, as given by the curve in Fig. 9.16a, are 0.23 and 0.033, with respect to the unit-time reference dose rate. Hence, the dose rate at 18 hours after the explosion is $50 \times 0.033 / 0.23 = 7.2$ rads/hr.

9.19 The results in Figs. 9.16a and b may be represented in an alternative form, as in Table 9.19, which is more convenient, although somewhat less complete. The dose rate, in any suitable units, is taken as 1,000 at 1 hour after a nuclear explosion; the expected dose rate in the same units at a number of subsequent times, for the same quantity of early fallout, are then as given in the

table. If the actual dose rate at 1 hour (or any other time) after the explosion is known, the value at any specified time, up to 1,000 hours, can be obtained by simple proportion.⁴

9.20 It should be noted that Figs. 9.16a and b and Table 9.19 are used for calculations of dose rates. In order to determine the total or accumulated radiation dose received during a given period it is necessary to multiply the average dose rate by the exposure time. However, since the dose rate is steadily decreasing during the exposure, appropriate allowance for this must be made. The results of the calculations based on Fig. 9.16a are expressed by the curve in Fig. 9.20. It gives the total dose received from early fallout, between 1 minute and any other specified time after the explosion, in terms of the unit-time reference dose rate.

9.21 To illustrate the application of Fig. 9.20, suppose that an individual becomes exposed to a certain quantity of gamma radiation from early fallout 2

⁴Devices, similar to a slide rule, are available for making rapid calculations of the decay of fallout dose rates and related matters.

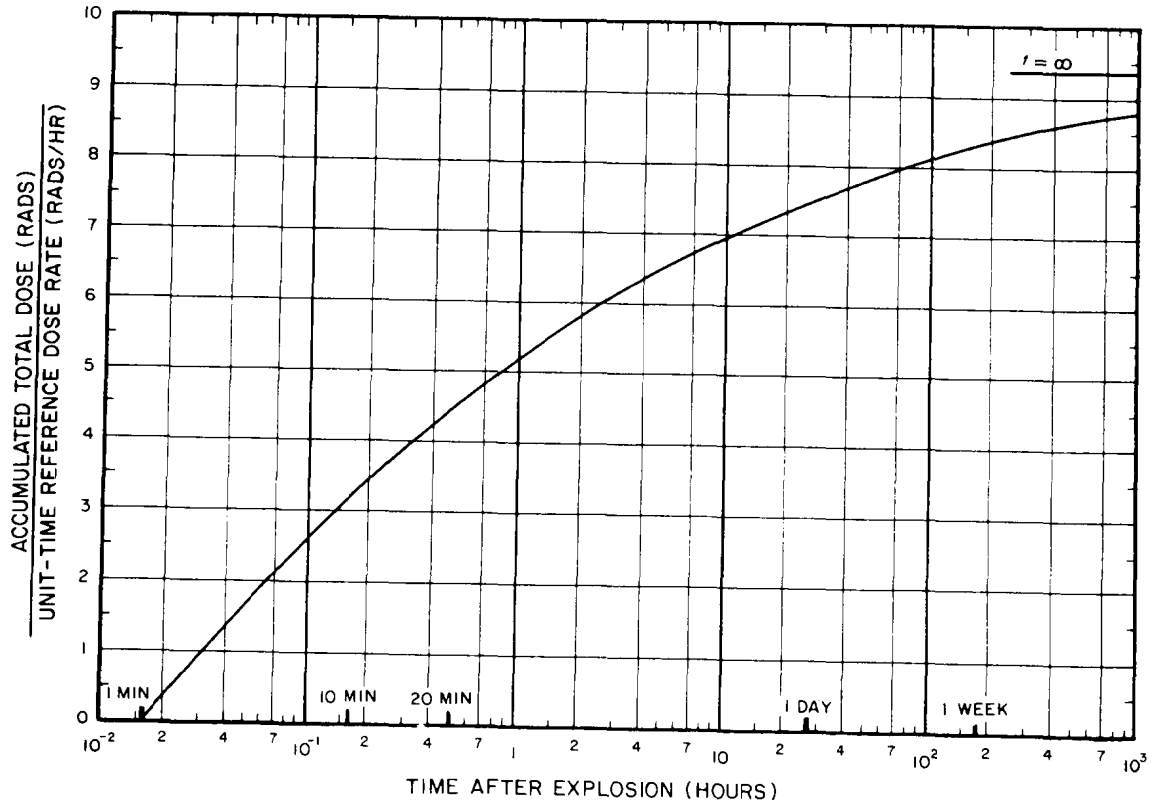

Figure 9.20. Curve for calculating accumulated total dose from early fallout at various times after explosion.

hours after a nuclear explosion and the dose rate, measured at that time, is found to be 1.5 rads/hr. What will be the total dose accumulated during the sub-

sequent 12 hours, i.e., by 14 hours after the explosion? The first step is to determine the unit-time reference dose rate. From Fig. 9.16a it is seen that

$$\frac{\text{Dose rate at 2 hours after explosion}}{\text{Unit-time reference dose rate}} = 0.40$$

and, since the dose rate at 2 hours is known to be 1.5 rads/hr, the reference value is $1.5/0.40=3.8$ rads/hr. Next,

from Fig. 9.20, it is found that for 2 hours and 14 hours, respectively, after the explosion,

$$\frac{\text{Accumulated dose at 2 hours after explosion}}{\text{Unit-time reference dose rate}} = 5.8$$

and

$$\frac{\text{Accumulated dose at 14 hours after explosion}}{\text{Unit-time reference dose rate}} = 7.1.$$

Hence, by subtraction

$$\frac{\text{Accumulated dose between 2 and 14 hours after explosion}}{\text{Unit-time reference dose rate}} = 1.3.$$

The unit-time reference dose rate is 3.8 rads/hr, and so the accumulated dose received in the 12 hours, between 2 and 14 hours after the explosion, is $3.8 \times 1.3 = 4.9$ rads.

9.22 The percentage of the accumulated "infinity dose" or "infinite time dose" that would be received from a given quantity of early fallout, computed from 1 minute to various times after a nuclear explosion, is shown in Table 9.22. The calculated infinite time dose is essentially equal to the dose that would be accumulated as a result of exposure to a fixed quantity of fallout for many years. These data can be used to determine the proportion of the infinite time dose received during any specified period following the complete deposition of the early fallout. Of course, if the deposition of fallout is incomplete

or part is removed, Table 9.22 would not be applicable.

9.23 If an individual is exposed to a certain amount of early fallout during the interval from 2 hours to 14 hours after the explosion, the percentage of the infinite time dose received may be obtained by subtracting the respective values in (or estimated from) Table 9.22, i.e., 76 (for 14 hours) minus 62 (for 2 hours), giving 14 percent, i.e., 0.14, of the infinite time dose. The actual value of the infinite time dose computed from 1 minute after detonation, is 9.3 times the unit-time reference dose rate (in rads/hr), as indicated by $t=\infty$ in Fig. 9.20. Hence, if the reference value is 3.8 rads per hour as in the above example, the accumulated dose received between 2 hours and 14 hours after the burst is $0.14 \times 9.3 \times 3.8 = 4.9$ rads, as before.

Table 9.22**PERCENTAGES OF INFINITE TIME RESIDUAL RADIATION DOSE RECEIVED FROM 1 MINUTE UP TO VARIOUS TIMES AFTER EXPLOSION**

Time (hours)	Percent of infinite time dose	Time (hours)	Percent of infinite time dose
1	55	72	86
2	62	100	88
4	68	200	90
6	71	500	93
12	75	1,000	95
24	80	2,000	97
48	83	10,000	99

9.24 With the aid of Figs. 9.16a and b and Fig. 9.20 (or the equivalent Tables 9.19 and 9.22) many different types of calculations relating to radiation dose rates and total doses received from early fallout can be made. The procedures can be simplified, however, by means of special charts, as will be shown below. The results, like those already given, are applicable to a particular quantity of fallout. If there is any change in the situation, either by further contamination or by decontamination, the conclusions will not be valid.

9.25 If the radiation dose rate from early fallout is known at a given location, the nomograph in Fig. 9.25 may be used to determine the dose rate at any

other time at the same location, assuming there has been no change in the fallout other than natural radioactive decay. The same nomograph can be utilized, alternatively, to determine the time after the explosion at which the dose rate will have attained a specified value. The nomograph is based on the straight line marked " $t^{-1.2}$ " in Figs. 9.16a and b which is seen to deviate only slightly from the continuous decay curve for times less than 6 months or so. It is thus possible to obtain from Fig. 9.25 approximate dose rates, which are within 25 percent of the continuous curve values of Figs. 9.16a and b for the first 200 days after the nuclear detonation.

(Text continued on page 404.)

The nomograph in Fig. 9.25 gives an approximate relationship between the dose rate at any time after the explosion and the unit-time reference value. If the dose rate at any time is known, that at any other time can be derived from the figure. Alternatively, the time after the explosion at which a specific dose rate is attained can be determined approximately.

For the conditions of applicability of Fig. 9.25, see § 9.30.

Example

Given: The radiation dose rate due to fallout at a certain location is 8 rads per hour at 6 hours after a nuclear explosion.

Find: (a) The dose rate at 24 hours after the burst. (b) The time after the

explosion at which the dose rate is 1 rad/hr.

Solution: By means of a ruler (or straight edge) join the point representing 8 rads/hr on the left scale to the time 6 hours on the right scale. The straight line intersects the middle scale at 69 rads/hr; this is the unit-time reference value of the dose rate.

(a) Using the straight edge, connect this reference point (69 rads/hr) with that representing 24 hours after the explosion on the right scale and extend the line to read the corresponding dose rate on the left scale, i.e., 1.5 rads/hr. *Answer*

(b) Extend the straight line joining the dose rate of 1 rad/hr on the left scale to the reference value of 69 rads/hr on the middle scale out to the right scale. This is intersected at 34 hours after the explosion. *Answer*

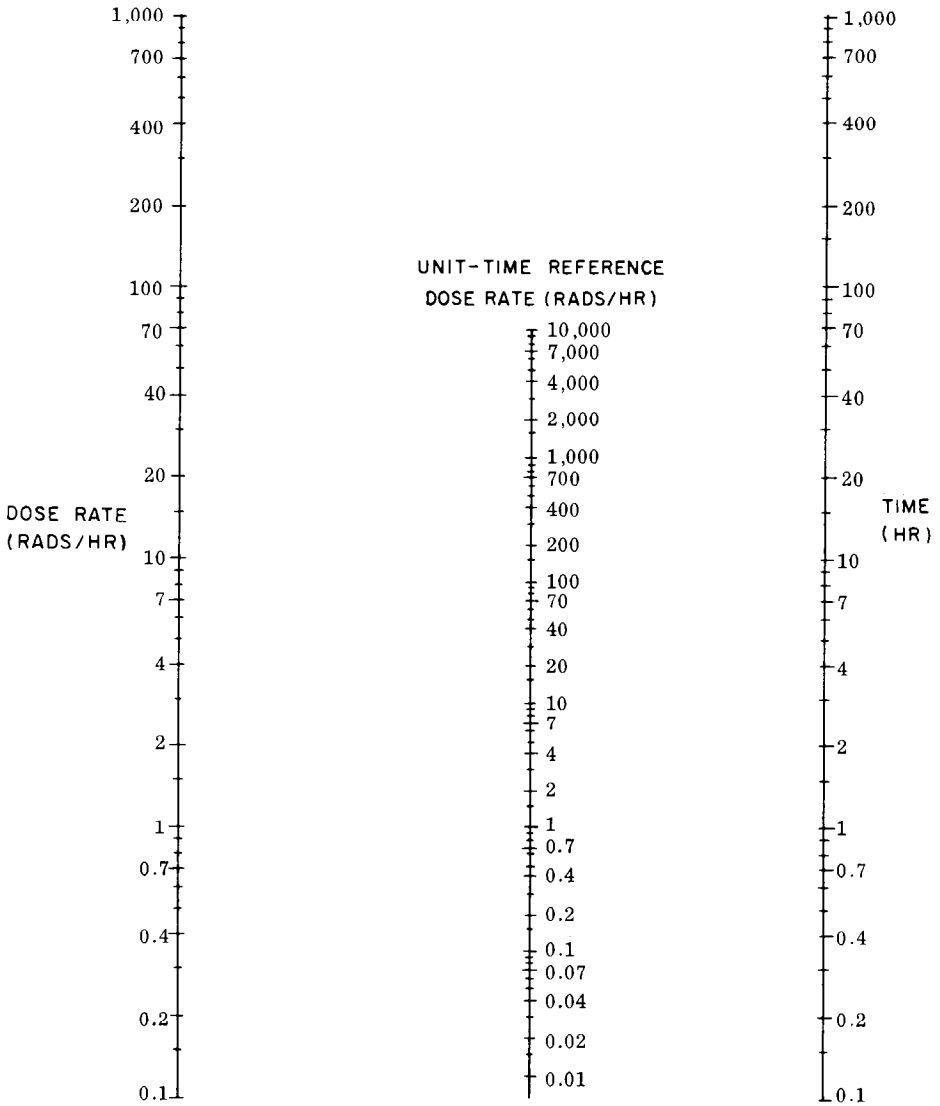

Figure 9.25. Nomograph for calculating approximate dose rates from early fallout.

From Fig. 9.26 the total accumulated radiation dose received from early fallout during any specified stay in a contaminated area can be estimated if the dose rate at some definite time after the explosion is known. Alternatively, the time can be calculated for commencing an operation requiring a specified stay and a prescribed total radiation dose.

For conditions of applicability of Fig. 9.26, see § 9.30.

Example

Given: The dose rate at 4 hours after a nuclear explosion is 6 rads/hr.

Find: (a) The total accumulated dose received during a period of 2 hours commencing at 6 hours after the explosion. (b) The time after the explosion when an operation requiring a stay of 5 hours can be started if the total dose is to be 4 rads.

Solution: The first step is to determine the unit-time reference dose rate (R_1).

From Fig. 9.25, a straight line connecting 6 rads/hr on the left scale with 4 hours on the right scale intersects the middle scale at 32 rads/hr; this is the value of R_1 .

(a) Enter Fig. 9.26 at 6 hours after the explosion (horizontal scale) and move up to the curve representing a time of stay of 2 hours. The corresponding reading on the vertical scale, which gives the multiplying factor to convert R_1 to the required total dose, is seen to be 0.19. Hence, the accumulated dose is

$$0.19 \times 32 = 6.1 \text{ rads. Answer}$$

(b) Since the accumulated dose is given as 4 rads and R_1 is 32 rads/hr, the multiplying factor is $4/32 = 0.125$. Entering Fig. 9.26 at this point on the vertical scale and moving across until the (interpolated) curve for 5 hours stay is reached, the corresponding reading on the horizontal scale, giving the time after the explosion, is seen to be

$$21 \text{ hours. Answer}$$

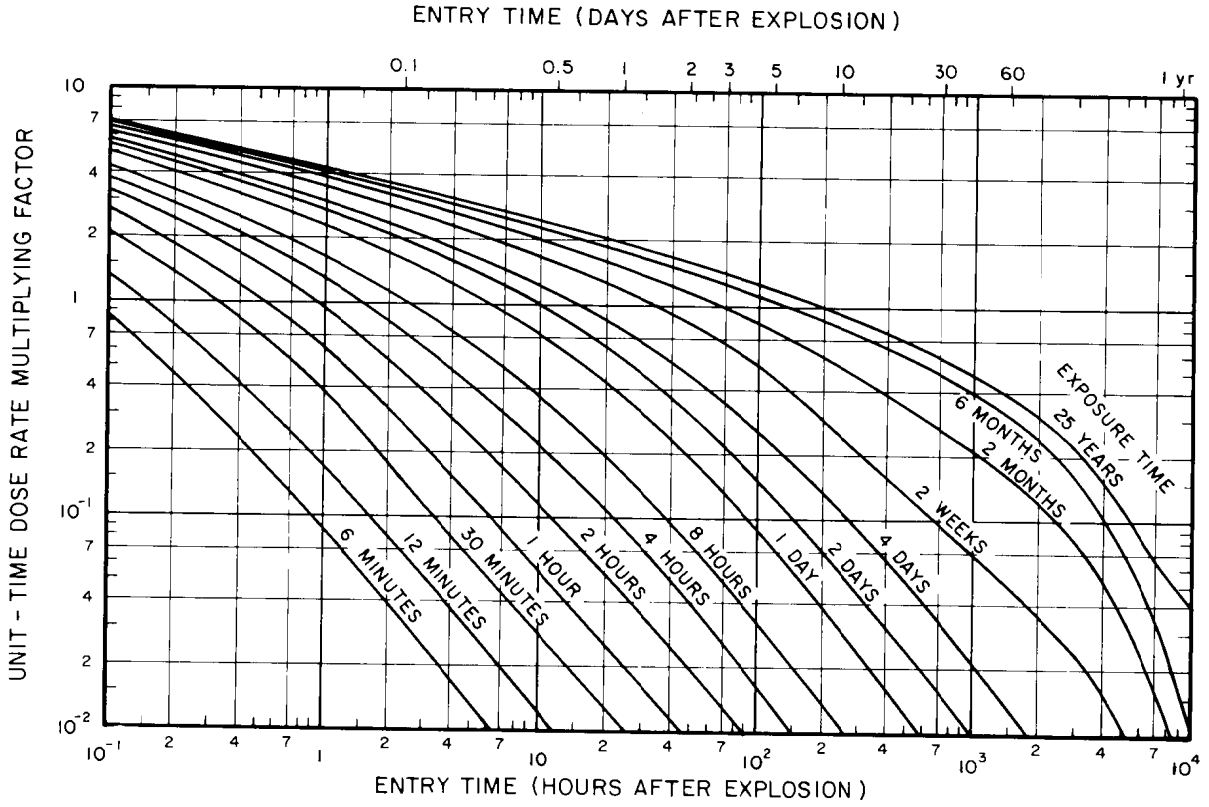

Figure 9.26. Curves for calculating accumulated radiation dose from early fallout based on unit-time reference dose rate.

From the chart in Fig. 9.27, the total accumulated radiation dose received from early fallout during any specified stay in a contaminated area can be estimated if the dose rate at the time of entry into the area is known. Alternatively, the time of stay may be evaluated if the total dose is prescribed.

For conditions of applicability of Fig. 9.27, see § 9.30.

Example

Given: Upon entering a contaminated area at 12 hours after a nuclear explosion the dose rate is 5 rads/hr.

Find: (a) The total accumulated radiation dose received for a stay of 2 hours.
(b) The time of stay for a total accumulated dose of 20 rads.

Solution: (a) Start at the point on Fig. 9.27 representing 12 hours after the ex-

plosion on the horizontal scale and move up to the curve representing a time of stay of 2 hours. The multiplying factor for the dose rate at the time of entry, as read from the vertical scale, is seen to be 1.9. Hence, the total accumulated dose received is

$$1.9 \times 5 = 9.5 \text{ rads. } \textit{Answer.}$$

(b) The total accumulated dose is 20 rads and the dose rate at the time of entry is 5 rads/hr; hence, the multiplying factor is $20/5 = 4.0$. Enter Fig. 9.27 at the point corresponding to 4.0 on the vertical scale and move horizontally to meet a vertical line which starts from the point representing 12 hours after the explosion on the horizontal scale. The two lines are found to intersect at a point indicating a time of stay of about $4\frac{1}{2}$ hours. *Answer.*

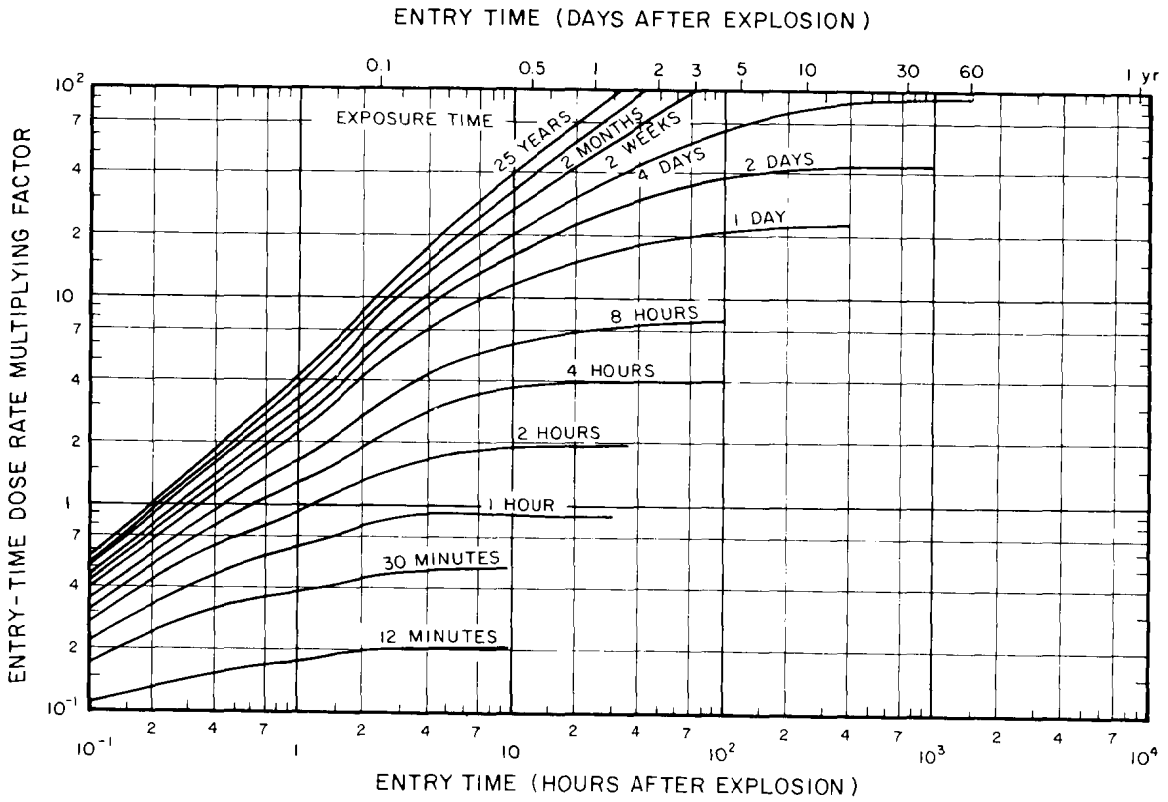

Figure 9.27. Curves for calculating accumulated radiation dose from early fallout based on dose rate at time of entry.

9.26 To determine the total accumulated radiation dose received during a specified time of stay in an area contaminated with early fallout, if the dose rate in that area at any given time is known, use is made of Fig. 9.26 in conjunction with Fig. 9.25. The chart may also be employed to evaluate the time when a particular operation may be commenced in a contaminated area in order not to exceed a specified accumulated radiation dose.

9.27 Another type of calculation of radiation dose in a contaminated area (from a fixed quantity of fallout) is based on a knowledge of the dose rate at the time when exposure commenced in that area. The procedure described in the examples facing Fig. 9.26, which also requires the use of Fig. 9.25, may then be applied to determine either the total dose received in a specified time of stay or the time required to accumulate a given dose of radiation. The calculation may, however, be simplified by means of Fig. 9.27 which avoids the necessity for evaluating the unit-time reference dose rate, provided the dose rate at the time of entry (or fallout arrival time) in the contaminated area is known.

9.28 If the whole of the early fallout reached a given area within a short time, Fig. 9.27 could be used to determine how the total accumulated radiation dose received by inhabitants of that area would increase with time, assuming no protection. For example, suppose the early fallout arrived at 6 hours after the explosion and the dose rate at that time was R rads per hour; the total dose received would be $9R$ rads in 1 day, $12R$ rads in 2 days, and $16R$ rads in 5 days.

9.29 It is evident that the first day or so after the explosion is the most hazardous as far as the exposure to residual nuclear radiation from the early fallout is concerned. Although the particular values given above apply to the case specified, i.e., complete early fallout arrival 6 hours after the explosion, the general conclusions to be drawn are true in all cases. The radiation doses that would be received during the first day or two are considerably greater than on subsequent days. Consequently, it is in the early stages following the explosion that protection from fallout is most important.

9.30 It is essential to understand that the tables and figures given above, and the calculations of radiation dose rates and doses in which they are used, are based on the assumption that an individual is exposed to a certain quantity of early fallout and remains exposed continuously (without protection) to this same quantity for a period of time. In an actual fallout situation, however, these conditions probably would not exist. For one thing, any shelter which attenuates the radiation will reduce the exposure dose rate (and dose) as given by the calculations. Furthermore, the action of wind and weather will generally tend to disperse the fallout particles in some areas and concentrate them in others. As a result, there may be a change in the quantity of early fallout at a given location during the time of exposure; the radiation dose rate (and dose) would then change correspondingly. The same would be true, of course, if there were additional fallout from another nuclear explosion.

NEUTRON-INDUCED ACTIVITY

9.31 The neutrons liberated in the fission process, but which are not involved in the propagation of the fission chain, are ultimately captured by the weapon residues through which they must pass before they can escape, by nitrogen (especially) and oxygen in the atmosphere, and by various materials present on the earth's surface (§ 8.16). As a result of capturing neutrons many substances become radioactive. They, consequently, emit beta particles, frequently accompanied by gamma radiation, over an extended period of time following the explosion. Such neutron-induced activity, therefore, is part of the residual nuclear radiation.

9.32 The activity induced in the weapon materials is highly variable, since it is greatly dependent upon the design and structural characteristics of the weapon. Any radioactive isotopes produced by neutron capture in the residues will remain associated with the fission products. The curves and tables given above have been adjusted to include the contribution of such isotopes, e.g., uranium-237 and -239 and neptunium-239 and -240. In the period from 20 hours to 2 weeks after the burst, depending to some extent upon the weapon materials, these isotopes can contribute up to 40 percent of the total activity of the weapon debris. At other times, their activity is negligible in comparison with that of the fission products.

9.33 When neutrons interact with oxygen and nitrogen nuclei present in the atmosphere, the resulting radioactivity is of little or no significance, as far as the early residual radiation is concerned.

Oxygen-16, for example, reacts to a slight extent with fast neutrons, but the product, an isotope of nitrogen, has a half-life of only 7 seconds. It will thus undergo almost complete decay within a minute or two.

9.34 The product of neutron interaction with nitrogen-14 is carbon-14 (§ 8.110), which is radioactive; it emits beta particles of low energy but no gamma rays. Carbon-14 has a long half-life (5,730 years), so that it decays and emits beta particles relatively slowly. In the form of carbon dioxide it is readily incorporated by all forms of plant life and thus finds its way into the human body. The carbon in all living organisms contains a certain proportion of carbon-14 resulting from the capture by atmospheric nitrogen of neutrons from naturally occurring cosmic rays and from weapons tests. The total reservoir of carbon-14 in nature, including oceans, atmosphere, and biosphere (living organisms), is normally from 50 to 80 tons; of this amount, about 1 ton is in the atmosphere and 0.2 ton in the biosphere. It is estimated that before September 1961 weapons testing had produced an additional 0.65 (short) ton of carbon-14 and about half had dissolved in the oceans. As a result of the large number of atmospheric nuclear tests, many of high yield, conducted during 1961 and 1962, the excess of carbon-14 in the atmosphere rose to about 1.6 (short) tons in the spring of 1963. By mid-1969, this excess had fallen to about 0.74 ton. In the course of time, more and more of the carbon-14 will enter the oceans and, provided there is no great addition as a result of weapons tests, the level in the atmosphere should continue to decrease. If the rate of de-

crease of excess carbon-14 in the atmosphere observed between 1963 and 1969 were to continue, the level should fall to less than 1 percent above normal in 40 to 80 years.

9.35 An important contribution to the residual nuclear radiation can arise from the activity induced by neutron capture in certain elements in the earth and in sea water. The extent of this radioactivity is highly variable. The element which probably deserves most attention, as far as environmental neutron-induced activity is concerned, is sodium. Although this is present only to a small extent in average soils, the amount of radioactive sodium-24 formed by neutron capture can be quite appreciable. This isotope has a half-life of 15 hours and emits both beta particles, and more important, gamma rays of relatively high energy.⁵

9.36 Another source of induced activity is manganese which, being an element that is essential for plant growth, is found in most soils, even though in small proportions. As a result of neutron capture, the radioisotope manganese-56, with a half-life of 2.6 hours, is formed. Upon decay it gives off several gamma rays of high energy, in addition to beta particles. Because its half-life is less than that of sodium-24, the manganese-56 loses its activity more rapidly. But, within the first few hours after an explosion, the manganese in soil may constitute a serious hazard, greater than that of sodium.

9.37 A major constituent of soil is silicon, and neutron capture leads to the

formation of radioactive silicon-31. This isotope, with a half-life of 2.6 hours, gives off beta particles, but gamma rays are emitted in not more than about 0.07 percent of the disintegrations. It will be seen later that only in certain circumstances do beta particles themselves constitute a serious radiation hazard. Aluminum, another common constituent of soil, can form the radioisotope aluminum-28, with a half-life of only 2.3 minutes. Although isotopes such as this, with short half-lives, contribute greatly to the high initial activity, very little remains within an hour after the nuclear explosion.

9.38 When neutrons are captured by the hydrogen nuclei in water (H_2O), the product is the nonradioactive (stable) isotope, deuterium, so that there is no resulting activity. As seen in § 9.33, the activity induced in the oxygen in water can be ignored because of the very short half-life of the product. However, substances dissolved in the water, especially the salt (sodium chloride) in sea water, can be sources of considerable induced activity. The sodium produces sodium-24, as already mentioned, and the chlorine yields chlorine-38 which emits both beta particles and high-energy gamma rays. However, the half-life of chlorine-38 is only 37 minutes, so that within 4 to 5 hours its activity will have decayed to about 1 percent of its initial value.

9.39 Apart from the interaction of neutrons with elements present in soil and water, the neutrons from a nuclear explosion may be captured by other nu-

⁵In each act of decay of sodium-24, there are produced two gamma-ray photons, with energies of 1.4 and 2.8 MeV, respectively. The mean energy per photon from fission products at 1 hour after formation is about 1 MeV.

clei, such as those contained in structural and other materials. Among the metals, the chief sources of induced radioactivity are probably zinc, copper, and manganese, the latter being a constituent of many steels, and, to a lesser extent, iron. Wood and clothing are unlikely to develop appreciable activity as a result of neutron capture, but glass could become radioactive because of the large proportions of sodium and silicon. Foodstuffs can acquire induced activity, mainly as a result of neutron capture by sodium. However, at such distances from a nuclear explosion and under such conditions that this activity would be significant, the food would probably not be fit for consumption for other reasons, e.g., blast and fire damage. Some elements, e.g., boron, absorb neutrons without becoming radioactive, and their presence will decrease the induced activity.

URANIUM AND PLUTONIUM

9.40 The uranium and plutonium which may have escaped fission in the nuclear weapon represent a further possible source of residual nuclear radiation. The common isotopes of these elements emit alpha particles and also some gamma rays of low energy. However, because of their very long half-lives, the activity is very small compared with that of the fission products.

9.41 The alpha particles from uranium and plutonium, or from radioactive sources in general, are completely absorbed in an inch or two of air (§ 1.66). This, together with the fact that the particles cannot penetrate ordinary clothing, indicates that uranium and plutonium deposited on the earth do not

represent a serious external hazard. Even if they actually come in contact with the body, the alpha particles emitted are unable to penetrate the unbroken skin.

9.42 Although there is negligible danger from uranium and plutonium outside the body, it is possible for dangerous amounts of these elements to enter the body through the lungs, the digestive system, or breaks in the skin. Plutonium, for example, tends to concentrate in bone and lungs, where the prolonged action of the alpha particles can cause serious harm (Chapter XII).

9.43 At one time it was suggested that the explosion of a sufficiently large number of nuclear weapons might result in such an extensive distribution of the plutonium as to represent a worldwide hazard. It is now realized that the fission products—the radioisotope strontium-90 in particular—are a more serious hazard than plutonium is likely to be. Further, any steps taken to minimize the danger from fission products, which are much easier to detect, will automatically reduce the hazard from the plutonium.

TRITIUM

9.44 The interaction of fast neutrons in cosmic rays with nitrogen nuclei in the air leads to the formation of some tritium in the normal atmosphere; this radioactive isotope of hydrogen has a half-life of about 12.3 years. Small amounts of tritium are formed in fission but larger quantities result from the explosion of thermonuclear weapons. The fusion of deuterium and tritium proceeds much more rapidly than the other thermonuclear reactions (§ 1.69) so that most of the tritium present (or formed in

the D-D and Li-n reactions) is consumed in the explosion. Nevertheless, some residual quantity will remain. Tritium is also produced by the interaction of nitrogen nuclei in the air with high-energy neutrons released in the fusion reactions. Most of the tritium remaining after a nuclear explosion, as well as that produced by cosmic rays, is rapidly converted into tritiated water, HTO; this is chemically similar to ordinary water (H₂O) and differs from it only in the respect that an atom of the radioactive isotope tritium (T) replaces one atom of ordinary hydrogen (H). If the tritiated water should become associated with natural water, it will move with the latter.

9.45 The total amount of tritium on earth, mostly in the form of tritiated water, attained a maximum in 1963, after atmospheric testing by the United States and the U.S.S.R. had ceased. The amount was then about 16 to 18 times the natural value, but this has been decreasing as a result of radioactive decay. By the end of the century, there will have been a decrease by a factor of eight or so from the maximum, provided there are no more than a few nuclear explosions in the atmosphere. A portion of the tritium produced remains in the lower atmosphere, i.e., the troposphere, whereas the remainder ascends into the stratosphere (see Fig. 9.126). The tritiated water in the troposphere is removed by precipitation and at times, in 1958 and 1963, following extensive nuclear weapons test series, the tritiated water in rainfall briefly reached values about 100 times the natural concentration. Tritium in the stratosphere is removed slowly, so that substantial amounts are still present in this region of

the atmosphere. As a general rule, the tritium (and other weapons debris) must descend into the troposphere before scavenging by rain or snow can be effective (§ 9.135).

9.46 When tritium decays it emits a beta particle of very low energy but no gamma rays. Consequently, it does not represent a significant external radiation hazard. In principle, however, it could be an internal hazard. Natural water is relatively mobile in the biosphere and any tritiated water present will be rapidly dispersed and become available for ingestion by man through both food and drink. But the hazard is greatly reduced by the dilution of the tritiated water with the large amounts of ordinary water in the environment. On the whole, the internal radiation dose from tritium is relatively unimportant when compared with the external (or internal) dose from fission products (§ 12.199).

CLEAN AND DIRTY WEAPONS

9.47 The terms "clean" and "dirty" are often used to describe the amount of radioactivity produced by a fusion weapon (or hydrogen bomb) relative to that from what might be described as a "normal" weapon. The latter may be defined as one in which no special effort has been made either to increase or to decrease the amount of radioactivity produced for the given explosion yield. A "clean" weapon would then be one which is designed to yield significantly less radioactivity than an equivalent normal weapon. Inevitably, however, any fusion weapon will produce some radioactive species. Even if a pure fusion weapon, with no fission, should be developed, its explosion in air

would still result in the formation of carbon-14, tritium, and possibly other neutron-induced activities. If special steps were taken in the design of a fusion device, e.g., by salting (§ 9.11),

so that upon detonation it generated more radioactivity than a similar normal weapon, it would be described as "dirty." By its very nature, a fission weapon must be regarded as being dirty.

RADIOACTIVE CONTAMINATION FROM NUCLEAR EXPLOSION

AIR BURSTS

9.48 An air burst, by definition, is one taking place at such a height above the earth that no appreciable quantities of surface materials are taken up into the fireball. The radioactive residues of the weapon then condense into very small particles with diameters in the range of 0.01 to 20 micrometers (see § 2.27 footnote). The nuclear cloud carries these particles to high altitudes, determined by the weapon yield and the atmospheric conditions. Many of the particles are so small that they fall extremely slowly under the influence of gravity, but they can diffuse downward and be deposited by atmospheric turbulence. The deposition takes place over such long periods of time that the particles will have become widely distributed and their concentration thereby reduced. At the same time, the radioactivity will have decreased as a result of natural decay. Consequently, in the absence of precipitation, i.e., rain or snow (§ 9.67), the deposition of early fallout from an air burst will generally not be significant.

9.49 An air burst, however, may produce some induced radioactive contamination in the general vicinity of ground zero as a result of neutron capture by elements in the soil. The extent

of the contamination will depend on the characteristics of the weapon, e.g., fusion and fission energy yields, the height of burst, and the composition of the surface material. The residual radioactivity which would arise in this manner will thus be highly variable, but it is probable that where the induced activity is substantial, all buildings except strong underground structures would be destroyed by blast and fire.

LAND SURFACE AND SUBSURFACE BURSTS

9.50 As the height of burst decreases, earth, dust, and other debris from the earth's surface are taken up into the fireball; an increasing proportion of the fission (and other radioactive) products of the nuclear explosion then condense onto particles of appreciable size. These contaminated particles range in diameter from less than 1 micron to several millimeters; the larger ones begin to fall back to earth even before the radioactive cloud has attained its maximum height, whereas the very smallest ones may remain suspended in the atmosphere for long periods. In these circumstances there will be an early fallout, with the larger particles reaching the ground within 24 hours. Photographs of typical fallout particles

are shown in Figs. 9.50a through d. The distribution of the radioactivity of the particles is indicated by the autoradiographs, i.e., self-photographs produced by the radiations. As a general rule, the contamination is confined to the surface of the particle, but in some cases the distribution is uniform throughout, indicating that the particle was molten when it incorporated the radioactive material.

9.51 The extent of the contamination of the earth's surface due to the residual nuclear radiation following a land surface or subsurface burst depends primarily on the location of the burst point. There is a gradual transition in behavior from a high air burst, at one extreme, where all the radioactive residues are injected into the atmosphere, to a deep subsurface burst, at the other extreme, where the radioactive materials remain below the surface. In neither case will there be any significant local fallout. Between these two extremes are surface and near-surface bursts which will be accompanied by extensive contamination due to early fallout. A shallow subsurface burst, in which part of the fireball emerges from the ground, is essentially similar to a surface burst. The distribution of the early fallout from surface and related explosions is determined by the total and fission yields, and the depth or height of burst, the nature of the soil, and the wind and weather conditions. These matters will be discussed in some detail later in this chapter.

9.52 For a subsurface burst that is not too deep, but deep enough to prevent emergence of the fireball, a considerable amount of dirt is thrown up as a column in the air and there is also

crater formation. Much of the radioactive material will remain in the crater area, partly because it does not escape and partly because the larger pieces of contaminated rock, soil, and debris thrown up into the air will descend in the vicinity of the explosion (Chapter VI). The finer particles produced directly or in the form of a base surge (§ 2.96) will remain suspended in the air and will descend as fallout at some distance from ground zero.

WATER SURFACE AND UNDERWATER BURSTS

9.53 The particles entering the atmosphere from a sea water surface or shallow subsurface burst consist mainly of sea salts and water drops. When dry, the particles are generally smaller and lighter than the fallout particles from a land burst. As a consequence of this difference, sea water bursts produce less close-in fallout than do similar land surface bursts. In particular, water surface and shallow underwater bursts are often not associated with a region of intense residual radioactivity near surface zero. Possible exceptions, when such a region does occur, are water surface bursts in extremely humid atmospheres or in shallow water. If the humidity is high, the hygroscopic, i.e., water-absorbing, nature of the sea salt particles may cause a cloud seeding effect leading to a local rainout of radioactivity.

9.54 The early residual radioactivity from a water burst can arise from two sources: (1) the base surge if formed (§ 2.72 *et seq.*) and (2) the radioactive material, including induced radioactivity, remaining in the water.

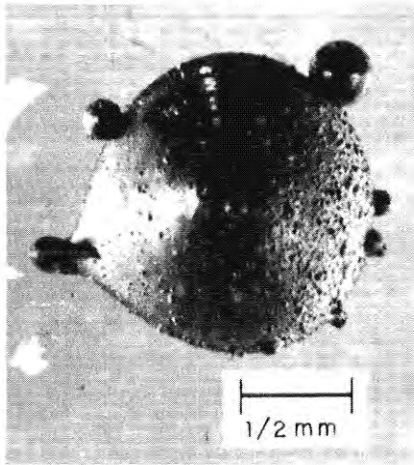

Figure 9.50a. A typical fallout particle from a tower shot in Nevada. The particle has a dull, metallic luster and shows numerous adhering small particles.



Figure 9.50b. A fallout particle from a tower shot in Nevada. The particle is spherical with a brilliant, glossy surface.

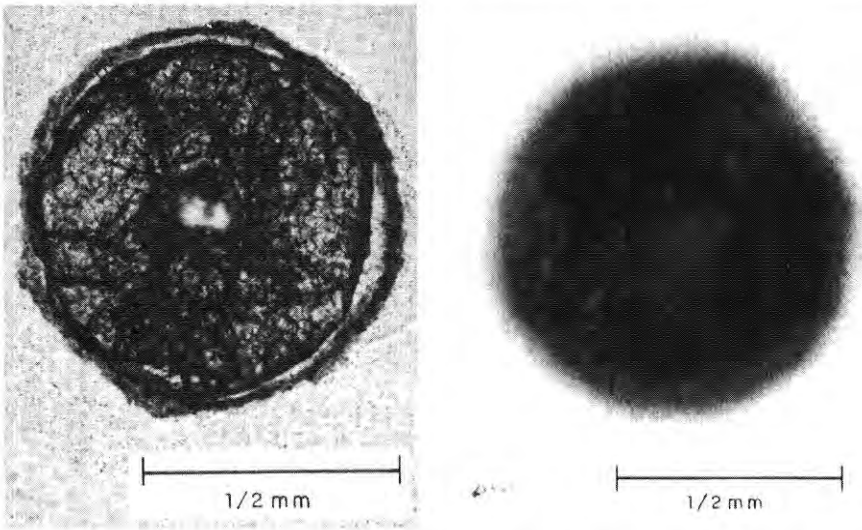

Figure 9.50c. Photograph (left) and autoradiograph (right) of a thin section of a spherical particle from a ground-surface shot at Eniwetok. The radioactivity is uniformly distributed throughout the particle.

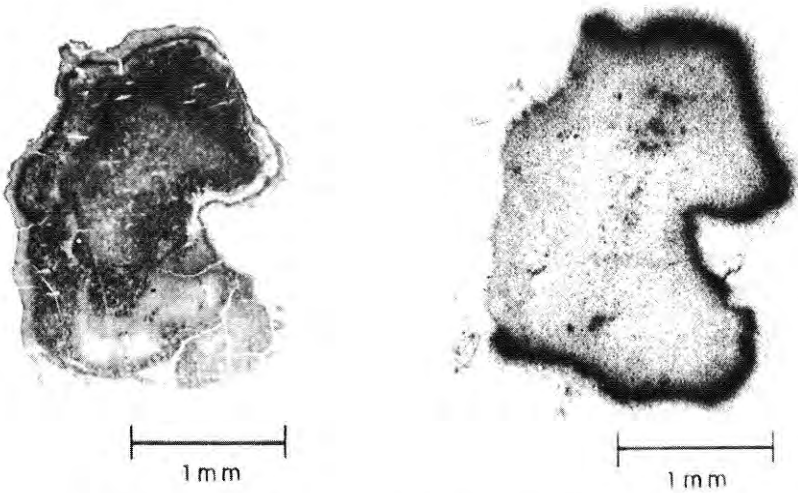

Figure 9.50d. Photograph (left) and autoradiograph (right) of a thin section of an irregular particle from a ground-surface shot at Bikini. The radioactivity is concentrated on the surface of the particle.

The base surge is influenced strongly by the wind, moving as an entity at the existing wind speed and direction. Initially, the base surge is highly radioactive, but as it expands and becomes diluted the concentration of fission products, etc., decreases. This dispersion, coupled with radioactive decay, results in comparatively low dose rates from the base surge by about 30 minutes after the burst (§ 2.77 *et seq.*).

9.55 The radioactivity in the water is initially present in a disk-like "pool," usually not more than 300 feet deep, near the ocean surface which is moved by the local currents. The pool gradually expands into a roughly annular form, but it reverts to an irregular disk shape at later times. Eventually, downward mixing and horizontal turbulent diffusion result in a rapid dilution of the radioactivity, thus reducing the hazard with time.

9.56 In the Bikini BAKER test (§ 2.63), the contaminated fallout (or rainout) consisted of both solid particles and a slurry of sea salt crystals in drops of water. This contamination was difficult to dislodge and had there been per-

sonnel on board the ships used in the test, they would have been subjected to considerable doses of radiation if the fallout were not removed immediately.⁶ Since the BAKER shot was fired in shallow water, the bottom material may have helped in the scavenging of the radioactive cloud, thus adding to the contamination. It is expected that for shallow bursts in very deep water the fallout from the cloud will be less than observed at the test in Bikini lagoon.

9.57 An indication of the rate of spread of the active material and the decrease in the dose rate following a shallow underwater burst is provided by the data in Table 9.57, obtained after the Bikini BAKER test. Although the dose rate in the water was still fairly high after 4 hours, there would be considerable attenuation in the interior of a ship, so that during the time required to cross the contaminated area the total dose received would be small. Within 2 or 3 days after the BAKER test the radioactivity had spread over an area of about 50 square miles, but the radiation dose rate in the water was so low that the region could be traversed in safety.

Table 9.57

DIMENSIONS AND DOSE RATE IN CONTAMINATED WATER AFTER THE 20-KILOTON UNDERWATER EXPLOSION AT BIKINI

Time after explosion (hours)	Contaminated area (square miles)	Mean diameter (miles)	Maximum dose rate (rads/hr)
4	16.6	4.6	3.1
38	18.4	4.8	0.42
62	48.6	7.9	0.21
86	61.8	8.9	0.042
100	70.6	9.5	0.025
130	107	11.7	0.008
200	160	14.3	0.0004

⁶The technique of washdown of ships, by continuous flow of water over exposed surfaces to remove fallout as it settles, was developed as a result of the Bikini BAKER observations.

9.58 The residual radiation dose rates and doses from the base surge and pool resulting from an underwater nuclear explosion vary significantly with weapon yield and burst depth, proximity of the ocean bottom to the point of detonation, wind velocity, and current

velocity. Consequently, the residual radiation distribution associated with an underwater burst is complex, and there is no simplified prediction system suitable for general application, such as has been developed for land surface bursts (§ 9.79 *et seq.*).

FALLOUT DISTRIBUTION IN LAND SURFACE BURSTS

DISTRIBUTION OF CONTAMINATION

9.59 More is known about the fallout from land surface and near-surface bursts than for other types of explosions. Consequently, the remainder of this chapter will be concerned mainly with the radioactive contamination resulting from bursts at or near the ground surface. The proportion of the total radioactivity of the weapon residues that is present in the early fallout, sometimes called the "early fallout fraction," varies from one test explosion to another. For land surface bursts the early fallout fraction, which depends on the nature of the surface material, has been estimated to range from 40 to 70 percent. Values somewhat higher than this are expected for shallow underground bursts. For water surface bursts, however, the fraction is generally lower, in the neighborhood of 20 to 30 percent, for the reason given in § 9.53. Some variability is expected in the fallout fraction for a given type of burst due to variations in environmental and meteorological conditions. Nevertheless, it will be assumed here that 60 percent of the total radioactivity from a land surface burst weapon will be in the early fallout. The remainder will contribute to

the delayed fallout, most of which undergoes substantial radioactive decay and, hence, decreases in activity before it eventually reaches the ground many hundreds or thousands of miles away (§ 9.121 *et seq.*).

9.60 The distribution on the ground of the activity from the early fallout, i.e., the "fallout pattern," even for similar nuclear yields, also shows great variability. In addition to the effect of wind, such factors as the dimensions of the radioactive cloud, the distribution of radioactivity within the mushroom head, and the range of particle sizes contribute to the uncertainty in attempts to predict the fallout pattern.

9.61 The spatial distribution of radioactivity within the cloud is not known accurately, but some of the gross features have been derived from observations and theoretical considerations. It is generally accepted that, of the total activity that is lofted, the mushroom head from a contact land-surface burst initially contains about 90 percent with the remainder residing in the stem. The proportion of activity in the stem may be even less for a water surface burst and almost zero for an air burst. However, it appears that some radioactive particles from the mushroom head fall or are

transported by subsiding air currents to lower altitudes even before the cloud reaches its maximum height. In addition to the radioactivity in the mushroom head and the stem, a considerable quantity of radioactivity from a surface burst is contained in the fallback in the crater and in the ejecta scattered in all directions around ground zero (Chapter VI). There is some evidence that, for explosions in the megaton range, the highest concentration of radioactivity initially lies in the lower third of the head of the mushroom cloud. It is probable, too, that in detonations of lower yield, a layer of relatively high activity exists somewhere in the cloud. The location of the peak concentration appears to vary with different detonations, perhaps as a function of atmospheric conditions.

9.62 Because particles of different sizes descend at different rates and carry different amounts of radioactive contamination, the fallout pattern will depend markedly on the size distribution of the particles in the cloud after condensation has occurred. In general, larger particles fall more rapidly and carry more activity, so that a high proportion of such particles will lead to greater contamination near ground zero, and less at greater distances, than would be the case if small particles predominated.

9.63 The particle size distribution in the radioactive cloud may well depend on the nature of the material which becomes engulfed by the fireball. A surface burst in a city, for example, could result in a particle size distribution and consequent fallout pattern which would differ from those produced under test conditions either in Nevada or in the

Pacific. However, in the absence of any definite evidence to the contrary, it is generally assumed that the fallout pattern for a surface burst in a large city will not differ greatly from those associated with surface and tower shots in the Nevada desert. This may not be the same as the patterns observed at tests in Pacific Ocean atolls.

AREA OF CONTAMINATION

9.64 The largest particles fall to the ground from the radioactive cloud and stem shortly after the explosion and hence are found within a short distance of surface zero. Smaller particles, on the other hand, will require many hours to fall to earth. During this period they may be carried hundreds of miles from the burst point by the prevailing winds. The very smallest particles have no appreciable rate of fall and so they may circle the earth many times before reaching the ground, generally in precipitation with rain or snow.

9.65 The fact that smaller particles from the radioactive cloud may reach the ground at considerable distances from the explosion means that fallout from a surface burst can produce serious contamination far beyond the range of other effects, such as blast, shock, thermal radiation, and initial nuclear radiation. It is true that the longer the cloud particles remain suspended in the air, the lower will be their activity when they reach the ground. However, the total quantity of contaminated material produced by the surface burst of a megaton weapon with a high fission yield is so large that fallout may continue to arrive in hazardous concentrations up to

perhaps 24 hours after the burst. Radioactive contamination from a single detonation may thus affect vast areas and so fallout must be regarded as one of the major effects of nuclear weapons.

9.66 An important factor determining the area covered by appreciable fallout, as well as its distribution within that area, is the wind pattern from the ground up to the top of the radioactive cloud. The direction and speed of the wind at the cloud level will influence the motion and extent of the cloud itself. In addition, the winds at lower altitudes, which may change both in time and space, will cause the fallout particles to drift one way or another while they descend to earth. The situation may be further complicated by the effect of rain (see below) and of irregularities in the terrain. These, as well as nonuniform distribution of activity in the cloud and fluctuations in the wind speed and direction, will contribute to the development of "hot spots" of much higher activity than in the immediate surroundings.

DEPOSITION OF RADIOACTIVE DEBRIS BY PRECIPITATION

9.67 If the airborne debris from a nuclear explosion should encounter a region where precipitation is occurring, a large portion of the radioactive particles may be brought to earth with the rain or snow. The distribution of the fallout on the ground will then probably be more irregular than in the absence of precipitation, with heavy showers producing local hot spots within the contaminated area. Although an air burst

does not normally produce any early fallout, precipitation in or above the nuclear cloud could, however, cause significant contamination on the ground as a result of scavenging of the radioactive debris by rain or snow. Precipitation can also affect the fallout from a surface or subsurface burst, mainly by changing the distribution of the local contamination that would occur in any event. Fallout from the cloud stem in a surface burst of high yield should not be greatly influenced by precipitation, since the particles in the stem will fall to earth in a relatively short time regardless of whether there is precipitation or not.

9.68 A number of circumstances affect the extent of precipitation scavenging of the stabilized nuclear cloud. The first requirement is, of course, that the nuclear cloud should be within or below the rain cloud. If the nuclear cloud is above the rain cloud, there will be no scavenging. The altitudes of the top of rain (or snow) clouds range from about 10,000 to 30,000 feet, with lighter precipitation generally being associated with the lower altitudes. The bottom of the rain cloud, from which the precipitation emerges, is commonly at an altitude of about 2,000 feet. Precipitation from thunderstorms, however, may originate as high as 60,000 feet. For low air or surface bursts, the height and depth of the nuclear cloud may be obtained from Fig. 9.96 and these data may be used to estimate the fraction of this cloud that might be intercepted by precipitation. For explosion yields up to about 10 kilotons essentially all of the nuclear cloud, and for yields up to 100 kilotons at least part of the cloud could be subject to scavenging. For yields in

excess of about 100 kilotons, precipitation scavenging should be insignificant. But if the nuclear cloud should encounter a thunderstorm region, it is possible that all of the cloud from explosions with yields up to several hundred kilotons and a portion from yields in the megaton range may be affected by precipitation.

9.69 If the horizontal diameter of the rain cloud is less than that of the nuclear cloud, only that portion of the latter that is below (or within) the rain cloud will be subject to scavenging. If the rain cloud is the larger, then the whole of the nuclear cloud will be available for precipitation scavenging. The length of time during which the nuclear cloud is accessible for scavenging will depend on the relative directions and speed of travel of the nuclear and rain clouds.

9.70 The time, relative to the burst time, at which the nuclear cloud encounters a region of precipitation is expected to have an important influence on the ground contamination resulting from scavenging. If the burst occurs during heavy precipitation or if heavy precipitation begins at the burst location during the period of cloud stabilization, a smaller area on the ground will be contaminated but the dose rate will be higher than if the nuclear cloud encountered the rain cloud at a later time. Even for such early encounters, the dose rates near ground zero will be lower than after a surface burst with or without precipitation. If the rainfall is light, the scavenging will be less efficient, and the ground distribution pattern will be elongated if the nuclear cloud drifts with the wind but remains in the precipitation system.

9.71 If the nuclear cloud should enter a precipitation region at some time after the burst, the surface contamination caused by scavenging will be decreased. In the first place, while the cloud is drifting, the radioactive nuclides (§ 1.30) decay continuously. Thus, the longer the elapsed time before the nuclear cloud encounters precipitation, the smaller will be the total amount of radioactive material present. Furthermore, the nuclear cloud, especially from a low-altitude burst, tends to increase in size horizontally with time, due to wind shear and eddy diffusion, without drastic change in the vertical dimensions, unless precipitation scavenging should occur. This increase in horizontal dimensions will decrease the concentration of radioactive particles available for scavenging. Finally, the particles that are scavenged will not be deposited on the ground immediately but will fall with the precipitation (typically 800 to 1,200 feet per minute for rain and 200 feet per minute for snow). Since the particles are scavenged over a period of time and over a range of altitudes, horizontal movement during their fall will tend to decrease the concentration of radioactivity (and dose rate) on the ground. The horizontal movement during scavenging and deposition will result in elongated surface fallout patterns, the exact shape depending on the wind shear.

9.72 After the radioactive particles have been brought to the ground by scavenging, they may or may not stay in place. There is a possibility that water runoff will create hot spots in some areas while decreasing the activity in others. Some of the radioactive material may be dissolved out by the rain and

will soak into the ground. Attenuation of the radiations by the soil may then reduce the dose rates above the ground surface.

9.73 Much of what has been stated concerning the possible effects of rain on fallout from both surface and air bursts is based largely on theoretical considerations. Nuclear test operations have been conducted in such a manner as to avoid the danger of rainout. The few recorded cases of rainout which have occurred have involved very low levels of radioactivity and the possibility of severe contamination under suitable conditions has not been verified. Nevertheless, there is little doubt that precipitation scavenging can affect the fallout distribution on the ground from both air and surface bursts with yields in the appropriate range. Because of the many variables in precipitation scavenging, the extent and level of surface contamination to be expected are uncertain. Some estimates have been made, however, of the amounts of rainfall necessary to remove given percentages of the radioactive particles from a nuclear cloud. These estimates are based partly on field experiments with suspended particles and partly on mathematical models for use with a computer; the results are thus dependent on the details of the model, e.g., particle size distribution.

9.74 Two types of precipitation scavenging have been treated in this manner: "rainout" (or "snowout"), when the nuclear cloud is within the rain (or snow) cloud, and "washout" when the nuclear cloud is below the rain (or snow) cloud. The rainfall rate appears to have little effect on rainout but washout is affected to a marked extent. The data in Tables 9.74a and b give rough estimates of the amounts of rainfall, expressed as the duration, required for the removal of specified percentages of the nuclear cloud particles by rainout and washout; the terms light, moderate, and heavy in Table 9.74b refer to 0.05, 0.20, and 0.47 inch of rain per hour, respectively, as measured at the surface. Thus, it appears that washout is a less effective scavenging mechanism than rainout. The tabulated values are based on the assumption that the nuclear and rain clouds remain in the same relative positions, with the rain cloud at least as large as the nuclear cloud (§ 9.69). It should be noted that the times in Tables 9.74a and b are those required for the radioactive debris to be removed by the rain; additional time will elapse before the radioactivity is deposited on the ground. The deposition time will depend on the altitude at which the debris is scavenged and the rate of fall of the rain.

Table 9.74a**ESTIMATED RAINFALL DURATION FOR RAINOUT**

Percent of Cloud Scavenged	Duration of Rainfall (hours)
25	0.07
50	0.16
75	0.32
90	0.53
99	1.1

Table 9.74b**ESTIMATED RAINFALL DURATION FOR WASHOUT**

Percent of Cloud Scavenged	Duration of Rainfall (hours)		
	Light	Moderate	Heavy
25	8	1.6	0.8
50	19	3.8	1.9
75	38	7.7	3.6
90	64	13	6.4
99	128	26	13

FALLOUT PATTERNS

9.75 Information concerning fallout distribution has been obtained from observations made during nuclear weapons tests at the Nevada Test Site and the Eniwetok Proving Grounds.⁷ However, there are many difficulties in the analysis and interpretation of the results, and in their use to predict the situation that might arise from a land surface burst over a large city. This is particularly the case for the megaton-range detonations

at the Eniwetok Proving Grounds. Since the fallout descended over vast areas of the Pacific Ocean, the contamination pattern of a large area had to be inferred from a relatively few radiation dose measurements (§ 9.105). Furthermore, the presence of sea water affected the results, as will be seen below.

9.76 Nuclear tests in the atmosphere in Nevada have been confined to weapons having yields below 100 kilotons and most of the detonations were from the tops of steel towers 100 to 700

⁷The Eniwetok Proving Grounds, called the Pacific Proving Ground before 1955, included test sites on Bikini and Eniwetok Atolls and on Johnston and Christmas Islands in the Pacific Ocean.

feet high or from balloons at levels of 400 to 1,500 feet. None of these could be described as a true surface burst and, in any event, in the tower shots there is evidence that the fallout was affected by the tower. There have been a few surface bursts, but the energy yields were about 1 kiloton or less, so that they provided relatively little useful information concerning the effects to be expected from weapons of higher energy. Tests of fusion weapons with yields up to 15 megatons TNT equivalent have been made at the Pacific Ocean test sites. A very few were detonated on atoll islands, but most of the shots in the Bikini and Eniwetok Atolls in 1958 were fired on barges in the lagoons or on coral reefs. In all cases, however, considerable quantities of sea water were drawn into the radioactive cloud, so that the fallout was probably quite different from what would have been associated with a true land surface burst.

9.77 The irregular nature of the fallout distribution from two tests in Nevada is shown by the patterns in Figs. 9.77a and b; the contour lines are drawn through points having the indicated dose rates at 12 hours after the detonation time. Figure 9.77a refers to the BOLTZMANN shot (12 kilotons, 500-foot tower) of May 28, 1957 and Fig. 9.77b to the TURK shot (43 kilotons, 500-foot tower) of March 7, 1955. Because of the difference in wind conditions, the fallout patterns are quite different. Furthermore, attention should be

drawn to the hot spot, some 60 miles NNW of the northern boundary of the Nevada Test Site, that was observed in connection with the BOLTZMANN test. This area was found to be seven times more radioactive than its immediate surroundings. The location was directly downwind of a mountain range and rain was reported in the general vicinity at the time the fallout occurred. Either or both of these factors may have been responsible for the increased radioactivity.

9.78 Measurement of fallout activity from megaton-yield weapons in the Pacific Ocean area has indicated the presence of marked irregularities in the overall pattern. Some of these may have been due to the difficulties involved in collecting and processing the limited data. Nevertheless, there is evidence to indicate that a hot spot some distance (50 to 75 miles) downwind of the burst point may be typical of the detonations at the Eniwetok Proving Grounds and, in fact, some fallout prediction methods have been designed to reproduce this feature. The occurrence of these hot spots may have been a consequence of the particular wind structure (§ 9.66). The times for most explosions at the Eniwetok Proving Grounds coincided with complex wind structures from the altitude of the stabilized cloud to the surface. The large directional changes in the wind served to contain the fallout more locally than if the wind were blowing in one direction.

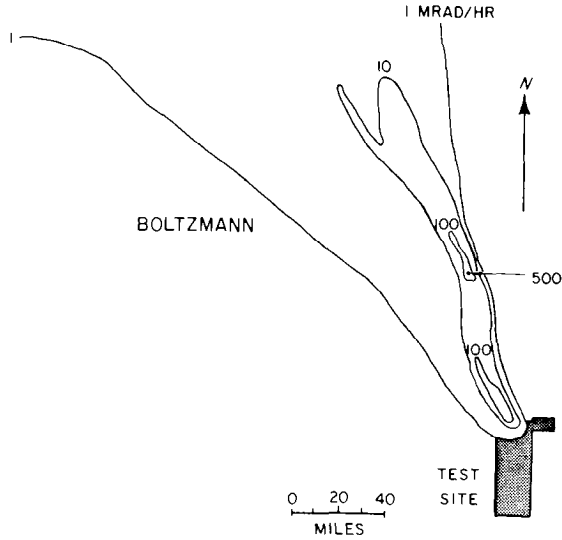

Figure 9.77a. Early fallout dose-rate contours from the BOLTZMANN shot at the Nevada Test Site.

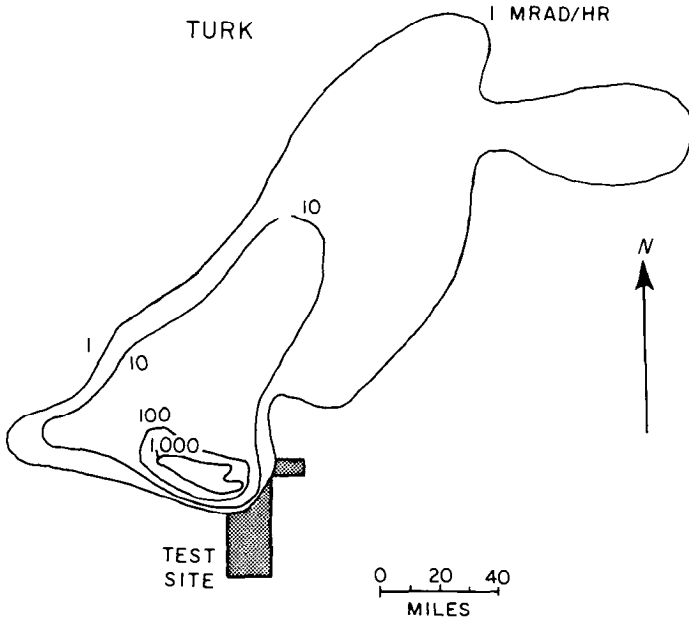

Figure 9.77b. Early fallout dose-rate contours from the TURK shot at Nevada Test Site.

FALLOUT PREDICTIONS FOR LAND SURFACE BURSTS

PREDICTION OF FALLOUT PATTERNS

9.79 Several methods, of varying degree of complexity, have been developed for predicting dose rates and integrated (total) doses resulting from fallout at various distances from ground (or surface) zero. These methods fall into four general categories; they are, in decreasing order of complexity, and hence detail, the mathematical fallout model, the analog method, the danger sector forecast, and the idealized fallout pattern. Each of these techniques requires, of course, a knowledge of the total and fission yields of the explosion, the burst height, and the wind structure to the top of the radioactive cloud in the vicinity of the burst. The more complex procedures require a forecast of the winds and weather in the locality over a period of several hours to a few days after the explosion. In making these forecasts, the considerable seasonal variations in wind patterns must be kept in mind.

9.80 In the fallout model method, an attempt is made to describe fallout mathematically and, with various inherent assumptions, to predict the dose-rate distribution contours resulting from a particular situation. The most reliable procedures are very complex and require use of a large digital computer in their application to a variety of circumstances. They are, consequently, employed primarily in theoretical studies of the fallout process, in making planning estimates, and in the preparation of templates for use with analog prediction

methods. Apart from a few instances, less detailed mathematical models, which do not require digital computers, have been used to predict fallout distribution patterns during nuclear tests.

9.81 The analog technique, which is essentially a comparison process, utilizes a pattern chosen from a catalog of fallout contour patterns covering a wide range of yields and wind conditions. The choice is determined by the similarity between the yield and wind in the given situation and those in the catalog pattern. The catalog can consist of actual fallout patterns and others interpolated and extrapolated from these, or of patterns obtained by calculation from a mathematical fallout model.

9.82 The danger sector forecast requires a minimum of detailed information in order to give a qualitative picture of the general fallout area and an idea of the arrival times. Although it provides a rough indication of the relative degree of hazard, there is little or no information concerning the actual dose rates to be expected at various locations. The method yields a prediction quickly and simply and is probably as accurate as the explosion yield and meteorological information will justify in an operational (field) situation. The fourth prediction method, based on the use of idealized fallout distribution patterns, is described in some detail below. Such idealized patterns are derived from a detailed mathematical model, as described in § 9.80, based on average or most probable conditions.

IDEALIZED FALLOUT PATTERNS

9.83 Idealized fallout contour patterns have been developed which represent the average fallout field for a given yield and wind condition. No attempt is made to indicate irregularities which will undoubtedly occur in a real fallout pattern, because the conditions determining such irregularities are highly variable and uncertain. Nevertheless, in spite of their limitations, idealized patterns are useful for planning purposes, for example in estimating the overall effect of fallout from a large-scale nuclear attack. Although they will undoubtedly underestimate the fallout in some locations and overestimate it in others, the evaluation of the gross fallout problem over the whole area affected should not be greatly in error.

9.84 For a detailed fallout distribution prediction, the winds from the surface to all levels in the radioactive cloud must be considered. However, for the idealized patterns, the actual complex wind system is replaced by an approximately equivalent "effective wind." Various methods have been used to define the effective wind, i.e., speed and direction, for the generation of idealized patterns. The effective wind that is appropriate for use with the idealized patterns described below should be obtained by first determining the average wind from the ground to the base and to the top of the stabilized cloud (§ 2.15). The effective wind is then the mean of these two average winds.

9.85 By assuming little or no wind shear, that is, essentially no change in wind direction at different altitudes, the idealized fallout contour patterns have a regular cigar-like shape, as will be seen

shortly. But if the wind direction changes with altitude, the fallout will spread over a wider angle, as in Fig. 9.77a, and the activity, i.e., the radiation dose rate, at a given distance from ground (or surface) zero will be decreased because the same amount of radioactive contamination will cover a larger area. Lower wind speeds will make the pattern shorter in the downwind direction because the particles will not travel so far before descending to earth; the activity at some distance from the burst point will be lower and the high dose rates immediately downwind of ground zero will be increased. If the wind speed is higher, the contaminated area will be greater, and the radioactivity will be higher at large distances from surface zero and lower immediately downwind of ground zero.

DEVELOPMENT OF FALLOUT PATTERN

9.86 Before showing an idealized fallout distribution pattern it is important to understand how such a pattern develops over a large area during a period of several hours following a surface burst. The situation will be illustrated by the diagrams in Figs. 9.86a and b, which apply to a 2-megaton explosion with 50 percent fission yield. The effective wind speed was taken as 15 miles per hour. Fig. 9.86a shows a number of contour lines for certain (arbitrary) round-number values of the dose rate, as would be observed on the ground, at 1, 6, and 18 hours, respectively, after the explosion. A series of total (or accumulated) dose contour lines for the same times are given in Fig. 9.86b. It will be understood, of course,

that the various dose rates and doses change gradually from one contour line to the next. Similarly, the last contour line shown does not represent the limit of the contamination, since the dose rate (and dose) will continue to fall off over a greater distance.

9.87 Consider, first, a location about 20 miles directly downwind from ground zero. At 1 hour after the detonation, the observed dose rate is seen to be roughly 3 rads/hr but it will rise rapidly and will reach a value over 500 rads/hr sometime between 1 and 2 hours. The dose rate will then decrease to about 200 rads/hr at 6 hours; at 18 hours it is down to roughly 50 rads/hr. The increase in dose rate after 1 hour means that at the specified location the fallout was not complete at that time. The subsequent decrease after about 2 hours is then due to the natural decay of the fission products. Turning to Fig. 9.86b, it is seen that the total radiation dose received at the given location by 1 hour after the explosion is small, because the fallout has only just started to arrive. By 6 hours, the total dose has reached more than 1,000 rads and by 18 hours a total dose of some 2,000 rads will have been accumulated. Subsequently, the total dose will continue to increase, toward the infinite time value, but at a slow rate (see Table 9.22).

9.88 Next, consider a point 100 miles downwind from ground zero. At 1 hour after the explosion the dose rate, as indicated in Fig. 9.86a, is zero, since the fallout will not have reached the specified location. At 6 hours, the dose rate is about 1 rad per hour and at 18

hours about 5 rads per hour. The fallout commences at somewhat more than 6 hours after the detonation and it is essentially complete at 9 hours, although this cannot be determined directly from the contours given. The total accumulated dose, from Fig. 9.86b, is seen to be zero at 1 hour after the explosion, less than 1 rad at 6 hours, and about 80 rads at 18 hours. The total (infinite time) dose will not be as great as at locations closer to ground zero, because the quantity of fission products reaching the ground decreases at increasing distances from the explosion.

9.89 In general, therefore, at any given location at a distance from a surface burst, some time will elapse between the explosion and the arrival of the fallout. This time will depend on the distance from ground zero and the effective wind velocity. When the fallout first arrives, the dose rate is small, but it increases as more and more fallout descends. After the fallout is complete, the radioactive decay of the fission products will cause the dose rate to decrease. Until the fallout commences, the accumulated dose will, of course, be small, but after its arrival the total accumulated radiation dose will increase continuously, at first rapidly and then somewhat more slowly, over a long period of time, extending for many months and even years.

9.90 The curves in Figs. 9.90a and b illustrate this behavior qualitatively; they show the variation with time of the dose rate and the accumulated dose from fallout at points near and far, respectively, in the downwind direction from a

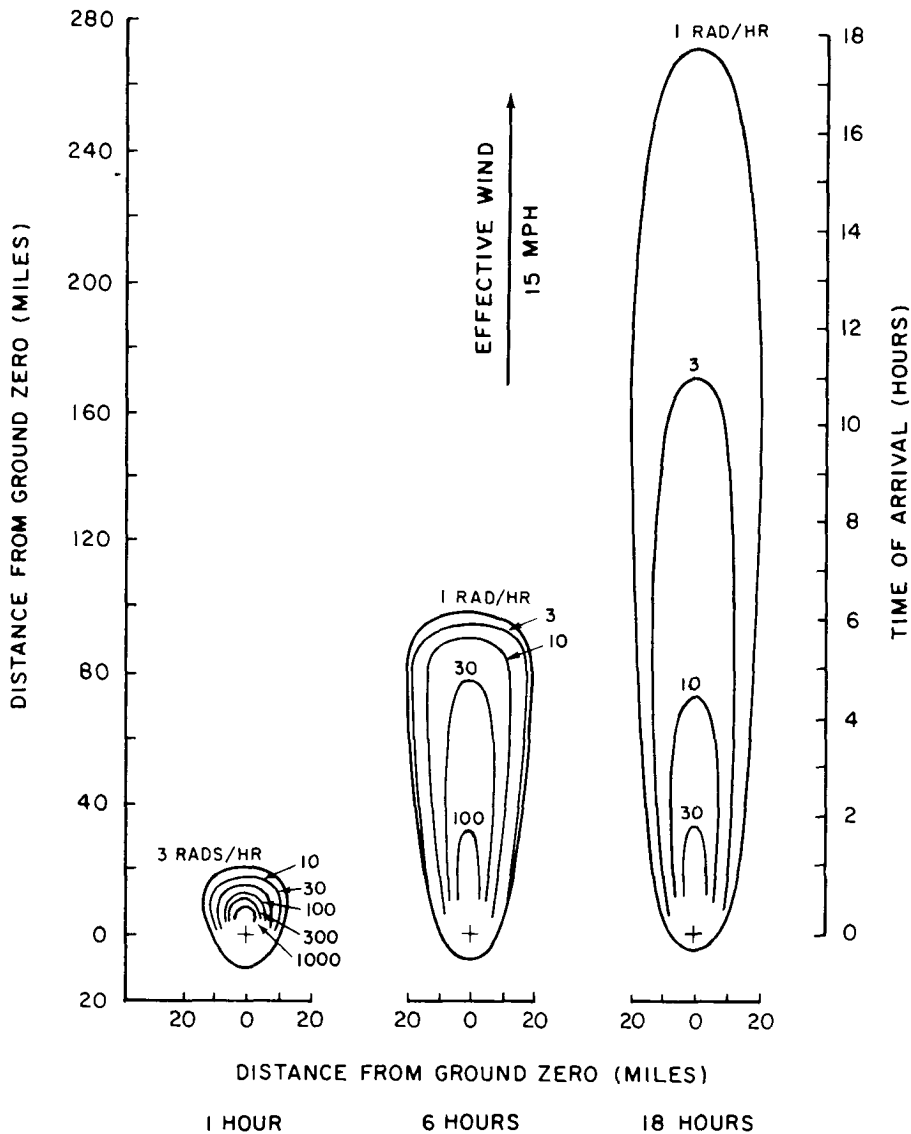

Figure 9.86a. Dose-rate contours from early fallout at 1, 6, and 18 hours after a surface burst with a total yield of 2 megatons and 1 megaton fission yield (15 mph effective wind speed).

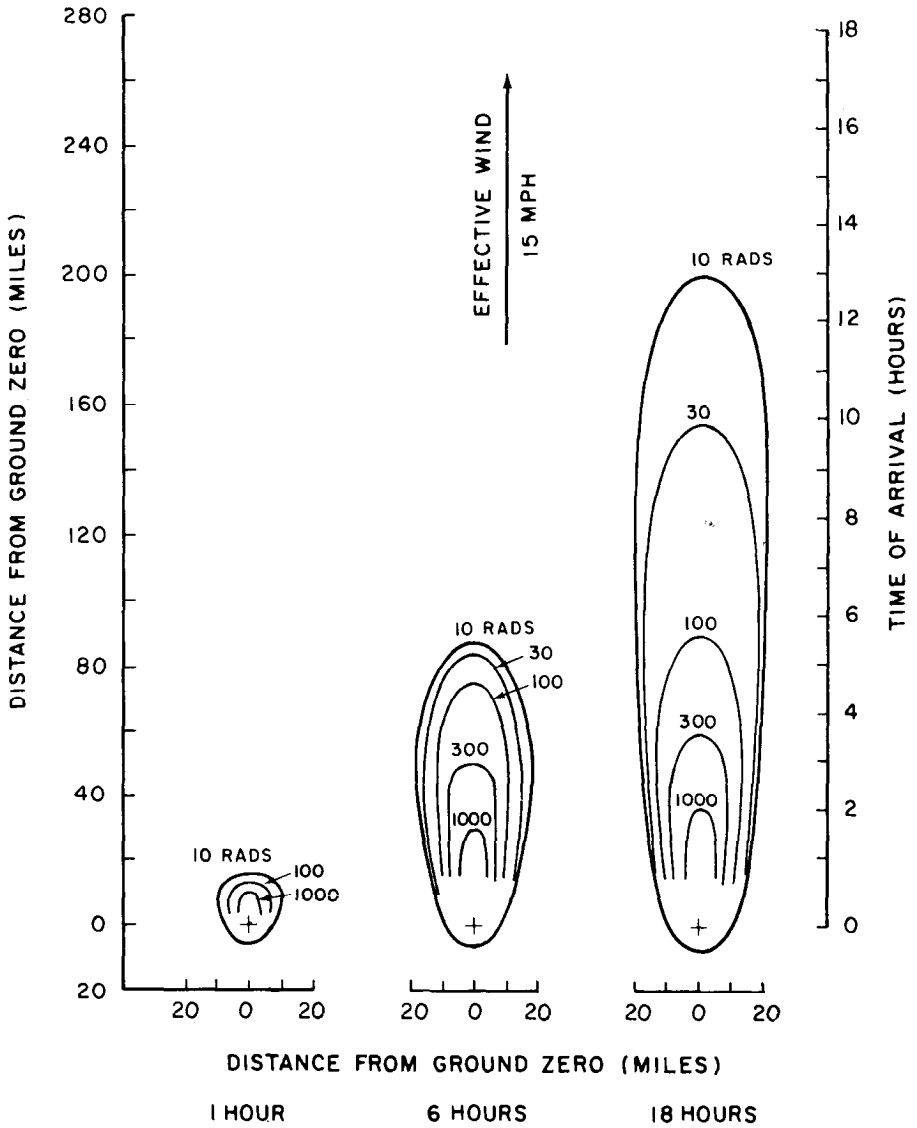

Figure 9.86b. Total-dose contours from early fallout at 1, 6, and 18 hours after a surface burst with a total yield of 2 megatons and 1-megaton fission yield (15 mph effective wind speed).

surface burst. Both the dose rate and the dose are zero until the fallout particles reach the given locations. At these times the dose rate commences to increase, reaches a maximum, and subsequently decreases, rapidly at first as the radioisotopes of short half-life decay, and then more slowly. The total accumulated dose increases continuously from the time of arrival of the fallout toward the limiting (infinite time) value.

9.91 Since the mushroom cloud grows rapidly in radius and reaches its stabilized altitude before the winds can act on it significantly, the time of arrival of the fallout at a particular location is measured by the distance from the portion of the cloud nearest to that location and the speed of the effective wind. The time of arrival is equal to the distance from ground zero to the point of interest minus the radius of the cloud, divided by the effective wind speed. For the present purpose the radius of the stabilized cloud as a function of yield may be obtained from Fig. 2.16. The radius is affected to some extent by the properties of the atmosphere, in particular by the height of the tropopause. The curve in Fig. 2.16 represents a reasonable average for mid-latitudes. The radius of the stabilized cloud is only important in calculating the time of arrival for locations relatively close to ground zero and for large-yield weapons. If the cloud radius is small in comparison with the distance from ground zero to the point of interest, e.g., for low yields or large distances, the cloud radius may be neglected in calculating fallout arrival times.

UNIT-TIME REFERENCE DOSE RATE

9.92 The representation of dose rate

and accumulated dose curves, of the form of Figs. 9.86a and b, for all times following a nuclear detonation would obviously be a highly complicated matter. Fortunately, the situation can be simplified by utilizing an idealized fallout pattern in terms of the unit-time reference dose rate, mentioned in § 9.16 *et seq.* By means of the curves given earlier in the chapter (Figs. 9.16a and b and Fig. 9.20) it is then possible to estimate dose rates and total doses from fallout at any given time for a specified distance downwind from the burst point. The calculations are valid only if all the early fallout has descended at that time.

9.93 The general form of the idealized unit-time reference dose-rate contours for land surface bursts is shown in Fig. 9.93. The dimensions that define the various contours are indicated for the 1-rad per hour contour. In a real situation all contour lines would be closed in the upwind direction as shown for the 1-rad per hour contour. The scaling relationships, for calculating the downwind distance, the maximum width, the ground-zero width of the idealized unit-time dose-rate contours, for contact surface bursts (§ 2.127 footnote) of W kilotons yield are summarized in Table 9.93. The effective wind is 15 miles per hour in each case with wind shear of 15° . The upwind distance depends on the cloud radius; it is estimated to be approximately one-half the ground-zero width, i.e., the upwind contours may be represented roughly by semicircles centered at ground zero. The contour scaling relationships are dependent upon the nature of the surface; the values in Table 9.93 are applicable to most surface materials in the continental United States (cf. § 9.63).

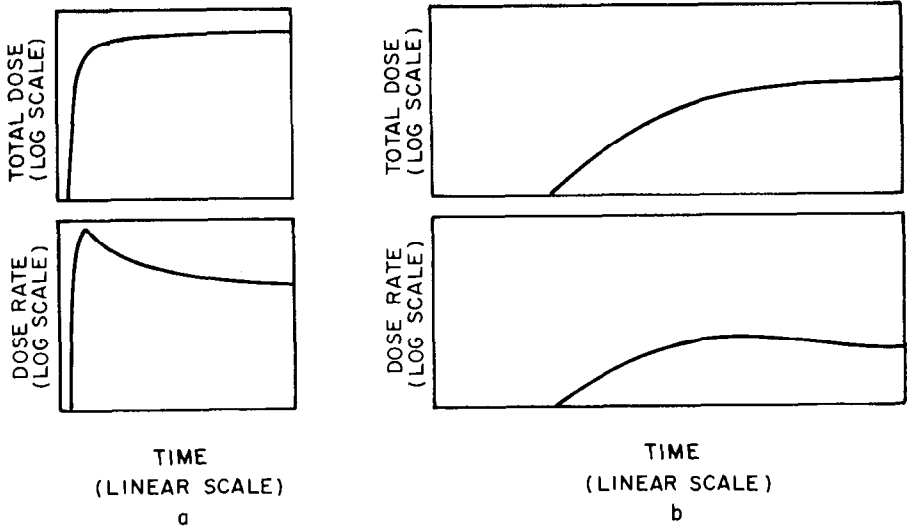

Figure 9.90a. Qualitative representation of dose rate and accumulated dose from fallout as a function of time after explosion at a point not far downwind from ground zero.

Figure 9.90b. Qualitative representation of dose rate and accumulated dose from fallout as a function of time after explosion at a point far downwind from ground zero.

9.94 Idealized contour shapes and sizes are a function of the total yield of the weapon, whereas the dose-rate contour values are determined by the fission yield. Thus, in order to obtain idealized fallout patterns for a weapon that does not derive all of its yield from fission, the dose-rate values of the contour lines for a weapon of the same total yield should be multiplied by the ratio of the fission yield to the total yield. For example, for a weapon having a total yield of W kilotons with 50 percent of the energy derived from fission, the contour dimensions are first determined from Table 9.93 for a yield of W kilotons. The unit-time reference dose rates are then multiplied by 0.5. Except for isolated points in the immediate vicinity of ground zero, observations indicate that unit-time reference dose rates greater than about 5,000 rads/hr are unlikely. In

any event, the locations of such high reference values will be within the areas of complete devastation from other effects.

9.95 The idealized reference dose rates obtained by the methods described above apply to doses that would be received in the open over a completely smooth surface. Such surfaces provide a convenient reference for calculations, but they do not occur to any great extent in nature. Even the surface roughness in relatively level terrain will make the actual values smaller than the idealized values. A reduction (or terrain shielding) factor of about 0.7 is appropriate under such circumstances. A reduction factor of 0.5 to 0.6 would be more suitable for rough, hilly terrain. Any shelter would decrease the dose received from early fallout (§ 9.120).

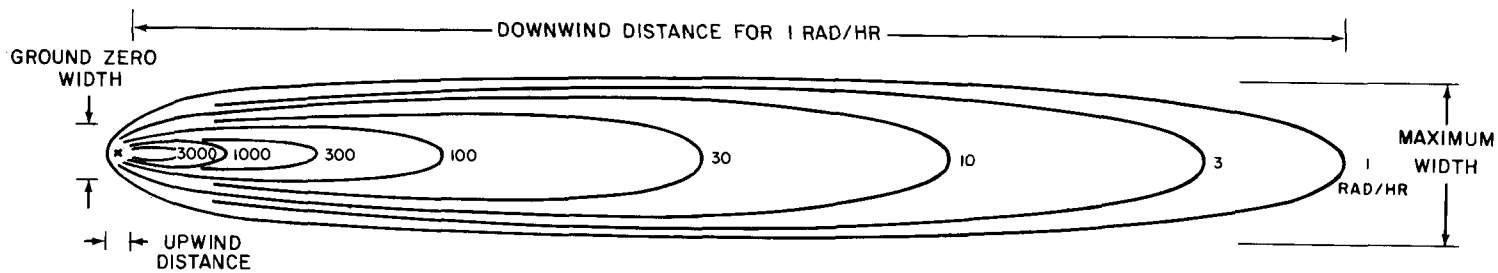

Figure 9.93. Illustration of idealized unit-time dose-rate pattern for early fallout from a surface burst. (The contour dimensions are indicated for a dose rate of 1 rad/hr.)

Table 9.93

SCALING RELATIONSHIPS FOR UNIT-TIME REFERENCE DOSE-RATE CONTOURS
FOR A CONTACT SURFACE BURST WITH A YIELD OF W KILOTONS AND A 15 MPH
WIND

Reference dose rate (rads/hr)	Downwind distance (statute miles)	Maximum width (statute miles)	Ground zero width (statute miles)
3,000	0.95 $W^{0.45}$	0.0076 $W^{0.86}$	0.026 $W^{0.58}$
1,000	1.8 $W^{0.45}$	0.036 $W^{0.76}$	0.060 $W^{0.57}$
300	4.5 $W^{0.45}$	0.13 $W^{0.66}$	0.20 $W^{0.48}$
100	8.9 $W^{0.45}$	0.38 $W^{0.60}$	0.39 $W^{0.42}$
30	16 $W^{0.45}$	0.76 $W^{0.56}$	0.53 $W^{0.41}$
10	24 $W^{0.45}$	1.4 $W^{0.53}$	0.68 $W^{0.41}$
3	30 $W^{0.45}$	2.2 $W^{0.50}$	0.89 $W^{0.41}$
1	40 $W^{0.45}$	3.3 $W^{0.48}$	1.5 $W^{0.41}$

SCALING FOR EFFECTIVE WIND

9.96 The effective wind speed and direction vary with the heights of the top and bottom of the stabilized cloud (§ 9.84). For a weapon of given yield, these heights will depend upon many factors, including the density and relative humidity of the atmosphere and the altitude of the tropopause. Nevertheless, within the accuracy of the idealized unit-time reference dose-rate contours, approximate values of the cloud heights may be used. The curves in Fig. 9.96 are based on the same model as was used in deriving the dose-rate contours and scaling relationships in § 9.93. They may be taken to be representative of the average altitudes to which nuclear clouds from surface (or low air) bursts of various yields might be expected to rise in the mid-latitudes, e.g., over the United States.

9.97 If there is no directional shear, then doubling the effective wind speed would cause the particles of a given size that originate at a particular location

within the cloud to reach the ground at twice the distance from ground zero, so that they are spread over roughly twice the area. However, particles of many different sizes will arrive at any given point on the ground as a result of the different travel times from different points of origin in the large nuclear cloud. Consequently, simple scaling relationships for wind speed are not possible. Examination of test data and the results of calculations with computer codes suggest the following approximate scaling procedure: for effective wind speeds of v miles per hour, the downwind distances derived from Table 9.93 are multiplied by the factor F , where

$$F = 1 + \frac{v - 15}{60}$$

for effective wind speeds greater than 15 miles per hour, and

$$F = 1 + \frac{v - 15}{30}$$

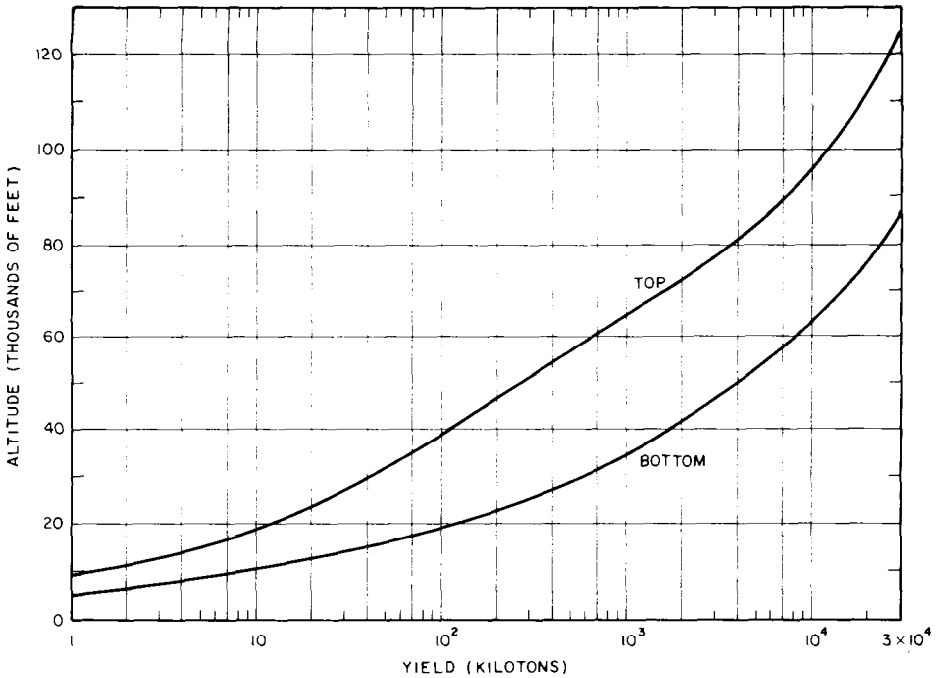

Figure 9.96. Altitudes of the stabilized cloud top and cloud bottom as a function of total energy yield for surface or low air bursts.

for wind speeds less than 15 miles per hour. These relations hold reasonably well for simple wind structures, i.e., for winds with very little directional shear, and for effective wind speeds between about 8 and 45 miles per hour. As defined in § 9.84, effective winds with speeds greater than 45 miles per hour are not common, and speeds less than 8 miles per hour generally result from large changes in directional wind shear with increasing altitude. The fallout patterns would then be too complex to be represented by idealized dose-rate contours.

9.98 As the downwind distance for a given unit-time reference dose-rate contour increases with increasing wind speed, the maximum width of that contour will decrease somewhat. Conversely, a decrease in downwind distance of a given contour with decreasing wind speed will be accompanied by an increase in maximum width of that contour. For an increase in wind speed, within the limits of the simple wind structures and wind speeds for which the idealized contours apply, the changes in maximum width of a given contour will be small, and wind scaling may be ig-

nored. This may also be done for the upwind distances and hence for the ground-zero widths. An increase in the wind speed will tend to decrease upwind distances by causing the particles to drift toward ground zero as they fall. At the lower 1-hour reference dose rates, e.g., 100 rads/hr or less, the upwind distances will in fact decrease with increasing wind speed. However, the larger particles, which are mainly responsible for the close-in high dose rates, descend very quickly and the high dose-rate contours will not be greatly affected by the wind speed. Consequently, since simple wind scaling is not possible and the upwind distances are relatively short, a conservative approach is to assume that wind speed has no effect on upwind distances (and ground-zero widths).

FALLOUT EXAMPLE

Given: A 10-megaton surface burst, 50-percent fission yield, with an effective wind speed of 30 miles per hour.

Find: The idealized unit-time reference dose rate, the fallout arrival time, and the dose accumulated by an exposed person during the first week following fallout arrival at points 100, 200, and 300 miles directly downwind from ground zero.

Solution: Preliminary estimates, based on Table 9.93, indicate that the

idealized unit-time reference dose rates are in the range of 300 to 3,000 rads/hr. For a total yield of 10 MT, i.e., $W = 10^4$ KT, and an effective wind of 30 mph ($F = 1.25$ from § 9.97), the following downwind distances are obtained from Table 9.93.

Dose rate	3,000	1,000	300 rads/hr
Distance	75	142	355 miles.

Interpolation indicates that the unit-time reference dose rates are 1,800 rads/hr at 100 miles, 620 rads/hr at 200 miles, and 360 rads/hr at 300 miles. (The best method of interpolation is to plot the known points on logarithmic paper and to read the desired values from a smooth curve connecting the points.) The corresponding idealized reference dose rates for 50 percent fission yield would then be 900, 310, and 180 rads/hr at 100, 200, and 300 miles, respectively. *Answer.*

From Fig. 2.16, the cloud radius for a 10 MT explosion is about 21 miles; this should be subtracted from the distances from ground zero in order to determine the fallout arrival (or entry) times. For a 30-mph wind, these are $(100-21)/30 = 2.6$ hours at 100 miles, $(200-21)/30 = 6$ hours at 200 miles, and $(300-21)/30 = 9.3$ hours at 300 miles. *Answer*

Within the accuracy of the idealized unit-time dose-rate contours, the entry times for Fig. 9.26 may be rounded off

to 3, 6, and 10 hours, respectively. The multiplying factors for an exposure 1 week after arrival of the fallout are then found to be about 2.3 at 100 miles, 1.6 at 200 miles, and 1.4 at 300 miles. The approximate total accumulated doses at the required distances would then be as follows:

Distance (miles)	Dose (rads)
100	$900 \times 2.3 = 2,070$
200	$310 \times 1.6 = 496$
300	$180 \times 1.4 = 252$

Answer

These doses would be reduced by the appropriate surface roughness (or terrain shielding) factor (§ 9.95).

LIMITATIONS OF IDEALIZED CONTOURS

9.99 Both the idealized 15-mile per hour pattern dimensions and the wind scaling procedure tend to maximize the downwind extent of the dose-rate contours since they involve the postulate that there is little wind shear. This is not an unreasonable assumption for the continental United States, since the wind shear is generally small at altitudes of interest from the standpoint of fallout. If there is a greater wind shear, e.g., 20° or more between the top and bottom of the mushroom head, the fallout pattern would be wider and shorter than that based on Table 9.93. The actual unit-time reference dose rate at a

specified downwind distance from ground zero for a given effective wind speed would then be smaller than predicted. The crosswind values at certain distances would, however, be increased. In some cases of extreme shear the pattern will extend from ground zero in two or more directions. In these cases, it is impossible to define a downwind direction, and idealized contours are of little value in describing the shape of the pattern (cf. Fig. 9.77b).

9.100 In order to emphasize the limitations of the idealized fallout patterns, Figs. 9.100a and b are presented here. The former shows the idealized unit-time reference dose-rate contours for a 10-megaton, 50-percent fission surface burst and an effective wind speed of 30 miles per hour. In Fig. 9.100b an attempt is made to indicate what the actual situation might be like as a result of variations in local meteorological and surface conditions. Near ground zero the wind is from the southwest but the mean wind gradually changes to a westerly and then a northwesterly direction over a distance of a few hundred miles. These changes in the mean wind are reflected in Fig. 9.100b, but, since the idealized pattern is based on a single effective wind, the changes in the mean wind do not affect Fig. 9.100a. The total contamination of the area is about the same in both cases, but the details of the distribution, e.g., the occurrence of hot spots, which are shown shaded in Fig. 9.100b, is quite

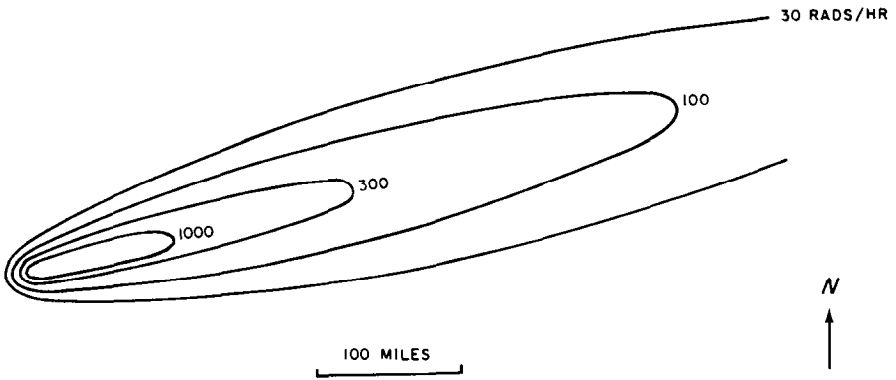

Figure 9.100a. Idealized unit-time reference dose-rate contours for a 10-megaton, 50-percent fission, surface burst (30 mph effective wind speed).

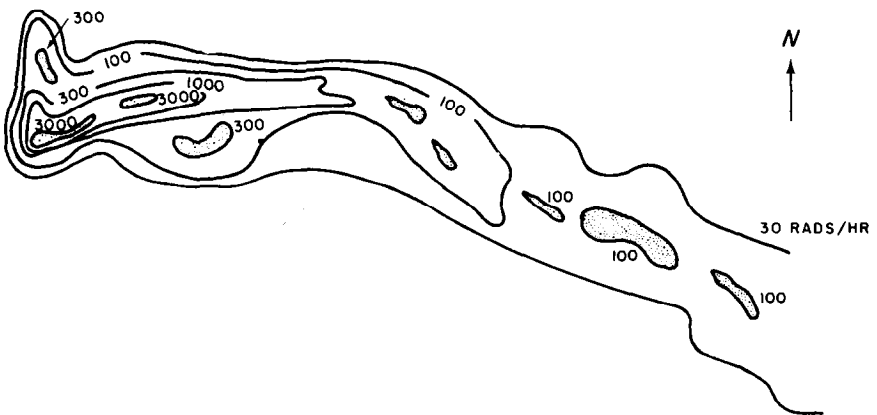

Figure 9.100b. Corresponding actual dose-rate contours (hypothetical).

different. The pattern in Fig. 9.100b is hypothetical and not based on actual observations; its purpose is to call attention to the defects of the idealized fallout pattern. But since the factors causing deviations from the ideal vary from place to place and even from day to day, it is impossible to know them in advance. Consequently, the best that can be done here is to give an idealized pattern and show how it may be used to provide an overall picture of the contamination while, at the same time, indicating that in an actual situation there may be marked differences in the details of the distribution.

FACTORS AFFECTING FALLOUT PATTERNS

9.101 It must be emphasized that the procedures described above for developing idealized fallout patterns are intended only for overall planning. There are several factors which will affect the details of the distribution of the early fallout and also the rate of decrease of the radioactivity. Near ground zero, activity induced by neutrons in the soil may be significant, apart from that due to the fallout. However, the extent of the induced activity is very variable and difficult to estimate (§ 9.49). The existence of unpredictable hot spots will also affect the local radiation intensity. Furthermore, precipitation scavenging will have an important effect on the fallout pattern (§ 9.67 *et seq.*). The data presented in the preceding paragraphs are applicable to very smooth surfaces of large size. As mentioned in § 9.95, even ground roughness in what would normally be considered flat countryside might reduce the dose rates to about 70

percent of those predicted for a smooth surface. In a city, buildings, trees, etc., will reduce the average intensity still further.

9.102 The rate of decay of the early fallout radioactivity, and hence the total dose accumulated over a period of time, will be affected by weathering. Wind may transfer the fallout from one location to another, thus causing local variations. Rain, after the fallout has descended, may wash the particles into the soil and this will tend to decrease the dose rate observed above the ground. The extent of the decrease will, of course, depend on the climatic and surface conditions. In temperate regions in the absence of rain, the weathering effect will probably be small during the first month after the explosion, but over a period of years the fallout dose rate would decrease to about half that which would otherwise be expected.

9.103 In attempting to predict the time that must elapse, after a nuclear explosion, for the radiation dose rate to decrease to a level that will permit re-entry of a city or the resumption of agricultural operations, use may be made of the (continuous) decay curves in Figs. 9.16a and b or of equivalent data. It is inadvisable, however, to depend entirely on these estimates because of the uncertainties mentioned above. Moreover, even if the decay curve could be relied upon completely, which is by no means certain, the actual composition of the fallout is known to vary with distance from ground zero (§ 9.08) and the decay rate will vary accordingly. At 3 months after a nuclear explosion, the dose rate will have fallen to about 0.01 percent, i.e., one ten-thousandth part, of its value at 1 hour, so that almost any

contaminated area will be safe enough to enter for the purposes of taking a measurement with a dose-rate meter, provided there has been no additional contamination in the interim.

THE HIGH-YIELD EXPLOSION OF MARCH 1, 1954

9.104 The foregoing discussion of the distribution of the early fallout may be supplemented by a description of the observations made of the contamination of the Marshall Islands area following the high-yield test explosion (BRAVO) at Bikini Atoll on March 1, 1954. The total yield of this explosion was approximately 15-megatons TNT equivalent. The device was detonated about 7 feet above the surface of a coral reef and the resulting fallout, consisting of radioactive particles ranging from about one-thousandth to one-fiftieth of an inch in diameter, contaminated an elongated area extending over 330 (statute) miles downwind and varying in width up to over 60 miles. In addition, there was a severely contaminated region upwind extending some 20 miles from the point of detonation. A total area of over 7,000 square miles was contaminated to such an extent that avoidance of death or radiation injury would have depended upon evacuation of the area or taking protective measures.

9.105 The available data, for the estimated total doses accumulated at various locations by 96 hours after the BRAVO explosion, are shown by the points in Fig. 9.105. Through these points there have been drawn a series of contour lines which appear to be in moderately good agreement with the data. However, other patterns are pos-

sible; one, for example, ascribes the large radiation doses on the northern islands of Rongelap Atoll to a hot spot and brings the 3,000-rad contour line in much closer to Bikini Atoll. Because of the absence of observations from large areas of ocean, the choice of the fallout pattern, such as the one in Fig. 9.105, is largely a matter of guesswork. Nevertheless, one fact is certain: there was appreciable radioactive contamination at distances downwind of 300 miles or more from the explosion.

9.106 The doses to which the contours in Fig. 9.105 refer were calculated from instrument records. They represent the maximum possible exposures that would be received only by individuals who remained in the open, with no protection against the radiation, for the whole time. Any kind of shelter, e.g., within a building, or evacuation of the area would have reduced the dose received. On the other hand, persons remaining in the area for a period longer than 96 hours after the explosion would have received larger doses of the residual radiation.

9.107 A radiation dose of 700 rads over a period of 96 hours would probably prove fatal in the great majority of cases. It would appear, therefore, that following the test explosion of March 1, 1954, there was sufficient radioactivity from the fallout in a downwind belt about 170 miles long and up to 35 miles wide to have seriously threatened the lives of nearly all persons who remained in the area for at least 96 hours following the detonation without taking protective measures of any kind. At distances of 300 miles or more downwind, the number of deaths due to short-term radiation effects would have been negli-

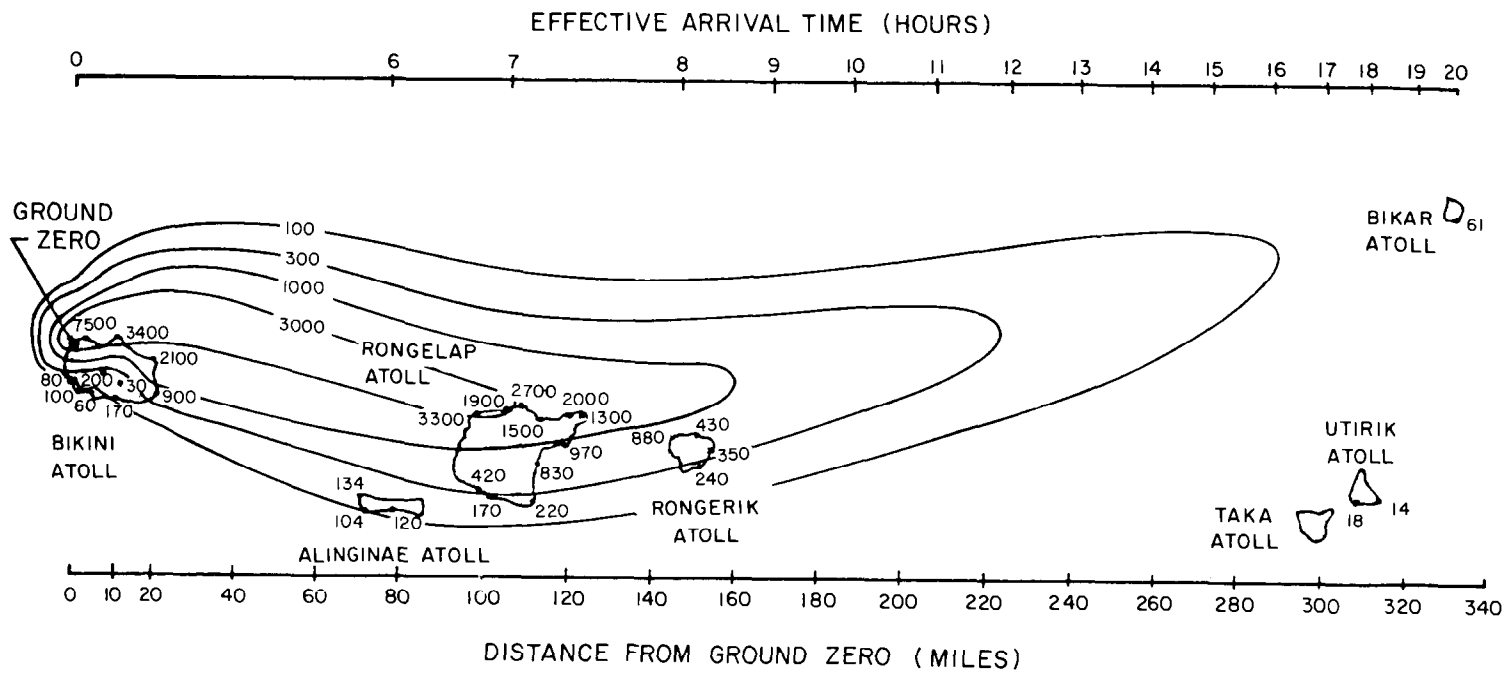

Figure 9.105. Estimated total (accumulated) dose contours in rads at 96 hours after the BRAVO test explosion.

gible, although there would probably have been many cases of sickness resulting in temporary incapacity.

9.108 The period of 96 hours after the explosion, for which Fig. 9.105 gives the accumulated radiation doses, was chosen somewhat arbitrarily. It should be understood, however, as has been frequently stated earlier in this chapter, that the radiations from the fallout will continue to be emitted for a long time, although at a gradually decreasing rate. The persistence of the external gamma radiation may be illustrated in connection with the BRAVO test by considering the situation at two different locations in Rongelap Atoll. Fallout began about 4 to 6 hours after the explosion and continued for several hours at both places.

9.109 The northwestern tip of the atoll, 100 miles from the point of detonation, received 3,300 rads during the first 96 hours after the fallout started. This was the heaviest fallout recorded at the same distance from the explosion and may possibly have represented a hot spot, as mentioned above. About 25 miles south, and 115 miles from ground zero, the dose over the same period was

only 220 rads. The inhabitants of Rongelap Atoll were in this area, and were exposed to radiation dosages up to 175 rads before they were evacuated some 44 hours after the fallout began (§§ 12.124, 12.156). The maximum theoretical exposures in these two areas of the atoll for various time intervals after the explosion, calculated from the decay curves given earlier in this chapter, are recorded in Table 9.109.

9.110 It must be emphasized that the calculated values in Table 9.109 represent the maximum doses at the given locations, since they are based on the assumption that exposed persons remain out-of-doors for 24 hours each day and that no measures are taken to remove radioactive contamination. Furthermore, no allowance is made for weathering or the possible dispersal of the particles by winds. For example, the dose rates measured on parts of the Marshall Islands on the 25th day following the explosion were found to be about 40 percent of the expected values. Rains were known to have occurred during the second week, and these were probably responsible for the major decrease in the contamination.

Table 9.109

**CALCULATED RADIATION DOSES AT TWO LOCATIONS IN RONGELAP ATOLL
FROM FALLOUT FOLLOWING THE MARCH 1, 1954 TEST AT BIKINI**

Exposure period after the explosion	Accumulated dose in this period (rads)	
	Inhabited location	Uninhabited location
First 96 hours	220	3,300
96 hours to 1 week	35	530
1 week to 1 month	75	1,080
1 month to 1 year	75	1,100
Total to 1 year	405	6,010
1 year to infinity	About 8	About 115

9.111 In concluding this section, it may be noted that the 96-hour dose contours shown in Fig. 9.105, representing the fallout pattern in the vicinity of Bikini Atoll after the high-yield explosion of March 1, 1954, as well as the idealized unit-time reference dose-rate contours from Table 9.93, can be regarded as more-or-less typical, so that they may be used for planning purposes. Nevertheless, it should be realized that they cannot be taken as an absolute guide. The particular situation which developed in the Marshall Islands was the result of a combination of circumstances involving the energy yield of the explosion, the very low burst height (§ 9.104), the nature of the surface below the point of burst, the wind system over a large area and to a great height, and other meteorological conditions. A change in any one of these factors could have affected considerably the details of the fallout pattern.

9.112 In other words, it should be understood that the fallout situation described above is one that can happen, but is not necessarily one that will happen, following the surface burst of a

high fission-yield weapon. The general direction in which the fallout will move can be estimated fairly well if the wind pattern is known. But the total and fission yields of the explosion and the height of burst, in the event of a nuclear attack, are unpredictable. Consequently, it is impossible to determine in advance how far the seriously contaminated area will extend, although the time at which the fallout will commence at any point could be calculated if the effective wind speed and direction were known.

9.113 In spite of the uncertainties concerning the exact fallout pattern, there are highly important conclusions to be drawn from the results described above. One is that the residual nuclear radiation from a surface burst can, under some conditions, represent a serious hazard at great distances from the explosion, well beyond the range of blast, shock, thermal radiation, and the initial nuclear radiation. Another is that plans can be made to minimize the hazard, but such plans must be flexible, so that they can be adapted to the particular situation which develops after the attack.

ATTENUATION OF RESIDUAL NUCLEAR RADIATION

ALPHA AND BETA PARTICLES

9.114 In their passage through matter, alpha particles produce considerable direct ionization and thereby rapidly lose their energy. After traveling a certain distance, called the "range," an alpha particle ceases to exist as such.⁸

The range of an alpha particle depends upon its initial energy, but even those from plutonium, which have a moderately high energy, have an average range of only just over 1½ inches in air. In more dense media, such as water or body tissue, the range is less, being about one-thousandth part of the range

⁸An alpha particle is identical with a nucleus of the element helium (§ 1.65). When it has lost most of its (kinetic) energy, it captures two electrons and becomes a harmless (neutral) helium atom.

in air. Consequently, alpha particles from radioactive sources cannot penetrate even the outer layer of the unbroken skin (epidermis). It is seen, therefore, that as far as alpha particles arising from sources outside the body are concerned, attenuation is no problem.

9.115 Beta particles, like alpha particles, are able to cause direct ionization in their passage through matter. But the beta particles dissipate their energy less rapidly and so have a greater range in air and in other materials. Many of the beta particles emitted by the fission products traverse a total distance of 10 feet (or more) in the air before they are absorbed. However, because the particles are continually deflected by electrons and nuclei of the medium, they follow a tortuous path, and so their effective (or net) range is somewhat less.

9.116 The range of a beta particle is shorter in more dense media, and the average net distance a particle of given energy can travel in water, wood, or body tissue is roughly one-thousandth of that in air. Persons in the interior of a house would thus be protected from beta radiation arising from fission products on the outside. It appears that even moderate clothing provides substantial attenuation of beta radiation, the exact amount varying, for example, with the weight and number of layers. Only beta radiation from material ingested or in contact with the body poses a hazard.

GAMMA RADIATION

9.117 The residual gamma radiations present a different situation. These gamma rays, like those which form part of the initial nuclear radiation, can pen-

etrate considerable distances through air and into the body. Shielding will be required in most fallout situations to reduce the radiation dose to an acceptable level. Incidentally, any method used to decrease the gamma radiation will also result in a much greater attenuation of both alpha and beta particles.

9.118 The absorption (or attenuation) by shielding materials of the residual gamma radiation from fission products and from radioisotopes produced by neutron capture, e.g., in sodium, manganese, and in the weapon residues, is based upon exactly the same principles as were described in Chapter VIII in connection with the initial gamma radiation. Except for the earliest stages of decay, however, the gamma rays from fallout have much less energy, on the average, than do those emitted in the first minute after a nuclear explosion. This means that the residual gamma rays are more easily attenuated; in other words, compared with the initial gamma radiation, a smaller thickness of a given material will produce the same degree of attenuation.

9.119 Calculation of the attenuation of the gamma radiation from fallout is different and in some ways more complicated than for the initial radiations. The latter come from the explosion point, but the residual radiations arise from fallout particles that are widely distributed on the ground, on roofs, trees, etc. The complication stems from the fact that the effectiveness of a given thickness of material is influenced by the fallout distribution (or geometry) and hence depends on the degree of contamination and its location relative to the position where protection is desired. Estimates of the attenuation of residual

radiation in various structures have been made, based partly on calculations and partly on measurements with simulated fallout.

9.120 Some of the results of these estimates are given in Table 9.120 in terms of a dose-transmission factor (§ 8.72). Ranges of values are given in view of the uncertainties in the estimates themselves and the variations in the degree of shielding that may be obtained at different locations within a structure. (Shielding data for the same structures for initial nuclear radiation are given in Table 8.72.) All of the structures are assumed to be isolated, so that possible effects of adjacent buildings have been neglected. For vehicles, such as auto-

mobiles, buses, trucks, etc., the transmission factor is about 0.5 to 0.7. Rough estimates can thus be made of the shielding from fallout radiation that might be expected in various situations. Depending upon his location, a person in the open in a built-up city area would receive from about 20 to 70 percent of the dose that would be delivered by the same quantity of fallout in the absence of the buildings. An individual standing against a building in the middle of a block would receive a much smaller dose than one standing at the intersection of two streets. In contaminated agricultural areas, the gamma-ray dose above the surface can be reduced by turning over the soil so as to bury the fallout particles.

Table 9.120

FALLOUT GAMMA-RAY DOSE TRANSMISSION FACTORS FOR VARIOUS STRUCTURES

Structure	Dose transmission factor
Three feet underground	0.0002
Frame house	0.3-0.6
Basement	0.05-0.1
Multistory building (apartment type):	
Upper stories	0.01
Lower stories	0.1
Concrete blockhouse shelter:	
9-in. walls	0.007-0.09
12-in. walls	0.001-0.03
24-in. walls	0.0001-0.002
Shelter, partly above grade:	
With 2 ft earth cover	0.005-0.02
With 3 ft earth cover	0.001-0.005

INTRODUCTION

9.121 There is, of course, no sharp change at 24 hours after a nuclear explosion when, according to the arbitrary definition (§ 9.03), the early fallout ends and the delayed fallout commences. Nevertheless, there is an important difference between the two types of fallout. The principal early fallout hazard is from exposure to gamma rays from sources outside the body, although there is also a possibility of some internal exposure (§ 9.16). A secondary hazard would arise from beta particles emitted by fallout in contact with the skin. The delayed fallout, on the other hand, is almost exclusively a potential internal hazard that would be due to the ingestion of iodine, strontium, and cesium isotopes present in food, especially milk. Both early and delayed fallout can have long-term genetic effects, but they are probably of less significance than other expected consequences. These and related biological aspects of fallout are discussed in Chapter XII.

9.122 Essentially all of the residues from an air burst contribute to the delayed fallout, for in an explosion of this type there is very little early (or local) fallout. For land surface bursts, about 40 percent of the radioactivity of the weapons residues remains in the atmosphere after the early fallout and for water surface bursts the proportion has been estimated to be roughly 70 percent (§ 9.59). The time required for the debris particles to descend to earth and the distance they will have traveled during this time depend on the size of the particles and the altitude to which

they have ascended in the nuclear cloud. The very fine particles, e.g., those with radii of a few micrometers or less, fall extremely slowly. Consequently, they may remain suspended in the atmosphere for a considerable time and may be carried over great distances by the wind. Ultimately, however, the particles are brought to the ground, primarily by precipitation scavenging (§ 9.67 *et seq.*), and the resulting delayed fallout will be spread over large areas of the earth's surface.

9.123 Much (if not all) of the debris from low air and surface bursts with yields less than about 100 kilotons does not rise above 30,000 feet or so (Fig. 9.96) and it soon becomes accessible to removal by precipitation. Should this occur within the first few weeks after the explosion, as it often will, the fallout will still contain appreciable amounts of radioisotopes with fairly short half-lives, as well as those with long half-lives. The main potential hazard then arises from the ingestion of iodine-131, which has a half-life of 8 days; like all isotopes of iodine, when it enters the body this isotope tends to become concentrated in the thyroid gland (§ 12.169 *et seq.*). Iodine-131 has been detected in rainfall and in milk from cows which have eaten contaminated forage at distances several thousand miles from but in the same hemisphere as the burst point. With increasing yield, a smaller proportion of the weapon debris remains in the atmosphere below 30,000 to 40,000 feet, from which it can be removed fairly rapidly; but this may be sufficient to produce significant deposition of iodine-131 on the ground, espe-

cially if the total fission yield is large.

9.124 For explosions of moderately high and high yields, most of the radioactive residues enter the stratosphere from which removal occurs slowly. The small particles in the stratosphere are effectively held in storage for a few months up to a few years, as will be seen shortly (§ 9.135 *et seq.*). During this time, the radioisotopes of short and moderate half-life will have decayed almost completely. Radioactive species with intermediate half-lives, from about a month to a year, have been detected on the ground within a few months after a nuclear test series. But the major biological hazard of the delayed fallout is from the long-lived isotopes strontium-90 (half-life 27.7 years) and cesium-137 (half-life 30.0 years) which might enter the body in food over a period of years. Strontium-90 can accumulate in the bone from which it is removed slowly by radioactive decay and by natural elimination processes; it can thus represent a prolonged internal hazard (§ 12.188 *et seq.*). Not only do these isotopes of strontium and cesium decay slowly, they constitute relatively large fractions of the fission products; thus, for every 1,000 atoms undergoing fission there are eventually formed from 30 to 40 atoms of strontium-90 and from 50 to 60 of cesium-137. Moreover, both of these isotopes have gaseous precursors (or ancestors), so that as a result of fractionation (§ 9.08) their proportions in the delayed fallout will tend to be greater, at least for surface bursts, than in the fission products as a whole.

9.125 The ultimate distribution of the delayed fallout over the earth's surface is not affected by the particular wind conditions at the time of the deto-

nation nearly as much as that of the early fallout. What is more important is the manner in which the contaminated particles enter the upper atmosphere. In order to understand the situation, it is necessary to review some of the characteristic features of the atmosphere.

STRUCTURE OF THE ATMOSPHERE

9.126 One of the most significant aspects of the atmosphere is the variation in temperature at different altitudes and its dependence on latitude and time. In ascending into the lower atmosphere from the surface of the earth, the temperature of the air falls steadily, in general, toward a minimum value. This region of falling temperature is called the "troposphere" and its top, where the temperature ceases to decrease, is known as the "tropopause." Above the troposphere is the "stratosphere," where the temperature remains more or less constant with increasing altitude in the temperate and polar zones. Although all the atmosphere immediately over the tropopause is commonly referred to as the stratosphere, there are areas in which the structure varies (Fig. 9.126). In the equatorial regions, the temperature in the stratosphere increases with height. This inversion also occurs at the higher altitudes in the temperate and polar regions. In the "mesosphere" the temperature falls off again with increasing height. At still higher altitudes is the "thermosphere" where the temperature rises rapidly with height.

9.127 Most of the visible phenomena associated with weather occur in the troposphere. The high moisture content, the relatively high temperature at the earth's surface, and the convective

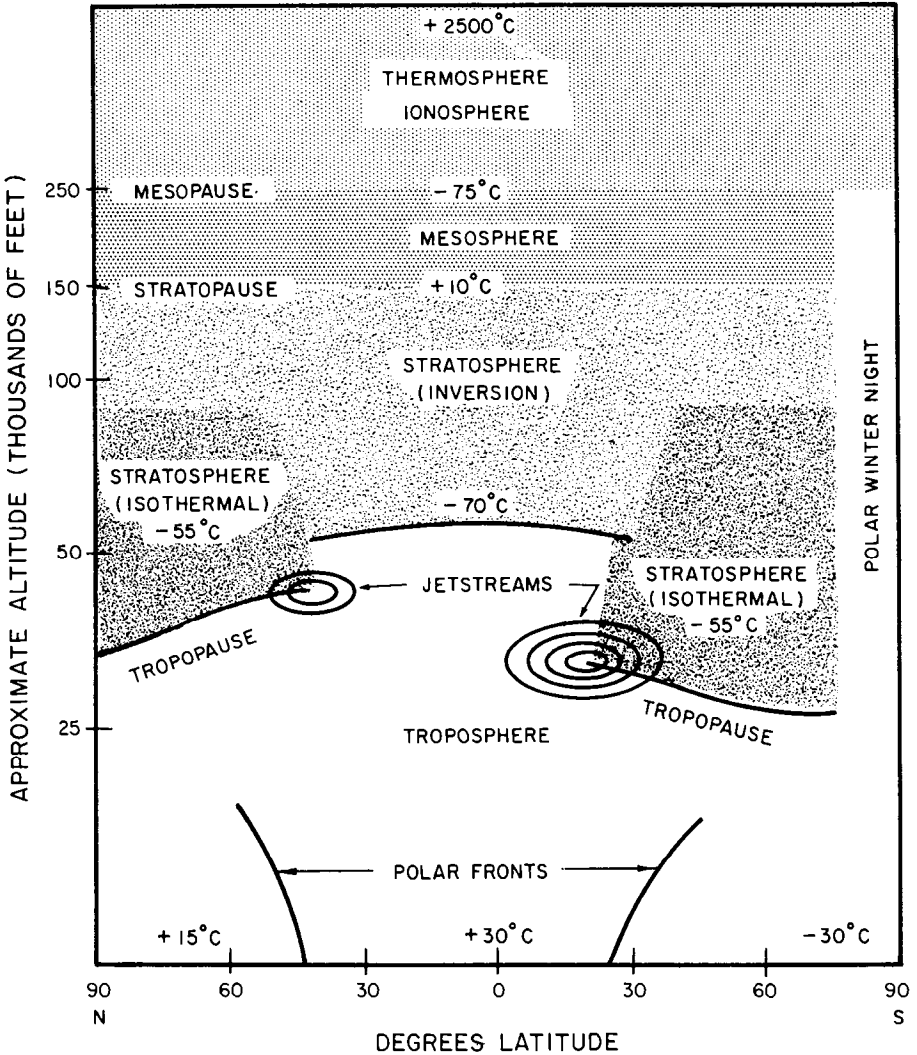

Figure 9.126. Structure of the atmosphere during July and August.

movement (or instability) of the air arising from temperature differences promote the formation of clouds and rainfall. In the temperate latitudes, at about 45° in the summer and 30° in the winter, where the cold polar air meets the warm air of the tropics, there are formed meandering, wavelike bands of storm fronts called "polar fronts" (Fig.

9.126). In these regions, the average rainfall is high.

9.128 The tropopause, that is the top of the troposphere, is lower in the polar and temperate zones than in the tropics; its height in the former regions varies from 25,000 to 45,000 feet, depending on latitude, time of year, and particular conditions of the day. In gen-

eral, the altitude is lowest in the polar regions. The tropopause may disappear entirely at times in the polar winter night. In the tropics, the tropopause usually occurs near 55,000 feet at all seasons. It is more sharply defined than in the temperate and polar regions because in the tropics the temperature increases with height above the tropopause instead of remaining constant. There is a marked gap or discontinuity in the tropopause in each temperate zone, as may be seen in Fig. 9.126, that constitutes a region of unusual turbulence. Each gap moves north and south seasonally, following the sun, and is usually located near a polar front. It is believed that considerable interchange of air between the stratosphere and troposphere takes place at the gaps. A jet stream, forming a river of air moving with high speed and circulating about the earth, is located at the tropical edge of the polar tropopause in each hemisphere.

9.129 Because of its temperature structure, there is very little convective motion in the stratosphere, and the air is exceptionally stable. This is especially noticeable in the tropics where the vertical movement of the radioactive cloud from a nuclear explosion has sometimes been less than 2 miles in three trips around the globe, i.e., approximately 70,000 miles. This stability continues up to the mesosphere where marked turbulence is again noted. The polar stratosphere is less stable than that in the tropics, particularly during the polar winter night when the stratospheric temperature structure changes to such an extent that the inversion may disappear. When this occurs there may be consid-

erable convective mixing of the air to great heights.

ATMOSPHERIC PATHS OF DELAYED FALLOUT: TROPOSPHERIC FALLOUT

9.130 The fallout pattern of the very small particles in the radioactive cloud which remain suspended in the atmosphere depends upon whether they were initially stabilized in the troposphere or in the stratosphere. The distribution of the radioactive material between the troposphere and the stratosphere is determined by many factors, including the total energy yield of the explosion, the height of burst, the environment of the detonation, and the height of the tropopause. Additional complications arise from scavenging by dirt and precipitation and from fractionation in surface bursts. Scavenging will tend to decrease the proportion of radioactive debris remaining in the cloud while increasing that in the early fallout, whereas fractionation will result in a relative increase in the amounts of strontium-90 and cesium-137 that remain suspended. Consequently, it is not yet possible to predict the quantitative distribution between troposphere and stratosphere, although certain qualitative conclusions can be drawn.

9.131 In general, a larger proportion of the weapon debris will go into the stratosphere in an air burst than in a surface burst under the same conditions; for one thing, there is essentially no local or early fallout in the former case and, for another, surface material taken up into the cloud tends to depress the height attained in the latter case. In the temperate and polar regions, more of the radioactive debris enters the strato-

sphere from an air burst than for an equivalent burst in the tropics. The reason is that the tropopause is lower and the stratosphere is less stable in the nontropic regions. For low-yield explosions, most of the radioactive material remains in the troposphere, with little entering the stratosphere. But since the altitude to which the cloud rises increases with the explosion energy yield, the proportion of debris passing into the stratosphere will increase correspondingly.

9.132 The small particles remaining in the troposphere descend to earth gradually over a period of time up to several months; this constitutes the "tropospheric fallout." The most important mechanism for causing this fallout appears to be the scavenging effect of rain and snow. The fine particles may be incorporated into the water droplets (or snow crystals) as they are formed and are thus brought down in the precipitation. Except for unusually dry or wet regions, the amount of delayed fallout deposited in adjacent areas is closely related to the amount of precipitation in those areas during the fallout period. Dry fallout has been recorded, but it probably represents a minor proportion of the tropospheric fallout in most instances.

9.133 The rate of removal of material from the troposphere at any time is roughly proportional to the amount still present at that time; consequently, the "half-residence time" concept is useful. It is defined as the period of time required at a given location for the removal of half the suspended material. If the cloud particles originally reached the upper part of the troposphere, the half-residence time for tropospheric fallout is

about 30 days. During the course of its residence in the atmosphere, the tropospheric debris is carried around the earth, by generally westerly winds, in perhaps a month's time. The bulk of the fallout on the average is then confined to a relatively narrow belt that spreads to a width of about 30° of latitude.

9.134 Since uniform winds and rainfall are not very probable, the tropospheric fallout patterns, like those of the early fallout, will vary and probably will be quite irregular. In view of the strong dependence of tropospheric fallout distribution on the weather, and in particular on precipitation, it is not practical to provide an idealized representation of the possible distribution.

STRATOSPHERIC FALLOUT

9.135 The radioactive debris that enters the stratosphere descends much more slowly than does the tropospheric fallout. This is mainly due to the fact that vertical motions in the stratosphere are slow, as stated above, and little moisture is available to scavenge the particles. It appears that almost the only way for the removal of the radioactivity from the stratosphere is for the air masses carrying the particles to move first into the troposphere, where the particles can be brought down by precipitation. There are at least three ways in which this transfer of air from the stratosphere to the troposphere can occur, they are (1) direct downward movement across the tropopause, (2) upward movement of the tropopause or its reformation at a higher altitude, and (3) turbulent, large-scale meandering horizontal circulation through the tropopause gaps. The relative importance

of these mechanisms depends upon the altitude, latitude, and time of year at which the injection into the stratosphere takes place. The first method may be important during the arctic winter and the second in the lower polar stratosphere in the early spring. The third mechanism is particularly applicable to material in the lower stratosphere near the gaps. Very little debris crosses the tropopause in equatorial regions.

9.136 The relatively complicated structure of the stratosphere and the varied modes by which contaminated particles may leave it, make it impossible to assign a single half-residence time for all stratospheric debris. However, semiempirical models have been developed that permit the calculation of stratospheric inventories, concentrations in air near the surface, and deposition of debris injected into the stratosphere, mesosphere, or higher levels. The model used here has successfully predicted the fallout from several specific injections of radioisotopes from atmospheric nuclear tests conducted since 1961. It also predicted the fate of the substantial amount of plutonium-238 released in the burnup of the SNAP-9A generator in a satellite launch-vehicle failure in 1964.

9.137 The model divides the stratosphere of each of earth's (north and south) hemispheres into two compartments: the region above 70,000 feet and that below 70,000 feet. For an injection of radioactive debris at an initial altitude above 70,000 feet, rapid transfer between the hemispheres is assumed to take place, based on what is known of air circulation in the upper atmosphere. The debris will begin to arrive below 70,000 feet during the winter or spring

season in each hemisphere after a delay of about one year from the time of injection. If the injection occurs in the stratosphere below 70,000 feet, the major influx of debris into the troposphere will begin during the first winter or spring season following the injection. At this lower altitude in the stratosphere, transfer between the hemispheres takes place at a much slower rate. Most of the radioactive debris tends initially to become a narrow band girdling the globe more or less at the latitude of injection, since the winds in the stratosphere below 70,000 feet are predominantly unidirectional, i.e., either easterly or westerly, depending on the place and the time. The band soon spreads out as a result of diffusion and in the winter and spring there is a poleward and downward transfer of the debris.

9.138 In the lower stratosphere, below 70,000 feet, the half-residence time for transfer between hemispheres is roughly 60 months, whereas the half-residence time for transfer to the troposphere is about 10 months. Since the half-residence time in the troposphere is only a month (§ 9.133), it is apparent that weapon residues entering the lower stratosphere in a particular hemisphere will tend to fall out in that hemisphere. Most nuclear tests have been conducted in the Northern Hemisphere and most of the debris injected into the stratosphere did not reach altitudes above 70,000 feet. Consequently, the amount of delayed fallout on the ground in this hemisphere is considerably greater than in the Southern Hemisphere. On the other hand, in the upper stratosphere, above 70,000 feet, the transfer between hemispheres is much more rapid than in the lower region and entry into the tro-

posphere is delayed. Hence, in the few injections that have occurred above 70,000 feet there has been a more even distribution of the fallout between the hemispheres.

9.139 Regardless of where it is injected, the major portion of the stratospheric fallout will reach the earth in the temperate latitudes. This is mainly due to high-rainfall regions near the polar fronts (§ 9.127). Since the half-residence time in the troposphere is so short, air coming down through the tropopause gap or on its poleward side and moving toward the equator will be depleted of its contaminated particles by scavenging before it can reach the tropics. Consequently, stratospheric fallout in the equatorial zone is low in spite of the heavy rainfall.

DELAYED FALLOUT FROM NUCLEAR WEAPONS TESTS

9.140 For making estimates of delayed fallout, it is the general practice to determine the amount of strontium-90, for several reasons. It has a long half-life compared with the residence time in the stratosphere, so that it does not decay to any great extent prior to its deposition on the earth; it is produced in relatively large quantities in fission, and it is fairly easy to identify and measure by standard radiochemical techniques. Furthermore, the concentration of strontium-90 is of special interest because it provides a measure of the hazard from delayed fallout.

9.141 The activity of strontium-90, as of radioactive materials in general, is conveniently expressed in terms of a

unit called the "curie." It is defined as the activity (or quantity) of any radioactive substance undergoing 3.7×10^{10} disintegrations per second. (This particular rate was chosen because it is close to the rate of disintegration of 1 gram of radium.) Where large amounts of active material are involved, the "megacurie" unit is employed; this is equal to 1 million curies and corresponds to disintegrations at the rate of 3.7×10^{16} per second. A megacurie of strontium-90 is that quantity of this isotope which emits 3.7×10^{16} beta particles per second.⁹

9.142 Since 1954, a number of sampling networks have been established in various parts of the world to determine the amounts of radioactive contamination in tropospheric and stratospheric air and in rainwater and soil, arising from weapons tests. The results obtained have shed a great deal of light on the possible mechanisms of the delayed fallout. The information so obtained, coupled with biological studies to determine the concentrations of certain radioisotopes in the diet and in human beings and animals, has permitted an evaluation to be made of the possible worldwide hazard (see Chapter XII).

9.143 The plots in Figs. 9.143a and b show the variations over a period of years of the megacuries of strontium-90 present in the total stratospheric inventory, i.e., the activity still remaining in the stratosphere at various times, and the ground inventory, i.e., the activity deposited on the ground. The extensive atmospheric nuclear test programs conducted by the U.S. and the U.S.S.R. during 1961 and 1962 are reflected by

⁹One megaton of fission yield produces about 0.11 megacurie of strontium-90.

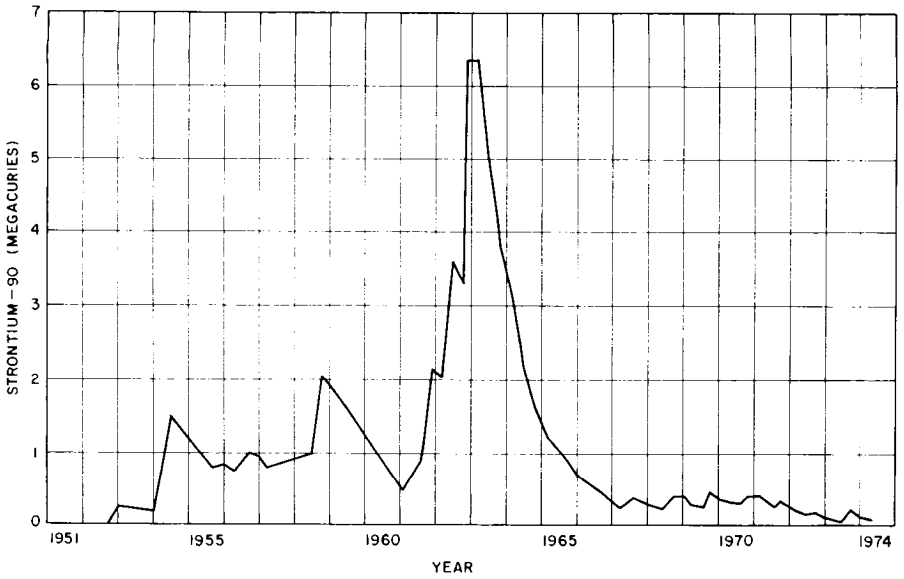

Figure 9.143a. Stratospheric burden (or inventory) of strontium-90.

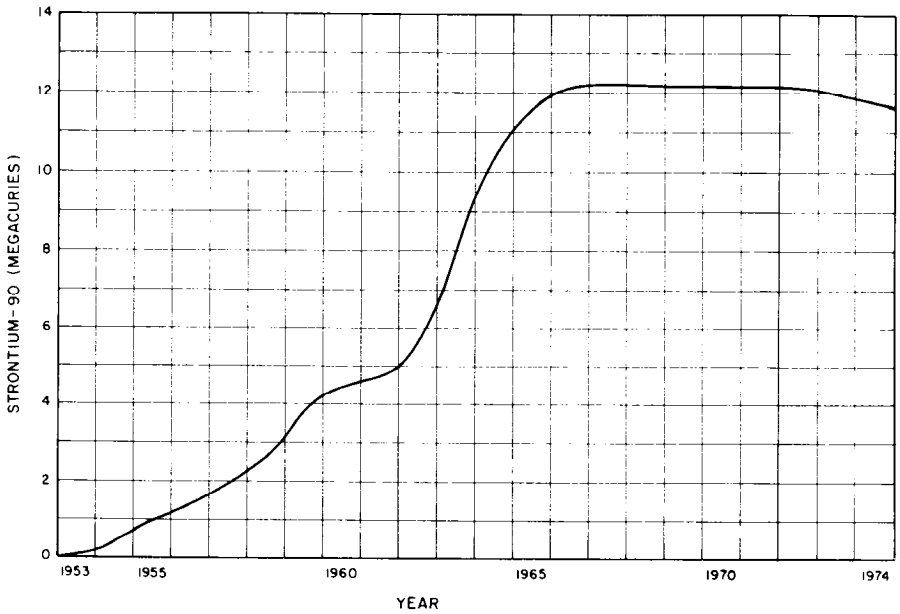

Figure 9.143b. Surface burden (or inventory) of strontium-90.

the large peak in the stratospheric inventory (Fig. 9.143a) which reached a maximum toward the end of 1962. The sharp increase in the ground inventory (Fig. 9.143b), which began in 1962 and continued through 1965, reflects the deposition of the strontium-90 during those years.

9.144 The maximum amounts of strontium-90 on the earth's surface will be attained when the rate of natural radioactive decay just begins to exceed the rate at which the isotope reaches the ground in delayed fallout. The atmospheric tests conducted by France and China during the late 1960's and early 1970's have not caused a significant increase in the surface inventory, and if

atmospheric testing were discontinued, the surface inventory should decrease steadily.

9.145 After strontium-90, the next most important radioisotope from the biological standpoint in the worldwide fallout is cesium-137. Fission products contain, after a short time, roughly 1.5 times as many cesium-137 atoms as strontium-90 atoms (§ 9.124). Since there is essentially no fractionation relative to one another of these two isotopes and they have half-lives which are not very different, the activity of cesium-137 on the ground can be determined, to a good approximation, by multiplying the values for strontium-90, e.g., Fig. 9.143b, by 1.5.

TECHNICAL ASPECTS OF RESIDUAL NUCLEAR RADIATION¹⁰

RATE OF DECAY OF FALLOUT ACTIVITY

9.146 The continuous curves in Figs. 9.16a and b, which represent the decrease in dose rate due to gamma radiation from radioactive fallout, have been obtained by summing the contributions of the more than 300 isotopes in the fission products and of the activity induced by neutrons in the weapons materials for various times after fission. The effects of fractionation, resulting from the partial loss of gaseous krypton and xenon (and their daughter elements) and from other circumstances, have also been taken into account (§ 9.08). The dose rates calculated in this manner vary

with the nature of the weapon, but the values plotted in Figs. 9.16a and b are reasonable averages for situations in which the fallout activity arises mainly from fission products. It is seen that the decrease in the dose rate with time cannot be represented by a simple equation which is valid at all times, but it can be approximated by the dashed straight lines labeled " $t^{-1.2}$ ", for times between 30 minutes to about 5,000 hours (200 days) after the explosion, to within 25 percent. For times longer than 200 days, the fallout decays more rapidly than indicated by the $t^{-1.2}$ line, so that the continuous curve may be used to estimate dose rates from fallout at these times.

¹⁰The remaining sections of this chapter may be omitted without loss of continuity.

9.147 During the interval in which the approximation is applicable, the decay of fallout activity at a given location may be represented by the simple expression

$$R_t \approx R_1 t^{-1.2}, \quad (9.147.1)$$

where R_t is the gamma radiation dose rate at time t after the explosion and R_1 is the dose rate at unit time; this is the unit-time reference dose rate which has been used earlier, e.g., in Figs. 9.16a and b, and Figs. 9.20 and 9.25. The actual value of R_1 will depend on the units in which the time is expressed, e.g., minutes, hours, days, etc. In this chapter, time is generally expressed in hours, so that the unit time for the reference dose rate R_1 is 1 hour.¹¹

9.148 It should be clearly understood that equation (9.147.1) is applicable provided there is no change in the quantity of fallout during the time interval under consideration. It cannot be used, therefore, at such times that the fallout is still descending, but only after it is essentially complete at the particular location. If fallout material is removed in any way, e.g., by weathering or by washing away during the time t , or if additional material is brought to the given point by wind or by another nuclear detonation, equation (9.147.1) could not be employed to determine the rate of decay of the fallout activity.

9.149 By rearranging equation (9.147.1) and taking logarithms, it follows that

$$\log \frac{R_t}{R_1} \approx -1.2 \log t, \quad (9.149.1)$$

so that a logarithmic plot of R_t/R_1 against t should give a straight line with a slope of -1.2 . When $t = 1$, i.e., 1 hour after the explosion, $R_t = R_1$ or $R_t/R_1 = 1$; this is the basic reference point through which the straight line of slope -1.2 is drawn in Figs. 9.16a and b.

9.150 The total accumulated dose received from a given quantity of fallout can be determined from Fig. 9.20 using the method described in § 9.21. The curve in Fig. 9.20 was obtained by numerical integration over time of the actual dose-rate (continuous) curve in Figs. 9.16a and b. However, for times between 0.5 hour (30 minutes) and 5,000 hours (200 days) after the explosion, an approximate analytical expression for the dose received during a given time interval can be obtained by direct integration of equation (9.147.1); thus if D is the total dose accumulated between the times t_a and t_b , then

$$\begin{aligned} D &\approx R_1 \int_{t_a}^{t_b} t^{-1.2} dt \\ &= 5R_1 (t_a^{-0.2} - t_b^{-0.2}). \end{aligned} \quad (9.150.1)$$

Hence if the unit-time reference dose rate R_1 is known or is determined, e.g., from Fig. 9.25 and the measured dose rate at any known time after the explosion, the total (or accumulated) dose for any required period can be calculated, provided the fallout activity decays in accordance with the $t^{-1.2}$ relationship during this period.

¹¹Physically the unit-time reference dose rate is the dose rate that would be received from the given (constant) amount of fallout at unit time, e.g., 1 hour after the explosion, although this quantity might actually be in transit at that time and would not have reached the location under consideration.

9.151 Measurements made on actual fallout from weapons tests indicate that, although the $t^{-1.2}$ decay represents a reasonable average, there have been instances where exponents in the range of -0.9 to -2.0 , rather than -1.2 , are required to represent the rate of decay. In fact, different exponents are sometimes needed for different times after the same explosion. These anomalies apparently arise from the particular circumstances of the explosion and are very difficult to predict, except possibly when a large quantity of neutron-induced activity is known to have been produced. Furthermore, fallout from two or more explosions occurring at different times will completely change the observed decay rate. In general, too, over a long period of time after the burst, weathering will tend to alter the dose rates in an unpredictable manner. Consequently, in an actual situation following a nuclear detonation, estimates based on either the $t^{-1.2}$ decay rule or even on the continuous curves in Figs. 9.16a and b must be used with caution and should be verified by actual measurements as frequently as possible.

9.152 Within the limits of applicability of the $t^{-1.2}$ decay relationship, equation (9.150.1) can be used to estimate the time which an individual can stay in a location contaminated by fission products without accumulating more than a specified dose of radiation. In this case, the accumulated dose is specified; t_a is the known time of entry into the contaminated area and t_b is the required time at (or before) which the exposed individual must leave. In order to solve this problem with the aid of equation (9.150.1), it is necessary to know the unit-time reference dose rate

R_1 . This can be obtained from equation (9.149.1), if the dose rate, R_t , is measured at any time, t , after the explosion, e.g., at the time of entry. The results can be expressed graphically as in Figs. 9.26 and 9.27.

9.153 In principle, equation (9.150.1) could be used to estimate the total accumulated dose received from fallout in a contaminated area, provided the whole of the fallout arrives in a very short time. Actually, the contaminated particles may descend for several hours, and without knowing the rate at which the fallout particles reach the ground, it is not possible to make a useful calculation. When the fallout has ceased, however, equations (9.149.1) and (9.150.1) may be employed to make rough estimates of accumulated radiation doses over moderate periods of time, up to about 200 days after the explosion, provided one measurement of the dose rate is available.

RADIATION DOSE RATES OVER CONTAMINATED SURFACES

9.154 It was seen in § 9.141 that the curie and megacurie are useful units for expressing the activity of radioactive material, and they will now be employed in connection with the contamination of areas. Because, as far as the external radiation dose is concerned, the gamma rays are more significant biologically than the beta particles, the early fallout activity may be stated in gamma-megacuries, as a measure of the rate of emission of gamma-ray photons, where 1 gamma-megacurie represents the production of 3.7×10^{16} photons per second.

9.155 If an area is uniformly con-

taminated with any radioactive material of known activity (in gamma-megacuries) at a given time, it is possible to calculate the gamma-radiation dose rate at various heights above the surface, provided the average energy of the gamma-ray photons is known. The results of such calculations, assuming a contamination density of 1 gamma-megacurie per square mile, for gamma rays having various energies, are represented in Fig. 9.155. If the actual contamination density differs from 1 megacurie per square mile, the ordinates in the figure would be multiplied in proportion.

9.156 The calculations upon which Fig. 9.155 is based take into account the effects of buildup in air (§ 8.103). Furthermore, it is assumed that the surface over which the contamination is distributed is perfectly smooth and infinite in extent. For actual terrain, which is moderately rough and may have a variety of radiation shielding, the dose rate at a specific height above the ground would be less than for an infinite, smooth plane. The actual reduction factor will, of course, depend on the terrain features and the extent of the contaminated area. A terrain shielding factor of 0.7 is commonly applied to the dose rates obtained from Fig. 9.155 to obtain approximate average values for a moderately rough terrain (§ 9.95).

9.157 The dose rate at greater heights above the ground, such as might be observed in an aircraft, can be estimated with the aid of Fig. 9.157. The curve gives approximate values of the attenuation factor for early fallout radiation as a function of altitude. It applies in particular to a uniformly contaminated area that is large compared to the

altitude of the aircraft. If the dose rate near, i.e., 3 feet above, the ground is known, then the value at any specified altitude can be obtained upon dividing by the attenuation factor for that altitude. On the other hand, if the dose rate is measured at a known altitude, multiplication by the attenuation factor gives the dose rate at about 3 feet above the ground at that time.

9.158 A possible use of the curve in Fig. 9.157 is to determine the dose rate near the ground and contamination density from data obtained by means of an aerial survey. For example, suppose a radiation measuring instrument suspended from an aircraft at a height of 1,000 feet showed a radiation dose of 0.24 rad/hr and that, from the known time after the explosion, the average energy of the gamma-ray photons was estimated to be 0.8 MeV. The attenuation factor for an altitude of 1,000 feet is approximately 27 and so the dose rate at 3 feet above ground at the time of the observation is roughly $0.24 \times 27 = 6.5$ rads/hr. It is seen from Fig. 9.155 that for a contamination density of 1 megacurie per square mile and a photon energy of 0.8 MeV, the dose rate 3 feet above the ground would be about 5.9 rads/hr. Hence, in the present case, the contamination density of the ground is approximately $6.5/5.9 = 1.1$ gamma-megacurie per square mile.

9.159 The gamma-ray activity from the fission products will vary depending upon the nature of the fissionable material; however, it has been calculated that a reasonable average would be about 530 gamma-megacuries per kiloton fission yield at 1 hour after the explosion. The average photon energy also depends

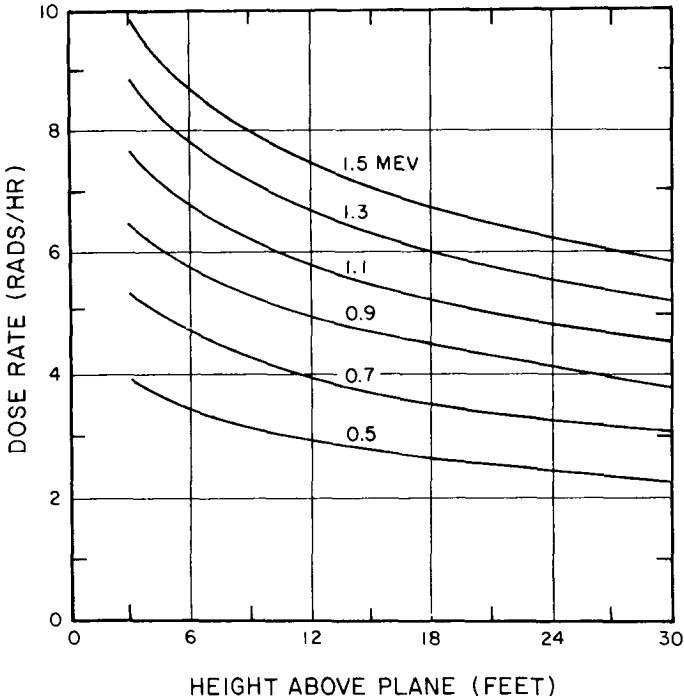

Figure 9.155. Dose rates above an ideal plane from gamma rays of various energies for a contamination density of 1 gamma-megacurie per square mile.

on the fissionable material, but at 1 hour after the explosion an average energy of about 0.7 MeV is a reasonable approximation. Thus, if all the (unfractionated) fission products from 1-kiloton fission yield were spread uniformly over a smooth plane 1 square mile in area, the radiation dose received at a point 3 feet above the plane can be estimated from Fig. 9.155 as 5.3×530 i.e., approximately 2,800 rads/hr. Activity induced by neutron capture in the weapon materials may add about 100 rads/hr to this figure, making a total of 2,900 rads/hr at 1 hour after the explosion.¹²

9.160 If all of the radioactivity in the weapon debris were deposited uniformly over a smooth surface of area 1 square mile, the 1 hour dose rate above this area would thus be about 2,900 rads/hr per kiloton of fission yield. If the same residues were spread uniformly over a smooth surface of A square miles in area, the 1-hour dose rate would be $2,900/A$ rads/hr; consequently, the product of the 1-hour dose rate and the area in square miles would be equal to 2,900 in units of (rads/hr) (miles)²/kt fission. If all the residues from 1-kiloton fission yield were deposited on a smooth

¹²The best values reported in the technical literature range from roughly 2,700 to 3,100 rads/hr for different fissionable materials and neutron energy spectra. The dose rate given here is considered to be a good average.

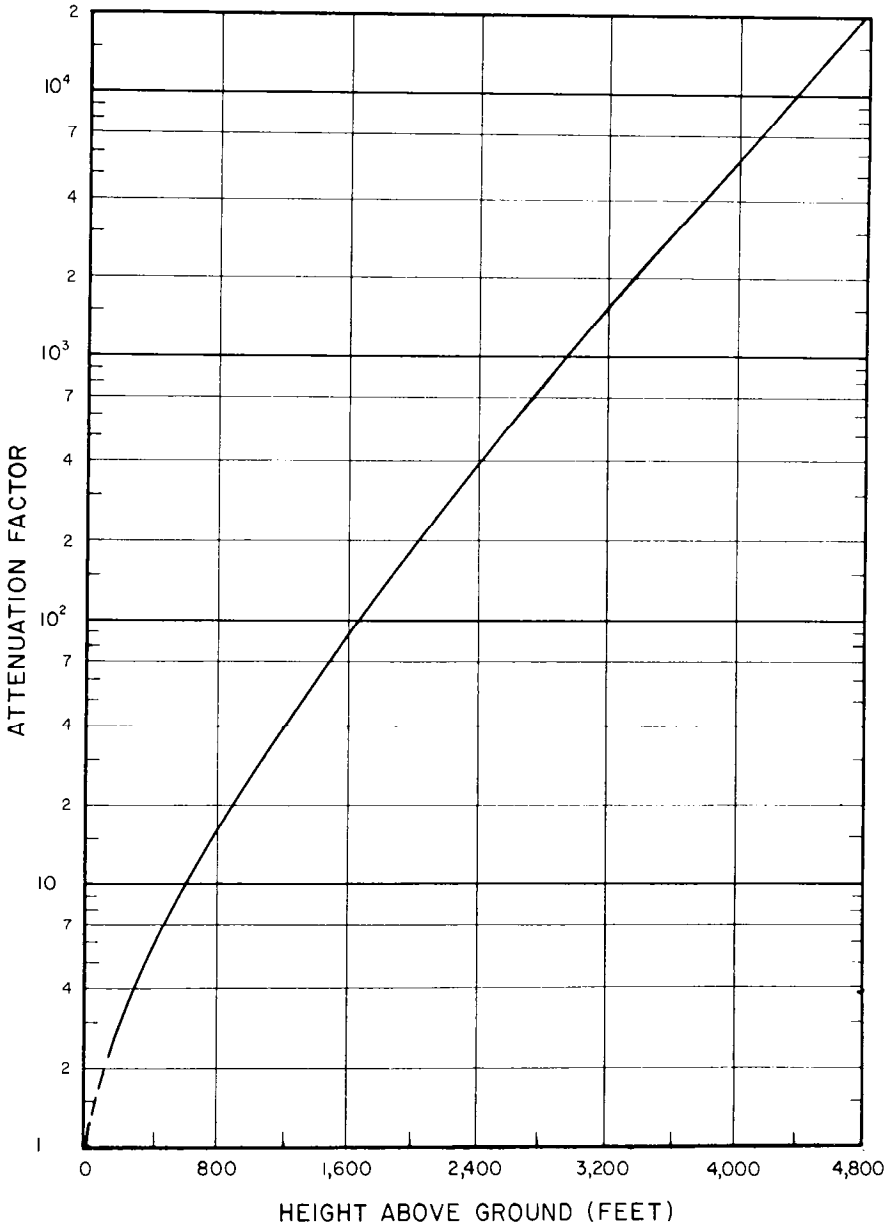

Figure 9.157. Altitude attenuation factor for early fallout radiation dose rate relative to the dose rate 3 feet above the ground.

surface in varying concentrations typical of an early fallout pattern, instead of uniformly, the product of the dose rate at 1 hour and the area would be replaced by the "area integral" of the 1-hour dose rate defined by

$$\text{Area Integral} = \int_A R_1 dA,$$

where R_1 is the 1-hour dose rate over an element of area dA and A square miles is the total area covered by the residues. Hence, regardless of the concentration pattern, the area integral of the 1-hour dose rate over a smooth surface would always be 2,900 (rads/hr) (miles)²/kt fission, assuming that the fallout had been completely deposited at that time.

9.161 Measurements after several nuclear tests have given a wide range of values, but a reasonable average is about 1,000 (rads/hr) (miles)²/kt fission. These measurements were made with radiation monitoring instruments at various times after the explosions. This value differs from the 2,900 (rads/hr) (miles)²/kt fission given above for two main reasons: first, only part of the radioactivity of the weapon residues appears in the early fallout, and second, corrections must be applied to the measured value for instrument response and terrain shielding. Typical ionization-chamber monitoring instruments that were used in the surveys, calibrated in the usual manner, will read about 25 percent too low as a result of a nonlinear response to gamma rays of various energies, directional response, and shielding provided by the operator. This correction increases the "observed" area integral from 1,000 to about 1,300 (rads/hr) (miles)²/kt fission. If the terrain

shielding factor is taken to be 0.7 (§ 9.156), the 1-hour dose rate area integral that would be measured over an ideal smooth plane, with no shielding, would be 1,300/0.7, i.e., approximately 1,900 (rads/hr) (miles)²/kt fission.

9.162 The ratio of 1,900 rads/hr to the theoretical 2,900 (rads/hr) (miles)²/kt fission indicates that about 60 percent of the total gamma-ray activity of the weapon residues is deposited in the early fallout from a land surface burst (§ 9.59). This value must be recognized as an estimate because the data upon which it is based are both limited and variable. For example, it depends to some extent on the nature of the surface material. Furthermore, as the burst height increases, the fraction of the weapon debris deposited as local fallout will decrease until the fireball no longer intersects the earth's surface.

RATE OF PARTICLE FALL

9.163 The time at which particles of a given size and density will arrive at the ground from specified heights in the nuclear cloud may be calculated from aerodynamic equations of motion. The effects of vertical air motions are generally ignored since they cannot be predicted, especially as they are believed to be generally small for particles which fall within 24 hours. However, field test data sometimes indicate times of arrival which are quite different from those predicted by the theoretical calculations; hence, it is probable that vertical wind components and other factors may sometimes significantly influence the particle fall. One such factor is precipitation (§ 9.67 *et seq.*), but this will be disregarded here.

9.164 Some typical results of time of fall calculations are shown in Fig. 9.164. The curves give the times required for particles of different sizes to fall to earth from various initial altitudes. The density of the fallout material is taken to be 2.5 g/cm^3 , which is roughly that of dry sand; the falling particles are assumed to be spherical, their radii being given in micrometers (μm). Actual fallout particles are sometimes quite irregular and angular in shape, although a large percentage tend to be fairly smooth and globular since they result from the solidification of fused spherical droplets of earth and of weapon debris (see Figs. 9.50a through d). Even if the particles are irregular, they can be assigned an effective radius and then treated as spheres for calculating times of fall.

9.165 The percentages given in Fig. 9.164 represent estimates of the proportions of the total activity deposited by particles with sizes lying between pairs of lines. Thus, particles with radii larger than $200 \mu\text{m}$ carry 1 percent of the activity; those between 150 and $200 \mu\text{m}$ carry 3 percent, and so on; at the other

extreme, particles less than $20 \mu\text{m}$ in radius carry 12 percent of the activity. This distribution of activity is known as "log-normal" because it obeys the normal (Gaussian) distribution law with the logarithm of the particle radius as the variable. It may not be strictly valid in any given case, since the activity distribution varies with the type of burst, the nature of the terrain at ground zero, etc. Nevertheless, it is characteristic of the activity distributions assumed for the theoretical analysis of fallout.

9.166 The method for estimating the arrival time of the fallout at a downwind location was described in § 9.91. Suppose that the time of arrival is 20 hours at a downwind distance of 300 miles from the explosion. If the nuclear cloud stabilizes at 60,000 feet, then it follows from Fig. 9.164 that, at this time, all particles with radii less than about 30μ will still be present, and that they carry roughly 28 percent of the total activity deposited in the early fallout. It is evident that, in spite of the decay which will have occurred in transit, fallout of appreciable activity may be expected 300 miles downwind at about 20 hours after the detonation.

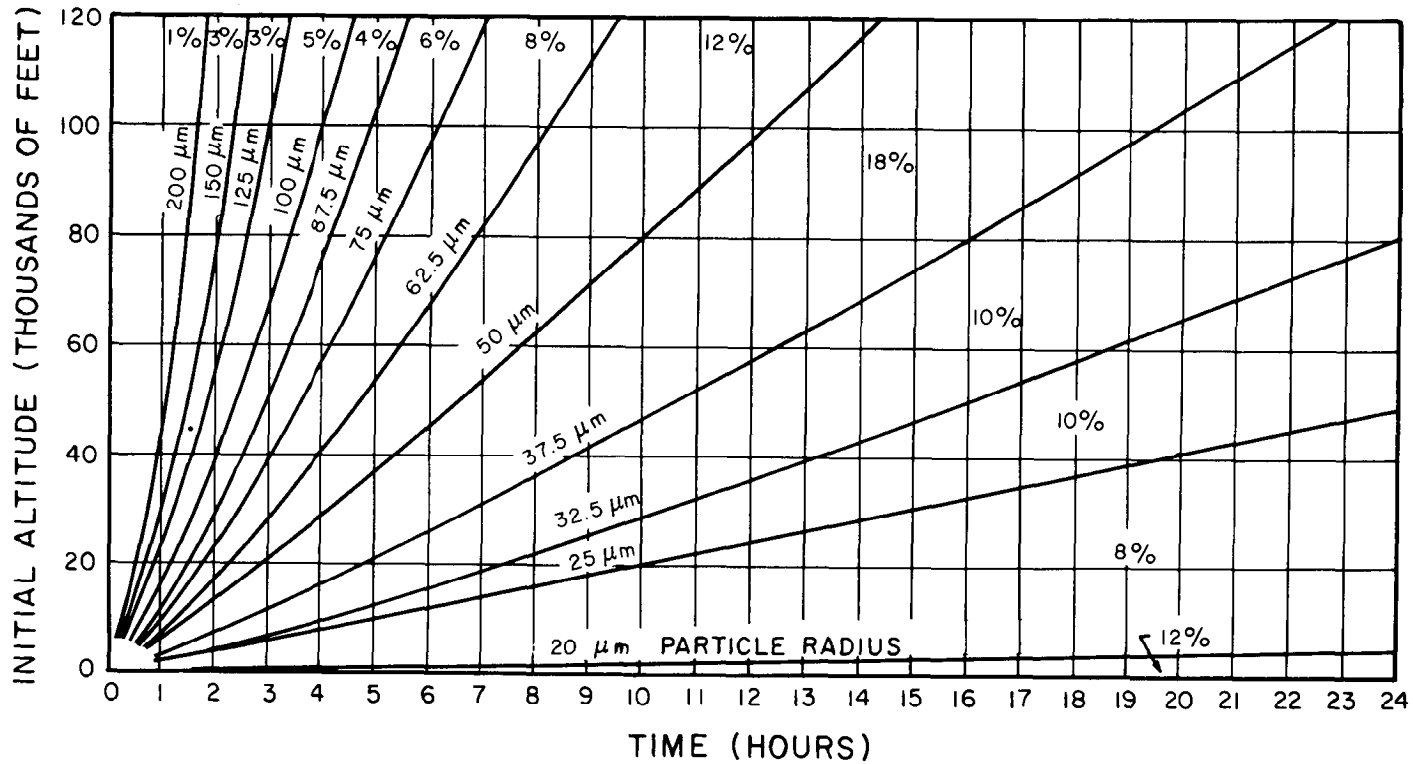

Figure 9.164. Times of fall of particles of different sizes from various altitudes and percentages of total activity carried.

BIBLIOGRAPHY

- BUNNEY, L. R., and D. SAM, "Gamma-Ray Spectra of Fractionated Fission Products," Naval Ordnance Laboratory, June 1971, NOLTR 71-103.
- BURSON, Z. G., "Fallout Radiation Protection Provided by Transportation Vehicles," EG & G, Inc., Las Vegas, Nevada, October 1972, EGG-1183-1566.
- CRAWFORD, T. V., "Precipitation Scavenging and 2BPUFF," University of California, Lawrence Livermore Laboratory, December 1971, UOPKA 71-14.
- CROCKER, G. R., "Fission Product Decay Chains: Schematics with Branching Fractions, Half-Lives, and Literature References," U.S. Naval Radiological Defense Laboratory, June 1967, USNRDL-TR-67-111.
- CROCKER, G. R., and T. TURNER, "Calculated Activities, Exposure Rates, and Gamma Spectra for Unfractionated Fission Products," U.S. Naval Radiological Defense Laboratory, December 1965, USNRDL-TR-1009.
- CROCKER, G. R., and M. A. CONNORS, "Gamma-Emission Data for the Calculation of Exposure Rates from Nuclear Debris, Volume I, Fission Products," U.S. Naval Radiological Defense Laboratory, June 1965, USNRDL-TR-876.
- CROCKER, G. R., J. D. O'CONNOR, and E. C. FREILING, "Physical and Radiochemical Properties and Fallout Particles," U.S. Naval Radiological Defense Laboratory, June 1965, USNRDL-TR-899.
- "Department of Defense Land Fallout Prediction System," Defense Atomic Support Agency, Washington, D.C.; U.S. Army Nuclear Defense Laboratory; U.S. Naval Radiological Defense Laboratory; Technical Operations Research, Burlington, Massachusetts, 1966, DASA 1800-I through 1800-VII.
- DOLAN, P. J., "Gamma Spectra of Uranium-235 Fission Products at Various Times After Fission," Armed Forces Special Weapons Project, Washington, D.C., March 1959, AFSWP 524.
- DOLAN, P. J., "Calculation of Abundances and Activities of the Products of High-Energy Neutron Fission of Uranium-238," Defense Atomic Support Agency, Washington, D.C., May 1959, DASA 525.
- DOLAN, P. J., "Gamma Spectra of Uranium-238 Fission Products at Various Times After Fission," Defense Atomic Support Agency, Washington, D.C., May 1959, DASA 526.
- *ENGLEMANN, R. J., and W. G. N. SLINN, Coordinators, "Precipitation Scavenging (1970)," AEC Symposium Series No. 22, U.S. Atomic Energy Commission, December 1970.
- FEELY, H. W., *et al.*, "Final Report on Project Stardust, Volumes I through III," Isotopes, A Teledyne Company, Westwood, New Jersey, October 1967, DASA 2166-1 through 2166-3.
- FERBER, G. J., "Distribution of Radioactivity with Height in Nuclear Clouds," Proceedings of the Second Conference sponsored by the Fallout Studies Branch, U.S. Atomic Energy Commission, November 1965.
- FREILING, E. C., and N. E. BALLOU, "Nature of Nuclear Debris in Sea Water," *Nature*, **195**, 1283 (1962).
- KNOX, J. B., T. V. CRAWFORD, and W. K. CRANDALL, "Potential Exposures from Low-Yield Free Air Bursts," University of California, Lawrence Livermore Laboratory, December 1971, UCRL-51164.
- *KREY, P. W., and B. KRAJEWSKI, "HASL Model of Atmospheric Transport," Health and Safety Laboratory, U.S. Atomic Energy Commission, New York, N.Y., September 1969, HASL-215.
- KREY, P. W., and B. KRAJEWSKI, "Comparison of Atmospheric Transport Model Calculations with Observations of Radioactive Debris," *J. Geophys. Res.*, **75**, 2901 (1970).
- *KREY, P. W., M. SCHONBERG, and L. TOONKEL, "Updating Stratospheric Inventories to April 1974," Fallout Program Quarterly Summary Report, Health and Safety Laboratory, U.S. Energy Research and Development Administration, New York, N.Y., July 1975, HASL-294.
- LEE, H., P. W. WONG, and S. L. BROWN, "SEER II: A New Damage Assessment Fallout Model," Stanford Research Institute, Menlo Park, California, May 1972, DNA 3008F.
- MARTIN, J. R., and J. J. KORANDA, "The Importance of Tritium in the Civil Defense Context," University of California, Lawrence Livermore Laboratory, March 1971, UCRL-73085.
- National Academy of Sciences, Advisory Committee on Civil Defense. Subcommittee on Fallout, "Response to DCPA Questions on Fallout," Defense Civil Preparedness Agency, Research Report No. 19, May 1973.
- PETERSON, "An Empirical Model for Estimating World-Wide Deposition from Atmospheric Nuclear Detonations," *Health Physics*, **18**, 357 (1970).

- *SLINN, W. G. N., "Aerosol Particle Size Dependence of the Rainout Rate," Battelle Pacific Northwest Laboratories, AEC Research and Development Report, June 1971, BNWL-1551 Vol. II, Part 1.
- STEWART, G. L., and R. K. FARNSWORTH, "United States Rainout and Hydrologic Implication," *Water Resources Research*, **4**, 273 (1968).
- *"Sr-90 and Sr-89 in Monthly Deposition at World Land Sites," Fallout Program Quarterly Summary Report, Appendix A, Health and Safety Laboratory, U.S. Atomic Energy Commission, New York, N.Y., April 1973, HASL-273 Appendix.
- VOLCHOK, H. L., "Strontium-90 Deposition in New York City," *Science*, **156**, 1487 (1967).
- *VOLCHOK, H. L., "Worldwide Deposition of ⁹⁰Sr Through 1974," Fallout Program Quarterly Summary Report, Health and Safety Laboratory, U.S. Energy Research and Development Administration, New York, N.Y., October 1975, HASL-297.

CHAPTER X

RADIO AND RADAR EFFECTS

INTRODUCTION

RADIO BLACKOUT

10.01 The transmission of electromagnetic waves with wavelengths of 1 millimeter or more, which are used for radio communications and for radar, is often dependent upon the electrical properties, i.e., the ionization (§ 8.17), of the atmosphere. The radiations from the fireball of a nuclear explosion and from the radioactive debris can produce marked changes in the atmospheric ionization. The explosion can, therefore, disturb the propagation of the electromagnetic waves mentioned above. Apart from the energy yield of the explosion, the effects are dependent on the altitudes of the burst and of the debris and on the wavelength (or frequency) of the electromagnetic waves. In certain circumstances, e.g., short-wave (high-frequency) communications after the explosion of a nuclear weapon at an altitude above about 40 miles, the electromagnetic signals may be completely disrupted, i.e., "blacked out," for several hours.

10.02 In this chapter, the normal ionization of the atmosphere will be described and this will be followed by a

discussion of the disturbances produced by nuclear bursts at various altitudes. Consideration will then be given to the effects of these disturbances on the propagation of electromagnetic waves in different frequency ranges. Apart from the effects that can be ascribed directly to changes in ionization, radio communications and radar signals can be degraded in other ways, e.g., by noise, distortion, changes in direction, etc. These disturbances, which cannot be treated in a quantitative manner, will be discussed briefly.

ELECTROMAGNETIC PULSE

10.03 Another consequence of a nuclear explosion that may cause temporary interference with radio and radar signals is an electrical (or electromagnetic) pulse of short duration emitted from the region of the burst. The most serious potential effects of this pulse are damage to electrical and electronic equipment, rather than to the propagation of electromagnetic waves. Hence, the electromagnetic pulse will be considered separately in Chapter XI.

ATMOSPHERIC IONIZATION PHENOMENA

EFFECT OF IONIZATION ON
ELECTROMAGNETIC WAVES

10.04 Ionization, that is, the formation of ion pairs consisting of separated electrons and positive ions, can be produced, either directly or indirectly, by the gamma rays and neutrons of the prompt nuclear radiation, by the beta particles and gamma rays of the residual nuclear radiation, by the X rays and the ultraviolet light present in the primary thermal radiation, and by positive ions in the weapon debris. Hence, after a nuclear explosion, the density of electrons in the atmosphere in the vicinity is greatly increased. These electrons can affect electromagnetic (radio and radar) signals in at least two ways. First, under suitable conditions, they can remove energy from the wave and thus attenuate the signal; second, a wave front traveling from one region into another in which the electron density is different will be refracted, i.e., its direction of propagation will be changed. It is evident, therefore, that the ionized regions of the atmosphere created by a nuclear explosion can influence the behavior of communications or radar signals whose transmission paths encounter these regions.

10.05 When an electromagnetic wave¹ interacts with free electrons, some of the energy of the wave is transferred to the electrons as energy of vibration. If the electrons do not lose this energy as the result of collisions with other particles (atoms, molecules,

or ions) in the air, they will reradiate electromagnetic energy of the same frequency, but with a slight time delay. Thus, the energy is restored to the wave without loss, but with a change in phase (§ 10.82 *et seq.*). If, however, the air density is appreciable, e.g., more than about one ten-thousandth (10^{-4}) of the sea-level value, as it is below about 40 miles altitude, collisions of electrons with neutral particles will take place at a significant rate. Even above 40 miles, collisions between electrons and ions are significant if the electron density is abnormally high. In such collisions, most of the excess (coherent) energy of the electron is transformed into kinetic energy of random motion and cannot be reradiated. The result is that energy is absorbed from the wave and the electromagnetic signal is attenuated.

10.06 Other conditions being the same, more energy is absorbed from an electromagnetic wave by an ionized gas as the wavelength of the signal is increased, i.e., as its frequency decreases. This may be regarded as being due to the longer time interval, as the frequency is decreased, between successive alternations (or reversals) of the oscillating electromagnetic field (§ 1.73). When the accelerating influence of the wave is applied for a longer time, a given electron will attain a higher vibrational velocity during each cycle of the wave, and will dissipate a greater amount of energy upon collision.

¹As used in this chapter, the term "electromagnetic wave" refers to radiations of wavelength of 1 millimeter or more, such as are used in radio and radar, and not to the entire spectrum described in § 1.74 *et seq.*

10.07 Positive and negative ions can also absorb energy from an electromagnetic wave. Because of their larger mass, however, the ions attain much lower velocities than electrons and so they are less effective in absorbing energy. Thus, the effects of ions may ordinarily be neglected. However, for some situations in the denser (low-altitude) portion of the atmosphere, where ions can persist for an appreciable time, or for frequencies low enough for the ions to have time to acquire significant velocity before reversal of the electromagnetic field, the effect of ions may be important.

10.08 A radio or radar wave traveling upward from the ground begins to be bent (refracted) when an increase of electron density is encountered. Increased electron density causes the wave path to bend away from the region of higher electron density toward the region of lower density (§ 10.85). As the electromagnetic wave penetrates farther into a region where the electron density increases toward a peak value, more and more bending occurs. For certain combinations of the angle of incidence (angle between propagation direction and the vertical), the electron density, and the frequency, the wave may actu-

ally be refracted back toward the earth (Fig. 10.08). This process is commonly referred to as "reflection," although it is not the same as true reflection, in which there would be no penetration of the ionized layer of air. True (or specular) reflection, as from a mirror, does occur to some extent especially with electromagnetic waves of the lowest radio frequencies.

IONIZATION IN THE NORMAL ATMOSPHERE

10.09 In order to understand the effects of free electrons on radio and radar systems, it is necessary to review briefly the ionization in the normal, undisturbed atmosphere. Below an altitude of about 30 miles, there is little ionization, but above this level there is a region called the "ionosphere," in which the density of free electrons (and ions) is appreciable (see Fig. 9.126). The ionosphere consists of three, more-or-less distinct, layers, called the D-, E-, and F-regions. Multiple layers, which sometimes occur in the E- and F-regions, may be disregarded for the

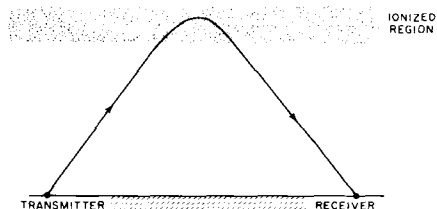

Figure 10.08. Reflection of a radio (or radar) wave by successive refractions in an ionized region of the atmosphere.

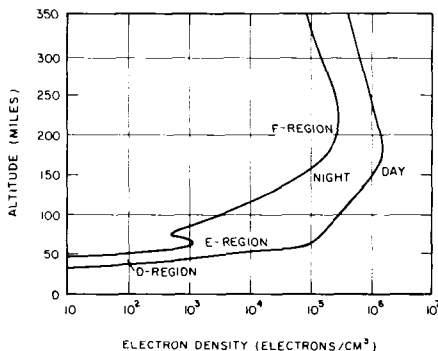

Figure 10.09. Typical electron densities in D-, E-, and F-regions of the ionosphere.

present purpose. Typical variations of electron density with altitude and with time of day are illustrated in Fig. 10.09. The approximate altitudes of the three main regions of the ionosphere are given in Table 10.09.

Table 10.09

**APPROXIMATE ALTITUDES OF
REGIONS IN THE IONOSPHERE**

Region	Approximate Altitude (miles)
D	30-55
E	55-95
F	Above 95

10.10 Although the D-, E-, and F-regions always exist in the daytime and the E- and F-regions at night, the details of the dependence of the electron density on altitude, especially in the F-region, vary with the season, with the geographic latitude, with the solar (sunspot) activity, and with other factors. The curves in Fig. 10.09 are applicable to summer, at middle latitudes, around the time of maximum sunspot activity. The effects of the variable factors mentioned above are fairly well known, so that the corresponding changes in the electron density-altitude curve can be predicted reasonably accurately.

10.11 In addition to these systematic variations in the electron density, there are temporary changes arising from special circumstances, such as solar flares and magnetic storms. Solar flares can cause a ten-fold increase in the electron density in the D-region, but that in the F-region generally increases by no more than a factor of two. Magnetic storms, on the other hand, produce most

of their effect in the F-region. In some latitudes, the maximum electron density in the ionosphere during a magnetic storm may decrease to some 6 to 10 percent of its normal value.

10.12 Apart from these major changes in electron density, the causes of which are known, there are other variations that are not well understood. Sometimes an irregular and rapidly varying increase in the electron density is observed in the E-region. Apparently one or more layers of high electron density are formed and they extend over distances of several hundred miles. This is referred to as the "sporadic-E" phenomenon. A somewhat similar effect, called "spread-F," in which there are rapid changes of electron density in space and time, occurs in the F-region. The areas affected by spread-F are generally much smaller than those associated with sporadic-E.

**CHARACTERISTICS OF THE
IONOSPHERE**

10.13 The composition of the atmosphere, especially at the higher altitudes, varies with the time of day and with the degree of solar activity; however, a general description that is applicable to daytime conditions and mean sunspot activity is sufficient for the present purpose. Near the earth's surface, the principal constituents of the atmosphere are molecular nitrogen (N_2) and molecular oxygen (O_2). These diatomic gases continue to be the dominant ones up to an altitude of approximately 75 miles. At about 55 miles, ultraviolet radiation from the sun begins to dissociate the oxygen molecules into two atoms of oxygen (O). The extent of

dissociation increases with altitude, so that above 120 miles or so, oxygen atoms are the dominant species in the low-pressure atmosphere. This condition persists up to an altitude of some 600 miles. Ozone (O_3) and nitric oxide (NO) are formed in the lower atmosphere by the action of solar radiations on the oxygen and nitrogen. Although the amounts of ozone and nitric oxide are quite small, they are important because each absorbs radiation and enters into chemical reactions in a characteristic manner.

10.14 The electrons (and positive ions) in the normal ionosphere are produced by the interactions of solar radiations of short wavelength with the various molecular and atomic species present in the atmosphere. In the D-region, the ions are almost exclusively NO^+ , and these ions are also the most important in the E-region; in the latter region, however, there are, in addition, about one-third as many O_2^+ ions. Atomic oxygen ions, O^+ , begin to appear in the upper parts of the E-region, and their proportion increases with altitude. In the F-region, the proportion of NO^+ and O_2^+ ions decreases, whereas that of O^+ increases steadily. Above an altitude of about 120 miles (up to 600 miles), O^+ ions are dominant.

10.15 The actual electron density at any altitude depends on the rate of formation of electrons as a result of ionization and their rate of removal, either by recombination with positive ions or by attachment to neutral particles (molecules or atoms). Recombination tends to be the more important removal process at high altitudes (low atmospheric pressure), whereas attachment to neutral particles predominates at lower alti-

tudes, where molecular nitrogen and oxygen are the main components of the atmosphere.

10.16 At altitudes below about 30 miles, i.e., below the D-region, where the air is relatively dense, the probability of interaction between free electrons and neutral molecules is large. The few electrons that are produced by short-wavelength solar radiation that penetrates so low into the atmosphere are thus rapidly removed by attachment. The density of free electrons in the atmosphere below about 30 miles is consequently so small that it can be neglected.

10.17 In the altitude range from roughly 30 to 55 miles (D-region of the ionosphere), the density of neutral particles is relatively low, between about 10^{-3} and 10^{-5} of the sea-level density. Because of this low density, the rate of attachment is not large and electrons remain free for several minutes. The average lifetime varies with location and the time of the year, but it is long enough for the radiation from the sun to maintain a peak density between about 10^2 and 10^3 electrons per cubic centimeter (electrons/cm³) in the daytime. At night, when electrons are no longer being generated by solar radiations, the free electrons in the D-region disappear. Although the density of neutral particles is small enough to permit the electrons (in the daytime) to have an appreciable average life, it is nevertheless sufficiently large for collisions to cause considerable attenuation of electromagnetic waves, in the manner described in § 10.05.

10.18 In the E-region of the ionosphere (55 to 95 miles altitude), the air density is quite low, about 10^{-5} to 10^{-8}

of the sea-level value, and the average lifetime of electrons is even longer than in the D-region. The daytime electron density is about 10^3 to 10^5 electrons/cm³, but most of the ionization, as in the D-region, disappears at night. However, because of the very low density of neutral particles, the frequency of collisions between them and electrons is so small that there is relatively little attenuation of electromagnetic signals in the E-region. If sporadic-E conditions exist, radio signals are reflected (§ 10.08) in an erratic manner.

10.19 The F-region extends upward from an altitude of about 95 miles. Here the neutral-particle density is so low that free electrons have extremely long lifetimes. At about 190 miles, the peak electron density in the daytime is approximately 10^6 electrons/cm³, decreasing to about 10^5 electrons/cm³ at night. During the day there are various layers of ionization in the F-region, which tend to merge and lose their identity at night. The altitude of peak ionization may also shift at night. Other factors causing changes in the F-region were referred to earlier (§ 10.12). Attenuation of electromagnetic signals in the F-region is

small, despite the high electron density, because of the very low electron-neutral collision frequency; however, reflection effects (§ 10.08) make the region important.

10.20 Normally, the low electron densities in the D-region are sufficient to reflect back to earth only those electromagnetic waves with frequencies below about 1 million hertz, i.e., 1 megahertz (§ 1.74), provided the angle of incidence is small. At larger angles, the limiting frequency for reflection by the normal D-region is increasingly less than 1 megahertz. Waves of higher frequency pass through the D-region, with some refraction (bending) and attenuation, and penetrate into the E-region or into the F-region if the frequencies are high enough. Reflection may then occur in the E- or F-region, where the electron densities are higher than in the D-region. For a given angle of incidence, the electron density required for reflection increases with the frequency of the electromagnetic wave. The smaller the angle of incidence, i.e., the more nearly vertical the direction of propagation, the higher the frequency that will be reflected by a given electron density.

IONIZATION PRODUCED BY NUCLEAR EXPLOSIONS

INTRODUCTION

10.21 Up to three-fourths of the energy yield of a nuclear explosion may be expended in ionizing the atmosphere. The resulting changes are characteristic of the given weapon and of the burst and debris altitudes. The ionization effects caused by the nuclear and thermal radi-

ations from a low-altitude nuclear explosion are much more intense within a limited volume of space, i.e., in and near the fireball, than the changes produced naturally, e.g., by solar flares. Nuclear explosions at high altitudes may affect a considerable portion of the ionosphere in ways somewhat similar to

changes in solar activity; however, the mechanisms and details of the interactions with the atmosphere are quite different. Because of the complexities of these interactions, descriptions of "typical" changes to be expected from a nuclear explosion are often not applicable or even very meaningful. A careful analysis of each situation, with the conditions stated fairly explicitly, is usually necessary.

10.22 Atmospheric ionization and disturbances to the propagation of electromagnetic signals caused by a nuclear explosion can be described in terms of four spatial regions: (1) the hot fireball, (2) the atmosphere surrounding the fireball, (3) the D-region, and (4) the high-altitude region which includes the normal E- and F-regions of the ionosphere.

10.23 Fireballs from explosions at low altitude are relatively small (roughly, a 1-megaton explosion at sea level produces a fireball of about 0.6 mile diameter at 1 second). The air inside the fireball is at a temperature of many thousands of degrees. Electron density and collision frequency are high, and the absorption of electromagnetic waves is so large that the fireball is considered to be opaque. At intermediate burst altitudes (up to about 50 or 60 miles), the early fireball is larger in size, but it is still defined as a hot, ionized mass of air which is opaque to radio and radar signals for many seconds. With increasing altitude the characteristics of the region of energy absorption change. At burst altitudes above about 190 miles, the atmosphere is very thin and the energy from the nuclear explosion can spread over very large distances.

10.24 When the burst point is below the D-region, the atmosphere

around the fireball is ionized in varying degrees by the initial thermal and nuclear radiations and by the delayed gamma rays and beta particles from the radioactive debris. The chemistry of the atmosphere may be modified significantly, thus making predictions of electron persistence difficult (and greatly complicating the problem of analyzing multiple-burst situations). For near-surface explosions, the density of the air prevents radiation from escaping very far from the fireball, and the ionization is both localized and short-lived due to very rapid attachment of free electrons to neutral particles. As the detonation altitude is increased the radiation can escape to greater distances, and the electron density will reach values at which electromagnetic signal propagation can be affected.

10.25 When prompt or delayed radiation from the explosion can reach the D-region, the electron density of that region is enhanced. Most of the widespread and persistent absorption of electromagnetic waves then takes place in and near the D-region of the normal ionosphere. For electromagnetic waves in the radio and radar frequency ranges, circumstances are such that the maximum attenuation usually occurs within a layer 10 miles deep centered at an altitude of about 40 miles (§ 10.128). Hence, most of the subsequent discussion pertaining to D-region ionization will be in terms of the free electron density at an altitude of 40 miles.

10.26 In the E- and F-regions of the ionosphere, the frequency of electron-neutral particle collisions is low, and refraction rather than absorption is generally the predominant effect. When the burst or debris altitude is high enough

for prompt or delayed radiation to reach the E- and F-regions, the electron density of those regions may be increased. On the other hand, nuclear explosions sometimes cause a decrease of electron density in the E- and F-regions, largely due to traveling hydrodynamic and hydromagnetic disturbances² and to changes in air chemistry (§ 10.71 *et seq.*).

10.27 Increased ionization in the D-region may occur not only in the vicinity of the nuclear explosion, but also at its magnetic conjugate in the earth's opposite hemisphere (§ 2.143). Charged particles, especially beta particles (electrons), resulting from the explosion will spiral along the earth's magnetic field lines. Upon reaching the conjugate region, the beta particles will cause ionization similar to that produced near the burst point.

ENERGY DEPOSITION

10.28 A detailed analysis of energy deposition, the starting point for examining the effects of nuclear explosions on the propagation of radio and radar signals, is very complicated. The fundamental principles, however, are well known and relatively simple. Consider ionizing radiation entering the earth's atmosphere from a nuclear explosion at high altitude or, as it normally does, from the sun. As it travels downward, the radiation at first encounters air of such low density that very few interactions occur with atmospheric atoms and molecules. Hence, very little ionization is produced. As the air density increases

with decreasing altitude, interactions of the atoms and molecules with the radiation take place at rapidly increasing rates and energy is removed from the radiation.

10.29 The concept of "stopping altitude" provides a useful approximate model for treating the interaction of ionizing radiation and the atmosphere in which the density changes with altitude. The stopping altitude for a given type of radiation is the level in the atmosphere to which that radiation coming from above will penetrate before losing so much of its energy that it produces little further ionization. The radiation is then said to have been "stopped." Most of the energy will actually be deposited within a few miles of the stopping altitude. Only a small proportion of the energy is absorbed at the higher altitudes where the air has a lower density and is relatively transparent to the radiation, and little energy remains to be given up at lower altitudes. Different types of radiation deposit their energy in the atmosphere in different ways and thus have different stopping altitudes. Table 10.29 shows approximate stopping altitudes for various ionizing outputs from a typical nuclear explosion. The altitude quoted for debris ions refers to ionization that results from the random (thermal) motion of these ions. The debris mass can, however, be carried to greater heights by the rising fireball and cause ionization by the emission of delayed radiations.

10.30 For detonations below 15 miles altitude, the minimum stopping altitude in Table 10.29, the air is essen-

²A hydrodynamic disturbance of the atmosphere is a direct result of the shock wave. The air is ionized and so its motion is affected by the earth's magnetic field. The combination of hydrodynamic and magnetic effects leads to hydromagnetic (or magnetohydrodynamic) disturbances.

Table 10.29**APPROXIMATE STOPPING ALTITUDES FOR PRINCIPAL WEAPON OUTPUTS
CAUSING IONIZATION**

Weapon Output	Stopping Altitude (miles)
Prompt radiation	
X rays	35 to 55
Neutrons and gamma rays	15
Debris ions	70
Delayed radiation	
Gamma rays	15
Beta particles	35

tially opaque to all ionizing radiations. The radiation will penetrate only a fairly short distance into the atmosphere before most of its energy is absorbed in causing ionization (or is transformed into other kinds of energy). As the altitude of the explosion increases to 15 miles and above, the radiation can escape to increasingly greater distances. Once the stopping altitude for a given ionizing radiation is reached, the atmosphere above the burst is relatively transparent to that radiation, which can then travel upward and outward to great distances.

10.31 Below the stopping altitude, in a region of uniform density, the nominal penetration distance of ionizing radiation of a particular kind and energy is inversely proportional to the air density. (The penetration distance is often expressed in terms of the mean free path, as described in § 2.113.) For a particular radiation of a single energy traveling through an undisturbed region of constant density, the penetration distance (or mean free path) can be calculated relatively easily. For a radiation spectrum covering a range of energies and for complex paths along which the air density changes, the computations

are more laborious. For a disturbed atmosphere, calculations of the penetration distance are difficult and not very reliable.

LOCATION OF RESULTANT IONIZATION

10.32 The region of maximum energy deposition is the location where ion-pair production is the greatest, but it is not always the location of the maximum density of free electrons. At altitudes below about 30 miles, i.e., at relatively high air densities, removal processes are so rapid that the average lifetime of a free electron is a fraction of a second. An extremely high ion-pair production rate is then required to sustain even a few free electrons per cubic centimeter. But in the D-region (starting at about 30 miles altitude) removal processes are not so rapid and higher electron densities are possible. For the delayed gamma rays, for example, the stopping altitude, i.e., the region of maximum energy deposition and ion-pair production rate, is 15 miles; however, the resultant electron density tends to a maximum at a higher altitude in the D-region.

10.33 To understand the ionization resulting from nuclear explosions, it is helpful to examine four detonation altitude regimes separately; they are: (1) below 10 miles, (2) between 10 and 40 miles, (3) between 40 and 65 miles, and (4) above 65 miles. Different mechanisms associated with various burst heights will be considered, but it should be understood that these altitude regimes are somewhat arbitrary and are chosen for convenience in bringing out the changes in behavior that occur with burst height. Actually, there are no lines of demarcation between the various altitude ranges; the changes are continuous, and one type of mechanism gradually supersedes another and becomes dominant. The four spatial regions where there may be significant effects (§ 10.22) also shift in importance as the altitudes of the detonation and of the radioactive debris change.

DETONATIONS BELOW 10 MILES ALTITUDE

10.34 For nuclear explosions at altitudes below 10 miles (and somewhat higher), most of the energy is deposited in the atmosphere in the immediate vicinity of the detonation, resulting in the formation of the fireball and the air blast wave, as described in Chapter II. The electron density within the fireball, initially at least equal to the particle density (about $10^{19}/\text{cm}^3$), will remain above about 10^8 electrons/ cm^3 for times up to 3 and 4 minutes, depending on the nature of the weapon. For about 10 seconds the fireball temperature will be high enough (above $2,500^\circ$ Kelvin) to cause significant ionization of the air by the thermal radiation (§ 10.04). After this period,

beta radiation from the radioactive debris within the fireball may sustain the ionization level for up to 3 or 4 minutes. Thus, the fireball region will be sufficiently ionized to absorb electromagnetic signals for a period of at least 10 seconds and possible for as long as 3 or 4 minutes; however, the spatial extent of the ionization will be small.

10.35 The fireball will be spherical in shape initially. After a few seconds, as the hot fireball rises upward buoyantly (§ 2.129), it will take the form of a torus. The torus, having lost its luminous qualities, will coalesce into a flattened cloud shape. The transition from a fireball or torus to a debris cloud is indefinite, but at late enough times—after a few minutes—the fireball as such will cease to exist, and only a cloud of radioactive debris will remain. This cloud will reach a final stabilization altitude in about 5 minutes. It will then be spread by whatever winds prevail at that altitude range. Typically, the average spreading velocity is about 35 feet per second.

10.36 The atmosphere surrounding the fireball will be ionized by prompt neutrons and by prompt gamma radiation, but the free electrons thus formed will persist less than a second. The air will also be ionized by the delayed radiation emitted continuously from the radioactive debris within the fireball. Close to the fireball, the continuous emission from the adjacent gamma-ray source will result in a high electron density in spite of the fairly rapid removal of electrons by attachment of air particles at the low altitudes under consideration. Thus, for detonations below 10 miles, there will be a region surrounding the fireball which will absorb

electromagnetic waves appreciably for tens of seconds. This effect will be negligible for most radiofrequency systems, but it may be significant for radars with highly directional beams that pass fairly near (in addition to those passing through) the fireball.

10.37 In the atmosphere around the region referred to above, the electron density will be much lower because the gamma rays are somewhat attenuated by the air, and the electrons that are formed are removed rapidly by attachment. Hence, the number of free electrons is not expected to be as large, neither will they be as widely distributed, as in the region around the fireball for bursts at higher altitudes (§ 10.43 *et seq.*). Refraction of radar signals (§ 10.118) and clutter (§ 10.120) may then be more significant than absorption. These effects are also important if the signals pass through or near the stem or cloud of a burst that is sufficiently low for debris from the surface to be carried aloft.

10.38 The D-region is not affected to any great extent by prompt radiation from nuclear explosions below 10 miles, since the burst is below the stopping altitude for X rays, neutrons, and gamma rays (Table 10.29). Ionization in the D-region may be increased, however, by delayed radiation, if the radioactive debris is carried upward by the rising fireball above 15 miles, the stopping altitude for gamma radiation. There may be additional ionization due to beta particles if the debris rises as high as 35 miles, but this is expected only for weapons of large yield (see Fig. 10.158c).

10.39 Ionization in the E- and F-regions is not changed significantly by

radiation from a nuclear explosion below 10 miles, except possibly by the rising debris from a high-yield burst (cf. § 10.41). However, perturbations in the refractive properties of the F-region have been noted following explosions in this altitude regime. Traveling disturbances (§ 10.26) that move outward in the E- and lower F-regions appear to result from the initial blast wave.

DETONATIONS AT 10 TO 40 MILES ALTITUDE

10.40 If the explosion occurs in the altitude regime of roughly 10 to 40 miles, thermal energy radiated as X rays will be deposited in the vicinity of the burst, as at lower altitudes, with subsequent reradiation to form the familiar fireball. Ionization by debris ions or by beta particles within the fireball may sustain the electron density after the temperature has fallen to the 2,500° Kelvin required for significant thermal ionization by air. The fireball region will be ionized to high levels—more than 10^7 electrons per cubic centimeter—for a period of at least 30 seconds and possibly for longer than 3 minutes. The spatial extent of the ionization will be larger than for detonations at the lower altitude considered previously.

10.41 The fireball will be spherical in shape initially, with the transition from sphere to torus occurring later than for bursts at lower altitudes. Furthermore, the debris, most of which is carried upward by the hot, rising fireball, may reach considerably greater heights. Multimegaton weapons detonated near the upper limit of the 10 to 40 miles altitude regime will begin to exhibit the effects of an initial ballistic impulse,

caused by pressure gradients across the large vertical diameter of the fireball (§ 2.129). As the fireball and debris rise into thinner air, they continue to expand. The ballistically rising fireball can reach altitudes far above the detonation point. Because of the rapid upward motion of the fireball and the decrease in atmospheric density with altitude, the density of the fireball may be greater than that of the surrounding atmosphere. Overshoot then occurs, and after reaching maximum altitude, the fireball descends until it encounters air of density comparable to its own.

10.42 When the cloud of debris stabilizes in altitude, its horizontal spread will be influenced by diffusion and by the prevailing winds. A spreading velocity of 165 feet per second is a reasonable estimate for debris at altitudes between about 50 and 125 miles; the spread is, however, more complex than is implied by such an assumption of a uniform expansion.

10.43 For bursts in the 10 to 40 miles altitude regime, the X rays are largely confined within the fireball, especially at the lower altitudes. Even though the prompt gamma rays carry only a small proportion of the explosion energy (§ 10.138), they will cause ionization in the surrounding air for a very short time. However, the main source of prompt ionization in the surrounding air (and also in the D-region for detonations above 15 miles) appears to be the fast neutrons. There are three important interaction processes of such neutrons with atomic nuclei in the atmosphere which can lead to ionization; they are absorption, inelastic scattering, and elastic scattering (see Chapter VIII). The amount of absorption is small for

fast neutrons and the inelastic scattering gamma rays are spread over a large volume, so that the resulting electron density is low. Most of the neutron-induced (prompt) ionization arises from elastic scattering of the neutrons. The nuclei that recoil from the scattering process have sufficient energy to produce ionization by interaction with atmospheric atoms and molecules.

10.44 The persistent ionization in the air is caused mainly, however, by delayed gamma radiation. Most of the beta particles from the radioactive debris are absorbed within the fireball, but the gamma rays can travel great distances when the debris is above their stopping altitude (15 miles). The size of the ionized region surrounding the fireball can then be quite large. Calculation of the electron densities is fairly complicated since it depends on the attenuation of the gamma rays by the atmosphere and the electron loss mechanisms which change with altitude.

10.45 Ionization in the D-region from delayed gamma rays and beta particles will be much more important for detonations in the 10 to 40 miles altitude regime than for those below 10 miles. If the debris attains an altitude above 15 miles, the delayed gamma rays can reach the D-region and produce ionization there. When the debris is below 35 miles, the stopping altitude for beta particles, the energy of these particles is deposited close to or within the debris cloud. The ionization is thus restricted to this region.

10.46 For the beta particles to cause ionization in the D-region, the debris must be above 35 miles. Because of their electric charge, the spread of the beta particles is largely prevented by the

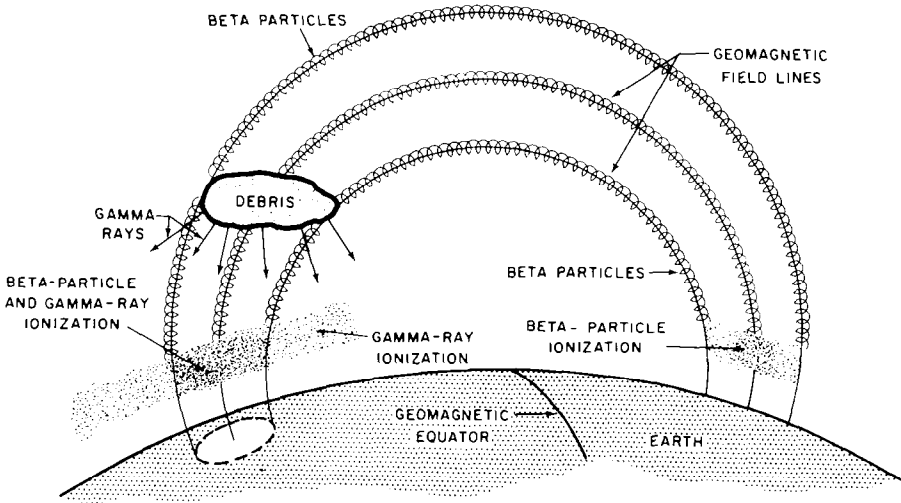

Figure 10.47. Location of beta and gamma ionization regions when the debris from an explosion in the northern hemisphere is above 40 miles altitude.

earth's magnetic (geomagnetic) field. The area over which the beta particles produce ionization in the D-region is thus essentially the same as the area of the debris when its initial expansion has ceased.

10.47 If the debris rises above 40 miles, the beta particles will travel back and forth along the geomagnetic field lines. They will then cause ionization in the local D-region and also in the magnetic conjugate region in the opposite hemisphere of the earth (Fig. 10.47). If the radioactive debris is uniformly distributed over a horizontal plane, the electron density in the D-region due to the beta particles will be about the same in both hemispheres. In practice, atmospheric winds and turbulence and geomagnetic anomalies cause the distribution of the debris to be nonuniform, but a uniform distribution is generally assumed for estimating electron densities resulting from nuclear explosions.

10.48 Unlike the beta particles, the

gamma rays are not affected by the geomagnetic field and they can therefore spread in all directions. If the debris rises above 40 miles, the delayed gammas can produce ionization over a large area in the D-region. The ionization is not restricted by the tube of magnetic field lines containing the debris, as is that from the beta particles. The D-region ionization caused by the delayed gamma rays is thus more extensive in area although usually less intense than that due to the beta particles.

10.49 Since the beta particles are largely prevented from spreading by the geomagnetic field, the ionization they produce (in the D-region) is not greatly affected by the altitude to which the radioactive debris rises, provided it is above 40 miles. For the accompanying gamma radiation, however, the intensity, and hence the associated ionization, decreases the higher the altitude of the debris above the D-region. The areal

extent increases at the same time. Gamma-ray ionization in the magnetic conjugate region will be much smaller and will arise from such debris ions as have traveled along the geomagnetic field lines and reached the vicinity of the D-region in the other terrestrial hemisphere (§§ 2.141, 10.64).

10.50 There are two other sources of ionization in the conjugate region, namely, Compton electrons and neutrons. Gamma rays lose part of their energy in the atmosphere by Compton scattering (§ 8.89). If the Compton electrons are formed above about 40 miles, they will either deposit their energy (and cause ionization) locally in the D-region or be guided by the geomagnetic field to the conjugate region. Since delayed gamma rays are spread over a fairly large volume when the radioactive debris is above about 15 miles, Compton electrons can produce widespread ionization. The space affected is larger than that in which beta particles cause ionization in both conjugate regions. Although the ionization from Compton electrons in the magnetic conjugate region is not large, the effects on the propagation of electromagnetic waves, especially those of lower frequencies, can be important.

10.51 Many of the neutrons produced in a nuclear explosion above 15 miles will travel upward, escaping to high altitudes. Since neutrons are not affected by the geomagnetic field, they spread over a large region. A free neutron disintegrates spontaneously, with a half-life of about 12 minutes, into a proton and an electron (beta particle). The latter will be trapped by the geomagnetic field lines and will produce ionization in the D-region after follow-

ing a field line into the atmosphere, either in the vicinity of the explosion or at the magnetic conjugate. The ionization levels produced by neutrons in this manner are low, but they have been detected at distances of several thousand miles from the burst point. From the times at which the effects were observed, they could have been caused only by neutrons.

10.52 Thermal X rays begin to escape from the fireball for detonations in the upper portion of the 10 to 40 miles altitude regime and can cause appreciable ionization in the E-region above the burst point. Ionization in the E- and F-regions will be perturbed by traveling disturbances to a greater extent from detonations in this altitude regime than from explosions of similar yield below 10 miles. A high-yield detonation near 40 miles altitude may produce a region of severe electron density depletion (§ 10.71 *et seq.*). Fireballs rising above 65 miles and beta particles escaping from fission debris above 40 miles also increase the electron density in the E- and F-regions.

DETONATIONS AT 40 TO 65 MILES ALTITUDE

10.53 X rays ionize a region of considerable extent around a detonation in the 40 to 65 miles regime. The mechanism of fireball formation changes appreciably in this range (§ 2.130 *et seq.*), since at 65 miles the X-ray stopping altitude has been exceeded, and the radiations can spread very widely. Starting at about 50 miles altitude, the interaction of the expanding weapon debris with the atmosphere becomes the dominant mechanism pro-

ducing a fireball. Above about 50 miles, the geomagnetic field will influence the location and distribution of the late time fireball, as will be seen shortly. The 40 to 65 miles altitude regime is also a transitional one for deionization mechanisms in the fireball, and for the dynamic motion of the rising fireball.

10.54 Above about 40 miles, the temperature of the fireball is no longer the governing factor in ionization. The electron density changes only in accordance with the increase in volume of the fireball, thus causing a wider distribution of the free electrons in space. Recombination of electrons with positive atomic ions, produced by the high temperatures in the fireball, is the main removal process. This is, however, much slower than the recombination with molecular ions which predominates in the normal D- and E-regions. Electron densities greater than 10^8 electrons/cm³ can then persist for tens of seconds, resulting in significant attenuation and refraction of electromagnetic waves. The persistence depends on how rapidly the fireball volume increases and on the detailed chemistry of the fireball gases.

10.55 For explosions of high and moderately high yields at altitudes near the upper limit of the regime under consideration, the fireball may rise to heights of hundreds of miles (see Figs. 10.158b and c). At these heights, the fireball and debris regions will be affected by the geomagnetic field lines (§ 10.63 *et seq.*). For smaller yields, the fireball generally rises buoyantly and smoothly to a nominal stabilization altitude, with no overshoot (Fig. 10.158a). A spreading velocity of 165 feet per second is frequently used to make rough

estimates of debris motion for stabilization altitudes between 50 and 125 miles. If more than a rough estimate is required, upper-altitude wind information must be used to calculate the spreading velocity.

10.56 The region identified for lower altitude bursts as that around the fireball now merges into the D-, and E-, and F-regions. Hence, it will not be discussed separately here or in the next section which is concerned with detonations above 65 miles altitude.

10.57 The D-region is more widely influenced by prompt radiation from detonations above 40 miles than from detonations below that altitude, since both X rays and neutrons have longer penetration distances at the higher altitudes. For detonations above 40 miles, X rays produce essentially all the prompt ionization in the D-region. As indicated in § 10.43, fast neutrons are apparently the main source of prompt ionization in this region for detonations at somewhat lower altitudes.

10.58 Continuing ionization of the D-region by delayed gamma rays and beta particles is of major importance when the burst altitude is between 40 and 65 miles. The situation is similar to that described in § 10.47 for the case in which the debris rises to a height of more than 40 miles. The beta-particle ionization is restricted to areas, in the D-regions of both hemispheres of the earth, which are each roughly equal to the area of the debris. The delayed gamma rays spread in all directions, however, and the ionization in the D-region near the burst point is consequently more extensive in area but is less intense than that due to the beta particles. The upward motion of the

debris can allow the gamma rays to irradiate areas of the D-region several hundred miles in radius. It is apparent that the electron densities resulting from such widespread irradiation will generally be low.

10.59 Compton electrons from delayed gamma rays and beta particles formed by the spontaneous disintegration of neutrons can cause widespread, although relatively weak, ionization in the D-region near the burst point and also at its magnetic conjugate. The general effects are similar to those described in §§ 10.50 and 10.51 for nuclear detonations at lower altitude.

10.60 Detonations above 40 miles, and particularly those above 50 or 55 miles, will irradiate the E-region extensively with X rays. Consequently, there will be prompt ionization, with the usual fairly long E-region recovery time, in addition to that caused by the continuing radiations from the radioactive debris. Ionization effects in the E-region, similar to sporadic-E (§ 10.12), have been noted following detonations above 40 miles.

10.61 Strong F-region disturbances, involving an initial increase followed by a decrease in electron density, were observed over an area of more than a thousand miles in radius for many hours after the TEAK megaton-range burst at about 48 miles altitude (§ 2.52). The proposed explanation for these disturbances is given in § 10.71 *et seq.* There also appeared to be an effect similar to spread-F (§ 10.12) which ended at sunrise, and some tilting of the normal ionospheric stratification which altered the path of reflected radio signals. Similar but less severe effects were

noted after subsequent high-altitude explosions.

DETONATIONS ABOVE 65 MILES

10.62 The mechanisms of fireball formation and growth continue to change as the detonation altitude increases above 65 miles. At these altitudes, X rays travel great distances in the very low-density atmosphere and do not produce a normal fireball. Below about 190 miles, depending on the weapon yield, the energy initially appearing as the high outward velocity of debris particles will still be deposited within a fairly short distance. This results in the formation of a heated and ionized region. The apparent size of this so-called "fireball" region may depend on the manner in which it is viewed. The optical (or radiating) fireball may not coincide with the radar fireball, i.e., the region affecting radar signals, and the fireball boundary may not be well defined. Because of the large dimensions, times of the order of a few seconds may be required before the initial motion of the debris is reduced significantly.

10.63 The geomagnetic field plays an increasingly important role in controlling debris motion as the detonation altitude increases. Above about 300 miles, where the density of the atmosphere is very low, the geomagnetic field is the dominant factor slowing the outward expansion of the weapon debris. This debris is initially highly ionized and is consequently a good electrical conductor. As it expands, it pushes the geomagnetic field out ahead of it, and the magnetic pressure caused by the deformation of the field can slow down

and stop the debris expansion. The debris may expand hundreds of miles radially before being stopped by the magnetic pressure. The problem of the expansion of ionized debris against a magnetic field is quite complex. Instabilities in the interface between the expanding debris and the geomagnetic field can cause jetting of debris across field lines, and some debris can escape to great distances.

10.64 Debris initially directed downward will be stopped by the denser air below the burst point at an altitude of about 70 miles, whereas upward-directed debris travels for long distances. If, in being stopped by the atmosphere, the downward-directed debris heats and ionizes the air, that heated region will subsequently rise and expand. Some upward-directed, ionized debris will follow geomagnetic field lines and will reach the conjugate region in the other hemisphere of the earth.

10.65 The geomagnetic field will also play an important role in determining the continued growth and location of the ionized region once it has formed. Expansion along the field lines can continue after expansion across the field has stopped. Arcs (or tubes) of charged particles, mainly beta particles, may be formed, extending from one hemisphere to the other. Ionization will then occur in the upper atmosphere in each conjugate region. This may happen even for detonations below 65 miles if the fireball is still highly ionized after it reaches altitudes of a few hundred miles.

10.66 Within the fireball, the rapidly moving debris ions cause ionization of the air; each such ion can ionize many air molecules and atoms before losing its kinetic energy. Because of the

reduced air density above 65 miles, the initial ionization within the fireball is less than for detonations at lower altitudes. However, if expansion is largely along the geomagnetic field lines, decrease in electron density due to volume expansion may be relatively slow. Dimensions across the geomagnetic field are typically a few hundred miles after a few minutes.

10.67 As stated in § 10.54, electron recombination with positive atomic ions will proceed slowly, and electron densities in the fireball high enough to produce attenuation of radar signals may last up to a few minutes. Electron densities sufficient to affect electromagnetic signals of lower frequency may persist much longer. The formation, location, and extent of the ionized regions are dependent both on weapon characteristics and atmospheric composition and are difficult to predict.

10.68 Apart from the ionization within the fireball region due to the kinetic energy of the debris ions, the radioactive debris causes ionization (in the D-region), after the initial expansion has ceased. This ionization results from the emission of beta particles and delayed gamma rays. Hence, the location of the debris after the initial expansion is important.

10.69 Neutrons and X rays traveling downward from a burst above about 65 miles altitude will irradiate large areas of the D-region. Some widespread ionization of low intensity will also be caused by the decay of neutrons in the earth's magnetic field, as described in § 10.51.

10.70 The debris that is initially directed upward or jets across the field lines will be in a position to release beta

particles in locations and directions suitable for trapping in the earth's magnetic field. These particles, traveling back and forth along the field lines and drifting eastward in longitude around the earth, will spread within a few hours to form a shell of high-energy beta particles, i.e., electrons, completely around the earth (§ 2.147).

INDIRECT EFFECTS OF HIGH-ALTITUDE EXPLOSIONS

10.71 The electron density in the E- and F-regions of the ionosphere may be changed by effects associated with a nuclear explosion other than direct ionization. The most important of these effects are hydrodynamic (shock) and hydromagnetic disturbances (see § 10.26 footnote) and changes in air chemistry. As the shock wave from the detonation propagates through the atmosphere, the air in a given region experiences first a compression phase and then a suction phase (§ 3.04). During the compression phase, the density of the air, and hence of the electrons present, increases because of the decrease in volume. However, the combined effect of heating by compression and of expansion of the air during the suction phase may be a decrease in the electron density below the normal value.

10.72 The TEAK high-altitude shot produced a shock wave which propagated for several hundred miles from the burst point. As the shock passed a particular location, the electron densities in the E- and F-regions first increased and

then decreased well below normal until local sunrise (§ 10.61). Changes in the chemistry of the atmosphere may have been partly responsible for the decrease in electron density.

10.73 As the shock wave slows down, it eventually becomes an acoustic (or sound) wave, often called a gravity acoustic wave because it is propagated in a medium (the atmosphere) whose density variation is determined by gravity. Acoustic waves travel thousands of miles from the burst point and can cause perturbations in the E- and F-regions at great distances. These perturbations are evidently hydromagnetic in nature, since the electron densities, which are difficult to calculate, are apparently dependent on the direction of propagation of the acoustic waves relative to the local geomagnetic field lines.

10.74 As well as causing ionization, X rays from a nuclear explosion, like gamma rays, can produce excited states (§ 8.23) of atoms and molecules of the air in the E- and F-regions. These excited neutral particles can undergo chemical reactions which affect electron densities. If the detonation altitude is above about 200 miles, the resulting changes can be widespread and may last for several hours. The moderate decrease in electron density in the F-region, observed out to more than 600 miles from the burst point after the STARFISH PRIME event (1.4 megatons at 250 miles altitude), has been attributed to changes in air chemistry caused by X rays.

EFFECTS ON RADIO AND RADAR SIGNALS

SIGNAL DEGRADATION

10.75 Nuclear explosions can degrade, i.e., attenuate, distort, or interfere with, signals from radar, communication, navigation, and other systems employing electromagnetic waves propagated through the atmosphere. In general, systems that depend on the normal ionosphere for propagation by reflection or scattering, as will be described in due course, can be affected over large areas for periods ranging from minutes to hours following a single burst at high altitude. Electromagnetic waves that pass through the ionosphere, but do not rely on it for propagation, e.g., satellite communication and some radar systems, can also be affected, but usually only over localized regions and for periods of seconds to minutes. Systems which use waves that propagate below the ionosphere, along lines-of-sight between ground stations or between ground stations and aircraft, will not, in general, experience signal degradation.

10.76 The signal strength required for acceptable systems performance is usually given in terms of a signal-to-noise ratio. The term "noise" refers to random signals that may originate within the receiver itself or may arise from external sources, usually thunderstorms and other electrical disturbances in the atmosphere. Nuclear explosions can also generate noise. When the signal-to-noise ratio falls below a minimum acceptable level, system degradation occurs in the form of increased error rate, e.g., symbol or word errors for communications systems and false

or missed targets for radars. As the result of a nuclear explosion, the signal-to-noise ratio may be decreased by attenuation of the signal strength or by increase in noise (or by both).

10.77 Detailed analysis of system performance requires consideration of many factors. These include the following: the geographic and geomagnetic locations of the burst point and of the propagation paths; time variations of the electromagnetic transmission properties along these paths, i.e., propagation channel characteristics; the effect of these characteristics on the desired signal, on noise generated within the receiver, and on undesired signals reaching the receiver; the signal processing used; the system mission; and criteria of system performance.

SIGNAL ATTENUATION

10.78 Absorption of energy from the electromagnetic waves is the major source of signal attenuation following the detonation of a nuclear weapon. In general, the absorption produced by a certain electron density is related inversely to the square of the wave frequency (§ 10.130); hence, absorption is more important for low- than for high-frequency systems that use the ionosphere for long-range transmission. The extent of absorption depends strongly on the location of the transmission path relative to the burst point and to the time after the burst. Shortly after the explosion, absorption may be so intense that there is a blackout and communication is impossible. This will be followed by a

period of reduced system performance before fairly normal conditions are restored. The duration of the blackout, particularly for systems operating below about 30 megahertz, is generally long in comparison with that of reduced performance. Absorption may also affect received noise levels if the noise reaches the receiver via the ionosphere.

10.79 When the electron densities are decreased by the effects of a nuclear explosion, signal attenuation, especially in the frequency range between 3 and 30 megahertz, can result from loss of reflection (due to refraction) from the E- and F-region. Signals which would normally reach the receiver by reflection from the ionosphere may then be only weakly refracted so that they continue into space.

NOISE

10.80 Two noise sources from a nuclear detonation are thermal radiation from the fireball and synchrotron radiation from beta particles traveling along the geomagnetic field lines. The fireball may remain at temperatures above 1,000° Kelvin for a few hundred seconds and may produce considerable noise if the antenna is pointed at the fireball. Thermal noise generally will be significant only for systems with low (internal) receiver noise. The actual noise received will depend on the properties of the fireball, e.g., whether or not it is absorbing at the frequency of interest, the amount of attenuation outside the fireball, and the directivity of the receiving antenna.

10.81 Beta particles spiraling along the geomagnetic field lines radiate electromagnetic energy in the form of what

is known as "synchrotron radiation." This covers a range of frequencies, but is much more intense at low than at high frequencies. Synchrotron radiation picked up by an antenna will produce noise in the receiver. However, the noise level is relatively weak and is not significant except for very sensitive, low-frequency systems with the antenna beam at right angles to the geomagnetic field lines.

PHASE EFFECTS

10.82 In free space, the phase velocity of an electromagnetic wave, i.e., the rate of propagation of a plane of constant phase, is equal to the velocity of light in a vacuum. In an ionized medium, however, the phase velocity exceeds the velocity of light by an amount which depends on the frequency of the wave and the electron density of the medium. If an electromagnetic signal traverses a region that has become ionized by a nuclear detonation, it will consequently suffer phase changes. A communication system that uses phase information will thus be affected. Furthermore, because the phase velocity varies with the wave frequency, a signal consisting of waves of several frequencies, as is commonly the case, will be distorted because the phase relationships between the waves will be changed.

10.83 If the propagation path passes through regions of varying electron densities, that is to say, if the electron densities encountered by the signal vary with time, a frequency shift (Doppler shift) occurs. For wide-band communications systems there may then be interference between adjacent channels.

As a result, the effective (or useful) bandwidth would be decreased.

10.84 Although the phase velocity of electromagnetic waves is greater in an ionized medium than in free space, the group velocity, i.e., the velocity with which the signal energy is transmitted, is less than the velocity of light. The group velocity is also dependent on the wave frequency and the electron density of the medium. A signal passing through an ionized region thus suffers frequency-dependent time delays as compared with propagation through free space. This will cause various errors in radar systems, as will be seen in § 10.119.

REFRACTION AND SCATTERING EFFECTS

10.85 The phase change of an electromagnetic wave in an ionized medium is related to the refractive index of the wave in this medium (§ 10.125). The index of refraction in free space is unity, but in an ionized region it is less than unity by an amount that increases with the electron density, for waves of a given frequency. As a result, the direction of propagation of an electromagnetic wave is changed in passing from free space, i.e., the nonionized (or very weakly ionized) atmosphere, into a region of significant ionization. This is the basis of the refraction (or bending) of electromagnetic waves by an ionized medium described in § 10.08. The wave is always bent away from the region of lower refractive index (higher electron density) toward that of higher refractive index (lower electron density).

10.86 If an electromagnetic wave is propagated through a region of increas-

ing electron density, i.e., of decreasing refractive index, the continued refraction may cause the wave to return to the region of low electron density from which it originally came. The wave is then said to be reflected. By increasing the electron density in the ionosphere, a nuclear detonation will change the reflection altitude of electromagnetic waves coming from the earth. Thus, systems that rely on reflection from the ionosphere for long-range communications can be adversely affected by the detonation. Even if reflected signals are not normally used, unwanted reflected signals may cause interference with the desired direct signals.

10.87 When an electromagnetic wave encounters patches (or blobs) of irregular ionization, successive refractions may lead to more-or-less random changes in the direction of propagation. This is referred to as "scattering." The term "forward scattering" is used when the propagation after scattering is in the same general direction as before scattering. If the electromagnetic wave is scattered toward the location from which it came, the effect is described as "backscattering."

10.88 Reflection and scattering of electromagnetic waves from ionized regions produced by a nuclear explosion can result in abnormal propagation paths between transmitter and receiver of a radio system. Multipath interference, which occurs when a desired signal reaches the receiver after traversing two or more separate paths, produces fading and signal distortion. Interfering signals, due to anomalous propagation from other radio transmitters, can increase noise levels to such an extent that the desired signal might be masked. In

radar systems, changes in the propagation direction due to refraction can cause angular errors. Moreover, if a radar signal is scattered back to the receiver, it can mask desired target returns or, depending on the characteristics of the scattering medium, it may generate a false target (§ 10.120 *et seq.*).

RADIO COMMUNICATIONS SYSTEMS

10.89 The general category of radio systems of interest includes those in which electromagnetic waves are reflected or scattered from the troposphere (§ 9.126) or the ionosphere. Such systems are used primarily for long-distance communications; however, other uses, e.g., over-the-horizon radars, also fall in this category.

10.90 Detailed analysis of communications systems, even for the normal atmosphere, is difficult and depends largely on the use of empirical data. Measurements made during nuclear tests have shown that both degradation and enhancement of signals can occur. The limited information available, however, has been obtained in tests for

weapon yields and detonation altitudes which were not necessarily those that would maximize the effects on communications systems.

10.91 It is convenient to discuss radio system effects in accordance with the conventional division of the radio-frequency spectrum into decades of frequency ranges. These ranges, with associated frequencies and wavelengths, are given in Table 10.91. Radar systems, which normally employ the frequency range of VHF or higher, are treated separately in § 10.114 *et seq.*

VERY-LOW-FREQUENCY RANGE (3 to 30 kHz)

10.92 The frequencies in the VLF band are low enough for fewer than 100 free electrons/cm³ to cause reflection of the signal (§ 10.20). The bottom of the ionosphere thus effectively acts as a sharp boundary which is not penetrated, and the electromagnetic radiation is confined between the earth and the ionosphere by repeated reflections. The resulting "sky wave," as it is called, may be regarded as traveling along a duct (or

Table 10.91

RADIOFREQUENCY SPECTRUM

Name of Range		Frequency Range*	Wavelength Range
Very Low Frequency	VLF	3-30 kHz	10 ⁷ -10 ⁶ cm
Low Frequency	LF	30-300 kHz	10 ⁶ -10 ⁵ cm
Medium Frequency	MF	300-3,000 kHz	10 ⁵ -10 ⁴ cm
High Frequency	HF	3-30 MHz	10 ⁴ -10 ³ cm
Very High Frequency	VHF	30-300 MHz	10 ³ -10 ² cm
Ultra High Frequency	UHF	300-3,000 MHz	10 ² -10 cm
Super High Frequency	SHF	3-30 GHz	10- 1 cm
Extremely High Frequency	EHF	30-300 GHz	10- 1 mm

*The abbreviation kHz, MHz, and GHz refer to kilohertz (10³ cycles/sec), megahertz (10⁶ cycles/sec), and gigahertz (10⁹ cycles/sec), respectively.

guide) whose boundaries are the earth and that level in the atmosphere at which the electron density is about 100 electrons per cubic centimeter. There is also a "ground wave" whereby the signal is transmitted along the surface of the earth and tends to follow its curvature. Global VLF broadcast communications and maritime and aerial navigation systems use the long propagation distances that are possible because ground wave attenuation is relatively low and the sky wave is reflected at the bottom of the ionosphere with little absorption.

10.93 The major effect of nuclear detonations is to cause ionization i.e., an increase in electron density, which may lower the ionospheric reflection altitude. Theoretical analyses and experimental data indicate that the major consequences are phase anomalies and changes in signal strength and in the noise from distant thunderstorms. These effects are expected to persist longer in the daytime than at night because of the slower decay of the electron density, assuming the same weapon yield and burst altitude.

10.94 Phase changes may be large and rapid, e.g., 1,000 degrees or so within a millisecond, and they are followed by a slow recovery of a few degrees per second. Such phase changes may be significant for navigation, synchronous communications, and phase modulation systems. VLF systems operating over short, medium, or long distances can be affected by the phase changes that result from the ionization produced by a nuclear explosion.

10.95 On paths of medium length,

where both ground and sky waves are received, the change in phase of the sky wave may result in mutual interference of the two signals. There will then be a reduction in the strength of the processed signal. Over relatively short transmission paths, when only the ground wave is normally used, the change in reflection altitude may cause the sky wave to be received. This may enhance or interfere with the ground wave, according to circumstances. For long-distance VLF communications, when only the sky wave is important, a nuclear explosion can cause large phase changes even at a distance. Thus, after the TEAK and ORANGE high-altitude shots (§ 2.52), the 18.6-kilohertz signal transmitted from the Naval Radio Station at Seattle, Washington, to Cambridge, Massachusetts, suffered an abrupt phase shift. The entire path was at least 3,000 miles from the burst points.

10.96 Distant thunderstorms produce some atmospheric noise in the VLF band, the noise level depending on the ionospheric reflection height. Hence, a change in this height can affect the signal-to-noise ratio. The system degradation or improvement following a nuclear detonation will depend on the relative geographic locations of the signal source, the noise source, the ionization produced, and the propagation path. Reduction of the signal-to-noise ratio appears to be significant primarily for long transmission paths with ionospheric reflection. A single high-altitude explosion or multiple explosions which produce ionization affecting appreciable portions of a propagation path will result in maximum degradation.

LOW-FREQUENCY RANGE (30 TO 300 kHz)

10.97 As the electromagnetic wave frequency is increased above 30 kilohertz, the normal ionosphere behaves much less as a sharp boundary. The wave penetrates several miles before being reflected back toward the earth. The altitude to which the wave penetrates and the attenuation normally experienced depend strongly on the magnitude and the rate of vertical change, i.e., the gradient, of electron density at the bottom of the ionosphere. Reflection extends the useful range of propagation, particularly at night when ionization in the lower D-region is normally absent. Attenuation of the sky wave increases in the daytime, especially for the higher frequencies because of their greater penetration. Although ground waves are commonly used for LF transmissions, sky waves often provide acceptable signals a few thousand miles from the transmitting station.

10.98 Ionization from nuclear explosions will generally not degrade the performance of LF systems which normally depend only on the ground wave unless the change in reflection altitude causes the sky wave to be received. As with VLF, this may enhance or interfere with the ground wave according to the circumstances; however, reception of the sky wave is less likely for LF than for VLF. Systems which rely on sky-wave propagation may experience attenuation lasting from a few minutes to several hours. For a given yield and burst height, the duration of the disturbance may be expected to be greatest in the daytime. The most severe attenuation appears to occur for long paths,

when ionization produced by the detonation affects appreciable portions of the propagation path. Furthermore, large phase shifts can occur.

MEDIUM-FREQUENCY RANGE (300kHz TO 3 MHz)

10.99 Normal propagation in the MF band is characterized by large attenuation of sky waves in the daytime, limiting communication at such times to ground waves. Increase of ionization in the D-region from high-altitude nuclear explosions will cause further attenuation of MF sky waves, and propagation may be limited to the ground wave during both day and night. In regions near the burst (or its magnetic conjugate) the sky wave may be blacked out for hours. Since atmospheric noise propagated by the ionosphere is a principal source of interference, absorption in the D-region may improve ground-wave reception for some paths. However, the limiting signal-to-noise ratio is determined primarily by local thunderstorm activity. Reduction of noise from distant thunderstorms will thus not improve marginal reception.

HIGH-FREQUENCY RANGE (3 TO 30 MHz)

10.100 The HF band is used extensively for long-range communications; the frequencies are high enough to permit transmission of information at a rapid rate and yet are sufficiently low to be reflected by the ionosphere. The signals are propagated from the transmitter to a receiver by successive reflections from the E- or F-region and the surface of the earth. Electromagnetic waves

with frequencies toward the lower end of the HF range are normally reflected from the E-region of the ionosphere after suffering some attenuation by absorption in the D-region. Reflection at the upper end of the range requires higher electron densities and occurs from the F-region (§ 10.135).

10.101 If a nuclear explosion increases the electron density in the D-region above its usual maximum value of about 10^3 electrons/cm³, signal attenuation by absorption will be increased. Furthermore, the increase in electron density may lower the reflection altitude and thus change the propagation path of the signal. Communications (and other) systems using the HF range can thus be seriously degraded. Disturbances resulting from an increase in the D-region electron density will persist longer in the daytime than at night, but decreases in the E- and F-regions may reverse the situation (§ 10.105).

10.102 Both prompt and delayed radiations from a nuclear burst can produce sufficient ionization to cause blackout of HF signals, lasting from a few seconds to several hours. The recovery time depends, among other things, on the weapon yield and the detonation altitude. The period during which the system is degraded is greater for lower than for higher frequencies, because a higher electron density is required in the latter case, and it increases with the number of times the propagation path traverses the region of enhanced ionization.

10.103 The effect of prompt radiation is greatest for high-altitude explosions. Thus, a megaton burst at a height of 200 miles in the daytime would be expected to disrupt HF systems out to a

distance of about 1,500 miles from the burst point. Recovery would require from a few hundred to a few thousand seconds, depending on the explosion yield, the signal frequency, and the number of traversals of the D-region made by the electromagnetic wave in its successive reflections from transmitter to receiver.

10.104 The signal degradation due to delayed radiations also varies with the explosion yield and altitude. For weapons detonated at low altitudes, in which the radioactive residues do not rise above 15 miles, the effects on HF systems will generally be small, except for propagation paths close to the burst point. If the debris reaches an altitude above 15 miles but below about 35 to 40 miles, the D-region above the debris will be ionized by delayed gamma rays and possibly by beta particles (§ 10.46). Should the debris rise above 40 miles, the beta particles will cause ionization both in the burst region and in the magnetic conjugate region. In the low-altitude detonation of weapons of large yield, the debris may rise above 15 miles and significant attenuation of HF signals can occur for propagation paths within several hundred miles of the burst point. For high-altitude detonation of such weapons, blackout may persist for many hours over regions thousands of miles in diameter. Even kiloton-yield detonations at very high altitudes may cause daytime blackout of HF systems over considerable areas for periods of minutes to tens of minutes.

10.105 Nuclear explosions may also affect HF communications by a decrease in the electron density in the E- and F-regions which changes their reflection characteristics. Following the

TEAK shot (in the D-region), the maximum usable frequency for long-distance communication was reduced over an area some thousands of miles in radius for a period lasting from shortly after midnight until sunrise (cf. § 10.72). Such severe changes in the reflection properties of the ionosphere were not noted, however, during the FISHBOWL high-altitude test series (§ 2.52). Nevertheless, electron depletion in the E- and F-regions is expected to be a significant degradation factor following large-yield detonations above about 65 miles during the nighttime. Restoration of the normal electron density following a daytime explosion of the same type should occur more rapidly.

10.106 For three events at the highest altitudes in the FISHBOWL series, a number of new propagation modes were noted; in some cases the use of exceptionally high frequencies, well into the VHF range, became possible. When such modes were in existence, in addition to the normal modes, considerable multipath propagation was experienced. The usefulness of the new modes depends markedly on the relative geometry of the transmitter and receiver, and on the reflection mechanism.

10.107 It is important to mention that, although HF communications can be degraded seriously by a nuclear explosion at high altitude, radio systems operating in this band may still be able to perform substantial portions of their mission in some circumstances. It is by no means certain, for example, that HF systems will be blacked out completely if the transmission path is at some distance from the burst point.

VERY-HIGH-FREQUENCY RANGE (30 TO 300 MHz)

10.108 Signals in the VHF range penetrate the normal ionosphere and escape from the earth. Consequently, this frequency range is primarily used for line-of-sight communications over short distances, e.g., commercial television channels and FM radio, but long-range communication is possible by making use of the small amount of transmitted energy that is scattered back to earth in a forward direction by patches of unusually intense ionization. Forward propagation ionospheric scatter (FPIS) systems are inefficient, since only a minute fraction of the energy of the transmitter reaches the receiver, but they make additional portions of the electromagnetic spectrum available for fairly reliable communication between ground stations at distances up to 1,500 miles apart.

10.109 Normally, VHF signals scatter from ionization irregularities caused by meteor trails or by turbulence in the upper part of the D-region. Since scattering from meteor trails occurs at altitudes of about 60 miles or more, the propagation path must traverse the region of maximum absorption (around 40 miles altitude) caused by delayed gamma and beta radiations from a nuclear burst. Meteor-scatter circuits normally operate with fairly small signal margins, and so absorption effects can be important.

10.110 Signals in FPIS systems scattered from irregularities in electron density caused by turbulence may be enhanced by the increased ionization from a nuclear explosion. However, absorption will reduce the signal return

from normal scatter heights to negligible magnitudes for only a short period of time. New propagation modes, produced by reflection from increased ionization in the F-region or by fireball ionization, can cause a multipath condition which will reduce the effective circuit bandwidth. Following the KINGFISH event (submegaton yield in the E-region), the Midway-to-Kauai ionospheric-scatter circuit in the Pacific was required to operate on a reduced bandwidth for 21 minutes. Pacific FPIS systems also experienced about 30 seconds of blackout following the STARFISH PRIME test (§ 10.74).

10.111 Line-of-sight propagation traversing the D-region, e.g., satellite communications, can be degraded by absorption due to an increase in electron density arising from delayed radiation. The degradation may last for tens of minutes over regions of hundreds of miles in radius. Attenuation and signal distortion caused by fireball regions above about 60 miles may also affect communication systems operating in the VHF band.

ULTRA-HIGH FREQUENCY RANGE (300 MHz TO 3 GHz)

10.112 In the UHF band (and the upper part of the VHF band), forward scattering by neutral molecules and small particles in the troposphere (below about 12 miles) is used to extend propagation beyond the line of sight. Weapons detonated above the troposphere are not expected to affect tropospheric propagation paths. Bursts at lower altitude may cause degradation for a few seconds if the fireball rises through the propagation path. Significant multipath

propagation due to increased ionospheric ionization appears unlikely.

10.113 Line-of-sight propagation through the ionosphere, such as is used by UHF satellite links, can be degraded if the propagation path passes through or near the fireball. Ionization by delayed radiation, especially beta particles, can produce absorption lasting a few minutes over regions of from tens of miles to a few hundred miles in radius. If the ground-to-satellite propagation path moves rapidly, the degradation period will depend primarily on the relative geometry of the path and the disturbed region. Wide-band satellite signals can be degraded by signal distortion.

RADAR SYSTEM EFFECTS (VHF AND ABOVE)

10.114 Radar systems are similar to radio communications systems in the respect that a transmitter and receiver of electromagnetic waves are used. However, in radar the receiver is located near the transmitter and may use the same antenna, which typically is highly directional. The transmitted signal, consisting of a series of pulses, is in part reflected back to the receiver, like an echo, by objects in the path of the pulsed beam. From the direction of the antenna, the travel time of the signal, and its speed of propagation, information can be obtained concerning the location and movement of the source of the echo. Frequencies normally employed in this connection are in the VHF range and above. There is little effect of ionization on signals of these frequencies provided both the radar and the target are below the ionosphere.

10.115 If the signal must pass

through the ionosphere, however, the interference from nuclear detonations becomes important. Radar signals traversing the ionosphere will, like radio signals, be subject to attenuation. Although any additional attenuation is undesirable, the amount which can be tolerated varies widely with the type of radar and the purpose of the system. In search radars, for example, where it is desired to detect each target at the greatest possible range, i.e., just as soon as the target return becomes observable against the background noise, even the smallest additional signal loss results directly in shortening of the range at which a given target can be detected. A tracking or guidance radar in a weapon system, on the other hand, usually takes over its target, well inside its maximum detection range, from another (search) radar which has already detected and tracked the object. In this case the signal can be attenuated to a much greater degree before the radar loses its ability to acquire or track.

10.116 A large amount of attenuation by absorption occurs when the propagation path traverses a fireball. The attenuation is determined by the properties of the fireball and these are strongly dependent on altitude. In general, it can be said that fireballs will be opaque to radar signals operating at frequencies of 10 gigahertz (10^4 megahertz) and below, for periods of tens of seconds to a few minutes.

10.117 The ionized atmosphere surrounding the fireball will absorb radar frequencies below a few gigahertz, i.e., a few thousand megahertz, when the fireball is above about 10 miles. A smaller region adjacent to the fireball will have the same effect for

detonations at lower altitudes (§ 10.36). The degree and areal extent of the absorption can be calculated with reasonable reliability but lengthy computations are required.

10.118 Although absorption is generally the main source of degradation of radar systems, there are a number of other mechanisms which may be important in some cases. For example, the signal path may be bent by refraction when the electromagnetic wave traverses a medium in which the electron density changes along the path length. As a result, directional errors can occur. This effect may be significant if the signal passes close to the fireball, but outside the region in which absorption predominates, where the electron gradients are large, or if the signal traverses the E-region where the electron density is high and the rate of collision with other particles is low (§ 10.137).

10.119 The velocity of propagation of the radar signal that is detected is equal to the group velocity of the electromagnetic wave described in § 10.84; this determines the travel time of the signal from the transmitter to the target and back. Changes in the group velocity as a result of propagation through an ionized medium will change the signal travel time and will introduce an error in estimating the range of the target. Since the change in the group velocity varies with the wave frequency, radar systems using wide bandwidths will have different travel times over the range of frequencies present in the signal. The return signals will then arrive at different times, leading to what is called "dispersion." The phenomenon is characteristic of transmission through a

highly ionized medium and causes substantial range errors.

10.120 The fireball and the charged particles in the tube enclosed by the geomagnetic field lines (§ 10.65) may reflect or scatter radar waves, thus producing spurious signals which may be confused with target return signals. This effect, known as "clutter," may occur by reflection from rapidly changing gradients of electron density or as backscatter from irregular patches of ionization or from particulate matter thrown into the air when a fireball touches the surface. Clutter returns may be so intense as to affect radars in the same way that terrain features sometimes cause difficulties by reflecting energy back to the receiver thereby masking weak targets.

10.121 If part of the energy of the radar pulses returning from a target ex-

periences forward scattering through small angles, the signals reaching the receiver will fluctuate both in phase and amplitude. The resulting effect is referred to as "scintillation." The phase fluctuations are equivalent to fluctuations in the angle of arrival of the signals, so that the apparent position of the target will appear to move somewhat randomly. The amplitude fluctuations make target identification difficult for the signal processing system.

SUMMARY OF NUCLEAR
DETONATION EFFECTS

10.122 The general effects of nuclear detonations on the various radio-frequency ranges used in radio and radar systems are summarized in Table 10.122.

TECHNICAL ASPECTS OF RADIO AND RADAR EFFECTS³

DENSITY OF THE ATMOSPHERE AND
ALTITUDE

10.123 The decrease in density of the atmosphere with increasing altitude can be represented approximately by the equation

$$\rho(h) \approx \rho_0 e^{-h/H_p} \text{ g cm}^{-3}, \quad (10.123.1)$$

where $\rho(h)$ and ρ_0 are the densities, in g/cm^3 at height h and at sea level, respectively, and H_p is called the scale height; h and H_p must be expressed in the same units of length, e.g., miles. Because both temperature and composi-

tion of the air change with altitude, the scale height is not actually a constant. However, below about 60 miles, use of a constant density scale height of 4.3 miles in equation (10.123.1) gives a fairly good representation of the change in atmospheric density with altitude. For higher altitudes the density scale height increases, i.e., the density varies more slowly with altitude, but since altitudes below 60 miles are of primary interest for the present purpose, the simple exponential relationships with constant scale height will be employed.

³The remaining sections of this chapter may be omitted without loss of continuity.

Table 10.122

EFFECTS OF NUCLEAR DETONATIONS ON RADIO AND RADAR SYSTEMS

Frequency Band	Degradation Mechanism	Spatial Extent and Duration of Effects*	Comments
VLF	Phase changes, amplitude changes	Hundreds to thousands of miles; minutes to hours	Ground wave not affected, lowering of sky wave reflection height causes rapid phase change with slow recovery. Significant amplitude degradation of sky wave modes possible
LF	Absorption of sky waves, defocusing	Hundreds to thousands of miles; minutes to hours	Ground wave not affected, effects sensitive to relative geometry of burst and propagation path
MF	Absorption of sky waves, defocusing	Hundreds to thousands of miles; minutes to hours	Ground wave not affected
HF	Absorption of sky waves, loss of support for F-region reflection, multipath interference	Hundreds to thousands of miles, burst region and conjugate; minutes to hours	Daytime absorption larger than nighttime, F-region disturbances may result in new modes, multipath interference
VHF	Absorption, multipath interference, or false targets resulting from resolved multipath radar signals	Few miles to hundreds of miles; minutes to tens of minutes	Fireball and D-region absorption, FPIS circuits may experience attenuation or multipath interference
UHF	Absorption	Few miles to tens of miles; seconds to few minutes	Only important for line-of-sight propagation through highly ionized regions

*The magnitudes of spatial extent and duration are sensitive functions of detonation altitude and weapon yield.

10.124 By setting H_0 in equation (10.123.1) equal to 4.3 miles, the result is

$$\rho(h) \approx \rho_0 e^{-h/4.3} \quad (10.124.1)$$

and this expression, with h in miles, will be used later. If the base of the exponent is changed from e to 10, where $e \approx 10^{-2.3}$, then

$$\rho(h) \approx \rho_0 10^{-h/4.3 \times 2.3} \approx \rho_0 10^{-h/10}$$

It follows, therefore, that in the altitude range of interest, the density of the atmosphere decreases approximately by a factor of 10 for every 10 miles increase in altitude. Thus, at an altitude of 40 miles the air density is about 10^{-4} and at 60 miles roughly 10^{-6} of the sea-level density.

ATTENUATION AND REFRACTION OF ELECTROMAGNETIC WAVES

10.125 The propagation of electromagnetic waves of a given frequency through a medium can be described in terms of a "complex" index of refraction, consisting of a real part and an imaginary part. The real part is a phase factor which determines the phase shift and ordinary index of refraction, i.e., the ratio of the phase velocity of the electromagnetic waves in a vacuum to that in the given medium. The imaginary part, on the other hand, is related to the attenuation of the waves by absorption in the medium. From the equations of motion of electromagnetic waves, it is possible to derive expressions for the index of refraction and for the attenuation in an ionized medium. Appropriate forms of these expressions are given and discussed below, with special reference

to the effects of nuclear explosions on the ionization of the atmosphere.

10.126 Attenuation of electromagnetic (and other) signals is commonly stated in terms of decibels; thus,

$$\text{Attenuation in decibels} = 10 \log \frac{P_{in}}{P_{out}}$$

where P_{in} is the signal power (or strength) before attenuation and P_{out} is that after attenuation. An attenuation of 10 decibels implies that the signal strength has been reduced to 10^{-1} , 20 decibels to 10^{-2} , 30 decibels to 10^{-3} , and so on, of the original strength. A decrease of 20 to 40 decibels, depending on the original signal power and the noise level, will generally result in serious degradation of communications. As a rough guide, it may be taken that an attenuation of 30 decibels will reduce substantially the effectiveness of a radio or radar system.

10.127 From the theory of the propagation of electromagnetic waves through an ionized medium, it is found that the signal attenuation, a , in decibels per mile of travel path, is given by

$$a = 7.4 \times 10^4 \frac{N_e \nu}{\omega^2 + \nu^2} \quad \text{decibels per mile,} \quad (10.127.1)$$

where N_e is the electron density, i.e., number of electrons per cubic centimeter, ν is the number of collisions per second which an electron makes with ions, molecules, or atoms, and ω is the (angular) frequency of the wave (in radians per second). It follows from equation (10.127.1) that if the collision frequency ν is small then, for a given wave frequency, a will be small because of the ν in the numerator. On the other

hand, if ν is very large, a will again be small because of the ν^2 in the denominator. Thus, the attenuation passes through a maximum for a particular value of the electron collision frequency.

10.128 Since the collision frequency is proportional to the density of the air, it will decrease exponentially with altitude. It is to be expected, therefore, that the values of ν for which attenuation of signals is important would occur only within a relatively narrow altitude region. Theoretical studies show that the attenuation of radio and radar signals caused by nuclear explosions occurs mainly within a 10-mile range centered about an altitude of 40 miles. Hence, by confining attention to the situation in the neighborhood of a 40 mile altitude, it is possible to avoid complexities and yet present a reasonably accurate picture of the effects of the burst on electromagnetic signals.

10.129 There are two exceptions to the foregoing generalizations: (1) attenuation within or close to the fireball or debris regions, and (2) nighttime attenuation by ionization resulting from prompt radiation. In the former case, the altitude of the region of maximum attenuation is governed by the altitude and size of the fireball or debris region. In the second case, the altitude of peak attenuation is about 55 miles, but since the electron density due to delayed radiation is dominant at night after only a few seconds, the prompt ionization can be ignored. The present treatment will, therefore, be mainly concerned with the 10-mile range of the atmosphere centered at an altitude of 40 miles.

10.130 For electromagnetic wave

frequencies greater than about 10 megahertz, ν^2 at an altitude of 40 miles may be neglected in comparison with ω^2 in the denominator of equation (10.127.1); this equation then reduces to

$$a \approx 7.4 \times 10^4 \frac{N_e \nu}{\omega^2} \text{ decibels per mile,} \quad (10.130.1)$$

so that the attenuation (in decibels) is approximately proportional to the electron collision frequency. At 40 miles altitude, the latter is roughly 2×10^7 per second. Upon inserting this value for ν in equation (10.130.1) and converting the wave frequency from radians per second to megahertz, the result is

$$a \approx 4 \times 10^{-2} \frac{N_e}{f^2} \text{ decibels per mile,}$$

where f is the wave frequency in megahertz, i.e., $10^{-6}\omega/2\pi$. If the signal beam has an angle of incidence i , referred to the vertical, and the ionized region is 10 miles thick, the total attenuation, A , is

$$A \approx 0.4 \frac{N_e}{f^2} \sec i \text{ decibels,} \quad (10.130.2)$$

for frequencies greater than about 10 megahertz.

10.131 The collision frequency used above is for electron collisions with neutral particles, since these predominate at 40 miles altitude. For electron densities greater than about 10^9 electrons/cm³, collisions of electrons with ions can be important, particularly within a fireball at or above 60 miles altitude, where the neutral particle density is low and electron-neutral collision frequencies are small. But for attenua-

tion of electromagnetic signals in the D-region at some distance from the fireball, equation (10.130.2) is applicable.

10.132 For operational HF circuits, the value of $\sec i$ is about 5 under normal conditions. It follows then from equation (10.130.2) that, for a frequency of 10 megahertz, a 10-mile thick layer with an electron density of about 1.5×10^3 electrons/cm³ at 40 miles altitude will produce 30 decibels of signal attenuation. For a frequency of 30 megahertz, the same attenuation will result from an electron density of about 1.4×10^4 electrons/cm³. These electron densities may be taken as indicative of the values required to degrade HF systems. Since radars usually operate at frequencies greater than 30 megahertz and $\sec i$ generally will be less than 5, densities exceeding 10^5 electrons/cm³ are necessary to cause serious attenuation when the signals pass through the D-region of the ionosphere.

10.133 Consideration will now be given to the phase aspects of the propagation of electromagnetic waves through an ionized medium. Provided the electron collision frequency, ν , is small in comparison with the wave frequency, ω , as has been assumed above, the ordinary (real) index of refraction, n , is given by

$$n = \left(1 - \frac{4\pi N_e e^2}{m\omega^2} \right)^{1/2}$$

$$= \left(1 - \frac{10^{-12} N_e e^2}{\pi m f^2} \right)^{1/2}, \quad (10.133.1)$$

where e is the charge (4.8×10^{-10} electrostatic unit) and m is the mass (9.1×10^{-28} gram) of the electron, and

f is the wave frequency in megahertz: Upon inserting the numerical values for e and m , it is found that

$$n = \left(1 - \frac{0.8 N_e}{10^4 f^2} \right)^{1/2}$$

Since electron densities are not known very accurately, this result may be approximated to

$$n \approx \left(1 - \frac{N_e}{10^4 f^2} \right)^{1/2}. \quad (10.133.2)$$

10.134 If an electromagnetic wave crosses a plane interface where the index of refraction changes sharply from 1 to n , a beam will be bent by an amount given by the familiar Snell's law, i.e.,

$$\frac{\sin i}{\sin r} = n,$$

where i is the angle of incidence and r the angle of refraction. If the index of refraction is such that $n = \sin i$, then $\sin r = 1$, i.e., $r = 90^\circ$, and critical reflection occurs; the refraction is so large that the signal is unable to penetrate the medium. The condition for critical reflection by an ionized medium is obtained by setting n in equation (10.133.2) equal to $\sin i$; the result obtained is

$$f \approx 10^{-2} \sqrt{N_e} \sec i$$

(for critical reflection). (10.134.1)

For reflection of an electromagnetic signal encountering a given ionized medium, with electron density N_e , the frequency must be less than that expressed by equation (10.134.1). Alternatively, for reflection of a signal of specified

frequency f , the electron density of the ionized medium must be greater than that given by this equation.⁴

10.135 As in § 10.132, sec i may be taken to be about 5 for an operational HF system. Hence, for a signal of 5 megahertz, at the lower end of the band, to be reflected, the electron density must exceed 10^4 electrons/cm³. For a frequency of 30 megahertz, the minimum density for reflection is 3.6×10^5 electrons/cm³. These densities are normally attained in the E- and F-regions of the ionosphere, respectively. A change in the electron density arising from the effects of a nuclear explosion can alter the altitude at which an electromagnetic wave is reflected and can consequently affect communications systems, as seen earlier in this chapter.

10.136 Equation (10.134.1) is applicable only when a nonionized medium is separated from an ionized one by a sharp boundary at which the change in refractive index, from 1 to n , occurs over a distance small in comparison to a wavelength at the propagating frequency. This condition does not exist either in the normal ionosphere or after it has been disturbed by a nuclear detonation. The refractive index does not change sharply and there is a gradual bending of the transmitted wave. In such situations, both the electron density and its gradient determine the phase (refraction) effects.

10.137 When the quantity N_e/f^2 is sufficiently large, electromagnetic

waves can be both attenuated and refracted by the ionized medium. The effect that predominates depends on the ratio of the electron density gradient to the electron collision frequency. If this ratio is large, then the wave will be refracted, but if it is small the main effect will be attenuation. In most circumstances associated with a nuclear explosion, attenuation around 40 miles altitude predominates. At altitudes above about 60 miles, however, where the collision frequency is small and the electron density gradient moderately large, refraction may be important. Also, near the fireball but outside the absorbing region, refraction of electromagnetic waves up to high frequencies, such as radar signals, is possible (§ 10.37). Although the collision frequency is large, the high electron density gradient is here the dominant factor. Within the fireball itself, however, electromagnetic waves are always strongly absorbed.

ELECTRON PRODUCTION BY PROMPT RADIATIONS

10.138 Consider a nuclear explosion of W kilotons yield and let k be the fraction of the yield radiated at a particular energy, i.e., as monochromatic radiation. For a point source of such radiation, assuming negligible scattering and no reradiation, the energy deposited (or absorbed) per unit volume of air, E_D ,

⁴The quantity $10^{-2}\sqrt{N_e}$ megahertz or, more exactly, $(4\pi N_e e^2/m)^{1/2}$ radians per second, is called the "critical frequency" or "plasma frequency" of an ionized medium, i.e., a plasma. It is the frequency for which the index of refraction of the given medium is zero. It is also the lowest frequency of an electromagnetic wave that can penetrate into the medium, and then only for normal incidence, i.e., for $i = 0$.

at an "observation" point at a slant distance D from the explosion is

$$E_D = \frac{kW}{4\pi D^2} \rho\mu_m e^{-\mu_m M} \tag{10.138.1}$$

where ρ is the air density at the observation altitude, μ_m is the mass (energy) absorption coefficient in air of the given radiation,⁵ and M is the penetration mass, i.e., the mass of air per unit area between the radiation source and the observation point. This equation may be used for all forms of prompt radiation, using the appropriate value of k given in Table 10.138. The fraction of the energy radiated as prompt gamma rays is small and its contribution to the electron density is generally less than the for other radiations. If the energy deposited in the air is reradiated or if the source photons or neutrons are scattered and follow a random path before depositing all their energy, equation (10.138.1) must be modified (§ 10.142).

Table 10.138

FRACTION OF EXPLOSION ENERGY AS PROMPT RADIATIONS

Radiation	k
X rays	0.7
Gamma rays	0.003
Neutrons	0.01

10.139 According to Table 1.45, 1 kiloton TNT equivalent of energy is equal to 2.6×10^{25} million electron volts. Furthermore, about 3×10^4 ions

pairs, i.e., 3×10^4 electrons, are produced for each million electron volts of energy absorbed in air (about 34 electron volts are required to produce an ion pair). Consequently, about 8×10^{29} electrons are produced for each kiloton of energy deposited in the air. Hence, the number of free electrons per unit volume, N_e , is obtained from equation (10.138.1), with W in kilotons, as

$$N_e = 2.4 \times 10^{18} \frac{kW}{D^2} \rho\mu_m e^{-\mu_m M} \text{ cm}^{-3}, \tag{10.139.1}$$

with ρ in grams per cubic centimeter, μ_m in square centimeters per gram, M in grams per square centimeter, and D in miles.

10.140 An expression for M may be obtained in the following manner. Let H_0 (Fig. 10.140) be the altitude of the explosion point and H that of the observation point which is at a distance D from the burst. Then if D' represents any position between the explosion and the observation point, and h is the corresponding altitude, the value of M in appropriate units is given by

$$M = \int_0^D \rho(D') dD' = \frac{D}{H - H_0} \int_{H_0}^H \rho(h) dh,$$

where, in deriving the second form, the curvature of the earth has been neglected. If $\rho(h)$ is now represented by

⁵The mass absorption coefficient is similar to the mass attenuation coefficient defined in § 8.100, except that it involves the energy absorption coefficient, referred to in the footnote to equation (8.95.1).

equation (10.124.1), it is found that

$$M = 6.8 \times 10^5 \frac{D}{H - H_0} \rho_0 \left(e^{-H_0/4.3} - e^{-H/4.3} \right) \text{ g cm}^{-2}, \quad (10.140.1)$$

where D , H , and H_0 are in miles and ρ_0 in grams per cubic centimeter; the factor 6.8×10^5 , which is the density scale height in centimeters (slightly less than 4.3 miles), is introduced to obtain the required units (g/cm^2) for M .

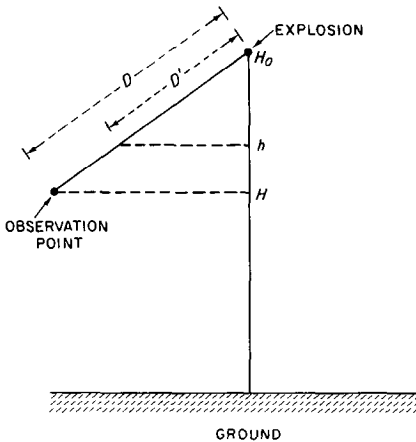

Figure 10.140. Quantities used in defining the penetration mass (M).

10.141 In general, the energy radiated from a nuclear explosion as gamma rays and X rays is not monochromatic but covers a range of photon energies. Hence, integration over the energy spectrum is necessary. For the range in which most of the gamma-ray energy is radiated, the mass absorption coefficient of air, μ_m , can be considered to be constant. But this is not the case

for X-ray photons (of lower energy) for which the mass absorption coefficient is approximately inversely proportional to the cube of the energy. Furthermore, the situation is complicated as a result of energy changes that occur when the photons are scattered. For neutrons, the highest electron densities arise from elastic scattering (§ 10.43) and the necessity for summing over multiple scattering angles makes the calculations difficult, especially in an (inhomogeneous) atmosphere of changing density.

10.142 Allowance for the effects of scattering and of the energy spectrum of the radiation can be made approximately by modifying equation (10.139.1) to take the form

$$N_e \approx 2.4 \times 10^{18} \frac{kW}{D^2} \rho F(M) \text{ cm}^{-3}, \quad (10.142.1)$$

where $F(M)$ is an effective mass absorption coefficient which is a function of the penetration mass, M . Values of $F(M)/\kappa$, where κ is a normalization factor that permits $F(M)$ for various radiations to be plotted on a single diagram, are given in Fig. 10.142. The values of κ used are shown in the insert.

10.143 The electron densities produced by the total prompt radiation (neutrons and X rays) are obtained by summing the contributions of the individual radiations as given by the appropriate forms of equation (10.142.1). In this manner, the curves in Fig. 10.143 for electron densities at a height of 40 miles as a function of horizontal distance⁶ were derived for a 1-megaton

⁶The term "horizontal distance," as used here and later, refers to the distance parallel to the earth's surface.

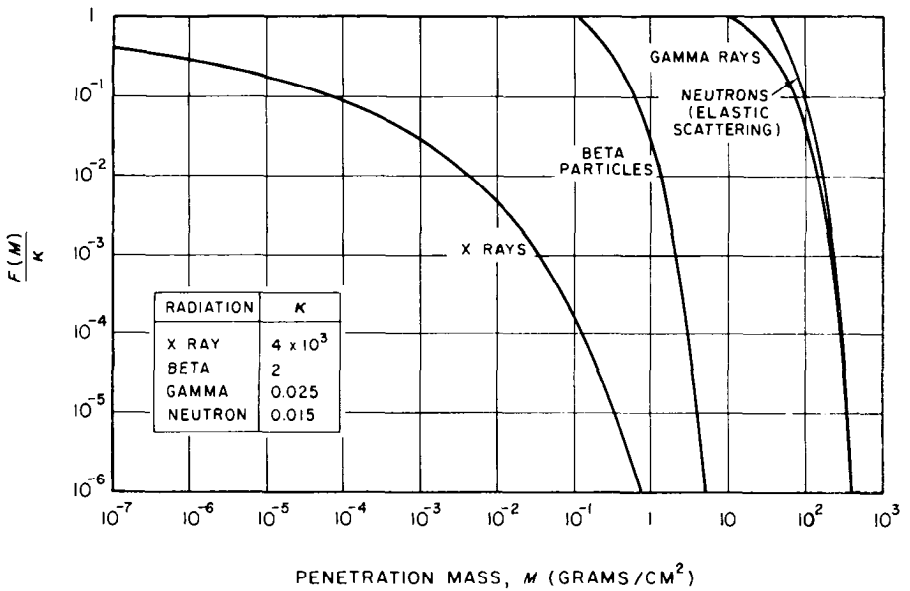

Figure 10.142. Values of $F(M)$ for various radiation sources.

explosion at various altitudes. Since the electron density is proportional to the energy yield, W , of the weapon, the results for other yields can be readily obtained from Fig. 10.143. In computing M for this figure, the effects of a curved earth and a variable density scale height were included. The calculations show that below about 40 miles, ionization due to neutrons predominates, but for nuclear detonations at higher altitudes the X rays produce essentially all the additional electrons from prompt ionization in the D-region.

10.144 It is seen from Fig. 10.143

that at low burst altitudes, up to about 20 miles, the ionization from prompt radiation is relatively small except at short distances. At higher burst altitudes, not only does the electron density (at 40 miles altitude) for a given horizontal distance increase, but the range for a given electron density, especially above 10^5 electrons/cm³, increases markedly. These densities are sufficient to cause blackout of HF systems that use the sky wave for long-distance propagation. However, it will be seen (§ 10.152) that the blackout would be of relatively short duration.

The curves in Fig. 10.143 show the initial electron densities at 40 miles altitude produced by the prompt radiation from a 1-megaton explosion as a function of distance, for various burst altitudes.

Scaling. For any specified combination of burst height and distance, the initial electron density at 40 miles altitude is directly proportional to the yield in megatons, i.e.,

$$N_e(W) = WN_e(1 \text{ MT}),$$

where $N_e(1 \text{ MT})$ is the value of the initial electron density at 40 miles altitude and the desired distance from a 1 MT explosion at the desired altitude, and $N_e(W)$ is the corresponding initial electron density for W MT.

Example:

Given: A 500 KT detonation at an altitude of (a) 20 miles, (b) 60 miles.

Find: In each case, the horizontal distance at an altitude of 40 miles at which the initial electron density from prompt radiations is 10^5 electrons/cm³ or more.

Solution: The corresponding electron density for 1 MT is

$$\begin{aligned} N_e(1 \text{ MT}) &= \frac{N_e(W)}{W} = \frac{10^5}{0.5} \\ &= 2 \times 10^5 \text{ electrons/cm}^3 \end{aligned}$$

From Fig. 10.143, the prompt radiation from a 1 MT explosion will produce initial electron densities of 2×10^5 electrons per cubic centimeter at an altitude of 40 miles

(a) to a horizontal range of about 190 miles, if burst is at an altitude of 20 miles. *Answer.*

(b) to a horizontal range of about 550 miles, if burst is at an altitude of 60 miles. *Answer.*

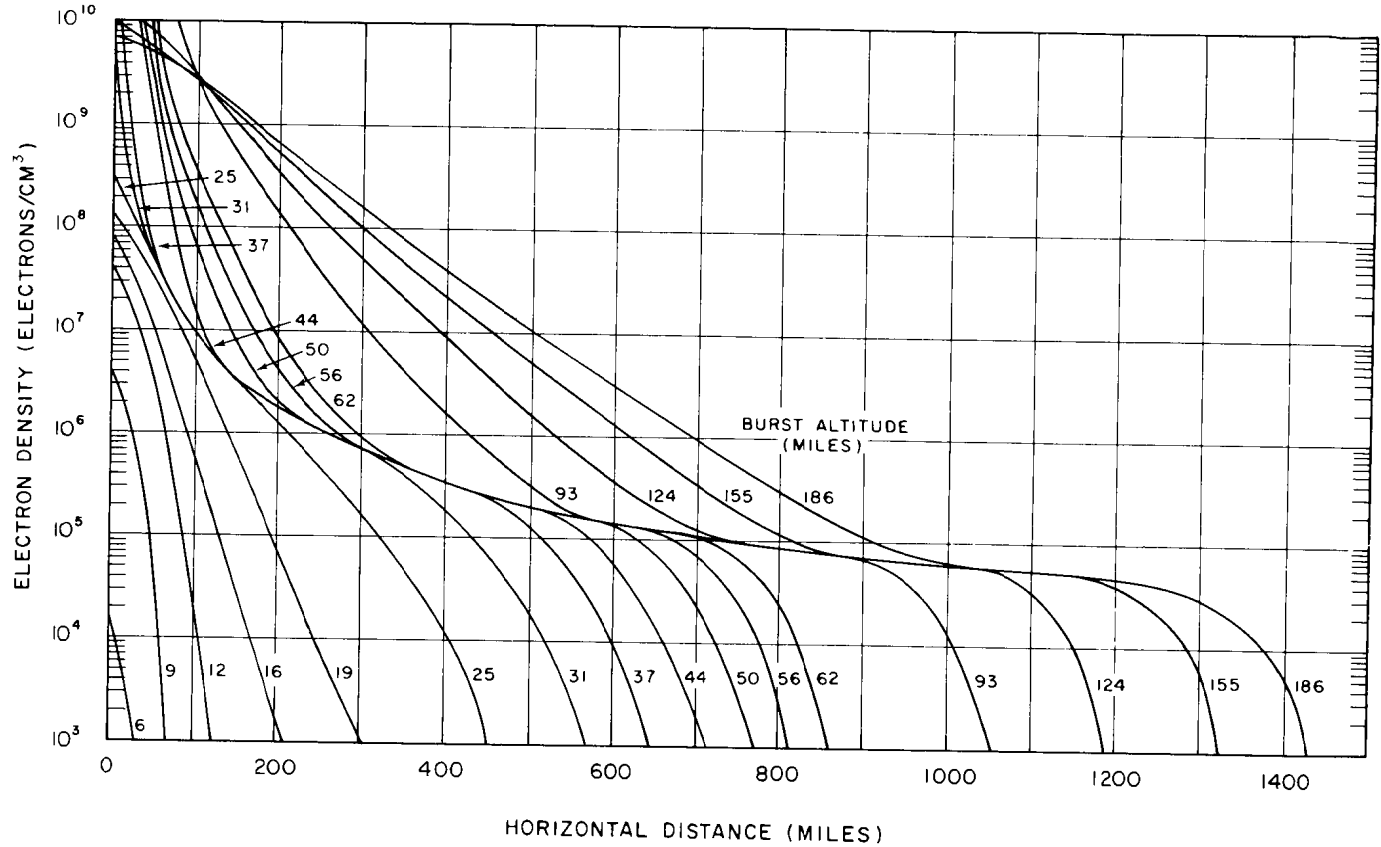

Figure 10.143. Initial electron density at 40-mile altitude produced by prompt radiation from a 1-megaton explosion, as a function of distance (miles), for various burst altitudes.

RATE OF DISAPPEARANCE OF FREE ELECTRONS PRODUCED BY PROMPT RADIATION

10.145 Free electrons are removed either by attachment to neutral particles (usually molecular oxygen in the D-region) or by recombination with positive ions. The electron loss by recombination is proportional to the number densities of electrons, N_e , and of positive ions, N_+ , so that

$$\frac{dN_e}{dt} = -\alpha_d N_+ N_e \quad (10.145.1)$$

where α_d is the recombination coefficient. Below an altitude of about 60 miles, α_d is approximately $2 \times 10^{-7} \text{ cm}^3 \text{ sec}^{-1}$.

10.146 Electron loss by attachment to molecular oxygen is proportional to the square of the atmospheric density and the number density of electrons; thus,

$$\frac{dN_e}{dt} = -\beta \rho^2 N_e, \quad (10.146.1)$$

where β is an attachment coefficient approximately equal to $4 \times 10^{13} \text{ cm}^6 \text{ g}^{-2} \text{ sec}^{-1}$. The quantity $\beta \rho^2$ is often called the attachment rate coefficient, K ; it decreases from $6 \times 10^7 \text{ sec}^{-1}$ at sea level to about $2 \times 10^{-3} \text{ sec}^{-1}$ at 55 miles altitude.

10.147 After electrons are attached to molecules to form negative ions, they may become detached by solar radiation or by collisional processes. The rate of free electron production by detachment is proportional to the number density of negative ions, N_- , and the detachment source strength, i.e.,

$$\frac{dN_e}{dt} = S N_-, \quad (10.147.1)$$

where S , the detachment rate coefficient, is related to the detachment source strength. In the daytime, S is approximately 0.4 sec^{-1} above about 35 miles altitude. Below about 35 miles the value of S is uncertain but apparently it is lower by several orders of magnitude. At night, detachment is negligible at altitudes less than about 50 miles.

10.148 Negative ions formed by attachment of electrons to molecular oxygen can also react with positive ions to form neutral molecules. Since the negative and positive ion densities affect the electron density, the ion loss by recombination must be considered. The rate of positive ion loss by recombination with negative ions is proportional to the number densities of both ions; thus,

$$\frac{dN_+}{dt} = \alpha_1 N_- N_+, \quad (10.148.1)$$

where α_1 , usually known as the mutual neutralization coefficient, is equal to about $3 \times 10^{-8} \text{ cm}^3 \text{ sec}^{-1}$ above 30 miles. Below 30 miles, α_1 is approximately proportional to the atmospheric density and is $4 \times 10^{-6} \text{ cm}^3 \text{ sec}^{-1}$ at sea level.

ELECTRON DENSITIES FROM PROMPT RADIATIONS

10.149 The differential equations describing the time history of electron and ion densities do not have a closed-form solution. However, a number of approximations are available, and numerical solutions have been obtained with the aid of computers for particular cases. An approximate solution, which gives reasonable results for many conditions, is the so-called "equal-alpha"

approximation. When α_d is taken equal to α_1 , the electron density, $N_e(t)$, as a function of time following a pulse of prompt radiation, can be represented by

$$N_e(t) = \frac{N_e(0)}{1 + \alpha N_e(0)t} \cdot \frac{S + Ke^{-(K + S)t}}{S + K}, \quad (10.149.1)$$

where $N_e(0)$ is the initial electron density, given by equation (10.142.1), α is an effective recombination coefficient, and t is the time after the burst.

10.150 Approximate values of α , S , and K in centimeter-gram-second units are given in Table 10.150 for an altitude of 40 miles in the daytime and 55 miles at night. These are the altitudes, for day and night, respectively, at which maximum attenuation of electromagnetic signals is to be expected (§ 10.129). Upon inserting the appropriate values into equation (10.149.1), the time history of electron density at the altitude of maximum attenuation is found to be

$$N_e(t) \text{ at 40 miles} \approx \frac{1}{3} \cdot \frac{N_e(0)}{1 + 10^{-7} N_e(0)t} \text{ cm}^{-3} \text{ (daytime)} \quad (10.150.1)$$

for times more than a few seconds after the burst in the daytime, and

$$N_e(t) \text{ at 55 miles} \approx \frac{N_e(0)}{1 + 2 \times 10^{-7} N_e(0)t} \text{ cm}^{-3} \text{ (nighttime)} \quad (10.150.2)$$

for nighttime conditions.

10.151 Calculations of the decay of electron densities from ionization produced by prompt radiations from a nuclear detonation have been made with a computer using numerical solutions that do not involve the equal-alpha approximation. The results for daytime conditions at a height of 40 miles are shown in Fig. 10.151; they are reasonably consistent with equation (10.150.1) provided the electron density is appreciably larger than the normal value in the ionosphere. Natural ionization sources must be considered when the electron density resulting from prompt radiation has decayed to values comparable to those normally existing at an altitude of 40 miles.

10.152 There are two aspects of Fig. 10.151 that are of special interest. First, it is seen that when the initial electron density, $N_e(0)$, is greater than 10^7 electrons/cm³, the electron density, $N_e(t)$, at any time more than about 1

Table 10.150

APPROXIMATE VALUES OF α , S , and K IN CGS UNITS

Coefficient	40 Miles (daytime)	55 Miles (nighttime)
α	10^{-7}	2×10^{-7}
S	0.4	2×10^{-2}
K	0.8	2×10^{-3}

The curves in Fig. 10.151 show the electron density from prompt radiation at 40 miles altitude in the daytime as a function of time after burst, for various values of the initial electron density. These curves together with those in Fig. 10.143 can be used to estimate the electron density at 40 miles altitude in the daytime for various combinations of explosion yields and burst altitudes.

Example:

Given: A 1 MT explosion in the daytime at an altitude of 30 miles.

Find: The one-way attenuation of a 100-MHz radar system that would result from D-region ionization at 30 seconds after the burst; the radar beam makes an angle of 80 degrees ($\sec i \approx 6$) with the vertical and intersects the 40 mile alti-

tude layer at a horizontal distance of 125 miles from the burst.

Solution: From Fig. 10.143, the initial electron density at a horizontal distance of 125 miles from a 1 MT explosion at an altitude of 30 miles is about 5×10^6 electrons/cm³. From Fig. 10.151, this initial value will have decayed to about 10^5 electrons/cm³ by 30 seconds after the burst. By use of equation (10.130.2), the attenuation is

$$\begin{aligned} A &\approx 0.4 \frac{N_e}{f^2} \sec i = 0.4 \frac{10^5}{10^4} \times 6 \\ &= 24 \text{ decibels. } \textit{Answer.} \end{aligned}$$

Note: The attenuation determined above is due only to prompt radiation. The effect of delayed radiation should also be investigated to estimate the overall effect on the system (§ 10.154 *et seq.*).

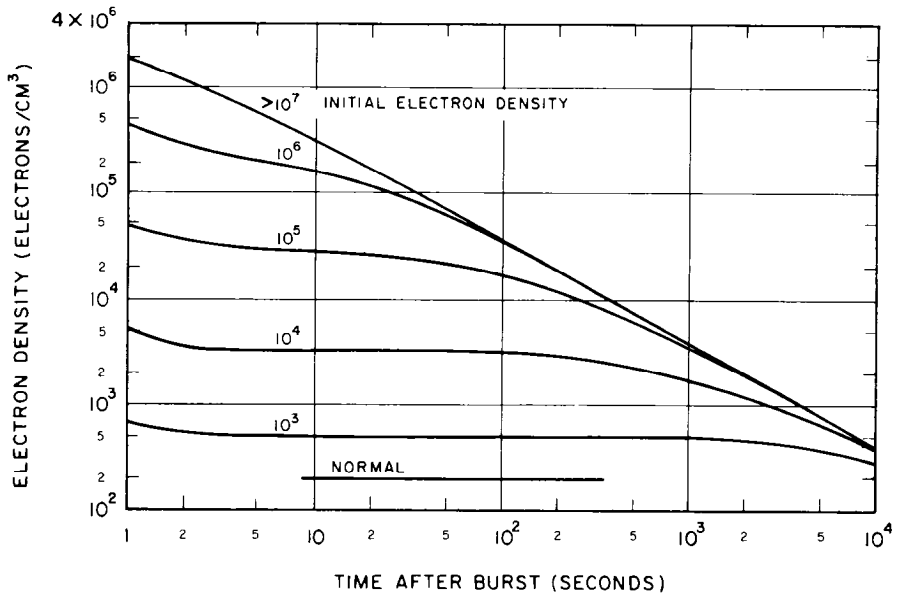

Figure 10.151. Decay of ionization from prompt radiation at 40 miles altitude in the daytime.

second after the burst (in daytime) is independent of the initial value. This condition is referred to as a "saturated atmosphere." It is to be expected from equation (10.150.1), since when $N_e(0)$ is more than 10^7 and t is at least a few seconds, the quantity $10^{-7}N_e(0)t$ in the denominator of the equation is greater than unity. Hence, the latter can be neglected and equation (10.150.1) reduces to

$$N_e(t) \approx \frac{1}{3 \times 10^{-7}t} \text{ cm}^{-3} ,$$

so that the electron density at time t is independent of the initial value.

10.153 The other matter of interest is that, regardless of the initial value, the electron density in the daytime will have decreased to 10^3 electrons/cm³ within an hour (or so). This fact is apparent from Fig. 10.151 or it can be derived from equation (10.150.1). It follows, therefore, that significant degradation of HF or radar systems as the result of ionization by prompt radiation will not persist for more than an hour or so in the daytime. At night, decay is faster, as is apparent from equation (10.150.2), and effects on electromagnetic waves of the prompt radiations can usually be neglected. As will be seen later, the effects of the delayed radiation may persist for longer times.

RATE OF ELECTRON PRODUCTION BY DELAYED RADIATIONS

10.154 The rate of energy emission as delayed (beta and gamma) radiation from the radioactive residues of a nuclear explosion, consisting mainly of

fission products but including activity induced by neutrons in the weapon material (§ 9.32), is represented by

$$I_t = I_1 (1 + t)^{-1.2}, \quad (10.154.1)$$

where I_t is the rate of energy emission at t seconds after the detonation and I_1 is the value after 1 second.⁷ The total beta and gamma energy emitted is obtained (approximately) by integrating between zero time and infinity; thus,

$$\begin{aligned} \text{Total energy} \\ &= \int_0^{\infty} I_1(1 + t)^{-1.2} dt = 5I_1 . \end{aligned}$$

The fraction of the delayed radiation energy emitted per second at time t is then

$$\frac{I_1(1 + t)^{-1.2}}{5I_1} = 0.2 (1 + t)^{-1.2} .$$

10.155 About 7 percent of the fission explosion energy is radiated as delayed beta particles and gamma rays, with approximately half carried by each kind of radiation. Hence, for an explosion of W_F kilotons fission yield, roughly $0.007 (1 + t)^{-1.2} W_F$ kilotons of energy per second are radiated by beta particles and the same amount by gamma rays.

10.156 The rate of production of ion pairs (and hence of electrons) by delayed gamma rays can be estimated from an expression similar to that used to determine the electron density arising from the prompt radiation. Thus, if kW in equation (10.142.1) is replaced by $0.007 (1 + t)^{-1.2} W_F$, the result, assum-

⁷For times that are long in comparison with 1 second, equation (10.154.1) reduces to the same form as equation (9.147.1).

ing a point source for the gamma rays (cf. § 10.138), is

$$q_\gamma(t) = 1.7 \times 10^{16} \frac{W_E}{D^2(1+t)^{1.2}} \rho(H)F(M) \text{ cm}^{-3} \text{ sec}^{-1}, \quad (10.156.1)$$

where $q_\gamma(t) \text{ cm}^{-3}\text{sec}^{-1}$ is the electron production rate at time t seconds after the nuclear detonation, as observed at a slant distance D miles at an altitude of H miles (see Fig. 10.140). The function $F(M)$ can be obtained from Fig. 10.142 with M defined by an equation similar to equation (10.140.1), except that the detonation altitude H_0 is replaced by the debris altitude H_D .

10.157 The radial motion of the beta particles is largely prevented by the geomagnetic field lines. The area of the D-region at an altitude of 40 miles where the beta ionization occurs is then approximately the same as the area of the debris (Fig. 10.47). If the latter rises above 40 miles, roughly half of the energy is deposited in the local D-region and half at the magnetic conjugate. The total area over which the beta-particle energy is deposited is thus twice the debris area. If the debris is assumed to be uniformly distributed over an area A , which may be taken to be πR^2 , where R is the debris radius, the electron production rate from ionization due to beta particles in each D-region is then

$$q_\beta(t) = 2.1 \times 10^{17} \frac{W_E}{2A(1+t)^{1.2} \sin \varphi} \rho(H)F(M) \text{ cm}^{-3} \text{ sec}^{-1}, \quad (10.157.1)$$

where φ is the local magnetic dip angle and A is in square miles. The change in the numerical factor (by 4π) arises from

the replacement of the area $4\pi D^2$ in equation (10.156.1) by $2A$ in equation (10.157.1) and $\sin \varphi$ is required because of the motion of the beta particles along the field lines. The function $F(M)$ is evaluated from Fig. 10.142 for

$$M = \frac{1}{\sin \varphi} \int_H^{H_D} \rho(h) dh \approx \frac{6.8 \times 10^5 \rho_0}{\sin \varphi} \left(e^{-H/4.3} - e^{-H_D/4.3} \right) \text{ g cm}^{-2}, \quad (10.157.2)$$

where H_D is the debris altitude in miles; in this expression the curvature of the earth is neglected.

10.158 In order to use equations (10.156.1) and (10.157.1) it is necessary to know the altitude, H_D , and radius, R , of the weapon debris. Determination of these quantities requires an understanding of the processes taking place as the debris cloud rises and spreads horizontally. The actual processes are very complex, but a simple model which parallels the gross features of the debris motion has been developed. The debris height and radius, as they change with time, for various burst altitudes as obtained from this model are shown in Figs. 10.158a, b, and c, for energy yields of 10 and 100 kilotons and 1 megaton, respectively. For interpolation between these yields, $W^{1/3}$ scaling may be used, at least for the first few minutes after the explosion. The extreme left-hand end of each curve indicates the altitude of the explosion and the initial size of the fireball. It should be noted that when using Figs. 10.158a, b, and c that W is the total energy yield

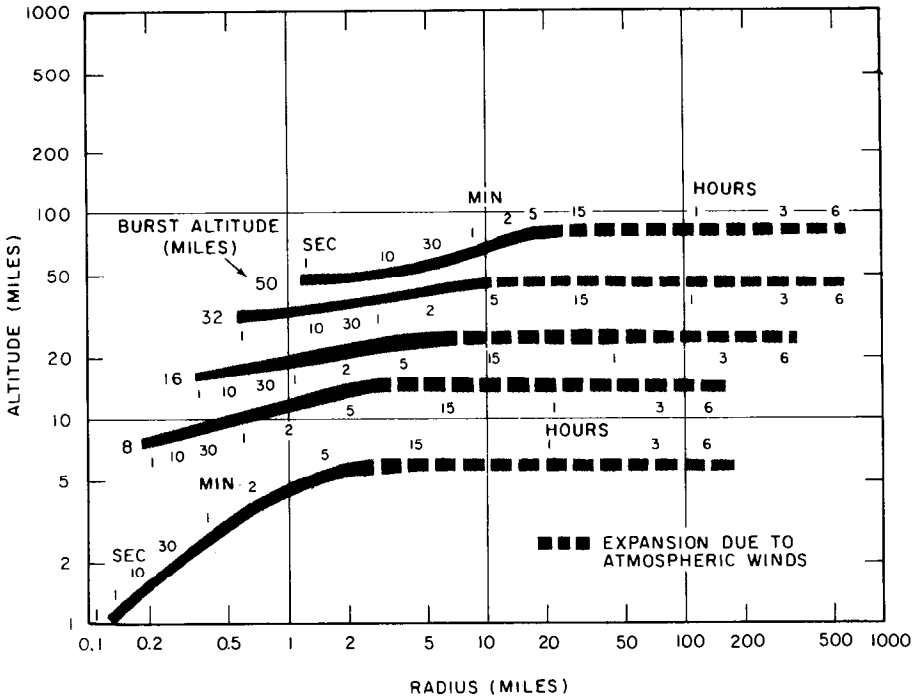

Figure 10.158a. Fireball/debris altitude and horizontal radius for 10-kiloton explosions at various altitudes.

of the explosion. For thermonuclear weapons, the fission yield W_F in equations (10.156.1) and (10.157.1) is generally taken to be half of the total yield.

ELECTRON DENSITIES FROM DELAYED RADIATIONS

10.159 The actual electron density, $N_e(t)$, arising from the delayed radiations at a particular location and time can be calculated by assuming that, soon after the detonation, a transient steady state exists at any instant. The value of $N_e(t)$ is then obtained by equating $q_b(t)$ or $q_\gamma(t)$ at any time t to the rate of loss of electrons by various recombination and attachment processes. The curves in Figs. 10.159a and b, for

delayed beta particles and gamma rays, respectively, were obtained in this general manner for an altitude of 40 miles, where maximum attenuation of electromagnetic signals due to ionization from delayed radiations occurs both during day and night. In computing the curves, an accurate treatment for the energy spectra of the radiations was used to evaluate the rate of formation of electrons; removal rates were calculated along the lines indicated in § 10.145 *et seq.*, with detailed consideration of all important loss mechanisms. The values shown in Fig. 10.159a were computed for a magnetic dip angle of 60° ; however, they provide reasonable estimates for dip angles between about 45° and 75° , i.e., for mid-latitudes.

(Text continued on page 511.)

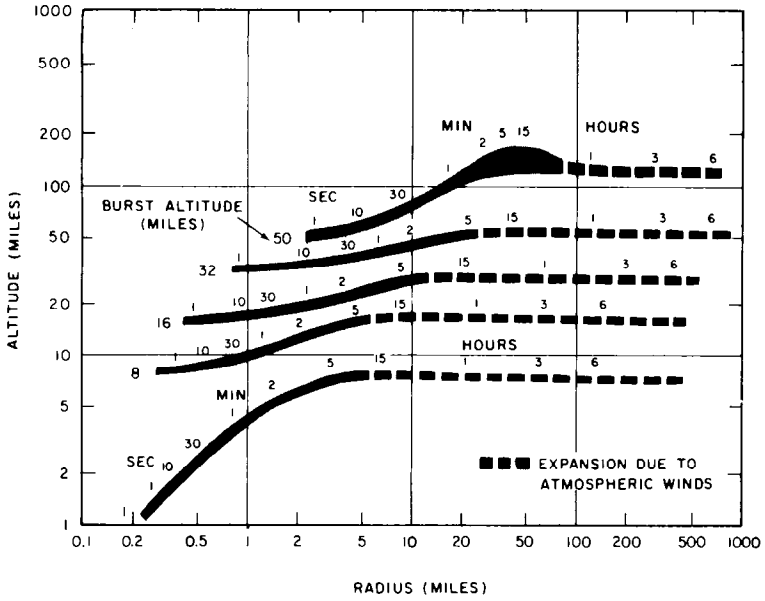

Figure 10.158b. Fireball/debris altitude and horizontal radius for 100-kiloton explosions at various altitudes.

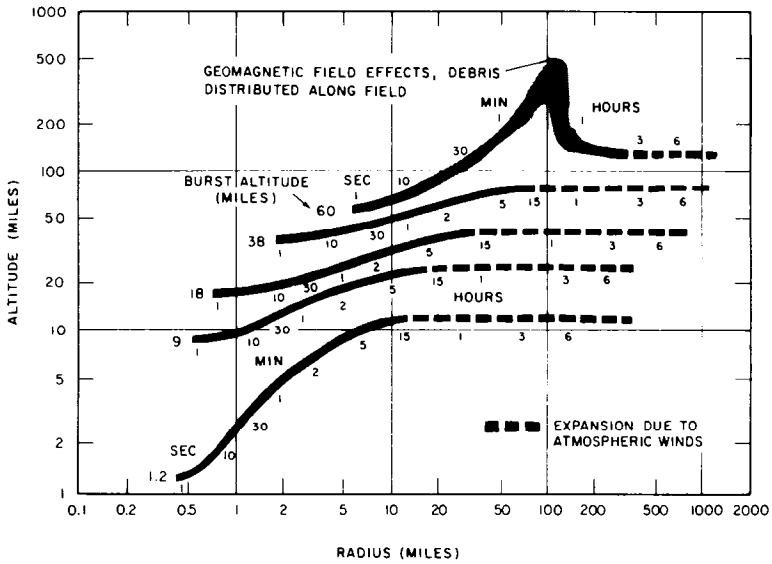

Figure 10.158c. Fireball/debris altitude and horizontal radius for 1-megaton explosions at various altitudes.

The curves in Figs. 10.159a and b show the electron densities at 40 miles altitude due to beta particles (for debris above 40 miles) and delayed gamma rays (for debris above 15 miles), respectively. Only the attenuation resulting from the highest electron density, which may arise from prompt radiations (Figs. 10.143 and 10.151), delayed gamma radiation, or beta particles, need be considered. The densities, and hence the attenuations, cannot be added directly. Figures 10.158a through c may be used to estimate the position and size of the debris for use with Figs. 10.159a and b. The curves of Fig. 10.159a (for beta particles) are for a magnetic dip angle of 60° , but they provide reasonable estimates for dip angles between about 45° and 75° . The possible effect of the earth's curvature on Fig. 10.159b (gamma rays) is obtained from Fig. 10.162.

Example:

Given: A 1 MT explosion during the night at an altitude of 25 miles and a location in the northern hemisphere where the magnetic dip angle is 60° .

Find: The electron density in the D-region at a horizontal distance of 250 miles north of the burst point (a) 5 minutes after the explosion, and (b) 2 hours after the explosion.

Solution: Since it is nighttime, any prompt ionization will have died away by the times of interest and can be neglected (§ 10.153).

(a) Interpolation of Fig. 10.158c suggests that by 5 minutes the debris will have reached an altitude (H_d) of about 60 miles, with a horizontal radius of about 30 miles. Since the beta particles follow the geomagnetic field lines, the ionization they cause at an altitude of 40 miles (H) will be centered about a point that is displaced a distance d horizontally from the center of the debris, where d is given (approximately) by

$$d \approx (H_d - H) \tan \varphi = (60 - 40) \tan 60^\circ = 35 \text{ miles.}$$

The radial extent of the ionized region will be approximately equal to the debris radius (30 miles). Thus, at 5 minutes after the explosion beta ionization will not affect a point that is located at a horizontal distance of 250 miles from the burst. Hence, at this time only the ionization caused by delayed gamma rays need be considered.

The distance D from the debris to the point of interest is about 250 miles and the time is 300 seconds. Since the total yield is 1 MT, the fission yield, W_F , may be taken to be 500 kilotons; hence,

$$\frac{W_F}{D^2(1+t)^{1.2}} = \frac{500}{(250)^2(301)^{1.2}} \approx 8 \times 10^{-6} .$$

The debris altitude (60 miles) and the horizontal distance (250 miles) are such that the conditions are in Region 1 of Fig. 10.162, so that Fig. 10.159b is applicable. The electron density due to

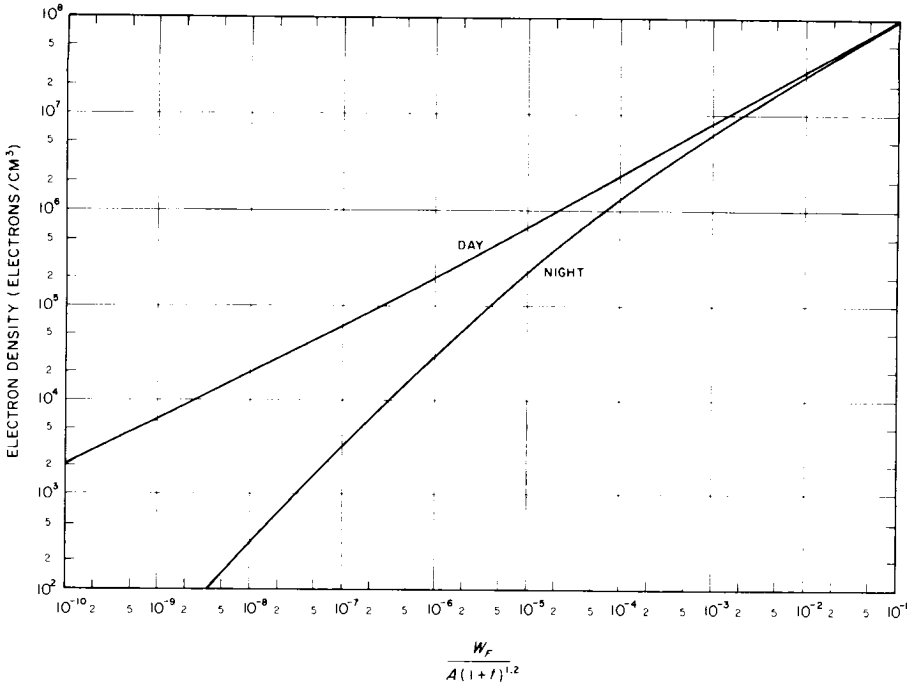

Figure 10.159a. Electron density at 40-mile altitude due to beta particles (for debris above 40 miles).

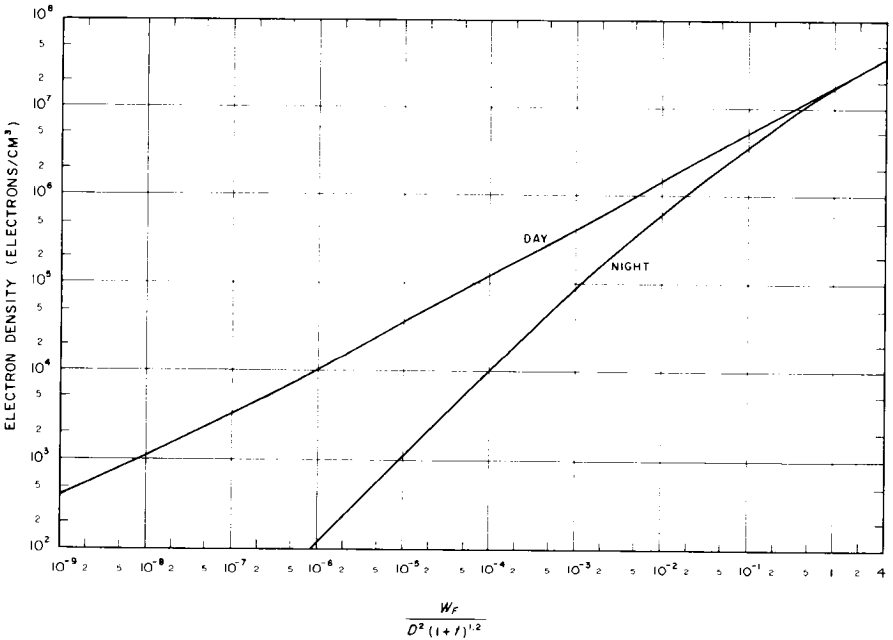

Figure 10.159b. Electron density at 40-mile altitude due to delayed gamma rays (for debris above 15 miles).

delayed gamma rays is then found to be 10^3 electrons/cm³. *Answer.*

(b) At 2 hours after the explosion, the debris will still be at an altitude of about 60 miles, but interpolation of Fig. 10.158c suggests that it will have spread to a radius of about 250 miles. Since the center of the beta ionization will be displaced about 35 miles farther north, the point of interest will be contained within the beta ionized region.⁸ At that time, i.e., $t = 7200$ sec,

$$\frac{W_F}{A(1+t)^{1.2}} = \frac{500}{\pi(250)^2(7201)^{1.2}}$$

$$\approx 6 \times 10^{-8} .$$

The electron density due to beta particles is found from Fig. 10.159a to be about 2×10^3 electrons/cm³. The electron density from the delayed gamma rays was estimated above to be 10^3 electrons/cm³ at 5 minutes after the explosion, and so it will be much less at 2 hours. Hence, the ionization due to the gamma rays can be neglected. *Answer.*

⁸It is assumed that the debris expands uniformly about a stationary center once it has ceased to rise. Motion of the debris caused by atmospheric winds introduces many uncertainties in the prediction of ionization at times more than a few minutes after the burst.

10.160 The curves in Fig. 10.159a for the electron density resulting from ionization by delayed beta particles are based on the assumption that the debris has risen above 40 miles. The particle energy is then equally distributed between the local D-region and the one at the magnetic conjugate. The electron densities given in the figure are those to be expected at the 40-mile altitude in each region. If the debris is below 35 miles, the delayed beta particles cause essentially no ionization in the D-region (§ 10.45); at altitudes of 35 through 40 miles, the ionization in this region is intense, but the electron densities are difficult to calculate. Because beta particles follow the geomagnetic field lines, the ionization they produce at any altitude is not affected by the earth's curvature. Gamma rays, on the other hand, travel in straight lines and may be so affected (§ 10.162).

10.161 The stopping altitude for the delayed gamma rays is about 15 miles; hence, the results in Fig. 10.159b are applicable only if the debris rises above this altitude. The principal source of error in the figure is that the gamma rays are assumed to originate from a point source at the center of the debris cloud. Since the atmospheric absorption of gamma rays is negligible above the stopping altitude, the straight-line path from the debris to the point of interest in the D-region (40 miles altitude) can lie in any direction, provided it does not pass through the stopping altitude.

10.162 As a consequence of the curvature of the earth, the path of the gamma rays, for sufficiently large distances, may intersect the stopping altitude, even when the debris rises above 15 miles. If this occurs, the energy of

the gamma rays will be largely absorbed. For the conditions in Region 1 of Fig. 10.162, the straight line from the debris (center) to the observation point at 40 miles altitude does not intersect the stopping altitude for gamma rays, and the electron densities in Fig. 10.159b are applicable. But in Region 2, most of the rays will intersect a volume of air below the stopping altitude before reaching the point of interest. As a result of the gamma-ray absorption, the electron densities will be substantially below those given in Fig. 10.159b. In the intermediate (unshaded) region of Fig. 10.162, part but not all of the gamma rays will encounter the stopping altitude and the electron densities will be somewhat lower than in Fig. 10.159b. When using this figure to determine the expected effects of a nuclear explosion on a radar system, for example, a conservative approach would be to assume that the unshaded portion in Fig. 10.162 is part of Region 1 for the user's radar, but that it is part of Region 2 for the opponent's radar.

10.163 As for prompt radiations (§ 10.149 *et seq.*), an approximate solution to the problem of calculating electron densities arising from the delayed radiations, which is consistent with Figs. 10.159a and b, can be obtained by using the equal alpha approximation to determine the loss rate at any instant. The result can be written in the form

$$N_e(t) = \frac{\sqrt{q(t)}}{\sqrt{\alpha}} \cdot \frac{S + \sqrt{\alpha q(t)}}{S + K + \sqrt{\alpha q(t)}} \text{ cm}^{-3}, \tag{10.163.1}$$

where $q(t)$ is either the value for beta particles from equation (10.157.1), or

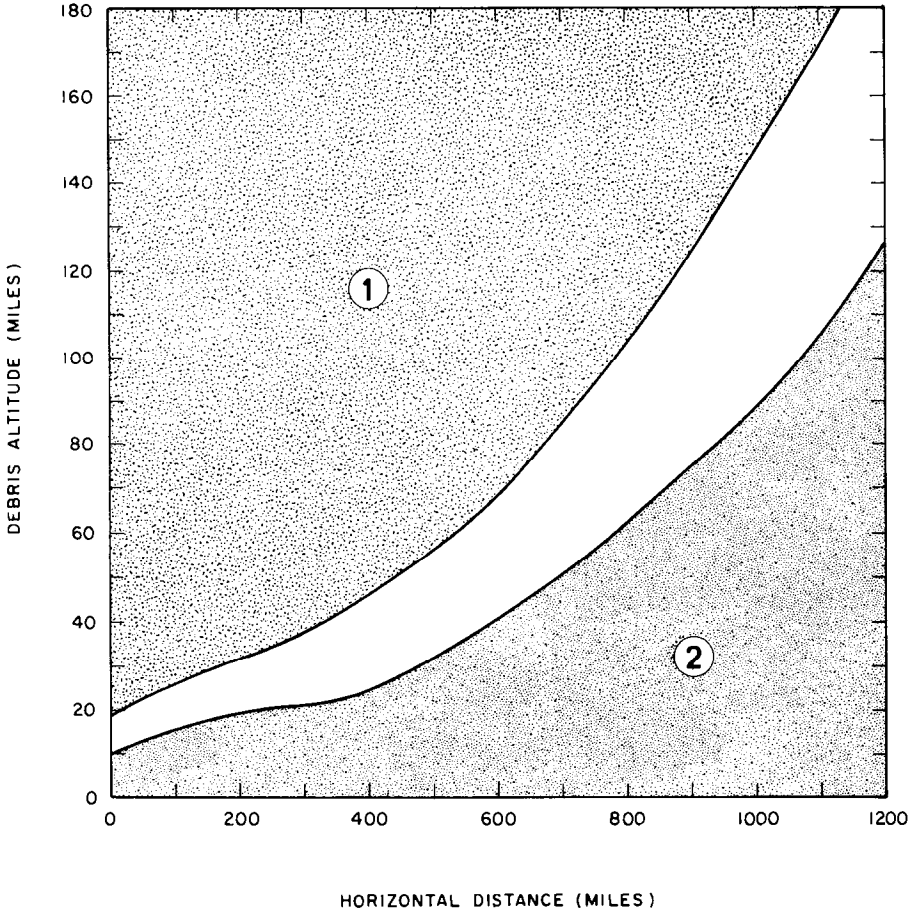

Figure 10.162. Effect of earth's curvature on delayed gamma-ray ionization at 40 miles altitude.

for gamma rays from equation (10.156.1); the coefficients α , S , and K have the same significance as before. By using the appropriate values of these coefficients for different altitudes, it has been found that the electron densities peak around an altitude of 40 miles for both daytime and nighttime conditions for slant distances more than 30 miles from the burst point. This is also the altitude for the maximum attenuation of electromagnetic signals by the ionization from delayed radiations (§ 10.159). For smaller distances from the burst point, the electron density peaks near the altitude of the debris region.

10.164 For electron production rates less than 10^6 electrons $\text{cm}^{-3} \text{sec}^{-1}$, equation (10.163.1), with the values of α , S , and K given in Table 10.150 for an altitude of 40 miles in the daytime, reduces to

$$N_e(t) \text{ at 40 miles} \\ \approx 10^3 \sqrt{q(t)} \text{ cm}^{-3} \text{ (daytime).}$$

At night, the values of α , S , and K at an altitude of 40 miles are 3×10^{-8} , 0, and 0.8, respectively, and then

$$N_e(t) \text{ at 40 miles} \\ \approx q(t) \text{ cm}^{-3} \text{ (nighttime),}$$

for production rates less than about 10^6 electrons $\text{cm}^{-3} \text{sec}^{-1}$. For production rates of about 10^7 (or more) electrons $\text{cm}^{-3} \text{sec}^{-1}$, the electron density at 40 miles is given approximately by

$$N_e(t) \text{ at 40 miles} \\ \approx 3 \times 10^3 \sqrt{q(t)} \text{ cm}^{-3},$$

for both daytime and nighttime. This result is consistent with Figs. 10.159a and b, in which the curves for day and night coincide when the circumstances are such as to lead to high electron densities. The conditions of applicability of these figures, as described in § 10.160 *et seq.*, also apply to the expressions given above.

BIBLIOGRAPHY

- CHRISTOFILOS, N. C., "The Argus Experiment," *J. Geophys. Res.* **64**, 869 (1959).
- CRAIN, C. M., "Decay of Ionization Impulses in the D and E Regions of the Ionosphere," *J. Geophys. Res.*, **68**, 2167 (1963).
- CRAIN, C. M., "Ionization Loss Rates Below 90 km," *J. Geophys. Res.* **65**, 1117 (1960).
- CRAIN, C. M., and P. TAMARKIN, "A Note on the Cause of Sudden Ionization Anomalies in Regions Remote from High-Altitude Nuclear Bursts," *J. Geophys. Res.*, **66**, 35 (1961).
- CUMMACK, C. H., and G. A. M. KING, "Disturbances in the Ionospheric F-Region Following a Johnston Island Nuclear Explosion," *New Zealand J. Geol. and Geophys.*, **2**, 634 (1959).
- DAVIS, K., "Ionospheric Radio Propagation," National Bureau of Standards, Monograph 80, April 1965.
- HOERLIN, H., "United States High-Altitude Test Experiences," University of California, Los Alamos Scientific Laboratory, October 1976, LA-6405.
- Journal of Geophysical Research*, Special Issue on the Artificial Radiation Belt, **68**, 605 *et seq.* (1963).
- KNAPP, W. S., C. F. MEYER, and P. G. FISHER, "Introduction to the Effects of Nuclear Explosions on Radio and Radar Propagation," General Electric Co., TEMPO, December 1967, DASA-1940.
- LATTER, R., and R. E. LELEVIER, "Detection of Ionization Effects from Nuclear Explosions in Space," *J. Geophys. Res.*, **68**, 1643 (1963).
- New Zealand Journal of Geology and Geophysics*, Special Nuclear Explosions Issue, **5**, 918 *et seq.* (1962).
- Proceedings of the IEEE*, Special Issue on Nuclear Test Detection, **53**, 1813 *et seq.* (1965).
- SAMSON, C. A., "Radio Noise Anomalies in August 1958," *J. Geophys. Res.*, **68**, 2719 (1963).
- SKOLNIK, M. I., "Introduction to Radar Systems," McGraw-Hill Book Company, 1962.
- STEIGER, W. R., and S. MATSUSHITA, "Photographs of the High-Altitude Nuclear Explosion TEAK," *J. Geophys. Res.*, **65**, 545 (1960).

CHAPTER XI

THE ELECTROMAGNETIC PULSE AND ITS EFFECTS

ORIGIN AND NATURE OF THE EMP

INTRODUCTION

11.01 Explosions of conventional high explosives can produce electromagnetic signals and so the generation of an electromagnetic pulse (EMP) from a nuclear detonation was expected. However, the extent and potentially serious nature of EMP effects were not realized for several years. Attention slowly began to focus on EMP as a probable cause of malfunction of electronic equipment during atmospheric nuclear tests in the early 1950's. Induced currents and voltages caused unexpected equipment failures and subsequent analysis disclosed the role of EMP in such failures. Finally, around 1960 the possible vulnerability of various civilian and military electrical and electronic systems to EMP was recognized. At about the same time it became apparent that the EMP could be used in the long-range detection of nuclear detonations.

11.02 For the foregoing reasons, theoretical and experimental efforts have been made to study the EMP and its effects. A limited amount of data had been gathered when aboveground test-

ing was halted in 1962. Subsequently, reliance has been placed on underground testing, analysis of existing atmospheric test data, nonnuclear simulation, and theoretical calculations. Extended efforts have been made to improve theoretical models and to develop associated computer codes for predictive studies. In addition, simulators have been developed which are capable of producing representative pulses for system coupling and response studies.

11.03 Nuclear explosions of all types — from underground to high altitudes — are accompanied by an EMP, although the intensity and duration of the pulse and the area over which it is effective vary considerably with the location of the burst point. The strongest electric fields are produced near the burst by explosions at or near the earth's surface, but for those at high altitudes the fields at the earth's surface are strong enough to be of concern for electrical and electronic equipment over a very much larger area.

11.04 The nuclear EMP is a time-varying electromagnetic radiation which increases very rapidly to a peak and then

decays somewhat more slowly. The radiation has a very broad spectrum of frequencies, ranging from very low to several hundred megahertz but mainly in the radiofrequency (long wavelength) region (Fig. 1.74). Furthermore, the wave amplitude (or strength) of the radiation varies widely over this frequency range. Because the EMP is a very complex phenomenon dependent upon the conditions of the burst, the descriptions given in this chapter are largely qualitative and sometimes oversimplified. They should, however, provide a general indication of the origin and possible effects of the EMP.

DEVELOPMENT OF AN ELECTRIC FIELD

11.05 The instantaneous (or prompt) gamma rays emitted in the nuclear reactions and those produced by neutron interactions with weapon residues or the surrounding medium (Fig. 8.14) are basically responsible for the processes that give rise to EMP from bursts in the lower atmosphere. The gamma rays interact with air molecules and atoms, mainly by the Compton effect (§ 8.89), and produce an ionized region surrounding the burst point (§ 8.17). In EMP studies this is called the "deposition region." The negatively charged electrons move outward faster than the much heavier positively charged ions and as a result there is initially a separation of charges. The region nearer to the burst point has a net positive charge whereas that farther away has a net negative charge. This separation of charges produces an electric field which can attain its maximum value in about 10^{-8} second, i.e., one

hundredth part of a microsecond (§ 1.54 footnote).

11.06 If the explosion occurred in a perfectly homogeneous (constant density) atmosphere and the gamma rays were emitted uniformly in all directions, the electric field would be radial and spherically symmetric, i.e., it would have the same strength in all directions outward from the center (Fig. 11.06a). There would then be no electromagnetic energy radiated from the ionized deposition region. In practice, however, such an ideal situation does not exist; there is inevitably some condition, such as differences in air density at different levels, proximity of the earth's surface, the nonuniform configuration of the exploding weapon (including auxiliary equipment, the case, or the carrying vehicle), or even variations in the water vapor content of the air, that will interfere with the symmetry of the ionized region. If the burst occurs at or near the earth's surface, the departure from spherical symmetry will clearly be considerable. In all these circumstances, there is a net vertical electron current generated within the ionized deposition region (Fig. 11.06b). The time-varying current results in the emission of a short pulse of electromagnetic radiation which is strongest in directions perpendicular to the current; this is the EMP. In a high-altitude explosion, the EMP arises in a somewhat different manner, as will be seen shortly.

NATURE OF THE EMP

11.07 After reaching its maximum in an extremely short time, the electric field strength falls off and becomes quite small in a few tens of microseconds. In

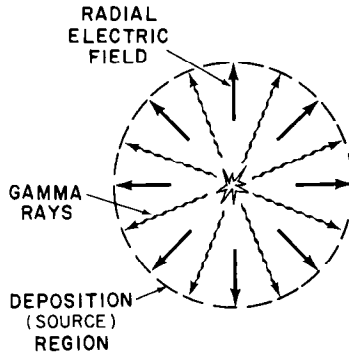

Figure 11.06a. Only a symmetric radial electron field is produced if the ionized deposition region is spherically symmetric; there is no net electron current.

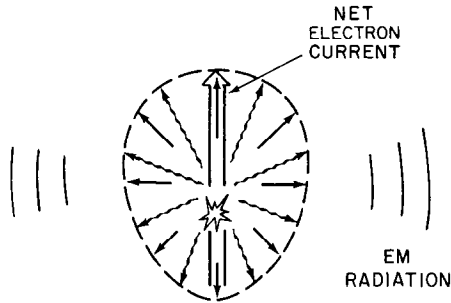

Figure 11.06b. Disturbance of symmetry results in a net electron current; a pulse of electromagnetic radiation is emitted which is strongest in directions perpendicular to the net current.

spite of the short duration of the pulse, it carries a considerable amount of energy, especially if the exploding weapon has a yield in the megaton range. As it travels away from the burst point at the speed of light, as do all electromagnetic waves (§ 1.73), the radiation can be collected by metallic and other conductors at a distance, just as radio waves are picked up by antennas. The energy of the radiation can then be converted into strong electric currents and high voltages. Electrical and electronic equipment connected to (or associated with) the

collector may thus suffer severe damage. The consequences could be serious for any system that relies on such equipment, e.g., commercial electric power generation and distribution systems, telecommunications, i.e., radio, radar, television, telephone, and telegraph systems, and electronic computers.

11.08 In a crude sense, the EMP radiations are somewhat similar to the familiar radio waves, although there are some important differences. Radio transmitters are designed to produce

electromagnetic waves of a particular frequency (or wavelength), but the waves in the EMP have a wide range of frequencies and amplitudes. Furthermore, the strength of the electric fields associated with the EMP can be millions of times greater than in ordinary radio waves. Nevertheless, in each case, the energy of electromagnetic waves is collected by a suitable antenna (or conductor) and transferred to attached or adjacent equipment. The energy from the EMP is received in such a very short time, however, that it produces a strong electric current which could damage the equipment. An equal amount of energy spread over a long period of time, as in conventional radio reception, would have no harmful effect.

11.09 The characteristics of the EMP depend to a great extent on the weapon yield and height of burst. For explosions in the atmosphere at altitudes of a few miles, the deposition region will have a radius of about 3 miles, but it will increase to roughly 9 miles with increasing height of the burst point up to altitudes of approximately 19 miles. In this altitude range, the difference in air density across the vertical dimension of the deposition region will not be large and so the EMP effect will be moderate. In addition to the EMP arising from air density asymmetries, a short pulse is emitted in a manner similar to that described in § 11.14 for high-altitude bursts. The electric fields produced on the ground from air bursts between a few miles and about 19 miles altitude will be less than those radiated from surface (or near-surface) and high-altitude explosions. These latter two types of nuclear explosions will be considered briefly here, and more will be said later

about them and about air bursts (§ 11.66 *et seq.*).

EMP IN SURFACE BURSTS

11.10 The mechanism of EMP formation is different in explosions at (or near) the surface and at high altitudes. In a surface burst, those gamma rays that travel in a generally downward direction are readily absorbed in the upper layers of the ground and there is essentially no charge separation or electric field in this direction. The gamma rays moving outward and upward, however, produce ionization and charge separation in the air. Consequently, there is a net vertical electron current (Fig. 11.10). As a result, the ionized deposition (source) region is stimulated to emit much of its energy as an electromagnetic pulse in the radiofrequency spectrum.

11.11 Since the ground is a relatively good conductor of electricity, it provides an alternative path for the electrons to return from the outer part of the deposition region toward the burst point where the positively charged ions, which have been left behind, predominate. Electric currents thus flow in the ground and generate strong magnetic fields in the region of the surface burst point.

11.12 The electric field produced in a surface burst is very strong but the radiated field falls off with increasing distance from the deposition region, at first quite rapidly and then somewhat less so. The potential hazard to electrical and electronic equipment from the EMP will thus be greatest within and near the deposition region which may extend over a radius around ground zero

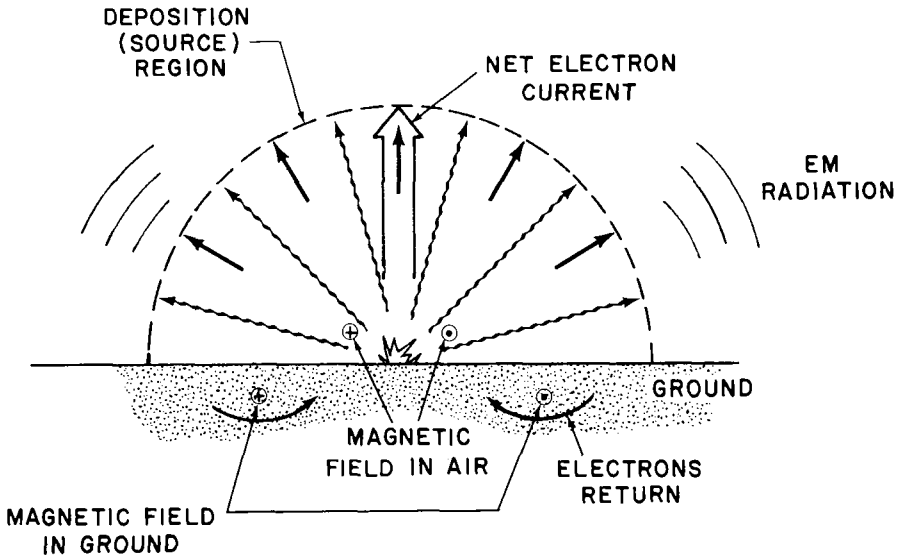

Figure 11.10. Schematic representation of the EMP in a surface burst.

of about 2 to 5 miles, depending on the explosion yield. In this area, structures in which equipment is housed may suffer severe damage, especially from high-yield explosions, unless they are blast resistant. However, the threat to electrical and electronic systems from a surface-burst EMP may extend as far as the distance at which the peak overpressure from a 1-megaton burst is 2 pounds per square inch, i.e., 8 miles (see Chapter III). The degree of damage, if any, will depend on the susceptibility of the equipment and the extent of shielding (§ 11.33 *et seq.*).

EMP IN HIGH-ALTITUDE BURSTS

11.13 If the nuclear burst is at an altitude above about 19 miles, the gamma rays moving in an upward direction will enter an atmosphere where the air density is so low that the rays travel great distances before being ab-

sorbed. On the other hand, the gamma rays emitted from the explosion in a generally downward direction will encounter a region where the atmospheric density is increasing. These gamma rays will interact with the air molecules and atoms to form the deposition (or source) region for the EMP (Fig. 11.13). This roughly circular region may be up to 50 miles thick in the center, tapering toward the edge, with a mean altitude of about 25 to 30 miles. It extends horizontally for great distances which increase with the energy yield and the height of the burst point (see Figs. 11.70a and b).

11.14 In the deposition region the gamma rays produce Compton electrons by interactions in the air; these electrons are deflected by the earth's magnetic field and are forced to undergo a turning motion about the field lines. This motion causes the electrons to be subjected to a radial acceleration which results, by a

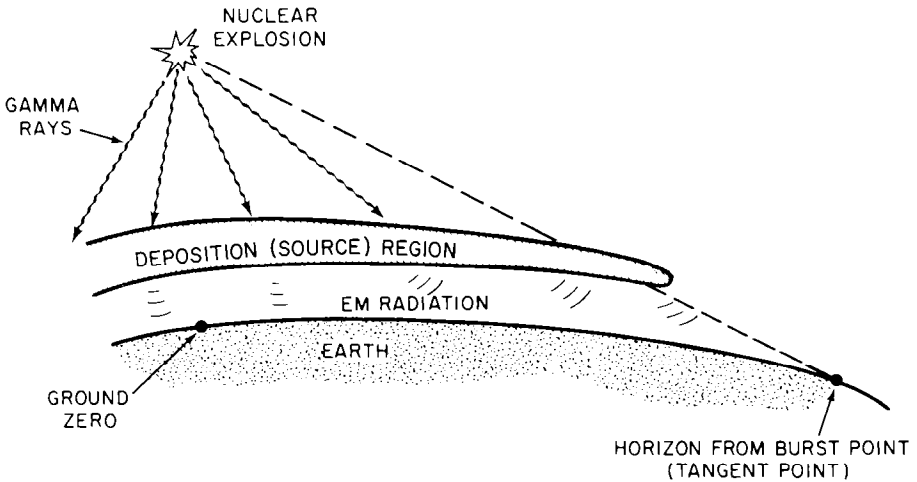

Figure 11.13. Schematic representation of the EMP in a high-altitude burst. (The extent of the deposition region varies with the altitude and the yield of the explosion.)

complex mechanism, in the generation of an EMP that moves down toward the earth. The pulse rises to a peak and then decreases, both taking place more rapidly than for a surface burst; as a result more of the electromagnetic energy appears in the higher frequency range (§ 11.63). The strength of the electric field observed at the surface from a high-altitude explosion is from one-tenth to a hundredth of the field within the source region from a surface burst. However, in a surface burst the radiated field strength drops off rapidly with distance outside this region and is then smaller than for a high-altitude burst. In the latter case, the radiated field does not vary greatly over a large area on the ground or in the atmosphere above the ground. The electric field is influenced by the earth's magnetic field, but over most of the area affected by the EMP, the electric field strength varies by not more than a factor of two for explosions with yields of a few hundred kilotons or more (§ 11.73).

11.15 For an explosion of high yield at a sufficient altitude, the area covered by the high-frequency EMP extends in all directions on the ground as far as the line-of-sight, i.e., to the horizon, from the burst point (see Fig. 11.13). The lower frequencies will constitute a significant pulse extending even beyond the horizon. For a nuclear explosion at an altitude of 50 miles, for example, the affected area on the ground would have a radius of roughly 600 miles and for an altitude of 100 miles the ground radius would be about 900 miles. For an explosion at 200 miles above the center of the (conterminous) United States, almost the whole country, as well as parts of Canada and Mexico, could be affected by the EMP. Thus, for a high-altitude burst, the damage could conceivably extend to distances from ground zero at which all other effects, except possibly eye injury at night (§ 12.79 *et seq.*), would be negligible. Furthermore, because the radiations travel with the speed of light,

the whole area could be affected almost simultaneously by the EMP from a single high-altitude nuclear explosion.

COLLECTION OF EMP ENERGY

11.16 For locations that are not within or close to the deposition region for a surface or air burst, both the amount and rate of EMP energy received *per unit area* on or near the ground will be small, regardless of the type of nuclear explosion. Hence, for damage to occur to electrical or electronic systems, it would usually be necessary for the energy to be collected over a considerable area by means of a suitable conductor. In certain systems, however, sufficient energy, mainly from the high-frequency components of the EMP, may be collected by small metallic conductors to damage very sensitive components (§ 11.31). The energy is then delivered from the collector (antenna) in the form of a strong current and voltage surge to attached equipment. Actually, the equipment does not have to be attached directly to the col-

lector; the EMP energy can be coupled in other ways (§ 11.27). For example, it is possible for an electric current to be induced or for a spark to jump from the conductor which collects the EMP energy to an adjacent conductor, not connected to the collector, and thence to a piece of equipment.

11.17 The manner in which the electromagnetic energy is collected from the EMP is usually complex, because much depends on the size and shape of the collector, on its orientation with respect to the source of the pulse, and on the frequency spectrum of the pulse. As a rough general rule, the amount of energy collected increases with the dimensions of the conductor which serves as the collector (or antenna). Typical effective collectors of EMP energy are given in Table 11.17. Deeply buried cables, pipes, etc., are generally less effective than overhead runs because the ground provides some shielding by absorbing the high-frequency part of the energy (see, however, § 11.68).

Table 11.17

TYPICAL COLLECTORS OF EMP ENERGY

Long runs of cable, piping, or conduit
 Large antennas, antenna feed cables, guy wires, antenna support towers
 Overhead power and telephone lines and support towers
 Long runs of electrical wiring, conduit, etc., in buildings
 Metallic structural components (girders), reinforcing bars, corrugated roof, expanded metal lath, metallic fencing
 Railroad tracks
 Aluminum aircraft bodies

SUMMARY OF EMP DAMAGE AND PROTECTION

11.18 The sensitivity of various systems and components to the EMP has

been studied by means of simulators which generate sharp pulses of electromagnetic radiation (§ 11.41 *et seq.*). The results are not definitive because the amount of EMP energy delivered to a

particular component would depend on the details of the circuit in which it is connected. Nevertheless, certain general conclusions seem to be justifiable. Computers and other equipment having solid-state components are particularly sensitive. Since computers are used extensively in industry and commerce, including electrical distribution and communications systems, the consequence of operational failure could be very serious. Vacuum-tube equipment (with no solid-state components) and low-current relays, switches, and meters, such as are used in alarm and indicator systems, are less susceptible. The least susceptible electrical components are motors, transformers, circuit breakers, etc., designed for high-voltage applications. The threat to any component, regardless of its susceptibility to operational upset (temporary impairment) or damage, is increased if it is connected (or coupled) to a large collector. Conversely, the danger is diminished if the collector is small. Thus, although transistorized circuits are generally sensitive to the EMP, portable (battery operated) radios with very short "whip" or ferrite core antennas are not readily damaged unless they are close to a collector. Disconnection of a piece of equipment from the electric power main supply will decrease the energy collected, but this is not always feasible because it would deny use of the equipment.

11.19 Various means are possible for protecting or "hardening" equipment against damage by the EMP. Such protection is generally difficult for existing systems, but it can be built into new systems. Some of the approaches to hardening which have been proposed are the following: metal shields to pre-

vent access of the radiation, good grounding to divert the large currents, surge arrestors similar to those used for lightning protection, and proper wiring arrangements. Finally, components that are known to be susceptible to damage by sharp pulses of electromagnetic energy should be eliminated. A further discussion of these procedures is given later in this chapter (§ 11.33 *et seq.*).

11.20 Except for locations close to a surface burst, where other effects would dominate in any event, the EMP radiation from a nuclear explosion is expected to be no more harmful to people than a flash of lightning at a distance. Tests on monkeys and dogs have shown that there are no deleterious effects from pulses administered either singly or repetitively over a period of several months. However, a person in contact with an effective collector of EMP energy, such as a long wire, pipe, conduit, or other sizable metallic object listed in Table 11.17, might receive a severe shock.

SYSTEM-GENERATED EMP

11.21 In addition to the EMP arising from the interaction of gamma rays from a nuclear explosion with the atmosphere (or the ground), another type of electromagnetic pulse, called the "system-generated EMP" (or SGEMP), is possible. This term refers to the electric field that can be generated by the interaction of nuclear (or ionizing) radiations, particularly gamma rays and X rays, with various solid materials present in electronic systems. The effects include both forward- and back-scatter emission of electrons and external and internal current generation.

11.22 The system-generated EMP is most important for electronic components in satellites and ballistic systems, above the deposition region, which would be exposed directly to the nuclear radiations from a high-altitude burst. The system-generated EMP can also be significant for surface and moderate-altitude bursts if the system is within the deposition region but is not subject to damage by other weapons effects. This could possibly occur for surface systems exposed to a burst of relatively low yield or for airborne (aircraft) systems and bursts of higher yield.

11.23 The system-generated EMP phenomenon is actually very complex, but in simple terms it may be considered to be produced in the following manner. The solid material in an electronic system or even in the shielding designed to protect the system from the external EMP contains atoms which are heavier than those present in the air. Consequently, interaction with gamma rays and high-energy X rays will produce electrons by both the Compton and photoelectric effects (§ 8.89 *et seq.*). These electrons can, in turn, interact with the solid material to release more electrons, called secondary electrons, by ionization. Such electrons as are produced, directly or indirectly, close to and on both faces of the solid material and have a velocity component perpendicular to the surface, will be emitted from the surface of the material. As a result, an electric field is generated near the surface. There are other effects, but they need not be considered here.

11.24 If the component has a cavity (or space) in which the gas pressure is very low, less than about 10^{-3} millimeter of mercury, very high electric

fields — about 100,000 to a million volts per meter — can occur near the interior walls. At higher gas pressures, however, the electrons cause substantial ionization of the gas, e.g., air, thereby releasing low-energy (secondary) electrons. The relatively large number of secondary (conduction) electrons form a current which tends to cancel the electric field, thus enabling the high-energy electrons to move across the cavity more easily.

11.25 The electric fields generated near the walls by direct interactions of ionizing radiations with the materials in an electronic system can induce electric currents in components, cables, ground wires, etc. Large currents and voltages, capable of causing damage or disruption, can be developed just as with the external EMP. Because of the complexity of the interactions that lead to the system-generated EMP, the effects are difficult to predict and they are usually determined by exposure to radiation pulses from a device designed to simulate the EMP radiation from a nuclear explosion (§ 11.42).

EMP EXPERIENCE IN HIGH-ALTITUDE TESTS

11.26 The reality of damage to electrical and electronic equipment by the EMP has been established in various nuclear tests and by the use of EMP simulators. A number of failures in civilian electrical systems were reported to have been caused by the EMP from the high-altitude test explosions conducted in the Johnston Island area of the Pacific Ocean in 1962. One of the best authenticated cases was the simultaneous failure of 30 strings (series-con-

nected loops) of street lights at various locations on the Hawaiian island of Oahu, at a distance of some 800 miles from ground zero. The failures occurred in devices called "fuses" which are installed across the secondaries of transformers serving these strings; the purpose of the fuses is to prevent damage to the lighting system by sudden current surges. Similar fuses associated with individual street lights were not affected. It was also reported that

"hundreds" of burglar alarms in Honolulu began ringing and that many circuit breakers in power lines were opened. These occurrences probably resulted from the coupling of EMP energy to the lines to which the equipment was connected and not to failure of the devices themselves. No serious damage occurred since these items are among the least susceptible to the EMP (§ 11.18).

EMP DAMAGE AND PROTECTION¹

COUPLING OF EMP ENERGY

11.27 There are three basic modes of coupling of the EMP energy with a conducting system; they are electric induction, magnetic induction, and resistive coupling (sometimes referred to as direct charge deposition). In electric induction a current is induced in a conductor by the component of the electric field in the direction of the conductor length. Magnetic induction occurs in conductors that form a closed loop; the component of the magnetic field perpendicular to the plane of the loop causes current to flow in the loop. The form of the loop is immaterial and any connected conductors, even the reinforcing bars in concrete, can constitute a loop in this respect. Resistive coupling can occur when a conductor is immersed in a conducting medium, such as ionized air, salt water, or the ground. If a current is induced in the medium by one of the coupling modes already de-

scribed, the conductor forms an alternative conducting path and shares the current with the medium.

11.28 If the EMP wave impinges upon the ground, a part of the energy pulse is transmitted through the air-ground surface whereas the remainder is reflected. An aboveground collector, such as an overhead power line or a radio antenna tower, can then receive energy from both the direct and reflected pulses. The net effect will depend on the degree of overlap between the two pulses. The EMP transmitted into the ground can cause a current to flow in an underground conductor either by induction or by resistive coupling.

11.29 The coupling of electromagnetic energy to a conductor is particularly efficient when the maximum dimension is about the same size as the wavelength of the radiation. The conductor is then said to be resonant, or to behave as an antenna, for the frequency

¹This section (§§ 11.27 through 11.59) is of particular interest to electrical and electronic engineers.

corresponding to this wavelength. Since EMP has a broad spectrum of frequencies, only a portion of this spectrum will couple most efficiently into a specific conductor configuration. Thus, a particular collection system of interest must be examined with regard to its overall configuration as well as to the component configuration. Most practical collector systems, such as those listed in Table 11.17, are complex and the determination of the amount of EMP energy collected presents a very difficult problem. Both computer methods and experimental simulation are being used to help provide a solution.

COMPONENT AND SYSTEM DAMAGE

11.30 Degradation of electrical and electronic system performance as a result of exposure to the EMP may consist of functional damage or operational upset. Functional damage is a catastrophic failure that is permanent; examples are burnout of a device or component, such as a fuse or a transistor, and inability of a component or subsystem to execute its entire range of functions. Operational upset is a temporary impairment which may deny use of a piece of equipment from a fraction of a second to several hours. Change of state in switches and in flip-flop circuits are examples of operational upset. The amount of EMP energy required to cause operational upset is generally a few orders of magnitude smaller than for functional damage.

11.31 Some electronic components are very sensitive to functional damage (burnout) by the EMP. The actual sensitivity will often depend on the characteristics of the circuit containing the

component and also on the nature of the semiconductor materials and fabrication details of a solid-state device. In general, however, the components listed in Table 11.31 are given in order of decreasing sensitivity to damage by a sharp pulse of electromagnetic energy. Tests with EMP simulators have shown that a very short pulse of about 10^{-7} joule may be sufficient to damage a microwave semiconductor diode, roughly 5×10^{-2} joule will damage an audio transistor, but 1 joule would be required for vacuum tube damage. Systems using vacuum tubes only would thus be much less sensitive to the EMP than those employing solid-state components. The minimum energy required to damage a microammeter or a low-current relay is about the same as for audio transistors.

Table 11.31

ELECTRONIC COMPONENTS IN ORDER OF DECREASING SENSITIVITY

- Microwave semiconductor diodes
- Field-effect transistors
- Radiofrequency transistors
- Silicon-controlled rectifiers
- Audio transistors
- Power rectifier semiconductor diodes
- Vacuum tubes

11.32 As seen earlier, the EMP threat to a particular system, subsystem, or component is largely determined by the nature of the collector (antenna). A sensitive system associated with a poor collector may suffer less damage than a system of lower sensitivity attached to a more efficient collector. Provided the EMP energy collectors are similar in all cases, electrical and electronic systems may be classified in the manner shown

in Table 11.32. However, the amount of energy collected is not always a sufficient criterion for damage. For example, an EMP surge can sometimes serve as a trigger mechanism by producing arcing or a change of state which, in turn, allows the normal operating voltage to cause damage to a piece of equipment. Thus, analysis of sensitivity to EMP

may require consideration of operational upset and damage mechanisms in addition to the energy collected.

PROTECTIVE MEASURES

11.33 A general approach to the examination of a system with regard to its EMP vulnerability might include the

Table 11.32

DEGREES OF SUSCEPTIBILITY TO THE EMP

Most Susceptible

- Low-power, high-speed digital computer, either transistorized or vacuum tube (operational upset)
- Systems employing transistors or semiconductor rectifiers (either silicon or selenium):
 - Computers and power supplies
 - Semiconductor components terminating long cable runs, especially between sites
 - Alarm systems
 - Intercom system
 - Life-support system controls
 - Some telephone equipment which is partially transistorized
 - Transistorized receivers and transmitters
 - Transistorized 60 to 400 cps converters
 - Transistorized process control systems
 - Power system controls and communication links

Less Susceptible

- Vacuum-tube equipment that does not include semiconductor rectifiers:
 - Transmitters
 - Receivers
 - Alarm systems
 - Intercom systems
 - Teletype-telephone
 - Power Supplies
- Equipment employing low-current switches, relays, meters:
 - Alarms
 - Life-support systems
 - Power system control panels
 - Panel indicators and status boards
 - Process controls
- Hazardous equipment containing:
 - Detonators
 - Squibs
 - Pyrotechnical devices
 - Explosive mixtures
 - Rocket fuels
- Other:
 - Long power cable runs employing dielectric insulation
 - Equipment associated with high-energy storage capacitors
 - Inductors

Least Susceptible

- High-voltage 60 cps equipment:
 - Transformers, motors
 - Lamps (filament)
 - Heaters
 - Rotary converters
 - Heavy-duty relays, circuit breakers
 - Air-insulated power cable runs

following steps. First, information concerning the system components and devices is collected. The information is categorized into physical zones based on susceptibility and worst-case exposure for these items. It must be borne in mind in this connection that energy collected in one part of a system may be coupled directly or indirectly (by induction) to other parts. By using objective criteria, problem areas are identified, analyzed, and tested. Suitable changes are made as necessary to correct deficiencies, and the modified system is examined and tested. The approach may be followed on proposed systems or on those already existing, but experience indicates that the cost of retrofitting EMP protection may often be prohibitive. Consequently, it is desirable to consider the vulnerability of the system early during the design stage.

11.34 A few of the practices that may be employed to harden a system against EMP damage are described below. The discussion is intended to provide a general indication of the techniques rather than a comprehensive treatment of what is a highly technical and specialized area. Some of the methods of hardening against the EMP threat are shielding, proper circuit layout, satisfactory grounding, and various protective devices. If these measures do not appear to be adequate, it may be advisable to design equipment with vacuum tubes rather than solid-state components, if this is compatible with the intended use of the equipment.

11.35 A so-called "electromagnetic" shield consists of a continuous metal, e.g., steel, soft iron, or copper, sheet surrounding the system to be protected. Shielding of individual compo-

nents or small subsystems is generally not practical because of the complexity of the task. Good shielding practice may include independent zone shields, several thin shields rather than one thick one, and continuous joints. The shield should not be used as a ground or return conductor, and sensitive equipment should be kept away from shield corners. Apertures in shields should be avoided as far as possible; doors should be covered with metal sheet so that when closed they form a continuous part of the whole shield, and ventilation openings, which cannot be closed, should be protected by special types of screens or waveguides. In order not to jeopardize the effectiveness of the shielding, precautions must be taken in connection with penetrations of the housing by conductors, such as pipes, conduits, and metal-sheathed cables (§ 11.59).

11.36 Recommendations for circuit layout include the use of common ground points, twisted cable pairs, system and intrasystem wiring in "tree" format (radial spikes), avoiding loop layouts and coupling to other circuits, use of conduit or cope trays, and shielded isolated transformers. The avoidance of ground return in cable shields is also recommended. Some procedures carry over from communications and power engineering whereas others do not.

11.37 From the viewpoint of EMP protection, cable design represents an extension of both shielding and circuit practices. Deeply buried (more than 3 feet underground) cables, shield layer continuity at splices, and good junction box contacts are desirable. Ordinary braid shielding should be avoided.

Compromises are often made in this area in the interest of economy, but they may prove to be unsatisfactory.

11.38 Good grounding practices will aid in decreasing the susceptibility of a system to damage by the EMP. A "ground" is commonly thought of as a part of a circuit that has a relatively low impedance to the local earth surface. A particular ground arrangement that satisfies this definition may, however, not be optimum and may be worse than no ground for EMP protection. In general, a ground can be identified as the chassis of an electronic circuit, the "low" side of an antenna system, a common bus, or a metal rod driven into the earth. The last depends critically on local soil conditions (conductivity), and it may result in resistively coupled currents in the ground circuit. A good starting point for EMP protection is to provide a single point ground for a circuit cluster, usually at the lowest impedance element — the biggest piece of the system that is electrically immersed in the earth, e.g., the water supply system.

11.39 Various protective devices may be used to supplement the measures described above. These are related to the means commonly employed to protect radio and TV transmission antennas from lightning strokes and power lines from current surges. Examples are arresters, spark gaps, band-pass filters, amplitude limiters, circuit breakers, and fuses. Typically, the protective device would be found in the "EMP room" at the cable entrance to an underground installation, in aircraft antenna feeds, in telephone lines, and at power entry panels for shielded rooms. On a smaller scale, diodes, nonlinear resistors, sili-

con-controlled rectifier clamps, and other such items are built into circuit boards or cabinet entry panels.

11.40 Few of the devices mentioned above are by themselves sufficient as a complete solution to a specific problem because each has some limitation in speed of response, voltage rating, power dissipation capacity, or reset time. Hence, most satisfactory protective devices are hybrids. For example, a band-pass filter may be used preceding a lightning arrester. The filter tends to stretch out the rise time of the EMP, thus providing sufficient time for the arrester to become operative. In general, a hybrid protection device must be designed specially for each application.

TESTING

11.41 Because of the complexities of the EMP response, sole reliance cannot be placed on predictions based on analysis. Testing is essential to verify analysis of devices, components, and complete systems early in the design stage. Testing also is the only known method that can be used to reveal unexpected effects. These may include coupling or interaction modes or weaknesses that were overlooked during the design. In some simple systems, nonlinear interaction effects can be analyzed numerically, but as a general rule testing is necessary to reveal them. As a result of the test, many of the original approximations can be refined for future analysis, and the data can improve the analytic capability for more complex problems. Testing also locates weak or susceptible points in components or systems early enough for economic improvement. After the improvements,

testing confirms that the performance is brought up to standard. A complete system should be tested to verify that it has been hardened to the desired level; subsequent periodic testing will indicate if any degradation has resulted from environmental or human factors.

11.42 Since the cessation of atmospheric weapons tests, heavy reliance has been placed on simulation to test the EMP hardness of systems. The classes of EMP tests include: (1) low-level current mapping; (2) high-level current injection; (3) high-level electromagnetic fields. Low-level current mapping should be used at the beginning of any test program. With the system power turned off, the magnitudes and signatures on internal cables are determined in a low-level field. This provides an insight into the work that must follow. After indicated improvements are made, a high-level current can be injected directly into the system with the system power on to explore for nonlinearities, and to uncover initial indications of system effects. If subsystems malfunction, it may be desirable to conduct extensive subsystem tests in the laboratory. Finally, test in a high-level electromagnetic field is essential.

11.43 The type of excitation must be defined in any type of test. The two principal choices are: (1) waveform simulations, which provide time-domain data, and (2) continuous wave (CW) signals, which provide frequency-domain data. If the intent is to match a system analysis in the frequency domain to measured system response, CW signals may be the more suitable. If the test results were being compared to known electronic thresholds, it is frequently necessary to test in

the time domain. Both types of tests should be considered for a complete analysis.

11.44 Large-scale simulators are required for the final test of large systems. The two principal kinds of large simulators are metallic structures that guide an electromagnetic wave past a test object, and antennas that radiate an electromagnetic field to the object. Each type of simulator may use either pulse generators (time domain) or CW signal generators (frequency domain). Pulse generators themselves can be either high-level single shot or low-level repetitive.

11.45 The essential elements of a guided-wave or transmission-line simulator include a pulser, a transition section, working volume, and a termination. An electromagnetic wave of suitable amplitude and wave shape is generated by the pulser. This wave is guided by a tapered section of transmission line (the transition section) from the small cross-sectional dimension of the pulser output to the working volume. The working volume, where the test object is located, should be large enough to provide a certain degree of field uniformity over the object. This condition is satisfied if the volume of the test object is about one-third (or less) that of the working volume, depending on the degree of field perturbation that is acceptable. The termination region prevents the reflection of the guided wave back into the test volume; it consists of a transition section that guides the incident wave to a geometrically small resistive load whose impedance is equal to the characteristic impedance of the transmission line structure.

11.46 The basic types of radiating

simulators are long wire, biconical dipole, or conical monopole. The long wire is usually a long dipole oriented parallel to the earth's surface. It is supported above the ground by nonconducting poles with high-voltage insulators. The two arms of the dipole are symmetric about the center and constructed from sections of lightweight cylindrical conductor, such as irrigation pipe. Pipe sections decrease in diameter with increasing distance from the center, and resistors are placed between the pipe sections to shape the current wave and to reduce resonances. The two arms of the dipole are oppositely charged, and when the voltage across the spark gap at the dipole center reaches the breakdown voltage, the gap begins conducting and a wave front propagates away from the gap.

11.47 Conical and biconical antennas use pulsers, such as Marx generators or CW transmitters, instead of relying on the discharge of static surface charges. The antennas consist of lightweight conducting surfaces or wire grids.

11.48 Electromagnetic scale modeling may sometimes be an important alternative to full-scale testing of a system. Because of the difficulty in introducing minute openings or poor bonds into models, and since these often control interior fields, the usefulness of modeling ordinarily is limited to the measurement of external fields, voltages, and currents. Once these parameters are known for a complex structure, perhaps having cable runs, analysis can often provide internal field quantities of interest.

EMP AND ELECTRIC POWER SYSTEMS

11.49 Some indication of the possible threat of the EMP to commercial electric power system may be obtained by considering the effects of lightning strokes and switching surges. In power systems, protection against lightning is achieved by means of overhead "ground" wires and lightning arresters of various types. By providing an effective shunt, an overhead ground can divert most of the lightning surge from the phase conductors. Such grounding, however, would afford only partial protection from the EMP. Furthermore, although there are some similarities between the consequences of lightning and those of the EMP, there are differences in the nature of the current (or voltage) pulse which make the lightning arresters in common use largely ineffective for the EMP.

11.50 The general manner of the growth and decay of the current induced by the EMP from a high-altitude burst in an overhead transmission line is indicated by the calculated curve in Fig. 11.50. The details of the curve will vary with the conditions, but the typical features of the current pulse are as shown: a very rapid rise to a peak current of several thousand amperes in a fraction of a microsecond followed by a decay lasting up to a millisecond for a long transmission line. The current surge in an overhead power line caused by a lightning stroke increases to a maximum more slowly and persists for a longer time than for the EMP. As a result, older conventional lightning arresters are less effective for the EMP from

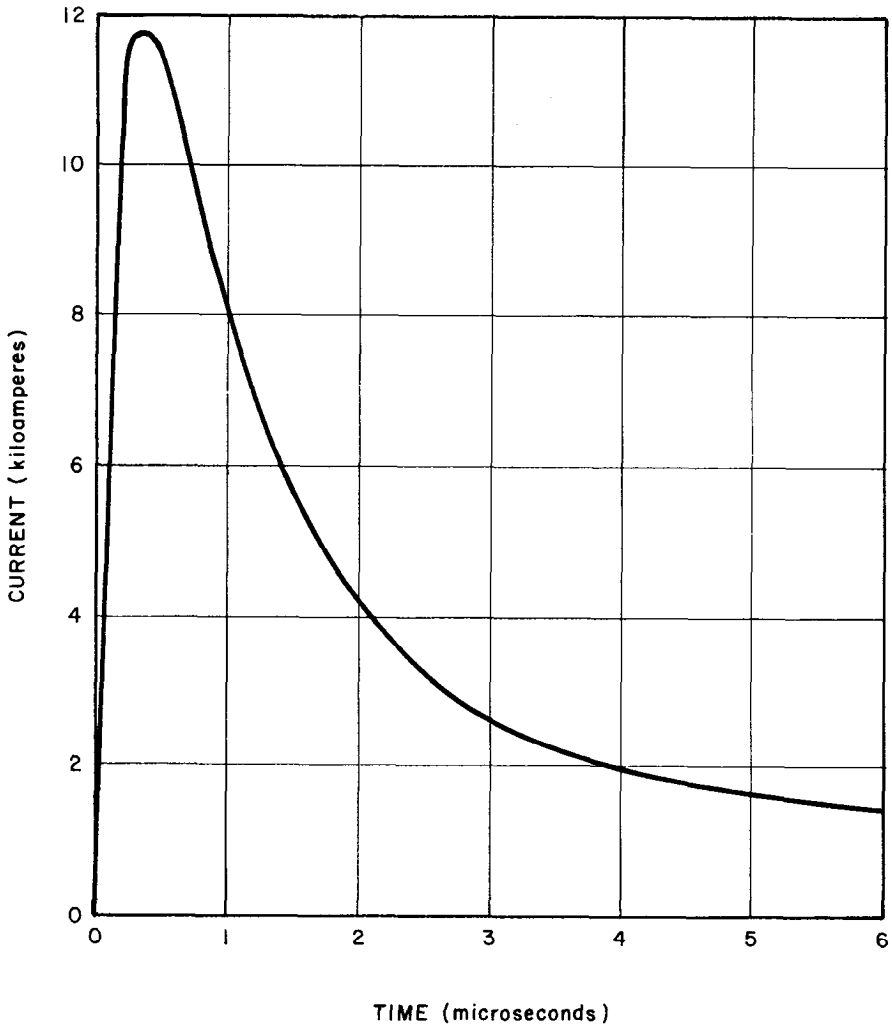

Figure 11.50. Typical form of the current pulse induced by the EMP from a high-altitude nuclear explosion in a long overhead power line. (The actual currents and times will depend to some extent on the conditions.)

high-altitude explosions than for lightning. Modern lightning arresters, however, can provide protection against EMP in many applications and hybrid arresters (§ 11.40) are expected to be even better.

11.51 In the absence of adequate

protection, the surge voltages on overhead power lines produced by the EMP could cause insulator flashover, particularly on circuits of medium and low voltage. (The components of high-voltage transmission systems should be able to withstand the EMP surge voltages.) If

flashovers occur in the event of a high-altitude burst many would be experienced over a large area. Such simultaneous multiple flashovers could lead to system instability.

11.52 Switching surges occur when power lines are energized or de-energized. In systems of moderate and low voltage such surges can cause breakers in the switching circuit to operate erroneously, but the effect of the EMP is uncertain because the current rise in a switching surge is even slower than for lightning. In extra-high-voltage (EHV) lines, i.e., 500 kilovolts or more, switching surges are accompanied by a rapidly increasing radiated electromagnetic field similar to that of the EMP. The currents induced in control and communications cables are sufficient to cause damage or malfunction in associated equipment. The information obtained in connection with the development of protective measures required for EHV switching stations should be applicable to EMP protection.

11.53 There is a growing movement in the electric power industry to substitute semiconductor devices for vacuum tubes in control and communications circuits. Solid-state components are, however, particularly sensitive to the EMP. Even a small amount of energy received from the pulse could result in erroneous operation or temporary failure. Computers used for automatic load control would be particularly sensitive and a small amount of EMP energy, insufficient to cause permanent damage, could result in faulty operation or temporary failure. Special attention is thus required in the protection of such equipment.

EMP AND RADIO STATIONS

11.54 Unless brought in underground and properly protected, power and telephone lines could introduce substantial amounts of energy into radio (and TV) stations. A major collector of this energy, however, would be the transmitting (or receiving) antennas since they are specially designed for the transmission and reception of electromagnetic energy in the radiofrequency region. The energy collected from the EMP would be mainly at the frequencies in the vicinity of the antenna design frequency.

11.55 Antenna masts (or towers) are frequently struck by lightning and spark gaps are installed at the base of the tower to protect the station equipment. But the gaps in common use, like those in power lines, are not very effective against the EMP. Actually, when an antenna is struck by lightning, the supporting guy wires, rather than the spark gaps, serve to carry most of the lightning current to the ground. Although the guy wires have insulators along their length, arcing occurs across them thereby providing continuity for the current. This flashover of the insulators would not, however, provide protection against the EMP. In fact, the guy wires would then serve as additional collectors of the EMP energy by induction.

11.56 In spite of protective devices, both direct and indirect, damage to radio stations by lightning is not rare. The most commonly damaged component is the capacitor in the matching network at the base of the antenna; it generally suffers dielectric failure. Capacitors and inductors in the phasor circuit are also subject to damage. It is expected that

high-voltage capacitors would be sensitive to damage by the EMP. Such damage could result in shorting of the antenna feed line to the ground across the capacitor, thus precluding transmission until the capacitor is replaced. Experience with lightning suggests that there may also be damage to coaxial transmission lines from dielectric flashover. Solid-state components, which are now in common use in radio stations, would, of course, be susceptible to damage by the EMP and would need to be protected.

11.57 Radio transmitting stations employ various means to prevent interference from their own signals. These include shielding of audio wiring and components with low-level signals, single-point grounding, and the avoidance of loops. Such practices would be useful in decreasing the EMP threat.

EMP AND TELEPHONE SYSTEMS

11.58 Some of the equipment in telephone systems may be susceptible to damage from the EMP energy collected by power supply lines and by the subscriber and trunk lines that carry the signals. Various lightning arresting devices are commonly used for overhead telephone lines, but they may provide

limited protection against the EMP unless suitably modified. Steps are being taken to improve the ability of the long-distance telephone network in the United States to withstand the EMP as well as the other effects of a nuclear explosion.

11.59 In a properly "hardened" system, coaxial cables are buried underground and so also are the main and auxiliary repeater or switching centers. In the main (repeater and switching) stations, the building is completely enclosed in a metal EMP shield. Metal flashing surrounds each metallic line, e.g., pipe, conduit, or sheathed cable, entering or leaving the building, and the flashing is bonded to the line and to the shield. Where this is not possible, protectors or filters are used to minimize the damage potential of the EMP surge. Inside the building, connecting cables are kept short and are generally in straight runs. An emergency source of power is available to permit operation to continue in the event of a failure (or disconnection) of the commercial power supply. The auxiliary (repeater) stations, which are also underground, do not have exterior shielding but the electronic equipment is protected by steel cases.

THEORY OF THE EMP²

DEVELOPMENT OF THE RADIAL ELECTRIC FIELD

11.60 The energies of the prompt gamma rays accompanying a nuclear

explosion are such that, in air, Compton scattering is the dominant photon interaction (see Fig. 8.97b). The scattered photon frequently retains sufficient en-

²The remainder of this chapter may be omitted without loss of continuity.

ergy to permit it to repeat the Compton process. Although scattering is somewhat random, the free electrons produced (and the scattered photons) tend, on the average, to travel in the radial direction away from the burst point. The net movement of the electrons constitutes an electron current, referred to as the Compton current. The prompt gamma-ray pulse increases rapidly to a peak value in about 10^{-8} second or so, and the Compton current varies with time in a similar manner.

11.61 When the electrons are driven radially outward by the flux of gamma rays, the atoms and molecules from which they have been removed, i.e., the positive ions, travel outward more slowly. This results in a partial separation of charges and a radial electric field. The lower energy (secondary) electrons generated by collisions of the Compton electrons are then driven back by the field toward the positive charges. Consequently, a reverse electron current is produced and it increases as the field strength increases. This is called the "conduction current" because, for a given field strength, its magnitude is determined by the electrical conductivity of the ionized medium. The conductivity depends on the extent of ionization which itself results from the Compton effect; hence the conductivity of the medium will increase as the Compton current increases. Thus, as the radial field grows in strength so also does the conduction current. The conduction current flows in such a direction as to oppose this electric field; hence at a certain time, the field will cease to increase. The electric field is then said to be "saturated." At points near the burst, the radial electric field reaches

saturation sooner and is somewhat stronger than at points farther away.

11.62 In a perfectly homogeneous medium, with uniform emission of gamma rays in all directions, the radial electric field would be spherically symmetrical. The electric field will be confined to the region of charge separation and no energy will be radiated away. In a short time, recombination of charges in the ionized medium occurs and the electric field strength in all radial directions decreases within a few microseconds. The energy of the gamma rays deposited in the ionized sphere is then degraded into thermal radiation (heat). If the symmetry of the ionized sphere is disturbed, however, nonradial oscillations will be initiated and energy will be emitted as a pulse of electromagnetic radiation much of which is in the radio-frequency region of the spectrum. Since, in practice, there is inevitably some disturbance of the spherical symmetry in a nuclear explosion, all such explosions are accompanied by a radiated EMP, the strength of which depends on the circumstances.

GENERAL CHARACTERISTICS OF THE EMP

11.63 The radiation in the EMP covers a wide range of frequencies with the maximum determined by the rise time of the Compton current. This is typically of the order of 10^{-8} second and the maximum frequency for the mechanism described above is then roughly 10^8 cycles per second, i.e., 10^8 hertz or 100 megahertz. Most of the radiation will, however, be emitted at lower frequencies in the radiofrequency range. The rise time is generally somewhat

shorter for high-altitude bursts than for surface and medium-altitude bursts; hence, the EMP spectrum in high-altitude bursts tends toward higher frequencies than in bursts of the other types.

11.64 The prompt gamma rays from a nuclear explosion carry, on the average, about 0.3 percent of the explosion energy (Table 10.138) and only a fraction of this, on the order of approximately 10^{-2} for a high-altitude burst and 10^{-7} for a surface burst, is radiated in the EMP. For a 1-megaton explosion at high altitude, the total energy release is 4.2×10^{22} ergs and the amount that is radiated as the EMP is roughly 10^{18} ergs or 10^{11} joules. Although this energy is distributed over a very large area, it is possible for a collector to pick up something on the order of 1 joule (or so) of EMP energy. The fact that a small fraction of a joule, received as an extremely short pulse, could produce either permanent or temporary degradation of electronic devices, shows that the EMP threat is a serious one.

11.65 Although all nuclear bursts are probably associated with the EMP to some degree, it is convenient to consider three more-or-less distinct (or extreme) types of explosions from the EMP standpoint. These are air bursts at medium altitudes, surface bursts, and bursts at high altitudes. Medium-altitude bursts are those below about 19 miles in which the deposition region does not touch the earth's surface. The radius of the sphere ranges roughly from 3 to 9 miles, increasing with the burst altitude. The EMP characteristics of air bursts at lower altitudes, in which the deposition region does touch the earth,

are intermediate between medium-altitude and surface bursts. At burst altitudes below about 1.2 miles, the radiated pulse has the general characteristics of that from a surface burst.

MEDIUM-ALTITUDE AIR BURSTS

11.66 In an air burst at medium altitude, the density of the air is somewhat greater in the downward than in the upward direction. The difference in density is not large, although it increases with the radius of the deposition (or source) region, i.e., with increasing altitude. The frequency of Compton collisions and the ionization of the air will vary in the same manner as the air density. As a result of the asymmetry, an electron current is produced with a net component in the upward direction, since the symmetry is not affected in the azimuthal (radial horizontal) direction. The electron current pulse initiates oscillations in the ionized air and energy is emitted as a short pulse of electromagnetic radiation. The EMP covers a wide range of frequencies and wave amplitudes, but much of the energy is in the low-frequency radio range. In addition, a high-frequency pulse of short duration is radiated as a result of the turning of the Compton electrons by the earth's magnetic field (§ 11.71).

11.67 The magnitude of the EMP field radiated from an air burst will depend upon the weapon yield, the height of burst (which influences the asymmetry due to the atmospheric density gradient), and asymmetries introduced by the weapon (including auxiliary equipment, the case, or the carrying vehicle). At points outside the deposit-

ion region, for the lower-frequency EMP arising from differences in air density, the radiated electric field $E(t)$ at any specified time t as observed at a distance R from the burst point is given by

$$E(t) = \frac{R_0}{R} E_0(t) \sin \theta, \quad (11.67.1)$$

where R_0 is the radius of the deposition region, $E_0(t)$ is the radiated field strength at the distance R_0 , i.e., at the beginning of the radiating region, at the time t , and θ is the angle between the vertical and a line joining the observation point to the burst point. It follows from equation (11.67.1) that, as stated in § 11.06, the EMP field strength is greatest in directions perpendicular to the (vertical) electron current. Values of $E_0(t)$ and R_0 are determined by computer calculations for specific situations; $E_0(t)$ is commonly from a few tens to a few hundred volts per meter and R_0 is from about 3 to 9 miles (§ 11.09). The interaction of the gamma rays with air falls off roughly exponentially with distance; hence, the deposition region does not have a precise boundary, but R_0 is taken as the distance that encloses a volume in which the conductivity is 10^{-7} mho per meter or greater.

SURFACE BURSTS

11.68 In a contact surface burst, the presence of the ground introduces a strong additional asymmetry. Compared with air, the ground is a very good absorber of neutrons and gamma rays and a good conductor of electricity. Therefore, the deposition region consists approximately of a hemisphere in

the air and there is a net electron current with a strong component in the upward direction. Further, the conducting ground provides an effective return path for the electrons with the result that current loops are formed. That is, electrons travel outward from the burst in the air, then return toward the burst point through the higher conductivity ground. These current loops generate very large azimuthal magnetic fields that run clockwise around the burst point (looking down on the ground) in the deposition region, especially close to the ground (Fig. 11.10). At points very near the burst, the air is highly ionized and its conductivity exceeds the ground conductivity. The tendency for the conduction current to shift to the ground is therefore reduced, and the magnetic fields in the ground and in the air are decreased correspondingly.

11.69 Large electric and magnetic fields are developed in the ground which contribute to the EMP, in addition to the fields arising from the deposition region. As a result of the number of variables that can affect the magnitude and shape of the fields, it is not possible to describe them in a simple manner. The peak radiated fields at the boundary of the deposition region are ten to a hundred times stronger in a direction along the earth than for a similar air burst. The variation with distance of the *peak* radiated electric field along the earth's surface is given by

$$E = \frac{R_0}{R} E_0, \quad (11.69.1)$$

where E_0 is the peak radiated field at the radius R_0 of the deposition region and E is the peak field at the surface distance R from the burst point. For observation

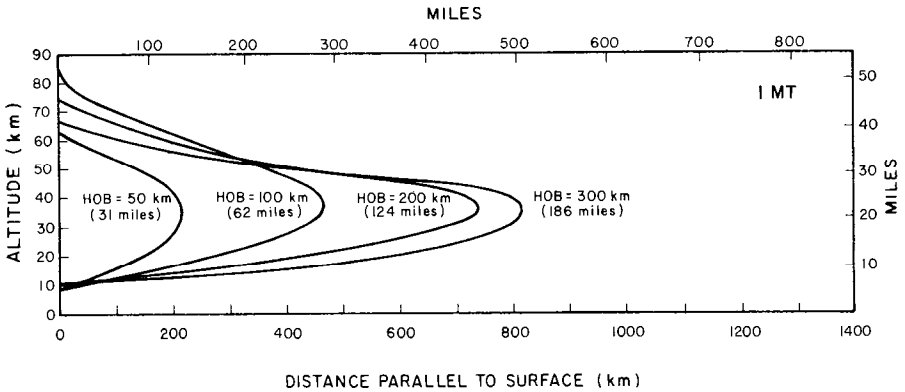

Figure 11.70a. Deposition regions for 1-MT explosions at altitudes of 31, 62, 124, and 186 miles.

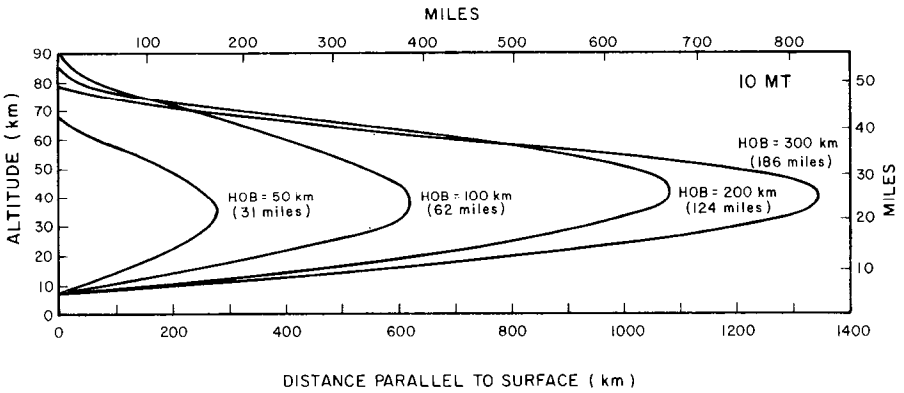

Figure 11.70b. Deposition regions for 10-MT explosions at altitudes of 31, 62, 124, 186 miles.

points above the surface the peak radiated field falls off rapidly with increasing distance. As stated in § 11.12, R_0 is roughly 2 to 5 miles, depending on the explosion yield; E_0 may be several kilovolts per meter.

HIGH-ALTITUDE BURSTS

11.70 The thickness and extent of half of the deposition region for bursts of 1 and 10 megatons yield, respectively, for various heights of burst (HOB) are shown in Figs. 11.70a and b. The abscissas are distances in the atmosphere measured parallel to the

earth's surface from ground zero. The curves were computed from the estimated gamma-ray emissions from the explosions and the known absorption coefficients of the air at various densities (or altitudes). At small ground distances, i.e., immediately below the burst, the deposition region is thicker than at larger distances because the gamma-ray intensity decreases with distance from the burst point. Since the gamma rays pass through air of increasing density as they travel toward the ground, most are absorbed in a layer between altitudes of roughly 40 and 10 miles.

11.71 Unless they happen to be ejected along the lines of the geomagnetic field, the Compton electrons resulting from the interaction of the gamma-ray photons with the air molecules and atoms in the deposition region will be forced to follow curved paths along the field lines.³ In doing so they are subjected to a radial acceleration and the ensemble of turning electrons; whose density varies with time, emits electromagnetic radiations which add coherently. The EMP produced in this manner from a high-altitude burst—and also to some extent from an air burst—is in a higher frequency range than the EMP arising from local asymmetries in moderate-altitude and surface bursts (§ 11.63).

11.72 The curves in Figs. 11.70a and b indicate the dimensions of the deposition (source) region, but they do not show the extent of coverage on (or near) the earth's surface. The EMP does not radiate solely in a direction down from the source region; it also radiates from the edges and at angles other than vertical beneath this region. Thus, the effect at the earth's surface of the higher-frequency EMP extends to the horizon (or tangent point on the surface as viewed from the burst). The lower frequencies, however, will extend even beyond the horizon because these electromagnetic waves can follow the earth's curvature (cf. § 10.92). Table 11.72 gives the distances along the surface from ground zero to the tangent point for several burst heights.

11.73 The peak electric field (and

Table 11.72

GROUND DISTANCE TO TANGENT POINT FOR VARIOUS BURST ALTITUDES

Burst Altitude (miles)	Tangent Distance (miles)
62	695
93	850
124	980
186	1,195
249	1,370
311	1,520

its amplitude) at the earth's surface from a high-altitude burst will depend upon the explosion yield, the height of burst, the location of the observer, and the orientation with respect to the geomagnetic field. As a general rule, however, the field strength may be expected to be tens of kilovolts per meter over most of the area receiving the EMP radiation. Figure 11.73 shows computed contours for E_{\max} , the maximum peak electric field, and various fractions of E_{\max} for burst altitudes between roughly 60 and 320 miles, assuming a yield of a few hundred kilotons or more. The distances, measured along the earth's surface, are shown in terms of the height of burst. The spatial distribution of the EMP electric field depends on the geomagnetic field and so varies with the latitude; the results in the figures apply generally for ground zero between about 30° and 60° north latitude. South of the geomagnetic equator the directions indicating magnetic north and east in the figure would become south and west, respectively. It is evident from Fig.

³At higher altitudes, when the atmospheric density is much less and collisions with air atoms and molecules are less frequent, continued turning of the electrons (beta particles) about the field lines leads to the helical motion referred to in §§ 2.143, 10.27.

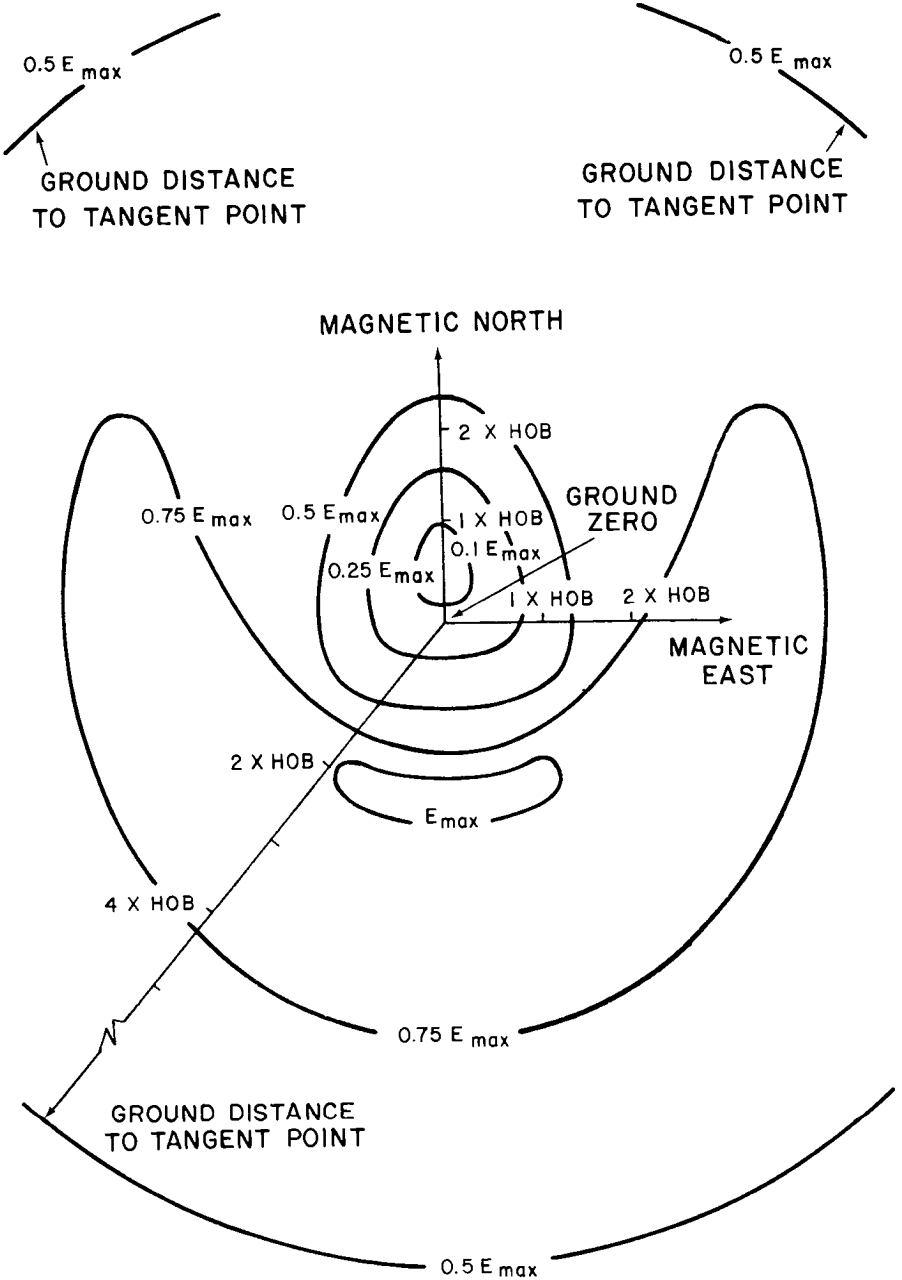

Figure 11.73. Variations in peak electric fields for locations on the earth's surface for burst altitudes between 60 and 320 miles and for ground zero between 30° and 60° north latitude. The data are applicable for yields of a few hundred kilotons or more.

11.73 that over most of the area affected by the EMP the electric field strength on the ground would exceed $0.5E_{\max}$. For yields of less than a few hundred kilotons, this would not necessarily be true because the field strength at the earth's tangent could be substantially less than $0.5 E_{\max}$.

11.74 The reason why Fig. 11.73 does not apply at altitudes above about 320 miles is that at such altitudes the tangent range rapidly becomes less than four times the height of burst. The distance scale in the figure, in terms of the HOB, then ceases to have any meaning. For heights of burst above 320 miles, a set of contours similar to those in Fig. 11.73 can be plotted in terms of fractions of the tangent distance.

11.75 The spatial variations of EMP field strength arise primarily from the orientation and dip angle of the geomagnetic field, and geometric factors related to the distance from the explosion to the observation point. The area of low field strength slightly to the north of ground zero in Fig. 11.73 is caused by the dip in the geomagnetic field lines with reference to the horizontal direction. Theoretically, there should

be a point of zero field strength in the center of this region where the Compton electrons would move directly along the field lines without turning about them, but other mechanisms, such as oscillations within the deposition region, will produce a weak EMP at the earth's surface. The other variations in the field strength at larger ground ranges are due to differences in the slant range from the explosion.

11.76 The contours in Fig. 11.73 apply to geomagnetic dip angles of roughly 50° to 70° . Although E_{\max} would probably not vary greatly with the burst latitude, the spatial distribution of the peak field strength would change with the dip angle. At larger dip angles, i.e., at higher latitudes than about 60° , the contours for E_{\max} and $0.75 E_{\max}$ would tend more and more to encircle ground zero. Over the magnetic pole (dip angle 90°), the contours would be expected theoretically to consist of a series of circles surrounding ground zero, with the field having a value of zero at ground zero. At lower dip angles, i.e., at latitudes less than about 30° , the tendency for the contours to become less circular and to spread out, as in Fig. 11.73, would be expected to increase.

BIBLIOGRAPHY

- BLOCK, R., *et al.*, "EMP Seal Evaluation," Physics International Co., San Leandro, California, January 1971.
- BRIDGES, J. E., D. A. MILLER, and A. R. VALENTINO, "EMP Directory for Shelter Design," Illinois Institute of Technology Research Institute, Chicago, Illinois, April 1968.
- *BRIDGES, J. E., and J. WEYER, "EMP Threat and Countermeasures for Civil Defense Systems," Illinois Institute of Technology Research Institute, Chicago, Illinois, November 1968.
- **"Electromagnetic Pulse Problems in Civilian Power and Communications," Summary of a seminar held at Oak Ridge National Laboratory, August 1969, sponsored by the U.S. Atomic Energy Commission and the Department of Defense/Office of Civil Defense.
- ***"Electromagnetic Pulse Sensor and Simulation Notes, Volumes 1-10," Air Force Weapons Laboratory, April 1967 through 1972, AFWL EMP 1-1 through 1-10.
- ***"EMP Protection for Emergency Operating Centers," Department of Defense/Office of

- Civil Defense, May 1971, TR-61-A.
- "EMP Protective Systems," Department of Defense/Office of Civil Defense, November 1971, TR-61-B.
- "EMP Protection for AM Radio Broadcast Stations," Department of Defense/Office of Civil Defense, May 1972, TR-61-C.
- FOSS, J. W., and R. W. MAYO, "Operation Survival," *Bell Laboratories Record*, January 1969, page 11.
- GILINSKY, V., and G. PEERLES, "The Development of a Radio Signal from a Nuclear Explosion in the Atmosphere," *J. Geophys. Res.*, **73**, 405 (1968).
- HIRSCH, F. G., and A. BRUNER, "Absence of Electromagnetic Pulse Effects on Monkeys and Dogs," *J. Occupational Medicine*, **14**, 380 (1972).
- KARZAS, W. J. and R. LATTER, "Detection of Electromagnetic Radiation from Nuclear Explosions in Space," *Phys. Rev.* **137**, B1369 (1965).
- LENNOX, C. R., "Experimental Results of Testing Resistors Under Pulse Conditions," Electrical Standards Division 2412, Sandia Laboratory, Albuquerque, New Mexico, November 1967.
- MINDEL, I. N., Program Coordinator, "DNA EMP Awareness Course Notes," 2nd ed., Illinois Institute of Technology Research Institute, Chicago, Illinois, August 1973, DNA 2772T.
- *NELSON, D. B., "Effects of Nuclear EMP on AM Broadcast Stations in the Emergency Broadcast System," Oak Ridge National Laboratory, July 1971, ORNL-TM-2830.
- NELSON, D. B., "EMP Impact on U.S. Defenses," *Survive*, **2**, No. 6, 2 (1969).
- NELSON, D. B., "A Program to Counter Effects of Nuclear EMP in Commercial Power Systems," Oak Ridge National Laboratory, October 1972, ORNL-TM-3552.
- RICKETTS, L. W., *et al.*, "EMP Radiation and Protective Techniques," Wiley-Interscience, 1976.
- *SARGIS, D. A., *et al.*, "Late Time Source for Close-In EMP," Science Applications, La Jolla, California, August 1972, DNA 3064F, SAI-72-556-L-J.

CHAPTER XII

BIOLOGICAL EFFECTS

INTRODUCTION

TYPES OF INJURIES

12.01 The three main types of physical effects associated with a nuclear explosion, namely, blast and shock, thermal radiation, and nuclear radiation, each have the potentiality for causing death and injury to exposed persons. Blast injuries may be direct or indirect; the former are caused by the high air pressure and the latter by missiles and by displacement of the body. For a given overpressure, a nuclear device is more effective in producing direct blast injuries than is a conventional, high-explosive weapon because, as will be seen, the human body is sensitive to the duration of the pressure pulse and this is relatively long in a nuclear explosion unless the yield is much less than 1 kiloton. On the whole, indirect blast injuries, especially those caused by missiles such as glass, wood, debris, etc., are similar for nuclear and conventional weapons. However, because of its longer duration, the blast wave from a nuclear explosion produces missile and displacement injuries at much lower overpressures than does a chemical explosion.

12.02 The frequency of burn inju-

ries due to a nuclear explosion is exceptionally high. Most of these are flash burns caused by direct exposure to the pulse of thermal radiation, although individuals trapped by spreading fires may be subjected to flame burns. In addition, persons in buildings or tunnels close to ground zero may be burned by hot gases and dust entering the structure even though they are shielded adequately from direct or scattered thermal radiation. Finally, there are potential harmful effects of the nuclear radiations on the body. These represent a source of casualties entirely new to warfare.

12.03 A nuclear explosion in the air or near the ground will inevitably be accompanied by damage and destruction of buildings, by blast, shock, and fire, over a considerable area. Consequently, a correspondingly larger number of personal casualties is to be expected. However, the actual number, as well as their distribution among the different kinds of injuries mentioned above, will be greatly dependent upon circumstances. As a general rule, for bursts of a given type, e.g., air, surface, or subsurface, the range of each of the major immediate effects—blast, thermal radiation, and initial nuclear radiation—in-

creases with the explosive yield of the weapon. But the relative importance of the various effects does not remain the same. The initial nuclear radiation, for example, is much more significant in comparison with blast and thermal radiation for nuclear explosions of low energy yield than it is for those of high yield. In other words, although the total number of casualties will increase with the energy of the explosion, under similar circumstances, the percentage of injuries due to initial nuclear radiation may be expected to decrease whereas the proportions of blast and thermal injuries will increase.

12.04 All other things, including exposure conditions, being the same, the number and distribution of casualties of various kinds for a nuclear explosion of given yield will be determined by the type of burst. Moreover, for an air burst, the height of burst will have an important influence. With other factors constant, there is an optimum height of burst which maximizes the range on the ground for a given overpressure in the blast wave (§ 3.73). This optimum height differs for each yield and for each value of the overpressure. Similarly, there are particular heights of burst, usually different from that for blast damage, which maximize the ranges for either thermal radiation or the initial nuclear radiation. It is evident, therefore, that considerable variations are possible both in the number and in the nature of the injuries associated with an air burst.

12.05 The effects of a surface or of a shallow subsurface burst will not be greatly different from those accompanying a low air burst. However, as increasing amounts of contaminated earth

and debris are sucked up into the radioactive cloud the hazard from the residual nuclear radiation in the early fallout increases. For an underground burst at a moderate depth, the injuries from blast and from thermal and initial nuclear radiations would be much less than from an air burst or even from a surface burst of the same yield. On the other hand, the effects of ground shock and the delayed nuclear radiation hazard would be greatly increased. In the case of a deep (completely contained) underground burst, casualties would result only from ground shock.

12.06 Apart from the explosion yield and burst conditions, local environmental circumstances can be a significant factor in the casualty potential of a nuclear weapon. Conditions of terrain and weather can influence the injuries caused by blast and by thermal radiation. Structures may have an important, although variable, effect. For example, the shielding in ordinary houses may markedly reduce the range over which significant casualties from flash burns can occur. This is particularly the case for heavier structures extending below as well as above ground; persons properly located in such buildings could be protected from blast and initial nuclear radiations as well as from thermal radiations. On the other hand, in certain buildings the frequency of indirect blast injuries may be greatly increased by the presence of large numbers of missiles.

12.07 As regards direct injuries resulting from the overpressure of the air in the blast wave, the effects of a structure are also quite variable. In some situations it is known that the magnitude of the peak overpressure inside a struc-

ture can be appreciably less than the free-field (open terrain) value. On the other hand, there is a possibility that, as a result of reflection at walls, etc., the air overpressure in the interior of a building may be increased twofold or more, depending on the geometry involved (see Chapter IV). There will also be changes in wind velocity inside structures, so that the magnitudes may differ markedly from those existing in the free field as the blast wave spreads outward from the burst point. Nevertheless, provided people do not lean against the walls or sit or lie on the floor, there is generally a lower probability of injury from direct overpressure effects inside a structure than at equivalent distances on the outside. This results from alterations in the pattern of the overpressure wave upon entering the structure.

JAPANESE CASUALTIES

12.08 The only direct information concerning human casualties resulting from a nuclear explosion is that obtained following the air bursts over Japan and this will be used as the basis for much of the discussion presented here. It should be pointed out, however, that the Japanese experience applies only to the particular heights of burst and yields of the weapons exploded over Hiroshima and Nagasaki (§ 2.24), and to the weather, terrain, and other conditions existing at the times and locations of the explo-

sions. Almost any kind of nuclear explosion in a populated area, except perhaps one deep under the surface, would be accompanied by a large number of deaths and injuries in a short interval of time, but the actual number of casualties and their distribution between blast (and shock), thermal, and nuclear radiation effects could vary markedly with the circumstances.

12.09 The data in Table 12.09 are the best available estimates¹ for civilian casualties resulting from all effects of the explosions over Hiroshima and Nagasaki. The population estimates are only for civilians within the affected area in each city and do not include an unknown number of military personnel. Three zones, representing different distances from ground zero, are considered: the first is a circular area of 0.6 mile radius about ground zero, the second is a ring from 0.6 to 1.6 miles from ground zero, and the third is from 1.6 to 3.1 miles from ground zero. In each case there is given the total population in a particular zone, the population density, i.e., number per square mile, and the numbers of killed and injured, in that zone. Also included are the total population "at risk" in the city, the average population density, and the total numbers of killed and injured. The standardized casualty rates are values calculated by proportion on the basis of a population density of one person per 1,000 square feet (or about 28,000 per square mile) of vulnerable area.

¹Computed from data in A. W. Oughterson and S. Warren (Editors), "Medical Effects of the Atomic Bomb in Japan," McGraw-Hill Book Co., Inc., Chapter 4, 1956. For further information, see also "Medical Effects of the Atomic Bomb," Report of the Joint Commission for the Investigation of the Effects of the Atomic Bomb in Japan, Office of the Air Surgeon NP-3041; "Medical Report on Atomic Bomb Effects," The Medical Section, Special Committee for the Investigation of the Effects of the Atomic Bomb, National Research Council of Japan, 1953; and the U.S. Strategic Bombing Survey, "The Effects of Atomic Bombs on Hiroshima and Nagasaki," 1946.

Table 12.09
CASUALTIES AT HIROSHIMA AND NAGASAKI

Zone	Population	Density (per square mile)	Killed	Injured
Hiroshima				
0 to 0.6 mile	31,200	25,800	26,700	3,000
0.6 to 1.6 miles	144,800	22,700	39,600	53,000
1.6 to 3.1 miles	80,300	3,500	1,700	20,000
Totals	256,300	8,500	68,000	76,000
Standardized Casualty Rate: 261,000 (Vulnerable area 9.36 square miles).				
Nagasaki				
0 to 0.6 mile	30,900	25,500	27,300	1,900
0.6 to 1.6 miles	27,700	4,400	9,500	8,100
1.6 to 3.1 miles	115,200	5,100	1,300	11,000
Totals	173,800	5,800	38,000	21,000
Standardized Casualty Rate: 195,000 (Vulnerable area 7.01 square miles).				

12.10 It is important to note that, although the average population densities in Hiroshima and Nagasaki were 8,500 and 5,800 per square mile, respectively, densities of over 25,000 per square mile existed in areas close to ground zero. For comparison, the average population density for the five boroughs of New York City, based on the 1970 census, is about 24,700 per square mile and for Manhattan alone it is 68,600 per square mile. The population density for the latter borough during the working day is, of course, much higher. The ten next largest U.S. cities have average population densities ranging from 14,900 to 3,000 persons per square mile.

12.11 The numbers in Table 12.09 serve to emphasize the high casualty potential of nuclear weapons. There are several reasons for this situation. In the first place, the explosive energy yield is very much larger than is possible with conventional weapons, so that both the

area and degree of destruction are greatly increased. Second, because of the high energy yields, the duration of the overpressure (and winds) associated with the blast wave, for a given peak overpressure, is so long that injuries occur at overpressures which would not be effective in a chemical explosion. Third, the proportion of the explosive energy released as thermal radiation is very much greater for a nuclear weapon; hence there is a considerably larger incidence of flash burns. Finally, nuclear radiation injuries, which are completely absent from conventional explosions, add to the casualties.

12.12 The data in the table also show that more than 80 percent of the population within 0.6 mile (3170 feet) from ground zero were casualties. In this area the blast wave energy, thermal exposure, and initial nuclear radiation were each sufficient to cause serious injury or death. Beyond about 1.6 miles, however, the chances of survival

were very greatly improved. Between 0.6 and 1.6 miles from ground zero a larger proportion of the population would probably have survived if immediate medical attention had been available. Although the particular distances mentioned apply to the yield and conditions of the Japanese explosions, it is to be expected quite generally that close to ground zero the casualty rate will be high, but it will drop sharply beyond a certain distance which scales with the energy yield of the explosion.

CAUSES OF FATALITIES

12.13 There is no exact information available concerning the relative significance of blast, burn, and nuclear radiation injuries as a source of fatalities in the nuclear bombings of Japan. It has been estimated that some 50 percent of the deaths were caused by burns of one kind or another, but this figure is only a rough estimate. Close to two-thirds of those who died at Hiroshima during the first day after the explosion were reported to have been badly burned. In addition, there were many deaths from burns during the first week.

12.14 The high incidence of flash burns caused by thermal radiation among both fatalities and survivors in Japan was undoubtedly related to the light and scanty clothing being worn, because of the warm summer weather prevailing at the time of the attacks. If there had been an appreciable cloud cover or haze below the burst point, the thermal radiation would have been attenuated somewhat and the frequency of flash burns would have been much less. Had the weather been cold, fewer people would have been outdoors and they

would have been wearing more extensive clothing. Both the number of people and individual skin areas exposed to thermal radiation would then have been greatly reduced and there would have been fewer casualties from flash burns.

12.15 None of the estimates of the causes of death bear directly on the incidence of those blast effects which result in early death, e.g., air (emboli) in the arteries, lung damage, and heart injury which tolerate very little post-injury activity, various bone fractures, severing of major blood vessels by sharp missiles, violent impact, and others. One of the difficulties in assessing the importance of injuries of various types lies in the fact that many people who suffered fatal blast injuries were also burned. As seen earlier, within about half a mile of ground zero in the Japanese explosions, either blast, burns, or nuclear radiation injury alone was lethal in numerous instances.

12.16 As a result of various circumstances, however, not everyone within a radius of half a mile was killed immediately. Among those who survived the first few days after the explosions at Hiroshima and Nagasaki, a number died two or more weeks later with symptoms which were ascribed to nuclear radiation injuries (see § 12.113 *et seq.*). These were believed to represent from 5 to 15 percent of the total fatalities. A rough estimate indicates that about 30 percent of those who died at Hiroshima had received lethal doses of nuclear radiation, although this was not always the immediate cause of death.

12.17 The death rate in Japan was greatest among individuals who were in the open at the time of the explosions; it

was less for persons in residential (wood-frame and plaster) structures and least of all for those in concrete buildings. These facts emphasize the influence of circumstances of exposure on the casualties produced by a nuclear weapon and indicate that shielding of some type can be an important factor in survival. For example, within a range of 0.6 mile from ground zero over 50 percent of individuals in Japanese-type homes probably died of nuclear radiation effects, but such deaths were rare among persons in concrete buildings within the same range. The effectiveness of concrete structures in providing protection from injuries of all kinds is apparent from the data in Table 12.17; this gives the respective average distances from ground zero at which there was 50-percent survival (for at least 20 days) among the occupants of a number of buildings in Hiroshima. School personnel who were indoors had a much higher survival probability than those who were outdoors at the times of the explosions.

Table 12.17

**AVERAGE DISTANCES FOR
50-PERCENT SURVIVAL AFTER
20 DAYS IN HIROSHIMA**

	Approximate Distance (miles)
Overall	0.8
Concrete buildings	0.12
School personnel:	
Indoors	0.45
Outdoors	1.3

**CAUSES OF INJURIES AMONG
SURVIVORS**

12.18 From surveys made of a large number of Japanese, a fairly good idea

has been obtained of the distribution of the three types of injuries among those who became casualties but survived the nuclear attacks. The results are quoted in Table 12.18; the totals add up to more than 100 percent, since many individuals suffered multiple injuries.

Table 12.18

**DISTRIBUTION OF TYPES OF INJURY
AMONG SURVIVORS**

Injury	Percent of Survivors
Blast (mechanical)	70
Burns (flash and flame)	65
Nuclear radiation (initial)	30

12.19 Among survivors the proportion of indirect blast (mechanical) injuries due to flying missiles and motion of other debris was smallest outdoors and largest in certain types of industrial buildings. Patients were treated for lacerations received out to 10,500 feet (2 miles) from ground zero in Hiroshima and out to 12,500 feet (2.2 miles) in Nagasaki. These distances correspond roughly to those at which moderate damage occurred to wood-frame houses, including the shattering of window glass.

12.20 An interesting observation made among the Japanese survivors was the relatively low incidence of serious mechanical injuries. For example, fractures were found in only about 4 percent of survivors. In one hospital there were no cases of fracture of the skull or back and only one fractured femur among 675 patients, although many such injuries must have undoubtedly occurred. This was attributed to the fact that persons who suffered severe concussion or

fractures were rendered helpless, particularly if leg injuries occurred, and, along with those who were pinned beneath the wreckage, were trapped and unable to seek help or escape in case fire ensued. Such individuals, of course, did not survive.

CASUALTIES AND STRUCTURAL DAMAGE

12.21 For people who were in buildings in Japan, the overall casualties were related to the extent of structural damage, as well as to the type of structure (§ 12.17). The data in Table 12.21 were obtained from a study of 1,600 Japanese who were in reinforced-concrete buildings, between 0.3 and 0.75 mile from ground zero, when the nuclear explosions occurred. At these distances fatalities in the open ranged from about 90 to 100 percent, indicating, once more, that people were safer inside buildings, even when no special protective action was taken because of the lack of warning. There may have been an increase of casualties in buildings from debris etc., but this was more than compensated by the reduction due to

shielding against the initial nuclear radiation and particularly from the thermal pulse.

12.22 In two concrete buildings closest to ground zero, where the mortality rate was 88 percent, about half the casualties were reported as being early and the other half as delayed. The former were attributed to a variety of direct and indirect blast injuries, caused by overpressure, structural collapse, debris, and whole-body translation, whereas the latter were ascribed mainly to burns and initial nuclear radiation. Minor to severe but nonfatal blast injuries no doubt coexisted and may have contributed to the delayed lethality in many cases. At greater distances, as the threat from nuclear radiation decreased more rapidly than did that from air blast and thermal radiation, the proportion of individuals with minor injuries or who were uninjured increased markedly. The distribution of casualties of different types in Japanese buildings was greatly influenced by where the people happened to be at the time of the explosion. Had they been forewarned and knowledgeable about areas of relative hazard and safety, there would probably have

Table 12.21

CASUALTIES IN REINFORCED-CONCRETE BUILDINGS IN JAPAN RELATED TO STRUCTURAL DAMAGE

Structural Damage	Percent of Individuals			
	Killed Outright	Serious Injury (hospital- ization)	Light Injury (no hospi- talization)	No Injury Reported
Severe damage	88	11	—	1
Moderate damage	14	18	21	47
Light damage	8	14	27	51

been fewer casualties even in structures that were badly damaged.

12.23 The shielding effect of a particular building is not only different for blast, the thermal pulse, and nuclear radiation, but it may also depend on the distance from the explosion and the height of burst. Furthermore, the locations and orientations of individuals in the building are important in determining the extent of the shielding. Hence, the protection offered by structures is quite variable. This fact must be kept in

mind in considering the data in Table 12.21. Although the table indicates a general correlation between structural damage and the frequency of casualties, the numbers cannot be used to estimate casualties from the degree of structural damage. In an actual situation, the effects would depend on many factors, including the type of structure, the yield of the nuclear explosion, the height of burst, the distance from the explosion point, the locations and orientations of people in the building, and the nature of prior protective action.

BLAST INJURIES

DIRECT BLAST INJURIES: BIOLOGICAL FACTORS

12.24 Blast injuries are of two main types, namely, direct (or primary) injuries associated with exposure of the body to the environmental pressure variations accompanying a blast wave, and indirect injuries resulting from impact of penetrating and nonpenetrating missiles on the body or as the consequences of displacement of the body as a whole. There are also miscellaneous blast injuries, such as burns from the gases and debris, and irritation and possibly suffocation caused by airborne dust. The present section will treat direct injuries, and indirect blast effects will be discussed later.

12.25 The general interactions of a human body with a blast wave are somewhat similar to that of a structure as described in Chapter IV. Because of the relatively small size of the body, the diffraction process is quickly over, the

body being rapidly engulfed and subjected to severe compression. This continues with decreasing intensity for the duration of the positive phase of the blast wave. At the same time the blast wind exerts a drag force of considerable magnitude which contributes to the displacement hazard.

12.26 The sudden compression of the body and the inward motion of the thoracic and abdominal walls cause rapid pressure oscillations to occur in the air-containing organs. These effects, together with the transmission of the shock wave through the body, produce damage mainly at the junctions of tissues with air-containing organs and at areas between tissues of different density, such as where cartilage and bone join soft tissue. The chief consequences are hemorrhage and occasional rupture of abdominal and thoracic walls.

12.27 The lungs are particularly prone to hemorrhage and edema (accumulation of fluid causing swelling), and

if the injury is severe, air reaches the veins of the lungs and hence the heart and arterial circulation. Death can occur in a few minutes from air embolic obstruction of the vessels of the heart or the brain or from suffocation caused by lung hemorrhage or edema. Fibrin emboli in the blood may also affect the brain and other critical organs. The emboli, apparently associated with severe hemorrhagic damage to the lungs, are a consequence of the disturbance of the blood-clotting mechanism. Damage to the brain due to air blast overpressure alone is improbable, but indirect damage may arise from injury to the head caused by missiles, debris, or displacement of the body. Bodily activity after blast damage to the heart and lungs is extremely hazardous and lethality can result quickly where recovery might otherwise have been expected. The direct blast effect was not specifically recognized as a cause of fatality in Japan, but it no doubt contributed significantly to early mortality even though most of the affected individuals may also have received mortal injury from debris, displacement, fire, or thermal and nuclear radiations.

12.28 Primary blast casualties have been reported after large-scale air attacks with conventional high-explosive bombs, mainly because of the provision of medical care for those who otherwise would have suffered the early death that is characteristic of serious blast injury to the lungs. However, persons who spontaneously survive for 24 to 48 hours in the absence of treatment, complications, and other injury usually recover and show little remaining lung hemorrhage after 7 to 10 days. In very severe injuries under treatment, recurring lung

hemorrhage has been reported as long as 5 to 10 days after injury. In view of such facts and overwhelming disruptive effects of the Japanese bombings on medical and rescue services, it can be concluded that individuals with significant direct blast injuries did not survive. Those with relatively minor blast injuries who did survive, did so without getting into medical channels, or if they did require medical care it was for post-blast complications, e.g., pneumonitis, or for causes other than blast injury to the lungs. For these reasons primary blast effects, except for eardrum rupture, were not commonly seen among Japanese survivors.

12.29 Many persons who apparently suffered no serious injury reported temporary loss of consciousness. This symptom can be due to the direct action of the blast wave, resulting from transient disturbance of the blood circulation in the brain by air emboli. However, it can also be an indirect effect arising from impact injury to the head caused by missiles or by violent displacement of the body by the air pressure wave.

12.30 A number of cases of ruptured eardrums were reported among the survivors in Hiroshima and Nagasaki, but the incidence was not high even for those who were fairly close to ground zero. Within a circle of 0.31 mile (1,640 feet) radius about 9 percent of a group of 44 survivors in Nagasaki had ruptured eardrums, as also did some 8 percent of 125 survivors in the ring from 0.31 to 0.62 mile from ground zero. In Hiroshima the incidence of ruptured eardrums was somewhat less. In both cities very few cases were observed beyond 0.62 mile.

DIRECT BLAST INJURIES: PHYSICAL FACTORS

12.31 Tests with animals have demonstrated that five parameters of the blast wave can affect the extent of the direct injuries to the body; they are (1) the ambient pressure, (2) the "effective" peak overpressure, (3) the rate of pressure rise (or "rise time") at the blast wave front, (4) the character and "shape" of the pressure pulse, and (5) the duration of the positive phase of the blast wave and the associated wind (see Chapter III). These parameters will be considered below as they arise.

12.32 The biologically effective peak overpressure depends on the orientation of the individual to the blast wave. If the subject is against a reflecting surface, e.g., a wall, the effective overpressure for direct blast injury is equal to the maximum reflected overpressure, which may be a few times the incident peak overpressure. On the other hand, in the open at a substantial distance from a reflecting surface, the effective overpressure is the sum of the peak incident overpressure and the associated peak dynamic pressure if the subject is perpendicular to the direction of travel of the blast wave and to the peak overpressure alone if the subject is parallel to this direction. Consequently, for a given incident overpressure, the blast injury is expected to be greatest if the individual is close to a wall and least if he is at a distance from a reflecting surface and is oriented with his body parallel to the direction in which the blast wave is moving.

12.33 The body, like many other structures, responds to the difference between the external and internal pres-

ures. As a consequence, the injury caused by a certain peak overpressure depends on the rate of increase of the pressure at the blast wave front. For wave fronts with sufficiently slow pressure rise, the increase in internal pressure due to inward movement of the body wall and air flow in the lungs keeps pace (to some extent) with the external pressure. Consequently, quite high incident overpressures are tolerable. In contrast, if the rise time is short, as it is in nuclear explosions under appropriate terrain and burst conditions, the damaging effect of a given overpressure is greater. The increase in internal pressure of the body takes a finite time and the response is then to the maximum possible pressure differential. Thus, a sharply rising pressure pulse will be more damaging than if the same peak overpressure is attained more slowly. In precursor formation (§ 3.79 *et seq.*), for example, the blast pressure increases at first slowly and then quite rapidly; the injury potential of a given peak overpressure is thus decreased.

12.34 An individual inside a building but not too close to a wall would be subject to multiple reflections of the blast wave from the ceiling, floor, and walls as well as to the incident wave entering the structure. Since the reflected waves would reach him at different times, the result would be a step loading, although the rise time for each step might be quite short. In such cases, where the initial blast pressure is tolerable and the subsequent pressure increase is not too great or occurs in stages (or slowly), a certain peak overpressure is much less hazardous than if it were applied in a single sharp pulse. Apparently the reason for the decreased

blast injury potential in these situations is that the early stage of the pressure pulse produces an increase in the internal body pressure, thereby reducing the pressure differential associated with the later portion of the pulse. In a manner of speaking, a new and higher "ambient" pressure is imposed on the body by the early part of the pressure pulse and tolerance to the later rise in overpressure is enhanced. A higher peak overpressure is then required to cause a certain degree of blast injury.

12.35 Clearly, for a given peak incident overpressure, the geometry² in which an individual is exposed inside a structure may have a significant effect on his response to air blast. A location against a wall is the most hazardous position because the effective peak overpressure, which is the maximum reflected overpressure, is high and is applied rapidly in a single step. A location a few feet from a wall is expected to decrease the direct blast injury, although the hazard arising from displacement of the body may be increased. Apart from the effects just described, oscillating pressures, for which no adequate biomedical criteria are available, often exist inside structures due to reverberating reflections from the inside walls.

12.36 The duration of the positive phase of the blast wave is a significant factor for direct blast injuries. Up to a point, the increase in the duration increases the probability of injury for a given effective peak overpressure. Beyond this point, which may be of the order of several tens to a few hundred milliseconds, depending on the body

size, it is only the magnitude of the overpressure that is important. The duration of the positive phase, for a given peak overpressure, varies with the energy yield and the height of burst (§ 3.75 *et seq.*). But for most conditions, especially for energy yields in excess of about 10 kilotons, the duration of the positive phase of the blast wave is so long—approaching a second or more—that the effective peak overpressure is the main factor for determining the potential for direct injury from a fast-rising pressure pulse.

12.37 A given peak pressure in the blast wave from conventional high explosives is less effective than from a nuclear explosion—except perhaps at unusually low yields—mainly because of the short duration of the positive phase in the former case. From observations made with small charges of chemical explosives, it has been estimated that deaths in humans would require sharp-rising effective overpressures as high as 200 to 400 (or more) pounds per square inch when the positive phase durations are less than a millisecond or so. These pressures may be compared with values of roughly 50 (or less) to about 100 pounds per square inch, with positive phase durations of the order of a second, for nuclear explosions.

12.38 Tentative criteria, in terms of effective peak overpressure as defined in § 12.32, for lung damage, lethality, and eardrum rupture caused by a fast-rising pressure pulse of long duration (0.1 second or more) are given in Table 12.38. The values for lung damage and

²The word "geometry" is used here as a general term to describe the location of an individual in relation to the details of the environment that may affect the blast wave characteristics.

lethality are average pressures obtained by extrapolation from animal data to man; the variability of the results is indicated by the numbers in parentheses. Rupture of the normal eardrum is apparently a function of the age of the individual as well as of the effective blast pressure. Failures have been recorded at overpressures as low as 5 pounds per square inch ranging up to 40 or 50 pounds per square inch. The values in Table 12.38 of the effective peak overpressures for eardrum rupture are based on relatively limited data from man and animals.

INDIRECT BLAST INJURIES

12.39 Indirect blast injuries are associated with (1) the impact of missiles, either penetrating or nonpenetrating (secondary effects), and (2) the physical displacement of the body as a whole (tertiary effects). The wounding potential of blast debris depends upon a number of factors; these include the impact (or striking) velocity, the angle

at which impact occurs, and the size, shape, density, mass, and nature of the moving objects. Furthermore, consideration must be given to the portion of the body involved in the missile impact, and the events which may occur at and after the time of impact, namely, simple contusions and lacerations, at one extreme, or more serious penetrations, fractures, and critical damage to vital organs, at the other extreme.

12.40 The hazard from displacement depends mainly upon the time and distance over which acceleration and deceleration of the body occur. Injury is more likely to result during the latter phase when the body strikes a solid object, e.g., a wall or the ground. The velocity which has been attained before impact is then significant. This is determined by certain physical parameters of the blast wave, as mentioned below, as well as by the orientation of the body with respect to the direction of motion of the wave. The severity of the damage depends on the magnitude of the impact velocity, the properties of the impact

Table 12.38

TENTATIVE CRITERIA FOR DIRECT (PRIMARY) BLAST EFFECTS IN MAN FROM FAST-RISING, LONG-DURATION PRESSURE PULSES

Effect	Effective Peak Pressure (psi)
Lung Damage:	
Threshold	12 (8-15)
Severe	25 (20-30)
Lethality:	
Threshold	40 (30-50)
50 percent	62 (50-75)
100 percent	92 (75-115)
Eardrum Rupture:	
Threshold	5
50 percent	15-20 (more than 20 years old) 30-35 (less than 20 years old)

surface, and the particular portion of the body that has received the decelerative impact, e.g., head, back, extremities, thoracic and abdominal organs, body wall, etc.

DISPLACEMENT VELOCITIES

12.41 Because the effects of both missiles and body displacement depend on the velocity attained before impact, it is convenient to consider the relationships between displacement velocity and the blast parameters for objects as small as tiny pieces of glass and as large as man. The significant physical factors in all cases are the magnitude and duration of the blast overpressure and the accompanying winds, the acceleration coefficient of the displaced object,³ ground shock, gravity, and the distance traveled by the object. The latter is important because, as a result of the action of the blast wave, the velocity of the object increases with the time and distance of travel until it attains that of the blast wind. Subsequently, the velocity falls because of negative winds or impact with the ground or other material.

12.42 As a result of the interaction of the various factors, large and heavy objects gain velocity rather slowly and attain a maximum velocity only after most of the blast wave has passed. The velocity is consequently determined by the duration of the overpressure and winds. In contrast, small and light objects reach their maximum velocity fairly quickly, often after a small proportion of the blast wave has passed over them. The maximum velocity is

thus not too sensitive to the duration of the overpressure and winds, but depends largely on the effective peak overpressure (cf. § 12.32). As a consequence of this fact, it has been found possible to relate the velocities attained by the fragments produced by the breakage of glass window panes to the effective overpressure. The results for glass panes of different thicknesses can be expressed in a fairly simple graphical manner as will be shown in § 12.238.

12.43 The variations of the overpressure and dynamic pressure with time (§ 3.57 *et seq.*) at the location of interest also have a bearing on the behavior of a displaced object. Data were obtained at nuclear weapons tests under such conditions that the blast wave was approximately ideal in behavior. Some of the median velocities, masses, and spatial densities (number of fragments per square foot) of window glass, from houses exposed to the blast, and of natural stones are summarized in Table 12.43. For glass, the velocities refer to those attained after 7 to 13 feet of travel; for the stones the distances are not known, but the velocities given in the table may be regarded as applicable to optimum distances of missile travel.

12.44 Studies have also been made of the displacement of anthropomorphic dummies weighing 165 pounds by the blast from a nuclear explosion. A dummy standing with its back to the blast attained its maximum velocity, about 21 feet per second, after a displacement of 9 feet within 0.5 second after the arrival of the blast wave. The free-field overpressure at the test loca-

³The acceleration coefficient is the product of the projected area presented to the blast wave and the drag coefficient (§ 4.19) divided by the mass of the object.

Table 12.43

VELOCITIES, MASSES, AND DENSITIES OF MISSILES

Missile	Peak Overpressure (psi)	Median Velocity (ft/sec)	Median Mass (grams)	Maximum Number per Sq Ft
Glass	1.9	108	1.45	4.3
Glass	3.8	168	0.58	159
Glass	3.9	140	0.32	108
Glass	5.0	170	0.13	388
Stones	8.5	286	0.22	40

tion was 5.3 pounds per square inch. The dummy traveled 13 feet before striking the ground and then slid or rolled another 9 feet. A prone dummy, however, did not move under the same conditions. The foregoing results were obtained in a situation where the blast wave was nearly ideal, but in another test, at a peak overpressure of 6.6 pounds per square inch, where the blast wave was nonideal (§ 3.79), both standing and prone dummies suffered considerably greater displacements. Even in such circumstances, however, the displacement of over 125 feet for the prone dummy was much less than that of about 250 feet for the standing one. The reason for the greater displacement of the standing dummy is that it acquired a higher velocity.

12.45 In order to study the displacements of moving objects, field tests have been made by dropping animal cadavers, including guinea pigs, rabbits, goats, and dogs, and stones and concrete blocks onto a flat, hard surface from a vehicle traveling between 10 and 60 miles per hour (14.7 to 88 feet per second). For a given initial velocity, the stopping distance for the animals increased somewhat with the mass, and a

relationship was found to represent the stopping distance as a function of velocity applicable to the animals over a wide range of mass (§ 12.239). One reason for the consistency of the data is probably that all the animals assumed a rolling position about their long axis regardless of the initial orientation. The animals remained relatively low to the ground and bounced very little. By contrast, stones and concrete blocks bounced many times before stopping; the data were not sensitive to mass, depended more on orientation, and were more variable than the results obtained with animals. On the whole, the stopping distances of the blocks and stones were greater for a given initial velocity. One of the conclusions drawn from the foregoing tests was that a person tumbling over a smooth surface, free from rocks and other hard irregularities, might survive, even if the initial velocity is quite high, if he could avoid head injury and did not flail his limbs.

MISSILE AND DISPLACEMENT
INJURY CRITERIA

12.46 Velocity criteria for the production of skin lacerations by penetrat-

ing missiles, e.g., glass fragments, are not known with certainty. Some reliable information is available, however, concerning the probability of penetration of the abdominal wall by glass. The impact velocities, for glass fragments of different masses, corresponding to 1, 50, and 99 percent penetration probability are recorded in Table 12.46.

12.47 The estimated impact velocities of a 10-gram (0.35-ounce) glass missile required to produce skin lacerations and serious wounds are summarized in Table 12.47. The threshold

value for skin lacerations is recorded as 50 feet per second and for serious wounds it is 100 feet per second.

12.48 Little is known concerning the relationship between mass and velocity of nonpenetrating missiles that will cause injury after impact with the body. Studies with animals showed that fairly high missile velocities are required to produce lung hemorrhage, rib fractures, and early mortality, but quantitative data for man are lacking. No relationship has yet been developed between mass and velocity of nonpen-

Table 12.46

PROBABILITIES OF GLASS FRAGMENTS PENETRATING ABDOMINAL WALL

Mass of Glass Fragments (grams)	Probability of Penetration (percent)		
	1	50	99
	Impact Velocity (ft/sec)		
0.1	235	410	730
0.5	160	275	485
1.0	140	245	430
10.0	115	180	355

Table 12.47

**TENTATIVE CRITERIA FOR INDIRECT (SECONDARY) BLAST EFFECTS FROM
PENETRATING 10-GRAM GLASS FRAGMENTS^a**

Effect	Impact Velocity (ft/sec)
Skin laceration: Threshold	50
Serious wounds: Threshold	100
50 percent	180
Near 100 percent	300

^aFigures represent impact velocities with unclothed skin. A serious wound is arbitrarily defined as a laceration of the skin with missile penetration into the tissues to a depth of 1 cm (about 0.4 inch) or more.

trating missiles that will cause injury as a result of impacts with other parts of the body wall, particularly near the spine, kidney, liver, spleen and pelvis. It appears, however, that a missile with a mass of 10 pounds striking the head at a velocity of about 15 feet per second or more can cause skull fracture. For such missiles it is unlikely that a significant number of dangerous injuries will occur at impact velocities of less than 10 feet per second. The impact velocities of a 10-pound missile for various effects on the head are given in Table 12.48.

12.49 Although there may be some hazard associated with the accelerative phase of body displacement (translation) by a blast wave, the deceleration, particularly if impact with a solid object is involved, is by far the more significant. Since a hard surface will cause a more serious injury than a softer one, the damage criteria given below refer to perpendicular impact of the displaced body with a hard, flat object. From various data it is concluded that an im-

pact velocity of 10 feet per second is unlikely to be associated with a significant number of serious injuries; between 10 and 20 feet per second some fatalities may occur if the head is involved; and above 20 feet per second, depending on trauma to critical organs, the probabilities of serious and fatal injuries increase rapidly with increasing displacement velocity. Impact velocities required to produce various indirect (tertiary) blast effects are shown in Table 12.49. The curves marked "translation near structures" in Fig. 12.49 may be used to estimate ground distances at which 1 percent and 50 percent casualties would be expected, as functions of height of burst, for a 1-kiloton explosion.⁵ Based on tests with animals, the criteria for 1 and 50 percent casualties were somewhat arbitrarily set at impact velocities of 8 and 22 feet per second, respectively. The results in Fig. 12.49 may be extended to other burst heights and yields by using the scaling law given in the example facing the figure.

Table 12.48

**TENTATIVE CRITERIA FOR INDIRECT BLAST EFFECTS INVOLVING
NONPENETRATING 10-POUND MISSILES**

Effect	Impact Velocity (ft/sec)
Cerebral Concussion:	
Mostly "safe"	10
Threshold	15
Skull Fracture:	
Mostly "safe"	10
Threshold	13
Near 100 percent	23

⁵In this connection, a casualty is defined as an individual so injured that he would probably be a burden on others. Some of the casualties would prove fatal, especially in the absence of medical care.

Table 12.49

TENTATIVE CRITERIA FOR INDIRECT (TERTIARY) BLAST EFFECTS INVOLVING IMPACT

Effect	Impact Velocity (ft/sec)
Standing Stiff-Legged Impact:	
Mostly "safe"	
No significant effect	< 8
Severe discomfort	8-10
Injury	
Threshold	10-12
Fracture threshold (heels, feet, and legs)	13-16
Seated Impact:	
Mostly "safe"	
No effect	< 8
Severe discomfort	8-14
Injury	
Threshold	15-26
Skull Fracture:	
Mostly "safe"	10
Threshold	13
50 percent	18
Near 100 percent	23
Total Body Impact:	
Mostly "safe"	10
Lethality threshold	21
Lethality 50 percent	54
Lethality near 100 percent	138

12.50 Evaluation of human tolerance to decelerative tumbling during translation in open terrain is more difficult than for impact against a rigid surface described above. Considerably fewer data are available for decelerative tumbling than for body impact, and there is virtually no human experience for checking the validity of extrapolations from observations on animal cadavers. Tests have been made with goats, sheep, and dogs, but for humans the information required to derive reliable hazards criteria for decelerative

tumbling are still not adequate. The initial velocities at which 1 and 50 percent of humans are expected to become casualties as a result of decelerative tumbling have been tentatively estimated to be 30 and 75 feet per second, respectively. The curves in Fig. 12.49 marked "translation over open terrain" are approximate, but they may be used to provide a general indication of the range within which casualties might occur from decelerative tumbling due to air blast from surface and air bursts.

(Text continued on page 560.)

The curves in Fig. 12.49 show 50 percent and 1 percent casualties resulting from translation near structures and over open terrain as a function of ground distance and height of burst for a 1 KT explosion in a standard sea-level atmosphere. The results apply to randomly oriented, prone personnel exposed to the blast wave in the open. The curves for translation over open terrain (decelerative tumbling) are approximate (§ 12.50).

Scaling. The required relationships are

$$\frac{d}{d_1} = \frac{h}{h_1} = W^{0.4}$$

where d_1 and h_1 are the distance from ground zero and height of burst, respectively, for 1 KT; and d and h are the corresponding distance and height of burst for W KT.

Example

Given: A 50 KT explosion at a height of 860 feet over open terrain.

Find: The ground distance at which translational effects would produce 50 percent casualties among prone personnel.

Solution: The corresponding burst height for 1 KT is

$$h_1 = \frac{h}{W^{0.4}} = \frac{860}{(50)^{0.4}} = 180 \text{ feet.}$$

From Fig. 12.49, at a height of burst of 180 feet, the ground distance at which 50 percent casualties among personnel in the open will occur is roughly 660 feet. The corresponding ground distance for 50 KT is then given approximately as

$$\begin{aligned} d &= d_1 W^{0.4} = 660 \times (50)^{0.4} \\ &= 3,150 \text{ feet. } \textit{Answer} \end{aligned}$$

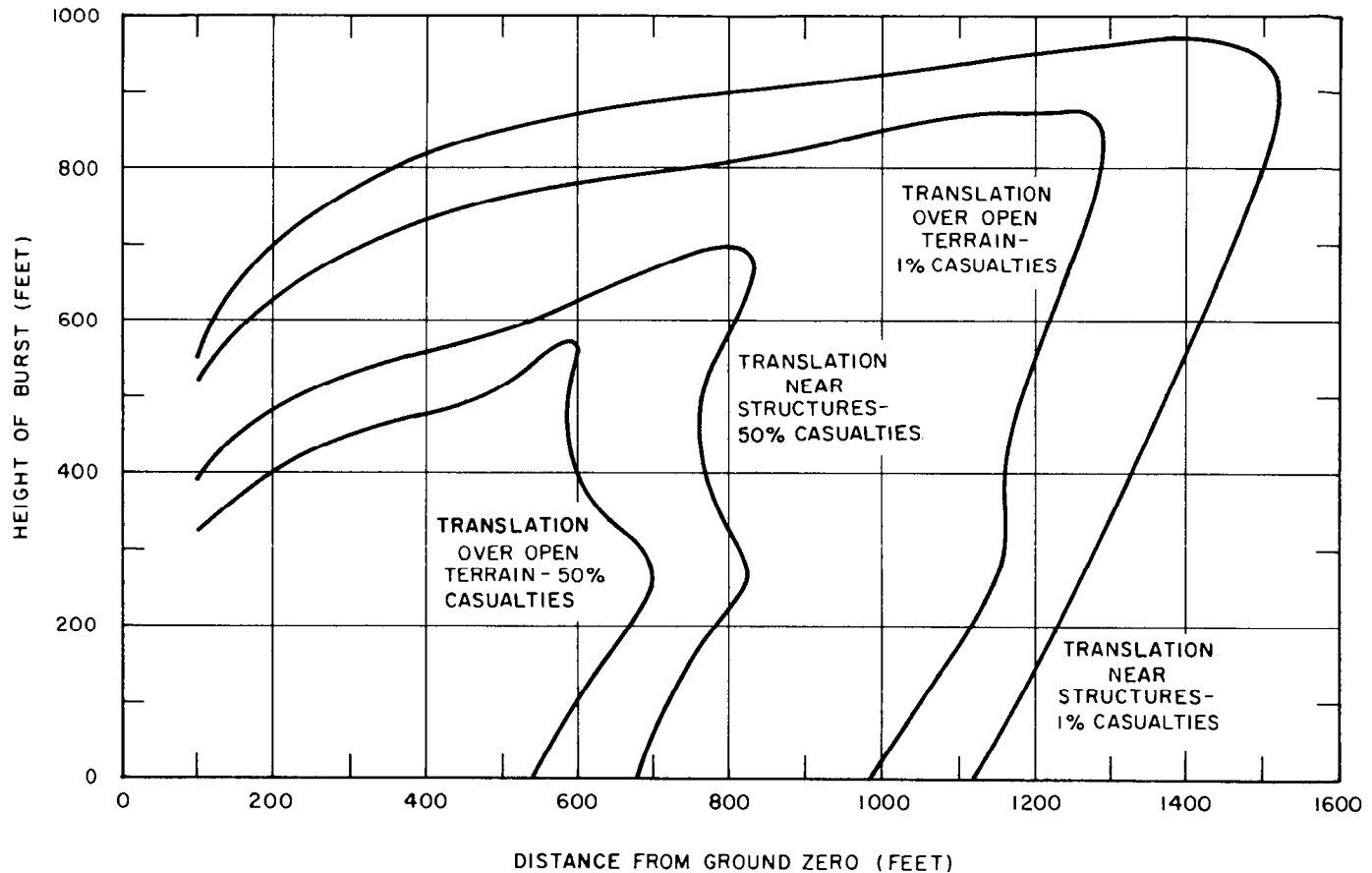

Figure 12.49. Casualties from translation near structures and over open terrain for a 1-kiloton explosion. (The curves for open terrain are more approximate than the others.)

BURN INJURIES

CLASSIFICATION OF BURNS

12.51 Thermal radiation can cause burn injuries either directly, i.e., by absorption of the radiant energy by the skin, or indirectly by heating or ignition of clothing, or as a result of fires started by the radiation. The direct burns are often called "flash burns," since they are produced by the flash of thermal radiation from the fireball. The indirect (or secondary) burns are referred to as "contact burns" or "flame burns"; they are identical with skin burns that result from touching a hot object or those that would accompany (or be caused by) any large fire no matter what its origin. In addition, individuals in buildings or tunnels close to ground zero may be burned from hot debris, gases, and dust (§ 12.02).

12.52 A skin burn is an injury caused by an increase in skin temperature resulting from direct absorption of thermal radiation, which varies with skin color, or from the transference of heat through clothing. The severity of the burn depends on the amount of the temperature increase and on the duration of the increase. For example, a skin temperature of 70°C (155°F) for a fraction of a second will produce the same type of burn as a temperature of 48°C (118°F) for a few minutes. Skin burns are generally classified as first, second, or third degree, in order of increasing severity of the burn. Pain associated with skin burns occurs when the temperature of certain nerve cells near the surface is raised to 43°C (109°F) or more. If the temperature is not suffi-

ciently high or does not persist for a sufficient length of time, pain will cease and no injury will occur. The amount of pain is not directly related to the severity of the burn injury, but it can serve a useful purpose in warning an individual to evade part of the thermal pulse from a nuclear explosion.

12.53 First-degree burns, which are the mildest, are characterized by immediate pain and by ensuing redness of the affected area. The pain continues even after the temperature of the skin has returned to normal. The first-degree burn is a reversible injury; that is to say, healing is complete with no scar formation. Sunburn is the classic example of first-degree burn.

12.54 Second-degree burns result from skin temperatures that are higher and/or of longer duration than those causing first-degree skin burns. The injury is characterized by pain which persists, and may be accompanied either by no immediate visible effect or by a variety of skin changes including blanching, redness, loss of elasticity, swelling, and development of blisters. After 6 to 24 hours, a scab will form over the injured area. The scab may be flexible and tan or brown, if the injury is moderate, or it may be thick, stiff, and dark, if the injury is more severe. The wounds will heal within one to two weeks unless they are complicated by infection. Second-degree burns do not involve the full thickness of the skin, and the remaining uninjured cells may be able to regenerate normal skin without scar formation.

12.55 If skin temperatures become sufficiently high and/or are of long du-

ration, third-degree burns will be produced. Pain is experienced at the peripheral, less injured areas only, since the nerve endings in the centrally burned areas are damaged to the extent that they are unable to transmit pain impulses. Immediately after suffering the burn, the skin may appear either normal, scalded, or charred, and it may lose its elasticity. The healing of third-degree burns takes several weeks and will always result in scar formation unless new skin is grafted over the burned area. The scar results from the fact that the full thickness of the skin is injured, and the skin cells are unable to regenerate normal tissue.

12.56 The distribution of burns into three groups obviously has certain limitations since it is not possible to draw a sharp line of demarcation between first- and second-degree, or between second- and third-degree burns. Within each class the burn may be mild, moderate, or severe, so that upon preliminary examination it may be difficult to distinguish between a severe burn of the second degree and a mild third-degree burn. Subsequent pathology of the injury, however, will usually make a distinction possible. In the following discussion, reference to a particular degree of burn should be taken to imply a moderate burn of that type.

12.57 The depth of the burn is not the only factor in determining its effect on the individual. The extent of the area of the skin which has been affected is also important. Thus, a first-degree burn over the entire body may be more serious than a third-degree burn at one spot. The larger the area burned, the more likely is the appearance of symptoms involving the whole body. Fur-

thermore, there are certain critical, local regions, such as the hands, where almost any degree of burn will incapacitate the individual.

12.58 Persons exposed to nuclear explosions of low or intermediate yield may sustain very severe burns on their faces and hands or other exposed areas of the body as a result of the short pulse of directly absorbed thermal radiation. These burns may cause severe superficial damage similar to a third-degree burn, but the deeper layers of the skin may be uninjured. Such burns will heal rapidly, like mild second-degree burns. Thermal radiation burns occurring under clothing or from ignited clothing or other tinder will be similar to those ordinarily seen in burn injuries of nonnuclear origin. Because of the longer duration of the thermal pulse from an air burst weapon in the megaton range, flash burns on exposed skin and burns of nonnuclear origin may also be similar.

BURNS UNDER CLOTHING

12.59 Skin burns under clothing, which depend on the color, thickness, and nature of the fabric, can be produced in the following ways: by direct transmittance through the fabric if the latter is thin and merely acts as an attenuating screen; by heating the fabric and causing steam or volatile products to impinge on the skin; by conduction from the hot fabric to the skin; or the fabric may ignite and hot vapors and flames will cause burns where they impinge on the skin. Burns beneath clothing can arise from heat transfer for some time after the thermal pulse ends. These burns generally involve deeper tissues

than the flash burns produced by the direct thermal pulse on bare skin. Flame burns caused by ignited clothing also result from longer heat application, and thus will be more like burns due to conventional conflagrations.

12.60 First- and second-degree burns of the uncovered skin and burns through thin clothing occur at lower radiant exposures (§ 7.35) than those which ignite clothing (Table 7.36). Because of these factors, first- and second-degree burns in exposed persons would involve only those body areas that face the explosion. Where the direct thermal pulse produces third-degree burns and clothing ignition takes place, persons wearing thin clothing would have such burns over parts of the body facing the burst. Persons wearing heavy clothing could suffer third-degree burns over the whole body if the ignited clothing could not be removed quickly. This phenomenon is typically seen in persons whose clothing catches fire by conventional means.

INCAPACITATION FROM BURNS

12.61 Burns of certain areas of the body, even if only of the first degree, will frequently result in incapacitation because of their critical location. Any burn surrounding the eyes that causes occluded vision, e.g., because of swelling of the eyelids, will be incapacitating. Burns of the elbows, knees, hands, and feet produce immobility or limitation of motion as the result of swelling, pain, or scab formation, and will cause ineffectiveness in most cases. The occurrence of burns of the face, neck, and hands are probable because these areas are most likely to be unprotected. Sec-

ond- or third-degree burns in excess of 20 percent of the surface area of the body should be considered major burns and will require special medical care in a hospital. If the nose and throat are seriously involved and obstructive edema (§ 12.27) occurs, breathing may become impossible and tracheotomy may be required as a life-saving measure.

12.62 Shock is a term denoting a generalized state of serious circulatory inadequacy. If serious, it will result in incapacitation and unconsciousness and if untreated may cause death. Third-degree burns of 25 percent of the body and second-degree burns of 30 percent of the body will generally produce shock within 30 minutes to 12 hours and require prompt medical treatment. Such treatment is complicated and causes a heavy drain on medical personnel and supply resources.

RADIANT EXPOSURES FOR BURNS ON EXPOSED SKIN

12.63 The critical radiant exposure for a skin burn depends on the duration of the radiation pulse and the thermal energy spectrum; both of these quantities vary with the yield and height of burst. Hence, although the radiant exposure is known as a function of distance and yield (see Chapter VII), it is not a simple matter to predict distances at which burns of different types may be expected from a given explosion. Apart from radiant exposure, the probability and severity of the burns will depend on several factors. One of the most important is the absorptive properties of the skin for thermal radiation. In a normal population, the fraction of the radiation

energy absorbed may vary by as much as 50 percent because of differences in skin pigmentation.

12.64 For thermal radiation pulses of 0.5 second duration or more, as is the case for explosions with yields exceeding 1 kiloton, the energy absorbed by the skin, rather than the radiant exposure, determines the extent of the burn injury. The spectral absorptance of the skin, i.e., the fraction of the incident radiation energy (or radiant exposure) that is absorbed, depends on the skin pigmentation. The curves in Fig. 12.64 have been derived from thermal energy spectra of nuclear explosions in the lower part of the atmosphere and measured values of the absorptance of different skin types. By considering explosions in the lower atmosphere, the height of burst variable is largely eliminated. The results in the figure are applicable to exposed skin when no evasive action is taken and there is no protection from structures or clothing. It is seen that the radiant exposure required to produce a given degree of burn injury varies significantly with skin pigmentation. In fact, people with very dark skins could receive burns from approximately two-thirds the incident radiant energy that will cause similar burns in very light-skinned people.

12.65 Figure 12.65 shows radiant exposures for the various probabilities of burn occurrence, again assuming no evasive or protective action. The solid lines represent the conditions under which it is probable that 50 percent of an average exposed population will receive skin burns of the indicated degree. The broken lines divide the burn probability distributions into ranges for three degrees of burn severity with average pro-

babilities of 18 percent and 82 percent assigned within the various ranges. For example, from Fig. 12.65 it is expected that, if a normal population is exposed to the thermal pulse from a 1-megaton explosion in the lower atmosphere, at distances where the radiant exposures are between 4.5 and 6 cal/cm², 18 percent of the population will receive second-degree burns and the remainder first-degree burns to the exposed (unprotected) skin.

12.66 With the aid of the yield-distance relationships for various radiant exposures given in Chapter VII, the curves in Fig. 12.65 may be used to determine the approximate distances from ground zero at which given burn probabilities may be experienced. Suppose that, in the example given above, the 1-megaton weapon is detonated at a height of 10,000 feet, which is within the lower atmosphere. According to Fig. 7.42, for air bursts below 20,000 feet and 12-mile visibility, the specified radiant exposure between 4.5 and 6 cal/cm², would be received at slant ranges of from 9 to 10 miles. Since these ranges are substantially greater than the height of burst (about 2 miles), they may be taken as the distances to ground zero to the accuracy of Fig. 7.42. Hence, within the radii of 9 and 10 miles from ground zero, it is probable that 18 percent of an average population subjected to the whole thermal pulse will receive second-degree burns and 82 percent first-degree burns to their exposed (unprotected) skin.

12.67 As already noted, the burn criteria given above are based on the supposition that no evasive action is taken. For air bursts with yields less than about 100 kilotons, the main part of

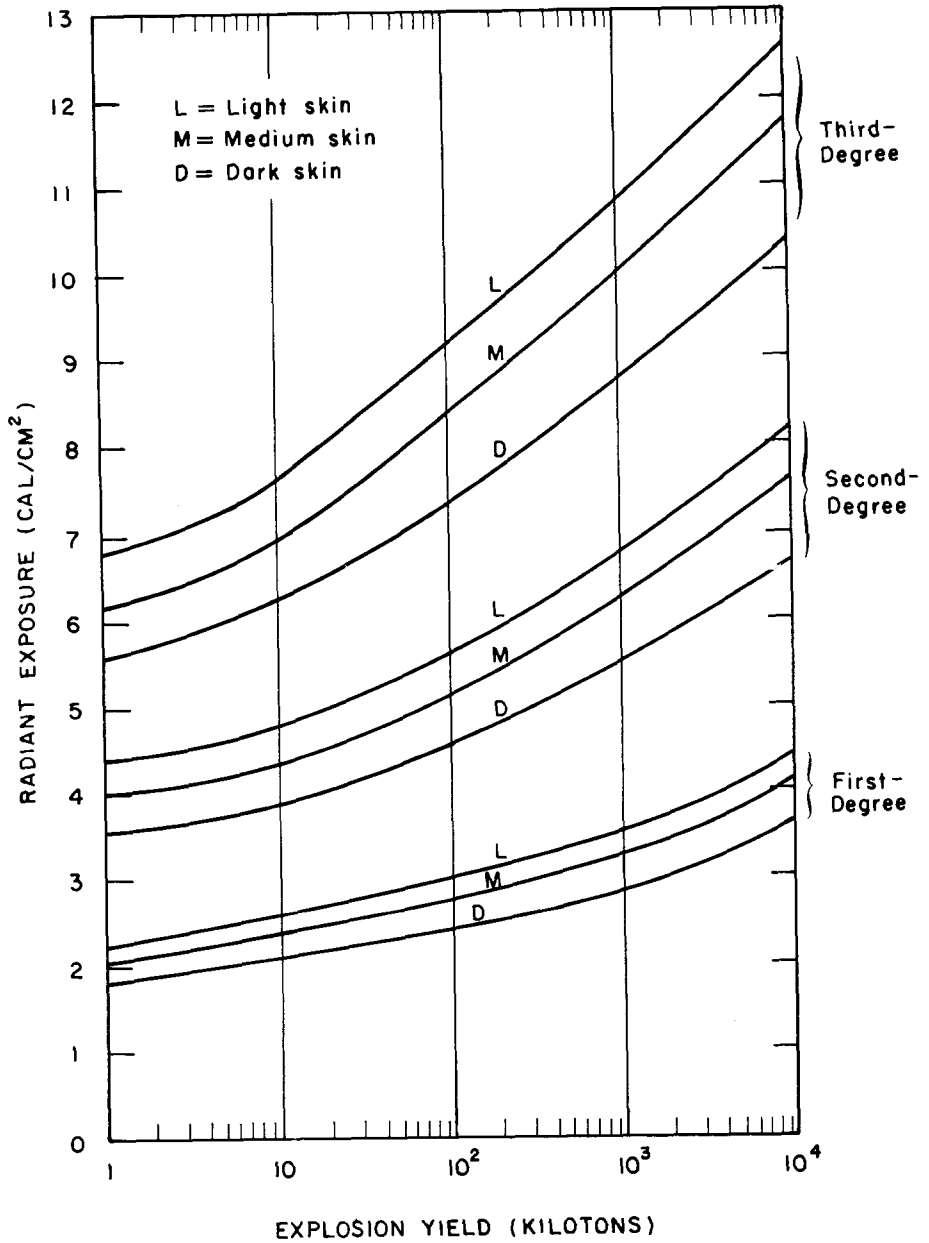

Figure 12.64. Radiant exposure required to produce skin burns for different skin pigmentation levels.

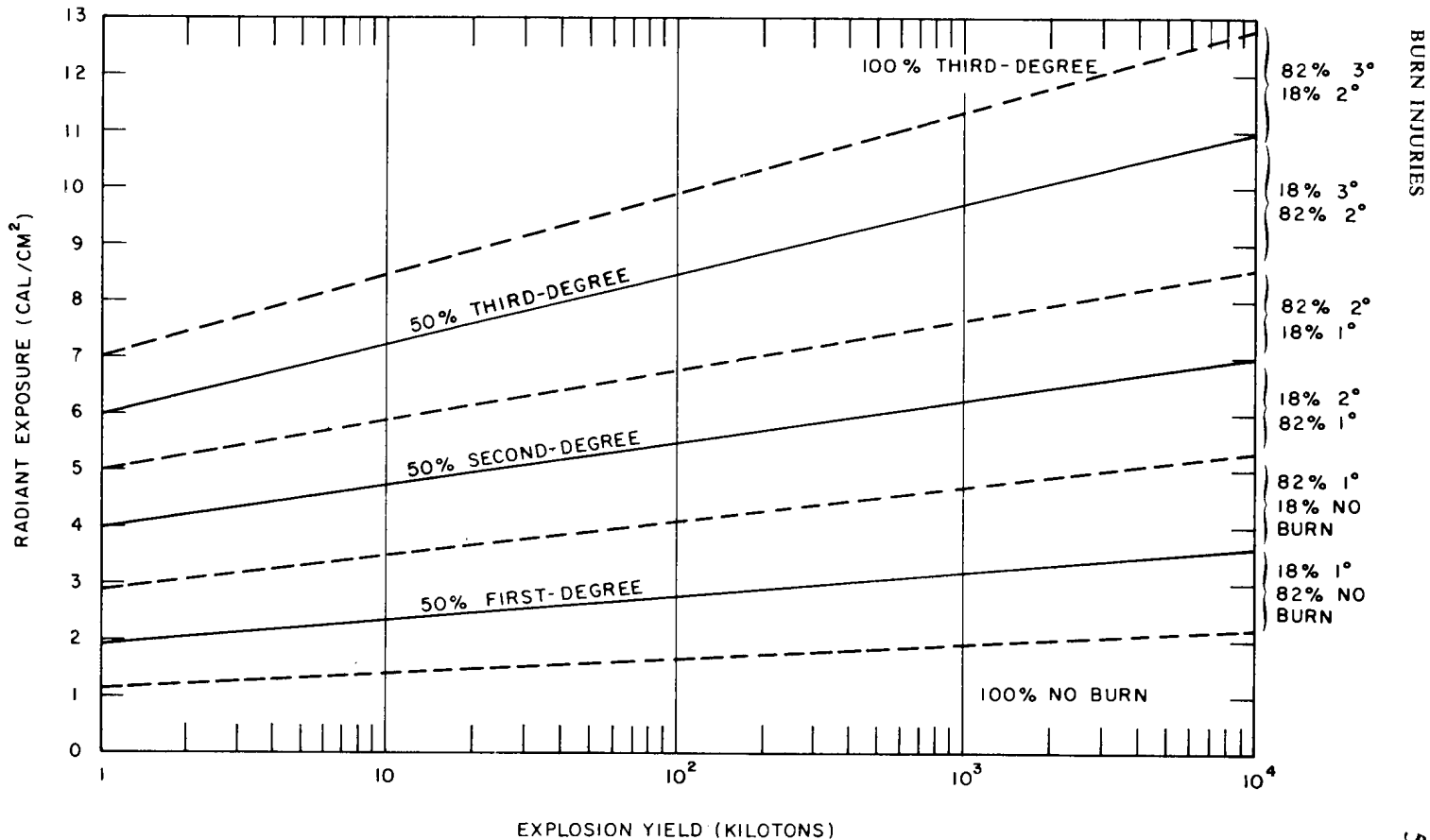

Figure 12.65. Skin burn probabilities for an average unshielded population taking no evasive action as a function of explosion yield and radiant exposure.

the thermal energy arrives too quickly for people to react and take some protective action. Evasion of part of the thermal energy that would be effective in reducing burn injuries is possible, however, for yields of 100 kilotons or more in the lower atmosphere. The length of the thermal pulse is then such that the pain could initiate a reaction which, if appropriate, might allow a person to obtain sufficient protection to decrease the severity of the potential burn (§ 7.87). The ability to react in this manner can apparently be improved by appropriate training.

BURN INJURIES IN JAPAN

12.68 Among the survivors of the nuclear explosions in Japan, the incidence of flame burns appeared to be very small. In fact, they constituted not more than 5 percent of the total burn injuries. This was the case because most of those who suffered flame burns did not survive, since they were caught in burning buildings and could not escape. The character of the flame burns was similar to that of burns caused by other conflagrations. The clothing usually caught fire and then large parts of the body suffered flame burns. By contrast, as will be seen below, flash burns were generally restricted to exposed skin areas, i.e., face, arms, hands, and legs.

12.69 One of the most striking consequences of the nuclear bombings of Japan was the large number of casualties due to flash burns caused by the thermal radiation. The situation was aggravated by the clear atmosphere and warm weather which prevailed at the time (§ 12.14). It was estimated that 20 to 30 percent of the fatal casualties in

Hiroshima and Nagasaki were caused by flash burns. In the former city alone, about 42,000 burn cases were reported and of those some 24,500 were recorded as being serious. Unless protected by heavy clothing, thermal radiation burns, apart from other injuries, would have been fatal to nearly all unshielded persons in the open at distances up to 6,000 feet (1.1 miles) or more from ground zero. Even as far out as 12,000 to 14,000 feet (2.3 to 2.6 miles), there were instances of such burns which were bad enough to require treatment.

THERMAL RADIATION BURNS IN JAPAN

12.70 A distinctive feature of the thermal radiation (flash) burns was their sharp limitation to exposed areas of the skin facing the center of the explosion. For this reason they are sometimes called "profile burns" (Fig. 12.70). The phenomenon occurred because most of the radiation received had traveled in a straight line from the fireball and so only regions that were directly exposed were affected. A striking illustration of this behavior was that of a man writing before a window. His hands were seriously burned, but his face and neck, which were not covered, suffered only slight burns because the angle of entry of the thermal radiation through the window was such as to place them in partial shadow.

12.71 Although flash burns were largely confined to exposed parts of the body, there were a few cases where such burns occurred through one, and very occasionally more, layers of clothing. Instances of this kind were observed when the radiant exposure was large



Figure 12.70. Partial protection against thermal radiation produced "profile" burns (1.23 miles from ground zero in Hiroshima; the radiant exposure was estimated to be 5.5 to 6 cal/cm²). The cap was sufficient to protect the top of the head against flash burn.

enough to overcome the protective effect of the particular fabric. When burns did occur through clothing, they frequently involved regions where the clothes were in contact with the skin, at the elbows and shoulders, for example. Such burns may have been due to heat transmitted from the hot fabric, rather than to the direct effect of radiation. Areas over which the clothing fitted loosely, so that an air space separated it from the skin, were generally unharmed by the thermal radiation (Fig. 12.71).

12.72 There were many instances in which burns occurred through black clothing, but not through white material worn by the same individual (Fig.

12.72). This was attributed to the reflection of thermal radiation by white or other light-colored fabrics, whereas materials of dark color absorbed radiation, became hot, and so caused contact burns. In some cases black outer clothing actually burst into flame and ignited the undergarments, so that flame burns resulted. It should be mentioned, however, that white clothing does not always necessarily provide protection against thermal radiation. Some materials of this kind transmit enough radiation to permit flash burning of the skin to occur.

12.73 The frequency of flash burns was, of course, greatest among persons



Figure 12.71. The skin under the areas of contact with clothing is burned. The protective effect of thicker layers can be seen on the shoulders and across the back.

who were in the open. Nevertheless, there were a surprising number of such burns among individuals who were indoors. This was largely because many windows, especially in commercial structures, were uncurtained or were wide open on account of the summer weather. Hence, many persons inside buildings were directly exposed to thermal radiation. In addition to the protection afforded by clothing, particularly if light in color, some shielding was provided by the natural promontories of the body, e.g., the nose, supraorbital (eye socket) ridges, and the chin.

GENERAL CHARACTERISTICS OF FLASH BURNS

12.74 In spite of the thousands of flash burns experienced after the nuclear

attacks on Japan, only their general features were reported. However, this information has been supplemented by observations made, especially on anesthetized pigs, both in the laboratory and at nuclear test explosions. The skin of white pigs has been found to respond to thermal radiation in a manner which is in many respects similar to, and can be correlated with, the response of human skin.

12.75 Severity of the flash burns in Japan ranged from mild erythema (reddening) to charring of the outermost layers of the skin. Among those who were within about 6,000 feet (1.1 miles) from ground zero, the burn injuries were depigmented lesions (light in color), but at greater distances, from 6,000 to 12,000 feet (1.1 to 2.3 miles), the initial erythema was followed by the develop-



Figure 12.72. The patient's skin is burned in a pattern corresponding to the dark portions of a kimono worn at the time of the explosion.

ment of a walnut coloration of the skin, sometimes called the "mask of Hiroshima."

12.76 Burns of moderate second degree (and milder) usually healed within four weeks, but more severe burns frequently became infected so that the healing process was much more prolonged. Even under the best conditions, it is difficult to prevent burns from becoming infected, and after the nuclear bombings of Japan the situation was aggravated by inadequate care, poor sanitation, and general lack of proper facilities. Nuclear radiation injury may have been a contributory factor in some

cases because of the decrease in resistance of the body to infection.

12.77 Experimental flash burns have been produced both in the laboratory and in nuclear tests which were apparently quite similar to those reported from Hiroshima and Nagasaki. In the more severe cases of circular experimental burns there was a central charred region with a white outer ring surrounded by an area of erythema. A definite demarcation both in extent and depth of the burns was noted, so that they were unlike contact burns which are generally variable in depth. The surface of the flash burns became dry

without much edema or weeping of serum.

12.78 Another phenomenon, which appeared in Japan after the healing of some of the more severe burns, was the formation of keloids, that is, thick overgrowths of scar tissue. It was suggested, at one time, that they might have been due to nuclear radiation, but this view is no longer accepted. The degree of keloid formation appears to have been influenced by infections, which complicated healing of the burns, and by malnutrition. A secondary factor is the known disposition for keloid formation to occur among the Japanese and other dark-skinned people as a racial characteristic. Many spectacular keloids, for example, were formed after the healing of burns produced in the incendiary bomb attacks on Tokyo. There is a tendency, however, for keloids to disappear gradually in the course of time.

EFFECTS OF THERMAL RADIATION ON THE EYES

12.79 It is of interest that, among the survivors in Hiroshima and Nagasaki, eye injuries directly attributable to thermal radiation appeared to be relatively unimportant. There were many instances of temporary blindness, occasionally lasting up to 2 or 3 hours, but only one case of retinal injury was reported.

12.80 The eye injury known as keratitis (an inflammation of the cornea) occurred in some instances. The symptoms, including pain caused by light, foreign-body sensation, lachrymation, and redness, lasted for periods ranging from a few hours to several days.

Among 1,000 cases, chosen at random, of individuals who were in the open, within some 6,600 feet (1.25 miles) of ground zero at the time of the explosions, only 42 gave a history of keratitis coming on within the first day. Delayed keratitis was reported in 14 additional cases, with symptoms appearing at various times up to a month or more after the explosion. It is possible that nuclear radiation injury, which is associated with delayed symptoms, as will be seen below, may have been a factor in these patients.

12.81 Investigators have reported that in no case, among 1,400 examined, was the thermal radiation exposure of the eyes apparently sufficient to produce permanent opacity of the cornea. This observation is not surprising since the cornea is transparent to the major portion of the thermal energy which is received in the visible and longer wavelength (infrared) parts of the spectrum. In approximately one-quarter of the cases studied there had been facial burns and often singeing of the eyebrows and eyelashes. Nevertheless, some 3 years later the corneas were found to be normal.

12.82 Several reasons have been suggested for the scarcity of severe eye injuries in Japan. For example, the detonations occurred in the morning in broad daylight when the eye pupil would be expected to be small. Another possible explanation is that the recessed position of the eyes and, in particular, the overhanging upper lids served to decrease the direct exposure to thermal radiation. Furthermore, on the basis of probability, it is likely that only a small proportion of individuals would be facing the explosions in such a way that the

fireball would actually be in their field of vision.

12.83 Exposure of the eye to the bright flash of a nuclear detonation can produce two possible injuries: flashblindness and retinal burns. Flashblindness (dazzle) is a temporary impairment of vision caused by a bleaching of the light-sensitive elements (rods and cones) in the retina of the eye. It may be produced by scattered light and does not necessarily require the eye to be focused on the fireball. Flashblindness will normally blank out the entire visual field of view with a bright afterimage. The effects persist only a short time and recovery is complete.

12.84 During the period of flashblindness (several seconds to minutes) useful vision is lost. This may preclude effective performance of activities requiring constant, precise visual function. The severity and time required for recovery of vision are determined by the intensity and duration of the flash, the viewing angle from the burst, the pupil size, brightness of the object being viewed and its background, and the visual complexity of the object. Flashblindness would be more severe at night since the pupil is larger and the objects and background are usually dimly illuminated.

12.85 A retinal burn is a permanent eye injury that occurs whenever the retinal tissue is heated excessively by the image of the fireball focused in the eye. The underlying pigmented cells absorb much of the light (radiation) energy and the temperature is increased in that area. A temperature elevation of 12 to 20°C (22 to 36°F) in the eye produces a ther-

mal injury that involves both the pigmented layer and the adjacent rods and cones, so that visual capacity is permanently lost in the burned area. The natural tendency of people to look directly at the fireball would increase the incidence of retinal burns. A retinal burn normally will not be noticed by the individual concerned if it is off the central axis of vision, but very small burned areas may be noticeable if they are centrally located. A person generally will be able to compensate for a small retinal burn by learning to scan around the burned area.

12.86 Retinal burns can be produced at great distances from nuclear detonations, because the probability of their occurrence does not decrease as the square of the distance from the detonation, as is true of many other nuclear weapons effects. Theoretically, the optical process of image formation within the eye should keep the energy per unit area on the retina a constant, regardless of the distance. However, meteorological conditions and the fact that the human eye is not a perfect lens, all contribute toward reducing the retinal burn hazard as the distance is increased between the observer and the detonation.

12.87 Explosions with yields of more than about 1 megaton at heights greater than some 25 miles may produce retinal burns as far out as the horizon on clear nights. If the burst height is greater than some 50 miles, the short pulse of thermal energy from the early-time weapon debris, as well as that from the X-ray pancake, can be effective in this respect (§ 7.91). Bursts above 90 miles

altitude probably will not cause retinal burns in persons on the ground, unless the yield is greater than 10 megatons. The eye's blink reflexes are sufficiently fast (roughly 0.25 second) to provide some protection against weapons of more than 100 kilotons yield detonated below about 25 miles. The blink time is too slow to provide any appreciable protection from smaller weapons or from bursts at higher altitudes. When people have adequate warning of an impending nuclear burst, evasive action, including closing or shielding the eyes, will prevent both flashblindness and retinal burns.

12.88 Safe separation distances from ground zero, i.e., distances beyond which persons on the ground would not receive incapacitating eye injuries, are shown in Figs. 12.88a and b as a function of weapon yield for two heights of burst (HOB). The curves in Fig. 12.88a are for a clear day; for a cloudy day the safe separation distances would be reduced to about half. The curves in Fig. 12.88b are for night conditions. The distances for retinal burns are those for which such burns will not occur provided the eye can blink within 0.25 second. A faster blink time will not change the values appreciably, but a slower time would increase them. Data

for the complete absence of flashblindness are not available and the distances in Figs. 12.88a and b are those within which a visual loss for about 10 seconds may be expected, to a degree sufficient to preclude the performance of a precision task under conditions of dim light, e.g., a pilot reading instruments at night.

12.89 The flashblindness and retinal burn safe separation distances do not bear a constant relationship to one another as the yield changes. In circumstances that require determination of complete eye safety (bearing in mind the 10-second visual loss criterion for flashblindness), the effect that occurs at the greater distance from the burst is the critical one. For example, for a height of burst of 50,000 feet at night, it is seen from Fig. 12.88b that for yields up to about 3 megatons, flashblindness is the important factor in determining the distance at which there will be no incapacitating eye effects. For larger yields, retinal burn becomes the limiting factor. Where only permanent eye damage is of interest and the temporary loss of vision from flashblindness is of little concern, the retinal burn curves should be used to estimate safe distances no matter what the explosion energy yield.

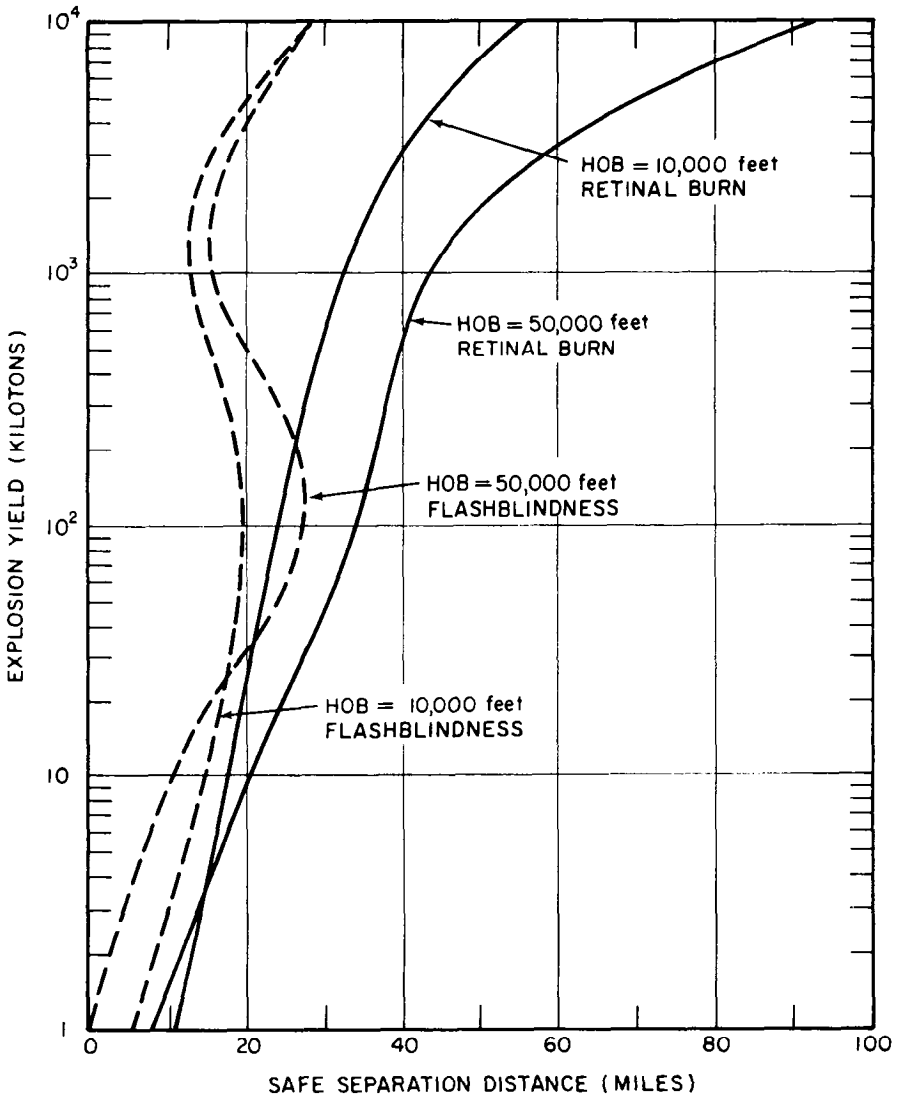

Figure 12.88a. Flashblindness and retinal burn safe separation distances for an observer on the ground, as a function of explosion yield, for burst heights of 10,000 feet and 50,000 feet on a clear day.

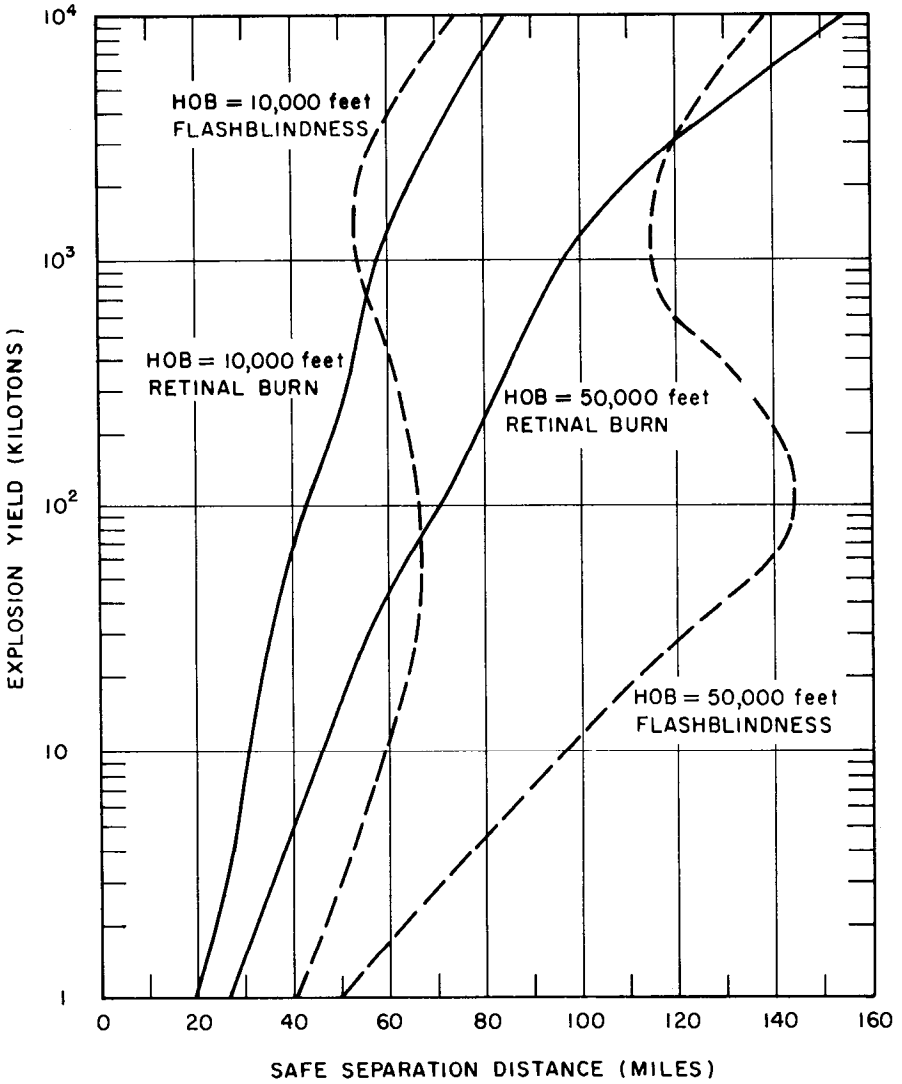

Figure 12.88b. Flashblindness and retinal burn safe separation distances for an observer on the ground, as a function of explosion yield, for burst heights of 10,000 feet and 50,000 feet at night.

NUCLEAR RADIATION INJURY

INTRODUCTION

12.90 The injurious effects of nuclear radiations from a nuclear explosion represent a phenomenon which is completely absent from conventional explosions. For this reason, the subject of radiation injury (or sickness) will be described at some length. It should be understood, however, that the extended discussion does not necessarily imply that nuclear radiation would be the most important source of casualties in a nuclear explosion. This was certainly not the case in Japan where the detonations occurred at heights of approximately 1,870 feet (Hiroshima) and 1,640 feet (Nagasaki) above the ground. Such injuries as were caused by nuclear radiation were due to the initial radiation. The effect of the residual radiation, in the form of early fallout and induced radioactivity, was negligible. However, as was seen in Chapter IX, the situation could be very different in the event of a surface burst.

12.91 It has long been known that exposure to radiations, such as X rays, alpha and beta particles, gamma rays, and neutrons, which are capable of producing ionization, either directly or indirectly (§§ 8.21, 8.58), can cause injury to living organisms. After the discovery of X rays and radioactivity, toward the end of the nineteenth century, it became increasingly apparent that an element of danger was associated with exposure to ionizing radiations.⁶ In

spite of the growing awareness by both scientists and physicians of the hazards inherent in many radiation sources, there were some excessive exposures. In the course of time, however, recommendations for preventing overexposures were adopted and radiation injuries became less frequent. Nevertheless, occasional overexposures have occurred among personnel operating radiographic equipment, powerful X-ray machines in industrial laboratories and hospitals, cyclotrons, and experimental nuclear reactors, or working with radioactive materials.

12.92 The harmful effects of nuclear radiations appear to be caused by the ionization (and excitation) produced in the cells composing living tissue. As a result of ionization, some of the constituents, which are essential to the normal functioning of the cells, are altered or destroyed. In addition, the products formed may act as poisons. Among the observed consequences of the action of ionizing radiations on cells are breaking of the chromosomes, swelling of the nucleus and of the entire cell, increase in viscosity of the cell fluid, increased permeability of the cell membrane, and destruction of cells. In addition, the process of cell division (or "mitosis") is delayed by exposure to radiation. Frequently, the cells are unable to undergo mitosis, so that the normal cell replacement occurring in the living organism is inhibited.

⁶The more general expression "ionizing radiations" is often employed instead of nuclear radiations, since this permits the inclusion of radiations of nonnuclear origin, e.g., X rays, having similar biological effects.

RADIATION DOSE UNITS

12.93 The radiation unit known as the roentgen was described in § 8.17. By definition, it is applicable only to gamma rays or X rays and not to other types of ionizing radiation, such as alpha and beta particles and neutrons. Since the roentgen refers to a specific result in air accompanying the passage of an amount of radiation through the air, it does not imply any effect that it would produce in a biological system. The roentgen is thus a measure of the "exposure" to gamma rays and X rays. The effect on a biological system, such as the whole body or a particular organ, however, depends on the amount of radiation energy that has been absorbed by the body or organ. The unit of absorbed dose, which applies to all kinds of ionizing radiations, including alpha and beta particles and neutrons, is the rad, as defined in § 8.18.

12.94 Although all ionizing radiations are capable of producing similar biological effects, the absorbed dose (measured in rads) which will produce a certain effect may vary appreciably from one type of radiation to another. This difference in behavior is expressed by means of the "relative biological effectiveness" (or RBE) of the particular nuclear radiation. The RBE of a given radiation is defined as the ratio of the absorbed dose in rads of gamma radiation (of a specified energy)⁷ to the absorbed dose in rads of the given radiation having the same biological effect. The value of the RBE for a particular type of nuclear radiation depends upon several factors, including the dose rate,

the energy of the radiation, the kind and degree of the biological damage, and the nature of the organism or tissue under consideration.

12.95 The "biological dose," also called the "RBE dose," that provides a direct indication of the expected effects of any ionizing radiation on the body (or organ), is stated in terms of the "rem," an abbreviation of "roentgen equivalent (in) man." It is equal to the absorbed dose in rads multiplied by the RBE for the particular radiation (or radiations) absorbed; thus,

$$\text{Dose in rems} = \text{Dose in rads} \times \text{RBE.}$$

An advantage of the rem is that it is possible to express the total biological effect that might result from the absorption of more than one kind of ionizing radiation. The absorbed dose in rads of each radiation type is multiplied by the appropriate RBE and the results are added. (In connection with radiological protection in peacetime activities, the "dose equivalent" in rems is defined as the absorbed dose in rads multiplied by a "quality factor," and sometimes by other modifying factors. The quality factor, which depends on the nature and energy of the absorbed radiation, replaces the RBE.)

12.96 All radiations capable of producing ionization (or excitation) directly or indirectly, e.g., alpha and beta particles, X rays, gamma rays, and neutrons, cause radiation injury of the same general type. Although the effects are qualitatively similar, the various radiations differ in the depth to which they penetrate the body and in the degree of injury corresponding to a specified

⁷Gamma rays from cobalt-60 have been commonly specified for this purpose.

amount of energy absorption. As seen above, the latter difference is expressed by means of the RBE.

12.97 The RBE for gamma rays is approximately unity, by definition, although it varies somewhat with the energy of the radiation. For beta particles, the RBE is also close to unity; this means that for a given amount of energy absorbed in living tissue, beta particles produce about the same extent of injury within the body as do X rays or gamma rays.⁸ The RBE for alpha particles from radioactive sources that have been taken into the body is in the range from 10 to 20, more specifically for the development of bone cancers. The RBE for neutrons varies with the energy and the type of injury. For the neutron energy spectrum of nuclear weapons, the RBE for immediate (acute) radiation injury is close to 1.0. But it is significantly larger (4 to 10) for the occurrence of opacities of the eye lens (cataracts), leukemia, and genetic changes (§ 12.144 *et seq.*, § 12.201 *et seq.*). For these biological effects, a certain amount of energy absorbed from exposure to neutrons is much more damaging than the same amount of energy (in rads) absorbed from gamma rays.⁹

GENERAL CHARACTERISTICS OF RADIATION EFFECTS

12.98 In considering the possible effects on the body of ionizing radiations from external sources, it is neces-

sary to distinguish between an "acute" (or "one-shot") exposure and a "chronic" (or extended) exposure. In an acute exposure the whole radiation dose is received in a relatively short interval of time. This is the case, for example, in connection with the initial nuclear radiation. It is not possible to define an acute dose precisely, but it may be somewhat arbitrarily taken to be the dose received during a 24-hour period. Although the delayed radiations from early fallout persist for longer times, the main exposure would be received during the first day and so it is regarded as being acute. On the other hand, an individual entering a fallout area after the first day or so and remaining for some time would be considered to have been subjected to a chronic exposure.

12.99 The importance of making a distinction between acute and chronic exposures lies in the fact that, if the dose rate is not too large, the body can achieve partial recovery from many (but perhaps not all) of the consequences of nuclear radiations. For example, an acute dose of 50 rems will generally cause changes in the constituents of the blood (§ 12.113), but the same dose spread over a period of years (or even less) will produce only minor effects on the blood cells. In an extreme case, an acute dose exceeding 600 rems would cause serious illness and in the great majority of instances death could occur within a few weeks. On the other hand,

⁸Beta particles from sources on or near the body can also cause skin lesions, called "beta burns" (§ 12.155 *et seq.*).

⁹The curves in Chapter VIII that show the neutron dose in rads at a particular location relative to a nuclear explosion calculated by considering the contributions of neutrons in various energy ranges at that location for typical weapons spectra. Multiplication of these doses by the appropriate RBE gives the corresponding biological dose in rems.

a chronic dose of the same total magnitude accumulated gradually over 20 years might have no observable effect.

12.100 The injury caused by a certain dose (and dose rate) of radiation will depend upon the extent and part of the body that is exposed. One possible reason is that when the exposure is restricted, the unexposed regions may be able to contribute to the recovery of the injured area. But if the whole body is exposed, many organs are affected and recovery is much more difficult.

12.101 Different portions of the body show different sensitivities to ionizing radiations, and there are variations in degree of sensitivity among individuals. In general, the most radiosensitive cells are found in the lymphoid tissue, bone marrow, spleen, organs of reproduction, and gastrointestinal tract. Of intermediate sensitivity are the skin, lungs, and liver, whereas muscle, nerve, and adult bones are the least sensitive.

EFFECTS OF ACUTE RADIATION DOSES

12.102 Before the nuclear bombings of Hiroshima and Nagasaki relatively little was known of the phenomena associated with acute whole-body exposure to ionizing radiation. In Japan, however, a large number of individuals received whole-body doses of radiation ranging from insignificant quantities to amounts which proved fatal. The effects were often complicated by other injuries and shock, so that the symptoms of acute radiation injury could not always be isolated. Because of the great numbers of patients and the lack of facilities after the explosions, it was

impossible to make detailed observations and keep accurate records. Nevertheless, certain important conclusions have been drawn from Japanese experience with regard to the effects of nuclear radiation on the human organism.

12.103 Information on this subject has also been gathered from other sources. These include a few laboratory accidents involving a small number of human beings, irradiation used in treating various diseases and malignancies, and extrapolation to man of observations on animals. In addition, detailed knowledge has been obtained from a careful study of over 250 persons in the Marshall Islands, who were accidentally exposed to nuclear radiation from fallout following the test explosion on March 1, 1954 (§ 9.104 *et seq.*). The exposed individuals included both Marshallese and a small group of American servicemen. The whole-body radiation doses ranged from relatively small values (14 rems), which produced no obvious symptoms, to amounts (175 rems) that caused prompt marked changes in the blood-forming system (§ 12.124).

12.104 No single source of data directly yields the relationship between the physical dose of ionizing radiation and the clinical effect in man. Hence, there is no complete agreement concerning the effect associated with a specific dose or dose range. Attempts in the past have been made to relate particular symptoms to certain narrow ranges of exposure; however, the data are incomplete and associated with many complicating factors that make interpretation difficult. For instance, the observations in Japan were very sketchy until 2 weeks following the exposures, and the people at that time were suffering from

malnutrition and pre-existing bacterial and parasitic infections. Consequently, their sickness was often erroneously attributed to the effects of ionizing radiation when such was not necessarily the case. The existing conditions may have been aggravated by the radiation, but to what extent it is impossible to estimate in retrospect.

12.105 In attempting to relate the acute radiation dose to the effect on man, it should be mentioned that reliable information has been obtained for doses up to 200 rems. As the dose increases from 200 to 600 rems, the data from exposed humans decrease rapidly and must be supplemented more and more by extrapolations based on animal studies. Nevertheless, the conclusions drawn can be accepted with a reasonable degree of confidence. Beyond 600 rems, however, observations on man are so sporadic that the relationship between dose and biological effect must be inferred or conjectured almost entirely from observations made on animals exposed to ionizing radiations. Such observations have been made in recent years at extremely high doses.

12.106 Individuals receiving acute whole-body doses of ionizing radiation may show certain signs and symptoms of illness. The time interval to onset of these symptoms, their severity, and their duration generally depend on the amount of radiation absorbed, although there may be significant variations among individuals. Within any given dose range the effects manifested can be divided conveniently into three time phases: initial, latent, and final.

12.107 During the initial phase, exposed individuals may experience nausea, vomiting, headache, dizziness,

and a generalized feeling of illness. The onset time decreases and the severity of these symptoms increases with increasing dose. During the latent phase exposed individuals will experience few, if any, symptoms and most likely will be able to perform useful tasks. The final phase is characterized by illness that requires hospitalization of people receiving the higher doses. In addition to the recurrence of the symptoms noted during the initial phase, skin hemorrhages, diarrhea, and loss of hair may appear, and, at higher doses, seizures and prostration may occur. The final phase is consummated by recovery or death.

12.108 With the foregoing in mind, Table 12.108 is presented as the best available summary of the effects of various whole-body dose ranges of ionizing radiation on human beings. Results of radiobiological studies are generally reported in terms of the (vertical) midline tissue dose in rads. This dose is lower than the dose that would be measured by instruments (and the dose that would be absorbed by tissue) near the surface of the body by a factor that depends upon the energy of the radiation and the size of the individual. The nuclear radiation data presented in Chapters VIII and IX refer to the absorbed dose in tissue at the surface of an individual that is nearest the burst, and thus they also correspond to the expected instrument readings. For consistency, the data in Table 12.108 are the doses (in rems) equivalent to the absorbed doses (in rads) in tissue at the surface of the individual. For gamma rays, these absorbed doses are essentially equal to the exposures in roentgens (§ 8.18). For nuclear weapon ra-

Table 12.108

SUMMARY OF CLINICAL EFFECTS OF ACUTE IONIZING RADIATION DOSES

Range	0 to 100 rems Subclinical range	100 to 1,000 rems Therapeutic range			Over 1,000 rems Lethal range	
		100 to 200 rems	200 to 600 rems	600 to 1,000 rems	1,000 to 5,000 rems	Over 5,000 rems
		Clinical surveillance	Therapy effective	Therapy promising	Therapy palliative	
Incidence of vomiting	None	100 rems: infrequent 200 rems: common	300 rems: 100%	100%	100%	
Initial Phase						
Onset	—	3 to 6 hours	½ to 6 hours	¼ to ½ hour	5 to 30 minutes	Almost immediately**
Duration	—	≤ 1 day	1 to 2 days	≤ 2 days	≤ 1 day	
Latent Phase						
Onset	—	≤ 1 day	1 to 2 days	≤ 2 days	≤ 1 day*	Almost immediately**
Duration	—	≤ 2 weeks	1 to 4 weeks	5 to 10 days	0 th 7 days*	
Final Phase						
Onset	—	10 to 14 days	1 to 4 weeks	5 to 10 days	0 to 10 days	Almost immediately**
Duration	—	4 weeks	1 to 8 weeks	1 to 4 weeks	2 to 10 days	
Leading organ		Hematopoietic tissue			Gastrointestinal tract	Central nervous system
Characteristic signs	None below 50 rems	Moderate leukopenia	Severe leukopenia; purpura; hemorrhage; infection. Epilation above 300 rems.		Diarrhea; fever; disturb- ance of electrolyte balance.	Convulsions; tremor; ataxia; lethargy.
Critical period post- exposure	—	—	1 to 6 weeks		2 to 14 days	1 to 48 hours

Therapy	Reassurance	Reassurance; hematologic surveillance.	Blood transfusion; antibiotics.	Consider bone marrow transplantation.	Maintenance of electrolyte balance.	Sedatives
Prognosis	Excellent	Excellent	Guarded	Guarded	Hopeless	
Convalescent period	None	Several weeks	1 to 12 months	Long	—	
Incidence of death	None	None	0 to 90%	90 to 100%	100%	
Death occurs within	—	—	2 to 12 weeks	1 to 6 weeks	2 to 14 days	< 1 day to 2 days
Cause of death	—	—	Hemorrhage; infection		Circulatory collapse	Respiratory failure; brain edema.

*At the higher doses within this range there may be no latent phase.

**Initial phase merges into final phase, death usually occurring from a few hours to about 2 days; this chronology is possibly interrupted by a very short latent phase.

diation, the midline tissue doses for average size adults would be approximately 70 percent of the doses in the table.

12.109 As shown in Table 12.108, below 100 rems the response is almost completely subclinical; that is to say, there is no sickness requiring special attention. Changes may, nevertheless, be occurring in the blood, as will be seen later. Between 100 and 1,000 rems is the range in which therapy, i.e., proper medical treatment, will be successful at the lower end and may be successful at the upper end. The earliest symptoms of radiation injury are nausea and vomiting, which may commence within about 15 minutes to 6 hours of exposure, depending on the dose, accompanied by discomfort (malaise), loss of appetite, and fatigue. The most significant, although not immediately obvious effect in the range under consideration, is that on the hematopoietic tissue, i.e., the organs concerned with the formation of blood. An important manifestation of the changes in the functioning of these organs is leukopenia, that is, a decline in the number of leukocytes (white blood cells). Loss of hair (epilation) will be apparent about 2 weeks or so after receipt of a dose exceeding 300 rems.

12.110 Because of the increase in the severity of the radiation injury and the variability in response to treatment in the range from 100 to 1,000 rems, it is convenient to subdivide this range into three subsections, as shown in Table 12.108. For whole-body doses from 100 to 200 rems, hospitalization is generally not required, but above 200 rems admission to a hospital is neces-

sary so that the patient may receive such treatment as may be indicated. Up to 600 rems, there is reasonable confidence in the clinical events and appropriate therapy, but for doses in excess of this amount there is considerably uncertainty and variability in response.

12.111 Beyond 1,000 rems, the prospects of recovery are so poor that therapy may be restricted largely to palliative measures. It is of medical interest, however, to subdivide this lethal range into two parts in which the characteristic major clinical effects are different. Although the dividing line has been somewhat arbitrarily set at 5,000 rems in Table 12.108, human data are so limited that this dose level might well have any value from 2,000 to 6,000 rems. In the range from 1,000 to (roughly) 5,000 rems, pathological changes in the gastrointestinal tract, which are apparent at lower doses, become very marked. Above 5,000 rems, the central nervous system also exhibits the consequences of major injury.

12.112 The superposition of radiation effects upon injuries from other causes may be expected to result in an increase in the number of cases of shock. For example, the combination of sublethal nuclear radiation exposure and moderate thermal burns will produce earlier and more severe shock than would the comparable burns alone. The healing of wounds of all kinds will be retarded because of the susceptibility to secondary infection accompanying radiation injury and for other reasons. In fact, infections, which could normally be dealt with by the body, may prove fatal in such cases.

CHARACTERISTICS OF ACUTE WHOLE-BODY RADIATION INJURY

DOSES OF 25 TO 100 REMS: NO ILLNESS

12.113 Single doses in the range of from 25 to 100 rems over the whole body will produce some changes in the blood (§ 12.124). These changes do not usually occur below this range and are not produced consistently unless the dose is 50 rems or more. Disabling sickness does not occur and exposed individuals should be able to proceed with their usual duties.

DOSES OF 100 TO 200 REMS: SLIGHT OR NO ILLNESS

12.114 A whole-body dose in the range of 100 to 200 rems will result in a certain amount of illness but it will rarely be fatal. Doses of this magnitude were common in Hiroshima and Nagasaki, particularly among persons who were at some distance from the nuclear explosion. Of the 267 individuals accidentally exposed to fallout in the Marshall Islands following the test explosion of March 1, 1954, a group of 64 received radiation doses in this range. The exposure of these individuals was not strictly of the acute type, since it extended over a period of some 45 hours. More than half the dose, however, was received within 24 hours and the observed effects were similar to those to be expected from an acute exposure of the same amount.

12.115 The illness from radiation doses in this range does not present a serious problem since most patients will suffer little more than discomfort and fatigue and others may have no symp-

toms at all. There may be some nausea and vomiting on the first day or so following irradiation, but subsequently there is a latent period, of up to 2 weeks or more (§ 12.107). The usual symptoms, such as loss of appetite and malaise, may reappear, but if they do, they are mild. The changes in the character of the blood, which accompany radiation injury, become significant during the latent period and persist for some time. If there are no complications, due to other injuries or infection, there will be recovery in essentially all cases. In general, the more severe the early stages of the radiation sickness, the longer will be the process of recovery. Adequate care and the use of antibiotics, as may be indicated clinically, can greatly expedite complete recovery of the small proportion of more serious cases.

DOSES OF 200 TO 1,000 REMS: SURVIVAL POSSIBLE

12.116 For doses between 200 and 1,000 rems the probability of survival is good at the lower end of the range but poor at the upper end. The initial symptoms are similar to those common in radiation sickness, namely, nausea, vomiting, diarrhea, loss of appetite, and malaise. The larger the dose, the sooner will these symptoms develop, generally during the initial day of the exposure. After the first day or two the symptoms disappear and there may be a latent period of several days to 2 weeks during which the patient feels relatively well, although important changes are occurring in the blood. Subsequently, there is



Figure 12.117. An example of epilation due to radiation exposure.

a return of symptoms, including fever, diarrhea, and a steplike rise in temperature which may be due to accompanying infection.

12.117 Commencing about 2 or 3 weeks after exposure, there is a tendency to bleed into various organs, and small hemorrhages under the skin (pe-

techiae) are observed. This tendency may be marked. Particularly common are spontaneous bleeding in the mouth and from the lining of the intestinal tract. There may be blood in the urine due to bleeding in the kidney. The hemorrhagic tendency depends mainly upon depletion of the platelets in the

blood, resulting in defects in the blood-clotting mechanism (see § 12.129). Loss of hair, which is a prominent consequence of radiation exposure, also starts after about 2 weeks, i.e., immediately following the latent period, for doses over 300 rems (Fig. 12.117).

12.118 Susceptibility to infection of wounds, burns, and other lesions, can be a serious complicating factor. This would result to a large degree from loss of the white blood cells, and a marked depression in the body's immunological process. For example, ulceration about the lips may commence after the latent period and spread from the mouth through the entire gastrointestinal tract in the terminal stage of the sickness. The multiplication of bacteria, made possible by the decrease in the white cells of the blood and injury to other immune mechanisms of the body, allows an overwhelming infection to develop.

12.119 Among other effects observed in Japan was a tendency to spontaneous internal bleeding toward the end of the first week. At the same time, swelling and inflammation of the throat was not uncommon. The development of severe radiation illness among the Japanese was accompanied by an increase in the body temperature, which was probably due to secondary infection. Generally there was a step-like rise between the fifth and seventh days, sometimes as early as the third day following exposure, and usually continuing until the day of death.

12.120 In addition to fever, the more serious cases exhibited severe emaciation and delirium, and death occurred within 2 to 8 weeks. Examination after death revealed a decrease in size of

and degenerative changes in testes and ovaries. Ulceration of the mucous membrane of the large intestine, which is generally indicative of doses of 1,000 rems or more, was also noted in some cases.

12.121 Those patients in Japan who survived for 3 to 4 months, and did not succumb to tuberculosis, lung diseases, or other complications, gradually recovered. There was no evidence of permanent loss of hair, and examination of 824 survivors some 3 to 4 years later showed that their blood composition was not significantly different from that of a control group in a city not subjected to nuclear attack.

LARGE DOSE (OVER 1,000 REMS): SURVIVAL IMPROBABLE

12.122 Very large doses of whole-body radiation (approximately 5,000 rems or more) result in prompt changes in the central nervous system. The symptoms are hyperexcitability, ataxia (lack of muscular coordination), respiratory distress, and intermittent stupor. There is almost immediate incapacitation for most people, and death is certain in a few hours to a week or so after the acute exposure. If the dose is in the range from 1,000 to roughly 5,000 rems, it is the gastrointestinal system which exhibits the earliest severe clinical effects. There is the usual vomiting and nausea followed, in more or less rapid succession, by prostration, diarrhea, anorexia (lack of appetite and dislike for food), and fever. As observed after the nuclear detonations in Japan, the diarrhea was frequent and severe in character, being watery at first and tending to become bloody later; how-

ever, this may have been related to pre-existing disease.

12.123 The sooner the foregoing symptoms of radiation injury develop the sooner is death likely to result. Although there may be no pain during the first few days, patients experience malaise, accompanied by marked depression and fatigue. At the lower end of the dose range, the early stages of the severe radiation illness are followed by a latent period of 2 or 3 days (or more), during which the patient appears to be free from symptoms, although profound changes are taking place in the body, especially in the blood-forming tissues. This period, when it occurs, is followed by a recurrence of the early symptoms, often accompanied by delirium or coma, terminating in death usually within a few days to 2 weeks.

EFFECTS OF RADIATION ON BLOOD CONSTITUENTS

12.124 Among the biological consequences of exposure of the whole body to an acute dose of nuclear radiation, perhaps the most striking and characteristic are the changes which take place in the blood and blood-forming organs. Normally, these changes will be detectable only for doses greater than 25 rems. Much information on the hematological response of human beings to nuclear radiation was obtained after the nuclear explosions in Japan and also from observations on victims of laboratory accidents. The situation which developed in the Marshall Islands in March 1954, however, provided the opportunity for a very thorough study of the effects of small and moderately large doses of radiation (up to 175 rems) on

the blood of human beings (§ 12.103). The descriptions given below, which are in general agreement with the results observed in Japan, are based largely on this study.

12.125 One of the most striking hematological changes associated with radiation injury is in the number of white blood cells. Among these cells are the neutrophils, formed chiefly in the bone marrow, which are concerned with resisting bacterial invasion of the body. During the course of certain types of bacterial infection, the number of neutrophils in the blood increases rapidly to combat the invading organisms. Loss of ability to meet the bacterial invasion, whether due to radiation or any other injury, is a very grave matter, and bacteria which are normally held in check by the neutrophils can then multiply rapidly; the consequences are thus serious. There are several types of white blood cells with different specialized functions, but which have in common the general property of resisting infection or removing toxic products from the body, or both.

12.126 After the body has received a radiation dose in the sublethal range, i.e., about 200 rems or less, the total number of white blood cells may show a transitory increase during the first 2 days or so, and then decrease below normal levels. Subsequently the white count may fluctuate and possibly rise above normal on occasions. During the seventh or eighth weeks, the white cell count becomes stabilized at low levels and a minimum probably occurs at about this time. An upward trend is observed in succeeding weeks but complete recovery may require several months or more.

12.127 The neutrophil count parallels the total white blood cell count, so that the initial increase observed in the latter is apparently due to increased mobilization of neutrophils. Complete return of the number of neutrophils to normal does not occur for several months.

12.128 In contrast to the behavior of the neutrophils, the number of lymphocytes, produced in parts of the lymphatic tissues of the body, e.g., lymph nodes and spleen, shows a sharp drop soon after exposure to radiation. The lymphocyte count continues to remain considerably below normal for several months and recovery may require many months or even years. However, to judge from the observations made in Japan, the lymphocyte count of exposed individuals 3 or 4 years after exposure was not appreciably different from that of unexposed persons.

12.129 A significant hematological change also occurs in the platelets, a constituent of the blood which plays an important role in blood clotting. Unlike the fluctuating total white count, the number of platelets begins to decrease soon after exposure and falls steadily and reaches a minimum at the end of about a month. The decrease in the number of platelets is followed by partial recovery, but a normal count may not be attained for several months or even years after exposure. It is the decrease in the platelet count which partly explains the appearance of hemorrhage and purpura in radiation injury.

12.130 The red blood cell (erythrocyte) count also undergoes a decrease as a result of radiation exposure and hemorrhage, so that symptoms of anemia, e.g., pallor, become apparent. But the

change in the number of erythrocytes is much less striking than that in the white blood cells and platelets, especially for radiation doses in the range of 200 to 400 rems. Whereas the response in these cells is rapid, the red cell count shows little or no change for several days. Subsequently, there is a decrease which may continue for 2 or 3 weeks, followed by a gradual increase in individuals who survive.

12.131 As an index of severity of radiation exposure, particularly in the sublethal range, the total white cell or neutrophil counts are of limited usefulness because of the wide fluctuations and the fact that several weeks may elapse before the maximum depression is observed. The lymphocyte count is of more value in this respect, particularly in the low dose range, since depression occurs within a few hours of exposure (§ 12.224). However, a marked decrease in the number of lymphocytes is observed even with low doses and there is relatively little difference with large doses.

12.132 The platelet count, on the other hand, appears to exhibit a regular pattern, with the maximum depression being attained at approximately the same time for various exposures in the sublethal range. Furthermore, in this range, the degree of depression from the normal value is roughly proportional to the estimated whole-body dose. It has been suggested, therefore, that the platelet count might serve as a convenient and relatively simple direct method for determining the severity of radiation injury in the sublethal range. The main disadvantage is that an appreciable decrease in the platelet count is not apparent until some time after exposure.

COMBINED INJURIES

GENERAL CONSIDERATIONS

12.133 Thus far, blast, thermal, and (ionizing) radiation injuries have been considered separately, but combined injuries, from two or more of these causes, would probably be common as a result of a nuclear explosion. Combined injuries might be received almost simultaneously, e.g., from a single detonation without fallout, or separated in time by minutes to days, e.g., from a single detonation followed by fallout or from multiple detonations. Injuries may consist of any combination of blast, thermal, and radiation effects. Furthermore, such injuries may be influenced by other conditions that might be expected during or after a nuclear attack, e.g., malnutrition, poor sanitation, fatigue, and various other environmental factors. Current knowledge concerning combined injuries is derived mainly from studies of the Japanese victims of nuclear bombs and from laboratory and field tests with a variety of animals.

12.134 The contribution of combined injuries to overall mortality and morbidity in Japan has never been determined adequately, but two general impressions have emerged: the combination of mechanical (blast) and thermal injuries was responsible for the majority of deaths that occurred within the first 48 hours after the attacks, and delayed mortality was higher and complications were more numerous among burned people exposed to ionizing radiation than would have been anticipated in the absence of such radiation. In Hiroshima

and Nagasaki, among those who survived for 20 days or more, about 50 percent of the people within 1.25 miles of ground zero received combined injuries, whereas the incidence was roughly 25 percent at distances from 1.25 to 3 miles from ground zero.

12.135 It should be recognized that the incidences of combined injuries in the two Japanese cities apply only to the particular circumstances of the nuclear explosions. The number and types of combined injuries will depend on the yield, height of burst, and the conditions of exposure. Air bursts, unaccompanied by fallout, with yields less than about 10 kilotons, would cause combinations of mechanical, thermal, and initial-radiation injuries. On the other hand, larger yields would be expected to produce a greater proportion of combined burn and mechanical injuries; initial-radiation injuries would be less significant in the surviving population. A nuclear explosion near (above or below) the surface would maximize radiation injuries due to fallout and in a large proportion of the casualties such injuries would be combined with mechanical and thermal effects. People who are outdoors and unshielded would have a greater probability of sustaining initial and/or fallout (residual) radiation injury in combination with flash burns than would those within buildings. In the latter case, burns would be minimized and combinations of mechanical and radiation injuries might be dominant.

12.136 No reliable criteria for incapacitation are known for persons receiving combined injuries. The avail-

able data do indicate, however, that individuals suffering such injuries that occur nearly simultaneously are unlikely to become casualties within a few hours, provided the individual injuries would not produce casualties if administered separately. Consequently, it is not unreasonable to make early casualty predictions for a single nuclear detonation on the basis of the most significant injury. If there is a substantial probability of another injury, this could contribute to combined injury and might result in increased casualties at later times.

12.137 The effects of combined injuries may be synergistic, additive, or antagonistic. That is to say, the overall response may be greater than, equal to, or less than, respectively, what would be predicted based on the assumption that the various injuries act independently of one another in producing casualties. Quantitative data from laboratory experiments suggests that in situations where a combined effect has been observed, the interaction of the various forms of injury has resulted in enhanced early as well as delayed mortality, although from the limited data available the latter seems to be the more common.

RADIATION AND THERMAL INJURIES

12.138 Exposure of laboratory animals to external ionizing radiation while subjected to thermal burn has been found to cause a substantial increase in mortality over that expected from the insults received separately. The extent of the increase depends on the radiation dose and the severity of the burn. Severely burned subjects exhibit

some anemia and the body is less able to cope with this stress if the immune mechanism and the activity of the bone marrow are depressed by the ionizing radiation. The enhanced mortality from the thermal burns combined with radiation exposure was not observed for doses of 25 rems or less and it is improbable that the synergistic effect would occur unless the dose is large enough to produce at least minimal effect on the immunologic and hematologic systems. Very little information is available on fallout (internal) radiation in combination with thermal or any other form of injury.

MECHANICAL AND RADIATION INJURIES

12.139 Mechanical and radiation injuries can be expected to be frequent, particularly if fallout is present. Studies indicate that there is a delay in wound healing with doses in excess of 300 rems, and that wounds in irradiated subjects are considerably more serious if treatment is delayed for more than 24 hours. In addition, missile and impact injuries that result in disruption of the skin and damage to the soft tissues provide a portal of entry for infection, and thus may be extremely hazardous to irradiated people. Injuries that are associated with significant blood loss would be more serious in those who have received a radiation dose large enough to interfere with normal blood clotting mechanisms.

12.140 One week after exposure to an external radiation dose which would by itself have resulted in 45 percent

mortality within 30 days, animals (rats) were subjected to a blast overpressure which would normally produce 5 percent early lethality. As a result, early lethality associated with blast-induced hemorrhage and lung injury was increased four fold and the delayed mortality was almost double that expected from the radiation alone. In these tests, ionizing radiation and blast were clearly synergistic in causing both early and delayed mortality.

THERMAL AND MECHANICAL INJURIES

12.141 Burns and mechanical injuries in combination are often encountered in victims of conventional explosions. Increased numbers of delayed complications, shorter times-to-death, and enhanced mortality rate are frequent occurrences. However, few quantitative data are available on this form of combined injury.

LATE EFFECTS OF IONIZING RADIATION

INTRODUCTION

12.142 There are a number of consequences of nuclear radiation which may not appear for some years after exposure. Among them, apart from genetic effects, are the formation of cataracts, nonspecific life shortening, leukemia, other forms of malignant disease, and retarded development of children in utero at the time of the exposure. Information concerning these late effects has been obtained from continued studies of various types, including those in Japan made chiefly under the direction of the Atomic Bomb Casualty Commission.¹⁰

12.143 The effects which occur later in life, like the acute reactions observed within a few weeks or months after irradiation, arise from changes in

cells and tissues at the time of exposure. If an exposed individual survives the acute reaction, cell replacement may be complete, but the cells may not necessarily be quite normal; however, the causes for the late effects are largely unknown although many theories have been proposed.

CATARACTS

12.144 The term "cataract" is commonly used to describe any detectable change in the normal transparency of the lens of the eye. Cataracts may range from small lesions, which cause only minor impairment of vision, to extensive opacification that results in total blindness. The vast majority of natural cataracts in man are of the senile

¹⁰The Atomic Bomb Casualty Commission (ABCC) of the U.S. National Academy of Sciences-National Research Council was sponsored by the U.S. Atomic Energy Commission (now the Energy Research and Development Administration) and administered in cooperation with the Japanese National Institute of Health. One of its purposes was to study the long-term effects of human exposure to nuclear radiation. In 1975, the ABCC was superseded by the Radiation Effects Research Foundation which is supported equally by Japan and the United States.

type; it is rare in people under 40 years old and its frequency increases with age. Sufficient exposure of the eye lens to ionizing radiations can cause cataracts in man and in other animal species. There is a latent period between exposure of the eye and development of an opacity ranging from a few months to several years. The duration of the latent period is shorter the greater the radiation exposure. Fast neutrons, such as those from a nuclear explosion, have been found to be more effective than gamma rays in producing cataracts. Studies with small animals indicate that fast neutrons have an RBE (§ 12.95) of about 4 to 6 for cataracts and it is commonly assumed that similar values are applicable to man.

12.145 Eye lens opacities caused by radiation from the nuclear explosions were first detected among the inhabitants of Hiroshima and Nagasaki in 1950, about five years after the attacks. In nearly all cases the individuals had suffered extensive epilation of the scalp, so that they had probably received whole-body doses of 300 rems or more. In 1963 and 1964 eye examinations were made on some 2,500 survivors, of whom an estimated 40 percent had received radiation doses in excess of 200 rems. A significantly larger number of cataracts were found among those who had received the highest doses. In another survey, there was a suggestion of impairment of visual acuity among children who were *in utero* at the time of the bombings and whose mothers had been exposed to radiation. The sample size was too small, however, for a statistically meaningful conclusion to be drawn.

12.146 In the great majority of Jap-

anese who developed eye opacities from radiation, proper correcting lenses provided serviceable vision. Furthermore, the opacities have apparently not become worse with the passage of time; in some cases, in fact, an improvement has been observed. Only a small proportion of the cataracts were bad enough to cause substantial diminution of central vision. There have been very few cases of eye lens opacities in people who received doses of less than 200 rems of ionizing radiation to the eyes. This tends to support the commonly held view that cataract formation is a threshold phenomenon; that is to say, it will not occur unless the eye dose exceeds a more-or-less definite minimum value. Not everyone receiving a radiation dose exceeding the threshold value will necessarily develop cataracts, but the probability of this occurring is expected to increase the larger the dose to the eyes.

LEUKEMIA

12.147 Studies of mortality rates have shown that, at least prior to about 1950, leukemia, a form of cancer in which there is a proliferation of white cells in the blood, was a much more common cause of death of radiologists than of other physicians. This has been attributed to chronic exposure to moderate amounts of radiation over many years. After protective measures were improved, the incidence of leukemia among radiologists declined markedly. A larger than expected frequency of leukemia has also been observed among a group of people in the United Kingdom who had received large doses of X rays to the spine for the treatment of a

form of arthritis known as ankylosing spondylitis. Three main types of leukemia are induced by radiation, namely, acute and chronic granulocytic and acute lymphocytic forms; the occurrence of chronic lymphocytic leukemia is not significantly increased by radiation. The development of leukemia as a result of an overexposure to radiation is associated with a latent period varying from one to 20 years or more. The disease is generally fatal, no matter what its cause.

12.148 The first evidence of an increased incidence of leukemia among the survivors of the Hiroshima and Nagasaki explosions appeared in 1947. The occurrence of the disease reached a peak in 1951 and 1952 and it has been declining since then. By the end of 1966, the frequency of acute granulocytic anemia was approaching the normal value for Japan. Children who were exposed to radiation when they were less than 10 years old were roughly twice as susceptible to leukemia as older individuals. One case of acute granulocytic leukemia was discovered in 1972 among the 53 inhabitants of Rongelap Atoll in the Marshall Islands who had received an estimated whole-body dose of 175 rems of gamma radiation from fallout in 1954 (§ 12.175 *et seq.*). The individual, a young man, had been a year old at the time of exposure.

12.149 The occurrence of leukemia, for a given estimated absorbed dose (in rads), appeared to be greater in Hiroshima than in Nagasaki. Later studies revealed that the Hiroshima (gun type, uranium-235) bomb emitted a larger proportion of neutrons, relative to gamma rays, than did the Nagasaki (implosion type, plutonium-239) de-

vice. By attributing an RBE of about 5 for the induction of leukemia by fast neutrons, the incidences (per rem) in the two cities were in general agreement. The evidence from Japan, and from other sources, is that the probability of the occurrence of leukemia is roughly proportional to the whole-body dose, and there is no indication of a threshold value. About 90 percent of the cases of leukemia among the survivors in Hiroshima and Nagasaki received doses of more than 200 rems, but not all the people who received such large doses developed the disease. An approximate estimate suggests that there were about 20 instances of leukemia per rem per million population exposed at age 10 years or more and roughly twice this number for younger individuals.

OTHER TYPES OF CANCER

12.150 It has been established from the mortality statistics of radiologists and of some of the spondylitic patients mentioned in § 12.147, from other exposures to radiation for various medical purposes, and from experiments with animals that large doses of radiation can increase the frequency of various types of cancer, in addition to leukemia. The same effect has been observed among the survivors of the nuclear attacks on Japan. For example, after a latent period of about 10 years, a significant increase was observed in the incidence of thyroid cancer among individuals who were within about half a mile from ground zero and consequently received large doses of ionizing radiations. Delayed thyroid abnormalities have also been found among the inhabitants of the

Marshall Islands whose glands were subjected to internal exposure from radioiodines in fallout, but only a small proportion were malignant (§ 12.181). The frequency of thyroid cancer induced by radiation is estimated to be roughly 10 per rem per million of exposed adults, but substantially more for children. Provided it is detected in time, however, thyroid cancer is rarely fatal in children and only in about 10 percent of adults.

12.151 A statistical study of mortality data, obtained from 1950 through 1970, of a large number of people who were in Hiroshima and Nagasaki at the times of the nuclear explosions shows an increased frequency of various other types of cancer. The most important sites appear to be the lung, the gastrointestinal system (other than the stomach), and the female breast. Although they are relatively rare, salivary gland tumors have been found to be more common among the Japanese exposed to radiation than in the unexposed population. In a group of 109,000 survivors who have been studied about 5,700 received whole-body doses of 100 rems or more. Among these, 690 were over 50 years of age at the time of exposure and during the period from 1960 to 1970 there were 47 deaths from cancer, other than leukemia, whereas about 30 would have been expected. Of the 820 children who were under 10 years of age when exposed, there were six such deaths, compared with 0.75 expected. Thus, although the actual increase in fatal cancers was smaller among those exposed at an early age, the relative increase, i.e., actual/expected, was much greater than in older persons.

LIFE SHORTENING

12.152 Laboratory studies with animals have indicated that shortening of the life span, apart from the effects of leukemia and other forms of malignant disease, can sometimes (but not always) result from partial or whole-body exposure to radiation. Such shortening may be the result of a number of factors, including decreased immunity to infection, damage to connective tissues, and possibly premature aging. The life shortening in a given animal, for a specific radiation dose, apparently depends on such factors as genetic constitution and on the age and physical condition at the time of the exposure.

12.153 It has been reported that for radiologists who received fairly large chronic doses of radiation in the course of their work, before adequate protective measures were instituted, the average age at death was about five years less than for other physicians. Part of the increase in death rate was due to leukemia and other forms of cancer, but after allowing for these and other specific effects of radiation, there were indications that ionizing radiations caused nonspecific life shortening. However, an examination of deaths occurring from 1950 through 1970 of survivors of the nuclear attacks on Japan suggests that, apart from various forms of cancer, there is little evidence that radiation accelerated aging.

RETARDED DEVELOPMENT OF CHILDREN

12.154 Among the mothers who were pregnant at the time of the nuclear

explosions in Japan, and who received sufficiently large doses to show the usual acute radiation symptoms, there was a marked increase over normal in the number of stillbirths and in the deaths of infants within a year of birth. The increase in mortality was significant only when the mothers had been exposed during the last three months of pregnancy. Among the surviving children there was a slight increase in frequency of mental retardation and head circumferences were smaller than normal. These effects were most marked when the radiation exposure occurred within

the first three or four months of pregnancy. Most of the mothers of the children referred to above were so close to ground zero that they must have received more than 200 rems of ionizing radiation. Maldevelopment of the teeth, attributed to injury to the roots, was also noted in many of the children. Children who were conceived after the nuclear attacks, even by irradiated parents, appear for the most part to be normal. The fear expressed at one time that there would be a sharp increase in the occurrence of abnormalities has not been substantiated.

EFFECTS OF EARLY FALLOUT

EXTERNAL HAZARD: BETA BURNS

12.155 In most circumstances, the whole-body dose from the gamma rays emitted by the early fallout will represent the major external hazard from the delayed nuclear radiation. The biological effects are then similar to those from equal acute doses of radiation (§ 12.102 *et seq.*). In addition, injury can arise in two general ways from external sources of beta particles. If the beta-particle emitters, e.g., fission products, come into actual contact with the skin and remain for an appreciable time, a form of radiation injury, sometimes referred to as "beta burn," will result. In addition, in an area of extensive early fallout, the whole surface of the body may be exposed to beta particles coming from many directions. It is true that clothing will attenuate this radiation to a considerable extent; nevertheless, the whole body could receive a large dose

from beta particles which might be significant.

12.156 Information concerning the development and healing of beta burns has been obtained from observations of the Marshall Islanders who were exposed to fallout in March 1954 (§ 12.103). Within about 5 hours of the burst, radioactive material commenced to fall on some of the islands. Although the fallout was observed as a white powder, consisting largely of particles of lime (calcium oxide) resulting from the decomposition of coral (calcium carbonate) by heat, the island inhabitants did not realize its significance. Because the weather was hot and damp, the Marshallese remained outdoors; their bodies were moist and they wore relatively little clothing. As a result, appreciable amounts of fission products fell upon the hair and skin and remained there for a considerable time. Moreover, since the islanders, as a rule, did not



Figure 12.158a. Beta burn on neck 1 month after exposure.

wear shoes, their bare feet were continually subjected to contamination from fallout on the ground.

12.157 During the first 24 to 48 hours, a number of individuals in the more highly contaminated groups experienced itching and a burning sensation of the skin. These symptoms were less marked among those who were less contaminated with early fallout. Within a day or two all skin symptoms subsided and disappeared, but after the lapse of about 2 to 3 weeks, epilation and skin lesions were apparent on the areas of the body that had been contaminated by fallout particles. There was apparently no erythema, as might have been expected, but this may have been obscured by the natural coloration of the skin.

12.158 The first evidence of skin damage was increased pigmentation, in the form of dark colored patches and raised areas (macules, papules, and raised plaques). These lesions devel-

oped on the exposed parts of the body not protected by clothing, and occurred usually in the following order: scalp (with epilation), neck, shoulders, depressions in the forearm, feet, limbs, and trunk. Epilation and lesions of the scalp, neck, and foot were most frequently observed (Figs. 12.158a and b).

12.159 In addition, a bluish-brown pigmentation of the fingernails was very common among the Marshallese and also among American negroes who were in a group of servicemen stationed on Rongerik Atoll (Fig. 9.105). The phenomenon appears to be a radiation response peculiar to the dark-skinned races, since it was not apparent in any of the white Americans who were exposed at the same time. The nail pigmentation occurred in a number of individuals who did not have skin lesions. It is probable that this was caused by gamma rays, rather than by beta particles, as the same effect has been observed in dark-skinned



Figure 12.158b. Beta burn on feet 1 month after exposure.

patients undergoing X-ray treatment in clinical practice.

12.160 Most of the lesions were superficial without blistering. Microscopic examination at 3 to 6 weeks showed that the damage was most marked in the outer layers of the skin (epidermis), whereas damage to the deeper tissue was much less severe. This is consistent with the short range of beta particles in animal tissue. After formation of dry scab, the lesions healed rapidly leaving a central depigmented area, surrounded by an irregular zone of

increased pigmentation. Normal pigmentation gradually spread outward in the course of a few weeks.

12.161 Individuals who had been more highly contaminated developed deeper lesions, usually on the feet or neck, accompanied by mild burning, itching, and pain. These lesions were wet, weeping, and ulcerated, becoming covered by a hard, dry scab; however, the majority healed readily with the regular treatment generally employed for other skin lesions not connected with radiation. Abnormal pigmentation ef-



Figure 12.161a. Beta burn on neck 1 year after exposure (see Fig. 12.158a).

fects persisted for some time, and in several cases about a year elapsed before the normal (darkish) skin coloration was restored (Figs. 12.161a and b).

12.162 Regrowth of hair, of the usual color (in contrast to the skin pigmentation) and texture, began about 9 weeks after contamination by fallout and was complete in 6 months. By the

same time, nail discoloration had grown out in all but a few individuals. Seven years later, there were only 10 cases which continued to show any effects of beta burns, and there was no evidence of malignant changes.

INTERNAL HAZARD

12.163 Wherever fallout occurs



Figure 12.161b. Beta burn on feet 6 months after exposure (see Fig. 12.158b).

there is a chance that radioactive material will enter the body through the digestive tract (due to the consumption of food and water contaminated with fission products), through the lungs (by breathing air containing fallout particles), or through wounds or abrasions. Even a very small quantity of radioactive material if retained in the body can produce considerable injury. Radiation

exposure of various organs and tissues from internal sources is continuous, subject only to depletion of the quantity of active material in the body as a result of physical (radioactive decay) and biological (elimination) processes. Furthermore, internal sources of alpha emitters, e.g., plutonium, or of beta particles, or soft (low-energy) gamma-ray emitters, can deposit their entire

energy within a small, possibly sensitive, volume of body tissue, thus causing considerable damage. Even if the radioisotope remains in the body for a fairly short time and causes no observable early injury, it may contribute to damage that does not become apparent for some time (§ 12.142 *et seq.*).

12.164 The situation with regard to internal exposure is sometimes aggravated by the fact that certain chemical elements tend to concentrate in specific organs or tissues, some of which are highly sensitive to ionizing radiation. The fate of a given radioactive element which has entered the blood stream will depend upon its chemical nature. Radioisotopes of an element which is a normal constituent of the body will follow the same metabolic processes as the naturally occurring, inactive (stable) isotopes of the same element. This is the case, for example, with iodine isotopes, all of which—radioactive and stable—tend to concentrate in the thyroid gland.

12.165 An element not usually found in the body, except perhaps in minute traces, will behave like one with similar chemical properties that is normally present. Thus, among the fission products, strontium and barium, which are similar chemically to calcium, would be largely deposited in the calcifying tissue of bone. The radioisotopes of the rare earth elements, e.g., cerium, which constitute a considerable proportion of the fission products, and plutonium, which may be present to some extent in the fallout, are also “bone-seekers.” Since they are not chemical analogues of calcium, however, they are deposited to a smaller extent and in other parts of the bone than are strontium and barium. Bone-seeking

radioisotopes are potentially hazardous for two reasons in particular; first, the radiations can damage the bone marrow and thus affect the whole body by decreasing blood-cell formation (§ 12.226), and second, the deposition of alpha- or beta-particle energy in a small volume can cause serious bone damage, including cancer (§ 12.173).

12.166 The extent to which early fallout contamination can enter the bloodstream as a result of ingestion, inhalation, or a wound is strongly influenced by the physical properties, e.g., size distribution, density, and surface area, of the particles, and by their solubility in the body fluids. Whether the material is subsequently deposited in some specific tissue or not will be determined by the chemical properties of the elements present, as indicated previously. Elements which do not tend to concentrate in a particular part of the body are eliminated fairly rapidly by natural processes.

12.167 The amount of radioactive material absorbed from early fallout by inhalation appears to be relatively small because the nose can filter out almost all particles over 10 micrometers (see § 2.27 footnote) in diameter, and about 95 percent of those exceeding 5 micrometers. Although particles of a wide range of sizes will be present, most of the particles descending in the fallout during the critical period of highest activity, e.g., within 24 hours of the explosion, will be the larger ones (§ 9.50), more than 10 micrometers in diameter. Consequently, only a small proportion of the early fallout particles present in the air will succeed in reaching the lungs. Furthermore, the optimum size for deposition in the alveolar (air) cells

of the lungs is as small as 1 to 2 micrometers.

12.168 Since many of the contaminated particles are relatively insoluble, the probability is low that inhaled fission products and other weapon residues present in the early fallout will reach the blood stream from the lungs. After deposition in the alveolar spaces of the lungs, particles of low solubility in the body fluids may be retained in these spaces for long periods until they are eventually dissolved or are removed by mechanical means, e.g., by cellular or lymphatic transport or in mucus. Particles leaving the lungs by way of the lymphatic system tend to accumulate principally in the tracheobronchial lymph nodes thereby leading to an intense, localized radiation dose.

12.169 Following ingestion or clearance of the upper respiratory tract after inhalation, the extent of absorption of fission products and other radioactive materials through the intestine is largely dependent upon the solubility of the particles. In the early fallout, the fission products as well as uranium and plutonium are chiefly present as oxides, many of which do not dissolve to any great extent in body fluids. The oxides of strontium and barium, however, are soluble, so that these elements enter the blood stream more readily and find their way into the bones.¹¹ The element iodine is also chiefly present in a soluble form and so it soon enters the blood and is concentrated in the thyroid gland.

12.170 The length of time a particular nuclide remains in the body depends on its radioactive half-life

(§ 1.63), which determines the rate of removal by natural decay, and on its "biological half-life," i.e., the time for the amount in the body to decrease to half of its initial value solely as a result of elimination by biological processes. The combination of radioactive and biological half-lives leads to the "effective half-life" as a measure of the net rate of loss of the radionuclide from the body by both decay and biological elimination. The retention pattern of a given element in the body represents the summation of the retentions in individual tissues. In those cases where practically all the body burden is in one tissue (or organ), e.g., iodine in the thyroid gland, the effective half-life is essentially that for this tissue (or organ). A major consideration in assessing the internal hazard from a given radionuclide is the total radiation dose (in rems) delivered while it is in the body (or a critical organ). The main factors in this respect are the effective half-life, which determines the time the nuclide is present in the body (or organ), the total quantity in the body (or organ), and the nature and energy of the radiation emitted. The importance of these factors in various circumstances will become apparent in due course.

12.171 The biological half-life of the element iodine, which is essentially that in the thyroid gland, has an average value of about 80 days, although it actually varies from a few days in some people to several years in others. A number of radioactive isotopes of iodine are present among the fission products, but most have moderate or short radio-

¹¹ Even under these conditions, only about 10 percent of the strontium or barium is actually absorbed.

active half-lives. The effective half-lives, which are related to the times the various isotopes are effective in the body (thyroid), are then determined mainly by the radioactive half-lives, rather than by the longer biological half-life. The heavier isotopes, iodine-132, -133, -134, etc., all of which have radioactive half-lives of less than a day, thus have short effective half-lives; consequently, they constitute a hazard only if delivered in sufficient amounts to the thyroid via the blood stream. The injury that might be caused by these isotopes is then largely dependent on the quantities that reach the thyroid gland within a short time. On the other hand, the common fission product iodine-131, with a half-life of about 8 days, has a longer effective half-life and can represent a hazard in smaller amounts because it remains active in the thyroid for a longer time.

12.172 In addition to radioiodine, the important potentially hazardous fission products, assuming sufficient amounts get into the body, fall into two groups. The first, and more significant, contains strontium-89, strontium-90, cesium-137, and barium-140, whereas the second consists of a group of rare earth and related elements, particularly cerium-144 and the chemically similar yttrium-91.

12.173 Another potentially hazardous element, which may be present to some extent in the early fallout, is plutonium, in the form of the alpha-particle emitting isotope plutonium-239. This isotope has a long radioactive half-life (24,000 years) as well as a long biological half-life in the skeleton (about 100 years) and the liver (about 40 years). As with any airborne particulate matter, a

fraction of the inhaled fallout particles contaminated with plutonium will be deposited in the alveolar spaces of the lungs. If the particles are relatively insoluble, they can be retained in the lungs for long periods with gradual removal by mechanical means or by slow absorption in the blood. With the more soluble particles, residence time in the lungs will be shorter and absorption into the blood stream will occur more rapidly. Plutonium that enters the blood stream tends to be deposited in the liver and on certain surfaces of the bone; the amount of plutonium present and its activity decrease at a very slow rate because of the long radioactive and biological half-lives. The continuous exposure for many years of a limited region of the body, e.g., lung, liver, or bone surface, to the short-range but high-energy alpha particles from plutonium can cause serious injury. Thus, the injection of sufficient amounts of soluble plutonium into some animals has been found to cause bone malignancies whereas inhalation of plutonium dioxide particles may result in the formation of lung tumors.

12.174 Despite the large amounts of radioactive material which may pass through the kidneys in the process of elimination, these organs ordinarily are not greatly affected by radiation. By contrast, uranium can cause damage to the kidneys, but as a chemical poison rather than because of its radioactivity. However, the quantity of uranium compounds found in the fallout that must be ingested in order to be potentially poisonous are so large that it is not considered to be of primary concern compared with other constituents of nuclear weapon debris.

MARSHALLESE EXPERIENCE

12.175 Early fallout accompanying the nuclear air bursts over Japan was insignificant and was not monitored. Consequently, no information was available concerning the potentialities of fission products and other weapon residues as internal sources of radiation. Following the incident in the Marshall Islands in March 1954, however, data of great interest were obtained. Because they were not aware of the significance of the fallout, many of the inhabitants ate contaminated food and drank contaminated water from open containers for periods up to 2 days before they were evacuated from the islands.

12.176 Internal deposition of fission products resulted mainly from ingestion rather than inhalation for, in addition to the reasons given above, the radioactive particles in the air settled out fairly rapidly, but contaminated food, water, and utensils were used all the time. The belief that ingestion was the chief source of internal contamination was supported by the observations on chickens and pigs made soon after the explosion. The gastrointestinal tract, its contents, and the liver were found to be much more contaminated than lung tissue.

12.177 From radiochemical analysis of the urine of the Marshallese subjected to the early fallout, it was possible to estimate the body burdens, i.e., the amounts deposited in the tissues, of various isotopes. It was found that iodine-131 made the major contribution to the activity at the beginning, but it soon disappeared because of its relatively short radioactive half-life (8 days). Somewhat the same was true for barium-140 (12.8 days half-life), but the

activity levels of the strontium isotopes were more persistent. Not only do these isotopes have longer radioactive half-lives, but the biological half-life of the element is also relatively long.

12.178 No elements other than iodine, strontium, barium, and the rare earth group were found to be retained in appreciable amounts in the body. Essentially all other fission products and weapon residue activities were rapidly eliminated, because of either the short effective half-lives of the radionuclides, the sparing solubility of the oxides, or the relatively large size of the fallout particles.

12.179 The body burden of radioactive material among the more highly contaminated inhabitants of the Marshall Islands was never very large and it decreased fairly rapidly in the course of 2 or 3 months. The activity of the strontium isotopes fell off somewhat more slowly than that of the other radioisotopes, because of the longer radioactive half-lives and greater retention in the bone. Nevertheless, even strontium could not be regarded as a dangerous source of internal radiation in the cases studied. At 6 months after the explosion, the urine of most individuals contained only barely detectable quantities of radioactive material.

12.180 In spite of the fact that the Marshallese people lived approximately 2 days under conditions where maximum probability of contamination of food and water supplies existed and that they took few steps to protect themselves, the amount of internally deposited radioactivity from early fallout was small. There seems to be little doubt, therefore, that, at least as far as short-term effects are concerned, the radiation

injury by early fallout due to internal sources can be minor in comparison with that due to the external radiation. However, delayed effects of internal radiation exposure, including one case of leukemia (§ 12.148), became apparent several years after the explosion.

12.181 Until 1963, no thyroid abnormalities had been detected among the inhabitants of the Marshall Islands that could be attributed to the fallout. In that year, one was found among the people of Rongelap Atoll, but by 1966 there were 18 cases; the total number increased to 22 by 1969 and to 28 by 1974. Of the Rongelap people who were exposed, 64 (plus one *in utero*) received external doses of about 175 rems; 18 others (plus one *in utero*), who were on the neighboring Alinginae Atoll (cf. Fig. 9.105) at the time of the nuclear test, received about 69 rems. The thyroid doses from radioiodines were much larger, especially in children under 16 years of age. In 1974, there were 22 individuals with thyroid lesions among the more highly exposed group and six among the others. In the former group there were three malignancies and two cases of atrophied thyroids (hypothyroidism); there were no definite malignancies in the latter group although there was one doubtful case. All other thyroid abnormalities were benign nodules.

12.182 Most of the lesions occurred in children who were less than 10 years old at the time of the explosion in 1954.

Of a total of 19 such children who were on Rongelap, 17 developed abnormalities, including one malignancy and two cases of hypothyroidism. The radiation doses from radioiodine isotopes that had been concentrated in the thyroids of these children were estimated to be from 810 to 1,150 rems. In 1974, a lesion was observed in one of the individuals who had been exposed *in utero*; the thyroid dose was uncertain but it must have been at least 175 rems. The six children in the less highly exposed group who were on Alinginae received estimated thyroid doses of 275 to 450 rems; by 1974, lesions were observed in two cases with one doubtful malignancy.

12.183 For purposes of comparison, studies were made on 194 people who normally lived on Rongelap Atoll but who were away on other islands and were not exposed to the fallout. There were nine thyroid abnormalities (none malignant), including one in 61 children who were less than 10 years old in 1954. An examination was also made of 157 inhabitants of Utirik Atoll who had received external doses of 14 rems from the fallout. The 58 children less than 10 years old at the time of the explosion received thyroid doses from radioiodines estimated to be 60 to 95 rems, but by 1974 no abnormalities had been observed. Six people in the older group of 99 were found to have thyroid lesions, one of which was malignant; the estimated thyroid doses were in the range of 27 to 60 rems.

LONG-TERM HAZARD FROM DELAYED FALLOUT¹²

CESIUM-137

12.184 Of the fission products which present a potential long-term hazard from either the atmospheric testing of nuclear weapons in peacetime or their use in warfare, the most important are probably the radioactive isotopes cesium-137 and strontium-90. Since both of these isotopes are fairly abundant among the fission products and have relatively long half-lives, they will constitute a large percentage of any delayed fallout. The process of fractionation will tend to increase the proportions of strontium and cesium still further (§ 9.08). Of course, the activity level due to these isotopes at late times in the early fallout pattern in the area close to a surface or subsurface burst will be considerably larger than in the delayed fallout from a given explosion. However, the special interest in the delayed fallout arises from the fact that it may occur in significant amounts in many parts of the globe remote from the point of the nuclear detonation, as explained in Chapter IX, as well as in close by areas.

12.185 Cesium-137 has a radioactive half-life of 30 years and is of particular interest in fallout that is more than a year old because it is the principal constituent whose radioactive decay is accompanied by the emission of gamma rays. The chemical and biochemical properties of cesium resemble those of potassium. The compounds of these el-

ements are generally more soluble than the corresponding compounds of strontium and calcium and the details of the transfer of these two pairs of elements from the soil to the human body are quite different. The element cesium is relatively rare in nature and the body normally contains only small traces. Because of the presence of cesium-137 in the delayed fallout, studies have been made of the behavior of this isotope in various biological systems and of the levels of uptake and retention in man. Regardless of its mode of entry—*inhalation, ingestion, or wounds*—cesium is soon distributed fairly uniformly throughout the body. A preferential deposition in muscle results in concentrations that are somewhat higher than in the body as a whole, whereas in some other tissues, e.g., the lungs and skeleton, the concentrations are lower than the body average.

12.186 From the studies referred to above, the biological half-life of cesium in human adults has been reported as ranging from 50 to 200 days. Factors contributing to this spread of values include diet, age, sex, race, and body weight. Because of the fairly uniform distribution of cesium, the entire body would be irradiated by both beta particles and gamma rays emitted as the cesium-137 decays. However, since the biological half-life of cesium is relatively short, compared with strontium,

¹²Much valuable information on delayed fallout and related problems can be found in the published Hearings before the Special Committee on Radiation of the Joint Committee on Atomic Energy, Congress of the United States: "The Nature of Radioactive Fallout and its Effects on Man," May 27 to June 7, 1957; "Fallout from Nuclear Weapons Tests," May 5 to 8, 1959; and "Biological and Environmental Effects of Nuclear War," June 22 to 26, 1959 (U.S. Government Printing Office).

and it does not tend to concentrate significantly in any organ or tissue, the residual cesium-137 in a given amount of delayed fallout is much less of a biological hazard than is the strontium-90.

12.187 The amount of internal exposure to cesium-137 is determined by the quantity of this isotope in food. If the major mechanism for its incorporation into the diet is through the root systems of plants, then the dose will be more or less proportional to the total amount of cesium-137 accumulated on the ground. On the other hand, if this isotope enters the diet mainly through material deposited directly on the leaves of plants, the internal dose will be more nearly proportional to the rate of descent of delayed fallout. It has been calculated that if the former mechanism prevails, the internal 30-year dose to the gonads, which is of interest in connection with possible genetic effects (§ 12.201 *et seq.*), would be much higher than if the alternative mechanism were of major importance. The best data presently available on cesium-137 levels in food suggest that, up to the present time, the fallout rate has been the dominant factor; but in the future a larger proportion of the cesium may get into food via the soil, provided no considerable amounts of cesium-137 are added to the atmosphere.

STRONTIUM-90

12.188 Strontium-90, because of its relatively long radioactive half-life of 27.7 years and its appreciable yield in the fission process, accounts for a considerable fraction of the total activity of fission products which are several years old. Strontium is chemically similar to calcium, an element essential to both plant and animal life; an adult human being, for example, contains over 2 pounds of calcium, mainly in bone. However, the relationship between strontium and calcium is not a simple one as will be seen in subsequent sections and, because of its complex metabolism in the body, the behavior of strontium-90 cannot be stated in terms of a single effective half-life (§ 12.170).¹³

12.189 The probability of serious pathological change in the body of a particular individual, due to the effects of radioisotopes deposited internally, depends upon the amount deposited, the energy of the radiations emitted, and the length of time the source remains in the body. Strontium-90 and its daughter, yttrium-90, emit beta particles which can cause serious localized damage following their deposition and long-term retention in the skeleton.¹⁴ Tests with animals indicate that the pathological effects resulting from sufficient quantities of inhaled, ingested, or injected

¹³Data from strontium-90 excretion by the Marshallese people and studies in a case of accidental inhalation indicate that for an acute intake the major portion of the absorbed strontium-90 is excreted with a biological half-life of 40 days during the first year. During the next 2 years, at least, a smaller fraction is excreted with a biological half-life of 500 days. The remaining portion (less than 10 percent) is tightly bound to bone and is excreted very slowly with a long biological half-life of about 50 years. In this latter case, the effective half-life (§ 12.170) would be about 18 years. The situation for a chronic intake e.g., from delayed fallout, although not the same, would be similar.

¹⁴The energy of the strontium-90 beta particles is 0.54 MeV. However, its daughter, yttrium-90, which has the short half-life of only 64 hours, emits 2.27-MeV beta particles (no gamma rays); the decay product is stable zirconium-90. Thus, both 0.54- and 2.27-MeV beta particles accompany the decay of strontium-90. (The energies quoted are maxima; the average energy is about one-third of the maximum.)

strontium-90 include bone necrosis, bone tumors, leukemia, and other hematologic dyscrasias (abnormalities).

12.190 Most of the strontium-90 in the delayed fallout is ultimately brought to earth by rain or snow, and it makes its way into the human body primarily (directly and indirectly) through plants. At first thought, it might appear that the ratio of strontium to calcium in man would be equal to that in the soil from which he obtains his food. Fortunately, however, a number of processes in the chain of biological transfer of these elements to the human body operate collectively to decrease the relative quantity of strontium that is stored in man by an overall factor of two to ten. The accumulation of strontium-90 in the human body by way of food is affected by the availability and proximity of strontium to the root system of a plant, strontium-90 uptake by the plant, transfer from plant to animal (where relevant), and transfer from plant or animal to man.

12.191 Greenhouse experiments show a slight discrimination in favor of calcium and against strontium when these elements are taken up by most plants from homogeneous soils. However, several factors make it difficult to generalize concerning the ratio of strontium to calcium in the plant compared to that in field soils. First, plants obtain most of their minerals through their root systems, but such systems vary from plant to plant, some having deep roots and others shallow roots. Most of the strontium-90 deposited in undisturbed soil has been found close to the surface, so that the uptake of this nuclide may be expected to vary with the root habit of the plant. Second, although strontium

and calcium, because of their chemical similarity, may be thought of as competing for entry into the root system of plants, not all of the calcium in soil is available for assimilation. Some natural calcium compounds in soil are insoluble and are not available as plant food until they have been converted into soluble compounds. Most of the strontium-90 in the delayed fallout, however, is in a water-soluble form. Third, in addition, to the strontium-90 which plants derive from the soil, growing plants retain a certain amount of strontium-90 from fallout deposited directly on the surface of the plant.

12.192 As the next link in the chain, animals consume plants as food, thereby introducing strontium-90 into their bodies. Once again, the evidence indicates that natural discrimination factors result in a strontium-90/calcium ratio in the edible animal products that is less than in the animal's feed. Very little strontium is retained in the soft tissue, so that the amount of strontium-90 in the edible parts of the animal is negligible. It is of particular interest, too, that the strontium-90/calcium ratio in cow's milk is much lower than that in the cow's feed, and thus is an important barrier to the consumption of strontium-90 by man. This barrier does not operate, of course, when plant food is consumed directly by human beings. However, it appears that about three-fourths of the calcium, and hence a large fraction of the strontium-90, in the average diet in the United States is obtained from milk and milk products. The situation may be different in areas where a greater or lesser dependence is placed upon milk and milk products in the diet.

12.193 Not all of the strontium-90

that enters the body in food is deposited in the human skeleton. An appreciable fraction of the strontium-90 is eliminated, just as is most of the daily intake of calcium. But there is always some fresh deposition of calcium taking place in the skeletal structure of healthy individuals, so that strontium-90 is incorporated at the same time. The rate of deposition of both calcium and strontium-90 is, of course, greater in growing children than in adults. In addition to the fact that the human metabolism discriminates against strontium, it will be noted that, in each link of the food chain, the amount of strontium-90 retained is somewhat less than in the previous link. Thus, a series of safeguards reduces deposition of strontium in human bone.

12.194 As there has been no experience with appreciable quantities of strontium-90 in the human body, the relationship between the probability of serious biological effect and the body burden of this isotope is not known with certainty. Tentative conclusions have been based on a comparison of the effects of strontium-90 with radium on test animals, and on the known effects of radium on human beings. From these comparisons it has been estimated that a body content of 10 microcuries (1 microcurie is a one-millionth part of a curie, as defined in § 9.141) of strontium-90 in a large proportion of the population would produce a noticeable increase in the occurrence of bone

cancer. On this basis, it has been recommended that the maximum activity of strontium-90 in the body of any individual who is exposed in the course of his occupation be taken as 2 microcuries. Since the average amount of calcium in the skeleton of an adult human is about 1 kilogram (or a little over 2 pounds), this corresponds to a concentration in the skeleton of 2 microcuries of strontium-90 per kilogram of calcium. Moreover, the limit generally considered to be acceptable for any individual member of the general population is 0.2 microcurie of strontium-90 per kilogram of calcium. The International Commission on Radiological Protection has suggested that the concentration of strontium-90 averaged over the whole population should not exceed 0.067 microcurie per kilogram of calcium.

12.195 As a result of nuclear test explosions in the atmosphere by various countries, there has been an increase in the strontium-90 content of the soil, plants, and the bones of animals and man. This increase is worldwide and is not restricted to areas in the vicinity of the test sites, although it is naturally somewhat higher in these regions because of the more localized (early) fallout.¹⁵ The fine particles of the delayed fallout descend from the stratosphere into the troposphere over a period of years, and are then brought down by rain and snow. Consequently, the amount of strontium-90 in the strato-

¹⁵ It is to be expected that areas near the explosion will be more highly contaminated in strontium-90 than are more distant regions, to an extent dependent upon such factors as the height (or depth) of burst, the total and fission yields of the explosion, and the prevailing atmospheric conditions. Because of the phenomenon of fractionation, the proportion of strontium-90 in the local (early) fallout will generally be less than that in the worldwide (delayed) fallout. It is of interest to mention, too, that the strontium-90 in early fallout appears to be in a less soluble form, and hence probably less readily accessible to plants, than that present in the delayed fallout.

sphere available to fall on earth is determined by the difference between the quantity introduced by nuclear explosions and that removed by precipitation (and radioactive decay). This net amount reached a maximum at the end of 1962, after the cessation of nuclear weapons testing in the atmosphere by the United States and the U.S.S.R. (see Fig. 9.143a). Subsequent additions of strontium-90 from nuclear tests made by France and mainland China have caused temporary increases in the stratospheric reservoir.

12.196 Calculations, based on somewhat uncertain premises, suggest that, in the event nuclear weapons were to be used in warfare, debris from many thousands of megatons of fission would have to be added to the stratosphere before the delayed fallout from these weapons would lead to an average concentration in the human body equal to the recommended maximum value for occupationally exposed persons, i.e., 2 microcuries of strontium-90 per kilogram of calcium.

CARBON-14 AND TRITIUM

12.197 Long-term radiation exposure can arise from carbon-14 and from tritium, the radioactive isotope of hydrogen; both of these substances are normally present in nature and they are also produced in considerable amounts in nuclear explosions. Carbon-14 is not strictly a component of fallout, but it is convenient to consider it here since it is formed by the action of fast neutrons, e.g., from a thermonuclear weapon, on nitrogen in the atmosphere (§ 9.34). Carbon-14, with a half-life of 5,730 years, emits beta particles, with the low average energy of about 0.05 MeV, and

no gamma rays. Tritium is a minor product of fission, but much larger amounts are released in thermonuclear explosions (§ 9.44). The half-life of tritium is 12.3 years and the beta particles it emits have even a lower energy (average approximately 0.006 MeV) than those from carbon-14; there are also no gamma rays.

12.198 As a consequence of the testing of thermonuclear weapons, starting in 1952, there has been a large increase in the quantity of carbon-14 in the atmosphere, particularly in the stratosphere. Although this has been decreasing since 1963, there is still a significant burden of carbon-14 in the stratosphere which will find its way into the lower part of the atmosphere (troposphere). Because of its long half-life, carbon-14 decays very slowly and the decrease in concentration in the troposphere is largely due to removal of carbon dioxide by gradual solution in ocean waters.

12.199 Carbon-14 does not tend to concentrate in any particular part of the body and is distributed almost uniformly throughout soft tissue; hence, the whole body is exposed to the low-energy beta particles. The whole-body dose from carbon-14 in nature before 1952 was somewhat less than 1 millirem per annum. By 1964, this dose had been roughly doubled by the additional carbon-14 arising from nuclear tests in the atmosphere. If there are no further substantial additions, the dose will decrease gradually and approach normal in another 100 years or so. Compared with the annual radiation dose from strontium-90, mainly to the skeleton, the contribution from carbon-14 produced by thermonuclear weapons is small.

12.200 Tritium, in the form of tritiated water (§ 9.44), can enter the body by the ingestion of food and water, by inhalation of air containing tritiated water vapor, and by absorption through the skin. Since it is an isotope of hydrogen, and has the same chemical properties, tritium soon becomes distributed throughout the body wherever hydrogen is normally found. There is no reason for believing that there is any

significant preferential concentration of tritium in any organ. In spite of the large increase in the quantity of tritium on the earth as a result of nuclear explosions, the annual whole-body dose was less than 0.1 millirem even at its maximum. Because of the low energy of the beta particles it emits and its relatively short half-life, tritium is much less of a long-range radiation hazard than the radioisotopes already considered.

GENETIC EFFECTS OF NUCLEAR RADIATIONS

SPONTANEOUS AND INDUCED MUTATIONS

12.201 The mechanism of heredity, which is basically similar in all sexually reproducing plants and animals, including man, is somewhat as follows. The nuclei of dividing cells contain a definite number of thread-like entities called "chromosomes" which are visible under the microscope. These chromosomes are believed to be differentiated along their length into several thousands (in man) of distinctive units, referred to as "genes." The chromosomes (and genes) exist in every cell of the body, but from the point of view of genetics (or heredity), it is only those in the germ cells, produced in the reproductive organs (sex glands), that are important.

12.202 Human body cells normally contain 46 chromosomes, made up of two similar (but not identical) sets of 23 chromosomes each. In sexual reproduction, the first step is the union of an egg cell, produced in the ovaries of the mother, with a sperm cell, originating in the testes of the father. Each of these

cells carries a set of 23 chromosomes, one representing the characteristics of the mother and the other set those of the father. The resulting fused cell then has the normal complement of 46 chromosomes. Subsequently, as the embryo develops, the cells reproduce themselves and, in general, the 46 chromosomes (and their constituent genes) are duplicated without change.

12.203 In rare instances, however, a deviation from normal behavior occurs and instead of a chromosome duplicating itself in every respect, there is a change in one or more of the genes. This change, called a "mutation," is essentially permanent, for the mutant gene is reproduced in its altered form. If this mutation occurs in a body cell, there may be some effect on the individual, but the change is not passed on. But, if the mutation occurs in a germ cell of either parent, a new characteristic may appear in a later generation, although there may be no observable effect on the individual in whom the gene mutation occurs. The mutations which arise nat-

urally, without any definitely assignable cause or human intervention, are called "spontaneous mutations."

12.204 The matter of immediate interest is that the frequency with which heritable mutations occur can be increased in various ways, one being by exposure of the sex glands (or "gonads"), i.e., testes or ovaries, to ionizing radiation. This effect of radiation has been observed with various insects and mammals, and it undoubtedly occurs also in human beings. The gene mutations induced by radiation (or by various chemicals or heat) do not differ qualitatively from those occurring spontaneously. In practice, it is impossible to determine in any particular instance if the change has occurred naturally or if it was a result of exposure to radiation. It is only the frequency with which the mutations occur that is increased by ionizing radiation. One of the concerns about radiation exposure of a large population is that there may be a substantial increase in the overall burden of harmful mutations. There would then be a greater than normal incidence of defects in subsequent generations.

12.205 All genes have the property of being either "dominant" or "recessive." If a gene is dominant, then the appropriate characteristic affected by that gene will appear in the offspring even if it is produced by the gonads of only one of the parents. On the other hand, a particular recessive gene must occur in the gonads of both parents if the characteristic is to be apparent in the next generation. A recessive gene may consequently be latent for a number of generations, until the occasion arises for the union of sperm and egg cells both of which contain this particular gene.

12.206 As a general rule, new mutations, whether spontaneous or induced by radiation, are recessive. Nevertheless, it appears that a mutant gene is seldom completely recessive, and some effect is observable in the next generation even if the particular gene is inherited from only one parent. Furthermore, in the great majority of cases, mutations have deleterious effects of some kind. A very few of the mutations are undoubtedly beneficial, but their consequences become apparent only in the slow process of biological evolution.

12.207 The harmful effects of a deleterious mutation may be moderate, such as increased susceptibility to disease or a decrease in life expectancy by a few months, or they may be more serious, such as death in the embryonic stage. Thus, individuals bearing harmful genes are handicapped relative to the rest of the population, particularly in the respects that they tend to have fewer children or to die earlier. It is apparent, therefore, that such genes will eventually be eliminated from the population. A gene that does great harm will be eliminated rapidly, since few (if any) individuals carrying such genes will survive to the age of reproduction. On the other hand, a slightly deleterious mutant gene may persist much longer, and thereby do harm, although of a less severe character, to a larger number of individuals.

GENE MUTATIONS INDUCED BY RADIATION

12.208 Since genetic effects of radiation are not apparent in exposed individuals, information concerning mutations can be obtained only from

observations on subsequent generations. Data on radiation-induced mutations are available only from laboratory studies on experimental organisms with short generation times. Unfortunately, these data cannot be extrapolated to man with any degree of certainty. The extensive investigations of genetic effects of radiation on mice appear to provide the most relevant information from which the possible effects on man may be estimated. Radiation can cause two general types of genetic change: gene (or point) mutations in which the general structure of the chromosomes remains unchanged, and chromosome abnormalities associated with gross structural changes. The former appear to be the more important and the subsequent discussion refers mainly to gene mutations.

12.209 From the earlier studies of radiation-induced mutations, made with fruitflies, it appeared that the number (or frequency) of mutations in a given population, i.e., the probability of the occurrence of mutations, is proportional to the total dose received by the gonads of the parents from the beginning of their development up to the time of conception. The mutation frequency appeared to be independent of the rate at which the radiation dose was received. The implication was that the damage to the gonads of the parents caused by radiation was cumulative with no possibility of repair or recovery. More recent experiments with mice, however, have shown that these conclusions must be revised, at least for mammals. When exposed to X rays or gamma rays, the

mutation frequency in these animals has been found to be dependent on the exposure (or dose) rate at which the radiation is received. There are definite indications that some recovery can occur at low exposure rates and not too large total exposure (or doses).

12.210 For exposure rates greater than about 90 roentgens per minute, the incidence of radiation-induced mutations in male mice appears to be proportional to the total (accumulated) gamma-ray (or X-ray) exposure to the gonads; that is to say, the mutation frequency *per roentgen* is independent of the exposure rate.¹⁶ For exposure rates from 90 down to 0.8 roentgens per minute, however, the mutation frequency per roentgen decreases as the exposure rate is decreased. Finally, below 0.8 roentgen per minute, the mutation frequency per roentgen once again becomes independent of the exposure rate, but the value is only about one-third as large as at the high exposure rates (above 90 roentgens per minute). In other words, a given radiation exposure will produce roughly one-third as many mutations at low than at high exposure rates.

12.211 The exposure-rate effect in female mice, for radiation exposure rates of less than 90 roentgens per minute, is even more marked than in males. The radiation-induced mutation frequency per roentgen decreases continuously with the exposure rate from 90 roentgens per minute downward. At an exposure rate of 0.009 roentgen per minute, the total mutation frequency in

¹⁶In the experiments with gamma and X rays, measurements were made of exposures in roentgens per minute; hence, these units are used here. The dose rates in rads (or rems) per minute to the mouse gonads are probably essentially the same as the exposure rates. All conclusions concerning exposure-rate effects thus apply equally to dose-rate effects.

female mice is indistinguishable from the spontaneous frequency. There thus seems to be an exposure-rate threshold below which radiation-induced mutations are absent or negligible, no matter how large the total (accumulated) exposure to the female gonads, at least up to 400 roentgens. Another important observation is that at the same high exposure rate of 90 roentgens per minute, the mutation frequency per roentgen at a total exposure of 50 roentgens is only one-third of that for a total exposure of 400 roentgens. The radiation-induced mutation frequency in female mice thus decreases both with decreasing exposure rate and with the total exposure, in the ranges studied.

12.212 For exposure to fission neutrons, no dose-rate effect has been observed for genetic mutations in male mice and only a small one in females. For large dose rates, equivalent to acute radiation exposures, the mutation frequency per rad of fast neutrons is five or six times as great as for gamma rays. It would thus appear that a RBE value of 5 or 6 should be applicable for genetic effects due to exposure to fast neutrons; but this is not strictly correct because the types of mutations induced in mice by neutron irradiation differ from those caused by X rays and gamma rays. Since there is virtually no dose-rate effect with neutrons, but a large one for X rays, the apparent RBE for neutrons becomes quite large at very low dose rates. This situation is, however, of limited interest in connection with weapons effects because neutron exposure can result only from the initial radiations and the dose rates are then in the high range.

12.213 A significant observation

made with adult female mice is that a delay of at least seven weeks between exposure to a substantial dose of radiation, either neutrons or gamma rays, and conception causes the mutation frequency in the offspring to drop almost to zero. In males, on the other hand, a lengthening of the interval between exposure and fertilization of the female has little effect on the mutation frequency. It is to be noted that in this as well as other respects male and female mice exhibit different responses to radiation in the occurrence of genetic mutations. The reason is that in mice (and other mammals) the mechanisms for the development of male and female germ cells are quite different.

12.214 Since the reproductive systems are basically the same in humans as in lower mammals, it is probable that the genetic effects of radiation in man will be at least qualitatively similar to those in mice, as described above. Thus, a decrease in mutation frequency per rad is expected at very low dose rates of gamma rays in humans, especially in females, and the apparent RBE for fast neutrons should be about 5 or 6.

GENETIC EFFECTS OF NUCLEAR EXPLOSIONS

12.215 In a nuclear explosion, people would be subjected to various amounts of initial ionizing radiation, consisting of gamma rays and neutrons, delivered at a high dose rate, and also possibly to the beta particles and gamma rays from fallout received at a very much lower dose rate. Because of interbreeding between exposed and unexposed persons, it is not possible to make accurate predictions of the genetic con-

sequences. A rough estimate is that an acute dose of about 50 rems to the gonads of all members of the population would result in additional mutations equal to the number occurring spontaneously. But this may not allow for the possible advantage that might arise from delaying conception for some months after exposure to radiation. Although, to judge from the observations on mice, this might not decrease the genetic effects of radiation in males, recovery in the female members of the population would bring about a substantial reduction in the "load" of mutations in subsequent generations.

12.216 Gamma rays from radionuclides of short half-life in the early fallout on the ground or in the surroundings will be part of the initial (acute) radiation dose to the gonads. Beta particles and gamma rays emitted from constituents of the fallout that enter the body and remain there for some time can also induce mutations. Genetic effects of strontium-90 are expected to be relatively minor. The element strontium tends to concentrate in the skeleton and because of the short range of the beta particles from strontium-90 in the body, they do not penetrate to the gonads. Furthermore, the intensity of the secondary X radiation (bremsstrahlung) produced by the beta particles is low. Finally, the amount of strontium-90 in soft tissue, from which the beta particles might reach the reproductive organs, is small. Radioiodines in the body would also not be important because all isotopes of iodine are taken up quite rap-

idly by the thyroid gland and the exposure of the gonads would be insignificant.

12.217 Cesium-137, carbon-14, and tritium are in a different category as internal sources because they are distributed throughout the body and so can cause irradiation of the gonads. Moreover, the decay of cesium-137 is accompanied by gamma rays of fairly long range.¹⁷ From the standpoint of the genetic impact of a particular radionuclide, the total radiation dose to the population over many generations must be taken into account. Hence, although the annual radiation dose to the gonads from carbon-14 is less than from cesium-137, the overall effect of these two substances may not be very different because of the much longer half-life of carbon-14. An additional effect can result from the radioactive decay of carbon-14 atoms in the molecules that carry genetic information. Replacement of a carbon atom by its decay product, nitrogen-14, would result in a change in the nature of the molecule.

12.218 The suggestion has been made that tritium may become concentrated in the genetic molecules and so represent a special hazard. There is, however, no convincing evidence that such is the case. It appears that the increase in mutation frequency that might arise from the presence of tritium in the gonads is not appreciably greater than would be expected from the dose to the body as a whole. Since the whole-body dose from tritium produced in a nuclear explosion is less than from car-

¹⁷Gamma rays accompanying the decay of cesium-137 (and of other species of moderately long half-life) deposited on the ground as delayed fallout, i.e., as an external source, can make a significant contribution to the genetic dose.

bon-14 and the effective half-life is considerably shorter, the genetic effects of tritium should be very much less than those of carbon-14.

12.219 In attempting to assess the genetic effects of internal radiation emitters, it should be borne in mind that, although the total radiation doses over many generations may be large, the dose rate is very low. In fact, it may be so low that the effects in females, in particular, will be negligible. Furthermore, the radiation from fallout should be compared with the gonad exposure of all members of the population to the

natural background radiation, i.e., apart from that due to nuclear explosions. In the United States, the average dose to the gonads, from cosmic rays and from radioactive isotopes in the body (especially potassium-40) and in the ground, is about 90 millirems per annum. It has been estimated that the fallout from explosions of a few hundred megatons yield would be necessary to double the overall mutation rate arising from background radiation. This, incidentally, represents probably only a small fraction of the total number of spontaneous mutations.

PATHOLOGY OF ACUTE RADIATION INJURY¹⁸

CELLULAR SENSITIVITY

12.220 The discussion presented in § 12.90 *et seq.* has been concerned chiefly with general symptoms and the clinical effects of radiation injury. These effects are due directly to the action of nuclear radiation upon individual organs and tissues. The changes in the peripheral blood, for example, reflect the damage done by nuclear radiation to the bone marrow and lymphatic tissue. The pathologic changes in other systems and organs caused by ionizing radiation, which are the basis of the clinical radiation syndrome, are discussed here briefly.

12.221 Radiation damage is the result of changes induced in individual cells. Morphologically demonstrable changes, such as chromosome breaks,

nuclear swelling, increased cytoplasmic viscosity, cellular permeability, and cellular death, are manifested as altered bodily functions when enough cells are affected to reduce the total function of the organ made up of these cells. In certain instances, cells may be killed outright with very high doses of radiation (interphase death), but more commonly irradiated cells die when they divide to reproduce (mitosis-linked death). Delayed death of this kind may occur after several cell divisions following irradiation, so that the effect may not be observed until some time after exposure. Mitosis-linked death is apparently caused by chromosomal and perhaps other nuclear abnormalities, but with time some of these abnormalities are repaired. Consequently, the longer

¹⁸The more technical discussion in § 12.220 through § 12.239 may be omitted without loss of continuity. A general treatment of radiation effects on plants and farm animals is given in § 12.240 *et seq.*

the time between cell divisions, the greater is the opportunity to recover from radiation damage. Cells of different types and organs have quite different degrees of radiosensitivity based mainly on the rapidity of the cell division. Chromosomal changes can also occur that will not result in cell death but in hereditary abnormalities (§ 12.208) or in cell transformations which may lead to cancer.

12.222 Of the more common tissues, the radiosensitivity decreases roughly in the following order: lymphoid tissue, bone marrow, gastrointestinal epithelium, germinal epithelium of the gonads, embryonic tissues, corneal tissue, endothelial cells of the blood vessels, germinal epithelium of the skin, differentiated nervous tissue, collagen and elastic tissue, and bone and cartilage. The lymphocytes are remarkable in that they are killed by relatively small acute radiation doses (see below).

LYMPHOID TISSUE

12.223 Lymphoid tissue is composed of the lymph nodes, tonsils, adenoids, spleen, and the submucosal islands of the intestine. The lymphocytes of the peripheral blood arise in these various sites. Wherever these cells occur, they are the most radiosensitive cells of the whole body. In fact, lymphocytes are killed outright by radiation doses as low as 100 rems or less.

12.224 Under the microscope, irradiated lymphocytes can be seen to be undergoing pyknosis and subsequent disintegration. As these cells die, their remnants are removed and the lymph nodes atrophy. This change was common among the victims of the nuclear

bombs in Japan. After damage by radiation, the lymph nodes do not produce new lymphocytes for periods that vary with the radiation dose. As a result of this cessation of production, combined with death of circulating lymphocytes, there is a rapid fall in the number of the latter. This easily measurable early change in the peripheral blood has been found to be a useful means of prognosis following radiation exposure. A rapid, almost complete, disappearance of lymphocytes implies that death is highly probable, whereas no change within 72 hours is indicative of an inconsequential exposure.

12.225 Atrophic lymph nodes, tonsils, adenoids, Peyer's patches of the intestine, appendices, and spleens were common findings among the radiation casualties in Japan.

BONE MARROW

12.226 Since all the other formed blood cells, except the lymphocytes, arise from radiosensitive marrow cells, the acute radiation exposure syndrome is accompanied by severe changes in cellular composition of the blood. Under normal circumstances, the mature blood cells leave the marrow and enter the blood stream where they remain until destroyed by natural processes and in defense against infection. The different kinds of cells have different spans of natural life. The shorter the life of a particular cell, the more quickly will radiation damage to the parents of that particular cell be revealed by a decrease in number of such cells in the circulation. The red blood cells, which have the longest life span (about 120 days), are the last to show a reduc-

tion in number even though their parent cells, the erythroblasts, are almost as radiosensitive as the lymphocytes.

12.227 Bone marrow exhibits striking changes soon after irradiation. There is at once a temporary cessation of cell division. Those cells in the process of dividing go on and complete the process, after which all the cells in the marrow mature progressively. Since they leave the marrow as rapidly as maturity is reached, the marrow becomes depleted at once of both adult and less mature cells. As time passes, the marrow, barring regeneration, becomes progressively more atrophic until in the final stage it consists of dilated blood-filled sinuses, with gelatinous edema of the spaces left empty by the loss of marrow cells, and large macrophages containing the debris of dead cells removed from the circulation. Such extreme atrophy of the marrow was common among those dying of radiation injury in Japan up to 4 months after exposure. In some of these delayed radiation deaths, the bone marrow showed a return of cellular reproductive activity.

HEMORRHAGE AND INFECTION

12.228 Hemorrhage is a common phenomenon after radiation exposure because the megakaryocytes, from which the blood platelets necessary for clotting are formed, are destroyed and platelets are not replenished. If hemorrhage occurs in vital centers, death can result. Often the hemorrhages are so widespread that severe anemia and death are the consequences.

12.229 The loss of the epithelial coverings of tissues, together with the loss of white blood cells and the de-

creased ability to produce antibodies, lowers the resistance of the body to bacterial and viral invasion. If death does not take place in the first few days after a large dose of radiation, bacterial invasion of the blood stream usually occurs and the patient dies of infection. Often such infections are caused by bacteria which, under normal circumstances, are harmless.

12.230 Very often in whole-body irradiation the outward signs of severe damage to the bone marrow, lymphatic organs, and epithelial linings are gangrenous ulcerations of the tonsils and pharynx. This condition (agranulocytic anemia) is also found in cases of chemical poisoning of the bone marrow that resemble the effect of radiation exposure. Such ulcerations and the pneumonia that often accompanies them are unusual in the respect that very little suppuration is found because of the paucity of leucocyte cells. Although most of the bacteria in such ulcerations can usually be controlled by antibiotic drugs, the viruses and fungi which also invade such damaged tissues are not affected by treatment, and fatal septicemia is common.

REPRODUCTIVE ORGANS

12.231 Cell division in the germinal epithelium of the testes stops at once with lethal exposure to ionizing irradiation. The first change is pyknosis or nuclear death of the spermatogonia, the most primitive of the male germinal epithelium. Following this change, the more developed cells undergo maturation without further division, so that the testicular germinal cells leave the testes as adult sperm, and the most primitive

cells disappear sequentially as they mature and die during cell division.

12.232 Changes in the ovaries caused by radiation are less striking than those in the testes. The primordial ova can be found in progressive stages of post irradiation atrophy and degeneration. In some Japanese irradiation victims, the ovarian follicles failed to develop normally and menstrual irregularities resulted. There was an increased incidence of miscarriages and premature births, along with an increased death rate among expectant mothers. These changes were related to the radiation dose, as determined by the distance from ground zero.

12.233 Morphologic changes in the human reproductive organs, compatible with sterility, are thought to occur with doses of 450 to 600 rems. Various degrees of temporary sterility were found among surviving Japanese men and women. Many supposedly sterile from exposure to significant doses of radiation have since produced children who are normal by ordinary measurements.

LOSS OF HAIR

12.234 Epilation was common among exposed Japanese surviving more than 2 weeks after the explosion. The onset of epilation from the head was between the 13th and 14th days after exposure in both sexes. Combing accentuated this change, although copious amounts of hair were lost spontaneously for about 2 weeks. The distribution of the radioepilation conformed in general with that expected from the senile changes of male ancestors. The hair of the eyebrows, eyelashes, and beard came out much less easily than from the

head. In severely exposed but surviving cases, hair began to return within a few months, and epilation was never permanent.

GASTROINTESTINAL TRACT

12.235 Some of the first gross changes noted in radiation-exposed Japanese were ulcerations of the intestinal lining. The mucosa of the first part of the small intestine is the most radiosensitive but usually does not ulcerate deeply. Ulcers are most commonly found after irradiation in the lymphoid tissues of the lower ileum and in the caecum, where bacterial invasion is common.

12.236 Microscopically profound changes are found throughout the gastrointestinal tract. For example, the acid-secreting cells of the stomach are lost. Mitosis stops in the crypts of the intestinal glands and, as a result, the cells covering the villi of the intestine are not replaced and the villi become swollen, turgid, and denuded. When bacterial invasion occurs, ulcers covered by a shaggy, fecally contaminated exudate develop. Since the white blood cells are simultaneously depleted and too few in number to combat infection, these intestinal ulcerations are often the point of entry of bacteria that kill the victim of heavy radiation exposure.

NERVOUS SYSTEM

12.237 Although certain nerve cells are among the most radioresistant cells in the adult body, the nervous tissue of the embryo and some cells of the adult cerebellum are relatively sensitive to radiation. Early disorientation and coma may be induced by brain damage at dose levels of thousands of rems.

BLAST-RELATED EFFECTS

VELOCITIES OF GLASS FRAGMENTS

12.238 Glass fragments produced by air blast are a substantial hazard and the injuries they can cause are related to the velocities attained (§ 12.42). Measurements have been made of the fragments produced from glass panes, mounted in either steel or wood frames, when destroyed by the blast from nuclear (11 to 29 kilotons) or conventional (15 to 500 tons) explosions. The types of glass ranged from 0.25-inch thick plate glass, through various standard thicknesses of single- and double-strength glass, to thin nonstandard panes 0.064 inch thick. The results obtained can be represented, with an accuracy of roughly ± 10 to 15 percent, by the straight line in Fig. 12.238. The geometric mean velocity, i.e., the antilogarithm of the mean of the logarithms of the velocities, represented by V_{50} feet per second, is modified by an empirical scaling factor for the thickness (t inches) of the glass panes. The effective peak overpressure (pounds per square inch) is equal to the peak reflected overpressure if the glass is oriented face-on to the blast wave and it is the same as the incident peak overpressure if the pane is located on the side or back of a structure

relative to the advancing shock front. From Fig. 12.238 the geometric mean velocity of the fragments can be determined for glass panes of any specified thickness exposed to a given effective peak overpressure.

DECELERATIVE TUMBLING

12.239 The results of the tests referred to in § 12.45, on the decelerative tumbling of various animal cadavers dropped onto a hard, flat surface at different velocities, are represented graphically in Fig. 12.239; the possible error is within the range of about ± 10 to 15 percent. The initial velocity V_i feet per second and the stopping distance S feet are scaled for the mass of the animal (m pounds). Scaled stopping times are also shown. Thus, for a given initial velocity and animal mass, the stopping distance for decelerative tumbling may be derived directly from the linear plot and the corresponding stopping time may be determined by interpolation. Although the data were obtained from tests with animals, it is thought that the results can be applied to the decelerative tumbling of humans provided there is no significant bouncing.

EFFECTS ON FARM ANIMALS AND PLANTS

INTRODUCTION

12.240 In general, the three main immediate physical effects of nuclear explosions, i.e., blast, thermal radiation, and the initial nuclear radiation,

have similar potential for causing damage to animals and plants as they do to humans. As biological systems, larger animals are similar to man and would experience much the same blast, burn,

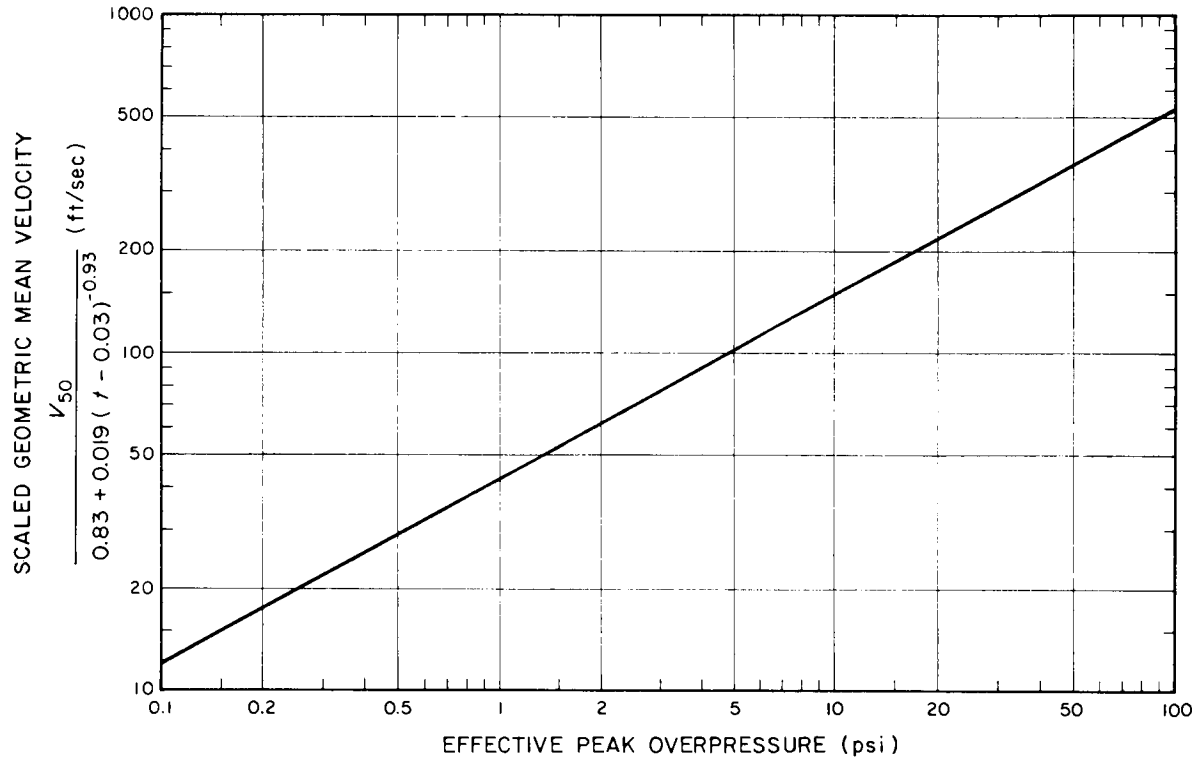

Figure 12.238. Geometric mean velocity of glass fragments (V_{50} feet per second) scaled according to pane thickness (t inches) versus the effective peak overpressure (pounds per square inch) of the blast wave. (Estimated accuracy ± 10 to 15 percent.)

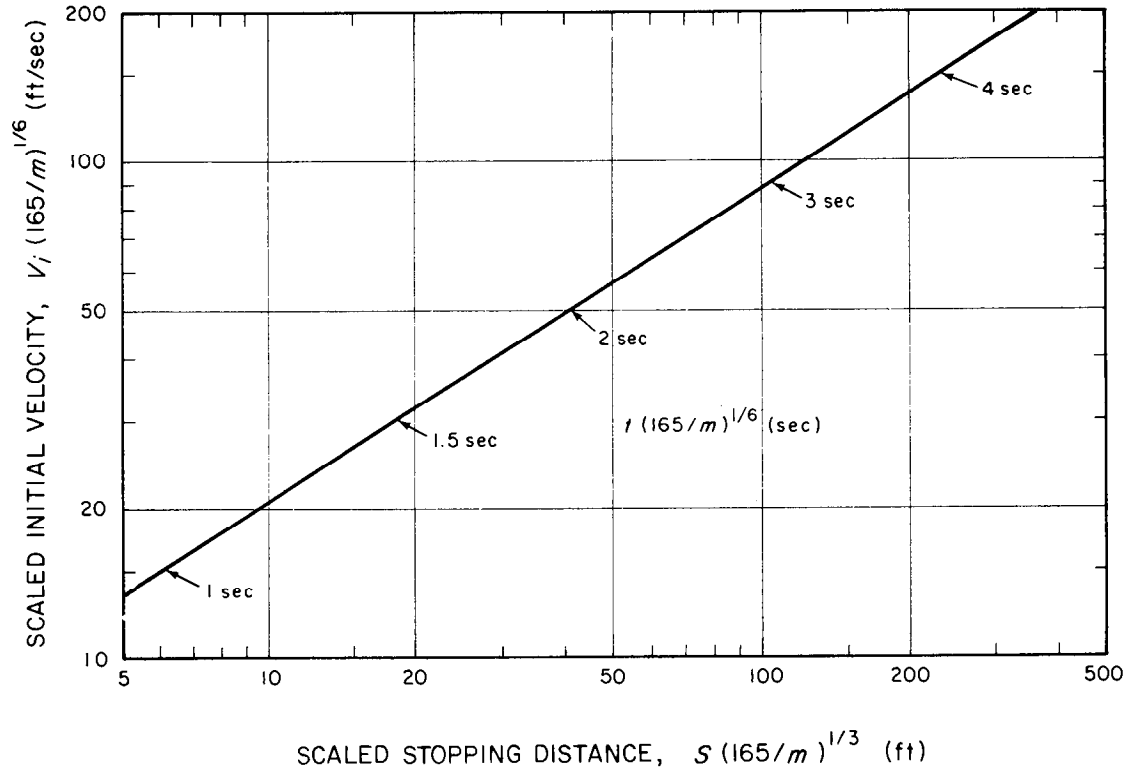

Figure 12.239. Initial velocity of animal (V_i feet per second) scaled according to the mass (in pounds) versus the stopping distance for decelerative tumbling on a hard, flat surface. Scaled stopping times are indicated on the plot. (Estimated accuracy ± 10 to 15 percent.)

and radiation injuries, if exposed in the same manner. In fact, much information concerning the expected effects of nuclear weapons on man, apart from the data from Japan, has been inferred from studies on animals. Plants, on the other hand, vary greatly in the characteristics that determine injury from the immediate physical effects of nuclear explosions. Consequently, for plants the range of biological responses is greater than for man or animals.

12.241 In nuclear warfare, an important need would be to assure an adequate food supply for the survivors, especially during the early post-attack period. The main concern would then not be with the immediate effects of the explosions, but rather with the effects of the fallout on farm animals and crop plants forming part of man's food chain. As a rule, the seriousness of these effects increases with increasing dose and dose rate of ionizing radiations. The total effect of a given dose is also influenced by the stage of development of the organism and the environmental conditions prior to, during, and after the exposure. As with the immediate effects of a nuclear explosion, plants show a wide range of sensitivity to fallout radiation.

12.242 Another factor to be considered is the possible consequences of the accumulation of various radioisotopes in food supplies due to the residual radioactivity in soils and water from deposited worldwide fallout. However, these effects are of a protracted nature and their importance is not well understood at present.

12.243 Another matter of interest in connection with the effects of nuclear explosions on plants and farm animals is

the possibility of serious ecological disturbances. These might be caused by large-scale fires, denuding of forests by fallout, destructive plagues of insects which are known to be relatively insensitive to radiation, and so on. It is not expected that such effects would be severe enough to prohibit or seriously delay recovery of food production facilities after a nuclear attack.

FALLOUT RADIATION EFFECTS ON LIVESTOCK

12.244 As with man, fallout may cause both internal and external radiation exposures to animals. The external (whole-body) exposure would arise mainly from gamma rays, and if the fallout particles should remain on the skin for some time, the animals could suffer beta burns (§ 12.155). Internal radiation exposure could result from farm animals consuming contaminated grass and thereby ingesting fallout particles. Beta radiations from these particles would then irradiate the walls of the intestinal tract whereas the gamma rays would contribute to the whole-body exposure. Certain radioisotopes may be leached from the fallout particles and enter the blood stream; they may then be deposited in specific parts of the body, e.g., iodine in the thyroid and strontium in the skeleton.

12.245 Skin injury caused by fallout was observed in cattle exposed at the TRINITY test (§ 2.36) and also in animals during atmospheric tests at the Nevada Test Site. Minor to severe injuries due to beta radiation have occurred, although none of the cattle died within 150 days of exposure. The skin injuries appeared to be similar to thermal burns

except that the latter are soon visible whereas the effects of beta particles may not be seen for three or four weeks.

12.246 The damage to the cattle at the TRINITY site was described as the development of zones of thickened and hardened skin which appeared as plaques and cutaneous horns. After 15 years, three of the exposed cows developed scale-like carcinomas of the skin in the affected regions, but it is not entirely clear that they were induced by radiation. In areas less severely affected, there was some loss and graying of the hair. The location of these cattle with respect to ground zero is not known, but it is estimated that the whole-body gamma radiation dose was about 150 rems, although the skin dose may have been very much larger. There was no evidence of radiation damage on the lower surfaces of the body that might have been caused by exposure from fallout on the ground.

12.247 Information concerning the possible effects of fallout on farm animals under various conditions has been obtained from studies with simulated fallout sources. Three main situations of interest, depending on the location of the animals, are as follows:

1. In a barn: whole-body exposure

to gamma rays from fallout on the roof and the surrounding ground.

2. In a pen or corral: whole-body exposure to gamma rays from fallout on the ground and exposure of the skin to beta particles from fallout deposited on the skin.

3. In a pasture: whole-body exposure to gamma rays from fallout on the ground, exposure of the skin to beta particles, and exposure of the gastrointestinal tract from fallout on the grass.

The exposure to gamma rays is simulated by means of an external cobalt-60 source. Skin irradiation is achieved by attaching to the back of the animal a flexible source of beta particles. Finally, the internal exposure is simulated by adding to the animal's feed a material consisting of yttrium-90 fused to 88-175 micrometers particles of sand, giving a specific activity of 10 microcuries per gram of sand. This product is considered to be representative of the beta radiation from the fallout produced by a land-surface detonation.

12.248 Observations have been made on animals exposed to whole-body gamma radiation alone (barn) or in combination with skin exposure (pen or corral) or with exposure of the skin and the intestinal tract (pasture) at dose rates

Table 12.248

ESTIMATED LIVESTOCK LETHALITY ($LD_{50/60}$) FROM FALLOUT

Animals	Total Gamma Exposure (roentgens)		
	Barn	Pen or Corral	Pasture
Cattle	500	450	180
Sheep	400	350	240
Swine	640	600*	550*
Horses	670	600*	350*
Poultry	900	850*	800*

*No experimental data available; estimates are based on grazing habits, anatomy, and physiology of the species.

of the order of magnitude expected from fallout. From the results, estimates were made of the total gamma exposure which would be fatal to 50 percent of a large group of animals within 60 days ($LD_{50/60}$); the values are summarized in Table 12.248. It is evident that, for cattle and sheep, which are ruminants, internal exposure can contribute substantially to the lethality of fallout.

12.249 The data in the table apply to extreme conditions and are intended only to indicate the different sensitivities to radiation of a few animal species, the kinds of doses that might prove fatal, and the effects of combining different types of exposures. The basic assumption involved is that the animals remain in a given situation while they accumulate an exposure of a few hundred roentgens of radiation.¹⁹ In practice, of course, the animals would probably be removed as soon as possible from a contaminated area and, in any event, contaminated grass would soon be replaced by clean fodder. Swine are normally fed in a drylot and would probably not ingest enough radioactivity to increase doses above those expected from whole-body irradiation alone.

12.250 There are considerable variations in radiation sensitivity in a given animal species, just as in man, but on the whole it appears, in agreement with the estimates in Table 12.248, that cattle and sheep are more sensitive to radiation than are swine. Furthermore, among those who survive, the recovery time is shorter in swine than in cattle and sheep. As a general rule, young animals are more sensitive to radiation than are

adults, but the difference appears to be less marked for swine than for cattle. At high exposure rates, the total exposure required to produce a certain degree of lethality is smaller than when the rate is low, suggesting the possibility of partial recovery by the animal from radiation injury. Again, this effect is more marked for swine than for other livestock.

12.251 The great majority of farm animals receiving an exposure of less than 400 roentgens of whole-body radiation alone would be expected to survive. However, they will show symptoms similar to those observed in man. The primary symptoms are those associated with damage to the blood-forming tissues; they usually include a severe drop in the number of platelets in the blood and gastrointestinal damage caused by failure in blood clotting. Increased permeability of the capillaries also contributes to the loss of blood cells, plasma, and electrolytes (salts). Most of these losses occur between 14 and 30 days after exposure, at which time the white-cell count is low; fever and bacterial invasion may also occur.

12.252 Cattle receiving whole-body exposures in the range of 200 to 600 roentgens commonly experience some loss of appetite and slight fever for about 24 hours. They then appear normal for about 14 days (latent stage), after which there is a marked fever in those receiving the larger radiation exposures; most of the latter will die within a month or so. Those animals which survive show only a mild fever. Very few, if any, of these survivors are

¹⁹In the tests, the gamma-ray exposures were measured in roentgens and so are expressed in this form in the table. The actual whole-body doses in rems would probably not be greatly different.

expected to suffer the serious loss of appetite and vomiting which are associated with the gastrointestinal radiation syndrome at higher exposures.

12.253 The effects of internal radiation exposures have been studied by adding the simulant mentioned in § 12.247 to the feed of sheep. The earliest symptoms were loss of appetite, diarrhea, weight loss, and fever. The sandy radioactive material tended to collect in "pockets" in the rumen and abomasum²⁰ where the radiations caused ulceration and accumulation of fibrinous exudate. No gross lesions were found in the intestines of sheep under these conditions. Loss of appetite was accompanied by stagnation in the rumen which prevented the normal passage of the animal's food. This was followed by severe diarrhea and weight loss. Sheep that survived usually returned to normal feed consumption within 60 days, but considerably more time was required to recover the loss of weight.

12.254 Whole-body exposure to 240 roentgens of external gamma radiation, at the high exposure rate of 60 roentgens per hour, affected neither the body weight nor the feed consumption of sheep and cattle. If the whole-body exposure was supplemented by a skin dose there was some decrease in weight, and an even greater decrease if there was also exposure of the intestinal tract. However, it appears that at radiation doses below lethal values and at dose rates expected from fallout, the effect on livestock production would be minor at most. As a rule, irradiated dairy cows produce as much milk as those which

have not been exposed, but lactation may be reduced as a result of destruction of thyroid tissue by radioiodines from ingested fallout. It is possible that the concentrations of strontium-90 and of iodine-131 may make the milk unsuitable for general use. Most sheep, cattle, and swine surviving the exposure to fallout, even those with gastrointestinal tract injuries from ingested fallout, could eventually be used for food under emergency conditions. Until more data are available, it has been recommended that, for 15 to 60 days after exposure to radiation levels that might cause some mortality, only muscle meat from surviving animals be used for food.

FALLOUT RADIATION EFFECTS ON PLANTS

12.255 Plants differ from animals (and man) with respect to radiation exposure from fallout; animals can move or be moved from the fallout field whereas plants in the ground must remain in the same location during their lifetime. Since food crops are harvested at the end of the growing season, the total exposure received will be greatly dependent on the stage of development at which the fallout occurs. Thus, a young seedling will receive a much larger radiation dose than will a fairly mature plant which is almost ready for harvesting. Furthermore, the sensitivity of a plant to radiation is different at different growth stages. These and other factors make it impossible to present any precise information concerning the expected effects of fallout on plants.

²⁰The rumen is the first stomach (or pouch) of a ruminant and the abomasum is the fourth (or true) stomach.

Nevertheless, some general conclusions can be drawn.

12.256 At sufficiently large doses, radiation can seriously reduce the growth and yield of a plant, particularly if it is exposed at certain stages of development. In addition, there may be loss of reproductive capacity, changes in shape and appearance, wilting, and ultimately death. There may also be changes in the normal plant tolerance to environmental stresses. The sensitivities of plants to radiation vary over a wide range and they are influenced by many biological, environmental, and radiological factors. The sensitivities of different species may differ as much as 100-fold or more, and there may be a 50-fold range of sensitivity in a given species at different stages of growth. Thus, certain stages of the development of reproductive structures, e.g., formation of flower buds, are very sensitive to radiation, but the ripe seeds are much more resistant.

12.257 As with animals, the response of a plant to a given dose of radiation depends on the dose (or exposure) rate, although the effect appears to be more marked for plants. A much larger total dose is usually required to produce a given degree of injury to plants when the dose rate is low than when it is high. At very high and very low dose rates, however, there is no observable evidence of a dose-rate effect.

12.258 Among the many important environmental conditions influencing the radiation response of plants are climate, temperature, light, soil moisture, and competition from other plants. Excluding the effects of drought, changes in environmental factors can result in as

much as a ten-fold change in apparent radiosensitivity of a given plant species. Significant exposures to radiation are expected to delay flower initiation and fruit ripening. Hence, plants with a growing season that is limited by climatic conditions, e.g., tomato, may survive through the growing season but would produce essentially no useful yield.

12.259 Since seeds are needed to provide the next crop, the viability of seeds from irradiated plants is important. Adverse characteristics are sometimes present, although the seed appears to be normal. Too little is known about this matter for any definite statements to be made. Seeds already formed are fairly resistant to radiation and seeds in storage will probably remain essentially unaffected. Seed potato tubers and small onion transplants are more sensitive than ordinary dry seeds. Exposure of seeds to sufficiently large doses of radiation is known to produce mutations, and mutations may well appear in seeds from exposed plants. Although most of the mutations are deleterious, a number of beneficial mutant forms have been developed from irradiated seeds.

12.260 Information on the effects of actual fallout on plants is meager. At the Nevada Test Site, trees and shrubs have been killed by radiation from fallout, but the plants have been close to the locations of cratering explosions. Substantial amounts of fallout particles were deposited on the leaves where they remained for some time because of the small rainfall in the desert area. No such occurrences have been observed following contained, buried nuclear explosions. Essentially all that is known about the effects of radiation on plants

has been obtained from tests in which plants at various stages of growth and development have been exposed to gamma rays from an external source.

12.261 Because of the great variations in radiosensitivity even among plants of the same species, the results obtained with experimental plants are applicable only under the precise conditions of the experiments. However, an important conclusion has emerged from these studies which should provide a general guide as to the expected effects of gamma radiation on plants. At equivalent growth stages and under similar conditions, the radiosensitivity of a plant is directly related to the size of the chromosomes, measured as the average volume occupied per chromosome in the cell nucleus. The larger the effective chromosome volume, the more sensitive is the plant to radiation. In other words, under equivalent conditions, a given total dose (or exposure) of radiation will cause a larger proportion of deaths and a greater decrease in yield from the surviving plants, the larger the chromosome volume. Or stated in another way, the larger the chromosome volume, the smaller the radiation dose required to produce a given degree of damage to the plants.

12.262 On the basis of chromosome volume (and experimental observations of lethality and yield) some important food crops can be placed in an approximate order of decreasing sensitivity to radiation as follows: onions, small-grain cereals, e.g., wheat, barley, oats, and corn (but not rice), field peas, lettuce, lima beans, potatoes, sugar beets, broccoli, and rice. It is of interest that young seedlings of rice appear to be exceptionally resistant to radiation. Even for

the least resistant plant species, a total exposure of about 1,000 roentgens (or more) in the seedling stage is required to kill about 50 percent of the exposed plants, whereas for the most radioresistant plant 15,000 roentgens may be required. The decrease in yield of the surviving plants after exposure to radiation follows the same order, in general, as the increase in lethality.

12.263 Although woody plants are not a source of food, they are of economic importance. Evergreen trees (gymnosperms), such as pines and related species, are quite sensitive to radiation. Deciduous trees, which shed their leaves at the end of each growing season, are much less sensitive; the exposures that will kill about half the exposed trees range from 2,600 to 7,700 roentgens. However, even smaller exposures would have a serious effect on the economic value of these trees.

12.264 The results described above refer to exposures from gamma radiation. In a fallout situation, however, the plant would be subjected to beta radiation in addition. In fact, it appears that for many crop plants, which typically have relatively little tissue mass around their most radiosensitive parts and which are often in contact (or near contact) with the fallout particles, the dose from beta radiation may be greater than from gamma rays. This would be particularly the case in the early stages of plant growth. Beta radiation may thus make an important contribution to the injury of plants and may be the dominant cause of damage in many situations. Apart from the view that beta and gamma radiation have equivalent effects for the same dose in rads, information concerning beta-radiation injury and the

possible synergism with gamma radiation is very sparse.

12.265 Food crops harvested from plants that have survived exposure to fallout would probably be safe to eat under emergency conditions, especially if the exposure occurred during the later stages of growth. Care would have to be taken to remove by washing any fallout

particles that might be attached to leaf or root vegetables. The major problem would arise from the possible presence in the edible parts of the plant of radionuclides taken up from the soil by the roots or from particles deposited on the leaves. Because of the complexities involved, no generalizations can be made and each situation would have to be evaluated individually.

BIBLIOGRAPHY²¹

- ALLEN, R. G., *et al.*, "The Calculation of Retinal Burn and Flashblindness Safe Separation Distances," U.S. Air Force School of Aerospace Medicine, September 1968, SAM-TR-68-106.
- BAIR, W. J., and R. C. THOMPSON, "Plutonium: Biomedical Research," *Science*, **183**, 715 (1974).
- BELL, M. C., L. B. SASSER, J. L. WEST, and L. WADE, "Effects of Feeding Yttrium-90 Labelled Fallout Simulant to Sheep," *Radiation Research*, **43**, 71 (1970).
- *BENSON, D. W., and A. H. SPARROW (Eds.), "Survival of Food Crops and Livestock in the Event of Nuclear War," Proceedings of a Symposium held at Brookhaven National Laboratory, September 15-18, 1970, AEC Symposium Series, No. 24, U.S. Atomic Energy Commission, 1971.
- BROOKS, J. W., *et al.*, "The Influence of External Body Radiation on Mortality from Thermal Burns," *Annals of Surgery*, **136**, 533 (1952).
- BROWN, S. L., W. B. LANE, and J. L. MACKIN, "Beta Dosimetry for Fallout Hazard Evaluation," Stanford Research Institute, Menlo Park, California, July 1970, EGU-8013.
- *BRUCER, M. "The Acute Radiation Syndrome: Y-12 Accident," Oak Ridge Institute of Nuclear Studies, April 1959, ORINS-25.
- BRYANT, F. J., *et al.*, U.K. Atomic Energy Authority Report AERE HP/R 2353 (1957); "Strontium in Diet," *Brit. Medical Journal*, **1**, 1371 (1958).
- *CONARD, R. A., *et al.*, "A Twenty-Year Review of Medical Findings in a Marshallese Population Accidentally Exposed to Radioactive Fallout," Brookhaven National Laboratory, September 1975, BNL 50424. (This report contains references to previous studies.)
- GERSTNER, H. B., "Acute Radiation Syndrome in Man," *U.S. Armed Forces Medical Journal*, **9**, 313 (1958).
- ISHIMARU, T., *et al.*, "Leukemia in Atomic Bomb Survivors, Hiroshima and Nagasaki," *Radiation Research*, **45**, 216 (1971).
- JABLON, S., *et al.*, "Cancer in Japanese Exposed as Children to Atomic Bombs," *The Lancet*, May 8, 1971, p. 927.
- JABLON, S. and H. KATO, "Studies of the Mortality of A-Bomb Survivors, 5. Radiation Dose and Mortality, 1950-1970," *Radiation Research*, **50**, 649 (1972).
- KATO, H. "Mortality in Children Exposed to the A-Bombs While In Utero, 1945-1969," *Amer. J. Epidemiology*, **93**, 435 (1971).
- KULP, J. I., A. R. SCHULERT, and E. J. HODGES, "Strontium-90 in Man: IV," *Science*, **132**, 448 (1960).
- LANE, W. B., "Fallout Simulant Development: Leaching of Fission Products from Nevada Fallout and Properties of Iodine-tagged Simulant," Stanford Research Institute, Menlo Park, California, June 1970, SRI-7968. (This report contains references to and summaries of previous studies.)
- LANGHAM, W. H. (Ed.), "Radiobiological Fac-

²¹The number of publications on the biological effects of nuclear weapons is very large; additional citations will be found in the selected references given here.

- tors in Manned Space Flight," Chapters 5 and 6, National Academy of Sciences-National Research Council, Publication No. 1487, 1967.
- LAPPIN, P. W., and C. F. ADAMS, "Analysis of the First Thermal Pulse and Associated Eye Effects," Aerospace Medical Research Laboratories, Wright Patterson Air Force Base, Ohio, December 1968, AM RL-TR-67-214.
- LOUITT, J. F., and R. S. RUSSELL, (Eds.), "The Entry of Fission Products into Food Chains," Progress in Nuclear Energy, Series VI, Vol. 3., Pergamon Press, Inc., 1961.
- MILLER, C. F., and P. D. LA RIVIERE, "Introduction to Long-Term Biological Effects of Nuclear War," Stanford Research Institute, Menlo Park, California, April 1966, MU-5779.
- MILLER, R. W., "Delayed Radiation Effects in Atomic Bomb Survivors," *Science*, **166**, 569 (1969).
- National Academy of Sciences-National Research Council, "The Biological Effects of Atomic Radiation," 1956 and 1960; "Pathological Effects of Atomic Radiation," Publication No. 452, 1961; "Effects of Inhaled Radioactive Particles," Publication No. 848, 1961; "Long-Term Effects of Ionizing Radiations from External Sources," Publication No. 849, 1961; "Effects of Ionizing Radiation on the Human Hematopoietic System," Publication No. 875, 1961; "The Effects on Populations of Exposure to Low Levels of Ionizing Radiation," 1972 (a complete review with numerous references to the biological effects of ionizing radiations); "Long-Term Worldwide Effects of Multiple Nuclear-Weapons Detonation," 1975; Washington, D.C.
- National Council on Radiation Protection and Measurements, "Basic Radiation Protection Criteria," NCRP Report No. 39, Washington, D.C., 1971.
- OUGHTERSON, A. W., and S. WARREN, "Medical Effects of the Atomic Bomb in Japan," National Nuclear Energy Series VIII, McGraw-Hill Book Co., Inc., 1956.
- *"Radiation Injuries and Sickness: A DDC Bibliography, Volume I, May 1957-July 1970," May 1971.
- RUBIN, P., and CASARETT, G. W., "Clinical Radiation Pathology," Vols. I and II, W. B. Saunders Company, 1968.
- RUSSELL, S. R., and A. H. SPARROW (Eds.), "The Effects of Radioactive Fallout on Food and Agriculture," North Atlantic Treaty Organization Report (1971).
- SPARROW, A. H., S. S. SCHWEMMER, and P. J. BOTTINO, "The Effects of External Gamma Radiation from Radioactive Fallout on Plants with Special Reference to Crop Production," *Radiation Botany*, **11**, 85 (1971).
- United Nations General Assembly Official Records, "Report of the United Nations Scientific Committee on the Effects of Atomic Radiation," A/5216 (1962); A/5814 (1964); A/6314 (1966); A/7613 (1969); A/8725 (1972); United Nations, New York.
- *WHITE, C. S., *et al.*, "Comparative Nuclear Effects of Biomedical Interest," Civil Effects Study, U.S. Atomic Energy Commission, January 1961, CEX-58.8.
- WHITE, C. S., *et al.*, "The Relation Between Eardrum Failure and Blast-Induced Pressure Variations," *Space Life Sciences*, **2**, 158 (1970).
- *WHITE, C. S., "The Nature of Problems Involved in Estimating the Immediate Casualties From Nuclear Explosions," Civil Effects Study, U.S. Atomic Energy Commission, July 1971, CEX 71.1.
- WHITE, C. S., *et al.*, "The Biodynamics of Air Blast," Advisory Group for Aerospace Research and Development, North Atlantic Treaty Organization, December 1971, AGARD-CP-88-71, p. 14-1. Also published as DASA 2738T, July 1971. (A complete review with numerous references.)
- WOOD, J. W. *et al.*, "Thyroid Cancer in Atomic Bomb Survivors, Hiroshima and Nagasaki," *Amer. J. Epidemiology*, **89**, 4 (1969).

GLOSSARY

- A-Bomb:** An abbreviation for atomic bomb. See *Nuclear weapon*.
- Absorbed Dose:** The amount of energy imparted by nuclear (or ionizing) radiation to unit mass of absorbing material. The unit is the rad. See *Dose, Rad*.
- Absorption:** The irreversible conversion of the energy of an electromagnetic wave into another form of energy as a result of its interaction with matter. As applied to gamma (or X) rays it is the process (or processes) resulting in the transfer of energy by the radiation to an absorbing material through which it passes. In this sense, absorption involves the photoelectric effect and pair production, but only part of the Compton effect. See *Attenuation, Compton effect, Pair production, Photoelectric effect*.
- Absorption Coefficient:** A number characterizing the extent to which specified gamma (or X) rays transfer their energy to a material through which they pass. The *linear energy absorption coefficient* is a measure of the energy transfer (or absorption) per unit thickness of material and is stated in units of reciprocal length (or thickness). The *mass energy absorption coefficient* is equal to the linear absorption coefficient divided by the density of the absorbing material; it is a measure of the energy absorption per unit mass. See *Attenuation coefficient*.
- Afterwinds:** Wind currents set up in the vicinity of a nuclear explosion directed toward the burst center, resulting from the updraft accompanying the rise of the fireball.
- Air Burst:** The explosion of a nuclear weapon at such a height that the expanding fireball does not touch the earth's surface when the luminosity is a maximum (in the second pulse).
- Alpha particle:** A particle emitted spontaneously from the nuclei of some radioactive elements. It is identical with a helium nucleus, having a mass of four units and an electric charge of two positive units. See *Radioactivity*.
- Angstrom:** A unit of length, represented by A, equal to 10^{-8} centimeter. It is commonly used to express the wavelengths of electromagnetic radiations in the visible, ultraviolet, and X-ray regions.
- Apparent Crater:** See *Crater*.
- Arching:** In the case of a buried structure, it is the tendency for the soil particles to lock together in the form of an arch, with the result that part of the stress is transmitted around the structure instead of through it.
- Atom:** The smallest (or ultimate) particle of an element that still retains the characteristics of that element. Every atom consists of a positively charged central nucleus, which carries nearly all the mass of the atom, surrounded by a number of negatively charged electrons, so that the whole system is electrically neutral. See *Electron, Element, Nucleus*.
- Atomic Bomb (or Weapon):** A term sometimes applied to a nuclear weapon utilizing fission energy only. See *Fission, Nuclear weapon*.
- Atomic Cloud:** See *Radioactive cloud*.
- Atomic Number:** See *Nucleus*.
- Atomic Weight:** The relative mass of an atom of the given element. As a basis of reference, the atomic weight of the common isotope of carbon (carbon-12) is taken to be exactly 12; the atomic weight of hydrogen (the lightest element) is then 1.008. Hence, the atomic weight of any element is *approximately* the mass of an atom of that element relative to the mass of a hydrogen atom.
- Attenuation:** Decrease in intensity of a signal, beam, or wave as a result of absorption and scattering out of the path of a detector, but not including the reduction due to geometric spreading (i.e., the inverse square of distance effect). As applied to gamma (and X) rays, attenuation refers to the loss of photons (by the Compton, photoelectric, and pair-production effects) in the passage of the radiation through a material. See *Absorption, Inverse square law, Photon, Scattering*.
- Attenuation Coefficient:** A number characterizing the extent of interaction of photons of specified gamma (or X) rays in their passage through a material. The *linear attenuation coefficient* is a measure of the photon interaction per unit thickness of material and is stated in units of reciprocal length (or thickness). The *mass attenuation coefficient* is equal to the linear attenuation

coefficient divided by the density of the material; it is a measure of the attenuation per unit mass. See *Absorption coefficient*.

Background Radiation: Nuclear (or ionizing) radiations arising from within the body and from the surroundings to which individuals are always exposed. The main sources of the natural background radiation are potassium-40 in the body, potassium-40 and thorium, uranium, and their decay products (including radium) present in rocks and soil, and cosmic rays.

Base Surge: A cloud which rolls outward from the bottom of the column produced by a subsurface explosion. For underwater bursts the visible surge is, in effect, a cloud of liquid (water) droplets with the property of flowing almost as if it were a homogeneous fluid. After the water evaporates, an invisible base surge of small radioactive particles may persist. For subsurface land bursts the surge is made up of small solid particles but it still behaves like a fluid. A soft earth medium favors base surge formation in an underground burst.

Bearing Wall: A wall which supports (or bears) part of the mass of a structure such as the floor and roof systems.

Beta Particle: A charged particle of very small mass emitted spontaneously from the nuclei of certain radioactive elements. Most (if not all) of the direct fission products emit (negative) beta particles. Physically, the beta particle is identical with an electron moving at high velocity. See *Electron, Fission products, Radioactivity*.

Beta Patch: A region of air fluorescence formed by absorption of beta particles from the fission products in the debris from a nuclear explosion above about 40 miles altitude.

Biological Half-Life: The time required for the amount of a specified element which has entered the body (or a particular organ) to be decreased to half of its initial value as a result of natural, biological elimination processes. See *Half-life*.

Black Body: An ideal body which would absorb all (and reflect none) of the radiation falling upon it. The spectral energy distribution of a black body is described by Planck's equation; the total rate of emission of radiant energy is proportional to the fourth power of the absolute temperature (Stefan-Boltzmann law).

Blast Loading: The loading (or force) on an object caused by the air blast from an explosion striking and flowing around the object. It is a combination of overpressure (or diffraction) and dynamic pressure (or drag) loading. See *Diffraction, Drag loading, Dynamic pressure, Overpressure*.

Blast Scaling Laws: Formulas which permit the calculation of the properties, e.g., overpressure, dynamic pressure, time of arrival, duration, etc., of a blast wave at any distance from an explosion of specified energy from the known variation with distance of these properties for a reference explosion of known energy (e.g., of 1 kiloton). See *Cube root law*.

Blast Wave: A pulse of air in which the pressure increases sharply at the front, accompanied by winds, propagated from an explosion. See *Shock wave*.

Blast Yield: That portion of the total energy of a nuclear explosion that manifests itself as a blast (or shock) wave.

Bomb Debris: See *Weapon debris*.

Boosted Fission Weapon: A weapon in which neutrons produced by thermonuclear reactions serve to enhance the fission process. The thermonuclear energy represents only a small fraction of the total explosion energy. See *Fission, Thermonuclear*.

Breakway: The onset of a condition in which the shock front (in the air), moves away from the exterior of the expanding fireball produced by the explosion of a nuclear (or atomic) weapon. See *Fireball, Shock front*.

Bremsstrahlung: Literally "braking radiation." Radiations covering a range of wave lengths (and energies) in the X-ray region resulting from the electrical interaction of fast (high-energy) electrons with atomic nuclei. Bremsstrahlung are produced by the interaction of beta particles with matter. See *X rays*.

Burst: Explosion or detonation. See *Air burst, High-altitude burst, Surface burst, Underground burst, Underwater burst*.

Clean Weapon: One in which measures have been taken to reduce the amount of residual radioactivity relative to a "normal" weapon of the same energy yield.

Cloud Chamber Effect: See *Condensation cloud*.

Cloud Column: The visible column of weapon debris (and possibly dust and water droplets) extending upward from the point of burst of a nuclear (or atomic) weapon. See *Radioactive cloud*.

Cloud Phenomena: See *Base surge, Cloud column, Fallout, Fireball, Radioactive cloud*.

Column (or Plume): A hollow cylinder of water and spray thrown up from an underwater burst of a nuclear (or atomic) weapon, through which the hot, high-pressure gases formed in the explosion

are vented to the atmosphere. A somewhat similar column of dirt is formed in an underground explosion.

Compton Current: Electron current generated as a result of Compton processes. See *Compton effect*, *Compton electron*.

Compton Effect: The scattering of photons (of gamma or X rays) by the orbital electrons of atoms. In a collision between a (primary) photon and an electron, some of the energy of the photon is transferred to the electron which is generally ejected from the atom. Another (secondary) photon, with less energy, then moves off in a new direction at an angle to the direction of motion of the primary photon. See *Scattering*.

Compton Electron: An electron of increased energy ejected from an atom as a result of a Compton interaction with a photon. See *Compton effect*.

Condensation Cloud: A mist or fog of minute water droplets which temporarily surrounds the fireball following a nuclear (or atomic) detonation in a comparatively humid atmosphere. The expansion of the air in the negative phase of the blast wave from the explosion results in a lowering of the temperature, so that condensation of water vapor present in the air occurs and a cloud forms. The cloud is soon dispelled when the pressure returns to normal and the air warms up again. The phenomenon is similar to that used by physicists in the Wilson cloud chamber and is sometimes called the cloud chamber effect.

Contact Surface Burst: See *Surface burst*.

Contained Underground Burst: An underground detonation at such a depth that none of the radioactive residues escape through the surface of the ground.

Contamination: The deposit of radioactive material on the surfaces of structures, areas, objects, or personnel, following a nuclear (or atomic) explosion. This material generally consists of fallout in which fission products and other weapon debris have become incorporated with particles of dirt, etc. Contamination can also arise from the radioactivity induced in certain substances by the action of neutrons from a nuclear explosion. See *Decontamination*, *Fallout*, *Induced radioactivity*, *Weapon debris*.

Crack: The light-colored region which follows closely behind the dark slick in an underwater burst. It is probably caused by the reflection of the water shock wave at the surface. See *Slick*.

Crater: The pit, depression, or cavity formed in the surface of the earth by a surface or underground explosion. Crater formation can occur by

vaporization of the surface material, by the scouring effect of air blast, by throwout of disturbed material, or by subsidence. In general, the major mechanism changes from one to the next with increasing depth of burst. The apparent crater is the depression which is seen after the burst; it is smaller than the true crater (i.e., the cavity actually formed by the explosion), because it is covered with a layer of loose earth, rock, etc.

Critical Mass: The minimum mass of a fissionable material that will just maintain a fission chain reaction under precisely specified conditions, such as the nature of the material and its purity, the nature and thickness of the tamper (or neutron reflector), the density (or compression), and the physical shape (or geometry). For an explosion to occur, the system must be supercritical (i.e., the mass of material must exceed the critical mass under the existing conditions). See *Supercritical*.

Cube Root Law: A scaling law applicable to many blast phenomena. It relates the time and distance at which a given blast effect is observed to the cube root of the energy yield of the explosion.

Curie: A unit of radioactivity; it is the activity of a quantity of any radioactive species in which 3.700×10^{10} nuclear disintegrations occur per second. The *gamma curie* is sometimes defined correspondingly as the activity of material in which this number of gamma-ray photons are emitted per second.

Damage Criteria: Standards or measures used in estimating specific levels of damage.

Debris: See *Weapon debris*.

Decay (or Radioactive Decay): The decrease in activity of any radioactive material with the passage of time due to the spontaneous emission from the atomic nuclei of either alpha or beta particles, sometimes accompanied by gamma radiation. See *Half-life*, *Radioactivity*.

Decay Curve: The representation by means of a graph of the decrease of radioactivity with respect to time.

Decontamination: The reduction or removal of contaminating radioactive material from a structure, area, object, or person. Decontamination may be accomplished by (1) treating the surface so as to remove or decrease the contamination; (2) letting the material stand so that the radioactivity is decreased as a result of natural decay; and (3) covering the contamination so as to attenuate the radiation emitted. Radioactive material removed in process (1) must be disposed of

by burial on land or at sea, or in other suitable way.

Delayed Fallout: See *Fallout*.

Deuterium: An isotope of hydrogen of mass 2 units; it is sometimes referred to as heavy hydrogen. It can be used in thermonuclear fusion reactions for the release of energy. Deuterium is extracted from water which always contains 1 atom of deuterium to about 6,500 atoms of ordinary (light) hydrogen. See *Fusion, Isotope, Thermonuclear*.

Diffraction: The bending of waves around the edges of objects. In connection with a blast wave impinging on a structure, diffraction refers to the passage around and envelopment of the structure by the blast wave. *Diffraction loading* is the force (or loading) on the structure during the envelopment process.

Dome: The mound of water spray thrown up into the air when the shock wave from an underwater detonation of a nuclear (or atomic) weapon reaches the surface.

Dosage: See *Dose*.

Dose: A (total or accumulated) quantity of ionizing (or nuclear) radiation. The *absorbed dose* in rads represents the amount of energy absorbed from the radiation per gram of specified absorbing material. In soft body tissue the absorbed dose in rads is essentially equal to the exposure in roentgens. The biological dose (also called the *RBE dose*) in rems is a measure of biological effectiveness of the absorbed radiation. See *Exposure, Rad, RBE, Rem, Roentgen*.

Dose Equivalent: In radiation protection associated with peacetime nuclear activities, the dose equivalent in rems is a measure of the biological effectiveness of absorbed ionizing radiation. It is similar to the biological dose which is used in connection with the large radiation exposures that might accompany a nuclear explosion. See *Dose, Rem*.

Dose Rate: As a general rule, the amount of ionizing (or nuclear) radiation which an individual or material would receive per unit of time. It is usually expressed as rads (or rems) per hour or in multiples or submultiples of these units, such as millirads per hour. The dose rate is commonly used to indicate the level of radioactivity in a contaminated area. See *Survey meter*.

Dosimeter: An instrument for measuring and registering the total accumulated dose of (or exposure to) ionizing radiations. Instruments worn or carried by individuals are called *personal dosimeters*.

Dosimetry: The theory and application of the principles and techniques involved in the measurement and recording of radiation doses and dose rates. Its practical aspect is concerned with the use of various types of radiation instruments with which measurements are made. See *Dosimeter, Survey meter*.

Drag Loading: The force on an object or structure due to the transient winds accompanying the passage of a blast wave. The *drag pressure* is the product of the dynamic pressure and the drag coefficient which is dependent upon the shape (or geometry) of the structure or object. See *Dynamic pressure*.

Dynamic Pressure: The air pressure which results from the mass air flow (or wind) behind the shock front of a blast wave. It is equal to the product of half the density of the air through which the blast wave passes and the square of the particle (or wind) velocity behind the shock front as it impinges on the object or structure.

Early Fallout: See *Fallout*.

Effective Half-Life: See *Half-life*.

Elastic Range: The stress range in which a material will recover its original form when the force (or loading) is removed. *Elastic deformation* refers to dimensional changes occurring within the elastic range. See *Plastic range*.

Elastic Zone: The zone beyond the plastic zone in crater formation in which the ground is disturbed by the explosion but returns to its original condition.

Electromagnetic Pulse: A sharp pulse of radio-frequency (long wavelength) electromagnetic radiation produced when an explosion occurs in an unsymmetrical environment, especially at or near the earth's surface or at high altitudes. The intense electric and magnetic fields can damage unprotected electrical and electronic equipment over a large area. See *Electromagnetic radiation, High-altitude burst*.

Electromagnetic Radiation: A traveling wave motion resulting from oscillating magnetic and electric fields. Familiar electromagnetic radiations range from X rays (and gamma rays) of short wavelength (high frequency), through the ultraviolet, visible, and infrared regions, to radar and radio waves of relatively long wavelength (low frequency). All electromagnetic radiations travel in a vacuum with the velocity of light. See *Photon*.

Electron: A particle of very small mass, carrying a unit negative or positive charge. Negative electrons, surrounding the nucleus, (i.e., orbital

electrons), are present in all atoms; their number is equal to the number of positive charges (or protons) in the particular nucleus. The term electron, when used alone, commonly refers to negative electrons. A positive electron is usually called a positron, and a negative electron is sometimes called a negatron. See *Beta particle*.

Electron Volt (EV): The energy imparted to an electron when it is moved through a potential difference of 1 volt. It is equivalent to 1.6×10^{-12} erg.

Element: One of the distinct, basic varieties of matter occurring in nature which, individually or in combination, compose substances of all kinds. Approximately ninety different elements are known to exist in nature and several others, including plutonium, have been obtained as a result of nuclear reactions with these elements.

EMP: See *Electromagnetic Pulse*.

Energy Absorption: See *Absorption*.

Energy Partition: The distribution of the total energy released by a nuclear explosion among the various phenomena (e.g., nuclear radiation, thermal radiation, and blast). The exact distribution is a function of time, explosion yield, and the medium in which the explosion occurs.

Exposure: A measure expressed in roentgens of the ionization produced by gamma (or X) rays in air. The *exposure rate* is the exposure per unit time (e.g., roentgens per hour). See *Dose*, *Dose rate*, *Roentgen*.

Fallout: The process or phenomenon of the descent to the earth's surface of particles contaminated with radioactive material from the radioactive cloud. The term is also applied in a collective sense to the contaminated particulate matter itself. The *early (or local) fallout* is defined, somewhat arbitrarily, as those particles which reach the earth within 24 hours after a nuclear explosion. The *delayed (or worldwide) fallout* consists of the smaller particles which ascend into the upper troposphere and into the stratosphere and are carried by winds to all parts of the earth. The delayed fallout is brought to earth, mainly by rain and snow, over extended periods ranging from months to years.

Fireball: The luminous sphere of hot gases which forms a few millionths of a second after a nuclear (or atomic) explosion as the result of the absorption by the surrounding medium of the thermal X rays emitted by the extremely hot (several tens of million degrees) weapon residues. The exterior of the fireball in air is initially sharply defined by the luminous shock front and later by the limits of the hot gases themselves

(radiation front). See *Breakaway*, *Thermal X-rays*.

Fire Storm: Stationary mass fire, generally in built-up urban areas, causing strong, inrushing winds from all sides; the winds keep the fires from spreading while adding fresh oxygen to increase their intensity.

Fission: The process whereby the nucleus of a particular heavy element splits into (generally) two nuclei of lighter elements, with the release of substantial amounts of energy. The most important *fissionable materials* are uranium-235 and plutonium 239; fission is caused by the absorption of neutrons.

Fission Fraction: The fraction (or percentage) of the total yield of a nuclear weapon which is due to fission. For thermonuclear weapons the average value of the fission fraction is about 50 percent.

Fission Products: A general term for the complex mixture of substances produced as a result of nuclear fission. A distinction should be made between these and the *direct fission products* or *fission fragments* which are formed by the actual splitting of the heavy-element nuclei. Something like 80 different fission fragments result from roughly 40 different modes of fission of a given nuclear species (e.g., uranium-235 or plutonium-239). The fission fragments, being radioactive, immediately begin to decay, forming additional (daughter) products, with the result that the complex mixture of fission products so formed contains over 300 different isotopes of 36 elements.

Flash Burn: A burn caused by excessive exposure (of bare skin) to thermal radiation. See *Thermal radiation*.

Fluence (or Integrated Flux): The product (or integral) of particle (neutron or photon) flux and time, expressed in units of particles per square centimeter. The absorbed dose of radiation (in rads) is related to the fluence. See *Flux*.

Flux (or Flux Density): The product of the particle (neutron or photon) density (i.e., number per cubic centimeter) and the particle velocity. The flux is expressed as particles per square centimeter per second and is related to the absorbed dose rate. It is numerically equal to the total number of particles passing in all directions through a sphere of 1 square centimeter cross-sectional area per second.

Fractionation: Any one of several processes, apart from radioactive decay, which results in change in the composition of the radioactive weapon debris. As a result of fractionation, the

delayed fallout generally contains relatively more of strontium-90 and cesium-137, which have gaseous precursors, than does the early fallout from a surface burst.

Free Air Overpressure (or Free Field Overpressure): The unreflected pressure, in excess of the ambient atmospheric pressure, created in the air by the blast wave from an explosion. See *Overpressure*.

Fusion: The process whereby the nuclei of light elements, especially those of the isotopes of hydrogen, namely, deuterium and tritium, combine to form the nucleus of a heavier element with the release of substantial amounts of energy. See *Thermonuclear*.

Gamma Rays (or Radiations): Electromagnetic radiations of high photon energy originating in atomic nuclei and accompanying many nuclear reactions (e.g., fission, radioactivity, and neutron capture). Physically, gamma rays are identical with X rays of high energy, the only essential difference being that X rays do not originate from atomic nuclei, but are produced in other ways (e.g., by slowing down (fast) electrons of high energy). See *Electromagnetic radiation, Photon, X rays*.

Genetic Effect: The effect of various agents (including nuclear radiation) in producing changes (mutations) in the hereditary components (genes) of the germ cells present in the reproductive organs (gonads). A mutant gene causes changes in the next generation which may or may not be apparent.

Ground Zero: The point on the surface of land vertically below or above the center of a burst of a nuclear (or atomic) weapon; frequently abbreviated to GZ. For a burst over or under water the corresponding term is *surface zero (SZ)*. Surface zero is also commonly used for ground surface and underground bursts.

Gun-Type Weapon: A device in which two or more pieces of fissionable material, each less than a critical mass, are brought together very rapidly so as to form a supercritical mass which can explode as the result of a rapidly expanding fission chain. See *Critical mass, Supercritical*.

Half-Life: The time required for the activity of a given radioactive species to decrease to half of its initial value due to radioactive decay. The half-life is a characteristic property of each radioactive species and is independent of its amount or condition. The *effective half-life* of a given isotope is the time in which the quantity in the body (or an organ) will decrease to half as a result of both radioactive decay and biological elimination. See *Biological half-life*.

Half-Residence Time: As applied to delayed fallout, it is the time required for the amount of weapon debris deposited in a particular part of the atmosphere (e.g., stratosphere or troposphere) to decrease to half of its initial value.

Half-Value Thickness: The thickness of a given material which will absorb half the gamma radiation incident upon it. This thickness depends on the nature of the material—it is roughly inversely proportional to its density—and also on the energy of the gamma rays.

H-Bomb: An abbreviation for hydrogen bomb. See *Hydrogen bomb*.

Height of Burst: The height above the earth's surface at which a bomb is detonated in the air. The *optimum height* of burst for a particular target (or area) is that at which it is estimated a weapon of a specified energy yield will produce a certain desired effect over the maximum possible area.

High-Altitude Burst: This is defined, somewhat arbitrarily, as a detonation at an altitude over 100,000 feet. Above this level the distribution of the energy of the explosion between blast and thermal radiation changes appreciably with increasing altitude due to changes in the fireball phenomena.

Hot Spot: Region in a contaminated area in which the level of radioactive contamination is somewhat greater than in neighboring regions in the area. See *Contamination*.

Hydrogen Bomb (or Weapon): A term sometimes applied to nuclear weapons in which part of the explosive energy is obtained from nuclear fusion (or thermonuclear) reactions. See *Fusion, Nuclear weapon, Thermonuclear*.

Hypocenter: A term sometimes used for ground zero. See *Ground zero*.

Implosion Weapon: A device in which a quantity of fissionable material, less than a critical mass, has its volume suddenly decreased by compression, so that it becomes supercritical and an explosion can take place. The compression is achieved by means of a spherical arrangement of specially fabricated shapes of ordinary high explosive which produce an inwardly-directed implosion wave, the fissionable material being at the center of the sphere. See *Critical mass, Supercritical*.

Impulse (Per Unit Area): The product of the overpressure (or dynamic pressure) from the blast wave of an explosion and the time during which it acts at a given point. More specifically, it is the integral, with respect to time of overpressure (or dynamic pressure), the integration

being between the time of arrival of the blast wave and that at which the overpressure (or dynamic pressure) returns to zero at the given point.

Induced Radioactivity: Radioactivity produced in certain materials as a result of nuclear reactions, particularly the capture of neutrons, which are accompanied by the formation of unstable (radioactive) nuclei. In a nuclear explosion, neutrons can induce radioactivity in the weapon materials, as well as in the surroundings (e.g., by interaction with nitrogen in the air and with sodium, manganese, aluminum, and silicon in soil and sea water).

Infrared: Electromagnetic radiations of wavelength between the longest visible red (7,000 Angstroms or 7×10^{-4} millimeter) and about 1 millimeter. See *Electromagnetic radiation*.

Initial Nuclear Radiation: Nuclear radiation (essentially neutrons and gamma rays) emitted from the fireball and the cloud column during the first minute after a nuclear (or atomic) explosion. The time limit of one minute is set, somewhat arbitrarily, as that required for the source of part of the radiations (fission products, etc., in the radioactive cloud) to attain such a height that only insignificant amounts of radiation reach the earth's surface. See *Residual nuclear radiation*.

Integrated Neutron Flux: See *Fluence*.

Intensity: The amount or energy of any radiation incident upon (or flowing through) unit area, perpendicular to the radiation beam, in unit time. The intensity of thermal radiation is generally expressed in calories per square centimeter per second falling on a given surface at any specified instant. As applied to nuclear radiation, the term intensity is sometimes used, rather loosely, to express the exposure (or dose) rate at a given location.

Internal Radiation: Nuclear radiation (alpha and beta particles and gamma radiation) resulting from radioactive substances in the body. Important sources are iodine-131 in the thyroid gland, and strontium-90 and plutonium-239 in bone.

Inverse Square Law: The law which states that when radiation (thermal or nuclear) from a point source is emitted uniformly in all directions, the amount received per unit area at any given distance from the source, assuming no absorption, is inversely proportional to the square of that distance.

Ionization: The separation of a normally electrically neutral atom or molecule into electrically charged components. The term is also employed to describe the degree or extent to which this

separation occurs. In the sense used in this book, ionization refers especially to the removal of an electron (negative charge) from the atom or molecule, either directly or indirectly, leaving a positively charged ion. The separated electron and ion are referred to as an *ion pair*. See *Ionizing radiation*.

Ionizing Radiation: Electromagnetic radiation (gamma rays or X rays) or particulate radiation (alpha particles, beta particles, neutrons, etc.) capable of producing ions, i.e., electrically charged particles, directly or indirectly, in its passage through matter. See *Nuclear radiation*.

Ionosphere: The region of the atmosphere, extending from roughly 40 to 250 miles altitude, in which there is appreciable ionization. The presence of charged particles in this region profoundly affects the propagation of long-wavelength electromagnetic radiations (radio and radar waves).

Ion Pair: See *Ionization*.

Isomer (or Isomeric Nuclide): See *Nuclide*.

Isotopes: Forms of the same element having identical chemical properties but differing in their atomic masses (due to different numbers of neutrons in their respective nuclei) and in their nuclear properties (e.g., radioactivity, fission, etc.). For example, hydrogen has three isotopes, with masses of 1 (hydrogen), 2 (deuterium), and 3 (tritium) units, respectively. The first two of these are stable (nonradioactive), but the third (tritium) is a radioactive isotope. Both of the common isotopes of uranium, with masses of 235 and 238 units, respectively, are radioactive, emitting alpha particles, but their half-lives are different. Furthermore, uranium-235 is fissionable by neutrons of all energies, but uranium-238 will undergo fission only with neutrons of high energy. See *Nucleus*.

Kilo-Electron Volt (or KEV): An amount of energy equal to 1,000 electron volts. See *Electron Volt*.

Kiloton Energy: Defined strictly as 10^{12} calories (or 4.2×10^{19} ergs). This is approximately the amount of energy that would be released by the explosion of 1 kiloton (1,000 tons) of TNT. See *TNT equivalent*.

Linear Attenuation Coefficient: See *Attenuation*.

Linear Energy Absorption Coefficient: See *Absorption*.

Lip Height: The height above the original surface to which earth is piled around the crater formed by an explosion. See *Crater*.

Loading: The force on an object or structure or element of a structure. The loading due to blast is equal to the net pressure in excess of the ambient value multiplied by the area of the loaded object, etc. See *Diffraction*, *Drag loading*.

Mach Front: See *Mach stem*.

Mach Region: The region on the surface at which the Mach stem has formed as the result of a particular explosion in the air.

Mach Stem: The shock front formed by the merging of the incident and reflected shock fronts from an explosion. The term is generally used with reference to a blast wave, propagated in the air, reflected at the surface of the earth. The Mach stem is nearly perpendicular to the reflecting surface and presents a slightly convex (forward) front. The Mach stem is also called the Mach front. See *Shock front*, *Shock wave*.

Mass Attenuation Coefficient: See *Attenuation*.

Mass Energy Absorption Coefficient: See *Absorption*.

Mass Number: See *Nucleus*.

Mean Free Path: The average path distance a particle (neutron or photon) travels before undergoing a specified reaction (with a nucleus or electron) in matter.

Megacurie: One million curies. See *Curie*.

Megaton Energy: Defined strictly as 10^{15} calories (or 4.2×10^{22} ergs). This is approximately the amount of energy that would be released by the explosion of 1,000 kilotons (1,000,000 tons) of TNT. See *TNT equivalent*.

MEV (or Million Electron Volt): A unit of energy commonly used in nuclear physics. It is equivalent to 1.6×10^{-6} erg. Approximately 200 MeV of energy are produced for every nucleus that undergoes fission. See *Electron volt*.

Microcurie: A one-millionth part of a curie. See *Curie*.

Micrometer: See *Micron*.

Micron: A one-millionth part of a meter (i.e., 10^{-6} meter or 10^{-4} centimeter); it is roughly four one-hundred-thousandths (4×10^{-5}) of an inch.

Microsecond: A one-millionth part of a second.

Million Electron Volt: See *MeV*.

Millirad: A one-thousandth part of a rad. See *Rad*.

Millirem: A one-thousandth part of a rem. See *Rem*.

Milliroentgen: A one-thousandth part of a roentgen. See *Roentgen*.

Millisecond: A one-thousandth part of a second.

Mirror Point: A point at which a charged particle, moving (in a spiral path) along the lines of a magnetic field, is reflected back as it enters a stronger magnetic field region. The actual location of the mirror point depends on the direction and energy of motion of the charged particle and the ratio of the magnetic field strengths. As a result, only those particles satisfying the requirements of the existing situation are reflected.

Monitoring: The procedure or operation of locating and measuring radioactive contamination by means of survey instruments which can detect and measure (as dose rates) ionizing radiations. The individual performing the operation is called a *monitor*.

Negative Phase: See *Shock wave*.

Neutron: A neutral particle (i.e., with no electrical charge) of approximately unit mass, present in all atomic nuclei, except those of ordinary (light) hydrogen. Neutrons are required to initiate the fission process, and large numbers of neutrons are produced by both fission and fusion reactions in nuclear (or atomic) explosions.

Neutron Flux: See *Flux*.

Nominal Atomic Bomb: A term, now becoming obsolete, used to describe an atomic weapon with an energy release equivalent to 20 kilotons (i.e., 20,000 tons) of TNT. This is very approximately the energy yield of the bombs exploded over Japan and in the Bikini test of 1946.

Nuclear Cloud: See *Radioactive cloud*.

Nuclear Radiation: Particulate and electromagnetic radiation emitted from atomic nuclei in various nuclear processes. The important nuclear radiations, from the weapons standpoint, are alpha and beta particles, gamma rays, and neutrons. All nuclear radiations are ionizing radiations, but the reverse is not true; X rays, for example, are included among ionizing radiations, but they are not nuclear radiations since they do not originate from atomic nuclei. See *Ionizing radiation*, *X-rays*.

Nuclear (or Atomic) Tests: Test carried out to supply information required for the design and improvement of nuclear (or atomic) weapons and to study the phenomena and effects associated with nuclear (or atomic) explosions. Many of the data presented in this book are based on measurements and observations made at such tests.

Nuclear Weapon (or Bomb): A general name

given to any weapon in which the explosion results from the energy released by reactions involving atomic nuclei, either fission or fusion or both. Thus, the A- (or atomic) bomb and the H- (or hydrogen) bomb are both nuclear weapons. It would be equally true to call them atomic weapons, since it is the energy of atomic nuclei that is involved in each case. However, it has become more-or-less customary, although it is not strictly accurate, to refer to weapons in which all the energy results from fission as A-bombs or atomic bombs. In order to make a distinction, those weapons in which part, at least, of the energy results from thermonuclear (fusion) reactions of the isotopes of hydrogen have been called H-bombs or hydrogen bombs.

Nucleus (or Atomic Nucleus): The small, central, positively charged region of an atom which carries essentially all the mass. Except for the nucleus of ordinary (light) hydrogen, which is a single proton, all atomic nuclei contain both protons and neutrons. The number of protons determines the total positive charge, or *atomic number*; this is the same for all the atomic nuclei of a given chemical element. The total number of neutrons and protons, called the *mass number*, is closely related to the mass (or weight) of the atom. The nuclei of *isotopes* of a given element contain the same number of protons, but different numbers of neutrons. They thus have the same atomic number, and so are the same element, but they have different mass numbers (and masses). The nuclear properties (e.g., radioactivity, fission, neutron capture, etc.) of an isotope of a given element are determined by both the number of neutrons and the number of protons. See *Atom, Element, Isotope, Neutron, Proton*.

Nuclide: An atomic species distinguished by the composition of its nucleus (i.e., by the number of protons and the number of neutrons). In *isomeric nuclides* the nuclei have the same composition but are in different energy states. See *Atom, Neutron, Nucleus, Proton*.

Overpressure: The transient pressure, usually expressed in pounds per square inch, exceeding the ambient pressure, manifested in the shock (or blast) wave from an explosion. The variation of the overpressure with time depends on the energy yield of the explosion, the distance from the point of burst, and the medium in which the weapon is detonated. The peak overpressure is the maximum value of the overpressure at a given location and is generally experienced at the instant the shock (or blast) wave reaches that location. See *Shock wave*.

Pair Production: The process whereby a gamma-ray (or X-ray) photon, with energy in

excess of 1.02 MeV in passing near the nucleus of an atom is converted into a positive electron and a negative electron. As a result, the photon ceases to exist. See *Photon*.

Photoelectric Effect: The process whereby a gamma-ray (or X-ray) photon, with energy somewhat greater than that of the binding energy of an electron in an atom, transfers all its energy to the electron which is consequently removed from the atom. Since it has lost all its energy, the photon ceases to exist. See *Photon*.

Photon: A unit or "particle" of electromagnetic radiation, carrying a quantum of energy which is characteristic of the particular radiation. If ν is the frequency of the radiation in cycles per second and λ is the wavelength in centimeters, the energy quantum of the photon in ergs is $h\nu$ or hc/λ , where h is Planck's constant, 6.62×10^{-27} erg-second and c is the velocity of light (3.00×10^{10} centimeters per second). For gamma rays, the photon energy is usually expressed in million electron volt (MeV) units (i.e., $1.24 \times 10^{-10}/\lambda$ where λ is in centimeters or $1.24 \times 10^{-2}/\lambda$ if λ is in angstroms).

Plastic Range: The stress range in which a material will not fail when subjected to the action of a force, but will not recover completely, so that a permanent deformation results when the force is removed. *Plastic deformation* refers to dimensional changes occurring within the plastic range. See *Elastic range*.

Plastic Zone: The region beyond the rupture zone associated with crater formation in which there is no visible rupture but in which the ground is permanently deformed and compressed to a higher density. See *Crater, Elastic Zone, Rupture zone*.

Plume: See *Column*.

Positive Phase: See *Shock wave*.

Precursor: An air pressure wave which moves ahead of the main blast wave for some distance as a result of a nuclear (or atomic) explosion of appropriate yield and low burst height over a heat-absorbing (or dusty) surface. The pressure at the precursor front increases more gradually than in a true (or ideal) shock wave, so that the behavior in the precursor region is said to be nonideal. See *Blast wave, Shock front, Shock wave*.

Proton: A particle of mass (approximately) unity carrying a unit positive charge; it is identical physically with the nucleus of the ordinary (light) hydrogen atom. All atomic nuclei contain protons. See *Nucleus*.

Quantum: See *Photon*.

Rad: A unit of absorbed dose of radiation; it represents the absorption of 100 ergs of nuclear (or ionizing) radiation per gram of absorbing material, such as body tissue.

Radiant Exposure: The total amount of thermal radiation energy received per unit area of exposed surface; it is usually expressed in calories per square centimeter.

Radiation: See *Ionizing Radiation, Nuclear radiation, Thermal radiation.*

Radiation Injury (or Syndrome): See *Syndrome (Radiation).*

Radioactive (or Nuclear) Cloud: An All-inclusive term for the cloud of hot gases, smoke, dust, and other particulate matter from the weapon itself and from the environment, which is carried aloft in conjunction with the rising fireball produced by the detonation of a nuclear (or atomic) weapon.

Radioactivity: The spontaneous emission of radiation, generally alpha or beta particles, often accompanied by gamma rays, from the nuclei of an (unstable) isotope. As a result of this emission the radioactive isotope is converted (or decays) into the isotope of a different (daughter) element which may (or may not) also be radioactive. Ultimately, as a result of one or more stages of radioactive decay, a stable (nonradioactive) end product is formed. See *Isotope.*

Radio Blackout: The complete disruption of radio (or radar) signals over large areas caused by the ionization accompanying a high-altitude nuclear explosion, especially above about 40 miles.

Radioisotope: A radioactive isotope. See *Isotope, Radioactivity.*

Radionuclide: A radioactive nuclide (or radioactive atomic species). See *Nuclide.*

Rainout: The removal of radioactive particles from a nuclear cloud by precipitation when this cloud is within a rain cloud. See *Washout.*

RBE (or Relative Biological Effectiveness): The ratio of the number of rads of gamma (or X) radiation of a certain energy which will produce a specified biological effect to the number of rads of another radiation required to produce the same effect is the RBE of the latter radiation.

Reflected Pressure: The total pressure which results instantaneously at the surface when a shock (or blast) wave traveling in one medium strikes another medium (e.g., at the instant when the front of a blast wave in air strikes the ground or a structure). If the medium struck (e.g., the ground or a structure) is more dense than that in

which the shock wave is traveling (e.g., air), the reflected pressure is positive (compression). If the reverse is true (e.g., when a shock wave in the ground or water strikes the air surface) the reflected pressure is negative (rarefaction or tension).

Reflection Factor: The ratio of the total (reflected) pressure to the incident pressure when a shock (or blast) wave traveling in one medium strikes another.

Rem: A unit of biological dose of radiation; the name is derived from the initial letters of the term "roentgen equivalent man (or mammal)." The number of rems of radiation is equal to the number of rads absorbed multiplied by the RBE of the given radiation (for a specified effect). The rem is also the unit of dose equivalent, which is equal to the product of the number of rads absorbed and the "quality factor" of the radiation. See *Dose, Dose equivalent, Rad, RBE.*

Residual Nuclear Radiation: Nuclear radiation, chiefly beta particles and gamma rays, which persists for some time following a nuclear (or atomic) explosion. The radiation is emitted mainly by the fission products and other bomb residues in the fallout, and to some extent by earth and water constituents, and other materials, in which radioactivity has been induced by the capture of neutrons. See *Fallout, Induced radioactivity, Initial nuclear radiation.*

Roentgen: A unit of exposure to gamma (or X) radiation. It is defined precisely as the quantity of gamma (or X) rays that will produce electrons (in ion pairs) with a total charge of 2.58×10^{-4} coulomb in 1 kilogram of dry air. An exposure of 1 roentgen results in the deposition of about 94 ergs of energy in 1 gram of soft body tissue. Hence, an exposure of 1 roentgen is approximately equivalent to an absorbed dose of 1 rad in soft tissue. See *Dose, Rad.*

Rupture Zone: The region immediately adjacent to the crater boundary in which the stresses produced by the explosion have exceeded the ultimate strength of the ground medium. It is characterized by the appearance of numerous radial (and other) cracks of various sizes. See *Crater, Plastic zone.*

Scaling Law: A mathematical relationship which permits the effects of a nuclear (or atomic) explosion of given energy yield to be determined as a function of distance from the explosion (or from ground zero), provided the corresponding effect is known as a function of distance for a reference explosion (e.g., of 1-kilton energy yield). See *Blast scaling law, Cube root law.*

Scattering: The diversion of radiation, includ-

ing radio, radar, thermal, and nuclear, from its original path as a result of interactions (or collisions) with atoms, molecules, or larger particles in the atmosphere or other medium between the source of the radiations (e.g., a nuclear explosion) and a point at some distance away. As a result of scattering, radiations (especially gamma rays and neutrons) will be received at such a point from many directions instead of only from the direction of the source.

Scavenging: The selective removal of material from the radioactive cloud from a nuclear explosion by inert substances, such as earth or water, introduced into the fireball. The term is also applied to the process of removal of fallout particles from the atmosphere by precipitation. See *Rainout*, *Snowout*, *Washout*.

Shear (Wind): Unless the term "velocity shear" is used, wind shear refers to differences in direction (directional shear) of the wind at different altitudes.

Shear Wall: A wall (or partition) designed to take a load in the direction of the plane of the wall, as distinct from lateral loads perpendicular to the wall. Shear walls may be designed to take lateral loads as well. See *Bearing wall*.

Shielding: Any material or obstruction which absorbs (or attenuates) radiation and thus tends to protect personnel or materials from the effects of a nuclear (or atomic) explosion. A moderately thick layer of any opaque material will provide satisfactory shielding from thermal radiation, but a considerable thickness of material of high density may be needed for nuclear radiation shielding. Electrically continuous housing for a facility, area, or component, attenuates impinging electric and magnetic fields.

Shock Front (or Pressure Front): The fairly sharp boundary between the pressure disturbance created by an explosion (in air, water, or earth) and the ambient atmosphere, water, or earth, respectively. It constitutes the front of the shock (or blast) wave. See *Shock wave*.

Shock Wave: A continuously propagated pressure pulse (or wave) in the surrounding medium which may be air, water, or earth, initiated by the expansion of the hot gases produced in an explosion. A shock wave in air is generally referred to as a *blast wave*, because it resembles and is accompanied by strong, but transient, winds. The duration of a shock (or blast) wave is distinguished by two phases. First there is the *positive (compression) phase* during which the pressure rises very sharply to a value that is higher than ambient and then decreases rapidly to the ambient pressure. The positive phase for the dy-

namic pressure is somewhat longer than for overpressure, due to the momentum of the moving air behind the shock front. The duration of the positive phase increases and the maximum (peak) pressure decreases with increasing distance from an explosion of given energy yield. In the second phase, the *negative (suction, rarefaction, or tension) phase*, the pressure falls below ambient and then returns to the ambient value. The duration of the negative phase may be several times the duration of the positive phase. Deviations from the ambient pressure during the negative phase are never large and they decrease with increasing distance from the explosion. See *Dynamic pressure*, *Overpressure*.

Skyshine: Radiation, particularly gamma rays from a nuclear explosion, reaching a target from many directions as a result of scattering by the oxygen and nitrogen in the intervening atmosphere.

Slant Range: The distance from a given location, usually on the earth's surface, to the point at which the explosion occurred.

Slick: The trace of an advancing shock wave seen on the surface of reasonably calm water as a circle of rapidly increasing size apparently darker than the surrounding water. It is observed, in particular, following an underwater explosion. See *Crack*.

Snowout: The removal of radioactive particles from a nuclear cloud by precipitation when this cloud is within a snow cloud. See *Rainout*.

Spray Dome: See *Dome*.

Stopping Altitude: The altitude in the vicinity of which a specified ionizing radiation coming from above (e.g., from a high-altitude nuclear explosion) deposits most of its energy by absorption in the atmosphere. The stopping altitude varies with the nature of the ionizing radiation.

Stratosphere: A relatively stable layer of the atmosphere between the tropopause and a height of about 30 miles in which temperature changes very little (in polar and temperate zones) or increases (in the tropics) with increasing altitude. In the stratosphere clouds of water never form and there is practically no convection. See *Tropopause*, *Troposphere*.

Subsurface Burst: See *Underground burst*, *Underwater burst*.

Supercritical: A term used to describe the state of a given fission system when the quantity of fissionable material is greater than the critical mass under the existing conditions. A highly supercritical system is essential for the produc-

tion of energy at a very rapid rate so that an explosion may occur. See *Critical mass*.

Surface Burst: The explosion of a nuclear (or atomic) weapon at the surface of the land or water at a height above the surface less than the radius of the fireball at maximum luminosity (in the second thermal pulse). An explosion in which the weapon is detonated actually on the surface (or within $5W^{0.3}$ feet, where W is the explosion yield in kilotons, above or below the surface) is called a *contact surface burst* or a *true surface burst*. See *Air burst*.

Surface Zero: See *Ground zero*.

Surge (or Surge Phenomena): See *Base surge*.

Survey Meter: A portable instrument, such as a Geiger counter or ionization chamber, used to detect nuclear radiation and to measure the dose rate. See *Monitoring*.

Syndrome, Radiation: The complex of symptoms characterizing the disease known as *radiation injury*, resulting from excessive exposure of the whole (or a large part) of the body to ionizing radiation. The earliest of these symptoms are nausea, vomiting, and diarrhea, which may be followed by loss of hair (epilation), hemorrhage, inflammation of the mouth and throat, and general loss of energy. In severe cases, where the radiation exposure has been relatively large, death may occur within 2 to 4 weeks. Those who survive 6 weeks after the receipt of a single dose of radiation may generally be expected to recover.

Tenth-Value Thickness: The thickness of a given material which will decrease the intensity (or dose) of gamma radiation to one-tenth of the amount incident upon it. Two tenth-value thicknesses will reduce the dose received by a factor of 10×10 , i.e., 100, and so on. The tenth-value thickness of a given material depends on the gamma-ray energy, but for radiation of a particular energy it is roughly inversely proportional to the density of the material.

Tests: See *Nuclear tests*.

Thermal Energy: The energy emitted from the fireball (or other heated region) as thermal radiation. The total amount of thermal energy received per unit area at a specified distance from a nuclear (or atomic) explosion is generally expressed in terms of calories per square centimeter. See *Radiant exposure*, *Thermal radiation*, *Transmittance*, *X-ray pancake*.

Thermal Energy Yield (or Thermal Yield): The part of the total energy yield of the nuclear (or atomic) explosion which is received as thermal energy usually within a minute or less.

In an air burst, the *thermal partition* (i.e., the fraction of the total explosion energy emitted as thermal radiation) ranges from about 0.35 to 0.45. The trend is toward the smaller fraction for low yields or low burst heights and toward the higher fraction at high yields or high bursts. Above 100,000 feet burst height, the fraction increases from about 0.45 to 0.6, and then decreases to about 0.25 at burst altitudes of 160,000 to 260,000 feet. At still greater burst heights, the fraction decreases rapidly with increasing altitude.

Thermal Radiation: Electromagnetic radiation emitted (in two pulses from an air burst) from the fireball as a consequence of its very high temperature; it consists essentially of ultraviolet, visible, and infrared radiations. In the early stages (first pulse of an air burst), when the temperature of the fireball is extremely high, the ultraviolet radiation predominates; in the second pulse, the temperatures are lower and most of the thermal radiation lies in the visible and infrared regions of the spectrum. For high-altitude bursts (above 100,000 feet), the thermal radiation is emitted as a single pulse, which is of short duration below about 270,000 feet but increases at greater burst heights.

Thermal X-Rays: The electromagnetic radiation, mainly in the soft (low-energy) X-ray region, emitted by the extremely hot weapon residue in virtue of its extremely high temperature; it is also referred to as the *primary thermal radiation*. It is the absorption of this radiation by the ambient medium, accompanied by an increase in temperature, which results in the formation of the fireball (or other heated region) which then emits thermal radiation. See *Weapon residue*, *X-ray pancake*, *X-rays*.

Thermonuclear: An adjective referring to the process (or processes) in which very high temperatures are used to bring about the fusion of light nuclei, such as those of the hydrogen isotopes (deuterium and tritium), with the accompanying liberation of energy. A *thermonuclear bomb* is a weapon in which part of the explosion energy results from thermonuclear fusion reactions. The high temperatures required are obtained by means of a fission explosion. See *Fusion*.

TNT Equivalent: A measure of the energy released in the detonation of a nuclear (or atomic) weapon, or in the explosion of a given quantity of fissionable material, expressed in terms of the mass of TNT which would release the same amount of energy when exploded. The TNT equivalent is usually stated in kilotons or megatons. The basis of the TNT equivalence is that the

explosion of 1 ton of TNT is assumed to release 10^9 calories of energy. See *Kiloton*, *Megaton*, *Yield*.

Transmittance (Atmospheric): The fraction (or percentage) of the thermal energy received at a given location after passage through the atmosphere relative to that which would have been received at the same location if no atmosphere were present.

Triple Point: The intersection of the incident, reflected, and merged (or Mach) shock fronts accompanying an air burst. The height of the triple point above the surface (i.e., the height of the Mach stem) increases with increasing distance from a given explosion. See *Mach stem*.

Tritium: A radioactive isotope of hydrogen, having a mass of 3 units; it is produced in nuclear reactors by the action of neutrons on lithium nuclei.

Tropopause: The imaginary boundary layer dividing the stratosphere from the lower part of the atmosphere, the troposphere. The tropopause normally occurs at an altitude of about 25,000 to 45,000 feet in polar and temperate zones, and at 55,000 feet in the tropics. See *Stratosphere*, *Troposphere*.

Troposphere: The region of the atmosphere, immediately above the earth's surface and up to the tropopause, in which the temperature falls fairly regularly with increasing altitude, clouds form, convection is active, and mixing is continuous and more or less complete.

True Surface Burst: See *Surface Burst*.

2W Concept: The concept that the explosion of a weapon of energy yield W on the earth's surface produces (as a result of reflection) blast phenomena identical to those produced by a weapon of twice the yield (i.e., $2W$) burst in free air (i.e., away from any reflecting surface).

Ultraviolet: Electromagnetic radiation of wave length between the shortest visible violet (about 3,850 Angstroms) and soft X-rays (about 100 Angstroms).

Underground Burst: The explosion of a nuclear (or atomic) weapon with its center more than $5W^{0.3}$ feet, where W is the explosion yield in kilotons, beneath the surface of the ground. See also *Contained underground burst*.

Underwater Burst: The explosion of a nuclear (or atomic) weapon with its center beneath the surface of the water.

Visibility Range (or Visibility): The horizontal distance (in kilometers or miles) at which a large dark object can just be seen against the horizon sky in daylight. The visibility is related to the

clarity of the atmosphere ranging from 170 miles (280 kilometers) for an exceptionally clear atmosphere to 0.6 mile (1.0 kilometer) or less for dense haze or fog. The visibility on an average clear day is taken to be 12 miles (19 kilometers).

Washout: The removal of radioactive particles from a nuclear cloud by precipitation when this cloud is below a rain (or snow) cloud. See *Rainout*, *Snowout*.

Weapon, Atomic (or Nuclear): See *Nuclear weapon*.

Weapon Debris: The highly radioactive material, consisting of fission products, various products of neutron capture, and uranium and plutonium that have escaped fission, remaining after the explosion.

Weapon Residue: The extremely hot, compressed gaseous residues formed at the instant of the explosion of a nuclear weapon. The temperature is several tens of million degrees (Kelvin) and the pressure is many millions of atmospheres.

Wilson Cloud Chamber: See *Condensation cloud*.

Worldwide Fallout: See *Fallout*.

X-Ray Pancake: A layer of air, about 30,000 feet thick at a mean altitude of roughly 270,000 feet, which becomes incandescent by absorption of the thermal X rays from explosions above 270,000 feet altitude. The heated air emits thermal radiation (of longer wavelengths) in a single pulse of several seconds duration. See *Thermal radiation*, *Thermal X rays*.

X Rays: Electromagnetic radiations of high energy having wavelengths shorter than those in the ultraviolet region, i.e., less than 10^{-6} cm or 100 Angstroms. Materials at very high temperatures (millions of degrees) emit such radiations; they are then called thermal X rays. As generally produced by X-ray machines, they are bremsstrahlung resulting from the interaction of electrons of 1 kilo-electron volt or more energy with a metallic target. See *Bremsstrahlung*, *Electromagnetic radiation*, *Thermal X-rays*.

Yield (or Energy Yield): The total effective energy released in a nuclear (or atomic) explosion. It is usually expressed in terms of the equivalent tonnage of TNT required to produce the same energy release in an explosion. The total energy yield is manifested as nuclear radiation, thermal radiation, and shock (and blast) energy, the actual distribution being dependent upon the medium in which the explosion occurs (primarily) and also upon the type of weapon and the time after detonation. See *TNT equivalent*.

Mass

pound	kilogram (kg)	0.4536
ounce	kilogram (kg)	2.835×10^{-2}

Energy

calorie	joule (J)	4.187
erg	joule (J)	1.00×10^{-7}
MeV	joule (J)	1.602×10^{-13}
ton (TNT equivalent)	joule (J)	4.2×10^9

Miscellaneous

density (lb/ft ³)	kg/m ³	1.602×10
pressure (psi)	pascal (Pa)	6.895×10^3
radiant exposure (cal/cm ²)	J/m ²	4.187×10^4
speed (ft/sec)	m/s	0.3048
speed (miles/hour)	m/s	0.4470
dose (rads)	gray (Gy)	1.00×10^{-2}
dose rate (rads/hour)	Gy/s	2.778×10^{-6}
curie	becquerel (Bq)	3.700×10^{10}

The only multiples or submultiples of SI to which appropriate prefixes may be applied are those represented by factors of 10^n or 10^{-n} where n is divisible by 3. Thus, kilometer (10^3m or 1 km), millimeter (10^{-3}m or 1 mm), and micrometer (10^{-6}m or 1 μm). The centimeter and gram are not used in the SI system, but they are included in the metric system proposed for adoption in the United States.

INDEX

- Aftershocks, 2.105, 6.24–6.27
Afterwinds, 2.09, 2.18
Air blast, *see* Blast
Air burst, 1.31–1.35, 1.78, 2.03–2.17, 2.32–2.51, *see also* High-altitude burst
afterwinds, 2.09, 2.18
blast wave, 2.32–2.37, *see also* Blast
damage, *see* Damage; Structures
definition, 1.31
EMP, 11.66, 11.67
energy distribution, 1.24–1.27
fireball, 2.03–2.05, 2.110–2.129
ground shock, 3.51, 3.52
injuries, *see* Injuries
nuclear radiation, 2.41–2.45, *see also* Nuclear radiation
radioactive cloud, *see* Cloud
contamination, 9.48, 9.49
radio and radar effects, *see* Radio and radar
thermal radiation, 2.38–2.40, *see also* Thermal radiation
- Aircraft, damage, 5.94, 5.95, 5.151–5.154
Alpha particles (or radiation), 1.65, 2.41, 8.01, 8.03, 9.40–9.42, 9.114
attenuation, 2.42, 9.114
contamination, 9.42
hazard, 9.114, 12.97, 12.165, 12.173
RBE, 12.97
sources, 2.41, 8.01, 9.40–9.43
- Animals, nuclear explosion effects, 12.240–12.254
- Arch, loading, 4.62–4.66
Arching effect, soil, 6.96–6.99
Area integral, fallout, 9.160
ARGUS effect, 2.146, 2.147
Atmosphere, density vs. altitude, 3.66, 10.123, 10.124
ionization, 10.09–10.12, *see also* Ionosphere
pressure vs. altitude, 3.66
properties, 3.66
scale height, 10.123
structure, 9.126–9.129
visibility, 7.12
- Atom, 1.07
Atomic bomb (or weapon), 1.11, *see also* Nuclear weapons
cloud, *see* Cloud
explosion, *see* Nuclear explosion
number, 1.09
structure, 1.06–1.09
- Atomic Bomb Casualty Commission, 12.142
Attenuation, radiation, *see* Alpha particles; Beta particles; Gamma rays, Neutrons; Transmission factors
Aurora, artificial, 2.62, 2.142–2.145
- Ball of fire, *see* Fireball
Base surge, *see* Surface burst; Underground burst; Underwater burst
Beta burns, 12.155–12.162
Beta particles (or radiation), 1.29, 1.43, 1.61–1.66, 2.42, 8.01, 9.13
attenuation, 2.42, 9.115, 9.116
and geomagnetic field, *see* Geomagnetic field
hazard, external, 12.155–12.162
internal, 12.163–12.172
RBE, 12.97
sources, 1.61–1.63
stopping altitude, 10.29
- Beta patch, 2.141
Biological effectiveness, relative (RBE), 12.95
Biological effects of nuclear radiations, *see* Nuclear radiations
Biological half-life, 12.170
Blackout radio, *see* Radio and radar
Blast (and Blast wave), 1.01, 1.25, 2.32–2.37, 3.01–3.85, 6.02, 6.80, 6.81, *see also* Dynamic pressure; Overpressure; Shock wave
altitude effect, 3.44–3.46, 3.64–3.68
arrival time, 3.09, 3.14, 3.63, 3.77
atmospheric effects on, 3.39–3.43
bending of, 3.42, 3.43
characteristics, 3.01–3.20
damage, *see* Damage
and height of burst, 3.30–3.34
development, 3.01–3.20
diffraction, 4.03, *see also* Loading
duration, 3.14, 3.15, 3.63, 3.76
front, 1.01, 2.32, 3.02, 3.03
and ground shock, 3.51, 3.52
impulse, 3.49
injuries, *see* Injuries
interaction with structures, 4.01–4.67
loading, *see* Loading
Mach effect, *see* Mach effect
and meteorological conditions, 3.39–3.43
negative phase, 3.04, 3.05
nonideal, 3.47, 4.67
positive phase, 3.05
precursor, 3.49, 3.79–3.85, 4.67

- pressure, *see* Dynamic pressure; Overpressure properties, 3.53–3.59
 height of burst curves, 3.73–3.77
 Rankine–Hugoniot relations, 3.53–3.56
 reflection, 3.21–3.29, 3.78, *see also* Mach effect
 irregular, 3.24
 regular, 3.22
 refraction, 3.42, 3.43
 scaling laws, 3.60–3.63
 and structures, *see* Damage; Loading surface (or terrain) effects, *see* Terrain effects
 target response, 5.08–5.18, *see also* Damage velocity, 3.55
 wind, 3.07, 3.13, 3.55
- Blood, radiation effects, 12.124–12.132
- Boltzmann constant, 7.73
 –Stefan law, 7.82
- Bone seekers, 12.165
- Boosted weapons, 1.72
- Breakaway, fireball, 2.120, 2.121
- Bridges, damage, 5.127, 5.139, 5.140
- Buildings, damage, *see* Damage
- Burns, 7.32, 12.13, 12.14, 12.22, 12.51–12.89
 beta, 12.155–12.162
 classification, 12.51–12.58
 under clothing, 12.59–12.60
 to eyes, *see* Eye injuries
 flame, 12.51
 flash, 7.32, 12.13, 12.14, 12.18, 12.51, 12.74–12.78
 incapacitation from, 12.61, 12.62
 in Japan, 12.13, 12.14, 12.18, 12.68–12.73
 profile, 12.70
 and radiant exposure, 12.63–12.69
- Buses, damage, 5.87
- Cancer, nuclear radiation, 12.147–12.151
- Capture gamma rays, 8.08
- Carbon-14, in nature, 12.198
 in weapons residues, 12.197–12.199
- Casualties, 12.01–12.21, *see also* Injuries
 in buildings, 12.17
 in Japan, 12.08–12.22
- Cataracts, nuclear radiation, 12.144–12.146
- Cattle, *see* Animals
- Cavity, in underground burst, 2.102, 6.85–6.88
- Cesium-137, in delayed fallout, 9.124, 12.184–12.187
- Chain reaction, *see* Fission
- Chimney, in underground burst, 2.103, 6.88, 6.89
- Clean weapon, *see* Nuclear weapons
- Cloud, condensation, 2.47–2.50, 2.66
 radioactive, 2.06–2.17, 2.19, 2.43, 2.68, 2.97, 9.07–9.09
 dimensions, 2.16
 height, 2.16, 9.96, 10.158
 rate of rise, 2.12
 radioactivity in, 9.61
 radius, 2.16
 scavenging, 9.67–9.74
 stabilized, 2.15, 9.84, 9.91, 9.96
 Column, in underwater burst, 2.67, 2.68
 Compton effect, 8.89, 8.90, 8.95, 8.97, 8.103, 11.105
 and EMP, 11.60–11.63, 11.66
 Concrete, radiation shielding, 8.41, 8.68, 8.69, 8.72, 9.120
 structures, damage, *see* Damage
 Conjugate points (or regions), 2.143, 10.49, 10.64, 10.65
 Condensation cloud, 2.47–2.50, 2.66
 Contamination, radioactive, 9.48–9.113, 9.154–9.162, *see also* Fallout; Fission products; Radioactivity, induced
 in air bursts, 9.48, 9.49
 decay, 1.64, 9.15–9.130, 9.146–9.153
 distribution patterns, 9.75–9.113
 dose calculations, 9.15–9.30
 hot spots, 2.31, 9.66, 9.105
 in surface and subsurface bursts, 9.50–9.52, 9.61
 in underwater bursts, 9.53–9.55
- Crack, in underwater burst, 2.65
- Crater, 2.21, 2.90, 6.03–6.11, 6.70–6.79
 dimensions, 6.08–6.11, 6.70–6.72
 formation mechanism, 2.92–2.94
 plastic zone, 6.07, 6.70
 rupture zone, 6.07, 6.70
 underwater, 6.60, 6.61
- Critical mass (or size), 1.46–1.53
 attainment in weapon, 1.51–1.53
- Crops, *see* Plants
- Cross section, neutron, 8.112
- Curie, 9.141
- Damage, 5.01–5.161, 6.104–6.114
 administrative buildings, 5.19–5.27, 5.139–5.141
 aircraft, 5.94, 5.95, 5.151–5.154
 arches and domes, 6.101
 automobiles, 5.86–5.91, 5.146
 brick structures, 5.139, 5.140
 bridges, 5.127, 5.139, 5.140
 buses, 5.87
 chimneys, 5.34
 commercial buildings, 5.19–5.27, 5.139, 5.140
 communications equipment, 5.122–5.126, 5.148
 concrete buildings, 5.20–5.27, 5.139, 5.140
 diffraction-sensitive structures, 5.139–5.145
 –distance relationships, 5.140, 5.146
 domestic appliances, 5.114
 drag-sensitive structures, 5.146–5.154
 dwellings, *see* Damage, residences
 electrical distribution systems, 5.98–5.105
 fabrics, 7.33–7.36, 7.44–7.48
 forests, 5.146, 5.149, 5.150, 7.60
 frame buildings, 5.25, 5.26, 5.37–5.51, 5.139, 5.140

- gas systems, 5.108–5.121
- houses, *see* Damage, residences
- hydraulic structures, 6.122–6.125
- industrial buildings, 5.04, 5.28–5.51, 5.139, 5.140
- in Japan, *see* Japan, nuclear explosions
- machine tools, 5.128–5.133
- masonry buildings, 5.76–5.79, 5.139, 5.140
- mobile homes, 5.80–5.84
- oil tanks, 5.155
- plastics, 7.39, 7.40
- railroad equipment, 5.92, 5.93, 5.146
- residences, 5.04, 5.52–5.84, 5.139, 5.140, 7.28
- ships, 5.96, 5.97, 5.146, 6.63–6.65
- smokestacks, 5.34
- storage tanks, 5.155
- subways, 6.106
- transportation equipment, 5.85–5.97, 5.146, 5.147
- tunnels, 6.109
- utilities, 5.98–5.121
- vehicles, 5.86–5.91, 5.146
- water systems, 5.106, 5.107
- Decay, radioactive, 1.02, 1.62
 - fission products, 1.54 *see also* Fallout, decay
- Decibel, 10.126
- Detection ionizing radiation, *see* Measurement
- Deuterium fusion reactions, 1.16, 1.67–1.71
- Diffraction loading, *see* Loading
 - sensitive structures, 5.139–5.145
- Dirty weapons, 9.47
- Dose (and dose rate), radiation, 8.17–8.19
 - absorbed, 8.18, 12.94
 - biologically effective, 12.93–12.97
 - exposure, 8.19, 12.93
 - from initial radiation, 8.33, 8.64, 8.121–8.127
 - from residual (fallout) radiation, 9.12–9.30
 - transmission factors, 8.72, 9.120
- Dosimeter, 8.21, 8.24, 8.29
- Drag loading, *see* Loading
 - sensitive structures, 5.146–5.154
- Ductility, materials and structures, 5.14–5.18
- Dynamic pressure, 3.06–3.08, 3.13–3.20
 - decay rate, 3.07, 3.13, 3.58
 - distance relationships, 3.75
 - duration, 3.76
 - and height of burst, 3.75
 - loading, *see* Loading, drag
 - Rankine-Hugoniot relations, 3.55
 - surface effects, 3.50, 3.82
 - and wind, 3.07, 3.13–3.17, 3.55
- Earth, shielding, 8.41, 8.72, 9.156, 9.161
- Earthquakes, and underground bursts, 6.24–6.27
- Effective half-life, 12.170
- Electrical and electronic equipment, EMP effects, 11.26–11.59
 - nuclear radiation effects, 8.73–8.88, 8.133–8.144
- Electromagnetic pulse (EMP), 1.38, 2.46, 2.61, 11.01–11.76
 - and animals, 11.20
 - characteristics, 11.04, 11.07–11.09, 11.63–11.65
 - and Compton current, 11.60, 11.61
 - damage, 11.18–11.20, 11.26, 11.30–11.33, 11.49–11.59
 - electrical systems, 11.26, 11.32, 11.33, 11.49–11.53
 - electronic equipment, 11.30, 11.31
 - and electrical power systems, 11.49–11.53
 - energy collectors, 11.16, 11.17
 - coupling, 11.27–11.29
 - high-altitude bursts, 11.03, 11.13–11.15, 11.26, 11.70–11.76
 - medium-altitude bursts, 11.66, 11.67
 - protection, 11.19, 11.33–11.40
 - and radio stations, 11.54–11.57
 - surface bursts, 11.03, 11.10–11.12, 11.68, 11.69
 - system-generated, 11.21–11.25
 - and telephone systems, 11.58, 11.59
 - testing for response, 11.41–11.48
 - theory, 11.60–11.76
- Electromagnetic radiation, 1.73–1.79, *see also* Thermal radiation
- Electromagnetic waves, *see* Radio and radar
- Electron, 1.08, *see also* Beta particles
- Electron volt, definition, 1.42
- EMP, *see* Electromagnetic pulse
- Energy distribution in nuclear explosions, 1.22–1.27, 7.88, 7.101, 7.102
- Energy, fission, 1.43
 - fusion, 1.69
- Energy yield, explosion, 1.20, 1.21, 1.45
- Evasive action, nuclear radiation, 8.48
 - thermal radiation, 7.87
- Explosion, atomic, *see* Nuclear explosion
- Eye injuries, 7.32, 12.79–12.89
 - cataracts, 12.144
 - flashblindness, 12.83, 12.84, 12.87–12.89
 - keratitis, 12.80
 - retinal burns, 12.85–12.89
- Fabric damage, thermal, 7.33–7.36, 7.44, 7.48
- Fallout, 2.18–2.31, 2.99, 9.01–9.166
 - air burst, 9.48, 9.49
 - attenuation of radiation from, 9.114–9.120
 - from BRAVO explosion, 9.114–9.120
 - cesium-137 in delayed, 9.124, 9.145, 12.184–12.187
 - contamination, 9.48–9.113
 - distribution, 9.75–9.113
 - contours, *see* Fallout patterns
 - decay, 1.64, 9.12–9.30, 9.145–9.153
 - half-residence time, 9.133
 - stratospheric, 9.130, 9.131, 9.135–9.139
 - tropospheric, 9.130–9.134

- from weapons tests, 9.140–9.141
 - distribution, 9.59–9.63, *see also* Fallout patterns
 - dose, 9.16–9.30, 9.146–9.162
 - rate, area integral, 9.160
 - early, 2.28, 9.03, 9.06–9.30
 - fractionation, 9.06–9.10
 - hazard, to animals, 12.244–12.254
 - to humans, 12.155–12.200
 - to plants, 12.255–12.265
 - and height of burst, 2.128
 - hot spots, 2.31, 9.66, 9.105
 - iodine in delayed, 9.120
 - local, *see* Fallout, early
 - particles, rate of fall, 9.163–9.166
 - patterns, 9.75–9.114
 - idealized, 9.83–9.103
 - limitations, 9.99–9.103
 - wind effect, 9.96–9.98
 - plutonium in, 9.40, 12.173
 - protection factors, 9.120
 - and rainfall, 9.67–9.74
 - rainout, 9.74
 - scavenging, 2.30, 9.67–9.74
 - stratospheric, 9.130, 9.131, 9.135–9.139
 - strontium-90 in delayed, 9.124, 9.140–9.145, 12.188–12.196
 - surface burst, 2.23–2.31, 9.50–9.52
 - surface (or terrain) effect, 9.95, 9.101, 9.156, 9.161
 - tropospheric, 9.130–9.134
 - underground burst, 2.99, 9.05, 9.51, 9.52
 - underwater burst, 2.82, 2.85, 9.05, 9.53–9.58
 - uranium in, 9.40–9.43
 - washout, 9.74
 - worldwide, *see* Fallout, delayed
- Farm animals, *see* Animals
- Film badge, 8.26
- Fireball, 1.32, 1.36, 1.40, 2.03–2.05, 2.18, 2.36, 2.38–2.40, 2.54–2.59, 2.110–2.137, 7.73–7.105
 - air burst, 2.03–2.05, 2.106–2.129, 7.83, 7.86
 - breakaway in, 2.120
 - debris uptake, 2.09, 2.18, 2.19, 9.50, 9.59
 - development, 2.110–2.121
 - dimensions, 1.32, 2.05, 2.127–2.129
 - high-altitude burst, 2.53–2.59, 2.132, 2.136, 7.22
 - ionization, 10.21–10.24, 10.40–10.44, 10.53–10.55, 10.62
 - shock front development, 2.115–2.120
 - surface burst, 2.18, 7.20
 - thermal power, 7.82–7.85
 - thermal radiation, 2.38–2.40, 7.01–7.04, 7.75, 7.76, 7.80–7.84
 - underground burst, 2.91, 7.21
 - underwater burst, 2.64, 7.21
 - X-ray, 2.110–2.119
- Fires, 7.49–7.70
 - in Japan, 7.61–7.80
 - mass, 7.58–7.60
 - origin, 7.49–7.53
 - spread, 7.54–7.60
- Firestorm, 7.58, 7.71
- Fission, 1.13, 1.14, 1.21, 1.42–1.56
 - chain, 1.42, 1.46–1.50, 1.54–1.59
 - energy, 1.15, 1.20, 1.21
 - distribution, 1.42–1.45
 - TNT equivalent, 1.45
 - explosion time scale, 1.54–1.59
 - fragments, 1.42, 1.43
 - generation time, 1.54
 - products, 1.15, 1.26, 1.29, 1.43, 1.60–1.66, 2.06, 2.10, 2.11, *see also* Fallout, decay weapons, *see* Nuclear weapons
- Flame burns, *see* Burns, flame
- Flash blindness, 12.83, 12.84, 12.87–12.89
- Flash burns, *see* Burns, flash
- Fluorescence radiation, high-altitude burst, 2.131, 2.138–2.141
- Fog, and thermal radiation, 7.16, 7.17
- Food plants, *see* Plants
- Forests, damage, 5.146, 5.149, 5.150, 7.60
- Fractionation, fallout, 9.06–9.10
- Fusion reactions, 1.13, 1.16–1.18, 1.67–1.72
 - weapons, *see* Thermonuclear weapons
- Gamma rays (or radiation), 1.28–1.30, 1.43, 1.61–1.66, 1.71, 8.01, 8.04, 8.08–8.48
 - attenuation, 8.38–8.42, 8.95–8.104, 9.117–9.120
 - coefficients, 8.95–8.102
 - biological effectiveness, 12.94
 - buildup factor, 8.103, 8.104
 - capture, 8.08
 - delayed, 8.13
 - delivery rate, 8.46–8.48
 - dose–distance relationships, 8.31–8.37, 8.125–8.132
 - evasive action, 8.48
 - half-value thickness, 8.39
 - hazard, 12.91–12.92
 - hydrodynamic enhancement, 8.36, 8.47
 - inelastic scattering, 8.09
 - interaction with matter, 8.17, 8.89–8.104
 - ionization by, 8.17, 8.21
 - measurement, 8.20–8.30
 - prompt, 8.12
 - RBE, 12.94
 - scattering, 8.44, 8.45
 - shielding, 8.05, 8.38–8.45, 8.72, 9.120
 - skyshine, 8.44
 - sources, 1.61–1.63, 8.08–8.16, 9.16
 - spectrum, nuclear explosion, 8.105
 - stopping altitude, 10.29
 - tenth-value thickness, 8.39–8.42, 8.102–8.104

- transmission factors, 8.72, 9.120
 - and weapon yield, 8.63, 8.64
- Gas systems, damage, 5.108–5.121
- Geiger counter, 8.21
- Genetic effects, radiation, 12.208–12.219
- Geomagnetic field, and auroral phenomena, 2.142–2.145
 - and beta particle motion, 2.143, 10.27, 10.46–10.51
 - conjugate regions, 2.141, 2.143, 10.27, 10.47, 10.64
 - and ionization, 10.46–10.51, 10.55, 10.63–10.66
 - and weapon debris, 10.55, 10.63, 10.64, 10.70
- Glass, missile hazard, 12.42, 12.43, 12.238
- Ground motion, in surface burst, 6.12–6.17
 - in underground burst, 6.33–6.40, 6.90–6.93
- Ground shock, *see* Shock
- Ground zero, 2.34
- Gun-barrel assembly, 1.52
- Half-life, biological, 12.170
 - effective, 12.170
 - radioactive, 1.63
- Half-residence time, delayed fallout, 9.133
- Half-value thickness, 8.39
- Harbor damage, *see* Hydraulic structures
- Height of burst and blast damage, 3.30–3.33
 - and blast wave arrival time, 3.77
 - and dynamic pressure, 3.75
 - duration, 3.76
 - and fallout, 2.128
 - optimum, 3.73
 - and overpressure, 3.73
 - duration, 3.76
 - scaling, 3.62
- Hematological effects, radiation, 12.124–12.132
- High-altitude burst, 1.24, 1.36, 1.37, 2.52–2.62, 2.130–2.150
 - auroral phenomena, 2.62, 2.142–2.145
 - beta patch, 2.141
 - blast, 3.68
 - definition, 1.36, 2.130
 - and EMP, *see* Electromagnetic pulse
 - energy distribution, 1.36, 2.130, 7.89–7.92
 - eye injuries, 12.87
 - fireball, 2.53–2.59, 2.131, 2.136, 7.22
 - FISHBOWL series, 2.52
 - fluorescence radiation, 2.131, 2.138–2.141
 - ionization, atmospheric, 10.40–10.74
 - and ozone layer, 2.148–2.150
 - phenomena, 1.36, 1.37, 2.52–2.60, 2.130–2.150
 - radio and radar effects, 10.89–10.121
 - shock wave, 2.136
 - thermal radiation, 2.131–2.135, 7.89–7.92, 7.102–7.105
 - X-ray pancake, 2.130, 7.91, 7.103
- Hiroshima, nuclear explosion, 2.24, *see also* Japan
- Hot spots, 2.31, 9.66, 9.105
- House damage, *see* Damage, residences
- Hydraulic fill, craters, 6.09
- Hydraulic structures, damage, 6.122–6.125
- Hydrodynamic enhancement, 8.36, 8.47, 8.128–8.131
 - phase, fireball, 2.117
 - separation, 2.115
- Hypocenter, explosion, 2.34
- Hydrogen bomb, *see* Thermonuclear weapons
- isotopes, 1.16, 1.17, 1.67–1.69
- Ignition, materials, 7.33–7.40
- Implosion, 1.53
- Impulse, 3.59, 3.63, 3.65, 3.66
 - and structure loading, 4.54, 4.56, 4.66
- Incendiary effects, *see* Fires
- Induced radioactivity, 8.16, 9.31–9.39
- Industrial buildings, damage, 5.04, 5.28–5.51, 5.139, 5.140
- Initial nuclear radiation, 1.02, 1.26–1.29, 1.34, 1.37–1.39, 2.41–2.45, 8.01–8.72, 8.89–8.124, 9.04, *see also* Gamma rays; Neutrons
- Injuries, 12.01–12.239, *see also* Burns; Casualties; Radiation injury
 - blast, direct 12.24–12.38, 12.239
 - indirect, 12.39–12.50, 12.238
 - blood, *see* Blood
 - burn, 12.51–12.78, *see also* Burns
 - causes, 12.18
 - combined, 12.133–12.143
 - eardrums, 12.38
 - eye, *see* Eye injuries
 - in Japan, 12.08–12.23, 12.68–12.78, 12.114–12.132, 12.144–12.154
 - ionizing radiation, 12.91, *see also* Radiation injury
 - lung damage, 12.38
 - from missiles, 12.41–12.48
 - nuclear radiation, *see* Burns, beta; Radiation injury
 - protection by buildings, 12.17
 - thermal radiation, *see* Burns
- Iodine in delayed fallout, 9.123
- Ionization, 1.38, 8.17, 10.04
 - atmospheric, 10.09–10.20, *see also* Geomagnetic field
 - and electromagnetic waves, 10.04–10.08, 10.125–10.137
 - in nuclear explosions, 10.21–10.74
 - below 10 miles, 10.34–10.39
 - 10 to 40 miles, 10.40–10.52
 - 40 to 65 miles, 10.53–10.61
 - above 65 miles, 10.62–10.74
- Ionizing radiation, 12.91, *see also* Nuclear radiation

- Ionosphere, 10.09–10.20
 electron density, 10.09
 delayed radiation effects, 10.154–10.164
 nuclear explosion effects, *see* Ionization, in nuclear explosions
 prompt radiation effects, 10.138–10.153
 radio and radar effects, *see* Radio and radar
- Ion pairs, 1.38, 8.17
- Iron, radiation shielding, 8.41, 8.104
- Isothermal sphere, fireball, 2.114–2.120, 2.124
- Isotopes, 1.09
 hydrogen, 1.16, 1.17, 1.67–1.69
- Japan, nuclear explosions, 2.24
 casualties, 12.08–12.23
 nuclear radiation injuries, 12.114–12.132, 12.144–12.154
 structural damage, 5.28–5.34, 5.52, 5.53, 5.85, 5.98, 5.106–5.108, 5.127
 thermal radiation, burns, 12.68–12.78
 incendiary effects, 7.61–7.72
 materials effects, 7.44–7.48
- Keloid formation, 12.78
- Keratitis, 12.80
- Leukemia, nuclear radiation, 12.147–12.149
- Lithium deuteride, 1.70, 1.71
- Loading, blast, 4.01–4.67, 6.94–6.103
 arched structures, 4.62–4.66
 buried structures, 6.94–6.103
 development, 4.22–4.37
 shape effect, 4.35–4.37
 size effect, 4.31–4.34
 diffraction, 4.03, 4.05–4.11
 drag, 4.12–4.14, 4.29
 nonideal blast wave, 4.67
 structures, 4.15–4.20, 4.41–4.67
 box-like, closed, 4.41–4.45
 partially open, 4.46–4.51
 cylindrical, 4.57–4.16
 open-frame, 4.52–4.56
- Lung injuries, 12.15, 12.28, 12.38
- Mach effect, 2.33–2.37, 3.24–3.31, 3.34
 front (or stem), 2.33–2.37, 3.25
 and height of burst, 3.29
 triple point, 3.25
- Machine tools damage, 5.128–5.133
- Marshall Islands, inhabitants, 12.175–12.183
- Masonry buildings, damage, 5.76–5.79, 5.139, 5.140
- Mean free path, 2.113, 7.79
- Measurement, ionizing radiation, 8.20–8.30, 8.58–8.62
- Megacurie, 9.141
- Mesosphere, 3.42, 9.126
- Meteorological effects, blast wave, 3.39–3.43
 fallout, 9.66–9.74, 9.102, *see also* Hot spots; Scavenging
 fires, 7.54, 7.58, 7.71, 7.72
 Million electron volt (or MeV), 1.42
- Mobile homes, damage, 5.80–5.84
- Monitoring, ionizing radiation, *see* Measurement
- Mutations, *see* Genetic effects
- Nagasaki, nuclear explosion, 2.24, *see also* Japan
- Neoplasms, nuclear radiation, 12.147–12.151
- Neutron, 1.08, 1.31, 8.01, 8.04, 8.49–8.72
 absorption (or attenuation), 8.66–8.72, 9.120
 capture, 8.08, 8.11, 8.16, 8.54, 8.56, 9.31–9.39
 cross section, 8.112
 delayed, 8.50
 dose–distance relationships, 8.121–8.124
 fast, 8.52
 fluence, 8.61
 flux, 8.60
 measurement, 8.58–8.62
 hydrodynamic enhancement, 8.50
 induced activity, 8.16, 9.31–9.39
 initial nuclear radiation, 8.01, 8.04, 8.49–8.72
 interaction with matter, 8.107–8.113
 ionization, 8.58, 8.59
 measurement, 8.58–8.62
 prompt, 8.50
 RBE, 12.97
 scattering, 2.41, 8.09, 8.52, 8.53, 8.107, 8.108
 shielding, 8.66–8.72, 9.120
 slow, 8.52
 slowing down, 8.54
 sources, 8.01, 8.04, 8.49–8.57
 spectrum, 8.53, 8.114–8.120
 equilibrium, 8.118, 8.119
 thermal, 8.52
 from thermonuclear (fusion) reactions, 1.69, 1.72, 8.57, 8.116, 8.117, 8.119
 transmission factors, 8.72, 9.120
 transmission from source, 8.52–8.56, 8.117–8.120
- Nitrogen, neutron reaction, 8.11, 8.54, 8.56, 8.110, 9.34
- Nuclear explosion, blast wave, 1.01, *see also* Blast; Shock
 casualties, *see* Casualties
 characteristics, 1.01–1.23
 and conventional explosions, 1.01–1.03
 damage, *see* Damage
 description, air burst, 2.03–2.51, *see also* Air burst
 high-altitude burst, 2.52–2.62, *see also* High-altitude burst
 surface burst, 2.03–2.51, *see also* Surface burst
 underground burst, 2.90–2.105
 underwater burst, 2.63–2.89

- fireball development, *see* Fireball
- incendiary effects, *see* Fires
- injuries, *see* Injuries; Radiation injury
- ionization, *see* Ionization
- nuclear radiation, *see* Nuclear radiation
- pressures, 2.107
- principles, 1.46–1.59
- radio and radar effects, *see* Radio and radar
- shock wave, 1.01, *see also* Blast; Shock
- temperatures, 1.23, 2.107, 7.75
- thermal radiation, *see* Thermal radiation
- types, 1.31–1.41, 2.01, 2.02
- Nuclear radiation, 1.02, 1.34–1.39, 2.41–2.45
 - from air burst, 1.33–1.35, 2.44, 2.45
 - biological effects, on animals, 12.240–12.254
 - on man, *see* Radiation injury
 - on plants, 12.240–12.243, 12.255–12.265
 - initial, *see* Initial nuclear radiation
 - injuries, *see* Radiation injury
 - prompt, 2.41
 - residual, *see* Residual nuclear radiation
 - from surface burst, 2.23–2.31, 8.37, 8.65, 9.50–9.52
 - transmission factors, 8.72, 9.120
 - from underground burst, 1.39, 2.99, 2.100
 - from underwater burst, 2.77–2.79, 2.81, 2.82, 2.89
- Nuclear weapons, 1.02, 1.11, 1.19–1.21, 1.51–1.72, *see also* Nuclear explosions
 - boosted, 1.72
 - clean and dirty, 9.47
 - criticality attainment, 1.51–1.53
 - fission, 1.46–1.59
 - fusion, 1.67–1.72, *see also* Thermonuclear weapons
 - salted, 9.11
 - thermonuclear, *see* Thermonuclear weapons
 - yield, 1.20, 1.21
- Nucleus, atomic, 1.08
- Nuclide, 1.10
 - radioactive, 1.30
- Oil-tank damage, 5.155
- Overpressure, 2.33, 3.01–3.05, 3.21–3.34, 3.53–3.85, *see also* Blast; Loading; Mach effect
 - decay rate, 3.09, 3.57
 - distance relationships, 3.73
 - duration, 3.76
 - free air, 3.72
 - and height of burst, 3.73, 3.76
 - loading, *see* Loading, diffraction
 - negative, 3.05
 - peak, 3.02, 3.74
 - arrival time, 3.77
 - Rankine–Hugoniot relations, 3.55, 3.56
 - reflected, 3.56, 3.78
 - scaling, 3.66
 - surface (terrain) effects, 3.47–3.50, 3.79–3.85
- Ozone layer, nuclear explosion effects, 2.148–2.150
- Pair production, gamma-ray, 8.92
- Particles, rate of fall, 9.163–9.166
- Pathology, radiation injury, 12.220–12.237
- Photoelectric effect, gamma-ray, 8.91
- Photon, 1.74, 7.79
- Planck equation (or theory), 1.74, 7.73, 7.74
- Plants, nuclear explosion effects, 12.240–12.243, 12.255–12.265
- Plastic deformation, 5.15
- Plastics, thermal damage, 7.39
- Plastic zone, crater, 6.07, 6.70
- Plutonium, fission, 1.14, 1.15, 1.18, 1.42, 1.44, 1.45
 - hazard, 12.173
 - in weapons residues, 9.40–9.43
- Polar front, 9.127
- Precursor, blast wave, 3.49, 3.79–3.85
 - loading, 4.67
- Pressure, blast and shock, *see* Dynamic pressure; Loading; Overpressure
- Profile burns, 12.70
- Protection, *see* Evasive action; Shielding
 - factors, initial radiation, 8.72
 - fallout, 9.120
- Proton, 1.08
- Quantum, 1.74
 - theory, *see* Planck
- Rad, 8.18
- Radar effects, *see* Radio and radar
- Radiant exposure, 7.35
 - power, 7.74, 7.82–7.84, 7.86
- Radiation injury, 12.90–12.237
 - acute, 12.102–12.132
 - blood, 12.124–12.132
 - cancer (neoplasms), 12.147–12.151
 - cataracts, 12.144–12.146
 - clinical phenomena, 12.108–12.123
 - delayed, 12.142–12.154
 - from fallout,
 - early, 12.155–12.183
 - delayed, 12.184–12.200
 - genetic, 12.208–12.219
 - pathology, 12.220–12.237
 - thyroid, 12.171, 12.181–12.183
- Radiation Effects Research Foundation, 12.142
- Radiation, nuclear, *see* Gamma rays; Neutrons; Nuclear radiation
- Radioactive capture, neutrons, 8.08
- Radioactive cloud, *see* Cloud
- Radioactive half-life, 1.63
- Radioactivity, 1.02, 1.28–1.30, 1.61–1.66, *see also* Fallout
 - induced, 8.16, 9.31–9.39

- Radioflash, *see* Electromagnetic pulse
 Radionuclide, 1.30
 Radio and radar effects, 10.01–10.164, *see also*
 Ionization, in nuclear explosions
 attenuation, signal, 10.78, 10.79
 blackout, 10.01
 Doppler shift, 10.83
 degradation, signal, 10.75–10.77
 HF (high-frequency), 10.100–10.107
 hydromagnetic disturbance, 10.26
 initial radiation, 10.149–10.153
 LF (low-frequency), 10.97, 10.98
 MF (medium-frequency), 10.82–10.84
 noise, 10.80, 10.81
 phase changes, 10.82–10.84, 10.94
 radar systems, 10.114–10.122
 radio systems, 10.89–10.113, 10.122
 residual radiation, 10.154–10.164
 scattering, 10.87, 10.88
 summary, 10.122
 UHF (ultrahigh-frequency), 10.112, 10.113
 VHF (very-high-frequency), 10.92–10.111
 VLF (very-low-frequency), 10.92–10.96
 Railroad equipment, damage, 5.92, 5.93, 5.146
 Rainout, 9.74
 Rankine–Hugoniot relations, 3.53–3.56
 RBE (Relative biological effectiveness), 12.94
 Reflection, blast wave, *see* Blast wave; Mach effect
 Reinforced-concrete buildings, damage, 5.20–5.27, 5.139, 5.140
 Relative biological effectiveness (RBE), 12.94
 Rem, 12.95
 Residences, damage, 5.04, 5.52–5.84, 5.139, 5.140, 7.28
 Residual nuclear radiation, 1.02, 1.26–1.30, 1.35, 1.39, 9.01–9.166, *see also* Fallout; Radioactivity, induced
 Response, spectrum, 6.90
 structures, 5.08–5.18, *see also* Damage
 Retinal burns, *see* Eye injuries
 Roentgen, 8.17
 Rupture zone, crater, 6.07, 6.70
 Scattering, *see* Compton effect; Gamma radiation; Thermal radiation; Neutrons
 Scavenging, fallout, 2.30, 9.67–9.74
 Scintillation counter, 8.23
 Seismic effects, 2.102, 2.105, 6.19–6.27
 Semiconductor detector, 8.22
 Semiconductor, EMP effects, 11.31, 11.32
 radiation effects, 8.77–8.80
 Shake, 1.54
 Shielding, gamma rays, 8.05, 8.38–8.45, 8.72, 9.120
 neutrons, 8.66–8.72
 thermal radiation, 7.18, 7.19
 Ships, damage, 5.96, 5.97, 5.146, 6.63–6.65
 Shock (and Shock wave), 1.01, 1.33, 6.82–6.84, *see also* Blast
 front, 1.01, 3.03
 in fireball, 2.155–2.120
 ground, in air burst, 3.51, 3.52
 damage from, 6.104–6.114
 in surface burst, 6.12–6.17
 in underground burst, 6.18, 6.19, *see also* Seismic effects
 in underwater burst, 6.14–6.52, 6.115–6.118
 Skin burns, *see* Burns
 Skyshine, gamma-ray, 8.44
 Slick, in underwater burst, 2.65
 Smoke, and thermal radiation, 7.16, 7.17
 Soil, vaporization in surface burst, 2.18
 Spray dome in underwater burst, 2.66, 2.84
 Stagnation pressure, 4.25
 Stefan-Boltzmann law, 7.82
 Stopping altitude, 10.29
 Storage tank, damage, 5.155
 Stratosphere, 9.126
 fallout from, 9.130, 9.131, 9.135–9.139
 Stopping altitude, radiation, 10.29
 Strontium-90 in delayed fallout, 9.124, 9.140–9.145
 radiation hazard, 12.188–12.196
 Structural damage, *see* Damage
 Structures, *see* Damage; Loading
 Subsurface bursts, *see* Surface; Underground; Underwater
 Subways, damage, 6.106
 Surface (and shallow underground) burst, 1.40, 2.18–2.31, 2.90–2.100, 6.01–6.18
 air blast, 2.32–2.37, 3.34–3.74, 6.02, 6.80, 6.81
 characteristics, 2.18–2.37, 2.90–2.100, 6.01–6.18
 contact, 3.34, 3.74
 crater formation, 2.21, 2.90–2.94, 6.03–6.11, 6.70–6.79, *see also* Crater
 damage in, 6.28–6.31, 6.94–6.103
 EMP effect, 11.03, 11.10–11.12, 11.68, 11.69
 fallout, 2.23–2.31, 9.50–9.52, *see also* Fallout
 fireball, 2.18, 7.20
 ground motion, 6.82–6.84
 ground shock, 6.12–6.18
 nuclear radiation, initial, 8.37, 8.65, *see also* Nuclear radiation
 residual, 2.23–2.31, 9.50–9.52
 radioactive cloud, 2.19–2.22
 contamination, 9.50–9.52
 thermal radiation, 7.20, 7.42, 7.101
 Surface effects on blast, *see* Terrain effects
 Surface zero, 2.34
 Survey meter, 7.30
 Tamper, nuclear weapon, 1.50
 Tenth-value thickness, 8.38, 8.102

- Terrain effects, on blast, 3.35-3.38, 3.47-3.50, 3.79-3.85
 on fallout, 9.95, 9.101, 9.156, 9.161
- Thermal layer, 3.80
- Thermal pulses, in air burst, 2.38-2.40, 7.86, 7.87
 in high-altitude burst, 2.132, 2.133, 7.89
- Thermal radiation, 1.02, 1.22-1.25, 1.73-1.79, 7.01-7.105
 absorption, in materials, 7.23-7.31, 7.33, 7.34
 in air burst, 1.33, 2.38-2.40, 7.03-7.05, 7.85-7.100
 and atmospheric conditions, 7.11-7.17, 7.98
 attenuation, 7.08-7.19, 7.94, 7.98
 burns, *see* Burns, flash
 damage, 7.33-7.40
 definition, 7.02
 effects, 7.23-7.53
 in Japan, 7.44-7.48, 7.61-7.72
 energy fraction, air burst, 1.25, 7.04, 7.88
 high-altitude burst, 7.22, 7.90, 7.102, 7.104
 surface burst, 7.101
 evasive action, 7.87
 exposure-distance relationship, 7.41-7.43, 7.93-7.105
 and fabrics, 7.27, 7.33-7.35
 from fireball, 7.01-7.22, 7.73-7.92
 in high-altitude burst, 7.22, 7.89-7.92, 7.102-7.105
 ignition exposures, 7.35, 7.40
 incendiary effects, 7.49-7.72
 injuries, 7.32, 12.51-12.78
 materials ignition, 7.33-7.40, 7.44-7.49
 and plastics, 7.39
 primary, 1.77, 7.01, 7.75, *see also* Thermal X-rays
 prompt, 7.02
 pulses, *see* Thermal pulses
 radiant exposure, 7.35
 power, 7.74, 7.82-7.84, 7.86
 scattering, 7.08, 7.10-7.17, 7.19, 7.95, 7.98
 shielding, 7.18, 7.19
 smoke and fog effects, 7.16, 7.17
 in surface burst, 7.20, 7.101
 transmittance, 7.95-7.98, 7.101, 7.104, 7.105
 underground burst, 2.99
 underwater burst, 2.80
- Thermal X-rays, 1.77-1.79, 7.01, 7.75, 7.80, 7.81, 7.90-7.92, 7.104
 ionization, 10.53, 10.57, 10.60, 10.62, 10.69
- Thermonuclear (fusion) reactions, 1.17-1.19, 1.67-1.72
 weapons, 1.67-1.72
 fallout patterns, 9.94
 gamma rays, 8.33
 neutrons, 8.64, 8.116, 8.117, 8.119
- Thermosphere, 3.43, 9.126
- Thyroid abnormalities, 12.171, 12.181-12.183
- Time scale, fission explosion, 1.54-1.59
 TNT equivalent, 1.20, 1.45
- Trailer coach, damage, 5.80-5.84
- Transient-radiation effects on electronics (TREE), 8.73-8.88, 8.133-8.144
 characteristics, 8.73-8.76
 effects on equipment, 8.77, 8.78
 mechanism, 8.133-8.144
- Transmission factors, initial nuclear radiation, 8.72
 residual nuclear radiation, 9.120
- Transmittance, thermal radiation, 7.95-7.98, 7.101-7.104, 7.105
- Transportation equipment, damage, 5.85-5.97, 5.146, 5.147
- Trinity test, 2.36, 12.245, 12.246
- Triple point, 3.25, *see also* Mach effect
- Tritium, thermonuclear (fusion) reactions, 1.67-1.70
 in residual radiation, 12.197, 12.200
- Tropopause, 2.13, 9.126
- Troposphere, 3.40, 9.126
 fallout from, 9.130-9.134
- Tunnels, damage, 6.109
- Ultraviolet radiation, 1.73, 1.78, 2.38, 2.39, 7.75, 7.76
- Underground burst (deep), 1.39, 2.90-2.105, 6.19-6.40, 6.85-6.93
 aftershocks, 2.105, 6.20-6.27
 air blast, 6.02, 6.53
 base surge, 2.96-2.98
 cavity, 2.102, 6.85-6.88
 characteristics, 2.90-2.105
 chimney, 2.103, 6.89
 damage criteria, 6.104-6.114
 fallout, 2.98, *see also* Fallout
 fault displacement, 6.20-6.27
 fireball, 2.91
 ground motion, 6.33-6.40
 loading, buried structures, 6.104-6.111
 seismic effects, 6.19-6.27
 shallow, *see* Surface burst
 shock wave, 6.18, 6.19, 6.33
 and structures, 6.33-6.40
- Underwater burst, 1.39, 2.63-2.89, 6.41-6.69, 6.115-6.125
 air blast, 6.53, 6.68, 6.69
 base surge, radioactive, 2.76-2.79
 visible, 2.72-2.75
 characteristics, 2.63-2.79, 6.41-6.69
 cloud, 2.69
 column, 2.67, 2.68
 contamination, water, 9.53-9.58
 crack, 2.65
 crater formation, 6.60, 6.61
 damage, 6.62-6.64
 deep, 2.81-2.89

- fireball, 2.64
- hydraulic structures, damage, 6.122-6.124
- nuclear radiation, 2.74-2.79, 2.81, 2.82, *see also* Fallout
- overpressure, water, 6.41
- plume, 2.67
- shallow, 2.63-2.82
- ships, damage, 6.58, 6.63-6.69
- shock wave, 6.41-6.52, 6.62-6.69, 6.115-6.118
 - reflection, 6.43, 6.44-6.52
 - surface cutoff, 6.43
- slick, 2.65
- thermal radiation, 2.80
- water waves, 2.70, 2.71, 6.54-6.59, 6.119-6.121
- Unit-time reference dose rate, 9.16-9.23, 9.92-9.95
- Uranium fission, 1.14, 1.15, 1.18, 1.42, 1.44, 1.45, 1.72
 - hazard, 12.174
 - in weapons residues, 9.31, 9.40-9.42
- Utilities, damage, 5.98-5.121
- Vehicle, damage, 5.86-5.91, 5.146
- Wall-bearing structures, 5.27, 5.139
- Wall failure, 5.145
- Weapons, nuclear, *see* Nuclear weapons
- Weather effects, *see* Meteorological effects
- Wien's displacement law, 7.77
- Wilson cloud, 2.47-2.50, 2.66
- Wind, and fallout patterns, 9.96-9.98
- Wind (dynamic pressure), 3.07, 3.08, 3.13, 3.14, 3.16
 - velocity, 3.07, 3.55
- Wood, thermal radiation effects, 7.37, 7.38, 7.40, 7.44
- Worldwide fallout, *see* Fallout, delayed
- X-ray fireball, 2.110
- X rays, 1.73, 1.77, 1.79
 - absorption, 2.134, 7.80, 7.81, 7.92
 - degradation, 1.78, 2.38, 7.02, 7.75
 - ionization, atmospheric, 10.53, 10.57, 10.60, 10.62, 10.69
 - pancake, 2.134, 2.135, 7.91, 7.103
 - stopping altitude, 10.29
 - thermal, *see* Thermal X-rays
- Yield, explosion, 1.20, 1.21, 1.45