

National Aeronautics and Space Administration

Physics of the Cosmos Program Annual Technology Report

Physics of the Cosmos
Program Office
October 2012

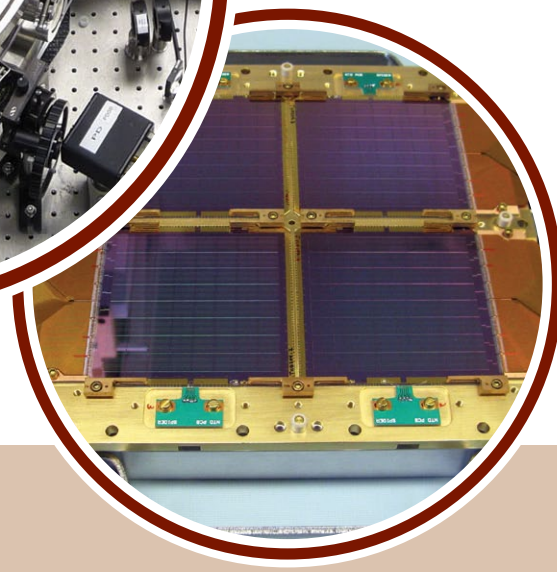
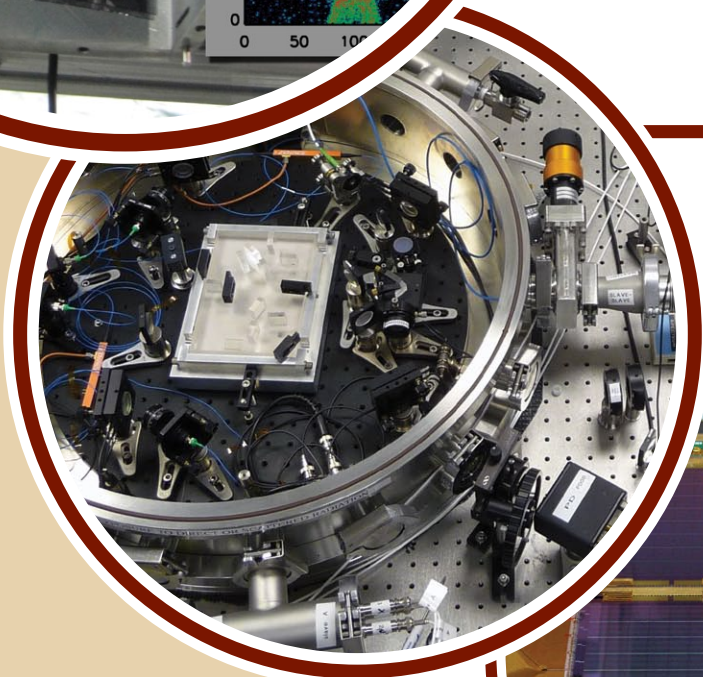
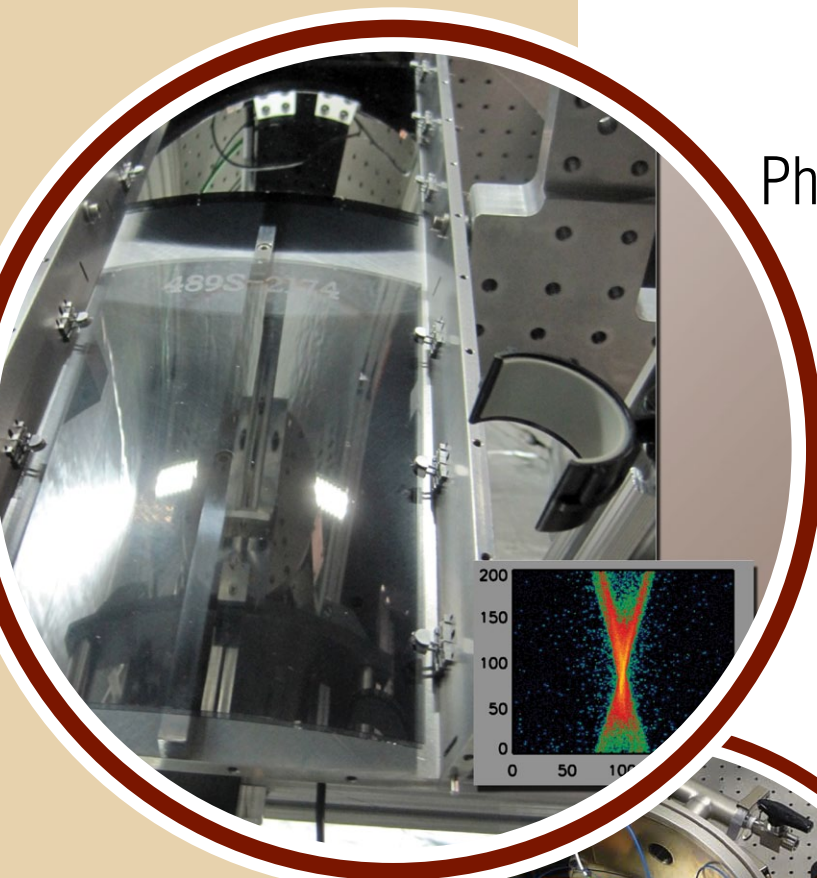

This page left blank intentionally

Table of Contents

	Executive Summary	5
1	Program Overview	7
	1.1 Background	9
	1.2 PCOS Program Technology Development	11
2	Technology Status	13
	2.1 Gravitational Wave Phasemeter Technology Development	15
	2.2 Gravitational Wave Telescope Technology Study	23
	2.3 X-ray Optics Technology	31
	2.4 Critical-Angle Transmission (CAT) Gratings for High-Resolution Soft X-ray Spectroscopy	37
	2.5 Off-Plane Grating Arrays for Future Missions	41
	2.6 X-Ray Microcalorimeter Spectrometer (XMS) Technology	49
	2.7 Moderate Angular Resolution Adjustable Full-shell Grazing Incidence X-ray Optics	55
	2.8 Directly Deposited Optical Blocking Filters for Imaging X-ray Detectors	61
	2.9 Planar Antenna-Coupled Superconducting Detectors for CMB Polarimetry	65
3	Program Technology Needs	71
4	Program Technology Priorities and Recommendations	95
5	Closing Remarks	101
6	Acronyms	103

This page left blank intentionally

Executive Summary

Welcome to the second Program Annual Technology Report (PATR) for the Physics of the Cosmos (PCOS) Program of the NASA Astrophysics Division. This report is the annual summary of the technology development activities of the PCOS Program for the fiscal year (FY) 2012. This document serves two purposes. First, it summarizes the program technology needs identified by the science community and the results of this year's prioritization of the technology needs by the Program Technology Management Board (TMB). Second, it provides a summary of the current status of all the technologies that were supported by the PCOS Supporting Research and Technology (SR&T) funding in FY12, including progress over the past year and planned development activities for this coming year. The PCOS Program Office resides at the NASA Goddard Space Flight Center (GSFC) and serves as the implementation arm for the Astrophysics Division at Headquarters (HQ) for PCOS Program related matters. Responsibility for generating this PATR rests with the Advanced Concepts and Technology Office (ACTO), within the PCOS Program Office (PO).

The PCOS Program seeks to shepherd critical technologies for NASA toward the goal of implementation into project technology development plans. These technologies can then serve as the foundation for robust mission concepts so that the community can focus on the scientific relevance of the proposed missions in subsequent strategic planning. The available PCOS SR&T FY12 funding is being used efficiently, as is evidenced by the excellent progress of development activities described in Section 2. The technology development status reports captured in Section 2 cover a number of efforts continued from the year before as well as some new ones. The continued efforts from FY11 were funded by targeted program funds. The new efforts include technology developments funded through the PCOS Strategic Astrophysics Technology (SAT) solicitation.

The technology needs prioritization process described in Sections 3 and 4 was essentially unchanged from last year. It again provided a rigorous, transparent ranking of technology needs based on the Program's goals, community scientific rankings of the relevant missions, the state of available technologies, and the external programmatic environment. The goals for the PCOS Program are driven by the National Research Council's (NRC) "New Worlds, New Horizons in Astronomy and Astrophysics" (NWNH) Decadal Survey report, released in 2010, which includes highly ranked science missions and technology development for dark energy, gravitational waves, X-ray astronomy, and cosmic inflation.

Section 3 of this report summarizes the technology needs collected from the astrophysics community during FY11–12. The majority of the technology needs were provided by the Physics of the Cosmos Program Analysis Group (PhysPAG). The PO greatly appreciates the time, attention, and organization that the PhysPAG invested in collecting and processing the information. For this year, the program technology needs list was similar to last year's. The needs list includes technology needs related to several major mission concepts including missions to study dark energy, gravitational waves, X-ray astronomy, and cosmic inflation.

The results of the TMB technology needs prioritization are included in Section 4. The prioritization process is a rigorous ranking of the program technology needs in 11 weighted categories. The technology needs are categorized into four groups. These groups describe the relative importance of the technologies to the PCOS science objectives and the urgency of the need. For this year, the highest ranked technologies were those determined to be key

enabling technologies for the highest ranked near-term missions including technologies for large format infrared detectors, X-ray calorimeters, optics and gratings, large format polarimeters, micronewton thrusters, and highly stable telescopes and lasers.

The prioritization results will be referenced by the Program over the upcoming year, as the calls for technology development proposals are drafted and investment decisions are made. The Board is cognizant that investment decisions will be made within a broader context and that other factors at the time of selection may affect these decisions. As with last year, this technology needs prioritization will be forwarded to other NASA programs (e.g., Small Business Innovation Research, or SBIR) and other Office of the Chief Technologist (OCT) technology development planning groups as requested.

During the implementation of the technology development process, the Program Office strives to: 1) improve the transparency of the prioritization and selection process by maintaining an open forum for community input, and providing the information in this PATR; 2) ensure the development of the most relevant technologies; 3) inform the community of current technology development investments and their progress; 4) inform the community of the process by which the PO technology development needs are identified and prioritized; 5) ensure the community has opportunities to provide input to and receive feedback about the prioritization process; 6) inform the community what the PO considers its highest technology needs; 7) leverage the technology investments of external organizations by defining technology needs and a customer in order to encourage non-NASA technology investments that will benefit PCOS science.

A key objective of the technology development process is to formulate and articulate the needs of the Program Office. Through a process of careful evaluation of the technologies proposed for development, the PO determines which technologies will meet its needs and then prioritizes them in order of its merit-based ranking for further development consideration. The PO then provides its recommendation to NASA HQ, in the form of this PATR, in an effort to aid decision makers in the process that ultimately results in the funding of selected technologies.

1 Program Overview

Physics of the Cosmos (PCOS) science addresses the fundamental physical laws and properties of the universe. The science objectives of the Program are to probe Einstein's General Theory of Relativity and the nature of spacetime, better understand the behavior of matter and energy in its most extreme environments, expand our knowledge of dark energy, precisely measure the cosmological parameters governing the evolution of the universe, test the inflation hypothesis of the Big Bang, and uncover the connection between galaxies and supermassive black holes. Physics of the Cosmos lies at the intersection of Physics and Astronomy. It uses the universe—the cosmic scale, the diversity of conditions, and the extreme objects and environments—as a laboratory to study the basic properties of nature.

In August 2011, the Agency Program Management Council authorized the PCOS Program to proceed into the program implementation phase. This is the second edition of the Program Annual Technology Report (PATR) following the implementation of the program.

The PCOS Program Office (PO) is located at the NASA Goddard Space Center. A primary function of the Program Office during the implementation phase is to develop and administer an aggressive technology program. In order to achieve this end, an Advanced Concepts and Technology Office (ACTO) has been chartered to facilitate, manage, and implement the technology policies of both the PCOS Program and the Cosmic Origins (COR) Program. The goal is to coordinate the infusion of technology into PCOS and COR missions, including the crucial phase of transitioning a wide range of nascent technologies into a targeted project's mission technology program when a project is formulated. ACTO oversees technology development applicable to PCOS missions, funding for which is supported by the PCOS Supporting Research and Technology (SR&T) budget. This PATR is an annual, comprehensive document detailing the technologies currently being pursued and supported by PCOS SR&T.

This page left blank intentionally

1.1 Background

The PCOS Program encompasses multiple science missions aimed at meeting Program objectives, each with unique science capabilities. The Program was established to integrate those missions into a cohesive effort that enables each project to build upon the technological and scientific legacy of its contemporaries and predecessors. Each project operates independently to achieve its unique set of mission objectives, which contribute to the overall Program objectives. The current PCOS operating missions are:

- *Chandra*
- *X-ray Multi-mirror Mission (XMM) – Newton*
- *Fermi Gamma-ray Space Telescope*
- *Planck*
- *NuSTAR* (launched June 2012)

Since the Program began formulation in 2009, the portfolio of future PCOS missions has changed dramatically. Starting with the release of the NRC’s “New Worlds, New Horizons” (NWNH) report, and culminating with NASA-HQ guidance, the PCOS Program focus has necessarily shifted from mission development to technology studies. Within the PCOS portfolio, the highly ranked NWNH priorities were as follows:

- *Laser Interferometer Space Antenna (LISA)*
- *International X-ray Observatory (IXO)*
- *Inflation Probe*

The decadal committee proposed, and ranked first, a mission called *Wide-Field Infrared Survey Telescope (WFIRST)*. WFIRST is envisioned to settle fundamental questions about the nature of dark energy, as well as open up a new frontier of exoplanet studies. While dark energy is PCOS science, for programmatic reasons NASA has decided that the Exoplanet Program Office at the Jet Propulsion Laboratory (JPL) will administer WFIRST. The committee ranked LISA and IXO as the third and fourth priorities for large space-based investments and ranked the Inflation Probe as the second priority for medium-size space-based investments.

In February 2012, following the recommendations of the NRC panel in its “Assessment of a Plan for U.S. Participation in Euclid,” NASA decided to participate in the ESA-led dark energy mission, *Euclid*. *Euclid* is a project within the PCOS Program that has been assigned to JPL.

In May 2012, the European Space Agency (ESA) announced that its L1 (first large launch for the next phase of future missions) Cosmic Visions launch opportunity would be for the Jupiter Icy Moons Explorer (JUICE), a mission to explore Jupiter. While recognized for their high scientific value, ESA decided not to pursue the lower-cost ESA-led mission concepts *Next Generation Gravitational-wave Observatory (NGO)* and the *Advanced Telescope for High-Energy Astrophysics (ATHENA)*, which would have superseded LISA and IXO, respectively. If either of these missions is selected for a future launch opportunity (L2 or L3) in the ESA Cosmic Visions process, NASA may play a minority role.

Physics of the Cosmos Program Annual Technology Report

Over the past year, the PCOS Program has thus shifted its efforts to administering its operational missions and managing mission concept development and associated technology studies. Two studies have recently been completed, and their reports were delivered to NASA HQ and publicly released in August 2012. These studies include the Gravitational Wave missions concepts and the X-ray astronomy mission concepts. Both reports are available for download at <http://pcos.gsfc.nasa.gov/>.

1.2 PCOS Program Technology Development

The PCOS SR&T funds a variety of technology developments that are determined to be necessary for the advancement of PCOS science missions. To make these determinations, the PCOS Program Office pursues a strategic vision that follows the space-based priorities set forth in the NWNH report. Specifically, the PCOS Program Office adopts the prioritized complement of missions and activities to advance the PCOS science priorities.

The PCOS technology management plan details the process that identifies PCOS technology needs, enables the maturation of those technologies in a prioritized fashion, and inserts them into new missions responsively. The process diagram (Fig. 1.2–1) illustrates the annual cycle by which this is achieved. Starting at the left, science needs and requisite technologies are derived from the current astrophysics community, and are presented into the Program’s technology development cycle.

The PhysPAG provides analyses through the process mandated by the Federal Advisory Committee Act (FACA). Meanwhile, the PCOS Program Office convenes its Technology Management Board (TMB), which prioritizes the technologies and publishes them annually in this PATR. The TMB recommends these priorities to NASA HQ, which solicits proposals for technology development. Grants are awarded to technology developers, who submit annual reports that are reviewed by the TMB. Because the technological progress also changes the landscape of the requirements for the science needs, this process is repeated annually to ensure the continued relevance of the priorities.

This PCOS PATR plays an important role in the Program’s technology development process. It describes the status of all technologies funded through PCOS SR&T, captures technology needs as articulated by the science community, and recommends a prioritized list of technologies for future funding. The PATR is an open and available source for the public, academia, industry, and the government to learn about the status of applicable mission concepts and the enabling technologies required to fulfill the PCOS Program science objectives.

The external scientific and technology communities are key stakeholders for the program technology development activities. The community participates in the program technology process in multiple ways, including through the PhysPAG, workshops held by the Program in conjunction with specific studies, as identifiers of technology needs and as developers through responses to solicitations. These workshops provide a mechanism for including community input into the program technology process.

The PCOS TMB is a program-level functional group that provides a formal mechanism for input to and review of the program technology development activities. The TMB prioritized those technologies identified by the community and communicated via the PhysPAG or directly submitted to the Program website. This prioritization provides crucial direction for the merit-based selection of technology development investment. This report, the annual PCOS PATR, is the means of disseminating this information publicly. The PCOS

Physics of the Cosmos Program Annual Technology Report

Program Office works to ensure that the broad astronomy community is informed of these technology developments. It is expected that new starts for missions will lead to project-specific technology development efforts.

For the Fiscal Year 2013, the driving objective is to maintain progress in those technologies that are either key enabling technologies for a future U.S.-led mission or establish a clear connection to a possible future contribution to the ESA L-Class missions, such as ATHENA or NGO via the Strategic Astrophysics Technology (SAT) call.

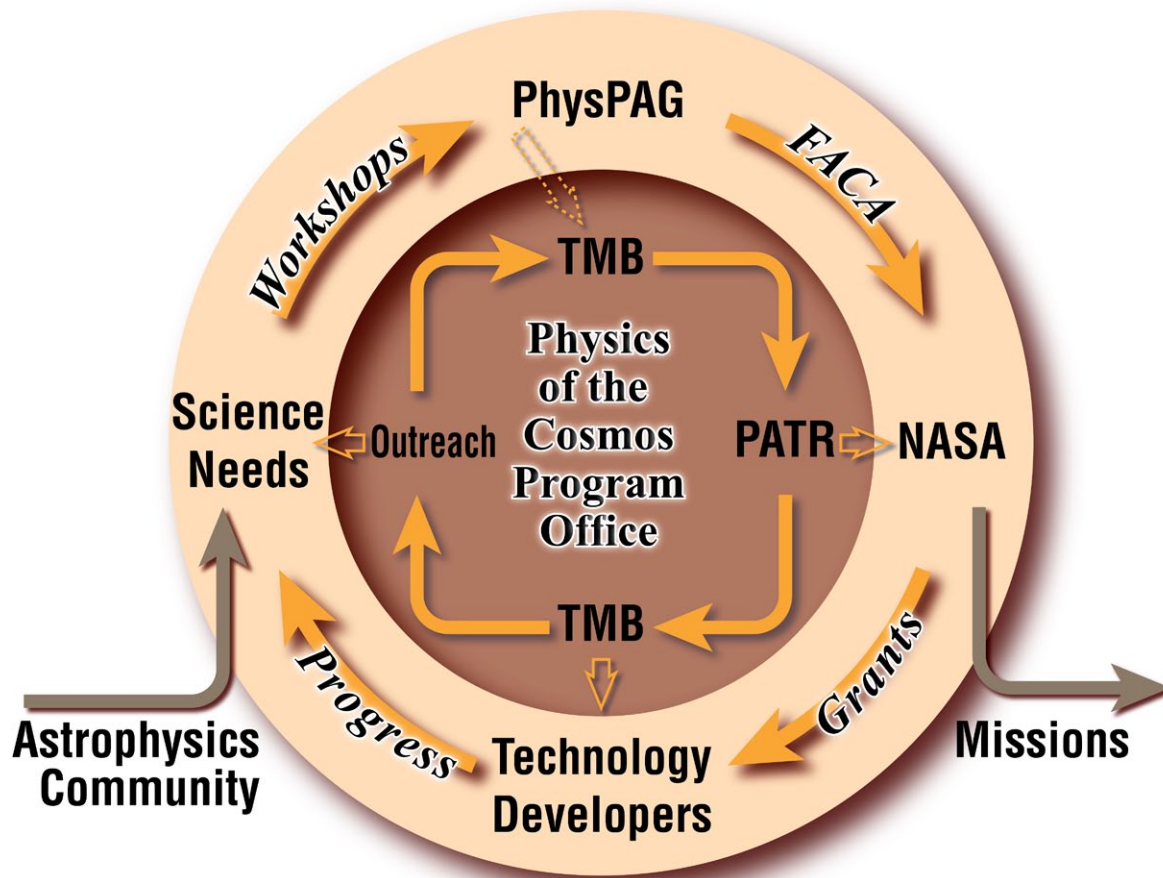

Figure 1.2-1. This diagram illustrates the PCOS annual technology management process.

2 Technology Status: Strategic Instrument Technology Development

FY 12 Program Strategic Technology Development

This section describes the current technology development status, progress over the past year, and planned development activities for all the technologies that were supported by the PCOS SR&T funding in FY12. These include technologies developed for potential future gravitational wave, X-ray astronomy and inflation probe missions. The information contained in this section provides technology overviews and is not intended to provide technical detail for flight implementation. The specific technology readiness levels (TRL) for each technology have been omitted by design, because the TRLs for each technology have yet to be vetted by the PCOS Program Technology Management Board (TMB). Vetting by the TMB occurs when technologists request a TRL review to present their case for TRL reassignment. The TMB assesses the request and, when warranted, provides concurrence. The typical forum for such a request is during the technologist's semi-annual presentation to the PO. Table 2–1 lists the technologies that received Program funding for development work in FY12. Table 2–1 also shows the respective PI leading the technology development, their work institution, and the section in this report where their work is described and statused.

Title	PI	Institution	See Section
Gravitational Wave Mission Phasemeter Technology Development	W. Klipstein	JPL	2.1
Gravitational Wave Telescope Technology Study	J. Livas	GSFC	2.2
X-ray Optics Technology	W. Zhang	GSFC	2.3
Critical-Angle Transmission (CAT) Gratings for High-Resolution Soft X-ray Spectroscopy	M. Schattenburg	MIT	2.4
Off-Plane Grating Arrays for Future X-ray Missions	R. McEntaffer	U. of Iowa	2.5
X-ray Microcalorimeter Spectrometer (XMS) Technology	C. Kilbourne	GSFC	2.6
Moderate Angular Resolution Adjustable Full-shell Grazing Incidence X-ray Optics	P. Reid	SAO	2.7
Directly Deposited Optical Blocking Filters for Imaging X-ray Detectors	M. Bautz	MIT	2.8
Planar Antenna-Coupled Superconducting Detectors for Cosmic Microwave Background Polarimetry	J. Bock	JPL	2.9

Table 2–1. PCOS strategic technology development in FY 2012.

Strategic Astrophysics Technology (SAT) Selections for FY13 Start

The latest selection of proposals for funding under the PCOS Strategic Astrophysics Technology (SAT) solicitation was announced in September, 2012. This selection was based on the following factors: 1) the overall scientific and technical merit of the proposal; 2) the programmatic relevance of the proposed work; and 3) the cost reasonableness of the proposed work. These technologies have recently been selected for funding and have not yet begun work, and hence each project’s status is not presented here. Their progress in the first year will appear in this section in the 2013 PATR. Table 2–2 lists the technologies, along with their respective PIs and their institutions, approved to start development in FY13 under the PCOS SAT award.

Title	PI	Institution
Next generation X-ray Optics: High Resolution, Light Weight, and Low Cost	W. Zhang	GSFC
Demonstrating Enabling Technologies for the High-Resolution Imaging Spectrometer of the Next NASA X-ray Astronomy Mission	C. Kilbourne	GSFC
Colloid Microthruster Propellant Feed System for Gravity Wave Astrophysics Missions	J. Ziemer	JPL
Telescope for a Space-based Gravitational Wave Mission	J. Livas	GSFC
Advanced Laser Frequency Stabilization Using Molecular Gasses	J. Lipa	Stanford U.

Table 2–2. PCOS SAT awarded for start in FY 2013.

2.1 Gravitational Wave Mission Phasemeter Technology Development

Prepared by: William Klipstein

(Jet Propulsion Laboratory/California Institute of Technology)

Summary

Phasemeter technology development during FY12 focused on two areas. The primary thrust of work was to demonstrate the viability of the phasemeter under different credible mission scenarios in which requirements differ from those of LISA. This will allow mission and design trades aimed at reducing the cost of a gravitational wave mission as well as to reduce the implementation risk of the phasemeter, a core piece of LISA-specific technology not addressed by LISA Pathfinder. A second area of work seeks to mature the technology readiness of the analog signal chain by assembling and testing a pre-amp board designed under previous funding.

Overview and Background

The driving LISA Instrument Metrology and Avionics System (LIMAS) requirement is to make an accurate measurement of the phase of the interferometric beat note between pairs of laser beams, both for the interspacecraft and local interferometry. LISA-specific challenges include microcycle/ $\sqrt{\text{Hz}}$ phase precision in the presence of large laser frequency fluctuations and a low signal-to-noise ratio (SNR) environment, and tracking the large changing Doppler shift over the frequency range of 4–18 MHz. The primary science phase measurements are to be provided in a low-pass filtered version allowing representation at 3 Hz sampling rate while representing a 1 Hz useful bandwidth.

In addition to measuring the phase of the primary heterodyne signal, the LISA phasemeter must perform several additional functions:

- Provide a low-latency, high-bandwidth output suitable for use in a laser phase-locking control system.
- Isolate and measure the phase of side-tones used for clock noise transfer.
- Provide an absolute phase measurement of different photoreceiver quadrants to support wavefront sensing.
- Demodulate pseudo-noise modulation to extract spacecraft range, clock offset information, and optical communication signals.

The phasemeter supports approximately 76 tracking channels per spacecraft.

The Phasemeter Subsystem is a digital phase-locked loop that is optimized to extract the phase from multiple carriers in a heterodyne beat note signal in the gravitational wave mission science photoreceiver. The phase is proportional to the separation between spacecraft, and measurements of the distances between the spacecraft and measurements of the laser noise are combined on the ground in a post-processing algorithm called Time Delay Interferometry (TDI) to extract fluctuations in the spacecraft separations with a precision of about 10 picometers. Figure 2.1–1 shows the main components of the subsystem.

The front-end electronics is a low-noise, high-bandwidth quadrant detector that is paired with a fast analog-to-digital converter (ADC). Incoming light from a distant spacecraft is mixed

with light from a local laser to generate interference fringes on the photodetector. These fringes are not stationary because the spacecraft are in constant motion, but the orbits are carefully chosen such that the beat note is an radio frequency (RF) between 1 and 20 MHz.

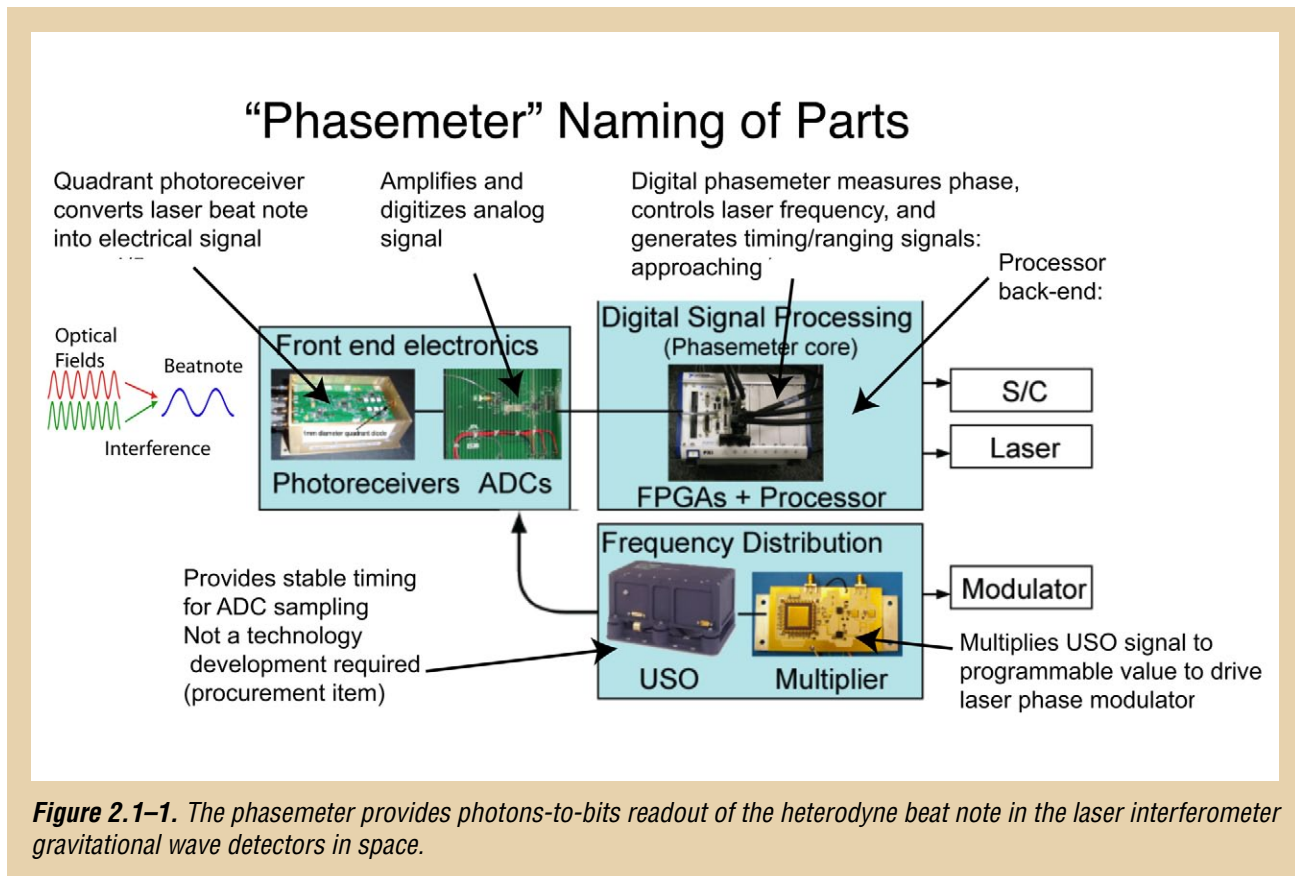

Phasemeters are general-purpose equipment required for laser interferometers in space. We have been developing phasemeters targeting LISA’s requirements, following a path described in the LISA Technology Development Plan (2005). We had previously proposed adapting our phasemeter to the Space Interferometry Mission (SIM), but at the time our design maturity was too low for infusion into that mission. The Earth Science Decadal Survey Tier III mission Gravity Recovery and Climate Experiment (GRACE-II) will use laser interferometry to improve over the measurement capability using microwave signals; the LISA phasemeter adapted the digital-phase-locked-loop architecture of the BlackJack GPS receiver used in the microwave instrument on GRACE to meet LISA’s more demanding requirements. A technology demonstration of interspacecraft interferometry is planned for the GRACE follow-on mission using a simplified version of the LISA phasemeter.

Objectives

Prior to FY12, our developments were funded directly by the LISA project. We have been working on two main tasks with funding granted through the TMB

Task 1: Design and demonstrate modifications to the phasemeter that support relaxation of LISA’s requirements on lasers, orbital parameters, and received optical power

- The LISA phasemeter was designed to support the point design baselined for LISA. We propose a series of design parameter studies and tests to demonstrate compatibility with a wider phase space of gravitational wave mission parameters

Task 2: Assemble and test analog signal chain pre-amp board

- We have designed a path-to-flight version of the analog signal chain between the photoreceivers and the digital phasemeter. With this task we will assemble and test it to mature the lowest maturity element in the signal chain.

Task 1 explicitly targets an expansion of the applicability of the LISA phasemeter to support trade studies aimed at reducing the cost of a gravitational wave mission. Key parameters for the phasemeter include understanding the limits of phasemeter performance in the presence of much lower light levels (smaller telescopes, greater separations, lower laser power), with different types of laser frequency noise (studies for lower power, lower cost lasers), different Doppler shifts coming from changes in the mission design, and potentially lower noise readout requirements for shorter baselines with the same desired strain sensitivity. Task 2 serves to mature the technology readiness of the analog signal chain by improving the design maturity of the least mature item.

Methodology and Technology Readiness Level

This work relies heavily on NASA's investment in phasemeter development and in the development of our interferometer-system test bed, which allows testing of the phasemeter in a relevant signal environment.

All gravitational wave mission concepts under consideration (except for the less-mature atom interferometer concepts) are heterodyne interferometers requiring a phasemeter. All concepts rely on time-delay interferometry (TDI) to overcome limitations of laser frequency noise. Through our LISA work, we have developed unique insights that can be adapted (for orbital dynamics, laser noise, signal strength, modulation/demodulation schemes) to understand the risks and opportunities in alternate mission concepts, each of which would require a phasemeter much like the one we have developed.

We have used this test bed to demonstrate the performance of the Interferometer Measurement System (IMS) in a representative signal environment using commercial equipment, as shown in Figure 2.1–2 and published in Physical Review Letters (de Vine et al., 2010). We have built a flight-like board representing the digital heart of the phasemeter and a path-to-flight photoreceiver meeting LISA's critical performance requirements. These units were assessed against LISA's requirements. With the recent studies for ways to realize the same science at reduced cost, there have been proposals that would increase the separation, use lower

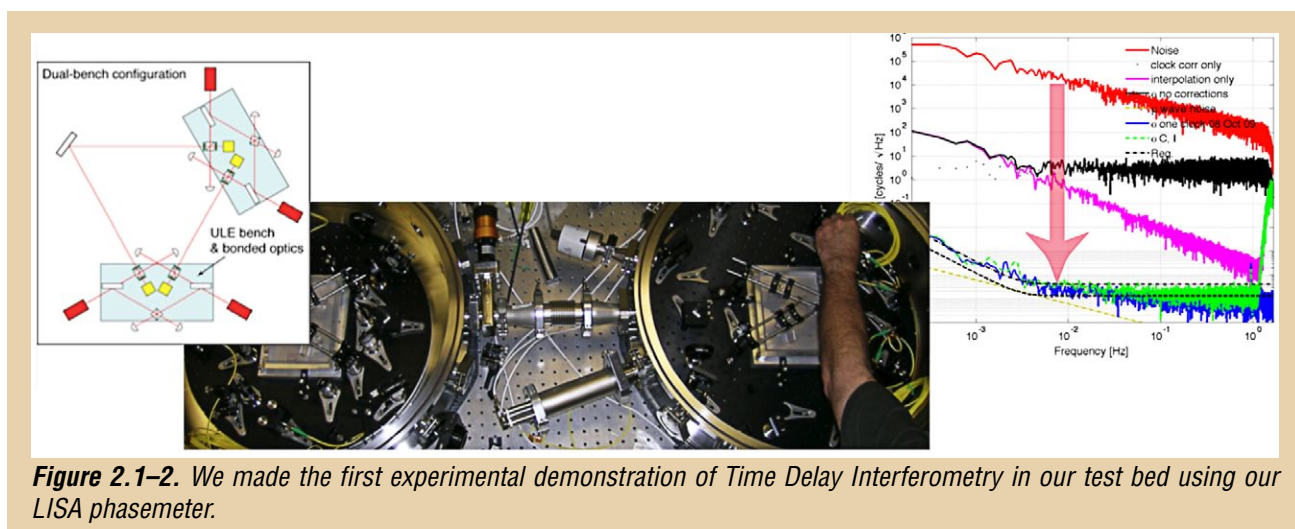

power lasers, smaller telescopes, and have different orbital dynamics. The primary objective of the proposed work is to evaluate our phasemeter capability against these different stressing environments. We start with our phasemeter performance models to predict our sensitivities to different input parameters, and then test these models through simulations and from direct tests with our Labview-based phasemeter. We also have different types of laser, including non-planar ring oscillator (NPRO) lasers, distributed feedback (DFB) lasers, external cavity lasers (ECL) that we can use to test for alternate noise types. We also have the ability to generate simulated noise, although we intend to improve the flexibility of this simulation capability to encompass more complex noise spectra.

Milestones and Schedule

Task	FY13												FY14											
	Oct	Nov	Dec	Jan	Feb	Mar	Apr	May	Jun	Jul	Aug	Sep	Oct	Nov	Dec	Jan	Feb	Mar	Apr	May	Jun	Jul	Aug	Sep
Phasemeter to TRL 5				▲	▲			▲			▲		▲				▲	▲				▲	▲	
Complete characterization of phasemeter impacts to high frequency noise and high Doppler shifts	▲	▲																						
Demonstrate the viability of the phasemeter over a range of noise inputs, Doppler shifts, and received signal powers		▲	▲																					
Test analog signal chain prototype in testbed	▲	▲																						
Develop analog signal chain V2				▲	▲																			
Design study for phoreceiver integrated circuit design				▲	▲	▲	▲	▲	▲	▲	▲	▲	▲	▲	▲	▲	▲	▲	▲	▲	▲	▲	▲	
Design and test flight-like signal conditioning board including samplers																								
Implement low visibility signals in interferometry testbed	▲	▲																						
Incorporate flight-like signal condition board in interferometer testbed																								
Incorporate flight-like phasemeter board with large number of quadrant signals																								
Interferometer testbed experiments with flight-like hardware																								
Use the GRACE Follow-On Interferometer as risk reduction for GW interferometers																								
Develop armlocking algorithms and experiments for potential demonstration on GRACE Follow-On	▲	▲	▲	▲	▲	▲	▲	▲	▲	▲	▲	▲	▲	▲	▲	▲	▲	▲	▲	▲	▲	▲	▲	
Develop TDI experiments that could be deployed on GRACE Follow-On																								
Future task: Seek opportunities for infusion into GRACE Follow-On interferometer																								

Task 1: Design and demonstrate modifications to the phasemeter that support relaxation of LISA’s requirements on laser noise, orbital parameters, and received optical power.

The LISA phasemeter was designed to support the point design baselined for LISA. We propose a series of design parameter studies to demonstrate compatibility with a wider phase space of GW mission parameters.

1a) Demonstrate phase locking and phasemeter readout with low received optical power compared to LISA’s 100 picowatts.

Status: Objective achieved. We have developed analytical models of the interplay between shot noise and phasemeter performance (see Fig. 2.1–3). Prior to this work, our phasemeter would acquire signals down to 40 pW. During this work, we realized that our acquisition

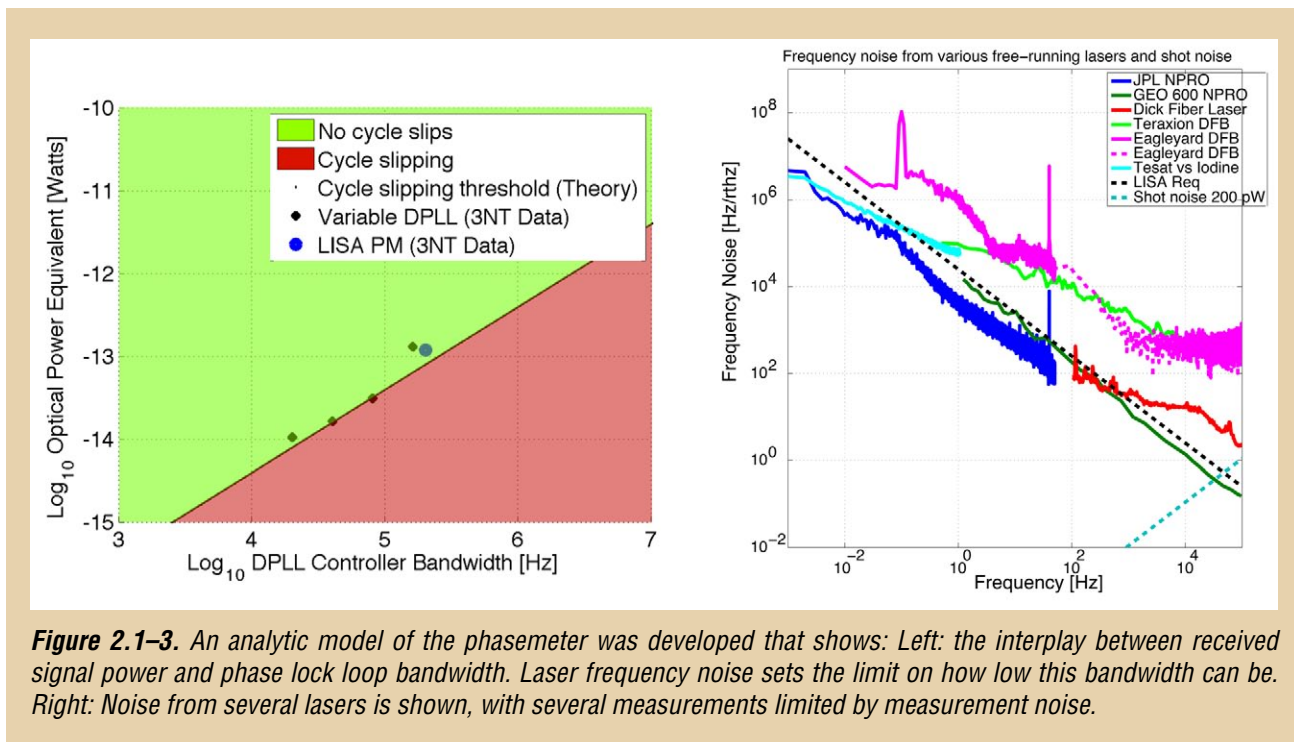

Figure 2.1-3. An analytic model of the phasemeter was developed that shows: Left: the interplay between received signal power and phase lock loop bandwidth. Laser frequency noise sets the limit on how low this bandwidth can be. Right: Noise from several lasers is shown, with several measurements limited by measurement noise.

algorithms needed to be changed to pick out the smaller signal in the presence of other types of physical laser noise, including Relative Intensity Noise (RIN). We demonstrated acquisition and tracking down to 3 pW in our test bed and intend to explore in future work even lower limits suggested by the analytical model.

1b) Design and test modifications to the phasemeter to work with lasers with higher/different intrinsic noise than the LISA NPRO laser.

- NPROs have extremely low intrinsic noise compared to other candidate lasers. We have NPROs, fiber lasers, distributed Bragg reflector, distributed feedback, and external-cavity diode lasers available in our lab.
- The goal would be to show compatibility with a range of laser “characteristics,” not to downselect any particular laser (known to require modification to phasemeter).

Status: Successful developments, but work still under way. In studying the interplay between laser noise and phasemeter design, we further developed our analytical understanding of the limits to phasemeter performance as it applies to laser frequency noise. Previously, LISA considered laser frequency noise primarily in the science bandwidth below 1 Hz, but the phasemeter is sensitive to noise at high frequencies, in the range of a few kHz to a few hundred kilohertz, determined by the design of the phasemeter tracking loop bandwidth and noise parameters. Initial tests with DFB lasers were unsuccessful because of excess white frequency noise above 1 kHz. We addressed limitations three ways:

- a) Using a frequency divider on the heterodyne signal to mitigate phase noise. This works by improving the effective phasemeter bandwidth compared to the noise. This also allows the phasemeter to work with higher Doppler shifts.
- b) Increased the digital phase-locked-loop bandwidth to handle higher noise.
- c) Developing analysis tools and frequency discriminators to properly characterize power-law noise as well as spurs in the spectrum.

As part of this activity, we had an opportunity to test the LISA Pathfinder engineering model laser from Tesat, which, while being an NPRO laser, turns out to have noise up to $200 \text{ kHz}/\sqrt{\text{Hz}}$ at 1 Hz (1/f), compared to laboratory NPROs, which are approximately 20× quieter. Our phasemeter was successful in tracking this excess noise, but we realized the criticality of understanding the limits of phasemeter performance with noise from real physical lasers. While GRACE-II paid for this testing, it relied extensively on techniques and equipment developed under the TMB and former LISA technology development tasks. TMB funding directly mitigated the risk of adapting the higher noise of the Tesat laser to GRACE-II.

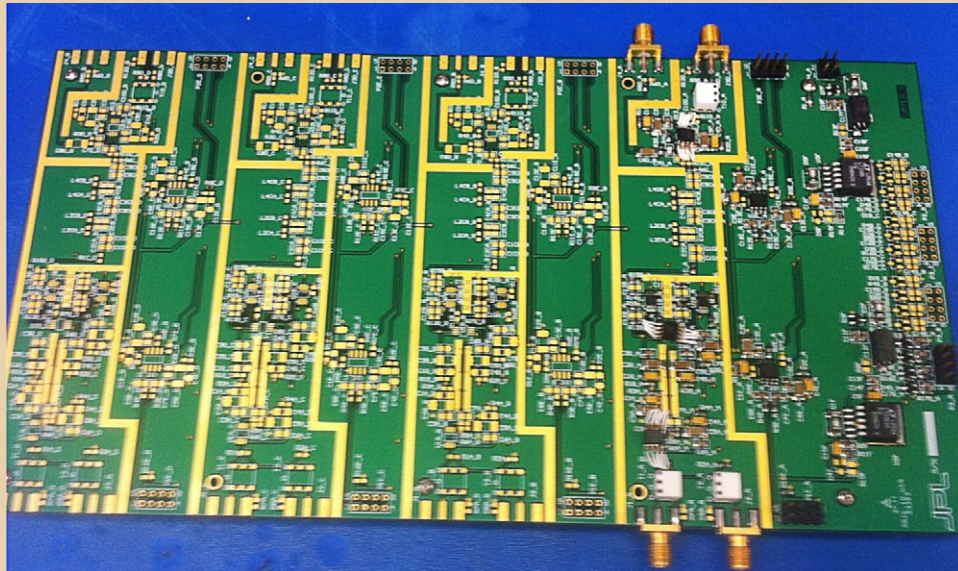

Figure 2.1–4. An analog signal chain board is shown with one channel of four populated.

During the course of this laser frequency noise work and field testing with a real laser, we realized the benefits of improving our phasemeter simulation capability and frequency noise characterization tools. As a result, we adjusted the priorities toward these tasks and deferred testing with several of the specific lasers we had in our lab. The appreciation of the significance of higher-frequency noise and the tools to measure and understand the interplay between phasemeter design and laser frequency noise spectrum above the science band appears likely to be the most enduring value of this work.

With FY12 funding, we will complete a characterization of phasemeter approaches to handling higher-frequency noise, Doppler shifts, and shot noise, and demonstrate the viability of the phasemeter over a range of signal levels, noise parameters, and Doppler shifts.

Task 2: This was a simpler effort to assemble and test the analog signal chain between the photoreceivers and the digital phasemeter.

Status: Work in progress. We built and tested one channel of the four-channel board, enough for a pair of quadrant detectors (see Fig. 2.1–4). In the course of testing and looking at the perceived requirements, we realized that a minor change to the design would allow improved performance and reduce electrical power and complexity by eliminating a secondary voltage. Rather than complete the four-channel board, we are building up a “Version 1.5” design, which we should be able to complete within our FY12-funded activities. Version 1.5 includes some minor fixes in the layout of Version 1.0 and also implements design changes to reduce the number of required voltages and parts to reduce the power and complexity.

Future Plans/Next Steps

Future work on the phasemeter and test bed will focus on continuing to advance the TRL of the phasemeter toward TRL-5, maintaining the phasemeter as a viable strategic capability for gravitational wave missions, and looking for opportunities to reduce risk to future missions using the planned GRACE-II interferometer.

The primary objectives of new activities proposed for support in FY13 include:

- 1) Complete the assessments of phasemeter performance as it relates to gravitational wave mission parameters and component technologies.
- 2) Maintain NASA as a viable partner in the (likely) scenario that ESA and NASA will partner in some form (ESA- or NASA-led).
- 3) Explore opportunities to leverage the GRACE-II interferometer technology demonstration to reduce the risk of a future gravitational wave mission.

Proposed tasks for FY13 funding:

- 1) Demonstrate the viability of phasemeter performance against a range of shot-noise and laser frequency noise limits and expose the limits of the design space.
- 2) Complete the tool set for evaluating noise from real lasers against the demonstrated capabilities of the phasemeter.
- 3) Improve test bed fidelity using advanced prototypes of component technologies and more representative light levels.
- 4) Explore opportunities to leverage the GRACE-II interferometer technology demonstration to reduce the risk of a future gravitational wave mission.

The tasks above would put the phasemeter on a 2- to 3-year path to TRL-5 and to lay the foundation to capitalize on the GRACE-II interferometer for an investment of approximately \$500k/year. Milestones for the next two years are shown in the Milestone Schedule (see Milestones and Schedule).

References

- Gravitational-Wave Community Science Team, Gravitational-Wave Core Team, and the Gravitational-Wave Science Task Force. "Gravitational-Wave Mission Concept Study Final Report." Submitted to NASA HQ July 2012.
- de Vine, G., Ware, B., McKenzie, K., Spero, R.E., Klipstein, W.M., and Shaddock, D.A. "Experimental Demonstration of Time-Delay Interferometry for the Laser Interferometer Space Antenna." *Physical Review Letters*, 104: 211103 (2010).
- LISA Technology Development Plan (2005).

This page left blank intentionally

2.2 Gravitational Wave Telescope Technology Study

Prepared by: Jeff Livas (NASA/GSFC)

Summary

The purpose of the telescope for the LISA baseline space-based gravitational-wave observatory missions is to function as a precision beam expander to efficiently deliver optical power from one spacecraft to another. The baseline application is to make a measurement of the separation of the spacecraft with a precision of 10^{-12} m (1 pm) over several million kilometers. Although various modifications to the baseline LISA mission have been considered over the past year or so by both ESA and NASA to reduce cost, the basic specifications for the telescope and the essential measurement precision remain essentially unchanged for the different variants. In the description that follows, the ESA designs are collectively referred to as “NGO” (New Gravitational-wave Observatory), or “eLISA,” and the NASA designs are referred to as “SGO” (Space-based Gravitational-wave Observatory).

The telescope design for the LISA baseline mission may be adequately satisfied by a near diffraction-limited classical Cassegrain-style optical system—either on-axis or off-axis. By itself, therefore, it is not a particularly risky development item. However, the gravitational wave application is for a precision length measurement system, not an imaging system, and so some of the requirements are different from those for an imaging system.

The two main challenges are: 1) the requirement for dimensional stability at the picometer level for the primary-to-secondary mirror spacing in the presence of both axial and transverse temperature gradients, and; 2) the requirement for low stray light levels. Stray light levels must be extremely low because the distance measurement is made using interferometric techniques that are very sensitive to low light levels and, also, because the telescope is used to transmit a one-watt beam and receive a 100-picowatt beam simultaneously. The typical imaging application for a telescope does not have these requirements.

The telescope technology study effort will develop a set of suitable requirements for the LISA metrology application and investigate the two key design challenges.

Overview and Background

The LISA concept telescope, although based on a conventional optical design, is optimized for precision pathlength measurements, so it must be dimensionally stable at the 10^{-12} m/ $\sqrt{\text{Hz}}$ level under the operating conditions expected for the LISA concept spacecraft, which include low temperatures (-65°C) and temperature gradients, both axial and transverse. Excellent knowledge of the physical properties, particularly the coefficient of thermal expansion (CTE), is also required to maintain alignment tolerances to better than 1 micron. Table 2.2–1 shows the nominal performance requirements for the ESA-led GW mission baseline concept, NGO.

An off-axis design would normally be the preferred choice because the lack of a central obstruction increases the optical efficiency and reduces stray light effects. However, a preliminary tolerance analysis performed prior to this study by both the ESA study contractor and by the Optics Branch (Code 551) at GSFC indicates that the design is very difficult to build in a normal optical shop. This is a problem because we need six flight units and

Parameter	Derived From	NGO/eLISA
1 Wavelength		1064 nm
2 Net wavefront quality of as built telescope subsystem over science field of view under flight-like conditions	Pointing	$\lambda/30\text{RMS}$
3 Telescope subsystem optical pathlength* stability under specified environment	Pathlength Noise/ Pointing	$1 \text{ pm} / \sqrt{\text{Hz}} \times \sqrt{\left(1 + \left(\frac{0.003}{f}\right)^4\right)}$ where $0.0001 < f < 1 \text{ Hz}$ $1 \text{ pm} = 10^{-12} \text{ m}$
4 Field-of-View (Acquisition)	Acquisition	+/- 200 μrad
5 Field-of-View (Science)	Orbits	+/- 7 μrad out-of-plane** +/- 4.2 μrad in-plane
6 Transmitted beam diameter (D) on primary mirror	Shot noise/ Pointing	0.92 x D (primary diameter)
7 Entrance Mirror Diameter	Noise/pointing	200 mm
8 Entrance Pupil	Pointing	Entrance of beam tube (or primary?)
9 Location of image of primary mirror (exit pupil)	Pointing	~10 cm (on axis) behind primary mirror
10 Pupil distortion	SNR	10%
11 Beam size on bench	Short-arm interferometer	5 mm
12 Mechanical length		350 mm
13 Optical efficiency	Shot noise	>0.85
14 Scattered Light	Displacement noise	< 10^{-10} of transmitted power

*Optical pathlength is the net total pathlength through the telescope as experienced by either the transmitted or received beam, which can be defined as the accumulated phase divided by the wavenumber ($2\pi/\lambda$).

**Out-of-plane or in-plane refers to two orthogonal spatial directions in the telescope. The final application for these telescopes involves mounting them in three spacecraft that form an equilateral triangle that is in the same orbit as the Earth about the sun, but lagging by 22 degrees in orbital phase. The plane of the triangle is inclined at 60 degrees from the ecliptic. In-plane refers to the plane of this triangle, and out-of-plane is normal to it.

Table 2.2–1. Performance requirements for the ESA LISA Mission variant New Gravitational-wave Observatory (NGO), or eLISA. Specifications #3 and #14 are particularly challenging and specific to the precision measurement application.

several for ground testing—approximately 10 telescopes total. A robust design is necessary to be sure that the fabrication of the telescopes is not an undue schedule risk, and also to allow the telescopes to be interchangeable. In addition, the expected thermal environment has both an axial and a transverse temperature gradient, so environmental effects would naturally tend to create off-axis aberrations. An on-axis design generally has better resistance to these environmental effects, but the on-axis spot in the center of the secondary mirror causes unacceptably high levels of scattered light. Therefore, the best design choice is not clear and requires further study.

The left-hand image in Fig. 2.2–1 shows a ray tracing of a nominal 20-cm aperture on-axis Cassegrain design suitable for the ESA-led NGO mission. The right-hand image in Fig. 2.2–1 shows an off-axis Cassegrain design with the same optical prescription as in the left-hand image, indicating that both designs are similar in conception.

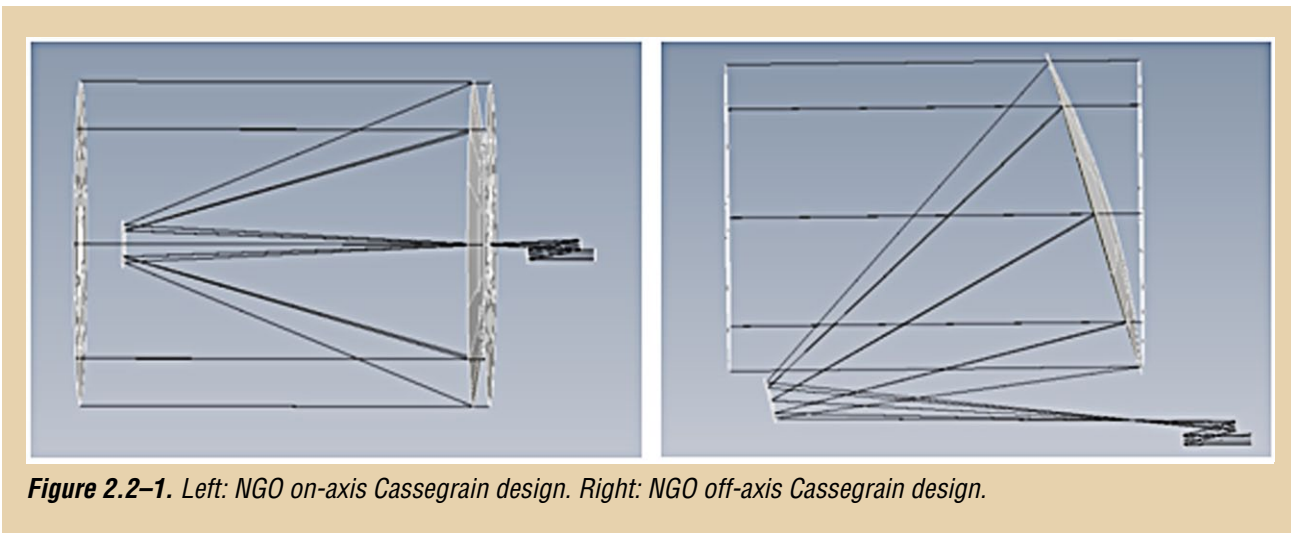

Future mission/missions enabled

Although the telescope technology is specifically targeted at the class of space-based gravitational wave missions, any precision distance measurement mission will benefit from the lessons learned. For example, laser-ranging capability will need dimensionally stable optics. Laser communications will benefit from the low stray light capability, which is needed for good transmit/receive isolation and to enable full duplex operation (simultaneous transmit and receive) with a single aperture.

Objectives

The proposed work concentrates on areas where the requirements for LISA, NGO, and SGO differ from standard optical design practices. The baseline concept for the gravitational wave (formerly LISA) telescope is not settled. The two competing telescope designs (on-versus off-axis) promise different benefits, but development and, more importantly, lab demonstrations are only just beginning. The major technical challenges in the gravitational wave telescope are stray light control and optical pathlength stability stemming from the stability of the primary-secondary spacer. Note that two telescopes are needed per arm, so a three-arm mission requires six telescopes for flight, as well as spares and units for ground testing. This means that these units must be designed for small-scale manufacturing, so there is a premium on simplicity and low cost for design, construction, and testing. The specific proposed activities are as follows:

- 1) Complete a requirements study to develop straw-man NGO specifications and kick off a study with an aerospace industrial partner to validate the design, including a detailed tolerance analysis and an assessment of manufacturability. For FY13, this work would continue on to procure a first prototype optical design that could be used for testing.
- 2) Continue studying scattered light reduction techniques by updating an existing LISA baseline model for NGO requirements and finish a promising anti-scattering mask design. In parallel, begin to make measurements on representative substrates to test different techniques for reducing scattered light, including a strategically placed and shaped hole, anti-reflection coatings, and blackening coatings made with carbon nanotubes with a proprietary process invented at GSFC.

These activities are a continuation of work begun in FY11. Note that the telescope spacer study, a technology development project not explicitly funded by the TMB in FY12, has already demonstrated that silicon carbide is a suitable material for the metering structure of a telescope and meets the stability requirements of a LISA-like mission precision metrology application. Some of the results of that work were published this year^[1].

Key challenges and innovations

The key challenge is to compare an on-axis design, which is more stable for the expected thermal environment, less expensive to build and test, but expected to have higher stray light levels against an off-axis design that has better stray light performance but is expected to be much more difficult to build. The key question is whether or not an on-axis design can meet the stray light requirements. Alternatively, a demonstrated capability for small-scale production of off-axis telescopes that meet requirements would also be an acceptable outcome because it would mean that the expected tolerance and fabrication tolerance issues for an off-axis design could be overcome.

Accomplishments

The accomplishments so far in FY12 are focused on five areas: 1) an eLISA design; 2) an SGO design; 3) an SAT proposal for follow-on funding; 4) a request for information (RFI) as a preliminary for an industrial study contract to develop and analyze a candidate design, including the manufacturability aspects, and; 5) the beginnings of a stray light analysis. We will award a telescope study contract for this analysis in October 2012, and the study is anticipated to conclude by the end of the 2012 calendar year. The main task originally planned for this study, which will probably not be accomplished simply due to lack of time and manpower, is an experimental study of stray-light suppression coating and mask designs.

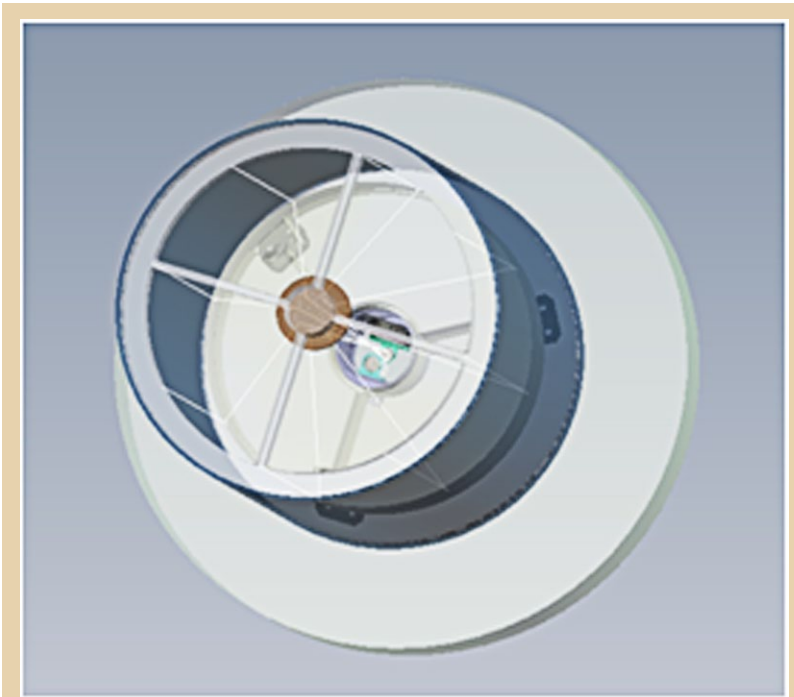

Figure 2.2-2. Mechanical model of the on-axis eLISA telescope design showing the spider and tertiary mirror. The telescope is mounted on a strongback that supports the optical bench and gravitational reference sensor.

NGO/eLISA design

We completed a first-order design for the ESA-led NGO (or eLISA) mission with both an on-axis and off-axis version with the same nominal prescription that nominally meets specifications by design. We used the eLISA “Yellow Book” document^[2] as a guideline for developing the specifications. A preliminary mechanical design for the on-axis version has been completed (Fig. 2.2–2) and includes a space-qualified focus mechanism. Further analysis is needed, including a tolerance analysis of both optical designs.

SGO design

A first-order design for an on-axis telescope has also been completed for the NASA SGO family of mission concepts (Fig. 2.2–3). As the constellation of spacecraft move in their orbits, the angles formed between the legs of the triangle vary slightly from the nominal 60 degrees that they would subtend if the triangle were perfectly equilateral. The variation in angle is larger than the field of view of the telescope, so it is necessary to move the telescope line of sight to follow. The SGO orbits allow for the possibility of an “in-field guiding” design that uses a pivoting mirror inside the telescope to steer the optical axis of the telescope and eliminate the need to move the entire telescope and optical bench assembly on a pivot. The large variation in the angles between spacecraft for the ESA eLISA mission constellation makes in-field guiding not practical for those missions because the required pivoting motion of the steering mirror is too large. A mechanical design for the SGO on-axis telescope is in process, but accommodation of the focus mechanism and additional relay optics required by the in-field guiding design have required iteration of the optical design to increase mechanical clearances while retaining the optical performance.

RFI Completed

As part of the process of developing a request for proposal (RFP) for an industrial study contact, we prepared and executed an RFI to gather some market data. The Office for Space

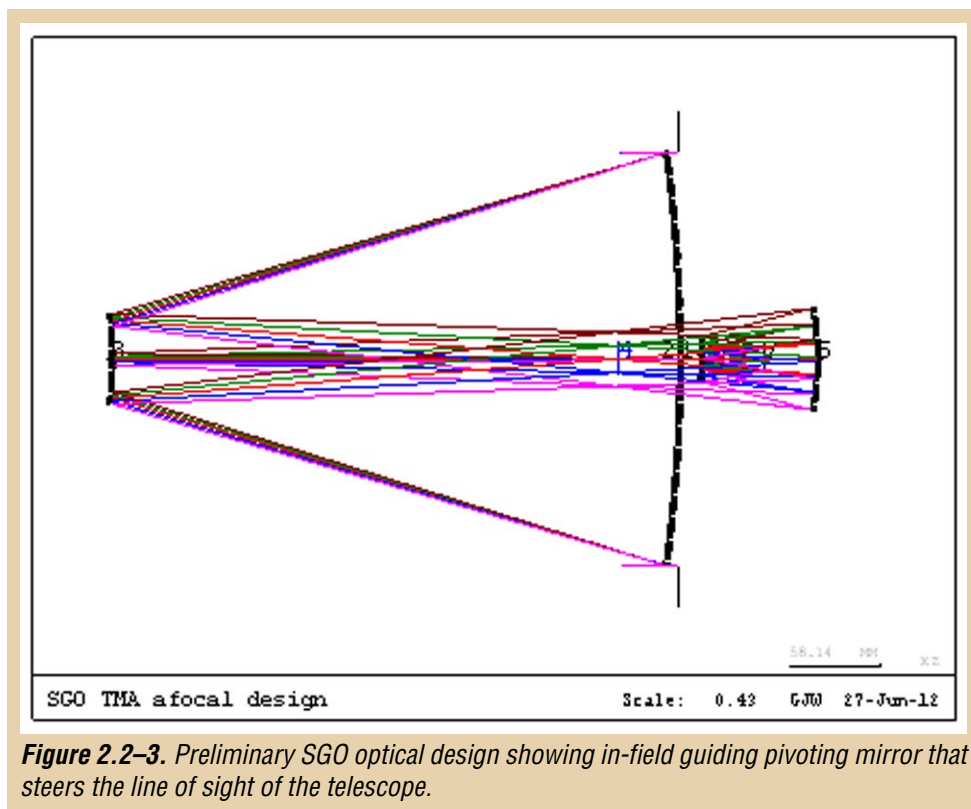

Figure 2.2–3. Preliminary SGO optical design showing in-field guiding pivoting mirror that steers the line of sight of the telescope.

Sciences (Code 210S) in the Procurement Operations Division Procurement office at GSFC required this extra step to help refine the study requirements and to get an idea of the type of response to expect to the RFP. Three vendors responded to the RFI. These responses have already been used to inform the documentation prepared for RFP solicitation NNG12441405R for an industrial study, which was released August 6, 2012. The responses were received August 28, and a contract is planned for award in October. The study is anticipated to conclude by the end of the 2012 calendar year.

Stray Light Study Results

A stray light analysis has been started using the commercial non-sequential ray-tracing package FRED. The analysis has focused on developing a model of the on-axis eLISA telescope, including obstructions, based on the optical prescription and a mechanical model, plus some simplified assumptions for surface roughness and cleanliness for materials and coatings. We used the University of Glasgow design^[3] for the LISA optical bench to locate the detectors and field stops, and have been plotting the ratio of power delivered to the output of the telescope divided by power scattered onto the detectors for several treatments of the on-axis region of the secondary mirror: a hole in the mirror, a region blackened with carbon nanotubes, and a phase mask designed to reduce on-axis scatter. Figure 2.2–4 shows preliminary results with a hole. The preliminary results show a scattered light power of 6×10^{-11} W (60 pW) on the detector for 1 W transmitted to the sky, and we expect a further reduction by a factor of 2 (to 30 pW) if polarization is taken into account. This level of stray light is below the expected 100 pW received signal from the far spacecraft, so it is approaching the right order of magnitude.

Milestones and Schedule

Task	FY13													FY14												
	Oct	Nov	Dec	Jan	Feb	Mar	Apr	May	Jun	Jul	Aug	Sep	Oct	Nov	Dec	Jan	Feb	Mar	Apr	May	Jun	Jul	Aug	Sep		
Major Milestones	▲ Complete requirements ▲ Mid-term													▲ Final report												
GSFC: Develop specifications				▲																						
GSFC: Update scattered light model								▲																		
GSFC: Study scattered light																							▲			

Future Plans/Next Steps

Under the existing task, there are two main immediate next steps for the telescope work that will be accomplished by the end of the 2012 calendar year. The first step is the completion of the industrial study to validate the telescope design, including a detailed tolerance analysis and an assessment of manufacturability (see the discussion in the Objectives section above for more detail). The study contract was awarded in September 2012 and results are anticipated by December 2012.

The second step is further progress on the study of stray light. Initial results for a hole in the secondary mirror show that stray light levels on the main science detectors are approximately 30 pW for 1 W of transmitted power, which is nominally acceptable. However, the model must be extended to include diffraction and polarization, and we need to consider an

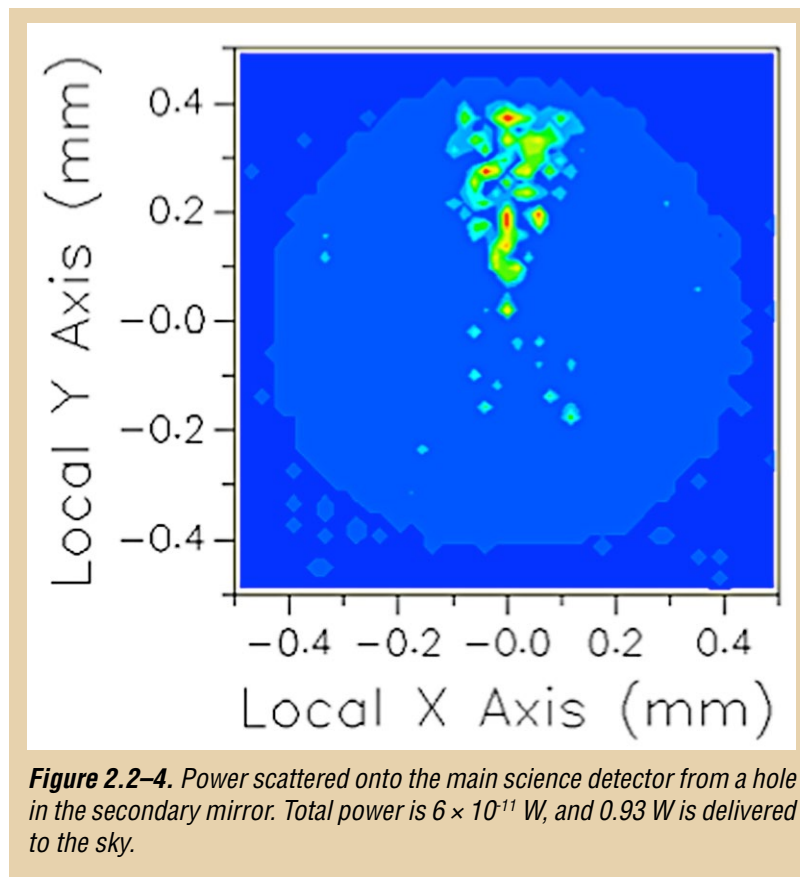

apodized mask design as well. The mask design work is in progress, and we should have results by the end of the 2012 calendar year. However, as with any model, the results need to be validated against measurements to be sure that the models are correct and that they include all relevant effects. Most likely, we will not have completed these measurements by the end of the year.

There are two clear steps for future telescope work beyond the end of the calendar year. The first is to continue the stray light analysis and start the experimental measurements of scattered light suppression techniques as just discussed, and the second is to actually fabricate and test a prototype telescope to verify that the design can meet requirements and that it is indeed possible to manufacture with reasonable optical shop practices.

Three tasks have been defined for this follow on work:

- Task1: Optical pathlength stability in a relevant environment. This would build on the work done to demonstrate a silicon carbide telescope spacer element, but for the complete telescope including optics.
- Task 2: Stray light suppression.
- Task 3: Manufacturability study and preliminary demonstration.

SAT Proposal

We applied for SAT funding to continue the telescope development work through the next two years. The proposal is to fabricate and test a telescope to verify that it meets the needs for precision interferometric metrology. Fabrication of the telescope is likely to follow the results of the industrial study that is funded by the TMS work for FY2012, but the procurement contract will not necessarily go to the same study contractor. The SAT proposal followed the second year of the original proposal to the TMB and requested a total of \$913k and three FTEs per year over 2 years.

The next steps will depend on the outcome of the SAT proposal. If funded, we will procure a prototype telescope and test it. If not, we will have to examine to prospects for securing funding elsewhere, including a possible collaboration with Europe.

References

- ^[1]Sanjuan, J., Preston, A., Korytov, A., Spector, A., Friese, A., Dixon, G., Livas, J., Mueller, G., *Carbon fiber reinforced polymer dimensional stability investigations for use on the laser interferometer space antenna mission telescope*, Rev Sci. Instrum., Vol.82, Iss. 12, 124501 (2011). URL: <http://link.aip.org/link/?RSI/82/124501> DOI: 10.1063/1.3662470
- ^[2]LISA assessment study report (Yellow Book), ESA/SRE(2011)3, URL: <http://sci.esa.int/science-e/www/object/index.cfm?fobjectid=48364>
- ^[3]LISA Optical Bench design courtesy of E.W. Fitzimons and H. Ward, Institute for Gravitational Research, School of Physics and Astronomy, University of Glasgow, Glasgow, UK G12 8QQ

2.3 X-ray Optics Technology

Prepared by: William W. Zhang (NASA/GSFC), Stephen L. O'Dell (NASA/MSFC), and Mark D. Freeman (SAO)

Summary

Lightweight X-ray optics is a key enabling technology for future astronomical missions. Three critical metrics—1) angular resolution, 2) mass per unit area, and 3) production cost per unit area—characterize any technology for manufacturing a telescope. Our objective is to mature a process for constructing X-ray telescopes that improves one or more of these metrics by at least an order of magnitude with respect to those of previous and current X-ray missions.

We have adopted a hierarchical telescope-design approach comprised of three major steps: 1) fabrication of mirror segments, 2) alignment and bonding of mirror segments into mirror modules, and 3) co-alignment and integration of mirror modules into a flight mirror assembly. This modular approach is robust and scalable, in that the basic elements (mirrors) and building blocks (modules) are relatively insensitive to the size of the mirror assembly itself and essentially independent of each other. As specific mission requirements govern the mirror-assembly design and as tolerances for integration into a mirror assembly are much less challenging than those for mirror fabrication and alignment and bonding into a mirror module, the focus of our development program is to mature processes for the first two steps.

We have made significant progress in both these areas. As of July 2012, we are able consistently to align and bond multiple mirror pairs into technology development modules that are flight-like except for containing fewer mirror pairs. We have conducted multiple X-ray tests demonstrating imaging performance near 15-arcsecond half-power diameter, depending upon relative thermal conditions during bonding and during testing. In FY2013, we expect to refine both the mirror-fabrication and alignment-and-bonding processes and to better control thermal conditions, toward improving image performance to better than 10-arcsecond. Additionally, we shall subject these modules to rigorous vibration and thermal environmental testing, to help identify and engineer solutions to meet all spaceflight requirements.

Overview and Background

X-ray telescopes are essential to the future of X-ray astronomy. The telescope's main performance characteristics—angular resolution and photon collecting area—determine a mission's science capability. The three operating facility-class missions—NASA's *Chandra*, ESA's *XMM-Newton*, and JAXA's *Suzaku*—represent the state of the art in X-ray telescopes and exemplify trades amongst angular resolution, collecting area, mass and volume constraints, and production cost. *Chandra*'s mirror assembly achieves truly exquisite angular resolution (0.5 arcsecond), but at the expense of large mass ($\approx 1,500$ kg), relatively small effective area ($\approx 1,000$ cm²), and high production cost. In contrast, *Suzaku*'s mirror assemblies are extremely lightweight and low-cost, but exhibit relatively poor angular resolution (≈ 120 arcseconds). *XMM-Newton*'s lies in the intermediate zone for each of these parameters.

Future X-ray observatories, from Explorer-class up to facility-class, require X-ray optics that are at least an order of magnitude better than current telescopes in one or more of the three metrics: 1) angular resolution, 2) mass per unit area, and 3) production cost per unit area. The proverbial holy grail of X-ray telescopes is to develop technologies that achieve *Chandra*'s angular resolution at *Suzaku*'s mass and cost per unit area.



Figure 2.3–1. These images illustrate the main steps in building a hierarchical X-ray telescope. Left: Fabricate large numbers of thin mirror segments. Middle: Align and bond numerous (typically on the order of one hundred) mirror pairs into a mirror module. Right: Co-align and integrate many (tens to hundreds) modules into a mirror assembly.

Figure 2.3–1 illustrates the three major steps in producing a hierarchical-design X-ray telescope: 1) fabrication of the mirror segments; 2) construction of the mirror modules, each containing hundreds of mirror segments; and 3) integration of a mirror assembly, comprising tens to hundreds of mirror modules. This technology has three salient characteristics:

1. Use of a replication process—namely, thermal slumping of commercially available thin glass sheets—renders fabrication of mirror segments much less time-consuming and expensive than traditional grinding and polishing. In the replication approach, only the mandrels require precision figuring and each mandrel is typically replicated at least a dozen times. This effectively reduces the cost per unit mirror area by more than an order of magnitude.
2. Due to the hierarchical structure of segmented optics, they are modular and scalable. Thus, they are suitable for small telescopes for Explorer-class missions up to large telescopes for facility-class missions. The size of a mirror module is essentially independent of the mirror assembly’s size, and the difference between large and small mirror assemblies lies mainly in the number of modules each assembly contains.
3. This technology is highly amenable to parallel mass production because the modular approach utilizes many identical mirror segments and modules. Hence, it allows flexibility in the project implementation schedule to promote efficiency while minimizing schedule and cost.

The precision needed for aligning and integrating modules into the mirror assembly is substantially less than that required for fabricating mirrors and aligning and bonding mirrors into the mirror module. Substantially similar tasks have been successfully performed many times for previous missions.

Objectives

Our objective is to develop and mature techniques necessary for making mirror segments and aligning and bonding them into mirror modules. In this context, this technology can be matured to TRL-5 without definition of a specific mission. Upon specification of a mission design and requirements, these techniques can be applied directly toward making high-fidelity modules, thus rapidly reaching TRL-6 for the specific mission. Upon achieving TRL-5,

this technology approach will allow accurate and reliable cost and schedule estimation for specific telescope mirror assemblies, including Explorer missions.

Our strategy is to develop, mature, and perfect the various technology elements so that processes are repeatedly demonstrated empirically and also understood analytically. Predictability and understanding will ensure process reliability and technology robustness, thus mitigating cost and schedule risk.

Accomplishments

FY2012 has been a productive year. We have worked on every component of this technology up to the module level, achieving consistent results.

1. **Forming-mandrel fabrication:** We obtained four fused-quartz mandrel blanks that were unused by the NuSTAR project and had them ground and polished into conical shapes, corresponding shells 368P/S and 356P/S. (The number is the mandrel's diameter in millimeter; "P" denotes primary and "S", secondary.) Then we re-commissioned a mandrel polisher at GSFC's optics fabrication shop. As of July 2012, we have polished and figured the 368P mandrel to its allocation for 5-arcsecond system-level performance. We are currently working on the 368S mandrel and expect to finish and qualify it by the end of August 2012. We plan to complete the 356P and 356S mandrels by December 2012. In addition, we procured eight pairs of fused-quartz mandrel blanks ranging in diameters from 200 to 215 mm, which will be ground and polished in FY2013 to meet the same performance requirement. By the end of FY2013, we anticipate having 13 forming-mandrel pairs spanning 200–500 mm in diameter, which will support fabrication of a technology development module (TDM) that is substantially similar to a flight mirror module.
2. **Mirror segment fabrication:** Continuing to refine the glass-slumping process, we optimized the temperature cycle and increased the production rate by 30% (from 1.5 to 2 substrates per mandrel per week). We also achieved a better understanding of the boron-nitride mandrel surface treatment, reducing the time required to condition a mandrel's surface from 15 to 10 weeks. Each of these improvements will significantly reduce the cost and schedule for implementing a future mission. As of July 2012, we consistently slump glass sheets to make substrates with about 6-arcsecond resolution (two-reflection half-power diameter, HPD), within the allocation for constructing modules meeting requirements for a 10-arcsecond telescope. Meanwhile, with support of a ROSES/APRA grant, we have been developing a new technique of fabricating mirror substrates from single-crystal silicon. Thus far, we have achieved initial proof of principle by making flat mirrors.

We have also conducted numerous experiments in coating mirrors to reduce coating stress, which can distort thin mirrors. These include magnetron sputtering with Dr. David Windt of RXO LLC, atomic layer deposition (ALD) with Dr. Philippe de Rouffignac of Arradiance Inc., and ALD with Dr. Laurent Lecordier of Cambridge NanoTech Inc. Thus far, the experimental results show that magnetron sputtering and ALD each have the potential of coating a thin mirror without causing excessive distortion; however, neither process has yet achieved consistent and repeatable results.

3. **Mirror-segment metrology:** We have improved precision for metrology of mirror substrate/segment by a factor of several. In doing this, we identified and mitigated three sources of measurement errors: 1) human-body heat that can elastically distort

the mirror's figure during measurement, 2) mirror-segment storage conditions that can temporarily distort a mirror segment due to glass viscoelasticity, and 3) measurements that have cross-calibrated two null lens and interferometer systems.

4. **Alignment and Bonding:** Fig. 2.3–2 illustrates the past year's most important accomplishment—validation of a mirror bonding process. Beginning in 2012, we were able to align and bond only one mirror pair at a time. As of July 2012, we have repeatedly co-aligned and bonded three mirror pairs to construct TDMs. We have conducted X-ray testing (Fig. 2.3–3) that demonstrates TDM performance near 15-arcsecond HPD.

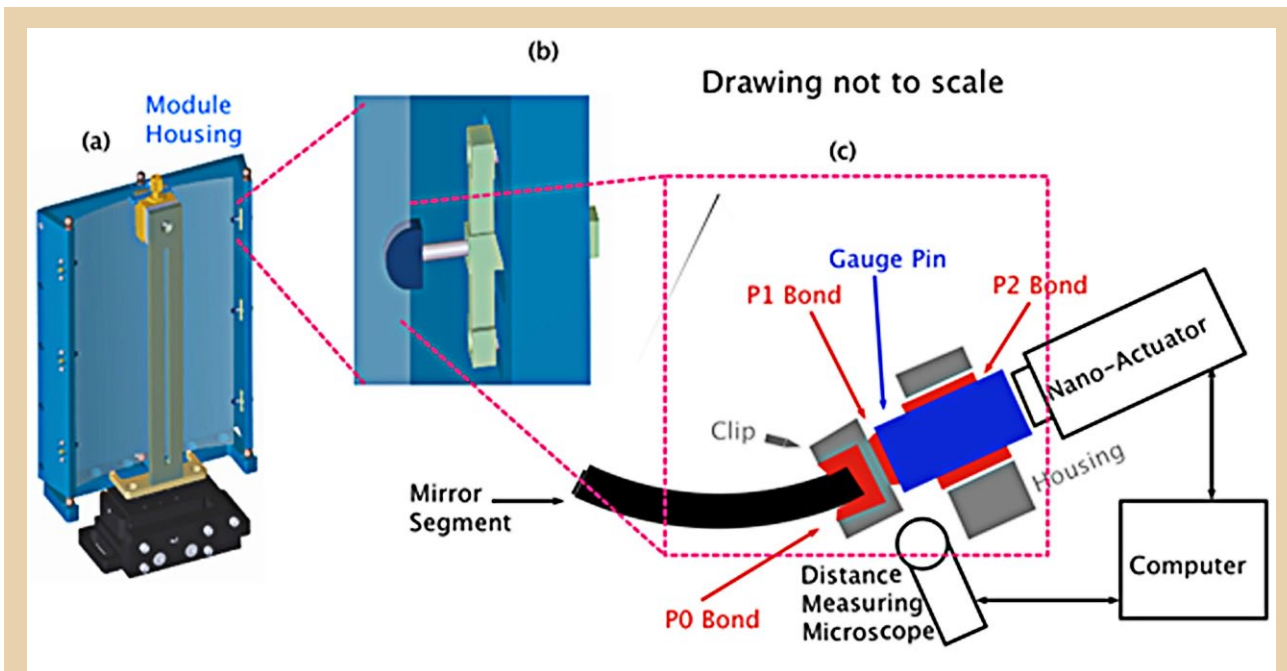

Figure 2.3–2. This schematic illustration shows the edge-bonding scheme for attaching each mirror to the module housing. Left: (a) Bonding each mirror at six attachment locations to the housing helps withstand launch loads. Center: (b) This zoomed view shows an attachment location. Right: (c) This further zoomed view elucidates details of the attachment, showing three levels of adhesive bonds—P0, P1, and P2. The nano-actuator, distance-measuring microscope, and computer are support equipment for the bonding and are not part of the mirror module.

5. **Module engineering, construction, and testing:** We have applied the edge-bonding process described above toward constructing TDMs, each containing three parabolic-hyperbolic mirrors pairs. Cycling some TDMs between 18 and 29°C shows little image degradation, indicating that the edge-bonding process would likely meet the thermal requirements of a future mission. In addition, we designed and fabricated a vibration testing fixture (Fig. 2.3–4) that mounts the TDM in a flight-like way—kinematically attached at three points near its middle. As of early August 2012, we have arranged vibration (initial sine sweep) testing at a facility in Frederick, MD for later in the month.

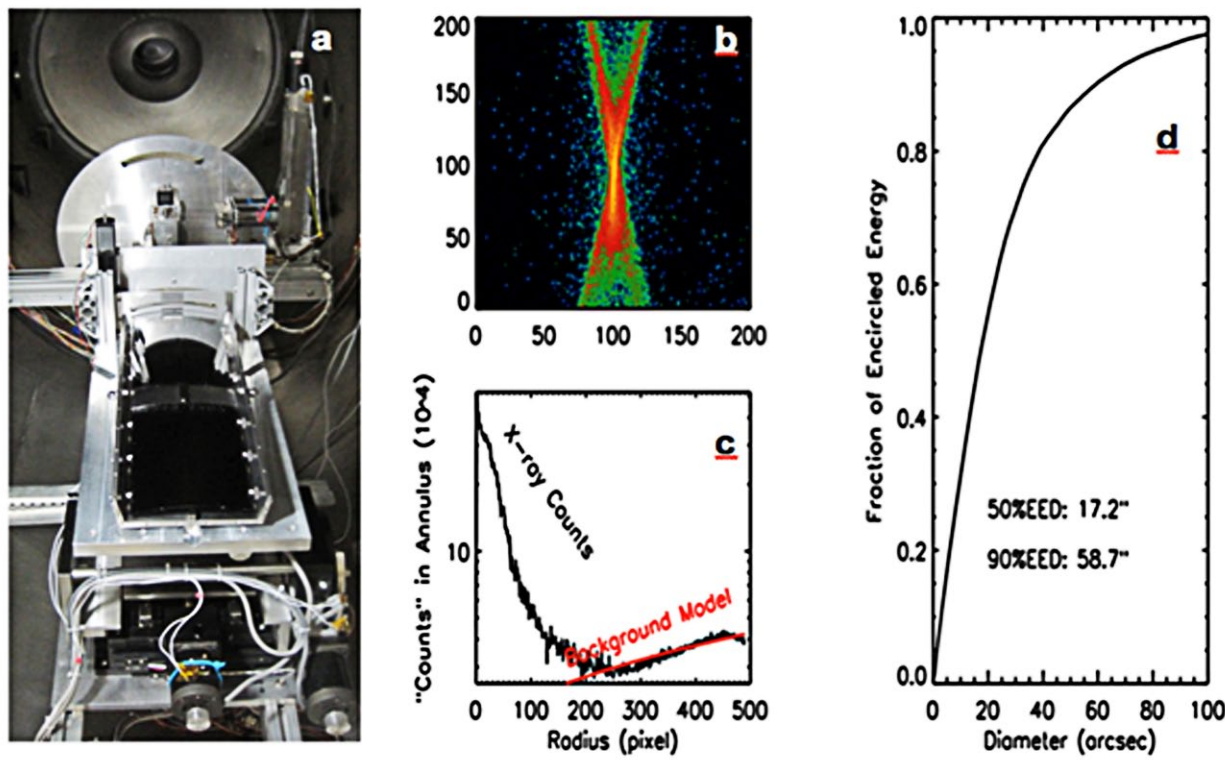

Figure 2.3-3. These images summarize a recent X-ray test of one of two technology development modules (TDMs), each containing three parabolic-hyperbolic mirror pairs co-aligned and bonded to a housing structure. Left: (a) A photograph of a TDM in a vacuum chamber at the end of GSFC's 600-m beam line. Center-top: (b) This is a typical X-ray (4.5 keV) image. Center-bottom: (c) Data from the same X-ray image is plotted as radial density (counts per unit distance from peak brightness), with the red curve displaying estimated background. Right: (d) The encircled-energy fraction (normalized integral of radial density) is shown as a function of diameter. This documents a 17.2-arcsec HPD for a three-mirror-pair TDM.

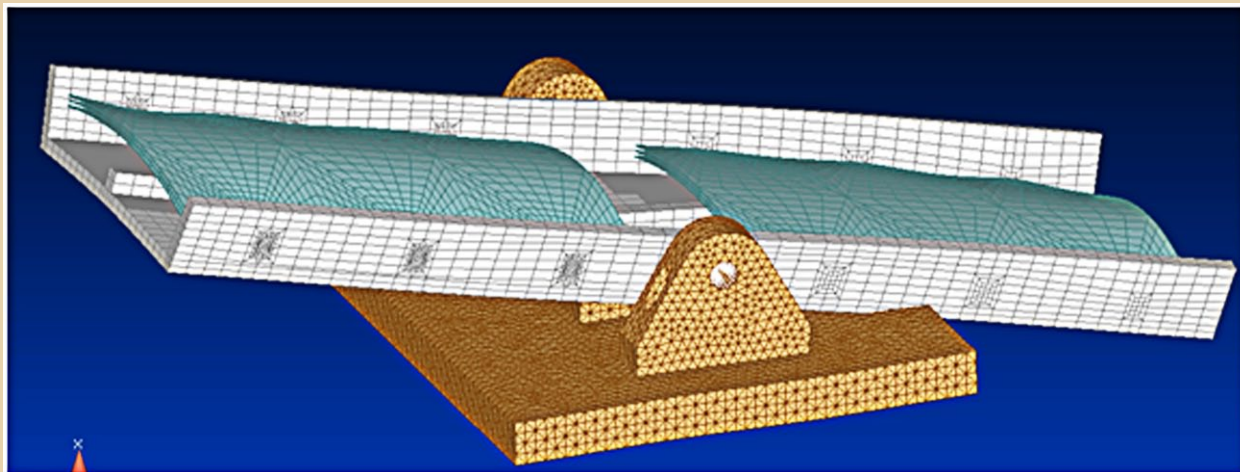

Figure 2.3-4. This wire-mesh illustration shows a finite-element analysis of vibration-induced deformation of a TDM held at three positions, two visible and the third on the back panel. This is a likely flight-like configuration.

Future Plans/Next Steps

We plan the following activities for FY2013:

1. Refine and improve the edge-bonding process to reduce its contribution to the surface error, so that the imaging performance will be better than 10-arcsecond HPD. Based upon evidence to date, we believe that the two leading factors are 1) differences in thermal environments during bonding and those during testing, and 2) properties and stability of adhesives used in bonding mirrors to the housing. We shall analyze and devise stand-alone experiments to investigate and characterize the effects of these two factors. We expect to eventually reduce the error contribution of the edge-bonding process to less than that of the mirror segments (approximately 6-arcsecond HPD).
2. Test TDMs, both for X-ray performance (image quality and effective area) and for robustness against spaceflight environments (vibration, thermal-vacuum, etc.). We shall use knowledge gained from the testing in designing the next TDM version.
3. Continue investigating two techniques for coating of mirror substrates—magnetron sputtering and atomic layer deposition—to maximize X-ray reflectance without unacceptable distortion of figure.
4. Further refine the glass-slumping process in two aspects: 1) Minimize the time needed to condition the mandrel surface treatment, and 2) compare mirror substrates of different thicknesses (0.3 and 0.4 mm). In parallel, we shall continue investigating the fabrication of lightweight single-crystal-silicon mirror substrates.
5. Finally, we shall continue in-house work on fabricating full-shell forming mandrels. We plan to complete grinding and polishing eight pairs of mandrels with diameters around 200 mm, such that we shall have a total of 13 pairs of parabolic-hyperbolic mandrels spanning 200–500 mm in diameter by the end of 2012. With the availability of these mandrels, we shall be in a position to construct more flight-like modules in FY2014.

2.4 Critical-Angle Transmission (CAT) Gratings for High-Resolution Soft X-ray Spectroscopy

Prepared by: Ralf K. Heilmann and Mark L. Schattenburg
(MIT Kavli Institute for Astrophysics & Space Research)

Summary

CAT gratings combine the advantages of traditional phase-shifting transmission gratings (relaxed alignment and figure tolerances, low mass, transparent at high energies) and blazed reflection gratings (high diffraction efficiency, high resolving power due to utilization of higher diffraction orders). In combination with grazing incidence X-ray mirrors and CCD detectors, they promise an increase of a factor of 5–10 in efficiency and 3–5 in resolving power over existing X-ray grating spectrographs.

We are fabricating CAT gratings from silicon-on-insulator (SOI) wafers, utilizing advanced lithographic tools and processes. The CAT grating principle has been demonstrated in the soft X-ray band on small samples with low throughput. Our goal is to produce large-area (tens of cm²) CAT gratings with minimal blockage from support structures and to bring this technology to TRL-6.

Overview and Background

The soft X-ray band contains many important diagnostic lines—Carbon (C), Nitrogen (N), Oxygen (O), Neon (Ne), and Iron (Fe) ions. Imaging spectroscopy with a spectral resolution of <2 eV has been demonstrated with small transition-edge-sensor-based microcalorimeter arrays, providing resolution >3000 for energies >6 keV. Toward longer wavelengths, however, energy-dispersive detectors cannot provide the spectral resolution that is required to address several of the NWNH high priority science objectives. The only known technology capable of enabling high spectral resolving power in this band is wavelength-dispersive, diffraction-grating-based spectroscopy. Absorption and emission line spectroscopy, with the performance made possible by a well-designed CAT X-ray grating spectrometer (CATXGS), will target science objectives concerning the large-scale structure of the universe, cosmic feedback, interstellar and intergalactic media, and stellar accretion. Kinematics of galactic outflows, hot gas in galactic halos, black hole growth, the missing baryons in galaxies and the Warm Hot Intergalactic Medium, and the effect of X-ray radiation on protoplanetary disks all pose questions that will be addressed by a CATXGS-carrying mission.

The technology currently used for grating-based soft X-ray spectroscopy was developed in the 1980s. The Chandra High Energy Transmission Grating Spectrometer (HETGS) carries polyimide-supported gold gratings with no more than 10% diffraction efficiency in the 1–5 nm wavelength band, but the whole moveable grating array weighs only about 10 kg. The *XMM-Newton* Reflection Grating Spectrometer (RGS) has more efficient grazing-incidence reflection gratings, but its mass is high (>100 kg) and it has low spectral resolving power (~300). CAT gratings combine the advantages of the HETGS and RGS gratings and promise up to 50% diffraction efficiency over a broad band with a resolving power >3000 for a 10-arcsecond telescope. Because CAT gratings become increasingly transparent at higher

energies, they also offer near-ideal synergy with a calorimeter-based imager. Thus, high-resolution spectroscopy could be performed with a CATXGS in tandem with a calorimeter over the range of ~ 0.2 –tens of keV.

A number of mission concepts submitted as responses to a NASA request for information (RFI NNH11ZDA018L) could be enabled with a CATXGS, such as AXSIO, AEGIS, and SMART-X, as well as the N-XGS that was studied by the Community Science Team (CST). Figures of merit for many types of observations—such as the accuracy of line centroid measurement in absorption line spectroscopy—could be improved by more than an order of magnitude over *Chandra* and XMM.

Objectives

We plan to bring CAT grating technology to TRL-6 to reduce the technology risk and cost for future CATXGS-bearing missions before they enter Phase A. Therefore, our objective is to demonstrate efficient large-area ($>30 \times 30 \text{ mm}^2$) CAT grating facets with minimal blockage from support structures. Facets will be mounted to thin and stiff frames, which can then be assembled into grating arrays with sizes on the order of m^2 .

The key challenges in the fabrication of CAT gratings lie in their structure: Small grating period (200 nm), small grating duty cycle (~ 40 nm wide grating bars with 160 nm spaces between), and large depth (4–6 μm) result in ultra-high aspect ratios (100–150) and require nm-smooth sidewalls. Additionally, the gratings should not be supported by a membrane, but instead be freestanding. Structures with such an extreme combination of geometrical parameters—or anything similar—have never before been made. Since beginning this project, we have fabricated small potassium hydroxide (KOH) wet-etched CAT grating prototypes that have met all of these requirements and measured their efficiency at a synchrotron source, demonstrating good agreement with theoretical predictions. Due to their extreme dimensions and the requirement to be freestanding, CAT gratings must be supported by slightly bulkier structures. We use a so-called L1 support mesh (period ~ 5 –20 μm) that is integrated into the SOI device layer and etched at the same time as the CAT gratings. Unfortunately, the wet-etch that provides the nm-smooth CAT grating sidewalls leads to widening L1 supports with trapezoidal cross sections and unacceptable X-ray blockage.

The next challenge is to develop a process that produces vertical L1 support sidewalls. We demonstrated such a process on bulk silicon more than a year ago, using deep reactive-ion etching (DRIE) on an advanced DRIE tool at the University of Michigan Lurie Nanofabrication Facility.

Accomplishments

In order to make large-area freestanding gratings, the L1 supports alone are not strong enough. We designed a high-throughput hexagonal L2 mesh that is etched out of the much thicker ($\sim 0.5 \text{ mm}$) SOI handle layer (back side). During the last year, we developed a process that allows us to etch the very fine and deep CAT grating bars and the slightly coarser L1 supports out of the thin SOI device layer (front side), stopping on the buried oxide (BOX) layer. Subsequently, we were able to etch the L2 mesh with a high-power DRIE into the back side, again stopping on the BOX layer, without damaging the delicate front side structures. The BOX layer is removed with a wet hydrofluoric acid etch, and the whole structure is critical-point dried. We have fabricated several $31 \times 31 \text{ mm}^2$ samples with decent yield (see Fig. 2.4–1).

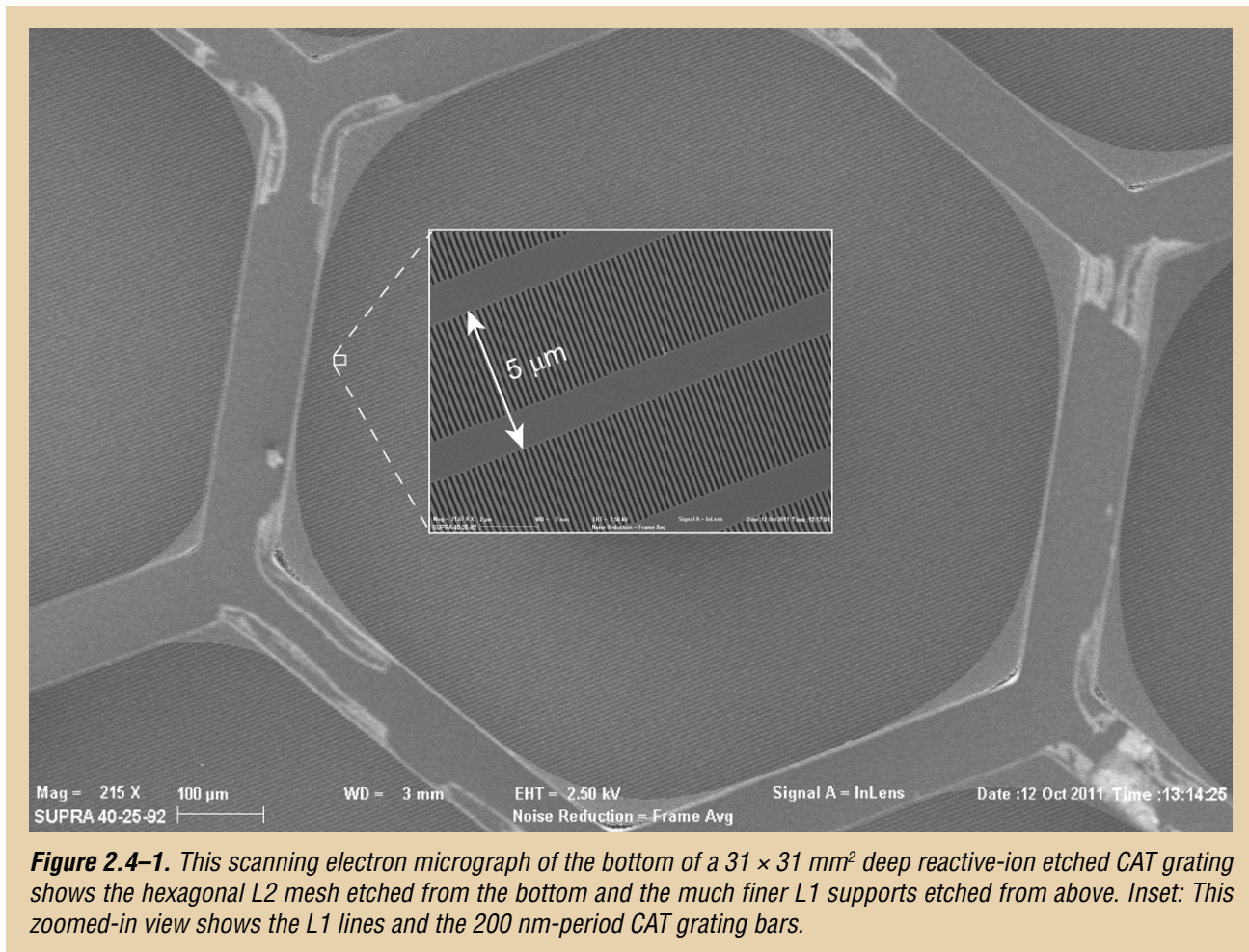

Figure 2.4–1. This scanning electron micrograph of the bottom of a $31 \times 31 \text{ mm}^2$ deep reactive-ion etched CAT grating shows the hexagonal L2 mesh etched from the bottom and the much finer L1 supports etched from above. Inset: This zoomed-in view shows the L1 lines and the 200 nm-period CAT grating bars.

2.5 Off-Plane Grating Arrays for Future Missions

Prepared by: Randall L. McEntaffer (University of Iowa)

Summary

High-resolution X-ray spectroscopy is a scientifically relevant technology capable of addressing many key science objectives such as detecting the large fraction of missing baryons thought to exist in the warm-hot phase of the intergalactic medium. Such observations will require a combination of high effective area and high spectral resolving power at energies below ~1.5 keV. These measurements can be enabled for future missions through the use of an X-ray grating spectrometer incorporating large-area optics, high-resolution gratings, and sensitive CCD cameras. Technology development efforts are occurring in each of these key areas in order to increase the readiness of such spectrometers. Here we describe efforts to develop an Off-Plane X-ray Grating Spectrometer, the achievements made over the past year, and the plans for future development.

Overview and Background

The purpose of this study is to advance high-resolution X-ray spectroscopy and its application in future NASA missions. Specifically, the project will concentrate on improving the technology readiness level (TRL) of off-plane reflection grating spectroscopy for soft X-rays (0.3–1.5 keV). This technology has applications in a variety of NASA missions from suborbital rockets, to Explorer class missions, to large observatories. It has been baselined for a proposed Explorer mission, the Warm-Hot Intergalactic Medium Explorer (WHIMex), and is applicable to many other mission concepts such as AXSIO, NXGS, and SMART-X. Soft X-ray grating spectrometers with high throughput and high resolving power can address many top science questions such as:

What controls the mass-energy-chemical cycles within galaxies?

How do baryons cycle in and out of galaxies, and what do they do while they are there?

What are the flows of matter and energy in the circumgalactic medium?

How do black holes work and influence their surroundings?

How do massive stars end their lives?

What controls the masses, spins, and radii of compact stellar remnants?

What are the progenitors of Type Ia supernovae and how do they explode?

These science goals can be addressed with high-quality X-ray spectra as specifically stated in the Decadal Survey of Astronomy and Astrophysics. At the lowest energies, the most efficient method of obtaining high resolving power ($\lambda/\Delta\lambda > 3000$) is through the use of grating spectrometers. Spectra at these resolutions could address a number of important astrophysical goals such as studying the dynamics of clusters of galaxies, determining how elements are created in the explosions of massive stars, and revealing most of the “normal” matter in the universe that is currently thought to be hidden in hot filaments of gas stretching between galaxies.

Future X-ray observatories will necessitate large-collecting-area optics coupled with high-quality gratings to achieve the science requirements. The main goal of the technology development effort described here is to increase the TRL of grating spectrometers by

demonstrating high throughput combined with spectral resolutions of $>3000 (\lambda/\Delta\lambda)$ over the soft X-ray band. To achieve this goal, we will utilize a spectrometer based on off-plane reflection gratings (McEntaffer et al. 2011; Cash 1983, 1991). Currently, off-plane gratings have only been used in suborbital rockets and tested in the lab. These applications and results have solidified a conservative TRL of 3 in the context of future X-ray observatories (McEntaffer and Cash, 2008; Oakley et al. 2011). There are a handful of well-defined tasks that need to be accomplished to heighten this TRL to 6. These tasks include 1) the fabrication of a master grating with a high-fidelity groove profile, 2) replication of this master profile onto high-fidelity grating substrates, and 3) precision alignment of these replicas into a high-fidelity module mount. Environmental and X-ray testing of an aligned, high-fidelity module will increase the TRL to 6. Therefore, in order to achieve our high-resolution goal and place off-plane reflection gratings in the context of Explorer missions and large observatories, our efforts concentrate on accomplishing these technology development tasks.

Objectives

The main objective is to demonstrate a medium- to high-fidelity X-ray grating spectrometer capable of achieving high throughput and spectral resolving power of $\lambda/\Delta\lambda > 3000$ over energies from 0.3–1.5 keV. This objective is critical to any low-energy future X-ray spectroscopy mission and, as such, is unchanged from the 2011 PATR and will remain unchanged for the foreseeable future. The key challenges to meeting this objective include the production of a large-area telescope with high-quality focus, efficient grating diffraction, negligible grating-induced aberration, and high quantum efficiency (QE) CCDs. The first goal is addressed in detail in the X-ray Telescope-Slumped Glass Mirror Technology (Section 2.3) of this document. Dr. William Zhang (GSFC), the principal investigator of the technology in Section 2.3 and a co-investigator on our current NASA Strategic Astrophysics Technology (SAT) grant, is responsible for the fabrication and alignment of mirrors used in performance testing of the spectrometers. The last goal is being studied by our collaborators at the Open University (OU), experts in X-ray CCD technology, led by Andrew Holland. The remaining two goals deal with the technology development of X-ray diffraction gratings in the off-plane mount, which is summarized here.

Accomplishments

A NASA SAT grant resulted in the accomplishments detailed below and, as such, these accomplishments follow a calendar-year schedule (period of performance: January 1, 2012—December 31, 2013), as opposed to the fiscal year. Yet, much has been accomplished in these first several months. Three of the four milestones for the first year have already been accomplished. These include a grating fabrication study, diffraction efficiency testing, and mirror fabrication/alignment. The final Year 1 goal, resolution testing, is planned for August 2012 at Marshall Space Flight Center (MSFC) and will be detailed in the Milestones and Schedule subsection.

Previous results from holographically ruled gratings have been promising for achieving high diffraction efficiency and resolving power via this fabrication method (McEntaffer, et al. 2004; Osterman, et al. 2004). However, these gratings may be limited in efficiency due to scatter introduced in the manufacturer's blazing procedures. They may also be limited in resolving power due to a limitation to the approximation of a radial profile; the interferogram created by the off-axis recording sources produces curved lines instead of straight. These problems are surmountable (given appropriate funding), however, it would be beneficial to identify suitable fabrication alternatives. We have, therefore, commenced a grating fabrication trade study, which, in addition to the SAT effort, has been bolstered by

a new Roman Technology Fellowship (RTF). This RTF grant follows the results of our SAT and extends technology developments for an additional 3 years (see the Milestones and Schedule subsection). The first fabrication method studied uses a laser tool to directly write each groove into a photomask that is deprojected onto a photoresist-coated silicon wafer. Subsequent etching transfers the groove pattern into the single-crystal silicon substrate. This process has produced a very high density, 6200 grooves/mm, rectangular profile, with radial grooves converging at 8.4 m to match existing optics. The major benefit to this method is that difficulties in shaping the grooves for maximum efficiency have been eased, given the possibility of creating a blazed profile with atomically smooth facets on silicon substrates (Chang et al. 2003) using subsequent processing procedures. The process that we are currently testing uses nanoimprinting to transfer the laser recorded, rectangular groove “pre-master” pattern to a resist-coated, off-axis cut silicon wafer that is etched down to a silicon crystal plane to create the grooves. This novel fabrication technique is a major focus of the RTF grant. Similar to holography, the laser writing process also approximates the radial profile. This is due to the finite step size of the laser tool, which approximates angled features using a series of steps. This effect is currently being modeled via ray tracing and compared to the holographic recording method.

The existing pre-master has been delivered by the vendor, LightSmyth, and has undergone performance testing for diffraction efficiency. These tests occurred at the Physikalisch Technische Bundesanstalt (PTB) beamline of the Berliner Elektronenspeicherring-Gesellschaft für Synchrotronstrahlung (BESSY) synchrotron facility in Germany. Our collaborators at OU have a user agreement in place with this facility, thus allowing for cost-effective, guaranteed time. The grating was tested from 0.3–1.0 keV with 50 eV steps for two graze angles. The resulting efficiencies are shown in Fig. 2.5–1. These tests provided critical data on a grating fabrication process that appears to be even more promising than holographic lithography. At a graze angle of 1.5°, the grating diffracts upwards of 55% (absolute efficiency, i.e., inclusive of reflectivity) of incident light into usable spectral orders and does so without noticeable scatter. The grating routinely achieves 30–40% absolute efficiencies over a wide range of energies at both graze angles. It is important to note that the grating was tested at $\alpha = 0$ (light parallel to the grooves). This led to a limitation on available orders at low energy, which results in only one or two measurable orders over a significant range of our bandpass for this configuration. Even so, diffraction efficiencies for these orders are quite high.

The effect of the laminar profile is evident—there are large contributions to zero order, the +/- orders contain a nearly equal number of photons, and the diffraction pattern is quite regular and stable over a large range of energies. While these are not necessarily detriments (merely an indicator that the rectangular grooves are clean and well-shaped), future observatories will require custom diffraction efficiency functions. These characteristics can be manipulated and optimized using blazed grating facets. A custom blaze profile can provide high throughput over a focused range of energies on only one side of zero order. Such a profile will also allow for testing larger α angles, which will quantify higher-order contributions at low energy. The process for blazing these gratings is a near-term to long-term focus of our SAT and RTF programs and is described in the Milestones and Schedule subsection. Regardless of blaze, however, these gratings still diffract a significant amount of X-rays into usable orders, thus proving the quality of their profile.

In addition to efficiency testing, we directed the diffracted beam onto an OU CCD camera to image the arc of diffraction. Given the small number of access ports to the test chamber, the camera was placed along the beam axis, thus limiting our graze to 0.25° and our spectral range to only the highest energies. Even so, we were able to run the monochromator at

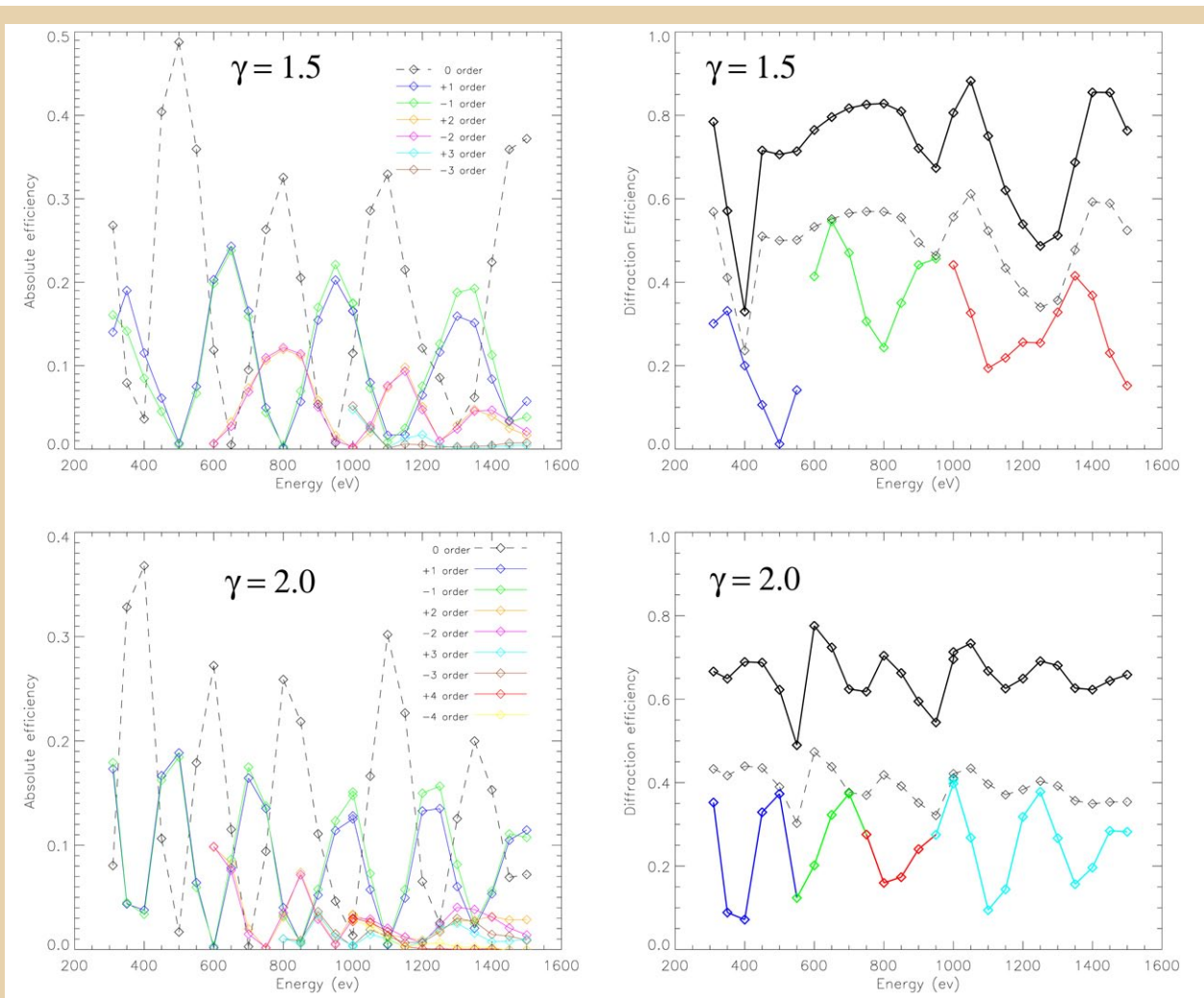

Figure 2.5-1. Upper left and right: These plots show results at a graze angle of 1.5° . Lower left and right: These plots pertain to a graze of 2° . Left column: These plots give the absolute efficiencies (inclusive of the reflectivity of Au at the appropriate graze) as a function of energy for all measurable orders. Right column: These plots give the efficiencies summed over available orders: blue = 1st order; green = 1st + 2nd; red = 1st + 2nd + 3rd; cyan = 1st + 2nd + 3rd (+ 4th); dashed black = 0th + 1st + 2nd + 3rd (+ 4th). The solid black lines show the relative efficiency (absolute efficiency divided by Au reflectivity at the appropriate γ).

1.9 keV and image two diffraction orders along with zero order on a single CCD. As shown in Fig. 2.5-2, the diffraction properties of the grating match the theoretical ray trace exactly, providing further verification on the high quality of the groove profile.

In summary, our achievements are centered around the fabrication and testing of a novel grating. This grating has produced excellent diffraction efficiencies and exhibits a radial profile. Further testing is scheduled for this fall and includes placing the grating in the beam of GSFC slumped-glass optics to measure the spectral resolving power. The grating will also be used in a novel processing procedure to produce high-quality blazed profiles.

Milestones and Schedule

As summarized in our Accomplishments subsection, three of four objectives for Year 1 of the SAT have been accomplished within FY12. We will extend our promising laser fabrication

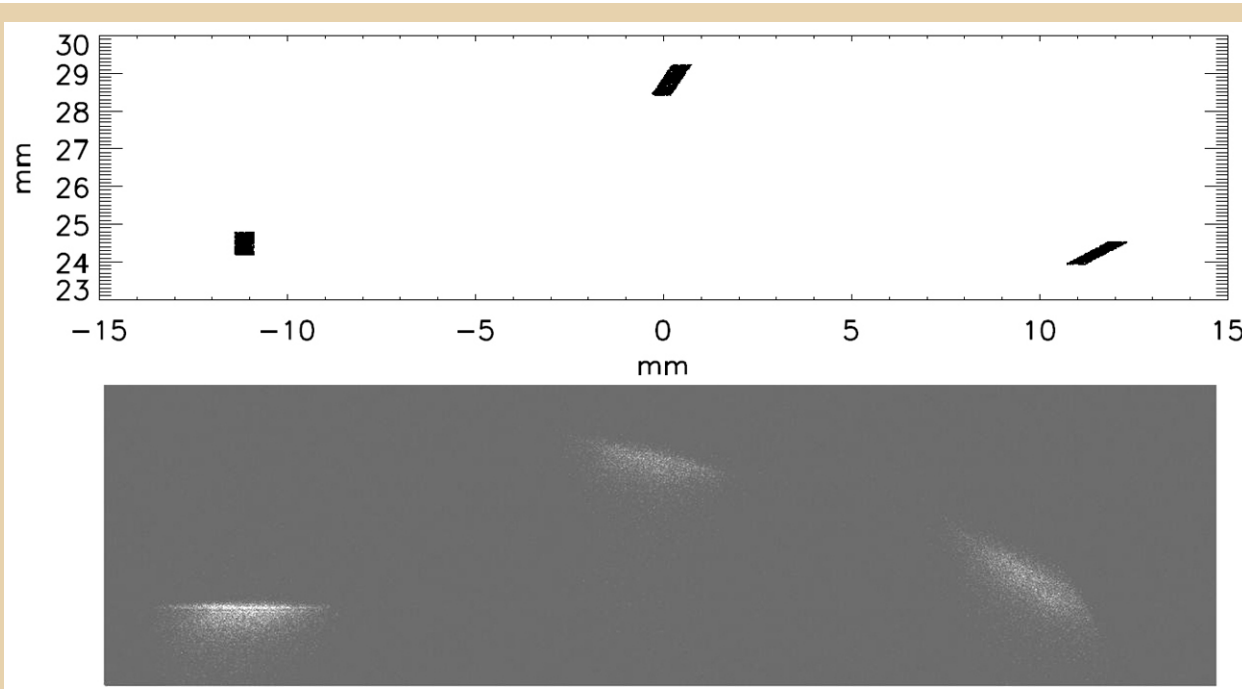

Figure 2.5-2. Top: This plot is a ray trace of the pre-grating in the BESSY beamline onto the CCD focal plane. The spot on the left is the zero-order image of the slit using 1.9 keV with 1st- and 2nd-order diffracted toward the right. Bottom: This plot is a CCD image of the actual arc of diffraction for 1.9 keV X-rays showing excellent agreement with the ray-trace predictions.

Milestones and Schedule

Task	FY13									FY14														
	Oct	Nov	Dec	Jan	Feb	Mar	Apr	May	Jun	Jul	Aug	Sep	Oct	Nov	Dec	Jan	Feb	Mar	Apr	May	Jun	Jul	Aug	Sep
Major Milestones	▲ Efficiency test blazed grating			▲ Substrate trade study			▲ Verified replication process			▲ TRL 5			▲ Procure nanoimprint tool			▲ High fidelity grating replicas								
	▲ RFT report due			▲ Fabricated module mount			▲ Aligned grating module			▲ Achieve resolution goal														
Publish FY12 results	▲			▲																				
Blaze gratings	▲		▲																					
Replicate gratings onto substrates	▲			▲																				
Replicate efficiency testing	▲			▲																				
Write Roman Fellowship report	▲			▲																				
Grating Module Fabrication	▲			▲																				
Grating alignment				▲			▲																	
Resolution test at MSFC with optics										▲		▲												
Environmental testing										▲														
Post-environmental verification										▲		▲												
Publish FY13 results										▲			▲											
Design and fabricate higher fidelity module mount										▲			▲											
Replicate gratings in-house													▲			▲			▲					
Maximize groove profile via etch technique																			▲			▲		

study to encompass other micro/nano-techniques such as e-beam lithography. We also plan to continue efficiency tests on our gratings as we develop our blazing process. Currently, the mirrors are aligned to our testing standards and require no further study for FY12 goals. The final Year 1 SAT milestone was originally planned outside of FY12, but we hope to perform the spectral resolution tests at MSFC in August. We are currently on the test schedule, the GSFC optics are aligned and ready for testing, and all testing equipment for the grating is in hand and prepared. We plan to report the findings of this test in the 2013 PATR.

In addition to the FY12 accomplishments listed above, we present a milestone schedule for FY13 and FY14 in the preceding milestone schedule. These milestones are driven by our goals outlined by the SAT and RTF efforts. A description of these tasks is summarized in our Future Plans/Next Steps subsection.

Future Plans/Next Steps

Over the next 18 months, our near-term goals follow the milestone schedule presented in the preceding milestone schedule. First, we will develop our etching process to produce blazed gratings for testing in October 2012. Fig. 2.5–3 shows a scanning electron microscope (SEM) image of the pre-master grating, which has a current duty cycle of 50%. This leads to large zero-order contributions and less light in dispersed orders. Transferring this laminar profile into a resist-coated, off-axis cut silicon (Si) wafer will allow us to etch down to the $\langle 111 \rangle$ Si crystal plane, leading to atomically smooth, blazed groove facets with nearly 100% duty cycle. This will have a two-fold bonus of increasing dispersed light and placing it on one side of zero order, thus limiting the required readout array for the detector. These efforts will fulfill an RTF goal and bolster the first-year Concept Report due in February 2013. Once a blazed grating is produced, we will use well-known replication techniques to replicate the grating onto various materials—Beryllium (Be), Silicon Carbide (SiC), and single-crystal Si—to perform a substrate trade study and achieve a Year 2 SAT goal. The culmination of these studies will produce high-performance blazed replicas. Verification of throughput and resolution will place these gratings firmly at TRL-4.

The next set of tasks involves producing a set of aligned gratings. We have already initiated the design process for the grating module mount and alignment metrology table. We are currently in the process of studying tolerances for grating-to-grating alignment and theoretically verifying that our mount and metrology setup will be capable of achieving these tolerances. This process will be aided by our upcoming resolution tests. Instead of one pair of optics, GSFC will be delivering a set of three aligned mirror pairs in a single assembly. We will use this opportunity to fabricate an engineering test module with three roughly aligned gratings to test with the optics. The X-ray results will give insight into our alignment strategy, verify our tolerance calculations, and provide feedback on the mount design. This feedback will assist in developing a higher-fidelity module mount slated for resolution testing at MSFC in early September 2013. We will therefore have much of the year to verify and test our alignment strategy. The FY13 tests will include an environmental test in between performance testing. Post-vibe verification of spectral resolving power on this medium-fidelity assembly will place off-plane grating spectrometers at TRL-5 near the end of FY13.

The remaining tasks in the preceding milestone schedule close out our SAT efforts and segue into our long-term activities for the RTF. It is important to note that our technology development has accelerated due to the excellent synergy between these two programs, which has allowed for the necessary resources to heighten the TRL significantly. The ultimate goal of

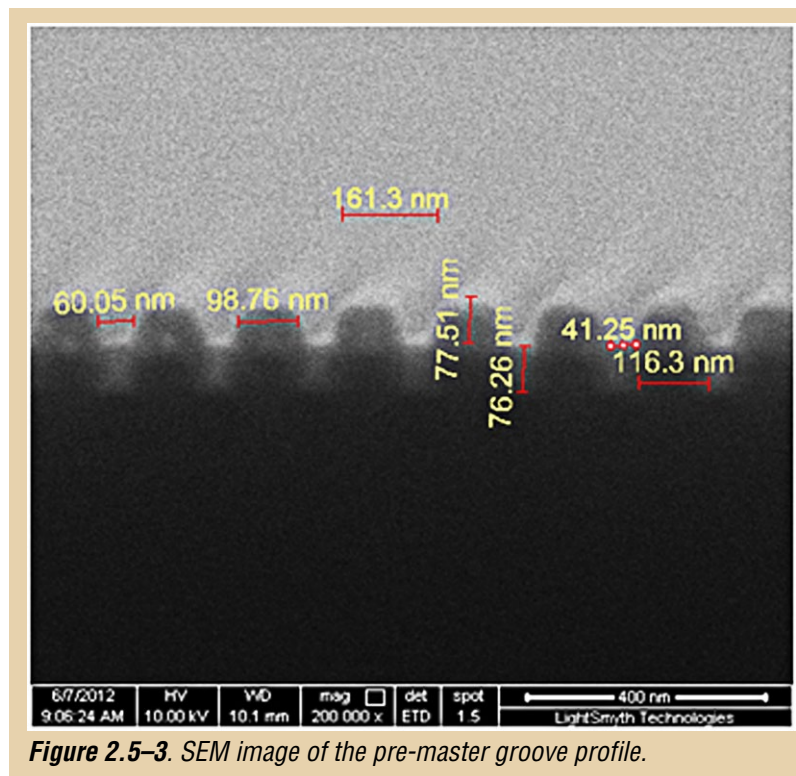

the 5-year RTF, and hence our long-term development, will be to develop a high-fidelity, fully populated grating module. At that time, we plan to have all processes necessary to produce this assembly completely in-house. This will allow us to tweak our grating and alignment parameters according to mission goals, thus placing our assembly near TRL-6 for any mission at that time. As we have already seen with the SAT/RTF combination, we expect that this development can be further accelerated, given the necessary resources, to accommodate a specific mission implementation and timeline if one should arise in the near term.

References

- Cash, W., "X-ray optics. 2: A technique for high resolution", 1991, *Appl. Opt.*, 30, 1749
- Cash, W., "X-ray spectrographs using radial groove gratings," 1983, *Appl. Opt.*, 22, 3971
- Chang, C.-H., et al., "Fabrication of sawtooth diffraction gratings using nanoimprint lithography," 2003, *J. Vac. Sci. Technol. B*, 21(6), 2755
- McEntaffer, R. L., Cash, W., Lillie, C., Casement, S., Zhang, W., Holland, A., Murray, N., O'Dell, S., Schattenburg, M., Heilmann, R., Tsunemi, H., "Development of off-plane gratings for WHIMex and IXO," 2011, *Proc. SPIE*, 8147, 81471K
- McEntaffer, R. L., & Cash, W., "Soft X-ray Spectroscopy of the Cygnus Loop Supernova Remnant," 2008, *ApJ*, 680, 328
- McEntaffer, R. L., Osterman, S. N., Cash, W., Gilchrist, J., Flamand, J., Touzet, B., Bonnemason, F., Brach, C., "X-ray performance of gratings in the extreme off-plane mount," 2004, *Proc. SPIE*, 5168, 492
- Oakley, P. H. H., McEntaffer, R. L., & Cash, W., "A Suborbital Payload for Soft X-ray Spectroscopy of Extended Sources," 2011, *Experimental Astronomy*, 31, 23
- Osterman, S. N., McEntaffer, R. L., Cahs, W., Shipley, A., "Off-plane grating performance for Constellation-X," 2004, *Proc. SPIE*, 5488, 302

This page left blank intentionally

2.6 X-ray Microcalorimeter Spectrometer (XMS) Technology

Principal Investigators: Caroline Kilbourne (NASA/GSFC) and Kent Irwin (NIST/Boulder) Prepared by: Simon Bandler (NASA/University of Maryland, College Park)

Summary

Large-format arrays of microcalorimeters are under development that will enable high-resolution X-ray imaging spectrometers for future X-ray observatories. These have very high spectral resolution, quantum efficiency, focal-plane coverage, and count-rate capability, combined with the ability to observe extended sources without spectral degradation. The latest arrays have been adapted from designs aimed at meeting the requirements of the *International X-ray Observatory* (IXO), to meeting those of the X-ray Microcalorimeter Spectrometer (XMS) proposed for the European Space Agency's (ESA) *Advanced Telescope for High-Energy Astrophysics* (ATHENA) mission, as well as for the new NASA mission concept the *Advanced X-Ray Spectroscopic Imaging Observatory* (AXSIO) and other notional calorimeter instrument formats currently under study by the X-ray community science team.

While the primary focus is the development of arrays with traditional pixel designs for ATHENA/AXSIO, some new innovative designs have been developed that utilize small pixels and position-sensitive arrays, known as "Hydras." The current XMS roadmap serves two purposes. First, it promotes the technology readiness of the simpler instrument by de-emphasizing lower-TRL components that are now absent in the down-scaled versions of the XMS. Second, the longer timescale that is now available for development has allowed us to include the development and integration of new microcalorimeter technologies with the potential for instrument simplification and enhanced capabilities at a lower cost.

The state-of-the-art arrays are now 32×32 in size, with wiring for all pixels in the array extending out of the focal plane region. Microstrip wiring has been introduced into the large-format arrays, thereby allowing high wiring density and low electrical cross-talk between pixels. The further development of multiplexed readout of these arrays continues, using both time-division and code-division multiplexing. This development will allow us to read out larger arrays of microcalorimeters with fewer readout amplifier chains, and with minimal loss of performance.

Overview and Background

The reference design for the IXO/XMS detector system consisted of a composite array of 2176 close-packed transition-edge sensor (TES) X-ray calorimeters read out by superconducting quantum interface device (SQUID) multiplexers. Molybdenum-gold (Mo/Au) TES thermometers with bismuth-gold (Bi/Au) thermalizing X-ray absorbers comprise the arrays. A 40×40 central array, arranged on a 0.3 mm pitch and contained within a 52×52 outer array of 0.6 mm pixels. In the outer array, 4 pixels are read by a single TES, and discrimination between the four positions is achieved via pulse-shape analysis. This microcalorimeter design is known as a "Hydra." The outer array contains 576 TES thermometers, compared with the 1600 of the inner array.

In the baseline time-division multiplexing (TDM) concept, the outputs from the dedicated input SQUIDs of individual TES pixels are coupled to a single amplifier, and multiplexing is achieved by sequential switching of these input SQUIDs. The reference design was based on 32-row multiplexing. Heat sinking of the frame of the arrays to the 50 milli-Kelvin (mK) stage is achieved via gold wire bonds to gold-coated areas on the array frame, into which heat from the underlying substrate is coupled. Heat sinking within an array is achieved via incorporation of a metallic grid.

For ATHENA, a single 32×32 array arranged on a 0.25 mm pitch is baselined, and there is no outer array. The scale of the multiplexing is reduced to 16-row TDM. In March 2008, the integrated XMS detector system successfully demonstrated the multiplexed (2×8) readout of 16 different pixels (in an 8×8 array) similar to what is needed for the ATHENA XMS reference design. Kilopixel arrays of this design have also now been developed. Although ATHENA was not picked for the next European L1 mission, it remains a prime candidate for the L2 spot, which will be chosen within the next 2 years. Therefore, the development of arrays for this mission concept remains a high priority.

For AXSIO, the reference design maintains the same number of TESs as IXO, but is updated to meet new mission requirements. Because the angular resolution requirement doubled (10 arcsec) and the focal length halved, the required pixel size of the main array remained the same (0.30 mm) and the field-of-view of the main array therefore doubled. In this design, there is no need for an outer array. A second array has been introduced at the center of the array, called the point source array (PSA). This 24×24 array of pixels on 0.075 mm pitch leverages a new microcalorimeter pixel array design in which each pixel has energy resolution less than 2 eV at 6 keV and also accommodates count rates of approximately 300 counts per second.

Because the 1.5 arcsec pixels significantly over-sample the point-spread function of the optic, X rays from a point source will spread over a large number of these pixels, thereby achieving a net count-rate capability of 15,000 counts per second. The high count-rate/fast timing capability of the PSA allowed AXSIO to remove an entire instrument without losing significant observatory capability. The notional calorimeter X-ray mission XMS (N-CAL) is

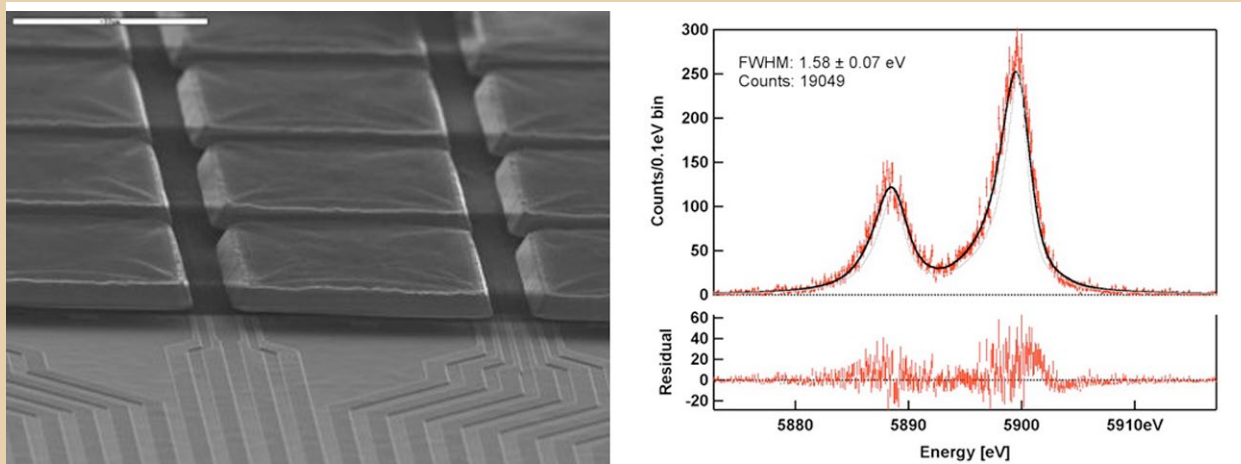

Figure 2.6-1. Left: This scanning electron microscope image of a PSA prototype array shows the close-packed pixels that are on a 75 micron pitch. Right: Shown here is a spectrum from one of the pixels of the type shown at left when a pixel is illuminated with X-rays from a $^{55}\text{Manganese}$ (^{55}Mn) source.

similar in design to the AXSIO XMS, except that the number of TESs is almost halved to 1120 TESs. This is achieved using a slightly smaller 16×16 PSA, and introducing position-sensitive detectors (“Hydras”) to the outer parts of the main array region. The number and size of all of the absorbers in the main array remains the same, allowing the Hydras to be fabricated together with single pixels on a single chip.

A number of mission concepts, including AXSIO, would benefit from the new small pixel designs, both the single pixel and the Hydra versions. These were recently described in the X-ray Astronomy Mission architecture study that resulted from a Request for Information (RFI) by NASA’s Physics of the Cosmos Program (<http://pcos.gsfc.nasa.gov/studies/x-ray-mission.php>). Versions with lower TES transition superconducting temperature (T_c) have been proposed for the *Spectral Analysis with High Angular Resolution Astronomy* (SAHARA) and the *Square Meter, Arcsecond Resolution X-ray Telescope* (SMART-X) mission concepts. These missions would benefit from the greater energy resolution possible from operating at lower temperatures, where high count-rate capability is not paramount. The Extreme Physics Explorer (EPE) mission concept, like AXSIO, would benefit from the high count-rate capability when operated at a higher T_c .

This technology can also enable a mission concept in a different science discipline, such as a study of the solar coronal heating problem—which has been one of the central issues in solar physics for more than half a century. Recent observations show the solar atmosphere to be significantly more dynamic and turbulent than previously suspected, involving non-equilibrium plasmas at high temperatures that evolve on timescales of a few seconds to a minute. A detailed physical understanding of these processes requires the ability to acquire high angular resolution, two-dimensional images with high energy resolution to separate and accurately measure the emission most sensitive to the physical properties of the plasma. This can be achieved with a microcalorimeter array with cadence high enough to track the evolution of the plasma properties as well as the fundamental energy release in impulsive events such as flares and nanoflares. For this concept, small pixels with high count-rate capability are also necessary.

Objectives

The biggest objective remains a demonstration of the core array prototype of an ATHENA-flight-like array at the 3×16 scale (3 columns, each with 16 multiplexed pixels) with performance better than 3 eV at 6 keV. This is an essential technology demonstration for ATHENA. The demonstration will be conducted at GSFC, using GSFC X-ray arrays and National Institute of Standards and Technology (NIST) SQUID multiplexers. NIST is fabricating the SQUID multiplexers with optimized coupling for the GSFC pixels, as well as optimized series array SQUIDs. Digital feedback and row-address cards operating at greater than 420-ns dwell times (with a goal of 320 ns) are being produced. Work being performed at GSFC includes fabricating 32×32 arrays at the ATHENA pitch, beginning to test and characterize the arrays to feed into the NIST readout, and preparing the software ready for automated, real-time data processing of all the channels.

Since the 2011 PATR was released, the design of the baseline SQUID multiplexer has been updated with the design of a slightly different amplifier architecture. Instead of baselining the required extremely low-noise amplifiers at room temperature, which would be a non-trivial upgrade, we have introduced a separate amplifier stage at a temperature above the coldest available temperature (1–4K). This stage consists of a large number SQUIDs, which together deposit a medium amount of power (~100 nW per SQUID array amplifier) that can

easily be absorbed by a system cooler interface in the 1–4K range. This amplifier means that standard room-temperature amplifiers are sufficient for the read out of multiplexed arrays without limiting performance. The possible improvement of room-temperature amplifiers will then possibly add margin to the readout performance.

The other main objective change has been the introduction of the PSA array for AXSIO XMS, as was described in the Overview. With the introduction of the PSA innovation, the readout of this type of array using a SQUID multiplexer has become a much more demanding challenge. With the need to accommodate count rates that are six times higher than planned for IXO and ATHENA, there are much greater readout requirements, and the use of code division multiplexing (CDM) becomes necessary, rather than simply desirable, to add engineering margin. Fortunately, there has been great progress in the version of CDM that is “drop-in compatible” with TDM multiplexing, known as flux-coupled CDM (G.M. Stiehl et al. 2012). The extension of this multiplexing technique from 8 to either 16 or 32 rows and the speeding up of the readout to 320 ns has become a key new objective.

Accomplishments

Progress continues in the development of 32×32 arrays. Our accomplishments and main areas of progress include:

- Demonstrated excellent uniformity of pixel properties
- Successfully integrated and verified stripline technology
- Improved pixel heat sinking
 - reduces thermal cross-talk
 - properties that meet ATHENA/AXSIO count-rate requirements
- Fabricated and began testing arrays on 250 μm pitch (ATHENA). At the pixel level, the designs are well established. The main challenge is process control, which involves controlling the T_c of the Mo/Au TES with the new substrates that were needed to incorporate stripline technology.
- Developed electronics, allowing switching at 3 MHz.

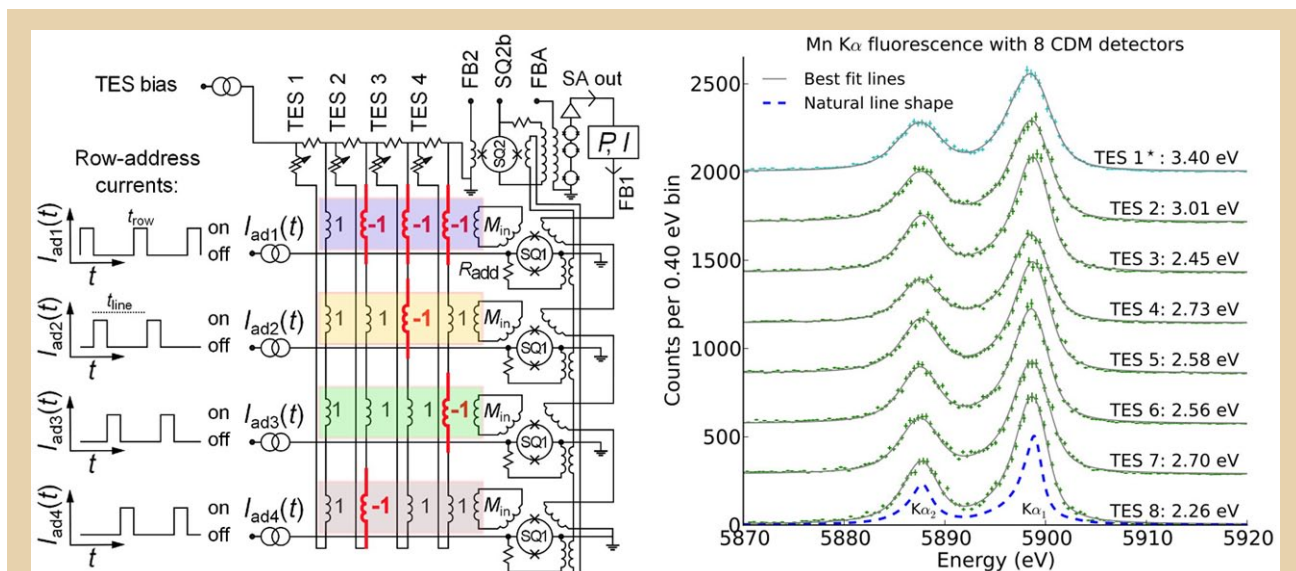
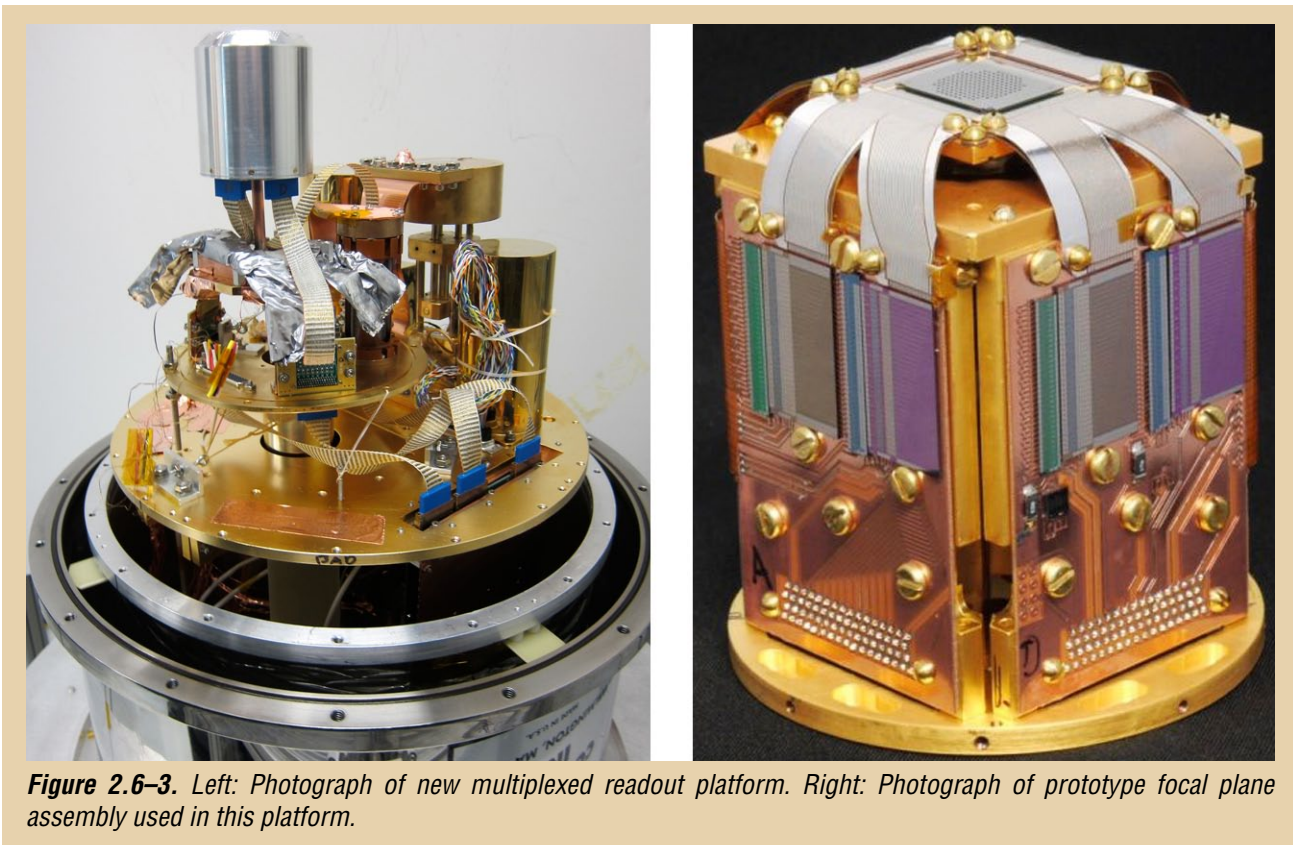

Figure 2.6–2. Left: The circuit shown depicts the operation of code division multiplexing of 4 TESs. Each TES is coupled to each SQUID, with polarity alternating in a pattern that allows TES signal to be determined during each of the individual first stage SQUID readout intervals. Right: The successful demonstration of CDM readout with an 8-row readout is shown (Stiehl et al. 2012).

- Multiplexed, flux-actuated switches were demonstrated, allowing greater performance with TDM and CDM readout.
- Developing a new multiplexed readout system with higher capability; greater bandwidth and more pixels readout capability.
- Demonstrated necessary readout performance parameters to achieve TRL-5 demonstration.

Milestones and Schedule

Task	FY13												FY14											
	Oct	Nov	Dec	Jan	Feb	Mar	Apr	May	Jun	Jul	Aug	Sep	Oct	Nov	Dec	Jan	Feb	Mar	Apr	May	Jun	Jul	Aug	Sep
Athena TRL-5 Demonstration	Demonstrate 3x16 readout with less than 3 eV energy resolution at 6 keV, with 250 micron pixels using time division multiplexing ▲																							
High count-rate demo on core array	Demonstrate high resolution spectroscopy (<3eV) for count rates up to 50 counts per second with 80% throughput in a single pixel ▲																							
High count-rate demo on PSA	Demonstrate high resolution spectroscopy (<3eV) for count rates up to 300 counts per second on point source array ▲																							
Uniform core array performance	Demonstrate ability to achieve < 3eV energy resolution in all pixels in a large prototype array ▲																							
Upgrade readout demo to add MPSA	Demonstrate multiplexed readout after integrating medium power series array ▲																							
Demonstrate automated read-out of Hydra pixels	Demonstrate that it is possible to optimally discriminate absorber location and energy resolution in real time ▲																							
Demonstrate single pixels and Hydras on same wafer	Demonstrate that it is possible to build both types of microcalorimeter on the same detector chip ▲																							
Perform CDM demonstration in TRL-5 platform	Demonstrate code division multiplexing with 16 to 32 rows, with traditional "IXO" style pixels ▲																							
PSA readout demo													Demonstrate multiplexed readout of PSA using code division multiplexing ▲											
Verify thermal/mechanical design of FPA	Verify that the focal plane assembly meets the thermal and mechanical requirements of a flight-like instrument ▲																							
Demo flight-like FPA with multiplexed read-out of kilo-pixel microcalorimeter arrays	Demonstrate multiplexed readout of a flight-like focal plane assembly ▲																							



Milestones achieved in FY12:

- Demonstrated flux-coupled CDM reading out 8 pixels simultaneously.
- Integrated and verified stripline technology within 32×32 arrays, which have all pixels wired out from the center of each array.
- Demonstrated <2 eV performance in PSA prototype (not planned).
- Developed and tested close-packed 32×32 PSA prototype arrays (not planned).
- There were some delays in TRL-5 demonstration activities due to unavailability of arrays with the correct properties. New arrays are being fabricated, and attempts will be made to accomplish TRL-5 demonstration by the end FY12.

2.7 Moderate Angular Resolution Adjustable Full-shell Grazing Incidence X-ray Optics

Prepared by: Paul B. Reid (Harvard-Smithsonian Center for Astrophysics)

Summary

This Strategic Astrophysics Technology (SAT) investigation seeks to develop and demonstrate Technology Readiness Level (TRL) 4 for 3- to 5-arcsecond resolution, thin wall, full shell metal replica grazing incidence X-ray optics. We are using lead magnesium niobate (PMN) electrostrictive adjusters (Fig.2.7-1) to correct the lowest axial and azimuthal order figure errors to achieve X-ray imaging performance of 3–5 arcseconds, from current performance of 10–15 arcseconds. We will accomplish this by using an array of actuators (adjusters) whose strain is oriented in the radial direction (normal to the optical axis).

The radial adjusters initially join a reference form and the innermost mirror shell. These adjusters are arrayed axially and azimuthally, as seen in Fig. 2.7-2. The adjusters are energized, and the appropriate voltages are set for each adjuster by using an optical Hartmann test as metrology for alignment (as on the *Chandra* X-ray Observatory) and low order azimuthal figure correction (as on the International X-ray Observatory technology development program). After achieving acceptable alignment and figure correction, voltage is removed from the adjusters, and the next layer of adjusters is installed at identical axial and azimuthal positions of the preceding set. The next shell is also glued to the adjusters. Alignment and figure correction then proceeds with the next shell, and so on.

Such optics would be adjusted only once—during assembly and alignment—to remove low spatial frequency figure errors that limit the performance of full shell metal replica optics. Importantly, the electrostrictive adjusters hold their dimensions when voltage is removed. There is no leakage current, and they can maintain their dimensions for many years. The adjusters would also be used as part of the mirror shell alignment, and would form an integral part of the mirror mounting system and mirror assembly structure. Prior work^[1,2] has suggested that nearly 98% of the lowest order errors can be corrected. The grazing incidence mirrors will be nickel/cobalt (Ni/Co) electroplated thin shells similar to those on the High Energy Replicated Optics (HERO) balloon experiment. These adjusters are arrayed axially and azimuthally, as seen in Fig. 2.7-2.

This is the first PATR filed on this program/technology.



Figure 2.7-1. Electrostrictive adjuster manufactured by Xinetics. When voltage is applied to the device, the length changes. The change in length is stable when the voltage is removed.

Overview and Background

The tasks necessary to develop this technology are the demonstration of correction of low order figure errors—roundness and delta-delta-radius (ddr)—resulting from electroforming full shell thin metal conical mirrors. The most common type of deformations of a full shell should be ovalization—ovalization in phase at both ends of the mirror, or roundness error, and “crossed ovalization”—ovalization clocked by 90 degrees from one end of the mirror to the other, or ddr. These errors can be of appreciable amplitudes (one to tens of micrometers) and can significantly degrade imaging resolution. These thin shell mirrors are typically used in either hard X-ray telescope applications, or moderate resolution, low-cost, moderate area X-ray telescopes.

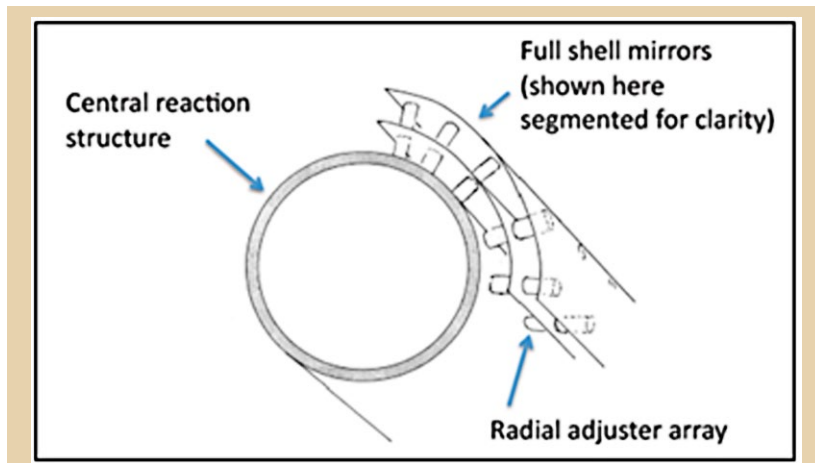

Figure 2.7–2. Schematic representation of the radial adjuster approach. The adjusters have their long axis in the radial direction and are arrayed in the axial and tangential directions. While the schematic shows Gen-X segments, we envision this approach for several arc second resolution full shell metal replica mirrors.

To demonstrate this approach, the major tasks are: 1) produce a thin (0.1 to 0.2 mm wall thickness) electroplated full shell mirror; 2) measure the shape of that mirror, particularly its out-of-roundness; 3) mount and correct it using the radial adjusters, and then; 4) remeasure. The initial experiment would be with a single shell mounted to a reaction structure, and the follow-on experiment will use two shells mounted concentrically to the reaction structure. A coordinate measuring machine (CMM) will be used to make the first measurements. As accuracy improves, the Centroid Detector Assembly (CDA)—a pupil scanning Hartmann tester—will be used for higher accuracy measurements.

This technology will be directly applicable to wide-field X-ray survey telescopes (i.e., the Wide Field X-ray Telescope) that will cover the bandwidth of 0.2–10 keV. The technology can also be employed to improve the imaging of hard X-ray telescopes, although the limit to collecting area imposed by the space between mirror shells necessary to accommodate the adjusters will limit applicability to the lower end of the hard X-ray bandwidth.

Current performance of these types of X-ray mirrors is limited to the 15–30 arcsec regime, although individual mirror shells and small telescopes have been made with resolution as good as 10 arcsec. Improving imaging resolution by a factor of 3–10 (to 3–5 arcsec) means

that noise limited sources will have 1/10 to 1/100 the background, resulting in significantly higher signal to noise and significantly higher minimum detectable flux levels. Achieving finer resolution will improve detection capability for hard X-ray sources, and provide more useful imaging for 0.2–10 keV objects.

Objectives

The objectives of this program are as proposed: 1) to advance this technology to TRL 4–5 by demonstrating correction of the lowest order axial and azimuthal figure errors; and 2) to develop this approach as a robust method of building up the mirror assembly. The first objective will improve the performance of moderate area X-ray missions while the second objective will lower assembly cost. Key challenges in developing this multiple shell adjustable systems include: 1) ensuring that piezo-induced figure corrections in a particular location do not add distortion elsewhere in the mirror, and; 2) that the forces from correcting figure errors in the outer shells do not create unwanted distortions in the inner mirrors as they effectively act as reaction structures.

Accomplishments

Several important tasks have been completed or are in process.

- Derived requirements for the reaction structure for the single shell test case. The main requirement on the reaction structure is the required stiffness relative to the mirror shell, which flows down to the reaction structure material and wall stiffness. We find a reaction structure of stainless steel with a minimum wall thickness of > 3.2 mm results in a stiffness of >102 times that of the 0.2 mm thick, 23 cm diameter, Ni/Co shell. The reaction structure is 18 cm diameter, which allows for 2.5 cm long adjusters.
- Modeled and derived the flexure design for attaching the radial adjusters to the reaction structure and the mirror. Of significance is that the radial adjusters require flexure attachments at both ends, rather than only at the outside end as previously thought.
- Started detailed design of reaction structure for machining. The design concept, shown in Fig. 2.7–4, includes adjustment for machining tolerances in the reaction structure and small variations in the length of the radial adjusters.
- Started fabrication of the 23 cm diameter Ni/Co shell. This will be complete in the fourth quarter.

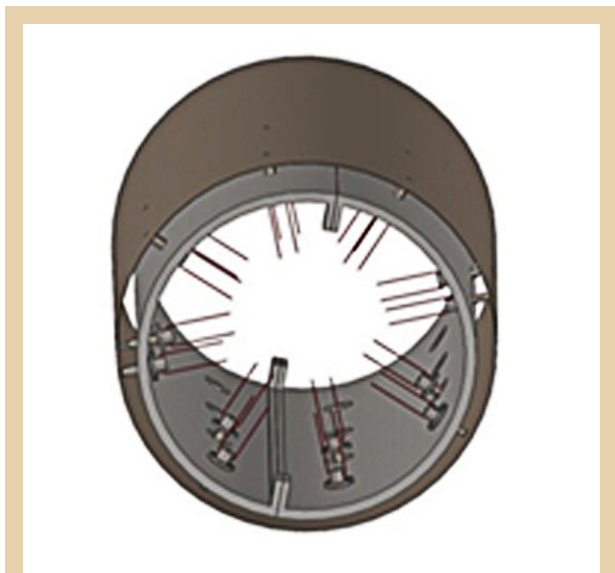

Figure 2.7–3. Assembly level design of the reaction structure, radial adjusters, and inner shell.

Milestones and Schedule

The project baseline assumed a January 1, 2012 start. Unfortunately, SAO did not receive funding until April 2012, delaying the start of activities. Since then, however, we have made progress against our plan.

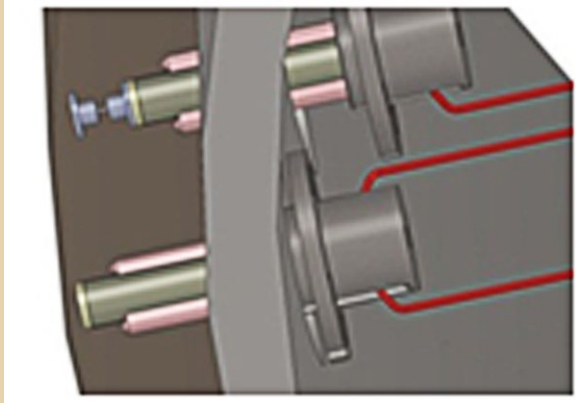

Figure 2.7-4. Reaction structure adjusters are shown.

Adjusting for the delayed start, we have completed, or are close to completing, our proposed tasks for this time period (Tasks 1, 2, and 3). We have completed requirements generation (Task 1) and will finish fabrication of the large reaction structure (Task 2) in October 2012. This will be closely followed by the generation of the first large mirror shells (Task 3). We are performing dry-runs of the assembly and test processes prior to the receipt of NiCo mirrors. We hope this will decrease the duration of the single shell assembly and test task (Task 4) and, at the very least, lower schedule risk. We will incorporate the lessons learned from this activity into our revised procedures.

Below is an updated schedule that adjusts for the program delay and incorporates our anticipated schedule savings from our development activities.

Task	FY13												FY14																	
	Oct	Nov	Dec	Jan	Feb	Mar	Apr	May	Jun	Jul	Aug	Sep	Oct	Nov	Dec	Jan	Feb	Mar	Apr	May	Jun	Jul	Aug	Sep						
Major Milestones	▲ TRL 4												▲ TRL 5																	
Requirements																														
Fabricate 23 cm diameter reaction structure	▲																													
Fabricate 23 cm diameter 0.2 mm thick Ni/Co mirror shell	▲		▲																											
Single mirror ass'y test			▲		▬						▲																			
Correlate measured data and finite element model			▲		▬						▲																			
Correction of low order figure to 5 arcsec HPD level: TRL 4					▲		▬		▲																					
Fabricate 15 cm diameter reaction structure									▲		▬		▲																	
Fabricate 15 cm diam and 23 cm diameter Ni/Co mirror shells (1 each)											▲		▬		▲															
Two shell assembly test													▲		▬						▲									
X-ray test: correction to < 5 arcsec HPD at 1 keV = TRL 5																			▲		▬		▲							

Future Plans/Next Steps

Our baseline development approach has not changed. In the short term, our most significant accomplishment will be the assembly of a single large mirror shell onto the reaction structure. The assembly and initial test will take place at SAO with X-ray testing conducted at MSFC in Q3 FY13 in support of TRL-4. The longer-term approach for reaching TRL-5 is predicated on successfully testing a multi-shell assembly. This is a significant step forward in the technology. We have already begun analyzing different concepts for the multi-shell design to ensure we can leverage our current work most efficiently.

Below is a detailed description of the tasks we intend to accomplish over the next 18 months prior to the end of the project:

- Correct low order errors of a single full shell conical mirror. In this activity we will align and bond the mirror element and adjustors to the reaction structure (SAO), and then measure our ability to adjust the shape of the mounted mirror. Mechanical measurements of mirror roundness and ddr will be made using the SAO CMM, with better than 1 μm Root Mean Square (RMS) accuracy. Axial figure measurements and changes in axial (as driven by the adjusters) will be measured both by CMM at SAO, and optically at MSFC using their Long Trace Profilometer (LTP).
- Correlate experimental results with Finite Element Model (FEM). This task could also be considered an intrinsic part of the task described directly above. However, we break it out individually to highlight the critical importance of this task. This activity will also include updating the FEM so as to better represent reality, thus making it a useful tool for analyzing a broader range of test cases than can be performed experimentally in a 2-year program.
- Test first mirror shell in X rays at MSFC Stray-light Test Facility. Verify that the observed performance matches performance predicted via optical and mechanical metrology.
- Technology Milestone 1/TRL-4. Achieving the goals of the above steps of the investigation will represent both our first technology milestone, and demonstrate TRL-4.
- Stability and Lifetime. Stability and lifetime is always a concern for a space-based instrument. A characteristic of these electrostrictive devices is that they have essentially zero leakage current, and therefore maintain their dimensions after voltage is removed (the condition is called electrically clamped, as charges are not free to move within the device). We will provide some limited testing of this capability using the flat mirror test fixture shown in Fig. 2.7-5, by introducing some deformations, removing voltage, and monitoring the mirror shape over time.

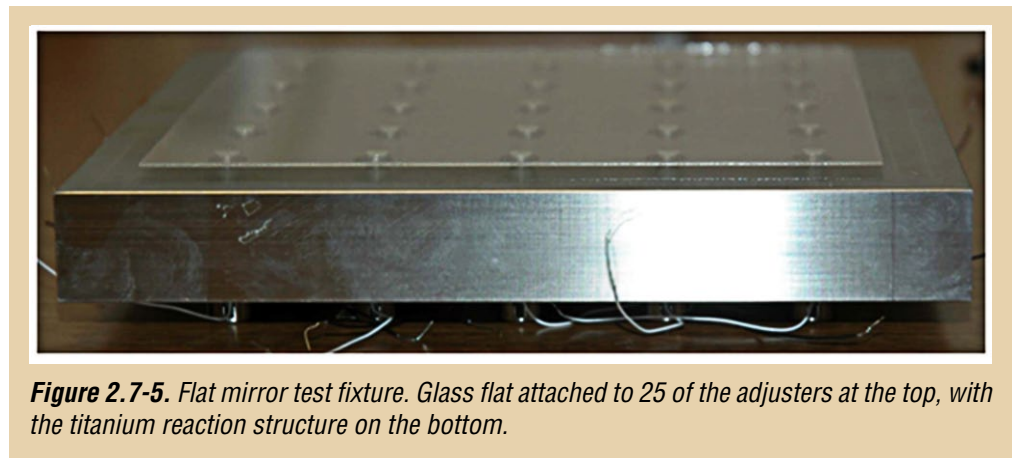

Figure 2.7-5. Flat mirror test fixture. Glass flat attached to 25 of the adjusters at the top, with the titanium reaction structure on the bottom.

- Build a two-shell mirror assembly and test in X rays. This task entails building a second reaction structure (MSFC), sized for a smaller, 15 cm, MSFC electroplating mandrel. (We take the expense of making two reaction structures because we believe: a) it will prove more difficult to mount and align a smaller shell and adjusters to the reaction structure; and b) it may prove more difficult to ascertain our level of success or failure with a more cylindrical—smaller cone angle, smaller radius—shell.) Mount, align, and adjust the inner shell (15 cm diameter) to the smaller reaction structure (SAO). Mount, align,

and adjust the outer shell to the inner shell (SAO). In both cases, verify adjustment and alignment using mechanical and optical metrology. Test the two-mirror shell telescope with X rays in the MSFC Stray-light Test Facility.

We have the engineering staff and facilities available to perform the above tasks.

References

1. Reid, P. B., *et al.*, "Development of adjustable grazing incidence X-ray optics," presented at AXRO2009, Dec. 2009, Prague, Czech Republic.
2. Reid, P. B., *et al.*, "Adjustable X-ray Optics," paper 40.07, HEAD2010, Mar. 2010, Waiakola, HI.

2.8 Directly Deposited Optical Blocking Filters for Imaging X-ray Detectors

Prepared by: Mark Bautz (MIT)

Program Motivation and Objectives

We aim to raise the technology readiness level (TRL) of enhanced CCDs capable of meeting the requirements of X-ray grating spectrometers (XGS) and wide-field X-ray imaging instruments for missions at a variety of scales. Because they are made of silicon, all X-ray CCDs require blocking filters to prevent corruption of the X-ray signal by out-of-band (mainly optical and near-IR) radiation. We propose to replace the fragile, extremely thin, free-standing blocking filter that is the current standard practice with a much more robust filter that is deposited directly on the detector.

Although high-performance, back-illuminated CCDs have flown with free-standing filters (e.g., one of our detectors on Suzaku) and other, relatively low-performance CCDs with directly deposited filters have flown (e.g., on the *XMM-Newton* Reflection Grating Spectrometer), a high-performance, back-illuminated CCD with a directly deposited filter has not yet been demonstrated. Our effort will be the first to demonstrate that such a filter can be deposited on a modern, high-performance, back-illuminated X-ray CCD that meets the requirements of future XGS instrument concepts. This work also has potential benefits for X-ray imaging instruments, such as wide-field imagers, which envision silicon CCD or active-pixel imagers. Successful completion of our program will also enable simpler, lighter, more reliable, and cheaper instruments for the Explorer-class Missions that will be so important to NASA's Astrophysics Program in this decade.

The overall goal is to demonstrate directly deposited filters that provide adequate light blocking without compromising the excellent low-energy ($E < 1.0$ keV) X-ray spectral resolution of modern CCD detectors. X-ray detector spectral resolution is essential to separate overlapping diffraction orders in X-ray grating spectrometers, and is also vital for achieving the science goals of wide-field X-ray imaging instruments. Because the low-energy spectral resolution of these detectors depends on the details of electric fields and lattice characteristics at the X-ray entrance surface, it is important to demonstrate that direct deposition of an aluminum blocking filter on this surface will not compromise device performance.

Approach and Work Plan

In summary, we take advantage of existing stocks of front-illuminated CCD detectors (generally engineering-grade devices produced for prior NASA and other U.S. Government programs) at the Massachusetts Institute of Technology (MIT) Lincoln Laboratory. We select amongst available front-illuminated devices and then apply suitable back-side treatment using Lincoln's micro-fabrication facilities. We then systematically apply aluminum blocking filters of various thicknesses, and characterize both the optical blocking of the filter and the X-ray performance of the devices.

In slightly more detail, we have defined four tasks:

Task 1: Select and thin existing CCID41 wafers and apply backside treatment

The existing front-illuminated detectors are currently in wafer form (typically four devices to a wafer). Using wafer-probe equipment, we identify the functional devices. We then subject selected wafers to a custom back-side treatment process, involving wafer thinning and molecular beam epitaxy passivation, that has already been shown to provide good X-ray results. Selected devices are packaged (removed from the wafer and installed in suitable test packages) for subsequent test at the MIT Kavli Institute (MKI).

Task 2: Establish baseline X-ray performance

We use established X-ray characterization facilities and procedures at MKI to verify suitable X-ray performance of the back-illuminated (but uncoated) devices.

Task 3: Apply filters and characterize filter-equipped devices

We use established thin-film deposition facilities at MIT Lincoln Laboratory to deposit aluminum blocking layers, and then package and test the filter-equipped devices. Filters are applied at the wafer level, with control areas masked to allow direct comparison of filtered and unfiltered areas of each device. We contemplate three cycles of filter deposition and test (one wafer per cycle), applying a 130-nm-thick filter in the first cycle, and then progressing, after successful test, to 60-nm and finally 30-nm filter thickness. The latter is the most demanding XGS requirement envisioned. All filters will be capped with a 10-nm AlO₂ layer to improve robustness and provide UV blocking. Both optical rejection and X-ray spectral resolution will be measured in the characterization protocol.

Task 4: Test robustness and stability

To verify temporal stability and robustness of the coatings to the repeated thermal cycling experienced by CCD detectors during instrument development and testing, we will perform thermal cycling and long-term (8–12 month) stability measurements.

Milestones and Schedule

Task	FY12			FY13												FY14													
	Jul	Aug	Sep	Oct	Nov	Dec	Jan	Feb	Mar	Apr	May	Jun	Jul	Aug	Sep	Oct	Nov	Dec	Jan	Feb	Mar	Apr	May	Jun	Jul	Aug	Sep		
BI processing & test (5 wafers)	▲————▲																												
Develop & test filter stack masks	▲————▲																												
Package baseline devices (2 devices)				▲————▲																									
Coat, pattern & test thick filter (1 wafer)					▲————▲																								
Package thick filter devices (2 devices)						▲————▲																							
Coat, pattern & medium filter (1 wafer)								▲————▲																					
Package medium filter devices (2 devices)									▲————▲																				
Coat, pattern & thin filter (1 wafer)											▲————▲																		
Package thin filter devices (2 devices)												▲————▲																	
Package additional devices (2 devices)															▲————▲														
MKI Facility Upgrade	▲————▲																												
Test baseline devices (X-ray only)						▲————▲																							
Test thick-filter devices (X-ray & optical, 2 devices)							▲————▲																						
Test med.-filter devices (X-ray & optical, 2 devices)									▲————▲																				
Test thin-filter devices (X-ray and optical, 2 devices)												▲————▲																	
Thermal cycle test (30 cycles, 3 devices)																▲————▲													
Long-term stability test (post-test, 3 devices)																			▲————▲										
Prepare Final Report																					▲————▲								

This page left blank intentionally

2.9 Planar Antenna-Coupled Superconducting Detectors for CMB Polarimetry

Prepared by: James J. Bock (Jet Propulsion Laboratory)

Summary

The NASA Inflation Probe will measure Cosmic Microwave Background (CMB) polarization to fundamental limits, in order to extract all the cosmological information from the CMB. The CMB is thought to carry an Inflationary polarization signal imparted by a gravitational-wave background produced $\sim 10^{-32}$ s after the Big Bang singularity. The Inflationary polarization signal is sensitive to the energy scale and shape of the Inflationary potential, and can be clearly distinguished from polarization produced by matter density variations due to its distinctive B-mode spatial signature. In addition, a B-mode polarization signal from gravitational lensing imparted by large-scale structure is sensitive to neutrino mass and dark energy. Finally, the CMB contains an E-mode polarization signal that probes the history of reionization. The expected role for a space mission will be to comprehensively measure all of the polarization signals over the entire sky down to astrophysical limits. These measurements require a factor of ~ 20 sensitivity increase over the bolometers currently observing the CMB in the ESA/NASA *Planck* satellite.

We propose to develop antenna-coupled superconducting detectors for sensitive space-borne CMB polarization measurements. Antenna-coupled bolometers are attractive because they have the sensitivity to realize photon-limited performance, and can be naturally adjusted to cover the entire frequency range, 30–300 GHz, needed to monitor and subtract polarized Galactic emission, using a single technology. Planar antennas are compact and low-mass, and naturally scale up to the large array formats required by the Inflation Probe. New designs can provide system-level improvements—multi-color response for higher focal plane density, noise stability for scanning operations, and RF multiplexing for simplified cold readout electronics.

SAT program funding advances antenna-coupled detector arrays for the Einstein Inflation Probe mission in NASA's Physics of the Cosmos Program. CMB polarization technology development was called out as a priority by the NWNH decadal review in 2010. This development advances detector technology, the most important technology for CMB polarization, in alignment with NASA strategic planning, and carries synergistic technology benefits for NASA far-infrared and X-ray detector development based on similar superconducting technologies.

Overview and Background

Our program will perfect the optical and polarization properties of the antennas, building on a base of experience assembled from multiple generations of devices developed on past NASA funding. We are advancing the development of two detectors compatible with antenna coupling, Transition-Edge Superconducting (TES) bolometers and Microwave Kinetic Inductance Detectors (MKIDs). This parallel sensor development is attractive due to the RF multiplexed readout for MKIDs, which has a significantly simpler implementation compared with the SQUID current amplifiers used with TES bolometers. Specifically, we will develop and test MKIDs for low photon backgrounds, and characterize cosmic ray susceptibility and

1/f noise in TES bolometers. Finally, we will develop a modular focal plane unit designed to scale up to the large multi-band focal planes needed for space. These technologies will be validated in separately funded ground-based and suborbital experiments.

Antenna-coupled detectors have the requisite attributes—sensitivity, frequency coverage, and control of systematic errors—called for in community studies of space-borne CMB polarization experiments. The antennas naturally cover a wide frequency range (30–300 GHz) with a single technology, and, coupled to a TES bolometer or an MKID sensor, provide superior sensitivity to that projected for future coherent amplifiers at frequencies above 100 GHz. TES bolometers realize near-background-limited sensitivity, and both MKID and TES bolometers have multiplexed readouts that scale to the array formats needed for space-borne CMB polarization measurements. Antenna-coupled TES bolometers are currently operating in ground-based CMB polarization experiments, and control of systematic errors with these devices is currently being demonstrated with astrophysical data.

Objectives

Advanced development builds upon current antenna-coupled detector technology to address specific challenges needed for a space mission. This work falls into four categories: 1) new antenna designs to provide improved sidelobe control and polarization matching; 2) improved propagation materials to allow flexible multi-color antennas; 3) developing MKID sensors appropriate to CMB photon levels and improving the stability and particle susceptibility of TES detectors; and 4) a modular focal plane unit for building large space-borne focal plane arrays.

Accomplishments

The proposal was planned and approved as a 2-year effort. Work in FY12 was replanned to fit with a 65% reduction in funding relative to the original SAT proposal. We were able to accomplish many of the high-priority tasks in FY12 at a reduced level of effort, starting in January 2012 when funds went on account at JPL. Tasks that could not be addressed in FY12 were pushed into FY13, when funding will increase to meet the total allocation. We developed refined planar antenna designs for 150 GHz to provide improved polarization matching. We have successfully demonstrated an improved antenna feed network that reduces cross-coupling between the two polarizations in the feed network. This cross-coupling manifested itself as a horizontal displacement between the vertical and horizontal polarization beams, producing a 10% beam mismatch, as shown on the left in Fig. 2.9–2. We also found an unexpected beam shift associated with a gradient in the propagation velocity in the niobium/silicon oxide/niobium (Nb/SiO₂/Nb) micro stripline used in the feed network that varies over the device wafer. The variations in propagation velocity are related to the properties of the Nb and depend on the patterning and deposition process. Our improved design virtually eliminates both effects, and we now measure matching through a full optical system at the 1–2 % level (see right in Fig. 2.9–2). We have developed a new tapered-beam antenna, which simulates a Gaussian beam pattern. Compared to earlier tophat designs, the Gaussian profile reduces secondary sidelobes, and such control is especially important in conjunction with an ambient-temperature telescope. We developed three tapered designs for three different antenna sizes, and found the beam pattern closely matched theoretical expectations.

We have been making investigations on RF losses in the dielectric materials used in the antenna feed network. Improvements in propagation loss promise improved optical efficiency. This design requires low loss in order to move the detectors outside of the

optically active part of the array. We have tested a variety of dielectric materials, including plasma-enhanced chemical vapor deposition (PECVD) silicon nitride, PECVD silicon dioxide, and sputtered silicon dioxide. Low propagation loss opens up new device architectures, e.g., antennas sensitive to multiple colors and with matched beam patterns in each color, and enable completely new structures such as planar dispersive spectrometers based on superconducting RF circuits for diverse astrophysics applications.

Finally, we have been developing a modular focal-plane unit with SQUID-multiplexed readouts integrated into the unit. The readouts are located behind the optically active focal plane sensors to use space behind the focal surface in order to maximize detector density (see Fig. 2.9–3). These modular units enable piecewise construction of the large multi-band focal plane arrays needed for the Inflation Probe. The module design incorporates the magnetic shielding arrangement developed in our current 512-element focal plane unit with four sub-arrays (see Fig. 2.9–1). We have fabricated a full design for 192 detector elements based on a detector sub-array made from a 100 mm Si wafer. The SQUIDs are mounted on a Macor (alumina circuit board material) board that provides a $\lambda/4$ backshort behind the antennas and a Nb magnetic shield for the SQUIDs. We have fabricated a thermal and mechanical prototype, and demonstrated that it maintains the required dimensional control of the $\lambda/4$ gap from room temperature to 4K.

Task	FY12						FY13												FY14					
	Apr	May	Jun	Jul	Aug	Sep	Oct	Nov	Dec	Jan	Feb	Mar	Apr	May	Jun	Jul	Aug	Sep	Oct	Nov	Dec			
Antennas																								
Uniformity - Develop uniform feed networks	▲ Test																							
Pol. Matching - Develop compensation to minimize polarized beam	▲ Test																							
Tapering - Develop tapered Gaussian planar antennas	▲ Test																							
Dielectrics																								
Loss - Measure loss in improved materials: PECVD nitride, amorphous Si	PECVD Si3N4 ▲						▲ SiO2						▲ SiO2											
Vias - Develop and test via process																			▲ Test					
MKIDs																								
Sensitivity - Demonstrate NEP under EIP optical loading																			Test ▲					
Stray Coupling - Measure and eliminate stray coupling							Test Current ▲						Test Delta Design ▲											
TES Sensors																								
Particles - Test particle response to develop mitigation techniques							Muxing ▲						▲ Resp						▲ New Design					
Stability - Demonstrate stability with pair differencing and bias switching																			Test Delta Design ▲					
Focal Plane Module - Develop modular focal plane unit and test noise, B-shielding, stray light	▲ Thermal						▲ B-Shield						▲ Full											

Milestones and Schedule

Future Plans/Next Steps

SAT Development Plans for FY13

In the coming year, we will extend the antenna designs to 90 GHz for polarized beam matching tests. We will complete the dielectric loss measurements including additional materials such as amorphous silicon, variations on sputtered silicon dioxide, and any losses associated with Nb processing. A fully assembled focal plane module will be tested. We will start work on aspects related to the photon sensing elements, including measurements

of MKIDs developed for the photon loadings appropriate for the Inflation Probe. On TES detectors, we will measure response to energetic particles with a cryogenic radioactive source. These data will be used to assess the influence of particle hits to the TES islands on the multiplexed readout. Furthermore, we plan to test the effect of particle hits on the silicon frame to determine if it can be a channel that influences the sensor through athermal electrons and phonons. We will also investigate a bias switching and demodulation scheme that promises improved $1/f$ noise and an additional layer of immunity to magnetic fields. We will complete the focal plane module, assemble a unit with SQUID amplifiers and bolometers, and test noise, magnetic shielding, and stray light control.

Longer term, technology development for the Inflation Probe must address systems design trades. A detailed working knowledge of the electrical, optical, and thermal interfaces and detector susceptibilities will form the basis of a space-borne instrument. For example, it will be valuable to demonstrate antenna-coupled focal plane arrays using a telescope without a Lyot stop, an ideal architecture for wide-band space-borne measurements, to understand the detailed interaction between the detector beams and the full optical system. Environmental mitigation will be integrated into the focal plane—thermally staged optical filtering, magnetic shielding, RF filtering, and stabilized readouts—necessary to develop a flight instrument.

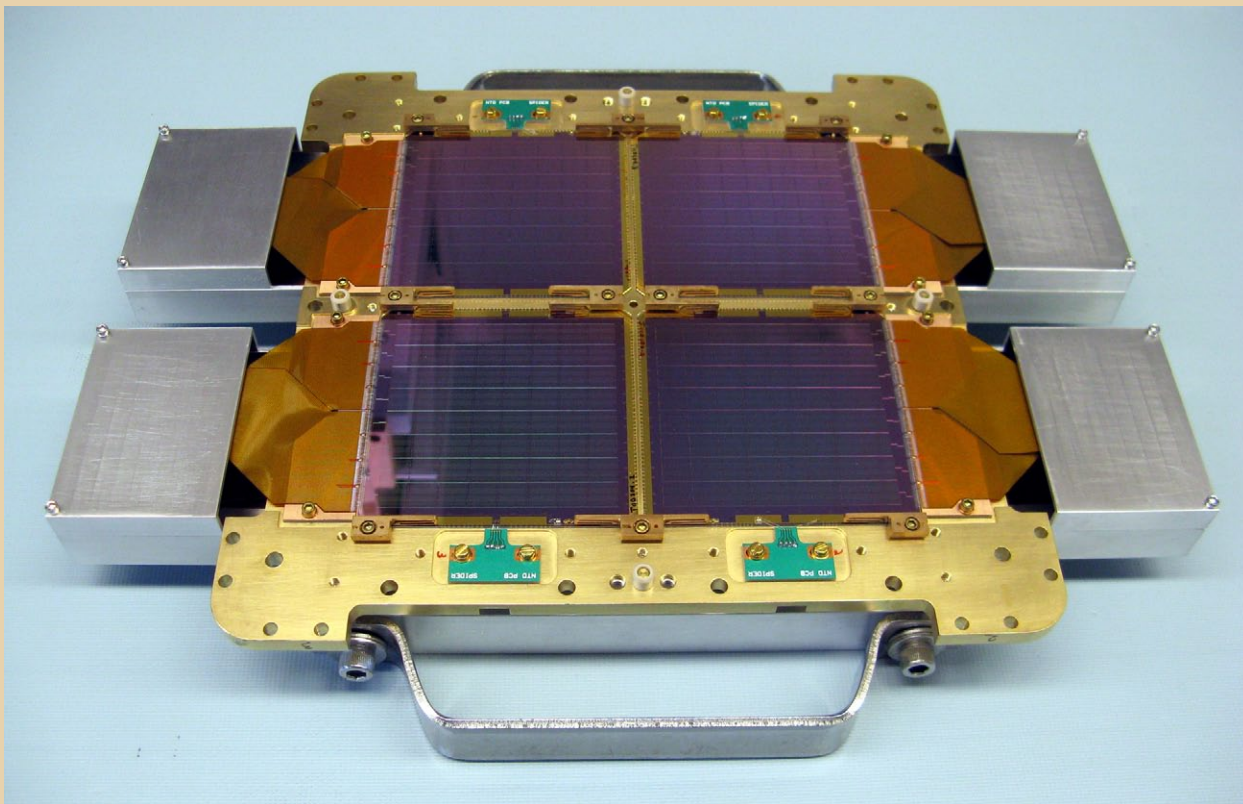

Figure 2.9–1. This image shows a focal plane array of planar antenna-coupled TES bolometers operating at 150 GHz. The focal plane uses four sub-arrays fabricated from 100 mm Si wafers, each with 128 polarization-sensitive detectors. Time-domain multiplexed SQUID readouts are placed in magnetically shielded boxes that fold behind the focal surface using flexible Kapton® ribbon cables.

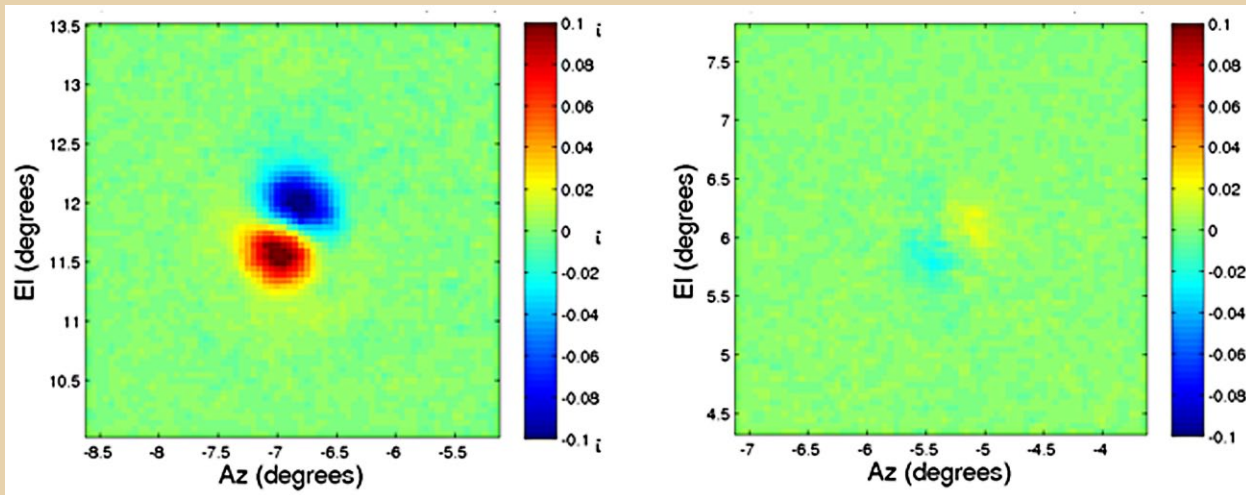

Figure 2.9-2. These images show the far-field beam difference pattern between two polarized detectors in a single antenna (shown is the beam pattern of the vertically polarized detector minus the beam pattern of the horizontally polarized detector). Left: Previous beam pattern measured for an antenna fabricated with Nb patterned using a liftoff process. The pointing shift between the two beams manifests itself in the vertical direction, which is expected because the antenna is more sensitive vertically to a gradient in the propagation wave speed. Right: Typical beam pattern for Nb sputtered and patterned using an etchback process. Exact cancellation minimizes temperature to polarization conversion, which must otherwise be carefully removed. The beam patterns here were both measured through the identical refracting optical system in the far-field of the telescope.

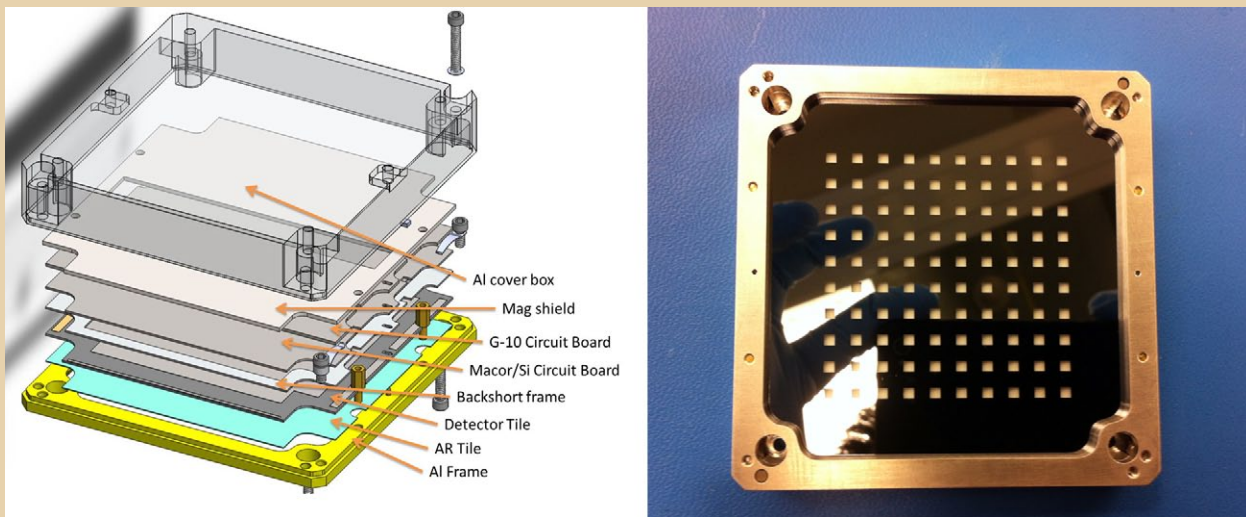

Figure 2.9-3. These images show a prototype focal plane module under development. A spacer Si wafer is placed on the back of the detector wafer to set the $\lambda/4$ backshort behind the antenna, and a Macor circuit board is placed on this spacer. Finally, a G-10 circuit board holding the SQUIDs is placed on the Macor board. Right: The mechanical prototype shown has a test wafer with square holes etched through the Si to allow us to precisely measure the distance to the backshort at cryogenic temperature.

This page left blank intentionally

3 Program Technology Needs

The first step in prioritizing the Program's technology needs is to identify and gather all of the perceived needs from the astrophysics community of scientists and technologists. As input to the technology development process, the Program invites potential stakeholders to provide a listing of what they identify as technology needs that can enable or enhance current and future missions within the Program's science portfolio. Input from the community comes through the Physics of the Cosmos Program Analysis Group (PhysPAG), and through an outreach program that targets both meeting venues and potential providers of specific technologies. The PhysPAG is constituted by the NASA Astrophysics Subcommittee to support community coordination and analysis of scientific and technological issues impacting NASA's PCOS Program. A technology need can be derived by anyone and provided to the Program for prioritization in two ways. The first way is to work through the PhysPAG to include it in the consolidated listing in response to the solicitation by the Program Office. The second way is to download, fill out, and submit the "Program Technology Needs Input" form located on the PCOS Program website, <http://pcos.gsfc.nasa.gov/technology>. Although technology needs are solicited annually and collected at the end of June to begin the annual prioritization process, they can be submitted to the PO at any time. After collection, consolidation, and tabulation, the inputs are then used by the Program's Technology Management Board (TMB) to evaluate and prioritize all the needs according to a set of prioritization criteria. These criteria are shown and described in detail in Section 4 of this report.

Last year's prioritization covered only the technologies that were included in the "draft" technology needs tables developed over the summer of 2011 by the PhysPAG's Technology Science Analysis Group (TechSAG) because the final version was not available when the TMB convened in early September. For this year's prioritization, in concurrence with the PhysPAG, the TMB used the "final" released version of the technology needs produced by the TechSAG, which included about a dozen more technologies than the "draft" version, and five technology needs inputs received via direct submission through our website. This brings the total number of technology needs assessed in this year's prioritization to 92.

The full set of technology needs collected this year for prioritization is shown in Tables 1 through 12 as submitted by the TechSAG. The TechSAG, working with the community, developed a technology roadmap with supporting tables to capture the needs as identified by the science and research community. The Technology Roadmap Table summarizes the mission concepts in roadmap format, with the missions and mission concepts identified in the columns phased by time. The roadmap is organized into three sections: a) missions recommended by the most recent Decadal Survey plus Fundamental Physics, requiring technology development in the present decade; b) near-term "push" mission concepts that require development of emerging technologies starting now and extending into the next decade; and c) long-term "push" concepts needing emerging technology development into the following decade.

Table 13 summarizes the technology needs submitted directly to the Program Office through our website. The science and research community is encouraged to continue to submit technology needs that enable current and future PCOS science objectives. The main conduit for collecting program technology needs is through the PhysPAG. However, direct submission to the Program Office via the PCOS website is also acceptable. Next year, both input formats will be coordinated so that the same information will be available in the PhysPAG submission and the direct Program Office submission.

Some inputs lacked definition and could not be prioritized because the TMB could not discern the specific need. The PO encourages inputs include as much of the information requested as possible and, most importantly, the technology's goals and objectives should be clear and quantified. For example, stating that a better cryocooler is needed is insufficient. A complete description with specific performance goals based on mission needs would be far more valuable. This allows the TMB to best assess the need, NASA HQ to develop proposal calls, and the research community to be informed and to best match candidate technologies and mission needs. If specifying the technical parameters is not possible due to the competition sensitivity of the information, then the submitter should consider specifying the ranges or targets of the important technical parameters. When relevant, the submitter should quantitatively and qualitatively explain how the need exceeds the current state-of-the-art. Additionally, a clear description of potential relevant NASA missions or application is also needed for the prioritization process. It would be instructive to view these inputs as a mini-proposal. The more compelling and relevant the case, the more likely it will receive favorable prioritization and/or funding recommendations.

For each technology shown in the technology needs tables, information was provided for the following categories:

- **Brief description:** summarizes the technology need and the associated key performance criteria for the technology. In general, technology needs that are well defined will tend to receive higher prioritization than those that are vague.
- **Goals and objectives:** details the goals and/or objectives for a candidate technology to fill the described need. For example, "The goal is to produce a detector with a sensitivity of X over a wavelength of Y to Z nm." Technology needs with objectives that are clearly quantified will receive higher prioritization than those without quantified objectives.
- **TRL:** specifies the current Technology Readiness Level(s) of the technology per NASA Procedural Requirements (NPR) 7120.8 with clear justification.
- **Tipping point:** provides a timeframe during which the technology can be brought to a level where its eventual viability can be assessed. This can be when the technology reaches the mid TRL thresholds (4, 5, or 6).
- **NASA capabilities:** describes NASA's current capability to implement and/or access the technology.
- **Benefit:** describes the scientific, engineering and/or programmatic benefits of fulfilling the technology need. If the need is enabling, then describe how and/or why. If the need is enhancing, then describe, and if possible quantify, the impact. Benefits could be scientific (i.e., better science output), engineering (e.g., lower mass), or programmatic (i.e., reduced cost or schedule). For example, "Material X is 50% stronger than the current state of the art and will enable the optical subsystem for a 2m telescope to be Y kg lighter." Technology needs with greater potential mission benefits will receive higher prioritization.
- **NASA needs:** details specific needs and performance requirements for NASA mission concepts.
- **Non-NASA but aerospace needs:** details specific needs and performance requirements for applications outside of NASA mission concepts and within the aerospace sector.
- **Non-aerospace needs:** describes specific needs and performance requirements for all other needs (not covered in the previous two categories).
- **Technical risk:** describes the known technical risks in developing the technology.
- **Sequencing/timing:** describes when the technology will be needed to support anticipated mission needs. Technology needs with the shorter time windows relative to required development times will receive higher prioritization.

- **Time and effort:** estimates the duration and scope of the technology development effort.

In addition to the above categories and to further inform the TMB during prioritization, the Program Office technology needs input form also requested the following information:

- **Technology is enabling or enhancing:** describes whether fulfilling the technology need is required to meet the associated missions' objectives, which makes the technology enabling, or whether it is an enhancing technology, because fulfilling the need would have significant benefits but is not absolutely required.
- **Potential relevant missions:** identifies future NASA missions or applications for which the technology need is relevant and discusses how the need applies. Technology needs with significant relevance to highly ranked missions or applications will be prioritized favorably.
- **Potential providers, capabilities, and known funding:** identifies any known potential providers of relevant technology. Describes the current capability as it relates to the technology need and any information regarding current funding sources for relevant technology development.

This page left blank intentionally

Technology Roadmap - PhysPAG Technology SAG - 10/15/11 *

Decadal Survey 2010 (New Worlds New Horizons)				Near Term Push Technologies **							Long Term Push Technologies **				
	WFIRST	LISA	IXO-like	Inflation Probe	Fundamental Physics	Advanced mm-wave/far-IR Arrays	Next Generation Hard X-ray Observatory	Next Generation EUV/Soft X-ray Observatory	Next Generation X-ray timing	Next Generation Medium-energy γ -ray Observatory	21cm Cosmology Array	Beyond LISA (Big Bang Observer)		Beyond IXO (Gen-X)	Next Generation γ -ray Focusing
		Table 1	Table 2	Table 3	Tables 4a, 4b	Table 3	Tables 5a, 5b	Table 6	Table 7	Table 8	Table 9	Table 10		Table 11	Table 12
Science Summary	Study the nature of dark energy via BAO, weak lensing and Snl _a , IR survey, census of exoplanets via microlensing.	Probe black hole astrophysics & gravity signatures from compact stars, binaries, and supermassive black holes.	Conditions of matter accreting onto black holes, extreme physics of neutron stars, chemical enrichment of the Universe.	Study the Inflationary Epoch of the Universe by observing the CMB B-mode polarization signal.	Precision measurements of space-time istoropy and gravitational effects.	Enhanced sensitivity or reduced resources for the Inflation Probe; far-infrared astrophysics.	Hard X-ray (5-600 keV) imaging all sky survey for BHs.	Spectroscopy of million degree plasmas in sources and ISM to study composition.	EOS of neutron stars, black hole oscillations, and other physics in extreme environments.	Signatures of nucleosynthesis in SNR, transients, and other sources; AGN and black hole spectra.	Track evolution of Universe from the Dark Ages (before the first stars), through Cosmic Dawn, and into the Epoch of Reionization using the highly-redshifted 21 cm hyperfine transition of neutral hydrogen.	To directly observe gravitational waves resulting from quantum fluctuations during the inflation of the universe.		Observe the first SMBH, study growth and evolution of SMBHs, study matter at extreme conditions	Signatures of nucleosynthesis in SNR, transients, and other sources.
Architecture	Single 1.5 m diameter telescope, with focal plane tiled with HgCdTe (TBD).	Three space craft constellation, each in Keplerian orbit. Sub nm displacement measured by lasers (Michelson interferometer).	Single 2.5 - 3 m grazing incidence 20 m focal length X-ray telescope.	High-throughput cooled mm-wave meter-class telescope with large-format polarization-sensitive detector arrays.	Individual spacecraft for space-time measurement and gravitational effects. Multiple spacecraft for precision timing of interferometric measurements.	High-sensitivity, large-format, multi-color focal planes for mm-wave to far-infrared imaging, polarimetry & spectroscopy.	Two wide-field (~130 x ~65 deg) coded mask telescopes. Full sky each ~95 min (5a); Alternatively a Nu-STAR architecture (5b).	Focusing optics with high resolution spectrometers based on advanced gratings.	large (>3 m ²) pointed arrays of solid state devices, with collimation to isolate sources or with arrays of concentrators.	Single platform designs to measure γ -ray lines.	Synthesis array of long-wavelength receptors distributed over a notional area of 10 km operating in an environment with extremely low levels of radio frequency interference.	Four Michelson interferometers each of three s/c (~12 s/c total), ~50,000 km separation, LISA-like.	Constellation of at least 2 cold atom differential accelerometers, 10,000 km measurement baseline.	16 m (50 m ² grazing incidence telescope with 60 m focal length).	2-platform designs to measure γ -ray lines.
Wavelength	0.6 to 2.0 μ m	Interferometer λ = 1.064 μ m - gravity wave period 10-10,000 sec.	0.3 to 40 keV	1 - 10 mm		30 μ m - 10 mm	Two architecture concepts within 5-600 keV range	5-500 Angstroms	2-80 keV	100 keV - 30 MeV	5-30 m	Visible & near IR: gravity waves periods of ~1-10 sec	Gravity wave periods 0.01 - 10 Hz	0.1-10 keV	100 keV-3 MeV
Telescopes and Optical Elements	Wide FOV, ~1.5 m diameter mirror.	Classical optical design; Surface roughness < 1 λ /30, backscatter/stray light.	lightweight, replicated X-ray optics.	High-throughput, light, low-cost, cold mm-wave telescope operating at low backgrounds; Anti-reflection coatings; Polarization modulating optical elements.	Coupling of ultra-stable lasers with high-finesse optical cavities for increased stability.	Large throughput, cooled mm-wave to far-infrared telescope operating at background limit.	Coded aperture imaging: ~5 mm thick W and ~2.5 mm holes; ~0.5 mm W and ~0.2 mm holes.	Gratings, single and multilayer coatings, nano-laminate optics.	Either X-ray concentrators or collimators.	Compton telescope on single platform.	Polyimide film-based dipole antennas.	~3 m precision optics	~ One meter precision optics (l/1000)	Lightweight adjustable optics to achieve 0.1 arcsec. High resolution grating spectrometer.	Focusing elements (e.g., Laue lens) on long boom or separege platform.
		Alignment sensing, Optical truss interferometer, Refocus mechanism.					Hard X-ray grazing incidence telescope with multilayer coatings.	Actuators		Self-deploying magnetic helices	LISA Heritage	Wavefront sensing with cold atoms; large area atom optics	0.1 arcsec adjustable optic		
	Classic telescope structure - HST heritage	Athermal design with a Temp gradient Dimensional stability: pm/sqrt(Hz) and um lifetime, angular stability < 8 nrad.	lightweight precision structure				(5a) 5 arcmin aspect requirement; (5b) 5 arcsec aspect requirement.	Arcsecond attitude control to maintain resolution.	Moderate accuracy pointing of very large planar array.	LISA Heritage	10 W near IR, narrow line	Extendale optical bench to achieve 60 m focal length.	Long booms or formation flying.		
Detectors & Electronics	HgCdTe CMOS (H4RG?)	Laser: 10 yr life, 2W, low noise, fast frequency and power actuators; Quadrant detector, low noise, 10 yr life, low noise (amplitude and timing) ADC's.	X-ray calorimeter central array (~1,000 pixels); 2.5 eV FWHM @ 6 keV, extended array; 10 eV FWHM @ 6 keV. High rate Si detector (APS). High resolution gratings (transmission or reflection).	Large format (1,000 - 10,000 pixels) arrays of CMB polarimeters with noise below the CMB photon noise and excellent control of systematics.	Molecular clocks/cavities with 10 ⁻¹⁵ precision over orbital period; 10 ⁻¹⁷ precision over 1-2 year experiment. Cooled atomic clocks with 10 ⁻¹⁸ to 10 ⁻¹⁹ precision over 1-2 year experiment.	Very large format (> 10 ⁵ pixels) focal plane arrays with background-limited performance and multi-color capability.	CZT detectors matched to system requirements.	Photocathodes, micro-channel plates, crossed-grid anodes.	>3 m ² Si (or CZT or CdTe) pixel arrays or hybrid pixels, with low-power ASIC readouts, possibly deployable.	Cooled Ge; arrays of Si, CZT or CdTe pixels and ASIC readouts.	Low-power radio frequency (RF) components, capable of operation and survival under large temperature variations.	Laser interferometer, ~1 kWatt laser, gravity reference unit (GRU) with ~100x lower noise.	Megapixel CCD camera	Gigapixel X-ray active pixel sensors, magapixel microcalorimeter array.	Scintillators, cooled Ge
Coolers & Thermal Control	Passively cooled telescope, actively cooled focalplane?	Low CTE materials, passive thermal shielding, power management for avionics thermal stability.	Cryocooler needed to cool detectors and other parts of instruments.	Passive Spitzer design plus cooling to 100 mK.	Thermal stability/control, less than 10 ⁻⁸ K variation.	Cooling to 50 - 300 mK	LHP to radiators for ~30 deg (Si) and ~5 deg (CZT) over large areas (5a).		Passive cooling of pixel arrays.	Active cooling of germanium detectors.	Science antennas not thermally controlled, electronics controlled only to the minimal level necessary, most likely at high temperature extremes.	LISA Heritage	Sun-shield for atom cloud.	Cryocooler < 100 mK with 1 mK stability (IXO Heritage).	Active cooling of germanium detectors.
Distributed Space Craft		Spacecraft in separate Keplerian orbits. No formation flying or station-keeping. Low contamination μ -Newton thrusters with low thrust noise.			Applicable as precision timing standard in distributed constellations.			Use low-cost launch vehicles for single payloads with few month mission duration.			Science antennas must be distributed, likely location is lunar far side.	~12 s/c total ~50,000 km separation, sub-micron position control.	Multi-platform s/c system to support above architecture.		2-platform formation flying is one approach.

Table 1: LISA Technology

Name of Technology	Laser	Phasemeter system	Alignment Sensing	Telescope	Gravitational Reference Sensor	Thrusters
Brief description of the technology	LISA laser requires power of P=2W in a linear polarized, single frequency, single spatial mode. It requires fast actuators (BW > 10kHz) for intensity and frequency stabilization to enable laser phase locking and relative intensity noise of 10^{-6}/rHz. Shot noise limited at 1mW laser power above 2 MHz.	The phasemeter measures the phase of laser beat signals with ucycl/rHz sensitivity. It is the main interferometry signal for LISA. The phasemeter consists of a fast photo receiver which detects the beat signal, an ADC which digitizes the laser beat signal, and a digital signal processing board which processes the digitized signal.	Alignment sensing in interferometric space missions like LISA or formation flying missions is required to maintain the alignment between the individual spacecraft. This is done with differential wavefront sensing between a local and the received laser beam. The missing key element is a four element fast, non-dispersive photo detector.	LISA and also formation flying missions require telescopes to exchange laser fields for position and alignment sensing. The requirements for these telescopes include unusual length and alignment stability requirements at the pm/nrad level. Scattered light from within the telescope could affect the interferometric measurements.	Gravitational Wave detectors (LISA and LISA follow-on missions) as well as other fundamental physics missions require gravitational reference sensors. For LISA, the residual acceleration of the GRS has to be in the sub-fg/rHz range. ESA has developed a gravitational reference sensor for the LISA pathfinder and will test it in flight in the upcoming years. This reference sensor consists of a proof mass in an electro-static housing. Key technologies include magnetic cleanliness, charge mitigation, gas damping, thermal noise, and actuator noise.	Thrusters for in-space operation with very low noise, tunable thrust, long lifetime (> 5 years) are required for LISA, LISA follow-on missions, and for formation flying missions. LISA needs low noise with less thrust (uN/rHz and 100uN thrust). The requirements for formation flying missions are mission specific. They are likely to require more thrust but can also tolerate more noise compared to LISA.
Goals and Objectives	The goal is to reach TRL 6 in 2015 with a laser system that meets LISA requirements.	The goal is to reach TRL 6 by 2015 with a phasemeter system that meets LISA requirements. This system is essential to support tests of other subsystems at the ucycl/rHz level and should be developed as soon as possible.	The goal is to reach TRL 6 by 2016 with the alignment sensing system. It should be developed together with the phasemeter system. Understanding the capabilities and the sensitivity of the alignment sensing system enables more targeted technology developments for LISA and allows to develop realistic designs for formation flying mission.	Athermal telescope designs have to be developed to meet the length and alignment requirements. Materials have to be tested for creep at the pm/nrad level. Study ways to predict and reduce the effects of back scatter on the interferometry.	The initial goal has to be the support of the LISA pathfinder and technology import to learn as much as possible form the pathfinder. This could raise the TRL above 6 immediately. Future R&D depends on the outcome of the pathfinder mission. The lessons learned should help to evaluate how far this technology can be pushed or if radically new ideas should be investigated.	TRL 6 for colloid thrusters meeting the LISA requirements. Scalability of these and other thrusters to meet formation flying requirements needs to be investigated.
TRL	Between TRL 4 and 5. Requires now efforts towards space qualification and testing in relevant environment.	TRL 5. The phasemeter has been demonstrated but only with single element photodetectors and most of the components are not space qualified.	TRL 4. This might just be testing commercially available quadrant detectors and identifying one that meets the requirements.	TRL 4 for length and alignment stability 2 for backscatter.	Pathfinder GRS: TRL > 6	Colloids: TRL 6
Tiping Point	Laser meeting these requirements exist already. Several designs have reached TRL 4. A focused effort could increase this to TRL 6 or at least identify the issues in a fairly short time.	The main missing elements are the quadrant photodetector and ADC's with low enough timing jitter. A focused effort could solve this problem in a fairly short time.	A survey of the available quadrant detectors and simple tests of the most promising ones might be sufficient to get this to TRL 6.	Length and alignment stability: This requires to build a real LISA telescope and test it. Note that a 40cm telescope is not a gigantic investment but developing the measurement capabilities requires some funding. The coherent backscatter has never been seriously analyzed and an initial minor investment would make a huge difference.	Yes, if NASA can take advantage of the LISA pathfinder.	This should be an ongoing effort
NASA capabilities	NASA's capabilities in this area appear to be restricted to testing and space qualification. Commercial laser companies or specialized groups in academia have the expertise and capabilities to collaborate with NASA on this effort.	NASA does not have the capabilities to develop the individual components alone but could collaborate with industry to design and test them. NASA and some groups in academia have the expertise to test these components and later the entire system.	NASA and several university groups have the capability to test these components. If the currently available components don't meet the requirements, NASA needs to work with industry to improve them.	NASA has the capability to build a 40cm LISA telescope but the capabilities to measure the length and alignment variation need to be developed. NASA (and many others) could analyze and test the back scatter.	ESA is building it and collaborates with NASA on the pathfinder.	Well within NASA capabilities
Benefit	It would allow to define the interfaces between the laser and all other subsystems in LISA. This simplifies and in some cases enables R&D on other important components. The laser system itself would also be useful for other laser interferometric missions such as formation flyers, multiple aperture missions, or Grace-follow on missions.	The capability to measure noise at the ucycl/rHz level is essential for the R&D on many other components. Having a well tested phasemeter system would enable and accelerate the R&D in general.	Maintaining the relative alignment between multiple components on one spacecraft and between separated spacecraft is essential for LISA and for formation flying missions.	The telescope is another key part of LISA and formation flying missions. Off-axis telescope with additional interferometer to control length and alignment of the components are an alternative but would increase mass and complexity.	A gravitational reference sensor with sub fg/rHz residual acceleration is critical for gravitational wave missions. Making sure that NASA has access to this technology should be one of the top priorities.	Formation flying would be a game changer. Thrusters are only a part of this. On going effort.
NASA needs	LISA and other laser interferometric missions such as formation flying missions, Grace follow-on.	LISA is the main customer but other interferometric space missions are planning to use similar phasemeter. Having a completely characterized system with ucycl/rHz sensitivity would meet many NASA needs.	Required for LISA and formation flying missions. Having a completely characterized system with ucycl/rHz sensitivity would meet many NASA needs.	On-axis telescopes which passively meet the requirements would significantly simplify LISA and formation flying missions.	LISA and LISA-follow on missions depend on it.	Formation flyer depend on it. Need for LISA solved with pathfinder demonstration except for lifetime.
Non-NASA but aerospace needs	Formation flying might have commercial and national security applications in the form of smaller satellite missions.	Formation flying might have commercial and national security applications in the form of smaller satellite missions.	Formation flying might have commercial and national security applications in the form of smaller satellite missions.	Formation flying might have commercial and national security applications in the form of smaller satellite missions.	No non-NASA needs known	Formation flying might have commercial and national security applications in the form of smaller satellite missions.
Non aerospace needs	Non. Non space-qualified lasers which meet the requirements are commercially available.	Science and Engineering applications.	Science and Engineering applications.	No non-NASA needs known	No non-NASA needs known	No non-NASA needs known
Technical Risk	The technical risk is low. Several commercial systems exists that meet the requirements except space qualification. No commercial company will space qualify a LISA laser to commercialize it.	Technical risk is low. The main challenge is to get the temperature dependent dispersion under control.	Technical risk is low. The main challenge is to get the temperature dependent dispersion under control without reducing bandwidth and area to much.	Technical risk for the longitudinal and alignment stability is low. Materials have been tested at the sub-pm level. The main challenge appears to be to develop the capabilities to perform the experiments. Backscatter: No risk. This is an assessment if on-axis telescopes will meet the requirements or if substantial R&D is required to develop an off-axis telescope.	ESA is taking most of the financial risk right now. If the pathfinder reaches the performance, technical risks for NASA are minimal.	Continuous development. Technical risk low
Sequencing/Timing	Should come as early as possible. The development of many other components depends on the specific laser system.	Should come as early as possible. The development of many other components depends on the availability of a phasemeter with ucycl/rHz sensitivity.	Requires phasemeter. Should start before phasemeter development is finished and should be finished 1-2 years after phasemeter is at TRL 6.	Length and alignment: The current status is sufficient for planing purposes. Tests on real models should start 2017. Backscatter: Start immediately as small effort.	The timing is set by ESA	Continuous development.
Time and Effort to achieve goal	3 year collaboration between industry and NASA.	3 year collaboration between industry, academia, and NASA.	2 year collaboration between academia and NASA.	3 year academia project	Effort and time depends on form of collaboration with ESA.	Continuous development.

Table 2: IXO-Like X-ray Telescope

Name of Technology (256 char)	Thermal formed (slumped) glass mirror segments	Large-scale alignment and mounting of thin glass mirror segments	Gratings for dispersive x-ray spectrometer	Large area x-ray calorimeter	Wide Field Detector
Brief description of the technology (1024)	Thermally form, to precision mandrels, thin glass sheets into Wolter I mirror segments. Includes cutting mirrors to appropriate size, and coating with x-ray reflective material.	Thousands of mirror segments need to be aligned to one another, made confocal, and mounted in a flight housing. Mounting must not distort the mirror figure.	High ruling density off-plane (OP) reflective and critical angle transmission (CAT) x-ray gratings for dispersive x-ray spectroscopy.	X-ray calorimeter for high resolving power non-dispersive spectroscopy coupled with moderate angular resolution imaging. Includes development of calorimeter pixel multiplexing, refrigeration, energy resolution, and field size (total number of pixels).	High-speed silicon imagers with active electronic elements in each pixel and large numbers of parallel readout channels.
Goals and Objectives (1024)	Requirement for perfectly aligned primary-secondary mirror pair are 3.3-6.6 arc-sec HPD for 5-10 arc-sec HPD mission, respectively. Manufactureability requirements drive fabrication yield and fabrication time/mirror segment. Need TRL 6 by 2014 for future mission development.	Alignment requirement for multiple segments and multiple shells is ~ 1.5 to 3 arc sec HPD. Figure distortion due to mounting and alignment must be less than 1.2 to 2.5 arc sec HPD. System must survive launch seismic and acoustic loads. TRL 6 by 2016 for future mission development.	Development of gratings with resolving power $\lambda/\Delta\lambda > 3000$ over wavelengths of ~ 1.2 to 5 nm. High efficiency required to make use of full resolving power. Many individual grating cells or plates must be coaligned. TRL 6 by 2018.	Develop large format (~ 100 to 1000 sq. mm area) detector with < 2.5 eV resolution. May include smaller pixels in central area and larger, lower resolution (< 10 eV), surrounding pixels. Minimize readout time and increase pixel multiplexing. TRL 6 by 2018.	Achieve CCD-like performance (5 electrons read noise or better, 50 microns depletion depth or better) in a 100mm focal plane mosaic Megapixel imager with kHz frame rates. Need TRL 6 by 2016--2018 for future IXO-like mission.
TRL	Estimate current TRL at 4 - 5. Have achieved ~ 8.5 arc-sec HPD, but have not yet demonstrated manufacturing times required for large area telescopes.	Estimate current TRL at 3. Mirror segment pairs have been aligned and mounted to < 1.5 arc sec HPD. Figure distortion due to mounting exceeds requirements. Have not yet demonstrated alignment and mounting of mirror segments from multiple shells.	Estimate current TRL 4. Single reflective OP gratings have been made but have not yet demonstrated resolving power of several thousand. Lithographically made CAT gratings have also been manufactured, but with insufficient efficiency.	TRL 4. 2.5 eV resolution has been demonstrated over limited number of detector pixels. Multiplexing 8 to 16 pixels has been demonstrated.	Currently at 4 for various different devices..
Tiping Point (100 words or less)	Better than 6.6 arc sec HPD will demonstrate performance for 10 arc sec mission positively rated by ASTRO2010. Process needs to be industrialized to make large scale production credible.	Moderate - alignment requirements met but mounting deformation ~ 5 times too high. Significant development still required.	Modest improvement in resolution will result in meeting science requirements.	10 mm x 10 mm detector area provides large enough area for small field of view telescope.	Moderate. Different device architectures currently meet individual requirements, but no device yet meets all requirements. Need lower noise in hybrid devices and/or deeper depletion in monolithic devices; thus development is still required.
NASA capabilities (100 words)	NASA GSFC leads in development of thermal forming and is fully equipped to continue experimentation.	NASA GSFC and SAO have developed alignment mounting techniques. Alternatives or similar approaches could be developed in optics industry.	NASA does not have capability but development capability exists at MIT, Univ. of Colo., and Iowa State.	NASA has developmetn capabilities, as do other research labs (NIST, MIT), and some European facilities.	NASA does not have this capability. Current commercial CMOS APS devices do not meet X-ray detection requirements, but FFRDC and commercial organizations (e.g. Lincoln Lab., Teledyne, Sarnoff) have development capabilities.
Benefit	Thin mirror segments enable collecting area to exceed 1 sq m with existing launch vehicles. > 10x area of Chandra and better resolution than XMM. This enables study of early Universe, BH dynamics and GR, and WHIM.	Thin mirror segments enable collecting area to exceed 1 sq m with existing launch vehicles. > 10x area of Chandra and better resolution than XMM. This enables study of early Universe, BH dynamics and GR, and WHIM.	Gratings yield the high resolving power spectrum over the 0.1 to 1 keV bandwidth.	Calorimeter provide high spectral resolution with higher rate capability than CCDs, and still provide imaging capabilities matched to telescope performance.	Better low-energy QE, better time resolution and count-rate capability, larger field of view, better radiation tolerance, less susceptible to contamination. Would allow game-changing X-ray imager capabilities.
NASA needs	Required for moderate to large collecting area x-ray telescopes.	Required for moderate to large collecting area x-ray telescopes.	Gratings are required for and high-resolution (resolving power $R>3000$) spectroscopy in the energy band below 1 keV; e.g., for spectroscopy of WHIM. Need 10x resolving power of Chandra gratings.	Required for high spectral resolution observations over large bandwidth. Necessary for studying BH dynamics and merger history, GR, NS EOS.	Needed for large area X-ray telescope missions. Could also have applications for UV, optical and IR.
Non-NASA but aerospace needs	NONE	NONE	NONE	Large formats also required for infrared and submillimeter observations.	Potentially interesting for night-vision applications.
Non aerospace needs				May have applications with X-ray microscopes for medical research	Potential medical applications
Technical Risk	Low - current performance within ~ 30 per cent of requirements	Moderate - alignment requirements met but mounting deformation ~ 5 times too high. Major development still required.	Moderate - improvements in efficiency required to produce useful technology	Low	Moderate: different device architectures currently meet different requirements, but no device meets all requirements.
Sequencing/Timing	As early as possible - "heart" of a telescope	As early as possible - "heart" of a telescope	Early in mission development as could drive spacecraft design, including focal plane design	Early in mission development as could drive spacecraft design, including focal plane design	As early as possible, since these devices could enable otherwise infeasible small (e.g., Explorer missions in this decade.
Time and Effort to achieve goal	3 year collaboration between NASA and industry	5 year collaboration between NASA and industry	3 - 5 year NASA funded development. Choose instrument development teams by AO	3 - 5 year NASA funded development. Choose instrument development teams by AO	~5 year NASA-funded collabrator involving universites, FFRDC and industry.

Table 3: Technologies for the Inflation Probe

Technology	Detectors			Optical system	Cryogenic system	Push Technology ^b Advanced mm-wave / far-IR Arrays
	Sensor Arrays	Multiplexing	Optical Coupling			
Brief Description of Technology	The Inflation Probe requires arrays of polarization-sensitive detectors with noise below the CMB photon noise at multiple frequencies between ~30 and ~300 GHz for foreground removal ^a ; up to 1 THz for Galactic science.	Multiplexed arrays of 1,000 - 10,000 low- temperature detectors will be required for the Inflation Probe.	The Inflation Probe requires coupling the light to the detectors with exquisite control of polarimetric systematic errors.	High-throughput telescope and optical elements with controlled polarization properties are required; possible use of active polarization modulation using optical elements.	The Inflation Probe requires cryogenic operation, passive radiators, mechanical cryo-coolers, and sub-Kelvin coolers.	Detector arrays with higher multiplexing factors and multi-color operation may provide simplified implementation for the Inflation Probe, and have diverse space-borne applications in X-ray calorimetry and far-infrared astronomy.
Goals and Objectives	Demonstrate arrays in sub-orbital instruments, and demonstrate the background-limited sensitivity appropriate for a satellite-based instrument in the laboratory.	Demonstrate multiplexed arrays of thousands of pixels in ground- and balloon-based instruments.	Demonstrate arrays of polarization-sensitive receivers with sufficient control of polarization systematics in sub-orbital and ground-based instruments.	Demonstrate all elements of an appropriate optics chain in sub-orbital and ground-based instruments.	Develop stable and continuous sub-Kelvin coolers appropriate in space for expected focal plane thermal loads.	Develop higher multiplexing factors with micro-resonators; demonstrate multi-color operation with antenna-coupled detectors to reduce focal plane mass.
TRL	TES: (TRL 4-5) Noise equivalent power (NEP) appropriate for a satellite has been demonstrated in the laboratory, and TES instruments have been deployed and used for scientific measurements in both ground-based and balloon-borne missions. HEMT: (TRL 4) Flight heritage, but extension to 3 QL noise, access to higher frequencies and lower power dissipation requires demonstration.	TDM: (TRL 4-5) Ground based arrays of up to 10,000 multiplexed pixels are working on ground-based telescopes. Kilopixel arrays will shortly fly in balloons. FDM: (TRL 4-5) Ground based arrays of up to 1,000 multiplexed pixels are working on ground-based telescopes, and initial balloon flights have occurred.	Planar antenna polarimeter arrays: (TRL 4-5) Ground based arrays deployed and producing science, balloon-borne arrays will soon be deployed. Lens-coupled antenna polarimeter arrays: (TRL 4-5). Ground based arrays deployed. Corrugated feedhorn polarimeter arrays: (TRL 4) Corrugated feeds have extensive flight heritage, but coupling kilopixel arrays of silicon platelet feeds to bolometers requires maturation. Ground-based arrays in this configuration are soon to be deployed.	Millimeter-wave AR coatings: (TRL 2-5) multi-layer to single-layer coatings. Polarization modulators: (TRL 2-4) half- wave plate modulators, variable polarization modulators, or on-chip solid-state modulators	Technology options for the sub-Kelvin coolers include He-3 sorption refrigerators, adiabatic demagnetization refrigerators, and dilution refrigerators. TRL for all options varies considerably from TRL 3 to TRL 9. Planck and Herschel provide flight heritage for some of these systems.	MKID: (TRL 3) Appropriate sensitivity needs to be demonstrated, small ground-based instruments are in development. Microresonators: (TRL 3) 2,000-channel ground-based MKID instruments are in preparation. Laboratory systems using microwave SQUIDs have been developed for small TES arrays. Hybrid combinations are possible. Multi-color pixels: (TRL 2) Multi-band lens-coupled antennas have shown proof of concept, but must meet exacting CMB requirements.
Tippling Point	For the TES, demonstrate appropriate sensitivity at all relevant wavelengths. For HEMTs, improved noise performance and low power dissipation.	For TDM and FDM, demonstrate full- scale operation on a balloon-borne instrument.	Extensive analysis of data from ground-based and balloon experiments is required to demonstrate control of systematics. Demonstrations required at all wavelengths of interest.	Demonstrate relevant optical system designs, including reflective and refractive optics, millimeter AR coatings, and polarization modulators.	Space cooling system can be leveraged on current technology efforts, but must provide extremely stable continuous operation	MKID instruments must demonstrate sensitivity in full sub-orbital instrument. For microresonators, a breakthrough is required on the room- temperature readout electronics. Multi-band pixels must be used in sub-orbital instrument.
NASA Capabilities	National labs (JPL, GSFC, NIST, and Argonne) and University groups (Berkeley) have extensive experience with the design and fabrication of arrays that have been used in previous missions in this wavelength range.			NASA and many University groups have developed and deployed optical systems as described here.	NASA has extensive heritage appropriate to the task, and some elements are commercially available.	National labs (JPL, GSFC, NIST, and Argonne) and University groups (Berkeley) have extensive experience with the design and fabrication of arrays.
NASA needs	The technology developed would leverage many other missions requiring low-temperature superconducting detectors, including IXO , Generation-X , and future far-infrared missions such as SPIRIT , SPECs , or SAFIR .		Pixel optical coupling technologies are candidates for future far-infrared missions such as SPIRIT , SPECs , or SAFIR .	Improvements in optical systems will benefit SPIRIT , SPECs , or SAFIR .	Developments will benefit any other future satellite mission requiring sub-Kelvin cooling, including IXO , SPICA , SAFIR , etc.	The technology developed would leverage many other missions requiring low-temperature superconducting detectors, including IXO , Generation-X , and future far-infrared missions such as SPIRIT , SPECs , or SAFIR .
Non-NASA aerospace needs	Arrays of sensitive bolometers may have national security applications either in thermal imaging of the earth, or in gamma spectroscopy of nuclear events.					
Non aerospace needs	Sensitive mm-wave bolometer arrays have applications in remote sensing, including concealed weapons detection, suicide bomber detection, medical imaging, and sensing through fog.					
Sequencing/Timing	Should come as early as possible. The entire Inflation Probe system is dependent on the capabilities of the sensors, and a new generation of ground-based and sub-orbital experiments are predicated on a rapid expansion in focal plane capability.			Early test of optical elements needed to gauge system issues.	The cryogenic system is specialized for space and not as time-critical.	These advanced options should be pursued in parallel to reduce cost and implementation risk.
Time and Effort to Achieve Goal	5-year collaboration between NASA, NIST, and university groups.				Leverage current development for space-borne coolers.	5-year collaboration between NASA, NIST, and university groups.

^aInformation on foregrounds across a broader range of frequencies (5 GHz to 1 THz) from sub-orbital and ground-based experiments is essential for optimizing the choice of bands for the Inflation Probe.

^bNear-term push technology from the PCOS TechSAG table, defined as emerging technologies needed for applications in the next decade.

Table 3: Technologies for the Inflation Probe

Computational Requirements

A common feature of the many of the technological developments for next generation missions is that they will enable us to detect fainter signals, in many cases by gathering correspondingly larger and richer data sets. The computational cost and complexity of the management and analysis of these data sets will therefore increase in step with the technology. For example, a next-generation CMB satellite mission (Inflation Probe) would likely follow two generations of path-finder suborbital experiments, with the data volume—and, hence, analysis cost—increasing by an order of magnitude with each generation. Note further that a 1000-fold increase in computational cost over the next 15 years exactly mirrors Moore’s Law, requiring us to stay on the leading edge of high performance computing over this period simply to keep up with the data.

At the same time the computational systems employed to perform these analyses are also developing, with the pursuit of Moore’s Law leading to increasingly hierarchical, heterogeneous systems. In the immediate future high performance computing systems will feature extraordinary (1M+) core counts over many-core and/or hybrid CPU/GPU nodes. Computing on these systems will be qualitatively different, requiring significant changes to our software to take advantage of their capabilities.

Any program of mission technology development must therefore be accompanied by a parallel track of appropriately targeted software development if we are going to realize the full scientific potential of the data we gather on the high-performance computing systems that will be available to us.

Table 4a: Fundamental Physics: Atom Interferometer for Gravitational Radiation

Name of Technology (256 char)	High brightness cold atom sources	Large area atom optics	Low phase noise laser source	Extended space structures/booms
Brief description of the technology (1024)	Science objectives require high repetition rate cold atomic sources, which run at low input power and deliver high flux.	Wavefront sensing is realized with cold atoms.	Narrow line, space-qualified, continuous-wave lasers are required for atom wave-packet manipulation in atom interferometers.	Long-baseline deployable booms are required for envisioned gravity wave sensors.
Goals and Objectives (1024)	The goal is to develop a high repetition rate (10 Hz) atomic sources capable of delivering >1e8 atoms/shot at temperatures less than 1e-6 K, in a compact (10 cm x 10 cm x 10 cm) form factor and requiring low input power (< 10 W).	Goal is to mature atom optics to a level where atomic wave packets are separated by meter scale distances, where current state of art is cm scale.	Laser must achieve >1 W output power at 780 nm with a linewidth < 1 kHz.	Extend deployable booms from 100 m to 300 m.
TRL	TRL is 5.	TRL 3.	TRL is 5.	TRL is 5.
Tipping Point (100 words or less)	This is the core sub-system for any atom interferometric sensor. A three year focussed program should bring TRL to level 6.	Large area atom optics have recently been demonstrated in the laboratory in compact apparatus.	A two year development program will result in a space qualified system.	A 2 year development program will result in the required structures.
NASA capabilities (100 words)	NASA does not have capability in this area. There are currently DoD and commercial efforts pursuing this technology development.	NASA does not have a group with expertise in this area, but collaboration with university and commercial groups is feasible.	NASA has capability in this area. Suitable groups exist in industry.	NASA does not have capability in this area. Industry capability exists for smaller commercial and defense systems.
Benefit	Such sources enable gravity wave antennas based on atom interferometry. They also support gyroscope developments for precision pointing applications, gravity gradiometers for geodesy and deep space navigation, inertial measurement units for constellation formation flying, and attitude determination for precision pointing applications.	Direct detection of gravitational radiation is one of the primary objective of relativistic astrophysics. Atom optics realized as a gravitational radiation detector could be revolutionary.	The laser source is the essential subsystem for the interferometry.	Large booms enable novel space structures.
NASA needs	High flux atom sources are the core components for precision atom interferometer-based gravity wave antennas, gravity gradiometers and inertial measurement units.	Gravitational wave detection using differential accelerometry is a novel path to meeting identified astrophysics goals for study of coalescing systems.	These laser sources are required for atom interferometer-based instruments.	Large deployable booms enable atom-based gravity wave antennas.
Non-NASA but aerospace needs	These sources are core components for next-generation inertial measurement units. Development for of non-NASA sources currently funded by DoD.	Large area atom optics enable accelerometer and gyroscope sensors.	Laser sources are core components for atom interferometric sensors.	Large, rigid, deployable structures may enable novel DoD systems.
Non aerospace needs	Applications to gravitational sensors for geophysics and oil/mineral exploration.	Large area atom optics enable compact gravitational sensors for geophysics and oil/mineral exploration.	Similar lasers have commercial applications in, for example, remote sensing systems.	None known.
Technical Risk	Technical risk is low. Design principles have been established and validated in design and prototype testing of DoD-relevant systems.	Technical risk is moderate. The appropriate techniques have been demonstrated in ground-based laboratory systems.	Technical risk is low.	Technical risk is low.
Sequencing/Timing	Should come as early as possible.	Should come as early as possible.	Should come as early as possible.	Should be concurrent with laser and atom source development. System trades depend on size of boom.
Time and Effort to achieve goal	3 year collaboration between industry and NASA	3 year collaboration between NASA, academia and industry.	2 year collaboration between industry and NASA	3 year collaboration between NASA and industry.

Table 4b: Fundamental Physics: Next Generation Clocks

Name of Technology (256 char)	Arrays of Rb clocks for high stability	New atomic media for compactness	Advanced cold atom microwave clocks
Brief description of the technology (1024)	Exploit mature Rb clock technology to achieve breakthrough in stability by producing packages with multiple units in package and combine outputs to get stability. The outputs would be combined by optimal iterative techniques. The resultant clock signals and frequencies would have with lower Allan variance than is currently available.	Exploit new technologies, such as Hg ions, to produce new compact designs for clocks delivering high stability and increased accuracy.	Take advantage of 30 years of science and technology in the area of laser cooling of atoms (Rb and/or Cs) that has resulted in tremendous improvement in performance of atomic frequency standards and clocks. Cold atom microwave clocks have demonstrated stability and accuracy about 100x better than traditional cell-based Rb frequency standards. Accuracy
Goals and Objectives (1024)	The goal of this area is to produce space qualified clocks that have very stable output with characteristics superior to individual clocks in both accuracy any long term performance. The objectives would be to demonstrate on orbit performance within 5 to 7 years.	The goal of this area is to produce space qualified clocks that have very stable output with characteristics superior to current individual clocks in both accuracy any long term performance. The objectives would be to demonstrate on orbit performance within 5 to 7 years.	The goal of this area is to develop and produce space qualified atomic clocks based on laser cold atoms and develop necessary commercial sources. The objectives would be to demonstrate on orbit performance within 5 to 7 years.
TRL	TRL is between 4 and 5. Requires efforts towards space qualification and testing in relevant environment.	TRL is between 4 and 5. Requires efforts towards space qualification and testing in relevant environment.	TRL ranges from 5 to 8. Additional work required for space qualification and reliability testing in relevant environment and development of reliable commercial sources. But space qualified hardware has already been built for the first cold atom microwave atomic clock demonstration mission that is scheduled to fly on the ISS in late 2013 (ESA ACES mission).
Tippling Point (100 words or less)	Prototypes components and subsystems exist and testing ensembles in relevant environment will bring to flight readiness quickly. Requires focused effort and demonstration to validate concepts.	Ground based and laboratory devices exist operating in controlled environments that could be directed toward flight read units quickly. Requires focused effort and demonstration to validate concepts.	Laboratory devices exist and operate in controlled environments that could be directed toward flight units relatively quickly. Transition to space qualified instruments is primarily detailed engineering, testing and validation. Particularly the validation of suitable semiconductor lasers that are now commercially available but relative to long-term reliability in space.
NASA capabilities (100 words)	No NASA center currently working on this technology. Commercial interests are limited since GPS applications are currently employed for positioning and timekeeping. Defense labs are investigating ground based concepts.	JPL currently working on Hg ion technology for ground based use and as possible long term option for GPS satellites.	There was a previous effort at JPL to develop cold atom atomic clocks for space as part of the old micro-gravity physics program. Other centers such as Goddard and Ames have also expressed interest.
Benefit	More stable and accurate space qualified clocks of benefit to multiple missions and applications in concert with GPS.	More stable and accurate space qualified clocks of benefit to multiple missions and applications in concert with GPS.	Atomic frequency standards (clocks) are a critical component of navigation and communication systems. Advanced atomic frequency standards will enable future enhancements and capabilities for navigation and communications.
NASA needs	More stable and accurate space qualified clocks of benefit to multiple missions and applications in concert with GPS.	More stable and accurate space qualified clocks of benefit to multiple missions and applications in concert with GPS.	More stable and accurate space qualified clocks of benefit to multiple missions and applications in concert with GPS.
Non-NASA but aerospace needs	Other time-keeping customers would include DoD. Remote sensing could also exploit e.g., in SAR or image time-tagging.	Other time-keeping customers would include DoD. Remote sensing could also exploit e.g., in SAR or image time-tagging.	see below, and note that time/frequency and navigation dominated by space-based GPS. Space remains key for future
Non aerospace needs	Defense and communications systems utilize large more complex systems for timekeeping and reliable continuous signal generation.	Use in other communities is primarily for ground based time keeping in major timing centers. Possible application for communications centers	DOD, FAA and as a result the aerospace industry have keen interest in higher performance atomic clocks, time keeping, and navigation infrastructure that can provide higher performance, improved reliability and reduced vulnerability relative to GPS signals. Important for air, space and ground missions in navigation and communication systems.
Technical Risk	Technical risk is low. The design principles are generally understood but progress comes through design iterations to refine performance based on completed units.	Technical risk is low. The design principles are generally understood but progress comes through design iterations to refine performance based on completed units.	Technical risk is low, although the appropriate semiconductor diode lasers should be validated for long-term reliable operation in space. The design principles are generally understood but progress comes through design iterations to refine performance based on completed units.
Sequencing/Timing	Should come as early as possible. Development of other system components depends on detector unit parameters.	Should come as early as possible. Development of other system components depends on	Should come as early as possible. This would be an enabling technology for new space missions and advance navigation and communication system capabilities.
Time and Effort to achieve goal	3 year collaboration between industry and NASA (example of minimal effort)	3 year collaboration between industry and NASA (example of minimal effort)	NASA, plus industry would be the most efficient collaborative effort toward development of cold atom atomic clocks for space.

Table 5a: Next Generation Hard X-ray

Name of Technology (256 char)	Large-Area, finely pixelated,thick CZT Detectors	Low-Noise, Low-power ASICs for Solid State Detectors	Active shield using avalanche photodiode
Brief description of the technology (1024)	A large array (4.5 m ²) of imaging (0.6 mm pixel) CZT detectors are needed to perform the first hard X-ray survey (5-600 keV) with well-localized (<20" at 5-sigma threshold) sources down to 0.06 mcrab (5-150 keV). Thick CZT detectors (0.5 cm) allow broad-band energy coverage for GRBs and black holes, from stellar to supermassive.	Low power ASICs (<20 microW/pixel) are needed to provide accurate time of arrival and energy for each photon but with low aggregate power per square meter.	BGO scintillators read out by two light guides on opposite edges, each coupled to two Avalanche Photo Diodes used as active shields to reduce in flight atmospheric albedo and cosmic-ray induced backgrounds.
Goals and Objectives (1024)	The goal is to achieve CZT detectors with 0.6mm pixels, 4 keV trigger threshold, and 2.4' angular resolution when used as imagng detectors for a 2m focal length coded aperture telescope.	A reduction of power consumption by a factor of ~4 compared to current designs (e.g. NuSTAR) is needed to implement the large detector array with typical solar panels and batteries. A low energy threshold of ~5 keV is needed.	The goal is to minimize cosmic ray induced internal background and to reduce the physical size of the active shielding system.
TRL	TRL is 6. Prototype detectors, with 2.5mm pixels and ~15 keV threshold and tiled array packaging, have flown on ProtoEXIST in 2009. Detectors with 0.6mm pixel size and ~6 keV threshold scheduled for balloon flight test in Sept. 2012.	TRL is 5. Portions of the functionality have been demonstrated but a full prototype that meets both the noise and power requirements has not yet been produced.	TRL is 5. BGO shields and APD readouts are well developed, but the compact packaging has not been demonstrated. Prototype designs are planned for flight.
Tipping Point (100 words or less)	Designs have reached TRL 6. Successful balloon flight test with 0.6mm pixel detectors close tiled in a 16cm x 16cm imaging array will increase the TRL to 7-8.	The lower-power ASIC is the key requirement, but a more compact ASIC readout using microvias rather than wirebonds is highly desirable. Successful design and fabrication will allow systems to be tested in relevant environments.	Prototypes to be flown.
NASA capabilities (100 words)	NASA's capabilities support test but pixel arrays are custom procurements under development by University groups with support from NASA and commercial sources.	NASA (or DoE) has not yet developed an ASIC that meets these requirements. The NuSTAR ASIC, designed and developed at Caltech is the prototype but does not meet the power or more compact readout (with microvias) requirements.	NASA has experience with scintillators and test capabilities. Scintillators and avalanche photodiodes can be procured from commercial sources.
Benefit	Thick pixelated CZT detectors will provide good position and energy resolution for an unprecedentedly broad energy range.	The ASIC is the principal limiting factor for the power budget, energy resolution, time resolution. ASIC performance directly translates into mission performance improvements.	Compact active shielding is important for NASA astrophysics missions and can produce reductions in mass and volume.
NASA needs	Pixelated CZT detectors of this type can be applied to various missions that need large area wide-field imaging and spectroscopy with broad energy coverage.	Low power, low-noise ASICs coupled with pixelated CZT detectors of this type can be applied to various missions that need large area wide-field imaging, and spectroscopy. Microvia readout is particularly important for compact packaging.	Compact active shielding is important for NASA astrophysics missions and can produce reductions in mass and volume
Non-NASA but aerospace needs	Space-based monitoring programs in other agencies	Space-based monitoring programs in other agencies	
Non aerospace needs	Nuclear medicine and ground-based nuclear materials detection applications	Nuclear medicine and ground-based nuclear materials detection applications	
Technical Risk	Technical risk is low. The design principles are generally understood but progress comes through design iterations to refine performance based on completed units.	Technical risk is moderate given access to (rare) analog ASIC design expertise. The history of analogous flight projects shows this task must not be underestimated. The main challenge is to get low power with low noise.	Technical risk is low.
Sequencing/Timing	CZT detectors with the required pixel size are currently being adapted from those flown on ProtoEXIST1. ProtoEXIST2 will incorporate 0.6mm pixels over tiled detector for balloon flight test in 2012.	ASICs based upon the NuStar ASIC are currently being adapted. Reduced power will be easier to achieve than microvia readout.	This concept will be tested in ProtoEXIST 2-3 and compared with existing active shielding concepts.
Time and Effort to achieve goal	3 year collaboration between University, industry and NASA	3 year collaboration between University, industry and NASA	3 year collaboration between University, industry and NASA

Table 5b: High-Resolution Imaging Hard X-ray Observatory

Name of Technology (256 char)	High resolution hard X-ray technology	Depth graded multilayer coatings	Very-finely-pixelated CZT detectors with associated custom-built direct-readout electronics.
Brief description of the technology (1024)	Hard X-ray grazing incidence optics with multilayer coatings with at least 5" angular resolution	Depth graded multilayer coatings for hard X-ray optics, to increase the maximum graze angle using Bragg reflection, allowing a larger field of view and / or extended energy range.	Finely pixelated detectors are needed that match the angular resolution of the optics, up to an order of magnitude finer spatial resolution than current NuSTAR detectors, with single-photon-counting and spectral resolution.
Goals and Objectives (1024)	Goals & Objectives: Achieve a HPD of 5 arc sec using, tightly nested full shell or segmented optics. Methods such as improved replication techniques or post-fabrication figure correction techniques will be used to achieve the required angular resolution.	Enlarge field of view and energy range with good throughput for high resolution hard x-ray imaging telescopes	The spatial resolution of these detectors will need to oversample the point spread function of the optics to preserve optic angular resolution. Pixel size is a function both of angular resolution and focal length. Single photon-counting capability is required with spectral resolution < 1 keV.
TRL	3-4 overall. Replication techniques more advanced than post-fabrication correction techniques.	4 to 5	2 to 4
Tipping Point (100 words or less)	Tipping Point: Mounting of multiple light-weight, high resolution optics yet to be demonstrated. Post fabrication figure correction on full optics not yet demonstrated.	good throughput at energies above 80 keV yet to be demonstrated	Challenge is mainly in the custom readout: accommodating whole electronic channels within tiny areas while preserving noise and threshold capabilities. May also be challenges with bump bonding crystal to readout.
NASA capabilities (100 words)	Facilities for replicated and full-shell optics exist at NASA facilities (Goddard, MSFC). Techniques for post-fabrication figure correction exist, such as differential deposition at MSFC and active optics control at SAO.	NASA funded capabilities at SAO and GSFC	NASA-funded capabilities exist at Caltech, for example.
Benefit	High-angular- resolution hard X-ray imaging will make possible detailed mapping of supernova remnants, black hole jets, etc. at >10 keV extending the work of Chandra to higher energies	Enlarging the usable field of view for high resolution hard X-ray telescopes improves science for extended sources and allows for serendipitous science. Also extends energy range for broader coverage.	Appropriate detectors and ASICs are crucial to the success of a future high resolution hard X-ray imaging mission
NASA needs	required to advance hard X-ray science to allow detailed spectroscopic imaging	Needed to support hard-x-ray high-angular resolution observatory.	Required to support hard-x-ray, high-angular- resolution observatory.
Non-NASA but aerospace needs			
Non aerospace needs	medical imaging ?		homeland security, medical imaging
Technical Risk	Moderate - significant improvements to NuSTAR-like mirrors and focal plane detectors are needed to achieve the required angular resolution	Low	moderate - significant increase in number of pixels over current hard x-ray detectors
Sequencing/Timing	as early as possible - "heart" of a telescope	Development of techniques would need to be in parallel with optics development.	Detector and readout electronics development must proceed in parallel with optics development. The pixel size must be appropriately matched to the optics.
Time and Effort to achieve goal	5 year collaboration between NASA and industry	5 year collaboration between NASA and industry	5 year collaboration between NASA and industry

Table 6: Next Generation EUV/Soft-X-ray Mission

Name of Technology (256 char)	Extended Duration Rockets	EUV or Soft X-ray detector systems	Gratings
Brief description of the technology (1024)	Modest launch vehicles capable of putting a few hundred kg in orbit for a few weeks, but also supportive of the objective of converting existing sounding rocket payloads into short-life satellites.	Existing EUV detectors suffer from low quantum efficiency which must be compensated by long observing time. Improved photocathodes and electronics improvements can be multipliers for system performance numbers	High-resolution blazed gratings for high power, replicated by emerging nanolayer technologies. This capability delivers high spectral resolution to analyze source spectral lines and separate them from spectral features of the interstellar medium.
Goals and Objectives (1024)	The goal is to reach flight readiness around 2015	The goal is to reach TRL 6 by 2015	The goal is to reach TRL 6 by 2015
TRL	Suitable vehicles have been tested a few times, hence have TRL 9. Satellite systems to match have not been developed	4 TRL is between 4 and 5. Requires efforts towards space qualification and testing in relevant environment.	TRL is 2 for new designs. Prototyping for new concepts has only begun
Tipping Point (100 words or less)	A single demonstration flight, such as was done for the SPARTAN concept in the 1980s would bring the concept to maturity	Pixel designs require custom ASIC development to meet targets for power combined with noise level.	Prototypes exist involving nano-fabrication using high-Z materials to deliver performance at higher energies.
NASA capabilities (100 words)	NASA's capabilities at WFF are central to this concept. There is no realistic alternative but DoD may be able to contribute constructively.	NASA's does not have an engineering group producing detectors of this kind but suitable commercial sources exist	NASA has no appropriate facilities but they also exist in other government departments and in industry.
Benefit	The benefit of a short orbital mission over a sounding rocket flight is roughly the ratio of the durations, i.e., $10^{6.5}$ s / $10^{2.5}$ s, or 10^4 .	The detector unit is crucial for envisioned next-generation systems	Gratings and multilayer coatings are essential for normal incidence spectrometers. Fabrication technologies for both are applicable at X-ray and UV wavelengths.
NASA needs	Mission capability intermediate between sounding rockets and explorers enables a strategy for maintaining the astrophysics community and training students in a time of lean budgets	The detectors that support EUV can with modifications be used on optical/NUV missions planned for later years	Gratings remain the preferred way to reach high spectral resolution at these energies
Non-NASA but aerospace needs	There is synergy with DoD use of similar LV and satellite systems, creating potential for partnerships	potential remote sensing applications	potential remote sensing applications
Non aerospace needs	Not applicable, by definition	Can be used in synchrotron and laser plasma research	Can be used in synchrotron and laser plasma research
Technical Risk	Technical risk is low; development paths are straightforward	Technical risk is low but there is some risk of backsliding in the industrial capabilities.	Technical risk is moderate for completely new approach.
Sequencing/Timing	Needed immediately to establish programmatic viability	Should come as early as possible. Development of other system components depends on it.	Essential to development of explorer class mission
Time and Effort to achieve goal	Moderate effort. 3 year collaboration between industry and NASA	Minimal effort. 3 year collaboration between industry and NASA	Minimal effort. 3 year collaboration between industry and NASA

Table 7: Next Generation X-ray Timing

Name of Technology (256 char)	Pixelated Large-Area Solid State X-ray Detectors	Low-Noise, Low-power ASICs for Solid State Detectors	Thin, Lightweight X-ray Collimators	Thin, lightweight X-ray concentrators	Point source optimized concentrators .	Lobster eye X-ray optics for All-sky Monitors
Brief description of the technology (1024)	X-ray timing science objectives call for achieving several square meters of X-ray sensitive collection, over range 2-30 keV, obtaining time of arrival and energy for each photon. Silicon pixel arrays, silicon drift detectors, pixel arrays of high-Z materials, or hybrids are possible choices but all need development.	Low power ASICs are needed to provide accurate time of arrival and energy for each photon but with low aggregate power per square meter.	Requirements of new X-ray timing instruments built around solid state elements require re-thinking design of the collimator unit that provides source isolation. In order to not dominate the mission mass and volume budgets, the collimator must be much thinner and lighter than previous honeycomb collimator designs.	Lightweight concentrators can focus X-ray beams onto small detectors; Concentration allows sensitivity gains of >1000 over pure collimation.	Concentrators optimized to provide large collecting area for much lower mass than typically seen in X-ray optics.	The Lobster optic gives wide-field focusing in the X-ray band for use in transient and GRB monitors. The focusing gives sensitivities that are factors of 30-100 higher than non-focusing scammers and CCD imagers.
Goals and Objectives (1024)	The goal is to achieve large area detectors that are thick enough to have significant stopping power above 30 keV. The technology should reach TRL 6 in by 2014, to meet opportunities for near-term explorers.	The ASIC must achieve noise performance good enough to allow a low energy threshold of <= 2 keV and energy resolution <= 600 eV with a total power budget less than 100 W/m ² . The ASIC must reach TRL 6 by 2014 to meet opportunities for near-term Explorers.	The goal is to produce collimators with FWHM <= 1 deg that are <1 cm thick, and have stopping power sufficient to effectively collimate X-rays at 50 keV.	Goal is to provide several square meters of effective area concentrated on to a beam a few arc-min HPD, over energy ranges from 0.3 to 30 keV	provide an order of magnitude improvement in effective area/mass ratio for 1 arcminute class optics to provide a large collecting area for future X-ray timing missions. Reduce cost compared to normal arcminute class optics by more than 50%.	Develop a full-scale Lobster module with optic ad CCD detector. The detector-optic separation should be 50 cm. The field of view should be 1.0 sr. The spectral resolution should be <200 eV FWHM at 1 keV. The angular resolution should be 5 arcsec FWHM.
TRL	TRL is between 4 and 5. Requires efforts towards space qualification and testing in relevant environment.	TRL is 3. Portions of the functionality have been demonstrated but a full prototype that meets both the noise and power requirements has not yet been produced.	TRL is 3 for new designs. Prototyping for new concepts has only begun	TRL for micro-channel plate optics/concentrators with area ~100 cm ² and ~5arcmin beam is 6 to 7; TRL for 1 m ² with ~arcmin beam is ~4	TRL5	The technology is currently available for small modules with 30 detector-optic separation and 0.1sr field of view, suitable for Explorer versions. The advance need for a future strategic mission is for longer focal length and wider field-of-view (larger area optics). The TRL for this advance configuration is TRL = 5.
Tippling Point (100 words or less)	Designs have reached TRL 4. A focused effort could increase this to TRL 6. A few cycles of fabrication and test are realistically necessary, but must be coordinated with ASIC development.	The ASIC is the key ingredient in achieving a system that meets the performance requirements. One successful design and fabrication will allow systems to be tested in relevant environments. An ASIC within power requirements needs to be demonstrated, mated to a detector.	Prototypes exist involving nano-fabrication using high-Z materials to deliver performance at higher energies.	Small prototypes exist, but mass production and quality control need to be expanded. quality control includes large scale figure and surface roughness.	Achieving > 200 cm ² /kg (effective area @ 1 keV/mirror mass)	Fabrication of a laboratory test unit with large-area Lobster optic and test-grade CCDs.
NASA capabilities (100 words)	NASA's capabilities support test but pixel arrays are custom procurements from commercial sources.	NASA's does not have an engineering group producing custom ASICs of this kind but suitable groups exist in DoE or at commercial sources.	NASA has nano-fabrication facilities but they also exist in other government departments and in industry.	None.	GSFC has produced light weight X-ray optics in the arcminute class delivering ~ 20 cm ² /kg @ 1 keV. MSFC has produced heavier mirrors which have superior imaging capability.	Small pieces of Lobster optic that have been tested in the X-ray beam at GSFC. A laboratory CCD was used at the focus. The tests were successful and produced nice images.
Benefit	The transition of X-ray missions from gas proportional counters to solid state designs will allow a 5-10x increase in effective area and a quantum leap in detector reliability.	The ASIC is the principal limiting factor for the power budget, energy resolution, time resolution. ASIC performance directly translates into mission performance improvements.	Older collimator designs are needlessly high in areal density (gm/cm ²) and have vertical thickness that is disadvantageous if detector units are stacked for launch and then deployed. Older collimator designs can needlessly dominate the mass budget for explorer-class missions.	Current concentrators have masses that are typically a significant fraction of the payload. lightweight systems may reduce the mass by 10x	Would support multiple missions (general X-ray timing science, millisecond pulsar timing array for gravitational radiation detection, cheap light buckets for high speed arcminute class spectroscopy missions, planetary XRF)	Enable a new generation of wide-field, sensitive X-ray telescope.
NASA needs	Pixelated silicon detectors of this type can be applied to various missions that need large area X-ray timing, wide-field imaging, and spectroscopy.	Low power, low-noise ASICs coupled with pixelated silicon detectors of this type can be applied to various missions that need large area X-ray timing, wide-field imaging, and spectroscopy.	Thin, light collimators with good stopping power can be used in a variety of NASA and laboratory settings.	Lightweight concentrators can be used in a variety of NASA missions using X-ray sensors	X-ray communication (XCOM) receivers optics	Future gamma-ray bursts and X-ray sky monitor missions.
Non-NASA but aerospace needs	Such devices might be used in certain envisioned applications such as X-ray navigation of satellites.	Such devices might be used in certain envisioned applications such as X-ray navigation of satellites.	Collimators might function in flight X-ray systems for applied uses.	Possible use in navigation systems using X-ray pulsar timing.	intelligence community	Applicable in aerospace for materials studies and medical imaging.
Non aerospace needs	Non space-qualified systems exist to meet non-space needs such as inspections.	Similar ASICs have commercial applications, but any connection is really via maintaining development teams that can support space and non-space needs.	Such collimators could be used for X-ray detector systems on the ground where collimation was a requirement	Concentrators at energies >10keV have medical applications.		This technology has wide application for materials studies and medical imaging.
Technical Risk	Technical risk is low. The design principles are generally understood but progress comes through design iterations to refine performance based on completed units.	Technical risk is moderate given access to (rare) analog ASIC design expertise. The history of analogous flight projects shows this task must not be underestimated. The main challenge is to get low power with low noise.	Technical risk is moderate for completely new approaches. Lacking such investment there would be fallback to older designs mismatched to requirements, resulting in sub-optimized mission performance.	Low	Low	Low
Sequencing/Timing	Should come as early as possible. Development of other system components depends on detector unit parameters. Some ongoing development under NASA APRA.	Should come as early as possible. Development of other system components depends on ASIC power performance. No active US program. Europeans modifying particle physics detectors.	Should come fairly early in mission development because it drives overall system characteristics.	Should come fairly early in mission development.	Should come fairly early in mission development.	Should come fairly early in mission development.
Time and Effort to achieve goal	3 year collaboration between industry and NASA	3 year collaboration between industry and NASA	3 year collaboration between industry and NASA	3 year collaboration between industry and NASA	3 year collaboration between industry and NASA	3 year collaboration between industry and NASA

Table 8: Next Generation Gamma-Ray - Compton

Name of Technology (256 char)	Solid State Detector Arrays	Advanced Scintillators and Readouts	ASICS	Active Cooling
Brief description of the technology (1024)	High spectral resolution is needed to obtain nucleosynthesis signatures and spatial resolution is needed to isolate sources and maximize signal to noise. This leads to Compton telescope designs with solid state detector arrays. Si, CZT, and CdTe do not need cooling. Ge delivers better resolution.	Modern scintillator materials (e.g., LaBr3, SrI2, Cs2LiYCl6:Ce (CLYC)) possess improved efficiency, light output, and time response. This permits greatly improved Compton telescope response and background rejection at reasonable cost, building directly off the experience of COMPTEL. New readout devices, such as Silicon Photo-Multipliers or Plasma Panel Sensors, reduce mass, volume, and fragility compared to PMTs. PPS offer potential for large areas at very low cost.	Low power ASICs are needed to provide accurate energy for each photon but with low aggregate power per square meter. ASICs for PMT/SiPM must accept higher input charge than for semiconductor detectors due to much higher gain. Development of ASICs couples directly to detector and readout technologies.	Germanium arrays need active cooling below 100K. Si and CZT also benefit from active cooling to reduce noise performance to desired levels. Small-scale applications are likely to reach while larger missions pose a greater challenge.
Goals and Objectives (1024)	The goal is to reach TRL 6 in 2015, to meet opportunities for near-term explorers	The goal is to reach TRL 6 in 2015, to meet opportunities for near-term explorers	The goal is to reach TRL 6 by 2015	The goal is to reach TRL 6 by 2015
TRL	TRL is between 4 and 5 depending on whether it is Si, CZT, CdTe or Ge. TRL for Ge may be higher for smaller-scale missions. Requires efforts toward space qualification and testing in relevant environment.	TRL is 5 for "traditional crystal" (LaBr3,SrI2,Cs2LiYCl6:Ce (CLYC))/PMT combination. TRL is 3 for alternate (cheaper) material growth (e.g., polycrystalline). TRL for SiPM readouts currently at 4. Requires efforts towards space qualification and testing in relevant environment. TRL for PPS for scintillator readout currently only at 2.	TRL is essentially undefined until the detector is specified. The ASIC is specific and integral to the detector and developed in co-evolution with it.	TRL is between 4 and 5. Primary effort is achieving large scale in heat removal per unit time and depends on scale of mission. Effort required towards space qualification and testing in relevant environment.
Tipping Point (100 words or less)	Designs have reached TRL 4. A focused effort could increase this to TRL 6. A few cycles of fabrication and testing are realistically necessary, but must be coordinated with ASIC development.	Designs have reached TRL 4. A focused effort could increase this to TRL 6. A few cycles of fabrication and test are realistically necessary, including balloon test flights.	Pixel and strip designs require custom ASIC development to meet targets for power combined with noise level.	Breakthroughs in refrigeration would make larger Ge arrays feasible, but also can enhance performance of room temperature semiconductors. This becomes increasingly important for larger missions.
NASA capabilities (100 words)	NASA's capabilities support test but solid state detectors are custom procurements from commercial sources.	NASA's capabilities support test but scintillators are custom procurements from commercial sources. SiPMs are COTS.	NASA has engineering groups producing custom ASICs at GSFC but suitable groups also exist in DoE or at commercial sources.	Refrigeration development capabilities exist in NASA and in industry.
Benefit	The detector array is the primary factor determining system performance, setting the size scale, sensitivity and other factors, enabling the entire mission concept, hence the science.	The detector array is the primary factor determining system performance, setting the size scale, sensitivity and other factors, enabling the entire mission concept, hence the science.	. Detector capability alone without an ASIC suitably matched to it could lead to prohibitive system power and make the concept unworkable. Multiple turns of development are likely needed.	. Solving refrigeration for for these applications could be enabling for other missions.
NASA needs	NASA needs medium-energy gamma-ray instruments to advance understanding of nuclear astrophysics and particle acceleration sources, including the Sun. Lunar prospecting is another application. Technical investment in this energy range applies to concepts that scale from near-term explorer to next generation missions.	NASA needs medium-energy gamma-ray instruments to advance understanding of nuclear astrophysics and particle acceleration sources, including the Sun. Lunar prospecting is another application. Technical investment in this energy range applies to concepts that scale from near-term explorer to next generation missions.	Specifically co-developed ASICs are required for the application of detector technologies. If the material is Ge, the ASIC is probably external to the refrigeration, but still needs to be low power.	Refrigeration is a general need for Ge detectors in space use and also improves performance of other detectors, e.g. limiting heating from electronics.
Non-NASA but aerospace needs	Such devices might have applied uses, including charged particle and other environmental monitoring done from space platforms including space weather	Such devices might have applied uses, including charged particle and other environmental monitoring done from space platforms	ASICs are an integral part of the system hence contribute similarly to detectors for non-NASA needs.	
Non aerospace needs	Detector systems have use in sea-level environmental monitoring e.g., for nuclear materials as well as nuclear medicine.	Detector systems have use in sea-level environmental monitoring e.g., for nuclear materials as well as nuclear medicine (e.g., SiPMs are being heavily investigated for PET systems),etc.	ASICs are an integral part of the system hence contribute similarly to detectors for non-aerospace needs;	
Technical Risk	Technical risk is low. The design principles are generally understood but progress comes through design iterations to refine performance based on completed units. Cost risk may drive material preferences.	Technical risk is low. The design principles are generally understood but progress comes through design iterations to refine performance based on completed units. Cost risk may drive material preferences.	Technical risk is low to moderate given access to (rare) analog ASIC design expertise. The history of analogous flight projects shows this task must not be underestimated.The main challenge is to get low power with low noise.	
Sequencing/Timing	Should come as early as possible. Development of other system components depends on detector unit parameters. Only modest programs in Ge and CZT are ongoing.	Should come as early as possible. Development of other system components depends on detector unit parameters. Only modest programs in LaBr3, advanced organics, and SiPMs are ongoing.	ASIC design must be matched to design of the detector element and cannot precede it, but should be roughly simultaneous.	Refrigeration system needs to be designed as part of mission system engineering.
Time and Effort to achieve goal	Minimal effort. 3 year collaboration between industry and NASA	Minimal effort. 3 year collaboration between industry and NASA	Minimal effort. 3 year collaboration between industry and NASA	to iii. Minimal to moderate effort depending on scale of mission. 3 year collaboration between industry and NASA.

Table 9: 21 cm Cosmology Array

Name of Technology (256 char)	Low-frequency, wide-bandwidth, low-mass science antennas	Ultra-low power, temperature resistant, radiation tolerant analog electronics	Ultra-low power, temperature resistant, radiation tolerant digital electronics	Autonomous low-power generation and storage	Low-mass high capability rovers	High-data rate lunar surface transport mechanism
Brief description of the technology (1024)	LRA science antennas must operate at frequencies below 100 MHz. The expected HI signals cover a large range in redshift, and the larger the bandwidth able to be received, the larger the range in cosmic evolution can be covered. Current ground-based science antennas obtain a frequency dynamic range of approximately 3.5:1. In order to achieve sufficient collecting area, a large number of antennas are required, demanding low mass for an individual antenna. Potential antenna types: Polyimide film-based dipoles Self-deploying helixes	Signals received from the science antennas must be amplified, and potentially bandpass filtered, then digitized. Analog electronics, including analog-to-digital converters (ADCs) that operate on the lunar surface during nighttime. Power required for combined analog and digital components, per antenna, < 100 mW.	After digitization, received signals must be converted to spectra and combined (cross-multiplied from antennas or correlated). This processing must occur on the lunar surface, potentially some of it during nighttime. Power required for combined analog and digital components, per antenna, < 100 mW. A digital correlator for combining the signals will also be required, with power required < 10 kW.	Electronics associated with antennas, or groups of antennas, will require power (~ 100 mW), capable of being generated or obtained during nighttime operation (~ 300 hr sustained) in an environment that is dark and cold (~ 125 K). Power sources and/or energy storage units must be low mass because of the large number of antennas. Power options: High specific capacity batteries Small Radioisotope Power Units (RPUs) Beamed power distribution	Antennas must be distributed over a geographical region ~ 10 km. Rovers must have a high payload/rover mass ratio, capable of sustained traverse speeds (~ 1 m/s), autonomous navigation capabilities, and dexterity to deploy antennas and associated electronics.	Antennas (and electronics) will be distributed over ~ 10 km. Data must be transported from individual antennas, or groups of antennas, to the central correlator. Data rates could exceed 400 Mbps, for as long as 300 hr. Potential options: Wireless radio Fiber optic Laser communication
Goals and Objectives (1024)	Reach TRL 6 by early next decade. Final mass target not needed as prototype system would be fewer antennas.	Demonstrate 4–6 bit, 200–400 Ms/s ADC with a power consumption < 10 mW	Demonstrate 12 nm process with < 1 V supply by late this decade	Demonstrate < 10 W production or capability by early next decade	Demonstrate autonomous navigation at 1 m/s traverse speed by early next decade	Demonstrate sustained > 100 Mbps data rates by early next decade
TRL	3–4. Requires technology selection. Technologies have		4. 350 nm process with 0.5 V supply at TRL 7. Requires effort to reduce	2. Requires technology selection, expanding	5. Rovers at TRL 7+. Requires effort to increase	5. Requires technology selection, and

Table 9: 21 cm Cosmology Array

Name of Technology (256 char)	Low-frequency, wide-bandwidth, low-mass science antennas	Ultra-low power, temperature resistant, radiation tolerant analog electronics	Ultra-low power, temperature resistant, radiation tolerant digital electronics	Autonomous low-power generation and storage	Low-mass high capability rovers	High-data rate lunar surface transport mechanism
	been tested in field, but not relevant environment. Requires efforts to test in relevant environment, and potentially space qualification, depending upon antenna type		feature size, supply voltage, and demonstrate in relevant environment.	operating temperature environment, and technology development, depending upon selection.	payload/rover mass ratio and increase traverse speed.	possible space qualification. Depending upon technology, requires mass reduction and increase in data rate transmission.
Tipping Point (100 words or less)	Antennas have been deployed in the field, but not in a relevant environment. A focused effort could increase this technology to TRL 6 in a fairly short time			Renewed production of Pu for radioisotope thermal generators and related technologies		
NASA capabilities (100 words)	NASA, in collaboration with JPL and NRL, has been a leader in developing and testing one of the leading technologies for future lunar antennas.			NASA has produced multiple generations of radioisotope thermal generators.	NASA has produced several generations of rovers for planetary science missions	NASA has partnered with other groups to demonstrate high data rate transfer in some of the relevant technologies.
Benefit						
NASA needs	LRA, potential Heliophysics and Planetary Science missions	All NASA missions could benefit from lower power analog components, particularly for digitization.	All NASA missions could benefit from lower power digital components.	LRA, outer solar system Planetary Science missions	LRA, missions both scientific and exploration to other solar system bodies	LRA, other lunar surface missions
Non-NASA but aerospace needs	None	Likely commercial and DoD benefits to lower power analog components	Likely commercial and DoD benefits to lower power digital components	None	Autonomous rovers also useful for DoD needs	Potential DoD needs for high data rate transfers
Non aerospace needs					Commercial operations in harsh environments	
Technical Risk	Technical risk limited to obtaining electromagnetic performance at minimal mass. Materials for space-based antennas are well developed.		Technical risk is low. Low-power digital electronics have been demonstrated in space, and a technology roadmap exists for future development.		Technical risk is low. Rovers are a mature technology, but further work is needed on autonomous navigation and reducing the mass of rovers.	
Sequencing/Timing	Continuous development, but potentially parallel with electronic and rover developments.	Continuous development, but potentially linked to antenna developments.	Continuous development, but potentially linked to antenna developments.	Continuous development.	Continuous development, but potentially linked to antenna and data transport developments.	Continuous development, but potentially linked to electronics and rover developments.
Time and Effort to achieve goal	7 year collaboration between NASA, academia, and industry	7 year collaboration between NASA, academia, and industry	7 year collaboration between NASA, DoD, academia, and industry	5-7 year collaboration between NASA, academia, and industry	7-10 year collaboration between NASA, DoD, academia, and industry	7 year collaboration between NASA, DoD, academia, and industry

Table 9: 21 cm Cosmology Array**H I 21 cm Cosmology and PCOS**

After the formation of the cosmic microwave background (CMB, $z \sim 1100$), the dominant baryonic component of the intergalactic medium (IGM) was neutral hydrogen, which produces a well-known hyperfine transition at a rest wavelength of 21 cm (frequency of 1420 MHz). The 21 cm brightness temperature of an IGM gas parcel at a redshift z , relative to the CMB, is (Madau et al. 1997; Furlanetto et al. 2006)

$$\delta T_b \approx 25 \text{ mK } X_{\text{HI}} (1 + \delta) [(1 + z)/10]^{1/2} [1 - T_{\text{CMB}}(z)/T_S] [H(z)/(1 + z)/dv_{\parallel}/dr_{\parallel}]$$

where X_{HI} is the neutral fraction, δ is the fractional IGM overdensity in units of the mean, T_{CMB} is the CMB temperature, T_S is the spin (or excitation) temperature of this transition, $H(z)$ is the Hubble constant, and $dv_{\parallel}/dr_{\parallel}$ is the line-of-sight velocity gradient.

All four of these factors contain unique cosmological or astrophysical information. From the PCOS perspective, the two most interesting are $H(z)$ and the “redshift-space distortions” $dv_{\parallel}/dr_{\parallel}$ encapsulated in the line-of-sight velocity gradient. The other factors are of more relevance to the Cosmic Origins (COS) theme, as the dependence on δ traces the development of the cosmic web and the other two factors depend on the ambient radiation fields in the Universe.

During the **Dark Ages** ($30 < z < 100$), before the first stars, $X_{\text{HI}} \sim 1$, and the H I gas was influenced only by gas collisions and absorption of CMB photons. The gas cooled rapidly as the Universe expanded, and the resulting cold temperatures caused the 21 cm signal to appear in absorption, relative to the CMB.

1. Because the H I 21 cm transition is a *spectral line*, the evolution of the signal can be tracked with redshift. This capability is in marked contrast to CMB measurements, which can be performed at only a single redshift. As a result, H I 21 cm measurements have the potential to probe a much larger volume of the Universe, obtaining a much larger number of modes with which to constrain cosmological parameters.
2. The evolution of the H I 21 cm signal in this epoch should depend only upon cosmological parameters (Ω_m , Ω_Λ , H_0 , ...). Any deviations would represent evidence of additional energy injection into the IGM, such as by dark matter decay.

The H I 21 cm signal is expected to disappear at $z \sim 30$ as the continuing expansion of the Universe decreased the gas density, thereby reducing the collision rate. Absorption of CMB photons then drove the spin temperature into equilibrium with the CMB. (The signal should reappear at lower redshifts, but these redshifts are more relevant to the COS theme.)

Table 10: Beyond LISA

Emerging technologies that have the potential for radical improvement in a measurement capability over the next 30 years:

A) High stability optical platforms:

Includes optical benches, telescopes, etc., requiring passive thermal insulation for temperature stability. Hydroxide or silicate bonding for precision alignment capability and dimensional stability. Precision materials such as Silicon Carbide and single crystal silicon.

B) Precision interferometry:

Requires CW single-frequency and frequency-stabilized lasers for space (GSFC applications so far are pulsed). Digital techniques including coded modulation for time-of-flight resolvable interference, and flexible in-flight changes. Time-Domain Interferometry (LISA's equal-path-length synthesis techniques).

C) Frequency combs:

Could be used for LIDAR/remote sensing applications to distinguish types of vegetation and resolve shrubs vs. trees on a slope. Requires frequency stabilization, pulsed lasers, and good detectors.

D) Single-mode fiber optic technology for space (now using multimode, mostly):

Now developed for wavelengths not usually used in space: 1550 nm
Fiber Bragg Gratings for frequency stability, references, and filters.
Modulators, isolators, and circulators. No alignment required and lightweight.
Changing traditional wavelengths to take advantage of telecom technology where possible.

E) Scattered light suppression:

Includes masks and apodization, black coatings, and cleaning/particulate/contamination techniques.

F) Optical communications:

Phase-array capabilities would obsolete DSN or single-pointing-capable telescopes. Orbiting TDRS-style relay network could obsolete DSN, form basis of a high reliability space-borne NETWORK for long-duration space flights/bases but also comm-constrained missions such as to the outer planets.

Technologies that cut across many different potential applications:

High Stability and/or fiber optics: atom interferometry, LISA, Grace, Exoplanets

Frequency combs: LIDAR/Remote sensing, atom interferometry

Scattered light suppression: atom interferometry, LISA, Grace, Exoplanets

Precision interferometry: optical communications, LISA, Grace

Measurement techniques that could enable new NASA missions not currently thought about in present agency strategic planning:

Precision interferometry and phase-sensitive optical detection (good for optical comm)

Frequency combs (sort of part of precision interferometry)

Time-Domain Interferometer.

Table 11: Gen-X-like Ultra-Light X-ray Telescope

Name of Technology (256 char)	Thermally formed (slumped) glass mirror segments as substrates for Wolter I or Wolter-Schwarzschild adjustable optics	Adjustable grazing incidence X-ray optics by deposition of piezoelectric thin film actuator layer on mirror back surface.	Mounting and alignment of adjustable optic mirror segments using thin film.	Figure correction control using thin film piezo adjusters for adjustable grazing incidence optics.
Brief description of the technology (1024)	Thermally form, to precision mandrels, thin glass sheets into Wolter I mirror substrates for adjustable optics. Includes cutting mirrors to appropriate size, and coating with X-ray reflective material. IXO-like technology as starting point.	Deposit full surface thin layer of low voltage piezoelectric material on back surface of conical mirror segment. Deposit pattern of electrodes (piezo cells) and printed leads with taps on mirror side edge for power connection.	Thousands of mirror segments need to be aligned to one another, made confocal, and mounted in a flight housing. Mounting must not distort the mirror figure.	Need the ability to connect ~ 400 separate power signals to the actuators on a single mirror, presumably using semiconductor-like technology. Develop software for figure correction using calibrated adjuster impulse functions, either on the ground with direct optical feedback, or on-orbit using X-ray point source imaging.
Goals and Objectives (1024)	Require ~ 5 arc sec HPD performance from perfectly aligned primary-secondary mirror pair before figure correction and piezo deposition. Figure error and roughness requirements different from IXO-like; greater requirement on roughness and mid frequency errors which cannot be corrected by adjusters. TRL 6 by 2014 to be consistent with adjustable mirror sub-orbital flight in 2016.	Require > 1 um thick piezoelectric layer with piezo coefficient > ~ 5 Coulombs/sq m, leakage current < ~ 10 micro-A/sq cm. Piezo cell size ~ 1 sq cm - 2 sq cm (~ 200 to 400 per mirror segment). TRL 6 by 2018 with sub-orbital flight in 2016-2017. Piezo voltages < 50 V with minimal power consumption (i.e., micro-amp leakage current). Optimization of influence function shape by shape of piezo cell and size/shape of cell electrode and electrode pattern. This is necessary to improve correction bandwidth and minimize introduction of pattern errors.	Require < 0.25 arc sec HPD alignment, including confocality. Mounting distortion of mirror figure < 2-3 arc sec HPD. TRL 6 by 2015, with several aligned mounted mirror pairs on sub-orbital demonstration flight in 2016-2017.	Piezoelectric adjuster power connections should not distort the mirrors. Control algorithms should converge reasonably rapidly. On-orbit approaches, if feasible, need to be completed in reasonable time period of five year mission (i.e., figure correction on time scale of 1 week to 1 month, max).
TRL	TRL 3: need to modify slumping process to change glass type and mandrel release layer for smoother roughness and mid frequency errors.	TRL 2: Have demonstrated deposition of piezoelectric layer on glass of sufficient thickness and high enough piezo coefficient, and have demonstrated ability to energize piezo cell and locally deform mirror in rough agreement with model predictions. Operating voltages < 20V and leakage currents of 10s of microamps.	TRL 2 - 3: Modification of IXO-like mission mirror mounting and alignment. Need to align better than IXO-like requirements, but distortion from mirror mounting is less critical (can be fixed during figure correction).	TRL 3: Semiconductor industry already bonds to hundreds of contact points at low voltage. Optimization algorithms exist. Need to demonstrate with actual computer programming. Need to demonstrate on-orbit adjustment is feasible within allotted time.
Tipping Point (100 words or less)	Demonstration of smooth mid frequency figure and roughness through use of sputtered release layer, along with successful slumping of high temperature glass. These will demonstrate feasibility of ultimate goals.	Repeatable high yield deposition of piezo material (with patterned electrodes) without minimal (a few microns) deposition distortions. Also, demonstration of significant lifetime when energized. Successful sounding rocket flight in 2016-2017.	Demonstration of alignment of mirror pairs from multiple shells to < 0.25 arc sec, including focus. Successful sounding rocket flight in 2016-2017.	Demonstration of correctability via software simulation.
NASA capabilities (100 words)	NASA GSFC leads in development of thermal forming and is fully equipped to continue experimentation.	NASA does not have the capability to develop this technology, but NASA funded investigators are developing the technology (SAO+PSU+MSFC)	NASA GSFC and SAO have developed alignment mounting techniques. Alternatives or similar approaches could be developed in optics industry.	NASA and many organizations have the capability to do software development. Software under development for adjustable X-ray optics at SAO.
Benefit	Thin mirror segments enable collecting area to exceed 1 sq m with existing launch vehicles. > 10x area of Chandra.	Adjustable thin grazing incidence optics enable Chandra-like imaging or better with > 10x collecting area. Will revolutionize study of the early Universe.	Adjustable thin grazing incidence optics enable Chandra-like imaging or better with > 10x collecting area. Will revolutionize study of the early Universe.	
NASA needs	Required for moderate to large collecting area X-ray telescopes. Required for adjustable optics X-ray telescopes with sub-arc second imaging.	Required for adjustable optics X-ray telescopes with sub-arc second imaging.	Required for moderate to large collecting area X-ray telescopes. Required for adjustable optics X-ray telescopes with sub-arc second imaging.	Required for adjustable optics X-ray telescopes with sub-arc second imaging.
Non-NASA but aerospace needs	Potential for synchrotron optics and X-ray lithography. Also plasma diagnostics.	Potential for synchrotron optics and X-ray lithography. Also plasma diagnostics.	Potential for synchrotron optics and X-ray lithography. Also plasma diagnostics.	Potential for synchrotron optics and X-ray lithography. Also plasma diagnostics.
Non aerospace needs				
Technical Risk	Moderate - significant changes between Gen-X-like requirements and IXO-like requirements, although overall performance levels are similar.	High: Current TRL is low and significant technical development necessary to achieve TRL 6 including; elimination of deposition deformations, increased deposition yield, optimization of influence function shape, demonstration of lifetime in space environment, deposition on curved mirrors.	Moderate: requires several factors improvement over currently achieved alignment levels for segmented mirrors, but difficulty is mitigated by reduced sensitivity to mirror segment deformation due to mounting by virtue of being able to correct mounting deformations during figure correction.	Low to Moderate:
Sequencing/Timing	As early as possible - "heart" of a telescope	As early as possible - the critical technology for an adjustable optic telescope, which is the critical technology for a large area sub-arc second broad band X-ray telescope.	As early as possible - "heart" of a telescope	Not critical for early demonstration, but should be resolved by 2015 for sub-orbital flight demonstration.
Time and Effort to achieve goal	3 year collaboration between NASA and industry	5 year collaboration between NASA and industry	5 year collaboration between NASA and industry	3 year collaboration between NASA and industry

Table 12: Next Generation Gamma-Ray - Laue

Name of Technology (256 char)	pixelated Ge or CZT detectors	ASICS	focusing optics
Brief description of the technology (1024)	High spectral resolution is needed to obtain nucleosynthesis signatures and spatial resolution is needed to isolate sources and maximize signal to noise. In this approach signal to noise is optimized using a focusing optical element in front of the detector array, thereby reducing the total number of detectors but requiring operation at higher count rates. Germanium and CZT have been considered as materials.	Low power ASICs are needed to provide accurate time of arrival and energy for each photon but with ability to handle higher counting rates produced by focusing	Science objective is achieved in a set of narrow energy bands but with high signal to noise in those bands achieved using focusing optics
Goals and Objectives (1024)	The goal is to reach TRL 6 in 2015, to meet opportunities for near-term explorers	The goal is to reach TRL 6 by 2015	The goal is to reach TRL 6 by 2015
TRL	TRL is 4 for CZT or Ge. Requires efforts towards space qualification and testing in relevant environment.	TRL is essentially undefined until the detector is specified. The ASIC is specific to the detector and developed in co-evolution with it.	TRL is 4.
Tippling Point (100 words or less)	Designs have reached TRL 4. A focused effort could increase this to TRL 6. A few cycles of fabrication and test are realistically necessary, but must be coordinated with ASIC development.	Pixel designs require custom ASIC development to meet targets for power combined with noise level.	If a breakthrough in optics is not achieved, the preferred option will be Compton telescopes meaning larger array dimensions but without optics
NASA capabilities (100 words)	NASA's capabilities support test but strip arrays are custom procurements from commercial sources.	NASA has engineering groups producing custom ASICs at GSFC but suitable groups also exist in DoE or at commercial sources.	NASA has no special facilities but they exist in other government departments, industry, and elsewhere, with choice of source depending on requirements and approach
Benefit	The detector array is the primary factor determining system performance, setting the size scale, sensitivity and other factors, enabling the entire mission concept, hence the science.	Detector capability alone without an ASIC suitably matched to it could lead to prohibitive system power and make the concept unworkable. Multiple turns of development are likely needed.	Producing optics for this application would be largely mission specific and not transferable to other uses, but the optical solution is enabling for this approach to a medium gamma-ray mission.
NASA needs	NASA needs a next generation medium-energy gamma-ray mission to advance understanding of nuclear astrophysics and black hole sources.	The detector alone is not sufficient and requires the ASIC. If the material is Ge, the ASIC is probably external to the refrigeration, but still needs to be low power.	Without optical system the NASA needs for a medium-energy gamma-ray mission are most likely to be achieved using Compton telescope designs.
Non-NASA but aerospace needs	none	none	none
Non aerospace needs	Detector systems might conceivably find use in sea-level environmental monitoring but would face competition from other approaches.	ASICs are an integral part of the system hence contribute similarly to detectors;	
Technical Risk	Technical risk is low. The design principles are generally understood but progress comes through design iterations to refine performance based on completed units.	Technical risk is low to moderate given access to (rare) analog ASIC design expertise. The history of analogous flight projects shows this task must not be underestimated. The main challenge is to get low power with low noise.	Technical risk is moderate for completely new approaches.
Sequencing/Timing	Should come as early as possible. Development of other system components depends on detector unit parameters.	Should come as early as possible. Development of other system components depends on ASIC power performance.	Should come first in mission development because it is a prerequisite
Time and Effort to achieve goal	Minimal effort. 3 year collaboration between industry and NASA	Minimal effort. 3 year collaboration between industry and NASA	Moderate effort, 3 year collaboration between industry and NASA

Table 13. Technology Needs Submitted to PCOS Program Office Via Email

Name of Technology Need	Plastic Lens Coatings	Piezoelectric Adjustable X-ray Optics	Broadband X-ray Polarimeter	Finely pixelated detectors for high angular resolution hard X-ray imaging.	Microvia (TSV) ASIC flip-chip bonding for close-tiled large area imaging detector readout
Brief Description of Technology Need	High-throughput optics with large fields of view, high stability, spectral resolution, and uniformity at many different temperatures as identified in NASA's "Science Instruments, Observatories, and Sensor Systems" Roadmap, November, 2010.	Light-weight grazing incidence optics which can be highly nested, with a figure which can be adjusted via in-plane piezoelectric elements to achieve a telescope with 0.5 arcsecond resolution for 1 keV X-rays.	Non-imaging broadband X-ray polarimeter	Development of room temperature solid state X-ray detectors with 100 micron spatial resolution covering the 1 keV-100 keV energy range. The focal plane instrumentation could use Cadmium Telluride (CdTe), Cadmium Zinc Telluride (CZT), or Si detectors, or a combination of such detectors.	Close-tiled large area arrays of active-pixel imaging detectors require the new technology of through Silicon vias (TSVs) that enables 3D connections of pixel data and control/power lines for each ASIC that is flip-chip bonded to an imaging detector (top) and mother board (below). This enables gap-less tiling of large area imaging detectors for wide-field telescopes with greatly reduced complexity and cost.
Goals and Objectives	The goal is to develop large lightweight Fresnel optics (using polymethyl methacrylate) with high throughput operating in the near UV (330-400 nm). The objectives are to develop manufacturing processes that reduce surface roughness to minimize the total integrated scatter losses and to develop a anti-reflective coating to minimize reflective losses.	Goal is a 3m ² 0.1 to 10 keV X--ray telescope, with 0.5 arcsec half power diameter imaging. Objectives are to demonstrate that 1--2 micron thick piezoelectric material can be deposited on curved, thin glass mirror elements of 200mm x 200mm dimensions; divided into a grid of 400 cells; and the cells independently activated to correct slope errors on spatial frequencies less than 0.05 per mm to 0.4arcsecond rms. Align the elements and shells to within an overall budget of 0.25 arcsec, including confocality.	Allow X-ray polarimetric observations over 0.1 keV-200 keV energy range with a photon detection efficiency exceeding 60%.	Recent advances in mirror technology make it possible to fabricate hard X-ray mirrors with <10 arcsec HPD angular resolutions. We need a detector technology for the focal plane instrumentation of state-of-the-art hard X-ray telescopes equipped with such high-angular resolution mirrors.	Develop low cost industrial processes to fabricate linear array of 87 through-silicon vias (TSVs) on 200um pitch. The TSVs are 100um diameter through a 300um thick Si wafer and applied prior to ASIC fabrication with connection traces to each group of TSVs on the top surface of the wafer.
TRL	4 - Polymethyl methacrylate (PMMA) has been tested in space so the material, itself, is at a high TRL level. The UV absorption and spectral index has been measured in the laboratory as a function of temperature. Fresnel lenses have been designed using this material and manufactured in diameters up to 1.5 meters. To reduce the scattering loss, the manufacturing technique needs to be refined to obtain a RMS surface roughness of <20 nm. A UV anti-reflective coating has been developed for PMMA and demonstrated on small samples. The technique for applying this coating to large lenses needs to be developed.	2 - TRL 2: Have deposited piezo cells on thin, flat glass pieces, and measured general agreement with finite element analysis predictions. IXO--like alignment has achieved TRL 3, and is starting point for further development. Slumping of thin glass is at TRL 3.	3 - In the 2-10 keV energy range, the GEMS soft X-ray polarimeter is at TRL 6; in the 20-60 keV energy range, the X-Calibur hard X-ray polarimeter is at TRL 4. Concepts exist (TRL 3) for extending polarimetric coverage to lower energies, and to improve the performance in the 5-20 keV energy range. The GEMS and X-Calibur polarimeters could be used together to make a polarimeter covering the 2-60 keV energy range. The detector hybrid would need some optimization.	4 - The NuSTAR mission uses CZT detectors with an ASIC with an energy threshold of 2 keV and a pixel pitch of 600 microns. We have made prototype measurements with 350 micron CdTe and CZT pixel detectors. Other groups have made exploratory measurements with detectors with 100 microns spatial resolution.	3 - TSV technology is available for 3D memory applications but not yet developed for ASIC fabrication. Low cost application to Si wafer processing not yet available.
Tiping Point	This lens technology is being pushed by the large international JEM-EUSO collaboration. Working with our Japanese and Europeans, we believe that the goals and objectives stated above can be reached in 2 years.	Produce an aligned and tested X-ray Optic pair, Jan 2015.	Already Achieved	Laboratory demonstration of 100 micron pixel pitch detectors with 1-2 keV energy threshold and excellent energy resolution (~ 1 keV FWHM).	2 year program could develop and demonstrate TSV technology for ASIC fabrication. This would allow two prototype development runs at an ASIC foundry: 1) develop TSV fabrication and connectivity from upper to lower surface pads on standard sized 300um thick Si wafers; and 2) substitute TSVs for WBs on NuSTAR ASIC for full wafer of TSV-ASICs.
NASA Capabilities		PSU/SAO have brought this technology to TRL 2, and are working toward TRL3 using internal funding plus NASA APRA plus a Moore foundation grant.			
Benefit/Ranking	Knowledge the UV background for observations of extensive air showers (EASs) from space will enable such observations to be made over the large areas needed for scientific investigations of extreme energy cosmic rays. Knowledge of this background will determine the duty cycle for EAS observations. Measurements of UV transient background signals will also provide information that will permit the design of trigger electronics which detects EAS signals while avoiding background.	This enables NASA to have an X-ray Observatory with angular resolution of 0.5 arcsec, comparable to Chandra, but with greater than 10 times the collecting area. That in turn enables detection of the first supermassive black holes in the early universe and following their growth-tree to the present time, studying the extreme physics of black holes and neutron stars, and the chemical enrichment of the Universe. Gives a sensitivity and angular resolution synergistic with major Observatories in the radio, mm, IR and optical wavelengths which are coming on-line by the end of this decade.	Technology will allow us to test models of black hole accretion, to study particle acceleration in compact objects, and to probe fundamental physics (General Relativity, Lorentz Invariance, neutron star equation of state).	Enable hard X-ray AGN census over z=0 to z=6 redshift range.	Closely tiled arrays of active pixel sensors are required for large area imaging detectors, e.g. each 20 x 20mm and with 32 x 32 pixels that are readout and controlled by ASIC flip-chip bonded to the detector. Such detectors cannot now be close-tiled (with no gaps) since present technology requires each ASIC to be connected with ~90 wirebonds along one edge. The wirebonds (WBs) themselves are expensive and incur risk for each detector. Elimination of WBs would allow active-pixel imaging detectors to be seamlesly tiled and flip-chip bonded to power and digital control on a single board. For X-ray (CMOS-Si) and hard X-ray/Gamma-Ray CdZnTe (CZT) detectors, elimination of WB gaps will reduce background on each detector, thereby increasing sensitivity, and allow larger area imaging arrays to be accomodated in the same physical space. This technology will reduce cost, technical risk, and fabrication complexity for large-scale imager development.

Table 13. Technology Needs Submitted to PCOS Program Office Via Email (Page 1 of 2)

Table 13. Technology Needs Submitted to PCOS Program Office Via Email

NASA Needs/Ranking	The “Science Instruments, Observatories, and Sensor Systems” Roadmap identifies “High-throughput optics with large fields of view, high stability, spectral resolution, and uniformity at many different temperatures” as one of six major challenges to support NASA’s mission needs.	Required for any moderate to large collecting area grazing incidence, sub--arcsecond imaging telescopes. This satisfies a need for high resolution imaging and therefore photon--limited sensitivity down to a flux of 10^{-19} ergs per cm^2 per s.	Broadband energy coverage with high detection efficiency; high reliability; low mass; low complexity.	The detector technology has to be combined with high-angular resolution mirrors. For a mission concept, see: http://arxiv.org/abs/1205.3691 .	This technology would greatly benefit proposed future missions such as Epoch of Reionization Energetic X-ray Survey (EREXS; formerly EXIST) and Wide-field X-ray Telescope (WFXT), both submitted in response to NNN11ZDA018 and presented at the XMAC on Dec. 15, 2011.
Non-NASA but Aerospace Needs	High throughput Fresnel optics is applicable to solar concentrators and large high throughput Fresnel optics for optical communications. The anti-reflective coating technology we propose to develop is applicable to a wide range of NASA missions operating in wavelengths from the UV to the Far infrared				This technology would likely be of interest to DoD reconnaissance imaging satellites incorporating wide-field, high time resolution spectral-imaging.
Non-Aerospace Needs	Potential military dual use applications for the anti-reflective coatings we propose to develop include Sun-Wind-Dust goggles, laser safety eye protective spectacles, chemical/biological protective face masks, ballistic shields for explosive ordnance disposal personnel, and vision blocks for light tactical vehicles. Commercial applications include solar panels, greenhouse enclosures, sports goggles and windows for public transport vehicles and armored cars.	Potential for synchrotron optics and x-ray lithography. Also plasma diagnostics.		Medical imaging (SPECT)	The ASIC-TSV technology proposed here would be of significant benefit to both Medical Imaging and Homeland Security, both of which use close-tiled arrays of high resolution imaging detectors for hard X-rays that require active pixel sensors. It would greatly improve imager resolution (by eliminating detector gaps) and cost (by eliminating complex wirebonds).
Technical Risk	There are two technical risks. The first is that manufacturing techniques cannot be developed or refined sufficiently to obtain the required surface roughness. The second is that a technique for uniformly applying the anti-reflective coating to the large Fresnel lenses cannot be developed.	Moderate risk for slumping thin glass and performing alignment. High risk for piezoelectric adjustment of elements to the 0.5 arcsecond level. For the optical adjustment, significant technical development is necessary to achieve TRL 6 including; elimination of deposition deformations, increased deposition yield, optimization of influence function shape, demonstration of lifetime in space environment, and deposition on curved mirrors.	Low	Low	TSVs have been developed by IBM and Samsung on prototype scales for integrating 3D memory modules. There should be minimal risk in applying this processing to large area wafers to allow fabrication of TSVs in Si wafers before (or possibly during) the standard 2D surface processing of an active pixel sensor ASIC, such as the 32 x 32 pixel (604um pitch) NuSTAR ASIC.
Sequencing/Timing	This optics technology described above is being pushed by the JEM-EUSO collaboration for use in the JEM-EUSO instrument that is planned for launch in 2017. Working with the Japanese and Europeans, we believe that the goals and objectives stated above can be reached in 2 years, which is in time to manufacture the flight lenses. The throughput of the optics is one of the factors that determine the signal strength. The second is the efficiency of the focal surface detector. The efficiency of the JEM-EUSO focal surface is ~25% using existing proved technology (multianode PMTs). New technology (backside illuminated silicon PMTs) is under investigation that could raise this to ~40%. If that technology were to mature rapidly, it would reduce the throughput requirement for the optics. We do not anticipate this technology will mature fast enough for the JEM-EUSO mission.	This is the “heart” of an X-ray Observatory Telescope, and is needed as early as possible. Specifically, will be needed by 2015 to conceive a mission which could be presented to the 2020 decadal survey committee for possible flight in the later 2020’s.	Ideally, the technology should be at TRL 6 at the time of the next SMEX or MIDEX announcement of opportunity.	Ideally, the technology should be at TRL 6 at the time of the next SMEX or MIDEX announcement of opportunity.	Demonstration ASIC could be produced in 2 years. Phase 1 ~6mo: develop TSV technology on already-thin (300um) Si wafers and demonstrate top-bottom surface connectivity with flip chip bonding. Phase 2 ~1.5years: post-process Si wafer with precision-placed TSVs into ASICs connected on top-surface of Si wafer and verify performance by dicing ASICs and flip chip bonding them to pixelated CZT detectors for performance validation in ProtoEXIST3 (or similar) detector system.
Time and Effort to Achieve Goal	We propose a two-year effort conducted in collaboration with our Japanese and Italian JEM-EUSO partners. The plan is to do the lens manufacturing in Japan and the testing in the US. The optics design work will be a shared effort of our Japanese and Italian collaborators. The anti-reflective coating development will be done in collaboration with AGILTRON Inc. who has developed the coating technology under an SBIR. We expect that this will be an 8 person-year effort.	3 year collaboration between NASA/industry and University/Research institutions to reach TRL 4. Additional 3 years to reach TRL 6	2-8 years; the energy range from 2-60 keV can be addressed with a short-term program (2 years of one R&D group); extending the energy range beyond this boundaries will take longer. Extension to higher energies is relatively simple by scaling up an existing Compton polarimeter in size. There exist concepts for <2 keV polarimeters, but the detection efficiency is rather low.	A 3 years targeted research program of 1-2 groups will give the required technology. The R&D requires the fabrication and tests of suitable detectors and readout ASICs.	2 years, total: Phase 1 and first year of Phase 2 with industrial partner (e.g. IBM); final 0.5 year at Harvard and GSFC for integration and testing in appropriately modified ProtoEXIST3 detector system.

Table 13. Technology Needs Submitted to PCOS Program Office Via Email (Page 2 of 2)

4 Program Technology Priorities and Recommendations

Section 3 discusses how the community technology needs are collected by the Program Office. In summary, a needs list was compiled as part of the annual technology needs prioritization process, then the Technology Management Board (TMB) scored these needs according to an agreed upon set of evaluation criteria. The results of this process are included herein.

Membership of the TMB includes senior members of the Astrophysics Division at NASA Headquarters and the PCOS Program Office. Subject matter experts, consultants, and internal/external personnel are included as needed. For 2012, the Board used a prioritization approach very similar to that used in 2011. The evaluation was based on 11 criteria. These criteria address the strategic alignment, benefits and impacts, risk reduction, timeliness, and effectiveness of investment of each technology need. These criteria, summarized in Table 4-1, have been carried over from 2011 with minor changes to the score definitions that take into account the lessons learned. For each criterion, a weight is assigned that is intended to reflect the importance that the PCOS Program places on that criterion. These were unchanged from 2011. Each criterion for each technology receives a score of 0 to 4 in the evaluation. The score is multiplied by the established weight for the criterion, and this product is summed across all criteria for each technology. The TMB reviews the prioritization criteria each year to maintain suitability and relevance.

The criteria are described below:

- 1. Scientific ranking of applicable mission concept:** The intent is that the technology needs associated with missions ranked highly by a major review process are scored higher than those associated with other missions. As with 2011, the NWNH report is the main source of the mission and science ranking for this year.
- 2. Overall relevance to applicable mission concept:** If a technology need is a key element of a mission concept, then it is scored higher than those that are less important. This criterion intentionally overlaps several more specific criteria below. The redundancy increases accuracy (by averaging scores over more targeted criteria) and captures any unanticipated aspects of mission applicability.
- 3. Scope of applicability:** If a technology need is generally useful to multiple missions, it is scored higher. For example, optics or detector technologies generally span more than one mission, whereas an ultra-high-precision timekeeping technology may have more limited applicability.
- 4. Time to anticipated need:** If a mission concept is not planned for implementation for a long time, its technology needs receive a lower score than more immediate needs.
- 5. Scientific impact:** This criterion captures the value of a technology in terms of its impact on the science return of a mission. If a technology need must be filled for mission success, it is scored highest. If it improves the scientific return from a mission, then its score reflects the improvement.

- 6. Implementation impact:** This criterion captures how important a technology need is to mission implementation. Primarily, it is a measure of the engineering impact. Technology needs that are required for a mission are scored highest. If a technology increases mission implementation efficiency or provides improvements in terms of major mission resources (cost, mass, power, etc.), then it is scored higher.
- 7. Schedule impact:** The intent of this criterion is to capture the likely impact a technology need has on mission schedule. If a technology is likely to drive mission schedule, then it receives a higher score.
- 8. Risk reduction:** The intent of this criterion is to help ensure that technology needs that provide important risk mitigation (i.e., secondary paths to mission implementation) are ranked appropriately. If a technology reduces the mission risk compared to the baseline mission concept, then it is scored higher. If it is already in the mission concept baseline, then it has no additional risk reduction benefits and is scored low.
- 9. Definition of required technology:** The intent of this criterion is to codify in this process the idea that well defined technology needs are better targets for development resources. If a technology need is well defined and described, then it is scored higher than those more vaguely defined.
- 10. Other sources of funding:** This criterion captures the likely return on NASA development funding. If research related to a particular technology need is already well funded by U.S. agencies and commercial and foreign investments, then additional NASA resources are unlikely to have a large impact. Thus, its score is low. In contrast, if a technology is not funded through any other sources, then NASA investments would be more effective.
- 11. Availability of providers:** This criterion seeks to ensure that a viable supplier base for a technology is developed and maintained. If there are few providers or a single provider, then the score is higher.

PCOS Technology Needs Prioritization Criteria

Score Meaning

#	Criterion	Weight	Score (0-4)	Weighted Score	General Description/Question	4	3	2	1	0
1	Scientific Ranking of Applicable Mission Concept	4	4	16	Scientific priority as determined by the Decadal Review, other community-based review, other peer review, or programmatic assessment. Captures the importance of the mission concept which will benefit from the technology.	Highest ranking	Medium rank	Low rank	Not ranked by the Decadal	No clear applicable mission concept
2	Overall Relevance to Applicable Mission Concept	4	4	16	Impact of the technology on the applicable mission concept. Captures the overall importance of the technology to the mission concept.	Critical key enabling technology - required to meet mission concept goals	Highly desirable technology - reduces need for critical resources and/or required to meet secondary mission concept goals	Desirable - offers significant benefits but not required for mission success	Minor implementation improvements	No implementation improvement
3	Scope of Applicability	3	4	12	How many mission concepts could benefit from this technology? The larger the number, the greater the reward from a successful development.	The technology applies to multiple mission concepts across multiple NASA programs and other agencies	The technology applies to multiple mission concepts across multiple NASA programs or other agencies	The technology applies to multiple mission concepts within a single NASA program	The technology applies to a single mission concept	No known applicable mission concept
4	Time To Anticipated Need	3	4	12	When does the technology need to be ready for implementation?	4 to 8 years (this decade)	9 to 14 years (early 2020s)	15 to 20 years (late 2020s)	Greater than 20 years (2030s)	No anticipated need
5	Scientific Impact to Applicable Mission Concept	2	4	8	Impact of the technology on the scientific harvest of the applicable mission concept. How much does this technology affect the scientific harvest of the mission?	Needed for applicable mission concept	Major improvement (> -2x) to primary scientific goals	Only enables secondary scientific goals	Minor scientific improvement	No scientific improvements
6	Implementation Impact to Applicable Mission Concept	2	4	8	Impact of the technology on the implementation efficiency of the applicable mission concept. How much does this technology simplify the implementation or reduce the need for critical resources?	Needed for applicable mission concept	Enables major savings in critical resources (e.g., smaller launch vehicle, longer mission lifetime, smaller spacecraft bus, etc.) or reduces a major risk	Enables minor savings in critical resources or reduces a minor risk	Minor implementation improvement	No implementation improvements
7	Schedule Impact to Applicable Mission Concept	2	4	8	Impact of the technology on the schedule of the applicable mission concept. How much does this technology simplify the implementation to bring in the schedule?	Technology is likely to drive the applicable mission schedule.	Technology is likely to drive the schedule for a major subsystem/component of the applicable mission concept	Technology is likely to drive the schedule for a minor applicable mission concept component	Technology is less likely to be a factor for the schedule of the applicable mission concept	Technology will not be a factor for the schedule of the applicable mission concept
8	Risk Reduction to Applicable Mission Concept	2	4	8	Ability of the technology to reduce risks by providing an alternate path for a high risk technology that is part of the applicable mission concept.	Technology is a direct alternative to a key technology envisioned for the applicable mission concept. No other known alternate technologies	Technology is a direct alternative to a key, technology envisioned for the applicable mission concept. At least one other known alternate technology	Technology is a direct alternative to a secondary technology envisioned. No other known alternate technologies	Technology is a direct alternative to a secondary technology. At least one other known alternate technology	No risk benefits or technology is already part of the applicable mission concept
9	Definition of Required Technology	1	4	4	How well defined is the required technology? Is there a clear description of what is sought?	Exquisitely defined	Well defined, but some vagueness	Well defined, but some conflicting goals not clarified	Not well defined, lacking in clarity	Poorly defined, not clear at all what is being described
10	Other Sources of Funding	1	4	4	Are there other sources of funding to mature this technology? If funding is expected to be available from other sources, this will lower the prioritization.	No, the Program is the only viable source of funding.	Interest from other sources can be developed during the development time of the technology	Interest from other sources is likely during the development time of the technology	Moderate investments (relative to the potential level for a NASA investment) in the technology are already being made by other programs, agencies, or countries.	Major investments (relative to the potential level for a NASA investment) in the technology are already being made by other programs, agencies, or countries.
11	Availability of Providers	1	4	4	Are there credible providers/developers of this technology? Where providers are scarce, there may be a compelling need to maintain continuity for the technology in the event there are no replacement technologies.	Potential providers/developers have insufficient capabilities to meet applicable mission concept needs.	Potential providers/developers have uncertain capability relative to applicable mission concept needs.	Single competent and credible provider/developer known	Two competent and credible providers/developers known	Multiple competent and credible providers/developers known

Table 4-1. This table shows the evaluation criteria for technology prioritization.

In 2011, the TMB ranked 58 technology needs for PCOS (after some editing and combining of the PhysPAG needs list). As discussed in Section 3, for 2012, the needs list added 17 new technology needs, consisting of 12 from the PhysPAG input that was received too late in 2011 to be ranked, and 5 that were submitted directly to the Program Office via the on-line technology need submission form. The new technologies were ranked this year in addition to the technology needs from the final 2011 needs list, which the PhysPAG did not change.

One significant change in approach from 2011 is the treatment of technology needs associated with dark energy missions (e.g., WFIRST). In 2011, the TMB concluded that because WFIRST is managed by the Exoplanet Program Office at JPL, dark-energy related technology needs would not be ranked by PCOS. In 2012, the TMB decided to include these technology needs in the ranking to ensure that technology advancement relating to dark energy, a PCOS science, would be covered in the prioritization.

Table 4–2 shows the results of the TMB technology needs prioritization for 2012. After all of the technology needs had been scored, they were binned into four groups. The divisions were based on a number of factors assessed by the TMB including primarily a natural grouping of the technology needs based on their overall scores. The bins are described as follows.

Priority 1: Contains technologies determined to be of the highest interest and urgency and the most compelling to the PCOS Program. These are generally key enabling technologies for the highest ranked near-term missions.¹

Priority 2: These four technology needs are all key for a future Inflation Probe mission. Since the Inflation Probe mission was not ranked as highly as WFIRST, LISA, and IXO in the NWNH decadal survey, these technology needs all received the second highest grouping of scores and have been binned together.

Priority 3: Generally contains enhancing and general-use technology needs that will benefit many missions across the Program or specific longer-term missions.

Priority 4: The remaining technology needs fall into this category. In general, these technology needs apply to longer-term missions or are less critical at this time.

Multiple factors are considered in any selection process, and the priority groups defined in this PATR comprise only one of those factors. After having considered all factors, the Board recommends that the PCOS Program seek to balance the technology investments across the multiple PCOS science objectives and anticipated missions. Finally, the Board is cognizant that investment decisions will be made within a broader context and that other factors relevant at the time of selection may affect these decisions.

¹One exception is the inclusion of the need for Large Format Arrays of Polarimeters. Despite relating to the Inflation Probe mission which was not as highly ranked by the NWNH survey, this technology need scored very highly in other criteria because it is so critical to enabling that mission.

Priority	PCOS Science Enabling or Enhancing Technologies	Science
1	Large format Mercury Cadmium Telluride CMOS IR detectors, 4K x 4K pixels	Dark Energy
	High-resolution X-ray microcalorimeter: central array (~1,000 pixels): 2.5 eV FWHM at 6 keV; extended array: 10 eV FWHM at 6 keV.	X-ray
	Dimensionally stable optical telescope: stringent length (pm) and alignment (nrad) stability with low straylight	Gravitational Wave
	Metrology laser: 10 yr life, frequency-stabilized, 2W, low noise, fast frequency and power actuators	Gravitational Wave
	Lightweight, replicatable x-ray optics	X-ray
	High resolution X-ray gratings (transmission or reflection)	X-ray
	Large format (1,000-10,000 pixels) arrays of CMB polarimeters with noise below the CMB photon noise and excellent control of systematics	Inflation
	Micronewton thrusters: 10 yr. life, low contamination, low thrust noise	Gravitational Wave
	Lightweight precision mirror mounting structure	X-ray
2	High throughput anti-reflection coatings with controlled polarization properties	Inflation
	Stable and continuous sub-Kelvin coolers for detectors	Inflation
	High-throughput, light, low-cost, cold, mm-wave telescope operating at low backgrounds	Inflation
	Polarization modulating optical elements	Inflation
3	Gigapixel X-ray active pixel sensors	X-ray
	Very large format (>10 ⁵ pixels) FPA with background-limited performance and multi-color capability	FarIR
	Molecular clocks/cavities with 10E-15 precision over orbital period; 10E-17 precision over 1-2 year experiment.	Fundamental Physics
	Cooled atomic clocks with 10E-18 to 10E-19 precision over 1-2 year experiment	Fundamental Physics
	Cryocooler <100 mK with 1 mK stability (IXO heritage)	X-ray
	Large throughput, cooled mm-wave to far IR telescope operating at background limit	FarIR
	Cooling to 50-300 mK	FarIR
	Megapixel microcalorimeter array	X-ray
	Coupling of ultra-stable lasers with high-finesse optical cavities for increased stability	Fundamental Physics
Lightweight adjustable optics to achieve 0.1 arcsec high resolution grating spectrometer	X-ray	

Table 4–2. Technology needs categorized in order of priority (Part 1 of 2)

Physics of the Cosmos Program Annual Technology Report

Priority	PCOS Science Enabling or Enhancing Technologies	Science
4	Coded aperture imaging: ~5 mm thick W and ~2.5 mm holes; ~0.5 mm W and ~0.2 mm holes	X-ray
	Wavefront sensing with cold atoms	Gravitational Wave
	Cooled Ge	Gamma
	Arrays of Si, CZT or CdTe Pixels	Gamma
	Finely pixelated CZT detectors for hard X-rays	X-ray
	ASIC on each ~20x20 mm crystal	X-ray
	Arcsecond attitude control to maintain resolution	X-ray
	Hard X-Ray grazing incidence optics with multi-layer coatings with at least 5" angular resolution	X-ray
	Loop Heat Pipe to radiators for ~-30 deg (Si) and ~-5 deg (CZT) over large areas	X-ray
	Low CTE materials	Gravitational Wave
	Large area atom optics	Gravitational Wave
	Long booms or formation flying	Gamma
	High rate X-ray Si detector (APS).	X-ray
	Compton telescope on single platform	Gamma
	1 m precision optics (1/1,000)	Gravitational Wave
	Sun-shield for atom cloud	Gravitational Wave
	Active cooling of germanium detectors	Gamma
	Passive cooling of pixel arrays	X-ray
	Low power ASIC readouts	X-ray
	Scintillators, cooled Ge	Gamma
	No optics; source isolation by collimator	X-ray
	ASIC readouts	Gamma
	Piezoelectric Adjustable X-ray Optics	X-ray
	Quadrant photodetector: low noise	Gravitational Wave
	ADC: 10 yr life, low noise (amplitude and timing)	Gravitational Wave
	Depth graded multilayer coatings for hard X-ray optics	Next
	Laser interferometer ~1 kWatt laser	Gravitational Wave
	extendable optical bench to achieve 60 m focal length	X-ray
	Active cooling of germanium detectors	Gamma
	>3 m ² Si (or CZT or CdTe) pixel arrays or hybrid pixels -- possibly deployable	X-ray
	Broadband X-ray Polarimeter	X-ray
	10 W near IR, narrow line	Gravitational Wave
	Finely pixelated detectors for high angular resolution hard X-ray imaging.	X-ray
	Gravity Reference Unit (GRU) with ~100x lower noise	Gravitational Wave
	focusing elements (e.g., Laue lens) on long boom or separate platform	Gamma
	Photocathodes, microchannel plates, crossed grid anodes	X-ray
	3 m precision optics	Gravitational Wave
	Low-frequency, wide-bandwidth, low-mass science antennas	21 cm
	Thin lightweight X-ray concentrator	X-ray
	Point source optimized X-ray concentrator	X-ray
	Lightweight, high throughput Fresnel optics	Near UV
	Advanced scintillators and readouts for gamma-ray detection	Gamma
Lobster eye X-ray optics for all-sky monitors	X-ray	
Megapixel CCD camera	Gravitational Wave	
Ultra-low power, temperature resistant, radiation tolerant analog electronics	21 cm	
Ultra-low power, temperature resistant, radiation tolerant digital electronics	21 cm	
Autonomous low-power generation and storage	21 cm	
Thermal stability/control less than 10E-8 K variation	Fundamental Physics	
Low-cost launch vehicles for single payloads with few months mission durations	X-ray	

Table 4-2. Technology needs categorized in order of priority (Part 2 of 2)

5 Closing Remarks

This Physics of the Cosmos 2012 PATR serves as a snapshot of the state of technology development under the PCOS Program Office and future directions for technology maturation. The PATR captures the technology needs as identified by the astrophysics community. The Technology Management Board established rankings for the technology needs. The priorities are intended to serve as the recommendation from the PCOS Program Office to NASA HQ for future technology investments to optimally serve Program goals.

This report is produced annually and reflects the continuing changes in the landscape of scientific needs and their requisite technologies, incorporating novel developments to allow for the dynamic nature of the field. The PCOS Program Office annual activities, leading to the release of the PATR, provide a continuity of overall vision and process for strategic purposes, while retaining the flexibility to adapt tactically to new opportunities. This report tracks the status annually of all technologies being matured to serve Program goals and identifies the next generations of technologies to be developed.

The Program Office will continue to interact with the broad scientific community—through the PhysPAG, its workshops, at public conferences, and via public outreach activities—to identify and incorporate the community's ideas about new science and new technology needs in a sustained process. The PCOS Program Office welcomes continued feedback from the community in developing the 2013 Program Annual Technology Report.

For more information about the PCOS Program, its Program activities, or to provide feedback, please visit: <http://pcos.gsfc.nasa.gov/>.

This page left blank intentionally

6 Acronyms

ACTOAdvanced Concepts and Technology Office
ADCAnalog-to-Digital Converter
AGNActive Galactic Nuclei
ALDAtomic Layer Deposition
APRAAstronomy and Physics Research and Analysis
ASICApplication Specific Integrated Circuit
ATHENAAdvanced Telescope for High-Energy Astrophysics
AXSIOAdvanced X-ray Spectroscopic Imaging Observatory
BESSYBerliner Elektronenspeicherring-Gesellschaft für Synchrotronstrahlung
CAT XGSCritical Angle Transmission X-ray Grating Spectrometer
CCDCharge-coupled Device
CDACentroid Detector Assembly
CDMCode Division Multiplexing
CMBCosmic Microwave Background
CMMCoordinate Measuring Machine
CMOSComplementary Metal-Oxide Semiconductor
CORCosmic Origins
CSTCommunity Science Team
CTECoefficient of Thermal Expansion
ddrDelta-Delta-Radius
DFBDistributed Feedback
DRIEDeep Reactive Ion Etching
eLISAevolved Lisa Interferometer Space Antenna
ECLExternal Cavity Laser
EPEExtreme Physics Explorer
ESAEuropean Space Agency
FACAFederal Advisory Committee Act
FEMFinite Element Model
FPAFocal Plane Assembly
FWHMFull Width Half Maximum
FYFiscal Year
GRACE-IIGravity Recovery and Climate Experiment Follow-on mission
GSFCGoddard Space Flight Center
HEROHigh Energy Replicated Optics
HETGSHigh-Energy Transmission Grating Spectrometer
HPDHalf-power Diameter
HQHeadquarters
IMSInterferometric Measurement System
IXOInternational X-ray Observatory
JEM-EUSOJapanese Experiment Module-Extreme Universe Space Observatory
JPLJet Propulsion Laboratory
JUICEJupiter Icy Moons Explorer
LIMASLISA Instrument Metrology and Avionics System
LISALaser Interferometer Space Antenna
LTPLong Trace Profilometer
MITMassachusetts Institute of Technology
MKIMIT Kavli Institute

MKIDsMicrowave Kinetic Inductance Detectors
MSFCMarshall Space Flight Center
N-CAL.Notional Calorimeter X-ray Mission XMS
NGONew Gravitational-wave Observatory
NISTNational Institute of Standards and Technology
NPRONon-planar Ring Oscillator
NRCNational Research Council
NWNH.	“New Worlds, New Horizons in Astronomy and Astrophysics,” a report released by the National Research Council in 2010
OCTOffice of the Chief Technologist
OUOpen University
PATR.Program Annual Technology Report
PCOSPhysics of the Cosmos
PECVDPlasma-Enhanced Chemical Vapor Deposition
PhysPAGPhysics of the Cosmos Program Analysis Group
POProgram Office
PSA.Point Source Assembly
PTBPhysikalisch Technische Bundesanstalt
QEQuantum Efficiency
RF.Radio Frequency
RFIRequest for Information
RFP.Request for Proposal
RGSReflection Grating Spectrometer
RIN.Relative Intensity Noise
RMSRoot Mean Square
RTF.Roman Technology Fellowship
SAHARASpectral Analysis with High Angular Resolution Astronomy
SAOSmithsonian Astrophysical Observatory
SAT.Strategic Astrophysics Technology
SBIR.Small Business Innovative Research
SEMScanning Electron Microscope
SEMScanning Electron Microscope
SGOSpace-based Gravitational-wave Observatory
SMART-XSquare Meter, Arcsecond Resolution X-ray Telescope
SNRSignal to Noise Ratio
SOI.Silicon-on-Insulator
SQUIDSuperconducting Quantum Interference Device
SR&TSupporting Research and Technology
TDI.Time Domain Interferometry
TDM.Time-Division Multiplexing
TechSAG.Technology Science Analysis Group
TES.Transition-Edge Sensor
TMBTechnology Management Board
TRL.Technology Readiness Level
WFIRST.Wide-Field Infrared Survey Telescope
WHIM.Warm-Hot Intergalactic Medium
WHIMexWarm-Hot Intergalactic Medium Explorer
XGSX-ray Grating Spectrometer
XMM.X-ray Multi-mirror Mission
XMSX-ray Microcalorimeter Spectrometer

Chemical Elements

BeBeryllium
Bi/AuBismuth Gold
BOXBuried Oxide
CCarbon
FeIron
KOHPotassium Hydroxide
Mo/AuMolybdenum Gold
NNitrogen
NB/SiO ₂ /NBNiobium/Silicon Oxide/Niobium
NeNeon
Ni/CoNickel/Cobalt
OOxygen
PMNLead Magnesium Niobate
SiSilicon
SiCSilicon Carbide

Units

arcsecarcseconds
cmcentimeters
cm ²square centimeters
CCelsius
Ddiameter
eVelectron volt
ffrequency
GHzGigahertz
Hzhertz
kthousand
keVkiloelectron volt
kgkilogram
kHzkilohertz
KKelvin
mmeters
m ²square meters
MHzmegahertz
mKmilli-Kelvin
mmmillimeters
mm ²square millimeters
nmnanometers
nsnanoseconds
nWnanowatts
pmpicometer
pWpicowatts
sseconds
μmmicron (micrometer)
Wwatt

