

**WFIRST-AFTA Update  
Presentation to the  
NAC Science Committee**

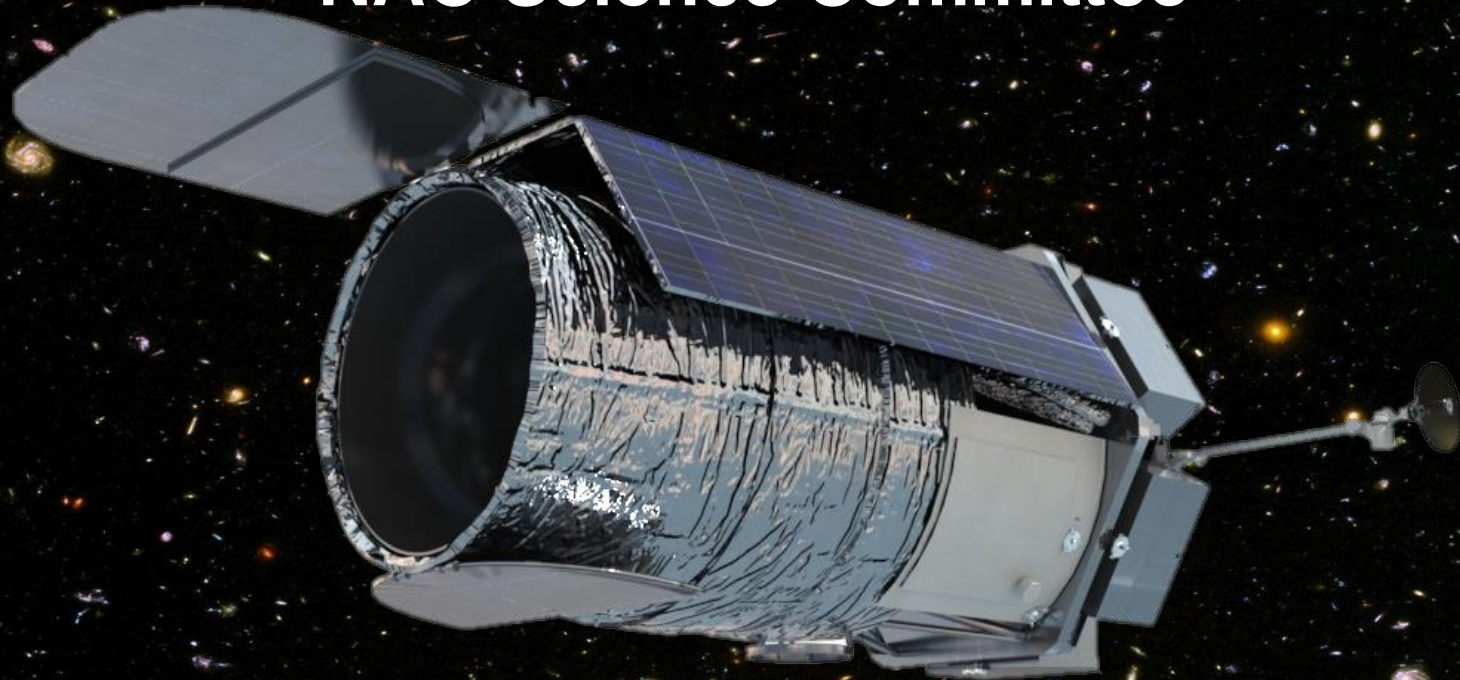

**Neil Gehrels (NASA-GSFC)  
WFIRST Study Scientist**

April 8, 2015

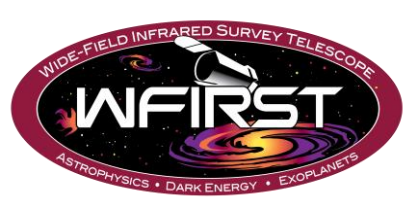

# WFIRST-AFTA SDT



## Co-Chairs

- David Spergel, Princeton University
- Neil Gehrels, NASA GSFC

## Members

- Charles Baltay, Yale University
- Dave Bennett, University of Notre Dame
- James Breckinridge, California Institute of Technology
- Megan Donahue, Michigan State University
- Alan Dressler, Carnegie Institution for Science
- Scott Gaudi, Ohio State University
- Tom Greene, NASA ARC
- Olivier Guyon, Steward Observatory
- Chris Hirata, Ohio State University
- Jason Kalirai, Space Telescope Science Institute
- Jeremy Kasdin, Princeton University
- Bruce Macintosh, Stanford University
- Warren Moos, Johns Hopkins University

- Saul Perlmutter, University of California Berkeley
- Marc Postman, Space Telescope Science Institute
- Bernie Rauscher, NASA GSFC
- Jason Rhodes, NASA JPL
- Yun Wang, IPAC/Cal Tech
- David Weinberg, Ohio State University

## Ex Officio

- Dominic Benford, NASA HQ
- Mike Hudson, Canadian Space Agency
- Woong-Seob Jeong, Korea Astronomy and Space Science Institute
- Yannick Mellier, European Space Agency
- Wes Traub, NASA JPL
- Toru Yamada, Japan Aerospace Exploration Agency

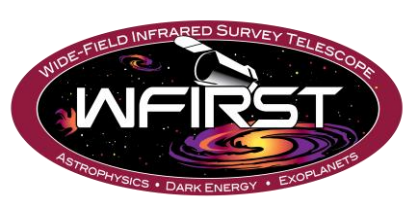

# Discovery Science



- Highest ranked large space mission in 2010 US Decadal Survey
- Use of 2.4m telescope enables
  - Hubble quality imaging over 100x more sky
  - Imaging of exoplanets with  $10^{-9}$  contrast with a coronagraph

## Dark Energy

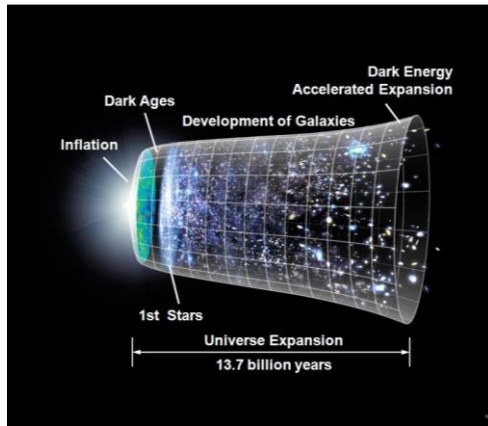

## Exoplanets

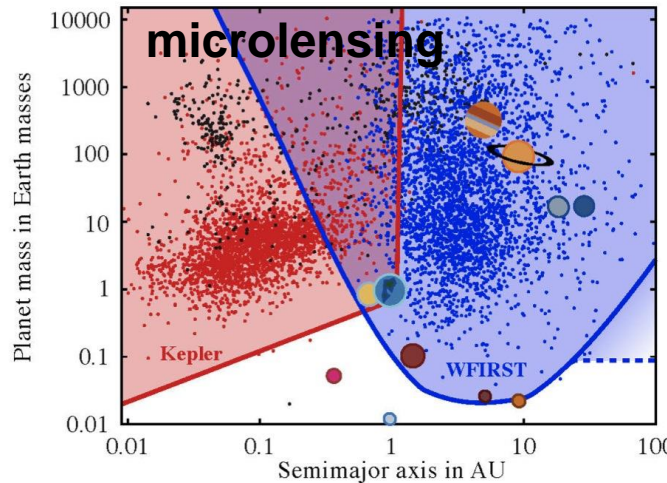

coronagraph

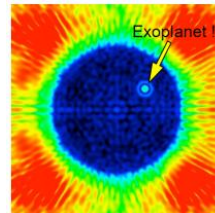

## Astrophysics



HST

WFIRST

# Gravitational Lensing

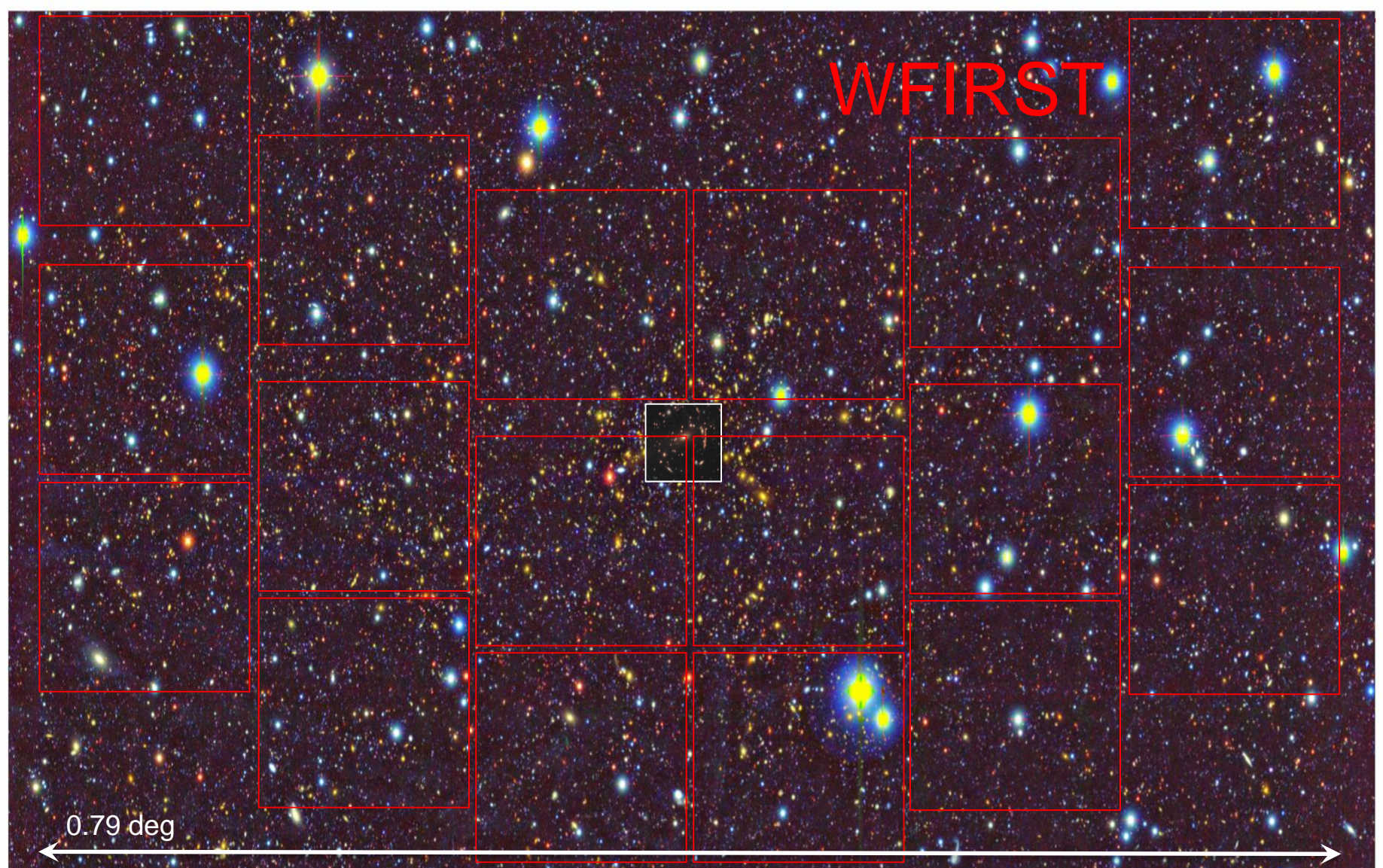

- Huge progress on WFIRST this year
- \$106M in FY14 & 15 has enabled major steps forward
  - H4RG detector development
  - Coronagraph development
  - Design cycles, Project work
- SDT 2014 study completed
- ROSES community studies
- Pasadena conference held
- Special session at AAS
- ExoPAG, COPAG, PhysPAG
- **Exciting times for WFIRST**

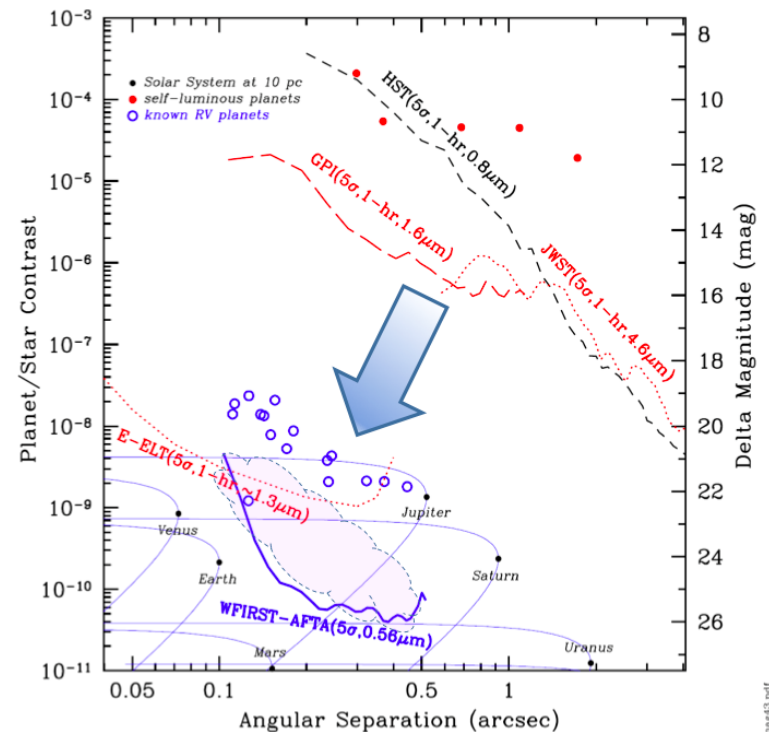

# WFIRST-AFTA Science

*complements  
Euclid*

**BARYON ACOUSTIC  
OSCILLATIONS**

**GRAVITATIONAL  
LENSING**

**LEGACY SCIENCE  
WITH SURVEYS**

*complements  
LSST*

**SUPERNOVAE**

*complements  
Kepler*

**MICROLENSING  
CENSUS**

**CORONAGRAPHY**

**GUEST  
OBSERVER  
PROGRAM**

*continues  
Great  
Observatory  
legacy*

## Supernova Survey

wide, medium, & deep imaging  
+  
IFU spectroscopy

2700 type Ia supernovae  
 $z = 0.1-1.7$



standard candle distances  
 $z < 1$  to 0.20% and  $z > 1$  to 0.34%

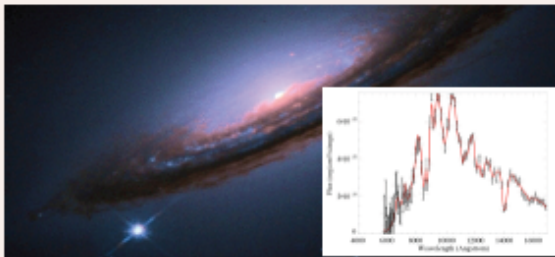

## High Latitude Survey

spectroscopic: galaxy redshifts  
20 million H $\alpha$  galaxies,  $z = 1-2$   
2 million [OIII] galaxies,  $z = 2-3$

imaging: weak lensing shapes  
500 million lensed galaxies  
40,000 massive clusters



### standard ruler

distances	expansion rate
$z = 1-2$ to 0.4%	$z = 1-2$ to 0.72%
$z = 2-3$ to 1.3%	$z = 2-3$ to 1.8%

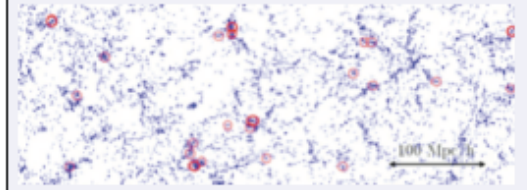

### dark matter clustering

$z < 1$  to 0.16% (WL); 0.14% (CL)  
 $z > 1$  to 0.54% (WL); 0.28% (CL)  
1.2% (RSD)

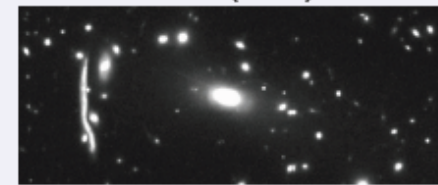

history of dark energy  
+  
deviations from GR

$w(z)$ ,  $\Delta G(z)$ ,  $\Phi_{REL}/\Phi_{NREL}$

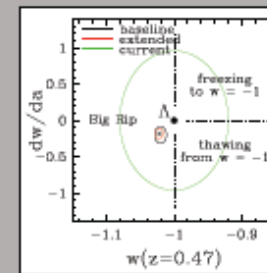

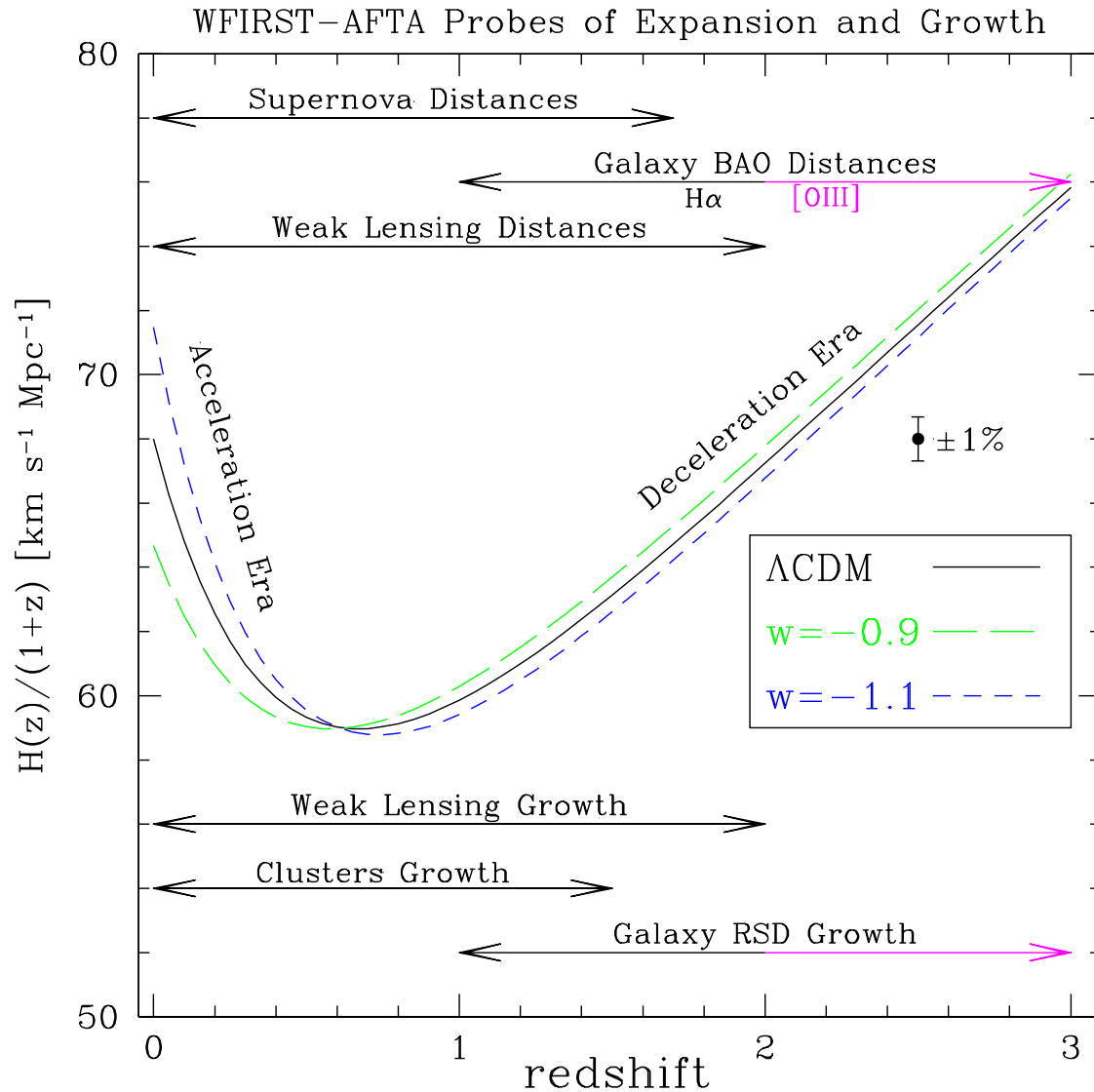



# Redshift Surveys

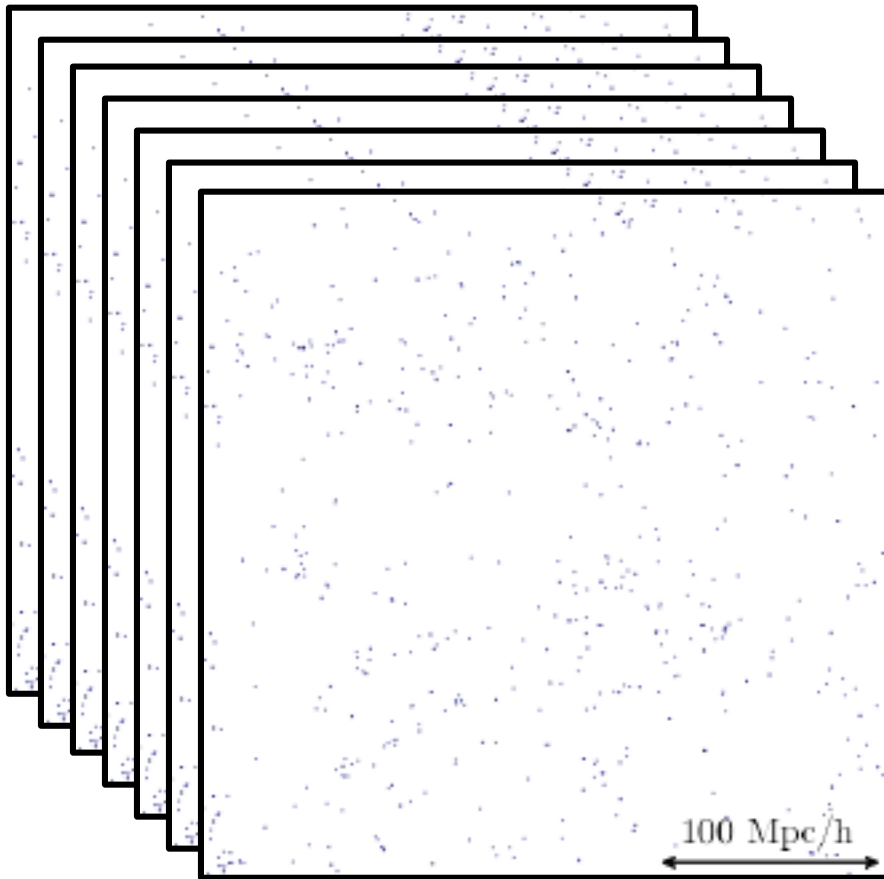

**Euclid**

**15,000 deg<sup>2</sup> @ 1700 gal/deg<sup>2</sup>**

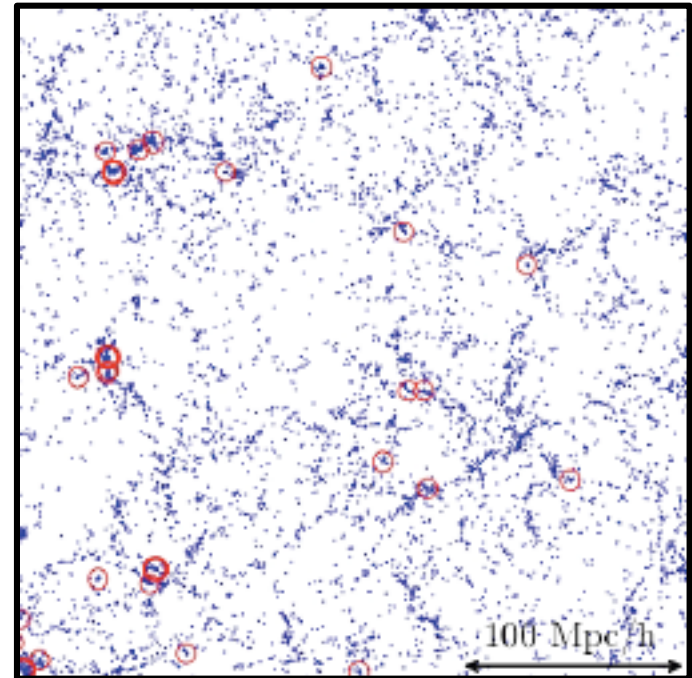

**WFIRST**

**2,050 deg<sup>2</sup> @ 12,600 gal/deg<sup>2</sup>**

*Large scale structure simulations from 2013 SDT Report – courtesy of Ying Zu*

# Microlensing Technique

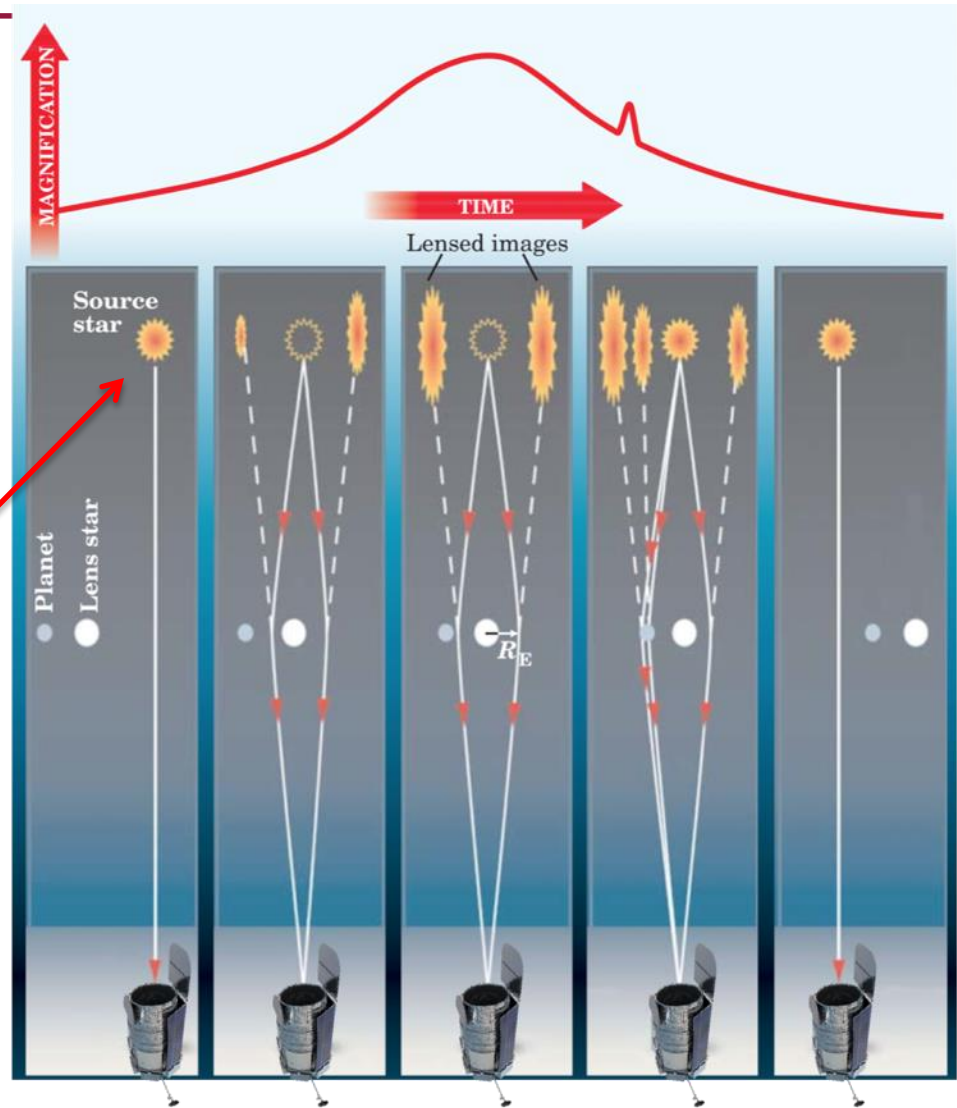
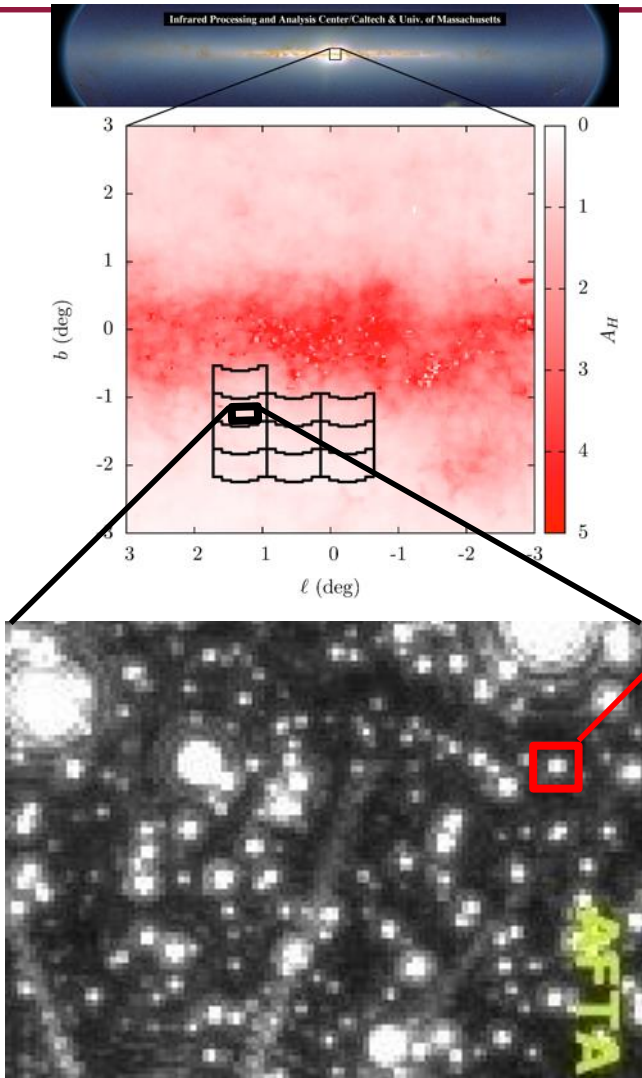

Great benefit of space observations in the crowded galactic bulge field

# Completing the Statistical Census of Exoplanets



Combined with space-based transit surveys, WFIRST-AFTA completes the statistical census of planetary systems in the Galaxy.

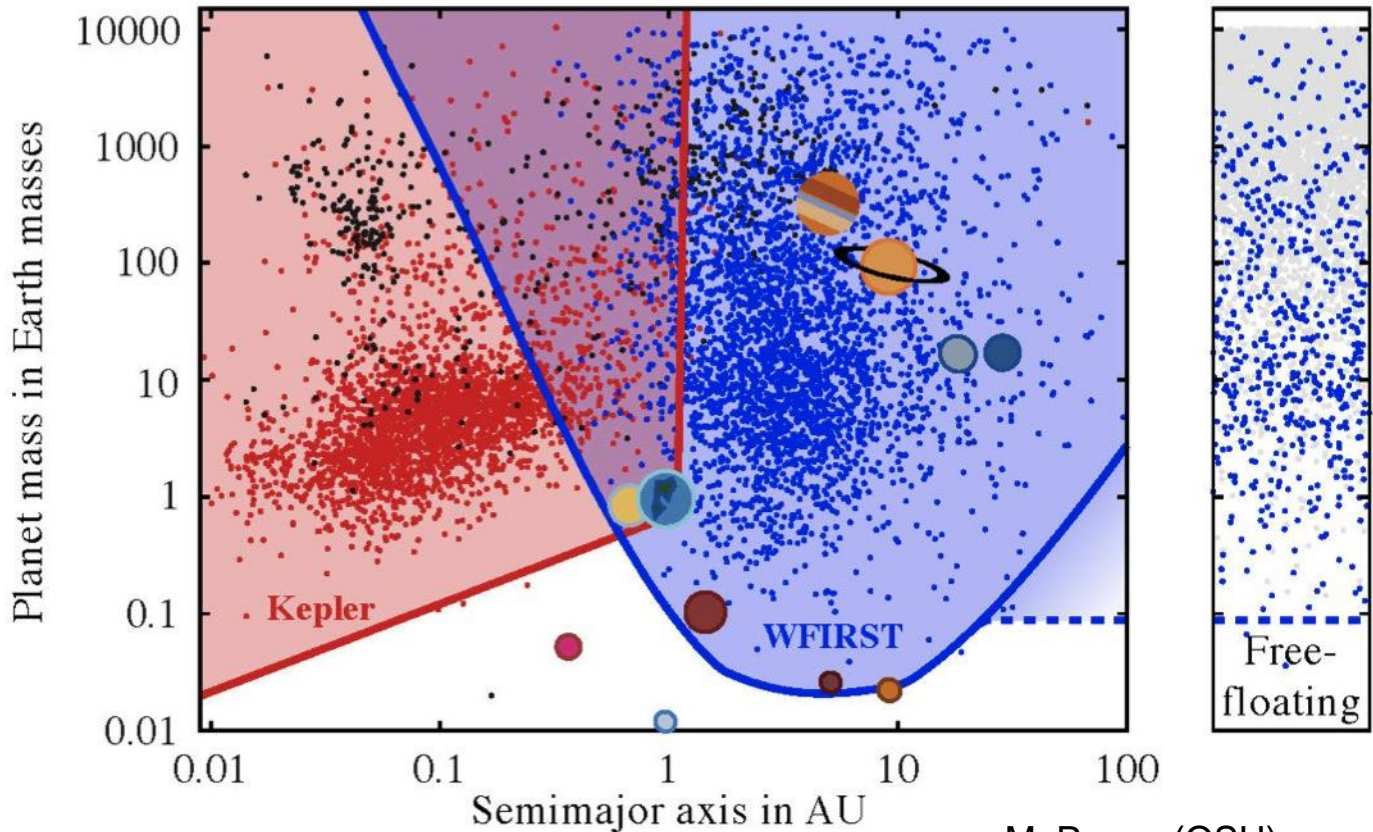

M. Penny (OSU)

# Completing the Statistical Census of Exoplanets



Combined with space-based transit surveys, WFIRST-AFTA completes the statistical census of planetary systems in the Galaxy.



WFIRST perfectly complements Kepler, TESS, and PLATO.

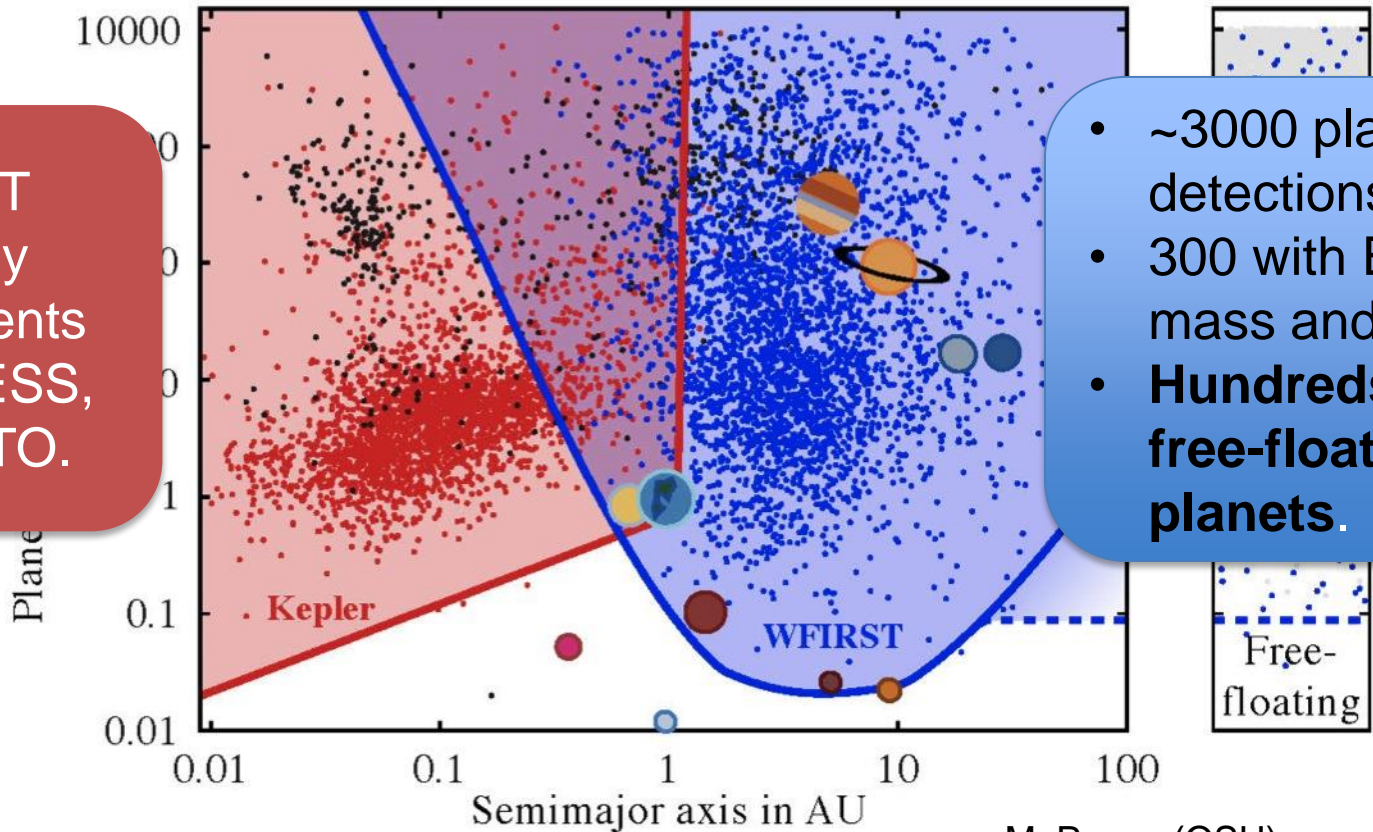

- ~3000 planet detections.
- 300 with Earth mass and below.
- **Hundreds of free-floating planets.**

M. Penny (OSU)

# Huge Dynamic Range

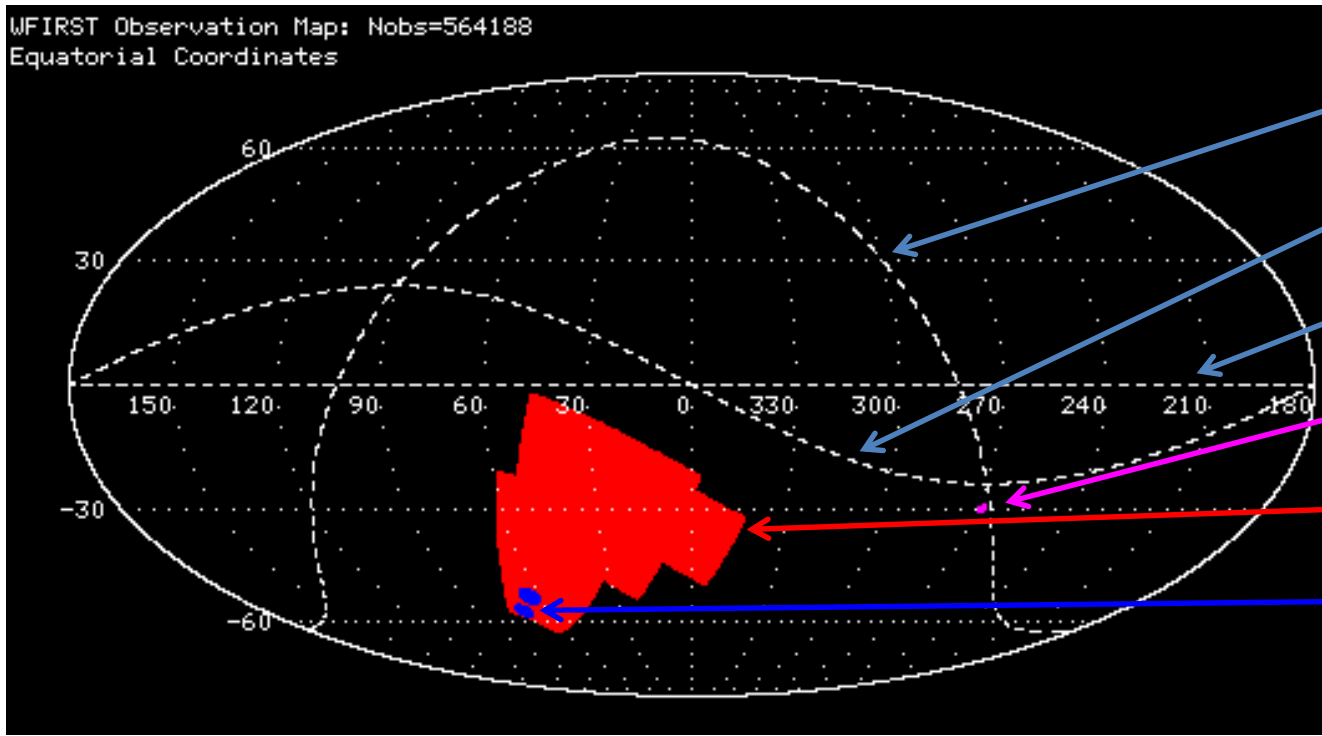

Galactic Plane

Ecliptic Plane

Celestial Equator

Microlensing Fields

High-Latitude Survey Area

SN Fields

100 deg

$\sim 10^6$  dynamic range in size  
 $\sim 2 \times 10^{12}$  resolution elements in HLS

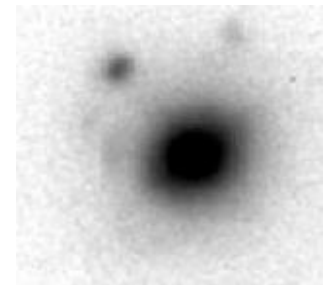

0.1 arcsec

## Weak Lensing (2200 deg<sup>2</sup>)

- High angular resolution
- Galaxy shapes in IR
- 380 million galaxies
- Photo-z redshifts
- 4 imaging filters

## Supernovae

- High quality IFU spectra
- 5 day sampling of light curves
- 2700 SNe

## Redshift survey (2200 deg<sup>2</sup>)

- BAO & Redshift Space Distortions
- High number density of galaxies
- 16 million galaxies

Sensitivities of LSST, WFIRST, and Euclid

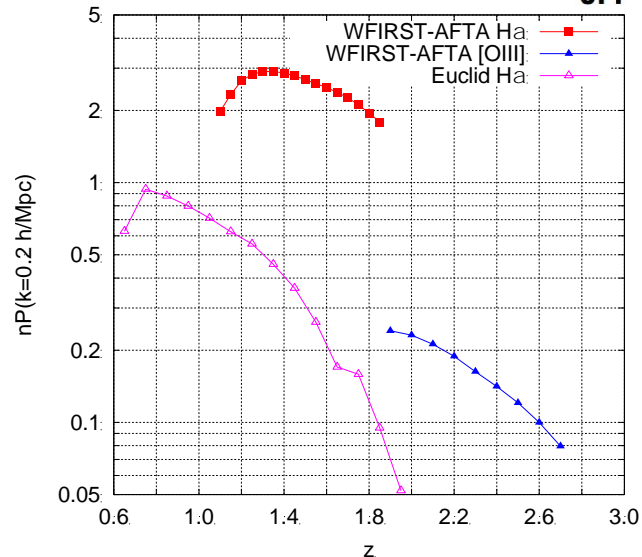
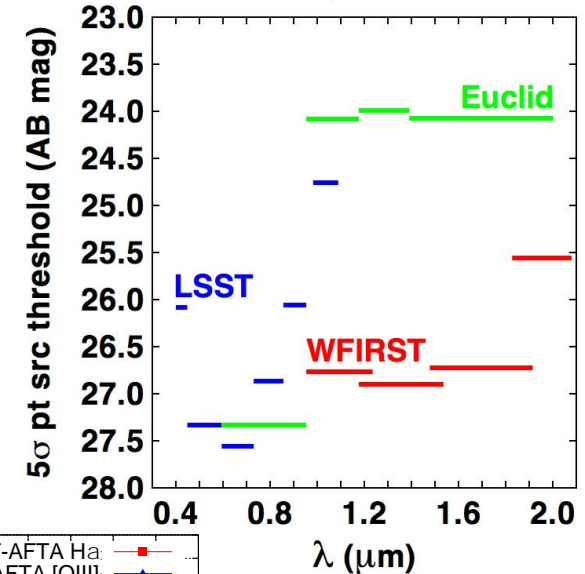

# WFIRST-AFTA Brings Humanity Closer to Characterizing exo-Earths

- WFIRST-AFTA advances many of the key elements needed for a coronagraph to image an exo-Earth
  - ✓ Coronagraph
  - ✓ Wavefront sensing & control
  - ✓ Detectors
  - ✓ Algorithms

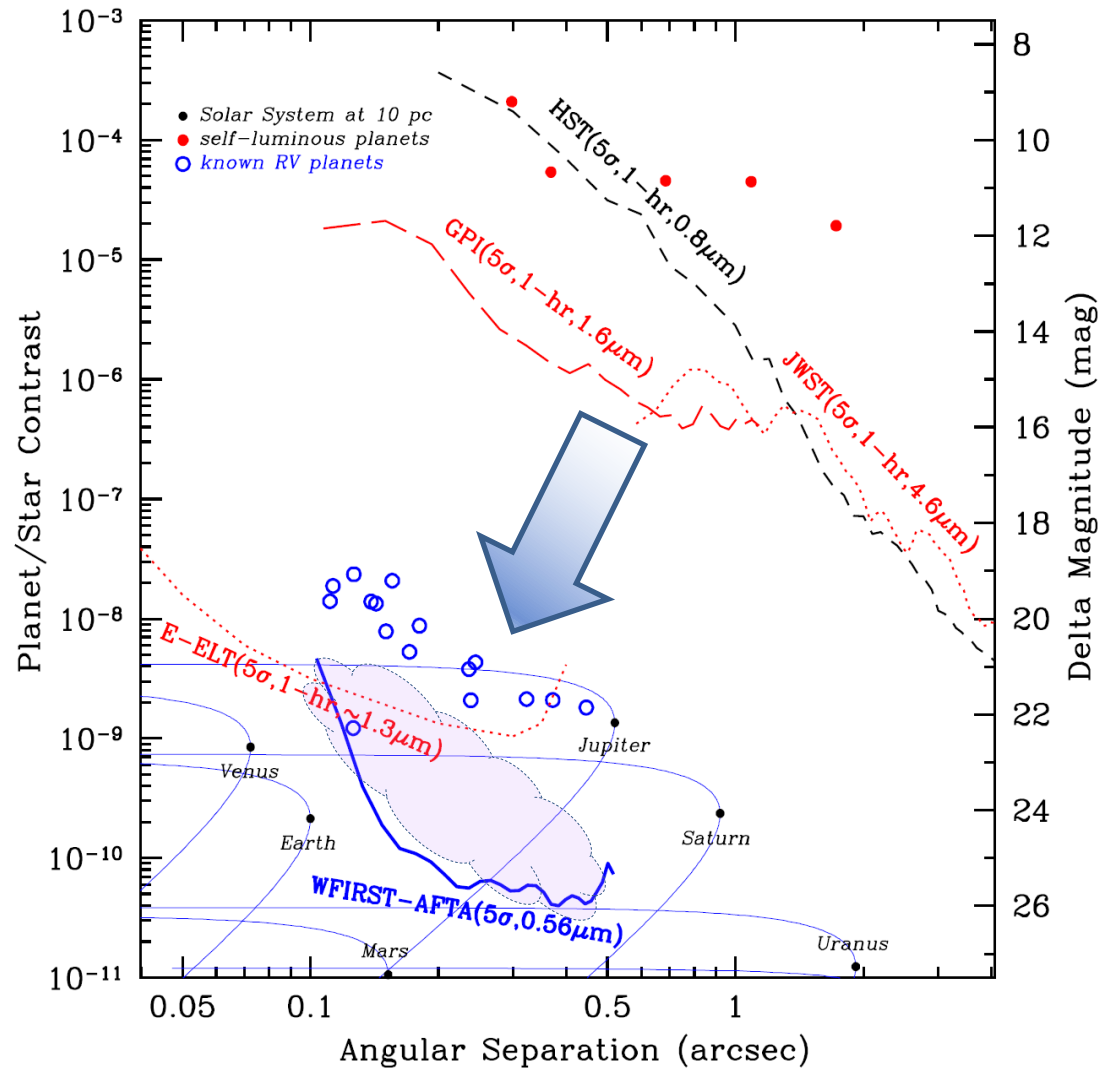

# Exoplanet Yield Estimates

	Giants (4-15 $R_E$ )	Sub-Neptunes (2-4 $R_E$ )	Super-Earths (1-2 $R_E$ )	Total
<b>Known RV Studies*</b>	16	0	0	16
<b>180-day Blind Search</b>	2	6	4	12
<b>Total**</b>	18	6	4	28

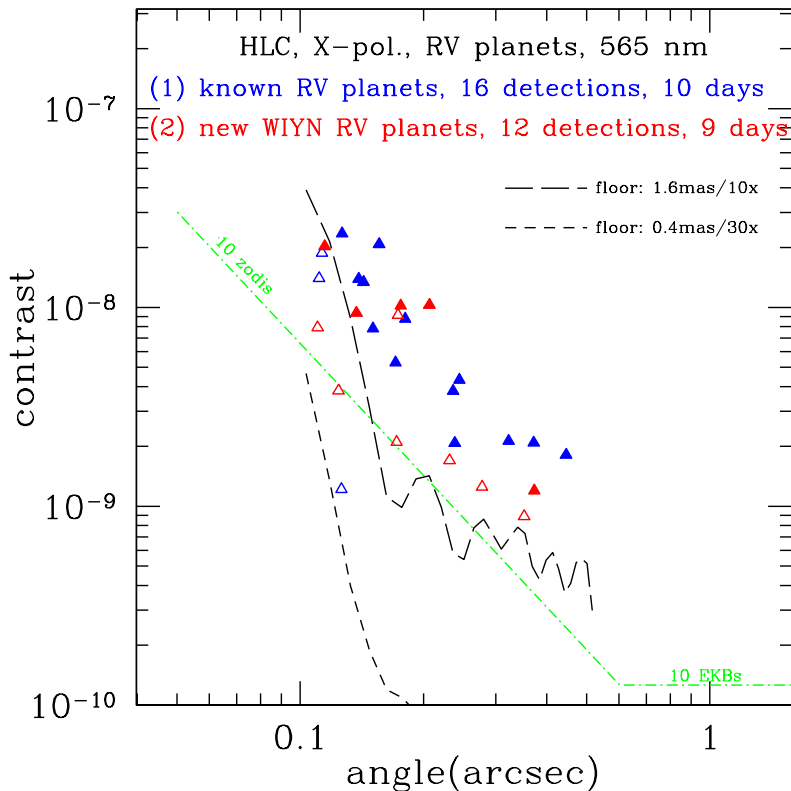

yrr190bhc0x-x-RV-2.pdf

\* RV yield will be augmented by the WIYN program for future RV observations  
 \*\* Yield assumes 0.4 jitter and 30x speckle attenuation

**New detections of (1) known RV exoplanets & (2) new exoplanets to be found with the aid of WIYN RV observations**



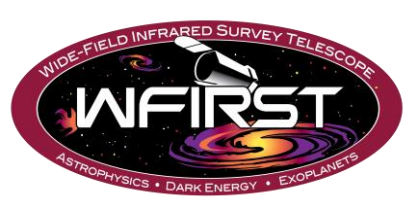

# 25% of WFIRST is GO Time



## Frequently discussed

#1 Large-Scale Priority - Dark Energy, Exoplanets

#1 Medium-Scale Priority - New Worlds Tech. Development  
(prepare for 2020s planet imaging mission)

## WFIRST covers many other NWNH science goals

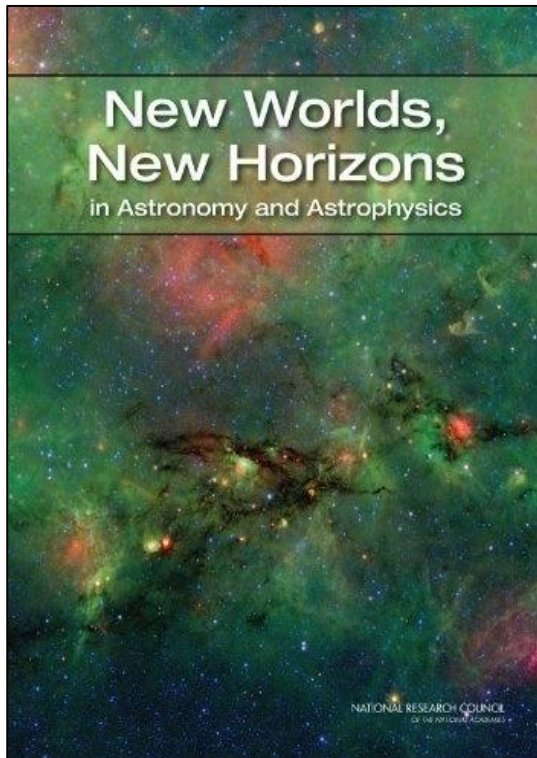

### 5 Discovery Science Areas

- ID & Characterize Nearby Habitable Exoplanets ✓
- Time-Domain Astronomy ✓
- Astrometry ✓
- Epoch of Reionization ✓
- Gravitational Wave Astrometry

### 20 Key Science Questions

- Origins (**7/7 key areas**)
- Understanding the Cosmic Order (**6/10 key areas**)
- Frontiers of Knowledge (**3/4 key areas**)

# Galaxy Luminosity Function

WFIRST's High-Latitude Survey will yield up to 2 orders of magnitude more high redshift galaxies than currently known

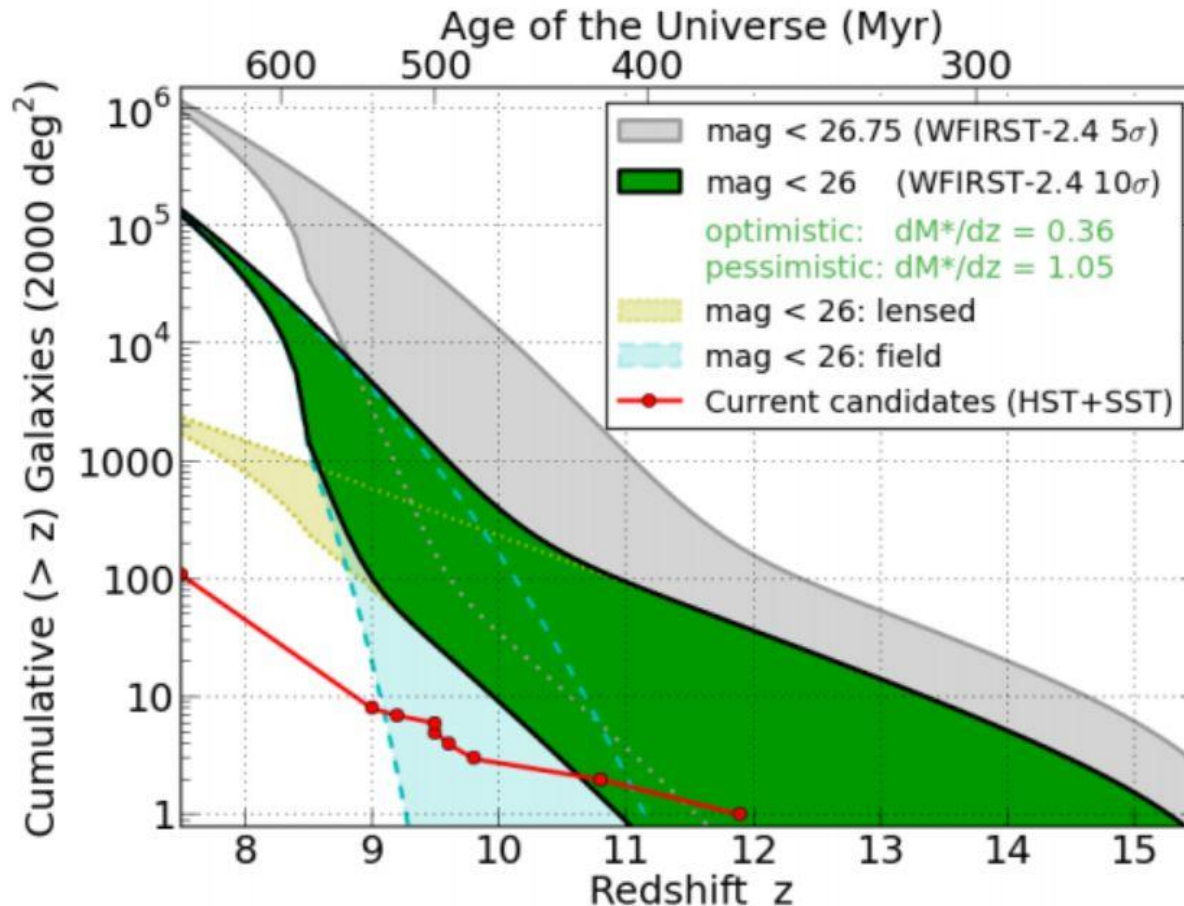

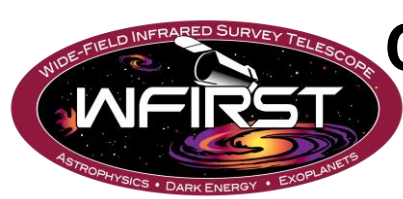

# Community Members that Submitted 1-page Descriptions of Potential GO Science Programs in the 2013 SDT Report



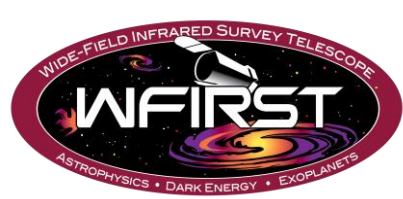

# Data Rights Considerations

---

- Standard of 1 year proprietary time for all data is probably no longer acceptable to NASA or the community
- WFIRST-AFTA wide field imager has wide FoV that makes proprietary data difficult
- Different science areas for WFIRST-AFTA have different data needs and processing requirements.
- An open data policy such as that of LSST and Fermi LAT may be the natural fit for most or all of the WFIRST-AFTA data
- Rapid public access to broad-use survey data has been demonstrated to maximize scientific output.
- Will the 1 year of coronagraph science be determined by a selected science team or by GOs or by a combination?

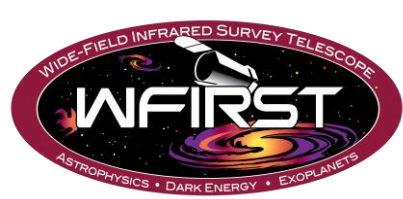

# Interests by Foreign Groups for Potential Contributions



- Japan
  - WFI: Could provide coordinated ground-based observations (wide and deep spectroscopy and deep optical imaging) and microlensing/galactic bulge science imaging processing pipeline & precursor ground observations
  - CGI: Interested in a polarization module, mask fabrication, analysis/algorithm support, PIAA module
- Canada
  - Strong science interest in SN and WL surveys as well as coronagraphy
  - WFI: Interested in the IFU, FGS, photometric calibration (pre-flight or flight), UV/blue wide-field instrument
  - CGI: Interested in the IFS, EMCCDs, LOWFS, filter/mask wheels, data reduction pipeline, data processing, and archiving
- UK and Europe
  - WFI: Interested in the IFU and opto-mechanical systems and associated electronics, ground processing of spectroscopy data, image/data processing and analysis pipeline, lenses and mounts, and calibration hardware
  - CGI:
    - Expertise in flight instruments, high contrast test bed for testing coronagraphs and post-coronagraphic techniques and detector technology
    - Interested in LOWFS design, optical element, CCDs and associated camera
- Korea
  - No formal statement in the report, discussions are at the very early stages, but strong interest & possible funding, likely centered around the HgCdTe detectors

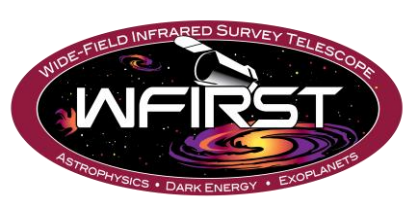

---

# Observatory Overview

# WFIRST Instruments

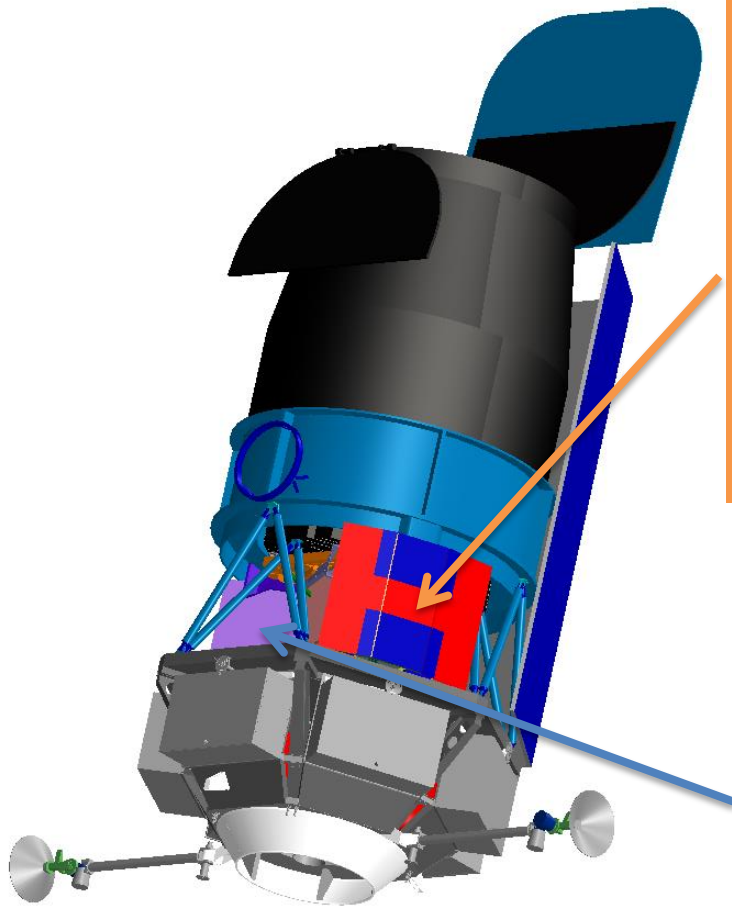

## Wide-Field Instrument

- *Imaging & spectroscopy over 1000s of sq. deg.*
- *Monitoring of SN and microlensing fields*
- 0.7 – 2.0 (2.4) micron bandpass
- 0.28 deg<sup>2</sup> FoV (100x JWST FoV)
- 18 H4RG detectors (288 Mpixels)
- 6 filter imaging, grism + IFU spectroscopy

## Coronagraph

- *Imaging of ice & gas giant exoplanets*
- *Imaging of debris disks*
- 400 – 1000 nm bandpass
- $\leq 10^{-9}$  contrast (after post-processing)
- 100 milliarcsec inner working angle at 400 nm

## Key Features

- **Telescope:** 2.4 m aperture primary mirror
- **Instruments**
  - Wide Field Imager/Spectrometer & Integral Field Unit
  - Internal Coronagraph with Integral Field Spectrometer
- **Overall Dry Mass:** 4059 kg (CBE)
- **Structure:** high stiffness composites; modular packaging for avionics
- **GN&C/Propulsion:** inertial pointing, 3-axis stabilized, mono-prop system for stationkeeping & momentum unloading
- **Data Downlink Rate:** Continuous 600 Mbps Ka-band to dedicated ground station
- **C&DH:** low rate bus for housekeeping and spacecraft control, high speed bus for science data
- **Power:** ~2400 W average power (CBE)
- **GEO orbit**
- **Launch Vehicle:** Delta IV Heavy
- **GSFC:** leads mission, wide field instrument, spacecraft
- **JPL:** leads telescope, coronagraph

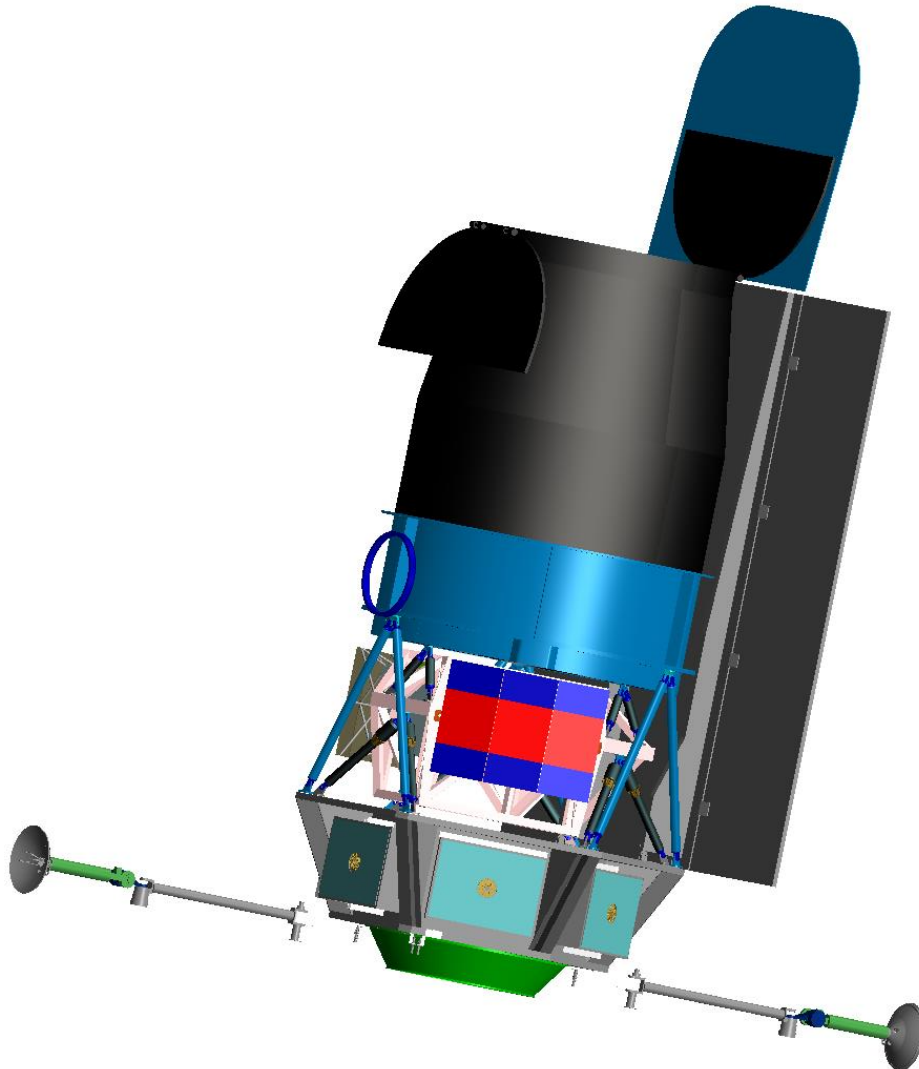



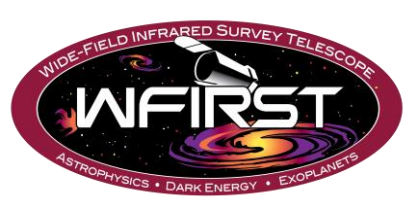

# Payload Design to Minimize Telescope Risk



- Exelis/JPL/Study Office have worked closely to understand the structural capability of the telescope aft metering structure.
- Current design with the instrument carrier as the interface between the spacecraft and the payload provides substantial margin at the qualified telescope interfaces.
  - Instrument carrier is the prime optical bench for the payload, telescope and both instruments are attached to it.
- Telescope operating temperature baseline is 282 K and is within the qualification limits of the heritage program.
- Electronics and actuators that are not available will use the latest designs from the Exelis product lines.

## Key Features

- Wide field channel instrument for both imaging and spectroscopy
  - 3 mirrors, 1 powered
  - 18 4k x 4k HgCdTe detectors cover 0.76 - 2.0  $\mu\text{m}$
  - 0.11 arc-sec plate scale
  - Single element wheel for filters and grism
  - Grism used for GRS survey covers 1.35 – 1.89  $\mu\text{m}$  with  $R = 461\lambda$  (~620 – 870)
- IFU channel for SNe spectra, single HgCdTe detector covers 0.6 – 2.0  $\mu\text{m}$  with  $R$  between 80-120

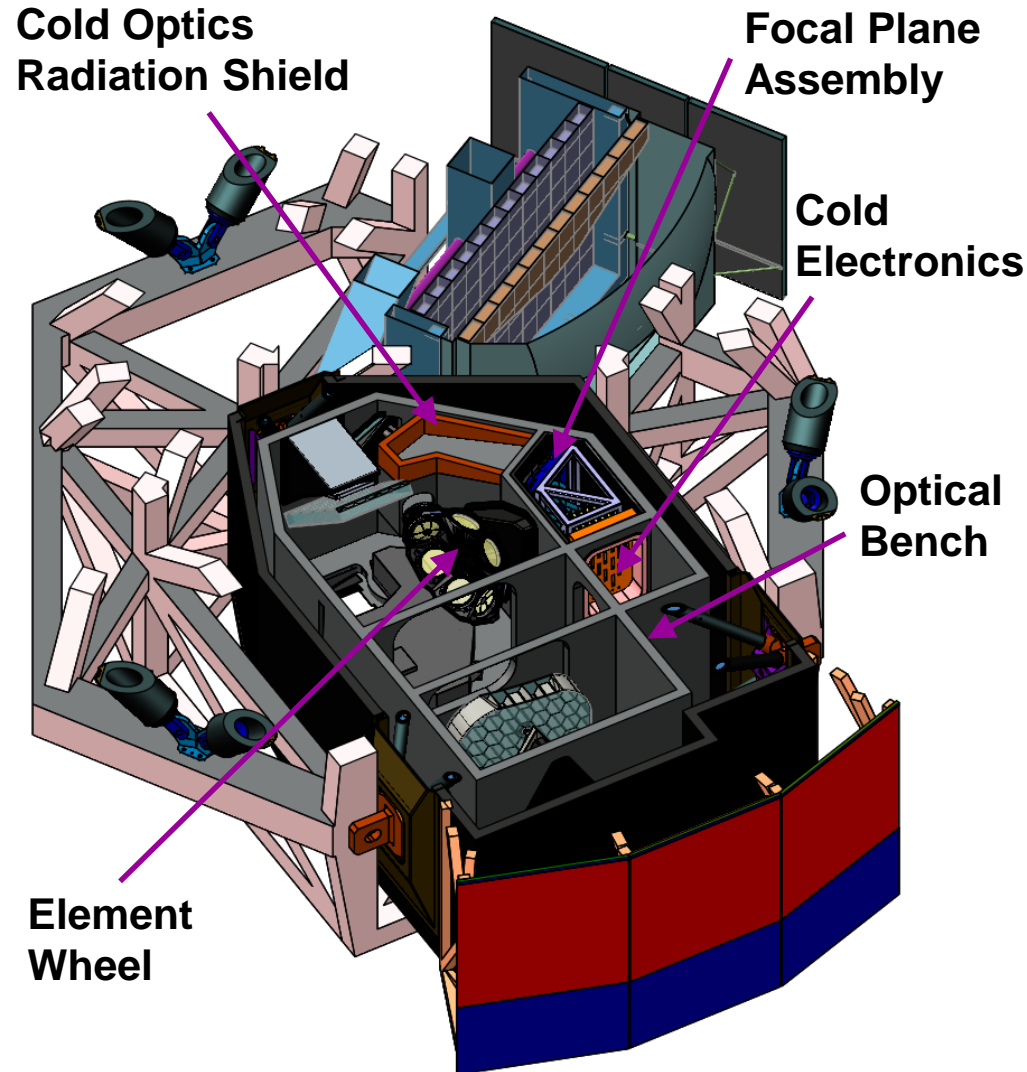

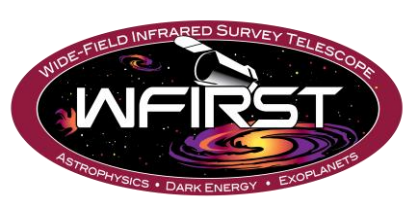

# Wide Field Detector Technology Maturation Progress



- Detector Technology Development Plan released with 5 key milestones identified to mature the HgCdTe detectors by the end of CY16.
  - First two milestones successfully completed.
- The Teledyne/GSFC Detector Team has completed a series of experiments (banded arrays) to determine the optimum detector composition for WFIRST. Full array flight composition detectors deliver this summer and will be characterized in the GSFC Detector Characterization Lab.
- The detector Read Out Integrated Circuit (ROIC) design has been optimized for WFIRST performance.
- Developed test hardware to eliminate hybridizing marginal ROICs to good detectors.
- Infrastructure – numerous investments have been made in the GSFC Detector Characterization Lab (DCL) to characterize/qualify individual detectors and test the entire focal plane

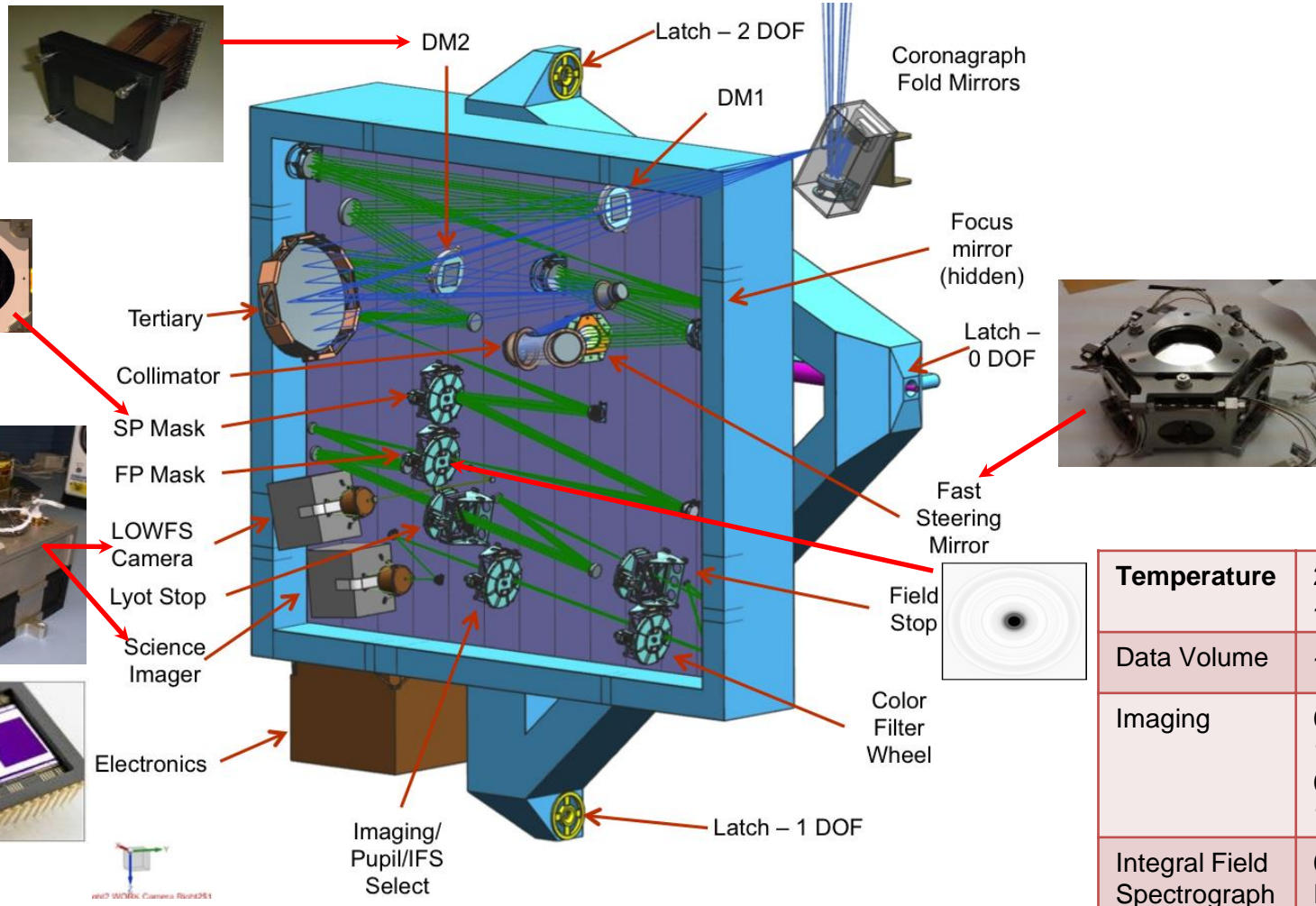

<b>Temperature</b>	293 K for instrument ~165 K for cameras
<b>Data Volume</b>	~30 Gbits/day
<b>Imaging</b>	0.43 – 0.97 microns, 1.63" FoV (radius), 0.01" pixel scale, 1Kx1K EMCCD
<b>Integral Field Spectrograph</b>	0.60 – 0.97 microns R~70

# Primary Architecture: Occulting Mask Coronagraph = Shaped Pupil + Hybrid Lyot

- SP and HL masks share very similar optical layouts
- Small increase in overall complexity compared with single mask implementation

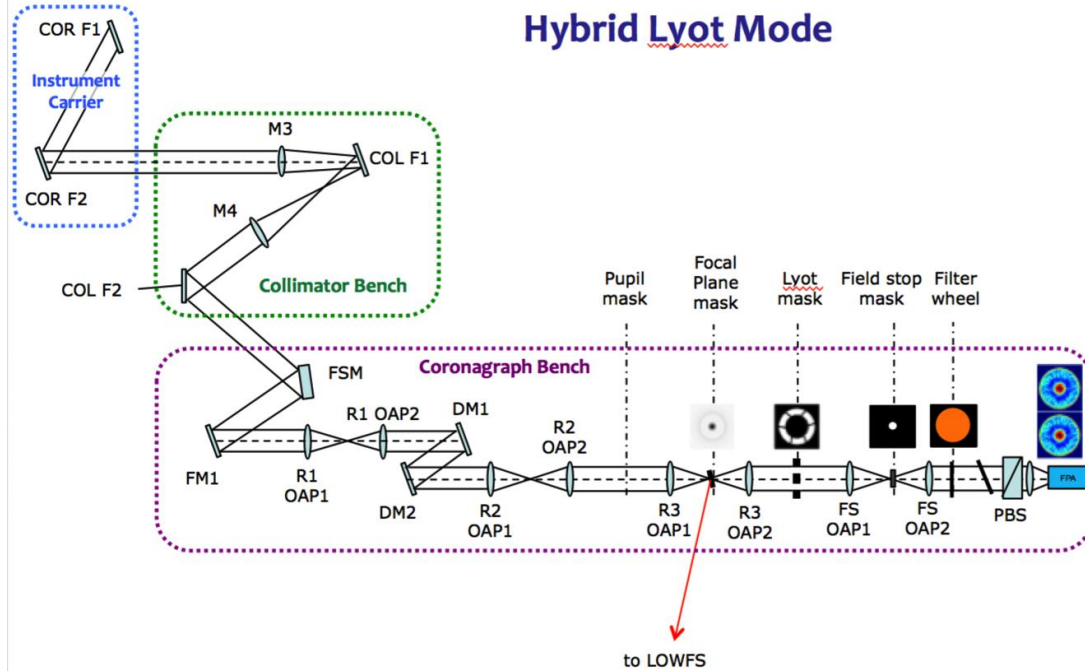
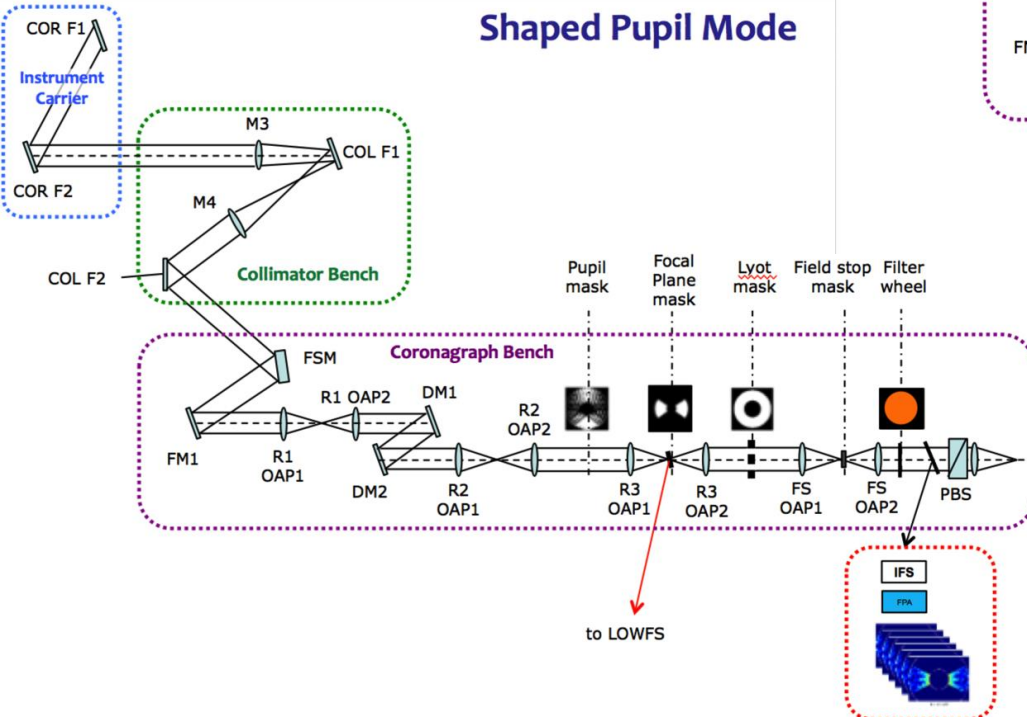

- In “SP mode” provides the simplest design, lowest risk, easiest technology maturation, most benign set of requirements on the spacecraft and “use-as-is” telescope. This translates to low cost/schedule risk which is critical for the independent CATE process.
- In “HL mode”, affords the potential for greater science, taking advantage of good thermal stability in GEO and low telescope jitter for more planet detections in a shorter time

# Coronagraph Technology Development Highlights

## Reflective shaped pupil mask

- Black Si on Al mirror coating demonstrated at JPL/MDL and Caltech/KN1
- High contrast demonstrated at HCIT

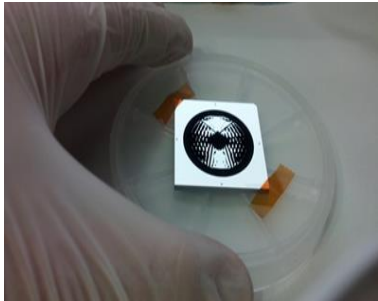

Milestone #1

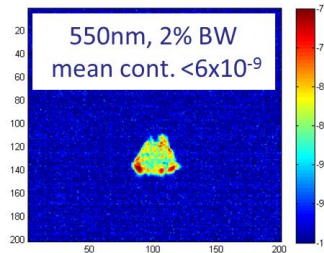

Milestone #2

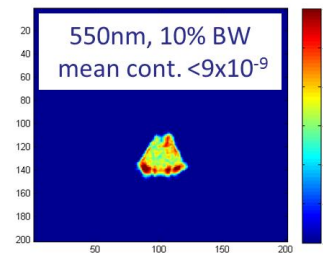

Preview of Milestone #5

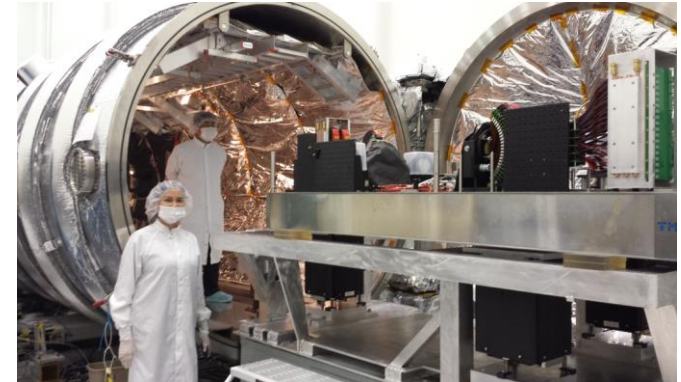

## Transmissive hybrid Lyot mask

- Circular mask fabricated and measured
- Testbed commissioned on 8/15/2014

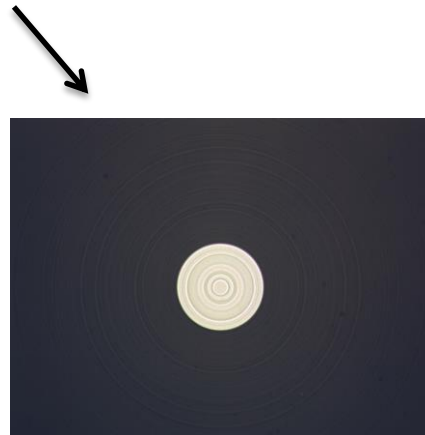
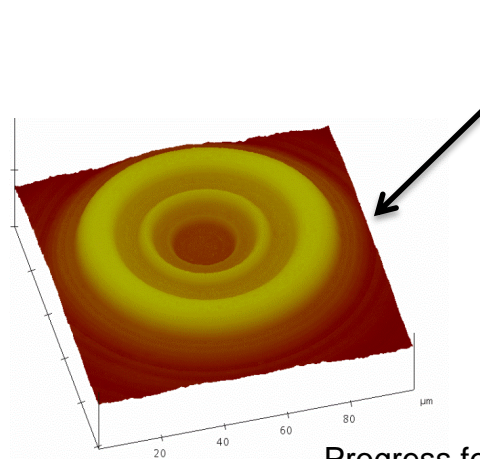

Progress for Milestone #4 to be completed this month



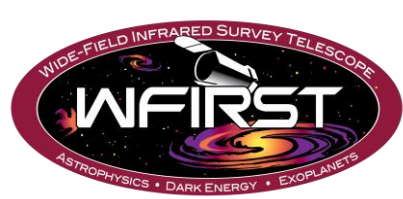

# Coronagraph Technology Maturation Progress



- High contrast testbed results have demonstrated that better than  $10^{-8}$  raw contrast is achievable with the WFIRST 2.4-m telescope.
- On track to demonstrate dynamic, broadband high contrast testbed performance during formulation.
- Significant investments in deformable mirrors, detectors, low order wavefront control, mechanisms and post-processing algorithms essential for high contrast coronagraphy.
- Developing an Integral Field Spectrograph (IFS) testbed at GSFC for delivery to JPL high contrast testbed this year.

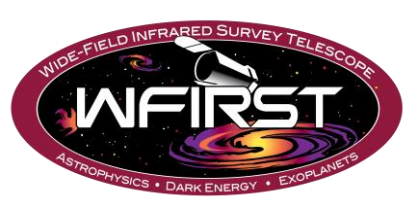

# Observatory Integrated Modeling



- Recent focus of Observatory analysis has been on integrated modeling (STOP and Jitter).
- Model fidelity is extremely high
  - Benefit of using the existing telescope
  - Required to optimize coronagraph mask designs
  - Critical for assessing PSF ellipticity for WL
- WFI STOP stability specs met with margin (10x) even for an extreme WFI Worst Slew Case w/MUFs applied
  - WFI spectroscopy and IFU modes and CGI STOP stability analysis in progress
- WFI Jitter stability specs met with margin (1.3x) for all disturbance sources even with MUFs applied
  - Modeled 4 RWAs, cryocooler and HGA jitter disturbances
  - WFI spectroscopy and IFU modes and CGI Jitter stability analysis in progress



## “Hot Off the Presses”

Initial simulations of coronagraph performance in WFIRST-AFTA environment indicate that the coronagraph is likely to achieve all performance goals with the current, unmodified telescope.

| 47 Uma -  $\beta$  Uma |

| 47 Uma - 61 Uma |

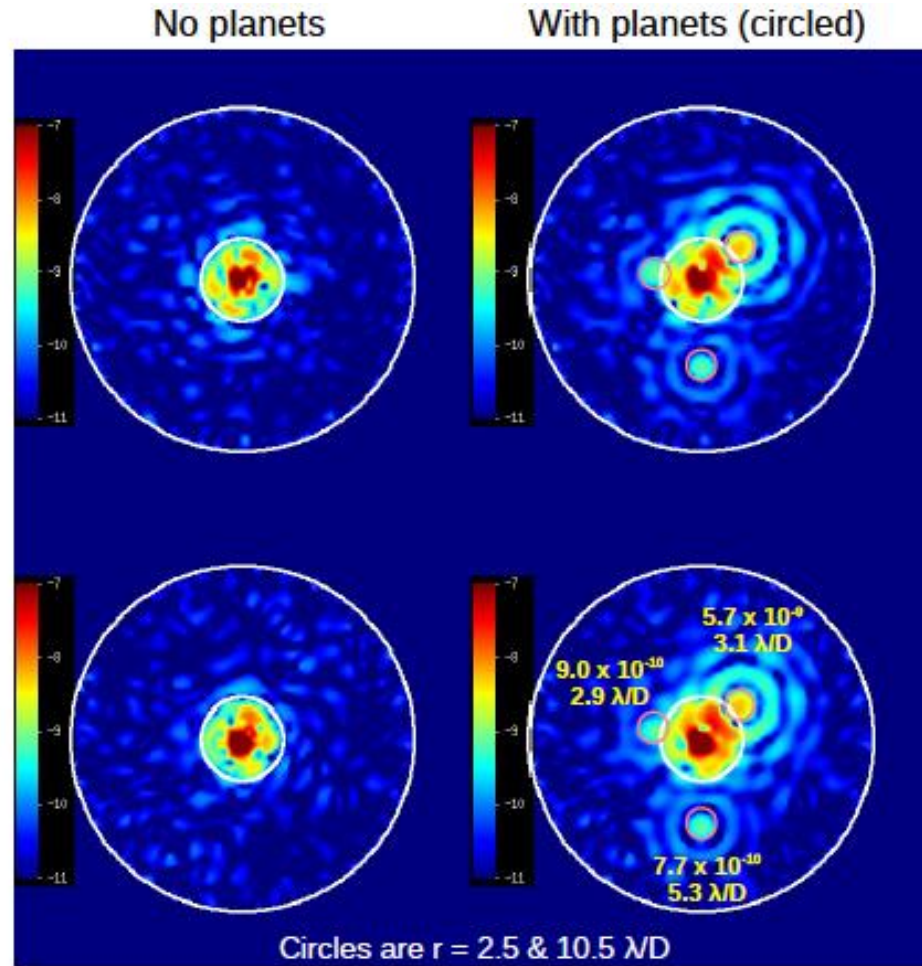

*Color differences between these stars are not important in 10% bandpass.*

Absolute differences of the mean images with DM LOWFC (1000 sec LOWFS integrations)

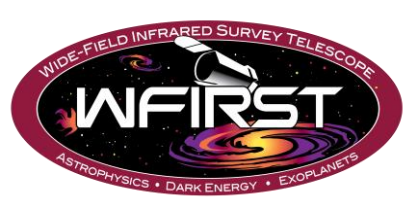

# Path Forward

- Optimization of the Reference Design
  - Study L2 mission concept and perform science/cost trade vs. GEO configuration
  - Study non-exoplanet uses for the coronagraph
  - Perform analysis to improve microlensing event rate predictions
  - Refine wide field IFU design to optimize wavelength range and resolution, and slice scale and sampling of the slices
- Systematic Error Control
  - Develop a calibration strategy
  - Characterize astrometric performance of the WFI
- Synergies with Other Observatories
  - Survey the need for precursor observations for microlensing, low z SNe and RV studies of coronagraph targets
  - Study opportunities for joint observations and requirements for joint analyses with Euclid, LSST and other ground telescopes
- Coronagraph
  - Develop more detailed coronagraph DRM
  - Perform deeper investigation of effects of coronagraph polarization and PSF subtraction
  - Assist with development of wavefront control technology
- Policy Issues
  - Consider possibilities for foreign involvement
- Observatory
  - Further refine servicing architecture and ops concept

# Summary

- Recent infusion of additional funding has allowed significant progress in technology maturation as well as additional fidelity in the design reference mission.
- WFIRST-AFTA with the 2.4-m telescope and coronagraph provides exciting science program, superior to that recommended by NWNH and also advances exoplanet imaging technology (the highest ranked medium-class NWNH recommendation).
- Great opportunity for astronomy and astrophysics discoveries. Broad community support for WFIRST.
- Key development areas are anchored in a decade of investments in JPL's HCIT and GSFC's DCL.
- Opportunity to enhance the scientific return from JWST and WFIRST if missions overlap

