

NAVIGATION

JOURNAL OF THE INSTITUTE OF NAVIGATION

Winter

2015

Volume 62

Number 4

GOVERNATION
DILA CÖPAGNIA
DILQS BELZA

GOVERNATION
DILA CÖPAGNIA
DILQS BELZA

GOVERNATION
DILA CÖPAGNIA
DILQS BELZA

THE INSTITUTE OF NAVIGATION

EXECUTIVE COMMITTEE*: 2015

President: Dorota Grejner-Brzezinska
Executive Vice President: John Raquet
Treasurer: Frank van Graas
Eastern Regional Vice President: Michael Veth
Western Regional Vice President: Gregory Turetzky
Satellite Division Chair: John Betz
Military Division Chair: Jan Anszperger
Immediate Past President: Patricia Doherty

Executive Director: Lisa L. Beaty

PAST PRESIDENTS

Colin H. McIntosh, 1945–46
Gordon C. Atwater, 1946–47
RADM C. G. McLintock, 1947–50
Paul Rosenberg, 1950–51
Capt. P. V. H. Weems, 1951–52
Samuel Herrick, 1952–53
Edwin A. Link, 1953–54
MG N. B. Harbold, 1954–55
RADM Robert W. Know, 1955–56
Giles Greville Healey, 1956–57
Vernon I. Weihe, 1957–58
Henry F. Rempt, 1958–59
Capt. Alton B. Moody, 1959–60
Capt. I. E. Rittenburg, 1960–61
Dot Lemon, 1961–62
John C. Bellamy, 1962–63
C. Towner French, 1963–65
John M. Wuerth, 1965–66
Raynor L. Duncombe, 1966–67
Gene R. Marner, 1967–68
William J. Tull, 1968–69

Maj. William L. Polhemus, 1969–70
Col. Leonard R. Sugerman, 1970–71
Thomas D. Nicholson, 1971–72
Loren E. DeGroot, 1972–73
Theodore C. Rynda, 1973–74
Alexander B. Winick, 1974–75
Lloyd J. Perper, 1975–76
BG Robert A. Duffy, 1976–77
Jeff Schmidt, 1977–78
David G. Hoag, 1978–79
P. Kenneth Seidelmann, 1979–80
Eugene O. Frye, 1980–81
Capt. Ross E. Freeman, 1981–82
Russell E. Weaver, 1982–83
Charles R. Bonham, 1983–84
David C. Scull, 1984–85
Richard A. VanderMeulen, 1985–86
Col. Gaylord B. Green, 1986–87
William J. Klepczynski, 1987–88
Eugene J. DeNezza, 1988–89
Joseph N. Portney, 1989–90

Keith D. McDonald, 1990–91
Richard L. Greenspan, 1991–92
Phillip W. Ward, 1992–93
Kenneth R. Holland, 1993–94
George Lowenstein, 1994–95
Zdzislaw "Stan" Lewantowicz, 1995–96
M. Elizabeth Cannon, 1996–97
Benjamin Peterson, 1997–98
Frank van Graas, 1998–99
Per Enge, 1999–2000
Karen Van Dyke, 2000–2001
Ron Hatch, 2001–2002
Rudy Kalafus, 2002–2003
Larry Hothem, 2003–2004
Penina Axelrad, 2004–2005
James Doherty, 2005–2007
John Lavrakas, 2007–2008
Christopher Hegarty, 2008–2009
Mikel Miller, 2009–2011
Todd Walter, 2011–2013
Patricia Doherty, 2013–2015

MEMBERS OF COUNCIL

Eastern Council Members-at-Large

Jason Rife
Sanjeev Gunawardena

Western Council Members-at-Large

Neil Gerein
John Nielson

Marine

Dana Goward
Alan Grant

Air

Michael Meurer
Thomas Pany

Space

Megan Mitchell
Oliver Montenbruck

Land

Logan Scott
Zainab Syed

Section Chairs

Keith McDonald
Gary Thomas
Mark Petovello

Herb Knierim
Todd Walter
Steve Rounds

Paul Benschhof
Thomas Pestak
Wayne Soehren

CHAIRS OF SPECIAL COMMITTEES

Technical Committee—John Raquet*
Finance—John Clark*
Awards—Terry Moore*
Meetings—Doug Taggart*
Nominating—Patricia Doherty*
Strategic Planning—John Raquet
Bylaws—Gary McGraw*
Fellow Selection—Pratap Misra*

Membership—Tim Murphy*
Publications—Boris Pervan*
Government Fellow Program—Clark Cohen
Historian—Marvin May
New Initiatives—Patricia Doherty

Listed officers and those indicated by * are members of the Council.

NAVIGATION

Editor: Boris Pervan
Associate Editors: Penina Axelrad, Richard Greenspan, Paul Groves, Christopher Hegarty, Changdon Kee, Gary McGraw, Thomas Pany, Benjamin Peterson, Mark Petovello, Jason Rife, Andrey Soloviev, and Maarten Uijt de Haag
Managing Editor: Lisa L. Beaty
Administrative Editor: Fiona Walter

NAVIGATION is indexed by Thompson Reuters in the following: Science Citation Index Expanded (also known as SciSearch®) Journal Citation Reports/Science Edition; Current Contents®/Engineering Computing and Technology.

NAVIGATION

JOURNAL OF THE INSTITUTE OF NAVIGATION

Winter 2015



VOL. 62, NO. 4

QUASI-TIGHTLY COUPLED GNSS-INS INTEGRATION	253
<i>Bruno Scherzinger</i>	
AUTOMATIC IDENTIFICATION AND CALIBRATION OF STOCHASTIC PARAMETERS IN INERTIAL SENSORS	265
<i>Stéphane Guerrier, Roberto Molinari and Jan Skaloud</i>	
ONLINE MOTION MODE RECOGNITION FOR PORTABLE NAVIGATION USING LOW-COST SENSORS	273
<i>Mostafa Elhoushi, Jacques Georgy, Aboelmagd Noureldin and Michael Korenberg</i>	
TRACKING AND RELATIVE POSITIONING WITH MIXED SIGNALS OF OPPORTUNITY	291
<i>Chun Yang and Thao Nguyen</i>	
A SINGLE DISTANCE MEASURING EQUIPMENT (DME) STATION-BASED POSITIONING SYSTEM FOR ALTERNATIVE POSITION NAVIGATION AND TIMING (APNT)	313
<i>O-Jong Kim, Chongwon Kim, Junesol Song, Taikjin Lee, Byungwoon Park and Changdon Kee</i>	
THE GPS BLOCK IIR AND IIR-M BROADCAST L-BAND ANTENNA PANEL: ITS PATTERN AND PERFORMANCE	329
<i>Willard A. Marquis and Daniel L. Reigh</i>	

Citation for the following article

The GPS Block IIR and IIR-M Broadcast L-band Antenna Panel: Its Pattern and Performance

Willard A. Marquis Daniel L. Reigh

How to cite

Marquis, W. A., and Reigh, D. L. (2015) The GPS Block IIR and IIR-M Broadcast L-band Antenna Panel: Its Pattern and Performance. *J Inst Navig*, 62: 329– 347. doi: 10.1002/navi.123.

Download Citation

If you have the appropriate software installed, you can download article citation data to the citation manager of your choice. Click below and select your citation manager software from the list.

<https://onlinelibrary.wiley.com/action/showCitFormats?doi=10.1002%2Fnavi.123>

The GPS Block IIR and IIR-M Broadcast L-band Antenna Panel: Its Pattern and Performance

WILLARD A. MARQUIS

Lockheed Martin Space Systems Company, Schriever AFB, Colorado Springs, CO 80912, USA

DANIEL L. REIGH

Lockheed Martin Information Systems and Global Solutions, King of Prussia, PA 19406, USA

Received March 2015; Revised June 2015

ABSTRACT: *The Global Positioning System (GPS) Block II Replenishment (IIR) space vehicle (SV) has made up at least one-half of the GPS constellation since 2006. This consists of the 12 original ‘classic’ IIR SVs and the eight ‘modernized’ IIR-M SVs. As a stepping-stone toward the IIR-M modernization, Lockheed Martin developed and deployed an updated version of the satellite antenna panel for the L-band broadcast signal. This is the signal used by the worldwide GPS user population. This paper describes both antenna panel versions, their broadcast signal patterns, the performance observed in factory testing, and their on-orbit performance. This is the initial publication of these antenna panel patterns. Ground and on-orbit measurements of both versions of the antenna show that all specification requirements are exceeded. They also reflect the increased antenna gain for the new IIR antenna. The L1 signal shows an increase of 1 dB in received power at edge of Earth, and L2 shows an increase of 2 dB in received power. All users, both terrestrial and on-orbit, benefit from this enhanced power profile. Copyright © 2015 The Authors NAVIGATION © 2015 Institute of Navigation*

INTRODUCTION

The Global Positioning System (GPS) Block II Replenishment (IIR) space vehicle (SV) began improving upon its baseline design in 2003 with the launch of the first Block IIR SV retrofitted with a redesigned ‘improved’ antenna panel. This is the Earth-facing panel providing the GPS L-band broadcast signal. This improved antenna panel includes redesigned L-band elements mounted on the SV Earth-facing structure in the same manner as the original ‘legacy’ antenna panel. This provided a stepping-stone toward the first new modernized Block IIR-M SV launched in 2005 and has benefitted all GPS users with increased signal strength.

Following a discussion of background concepts, this paper presents the antenna performance requirements, highlights design features of both the legacy and improved antenna panels, and examines antenna panel performance from factory test data and on-orbit measurements. Finally, the antenna panel patterns of both antenna designs are also described and presented in this paper.

BACKGROUND

In 1989, Lockheed Martin Space Systems Company and its payload system subcontractor, Exelis/ITT, were put on contract to build the GPS Block IIR SV (Figure 1). The direction to modernize eight of the original 21 SVs into the modernized Block IIR-M version was given in 2001. The exterior view of the IIR-M SV is very similar to the IIR SV (Figure 1), with the exception of the antenna panel.

Between 1997 and 2009, 20 IIR/IIR-M SVs were placed on-orbit to form the largest portion of the GPS constellation. These SVs, as operated by the Second Space Operations Squadron (2 SOPS) of the Air Force Space Command (AFSPC), continue to provide exceptional accuracy and availability on-orbit [1, 2]. The first of the original 21 IIR SVs, Space Vehicle Number 42 (SVN42), was destroyed in a booster accident [3]. The eight final SVs were retrofitted to incorporate the improved antenna panel, modernized L-band boxes [4, 5], and other improved components.

The GPS Block IIR and IIR-M SVs were built with one of two different antenna panel types. The original legacy antenna panel was used on the first eight of 12 classic IIR SVs. The improved antenna panel was used on the final four of 12 classic IIR

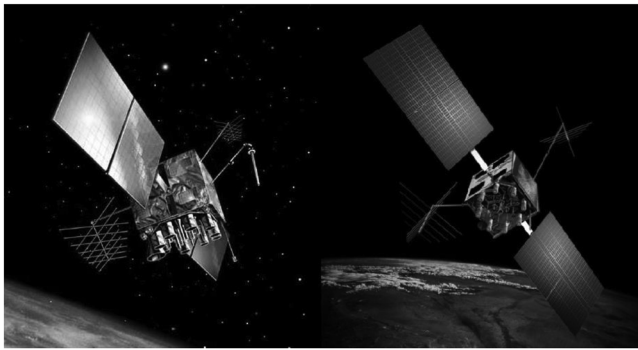

Fig. 1—Two artist's concepts of the GPS Block IIR SV

SVs, and all eight of the modernized IIR-M SVs. The GPS Block IIR improved antenna includes new antenna element designs and configurations on the panel, which will be described in the next section. Table 1 shows which panel type was used on which SV version, with the SVs listed in launch order from first to last. This table also indicates which eight of the SVs were modernized from the classic IIR SV configuration to the modernized IIR-M configuration. All SVs with the improved antenna panel benefit from increased power compared with the legacy panel. The eight IIR-M SVs also provide additional power because of higher power transmitters. These new transmitters have the option to increase power in a few selected configurations. The total power envelope is further increased on IIR-M SVs with the new modernized signals.

The signal strength for L1 and L2 frequencies is specified by requirements (see next section) and was measured in factory test and on-orbit operation

Table 1—IIR/IIR-M Versions

SVN (launch order)	SV type		Antenna panel type	
	Classic IIR SV	IIR- M SV	Legacy antenna panel	Improved antenna panel
43	✓		✓	
46	✓		✓	
51	✓		✓	
44	✓		✓	
41	✓		✓	
54	✓		✓	
56	✓		✓	
45	✓		✓	
47	✓			✓
59	✓			✓
60	✓			✓
61	✓			✓
53		✓		✓
52		✓		✓
58		✓		✓
55		✓		✓
57		✓		✓
48		✓		✓
49		✓		✓
50		✓		✓

(see section on The GPS IIR/IIR-M Antenna Panel Performance) with the specific criteria defined at edge of Earth (EoE). EoE is defined as 5° elevation to the ground-based terrestrial user. This is equivalent to 13.8° from antenna boresight for the Earth-facing (nadir) SV antenna panel.

The antenna panel pattern is recorded and presented in terms of beam directivity and phase across the face of the panel. Directivity (D) is the signal power density in a specific direction measured in dB. Average directivity plots are presented in the section on The GPS IIR/IIR-M Antenna Panel Pattern for both antenna panel types. SV-specific pattern plots and data, including the directivity, are available online at <http://www.lockheedmartin.com/us/products/gps/gps-publications.html>.

The GPS signal, on each of the L1 and L2 frequencies, is spread through the application of a pseudo-random noise (PRN) code sequence [6]. The classic IIR SVs, with either antenna panel version, have only one code sequence, the precision code (P-code), applied to L2 (thus, abbreviated as 'L2P'). On the L1 frequency, there are two different code sequences, C/A and P (thus, 'L1C/A' and 'L1P', respectively).

On the newer IIR-M SVs, L1 still has the same two original code sequences as the IIR SVs (L1C/A and L1P), but L2 has a second code sequence, L2C. In addition, both L1 and L2 have side lobes from a binary offset carrier (BOC) that host the new military code (M-code) sequence (L1M and L2M). These new, modernized code sequences and BOC side lobes increase the total broadcast signal power envelope.

The varying code sequence combinations on the broadcast frequencies affect the signal performance analysis. Comparisons of received signal strength should only be made in terms of code power levels. Combined signal power is generally only applicable to SV system considerations. For example, classic IIR L2P should only be compared with IIR-M L2P, excluding L2C and L2M.

ANTENNA PERFORMANCE REQUIREMENTS

Both terrestrial service and space service requirements will be discussed in this section.

GPS Terrestrial Service Requirements

The IIR and IIR-M SV broadcast power requirement specifications, as well as factory and on-orbit measured performance data, are quantified in terms of L-band signals and code power at EoE [7]. This is the signal power as received by a terrestrial user. Table 2 shows the L-band power requirements for the various IIR SV configurations and signals. This table lists the IIR/IIR-M SV

Table 2—IIR/IIR-M SV System Specification L-Band Power Requirements

	IIR with legacy panel	IIR with improved panel	IIR-M
L1 C/A (dBW)	-160.0	-160.0	-158.7
L1P (dBW)	-163.0	-163.0	-160.6
L1M (dBW)	—	—	-158.0
L1 total (derived) (dBW)	-158.2	-158.2	-154.2
L2C (dBW)	—	—	-161.4
L2P (dBW)	-166.0	-166.0	-160.9
L2M (dBW)	—	—	-161.4
L2 total (derived) (dBW)	-166.0	-166.0	-156.5

system-level specification requirements defined by the Air Force. The SV was built to meet these requirements. Also shown in the table are the ‘derived’ total power values for the L1 and L2 frequencies. For L2, this derived value is unchanged because the only code that is carried by L2 is L2P for the classic IIR SV. For L1, the derived total power value is the summation of the L1C/A and L1P values.

The specified received signal strength for the IIR legacy panel (Table 2, column 2) is defined as the signal strength received by a +3 dBi linear antenna. This received strength has been attenuated by a 0.5-dB atmospheric loss for the worst case link (minimum antenna gain and minimum transmitter power) and a 2.0-dB atmospheric loss for the nominal link (nominal gain and transmitter power). The IIR SV with the improved antenna panel was required to meet the same specifications (Table 2, column 3).

The received signal strength for IIR-M is defined in the revised Air Force specification as the signal strength received by a 0 dBi circularly polarized antenna with a 0.5-dB atmospheric loss for the worst case link (minimum antenna gain and minimum transmitter power, averaged about azimuth). The ‘0 dBi’ power levels are specified as -157.7 dBW for L1 C/A, -159.6 dBW for L1P, -157.0 dBW for L1M, -160.0 dBW for L2C, -159.6 dBW for L2P, and -160.0 dBW for L2M. In order to compare the IIR-M specifications with the IIR values, these circular 0 dBi values must be converted into the +3 dBi linear antenna values. This is accomplished by considering the antenna’s axial ratio requirements and the resultant impact to the link. The revised IIR-M requirements, as received by a +3 dBi linear antenna, are roughly equal to the values recorded in Table 2, column 4.

Table 3 shows the GPS Interface Control Document (ICD) or Interface Specification (IS) performance the user expects [8, 9]. The ICD/IS requirements provided guidance to the SV specifications in Table 2. The IIR SV design requirements were originally based on the earlier

Table 3—GPS ICD L-Band Power Requirements

	ICD-GPS-200C	IS-GPS-200H	IS-GPS-200H
	Block IIR	Block IIR	Block IIR-M
L1 C/A (dBW)	-160.0	-158.5	-158.5
L1P (dBW)	-163.0	-161.5	-161.5
L1M (dBW)	—	—	-158.0*
L1 total (derived) (dBW)	-158.2	-156.7	-154.3
L2C (dBW)	—	—	-160.0**
L2P (dBW)	-166.0	-164.5	-161.5
L2M (dBW)	—	—	-161.0*
L2 total (derived) (dBW)	-166.0	-164.5	-156.5**
Terrestrial req	Measured at EoE		
Space service volume req	None for IIR/IIR-M***		

*Air Force specification.

**Per LMSSC exception letter, L2C should be -161.4 dBW.

***GPS IIF and GPS III SSV requirements shown in Table 4 for comparison purposes only.

Revision C specification. The most recent Revision H (as well as every version since revision D) specifies higher power and modernized requirements. The 1.5-dB change in the ICD between Rev C and H is due to the removal of conservatism in the atmospheric losses in the link budget. The table also provides the derived values for the total power on L1 and L2.

The plots of the minimum received power versus elevation angle, as specified by ICD-GPS-200, are shown in Figure 2 for Rev. C [8] and Figure 3 for Rev. H [9]. The elevation angle range for both plots is from EoE to zenith (SV directly overhead). The

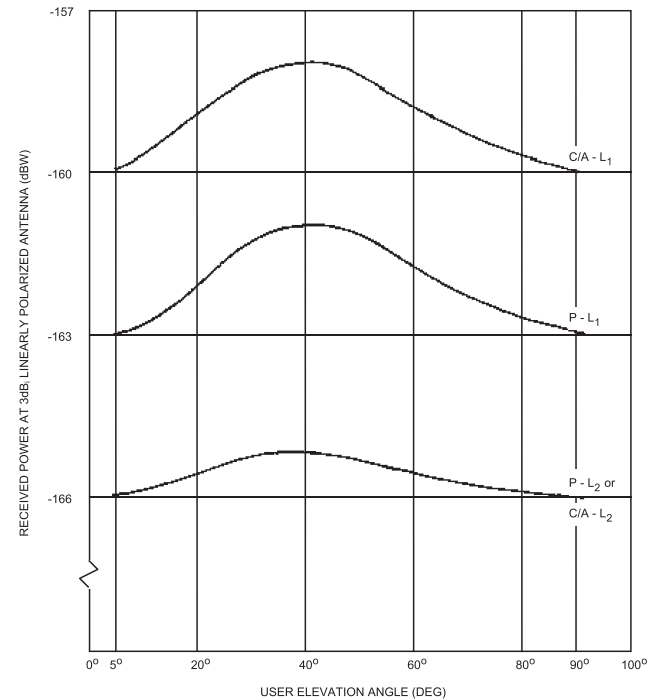

Fig. 2—User received minimum signal levels (source: ICD-GPS-200C [8])

curves represent the notional terrestrial service received power.

This power is required to extend from nadir to EoE for the classic IIR and IIR-M SVs (13.8° half-cone; a 27.6° cone). This terrestrial service volume is defined as the near-Earth region up to 3000 km altitude (Figure 4).

GPS Space Service Requirements

For GPS Block IIF SVs, the broadcast signal also has an orbital environment requirement to extend out from EoE to 23° off-nadir. This is called the space service volume (SSV) (Figure 5) [10]. The SSV is defined as the spherical shell up to 36,000 km altitude (approximately the geosynchronous orbit altitude). The new GPS III SV also has an SSV requirement that is defined at 23.5° for L1 and 26° for L2 and L5. Table 4 summarizes the SSV requirements for GPS Block IIF and GPS III.

The SSV is not a requirement for GPS Block IIR/IIR-M SVs, but some service is available (section on

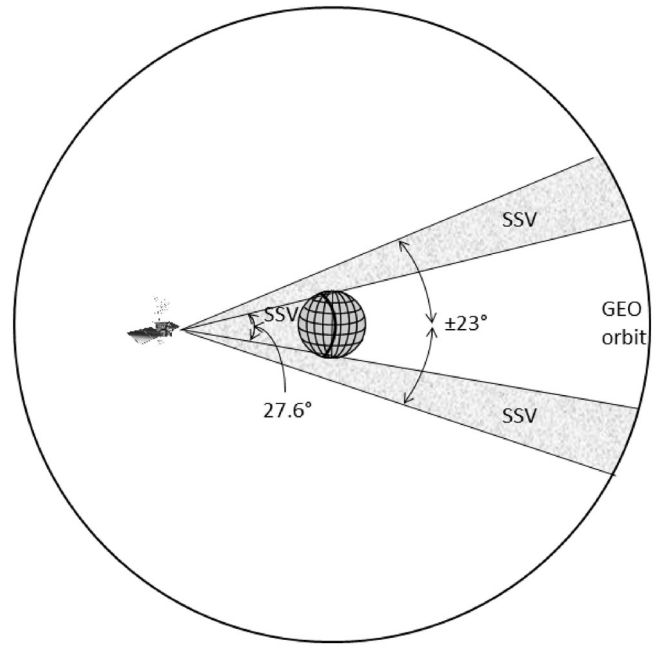

Fig. 5—Space service volume (SSV) definition

The GPS IIR/IIR-M Antenna Panel Performance). Recent SSV use of the GPS signal is reflected in references relating to geosynchronous use such as [11–23], references relating to high Earth orbit use such as [24–27], and references relating to use for Lunar missions, such as [28–30].

GPS IIR/IIR-M ANTENNA PANEL DESCRIPTION

The two antenna panel variations are the legacy antenna panel and the improved antenna panel. This section will highlight some of the basic design features of each, with an emphasis on the differences.

Legacy Antenna Panel Design

The GPS Block IIR legacy antenna panel is pictured in Figure 6. This panel was installed on the first eight of 12 IIR SVs. It consists of eight helix elements positioned in a circle with four helix elements in the center on the Earth-facing antenna panel. These elements are the taller, thinner, pointed structures seen in the picture. The shorter, thicker, antenna elements seen in Figure 6 serve the ultra-high frequency (UHF) communications of the SV. This subsystem is beyond the scope of this paper.

The 12 antenna elements are fed by a low loss Beam Forming Network (BFN) consisting of several coaxial cables and a 12-way power divider. The BFN supplies a weighted signal power distribution to the elements including the addition of a phase offset between the two rings. This differential phasing provides a balanced power over the horizon-to-nadir Earth coverage range of the

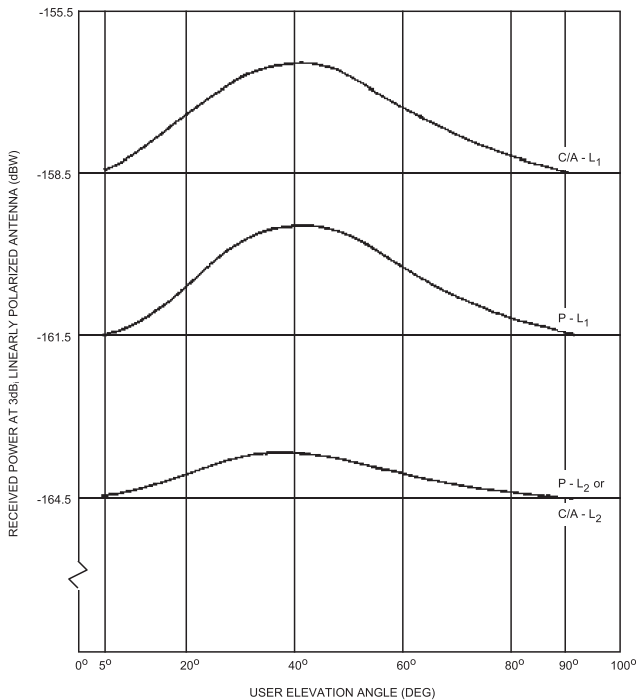

Fig. 3—User received minimum signal levels (source: IS-GPS-200H [9])

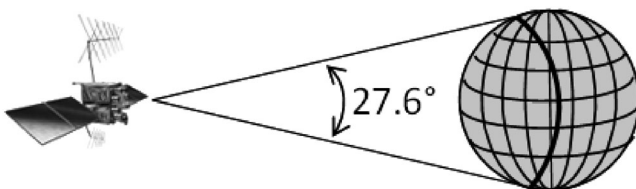

Fig. 4—Earth terrestrial service volume definition

Table 4—GPS Block IIF and GPS III Space Service Volume Requirements

	GPS Block IIF*		GPS III*	
	From EoE out to 20° off-nadir	From EoE out to 23° off-nadir, decrease monotonically down to ...	From EoE out to 23.5° off-nadir	From EoE out to 26° off-nadir, decrease monotonically down to ...
L1 C/A (dBW)	<10 dB decrease	<18 dB decrease	-184.0	N/A
L1 P(Y) (dBW)	<10 dB decrease	<18 dB decrease	-187.0	N/A
L2 P(Y) (dBW)	N/A	<10 dB decrease	N/A	-186.0
L2C (dBW)	N/A	<10 dB decrease	N/A	-183.0

*Ref. IS-GPS-200H [9].

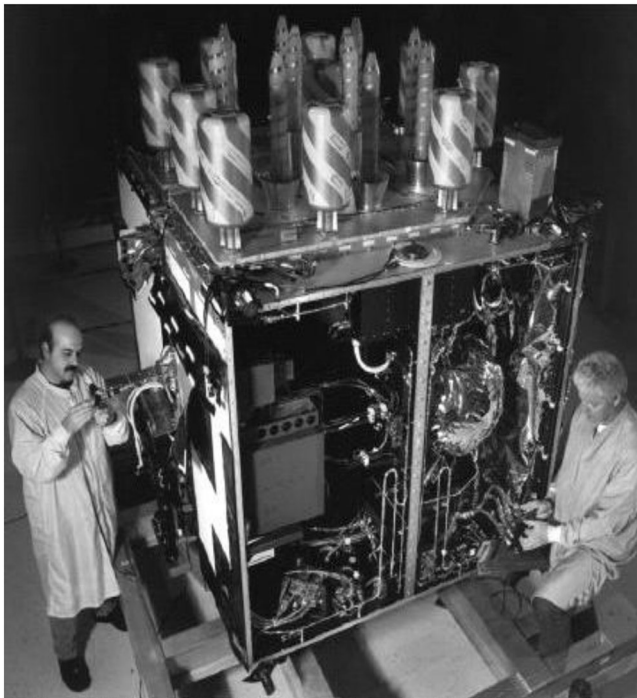

Fig. 6—Legacy (classic) antenna panel

antenna panel (13.8°). The nominal antenna panel directivity pattern curves from the two rings are shown in Figure 7. The directivity pattern from the inner ring of four L-band elements (a wide-angle broadcast) combined with a phase-offset of the directivity pattern from the outer eight L-band elements (a narrow-angle broadcast) produces a total pattern with the desired Earth-shaped result. Overall, the array forms a shaped, 27.6° Earth coverage pattern with signal power roll off and side lobes extending beyond the EoE.

Improved Antenna Panel Design

The final four classic IIR and all eight modernized IIR-M SVs were retrofitted with the improved antenna panel [31]. This panel is pictured in Figure 8. The new panel reused the existing structure and L-band transmitter interface. New element designs and optimized alignment on the panel provide the improved performance.

The new L-band elements are formed from copper wire in a helix shape on a tapered G10 core as

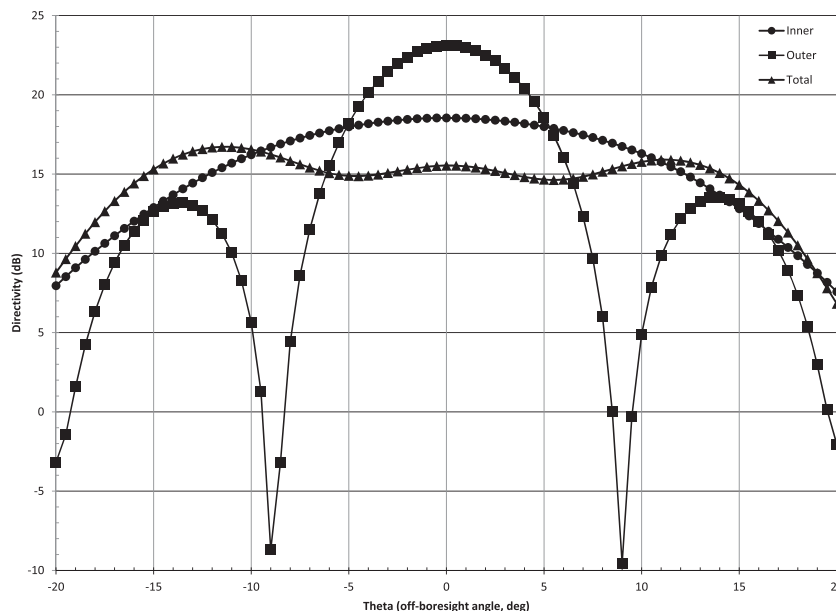

Fig. 7—Nominal antenna panel pattern from inner and outer rings

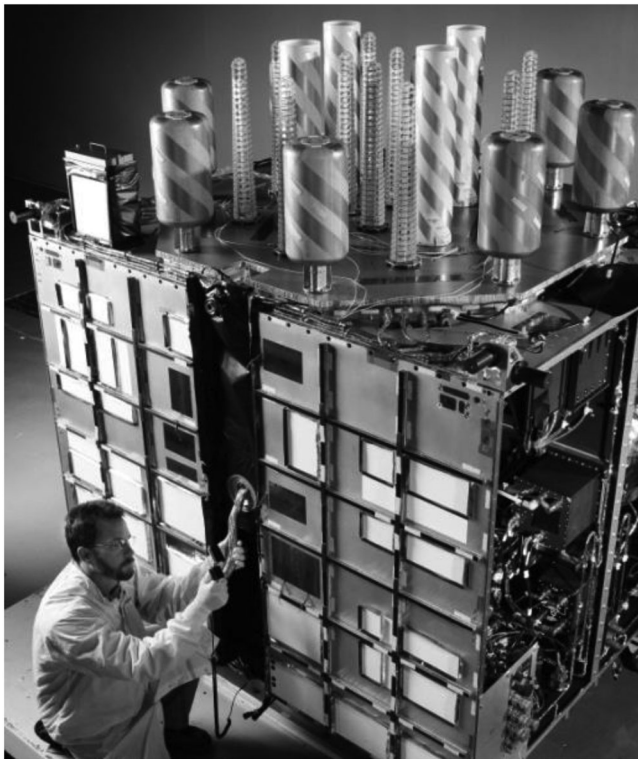

Fig. 8–Improved antenna panel

opposed to the earlier design of copper tape on a cylindrical structure with a conical top.

As with the legacy panel, a BFN distributes the L-band power to the antenna elements. This provides the proper amplitude weighting and phasing between the inner and outer rings.

Antenna Panel Coordinate System and SV Mounting Alignment

This section describes the antenna panel coordinate system and the mounting alignment (orientation) of the antenna panel on the SV. This information may be used in conjunction with the IIR SV yaw model [32, 33] to predict the alignment of the broadcast L-band pattern at a particular receiver location as is carried out in references [34–36].

The IIR SV body axes are shown in Figure 9. They are defined as follows:

- +Z axis directed toward Earth (nadir),
- +Y axis along the ‘positive’ solar array axis, and
- +X completes right-handed system.

The location of the S-band antenna is identified in Figure 9 to serve as a reference point. The antenna panel is oriented on the SV such that the tall S-band antenna element is located in the (+X, -Y) corner of the SV structure. Both versions of the antenna panels are mounted to the SV structure in the same orientation.

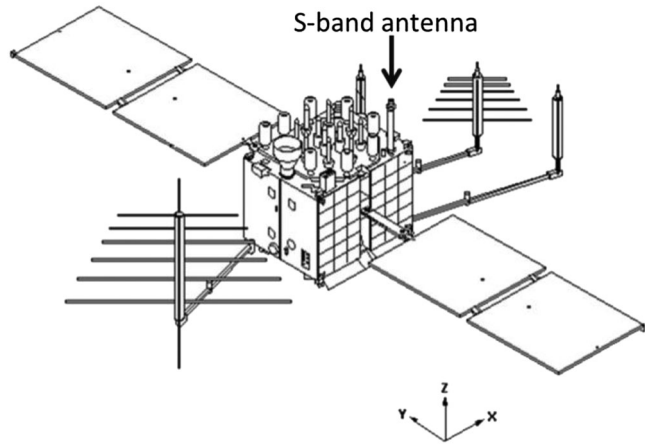

Fig. 9–Space vehicle body axis definition

Antenna Panel Pattern Measurement Coordinates

The antenna panel pattern measurement coordinates are defined by two angles: phi (φ) and theta (θ). The angles φ and θ are used in the description of the antenna panel patterns in that section later in this paper. Refer to Figures 10–12 for visualization of the φ and θ angle definitions. The view of the SV in Figures 10 and 11 is in the -Z direction (into the antenna panel).

- φ = the angle that is counter-clockwise around the antenna panel boresight (Earth-facing) axis with a range of 0° – 360° (Figure 10). The axis of rotation of φ is around the SV +Z axis (which is in the direction of the SV yaw attitude angle), with $\varphi = 0^\circ$ referenced to the IIR SV +X axis.
- θ = the angle that is across the face of antenna panel, from the +Y solar array ($\theta = -90^\circ$), through the nadir direction ($\theta = 0^\circ$), to the -Y solar array ($\theta = +90^\circ$) (Figures 11 and 12). The axis of rotation of θ is around the SV +X axis.

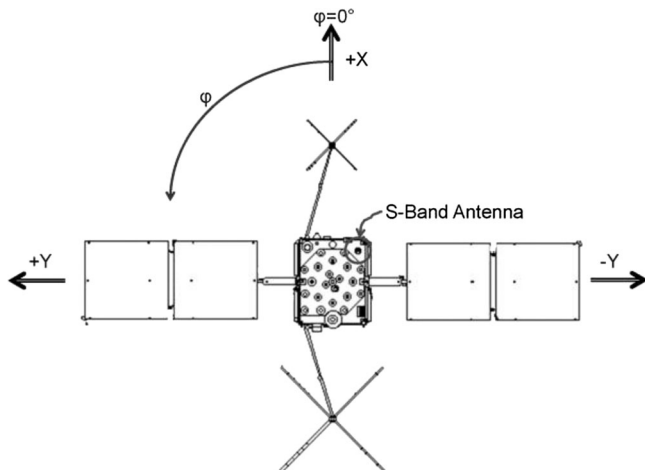

Fig. 10–Antenna orientation – around boresight

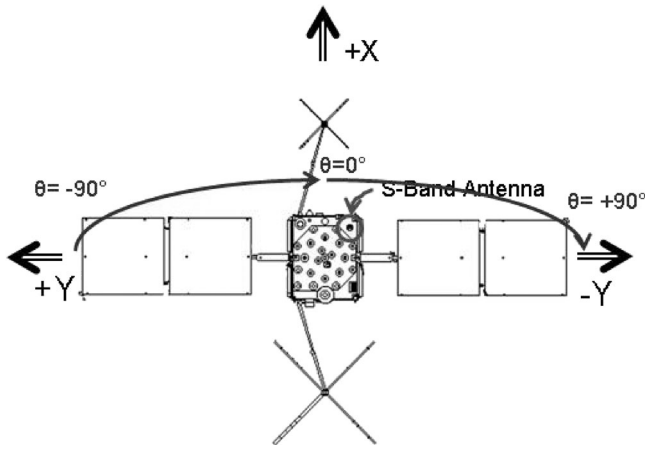

Fig. 11—Antenna orientation – off-boresight

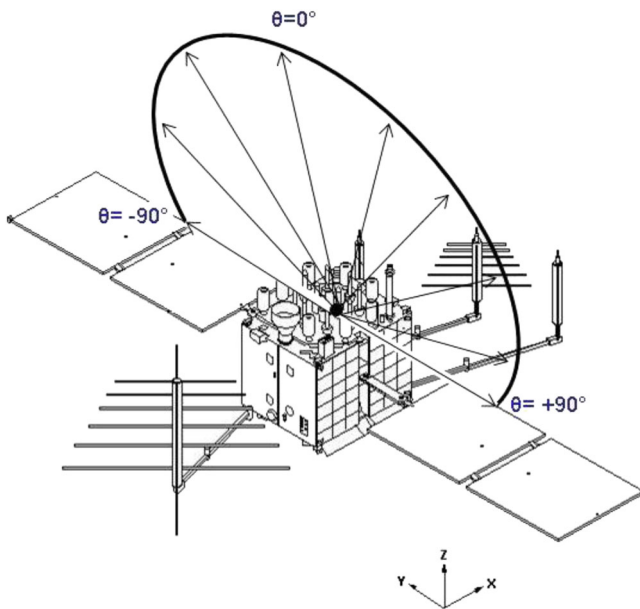

Fig. 12—Antenna orientation – off-boresight, side view

Recall that the EoE boresight angle is defined as $\theta = \pm 13.8^\circ$ for the GPS orbit.

The antenna panel mounting orientation on the Earth face of the IIR SV is specified as having the panel reference line, $\varphi = -90^\circ$, aligned along the $-Y$ SV body axis (SV S-band antenna boom in the ‘upper right’ corner). This can be seen in Figure 10.

THE GPS IIR/IIR-M ANTENNA PANEL PERFORMANCE

This section will present the factory and on-orbit performance measurements for the L1 and L2 signals on both the legacy and improved antenna panels. The focus will be on the signal strength received by the terrestrial user and its comparison with the specifications as described earlier in the paper.

Factory Measured Performance

The legacy and improved antenna panel versions were both tested throughout development. Each antenna panel was characterized prior to installation on the SV structure. The legacy antenna panels were tested in the spherical near-field range at the Lockheed Martin Valley Forge factory. The improved antenna panels were tested in the spherical near-field range at the Lockheed Martin Newtown factory. The developmental panel for the improved antenna was tested in the Valley Forge range and also verified in a compact range in Newtown, PA, USA. Test results of the improved panel showed consistent results over all the SVs exceeding the required specifications for both IIR and IIR-M. On-orbit performance closely matched predictions that were based on factory test data.

The range measurements were made with the antenna deck (ground plane and elements) mounted on an SV Earth-deck simulator that simulated the nadir (Earth-facing) panel of the SV and included all items that are present on the SV. These structures included the Earth sensors, environment sensors, and the S-band antenna mast.

The directivity and phase data were collected at multiple φ angles from 0° to 360° . The step size was 7.5° for the L-band spectrum, which met the Nyquist criteria. The raw measurement data were processed through software that averaged the redundant scans to remove range effects and then processed into spherical modes. From the spherical modes, any far-field or near-field pattern can be generated. The raw data were fairly clean, with very similar far-field patterns resulting from processing the entire file versus processing the ‘first’ or the ‘second’ half of the measurement pattern.

Tests were also performed at Pt. Mugu Naval Warfare Center Radar Reflectivity Laboratory on a range configuration that provided a far-field indoors baseline (Figure 13). This test on an independent

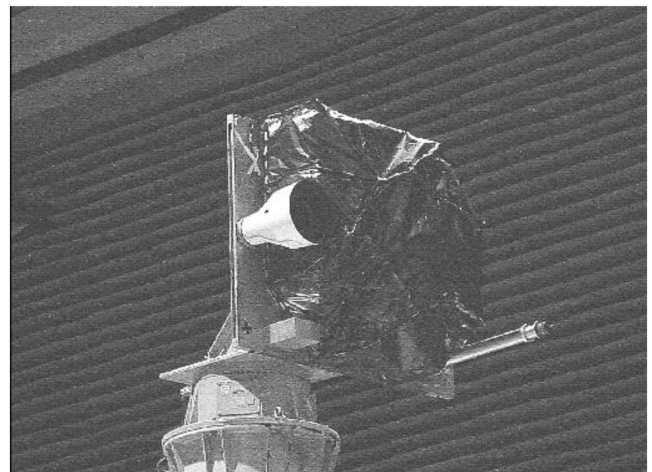

Fig. 13—Antenna panel test configuration

range provided verification of range measurement accuracy and also validated IIR antenna performance for L-band gain and axial ratio.

The factory-measured performance for the improved antenna panel was plotted in comparison with the legacy panel. This is shown in Figure 14 for L1. These patterns are based on actual measurements of flight panels and transmitters. Measurements from the legacy panel originally built for SVN47 were compared with the improved panel for the same SV once it was retrofitted. This provided a before-and-after check.

This figure shows the typical measured performance for L1 total signal power. The legacy panel exceeds the -158.2 dBW derived requirement (Table 3) by

over 3 dB at EoE. The improved panel shows an additional improvement of 1 dB (26%) at EoE.

The typical improved performance for the L2 signal is shown in Figure 15. As with L1, the measured patterns are based on actual measurements of flight panels and transmitters. An improvement of approximately 2 dB (58%) over the legacy panel can be seen at EoE. This improved performance exceeds the IIR L2 requirement (-164.5 dBW) by over 5 dB.

On-Orbit L1 Signal Performance

SRI, Inc. (formerly known as the Stanford Research Institute) is based in the San Francisco area with the ability to measure the signal power and track the

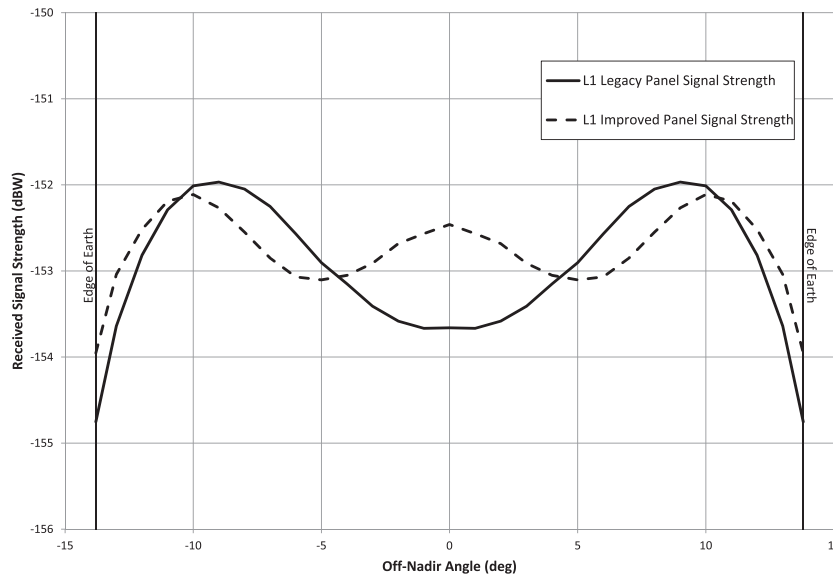

Fig. 14–Factory measured L1 total power – legacy versus improved

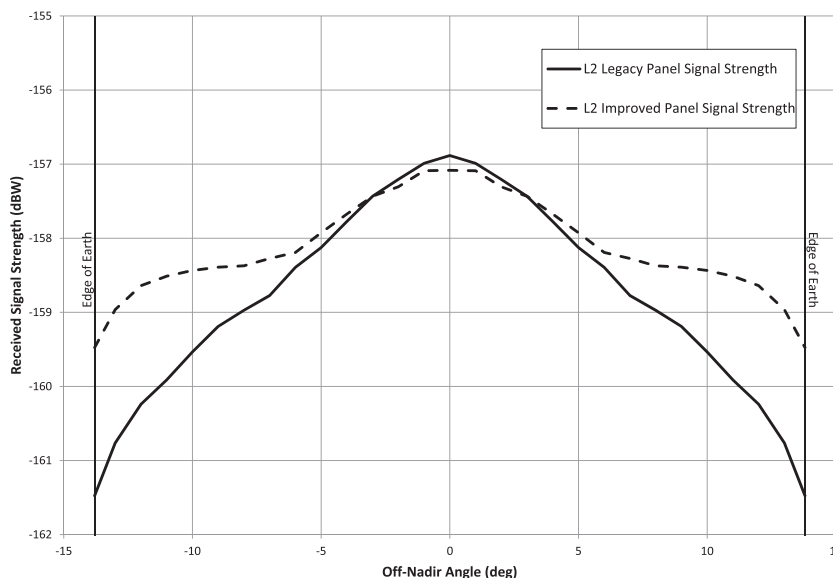

Fig. 15–Factory measured L2 total power – legacy versus improved

codes of the GPS signals. SRI has a 150-ft antenna and a 10-ft antenna. They perform periodic and event-driven measurements of the GPS signals using either antenna, depending upon availability. Periodic (quarterly or monthly) signal state-of-health measurements are performed for all SVs in the constellation. In addition, as each new SV is launched and the L-band transmitters are turned on, SRI tracks the initial signal to ensure it is performing properly. Measurement accuracy is typically seen to be on the order of 0.5 dB because of local atmospheric conditions and ground-based interference.

A comparison of several GPS Block II, Block IIA, and Block IIR SVs is shown in Figure 16. This figure shows the L1 frequency total power (L1C/A plus L1P) measured for three candidate Block IIR SVs (SVNs 43, 44, and 46), a representative Block II SV (SVN13), and a Block IIA SV (SVN37). The curves are labeled for the SV number as well as the year and day-of-year of measurement (e.g., '1999-320' for November 16, 1999). Some curves double back from low elevation to high elevation to low elevation if a longer pass was tracked.

These data, obtained over a period of several years, show that the signal strength performance of all SVs exceed the -156.7 -dBW derived specification (Table 3). The figure also shows that the curve shapes generally match the notional curve shown in the ICD (Figure 3). No significant difference can be detected between Block II, Block IIA, or Block IIR SV performance.

The L1 frequency measured power is plotted in Figure 17 for all eight Block IIR SVs with legacy antenna panels. All SVs can be seen to exceed the specification in ICD-GPS-200 [8]. As with Figure 16, these measurements were obtained over several years and also show performance similar to the ICD notional curve in Figure 3.

SVN43 is the oldest GPS Block IIR SV. SVN43's lifetime trend of measured L1 total power is traced in Figure 18. The curves cover 15 of its 17 years on-orbit. The plot shows that SVN43 exceeds the specification in ICD-GPS-200 [8] and has had a consistent performance over its entire life span.

The L1 signal performance of the improved antenna panels in comparison with the legacy panels

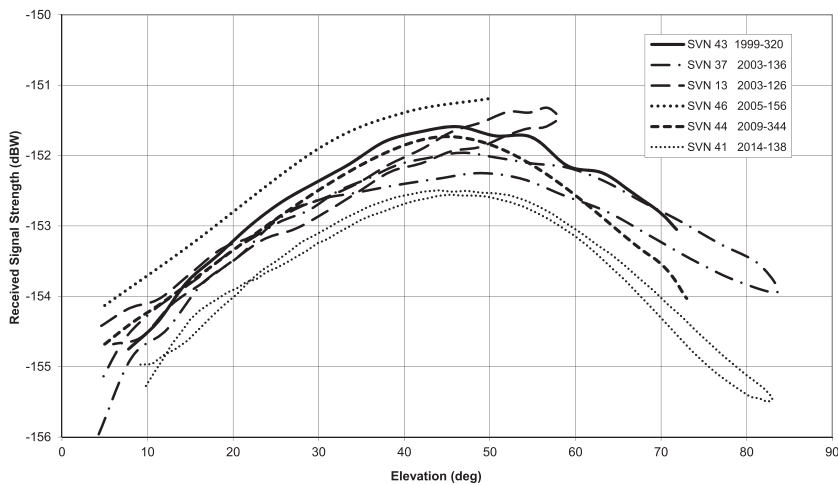

Fig. 16–L1 power – Block II/IIA/IIR SVs

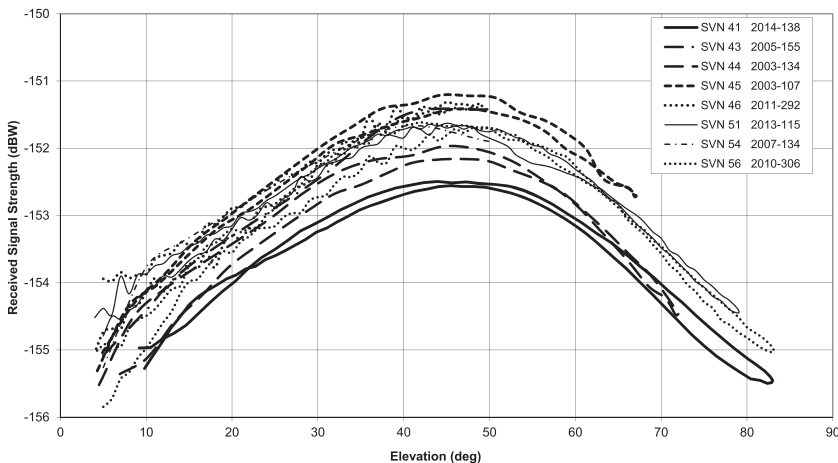

Fig. 17–L1 power – legacy panel Block IIR SVs

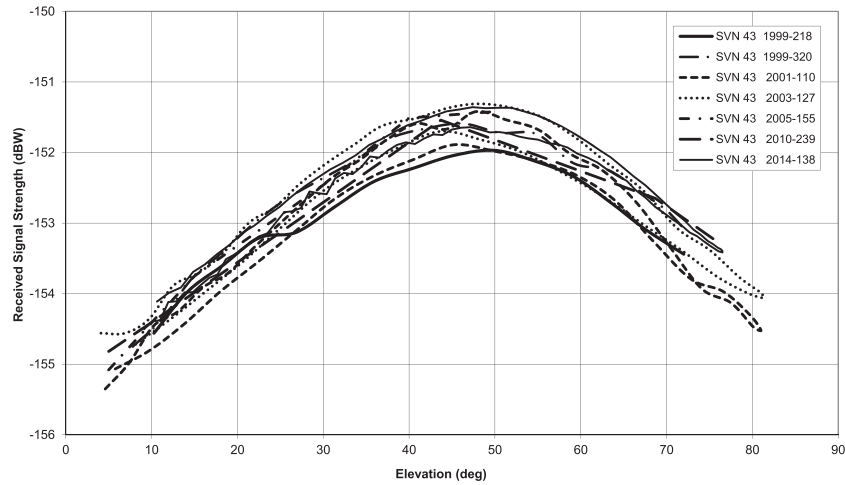

Fig. 18-L1 power – SVN 43 history, 1999-2014

is shown in Figure 19. The four classic IIR SVs with the improved panels are seen in solid lines near the top of the set of curves. The other eight curves are the eight Block IIR SVs with the legacy panels. It is clear that the L1 EoE performance is improved by at least 1dB. For L1 total power at EoE, the improved panel performance exceeds the ICD/IS requirements by at least 2 dB.

The L1 signal total power measurements for all eight IIR-M SVs are shown in Figure 20. All SVs demonstrate consistent performance, and all SVs exceed the specified requirements.

On-orbit L2 Signal Performance

The comparison of the L2 signal performance of the improved antenna panels and the legacy panels is shown in Figure 21. The four classic IIR SVs with the improved panels are seen in solid lines near the top of the curves. The other eight curves are the eight Block IIR SVs with the legacy panels. It is clear

that the L2 EoE performance is improved by at least 2 dB. The entire L2 curve, from EoE to zenith, shows general improvement with the new panel. For the L2 signal at EoE, the improved panel exceeds the original ICD/IS requirements by at least 5 dB.

The L2 signal total power measurements for all eight IIR-M SVs are shown in Figure 22. All SVs demonstrate consistent performance, and all SVs exceed the specified requirements.

On-orbit Code Power Performance

This section will examine the code power results for both L1 and L2, as opposed to the total power measurements seen in the previous three sections. For L1, the code power comparison is shown for several SVs in Figure 23: SVN30 (a Block IIA), SVN51 (a Block IIR with a legacy antenna panel), SVN47 (a Block IIR with an improved antenna panel), and SVN53 (a Block IIR-M). The plot shows three groups of curves, distinguishing the several

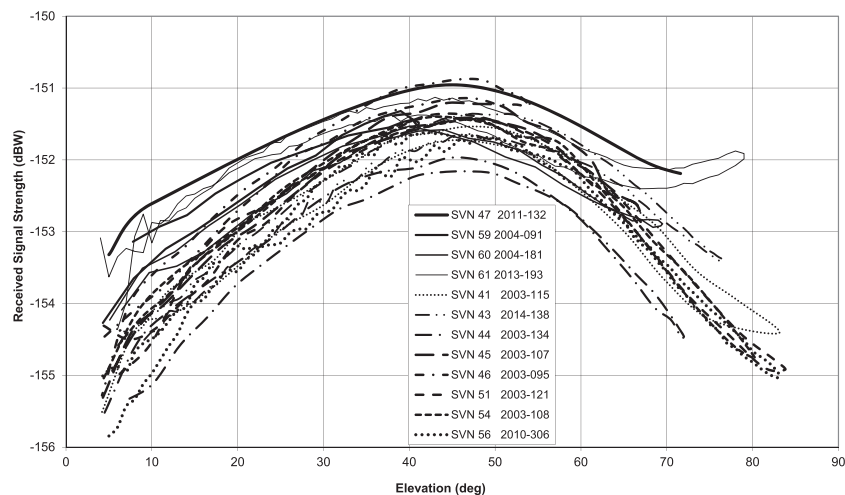

Fig. 19-L1 power – legacy versus improved panels

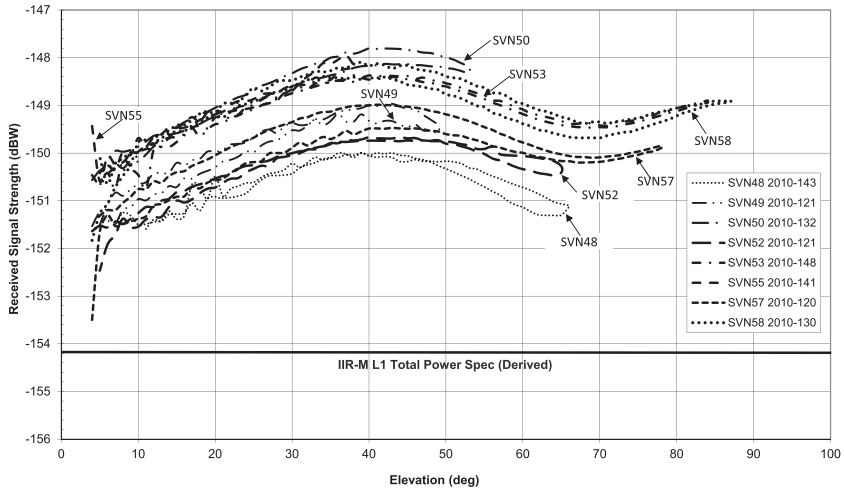

Fig. 20—Power measurements for all IIR-M SVNs – L1

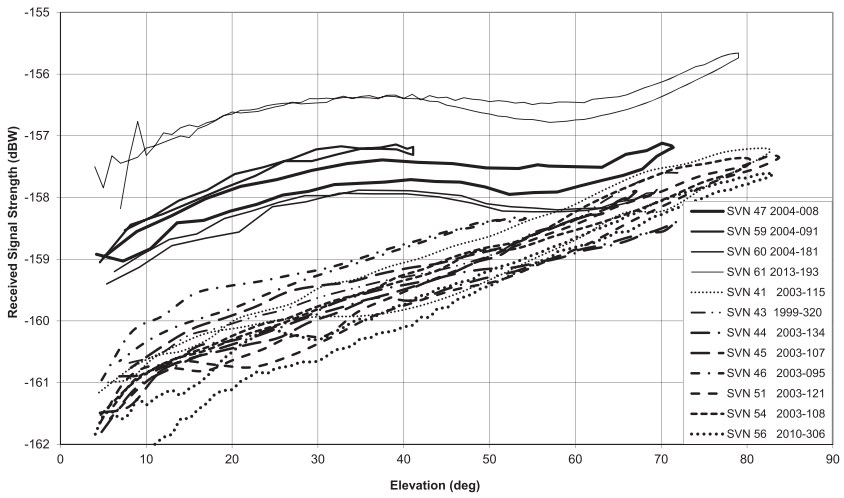

Fig. 21—L2 power – legacy versus improved panels

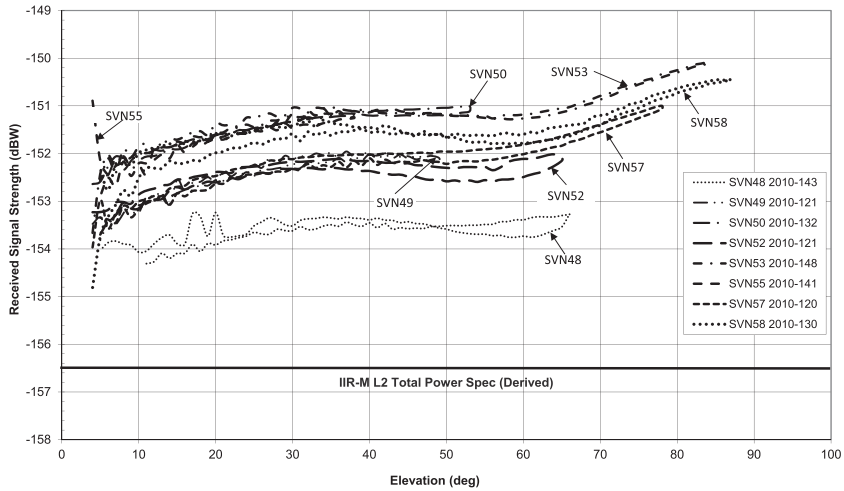

Fig. 22—Power measurements for all IIR-M SVNs – L2

code power levels. The lowest grouping shows L1P power for SVNs 30, 51, 47, and 53, in ascending order based on the EoE values. The middle grouping

in Figure 23 shows L1 total power (L1C/A plus L1P) for SVNs 30, 51, and 47 in ascending order. The top line in the plot shows the SVN53 total power

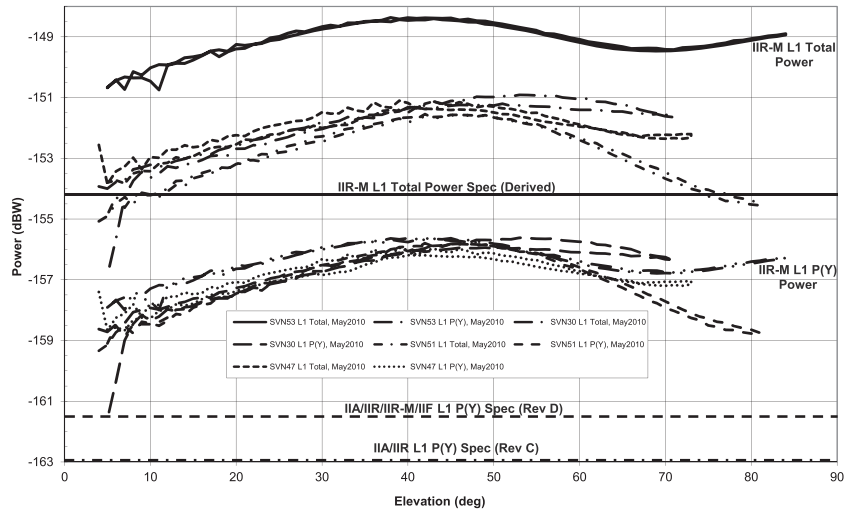

Fig. 23—Code power measurements – L1

(L1C/A plus L1P plus L1M). Also shown in the figure are the specification requirements to be met at EoE for each of the codes. It can be seen that all SVs exceed the specified requirements. To avoid unnecessary plot complexity, L1C/A is not shown.

The L1M and L2M specific power levels have been previously reported [37–39] and found to exceed specified required levels at all points.

In a similar fashion, Figure 24 shows three code power groupings for L2: L2P, L2C, and L2 total. The specification requirements are also shown. This figure shows that all SVs exceed the specified requirements.

Summation of Performance Results, Terrestrial and Space

Table 5 shows a comparison between the requirements and the performance of the classic IIR SVs with the improved antenna panel. The IIR legacy panel exceeds specifications for L1 (L1P and L1C/A) and for L2 (L2P). The improved

panel on the classic IIR SVs (with a higher specification level) exceeds specifications for L1 (L1P and L1C/A) and for L2 (L2P). The improved panel on the IIR-Ms SV (also with a higher specification level) exceeds specifications for L1 (L1P, L1C/A, and L1M) and for L2 (L2P, L2C, and L2M).

The results show that IIR performance exceeds all ICD/IS requirements, and the IIR improved antenna panel provides a stronger terrestrial service signal. The new IIR-M SV also performs better, because of the higher power L-band transmitters combined with the improved antenna panel.

Table 6 shows SSV results for both the legacy and improved panels. The results show that some SSV is available from IIR and IIR-M, although not all levels specified for GPS Block IIF and GPS III are met. Recall that the SSV service is not a requirement for GPS Block IIR/IIR-M.

The IIR improved panel provides stronger SSV signal than the legacy panel.

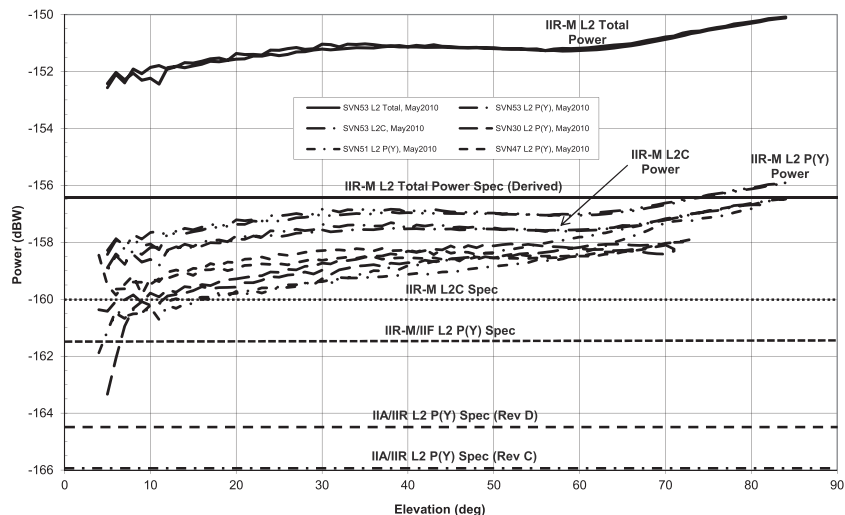

Fig. 24—Code power measurements – L2

Table 5—Legacy and Improved Panel Results versus Terrestrial Requirements

	IIR system requirements IIR/IIR-M	ICD Rev C requirements [8]	IS Rev H requirements [9] IIR/IIR-M	Classic IIR SV legacy panel measured performance	Classic IIR SV improved panel measured performance	IIR-M SV improved panel measured performance
L1 C/A (dBW)	−160.0/−158.7	−160.0	−158.5	−157.7	−156.9	−155.2
L1P (dBW)	−163.0/−160.6	−163.0	−161.5	−159.2	−158.7	−157.9
L2C (dBW)	−/−161.4	—	−/−160.0	—	—	−158.9
L2P (dBW)	−166.0/−160.9	−166.0	−164.5/−161.5	−161.8	−159.4	−158.4

Table 6—IIR/IIR-M Space Service Volume Results

Though not a IIR requirement, the following service is provided at the levels presented in IS-GPS-200H:				
	L1, at 20° off-nadir	L1, at 23° off-nadir	L2, at 23° off-nadir	L2, at 26° off-nadir
IIR legacy panel	At some SV yaw angles	At some SV yaw angles	Yes	At some SV yaw angles
IIR improved panel	At some SV yaw angles	Yes	Yes	Yes

THE GPS IIR/IIR-M ANTENNA PANEL PATTERN

The antenna panel pattern is described by beam directivity and phase around the shape of the panel in θ and ϕ coordinates. The plots presented in this section are the average directivity for each type of antenna panel at the L1 and L2 frequencies. SV-specific plots and data for the 20 GPS Block IIR/IIR-M SVs are available online at <http://www.lockheedmartin.com/us/products/gps/gps-publications.html>. The directivity measurement uncertainty is typically ± 0.25 dB.

Antenna gain (G) is derived from the directivity (D) by applying the gain correction factor (G_{CF}) value for each SV using Equation (1).

$$G = D + G_{CF} \quad (1)$$

The gain correction factor, G_{CF} , is computed from the measurement of a standard gain horn, the measurement of the panel, and the directivities for each frequency. It is the antenna loss in dB at the L1 and L2 frequencies. Table 7 provides the measured G_{CF} values at L1 and L2 for all IIR and IIR-M SVs.

Average Antenna Panel Pattern – L1 Signal

The average L1 directivity pattern from both the eight legacy and 12 improved panels will be presented and compared in this section.

Legacy Antenna Panel Pattern, L1 Signal

The legacy antenna pattern for L1 is seen in Figure 25. This figure shows plots of the average of the eight legacy panels for L1 directivity as a function of off-boresite angle (θ), for ϕ cuts every 10°.

Table 7—IIR/IIR-M Gain Correction Factor (G_{CF}) Values

SVN (launch order)	L1 G_{CF} (dB)	L2 G_{CF} (dB)
43	−0.9	−1.1
46	−1.0	−1.2
51	−0.7	−1.2
44	−1.1	−1.0
41	−0.9	−1.1
54	−0.8	−1.0
56	−0.7	−1.1
45	−1.1	−1.2
47	−1.3	−0.8
59	−1.3	−0.8
60	−1.3	−0.7
61	−1.2	−0.8
53	−1.4	−0.8
52	−1.2	−0.7
58	−1.3	−0.9
55	−1.3	−0.8
57	−1.3	−0.8
48	−1.4	−0.9
49	−1.3	−0.8
50	−1.3	−0.8

Each of the 36 curves (in ϕ) in the complex plot is a cut through the broadcast pattern with θ varying from -90° to $+90^\circ$. The terrestrial service is labeled ('Earth Service') on the plot for $\theta = -13.8^\circ$ to $\theta = +13.8^\circ$. The space service is from $\theta = -13.8^\circ$ to $\theta = -90^\circ$ (the left side of the plots) as well as from $\theta = +13.8^\circ$ to $\theta = +90^\circ$ (the right side of the plots). These plot ranges cover well beyond the specific SSV definition in Figure 5.

The Earth-shaped pattern is clearly seen for the designated Earth service region. At the edge of each side of the Earth service pattern, the directivity drops off significantly to the -20° or $+20^\circ$ angle off-boresight. Beyond that, on each side of the plot, the side lobes of the signal are seen to vary significantly over the changing ϕ angle.

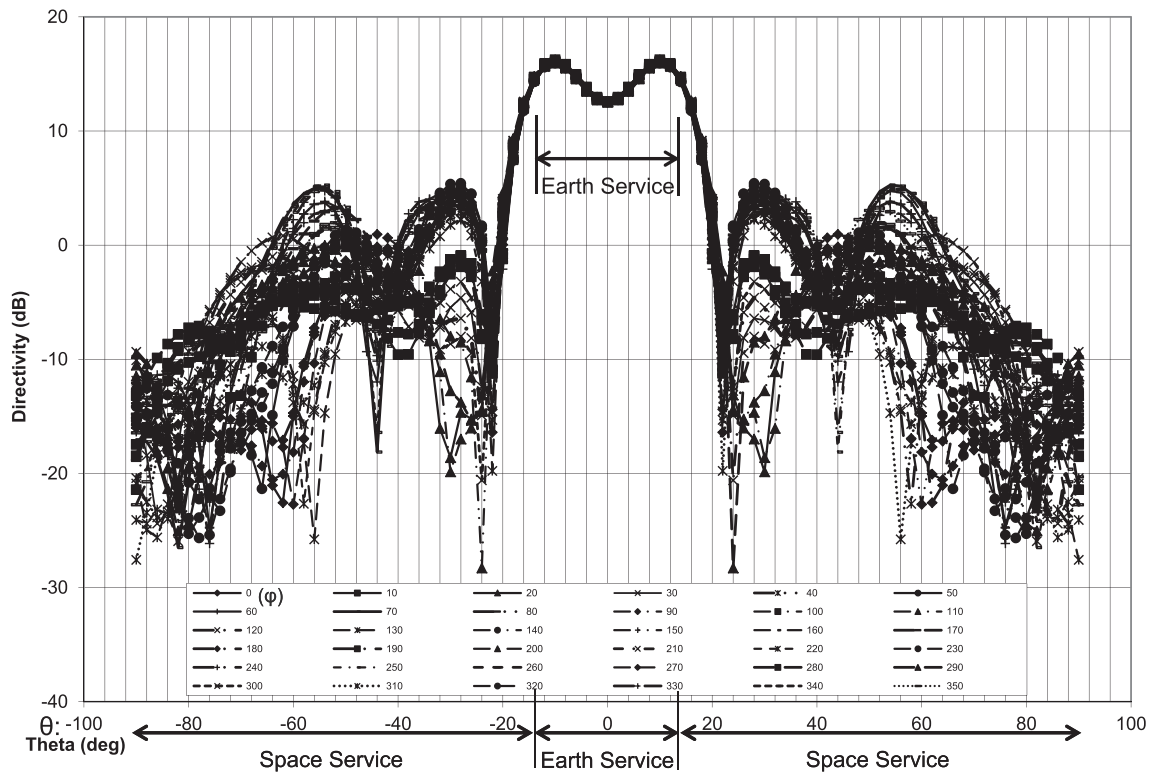

Fig. 25-Average legacy antenna pattern - L1

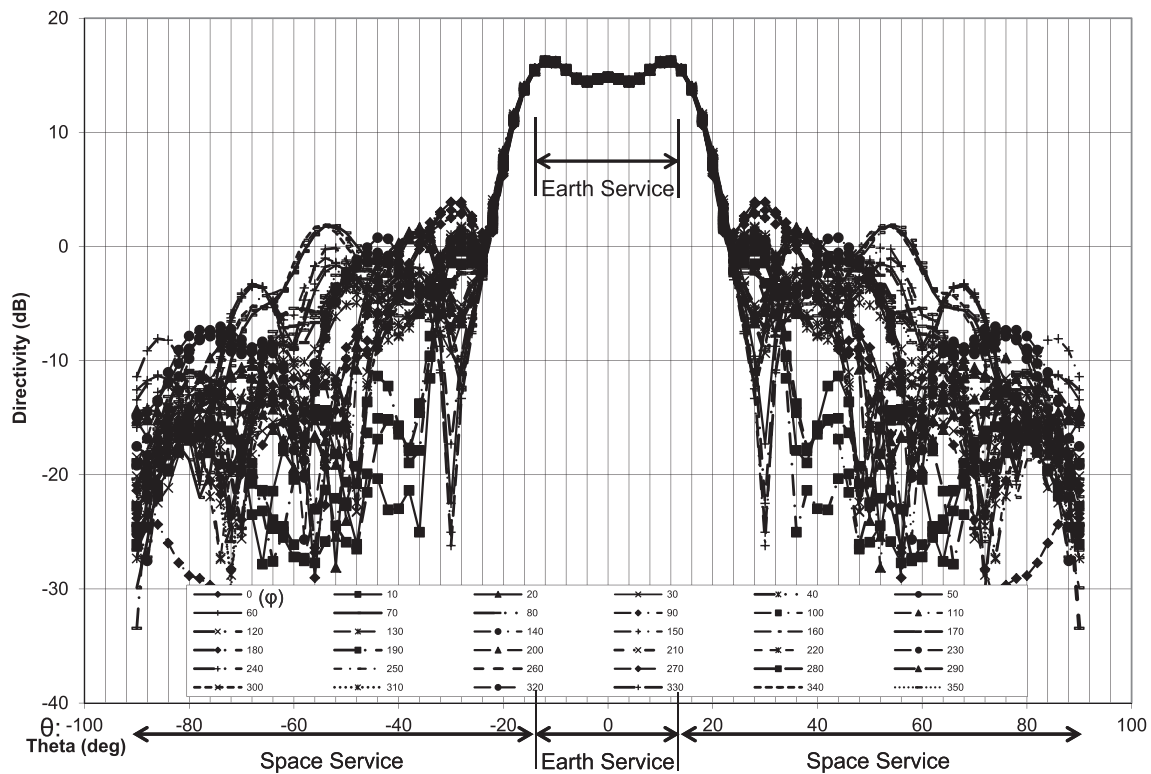

Fig. 26-Average improved antenna pattern - L1

Improved Antenna Panel Pattern, L1 Signal

The improved antenna pattern is seen in Figure 26. This figure shows plots of the average of the 12 improved panels for L1 directivity as a function of off-boresite angle (θ), for φ cuts every 10° .

Table 8 presents a comparison between the legacy and the improved antenna panels for the L1 directivity pattern. The terrestrial service is indicated by the EoE performance, and the SSV service is indicated by the signal beyond EoE.

It is observed that at EoE, the improved panel signal strength is +1 dB over the legacy panel.

Average Antenna Panel Pattern – L2 Signal

The average L2 directivity pattern from both the legacy and improved panel will be presented and compared in this section.

Legacy Antenna Panel Pattern, L2 Signal

The legacy antenna pattern is seen in Figure 27. This figure shows plots of the average of the eight legacy panels for L2 directivity as a function of off-boresite angle (θ), for φ cuts every 10° .

Improved Antenna Panel Pattern, L2 Signal

The improved antenna pattern is seen in Figure 28. This figure shows plots of the average of the 12 improved panels for L2 directivity as a function of off-boresite angle (θ), for φ cuts every 10° .

Table 9 presents a comparison between the legacy and the improved antenna panels for the L2 directivity pattern. The terrestrial service is indicated by the EoE performance and the SSV service is indicated by the signal beyond EoE.

It is observed that at EoE, the improved panel signal strength is +2 dB over the legacy panel.

Table 8—Legacy versus improved panel – L1

	Edge of Earth (EoE) (dB)	EoE out to 20°		EoE out to 23°	
		Magnitude (dB)	Reduction (dB)	Magnitude (dB)	Reduction (dB)
Legacy panel	+15	+4 to -5	-11 to -20	-2 to -19	-17 to -34
Improved panel	+16	+9 to +5	-7 to -11	+2 to -4	-14 to -20
Change from legacy to improved	+1	+5 to +10		+4 to +15	

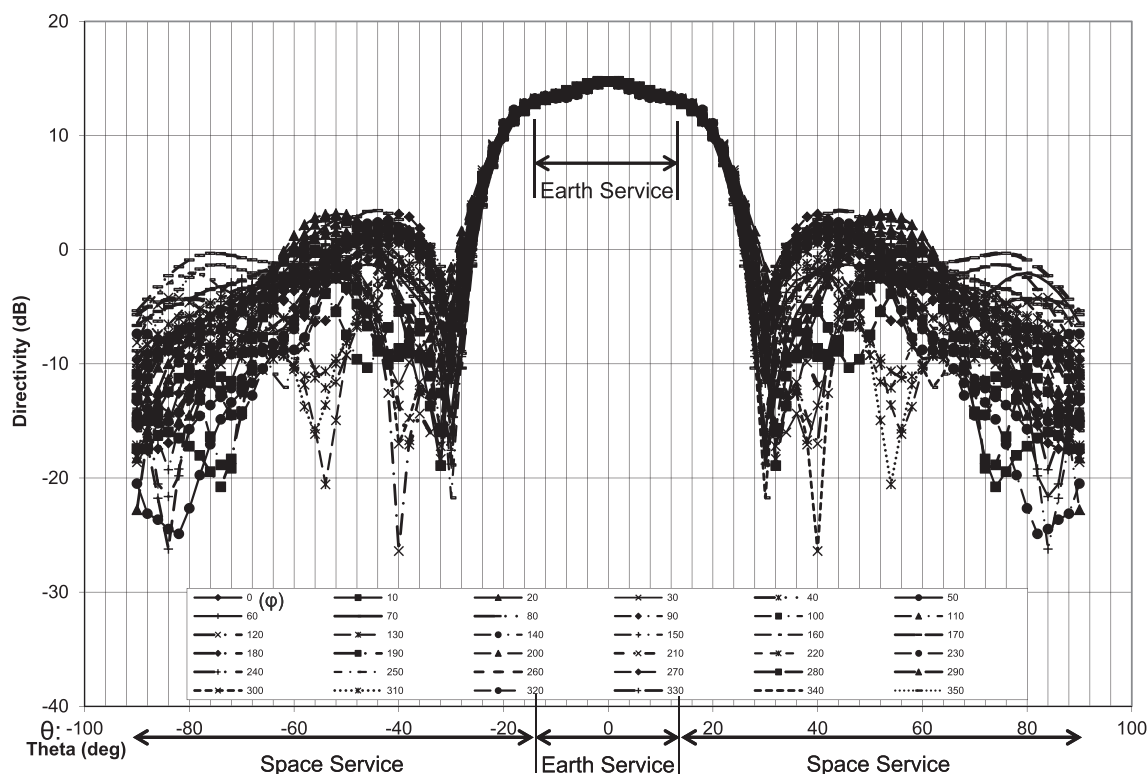

Fig. 27—Average legacy antenna pattern – L2

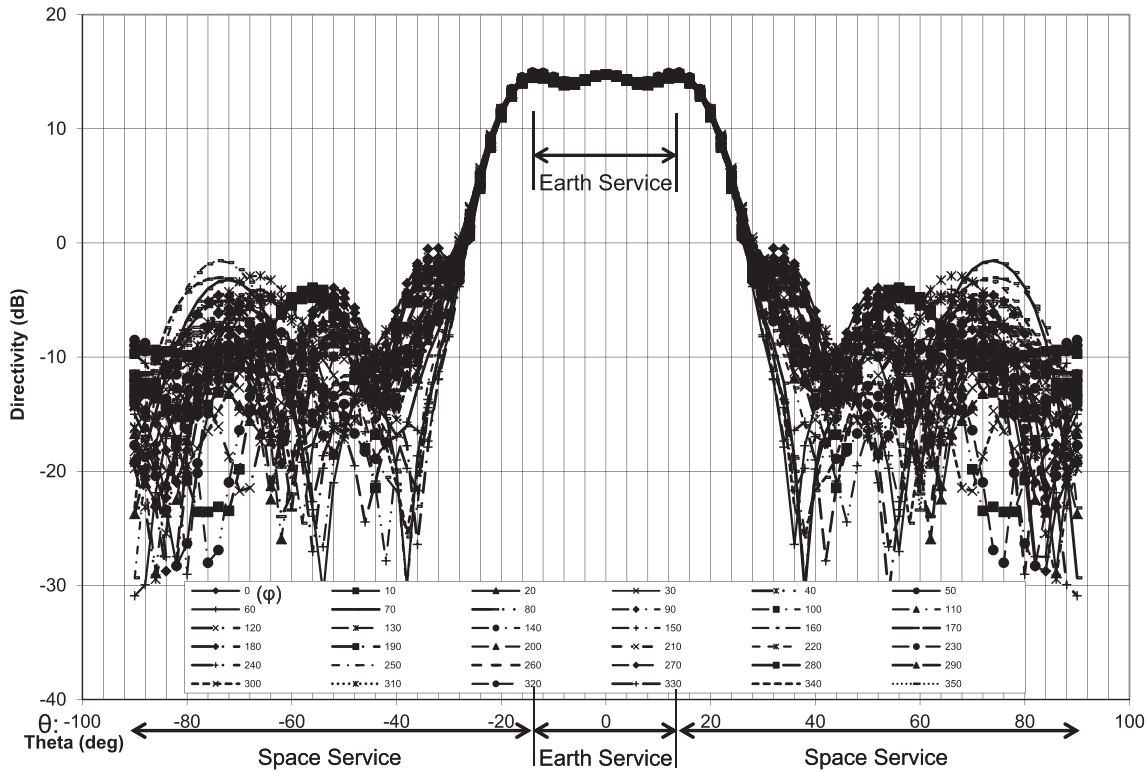

Fig. 28—Average improved antenna pattern – L2

Table 9—Legacy versus improved panel – L2

	Edge of Earth (EoE) (dB)	EoE out to 23°		EoE out to 26°	
		Magnitude (dB)	Reduction (dB)	Magnitude (dB)	Reduction (dB)
Legacy panel	+13	+9 to +5	-5 to -9	+5 to -3	-9 to -17
Improved panel	+15	+9 to +6	-6 to -9	+5 to 0	-10 to -15
Change from legacy to improved	+2	0 to +1		0 to +3	

FUTURE WORK

With 20 GPS Block IIR/IIR-M SVs currently serving as the backbone of the GPS constellation, it is expected that they will continue to provide a quality broadcast L-band service for many years to come. These SVs will continue to be monitored regularly, as they remain active in the GPS constellation.

Additional ground testing is being considered for a spare or engineering design model of the improved antenna panel in a current test facility in order to validate and calibrate on-orbit measurements.

Within the next few years, all of the GPS Block IIF SVs will be launched to replace most of the old IIA SVs. Following this, the new GPS III SVs (Figure 29) [40] will begin to be launched. The constellation arrangement in Figure 30 depicts what the GPS constellation might look like in a few years, having a mixture of IIR, IIR-M, IIF, the first few GPS III SVs, and even a couple of lingering IIA SVs.



Fig. 29—GPS III SV

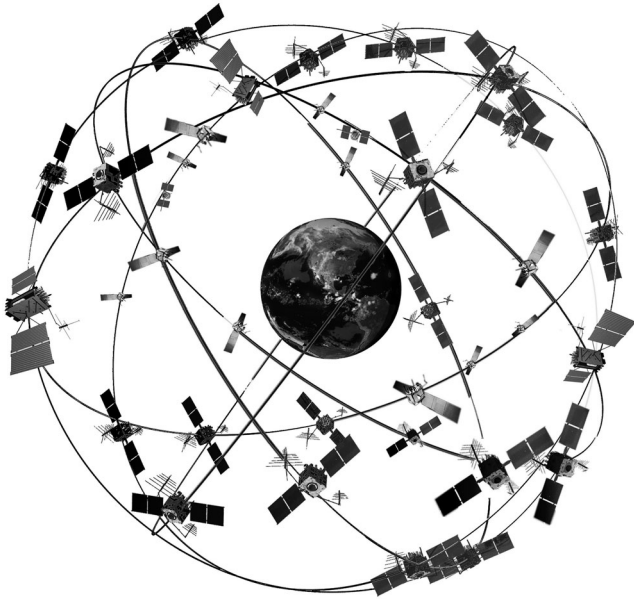

Fig. 30—Possible near-future GPS constellation

Lockheed Martin is currently building the first of the new GPS III SVs. The antenna panel pattern measurements for GPS III are expected to be released at some point after the first SVs have been built, tested, and launched. As with the GPS Block IIR/IIR-M patterns presented in this paper, SSV users are already requesting this information.

CONCLUSIONS

Presented in this paper for the first time are the GPS Block IIR/IIR-M antenna panel patterns. This information is of significant interest to SV designers and mission planners who use the GPS signal in terrestrial or space applications.

The results presented show that the GPS Block IIR and IIR-M SVs exceed all terrestrial service requirements for the GPS broadcast L-band power. The GPS Block IIR and IIR-M SVs provide much of the desired space service volume levels, although these are not applicable requirements to IIR. The GPS IIR improved antenna panel provides stronger terrestrial and space service. Specifically, the improved panel provides at least 1dB greater received signal strength on L1 at EoE and at least 2dB greater received power on L2 at EoE. The IIR-M SV also exceeds requirements using this improved antenna panel.

The boost in signal performance should aid tracking by the user in all environments, especially marginal situations such as under dense foliage, in urban canyons, and other signal-challenged environments. This increased performance will enable users to obtain and maintain signal lock in less than optimal conditions.

ACKNOWLEDGEMENTS

The GPS Block IIR improved antenna panel development was funded under Lockheed Martin internal development funds and performed primarily at the LMSSC Communications and Power Center in Newtown, PA, USA, with support from subsystems specialists at the LMSSC Valley Forge IIR factory.

The authors would like to thank the following individuals for their contributions and comments on this work: Don Edsall, Josh Pearsall, Mike Allen, Kyle Wolma, Kyle McConaughy, and Dan Thornton of Lockheed Martin and Tom Mullikin of Aerospace Consulting.

REFERENCES

1. Marquis, W., "Increased Navigation Performance from GPS Block IIR," *NAVIGATION*, Vol. 50, No. 4, Winter 2003–2004, pp. 219–233.
2. Marquis, W., "Recent Developments in GPS Performance and Operations," *Advances in the Astronautical Sciences, Guidance and Control 2011*, Vol. 141, 2011, pp. 3–21.
3. Covault, C., "Delta Explosion Halts \$1 Billion in Launches," *Aviation Week and Space Technology*, Vol. 146, No. 4, January 1997, pp. 30–33.
4. Hartman, T., Boyd, L., Koster, D., Rajan, J., and Harvey, J., "Modernizing the GPS Block IIR Spacecraft," *Proceedings of the 13th International Technical Meeting of the Satellite Division of The Institute of Navigation (ION GPS 2000)*, Salt Lake City, UT, September 2000, pp. 2115–2121.
5. Marquis, W., "M is for Modernization: Block IIR-M Satellites Improve on a Classic," *GPS World*, Vol. 12, No. 9, January 2001, pp. 38–44.
6. Kaplan, E. and Hegarty, C., (ed.), *Understanding GPS: Principles and Applications*, 2nd ed., Artech House Publishers, Boston, 2006, Sect. 4.2.1.
7. Kaplan, E. and Hegarty, C., (ed.), *Understanding GPS: Principles and Applications*, 2nd ed., Artech House Publishers, Boston, 2006, Sect. 4.3.2.
8. *NAVSTAR GPS Space Segment/Navigation User Interfaces*, ICD-GPS-200, Rev. C through IRN-004, April 2000.
9. *NAVSTAR GPS Space Segment/Navigation User Interfaces*, IS-GPS-200H, GPS Directorate, September 2013.
10. Bauer, F., Moreau, M. C., Dahle-Melsaether, M. E., Petrofski, W. P., Stanton, B. J., Thomason, S., Harris, G. Al., Sena, R. P., and Temple, L. P., III, "The GPS Space Service Volume," *Proceedings of the 19th International Technical Meeting of the Satellite Division of The Institute of Navigation (ION GNSS 2006)*, Ft. Worth, TX, September 2006, pp. 2503–2514.
11. Wu, S., Yunck, T., Lichten, S., Haines, B., and Malla, R., "GPS-Based Precision Tracking of Earth Satellites from Very Low to Geosynchronous Orbits," *Proceedings of the National Telesystems Conference*, May 1992, pp. 4/1–4/8.

12. Chao, C. and Bernstein, H., "Onboard Stationkeeping of Geosynchronous Satellites Using a Global Positioning System Receiver," *Journal of Guidance, Control, and Dynamics*, Vol. 17, No. 4, 1994, pp. 778–786.
13. Ferrage, P., Issler, J. L., Campan, G., and Durand, J. C., "GPS Techniques for Navigation of Geostationary Satellites," *Proceedings of the 8th International Technical Meeting of the Satellite Division of The Institute of Navigation (ION GPS 1995)*, September 1995, pp. 257–268.
14. Chao, C., et al., "Challenges and Options for GEO Use of GPS," AAS 97-677, *AAS/AIAA Astrodynamics Specialist Conference*, August 1997, pp. 1171–1183.
15. Powell, T., Feess, W., and Menn, M. D., "Evaluation of GPS Architecture for High Altitude Spaceborne Users," *Proceedings of the 54th Annual Meeting of The Institute of Navigation*, Denver, CO, June 1998, pp. 157–165.
16. Kronman, J., "Experience Using GPS for Orbit Determination of a Geosynchronous Satellite," *Proceedings of the 13th International Technical Meeting of the Satellite Division of The Institute of Navigation (ION GPS 2000)*, Salt Lake City, UT, September 2000, pp. 1622–1626.
17. Ruiz, J. and Frey, C., "Geosynchronous Satellite Use of GPS," *Proceedings of the 18th International Technical Meeting of the Satellite Division of The Institute of Navigation (ION GNSS 2005)*, Long Beach, CA, September 2005, pp. 1227–1232.
18. Bamford, B., Winternitz, L., and Moreau, M., "Real-time Geostationary Orbit Determination Using the Navigator GPS Receiver," *2005 Flight Mechanics Symposium*, October 2005.
19. Bamford, W., Naasz, B. and Moreau, M., "Navigation Performance in High Earth Orbits using Navigator GPS Receiver," AAS-06-045, *Advances in the Astronautical Sciences, Guidance and Control 2006*, Vol. 125, 2006, pp. 261–276.
20. Barker, L., "GPS Beyond LEO: Signal Environment System Design Considerations," AAS-08-003, *Advances in the Astronautical Sciences, Guidance and Control 2008*, Vol. 131, February 2008, pp. 31–48.
21. Barker, L. and Frey, C., "GPS at GEO – SBIRS GEO1 First Look," AAS 12-044, *Advances in the Astronautical Sciences, Guidance and Control 2012*, Vol. 144, February 2012, pp. 199–212.
22. Burkert, J., Frey, C., and Mottinger, B., "GPS Navigation at GEO," *Lockheed Martin Joint Technical Focus Group Conference*, April 2012.
23. Larson, K., Gaylor, D., and Winkler, S., "GOES-R Worst-case GPS Constellation for Testing Navigation at Geosynchronous Orbit," AAS 13-064, *Advances in the Astronautical Sciences, Guidance and Control 2013*, Vol. 149, February 2013, pp. 403–416.
24. Balbach, O., Eissfeller, B., Hein, G. W., Zink, T., Enderle, W., Schmidhuber, M., and Lemke, N., "Tracking GPS Above GPS Satellite Altitude: Results of the GPS Experiment on the HEO Mission Equator-S," *Proceedings of the 11th International Technical Meeting of the Satellite Division of The Institute of Navigation (ION GPS 1998)*, Nashville, TN, September 1998, pp. 1555–1564.
25. Moreau, M., Axelrad, P., Garrison, J., and Long, A., "GPS Receiver Architecture and Expected Performance for Autonomous Navigation in High Earth Orbits," *NAVIGATION*, Vol. 47, No. 3, Fall 2000, pp. 191–204.
26. Moreau, M., Davis, E., Carpenter, J., Kelbel, D., Davis, G., Axelrad, P., "Results from the GPS Flight Experiment on the High Earth Orbit AMSAT OSCAR-40 Spacecraft," *Proceedings of the 15th International Technical Meeting of the Satellite Division of The Institute of Navigation (ION GPS 2002)*, Portland, OR, September 2002, pp. 122–133.
27. Bamford, W., Winternitz, L., and Hay, C., "Autonomous GPS Positioning at High Earth Orbits," *GPS World*, Vol. 17, No. 4, April 2006, pp. 50–55.
28. Carpenter, J., Folta, D., Moreau, M., Quinn, D., "Libration Point Navigation Concepts Supporting the Vision for Space Exploration," AIAA-2004-4747, *AAS/AIAA Astrodynamics Specialist Conference*, August 2004, pp. 319–338.
29. Lee, T., Long, A., Berry, K., Carpenter, R., Moreau, M., Holt, G., "Navigating the Return Trip from the Moon using Earth-based Ground Tracking and GPS (AAS 09-056)," *Advances in the Astronautical Sciences, Guidance and Control 2009*, Vol. 133, February 2009, pp. 319–338.
30. Silva, P., Lopes, H. D., Peres, T. R., Silva, J. S., Ospina, J., Cichocki, F., Dobis, F., Musumeci, L., Serant, D., Calmettes, T., Pessina, I., and Perello, J. V., "Weak GNSS Signal Navigation to the Moon," *Proceedings of the 26th International Technical Meeting of the Satellite Division of The Institute of Navigation (ION GNSS+ 2013)*, Nashville, TN, September 2013, pp. 3357–3367.
31. Marquis, W. and Reigh, D., "On-orbit Performance of the Improved GPS Block IIR Antenna Panel," *Proceedings of the 18th International Technical Meeting of the Satellite Division of The Institute of Navigation (ION GNSS 2005)*, Long Beach, CA, September 2005, pp. 2418–2426.
32. Bar-Sever, Y., "Performance Evaluation of the GPS Yaw Bias Implementation," *Proceedings of the 8th International Technical Meeting of the Satellite Division of The Institute of Navigation (ION GPS 1995)*, Palm Spring, CA, September 1995, pp. 599–611.
33. Kouba, J., "A Simplified Yaw-attitude Model for Eclipsing GPS Satellites," *GPS Solutions*, Vol. 13, No. 1, January 2009, pp. 1–12.
34. Tetewsky, A., Okerson, G., and Ross, J., "Inter Signal Correction Sensitivity Analysis: Assessing SV Aperture Dependent Delays and Ground Control Approximations on Modernized GPS Dual Frequency Navigation," *The Institute of Navigation Joint Navigation Conference (ION JNC)*, June 2014.
35. Tetewsky, A., Okerson, G., Kang, N., Watjen, J., Anzperger, J., Lozow, J., Soltz, A., Vaughn, N., O'Brien, C., Graham, D., Wilmart, R., O'Grady, C., Pierce, D., Ross, J., Edgar, C., Powell, T., Kovach, K., Harrington, P., Marquis, W., Czopek, F., "White Paper for Establishing a Theoretical and Practical Process for Measuring and Reporting Min and Max Powers per ICD 200F, 705B, 700B, and 700A NATO with SVN45 as a Case Example," unpublished work, 2012.

36. Winkler, S., Voboril, C., Hart, R., and King, M., "GOES-R Use of GPS at GEO," AAS 13-063, *Advances in the Astronautical Sciences, Guidance and Control 2013*, Vol. 149, 2013, pp. 391–402.
37. ARINC, "Test Report for the Block IIR-M On-orbit Test," April 2006.
38. Marquis, W., Burdick, J., Harvey, J., and Forsyth, M., "GPS Block IIR Modernized Services to the Warfighter," The Institute of Navigation Joint Navigation Conference (ION JNC), Jun. 2011.
39. Marquis, W. and Pearsall, J., "Performance of the GPS Constellation – A Mixed Population," Institute of Navigation Joint Navigation Conference, Jun. 2012.
40. Marquis, W. and Shaw, M., "Design of the GPS III Space Vehicle," *Proceedings of the 24th International Technical Meeting of the Satellite Division of The Institute of Navigation (ION GNSS 2011)*, Portland, Oregon, September 2011, pp. 3067–3075.

THE INSTITUTE OF NAVIGATION is organized as a scientific society, designed to advance the art and science of navigation through the publication of *Navigation*, through periodic bulletins and newsletters, regional and national meetings, and through its officers and working committees.

MEMBERSHIP The Institute of Navigation is open to anyone interested in navigation or the related arts and sciences. Regular annual membership includes a subscription to *Navigation*. The Institute welcomes new members, new ideas, criticism, and constructive suggestions, at all times. All members of The Institute are invited to volunteer for work with established committees. Individual members and officers of The Institute's various sections are invited to submit news items of interest to the membership in general.

THE INSTITUTE as an organization does not take sides in any controversy. Members are free to assume political or controversial positions on any issues as they deem it necessary or advisable, but such action by individual members does not necessarily constitute the option or sanction of the official body of The Institute.

NAVIGATION is a quarterly journal published by The Institute of Navigation. The journal publishes original, peer-reviewed articles on all areas related to the science and technology of air, sea, land and space navigation, including estimation of position, velocity, altitude, and time, and the technologies that support the determination of these quantities. Supporting technologies include navigation aids and instrumentation, algorithms and methods, error and integrity analysis, signal processing, biological navigation systems, surveying and geodesy. The journal also publishes selected historical and survey articles, as well as papers of exceptional quality drawn from The Institute's conference proceedings.

NAVIGATION is indexed by Thompson Reuters in the Following: Science Citation Index Expanded (also known as SciSearch[®]) Journal Citation Reports/Science Edition; Current Contents[®]/Engineering Computing and Technology.

AUTHORS should reflect clear thought through chosen, specific words composed in direct, responsible and active syntax. The Editor cannot undertake to rewrite papers and therefore will return manuscripts found deficient in style, form, or clarity. Submission of a manuscript is a representation that the paper has not been previously published in open literature, is not currently submitted for publication elsewhere, and that the author(s) have not assigned or transferred copyright.

MANUSCRIPTS for review and publication should be submitted electronically at <http://mc.manuscriptcentral.com/navigation>. The online manuscript handling system has explicit instructions on format and other matters that should be followed. This Journal has a completely digital submission, review, and production process. We therefore ask for production-quality files at initial submission and in any case at the submission of your revised article. Manuscripts should be typewritten with double spacing and wide margins on one side of 8½×11 in paper. A brief abstract stating the principal points and conclusions of the paper should be included. Equations require special typographical consideration and additional space and margin area should be allowed.

REFERENCES should be numbered consecutively in the text using bracketed numerals and listed in the same order at the end of the paper. Give author(s) name, initials, title of article, journal or book, volume, initial page number and year.

FOOTNOTES should be avoided.

ILLUSTRATIONS must be referenced in the text and numbered in order of appearance. Photographs that will require half-tone reproduction must be glossy prints. Line drawings may be submitted in original form or as glossy prints. Illustrations produced by office-type copying machines are generally unsuitable and generally will be rejected. While preparing line illustrations, it is important to avoid extremes of light and dark contrast. Lettering should be done with uniform character size and properly proportioned to the figure, bearing in mind that it is usually necessary to enlarge or reduce the illustration photographically in order to accommodate page format characteristics.

PAGE proof is sent to the author. It should be proofread carefully, marked according to instructions, and returned to the Editor promptly. Extensive alterations and revisions are costly, time consuming and may delay publication. Excessive costs will be charged to the author.

REPRINT, Reprints may be ordered from Wiley-Blackwell.

CORPORATE MEMBERS OF THE INSTITUTE OF NAVIGATION

Corporations

Acutronic USA, Inc.
Airbus DS GmbH
Air Force Research Lab
Appplanix Corporation
ATK Aerospace Group
Aviation Data Communication Corporation
Braxton Technologies, LLC
BROADCOM
CAST, Navigation LLC
Caterpillar Inc.
Chronos Technology Limited
CMC Electronics, Inc.
C.S. Draper Laboratory, Inc.
DataGrid Inc.
Defence Science & Technology
Laboratory
DEIMOS Space S.L.
Emcore Corporation
European GNSS Agency
Falcon Reconnaissance
Systems, Inc.
Fraunhofer IIS
Frequency Electronics, Inc.
Fugro Satellite Positioning, Inc.
General Lighthouse Authorities
Geodesicx, Inc.
Geo++ GmbH
German Aerospace Center (DLR)
GMV
GPS Networking, Inc.
GPS World
Harris Corporation
Hemisphere GNSS, Inc.
Honeywell, Inc.
Honeywell Technology Solutions Lab
Ideal Aeromsmith
Inmarsat
**Inside GNSS/Gibbons Media &
Research LLC**
INSITU, Inc.
Institute of Flight Guidance, TU-BS
Intel Corporation ISAE - SUPAERO
ISAE-Supaero
ISI, A Pragmatics Inc. Company
ISRO Satellite Center
InvenSense Inc.

Javad GNSS, Inc.

John Deere
Kongsberg Seatex AS
KVH Industries, Inc.
L-3 Interstate Electronics Corporation
Labsat by Racelogic
Lange-Electronic GmbH
Lightsquared
LinQuest Corporation
Lockheed Martin
Microsemi
Moog-Crossbow Technology, Inc.
MTSI
Navcom Technology, Inc.
NavtechGPS
NavXperience GmbH
Nikon-Trimble Co., Ltd.
**Northrop Grumman
Electronic Systems**
Novatel, Inc.
NSL
Oceanering International, Inc.
Overlook Systems Technologies
Oxford Technical Solutions, Ltd.
Pretalen Ltd.
Rakon Ltd.
Raytheon
Resilient Navigation &
Timing Foundation
Rincon Research Corporation
Rockwell Collins
Rohde & Schwarz, Inc.
Romona, Inc.
RX Networks Inc.
Samsung Semiconductor, Inc.
Sandia National Laboratories
Septentrio Satellite Navigation
Silicon Sensing Systems Ltd.
Skyguide (Swiss Air Navigation
Services)
Southern Avionics Co.
Space Applications Centre
Sparton Defense & Security Systems
Spirent Communications SW Ltd
Spirent Federal Systems
SP Technical Research Institute
Sweden

ST Microelectronics
Steve Lieber & Associates, Inc.
SubCarrier Systems Corp (SCSC)
Systron Donner Inertial
Technology Advancement Group
TerraStar GNSS Limited
Thales ATM U.S.
The Aerospace Corporation
The MITRE Corporation
Topcon Positioning Systems
Trimble
Trimble Navigation, Ltd.
U-BLOX AG
Unicore Communications Inc.
Universal Avionics Corporation
UrsaNav, Inc.
Vectornav Technologies
Yantel Corporation

Government Agencies

746 Test Squadron
Federal Aviation Administration
National Geodetic Survey
National Geospatial Intelligence Agency
SPAWAR Systems Center Atlantic
USAF GPS Directorate
U.S. Army CERDEC/CP&I
U.S. Coast Guard Command &
Control Engineering Center
U.S. Coast Guard NAVCEN
USCG R&D Center
USDOT/Volpe Center
U.S. Naval Observatory

Educational Institutions

Ohio University, Avionics Engineering
Center
PSU/ARL Navigation R&D Center
The Johns Hopkins University,
Applied Physics Laboratory
The University of Texas
U.S. Coast Guard Academy
U.S. Merchant Marine Academy

The Institute of Navigation would like to thank our partners: **Benefactors • Patrons • Contributors**

THE INSTITUTE OF NAVIGATION



8551 Rixlew Lane, Suite 360
Manassas, VA 20109
Phone: (703) 366-2723 • Fax: (703) 366-2724
Web site address: www.ion.org
E-mail address: membership@ion.org