

Panasonic[®]

Operating Instructions Digital Camera

Model No. **DMC-LX2**

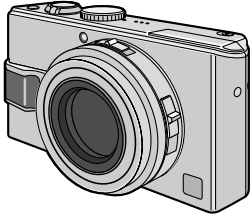

LUMIX

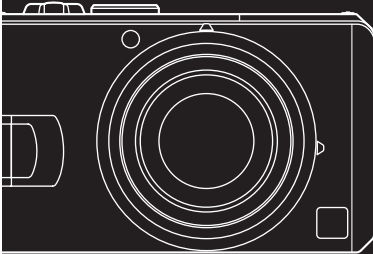

LEICA
DC VARIO-ELMARIT

Before connecting, operating or adjusting this product, please read the instructions completely.

For USA assistance, please call: 1-800-272-7033 or send e-mail to : digitalstillcam@us.panasonic.com

For Canadian assistance, please call: 1-800-561-5505 or visit us at www.panasonic.ca

PP

VQT0Y44-2

Dear Customer,

We would like to take this opportunity to thank you for purchasing this Panasonic Digital Camera. Please read these Operating Instructions carefully and keep them handy for future reference.

Information for Your Safety

WARNING

TO REDUCE THE RISK OF FIRE OR SHOCK HAZARD AND ANNOYING INTERFERENCE, USE ONLY THE RECOMMENDED ACCESSORIES AND DO NOT EXPOSE THIS EQUIPMENT TO RAIN OR MOISTURE. DO NOT REMOVE THE COVER (OR BACK); THERE ARE NO USER SERVICEABLE PARTS INSIDE. REFER SERVICING TO QUALIFIED SERVICE PERSONNEL.

Carefully observe copyright laws.

Recording of pre-recorded tapes or discs or other published or broadcast material for purposes other than your own private use may infringe copyright laws. Even for the purpose of private use, recording of certain material may be restricted.

- Please note that the actual controls and components, menu items, etc. of your Digital Camera may look somewhat different from those shown in the illustrations in these Operating Instructions.
- SDHC Logo is a trademark.
- Leica is a registered trademark of Leica Microsystems IR GmbH.
- Elmarit is a registered trademark of Leica Camera AG.
- Other names, company names, and product names printed in these instructions are trademarks or registered trademarks of the companies concerned.

THE SOCKET OUTLET SHALL BE INSTALLED NEAR THE EQUIPMENT AND SHALL BE EASILY ACCESSIBLE.

CAUTION

Danger of explosion if battery is incorrectly replaced. Replace only with the same or equivalent type recommended by the manufacturer. Dispose of used batteries according to the manufacturer's instructions.



A lithium ion/polymer battery that is recyclable powers the product you have purchased. Please call 1-800-8-BATTERY for information on how to recycle this battery.

FCC Note: (U.S. only)

This equipment has been tested and found to comply with the limits for a Class B digital device, pursuant to Part 15 of the FCC Rules. These limits are designed to provide reasonable protection against harmful interference in a residential installation. This equipment generates, uses, and can radiate radio frequency energy and, if not installed and used in accordance with the instructions, may cause harmful interference to radio communications. However, there is no guarantee that interference will not occur in a particular installation. If this equipment does cause harmful interference to radio or television reception, which can be determined by turning the equipment off and on, the user is encouraged to try to correct the interference by one or more of the following measures:

- Reorient or relocate the receiving antenna.
- Increase the separation between the equipment and receiver.
- Connect the equipment into an outlet on a circuit different from that to which the receiver is connected.
- Consult the dealer or an experienced radio/TV technician for help.

FCC Caution: To assure continued compliance, follow the attached installation instructions and use only shielded interface cables with ferrite core when connecting to computer or peripheral devices.

Any changes or modifications not expressly approved by the party responsible for compliance could void the user's authority to operate this equipment.

Trade Name: Panasonic
 Model No.: DMC-LX2
 Responsible party: Panasonic Corporation of North America
 One Panasonic Way,
 Secaucus, NJ 07094
 Support Contact: Panasonic Consumer Electronics Company
 1-800-272-7033

This device complies with Part 15 of the FCC Rules. Operation is subject to the following two conditions: (1) This device may not cause harmful interference, and (2) this device must accept any interference received, including interference that may cause undesired operation.

This Class B digital apparatus complies with Canadian ICES-003



The logo features the FCC symbol on the left, followed by the word "Panasonic" in a bold, sans-serif font, and "DMC-LX2" in a smaller font below it.

-If you see this symbol-**Information on Disposal in other Countries outside the European Union**

This symbol is only valid in the European Union. If you wish to discard this product, please contact your local authorities or dealer and ask for the correct method of disposal.

■ Care for the camera

- **Do not strongly shake or bump the camera.** The camera may not be operated normally, recording of pictures may be disabled or the lens and the LCD monitor may be damaged.
- Retract the lens before carrying the camera.
- Retract the lens before playing back pictures.
- **Sand or dust may cause the camera to malfunction. Make sure that sand or dust does not get into the lens, the flash or the terminals when using the camera on a beach etc.**
- Make sure that water does not get into the camera when using it on a rainy day or on a beach.
- **This camera is not waterproof. In case the camera comes into contact with water, wipe it off with a dry cloth. When the camera does not operate normally, contact your dealer or your nearest servicenter.**

■ About the LCD monitor

- **Do not press the LCD monitor with excessive force. Uneven colors may appear on the LCD monitor and it may malfunction.**
- Condensation may form on the LCD monitor in places with large temperature differences. Wipe the condensation with a soft, dry cloth.
- If the camera is cold when you turn it on, the picture on the LCD monitor will be slightly darker than usual at first. However, the picture will return to normal brightness when the internal temperature of the camera increases.

Extremely high precision technology is employed to produce the LCD monitor screen. However there may be some dark or bright spots (red, blue or green) on the screen. This is not a malfunction. The LCD monitor screen has more than 99.99% effective pixels with a mere 0.01% of the pixels inactive or always lit. The spots will not be recorded in pictures stored in the built-in memory or a card.

■ About the Lens

- Do not press the lens or the lens barrel with excessive force.
- Do not leave the camera with the lens facing the sun as it may cause the camera to malfunction. Also, be careful when you leave the camera outside or near a window.
- When there is dirt (water, oil, and fingerprints, etc.) on the surface of the lens, the picture may be affected. Lightly wipe the surface of the lens with a soft, dry cloth before and after taking pictures.

■ About Condensation (When the lens is fogged up)

- Condensation occurs when the ambient temperature or humidity changes as described below. Be careful of condensation since it causes lens stains, fungus and camera malfunction.
 - When the camera is taken from the cold outdoors to the warm indoors
 - When the camera is taken from outside to inside an air-conditioned car
 - When cool wind from an air conditioner etc. blows directly on the camera
 - In humid places
- To prevent condensation, put the camera in a plastic bag until the temperature of the camera is close to the ambient temperature. If condensation occurs, turn the camera off and leave it for about 2 hours. The fog will disappear naturally when the temperature of the camera becomes close to the ambient temperature.

■ When not using the camera for a long period of time

- Store the battery in a cool and dry place with a relatively stable temperature. [Recommended temperature: 15°C to 25°C (59°F to 77°F), Recommended humidity: 40% to 60%]
- Always remove the battery and the card from the camera.
- If the battery is left inserted in the camera it will discharge even if the camera is turned off. If the battery continues to be left in the camera, it will discharge excessively and may become unusable even if charged.
- When storing the battery for a long period of time, we recommend charging it once a year. Remove the battery from the camera and store it again after it has completely discharged.
- We recommend storing the camera with a desiccant (silica gel) when you keep it in a closet or a cabinet.

■ About cards that can be used in this unit

You can use an SD Memory Card, an SDHC Memory Card and a MultiMediaCard.

- When the term **card** is used in these operating instructions this refers to the following types of Memory Cards.
 - SD Memory Card (8 MB to 2 GB)
 - SDHC Memory Card (4 GB)
 - MultiMediaCard

More specific information about memory cards that can be used with this unit.

- You can only use an SDHC Memory Card if using cards with 4 GB or more capacity.
- A 4 GB Memory Card without an SDHC logo is not based on the SD Standard and will not work in this product.

About The Mode dial

Adjust part ④ to the desired mode.

The mode dial can be rotated 360°. Rotate it slowly and surely to adjust to each mode. (Do not adjust it to parts where there is no mode.)

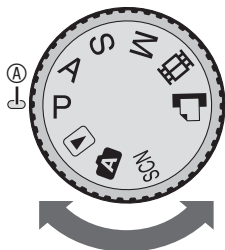

P : Program AE mode (P26)

The exposure is automatically adjusted by the camera.

A : Aperture-priority AE (P53)

The shutter speed is automatically determined by the aperture value you set.

S : Shutter-priority AE (P53)

The aperture value is automatically determined by the shutter speed you set.

M : Manual exposure (P54)

The exposure is adjusted by the aperture value and the shutter speed which are manually adjusted.

: Motion picture mode (P75)

This mode allows you to record motion pictures with audio.

: Print mode (P110)

This mode allows you to print pictures from a PictBridge-compliant printer connected directly to the camera.

SCN : Scene mode (P62)

This mode allows you to take pictures depending on the recording scenes.

A : Auto mode (P30)

This is the recommended mode for beginners.

: Playback mode (P36)

This mode allows you to play back recorded pictures.

■ About indications in these operating instructions



Modes indicated here allow you to use the functions or settings described on this page. Set the Mode dial to any of the modes to use the functions or settings.



Convenient or useful information about this camera is described.

■ About illustrations in these operating instructions

Please note that the appearance of the product, the illustration or the menu screen are a little different from those in actual use.

■ About illustrations of the cursor button and the joystick

In those operating instructions, the operations on the cursor button and the joystick are described as illustrated below.

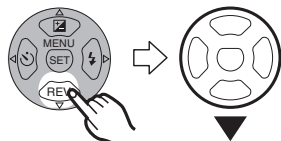

For example: Pressing the ▼ cursor button



For example: Moving the joystick to the right



For example: Pressing the joystick

Contents

<hr/> <hr/>	
Before Use	
<hr/> <hr/>	
Information for Your Safety	2
About The Mode dial	6
<hr/> <hr/>	
Preparation	
<hr/> <hr/>	
Standard Accessories	9
Names of the Components	10
Quick Guide	12
Charging the Battery with the Charger	13
About the Battery (charging/number of recordable pictures)	14
Inserting/Removing the Battery	15
Inserting/Removing the Card (Optional)	16
About the Built-in Memory/the Card	17
Attaching the Lens Cap/Strap	19
Setting Date/Time (Clock Set)	20
• Changing the clock setting	20
Setup Menu	21
<hr/> <hr/>	
Basic	
<hr/> <hr/>	
Taking Pictures	26
Taking Pictures in Auto Mode	30
Taking Pictures with the Zoom	32
• Using the Optical Zoom	32
• Using the Extended Optical Zoom (EZ)	33
• Using the Digital Zoom	
Further extending the zoom	34
Checking the Recorded Picture (Review)	35
Playing Back Pictures	36
Deleting Pictures	37
<hr/> <hr/>	
Advanced	
<hr/> <hr/>	
About the LCD Monitor	39
• Changing the information displayed	39
• Brightening the LCD Monitor (Power LCD/High angle mode)	41
Taking Pictures using the Built-in Flash	43
Taking Pictures with the Self-timer	47
Compensating the Exposure	48
Taking Pictures using Auto Bracket	49
Optical Image Stabilizer [STABILIZER]	50
Taking Pictures using Burst Mode	51
Taking pictures by setting the aperture/shutter speed manually	53
• Aperture-priority AE	53
• Shutter-priority AE	53
Taking pictures by setting the exposure manually	54
• Manual exposure	54
Taking Pictures with Manual Focus	56
Taking Close-up pictures	59
Setting the aspect ratio	60
AF/AE Lock (AF: Auto focus/AE: Auto exposure)	61
Scene mode	62
– Portrait mode	63
– Soft skin mode	63
– Scenery mode	63
– Sports mode	63
– Night portrait mode	64
– Night scenery mode	64
– Self portrait mode	64
– Food mode	65
– Party mode	65
– Candle light mode	66
– Fireworks mode	66
– Starry sky mode	67
– Beach mode	67
– Aerial photo mode	68
– Snow mode	68
– High Sensitivity mode	68
– Baby mode 1	69
– Baby mode 2	69
Recording which day of the vacation you take the picture	70
Displaying the time at the travel destination	72
• Location candidates for World Time settings	74
Motion picture mode	75
Displaying Multiple Screens (Multi Playback)	77
Displaying pictures by recording date (Calendar playback)	78
Using the Playback Zoom	79

Playing Back Pictures with Audio/Motion pictures	80
--	----

Menu Settings

Using the [REC] mode menu	81
• [W.BALANCE] Adjusting the hue for a more natural picture	82
• [WB ADJUST.] Finely Adjusting the White Balance ..	84
• [SENSITIVITY] Setting the light sensitivity	84
• [PICT.SIZE]/[QUALITY] Setting a picture size and quality that matches your use of the pictures ..	86
• [AUDIO REC.] Recording still pictures with audio ..	87
• [METERING MODE] Deciding the method to measure brightness	88
• [AF MODE] Setting the focus method	88
• [CONT.AF] Continuously focusing on a subject ..	90
• [AF ASSIST LAMP] Focusing in low light conditions becomes easier	90
• [COL.EFFECT] Setting color effects for the recorded pictures	91
• [PICT.ADJ.] Adjusting the picture quality for the recorded pictures	91
• [FLIP ANIM.] Connecting images to create a motion picture file	92
• [CLOCK SET] Setting the date, time and display ..	93
Using the [PLAY] mode menu	94
• [SLIDE SHOW] Playing back pictures in order for a fixed duration	95
• [FAVORITE] Setting your favorite pictures	96
• [ROTATE DISP.]/[ROTATE] To display the picture rotated	97
• [DPOF PRINT] Setting the Picture to be Printed and the Number of Prints	99

• [PROTECT] Preventing Accidental Erasure of the Picture	100
• [AUDIO DUB.] Adding Audio to Recorded Pictures	101
• [RESIZE] Making the picture smaller	102
• [TRIMMING] Enlarging a picture and trimming it	103
• [ASPECT CONV.] Changing the aspect ratio of a 16:9 picture	104
• [COPY] Copying the picture data	105
• [FORMAT] Initializing the built-in memory or a card	106

Connecting to other equipment

Connecting to a PC	107
Connecting to a PictBridge-compliant Printer	110
Playing Back Pictures with a TV Screen	114

Others

Screen Display	115
Cautions for Use	118
Message Display	120
Troubleshooting	122
Number of recordable pictures and available recording time	128
Specifications	132
Digital Camera Accessory System ..	135
Digital Camera Accessory Order Form (For USA Customers)	136
Request for Service Notice (For USA Only)	137
Limited Warranty (For USA Only)	138
Customer Services Directory (For USA Only)	140
Index	141
Spanish Quick Use Guide/ Guía rápida en español	143

Standard Accessories

Before using your camera, check the contents.

■ Battery Pack

CGA-S005A

(In the text, it is indicated as "Battery")



■ Battery Charger

DE-A11B

(In the text, it is indicated as "Charger")

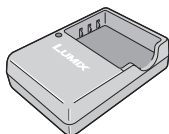

■ AV Cable

K1HA08CD0008



■ USB Connection Cable

K1HA08CD0007

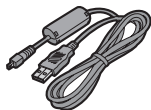

■ CD-ROM



■ Strap

VFC4082

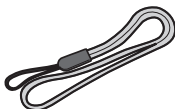

■ Battery Carrying Case

VYQ3509



■ Lens Cap

VYF3109 (Silver)

VYF3110 (Black)



■ Lens Cap String

VFC4137



• Card is optional.

You can record or play back pictures on the built-in memory when you are not using a card. (P17)

- For information about optional accessories, please refer to "Digital Camera Accessory System". (P135)
- If any of the accessories are lost, please contact Panasonic's parts department at 1 800 833-9626 (For USA) or in Canada call 1 800 561-5505 for more details on how to obtain replacement parts.

Names of the Components

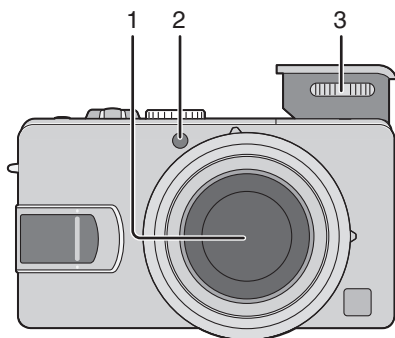

- 1 Lens part (P5)
- 2 Self-timer Indicator (P47)
AF Assist Lamp (P90)
- 3 Flash (P43)

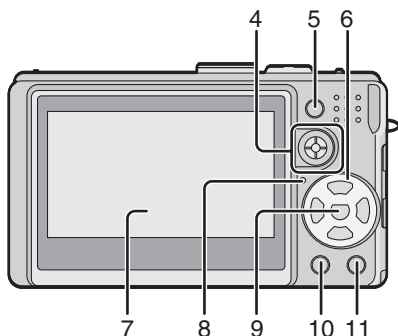

- 4 Joystick (P27, 53, 54, 56, 82)
- 5 AF/AE Lock Button (P61)
- 6 Cursor buttons
 - ◀/Self-timer Button (P47)
 - ▼/[REV] Button (P35)
 - ▶/Flash Mode Button (P43)
 - ▲/Backlight Compensation in Auto Mode (P31)/Exposure Compensation (P48)/Auto Bracket (P49)/Flash Output Adjustment (P46) Button
- 7 LCD Monitor (P39, 115)
- 8 Status Indicator (P23)
- 9 [MENU/SET] Button (P20)
- 10 [DISPLAY/LCD MODE] Button (P39, 41)
- 11 Single/Burst Mode (P51)/Delete Button (P37)

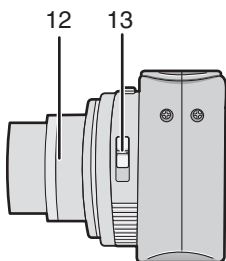

- 12 Lens barrel
- 13 Focus switch (P26, 56, 59)

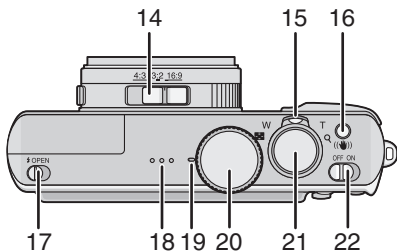

- 14 Aspect ratio switch (P60)
- 15 Zoom Lever (P32)
- 16 Optical Image Stabilizer Button (P50)
- 17 Flash Open Switch (P43)
- 18 Speaker (P80)
- 19 Microphone (P75, 87)
- 20 Mode Dial (P6)
- 21 Shutter Button (P26, 75)
- 22 Camera Switch (P20)

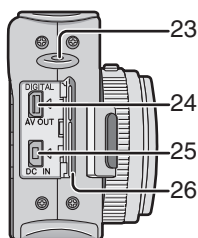

- 23 Lens Cap/Strap Eyelet (P19)
- 24 [DIGITAL/AV OUT] Socket (P107, 110, 114)
- 25 [DC IN] Socket (P107, 110)
 - Always use a genuine Panasonic AC adaptor (DMW-AC5; optional).
 - This camera cannot charge the battery even though the AC adaptor (DMW-AC5; optional) is connected to it.

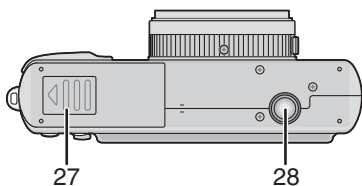

- 26 Terminal Cover
- 27 Card/Battery Door (P15, 16)
- 28 Tripod Receptacle
 - When you use a tripod, make sure the tripod is stable with the camera attached to it.

Quick Guide

This is the overview of the procedure to record pictures with this camera. For each operation, be sure to refer to the corresponding pages.

1 Charge the battery. (P13)

- The battery is not charged when the camera is shipped. Charge the battery before use.

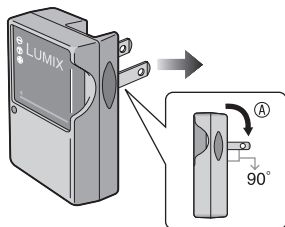

A: Open until it clicks.

2 Insert the battery and the card. (P15, 16)

- When you do not use the card (optional), you can record or play back pictures on the built-in memory (P17). Refer to P18 when you use a card.

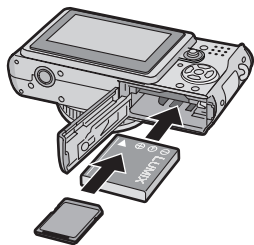

3 Turn the camera on to take pictures.

- Set the clock. (P20)

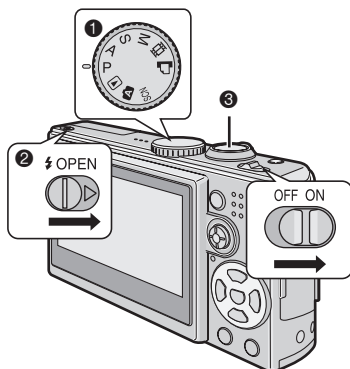

- 1 Set the mode dial to [P].
- 2 Open the flash. (When using the flash) (P43)
- 3 Press the shutter button to take pictures. (P26)

4 Play back the pictures.

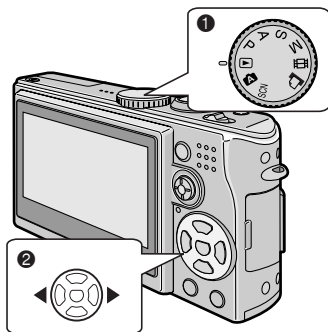

- 1 Set the mode dial to [▶].
- 2 Select the picture you want to view. (P36)

Charging the Battery with the Charger

The battery is not charged when the camera is shipped. Charge the battery before use.

1 Attach the battery with attention to the direction of the battery.

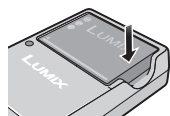
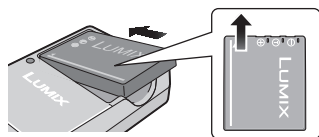

2 Connect the charger to the electrical outlet.

- When the [CHARGE] indicator **A** lights in green, charging starts.
- When the [CHARGE] indicator **A** turns off (in about 130 minutes), charging is completed.
- Refer to P14 when the [CHARGE] indicator blinks.

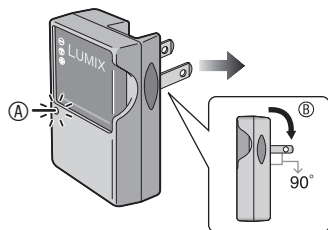

B: Open until it clicks.

3 Detach the battery after charging is complete.



- After charging is completed, be sure to disconnect the charger from the electrical outlet.
- The battery becomes warm after use/charge or during charge. The camera also becomes warm during use. However, this is not a malfunction with the camera.
- The battery will discharge if left for a long time after charging. Recharge it.
- You can recharge the consumed portion before exhausting the remaining charge.
- **Use the dedicated charger and battery.**
- **Charge the battery with the charger indoors.**
- **Do not disassemble or modify the charger.**

About the Battery (charging/number of recordable pictures)

■ Battery indication

The remaining battery power appears on the screen. [It does not appear when you use the camera along with the AC adaptor (DMW-AC5; optional).]



- The battery indication turns red and blinks. (The status indicator blinks when the LCD monitor turns off.) Recharge the battery or replace it with fully charged battery.

■ The lifetime of the battery

The number of recordable pictures by CIPA standards (In Program AE mode)

- CIPA is an abbreviation of [Camera & Imaging Products Association].

Number of recordable pictures	Approx. 300 pictures (Approx. 150 min.)
-------------------------------	--

(Recording conditions by CIPA standards)

- Temperature: 23°C (73.4°F)/ Humidity: 50% when LCD monitor is on.
- Using a Panasonic SD Memory Card (Not supplied: 16 MB).
- Using the supplied battery.
- Recording starts 30 seconds after the camera is turned on. (When the optical image stabilizer function is set to [MODE1])
- **Record once every 30 seconds**, with full flash every other recording.
- Rotating the zoom lever towards Tele to Wide and vice versa in every recording.
- Turn the camera off every 10 recordings./Leaving the camera until the battery is cooled down.

Note: When the Power LCD function or high angle function (P41) is used, the number of recordable pictures decreases.

The actual number of pictures you can take depends on the interval you leave between shooting. The number of shots reduces proportionately to the interval you leave.

[e.g. When recording once every 2 minutes, the number of recordable pictures decreases to about 75.]

■ Playback time

Playback time	Approx. 300 min.
---------------	------------------

The number of recordable pictures and playback time will vary depending on the operating conditions and storing condition of the battery.

■ Charging

Charging time	Approx. 130 min.
---------------	------------------

Charging time and the number of recordable pictures with the optional battery pack (CGA-S005A) are the same as the above.

- When charging starts, the [CHARGE] indicator lights.

■ When the [CHARGE] indicator flashes

- The battery is over discharged (discharged excessively). In a while, [CHARGE] indicator will light up and normal charging will start.
- When the battery temperature is excessively high or low, [CHARGE] indicator flashes and the charging time will be longer than normal.
- The terminals of the charger or the battery are dirty. In this case, wipe them with a dry cloth.
- When the operating time of the camera becomes extremely short even after properly charging the battery, the life of the battery may have expired. Buy a new battery.

■ Charging conditions

- Charge the battery under temperature of 10°C to 35°C (50°F to 95°F). (Battery temperature should be the same.)
- The performance of the battery may be temporarily deteriorated and the operating time may become shorter in low temperature conditions (e.g. skiing/snowboarding).

Inserting/Removing the Battery

- Check that the camera is turned off and that the lens is retracted.
- Close the flash.

1 Slide the card/battery door to open it.

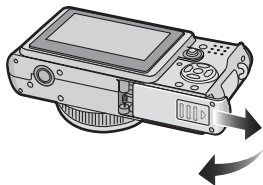

- Always use genuine Panasonic batteries (CGA-S005A).

2 Insert:

Insert the charged battery paying attention to the direction of the battery.

Remove:

Slide the lock (A) to remove the battery.

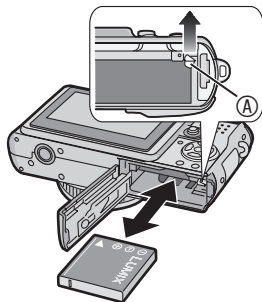

- ## 3
- 1 Close the card/battery door.
 - 2 Slide the card/battery door to the end and then close it firmly.

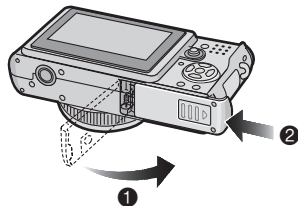

- Remove the battery after use. Store the removed battery in the battery carrying case (supplied). (P9)
- When fully charged battery has been inserted for more than 24 hours, the clock setting is stored (in the camera) for at least 3 months even if the battery is removed. (The storing may be shorter if the battery is not charged sufficiently.) If more than 3 months have passed, the clock setting will be lost. In this case, set the clock again. (P20)
- Do not remove the card or the battery while the camera accesses the built-in memory or a card. The data may be damaged. (P17)
- Remove the battery after turning the camera off and making sure the LCD monitor and the status indicator (green) are off. Otherwise, the settings on the camera may not be stored properly.
- The supplied battery is designed only for use with this camera. Do not use it with any other equipment.

Inserting/Removing the Card (Optional)

- Check that the camera is turned off and that the lens is retracted.
- Prepare an SD Memory Card (optional), an SDHC Memory Card (optional) or a MultiMediaCard (optional).
- Close the flash.
- **You can record or play back pictures on the built-in memory when you are not using a card. (P17)**

1 Slide the card/battery door to open it.

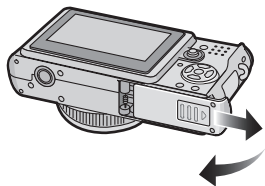

2 Insert:

Insert the card with the label side facing the back of the camera until it clicks and locks.

Remove:

Push the card until it clicks, then pull the card out upright.

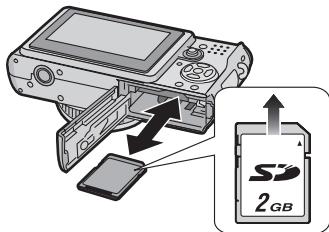

- Check the direction of the card.
- Do not touch the connection terminals on the back side of the card.
- The card may be damaged if it is not fully inserted.

- 3 1 Close the card/battery door.
- 2 Slide the card/battery door to the end and then close it firmly.

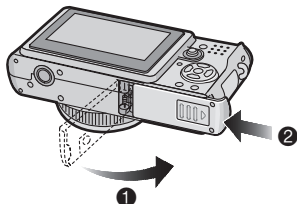

- If the card/battery door cannot be completely closed, remove the card, check its direction and insert it again.



- The card and the data may be damaged if it is inserted or removed while the camera is on.
- We recommend using Panasonic's SD Memory Card/SDHC Memory Card.

About the Built-in Memory/the Card

■ Built-in Memory [IN]

You can record or play back pictures on the built-in memory when you are not using a card.

- The built-in memory capacity is about 13 MB.
- Picture size is fixed to QVGA (320×240 pixels) when recording motion pictures to the built-in memory. (P75)

■ Card [^]

You can record or play back pictures on a card.

(The built-in memory cannot be used when a card is inserted.)

■ Access to the built-in memory or the card

- The access indication (ⓐ or ⓓ) lights red when pictures are being recorded on the built-in memory (or the card).
- Do not do the following when the access indication lights, pictures are being read or deleted or the built-in memory (or the card) is being formatted (P106).

- Turn the camera off.
- Remove the battery or the card (if used).
- Shake or impact the camera.
- Disconnect the AC adaptor (DMW-AC5; optional). (when using the AC adaptor)

The card or the data may be damaged and the camera may not operate normally.

Icons displayed on the screen:

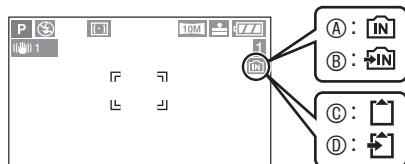

- Ⓐ: When using the built-in memory
- Ⓑ: When accessing the built-in memory
- Ⓒ: When using the card
- Ⓓ: When accessing the card

- **Picture data recorded on the built-in memory or a card can be copied from the built-in memory to the card or vice versa. (P105)**



- **The built-in memory (about 13 MB) can be used as a temporary storage device when the card being used becomes full.**
- The access time for the built-in memory may be longer than the access time for a card. (Max. about 7 sec.)

■ About SD Memory Card (optional), SDHC Memory Card (optional) and MultiMediaCard (optional)

- The SD Memory Card, the SDHC Memory Card and the MultiMediaCard are small, lightweight, removable external memory cards.
- The SDHC Memory Card is a memory card standard decided by the SD Association in 2006 for high capacity memory cards more than 2 GB.
- The reading/writing speed of the SD Memory Card and the SDHC Memory Card is fast. The SD Memory Card and the SDHC Memory Card are equipped with a Write-Protect switch  that can inhibit writing and formatting. (When the switch is slid to the [LOCK] side, it is not possible to write or delete data on the card and format it. When the switch is unlocked, these functions become available.)

SD Memory Card



Please confirm the latest information on the following website.

<http://panasonic.co.jp/pavc/global/cs>
(This site is in English only.)

- Refer to page 128 for the number of recordable pictures and available recording time on a card.
- This unit supports SD Memory Cards formatted in the FAT12 and FAT16 systems that comply with SD Memory Card Specifications. It also supports SDHC Memory Cards formatted in the FAT32 system.

- This unit (SDHC compliant equipment) supports both SD Memory Cards and SDHC Memory Cards. You can use SDHC Memory Cards on equipment that supports them. You cannot use SDHC Memory Cards on equipment that supports SD Memory Cards only. (When you use SDHC Memory Cards on other equipment, make sure to read the equipment's operating instructions.)
- This unit does not support recording motion pictures on MultiMediaCards. We recommend using High Speed SD Memory Cards/SDHC Memory Cards when recording motion pictures (P75).

■ About handling a card

Save important data in such places as your PC (P107) as well. Electromagnetic waves, static electricity, unit malfunctions, card damages and other factors may destroy or erase data.

- If the card was formatted on a PC or other equipment, format it again on the camera. (P106)



- The reading/writing speed of a MultiMediaCard is slower than an SD Memory Card. When a MultiMediaCard is used, the performance of certain features may be slightly slower than advertised.
- Keep the Memory Card out of reach of children to prevent swallowing.

Attaching the Lens Cap/Strap

■ Lens Cap (supplied)

1 Remove the lens cap.

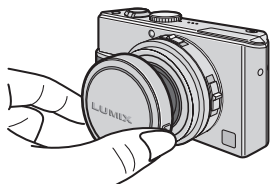

2 Pass the string through the hole on the lens cap.



3 Pass the string through the hole on the camera.

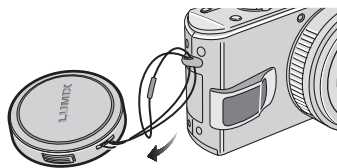

4 Attach the lens cap.

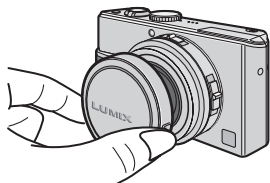

■ Strap (supplied)

1 Pass the strap through the hole at the Strap Eyelet.

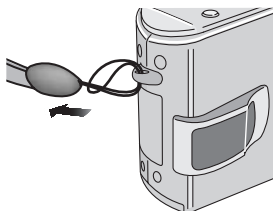

- Check that the strap is firmly attached to the camera.
- When you turn the camera off, carry the camera or play back the pictures, attach the lens cap to protect the surface of the lens.
- Detach the lens cap before turning on the camera in the recording mode.
- When the mode dial is set to one of the recording modes and the camera is turned on with the lens cap attached, the message [REMOVE LENS CAP AND PRESS ► BUTTON] appears. After removing the lens cap, press the ► cursor button.
- Be careful not to lose the lens cap.
- When detaching the strap, use a pointed object to loosen the knot and then detach it.
- When using the lens cap and the strap at the same time, attach the strap before the lens cap. If you attach the lens cap first, it may become difficult to attach the strap.

Setting Date/Time (Clock Set)

■ Initial setting

The clock is not set when the camera is shipped. When you turn the camera on, the following screen appears.

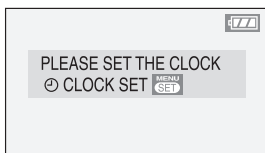
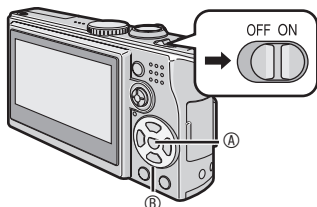

- Ⓐ: [MENU/SET] button
 Ⓑ: Cursor buttons

1 Press [MENU/SET].

2 Press ▲/▼/◀/▶ to select the date and time.

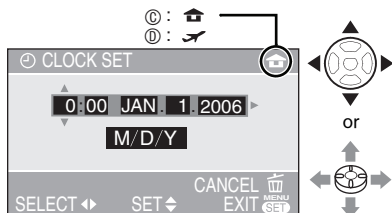

- Ⓒ: Time at the home area
 Ⓓ: Time at the travel destination (P72)
- ◀/▶ : Select the desired item.
 - ▲/▼ : Set date and time.
- Refer to [WORLD TIME] (P72) for information about setting the local time at the travel destination area.
- You can press [EXIT] to cancel the operation without setting the clock.

3 Press [MENU/SET] several times to close the menu.

- You can also press the joystick to close the menu.
- Turn the camera off after finishing setting the clock. Then turn it on and check that the clock setting is correct.

Changing the clock setting

- Press [MENU/SET].
- Press ▲/▼ to select [CLOCK SET] (P93).
- Press ▶ and perform the above steps 2 and 3 for setting.

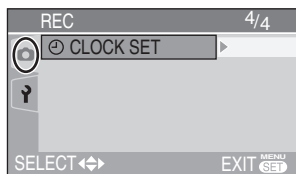

- You can set the clock from the setup menu (P21) while in playback mode ([▶]).
- You can use both the cursor buttons and joystick for this operation.



- When a fully charged battery has been inserted for more than 24 hours, the clock setting is stored (in the camera) for at least 3 months even if the battery is removed.
- You can set the year from 2000 to 2099. The 24-hour system is used.
- If you do not set the date, the date cannot be printed when you go to a photo studio for digital printing. (P100)

Setup Menu

- Change the settings if necessary. (See pages 22 to 25 for details about the settings.)
- Menu items differ depending on the mode selected with the mode dial (P6). The following example shows how to set [BEEP] when program AE mode [P] is selected.
- Select [RESET] to return the settings to the initial settings at the time of purchase. (P24)

1 Press [MENU/SET] and then press ◀.

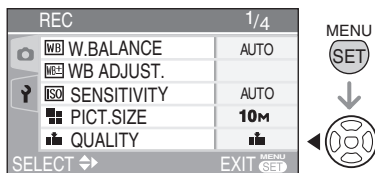

2 Press ▼ to select the [SETUP] menu icon [?] and then press ▶.

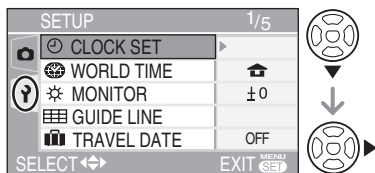

3 Press ▲/▼ to select the menu item.

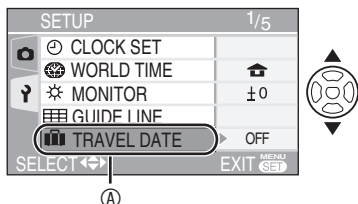

- Press ▼ at ① to switch to the next menu screen. Continue to press ▼ to select [BEEP].

4 Press ▶, press ▲/▼ to select the setting and then press [MENU/SET].

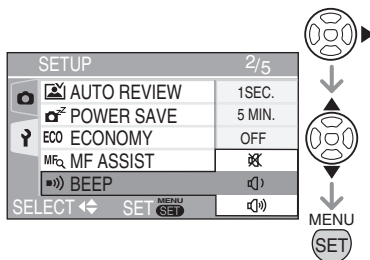

5 Press [MENU/SET] to close the menu.

- You can also press the shutter button halfway to close the menu.

■ About menu operations using the joystick

You can also use the joystick for menu settings.

- 1 Press [MENU/SET].
- 2 Move the joystick ▲/▼/◀/▶ to select the item for setting and press the joystick.
- 3 Press the joystick to close the menu.

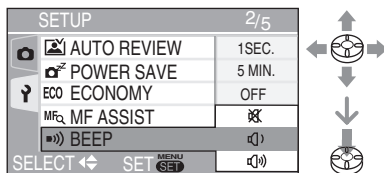





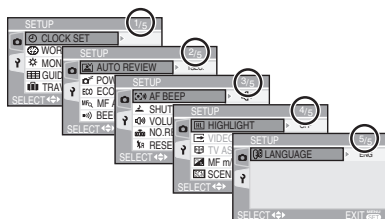











■ About the menu screen items



- There are 5 menu screens (1/5, 2/5, 3/5, 4/5 and 5/5).
- You can switch menu screens from any menu item by rotating the zoom lever.





















Press [] to display menu, enter [SETUP] and select the item. (P21)

Menu	Functions
 CLOCK SET	Change date and time. (P20)
 WORLD TIME	[]: The time at your home area is set. []: The local time at the travel destination area is set. • Refer to P72 for information about setting [WORLD TIME].
 MONITOR	Adjust the brightness of the LCD monitor in 7 steps.
 GUIDE LINE	You can set guide line patterns displayed at the recording mode. You can set whether to display recording data and histograms with guide lines or not (P40). [REC.INFO.]: [OFF]/[ON] [HISTGRAM]: [OFF]/[ON] [PATTERN]: []/[]
 TRAVEL DATE	[SET]: When taking a picture, the date on which it was taken is recorded. [OFF]: When taking a picture, the date on which it was taken is not recorded. • Refer to P70 for information about setting [TRAVEL DATE].
 AUTO REVIEW	[1 SEC.]:The recorded picture automatically appears on the screen for about 1 second. [3 SEC.]:The recorded picture automatically appears on the screen for about 3 seconds. [ZOOM]:The recorded picture automatically appears on the screen for about 1 second. Then it is enlarged 4 times and appears for about 1 second. This mode is useful for confirming focus. Pictures in burst mode, auto bracket, pictures with audio are not enlarged even if [ZOOM] is selected. [OFF]: The recorded picture does not automatically appear. • In motion picture mode [], auto review function is not activated. • Auto review activates if you shoot with auto bracket [] (P49) or burst modes [], [], and [] (P51), irrespective of the auto review setting. (But the picture is not enlarged.) • When taking pictures with audio, the auto review function works while recording regardless of the setting on the auto review function. (The picture is not enlarged.) • When the quality is set to [RAW], the auto review function works until the end of recording onto the card. (The picture is not enlarged.) • You cannot change the auto review setting when using auto bracket, using burst modes, shooting motion pictures, using [SELF PORTRAIT] in scene mode, recording sound and setting quality to [RAW]. • When [HIGHLIGHT] (P24) is set to [ON], white saturated areas blink in black during auto review.





Press [] to display menu, enter [SETUP] and select the item. (P21)

Menu	Functions
 POWER SAVE	<p>[1 MIN.]/[2 MIN.]/[5 MIN.]/[10 MIN.]: If you perform no operations, the camera turns off automatically after the interval you set to save the battery.</p> <p>[OFF]: The camera is not automatically turned off.</p> <ul style="list-style-type: none"> • Press the shutter button halfway or turn the camera off and on to recover from the power save mode. • In economy mode, power save mode is fixed to [2 MIN.]. • When using the AC adaptor (DMW-AC5; optional)/connecting to a PC or a printer/recording motion pictures/playing back motion pictures/during Slide Show, the power save mode is not activated. (However, the setting for power save mode is fixed to [10 MIN.] while pausing a slide show or playing back a manual slide show.)
ECO ECONOMY	<p>Battery life is saved by reducing the brightness of the LCD monitor and turning it off automatically when the camera is not being used in recording mode.</p> <p>[LEVEL 1]: The LCD monitor turns off if the camera is not operated for about 15 seconds in recording mode.</p> <p>[LEVEL 2]: The LCD monitor turns off if the camera is not operated for about 15 seconds in recording mode or for about 5 seconds after taking a picture.</p> <p>[OFF]: Economy mode cannot be activated.</p> <ul style="list-style-type: none"> • In economy mode, the LCD monitor is turned off while the flash is being charged. • The status indicator lights while the LCD monitor is turned off. Press any button to turn on the LCD monitor again. • Power save mode is fixed to [2 MIN.] in economy mode. [However, power save mode is not activated when using the AC adaptor (DMW-AC5; optional).] • Economy mode will not work when using the AC adaptor (DMW-AC5; optional), recording in motion picture mode, the menu screen is displayed or the self-timer is set. • The brightness of the LCD monitor is not reduced in Power LCD mode and high angle mode.
 MF ASSIST (Recording mode only)	<p>In manual focus, assistance screen appears on the center of the screen to facilitate focusing on the subject. (P56)</p> <p>[MF1]: The center of the screen is enlarged. You can adjust the focus while determining the composition of the whole of the screen.</p> <p>[MF2]: The whole of the screen is enlarged. This is convenient for adjusting the focus in Wide angle shots.</p> <p>[OFF]: The screen is not enlarged.</p>

Press [] to display menu, enter [SETUP] and select the item. (P21)

Menu	Functions
 BEEP	Set to select the volume of operational sound.  : No operational sound  : Soft operational sound  : Loud operational sound
 AF BEEP	 : No focus beep  : Soft focus beep  : Loud focus beep
 SHUTTER	Set to select the volume of shutter sound.  : No shutter sound  : Soft shutter sound  : Loud shutter sound
 VOLUME	The volume of speakers can be adjusted in 7 steps. (LEVEL6 to 0) <ul style="list-style-type: none"> When you connect the camera to a TV, the volume of the speakers of the TV is not changed.
 NO.RESET	Set this when you want to start the file number of the picture from 0001 on the next recording. (The folder number is updated, and the file number starts from 0001.) <ul style="list-style-type: none"> The folder number can be assigned from 100 to 999. When the folder number reaches 999, it cannot be reset. We recommend formatting the card after saving the data on a PC or elsewhere. To reset the folder number to 100, you must first reformat the built-in memory or the card (P106). After this perform [NO.RESET] to reset the file number, after which a screen appears asking whether you want to reset the folder number. Select [YES]. For details about file and folder numbers, see page 108.
 RESET	The settings on the recording or the [SETUP] menu are reset to the initial settings. <ul style="list-style-type: none"> The birthday setting for [BABY1]/[BABY2] (P69) in scene mode and the number of days that have passed since the departure date for [TRAVEL DATE] (P70) and the [WORLD TIME] setting (P72) are also reset when the [SETUP] menu settings are reset. Also, [FAVORITE] (P96) is fixed to [OFF] and [ROTATE DISP.] (P97) is fixed to [ON]. The folder number and the clock setting are not changed.
 HIGHLIGHT	[ON]: When the auto review or review function is activated, a white saturated area appears blinking in black and white. (P40) [OFF]: No highlight display
 VIDEO OUT (Playback mode only)	[NTSC]: Video output is set to NTSC system. [PAL]: Video output is set to PAL system. (P114)

Press [MENU/SET] to display menu, enter [SETUP] and select the item. (P21)

Menu	Functions
 TV ASPECT (Playback mode only)	<p>[16:9]: Select if your television has a 16:9 aspect ratio.</p> <ul style="list-style-type: none"> This mode is best for showing [16:9] aspect ratio images on a 16:9 aspect ratio television. Pictures shot in the [4:3] or [3:2] aspect ratio have black bands added to either side. <p>[4:3]: Select if your television has a 4:3 aspect ratio.</p> <ul style="list-style-type: none"> When the aspect ratio is set to [4:3], pictures taken in the aspect ratios of [16:9] and [3:2] appear with black bands above and below on a 4:3 ratio television. (The LCD monitor shows pictures taken in the [3:2] and [4:3] aspect ratios with black bands on their left and right.)
 MF m/ft	<p>[m]: The focal distance is indicated in meters in manual focusing.</p> <p>[ft]: The focal distance is indicated by feet in manual focusing.</p> <ul style="list-style-type: none"> Refer to P56 for information about manual focusing.
 SCENE MENU	<p>[AUTO]: [SCENE MODE] menu appears automatically when setting the mode dial to scene mode. Select the desired scene mode. (P62)</p> <p>[OFF]: [SCENE MODE] menu does not appear when setting the mode dial to scene mode and the camera is operated in scene mode currently selected. If you change the scene mode, press [MENU/SET] to display the [SCENE MODE] menu and then select the desired scene mode.</p>
 LANGUAGE	<p>Set to the language on the menu screen from the following 7 languages.</p> <p>Set to the desired language with ▲/▼ and determine it with [MENU/SET].</p> <p>[ENGLISH]: English [DEUTSCH]: German [FRANÇAIS]: French [ESPAÑOL]: Spanish [ITALIANO]: Italian [中文]: Chinese (Traditional) [日本語]: Japanese</p> <ul style="list-style-type: none"> When you set to other language by mistake, select [Q] from the menu icons to set the desired language.

Taking Pictures



The camera automatically sets the shutter speed and the aperture value according to the brightness of the subject.

- Remove the lens cap.

- 1 Turn the camera on.
- 2 Set the mode dial to program AE mode [P].
- 3 Slide the focus switch to [AF].

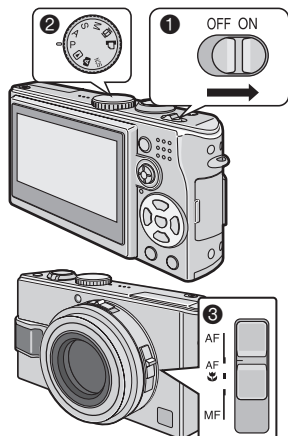

- 2 Aim the AF area ① to the point you want to focus and then press the shutter button halfway.

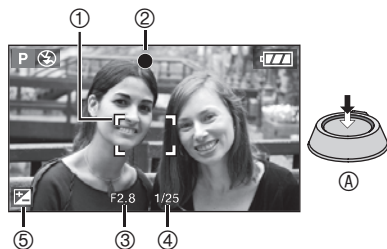

- (A) : Press the shutter button halfway to focus.

- The focus indication ② is lit and then the aperture value ③ and the shutter speed ④ are displayed.
- The shutter speed is not displayed when the ISO sensitivity is set to [ISO] (P84).
- You can select the AF area when the AF mode is set to 1-area-focusing or 1-area-focusing (high speed). (P89)
- If 9-area-focusing or 3-area-focusing (High speed) is used in AF mode, the AF area does not appear until the subject is brought into focus. (P88)
- The AF area displayed is bigger than usual when using the digital zoom or when taking pictures in dark places. (P89)
- Refer to P48 for compensating the exposure ⑤.
- Refer to P27 for Program shift.

Focus range

	Wide	Tele
In normal picture mode	50 cm (1.64 feet) to ∞	1.0 m (3.28 feet) to ∞

	When the subject is not focused	When the subject is focused
Focus indication	Blink (green)	On (green)
AF area	Turns from white to red or no AF area	Turns from white to green
Sound	Beeps 4 times	Beeps 2 times

- 3 Take a picture.

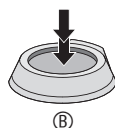

- (B) : Press the shutter button fully to take the picture.



- We recommend checking that the clock is set properly before taking pictures. (P20)
- When you press the shutter button, the screen may become bright or dark for a moment. This function allows easy adjustment of focus and the recorded picture will not be affected.
- When the time for power save is set (P23), the camera is automatically turned off if you do not operate it within the set time. When operating the camera again, press the shutter button halfway or turn the camera off and on.
- To avoid picture noise, we recommend decreasing the ISO sensitivity, setting [NOISE REDUCTION] in [PICT.ADJ.] to [HIGH] or setting every item except [NOISE REDUCTION] to [LOW]. (P91) (ISO sensitivity is set to [AUTO] when the camera is shipped. Therefore, when taking pictures indoors etc. the ISO sensitivity increases.)

■ Program shift

In Program AE mode, you can change the preset aperture value and the shutter speed under the same exposure. This is called Program shift.

By this function, you can make the background more blurred (by decreasing the aperture value) or record the moving subject more dynamically (by setting to slow shutter speed) in Program AE mode.

- Press the shutter button halfway and perform the program shift with the joystick while the aperture value and the shutter speed are displayed (about 10 seconds).



①

- When the Program shift is activated, the Program shift indication ① appears on the screen.
- Program shift is canceled if the camera is turned off or the joystick is moved up and down until the program shift indication disappears.

■ Example of Program shift

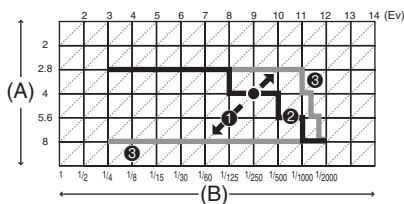

(A): Aperture value

(B): Shutter speed

- ① Program shift amount
- ② Program shift line chart
- ③ Program shift limit

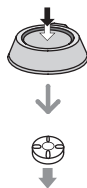



- If the exposure is not adequate when the shutter button is pressed halfway, the aperture value and shutter speed turns red.
- When 10 or more seconds have passed after the Program shift becomes effective, the status to activate the Program shift is canceled and returned to the Program AE mode. However, the setting on the Program shift is memorized.
- The Program shift may not be activated depending on the brightness of the subject.
- The Program shift does not activate when the ISO sensitivity is set to [ISO].

■ Tips for taking good pictures

- Hold the camera gently with both hands, keep arms stationary at your side and stand with your feet slightly apart.
- Be careful not to move the camera when you press the shutter button.
- Do not cover the microphone or the AF assist lamp with your finger or other objects.
- Do not cover the photo flash with your finger or other objects.
- Do not touch the lens part.
- If the LCD monitor screen is difficult to see because of light from the sun etc. shining on it, we recommend using your hand or another object to block the light when using the camera.

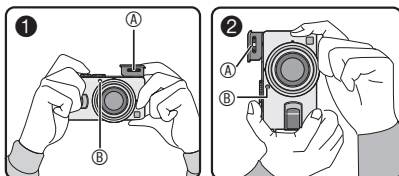

- ① : When holding the camera sideways
 ② : When holding the camera vertically
 (A) : Photo flash
 (B) : AF assist lamp

■ Direction detection function

- If you take pictures by holding the camera vertically, the information of the rotation on the pictures are automatically added and recorded to the pictures.
 When [ROTATE DISP.] (P97) is set to [ON], you can rotate and display pictures on the screen or the TV according to the information of the rotation on the pictures.
- This function may not work properly on pictures recorded by aiming the camera up or down.
- In motion picture mode [MOVIE] or [FLIP ANIM.], you cannot use the direction detection function.

■ Focusing

- The focus range is 50 cm (1.64 feet) to ∞ (Wide), 1.0 m (3.28 feet) to ∞ (Tele). Use macro mode when recording close-up pictures. (P59)
 - If the distance between the camera and the subject is beyond the focus range of the camera, the picture may not be properly focused even if the focus indication lights.
 - In the following cases, the camera cannot focus on subjects properly.
 - When including both near and distant subjects in a scene.
 - When there is dirt or dust on the glass between the lens and the subject.
 - When there are illuminated or glittering objects around the subject.
 - When taking a picture in a dark place.
 - When the subject is moving fast.
 - When the scene has low contrast.
 - When jitter occurs.
 - When recording a very bright subject.
- We recommend taking pictures using prefocus (P58) and AF/AE lock (P61). In dark places, the AF assist lamp (P90) may turn on to focus on the subject.
- Even if the focus indication appears and the subject is focused, it is canceled when you release the shutter button. Press the shutter button halfway again.

■ Preventing jitter (camera shake)

- Be careful of jittering when pressing the shutter button.
- The jitter alert ① appears when the shutter speed is slow and the chances of blurring are greater.

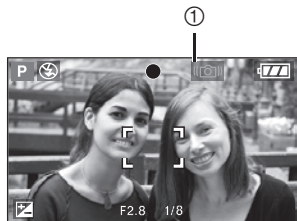

- When the jitter alert appears, take special care with the shooting methods described on P28, or use a tripod for best results. By combining the use of a tripod with the self-timer (P47), you can avoid blurring caused when you press the shutter button.
- Shutter speed will be slower particularly in the following cases. Keep the camera still from the moment the shutter button is pressed until the picture appears on the screen. We recommend using a tripod.
 - Slow sync./Red-eye reduction [⚡S👁] (P43)
 - [NIGHT PORTRAIT] (P64), [NIGHT SCENERY] (P64), [PARTY] (P65), [CANDLE LIGHT] (P66), [FIREWORKS] (P66), [STARRY SKY] (P67) in scene mode
 - When you have reduced shutter speed (P53, 54)

■ Exposure

- If you press the shutter button halfway when the exposure is not adequate, the indication of the aperture value and the shutter speed turns red. (However, the aperture value and the shutter speed do not turn red when the flash is activated.)
- The brightness of the screen may differ from the brightness of the recorded pictures especially when recording in low light conditions.
- When most of the subjects in the screen are bright (e.g. blue sky on a clear day, snowy field, etc.), the recorded pictures may become dark. In this case, compensate the exposure value on the camera. (P48)

Taking Pictures in Auto Mode



Auto mode makes it easy for inexperienced users. It displays only simple menu settings and allows you to take pictures without error.

Basic menu settings

1 Press [MENU/SET].

2 Press ▲/▼ to select the desired menu item and then press ►.

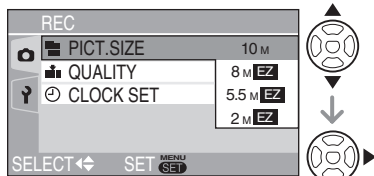

3 Press ▲/▼ to select the desired setting and then press [MENU/SET].

4 Press [MENU/SET] to close the menu.

- You can also press the shutter button halfway to close the menu.
- You can also use the joystick to perform steps 2 to 4.

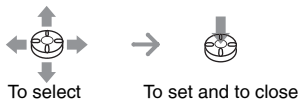

Settings in Auto mode

- For details, refer to the pages corresponding to each item.

[PICT.SIZE] : P86

[QUALITY] : P86

[CLOCK SET] : P93

Other Settings in Auto mode

In Auto mode, other settings are fixed as follows. For details, refer to the pages corresponding to each item.

Focus range ([AF]/[AF] / [MF])	5 cm (0.16 feet) to ∞ (Wide) 30 cm (0.98 feet) to ∞ (Tele)	
White balance	[AUTO]	P82
ISO sensitivity	[ISO]	P84
Picture Adjustment	[STD.]	P91
Audio Recording	[OFF]	P87
Metering Mode	[•] (Multiple)	P88
AF mode	[■] (1-area-focusing)	P88
Continuous AF	[OFF]	P90
AF assist lamp	[ON]	P90

- You cannot use the following functions in the Auto mode.

–[WB ADJUST.]
–Exposure compensation
–Auto bracket
–[COL.EFFECT]
–Flash Output Adjustment
–AF area selection
–AF/AE Lock
–[D.ZOOM]
–Flip animation

■ The Backlight Compensation

Backlight is a situation where light comes from behind the subject. Subjects such as people become dark when pictures are recorded in the backlight. If you press ▲, [] (compensating backlight ON indication) appears and the backlight compensation function is activated. This function compensates the backlight by brightening the whole of the picture.

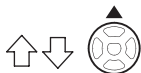

- If you press ▲ while [] is displayed, [] disappears and the backlight compensation function is canceled.
- When you use the backlight compensation function, we recommend using the flash. (When you use the flash, the flash setting is fixed to Forced ON [].)
- When you use the flash with the backlight compensation off, the flash setting is fixed to AUTO/Red-eye reduction [].



- You cannot set the following items in the Auto mode.
 - [VIDEO OUT]
 - [TV ASPECT]
- The settings [PICT.SIZE], [QUALITY] and [CLOCK SET] on the Auto mode are applied to other recording modes.

Taking Pictures with the Zoom

Using the Optical Zoom



You can make people and subjects appear closer with the 4 times optical zoom, and landscapes can be recorded in wide angle. (35 mm film camera equivalent: 28 mm to 112 mm when the aspect ratio is set to [16:9])

■ To make subjects appear closer use (Tele)

Rotate the zoom lever towards Tele.

When the setting for picture size is [10M] (10M)



■ To make subjects appear further away use (Wide)

Rotate the zoom lever towards Wide.

When the setting for picture size is [10M] (10M).



- The optical zoom is set to Wide (1x) when the camera is turned on.
- Depending on the zoom magnification, the picture may have some distortion. Distortion will be more visible when using a wider area of the zoom lens as you move closer to the subject.
- Depending on the zoom magnification, the picture may have some colored fringes around the subject. This is called chromatic aberration.
- If you use the zoom function after focusing on the subject, focus on the subject again.
- The indicated zoom magnification is an approximation.
- The lens barrel (P10) extends or retracts according to the zoom position. Take care not to interrupt the motion of the lens barrel while the zoom lever is rotated.
- In motion picture mode [MOV], the zoom magnification is fixed to the value set at the start of recording.
- **When you rotate the zoom lever, you may hear some sound from the camera or the camera may be shaken. This is not a malfunction.**

Using the Extended Optical Zoom (EZ)



This camera has a 4x optical zoom. However, if the picture size is not set to the highest setting for each aspect ratio [**16:9** / **3:2** / **4:3**], a maximum of 6.2x optical zoom can be achieved with no picture quality deterioration.

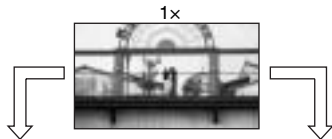

Picture size with the extended optical zoom not activated [example: **[10M]** (10M)]

Picture size with the extended optical zoom activated [example: **[2M]** (2M EZ)]



How the extended optical zoom works

- The extended optical zoom works by extracting the center of the picture and expanding it for a higher telephoto effect. So, for example, if you choose **[2M]** (2M EZ), 2 million pixels (out of the total **[10M]**, 10.2 million possible with the CCD) are taken in your shot.

Resolution and maximum zoom

Aspect ratio	Pixels	Maximum zoom
16:9	[10M]	4x
	[8M] EZ	4.4x
	[5.5M] EZ / [2M] EZ	5.5x
3:2	[8.5M]	4x
	[7M] EZ	4.4x
	[4.5M] EZ / [2.5M] EZ	5.6x
4:3	[7.5M]	4x
	[6M] EZ	4.4x
	[4M] EZ	5.5x
	[3M] EZ / [2M] EZ / [1M] EZ	6.2x



- Refer to P60 for aspect ratio settings, P86 for picture size.
- “EZ” is an abbreviation of [Extended optical Zoom].
- You can further enhance the zoom magnification with the extended optical zoom without worrying about further picture distortion.
- If you set a picture size that activates the extended optical zoom, the extended optical zoom icon **[EZ]** is displayed on the screen when you use the zoom function.
- The zoom movement becomes quicker near the **[W]** (1x) when using the extended optical zoom.
- The indicated zoom magnification is an approximation.
- The on-screen zoom indication may not change consecutively if you rotate the zoom lever near the Tele position when the extended optical zoom is used. This is not a malfunction.
- In motion picture mode (**[M]**) and **[HIGH SENS.]** in scene mode, the extended optical zoom does not work.



Using the Digital Zoom Further extending the zoom



A maximum of 16x zoom can be achieved with the 4x optical zoom and the 4x digital zoom when [D.ZOOM] is set to [ON] in the [REC] menu. However, if a picture size that can use extended optical zoom is selected, a maximum of 24.8x zoom can be achieved with the 6.2x extended optical zoom and the 4x digital zoom.

Menu operation

1 Press [MENU/SET].

- When a scene mode is selected, press ◀ in the [SCENE MODE] menu (P62), press ▼ to select the [REC] menu icon and then press ▶.

2 Press ▲/▼ to select [D.ZOOM] and then press ▶.

3 Press ▼ to select [ON] and then press [MENU/SET].

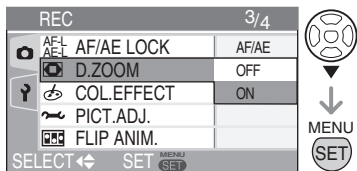

4 Press [MENU/SET] to close the menu.

- You can also press the shutter button halfway to close the menu.
- You can also use the joystick to perform steps 2 to 4.



To select



To set and to close

Entering the digital zoom range

When you rotate the zoom lever to the extreme Tele position, the on-screen zoom indication may momentarily pause. You can enter the digital zoom range to continuously rotate the zoom lever to Tele or to release the zoom lever once and then rotate it to Tele again.

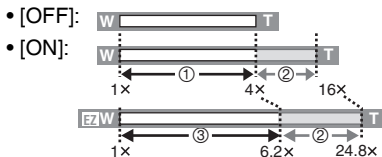

- ① Optical zoom
- ② Digital zoom
- ③ Extended optical zoom



- The AF area is displayed with a size wider than usual and set only to a point on the center of the screen in the digital zoom range. (P89)
- When using the digital zoom, the picture quality becomes deteriorated.
- In the digital zoom range, the stabilizer function may not be effective.
- When using the digital zoom, use a tripod and the self-timer (P47) for best results.
- The indicated zoom magnification is an approximation.
- The digital zoom does not operate in the following cases.
 - In Auto mode [**A**]
 - In [SPORTS] (P63), [HIGH SENS.] (P68) and [BABY1]/[BABY2] (P69) in scene mode
 - When quality is set to [RAW]
 - When ISO sensitivity is set to ISO

Checking the Recorded Picture (Review)



You can check the recorded pictures while still in [REC] mode.

1 Press ▼ [REV].

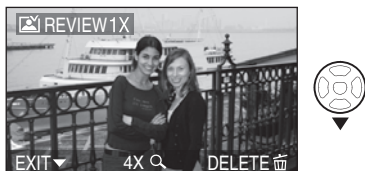

- The last recorded picture appears for about 10 seconds.
- Review is canceled when the shutter button is pressed halfway or the ▼ [REV] is pressed again.
- You can check the previous or following picture with ◀▶.
- When the recorded pictures are too bright or dim, compensate the exposure. (P48)

2 Rotate the zoom lever towards [Q] [T] to enlarge the picture.

- Rotate the zoom lever to [Q] [T] for a 4x magnification and then rotate it even more for a 8x magnification. When you rotate the zoom lever towards [W] after enlarging the picture, the magnification becomes lower.

3 Press ▲/▼/◀▶ to move the position.



- When you change the magnification or the position to be displayed, the zoom position indication (A) appears for about 1 second to check where is enlarged.

Recorded pictures can be deleted during the review (Quick Deletion)

- 1 Press [W].
- 2 Press ▲ to select [YES].
- 3 Press [MENU/SET].

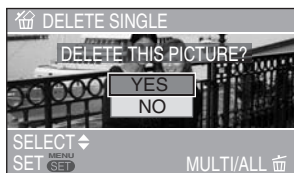

- You can also use the joystick for these operations.
- Once deleted, pictures cannot be recovered. Please double-check before deleting pictures.
- Multi pictures or all pictures can be deleted. Read P37 to operate them.



- When [ROTATE DISP.] is set to [ON], pictures recorded holding the camera vertically are played back vertically (rotated) (P97).

Playing Back Pictures



The picture data on the built-in memory appears when a card is not inserted. The picture data on the card appears when a card is inserted. (P17)

Press ◀▶ to select the picture.

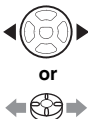

◀ : Play back the previous picture.

▶ : Play back the next picture.

- The picture following the last one is the first picture.
- When [ROTATE DISP.] (P97) is set to [ON], pictures recorded by holding the camera vertically are played back vertically.



Fast forwarding/Fast rewinding

Press and hold ◀▶ during playback.

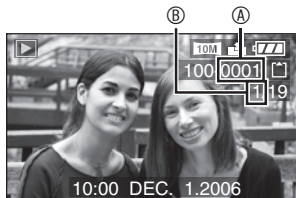

▶ : Fast forward

◀ : Fast rewind

- The file number ① and the picture number ② only change one by one. Release ◀▶ when the number of the desired picture appears to play back the picture.

- If you press and hold ◀▶, the number of files forwarded/rewound at one time increases. The actual number of files forwarded/rewound at one time depends on the number of files recorded.
- In review playback (P77) in the recording mode or multi playback (P77), the picture can only be forwarded or rewound one by one.



- This camera is based on the DCF standards (Design rule for Camera File system) which was established by the Japan Electronics and Information Technology Industries Association (JEITA).
- The file format that can be played back with this camera is JPEG. (There are also pictures that on some occasions cannot be played back in JPEG format.)
- The LCD monitor may not be able to display the details of the recorded pictures. You can use the playback zoom (P79) to check the details of the pictures.
- If you play back pictures that have been recorded with other equipment, the picture quality may deteriorate. (The pictures are displayed as [THUMBNAIL IS DISPLAYED] on the screen.)
- When changing the folder name or file name on a PC, the pictures will not be played back.
- When playing back a file out of standard, the folder/file number is indicated by [—] and the screen may turn black.
- An interference fringe may appear on the screen depending on the subject. This is called moire. This is not a malfunction.

Deleting Pictures



The picture data on the built-in memory is deleted when a card is not inserted. The picture data on the card is deleted when a card is inserted. (P17)

■ To delete a single picture

1 Select the picture with .



: Play back the previous picture.

: Play back the next picture.

2 Press .

3 Press to select [YES] and then press [MENU/SET].



- While deleting the picture, appears on the screen.

■ To delete [MULTI DELETE]/[ALL DELETE]

1 Press twice.

2 Press / to select [MULTI DELETE] or [ALL DELETE] and then press [MENU/SET].

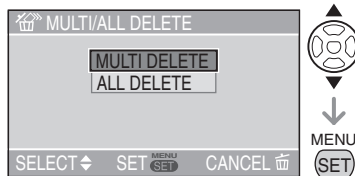



- If you select [MULTI DELETE], perform steps 3 onwards.
- If you select [ALL DELETE], perform steps 5 onwards.
- When [FAVORITE] (P96) is set to [ON], [ALL DELETE EXCEPT ★] appears. If you select [ALL DELETE EXCEPT ★], perform steps 5 onwards. (However, if none of the pictures have [★] displayed, you cannot select [ALL DELETE EXCEPT ★] even if [FAVORITE] is set to [ON].)

3 Press to select the picture and then press to set.

(Only when selecting [MULTI DELETE])



- Repeat the above procedure.
- The selected pictures appear with . When  is pressed again, the setting is canceled.
- The icon  blinks red if the selected picture cannot be deleted. Cancel the protect setting. (P100)

4 Press .

5 Press to select [YES] and then press [MENU/SET] to set.

(Screen when selecting [MULTI DELETE])

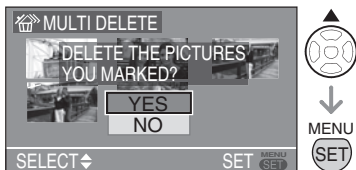

- [DELETE ALL PICTURES IN THE INTERNAL MEMORY ?] or [DELETE ALL PICTURES IN THE MEMORY CARD ?] is displayed when using [ALL DELETE], and [DELETE ALL EXCEPT ★?] is displayed when using [ALL DELETE EXCEPT ★].
- When you delete all pictures, only pictures in either of the built-in memory or the card can be deleted. (You cannot delete pictures in both the built-in memory and the card at the same time.)
- If you press [MENU/SET] while deleting pictures using [ALL DELETE] or [ALL DELETE EXCEPT ★], the deleting will stop halfway.



- Once deleted, pictures cannot be recovered. Please double-check before deleting pictures.
- Do not turn off the camera while deleting.
- When you delete pictures, use a battery with sufficient battery power (P14) or use with the AC adaptor (DMW-AC5; optional).
- It is possible to delete up to 50 pictures at one time using [MULTI DELETE].
- The more pictures there are to delete, the more time it takes.
- In the following cases, pictures are not deleted even if [ALL DELETE] or [ALL DELETE EXCEPT ★] is selected.
 - When the Write-protect switch of the SD Memory Card or SDHC Memory Card is set to the [LOCK] side (P18)
 - When files do not conform to the DCF (P36)
 - When pictures are protected  (P100)
- You can also use the joystick for these operations.



To select



To set and to close

About the LCD Monitor

Changing the information displayed

■ Selecting the screen to be used

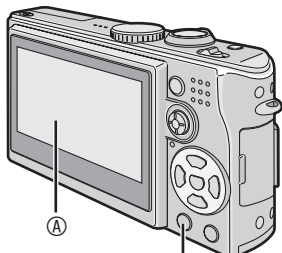

DISPLAY/LCD MODE

Ⓐ LCD monitor (LCD)

Press the [DISPLAY/LCD MODE] button to switch to the screen to be used.

- When the menu screen appears, the [DISPLAY] button is not activated. During playback zoom (P79), while playing back motion pictures (P80) and during a slide show (P95), you can only select “Display” or “Non-display”.

In recording mode (P26)

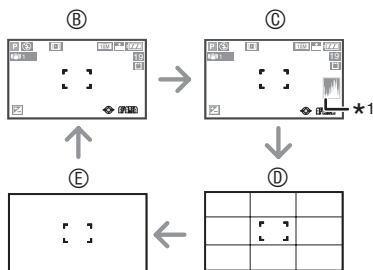

Ⓑ Display

Ⓒ Display with histogram

Ⓓ Guide line display *2

Ⓔ Non-display

*1 Histogram

- *2 You can set guide line patterns for display in the guide line display (P22) in the setup menu. You can also set whether to display recording data or histograms with guide lines or not.

In playback mode (P36)

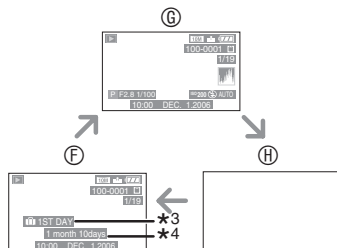

Ⓕ Display

Ⓖ Display with recording information and histogram

Ⓗ Non-display

- *3 The number of days that have passed since the travel date is displayed when a picture was taken with [TRAVEL DATE] (P70) setting.

- *4 Displayed when you set birthday setting for [BABY1]/[BABY2] in scene mode (P69), and [WITH AGE] is selected at taking pictures.

■ About guide line display

When you align the subject on the guide lines or the cross point of these lines, you can take pictures with well-designed composition by viewing the size, the slope and the balance of the subject.

When [] is selected

Used to divide the screen into three equal-sized sections for recording a balanced picture.



When [] is selected

Used to position the subject in the center of the screen.

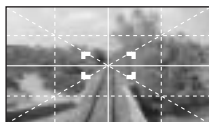

■ Highlight display

When setting [HIGHLIGHT] to [ON] on the [SETUP] menu (P24) while the auto review or review function is activated, any white saturated area (extremely bright or glistening part) on the picture appears blinking in black and white.

No highlight display



With highlight display



- If you compensate the exposure to minus, refer to the histogram and then take a picture again, it may result in a good picture.
- When taking a picture with the flash on and the subject too close, white saturation may occur. When highlight display is set to [ON], white saturation emerges in places illuminated with the flash as shown below. The saturated areas appear blinking in black and white.

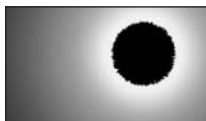

■ Histogram

- A histogram is a graph that displays brightness along the horizontal axis (black to white) and the number of pixels at each brightness level on the vertical axis.
- It allows the camera user to easily check the way a picture is being exposed.
- When the values are concentrated to the left Ⓐ, the picture is under exposed. Pictures that are mostly black, such as night scenery, forms this type of histogram.
- When the values in the histogram are distributed evenly Ⓑ, the exposure is adequate and the brightness is well-balanced.
- When the values are concentrated to the right Ⓒ, the picture is over exposed. Pictures that are mostly white, form this type of histogram.

Example of histogram

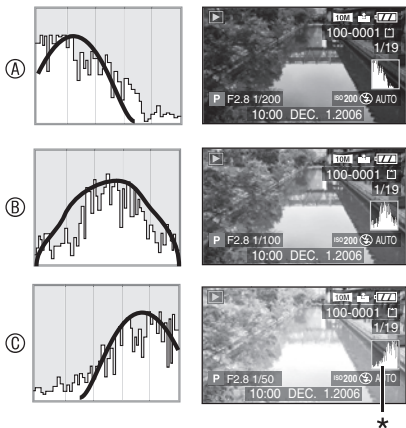

- (A) Under Exposed
 (B) Properly Exposed
 (C) Over Exposed

*Histogram



- When the recorded picture and the histogram do not match each other under the following conditions, the histogram is displayed in orange.

–When the exposure is compensated or the manual exposure assistance level in the manual exposure mode is other than [0]

–When using the fireworks mode (P66) or starry sky mode (P67) in scene mode

–When the flash is activated

–When the flash is closed

- ① When the brightness of the screen is not correct in dark places
- ② When the exposure is not adequately adjusted

- The histogram in the recording mode is an approximation.

- The histogram in recording and playback may not match each other.

- The histogram in this camera does not match the one displayed in image editing software used with a PC, etc.

- Check white saturated areas with the highlight display in the auto review function or the review function. (P40)
- No histogram appears in the following cases.
 - In the motion picture mode.
 - While multi playback is in progress.
 - While playback zoom is in use.
 - While calendar playback is in progress.

Brightening the LCD Monitor (Power LCD/High angle mode)



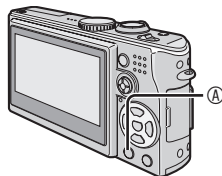

- 1 Press [DISPLAY/LCD MODE] (A) for one second.

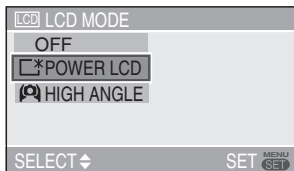

- 2 Press ▲/▼ to select a mode.



[]: POWER LCD	The LCD monitor becomes brighter and easier to see even when taking pictures outdoors.
[]: HIGH ANGLE	The LCD monitor is easier to see when taking pictures with the camera held high above your head. This is useful when you cannot get close to the subject because there is a person in the way. (However it becomes more difficult to see when looked at straight on.) 
[OFF]	The LCD monitor returns to the normal brightness.

■ Canceling High angle mode or Power LCD mode

- If you press and hold [DISPLAY/LCD MODE] again for 1 second the screen shown in step 2 is displayed. Select [OFF] to cancel Power LCD mode or High angle mode.



- High angle mode is also canceled if you turn the camera off or power save mode is activated.
- The brightness of the pictures displayed on the LCD monitor is adjusted when Power LCD mode or High angle mode is activated. Therefore, some subjects may look different on the LCD monitor. However, this does not affect the recorded pictures.
- The LCD monitor automatically returns to normal brightness after 30 seconds when recording in Power LCD mode. Press any button to make the LCD monitor bright again.
- You may not notice the High angle mode effect if the LCD monitor is difficult to see because of light from the sun etc. shining on it. In this case, we recommend using your hand or another object to block the light when using the camera.
- High angle mode is not activated in the following cases.
 - In playback mode
 - While the menu screen is displayed
 - While the review screen is displayed

3 Press [MENU/SET].

- The [POWER LCD] or [HIGH ANGLE] icon appears.



Ⓑ: 

Ⓒ: 

Ⓑ: POWER LCD

Ⓒ: HIGH ANGLE

- You can also use the joystick to perform steps 2 and 3.



Taking Pictures using the Built-in Flash



■ To open the flash

Slide the [⚡ OPEN] switch (A).

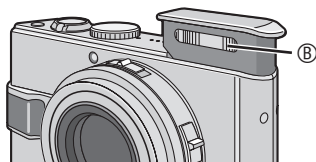
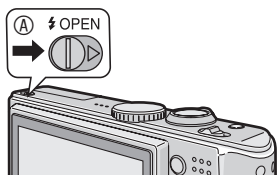

(B): Photo flash

- Do not cover the photo flash with your fingers or any other items.

■ To close the flash

Press the flash until it clicks.

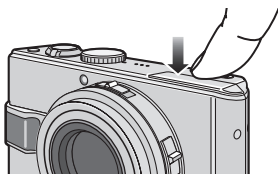

- To close the flash securely, press the center of the flash until it clicks. When you press on the edge, locking the flash may become difficult.
- Be sure to close the flash when not in use.
- The flash setting is fixed to Forced OFF [⚡ OFF] while the flash closes.

■ Switching to the appropriate flash setting

Set the flash setting of the built-in flash according to the scene to be recorded.

1 Press [⚡].

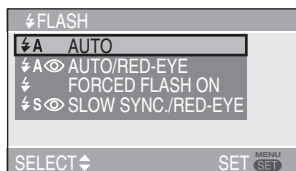

2 Press ▲/▼ or ► [⚡] to switch the flash setting.

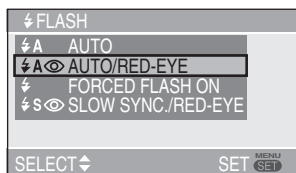

- When 5 seconds pass without any operation, the setting selected at the time is automatically adopted.
- For the flash setting contents, refer to “Flash setting” (P44). For the selectable flash setting, refer to “Available flash settings by recording mode” (P44).

3 Press [MENU/SET].

- You can also press the shutter button halfway to finish.
- You can also use the joystick for performing steps 2 and 3.



To select



To set

■ Flash setting

: AUTO

The flash is automatically activated according to the recording condition.

: AUTO/Red-eye reduction*¹

The flash is automatically activated according to the recording condition. It reduces the red-eye phenomenon (eyes of the subject appear red in photo flash) by triggering the flash before actually recording the picture.

After that, the flash is activated for actual recording again.

- Use this when you take pictures of people in low lighting conditions.

: Forced ON

The flash is activated every time regardless of the recording condition.

- Use this when your subject is back-lit or under fluorescent light.

: Forced ON/Red-eye reduction*¹

- In [PARTY] (P65) or [CANDLE LIGHT] (P66) in scene mode, the flash mode is set to Forced ON/Red-eye reduction.

: Slow sync./Red-eye reduction*¹

When you take a picture with a dark background landscape, this feature makes the shutter speed slow when the flash is activated, so that the dark background landscape will become bright. Simultaneously it reduces the red-eye phenomenon.

- Use this when taking pictures of people in front of a dark background.

: Forced OFF

The flash is not activated in any recording condition.































- Use this when taking pictures in places where the use of the flash is not permitted.

*¹ The flash is activated twice. The subject should not move until the second flash is activated.

■ Available flash settings by recording mode

The available flash settings depend on the recording mode.

(○ : Available, — : Not available)

						
	—	○* ¹	○* ²	—	—	○
	○	○	○	—	○	○
	○	○	○	—	○	○
	○	○	○	—	—	○
	○	○	○	—	—	○
	—	—	—	—	—	○
	○	○	○	—	—	○
	○	○	○	—	—	○
	—	—	—	—	—	○
	○	○	○	—	—	○
	—	—	—	—	—	○
	—	—	—	—	○	○
	—	—	—	—	—	○
	○	○	○	—	—	○
	○	—	○	—	—	○
	—	—	—	○	○	○
	—	—	—	—	—	○
	—	—	—	—	—	○
	—	—	○	—	—	○
	—	—	—	—	—	○
	○	—	○	—	—	○
	—	—	—	—	—	○
	○	○	○	—	—	○
	○	○	○	—	—	○

*¹ When the backlight compensation is off

*² When the backlight compensation is on



- The flash setting may change when you change the recording mode. Make flash settings in various recording modes according to your preference and available settings shown in the above table.

■ The available flash range to take pictures







The available flash range to take pictures depends on the ISO sensitivity selected (P84).

ISO sensitivity	Available flash range
AUTO	60 cm (1.97 feet) to 4.9 m (16.08 feet) (Wide) 30 cm (0.98 feet) to 2.8 m (9.19 feet) (Tele)
 ISO	60 cm (1.97 feet) to 4.9 m (16.08 feet) (Wide) 30 cm (0.98 feet) to 2.8 m (9.19 feet) (Tele)
ISO100	60 cm (1.97 feet) to 1.9 m (6.23 feet) (Wide) 30 cm (0.98 feet) to 1.1 m (3.61 feet) (Tele)
ISO200	60 cm (1.97 feet) to 2.7 m (8.86 feet) (Wide) 30 cm (0.98 feet) to 1.5 m (4.92 feet) (Tele)
ISO400	60 cm (1.97 feet) to 3.9 m (12.8 feet) (Wide) 40 cm (1.31 feet) to 2.2 m (7.22 feet) (Tele)
ISO800	80 cm (2.62 feet) to 5.5 m (18.0 feet) (Wide) 60 cm (1.97 feet) to 3.1 m (10.17 feet) (Tele)
ISO1600	115 cm (3.77 feet) to 5.7 m (18.7 feet) (Wide) 90 cm (2.95 feet) to 3.2 m (10.5 feet) (Tele)

- The available flash range is an approximation.
- Refer to P29 for the focus range.
- Refer to P84 for the ISO sensitivity.
- If ISO sensitivity is set to [AUTO] or [ ISO] when using the flash, it will be automatically increased to a maximum of [ISO640].

- To avoid picture noises, we recommend reducing the ISO sensitivity, setting [NOISE REDUCTION] in [PICT.ADJ.] to [HIGH] or setting the items except [NOISE REDUCTION] to [LOW] to take pictures. (P91)
- In motion picture mode [] (P75), [SCENERY] (P63), [NIGHT SCENERY] (P64), [FIREWORKS] (P66), [STARRY SKY] (P67), [AERIAL PHOTO] (P68) or [HIGH SENS.] (P68) in scene mode, the flash mode is fixed to Forced OFF [] even if the flash is open.

■ Shutter speed for each flash mode

Flash mode	Shutter speed (sec.)
 : AUTO	1/30 to 1/2000
 : AUTO/Red-eye reduction	1/30 to 1/2000
 : Forced ON  : Forced ON/Red-eye reduction	1/30 to 1/2000
 : Slow sync./Red-eye reduction	1 to 1/2000
 : Forced OFF	1 to 1/2000 (In Program AE mode)

- Refer to P55 for the Aperture-priority AE, Shutter-priority AE or Manual exposure mode.
- The settings may be different from those shown here if you are using scene modes.
 - [NIGHT SCENERY] (P64):
8 seconds to 1/2000th of a second
 - [FIREWORKS] (P66):
1/4th of a second, 2 seconds
 - [STARRY SKY] (P67):
15 seconds, 30 seconds, 60 seconds

■ Adjusting flash output

Adjust the flash output when the subject is small or reflection ratio is extremely high or low.

- 1** Press **▲** [**FLASH**] several times until [**FLASH**] appears and then press **◀▶** to set the flash output.

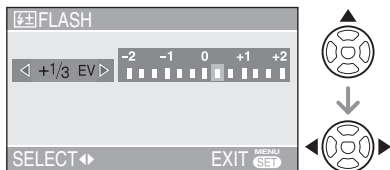

- You can adjust from [-2 EV] to [+2 EV] in steps of [1/3 EV].
- Select [0 EV] to return to the original flash output.

2 Press [MENU/SET] to finish.

- You can also press the shutter button halfway to finish.
- When the flash output is adjusted, the flash output value appears on the upper left of the screen.
- The flash output setting is memorized even if the camera is turned off.
- In Auto mode [**A**], motion picture mode [**M**], and [SCENERY] (P63), [NIGHT SCENERY] (P64), [FIREWORKS] (P66), [STARRY SKY] (P67), [AERIAL PHOTO] (P68) or [HIGH SENS.] (P68) in scene mode, you cannot adjust the flash output.



- Do not look directly at the flash at close range when it is activated.
- Do not bring the flash too close to objects or close the flash while it is activated. The objects may be discolored by its heat or lighting.
- Do not cover the photo flash with your fingers or any other items.

- In economy mode, the LCD monitor turns off and the status indicator blinks while the flash is charged. [This does not happen when using the AC adaptor (DMW-AC5; optional).]

If the remaining battery power is low, the length of time that the LCD monitor turns off to charge may become longer.

- The flash icon turns red when activating the flash and pressing the shutter button halfway.
- When the jitter alert appears, we recommend using a tripod.
- When you take a picture beyond the available flash range, the exposure may not be adjusted properly and the picture may become bright or dark.
- When taking a picture with the flash, the white balance will be automatically adjusted [except for [☀] (Daylight), [⚡] (Flash)], but the white balance may not be properly adjusted if the photo flash is insufficient. (P82)
- When the shutter speed is fast, the flash effect may not be sufficient.
- When you repeat taking a picture, recording may be disabled even if the flash is activated. Take a picture after the access indication disappears.
- When the flash is being charged, the flash icon blinks red, and you cannot take a picture even when you press the shutter button fully.
- Do not close the flash immediately after using a secondary light source, for example AUTO/Red-eye reduction [**⚡**]. Doing so can damage the camera.
- The red-eye reduction effect differs between people. Also, if the subject was far away from the camera or was not looking at the first flash, the effect may not be evident.
- When you set burst mode or auto bracket, only 1 picture is recorded for every flash activated.
- You can extend the shutter speed by up to 1/8 by using exposure compensation.
- Sand or seawater may cause the camera to malfunction. Make sure that sand or seawater does not come in touch with the flash.

Taking Pictures with the Self-timer



1 Press .



OFF : No display (canceled)

: Self-timer set to 10 seconds

: Self-timer set to 2 seconds

2 Press or to switch the self-timer mode.



- When 5 seconds pass without any operation, the setting selected at the time is automatically adopted.

3 Press [MENU/SET].

- You can also press the shutter button halfway to finish.

- You can also use the joystick for performing steps 2 and 3.



4 Press the shutter button halfway to focus and then press it fully to take a picture.



- The self-timer indicator

- The self-timer indicator blinks and the shutter is activated after 10 seconds (or 2 seconds).

- If you press [MENU/SET] when the self-timer is set, the self-timer setting is canceled.

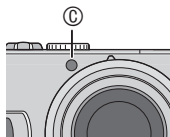

- When using a tripod or in other cases, setting the self-timer to 2 seconds is a convenient way to stabilize the jitter caused by pressing the shutter button.
- When you press the button fully with one stroke, the subject is automatically focused just before the recording. In dark places, the self-timer indicator blinks and then it may turn on brightly to work as the AF assist lamp (P90) for focusing on the subject.
- When you set the self-timer in burst mode, the camera starts taking a picture 2 or 10 seconds after the shutter button is pressed. The number of pictures taken at one time is fixed to 3.
- We recommend using a tripod when setting the self-timer. (When using a tripod, be sure to confirm that the tripod is stable when this unit is attached.)
- The self-timer is fixed at 2 seconds when you are using [SELF PORTRAIT] in scene mode (P64).

Compensating the Exposure



Use this function when you cannot achieve appropriate exposure due to the difference of brightness between the subject and the background.

Over exposed



↓
Compensate the exposure toward negative.

Properly Exposed



↑
Compensate the exposure toward positive.

Under exposed



Joystick operations

1 Move the joystick **◀** to select [] and move it **▲/▼** to compensate the exposure.



Ⓐ

Ⓐ: The exposure compensation value

- You can compensate from -2 EV to $+2$ EV in steps of $1/3$ EV.
- Select only [] (0 EV) when you do not compensate the exposure.

Cursor button operations

1 Press **▲** [] to display [] **EXPOSURE** and press **◀/▶** to compensate the exposure.



- You can compensate from -2 EV to $+2$ EV in steps of $1/3$ EV.
- Select [0 EV] to return to the original exposure.

2 Press [**MENU/SET**] to finish.

- You can also press the shutter button halfway to finish.



- EV is an abbreviation of “Exposure Value”, and it is the amount of light given to the CCD by the aperture value and the shutter speed.
- The exposure compensation value appears on the lower left of the screen.
- The exposure value is memorized even if the camera is turned off.
- The compensation range of the exposure will be limited depending on the brightness of the subject.
- You cannot compensate the exposure with [**STARRY SKY**] in scene mode (P67).

Taking Pictures using Auto Bracket



In this mode, 3 pictures are automatically recorded by each press of the shutter button according to the compensation range of the exposure.

You can select the desired exposure among the 3 types of pictures.

1 Press \blacktriangle [\pm] several times until  AUTO BRACKET appears, set the compensation range of the exposure with \blacktriangleleft \blacktriangleright .

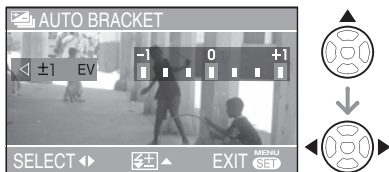

- You can select [OFF] (0), [$\pm 1/3$ EV], [$\pm 2/3$ EV] or [± 1 EV].
- When you do not use auto bracket, select [OFF] (0).

2 Press [MENU/SET] to finish.

- You can also press the shutter button halfway to finish.



- When setting auto bracket, the auto bracket icon () appears on the screen.
- When taking pictures using auto bracket after the exposure compensation, the pictures are based on the compensated exposure. When the exposure is compensated, the exposure compensation value appears at bottom left of the screen.
- When setting auto bracket and the burst mode simultaneously, auto bracket will be performed.
- Auto review works if you activate auto bracket, irrespective of the auto review setting. (But the picture is not enlarged.) You cannot change the auto review setting in the setup menu.
- When setting auto bracket, you cannot use the audio recording function.
- The exposure may not be compensated with auto bracket depending on the brightness of the subject.
- You cannot use auto bracket if you have set quality to [RAW].
- In shutter-priority AE and manual exposure, if the shutter speed is set to more than 1 second auto bracket is disabled.
- When the flash is activated, you can take only 1 picture.
- You cannot use auto bracket when there are only one or two pictures remaining.
- You cannot use auto bracket in [SPORTS] (P63), [STARRY SKY] (P67) and [BABY1]/[BABY2] (P69) in scene mode.
- You cannot take pictures using auto bracket when the ISO sensitivity is set to [ISO].

Optical Image Stabilizer [STABILIZER]



This mode recognizes and compensates for jitter.

- 1 Press and hold the optical image stabilizer button (A) until [STABILIZER] appears.**

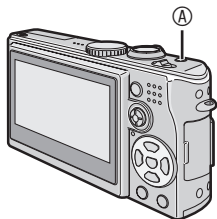

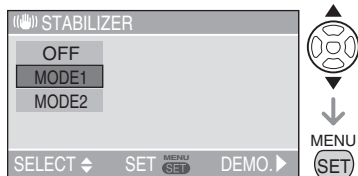

- 2 Press ▲/▼ to select the stabilizer function mode and then press [MENU/SET].**





- You can also use the joystick to perform step 2.



MODE1 ()	The stabilizer operates continuously and can assist during photo composition.
MODE2 ()	The jitter is compensated for when the shutter button is pressed. There is a greater stabilizing effect.
OFF ()	When image stabilization is not desired.

■ Demonstration of the optical image stabilizer (Demonstration Mode)

When you press , the demonstration appears. After the demonstration ends, the screen returns to the stabilizer function mode selection menu. If you want to exit the demonstration halfway through, press  again.

While the demonstration is displayed, the optical zoom is fixed to Wide (1×) and the zoom function cannot be activated.

Moreover, you cannot take pictures.



- The stabilizer function may not work in the following cases so take special care not to move the camera when pressing the shutter button.
 - When too much jitter occurs.
 - When the zoom magnification is high.
 - In digital zoom range.
 - When taking pictures while following subjects in motion.
 - When the shutter speed is extremely slow due to dark conditions or other reasons.
- In [SELF PORTRAIT] (P64) in scene mode, the stabilizer function is set to [MODE2]. In starry sky mode (P67), the function is set to [OFF]. In these modes, the camera does not display the menu for selecting the optical image stabilizer.
- In motion picture mode () [MODE2] cannot be set.

Taking Pictures using Burst Mode



- 1 Press and hold the burst mode button until the burst menu is displayed.**

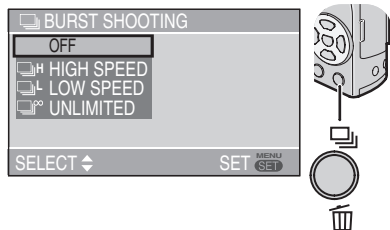

OFF: No display (canceled)

: High speed

: Low speed

: Unlimited

- 2 Press ▲/▼ or the burst mode button to switch burst mode settings.**

- When 5 seconds pass without any operation, the setting selected at the time is automatically adopted.

- 3 Press [MENU/SET].**

- You can also press the shutter button halfway to finish.
- You can also use the joystick to perform steps 2 and 3.



- 4 Take a picture.**

- Hold down the shutter button fully to activate the burst mode.



Number of pictures recorded in burst mode

	Burst speed (pictures/second)	Number of recordable pictures (pictures)	
	2*	max. 3	max. 5
	1*	max. 3	max. 5
	approx. 1	Depends on the remaining capacity of the built-in memory/card.	

*The transfer speed of the card has no effect on the burst speed.

- The number of pictures indicated is when the shutter speed is faster than 1/60 and the flash is not activated.
- The burst speed (pictures/second) may become slower depending on brightness and other recording conditions.



- **When the flash is activated or [STARRY SKY] in scene mode is selected, you can take only 1 picture.**
- When the burst mode setting is set to Unlimited:
 - You can take pictures until the capacity of the built-in memory or the card is full.
 - The burst speed will become slower halfway. When the built-in memory is used, the burst speed becomes a maximum of 1 picture approximately every 6 seconds. However, the exact timing of this depends on the number of recordable pictures and the card.
- The focus is fixed in the first picture.
- The ways to control the exposure and the white balance vary depending on the burst mode setting. When the burst mode is set to [, they are fixed to the values set for the first picture. When the burst speed is set to [] or [, they are adjusted each time you take a picture.
- When the self-timer is used, the number of recordable pictures in burst mode is fixed to 3.
- Burst mode is not canceled when the camera is switched off.
- When the burst mode is activated, the audio recording function cannot be used.
- When setting auto bracket and the burst mode simultaneously, auto bracket will be performed.
- In Burst mode, auto review is activated even the setting is off. (The picture is not enlarged.) You cannot change the auto review setting in the setup menu.
- You cannot use burst mode if you have set quality to [RAW].

Taking pictures by setting the aperture/shutter speed manually

A Aperture-priority AE



When you want the background to be in sharp focus, set the aperture value to a higher number. The higher the aperture value is the smaller the aperture opening will be. For a soft focus background, set the aperture value to a lower number which corresponds to a larger aperture opening.

1 Move the joystick towards ▲/▼ to set the aperture value.



Ⓐ Aperture value

▲: Increase

▼: Decrease

2 Take a picture.



S Shutter-priority AE



When you want to take a sharp picture of a fast moving subject, set to a faster shutter speed. When you want to create a trail effect, set to a slower shutter speed.

1 Move the joystick towards ▲/▼ to set the shutter speed.



Ⓐ Shutter speed

▲: Faster

▼: Slower

2 Take a picture.



- Refer to P55 for the available range of the aperture value and the shutter speed.
- The brightness of the screen may differ from that of the actual pictures. Check it using review function or setting to the playback mode.
- The ISO sensitivity cannot be set to [AUTO] or [ISO]. (When the recording mode is switched to Aperture-priority AE or Shutter-priority AE, the ISO sensitivity is automatically set to [ISO100] even though it was set to [AUTO] or [ISO] beforehand.)
- You cannot set to Slow sync./Red-eye reduction [S/O] in Shutter-priority AE.
- When the exposure is not adequate, the aperture value and the shutter speed on the screen turn red.
- Set the aperture value to a higher number when the subject is too bright. Set the aperture value to a lower number when the subject is too dim.
- When the shutter speed is slow, we recommend using a tripod.

Taking pictures by setting the exposure manually

M Manual exposure



Decide the exposure by setting the aperture value and the shutter speed manually.

1 Move the joystick towards ▲/▼/◀/▶ to set the aperture value and the shutter speed.



Ⓐ Ⓑ

- ▲/▼: Set the aperture value Ⓐ and the shutter speed Ⓑ.
- ◀/▶: Select the aperture value and the shutter speed.

2 Press the shutter button halfway.



Ⓒ

- Indication for the condition of exposure Ⓒ (manual exposure assistance) appears for about 10 seconds.
- When the exposure is not adequate, set the aperture value and the shutter speed again.

3 Take the picture.



■ Manual Exposure Assistance

	The exposure is adequate.
	Set to faster shutter speed or larger aperture value.
	Set to slower shutter speed or smaller aperture value.

- The manual exposure assistance is an approximation. We recommend taking pictures and then checking them using the review function.



- Refer to P55 for the available range of the aperture value and the shutter speed.
- You cannot set the following items in manual exposure.
 - Slow sync./Red-eye reduction [] (P43)
 - [AUTO] or [] in ISO sensitivity (P84) (When the recording mode is switched to Manual exposure, the ISO sensitivity is automatically set to [ISO100] even though it was set to [AUTO] or [] beforehand.)
 - Compensating the Exposure (P48)
- The brightness of the LCD may differ from the brightness of pictures you take. Check the picture with review or play mode.
- If the exposure is not adequate, the aperture value and the shutter speed turn red when pressing the shutter button halfway.
- When the shutter speed is slow, we recommend using a tripod.

■ Aperture Value and Shutter Speed

Shutter-priority AE

Available Shutter Speed (Sec.) (Per 1/3 EV)				Aperture Value
8	6	5	4	F2.8 to F8.0
3.2	2.5	2	1.6	
1.3	1	1/1.3	1/1.6	
1/2	1/2.5	1/3.2	1/4	
1/5	1/6	1/8	1/10	
1/13	1/15	1/20	1/25	
1/30	1/40	1/50	1/60	
1/80	1/100	1/125	1/160	
1/200	1/250	1/320	1/400	
1/500	1/640	1/800	1/1000	
1/1300				F4.0 to F8.0
1/1600				F5.6 to F8.0
1/2000				F8.0

Aperture-priority AE

Available Aperture Value (Per 1/3 EV)			Shutter Speed (Sec.)
F8.0			8 to 1/2000
F7.1	F6.3	F5.6	8 to 1/1600
F4.9	F4.5	F4.0	8 to 1/1300
F3.6	F3.2	F2.8	8 to 1/1000

Manual exposure

Available Aperture Value (Per 1/3 EV)	Available Shutter Speed (Sec.) (Per 1/3 EV)
F2.8 to F3.6	60 to 1/1000
F4.0 to F4.9	60 to 1/1300
F5.6 to F7.1	60 to 1/1600
F8.0	60 to 1/2000



- The aperture values in the table above are the values when the zoom lever is rotated to Wide at maximum.
- Some of the aperture values cannot be selected depending on the zoom magnification.

Taking Pictures with Manual Focus



Use this function when you want to fix the focus or when the distance between the lens and the subject is determined and you do not want to activate auto focus.

1 Slide the focus switch to [MF].

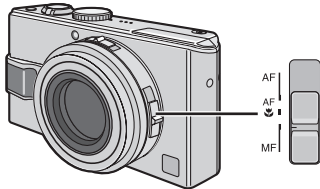

- AF: Auto focus
- AF : AF Macro mode
- MF: Manual focus

2 Move the joystick / to focus.

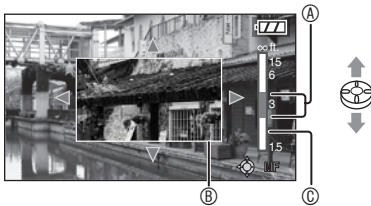

- : Further
- : Closer
- **A**: Focal distance
- The manual focusing assistant **B** appears.
- The MF assistant disappears 2 seconds after you stop operating the joystick.
- The moving focus indication **C** disappears 5 seconds after you stop operating the joystick.

3 Take the picture.



MF assistance

Move the joystick / while [MF ASSIST] is set to [MF1] or [MF2] to enlarge the picture to help focusing. This allows you to focus on the subject more easily.

1 Press [MENU/SET].

2 Press .

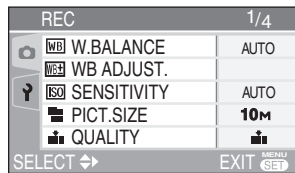

3 Press to select the [SETUP] menu icon and then press .

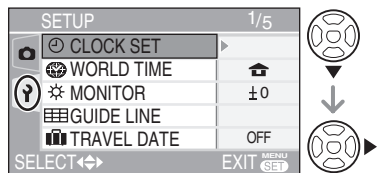

4 Press ▲/▼ to select [MF ASSIST] and then press ►.

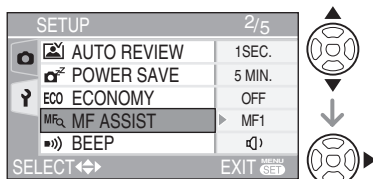

5 Press ▲/▼ to select [MF1] or [MF2] and then press [MENU/SET].

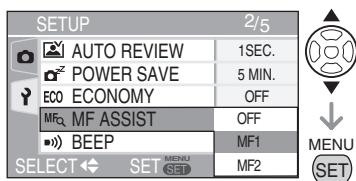

- [MF1]: The center area of the picture is enlarged. You can focus while considering the overall composition of the picture.
- [MF2]: The whole picture is enlarged. You can easily focus when you are not sure of the focus at Wide.
- [OFF]: The screen is not enlarged.

6 Press [MENU/SET] to close the menu.

- You can also close the menu by pressing the shutter button halfway.
- You can also use the joystick to perform steps 2 to 6.



■ Shifting the enlarged section

You can shift the enlarged section while enlarging the picture with MF assistance. The function is convenient for changing the point on which you want to focus.

- 1 Move the joystick ▲/▼ to display MF assistance.



- 2 Press cursor buttons ▲/▼/◀▶ to shift the enlarged section.



- The picture enlargement is canceled about 2 seconds later.
- The displayed picture returns to the original MF assist area when:
 - The Focus switch is set to [AF] or [AF ∞].
 - The number of recording pixels or the aspect is changed.
 - The camera is turned off.

■ Technique for Manual focus



- ① Move the joystick ▲/▼.
- ② Even if the subject is focused, move it a little more.
- ③ Return to the center to make fine adjustments.

■ Prefocus

This is a technique to focus on the point to take pictures in advance when it is difficult to focus on the subject with auto focus due to its quick motion.

This function is suitable when the distance between the camera and the subject is established.



- You can also record with manual focus in motion picture mode [M]. When starting the recording, the focus is fixed.
- When you focus on the subject in Wide, the focus may not be adequate in Tele. In this case, focus on the subject again.
- The MF assistance does not appear in digital zoom range.
- The distance shown shows roughly how far away the point of focus is.
- Use the MF assistance to make final adjustments to the focus.
- After canceling power save mode, focus on the subject again.
- When setting the manual focus, you cannot set the continuous AF (P90).
- The AF lock is released when you select manual focus.

Taking Close-up pictures

This mode allows you to take close-up pictures of the subject, e.g. When taking pictures of flowers.

You can take pictures approaching the subject at a distance up to 5 cm (0.16 feet) from the lens by rotating the zoom lever upmost to Wide (1×).

1 Select [AF🌸] with the focus switch.

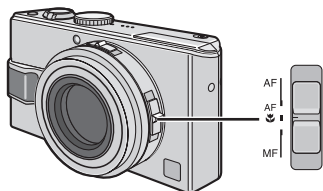

- AF: Auto focus
- AF🌸: AF Macro mode
- MF: Manual focus

■ Focus range

- Normal

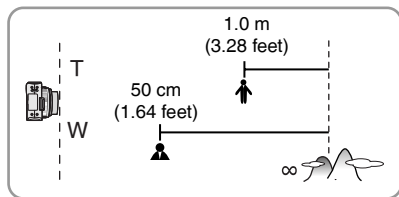

- [AF🌸]

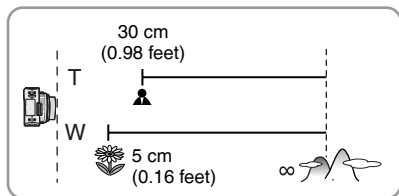

- Use a tripod and the self-timer (P47) for best results.
- When the subject is close to the camera, the effective focus range (depth of field) is significantly narrowed. Therefore, you will have difficulty in focusing on the subject if the distance between the camera and the subject is changed after focusing on the subject.
- When the camera lens is at a distance beyond the available range from the subject, the subject may not be focused even if the focus indication lights.
- AF Macro mode gives priority to a subject close to the camera. Therefore it takes longer for the camera to focus in macro mode than in standard AF mode [AF] when the subject is 50 cm (1.64 feet) or more away.
- The available flash range is about 60 cm (1.97 feet) to 4.9 m (16.08 feet) (Wide). (This is applied when you set the ISO sensitivity to [AUTO].) We recommend setting the flash to Forced OFF [🚫] when you take pictures at close range.
- It is normal for the resolution of the edges of pictures taken with [AF🌸] at short distances to be lower.



Setting the aspect ratio



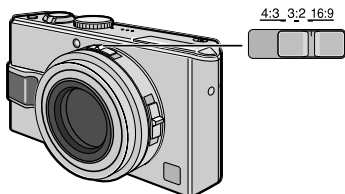

Aspect ratio is the ratio of the width and the height of the picture. By changing the aspect ratio, you can select an angle of view that matches the subject.

1 Slide the aspect ratio switch to change the setting.



- You cannot select [3:2] when recording motion pictures [] with a card. You cannot select [16:9] or [3:2] when recording motion pictures [] with the built-in memory.
- The ends of the recorded pictures may be cut at printing. (P126)

16:9	<p>This is suitable for landscapes etc. where a wide view is preferable. This is also suitable for playing back pictures on a wide-screen TV, high-definition TV etc.</p> 
3:2	<p>Select to take pictures with the same 3:2 aspect ratio as 35 mm film.</p> 
4:3	<p>Select to take pictures with the same aspect ratio as a 4:3 TV or a computer monitor.</p> 

AF/AE Lock (AF: Auto focus/AE: Auto exposure)



Locking the focus with [AF/AE LOCK] button is useful when the subject is outside the AF area or when the subject in extremely high contrast prevents the camera from obtaining the appropriate exposure.

AF: Through this function, the camera automatically focuses on the subject.

AE: Through this function, the camera judges brightness of the subject and automatically selects the exposure.

■ Setting the items to lock

1 Press [MENU/SET].

2 Press ▲/▼ to select [AF/AE LOCK] and press ►.

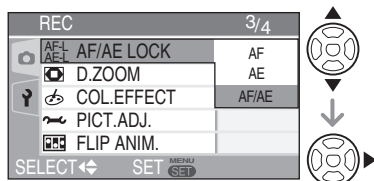

3 Press ▲/▼ to select the item and press [MENU/SET].

- AF : Auto focus locked
- AE : Auto exposure locked
- AF/AE : Both locked

4 Press [MENU/SET] to close the menu.

- You can also close the menu by pressing the shutter button halfway.
- You can also use the joystick to perform steps 2 to 4.



■ Recording pictures

- 1 Aim the AF area at the subject.
- 2 Press and hold [AF/AE LOCK].



- Ⓐ AF-L : only the focus is locked (AF)
 AE-L : only the exposure is locked (AE)
 AF-L AE-L : both the focus and the exposure are locked (AF/AE)
- Press and hold [AF/AE LOCK] again to unlock.
- 3 Move the camera back to the shot you want to take and press the shutter button fully.



- The exposure remains the same even if brightness of the subject changes.
- While using AE Lock, you can still refocus by pressing the shutter button halfway.
- While using AE Lock, you can still set the Program shift. (P27)
- You can not use AE Lock in manual exposure mode, scene mode or motion picture mode.
- Only the AE lock is effective when you are using manual focus.

Scene mode



When you select a scene mode to match the subject and recording situation, the camera sets the optimal exposure and hue to obtain the desired picture.

- Refer to P63 to 69 for each scene menu.

1 Press ▲/▼ to select the scene mode.

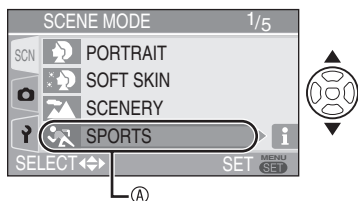

- Press ▼ at ① to switch to the next menu screen.
- If [SCENE MODE] menu does not appear, press [MENU/SET] to display the [SCENE MODE] menu.
- When you press ►, explanations about each scene mode are displayed. (When you press ◀, the screen returns to the [SCENE MODE] menu.)

2 Press [MENU/SET].

■ About the menu screen items

- There are 5 menu screens (1/5, 2/5, 3/5, 4/5 and 5/5).
- You can switch menu screens from any menu item by rotating the zoom lever.

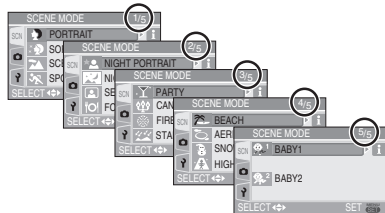

■ About menu operations using the joystick

You can also use the joystick for menu operations.

- 1 Move the joystick ▲/▼ to select the scene mode.
 - When you move the joystick ►, explanations about each scene mode are displayed. (When you move the joystick ◀, the screen returns to the [SCENE MODE] menu.)
- 2 Press the joystick to set the mode.

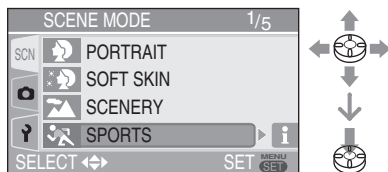

- The color of the picture may seem strange if you use a scene mode that is unsuitable for the shot.
- Use exposure compensation to adjust the brightness of pictures you take. (P48) (However, the exposure cannot be compensated in [STARRY SKY].)
- Press ◀ and then press ▲/▼ in the [SCENE MODE] menu to select either the [REC] menu icon [📷] (P81) or the [SETUP] menu icon [⚙️] (P21) and set the desired items.
- The following cannot be set in scene mode because the camera automatically adjusts them to the optimal setting.
 - [W.BALANCE] (P82)
 - [SENSITIVITY] (P84)
 - [METERING MODE] (P88)
 - [COL.EFFECT] (P91)
 - [PICT.ADJ.] (P91)

Press [MENU] [SET] to display the [SCENE MODE] menu and select a scene mode. (P62)



Portrait mode

The background is blurred and the person stands out with a healthier complexion.

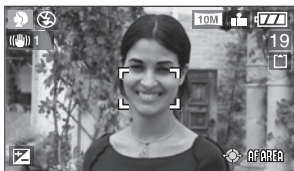

■ Technique for Portrait mode

To make this mode more effective:

- 1 Rotate the zoom lever to Tele as far as possible.
- 2 Move close to the subject to make this mode more effective.



- This mode is suitable for outdoors in the daytime.
- The ISO sensitivity is fixed to [ISO100].



Soft skin mode

The camera detects the face or skin area to achieve a smoother appearance of the skin than portrait mode. Use this mode when taking portraits from the chest up.

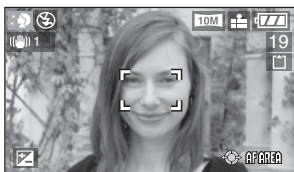

■ Technique for Soft skin mode

To make this mode more effective:

- 1 Rotate the zoom lever to Tele as far as possible.
- 2 Move close to the subject to make this mode more effective.



- This mode is suitable for outdoors in the daytime.
- If there are other flesh-colored elements in the shot, they will also be softened.
- The effect may not be as obvious if there isn't enough light.
- The ISO sensitivity is fixed to [ISO100].



Scenery mode

This mode allows you to take a picture of a wide landscape. The camera focuses on a distant subject preferentially.

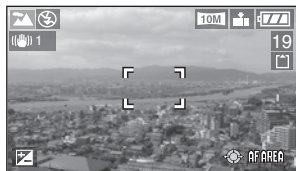

- Slide the focus switch to [AF].
- The focus range is 5 m (16.4 feet) to ∞.
- The Flash setting is fixed to Forced OFF [OFF].
- The setting on the AF assist lamp is disabled.



Sports mode

This mode allows you to take pictures of a fast moving subject. (e.g. When taking pictures of outdoor sports.)



■ Technique for Sports mode

This mode is more effective when taking pictures in the daytime on a clear day.



- Slide the focus switch to [AF].
- This mode is suitable for outdoors in the daytime, keeping 5 m (16.4 feet) or more away from the subject.
- The [ISO] function allows you to automatically increase the ISO sensitivity for preventing jitter when taking pictures of a fast moving subject indoors.
- The ISO sensitivity is fixed to [ISO].
- The auto bracket setting is disabled.
- The digital zoom is fixed to [OFF].

Press [MENU] to display the [SCENE MODE] menu and select a scene mode. (P62)

Night portrait mode

The subject can be recorded with brightness in real life by using the flash and the slow shutter speed.

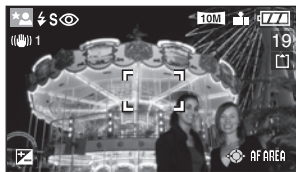

■ Technique for Night portrait mode

- **Open the flash. (P43)**
- Due to the slow shutter speed, use a tripod and the self-timer (P47) for best results.
- Keep the subject still for about 1 second after taking a picture.
- We recommend taking pictures by rotating the zoom lever to Wide (1x), and being at a distance about 1.5 m (4.92 feet) from the subject.



- The focus range is 1.2 m (3.94 feet) to 5 m (16.4 feet). (See page 45 for details about available flash range to take pictures.)
- Be sure to close the flash when not in use.
- The shutter may be kept closed (max. about 1 sec.) after taking a picture because of signal processing. This is not a malfunction.
- When you take pictures in dark places, noises may become visible.
- When using the flash, Slow sync./Red-eye reduction [] is selected and the flash is activated every time.
- You cannot use [CONT.AF] while in this mode.

Night scenery mode

This mode allows you to take a picture of a nightscape. The landscape can be recorded vividly by using the slow shutter speed.

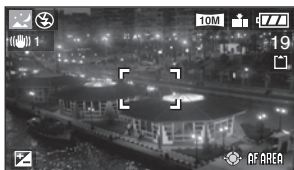

■ Technique for Night scenery mode

- Slide the focus switch to [AF].
- Use a tripod as the shutter may be open for as long as 8 seconds. Use the self-timer for best results. (P47)



- The focus range is 5 m (16.4 feet) to ∞ .
- The shutter may be kept closed (max. about 8 seconds) after taking a picture because of signal processing. This is not a malfunction.
- When you take pictures in dark places, noise may become visible.
- The Flash setting is fixed to Forced OFF [].
- The ISO sensitivity is fixed to [ISO100].
- The settings on the AF assist lamp is disabled.
- You cannot use [CONT.AF] while in this mode.

Self portrait mode

This mode allows you to take a picture of yourself.

■ Technique for Self-portrait mode

When you are focused by pressing the shutter button halfway, the self-timer indicator lights up. Fix the camera firmly and then press the shutter button fully.

Press [MENU/SET] to display the [SCENE MODE] menu and select a scene mode. (P62)

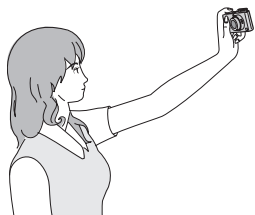

- A blinking self-timer lamp indicates that the camera has not focused. Press the shutter button halfway again to focus.
- The captured picture automatically appears for about 10 seconds on the LCD monitor for reviewing. Refer to P35 for operations on the review function.
- When the picture may be blurred by slow shutter speed, we recommend using the 2 seconds self-timer. (P47)



- The available focus range is 30 cm (0.98 feet) to 70 cm (2.3 feet).
- You can take a picture of yourself with audio (P87). In this time, the self-timer indicator lights up while recording the audio.
- When you select self-portrait mode [👤], the zoom lever is automatically moved to Wide (1x). If you rotate the zoom lever, it will become difficult to focus.
- The self-timer can be set to [OFF] or [2SEC.]. (P47) When you set to [2SEC.], it is kept until the camera is turned off or the mode dial is rotated.
- The stabilizer function is fixed to [MODE2]. (P50)
- The AF mode is fixed to 9-area-focusing. (P88)
- The setting on the AF assist lamp is disabled.

Food mode

Use this mode to take pictures of food in restaurants, irrespective of the lighting, so that the natural colors of the subject come out.

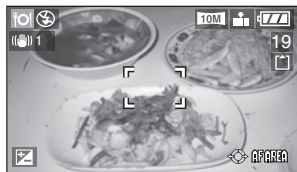

- The focus range is 5 cm (0.16 feet) (Wide)/30 cm (0.98 feet) (Tele) to ∞.

Party mode



Select this mode when you want to take pictures at wedding receptions, indoor parties, etc. Both the people and the background can be recorded with brightness in real life by using the flash and slowing down the shutter speed.



■ Technique for Party mode

- **Open the flash. (P43)**
- Due to the slow shutter speed, use a tripod and the self-timer (P47) for best results.
- We recommend taking pictures by rotating the zoom lever to Wide (1x), and being at a distance about 1.5 m (4.92 feet) from the subject.



- The flash setting can be set to Forced ON/Red-eye reduction [] or Slow sync./Red-eye reduction [].

Press [MENU] [SET] to display the [SCENE MODE] menu and select a scene mode. (P62)

Candle light mode

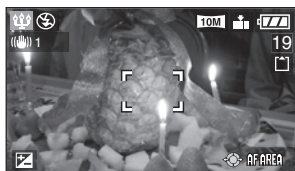

Use this mode to get the most from the mood created by candlelight.



■ Technique for Candle light mode

- This is most effective if you don't use the flash.
- Use a tripod and the self-timer (P47) for best results.



- The focus range is 5 cm (0.16 feet) (Wide)/30 cm (0.98 feet) (Tele) to ∞.
- The flash setting can be set to Forced ON/ Red-eye reduction [] or Slow sync./ Red-eye reduction [].

Fireworks mode

This mode allows you to take beautiful pictures of fireworks exploding in the night sky.

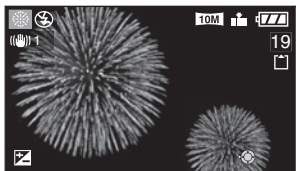

■ Technique for Fireworks mode

- Since the shutter speed becomes slower, we recommend using a tripod.



- This mode is most effective on subjects that are 10 m (32.8 feet) or more from the camera.
- The shutter speed becomes the following.
 - When [OFF] is set on the optical image stabilizer function: Fixed to 2 second
 - When [MODE1] or [MODE2] is set on the optical image stabilizer function: 1/4th or 2 second (The shutter speed becomes 2 second only when the camera has determined that there is little jitter such as when using a tripod etc.)
- Histograms are always displayed in orange. (P40)
- The Flash setting is fixed to Forced OFF [].
- The settings on the AF assist lamp is disabled.
- You cannot use [CONT.AF] while in this mode.
- The ISO sensitivity is fixed to [ISO100].

Press **[MENU/SET]** to display the [SCENE MODE] menu and select a scene mode. (P62)

Starry sky mode

Choose this setting to take clear pictures of the night sky or other dark subjects. The slow shutter speed makes the stars sparkle.



■ Setting the shutter speed

You can choose a shutter speed of 15, 30, or 60 seconds.

- 1 Press **▲/▼** to select the shutter speed, then press **[MENU/SET]**.

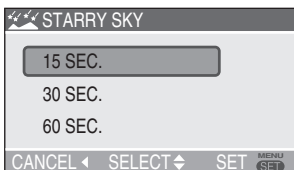

- 2 Take a picture.



- The countdown screen appears when you press the shutter button. Do not move the camera. After the countdown is finished, [PLEASE WAIT...] is displayed for the same amount of time as the shutter speed you used. This is to process the signals.
- Press **[MENU/SET]** to stop taking the picture while the countdown screen is displayed.

■ Technique for Starry sky mode

- The shutter opens for 15, 30 or 60 seconds. Due to the slow shutter speed, use a tripod and the self-timer (P47) for best results.



- The histogram is always orange. (P40)
- The Flash setting is fixed to Forced OFF **[OFF]**.
- The stabilizer function is fixed to [OFF]. (P50)
- The ISO sensitivity is fixed to [ISO100].
- You cannot use [CONT.AF] while in this mode.
- You cannot use exposure compensation, auto bracket mode, burst mode, or recording audio.

Beach mode

This mode allows you to take pictures on a beach. It prevents under exposure of the subject under strong sunlight.



■ Technique for Beach mode

- Use the flash.



- Do not touch the camera with wet hands.
- Sand or seawater may cause the camera to malfunction. Make sure that sand or seawater does not come in touch with the camera, particularly its lens, flash or terminals.

Press **[MENU/SET]** to display the **[SCENE MODE]** menu and select a scene mode. (P62)

Aerial photo mode

This mode allows you to take pictures through an airplane window.



■ **Technique for Aerial photo mode**

We recommend using this technique if it is difficult to focus when taking pictures of clouds etc. Aim the camera at something with high contrast, press the shutter button halfway to fix the focus and then aim the camera at the subject and press the shutter button fully to take the picture.



- **Turn the camera off when taking off or landing.**
- **When using the camera, follow all instructions from the cabin crew.**
- Be careful about the reflection from the window.
- The flash setting is fixed to Forced OFF [].
- The setting on the AF assist lamp is disabled.

Snow mode

The exposure and the white balance are adjusted to make the white color of the snow stand out.



High Sensitivity mode

This mode allows you to take pictures at [ISO3200] level with high sensitivity processing.



- The focus range is 5 cm (0.16 feet) (Wide)/30 cm (0.98 feet) (Tele) to ∞ .
- The resolution of the recorded picture decreases significantly because of high sensitivity processing. This is not a malfunction.
- You can take pictures suitable for 4"x6"/10x15 cm printing.
- The flash setting is fixed to Forced OFF [].
- The extended optical zoom and digital zoom cannot be used.
- You cannot set quality to [RAW] in high sensitivity mode.

Press [MENU/SET] to display the [SCENE MODE] menu and select a scene mode. (P62)

1 *Baby mode 1*
2 *Baby mode 2*

This mode adjusts the exposure and tone to bring out the healthy color of your baby's skin. The flash will be weaker than normal if you choose to use it.

You can set the birthdays of two babies by using [BABY1] and [BABY2].

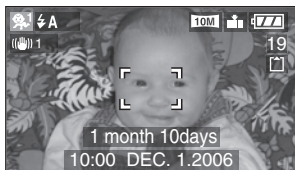

- The baby's age appears when you are showing the picture later.
- You can also use the [LUMIX Simple Viewer] or [PHOTOfunSTUDIO-viewer-] software on the included CD-ROM to print your baby's age. (For details, refer to the separate operating instructions for PC connection.)

■ Age display setting

- To show age, first enter the birthday, select [WITH AGE], and press [MENU/SET].
- To not show age, select [WITHOUT AGE], and press [MENU/SET].

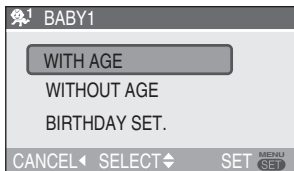

■ Birthday setting

- 1 Select [BIRTHDAY SET.] and press [MENU/SET].
 - 2 [PLEASE SET THE BIRTHDAY OF THE BABY] appears on the display. Select year/month/day with ◀/▶, then change the date with ▲/▼.
 - 3 Press [MENU/SET] to exit.
- If you select [WITH AGE] but you haven't set the birthday, a message appears. Press [MENU/SET] and follow steps 2 and 3 to enter the birthday.



- The focus range is 5 cm (0.16 feet) (Wide)/30 cm (0.98 feet) (Tele) to ∞.
- The ISO sensitivity is fixed to [ISO].
- The auto bracket setting is disabled.
- The digital zoom is fixed to [OFF].
- After turning on the camera in [BABY1]/[BABY2] in scene mode or switching to [BABY1]/[BABY2] from other scene modes, the age and current date and time are displayed for about 5 seconds at the bottom of the screen.
- Actual age displays depend on the [LANGUAGE] setting.
- The display style when printing may differ slightly from the display style on the screen.
- The display on the actual day of your baby's birth will be 0 month 0 day.
- Check the clock and birthday settings if the age shown is incorrect.
- Note that if you have selected [WITHOUT AGE], age information will not be recorded for any pictures you take. The information will not appear even if you select [WITH AGE] after taking pictures.
- For resetting the birthday setting, use [RESET] in the [SETUP] menu. (P24)

Recording which day of the vacation you take the picture



If you set the departure date in advance, you can record which day of the vacation you take the picture.

- When you play back a picture, the date on which it was taken is displayed.

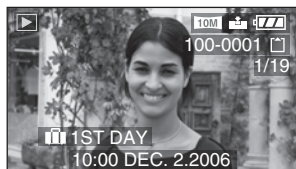

- The number of days that have passed since the departure date can be printed on each picture by using the software [LUMIX Simple Viewer] or [PHOTOfunSTUDIO-viewer-] in the CD-ROM (supplied). (For information about printing, refer to the separate operating instructions for PC connection.)

■ Setting the travel date

(Screen shows an example for the Program AE mode [P])

1 Press [MENU/SET].

2 Press .

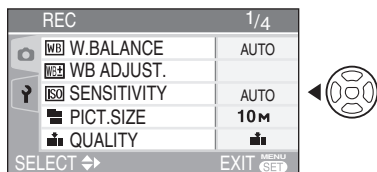

3 Press to select the [SETUP] menu icon and then press .

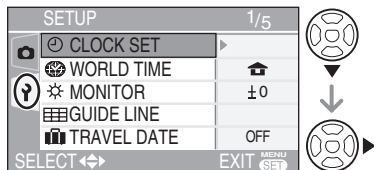

4 Press / to select [TRAVEL DATE] and then press .

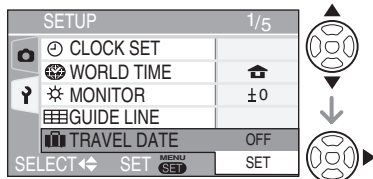

5 Press to select [SET] and then press [MENU/SET].

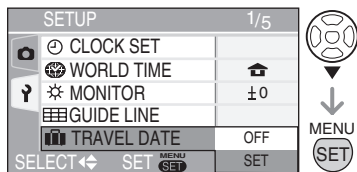

6 Press /// to select the date.



/: Select the desired item.

/: Set the year, month and date.

7 Press [MENU/SET] twice to close the menu.

- You can also use the joystick to perform steps 2 to 7.



8 Take a picture.

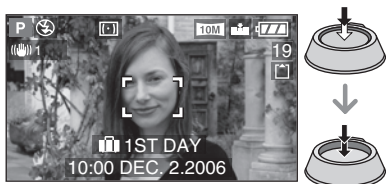

- The current date and time and which day of the vacation it is are displayed for about 5 seconds at the bottom of the screen if the camera is turned on when the travel date is set, after setting the clock, departure date or travel date, after changing the world time setting and after switching from playback mode to another mode.
- When [TRAVEL DATE] is set, [] appears on the lower right of the screen.

■ Canceling the travel date

If you leave [TRAVEL DATE] set to [SET], the number of days that have passed since the departure date will continue to be recorded.

When the vacation is finished, set [TRAVEL DATE] to [OFF] on the screen shown in step 5 and then press [MENU/SET] twice.



- The travel date is calculated using the date in the clock setting (P20) and the departure date you set. If you set [WORLD TIME] (P72) to the travel destination, the travel date is calculated using the date in the clock setting and the travel destination setting.
- The travel date setting is memorized even if the camera is turned off.
- If you set a departure date and then take a picture on a date before this departure date, [-] (minus) is displayed in orange and the day of the vacation that you took the picture is not recorded.
- If you set a departure date and then change the clock setting to the date and time at the travel destination, [-] (minus) is displayed in white and the day of the vacation that you took the picture on is recorded when the travel destination date is, for example, one day before the departure date.
- If [TRAVEL DATE] is set to [OFF], the number of days that have passed since the departure date will not be recorded even if you set the travel date or the clock. Even if [TRAVEL DATE] is set to [SET] after taking the pictures, the day of the vacation you took them on is not displayed.
- If you set a departure date when the clock is not set, the message [PLEASE SET THE CLOCK] appears. In this case, set the clock (P20).

Displaying the time at the travel destination



If you set your home area and the travel destination area when traveling abroad etc., the local time at the travel destination area can be displayed on the screen and recorded on the pictures taken.

- Select [CLOCK SET] to set the current date and time in advance. (P20)

1 Press [MENU/SET].

2 Press ◀.

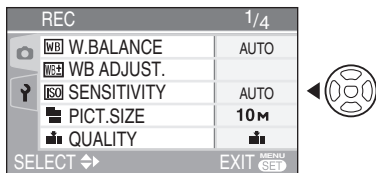

3 Press ▼ to select the [SETUP] menu icon [⤵] and then press ▶.

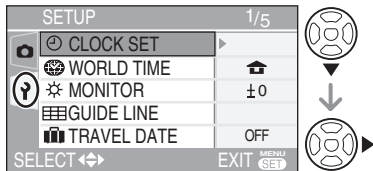

4 Press ▲/▼ to select [WORLD TIME] and then press ▶.

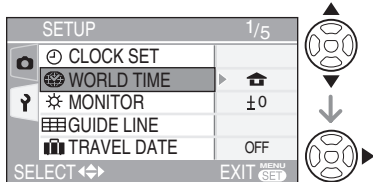

- You can also use the joystick to perform steps 2 to 4.



- If you are setting the world time for the first time, the message [PLEASE SET THE HOME AREA] appears. If this message appears, press [MENU/SET] and then set home area from the screen shown in step ② in "Setting the home area [HOME]".

■ Setting the home area [HOME]

(Perform steps 1, 2, 3 and 4.)

- 1 Press ▼ to select [HOME] and then press [MENU/SET].

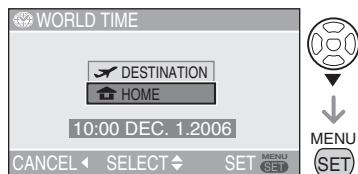

- 2 Press ◀/▶ to select your home area and then press [MENU/SET].



- You can also use the joystick to perform steps ① and ②.
- The current time is displayed on the top left of the screen and the time difference from GMT (Greenwich Mean Time) is displayed on the bottom left of the screen.
- If daylight saving time [⚙️] is used at the home area, press ▲ again to return to the original time.
- The daylight saving time setting for the home area does not advance the current time. Advance the clock setting by one hour. (P20)

Finishing setting the home area

- If you are setting the home area for the first time, the screen returns to the screen shown in step ① of "Setting the home area [HOME]" after you press [MENU/SET] to set your home area. Press ◀ to return to the screen shown in step 4 and then press [MENU/SET] to close the menu.
- If you are setting the home area for the second time etc., the screen returns to the screen shown in step 4 after you press [MENU/SET] to set your home area. Press [MENU/SET] again to close the menu.

■ Setting the travel destination area

(Perform steps 1, 2, 3 and 4 on P72.)

- ① Press ▲ to select [DESTINATION] and then press [MENU/SET] to set.

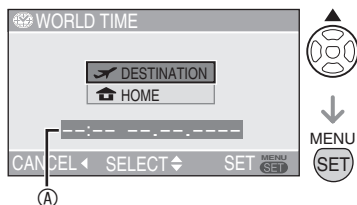

- Ⓐ: Depending on the setting, the time at the travel destination area or the home area is displayed.

- If you are setting the travel destination area for the first time, the date and time are displayed as shown in the screen above.
- ② Press ◀▶ to select the area the travel destination is in and then press [MENU/SET] to set.

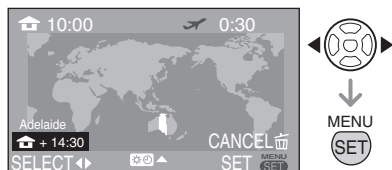

- The current time at the selected travel destination area is displayed on the top right of the screen and the time difference from the home area is displayed at the bottom left of the screen.
- If daylight saving time [☀🌙] is used in your travel destination, press ▲. (The time advances by one hour.) Press ▲ again to return to the original time.
- The names of major cities in the selected area are displayed. Also, the time difference between the selected area and the home area is displayed on the bottom left of the screen. (Refer to P74 for information about the names of the major cities that are displayed.)
- ③ Press [MENU/SET] to close the menu.

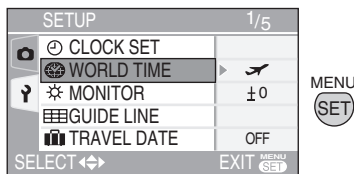

- You can also use the joystick to perform steps ① to ③.
- The icon changes from [🏠] to [✈️] after setting the travel destination.



- Return the setting to [HOME] when the vacation is finished by performing steps 1, 2, 3, 4 and then steps ① and ② of "Setting the home area [HOME]" (P72).
- If you cannot find the travel destination in the areas displayed on the screen, set by the time difference from the home area.

Location candidates for World Time settings

Offset from GMT	Listed location name			
-11	Midway Islands	Samoa		
-10	Hawaii	Honolulu	Tahiti	
-9	Alaska	Anchorage		
-8	Vancouver	Seattle	Los Angeles	
-7	Denver	Phoenix		
-6	Chicago	Houston	Mexico City	
-5	Toronto	New York	Miami	Lima
-4	Caracas	Manaus	La Paz	
-3:30	Newfoundland			
-3	Rio de Janeiro	Sao Paulo	Buenos Aires	
-2	Fernando de Noronha			
-1	Azores			
0	London	Casablanca		
+1	Berlin	Paris	Rome	Madrid
+2	Helsinki	Athens	Cairo	Johannesburg
+3	Moscow	Kuwait	Riyadh	Nairobi
+3:30	Tehran			
+4	Dubai	Abu Dhabi		
+4:30	Kabul			
+5	Islamabad	Karachi	Male	
+5:30	Delhi	Kolkata	Mumbai	Chennai
+5:45	Kathmandu			
+6	Dacca	Colombo		
+6:30	Yangon			
+7	Bangkok	Jakarta		
+8	Beijing	Hong Kong	Kuala Lumpur	Singapore
+9	Seoul	Tokyo		
+9:30	Adelaide			
+10	Guam	Sydney		
+11	Solomon Islands	New Caledonia		
+12	Fiji	Auckland	Wellington	
+12:45	Chatham Islands			

* "GMT" is an abbreviation of [Greenwich Mean Time].

Motion picture mode



- 1 Press the shutter button halfway to focus and then press it fully to start recording.**



- When the subject is focused, the focus indication lights.
- The focus, zoom and aperture value are fixed to those set at the beginning of recording (for the first frame).
- The available recording time **A** is displayed on the top right and the elapsed recording time **B** is displayed on the bottom right of the screen. For example, 1 hour 20 minutes and 30 seconds is displayed as [1h20m30s].
- The available recording time and the elapsed recording time are approximations.
- The audio recording starts simultaneously from the built-in microphone of the camera.
- Select the aspect ratio from either [**16:9**] or [**4:3**] when you record a motion picture on a card (P60). You cannot shoot motion pictures when the aspect ratio is set to [**3:2**].
- Select the [**4:3**] aspect ratio when you record a motion picture in the built-in memory (P60). You can not shoot motion pictures when the aspect ratio is set to [**16:9**] or [**3:2**].

- 2 Press the shutter button fully to stop recording.**

- If the built-in memory or the card becomes full in the middle of recording, the camera stops recording automatically.

- Changing the picture quality setting**

- 1 Press [MENU/SET].**

- 2 Press ▲/▼ to select [PICT.MODE] and then press ►.**

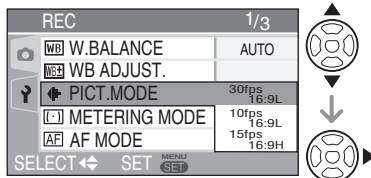

- 3 Press ▲/▼ to select the item and then press [MENU/SET].**

- When the aspect ratio setting is [**16:9**]**

Item	Picture size	fps
30fps16:9L	848×480pixels	30fps
10fps16:9L	848×480pixels	10fps
15fps16:9H	1280×720pixels	15fps

- When the aspect ratio setting is [**4:3**]**

Item	Picture size	fps
30fpsVGA	640×480pixels	30fps
10fpsVGA	640×480pixels	10fps
30fpsQVGA	320×240pixels	30fps
10fpsQVGA	320×240pixels	10fps

- fps (frame per second); This refers to the number of frames used in 1 second.
- You can record smoother motion pictures with 30 fps.
- You can record longer motion pictures with 10 fps although the picture quality is lower.
- [15fps16:9H] offers a large number of recording pixels, but you cannot record motion pictures as smooth as [30fps16:9L].
- [10fpsQVGA]: The file size is smaller, so the files are suitable to be attached to e-mails.

* You can only record to the built-in memory if the picture size is set to QVGA (320×240 pixels).

(○: Available, —: Not available)

Item	SD Memory Card/SDHC Memory Card	Built-in Memory
30fpsVGA	○	—
10fpsVGA	○	—
30fpsQVGA	○	○
10fpsQVGA	○	○
30fps16:9L	○	—
10fps16:9L	○	—
15fps16:9H	○	—

4 Press [MENU/SET] to close the menu.

- You can also press the shutter button halfway to close the menu.
- You can also use the joystick to perform steps 2 to 4.



To select



To set and to close



- The focus range is 50 cm (1.64 feet) [5 cm (0.16 feet) when using AF Macro/MF] to ∞ (Wide), 100 cm (3.28 feet) [30 cm (0.98 feet) when using AF Macro/MF] to ∞ (Tele).
- Refer to P131 for information about the available recording time.
- The remaining recordable time shown on the LCD may not reduce regularly.
- The motion pictures cannot be recorded without audio.
- This camera cannot take motion pictures if you are using a MultiMediaCard.
- When [PICT.MODE] is set to [30fpsVGA], [30fps16:9L] or [15fps16:9H], we recommend you to use cards offering “10

MB/s” or higher speeds (printed on their packages and elsewhere) for best results.

- Depending on the type of SD Memory Card or SDHC Memory Card, recording may stop in the middle.
- We recommend using Panasonic’s SD Memory Card/SDHC Memory Card.
- Depending on the type of card you are using, the card access indication may appear for a while after shooting motion pictures. This is normal.
- When motion pictures recorded with this camera are played back on other equipment, the quality of pictures and sounds may be deteriorated or it may not be possible to play them back. Also the recording information may not be displayed correctly.
- In motion picture mode [, you cannot use the direction detection function and the review function.
- You cannot set [MODE2] on the Optical Image Stabilizer function.
- The bundled software includes QuickTime to play back motion picture files recorded with the camera on the PC.

Displaying Multiple Screens (Multi Playback)



1 Rotate the zoom lever towards [] [W] to display multiple screens.

For example: When you have chosen to show 9 pictures



- []: 1 screen → 9 screens → 25 screens → Calendar screen display (P78)
- After the multiple screens are displayed, rotate the zoom lever further towards [] [W] to display 25 screens and the calendar screen (P78). Rotate the zoom lever towards [Q] [T] to return to the previous screen.
- When you select multi playback, the scroll bar **A** appears so you can check the position of the selected picture in the total pictures.

2 Press ▲/▼/◀/▶ to select a picture.

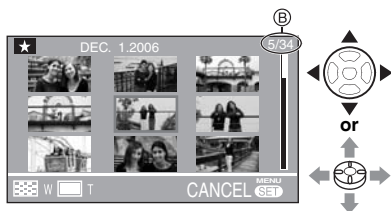

- B**: Number of the selected picture and the total number of recorded pictures
- The recording date and number of the selected picture and the total number of recorded pictures are displayed.

- Depending on the recorded picture and the setting, the following icons will appear.
 - [★] (Favorites)
 - [] (Motion picture)
 - [BABY1]/[BABY2] in scene mode)
 - [] (Travel date)
 - [] (Flip animation)

■ Examples of 25 screens

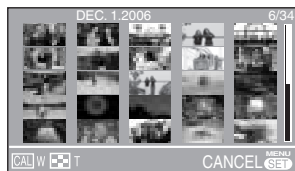

■ To return to the normal playback

Rotate the zoom lever towards [Q] [T], or press [MENU/SET] or joystick.

- The picture framed in an orange box appears.

■ To delete a picture during a multi playback

- 1 Press ▲/▼/◀/▶ to select a picture and then press [].
- 2 Press ▲ to select [YES].
- 3 Press [MENU/SET] or joystick.



- Even if the indications on the screen are turned off in normal playback mode (P39), the recording information etc. appears on the screen in multi playback. If you return to the previous screen, the indications on the screen are displayed as in normal playback mode.
- Pictures will not be displayed in the rotated direction even if [ROTATE DISP.] is set to [ON] (P97).

Displaying pictures by recording date (Calendar playback)



You can display pictures by recording date using the calendar playback function.

1 Rotate the zoom lever towards [W] [T] to display the calendar screen.



- The recording date of the picture selected in the playback screen becomes the date selected when the calendar screen is first displayed.
- If there are multiple pictures with the same recording date, the first picture recorded on that day is displayed.
- The calendar is displayed monthly.

2 Press ▲/▼/◀/▶ to select the date to be played back.

◀/▶: Select the date

▲/▼: Select the month

- If there were no pictures recorded during a month, the month is not displayed.

3 Press [MENU/SET] to display the pictures that were recorded on the selected date.

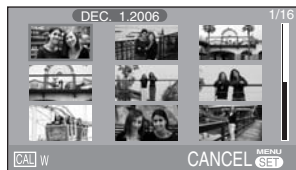

- The pictures that were recorded on the selected date are displayed on the 9 screens playback screen.

- Rotate the zoom lever towards [W] [T] to return to the calendar screen.

4 Press ▲/▼/◀/▶ to select a picture and then press [MENU/SET].

- The selected picture is displayed on the 1 screen playback screen.
- You can also use the joystick to perform steps 2 to 4.



To select



To set

■ To return to the 1 screen playback screen

After the calendar screen is displayed, rotate the zoom lever towards [Q] [T] to display 25 screens, 9 screens and 1 screen. (P77)



- The pictures are displayed without being rotated even if you set [ROTATE DISP.] to [ON]. (P97)
- You can display the calendar between January 2000 and December 2099.
- If the recording date of the picture selected in 25 screens multi playback is not between January 2000 and December 2099, the camera automatically displays it in the oldest calendar date.
- Pictures edited on a PC or processed on other equipment may be displayed with dates different from the actual recording dates.
- If the date is not set in the camera (P20), the recording date is set as January 1st, 2006.
- If you take pictures after setting the travel destination in [WORLD TIME] (P72), the pictures are displayed by the dates at the travel destination in calendar playback.

Using the Playback Zoom



1 Rotate the zoom lever towards [Q] [T] to enlarge the picture.



- **Q**: 1x→2x→4x→8x→16x
- When you rotate the zoom lever towards [] [W] after enlarging the picture, the magnification becomes lower. When you rotate the zoom lever towards [Q] [T], the magnification becomes higher.
- When you change the magnification, the zoom position indication **A** appears for about 1 second to check the position of the section enlarged.

2 Press ▲/▼/◀▶ to move the position.

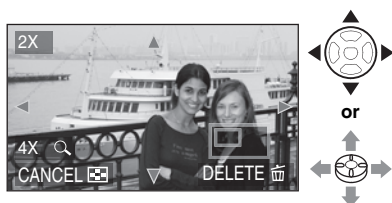

- When you move the position to be displayed, the zoom position indication is displayed for about 1 second.

■ To stop using the playback zoom

Rotate the zoom lever towards [] [W] or press [MENU/SET] or joystick.

■ To delete a picture during the playback zoom

- 1 Press [].
- 2 Press ▲ to select [YES].
- 3 Press [MENU/SET] or joystick.



- Even if the indication on the LCD monitor are turned off in normal playback mode (P39), the magnification and enabled operations appear on the LCD monitor when the playback zoom is activated. You can switch the display on or off by pressing the [DISPLAY] button. When you set the magnification to 1x, the indication on the LCD monitor are displayed as in normal playback mode.
- The more the picture is enlarged, the more its quality deteriorates.
- If you want to save the enlarged picture, use the trimming function. (P103)
- The playback zoom may not operate if pictures have been recorded with other equipment.

Playing Back Pictures with Audio/Motion pictures



■ Motion pictures

Press ◀▶ to select a picture with a motion picture icon [] and then press ▼ to play back.



- You can also use the joystick for these operations.
- The motion picture recording time (A) is displayed on the LCD monitor. After playback starts, the motion picture recording time disappears and the elapsed playback time is displayed on the bottom right of the LCD monitor. For example, 1 hour 20 minutes and 30 seconds is displayed as [1h20m30s].
- The cursor displayed during playback corresponds to ▲/▼/◀▶.
- Motion picture playback stops and the normal playback is restored by pressing ▼.

Fast forwarding/Fast rewinding

During motion picture playback, keep pressing ◀▶.

▶: Fast forward

◀: Fast rewind

- When releasing the button, it turns to normal motion picture playback.

To pause

Press ▲ during motion picture playback.

- Press ▲ again to cancel pause.

■ Pictures with audio

Press ◀▶ to select a picture with the audio icon [] and then press ▼ to play back.



- You can also use the joystick for these operations.
- Refer to [AUDIO REC.] (P87) and [AUDIO DUB.] (P101) for information about how to create still pictures with audio.



- Sound can be heard through the speaker. Refer to [VOLUME] (P24) for information about how to adjust the volume in the [SETUP] menu.
- The file format that can be played back with this camera is QuickTime Motion JPEG.
- Please note that the bundled software includes QuickTime to play back motion picture files created with the camera on the PC.
- Some QuickTime Motion JPEG files recorded by a PC or other equipment may not be played back with this camera.
- When playing back motion pictures that have been recorded with other equipment, the quality of pictures may be deteriorated or it may not be possible to play them back.
- When using a high capacity card, it is possible that fast rewinding may be slower than usual.
- You cannot use the following functions with motion pictures and pictures with audio.
 - Playback zoom (While playing back or pausing motion pictures and while playing audio)
 - [ROTATE DISP.]/[ROTATE]/[AUDIO DUB.] (Motion pictures only)
 - [RESIZE]/[TRIMMING]/[ASPECT CONV.]

Using the [REC] mode menu



Setting the hue, picture quality adjustment, etc. allows you to create wide variations on taking pictures.

- Set the mode dial to the desired recording mode.
- Menu items differ depending on the mode selected with the mode dial (P6). This page describes how to set [AUDIO REC.] in program AE mode [P]. (Refer to P82 to 93 for each menu item.)
- Select [RESET] in the [SETUP] menu to return the menu settings to the initial settings at the time of purchase. (P24)

1 Press [MENU/SET].

2 Press ▲/▼ to select the menu item.

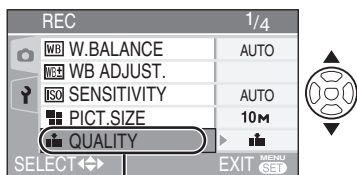

- Press ▼ at (A) to switch to the next menu screen.

3 Press ►, press ▲/▼ to select the setting and then press [MENU/SET].

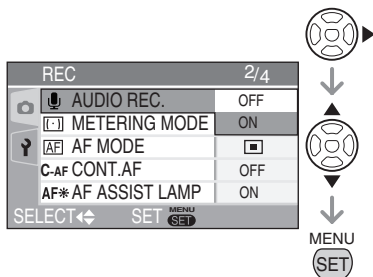

4 Press [MENU/SET] to close the menu.

- You can also press the shutter button halfway to close the menu.

■ About menu operations using the joystick

You can also use the joystick for menu operations.

- 1 Press [MENU/SET].
- 2 Move the joystick ▲/▼/◀/▶ to select setting contents and press the joystick.
- 3 Press the joystick to close the menu.

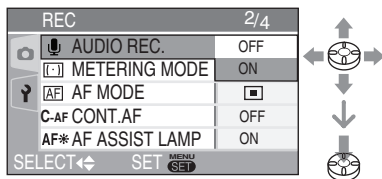

■ About the menu screen items

- There are 4 menu screens (1/4, 2/4, 3/4 and 4/4).
- You can switch menu screens from any menu item by rotating the zoom lever.

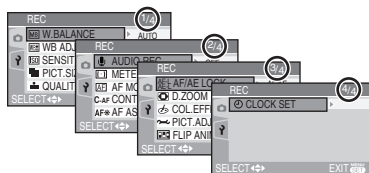

■ Using the Quick setting



You can change the following with the joystick when recording.

- [AF MODE] (P88)
- [METERING MODE] (P88)
- [W.BALANCE] (right)
- [SENSITIVITY] (P84)
- [PICT.SIZE] (P86)
- [QUALITY] (P86)

1 Keep pressing the joystick when recording.

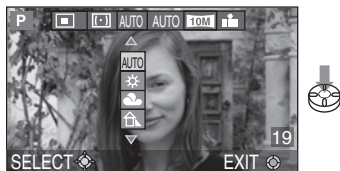

- The Quick setting menu appears.

2 Move the joystick towards ▲/▼/◀ to select an item and then press the center of the joystick to finish.



- You can also use the cursor button and [MENU/SET] to select menu items and finish.



- The menu items depend on the selected recording mode.
- [MENU/SET] (white set) does not appear for white balance when using the Quick setting.

Press [MENU/SET] to display the [REC] mode menu and select the item to set. (P81)



This function allows you to reproduce a white color closer to the tone in real life on the pictures recorded under sunlight, halogen lighting, etc. in which the white color may appear reddish or bluish. Select a setting that matches the recording conditions.

AUTO	for auto setting (auto white balance)
[Sun icon] (Daylight)	for recording outdoors on a bright day
[Cloud icon] (Cloudy)	for recording outdoors on a cloudy day
[House icon] (Shade)	for recording in shaded areas outdoors on a bright day
[Sun with rays icon] (Halogen)	for recording under halogen lighting
[Flash icon] (Flash)	for recording with the flash only
[1 icon] (White set 1)	for using the preset white balance
[2 icon] (White set 2)	for using the preset white balance
[Camera icon] SET (White set)	for using set mode 1 or 2 with a different white balance setting (P83)

■ Auto White Balance

Use of auto white balance adjustment in inappropriate lighting conditions may result in reddish or bluish pictures. Where the subject is surrounded by many light sources, auto white balance adjustment may not operate properly.

In this case, set the white balance to a mode except [AUTO] manually.

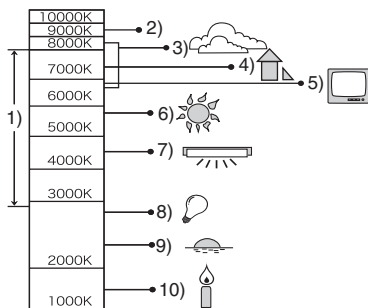

- 1 The range that is controlled by the auto white balance adjustment mode of this camera
- 2 Blue sky
- 3 Cloudy sky (Rain)
- 4 Shade
- 5 TV screen
- 6 Sunlight
- 7 White fluorescent light
- 8 Incandescent light bulb
- 9 Sunrise and sunset
- 10 Candlelight



K=Kelvin Color Temperature

■ Setting the white balance manually (White set SET)

Use this to set the white balance manually.

- 1 Select [ SET] (White set) and then press [MENU/SET].
- 2 Select [ WHITE SET 1] or [ WHITE SET 2] and then press [MENU/SET].

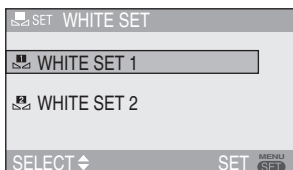

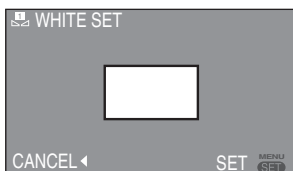

- 3 Aim the camera at a sheet of white paper or a similar white object so that the frame on the center of the screen turns white and then press [MENU/SET].



- 4 Press [MENU/SET] twice to close the menu.
- You can also press the shutter button halfway to finish.



- When taking a picture with the flash, the white balance will be automatically adjusted [except for  (Daylight)]/ (Flash)], but the white balance may not be properly adjusted if the photo flash is insufficient.
- The white balance cannot be set in Auto mode [ A] and scene mode.
- You can also use the joystick for these operations.

Press [**MENU/SET**] to display the [REC] mode menu and select the item to set. (P81)

[WB ADJUST.]

WB± *Finely Adjusting the White Balance*

P A S M

When you cannot acquire the desired hue by setting the white balance, you can finely adjust the white balance.

1 Press ▲/▼/◀▶ to adjust the white balance finely.

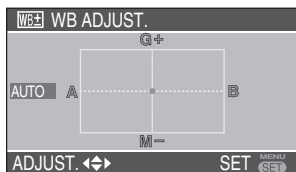



◀: A (amber: orange tint)

▶: B (blue: bluish)

▲: G+ (green: greenish)

▼: M- (magenta: reddish)

- When white balance is finely adjusted in A (amber) or B (blue) direction, the white balance icon displayed on the LCD Monitor turns to the finely adjusted color.



- When white balance is finely adjusted in G+ (green) or M- (magenta) direction, [+] (e.g.: ) or [-] (e.g.: ) is added to the white balance icon displayed on the LCD Monitor.

- When you do not adjust white balance finely, select the central point.

2 Press [MENU/SET] twice to close the menu.

- You can also press the shutter button halfway to finish.



- You can set the value independently for each of the modes in white balance.
- The setting on the fine adjustment of the white balance is reflected to the picture when taking a picture with the flash.
- The white balance fine adjustment setting is memorized even if the camera is turned off.
- When you change white balance setting in set mode [ SET], fine adjustment levels for [] and [] return to the standard (central point).
- When the color effect is set to any of [COOL], [WARM], [B/W] or [SEPIA] (P91), you cannot finely adjust the white balance.
- You can also use the joystick for these operations.

[ISO] *Setting the light sensitivity*

P A S M

ISO sensitivity represents the sensitivity of the image sensor to light. If you set the ISO sensitivity higher, the camera becomes more suitable for recording in dark places.

ISO sensitivity	100	←	→	1600
Use in bright places (e.g. outdoors)	Suitable			Not suitable
Use in dark places	Not suitable			Suitable
Shutter speed	Slow			Fast
Noise	Less			Increased

ISO sensitivity	Setting contents
AUTO	ISO sensitivity is automatically adjusted according to brightness.
ISO (intelligent)	ISO sensitivity is adjusted according to subject movements and brightness.
ISO100	ISO sensitivity is fixed at respective levels.
ISO200	
ISO400	
ISO800	
ISO1600	

- When setting to [AUTO], the ISO sensitivity is automatically adjusted from [ISO100] to [ISO200] according to the brightness. (When using the flash, the adjustment range becomes [ISO100] to [ISO640].)

■ About ISO (intelligent ISO sensitivity control)

The camera detects movements of the subject near the center of the frame and sets the optimum ISO sensitivity and shutter speed according to the movements and brightness.

- When shooting a moving subject indoors, you can reduce blur by raising ISO sensitivity and increasing the shutter speed.



1/125 ISO800

- When taking pictures of a motionless subject, you can reduce noise by setting ISO sensitivity at a low level.

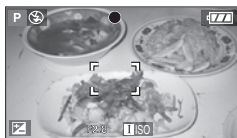

1/30 ISO200

- When you set ISO sensitivity to ISO, ISO sensitivity is automatically raised up to [ISO800] (up to [ISO640] when the flash is used).
- When you press the shutter button halfway, ISO appears. When you press the shutter button fully, the shutter speed is displayed for a while.



- You cannot use the digital zoom (P34) and auto bracket (P49) when ISO is selected.
- Even when ISO is selected, brightness or the subject's moving speed may cause pictures to blur.
- Movement detection may not be possible in the following cases.
 - When the moving subject is too small
 - When the moving subject is on the edge of the frame
 - In case the subject began to move the moment you pressed the shutter button fully
- The ISO sensitivity is fixed to ISO in Auto Mode [], [SPORTS] (P63) and [BABY1]/[BABY2] (P69) in scene mode.
- The ISO sensitivity cannot be set in motion picture mode [].
- You cannot use program shift (P27) when ISO is selected.
- The ISO sensitivity is fixed to [ISO3200] in [HIGH SENS.] in Scene mode (P68).
- The ISO sensitivity cannot be set to [AUTO] or ISO in Aperture-priority AE, Shutter-priority AE or Manual exposure.
- To avoid picture noises, we recommend reducing the ISO sensitivity, setting [NOISE REDUCTION] in [PICT.ADJ.] to [HIGH] or setting the items except [NOISE REDUCTION] to [LOW] to take pictures. (P91)
- Refer to P55 for information about Shutter speed.

Press [MENU/SET] to display the [REC] mode menu and select the item to set. (P81)

[PICT.SIZE]/[QUALITY]
Setting a picture size and quality that matches your use of the pictures

A P A S M SCN

A digital picture is made of numerous dots called pixels. Although you cannot see the difference on the camera's screen, the more the pixels the finer the picture will be when it is printed on a large piece of paper or displayed on a computer monitor. Picture quality refers to the compression rate when saving digital pictures.

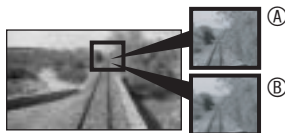

Ⓐ Many pixels (Fine)

Ⓑ Few pixels (Rough)

* These pictures are examples to show the effect.

■ Number of pixels

Select a higher number of pixels for clearer pictures when printing.

Select a lower number of pixels to store more pictures. Fewer pixels also means it is easier to send pictures by e-mail or use them on a homepage.

■ When the aspect ratio setting is [16:9]

10M (10M)	4224×2376 pixels
8M (8M EZ)	3840×2160 pixels
5.5M (5.5M EZ)	3072×1728 pixels
2M (2M EZ)	1920×1080 pixels

■ When the aspect ratio setting is [3:2]

8.5M (8.5M)	3568×2376 pixels
7M (7M EZ)	3248×2160 pixels
4.5M (4.5M EZ)	2560×1712 pixels
2.5M (2.5M EZ)	2048×1360 pixels

■ When the aspect ratio setting is [4:3]

7.5M (7.5M)	3168×2376 pixels
6M (6M EZ)	2880×2160 pixels
4M (4M EZ)	2304×1728 pixels
3M (3M EZ)	2048×1536 pixels
2M (2M EZ)	1600×1200 pixels
1M (1M EZ)	1280×960 pixels



■ Quality

You can increase the number of recordable pictures without changing the picture size if quality is set to [].

	Fine (Low compression): This type gives priority to picture quality. Picture quality will be high.
	Standard (High compression): This type gives priority to the number of recordable pictures and records standard quality pictures.
RAW	RAW (Uncompressed): This type is suitable when editing and processing pictures with a computer.



- The number of pixels that can be selected differs depending on the aspect ratio. If you change the aspect ratio, set the picture size.
- [EZ] is an abbreviation of [Extended optical Zoom]. This is a function which further extends the optical zoom ratio. If you select a picture size with EZ displayed, the zoom ratio is extended to a maximum of 6.2× when the digital zoom is set to [OFF]. (P33)

- The extended optical zoom does not work in [HIGH SENS.] (P68) in scene mode so the picture size for [EZ] is not displayed.
- In motion picture mode [, the picture size is fixed to VGA (640×480 pixels), QVGA (320×240 pixels) or 16:9 (1280×720 pixels or 848×480 pixels).
- Pictures may have a mosaic-like appearance depending on the subject or the recording condition.
- Refer to P128 for the number of recordable pictures.
- The number of recordable pictures depends on the subject.
- The number of remaining pictures may not correspond with recorded frames.
- When the quality is set to [RAW], a JPEG picture with the quality equal to the Standard [] is created at the same time. The JPEG file is also erased if you erase the associated RAW file.
- The maximum resolution (P86) for each aspect ratio is fixed if you select [RAW].
- You cannot set quality to [RAW] in high sensitivity mode in scene mode.
- The following functions cannot be used for pictures recorded in [RAW].
 - Burst mode
 - Digital zoom
 - [AUDIO REC.]
 - Auto bracket
- The following functions are not available for pictures taken by setting quality to [RAW].
 - [AUDIO DUB.]
 - [RESIZE]
 - [TRIMMING]
- Picture editing at higher levels becomes possible when you use RAW format files. Using Ichikawa Soft Laboratory's [SILKYPIX Developer Studio] in the supplied CD-ROM, you can develop and edit pictures in RAW format files and save them in other formats that allow display on PCs (such as JPEG and TIFF).

Press [] to display the [REC] mode menu and select the item to set. (P81)

[AUDIO REC.]



Recording still pictures with audio



You can record audio with the still picture if this is set to [ON]. This means you can record the conversation that took place when you were recording or an explanation of the picture.

- When you set [AUDIO REC.] to [ON], [] appears on the screen.
- When you start recording by focusing on the subject and pressing the shutter button, the audio recording will be automatically stopped in 5 seconds. There is no need to keep pressing the shutter button.
- Audio is recorded from the built-in microphone of the camera.
- If you press [MENU/SET] during the audio recording, the audio recording will be canceled. The audio cannot be recorded.



- You cannot record pictures with audio in auto bracket, burst mode, when the quality is set to [RAW], or [STARRY SKY] in scene mode.





Press [MENU/SET] to display the [REC] mode menu and select the item to set. (P81)

[METERING MODE]

[METERING MODE] Deciding the method to measure brightness

PASM

You can switch to the following metering modes.

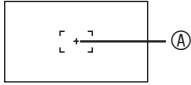
	<p>Multiple: This is the method in which the camera measures the most suitable exposure by judging the allocation of brightness on the whole screen automatically. Usually, we recommend using this method.</p>
	<p>Center weighted: This is the method used to focus on the subject on the center of the screen and measure the whole screen evenly.</p>
	<p>Spot: This is the method to measure the subject in the spot metering target .</p> 









- This is fixed to Multiple [.

[AF MODE]

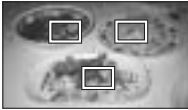
Setting the focus method

PASM

Select the mode that matches the recording conditions and the composition.

	<p>9-area-focusing: The camera focuses on any of 9 focus areas. This is effective when the subject is not in the center of the screen.</p> 
	<p>3-area-focusing (high speed): The camera quickly focuses on any of 3 focus areas - left, right or center. This is effective when the subject is not in the center of the screen.</p> 
	<p>1-area-focusing (high speed): The camera quickly focuses on the subject in the AF area on the center of the screen.</p> 
	<p>1-area-focusing: The camera focuses on the subject in AF area on the center of the screen.</p> 

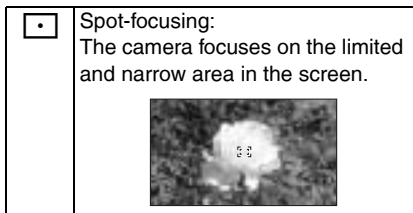

■ About 1-area-focusing (High speed) and 3-area-focusing (High speed)

- You can focus on the subject more quickly than other AF modes.
- Pictures may become still in the condition they were in before the subject was focused when you press the shutter button halfway. However, it is not a malfunction.



- When using the digital zoom or when you take pictures in dark places, the AF area is displayed on the center of the screen with a size wider than usual.
- When multiple AF areas (max. 9 areas) light at the same time, the camera is focusing on all the AF areas. The focus position is not predetermined because it is set to the position the camera automatically determines at the time of focusing. If you want to determine the focus position to take pictures, switch the AF mode to 1-area-focusing, 1-area-focusing (high speed) or Spot-focusing mode.
- Switch the AF mode to 1-area-focusing mode (High speed) or 1-area-focusing mode if it is difficult to focus using Spot-focusing mode.
- You cannot change the AF mode setting when using [SELF PORTRAIT] and [FIREWORKS] in scene mode (P62).
- This is fixed to 1-area-focusing in Auto mode [A].



■ About AF area selection

When the AF mode (P88) is one-area focusing or one-area focusing (high speed), you can select the AF area as follows. In the spot metering mode, the metering target shifts according to the AF area.

- 1 Set the Focus switch to [AF] or [AF⁺].
- 2 Move the joystick ► to select [AF AREA].
- 3 Press the joystick.



- 4 Press cursor buttons or move the joystick ▲/▼/◀/▶ to change the AF area.

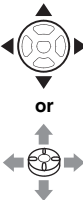

- 5 Press [MENU/SET] or the joystick.
- The AF area returns to the original in the following cases.
 - When the mode dial is set to Auto mode [A].
 - When the camera is turned off.

Press [MENU/SET] to display the [REC] mode menu and select the item to set. (P81)

[CONT.AF]

CAF Continuously focusing on a subject



This mode allows you to compose a picture more easily by always focusing on the subject.

When the AF mode is set to 1-area-focusing, 1-area-focusing (high speed) or spot-focusing, the time required for focusing when pressing the shutter button halfway will be reduced.

- When it is set to [ON], the [CAF] indication appears.



- The battery may be consumed faster than usual.
- It may take time to focus on the subject after rotating the zoom lever from Wide to Tele or suddenly changing the subject from a distant one to a nearby one.
- Press the shutter button halfway again when it is difficult to focus on the subject.
- The [CONT.AF] setting is fixed to [OFF] in Auto mode [A], [NIGHT PORTRAIT] (P64), [NIGHT SCENERY] (P64), [FIREWORKS] (P66) and [STARRY SKY] (P67) in scene mode, and when manual focus is set.
- If the focus switch is set to [AF], the time to focus will not be shorter.

[AF ASSIST LAMP]

AF* Focusing in low light conditions becomes easier



Illuminating the subject with the AF assist lamp allows the camera to focus on the subject in low light conditions.

If the AF assist lamp is set to [ON], an AF area with a size wider than usual is displayed and the AF assist lamp  turns on when you press the shutter button halfway in dark places etc.

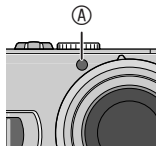

ON	The AF assist lamp turns on under low light conditions. In this time, the AF assist lamp icon [AF*] appears on the screen. The effective range of the AF assist lamp is 1.5 m (4.92 feet).
OFF	The AF assist lamp does not turn on.



- Be sure of the following points when the AF assist lamp is in use.
 - Do not look into the AF assist lamp closely.
 - Do not cover the AF assist lamp with your fingers or other objects.
- When the AF assist lamp is turned on, the AF area on the center of the screen is displayed and it is bigger than usual. (P89)
- When you do not want to use the AF assist lamp (e.g. when you take a picture of a subject in a dark place), set the [AF ASSIST LAMP] to [OFF]. In this case, it becomes difficult to focus on the subject.
- The AF assist lamp is fixed to [ON] while the camera is in Auto mode [A].
- You cannot use the AF assist lamp in [SCENERY], [NIGHT SCENERY], [SELF PORTRAIT], [FIREWORKS] and [AERIAL PHOTO] in scene mode. (P62)

Press [**MENU**] to display the [REC] mode menu and select the item to set. (P81)

[COL.EFFECT]



Setting color effects for the recorded pictures



You can use 4 types of color effects depending on the image of the picture.

COOL	The picture becomes bluish.
WARM	The picture becomes reddish.
B/W	The picture becomes black and white.
SEPIA	The picture becomes sepia.

[PICT.ADJ.]



Adjusting the picture quality for the recorded pictures



Use this function according to the recording situation and the atmosphere of the picture.

CONTRAST	HIGH	Increases the difference between the brightness and the darkness in the picture.
	LOW	Decreases the difference between the brightness and the darkness in the picture.
SHARPNESS	HIGH	The picture is sharply defined.
	LOW	The picture is softly focused.
SATURATION	HIGH	The colors in the picture become vivid.
	LOW	The colors in the picture become natural.
NOISE REDUCTION	HIGH	The noise reduction effect is enhanced. The resolution of the picture may be slightly deteriorated.
	LOW	The noise reduction effect is reduced. You can obtain pictures with higher resolution.



- When you take pictures in dark places, noise may become visible. To avoid picture noise, we recommend setting [NOISE REDUCTION] in [PICT.ADJ.] to [HIGH] or setting the items except [NOISE REDUCTION] to [LOW] to take pictures.
- In Auto mode [**A**], you cannot use [PICT.ADJ.].

Press [MENU/SET] to display the [REC] mode menu and select the item to set. (P81)

[FLIP ANIM.]

 Connecting images to create a motion picture file

P A S M SCN

This camera allows you to create motion picture files up to 20 seconds long by connecting pictures recorded in flip animation mode.

Example:

When capturing pictures of the subject in sequence moving the camera little by little and aligning the pictures, the subject looks as if it is moving.



- You can play back created flip animations with the same method used to play back motion pictures. (P80)

1 Press ▲/▼ to select [FLIP ANIM.] and then press ►.

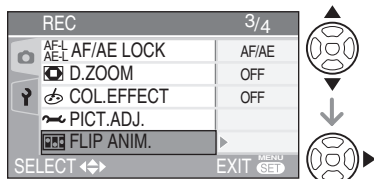

2 Select [PICTURE CAPTURE] and then press ►.

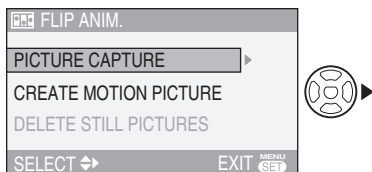

- The picture size is 320×240 pixels.

3 Press the shutter button and capture the images one frame at a time.



- You can check the recorded picture with ▼ and the previous or following picture with ◀/▶.
- Delete unnecessary pictures with [RECALL] button.
- You can record up to 100 pictures. The number of recordable pictures displayed is an approximation.

4 Press [MENU/SET], press ▲/▼ to select [CREATE MOTION PICTURE] and then press ►.

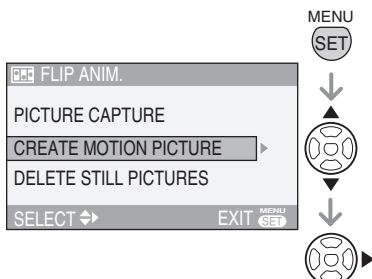

Press [**MENU/SET**] to display the [REC] mode menu and select the item to set. (P81)

5 Select [FRAME RATE] and then press **▶**.

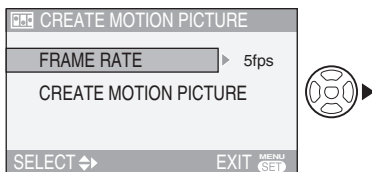

6 Press **▲/▼** to select [5fps] or [10fps] and then press [**MENU/SET**].

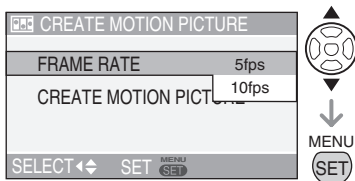

5fps	5 frames/sec.
10fps	10 frames/sec. (The motion pictures become smoother.)

7 Press **▼** to select [CREATE MOTION PICTURE], press **▶** and then create a flip animation.

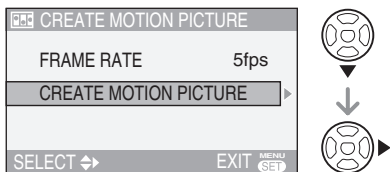

- The file number appears after creating a flip animation.
- Press [**MENU/SET**] three times to close the menu after creating the flip animation.

■ Deleting all still pictures used to create flip animation

When selecting [DELETE STILL PICTURES] in [FLIP ANIM.] menu, a confirmation screen appears. Select [YES] with **▲** and then press [**MENU/SET**].



- You cannot use pictures with audio, burst mode and auto bracket and the direction detection function.
- The pictures in each frame do not appear in normal review. (P35)
- If you execute [CREATE MOTION PICTURE], flip animation is made from all pictures recorded for flip animation. Delete unnecessary pictures.
- Audio cannot be recorded.
- You cannot record audio using the audio dubbing. (P101)
- Flip animations may not be played back by other equipment. The audio is not recorded on flip animations, however, you may hear varying levels of noises when you play back flip animations with other equipment which does not have a mute function.
- You can also use the joystick for these operations.

[CLOCK SET] Setting the date, time and display



Set the clock when you change the date or time (P20).

Using the [PLAY] mode menu



You can use various functions in playback mode to rotate pictures, set protection for them etc.

- Refer to P95 to 106 for each menu item.

1 Press [MENU/SET].

2 Press ▲/▼ to select the menu item.

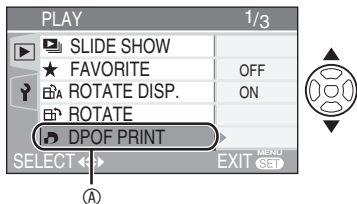

- Press ▼ at (A) to switch to the next menu screen.

3 Press ►.

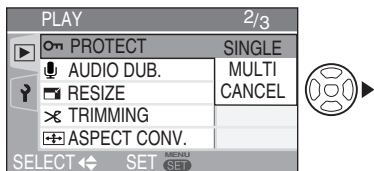

- After selecting a menu item in step 3, refer to the description of the menu item in the operating instructions and then set it.

■ About the menu screen items

- There are 3 menu screens (1/3, 2/3 and 3/3).
- You can switch menu screens from any menu item by rotating the zoom lever.

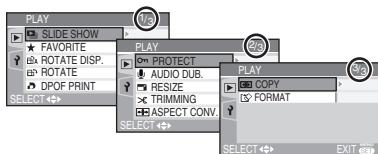

■ About menu operations using the joystick

You can also use the joystick for menu operations.

- 1 Press [MENU/SET].
- 2 Move the joystick ▲/▼/◀▶ to select setting contents and press the joystick.
- 3 Press the joystick to close the menu.

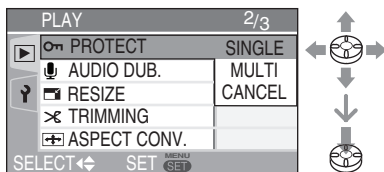

Press [MENU/SET] to display the [PLAY] mode menu and select the item to set. (P94)

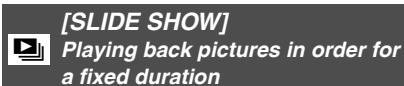

This is recommended when playing back pictures on a TV screen. You can skip unwanted pictures if [FAVORITE] (P96) has been set.

1 Press ▲/▼ to select [ALL] or [★] and then press [MENU/SET].

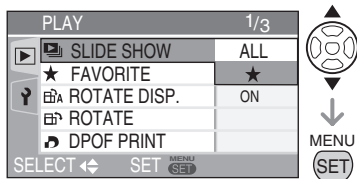

ALL	For playing back all pictures
★	For showing pictures in your favorites list (P96)

- The screen shown in step 1 appears when [FAVORITE] is set to [ON]. When [FAVORITE] is set to [OFF], perform step 2 onwards.
- If none of the pictures have [★] displayed, you cannot select [★] even if [FAVORITE] is set to [ON].

2 Press ▲ to select [START] and then press [MENU/SET].

(Screen when [ALL] is selected)

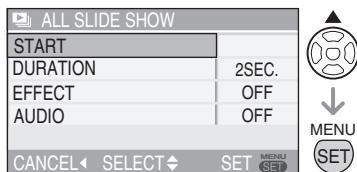

- The cursor displayed during a slide show ④ or while a slide show is paused ⑤ or during [MANUAL] slide show ⑥ is the same as ▲/▼/◀▶.
- Press ▲ to pause the slide show. Press ▲ again to cancel pause.
- Press ◀▶ while paused to display the previous or next picture.

3 By pressing the ▼, the Slide Show stops.

■ About playback duration, effect and audio settings

Select [DURATION], [EFFECT] or [AUDIO] for setting on the screen displayed in step 2.

DURATION	Select intervals of 1, 2, 3, 5 seconds or MANUAL.
EFFECT	<p>You can select slide show effects.</p> <p>OFF: No effect is set</p> <p>☐: Pictures slide sideways and switch</p> <p>▒: Pictures switch after turning translucent and creating overlaps</p> <p>■: New pictures spread from the center and replace</p> <p>[MIX]: Pictures switch in random ways</p> <ul style="list-style-type: none"> • When you select [MANUAL] (manual setting), the set effect is canceled.
AUDIO	By setting it to [ON], the audio from pictures recorded with audio can be played back during Slide Show.

- Playback intervals are estimates. Actual playback intervals vary according to pictures you play back.
- You can select [MANUAL] if you have selected [★] in step 1.
- Press ◀▶ to display the previous or next picture when [MANUAL] is selected.



- When you set [AUDIO] to [ON] and then play back a picture with audio, the picture changes when the audio finishes.
- You cannot play back motion pictures and use power save in a slide show. (However, the setting for power save mode is fixed to [10MIN.] while pausing a slide show or playing back a manual slide show.)
- You can also use the joystick for these operations.

Press [MENU/SET] to display the [PLAY] mode menu and select the item to set. (P94)

[FAVORITE] Setting your favorite pictures

You can do the following if a mark has been added to pictures and they have been set as favorites.

- Delete all the pictures not set as favorites. ([ALL DELETE EXCEPT ★]) (P37)
- Play back the pictures set as favorites only as a slide show. (P95)
- Print only the pictures set as favorites. (P111)

1 Press ▼ to select [ON] and then press [MENU/SET].

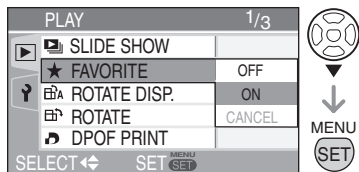

- You cannot set pictures as favorites if [FAVORITE] is set to [OFF]. Also the favorites icon [★] will not appear when [FAVORITE] is set to [OFF] even if it was previously set to [ON].
- You cannot select [CANCEL] if none of the pictures have [★] displayed.

2 Press [MENU/SET] to close the menu.

Press [**MENU/SET**] to display the [PLAY] mode menu and select the item to set. (P94)

3 Press ◀▶ to select the picture then press ▲.

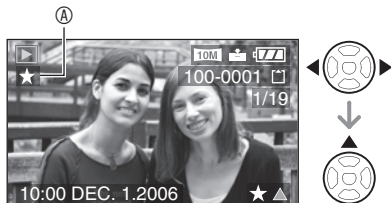

- Repeat the above procedure.
- If ▲ is pressed while the [★] favorites icon (A) is displayed, [★] is cleared, and the favorites setting is canceled.
- You can place up to 999 pictures in your favorites list.

■ Canceling all favorites

- 1 Select [CANCEL] on the screen shown in step 1 and then press [MENU/SET].
- 2 Press ▲ to select [YES] and then press [MENU/SET].
- 3 Press [MENU/SET] to close the menu.



- When printing pictures at a photo printing store, [ALL DELETE EXCEPT ★] (P37) is useful so only the pictures you want to be printed remain on the card.
- Use [LUMIX Simple Viewer] or [PHOTOfunSTUDIO-viewer-] (on the included CD-ROM) to change settings, check, or erase your pictures in your favorites list. (For details, refer to the separate operating instructions for PC connection.)
- You may not be able to put pictures you have shot on other equipment into your favorites list.
- You can also use the joystick for these operations.

[ROTATE DISP.]/[ROTATE] To display the picture rotated

This mode allows you to automatically display pictures vertically if they were recorded holding the camera vertically or rotate pictures manually in 90° steps.

■ Rotate display (The picture is automatically rotated and displayed.)

1 Press ▼ to select [ON] and then press [MENU/SET].

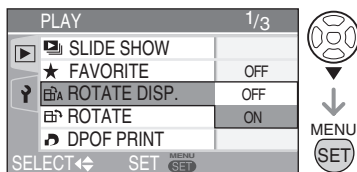

- When you select [OFF], the pictures are displayed without being rotated.
- Refer to P36 for how to play back pictures.

2 Press [MENU/SET] to close the menu.

Press [MENU/SET] to display the [PLAY] mode menu and select the item to set. (P94)

■ Rotate (The picture is rotated manually.)

1 Press ◀▶ to select the picture and then press ▼.



- When [ROTATE DISP.] is set to [OFF], [ROTATE] function is disabled.
- Motion pictures and protected pictures cannot be rotated.

2 Press ▲/▼ to select the direction to rotate the picture and then press [MENU/SET].



	The picture rotates clockwise in steps of 90°.
	The picture rotates counter-clockwise in steps of 90°.

3 Press [MENU/SET] twice to close the menu.

■ Example When rotating clockwise (↷)

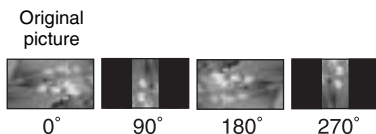

- When [ROTATE DISP.] is set to [ON], pictures recorded holding the camera vertically are played back vertically (rotated).
- If you take pictures when aiming the camera up or down, it may not be possible to display the pictures vertically. (P28)
- The picture may be slightly blurred when the camera is connected to the TV with the AV cable (supplied) and played back vertically.
- When you play the picture on a PC, you cannot play rotated pictures without an OS or a software compatible with Exif. Exif is the file format for still pictures, to which recording information and other can be added, established by JEITA [Japan Electronics and Information Technology Industries Association].
- When playing back rotated pictures in multi playback, pictures appear in original orientation.
- You may not be able to rotate images shot on other equipment.
- You can also use the joystick for these operations.

Press [MENU/SET] to display the [PLAY] mode menu and select the item to set. (P94)

[DPOF PRINT]

Setting the Picture to be Printed and the Number of Prints

DPOF (Digital Print Order Format) is a system that allows the user to select which pictures to print, how many copies of each picture to print and whether or not to print the recording date on the pictures when using a DPOF compatible photo printer or photo printing store. For details, ask at your photo printing store.

When you want to use a photo printing store to print pictures recorded on the built-in memory, copy them to a card (P105) and then set the DPOF setting.

For more information please visit:
http://panasonic.jp/dc/dpof_110/white_e.htm

Press ▲/▼ to select [SINGLE], [MULTI] or [CANCEL] and then press [MENU/SET].

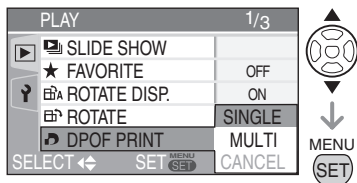

- You cannot select [CANCEL] if there are no prints that have been set in the DPOF print settings.

■ Single setting

1 Press ◀▶ to select the picture to print and then press ▲/▼ to set the number of prints.



- The number of prints icon [] appears.
- The number of prints can be set from 0 to 999. When the number of prints is set to "0", DPOF print setting is canceled.

2 Press [MENU/SET] twice to close the menu.

■ Multi setting

1 Press ◀▶ to select the picture to print and then press ▲/▼ to set the number of prints.

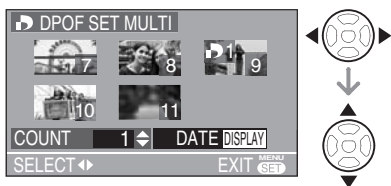

- Repeat the above procedure. (You cannot set all the pictures at one time.)
- The number of prints icon [] appears.
- The number of prints can be set from 0 to 999. When the number of prints is set to "0", DPOF print setting is canceled.

2 Press [MENU/SET] twice to close the menu.

Press [MENU/SET] to display the [PLAY] mode menu and select the item to set. (P94)

■ To cancel all settings

1 Press ▲ to select [YES] and then press [MENU/SET].

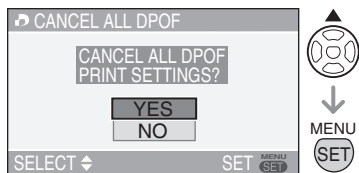

2 Press [MENU/SET] to close the menu.

- DPOF print settings on the built-in memory are canceled when a card is not inserted. DPOF print settings on the card are canceled when a card is inserted.

■ To print the date

You can set/cancel the printing with the recorded date each press of the [DISPLAY] button when setting the number of prints.



- The date print icon [DATE] appears.
- When you go to a photo studio for digital printing, be sure to order the printing of the date additionally if required.
- The date may not be printed depending on photo studios or printers even if you set the date print. For further information, ask the photo studio for details or refer to the operating instructions of the printer.



- DPOF is an abbreviation of [Digital Print Order Format]. This feature allows you to write print information to media and then use the information on a DPOF-compliant system.
- DPOF print setting is a convenient function when you print pictures with printers supporting PictBridge. (P110) The date printing setting on the printer may take priority over the date printing setting on the camera. Check the date printing setting on the printer also. (P110)
- When setting the DPOF print, delete any previous DPOF print settings made by other equipment.
- If the file is not based on the DCF standard, the DPOF print setting cannot be set. DCF is an abbreviation of [Design rule for Camera File system], stipulated by JEITA [Japan Electronics and Information Technology Industries Association].
- You can also use the joystick for these operations.

[PROTECT]



Preventing Accidental Erasure of the Picture

You can set protection for the pictures you do not want to delete to prevent them from accidental erasure.

Press ▲/▼ to select [SINGLE], [MULTI] or [CANCEL] and then press [MENU/SET].

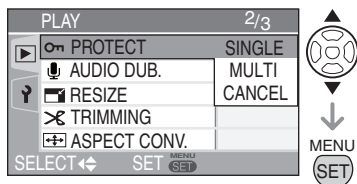

Press **[MENU/SET]** to display the [PLAY] mode menu and select the item to set. (P94)

■ Single setting

1 Press **◀▶** to select the picture and then press **▼** to set/cancel.



SET	The protect icon [On] appears.
CANCEL	The protect icon [On] disappears.

2 Press **[MENU/SET]** twice to close the menu.

■ Multi setting/To cancel all settings

Perform the same operation as in [[DPOF PRINT] Setting the Picture to be Printed and the Number of Prints]. (P99 and 100)



- The protect setting may not be effective in other equipment.
- If you want to delete protected pictures, cancel the protect setting first.
- While this feature protects the pictures from accidental erasure, formatting the card will permanently delete all data. (P106)
- Sliding the Write-Protect switch **A** of the SD Memory Card or the SDHC Memory Card to [LOCK] prevents pictures from deletion even if protection is not set.



- The following functions cannot be used with protected pictures.
 - [ROTATE]
 - [AUDIO DUB.]
- You can also use the joystick for these operations.

[AUDIO DUB.] Adding Audio to Recorded Pictures

You can record the audio after taking a picture.

1 Press **◀▶** to select the picture and then press **▼** to start audio recording.

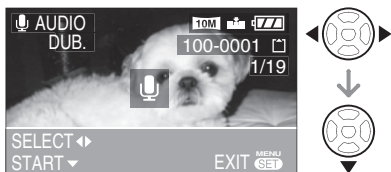

- The message [OVERWRITE AUDIO DATA?] screen appears when audio has already been recorded. Press **▲** to select [YES], and then press [MENU/SET] to start audio recording. (The original audio is overwritten.)
- Audio dubbing cannot be used with the following pictures.
 - Motion pictures
 - Protected pictures
 - Pictures recorded after setting the quality to [RAW]

2 Press **▼** to stop recording.

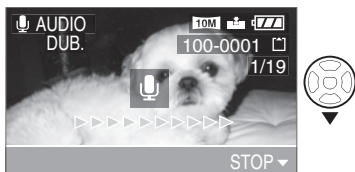

- Even if you do not press **▼**, after about 10 seconds the audio recording stops automatically.

3 Press **[MENU/SET]** twice to close the menu.



- You may not be able to record audio on images shot on other equipment.
- You can also use the joystick for these operations.

Press [**MENU/SET**] to display the [PLAY] mode menu and select the item to set. (P94)



[RESIZE]

Making the picture smaller

This function is useful if you want to reduce the file size of the picture in cases when it needs to be attached to an e-mail or uploaded to a website.

1 Press **◀▶** to select the picture and then press **▼**.



- The following pictures cannot be resized.
 - When the aspect ratio setting is [**16:9**]
 - Pictures whose [PICT.SIZE] is [**2M**] (2M EZ)
 - When the aspect ratio setting is [**3:2**]
 - Pictures whose [PICT.SIZE] is [**2.5M**] (2.5M EZ)
 - When the aspect ratio setting is [**4:3**]
 - Pictures whose [PICT.SIZE] is [**0.3M**]
 - Pictures recorded as [RAW]
 - Motion pictures
 - Flip animation
 - Pictures with audio

2 Press **◀▶** to select the size and then press **▼**.



- Sizes smaller than the recorded picture are displayed.
- When the aspect ratio setting is [**16:9**]
 - [**8M**]/[**5.5M**]/[**2M**]
- When the aspect ratio setting is [**3:2**]
 - [**7M**]/[**4.5M**]/[**2.5M**]
- When the aspect ratio setting is [**4:3**]
 - [**6M**]/[**4M**]/[**3M**]/[**2M**]/[**1M**]/[**0.3M**]
- The message [DELETE ORIGINAL PICTURE?] appears.

3 Press **▲▼** to select [YES] or [NO] and then press [**MENU/SET**].

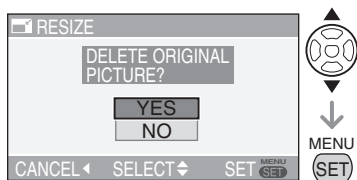

- When you select [YES], the picture is overwritten. When resized pictures are overwritten, they cannot be restored.
- When you select [NO], a resized picture is newly created.
- When the original picture is protected, you cannot overwrite the resized picture. Select [NO] and newly create a resized picture.

4 Press [**MENU/SET**] twice to close the menu.



- You may not be able to resize pictures you have shot on other equipment.
- You can also use the joystick for these operations.

Press [MENU/SET] to display the [PLAY] mode menu and select the item to set. (P94)

[TRIMMING] Enlarging a picture and trimming it

Use this function when you trim unnecessary parts of the recorded picture.

1 Press to select the picture and then press .



- The following pictures cannot be trimmed.
 - Images recorded as [RAW]
 - Motion pictures
 - Flip animation
 - Pictures with audio

2 Enlarge or decrease the parts to be trimmed with the zoom lever.



3 Press to move the position of the part to be trimmed.



4 Press the shutter button.

- The message [DELETE ORIGINAL PICTURE?] appears.

5 Press to select [YES] or [NO] and then press [MENU/SET].

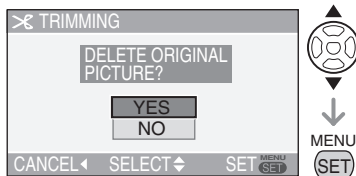

- When you select [YES], the picture is overwritten. When trimmed pictures are overwritten, they cannot be restored.
- When you select [NO], a trimmed picture is newly created.
- When the original picture is protected, you cannot overwrite the trimmed picture. Select [NO] and newly create a trimmed picture.

6 Press [MENU/SET] twice to close the menu.



- If you trim a picture, the number of pixels may be fewer in the trimmed picture than in the original.
- The picture quality of the trimmed picture may be deteriorated.
- It may not be possible to trim pictures recorded with other equipment.
- You can also use the joystick for these operations.

Press [MENU/SET] to display the [PLAY] mode menu and select the item to set. (P94)

[ASPECT CONV.]

Changing the aspect ratio of a 16:9 picture

Resize pictures taken in 16:9 aspect ratio for printing to 3:2 or 4:3.

1 Press ▲/▼ to select [3:2] or [4:3] and then press [MENU/SET].

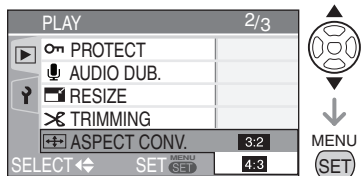

• Only pictures taken with a [16:9] aspect ratio can be converted.

2 Press ◀/▶ to select a picture and then press ▼.



• If you select and set a picture with an aspect ratio other than [16:9], the message [CANNOT BE SET ON THIS PICTURE] is displayed on the screen.

3 Press ◀/▶ to determine the horizontal position and press the shutter button to set.



- Use ▲/▼ to set the frame position for pictures rotated vertically.
- The message [DELETE ORIGINAL PICTURE?] appears.

4 Press ▲/▼ to select [YES] or [NO] and then press [MENU/SET].

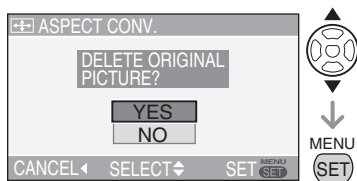

- The picture is overwritten when you select [YES]. If you convert the aspect ratio of a picture and then overwrite it, you cannot restore it.
- A picture with the converted aspect ratio is newly created when you select [NO].
- When the original picture is protected, you cannot overwrite it. Select [NO] and newly create a picture with the converted aspect ratio.

5 Press [MENU/SET] twice to close the menu.

Press [MENU/SET] to display the [PLAY] mode menu and select the item to set. (P94)



- You may end up with a higher-resolution picture after changing to a different aspect ratio.
- You cannot change the aspect ratio of pictures taken as [RAW], motion pictures, or still pictures with audio.
- Files that do not conform to the DCF standard cannot be converted. DCF is an abbreviation of [Design rule for Camera File system], stipulated by JEITA [Japan Electronics and Information Technology Industries Association].
- You may not be able to convert pictures taken on other equipment.
- You can also use the joystick for these operations.



[COPY]

Copying the picture data

You can copy recorded picture data from the built-in memory to a card or vice versa.

1 Press ▲/▼ to select the copy destination and then press [MENU/SET].

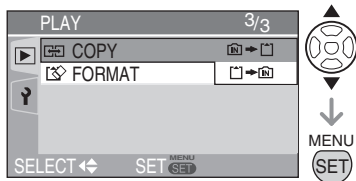

- → :
All the picture data in the built-in memory are copied onto the card at one time.
(Perform step 3)
- → :
One picture at a time is copied from the card to the built-in memory.
(Perform step 2)

2 Press ◀▶ to select the picture and then press ▼.



- When you copy picture data from the built-in memory to the card, all the pictures are selected at one time so this screen does not appear.

3 Press ▲ to select [YES] and then press [MENU/SET].

(The illustration shows the screen when pictures are copied from the built-in memory to a card.)

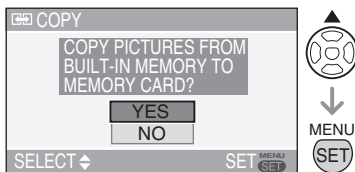

- The message [COPY THIS PICTURE TO BUILT-IN MEMORY?] appears when you copy pictures from the card to the built-in memory.
- If you press [MENU/SET] while copying pictures from the built-in memory to the card, the copying will stop halfway.
- Do not turn the camera off or do any other operations before copying is finished. The data on the built-in memory or the card may be damaged or lost.

Press [**MENU/SET**] to display the [PLAY] mode menu and select the item to set. (P94)

4 Press [MENU/SET] several times to close the menu.

- If you copy picture data from the built-in memory to a card, the screen automatically returns to the playback screen when all the pictures are copied.

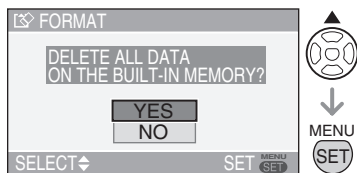

- When a card is not inserted, you can format the built-in memory. When a card is inserted, you can format the card.
- If you press [MENU/SET] while formatting the built-in memory, the formatting will stop halfway. (However, all the pictures will be deleted.)



- If you copy picture data from the built-in memory to a card, we recommend using a card which has more free space than the built-in memory (about 13 MB).
- It may take time to copy the picture data.
- Only pictures recorded with a Panasonic digital camera (LUMIX) will be copied. (Even if the pictures were recorded with a Panasonic digital camera, you may not be able to copy them if they were edited with a PC.)
- DPOF settings on the original picture data will not be copied. Set the DPOF settings again after copying is finished. (P99)
- If a picture with the same name as the picture to be copied exists in the copy destination, the picture will not be copied.
- If you copy picture data from the built-in memory to a card which does not have sufficient free space, the picture data will only be copied halfway.
- You can also use the joystick for these operations.



- Once the card is formatted, all data including protected images are irretrievably erased. Please confirm that all data is transferred to your PC before proceeding with format function.
- If the card has been formatted on a PC or other equipment, format it on the camera again.
- When you format the card, use a battery with sufficient battery power (P14) or AC adaptor (DMW-AC5; optional).
- During formatting, do not turn the camera off.
- It may take longer to format the built-in memory than the card. (Max. about 15 sec.)
- Sliding the Write-Protect switch of the SD Memory Card or the SDHC Memory Card to [LOCK] prevents formatting. (P18)
- If the built-in memory or the card cannot be formatted, consult your nearest servicenter.



[FORMAT]

Initializing the built-in memory or a card

Usually, it is not necessary to format the built-in memory and the card. Format them when the message [BUILT-IN MEMORY ERROR] or [MEMORY CARD ERROR] appears.

Press ▲ to select [YES] and then press [MENU/SET].

(The illustration shows the screen when the built-in memory is formatted.)

For USA assistance, please call: 1-800-272-7033 or send e-mail to : digitalstillcam@us.panasonic.com

For Canadian assistance, please call: 1-800-561-5505 or visit us at www.panasonic.ca

- You can also use the joystick for these operations.

Connecting to a PC



Set the camera's mode dial to a mode other than Print mode [P].

- By connecting the camera to a computer, you can upload your pictures, then use the software on the included CD-ROM ([LUMIX Simple Viewer] and [PHOTOfunSTUDIO-viewer-] for Windows®) to print or send your images by e-mail.
- If you use Windows 98/98SE, install the USB driver and then connect the camera to the computer.
- For details about installing [LUMIX Simple Viewer] or [PHOTOfunSTUDIO-viewer-] etc., refer to the separate operating instructions for PC connection.

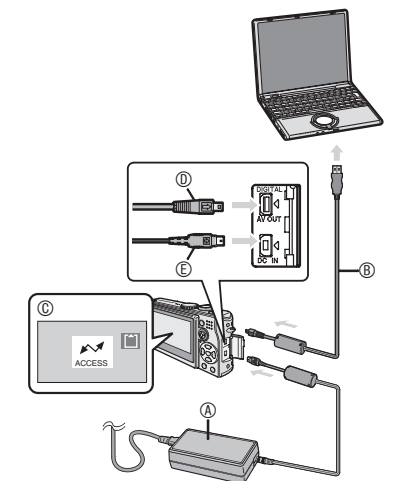

- (A) : AC adaptor (DMW-AC5; optional)
- Use a battery with sufficient battery power (P14) or the AC adaptor (DMW-AC5; optional).
 - Make sure this unit is off before connecting or disconnecting the AC adaptor (DMW-AC5; optional).
- (B) : USB connection cable (supplied)
- (C) : This message appears during data transfer.

(D)(E) : Check the facing of the connector and push straight in.

1 Turn on the camera and the PC.

2 Connect the camera to a PC via the USB connection cable (supplied).

- Connect the USB connection cable with the [➔] mark facing the [◀] mark on the [DIGITAL] socket.
- Hold (D) and then insert or pull the USB connection cable straight. Do not try to force the connector in backwards or sideways. This can damage this unit and the equipment you are connecting.

[Windows]

The drive appears on the [My Computer] folder.

- If it is the first time you are connecting the camera to a PC, the required driver is installed automatically so that the camera can be recognized by the Windows Plug and Play, then it appears on the [My Computer] folder.

[Macintosh]

The drive is displayed on the screen.

- The drive is displayed as [LUMIX] when you connect the camera with no card inserted.
- The drive is displayed as [NO_NAME] or [Untitled] when you connect the camera with a card inserted.

■ Motion picture playback on a PC

Use "QuickTime" (for Windows 2000/XP) in the supplied CD-ROM when you play back motion pictures recorded on this camera on your PC.

- Download [QuickTime6.5.2 for PC] from the following website and install it on your PC when you use Windows98/98SE/Me. <http://www.apple.com/support/quicktime/>
- The software is a standard Macintosh feature.

Folder Composition

Folders appear as follows.

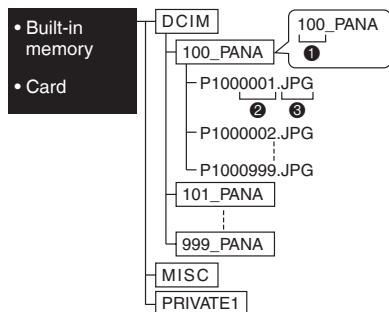

❶ Folder number

❷ File number

❸ JPG : Pictures

MOV : Motion pictures

RAW : RAW format files

The contents of each folder are:

DCIM	100_PANA to 999_PANA
100_PANA to 999_PANA	Pictures/Motion pictures/ Pictures in RAW files
MISC	File with DPOF setting
PRIVATE1	Flip animation files

- This unit stores up to 999 picture files in each folder. A new folder is created after this maximum is reached.
- To reset file and folder numbers, use [NO.RESET] in the setup menu. (P24)

Conditions under which a different folder number is used

In the following cases, the picture is not recorded in the same folder as the previously recorded picture. It is recorded in a folder with a new number.

- The folder containing the picture you just shot had a file numbered 999 in it (example: P1000999.JPG).
- When the card just recorded to contains, for example, a folder with the number 100 (100_PANA) in it and that card is removed and replaced with a card that has a folder with the number 100 in it recorded by a camera from a different maker (100XXXXX, with XXXXX being the name of the maker) and then a picture is recorded.
- You start shooting again after using [NO.RESET] in the setup menu (P24). (It is recorded to a new folder that has a number following on from the one previous. You can also reset the folder number to 100 by using [NO.RESET] immediately after formatting the card when there are no folders or pictures on the card.)

Connection in the PTP mode

Windows XP/Mac OS X users can establish connection in the PTP mode by setting the camera in print mode [,] and connecting it to their PC.

- You can only load pictures from the camera and cannot write them on the card or delete them.
- When there are 1000 or more pictures on a card, the pictures may not be imported.
- When you set the camera in print mode [,] and connect it to a PC, [PLEASE CONNECT TO THE PRINTER] appears on the camera's LCD monitor. This is not a malfunction.



- Do not use any other USB connection cables except the supplied one.
- While [ACCESS] is being displayed, do not disconnect the USB connection cable.
- Data transmission takes time when a card contains a large number of pictures.
- If the remaining battery power is exhausted during communication, the recorded data may be damaged. When you connect the camera to the PC, use a battery with sufficient battery power (P14) or the AC adaptor (DMW-AC5; optional).
- If the remaining battery power becomes low while the camera and the PC are communicating, the status indicator blinks and the alarm beeps. In this case, stop the communication at once on the PC.
- **When connecting the camera to a Windows 2000 OS PC with the USB connection cable, do not replace the card while the camera and the PC are connected. The information on the card may be damaged. Disconnect the USB connection cable before replacing the card.**
- Pictures edited or rotated with a PC may be displayed in black in playback mode (P36), multi playback (P77) and calendar playback (P78).
- For information about this, refer to the separate operating instructions for PC connection.
- Refer to the operating instructions of the PC, too.
- If a card is not inserted when the camera is connected to the PC, you can edit or access the picture data on the built-in memory. If a card is inserted, you can edit or access the picture data on it.
- You cannot switch between the built-in memory and the card while the camera is connected to the PC. When you want to switch between the built-in memory and the card, disconnect the USB connection cable, insert (or remove) the card and then connect the USB connection cable to the PC again.
- When you change the mode dial to print mode [] with the camera connected to the PC, [PLEASE RE-CONNECT THE PRINTER.] appears on the camera's LCD monitor. Before reconnecting the camera to a printer, change the mode from [] to another one and make sure that data transmission is not in progress. ([ACCESS] appears on the camera's LCD monitor while data transmission is in progress.)

Connecting to a PictBridge-compliant Printer



By connecting the camera directly to a printer supporting PictBridge via the USB connection cable (supplied), you can select the pictures to be printed or start printing on the LCD monitor. Make the necessary settings on your printer beforehand. (Read your printer's operating instructions.)

1 Turn on the camera and the printer.

2 Set the mode dial to [📄].

- [PLEASE CONNECT TO THE PRINTER] appears.

3 Connect the camera to a printer via the USB connection cable ^(A) (supplied).

- Connect the USB connection cable with the [➡] mark facing the [⬅] mark on the [DIGITAL] socket.
- Hold ^(C) and then insert or pull the USB connection cable straight.



- Do not use any other USB connection cables except the supplied one.
- When you connect the camera to a printer without setting the mode dial to [📄], remove the cable, set the mode dial to [📄], turn the camera and the printer off and on, and connect again.
- If a card is not inserted when the camera is connected to the printer, you can print the picture data on the built-in memory. If a card is inserted, you can print the picture data on it.
- You cannot switch between the built-in memory and the card while the camera is connected to the printer. When you want to switch between the built-in memory and the card, disconnect the USB connection cable, insert (or remove) the card and then connect the USB connection cable to the printer again.

- To print the age in [BABY1]/[BABY2] (P69) in scene mode or the departure date for [TRAVEL DATE] (P70), use the software [LUMIX Simple Viewer] or [PHOTOfunSTUDIO-viewer-] in the CD-ROM (supplied) and print from the PC. For information about this, refer to the separate operating instructions for PC connection.
- To find out more about PictBridge compliant printers, contact your local dealer.

■ To connect

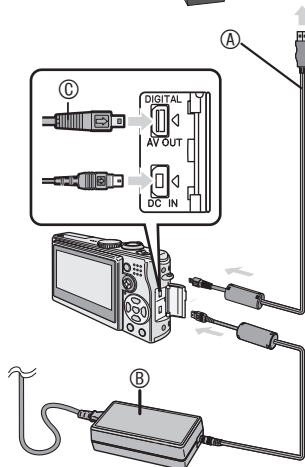
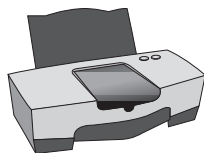

^(A) : USB connection cable (supplied)

^(B) : AC adaptor (DMW-AC5; optional)

- It may take time to print some pictures. Therefore, we recommend using a battery with sufficient power (P14) or the AC adaptor (DMW-AC5; optional) when you connect to a printer.
- Make sure this unit is off before connecting or disconnecting the AC adaptor (DMW-AC5; optional).

■ Printing the selected picture (making a single print)

1 Press ◀▶ to select the picture and then press [MENU/SET].

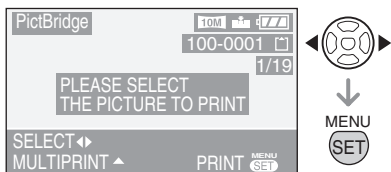

- A message displays for about 2 seconds.

2 Press ▲ to select [PRINT START] and then press [MENU/SET].

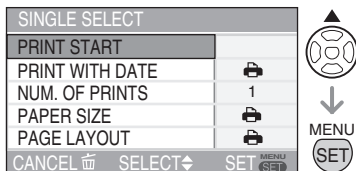

- Press [MENU/SET] to cancel printing.

3 Disconnect the USB connection cable after printing.

■ Selecting multiple pictures for printing

1 Press ▲.

Press [⏪] to return to the original screen.

2 Press ▲/▼ to select an item and then press [MENU/SET].

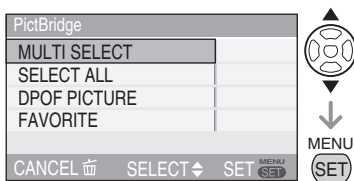

Item	Setting contents
MULTI SELECT	Multiple pictures are selected at once for printing. [Operation] On the plural pictures screen, press ◀▶ to select pictures. When you press ▼, [⏪] is displayed with the picture you selected for printing. (When you press ▼ once more, the print setting is canceled.) Press [MENU/SET] when you finish selection.
SELECT ALL	All pictures in the built-in memory or the card are printed.
DPOF PICTURE	Pictures in the [DPOF PRINT] setting (P99) are printed.
FAVORITE	Pictures set as favorites (P96) are printed. <ul style="list-style-type: none"> • This item appears only when favorite setting (P96) is [ON]. • You can not select any picture when [FAVORITE] is set to [ON], but no picture is marked with [★].

3 Press **▲** to select [PRINT START] and then press [MENU/SET].

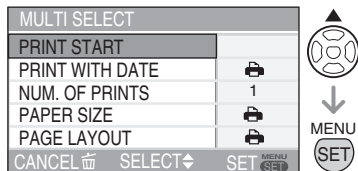

- In DPOF setting, [PRINT WITH DATE] and [NUM. OF PRINTS] are not displayed.
- When you select [DPOF PICTURE], [DPOF SET] is selectable. When you select [DPOF SET], refer to P99 and make DPOF setting.
- Press [MENU/SET] when you wish to cancel printing halfway.
- When you select [MULTI SELECT], [SELECT ALL] or [FAVORITE], the print confirmation screen appears. Select [YES] and perform printing.
- When the number of prints exceeds 1,000, [PRINTING --- PICTURES DO YOU WANT TO PROCEED?] appears on the print confirmation screen.

4 Disconnect the USB connection cable after printing.

Setting the date printing with the DPOF print in advance

When the printer supports the date printing by DPOF setting, we recommend setting the date printing with the DPOF print in advance. (P100)

The recording date can be printed by selecting [DPOF PICTURE] to start printing.

■ Setting date printing, the number of prints, the paper size and the page layout

Select an item to set on the screen for step 2 in "Printing the selected picture (making a single print)" (P111) or on the screen for

step 3 in "Selecting multiple pictures for printing" (P111 and 112).

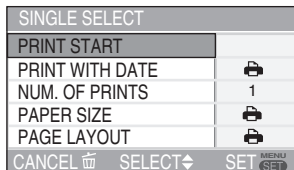

- The items which are not supported by the printer are displayed in gray and cannot be selected.
- When you want to print pictures in a paper size or a layout which is not supported by the camera, set [PAPER SIZE] and [PAGE LAYOUT] to [] and then set the paper size or the layout on the printer. (For details, refer to the operating instructions of the printer.)

• [PRINT WITH DATE]

	Settings on the printer are prioritized.
OFF	Date is not printed.
ON	Date is printed.

- If the printer does not support date printing, the date cannot be printed on the picture.

• [NUM. OF PRINTS]

Set the number of prints.

- You can set up to 999 prints.

• [PAPER SIZE]

(Possible paper sizes on the camera)

The items are listed on 1/2 and 2/2.

Press ▼ to select the desired item.





1/2	
	Settings on the printer are prioritized.
L/3.5"×5"	89 mm×127 mm
2L/5"×7"	127 mm×178 mm
POSTCARD	100 mm×148 mm
A4	210 mm×297 mm

2/2*	
CARD SIZE	54 mm×85.6 mm
10×15cm	100 mm×150 mm
4"×6"	101.6 mm×152.4 mm
8"×10"	203.2 mm×254 mm
LETTER	216 mm×279.4 mm

*These items cannot be displayed when the printer does not support the paper sizes.

• [PAGE LAYOUT]

(Possible layouts on the camera)

	Settings on the printer are prioritized.
	1 page with no frame print
	1 page with frame print
	2 pages print
	4 pages print

- An item cannot be selected if the printer does not support the page layout.

■ Layout printing





• When printing a picture several times on 1 sheet of paper

For example, if you want to print a picture 4 times on 1 sheet of paper, set [PAGE LAYOUT] to  and then set the number of prints to 4 for the picture on [NUM. OF PRINTS].

• When printing different pictures on 1 sheet of paper

For example, if you want to print 4 different pictures on 1 sheet of paper, set [PAGE LAYOUT] to 4-picture printing  and then set [NUM. OF PRINTS] for the pictures to 1 in [MULTI SELECT] (P111).



- Do not disconnect the USB connection cable when the cable disconnection warning icon  is indicated. (Depending on the printer, the icon may not be displayed.)
- If the remaining battery power becomes low while the camera and the printer are connected, the status indicator blinks and the alarm beeps. If this happens during printing, press [MENU/SET] and stop printing at once. If not printing, disconnect the USB connection cable.
- The camera is receiving an error message from the printer when the  indication lights orange during printing. After finishing printing, make sure there are no problems with the printer.
- If the total number of ordered prints or the number of pictures set for print is large, printing is performed at intervals. In such cases, the number of remaining prints shown on the display will differ from the number of prints you set. The discrepancy, however, does not indicate an error.
- Date print, paper size and page layout settings on the printer may have priority over the same settings on the camera. Check these settings on the printer as well.
- When printing RAW format files, JPEG pictures associated with RAW format files will be printed. When no associated JPEG picture exists, printing may not be possible.
- When printing did not go normally, turn the camera and the printer off and on.
- When the mode dial is set to a choice other than print mode , [USB MODE CHANGED. PLEASE REMOVE THE USB CABLE.] appears on the camera's LCD monitor. Set the mode dial back to  before disconnecting the USB cable. Disconnect the cable after canceling printing.

Playing Back Pictures with a TV Screen



■ Playing back pictures with the supplied cable

- Set the [TV ASPECT]. (P25)
- Turn the camera and the TV off.

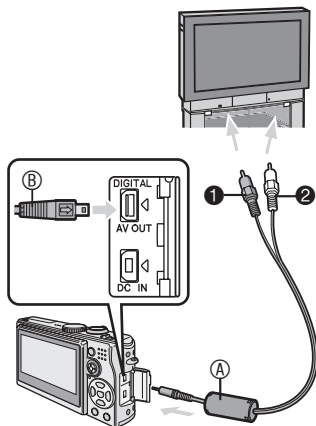

1 Connect the AV cable **A** (supplied) to the [AV OUT] socket of the camera.

- Connect the AV cable with the [➡] mark facing the [◀] mark on the [AV OUT] socket.
- Hold **B** and then insert or pull the AV cable straight.

2 Connect the AV cable to the video input and the audio input sockets of the TV.

- **1** Yellow: to the video input socket
- **2** White: to the audio input socket

3 Turn the TV on and select external input.

4 Turn the camera on.



- Do not use any other AV cables except the supplied one.
- The top and bottom or left and right of the picture may be cut off slightly when it is displayed due to the characteristics of the TV.
- Depending on the screen mode setting of the TV when you connect the camera to a wide-screen TV or a high-definition TV, the picture may be stretched horizontally or vertically and the top and bottom and or left and right of the picture may be cut off when it is displayed. In this case, change the screen mode setting.
- Read the TV operating instructions too.
- Audio playback is in monaural.
- Pictures might be slightly blurred if you show them vertically on a television.
- You can view pictures on TVs in other countries (regions) which use the NTSC or PAL system when you set [VIDEO OUT] in the [SETUP] menu. Even if you set [VIDEO OUT] to [PAL], the output signal will still be NTSC in the recording mode.

■ Playback pictures on TV with SD Memory Card slot

You can put your SD Memory Card in a television with an SD Memory Card slot to show still images.



- You can not play back pictures stored in the SDHC Memory Card on a TV that does not support the card.
- Depending on the television, some pictures may not take up the whole screen.
- You cannot play motion pictures. To play back motion pictures, connect the camera to the TV with the AV cable (supplied).
- You may be unable to play MultiMedia Cards.

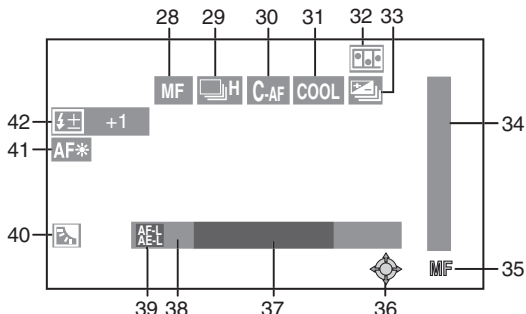

28 MF indication (P56)/AF  (P59)

29 Burst (P51)

 : Audio recording (P75, 87)

30 Continuous AF (P90)

31 Color effect (P91)

32 Flip animation (P92)

33 Auto bracket (P49)

34 Moving focus (P56)

35 MF operation (P56)

36 Joystick operations
(P27, 53, 54, 56, 82)

37 Number of days that have passed since
the travel date (P70)

- This is displayed for about 5 seconds if the camera is turned on when the travel date is set, after setting the clock, departure date or travel date, after changing the world time setting and after switching from playback mode to another mode.

38 Age display (P69)

- Whenever you turn the camera on in Baby mode, switch to Baby mode from any other mode, or after setting the birthday or clock, your baby's age and the current date and time appear on the display for about 5 seconds.

39 AF/AE Lock indication (P61)

40 Backlight compensation (P31)

41 AF assist lamp (P90)

42 Flash Output Adjustment (P46)

■ In Playback

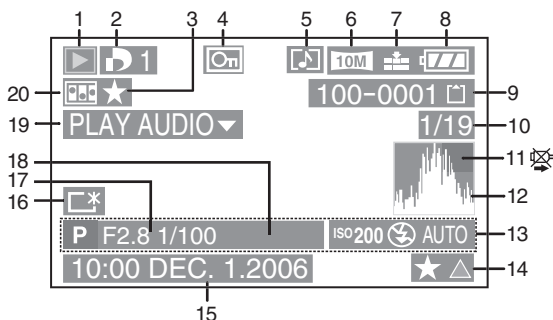

- | | |
|--|---|
| 1 Playback mode (P36) | 12 Histogram (P40) |
| 2 Number of DPOF [] prints (P99) | 13 Recording information |
| 3 Favorites indicator (P96) | 14 Favorites setting (P96)/
Elapsed playback time (P80) :
1h 20m 30s |
| 4 Protected picture (P100) | 15 Recorded date and time |
| 5 Still or motion pictures with audio (P80) | 16 Power LCD indication (P41) |
| 6 Picture size (P86) | 17 Number of days that have passed since
the travel date (P70) |
| 7 Quality (P86) | 18 Age display (P69) |
| In Motion picture mode (P80) : | 19 Audio playback (P80) |
| []/[]/[]/[]/ | PLAY MOTION |
| []/[]/[] | PICTURE ▾ : In Motion picture mode (P80) |
| 8 Battery indication (P14) | 20 Flip animation (P92) |
| 9 Folder/File number (P108) | |
| Built-in memory/Card (P17) | |
| : Built-in memory | |
| : Card | |
| 10 Picture number/Total pictures | |
| 11 Cable disconnection warning icon
(P113) | |
| • This is displayed when printing using
a printer supporting PictBridge.
(Depending on the printer, the icon
may not be displayed.) | |
| Motion picture recording time (P80) : | |
| 1h 20m 30s | |

Cautions for Use

■ Optimal Use of the Camera

Take care not to drop or knock the unit or put a lot of pressure on it.

- Do not leave the unit in your pants pocket when you sit down or forcefully insert it into a full bag etc.
- Take care not to drop or knock the bag that you inserted the unit in as it may strongly shock the unit.
- A strong shock may break the lens, screen or outer case and cause the camera to malfunction.



Keep the camera as far away as possible from electromagnetic equipment (such as microwave ovens, TVs, video games etc.).

- If you use the camera on top of or near a TV, the pictures and sound on the camera may be disrupted by electromagnetic wave radiation.
- Do not use the camera near cell phones because doing so may result in noise adversely affecting the pictures and sound.
- Recorded data may be damaged, or pictures may be distorted, by strong magnetic fields created by speakers or large motors.
- Electromagnetic wave radiation generated by microprocessors may adversely affect the camera, disturbing the pictures and sound.
- If the camera is adversely affected by electromagnetic equipment and stops functioning properly, turn the camera off and remove the battery or disconnect AC adaptor (DMW-AC5; optional). Then reinsert the battery or reconnect AC adaptor and turn the camera on.

Do not use the camera near radio transmitters or high-voltage lines.

- If you record near radio transmitters or high-voltage lines, the recorded pictures and sound may be adversely affected.

Make sure to use the supplied cords and cables. If you use optional accessories, use the cords and the cables supplied with them. Do not extend the cords and the cables.

Do not spray insecticides or volatile chemicals onto the camera.

- If the camera is sprayed with such chemicals, the camera body may be damaged and the surface finish may peel off.
- Do not keep rubber or plastic products in contact with the camera for a long period of time.

Do not use benzene, thinner or alcohol for cleaning the camera.

- Before cleaning the camera, remove the battery or disconnect the AC adaptor (DMW-AC5; optional) from the electrical outlet.
- The camera body may be deformed and the surface finish may peel off.
- Wipe the dust or fingerprints with a soft, dry cloth. To remove stubborn stains, soak a dry cloth in water and then use it to wipe the dirt. Then wipe again with a dry cloth.
- Do not use a kitchen detergent or a chemically treated cloth.
- In case rain or other sources of water splash onto the camera, wet a soft cloth with tap water, wring it well, and use it to wipe the camera body carefully. Then wipe it again with a dry cloth.

■ Card

Do not leave the card in places where there is high temperature or direct sunlight, or where electromagnetic waves or static electricity are easily generated.

Do not bend or drop the card.

- The card may be damaged or the recorded content may be damaged or erased.
- Store the card in the card case or the storage bag after use and when you store or carry the card.
- Do not allow dirt, dust or water to enter the terminals on the back of the card and do not touch the terminals with your fingers.

■ Battery

The battery is a rechargeable lithium ion battery. Its ability to generate power is based upon the chemical reaction that takes place inside it. This reaction is susceptible to the surrounding temperature and humidity, and, if the temperature is too high or too low, the operating time of the battery will be shorter.

After use, be sure to remove the battery. Store the removed battery in the battery carrying case (supplied).



If you drop the battery accidentally, check to see if the battery body and terminals are damaged.

- Inserting a damaged battery in the camera will damage the camera.

We recommend you to take a spare battery with you when you leave home.

- Be aware that the operating time of the battery will become shorter in low temperatures such as outdoors at a ski resort.
- When you travel, be sure to prepare the supplied charger to charge the battery on the spot.

Dispose of an unusable battery.

- The battery has a limited life.
- Do not throw the battery into fire because it may cause an explosion.
- An unusable battery should be discarded in accordance with battery recycling laws. For information you can call the RBRC hotline at 1-800-822-8837.

Do not allow the battery terminals to come in contact with metal objects (such as necklaces, hairpins, etc.).

- This can result in a short circuit or heat generation and, if you touch the battery in this condition, you may be badly burned.

■ Charger

- If you use the charger near a radio, radio reception may be disturbed. Keep the charger 1 m (3.28 feet) or more away from radio.
- When the charger is in use, it may generate whirring sounds. However, this is not a malfunction.
- After use, be sure to disconnect the charger from the electrical outlet. (If it is left connected, a minute amount of current is consumed.)
- Keep the terminals of the charger and battery clean.

Message Display

Confirmation messages or error messages will be displayed on the screen in some cases. The major messages are described below as examples.

[THIS MEMORY CARD IS PROTECTED]

Cancel the card lock. (P18, 101)

[NO VALID PICTURE TO PLAY]

Play back after recording or after inserting a card with a recorded picture.

[THIS PICTURE IS PROTECTED]

After canceling the protect setting (P101), you can delete or overwrite the picture.

[THIS PICTURE CANNOT BE DELETED]/ [SOME PICTURES CANNOT BE DELETED]

The pictures not based on the DCF standard cannot be deleted.

- To delete this kind of picture, first save your data to your computer, then use this unit to reformat the card. (P106)

[NO ADDITIONAL DELETE SELECTIONS CAN BE MADE]

- You have exceeded the number of pictures that can be set at once with multi-delete setting.
- You have placed more than 999 pictures in your favorites list.

[CANNOT BE SET ON THIS PICTURE]/ [CANNOT BE SET ON SOME PICTURES]

If the pictures are not based on the DCF standard, the DPOF print cannot be set.

[NOT ENOUGH SPACE ON BUILT-IN MEMORY]/[NOT ENOUGH MEMORY IN THE CARD]

There is no space left on the built-in memory or the card.

- When you copy pictures from the built-in memory to the card (batch copy), the pictures are copied until the capacity of the card becomes full.

[SOME PICTURES CANNOT BE COPIED]/[COPY COULD NOT BE COMPLETED]

The following pictures cannot be copied.

- When a picture with the same name as the picture to be copied exists in the copy destination.
- Files not based on the DCF standard. Moreover, pictures recorded or edited by other equipment may not be copied.

[BUILT-IN MEMORY ERROR FORMAT BUILT-IN MEMORY?]

This message will be displayed when you format the built-in memory on the PC or remove the battery without turning the camera off. Format the built-in memory of the camera again. (P106) The data on the built-in memory will be deleted.

[MEMORY CARD ERROR FORMAT THIS CARD?]

The format of the card cannot be recognized by this camera. Format the card again with this camera. Save your data to your computer, then use this unit to reformat the card. (P106)

[REMOVE LENS CAP AND PRESS ► BUTTON]

This message appears when the lens cap is left on the activated camera or when you exert pressure on the lens with your hand etc. and the camera does not operate properly.

- Remove the lens cap and press ► when the lens cap is on.
- Turn the camera off and on when the lens cap is removed.

If the message persists, contact the dealer or your nearest servicenter.

**[MEMORY CARD ERROR
PLEASE CHECK THE CARD]**

- Failed access to the card.
Insert the card again.

**[READ ERROR
PLEASE CHECK THE CARD]**

Data reading error.
Insert the card again. Make sure the card is inserted properly and then play back again.

**[WRITE ERROR
PLEASE CHECK THE CARD]**

Data writing error.
Turn the camera off and remove the card. Then insert the card and turn the camera on again. Be sure that the camera is turned off before removing or inserting the card to avoid damage. This error may also indicate that the card is damaged.

**[MOTION RECORDING WAS
CANCELLED DUE TO THE LIMITATION
OF THE WRITING SPEED OF THE
CARD]**

- When you set the [PICT.MODE] to [30fpsVGA], [30fps16:9L] or [15fps16:9H], we recommend using cards that offer 10 MB/second or higher speeds (shown on their packages and elsewhere) for best results.
- Depending on the type of Card, recording may stop in the middle.

[A FOLDER CANNOT BE CREATED]

A folder cannot be created because there are no remaining folder numbers that can be used. (P108)
Save your data to your computer, then use this unit to reformat the card. (P106)
If you execute [NO.RESET] in the [SETUP] menu after formatting, the folder number is reset to 100. (P24)

**[MOTION MODE IS NOT AVAILABLE IN
3:2 ASPECT. SET THE ASPECT SWITCH
IN 4:3 OR 16:9.]**

You cannot record a motion picture on a card when the aspect ratio is set to [3:2]. Set the aspect ratio to either [16:9] or [4:3]. (P60)

**[SELECT 4:3 TO STORE MOTION PIC.
TO INT. MEMORY.]**

You cannot record a motion picture on the built-in memory when the aspect ratio is set to [16:9] or [3:2]. Set the aspect ratio to [4:3]. (P60)

**[PICTURE IS DISPLAYED FOR 16:9 TV/
PICTURE IS DISPLAYED FOR 4:3 TV]**

- The AV cable is connected to the camera. Press [MENU/SET] if you want to delete this message at once.
- Select [TV ASPECT] in the [SETUP] menu to change the TV aspect. (P25)
- This message also appears when the USB connection cable is connected to the camera only. In this case, connect the other end of the USB connection cable to a PC or a printer. (P107, 110)

[PLEASE RE-CONNECT THE PRINTER.]

- This message appears when you change the mode dial to print mode [] with the camera connected to a PC. Reconnect the printer after changing the mode from [] to another one and making sure that data transmission is not in progress. ([ACCESS] appears on the camera's LCD monitor while data transmission is in progress.)

**[USB MODE CHANGED. PLEASE
REMOVE THE USB CABLE.]**

- This message appears when you set the mode dial to a choice other than print mode [] with the camera connected to the printer. Set the mode dial back to [] before disconnecting the USB cable. Disconnect the cable after canceling printing.

Troubleshooting

If you put the menu back to the settings at the time of purchase, the conditions may be improved. **Carry out the [RESET] in the setup menu. (P24)**

■ Battery and power supply

Conditions	Causes
The camera will not turn on.	Is the battery inserted correctly? Check the direction of the battery. Is the battery sufficiently charged? Use a battery that has been sufficiently charged.
The picture is not displayed on the LCD monitor.	Is the power save mode (P23) or economy mode (P23) activated? Press the shutter button halfway to deactivate these modes. Is the battery charge insufficient to operate the camera? Use a battery that has been sufficiently charged.
The camera turns off soon after turning it on.	<ul style="list-style-type: none"> Is the battery charge insufficient to operate the camera? Use a battery that has been sufficiently charged. If you leave the camera on, the battery will be exhausted. Turn the camera off frequently by using power save mode (P23) or economy mode (P23) etc.

■ Shooting

Conditions	Causes
The picture cannot be recorded.	Is the mode dial correctly set? Is there any memory capacity left on the built-in memory or the card? Before recording, delete some pictures. (P37)
The recorded pictures are pale. There is dirt on the lens.	Stains, such as fingerprints, may be on the lens. If the surface of the lens is dirty, clean it with a soft cloth.
The recorded picture is too bright or dark.	Check that the exposure is correctly compensated. (P48)
The subject is not focused properly.	The focus range varies depending on the recording mode. To set the proper mode for the distance to the subject, change the focus switch position or rotate the mode dial. Is the subject out of the focus range? (P29) Have you taken a picture with jitter?
Sometimes two or three pictures are taken with a single press on the shutter button.	Is the camera set in auto bracket (P49) or burst mode (P51)?
The recorded picture is blurred. The optical image stabilizer is not effective.	When taking a picture in shaded areas or indoors, the shutter speed becomes slow and the Optical Image Stabilizer function may not work properly. In this case, we recommend holding the camera with both hands firmly to take pictures (P28).

Conditions	Causes
Images are grainy or noisy.	<p>Is the ISO sensitivity high or the shutter speed slow? (When set to [AUTO], ISO sensitivity increases for indoor and other shooting occasions. When set to [ISO], ISO sensitivity may increase depending on movements and brightness of the subject.)</p> <ul style="list-style-type: none"> • Reduce ISO sensitivity. (P84) • Set [NOISE REDUCTION] in [PICT.ADJ.] to [HIGH] or set every item except [NOISE REDUCTION] to [LOW]. (P91) • Improve the ambient light. <p>In [HIGH SENS.] (P68) in scene mode, the resolution of the recorded picture decreases slightly because of high sensitivity processing. This is not a malfunction.</p>
Shooting of motion pictures stops unexpectedly.	<p>This camera is not compatible with motion picture recording on MultiMediaCards.</p> <ul style="list-style-type: none"> • When you set the [PICT.MODE] to [30fpsVGA], [30fps16:9L] or [15fps16:9H], we recommend using cards that offer 10 MB/second or higher speeds (shown on their packages and elsewhere) for best results. • Depending on the type of SD Memory Card, recording may stop in the middle.
The picture freezes momentarily when the shutter button is pressed halfway.	<ul style="list-style-type: none"> • Is the AF mode 3-area-focusing (high speed) or 1-area-focusing (high speed)? (P88)

■ LCD

Conditions	Causes
The LCD monitor sometimes turns off although the camera is turned on.	<p>Have you set economy mode? (P23)</p> <p>–In economy mode, the LCD monitor turns off while the flash is charged.</p> <p>After recording, the LCD monitor is turned off until the camera is ready for the next picture to be taken. The LCD monitor is turned off for a maximum of 6 seconds particularly when using the built-in memory.</p>
The brightness of the LCD monitor becomes dark or bright for a moment.	<p>This phenomenon appears when pressing the shutter button halfway to set the aperture value and does not affect the recorded pictures.</p>
The LCD monitor flickers indoors.	<p>The LCD monitor may flicker for a few seconds after turning the camera on indoors under fluorescent light.</p> <p>This is not a malfunction.</p>
The LCD monitor is too bright or dark.	<p>Adjust the brightness of the LCD monitor. (P22)</p> <p>Is the Power LCD function or high angle mode activated? (P41)</p>
Black, red, blue and green dots appear on the LCD monitor.	<p>This is not a malfunction.</p> <p>These pixels do not affect the recorded pictures.</p>

Conditions	Causes
Noise appears on the LCD monitor.	In dark places, noise may appear to maintain the brightness of the LCD monitor. This does not affect the pictures you are recording.
A vertical line appears on the LCD monitor.	This is a phenomenon called smear. It is a characteristic of CCD and appears when the subject has a bright part. Uneven colors may also appear around the smear. This is not a malfunction. It is recorded in motion pictures but is not recorded on still pictures.
Distortion in the LCD monitor.	When holding the edge of the LCD monitor, there may be some distortion, however this is not a malfunction. Moreover, this has no effect on the pictures taken or playback.

■ Flash

Conditions	Causes
Flash is not activated.	Make sure the flash is open. Slide the [OPEN] switch. (P43)
	The flash is not activated when motion picture mode [], [SCENERY], [NIGHT SCENERY], [FIREWORKS], [STARRY SKY], [AERIAL PHOTO] or [HIGH SENS.] in scene mode (P62) is selected.
The flash is activated 2 times.	When you select red-eye reduction (P43), the flash is activated once before the actual recording to reduce the red-eye phenomenon (eyes of the subject appearing red in the picture) and then activated again for the actual recording.

■ Playback

Conditions	Causes
Pictures rotate unexpectedly.	One of the features of this unit can automatically detect when you have turned the camera side on to take a picture, then rotate that picture for you when you play it back. In some cases, the unit may detect that you have turned the camera side on, when in fact you are facing it up or down. <ul style="list-style-type: none"> • Set [ROTATE DISP.] (P97) to [OFF] so that the camera does not rotate these kinds of pictures for you. • You can use [ROTATE] (P97) to rotate the pictures when necessary.
The picture is not played back.	Is the mode dial set to playback []?
	Is there a picture on the built-in memory or the card? <ul style="list-style-type: none"> • The pictures on the built-in memory appear when a card is not inserted. The picture data on the card appears when a card is inserted. (P17)

Conditions	Causes
Folder or file number appears as [-] and the display goes black.	<p>The picture may have been changed on a computer or taken on a different manufacturer's camera.</p> <p>This problem can also occur if you remove the battery immediately after taking a picture or if the battery had very little charge left.</p> <ul style="list-style-type: none"> You will need to reformat the card to delete this type of picture. (P106) (Remember that all data will be irretrievably erased when you format the card, so save your data and check the card before proceeding.) Pictures edited or rotated with a PC may be displayed in black in playback mode (P36), multi playback (P77) and calendar playback (P78).
The picture is displayed with a date different from the actual recording date in calendar playback.	<p>Was the picture edited with a PC or recorded with a digital camera from another manufacturer?</p> <p>This kind of picture may be displayed with a date different from the actual recording date in calendar playback. (P78)</p>
	<p>Is the clock in the camera set properly? (P20)</p> <p>For example, if the clock setting on the camera is different from the date and time set on the PC and you acquire pictures recorded with the camera to the PC and then write them back to the card, the pictures may be displayed with dates different from the actual recording dates in calendar playback etc.</p>

■ Connecting to a TV, computer or printer

Conditions	Causes
The picture does not appear on the television. The TV screen is disturbed or displayed in monochrome.	Is the camera connected to the TV correctly? Check it.
	Set the TV to video input mode.
The display areas on the TV screen and the camera's LCD monitor are different.	Depending on the TV model, the area display may be smaller so the picture may be stretched horizontally or vertically and the top and bottom or left and right of the picture may be cut off when it is displayed. This is due to the TV specifications and is not a malfunction.
Cannot play motion pictures on a television.	<p>You cannot play motion pictures if you have inserted the card into a card slot on a television.</p> <p>Connect the camera to the television with the included AV cable and play the pictures on this unit. (P114)</p>
Cannot upload pictures to your computer.	Check the connections.
	Check that the computer has correctly recognized the camera.
	Set the camera's mode dial to a mode other than Print mode (P107).

Conditions	Causes
The computer does not recognize the card. (The built-in memory is recognized.)	Disconnect the USB connection cable, then insert the card and reconnect the cable.
The pictures cannot be printed with printers.	Does the printer support PictBridge? You cannot print pictures with printers which do not support PictBridge. (P110) Set the camera's mode dial to Print mode (P110).
The sides of printed images are cut off.	<ul style="list-style-type: none"> If your printer has trimming and border settings, change the settings so that there is no trimming and no border. (Read your printer's operating instructions.) Some photography shops can handle pictures shot in the [16:9] aspect ratio (P60). Enquire before sending them for printing.
The picture size does not fit the TV screen.	Check the [TV ASPECT] setting on this unit. (P25)

■ Others





Conditions	Causes
Unreadable language was selected by mistake.	Press [MENU/SET], select the [SETUP] menu icon [] and then select the [] icon to set the desired language. (P25)
The camera will make sounds caused by internal mechanical movement when it is shaken.	The sound arises when the lens moves. This is not a malfunction.
Cannot change the auto review setting.	You cannot change the auto review setting when using auto bracket, using burst modes, shooting motion pictures, using [SELF PORTRAIT] in scene mode, recording sound and setting quality to [RAW].
A certain part of the picture blinks.	<ul style="list-style-type: none"> Is [HIGHLIGHT] set to [ON]? (P24) –This appears due to the highlight display function which shows white saturated areas. (P40)
When the shutter button is pressed halfway, a red lamp turns on sometimes.	In dark places, the AF assist lamp (P90) lights red to make it easier to focus on a subject.
The AF assist lamp does not turn on.	<p>Is [AF ASSIST LAMP] on the [REC] mode menu set to [ON]? (P90)</p> <p>Are you taking pictures in dark places? The AF assist lamp does not turn on in bright places.</p> <p>The AF assist lamp does not turn on when [SCENERY], [NIGHT SCENERY], [SELF PORTRAIT], [FIREWORKS] or [AERIAL PHOTO] in scene mode (P62) is selected.</p>





Conditions	Causes
The camera gets hot.	The camera may get a little warm while you are using it, but this is normal.
The lens clicks.	When brightness has changed due to the zoom or the movement of the camera or other, the lens may click and the picture on the screen may be drastically changed, however, the pictures are not affected. The sound is caused by automatic adjustment of the aperture. It is not a malfunction.
The clock setting is reset.	If you do not use the camera for a long time, the clock setting may be reset. When the message [PLEASE SET THE CLOCK] appears, set the clock again. (P20) When you take a picture before setting the clock, [0:00 0. 0. 0] is recorded.
Strange colors appear around the edge of the image.	Depending on the zoom magnification, the picture may have some colored fringes around the subject. This is called chromatic aberration and may be more visible when recording distant subjects. However this is not a malfunction.
File numbers are not created in order.	Certain operations cause pictures to be saved in folders with different numbers. (P108)
The file numbers are recorded in ascending order.	If the battery is inserted or removed when the camera is not turned off, the recorded folder numbers are lost. However if you turn the camera on again and record pictures, the recorded folder numbers are different from the prior recorded folder numbers.

Number of recordable pictures and available recording time

- The number of recordable pictures and the available recording time are an approximation. (These vary depending on the recording conditions and the type of card.)
- The number of recordable pictures varies depending on the subjects.

■ Number of recordable pictures

Aspect ratio		16:9				
Picture size		10M : 10M (4224×2376 pixels)			8M : 8M EZ (3840×2160 pixels)	
Quality				RAW		
Built-in Memory (Approx. 13 MB)		1	4	0	2	5
Card	16 MB	2	5	0	2	6
	32 MB	5	11	1	6	13
	64 MB	11	24	2	14	29
	128 MB	24	49	5	29	59
	256 MB	48	97	10	58	115
	512 MB	97	190	20	115	230
	1 GB	190	380	41	230	460
	2 GB	390	770	84	470	930
4 GB	770	1520	165	930	1820	

Aspect ratio		16:9			
Picture size		5.5M : 5.5M EZ (3072×1728 pixels)		2M : 2M EZ (1920×1080 pixels)	
Quality					
Built-in Memory (Approx. 13 MB)		4	9	11	22
Card	16 MB	4	10	12	25
	32 MB	10	21	27	53
	64 MB	22	45	57	105
	128 MB	46	92	115	220
	256 MB	91	180	230	430
	512 MB	180	350	450	860
	1 GB	360	710	910	1720
	2 GB	730	1420	1800	3410
4 GB	1450	2800	3540	6700	

Aspect ratio		3:2				
Picture size		8.5M : 8.5M (3568×2376 pixels)			7M : 7M EZ (3248×2160 pixels)	
Quality				RAW		
Built-in Memory (Approx.13 MB)		2	5	0	3	6
Card	16 MB	2	6	0	3	7
	32 MB	6	13	1	7	16
	64 MB	14	28	2	17	34
	128 MB	29	58	5	35	70
	256 MB	57	110	10	69	135
	512 MB	110	220	21	135	270
	1 GB	230	450	42	270	540
	2 GB	460	910	86	560	1090
4 GB	910	1800	165	1100	2150	

Aspect ratio		3:2			
Picture size		4.5M : 4.5M EZ (2560×1712 pixels)		2.5M : 2.5M EZ (2048×1360 pixels)	
Quality					
Built-in Memory (Approx.13 MB)		5	11	8	17
Card	16 MB	5	12	9	18
	32 MB	13	26	20	40
	64 MB	27	54	43	83
	128 MB	56	110	88	165
	256 MB	110	210	170	330
	512 MB	210	430	340	650
	1 GB	440	860	680	1310
	2 GB	890	1700	1360	2560
4 GB	1740	3350	2680	5020	

Aspect ratio		4:3				
Picture size		7.5M : 7.5M (3168×2376 pixels)	6M : 6M EZ (2880×2160 pixels)			
Quality				RAW		
Built-in Memory (Approx. 13 MB)		2	6	0	3	7
Card	16 MB	3	6	0	3	8
	32 MB	7	15	1	9	18
	64 MB	15	32	2	19	38
	128 MB	32	65	5	39	79
	256 MB	64	125	10	78	150
	512 MB	125	250	21	155	300
	1 GB	250	510	42	310	610
	2 GB	520	1020	87	630	1220
4 GB		1030	2010	170	1240	2410

Aspect ratio		4:3			
Picture size		4M : 4M EZ (2304×1728 pixels)	3M : 3M EZ (2048×1536 pixels)		
Quality					
Built-in Memory (Approx. 13 MB)		5	12	7	15
Card	16 MB	6	13	8	16
	32 MB	14	28	18	36
	64 MB	30	59	38	75
	128 MB	61	120	78	150
	256 MB	120	230	150	290
	512 MB	240	470	300	590
	1 GB	480	940	600	1180
	2 GB	970	1860	1220	2360
4 GB		1910	3650	2410	4640

Aspect ratio		4:3			
Picture size		2M : 2M EZ (1600×1200 pixels)	1M : 1M EZ (1280×960 pixels)		
Quality					
Built-in Memory (Approx. 13 MB)		12	25	19	36
Card	16 MB	13	27	21	40
	32 MB	29	58	45	85
	64 MB	61	120	93	175
	128 MB	125	240	190	350
	256 MB	240	470	370	690
	512 MB	480	940	730	1370
	1 GB	970	1880	1470	2740
	2 GB	1920	3610	2920	5120
4 GB		3770	7090	5740	10050

■ Available recording time (In Motion picture mode)

Picture quality setting		30fps VGA	10fps VGA	30fps QVGA	10fps QVGA	30fps 16:9L	10fps 16:9L	15fps 16:9H
Built-in Memory (Approx.13 MB)		—	—	24 s	1 min 15 s	—	—	—
Card	16 MB	6 s	26 s	26 s	1 min 23 s	5 s	22 s	4 s
	32 MB	17 s	59 s	59 s	2 min 55 s	14 s	50 s	12 s
	64 MB	39 s	2 min	2 min	6 min	33 s	1 min 46 s	29 s
	128 MB	1 min 23 s	4 min 10 s	4 min 10 s	12 min 20 s	1 min 11 s	3 min 35 s	1 min 1 s
	256 MB	2 min 45 s	8 min 10 s	8 min 10 s	24 min	2 min 20 s	7 min	2 min
	512 MB	5 min 30 s	16 min 20 s	16 min 20 s	47 min 50 s	4 min 40 s	14 min	4 min
	1 GB	11 min	32 min 50 s	32 min 50 s	1 h 35 min 50 s	9 min 20 s	28 min 10 s	8 min 10 s
	2 GB	22 min 30 s	1 h 7 min	1 h 7 min	3 h 15 min	19 min 20 s	57 min 30 s	16 min 50 s
	*4 GB	44 min 20 s	2 h 11 min 50 s	2 h 11 min 50 s	6 h 22 min 50 s	38 min	1 h 53 min 10 s	33 min 20 s

* The volume of motion picture is limited to 2GB per recording session.



- When you select [RAW], the recording pixel size is fixed to the maximum number of recording pixels for each aspect ratio.
- The number of recordable pictures and the available recording time displayed on the LCD monitor may not decrease in order.
- This unit does not support recording motion pictures on MultiMediaCards.
- The extended optical zoom does not work in [HIGH SENS.] (P68) in scene mode so the picture size for [EZ] is not displayed.

Specifications

Digital Camera: Information for your safety

Power Source:	DC 5.1 V
Power Consumption:	1.6 W (When recording) 0.9 W (When playing back)

Camera Effective pixels: 10,200,000 pixels

Image sensor: 1/1.65" CCD, total pixel number 10,410,000 pixels
Primary color filter

Lens: Optical 4x zoom, f=6.3 to 25.2 mm [35 mm film camera equivalent: 28 to 112 mm (aspect ratio [16:9])/F2.8 to F4.9
Max. 4x

Digital zoom:

Extended optical zoom: (Except for the maximum picture size for each aspect ratio)

When aspect ratio is set to [16:9]: max 5.5x

When aspect ratio is set to [3:2]: max 5.6x

When aspect ratio is set to [4:3]: max 6.2x

Focus:

Normal/AF Macro/Manual

9-area-focusing/3-area-focusing (high speed)/1-area-focusing (high speed)/1-area-focusing/Spot-focusing

Focus range:

Normal AF : 50 cm (1.64 feet) (Wide)/100 cm (3.28 feet) (Tele) to ∞

AF Macro/MF: 5 cm (0.16 feet) (Wide)/ 30 cm (0.98 feet) (Tele) to ∞

[In Auto Mode [A]: 5 cm (0.16 feet) (Wide)/ 30 cm (0.98 feet) (Tele) to ∞]

Shutter system:

Electronic shutter+Mechanical shutter

Burst recording

Burst speed:

2 frames/second (high speed), 1 frame/second (low speed),
Approx. 1 frame/second (unlimited)

Number of recordable pictures:

Max. 5 frames (standard), max. 3 frames (fine),
Depends on the remaining capacity of the Built-in memory or the card. (unlimited)

(Performance in burst recording is only with SD Memory Card/SDHC Memory Card. MultiMediaCard performance will be less.)

Motion picture recording: Aspect ratio [16:9]:

1280×720 pixels (15 frames/second with audio. When a card is used.)/848×480 pixels (30 or 10 frames/second with audio. When a card is used.)

Aspect ratio [4:3]:

640×480 pixels (30 or 10 frames/second with audio. When a card is used.)/320×240 pixels (30 or 10 frames/second with audio.)

The maximum recording time depends on the capacity of the built-in memory or the card.

ISO sensitivity:	AUTO/[]ISO/100/200/400/800/1600 [HIGH SENS.] mode: 3200
Shutter speed:	60 to 1/2,000th [STARRY SKY] mode: 15 seconds, 30 seconds, 60 seconds Motion picture mode: 1/30th to 1/6,400th
White balance:	AUTO/Daylight/Cloudy/Shade/Halogen/Flash/White set 1/ White set 2
Exposure (AE):	Program AE (P)/Aperture-priority AE (A)/ Shutter-priority AE (S)/Manual exposure (M) Exposure compensation (1/3 EV Step, -2 to +2 EV)
Metering mode:	Multiple/Center weighted/Spot
LCD monitor:	Low-temperature polycrystalline TFT LCD 2.8" (Approx. 207,000 pixels) (field of view ratio about 100%)
Flash:	Flash range: (ISO AUTO) Approx. 60 cm (1.97 feet) to 4.9 m (16.08 feet) (Wide) AUTO, AUTO/Red-eye reduction, Forced ON (Forced ON/Red-eye reduction), Slow sync./Red-eye reduction, Forced OFF
Microphone:	Monaural
Speaker:	Monaural
Recording media:	Built-in Memory (Approx. 13 MB)/SD Memory Card/SDHC Memory Card/MultiMediaCard (Still pictures only)
Picture size:	
Still picture:	Aspect ratio [16:9]: 4224×2376 pixels, 3840×2160 pixels, 3072×1728 pixels, 1920×1080 pixels Aspect ratio [3:2]: 3568×2376 pixels, 3248×2160 pixels, 2560×1712 pixels, 2048×1360 pixels Aspect ratio [4:3]: 3168×2376 pixels, 2880×2160 pixels, 2304×1728 pixels, 2048×1536 pixels, 1600×1200 pixels, 1280×960 pixels
Motion picture:	Aspect ratio [16:9]: 1280×720 pixels(Only when using an SD Memory card/SDHC Memory Card), 848×480 pixels(Only when using an SD Memory card/SDHC Memory Card) Aspect ratio [4:3]: 640×480 pixels(Only when using an SD Memory card/SDHC Memory Card), 320×240 pixels Fine/Standard/RAW
Quality:	
Recording file format	
Still Picture:	JPEG (Design rule for Camera File system, based on Exif 2.21 standard)/RAW, DPOF corresponding
Picture with audio:	JPEG (Design rule for Camera File system, based on Exif 2.21 standard)+QuickTime (picture with audio)
Motion pictures:	QuickTime Motion JPEG (motion pictures with audio)

Interface

Digital:	USB 2.0 (Full Speed)
Analog video/audio:	NTSC/PAL Composite (Switched by menu), Audio line output (monaural)

Terminal

AV OUT/DIGITAL: AV/USB Dedicated jack (8 pin)

DC IN: Dedicated jack (2 pin)

Dimensions:

4 1/8"(W) × 2 1/4"(H) × 1"(D)
(105.7 mm (W)×55.8 mm (H)×26.3 mm (D))
(excluding the projection part)

Weight:

Approx. 6.60 oz/187 g
(excluding Memory Card and battery)

Approx. 7.65 oz/217 g
(with Memory Card and battery)

Operating Temperature: 0 °C to 40 °C (32 °F to 104 °F)

Operating Humidity: 10 % to 80 %

Battery Charger

(Panasonic DE-A11B): Information for your safety

Input:	110 to 240 V ~ 50/60 Hz, 0.2 A
Output:	CHARGE 4.2 V---0.8 A







Equipment mobility: Movable

Battery Pack (lithium-ion)

(Panasonic CGA-S005A): Information for your safety

Voltage/capacity:	3.7 V, 1150 mAh
--------------------------	-----------------

Digital Camera Accessory System

Accessory#	Figure	Description
CGA-S005A		Lithium Ion Battery (Same as the included battery)
DMW-AC5		AC Adaptor (The battery cannot be recharged in the camera even if you supply it with AC power.)
DMW-CLXA1		Leather Case
DMW-CTA1		Leather Case
DMW-CTH1		Semi Hard Case
RP-SDR04GU1K RP-SDK02GU1A RP-SDR02GU1A RP-SDK01GU1A RP-SDH01GU1A RP-SDR01GU1A RP-SDK512U1A RP-SDR512U1A RP-SDH256U1A RP-SDR256U1A RP-SD128BU1A RP-SD064BPPA		4 GB SDHC Memory Card 2 GB SD Memory Card 2 GB SD Memory Card 1 GB SD Memory Card 1 GB SD Memory Card 1 GB SD Memory Card 512 MB SD Memory Card 512 MB SD Memory Card 256 MB SD Memory Card 256 MB SD Memory Card 128 MB SD Memory Card 64 MB SD Memory Card

- Please refer to page 14, for details on the battery charging time and available recording time.
- NOTE: Accessories and/or model numbers may vary by country. Please consult your local dealer.

Digital Camera Accessory Order Form

(For USA Customers)

Please photocopy this form when placing an order.

1. Digital Camera Model # _____
 2. Items Ordered

Accessory #	Description	Price Each	Quantity	Total Price
Subtotal				
Your State & Local Sales Tax				
Shipping & Handling				6.95
Total Enclosed				

3. Method of payment (check one)

- Check of Money Order enclosed (NO C.O.D.SHIPMENTS)
 VISA Credit Card # _____
 MasterCard Expiration Date _____
 Discover Customer Signature _____

Make Check or Money Order to: PANASONIC ACCESSORIES

(Please do not send cash)

4. Shipping information (UPS delivery requires complete street address)

Ship To:

Mr.

Mrs.

Ms.

First

Last

Phone#:

Day () _____

Street Address

Night () _____

City

State Zip

TO OBTAIN ANY OF OUR DIGITAL CAMERA ACCESSORIES YOU CAN DO ANY OF THE FOLLOWING:

VISIT YOUR LOCAL PANASONIC DEALER

OR

CALL PANASONIC'S ACCESSORY ORDER LINE AT 1-800-332-5368

[6 AM-5 PM M-F, 6 AM-10:30 AM SAT, PACIFIC TIME]

OR

MAIL THIS ORDER TO: PANASONIC SERVICES COMPANY ACCESSORY ORDER OFFICE

20421 84th Avenue South Kent, WA. 98032

In CANADA, please contact your local Dealer for more information about accessories.

Request for Service Notice (For USA Only)

Please photocopy this form when making a request for service notice.

In the unlikely event this product needs service.

Request for Service Notice: (USA Only)

- Please include your **proof of purchase.**
(Failure to do so will delay your repair.)
 - To further speed your repair, please provide an explanation of what wrong with the unit and any symptom it is exhibiting.
-
-
-
-

Mail this completed form and your Proof of Purchase along with your unit to:

Panasonic Services Company
410B Airport Road
Elgin, IL 60123-9333
Attn: Digital Camera Repair

Limited Warranty (For USA Only)

PANASONIC CONSUMER ELECTRONICS COMPANY, DIVISION OF
PANASONIC CORPORATION OF NORTH AMERICA

One Panasonic Way, Secaucus, New Jersey 07094

PANASONIC PUERTO RICO, INC.

Ave. 65 de Infantería, Km. 9.5, San Gabriel Industrial Park, Carolina, Puerto Rico 00985

Panasonic Digital Still Camera Limited Warranty

Limited Warranty Coverage

If your product does not work properly because of a defect in materials or workmanship, Panasonic Consumer Electronics Company or Panasonic Puerto Rico, Inc. (collectively referred to as “the warrantor”) will, for the length of the period indicated on the chart below, which starts with the date of original purchase (“warranty period”), at its option either (a) repair your product with new or refurbished parts, or (b) replace it with a new or refurbished product. The decision to repair or replace will be made by the warrantor.

PRODUCT OR PART NAME	PARTS	LABOR
DIGITAL STILL CAMERA (EXCEPT ITEMS LISTED BELOW)	1 (ONE) YEAR	90 (NINETY) DAYS
CCD	6 (SIX) MONTHS	90 (NINETY) DAYS
RECHARGEABLE BATTERY PACK (IN EXCHANGE FOR DEFECTIVE BATTERY PACK)	90 (NINETY) DAYS	NOT APPLICABLE
SD MEMORY CARD (IN EXCHANGE FOR DEFECTIVE SD CARD)	90 (NINETY) DAYS	NOT APPLICABLE

During the “Labor” warranty period there will be no charge for labor. During the “Parts” warranty period, there will be no charge for parts. You must carry-in or mail-in your product during the warranty period. If non-rechargeable batteries are included, they are not warranted. This warranty only applies to products purchased and serviced in the United States or Puerto Rico. This warranty is extended only to the original purchaser of a new product which was not sold “as is”. A purchase receipt or other proof of the original purchase date is required for warranty service.

Carry-In or Mail-In Service

For Carry-In or Mail-In Service in the United States call
1-800-272-7033.

For assistance in Puerto Rico call Panasonic Puerto Rico, Inc.
(787)-750-4300 or fax (787)-768-2910.

This warranty ONLY COVERS failures due to defects in materials or workmanship, and DOES NOT COVER normal wear and tear or cosmetic damage. The warranty ALSO DOES NOT COVER damages which occurred in shipment, or failures which are caused by products not supplied by the warrantor, or failures which result from accidents, misuse, abuse, neglect, mishandling, misapplication, alteration, faulty installation, set-up adjustments, misadjustment of consumer controls, improper maintenance, power line surge, lightning damage, modification, or commercial use (such as in a hotel, office, restaurant, or other business), rental use of the product, service by anyone other than a Factory Servicenter or other Authorized Servicer, or damage that is attributable to acts of God.

THERE ARE NO EXPRESS WARRANTIES EXCEPT AS LISTED UNDER "LIMITED WARRANTY COVERAGE". THE WARRANTOR IS NOT LIABLE FOR INCIDENTAL OR CONSEQUENTIAL DAMAGES RESULTING FROM THE USE OF THIS PRODUCT, OR ARISING OUT OF ANY BREACH OF THIS WARRANTY. (As examples, this excludes damages for lost time, travel to and from the servicer, loss of media or images, data or other memory content. The items listed are not exclusive, but are for illustration only.) **ALL EXPRESS AND IMPLIED WARRANTIES, INCLUDING THE WARRANTY OF MERCHANTABILITY, ARE LIMITED TO THE PERIOD OF THE LIMITED WARRANTY.**

Some states do not allow the exclusion or limitation of incidental or consequential damages, or limitations on how long an implied warranty lasts, so the exclusions may not apply to you.

This warranty gives you specific legal rights and you may also have other rights which vary from state to state. If a problem with this product develops during or after the warranty period, you may contact your dealer or Servicenter. If the problem is not handled to your satisfaction, then write to the warrantor's Consumer Affairs Department at the addresses listed for the warrantor.

PARTS AND SERVICE WHICH ARE NOT COVERED BY THIS LIMITED WARRANTY ARE YOUR RESPONSIBILITY.

Customer Services Directory (For USA Only)

**For Product Information, Operating Assistance, Literature Request, Dealer Locations, and all Customer Service inquiries please contact:
1-800-272-7033, Monday-Friday 8:30am-8pm EST.**

**Web Site: <http://www.panasonic.com/consumersupport>
You can purchase parts, accessories or locate your nearest servicenter by visiting our Web Site.**

Accessory Purchases

Purchase Parts, Accessories and Instruction Books online for all Panasonic Products by visiting our Web Site at:

<http://www.pasc.panasonic.com>

or, send your request by E-mail to:

npcparts@us.panasonic.com

You may also contact us directly at:

1-800-332-5368 (Phone) 1-800-237-9080 (Fax Only)

(Monday - Friday 9 am to 9 pm, EST.)

Panasonic Services Company 20421 84th Avenue South, Kent, WA 98032

(We Accept Visa, MasterCard, Discover Card, American Express, and Personal Checks)

Product Repairs

Centralized Factory Servicenter

MAIL TO :

Panasonic Services Company

410B Airport Road

Elgin, IL 60123-9333

Attention: Digital Camera Repair

Please carefully pack and ship, prepaid and insured, to the Elgin Centralized Factory Servicenter.

Customer's in Puerto Rico, please ship or carry in to location below ("Service in Puerto Rico").

Service in Puerto Rico

Panasonic Puerto Rico, Inc.:

Ave. 65 de Infantería, Km. 9.5, San Gabriel Industrial Park,

Carolina, Puerto Rico 00985

Phone (787) 750-4300 Fax (787) 768-2910

As of May 2006

Index

A

AC adaptor	107, 110, 135
Access indication	17
Adjusting flash output	46
Aerial photo mode	68
AF Assist Lamp	90
AF Macro mode	59
AF Mode	88
AF/AE Lock	61
Aperture-priority AE	53, 55
Aspect ratio	60, 75
Audio Dubbing	101
Audio Recording	75, 87
Auto Bracket	49
Auto Mode	30
Auto Review	22
Auto White Balance	83
Available recording time	131
AV cable	114

B

Baby mode	69
Backlight Compensation	31
Beach mode	67
Built-in Flash	43
Built-in memory	17
Burst Mode	51

C

Calendar playback	78
Candle light mode	66
Center weighted	88
Charger	13
Color Effect	91
Condensation	5
Continuous AF	90
Copy	105

D

Date Printing	100, 112
Deleting Pictures	37
Demonstration of the optical image stabilizer	50
Digital Zoom	34
DPOF Print	99

E

Economy mode	23
Exposure	29
Exposure Compensation	48
Extended optical zoom	33
EZ	33, 86

F

Favorites setting	96
File number	24, 108
Fine	86
Fireworks mode	66
Flip Animation	92
Focus beep	24
Focusing	29
Folder Composition	108
Folder number	24, 108
Food mode	65
Formatting	106

G

Guide line display	40
--------------------	----

H

High angle mode	41
Highlight display	24, 40
High sensitivity mode	68
Histogram	40

I

ISO Sensitivity	84
Intelligent ISO sensitivity control	85

J

Jitter	29
--------	----

L

Language setting	25
LCD Monitor	4, 39, 115
Lens Cap	19

M

MANUAL	95
Manual exposure	54, 55
Manual exposure assistance	54

Manual Focus	56	Quick setting	82
Metering mode	88		
MF Assist	56	R	
MF m/ft	25	RAW	86
Monitor	22	Reset	24
Motion picture mode	75	Resize	102
Multi Playback	77	Review	35
Multiple	88	Rotate	97
		Rotate Display	97
N			
Night portrait mode	64	S	
Night scenery mode	64	Scene menu	25, 62
NO.RESET	24	Scene mode	62
NTSC	24, 114	Scenery mode	63
Number of Prints	99, 112	Self portrait mode	64
Number of recordable pictures	14, 128	Self-timer	47
		Setting Date/Time	20, 22, 93
O		Setup Menu	21
Operational sound	24	Shutter-priority AE	53, 55
Optical Image Stabilizer	50	Shutter sound	24
Optical Zoom	32	Slide Show	95
		Snow mode	68
P		Soft skin mode	63
Page layout	113	Sports mode	63
PAL	24, 114	Spot	88
Paper size	112	Spot-focusing	89
Party mode	65	Standard	86
PC	107	Starry sky mode	67
PictBridge	110	Status Indicator	23
Picture Adjustment	91	Strap	19
Picture Quality Setting (Motion Picture Mode)	75		
Picture Size	86	T	
Picture with audio	80	Travel date	22, 70
Playback Zoom	79	Trimming	103
Playing Back Motion Pictures	80	TV ASPECT	25
Playing Back Pictures with a TV Screen	114		
Portrait mode	63	U	
Power LCD function	41	USB Connection Cable	107, 110
Power save	23		
Prefocus	58	V	
Print mode	110	Video Output	24, 114
Program AE	26	Volume of Speakers	24
Program shift	27		
Protect	100	W	
		White Balance	82
Q		White balance fine adjustment	84
Quality	86	White set	83
		World time	72

Spanish Quick Use Guide/Guía rápida en español

Ésta es una visión de conjunto que trata del procedimiento para grabar las imágenes con esta cámara.

1 Cargue la batería.

- Cuando se envía la cámara, la batería está sin carga. Carguela antes del uso.

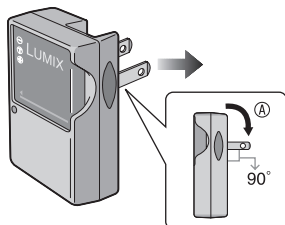

A: Abra hasta que haga clic.

2 Inserte la batería y la tarjeta.

- Cuando no utilice la tarjeta (opcional), puede grabar o reproducir las fotos haciendo uso de la memoria integrada.

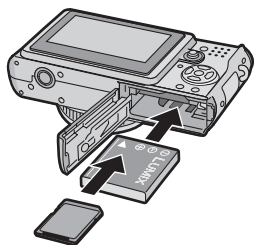

3 Encienda la cámara para sacar las imágenes.

- Ajuste el reloj.

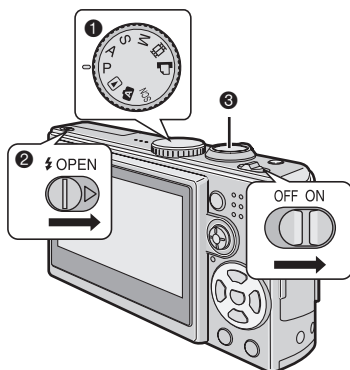

- 1 Ajuste el disco del modo a [P].
- 2 Abra el flash. (Cuando usa el flash)
- 3 Oprima el botón del obturador para sacar las imágenes.

4 Reproduzca las imágenes.

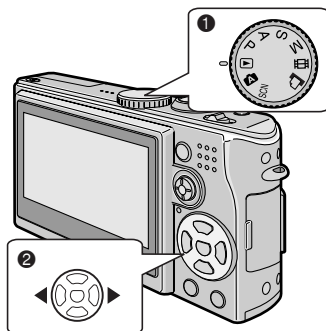

- 1 Ajuste el disco del modo a [▶].
- 2 Seleccione la imagen que quiere ver.



QuickTime and the QuickTime logo are trademarks or registered trademarks of Apple Computer, Inc., used under license.

**Panasonic Consumer Electronics Company,
Division of Panasonic Corporation of North America**

One Panasonic Way, Secaucus, NJ 07094

Panasonic Puerto Rico, Inc.

Ave. 65 de Infantería, Km. 9.5, San Gabriel Industrial Park, Carolina, Puerto Rico 00985

Panasonic Canada Inc.

5770 Ambler Drive, Mississauga, Ontario, L4W 2T3

© 2006 Matsushita Electric Industrial Co., Ltd.



VQT0Y44-2

H0706ZZ2086

