

# Emergency Evacuation Procedures

## Music Practice North

### Page Navigation

- [Severe Weather](#)
  - [Bomb Threat/Fire](#)
  - [Building Evacuation Maps](#)
- 

### Severe Weather

In the event of severe weather, all building occupants should immediately seek shelter in the designated shelter-in-place area in the building. If unable to safely move to the designated shelter-in-place area, seek shelter in a windowless interior room or hallway on the lowest floor of the building.

**All staff and others will proceed to the Men's and Women's restrooms on the first floor.**

---

### Bomb Threat/Fire

In the event of a bomb threat or fire in the building, all building occupants should immediately evacuate the building using the nearest exit. Once outside, proceed to the designated assembly area. If unable to safely move to the designated assembly area, contact one or more members of your department or unit to let them know you are safe and inform them of your whereabouts.

Persons with mobility impairments who are unable to safely exit the building should move to a designated area of refuge and await assistance from emergency responders.

**All exits are clearly marked and all staff and others will immediately evacuate the building and proceed to the west section of parking lot 26 west of the Music Practice South building. Once you leave the building, do not re-enter for any reason.**

---

### Building Evacuation Maps

[Print Full Size Map](#)

# MUSIC PRACTICE NORTH

## BUILDING #0124

### 09-2006

Exterior Gross Area  
8242

#### Safety Legend

 Areas of Refuge

 Tornado Shelter Areas

 Exit/Evacuation Routes

*In case of fire, do not use elevator*

[AED] Automatic External Defibrillator

[CHAIR] Evacuation Chair

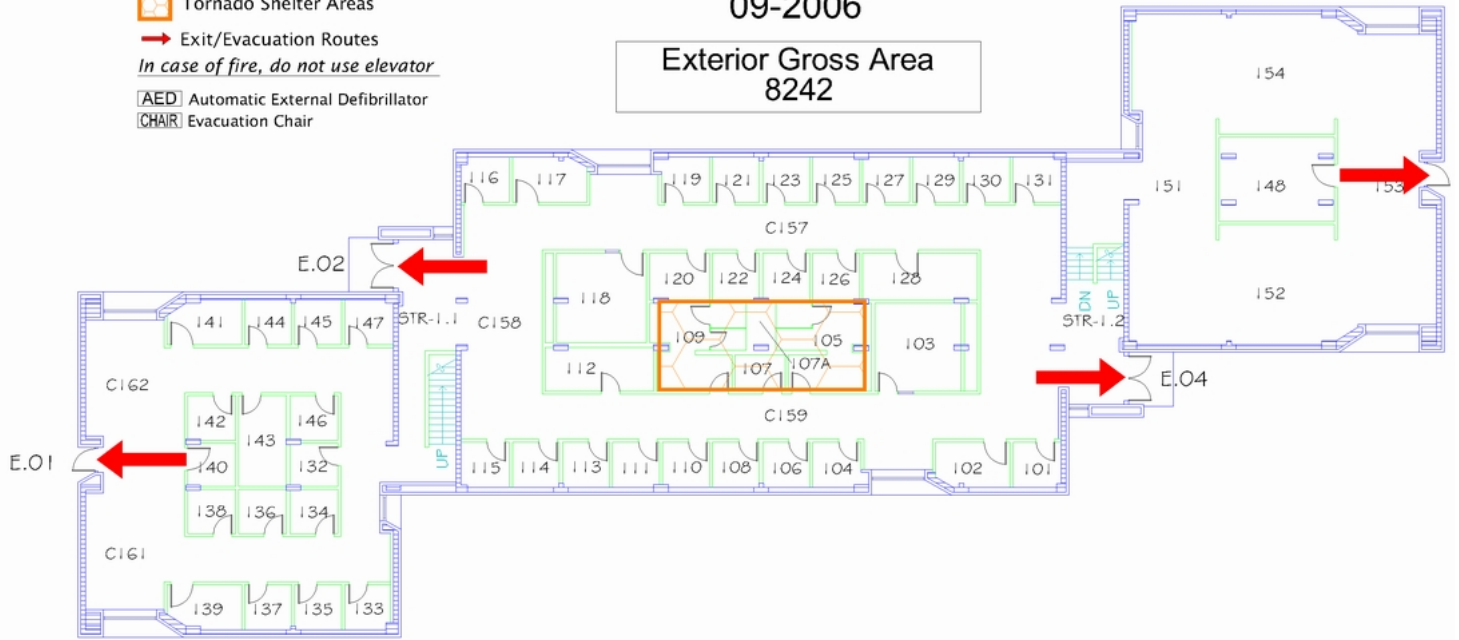

## FIRST FLOOR PLAN

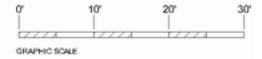

[Print Full Size Map](#)

# MUSIC PRACTICE NORTH

## BUILDING #0124

### 09-2006

Exterior Gross Area  
8245

#### Safety Legend

 Areas of Refuge

 Tornado Shelter Areas

 Exit/Evacuation Routes

*In case of fire, do not use elevator*

 AED Automatic External Defibrillator

 CHAIR Evacuation Chair

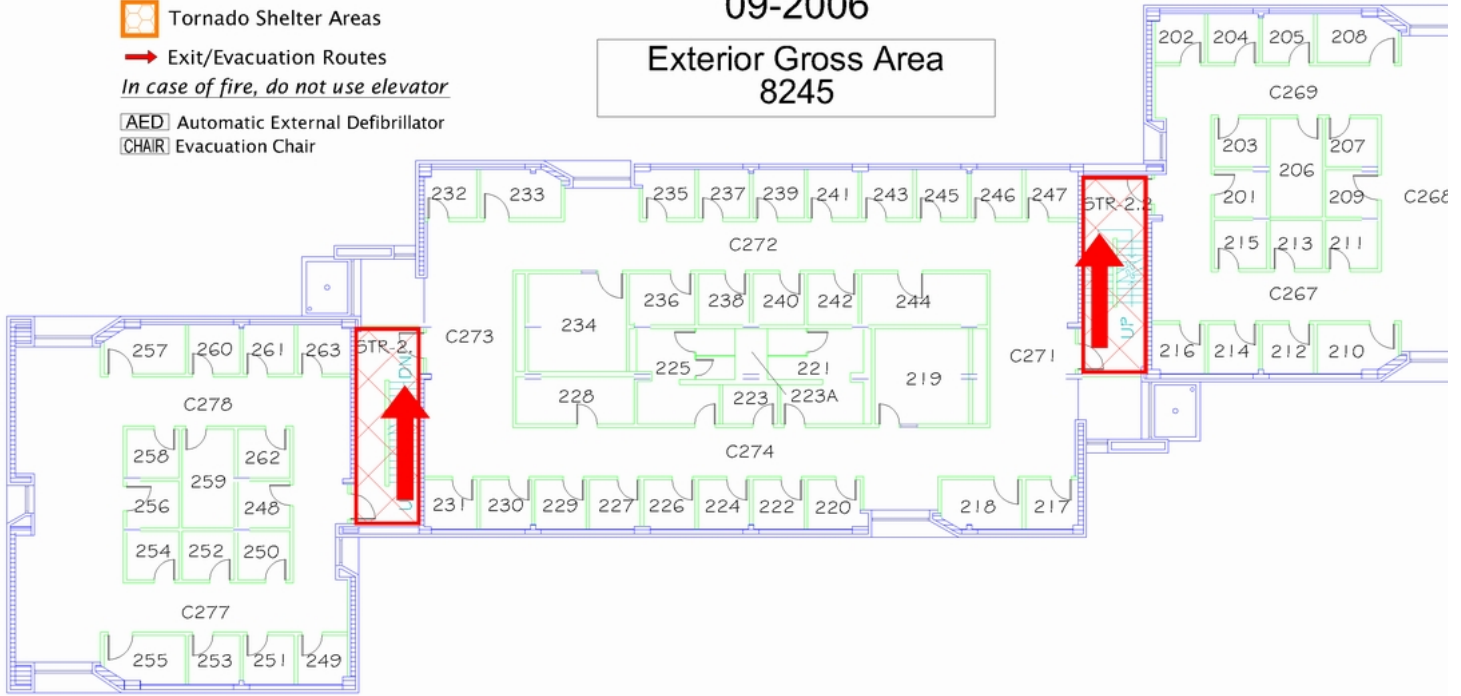

## SECOND FLOOR PLAN

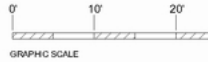

[Print Full Size Map](#)

# MUSIC PRACTICE NORTH



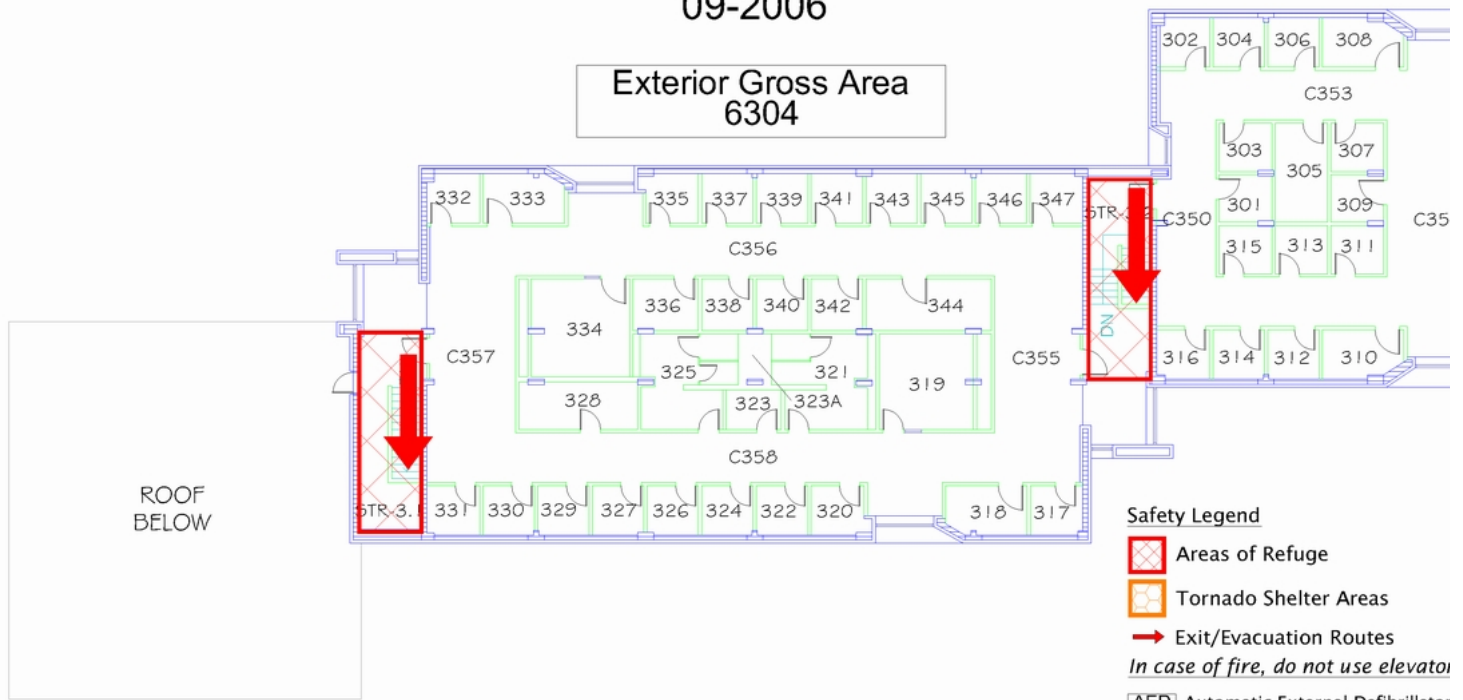

## BUILDING #0124

### 09-2006

Exterior Gross Area  
6304



#### Safety Legend

-  Areas of Refuge
-  Tornado Shelter Areas
-  Exit/Evacuation Routes
- In case of fire, do not use elevator*
-  AED Automatic External Defibrillator
-  CHAIR Evacuation Chair



## THIRD FLOOR PLAN

