

# Emergency Evacuation Procedures

## Crumley Hall

### Page Navigation

- [Severe Weather](#)
  - [Bomb Threat/Fire](#)
  - [Building Evacuation Maps](#)
- 

### Severe Weather

In the event of severe weather, all building occupants should immediately seek shelter in the designated shelter-in-place area in the building. If unable to safely move to the designated shelter-in-place area, seek shelter in a windowless interior room or hallway on the lowest floor of the building.

**Residents should take shelter in the hallways of the lowest level of their respective wing away from any windows.**

---

### Bomb Threat/Fire

In the event of a bomb threat or fire in the building, all building occupants should immediately evacuate the building using the nearest exit. Once outside, proceed to the designated assembly area. If unable to safely move to the designated assembly area, contact your RA to let them know you are safe and inform them of your whereabouts.

Persons with mobility impairments who are unable to safely exit the building should move to a designated area of refuge and await assistance from emergency responders.

**Residents should congregate in the Willis Library Mall.**

---





### Building Evacuation Maps

[Print Full Size Map](#)

# CRUMLEY HALL BLDG # 0178 04-2009

Exterior Gross Area  
26144

### Safety Legend

-  Areas of Refuge
-  Tornado Shelter Areas
-  Exit/Evacuation Routes
- In case of fire, do not use elevator*
-  AED Automatic External Defibrillator
-  CHAIR Evacuation Chair

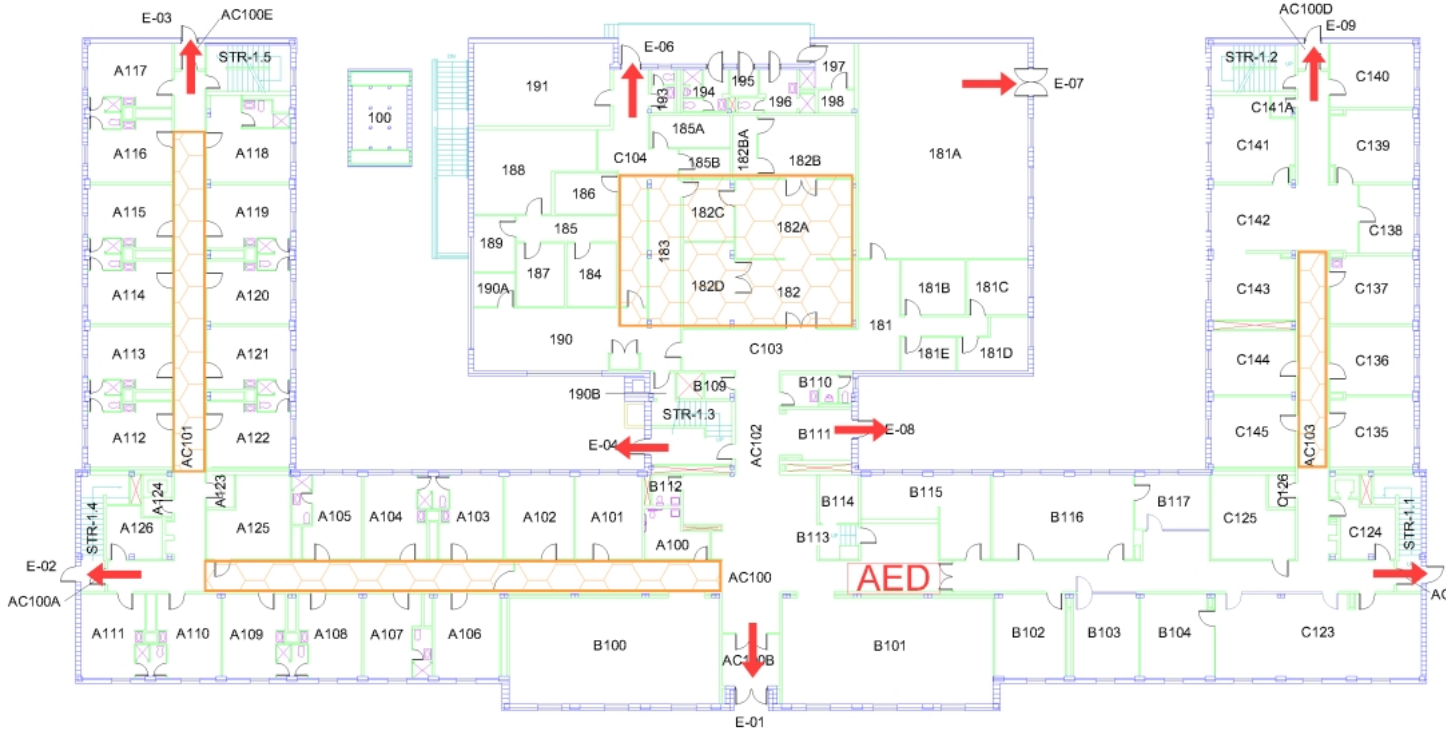

## FIRST FLOOR PLAN

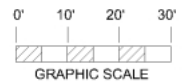





[Print Full Size Map](#)

# CRUMLEY HALL BLDG # 0178 06-2008

Exterior Gross Area  
21092

### Safety Legend

-  Areas of Refuge
-  Tornado Shelter Areas
-  Exit/Evacuation Routes
- In case of fire, do not use elevator*
-  AED Automatic External Defibrillator
-  CHAIR Evacuation Chair

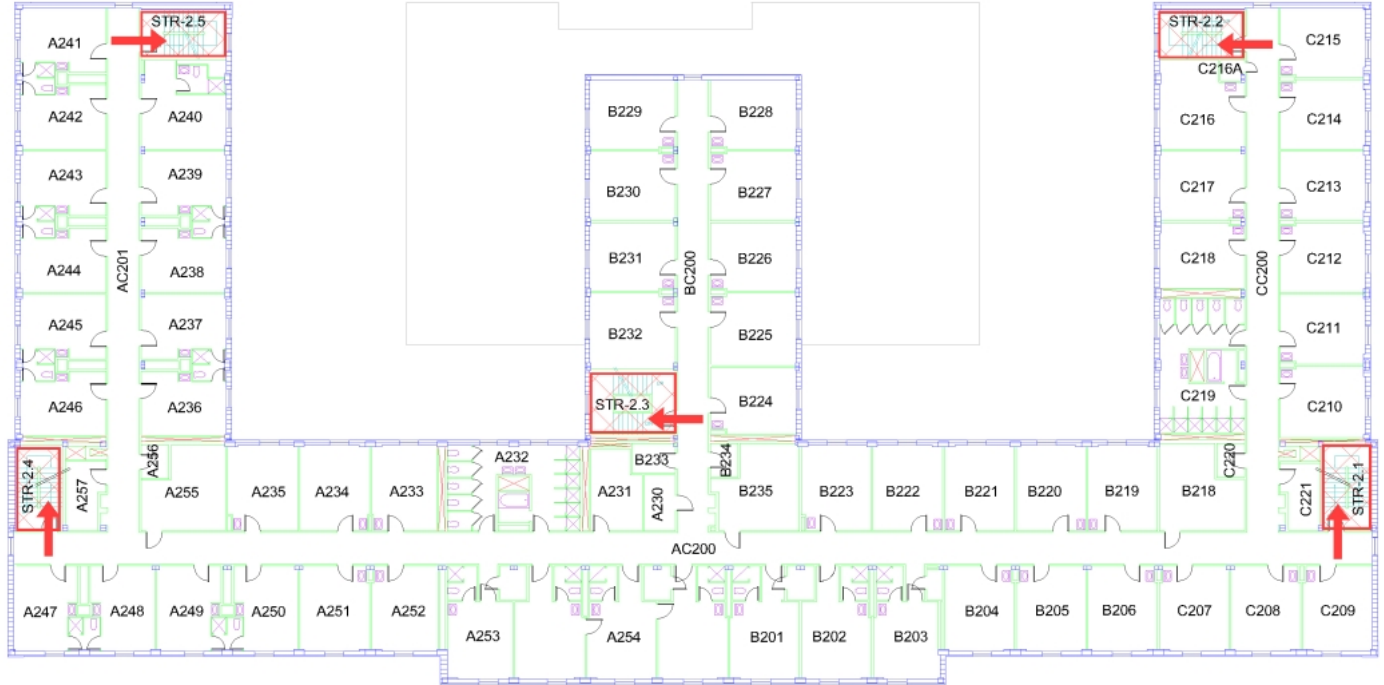

## SECOND FLOOR PLAN

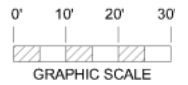



[Print Full Size Map](#)

# CRUMLEY HALL BLDG # 0178 06-2008

Exterior Gross Area  
21092

### Safety Legend

 Areas of Refuge

 Tornado Shelter Areas

 Exit/Evacuation Routes

*In case of fire, do not use elevator*

 AED Automatic External Defibrillator

 CHAIR Evacuation Chair



## THIRD FLOOR PLAN

N

