



SAN ANTONIO RIVER BASIN LOW IMPACT DEVELOPMENT TECHNICAL GUIDANCE MANUAL



SAN ANTONIO
RIVER AUTHORITY

Leaders in Watershed Solutions

Foreword

The San Antonio River Authority (SARA) is leading activities within the San Antonio River Basin to promote sustainable land use. These efforts work towards preserving natural watershed functions that manage the quality and quantity of stormwater runoff through a balance of economic, environmental, and quality of life considerations.

As with most other watersheds in the United States, development within the San Antonio River Basin has modified the natural function of the basin. In the San Antonio River Basin, infrastructure has been built to direct stormwater runoff into nearby rivers and creeks. SARA water quality monitoring data indicates that pollutants carried by stormwater runoff are the greatest threat to creek and river health. During storm events, rainwater runoff picks up bacteria, oils, hydrocarbons, sediment, fertilizers and other contaminants from yards, fields, sidewalks, parking lots and streets and deposits these contaminants into our creeks and rivers. This is especially problematic in urban areas during small rain events, where the high concentration of “first flush” pollutants can reduce a creek’s dissolved oxygen, resulting in fish kills and building concentrations of other containments in a creekbed’s sediment.

Ensuring the sustainability of our rivers and creeks and the bays and estuaries into which they flow involves reducing direct runoff and capitalizing on the land’s natural ability to filter pollutants. Low Impact Development (LID) is a stormwater management strategy that works to replicate the predevelopment hydrologic processes and reduce the harmful impacts of urban runoff. LID techniques have been shown to improve water quality, reduce localized flooding and, when incorporated into a project’s design early in the process, reduce overall costs.

Multiple regional partners have established goals for improving the sustainability of the San Antonio River Basin’s watersheds. The Bexar Regional Watershed Management (BRWM) partnership seeks, through a committee process, to address water quality issues collaboratively and to provide public information and education about water quality issues. Additionally, the SA2020 community vision plan initiated by Mayor Julián Castro has established performance metrics for stewardship of the area’s natural resources and encourages development practices that are focused on Smart Growth, LID and Green Building.

To meet this need, the BRWM’s Low Impact Development Manual Technical Subcommittee worked collaboratively with SARA to develop the San Antonio River Basin Low Impact Development Technical Guidance Manual. The subcommittee started with the premise that a manual is a necessary step for educating the professional community on the strategies and standard practices for stormwater management LID techniques. This collaborative effort brought together governmental, technical, design, business and advocacy interests to develop the goals and content of the manual. This extensive process provided a forum for engineers, architects, landscape architects, resource managers, scientists, policy and planning managers, vendors and designers to provide ideas for the development of the manual, as well as review of its content.

This manual is intended to be used by the communities in the San Antonio River Basin to plan and design stormwater best management practices (BMPs). It provides guidance on the proper selection, design, inspection and maintenance of LID BMPs. The overarching goal is to provide clear, unambiguous design guidance that is customized to the unique land formation and soil conditions in the San Antonio region.

Foreword

The development of this manual has benefitted from the input and review of the following participants.

City of San Antonio Department
of Planning & Community
Development

City of San Antonio Capital
Improvements Management
Services

City of San Antonio Public
Works

City of San Antonio
Development Services

Texas Commission on
Environmental Quality

Texas Department of
Transportation

Bexar County Public Works

City Public Service

United States Department of
Defense Joint Base San Antonio,
TX

Edward's Aquifer Authority

San Antonio Water System

Malcolm Pirnie | The Water
Division of ARCADIS

Atkins

Kleinfelder

Pape-Dawson Engineers, Inc

CH2MHill

RVK Architects

Contech Engineered Solutions
LLC

Pavestone, LLC

Professional Engineers in Private
Practice Bexar Chapter

Jones & Carter

Cude Engineers

The San Antonio River Authority (SARA) wishes to thank these organizations for their efforts, time and expertise.



Preferred Citation

Dorman, T., M. Frey, J. Wright, B. Wardynski, J. Smith, B. Tucker, J. Riverson, A. Teague, and K. Bishop.
2013. San Antonio River Basin Low Impact Development Technical Design Guidance Manual, v1.
San Antonio River Authority. San Antonio, TX.

Prepared in Cooperation with :



Bexar Regional Watershed Management



San Antonio River Authority
100 East Guenther Street
San Antonio, TX 78283

Prepared By:

Tetra Tech
700 N. Saint Mary's St., Suite 300
San Antonio, Texas 78205

Contents

1	Introduction.....	1
1.1	Purpose of the Manual.....	1
1.2	Applicability of the Manual.....	2
1.3	How to Use the Manual.....	2
1.4	Background.....	4
1.5	Site Design Principles and LID.....	9
1.6	Example LID Conceptual Design.....	12
1.6.1	Phase I—Site Assessment.....	13
1.6.2	Phase II—Preliminary Design.....	17
1.6.3	Phase III—Determine Low Impact Development Final Design.....	27
1.7	Multiple Benefits of LID.....	28
1.8	References.....	30
2	Regional Considerations.....	33
2.1	Physical Features and Climate.....	33
2.1.1	Soils and Geology.....	33
2.1.2	Aquifer Recharge Zones.....	34
2.1.3	Eco-Regions and the Impact on LID Implementation.....	37
2.1.4	Climatology and Topography.....	37
2.2	Relevant Federal and State Regulations and Guidelines.....	39
2.2.1	National Pollutant Discharge Elimination System Stormwater Regulations.....	39
2.2.2	TCEQ- 30 Texas Administrative Code (TAC) 213.5.....	39
2.3	Incorporating LID in Capital Improvement Projects.....	40
2.4	References.....	41
3	LID Selection—Structural BMPs.....	43
3.1	Selecting Structural BMPs.....	43
3.2	BMP Sizing.....	44
3.3	General Description of BMP Functions.....	44
3.4	Infiltration BMPs.....	46
3.4.1	Bioretention.....	47
3.4.2	Bioswales.....	54
3.4.3	Permeable Pavement.....	57
3.5	Filtration BMPs.....	61
3.5.1	Planter Boxes.....	61
3.5.2	Green Roofs.....	64
3.5.3	Sand Filter.....	66

Contents

3.6	Volume-Storage and Reuse BMPs	70
3.6.1	Stormwater Wetlands.....	70
3.6.2	Rainwater Harvesting	73
3.7	Conveyance and Pretreatment BMPs	78
3.7.1	Vegetated Swales.....	78
3.7.2	Vegetated Filter Strips	80
3.8	BMP Selection Matrix.....	84
3.9	Maximizing Multiple Benefits of BMPs	86
3.10	References	87
4	Execution Considerations	95
4.1	BMP Construction.....	95
4.1.1	Temporary Erosion and Sediment Control Practices.....	96
4.1.2	BMP Construction Inspection.....	98
4.2	Post Construction BMP Inspection.....	100
4.3	BMP Operation and Maintenance	101
4.3.1	Bioretention	102
4.3.2	Bioswale.....	104
4.3.3	Planter Box	105
4.3.4	Sand Filter.....	105
4.3.5	Permeable Pavement.....	106
4.3.6	Rainwater Harvesting	106
4.3.7	Wetlands	107
4.3.8	Green Roofs	108
4.4	BMP Monitoring	109
4.4.1	Monitoring Hydrology.....	109
4.4.2	Monitoring Water Quality.....	114
4.4.3	Sample Collection and Handling	114
4.5	Reducing Project Costs.....	115
4.6	Demonstration Projects	115
4.7	References	117
5	LID Review Process	119
5.1	LID Review Process.....	119
5.2	Incentives.....	132
5.3	Stormwater Fee-in-Lieu Programs	133
5.4	References	134
	Glossary	135

Figures

Figure 1-1. Document organization and intended users..... 4

Figure 1-2. Typical water cycle in an undeveloped area versus an urban setting (adapted from FISRWG 1998, USEPA 2005). 5

Figure 1-3. LID incorporated into traditional parking lot design minimizes alterations to natural hydrology. 7

Figure 1-4. A bioretention area provides attractive landscaping that is also functional. 7

Figure 1-5. Bioretention cell (Broadway Avenue Better Block). 9

Figure 1-6. Example of bioretention curb pop-out..... 10

Figure 1-7. Steps to develop an LID-based site plan. 11

Figure 1-8. Example capital improvement project conceptual site for LID..... 12

Figure 1-9. Identify applicable zoning requirements, utility easements, and site setbacks. 13

Figure 1-10. Protect natural and sensitive areas (wetlands, native tree groves, steep hillside) and conduct geotechnical survey to characterize infiltration capacity of soils..... 16

Figure 1-11. Identify and protect key hydrologic areas, such as infiltrating soils (blue area) and wetlands (orange areas). 17

Figure 1-12. Identify ideal locations for LID implementation according to site conditions..... 18

Figure 1-13. Establish grading envelope to protect natural areas and infiltrating soils. 20

Figure 1-14. Site example demonstrating placement of pervious material (red) and opportunities to minimize connected impervious area (yellow). 21

Figure 1-15. Bioretention incorporated into a pop-out. 22

Figure 1-16. Example of an intersection pop-out. 23

Figure 1-17. Site plan indicating all possible BMP locations (blue areas) and types (annotated). 26

Figure 1-18. Completed site plan including iterations of Steps 4–7 and BMP sizing completed. 28

Figure 2-1. Hydrologic soil groups for SARB. 35

Figure 2-2. SARB artesian, drainage, recharge, and transition zones..... 36

Figure 2-3. Topography of SARB..... 38

Figure 2-4. Bioretention Terrace Suitable for Use on Slopes 10-20% (NCDENR 2009)..... 39

Figure 2-5. Cross-section rendering of Alamo Street. 41

Figure 3-1. Treatment train featuring a vegetated filter strip pretreating runoff before entering a grassed bioretention area. 46

Figure 3-2. Pollutant removal depths in a bioretention area. 50

Figure 3-3. Parking lot bioretention area. 51

Figure 3-4. Parking lot island bioretention area..... 51

Figure 3-5. Roadside bioretention can be retrofit into the right-of-way to intercept street runoff through curb cuts. 52

Figure 3-6. Bioretention in a pop-out. A curb cut is provided at the upslope end of the pop-out to accept runoff from the gutter. 53

Contents

Figure 3-7. Bioretention in a common area.	54
Figure 3-8. Road median bioswale.	57
Figure 3-9. Pervious concrete parking lot.	60
Figure 3-10. PICP parking stalls.	60
Figure 3-11. Permeable pavement pedestrian plaza.	60
Figure 3-12. Permeable pavement fire access lane.	61
Figure 3-13. Planter boxes near a building.	63
Figure 3-14. Planter box in an ultra-urban setting.	63
Figure 3-15. Extensive green roofs reduce stormwater runoff while providing cooling effects, habitat for pollinators, and aesthetic value.	65
Figure 3-16. Intensive green roofs provide recreational, aesthetic, and educational opportunities in addition to stormwater benefits.	66
Figure 3-17. Surface sand filter.	69
Figure 3-18. Subsurface sand filter.	69
Figure 3-19. A large linear stormwater wetland.	72
Figure 3-20. Small wetlands along the perimeter of a neighborhood.	72
Figure 3-21. Typical plastic cistern.	74
Figure 3-22. Wood wrapped cistern.	75
Figure 3-23. Decorative cistern.	75
Figure 3-24. Below ground cistern.	76
Figure 3-25. Residential rain barrel.	77
Figure 3-26. Rain barrels adequately sized for contributing roof area.	77
Figure 3-27. Vegetated swale in an institutional setting.	79
Figure 3-28. Roadside vegetated swale.	80
Figure 3-29. Vegetated filter strip that pretreats roadway runoff.	82
Figure 3-30. Vegetated filter strip surrounding a bioretention area in a parking lot.	83
Figure 3-31. Vegetated filter strip next to a parking lot.	83
Figure 4-1. Example of a bioretention area installed before permanent site stabilization with the inset photo showing the clay layer clogging the mulch surface.	97
Figure 4-2. Accumulated fines layer as a result of improper construction sequencing.	97
Figure 4-3. Accurate grading and outlet elevations must be provided to achieve intended hydrologic and water quality functions.	98
Figure 4-4. Heavy equipment (especially wheeled equipment) should be operated outside the excavated area to prevent compaction.	99
Figure 4-5. For infiltrating practices, mitigate subsoil compaction by ripping grade to a depth of 12 inches.	100
Figure 4-6. Bioretention area clogged with sediment.	103
Figure 4-7. Inlet sump to remove gross solids.	104

Figure 4-8. Erosion caused by excessive flows in a bioswale. 105

Figure 4-9. Plant growth, debris buildup, and puddles indicate that permeable pavement is clogging. Prompt maintenance should be performed to prevent joints from fully sealing. 106

Figure 4-10. Self-cleaning inlet filters. 107

Figure 4-11. Outlet varied with weir boards. 108

Figure 4-12. Outlet with a trash rack. 108

Figure 4-13. White gravel indicates a no plant zone for a green roof. 109

Figure 4-14. Inflow pipe to bioretention area equipped with compound weir and bubbler for flow measurement. Water quality sampling tube and strainer are visible inside pipe. 110

Figure 4-15. Inlet curb cut with a v-notch weir. 110

Figure 4-16. Outlet of a roadside bioretention pop-out equipped with a V-notch weir for flow monitoring. 111

Figure 4-17. Underdrains from permeable pavement equipped with 30° V-notch weir boxes and samplers for flow and water quality monitoring. 111

Figure 4-18. Example of a bioretention underdrain outlet with sufficient drop to install a flow monitoring weir without encountering tailwater. 112

Figure 4-19. Poorly installed H-flume at the inlet to a bioretention area in which the invert of the weir is too low and tailwater from the bioretention will interfere with measurement. 113

Figure 4-20. Monitoring points. 113

Figure 4-21. Example of manual (left) and tipping bucket (right) rain gauges. 114

Figure 4-22. Rain garden incorporated into Better Block street revitalization project. 115

Figure 5-1. General planning review process. 120

Figure 5-2. Traditional vs. LID design review process. 121

Figure 5-3. Review process for bioretention. 123

Figure 5-4. Review process for bioswales. 124

Figure 5-5. Review process for permeable pavement. 125

Figure 5-6. Review process for planter boxes. 126

Figure 5-7. Review process for green roofs. 127

Figure 5-8. Review process for sand filters. 128

Figure 5-9. Review process for cisterns. 129

Figure 5-10. Review process for stormwater wetlands. 130

Figure 5-11. Review process for vegetated swales and vegetated filter strips. 131

Contents

Tables

Table 1-1. Studies showing increased property values related to LID and open space	30
Table 2-1. Summary of BMPs Approved by TCEQ.....	40
Table 3-1. Water quality unit processes for pollutant removal	44
Table 3-2. Hydrologic and water quality unit processes for BMPs	45
Table 3-3. Advantages and limitations of bioretention areas.....	47
Table 3-4. Advantages and limitations of bioswales	55
Table 3-5. Advantages and limitations of permeable pavement	58
Table 3-6. Advantages and limitations of planter boxes.....	62
Table 3-7. Advantages and limitations of green roofs	64
Table 3-8. Advantages and limitations of sand filters.....	67
Table 3-9. Advantages and limitations of stormwater wetlands	70
Table 3-10. Advantages and limitations of rainwater harvesting	73
Table 3-11. Advantages and limitations of vegetated swales	78
Table 3-12. Advantages and limitations of filter strips.....	81
Table 3-13. LID management practice selection matrix according to site characteristics.....	85
Table 5-1. Sample management approach blending water quality and flood control.....	134

Acronyms and Abbreviations

%	percent
°F	degrees Fahrenheit
ADA	Americans with Disabilities Act
ADV	acoustic Doppler velocimeter
ASTM	American Society for Testing and Materials
BMPs	best management practices
BOD	biochemical oxygen demand
BRWM	Bexar Regional Watershed Management
C	rational method coefficient
CEC	cation exchange capacity
CIPs	capital improvement projects
CO ₂	carbon dioxide
COSA	City of San Antonio
ETJ	extraterritorial jurisdiction
FILO	fee in lieu of
ft ²	square feet
hr	hour
HSG	hydrologic soil groups
HSPF	Hydrologic Simulation Program in Fortran
IMPLND	impervious land
in	inch
IPM	integrated pest management
IWS	internal water storage zone
LID	low impact development
LOMC	letter of map change
meq	milliequivalents
mg/L	milligrams per liter
mm	millimeter
MS4	Municipal Separate Storm Sewer System
NCDC	National Climatic Data Center
NO ₂	nitrogen dioxide
NPDES	National Pollutant Discharge Elimination System

Acronyms and Abbreviations

NRCS	Natural Resources Conservation Service
O ₃	ozone
O&M	operation and maintenance
OSHA	Occupational Safety and Health Administration
P.E.	professional engineer
PM-10	particulate matter that is 10 µm or smaller
ppm	parts per million
PVC	polyvinyl chloride
QAPP	quality assurance project plan
s	second
SARA	San Antonio River Authority
SAWS	San Antonio Water System
sec	second
SO ₂	sulfur dioxide
SUSTAIN	System for Urban Stormwater Treatment and Analysis INtegration
SWMP	stormwater management plan
SWPPP	stormwater pollution prevention plan
T _c	time of concentration
TCEQ	Texas Commission on Environmental Quality
TGM	Edwards Aquifer Rules—Technical Guidance on Best Management Practices
TKN	total Kjeldhal nitrogen
TMDLs	total maximum daily loads
TSS	total suspended solids
TxDOT	Texas Department of Transportation
UDC	Unified Development Code
U.S. EPA	U.S. Environmental Protection Agency
VFS	vegetated filter strip
VS	vegetated swale
WDM	Watershed Data Management
yrs	years
µ	micro (one millionth or 10 ⁻⁶)

1 Introduction

1.1 Purpose of the Manual

Land development and urbanization alter and inhibit the natural hydrologic processes of surface water runoff patterns, infiltration, percolation to ground water, and evapotranspiration. Under predevelopment conditions, up to half of the annual rainfall infiltrates through the sandy soils and percolates downward where portions of it can recharge the ground water or provide base flow to streams (USEPA 2005). In contrast, developed areas can generate up to five times the annual runoff and allow one-third the infiltration of natural areas (FISRWG 1998, USEPA 2005). This change leads to increased erosion, reduced ground water recharge, diminished base flow in streams, increased stream flows during storm events, and degraded water quality.

Traditional engineering approaches to stormwater management convey runoff rapidly from developed surfaces into drainage systems, discharging large volumes of stormwater and pollutants to downstream receiving waters. As a result, stormwater runoff from developed land is a significant source of many water quality, stream morphology, and ecological impairments (USEPA 1999).

Reducing the overall imperviousness and using the natural drainage features of a site are important design strategies to maintain or enhance the site's hydrologic characteristics after development. This can be achieved by applying Low Impact Development (LID) stormwater management strategies. LID, which works to replicate predevelopment, natural hydrologic processes and reduce the disruptive effects of urban development on runoff patterns, has emerged as an alternative stormwater management approach that is complementary to conventional stormwater management measures including stormwater *best management practices (BMPs)*.

LID strategies are structural stormwater BMPs and planning techniques that are intended to reproduce predevelopment hydrologic conditions by reducing impervious surfaces and infiltrating, evaporating, and storing stormwater runoff using native or improved soils, vegetation, and bioengineering. Unlike the conventional method of quickly discharging stormwater off-site and conveying it to a downstream watershed, LID treats stormwater as a resource on-site. Site assessment, site planning, and on-site stormwater management guide the initial design phases of a project to maintain a more hydrologically functional landscape even in denser urban settings.

The San Antonio River Authority (SARA) and its Bexar Regional Watershed Management (BRWM) partners have developed this design manual to proactively address water quality and water resource protection in the San Antonio River Basin while building a sustainable community that balances these environmental concerns with economic and quality of life benefits. This manual is intended to provide property owners, reviewers, designers, policymakers, citizens of the San Antonio River watershed, and other stakeholders with a common understanding of LID goals, objectives, and specifications for individual BMPs. The LID practitioner can use this manual to evaluate the applicability of LID BMPs to a site, perform site assessment and planning, and design BMPs appropriate to specific site conditions. The best, most applicable techniques for the San Antonio region are included in this manual, and design details have been created to fit local preferences on the basis of input from the BRWM LID Subcommittee. Other LID BMP options exist; however, the BRWM LID Subcommittee chose to focus on the nine presented in this manual.

1. Introduction

This manual is intended to provide sufficient instruction and technical resources to help properly plan, select, design, and maintain LID BMPs. To accomplish this, the manual provides a balance of detailed technical information with clearly described step-by-step site assessment, planning, layout, selection, and BMP design instructions that complement existing or established hydraulic and hydrologic treatment standards. Before referencing this manual for guidance, users should first become familiar with the fundamental principles and regulatory drivers for LID in the opening chapter as well as current stormwater standards governing stormwater runoff in the San Antonio River Basin (see Appendix G) to effectively use this manual to meet stormwater requirements.

1.2 Applicability of the Manual

This manual establishes design guidelines to meet local stormwater and water quality protection goals. It does not establish a legal standard for such functions and is not intended to do so. Moreover, the guidelines do not supersede requirements and policies established through adopted community plans, regional and city standard drawings, or other city council adopted policy or regulatory documents. Instead, the manual is intended to work in concert with those policies and regulations. The manual complements other acceptable methods used to meet existing stormwater management regulations, including those in the Edwards Aquifer Recharge and Transition Zones, and is applicable to private development and public infrastructure projects in cities and counties in the region. The guidance is applicable to newly developing areas and to older developments that are undergoing revitalization or redevelopment.

1.3 How to Use the Manual

The *Low Impact Development Technical Design Guidance Manual* aids owners, designers, and caretakers in analyzing, planning, designing, constructing, maintaining, and monitoring LID projects from start to finish. The manual has five chapters and seven appendices, and the content is intended to be used by practitioners with knowledge of stormwater processes (Figure 1-1).

The Introduction (Chapter 1) provides the local context for LID implementation, a general description of LID, site design principles, and the benefits of LID. Chapter 2: Regional Considerations describes regional geology and climate as well as the local regulatory framework when developing and implementing LID BMPs. LID Selection—Structural BMPs (Chapter 3) outlines unit-process-based design for selection and placement of LID BMPs, and Appendix B expands on these concepts by providing detailed design guidance. Construction considerations that can affect BMP design and implementation are included in Chapter 4: Execution Considerations. Finally, Chapter 5: LID Review Process provides guidance for reviewers who are tasked with evaluating LID designs and approaches for agencies that plan to allow LID implementation in their jurisdictions.

Seven supporting technical appendices are integral to the steps, processes, construction, and operation and maintenance of LID BMPs described in the main document. Appendix A: BMP Sizing and Example Calculations presents a tool for sizing LID BMPs. As mentioned, Appendix B: BMP-Specific Details for Design provides in-depth design guidance, including specifications, considerations, and renderings. Appendix C: Design Examples and Templates includes design details for each type of LID practice, and Appendix D: BMP Design Fact Sheets presents a summary of design specifications for each BMP type. Appendix E: Plant List includes a list and attributes of plants that are well-suited for LID practices in San Antonio and plants that should not be used. Appendix F: Facility Inspection and Maintenance Checklist is a tool for practitioner's use to help ensure that each facility is designed, installed, and maintained correctly. Appendix G: Cost Estimates and Regulatory guidance provides planning level cost estimates for implementation and annual estimates for operation and maintenance along with an overview of regulations that impact LID implementation for each jurisdiction in the San Antonio River Basin.

Organization of the Manual

- Chapter 1: Introduction** provides the general background and need for implementing LID practices. It also provides step-by-step instructions for site assessment, planning, and preliminary layout of LID BMPs.
- Chapter 2: Regional Considerations** discusses local ecology, geology, and climate factors relevant to LID design. It includes a discussion of federal, state, regional, and local regulation applicable to stormwater management and LID implementation.
- Chapter 3: LID Selection—Structural BMPs** includes a summary description of all recommended LID BMPs and instructions for selecting site-appropriate BMPs.
- Chapter 4: Execution Considerations** summarizes implementation considerations, including operation and maintenance needs and cost-reduction measures.
- Chapter 5: LID Review Process** gives guidance for reviewers who are tasked with evaluating LID designs and approaches for entities that plan to implement LID in their jurisdictions.
- Appendix A: BMP Sizing** that is based on site conditions and local rainfall information, including instructions for using a tool that assists with sizing LID BMPs and a description of the tool's development.
- Appendix B: BMP Design Guidance** provides design specifications, considerations, and helpful renderings of what a system might look like once built. Also provided are real-world renderings of design adaptations.
- Appendix C: BMP Design Templates** includes one-page examples of design details for individual BMP applications. Electronic files are also available for download, in AutoCAD format, for incorporation into construction drawings.
- Appendix D: Fact Sheets** contains design fact sheets for all LID BMPs included in the manual. The fact sheets are intended to be a one-page summary of key BMP design, construction, and maintenance considerations.
- Appendix E: Plant List** includes a detailed plant list, specific to the San Antonio region, to help with LID BMP design.
- Appendix F: Inspection and Maintenance Checklist** provides a facility inspection and maintenance checklist for LID BMPs with checklists combined, in the case of multiple BMPs used together as a treatment train.
- Appendix G: Cost Estimates and Regulatory Guidance** includes planning-level cost estimates for each BMP type and a summary of relevant regulations for the jurisdictions in the San Antonio River Basin.

1. Introduction

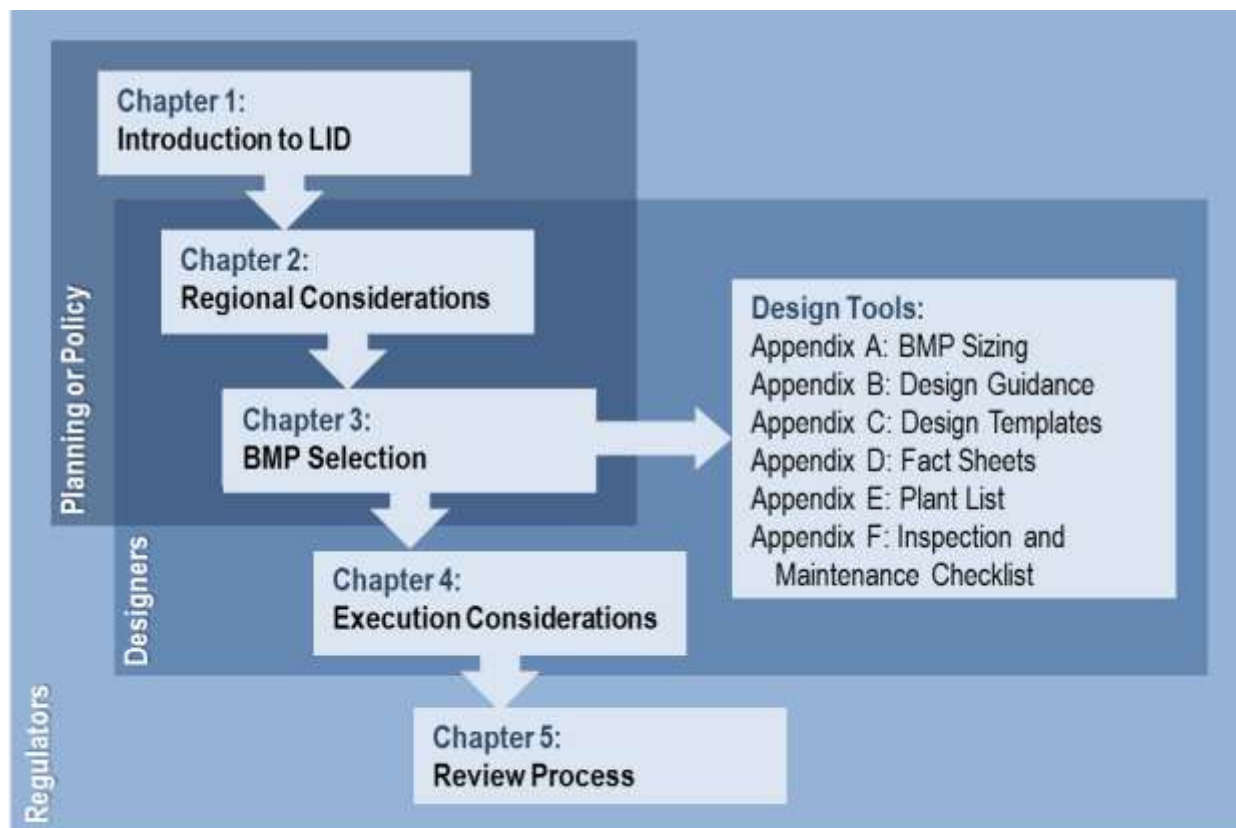

Figure 1-1. Document organization and intended users.

As a design team¹ develops a greater understanding of LID principles and becomes more experienced in designing BMPs, use of this manual can be further simplified by relying on the templates and fact sheets in Appendix C and Appendix D. Designers familiar with the design process could choose to reference the one-page fact sheets during the design process to remind themselves of key assumptions and design recommendations.

1.4 Background

In natural, undeveloped landscapes, the hydrologic processes of infiltration of surface water into the ground (both near surface and deep percolation), evaporation, and transpiration work to recycle rainwater through plants and soil minimizing the transfer of pollutants to surface and ground waters (Figure 1-2). As land development and urbanization occur, natural or vegetated areas are replaced with streets, parking lots, buildings, and compacted soils. Such impervious surfaces modify the natural hydrology, decrease the permeability of the landscape, and dramatically affect the natural hydrologic cycle.

Stormwater runoff from increased impervious surfaces in urban areas has emerged as a significant threat to water quality.

Source: USEPA 2004

¹ LID works best when incorporated into projects early in the design stage by an integrated, multi-disciplinary team consisting of architects, engineers, and landscape architects.

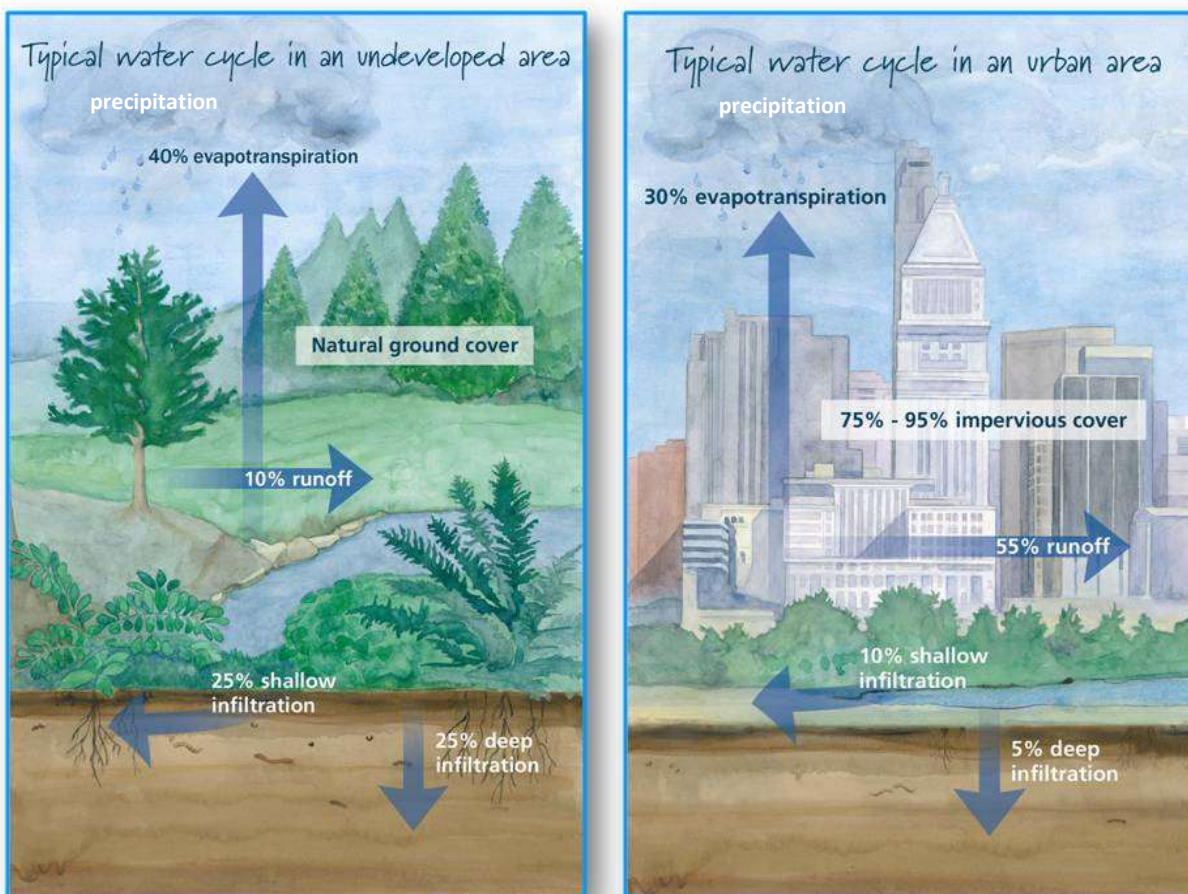

Figure 1-2. Typical water cycle in an undeveloped area versus an urban setting (adapted from FISRWG 1998, USEPA 2005).

Depression storage, infiltration, percolation (deep infiltration), and interception (the capture of water by vegetation before reaching the ground) all decrease as a natural site is developed with higher impervious cover. Impervious areas and compacted soils reduce infiltration, which creates increased overland runoff and shorter times of concentration that can have cascading effects throughout the watershed. The impact of imperviousness can include increases in annual runoff volumes, increased peak discharges, increased pollutant loads, increased frequency and magnitude of flooding, stream habitat degradation, and diminished stream base flows (CWP 2004).

The amount of impervious cover in a watershed has been identified as a common factor in watersheds with stream degradation (Prince George's County 1999), and significant declines in the biological integrity or physical habitat of a stream have been found in watersheds with as little as 10 percent imperviousness (Schueler 1994). With decreased percolation of infiltrated runoff, shallow ground water recharge rates to streams and surface waters (interflow) are reduced. In turn, this reduces the amount of base flow in the surface waters, which can noticeably alter the physical habitat conditions of streams or shoreline areas. Both reduced infiltration rates and high-velocity surface flows can lead to increased surface erosion and gully formation. These processes ultimately destabilize stream banks and often wash sediment into surface waters. Finally, decreased infiltration leads to greater stormwater volumes and longer durations of peak flows. Energy generated by the increased peak volumes is further compounded

1. Introduction

as flows are directed into conveyance systems that slope toward surface waters, increasing flow velocity. Once discharged to surface waters, the energized flow can erode streambeds and banks (USEPA 2005; MacRae 1996). Ultimately, these erosive flows to surface waters can dramatically degrade water quality and significantly affect aquatic ecosystems.

Historically, the goal of urban drainage infrastructure was to convey water quickly away from a developed site to prevent localized flooding. Such conveyance systems were engineered to direct flows from impervious surfaces (e.g., streets, parking lots, sidewalks, and buildings) to curbs, gutters, storm drains, and, ultimately, to surface waters such as streams and rivers. Therefore, these conveyance systems carry runoff and pollutants from developed areas directly into the receiving waters. Urban runoff is considered among the most significant threats affecting the nation's waterways (USEPA 2004). Pollutants commonly associated with urban runoff are sediment, trash, organic matter, nutrients (particularly phosphorus and nitrogen), hydrocarbons such as gasoline and oil, pesticides/herbicides, fertilizers, metals, and pathogens associated with fecal waste.

Later approaches to stormwater management focused on peak flow control (e.g., extended detention), which provided flood control and some water quality benefits but did little to protect headwater streams or address the total volume of runoff entering receiving waters. In recent years, LID has been tested and shown to be successful in a variety of settings both nationally and internationally and has risen to the forefront of stormwater management approaches.

Functioning as a first line of defense against the negative impacts of excess stormwater, LID is a fundamentally different approach from traditional stormwater management. LID aims to manage stormwater at the site, often including some form of treatment and volume control for smaller storm events. Treating stormwater at the site minimizes the volume that is washed overland and into traditional conveyance systems. Minimizing such volumes reduces pollutants washed into surface waters and can result in significant water quality improvement (USEPA 2009) and reduce exposure to flood hazards (Medina et al. 2011).

LID practices offer an innovative way to integrate stormwater management into natural landscapes, minimizing alterations to the natural hydrologic regime and reducing the volume of site runoff (Figure 1-3). Implementing LID practices can enhance water quality treatment, encourage ground water recharge, and reduce soil erosion and pollutant transport. Additional benefits of LID implementation are the potential to use LID practices to enhance improved greenways and park lands, enrich natural environmental aesthetics in urban settings (Figure 1-4), and reduce the need for traditional drainage infrastructure (see Section 1.7 for an expanded discussion of the multiple benefits of LID). These concepts are of great interest in areas with high quality aquatic recreation or aquatic life habitats and can effectively complement the efforts to improve the San Antonio River and its tributaries.

Offering considerable versatility with design and implementation, LID concepts can be incorporated into new and existing developments and can, in some cases, be less costly than traditional, structural stormwater management systems (USEPA 2007, 2012a). It is important to integrate LID BMPs with other on-site drainage that can safely convey flows from larger storms to downstream systems or streams.



Los Angeles, California Source: Tetra Tech.

Figure 1-3. LID incorporated into traditional parking lot design minimizes alterations to natural hydrology.



Portland, Oregon Source: Tetra Tech.

Figure 1-4. A bioretention area provides attractive landscaping that is also functional.

1. Introduction

LID implementation and associated benefits can be considered at three scales—the site or block scale, the community or neighborhood scale, and the regional or large watershed scale. Because the influences of urbanization are evident at all three scales, individual LID BMPs can mitigate the negative effects of urban runoff at the site and neighborhood as well as the watershed as a whole.

At the watershed scale, decisions on where and how to develop are critical to water quality and natural resource protection. In San Antonio, citizens and the collective community have chosen to influence growth patterns over the Edwards Aquifer Recharge and Contributing Zones. Growth, development, and redevelopment offer resources and opportunities to revitalize a downtown, refurbish streets, build new schools, and develop diverse places to live, work, shop, and play. Growth creates challenges for communities striving to protect or restore their natural resources. Development approaches must be transformed to use land efficiently and protect sensitive natural and cultural areas while treating water as a resource that can be used on-site or recharged for extended use as base flow or water supply. Incorporating smart growth and LID principles into planning and zoning are important tools to achieve multiple environmental, community, and aesthetic benefits throughout the watershed.

Once local governments have assessed the best placement for growth and preservation in a watershed, many LID practices can be applied at the community or neighborhood scale. These community-scale techniques, such as reducing road widths, replacing curb and gutter with roadside swales, and refocusing development practices, necessarily extend beyond individual development sites and can be applied throughout a neighborhood.

Finally, site-specific stormwater strategies, such as rain gardens, green roofs, rain water harvesting, or disconnected downspouts and impervious areas, are integrated in each development or parcel of land to benefit the whole community. Many LID practices can be applied at all three scales. For example, opportunities to maximize infiltration occur in all scale categories. Likewise, all LID practices strive to decrease the overall amount of effective impervious cover. Some approaches used to minimize impervious cover and maximize infiltration are:

- Minimizing land clearing and disturbance
- Clustering buildings
- Encouraging development on already affected land (e.g., vacant urban lots)
- Using narrower roads, designing smaller parking lots, and co-locating uses that have different peak traffic times
- Using permeable pavement
- Encouraging mixed use developments that encourage residents to walk rather than drive
- Designing more compact residential lots with shared common open space (Conservation Development requires 50% open space)
- Increasing residential unit densities through vertical building or zero lot lines and preserving more open space

These principles, implemented within a sound regulatory approach, improve livability and meet community goals for environmental sustainability while sometimes reducing development cost. This design guidance manual is a resource to proactively address water quality and water resource protection in the San Antonio River Basin while building a sustainable community that promotes improved health and quality of life.

1.5 Site Design Principles and LID

LID practices use natural features to slow and filter stormwater runoff. Project characteristics will define which LID BMPs are applicable. When determining the appropriate LID requirements, project managers must consider characteristics such as site location, existing topography and soils, and planning elements. These characteristics and their impacts on design are important because LID BMPs are permanent features that can affect other project elements; therefore, it is critical to conduct thorough site assessments to avoid the need for redesign later. Incorporating LID early in the site design stage could reduce the need for and cost of traditional drainage infrastructure by reducing the amount of stormwater to be conveyed off-site.

The following are the fundamental planning concepts of LID (Prince George's County 1999):

1. *Using hydrology as the integrating framework*

Integrating hydrology during site planning begins with identifying sensitive areas, including streams, floodplains, wetlands, steep slopes, highly permeable soils, and woodland conservation zones. Through that process, the development envelope—the total site area that affects the hydrology—is defined. This effort must include evaluating both upstream and downstream flowpaths and drainage areas that may be affected.

2. *Use distributed practices*

Distributed control of stormwater throughout the site can be accomplished by applying small-scale LID BMPs throughout the site (e.g., bioretention in landscaped areas, permeable pavement parking stalls). This may include preserving areas that are naturally suited to stormwater infiltration and require little or no engineering. Such small-scale, LID BMPs foster opportunities to maintain the natural hydrology, provide a much greater range of control practices, allow control practices to be integrated into landscape design and natural features of the site, reduce site development and long-term maintenance costs, and provide redundancy if one technique fails.

3. *Controlling stormwater at the source*

Undeveloped sites possess natural stormwater mitigation functions such as interception, depression storage, and infiltration. Those hydrologic functions should be restored or designed as close as possible to the disturbed area (e.g. parking lot, building) to minimize and then mitigate the hydrologic effects of site development. Bioretention cells, as shown in Figure 1-5, are an example LID practice that can serve this function.

4. *Using simple, non-engineered methods*

Methods employing existing soils, native vegetation, and natural drainage features can be integrated into LID designs. These designs integrate natural elements into stormwater management and limit structural material including concrete troughs and vault systems.



Broadway Avenue Better Block Source: Bender Wells Clark Design.

Figure 1-5. Bioretention cell (Broadway Avenue Better Block).

1. Introduction

Examples include bioretention cells, curb pop-outs, and depressed medians, as shown in Figure 1-6.

5. *Creating a multifunctional landscape*

Urban landscape features such as streets, sidewalks, parkways, and green spaces, can be designed to be multifunctional by incorporating detention, retention, and filtration functions, such as curb pop-outs, as shown in Figure 1-6.

Siting and selecting appropriate LID practices is an iterative process that requires comprehensive site planning with careful consideration of all nine steps detailed in this chapter. A site planner, landscape architect, or engineer can follow these steps in developing final site plans, as described in Figure 1-7. The steps are arranged on the basis of the anticipated design phases of site assessment, preliminary design, and final design (Phases I, II, and III, respectively).

A thorough site assessment is needed initially to identify the development envelope and minimize site alterations. The primary objective of the site assessment process is to identify limitations and development opportunities specific to LID. For example, development opportunities include available space, use of right-of-way as appropriate, and maximizing opportunities where properly infiltrating soils exist. Constraints or limitations that need to be factored into site planning when implementing LID practices include

- Slow-infiltrating soils (typically clays)
- Soil contamination
- Steep slopes
- Adjacent foundations of structures
- Wells
- Shallow bedrock
- High seasonal water table

For both new development and redevelopment, in the preliminary site plan, the development envelope (construction limits) is delineated. Applicable zoning, land use, subdivision, local road design regulations, and other local requirements should be identified to the extent applicable at this stage (Step 1 above; see Appendix G for information on local requirements). To make the best and most optimal use of LID techniques on a site, a comprehensive site assessment must be completed that includes an evaluation of existing site topography, soils, vegetation, and hydrology including surface water and ground water features. High quality ecological resources (e.g., wildlife habitat, mature trees) should also be identified for conservation or protection. With such considerations, the site assessment phase provides the foundation for consideration of and proper planning around existing natural features and to retain or mimic the site's natural hydrologic functions (Steps 2 and 3).



Portland, Oregon Source: Tetra Tech.

Figure 1-6. Example of bioretention curb pop-out.

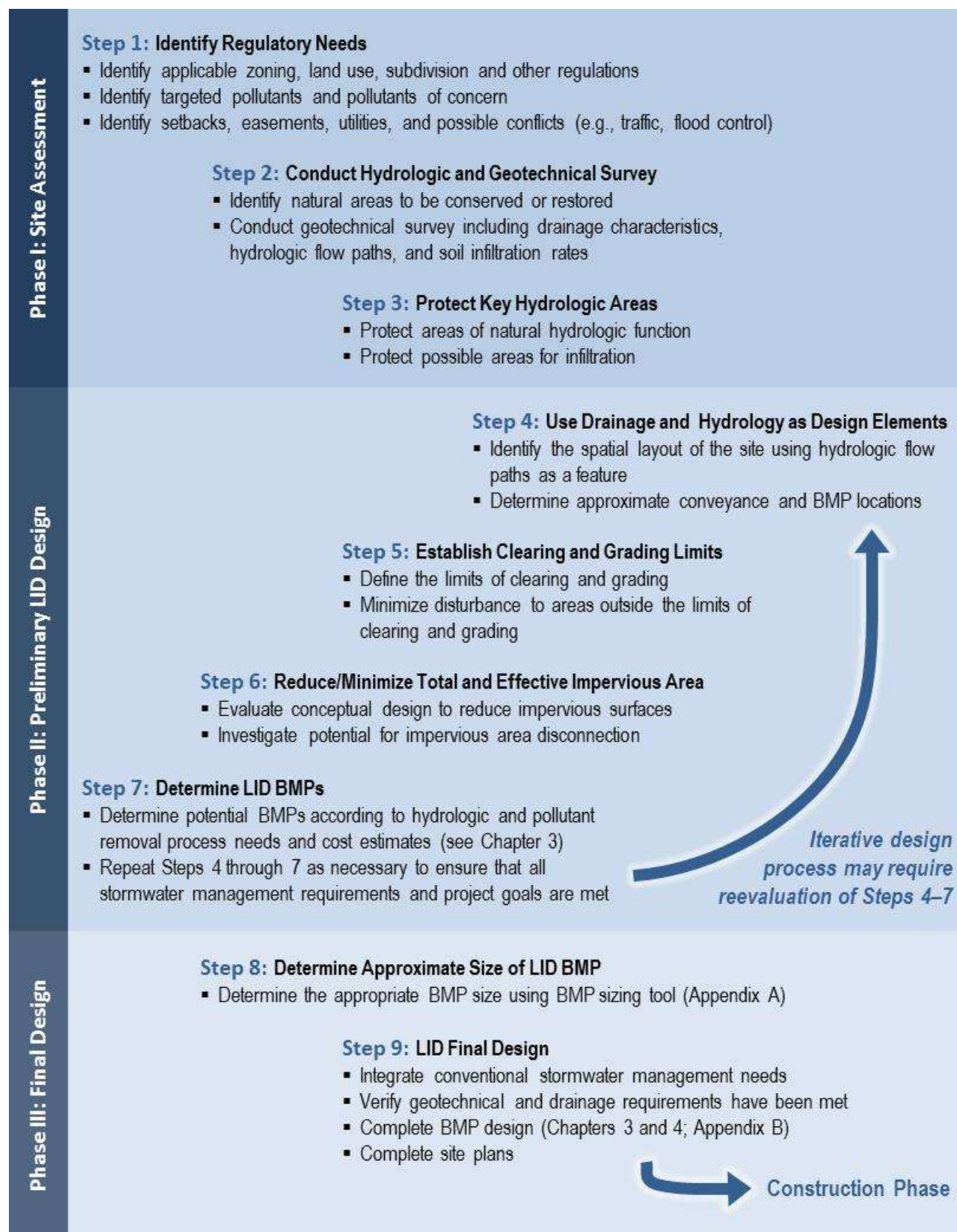

Figure 1-7. Steps to develop an LID-based site plan.

1. Introduction

Phase II, site planning, covers Steps 4–7. Defining preexisting and site-specific drainage patterns is essential for determining potential locations of LID BMPs (Step 4). Once natural and hydrologic features are identified and slated to be preserved, areas can be designated for clearing, grading, structures, and infrastructure (Step 5). After the preliminary site configuration has been determined in light of the existing features, impervious area site plans (buildings, roadways, parking lots, sidewalks) can be evaluated for opportunities to minimize total impervious area in the site planning phase (Step 6). The specific types of LID BMPs are determined next (Step 7; e.g., a bioretention cell versus porous pavement for stormwater storage and infiltration).

In Phase III, final LID BMP footprints and sizes are estimated (Step 8; and for sizing, see Appendix A). An iterative process working between Steps 4 and 7 can help determine the final site layout for completing the design process (Step 9). These steps are presented in more detail in the following sections. When Step 6 is completed, detailed determination of stormwater management practice selection and design that considers BMP construction, and operation and maintenance (Chapters 3 and 4) should be made to complete Phase III and the final site design process. Steps 8 and 9 assist in determining BMP sizing and final design.

1.6 Example LID Conceptual Design

A series of conceptual site renderings, starting with Figure 1-8 below, demonstrate the phases of site assessment, preliminary design and planning through the final designs and shows how the site changes with each step. Figure 1-8 demonstrates a hypothetical site planned to include the construction of a new library, adjoining parking lot, and a surrounding park. This example site will be used to illustrate the steps described in the following sections.

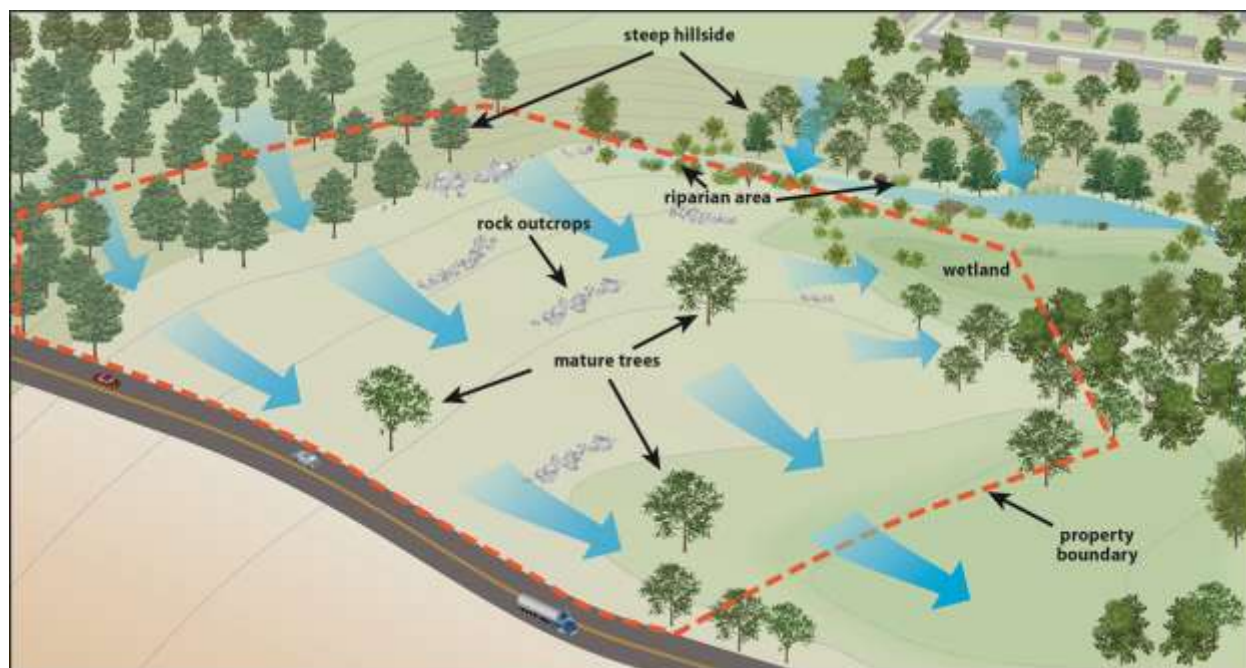

Figure 1-8. Example capital improvement project conceptual site for LID.

1.6.1 Phase I—Site Assessment

The first phase of site planning is composed of the site assessment. Steps 1 through 3 below delineate the site assessment process.

Step 1: Identify Regulatory Needs

LID implementation must be consistent with the applicable federal, state, and local regulations; a general discussion of how the LID standards work with local regulations is in Chapter 2 and Appendix G.

Identify applicable zoning land use, subdivision, and other local regulations

Zoning ordinances and comprehensive planning by any local government entity (county, city, and such) provide a framework to establish a functional and visual relationship between growth and urbanization (Prince George's County 1999). San Antonio's zoning requirements are in Article III of the Unified Development Code. It is recommended that identified land uses also be shown in a visual format similar to Figure 1-9.

To Complete Step 1:

- Identify applicable zoning, land use, subdivision, and other regulations
- Identify setbacks, easements, and utilities (Call 811 for utility location)
- Identify targeted pollutants and pollutants of concern

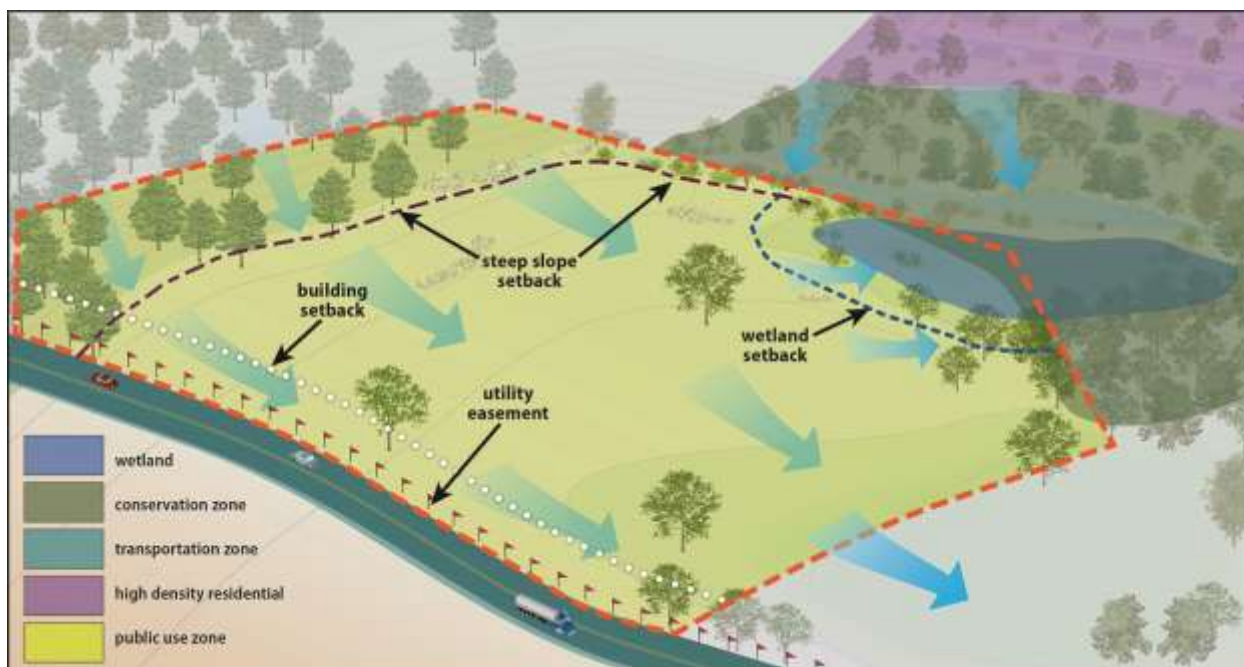

Figure 1-9. Identify applicable zoning requirements, utility easements, and site setbacks.

Identify setbacks, easements, and utilities

Defining the boundaries of the site (yellow-dashed line indicating parcel boundaries) also includes identifying the required setbacks and any easements or utilities on the site. Municipal ordinances provide the basic regulations regarding the size and scale of development, such as permitted density, setbacks and structure height on the basis of the applicable zoning code (see Appendix G). Setbacks will restrict the buildable area. In addition to municipal ordinances, the Pollution Prevention Criteria Sec. 34-913 of the

1. Introduction

SAWS Water Quality Ordinance requires buffers adjacent to streams in the recharge and contributing zones.

Planning and assessment must also include identifying easements on the site. Easements that could be present are a road or sidewalk (right-of-way) easement; a public utility easement that allows a utility to run gas, water, sewer or power lines through a private property; or a railway easement. Local utilities departments (e.g., electric, wastewater) should be consulted to determine whether utilities are above or below ground and the required distance that site disturbance should be maintained from any utilities present. Easements on a site can be determined by consulting as-built drawings and records research; these should be included on site drawings as illustrated in Figure 1-9.

Identify targeted pollutant and flow alteration needs

Section 30 of the Texas Administration Code (TAC) Chapter 213.5 includes a water quality performance standard that requires development in the Edward Aquifer Recharge or Transition Zone to design, construct, operate, and maintain permanent BMPs to remove 80 percent of the incremental increase in the annual mass loading of total suspended solids (TSS) from the site caused by the regulated activity. This Chapter also requires any development with more than 20 percent impervious cover to implement permanent BMPs. Those sites with less than 20 percent impervious are subject to local regulations that presently do not include water quality treatment for small storms.

The Texas Commission on Environmental Quality identifies impaired water bodies in the state that warrant attention and additional resources (see the *San Antonio River Basin Clean Rivers Program 2012 Basin Highlight Report and Watershed Characterization for Selected Watersheds* at http://www.sara-tx.org/public_resources/library/documents/water_quality_monitoring/2012_Watershed_Characterization_Report-final.pdf [San Antonio River Authority and Texas Clean Rivers Program 2012]). For impaired waters that fail to meet the Texas Surface Water Quality Standards defined in 30 TAC Chapter 307, Texas Commission on Environmental Quality requires development of total maximum daily loads (TMDLs) that identify the pollutant load reductions needed to meet water quality standards. Implementation plans for TMDLs are then developed, which often target pollutants by requiring the incorporation of BMPs; implementing LID offers an effective tool to improve water quality in these water bodies (USEPA 2009). For that reason, site planners should identify any impaired water or waters near or downstream of the site and determine the pollutants of concern to allow planners and designers to consider target pollutant reduction needs in the design phase.

Step 2: Define Natural Site Features

Site planners and designers should consider how to use existing natural features of the site in an effort to retain natural hydrologic functions and potentially reduce the cost of drainage infrastructure (see Appendix G for LID cost considerations). Identifying natural or sensitive areas is an integral factor in defining the site area for development and placing site needs and features in the context of the overall watershed.

To Complete Step 2:

- Identify natural areas to be conserved or restored
- Conduct a geotechnical survey including drainage characteristics, hydrologic flow paths, and soil infiltration tests

Naturally functioning areas

To enhance a site's ability to support source control and reduce runoff, natural areas that can infiltrate stormwater should be identified in the site design process and conserved or restored. These areas can intercept stormwater without engineered controls, thereby reducing the amount of runoff and the size and extent of drainage infrastructure. Such natural features can result in cost savings due to decreased infrastructure costs.

The following are fundamental principles encouraging conservation and restoration of natural areas:

- Minimize site grading and the area of disturbance by isolating areas where construction will occur (See Step 5). Doing so will reduce soil compaction from construction activities. Additionally, reduced disturbance can be accomplished by increasing building density or height.
- When possible, the site should be planned to conform to natural landforms and to replicate the site's natural drainage pattern. Building roads and sidewalks on the existing contour ensures that natural flow paths and hydrology continue to function.
- An essential factor in optimizing a site layout includes conserving natural soils and vegetation, particularly in sensitive areas such as habitats of sensitive species, wetlands, existing trees, hillsides, conservation areas, karst features, and existing water bodies. Such areas can be used as natural features in site planning to avoid or reduce potential effects of development. Wetlands, for example, provide habitat for several sensitive species, and off-site mitigation does not always provide the same type or quality of habitat.
- In areas of disturbance, topsoil can be removed before construction and replaced after the project is completed. When handled carefully, such an approach limits the disturbance to native soils and reduces the need for additional (purchased) topsoil later.
- Impervious areas (e.g., square footage of parking lots, sidewalks, and roofs) should be minimized by designing compact, taller structures; narrower streets; and using underground or under-building parking.

In the example shown in Figure 1-10, the natural and sensitive areas that should be considered for protection during development are identified on the site map, including wetlands, high-quality vegetation, and steep slopes (hillside).

Understand soils through geotechnical surveys

Any project that includes LID practices should include a soil evaluation or geotechnical investigation. A licensed engineer (P.E.) with geotechnical expertise, a licensed geologist, engineering geologist, hydrogeologist, or other licensed professional acceptable to the local jurisdiction should perform a detailed evaluation of soils, shallow ground water and bedrock conditions. A soil evaluation including soil infiltration testing is intended to identify and protect soils that provide greater infiltration as potential locations for LID BMPs (Figure 1-10). The presence and depth to the seasonal water table or shallow bedrock should also be identified, which will inform BMP design under Phase II. In addition, natural drainage characteristics and hydrologic flow paths should be identified. These features can be used in the design and protected in future steps to maintain the site's natural drainage characteristics.

1. Introduction

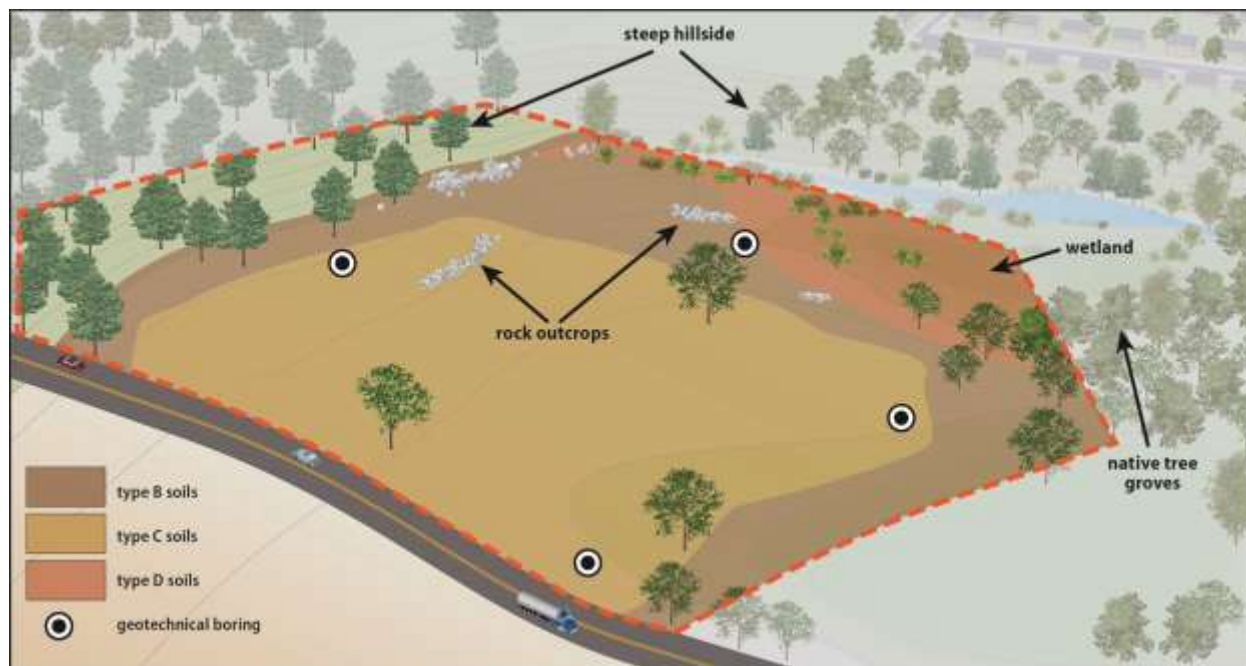

Figure 1-10. Protect natural and sensitive areas (wetlands, native tree groves, steep hillside) and conduct geotechnical survey to characterize infiltration capacity of soils.

Step 3: Protect Key Hydrologic Areas

Following the LID site planning concept of using hydrology as the integrating framework, the key hydrologic areas such as hydrologic flow paths and infiltrating soils are protected. To the extent possible, natural hydrologic functions of the site should be preserved. Applying LID techniques results in a hydrologically functional landscape that can function to slow runoff rates, protect receiving waters, and reduce the total volume of runoff.

To Complete Step 3

- Protect areas of natural hydrologic function
- Protect possible areas for infiltration

Second only to flow regimes in ensuring proper hydrology, healthy soils or media often serve as essential elements for achieving LID functions and providing source control for stormwater treatment. For example, upper soil layers are conducive to slowly filtering and storing stormwater, allowing unit processes such as infiltration, sorption, evapotranspiration, and surface retention to occur.

Site features that should be protected are riparian areas, floodplains, stream buffers, wetlands, and soils with infiltration potential. Using the information collected in the Step 2 soil evaluation, more specific locations of soils with greater infiltration rates that are near or on hydrologic flow paths should be protected to avoid or limit hydrologic impacts. As an example, Figure 1-11 indicates the key hydrologic areas that should be considered for protection. The blue area identified as an area for possible infiltration should be separated from other site features by surrounding it with construction fencing to prevent access and avoid compaction. In addition, the areas having a natural hydrologic function either through storage or conveyance should be protected (also see Figure 1-11 in setting site clearing and grading limits).

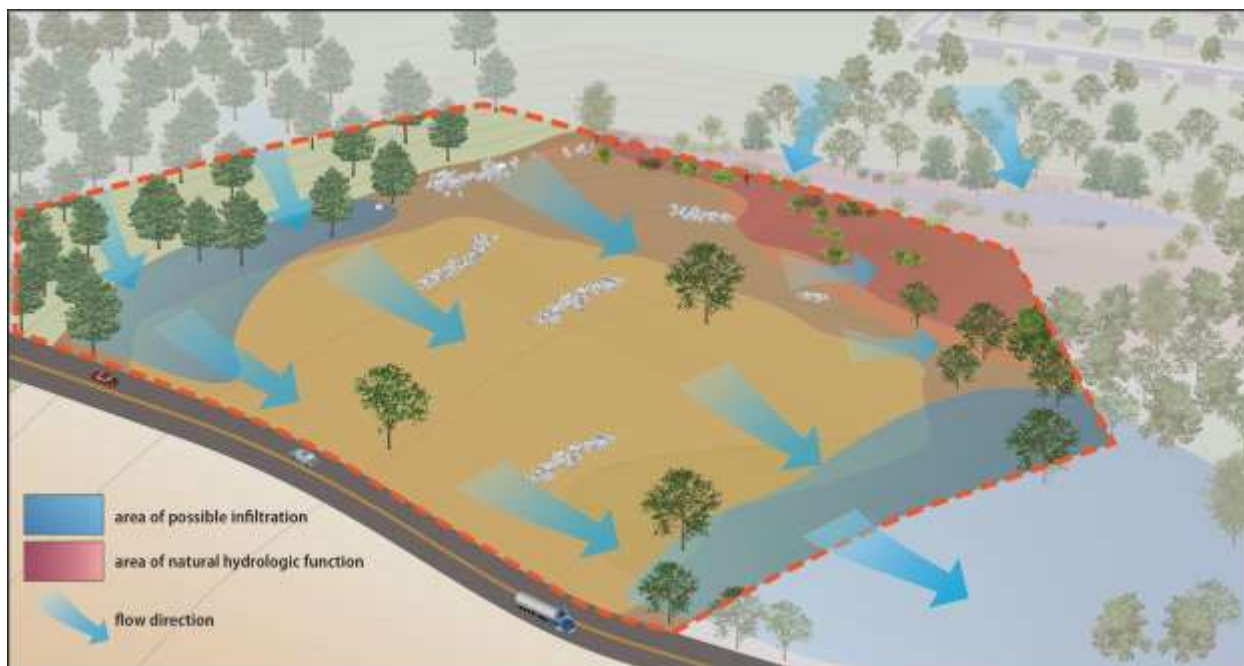

Figure 1-11. Identify and protect key hydrologic areas, such as infiltrating soils (blue area) and wetlands (orange areas).

With the conclusion of Phase I, the initial site assessment has been completed. The decisions made regarding LID practices during the site assessment process should be documented to ensure that if changes are required in future Phases II and III, the original design ideas are available for reference. That helps ensure that LID concepts are considered during every component of project site planning. Phase II of site planning, described below, results in a preliminary design plan.

1.6.2 Phase II—Preliminary Design

The result of the second phase of site planning is a completed preliminary design done by conducting Steps 4 through 7, below. Working through those steps is an iterative process for designing a preliminary plan that implements LID concepts as fully as possible.

Step 4: Use Drainage and Hydrology as a Design Element

Natural hydrologic functions (e.g., flow paths) should be included as a fundamental component of the preliminary design. Naturally present functions should be retained, or if that is not an option, replicate natural functions with appropriate BMP placement.

Spatial site layout options

Natural hydrologic functions, including interception, depression storage, and infiltration, should be distributed throughout the site to the extent possible. In conserving predevelopment and retrofit hydrology, runoff volume, peak runoff rate, flow frequency and duration, and water quality control must

To Complete Step 4:

- Identify the spatial layout of the site using hydrologic flow paths and natural drainage as a feature
- Determine approximate locations for infiltration and conveyance BMPs

1. Introduction

be considered. Rainfall abstractions are the physical processes of interception, evaporation, transpiration, infiltration, and storage of precipitation.

Runoff flow frequency and duration should try to mimic predevelopment conditions by implementing practices to minimize runoff volume and rate. LID practices also provide pollutant removal processes that enhance water quality treatment for the designed treatment volume.

By setting the development envelope back from natural drainage features, the drainage can retain its hydrologic functions and its water quality benefit to the watershed as shown in the example in Figure 1-12, assuming that runoff from the contributing watershed is mitigated to predevelopment conditions.

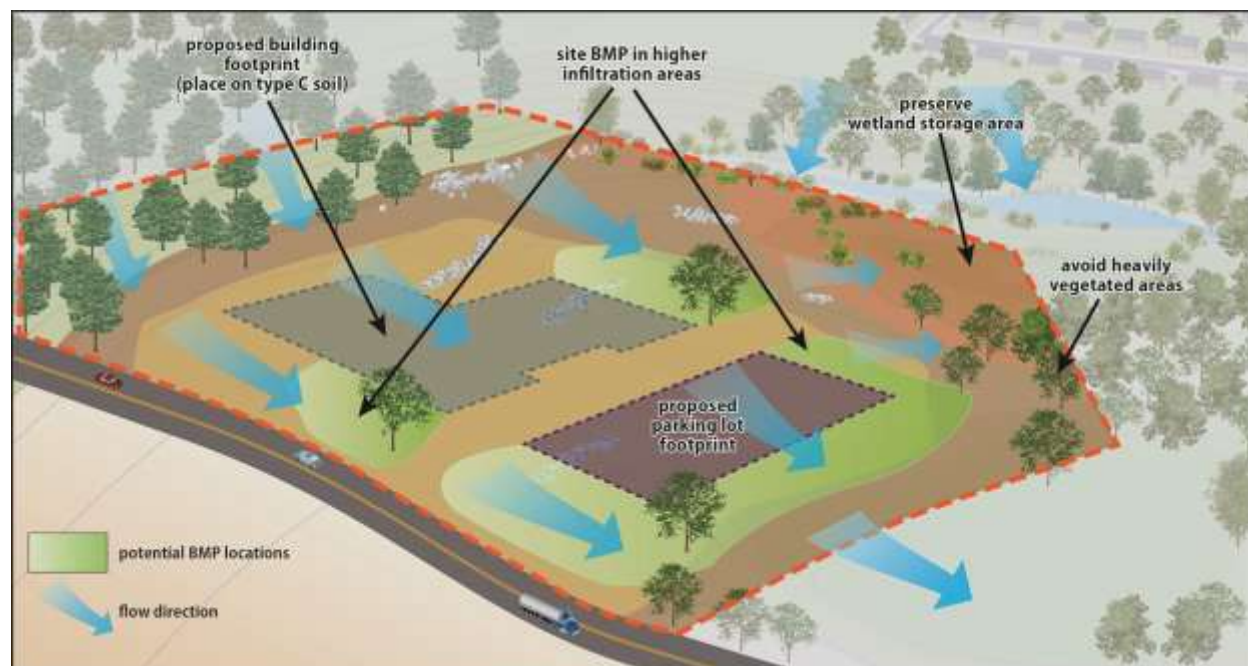

Figure 1-12. Identify ideal locations for LID implementation according to site conditions.

Spatial layout should use the natural landforms and hydrologic flow paths identified in Step 2 as a major design element of the site. Common elements using that premise include designing open drainage systems to function as both treatment and conveyance devices. Impervious elements such as parking lots, roadways, and sidewalks can be designed on the existing contour to minimize effects on the natural hydrologic flow path.

Determine potential BMP locations

Stormwater management practices can be designed to achieve water quality and flood protection goals by applying four basic elements, alone or in combination: infiltration, retention/detention, filtration, and evapotranspiration.

Infiltration systems should be designed to match predevelopment hydrology and to infiltrate the majority of runoff from small storm events, when applicable and to the extent possible. Existing site soil conditions generally determine whether infiltration is feasible without soil amendments or underdrains. Other site conditions that preclude infiltration are high ground water

Stormwater management practices can be designed to achieve water quality and flood protection goals by applying four basic elements: infiltration, retention/detention, filtration, and evapotranspiration.

tables, steep slopes, or shallow bedrock. Infiltration systems can also help control peak flow rates by providing retention and volume control.

Retention/detention systems are intended to store runoff for gradual release or reuse. Retention/detention basins also allow for evaporation of runoff and evapotranspiration by plants. They are most appropriate where soil percolation rates are low or where longer retention times are designed into the system. They are also appropriate when designing to control peak flow rates for downstream flood and channel protection.

Biofiltration devices are designed using vegetation to achieve low-velocity flows, to allow settling of particulates and filtering of pollutants by vegetation, rock, or media. Pollutant degradation can also occur through biological activity and sunlight exposure. Biofilters can be designed to be linear features that are especially useful in treating runoff from parking lots and along highways.

Evapotranspiration is inherent in all BMP systems. Evaporation is maximized in systems that retain or detain runoff, and vegetated systems maximize transpiration as plants use the stored water for growth.

Selecting the appropriate structural BMPs for a project area should be on the basis of site-specific conditions (e.g., land availability, slope, soil characteristics, climate condition, and utilities) and stormwater control targets (e.g., peak discharge, runoff volume, or water quality targets).

In the example shown in Figure 1-12, areas are identified that will be developed for parking and building footprints. The figure also indicates ideal locations where LID BMPs can be placed (such as a biofiltration swale and bioretention) and can be incorporated into the natural drainage paths to function as conveyance and treatment LID BMPs. The infiltration opportunities identified in Figure 1-11 suggest that the blue oval near the road (Figure 1-12), which is on hydrologic soil group C, would be more suitable for a biofiltration BMP, while much of the rest of the potential BMP area is on hydrologic soil group B, indicating that this area would be better for infiltration systems. Note that both biofiltration and infiltration BMPs can also meet landscaping requirements and create features that enhance and beautify the site.

Step 5: Establish Clearing and Grading Limits

Limits of clearing and grading refer to the total site area that is to be developed, including all impervious and pervious areas. The area of development ideally should be in less sensitive locations with respect to hydrologic function and should be outside protected areas and areas containing setback regulations, easements, and utilities.

To Complete Step 5:

- Define the limits of clearing and grading
- Minimize disturbance to areas outside the limits of clearing and grading

Site fingerprinting refers to site clearing and development with minimal disturbance of existing vegetation and soils. Such techniques include reducing paving and compaction of highly permeable soils, minimizing the size of construction easements and material storage areas, site clearing and grading to avoid tree removal, delineating and flagging the smallest site disturbance area possible, and maintaining existing topography to the extent possible. Figure 1-13 illustrates the use of orange construction fencing to preserve the natural features, drainage pathways, and maintain infiltration on suitable soils at the example site as identified in previous steps.

1. Introduction

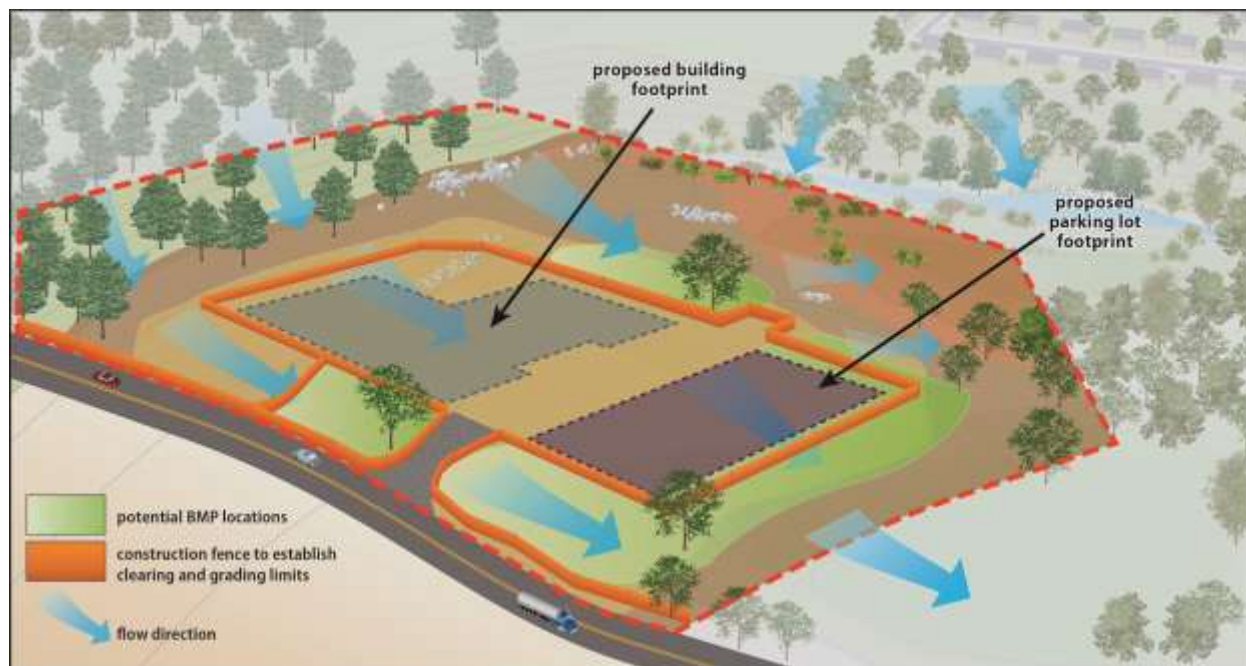

Figure 1-13. Establish grading envelope to protect natural areas and infiltrating soils.

Step 6: Reduce/Minimize Total and Effective Impervious Area

Rainfall that does not infiltrate or pool where it falls results in runoff. As the imperviousness of the site increases, runoff also increases with each acre of impervious cover producing approximately 27,150 gallons of stormwater for each inch of rainfall.

Predevelopment runoff, measured as a runoff coefficient or the ratio of runoff volume to the total amount of rainfall, can be maintained by compensating for increases in impervious areas, soil compaction, and the loss of abstraction through planning and design. Such tools can be used to also manage the peak runoff rate and volume and protect water quality.

To Complete Step 6:

- Investigate the potential for impervious area disconnection
- Evaluate the conceptual design to reduce impervious surfaces

Disconnect impervious area

Diverting stormwater runoff from impervious areas such as rooftops and pavement to adjacent pervious areas can be used to infiltrate stormwater runoff and to reduce flow rates (shown in Figure 1-13). Proper design can align pervious surfaces with building drainage. Such a technique is also referred to as impervious area disconnect.

To reduce the storage and conveyance requirements, the directly connected impervious area of the site should be minimized to the extent practicable. That can be accomplished by increasing the building density by increasing the vertical extent and minimizing the horizontal extent. Impervious area disconnect can also include using permeable features instead of impermeable including permeable pavement for walkways, trails, patios, parking lots, and alleys; and constructing streets, sidewalks, and parking lot aisles to the minimum width necessary.

Possible locations for impervious area disconnect techniques are shown in Figure 1-14 below in yellow. As shown in the figure, the medians along either side and in the middle of the roadway provide vegetated pervious areas for minimizing or reducing the impacts associated with the total impervious area and for infiltration and filtration processes to take place. The figure also demonstrates the use of pervious pavement in the parking lot and along the roadway (in red).



Figure 1-14. Site example demonstrating placement of pervious material (red) and opportunities to minimize connected impervious area (yellow).

Minimize impervious area

Street layouts often can be designed to reduce the extent of paved areas, and street widths can be narrowed to decrease the total impervious area as long as applicable street design criteria are satisfied. Eliminating curbs and gutters along streets and including curb cuts around parking areas, where consistent with city standards and where appropriate, can promote drainage to on-site pervious areas and decrease directly connected area considerably. Other options include replacing curbs and gutters with roadside vegetated swales and directing runoff from the paved street or parking areas to adjacent LID facilities. Such an approach for alternative design can reduce the overall capital cost of the site development while addressing stormwater quantity and quality issues and improving the site's aesthetic values. Figure 1-14 illustrates the inclusion of pervious paving and bioretention systems with curb cuts along the street right-of-way to demonstrate locations where that can be achieved.

Specific examples of alternative transportation options include narrow paved travel lanes, consolidated travel lanes, increased green parking areas, and horizontal deflectors (chicanes) or intersection pop-outs. Such options can be included for other multi-beneficial purposes such as traffic calming and pedestrian safety (Ewing 1999), increased parking spaces, and improved aesthetics. Four examples of transportation alternatives are described below.

Narrowed travel lanes: Narrow travel lanes can help reduce impervious area and infrastructure costs, calm traffic in pedestrian-oriented areas, and create room for stormwater facilities. Existing roadways can

1. Introduction

be narrowed to minimum widths in accordance with established roadway standards. Residential street crossings are often combined with traffic-calming measures, which reduce street width and are designed to maintain low vehicle speeds, such as raised crosswalks, chicanes, and gateway narrowing.

Consolidated travel lanes: Consolidating travel lanes or converting unused pavement next to travel lanes into landscape areas can result in reduced imperviousness. The increased landscape space could be used for stormwater facilities and create space for bike lanes, wider sidewalks, and a more balanced and vibrant streetscape. Parking lanes can also be converted to permeable paving that can be used for stormwater management.

Increased green parking: Techniques used to reduce the total impervious coverage and consequential runoff from parking lots are broadly referred to as *green parking*. Green parking techniques include minimizing the number and dimension of parking stalls, using alternative pervious pavers wherever suitable, incorporating stormwater BMPs such as depressed bioretention islands into parking lot designs, encouraging shared parking and incentivizing structured parking (Figure 1-14). When implemented together, green parking alternatives reduce volume and the mass of pollutants generated from parking lots, reduce the urban heat island effect, and enhance a site's aesthetics.

Intersection deflectors (chicane): A chicane is a traffic channelization that causes a series of tight turns in opposite directions in an otherwise straight stretch of road (City of San Antonio 2013). The combination of narrowed street width and the serpentine path of travel slow traffic (Figure 1-15). On new streets, chicanes narrow the street by widening the sidewalk or landscaped parkway. On streets considered for retrofit, raised islands can be installed to narrow the street. Advantages of chicanes include reduced traffic speeds, opportunities for landscaping, and created spaces for stormwater management facilities. Chicanes are inappropriate for use on streets classified as collector or higher, bus routes, emergency response routes, where there is a grade that exceeds 5 percent, or where stopping sight distance is limited such as at the crest of a hill.



Kansas City, Missouri Source: Tetra Tech

Figure 1-15. Bioretention incorporated into a pop-out.

Intersection pop-outs: Intersection pop-outs are curb extensions that narrow the street at intersections by widening the sidewalks at the point of crossing. They are used to make pedestrian crossings shorter and reduce the visual width of long, straight streets (Figure 1-16). Where intersection pop-outs are constructed by widening the landscaped planting strip, they can improve the aesthetics of the neighborhood and provide more opportunities for stormwater controls at the site by facilitating interception, storage, and infiltration. Intersection pop-outs should be designed to properly accommodate bicyclists, transit vehicles, and emergency response vehicles. Intersection pop-outs can be installed on local streets; however, pop-outs are inappropriate on major streets and primary arterials.



Friday Harbor, San Juan Island, Washington Source: Tetra Tech

Figure 1-16. Example of an intersection pop-out.

Many LID street design features can have multiple benefits in addition to stormwater benefits. The San Antonio Complete Streets Initiative, developed in 2011, includes a provision that states, “San Antonio will encourage green infrastructure and LID principles on Complete Streets to help manage stormwater runoff and provide landscaping amenities” (City of San Antonio 2011). Complete Streets offer opportunities to incorporate stormwater BMPs while enhancing safety and convenience for pedestrians, bicyclists, individuals with disabilities, seniors, and users of public transportation.

Reduced width of road sections can also reduce total site imperviousness. Streets, sidewalks, and parking lot aisles should be constructed to the minimum width possible without compromising public safety and access. Additionally, sidewalks and parking lanes can be limited to one side of the road.

Traffic or road layout can significantly influence the total imperviousness of a site plan. Selecting an alternative road layout can result in a sizeable reduction in total site imperviousness. Alternative road layout options that can reduce imperviousness from the traditional layout pattern use queuing lanes,

1. Introduction

parking on only one side of the street, incorporating islands in cul-de-sacs, and using alternative turn areas that require less pavement (CWP 1998).

Other transportation opportunities for reducing impervious area include using shared driveways, limiting driveway widths to 9 feet and using driveway and parking area materials that reduce runoff and increase the time of concentration (e.g., grid systems and paver stones).

Several iterations of manipulating site imperviousness can be done to consider natural features, areas of infiltration, and hydrologic pathways to best achieve a balance between necessary imperviousness with disconnected and pervious site features. Once the total area of imperviousness has been minimized, the impervious areas can be incorporated into the site plan or capital improvement roadway project.

In Figure 1-14 opportunities for imperviousness reduction and runoff disconnection were identified for both the building site and for alternative transportation options. The sidewalk surrounding the building was disconnected by routing runoff to the pervious landscaped areas surrounding the building (shown in yellow) and pervious paving was identified in the low-traffic areas of the parking lot to reduce site imperviousness. Pervious paving was also identified as an opportunity for reduction in impervious area for on-street parking (shown in red) and a median bioswale along with right-of-way bioretention were identified as methods for runoff disconnection (shown in yellow).

Step 7: Determine LID BMPs

LID BMPs employ a number of processes: settling/sedimentation, filtration, sorption, photolysis, biological processes (bioaccumulation and biotransformation/phytoremediation), and chemical processes (for complete descriptions, see Section 3.3) for pollutant removal. In addition to pollutant removal, LID BMPs provide hydrologic controls by reducing peak flows and volume through processes of infiltration, evaporation, and storage and reproducing predevelopment hydrologic functions.

To Complete Step 7:

- Determine potential BMPs according to hydrologic and pollutant removal process needs and cost estimates (see Chapter 3)
- Repeat Steps 4 through 7 as necessary to ensure that all stormwater management requirements are met

During BMP selection, it is important to consider a BMP's unit processes to ensure that the management practice will provide the necessary benefits and avoid potential complications.

Hydrologic controls dictate how incoming stormwater is partitioned into the various components of the hydrologic budget. Stormwater volume can be detained, infiltrated, evapotranspired, drained, or bypassed depending on the design of hydrologic controls and features such as impermeable liners, underdrains, inlet and outlet structures, soil media permeability, and storage capacity.

Settling/sedimentation is the physical process of particle separation as a result of a difference in density between the solids and water. Most BMPs use settling to some degree, especially through detention or retention practices such as bioretention. Settling is enhanced by slowing down or spreading out runoff to create low velocity flow conditions.

Filtration is the physical process of separating solids from a liquid media; particles are filtered from water by the smaller interstitial space the water flows through in the porous medium. Sedimentation and sorption can also occur as water passes through a filtering practice. *Sorption* refers to the processes of *absorption* (an incorporation of a pollutant into a substance of a different state) and *adsorption* (the

adherence of a pollutant to the surface of another molecule). Sorption is also referred to under chemical treatment processes. Filtration is a common unit process in a number of BMPs such as bioretention and planter boxes.

Floatation is a treatment unit process where the mechanism for pollutant removal is opposite to that in settling and sedimentation. In floatation, the density of pollutants, such as trash and petroleum, is less than that of water. Oil/water separators and trash guards are the primary BMP practices that use floatation.

Biological treatment processes (bioaccumulation, biotransformation, phytoremediation) are processes that occur in practices that incorporate soils and plants for pollutant removal via biological transformation or mineralization, pollutant uptake and storage, or microbial transformation. It can also include organisms that consume bacteria. BMPs that can be designed to use such unit processes are bioretention, bioswales, and planter boxes.

Chemical treatment processes include sorption, coagulation/flocculation, and disinfection. Chemical characteristics of stormwater such as pH, alkalinity, and reduction-oxidation (redox) potential, determine which chemical process is appropriate. Sorptive BMPs generally include engineered media for removing pollutants of concern. Precipitation and disinfection processes require actively adding chemicals to encourage coagulation/flocculation and precipitation or chemicals such as chlorine to mitigate pathogenic microbes in stormwater. Chemical treatment processes are usually employed as end of pipe solutions where no other BMP can effectively treat an existing storm drain system. In these cases, low flow may be more effectively treated by pumping into a sanitary sewer.

Using multiple treatment processes either in individual or multiple BMPs is called a *treatment train*. Meeting targeted treatment objectives can usually be achieved using a series of LID BMPs in a treatment train. Treatment trains can often be designed along rights-of-way, in parking lots, underground, or incorporated into landscaped areas. LID site planning should result in a treatment train of LID strategies and BMPs to meet treatment and water quality goals. For further details on treatment train BMP implementation, see Section 3.3.

Using multiple treatment processes either in individual or multiple BMPs is called a treatment train.

A number of factors should be considered for choosing appropriate BMPs for a site. For example, the presence of group C or D soils on a site might preclude the use of an infiltration BMP or require the use of an underdrain into the design of infiltration BMPs (see Appendix B, Section 11.4). Additionally, the low level of precipitation and high evapotranspiration rates usually present in San Antonio would likely exclude the use of a BMP requiring a permanent pool, such as a stormwater wetland, because precipitation is not great enough to maintain a continual or permanent pool of water. Native vegetation, which is adapted to the local climate and soils, should be used for vegetated BMPs, as much as possible, when soils allow. If native soils are replaced with imported soils to improve infiltration, non-native non-invasive but drought-tolerant plants might be a desired choice. For a table of appropriate vegetation, see Appendix E. Other geotechnical, site-specific considerations include the level of the underlying water table and bedrock, any existing infrastructure in retrofit designs, and the presence of areas of concern that exhibit soil and ground water contamination.

The information gathered and organized during Steps 1–6 provide the foundation for selecting BMP types that are most appropriate to meet the stormwater management needs of the site. Chapter 3 of this manual summarizes information about specific LID BMPs and provides thorough guidance on selecting appropriate LID BMPs for a site. Table 3-1 succinctly summarizes the selection criteria and should be consulted to assist in the process. Additionally, Appendix B provides substantial detail about BMP applicability and design requirements and can be referenced during the process.

1. Introduction

At the completion of Phase II, the site planning for the project is complete. At that point in the site planning process, the development area should be delineated and the approximate type and potential locations for appropriate BMPs should be identified. The preliminary plan should be documented in addition to the decisions that were made in developing the preliminary plan for future reference and to ensure that the LID planning concepts are carried through to project construction. After the preliminary design is completed, the final design is achieved through identifying the appropriate LID facility type and size for meeting stormwater management needs and requirements.

The example shown in Figure 1-17 indicates the approximate type and locations of potential stormwater management practices. The type, size, or location could change according to site construction or other site design changes and requirements.

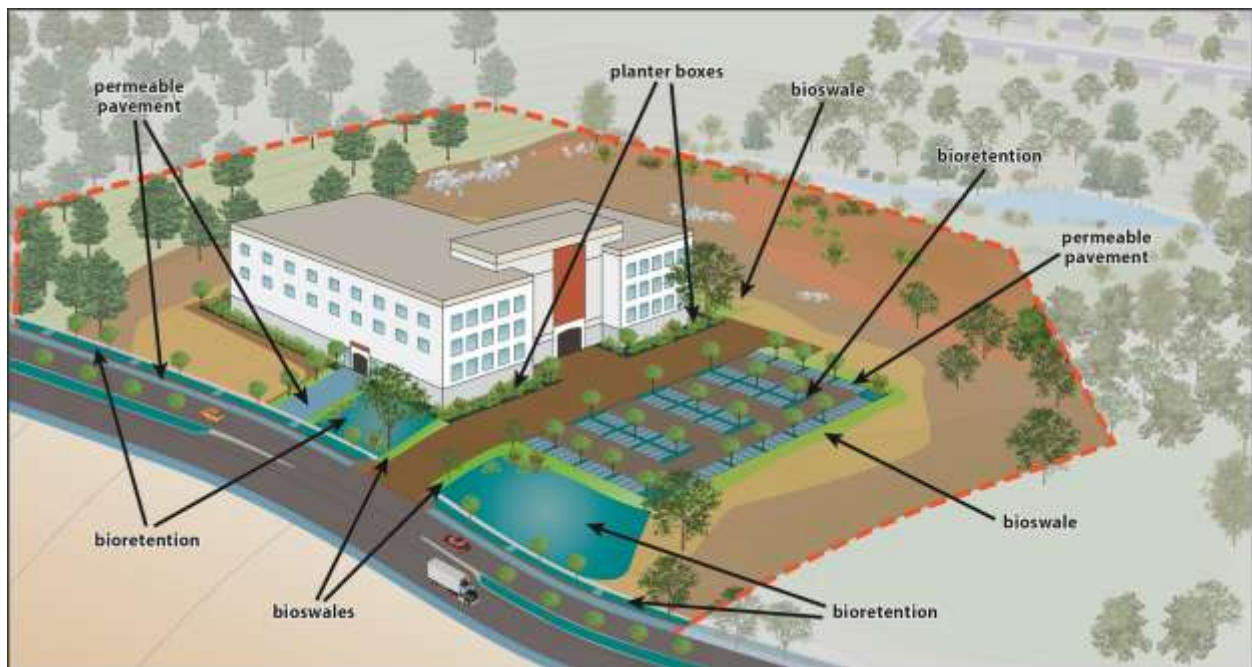

Figure 1-17. Site plan indicating all possible BMP locations (blue areas) and types (annotated).

Results of Phase II

The analyses in Phase II should produce a preliminary site plan that includes:

- Hydrologic flow paths and natural drainage features (Step 4)
- Locations where infiltration and conveyance features could be located (Step 4)
- Limits of clearing and grading (Step 5)
- Results of an impervious area reduction analysis (e.g., parking area reduction, permeable pavement options) (Step 6)
- Candidate BMPs (see Chapter 3) and their approximate locations (Step 7)

1.6.3 Phase III—Determine Low Impact Development Final Design

Step 8: Determine Approximate Size of LID BMPs

The level of control that is required for a site to achieve stormwater management goals can be determined through a site-specific hydrologic evaluation. The hydrologic evaluation is performed using hydrologic modeling and analysis techniques. A stepwise process is followed to conduct a hydrologic evaluation:

1. Delineate the watershed and subwatershed areas.
2. Define the design storm (for BMP sizing guidance, refer to Appendix A and the “Size the System” subsections of Appendix B).
3. Determine the type of model to be used.
4. Collect data for predevelopment conditions.
5. Using hydrologic models, evaluate predevelopment, baseline conditions.
6. Using hydrologic models, evaluate the hydrologic benefits from decreasing and disconnecting impervious areas, and compare the benefits to baseline conditions.
7. Using hydrologic models, evaluate the hydrologic control from implementation of one or more LID BMPs.

To Complete Step 8:

- Determine the approximate BMP size using the BMP sizing tool (Appendix A)

Step 9: LID Final Design

Following iterations of Steps 4–7 and BMP sizing in Step 8, additional conventional stormwater control techniques can be added to the site as necessary to meet site drainage and other requirements (Figure 1-18). Review of the earlier documentation of decisions made during planning phases should also be conducted to ensure that the intent of the LID planning principles were carried through to the final design. The iterative review process can result in more or less area required for stormwater management. Notice that in Figure 1-18, the iterative process resulted in the elimination of planter boxes at the base of the building as the other LID BMPs provided the required volume of capture.

To Complete Step 9:

- Integrate conventional stormwater management needs
- Verify that geotechnical and drainage requirements have been met
- Complete BMP designs such as finish details and notes
- Complete the site plans

The key to finalizing the BMP design process is to consult the design instructions for the selected BMP types in Appendix B of this manual. By following those instructions and using the example engineering drawing templates in Appendix C, the designer can develop final details, plan views, cross sections, profiles, and notes. The example shown in Figure 1-18 illustrates the final site layout, including the properly sited and sized BMP locations.

1. Introduction



Figure 1-18. Completed site plan including iterations of Steps 4–7 and BMP sizing completed.

Completing Step 9 concludes Phase III of the design process. Chapter 4 provides important considerations for the design, construction, and operation of the chosen BMPs, including BMP construction, inspection, and operation and maintenance.

1.7 Multiple Benefits of LID

Proper stormwater management achieves several important purposes for municipalities and developers. Restoring predevelopment hydrology and realizing associated water quality benefits are of primary importance, particularly with respect to stormwater pollution effects on aquatic life habitats. Degraded water quality will also negatively affect or restrict recreational opportunities by limiting contact with surface waters and reducing recreational fishing opportunities. Loss of these recreational resources in the San Antonio region can negatively impact local economics and the quality of life for San Antonio residents. Another factor to consider is that local drinking water supplies rely heavily on ground water recharge and can be impacted by poor surface water quality.

Considerable cost savings over traditional approaches often can be achieved through proper stormwater management and LID implementation.

In addition to reducing flood hazards (Medina et al. 2011) and protecting and enhancing water quality (USEPA 2009), stormwater management systems or programs should be designed to comply with federal and state regulatory requirements. Relevant regulations are discussed in Chapter 2 and Appendix G. Ancillary to the direct water pollution benefits of LID, these practices can reduce the cost of TMDL implementation incrementally. Where stormwater fees are levied, green infrastructure can reduce the cost to implement the stormwater management program because the amount of stormwater needing treatment on a regional scale is reduced.

Considerable cost savings over traditional approaches often can be achieved through proper stormwater management and LID implementation. For example, LID practices typically involve less construction material, replacing structures such as pipes with natural materials (plants, soils), and have been found to

reduce the overall cost of stormwater management (USEPA 2012b). Additionally, maintaining LID BMPs at the surface is typically less expensive than subsurface storage units or conveyance pipes. **Finally, controlling stormwater runoff and associated pollutants on-site decreases the costs of mitigation and restoration activities.**

From a life cycle perspective, the long-term costs of maintenance and replacement can be lower for LID practices because their vegetation becomes enhanced as it grows over time, whereas traditional engineered materials tend to deteriorate over time. Also, LID maintenance typically does not require heavy equipment or specialized expertise, whereas maintaining pipes, forebays, basins, and embankments can be more costly.

The visible, above-ground and accessible qualities of LID practices provide additional benefits when compared to traditional drainage infrastructure.

The visible, above-ground and accessible qualities of LID practices provide additional benefits when compared to traditional drainage infrastructure, including educating the public, creating habitat for wildlife, improving air quality, improving aesthetics, and offering recreational opportunities (CNT 2010). Because of its visible nature, LID offers enhanced public education opportunities, especially when signage is used to inform viewers of the features and functions of the various types of facilities.

Vegetated LID practices can provide air quality benefits, particularly those that incorporate trees. Trees absorb air pollutants, notably carbon dioxide (CO₂) but also nitrogen dioxide (NO₂), ground-level ozone (O₃), sulfur dioxide (SO₂), and particulate matter that is 10 µm or smaller (PM-10). Green infrastructure's ability to sequester carbon in vegetation can help to meet greenhouse gas emission goals by contributing to a carbon sink (CNT 2010).

Trees create shade that reduce indoor air temperatures and reduce the demand for energy for cooling. This yields direct cost savings to electricity consumers and, through reduced electricity demand, reduces air pollution emissions from electricity generation. Reduced emissions of air pollution benefits human health through lowered incidence and severity of respiratory ailments and reduces costs associated with air quality regulation compliance (ECONorthwest 2011).

Green infrastructure that includes trees and other vegetation can reduce the urban heat island effect, which is the phenomenon of urban area temperatures that are several degrees higher than surrounding rural land uses. The U.S. EPA (2012b) indicates that annual mean air temperature can be 1.8 °F to 5.4 °F higher in urban centers and up to 22 °F higher in the evening. Tree cover does not absorb heat like pavements do, and trees reduce temperatures through shading and evapotranspiration. Reducing urban heat islands through tree planting achieves energy reduction (reduced need for cooling, along with the ancillary benefits described above) and can reduce the incidence and severity of heat-related illnesses.

Green infrastructure that includes attractive vegetation can improve property aesthetics, which can translate into increased property values (Table 1-1). This vegetation also provides habitat for urban wildlife, particularly birds and insects, even at small scales of implementation. Larger-scale facilities that include public access, such as constructed wetlands, offer recreational opportunities (e.g., fishing, bird-watching) as well as habitat for wildlife and water quality/quantity improvements.

1. Introduction

Table 1-1. Studies showing increased property values related to LID and open space

Source	Percent increase in property value	Notes
Ward et al. (2008)	3.5 to 5%	Estimated effect of green infrastructure on adjacent properties relative to those farther away in King County (Seattle), WA.
Shultz and Schmitz (2008)	0.7 to 2.7%	Referred to effect of clustered open spaces, greenways and similar practices in Omaha, NE.
Wachter and Wong (2008)	2%	Estimated the effect of tree plantings on property values for select neighborhoods in Philadelphia.
Anderson and Cordell (1988)	3.5 to 4.5%	Estimated value of trees on residential property (differences between houses with five or more front yard trees and those that have fewer), Athens-Clarke County (GA).
Voicu and Been (2008)	9.4%	Refers to property within 1,000 feet of a park or garden and within 5 years of park opening; effect increases over time
Espey and Owasu-Edusei (2001)	11%	Refers to small, attractive parks with playgrounds within 600 feet of houses
Pincetl et al. (2003)	1.5%	Refers to the effect of an 11% increase in the amount of greenery (equivalent to a one-third acre garden or park) within a radius of 200 to 500 feet from the house
Hobden, Laughton and Morgan (2004)	6.9%	Refers to greenway adjacent to property
New Yorkers for Parks and Ernst & Young (2003)	8 to 30%	Refers to homes within a general proximity to parks

Some evidence exists that residents' health and well-being are improved by the presence of larger-scale green space that offers recreational opportunities (Stratus Consulting 2009). Riparian area improvements that enhance stream stability can include recreational trails for walking, running, and biking. Also, creation of parks, green space, and plaza space into which green infrastructure can be integrated can create gathering spaces for local residents.

Green infrastructure can be used in concert with public safety measures to enhance walkability. Green streets that include curb pop-outs at pedestrian crossings improve pedestrian safety by slowing traffic and decreasing the distance that pedestrians must travel in the roadway.

1.8 References

Anderson, L., and H. Cordell. 1988. Influence of Trees on Property Values in Athens, Georgia (USA): A Survey on Actual Sales Prices. *Landscape and Urban Planning* 15(1-2):153–164.

City of San Antonio. 2011. *San Antonio Complete Streets Policy*. <http://www.sanantonio.gov/planning/regionalplanning/completestreets.aspx>. Accessed February 14, 2013.

City of San Antonio. 2013. *Traffic Calming Handbook*. <http://www.sanantonio.gov/publicworks/pdf/TCHandbook2013.pdf>. San Antonio Department of Public Works. Accessed February 14, 2013.

- CNT (Center for Neighborhood Technology). 2010. *The Value of Green Infrastructure: A Guide to Recognizing its Economic, Environmental, and Social Benefits*. <http://www.cnt.org/repository/gi-values-guide.pdf>. Accessed November 23, 2012.
- CWP (Center for Watershed Protection). 1998. *Better Site Design: A Handbook for Changing Development Rules in Your Community*. Prepared for the Site Planning Roundtable by the Center for Watershed Protection, Ellicott City, MD.
- CWP (Center for Watershed Protection). 2004. *Urban Subwatershed Restoration Manual Series – An Integrated Framework to Restore Small Urban Watersheds, Manual 1*. Center for Watershed Protection, Ellicott City, MD.
- ECONorthwest. 2011. *Economic Benefits of Green Infrastructure: Chesapeake Bay Region*. ECONorthwest, Eugene, OR.
- Espey, M., and K. Owusu-Edusei. 2001. Neighborhood Parks and Residential Property Values in Greenville, South Carolina. *Journal of Agricultural and Applied Economics* 33(3):487–492.
- Ewing, R.H. 1999. *Traffic Calming: State of the Practice*. Publication: no. IR-098. Prepared by the Institute of Transportation Engineers, Washington, DC, for the U.S. Department of Transportation, Federal Highway Administration, Office of Safety Research and Development, McLean, VA, and Office of Human Environment, Washington, DC.
- FISRWG (Federal Interagency Stream Restoration Working Group). 1998. *Stream Corridor Restoration: Principles, Processes, and Practices*. GPO Item No. 0120-A; SuDocs No. A 57.6/2:EN 3/PT.653. ISBN-0-934213-59-3.
- Hobden, D., G. Laughton. and K. Morgan. 2004. Green Space Borders—a Tangible Benefit? Evidence from Four Neighborhoods in Surrey, British Columbia. *Land Use Policy* 21(2):129-138.
- MacRae, C. 1996. Experience from Morphological Research on Canadian Streams: is Control of the Two-Year Frequency Runoff Event the Best Basis for Stream Channel Protection? In *Effects of Watershed Development and Management on Aquatic Systems*, ed. L. Roesner. Proceedings of Engineering Foundation Conference, Snowbird, UT, August 4–9, 1996, pp. 144–160.
- Medina, D.E., J. Monfils, and Z. Baccala. 2011. Green Infrastructure Benefits for Floodplain Management: A Case Study. http://www.stormh2o.com/SW/Articles/Green_Infrastructure_Benefits_for_Floodplain_Manag_15593.aspx. Accessed June 21, 2013.
- New Yorkers for Parks and Ernst & Young. 2003. Analysis of Secondary Economic Impacts Resulting from Park Expenditures. New Yorkers for Parks, New York, NY.
- Pincetl, S., J. Wolch, J. Wilson, and T. Longcore. 2003. Toward a Sustainable Los Angeles: A —Nature’s Services Approach. USC Center for Sustainable Cities, Los Angeles, CA.
- Prince George’s County. 1999. *Low-Impact Development Design Strategies: An Integrated Design Approach*. Prepared by Prince George’s County, Maryland, Department of Environmental Resources, Programs and Planning Division, Largo, MD.

1. Introduction

- San Antonio River Authority and Texas Clean Rivers Program. 2012. *San Antonio River Basin Clean Rivers Program 2012 Basin Highlight Report and Watershed Characterization for Selected Watersheds*. http://www.sara-tx.org/public_resources/library/documents/water_quality_monitoring/2012_Watershed_Characterization_Report-final.pdf. Accessed June 25, 2013.
- Schueler, T. 1994. The importance of imperviousness. *Watershed Protection Techniques* 1(3):100–111.
- Shultz, S., and N. Schmitz. 2008. *How Water Resources Limit and/or Promote Residential Housing Developments in Douglas County*. University of Nebraska-Omaha Research Center, Omaha, NE.
- Stratus Consulting. 2009. *A Triple Bottom Line Assessment of Traditional and Green Infrastructure Options for Controlling CSO Events in Philadelphia's Watersheds*. Office of Watersheds, City of Philadelphia Water Department. Philadelphia, PA.
- USEPA (U.S. Environmental Protection Agency). 1999. *Preliminary Data Summary of Urban Storm Water Best Management Practices*. EPA-821-R-99-012. Office of Water, Washington, DC.
- USEPA (U.S. Environmental Protection Agency). 2004. *Storm Water Best Management Practice Design Guide: Volume 1, General Considerations*. EPA/600/R-04/121. U.S. Environmental Protection Agency, Washington, DC.
- USEPA (U.S. Environmental Protection Agency). 2005. *National Management Measures to Control Nonpoint Source Pollution from Urban Areas*. <http://water.epa.gov/polwaste/nps/urban/index.cfm>. Accessed June 20, 2013.
- USEPA (U.S. Environmental Protection Agency). 2007. *Reducing Stormwater Costs through Low Impact Development (LID) Strategies and Practices*. EPA 841-F-07-006. U.S. Environmental Protection Agency, Washington, DC.
- USEPA (U.S. Environmental Protection Agency). 2009. *Incorporating Low Impact Development into Municipal Stormwater Programs*. EPA 901-F-09-005. <http://www.epa.gov/region1/npdes/stormwater/assets/pdfs/IncorporatingLID.pdf>. Accessed June 2009.
- USEPA (U.S. Environmental Protection Agency). 2012a. *Costs of Low Impact Development, LID Saves Money and Protects your Community's Resources*. LID Barrier Busters Fact Sheet Series. EPA 841-N-12-003C. U.S. Environmental Protection Agency, Washington, DC.
- USEPA (U.S. Environmental Protection Agency). 2012b. *What is Green Infrastructure?* http://water.epa.gov/infrastructure/greeninfrastructure/gi_what.cfm. Last updated March 21, 2012. Accessed November 23, 2012.
- Voicu, I., and V. Been. 2009. The Effect of Community Gardens on Neighboring Property Values. *Real Estate Economics* 36(2):241–283.
- Wachter, S. and G. Wong. 2008. What is a Tree Worth? Green-City Strategies, Signaling and Housing Prices. *Real Estate Economics* 36(2):213-239.
- Ward, B., E. MacMullan, and S. Reich. 2008. *The Effect of Low-impact Development on Property Values*. ECONorthwest, Eugene, OR.

2 Regional Considerations

2.1 Physical Features and Climate

The San Antonio River basin is ecologically diverse, with portions of five of Texas' ten ecoregions: the Edwards Plateau (Hill Country), the Blackland Prairie, the Post Oak Savannah, the South Texas Plains, and the Gulf Coast Prairies and Marshes. Bexar County contains the largest portion of urban area of the four counties and is thus covered in more detail in this Manual. However, the guidelines provided in this Manual are applicable to all four counties. Bexar County elevations range from 600 feet above sea level in the southeast corner of the county to about 1,900 feet above sea level in the northwest extents. Elevations drop to 40 feet above sea level in Goliad County. Bexar County is bisected by the Balcones Escarpment, a geologic fault zone that divides the Edwards Plateau from the coastal plains. The escarpment also serves as a mild climatic influence by pooling moisture-laden air carried on the prevailing southeasterly winds from the Gulf of Mexico. Rainfall for the four counties averages 26 to 34 inches per year, according to mean annual precipitation data (1981–2010) from Oregon State University's PRISM Climate Group. According to TCEQ, more than three quarters of the annual rainfall volume is delivered by storms with less than 1-inch depth (TCEQ 2005). It is also common for little to no rainfall to occur for periods of 60–90 days, which creates significant plant stress. In this context, an understanding of soils, geology, topography, climate, native vegetation, and pre-development land cover and hydrology is necessary for optimizing application of LID.

2.1.1 Soils and Geology

One of the fundamental concepts of LID is to use the infiltration capacity of the native soils to the extent possible to mimic natural hydraulic conditions. This stormwater management concept is unique to LID design strategies where a smaller design storm (typically between 1 and 1.5 inches) is targeted. In contrast, current local development codes are geared toward conservative flow estimates that are used to size road and drainage infrastructure. The local regulatory focus on flood control is important because Bexar County is located in a region known as "Flash Flood Alley" (see <http://floodsafety.com/>). During the regulatory 1 percent annual chance design flood, infiltration capacity is much less significant given the runoff volume of the target storm. However, infiltration can have a significant impact in runoff volume reduction for the typical LID design storm, making actual soil type an integral design parameter.

One of the fundamental concepts of LID is to use the infiltration capacity of the native soils to the extent possible to mimic natural hydraulic conditions.

Bexar County soil types present a wide variety of opportunities and challenges for stormwater management. As described in previous sections, a site assessment to evaluate infiltration capacity will be required to determine the most appropriate location for BMPs and the most effective treatment train. This assessment must extend deep enough to determine whether shallow groundwater or rock layers will reduce infiltration capacity once surface soils are saturated. Site geotechnical analyses are further discussed in Chapter 4.

Bexar County soil characteristics vary widely from thin calcareous clays to deep sandy loams. Vegetation establishment in the Edwards Plateau region is particularly challenging because of soil loss. The region was developed through ranching because the land was difficult to plow. It is predominantly used for grazing cattle, sheep, goats, exotic game animals, and native wildlife (Griffith et al. 2004). Today, poor

2. Regional Considerations

quality forbs and grasses dominate much of the Edwards Plateau with juniper woodland being the dominant plant habitat of the region (TPWD no date). Juniper is particularly detrimental to the establishment of a good soil profile because its needles are toxic to native grass species that contribute to soil formation and stabilization through growth and die-off of deep root systems. Soil loss under and between juniper canopy results in less interception and infiltration of rainfall. In areas impacted by agricultural operations (including ranching) it is important to understand that pre-development hydrology likely produced less runoff than modern land cover. Watershed protection or restoration through LID can increase infiltration and improve groundwater resource availability.

Soils are classified into four hydrologic soil groups (HSG) by the Natural Resources Conservation Service (NRCS) on the basis of the soil's potential for runoff. The NRCS soil groups are as follows:

- Soil Group A: sand, loamy sand, or sandy loam, which have low runoff potential and high infiltration rates even when thoroughly wetted.
- Soil Group B: silt loam or loam, which have a moderate infiltration rate when thoroughly wetted.
- Soil Group C: sandy clay loam, which has low infiltration rates when thoroughly wetted.
- Soil Group D: clay loam, silty clay loam, sandy clay, silty clay, or clay, which have very low infiltration rates when thoroughly wetted.

Bexar, Wilson, Karnes and Goliad counties have high concentration of Group C and D soils (Figure 2-1). Group C and D soils are characterized by relatively low percolation rates and could present additional challenges for infiltration. Generalized soil maps produced by the NRCS can provide guidance on soil characteristics but infiltrating rain gardens have been used successfully in areas of Bexar County with soil labeled hydrologic soil group D. Areas with C and D soils require careful attention and often some variations to the typical standards for designing and implementing LID BMPs; underdrains or soil amendments could be required to increase infiltration or allow for filtration through a soil media, as discussed in Appendix B.

2.1.2 Aquifer Recharge Zones

Groundwater plays an important role in both baseflow maintenance and water supply throughout the region. The Trinity, Edwards, Carrizo-Wilcox, Queen City/Sparta and Yegua-Jackson aquifers all have recharge zones that outcrop at the surface. The Edwards Aquifer is particularly sensitive to surface water quality due to the fractured nature of the limestone that makes up the recharge and artesian zones (Figure 2-2). The limestone typically is covered by less than six inches of soil that can contain high fractions of clay. The permeability of the soils and the underlying rocks are highly variable depending on the site and proximity to faults and solution features. The TCEQ requires identification of sensitive features within the Edwards Aquifer Recharge Zone to protect both endangered species and water quality; current TCEQ regulations for the Edwards Aquifer are discussed in Section 2.2. LID features that typically use infiltration (e.g., bioretention areas and permeable pavements) should be designed with groundwater protection in mind to ensure that pollutants are not concentrated in BMPs and transported into the aquifer. Details regarding the design of BMPs in sensitive groundwater areas are provided in Appendix B.

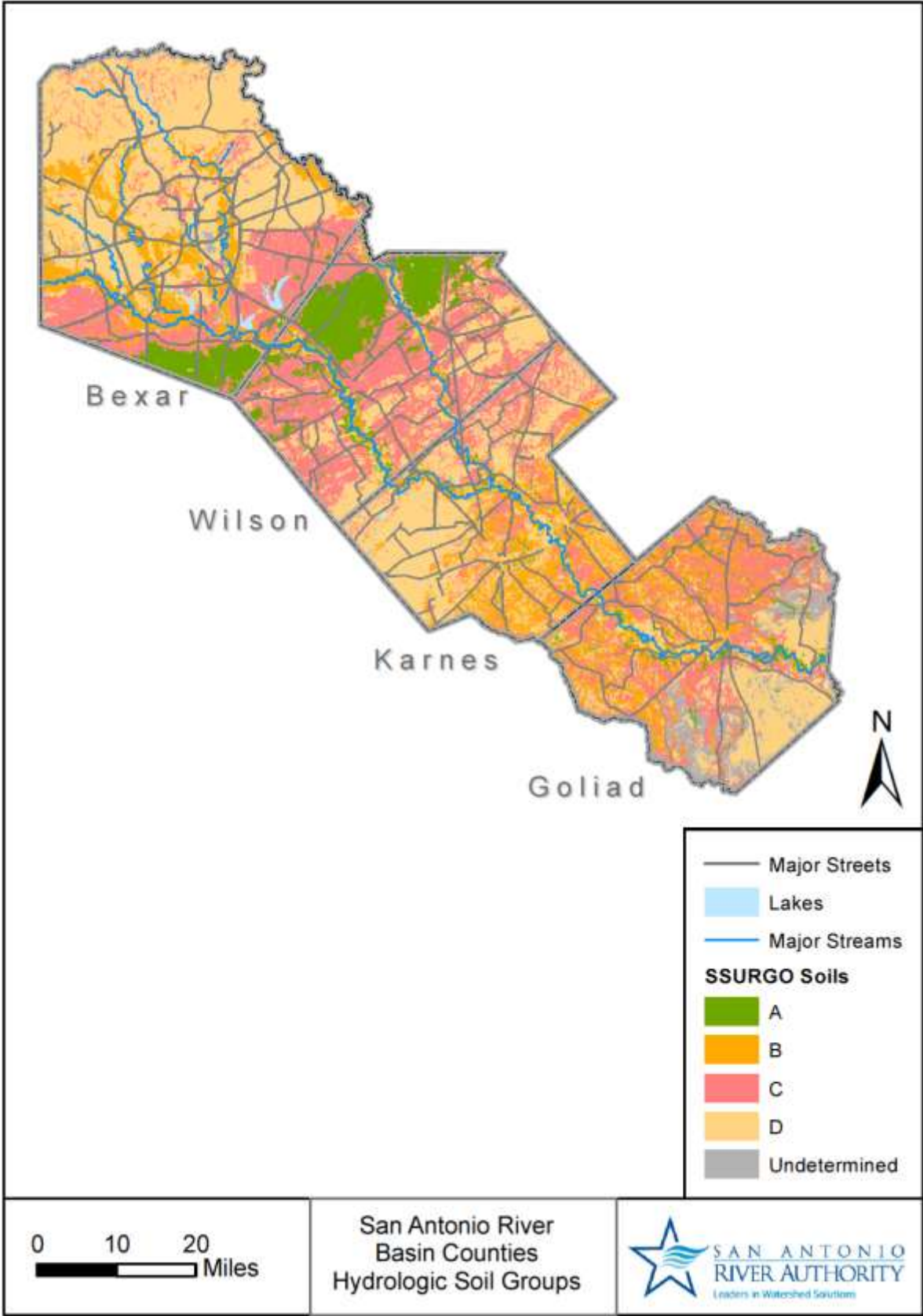

Figure 2-1. Hydrologic soil groups for SARB.

2. Regional Considerations

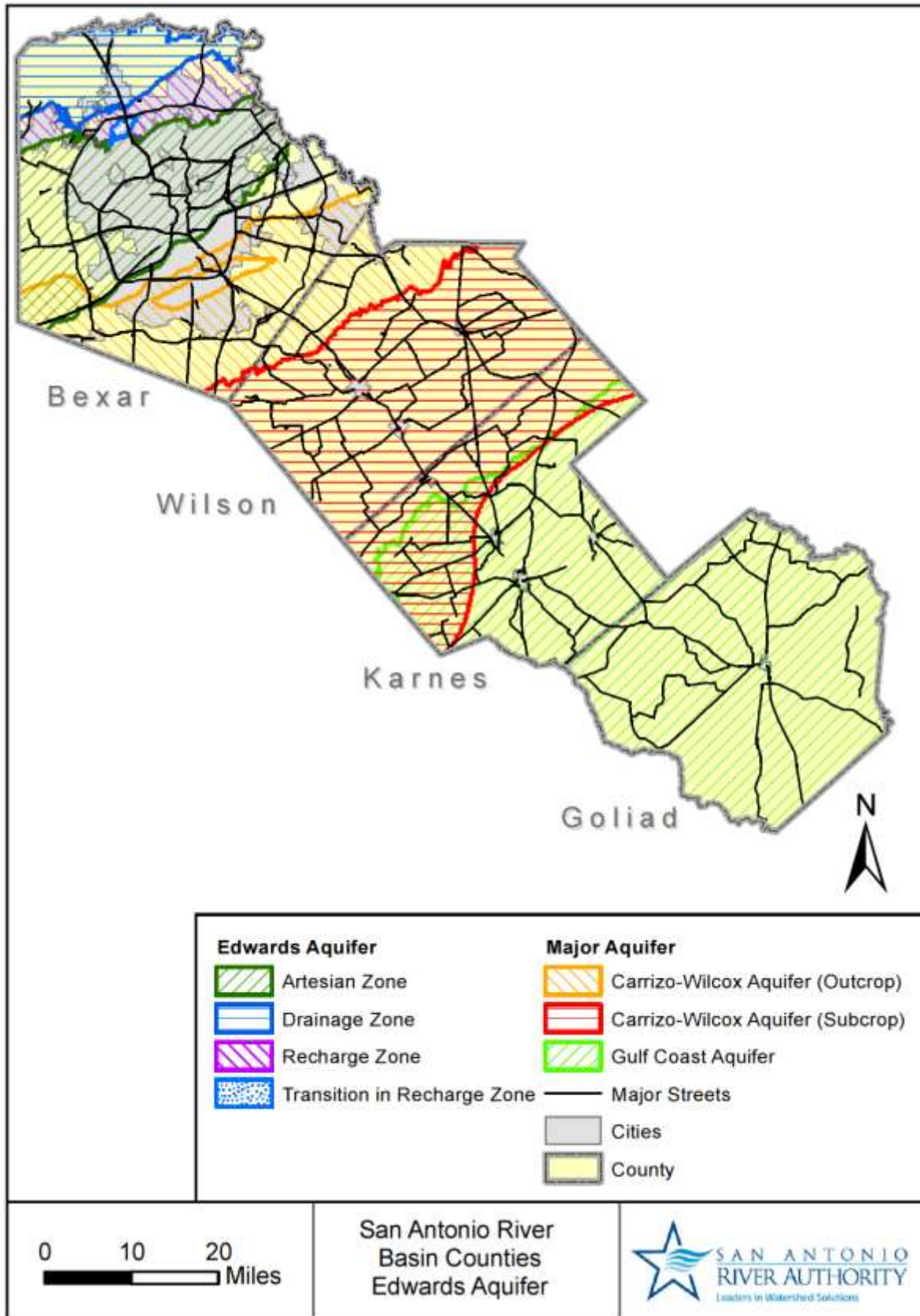

Figure 2-2. SARB artesian, drainage, recharge, and transition zones.

2.1.3 Eco-Regions and the Impact on LID Implementation

The five ecoregions in the SARB help guide LID design decisions by integrating hydrology, geology, soil types, rainfall patterns, and plant communities. Consideration of the different landscape characteristics assists in items as preliminary as BMP placement or choice, to farther reaching items such as long-term maintenance. For example, residential development in the Edwards Plateau would require minimizing development near karst topography and riparian river crossings due to limited soil layers and steep slopes that increase erosion possibilities and pose a threat to water quality. Additionally, from a regulatory standpoint, implementation of LID in certain portions of the Edwards Plateau will require design modifications as described later. In areas that have deeper soil profiles and gentler slopes, such as the Post Oak Savannah of Wilson and Goliad counties, infiltration rates vary from that of the nearby Edwards Plateau eco-region. A large swath of south Bexar County and northern Wilson contain sandy, HSG A soils covered by Post Oak trees that are sensitive to prolonged inundation and soil compaction. Appropriate species selection should also be considered for each of the ecoregions, particularly when using native soils or reestablishing native plant communities in previously cleared areas. The plant list in Appendix E includes vegetation appropriate for all five eco-regions in the SARB.

2.1.4 Climatology and Topography

The Hill Country and Coastal Plains experience very intense rainfall events that produce flashy, high volume floods. LID designs must incorporate energy dissipation, flow transition and bypass features to handle extreme events without causing excessive damage. In areas of steep slopes (Figure 2-3), LID practices require more assessment and careful design. BMP options include terracing of bioretention features, using rock berms to spread flow, permeable pavement that collect and infiltrate water, and site planning to avoid steep slopes. A series of level bioretention areas down a slope will calm flows and allow stormwater to pond temporarily behind internal control features before flowing to the next treatment area (Figure 2-4). Similarly, natural channel design techniques that use step-pool type design can provide designed grade control features that reduce erosion potential and transition water into riparian areas. Level spreaders, plunge pools, and vanes can be used to control velocity and energy dissipation prior to discharge from a collection system or BMP into conservation areas. The City of San Antonio's Tree Preservation ordinance (UDC Sec. 35-523) includes steep slopes as part of the definition of environmentally sensitive areas that require protection of native landscape and plant life through tree canopy preservation.

2. Regional Considerations

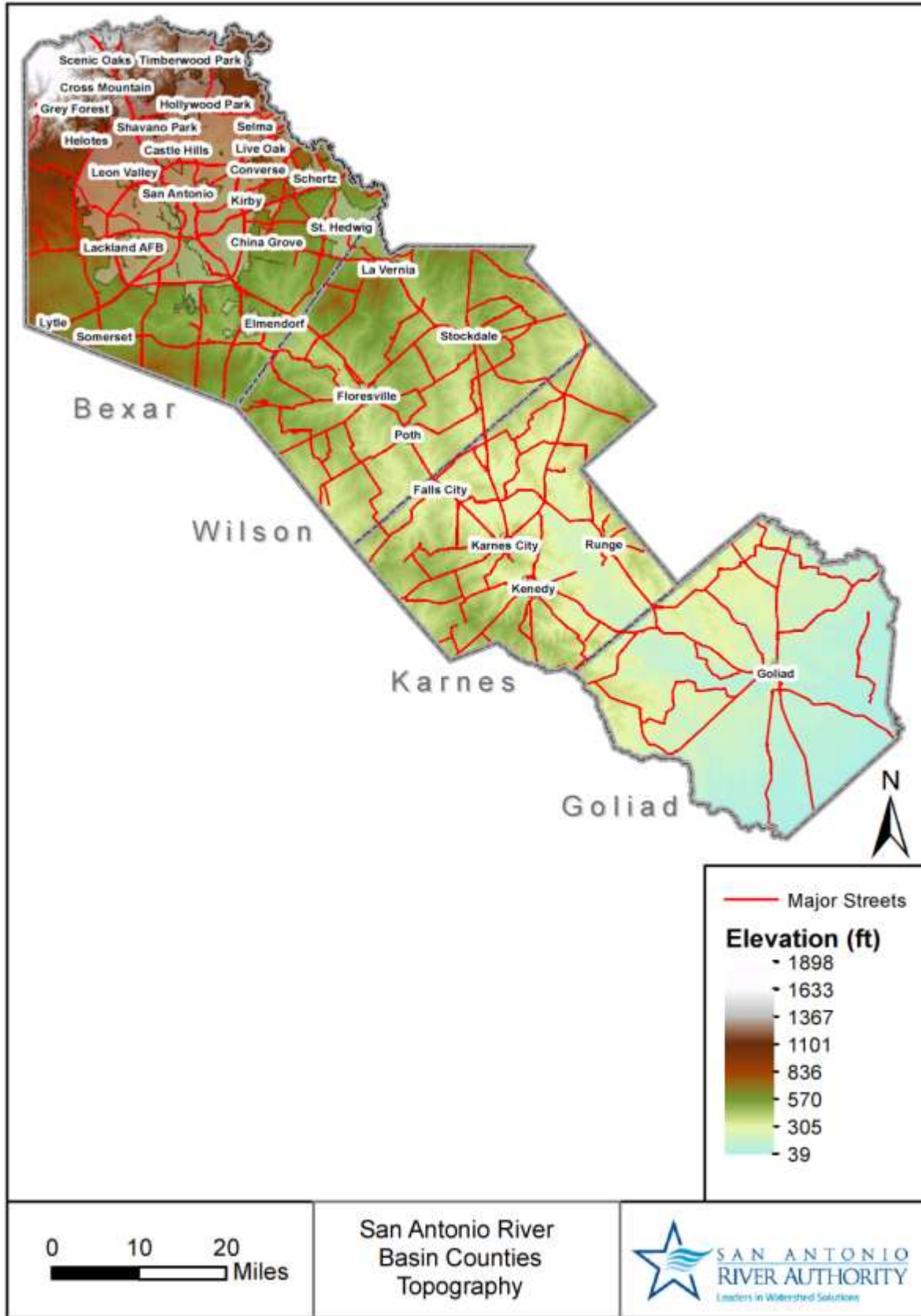

Figure 2-3. Topography of SARB.

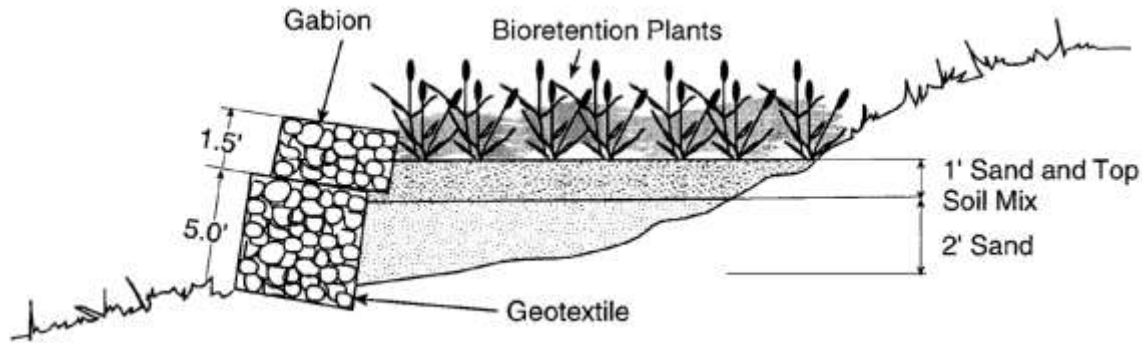

Figure 2-4. Bioretention Terrace Suitable for Use on Slopes 10-20% (NCDENR 2009)

2.2 Relevant Federal and State Regulations and Guidelines

Stormwater management is guided by local regulations and guidance as well as federal and state regulations. The following sections describe federal and state regulations, and local regulations and guidance are presented in Appendix G.

2.2.1 National Pollutant Discharge Elimination System Stormwater Regulations

The local cities' and Bexar County's requirements for development projects to implement stormwater BMPs is based on section 402 (p) of the Clean Water Act. The Clean Water Act amendments of 1987 established a framework for regulating storm water discharges from municipal, industrial, and construction activities under the National Pollutant Discharge Elimination System (NPDES) program. Under the Clean Water Act, municipalities of sufficient size throughout the nation are issued a Municipal NPDES Permit. The primary goal of the permit is to stop polluted discharges from entering the municipally owned storm water conveyance system (the Municipal Separate Storm Sewer System, or MS4), and thus local receiving and coastal waters. The U.S. EPA is currently involved in national rulemaking, which may generate more prescriptive requirements and performance standards for stormwater management under the NPDES program. These proposed standards, which could take effect as early as 2014, may focus on regulation of stormwater volume (particularly from high-frequency storm events) from development and redevelopment activities; as such, LID will likely serve a critical role in satisfying volume-based performance standards.

2.2.2 TCEQ- 30 Texas Administrative Code (TAC) 213.5

The Edwards Aquifer rules protecting water quality are implemented through the TCEQ. Permanent BMPs are required for regulated activities that have the potential for polluting the Edwards Aquifer and hydrologically connected surface streams. Regulated activities generally apply to any development with more than 20% impervious cover including public infrastructure projects such as roadways and utilities. Development is required to mitigate 80% of the increase of total suspended solids (TSS) from existing to proposed conditions. This goal is more tailored than the broader LID goals that also address hydromodification, nutrients, and metals.

The typical BMPs approved by the TCEQ are listed in Table 2-1, but sand filters are the primary BMP currently used in the region. No retention facilities or pervious pavement without an impermeable liner are allowed over the recharge zone to discourage the infiltration of pollutants. Although this limitation must be understood prior to site assessment for infiltration BMPs in the recharge zone, LID BMPs can be adapted for use in all Edwards Aquifer Zones.

2. Regional Considerations

Table 2-1. Summary of BMPs Approved by TCEQ (2005).

BMPs	Does it Remove 80% TSS?	Is it in the TCEQ Technical Guidance Manual?	Is it Cost Effective?
Permanent BMPs			
Vegetative Filter Strip	Yes	Yes	Yes
Extended Detention Pond	No	Yes	Yes
Bioretention	Yes	Yes	Yes
Infiltration	Yes	No	Yes
Sand Filters	Yes	Yes	Yes
Wet Basins	Yes	Yes	Maybe
Constructed Wetlands	Yes	Yes	Maybe
Retention/Irrigation	Yes	Yes	Yes if water needed
Stormwater Credits			
Porous Pavement	Variable	Yes	Maybe
Rainwater Harvesting	Yes	No	Yes
Soil Amendment and Conservation Landscaping	Yes	No	Yes
Roof-top Disconnection	Yes	No	Yes
Natural Area Preservation	Yes	Yes	Yes

2.3 Incorporating LID in Capital Improvement Projects

Although this manual can guide engineers, architects, landscape architects, and project managers in a wide variety of private projects, many opportunities exist to incorporate LID practices into municipal capital improvement projects (CIPs). CIPs typically include infrastructure improvements such as developing roads and bridges, renovating municipal buildings, and enhancing parks and open space. An increasing number of CIPs are designed to incorporate LID BMPs to serve as pilot projects for local municipalities. As an example, Figure 2-5 show conceptual renderings of the Hemisfair Complete Streets concept for Alamo Street.

The San Antonio River Authority's Sustainability Matrix allows a quick assessment of the sustainability of a project. Visit http://www.sara-tx.org/sustainability/sustainability_matrix/

With proper planning, LID design alternatives can be incorporated into such CIPs to minimize site disturbance, protect the hydrology of native, natural areas such as ephemeral wetlands, and use key hydrologic features such as flow path directions (see Section 1.5 for LID site design principles and Chapter 3 for LID BMP options). The San Antonio River Authority has developed a web-based sustainability matrix that allows quick assessment of a project. The tool, available at http://www.sara-tx.org/sustainability/sustainability_matrix/, gives guidance on the BMPs that may be most applicable to a project.

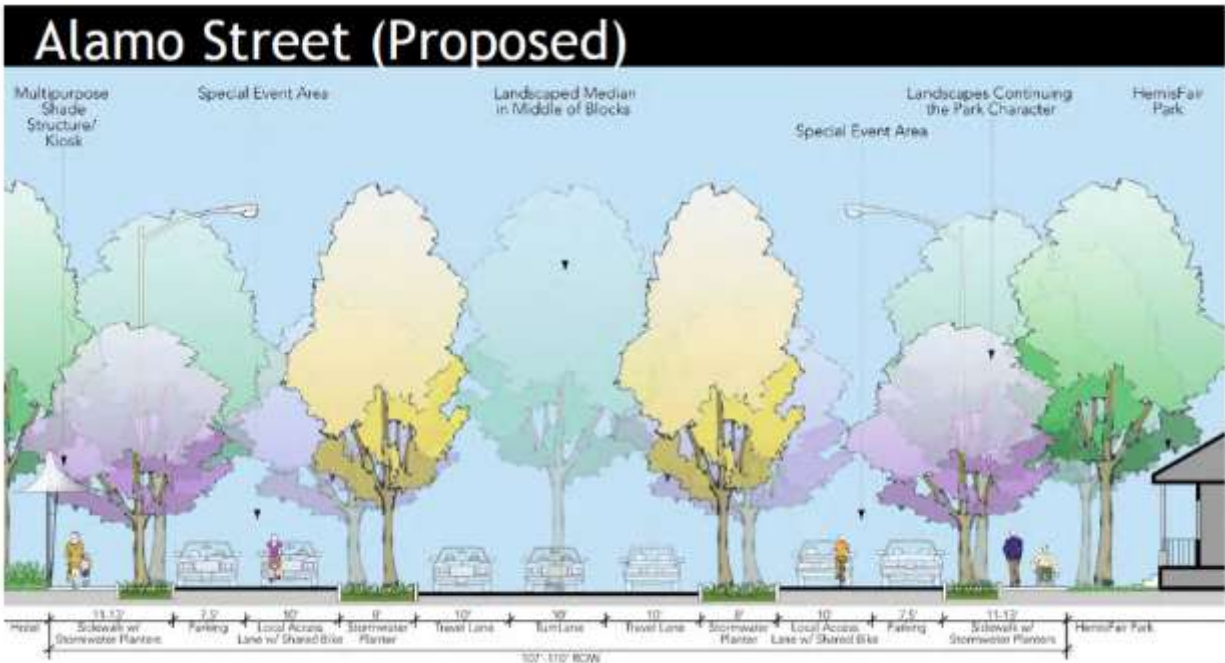

Source: <http://www.hemisfair.org/>

Figure 2-5. Cross-section rendering of Alamo Street.

Ultimately, incorporating LID into CIPs can minimize site runoff, enhance water quality, and assist in regulatory compliance. In most municipalities, planning and designing CIP projects tend to be a collaboration of multiple departments such as Engineering and Capital Projects Department, Streets Division, Environmental Services, Planning Division and the Stormwater Department. To maintain adequate focus on meeting the required storm water management needs, such collaboration requires strong inter-departmental communication, well-established goals and objectives, and clear technical guidance to all involved; this *Low Impact Development Technical Design Guidance Manual* is meant to provide such guidance. Specifically, the site assessment process described in Section 1.5 is crucial for proper CIP site design. Additionally, technical details, renderings of example LID applications, and specific design steps are offered in Appendix B to provide guidance with incorporating LID into CIPs.

2.4 References

- Griffith, G.E., S.A. Bryce, J.M. Omernik, J.A. Comstock, A.C. Rogers, B. Harrison, S.L. Hatch, and D. Bezanson. 2004. Ecoregions of Texas. Two-sided color poster with map, descriptive text, summary tables, and photographs. U.S. Geological Survey, Reston, VA. Scale 1:2,500,000.
- NCDENR (North Carolina Department of Environment and Natural Resources). 2009. Chapter 12 Bioretention. *NCDENR Stormwater BMP Manual*. July 24, 2009. Raleigh, NC. <http://portal.ncdenr.org/web/wq/ws/su/bmp-ch12>
- TCEQ (Texas Commission on Environmental Quality). 2005. *Complying with the Edwards Aquifer Rules—Technical Guidance on Best Management Practices*. RG-348 (Revised) with Addendum. Texas Commission on Environmental Quality, Austin, TX <http://www.tceq.texas.gov/field/eapp>.
- TPWD (Texas Parks and Wildlife Department). No date. Edwards Plateau Ecological Region. http://www.tpwd.state.tx.us/landwater/land/habitats/cross_timbers/ecoregions/edwards_plateau.p.html. Accessed February 14, 2013.

2. Regional Considerations

This page is intentionally blank.

3 LID Selection—Structural BMPs

Structural BMPs are implemented to capture, infiltrate, filter, and treat stormwater runoff from a project area to meet the required level of controls in terms of water quality and quantity. Selecting the appropriate BMP for a project area should be based on site-specific conditions and stormwater control targets. Selected BMPs should be sized to capture and treat the design storm according to the numeric sizing requirements for treatment control BMPs that are presented in Appendix A. A general description for each BMP is presented in this chapter. For a more detailed description and design specifications for each BMP, see Appendix B.

3.1 Selecting Structural BMPs

Selecting the proper BMP type and location depends on site-specific precipitation patterns, soil characteristics, slopes, existing utilities, and any appropriate setbacks from buildings or other infrastructures as determined in Step 1 of Section 1.6.1. Further, selecting applicable and feasible BMPs will depend on the type of project, its characteristics, and the planning elements associated with the location of the project.

A general checklist for characterizing drainage areas and BMPs is below.

Drainage Area Characterization

- Total drainage area
- Percent imperviousness: total and directly connected
- Soil characteristics
- Known/expected runoff water quality constituents
- Depth to seasonal high water table and bedrock
- Topography, slope
- Land cover and land use (existing and future)
- Utilities
- Development history and existing buildings
- Storm drainage systems, location of outfalls
- Projected roadway alignment modifications, roadway expansion
- Rainfall records and statistical analysis of storm characteristics and frequency

BMP Characterization

- Type of BMP
- BMP surface area
- Surrounding soil characteristics
- Depth to water table

3. LID Selection—Structural BMPs

- Design target(s) according to any combination of volume, flow, or water quality control criteria
- Inlet and outlet features
- Primary stormwater treatment unit process

A BMP selection matrix based on the potential function and configuration of each BMP is presented in Section 3.8. The function and configuration that dictate BMP selection include drainage area size and land use, available site area for BMP implementation, slope, depth to seasonal high water table and bedrock, soil characteristics and infiltration rates, setbacks, and pollutant reduction potential.

3.2 BMP Sizing

LID BMPs are typically sized to manage runoff from frequent smaller storm events (typically in the range of one to two inches over 24 hours). The size of a BMP should be established using the characterization of the drainage area and local hydrology. BMPs should be designed by applying either volume- or flow-based design criteria. Further details regarding BMP sizing and example calculations are in Appendix A.

3.3 General Description of BMP Functions

The objectives of stormwater BMPs are to first slow and filter runoff using natural features. Infiltration and evapotranspiration, along with retention for reuse, offer additional benefits of the BMPs. Identifying and selecting BMPs on the basis of the pollutant(s) of concern is a function of site constraints, properties of the pollutant(s) of concern, BMP performance, stringency of permit requirements, and watershed-specific requirements such as TMDLs or Watershed Protection Plans. Pollutants of concern are especially important in water quality-limited stream segments and must be carefully reviewed in relationship to unit processes and potential BMP performance. Targeted constituents can include sand, silt, and other suspended solids; trash; metals such as copper, lead, zinc; nutrients such as nitrogen and phosphorus; pathogens; and organics such as petroleum hydrocarbons and pesticides. Table 3-1 indicates the major or dominant unit processes used for pollutant removal and secondary and optional processes based on designs of BMPs that incorporate those unit processes (Claytor and Schueler 1999).

Table 3-1. Water quality unit processes for pollutant removal

Pollutants	Removal processes					
	Settling	Filtration/ straining	Absorption/ Adsorption	Bioaccumulation	Biotransformation/ phytoremediation	Other (e.g., photolysis; volatilization)
Sediment	●	●	○	○	○	○
Total Nitrogen	●	◐	◐	(◐) [#]	●	○
Total Phosphorus	●	◐	●	(◐) [#]	○	○
Trash	●	●	○	○	○	◐
Metals	●	○	●	●	●	○
Bacteria	●	(●)	○	●	● &	● *
Oil and grease	○	●	●	◐	●	●
Organics	●	◐	◐	●	●	●

Symbols: ● major function; ◐ secondary function; ○ insignificant function; () optional function; [#]removal from system if vegetation is harvested; & consumed by other organisms; * photolysis

BMPs often provide multiple unit processes, depending on design. Table 3-2 shows the removal processes for each BMP type including the major functions, followed by secondary and possible optional unit operations, depending on design (Claytor and Schueler 1999). BMPs can be used singularly or in series with multiple BMP types integrated as management practices to achieve the desired level of pollutant removal. Using a combination of BMPs with multiple treatment processes in one system is called a treatment train. Meeting targeted treatment objectives can usually be achieved using a series of stormwater treatment systems in a treatment train. That approach can apply to new designs and in retrofitting existing BMPs and sites. Such systems can often be designed along rights-of-way, in parking lots, or incorporated into landscaped areas to fit in relatively small or long, linear areas.

BMPs can be used singularly or in combination, or shared by multiple drainage areas, pursuant to local regulatory criteria (depending on project location and its jurisdiction), as outlined in Chapter 2.

Table 3-2. Hydrologic and water quality unit processes for BMPs

Structural BMPs	Hydrologic controls			Removal processes					
	Storage/detention or flow attenuation	Infiltration	Evapotranspiration	Settling	Filtration	Sorption	Bioaccumulation	Biotransformation/phytoremediation	Other (e.g., photolysis; volatilization)
<i>Infiltration BMPs</i>									
Bioretention	●	(●)	◐	◐	●	◐	●	●	(◐)
Bioswale	(●)	(●)	◐	◐	◐	◐	◐	◐	(◐)
Permeable pavement	●	(●)	○	●	◐	(◐)	○	◐	○
<i>Filtration BMPs</i>									
Planter boxes	●	(●)	◐	◐	●	◐	(●)	(●)	(◐)
Green roofs	(●)	○	●	◐	○	○	(◐)	(◐)	○
Sand filter	◐	(◐)	○	○	●	(◐)	○	○	(◐)
<i>Volume-Storage and Reuse BMPs</i>									
Cisterns/rain barrels	●	○	○	<i>Treatment typically provided by downstream BMP</i>					
Stormwater wetlands	(●)	○	◐	●	●	◐	●	●	(◐)
<i>Conveyance and Pretreatment BMPs</i>									
Vegetated filter strip	○	●	●	◐	◐	◐	○	○	○
Vegetated swale	(◐)	(◐)	◐	●	●	○	○	○	○

Symbols: ● major function; ◐ secondary function; ○ insignificant function; () optional function

An example of how BMPs can be implemented in combination to provide the maximum potential treatment for a site configuration include a treatment train utilizing vegetated filter strips draining to a vegetated swale that then convey the stormwater to a bioretention area where stormwater is infiltrated or filtered through a soil media. An example of a treatment train is shown in Figure 3-1. Such a treatment train can be integrated into the site to maximize hydrologic and water quality treatment using the unit processes of each BMP type. Effectiveness of individual or multiple integrated practices can be compared in terms of removing substances or groups of pollutants. Water quality performance data from multiple sources is presented for each BMP type in Section 3.4. Typical sources present an average of water

3. LID Selection—Structural BMPs

quality performance data collected from multiple storm events over a multi-year period. BMPs sized to treat the volume produced by wet weather events will have the capacity to treat the smaller volume produced by dry weather flow with the same water quality performance. Water quality data is typically a combination of effluent and overflow samples.



Raleigh, North Carolina. Source: Tetra Tech

Figure 3-1. Treatment train featuring a vegetated filter strip pretreating runoff before entering a grassed bioretention area.

When no specific pollutant has been targeted for removal, regulators should work with designers to address pollutant removal through flow- or volume-based requirements or both. Under such circumstances, cost may become the most important deciding factor in BMP selection rather than pollutant removal performance.

3.4 Infiltration BMPs

Infiltration BMPs are designed to encourage percolation and ground water recharge and can provide volume reduction. Infiltration BMPs mainly use the interaction of the chemical, physical, and biological processes between soils and water to filter out sediments and sorb constituents from stormwater (FHWA 2002). As stormwater percolates into the ground, the soil captures the dissolved and suspended material in stormwater.

Infiltration BMPs are subject to several important limitations and cannot be used in all locations. Native soils must be tested to determine if the infiltration rates of the soils are acceptable for infiltration BMPs. Infiltration BMPs are not applicable at locations where ground water is close to the surface and would prevent stormwater infiltration from draining between storm events or where ground water pollution

potential is high because of high pollution loads (*hotspots*) or sensitive ground water areas (*areas of concern*) (see Appendix G for rules governing infiltration in the Edwards Aquifer zones). Pollution prevention should be carefully implemented to protect ground water quality at sites where infiltration BMPs are used. It is important that infiltration BMPs have sufficient clearance from the bottom of the BMPs to the seasonal high ground water level or any impermeable soil layers. An internal water storage (IWS) zone can be incorporated into any BMP with an underdrain to improve nitrogen removal and enhance infiltration in HSG type C and D soils. For more information on underdrains, see Appendix B.11.4. An IWS zone can be designed as either a permanent zone or a variable zone with the upturned elbow at the outlet of the underdrain. This “sump” can store stormwater and release it slowly through infiltration/exfiltration and evapotranspiration, while maintaining an aerobic root zone for plant health. Details on designing IWS zones are in Appendix B.1.1.

3.4.1 Bioretention

Bioretention areas are landscaped, shallow depressions that capture and temporarily store stormwater runoff. Bioretention areas are the most commonly implemented LID technique because they mimic predevelopment hydrologic conditions, enhance biodiversity and water quality, and can be easily incorporated into both new and existing development (Davis et al. 2009). Runoff intercepted by the practice is temporarily captured in shallow, vegetated depressions then filtered through the soil (often engineered soil) media. Pollutants are removed through a variety of physical, biological, and chemical treatment processes. Bioretention areas usually consist of a pretreatment system, surface ponding area, mulch layer, and planting soil media. The depressed area is planted with small- to medium-sized vegetation including trees, shrubs, and groundcover that can withstand urban environments and tolerate periodic inundation and dry periods. Plantings also provide habitat for beneficial pollinators and aesthetic benefits for stakeholders and can be customized to attract butterflies or particular bird species. Ponding areas can be designed to increase flow retention and flood control capacity. Bioretention areas are well suited to the San Antonio region because they can be adapted to a variety of site constraints and take advantage of the semi-arid climate for evapotranspiration. Advantages and limitations of bioretention areas are outlined below in Table 3-3.

Table 3-3. Advantages and limitations of bioretention areas

Advantages	Limitations
<ul style="list-style-type: none"> • Efficient removal of suspended solids, heavy metals, adsorbed pollutants, nitrogen, phosphorus, and pathogens • Can effectively reduce peak runoff rates for relatively frequent storms, reduce runoff volumes, and recharge ground water if soil conditions allow • Flexible to adapt to urban retrofits • Applicable for use in recharge zones, karst, expansive clays, and hotspots when properly designed with impermeable liners • Well suited for use in small areas, and multiple, distributed units can provide treatment in large drainage areas • Can be integrated naturally into landscaping to enhance aesthetics and provide habitat • Standing water only present for 12-24 hours to minimize vector control concerns 	<ul style="list-style-type: none"> • Surface soil layer will require restoration if clogged over time • Frequent trash removal might be required, especially in high-traffic areas • Vigilance in protecting native soils from compaction during construction is essential • Single units can serve only small drainage areas • Requires maintenance of plant material and mulch layer

3. LID Selection—Structural BMPs

3.4.1.1 Hydrologic Functions

Temporary surface storage is provided in a shallow basin to accommodate the capture of runoff from the drainage area. The captured runoff infiltrates through the bottom of the depression and a layer of planting soil, approximately 2 to 4 feet deep, that has an infiltration rate capable of draining the bioretention area within a specified design drawdown time (usually surface water should draw down in 12–24 hours, and subsurface water should drain in 48–72 hours (Davis et al 2009; Hunt and Lord 2006).

After the stormwater percolates through the soil media, it infiltrates into the underlying subsoil if site conditions allow for adequate infiltration rates (typically greater than 0.5 in/hr). The volume-reduction capability of bioretention areas can be enhanced by providing a gravel drainage layer beneath the bioretention area. When subsoil infiltration rates are slower than 0.5 in/hr, filtered water is directed toward a stormwater conveyance system or other BMP via underdrain pipes. Volume reduction via partial infiltration and storage in the soil (approximately 20 to 70 percent, depending on soil conditions) can still occur when underdrains are present as long as an impermeable liner is not installed (Davis et al. 2012); partial infiltration occurs in those cases because some of the stormwater bypasses the underdrain and percolates into the subsoil (Strecker et al. 2004; Hunt et al. 2006; Davis et al. 2012). Volume reduction can be enhanced by treating the subgrade with scarification, ripping, or trenching (as discussed in Appendix B.1.2.1; Tyner et al. 2009; Brown and Hunt 2010). Additionally, underdrains can be modified to create a sump or IWS zone which enhances stormwater volume and pollutant load reduction, while maintaining an aerated root zone for plant health (Brown and Hunt 2011).

Where conditions altogether prevent infiltration (such as in the Edwards Aquifer Recharge Zone, karst geology, or near building foundations), bioretention areas should be lined with an impermeable barrier (see Section 2.1.2 for Edwards Aquifer zone delineations). Moderate volume reduction can still be achieved by lined systems because significant stormwater volumes can be stored in the available pore space of the media to be used by vegetation between storm events (Li et al. 2009; Davis et al. 2012).

Bioretention areas are typically planted with grasses, shrubs, and trees that can withstand short periods of saturation (i.e., 12–72 hours) followed by longer periods of drought. In addition to transpiring significant stormwater volumes, vegetation can enhance pollutant removal, reduce soil compaction, and provide ecological and aesthetic value (Hatt et al. 2009; Li et al. 2009; Barrett et al. 2013). Vegetation adapted to the San Antonio region is preferable for use in bioretention areas because native ecotypes, such as prairie grasses and forbs, can typically tolerate extreme hydroperiods and can promote infiltration and evapotranspiration with their deep root systems. Bioretention vegetation can be specified to mimic predevelopment communities while being aesthetically pleasing. IWS is recommended to improve soil moisture retention and plant survival in the San Antonio region (Li et al. 2010; Barrett et al. 2012; Houdeshel et al. 2012). A plant list to guide vegetation selection is located in Appendix E.

Bioretention areas are designed to capture a specified design volume and can be configured as online or offline systems. Online bioretention areas require an overflow system for passing larger storms. Offline bioretention areas do not require an overflow system but do require some freeboard (the distance from the overflow device and the point where stormwater would overflow the system). Bioretention can also be designed for peak flow mitigation to satisfy local requirements. Controlled experiments in Texas demonstrated reductions in peak discharge from fully lined (non-infiltrating) bioretention cells with as little as 2 feet of filter media (Li et al. 2010). Peak attenuation is most effectively achieved by infiltrating practices with high surface storage and media pore volume, and by pairing bioretention in a treatment train with a detention-type BMP (Hunt et al. 2012; Davis et al. 2012; Brown et al. 2012).

3.4.1.2 Water Quality Performance

Bioretention areas remove pollutants at various depths through physical, chemical, and biological mechanisms. Specifically, they use absorption, microbial activity, plant uptake, sedimentation, and filtration. Bioretention areas provide relatively consistent and high pollutant removal for sediment, metals, and organic pollutants (e.g., hydrocarbons). Most sediment removal occurs in pretreatment practices, in the mulch layer, and in the top 2 to 8 inches of soil media (Hatt et al. 2008; Li and Davis 2008; Stander and Borst 2010). The Texas Commission on Environmental Quality (TCEQ) recommends bioretention for compliance with the sediment removal requirements of the *Complying with the Edwards Aquifer Rules: Technical Guidance on Best Management Practices* (TCEQ 2005). Metals are commonly sediment-bound and are removed in the top 8 inches of media (Hsieh and Davis 2005; Hunt et al. 2012).

Nitrogen and phosphorus removal is less consistent. Total phosphorus percent removal has been found to vary between a 240 percent increase (production) and a 99 percent decrease (removal). The significant increase is suspected to be the result of excessive phosphorus levels in the furnished soil media (Hsieh and Davis 2005; Hunt et al. 2006; Davis 2007). Greater total phosphorus removal can be achieved by using soil media with total phosphorus concentrations below 15 parts per million (ppm) (Hunt and Lord 2006). A study in Texas indicated that nutrient export can also occur when bioretention soils are amended with excessive compost (Li et al. 2010). Nitrate removal has been found to vary between a 1 and 80 percent decrease (Kim et al. 2003; Hunt et al. 2006). Total Kjeldhal nitrogen (TKN) has been found to vary between a 5 percent increase and 65 percent decrease (Kim et al. 2003; Hunt and Lord 2006). Greater nitrate and TKN removal can be achieved by reducing the infiltration rate in the planting soil to 1–2 in/hr and ensuring that the soil media is at least 3 feet deep (Hunt and Lord 2006). Nitrate removal can be improved by incorporating a saturated layer in the soil media to promote anaerobic conditions for denitrification (Kim et al. 2003; Hunt and Lord 2006; Passeport et al. 2009). Additionally, studies performed in Texas demonstrated significantly improved nutrient reduction efficiency, relative to unvegetated filters, when bioretention soil was planted with a native prairie grass (Barrett et al. in press).

Several streams in the San Antonio region (including the Upper and Lower San Antonio River) are impaired by bacteria for contact recreation and high aquatic life use (TCEQ 2007, 2008). Bioretention represents a technology to mitigate pathogens from urban watersheds (especially when volume reduction is considered), although limited data exist for bacteria, virus, and protozoa removal. Most scientists and engineers agree that bacteria die-off occurs at the surface where organisms are exposed to solar radiation and dry (desiccating) conditions; dense vegetation in the bioretention area can limit the penetration of sunlight, but it can provide habitat for bacterivores and other beneficial pathogen predators (Hunt and Lord 2006; Hunt et al. 2008; Hathaway et al. 2009). Microbes are also sequestered by sedimentation and sorption; therefore, 2 feet minimum media depth and slower infiltration rates (1–2 in/hr) are recommended to enhance pathogen removal (Hathaway et al. 2011; Hunt et al. 2012).

In addition to chemical and biological pollutant removal, bioretention can be designed to reduce thermal loading to waterways. Thermally enriched runoff can increase stream temperatures and have adverse impacts on stream biota and dissolved oxygen (Booth et al. 2013; USEPA 1986). Research suggests that deep media beds (generally four feet or greater) can buffer extreme temperatures and that infiltration of stormwater can decrease overall thermal loading (Hunt et al. 2012; Jones and Hunt 2009; Winston et al. 2011; Wardynski et al. 2013). Thermal mitigation can likely be enhanced by shading bioretention areas with tree canopy cover and including IWS (Hunt et al. 2012; Jones et al. 2012). The depths where typical pollutant removal occurs are shown in Figure 3-2.

3. LID Selection—Structural BMPs

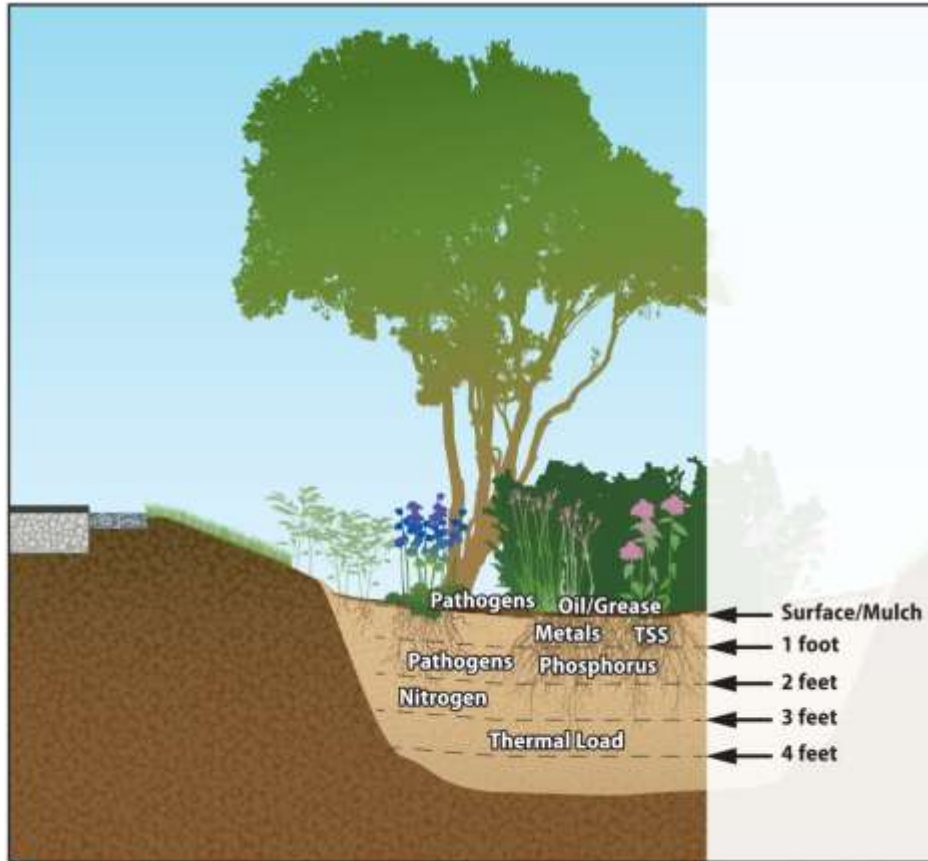

Figure 3-2. Pollutant removal depths in a bioretention area.

3.4.1.3 Applications and Configurations

Appendix B.1 outlines major design components and site considerations and describes the process for designing bioretention areas. Typical site applications and configurations are described further below.

3.4.1.4 Parking Lots

Bioretention areas can be used in parking lot islands or along the edge of the parking lot where water can be diverted into the bioretention area. Linear bioretention can also be used in the median areas between the parking spaces. Hydraulic restriction barriers should be installed and extended below adjacent pavement subgrades to protect pavement from water-induced structural issues (see Appendix B.11.6). Figure 3-3 and Figure 3-4 show examples of parking lot island bioretention areas.



Los Angeles, California Source: Tetra Tech

Figure 3-3. Parking lot bioretention area.



Durham, North Carolina Source: Tetra Tech

Figure 3-4. Parking lot island bioretention area.

3. LID Selection—Structural BMPs

3.4.1.5 Roads

Bioretention can also be integrated into the right-of-way of roads. Similar concepts apply to roads as parking lots. Some pretreatment is required to remove large particles and slow the runoff to non-erosive flows. Impermeable liners must be installed to protect adjacent pavement from water-induced structural issues (see Appendix B.11.7). Bioretention can be used along the edge of roads, as shown in Figure 3-5, or in medians.



Broadway Street, Witte Museum, San Antonio, Texas (rendering) Source: Bender Wells Clark Design

Figure 3-5. Roadside bioretention can be retrofit into the right-of-way to intercept street runoff through curb cuts.

Bioretention designs can be incorporated into the edge of roadways using traffic calming devices (e.g. curb extensions or “pop-outs”) and the grassed strip or other areas between the edge of the roadway and the sidewalk. Figure 3-6 shows an example of bioretention incorporated into a traffic calming device.



Kansas City, Missouri Source: Tetra Tech

Figure 3-6. Bioretention in a pop-out. A curb cut is provided at the upslope end of the pop-out to accept runoff from the gutter.

For standard traffic calming and roadway specifications, see the street design specifications in the Texas Department of Transportation Roadway Design Manual (Texas Department of Transportation 2010). For additional guidance See Appendix G. Landscaping is often required or expected in traffic calming features, which can be converted to a bioretention area to treat stormwater runoff from the paved surfaces. The maximum width of the right-of-way, minimum allowable roadway width, and required sidewalk width should be considered when optimizing bioretention implementation in the roadside environment.

Further details and design templates for bioretention areas in the right-of-way are provided in Appendix C.

3.4.1.6 Residential and Commercial Landscape

Bioretention can also be integrated into the landscape of a site in open or common areas. Runoff can be routed into the bioretention areas from rooftops, sidewalks, or impervious areas on a site. Energy dissipation is important to prevent erosion in the bioretention area and is usually accomplished in tandem with pretreatment using a stabilized forebay inlet or a vegetated filter strip. When bioretention is integrated into landscapes, it is important to consider any effects that could be made to surrounding structures from infiltration. Figure 3-7 shows a bioretention area that was integrated into a building's common area used as open space.

3. LID Selection—Structural BMPs



Buckman Heights Apartments, Portland, Oregon Source: NCSU BAE

Figure 3-7. Bioretention in a common area.

3.4.2 Bioswales

Bioswales are shallow, narrow, vegetated channels, often referred to as linear bioretention, that are designed to treat runoff primarily by vertical filtration of runoff through soil media and infiltration into underlying soils. Bioswales can serve as conveyance for stormwater and can be used in place of traditional curbs and gutters; however, when compared to traditional vegetated swale systems, **the primary objective of bioswales is infiltration and water quality enhancement rather than conveyance (except for excessive flow)**. Bioswales significantly vary in design configuration and can be constructed with or without check dams, subsurface storage media, and underdrains. Soil media, such as that used in bioretention areas, can be added to a bioswale to improve water quality, reduce the runoff volume, and modulate the peak runoff rate, while also providing conveyance of excess runoff. Advantages and limitations of bioswales are outlined in Table 3-4.

Table 3-4. Advantages and limitations of bioswales

Advantages	Limitations
<ul style="list-style-type: none"> • Efficient removal of suspended solids, heavy metals, adsorbed pollutants, nitrogen, phosphorus, and pathogens • Can effectively reduce peak runoff rates for relatively frequent storms, reduce runoff volumes, and recharge ground water if soil conditions allow • Flexible to adapt to urban retrofits including bordering parking lots and linearly along impervious surfaces • Well suited for use in small areas, and multiple, distributed units can provide treatment in large drainage areas • Can be integrated naturally into landscaping to enhance aesthetics • Can reduce need/cost for more traditional, subsurface conveyance strategies • Standing water only present for 12-24 hours, so minimal vector control concerns 	<ul style="list-style-type: none"> • Surface soil layer can clog over time (though it can be restored) • Frequent trash removal might be required, especially in high-traffic areas • Vigilance in protecting native soils from compaction during construction is essential • Single units can serve only small drainage areas • Require maintenance of plant material and mulch layer • Site slopes greater than 4% may limit application

3.4.2.1 Hydrologic Function

Bioswales share the same functions as bioretention areas in that they are vegetated and mulched or grassed (i.e., landscaped) shallow depressions that capture and temporarily store stormwater runoff but are designed to be narrow and linear to fit within certain site constraints. The captured runoff is temporarily stored on the surface then infiltrates through the bottom of the depression and a layer of soil media, approximately 2 to 4 feet deep, that has an infiltration rate capable of draining the bioretention area (to the bottom of the media) within a specified design drawdown time (usually 12 to 48 hours). The soil media provides treatment through filtration, adsorption, and biological uptake.

After the stormwater infiltrates through the soil media, it percolates into the underlying subsoil, if site conditions allow for adequate infiltration and slope protection (see Appendix B). If site conditions do not allow for adequate infiltration or slope protection, filtered water is directed toward a stormwater conveyance system or other BMP via underdrain pipes.

Bioswales are designed to capture a specified design volume and can be configured as online or offline systems. Online bioswales require an overflow system for passing larger storms. Offline bioswales do not require an overflow system but do require some freeboard (the distance from the overflow device and the point where stormwater would overflow the system).

If an underdrain is not needed because infiltration rates are adequate and slope is not a concern, the remaining stormwater passes through the soil media and percolates into the subsoil. Partial infiltration (approximately 20 to 25 percent, depending on soil conditions) can still occur when underdrains are present as long as no impermeable barrier is between the soil media and subsoil. Partial infiltration occurs in such cases because some of the stormwater bypasses the underdrain and percolates into the subsoil (Strecker et al. 2004; Hunt et al. 2006). Volume reduction can be further enhanced by including IWS and by treating the subgrade with scarification, ripping, or trenching (as discussed in Appendix B.1.2.1; Tyner et al. 2009; Brown and Hunt 2010).

3. LID Selection—Structural BMPs

Bioswales are typically planted with grasses, shrubs, and trees that can withstand short periods of saturation (12 to 72 hours) followed by longer periods of drought. Inclusion of IWS can improve soil water retention for plant survival.

3.4.2.2 Water Quality Performance

Bioswales are volume-based BMPs intended primarily for water quality treatment and, depending on site slope and soil conditions, can provide high volume reduction. Where site conditions allow, the volume-reduction capability can be enhanced for achieving additional credit toward meeting the volume-reduction requirement by omitting underdrains and providing a gravel drainage layer beneath the bioswale.

Bioswales function similarly to bioretention areas and remove pollutants through physical, chemical, and biological mechanisms. Specifically, they use absorption, microbial activity, plant uptake, sedimentation, and filtration. Refer to Section 3.4.1.2 for water quality performance details.

3.4.2.3 Applications and Configurations

Appendix B.2 outlines major design components and site considerations and describes the process for designing bioswales. Typical site applications and configurations are described further below.

3.4.2.4 Parking Lots

Bioswales are especially useful along the edge of parking lots or between facing parking stalls where narrow, linear space is available for stormwater treatment. Pretreatment is important for parking lot areas to remove large sediments and to slow the runoff to non-erosive flow rates (1 in/hr for mulch and 3 in/hr for sod). Pretreatment typically consists of a gravel verge followed by turf.

3.4.2.5 Roads

Bioswales can also be integrated into the right-of-way and medians of roads. Similar concepts apply to roads as parking lots. Some pretreatment could be required to remove large particles and slow the runoff to non-erosive flows. Bioswales can be used along the edge of roads or in medians as shown in Figure 3-8.

For standard median and right-of-way specifications, see local street design standards. To allow space for bioswale implementation, new roads should be designed with the maximum right-of-way width and minimum curb-to-curb spacing.



Columbia Memorial Learning Center, Downey, California Source: Tetra Tech

Figure 3-8. Road median bioswale.

3.4.3 Permeable Pavement

Permeable pavement is a highly versatile stormwater BMP because it can effectively reduce pollutants and can be integrated into site plans with various configurations and components. Permeable pavement allows streets, parking lots, sidewalks, and other impervious covers to retain the infiltration capacity of underlying soils while maintaining the structural and functional features of the materials they replace. Permeable pavement has small voids or aggregate-filled joints that allow water to drain through to an aggregate reservoir. Stormwater stored in the reservoir layer can then infiltrate underlying soils or drain at a controlled rate via underdrains to other downstream stormwater control systems. Permeable pavement systems can be designed to operate as underground detention if the native soils do not have sufficient infiltration capacity, or if infiltration is precluded by aquifer protection, hotspots, or adjacent structures. Permeable pavement can be developed using modular paving systems (e.g., permeable interlocking concrete pavers, concrete grid pavers, or plastic grid systems) or poured in place solutions (e.g., pervious concrete or porous asphalt). Some pervious concrete systems can also be precast. In many cases, especially where space is limited, permeable pavement is a cost-effective solution relative to other practices because it doubles as both transportation infrastructure and a BMP. Advantages and limitations of permeable pavement are outlined in Table 3-5.

3. LID Selection—Structural BMPs

Table 3-5. Advantages and limitations of permeable pavement

Advantages	Limitations
<ul style="list-style-type: none"> • Replaces completely impervious surfaces with partially impervious surfaces • Reduces stormwater runoff rate and volume • Reduces loads of some pollutants in surface runoff by reducing the volume of stormwater leaving a site • Reduces stormwater infrastructure footprint and promotes multi-benefit uses by using treatment area for parking/driving with possible cost reductions • Increases ground water recharge • Adaptable to urban retrofits • Many options available depending on specific site needs and aesthetics • Applicable for use in recharge zones, karst, expansive clays, and hotspots when properly designed 	<ul style="list-style-type: none"> • Potential for clogging of porous media by sediment, which could lead to reduced effectiveness without proper maintenance • Should not receive runoff from adjacent pervious surfaces with high sediment/debris yield • Typically not cost effective for high-traffic areas or for use by heavy vehicles (requires increased structural design and maintenance frequency) • Permeable pavement should be installed only by contractors qualified and certified for permeable pavement installation • Typically recommended for grades of 5% or less

3.4.3.1 Hydrologic Functions

Permeable pavement systems are designed to reduce surface runoff by allowing stormwater to infiltrate the pavement surface. While the specific design can vary, most permeable pavements have a similar structure consisting of a surface course layer and an underlying stone aggregate reservoir layer. Modular storage units, chambers, and pipes can also be integrated for additional subsurface storage. Where soils permit, permeable pavement allows captured runoff to fully or partially infiltrate into underlying soils; where infiltration is restricted (such as in the Edwards Aquifer Recharge Zone, karst, or near building foundations), permeable pavement can be lined with an impermeable membrane and used as detention systems.

Volume reduction primarily depends on the drainage configuration and subsoil infiltration capacities. Systems installed without underdrains in highly permeable soils can achieve practically 100 percent volume reduction efficiency (Bean et al. 2007). Systems installed in restrictive clay soils can still give significant volume reduction (Tyner et al. 2009; Fassman and Blackburn 2010). The volume reduction can be further enhanced by treating the subgrade with scarification, ripping, or trenching (as discussed in Appendix B.5.2; Tyner et al. 2009; Brown and Hunt 2010), by omitting underdrains (where practicable), or by incorporating an internal water storage layer by upturning underdrain inverts to create a sump (Wardynski et al. 2013). Peak flow can be also effectively attenuated by permeable pavement systems by reducing overall runoff volumes, promoting infiltration, and increasing the lag time to peak discharge (Collins et al. 2008).

3.4.3.2 Water Quality Performance

Permeable pavement systems, when designed and installed properly, consistently reduce concentrations and loads of several stormwater pollutants, including heavy metals, motor oil, sediment, and some nutrients. The aggregate subbase provides water quality improvements through filtering and chemical and biological processes, but the primary pollutant removal mechanism is typically load reduction by infiltration into subsoils.

Pollutant-removal efficiencies for permeable pavements have been well studied. Permeable pavement systems consistently reduce sediment concentrations and loads; however, high loadings of TSS significantly reduce the functional life of permeable pavement systems because of clogging in the void space. TSS reductions have been shown to range from 32 to 96 percent, with average removal efficiency of 81 percent (MWWCOG 1983; Schueler 1987; Pagotto et al. 2000; Rushton 2001; Gilbert and Clausen 2006; Bean et al. 2007; CWP 2007; Toronto and Region Conservation Authority 2007; Roseen et al. 2009, 2011; Fassman and Blackbourn 2011). TSS can be practically eliminated (100 percent reduction) when systems fully infiltrate captured runoff. Because phosphorus tends to be associated with sediment particles, total phosphorus reduction is fairly consistent, and removal efficiencies range from 20 to 78 percent (MWWCOG 1983; Schueler 1987; Rushton 2001; Gilbert and Clausen 2006; Bean et al. 2007; CWP 2007; Toronto and Region Conservation Authority 2007; Roseen et al. 2009, 2011; Yong et al. 2011). As with phosphorus, sediment-bound metals are also reliably reduced; average removal efficiencies for cadmium, lead, zinc, and copper range from 65 to 84 percent (MWWCOG 1983; Schueler 1987; Pagotto et al. 2000; Rushton 2001; Dierkes et al. 2002; Brattebo and Booth 2003; Gilbert and Clausen 2006; Bean et al. 2007; Toronto and Region Conservation Authority 2007; CWP 2007; Roseen et al. 2009, 2011; Fassman and Blackbourn 2011).

Nitrogen removal is more variable because permeable pavement does not typically provide the mechanisms for denitrification. Total nitrogen removal efficiency has been shown to range from –40 to 88 percent (MWWCOG 1983; Schueler 1987; CWP 2007; Collins et al. 2010). High removal efficiencies have been reported for hydrocarbons (92–99 percent; Roseen et al. 2009, 2011). Permeable pavement has demonstrated mixed performance for reducing indicator bacteria counts from effluent (Myers et al. 2009; Tota-Maharaj and Scholz 2010); however, infiltrating systems could effectively reduce pathogen counts by filtering runoff through underlying soils and reducing the overall stormwater volume.

Similar to bioretention, research indicates that permeable pavement can be used to mitigate thermal loading to waterways by buffering extreme temperatures within the aggregate profile and by infiltrating runoff into subsoils (Wardynski et al. 2013).

3.4.3.3 Applications and Configurations

Appendix B.3 outlines major design components and site considerations and describes the process for designing permeable pavement. Typical site applications and configurations are described further below.

Parking Lots

Permeable pavement is typically used in a parking lot to provide a pervious alternative to a typically impervious area. The entire lot or only portions can be permeable; typically the parking stalls will be permeable and the driving lanes consist of standard paving. If a high level of traffic is anticipated regularly (such as in a drive-through) or heavy vehicles must pass through (such as garbage trucks) it may be cost effective to design the travel lane with standard paving materials and slope them toward the permeable parking stalls; however, permeable pavements can be designed for heavy traffic loading by using abrasion resistant materials and by increasing the structural base layer depth. Figure 3-9 shows an example of the entire parking lot being permeable pavement, and Figure 3-10 shows only the parking stalls being permeable.

3. LID Selection—Structural BMPs



Cottonwood Park, Encinitas, California
Source: Tetra Tech

Figure 3-9. Pervious concrete parking lot.



Oaks Business Park, San Antonio, Texas
Source: Bender Wells Clark Design

Figure 3-10. PICP parking stalls.

Sidewalks and Pedestrian Plazas

Permeable pavement can also be effective for pedestrian uses, and most types of permeable surface courses are ADA compliant. Sidewalks can be constructed of pervious pavement materials to reduce runoff in highly impervious areas. This can be effective in malls, plazas, promenades, and other outdoor hardscapes with low sediment loads. Care should be taken during site layout to allow for ease of maintenance (for details on maintaining permeable sidewalks, see Section 4.3.5). An example of permeable pavement in a pedestrian plaza is shown in Figure 3-11.



James Madison High School Agriscience Building, San Antonio, Texas Source: Bender Wells Clark Design

Figure 3-11. Permeable pavement pedestrian plaza.

Access Roads and Shoulders

Permeable pavement can also be used in areas that receive little traffic, such as fire lanes, shown in Figure 3-12, or vegetated shoulders for temporary parking. Most pavers are rated for loading of heavy vehicles such as fire trucks as long as sufficient structural base layers are provided.



San Diego, California Source: Tetra Tech

Figure 3-12. Permeable pavement fire access lane.

3.5 Filtration BMPs

Filtration BMPs have been used widely because of their relatively small footprint and moderate physical requirements (FHWA 2002). Because of their versatility, filtration BMPs can be incorporated into a wide range of landscapes including roadway corridors, rights-of-way, sidewalks, and areas with limited space; certain filtration BMPs (e.g., sand filters) can also be implemented underground. Most filtration BMPs are designed to treat only a portion of a storm event, usually based on volume- or flow-based designs. Stormwater quality management is primarily provided by filtration, sedimentation, straining, and sorption as stormwater passes through small pore spaces. Filtration BMPs are not intended to infiltrate runoff into subsoils.

3.5.1 Planter Boxes

A planter box is a concrete box containing soil media and vegetation that functions similarly to a small bioretention area but is completely lined and must have an underdrain. Planter boxes have been implemented around paved streets, parking lots, and buildings to provide initial stormwater detention and treatment of runoff. Such applications offer an ideal opportunity to minimize directly connected impervious areas in highly urbanized areas. In addition to stormwater management benefits, planter boxes provide on-site stormwater treatment options, green space, and natural aesthetics in tightly confined urban environments. The vegetation and soil media in the planter box provide functions similar to bioretention area. Advantages and limitations of planter boxes are outlined below in Table 3-6.

3. LID Selection—Structural BMPs

Table 3-6. Advantages and limitations of planter boxes

Advantages	Limitations
<ul style="list-style-type: none"> • Efficient removal of suspended solids, heavy metals, adsorbed pollutants, nitrogen, phosphorus, and pathogens • Can effectively reduce peak runoff rates for the water quality design storm and reduce runoff volumes through evapotranspiration • Flexible to adapt to urban retrofits and are well suited for small, highly impervious, areas • Can be integrated naturally into landscaping to enhance aesthetics and provide multi-benefit use • Does not require a setback from structural foundations • No geotechnical limitations—can be used where infiltration is restricted (e.g., Edwards Aquifer Recharge Zone, clay soils) 	<ul style="list-style-type: none"> • Surface soil layer could clog over time (though it can be restored) • Frequent trash removal could be required, especially in high-traffic areas • Single units can serve only small drainage areas • Requires maintenance of plant material and mulch layer • Does not promote deep infiltration to supplement ground water recharge

3.5.1.1 Hydrologic Functions

Planter boxes are vegetated and mulched or grassed (i.e., landscaped), shallow depressions that capture, temporarily store, and filter stormwater runoff before directing the filtered stormwater toward a stormwater conveyance system or other BMP via underdrain pipes. The captured runoff infiltrates through the bottom of the depression and a soil media layer approximately 2 to 4 feet deep that has an infiltration rate capable of draining the planter box (to the bottom of the soil media) within a specified design drawdown time (usually 12 to 48 hours; Davis et al 2009; Hunt and Lord 2006). The soil media provides treatment through filtration, adsorption, and biological uptake. Some volume reduction is possible through evapotranspiration and storage in the soil media. Planter boxes are typically planted with grasses, shrubs, and trees that can withstand short periods of saturation (12 to 24 hours; Davis et al 2009; Hunt and Lord 2006) followed by longer periods of drought.

3.5.1.2 Water Quality Performance

Planter boxes are volume-based BMPs intended, primarily, for water quality treatment that can provide limited peak-flow reduction for the water quality or design storm and volume reduction. Planter boxes should be used only in place of bioretention areas where geotechnical conditions do not allow for infiltration. Although planter boxes do not allow for infiltration into the subsoils, they still provide functions considered fundamental for LID practices. Research has shown that runoff volume can be reduced by as much as 15 to 20 percent by systems that are lined or completely contained (Hunt et al. 2006) through evapotranspiration. They are considered only as a last resort to provide some water quality treatment in areas where infiltration is not recommended.

Planter boxes remove pollutants through physical, chemical, and biological mechanisms. Specifically, they use absorption, microbial activity, plant uptake, sedimentation, and filtration, similar to bioretention areas. Planter boxes are capable of consistent and high pollutant removal for sediment, metals, and organic pollutants (e.g., hydrocarbons). Current research shows that pollutant removal is possible with underdrains through the function provided at the surface and by the soil media. Most of the sediment removal occurs in the top mulch layer, while metals removal commonly occurs in the first 18 inches of the soil media (Hsieh and Davis 2005; Hunt and Lord 2006).

3.5.1.3 Applications and Configurations

Appendix B.4 outlines major design components and site considerations and describes the process for designing planter boxes. Typical site applications and configurations are shown below. Figure 3-13 shows how a planter box can be incorporated next to a building, and Figure 3-14 shows a planter box in an ultra-urban area.



San Diego, California Source: Tetra Tech

Figure 3-13. Planter boxes near a building.



Philadelphia, Pennsylvania Source: Tetra Tech

Figure 3-14. Planter box in an ultra-urban setting.

3. LID Selection—Structural BMPs

3.5.2 Green Roofs

Green roofs reduce runoff volume and rates by intercepting rainfall in a layer of rooftop growing media. Rainwater captured in rooftop media then evaporates or is transpired by plants back into the atmosphere. Rainwater in excess of the media capacity is detained in a drainage layer before flowing to roof drains and downspouts. Green roofs are highly effective at reducing or eliminating rooftop runoff from small to medium storm events, which can reduce downstream pollutant loads; however, green roofs do not typically improve the quality of captured rainwater. In addition to stormwater volume reduction, green roofs offer an array of benefits, including extended roof lifespan (due to additional sealing, liners, and insulation), improved building insulation and energy use, reduction of urban heat island effects, opportunities for recreation and rooftop gardening, noise attenuation, air quality improvement, bird and insect habitat, and aesthetics (Tolderlund 2010; Berndtsson 2010; Getter and Rowe 2006). Green roofs can be designed as extensive, shallow-media systems or intensive, deep-media systems depending on the design goals, roof structural capacity, and available funding. Extensive green roofs in the San Antonio region may require drip irrigation to sustain vegetation through hot summer months, but air conditioner condensate or harvested rainwater can be used for this purpose. To improve vegetation resistance and resilience, a biodiverse, locally-adapted plant palette should be used. Even with careful plant selection, many “green” roofs will remain brown during much of the year. *Blue roofs* are another form of rooftop runoff management also known as *rooftop ponding areas* or *rooftop detention* that can be effective for volume and flow control. Brown roofs are another form of rooftop runoff management focused on grasses or other “brown” vegetation rather than succulents, although this manual focuses on vegetated roofs because of their multi-use benefits. Additional information and design recommendations for blue roofs and brown roofs can be found in *Guidelines for the Design and Construction of Stormwater Management Systems* from the New York City Department of Environmental Protection and New York City Department of Buildings. Table 3-7 describes the advantages and limitations of green roofs.

Table 3-7. Advantages and limitations of green roofs

Advantages	Limitations
<ul style="list-style-type: none"> • Reduces stormwater volume and peak flow through evapotranspiration • Independent of site soils and geological setting • Can be used to reduce size of downstream BMPs • Improve building energy use and reduce energy costs • Enhance roof lifespan • Provide rooftop recreation and gardening opportunities • Reduce noise and air pollution • Provide urban bird and insect habitat • Improve aesthetics and increase property values (if visible) 	<ul style="list-style-type: none"> • Structural constraints could preclude use • Installation can be challenging in certain locations • Tend to be costly compared to other stormwater volume reduction practices • Although total stormwater volume is reduced, tend to export high nutrient concentrations and possibly pathogens (Berndtsson 2010) • Roof slopes steeper than 45° tend to require special design • May require irrigation for maintenance of vegetation during summer months (depends on plant selection and design goals)

3.5.2.1 Hydrologic Functions

The main benefits of green roofs are from significant rainfall volume retention, evapotranspiration, and reduced peak discharge from rooftops. While hydrologic performance of green roofs varies with media and material type, roof pitch, vegetation, climate, and season, green roofs tend to retain (on average) between 45 and 75 percent of annual rainfall (Berndtsson 2010). Vegetation has been shown to significantly enhance rooftop rainwater retention when compared with unplanted soil media, especially in the summer and in arid environments, although the majority of water retention and evaporation occurs in

the soil media (Wolf and Lundholm 2008; Berndtsson 2010; Schroll et al. 2011). High runoff retention mimics evapotranspiration and canopy interception of natural systems, which shifts the urban water balance more toward predevelopment hydrology conditions.

3.5.2.2 Water Quality Performance

The body of knowledge surrounding green roof effluent quality is limited, but in general, green roofs are expected to export higher phosphorus and nitrogen concentrations than measured in rainfall (Berndtsson 2010). This is mainly from decomposition and release of nutrients from organic matter in the green roof soil media. Nevertheless, overall nutrient loads can be reduced when water volume reduction is considered (Kohler et al. 2002). Green roofs also tend to reduce heavy metal loads relative to incoming loads from precipitation (Berndtsson 2010).

3.5.2.3 Applications and Configurations

Appendix B.5 outlines major design components and site considerations and describes the process for designing green roofs. Green roofs are typically differentiated into two categories (intensive and extensive) based on desired function and structural capacity of the roof. Some examples of each type are provided below.

Extensive Green Roof

Green roofs with shallow, lightweight media are generally known as extensive. Media depths typically range from 4 to 6 inches to minimize loading on structures. Extensive green roofs are typically implemented solely for stormwater management, although alternative benefits are often realized (including reduced energy costs, improved roof lifespan, and pollinator habitat). An example of an extensive green roof is provided in Figure 3-15.



Live Roof System, Hipolito F. Garcia Federal Building, San Antonio, Texas Source: Joss Growers

Figure 3-15. Extensive green roofs reduce stormwater runoff while providing cooling effects, habitat for pollinators, and aesthetic value.

3. LID Selection—Structural BMPs

Intensive Green Roof

Roof gardens and rooftop parks with media deeper than 6 inches are commonly known as intensive green roofs. Unlike extensive green roofs, intensive green roofs are typically installed primarily for recreational and aesthetic purposes and provide stormwater benefits as an auxiliary function. Because deep media depth exerts high loads on underlying structures, implementation of intensive green roofs is common on the top level of parking decks, high-rise buildings, and other structures specifically designed for extreme loading. Example of an intensive green roof is shown in Figure 3-16.



James Madison High School Agriscience Building, San Antonio, Texas Source: Bender Wells Clark Design

Figure 3-16. Intensive green roofs provide recreational, aesthetic, and educational opportunities in addition to stormwater benefits.

3.5.3 Sand Filter

A sand filter is a treatment system used to remove particulates and solids from stormwater runoff by facilitating physical filtration. It is a flow-through system designed to improve water quality from impervious drainage areas by slowly filtering runoff through sedimentation and filtration chambers. With increased detention time, the sedimentation chamber allows larger particles to settle in the chamber. The filtration chamber removes pollutants and enhances water quality as the stormwater is strained through a layer of sand. The treated effluent is collected by underdrain piping and discharged to the existing stormwater collection system or another BMP. Advantages and limitations of sand filters are outlined below in Table 3-8.

Table 3-8. Advantages and limitations of sand filters

Advantages	Limitations
<ul style="list-style-type: none"> • Efficient removal of suspended solids, heavy metals, oil and grease, particle-bound nutrients, and pathogens • Can effectively reduce peak runoff rates for relatively frequent storms, reduce runoff volumes, and recharge ground water if soil conditions allow • Flexible to adapt to urban retrofits • Can incorporate deeper ponding depths and require less space • Can be placed underground in areas where space is limited • Can have high infiltration rates 	<ul style="list-style-type: none"> • Surface layer can clog over time (though it can be restored) • Frequent trash removal might be required, especially in high-traffic areas • Vigilance in protecting native soils from compaction during construction might be necessary (for infiltrating systems) • Can be unattractive in some areas • Standing water in sedimentation/grit chambers can provide vector breeding habitat • Higher overall cost for implementation

3.5.3.1 Hydrologic Functions

Sand filters are filtering BMPs that remove trash and pollutants by passing stormwater vertically through a sand media. Sand filters are generally applied to land uses with a large fraction of impervious surfaces and ultra-urban locations. Although an individual sand filter can handle only a small contributing drainage area, multiple units can be dispersed throughout a large site. Two strategies are available for incorporating sand filters into the site design. One option is the open basin or above ground design that allows sunlight penetration to enhance pathogen removal. The second option is a closed basin or below ground design that requires very little space in a site but has reduced pollutant-removal capabilities. Because sand filters can be implemented underground, they can also be used in areas with limited surface space.

Sand filters are designed primarily for water quality enhancement; however, surface sand filters can store a substantial volume of water and be used for peak flow attenuation. Sand filters typically employ underdrain systems to collect and discharge treated stormwater but can also be designed as infiltration-type systems when in soils with sufficient permeability or infiltration rates. Infiltration further enhances a sand filter’s ability to mitigate flood flows and reduces the erosive potential of urban runoff.

3.5.3.2 Water Quality Performance

Sand filters are capable of removing a wide variety of pollutant concentrations in stormwater via settling, filtering, and adsorption processes. Sand filters have been a proven technology for drinking water treatment for many years and are capable of removing many particulate-bound urban stormwater pollutants including TSS, particulate-bound nutrients, and metals (Barrett 2008). Sand filters are volume-based BMPs intended primarily for treating the water quality design volume. In many cases, sand filters are contained within enclosed concrete or block structures with underdrains; therefore, only minimal volume reduction occurs via evaporation as stormwater percolates through the filter to the underdrain.

Because sand filters rely on filtration as the primary function for pollutant reduction, infiltration rates could be higher than what is recommended for a bioretention area, allowing a greater volume to pass through the media in a short time. That requires less surface area of the BMP to treat the same volume with a lower performance for some pollutants. Sand filters generally have high removal rates for sediment, BOD, and fecal coliform bacteria (USEPA 1999). Effluent concentrations of sediment and sediment-bound pollutants tend to be relatively independent of influent concentrations, indicating sand

3. LID Selection—Structural BMPs

filters can be expected to discharge constant effluent quality regardless of influent concentrations (Barrett 2008). TSS removal rates range from 74 to 95 percent, with a typical efficiency of 90 percent (Bell et al. 1995; Horner and Horner 1995; Barrett 2003, 2008, 2010). TSS effluent concentrations ranged from 13 to 25 mg/L for five study sites in Texas (compared to influent concentrations of 69 to 304 mg/L; Barrett 2010).

Barrett (2010) reported the following pollutant removal rates (percent reductions in event mean concentration from inlet to outlet) for five sand filter study sites in Texas:

- Total phosphorus: –14 percent (export) to 69 percent (reduction)
- BOD: –27 percent (export) to 55 percent (reduction)
- Zinc: 35 to 87 percent reduction
- Copper: 14 to 59 percent reduction
- Lead: 61 to 86 percent reduction
- Fecal coliform: –70 percent (export) to 54 percent (reduction)
- Fecal streptococcus: 11 to 68 percent reduction

In another study, Barrett (2008) reported that total nitrogen is modestly removed, with an average efficiency of approximately 20 percent, while removal of total metals ranges from 50 to 87 percent, with lower removal of dissolved metals.

3.5.3.3 Applications and Configurations

Appendix B.6 outlines major design components and site considerations and describes the process for designing sand filters. Typical site applications and configurations are described below.

Surface

Surface sand filters require some method of pretreatment, such as a filter strip or swale, to remove large solids and reduce the velocity of stormwater entering the BMP. Surface sand filters can be integrated into the site plan as recreational facilities such as volleyball courts or open space as shown in Figure 3-17.



Parman Library, San Antonio, Texas Source: Bender Wells Clark Design

Figure 3-17. Surface sand filter.

Subsurface

Subsurface sand filters require very little space and are easily incorporated belowground into the edge of parking lots and roadways. Subsurface sand filters require a pretreatment sedimentation chamber that is a minimum of 1.5 feet wide to allow for settling of large solids. An example of a subsurface sand filter with a sedimentation chamber is shown in Figure 3-18.



Raleigh, North Carolina Source: Tetra Tech

Figure 3-18. Subsurface sand filter.

3. LID Selection—Structural BMPs

3.6 Volume-Storage and Reuse BMPs

Stormwater wetlands can be effectively implemented in open space areas to temporarily capture and store runoff where infiltration is limited or not feasible. Using BMPs around buildings is intended to maximize rainfall interception and minimize pollutant introduction into stormwater. Cisterns and rain barrels are examples of volume-storage and reuse BMPs that reduce runoff washed from buildings. With the goal of reducing the total runoff volume washed into the traditional stormwater conveyance system (MS4), stormwater wetlands, cisterns, and rain barrels are especially effective in capturing volumes from smaller storm events. Once captured, the stormwater is slowly released between storm events and can be used for irrigation. The controlled release from cisterns reduces peak storm volumes and, therefore, reduces runoff and erosion potential.

3.6.1 Stormwater Wetlands

Stormwater wetlands are engineered, shallow-water ecosystems designed to treat stormwater runoff. Commonly implemented in low-lying areas, stormwater wetlands are well suited to areas along river corridors where water tables are higher. Sediment and nutrients are efficiently reduced by stormwater wetlands by means of sedimentation, chemical and biological conversions, and uptake. Stormwater wetlands provide flood control benefits by storing water and slowly releasing it over 2 to 5 days. In addition to stormwater management, stormwater wetlands provide excellent plant and wildlife habitat and can often be designed as public amenities. Research has indicated that a home located next to stormwater wetlands can have a 20 to 30 percent higher selling price (Russell et al. 2012). Advantages and limitations of stormwater wetlands are outlined in Table 3-9.

Table 3-9. Advantages and limitations of stormwater wetlands

Advantages	Limitations
<ul style="list-style-type: none">• Excellent sediment and nutrient reduction• Useful in low-lying areas, areas with high water tables, or where infiltration is otherwise restricted/discouraged• Construction and design techniques similar to conventional detention ponds• Provide multi-benefit uses by enhancing biodiversity and providing recreational/educational opportunities• Typically require fewer vector control efforts than unvegetated ponds because properly maintained habitat supports mosquito predators (dragonflies and fish)	<ul style="list-style-type: none">• Limited use in semi-arid climates where supplemental water would be required to maintain water level (a site-specific water balance must be performed to justify implementation)

3.6.1.1 Hydrologic Functions

Runoff enters stormwater wetlands and is stilled in a forebay where large solids and debris are captured. The design volume then fills the wetland to a depth of 12 inches or less and drains over 2 to 5 days through a drawdown orifice installed at the elevation of the permanent pool. Runoff in excess of the design volume can bypass to the downstream stormwater network or can be detained using a riser structure or weir. Although stormwater wetlands can mitigate peak discharge, they are not designed for volume reduction—in fact, infiltration is discouraged to ensure that permanent pools are maintained for plant survival and aesthetic purposes (more information in Appendix B.7).

3.6.1.2 Water Quality Performance

Similar to natural wetlands, water quality improvement is effectively achieved in constructed wetlands through physicochemical and biological processes as water is temporarily stored. Specific unit processes include sedimentation, denitrification, and uptake. Consequently, the flow path through the wetland should be maximized to increase residence time and contact with vegetation, soil, and microbes. Very high sediment removal efficiencies have been reported for properly sized stormwater wetlands (50 to 80 percent reduction), with average effluent concentrations near 9 mg/L (Hathaway and Hunt 2010; Geosyntec Consultants, Inc. and Wright Water Engineers, Inc. 2012). Subsequently, particle-bound metals are thought to be reduced as sediment falls out of suspension, and significant reduction of total copper, total cadmium, total lead, and total zinc is expected (although metals can dissociate from sediment and organic matter into solution under anaerobic conditions; Newman and Pietro 2001; Geosyntec Consultants, Inc. and Wright Water Engineers, Inc. 2012).

High phosphorus removal rates have been observed in stormwater wetlands, but, similar to metals, phosphorus can desorb from sediments under anaerobic conditions (Hathaway and Hunt 2010). Stormwater wetlands typically perform well for nitrate removal because the anaerobic conditions and organic material in wetland sediment create an ideal environment for denitrification (converting nitrate into nitrogen gas). Significant nitrate reduction is commonly observed in stormwater wetlands, but total nitrogen reduction depends on the species and concentration of incoming nitrogen (Hathaway and Hunt 2010; Moore et al. 2011; Geosyntec Consultants, Inc. and Wright Water Engineers, Inc. 2012). Pathogen removal in stormwater wetlands is expected because of predation, solar radiation, and sedimentation (Davies and Bavor 2000; Struck et al. 2008; Geosyntec Consultants, Inc. and Wright Water Engineers, Inc. 2012); furthermore, wetlands tend to reduce bacteria more than do traditional wet detention ponds (Davies and Bavor 2000).

3.6.1.3 Applications and Configurations

Appendix B.7 outlines major design components and site considerations and describes the process for designing stormwater wetlands. In general, stormwater wetlands are particularly well suited to low-lying sites with large drainage areas. The configuration of the stormwater wetland will vary by site and can be adapted to the available space and desired functions. Long, linear wetlands can be installed along the perimeter of sites, smaller pocket wetlands can be distributed throughout a development, or larger wetlands can be installed at the downstream end of a catchment. Figure 3-19 and Figure 3-20 illustrate examples of stormwater wetlands.

3. LID Selection—Structural BMPs



Lenoir, North Carolina Source: Tetra Tech

Figure 3-19. A large linear stormwater wetland.



Wilmington, North Carolina Source: Tetra Tech

Figure 3-20. Small wetlands along the perimeter of a neighborhood.

3.6.2 Rainwater Harvesting

Cisterns or their smaller counterpart, rain barrels, are containers that capture runoff and store it for future use. With control of the timing and volume, the captured stormwater can be more effectively released for irrigation or alternative grey water uses between storm events. Rain barrels tend to be smaller systems, less than 100 gallons. Cisterns are larger systems that can be self-contained aboveground or belowground systems generally larger than 100 gallons. Belowground systems often require a pump for water removal. For San Antonio and surrounding areas, cisterns and rain barrels primarily provide control of stormwater volume; however, water quality improvements can be achieved when cisterns and rain barrels are used in a treatment train with BMPs such as bioretention areas. Water in cisterns or rain barrels can be controlled by permanently open outlets or operable valves depending on project specifications. Cisterns and rain barrels can be a useful method of reducing stormwater runoff volumes in urban areas where site constraints limit the use of other BMPs. Advantages and limitations of rainwater harvesting are outlined in Table 3-10.

Table 3-10. Advantages and limitations of rainwater harvesting

Advantages	Limitations
<ul style="list-style-type: none"> • Provides peak flow mitigation for frequent and infrequent storm events • Aids in infiltration by delaying runoff • Variable configurations to meet site constraints • Can reduce the size of infiltration BMPs • Can be designed for high visibility to raise stormwater awareness or can be hidden from view • Effective where underground utilities or other constraints preclude use of surface/subsurface storage BMPs • Can be designed to supplement or replace nonpotable water supplies (for nonresidential uses) or for irrigation (residential or nonresidential) • Rainwater harvesting equipment is exempt from sales tax under Texas Tax Code 151.355 	<ul style="list-style-type: none"> • Requires regular maintenance of inlet filters and mosquito control screens • Can require structural support • Reuse systems may require filtration and disinfection per intended use and local plumbing codes

3.6.2.1 Hydrologic Functions

Cisterns are typically placed near roof downspouts such that flows from existing downspouts can be easily diverted into the cistern. Runoff enters the cistern near the top and is filtered to remove large sediment and debris. Collected water exits the cistern from the bottom or can be pumped to areas more conducive for infiltration. Cisterns can be used as a reservoir for temporary storage or as a flow-through system for peak flow control. Cisterns are fitted with a valve that can hold the stormwater for reuse, or they release the stormwater from the cistern at a rate below the design storm rate. Regardless of the intent of the storage, an overflow must be provided if the capacity of the cistern is exceeded. The overflow system should route the runoff to a BMP for treatment or safely pass the flow into the stormwater drainage system. The overflow should be conveyed away from structures. The volume of the cistern should be allowed to slowly release, preferably into a BMP for treatment or into a landscaped area where infiltration has been enhanced.

Cisterns have been used for millennia to capture and store water. Droughts in recent years have prompted a resurgence of rainwater harvesting technology as a means of offsetting potable water use. Studies have shown that adequately designed and used systems reduce the demand for potable water and can provide

3. LID Selection—Structural BMPs

important hydrologic benefits (Vialle et al. 2012; DeBusk et al. 2012). Hydrologic performance of rainwater harvesting practices varies with design and use; systems must be drained between rain events to reduce the frequency of overflow (Jones and Hunt 2010). When a passive drawdown system is included (e.g., an orifice that slowly bleeds water from the cistern into an adjacent vegetation bed or infiltrating practice), significant runoff and peak flow reduction can be achieved (DeBusk et al. 2012; AECOM Technical Service, Inc. 2011).

3.6.2.2 Water Quality Performance

Because most rainwater harvesting systems collect rooftop runoff, the water quality of runoff harvested in cisterns is largely determined by surrounding environmental conditions (overhanging vegetation, bird and wildlife activity, atmospheric deposition, and such), roof material, and cistern material (Thomas and Greene 1993; Despins et al. 2009; Lee et al. 2012). Rooftop runoff tends to be relatively clean regarding physical and chemical pollutants, but elevated microbial counts are typical (Thomas and Greene 1993; Lye 2009; Gikas and Tsihrintzis 2012; Lee et al. 2012). Physicochemical contaminants can be further reduced by implementing a first-flush diverter (discussed later); however, first-flush diverters can have little impact on reducing microbial counts (Lee et al. 2012; Gikas and Tsihrintzis 2012).

The pollutant reduction mechanisms of cisterns are not yet well understood, but it is thought that water quality improvement can be achieved by sedimentation and biochemical transformations (given adequate residence time). Despite limited data describing reduction in stormwater contaminant concentrations in cisterns, rainwater harvesting can greatly reduce pollutant loads to waterways if stored rainwater is infiltrated into surrounding soils using a low-flow drawdown configuration or when it is used for alternative purposes such as toilet flushing or vehicle washing (Khastagir and Jayasuriya 2010). Rainwater harvesting systems can also be equipped with filters to further improve water quality.



Pine Knoll Shores, North Carolina Source: Tetra Tech

Figure 3-21. Typical plastic cistern.

3.6.2.3 Applications and Configurations

Appendix B.8 outlines major design components and site considerations and describes the process for designing rainwater harvesting systems that are in compliance with the San Antonio plumbing code (City of San Antonio 2009). Additional Texas-specific resources are provided in TCEQ (2011), Texas Water Development Board (2005), and Texas A&M AgriLife Extension Services (2013). Typical site applications and configurations are described below.

A cistern typically holds several hundred to several thousand gallons of rainwater that can be used in a variety of settings in residential, commercial, governmental, and industrial applications. Cisterns provide non-potable water for irrigation, toilet flushing, cooling system makeup, and equipment and vehicle washing and come in a variety of shapes, colors, and configurations. Figure 3-21 shows a typical above ground plastic cistern and Figure 3-22 shows the same cistern with a wooden wrap. Cisterns can also be decorative such as the one shown in Figure 3-23 at the Children’s Museum in Santa Fe, NM or below ground as shown in Figure 3-24.



Pine Knoll Shores,, North Carolina Source: Tetra Tech

Figure 3-22. Wood wrapped cistern.



Source: Santa Fe, New Mexico, Children's Museum

Figure 3-23. Decorative cistern.

3. LID Selection—Structural BMPs



Fayetteville, North Carolina Source: Tetra Tech

Figure 3-24. Below ground cistern.

Smaller cisterns (less than 100 gallons), commonly referred to as rain barrels, are mostly used on a residential scale (Figure 3-25). Rain barrels are much less complicated to install because of their size and have similar components as cisterns. Rain barrels require an inlet connection to the downspout, an outlet, and an overflow. Water that is collected can be used to supplement municipal water for nonpotable uses, primarily irrigation. Although useful for raising public awareness and for meeting basic irrigation needs, rain barrels do not typically provide substantial hydrologic benefits because they tend to be undersized relative to their contributing drainage area. Nevertheless, modeling has suggested that the cumulative effects of watershed-wide rain barrel implementation in the San Antonio region (particularly when paired with rain gardens) can have significant impacts on 100-yr peak flow and annual volume reduction (AECOM Technical Services, Inc. 2011). Figure 3-26 shows rain barrels adequately sized for the contributing roof area.



Wilmington, North Carolina Source: Tetra Tech
Figure 3-25. Residential rain barrel.



Asheville, North Carolina Source: Tetra Tech
Figure 3-26. Rain barrels adequately sized for contributing roof area.

3. LID Selection—Structural BMPs

3.7 Conveyance and Pretreatment BMPs

3.7.1 Vegetated Swales

Vegetated swales are shallow, open grass channels that are LID alternatives to traditional curbs and gutters. Swales are designed to convey runoff while providing limited pollutant removal by sedimentation and horizontal filtration through vegetation. Swales are effective for pretreatment of concentrated flows before discharge to a downstream BMP. **Vegetated swales should not be confused with bioswales, which rely on vertical filtration of runoff through subsurface bioretention media.** Compared with other LID practices, vegetated swales have a relatively low construction cost, a moderate maintenance burden, and require only a moderate amount of surface area.

Advantages and limitations of vegetated swales are outlined in Table 3-11.

Table 3-11. Advantages and limitations of vegetated swales

Advantages	Limitations
<ul style="list-style-type: none">• Combines limited stormwater treatment with runoff conveyance• Often less expensive than curb and gutter• Provides limited peak flow reduction• Can be installed in narrow, marginal spaces along roadways and parking lots to convey runoff to downstream BMPs	<ul style="list-style-type: none">• Higher maintenance than curb and gutter• Impractical in areas with very flat grades or steep topography (can cause nuisance standing water and vector issues)• Not as effective for high flow volumes/velocities• Not effective for volume reduction

3.7.1.1 Hydrologic Functions

Vegetated swales are flow-based BMPs intended primarily for water quality treatment. Depending on site slope and soil conditions, swales provide minimal volume reduction. Vegetated swales are not intended to be a primary BMP for meeting stormwater volume and quality goals, although they can help reduce the peak flow rate by increasing the site's T_C and providing marginal volume reduction through infiltration.

3.7.1.2 Water Quality Performance

Vegetated swales can remove sediment and particulate-bound pollutants by sedimentation and filtration (Deletic and Fletcher 2006). Particle removal performance primarily depends on flow-rate, particle setting velocity, and flow length (Deletic and Fletcher 2006; Yu et al. 2001; Bäckström 2003; Bäckström 2006). In some cases, swales can export metals and pathogens (Bäckström 2003; USEPA 2012). The effectiveness of vegetated swales can be enhanced by adding check dams at approximately 50-foot increments along their length (depending on slope). The dams maximize the retention time in the swale, decrease flow velocities, and promote particulate settling. Incorporating vegetated filter strips parallel to the top of the channel banks can help to treat sheet flows entering the swale (Barrett et al. 1998).

3.7.1.3 Applications and Configurations

Appendix B.9 outlines major design components and site considerations and describes the process for designing vegetated swales. Although it might be difficult to use vegetated swales to receive stormwater runoff in urban areas because of space constraints, they can be used to receive stormwater on a wide variety of development sites in rural and suburban areas, including residential, commercial, industrial, and institutional development sites. Figure 3-27 shows a vegetated swale at James Madison High School

Agriscience in San Antonio. Vegetated swales also are well suited for use in the right-of-way of linear transportation corridors; Figure 3-28 shows a vegetated swale along a roadside.



James Madison High School Agriscience Building, San Antonio, Texas
Source: Bender Wells Clark Design

Figure 3-27. Vegetated swale in an institutional setting.

3. LID Selection—Structural BMPs



San Antonio, Texas Source: Tetra Tech

Figure 3-28. Roadside vegetated swale.

3.7.2 Vegetated Filter Strips

Vegetated filter strips are bands of dense, permanent vegetation with a uniform slope, designed to provide pretreatment of runoff generated from impervious areas before flowing into another BMP as part of a treatment train. Vegetated filter strips on highly permeable soils can also provide infiltration, improving volume reduction. Increased infiltration can decrease the necessary horizontal length. Such characteristics make it ideal to use vegetated filter strips as a BMP around roadside shoulders or safety zones.

Vegetated filter strips are implemented for improving stormwater quality and reducing runoff flow velocity. As water sheet flows across the vegetated filter strip, the vegetation filters out and settles the particulates and constituents, especially in the initial flow of stormwater. Removal efficiency often depends on the slope, length, gradient, and biophysical condition of the vegetation in the system. Advantages and limitations of filter strips are outlined in Table 3-12.

Table 3-12. Advantages and limitations of filter strips

Advantages	Limitations
<ul style="list-style-type: none"> • Good pretreatment BMP • Simple to install (often requiring only minimal earthwork and planting) • Simple, aesthetically pleasing landscaping • Low cost/maintenance 	<ul style="list-style-type: none"> • Must be sited next to impervious surfaces • Might not be suitable for industrial sites or large drainage areas • May require large footprint for sufficient treatment • Requires sheet flow across vegetated area • Application in arid areas is limited because of the need for thick vegetation • Does not provide attenuation of peak flows

3.7.2.1 Hydrologic Functions

Filter strips are often used as pretreatment devices for other, larger-capacity BMPs such as bioretention areas and assist by filtering sediment and associated pollutants before they enter the larger-capacity BMP, preventing clogging and reducing the maintenance requirements for larger-capacity BMPs. Filter strips provide an attractive and inexpensive vegetative BMP that can be easily incorporated into the landscape design of a site. Filter strips are commonly used in the landscape designs of residential, commercial, industrial, institutional, and roadway applications. They must be adjacent to the impervious areas they are intended to treat. Vegetated filter strips are flow-based BMPs intended for achieving water quality treatment. Depending on site slope and soil conditions, they can provide some volume reduction and can increase a site’s time of concentration (T_c). However, vegetated filter strips are not intended to act as a standalone, primary BMP for meeting volume-reduction objectives.

3.7.2.2 Water Quality Performance

Vegetated filter strips are well suited for treating runoff from roads, highways, driveways, roof downspouts, small parking lots, and other impervious surfaces. They can also be used along streams or open vegetated waterways to treat runoff from adjacent riparian areas. In such applications, they are commonly referred to as buffer strips. Because of their limited ability to provide peak attenuation and their ability to decrease sediment loads, vegetated filter strips are often used as a pretreatment for other BMPs such as bioretention or permeable pavement. They have not been widely accepted as primary BMPs because of the wide range of pollutant removal efficiencies (Schueler et al. 1992; Young et al. 1996).

Whereas some assimilation of dissolved constituents can occur, filter strips are generally more effective in trapping sediment and particulate-bound metals and nutrients (in the absence of erosion; Knight et al. 2013; Winston et al. 2011). Nutrients that bind to sediment include phosphorus and ammonium; soluble nutrients include nitrate. Biological and chemical processes could help break down pesticides, uptake metals, and use nutrients that are trapped in the filter. Vegetated filter strips also exhibit good removal of litter and other debris when the water depth flowing across the strip is below the vegetation height.

3.7.2.3 Applications and Configurations

Appendix B.10 outlines major design components and site considerations and describes the process for designing filter strips. Figure 3-29 and Figure 3-30 show vegetated filter strips between impervious areas and bioretention facilities. Figure 3-31 shows a filter strip next to a parking lot.

3. LID Selection—Structural BMPs



Apex, North Carolina Source: Tetra Tech

Figure 3-29. Vegetated filter strip that pretreats roadway runoff.



Raleigh, North Carolina Source: Tetra Tech

Figure 3-30. Vegetated filter strip surrounding a bioretention area in a parking lot.



San Antonio, Texas Source: Tetra Tech

Figure 3-31. Vegetated filter strip next to a parking lot.

3. LID Selection—Structural BMPs

3.8 BMP Selection Matrix

Table 3-13 is a tool to help select practices according to site characteristics and constraints when considering LID stormwater management practices. Existing or expected site characteristics can be used to determine individual practices or a suite of practices that might be appropriate in site design. Vegetated swales and filter strips are not included in the table because this manual considers these practices appropriate for pretreatment and not as standalone water quality BMPs. In addition, relative cost considerations can assist in specific BMP selection, particularly between two or more BMPs that achieve the project's goal. As such, the table lists dollar signs as qualitative costs for a relative comparison between types of BMPs rather than actual values. BMP costs can vary widely and overlap between BMP types depending on the complexity of the BMP configuration required. Costs should be used as a relative guide with emphasis on the water quality performance and the site conditions and configuration in selecting the BMP type.

Estimated costs in this table and in Appendix B cover all components of construction and operation and maintenance for various-sized projects but do not cover other conveyance needs that might be applicable. Cost estimates are based on the design standards recommended in Appendix B and can vary widely by the necessary configuration of the BMP and site constraints. These cost numbers are estimates and intended for planning purposes only. The project manager must refine these numbers throughout the phases of design to prepare a more accurate project construction estimate for bidding purposes. Cost estimates, particularly the maintenance costs, do not account for cost savings accompanied with integrated practices, such as incorporating BMP retrofits into CIP projects or integrating bioretention areas into landscaping where the routine maintenance could be included in the budget for typical landscape maintenance. The inclusion of various sizes of projects in the maintenance costs attempts to include those costs in which an economy of scale has been observed. The sizes selected for this analysis were as follows:

- Large BMP system = 4,000 ft²
- Medium BMP system = 2,000 ft²
- Small BMP system = 500 ft²

These categories are based on typically sized BMPs and are intended to account for the varying degrees of economy of scale. Cost estimates for small BMPs could be used for the projects where the only maintenance required for the project will be for the BMPs. Estimates for the large systems could be used for projects where maintenance for landscaping as well as the BMPs will be accounted for providing an economy of scale. Fixed costs for maintenance, such as equipment, mobilization, and disposal, can be dispersed more effectively for larger more complex project resulting in a lower unit cost. As a BMP area represents a system, the area can include the application of multiple BMPs. Appendix G also provides more detailed information on costs, including actual cost numbers, that are based on the frequency and type of maintenance required, such as routine maintenance (costs associated with maintenance required monthly up to every 2 years), intermediate maintenance (costs associated with maintenance required every 6 to 10 years) and replacement maintenance (costs associated with replacement of the system; estimated as a service life of 20 years). Table 3-13 does not include the more detailed frequency costs.

Once individual or groups of BMPs have been selected using this matrix, consult Appendix B to develop detailed designs and Appendix G to develop a more detailed cost estimate.

Table 3-13. LID management practice selection matrix according to site characteristics

Attribute	Bioretention		Bioswale		Permeable pavement		Planter boxes	Green roofs	Sand filter		Rainwater harvesting	Stormwater wetlands	
	Infiltrating	Lined	Infiltrating	Lined	Infiltrating	Lined			Infiltrating	Lined			
Edwards Aquifer Zone Allowed (see Section 2.2)	Artesian	All	Artesian	Artesian	Artesian, Contributing	All	All	All	Artesian	All	All	All	
Typical contributing drainage area (acres)	< 5		< 2		0 ^a		< 0.35	Rooftop	< 5		Rooftop	> 5	
Min. elevation difference between inlet and outlet (ft)	3.5 (2.5 if using IWS)		3.5 (2.5 if using IWS)		1 to 2 (depends on design)		2.5	N/A	2.5 (2 if using IWS)		N/A	2	
Separation of subgrade from bedrock and seasonal high water table (ft)	≥ 3		≥ 3		≥ 3		Above water table	N/A	≥ 3		Above water table and bedrock ^b	At or below permanent pool elevation	
Practice slope	< 2%		< 2%		< 2%		N/A	N/A	< 6%	< 6%	< 5%	< 5%	
Underdrain required?	If soil infiltration < 0.5 in/hr	Yes	If soil infiltration < 0.5 in/hr	Yes	If soil infiltration < 0.5 in/hr	Yes	Yes	N/A	If soil infiltration < 0.5 in/hr	Yes	N/A	N/A	
Pollutant removal ^e	Sediments	High		High		High		Typically water quality is not improved by green roofs (although stormwater volume reduction can reduce total pollutant loads)	High		Pollutant removal provided by downstream BMP, refer to specific BMP for removal efficiency	High	
	Nutrients	Medium		Medium		Low			Low			High	
	Trash	High		High		High			High			High	
	Metals	High		High		High			Low			High	
	Bacteria	High		High		Medium			Medium			High	
	Oil and grease	High		High		Medium			Medium			High	
	Organics	High		High		Low			Medium			High	
Runoff volume reduction	High	Low	High	Low	High	Low	Low	High	Low	Low	Varies based on cistern size and water demand	None	
Peak flow control	Medium		Medium		Medium		Low	Medium	Medium	Medium		High	
Setbacks (ft)	Structures	> 10		> 10		> 10		N/A	N/A	> 10		> 5	> 10
	Steep slopes	> 50		> 50		> 50		> 50	N/A	> 50		> 50	> 50
Costs ^c	Construction	\$-\$		\$-\$		\$-\$-\$		\$	\$	\$	\$-\$	\$	
	O & M (small)	\$-\$-\$		\$-\$-\$		\$-\$-\$		\$	\$-\$	\$-\$-\$	\$	\$-\$	
	O & M (med.)	\$-\$-\$ ^d		\$-\$		\$		\$-\$	\$-\$	\$	\$-\$	\$-\$	
	O & M (large)	\$-\$-\$ ^d		\$-\$		\$-\$		\$-\$	\$-\$	\$-\$	\$-\$	\$-\$	

a. Typically permeable pavements are designed to treat direct rainfall, but, if located outside the Edwards Aquifer Recharge, Contributing, or Transition Zones, a 1:1 drainage area to permeable pavement area ratio can be accommodated with adequate maintenance. b. For tank outlet and overflow. c. Costs are relative, can vary project to project, and are generalized; for more specific cost information, see Appendix G. d. Based on necessary regular landscape maintenance already required. e. Pollutant removal performance is based on facilities constructed per design specifications in Appendix B.

3. LID Selection—Structural BMPs

3.9 Maximizing Multiple Benefits of BMPs

The targets for treating stormwater runoff in the San Antonio River Basin can be expressed as either volume- or flow-based criteria. The volume-based requirement for an LID facility is to capture and treat the entire runoff volume from the volume-based design storm event. The flow-based requirement for a BMP facility is to treat the design runoff rate by applying the rainfall intensity-based water quality design storm. Methods for determining treatment volume and flow rates are provided in Appendix A for a range of design criteria.

LID BMPs can provide excellent ecosystem services and aesthetic value to stakeholders (see Section 1.7 for an expanded discussion of the multiple benefits of LID). Bioretention areas can also enhance biodiversity and beautifying the urban environment with native vegetation. Permeable pavements inherently provide multi-use benefits because the facilities double as parking lots and transportation corridors and rainwater harvesting allows for the provision of an alternative non-potable water source. The following components can be incorporated into BMPs to promote multi-use benefits:

- Simple signage or information kiosks to raising public awareness of stormwater issues and educate the public on the benefits of watershed protection measures or provide a guide for native plant and wildlife identification
- Volunteer groups can be organized to perform basic maintenance as an opportunity to raise public awareness
- Larger BMPs can be equipped with pedestrian cross-paths or benches for wildlife viewing
- Sculptures and other art can be installed within the BMP and outlet structures incorporating aesthetically-pleasing colors, murals, or facades
- Vegetation with canopy cover can provide shade, localized cooling (heat island mitigation), and noise dissipation
- Enhanced pavement textures, colors, and patterns and other “complete streets” components can calm traffic, increase aesthetic appeal, enhance pedestrian safety, and draw attention to multi-use stormwater practices
- Bird and butterfly feeders can be used to attract wildlife to the BMPs
- Ornamental plants can be cultivated along the perimeter and in the bed of vegetated BMPs (invasive plants should be avoided)
- BMPs can function as irrigation beds for stormwater captured by other BMPs, such as rainwater harvesting or the reservoir layer of permeable pavement
- Reuse of captured runoff offsetting non-potable water supplies used for toilet flushing, car washing, swimming pools, street sweeping, and other uses
- Permeable pavers can be selected to maintain the character of historic districts while providing stormwater management solutions
- Incorporating creative downspout designs for small practices (rain chains)

3.10 References

- AECOM Technical Service, Inc. 2011. *Leon Creek Watershed Master Plan*. Prepared for San Antonio River Authority, San Antonio, TX.
- Bäckström, M. 2003. Grassed swales for stormwater pollution control during rain and snowmelt. *Water Science and Technology* 48(9):123-132.
- Bäckström, M., Viklander, M., and Malmqvist, P.A. 2006. Transport of stormwater pollutants through a roadside grassed swale, *Urban Water Journal* 3(2):55-67.
- Barrett, M.E., M. Limouzin, and D.F. Lawler. 2012. Effects of media and plant selection on biofiltration performance *Journal of Environmental Engineering* 139(4):462-470.
- Barrett, M.E., P.M. Walsh, J.F. Malina Jr., and R. J. Charbeneau. 1998. Performance of vegetative controls for treating highway runoff. *Journal of Environmental Engineering* 124(11):1121-1128
- Barrett, M.E. 2003. Performance, Cost, and Maintenance Requirements of Austin Sand Filters. *Journal of Water Resources Planning and Management* 129(3):234–242.
- Barrett, M.E. 2008. Comparison of BMP performance using the International BMP Database. *Journal of Irrigation and Drainage Engineering* 134(5):556–561.
- Barrett, M.E. 2010. *Evaluation of Sand Filter Performance*. CRWR Online Report 10-07. Center for Research in Water Resources, Bureau of Engineering Research, University of Texas at Austin.
- Bean, E.Z., W.F. Hunt, and D.A. Bidelspach. 2007. Evaluation of four permeable pavement sites in eastern North Carolina for runoff reduction and water quality impacts. *Journal of Irrigation and Drainage Engineering* 133(6):583–592.
- Bell, W., L. Stokes, L.J. Gavan, and T. Nguyen. 1995. *Assessment of the Pollutant Removal Efficiencies of Delaware Sand Filter BMPs*. City of Alexandria, Department of Transportation and Environmental Services, Alexandria, VA.
- Berndtsson, J.C. 2010. Green roof performance towards management of runoff water quantity and quality: A review. *Ecological Engineering* 36(4):351–360.
- Booth, D.B., K.A. Kraseski, and C. Rhett Jackson. 2013. Local-scale and watershed-scale determinants of summertime urban stream temperatures. *Hydrological Processes*.
- Brattebo, B.O., and D.B. Booth. 2003. Long-term stormwater quantity and quality performance of permeable pavement systems. *Water Research* 37(18):4369–4376.
- Brown, R.A., and W.F. Hunt. 2010. Impacts of construction activity on bioretention performance. *Journal of Hydrologic Engineering* 15(6):386–394.
- Brown, R.A., and W.F. Hunt. 2011. Underdrain configuration to enhance bioretention exfiltration to reduce pollutant loads. *Journal of Environmental Engineering* 137(11):1082–1091.
- Brown, R.A., D.E. Line, and W.F. Hunt. 2012. LID treatment train: Pervious concrete with subsurface storage in series with bioretention and care with seasonal high water tables. *Journal of Environmental Engineering* 138(6):689–697.

3. LID Selection—Structural BMPs

- City of San Antonio. 2009. Appendix C Gray Water Recycling Systems and Reclaimed/Recycled Water Systems. *2009 International Plumbing Code and 2009 International Fuel Gas Code/Local Amendments*. San Antonio, TX.
- Collins, K.A., W.F. Hunt, and J.M. Hathaway. 2008. Hydrologic comparison of four types of permeable pavement and standard asphalt in eastern North Carolina. *Journal of Hydrologic Engineering* 13(12):1146–1157.
- Collins, K.A., W.F. Hunt, and J.M. Hathaway. 2010. Side-by-side comparison of nitrogen species removal for four types of permeable pavement and standard asphalt in eastern North Carolina. *Journal of Hydrologic Engineering* 15(6):512–521.
- Claytor, R.A and T. R. Schueler. 1996. Design of Stormwater Filtering Systems. Center for Watershed Protection, Ellicott City, MD.
- CWP (Center for Watershed Protection). 2007. National Pollutant Removal Performance Database. Center for Watershed Protection, Ellicott City, MD.
- Davies, C.M., and H.J. Bavor. 2000. The fate of stormwater-associated bacteria in constructed wetland and water pollution control pond systems. *Journal of Applied Microbiology* 89(2):349–360.
- Davis, A.P. 2007. Field performance of bioretention: Water quality. *Environmental Engineering Science* 24(8):1048–1063.
- Davis, A.P., W.F. Hunt, R.G. Traver, and M. Clar. 2009. Bioretention technology: Overview of current practice and future needs. *Journal of Environmental Engineering* 135(3):109–117.
- Davis, A.P., R.G. Traver, W.F. Hunt, R. Lee, R.A. Brown, and J.M. Olszewski. 2012. Hydrologic performance of bioretention storm-water control measures. *Journal of Hydrologic Engineering* 17(5):604–614.
- DeBusk, K.M., W.F. Hunt, M. Quigley, J. Jeray, and A. Bedig. 2012. Rainwater harvesting: Integrating water conservation and stormwater management through innovative technologies. *World Environmental and Water Resources Congress 2012: Crossing Boundaries, Proceedings of the 2012 Congress*, pp. 3703–3710.
- Deletic, A, and T.D. Fletcher. 2006. Performance of grass filters used for stormwater treatment – a field and modeling study. *Journal of Hydrology* 317:261-275.
- Despins, C., K. Farahbakhsh, and C. Leidl. 2009. Assessment of rainwater quality from rainwater harvesting systems in Ontario, Canada. *Journal of Water Supply: Research and Technology—AQUA* 58(2):117–134.
- Dierkes, C., L. Kuhlmann, J. Kandasamy, and G. Angelis. 2002. Pollution retention capability and maintenance of permeable pavements. In *Proc. 9th International Conference on Urban Drainage, Global Solutions for Urban Drainage*. September 8–13, 2002, Portland, OR.
- Fassman, E.A., and S.D. Blackbourn. 2010. Urban runoff mitigation by a permeable pavement system over impermeable soils. *Journal of Hydrologic Engineering* 15(6):475–485.

- Fassman, E.A., and S.D. Blackbourn. 2011. Road runoff water-quality mitigation by permeable modular concrete pavers. *Journal of Irrigation and Drainage* 137(11):720–729.
- FHWA (Federal Highway Administration). 2002. *Storm Water Best Management Practices in an Ultraurban Setting: Selection and Monitoring*. Federal Highway Administration, Washington, DC.
- Getter, K.L., and D.B. Rowe. 2006. The role of extensive green roofs in sustainable development. *HortScience*. 41(5):1276-1285.
- Geosyntec Consultants, Inc., and Wright Water Engineers, Inc. 2012. *International Stormwater Best Management Practices (BMP) Database Pollutant Category Summary Statistical Addendum: TSS Bacteria, Nutrients, and Metals*. http://www.bmpdatabase.org/Docs/2012%20Water%20Quality%20Analysis%20Addendum/BMP%20Database%20Categorical_SummaryAddendumReport_Final.pdf. Updated July 2012; accessed March 19, 2013.
- Gikas, G.D., and V.A. Tsihrintzis. 2012. Assessment of water quality of first-flush roof runoff and harvested rainwater. *Journal of Hydrology* 466–467:115–126.
- Gilbert, J.K., and J.C. Clausen. 2006. Stormwater runoff quality and quantity from asphalt, paver, and crushed stone driveways in Connecticut. *Water Research* 40:826–832.
- Hathaway, J.M., and W.F. Hunt. 2010. Evaluation of storm-water wetlands in series in Piedmont North Carolina. *Journal of Environmental Engineering* 136(1):140–146.
- Hathaway, J.M., W.F. Hunt, and S.J. Jadlocki. 2009. Indicator bacteria removal in stormwater best management practices in Charlotte, North Carolina. *Journal of Environmental Engineering* 135(12):1275–1285.
- Hathaway, J.M., W.F. Hunt, A.K. Graves, and J.D. Wright. 2011. Field evaluation of bioretention indicator bacteria sequestration in Wilmington, NC. *Journal of Environmental Engineering* 137(12):1103–1113.
- Hatt, B.E., T.D. Fletcher, and A. Deletic. 2008. Hydraulic and pollutant removal performance of fine media stormwater filtration systems. *Environmental Science & Technology* 42(7):2535–2541.
- Hatt, B.E., T.D. Fletcher, and A. Deletic. 2009. Hydrologic and pollutant removal performance of stormwater biofiltration systems at the field scale. *Journal of Hydrology* 365(3–4): 310–321.
- Horner, R.R., and C.R. Horner. 1995. *Design, Construction, and Evaluation of a Sand Filter Stormwater Treatment System*. Part II: Performance Monitoring. Prepared for Alaska Marine Lines, Seattle, WA.
- Hsieh, C.H., and A.P. Davis. 2005. Evaluation and optimization of bioretention media for treatment of urban stormwater runoff. *Journal of Environmental Engineering* 131(11):1521–1531.
- Houdeshel, C.D., C.A. Pomeroy, and K.R. Hultine. 2012. Bioretention design for xeric climates based on ecological principles. *Journal of the American Water Resources Association* 48(6):1178–1190.

3. LID Selection—Structural BMPs

- Hunt, W.F., and W.G. Lord. 2006. *Bioretention Performance, Design, Construction, and Maintenance*. North Carolina Cooperative Extension, Raleigh, NC.
- Hunt, W.F., A.R. Jarrett, J.T. Smith, and L.J. Sharkey. 2006. Evaluating bioretention hydrology and nutrient removal at three field sites in North Carolina. *Journal of Irrigation and Drainage Engineering* 132(6):600–608.
- Hunt, W.F., J.T. Smith, S.J. Jadlocki, J.M. Hathaway, and P.R. Eubanks. 2008. Pollutant removal and peak flow mitigation by a bioretention cell in urban Charlotte, NC. *Journal of Environmental Engineering* 134(5):403–408.
- Hunt, W.F., A.P. Davis, and R.G. Traver. 2012. Meeting hydrologic and water quality goals through targeted bioretention design. *Journal of Environmental Engineering* 138(6):698–707.
- Jones, M.P., W.F. Hunt, and R.J. Winston. 2012. Effect of urban catchment composition on runoff temperature. *Journal of Environmental Engineering* 138(12):1231–1236.
- Jones, M.P., and W.F. Hunt. 2010. Effect of stormwater wetlands and wet ponds on runoff temperature in trout sensitive waters. *Journal of Irrigation and Drainage Engineering* 136(9):656–661.
- Jones, M.P., and W.F. Hunt. 2009. Bioretention impact on runoff temperature in trout sensitive waters. *Journal of Environmental Engineering* 135(8):577–585.
- Khastagir, A., and L.N.N. Jayasuriya. 2010. Impacts of using rainwater tanks on stormwater harvesting and runoff quality. *Water Science and Technology* 62(2):324-329.
- Kim, H., E.A. Seagren, and A.P. Davis. 2003. Engineered bioretention for removal of nitrate from stormwater runoff. *Water Environment Research* 75(4):355–367.
- Knight, E.M.P., W.F. Hunt, and R.J. Winston. 2013. Side-by-side evaluation of four level spreader-vegetated filter strips and a swale in eastern North Carolina. *Journal of Soil and Water Conservation*. 68(1):61-72
- Kohler, M., M. Schmidt, F.W. Grimme, M. Laar, V.L. de Assunção Paiva , and S. Tavares. 2002. Green roofs in temperate climates and in the hot-humid tropics—far beyond the aesthetics. *Environment and Health* 13:382–391.
- Lee, J.Y., G. Bak, and M. Han. 2012. Quality of roof-harvested rainwater—Comparison of different roofing materials. *Environmental Pollution* 162:422–429.
- Li, H., and A.P. Davis. 2008. Urban particle capture in bioretention media. I: Laboratory and field studies. *Journal of Environmental Engineering* 143(6):409–418.
- Li, H., L.J. Sharkey, W.F. Hunt, and A.P. Davis. 2009. Mitigation of impervious surface hydrology using bioretention in North Carolina and Maryland. *Journal of Hydrologic Engineering* 14(4):407–415.
- Li, M.-H., C.Y. Sung, M.H. Kim, and K.-H. Chu. 2010. *Bioretention for Stormwater Quality Improvements in Texas: Pilot Experiments*. Texas A&M University in cooperation with Texas Department of Transportation and the Federal Highway Administration.

- Lye, D.J. 2009. Rooftop runoff as a source of contamination: A review. *Science of the Total Environment* 407:5429–5434.
- Moore, T.C., W.F. Hunt, M.R. Burchell, and J.M. Hathaway. 2011. Organic nitrogen exports from urban stormwater wetlands in North Carolina. *Ecological Engineering* 37(4):589–594.
- MWCOG (Metropolitan Washington Council of Governments). 1983. *Urban Runoff in the Washington Metropolitan Area: Final Report, Urban Runoff Project, EPA Nationwide Urban Runoff Program*. Metropolitan Washington Council of Governments, Washington, DC.
- Myers, B.R., S. Beecham, J.A. van Leeuwen, and A. Keegan. 2009. Depletion of *E. coli* in permeable pavement mineral aggregate storage and reuse systems. *Water Science and Technology* 60(12):3091–3099.
- Newman, S., and K. Pietro. 2001. Phosphorus storage and release in response to flooding: implications for Everglades stormwater treatment areas. *Ecological Engineering* 18(1):23–38.
- New York City Department of Environmental Protection and New York City Department of Buildings. 2012. *Guidelines for the Design and Construction of Stormwater Management Systems*. July 2012. http://www.nyc.gov/html/dep/pdf/green_infrastructure/stormwater_guidelines_2012_final.pdf. Accessed June 10, 2013.
- Pagotto, C, M. Legret, and P. Le Cloirec. 2000. Comparison of the hydraulic behaviour and the quality of highway runoff water according to the type of pavement. *Water Research* 34(18):4446–4454.
- Passeport, E., W.F. Hunt, D.E. Line, R.A. Smith, and R.A. Brown. 2009. Field study of the ability of two grassed bioretention cells to reduce stormwater runoff pollution. *Journal of Irrigation and Drainage Engineering* 135(4):505–510.
- Roseen, R.M., T.P. Ballesterro, J.J. Houle, P. Avellaneda, J.F. Briggs, G. Fowler, and R. Wildey. 2009. Seasonal performance variations for storm-water management systems in cold climate conditions. *Journal of Environmental Engineering* 135(3):128–137.
- Roseen, R.M., T.P. Ballesterro, J.J. Houle, J.F. Briggs, and K.M. Houle. 2011. Water quality and hydrologic performance of a porous asphalt pavement as a stormwater treatment strategy in a cold climate. *Journal of Environmental Engineering* 138(1):81–89.
- Russell, M.A., A. Teague, F. Alvarez, D. Dantin, and J. Nestlerode. 2012. Ecosystem goods and services at the neighborhood scale. *Ecosystem Services Partnership Conference July 31, 2012 – August 4, 2012*.
- Rushton, B.T. 2001. Low-impact parking lot design reduces runoff and pollutant loads. *Journal of Water Resources Planning and Management* 127(3):172–179.
- Schroll, E., J. Lambrinos, T. Righetti, and D. Sandrock. 2011. The role of vegetation in regulating stormwater runoff from green roofs in a winter rainfall climate. *Ecological Engineering* 37(4):595–600.
- Schueler, T.R. 1987. *Controlling Urban Runoff: A Practical Manual for Planning and Designing Urban BMPs*. Metropolitan Washington Council of Governments, Washington, DC.

3. LID Selection—Structural BMPs

- Schueler, T.R., P.A. Kumble, and M.A. Heraty. 1992. *A Current Assessment of Urban Best Management Practices, Techniques for Reduction Non-Point Source Pollution in the Coastal Zone*. Metropolitan Washington Council of Governments, Anacostia Restoration Team, Department of Environmental Programs, Washington D.C.
- Stander, E.K., and M. Borst. 2010. Hydraulic test of a bioretention media carbon amendment. *Journal of Hydrologic Engineering* 15(6):531–536.
- Strecker, E.W., M.M. Quigley, B. Urbonas, and J. Jones. 2004. Analyses of the expanded EPA/ASCE International BMP Database and potential implications for BMP design. In *Proceedings of the World Water and Environmental Resources Congress*, American Society of Civil Engineers, Salt Lake City, UT, June 27–July 1, 2004.
- Struck, S.D., A. Selvakumar, and M. Borst. 2008. Prediction of effluent quality from retention ponds and constructed wetlands for managing bacterial stressors in storm-water runoff. *Journal of Irrigation and Drainage* 134(5):567–578.
- TCEQ (Texas Commission on Environmental Quality). 2011. *Rainwater Harvesting with Rain Barrels. A “Take Care of Texas” Guide*. GI-383. Austin, TX.
- TCEQ (Texas Commission on Environmental Quality). 2007. *Three TMDLs for Bacteria in the San Antonio Area*. Chief Engineer’s Office, Water Programs, TMDL Section, Austin, TX.
- TCEQ (Texas Commission on Environmental Quality). 2008. *One TMDL for Bacteria in the Lower San Antonio River, Segment 1901*. Chief Engineer’s Office, Water Programs, TMDL Section, Austin, TX.
- TCEQ (Texas Commission on Environmental Quality). 2005. *Complying with the Edwards Aquifer Rules—Technical Guidance on Best Management Practices*. RG-348 (Revised) with Addendum. Texas Commission on Environmental Quality, Austin, TX <http://www.tceq.texas.gov/field/eapp>.
- Texas A&M AgriLife Extension Service. 2013. Rainwater Harvesting (online). Accessed 20 June 2013 at <http://rainwaterharvesting.tamu.edu/>.
- Texas Department of Transportation. 2010. *Roadway Design Manual*. Texas Department of Transportation, Design Division. <http://onlinemanuals.txdot.gov/txdotmanuals/rdw/rdw.pdf>. Revised May, 2010, Accessed March 27, 2013.
- Texas Water Development Board. 2005. *The Texas Manual on Rainwater Harvesting*. Third Edition. Austin, TX.
- Thomas, P.R., and G.R. Greene. 1993. Rainwater quality from different roof catchments. *Water Science and Technology* 28(3–5):291–299.
- Tolderlund, L. 2010. *Design Guidelines and Maintenance Manual for Green Roofs in the Semi-Arid and Arid West*. Denver, CO.
- Toronto and Region Conservation Authority. 2007. *Performance Evaluation of Permeable Pavement and a Bioretention Swale*. Interim Report #3. Seneca College, King City, Ontario.

- Tota-Maharaj, K., and M. Scholz. 2010. Efficiency of permeable pavement systems for the removal of urban runoff pollutants under varying environmental conditions. *Environmental Progress and Sustainable Energy* 29(3):358–369.
- Tyner, J.S., W.C. Wright, and P.A. Dobbs. 2009. Increasing exfiltration from pervious concrete and temperature monitoring. *Journal of Environmental Management* 90:2636–2641.
- USEPA (United States Environmental Protection Agency). 1986. *Quality Criteria for Water*. Office of Water, Regulations and Standards, Washington, D.C. EPA 440/5-86-001.
- USEPA (U.S. Environmental Protection Agency). 1999. *Stormwater Management Fact Sheet: Sand Filters*. EPA-832-F-99-007. U.S. Environmental Protection Agency, Washington, DC.
- USEPA (U.S. Environmental Protection Agency). 2012. Grassed Swales. National Pollutant Discharge Elimination System (NPDES) Menu of BMPs. <http://cfpub.epa.gov/npdes/stormwater/menuofbmps/index.cfm>. Updated July 23, 2012; accessed April 26, 2013.
- Vialle, C., C. Sablayrolles, M. Lovera, M.-C. Huau, S. Jacob, and M. Montrejaud-Vignoles. 2012. Water quality monitoring and hydraulic evaluation of a household roof runoff harvesting system in France. *Water Resource Management* 26:2233–2241.
- Wardynski, B.J., R.J. Winston, and W.F. Hunt. 2013. Internal water storage enhances exfiltration and thermal load reduction from permeable pavement in the North Carolina mountains. *Journal of Environmental Engineering* 139(2):187–195.
- Winston, R.J., W.F. Hunt, and W.G. Lord. 2011. Thermal mitigation of urban stormwater by level spreader—Vegetative filter strips. *Journal of Environmental Engineering* 137(8):707–716.
- Winston, R.J., W.F. Hunt, D.L. Osmond, W.G. Lord, and M.D. Woodward. 2011. Field evaluation of four level spreader-vegetative filter strips to improve urban storm-water quality. *Journal of Irrigation and Drainage Engineering* 137(3): 170-182.
- Wolf, D., and J.T. Lundholm. 2008. Water uptake in green roof microcosms: Effects of plant species and water availability. *Ecological Engineering* 33:179–186.
- Yong, C.F., A. Deletic, T.D. Fletcher, and M.R. Grace. 2011. Hydraulic and treatment performance of pervious pavements under variable drying and wetting regimes. *Water Science and Technology* 64(8):1692–1699.
- Young, G.K., S. Stein, P. Cole, T. Kammer, F. Graziano, and F. Bank. 1996. *Evaluation and Management of Highway Runoff Water Quality*. Rep. No. FHWA-PD-96-032. Federal Highway Administration, Washington, DC.
- Yu, S. L., Kuo, J., Fassman, E.A., and Pan, H. 2001. Field test of grassed-swale performance in removing runoff pollution. *Journal of Water Resources Planning and Management* 127(3):168-171.

3. LID Selection—Structural BMPs

This page is intentionally blank.

4 Execution Considerations

Permanent structural stormwater control BMPs require smaller operation and maintenance budgets over the design life when important life-cycle activities, including inspections and maintenance, are considered early in the planning and design process. Because post construction inspections and maintenance are essential to facility function, it is important to ensure that necessary equipment, access, and methods to complete maintenance and BMP evaluation tasks during the operation phase are considered during the design phase.

BMP execution can be complicated by problems stemming from design needs that are not understood, inexperienced contractors performing the construction, or inadequate operation and maintenance. Chapter 4 includes considerations for BMP construction observation, post-construction inspection, and operation and maintenance. It is recommended that the project manager include in the project specifications the considerations presented in this section.

4.1 BMP Construction

In this section, potential construction problems are reviewed so that LID BMP designers can improve designs and avoid future issues. Essential functions of permanent LID BMPs (e.g. bioswale, wetland) can be deteriorated by common construction practices, such as compacted soils from heavy equipment, erosion and sediment build-up, or work performed in saturated conditions. Construction observation and inspections by a qualified inspector familiar with the functions of structural BMPs are recommended for quality control and assurance. As part of construction oversight, inspectors should ensure that the proper temporary erosion control practices are implemented in accordance with federal, state, and local regulations. Construction specifications might include the following measures to protect the permanent LID BMP (e.g. bioretention, permeable pavement) while construction operations are underway:

- Establish a protective zone around valued natural areas and trees that will be preserved.
- Minimize the use of heavy equipment, especially in areas where infiltration BMPs will be.
- Minimize soil disturbance and unprotected exposure of disturbed soils.
- Expose only as much area as needed for immediate construction.
- As areas are cleared and graded, apply appropriate erosion controls to minimize soil erosion.
- Protect stormwater infiltration BMPs from unwanted sedimentation during the construction phase.
- Provide a temporary outlet to convey runoff down slope with sediment traps at outlets and inlets.
- Minimize the movement of soil into the drainage system.
- Use sediment and erosion protection practices early in the site clearing and grading process to reduce the sediment-laden runoff reaching soils intended for future infiltration.
- Protect future infiltration facilities from sediment from adjacent properties.

Sensitive areas that need to be protected should be delineated before grading and clearing starts. It is best to indicate such restrictions on the site plan. Areas of existing vegetation that are planned for preservation should be clearly marked with a temporary fence. If trees have been designated for preservation,

4. Execution Considerations

equipment should be prohibited within the drip line to prevent root and trunk damage. Trenching and excavating should not occur within the drip line, and trenches outside but adjacent to the drip line should be filled in quickly to avoid root drying.

4.1.1 Temporary Erosion and Sediment Control Practices

Soil-disturbing activities at the construction site can increase erosion and sediment risks. Apply an effective combination of temporary soil erosion and sediment controls to minimize the discharge of sediments from the site or into a stormwater drainage system or natural receiving water. TCEQ's *Complying with the Edwards Aquifer Rules Technical Guidance on Best Management Practices* provides detailed specifications for erosion and sediment control BMPs that are applicable to all construction sites (TCEQ 2005). Properly applying the temporary controls (both on-site and for drainage from off-site parcels with the potential to contribute sediment) is essential and can help preserve the long-term capacity and functions of the permanent stormwater BMPs. Inspection and maintenance of these temporary controls are required to ensure that they remain effective. These controls are in addition to the SWPPP measures that are required by the TCEQ's general NPDES permit to limit movement of sediment off a site.

Proper construction sequencing can reduce the risk of clogging by excessive accumulation of fine particles in the soil media layers. Designers should specify proper construction sequencing to minimize potential disturbance to LID structures. During construction, the extent of disturbed, exposed soils should be limited to reduce the risk of erosion by specifying the timing and extent of permanent vegetation establishment. Imported soil media should not be incorporated into BMPs until the drainage area has been stabilized. Soil media should not be installed until at least the first course of pavement has been set for roads and parking lots, which minimizes the amount of fines washed from the bedding layers into the BMP. A geotextile liner might not be sufficient to prevent fines from migrating into and clogging the soil media layer; for that reason, proper construction sequencing is crucial. Figure 4-1 and Figure 4-2 are examples of the fines that can accumulate and clog the soil media if proper construction sequencing is not followed.



Source: NCSU BAE

Figure 4-1. Example of a bioretention area installed before permanent site stabilization with the inset photo showing the clay layer clogging the mulch surface.

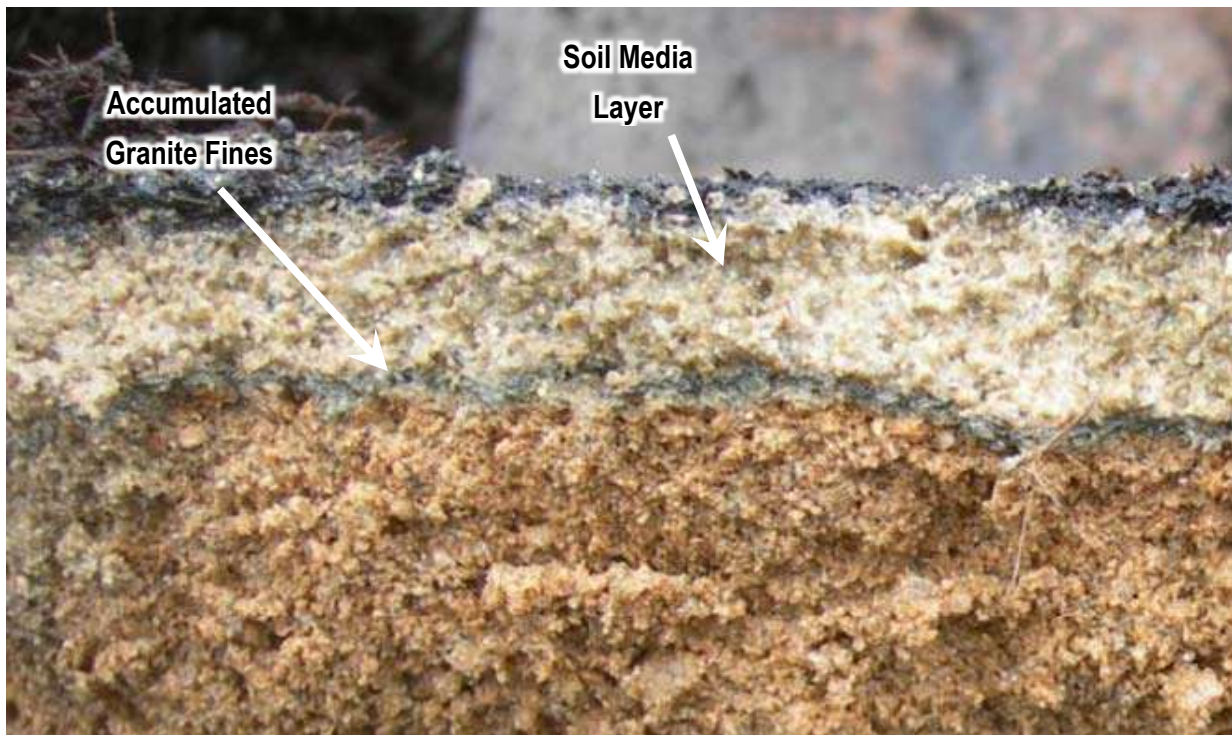

Source: NCSU-BAE

Figure 4-2. Accumulated fines layer as a result of improper construction sequencing.

4. Execution Considerations

4.1.2 BMP Construction Inspection

It is essential to inspect all construction phases to ensure that BMPs are properly installed, especially when critical elements of a structural BMP are being installed, such as inverts, inlets, outlets, overflow, and underdrains. In the design notes, designers should stipulate whether the type of materials specified cannot be substituted because they might not perform as well (e.g., engineered media). If an element of a structural BMP system was not properly constructed or the wrong materials were used, the entire system could fail to achieve the desired stormwater benefits. Construction inspection should be performed by the design professional of record or a certified inspector with specific training and experience on BMP construction.

Accurate grading of stormwater infrastructure, including structural BMPs and hardscape areas, is critical to ensure gravity drainage and the desired BMP functions. Research has shown that structural practices with insufficient storage capacity (whether because of carelessness when specifying outlet structure elevations or inaccurate grading) might not perform the functions for which they were installed (Brown and Hunt 2011; Luell et al. 2011). The designer and contractor should work together to ensure that the project is correctly built to plan. Spot elevations of critical components should be available from construction plans to verify construction. If necessary, arrange for appropriate contractor training before starting a BMP construction project and make training available on demand during construction. It is important to perform field survey during construction and verify that the designed average ponding depth has been provided (Figure 4-3); simply measuring the height of the outlet structure relative to the ground surface is inadequate (Wardynski and Hunt 2012).

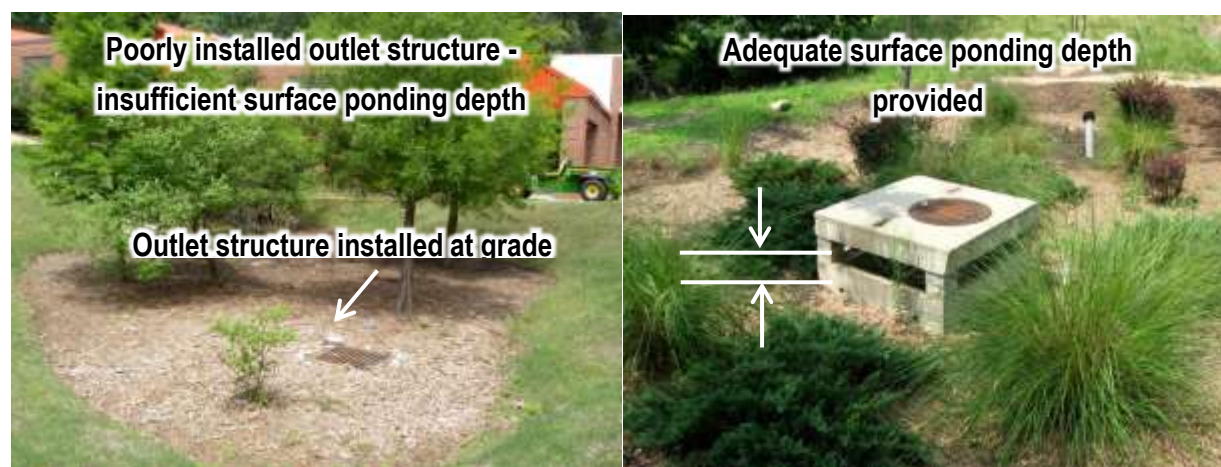

Source: Tetra Tech

Figure 4-3. Accurate grading and outlet elevations must be provided to achieve intended hydrologic and water quality functions.

Construction activities inherently compact site soils, which can dramatically decrease infiltration rates. Contractors should be clearly instructed to minimize compaction by using tracked equipment, excavating the last 12 inches using a toothed excavator bucket, and by minimizing the number of passes over the proposed subgrade while operating the equipment outside of the BMP area where possible (Figure 4-4). Earth moving activities should take place during dry conditions, to the extent practicable, to reduce the occurrence of smearing the soil surface, which can reduce soil permeability. To mitigate compaction and partly restore infiltration capacity (for practices that are intended to infiltrate), the subgrade should be treated by scarification or ripping to a depth of 9–12 inches (Figure 4-5; Tyner et al. 2009). A soil test may be required after scarifying to verify that infiltration rates have been restored. If the design infiltration rate is not restored after scarifying or ripping, trenches can be installed along the subgrade to

enhance infiltration. Trenches should be constructed 1-foot-wide by 1-foot-deep on 6-foot centers and filled with a 0.5-inch layer of washed sand, then topped off with pea gravel (Tyner et al. 2009).

Many urban sites, especially retrofit conditions, have little or no organic material in the soil structure because they have been paved over for many years. Excavation also tends to unearth relatively infertile subsoils. If engineered soil is not specified, a soil test (<http://soiltesting.tamu.edu/files/urbansoil.pdf>) is recommended to determine the suitability of site soils for plant growth, especially for practices where vegetation will be planted in on-site excavated soils (such as stormwater wetlands). Amendment with 2 to 4 inches of topsoil could be required to improve plant establishment. Appendix B provides information on specific media requirements to prepare the BMP site for planting. Consultation with the landscape architect is recommended to verify rooting depths and establish construction guidance for the landscape contractor. The planting plan should also include guidance on the appropriate time of year to plant trees, shrubs and grass to reduce plant stress during establishment.



Source: Tetra Tech

Figure 4-4. Heavy equipment (especially wheeled equipment) should be operated outside the excavated area to prevent compaction.

4. Execution Considerations



Source: NCSU-BAE

Figure 4-5. For infiltrating practices, mitigate subsoil compaction by ripping grade to a depth of 12 inches.

4.2 Post Construction BMP Inspection

To maintain the effectiveness of structural BMPs, regular inspection is essential. Generally, BMP inspection and maintenance can be categorized as routine and as needed. Routine activities, performed regularly (e.g., monthly) ensure that the BMP is in good working order and continues to be aesthetically pleasing. Routine inspection is an efficient way to prevent potential nuisance situations from developing and reduce the need for repair or maintenance. Routine inspection also reduces the chance of degrading the quality of the effluent by identifying and correcting potential problems regularly. Property maintenance personnel should be instructed to inspect BMPs during their normal routines.

In addition to routine inspections, as-needed inspection/ maintenance of all BMPs should be performed after any event or activity that could damage the BMP, particularly after every large storm event. Post-storm inspections should occur after the expected drawdown period for the BMP, when the inspector can determine if the BMP is draining correctly.

Checklists with maintenance specifications and requirements are provided in Appendix F. In general, individual BMPs can be described with minimum performance expectations, design criteria, structural specifications, date of implementation, and expected life span as provided in Chapter 3 and detailed in Appendix B. Recording such information will help the inspector determine whether a BMP's maintenance schedule is adequate or requires revision and will allow comparison between the intended design and the as-built conditions. Checklists also provide a useful way for recording and reporting whether major or minor renovation or routine repair is needed. The effectiveness of a BMP might be a function of the BMP's location, design specifications, maintenance procedures, and performance expectations. Inspectors should be familiar with the characteristics and intended function of the BMP so they can recognize problems and know how they should be resolved.

Routine and as-needed BMP inspections consist of technical and non-technical activities as summarized below:

- Inspect the general conditions of the BMP and areas directly adjacent.
- Maintain access to the site including the inlets, side slopes (if applicable), forebay (if one exists), BMP area, outlets, emergency spillway, and so on.
- Examine the overall condition of vegetation.
- Eliminate any possibility of public hazards (vector control, unstable public access areas).
- Check the conditions of inflow points, pretreatment areas (if they exist), and outlet structures.
- Inspect and maintain the inlet and outlet regularly and after large storms.
- Ensure that the pretreatment areas meet the original design criteria.
- Check the encroachment of undesirable plants in vegetated areas. This could require more frequent inspections in the growing season.
- Inspect water quality improvement components. Specifically, check the stormwater inflow, conveyance, and outlet conditions.
- Inspect hydrologic functions such as maintaining sheet flow where designed, ensuring functional pretreatment, maintaining adequate design storage capacity, and verifying proper operation of outlet structures.
- Check conditions downstream of the BMP to ensure that flow is properly mitigated below the facility (e.g., excessive erosion, sedimentation).

In every inspection, whether routine or as needed, the inspector should document whether the BMP is performing correctly and whether any damage has occurred to the BMP since the last inspection. Ideally, the inspector will also identify what should be done to repair the BMP if damage has occurred.

Documentation is very important in maintaining an efficient inspection and maintenance schedule, providing evidence of ongoing inspection and maintenance, and detecting and reporting any necessary changes in overall management strategies.

4.3 BMP Operation and Maintenance

The major goal of BMP operation and maintenance (O&M) is to ensure that the BMP is meeting the specified design criteria for stormwater flow rate, volume, and water quality control functions. If structural LID systems are not properly maintained, BMP effectiveness can be reduced, resulting in water quality impacts. The design professional should provide an O&M manual with the construction documents or final as-built plans. It is important that routine maintenance and any need-based repairs for a structural BMP be completed according to schedule or as soon as practical after the problem is discovered. Deferred BMP maintenance could result in detrimental effects on the landscape and increased potential for water pollution and local flooding.

Training should be included in program development to ensure that maintenance staff has the proper knowledge and skills. Most structural BMP maintenance work—such as mowing, removing trash and debris, removing sediment, and the like—is non-technical and is already performed by property maintenance personnel. More specialized maintenance training might be needed for more complex systems. General maintenance activities for the two major categories of structural facilities (filtration and infiltration) are as follows:

4. Execution Considerations

Infiltration BMPs

- Mowing and maintaining upland vegetated areas if applicable.
- Cleaning and removing debris after major (around 0.5 inch or greater) storm events.
- Cleaning out accumulated sediment.
- Repairing or replacing stone aggregate.
- Maintaining inlets and outlets.
- Removing accumulated sediment from forebays or sediment storage areas when 50 percent of the original volume has been lost.
- Maintaining porosity of the substrate.

Biofiltration and Filtration BMPs

- Removing trash and debris from control openings.
- Watering and mowing vegetated areas.
- Removing all dead and diseased vegetation and replacing as necessary.
- Stabilizing eroded side slopes and bottom by replanting.
- Repairing erosion areas by regrading, adding flow dispersion, or energy dissipation.
- Mulching void areas if needed.
- Maintaining inlets and outlets.
- Repairing leaks from the sedimentation chamber or from deteriorating structural components.
- Cleaning out accumulated sediment from the filter bed once depth exceeds approximately one-half inch or when the filter layer no longer draws down within 24 hours.

In regions where dry and wet seasons are clearly distinguished, as is the case in Bexar County, conducting special maintenance activities before spring and fall storms can be very helpful to prevent increased erosion. If a BMP does not meet the specified design criteria, it must be repaired, improved, or replaced before a wet season starts. Any accumulated sediment and trash should be removed to maximize the performance of the facility throughout the following wet season. Detailed descriptions of operation and maintenance for specific types of LID BMPs are in Appendix B, and general maintenance issues are presented in the following sections.

4.3.1 Bioretention

Maintenance activities for bioretention units should be focused on the major system components, especially landscaped areas. Bioretention landscape components should blend over time through plant and root growth, organic decomposition, and natural soil horizon development. Those biological and physical processes over time will lengthen the facility's life span and reduce the need for extensive maintenance. Refer to Chapter 3 and Appendix B for design guidance on soil media and plant selection.

Irrigation of vegetated areas might be needed during the plant establishment period but fertilizer and pesticide application should be minimized. In periods of extended drought, temporary supplemental irrigation could be used to maintain plant vitality. Irrigation frequency will depend on the season and type of vegetation. Properly selected vegetation will go dormant during dry periods but will revitalize when rainfall occurs. Native plants generally require less irrigation than non-native plants and should be

incorporated into site designs where feasible. Native plants are also less susceptible to disease and require fewer pesticides. Controlled drainage can also be used to manage soil moisture by selectively elevating the underdrain outlet in dry periods; this will result in greater soil moisture retention between rainfall events. The underdrain outlet should always be no less than 18 inches below the soil surface to prevent saturation of the plant rooting zone.

Routine maintenance should include a twice-yearly evaluation of the trees and shrubs and subsequent removal of any dead or diseased vegetation (USEPA 1999). Corrective actions should be taken to remove areas with standing water for more than 24 hours in the BMP to restore proper infiltration rates and prevent mosquito and other vector habitat formation. An Integrated Pest Management (IPM) Plan should be developed to minimize the use of broad-spectrum pesticides that may kill beneficial insects that feed and pollinate the native vegetation. To maintain the treatment area's appearance, it might be necessary to prune and weed. Replace mulch for aesthetics or when erosion is evident. Depending on pollutant loads, soil media might need to be replaced within 5 to 10 years of construction (USEPA 2000).

Stabilizing the area around the bioretention area can reduce maintenance by reducing the sediment flowing into the BMP. Figure 4-6 shows an example of how a bioretention area can clog with sediment if the surrounding area is not properly stabilized. Proper design of inlet systems can also reduce maintenance requirements by removing trash and other gross solids keeping floatables out of the bioretention area and, in some cases, in the street for easy collection and removal by a street sweeper or maintenance crew as shown in Figure 4-7.



Source: NCSU-BAE

Figure 4-6. Bioretention area clogged with sediment.

4. Execution Considerations



Source: Portland BES

Figure 4-7. Inlet sump to remove gross solids.

4.3.2 Bioswale

The maintenance objectives for bioswale systems consist of retaining stormwater conveyance capacity, runoff volume control, and pollutant removal efficiency. To meet those objectives, it is important to maintain a consistent ground cover in the bioswale. Maintenance activities involve replacing or redistributing mulch, mowing (where appropriate), weed control, irrigating during drought conditions, reseeding or sodding bare areas, and clearing debris and blockages. Manage vegetation on a regular schedule during the growth season to maintain adequate coverage. Accumulated sediment should also be removed manually to avoid concentrated flow. During the plant establishment period, minimize fertilizer and pesticide application. Irrigation might be needed to maintain plant vitality, especially during plant establishment or in periods of extended drought. Irrigation frequency will depend on the season and type of vegetation. Properly selected vegetation will go dormant during dry periods but will revitalize when rainfall occurs. Native plants require less irrigation than non-native plants and should be incorporated into site designs where feasible. Native plants are also less susceptible to disease and require fewer pesticides. An IPM Plan should be developed to minimize the use of broad-spectrum pesticides that may kill beneficial insects that feed and pollinate the native vegetation. Bioswales should be designed to minimize flow velocity and prevent the type of erosion shown in Figure 4-8. If excessive flows are identified as the cause of the problem, they should be diverted using the design methods identified in Appendix B to prevent erosion and minimize maintenance.



Source: Tetra Tech

Figure 4-8. Erosion caused by excessive flows in a bioswale.

4.3.3 Planter Box

General maintenance requirements for planter boxes are the same as the routine periodic maintenance of other landscaped areas or bioretention BMPs. The primary maintenance requirement for planter boxes is to inspect the vegetation and soil media. Regularly remove any accumulated trash and sediment in the device, especially after large storms, or as needed during periods where overhanging vegetation is dropping leaves. Inspect soils to evaluate root growth and mitigate channel formation or uneven distribution in the soil media.

4.3.4 Sand Filter

The primary maintenance requirement for sand filters is to remove trash, accumulated sediment, and media contaminated with hydrocarbons. If the filter does not drain within 48 hours, or if sediment has accumulated to a depth of 6 inches, the top layer (1–3 inches) of sand (media) must be replaced. TCEQ (2005) provides similar recommendations for sand filters in the Edwards Aquifer Recharge and Contributing zones.

4. Execution Considerations

4.3.5 Permeable Pavement

The primary maintenance requirement for permeable pavement consists of regular inspection for clogging (Figure 4-9). The main goal of the maintenance program is to prevent clogging by fine sediment particles, which should be accomplished through a combination of preventative tasks including timely removal of debris (leaf litter, acorns, grass clippings, mulch, and such) and stabilizing surrounding areas. To maintain the infiltrative capacity of permeable pavements, vacuum sweeping should be performed a minimum of twice a year. Frequency of vacuum sweeping should be adjusted according to the intensity of use and deposition rate on the permeable pavement surface. Settled paver block systems might require resetting. When modular pavements incorporate turf into their void area, normal turf maintenance practices, including watering, fertilization, and mowing might be required (FHWA 2002).



Source: Tetra Tech

Figure 4-9. Plant growth, debris buildup, and puddles indicate that permeable pavement is clogging. Prompt maintenance should be performed to prevent joints from fully sealing.

For proper performance, maintenance staff must ensure that stormwater is infiltrating properly and is not standing or pooling on the surface of the permeable pavement for extended periods of time. Standing water can indicate clogging of the pavement void space and vacuuming is necessary to restore infiltration. If ponding still occurs, inspect/replace the media sublayer and check the underdrain for blockage.

4.3.6 Rainwater Harvesting

General maintenance activities for cisterns and rain barrels are easily performed by maintenance personnel or homeowners. The Texas A&M Agrilife Extension Service's Rainwater Harvesting (2008) guide provides maintenance recommendations to homeowners. The primary maintenance requirement is to inspect the tank and distribution system and test any backflow-prevention devices (See Appendix B). Rain barrels require minimal maintenance several times a year and after major storms to prevent any clogging. Cisterns require inspections for clogging and structural soundness twice a year, including

inspection of all debris and vector control screens. If a first-flush diverter is used, it should be dewatered and cleaned between each storm event that fills the diverted storage pipe. Self-cleaning filters and screens, such as the ones shown in Figure 4-10, can help prevent debris from entering the cistern and reduce maintenance. Accumulated sediment in the tank must be removed at least once a year. The Texas Manual for Rainwater Harvesting: Third Edition (TWDB 2005) provides additional measures for systems designed for potable water supply or drip irrigation applications.



Source: Tetra Tech

Figure 4-10. Self-cleaning inlet filters.

4.3.7 Wetlands

Maintenance activities for wetlands involve removing accumulated sediments and ensuring that plant distribution and flow paths remain as designed. Constructed wetlands built for the express purpose of stormwater treatment are not considered jurisdictional wetlands in most regions of the country, but designers should check with their wetland regulatory authorities (USACE Region 6) to ensure this is the case (Virginia 2011). Bedload sediment tends to be concentrated in pretreatment areas and forebays; it is important that this sediment not enter the rest of the wetland, because accumulated coarse sediments can affect the growing conditions of the wetland plants or change flow paths and design depths. Sediment removal should be performed more frequently, or pretreatment and forebay areas should be resized, if excessive sediment is found outside designated areas. Sediment removal in vegetated areas should be performed carefully to prevent damage to plants. Depending on the land use of contributing areas, sediment testing might be necessary to determine if accumulated pollutants require special disposal. Wetlands should be inspected according to the schedule provided in Appendix B or as-needed after storm events. Inspectors should refer to a map of the wetland as designed to determine if the types and distribution of plants are as intended. Undesirable species should be identified and removed as needed. If plant die-off has occurred, reevaluate growing conditions and select replacement plants adapted to those conditions. Ensure that design depths and flow paths are maintained, and remove trash and debris that has accumulated in or around the wetland. Outlets should be designed such that the water level in the wetland can be varied for establishment periods and maintenance using a variable outlet control similar to that shown in Figure 4-11. A minimum orifice size should be considered and a trash rack, similar to the one shown in Figure 4-12, can be used to minimize and limit clogging. Details on outlet design are provided in Appendix B.

4. Execution Considerations



Source: Tetra Tech

Figure 4-11. Outlet varied with weir boards.



Source: NCSU-BAE

Figure 4-12. Outlet with a trash rack.

4.3.8 Green Roofs

Operation and maintenance of stormwater management (green, blue, brown, biodiverse) roofs primarily involves maintaining drainage structures and vegetation. Roof drains, gutters, and downspouts should be routinely inspected for clogging. If excess material tends to build up around drainage structures, the source of the problem should be remediated. To prevent vegetation from growing too close to roof drains and to identify roof drains for maintenance personnel, a circle of white gravel can be placed around the drain to designate a *no plant zone* as shown in Figure 4-13. Vegetation should be inspected periodically, especially during prolonged dry weather, to determine irrigation needs and general health. Properly selected vegetation will go dormant during dry periods but will revitalize when rainfall occurs. Periodic inspection of growing media and underlying drainage layers might also be necessary for extensive green roofs to ensure that reservoir layers are not filling with sediment deposits or extensive root networks. Intensive green roofs could require pruning and mowing at the end of the growing season, depending on vegetation type. Roofs require appropriate health and safety protocols for fall protection. Maintenance staff and designers should consult their office Safety Officer or OSHA guidance for proper equipment and safety plans. Foot traffic should be limited, to the extent practicable, to reduce plant damage and preserve aesthetic design goals. Additional guidance on roof design, maintenance, and leak detection is available from *Design Guidelines and Maintenance Manual for Green Roofs In the Semi-Arid and Arid West* (Tolderlund, 2010).



Source: Amy Hathaway

Figure 4-13. White gravel indicates a no plant zone for a green roof.

4.4 BMP Monitoring

Performance monitoring of stormwater BMPs is an important component of LID implementation programs. Monitoring provides the BMP designer and regulator with a mechanism to validate certain design assumptions and to quantify compliance with pollutant-removal performance objectives. Specific monitoring objectives should be considered early in the design process to ensure that LID practices are adequately configured for monitoring. Detailed monitoring guidance provided by the U.S. EPA is listed in this chapter's references section (USEPA 2012). The TCEQ also provides templates and guidance on Quality Assurance Project Plans (QAPP) for Nonpoint Source Projects through their website (TCEQ 2013). The instrumentation and monitoring configuration will vary from site to site, but the following general principles should be considered.

4.4.1 Monitoring Hydrology

An inlet/outlet sampling setup is suggested as the most effective monitoring approach to quantify flow and volume in stormwater BMPs. The runoff source and type of BMP will dictate the configuration of inflow monitoring. A weir or flume is typically installed at the inlet of BMPs that receive concentrated, open channel flow (i.e., from a pipe, curb cut, or a swale as shown in Figure 4-14, Figure 4-15, and Figure 4-16). Often a baffle or weir box is used in conjunction with weirs to still flows for more precise readings, as shown in Figure 4-17 and Figure 4-17. The height of water flowing over the structure is automatically recorded (typically with a pressure transducer, such as a bubbler), which is used to calculate the rate of inflow. By integrating the flow rate over each monitored time step, total runoff volume for each storm event can be calculated. When runoff enters a BMP via conduit, weirs or weir boxes can still be used for monitoring, but acoustic Doppler velocimeters (ADV) might be preferred. ADVs measure flow by

4. Execution Considerations

recording the velocity and depth of water and will provide more accurate results if inflow conduits are expected to flow full (pressure flow), although some models require heavy turbidity to attain accurate readings. Outflow can be monitored using similar techniques as inflow by installing a weir or ADV at the point of overflow/outfall.



Source: Tetra Tech

Figure 4-14. Inflow pipe to bioretention area equipped with compound weir and bubbler for flow measurement. Water quality sampling tube and strainer are visible inside pipe.



Source: Tetra Tech

Figure 4-15. Inlet curb cut with a v-notch weir.



Source: Tetra Tech

Figure 4-16. Outlet of a roadside bioretention pop-out equipped with a V-notch weir for flow monitoring.



Source: Tetra Tech

Figure 4-17. Underdrains from permeable pavement equipped with 30° V-notch weir boxes and samplers for flow and water quality monitoring.

4. Execution Considerations

It is critical during hydrologic monitoring that no downstream tailwater interfere with the monitoring device or false readings will be generated. To prevent tailwater effects at the inlet, the invert of the inflow pipe should be well above the expected temporary ponding depth of the BMP (Figure 4-18)—this is typically not possible with offline BMPs because the weir elevation controlling the bypass is at the maximum elevation in the BMP. Additional freeboard between the inlet and the maximum expected water depth should be provided to prevent the inlet monitoring device from being inundated by tailwater from the BMP (Figure 4-19). The same considerations should be addressed when monitoring outflow by ensuring that the receiving storm drain network has sufficient capacity to convey high flows such that no tailwater inundates the outflow monitoring device. Figure 4-20 shows an example of potential monitoring points.



Source: Tetra Tech

Figure 4-18. Example of a bioretention underdrain outlet with sufficient drop to install a flow monitoring weir without encountering tailwater.



Source: Tetra Tech

Figure 4-19. Poorly installed H-flume at the inlet to a bioretention area in which the invert of the weir is too low and tailwater from the bioretention will interfere with measurement.

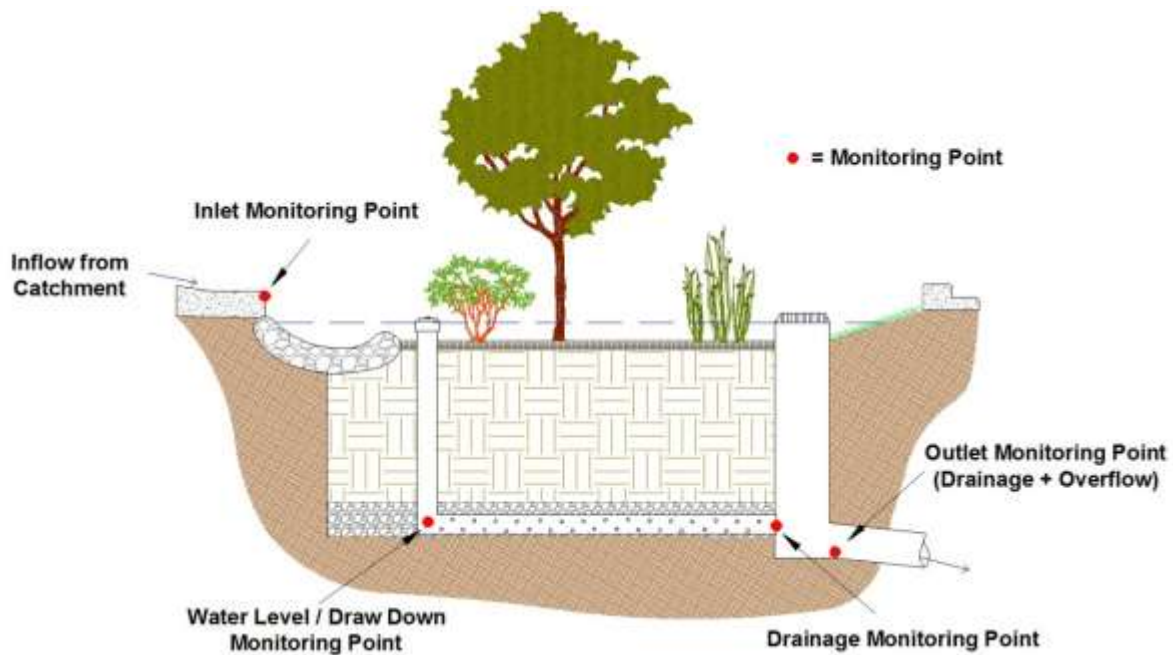

Figure 4-20. Monitoring points.

4. Execution Considerations

In addition to monitoring inflow and outflow, rainfall should be recorded on-site. Rainfall data can also be used to estimate inflow to BMPs that receive runoff only by sheet flow or direct rainfall (i.e., permeable pavement or green roofs). The type of rain gauge depends on monitoring goals and frequency of site visits (USEPA 2012). An automatic recording rain gauge (i.e., tipping bucket rain gauge), used to measure rainfall intensity and depth, is often paired with a manual rain gauge for data validation (Figure 4-21). For more advanced monitoring, weather stations can be installed to simultaneously monitor relative humidity, air temperature, solar radiation, and wind speed. These parameters can be used to estimate evapotranspiration.

Water level (and drawdown rate) is another useful hydrologic parameter. Depending on project goals, perforated wells or piezometers can be installed to measure infiltration rate and drainage. Care should be taken when installing wells to ensure that runoff cannot enter the well at the surface and *short circuit* directly to subsurface layers; short circuiting can result in the discharge of untreated runoff that has bypassed the intended treatment mechanisms. It might be useful to pair soil moisture sensors with water level loggers in instances where highly detailed monitoring performance data are required (such as for calibration and validation of models).



Source: Tetra Tech

Figure 4-21. Example of manual (left) and tipping bucket (right) rain gauges.

4.4.2 Monitoring Water Quality

Although hydrologic monitoring can occur as a standalone practice, water quality data must be paired with flow data to calculate meaningful results of constituent loading. Flow-weighted automatic sampling is the recommended method for collecting samples that are representative of the runoff event and can be used to calculate pollutant loads (total mass of pollutants entering and leaving the system). Simply measuring the reduction in constituent concentrations (mass per unit volume of water) from inlet to outlet can provide misleading results because it does not account for load reductions associated with infiltration, evapotranspiration, and storage.

Influent water quality samples are typically collected just upstream of the inlet monitoring device (weir box, flume, and such) just before the runoff enters the BMP. The downstream sampler should be at the outlet control device just before the overflow entering the existing storm drain infrastructure. A strainer is usually installed at collecting end of the sampler tubing to prevent large debris and solids from entering and clogging the sampler. Automatic samplers should be programmed to collect single-event, composite samples according to the expected range of storm flows. Depending on the power requirements, a solar panel or backup power supply might be needed.

In addition to collecting composite samples, some water quality constituents can be monitored in real time. Some examples include dissolved oxygen, turbidity, conductivity, and temperature.

4.4.3 Sample Collection and Handling

Quality assurance and quality control protocols for sample collection are necessary to ensure that samples are representative and reliable. The entire sample collection and delivery procedure should be well documented in the QAPP, including chain of custody (list of personnel handling water quality samples) and notes regarding site condition, time of sampling, and rainfall depth in the manual rain gauge. Holding times for water quality samples vary by constituent, but all samples should be collected and delivered to

the laboratory on ice as soon as possible (typically 6 to 24 hours) after a rainfall event. Some water quality constituents require special treatment upon collection, such as acidification, to preserve the sample for delivery. Appropriate health and safety protocol should always be followed when on-site, including, for example, using personal protective equipment such as safety vests, nitrile gloves, and goggles.

4.5 Reducing Project Costs

Implementing more natural stormwater management practices with less reliance on conventional, conveyance focused designs can reduce overall project costs (USEPA 2007). In addition, such facilities can help provide social, environmental, and economic benefits (CNT 2010). Using an LID approach can be one of the more effective ways to reduce construction costs to minimize the effects on the existing stormwater collection systems. Long-term operation and maintenance cost reduction goals can be achieved when more naturalized approaches are used because the native vegetation is adapted to the local weather conditions requiring less irrigation and other maintenance attention resulting in effective treatment with minimal maintenance.

Installing stormwater BMPs at upstream areas can provide considerable cost saving opportunities for the downstream areas. Any potential increase in costs to implement stormwater BMPs might be offset by reduced costs associated with flood controls, pollution mitigation, and public health issues in the watershed-scale evaluation.

Implementing green parking techniques like applying permeable pavement and other alternative transportation options can reduce stormwater management costs as well. Minimizing stall dimensions and encouraging shared parking can result in considerable construction cost savings.

Relative cost-effectiveness of a structural BMP can be established on the basis of planning, design, and construction costs. Annual operation and maintenance expenses for the expected life of the management practice should also be included in cost-effective assessments. Appendix G provides cost guidance for construction and maintenance activities that can be used to develop planning level cost estimates. Such cost information and the use of specified removal efficiencies for a structural BMP can be a useful tool when implementing pilot projects to determine costs and benefits for stormwater controls at a larger, citywide scale.



Source: Bender Wells Clark Design

Figure 4-22. Rain garden incorporated into Better Block street revitalization project.

4.6 Demonstration Projects

Demonstration or pilot projects provide valuable information to the planning, design, and maintenance communities. Features that were done correctly and those that were done incorrectly can serve as learning opportunities and provide essential information on successful components and components that must be improved through all phases of design, construction and post-construction. Information gathered can also

4. Execution Considerations

provide further understanding and acceptance for non-municipal entities through the application of LID BMPs. That understanding can reduce concerns about risk as experience and technical knowledge is gained from implementing demonstration projects.

Demonstration projects provide concrete examples of how LID BMPs can be implemented in an environment. Successful projects reduce uncertainty about whether the LID BMPs will produce the desired result in a particular setting. Demonstration projects can offer overall guidelines and examples for the designs, materials, and implementation of structural BMPs and inform site planning, design, and development strategies associated with integrating LID management practices. Those projects can be used as guidelines for performance evaluations, long-term operation and maintenance needs, and cost estimations for individual or integrated LID treatment trains. The projects also allow engineers and designers to verify proper function and maintenance of the systems.

Demonstration projects can illustrate how stormwater LID BMP strategies might be incorporated into other areas of site development strategies. Alternative transportation options to enhance safer street environments, such as traffic safety and control, can improve stormwater quantity and quality problems. Demonstration projects can also be useful in forensic engineering into systems that fail or do not meet quality or flow-control expectations. Improvements can then be made on future designs through the iterative, adaptive management approach common at that stage of understanding according to the number of projects completed to date.

Monitoring of demonstration projects is essential. Monitoring is a fundamental component of implementing stormwater management plans and facilities to evaluate how successfully the plan or facility is and whether changes are needed in operation, maintenance (procedures or frequency), or design to meet regulatory goals. The monitoring program is often unique to each BMP or demonstration site and must be designed in the context of the objectives of the program. For example, a monitoring program for a municipality seeking to comply with monitoring requirements under its NPDES permit might have relatively straightforward goals for certain pollutants of concern. However, also important is the more in-depth monitoring information gathered when determining factors affecting LID facility performance.

By monitoring demonstration projects for performance, results can be used to make predictions on the water quality and flow benefits gained by implementation compared to costs. This will help decision makers determine the most cost-efficient facility for various conditions that will have the most benefit to water quality and help meet regulatory requirements. In addition, the information gathered on technical performance of BMPs is expected to provide important input for simulation modeling of pollutant impacts associated with specific management scenarios in other locations or at a larger scale. Key principles of monitoring pilot projects include the following:

- Dedicate the time and resources to develop a sound monitoring plan. Complexities of plans will vary depending on monitoring objectives.
- Be sure to plan and budget for an adequate number of samples to enable proper data interpretation.
- Be aware of the many variables that need to be documented as part of a monitoring program.
- Be sure that the monitoring design properly identifies the relationship between storm characteristics and the design basis of the BMP and answers selected management questions.
- Properly implement and follow the monitoring plan, clearly documenting any adjustments to the program. Particularly important are proper equipment installation and calibration, proper sample collection techniques and analysis, and maintenance of equipment for longer term programs.

- Maintain data in an organized and well-documented manner, including monitoring data, BMP design and maintenance practices, and site characteristics.
- Clearly report study limitations and other caveats on using the data.

4.7 References

- Brown, R.A., and W.F. Hunt. 2011. Impacts of media depth on effluent water quality and hydrologic performance of under-sized bioretention cells. *Journal of Irrigation and Drainage Engineering* 137(3):132–143.
- Brown, R.A., and W.F. Hunt. 2010. Impacts of construction activity on bioretention performance. *Journal of Hydrologic Engineering* 15(6):386–394.
- CNT (Center for Neighborhood Technology). 2010. *The Value of Green Infrastructure: A Guide to Recognizing Its Economic, Environmental and Social Benefits*. Center for Neighborhood Technology, Chicago, Illinois. <http://www.cnt.org/repository/gi-values-guide.pdf>
- FHWA (Federal Highway Administration). 2002. *Storm Water Best Management Practices in an Ultra-Urban Setting: Selection and Monitoring*. Federal Highway Administration, Washington, DC. <http://environment.fhwa.dot.gov/ecosystems/ultraurb/index.asp>. Accessed February 25, 2013.
- Luell, S.K., W.F. Hunt, and R.J. Winston. 2011. Evaluation of undersized bioretention stormwater control measures for treatment of highway bridge deck runoff. *Water Science & Technology* 64(4):974–979.
- TCEQ (Texas Commission on Environmental Quality). 2005. *Complying with the Edwards Aquifer Rules—Technical Guidance on Best Management Practices*. RG-348 (Revised) with Addendum. Texas Commission on Environmental Quality, Austin, TX <http://www.tceq.texas.gov/field/eapp>.
- TCEQ (Texas Commission on Environmental Quality). 2013. *Quality Assurance Project Plans for Nonpoint Source Projects*. Texas Commission on Environmental Quality, Austin, TX <http://www.tceq.texas.gov/waterquality/nonpoint-source/grants/nps-qapp>.
- Texas A&M Agrilife Extension Service. 2008. *Rainwater Harvesting*, Texas A&M Agrilife Extension Service. College Station, Texas. Available from <http://rainwaterharvesting.tamu.edu/rainwater-basics/>
- Tolderlund, L, 2010 *Design Guidelines and Maintenance Manual for Green Roofs In the Semi-Arid and Arid West*. University of Colorado, Denver, Colorado
- TWDB (Texas Water Development Board). 2005. *The Texas Manual on Rainwater Harvesting: Third Edition*. Texas Water Development Board. Austin, Texas.
- Tyner, J.S., W.C. Wright, and P.A. Dobbs. 2009. Increasing exfiltration from pervious concrete and temperature monitoring. *Journal of Environmental Management* 90:2636–2641.
- USEPA (U.S. Environmental Protection Agency). 1999. *Stormwater Technology Fact Sheet: Bioretention*. EPA 832-F-99-012. U.S. Environmental Protection Agency, Office of Water, Washington, DC. http://water.epa.gov/scitech/wastetech/upload/2002_06_28_mtb_biortn.pdf. Accessed February 25, 2013.

4. Execution Considerations

USEPA (U.S. Environmental Protection Agency). 2000. *Low Impact Development: A Literature Review*. EPA-841-B-00-005. U.S. Environmental Protection Agency, Office of Water, Washington, DC. http://www.lowimpactdevelopment.org/pubs/LID_litreview.pdf. Accessed February 25, 2013.

USEPA (U.S. Environmental Protection Agency). 2007. *Reducing Stormwater Costs through Low Impact Development (LID) Strategies and Practices*. EPA-841-F-07-006. U.S. Environmental Protection Agency, Office of Water, Washington, DC. http://water.epa.gov/polwaste/green/costs07_index.cfm. Accessed February 25, 2013.

USEPA (U.S. Environmental Protection Agency). 2012. *Urban Stormwater BMP Performance Monitoring*. U.S. Environmental Protection Agency, Office of Water, Washington, DC. <http://water.epa.gov/scitech/wastetech/guide/stormwater/monitor.cfm>. Accessed February 27, 2013.

Virginia. 2011. *Virginia Department of Conservation and Recreation Stormwater Design Specification No. 13*. State of Virginia <http://vwrrc.vt.edu/swc/NonPBMPSpecsMarch11/VASWMBMPSpec13CONSTRUCTEDWETLAND.html>. Accessed June 21, 2013

Wardynski, B.J., and W.F. Hunt. 2012. Are bioretention cells being installed per design standards in North Carolina: A field assessment. *Journal of Environmental Engineering* 138(12):1210–1217.

5 LID Review Process

5.1 LID Review Process

Municipalities in the San Antonio River Basin generally follow a development review process that begins with submission of a plat or initial planning and zoning package. After initial approvals or coordination, civil engineers or contractors submit construction plans for review by agency staff or city engineers. Site clearing and grading may begin prior to final plan approval or immediately after receiving building permits from the city/county. Designing a site for LID practices either for new development or redevelopment requires a reorganized process from the typical project engineering approach. The site planning process presented in Section 1.5 is iterative and requires input from a geotechnical engineer, landscape architect, civil engineer, and the building architect. Reviewers and developers or their engineers need to have a clear understanding of the stormwater management goals for the community and the best LID practices for a particular site to meet watershed-based targets. LID encourages adaptive land use such as minimizing impervious cover that often requires interpretation of paving, parking, and sidewalk ordinances. The process also lends itself to meeting with regulatory staff early in the process to agree upon and document analysis criteria and stormwater management goals that may vary from watershed to watershed and among land uses. Early coordination reduces interpretation of stormwater management approaches during the plan review stage and it can provide an opportunity for communities to offer expedited review to developers that implement LID to meet stormwater management goals.

Although most municipalities follow a similar plan review process, large cities require approvals from several departments while smaller towns may only have a few individuals involved. A general planning review process is presented in Figure 5-1 to highlight the traditional plan review process and present a potential LID alternative. Each municipality is encouraged to develop checklists or review flow charts that fit their ordinances and organizational structure.

The traditional stormwater management approach in the San Antonio River Basin has focused primarily on flow rates for extreme storm events (e.g., 5-year, 10-year, 50-year, 100-year). This approach is based on the long history of catastrophic floods that have occurred from hurricanes, severe thunderstorms and tropical storms. Peak flow rates are analyzed to prove No Adverse Impact, size infrastructure, and verify detention measures to mitigate increased runoff if required. The same analysis will be needed for LID-based site design. However, when analyzing smaller design storms, BMP siting, sensitive area preservation, soil definition, and natural topography influence stormwater management to a much greater degree. Chapter 1 includes background on overall stormwater management approaches and site planning that each regulator or reviewer can reference. Careful assessment of pre-project hydrology will be required to ensure LID BMPs mimic the volume and flow rate after development for the water quality design storm. In addition, construction envelopes will have to be verified during construction to preserve sensitive areas. Figure 5-2 outlines the traditional stormwater management review process along with a sample LID-based approach that can be used as an initial template. It is recommended that each municipality tailor this process to meet their adopted stormwater regulations based on input from, at a minimum, planning, engineering, environmental, maintenance, and landscaping departments.

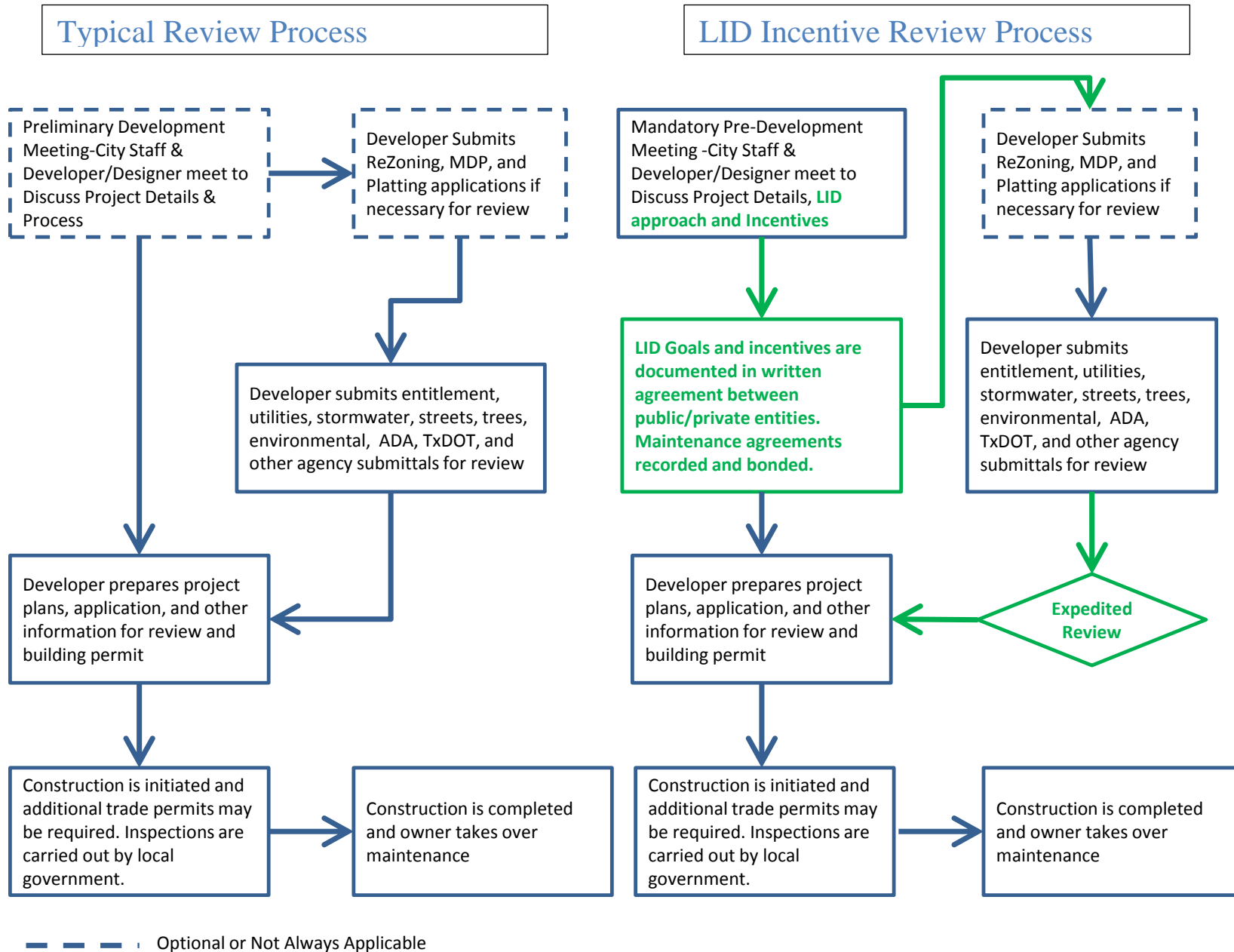

Figure 5-1. General planning review process.

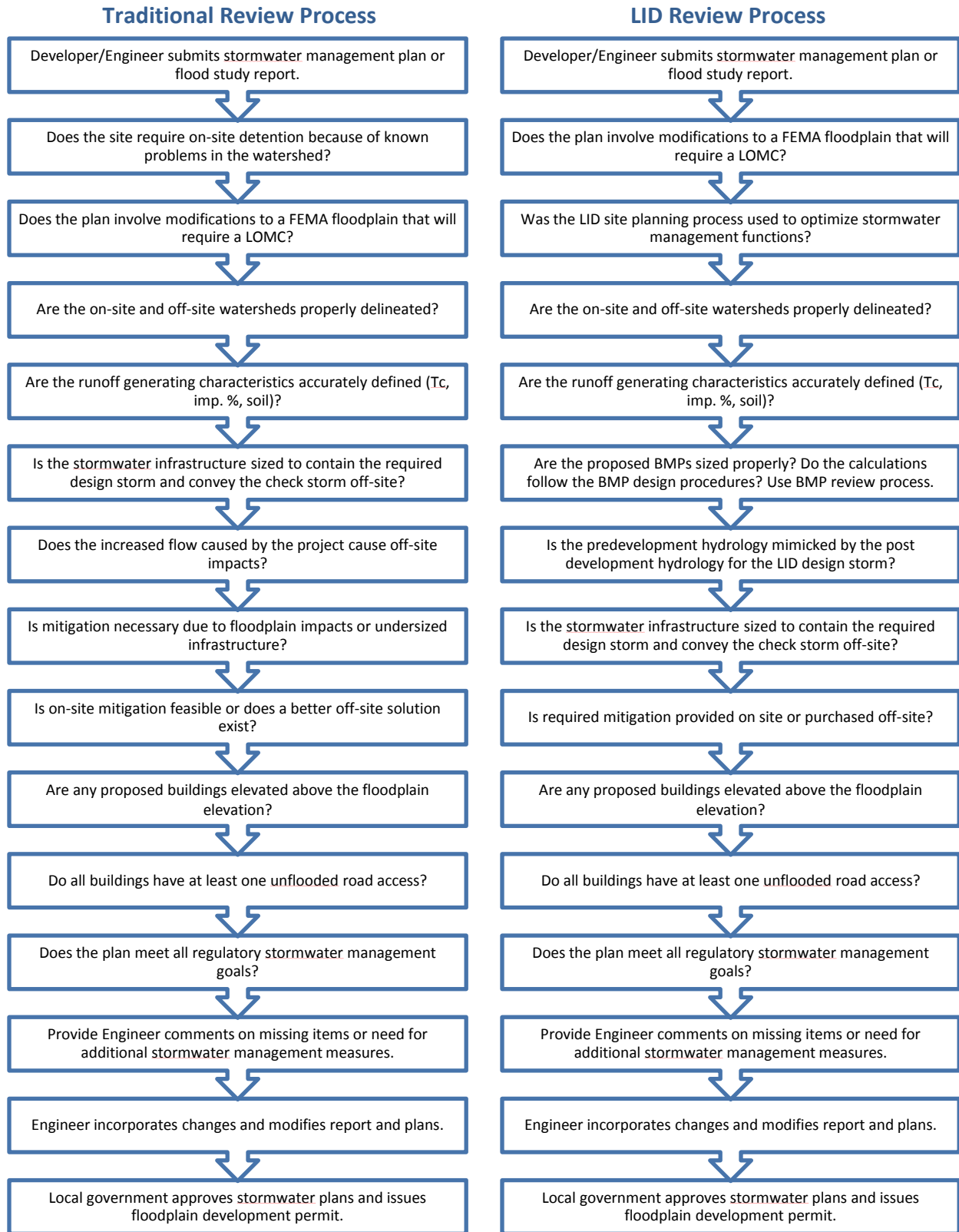

Figure 5-2. Traditional vs. LID design review process.

5. LID Review Process

The LID BMPs presented in Chapter 3 necessarily provide the designer with flexibility to adapt to each site. The flexibility also presents more opportunity for unintended design consequences, especially where hydraulic controls are needed to meet water quality goals. Reviewers are encouraged to read the general information in Chapter 3 and the detailed design steps in Appendix B prior to evaluating the individual BMPs proposed for a project or site plan. Armed with this knowledge, the reviewer can look for flaws that may not be apparent while assessing the typical components of each treatment process.

The BMPs share many elements that are presented in Appendix B-Common Design Elements, but a tailored process for each BMP type is helpful to guide the reviewer in the specific application. Figure 5-3 to Figure 5-11 provide a template review process for each of the BMP types covered in this manual. They can be used separately or in series if multiple BMPs are used in a treatment train. Review agencies are encouraged to adapt the steps or format to their internal processes rather than rely exclusively on these diagrams. They are recommended for use as part of the overall site stormwater management review process rather than a stand-alone function. The flow charts are ordered to step through the design process while providing check points for assessing interaction with other site elements such as pavement and buildings. Vegetated filter strips and swales are included in the same flow chart because they use an almost identical design process. They also only provide filtering functions as pretreatment for other BMPs. Green roofs are usually the most complex BMP to design due to structural building considerations. Detailed technical references are provided in Appendix B for understanding the full design scope of their application.

Bioretention, bioswales, planter boxes, and sand filters are used in very similar ways throughout a site but apply to different drainage area sizes. The main differences occur in residence time and removal functions, which are described in Tables 3.1 and 3.2. Cisterns are primarily a volume capture and storage process, which initially seem straightforward to size and place on a site. The review flow chart focuses on the interaction with surrounding buildings where excess water can create maintenance and structural issues. Permeable pavement review is focused on siting and maintenance issues that can lead to clogging and long-term performance issues. Stormwater wetlands are the most marginal BMP choice in the San Antonio River Basin's semiarid climate due to permanent water needs. Wetlands should not require make-up water unless reuse water is available and no higher use (flushing, irrigation, etc.) is necessary.

Bioretention Review Process

- Is the watershed delineated correctly (<5 acres)?
- Are the runoff generating characteristics accurately defined (Tc, imp. %, soil)?
- Is the treatment volume calculated correctly?
- Do the media storage capacity and ponding depth meet the required volume?
- Does the soil media meet the design guidance? If proprietary is the claimed flow rate too high (< 30 in/hr)?
- Is the bioretention area properly sized and configured on the site plan?
- Will the BMP use infiltration? Is there technical data to support an adequate infiltration rate (>0.5 in/hr)?
- Does the inlet configuration assure flow capture? Is there enough head difference? Is the inlet big enough to resist plugging?
- Is the inlet transition designed to reduce erosion (cobble, drop basin)?
- Is a forebay or other pretreatment BMP provided to capture sediment?
- Is the BMP configured with an overflow or bypass? Is it sized correctly?
- If infiltrating BMP, are lateral flows restricted if necessary to prevent pavement or foundation damage?
- Are ancillary benefits (e.g., habitat, education, shade) maximized?
- Does the vegetation meet the aesthetic, seasonal, sun exposure, and maintenance needs of the site?
- Are there physical hazards to pedestrian, cyclists, or traffic with the design?

Figure 5-3. Review process for bioretention.

Bioswale Review Process

- Is the contributing area delineated correctly? Bioswales typically treat small watersheds or one side of a roadway/parking lot.
- Are the runoff-generating characteristics accurately defined (T_c , imp. %, soil)?
- Is the treatment volume calculated correctly?
- Do the media storage capacity and ponding depth meet the required volume?
- Does the soil media meet the design guidance? Will it support plant growth and reduce inflow nutrient concentrations?
- Is the bioswale area properly sized and configured on the site plan?
- Will the BMP use infiltration? Does the underlying soil have an adequate infiltration rate (>0.5 in/hr)?
- Does the inlet configuration assure flow capture? Is there enough head difference to prevent ponding and flooding?
- Is the inlet transition designed to reduce erosion (filter strip, cobble, gravel splash pad)?
- Will velocity remain below 1 ft/s for mulched swales and below 3 ft/s for grassed swales?
- Is the BMP configured with an overflow or bypass? Is it sized correctly?
- If infiltrating design, are lateral flows restricted to prevent pavement or foundation damage?
- Is the underdrain sized properly? Will the bed drain completely if required?
- Are ancillary benefits (e.g., habitat, education, shade) maximized?
- Does the vegetation meet the aesthetic, seasonal, sun exposure, and maintenance needs of the site?
- Are there physical hazards to pedestrians, cyclists, or traffic with the design?

Figure 5-4. Review process for bioswales.

Permeable Pavement Review Process

- Is the watershed draining to the BMP delineated correctly (1:1 ratio of watershed to BMP allowed with proper maintenance)?
- Are the runoff-generating characteristics accurately defined (T_c , imp. %)?
- Is the treatment volume calculated correctly?
- Do the aggregate base storage capacity and ponding depth meet the required storage volume? Have the structural requirements been verified by a geotechnical engineer?
- Is the BMP area sized correctly? Is the infiltration rate high enough to handle the peak rainfall or flow rate?
- Is the BMP used in pedestrian walkways, parking stalls, and low volume traffic areas and not used in loading or dumpster parking areas?
- Does the site grading divert water that may contain sediment or floatables away from the pavement?
- Are edge restraints provided for all discrete sections of pavement to prevent lateral shifting and edge unraveling?
- Will the BMP use infiltration? Does the underlying soil have an adequate infiltration rate (>0.5 in/hr)?
- If roof drainage is directed to the pavement, is the flow screened to remove leaves, trash and other materials that may clog the BMP?
- Is the BMP configured with an overflow or bypass? Is it sized correctly?
- If infiltrating are lateral flows restricted if necessary to prevent pavement or foundation damage?
- Is the underdrain sized properly? Will the aggregate base drain completely if required?
- Are ancillary benefits (e.g., education, rainwater reuse, tree protection, detention) maximized?
- Is signage provided to prohibit activities that cause premature clogging and notify owners the pavement is intended to be permeable?
- Are there physical hazards to pedestrians, cyclists, or wheelchair users

Figure 5-5. Review process for permeable pavement.

Planter Box Review Process

- Is the contributing area delineated correctly? Planter boxes offer treatment for single downspouts or small impervious areas.
- Are the runoff generating characteristics accurately defined (T_c , imp. %)?
- Is the treatment volume calculated correctly?
- Do the media storage capacity and ponding depth meet the required volume?
- Is the ponding depth too deep? Could it overflow and flood a building?
- Does the soil media meet the design guidance? Is the claimed flow rate for proprietary media sufficient to treat flow?
- Will the media support plant growth and reduce inflow nutrient concentrations?
- Is the planter box properly sized and configured on the landscaping/site plan?
- Does the inlet configuration assure flow capture? Is there enough head difference to prevent bypass or unintended washout?
- Is the inlet transition designed to reduce erosion (cobble, gravel splash pad, concrete apron)?
- Is the BMP configured with an overflow or bypass? Is it sized correctly? Will it create ponding issues or backup the storm drain or downspout?
- Is the concrete box or hydraulic restriction layer sufficient to prevent damage to surrounding structures?
- Is the underdrain sized properly? Will the bed drain completely or to the internal water storage elevation?
- Are ancillary benefits (e.g., habitat, education, shade) maximized?
- Does the vegetation meet the aesthetic, seasonal, sun exposure, and maintenance needs of the site?
- Are there physical hazards to pedestrians, cyclists, or traffic with the design?

Figure 5-6. Review process for planter boxes.

Green Roof Review Process

- Is the total roof area correctly delineated?
- Is the treatment volume reasonable based on media depth and area?
- Has a structural engineer calculated the roof loading?
- Is the roof extensive (< 6 in media) or intensive (> 6 in media)?
- Is the impermeable liner properly specified?
- Is the drainage layer included and separated from the soil media by a geotextile?
- Does the soil media meet the requirements for green roofs (well drained, high porosity, lightweight, permanent, stable, etc.)?
- Is the underdrain sized to convey the peak flow rate through the media?
- Is the underdrain routed safely off the building to a proper discharge point?
- Is the water quality volume drained to an irrigation or infiltration area?
- Is the BMP configured with an overflow or bypass? Is it sized correctly to convey the 100-year storm?
- Is the overflow or bypass water routed safely away from the building?
- Is the vegetation selected properly based on type of green roof? Extensive roofs are more limited.
- Is condensate or rainwater harvesting available to make up irrigation needs in summer?
- Are ancillary benefits (e.g., insulation, green space, water reuse) maximized?
- If green space for public access is intended, are proper safety measures in place to prevent falls?

Figure 5-7. Review process for green roofs.

Sand Filter Review Process

- Is the watershed delineated correctly (<5 acres)?
- Are the runoff generating characteristics accurately defined (Tc, imp. %, soil)?
- Is the treatment volume calculated correctly? Will the BMP bypass before overflowing or backing up into the site?
- Do the media storage capacity and ponding depth (<3 feet) meet the required volume?
- Is the sand filter properly sized and configured on the site plan? Is the surface area large enough?
- Does the sand media meet the design guidance? Is it at least 1.5 feet thick?
- Will the BMP use infiltration? Does the underlying soil have an adequate infiltration rate (>0.5 in/hr)?
- If infiltrating are lateral flows restricted if necessary to prevent pavement or foundation damage?
- Does the inlet configuration assure flow capture? Is there enough head difference? Is the inlet big enough to resist plugging?
- Is the inlet transition designed to reduce erosion (cobble, drop basin)?
- Is a forebay, grass filter strip or vegetated swale provided as pretreatment?
- Is the BMP configured with an overflow or bypass? Is it sized correctly?
- Is the underdrain sized properly? Will the bed drain completely if required?
- Does the vegetation meet the aesthetic, seasonal, sun exposure, and maintenance needs of the site?
- Are ancillary benefits (e.g., recreation, education, detention) maximized?
- Are there physical hazards to pedestrians or site users?

Figure 5-8. Review process for sand filters.

Cistern Review Process

- Is the roof area draining to the cistern identified correctly?
- Is the Time of Concentration correct?
- Is the treatment volume calculated correctly?
- Will the foundation support the weight of a full tank?
- Will the pipe from the roof to the cistern safely convey the 100-year flow?
- Is a self-cleaning inlet filter provided?
- Is a first flush diverter included and configured properly?
- Is the first flush volume routed to another BMP?
- Is the low flow outlet sized to drain the water quality volume from the tank within two days?
- Is the water quality volume drained to an irrigation or infiltration area?
- Is the BMP configured with an overflow or bypass? Is it sized correctly?
- Is the overflow or bypass water routed safely away from the building?
- Is signage stating “Caution: Reclaimed Water, Do Not Drink” provided?
- Are pipes conveying water painted Pantone color #512, and do valves have locking features?
- Are ancillary benefits (e.g., irrigation, toilet flushing, car washing) maximized?
- Are all inlets and outlets covered by 1-mm or smaller mesh to prevent mosquito entry?

Figure 5-9. Review process for cisterns.

Stormwater Wetland Review Process

- Is the contributing area delineated correctly? Wetlands can treat watersheds greater than 5 acres.
- Are the runoff generating characteristics accurately defined (Tc, imp. %, soil)?
- Is the treatment volume calculated correctly? Add 20% to runoff volume for sediment accumulation.
- Is a water balance provided showing enough water for a permanent deep pool(s)?
- Wetlands require an impermeable liner or low permeability *in situ* soils. Has a geotechnical study of the pond site been performed?
- Is the wetland properly sized and configured on the site plan to collect drainage by gravity?
- Does the inlet configuration ensure flow capture? Is there enough head difference to provide conveyance into pond?
- Is the inlet designed to reduce erosion from large storms? Will hydraulic jump occur at outlet of collection system?
- Is the forebay sized to still the incoming flow, settle large particles and collect floatables?
- Is a berm or weir provided to dissipate flow into the main body of the wetland?
- Are the required four zones designed into the wetland? Is the flow length maximized?
- Is the BMP configured with an overflow or bypass? Is it sized correctly? Is an emergency spillway provided?
- Is a maintenance/emergency dewatering intake provided? Is it sized to drain the wetland in 24 hours?
- Does the soil media support establishment of native wetland plant species?
- Does the vegetation meet the criteria for wetland plants?
- Are the planting areas 3–6 inches deep to prevent undesirable plants?
- Are ancillary benefits (e.g., habitat, education, shade, park space) maximized?

Figure 5-10. Review process for stormwater wetlands.

Vegetated Swale/Vegetated Filter Strip Review Process

- Is the contributing area delineated correctly (< 50 ft for VFS or <1 acres for VS)?
- Are the runoff generating characteristics accurately defined (Tc, imp. %, soil)?
- Is the treatment flow rate calculated correctly?
- Does the site plan provide room for the VS or VFS? Does the siting fit the guidelines for VS or VFS placement to collect sheet flow or runoff from small on-site areas?
- Will the proposed configuration support vegetative cover sufficient to provide treatment? Check grass type, slope, soil depth (**min. 6 inches**), sun exposure, and water needs.
- Do the cross-sectional area, width and slope result in the calculated velocity?
- Does the calculated velocity provide for the recommended 10 minute detention time? Will velocity remain below 1 ft/s and depth below 1 inch for VFS?
- Can the VFS/VS convey higher design storm flow (5- to 25-yr) without excessive erosion or damage?
- Does the inlet configuration assure flow capture? Is there enough head difference? Is the inlet big enough to resist plugging?
- Will the curb inlet or grading configuration encourage sheet flow? Is a level spreader needed to prevent rill formation?
- Are swale side slopes greater than 3:1? Are internal check dams or trees included to maximize water retention? Can the tree species survive short periods of inundation?
- Will ponding or increased infiltration cause hazards or nuisance problems?

Figure 5-11. Review process for vegetated swales and vegetated filter strips.

5.2 Incentives

A variety of incentives can be used by regulators to encourage LID implementation for new development and existing development. Incentives can encourage developers to use LID practices during the planning and design process for new development projects. For existing development, incentives can help property owners retrofit their sites with LID BMPs. According to the U.S. EPA, four common incentive mechanisms used at the local level are fee discounts or credits, development incentives, BMP installation subsidies, and awards and recognition programs, as described below (USEPA 2012):

1. *Stormwater fee discount or credit*

Municipalities often charge a stormwater fee based on the amount of impervious surface area on a property. If a property owner decreases a site's imperviousness or adds LID practices to reduce the amount of stormwater runoff that leaves the property, the municipality will reduce the stormwater fee or provide a credit that helps the landowner meet a water quality performance or design requirement.

2. *Development incentives*

Local governments can offer incentives that are only available to a developer who uses LID practices. Some economic development corporations will use these incentives to encourage development on targeted sites, such as redevelopment in downtown or underserved areas. For example, cities might offer to waive or reduce permit fees, expedite the permit process, allow higher density developments, or provide exemptions from local stormwater permitting requirements for developers that use LID practices to meet stormwater management goals.

3. *Rebates and installation financing*

To offset costs, cities might offer grants, matching funds, low-interest loans, tax credits or reimbursements to property owners who install specific LID practices or systems. For example, some communities offer programs that subsidize the cost of rain barrels, plants and other materials that can be used to control stormwater. Similarly, public improvements financed through public/private partnerships can require LID implementation to meet community goals.

4. *Awards and recognition programs*

More communities are holding LID-design contests to encourage local participation and innovation. Many communities highlight successful LID sites by featuring them in newspaper articles, on websites and in utility bill mailings. Some also issue yard signs to recognize property owners who have installed LID. Recognition programs can help to increase property values, promote property sales and rentals, and generally increase demand for the properties. Businesses receiving green awards can enhance sales materials to generate increase revenue.

Local Incentives for Green Infrastructure

Fee discounts or credits require a stormwater fee that is based on impervious surface area. If property owners can reduce need for service by reducing impervious area, the municipality reduces the fee.

Development incentives are offered to developers during the process of applying for development permits. They include zoning upgrades, expedited permitting, reduced stormwater requirements, and other incentives.

Rebates and installation financing give funding, tax credits or reimbursements to property owners who install specific practices. These incentives are often focused on practices needed in certain areas or neighborhoods.

Awards and recognition programs provide marketing opportunities and public outreach for exemplary projects. These programs may include monetary awards.

Source: USEPA 2010

Resources

Green Infrastructure Case Studies: Municipal Policies for Managing Stormwater with Green Infrastructure

In 2010, EPA developed a report presenting common trends among 12 local governments that developed and implemented stormwater policies to support green infrastructure. Stormwater fee discounts and other incentives are discussed in detail, including a framework for stormwater fee discount programs. The report can be found at http://www.epa.gov/owow/NPS/lid/gi_case_studies_2010.pdf.

Managing Wet Weather with Green Infrastructure Municipal Handbook Incentive Mechanisms

EPA's Municipal Handbook provides local governments with a step-by-step guide to growing green infrastructure in their communities. The Incentive Mechanisms chapter describes a number of incentives that municipalities can offer to promote the implementation of green infrastructure on private properties and reduce their stormwater management costs. The guide can be found at

http://water.epa.gov/infrastructure/greeninfrastructure/upload/gi_munichandbook_incentives.pdf.

Green Infrastructure Funding and Incentives Webcast

In 2009 EPA held a webcast on green infrastructure funding and incentives, which can be viewed at http://cfpub.epa.gov/npdes/courseinfo.cfm?program_id=0&outreach_id=460&schedule_id=1059.

5.3 Stormwater Fee-in-Lieu Programs

Traditional programs for stormwater management have allowed participation in regional programs that fund municipally owned detention basins, conveyance channels, and large underground storm drainage systems. This approach has been preferred by municipalities for maintenance reasons, to provide funding to fix existing flooding issues, and in some cases as a means to create public open space with water features that provide aesthetic benefits. Traditional programs usually focus on rare flood events such as the 10-year or 100-year event that, while damaging, occur infrequently.

LID approaches typically use distributed small-scale BMPs throughout a site to manage stormwater from frequent storms close to the impervious surfaces that create increased runoff. This on-site stormwater management is necessary due to excessive costs that would be required to meet water quality goals with end-of-pipe solutions in a typical development scenario. With redevelopment, there is often minimal open space near streams to fit large regional stormwater management practices.

On-site stormwater management programs incorporating LID tend to limit payment of fees in lieu of on-site stormwater mitigation (referred to as fee-in-lieu-of or FILO). These programs often allow purchasing off-site credits from private retention credit banks. Regulatory agencies may choose to require a minimum on-site treatment (for example 50% of required water quality volume) for very small storms in the range of one half inch or less. Similar programs exist locally for tree mitigation where a land owner may choose to protect additional trees on a site and sell the credits to other developers. Stormwater management requires a watershed-based approach to credit programs so that volume reduction and treatment required to meet integrated stormwater management goals occurs upstream of monitoring points or regulated discharges. To date, most programs have been implemented as part of stormwater utilities or MS4 permit compliance measures and work in concert with stormwater fees assessed monthly based on either flat rates for residential properties or rates based on the amount of impervious cover on a site.

5. LID Review Process

There are many opportunities to develop a comprehensive fee structure for stormwater management that blends flood control and LID outcomes. Non-structural LID approaches reduce impervious cover, preserve vegetation and protect high infiltration soils that can be exploited for increased treatment. This reduces overall stormwater impacts, which results in lower impact fees. Structural LID BMPs reduce runoff volumes and increase interception at the onset of all storms, which preserves detention volume for flood peaks. Many BMPs can also be oversized to temporarily detain flood volumes, which reduces storm drainage infrastructure costs. Integrated approaches may use varying requirements for design storms based on water quality and flood control needs. An example approach is presented in Table 5-1 below.

Table 5-1. Sample management approach blending water quality and flood control.

Storm Size	Water Quality Management	Volume Management	Flow Rate Management	Conveyance Management
90 th percentile annual storm	✓	✓	✓	✓
2- to 25-year storms			✓	✓
100-year storm				✓

A site that fully implements LID with on-site detention can reduce or eliminate monthly stormwater fees and offset or eliminate flood control impact fees.

5.4 References

- USEPA (U.S. Environmental Protection Agency). 2010. *Green Infrastructure Case Studies: Municipal Policies for Managing Stormwater with Green Infrastructure*.
http://www.epa.gov/owow/NPS/lid/gi_case_studies_2010.pdf. Accessed March 4, 2013.
- USEPA (U.S. Environmental Protection Agency). 2012. *Encouraging Low Impact Development: Incentives Can Encourage Adoption of LID Practices in Your Community*.
http://www.epa.gov/owow/NPS/lid/gi_case_studies_2010.pdf. Accessed March 4, 2013.

Glossary

Absorption – The uptake of molecules of one substance directly into another substance.

Abstraction – Storage of precipitation on leaves, stems, organic litter, and shallow depressions on the land surface. The total storage is unavailable for runoff in hydrologic modeling of storm events.

Adsorption – The adhesion of atoms, ions, or molecules from a gas, liquid, or dissolved solid to a surface.

Alkalinity – The capacity of water for neutralizing an acid solution.

Area of concern – Areas where infiltration should be limited, such as sensitive groundwater areas or areas prone to sinkholes.

Artesian zone (Edwards Aquifer) – The downstream-most zone located directly above the confined Edwards Aquifer. Recharge is limited by relatively impermeable layers overlying the Edwards Aquifer and positive hydraulic pressure of the confined aquifer.

As-built – Drawings prepared by the construction contractor showing changes to the construction plans or recording final dimensions or elevations.

Base flow – The portion of stream flow that occurs during fair weather and is contributed by groundwater sources such as interflow or spring flow.

Best management practices (BMPs) – Nonpoint Source BMPs are specific practices or activities used to reduce or control impacts to water bodies from nonpoint sources, most commonly by reducing the loading of pollutants from such sources into storm water and waterways. (TCEQ)

Bioaccumulation – The accumulation of substances, such as pesticides, or other organic chemicals in an organism.

Biofiltration – The process of removing contaminants from stormwater using biological processes of plants, microorganisms, and organic matter.

Biological integrity – The ability of an ecosystem to support and maintain a balanced, integrated, and adaptive community of organisms having a species composition, diversity, and functional organization comparable to the best natural habitats within a region.

Bioretention (rain gardens) – A stormwater management technique that typically uses parking lot islands, planting strips, or swales to collect and filter urban stormwater. The cells include grass and sand filters, loamy soils, mulch, shallow ponding and native trees and shrubs.

Biotransformation – The chemical modification (or modifications) made by an organism on a chemical compound.

Chicanes – A horizontal diversion of vehicular traffic designed to reduce speed and increase safety for pedestrians, bicyclists and motorists.

Glossary

Coagulation – A joining together of particles that settle out in waste water. Lime, alum, and iron salts induce the clumping of particles.

Complete street – Streets designed and operated to enable safe access and travel for all users. Pedestrians, bicyclists, motorists, transit users, and travelers of all ages and abilities will be able to move along the street network safely.

Contributing zone (Edwards Aquifer) – Located on the Edwards Plateau, the contributing zone is the upstream-most zone of the Edwards Aquifer drainage area. Rainfall infiltrates to recharge the water table aquifer or runs off overland to the recharge zone.

Conveyance systems – Stormwater management systems designed to efficiently convey runoff from a site or watershed into a receiving stream. Systems are typically comprised of impervious segments such as driveways, streets, closed pipes, lined channels and engineered earthen channels.

Curb cuts – An opening formed or cut into curbs to allow runoff collected in the street to enter a surface stormwater management feature.

Curbs A concrete barrier on the margin of a road or street that is used to direct stormwater runoff to an inlet, protect pavement edges, and protect lawns and sidewalks from encroachment by vehicles.

Depression storage – The amount of rainfall stored on the surface of the ground in small depressions or puddles. This storage reduces initial storm runoff and the water is lost to evaporation, transpiration, or infiltration.

Detention – A stormwater management approach that temporarily holds back water and releases it at a rate slower than the maximum inflow rate. Detention is not typically design to reduce the total volume of runoff.

Development envelope – The limit of disturbance that will meet the site development plan while causing the smallest hydrologic impact

Drip line – A ring around the tree canopy on the ground level that receives most of the rainwater shed from the tree canopy. Feeder root locations go beyond the drip line to get moisture and nutrients being created from organic matter in and on top of the soil.

Easements – An easement is defined as a right, privilege or advantage in real property, existing distinct from the ownership of the land. Most commonly, an easement entails the right of a person (or the public) to use the land of another in a certain manner such as electric, cable, drainage, gas and water easements.

Ecological impairments – an impact resulting from pollutant loading, channel degradation, increased flow, and loss of habitat structure that reduces the livability or long term health of aquatic habitat.

Emergent vegetation – Herbaceous wetland plants that root in shallow water and extend above the water surface.

Ephemeral stream – A stream or waterway that holds water only for a few hours or days, and dries up shortly after rain storms.

Erosion – The wearing away of land surface by wind or water. Erosion occurs naturally from weather or runoff but can be intensified by increased runoff and land-clearing practices related to farming, residential or industrial development, road, building, or timber cutting.

Evapotranspiration – The combined loss of water from a given area, and during a specified period of time, by evaporation from the soil surface and transpiration from plants into the atmosphere.

Exfiltration – The seepage of water into the native subsoil beneath a stormwater infiltration BMP.

Floatables – Any foreign matter that may float or remain suspended in the water column and includes plastic, aluminum cans, wood products, bottles, and paper products.

Flocculation – The process by which suspended colloidal or very fine particles are assembled into larger masses or floccules that eventually settle out of suspension.

Green Infrastructure (GI) – Sustainable pollution reduction practices that also provide ecosystem services. GI includes both preserved natural areas and man-made BMPs.

Ground water – Water stored underground that fills the spaces between soil particles or rock fractures. A zone underground with enough water to withdraw and use for drinking water or other purposes is called an aquifer.

Horizontal deflectors – See **chicanes**.

Hotspot (Stormwater Hotspot) – Areas where infiltration into native soils should be restricted due to risk of contamination. Areas include, but are not limited to: fueling stations, vehicle/equipment maintenance and wash facilities, solid waste facilities, and trucking/railroad facilities.

Hydrologic cycle – The natural cycle of water on earth, including precipitation as rain and snow, runoff from land, storage in lakes, streams, and oceans, and evaporation and transpiration (from plants) into the atmosphere.

Hydrologic flow path – The path that water follows across the ground, through the soil, or in groundwater.

Hydroperiod – The seasonal pattern of water levels in a wetland including periods of filling, draining, and dry periods. Wetland plants and animals are affected by changing hydroperiods caused by increased runoff.

Impervious cover – Any surface which cannot be effectively (easily) penetrated by water. Examples include conventional pavements, buildings, highly compacted soils, and rock outcrops.

Infiltration – The downward entry of water into the surface of the soil, as contrasted with percolation which is movement of water through soil layers.

Interception – The capture and storage of water on leaves, grass and buildings that are above the ground surface.

Interflow – Movement of water laterally through the unsaturated soil zone from a high topographic point to an outlet in a stream prior to becoming groundwater.

Glossary

Intersection pop-outs – A form of bioretention used at intersections in the space that is the continuation of on street parking lanes. The space is typically signed or striped no parking to preserve sight distances.

Karst – A landscape formed from the dissolution of soluble rocks including limestone, dolomite and gypsum. It is characterized by sinkholes, caves, and underground drainage systems.

LID strategies – Approaches to land development that are applied at the regional or watershed scale to protect undisturbed natural lands, cultural resources, and ecological value while encouraging efficient land use. Strategies can take the form of riparian, habitat, or sensitive area protection.

LID practitioner – People who are involved in the design, maintenance, monitoring and performance of LID.

Low impact development – A stormwater management and land development strategy that emphasizes conservation and the use of on-site natural features integrated with engineered, small-scale hydrologic controls to more closely reflect pre-development hydrologic functions.

Manway – A hatch or port providing access to a cistern.

Mass loading – The total load of a pollutant that enters a receiving water over a specified unit of time. The mass load is found by multiplying the flow rate by the pollutant concentration over the time period.

Non-Point Source (NPS) Pollution - Nonpoint source pollution generally results from land runoff, precipitation, atmospheric deposition, drainage, seepage or hydrologic modification. NPS pollution is caused by rainfall or snowmelt moving over and through the ground. As the runoff moves, it picks up and carries away natural and human-made pollutants, finally depositing them into lakes, rivers, wetlands, coastal waters and ground waters.

Peak flow control – A stormwater management approach that focuses on limiting peak flow during design storms (water quality, flood control or combination) to a target usually set by existing or pre-development conditions.

Percolation – The downward movement of water through soil layers, as contrasted with infiltration which is the entry of water into the surface of the soil.

Photolysis – The breakdown of a material by sunlight; an important mechanism for the degradation of contaminants in air, surface water, and the terrestrial environment.

Phytoremediation – The direct use of green plants and their associated microorganisms to stabilize or reduce contamination in soils, sludges, sediments, surface water, or ground water.

Precipitation – A method of causing contaminants that are either dissolved or suspended in solution to settle out of solution as a solid precipitate, which can then be filtered or otherwise separated from the liquid portion. Chemical precipitation is a widely used, proven technology for the removal of metals and other inorganics, suspended solids, fats, oils, greases, and some other organic substances from wastewater, drinking water, and occasionally in wastewater.

Pre-development – The description of land cover, soil profile, hydrologic characteristics and water movement within a site or study area that would exist without human disturbance.

Recharge – Infiltration of surface water to groundwater.

Recharge zone (Edwards Aquifer) – The recharge zone is directly downstream from the contributing zone and consists of highly fractured limestone. Rainfall and runoff directly recharge the confined Edwards Aquifer through deep networks of fissures, faults, and sinkholes.

Reduction-oxidation (redox) potential – A chemical reaction consisting of an oxidation reaction in which a substance loses or donates electrons, and a reduction reaction in which a substance gains or accepts electrons. Redox reactions are always coupled because free electrons cannot exist in solution and electrons must be conserved.

Retention – A stormwater management technique that captures water permanently and reduces volume and flow rate. The captured water is reused for irrigation or allowed to naturally infiltrate and evapotranspire.

Right-of-way – Right of way is a general term denoting land, property or interest therein, usually in a strip, acquired for or devoted to a highway for the construction of the roadway. Right of way is the entire width of land between the public boundaries or property lines of a highway.

Runoff coefficient – The runoff coefficient is based on permeability and determines the portion of rainfall that will run off the watershed. The runoff coefficient value, expressed as C, can vary from close to zero to up to 1.0. A low C value indicates that most of the water is retained for a time on the site, as by soaking into the ground or forming puddles, whereas a high C value means that most of the rain runs off.

Screeding – Leveling the surface of poured materials (such as pervious concrete or aggregate) using a flat board, beam, or plate.

Sensitive Natural Areas – Natural areas requiring protection of native landscape, plant life, wildlife, or ecological values. The areas include recharge features, endangered species habitat, steep slopes and riparian buffers.

Sensitive Cultural Areas – Areas with significant cultural value that require protection. Areas include ceremonial structures, cemeteries, large trees, artifact sites and locations of significant historical events.

Setbacks – A zone designated to protect sensitive areas from negative impacts associated with development.

Short circuit – A situation in which polluted runoff bypasses a stormwater treatment facility.

Site fingerprinting – A site design technique that minimizes disturbance during construction by defining the limits of clearing, soil compaction, material storage, and underground facilities.

Soil compaction – The process where soil particles are pressed together, reducing pore space between them. Compacted soils typically contain few large pores and have a reduced rate of both water infiltration and drainage from the compacted layer. Soil compaction is a result of equipment, vehicle and pedestrian traffic.

Smart growth A set of development principles to improve community livability, including mixing land uses, creating a range of housing types, preserving green space, creating compact and walkable development with a variety of transportation options, and focusing new development in or near areas of existing development.

Glossary

Stream morphology – The form and structures of streams that can be assessed to determine the stability, progression and health of streams.

Sustainable – A method, practice or approach that creates and maintains the conditions under which humans and nature can exist in productive harmony, that permit fulfilling the social, economic and other requirements of present and future generations.

Time of concentration – The time required for runoff to travel from the hydraulically most distant point in the watershed to the outlet.

Total maximum daily loads (TMDLs) – The sum of the individual wasteload allocations (WLAs) for point sources, load allocations (LAs) for nonpoint sources and natural background, and a margin of safety (MOS). TMDLs can be expressed in terms of mass per time, toxicity, or other appropriate measures that relate to a state's water quality standard.

Transition zone (Edwards Aquifer) – Located between the recharge zone and the artesian zone, this area features both deep infiltration and artesian springs.

Treatment train – A stormwater technique in which several treatment types (filtration, infiltration, retention, evaporation) are used in conjunction with one another and are integrated into a comprehensive runoff management system.

Urbanization – Urbanization refers to the concentration of human populations into discrete areas, leading to transformation of land for residential, commercial, industrial & transportation purposes. It can include densely populated centers, as well as their adjacent periurban or suburban fringes (EPA).

Walkability – The ease with which pedestrians can access businesses, schools, and facilities, in terms of distance and safety.

Zoning – A set of regulations and requirements which govern the use, placement, spacing, and size of land and buildings within a specific area (zone). Zoning regulations serve to promote the public health, safety, morals, or general welfare and to protect and preserve places and areas of historical, cultural, or architectural importance and significance.

Appendix A. BMP Sizing

Contents

- A.1 IntroductionA-1
- A.2 Stormwater Management Methods.....A-1
 - A.2.1 Volume Management.....A-1
 - A.2.2 Flow ManagementA-2
- A.3 BMP Performance CurvesA-2
- A.4 BMP SizingA-34
 - A.4.1 Volume-based Method 1A-34
 - A.4.2 Volume-based Method 2.....A-35
- A.5 Flow-based Control Practices.....A-36
 - A.5.1 Flow-based Method 1A-36
 - A.5.2 Flow-based Method 2A-37
- A.6 ReferencesA-37

Appendix A. BMP Sizing

Figures

Figure A-1. Schematic of simulated HSPF and SUSTAIN processes and surface runoff linkage.	A-3
Figure A-2. Comparison of WDM precipitation at 12921 with corresponding NCDC long-term observed precipitation data.	A-4
Figure A-3. HSPF modeled annual average bacteria export by impervious land use category.	A-5
Figure A-4. Example performance curves showing flow volume reduction versus bioretention basin size.	A-6

Tables

Table A-1. Summary of land use types from the Salado and USAR HSPF models.	A-3
Table A-2. Matrix of BMP model responses by site condition and BMP type.	A-5

A.1 Introduction

Stormwater management techniques incorporating LID BMPs are focused on frequent smaller storm events typically in the range of one to two inches over 24 hours. Many jurisdictions provide either a volume target based on a storm depth or a flow rate target based on annual storm intensity. Permitting agencies in the San Antonio River Basin are encouraged to develop their own criteria based on national, state, and local guidance. Regulators or designers can perform localized BMP modeling to better define stormwater management goals or outcomes for a particular site. Refer to section A.3 for discussion on BMP modeling software. Alternatively, regulators could allow designers to use either of the following design criteria:

- **Volume-based control practices:** infiltrate, filter, or treat the volume of runoff necessary to meet a treatment target based on either the volume necessary to meet a specific annual pollutant reduction or the volume of runoff produced by a design storm (85th to 95th percentile storm event dependent on the city or county guidance).

or

- **Flow-based control practices:** infiltrate, filter, or treat the maximum flow rate from the design intensity (typically exceeds 2.0 inches per hour) or *twice* the maximum flow rate from the design storm hourly rainfall intensity (typically 0.5 to 1.1 inch per hour intensity depending on the city or county guidance).

In fundamental terms, these design guidelines present sizing methodologies that ensure management of frequent small events with low to medium rainfall intensities while bypassing runoff from typical flooding events. The result is that a large portion of total annual runoff (i.e., runoff from the majority of storms that are smaller than the 90th percentile event) is managed by the BMP without the significant expense of oversized BMPs necessary to capture a 5-year to 100-year storm. These methods are summarized briefly below.

A.2 Stormwater Management Methods

A.2.1 Volume Management

Volume management is typically required for offsetting hydromodification effects and to extend treatment times in BMP's for nutrient, metals, and temperature management. There are currently (2013) no statewide or San Antonio River Basin specific mandates for runoff volume management. However, the following methods to size BMPs for infiltrating, filtering, or treating stormwater to meet volume criteria are appropriate:

1. A hydrologic evaluation performed using continuous simulation hydrologic modeling and analysis techniques to determine the required treatment to meet multiple pollutant reduction and treatment goals. BMP performance curves for determining the rainfall depth that must be treated for a variety of pollutant reduction targets are presented in Section A.3 of this Appendix.

or

2. The volume of runoff produced from a percentile storm event required by local regulations or encouraged through incentives. [Note: applicants may calculate the regulatory percentile storm event using local rain data, when available.]

or

Appendix A. BMP Sizing

3. The volume of annual runoff based on unit basin storage volume, to achieve 90 percent or more volume treatment by the method recommended in the latest edition of *Complying with the Edwards Aquifer Rules—Technical Guidance on Best Management Practices* (TGM) (TCEQ 2005). Please note that the TCEQ criteria do support the use of LID BMPs and treatment trains can be used to meet TSS reduction requirements and volume management.

For each of the methods presented above, a rainfall or precipitation depth will be determined. The water quality or treatment volume necessary to meet the treatment goals will be determined using the rainfall depth and the methods presented in Section A.4.

A.2.2 Flow Management

Flow based designs are typically used for configuring inlets, sizing conveyance, or setting hydraulic controls. Flow based BMP's such as vegetative filter strips, high rate filter media, and grass swales can be used as part of a treatment train to meet LID criteria. Flow based methods are presented in Section A.5.

A.3 BMP Performance Curves

Process-based continuous simulation models were used to generate the BMP performance curves. The watershed runoff response was simulated using the Hydrologic Simulation Program in FORTRAN (HSPF), while BMP responses were simulated using the System for Urban Stormwater Analysis and INtegration (SUSTAIN). Both HSPF and SUSTAIN estimate runoff volume and pollutant fate and transport at a high temporal resolution (i.e. hourly or sub-hourly). Although not used in this analysis, another model commonly used for rainfall/runoff and storage/transport simulation is the StormWater Management Model (SWMM). One advantage of continuous simulation is its ability to show varied storm responses as a function of antecedent conditions. For example, a storm occurring in the spring immediately after another rainfall event will have a notably different response than an isolated storm of the same size occurring in the summer. Not only would runoff and pollutant loads differ, but also BMP performance would differ. The modeling approach used to generate the BMP performance curves considers all of those interactions when estimating BMP performance. In fact, it is the aggregations of those interactions that make BMP performance vary in a non-linear way as a function of BMP size.

Runoff hydrograph and pollutograph boundary conditions for the BMP performance curves presented here were generated using the HSPF models provided to Tetra Tech by SARA. The two major drainage basins represented by these models were Salado Creek and the Upper San Antonio River in Bexar County, Texas. The impervious land (IMPLND) blocks from those existing HSPF models served as the basis for generating runoff boundary conditions as input to SUSTAIN. The IMPLND block produces runoff volume and associated pollutant loadings, which represent BMP inflow for SUSTAIN. Figure A-1 is a schematic illustrating the various HSPF and SUSTAIN processes as well as the linkage between the two models.

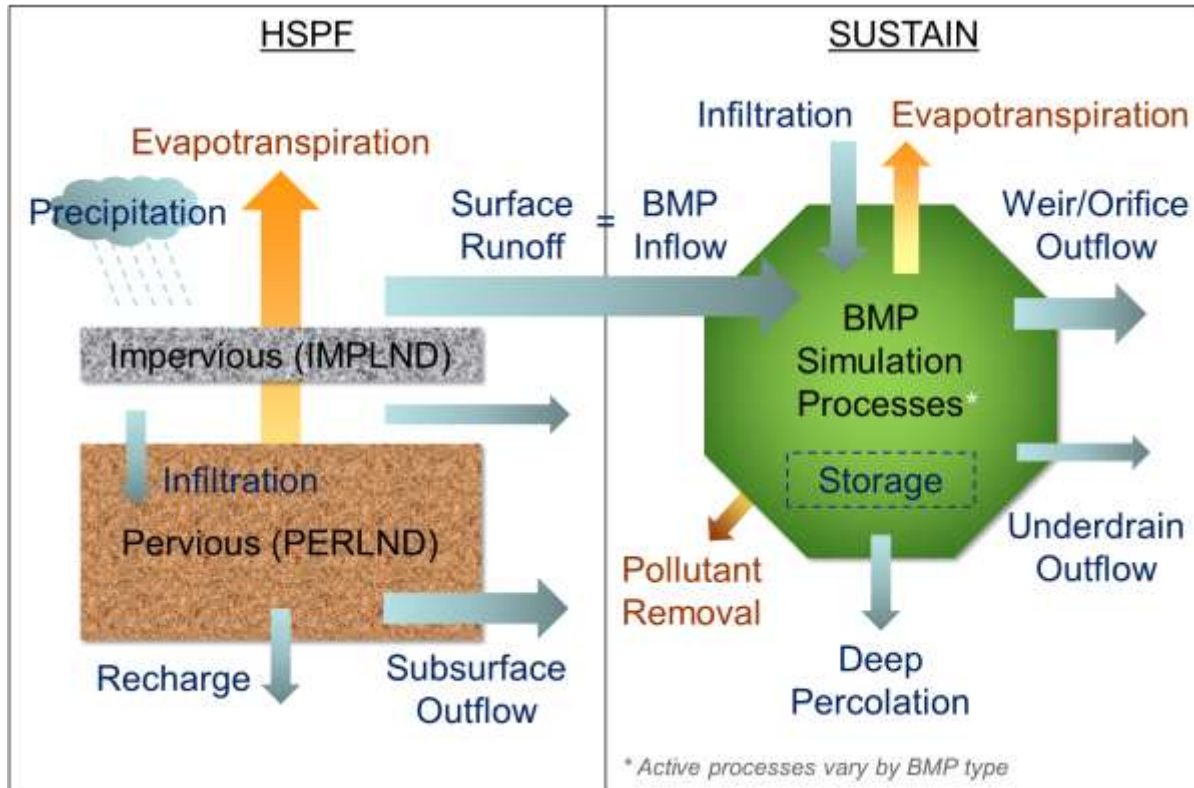

Figure A-1. Schematic of simulated HSPF and SUSTAIN processes and surface runoff linkage.

Model evaluation revealed that there were two unique groups of IMPLND runoff boundary conditions represented in the HSPF models, as summarized in Table A-1. Meteorological data from Station #12921 in the HSPF Watershed Data Management (WDM) file for calendar year 2007 were used to generate runoff hydrographs and pollutographs. That selected rainfall gage (12921) was evaluated against long-term National Climatic Data Center (NCDC) observed rainfall at San Antonio International Airport, as summarized in Figure A-2. Among calendar years-in-common, 2007 was selected for this analysis because it had both the highest annual precipitation volume and the highest number of days with rainfall than any other year available in the HSPF WDM file.

Table A-1. Summary of land use types from the Salado and USAR HSPF models.

Land use group	Land use type	HSPF classification
Residential	Dispersed	Residential dispersed
	Low	Residential low
	Medium	Residential medium
	High	Residential high
	Multi-Family	Residential multi-family
Other urban	Commercial	Commercial
	Industrial	Industrial
		Services mixed-use
		Services utilities
	Transportation	Transportation
	Open Space	Open space easements
Water	Water (not considered here)	Water

Appendix A. BMP Sizing

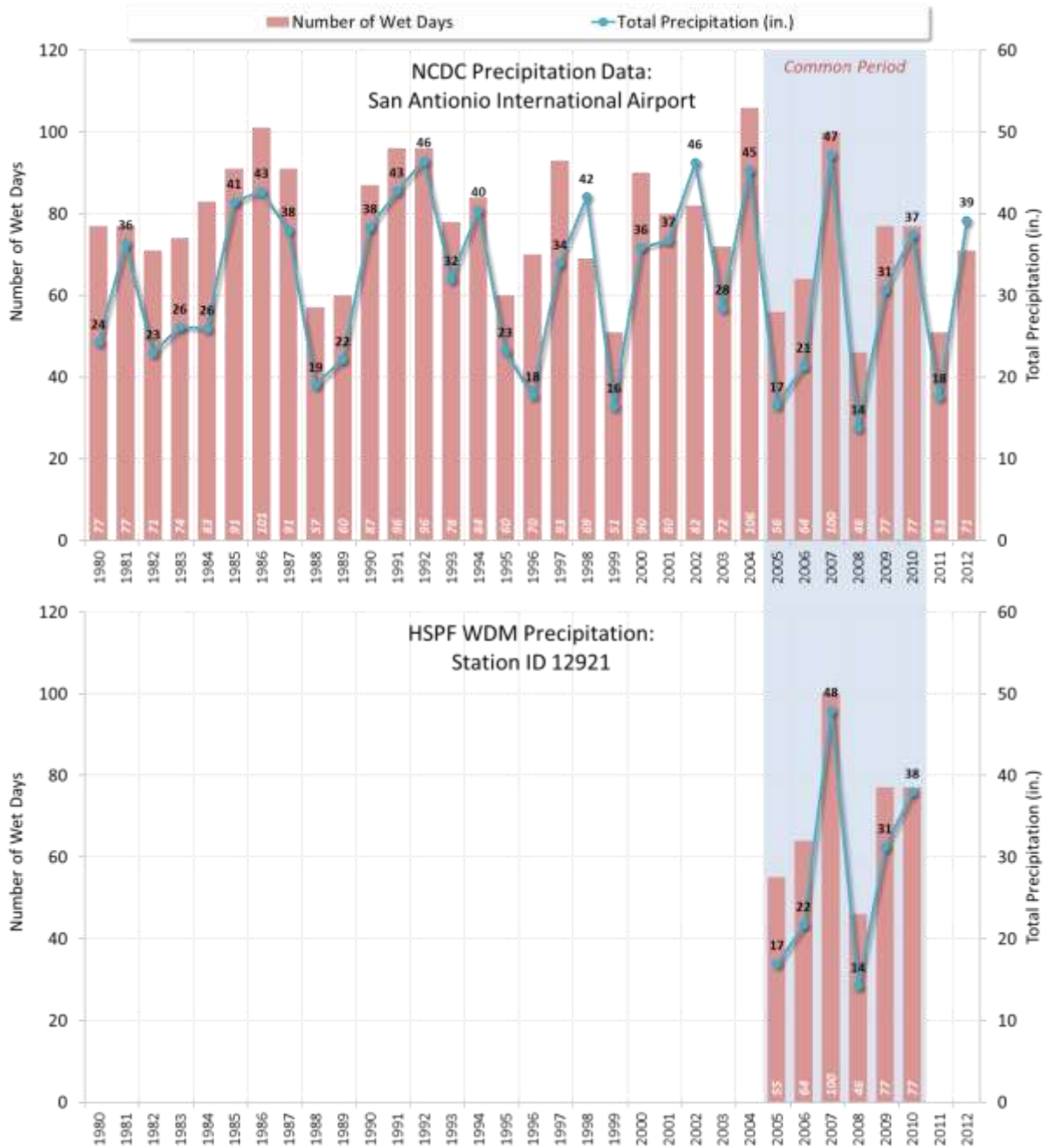

Figure A-2. Comparison of WDM precipitation at 12921 with corresponding NCDC long-term observed precipitation data.

Input parameters for the SUSTAIN model runs for all BMPs are available from the San Antonio River Authority upon request. BMPs were modeled for a range of site conditions, defined by hydrologic soil groups A, B, C, and D. An underdrain option was available for certain BMP types, as outlined in Table A-2 below. As shown in Table A-2, eight responses were modeled for every type of BMP. For bacteria, two different responses were modeled because the HSPF runoff loads from non-residential land use types were 50 percent lower than those from residential (as shown in Figure A-3 below). With the exception of

Open Space Easements and Water, which are not relevant for runoff inputs for this BMP analysis, all other modeled HSPF boundary condition outputs were identical for all land use types.

Table A-2. Matrix of BMP model responses by site condition and BMP type.

Site conditions	BMP types	Model responses
A & B soils, no underdrain option	Bioretention basin	1) Flow volume 2) Bacteria a) Residential b) Com/Ind/Trans 3) CBOD 4) Sediment 5) Total-N 6) Total-P 7) Total-Pb 8) Total-Zn
A & B soils, with underdrain option	Bioswale	
C & D soils, with underdrain option	Permeable pavement	
A, B, C, and D soils (underdrain option is not applicable)	Stormwater wetland	
	Vegetated filter strip (VFS)	
Site-specific BMPs (native soil type is not applicable)	Cistern	
	Green roof	
	Planter box	
	Rain barrel	
	Sand filter	

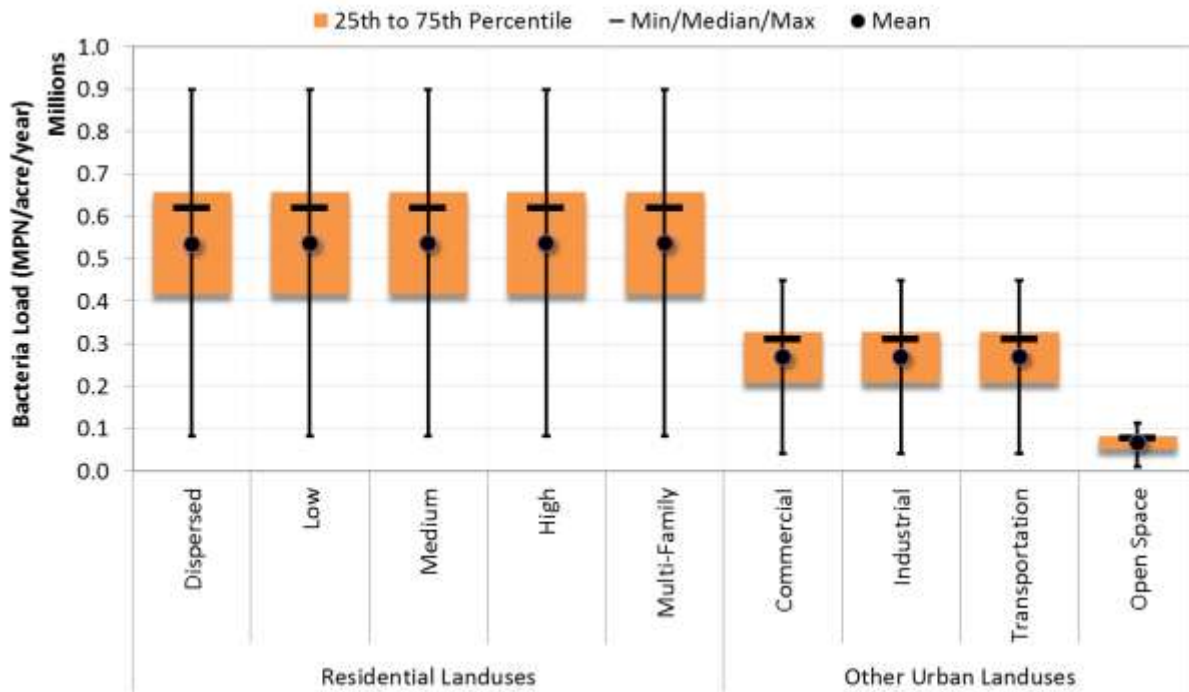

Figure A-3. HSPF modeled annual average bacteria export by impervious land use category.

For each of the unique modeled responses, there are six graphs: (1) bioretention basin, (2) bioswale, (3) permeable pavement, (4) stormwater wetland, (5) VFS, and (6) other site-specific BMPs. Each graph has multiple curves corresponding to the various applicable site conditions. There is only one graph for each of the five site-specific BMP types since they do not depend on the infiltration rate of the native soil. The last graph of each set of modeled responses presents results for all five site-specific BMP types. As

Appendix A. BMP Sizing

previously noted, there are two different sets of modeled responses for bacteria because of land use differences in the HSPF boundary condition (i.e., *Residential* and *Commercial/Industrial/Transportation*).

Figure A-4 presents example performance curves showing flow volume reduction as a function of bioretention basin size. Annual percent reduction is for the modeled calendar year 2007. The x-axis represents BMP size and is interpreted as the equivalent *runoff* depth or rainfall depth captured from one acre of impervious area. This depth is equal to the rainfall depth if one assumes that flow abstractions along the impervious surface upstream of the BMP are negligible. Figure A-4 presents two examples for how to use the curves to assist in BMP designs. The curves can be used either to estimate the benefit of sizing a BMP to a given size or to estimate the required size to achieve a desired level of performance. The first example (1 → 2 → 3) is for a bioretention basin with underdrain to be built in an area with native C-soils. For this example, the light-blue curve is used. If the BMP is being sized to capture 1.5 inches of runoff, equivalent to a rainfall depth of 1.5 inches, it is expected to reduce annual average runoff by 50 percent (for selected the 2007 wet year). The second example (4 → 5 → 6) is for a BMP to be built in an area with native B-soils, with no underdrain. For this example, the green curve is used. This time, the desire is to control 75 percent of annual runoff (for 2007); therefore, the BMP must be sized to capture 2.2 inches of runoff, equivalent to a rain fall depth of 2.2 inches. The runoff or rainfall depths determined in the performance curves below is then applied to the methods presented in section A.4.1 to determine the water quality volume.

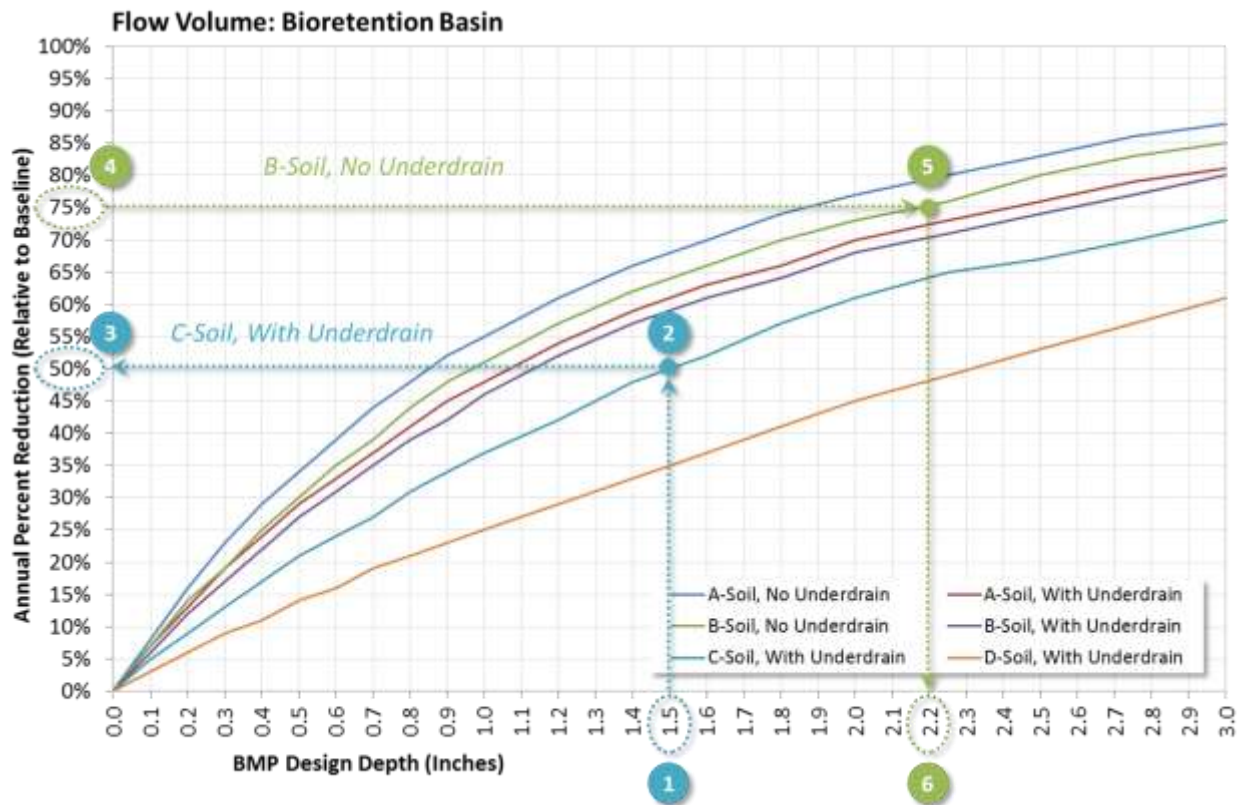
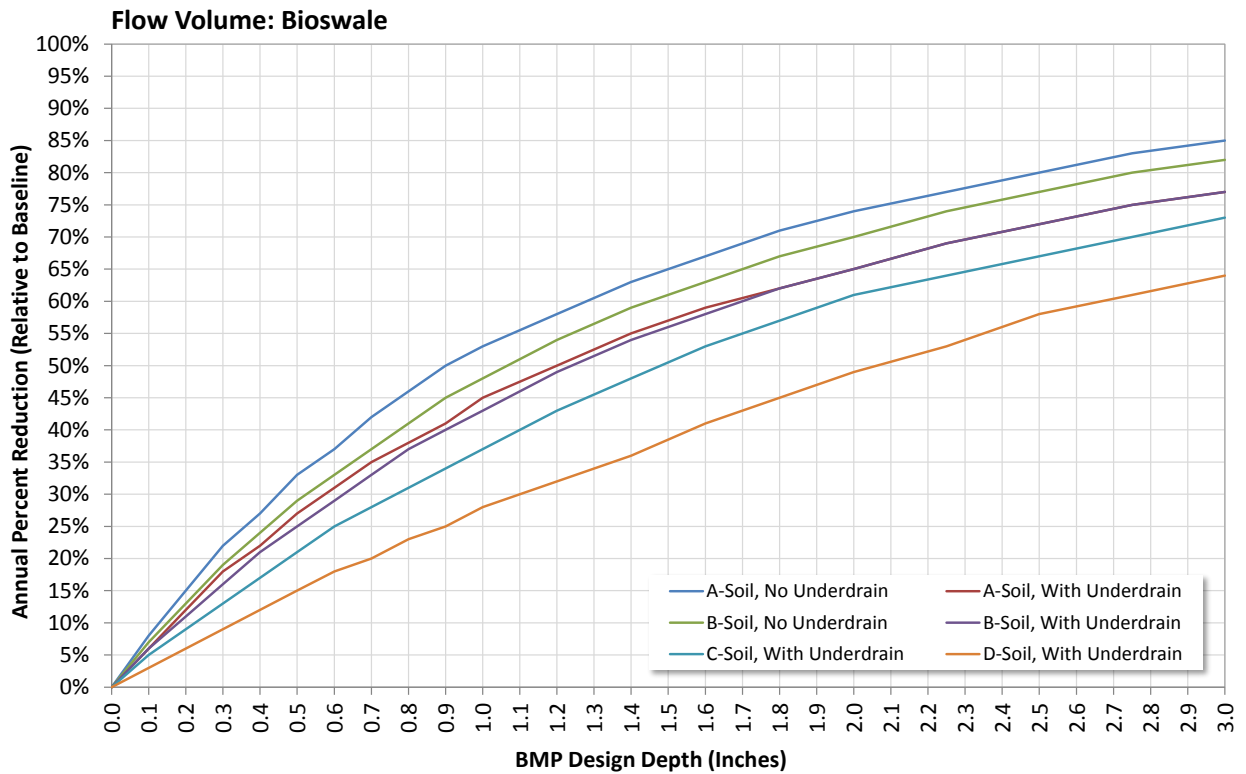
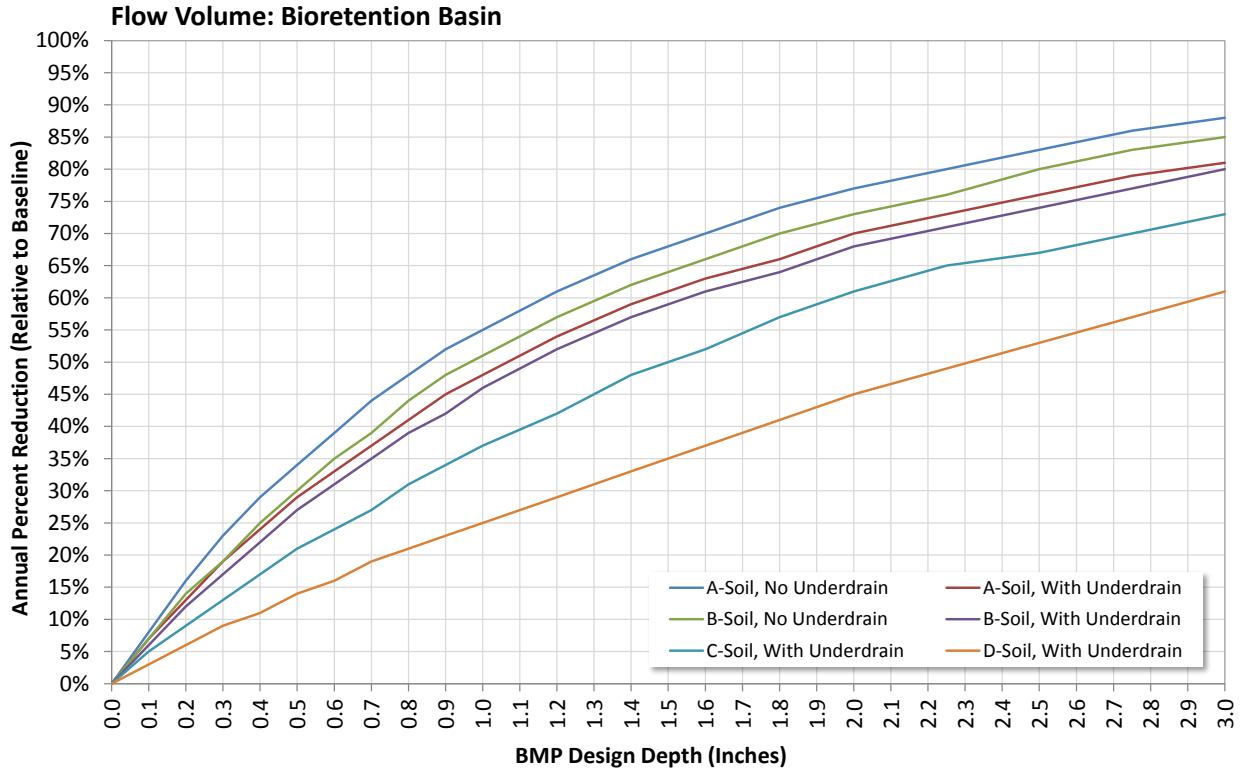
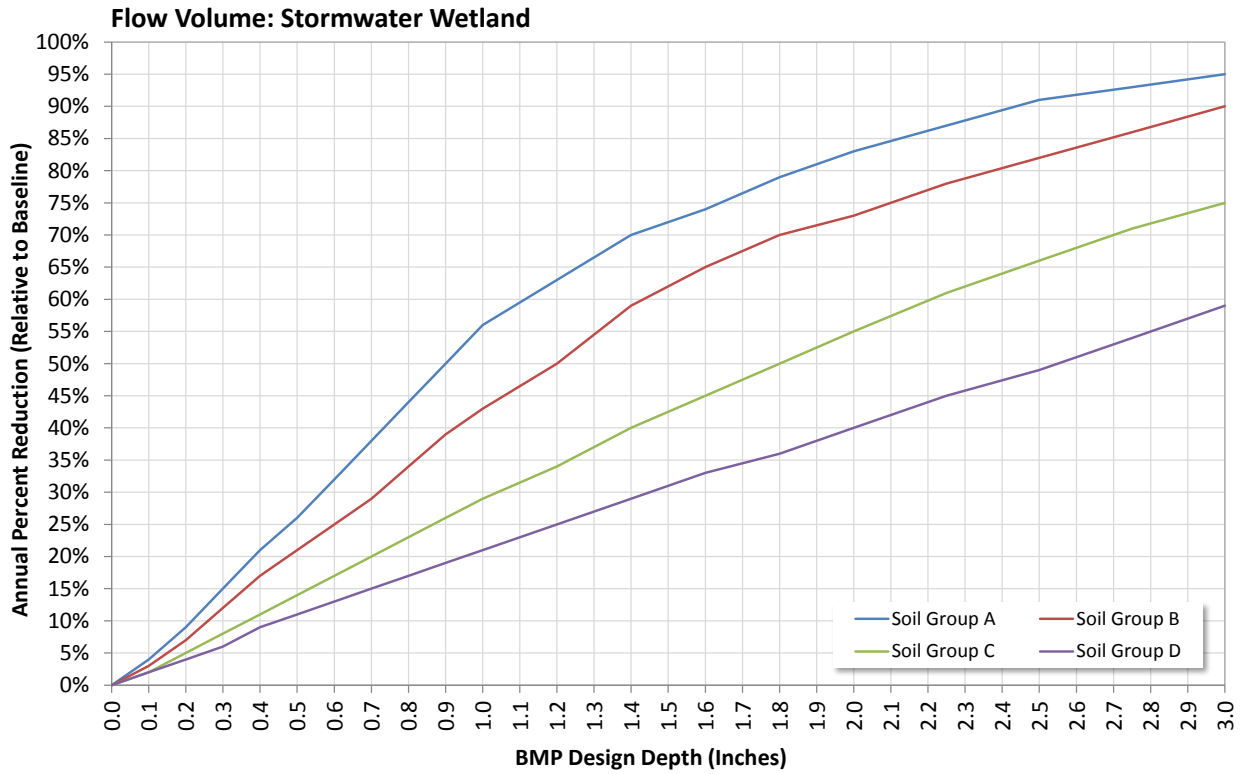
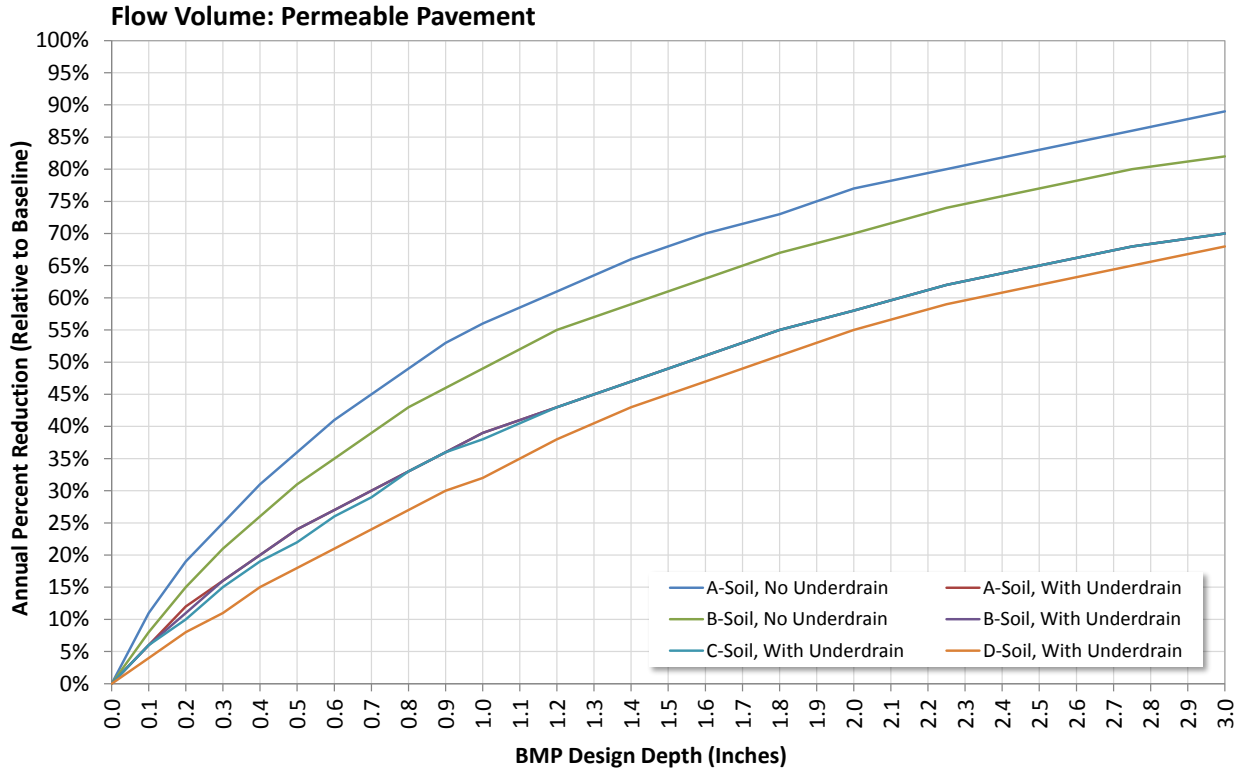
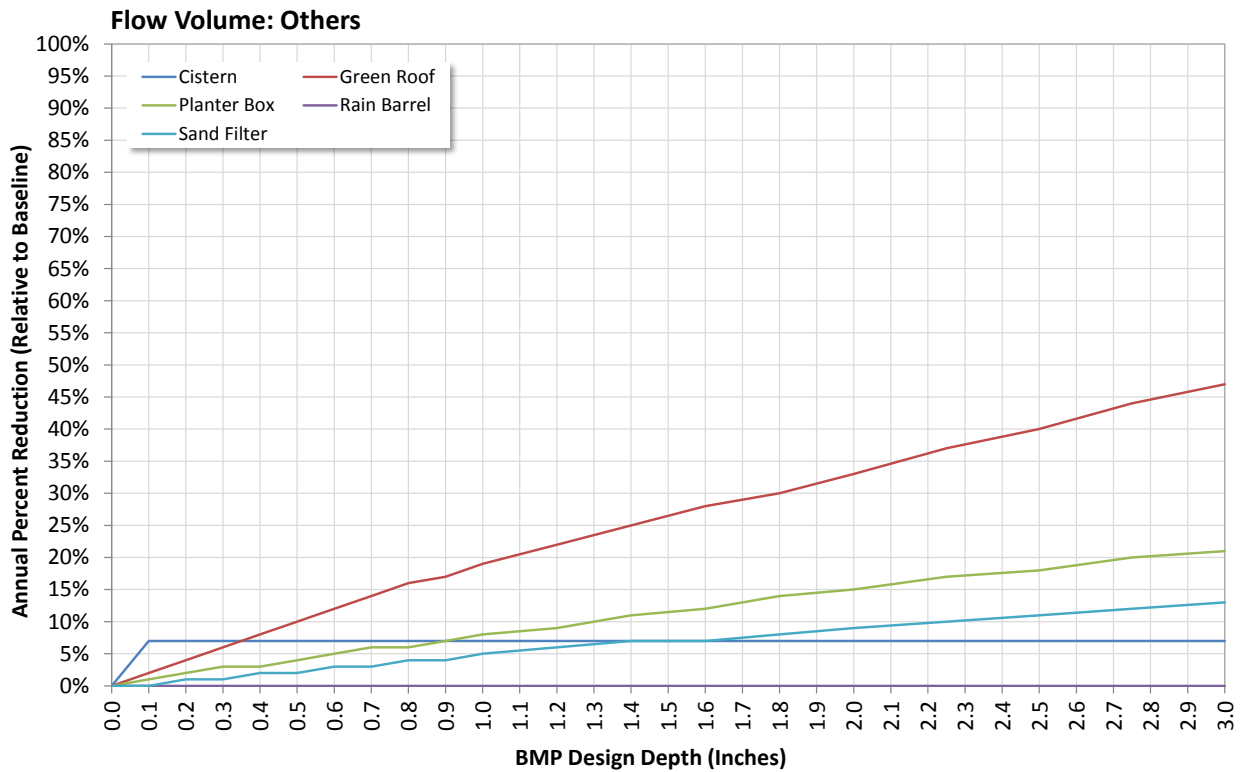
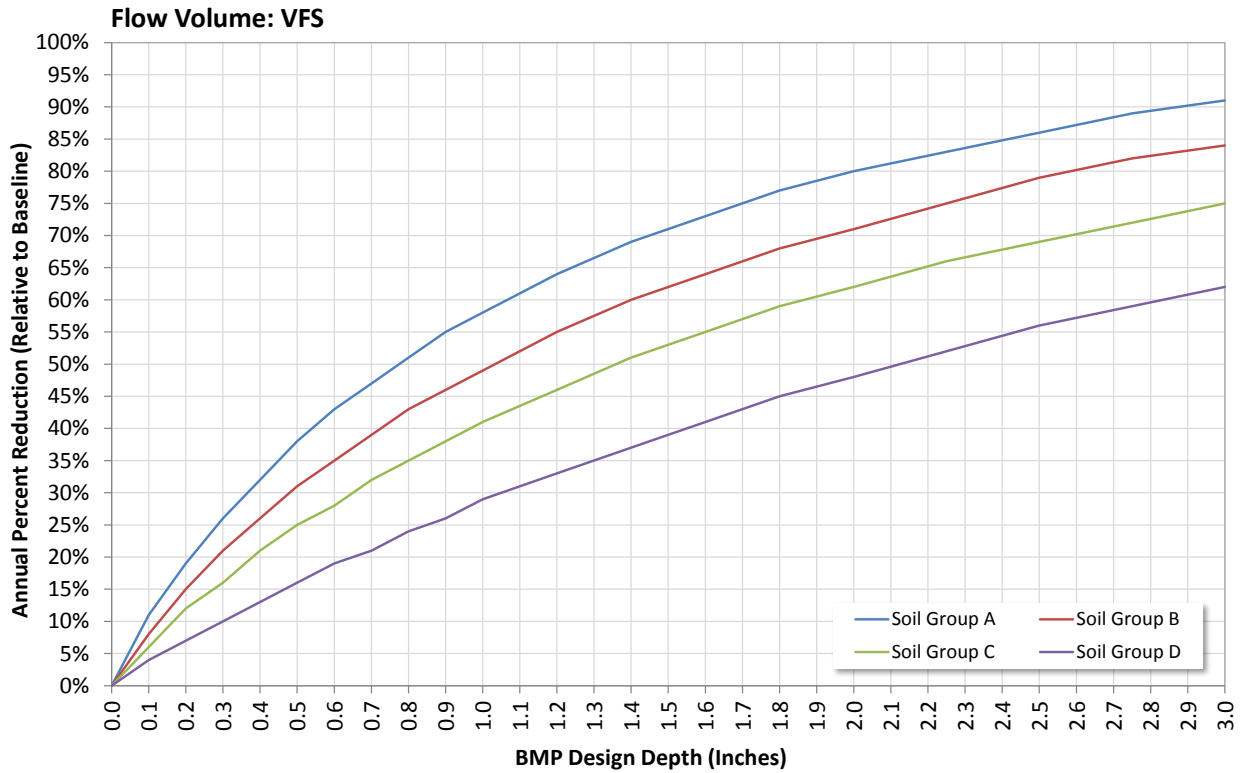

Figure A-4. Example performance curves showing flow volume reduction versus bioretention basin size.



Appendix A. BMP Sizing





Appendix A. BMP Sizing

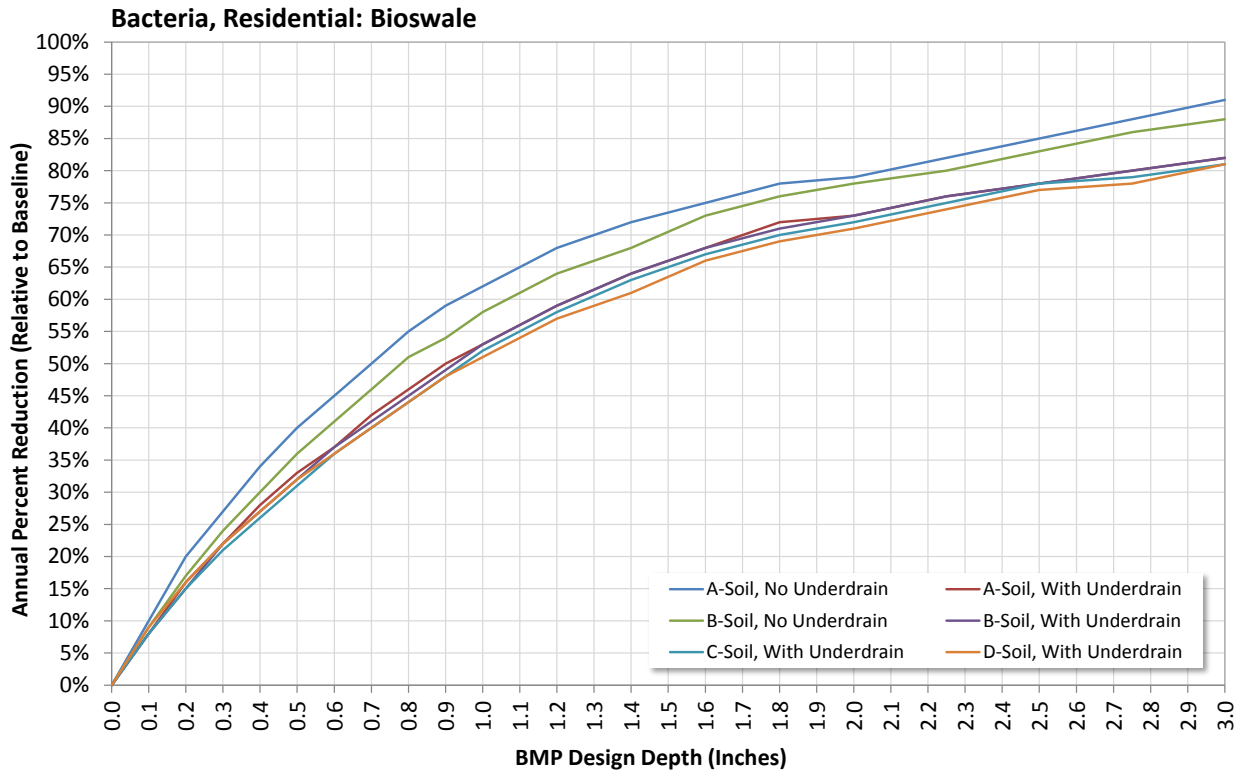
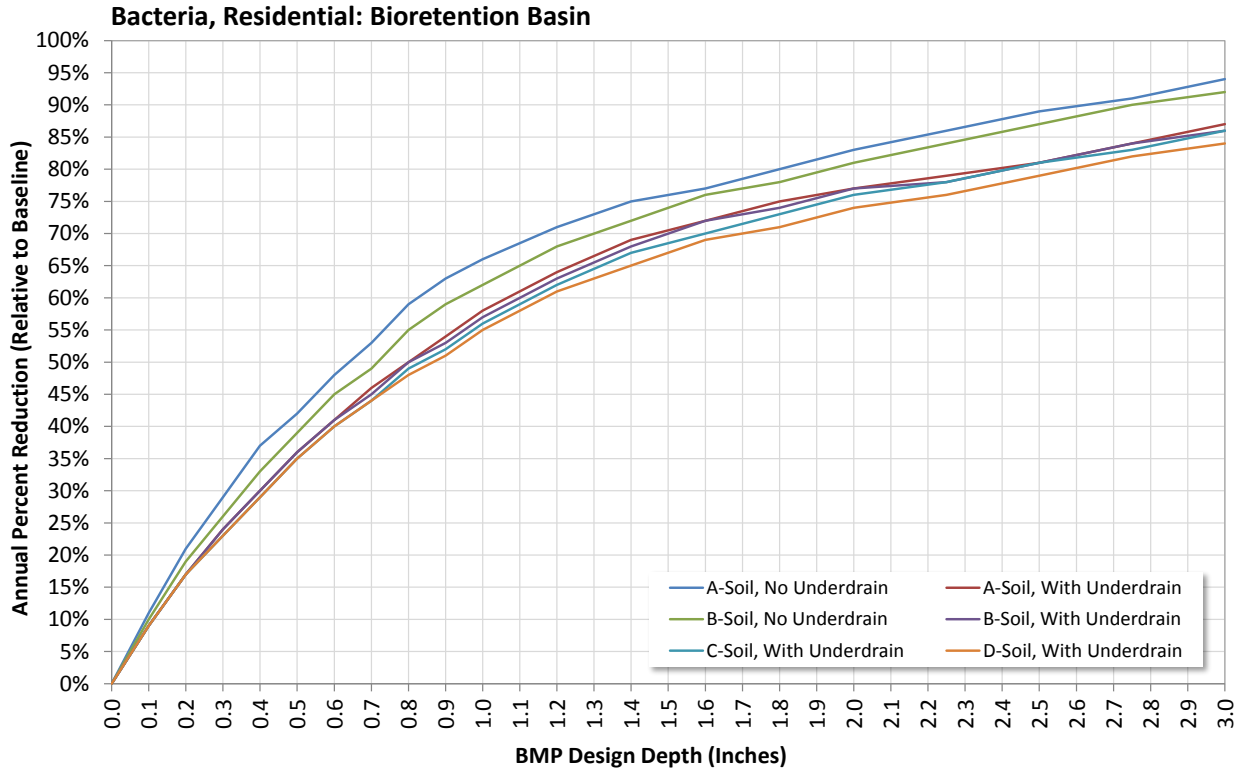

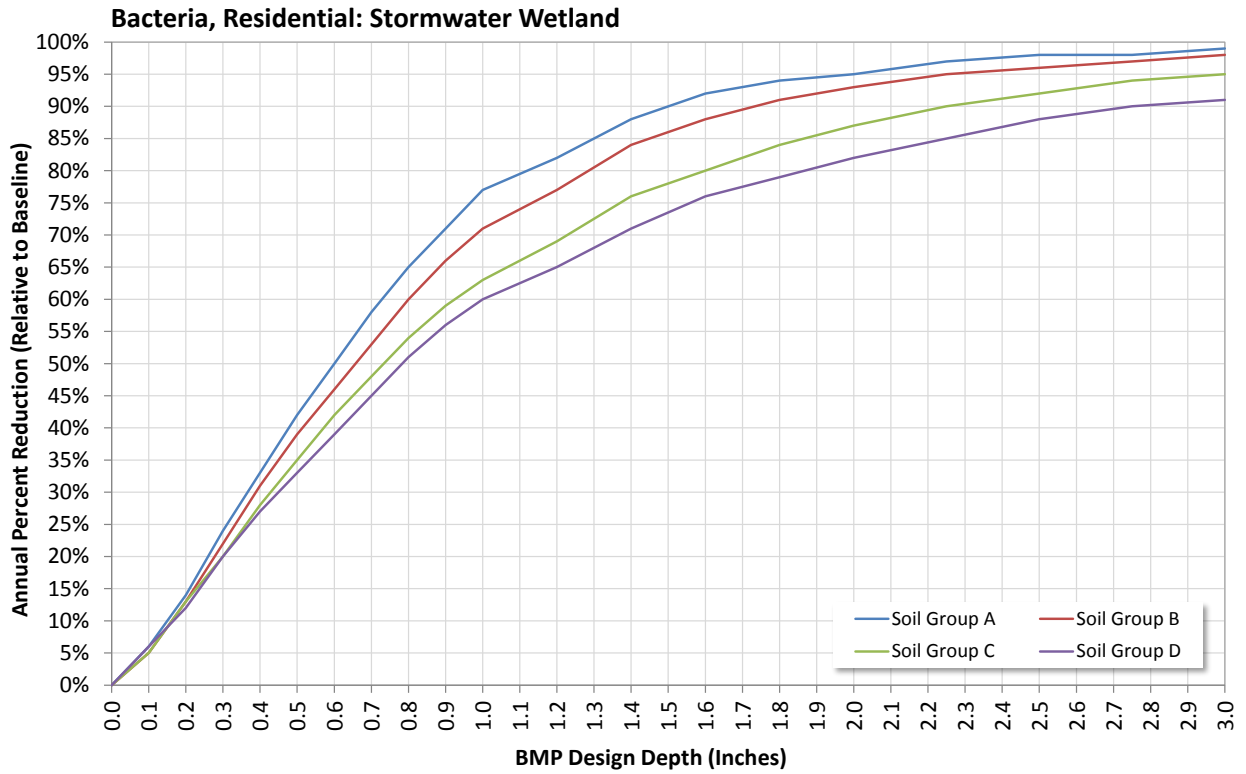
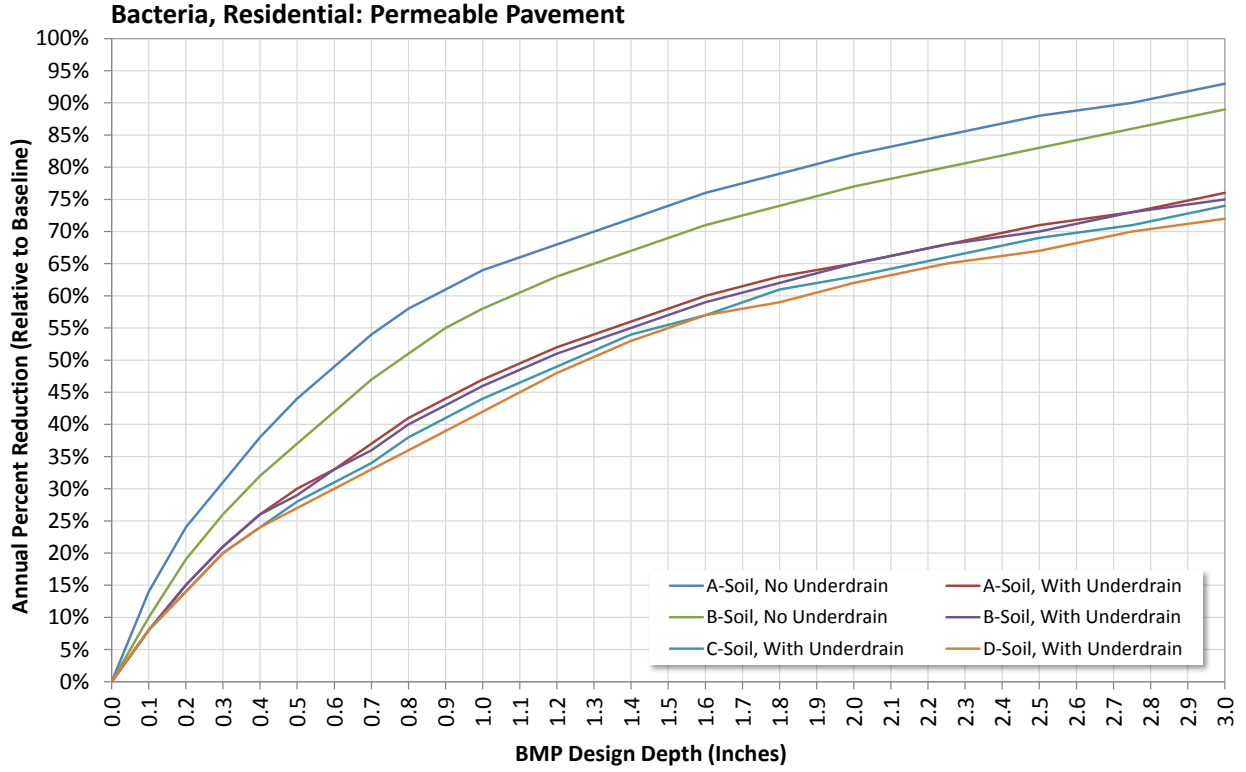

Appendix A. BMP Sizing

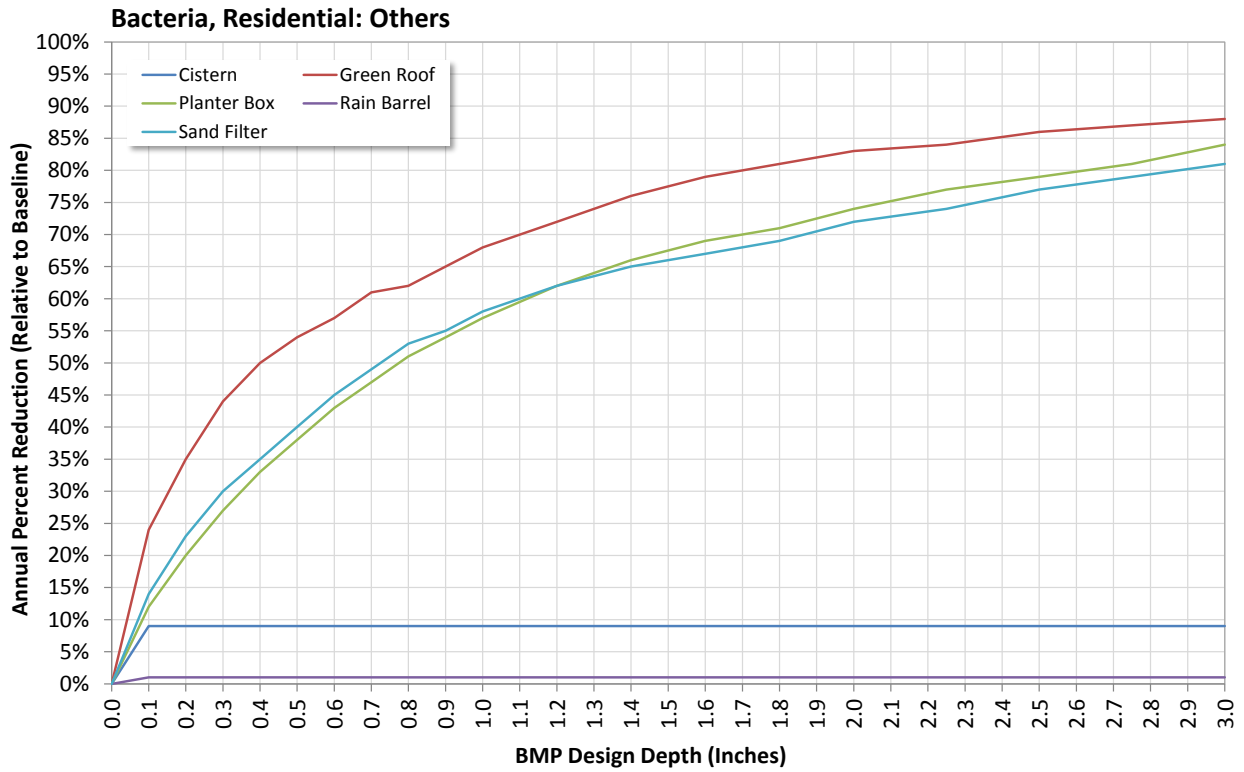
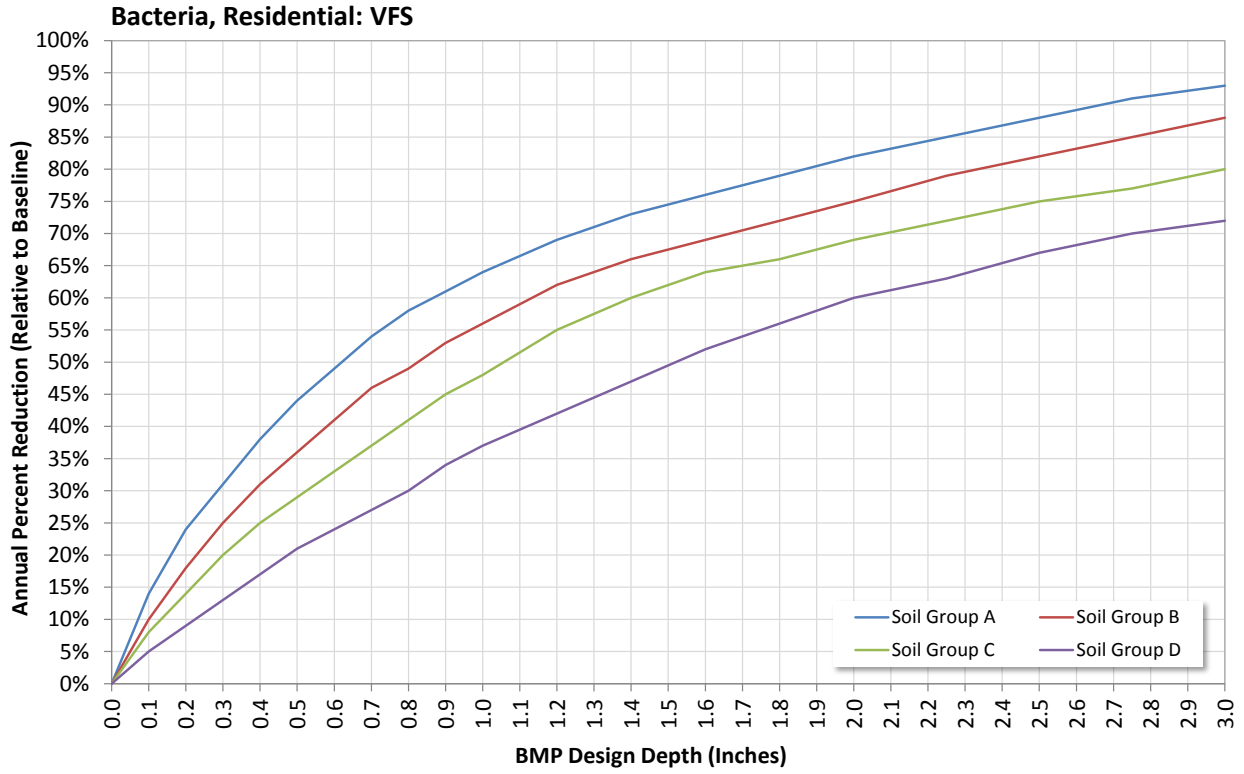

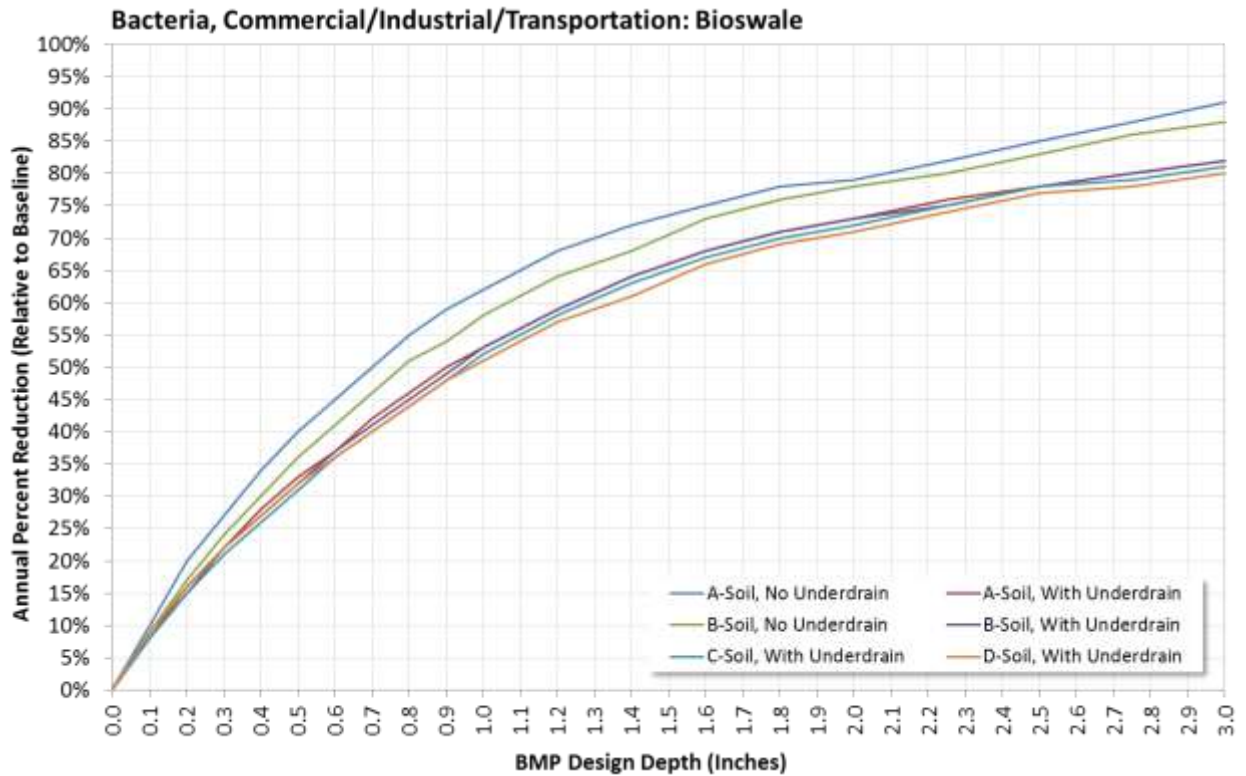
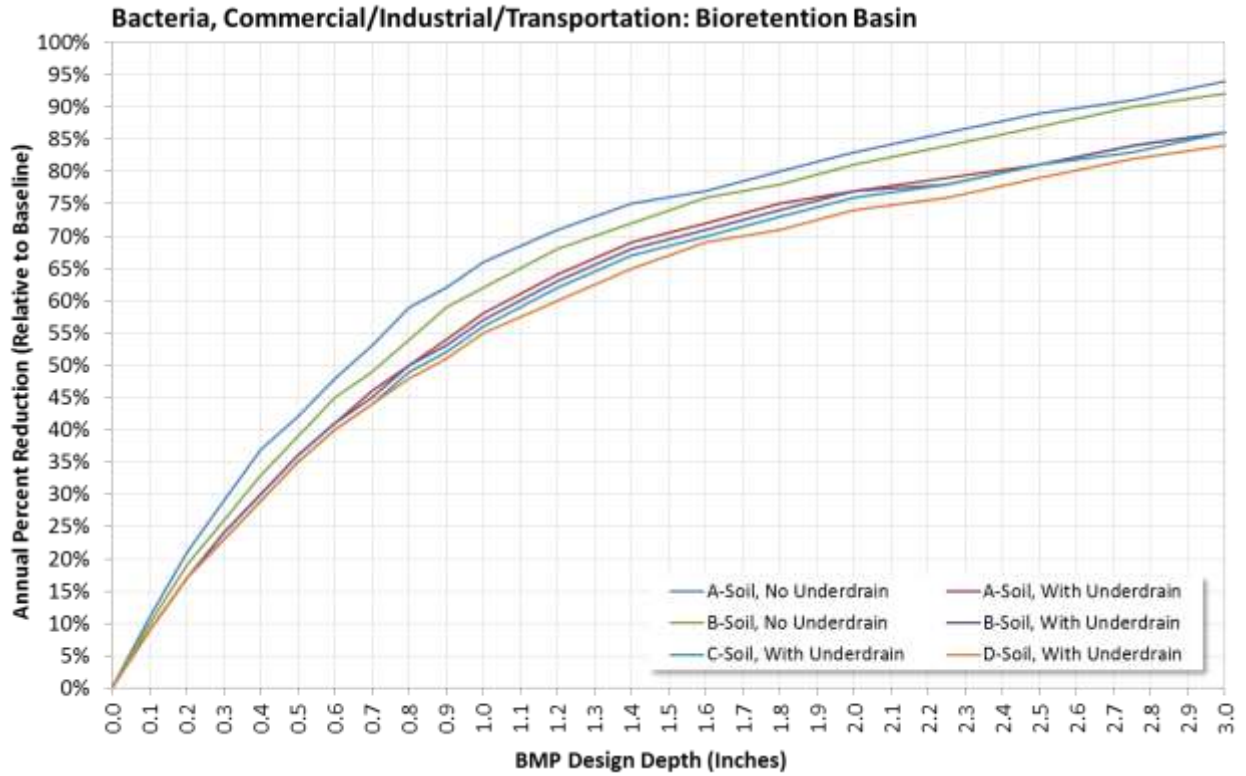

Appendix A. BMP Sizing

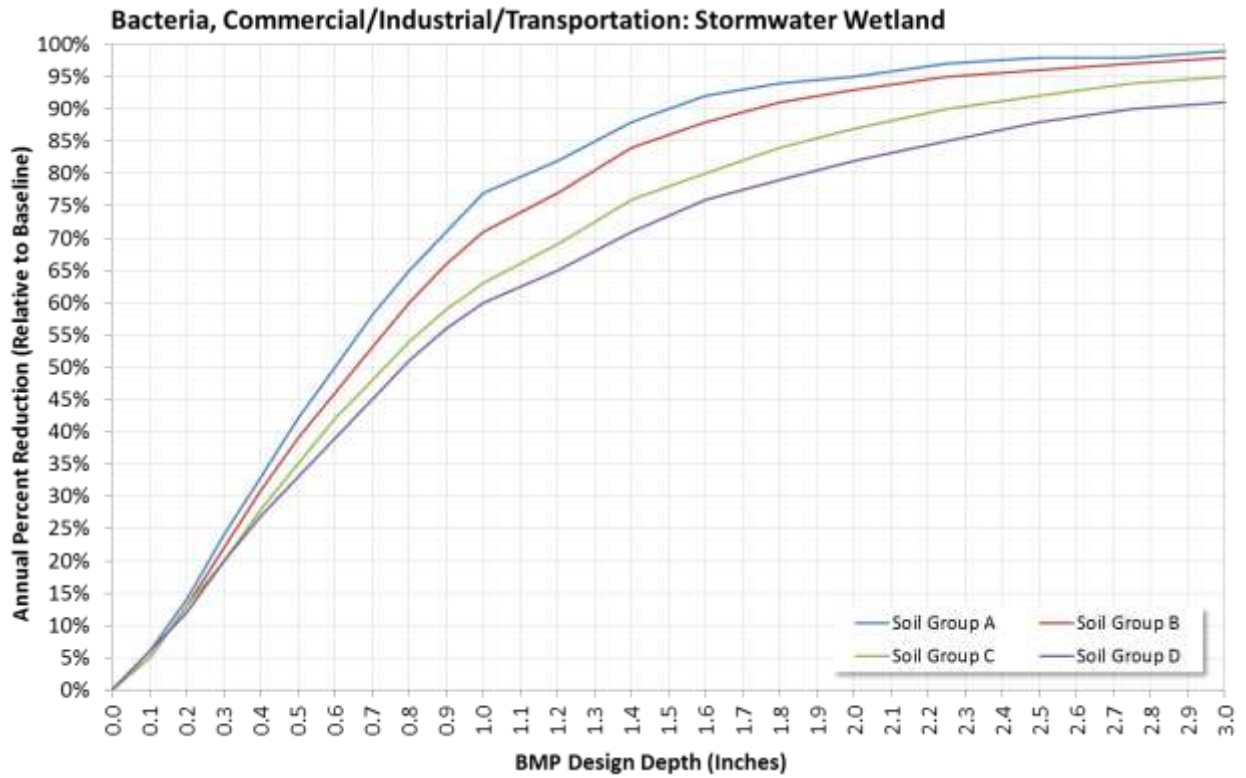
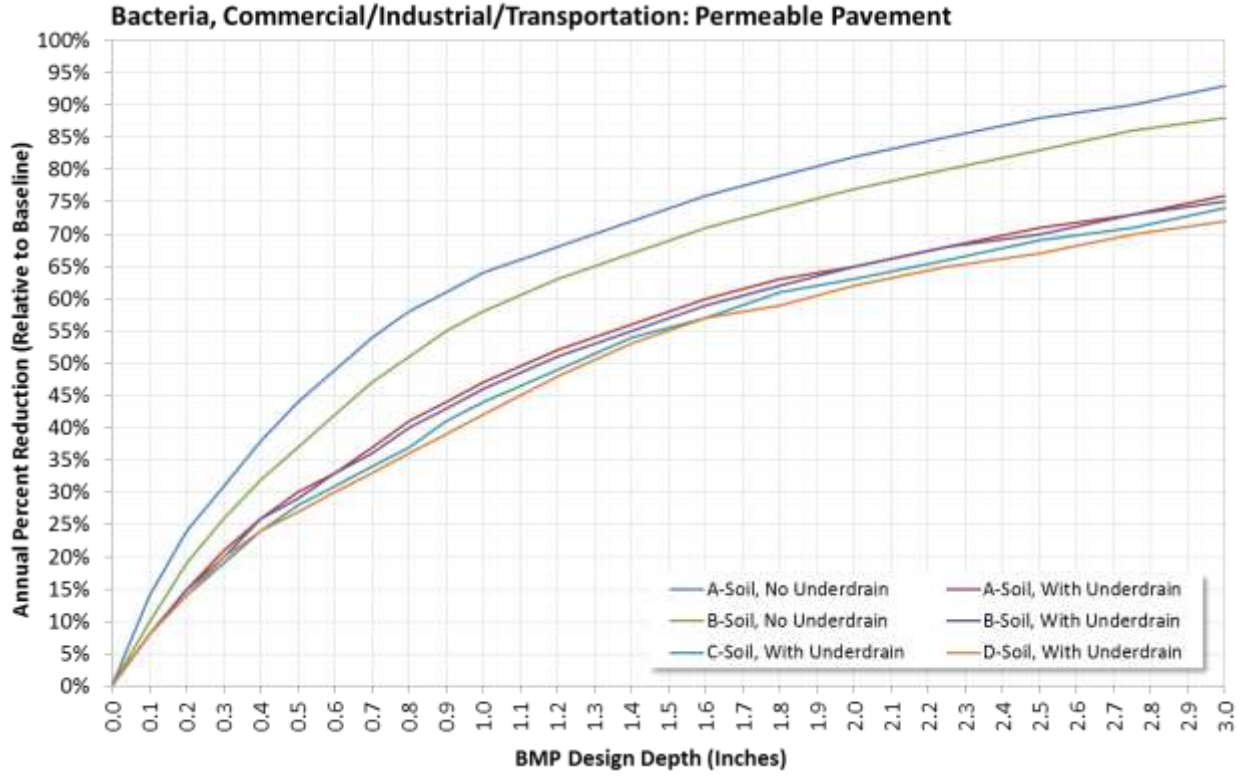

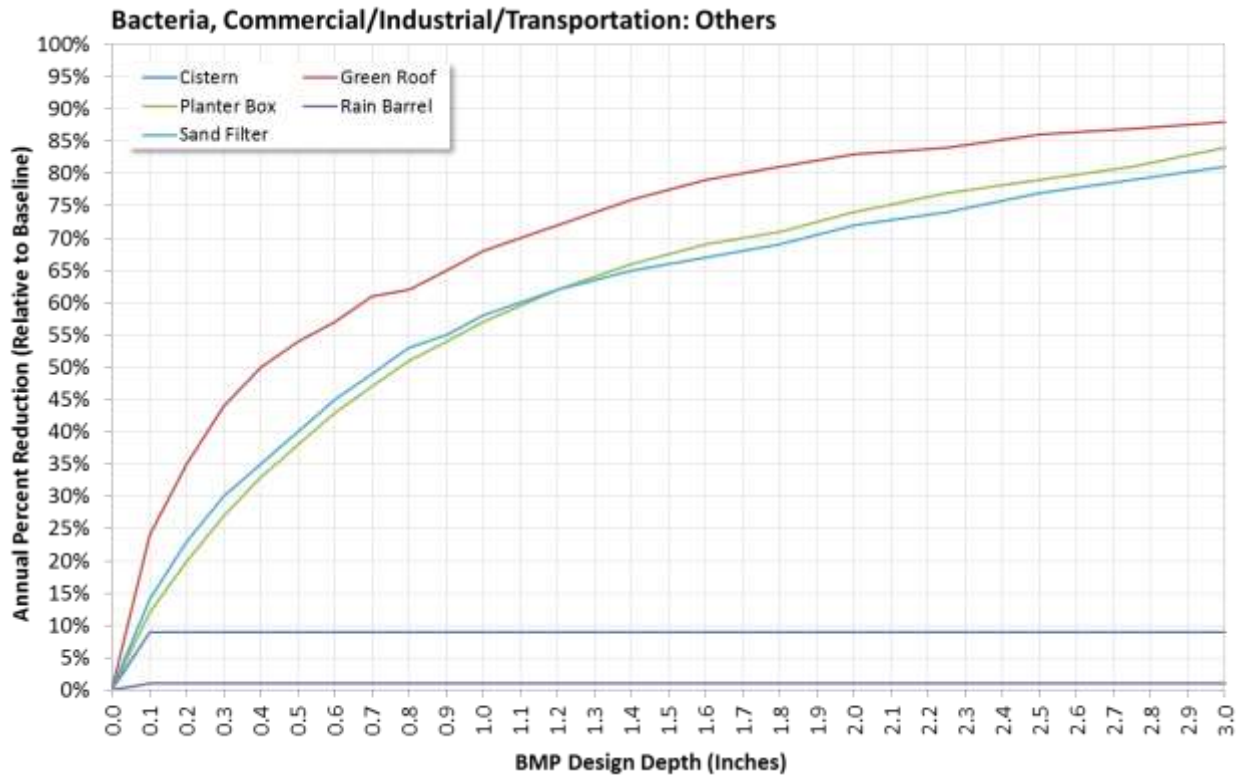
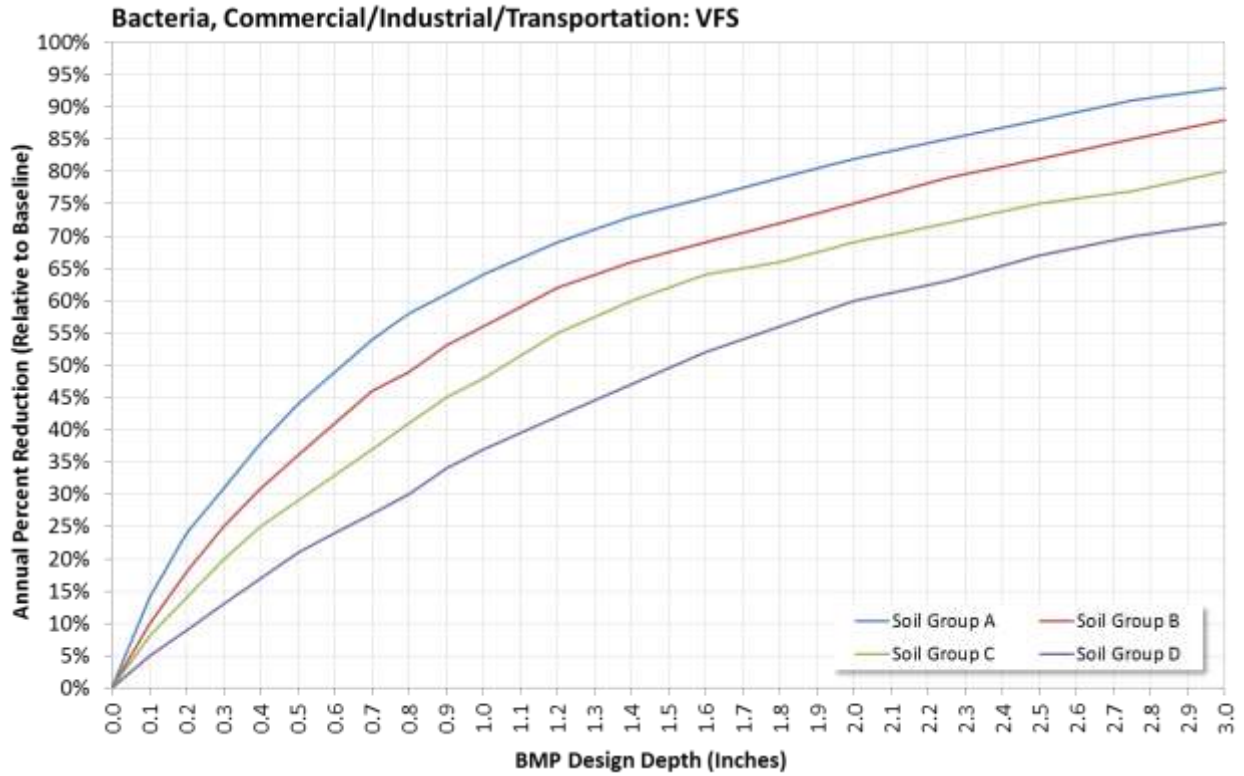

Appendix A. BMP Sizing

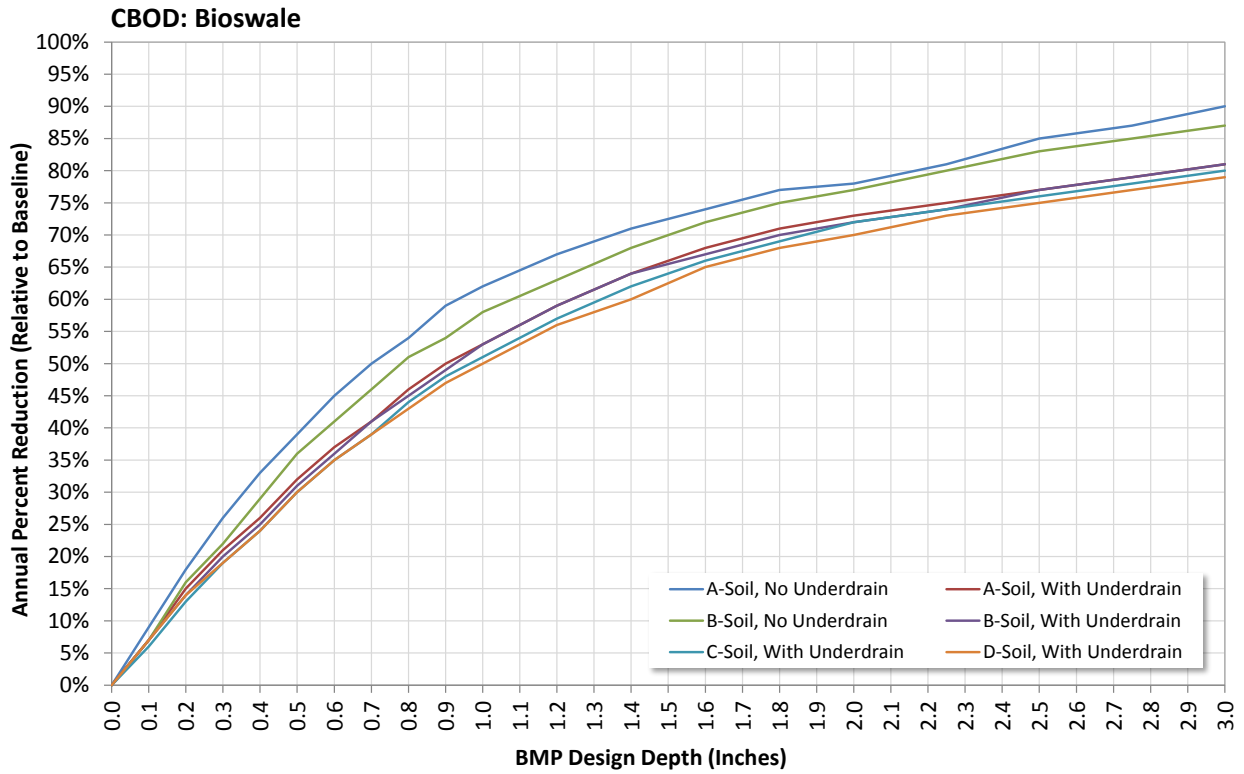
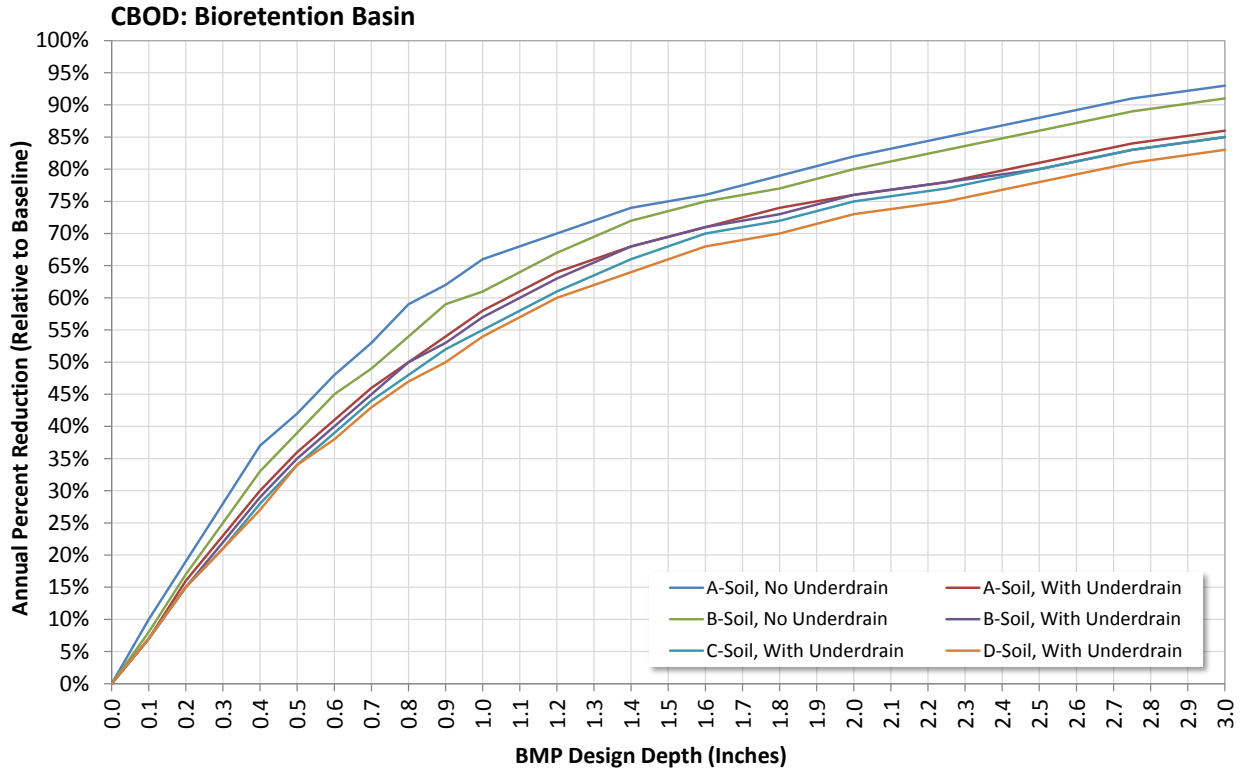

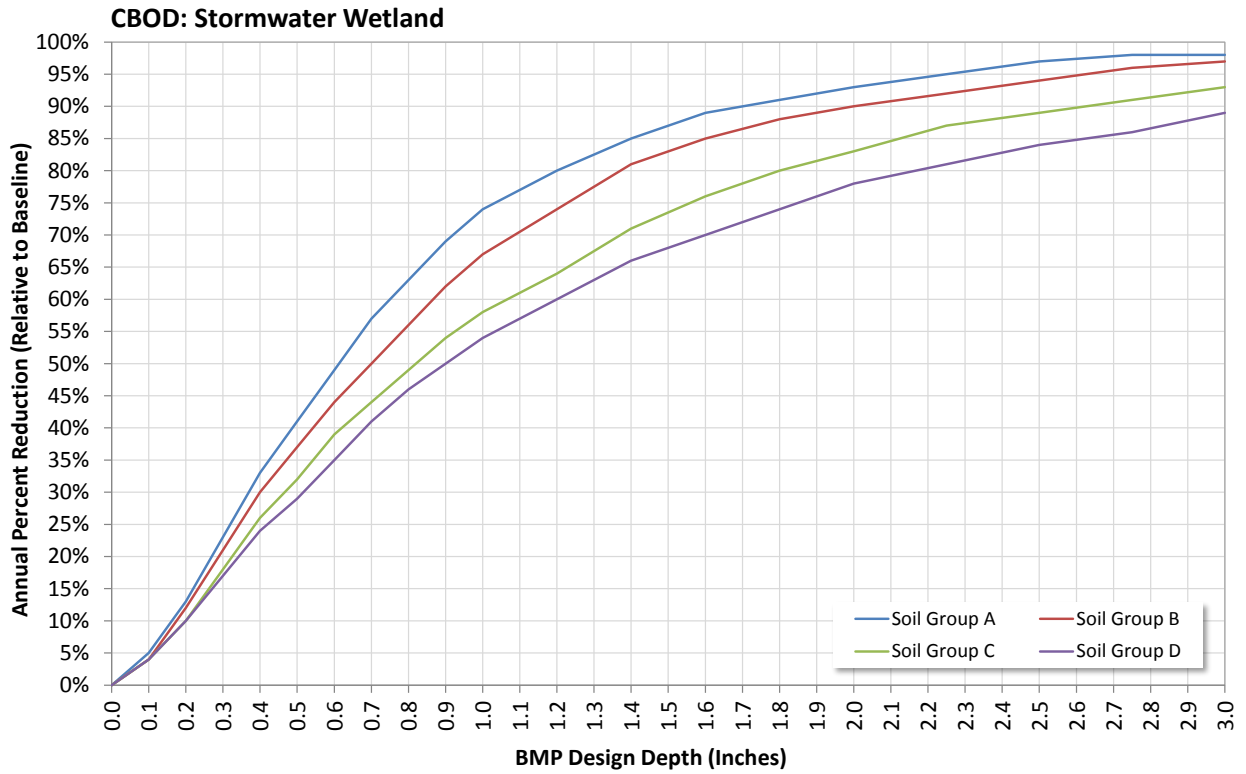
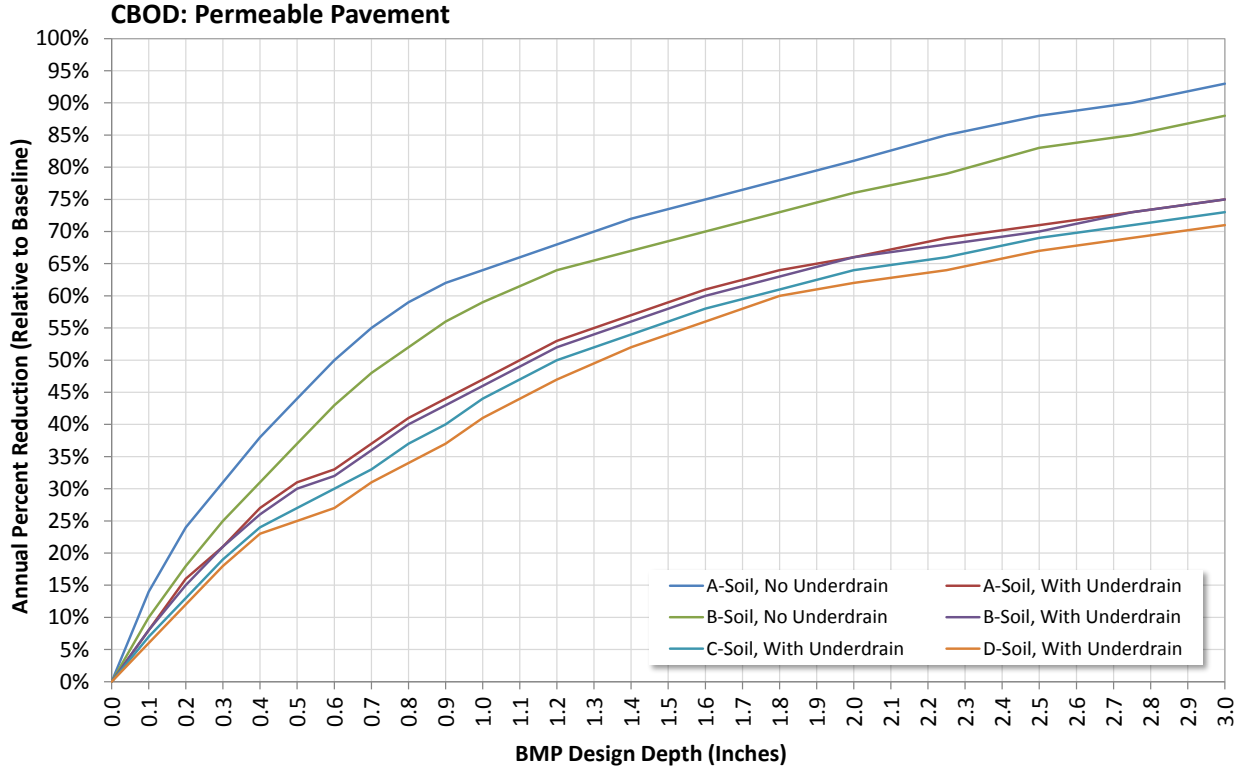

Appendix A. BMP Sizing

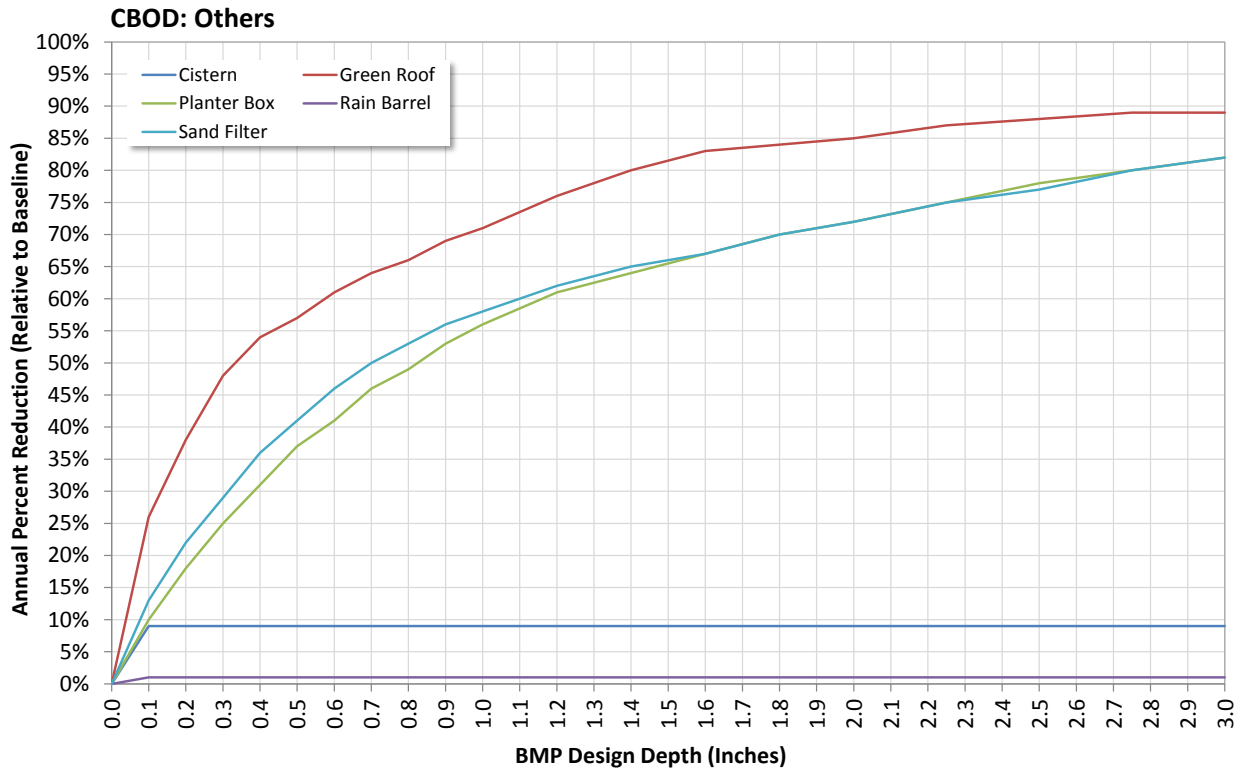
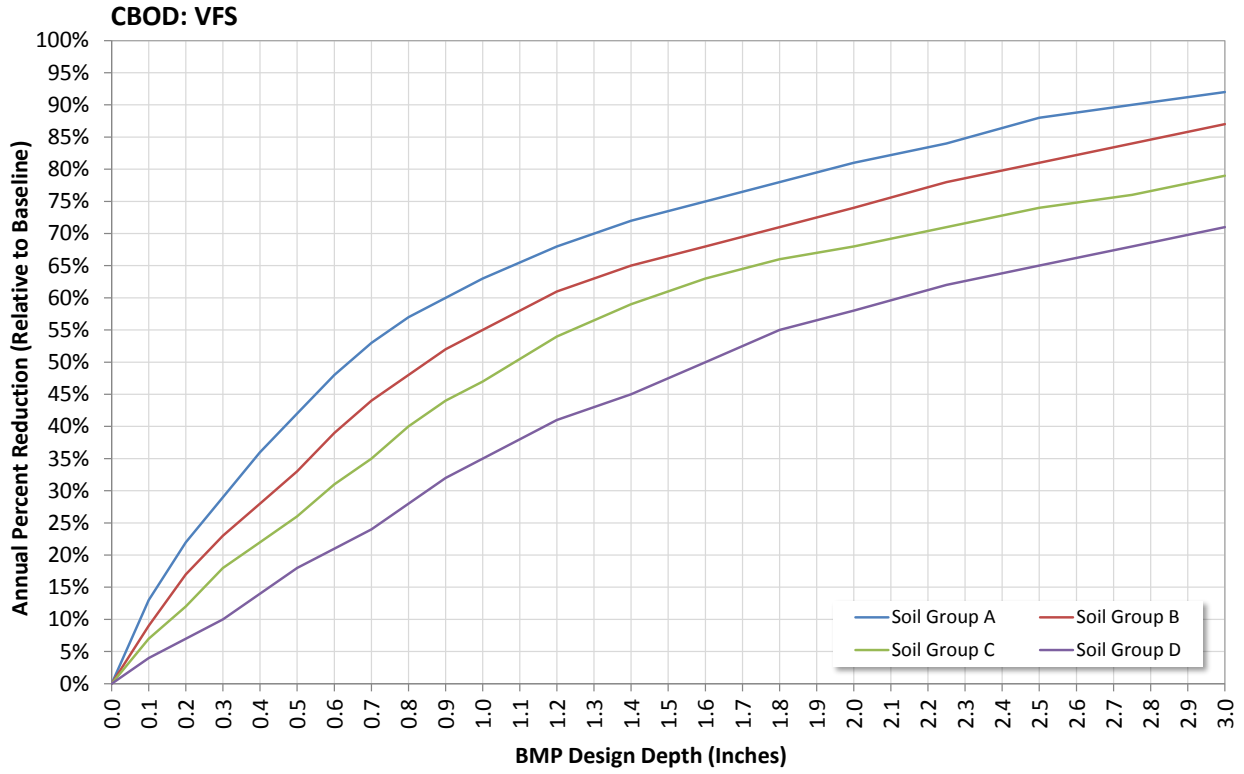

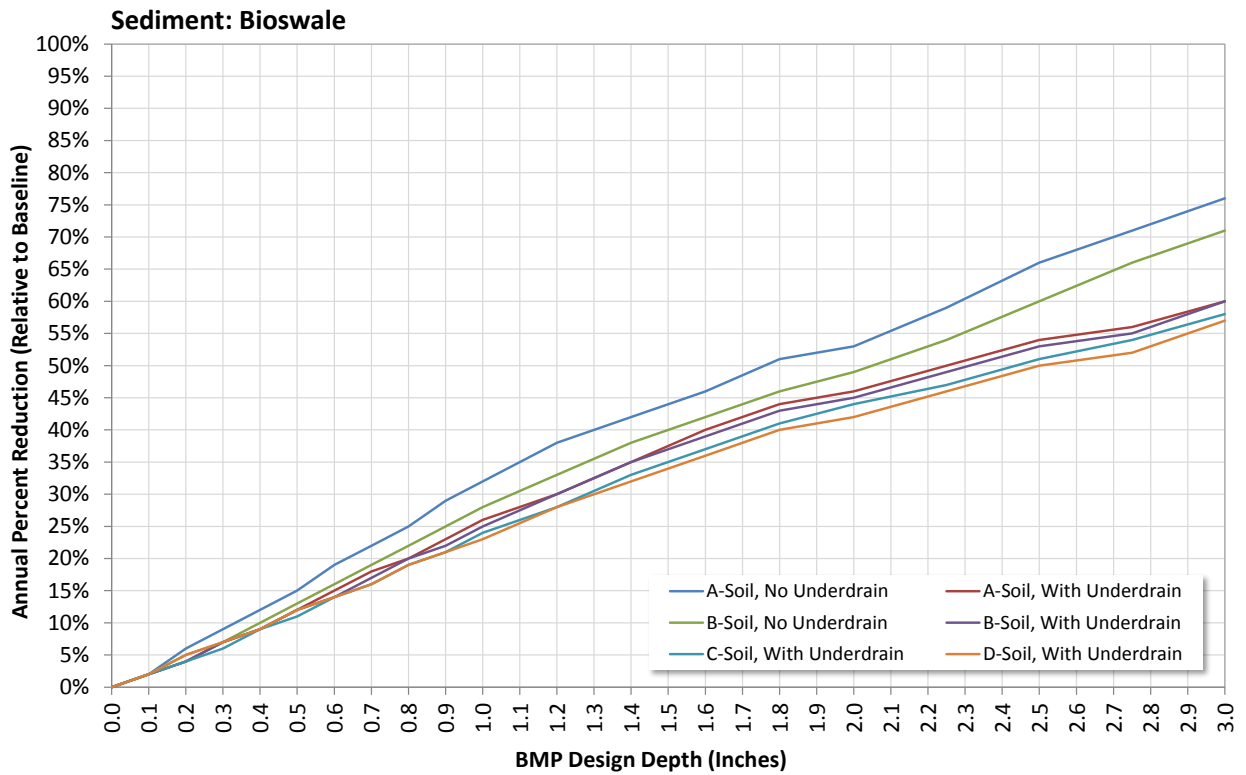
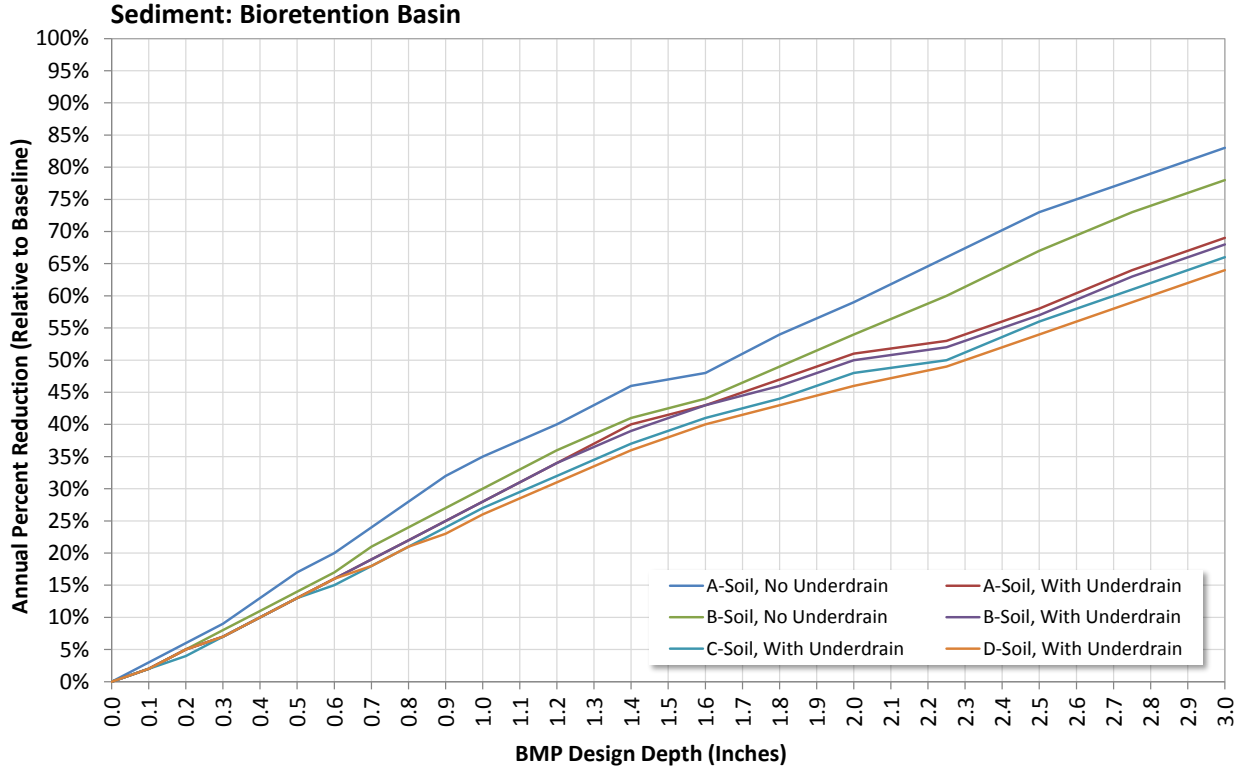

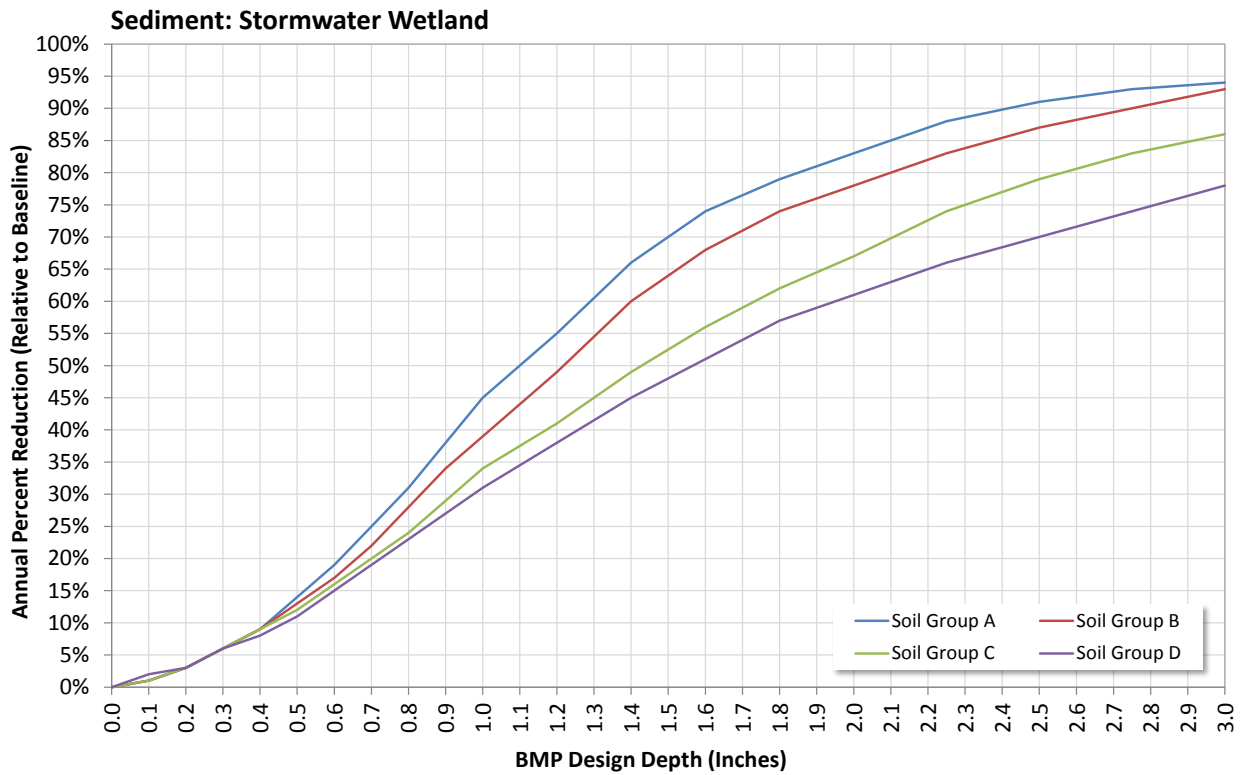
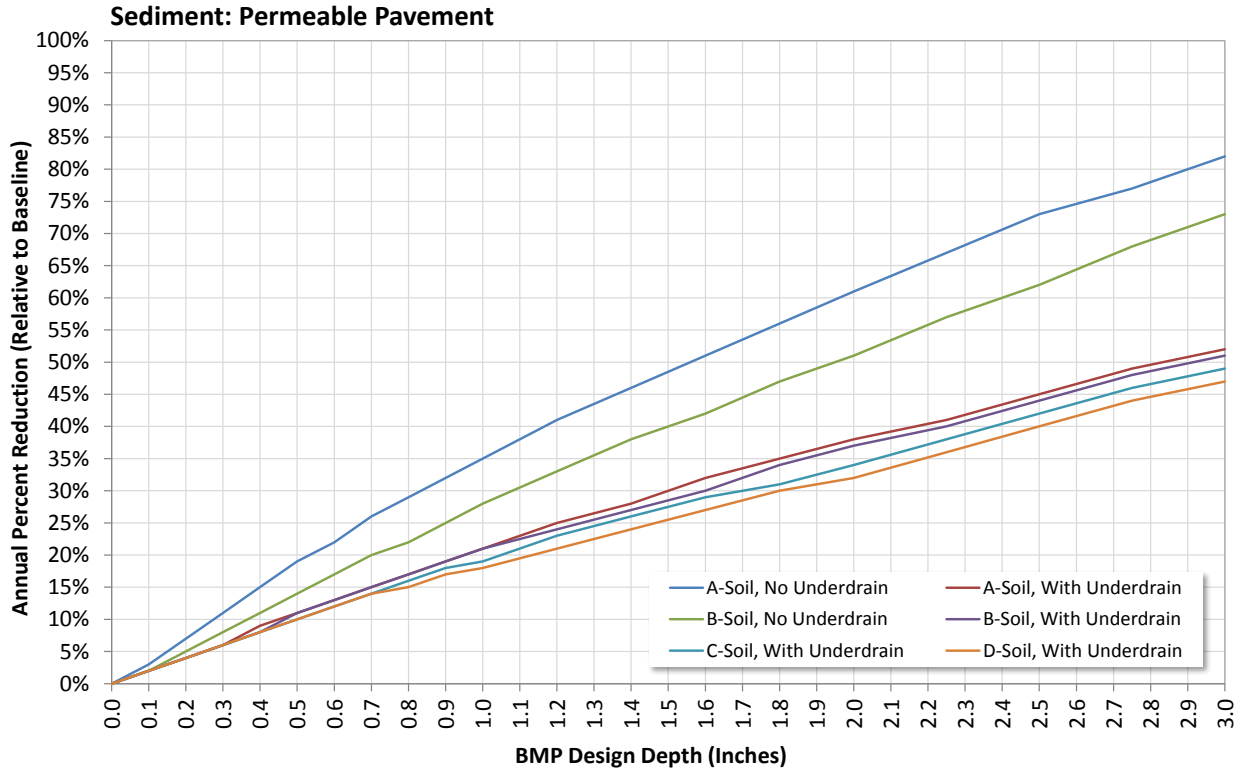

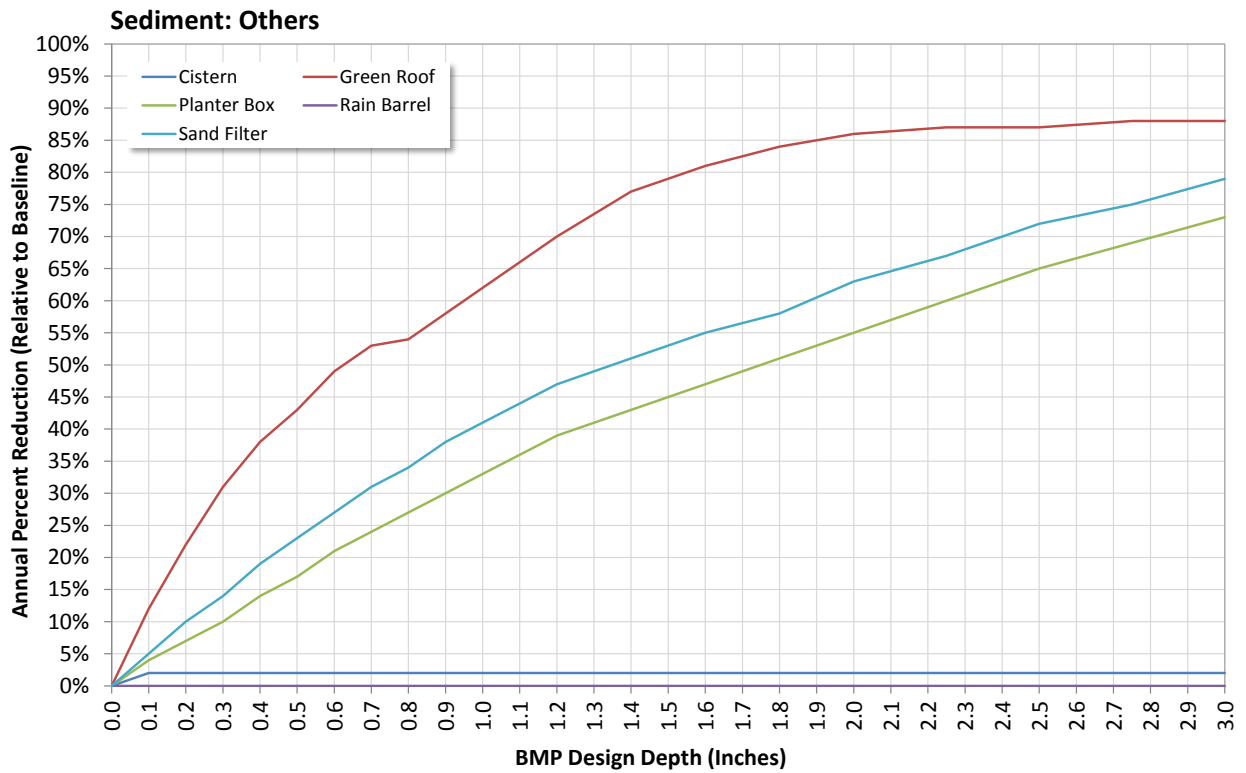
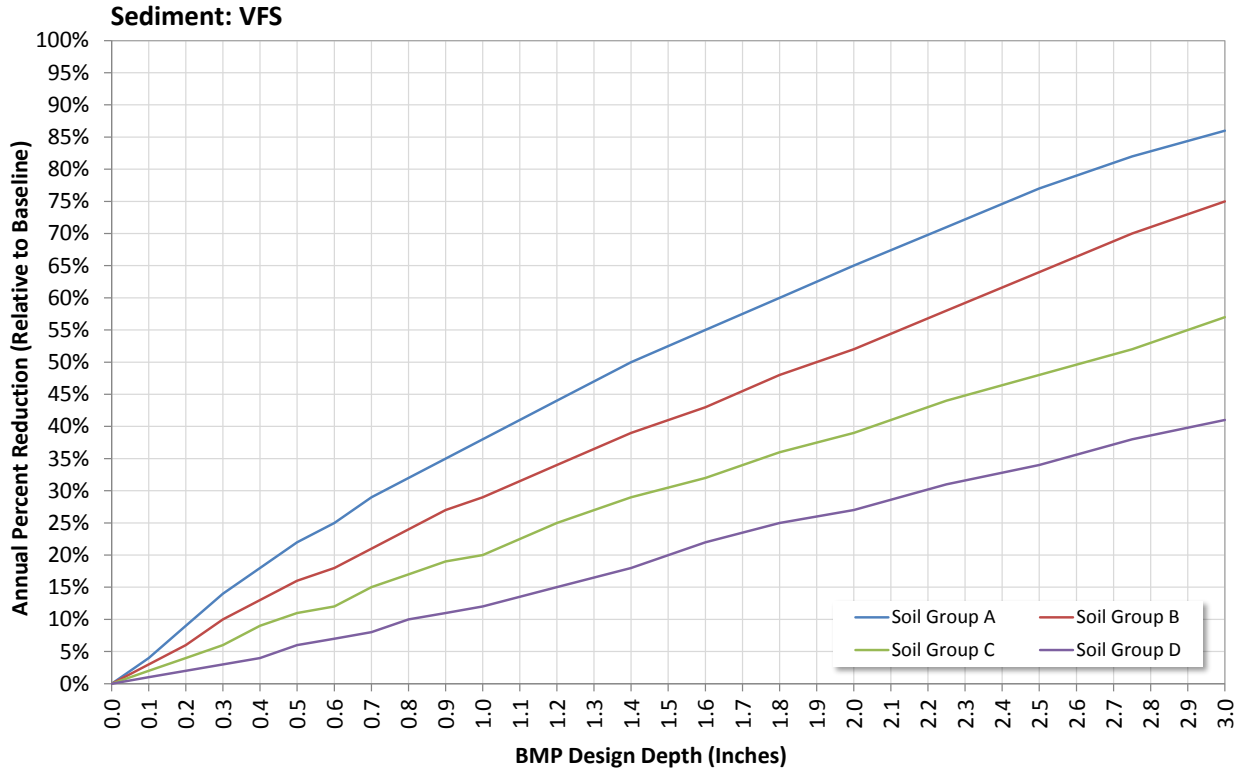

Appendix A. BMP Sizing

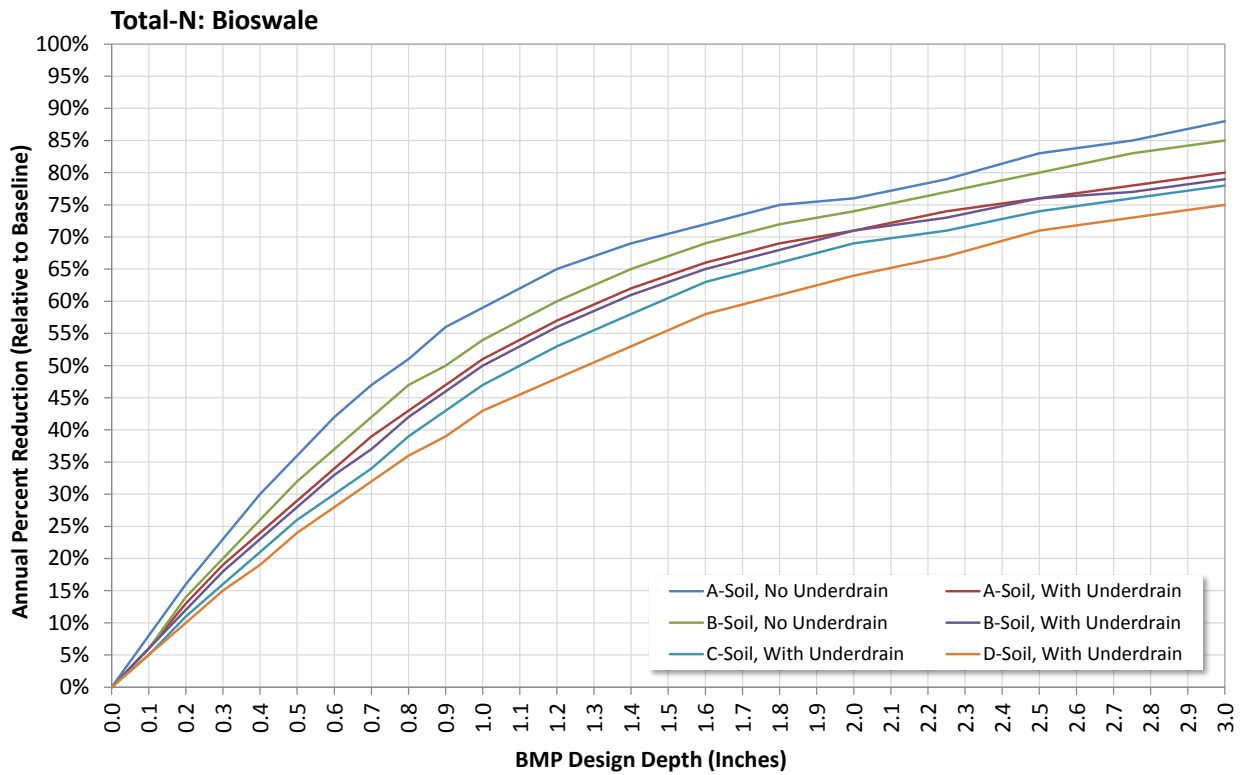
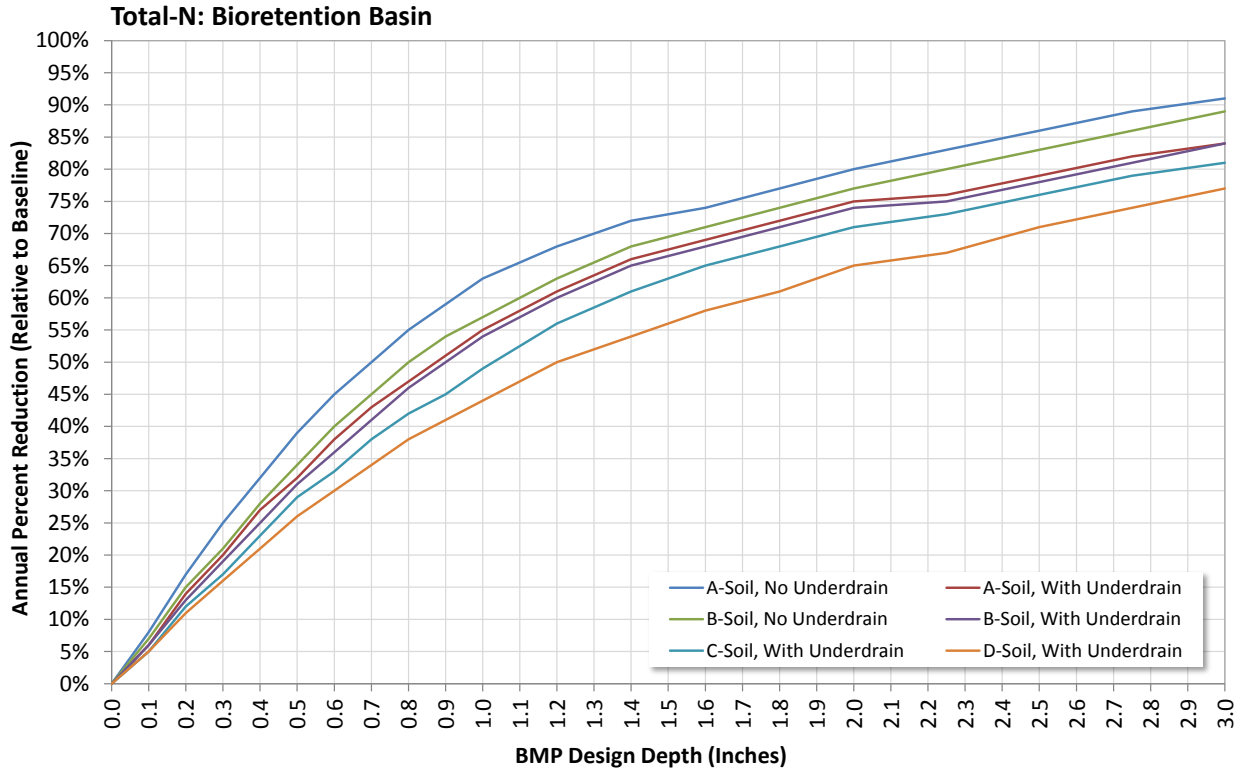

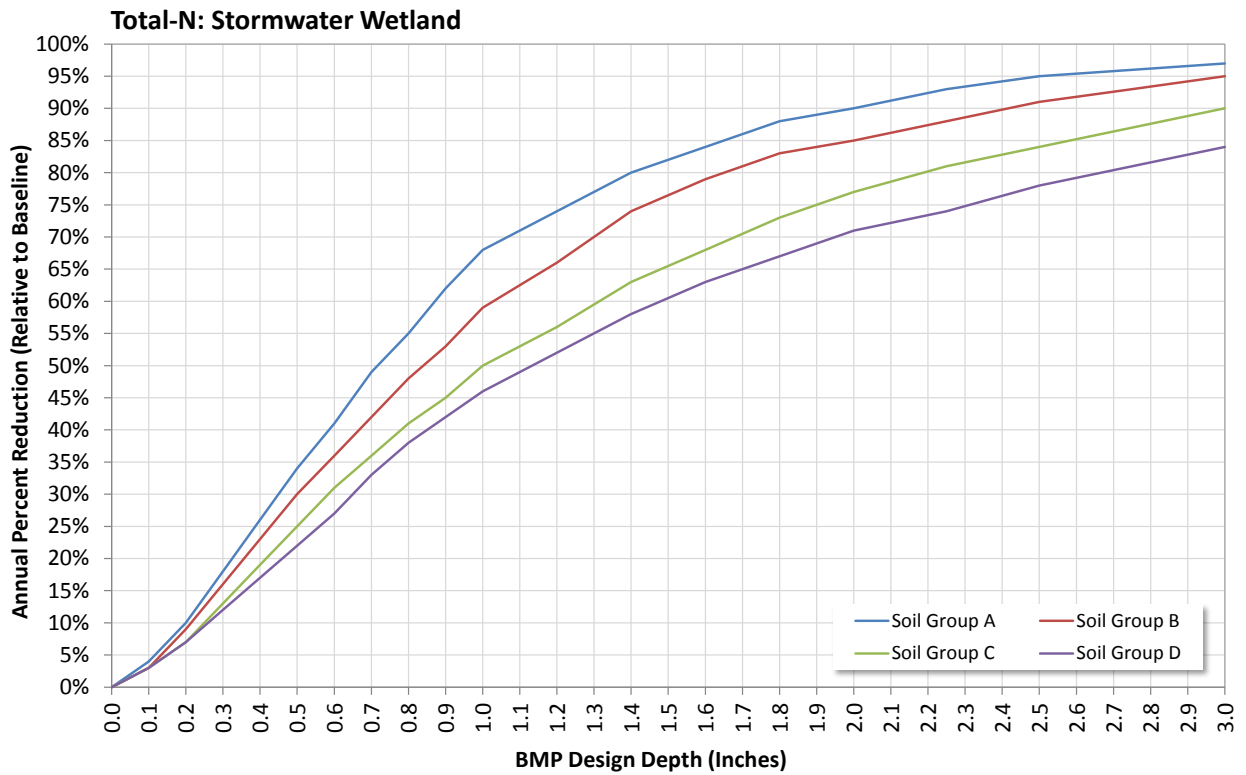
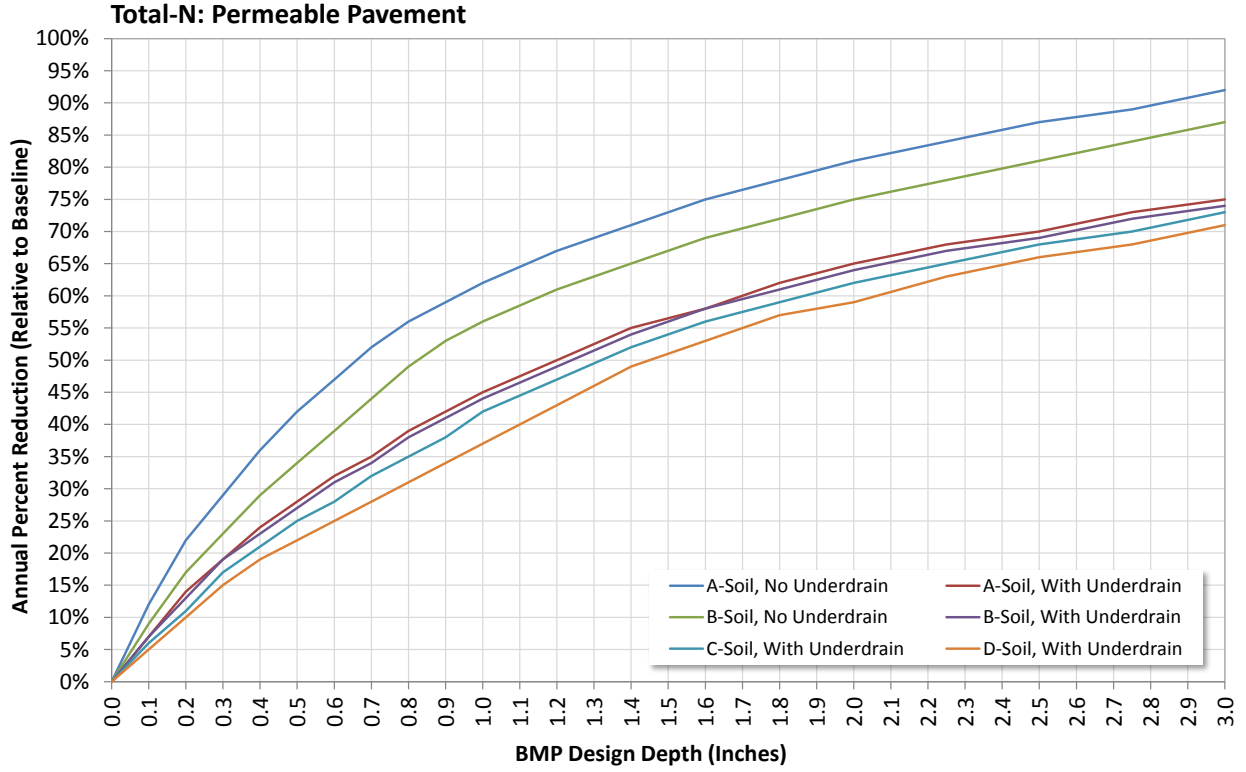

Appendix A. BMP Sizing

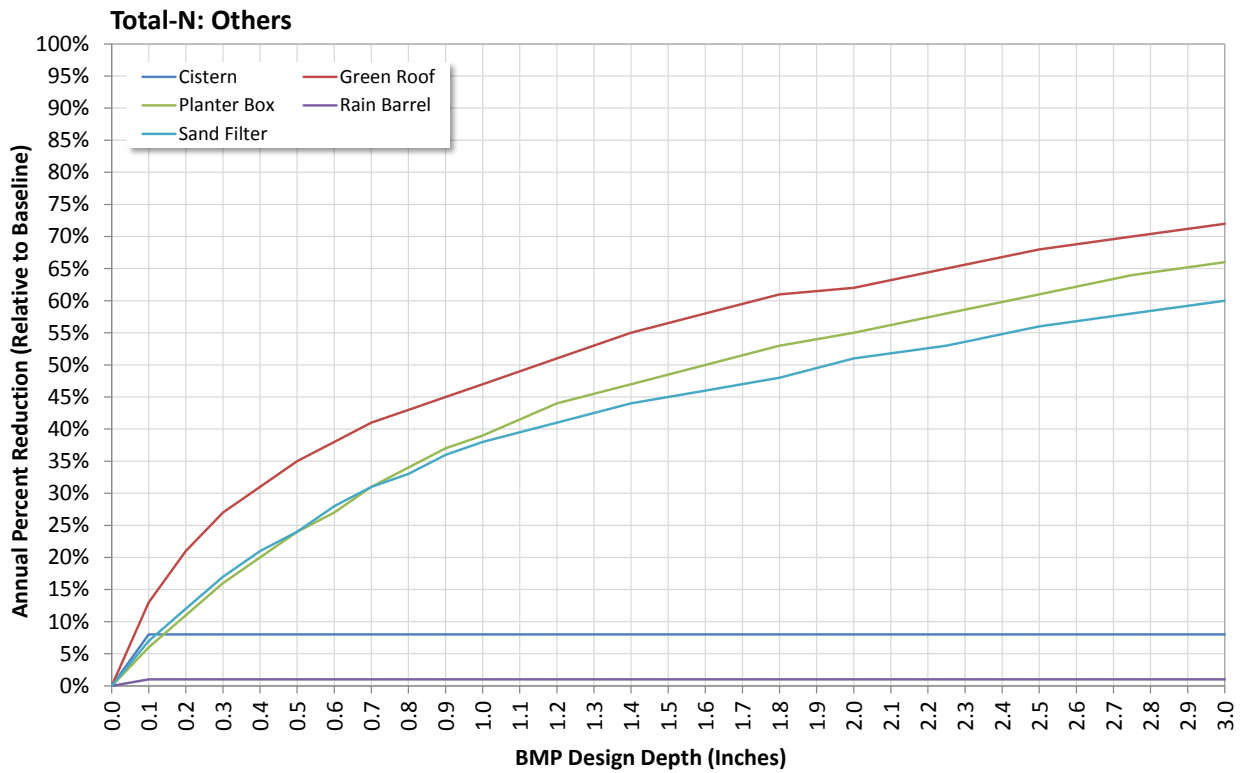
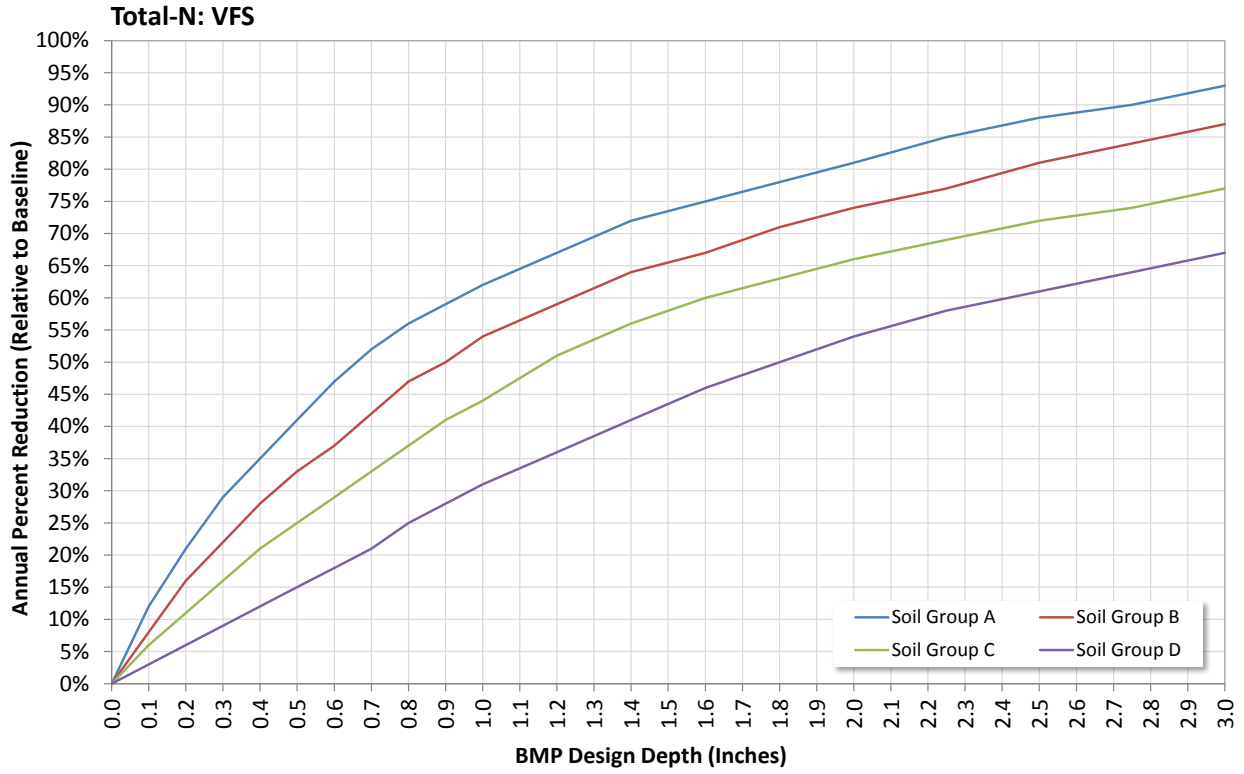

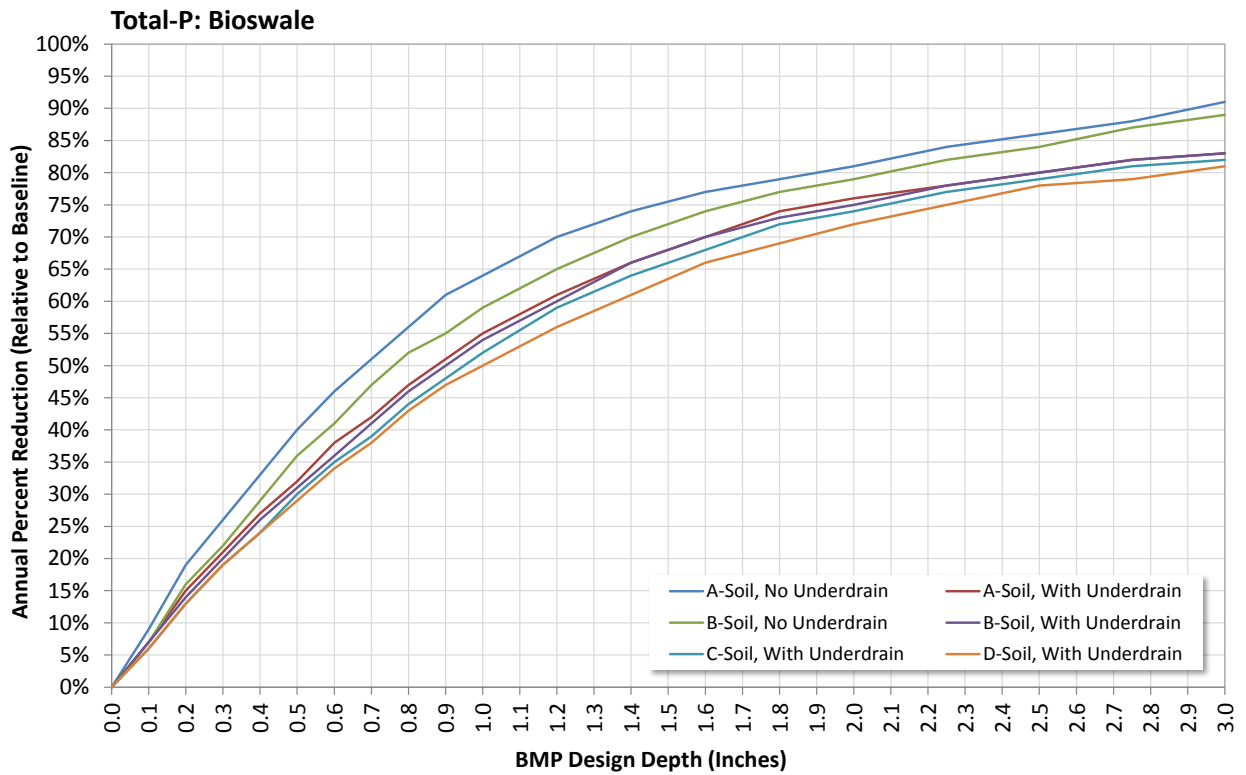
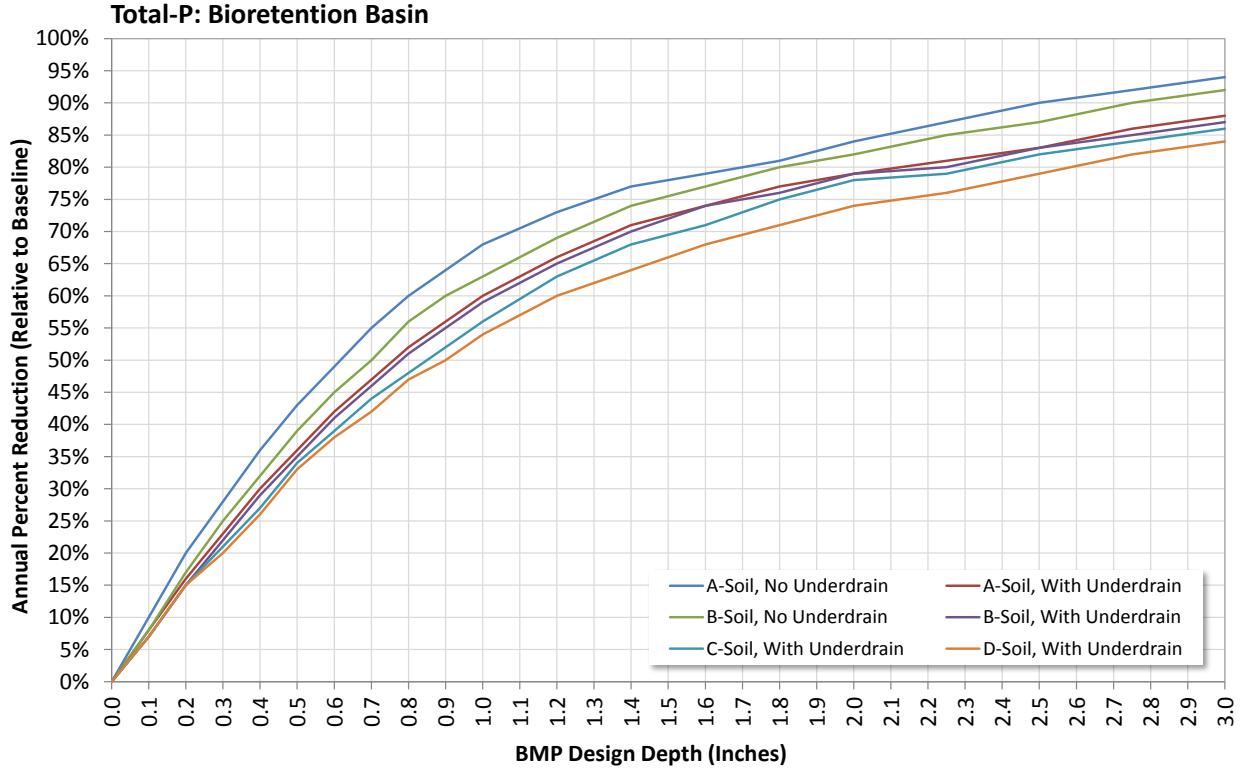

Appendix A. BMP Sizing

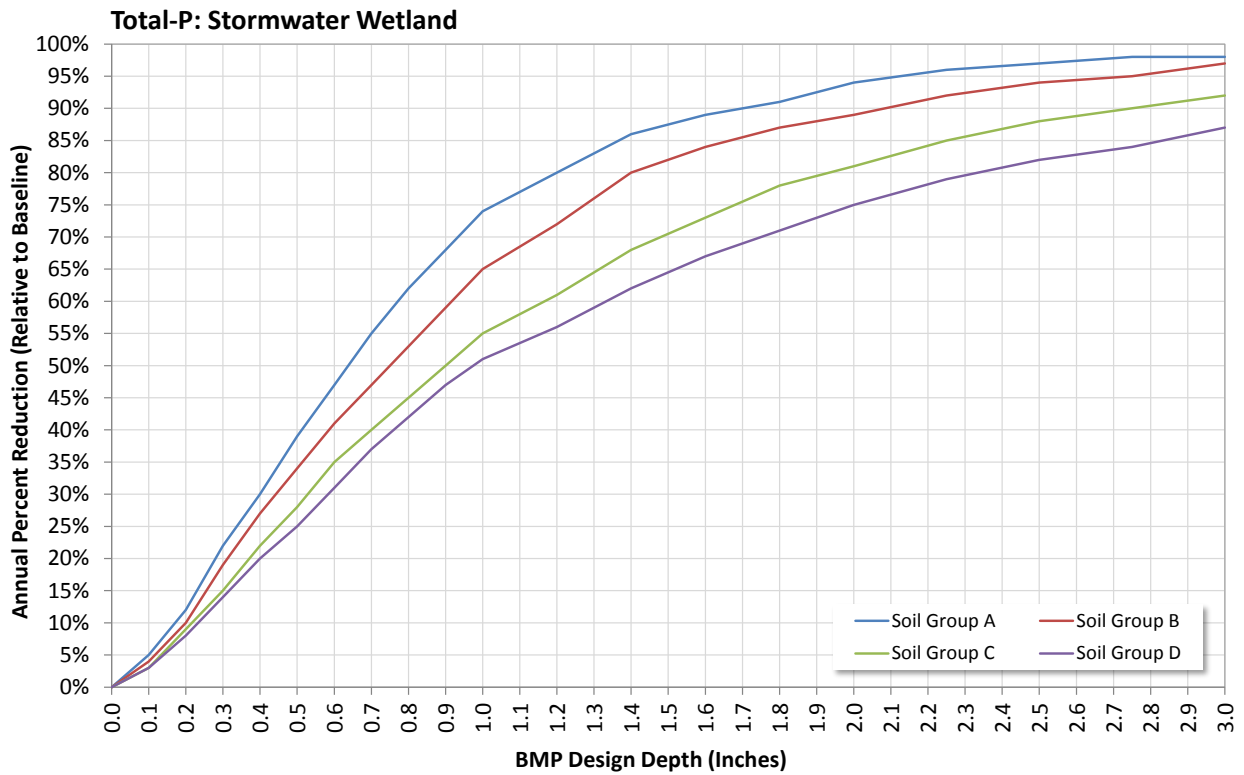
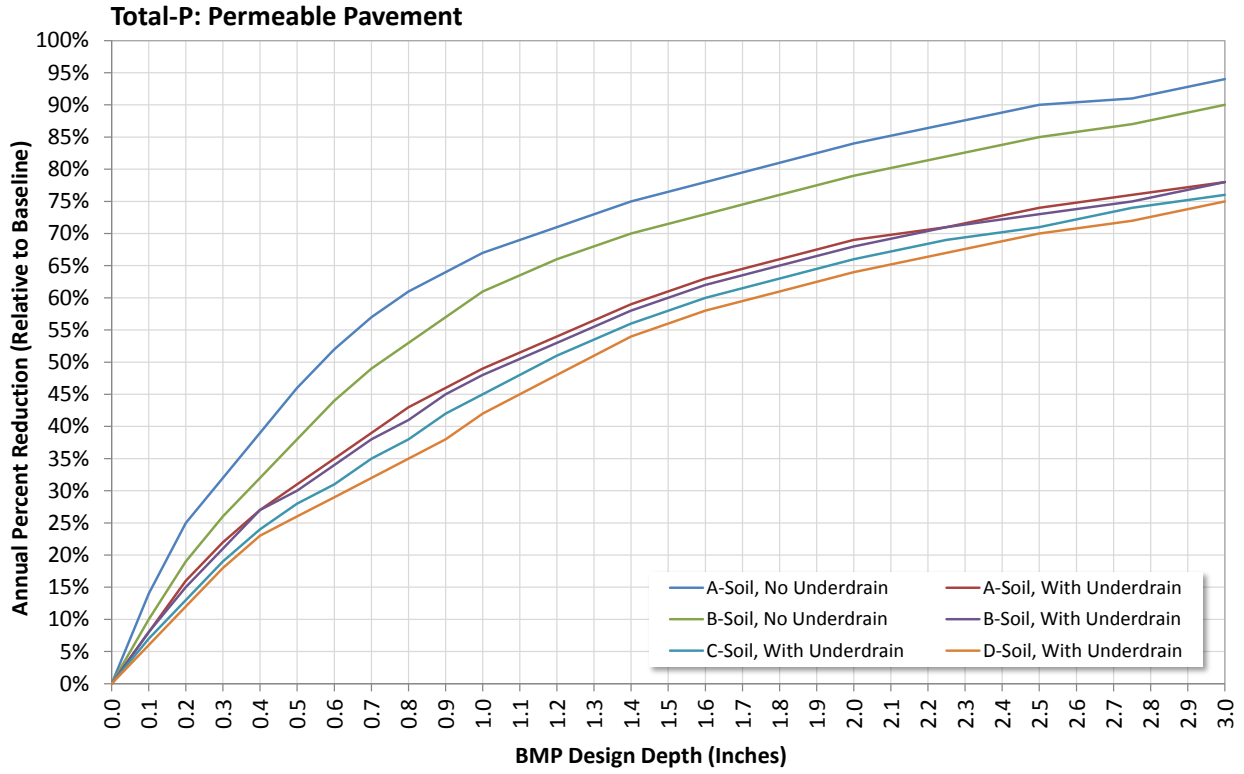

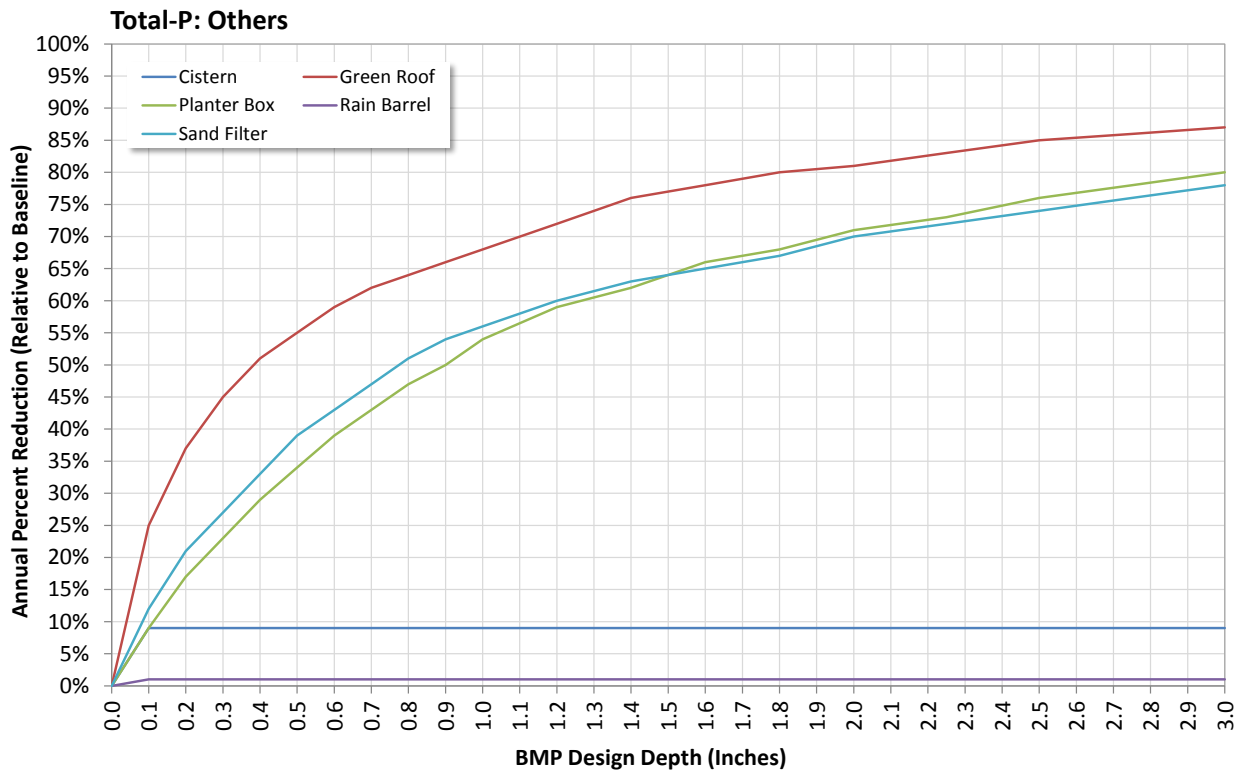
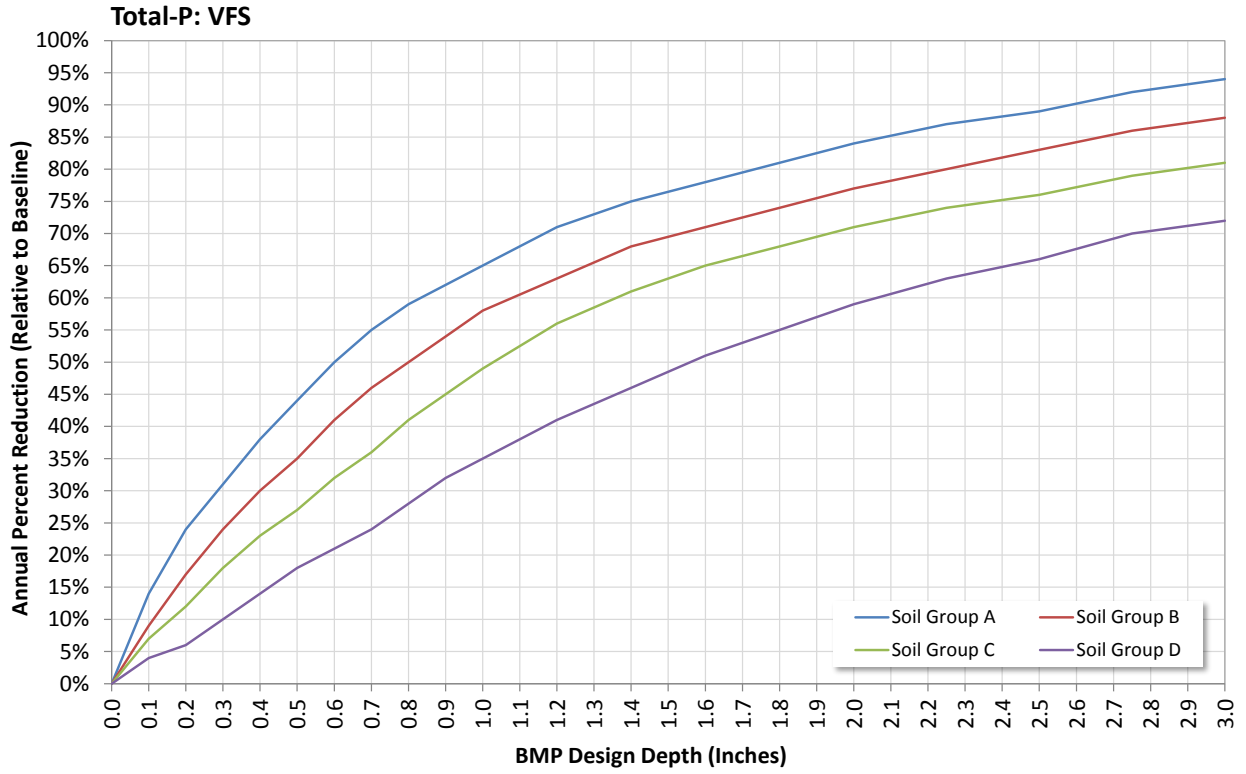

Appendix A. BMP Sizing

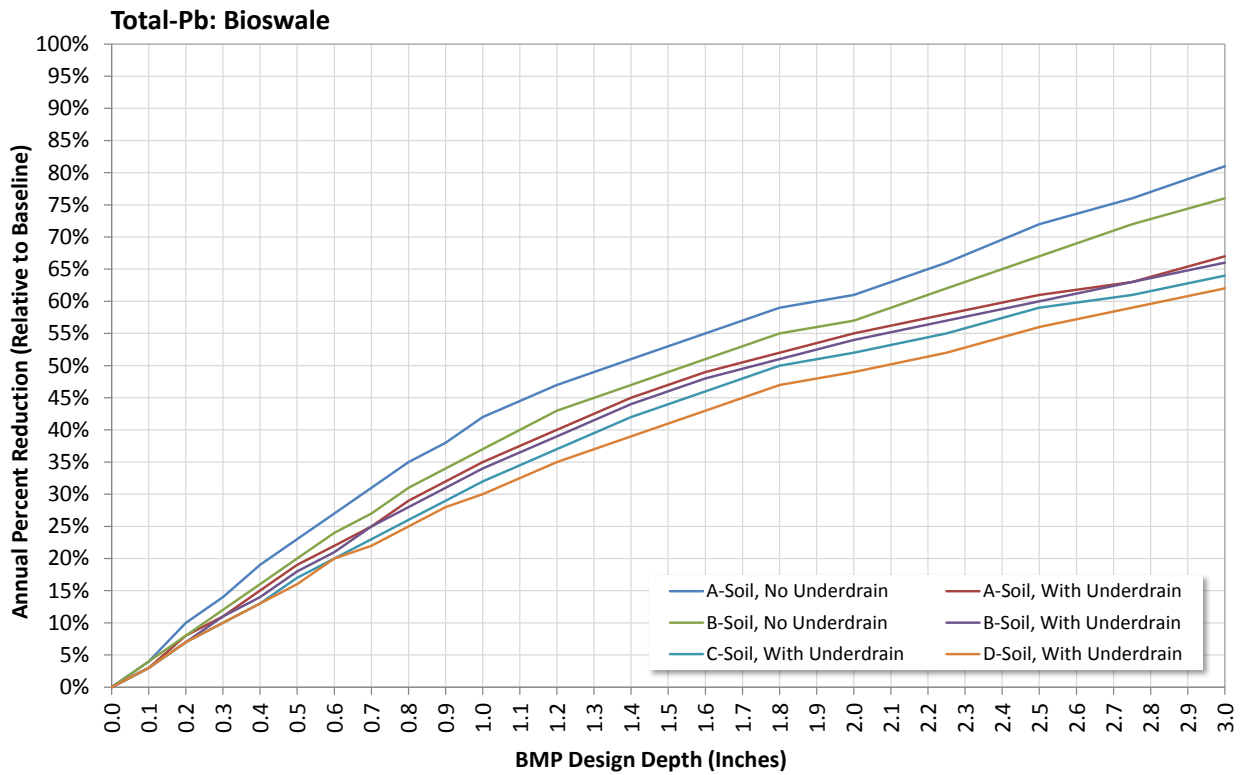
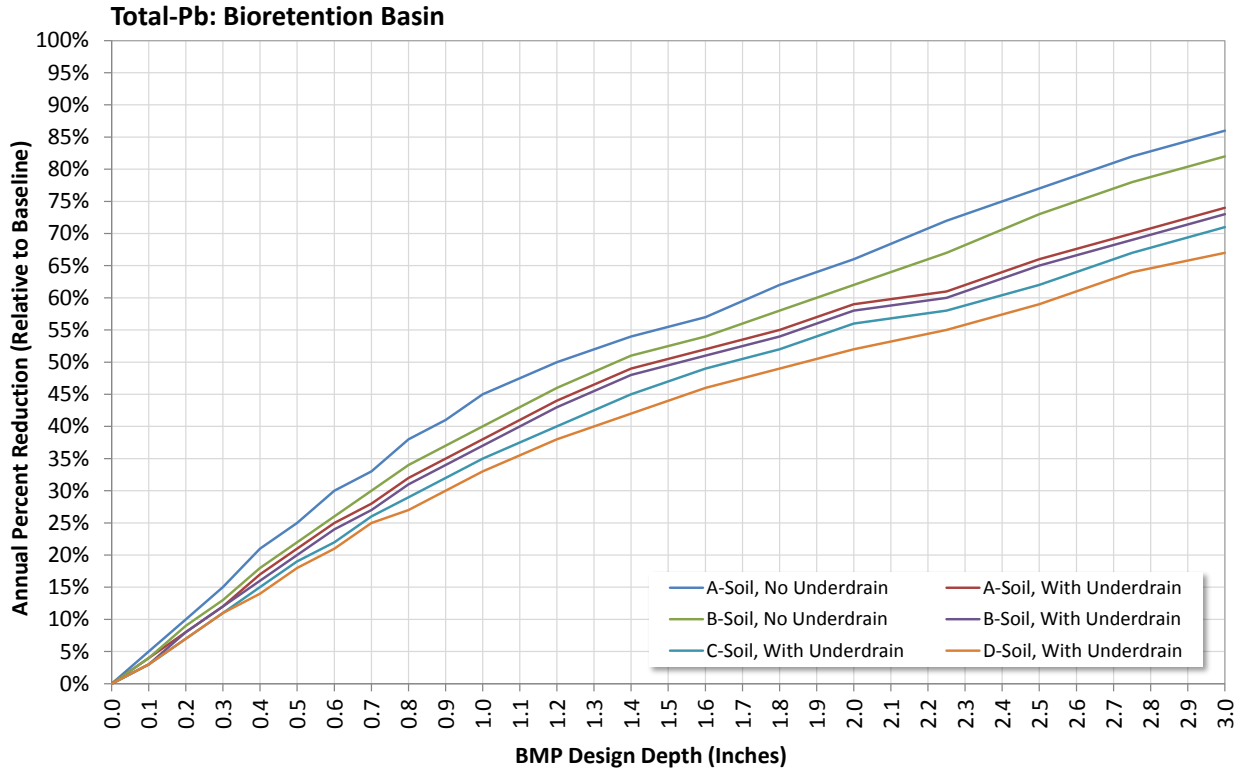

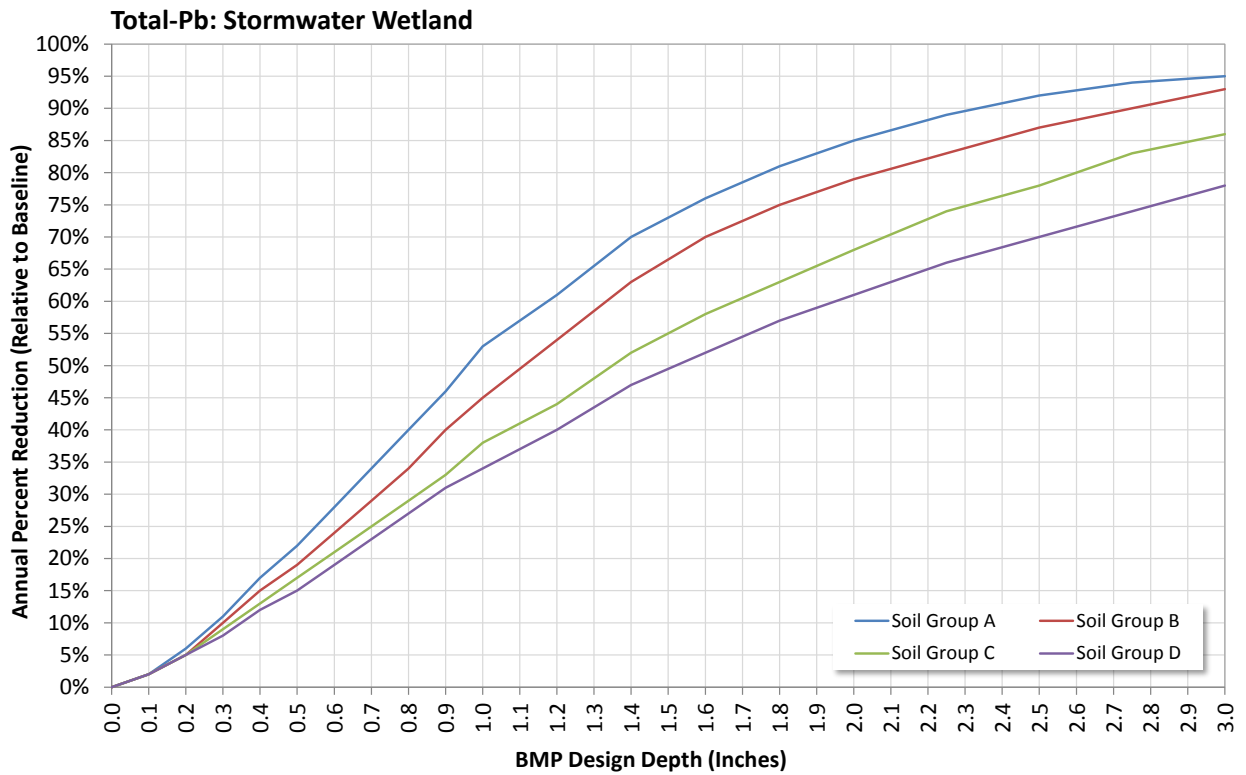
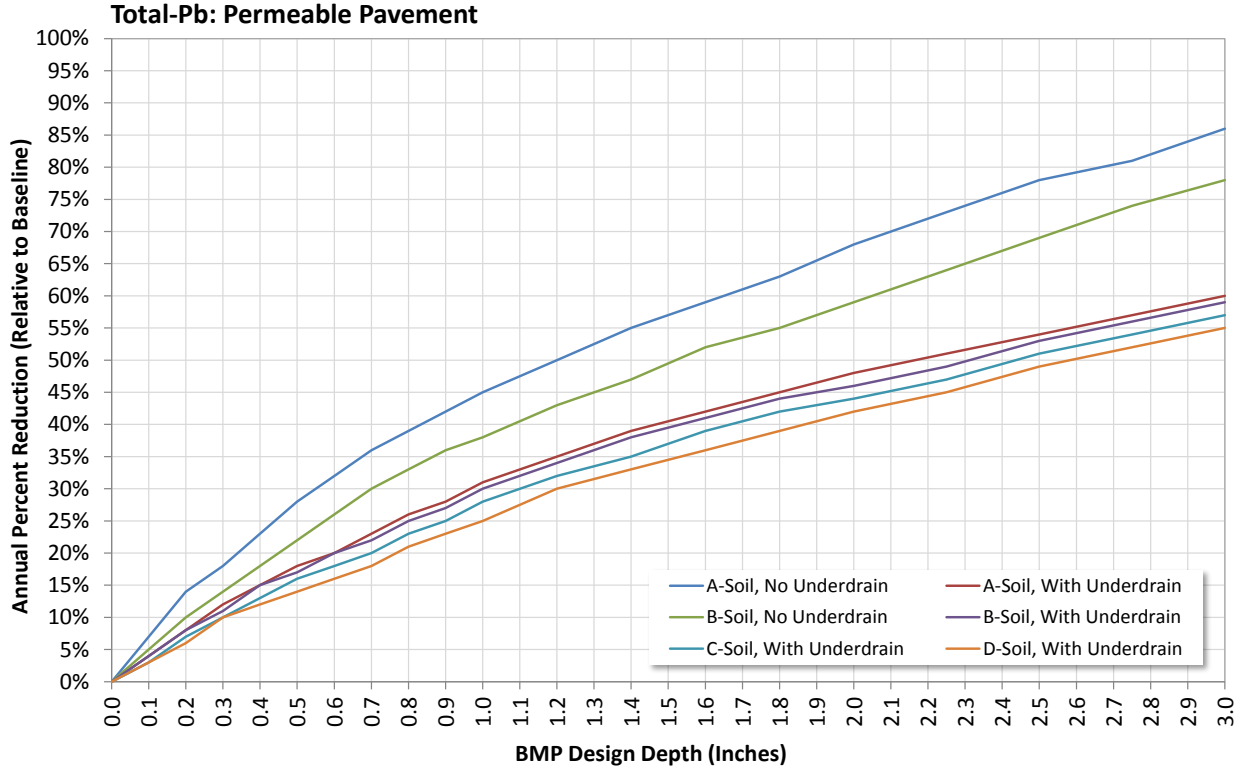

Appendix A. BMP Sizing

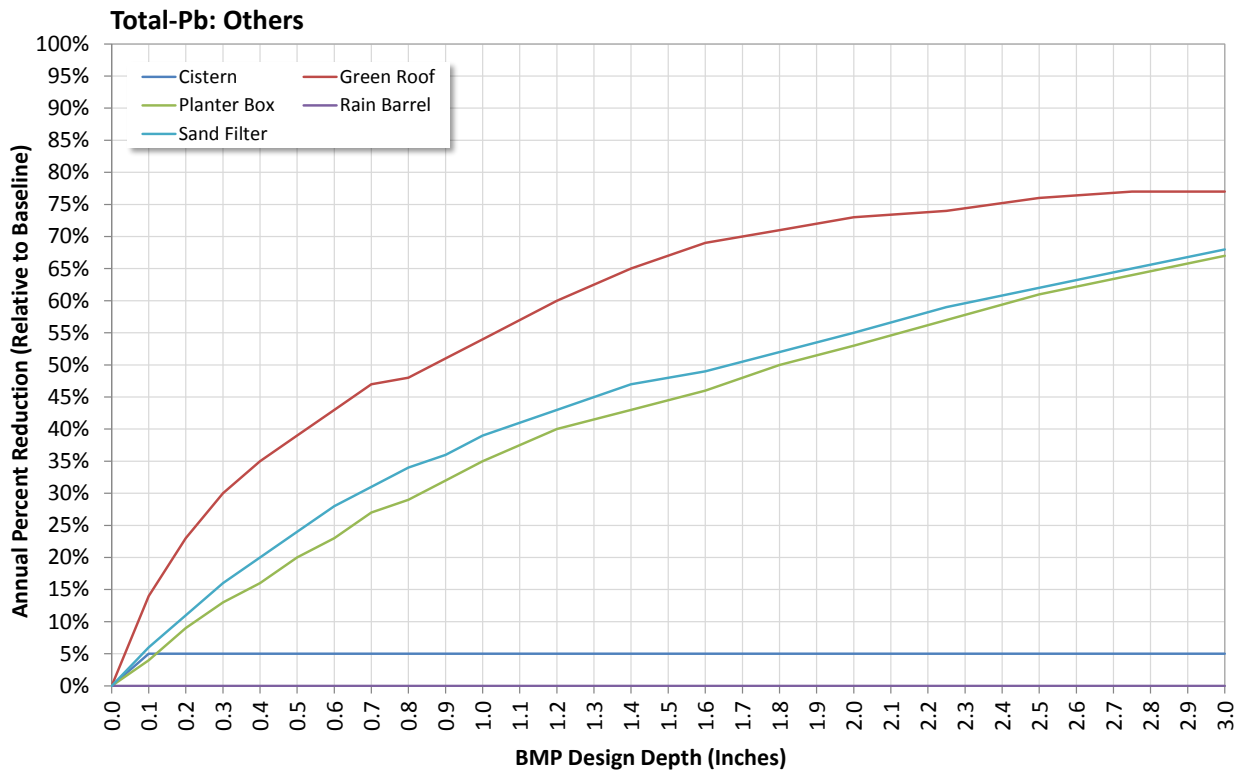
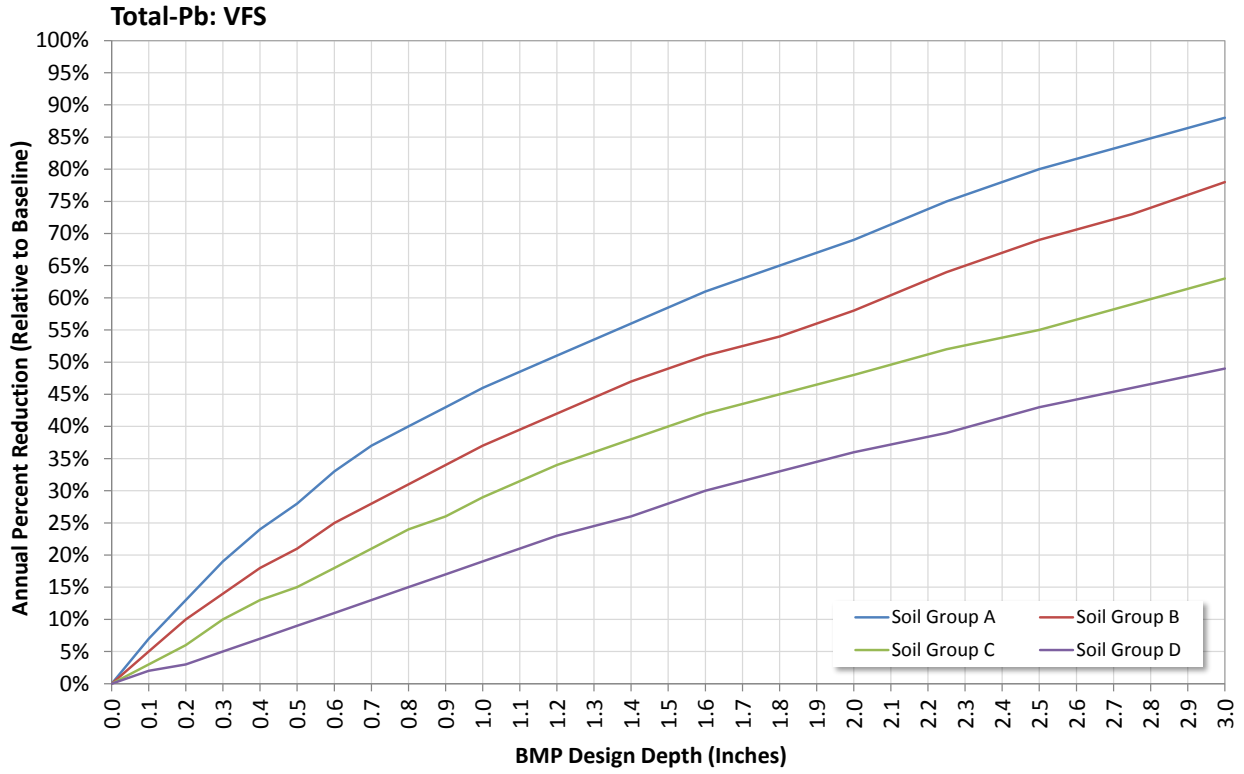

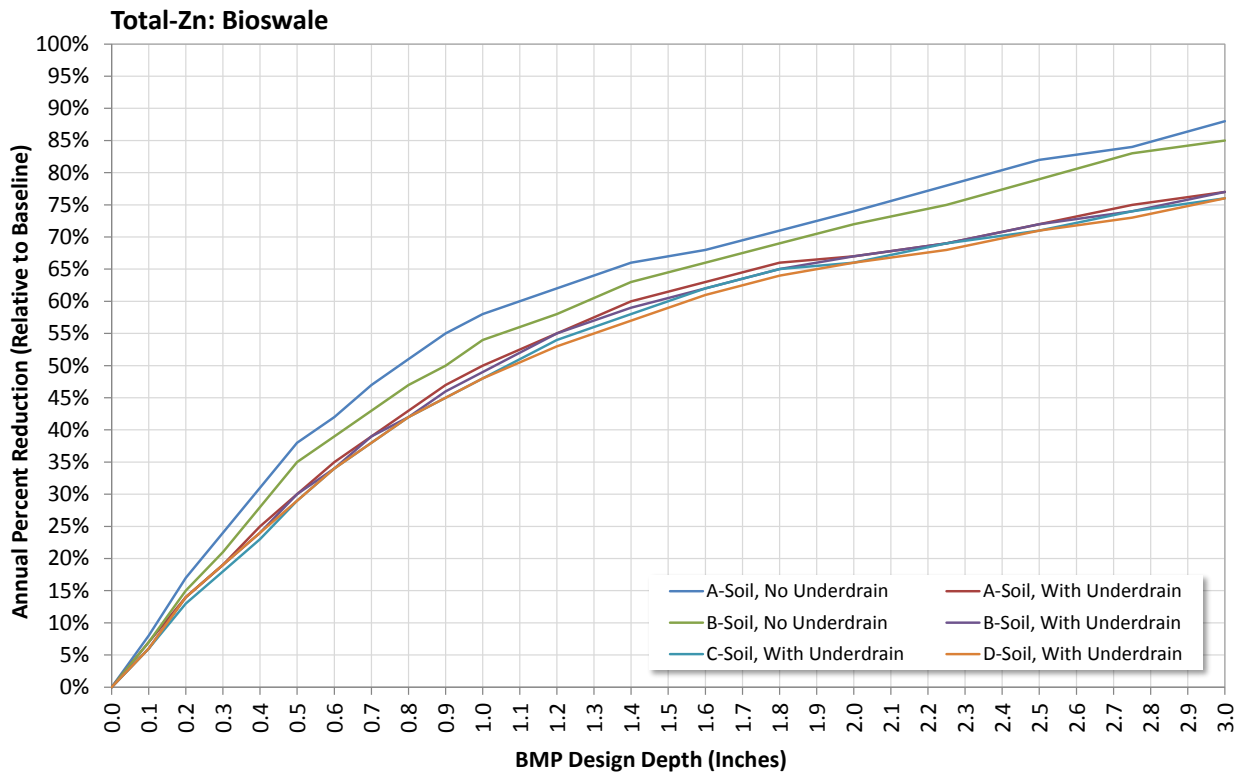
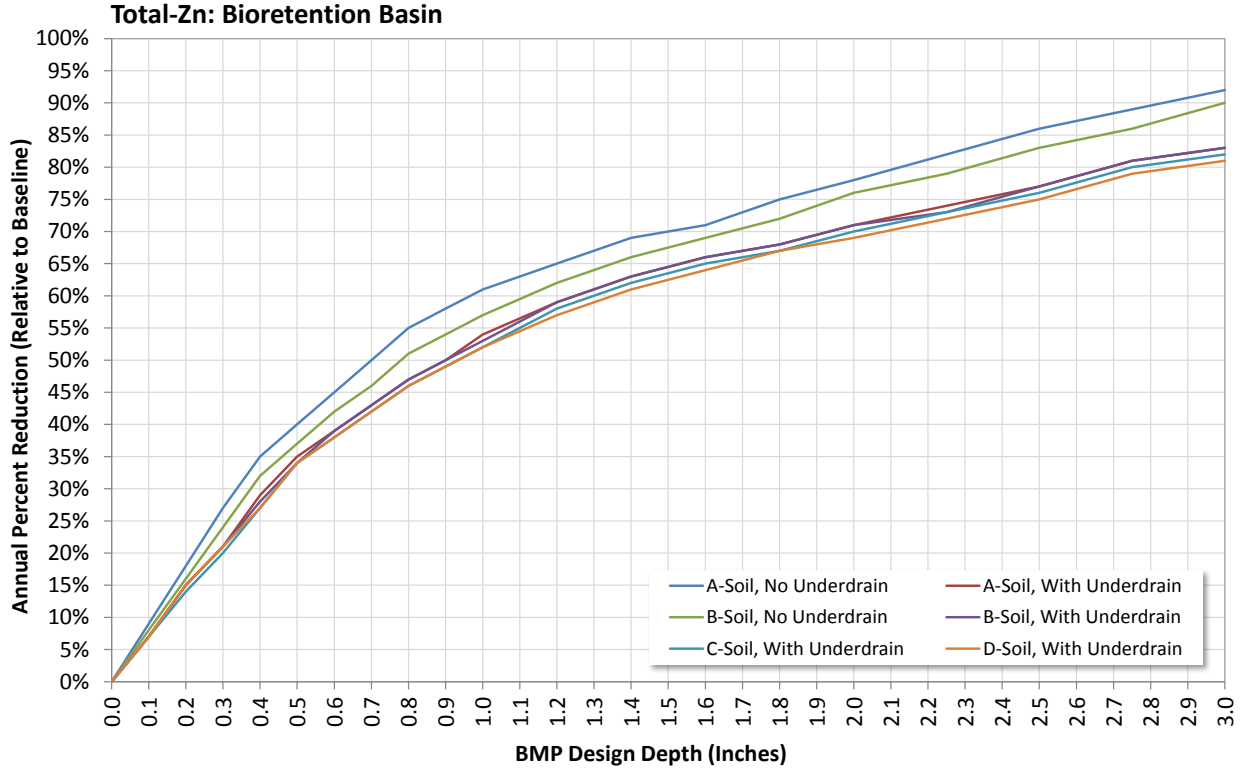

Appendix A. BMP Sizing

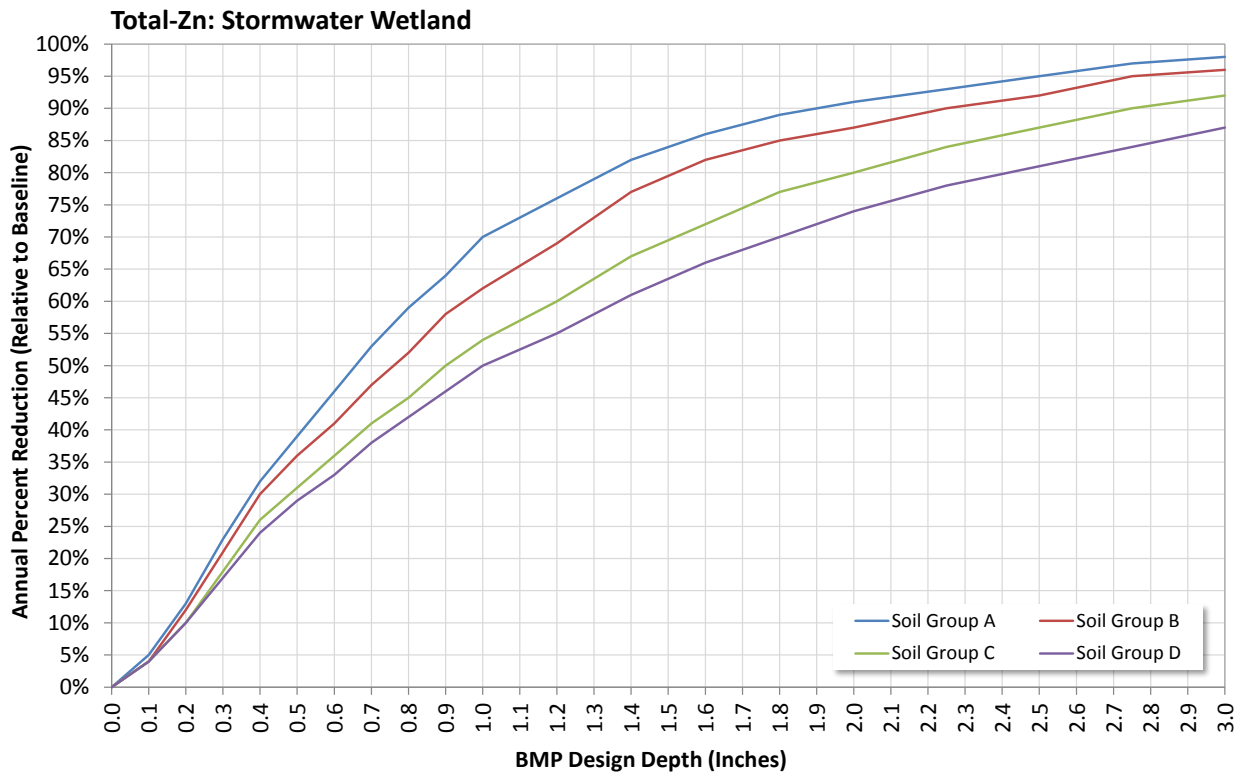
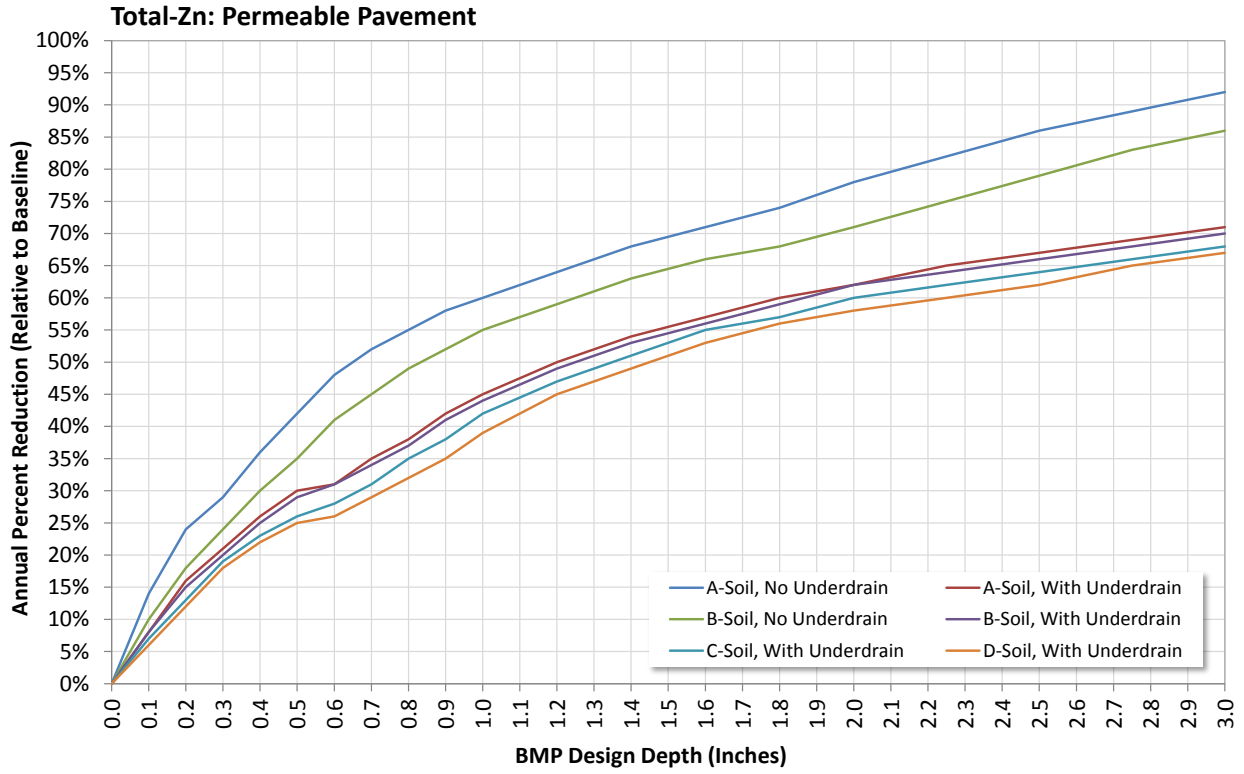

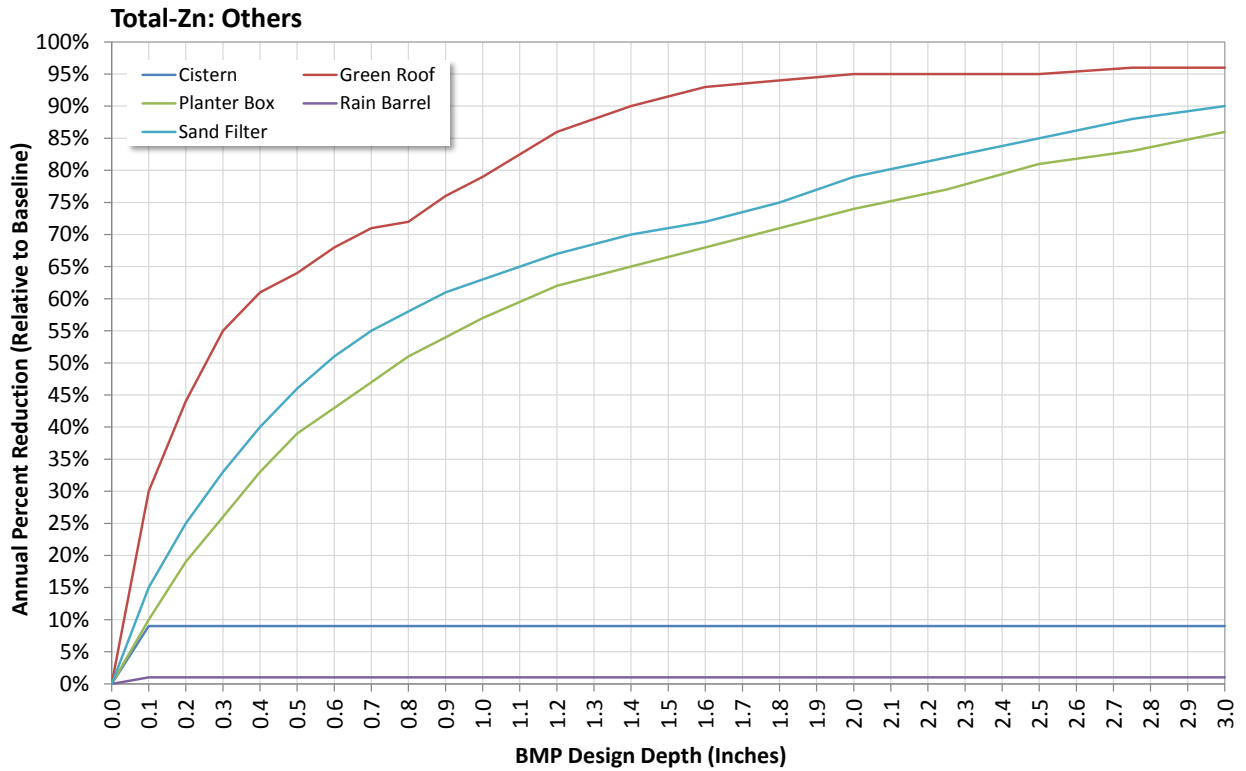
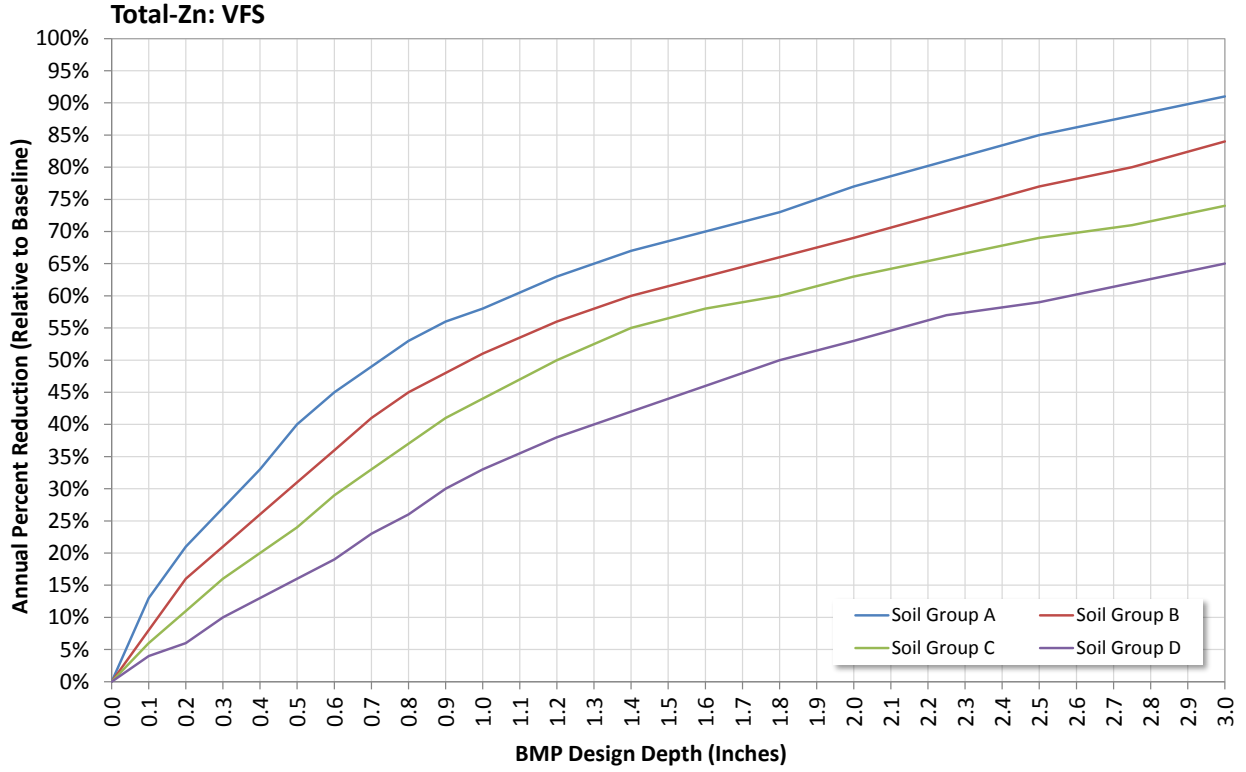

A.4 BMP Sizing

A.4.1 Volume-based Method 1

Two runoff volume calculation methods are used throughout the region and are adopted in this analysis. These are the Rational Method application for runoff volume estimation described in Section 6 of *Complying with the Edwards Aquifer Rules—Technical Guidance on Best Management Practices* (TCEQ 2005), and the Natural Resources Conservation Service (NRCS) hydrologic method described in the *San Antonio River Basin Regional Modeling Standards for Hydrology and Hydraulic Modeling* (SARA undated). As the Rational Method is recommended for watersheds less than 200 acres in area, that is the approach that is evaluated here. Local regulations may require the use of the NRCS or other rainfall-runoff analysis methods to calculate volumes or flow rates. In those cases, standard hydrologic software such as HEC-HMS can be utilized.

The Rational Method is implemented as follows:

$$WQV = C * \left(\frac{P_x}{12}\right) * A \quad \text{[Equation 1]}$$

Where:

WQV = BMP water quality storage volume (ft³),

C = runoff coefficient,

P_x = rainfall depth (determined in Section A.3 or alternative from A.2),

A = watershed area draining to the BMP (ft²), and

$$C = C_i * (\%Imp) + C_p * (1 - \%Imp) \quad \text{[Equation 2]}$$

The value of C_i can be set to 0.95 to 1.0 depending on slope and roughness or may be calculated as a composite value for watersheds with multiple impervious cover types. Lower values would be appropriate for flat asphalt parking lots and higher values for metal, sloped roof buildings. The parameter C_p (pervious areas) will vary by hydrologic soil group (HSG) and land use type. In developed areas, the primary pervious areas are either undisturbed woods/brush or maintained lawns. Table A-3 lists runoff coefficients by HSG that are appropriate for use in the San Antonio River Basin and can be translated to curve numbers when evaluating BMP practices in watersheds over 200 acres.

Table A-3. Runoff coefficients for open space areas by hydrologic soil group (Schwab and Frevert 1993).

Hydrologic Soil Group	Woods, no grazing	Pasture (lawns)
A	0.06	0.10
B	0.13	0.20
C	0.16	0.25
D	0.20	0.30

A.4.2 Volume-based Method 2

Volume-based method 2 is described in Section 3.3 of the TGM (TCEQ 2005) and was developed to achieve TSS reduction targets by treating a percent of the annual rainfall volume. The calculation approach is applicable to LID design since it results in a capture volume based on watershed area. The method is implemented as:

$$WQV = \text{Rainfall Depth (in)} * \frac{\text{Runoff Coefficient}}{12} * \text{Area(ft}^2\text{)} * 1.2 \quad \text{[Equation 3]}$$

The runoff coefficient is estimated from Figure A-5 or calculated from

$$\text{Runoff Coefficient} = 1.72 * \%Imp^3 - 1.97 * \%Imp^2 + 1.23 * \%Imp + 0.02 \quad \text{[Equation 4]}$$

the rainfall depth is determined from Table A-4, and the area is the total watershed draining to the BMP in square feet. The storage factor 1.2 is provided to account for stored sediment that would reduce volume in between maintenance cycles.

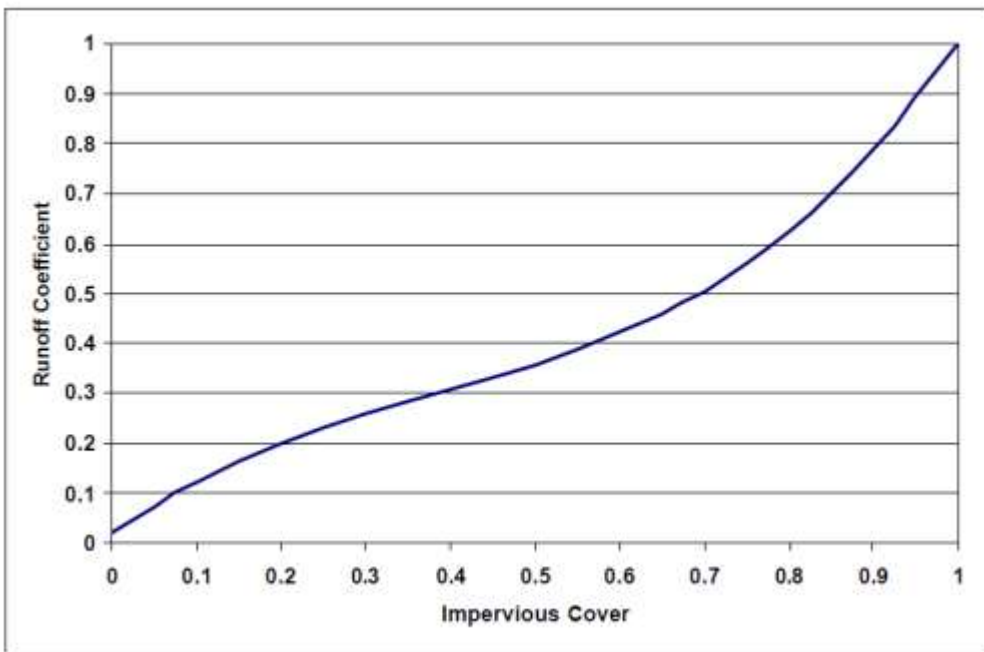

Figure A-5. Relationship between runoff coefficient and impervious cover (Figure 3-12 from TCEQ 2005).

Appendix A. BMP Sizing

Table A-4. Relationship between fraction of annual rainfall and rainfall depth (in)
(Table 3-5 from TCEQ 2005).

F	Rainfall Depth	F	Rainfall Depth	F	Rainfall Depth	F	Rainfall Depth
1.00	4.00	0.80	1.08	0.60	0.58	0.40	0.29
0.99	3.66	0.79	1.04	0.59	0.56	0.39	0.28
0.98	3.33	0.78	1.00	0.58	0.54	0.38	0.27
0.97	3.00	0.77	0.97	0.57	0.52	0.37	0.25
0.96	2.80	0.76	0.94	0.56	0.50	0.36	0.24
0.95	2.60	0.75	0.92	0.55	0.49	0.35	0.23
0.94	2.40	0.74	0.89	0.54	0.47	0.34	0.23
0.93	2.20	0.73	0.86	0.53	0.46	0.33	0.22
0.92	2.00	0.72	0.83	0.52	0.45	0.32	0.21
0.91	1.80	0.71	0.80	0.51	0.44	0.31	0.20
0.90	1.70	0.70	0.78	0.50	0.42	0.30	0.19
0.89	1.60	0.69	0.75	0.49	0.41	0.29	0.18
0.88	1.50	0.68	0.73	0.48	0.40	0.28	0.18
0.87	1.44	0.67	0.71	0.47	0.38	0.27	0.17
0.86	1.38	0.66	0.69	0.46	0.37	0.26	0.16
0.85	1.32	0.65	0.67	0.45	0.36	0.25	0.15
0.84	1.26	0.64	0.66	0.44	0.34		
0.83	1.20	0.63	0.64	0.43	0.33		
0.82	1.16	0.62	0.62	0.42	0.32		
0.81	1.12	0.61	0.60	0.41	0.31		
0.80	1.08	0.60	0.58	0.40	0.29		

A.5 Flow-based Control Practices

Similar to the volume based control methods, two regionally appropriate methods are available to calculate flow-based sizing criteria for infiltrating, filtering, or treating:

1. The maximum flow rate of runoff produced from a rainfall intensity of 1.1 inch of rainfall per hour for each hour of a storm event (TCEQ 2005). Local rainfall analysis by TCEQ indicates 90 percent of the annual rainfall occurs at intensities below this level.

or

2. The maximum flow rate of runoff produced by the regulatory percentile hourly rainfall intensity, as determined from the local historical rainfall record, multiplied by a factor of two.

Both methods describe how to apply the design rainfall intensity for flow-based control practices (i.e., applying a uniform 1.1 inches per hour intensity or applying the regulatory percentile hourly rainfall intensity after multiplying by 2 as a safety factor).

A.5.1 Flow-based Method 1

The water quality flow (WQF, cfs) is calculated as

$$WQF = C * 1.1 * A, \quad \text{[Equation 5]}$$

where C is the rational method coefficient, as described above in Section A.4, 1.1 in/hr is the rainfall intensity from the TCEQ's Edwards Aquifer compliance design manual, and A is the drainage area in square feet.

A.5.2 Flow-based Method 2

Flow-based method 2 is similar to method 1, except that the flow is based on the regulatory percentile peak intensity value from a local rainfall analysis (i), multiplied by a safety factor:

$$WQF = C * (i * 2) * A \quad \text{[Equation 6]}$$

The intensity should be calculated from rainfall data that covers at least 30 years of automated 5 to 15 minute automated recording gage data. Alternatively, hourly rainfall estimates could be used for areas with sparse gage data.

A.6 References

SARA (San Antonio River Authority). Undated. San Antonio River Basin Regional Modeling Standards for Hydrology and Hydraulic Modeling.

TCEQ (Texas Commission on Environmental Quality). 2005. *Complying with the Edwards Aquifer Rules—Technical Guidance on Best Management Practices*. RG-348 (Revised) with Addendum. Texas Commission on Environmental Quality, Austin, TX <http://www.tceq.texas.gov/field/eapp>.

Appendix A. BMP Sizing

Example Problem

A property owner has a 5-acre, 75-percent-impervious commercial tract that discharges to a stream that is impaired for bacteria. The local municipality's stormwater management plan requires a 60 percent bacteria reduction for commercial properties in their jurisdiction. The site has surface parking and typical landscaping for the area, but the onsite soil is classified as low permeability clay (HSG D). You have evaluated the site and determined that bioretention within existing landscape areas is the most cost effective solution. Your city adopted the BMP curves in A.2 to calculate the required water quality volume. Determine the required volume to submit in support of your building permit.

Solution:

Bioretention is a volume based BMP that can be sized using Volume Based Method 1 (A.3.1) and the Rational Method equation (Equation 1)

$$WQV = C * \left(\frac{P_x}{12}\right) * A$$

The composite runoff coefficient is calculated from $C = C_i * (\%Imp) + C_p * (1 - \%Imp)$ (Equation 2) using a C_p of 0.30 (HSG D) from Table A-3 and C_i of 0.97 to reflect a mix of impervious surfaces and rooftops.

$$C = 0.97 * 0.75 + 0.3 * (1 - 0.75) = 0.8025$$

The rainfall depth is selected from the top figure on page A-12. Starting on the y-axis (annual percent reduction) at 60 percent and reading across to the right until intersecting the orange line (D soil, with underdrain). Follow the vertical lines down and read the BMP design depth of 1.2 inches from the x-axis.

Inserting these values into the equation produces

$$WQV = 0.8025 * \left(\frac{1.2}{12}\right) * 5 \text{ ac} * 43,560 \text{ ft}^2 = 17,478.5 \text{ ft}^3$$

Appendix B. BMP Design Guidance

Contents

- 1 Bioretention Areas B-1
 - 1.1 Design..... B-2
 - 1.2 Critical Construction Considerations B-22
 - 1.3 Operation and Maintenance..... B-22
 - 1.4 References B-25
- 2 Bioswales B-27
 - 2.1 Design..... B-28
 - 2.2 Critical Construction Considerations B-36
 - 2.3 Operation and Maintenance..... B-36
 - 2.4 References B-38
- 3 Permeable Pavement B-39
 - 3.1 Design..... B-40
 - 3.2 Critical Construction Considerations B-59
 - 3.3 Operation and Maintenance..... B-60
 - 3.4 References B-61
- 4 Planter Boxes B-64
 - 4.1 Design..... B-65
 - 4.2 Critical Construction Considerations B-69
 - 4.3 Operation and Maintenance..... B-69
- 5 Green Roofs B-70
 - 5.1 Design..... B-71
 - 5.2 Critical Construction Considerations B-77
 - 5.3 Operation and Maintenance..... B-78
 - 5.4 References B-78
- 6 Sand Filters B-79
 - 6.1 Design..... B-80
 - 6.2 Critical Construction Considerations B-88
 - 6.3 Operation and Maintenance..... B-88
 - 6.4 References B-89
- 7 Stormwater Wetlands..... B-90
 - 7.1 Design Steps B-91
 - 7.2 Critical Construction Considerations B-103

Appendix B. BMP Design Guidance

7.3	Operation and Maintenance.....	B-103
7.4	References	B-104
8	Cisterns	B-105
8.1	Design.....	B-106
8.2	Critical Construction Considerations	B-122
8.3	Operation and Maintenance.....	B-122
8.4	References	B-123
9	Vegetated Swales	B-124
9.1	Design.....	B-125
9.2	Critical Construction Considerations	B-129
9.3	Operation and Maintenance.....	B-129
10	Vegetated Filter Strips	B-131
10.1	Design.....	B-132
10.2	Critical Construction Considerations	B-134
10.3	Operation and Maintenance.....	B-134
10.4	References	B-135
11	Common Design Elements.....	B-136
11.1	Geotechnical Investigation	B-136
11.2	Curb Cuts.....	B-137
11.3	Stabilization and Energy Dissipation	B-142
11.4	Underdrain Design	B-146
11.5	Trash Racks	B-148
11.6	Diversion Structures	B-150
11.7	Impermeable Liners and Hydraulic Restriction Barriers.....	B-151
11.8	Utilities	B-155
11.9	Connectivity	B-155
11.10	ADA Requirements	B-156
11.11	References	B-158

Figures

Figure B-1-1. Basic bioretention components. B-4

Figure B-1-2. Conventionally drained bioretention cross section showing underdrain..... B-6

Figure B-1-3. Bioretention cell profile with IWS drainage configuration..... B-7

Figure B-1-4. Upturned underdrains inside bioretention outlet structures create IWS in soil media to improve infiltration, water quality, and plant health..... B-7

Figure B-1-5. Gravel fringe and vegetated filter strip pretreatment. B-11

Figure B-1-6. Inlet and pretreatment provided by mortared cobble forebay and energy dissipater. B-12

Figure B-1-7. Inlets stabilized with mortared cobble..... B-13

Figure B-1-8. Upturned inlet from rooftop bubbles up diffusely onto gravel pad..... B-13

Figure B-1-9. Offline bioretention area where system fills to capacity and excess flow bypasses along curblineline at inlet. B-14

Figure B-1-10. Online bioretention area with a vertical riser overflow with a variable flow outlet structure. B-15

Figure B-1-11. Bioretention outlet structures designed for peak flow mitigation. B-16

Figure B-1-12. Triple-shredded hardwood mulch. B-18

Figure B-1-13. Example bioretention planting plan. B-19

Figure B-1-14. Signage posted in front of ultra-urban bioretention area raises public awareness. B-20

Figure B-1-15. Cobbled bioretention area that invites pedestrian interaction. B-21

Figure B-1-16. Overflow from a rainwater cistern is discharged to a cobbled bioretention area. B-21

Figure B-2-1. Bioswale components..... B-30

Figure B-2-2. Example bioswale cross section with hydraulic restriction barrier to prevent lateral seepage to adjacent pavement subgrade. B-31

Figure B-2-3. Bioswale incorporating IWS and a partition baffle to enhance exfiltration. B-32

Figure B-2-4. Bioswale with a check dam. B-33

Figure B-2-5. Example profile of a bioswale with a check dam to retain the design storm volume. B-33

Figure B-2-6. Left: An offline bioswale along the road right of way (excess flow bypass along gutterline). Right: An online bioswale with an overflow outlet structure along a roadway and parking lot (this practice is used in a treatment train with an adjacent detention basin)..... B-35

Figure B-3-1. Permeable pavement and bioretention treatment train. B-42

Figure B-3-2. Typical porous asphalt cross section. B-44

Figure B-3-3. Example of porous asphalt. B-45

Figure B-3-4. Typical pervious concrete cross section..... B-46

Figure B-3-5. Example of pervious concrete..... B-47

Figure B-3-6. Typical PICP cross section..... B-48

Figure B-3-7. Example of PICPs in a herringbone pattern. B-49

Figure B-3-8. Example of CGPs with volcanic rock bedding course. B-50

Appendix B. BMP Design Guidance

Figure B-3-9. Typical plastic grid system cross section.	B-51
Figure B-3-10. Example of plastic grid systems.	B-52
Figure B-3-11. Example of permeable pavement with trenched underdrain.	B-53
Figure B-3-12. Example permeable pavement profile featuring IWS.	B-54
Figure B-3-13. Observation well installed in permeable pavement.	B-54
Figure B-3-14. A 1-foot concrete transition strip is used as an edge restraint between PICP and impermeable asphalt.	B-58
Figure B-4-1. Downspout configuration.	B-67
Figure B-4-2. Planter box inlet configuration.	B-68
Figure B-4-3. Schematic of planter box with a vertical riser.	B-69
Figure B-5-1. Example of an extensive green roof.	B-72
Figure B-5-2. Example of an intensive green roof.	B-73
Figure B-5-3. Typical extensive green roof profile.	B-74
Figure B-5-4. Light-colored gravel delineates the no-planting zone for maintenance personnel.	B-75
Figure B-5-5. Rooftop gardens provide recreational opportunities.	B-77
Figure B-6-1. Surface sand filter.	B-82
Figure B-6-2. Subsurface sand filter.	B-83
Figure B-6-3. Conceptual schematic of an infiltrating surface sand filter with IWS.	B-84
Figure B-6-4. Sand filter geometry and profile.	B-85
Figure B-6-5. Belowground sand filter with diffuse flow inlet and slot weirs between sedimentation chamber and sand filter chamber.	B-87
Figure B-7-1. Example wetland configuration.	B-93
Figure B-7-2. Forebay visible in a newly planted wetland.	B-94
Figure B-7-3. A sinuous pattern increases the flow path in a stormwater wetland.	B-95
Figure B-7-4. An earthen berm elongates the flow path in a <i>racetrack</i> -style stormwater wetland where the inlet and outlet are located in close proximity.	B-96
Figure B-7-5. Wetland zones.	B-97
Figure B-7-6. Wetland outlet structure schematic.	B-98
Figure B-7-7. A downturned inlet pipe with an orifice extends into a deep pool in a small stormwater wetland.	B-99
Figure B-7-8. Example schematic of an adjustable orifice plate.	B-99
Figure B-7-9. A flashboard riser allows adjustment of water level during plant establishment and for maintenance.	B-100
Figure B-7-10. Dewatering intake in a detention facility (similar design applies to stormwater wetlands).	B-101
Figure B-8-1. Minimum design components of a rainwater harvesting system.	B-107
Figure B-8-2. Cistern less than 2,000 psi on a gravel foundation.	B-108
Figure B-8-3. Cistern greater than 2,000 psi on a concrete foundation.	B-109

Figure B-8-4. Cistern on a concrete foundation..... B-109

Figure B-8-5. Dry conveyance inlet configuration. B-110

Figure B-8-6. Inlet in the top of the cistern..... B-111

Figure B-8-7. Inlet in the sides of the man way..... B-111

Figure B-8-8. Cistern with wet conveyance featuring a drawdown valve for maintenance. B-112

Figure B-8-9. Cistern with a wet conveyance inlet configuration. B-112

Figure B-8-10. Inlet filters at the gutter. B-113

Figure B-8-11. Inlet filters at the downspout..... B-113

Figure B-8-12. Flow-through inlet filter. B-114

Figure B-8-13. Self-flushing filter with a bypass. B-114

Figure B-8-14. Valve for a first-flush diverter..... B-115

Figure B-8-15. First-flush diverter configuration. B-115

Figure B-8-16. Cistern outlet. B-116

Figure B-8-17. Top: a low flow outlet is placed to provide equal parts detention storage and storage for alternative use. Bottom: placing the low flow outlet at the bottom of the cistern ensures maximum design storm storage..... B-117

Figure B-8-18. Left: A channel directs overflow away from building. Right: A cistern overflows to an adjacent bioretention area. B-118

Figure B-8-19. Two cisterns with purple pipe connections. B-119

Figure B-8-20. Top: Conceptual schematic of cistern with submersible pump. Bottom: conceptual schematic of cistern with external pump. B-121

Figure B-11-1. Typical curb cut diagram..... B-138

Figure B-11-2. A typical curb cut. B-139

Figure B-11-3. Multiple, small curb cuts distribute parking lot runoff to bioretention area without erosive force..... B-140

Figure B-11-4. Curb cuts and vegetated filter strip for a roadside bioretention area..... B-141

Figure B-11-5. Armored curb cuts..... B-141

Figure B-11-6. Covered curb cut with a sump..... B-142

Figure B-11-7. Stone flow dissipater/forebay..... B-143

Figure B-11-8. Concrete energy dissipater. B-143

Figure B-11-9. Uprturned roof downspout energy dissipater. B-144

Figure B-11-10. Typical level spreader profile view..... B-144

Figure B-11-11. Typical level spreader plan view..... B-145

Figure B-11-12. Figure illustrating proper installation of arced level spreader (left) and improper level spreader arc (right)..... B-145

Figure B-11-13. Underdrain barrier option 1: soil media barrier..... B-147

Figure B-11-14. Underdrain barrier option 2: geotextile liner..... B-148

Figure B-11-15. Drawdown pipe with a downturned elbow..... B-149

Appendix B. BMP Design Guidance

Figure B-11-16. Outlet structure with a trash rack and protected drawdown orifice.....	B-149
Figure B-11-17. Schematic of a trash rack for dewatering sedimentation chambers and stormwater wetlands (adapted from Barrett 2005).	B-150
Figure B-11-18. Typical diversion structure.....	B-151
Figure B-11-19. Lateral hydraulic restriction layers in a roadside bioretention area prevent horizontal seepage while allowing infiltration at a safe depth.....	B-152
Figure B-11-20. Bioretention area with clay liner and lateral hydraulic restriction barriers.	B-154
Figure B-11-21. Bioretention area with geomembrane liner.	B-154
Figure B-11-22. Bioretention area completely lined with concrete barrier (planter box).....	B-155
Figure B-11-23. Access over linear BMPs.	B-156
Figure B-11-24. Low-level fencing.	B-157
Figure B-11-25. Low-profile curbing.	B-157

Tables

Table B-1-1. Iterative design step process	B-2
Table B-1-2. Decision table for determining underdrain and impermeable liner requirements	B-5
Table B-1-3. Minimum bioretention media depth to treat pollutants of concern (Hunt et al. 2012)	B-8
Table B-1-4. Bioretention soil media specifications (Hunt et al. 2012)	B-10
Table B-1-5. Inspection and maintenance tasks.....	B-24
Table B-2-1. Iterative design step process	B-28
Table B-2-2. Inspection and maintenance tasks.....	B-37
Table B-3-1. Iterative design step process	B-40
Table B-3-2. Decision table for determining underdrain and impermeable liner requirements	B-53
Table B-3-3. Geotextile layer specifications.....	B-55
Table B-3-4. Subgrade treatments for infiltration enhancement.....	B-60
Table B-3-5. Operation and maintenance tasks for permeable pavement.....	B-61
Table B-4-1. Iterative design step process	B-65
Table B-5-1. Design step process	B-71
Table B-5-2. Example green roof media specifications.....	B-76
Table B-5-3. Inspection and maintenance activities for green roofs	B-78
Table B-6-1. Iterative design step process	B-80
Table B-6-2. Sand filter soil media specifications	B-85
Table B-6-3. Inspection and maintenance tasks for sand filters	B-89
Table B-7-1. Iterative design step process	B-91
Table B-7-2. Recommended specifications for stormwater wetland forebay design	B-95
Table B-7-3. Wetland Zones.....	B-96

Table B-7-4. Inspection and maintenance tasks for stormwater wetlands B-104

Table B-8-1. Iterative design step process B-106

Table B-8-2. Irrigation area requirements for cisterns in the Edwards Aquifer Recharge,
Contributing, and Transition Zones (applicable to all areas)..... B-116

Table B-8-3. Inspection and maintenance tasks for cisterns B-123

Table B-9-1. Iterative design step process B-125

Table B-9-2. Inspection and maintenance tasks..... B-130

Table B-10-1. Iterative design step process B-132

Table B-10-2. Inspection and maintenance tasks..... B-135

Table B-11-1. Underdrain specifications (Barrett 2005) B-146

Table B-11-2. Geotextile layer specifications (Barrett 2005) B-147

Table B-11-3. Clay liner specifications (Barrett 2005)..... B-153

Table B-11-4. Protective geotextile fabric specifications (Barrett 2005) B-153

Appendix B. BMP Design Guidance

This page is intentionally blank.

1 Bioretention Areas



Bioretention in the right-of-way on Broadway Street, Witte Museum, San Antonio (rendering). Runoff is intercepted from the street through curb cuts and from the sidewalk by sheet flow.

1.1 Design

The design of a bioretention area can be broken down to a nine-step process. Table B-1-1 summarizes the steps, which are described in greater detail in this chapter.

Table B-1-1. Iterative design step process

Design step		Design component/ consideration	General specification
1	Determine BMP Treatment Volume	Use Appendix A	
2	BMP Siting (B-3)	Based on available space and maintenance access, incorporate into parking lot islands, medians, and perimeter; install along the roadway right-of-way; incorporate as landscaped areas throughout the property; or dedicate space for larger, centralized bioretention areas	
3	Determine BMP Function and Configuration (B-4)	Impermeable liner	If non-infiltrating (per geotechnical investigation), use an impermeable clay layer, geomembrane liner, and concrete (as described in Common Design Elements)
		Lateral hydraulic restriction barriers	Use concrete or geomembrane to restrict lateral flows to adjacent subgrades, foundations, or utilities.
		Underdrain (required if subsoil infiltration rate is less than 0.5 in/hr)	Schedule 40 PVC pipe with perforations (slots or holes) every 6 inches. 4-inch diameter lateral pipes should join a 6-inch collector pipe, which conveys drainage to the downstream storm network. Provide cleanout ports/observation wells for each underdrain pipe at spacing consistent with local regulations. See Common Design Elements
		Internal water storage (IWS)	If using underdrain and infiltration, elevate the outlet to create a sump for additional moisture retention to promote plant survival and enhanced treatment. Top of IWS should be greater than 18 inches below surface.
		No underdrain	If design is fully infiltrating, ensure that subgrade compaction is minimized.
4	Size the System (B-8)	Temporary ponding depth	6-18 inches (6-12 inches near schools or in residential areas); average ponding depth of 9 inches is recommended
		Soil media depth	2-4 feet (deeper for better pollutant removal, hydrologic benefits, and deeper rooting depths)
		Surface area	Find surface area required to store treatment volume within temporary ponding depth, soil media depth, and gravel drainage layer depth (media porosity ≈ 0.35 and gravel porosity ≈ 0.4)
5	Specify Soil Media (B-9)	Composition and texture	85-88% sand, 8-12% fines, 2-5% plant-derived organic matter (animal wastes or by-products should not be applied)
		Permeability	1-6 in/hr infiltration rate (1-2 in/hr recommended)
		Chemical composition	Total phosphorus < 15 ppm, pH 6-8, CEC > 5 meq/100 g soil
		Drainage layer	Separate soil media from underdrain layer with 2 to 4 inches of washed sand, followed by 2 inches of choking stone (ASTM No. 8) over a 1.5-foot envelope of ASTM No. 57 stone.
6	Design Inlet and Pretreatment (B-10)	Inlet	Provide stabilized inlets (see Common Design Elements)
		Pretreatment	Install rock armored forebay (concentrated flow), gravel fringe and vegetated filter strip (sheet flow), or vegetated swale

Design step		Design component/ consideration	General specification
7	Select and Design Overflow/Bypass Method (B-14)	Outlet configuration	Online: All runoff is routed through system—install an elevated overflow structure or weir at the elevation of maximum ponding Offline: Only treated volume is diverted to system—install a diversion structure or allow bypass of high flows (see Diversion Structures for details)
		Peak flow mitigation	Provide additional detention storage and size an appropriate non-clogging orifice or weir to dewater detention volume
8	Select Mulch and Vegetation (B-17)	Mulch	Dimensional chipped hardwood or triple shredded, well-aged hardwood mulch 3 inches deep.
		Vegetation	See Plant List (Appendix E)
9	Design for Multi-Use Benefits (B-19)	Include features to enhance habitat, aesthetics, public education, and shade.	

Step 1. Determine the Volume of Water and Flow Rates to Treat

The bioretention area must be sized to fully capture the desired or required design storm volume and filter it through the soil media. Relevant regulatory requirements are summarized in Chapter 2. Surface storage (in the ponding area) and soil pore space (in the plant rooting zone and the underlying media and gravel drainage layers) provide capacity for the design storm volume retention. Appendix A outlines methods for determining design runoff depths associated with a range of annual treatment efficiencies. Once the design runoff depth is determined (on the basis of the desired level of treatment), a runoff volume can be determined for the contributing watershed using this depth and the methods outlined in Appendix A, *San Antonio Unified Development Code*, or *San Antonio River Basin Regional Modeling Standards for Hydrology and Hydraulic Modeling*.

Peak flow rates for the design storm should also be calculated, using the methods outlined in Appendix A so that the inlet and pretreatment can be accordingly sized and flow attenuation can be considered.

Step 2. BMP Siting

Bioretention is a versatile stormwater BMP that can effectively reduce pollutants and can be integrated into site plans with various configurations and components. Stormwater treatment should be considered as an integral component and incorporated in the site design and layout from conception. Many times, determining how the bioretention area will be included in the site design is a critical and required first step. How the water is routed to the bioretention area and the available space will be key components in determining how the bioretention area is configured. Site assessment, planning, and site design are discussed in detail in Section 1.5. The following is a list of settings where bioretention can be incorporated to meet more than one project-level or watershed-scale objective:

- Landscaped parking lot islands
- Common landscaped areas
- In parks and along open space edges
- Within rights-of-way along roads

Appendix B. BMP Design Guidance

How the bioretention area is configured will determine the required components. Bioretention areas can serve the dual purpose of stormwater management and landscape design and can significantly enhance the aesthetics of a site. Figure B-1-1 shows an example of the components of a typical bioretention area. When siting bioretention, consideration must always be given to providing access for routine, intermittent, and rehabilitative maintenance activities.

Bioretention areas can be combined with other BMPs to form a treatment train that can provide enhanced water quality treatment and reductions in runoff volume and rate. For example, runoff can be collected from a roadway in a vegetated swale that then flows to a bioretention area. Both facilities can be reduced in size on the basis of demonstrated performance for meeting the stormwater runoff requirements as outlined in Chapter 2 and addressing targeted pollutants of concern.

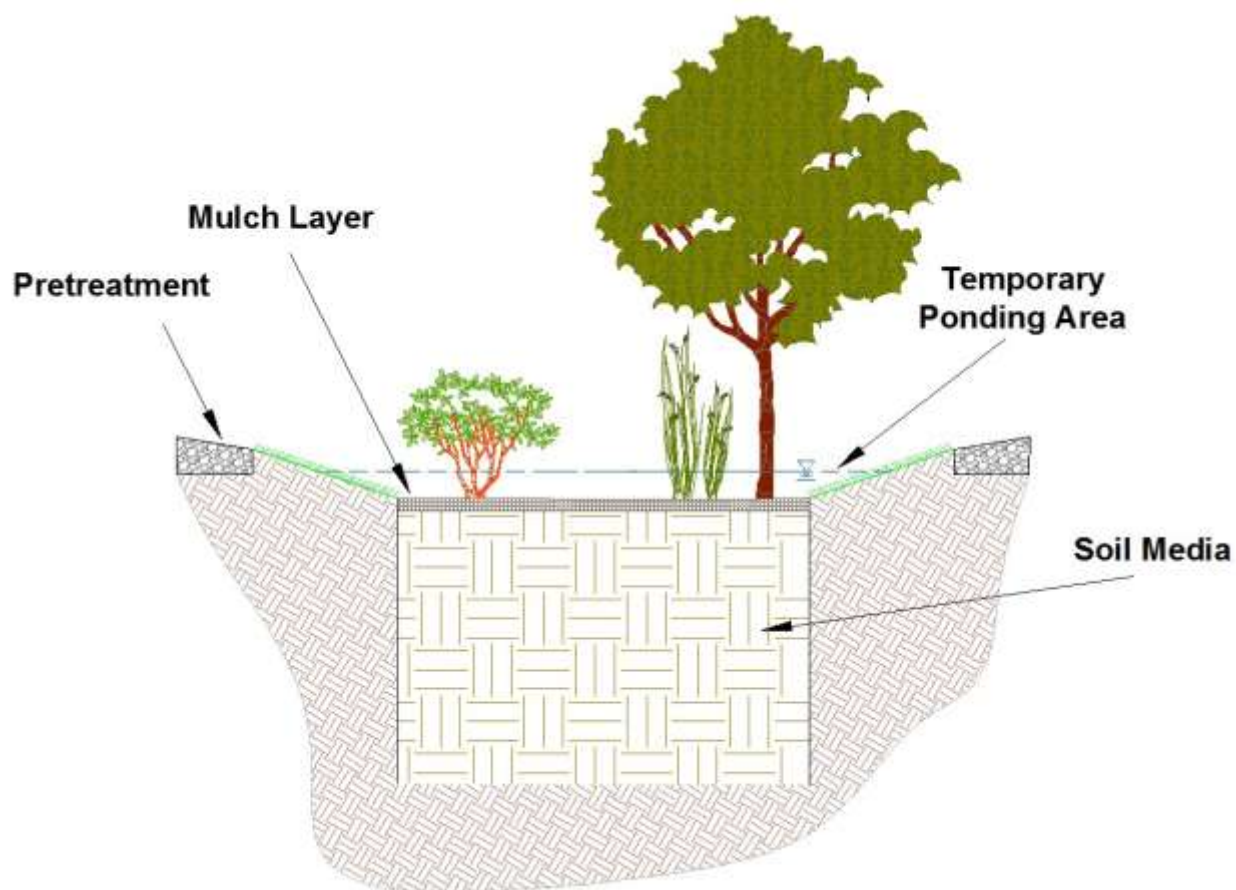

Figure B-1-1. Basic bioretention components.

Step 3. Determine BMP Function and Configuration

Intended bioretention functions and configuration must be characterized early in the design process. Infiltration through native soils provides the greatest treatment potential and lowest cost. Where infiltration is limited, a high level of treatment can still be provided by filtering stormwater through an engineered soil media. The following subsections describe the necessary steps to determine if the bioretention area will safely function as an infiltration or filtration BMP.

Geotechnical Investigation

A licensed soil scientist or geotechnical engineer should conduct a geotechnical investigation before the BMP design. The investigator should determine the infiltration rate of the soils at the potential subgrade of the bioretention cell, the depth to the seasonally high groundwater table, presence of expansive clay minerals, and whether there is a risk of sinkhole formation. Site location with respect to aquifer recharge zones, steep slopes, water supply wells, and septic drain fields must also be assessed. For more details, see [Common Design Elements](#).

Determine if Underdrains and Impermeable Liners are Needed

Underdrains will be required if a bioretention cell is lined, adjacent to a steep slope, or if the subsoil infiltration rate (as determined during the geotechnical analysis) is less than 0.5 inch per hour (in/hr). Use Table B-1-2 to determine if a bioretention area requires an impermeable liner or underdrain. For more information concerning the use of fully lined bioretention, see [Planter Boxes](#).

Table B-1-2. Decision table for determining underdrain and impermeable liner requirements

Impermeable liners must be used if...	Underdrains must be used if...
<ul style="list-style-type: none"> • Site is in Edwards Aquifer Recharge Zone, Contributing Zone, or Transition Zone (Barrett 2005) • Soil contamination is expected or present • Karst geology presents risk of sinkhole formation • Runoff could unintentionally be received from a stormwater hotspot • Site is within 100 feet of a water supply well or septic drain field • Site is within 10 feet of a structure/foundation • Infiltrated water could interfere with utilities 	<ul style="list-style-type: none"> • An impermeable liner is needed • Infiltration rate of underlying soils is less than 0.5 in/hr • Site is within 50 feet of a steep, sensitive slope (as determined in the geotechnical analysis— see Common Design Elements)

Determine if Lateral Hydraulic Restriction Barriers are Needed

When bioretention areas are near sensitive infrastructure such as pavement subgrades or buried utilities, hydraulic restriction barriers are often required to prevent lateral seepage. Hydraulic restriction barriers are often installed the full depth of excavation, but occasionally they are keyed in to greater depths to ensure vertical, deep infiltration; the geotechnical investigator should determine the required extent of hydraulic restriction barriers. [Common Design Elements](#) provides specific details concerning lateral hydraulic restriction barrier design.

Design Underdrain and Internal Water Storage

The underdrain configuration greatly affects the gradient for water movement through a bioretention cell, and the hydrologic and water quality performance. Conventionally drained cells feature an underdrain that freely drains and outlets at the elevation of the subgrade (Figure B-1-2). Infiltration and pollutant load reduction can be further enhanced by upturning the underdrain to create a sump (Brown and Hunt 2011a). This internal water storage (IWS) zone enhances exfiltration into underlying soils while maintaining aerobic soil conditions in the plant rooting zone. It is most convenient to upturn the underdrain in the outlet structure using a tee-connection; this allows easy access to the underdrain for inspection and maintenance (Figure B-1-3 and Figure B-1-4). IWS can be used in conjunction with an impermeable liner, but volume calculations must account for the possibility of prolonged saturation in the lower media.

Appendix B. BMP Design Guidance

Inclusion of IWS is recommended in arid and semi-arid regions (such as San Antonio) to maintain soil moisture for plant health (Li et al. 2010; Barrett et al. 2012; Houdeshel et al. 2012). To provide an aerobic root zone and to reduce mobilization of previously captured pollutants, the IWS zone should be at least 18 inches below the surface (Hunt et al. 2012). For recommended underdrain specifications, see [Common Design Elements](#).

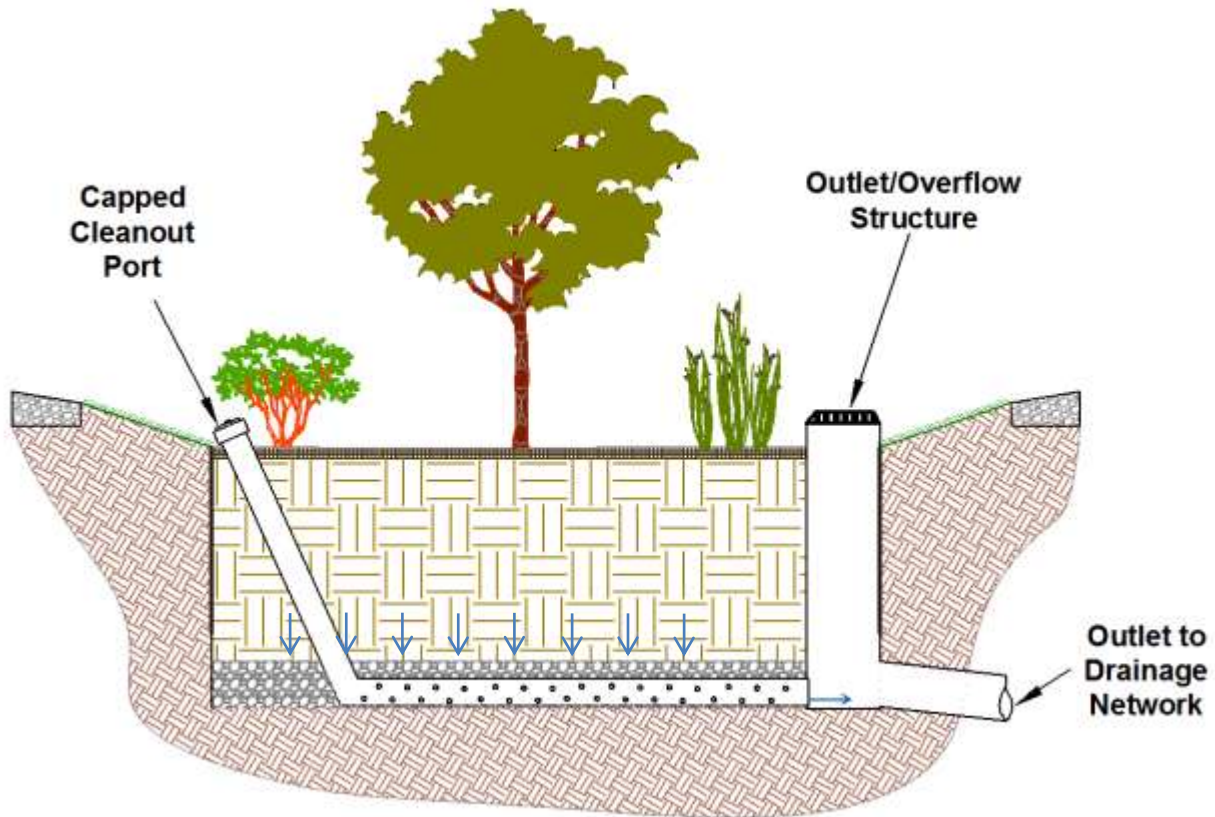

Figure B-1-2. Conventionally drained bioretention cross section showing underdrain.

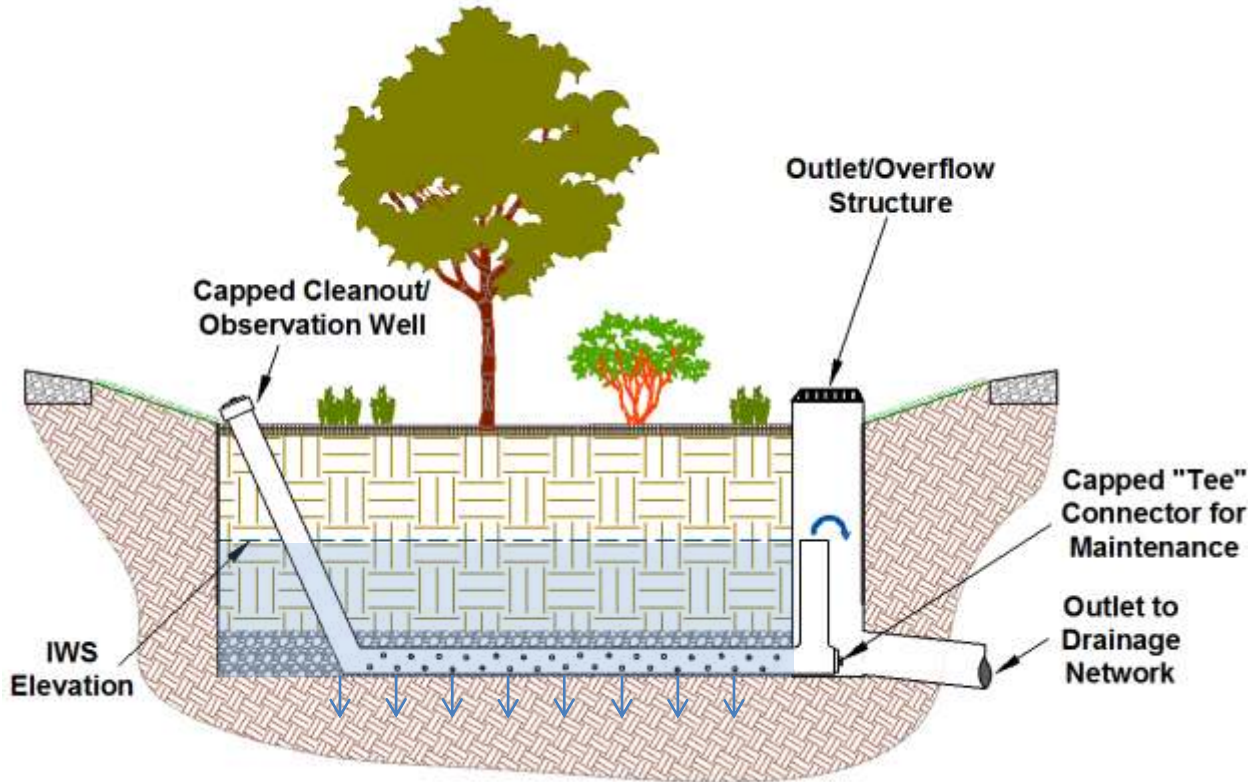

Figure B-1-3. Bioretention cell profile with IWS drainage configuration.



Raleigh, North Carolina. Source: Tetra Tech



Rocky Mount, North Carolina. Source: NCSU BAE

Figure B-1-4. Upturned underdrains inside bioretention outlet structures create IWS in soil media to improve infiltration, water quality, and plant health.

Appendix B. BMP Design Guidance

Step 4. Size the System

The required water quality treatment volume is determined in Appendix A. Vertical dimensions should be selected on the basis of pollutants of concern and site constraints before calculating the BMP footprint. The following subsections provide guidance on sizing the surface ponding depth, media depth, and footprint of bioretention areas.

Surface Ponding Depth

Bioretention areas should have a maximum ponding depth of 12 inches but can temporarily detain runoff to a depth of 18 inches if designed for peak flow mitigation (Heasom et al. 2006; more detail concerning peak flow mitigation is provided in [Step 7](#)). Although research has demonstrated excellent performance from bioretention areas with deeper ponding depths (more than 12 inches), greater care must be taken to select vegetation that can withstand both inundation and drought, and public safety must be considered (Hunt et al. 2012). Maximum ponding depth might also be limited by vertical constraints of the site, including the elevation of existing downstream storm drain networks. For these reasons, a 9-inch average ponding depth is typically preferred. Local freeboard requirements (typically 1.0 foot for online systems and 0.5 foot for offline systems) should also be considered when selecting a ponding depth (Barrett 2005).

Soil Media Depth

Soil media depth should be optimized to meet hydrologic and water quality goals but should have a minimum depth of 2 feet (3 feet is recommended for systems with IWS; Hunt et al. 2012). The soil media provides a beneficial root zone for the chosen plant palette and adequate water storage for the water quality volume. A deeper soil media depth will provide a smaller surface area footprint by allowing more storage in the pore spaces and subsequently more evapotranspiration of stormwater by plants.

Table B-1-3 summarizes the minimum recommended media depths for targeted removal of various pollutants (as detailed in Chapter 3). Considering the target pollutant, the depth of the media in a bioretention cell should be between 2 and 4 feet. That range reflects the fact that most of the pollutant removal occurs within the first 2 feet of soil, and excavations deeper than 4 feet become more expensive. The depth should accommodate the desired vegetation (shrubs or trees). If the minimum depth of 2 feet is used over restrictive underlying soils or an impermeable liner, only shallow-rooted vegetation should be planted; grassed bioretention cells can be as shallow as 2 feet. Bioretention facilities where shrubs or trees are planted could be as shallow as 3 feet unless a soil test indicates that shallower depths will support plant health. Media depths greater than 3 feet might be desired for additional pollutant removal, thermal load reduction, and hydrologic benefits, but 3 feet is typically sufficient. If large trees are to be planted in deep fill media, care should be taken to prevent overturning in high winds. Stakes and guy lines might be required to stabilize the trees during establishment.

Table B-1-3. Minimum bioretention media depth to treat pollutants of concern (Hunt et al. 2012)

Pollutant of concern	Removal zone	Recommended depth
Sediment	Surface, top 2-8 inches	2 feet
Total nitrogen	At depth in IWS layer (>2 feet)	3 feet
Total phosphorus	Top 1-2 feet	2 feet
Pathogens	Top 1-2 feet	2 feet
Metals	Top 1-2 feet	2 feet
Oil and grease	Surface	2 feet
Temperature	At depth	4 feet

Size Surface Area

The footprint of the bioretention area should be calculated after the desired ponding depth and soil media depth have been selected. Bioretention areas should be sized to fully capture the treatment volume (from Appendix A) within the surface ponding zone and subsurface pore space. Available storage in the subsurface soil media and gravel drainage layer should be determined on the basis of the laboratory-measured porosity of materials that will be installed on-site; this information is typically available from suppliers or quarries. The porosity, n , of bioretention media can be estimated as 0.35, and the porosity of ASTM No. 57 gravel can be estimated as 0.40 for preliminary calculations (Brown et al. in press).

$$n = \frac{V_v}{V_T} \quad \text{[Equation B-1-1]}$$

where

- n = porosity (volume/volume)
- V_v = volume of void space
- V_T = total volume

The equivalent storage depth for a unit bioretention cross section can be calculated as follows:

$$D_{eq} = (D_{surface}) + (n_{media} \times D_{media}) + (n_{gravel} \times D_{gravel}) \quad \text{[Equation B-1-2]}$$

where

- D_{eq} = equivalent depth of water stored in representative cross sectional of bioretention
- $D_{surface}$ = average depth of temporary surface ponding (maximum 12 inches)
- n_{media} = porosity of soil media
- D_{media} = depth of soil media
- n_{gravel} = porosity of gravel drainage layer
- D_{gravel} = depth of gravel drainage layer

If the bioretention area is being used for peak flow mitigation, the detention storage depth (volume that will bypass the soil media) cannot be included in $D_{surface}$. More information is provided in [Step 7](#).

The treatment volume (V_{wq}) is divided by the equivalent depth (D_{eq}) to calculate the required bioretention footprint:

$$A = \frac{V_{wq}}{D_{eq}} \quad \text{[Equation B-1-3]}$$

where

- A = required bioretention footprint (area)
- V_{wq} = water quality treatment volume (determined in Appendix A)
- D_{eq} = equivalent depth

Step 5. Specify Soil Media

Bioretention areas are intended to drain to below the surface in less than 24 hours but should be designed to drain in 12 hours or less as a safety factor. Typically the soil media is dewatered in less than 48 hours for plant health. If a gravel drainage layer is included beneath the bioretention area soil media, stored

Appendix B. BMP Design Guidance

runoff in the drainage layer should drain in less than 72 hours. The soils must be allowed to dry out periodically to restore hydraulic capacity to receive flows from subsequent storms, maintain infiltration rates, maintain adequate soil oxygen levels for healthy soil biota and vegetation, and to provide proper soil conditions for biodegradation and retention of pollutants.

Organic matter is considered an additive to help vegetation initially establish and contributes to sorption of pollutants; however, organic materials will oxidize over time causing an increase in ponding that could adversely affect the performance of the bioretention area. Additionally, studies in Texas have demonstrated pollutant leaching when bioretention soils were amended with excessive compost (Li et al. 2010). Organic material should therefore be minimized (less than 5 percent of media volume) and consist of minimal plant-based materials. Organic amendments should *not* include any animal manure or by-products, which can export nutrients and pathogens.

High levels of phosphorus in the media have been identified as the main cause of bioretention areas exporting nutrients (Hunt and Lord 2006). All bioretention media should be analyzed for background levels of nutrients. All soil properties should be measured by a qualified soils laboratory with AASHTO, USACE, or State accreditation.

Soil media should meet the specifications listed in Table B-1-4. If the existing soils meet the criteria, it can be used as the soil media. If the existing soils do not meet the criteria, soils should be amended with the appropriate components or a substitute media must be used.

Table B-1-4. Bioretention soil media specifications (Hunt et al. 2012)

Parameter	Specification
Texture and Composition (by volume)	Soil media should consist of a loamy sand conforming to the following specifications: <ul style="list-style-type: none">• 85 to 88% washed coarse sand (concrete sand passing a one-quarter-inch sieve or thoroughly washed mortar sand passing a one-eighth-inch sieve)• 8 to 12% fines passing a #270 sieve (8% fines typically yields an infiltration rate near 2 in/hr, whereas 12% fines yields an infiltration rate near 1 in/hr)• 2 to 5% organic matter
Organic Matter Material	Aged bark fines, hardwood chips, leaf litter, or similar plant-derived organic material. Studies have also shown newspaper mulch to be an acceptable additive (Kim et al. 2003; Davis 2007). Organic matter should not include animal manure or by-products.
Infiltration Rates	0.5 to 6 in/hr (1-2 in/hr recommended for comprehensive pollutant treatment and hydrologic benefit; Hunt et al. 2012)
pH	6 to 8
Cation Exchange Capacity (CEC)	Greater than 5 milliequivalents (meq)/100 g soil
Phosphorus	Total phosphorus should not exceed 15 ppm

Step 6. Design Inlet and Pretreatment

Inlets must be designed to convey the design storm volume into the bioretention area while limiting ponding or flooding at the entrance to the bioretention area and protecting the interior of the bioretention area from damage. Take care during grading to ensure that the drainage area is properly sloped toward the bioretention area and that the inlet elevation is at least as high as the intended maximum ponding depth (for more information, see [Critical Construction Considerations](#)). In addition to inlet design, pretreatment is critical to remove coarse sediment and debris to prolong the functional life of the soil media. Several

options are available depending on the configuration of the bioretention area and the drainage area characteristics.

Inlets

The way in which runoff is routed to the bioretention area will dictate the type of inlet. If sheet flow constitutes the source of runoff, curb cuts are typically used; design guidance for curb cuts is provided in the [Common Design Elements](#) section. If flows are concentrated, channels or conduit can be used to convey runoff to the bioretention area.

Energy Dissipation and Pretreatment

Design of pretreatment measures will vary depending on the site layout. If sheet flow (such as parking lot runoff) is conveyed to the treatment area, the site must be graded in such a way that minimizes erosive conditions. Gravel fringes between pavement and grassed surfaces can help distribute flow and provide initial pretreatment. Gravel should consist of a 2-inch layer of ASTM No. 57 stone (underlain by filter fabric) extending 2 to 3 feet from the pavement edge, where space allows (Figure B-1-5). Filter strips should ideally be sodded and graded at 3:1 (horizontal:vertical) slopes or flatter. Any slopes that convey flow should be routinely inspected for rill erosion, which can contribute excessive sediment to the bioretention area and often represents the most common maintenance issue (Wardynski and Hunt 2012). Take care to prevent flow from concentrating between parking lot curb stops/blocks.



Louisburg, North Carolina. Source: NCSU B AE

Figure B-1-5. Gravel fringe and vegetated filter strip pretreatment.

Appendix B. BMP Design Guidance

Runoff can be routed to a bioretention area through a vegetated swale to pretreat incoming flows from impervious surfaces. Whenever concentrated flow is conveyed to the bioretention area (via channels or conduit) a rock-armored forebay should be used to dissipate energy and provide pretreatment of gross solids and sediment. Forebays should compose approximately 10 percent of the total bioretention area and should be designed to dewater between storm events to prevent vector hazards (Hunt and Lord 2006, Hunt et al 2007). Armored inlets can be used where space is limited (as shown in Figure B-1-6 and Figure B-1-7).

Bioretention areas that treat runoff from residential roofs or other *cleaner* (low sediment and debris yield) surfaces might not require pretreatment for trash or sediment but should include energy dissipation to the extent practicable. Energy dissipation can be provided by upturning inflow pipes so that they bubble up diffusely onto a rock apron (Figure B-1-8); otherwise, baffles, blocks, or cobbles can be used to still high velocities. Flow velocities should not exceed 3 feet per second (ft/sec) for grassed surfaces and 1 ft/sec for mulched surfaces.



Los Angeles, California. Source: Tetra Tech

Figure B-1-6. Inlet and pretreatment provided by mortared cobble forebay and energy dissipater.



Los Angeles, California. Source: Tetra Tech

Figure B-1-7. Inlets stabilized with mortared cobble.



Chocowinity, North Carolina. Source: Tetra Tech

Figure B-1-8. Upturned inlet from rooftop bubbles up diffusely onto gravel pad.

Step 7. Select the Appropriate Outlet or Bypass Method

Two design configurations (offline or online) can be used for treating storms that are larger than the bioretention area is designed to store. If peak flow cannot be fully mitigated by the flow rate through the soil media, the outlet can be adapted to meter the rate of outflow.

Offline

An offline bioretention area (Figure B-1-9) can be designed such that stormwater bypasses the bioretention area once the capacity has been exceeded. A structure can also be designed that diverts into the bioretention area only the volume of stormwater for which the bioretention area is designed. For more information on diversion structures, see [Common Design Elements](#).

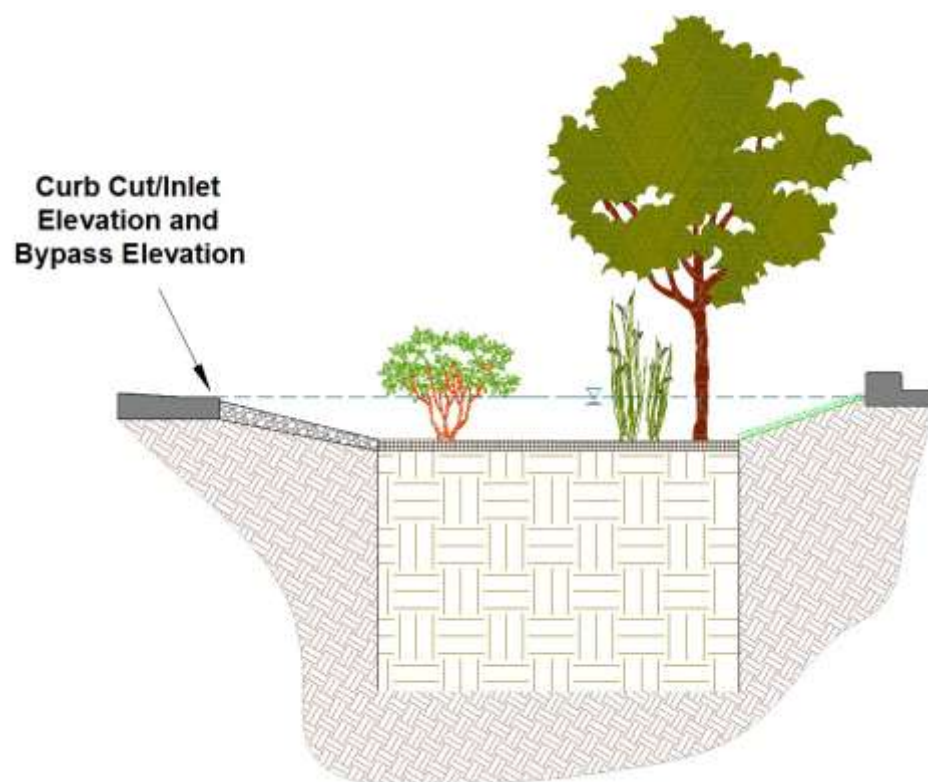

Figure B-1-9. Offline bioretention area where system fills to capacity and excess flow bypasses along curbline at inlet.

Online

For online systems, all flow is routed through the bioretention area and excess runoff overflows an outlet structure. Outlet systems for online bioretention areas can be designed to provide some peak flow mitigation in addition to storing the design volume (see Designing for Peak Flow Mitigation). Appropriate energy dissipation should be incorporated in online systems such that media is not scoured during higher flow events. Two basic options can be used for outlets or overflow for online bioretention systems.

Option 1: Vertical riser

1. An elevated outlet structure (typically an above-grade concrete drop inlet for larger bioretention areas or a PVC pipe for smaller bioretention areas) that is connected to the underdrain or directly to the drainage system.
2. The vertical riser should be sized to safely convey flow greater than the water quality volume. The vertical pipe will provide access for cleaning the underdrains.
3. The inlet to the riser should be set at the specified ponding depth and capped with an appropriate non-clogging grate. Figure B-1-10 shows an example of an online bioretention area with a vertical riser overflow design.

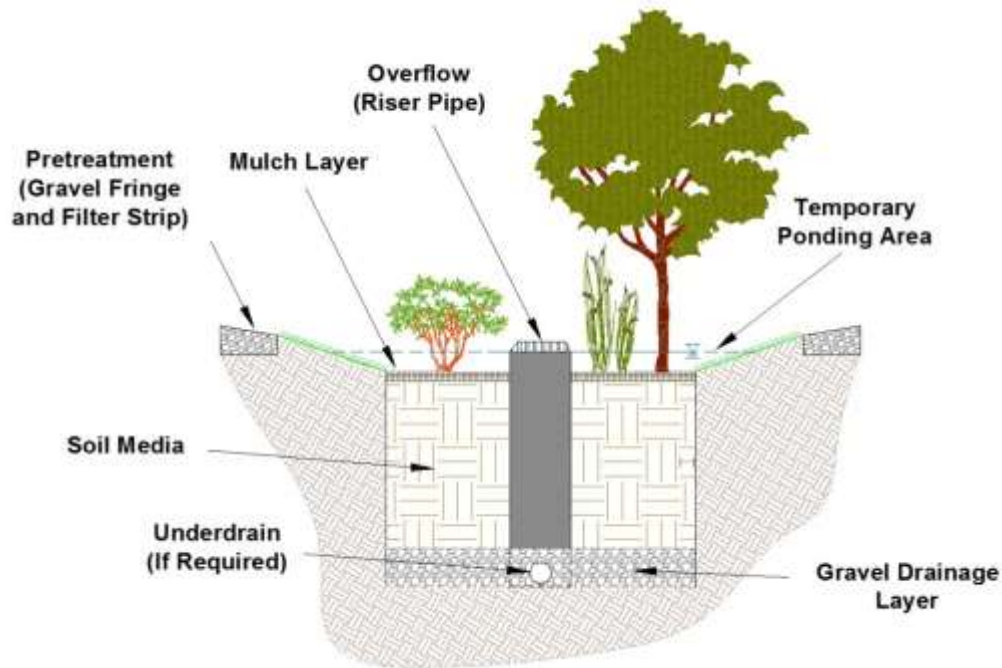

Figure B-1-10. Online bioretention area with a vertical riser overflow with a variable flow outlet structure.

Option 2: Level spreader

1. A level spreader can be used to diffuse overflows from the bioretention area and should be installed along the exit edge or outflow section of the bioretention area. The level spreader should be concrete.
2. The top surface of the level spreader should be installed at a height equal to the ponding depth, or slightly greater if in conjunction with a vertical riser, to allow runoff exceeding the capacity of the bioretention area to safely pass.
3. The level spreader can be designed as a weir to allow for varied outlet flows providing some peak flow mitigation.
4. See [Common Design Elements](#) for details on level spreader design.

Appendix B. BMP Design Guidance

Typically, bioretention areas constructed in the right-of-way should be designed as offline stormwater treatment facilities. Once a bioretention area constructed in the right-of-way has reached capacity, stormwater flows should bypass the system and continue flow in the existing stormwater drainage system or continue to the next BMP. If a bioretention area constructed in the right-of-way requires underdrains, a vertical riser overflow system can be incorporated as the primary overflow method in addition to the bypass.

Designing for Peak Flow Mitigation

Bioretention areas can be designed for peak flow mitigation (according to local regulations, as discussed in Chapter 2) by providing additional storage and, if necessary, modifying the outlet structure to discharge water at a controlled rate. Some additional water can be retained in the system above the water quality treatment volume for a short period without affecting the vegetation. If additional ponding depth is provided to store the flood control volume, maximum ponding depth must not exceed 18 inches. The riser should be designed to mitigate for the required peak flow without exceeding the maximum ponding time of 24 hours. This requirement can be achieved by incorporating an orifice or a weir with its invert at the elevation of the water quality treatment volume ponding depth (Figure B-1-11). Orifices that could be clogged by floating mulch or debris should be protected with a trash rack, a hood, or by installing a downturned pipe (for design of nonclogging orifices, see [Stormwater Wetlands](#)). The volume of water detained above the elevation of the drawdown orifice or weir cannot be credited toward the water quality treatment volume because this excess water will drain untreated to the storm sewer network without filtering through the soil media. Alternatively, underdrain outflow can be regulated using a restrictor plate, and all runoff can be routed through the soil media.



(Left) Fort Pendleton, California. Source: Tetra Tech (Right) Gastonia, North Carolina. Source: Tetra Tech, Inc.

Outlet structures designed for peak flow mitigation in Camp Pendleton, CA (left) where a graduated riser pipe regulates drawdown of the detention volume, and (right) Southwest Middle School, Gastonia, NC, where orifices allow controlled dewatering of the detention volume—the water quality treatment volume is retained below the orifice elevation.

Figure B-1-11. Bioretention outlet structures designed for peak flow mitigation.

Discharge of the detention volume through orifices and weirs can be calculated using the following equations. For further guidance on hydraulic design, refer to USDA-SCS (1956) or Chow (1959).

$$\text{Orifice: } Q = C_d A \sqrt{2gH} \quad [\text{Equation B-1-4}]$$

$$\text{Weir: } Q = CLH^{3/2} \quad [\text{Equation B-1-5}]$$

where

Q = discharge (cubic feet per second)

C_d = coefficient of discharge (0.6 for sharp openings, 0.8 for pipe openings)

A = cross sectional area of orifice (square feet)

g = acceleration due to gravity (32.2 ft/s²)

H = head of water acting on the structure (height of water over the centerline of the orifice or height of water over the crest of the weir; feet)

C = discharge coefficient (3.33 for broad-crested weir, 3.0 for sharp crested weir)

L = total length of weir (perpendicular to flow; feet)

Step 8. Select Mulch and Vegetation

Both mulch and vegetation are critical design components of bioretention areas from hydrologic, water quality, and aesthetic perspectives. Much of the biological activity in bioretention areas occurs in the mulch and root zone. The following subsections provide specifications for mulch and vegetation.

Mulch

Mulch is a critical component of the bioretention area because it provides a food source and habitat for many of the biological organisms critical to the function of the bioretention area. Much of the hydrocarbon, metals, and total suspended solids removal is believed to occur near the surface in the mulch layer (Hong et al. 2006; Hatt et al. 2008; Li and Davis 2008; Stander and Borst 2010). The bioretention area should be covered with mulch when constructed and annually replaced to maintain adequate mulch depth. Mulch is also important to sustain nutrient levels, suppress weeds, retain moisture for the vegetation, and maintain infiltrative capacity. Mulch should meet the following criteria:

- Dimensional chipped hardwood material is preferred for its permeability of both water and air. Well-aged, triple-shredded hardwood material can also be used if dimensional chipped hardwood material is unavailable (well-aged mulch is defined as mulch that has been stockpiled or stored for at least 12 months).
- Free of weed seeds, soil, roots, and other material that is not hardwood material.
- Mulch depth will be 2 to 4 inches thick, with 3 inches preferred (thicker applications can inhibit proper oxygen and carbon dioxide cycling between the soil and atmosphere).
- Grass clippings, pine nuggets, or pure bark should not be used as mulch.



Source: Tetra Tech, Inc

Figure B-1-12. Triple-shredded hardwood mulch.

Vegetation

One advantage of bioretention areas is that they can be used for the dual purpose of stormwater treatment and landscaping or be integrated into the existing landscape. Bioretention areas can be used toward meeting the 40 percent tree canopy cover goal of San Antonio’s *SA2020 Plan*. For bioretention areas to function properly as stormwater treatment and blend into the landscape, vegetation selection is crucial. Appropriate vegetation will have the following characteristics:

1. Plant materials must be tolerant of summer drought and extreme heat, ponding fluctuations, and saturated soil conditions for 12 to 48 hours.
2. It is recommended that a minimum of three tree, three shrub, and three herbaceous groundcover species be incorporated to protect against facility failure from disease and insect infestations of a single species.
3. Vegetation with deep and extensive root systems are more tolerant of extreme hydroperiods and can effectively transpire large volumes of soil water. Planting deep-rooting vegetation directly above buried underdrains should be avoided (although interference of plant roots with underdrains is not a common maintenance issue).
4. Native plant species or hardy cultivars that are not invasive and do not require chemical inputs are recommended to be used to the maximum extent practicable. Only native non-invasive species will be selected in areas designated as natural open space.
5. Shade trees should be free of branches for the bottom 1/3 of their total height and lines of sight must be maintained when planting along roadways.:
6. Tree height and placement should consider overhead utilities.

7. If turfgrass is preferred, sod should be specified that was not grown in clay soils (or washed *bare root* sod should be specified).
8. An example list of native plants appropriate for bioretention areas in the San Antonio region is in Appendix E.

Many options exist for vegetation arrangement and will most likely depend on the landscaping of the area around the bioretention. Size-limited landscaping could be required for bioretention areas in the right-of-way to maintain the required sight distances. Consideration should be given to water depth, bioretention configuration, desired aesthetic appearance, and potential multi-use benefits. An example planting plan is shown in Figure B-1-13 and a full plant list for the San Antonio region is provided in Appendix E.

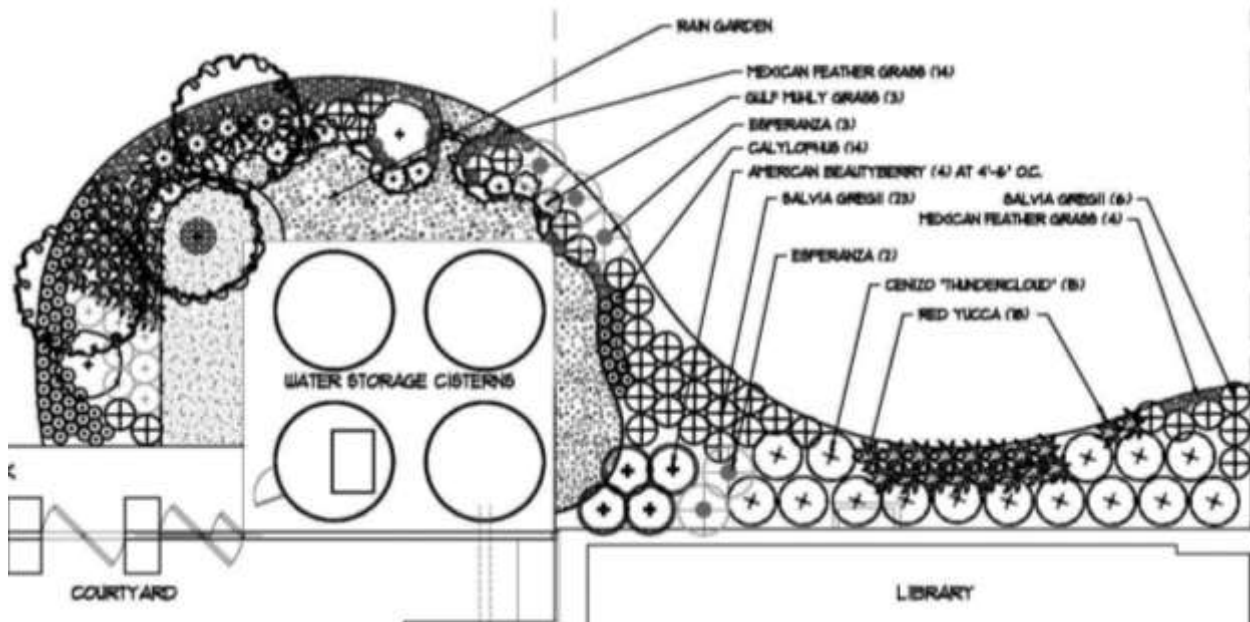

Figure B-1-13. Example bioretention planting plan.

Step 9. Design for Multi-Use Benefits

Bioretention can provide excellent ecosystem services and aesthetic value to stakeholders. In addition to enhancing biodiversity and beautifying the urban environment with native vegetation, the following components can be incorporated into bioretention to promote multi-use benefits:

- Simple signage or information kiosks can educate the public on the benefits of watershed protection measures or provide a guide for native plant and wildlife identification (Figure B-1-14).
- Bird and butterfly feeders can be used to attract wildlife to the bioretention area.
- Sculptures and other art can be installed in the bioretention area, and outlet structures can be painted lively colors.
- Bioretention along the roadway (pop outs and curb extensions) can serve as a traffic calming features

Appendix B. BMP Design Guidance

- Ornamental plants can be cultivated along the perimeter and in the bed of bioretention areas (invasive plants should be avoided).
- Larger bioretention areas can be equipped with pedestrian cross-paths or benches for wildlife viewing (Figure B-1-15).
- Bioretention areas can function as irrigation beds for stormwater captured by other BMPs, such as rainwater harvesting or the reservoir layer of permeable pavement (Figure B-1-16).
- Vegetation with canopy cover can provide shade, localized cooling, and noise dissipation.
- Volunteer groups can be organized to perform basic maintenance as an opportunity to raise public awareness.



Philadelphia, Pennsylvania. Source: Tetra Tech

Figure B-1-14. Signage posted in front of ultra-urban bioretention area raises public awareness.



Offices of Bender Wells Clark Design, San Antonio. Source: Bender Wells Clark Design

Figure B-1-15. Cobbled bioretention area that invites pedestrian interaction.



Mission Library, San Antonio. Source: Bender Wells Clark Design

Figure B-1-16. Overflow from a rainwater cistern is discharged to a cobbled bioretention area.

1.2 Critical Construction Considerations

Construction technique and sequencing are critical to bioretention cell performance. Failure of improperly constructed systems can be easily avoided by effective communication with the contractor and by inspection during key steps. In addition to the general construction considerations provided in Chapter 4, emphasizing the following points will help ensure successful installation of bioretention cells.

1.2.1 Minimize and Mitigate Compaction by Scarifying Subsoil Surface

Compaction of underlying soils (an inherent consequence of construction) can decrease infiltration rates and result in poor drainage, extended periods of standing water, plant die-off, and, in some cases, leaching of previously captured pollutants. Construction effects on underlying soils can be mitigated by excavating the last 12 inches of cut with a toothed excavator bucket. This method breaks up compacted layers and prevents *smearing*, which can seal the subsoil surface (Brown and Hunt 2010). Infiltration can also be significantly enhanced by ripping or trenching the subsoils to a depth of 9–12 inches (Tyner et al. 2009). Ripped furrows (on 3-foot centers) should be filled with a clean sand to maintain free-flowing conditions. Trenches are typically constructed 12 inches wide on 6-foot centers and are filled with pea gravel.

1.2.2 Inspect Soil Media before Placement

It is important to ensure that the soil media is consistent with specifications before installation—media that is too sandy will not provide adequate treatment, whereas media that is too fine might not drain in adequate time (Carpenter and Hallam 2010). To field-verify the texture of soil media, moisten the soil and form into a 1-inch ball. Drop the ball from 1 foot onto the open palm of the hand. The ball should break apart on impact, indicating that it is a sandy soil. When rubbed between the fingers, the moist soil should also leave a thin layer of mud residue on the skin, indicating that fines are present in the mix. Soil media should also contain a small amount of plant-based organic matter evenly distributed throughout the mix—the organic matter should not smell like manure. Note: These inspection techniques are intended for field verification and do *not* substitute for laboratory soil test results.

1.2.3 Verify that Average Ponding Depth is Provided

It is important to verify that the intended design volume of runoff can be captured by the bioretention cell. Contractors who are unfamiliar with construction of bioretention may try to minimize surface ponding by installing the outlet elevation too low. Cells that do not provide their intended capacity of surface storage will overflow more often than intended and discharge untreated runoff to waterways (Brown and Hunt 2011b; Luell et al. 2011). Therefore, it is critical to check that the average surface ponding depth has been provided and that the bed of the cell has been uniformly graded—this can be performed by simply verifying the overflow/bypass elevation of the system relative to the average elevation of the mulch bed surface. An average depth must be measured because the height of the outlet structure relative to adjacent ground surface is not a reliable indicator of average ponding depth (Wardynski and Hunt 2012). Excessive mulch (deeper than 4 inches) can also displace surface storage volume and should be avoided.

1.3 Operation and Maintenance

Bioretention areas require regular plant, soil, and mulch layer maintenance to ensure optimum infiltration, storage, and pollutant-removal capabilities. Table B-1-5 provides a detailed list of maintenance activities and general maintenance considerations are provided in Section 4.3. In general, bioretention maintenance requirements are typical landscape care procedures and consist of the following:

1. Erosion control: Inspect flow entrances, ponding area, and surface overflow areas periodically during the rainy season, and replace soil, plant material, or mulch layer in areas if erosion has occurred (for a bioretention inspection and maintenance checklist, see Appendix F). Properly

designed facilities with appropriate flow velocities should not have erosion problems except perhaps in extreme events. If erosion problems occur, the following must be reassessed: (1) flow velocities and gradients within the cell, and (2) flow dissipation and erosion protection strategies in the pretreatment area and flow entrance. If sediment is deposited in the bioretention area, immediately determine the source within the contributing area, stabilize, and remove excess surface deposits. Any exposed soil in the catchment should be permanently stabilized with grass, rock, or other erosion-resistant materials (per TxDOT 2011).

2. **Inlet:** The inlet of the bioretention area should be inspected after the first storm of the season, then monthly during the rainy season to check for sediment accumulation and erosion. Sediment can accumulate especially at inlets where curb cuts or bypass structures are used and should be inspected regularly. Any accumulated sediment that impedes flow into the bioretention area should be removed and properly disposed of.
3. **Overflow and underdrains:** Sediment accumulation in the overflow device or underdrain system can cause prolonged ponding and potential flooding. Excess ponding can have adverse effects on vegetation and vector control. Overflow and underdrain systems should be inspected after the first storm of the season, then monthly during the rainy season to remove sediment and prevent mulch accumulation around the overflow. The underdrain system should be designed so that it can be flushed and cleaned as needed. If water is ponded in the bioretention area for more than 72 hours, the underdrain system should be flushed with clean water until proper infiltration is restored.
4. **Plant material:** Depending on aesthetic requirements, occasional pruning and removing dead plant material might be necessary. Replace all dead plants, and if specific plants have a high mortality rate, assess the cause and, if necessary, replace with more appropriate species. Periodic weeding is necessary until plants are established. The weeding schedule can become less frequent if the appropriate plant species and planting density have been used and, as a result, undesirable plants are excluded.
5. **Nutrient and pesticides:** The soil mix and plants are selected for optimum fertility, plant establishment, and growth. Nutrient and pesticide inputs should not be required and can degrade the pollutant processing capability of the bioretention area and contribute pollutant loads to receiving waters. By design, bioretention areas are located in areas where phosphorous and nitrogen levels are often elevated, and they should not be limiting nutrients. If in question, have the soil analyzed for fertility.
6. **Mulch:** Replace mulch annually in bioretention areas where heavy metal deposition is likely (e.g., contributing areas that include industrial and auto dealer/repair parking lots and roads). In areas where metal deposition is not a concern, add mulch as needed to maintain a 2- to 3-inch depth. Mulch should be replaced every 2 to 5 years.
7. **Soil:** Soil mixes for bioretention areas are designed to maintain long-term fertility and pollutant processing capability. Estimates from metal attenuation research suggest that metal accumulation should not present an environmental concern for at least 20 years in bioretention systems. Replacing mulch in bioretention areas where heavy metal deposition is likely provides an additional level of protection for prolonged performance. If in question, have the soil analyzed for fertility and pollutant levels and consult local regulations for disposal protocol.
8. **Watering:** Plants must be selected to be drought tolerant and not require watering after establishment (2 to 3 years). Watering could be required during prolonged dry periods after plants are established.

Appendix B. BMP Design Guidance

Table B-1-5. Inspection and maintenance tasks

Task	Frequency	Indicator maintenance is needed	Maintenance notes
Catchment inspection	Weekly or biweekly with routine property maintenance	Excessive sediment, trash, or debris accumulation on the surface of bioretention.	Permanently stabilize any exposed soil and remove any accumulated sediment. Adjacent pervious areas might need to be regraded.
Inlet inspection	Weekly or biweekly with routine property maintenance	Internal erosion or excessive sediment, trash, and/or debris accumulation	Check for sediment accumulation to ensure that flow into the bioretention is as designed. Remove any accumulated sediment.
Litter and leaf litter removal	Weekly or biweekly with routine property maintenance	Accumulation of litter and leafy debris within bioretention area	Litter and leaves should be removed to reduce the risk of outlet clogging, reduce nutrient inputs to the bioretention area, and to improve facility aesthetics.
Pruning	1–2 times/year	Overgrown vegetation that interferes with access, lines of sight, or safety	Nutrients in runoff often cause bioretention vegetation to flourish.
Mowing	2–12 times/year	Overgrown vegetation that interferes with access, lines of sight, or safety	Frequency depends on location and desired aesthetic appeal.
Mulch removal and replacement	1 time/2–3 years	Less than 3 inches of mulch remains on surface	Mulch accumulation reduces available surface water storage volume. Removal of decomposed mulch also increases surface infiltration rate of fill soil. Remove decomposed fraction and top off with fresh mulch to a total depth of 3 inches
Temporary Watering	1 time/2–3 days for first 1–2 months, sporadically after established	Until established and during severe droughts	Watering after the initial year might be required.
Fertilization	1 time initially	Upon planting	One-time spot fertilization for first year vegetation.
Remove and replace dead plants	1 time/year	Dead plants	Plant die-off tends to be highest during the first year (commonly 10% or greater). Survival rates increase with time.
Outlet inspection	Once after first rain of the season, then monthly during the rainy season	Erosion at outlet	Remove any accumulated mulch or sediment.
Miscellaneous upkeep	12 times/year	Tasks include trash collection, plant health, spot weeding, removing invasive species, and removing mulch from the overflow device.	

1.4 References

- Barrett, M.E., M. Limouzin, and D.F. Lawler. 2012. Effects of media and plant selection on biofiltration performance *Journal of Environmental Engineering* 139(4):462-470.
- Barrett, M.E. 2005. *Complying with the Edwards Aquifer Rules. Technical Guidance on Best Management Practices*. RG-348. Prepared for Texas Commission on Environmental Quality, Field Operations Division, Austin, TX.
- Brown, R.A., and W. F. Hunt. 2010. Impacts of construction activity on bioretention performance. *Journal of Hydrologic Engineering* 15(6):386–394.
- Brown, R.A., Skaggs, R.W., and Hunt, W.F. In press. Calibration and validation of DRAINMOD to model bioretention hydrology. *Journal of Hydrology*.
- Brown, R.A., and W.F. Hunt. 2011a. Underdrain configuration to enhance bioretention exfiltration to reduce pollutant loads. *Journal of Environmental Engineering* 137(11):1082–1091.
- Brown, R.A., and W. F. Hunt. 2011b. Impacts of media depth on effluent water quality and hydrologic performance of under-sized bioretention cells. *Journal of Irrigation and Drainage Engineering* 137(3):132–143.
- Brown, R. A. and W. F. Hunt. 2010. Impacts of construction activity on bioretention performance. *Journal of Hydrologic Engineering* 15(6): 386-394.
- Carpenter, D.D., and L. Hallam. 2010. Influence of planting soil mix characteristics on bioretention cell design and performance. *Journal of Hydrologic Engineering* 15(6):404–416.
- Chow, V.T. 1959. *Open-Channel Hydraulics*. McGraw-Hill, New York, NY.
- Davis, A.P. 2007. Field performance of bioretention: Water quality. *Environmental Engineering Science* 24(8):1048–1063.
- Hatt, B.E., T.D. Fletcher, and A. Deletic. 2008. Hydraulic and pollutant removal performance of fine media stormwater filtration systems *Environmental Science & Technology* 42(7):2535–2541.
- Heasom, W., R. Traver, and A. Welker. 2006. Hydrologic modeling of a bioinfiltration best management practice. *Journal of the American Water Resources Association* 42(5):1329–1347.
- Houdeshel, C.D., C.A. Pomeroy, and K.R. Hultine. 2012. Bioretention design for xeric climates based on ecological principles. *Journal of the American Water Resources Association* 48(6):1178–1190.
- Hong, E., M. Seagren, and A.P. Davis. 2006. Sustainable oil and grease removal from synthetic stormwater runoff using bench-scale bioretention studies. *Water Environment Research*. 78(2):141-155.
- Hunt, W.F., and W.G. Lord. 2006. *Bioretention performance, design, construction, and maintenance*, North Carolina Cooperative Extension, Raleigh, NC.
- Hunt, W.F., A.P. Davis, and R.G. Traver. 2012. Meeting hydrologic and water quality goals through targeted bioretention design. *Journal of Environmental Engineering* 138(6):698–707.

Appendix B. BMP Design Guidance

- Kim, H., E.A. Seagren, and A.P. Davis. 2003. Engineered bioretention for removal of nitrate from stormwater runoff. *Water Environment Research* 75(4):355–367.
- Li, H., and A.P. Davis. 2008. Urban particle capture in bioretention media. I: Laboratory and field studies. *Journal of Environmental Engineering* 143(6):409–418.
- Li, M.-H., C.Y. Sung, M.H. Kim, and K.-H. Chu. 2010. *Bioretention for Stormwater Quality Improvements in Texas: Pilot Experiments*. Texas A&M University in cooperation with Texas Department of Transportation and the Federal Highway Administration.
- Luell, S.K., W.F. Hunt, and, R.J. Winston. 2011. Evaluation of undersized bioretention stormwater control measures (SCMs) for treatment of highway bridge deck runoff. *Water Science and Technology* 64(4):974–979.
- Stander, E.K., and M. Borst. 2010. Hydraulic test of a bioretention media carbon amendment. *Journal of Hydrologic Engineering* 15(6):531–536.
- Tyner, J.S., W.C. Wright, and P.A. Dobbs. 2009. Increasing exfiltration from pervious concrete and temperature monitoring. *Journal of Environmental Management* 90:2636–2641.
- USDA-SCS (United States Department of Agriculture Soil Conservation Service). 1956. Section 5 Hydraulics. National Engineering Handbook. 210-VI-NEH-5.
<ftp://ftp.wcc.nrcs.usda.gov/wntsc/H&H/NEHhydraulics/neh5.pdf>
- Wardynski, B.J., and W.F. Hunt. 2012. Are bioretention cells being installed per design standards in North Carolina: A field assessment. *Journal of Environmental Engineering* 138(12):1210–1217.

2 Bioswales



Bioswale at Elmer Avenue, Los Angeles, California. Source: Tetra Tech

2.1 Design

The design of a bioswale is very similar to a bioretention area and can similarly be broken down to a nine-step process, as outlined in Table B-2-1. Unlike [vegetated swales](#) that provide limited horizontal filtration and sedimentation, bioswales are intended to filter runoff vertically through soil media; conveyance should be considered a secondary design element.

Table B-2-1. Iterative design step process

Design step		Design component/ consideration	General specification
1	Determine BMP Size	Use Appendix A	
2	BMP Siting (B-29)	Based on available space and maintenance access, incorporate into parking lot islands, medians, and perimeter; install along the roadway right-of-way; incorporate as landscaped areas throughout the property.	
3	Determine BMP Function and Configuration (B-30)	Impermeable liner	If non-infiltrating (per geotechnical investigation), use impermeable clay liner, geomembrane, or concrete (as described in Common Design Elements).
		Lateral hydraulic restriction barriers	Use concrete or geomembrane to restrict lateral seepage to adjacent subgrades, foundations, or utilities.
		Underdrain (required if subsoil infiltration rate is less than 0.5 in/hr)	Schedule 40 PVC pipe with perforations (slots or holes) every 6 inches. 4-inch diameter lateral pipes should join a 6-inch collector pipe, which conveys drainage to the downstream storm network. Provide cleanout ports/observation wells for each underdrain pipe at spacing consistent with local regulations. See Common Design Elements
		Internal water storage (IWS)	If using underdrain and infiltration, elevate the outlet to create a sump for additional moisture retention to promote plant survival and treatment. Top of IWS should be greater than 18 inches below surface.
		No underdrain	If design is fully infiltrating, ensure that subgrade compaction is minimized.
4	Size the System (B-32)	Temporary ponding depth	Use check dams to provide 6-18 inches surface ponding (6-12 inches near schools or in residential areas); average ponding depth of 9 inches is recommended
		Soil media depth	2-4 feet (deeper for better pollutant removal, hydrologic benefits, and deeper rooting depths)
		Slope and grade control	If necessary, use check dams to maintain maximum 2% bed slope. Install a 4-inch deep layer of ASTM No. 57 stone (underlain by filter fabric) extending 2 feet downslope from check dam to prevent erosion.
		Surface area	Accounting for slope, find surface area required to store treatment volume within temporary ponding depth, soil media depth, and gravel drainage layer depth (media porosity \approx 0.35 and gravel porosity \approx 0.4)
5	Specify Soil Media (B-34)	Media composition and texture	85-88% sand, 8-12% fines, 2-5% plant-derived organic matter (animal wastes or by-products should not be applied)
		Media permeability	1-6 in/hr infiltration rate (1-2 in/hr recommended)
		Chemical analysis	Total phosphorus < 15 ppm, pH 6-8, CEC > 5 meq/100 g soil
		Drainage layer	Separate soil media from underdrain with 2–4 inches of washed concrete sand (ASTM C33), followed by 2 inches of choking stone (ASTM No. 8) over a 1.5 ft envelope of ASTM No. 57 stone.

Design step		Design component/ consideration	General specification
6	Design Inlet and Pretreatment (B-34)	Inlet	Provide stabilized inlets (see Common Design Elements)
		Pretreatment	Install rock armored forebay (concentrated flow), gravel fringe and vegetated filter strip (sheet flow), or vegetated swale
7	Select and Design Overflow/Bypass Method (B-34)	Outlet configuration	Online: All runoff is routed through system—install an elevated overflow structure or weir at the elevation of maximum ponding Offline: Only treated volume is diverted to system—install a diversion structure or allow bypass of high flows
		Peak flow mitigation	Provide additional detention storage and size an appropriate non-clogging orifice or weir to dewater detention volume
8	Select Mulch and Vegetation (B-35)	Mulch	Dimensional chipped hardwood or triple shredded, well-aged hardwood mulch 3 inches deep.
		Vegetation	See Plant List (Appendix E)
9	Design for Multi-Use Benefits (B-36)	Include features to enhance habitat, aesthetics, public education, and shade.	

Step 1. Determine the Volume of Water and Flow Rates to Treat

The bioswale must be sized to fully capture the desired or required design storm volume and filter it through the soil media. Relevant regulatory requirements are presented in detail in Chapter 2. Surface storage (in the ponding area) and soil pore space (in the plant rooting zone and the underlying media and gravel drainage layers) provide capacity for the design storm volume retention. Appendix A outlines methods for determining design runoff depths associated with a range of annual treatment efficiencies. Once the design runoff depth is determined (on the basis of the desired level of treatment), a runoff volume can be determined for the contributing watershed using this depth and the methods outlined in Appendix A, *San Antonio Unified Development Code*, or *San Antonio River Basin Regional Modeling Standards for Hydrology and Hydraulic Modeling*.

Peak flow rates for the design storm should also be calculated, using the methods outlined in Appendix A so that the inlet and pretreatment can be accordingly sized and flow attenuation can be considered.

Step 2. BMP Siting

Bioswales are intended to provide the same function as a bioretention area with the same pollutant-removal capacity with a narrow width to be more easily configured into the site plan for parking lot edges and narrow rights-of-way. Bioswales are a versatile stormwater BMP because they can effectively reduce pollutants and can be integrated into the site plan with various configurations and components. Stormwater treatment should be considered as an integral component and incorporated in the site design and layout from conception. Many times, determining how the bioswale will be included in the site design is a critical and required first step. How the water is routed to the bioswale and the available space will be key components in determining how the bioswale will be configured. Access for maintenance activities must also be provided. Site assessment, planning, and site design are discussed in detail in Section 1.6. The following is a list of settings where bioswales can be incorporated to meet more than one project-level or watershed-scale objective:

- Along the edge and between parking stalls in parking lots
- Within rights-of-way along roads

Appendix B. BMP Design Guidance

How the bioswale is configured determines the required components. Pretreatment at some level is always recommended to remove gross solids where possible and reduce flows to a non-erosive rate. Curb cuts can be required to allow stormwater to enter the bioswale, while providing some delineation in high-traffic areas. Bioswales can serve the dual purpose of stormwater management and landscape design and can significantly enhance the aesthetics of a site. Figure B-2-1 shows an example of the components of a typical bioswale. Bioswales typically have multiple components including the following:

- Filter strip or grass buffer for pretreatment
- Media layer for filtration
- Ponding area for storage
- Plants for pollutant uptake and landscaping

In addition, bioswales can be combined with other BMPs to form a treatment train that can provide enhanced water quality treatment and reductions in runoff volume and rate. For example, runoff can be collected from a roadway or a parking lot in a bioswale that then overflows to a bioretention area. Both facilities can be reduced in size on the basis of demonstrated performance for meeting the stormwater runoff requirements as outlined in Chapter 2 and addressing targeted pollutants of concern.

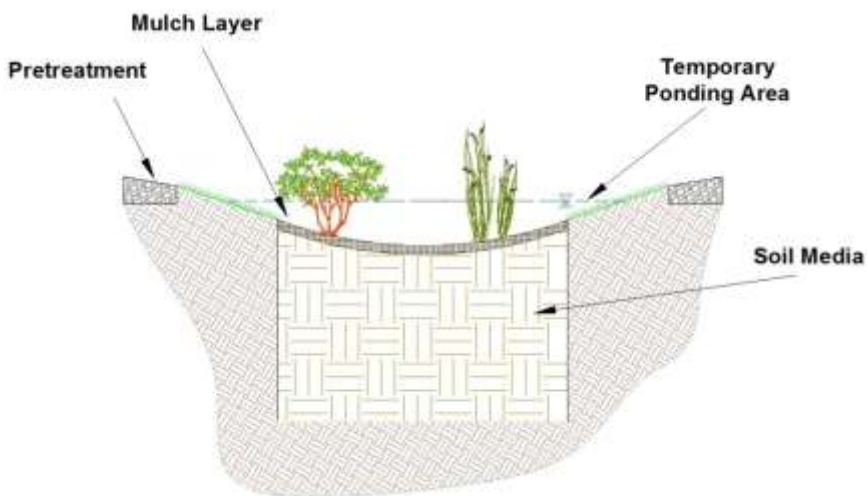
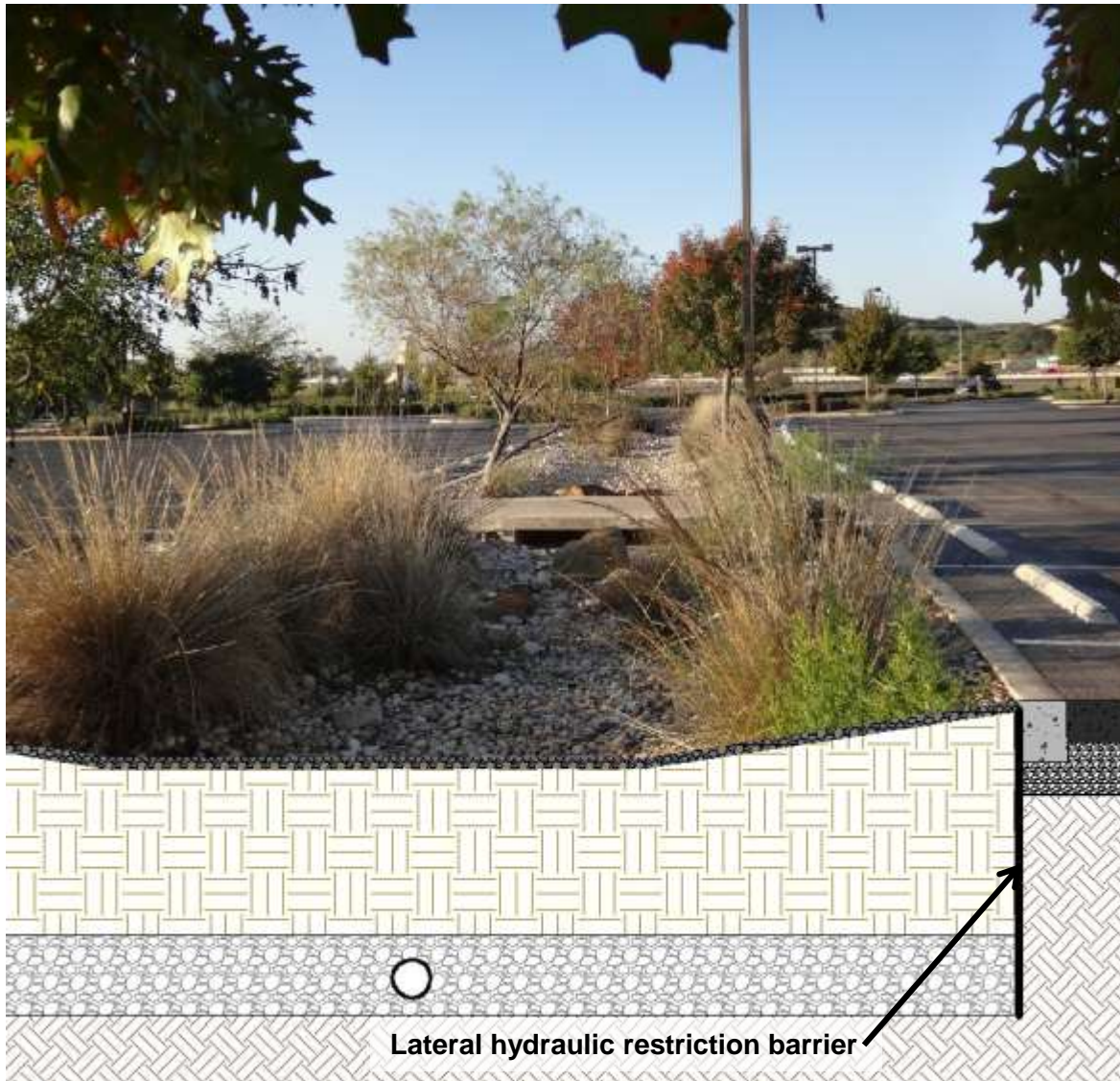

Figure B-2-1. Bioswale components.

Step 3. Determine BMP Function and Configuration

Bioswales can be designed as infiltrating or filtering BMPs, similar to [bioretention](#). Because of the narrow configuration of a bioswale and its intended use along the edges of parking lots and roads, infiltration pathways will most likely need to be restricted to prevent unintended effects on roads, foundations, other infrastructure, or hotspot locations. In some conditions, lateral seepage can cause damage to surrounding structures depending on the type of soils in the area (Figure B-2-2). Areas that have a potential for settling under saturated conditions, as determined in the geotechnical investigation, should be protected from lateral flows. Types of clay that have a high potential for expansion when saturated should be protected from moisture in load-bearing conditions. For details on hydraulic restriction barriers, see [Common Design Elements](#).

Where infiltration is allowed, IWS can be used to enhance exfiltration, pollutant removal, and soil moisture for plant health (Li et al. 2010; Brown and Hunt 2011; Barrett et al. 2012; Houdeshel et al. 2012). As with [bioretention](#), the IWS zone should be at least 18 inches below the surface throughout the length of the bioswale. Excavating the subgrade in tiers and creating partitions between cells of the bioswale will further improve performance by providing more uniform exfiltration across the subgrade (as illustrated in Figure B-2-3).



Bioswale at Rim Retail Center, San Antonio, Texas

Figure B-2-2. Example bioswale cross section with hydraulic restriction barrier to prevent lateral seepage to adjacent pavement subgrade.

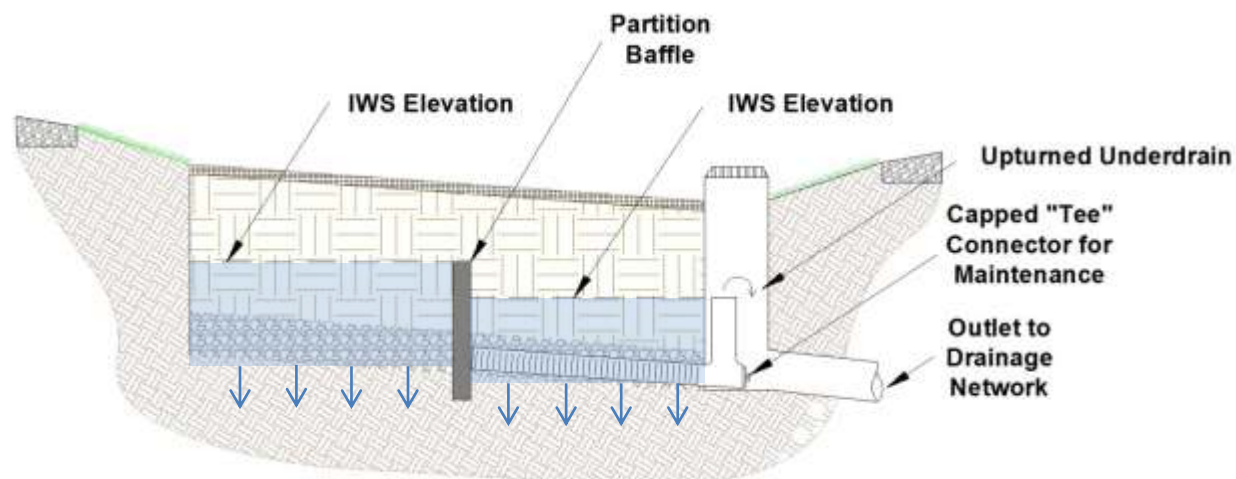

Figure B-2-3. Bioswale incorporating IWS and a partition baffle to enhance exfiltration.

Step 4. Size the System

The bioswale water quality treatment volume can be determined by using Appendix A. The following subsections discuss sizing bioswales for water quality and conveyance.

Geometry, Temporary Ponding Depth, and Soil Media Depth

Bioswale dimensions have similar standards to bioretention areas except that they are typically long and narrow with widths between 2 and 8 feet. Bioswales have a maximum ponding depth of 18 inches, with an average depth of 9 inches. Soil media depth should be specified according to the pollutant of concern, hydrologic goals, and drainage configuration, as outlined in the [bioretention](#) section.

Slope and Grade Control

Bioswales are to be sized to capture and treat the volume produced by the design storm and, where site conditions allow, should also be sized to infiltrate the volume-reduction requirement. For the stormwater runoff requirements and calculations, see Appendix A. If the bioswale will have longitudinal slope (parallel to flow), flow velocity should generally not exceed 1 ft/sec in mulched swales and 3 ft/sec in grassed swales and the shear stress should not exceed the permissible shear stress of the bed materials, as suggested in TxDOT (2011). Guidance for calculating flow velocity is provided in the [vegetated swales](#) section. Check dams might be required to ensure retention and infiltration of the design storm volume into the soil media. The maximum bed slope of the bioswale may not exceed 2 percent to prevent erosion, but bioswales with check dams may contain average slopes (from upslope to downslope end) of up to 5 percent (the bed slope of each section between check dams must be 2 percent or less). Check dams should be adequately embedded in the side slopes and can be constructed of concrete, metal sheet pile, or wood (Figure B-2-4). Earthen and stone check dams should not be used because of risk of erosion. The area downslope of check dams should be armored with at least a 4-inch-deep gravel or cobble layer extending 2 feet from the base of the check dam (as shown in Figure B-2-5). Gravel should consist of No. 57 stone and should be underlain by geotextile to prevent scour and erosion of underlying soil. Cobble can be mortared to prevent removal.



Los Angeles, California. Source: Tetra Tech
Figure B-2-4. Bioswale with a check dam.

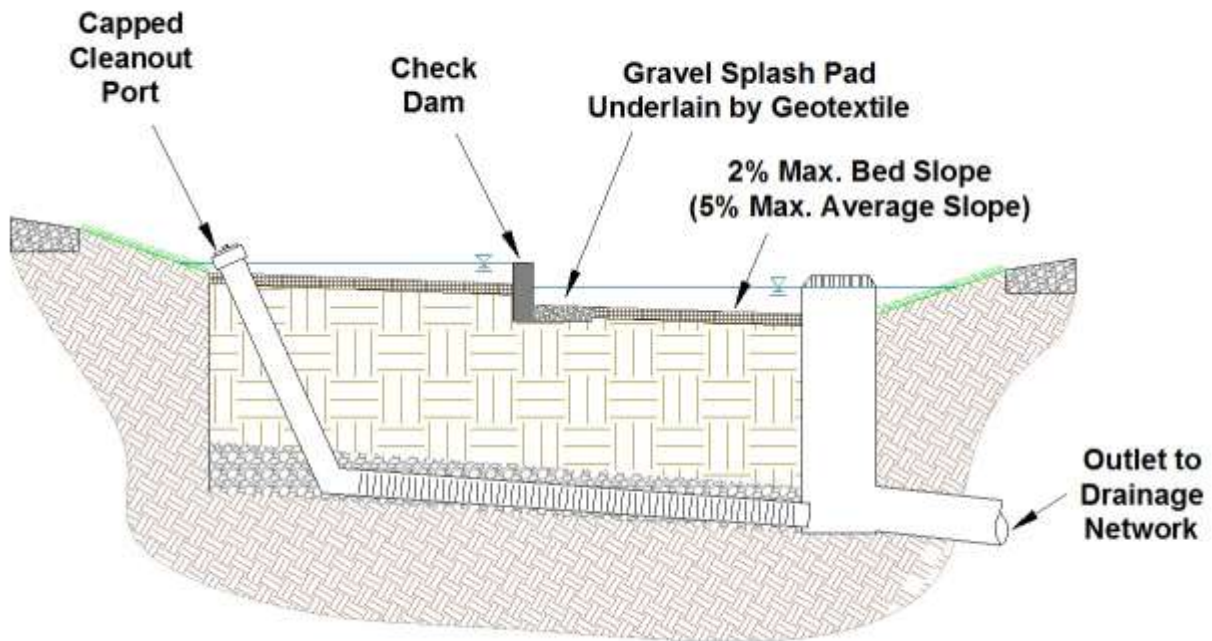

Figure B-2-5. Example profile of a bioswale with a check dam to retain the design storm volume.

Appendix B. BMP Design Guidance

Size surface area

The footprint of the bioswale should be calculated following the methods provided in the [bioretention](#) section, but slope must be taken into account when specifying an average ponding depth. The required surface area can be calculated using the equations in the [bioretention](#) section assuming a nine-inch ponding depth. The swale configuration should be adjusted to attain the desired surface area. If the bed of the bioswale is sloped, the required number of check dams to create the desired ponding depth can be estimated using the following equations:

$$N = \frac{L_{swale} \times S}{h_{dam}} \quad \text{[Equation B-2-1]}$$

$$L_{dam} = \frac{L_{swale}}{N} \quad \text{[Equation B-2-2]}$$

where

N = number of check dams required

L_{swale} = total length of bioswale (ft)

S = longitudinal slope of bioswale (ft/ft)

$h_{dam} = (2 \times D_{surface})$ = height of check dams (ft; use a maximum height of 1.5)

L_{dam} = distance between check dams (ft)

The above equation is simplified and should be adjusted on the basis of specific site conditions and bioswale configuration. The slope of a site can vary, the number of check dams required should be calculated separately for each significant change in slope.

Step 5. Specify Soil Media

The soil media in the bioswale should meet the requirements specified in the [bioretention](#) section.

Step 6. Design Inlet and Pretreatment Configuration

Inlets must be designed to convey the design storm volume into the bioswale while limiting ponding or flooding at the entrance and protecting the interior from damage. Several options are available depending on the configuration of the bioswale. Ideally, runoff will pass over a filter strip where flow can be dispersed and gross solids removed before it enters the bioswale. That is not always possible, especially in retrofit situations where space might not be available. Methods used for designing [bioretention inlets and pretreatment](#) are applicable to bioswales. Typical inlet configurations are also described in [Common Design Elements](#).

Step 7. Select the Appropriate Outlet or Bypass Method

Bioswales, like bioretention, can be designed as either offline or online systems (for design guidance, see [bioretention](#)). Examples of offline and online bioswales are shown in Figure B-2-6. When flows through a bioswale could exceed the recommended maximum flow rates, regardless of whether a system is designed to be online or offline, a bypass structure is recommended to prevent erosion in the bioswale. The flow velocity in a mulched system should not exceed 1 ft/sec, and flow in a grassed system should not exceed 3 ft/sec. Flows can be greater (up to 14 ft/sec) with the use of reinforced turf matting and will depend on the matting selected. Flow rate can be calculated using methods in TxDOT (2011).



Rosemead Boulevard, Los Angeles, California. Source: Tetra Tech (Right) Dallas, North Carolina. Source: Tetra Tech

Figure B-2-6. Left: An offline bioswale along the road right of way (excess flow bypass along gutterline). Right: An online bioswale with an overflow outlet structure along a roadway and parking lot (this practice is used in a treatment train with an adjacent detention basin).

Step 8. Select Mulch and Vegetation

Both mulch and vegetation are critical design components of bioswales from hydrologic, water quality, and aesthetic perspectives. The following subsections provide specifications for mulch and vegetation.

Mulch

Bioswales intended to be mulched must be covered with mulch when constructed and annually replaced to maintain adequate mulch depth. Mulch can help sustain nutrient levels, suppress weeds, and maintain infiltrative capacity. Mulch should meet the specifications provided in the [bioretention](#) section.

Vegetation

One advantage of a bioswale, similar to bioretention areas, is that they can be used for the dual purpose of stormwater treatment and landscaping or be integrated into the existing landscape. For bioswales to function properly as stormwater treatment and blend into the landscaping, vegetation selection is crucial. Appropriate vegetation will have the following characteristics:

1. Plant materials must be tolerant of summer drought, ponding fluctuations, and saturated soil conditions for 10 to 48 hours.
2. It is recommended that a minimum of three tree, three shrub, and three herbaceous groundcover species be incorporated to protect against facility failure from disease and insect infestations of a

Appendix B. BMP Design Guidance

single species. Plant rooting depths must not damage the underdrain, if present. Slotted or perforated underdrain pipe must be more than 5 feet from tree locations (if space allows).

3. Native plant species or hardy cultivars that are not invasive and do not require chemical inputs are recommended to be used to the maximum extent practicable.
4. Shade trees should be free of branches for the bottom 1/3 of their total height and lines of sight must be maintained when planting along roadways.
5. A list of native plants appropriate for San Antonio is in Appendix E.

Endless options for vegetation arrangement are available, and the one chosen will most likely depend on the landscaping of the area around the bioswale.

Step 9. Designing for Multi-Use Benefits

Because of their adaptability to many different settings, bioswales can be designed to provide all of the beneficial uses specified in the [bioretention](#) section.

2.2 Critical Construction Considerations

Construction technique and sequencing are critical to bioretention cell performance. For construction and implementation notes, see [bioretention](#) and Chapter 4.

2.3 Operation and Maintenance

Bioswales, similar to bioretention areas, require regular plant, soil, and mulch layer maintenance to ensure optimum infiltration, storage, and pollutant-removal capabilities. Table B-2-2 lists maintenance tasks for bioswales. In general, bioswale maintenance requirements are typical landscape care procedures and consist of the following:

1. Erosion control: Inspect flow entrances, ponding area, and surface overflow areas periodically during the rainy season, and replace soil, plant material, or mulch layer in areas if erosion has occurred (for a bioswale inspection and maintenance checklist, see Appendix F). Properly designed facilities with appropriate flow velocities will not have erosion problems except perhaps in extreme events. If erosion problems occur, the following must be reassessed: (1) flow velocities and gradients within the cell, and (2) flow dissipation and erosion protection strategies in the pretreatment area and flow entrance. If sediment is deposited in the bioswale, immediately determine the source in the contributing area, stabilize, and remove excess surface deposits. Any exposed soil in the catchment should be permanently stabilized with grass, rock, or other erosion-resistant materials per TxDOT (2011).
2. Inlet: The inlet area should be inspected after the first storm of the season, then monthly during the rainy season to check for sediment accumulation and erosion. Sediment can accumulate especially at inlets where curb cuts or bypass structures are used and should be inspected regularly. Any accumulated sediment that impedes flow into the bioswale should be removed and properly disposed of.
3. Overflow and underdrains: Sediment accumulation in the overflow device or underdrain system can cause prolonged ponding and potential flooding. Excess ponding can have adverse effects on vegetation and vector control. Overflow and underdrain systems should be inspected after the first storm of the season, then monthly during the rainy season to remove sediment and prevent mulch accumulation around the overflow. The underdrain systems should be designed so that it can be

flushed and cleaned as needed. If water is ponded in the bioswale for more than 72 hours, the underdrain system should be flushed with clean water until proper infiltration is restored.

4. **Plant material:** Depending on aesthetic requirements, occasional pruning and removing of dead plant material might be necessary. Replace all dead plants, and if specific plants have a high mortality rate, assess the cause and, if necessary, replace with more appropriate species. Periodic weeding is necessary until plants are established. The weeding schedule could become less frequent if the appropriate plant species and planting density have been used and, as a result, undesirable plants are excluded.
5. **Nutrient and pesticides:** The soil mix and plants are selected for optimum fertility, plant establishment, and growth. Nutrient and pesticide inputs should not be required and can degrade the pollutant processing capability of the bioswale, and contribute pollutant loads to receiving waters. By design, bioswales are located in areas where phosphorous and nitrogen levels are often elevated, and those should not be limiting nutrients. If in question, have the soil analyzed for fertility.
6. **Mulch:** Replace mulch annually where heavy metal deposition is likely (e.g., contributing areas that include industrial and auto dealer/repair parking lots and roads). In areas where metal deposition is not a concern, add mulch as needed to maintain a 2- to 3-inch depth. Mulch should be replaced every 2 to 5 years.
7. **Soil:** Soil mixes are designed to maintain long-term fertility and pollutant processing capability. Estimates from metal attenuation research suggest that metal accumulation should not present an environmental concern for at least 20 years. Replacing mulch where heavy metal deposition is likely provides an additional level of protection for prolonged performance. If in question, have soil analyzed for fertility and pollutant levels and check local regulations for disposal protocol.
8. **Watering:** Drought-tolerant plants should be selected to reduce watering after establishment (2 to 3 years). Watering might be required during prolonged dry periods after plants are established.

Table B-2-2. Inspection and maintenance tasks

Task	Frequency	Indicator maintenance is needed	Maintenance notes
Catchment inspection	Weekly or biweekly with routine property maintenance	Excessive sediment, trash, or debris accumulation on the surface of bioswale.	Permanently stabilize any exposed soil and remove any accumulated sediment. Adjacent pervious areas might need to be regraded.
Inlet inspection	Weekly or biweekly with routine property maintenance	Internal erosion or excessive sediment, trash, or debris accumulation	Check for sediment accumulation to ensure that flow into the bioretention is as designed. Remove any accumulated sediment.
Litter and leaf litter removal	Weekly or biweekly with routine property maintenance	Accumulation of litter and leafy debris in the bioswale area	Litter and leaves should be removed to reduce the risk of outlet clogging, reduce nutrient inputs to the bioretention area and to improve facility aesthetics.
Pruning	1–2 times/year	Overgrown vegetation that interferes with access, lines of sight, or safety	Nutrients in runoff often cause bioretention vegetation to flourish.
Mowing	2–12 times/year	Overgrown vegetation that interferes with access, lines of sight, or safety	Frequency depends on location and desired aesthetic appeal.

Appendix B. BMP Design Guidance

Task	Frequency	Indicator maintenance is needed	Maintenance notes
Mulch removal and replacement	1 time/2–3 years	Less than 3 inches of mulch remains on the surface	Mulch accumulation reduces available surface water storage volume. Removing decomposed mulch also increases surface infiltration rate of fill soil. Remove decomposed fraction and top off with fresh mulch to a total depth of 3 inches
Temporary Watering	1 time/2–3 days for first 1–2 months, sporadically after established	Until established and during severe droughts	Watering after the initial year might be required.
Fertilization	1 time initially	Upon planting	One-time spot fertilization for first year vegetation.
Remove and replace dead plants	1 time/year	Dead plants	Plant die-off tends to be highest during the first year (commonly 10% or greater). Survival rates increase with time.
Outlet inspection	Once after first rain of the season, then monthly during the rainy season	Erosion at outlet	Remove any accumulated mulch or sediment.
Miscellaneous upkeep	12 times/year	Tasks include trash collection, plant health, spot weeding, removing invasive species, and removing mulch from the overflow device.	

2.4 References

- Barrett, M.E., M. Limouzin, and D.F. Lawler. 2012. Effects of media and plant selection on biofiltration performance *Journal of Environmental Engineering* 139(4):462-470.
- Brown, R.A. and W.F. Hunt. 2011. Underdrain configuration to enhance bioretention exfiltration to reduce pollutant loads. *Journal of Environmental Engineering* 137(11):1082–1091.
- Houdeshel, C.D., C.A. Pomeroy, and K.R. Hultine. 2012. Bioretention design for xeric climates based on ecological principles. *Journal of the American Water Resources Association* 48(6):1178–1190.
- Li, M.-H., C.Y. Sung, M.H. Kim, and K.-H. Chu. 2010. *Bioretention for Stormwater Quality Improvements in Texas: Pilot Experiments*. Texas A&M University in cooperation with Texas Department of Transportation and the Federal Highway Administration.
- TxDOT (Texas Department of Transportation). 2011. Chapter 13, Section 2. Soil Erosion Control Considerations. *Hydraulic Design Manual*. Austin, TX.

3 Permeable Pavement



Oaks at University Business Park, San Antonio, Texas Source: Bender Wells Clark Design

3.1 Design

The design of a permeable pavement system follows a nine-step process, as described in Table B-3-1.

Table B-3-1. Iterative design step process

Design step		Design component/ consideration	General specification
1	Determine BMP Size	Use Appendix A	
2	BMP Siting (B-41)	Based on available space, incorporate into parking lots (solely parking stalls or parking stalls and driving lanes), parking lanes along roadways, pedestrian sidewalks and plazas, and fire access roads. If outside the Edwards Aquifer Contributing Zone or if the system will be lined with an impermeable liner, runoff from adjacent impervious surfaces less than or equal to the permeable pavement area is allowed.	
3	Select Permeable Pavement Surface Course (B-43)	Surface course type	Pervious concrete, porous asphalt, and permeable interlocking concrete pavers (PICP) are the preferred types of permeable pavement because detailed industry standards and certified installers are available. Concrete grid pavers and plastic grid systems also have useful applications.
4	Determine BMP Function and Configuration (B-52)	Impermeable liner	If non-infiltrating (per geotechnical investigation), use impermeable clay liner, geomembrane, or concrete (as described in Common Design Elements)
		Lateral hydraulic restriction layers	Use concrete or geomembrane to restrict lateral flows to adjacent subgrades, foundations, or utilities.
		Underdrain (required if subsoil infiltration rate < 0.5 in/hr)	Schedule 40 PVC pipe with perforations (slots or holes) every 6 inches. 4-inch diameter lateral pipes should join a 6-inch collector pipe, which conveys drainage to the downstream storm network. Provide orifice at underdrain outlet sized to release water quality volume over 2-5 days. See Common Design Elements
		Internal water storage (IWS)	If using underdrain and infiltration is feasible, elevate the outlet to create a sump to enhance infiltration and treatment.
		No underdrain	If design is fully infiltrating, ensure that subgrade compaction is minimized.
		Observation wells	Provided capped observation wells to monitor drawdown.
5	Design the Profile (B-55)	Subgrade slope and Geotextile	Subgrade slope should be 0.5% or flatter. Baffles should be used to ensure water quality volume is retained. Geotextile should be used along perimeter of cut to prevent soil from laterally entering the aggregate voids.
		Temporary surface ponding depth (Edwards Aquifer Zones)	Surface ponding should be provided (by curb and gutter) to capture the design storm in the event that the permeable pavement surface clogs
		Specify sand/soil filter layer	<ul style="list-style-type: none"> With underdrains: min. 4-inch layer of ASTM C-33 washed sand above gravel of underdrain drainage layer No underdrains: min. 12-inch subsoil (see Common Design Elements)
	Calculate surface area and reservoir depth	Water quality volume should be fully stored within the aggregate base layers below the surface course. Base layer should be washed ASTM No. 57 stone (washed ASTM No. 2 may be used as a subbase layer for additional storage).	

Design step		Design component/ consideration	General specification
		Structural design	A pavement structural analysis should be completed by a qualified and licensed professional
6	Design for Safe Bypass/Conveyance of Larger Storms (B-56)	Large storm routing	<ul style="list-style-type: none"> • Poured in place systems (pervious concrete or porous asphalt): system can overflow internally or on the surface • Modular/Paver-type systems (PICP): internal overflow is required to prevent upflow and transport of bedding course
7	Edge Restraints and Transitions (B-57)	Transition strip	Provide a concrete transition strip between any permeable and impermeable surfaces and around the perimeter of PICP installations
8	Design Signage (B-58)	Signage should prohibit activities that cause premature clogging and indicate to pedestrians and maintenance staff that the surface is intended to be permeable	
9	Design for Multi-Use Benefits (B-58)	Provide educational signage, enhanced pavement colors, or stormwater reuse systems.	

Step 1. Determine Required Storage Volume

Permeable pavement must be sized to fully treat the desired or required design storm volume. Relevant regulatory requirements are presented in detail in Chapter 2. Aggregate pore space provides capacity for the design storm volume retention. Appendix A outlines methods for determining design runoff depths associated with a range of annual treatment efficiencies. Once the design runoff depth is determined (on the basis of the desired level of treatment), a runoff volume can be determined for the contributing watershed using this depth and the methods outlined in Appendix A, *San Antonio Unified Development Code*, or *San Antonio River Basin Regional Modeling Standards for Hydrology and Hydraulic Modeling*.

Peak flow rates for the design storm should also be calculated, using the methods outlined in Appendix A so that the inlet and pretreatment can be accordingly sized and flow attenuation can be considered.

Step 2. BMP Siting

Permeable pavement is a highly versatile stormwater BMP because it can effectively reduce pollutants and can be integrated into site plans with various configurations and components. Stormwater treatment should be considered as an integral component and incorporated in the site design and layout from conception. Many times, determining how permeable pavement will be included in the site design is a critical and required first step. How the water is routed to the permeable pavement and the available space will be key components in determining how the permeable pavement is configured. Site assessment, planning, and site design are discussed in detail in Section 1.6.

Permeable pavement is typically designed to treat stormwater that falls on the actual pavement surface area and has been used at commercial, institutional, and residential sites in spaces that are traditionally impervious. Outside the Edwards Aquifer Contributing Zone, Transition Zone, and Recharge Zone, runoff from adjacent surfaces is allowed but must be limited to runoff from stabilized areas with very little sediment yield. A maximum drainage area to permeable pavement area ratio of 1:1 is recommended.

Runoff from pervious surfaces or high-sediment areas should be prevented, and permeable pavement should not be installed in areas prone to flooding with sediment-laden water (e.g., floodplains) because excessive sediment can prematurely clog the pores. Overhanging trees should also be avoided to reduce the deposition of detritus on the pavement surface, which can be ground into joints and pores if not routinely removed.

Appendix B. BMP Design Guidance

Because permeable pavements are intended for use in fully stabilized catchments, pretreatment measures are generally not required. An exception is presented if runoff is contributed to the permeable pavement from adjacent rooftops; leaves and debris should be screened before discharge onto the pavement surface.

Following is a list of settings in which permeable pavement can be incorporated to meet more than one project-level or watershed-scale objective:

- Parking lots
- Parking lanes in rights-of-way along roads
- Sidewalks and pedestrian plazas
- Access roads and shoulders

In addition, permeable pavement areas can be combined with other BMPs to form a treatment train that provides enhanced water quality treatment and reductions in runoff volume and rate. For example, runoff can flow from a roadway to the permeable pavement section and overflow to a bioretention area as shown in Figure B-3-1. Both facilities can be reduced in size according to demonstrated performance for meeting the stormwater runoff requirements as outlined in Chapter 2 and addressing targeted pollutants of concern.



Figure B-3-1. Permeable pavement and bioretention treatment train.

Step 3. Select Permeable Pavement Surface Course and Aggregate Materials

Several types of permeable pavement are available: pervious concrete, porous asphalt, permeable interlocking concrete pavers, concrete grid pavers, and plastic grid systems, among others. Each type of pavement has advantages and disadvantages, so factors such as cost, pavement use (parking area, driveway, sidewalk, fire lane, and such) and maintenance requirements should be considered on a site-by-site basis. When applicable, follow manufacturers' instructions to ensure a successful implementation.

Pervious concrete and porous asphalt are typically better suited for large parking areas. The advantage to those systems is that the same mixing and application equipment is used as for traditional asphalt and concrete. PICPs, grid pavers, and plastic grid systems are generally better suited to smaller areas because of the labor involved with installation; however, many contractors now employ mechanical placement technologies to expedite the installation of pavers making larger parking areas more feasible. PICP and block pavers can be used for driveways, entryways, walkways, or terraces to achieve a more traditional, formal appearance.

More detailed information for the various types of permeable pavement follow.

Porous Asphalt

Porous asphalt pavement consists of fine- and course-aggregate stone bound by a bituminous-based binder. The amount of fine aggregate is reduced to allow for a larger void space of typically 15 to 20 percent. Because porous asphalt is a hot-mixed pavement, binder temperature performance grade (PG) should be specified on the basis of the anticipated climate to prevent premature failure (melting and sealing) under extreme heat conditions. PG 76-22 liquid asphalt binder is recommended (CAPA n.d.; TxDOT 2004). Thickness of the asphalt depends on the traffic load but usually ranges from 3 to 7 inches. A required underlying base course, typically a washed No. 57 stone, increases storage, and adds strength because porous asphalt is design to be a flexible pavement (Ferguson 2005). A 1- to 2-inch layer of choker course (single-sized crushed aggregate, one-half inch) is typically required to stabilize the surface. Porous asphalt with an aggregate reservoir layer is currently not approved by TCEQ to meet the TSS reduction criteria in the Edwards Aquifer rules (TCEQ 2012).

Porous asphalt can also be installed directly over existing concrete to form a permeable friction course (PFC) overlay. PFCs do not provide the volume storage capacity of porous asphalt systems with reservoir layers, but they can provide excellent water quality improvements in addition to enhanced driver safety (reduced hydroplaning, improved stopping distance, reduced spray, and improved visibility), noise reduction, and improved ride quality (Rand 2006; NCHRP 2009; Eck et al. 2012). PFC overlays have been used with great success on San Antonio and other Texas highways and have been approved to meet the TSS removal rules in the Edwards Aquifer (Rand 2006; TCEQ 2012). A typical porous asphalt profile is shown in Figure B-3-2.

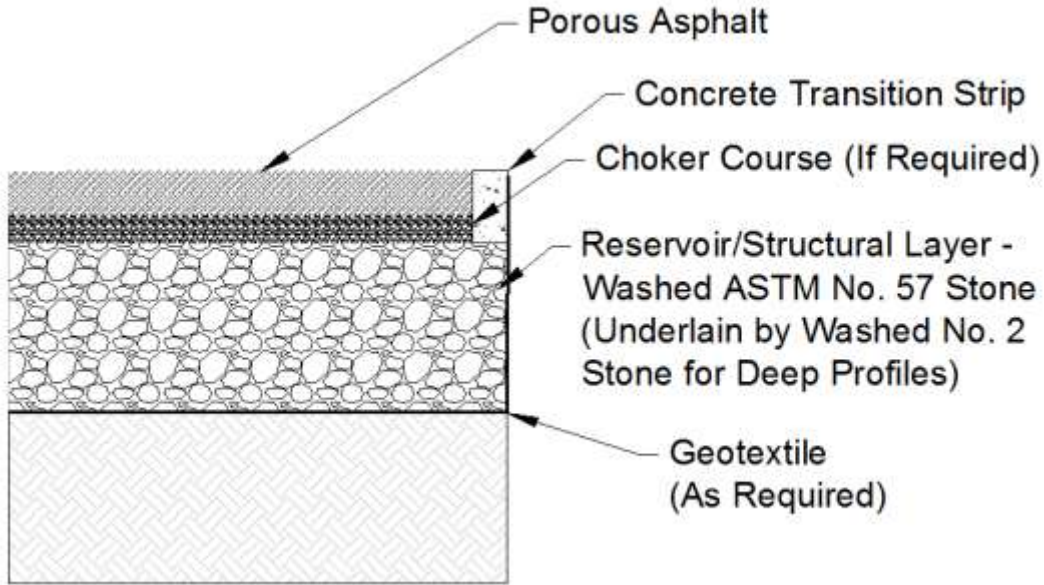

Figure B-3-2. Typical porous asphalt cross section.

The properties of porous asphalt depend on the materials used and the compaction procedures. Specified mix design should be in accordance with the National Asphalt Pavement Association (NAPA) *Porous Asphalt Pavements for Stormwater Management* (NAPA 2008). General guidelines are provided below.

Permeability. Typical flow rates for water through porous asphalt range from 150 to 300 in/hr (Roseen and Ballesterro 2008). Those values exceed the typical permeability of subsurface soils, so the soils would be the limiting factor.

Aggregates. A typical aggregate size distribution for porous asphalt is below.

Aggregate gradation size	Percent passing
0.75 inch	100%
0.50 inch	85%–100%
0.375 inch	55%–75%
No. 4	10%–25%
No. 8	5%–10%
No. 200	2%–4%

Durability. As with all BMPs, the longevity of porous asphalt (Figure B-3-3) is highly dependent on proper maintenance. Many porous asphalt parking lots have been in service for more than 20 years.



San Diego, California Source: Tetra Tech

Figure B-3-3. Example of porous asphalt.

Pervious Concrete

Pervious concrete is a mixture of Portland cement, fly ash, washed gravel, and water. The water-to-cementitious material ratio is typically 0.35–0.45 to 1 such that the mixture displays a wet metallic sheen without the paste flowing from the aggregate (NRMCA 2004; Barrett 2005). Unlike traditional installations of concrete, permeable concrete usually contains a void content of 15 to 25 percent, which allows water to infiltrate directly through the pavement surface to the subsurface. A fine, washed gravel, less than 13 mm in size (No. 8 or 89 stone), is added to the concrete mixture to increase the void space (GCPA 2006). An admixture improves the bonding and strength of the pavements. The pavements are typically laid with a 4- to 8-inch (10 to 20 cm) thickness over a gravel reservoir (depth varies according to water volume capture requirements), typically a washed No. 57 stone. Pervious concrete is a rigid pavement and therefore does not require an aggregate base course for structural support. Pervious concrete will typically exhibit a coarser surface texture than impervious concrete but is ADA compliant. A typical pervious concrete profile is shown in Figure B-3-4.

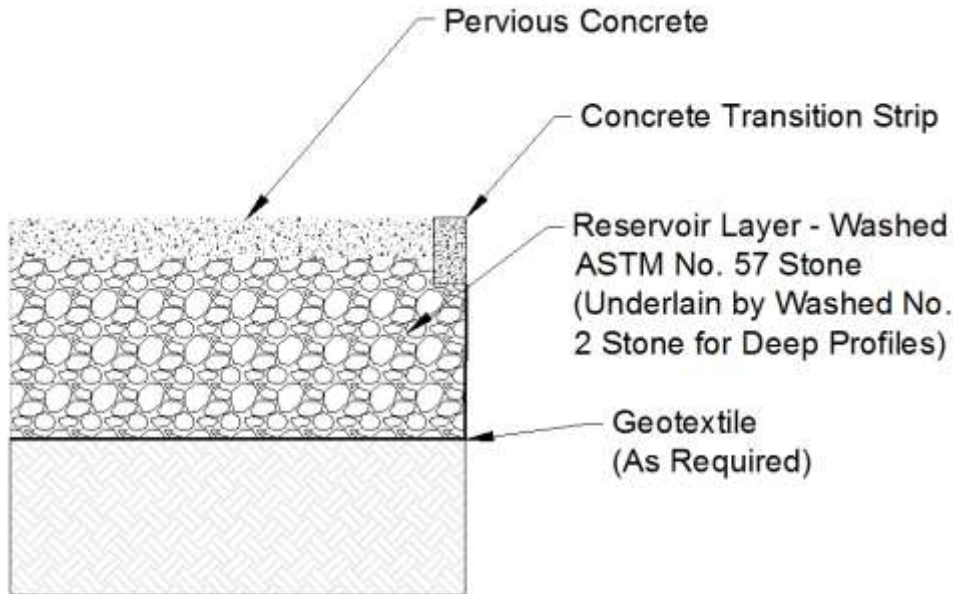

Figure B-3-4. Typical pervious concrete cross section.

The properties of pervious concrete (Figure B-3-5) vary with design and depend on the materials used and the compaction procedures. Design mix should conform to the latest version of the American Concrete Institute's ACI 522.1-08 *Specification for Pervious Concrete Pavements*. General guidelines for specifications are provided below.

Permeability. Typical flow rates through well-maintained pervious concrete average greater than 1,500 in/hr (Bean et al. 2007).

Compressive Strength. Pervious concretes can develop compressive strengths in the range of 500 to 4,000 pounds per square inch (psi)—suitable for a wide range of applications.

Flexural Strength. Flexural strength of pervious concrete ranges between 150 and 550 psi. Pervious concrete does not typically incorporate rebar.

Shrinkage. Drying shrinkage of pervious concrete is faster but much less than that experienced with conventional concrete. Pervious concretes should be constructed with control joints to regulate cracking. In general, joints should be cut one-quarter of the pervious concrete thickness, be placed a maximum of 20 feet on centers (15 feet is typical) perpendicular to the curb, and should form square panels.

Abrasion resistance. Because of the rougher surface texture and open structure of pervious concrete, abrasion and raveling of aggregate particles can be a problem. Surface raveling in new pervious concrete can occur when rocks loosely bound to the surface break free under traffic loads. Such raveling is considerably reduced after the first few weeks. Raveling can be reduced by carefully covering the pervious concrete during curing to prevent the surface from drying prematurely. Polypropylene fibers and/or latex can also be added to reduce abrasion resistance (Dong et al. 2010).



Kinston, North Carolina Source: NCSU BAE

Figure B-3-5. Example of pervious concrete.

Permeable Interlocking Concrete Pavement

PICPs are available in many different shapes and sizes. When laid, the blocks form patterns that create openings through which rainfall can infiltrate. Orientation of rectangular pavers is important for structural purposes—*herringbone* patterns tend to provide the most efficient structural design, especially where vehicle stopping and turning are expected. ASTM C936-13 specifications state that the pavers be at least 2.36 inches (60 mm) thick with a compressive strength of 55 MPa (8,000 psi) or greater. Typical installations consist of the pavers and crushed aggregate fill, a 1.5- to 3.0-inch (38 to 76 mm No. 8) fine-aggregate bedding layer, and an aggregate base-course, typically a washed No. 57 stone, storage layer (Smith 2011). If greater storage is required, a reservoir subbase layer of No. 2 stone can be included. More details on PICP can be found in Smith (2011). An example PICP profile is shown in Figure B-3-6.

Appendix B. BMP Design Guidance

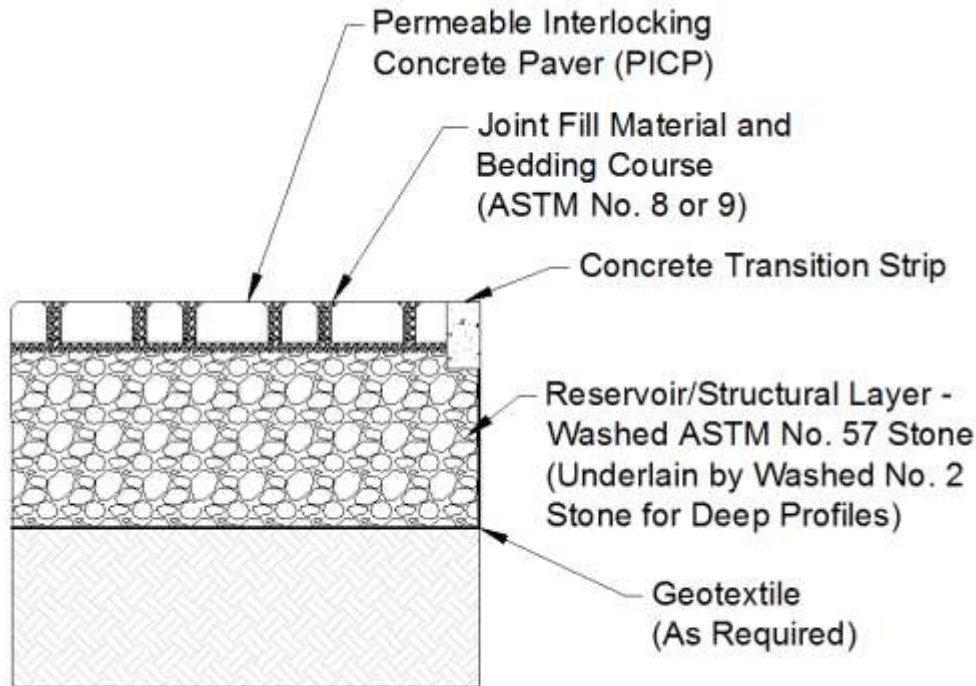

Figure B-3-6. Typical PICP cross section.

Unlike permeable concrete and porous asphalt, PICP (Figure B-3-7) is not subject to time and temperature limitations in installation. Interlocking Concrete Pavement Institute (ICPI) standards should be followed during design and construction. Below are listed general specification guidelines.

Permeability. Lifetime infiltration rates on maintained PICP surfaces range from 14 to 4,000 in/hr depending on the joint filling material (Borgwardt 2006; Bean et al. 2007).

Compressive Strength. PICP has a minimum compressive strength of 8,000 psi (55 MPa).

Durability. Regularly maintained permeable pavement systems can last more than 20 years and provide an initial high level of surface infiltration even as the surface takes in moderate amounts of sediment.



La Jolla, California. Source: Tetra Tech.

Figure B-3-7. Example of PICPs in a herringbone pattern.

Concrete Grid Pavers

Concrete grid pavers (CGPs) conform to ASTM C 1319, *Standard Specification for Concrete Grid Paving Units* which describes paver properties and specifications. CGP units have a minimum thickness of 3.125 inches (80 mm) thick with a maximum 24 × 24 inch (60 × 60 cm) dimension. The percentage of open area ranges from 20 to 50 percent and can contain topsoil and grass, sand, or aggregate in the void space (Figure B-3-8). The minimum average compressive strength of CGP units can be no less than 35 MPa (5,000 psi). A typical installation consists of grid pavers with fill media, 1–1.5 inches (25 to 38 mm) of bedding sand or No. 8 gravel, gravel base course typically consisting of washed No. 57 stone, and a loosely compacted soil subgrade (ICPI 2004). If sand is used, a geotextile should be used between the sand course and the reservoir media to prevent the sand from migrating into the stone media.

The ICPI provides design standards for CGP design and installation, but application of CGPs is typically limited to very low traffic areas (such as emergency vehicle access roads or event overflow parking). This limitation is because of differential settling and subsequent *rocking* of pavers that can occur because CGPs (unlike PICP) do not interlock.



San Diego, California. Source: Tetra Tech.

Figure B-3-8. Example of CGPs with volcanic rock bedding course.

Plastic Grid Systems

Plastic grid systems, also called geocells, turf pavers, or turf reinforcing grids, consist of flexible-plastic, interlocking units that allow for infiltration through large gaps filled with gravel or topsoil planted with turf grass. Similar to PICP, a 1–2 inch sand bedding layer and gravel base course are often added to increase infiltration and storage. The empty grids are typically 90 to 98 percent open space, so void space depends on the fill media (Ferguson 2005). To date, no uniform standards exist; however, one product specification defines the typical load-bearing capacity of empty grids at approximately 13.8 MPa (2,000 psi) (Invisible Structures 2001). That value increases up to 38 MPa (5,500 psi) when filled with various materials (Invisible Structures 2001). If sand is used, a geotextile should be used between the sand course and the reservoir media to prevent the sand from migrating into the stone media. Plastic grid systems are currently not approved by TCEQ to meet the TSS reduction criteria in the Edwards Aquifer rules. A typical plastic grid system profile is shown in Figure B-3-9.

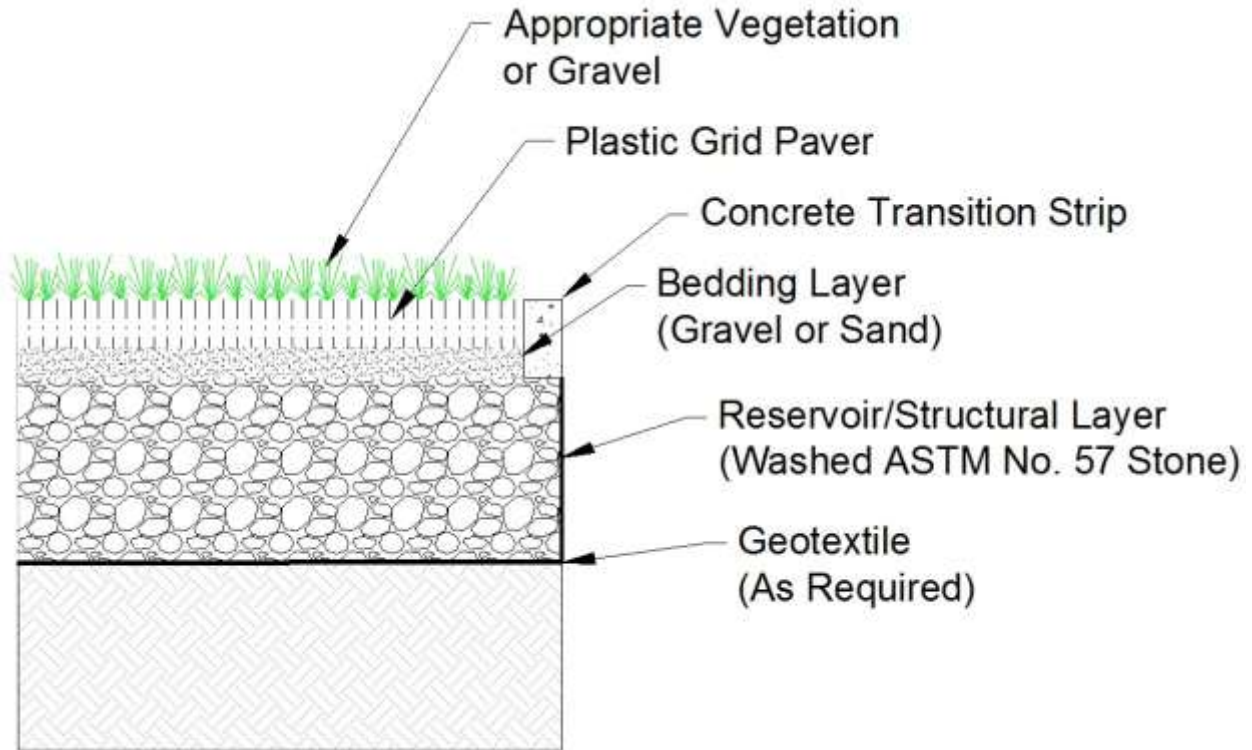

Figure B-3-9. Typical plastic grid system cross section.

Plastic grids (Figure B-3-10) provide structural support but are generally limited to very low traffic areas such as emergency vehicle access lanes and event overflow parking. They are usually planted with grass. Several companies manufacture plastic grid systems.

Load bearing capacity. Plastic grid systems have a load-bearing capacity up to 6,700 psi when filled (CONTECH 2011).

Durability. Because plastic grid systems are typically manufactured from high-density polyethylene (HDPE), long service lives, up to 50 years, can be expected with proper maintenance.



(Left) Carolina Beach, North Carolina. Source: Tetra Tech

(Right) Kinston, North Carolina. Source: Tetra Tech

Figure B-3-10. Example of plastic grid systems.

Step 4. Determine BMP Function and Configuration

The hydrologic and water quality performance of permeable pavement is largely determined by the drainage configuration. Furthermore, some areas might *not* warrant infiltration. The following design steps can be used to determine the drainage configuration design.

Perform Geotechnical Investigation

Once the appropriate surface course has been selected and discussed with the property owner, the in situ soils must be tested before the system can be sized. Performing soil tests during the conceptual and preliminary design phases will ensure that the proposed permeable pavement system is optimized to actual site conditions and to prevent costly change orders resulting from poorly estimated soil parameters.

A geotechnical investigation should be performed by a licensed soil scientist or geotechnical engineer. All soil testing should be performed at the depth of the initially proposed subgrade because this is the soil strata where infiltration might occur. If a detention (non-infiltrating system) is proposed, soil tests must still be performed to determine structural requirements and to identify the elevation of the seasonal high water table. For details on geotechnical analyses, see [Common Design Elements](#).

Determine if Underdrains and Impermeable Liners are Needed

On the basis of the infiltration rate measured in the previous step, the drawdown time of the system at full capacity should be calculated. If the infiltration rate of the soils on which the permeable pavement area will be installed is less than 0.5 in/hr, underdrains will be required (as described in Table B-3-2). The underdrains can be embedded in the aggregate reservoir layer or in a gravel trench below the reservoir layer, as shown in Figure B-3-11. For information on designing an underdrain system, see [Common Design Elements](#). IWS should be included in all infiltrating systems to enhance infiltration (Wardynski et al. 2013). The elevation of the upturned underdrain outlet dictates the volume of water retained in the profile, which should be greater than or equal to the water quality volume (as determined in [step 5](#)). An example permeable pavement profile containing IWS is provided in Figure B-3-12.

If infiltration is disallowed, the system should be lined with a hydraulic restrictive layer. Factors prescribing an impermeable liner are provided in Table B-3-2. Non-infiltrating systems are also known as

detention systems and can be designed similar to other detention structures. Outflow should be regulated in accordance with water quality (releasing water over the course of 2 to 5 days) and flood control requirements for detention structures (discussed in [Step 6](#)).

Table B-3-2. Decision table for determining underdrain and impermeable liner requirements

Impermeable liners must be used if...	Underdrains must be used if...
<ul style="list-style-type: none"> • Site is in Edwards Aquifer Recharge Zone or Transition Zone • Soil contamination is expected or present • Karst geology presents risk of sinkhole formation • Runoff may unintentionally be received from a stormwater hotspot • Site is within 100 feet of a water supply well or septic drain field • Site is within 10 feet of a structure/foundation • Infiltrated water may interfere with utilities 	<ul style="list-style-type: none"> • An impermeable liner is needed • Infiltration rate of underlying soils is less than 0.5 in/hr • Site is within 50 feet of a steep, sensitive slope



Alamo Heights Fire Station, Alamo Heights, Texas Source: Tetra Tech

Figure B-3-11. Example of permeable pavement with trenched underdrain.

Appendix B. BMP Design Guidance

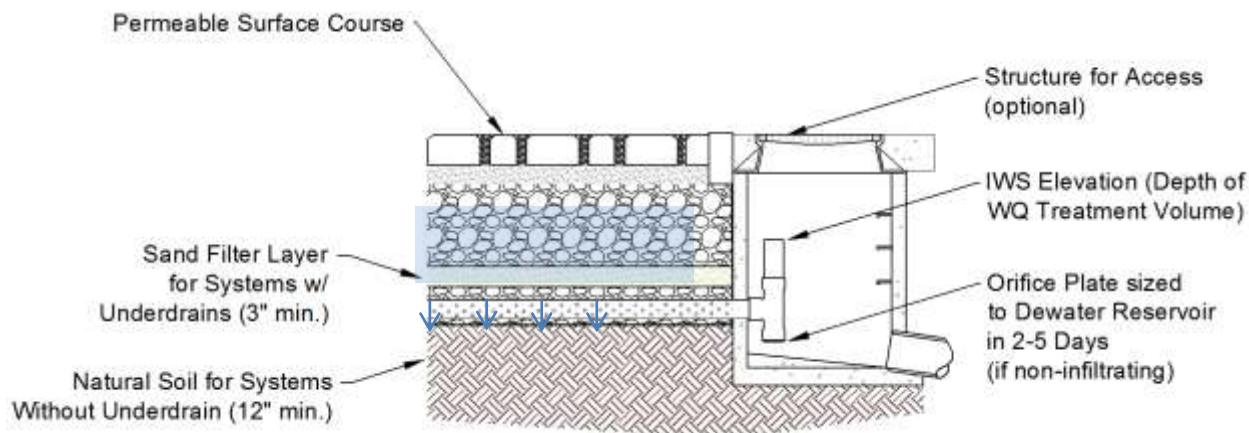

Figure B-3-12. Example permeable pavement profile featuring IWS.

Observation Wells

Design drawings should specify installation of observation wells to monitor the drawdown rate of permeable pavement reservoir layers. Wells should be constructed of perforated PVC pipe (4-inch diameter or greater) and should be designed to prevent damage from vehicular traffic. If necessary, observation wells can be installed at an angle and daylight in adjacent landscape areas (as long as the well extends the full depth of the reservoir layer). Wells should be securely sealed with watertight caps. Figure B-3-13 provides examples of observation wells installed in permeable pavement applications.



Source: NCSU-BAE

Figure B-3-13. Observation well installed in permeable pavement.

Design Subgrade Slope and Specify Geotextile

The subgrade slope should not exceed 0.5 percent to ensure that the design volume is captured and evenly distributed and to maintain structural integrity. Baffles can be installed along the subgrade to provide grade control if necessary. In fully lined systems, a drawdown orifice should be provided in each baffle to allow dewatering between storm events.

A geotextile should be placed beneath the reservoir media and along the perimeter of the cut in all infiltrating systems. A needled, non-woven, polypropylene geotextile conforming to the specifications in Table B-3-3 should be specified. It is important to line the entire trench area, including the sides, with a geotextile before placing the aggregate. The geotextile serves an important function by inhibiting soil from migrating into the reservoir layer and reducing storage capacity.

Table B-3-3. Geotextile layer specifications

Geotextile property	Value	Test method
Grab tensile strength (lbs)	≥ 120	ASTM D4632
Mullen burst strength (lbs/sq. in.)	≥ 225	ASTM D3786
Permeability (gpm/sq. ft.)	≥ 125	ASTM D4491
Apparent opening size (sieve size)	#70–#80 (min)	ASTM D4751

*The geotextile apparent opening size selection is based on the percent passing the No. 200 sieve in A Soil subgrade, using FHWA or AASHTO selection criteria.

Step 5. Design the Profile

The permeable pavement profile must be designed to capture the water quality treatment volume and filter it through soil or a sand filter layer. In fully lined (non-infiltrating systems), the treatment volume should ideally be detained for 2 to 5 days (orifice sizing equations are in the [Stormwater Wetlands](#) section). Additionally, the profile must provide structural support for the anticipated vehicular loading.

Temporary Surface Ponding Depth (Edwards Aquifer Zones)

When permeable pavement is used in the Edwards Aquifer protection zones, surface ponding must be provided (by curb and gutter) such that the design storm volume will be retained onsite if the permeable pavement surface clogs (Barrett 2005). Curb edging and driveways should be elevated such that the design water quality volume ponds on the surface and does not flow offsite. This is not typically a requirement outside the Edwards Aquifer protection zones.

Specify Sand/Soil Filter Layer

Percolating runoff through native soils is the most effective way to improve water quality. When no underdrains are required (when subsoil infiltration rates greater than 0.5 in/hr), a minimum of 12 inches of native soil should be provided at the subgrade to filter captured stormwater before infiltration (for soil specifications, see [Common Design Elements](#)). If underdrains are used, or if subsoils are not suitable for stormwater filtration, a minimum of 4 inches of ASTM C-33 washed sand should be included above the aggregate of the underdrain drainage layer. A layer of choking stone might be needed between the sand filter layer and the gravel drainage layer, as discussed in [Common Design Elements](#).

Calculate Surface Area and Reservoir Media Depth

The aggregate base course should be designed to store at a minimum the water quality treatment volume determined in Appendix A. For infiltrating systems, this volume should be retained in the profile using IWS (as described in [step 4](#)). The stone aggregate used should be washed, angular, crushed stone, 0.75 to 2.5 inches in diameter with a void space of about 40 percent (No. 57 stone). ASTM No. 2 stone may be used as a subbase layer below the base course for additional storage. Aggregate contaminated with soil and typical *crusher run* stone should not be used because those materials will clog the pores at the bottom of the pavement.

Appendix B. BMP Design Guidance

If the area of permeable pavement is known, the following equation can be used to determine the depth of storage layer (aggregate base course) needed to capture the water quality treatment volume:

$$d = \frac{V}{An} \quad \text{[Equation B-3-1]}$$

where

d = aggregate layer depth (ft)

V = water quality volume (ft³)

A = surface area (square ft)

n = porosity (use actual laboratory measured porosity of material)

Structural Design Requirements

If permeable pavement will be used in a parking lot or other setting that involves vehicles, the pavement surface must be able to support the maximum anticipated traffic load. The structural design process will vary according to the type of pavement selected, and the manufacturer's specific recommendations should be followed. The thickness of the permeable pavement and reservoir layer must be sized to support structural loads and to temporarily store the design storm volume (e.g., the water quality, channel protection, and flood-control volumes). On most new development and redevelopment sites, the structural support requirements will dictate the depth of the underlying stone reservoir.

The structural design of permeable pavements involves considering four main site elements:

- Total traffic
- In situ soil strength
- Environmental elements
- Bedding and reservoir layer design

The resulting structural requirements can include the thickness of the pavement, filter, and reservoir layer. Designers should note that if the underlying soils have a low California Bearing Ratio (less than 4 percent), the soil might need to be compacted to at least 95 percent of the Standard Proctor Density, which generally rules out their use for infiltration.

Designers should determine structural design requirements by consulting transportation design guidance sources, such as the following:

- AASHTO Guide for Design of Pavement Structures (1993)
- AASHTO Supplement to the Guide for Design of Pavement Structures (1998)

Step 6. Design for Safe Bypass/Conveyance of Large Storm

Permeable pavement systems, as with any other stormwater BMP, must be designed to safely route runoff in excess of the intended design flow. The method of large-storm routing is largely site specific and depends on the type of permeable surface course. When poured in place, surface courses are used (pervious concrete or porous asphalt), volume in excess of the system storage capacity can be allowed to bubble up through the profile and run off the site safely as surface flow. Catch basins or slot drains could be installed around the perimeter of the permeable pavement to drain any overflow; inlets can be specified slightly above the elevation of the finished surface to allow some surface ponding, if allowable.

Modular paving systems (PICP, CGP, or plastic grid systems) should *not* be designed to overflow in this manner, however, because upflowing water could dislodge and carry away aggregate from the bedding course. When surface overflow is not a feasible or preferred option, the system can be designed to (1) completely store the 25-year storm volume in the aggregate reservoir and exfiltrate into underlying soils, (2) convey larger storms safely through the system using underdrains (equipped with orifices, if required), or (3) use other internal controls to allow bypass of larger storms. Large storm routing can be designed to satisfy detention requirements, per local requirements (see Chapter 2).

Step 7. Edge Restraints and Intersections

Providing separation between permeable pavements and adjacent impermeable surfaces serves multiple purposes, including the following:

1. Clearly identifying for maintenance personnel the transition between permeable and impermeable surfaces
2. Restraining modular (block) pavers and porous asphalt to prevent lateral shifting or unraveling of edges
3. Creating a hydraulic restriction layer to prevent lateral seepage of runoff below adjacent pavements and structures
4. Delineating parking zones with clean, aesthetically pleasing lines

Restraints for flexible pavements are typically composed of standard concrete curbs (elevated or at grade, depending on application) or specially designed monolithic concrete walls. At intersections between permeable and impermeable surfaces, a hydraulic restriction layer (typically a geomembrane) is installed along the entire length of the cut and at least 2 feet laterally along the subgrade and under the *impermeable* surface. Figure B-3-14 shows an example of an edge restraint.



Los Angeles, California. Source: Tetra Tech.

Figure B-3-14. A 1-foot concrete transition strip is used as an edge restraint between PICP and impermeable asphalt.

Step 8. Design Signage

It is good practice to specify signage on engineering plans; signage educates the public and identifies permeable pavements to maintenance personnel. Prohibited practices, such as stockpiling soils or mulch, should be clearly displayed to protect permeable pavements from premature clogging. Signage will also prevent poured in place permeable pavements from being mistaken as impermeable and then paved over during repair.

Step 9. Design for Multi-Use Benefits

Permeable pavements inherently provide multi-use benefits because the facilities double as parking lots and transportation corridors. In addition to these benefits, permeable pavement can be enhanced by incorporating the following design elements:

- Enhanced pavement textures, colors, and patterns can calm traffic, increase aesthetic appeal, enhance pedestrian safety, and draw attention to multi-use stormwater practices.
- Stormwater reuse systems can be installed to harvest and use captured runoff for non-potable use (irrigation, ornamental water features, and such).

- Permeable pavers can be used to maintain the character of historic districts while providing stormwater management solutions.
- Educational kiosks and signage raise public awareness of stormwater issues.

3.2 Critical Construction Considerations

Notes on construction plans should specify that tracked vehicles (versus wheeled vehicles) be used whenever practicable to minimize compaction of subsoils. Construction specifications should also include notes requiring the testing of subgrade infiltration rates before installing aggregate (for infiltrating systems). This step ensures that captured water will draw down in the required duration. If subgrade infiltration rates are drastically lower than design values, the subgrade should be treated by scarifying, ripping, or trenching according to the recommendations in [bioretention](#). If infiltration rates remain lower than required, the profile depth must be changed to provide additional storage or the drainage configuration must be altered to regulate the drawdown.

Careful inspection of several construction steps can prevent costly errors. Construction of permeable pavement systems should be performed only by a contractor with experience in permeable pavement installation and that is certified by the Interlocking Concrete Pavement Institute or the National Ready Mix Concrete Association. Lists of certified contactors are at <http://www.icpi.org> or <http://www.nrmca.org>. In addition to the general considerations in Chapter 4, the following practices should be completed by the designer or a trained inspector.

3.2.1 Inspect Aggregate Upon Delivery

Stone aggregate bedding, base, and subbase courses should be thoroughly washed to prevent fines from clogging the subsoil interface or underdrains (Fassman and Blackbourne 2010). Before placement, the furnished aggregate should appear free of fines and leave no substantial dust on the skin when handled. Unwashed aggregate should be replaced or washed onsite using proper construction site sediment control practices.

3.2.2 Inspect Elevations

Elevation discrepancies during grading or placing pipe inverts can result in undersized (and underperforming) systems. Verifying the average subgrade elevation and the elevation of the outlet invert will help ensure that the specified reservoir storage volume has been provided.

3.2.3 Test Actual Subgrade Infiltration Rate

After excavation and before installing aggregate, the actual in situ infiltration rate should be measured using the methods in [Common Design Elements](#). This is a critical step to determine the level of compaction experienced during construction so that adequate mitigation practices can be recommended.

3.2.4 Mitigate Soil Compaction to Enhance Exfiltration

If exfiltration rates (as determined in previous step) are substantially lower than design values, the subgrade should be treated according to Table B-3-4 to mitigate compaction. If subgrade exfiltration rates are substantially lower than original design rates, it may be necessary to provide additional aggregate reservoir depth to accommodate storage and exfiltration of subsequent rainfall events.

Table B-3-4. Subgrade treatments for infiltration enhancement

Subgrade compaction	Minimum subgrade treatment	Specification
Low	Scarification	Loosen the top 6 to 9 inches of subgrade using the teeth of an excavator bucket (or comparable). This can be achieved by excavating the final 1 foot using a toothed bucket.
Low-Medium	Ripping	Using a subsoil ripper or metal bar, rip the subgrade to a depth of 9 to 12 inches, every 3 feet (on center). When operating in silty, loamy, or clay soils, fill ripped areas with coarse sand to maintain free-flowing trenches.
High	Trenching	Excavate 1-foot-deep by 1-foot wide trenches into the subgrade, every 6 feet (on center). Fill the bottom of the trench with one-half inch of coarse sand, and top off trench with washed aggregate (No. 57 stone or comparable).

Source: Based on findings in Tyner et al. 2009 and Brown and Hunt 2010

3.2.5 Inspect Surface Course Placement and Curing

Poured in place surface courses should be inspected during placement to ensure proper mix characteristics. After screeding and compaction, inspectors should ensure that the surface of pervious concrete is not smeared (particularly when placing plastic over the surface for curing).

3.3 Operation and Maintenance

Maintenance of permeable pavement systems is critical to the overall and continued success of the system. Specific maintenance activities are listed in Table B-3-5. Key maintenance procedures consist of the following:

1. Adjacent areas that drain to the permeable pavement area should be permanently stabilized and maintained to limit the sediment load to the system.
2. Vacuum sweeping should be typically performed a minimum of twice a year. Adjust the frequency according to the intensity of use and deposition rate on the permeable pavement surface.
3. Any weeds that grow in the permeable pavement should be sprayed with pesticide immediately. Weeds should not be pulled, because doing so can damage the fill media.
4. Mowing and trimming turf grass used with permeable pavers and plastic grid systems must be performed regularly according to site conditions. Grass should be mowed at least once a month in the growing season. All vegetated areas must be inspected at least annually for erosion and scour.

Table B-3-5. Operation and maintenance tasks for permeable pavement

Task	Frequency	Indicator maintenance is needed	Maintenance notes
Catchment inspection	Weekly or biweekly during routine property maintenance	Sediment accumulation on adjacent impervious surfaces or in voids/joints of permeable pavement	Stabilize any exposed soil and remove any accumulated sediment. Adjacent pervious areas might need to be graded to drain away from the pavement.
Miscellaneous upkeep	Weekly or biweekly during routine property maintenance	Trash, leaves, weeds, or other debris accumulated on permeable pavement surface	Immediately remove debris to prevent migration into permeable pavement voids. Identify source of debris and remedy problem to avoid future deposition.
Preventative vacuum/regenerative air street sweeping	Twice a year in higher sediment areas	N/A	Pavement should be swept with a vacuum power or regenerative air street sweeper at least twice per year to maintain infiltration rates.
Replace fill materials	As needed	For paver systems, whenever void space between joints becomes apparent or after vacuum sweeping	Replace bedding fill material to keep fill level with the paver surface.
Restorative vacuum/regenerative air street sweeping	As needed	Surface infiltration test indicates poor performance or water is ponding on pavement surface during rainfall	Pavement should be swept with a vacuum power or regenerative air street sweeper to restore infiltration rates.

3.4 References

- American Association of State Highway and Transportation Officials (AASHTO). 1993. *Guide for Design of Pavement Structures, 4th Edition*. Washington, DC.
- American Association of State Highway and Transportation Officials (AASHTO). 1998. Supplement to *Guide for Design of Pavement Structures, 4th Edition*. Washington, DC.
- ASTM (American Society for Testing and Materials) C936-13. <http://www.astm.org/Standards/C936.htm>
- Barrett, M.E. 2005. *Complying with the Edwards Aquifer Rules. Technical Guidance on Best Management Practices*. RG-348. Prepared for Texas Commission on Environmental Quality, Field Operations Division, Austin, TX.
- Bean, E.Z., W.F. Hunt, and D.A. Bidelspach. 2007. Field survey of permeable pavement surface infiltration rates. *Journal of Irrigation and Drainage Engineering* 133(3):247–255.
- Borgwardt, S. 2006. Long-term in situ infiltration performance of permeable concrete block pavement, In *Proceedings of the 8th International Conference on Concrete Block Paving*, Interlocking Concrete Pavement Institute, Washington, DC.
- Brown, R.A., and W.F. Hunt. 2010. Impacts of construction activity on bioretention performance. *Journal of Hydrologic Engineering* 15(6):386–394.

Appendix B. BMP Design Guidance

- CAPA (Carolina Asphalt Paving Association). n.d. *Porous Paving Parking Lots Guide Specifications*. Raleigh, NC.
- Collins, K.A., W.F. Hunt, and J.M. Hathaway. 2010. Side-by-side comparison of nitrogen species removal for four types of permeable pavement and standard asphalt in eastern North Carolina. *Journal of Hydrologic Engineering* 15(6):512-521.\
- Contech. 2011. Urban Green Grass Pavers. Contech Construction Products, Inc. Scarborough, ME.
- Dong, Q., H. Wu, B. Huang, and S. Xiang. 2010. *Development of a Simple and Fast Test Method for Measuring the Durability of Portland Cement Pervious Concrete*. SN3149, Portland Cement Association, Skokie, IL.
- Eck, B.J., R.J. Winston, W.F. Hunt, and M.E. Barrett. 2012. Water Quality of Drainage from Permeable Friction Course. *Journal of Environmental Engineering* 138(2):174–181.
- Fassman, E.A., and S.D. Blackbourn. 2010. Urban runoff mitigation by a permeable pavement system over impermeable soils. *Journal of Hydrologic Engineering* 15(6):475–485.
- Fassman, E.A., and S.D. Blackbourn. 2011. Road runoff water-quality mitigation by permeable modular concrete pavers. *Journal of Irrigation and Drainage* 137(11):720–729.
- Ferguson, B.K. 2005. *Porous Pavements*. CRC Press, Boca Raton, FL.
- GCPA (Georgia Concrete and Products Association). 2006. *Guide for Construction of Portland Cement Concrete Pervious Pavement*. Georgia Concrete and Products Association, Tucker, GA. <<http://www.gcpa.org/>>. Accessed June 23, 2010.
- Invisible Structures. 2001. *Grasspave2™ Technical Specifications*. Invisible Structures, Inc., Golden, CO.
- ICPI (Interlocking Concrete Pavement Institute). 2004. *Tech Spec 8, Concrete Grid Pavements*. Interlocking Concrete Pavement Institute, Washington, DC.
- National Asphalt Pavement Association (NAPA). 2008. *Porous Asphalt Pavements for Stormwater Management. Design, Construction and Maintenance Guide*. Information Series 131. Lanham, MD.
- NCHRP (National Cooperative Highway Research Program). 2009. *Construction and maintenance practices for permeable friction courses*. Rep. 640, Transportation Research Board, Washington, DC.
- NRMCA (National Ready Mixed Concrete Association). 2004. *CIP 38 – Pervious Concrete. Concrete in Practice*. National Ready Mixed Concrete Association, Silver Spring, MD. <<http://www.nrmca.org/GreenConcrete/CIP%2038p.pdf>>. Accessed June 23, 2010.
- Rosen, R.M., and T.P. Ballestero. 2008. Porous asphalt pavements for stormwater technology. *Hot Mix Asphalt Technology* pp. 26–34.
- Smith, D. 2011. *Permeable Interlocking Concrete Pavements*. Fourth Edition. Herndon, VA.

TCEQ (Texas Commission on Environmental Quality). 2012. *Addendum Sheet to Complying with the Edwards Aquifer Rules. Technical Guidance on Best Management Practices*. RG-348 (Revised July 2005). July 5, 2012. Austin, TX.

TxDOT (Texas Department of Transportation. 2004. *Standard Specifications for Construction and Maintenance of Highways, Streets, and Bridges*. June 1, 2004. Austin, TX.

Tyner, J.S., W.C. Wright, and P.A. Dobbs. 2009. Increasing exfiltration from pervious concrete and temperature monitoring. *Journal of Environmental Management* 90:2636–2641.

Wardynski, B.J., R.J. Winston, and W.F. Hunt. 2013. Internal water storage enhances exfiltration and thermal load reduction from permeable pavement in the North Carolina mountains. *Journal of Environmental Engineering* 139(2):187–195.

4 Planter Boxes



Planter box retrofit to treat rooftop runoff at Sunset Station, San Antonio, Texas (rendering)

4.1 Design

Planter boxes provide similar function to a bioretention area but can be used to provide treatment where infiltration is not possible because of geotechnical limitations or vertical constraints. The design process is similar to that of lined (non-infiltrating) bioretention cells with a few noted exceptions in Table B-4-1.

Table B-4-1. Iterative design step process

Design step		Design component/ consideration	General specification
1	Determine BMP Treatment Volume	Use Appendix A	
2	BMP Siting (B-66)	Based on available space, incorporate along the perimeter of buildings, along the roadway right-of-way, or near the outlet of a green roof or cistern.	
3	Determine BMP Function and Configuration (B-66)	Impermeable liner	Planter boxes are typically contained in a concrete vault (as described in Common Design Elements)
		Underdrain (required)	Schedule 40 PVC pipe with perforations (slots or holes) every 6 inches. 4-inch diameter lateral pipes should join a 6-inch collector pipe, which conveys drainage to the downstream storm network. Provide cleanout ports/observation wells for each underdrain pipe at spacing consistent with local regulations. See Common Design Elements
		Internal water storage (IWS)	With careful plant selection, the outlet can be slightly elevated to create a sump for additional moisture retention to promote plant survival and enhanced treatment. Top of IWS should be more than 18 inches below surface.
4	Size the System (B-67)	Temporary ponding depth	6-18 inches (6-12 inches near schools or in residential areas); average ponding depth of 9 inches is recommended
		Soil media depth	2-4 feet (deeper for better pollutant removal, hydrologic benefits, and deeper rooting depths)
		Surface area	Find surface area required to store treatment volume in temporary ponding depth, soil media depth, and gravel drainage layer depth (media porosity ≈ 0.35 and gravel porosity ≈ 0.4)
5	Specify Soil Media (B-67)	Composition and texture	85-88% sand, 8-12% fines, 2-5% plant-derived organic matter (animal wastes or by-products should never be applied)
		Permeability	1-6 in/hr infiltration rate (1-2 in/hr recommended)
		Chemical composition	Total phosphorus < 15 ppm, pH 6-8, CEC > 5 meq/100 g soil
		Drainage layer	Separate soil media from underdrain with 2 to 4 inches of washed sand, followed by 2 inches of choking stone (ASTM No. 8) over a 1.5 foot envelope of ASTM No. 57 stone.
6	Design Inlet and Pretreatment (B-67)	Inlet	Provide stabilized inlets (see Common Design Elements)
		Pretreatment	Minimal pretreatment is required if receiving rooftop runoff; however, pretreatment recommendations provided in bioretention section should be followed if receiving surface runoff from paved areas.

Appendix B. BMP Design Guidance

Design step		Design component/ consideration	General specification
7	Select and Design Overflow/Bypass Method (B-68)	Outlet configuration	Online: All runoff is routed through system—install an elevated overflow structure or weir at the elevation of maximum ponding Offline: Only treated volume is diverted to system—install a diversion structure or allow bypass of high flows
		Peak flow mitigation	Provide additional detention storage and size an appropriate non-clogging orifice or weir to dewater detention volume
8	Select Mulch and Vegetation (B-69)	Mulch	Dimensional chipped hardwood or triple shredded, well-aged hardwood mulch 3 inches deep.
		Vegetation	See Plant List (Appendix E)
9	Design for Multi-Use Benefits (B-69)	Include features to enhance habitat, aesthetics, public education, and shade.	

Step 1. Determine the Volume of Water and Flow Rates to Treat

The planter box must be sized to fully capture the desired or required design storm volume and filter it through the soil media. Relevant regulatory requirements are presented in detail in Chapter 2. Surface storage (in the ponding area) and soil pore space (in the plant rooting zone and the underlying media and gravel drainage layers) provide capacity for the design storm volume retention. The volume of water that must be treated is equal to the design storm volume and can be calculated using the information in Appendix A. Once the design runoff depth is determined (according to the desired level of treatment), a runoff volume can be determined for the contributing watershed using this depth and the methods outlined in Appendix A, *San Antonio Unified Development Code*, or *San Antonio River Basin Regional Modeling Standards for Hydrology and Hydraulic Modeling*.

Peak flow rates for the design storm should also be calculated, using the methods outlined in Appendix A, so that the inlet and pretreatment can be accordingly sized and flow attenuation can be considered.

Step 2. BMP Siting and Configuration

Planter boxes, like bioretention areas, can be incorporated into the site design with various configurations and components. Unlike bioretention areas, planter boxes, because they are completely contained, can be included close to buildings and other structural foundations without affecting structural stability as long as underdrain outflow and overflow are routed in a safe direction. Planter boxes can be *perched* above grade on structures and/or be placed in series along a grade (tiered systems) to take advantage of vertical structures.

Step 3. BMP Function and Configuration

Planter boxes have the same drainage requirements as [bioretention](#) but are typically hydraulically isolated from subsoils so underdrains are always required. IWS is not generally incorporated into planter box design unless a very shallow reservoir is provided. Care must be taken to select plants that can withstand saturated root zones if IWS is selected as a design option.

Step 4. Size the System

Planter boxes have the same sizing standards as a [bioretention](#) area.

Step 5. Specify Soil Media

Planter boxes must meet same soil media standards as a [bioretention](#) area.

Step 6. Design Inlet and Pretreatment

Inlets for a planter box must meet the same standards as inlets for [bioretention](#) area. Planter boxes can incorporate filter strips, forebays, and curb cuts if located along the right-of-way. Because of the ability to install planter boxes adjacent to structural foundations, a planter box inlet can also incorporate a downspout from an adjacent building. Pipe flow and downspouts can be stabilized using similar strategies for a curb cut using sod, if the flow rate is less than 3 cubic feet per second (cfs), stone, splash block, or other erosion protection material for higher flows. Alternatively, downspouts can be upturned to *bubble up* into the planter box in a diffuse manner. A potential inlet configuration is shown in Figure B-4-1 and Figure B-4-2.



San Diego, California Source: Tetra Tech

Figure B-4-1. Downspout configuration.

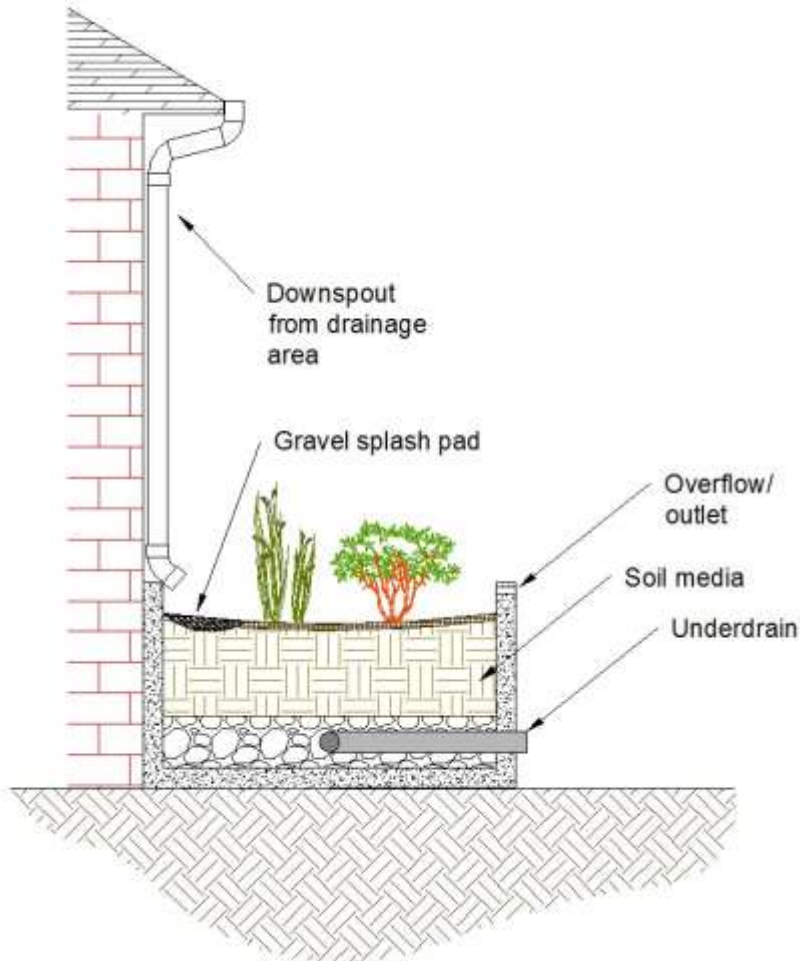

Figure B-4-2. Planter box inlet configuration.

Step 7. Select the Appropriate Outlet or Bypass Method

Planter boxes can be designed as offline or online systems. Planter boxes designed in the right-of-way should be designed as offline systems. Because underdrains will be required for planter boxes, the overflow system will typically include a vertical riser in both online or offline systems. The vertical riser should be designed as described in the [bioretention](#) section. Figure B-4-3 shows an example of a planter box with a vertical riser.

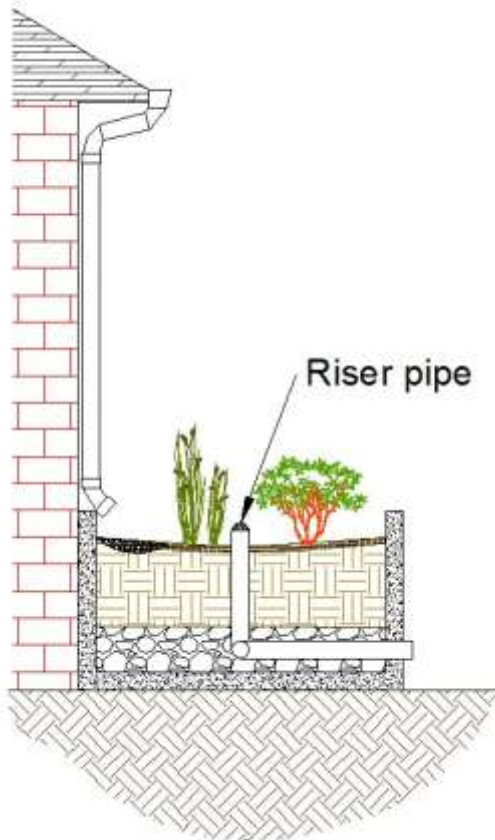

Figure B-4-3. Schematic of planter box with a vertical riser.

Step 8. Select Mulch and Vegetation

The mulch and vegetation will be the same for a planter box as a [bioretention](#) area. Some consideration should be taken as to the location of the planter box when selecting the vegetation. Shade-tolerant plants should be selected if the planter box will be shaded by surrounding structures. Planter boxes in the right-of-way should be vegetated with low shrubs to comply with sight distance requirements.

Step 9. Design for Multi-Use Benefits

Planter boxes can fulfill similar multi-use benefits as [bioretention](#) areas, but they can be more adaptable to highly impervious urban landscapes.

4.2 Critical Construction Considerations

The same construction considerations for [bioretention](#) should be employed in constructing planter boxes, except subgrade compaction does not require mitigation. In fact, depending on the weight of the planter box, aboveground systems might require a gravel or concrete footer to distribute the load (see foundation requirements in [Cisterns](#)).

4.3 Operation and Maintenance

Planter boxes require the same operation and maintenance as a bioretention area. For appropriate operation and maintenance, see [Bioretention](#).

5 Green Roofs



County Offices, San Diego, California. Source: Tetra Tech

5.1 Design

Green roof design is largely dependent on structural constraints of the subject and desired goals. Table B-5-1 summarizes the nine basic design steps, which are described in more detail below. Additional design guidance can be found in Tolderlund (2010) and New York City Department of Environmental Protection and New York City Department of Buildings (2012).

Table B-5-1. Design step process

Design step		Design component/ consideration	General specification
1	Determine Green Roof Type	Extensive	Shallow growing media (4–6 inches), small, drought-tolerant vegetation, no irrigation needed.
		Intensive	Growing media more than 6 inches, regular irrigation required deeper rooted vegetation. Contact qualified professional with experience designing intensive green roofs.
2	Determine Green Roof Size	Use Appendix A	
3	Determine Structural Capacity of Roof	Underlying roof deck and building structure	Evaluate proposed or existing building and roof structure to determine additional dead and live load capacity available to accommodate green roof installation
4	Specify Impermeable Liner and Root Barrier	Roof liner	Select waterproof liner. Conventional roof waterproofing tar is typically sufficient but can be supplemented with waterproof geomembranes if desired.
		Root barrier	Select root barrier. Geomembranes used as waterproof liners can sometimes double as root barriers.
5	Specify Drainage Layer	Aggregate	Minimum 2 inches of clean washed No. 8 stone or alternative lightweight, high-porosity, inorganic or synthetic aggregate. Geotextile fabric should be installed between the media and the aggregate.
		Manufactured	Select drainage layer specified for green roof applications that incorporates minimum 0.75 inch of retention storage of rainfall. Geotextile fabric should be installed between the media and the drainage layer.
6	Design Outlet Components	Roof drains	Provide roof drains or scuppers consistent with local building code requirements. Surround outlets with minimum 12 inches of high-porosity drainage material (washed ASTM No. 57 stone or comparable)
6	Specify Media	Depth	Minimum 4-inch depth (intensive green roofs)
		Content	Media should consist of a well-drained, high-porosity mix of primarily lightweight aggregate (preferred media is site specific, but expanded mineral materials are typically specified for intensive green roofs). pH = 6.5–8.0, CEC greater than 10 meq/100 g.
8	Select Vegetation	Low growing, drought-tolerant species	See plant list in Appendix E
9	Design for Multi-Use Benefits	Site specific	Include features to enhance recreational opportunities, habitat, aesthetics, and energy savings.

Appendix B. BMP Design Guidance

Step 1. Determine Green Roof Type

Green roofs can be categorized into one of two basic types according to design goals, structural constraints, and funding: extensive and intensive. The following subsections describe each type of green roof.

Extensive Green Roofs

Green roofs with less than 6 inches of media and shallow-rooting, xeric vegetation are considered extensive (Figure B-5-1). These roofs require little or no irrigation and contribute lighter loads to rooftops than intensive green roofs. Vegetation is typically composed of small succulents like stonecrops (*Sedum* spp.) or other desert plants that can withstand extreme temperature and moisture fluctuations. In the semi-arid environment, extensive green roofs typically require drip irrigation during plant establishment and dryer summer months. Irrigation should be achieved using air conditioner condensate or harvested rainwater. If sufficient water is not available from these sources, deeper media with higher water holding capacity can be specified or an alternative BMP should be selected. Various manufactured systems are available on the market with modular trays and built-in drainage layers to simplify design and installation.



East Lansing, Michigan. Source: Tetra Tech.

Figure B-5-1. Example of an extensive green roof.

Intensive Green Roofs

When a green roof has more than 6 inches of media and features deeper-rooting plants, it is considered intensive (Figure B-5-2). Intensive green roofs can be installed where structural support can handle the extreme weight of deep, saturated soils and vegetation. Often intended to function as small rooftop parks or gardens, intensive green roofs can provide many amenities; however, park-like landscaping on a rooftop might require irrigation, so take care to select water-efficient plants, especially if limited air conditioner condensate is available (Bexar Regional Watershed Management will not support BMPs that require permanent irrigation systems). Because of the wide variability in intensive green roof layout, media type and depth, irrigation demand and landscaping, it is not appropriate to explore the design process in this manual. For more design guidance, contact a qualified professional with experience in implementing intensive green roofs.



James Madison High School Agriscience Building, San Antonio, Texas Source: Bender Wells Clark Design

Figure B-5-2. Example of an intensive green roof.

Step 2. Determine the Volume of Water and Flow Rates to Treat

Green roofs typically treat only direct rainfall, except for certain situations where runoff is generated from adjacent roof areas or where air conditioner condensate is captured. Design volume and flow rates can be determined using the methods in Appendix A.

Step 3. Determine Structural Capacity of Roof

Green roof design primarily depends on the excess load that can be applied to a rooftop. **A qualified structural engineer should be consulted to determine the structural capacity of the roof in question to support additional dead and live load resulting from green roof installation.** For new construction, the building designer might consider the additional roof load in selecting building structural components. In either scenario the dead and live roof loads from the green roof installation will depend on the specific green roof components and must be evaluated case by case. In general, extensive green roofs can be expected to exert a dead load (fully saturated) of 15 lb/square foot to 55 lb/square foot. Loading by intensive green roofs will widely vary based on soil depth and other components (Tolderlund 2010).

Step 4. Specify Impermeable Liner and Root Barrier

As with all roofs, a watertight barrier must be provided to prevent rainwater from infiltrating the underlying structure. Watertight tar surfaces (conventionally used for roof sealing) are usually sufficient impermeable liners, but additional plastic or rubber membranes can be placed over the tar for added protection. The liner should be resistant to heat, desiccation, and ultraviolet radiation. A root barrier should be specified and placed directly above the impermeable liner or alternatively above an optional insulation layer that can be placed directly on the liner.

Step 5. Specify Drainage Layer

A drainage layer, also known as a drainage net or sheet drain, is necessary to convey excess rainwater to the roof drains. This layer will also maintain an aerobic root zone for plant health. Geotextile should be placed between the media and the drainage layer to prevent migration of media and act as a root barrier. Geotextiles containing chemicals that prevent root penetration can be used so root systems do not infiltrate and clog the drainage layer. A typical green roof cross section is shown in Figure B-5-3.

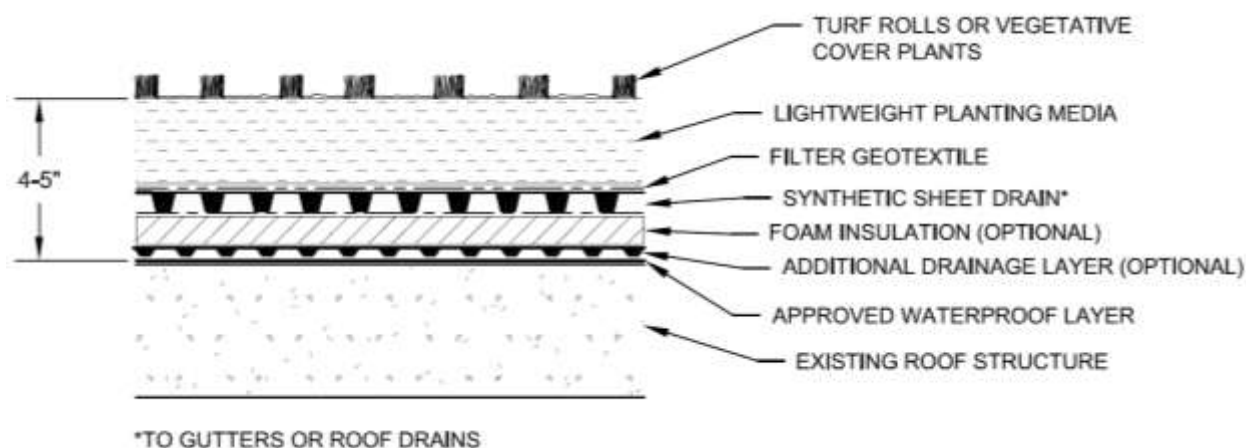

Figure B-5-3. Typical extensive green roof profile.

Step 6. Design Outlet Structures

As with all roofs, components must be incorporated into the roof structure to allow free drainage of excess runoff from the rooftop and away from the building. For extensive green roof applications, drainage components can include internal roof drains or roof scuppers along roof perimeters. These components should be designed in accordance with local building codes. To ensure adequate conveyance of roof runoff from the drainage layer to the outlets, green roofs should be set back a minimum of 12

inches from roof drains. The area surrounding the roof drains should be filled with clean washed No. 57 stone or alternative high-porosity material. Placing light-colored stone buffer around the roof drains also delineates a *no-plant zone* for maintenance staff (Figure B-5-4). The no-plant zone should remain free of vegetation to prevent drain clogging.



Raleigh, North Carolina. Source: Amy Hathaway, City of Raleigh

Figure B-5-4. Light-colored gravel delineates the no-planting zone for maintenance personnel.

Step 7. Specify Soil Media

Green roofs can be designed as flow-through systems or can be designed to detain a specific design volume of water (as determined by a qualified structural engineer). Sizing methodology presented in [Bioretention](#) can be used to design the system to capture a specific design volume. Soil media for green roofs should have the following characteristics:

- Well drained and aerated
- High porosity
- High nutrient holding capacity (cation exchange capacity)
- Permanent (non-biodegrading)
- Lightweight
- Windproof
- Stable (must support plants)

Appendix B. BMP Design Guidance

Several media types are available from green roof component suppliers, but generally expanded lightweight aggregates are preferred (e.g., expanded slate, expanded shale, expanded clay, terra cotta). For extensive green roofs, a minimum of 4 inches of media should be provided. The specifications provided in Table B-5-2 are example parameters that should be specified on design plans. Intensive green roofs should also employ lightweight aggregate media, but structural capacity generally allows a wider range of soil materials. Green roof media installation can be challenging and may require the use of a crane, auger, conveyor, or pneumatic delivery system.

Table B-5-2. Example green roof media specifications

Parameter	Specification
Non-capillary pore space at field capacity	15% (vol)
Moisture content at field capacity	12% (vol)
Maximum media water retention	30% (vol)
Alkalinity, Ca CO ₃ equivalents	2.5%
Total organic matter by wet combustion	3-15% (dry wt.)
pH	6.5-8.0
Soluble salts	6 mmhos/cm
Cation exchange capacity	10 meq/100g
Saturated hydraulic conductivity for single media assemblies	0.05 in/min
Clay fraction (2 micron)	0
Pct. passing US#200 sieve (i.e., silt fraction)	5%
Pct. passing US#60 sieve	10%
Pct. passing US#18 sieve	5%–50%
Pct. passing 1/8-inch sieve	20%–70%
Pct. passing 3/8-inch sieve	75%–100%

Source: based on East Baton Rouge Parish 2007

Step 8. Specify Vegetation

Green roof vegetation should consist of low-growing, highly drought-tolerant, biodiverse species that are adapted to survive in the harsh environment of a rooftop. Appropriate vegetation should be selected based on the specific site conditions and recommendations by local horticulturalists and green roofs manufacturers.

Step 9. Design for Multi-Use Benefits

Green roofs can provide benefits to the urban environment in which they are placed. In various studies they have been shown to increase property values, reduce energy use, reduce heat island effect, increase roof lifespan, reduce air pollution, and enhance the health of adjacent property owners. Studies evaluating the multi-use benefits of green roofs are listed in Chapter 3.



James Madison High School Agriscience Building, San Antonio, Texas. Source: San Antonio River Authority

Figure B-5-5. Rooftop gardens provide recreational opportunities.

5.2 Critical Construction Considerations

Green roofs inhabit a unique location in the urban landscape that results in designers facing construction considerations that are not applicable to landscape-based BMPs.

5.2.1 Provide Access for Installation, Inspection, and Maintenance

During construction, green roof materials must be transported to the rooftop. This can be done via ladder lifts, elevators, or human physical labor; the most efficient method is typically using a crane. Media can be pneumatically blown onto the roof surface. Adequate areas must be available at the building perimeter for material and equipment staging. To accommodate regular inspection, a physical access method should be provided to the rooftop. Designated pathways across the green roof surface should be provided to prevent damage to plants and compaction of media during maintenance activities.

5.2.2 Consider Supplemental Irrigation during Plant Establishment

In the plant establishment phase, supplemental irrigation might be necessary to ensure plant survival and full roof coverage of roofing materials.

Appendix B. BMP Design Guidance

5.2.3 Visitor Safety

Where public access is provided to the green roof for recreation or other purposes, consider barriers to mitigate fall risk. If vegetation includes grasses or other species that results in significant dead vegetation matter, incorporate fire prevention into maintenance plans or public signage.

5.3 Operation and Maintenance

Inspection and maintenance are critical to ensuring safe and effective functioning of green roofs. Table B-5-3 provides specific inspection and maintenance tasks.

Table B-5-3. Inspection and maintenance activities for green roofs

Task	Frequency	Indicator maintenance is needed	Maintenance notes
Media inspection	2 times/year	Internal erosion of media from runoff or wind scour, exposed underlayment components	Replace eroded media and vegetation. Adopt additional erosion prevention practices as appropriate.
Liner inspection	1 time/year	Liner is exposed or tenants have experienced leaks	Evaluate liner for cause of leaks. Repair or replace as necessary.
Outlet inspection	2 times/year	Accumulation of litter and debris around the roof drain or scupper or standing water in adjacent areas.	Litter, leaves, and debris should be removed to reduce the risk of outlet clogging. If sediment has accumulated in the gravel drain buffers, remove and replace the gravel.
Vegetation inspection	1 time/year	Dead plants or excessive open areas on green roof	Within the first year, 10% of plants can die. Survival rates increase with time.
Invasive vegetation	2 times/year	Presence of unwanted or undesirable species	Remove undesired vegetation. Evaluate green roof for signs of excessive water retention.
Temporary watering	1 time/2–3 days for first 1–2 months	Until established and during severe drought	Watering after the first year might be required.

5.4 References

East Baton Rouge Parish. 2007. *Stormwater*. Chapter 7. September 2007. Accessed January 7, 2013. <http://brgov.com/dept/planning/WWS/pdf/bmp7.pdf>.

New York City Department of Environmental Protection and New York City Department of Buildings. 2012. *Guidelines for the Design and Construction of Stormwater Management Systems*. July 2012. http://www.nyc.gov/html/dep/pdf/green_infrastructure/stormwater_guidelines_2012_final.pdf.

Tolderlund, L. 2010. *Design Guidelines and Maintenance Manual for Green Roofs in the Semi-Arid and Arid West*. Denver, CO.

6 Sand Filters



Surface sand filter at Remington Oaks, San Antonio, Texas Source: Bender Wells Clark Design

6.1 Design

Sand filters have many of the same design elements as bioretention but are typically not planted. Table B-6-1 lists the steps involved in sand filter design.

Table B-6-1. Iterative design step process

Design step		Design component/ consideration	General specification
1	Determine BMP Size	Use Appendix A	
2	BMP Configuration (B-81)	Sand filter type	Based on available space and required access for maintenance, determine location and type of sand filter <ul style="list-style-type: none"> • Surface sand filters: installed in shallow depressions on surface. Require pretreatment by vegetated swales, filter strip, or forebay. • Subsurface sand filters: can be installed along the edges of roads and parking lots to conserve space. Must include a sedimentation chamber for pretreatment.
3	Determine BMP Function (B-83)	Impermeable liner	If non-infiltrating (per geotechnical investigation), use one of the following (as described in Common Design Elements): <ul style="list-style-type: none"> • Impermeable clay liner • Geomembrane liner • Concrete
		Lateral hydraulic restriction barrier	Use concrete or geomembrane to restrict lateral seepage to adjacent subgrades, foundations, or utilities.
		Underdrain	Schedule 40 PVC pipe with perforations (slots or holes) every 6 inches. 4-inch diameter lateral pipes should join a 6-inch collector pipe, which conveys drainage to the downstream storm network. Provide cleanout ports/observation wells for each underdrain pipe at spacing consistent with local regulations. See Common Design Elements .
		internal water storage (IWS)	If using underdrain and infiltration, elevate the outlet to create a sump for additional moisture retention to promote plant survival and treatment. Top of IWS should be more than 10 inches below the surface.
		No underdrain	If design is fully infiltrating, ensure that subgrade compaction is minimized.
4	Size the System (B-84)	Temporary ponding depth	No deeper than 8 feet (shallower depth should be used in residential areas or near schools and parks)
		Soil media depth	1.5–4 feet (deeper for better pollutant removal, hydrologic benefits, and deeper rooting depths)
5	Specify Soil Media (B-85)	Gradation	Washed concrete sand (ASTM C-33) free of fines, stones, and other debris
		Chemical composition	Total phosphorus < 15 ppm
		Gravel drainage layer	Separate sand media from underdrain with 2 inches of choking stone (ASTM No. 8) or geotextile over a 1.5-foot envelope of ASTM No. 57 stone
6	Design Inlet and Pretreatment (B-86)	Inlet	Provide stabilized inlets (see Curb Cuts and Energy Dissipation)
		Pretreatment	Install rock armored forebay (concentrated flow), gravel fringe and vegetated filter strip (sheet flow), or vegetated swale

Design step		Design component/ consideration	General specification
7	Select and Design Overflow/Bypass Method (B-87)	Outlet configuration	Online: All runoff is routed through system—install an elevated overflow structure or weir at the elevation of maximum ponding Offline: Only treated volume is diverted to system—install a diversion structure or allow bypass of high flows
8	Design for Multi-Use Benefits (B-88)	Include features to enhance aesthetics and public education.	

Step 1. Determine the Volume of Water or Flow to Treat

The sand filter must be sized to fully capture the desired or required design storm volume and filter it through the soil media. The sand filter should be oversized by 20 percent to accommodate the sediment accumulation in the surface of the sand filter, which reduces design volume (according to Barrett 2005). Relevant regulatory requirements are presented in detail in Chapter 2. Surface storage (in the ponding area) and soil pore space provide capacity for the design storm volume retention. Appendix A outlines methods for determining design runoff depths associated with a range of annual treatment efficiencies. Once the design runoff depth is determined (according to the desired level of treatment), a runoff volume can be determined for the contributing watershed using this depth and the methods outlined in Appendix A, *San Antonio Unified Development Code*, or *San Antonio River Basin Regional Modeling Standards for Hydrology and Hydraulic Modeling*.

Peak flow rates for the design storm should also be calculated, using the methods outlined in Appendix A so that the inlet and pretreatment can be accordingly sized and flow attenuation can be considered.

Step 2. Determine BMP Configuration

Sand filters require less space than many BMPs and are typically used in parking lots or other highly impervious areas. Two basic configurations are available for sand filters: surface sand filters with a vegetated filter strip as a pretreatment element, or subsurface sand filters with a sedimentation/grit chamber. The aboveground option requires more space to incorporate the pretreatment filter, and it provides more pathogen reduction from the surface’s exposure to sunlight.

Surface: Surface sand filters require some method of pretreatment, such as a filter strip or swale, to remove large solids and reduce the velocity of stormwater entering the BMP. Surface sand filters can be integrated into the site plan as recreation facilities or open space as shown in Figure B-6-1. Access should always be provided for routine, intermittent, and rehabilitative maintenance activities.



Parman Library, San Antonio. Source: Tetra Tech

Figure B-6-1. Surface sand filter.

Subsurface: Subsurface sand filters require very little space and are easily incorporated belowground into the edge of parking lots and roadways. Subsurface sand filters require a pretreatment sedimentation chamber (typically 1.5-feet-wide) to allow large solids to settle. An example of a subsurface sand filter with a sedimentation chamber is shown in Figure B-6-2.

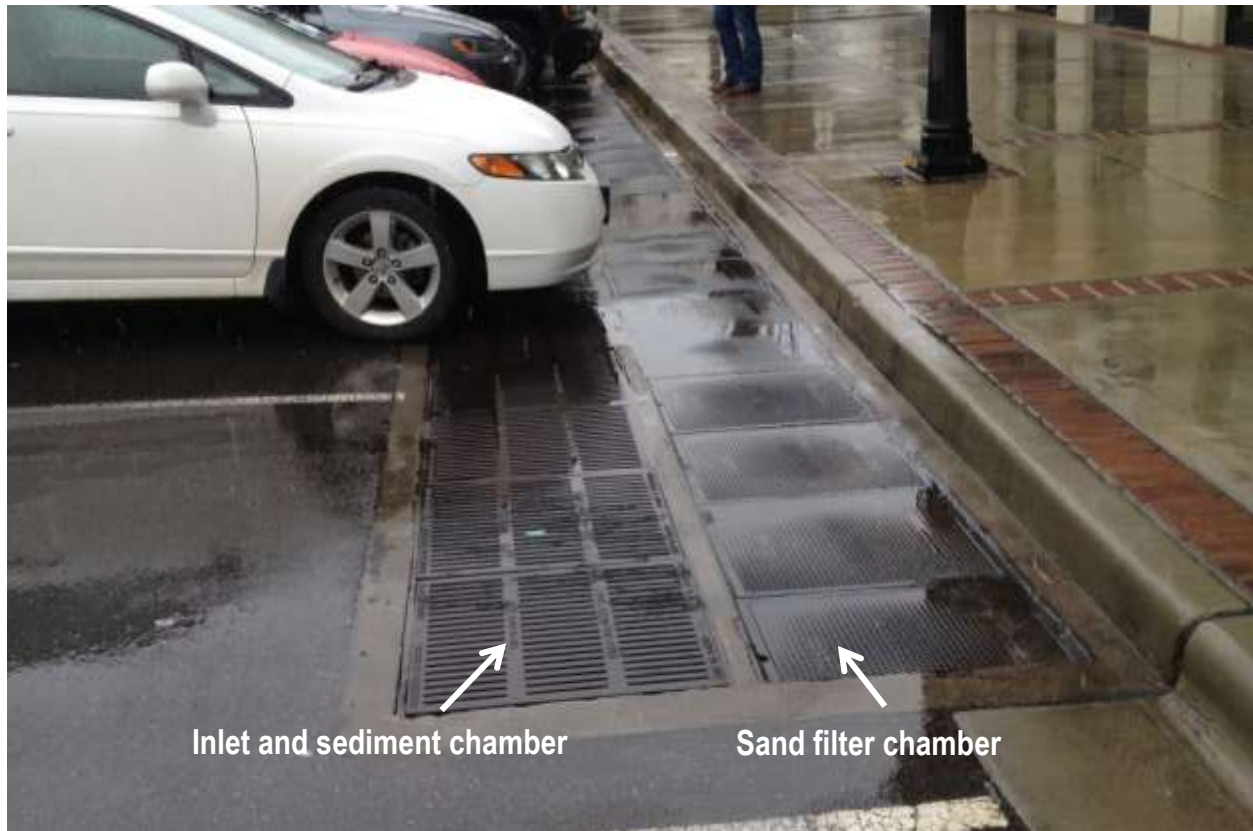

Raleigh, North Carolina. Source: Tetra Tech.

Figure B-6-2. Subsurface sand filter.

Step 3. Determine BMP Function

Sand filters should be designed as infiltrating practices whenever practicable. Geotechnical testing and drainage requirements are the same as for [bioretention](#). Additionally, IWS can be used in infiltrating sand filters to increase residence time and improve volume reduction if subsoil infiltration rate is sufficiently high (e.g. infiltration rates of greater than 0.5 in/hr). Because plant survival is not a consideration in sand filters, the IWS elevation (underdrain outlet elevation) can be specified at 10 inches below the media surface. The IWS layer should not extend within 10 inches of the media surface because this is where the majority of sediment (and associated constituents) is captured; prolonged saturation of deposited sediments could cause previously captured pollutants to desorb/dissolve (Hunt et al. 2012). An example of a sand filter with IWS is shown in Figure B-6-3.

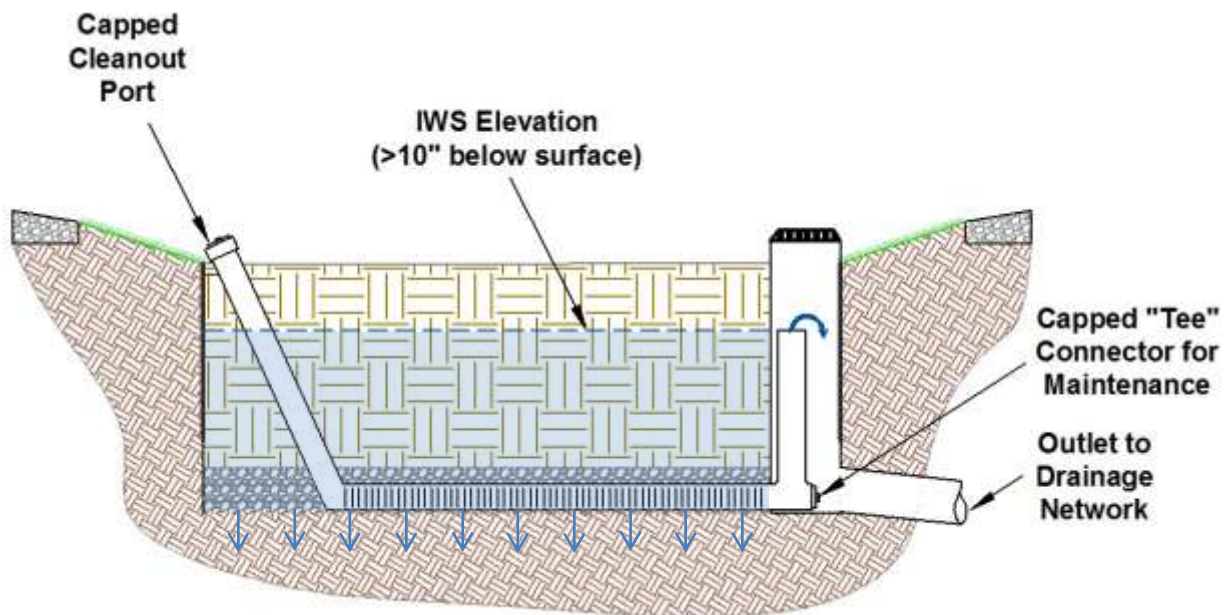

Figure B-6-3. Conceptual schematic of an infiltrating surface sand filter with IWS.

Step 4. Size the System

Vertical components of sand filters are similar to bioretention, except that there are no constraints imposed by vegetation. The following subsections describe sand filter sizing.

Surface Ponding Depth

The ponding depth of sand filters is not limited as with some BMPs because the effect on vegetation is not a concern. Depth is determined by the ability of the sand filter to completely drain within 48 hours and, therefore, is a function of the surface area and infiltration rate of the sand media. Ponding depth should not exceed 8 feet as a safety precaution, and it should be shallower near residential areas, parks, and schools. When surface sand filters feature deep ponding depths, safety precautions consistent with conventional ponds (shallow water safety shelves, fencing, etc.) should be specified in the design.

Media Depth

Sand media depth should be a minimum of 1.5 feet for sediment removal. For pollutant-specific media depths, see the [bioretention](#) section.

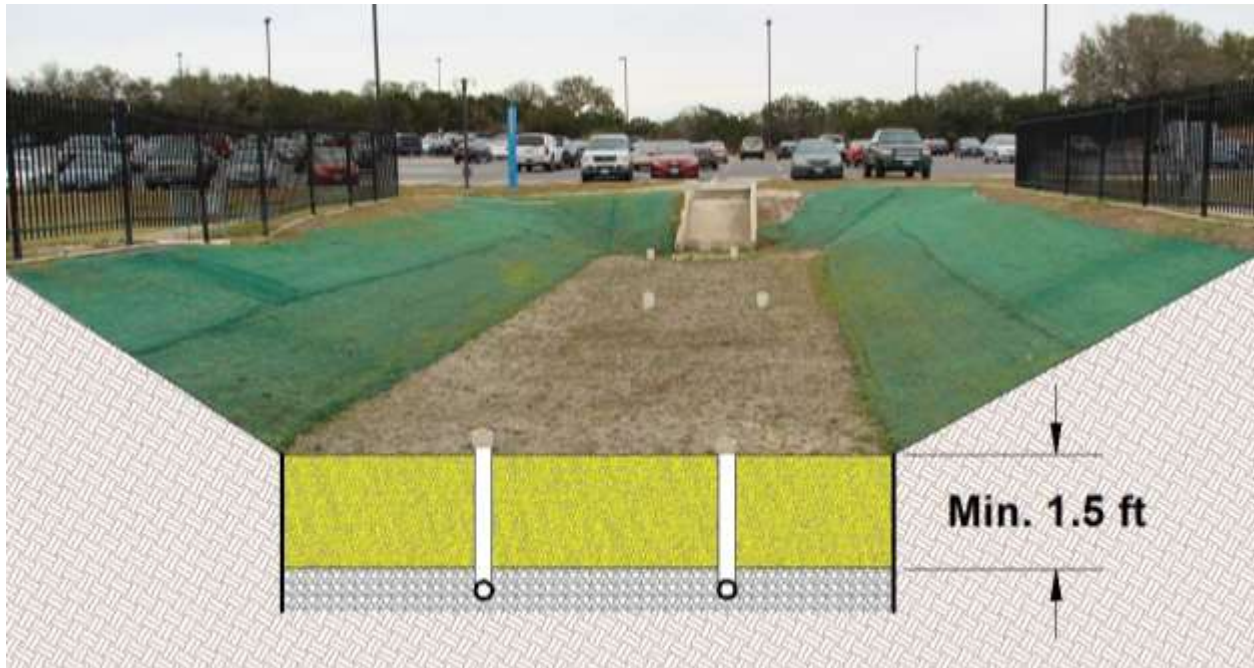

University of Texas at San Antonio, San Antonio, Texas. Source: Tetra Tech

Figure B-6-4. Sand filter geometry and profile.

Surface Area

The footprint of the sand filter should be sized using the equations provided in the [bioretention](#) section. Porosity of sand filter sand can be assumed equal to 0.4 for preliminary calculations, but actual laboratory-measured porosity should be used for final calculations. Although the footprint of sand filters can be smaller than bioretention because of deeper allowable surface ponding depths, smaller sand filters will require more frequent rehabilitative maintenance.

Step 5. Specify Soil Media

The soil media in the sand filter should be highly permeable; free of fines, stones, and other debris; and should meet the criteria listed in Table B-6-2. Media should be separated from gravel drainage layer using 2 inches of ASTM No. 8 choking stone or geotextile, as described in [Common Design Elements](#).

Table B-6-2. Sand filter soil media specifications

Parameter	Specification
Gradation	Media in the sand filter should consist of clean washed concrete sand (passing a one-quarter-inch sieve) per ASTM C-33.
Total phosphorus	High levels of phosphorus in the media have been identified as the main cause of BMPs exporting nutrients. All media should be analyzed for background levels of nutrients. Total phosphorus should not exceed 15 ppm.

Step 6. Design Inlet and Pretreatment

Erosive velocities and high sediment loads can be detrimental to sand filters. Both aboveground and belowground sand filters require some type of pretreatment before stormwater contacts the filter media. Aboveground sand filters should be constructed with a flow diversion, where possible, to divert volumes that exceed the water quality volume away from the sand filter to prevent excessive loads and erosive flow from affecting the filter media. Side slopes of above ground sand filters should be similar to a bioretention area. Below ground sand filters are typically installed in vaults and may be vertical. For more detail on diversion structures, see [Common Design Elements](#). Vegetated filters can also be used with aboveground sand filters where space is available. Flows entering sand filters should be diffused by passing over a level spreader before contacting the filter media to reduce flows, minimize filter media erosion, and distribute the flow over a larger surface area (see [Vegetated Filter Strips](#) for level spreader design details). Flows entering a subsurface sand filter should enter the sedimentation chamber and can be either concentrated or diffuse, depending on the inlet type. Concentrated flow, such as the flow for the end of a stormwater pipe, should enter the sedimentation chamber and flow into the media chamber over a level spreader to diffuse the flow before contacting the filter media as shown in Figure B-6-5. Diffuse flow passing into the sediment chamber over a level lip, such as the edge of a parking lot, should still flow over a level spreader before contacting the filter media. Figure B-6-5 shows a belowground sand filter with a diffuse flow inlet in a parking lot. It is important to distribute the flow across the surface area of the sand filter as much as possible to prevent the inflow from concentrating in one area, causing increased maintenance. The sedimentation chamber should be dewatered between storm events to prevent vector issues; this can be done by installing a perforated riser pipe surrounded by a gravel envelope in a trash rack (see [Common Design Elements](#)). Sedimentation chambers can vary in size depending on configuration, but should typically be designed to hold 50% of the design water quality volume and have a depth of 2 feet to 3 feet to minimize scour of sediment deposition (Knox County 2008; Claytor and Schueler 1996). Detailed pretreatment sizing guidance can be found in Claytor and Schueler (1996).

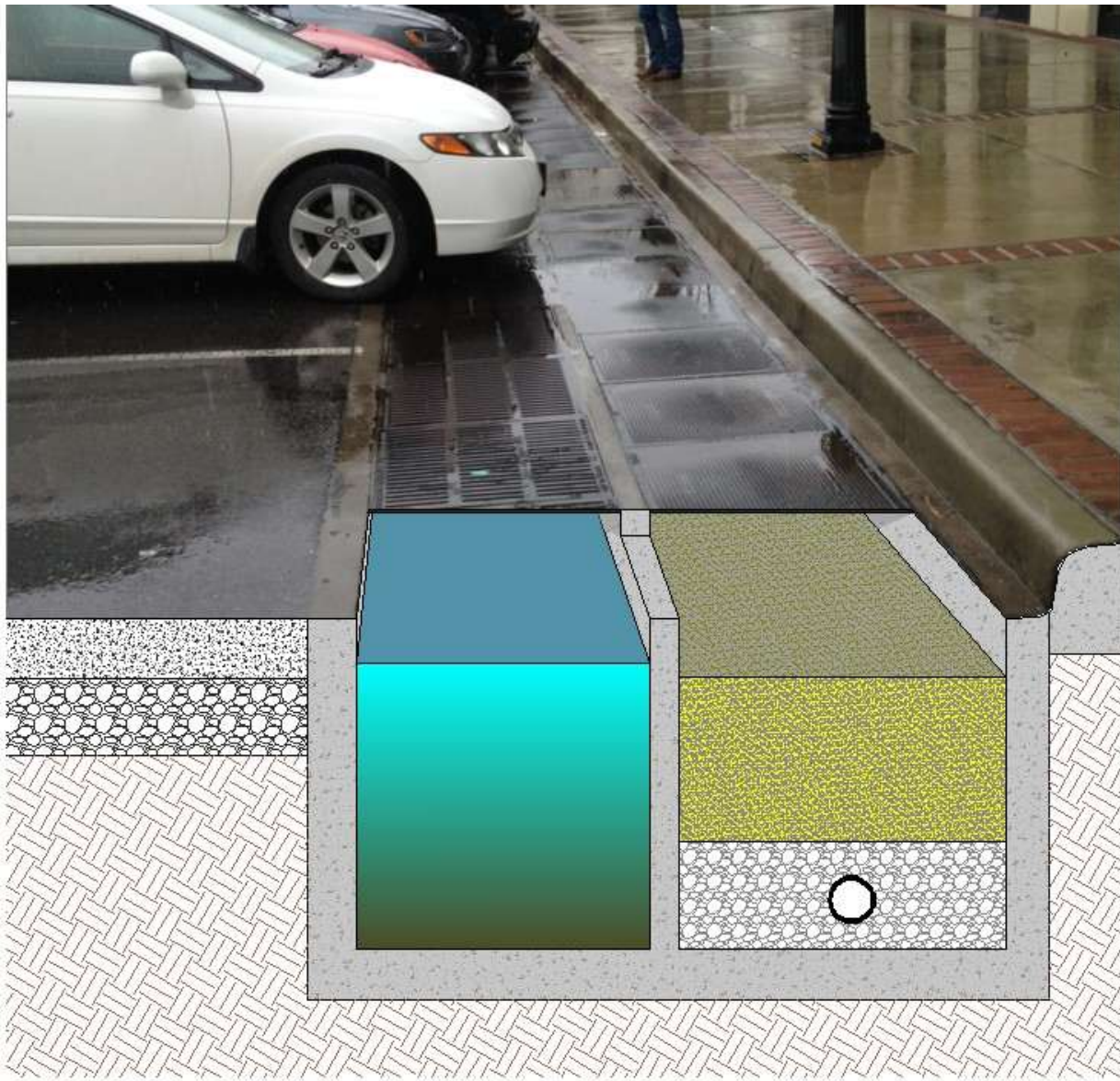

Raleigh, North Carolina. Source: Tetra Tech.

Figure B-6-5. Belowground sand filter with diffuse flow inlet and slot weirs between sedimentation chamber and sand filter chamber.

Step 7. Select and Design Overflow/Bypass Method

Sand filters can be designed as online or offline systems, but offline configurations are typically preferred to preserve the functional life of the filter media. Details for designing diversion structures for offline systems are provided in [Common Design Elements](#). An alternative overflow should be incorporated for all configurations as a contingency for when the filter media clogs; doing so will prevent damage to the BMP and surrounding areas. Overflow options are described in [Bioretention](#).

Step 8. Design for Multi-Use Benefits

Subsurface sand filters inherently provide multi-use benefits because they can be installed below areas dedicated for parking. Multi-use benefits should be provided for surface sand filters by including educational signage and kiosks.

6.2 Critical Construction Considerations

Construction considerations for sand filters are similar to those for [bioretention](#). For subsurface sand filters, care should be taken to verify elevations of all structures and allow for ease of access for maintenance.

6.3 Operation and Maintenance

Sand filters require regular, frequent maintenance of the media layer and pretreatment devices to ensure optimum infiltration, storage, and pollutant removal capabilities. Specific tasks are listed in Table B-6-3 and key activities are described below:

1. Erosion control: Inspect flow entrances, ponding area, and surface overflow areas periodically during the rainy season, and replace vegetation or erosion control materials if erosion has occurred (for a sand filter inspection and maintenance checklist, see Appendix F). Properly designed facilities with appropriate flow velocities will not have erosion problems except perhaps in extreme events. If erosion problems occur, the following must be reassessed: (1) flow velocities and gradients within the filter, and (2) flow dissipation and erosion protection strategies in the pretreatment area and flow entrance. If sediment other than the designed soil media is deposited in the media chamber, immediately determine the source in the contributing area, stabilize, and remove excess surface deposits.
2. Inlet: The inlet should be inspected after the first storm of the season, then monthly during the rainy season to check for sediment accumulation and erosion. Sediment can accumulate, especially at inlets where bypass structures are used, and should be inspected regularly. Any accumulated sediment that impedes flow into the sand filter should be removed and properly disposed of. Flow spreaders should be cleaned and reset as needed to maintain diffuse flows.
3. Overflow and underdrains: Sediment accumulation in the overflow device or underdrain system can cause prolonged ponding and potential flooding. Overflow and underdrain systems should be inspected after the first storm of the season, then monthly during the rainy season to remove sediment accumulation around the overflow. The underdrain system should be designed so that it can be flushed and cleaned as needed. If water is ponding over the filter media for more than 72 hours, the underdrain system should be flushed with clean water until proper infiltration is restored. Flow spreaders should be checked to maintain diffuse flow.
4. Sand media: If in question, have the soil analyzed for pollutant levels. A sediment depth indicator may be installed in the sedimentation chamber to indicate the depth of sediment accumulation as an indication that maintenance is required (according to Barrett 2005).
5. General maintenance: Trash and debris should be removed from the sand filter as needed. Any visual evidence of contamination from pollutants such as oil and grease should be removed as needed.

Table B-6-3. Inspection and maintenance tasks for sand filters

Task	Frequency	Indicator maintenance is needed	Maintenance notes
Catchment inspection	Weekly or biweekly with routine property maintenance	Excessive sediment, trash, or debris accumulation on the surface of sand filter.	Permanently stabilize any exposed soil and remove any accumulated sediment. Adjacent pervious areas might need to be regraded.
Inlet inspection	Once after first major rain of the season, then every 2 to 3 months depending on observed sediment and debris loads	Debris or sediment has blocked inlets	Remove any accumulated material.
Sedimentation chamber/forebay inspection	Every 2 months	Sediment has reached 6 inches deep (install a fixed vertical sediment depth marker) or litter and debris has clogged weirs between sedimentation chamber and sand filter chamber (for subsurface filters)	Remove accumulated material from sedimentation chamber. Remove and replace top 2 to 3 inches of sand filter if necessary.
Sand filter surface infiltration inspection	After major storm events or biannually	Surface ponding draws down in more than 48 hours	Remove and replace top 2 to 3 inches of sand filter, or as needed to restore infiltration capacity. Inspect watershed for sediment sources.
Outlet inspection	Once after first major rain of the season, then monthly	Erosion or sediment deposition at outlet	Check for erosion at the outlet and remove any accumulated sediment.
Miscellaneous upkeep	12 times/year		Tasks include trash collection, spot weeding, replacing soil media, and removing visual contamination.

6.4 References

- Barrett, M.E. 2005. *Complying with the Edwards Aquifer Rules. Technical Guidance on Best Management Practices*. RG-348. Prepared for Texas Commission on Environmental Quality, Field Operations Division, Austin, TX.
- Claytor, R.A., and T.R. Schueler. 1996. *Design of Stormwater Filtering Systems*. Center for Watershed Protection, Silver Spring, MD.
- Hunt, W.F., A.P. Davis, and R.G. Traver. 2012. Meeting hydrologic and water quality goals through targeted bioretention design. *Journal of Environmental Engineering* 138(6):698–707.
- Knox County. 2008. *Knox County Tennessee Stormwater Management Manual. Volume 2 (Technical Guidance)*. [http://www.knoxcounty.org/stormwater/pdfs/vol2/3-1-8 Water Balance Calculations.pdf](http://www.knoxcounty.org/stormwater/pdfs/vol2/3-1-8%20Water%20Balance%20Calculations.pdf).

7 Stormwater Wetlands



Stormwater wetland in Lenoir, North Carolina. Source: Tetra Tech, Inc.

7.1 Design Steps

The design of a constructed stormwater wetland can be broken down to a nine-step process. Table B-7-1 summarizes the steps, which are described in greater detail.

Table B-7-1. Iterative design step process

Design step		Design component/ consideration	General specification
1	Determine BMP Treatment Volume	Use Appendix A. The design volume should be oversized by 20% to account for sediment accumulation over time.	
2	Perform Feasibility Water Balance	Evapotranspiration, infiltration	Estimate rate of water loss during drought to ensure that water is maintained in deep pools (shallow water zones do not need to remain wet year round)
2	BMP Siting and Configuration	BMP size	Incorporate into lowest areas of site
3	Determine Geotechnical Requirements and Specify Liner	Geotechnical investigation and impermeable liners	See Common Design Elements
4	Design Inlet and Pretreatment	Sediment forebay	Forebay should be 18–36 inches deep, 10% of the temporary ponding surface area, and should be lined with riprap for energy dissipation
5	Design wetland flow path and zones	Maximum flow path	The minimum length to width (L:W) ratio should be 2:1, but L:W should be maximized by creating a sinuous flow path and placing the outlet as far from the inlet as possible
		Wetland zones	<p>Deep Pools: 15%–20% of wetland surface area (including forebay), 18–36 inches deep</p> <p>Transition: 10%–15% of wetland surface area, transition between deep pool and shallow water, 12–18 inches deep, maximum slope of 1.5:1.</p> <p>Shallow Water: 40% of wetland surface area, 3–6 inches deep, flat or 6:1 slope (at least 6-foot radius around all deep pools to provide safety shelf). Shallow water depths (less than 6 inches) provide optimum conditions for plant survival and should be verified during construction inspection.</p> <p>Temporary Inundation: 30%–40% of wetland surface area, up to 12 inches deep, 3:1 slopes</p> <p>Detention Storage/Upland: Additional ponding depth can be provided for peak flow mitigation, as needed, but depth should generally not exceed 4 feet above the permanent pool elevation</p>

Appendix B. BMP Design Guidance

Design step		Design component/ consideration	General specification
6	Select and Design Outlet/Bypass Method	Outlet configuration	<p>Online: All runoff is routed through the wetland basin—install an elevated riser structure or weir with an orifice at the permanent pool elevation and an overflow at the maximum temporary ponding elevation (if additional peak flow mitigation is required, a second orifice can be placed at the temporary ponding elevation and the overflow can be elevated to detain the necessary runoff)</p> <p>Offline: Runoff in excess of the design water quality volume bypasses the wetland basin—design a diversion structure per the guidance in Common Design Elements</p>
		Design drawdown orifice	Non-clogging orifices should feature a downturned pipe that extends 6 to 12 inches below the permanent pool elevation in an area of open water (deep pool) and allows drawdown of temporary ponding in 2 to 5 days
		Maintenance and emergency dewatering design	A protected inlet should be provided near the base of the outlet structure with a tamper-proof manual valve (intake should be sized one standard pipe size larger than needed to dewater the basin in 24 hours)
		Outfall pipe and emergency overflow	The outlet pipe should incorporate measures to prevent lateral seepage and should discharge to an adequately stabilized area; an emergency spillway should be provided to safely bypass extreme flood flows
7	Specify Soil Media	Wetland vegetation substrate	At least 1 to 4 inches of low-phosphorus, organic topsoil over the impermeable layer is typically required for plant establishment
8	Select Vegetation	Wetland vegetation by zone	See Plant List (Appendix E)
9	Design for Multi-Benefit Uses	Site specific	Include features to enhance habitat, aesthetics, recreation, and public education as desired.

Step 1. Determine the Volume of Water and Flow Rates to Treat

The methods for determining wetland size are outlined in Appendix A. The wetland should be oversized by 20 percent to accommodate the sediment accumulation in the wetland, which reduces design volume (according to Barrett 2005).

Peak flow rates should also be calculated using methods outlined in the *San Antonio Unified Development Code* or *San Antonio River Basin Regional Modeling Standards for Hydrology and Hydraulic Modeling*, so that the inlet, pretreatment, outlet, bypass and other hydraulic features can be accordingly sized and flow attenuation considered.

Step 2. Perform Feasibility Water Balance

A stormwater wetland's function relies on the wetland retaining an adequate supply of water between storm events to ensure plant vigor and to maintain habitat for mosquito-eating fish (Hunt et al. 2005).

Wetlands should have enough water supplied from groundwater, runoff, or baseflow so that the permanent pools will not draw down by more than 2 feet after a 30-day drought. Where seasonally low groundwater elevations intersect with the wetland features (see step 4) groundwater resources might be

sufficient to supply enough water to ensure plant survival. In areas where an impermeable liner is incorporated into the wetland design, a water balance evaluation should be conducted to determine if the necessary water will be retained in the deep pools. In doing this, the designer should consider precipitation, evapotranspiration, runoff, infiltration (if unlined), and any other inputs or outputs of water from the system. Note that the water balance should be performed only for the deep pools because wetland plants established in shallow water zones are well-adapted to periods of drought. Guidance on one method for conducting a water balance is in Hunt et al. (2007) and Knox County (2008).

Step 3. BMP Siting and Configuration

Constructed stormwater wetlands are typically constructed in the lowest area of a site such that runoff can be conveyed by gravity flow and so that excavation is minimized. The stormwater wetland location should provide adequate elevation difference, typically 3 feet or more, to discharge water to the existing stormwater network without the need for pumps. Constructed wetlands can be incorporated along the perimeter of a site by designing a long, linear footprint, or it can serve as an attractive amenity in common areas of developments. If the entire design volume cannot be stored in one location or if utility conflicts are apparent, wetland pockets can be distributed between several locations and connected with vegetated channels or buried conduit. For an example wetland configurations, see Figure B-7-1.

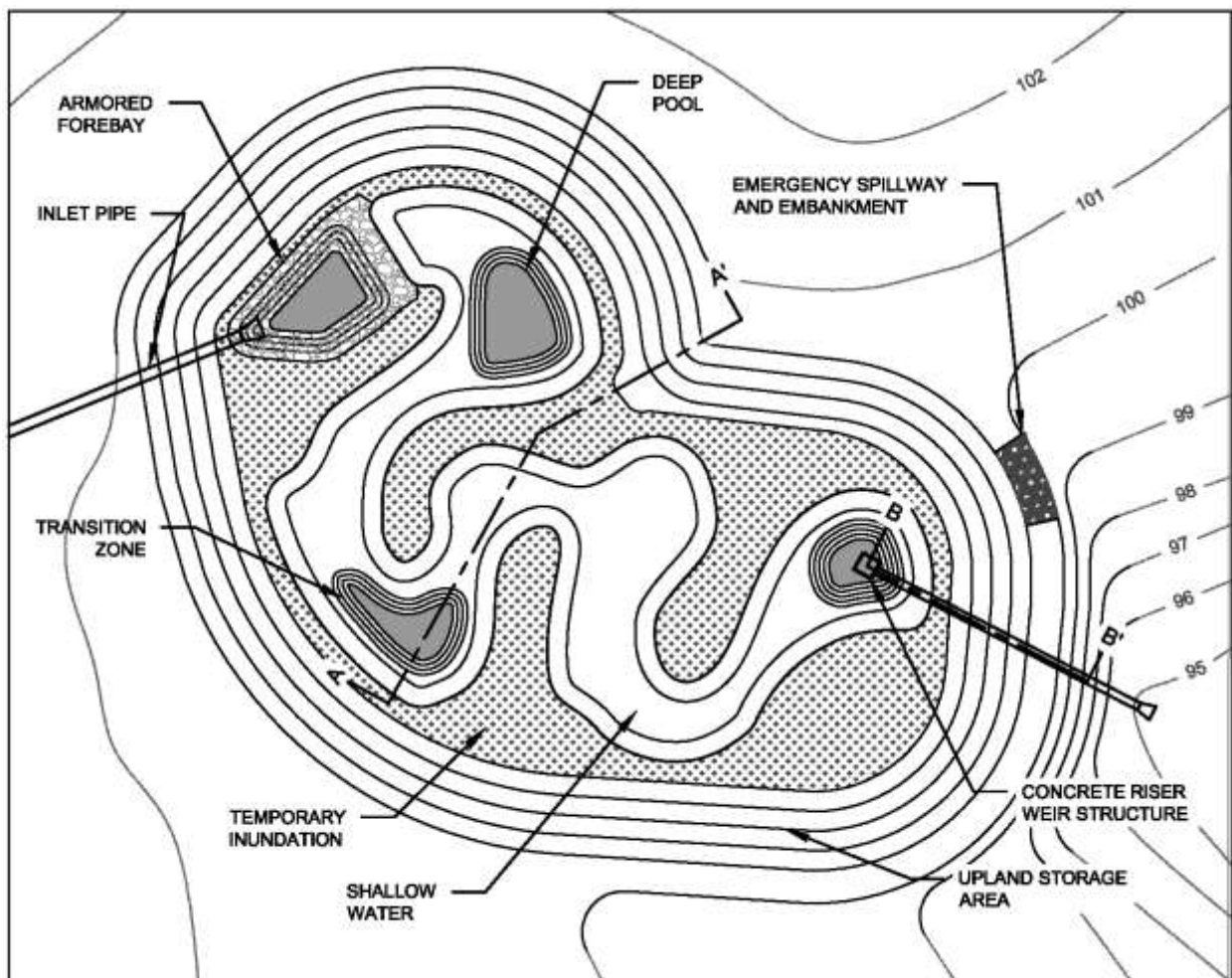

Figure B-7-1. Example wetland configuration.

Appendix B. BMP Design Guidance

Step 4. Determine Geotechnical Requirements

Unlike many other stormwater BMPs, stormwater wetlands are *not* intended to infiltrate runoff. As such, the subsoil conditions must be investigated to determine in situ infiltration rates, depth to seasonal high groundwater table, and underlying geology (including proximity to Edwards Aquifer Recharge, Contributing, and Transition zones). For details regarding geotechnical investigations, see [Common Design Elements](#).

If the site features a high groundwater table and is in an area where infiltration is permitted, hydraulic restriction layers might not be needed—in these situations the high groundwater table will help maintain a permanent pool in the stormwater wetland. If the groundwater table is deeper than the proposed permanent pool elevation or the site is in an area with sensitive subsurface resources, adequate hydraulic restriction layers should be specified to prevent infiltration. For details on designing hydraulic restriction barriers, see [Common Design Elements](#).

Step 5. Design Inlet and Pretreatment

A rock-lined forebay stills incoming runoff and allows larger particles to settle. Forebays should conform to the design recommendations provided in Table B-7-2 and illustrated in Figure B-7-2.



Wilmington, North Carolina. Source: Tetra Tech.

Figure B-7-2. Forebay visible in a newly planted wetland.

Table B-7-2. Recommended specifications for stormwater wetland forebay design

Component	Specification
Area	10% of wetland surface area
Depth	3–5 feet deep near inlet, then sloping up to 2–3 feet deep toward berm (incline dissipates energy and promotes particle settling); deeper depths can be provided for sediment storage
Berm/Weir Elevation	A berm or weir should contain inflow up to the elevation of temporary ponding and provide for safe and diffuse overflow into main body of the wetland (overflow should <i>not</i> occur near side slopes and embankments)
Materials	The entire forebay should be lined with appropriately sized riprap (Class B is typically sufficient) or concrete (concrete provides for easy maintenance with vacuum truck) such that aggregate will not be transported under high flows.

Step 6. Design Wetland Flow Path, Zones and Footprint

Designing the internal wetland features, zones, and footprint is an iterative process. The design must balance storage volume requirements with existing site grading and desired flow length ratios.

The flow length through the wetland should be maximized to improve residence time and treatment. This can be done by incorporating a sinuous flow path or by using berms to form *racetrack* style configurations (see Figure B-7-3 and Figure B-7-4). The L:W ratio (as measured from inlet to outlet and using the average width of the basin) should be 2:1, minimum, but 3:1 is preferred. The width of the flow path will be determined by the flow length and the desired shallow water area.



Wilmington, North Carolina. Source: Tetra Tech.

Figure B-7-3. A sinuous pattern increases the flow path in a stormwater wetland.



Lenoir, North Carolina. Source: Tetra Tech.

Figure B-7-4. An earthen berm elongates the flow path in a racetrack-style stormwater wetland where the inlet and outlet are located in close proximity.

The wetland area should be divided into four zones, as specified in Table and Figure B-7-5. Although deep pools are important for maintenance of water and wildlife (including mosquito-eating predators) during dry periods, the shallow water zone is also critical for plant survival. One of the most common causes of wetland plant die-off is designing the shallow water zone *too* deep—depths greater than 6 inches will reduce plant survival rates and encourage the encroachment of invasive plant monocultures (which can, in turn, harbor mosquito habitat; Hunt et al. 2005).

Table B-7-3. Wetland Zones

Deep Pools: 15%–20% of wetland surface area (including forebay), 18–36 inches deep
Transition: 10%–15% of wetland surface area, transition between deep pool and shallow water, 12–18 inches deep, maximum slope of 1.5:1.
Shallow Water: 40% of wetland surface area, 3–6 inches deep, flat or 6:1 slope (at least 6-foot radius around all deep pools to provide safety shelf). Shallow water depths (less than 6 inches) provide optimum conditions for plant survival and should be verified during construction inspection.
Temporary Inundation: 30%–40% of wetland surface area, up to 12 inches deep, 3:1 slopes
Detention Storage/Upland: Additional ponding depth can be provided for peak flow mitigation, as needed, but depth should generally not exceed 4 feet above the permanent pool elevation

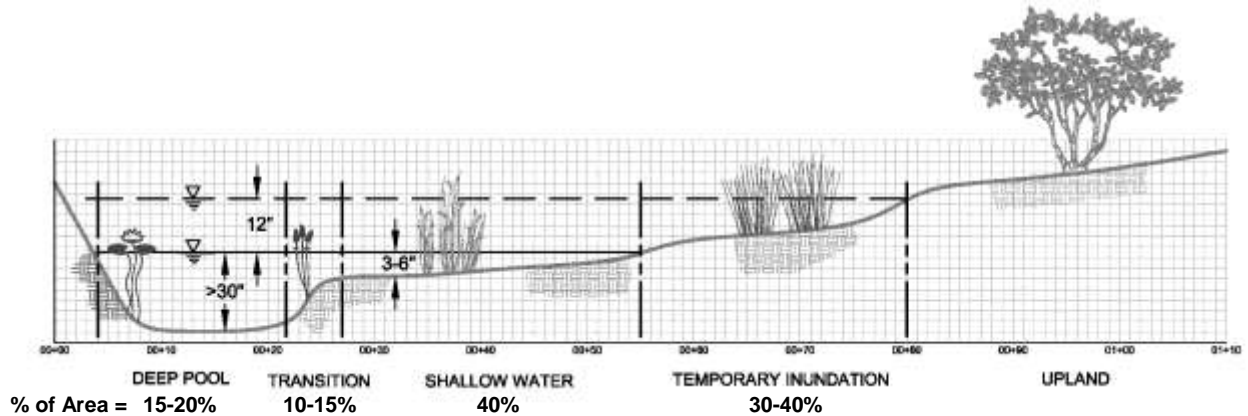

Figure B-7-5. Wetland zones.

The wetland footprint must be configured so that the wetland contains in its temporary and permanently ponded areas a storage volume equal to or greater than the treatment volume detailed in step 1. Determine the storage volume by using algorithms available in computer aided design software, which is typically used to develop the wetland grading plan. Alternatively, use the equation below to evaluate the storage volume for a proposed wetland configuration.

$$V = (2DP) + (0.375SW) + (1.25TZ) + [TP(DP + SW + TZ)] + \left[TI \left(\frac{1}{2TP} \right) \right] \quad \text{[Equation B-7-1]}$$

where

- V = treatment volume contained in the stormwater wetland
- DP = area of wetland dedicated to deep pool zone (sq ft)
- SW = area of wetland dedicated to shallow water zone (sq ft)
- TZ = area of wetland dedicated to transition zone (sq ft)
- TP = temporary ponding depth of wetland (ft)
- TI = area of wetland dedicated to temporary inundation zone

Step 7. Select and Design Outlet/Bypass Method

As with other BMPs, stormwater wetlands can be designed as online or offline systems. Regardless of the configuration, mechanisms are required to draw down water in the wetland basin between storm events and for maintenance. The following sections discuss the outlet design.

Online versus Offline Configuration

The outlet or bypass configuration will depend on the drainage area size, available space for onsite detention, and design goals. If a wetland is designed as an offline system, a diversion structure should be installed to route the design volume into the basin (according to the guidance provided in [Common Design Elements](#)). Offline wetlands can be smaller than online wetlands, which makes them ideal for retrofit scenarios because they need not provide capacity (volumetrically and hydraulically) for routing higher flows.

If an online system is desired, all runoff from the catchment is routed through the basin and out a multistage outlet structure with capacity to allow high-volume flows to safely overflow. The outlet structure should be placed near the edge of the wetland for easy maintenance access. If additional peak

Appendix B. BMP Design Guidance

flow mitigation is desired, a secondary orifice or weir can be installed at the elevation of temporary ponding and the overflow can be elevated to allow larger storms to bypass. The maximum detention depth should be 4 feet above the permanent pool to reduce effects on wetland vegetation. Example outlet structures are shown in Figure B-7-6.

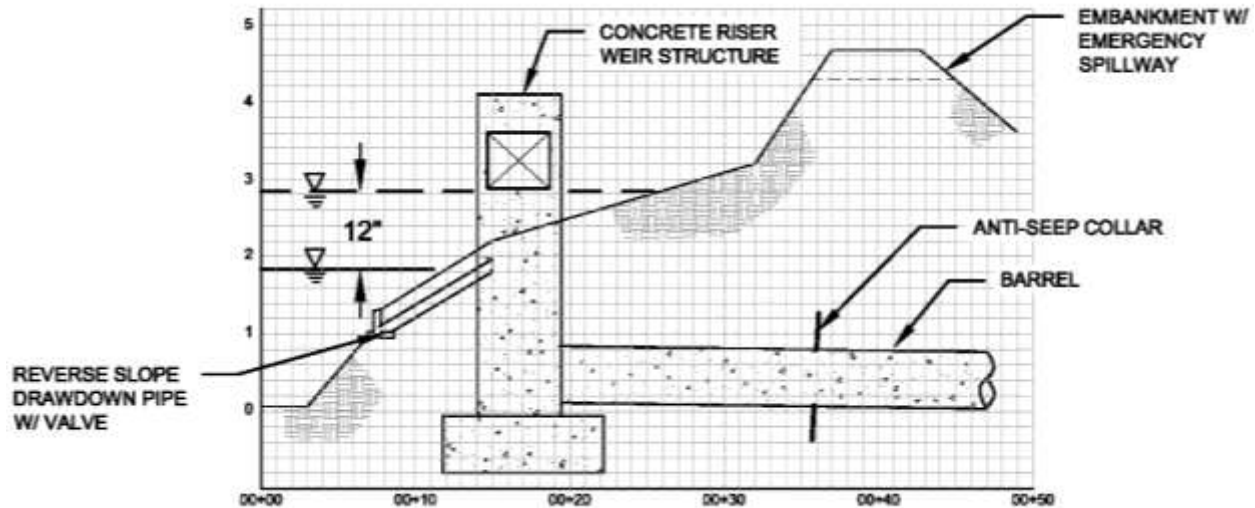

Figure B-7-6. Wetland outlet structure schematic.

Design Drawdown Orifice

A non-clogging orifice should be designed to draw down the water quality design volume in 2 to 5 days. Longer residence times are preferred to maximize treatment efficiency. The orifice should be equipped with a trash rack or a downturned intake pipe that extends 6 to 12 inches below the surface of a nearby area of open water, as shown in Figure B-7-7. Submerging the intake pipe will reduce the risk of blockage caused by floating debris. A capped tee-connection can be installed on the end of the pipe for easy cleaning (when the cap is removed, a ramrod can be used to dislodge any debris that has accumulated around the submerged intake). Additional guidance on trash racks and non-clogging orifices is provided in [Common Design Elements](#) and Barrett (2005).

Additionally, installing an adjustable orifice can help with plant establishment (an example shown in Figure B-7-8 uses an orifice in a metal plate that can be rotated on a flange fitting to adjust orifice elevation); lowering the orifice to maintain shallower permanent pool depths for several weeks after planting will improve plant survival rates. After plants are established, the adjustable orifice can be elevated to capture the intended water quality design volume. Alternatively, the outlet structure can include a flashboard riser that uses removable boards to control the stage of water in the wetland (Figure B-7-9).



Raleigh, North Carolina. Source: Tetra Tech.

Figure B-7-7. A downturned inlet pipe with an orifice extends into a deep pool in a small stormwater wetland.

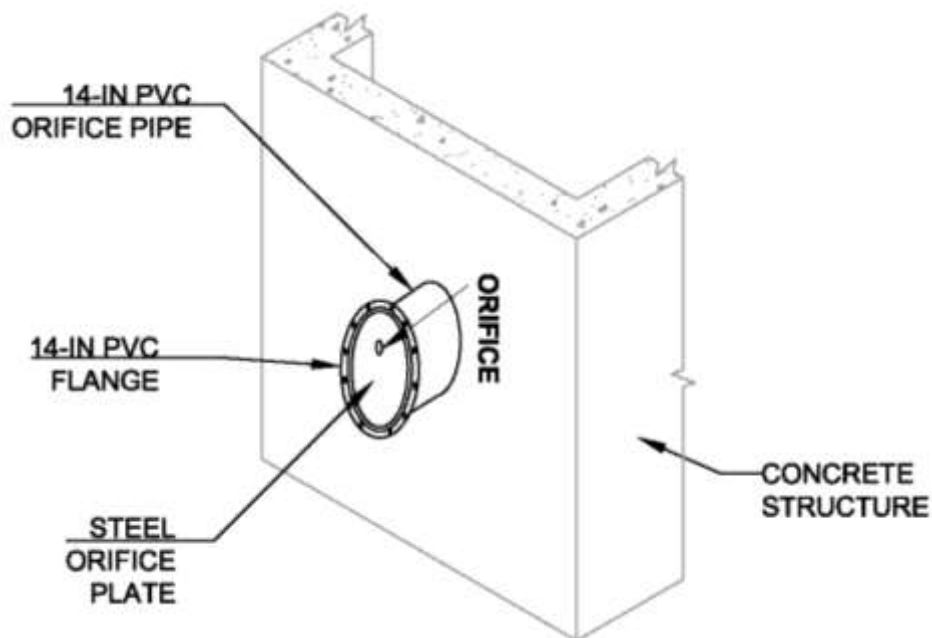

Figure B-7-8. Example schematic of an adjustable orifice plate.



Wilmington, North Carolina. Source: Tetra Tech.

Figure B-7-9. A flashboard riser allows adjustment of water level during plant establishment and for maintenance.

The drawdown orifice should be sized to draw down the temporary ponding depth using the following orifice equation:

$$Q = C_d \pi \left(\frac{d^2}{48} \right) \sqrt{2gH} \quad \text{[Equation B-7-2]}$$

where

Q = Discharge (cfs) computed by dividing the storage volume above the permanent pool by the desired drawdown period

C_d = Coefficient of Discharge (0.60 for sharp edged orifice without projections)

π = pi (3.14)

d = orifice diameter (in)

g = acceleration of gravity (32.2 ft/sec²)

H = driving head (ft) measured from the *center* of the drawdown orifice to water surface.

Note: Use $H = \frac{H_0}{3}$ as an approximation of the driving head throughout the drawdown period.

where

H_o = Driving head (ft) measured from the center of the drawdown orifice to the crest of the overflow/bypass weir.

Design Maintenance/Emergency Dewatering Intake

A manually operated intake valve should be provided at the lowest possible stage of the wetland to allow drawdown for maintenance. The intake should be protected with gravel or a trash rack, or both, to minimize clogging and be sized one standard pipe size larger than would be needed to dewater the entire wetland basin within 24 hours. The valve should have locking features to prevent unauthorized dewatering. Figure B-7-10 shows an example of a maintenance dewatering intake. A flashboard riser can also be installed for rapid dewatering (as discussed in the previous subsection).



Raleigh, North Carolina. Source: Tetra Tech.

Figure B-7-10. Dewatering intake in a detention facility (similar design applies to stormwater wetlands).

Appendix B. BMP Design Guidance

Outfall Pipe and Emergency Spillway

The outfall should be adequately stabilized with energy-dissipation devices to prevent scour of downstream sediment (for energy dissipation configurations, see Common Design Elements). A pipe collar or other engineering solution should also be installed to prevent seepage of water through the soil along the edge of the pipe. This *pipng* can cause dangerous failure of embankments and drain the wetland's permanent pool. Additionally, an emergency spillway should be provided to allow 1 foot of freeboard during the 25-year event and should safely convey flows up to and including the 1percent average recurrence interval event (Barrett 2005).

Step 8. Specify Soil Media

A 1- to 4-inch layer of topsoil must be provided for plant establishment because stormwater wetlands are typically lined with hydraulic restriction layers. Depth of soil will depend on specified plantings and underlying soil characteristics—consult a plant specialist as needed. Native soils excavated in construction can be used, but a soil test should confirm that the soils contain adequate nutrients for plant survivability (subsoils tend to be relatively *infertile*, so topsoil should be separately stockpiled for this purpose). Soils should not contain excessive levels of phosphorus (greater than 15 ppm) because this nutrient tends to dissociate from the soil under saturated conditions.

Step 9. Specify Vegetation

Although wetlands are typically wet, most native wetland plants are well adapted to surviving long periods of drought. Emergent plant survival rates, however, dramatically decrease when normal water depth exceeds 6 inches and invasive plants can begin to establish monocultures. Monocultures of reeds and cattails tend to provide refuge for mosquitos. For these reasons, it is critical that a diverse selection of flowering, emergent vegetation are planted in 3 to 6 inches of water. This will provide the optimum habitat for mosquito predators, such as dragonflies, and reduce plant die-off. At least three species, preferably more, should be planted in each zone of the wetland.

Although trees and shrubs can provide habitat, shade, and aesthetic benefits, take care to immediately remove woody vegetation from embankments to prevent geotechnical failures. A full plant list is in Appendix E.

Step 10. Design for Multi-Use Benefits

Stormwater wetlands can provide excellent ecosystem services and aesthetic value to stakeholders. In addition to enhancing biodiversity and beautifying the urban environment with native vegetation, the following components can be incorporated into stormwater wetlands to promote multi-use benefits:

- Simple signage or information kiosks can educate the public on the benefits of watershed protection measures or provide a guide for native plant and wildlife identification.
- Boardwalks, wildlife viewing platforms, and benches can be provide to encourage interaction.
- Volunteer groups can be organized to perform basic maintenance as an opportunity to raise public awareness.
- Wetlands can be used as outdoor classrooms for school science projects and field trips.

7.2 Critical Construction Considerations

7.2.1 Provide Maintenance Access

To maintain stormwater wetlands, maintenance crews and equipment must occasionally access wetland components. Wetland design should incorporate a dedicated access easement from a public road to the wetland and an appropriate maintenance staging area. The grading plan for the wetland should incorporate access paths as appropriate for maintenance equipment to reach critical maintenance points including, for example, the forebay and outlet. The site geotechnical analysis will determine whether the access path must be stabilized to support heavy equipment.

7.2.2 Incorporate Nuisance Wildlife Deterrents

Improperly maintained stormwater treatment wetlands provide ideal habitat for urban waterfowl and other nuisance wildlife. Some species such as snakes might be perceived as distasteful to nearby citizens but do not negatively affect the function of the wetland itself. Other species such as Canada geese and nutria might negatively affect the wetland including grazing wetland plants, disturbing bottom sediments, and contributing pollutants through fecal matter. Burrowing animals may also compromise the geotechnical stability of embankments. Various methods can be used to deter or remove nuisance species from the wetland. Each method should be considered in the context of project objectives, local laws, and stakeholder perception of the nuisance. The most effective method control of nuisance waterfowl is to maintain tall vegetation around the entire perimeter of the wetland because waterfowl tend to be wary of tall vegetation for fear of hidden predators. Abundant, diverse vegetation can also provide favorable habitat for dragonflies and other mosquito predators, whereas monocultures of invasive vegetation (such as *Typha. spp. or Phragmites spp.*) can harbor mosquito larvae in dense mats of roots and detritus (Hunt et al. 2005). Where advanced vector control is required, Barrett (2005) recommends introducing *Gambusia affinis* (mosquito fish) at a density of 200 fish per acre of permanent pool. Several references are available for appropriate methods of nuisance wildlife control:

- *Managing Waterfowl in Stormwater Ponds*: http://www.clemson.edu/extension/natural_resources/water/stormwater_ponds/nuisance_wildlife/waterfowl/
- *Goose Control Best Management Practices to Prevent Pollution of Ponds, Streams, and Rivers*: http://www.pittsfieldtwp.org/NRC_Goose_Control
- *Nuisance Wildlife Repellent Handbook*: http://files.dnr.state.mn.us/assistance/backyard/livingwith_wildlife/repellent_handbook.pdf

7.3 Operation and Maintenance

Inspection and maintenance area key to ensure the proper function and aesthetics of stormwater wetlands. Table B-7-4 lists specific operation and maintenance tasks.

Appendix B. BMP Design Guidance

Table B-7-4. Inspection and maintenance tasks for stormwater wetlands

Task	Frequency	Indicator maintenance is needed	Maintenance notes
Forebay inspection	Weekly or biweekly	Internal erosion or excessive sediment, trash, or debris accumulation	Check for sediment accumulation to ensure that forebay capacity is as designed. Remove any accumulated sediment.
Basin inspection	1 time/year	Excessive sediment, trash, and/or debris accumulation in the wetland	Remove any accumulated sediment. Adjacent pervious areas might need to be regraded.
Outlet inspection	Weekly or biweekly with routine property maintenance	Accumulation of litter and debris in wetland area, large debris around outlet, internal erosion	Remove litter, leaves, and debris to reduce the risk of outlet clogging and to improve facility aesthetics. Erosion should be repaired and stabilized.
Mowing	2–12 times/year	Overgrown vegetation on embankment or adjacent areas	Frequency depends on location and desired aesthetic appeal.
Embankment inspection	1 time/year	Erosion at embankment	Repair eroded areas and revegetate.
Remove and replace dead vegetation	1 time/year	Dead plants or excessive open areas in wetland	Within the first year, 10% of plants can die. Survival rates increase with time.
Temporary watering	1 time/2–3 days for first 1–2 months	Until establishment and in severe drought	Watering after the initial year might be required.
Nuisance wildlife management	Biweekly or as needed	Animals, feces, or burrows evident in or around wetland. Excessive mosquitos.	Maintain diverse vegetated shelf around entire basin. Eliminate monocultures and replace with diverse, flowing vegetation. Employ qualified wildlife management professionals if needed.
Fertilization	1 time initially	Upon planting	One-time spot fertilization for first year vegetation.

7.4 References

- Barrett, M.E. 2005. *Complying with the Edwards Aquifer Rules. Technical Guidance on Best Management Practices*. RG-348. Prepared for Texas Commission on Environmental Quality, Field Operations Division, Austin, TX.
- Hunt, W.F., C.S. Apperson, and W.G. Lord. 2005. Mosquito Control for Stormwater Facilities. *Urban Waterways*. <http://www.bae.ncsu.edu/stormwater/PublicationFiles/Mosquitoes2005.pdf>
- Hunt, W., M. Burchell, J. Wright and K. Bass. 2007. Stormwater Wetland Design Update: Zones, Vegetation, Soil and Outlet Guidance. *Urban Waterways*. North Carolina State Cooperative Extension Service, Raleigh, NC. <http://www.bae.ncsu.edu/stormwater/PublicationFiles/WetlandDesignUpdate2007.pdf>
- Knox County. 2008. 3.1.8 Water Balance Method. *Knox County Tennessee Stormwater Management Manual. Volume 2 (Technical Guidance)*. [http://www.knoxcounty.org/stormwater/pdfs/vol2/3-1-8 Water Balance Calculations.pdf](http://www.knoxcounty.org/stormwater/pdfs/vol2/3-1-8%20Water%20Balance%20Calculations.pdf).

8 Cisterns



Cliff Morton Development and Business Services Center, San Antonio, Texas. Source: Bender Wells Clark Design

8.1 Design

The design of a cistern or rain barrel can be broken down into an eight-step process, as listed in Table B-8-1. Additional resources are provided in TCEQ (2011), Texas Water Development Board (2005), and Texas A&M AgriLife Extension Services (2013).

Table B-8-1. Iterative design step process

Design step		Design component/ consideration	General specification
1	Determine BMP Size	Use Appendix A	
2	Determine BMP Configuration (B-107)	Based on volume and desired alternative uses, incorporate next to buildings or underground. A foundation of gravel should be provided if the weight of the cistern at capacity is less than 2,000 pounds, otherwise a concrete foundation should be provided.	
3	Select and Size Inlet Configuration (B-110)	Conveyance type	Runoff should be conveyed to the cistern such that no backwater onto roofs occurs during the 100-year event. Two types of inlet configurations are available: <ul style="list-style-type: none"> • Dry conveyance: conduit freely drains to cistern with no water storage in pipe • Wet conveyance: a bend in the conduit retains water between rainfall events
4	Design Inlet Pretreatment Configuration (B-112)	Inlet filter	A self-cleaning inlet filter should be provided to strain out large debris such as leaves. Some systems incorporate built-in bypass mechanisms to divert high flows.
		First flush diverter	A passive first flush diverter should be incorporated in areas with high pollutant loads to capture the first washoff of sediment, debris, and pollen during a rainfall event. First flush diverters are typically manually dewatered between events.
5	Select and Size Appropriate Outlet and Overflow/Bypass Method (B-115)	Low-flow outlet	An outlet should be designed to dewater the water quality storage volume to a vegetated area in 2 days minimum. The elevation of the outlet depends on the volume of water stored for alternative purposes.
		Overflow or bypass	Emergency overflow (set slightly below the inlet elevation) or bypass must be provided to route water safely out of the cistern when it reaches full capacity.
6	Specify Cautionary Signage, Pipe Color, and Locking Features (B-118)	Signage	Signage indicating: “Caution: Reclaimed Water, Do Not Drink” (preferably in English and Spanish) must be provided anywhere cistern water is piped or outlets.
		Pipe color and locking features	All pipes conveying harvested rainwater should be Pantone color #512 and be labeled as reclaimed water. All valves should feature locking features.
7	Design for Multi-Use Benefits (B-119)	Harvested rainwater should be used to offset potable water uses, such as irrigation, toilet flushing, car washing, etc. Additionally, educational signage and aesthetically pleasing facades should be specified.	
8	Additional Design Specifications (B-120)	Vector control	All inlets and outlets to the cistern must be covered with a 1-mm or smaller mesh to prevent mosquito entry/egress
		Routing water for use	Regardless of gravity or pumped flow, adequate measures must be taken to prevent contamination of drinking water supplies
		Makeup water supply	A makeup water supply can be provided to refill the cistern to a desired capacity when harvested water has a dedicated use.
		Cistern material	Tanks should typically be opaque to prevent algal growth.

Step 1. Determine the Volume of Water or Flow to Treat

The volume of water to be treated will help managers determine the appropriate cistern size and configuration. Methods for calculating the volume required for treatment are outlined in Appendix A. The treatment volume must be treated on-site and can be treated by multiple BMPs. Cisterns will typically be part of a treatment system that would include cisterns and other BMPs including bioretention or pervious pavement. The cistern could be included to reduce the size of another BMP. Peak runoff flow rates should also be calculated using the methods in Appendix A, *San Antonio Unified Development Code*, or *San Antonio River Basin Regional Modeling Standards for Hydrology and Hydraulic Modeling* such that pipes can be sized accordingly to allow overflow or bypass of the 100-year peak discharge.

Step 2. Determine BMP Configuration

Cisterns are available commercially in numerous sizes, shapes, and materials. Many are made to custom fit the available space and can be short and wide, tall and narrow, round, rectangular, and almost any size imaginable. They can be made from multiple materials but are primarily constructed of plastic or metal. Plastic cisterns can be covered with wood facades to provide a more finished appearance or can be painted with any image desired.

Cisterns are usually intended to capture runoff from elevated surfaces, such as rooftops, and, therefore, must be next to structures where runoff can be collected. Cisterns are typically designed to capture runoff from concentrated sources or collection systems such as a downspout. Multiple cisterns placed around a structure can be hydraulically connected to take advantage of maximum storage capacity. The typical components of a cistern are shown in Figure B-8-1.

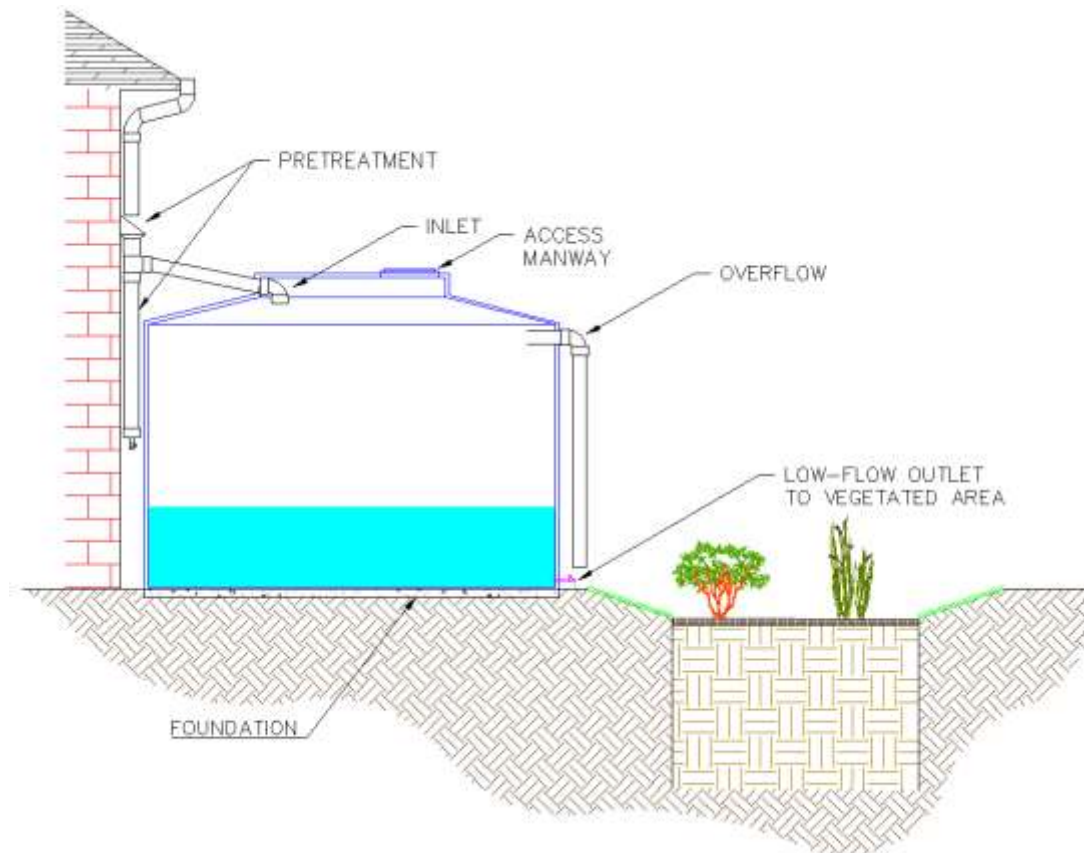

Figure B-8-1. Minimum design components of a rainwater harvesting system.

Appendix B. BMP Design Guidance

The conditions or layout of the site could determine if the foundation can be excavated and what materials will be used to support the cistern. Cisterns, especially large systems, must have a proper foundation to support the weight when they are at capacity. Two options exist for foundations (Jones and Hunt 2008):

- Cisterns exerting less than 2,000 pounds per square foot: The foundation of the cistern should be cleared and leveled. The foundation should be at least 6 inches of No. 57 gravel or concrete, depending on the stability of the underlying soils.
- Cisterns exerting greater than 2,000 pounds per square foot: The area beneath the cistern should be cleared and leveled. Concrete should be poured such that gravity flow can be maintained and the cistern can be drained to the level of the outlet valve.

The threshold where a concrete pad is required will vary depending on the soil type. If the structural capacity of the site to support a full cistern is in doubt, a geotechnical evaluation should be performed to determine the structural capacity of the soils. Figure B-8-4 to Figure B-8-4 shows the foundation options.



New Bern, North Carolina. Source: NCSU BAE

Figure B-8-2. Cistern less than 2,000 psi on a gravel foundation.



Source: NCSU BAE

Figure B-8-3. Cistern greater than 2,000 psi on a concrete foundation.



Hardberger Park, San Antonio, Texas. Source: Tetra Tech

Figure B-8-4. Cistern on a concrete foundation.

Appendix B. BMP Design Guidance

Step 3. Select and Size Inlet Configuration

Inlet connections can feature either dry conveyance or wet conveyance. The following subsections describe each configuration.

Dry Conveyance

When downspouts freely drain to the cistern without any trapped water, the system uses dry conveyance. Connections can be made through the top of the cistern as shown in Figure B-8-5 and Figure B-8-6 or through the sides of the vertical portion formed for the opening of the cistern, often referred to as the manway, as shown in Figure B-8-7. Inlet connections made through the top of the cisterns can also include a basket filter as an inlet filter option. Inlet connections through the sides with the proper gaskets are recommended for ease of maintenance and access to the cistern.

When designing dry conveyance, downspout pipes should be sized to convey the 100-year discharge without causing any backwater on the roof.

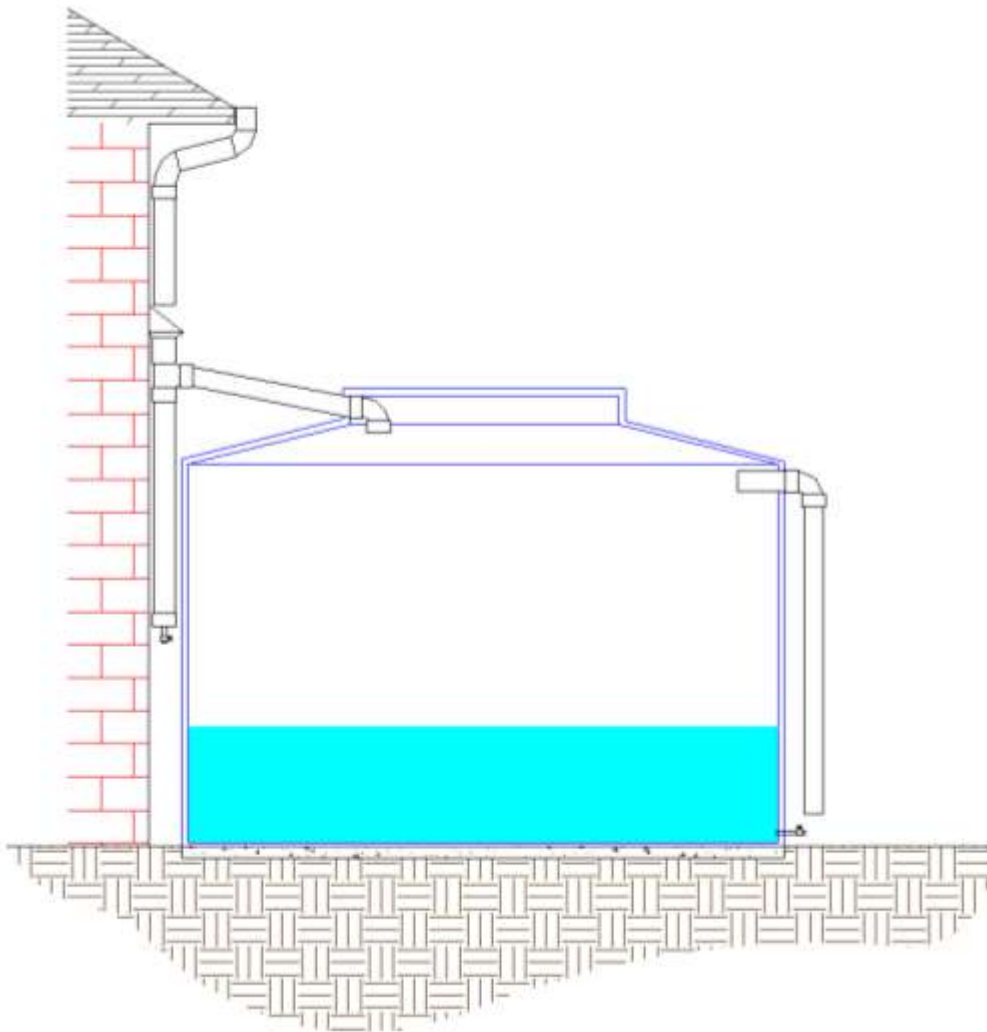

Figure B-8-5. Dry conveyance inlet configuration.



Texas A&M University at San Antonio, San Antonio, Texas. Source: San Antonio River Authority

Figure B-8-6. Inlet in the top of the cistern.



Greensboro, North Carolina. Source: Tetra Tech

Figure B-8-7. Inlet in the sides of the man way.

Wet Conveyance

When the downspout features a bend, causing water to be trapped between runoff events, this system is known as wet conveyance (Figure B-8-8 and Figure B-8-9). Wet conveyance systems with buried downspouts can allow for cisterns to be placed further from buildings and might be preferable for aesthetic or overhead clearance purposes. When designing wet conveyance systems, the 100-year discharge from the catchment must be conveyed without any backwater onto the rooftop (considering all head losses through the pipe). Because water will permanently be stored in the downspout, watertight connections must be used to prevent leakage. A drain at the lowest elevation of the downspout can be installed, if desired, for dewatering and emergency maintenance.

Appendix B. BMP Design Guidance

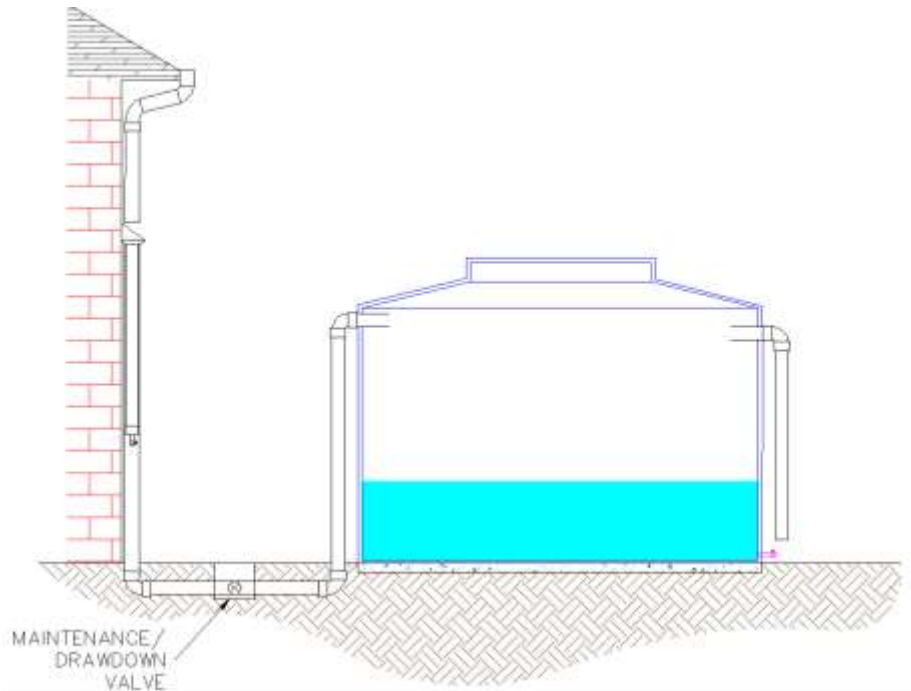

Figure B-8-8. Cistern with wet conveyance featuring a drawdown valve for maintenance.



Dallas, Texas. Source: NCSU-BAE

Figure B-8-9. Cistern with a wet conveyance inlet configuration.

Step 4. Design Inlet Pretreatment Configuration

Stormwater runoff must be filtered before it enters the cistern to remove debris and particles that could clog the outlet. Two types of systems can be used: inlet filters and first-flush diverters. The following subsections discuss each pretreatment configuration in greater detail.

Inlet Filters

Inlet filters are designed to remove particles as runoff passes through the filters before entering the cistern; many filter options are available. The size and type of filter used will depend on the size of the area draining to the downspout. The filters can be installed at the gutter as shown in Figure B-8-10 or at the end of the downspout as shown in Figure B-8-11 depending on the configuration of the downspouts. Flow through filters that force all the runoff through the filter can be used for smaller drainage areas (less than 1,500 square feet). Filters capable of bypassing larger event flow could be required for larger drainage areas (1,500 to 3,000 square feet). A self-cleaning screen used for inlet filters should provide a minimum angle of declination of at least 45 degrees from horizontal, but angles of more than 45 degrees tend to enhance self-cleaning and prevent clogging (Nel 1996). Examples of two types of filters are shown in Figure B-8-12 and Figure B-8-13.



Greensboro, North Carolina. Source: Tetra Tech

Figure B-8-10. Inlet filters at the gutter.



Wilmington, North Carolina. Source: Tetra Tech

Figure B-8-11. Inlet filters at the downspout.

Appendix B. BMP Design Guidance



Source: Tetra Tech

Figure B-8-12. Flow-through inlet filter.

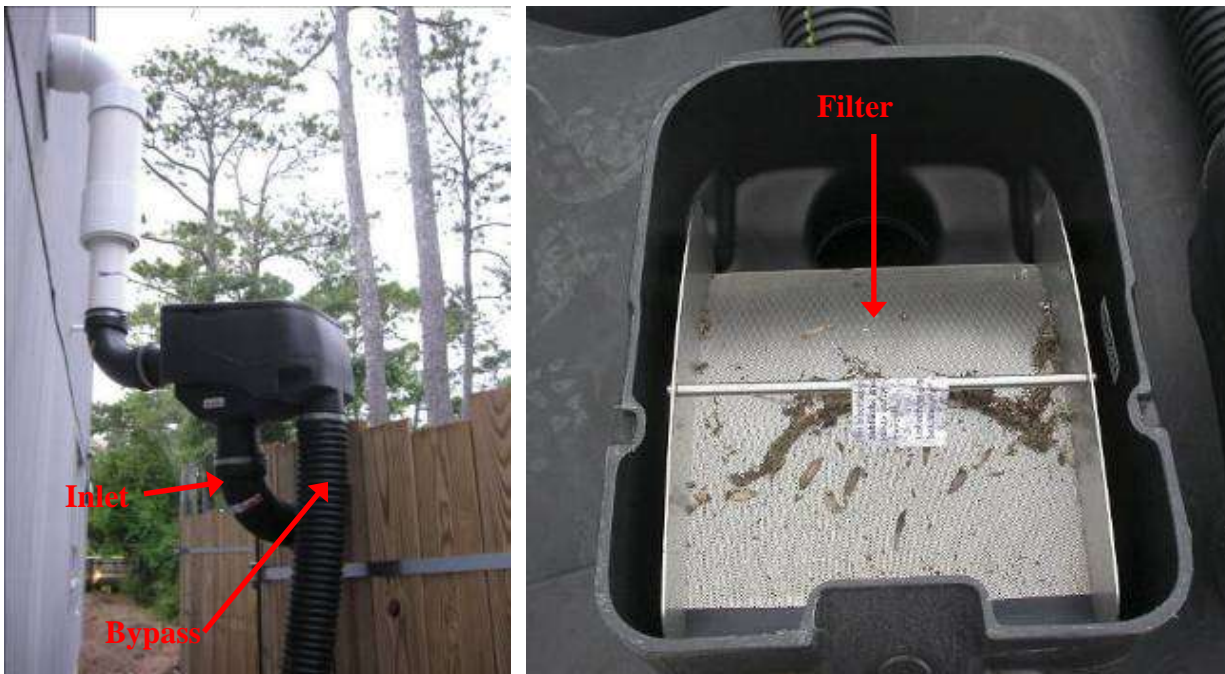

Source: Tetra Tech

Figure B-8-13. Self-flushing filter with a bypass.

First-Flush Diverter

First-flush diverters can be installed after the inlet filter and are designed to divert an initial volume of water away from the cistern to prevent small particles—initially washed off of the roof—from clogging the outlet. First-flush diverters are typically attached to the inlet or, in some cases, the inlet filter with a 4- to 6-inch diameter pipe with a small relief valve from which water can be diverted. The volume of water diverted away from the cistern depends on the length of the pipe. Once the diverter is full, a valve closes and water flows into the cistern. A first-flush diverter is not always required and inclusion is up to the designer depending on site conditions. A first-flush diverter is recommended for sites where pollen or other fine particles might not be removed by an inlet filter. Diverters must be routinely drained to provide capacity for the next runoff event.



Source: NCSU BAE

Figure B-8-14. Valve for a first-flush diverter.



Source: NCSU BAE

Figure B-8-15. First-flush diverter configuration.

Step 5. Select and Size the Appropriate Outlet and Overflow/Bypass Method

Low-Flow Outlet

The outlet of the cistern should be designed to release the volume of captured runoff at a rate below the design storm rate at its maximum capacity. The outlet of the cistern should be directed to a bioretention area or other pervious surface with enhanced infiltration capacity as demonstrated in Figure B-8-16. Irrigation area requirements for the Edwards Aquifer Recharge, Contributing, and Transition Zones are presented in Table B-8-2; these requirements are applicable to all areas.



San Diego, California. Source: Tetra Tech.

Figure B-8-16. Cistern outlet.

Table B-8-2. Irrigation area requirements for cisterns in the Edwards Aquifer Recharge, Contributing, and Transition Zones (applicable to all areas)

Irrigation/infiltration area requirements
<ul style="list-style-type: none">• 12 inches of soil cover, according to geotechnical investigation• 100 feet from wells, septic systems, natural wetlands, and streams• No sensitive or geologic features that could allow water to directly enter the aquifer• Coarse soil material (diameter greater than 0.5 inch) does not make up more than 30% of the soil volume• Slopes less than 10%• Soil permeability and surface area sufficient to produce no runoff

Source: Barrett 2005

The elevation of the low-flow outlet depends on the demand for alternative water use. When water demand and use is high (such as when the cistern is being used for toilet flushing, car washing, or consistent irrigation), the low-flow outlet can be placed such that half of the tank remains full for use. If stormwater management is the sole purpose of the cistern, the low-flow outlet should be placed at the bottom so that the tank can dewater and provide maximum capacity for storage of subsequent rain events.

Figure B-8-17 illustrates example low flow outlet placement. Regardless of where the outlet is placed, temporary storage must be provided above the outlet elevation to capture the design storm volume. Models, such as the *Rainwater Harvester Design Model* (North Carolina State University 2008), can be used to optimize orifice placement.

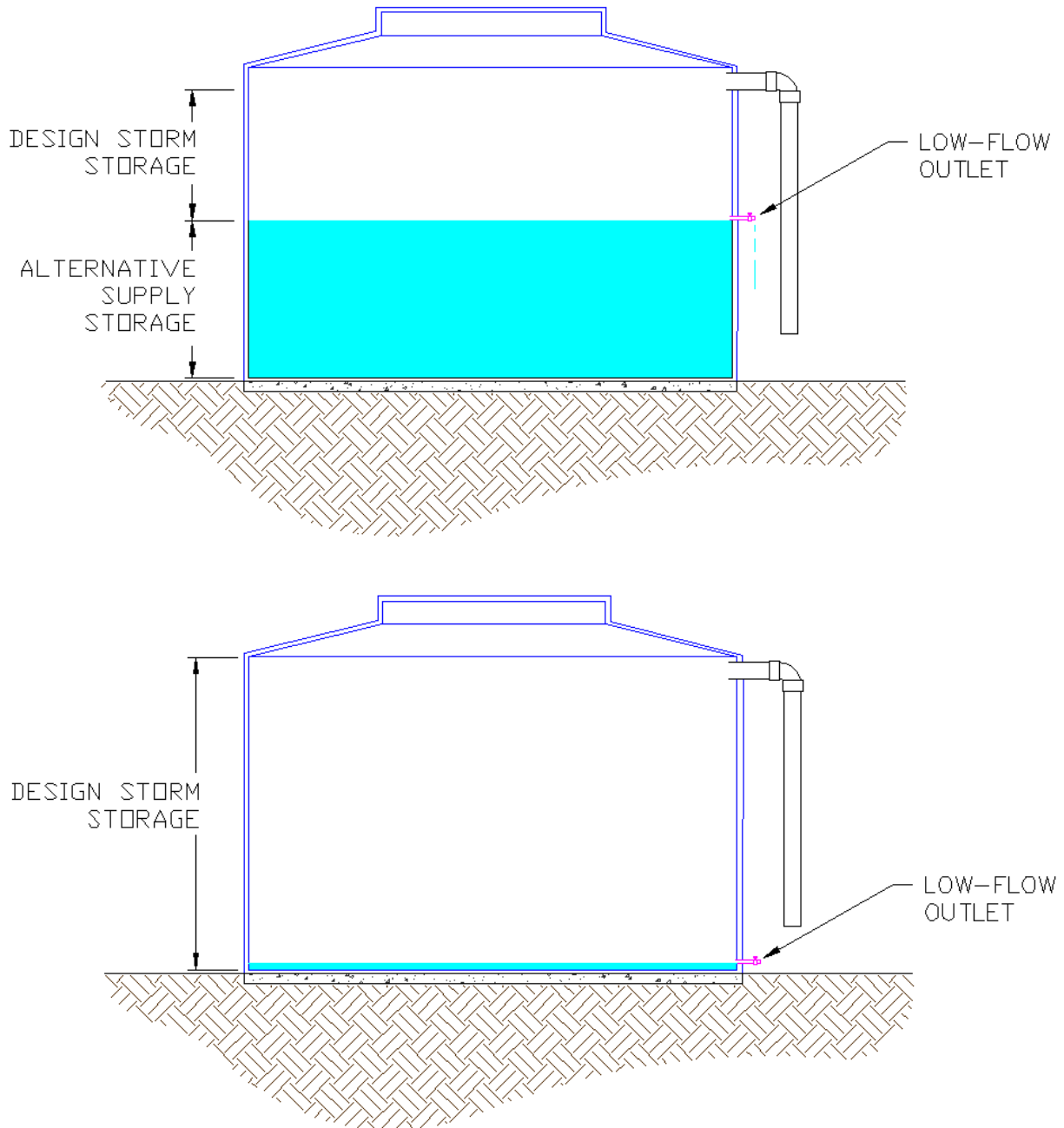

Figure B-8-17. Top: a low flow outlet is placed to provide equal parts detention storage and storage for alternative use. Bottom: placing the low flow outlet at the bottom of the cistern ensures maximum design storm storage.

Appendix B. BMP Design Guidance

Overflow or Bypass

All cisterns should have an overflow for runoff volumes that exceed the capacity of the cistern. The overflow should be set slightly below the inlet. Overflow connections should be connected to the tank using appropriate watertight gaskets.. An additional bypass can be incorporated using an appropriate inlet filter. Examples of an overflow discharging to vegetated areas are provided in Figure B-8-18.



Left: Shavano Park Fire Station, Shavano Park, Texas. Right: Mission Library, San Antonio, Texas Source: Bender Wells Clark Design

Figure B-8-18. Left: A channel directs overflow away from building. Right: A cistern overflows to an adjacent bioretention area.

All overflow and outlet volumes should be directed safely away from all structural foundations and any areas where infiltration could have an adverse effect. Overflow and bypass mechanisms should be sized to safely convey the 100-yr discharge without any backwater onto the adjacent roof. Calculation of 100-yr conveyance should account for head losses through all pipe sections, elbows, entrances, and exits.

Step 6. Specify Cautionary Signage, Pipe Color, and Locking Features

Per Section 608.8 and Section C104.4 of the City of San Antonio amendments to the International Plumbing Code (City of San Antonio 2009), clear and obvious signage must be provided wherever harvested rainwater is used. Signs with purple background (Pantone color #512) and black lettering should read: “Caution: Reclaimed Water, Do Not Drink” in English and Spanish. Areas requiring signage include entrances to rooms (including mechanical rooms) where harvested water is piped or used, irrigation and automobile washing hoses, low-flow outlet orifices, toilet tanks that use harvested water for flushing, and any spigots, drawdown pipes, or access hatches. Specific signage language for these uses is provided in Section C104.7 of the City of San Antonio amendments to the International Plumbing Code. All pipes and hoses used to convey harvested water should be purple in color (Pantone color #512; Figure B-8-19) or continuously wrapped with purple mylar tape (per Section C104.4 of the City of San Antonio

amendments to the International Plumbing Code; City of San Antonio 2009) to indicate that the water is not safe to drink. Tape-wrapped pipe shall display the warning provided above in nominal ½-inch black, uppercase lettering in two parallel lines such that after wrapping the pipe a full line of text is visible. Pipes that are completely colored purple shall display the warning on both sides at intervals not exceeding 3 feet. All valves (except fixture supply control valves) must be equipped with locking features.

In addition to preventing accidental ingestion, signage on cistern manways should restrict access to individuals with appropriate confined space credentials.



Hardberger Park, San Antonio, Texas Source: Bender Wells Clark Design

Figure B-8-19. Two cisterns with purple pipe connections.

Step 7. Design for Multi-Use Benefits

By design, rainwater harvesting practices offer multi-use benefits by providing an alternative non-potable water source while controlling runoff volume and rate. In addition to hydrologic and water quality benefits, cisterns and rain barrels can be designed for multi-use benefits by

- Providing irrigation for landscape beds and vegetated stormwater practices
- Offsetting non-potable water supplies used for toilet flushing, car washing, swimming pools, street sweeping, and other uses (nonresidential cisterns only)
- Incorporating aesthetically pleasing colors, murals, or facades

Appendix B. BMP Design Guidance

- Incorporating creative downspout designs for small practices (rain chains)
- Raising public awareness of stormwater issues with signage

Step 8. Additional Design Specifications

The following considerations relevant to safety and water reuse should be included in design plan notes and specifications.

Vector Control

The inlets and outlets of cisterns and rain barrels should be covered with a simple piece of filter material, such as a screen or wire mesh, to prevent mosquito breeding. A 1 mm or smaller mesh is recommended. Screens at the inlet should be placed downstream of debris filters to prevent clogging by leaves. Overflow/bypass openings should be covered with a non-clogging configuration, such as a screen mesh flap that hangs across the pipe opening—the bottom of the flap should be weighted or attached with small magnets such that it remains closed when no flow is present, but can easily open to allow overflow when the tank is full.

Routing Water for Use

The method of routing water depends on the intended use. For basic irrigation, gravity can often be used to route harvested rainwater to nearby vegetation beds or infiltrating stormwater practices. To route water for use inside nonresidential structures or for greater distances from the cistern, a pump might be required. Submersible water pumps are commonly used, but pumps can also be installed in utility boxes next to the cistern. Pipes conveying harvested water may not be placed in the same trench as potable water pipes, a 2-foot horizontal separation must be maintained between harvested and potable water at all times. Buried potable water pipes that cross harvested water pipes must be at least 12 inches above the harvested water and must have a PVC sleeve that extends horizontally 2 feet to either side of the crossing. Harvested water should also be protected from contamination by sewer pipes in the same manner as potable water pipes (Section C104.3.3 of the City of San Antonio amendments to the International Plumbing Code; City of San Antonio 2009).

Makeup Water Supply for Dedicated Use

If the cistern will be used to offset non-potable water demand of nonresidential buildings (such as for toilet flushing) a makeup, or backup, water supply system is typically installed to maintain a minimum volume of storage water in the cistern for dedicated use. A number of different makeup systems are available, most of which use floats and valves similar to toilet tank components. When the cistern level drops below the minimum capacity, the valve is opened and municipal water supply is used to fill the tank to a specified level. When municipal water is used as a makeup supply for cisterns, both an air gap and a reduced pressure backflow device must be installed, and access to backflow preventers must be maintained (per section 608 and section C104.3.4 of the City of San Antonio amendments to the International Plumbing Code; City of San Antonio 2009).

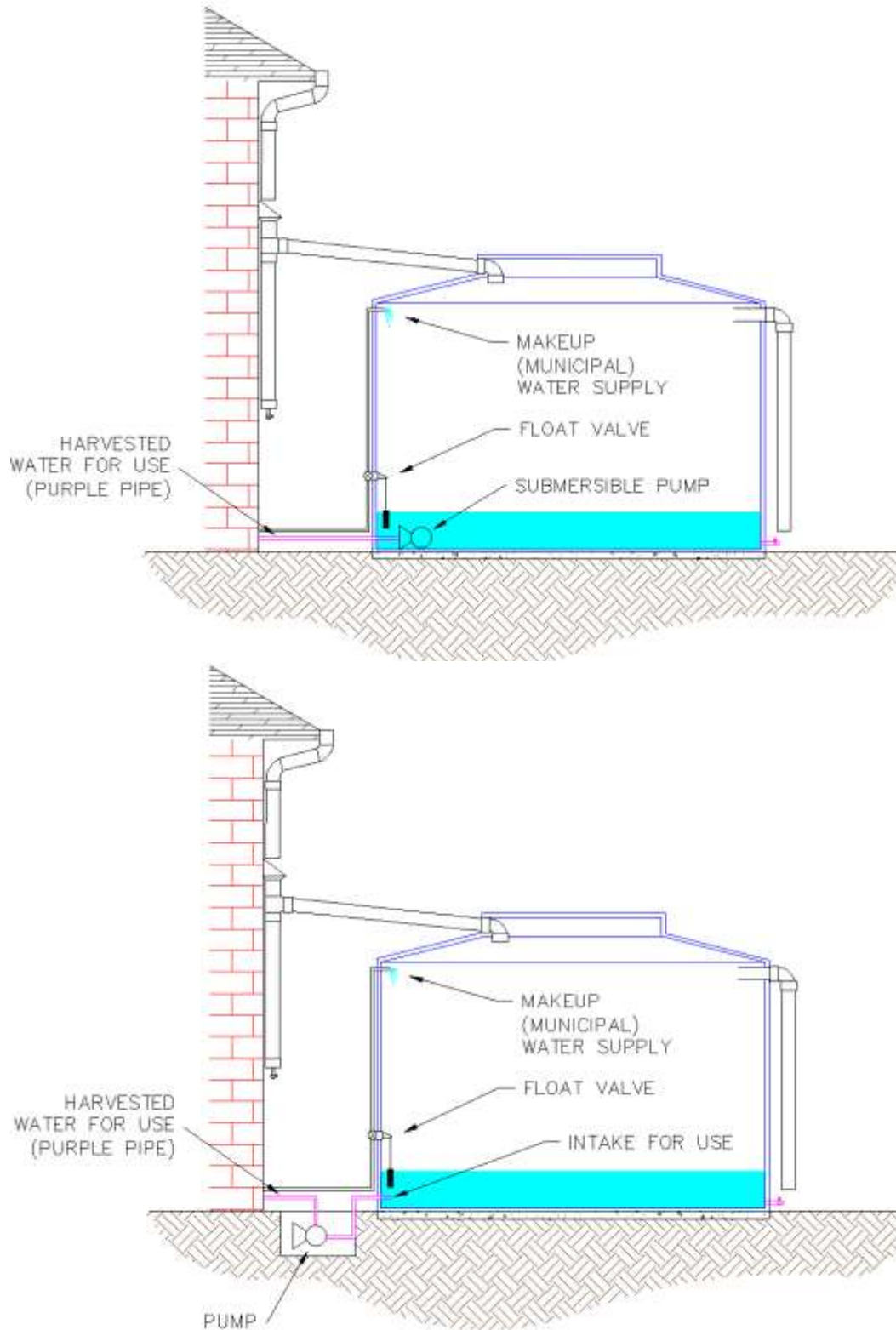

Figure B-8-20. Top: Conceptual schematic of cistern with submersible pump. Bottom: conceptual schematic of cistern with external pump.

Appendix B. BMP Design Guidance

Cistern Material Specification

Rainwater harvesting tanks are typically constructed of plastic, metal, or concrete. The specified material will affect the quality of captured runoff, aesthetics, configuration, installation, and cost. Plastic tanks can experience algal growth if not completely opaque. In general, cisterns are expected to last 20 to 50 years (Kowalsky and Thomason 2011). A detailed description of cistern materials is provided in Texas Water Development Board (2005).

8.2 Critical Construction Considerations

Cisterns and rain barrels can present safety hazards if improperly designed. Engineers should direct contractors to implement appropriate OSHA health and safety protocol when installing cisterns. Elevated rain barrels and tall cisterns should be securely anchored to prevent toppling and subsequent injury.

8.3 Operation and Maintenance

Cisterns require regular maintenance during the rainy season to ensure proper function. Table B-8-3 lists specific tasks which are described below:

1. The main source of debris in the cistern is leaf litter and other detritus collected in the gutter system. The gutter systems should be inspected and cleaned. Any leaks should be immediately repaired.
2. Check inlet filters to prevent clogging and debris accumulation to allow for proper flow into the cisterns. Clean as needed to ensure proper operation.
3. Outlet pipes and fittings should be inspected to verify proper flows from the cistern. Cisterns should empty within 24 to 48 hours.
4. Overflow systems should direct water away from any structural foundations.
5. Cisterns should be checked for structural stability and secured as necessary.
6. It is possible for some sediment and debris to accumulate in the bottom of the cistern. Access to the cistern should be maintained, and it is necessary to conduct a visual inspection to verify debris in the cistern.

When harvested rainwater is used to replace non-potable water demand, inspections must occur upon installation and annually to ensure proper function of backflow preventers (per City of San Antonio amendments to the International Plumbing Code).

Table B-8-3. Inspection and maintenance tasks for cisterns

Task	Frequency	Indicator maintenance is needed	Maintenance notes
Gutter and rooftop inspection	Biannually and before heavy rains	Inlet clogged with debris	Clean gutters and roof of debris that have accumulated, check for leaks
Remove accumulated debris	Monthly	Inlet clogged with debris	Clean debris screen to allow unobstructed stormwater flow into the cistern
Structure inspection	Biannually	Cistern leaning or soils slumping/eroding	Check cistern for stability, anchor system if necessary
Structure inspection	Annually	Leaks	Check pipe, valve connections, and backflow preventers for leaks
Add ballast	Before any major wind-related storms	Tank is less than half-full	Add water to half full
Miscellaneous upkeep	Annually		Make sure cistern manhole is accessible, operational, and secure

8.4 References

- Barrett, M.E. 2005. *Complying with the Edwards Aquifer Rules. Technical Guidance on Best Management Practices*. RG-348. Prepared for Texas Commission on Environmental Quality, Field Operations Division, Austin, TX.
- City of San Antonio. 2009. Appendix C Gray Water Recycling Systems and Reclaimed/Recycled Water Systems. *2009 International Plumbing Code and 2009 International Fuel Gas Code/Local Amendments*. San Antonio, TX.
- Jones, Matthew P and Hunt, W.F. 2008. *Rainwater Harvesting: Guidance for Homeowners*. North Carolina Cooperative Extension, Raleigh, NC.
- Kowalsky, G., and K. Thomason. 2011. *Cistern Design Considerations for Large Rainwater Harvesting Systems*. <http://rfcd.pima.gov/pdd/lid/pdfs/cistern-design-for-water-harvesting.pdf>.
- Nel, C. 1996. “Die ontwikkeling van ‘n struktuur vir die verwydering van vaste besoedeling uit stormwateraflope”. Unpublished DTechEng thesis, Technikon Pretoria.
- North Carolina State University. 2008. *Rainwater Harvester Design Model*. North Carolina State University, Department of Biological and Agricultural Engineering, Stormwater Engineering Group. http://www.bae.ncsu.edu/topic/waterharvesting/RainwaterHarvester_2.0.zip.
- Texas A&M AgriLife Extension Service. 2013. Rainwater Harvesting (online). Accessed 20 June 2013 at <http://rainwaterharvesting.tamu.edu/>.
- TCEQ (Texas Commission on Environmental Quality). 2011. *Rainwater Harvesting with Rain Barrels. A “Take Care of Texas” Guide*. GI-383. Austin, TX.
- Texas Water Development Board. 2005. *The Texas Manual on Rainwater Harvesting*. Third Edition. Austin, TX.

9 Vegetated Swales

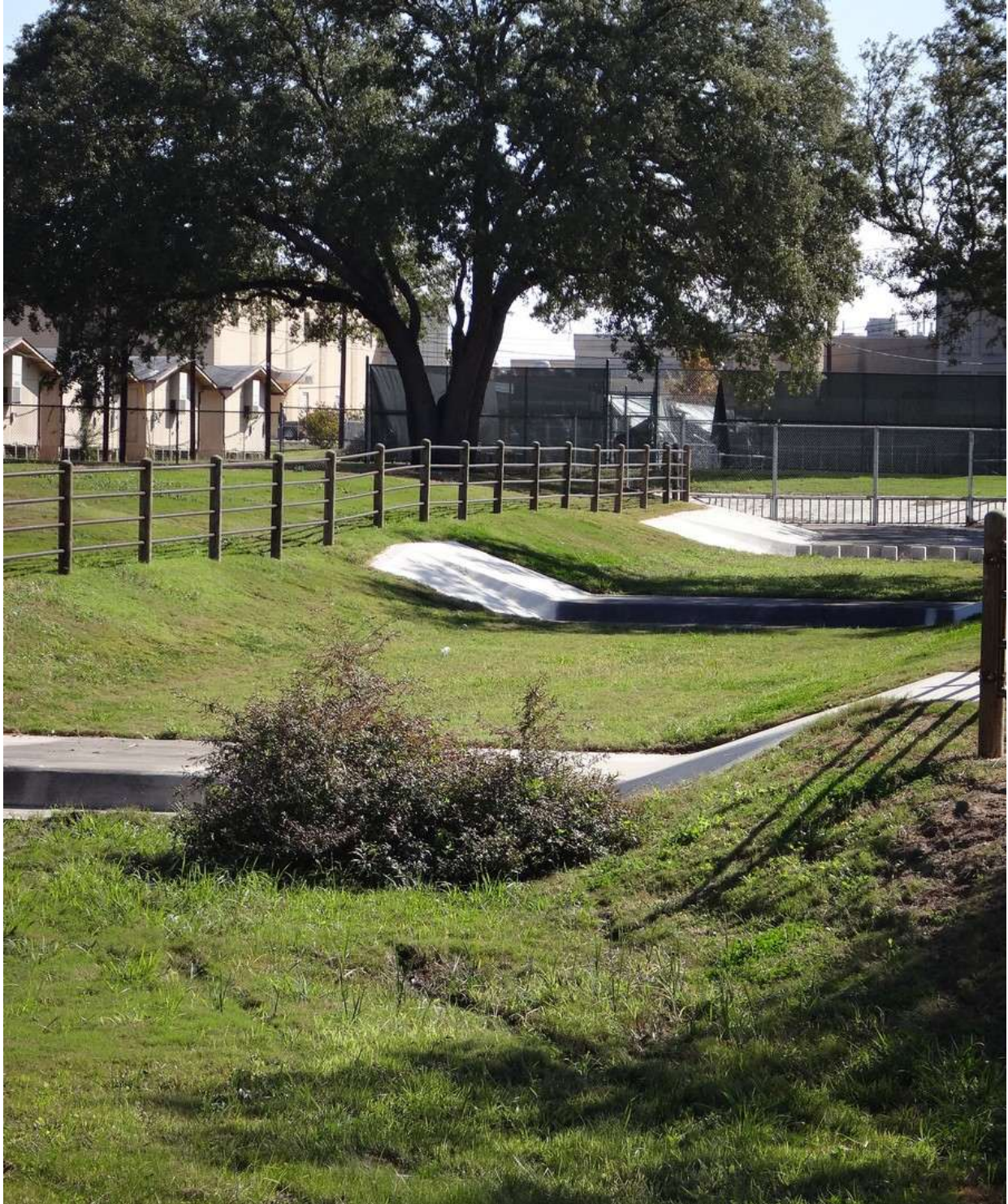

Madison High School AgriScience Building, San Antonio, Texas. Source: Bender Wells Clark Design

9.1 Design

Vegetated swales can be used as pretreatment for other stormwater BMPs or in a treatment train, but they should not typically be installed as standalone practices for water quality improvement. For water quality swale design, see [Bioswales](#). The design of vegetated swales can be broken down to an eight-step process (summarized in Table B-9-1).

Table B-9-1. Iterative design step process

Design step	Design component/ consideration	General specification
1	Determine design flows	Use Appendix A and local guidelines
2	Adjust Preliminary Swale Layout to Fit Site (B-125)	Swale dimensions Determine allowable swale dimensions per site constraints
3	Calculate Swale Cross Sectional Dimensions (B-126)	Bottom width, side slopes, and longitudinal slope Design flow depth should not exceed two-thirds the height of vegetation for optimum pretreatment
4	Determine Design Flow Velocity (B-127)	Design velocity Velocity should be less than 1 ft/s to reduce risk of erosion
5	Calculate Swale Length (B-127)	Residence time If designed for water quality improvement, the hydraulic residence time should be at least 10 minutes to promote sedimentation
6	Provide Conveyance Capacity for Flows Higher than Water Quality Event (B-127)	25-year, 24-hour storm The 25-year, 24-hour storm should be conveyed at less than 3 ft/s to prevent erosion
7	Determine if Soils Need to be Amended (B-128)	If additional water quality improvement and infiltration are desired, amend the soil with minimum 2 inches of soil media (for media standards, see bioretention)
8	Select Vegetation (B-128)	Native, noninvasive turf grasses (not bunch grasses) should be planted and maintained at a minimum height of 4 inches (see Appendix E)

Step 1. Determine Design Flows

Swales are conveyance, flow-based BMPs, so treatment is based on a water quality design flow. The flow associated with the water quality design storm should be calculated based on information provided in Appendix A, *San Antonio Unified Development Code*, or *San Antonio River Basin Regional Modeling Standards for Hydrology and Hydraulic Modeling*. In addition to the water quality design flow, the vegetated swale should be designed to safely convey the 25-year storm event unless a diversion structure is installed to allow only the water quality flow into the swale (for details on diversion structures, see [Common Design Elements](#)).

Step 2. Adjust Preliminary Swale Layout to Fit Site

Vegetated swales can be in many different areas, particularly road sides, around parking lots, medians, and open areas. The linear structure of swales favors their use in the treatment of runoff from highways, residential roadways and common areas in residential subdivisions, along property boundaries and in and around parking lots. If permitted, vegetated swales are an excellent alternative to curbs and gutters, providing water quality and quantity benefits and adding an aesthetic appeal. Generally, a vegetated filter strip or buffer should be placed between the roadway and the vegetated swale to limit the amount of sediment entering the swale.

Appendix B. BMP Design Guidance

Step 3. Calculate Swale Cross Sectional Dimensions

The flow capacity of a vegetated swale is a function of the longitudinal slope (parallel to flow), the resistance to flow (e.g., Manning's roughness), and the cross-sectional area. The cross section is normally approximately trapezoidal, and the area is a function of the bottom width and side slopes. The flow capacity of vegetated swales should be such that the design water quality flow rate will not exceed a flow depth of two-thirds the height of the vegetation in the swale or 4 inches at the peak of the water quality design storm intensity.

The design procedure detailed below uses an iterative method for solving Manning's equation for a trapezoidal, open channel when the longitudinal channel slope, Manning's roughness, and design flow rate are known. The general Manning's equation is as follows, assuming the design flow rate is Q_{wq} :

$$Q_{wq} = \left(\frac{1.49}{n} \right) A R^{\frac{2}{3}} s^{\frac{1}{2}} \quad \text{[Equation B-9-1]}$$

where

- Q_{wq} = design storm flow rate (cfs)
- n = Manning's roughness coefficient (no units)
- A = cross-sectional area of flow (ft²)
- R = hydraulic radius (ft) = area (A) divided by wetted perimeter (P)
- P = wetted perimeter, the perimeter that is in contact with the swale during the design flow
- s = longitudinal channel slope (along direction of flow) (ft/ft)

For the purposes of the trial and error process presented below, Manning's equation can be rearranged as follows (Barrett 2005):

$$b = \frac{0.134Q}{y^{1.67} s^{0.5}} - zy \quad \text{[Equation B-9-2]}$$

where

- b = swale bottom width (ft)
- y = depth of flow (ft)
- z = side slope of swale in the form $z:1$ (should not exceed 3)

An iterative process is best used to determine the depth of flow, y , bottom width, b , and side slope, z . Trial values of bottom width, flow depth, and side slope should be used to determine A , P , and R for the swale's cross section until the equations are equal and the flow depth, bottom width, and channel side slope are within the guidelines established in the previous sections. The equations for A and R for a trapezoidal channel are provided below:

$$R = \frac{A}{P} \quad \text{[Equation B-9-3]}$$

$$A = (b + zd)d \quad \text{[Equation B-9-4]}$$

$$P = b + 2d(1 + z^2)^{0.5} \quad \text{[Equation B-9-5]}$$

Although slope is often determined by site conditions, the slope should not exceed 2.5% for optimum water quality performance. Check dams can be used to reduce the effective slope of a swale (see

[Bioswales](#) and Barrett 2005 for check dam design information). While not required, spreadsheet or computer-based models with “goal seek” functions can assist with this analysis.

Step 4. Determine Water Quality Design Flow Velocity

The flow continuity equation should be used to calculate the design flow velocity through the swale:

$$V_{wq} = \frac{Q_{wq}}{A_{wq}} \quad \text{[Equation B-9-6]}$$

where

Q_{wq} = design flow (ft³/sec)

V_{wq} = design flow velocity (ft/sec)

$A = (b + zd)d$ = cross-sectional area (ft²) of flow at the design depth, where z = side slope length per unit height

The swale should convey the design storm without the threat of erosion. If the design flow velocity exceeds 1 ft/sec, one or more of the design parameters (longitudinal slope, bottom width, or flow depth) must be altered to reduce the design flow velocity to 1 ft/sec or less. It is desirable to have the design velocity as low as possible, both to improve treatment effectiveness and to reduce swale length requirements.

Step 5. Calculate Swale Length

The residence time in a swale should be at least 10 minutes to optimize pretreatment and sediment removal, although this is not always feasible given certain site constraints. Use the following equation to determine the necessary swale length to achieve a hydraulic residence time of at least 10 minutes (600 seconds):

$$L = 600V_{wq} \quad \text{[Equation B-9-7]}$$

where

L = swale length (ft)

V_{wq} = design flow velocity (ft/sec)

If the swale is too long to fit in the site, the design parameters can be adjusted to provide the flow velocity required to meet the recommended residence time. Additionally, a sinuous pattern can be used to increase total swale length (and decrease bed slope) over a distance.

Step 6. Provide Conveyance Capacity for Flows Higher than the Design Storm

Vegetated swales are often designed as online systems that convey flows higher than the design storm flow but can be designed as offline systems incorporating a high-flow bypass or diversion structure upstream of the swale inlet. A high-flow bypass usually results in a smaller swale size. If a high-flow bypass is required, see details on designing diversion structures in [Common Design Elements](#) of this Appendix B.

If the swale will be designed as an online system, confirm that the swale can convey the post-development peak stormwater discharge rate for the 25-year, 24-hour storm event (or local surrogate). The post-development peak stormwater runoff velocity for the 25-year, 24-hour storm should be less than

Appendix B. BMP Design Guidance

3.0 ft/sec. If the 25-year, 24-hour peak flow velocity exceeds 3.0 ft/sec, increase the bottom width or reduce the longitudinal slope as necessary to reduce the peak flow velocity to 3.0 ft/sec or less. If the longitudinal slope is reduced, the swale bottom width must be recalculated and must meet all guidelines established in the previous section.

Step 7. Determine if Soils Need to be Amended

If enhanced infiltration and water holding capacity is desired, vegetated swale soils may be amended with 2 inches of soil media (for soil media specifications, see [bioretention](#)) unless the organic content is already greater than 5 percent. The soil media should be mixed into the native soils to a depth of 6 inches to prevent soil layering.

Step 8. Select Vegetation

Swales must be vegetated to provide adequate treatment of runoff via filtration. Vegetation, when chosen and maintained appropriately, also improves the aesthetics of a site. It is important to maximize water contact with vegetation and the soil surface. The following criteria should be used for selecting appropriate vegetation:

1. The swale area must be appropriately vegetated with a mix of erosion-resistant plant species that effectively bind the soil. A diverse selection of low-growing plants that thrive under the specific site, climatic, and watering conditions should be specified. A mixture of dry-area and wet-area grass species that can continue to grow through silt deposits is most effective. Native or adapted grasses are preferred because they generally require less fertilizer, limited maintenance, and are more drought resistant than exotic plants. When appropriate, swales that are integrated in a project can use turf or other more intensive landscaping, while swales that are on the project perimeter, in a park, or close to an open space area should be planted with a more naturalistic plant palette. Vegetation in the swale must be rooted before the wet season. If vegetation cannot be rooted in time, turf should be installed and properly stabilized.
2. Trees or shrubs can be used along the banks as long as they do not over-shade the turf—woody vegetation should generally be avoided in the bottom of the swale to prevent increased velocities as water flows around the trunks.
3. Above the design treatment elevation, a typical lawn mix or landscape plants can be used, provided they do not shade the swale vegetation.
4. Temporary irrigation is required if the seed is planted in spring or summer. Seed should be properly stabilized with straw or equivalent mulch. Drought-tolerant grasses should be specified to minimize irrigation requirements.
5. Sod is the most effective and efficient way to vegetate swales; ensure that sod remains adequately irrigated during establishment. Sod should be laid perpendicular to flow and staggered such that no preferential flow paths are created by the seams between sod rolls. To maximize incidental infiltration, sod should be sourced from facilities that do **not** grow sod in clay soils. Washed sod can also be furnished if desired.
6. Vegetative cover should be at least 4 inches high, ideally 6 inches. Swale water depth will ideally be 2 inches below the height of the shortest plant species.

For a local plant list, see Appendix E.

9.2 Critical Construction Considerations

Accurate fine grading of vegetated swales is important to prevent nuisance ponding and subsequent vector issues. Care should be taken to ensure positive drainage by providing slopes of 0.5% or steeper. Proper erosion control procedures are also important to protect swales during vegetation establishment. Temporary erosion control blankets, mats, and/or mulch should be applied per the recommendations in Barrett (2005). Turf reinforcement matting may be necessary for high flow areas.

9.3 Operation and Maintenance

1. Inspect vegetated swales for erosion or damage to vegetation at least twice annually for offline swales, preferably at the beginning and end of the wet season. Additional inspection during the wet season(s) and after periods of heavy runoff is recommended. Each swale should be checked for debris and litter and areas of sediment accumulation (for a vegetated swale inspection and maintenance checklist, see Appendix F).
2. Inspect inlets for erosion and sediment accumulation twice annually. Remove sediment if it is blocking the entry of stormwater. After sediment is removed, vegetation replanting or reseeding might be required. Repair erosion immediately and stabilize.
3. Side slopes should be maintained to prevent erosion. Slopes should be stabilized and planted using appropriate vegetation when native soil is exposed or erosion is observed.
4. Swales should drain within 48 hours. If a gravel drainage layer is incorporated underneath the swale to promote infiltration, the layer should drain within 72 hours of the end of the storm. Till the swale if compaction or clogging occurs. The perforated underdrain pipe, if present, should be cleaned if necessary.
5. Vegetation should be healthy and dense enough for filtration while protecting underlying soils from erosion. Specific maintenance items for vegetation are listed in Table B-9-2 and consist of the following:
 - Vegetation, large shrubs, or trees that interfere with landscape swale operation should be pruned.
 - Fallen leaves and debris from deciduous plant foliage should be removed.
 - Grassy swales should be mowed to keep grass 4 to 6 inches high. Grass clippings should be removed, and mowing should be performed perpendicular to the direction of flow such that no preferential flow paths are created by ruts.
 - Invasive vegetation must be removed and replaced with non-invasive species.
 - Dead vegetation should be removed if it composes more than 10 percent of the area covered or when swale function is impaired. Vegetation should be replaced and established before the wet season to maintain cover density and control erosion where soils are exposed.
6. Check dams (if present) should control and distribute flow across the swale. Identify causes for altered water flow and channelization, and clear obstructions. If damaged, repair check dams and swale should.

Appendix B. BMP Design Guidance

7. The vegetated swale should be well maintained; trash and debris, sediment, visual contamination (e.g., oils), and noxious or nuisance weeds should be removed.

Table B-9-2. Inspection and maintenance tasks

Task	Frequency	Maintenance notes
Inlet inspection	Twice annually	Check for sediment accumulation and erosion in the swale.
Mowing	2–12 times / year	Frequency depends on location and desired aesthetic appeal.
Watering	1 time/2–3 days for first 1–2 months. Sporadically after establishment	If droughty, watering after the initial year may be required.
Fertilization	1 time initially	One-time spot fertilization for first year vegetation.
Remove and replace dead plants	1 time/year	Within the first year 10% of plants can die. Survival rates increase with time.
Check dams	1 time before the wet season(s) and monthly during the wet season(s).	Check for sediment accumulation and erosion around or underneath the dam materials.
Miscellaneous upkeep	12 times/year	Tasks include trash collection, spot weeding, and removing mulch from overflow device.

10 Vegetated Filter Strips



Oak Hills Church, San Antonio, Texas. Source: Tetra Tech

10.1 Design

The primary function of vegetated filter strips is to maintain sheet flow of runoff for pretreatment and energy dissipation. The steps for designing vegetated filter strips are provided in Table B-10-1.

Table B-10-1. Iterative design step process

Design step		Design component/ consideration	General specification
1	Determine Design Flows	Use Appendix A and local guidelines	
2	Determine Available Filter Strip Width and Slope (B-132)	Based on existing site conditions	
3	Determine Vegetative Cover (B-132)	Vegetation	Native, drought-tolerant turf grasses (not bunch grasses) should be maintained at a height of no less than 4 inches. See Appendix E.
4	Calculate the Design Flow Depth (B-133)	Design flow depth	Flow depth should be less than 1 inch to achieve effective water quality improvement
5	Calculate the Design Velocity (B-133)	Design velocity	Velocity should be less than 1 ft/s for the water quality event and less than 3 ft/s for the 25-year, 24-hour event
6	Calculate the Desired Length of the Filter Strip (B-133)	Length and residence time	Filter strip length should provide for a 10-minute hydraulic residence time if substantial water quality improvement is desired.
7	Design Level Spreader/Energy Dissipater if Needed (B-134)	Level spreader	A level spreader and energy dissipater must be designed if concentrated flows are present.
8	Determine if Soils Need to be Amended (B-134)	If additional water quality improvement and infiltration are desired, amend the soil with 2 inches of media (for media standards, see bioretention)	
9	Specify Signage (B-134)	Signage should identify filter strip as stormwater treatment practice and prohibit foot traffic and other activities that could compact or rut filter strip soils.	

Step 1. Determine the Design Flow Rate

Vegetated filter strips are conveyance, flow-based BMPs, so treatment is based on a water quality design flow. The flow associated with the water quality design storm should be calculated according to information provided in Appendix A, *San Antonio Unified Development Code*, or *San Antonio River Basin Regional Modeling Standards for Hydrology and Hydraulic Modeling*. In addition to the water quality design flow, the filter strip should be designed to safely convey the 25-year storm event.

Step 2. Determine Available Filter Strip Width and Slope

In some design cases, the filter strip width and slope are predetermined on the basis of existing conditions. However, in many cases, determining the final width and slope are part of the design process.

Step 3. Determine Vegetative Cover

Select vegetative cover for the filter strip that is appropriate for local soil and climate conditions. Considerations should include requirements for maintenance, irrigation, and fertilization. See [vegetated swale](#) vegetation specifications.

Step 4. Calculate the Flow Depth of the Design Flow

Hydraulically, filter strips should be designed according to two primary criteria: maximum depth of flow and maximum flow velocity.

Depth of runoff flow generated by the design storm in the filter strip should be limited to less than or equal to 1 inch. The design configuration having the greatest effect on those design standards are the contributing watershed area, longitudinal slope (along the direction of flow), the resistance to flow (Manning's n), and the width and slope of the filter strip. The design flow depth (d) is calculated on the basis of the width and the slope (parallel to the flow path) using a modified Manning's equation as follows:

$$d = \left(\frac{Q_{wq} \times n_{wq}}{1.49ws^{0.5}} \right)^{0.6} \quad \text{[Equation B-10-1]}$$

where

d = design flow depth (ft)

Q_{wq} = water quality design flow rate (cfs)

w = width of strip perpendicular to flow that equals the width of impervious surface contributing to the filter strip (ft)

s = slope (ft/ft) of strip parallel to flow, average over the whole width

n_{wq} = Manning's roughness coefficient (0.025–0.03)

If d is greater than 1 inch, a smaller slope is required, or the filter strip may not provide substantial water quality improvement.

Step 5 Calculate the Design Velocity

Maximum design storm flow velocity should be limited to 1 ft/sec. The design flow velocity is based on the design flow, design flow depth, and width of the strip as follows:

$$v_{wq} = \frac{Q_{wq}}{dw} \quad \text{[Equation B-10-2]}$$

where

v_{wq} = water quality design flow velocity (ft/sec)

Q_{wq} = water quality design flow rate (cfs)

d = design flow depth (ft)

w = width of strip perpendicular to flow that equals the width of impervious surface contributing to the filter strip (ft)

Step 6: Calculate the Desired Length of the Filter Strip

Determine the required length (L) to achieve a desired residence time of 10 minutes using this equation:

$$L = 600v_{wq} \quad \text{[Equation B-10-3]}$$

where

L = swale length (ft)

v_{wq} = design water quality flow velocity (ft/sec)

Appendix B. BMP Design Guidance

If the design parameters as computed in steps 1 through 6 above are not within the recommended standards, an alternative BMP, such as a grassed swale should be considered to treat stormwater runoff.

Step 7: Level Spreader/Energy Dissipater

The transition of stormwater runoff from upslope, impervious areas to the gently sloping, vegetated surface of a filter strip is critical to the proper function of the BMP. Flow should not be concentrated and should not transition to flow over the filter strip such that it causes concentration or erosive flows. Where flow originates on roadways and parking lots, the designer can elect to incorporate an energy-dissipation device at the interface between the hardened pavement surface and the filter strip. Energy dissipaters typically take the form of a gravel flow spreader consisting of a gravel filled trench that is perpendicular to the direction of flow. The gravel flow spreader should have the following characteristics:

- The gravel flow spreader must be a minimum of 6 inches deep and 12 inches wide.
- The gravel surface should be a minimum of 1 inch below the surface of the adjacent pavement.

Vegetated filter strips are often used in combination with concrete level spreaders to provide energy dissipation.

Step 8: Determine if Soils Need Amending

If enhanced infiltration is desired, vegetated filter strips can be amended with 2 inches of soil media (for soil media specifications, see [bioretention](#) design chapter) or plant-derived compost unless the organic content is already greater than 5 percent. The amendment should be mixed into the native soils to a depth of 6 inches to prevent soil layering.

Step 9: Specify Signage

It is important to specify installation of signage so that the vegetated filter strip is properly maintained. Signage should label the practice as a stormwater BMP, prohibit foot traffic, and instruct maintenance crews to maintain vegetation at a height of approximately 4 inches—this will ensure maximum treatment and soil stabilization.

10.2 Critical Construction Considerations

The primary mechanism of failure for filter strips is the development of concentrated flow, which results in erosion and the formation of rills. Vegetated filter strips should thus be carefully graded to prevent concentration of flow and level spreaders (if used) should be completely level.

10.3 Operation and Maintenance

The primary maintenance requirement of a vegetated filter strip is managing vegetation in the filter strip. As a result, specialized equipment and training of maintenance crews is typically not necessary. Maintenance activities for vegetated filter strips are listed in Table B-10-2 and include the following:

- Regular mowing to maintain visual aesthetics. Grass height should be maintained at a minimum of 4 inches high. Clippings should be removed so flow is not impeded. Mowing should be performed perpendicular to the direction of flow to prevent preferential flow paths caused by wheel ruts.
- Remove accumulated sediment from the inlet lip of the vegetated filter strip when accumulation is obvious (monthly during seasons of heavy rainfall).

- Weeds and other vegetation should be removed as needed being careful not to cause pits or exposed soil that could lead to increased erosion.

Table B-10-2. Inspection and maintenance tasks

Task	Frequency	Maintenance notes
Mowing	2–12 times/year	As needed to maintain aesthetics. Grass height should be a minimum of 4 inches.
Inlet inspection	Once after first major rain of the season, then monthly during the rainy season(s)	Check for sediment accumulation to ensure that flow into the system is as designed. Remove any accumulated sediment.
Miscellaneous upkeep	12 times/year	Tasks include trash collection, spot weeding, and irrigation as necessary.

10.4 References

Chow, V.T. 1959. *Open-Channel Hydraulics*. McGraw-Hill, New York, NY.

11 Common Design Elements

Many BMPs have similar elements or standards. Those common elements and associated design standards are outlined in this section.

11.1 Geotechnical Investigation

The design of most BMPs will rely on an initial geotechnical investigation. Performing soil tests early in the conceptual and preliminary design phases will ensure that the proposed system is optimized to actual site conditions and to prevent costly change orders resulting from poorly estimated soil parameters.

The investigation should include both desktop and field analyses to fully characterize the structural and hydrologic characteristics of a site. Desktop analyses can be used to generate a conceptual site design but should always be verified with field investigation. The following parameters can be determined by desktop analyses:

- Underlying geology (especially presence of karst geology or shallow bedrock)
- Site location with respect to Edwards Aquifer Recharge Zone
- Proximity to steep slopes
- Proximity to structural foundations, roadway subgrades, utilities, and other infrastructure
- Proximity to water supply wells
- Proximity to septic drain fields

Field investigations should be performed by a licensed soil scientist or geotechnical engineer. All soil testing should be performed at the depth of the initially proposed subgrade because this is the soil strata where infiltration could occur. If a detention (non-infiltrating system) is proposed, soil tests must still be performed to determine structural requirements and to identify the elevation of the seasonal high water table.

Sufficient test pits or borings should be done to adequately characterize the site soil conditions, but, at a minimum, the greater of 2 samples or 1 sample per 50,000 square feet of BMP area should be collected. Soils should be investigated to a depth of at least 3 feet below the proposed BMP subgrade. The following key parameters should be determined or verified by field investigation:

- The infiltration rate of the soils at the potential subgrade (ASTM D 3385 *Standard Test Method for Infiltration Rate of Field Soils Using Double-Ring Infiltrometer*, or a comparable method)
- The depth and texture of subsoils
- The depth to the seasonal high groundwater table
- Structural capacity of soils (if surface BMP, such as cistern or planter box, is intended)
- Presence of expansive clay minerals
- Presence of compacted or restrictive layers
- Underlying geology (especially presence of karst geology or shallow bedrock)
- Proximity to steep slopes

- Proximity to structural foundations, roadway subgrades, utilities, and other infrastructure
- Proximity to water supply wells
- Proximity to septic drain fields

In the Edwards Aquifer Recharge, Contributing, and Transition zones, at least 12 inches of natural soil must be provided wherever a practice is intended to discharge stormwater for infiltration (e.g. permeable pavement in the Contributing Zone or irrigation with harvested water from a cistern). Fill material may be used, but it must have a texture comparable to natural site soils. All soils should contain no wastes, debris, deleterious material, or material that can leach contaminants. Soils should contain less than 30 percent coarse material by volume, which is defined as material larger than 0.5 inch in diameter.

11.2 Curb Cuts

When BMPs are incorporated into highly impervious areas, such as parking lots and in road rights-of-way, curb cuts can be required to allow surface runoff to enter the BMP. Curb cuts are designed such that the design storm can pass through the curbing without causing water to pond in the travel lanes. Example curb cuts are shown in Figure B-11-1 and Figure B-11-2.

Designs have the following recommendations:

- The opening should be at least 18 inches wide at the base to prevent clogging and to provide dispersed flow.
- The curb cut can have vertical sides or have chamfered sides at 45 degrees.
- Slope the bottom of the concrete curb cut toward the stormwater facility.
- Provide a minimum 2-inch drop in grade between the curb cut entry point and the finished grade of the stormwater facility.
- The curb cut must pass the design storm flow without causing backup that would disrupt normal travel in the lane.
- The curb cut opening should be armored to prevent erosion. Concrete, stone, or sod can be used to armor the flow path to the base of the bioretention area. If a vegetated filter strip is provided downstream from the curb cut, a turf reinforcement mat may be required to stabilize the soil if flows are expected to exceed 3 ft/sec.

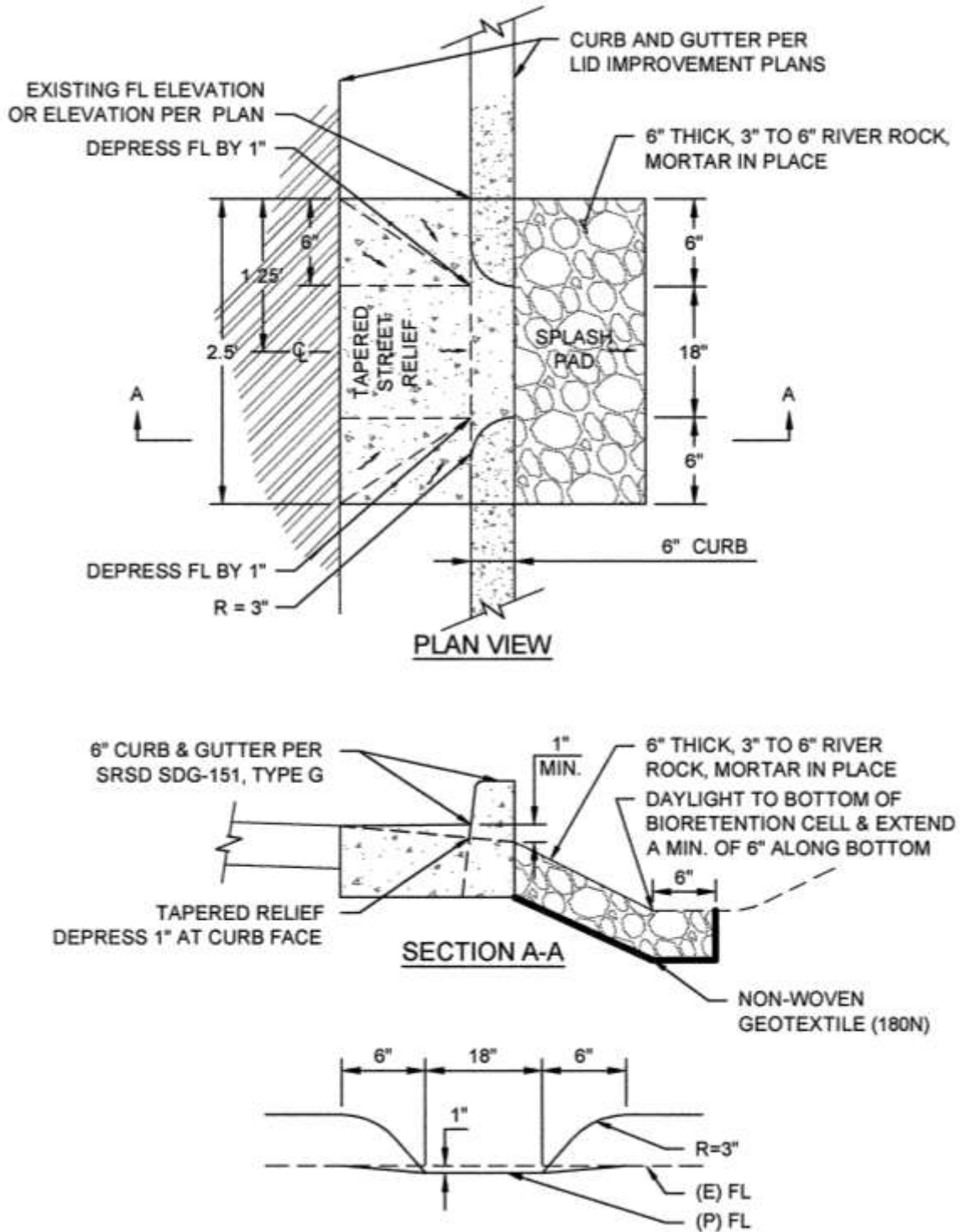

Figure B-11-1. Typical curb cut diagram.



LA Zoo, Los Angeles, California. Source: Tetra Tech.

Figure B-11-2. A typical curb cut.

Some pretreatment flow reduction can be provided by using multiple, smaller curb cuts to minimize the flow at each opening and by armoring the curb opening from the back of the curb to the base elevation of the bioretention area (Figure B-11-3).



Bioretention at Mission Library, San Antonio. Source: Bender Wells Clark Design.

Figure B-11-3. Multiple, small curb cuts distribute parking lot runoff to bioretention area without erosive force.

Figure B-11-4 and Figure B-11-5 show examples of potential curb cut configurations. Figure B-11-16 shows a covered curb cut that would be appropriate in areas experiencing high levels of pedestrian traffic. Inlets can be covered or protected for pedestrians or other traffic using a covered curb cut. Covered curb cuts, such as the one shown in Figure B-11-16, are preferred over other curb inlet methods including the use of pipes or linear cuts in the curbing for ease of maintenance. Covering the inlet with a removable grate allows for easy visual inspection of the inlet and can reduce the effort required for maintenance. Such curb cuts can also be modified with a small sump or lip to capture coarse sediments and trash. Armoring the curb opening from the back of the curb to the base elevation of the bioretention will reduce inlet velocities, preventing scour and erosion in the BMP.



Apex, North Carolina. Source: Tetra Tech.

Figure B-11-4. Curb cuts and vegetated filter strip for a roadside bioretention area.



(Left) Raleigh, North Carolina. Source: Tetra Tech.



(Right) Downey, California. Source: Tetra Tech.

Figure B-11-5. Armored curb cuts.



Source: City of San Diego LID Design Manual

Figure B-11-6. Covered curb cut with a sump.

11.3 Stabilization and Energy Dissipation

In some cases, the inlet or outlet can be a pipe with concentrated flow. Flow dissipation is difficult yet critical in such situations. Several options can be used for dissipating flow from a pipe. The flow can be discharged into a shallow forebay. Energy dissipation can be implemented at the outlet of the pipe, such as by using sod or stones, to slow the flow as shown in Figure B-11-7. All stone armoring should be sized such that it is not mobilized during high flows and should be underlain with appropriate geotextile fabric to prevent scour of underlying soils. Another option to dissipate energy from small pipes would be to install an elbow at the end of the pipe, with stable materials around the elbow, to slow the flow and allow the water to cascade onto a gravel pad. A small weep hole should be used to prevent water from permanently ponding in the elbow. An example of a constructed energy dissipater is shown in Figure B-11-8, and an upturned elbow used for energy dissipation is shown in Figure B-11-9.



Cary, North Carolina. Source: Tetra Tech.

Figure B-11-7. Stone flow dissipater/forebay.



University of Texas at San Antonio, San Antonio, Texas. Source: Tetra Tech

Figure B-11-8. Concrete energy dissipater.



Chocowinity, North Carolina. Source: Tetra Tech, Inc.

Figure B-11-9. Upturned roof downspout energy dissipater.

Level spreaders are another technique for converting concentrated flows into diffuse, sheet flow. Runoff is distributed through a dead-end channel (sometimes called a *blind swale*) along the upslope side of the vegetated filter strip and evenly dispersed onto the vegetated filter strip along the level spreader as shown in Figure B-11-10 and Figure B-11-11. It is important that the lip of the level spreader be accurately level across the entire length and that a minimum 2-inch drop is provided from the lip to the gravel pad below. Level spreaders can be installed in an “arced” configuration if necessary, but the arc should always be convex such that flow is never concentrated (Figure B-11-11). Weir overflow equations can be used to determine the required level spreader length to produce nonerosive flows (Chow 1959).

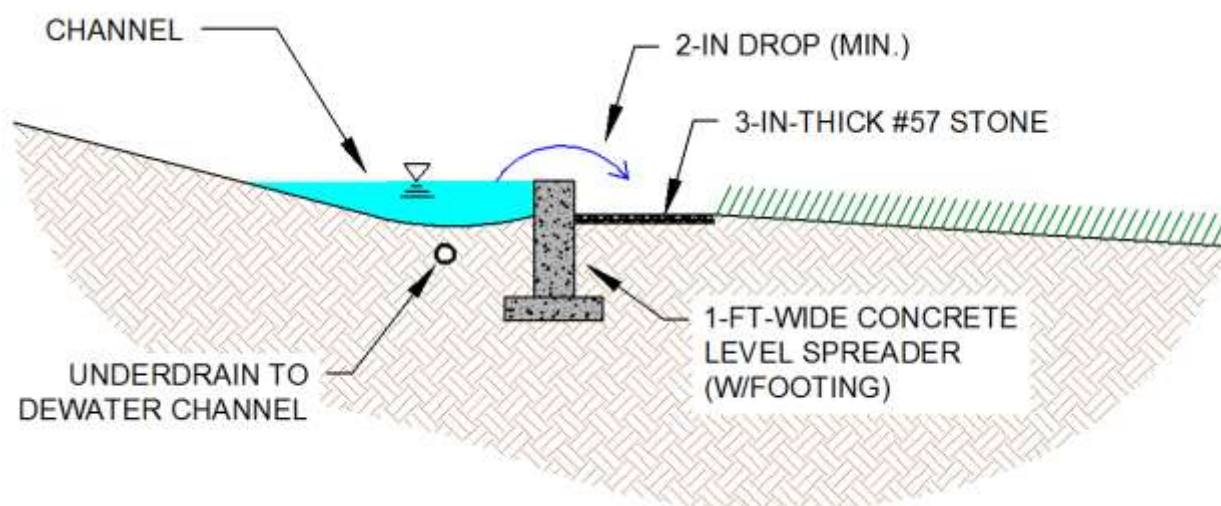

Figure B-11-10. Typical level spreader profile view.

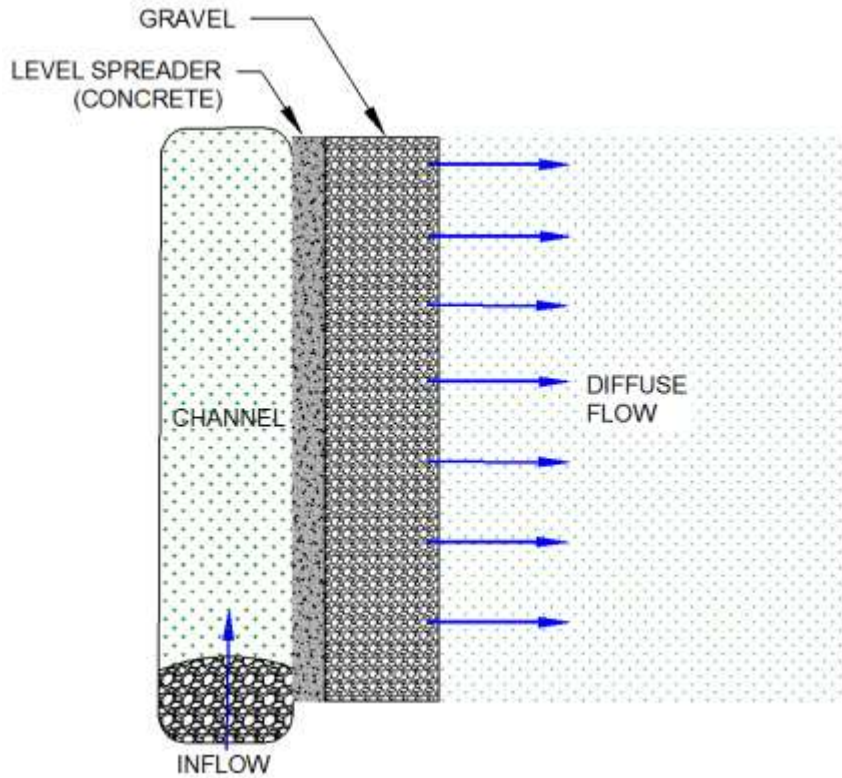

Figure B-11-11. Typical level spreader plan view.

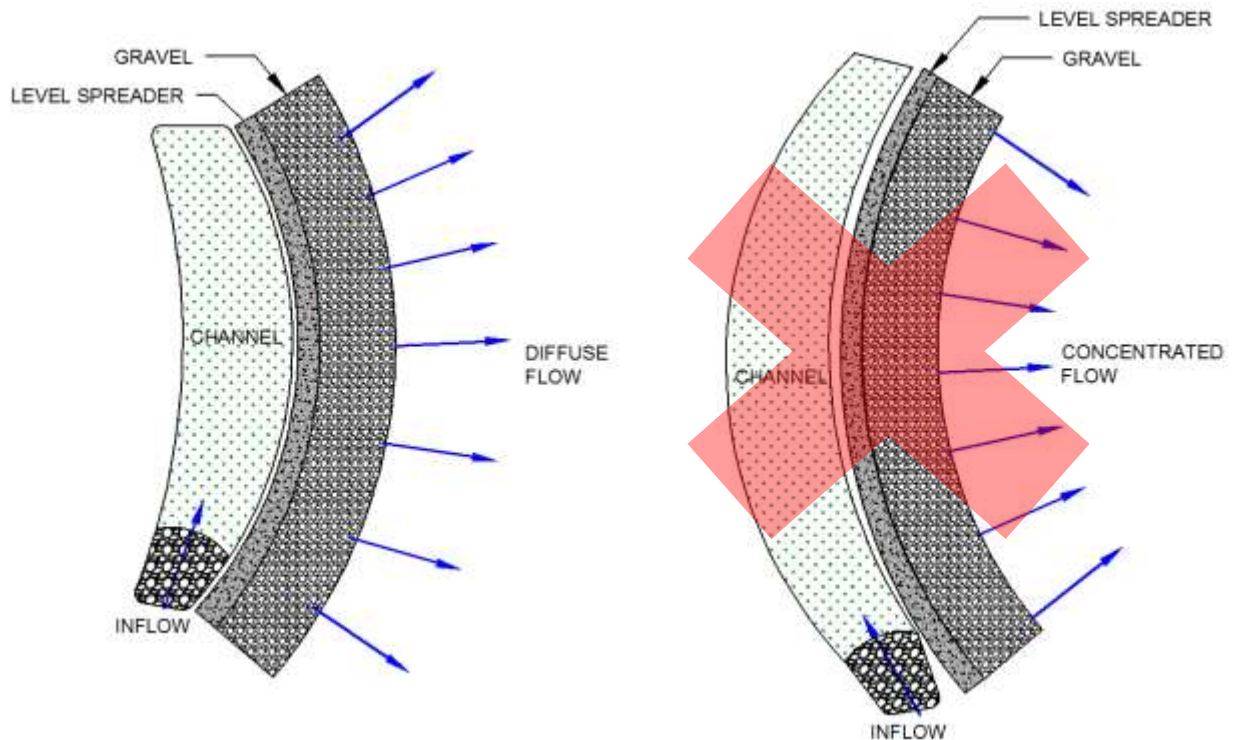

Figure B-11-12. Figure illustrating proper installation of arced level spreader (left) and improper level spreader arc (right)

11.4 Underdrain Design

Underdrains are common design elements in bioretention areas, bioswales, planter boxes, and sand filters. Soil testing should be performed at the site by a licensed soil scientist or geological engineer to determine the infiltration rate of the soils and the depth to the seasonally high groundwater table. If the infiltration rate of the soils where the infiltrating practice will be installed is less than 0.5 in/hr, or if a site is near a steep slope, underdrains will be required. If underdrains are used, they should meet the recommended specifications in Table B-11-1.

Table B-11-1. Underdrain specifications (Barrett 2005)

Component	Specification
Diameter	4-inch minimum
Material	Perforated Schedule 40 PVC
Perforation Type	Slotted or round, although slotted underdrains provide greater intake capacity, clog resistant drainage, and reduced entrance velocity into the pipe, thereby reducing the chances of solids migration
Perforation Spacing and Placement	The maximum spacing between perforations should not exceed 6 inches, but spacing of perforations is typically not critical to the function of the BMP as long as the total opening area provides capacity for the expected underdrain flow and does not limit infiltration through the soil media. The perforations can be placed closest to the invert of the pipe to achieve maximum potential for draining the facility. If an anaerobic zone is intended, the perforation can be placed at the top of the pipe.
Slope	1% minimum slope toward outlet
Cleanout Access	Rigid, unperforated observation pipes with a diameter equal to the underdrain diameter should be connected to each individual underdrain (every 250 to 300 feet in larger systems) to provide a cleanout port and an observation well to monitor dewatering rates. The wells/cleanouts should be connected to the perforated underdrain with the appropriate manufactured connections. The wells/cleanouts must extend 6 inches above the mulch or sod layer and be capped with a screw cap to avoid damage from maintenance and vandalism. The ends of upgradient, lateral underdrain pipes not terminating in an observation well/cleanout must also be capped.
Outfall	The underdrain can be connected to a vegetated swale, to another filter cell as part of a connected treatment system, daylight to a vegetated dispersion area using an effective flow dispersion device, stored for reuse, or to a stormwater drainage system.

A barrier to separate the soil media from the drainage layer should be installed. Two options can be used for providing the separation from the soil media and the drainage layer:

- Option 1: Place a thin, 2- to 4-inch layer of pure sand and a thin layer (nominally 2 inches) of choking stone (such as ASTM No. 8) between the soil media and the drainage stone as shown in Figure B-11-13.
- Option 2: The drainage stone should be a washed No. 57 stone, or similar alternative that has been washed to remove all fines. The drainage stone should be used to provide a gravel blanket and bedding for the underdrain pipe. Place the underdrain on a 3-foot-wide bed of the drainage stone 6 inches deep and cover with the same drainage stone to provide a 16-inch minimum depth around the bottom, sides, and top of the slotted pipe.

A geotextile fabric should be placed between the soil media and the drainage layer as shown in Figure B-11-14. If a geotextile fabric is used, it must meet the minimum materials requirements listed in Table B-11-2.

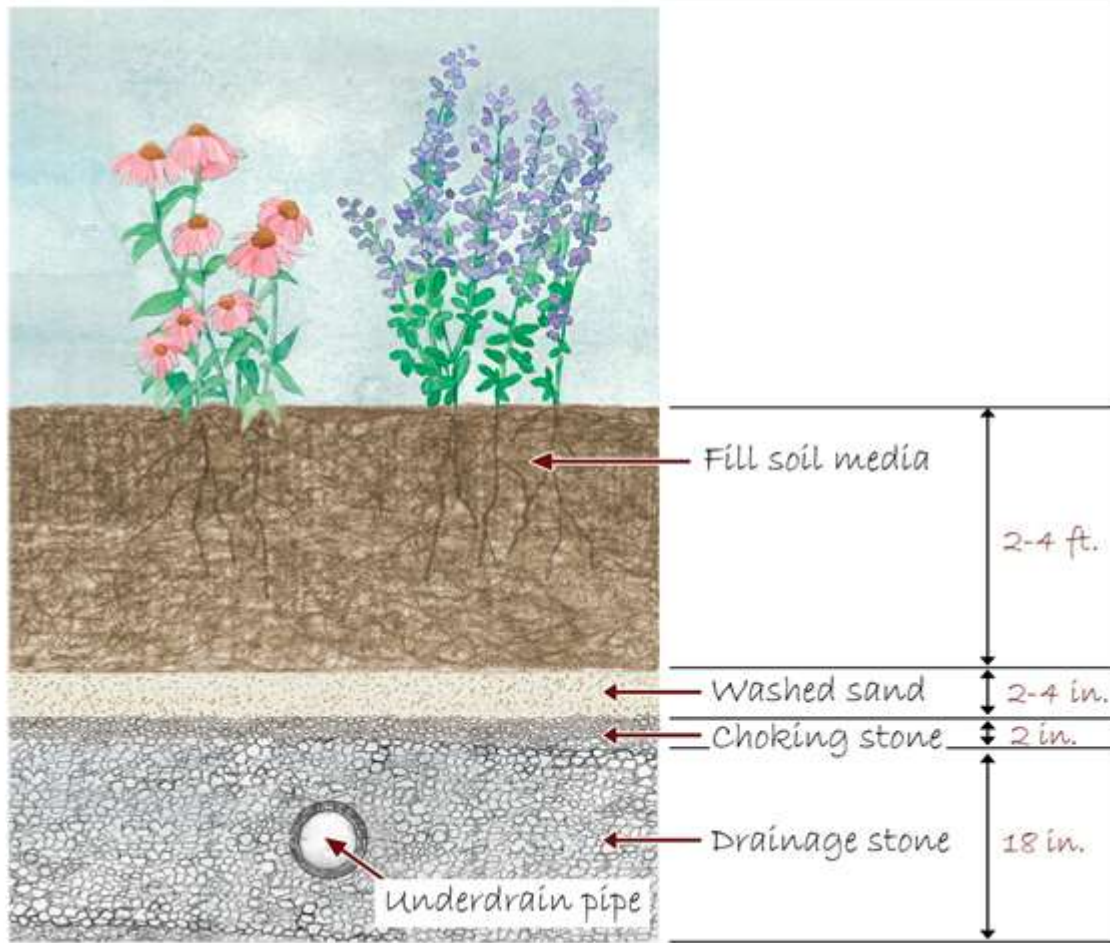

Source: City of San Diego LID Design Manual

Figure B-11-13. Underdrain barrier option 1: soil media barrier.

Table B-11-2. Geotextile layer specifications (Barrett 2005)

Geotextile property	Value	Test method
Trapezoidal tear (lbs)	40 (min)	ASTM D4533
Permeability (cm/sec)	0.2 (min)	ASTM D4491
AOS (sieve size)	#60-#70 (min)	ASTM D4751
Ultraviolet resistance	70% or greater	ASTM D4355

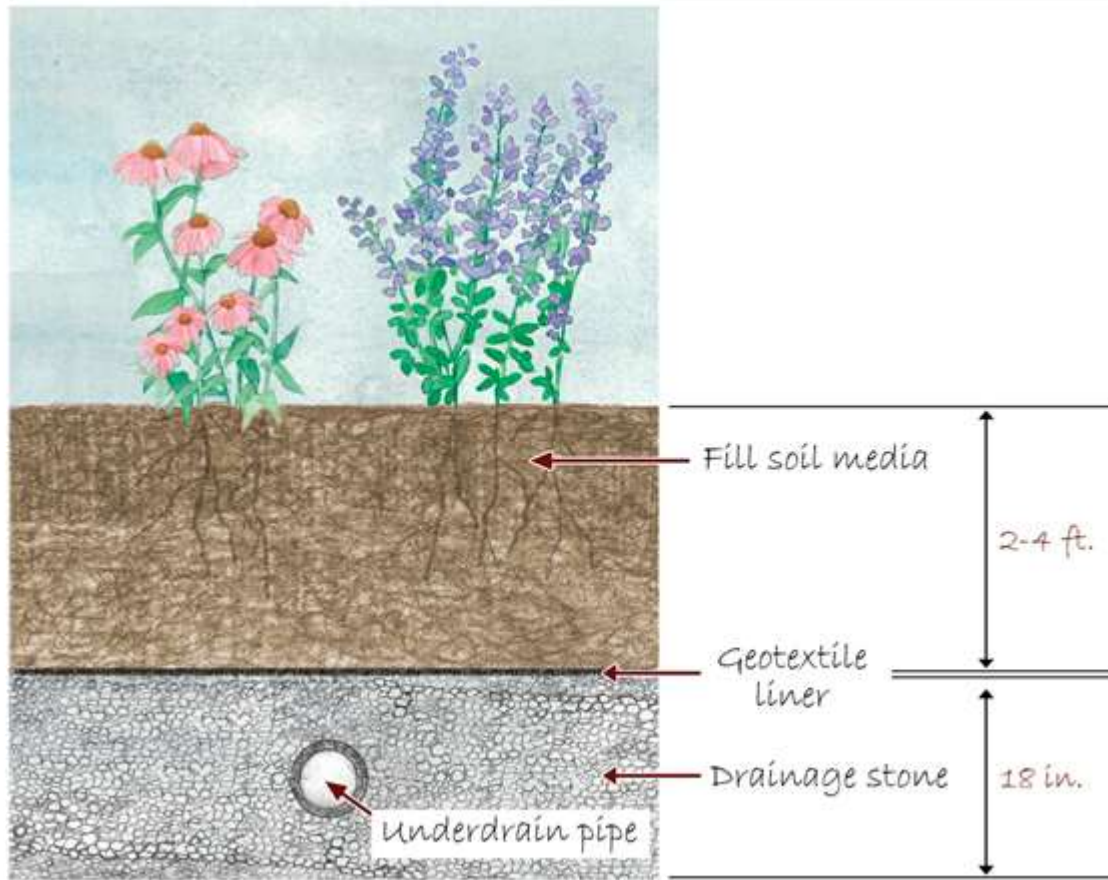

Source: City of San Diego LID Design Manual

Figure B-11-14. Underdrain barrier option 2: geotextile liner.

Option 2 is a common method; however, geotextile clogging and biofouling has been observed in field investigations. In situations where there is concern of clogging around the geotextile, option 1 is recommended.

11.5 Trash Racks

Non-clogging intake designs should be specified whenever litter or debris pose a risk of clogging drawdown pipes. For stormwater wetlands, an intake pipe with downturned opening extending 6 to 12 inches below the permanent pool (Figure B-11-15) or enclosing the drawdown orifice (Figure B-11-16) will reduce the risk of clogging by floating debris. Providing a downward slope on the entire intake pipe can also reduce deposition of sediment within the pipe itself.



Source: NCSU BAE

Figure B-11-15. Drawdown pipe with a downturned elbow.



Wilmington, North Carolina. Source: NCSU BAE

Figure B-11-16. Outlet structure with a trash rack and protected drawdown orifice.

Appendix B. BMP Design Guidance

When additional exclusion of trash and debris is required (such as in sand filter sedimentation chambers or for emergency/maintenance dewatering intakes in stormwater wetlands) a trash rack or other debris exclusion device should be specified. A simple trash rack can be designed by nesting a perforated riser pipe within a wire mesh cage. The bottom portion of the pipe should be enveloped in a cone of washed stone (ASTM No. 57 stone is adequate) as shown in Figure B-11-17. The specific trash rack configuration will depend on site conditions and design goals, but regardless of configuration all trash rack should allow for safe bypass of high flows. For further guidance on trash rack design, see Barrett (2005) and UDFCD (2010).

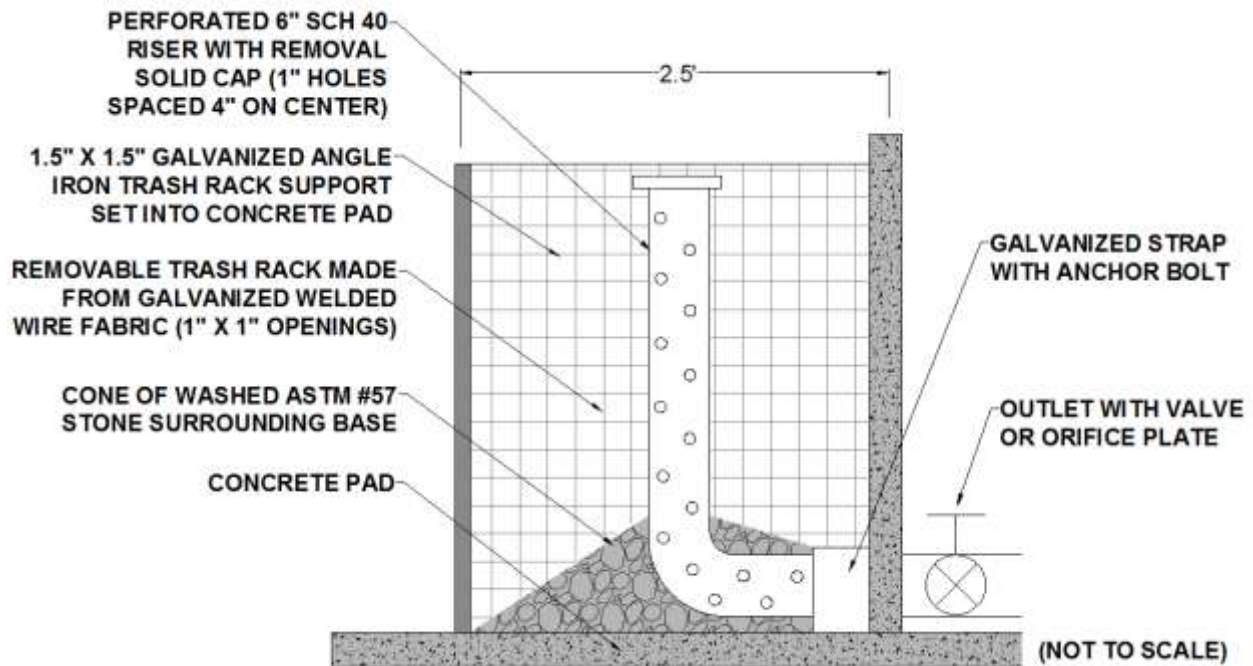

Figure B-11-17. Schematic of a trash rack for dewatering sedimentation chambers and stormwater wetlands (adapted from Barrett 2005).

11.6 Diversion Structures

If a BMP is designed to be an offline system, a structure will be required to divert the design volume into the BMP. Figure B-11-18 shows an example of a typical diversion structure. When the capacity of the BMP is exceeded or the flow exceeds the capacity of the diversion pipe, the flow bypasses over the weir and flows directly to the stormwater drainage system. The bypass pipe should be sized to limit the flow into the BMPs to non-erosive flows. When flows through a BMP could exceed the recommended maximum flow rates, regardless of whether a system is online or offline, a diversion structure is recommended to prevent erosion in the BMP. The flow velocity in a mulched system should not exceed 1 ft/sec. Flow in a grassed system should not exceed 3 ft/sec. Flows can be greater (up to 14 ft/sec) with the use of reinforced turf matting and will depend on the matting selected. A diversion structure should be used to ensure that flows through the system do not exceed the recommended design flow. More information on determining erosive flows can be found in TxDOT (2011).

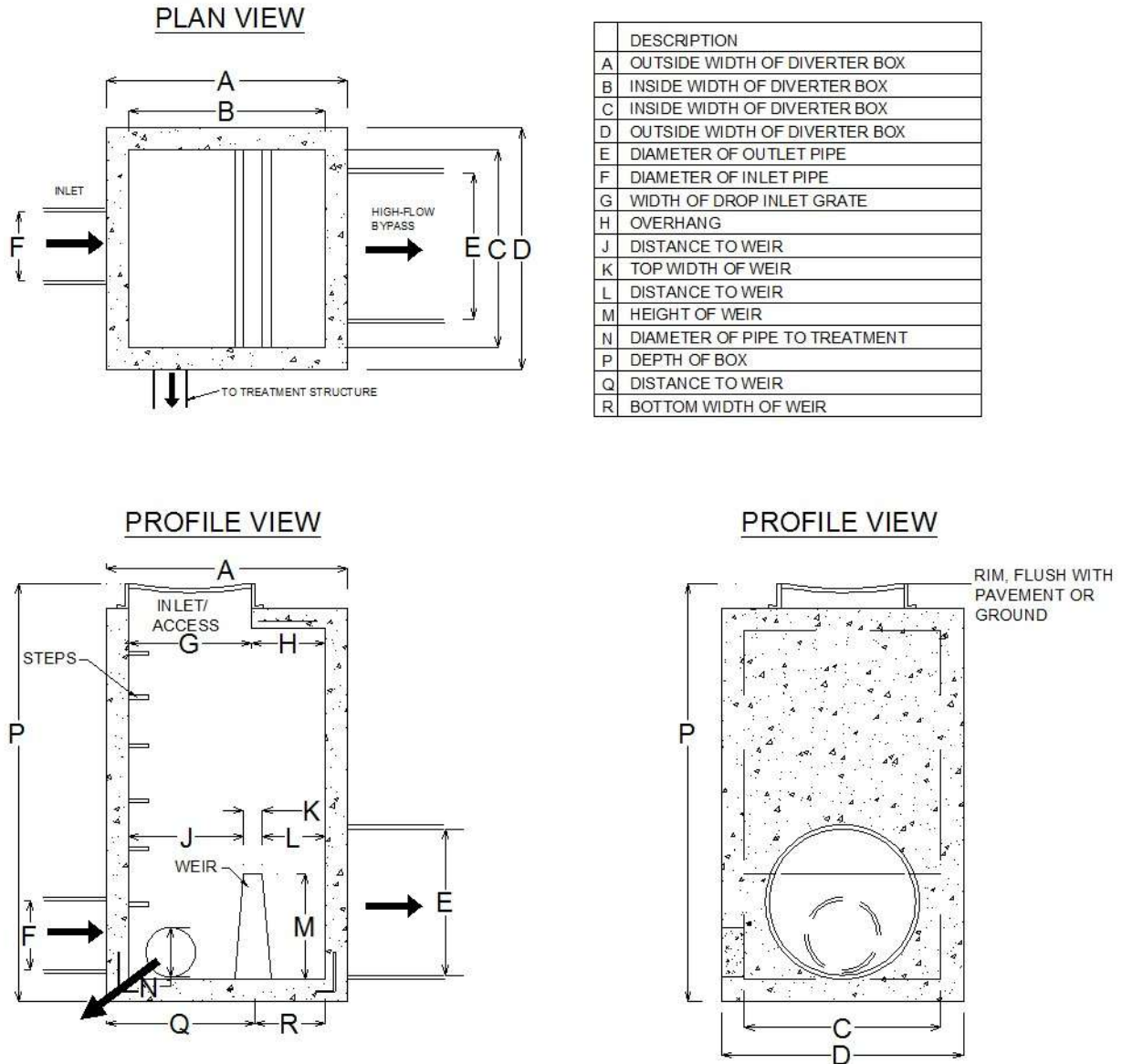

Figure B-11-18. Typical diversion structure.

In situations where stormwater is collected in a pipe and routed to a BMP, a diversion structure should be designed at the inlet of the BMP to divert flows that exceed the volume or flow capacity of the BMP.

11.7 Impermeable Liners and Hydraulic Restriction Barriers

The most ideal configuration, from a stormwater pollutant-removal perspective, is to infiltrate as much runoff as possible. Types of clay that have a high potential for expansion when saturated should be protected from moisture in load bearing conditions; however, expansive clays do not preclude infiltration. When infiltrating BMPs are hydraulically isolated from structures (by vertical or horizontal distance or by using hydraulic restriction layers), systems installed in tight clays soils can still experience significant volume reductions (Fassman and Blackburn 2010). In situations where conditions require limiting infiltration, two basic options can be used for hydraulic restriction layers.

Appendix B. BMP Design Guidance

The preferred option is to restrict lateral flow while allowing for deep percolation infiltration of stormwater. To allow infiltration, the bottom of the bioretention area should remain unlined. The hydraulic restriction layer should extend the full depth of the media to the base of the drainage layer in situations where underdrains are required. In situations where underdrains are not required, the hydraulic restriction layer should extend to a depth where saturation will not affect any adjacent load-bearing soils. Areas that have a potential for settling under saturated conditions should be protected from lateral flows. An example is shown in Figure B-11-19.



Broadway Street, Witte Museum, San Antonio (rendering). Source: Bender Wells Clark Design

Figure B-11-19. Lateral hydraulic restriction layers in a roadside bioretention area prevent horizontal seepage while allowing infiltration at a safe depth.

In situations where infiltration is not possible, because of limiting soil capacity or aquifer protection (i.e., Edwards Aquifer Recharge, Contributing, and Transition zones), the entire perimeter of the soil media should be lined to prevent infiltration into the existing soils while gaining some pollutant removal from the soil media. Infiltration pathways might also need to be restricted using impermeable barriers because of the close proximity of roads, foundations, other infrastructure, or hotspot locations as determined in the geotechnical investigation. A full geotechnical investigation should be performed by a licensed soil scientist or geotechnical engineer, as detailed in [Geotechnical Investigation](#). That should be done for all sites to determine the effect of infiltration, including the appropriate depth and type of the hydraulic restriction layer.

In the Edwards Aquifer Recharge, Transition, and Contributing zones, three types of hydraulic restriction layers are recommended: clay liners, concrete, or geomembranes (Barrett 2005). Specifications for clay liners are provided in Table B-11-3 and an example is shown in Figure B-11-20.

Table B-11-3. Clay liner specifications (Barrett 2005)

Property	Test method	Unit	Specifications
Thickness	--	inch	12
Permeability	ASTM D-2434	cm/sec	1 x 10 ⁻⁶
Plasticity Index of Clay	ASTM D-423 & D-424	%	Not less than 15
Liquid Limit of Clay	ASTM D-2216	%	Not less than 30
Clay Particles Passing	ASTM D-422	%	Not less than 30
Clay Compaction	ASTM D-2216	%	95% of Standard Proctor Density

Source: Barrett 2005

If geomembrane is used, it should be a minimum of 30 mils thick and ultraviolet resistant. A suitable geotextile fabric should be placed on the top and bottom of the membrane for puncture protection and the liners covered with a minimum of 6 inches of compacted topsoil. The topsoil should be stabilized with appropriate vegetation. The geotextile fabric (for protection of geomembrane) should be nonwoven geotextile fabric and meet the specifications in Table B-11-4. Construction plans should specify the method for sealing the seams of the geomembrane (per manufacturer recommendations). Seams are typically head sealed by the manufacture but can be sealed in the field following ASTM D7408 standards and all manufacture requirements. An example of a geomembrane liner is shown in Figure B-11-21.

Table B-11-4. Protective geotextile fabric specifications (Barrett 2005)

Property	Test Method	Unit	Specifications
Unit weight	--	oz/yd ²	8
Filtration rate	ASTM D-423 & D-424	0.08	0.08
Puncture strength	ASTM D-751*	lb	125
Mullen burst strength	ASTM D-751	psi	400
Tensile strength	ASTM D-1682	lb	200
Equiv. opening size	US Standard Sieve	No.	80

Source: Barrett 2005

In addition to geomembranes and clay liners, project sites can use concrete barriers along roadways or other structural features to prevent lateral seepage to adjacent utilities or areas of concern (as shown in Figure B-11-22). Concrete barriers can be constructed as extensions of the surrounding curb installed vertically to the depth where saturation will not affect the stability of the load-bearing soils. Concrete barriers will prevent damage that can occur from maintenance required for utilities in the right-of-way.



Broadway Street, Witte Museum, San Antonio (rendering). Source: Bender Wells Clark Design

Figure B-11-20. Bioretention area with clay liner and lateral hydraulic restriction barriers.

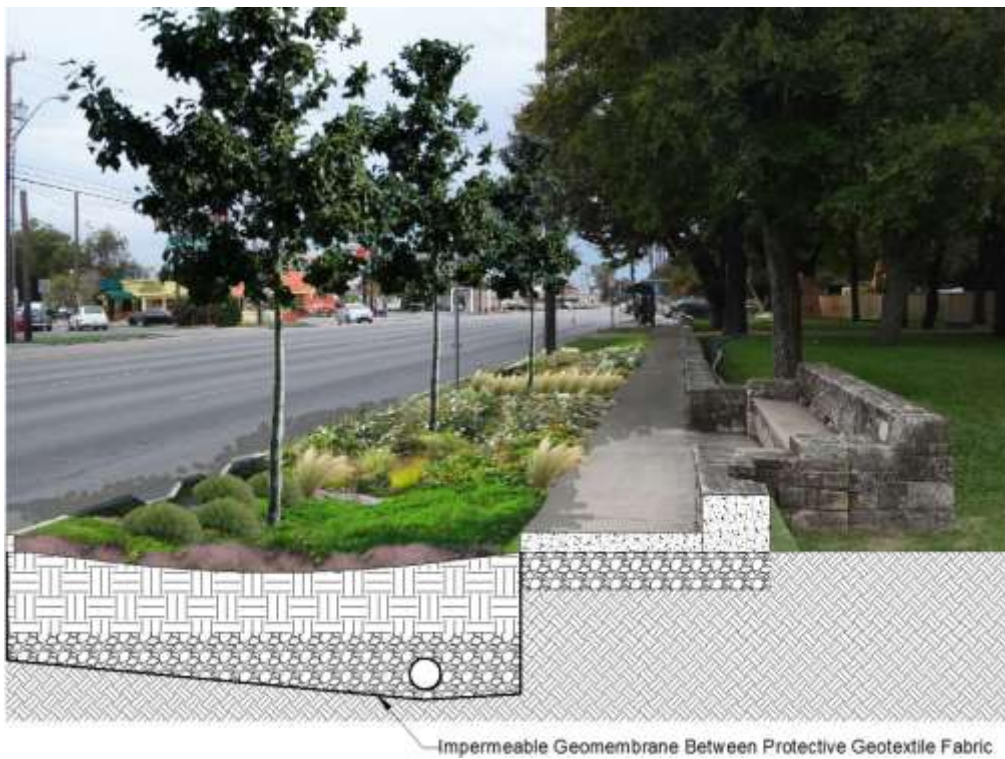

Broadway Street, Witte Museum, San Antonio (rendering)

Figure B-11-21. Bioretention area with geomembrane liner.



Broadway Street, Witte Museum, San Antonio (rendering). Source: Bender Wells Clark Design

Figure B-11-22. Bioretention area completely lined with concrete barrier (planter box).

11.8 Utilities

When implementing BMPs, avoid utilities where possible. In many cases, the BMP can be shifted in the landscape to prevent implementation over utilities. In cases where utilities cannot be avoided, take care to prevent effects from infiltration or saturation by using hydraulic restricting layers to direct infiltration away from the utility. The utility should pass through the hydraulic restriction layer, and the liner should be appropriately sealed to prevent any lateral seepage from the BMP. Liners can be easily sealed by using a patch that adheres to the utility line and sealed directly to the liner. Local plumbing codes should be reviewed for restrictions pertaining to water and sewer utilities.

The location of future utilities should also be considered in the site layout and location of BMPs. Long, linear BMPs, such as a bioretention area or bioswale in the right-of-way, should have periodic breaks to allow for future utility trenches. At least one access point should be placed along any BMP for each parcel where there is a separation or break in the liner for a utility trench. BMPs in such a scenario should be designed as separate systems with separate hydraulic restriction layers, but they could be connected at the subsurface through the underdrain or at the surface by a trench with a grate similar to a covered curb cut. For more details, see [Connectivity](#).

11.9 Connectivity

When BMPs are implemented in the right-of-way and parking lots, it is important to maintain pedestrian access routes to prevent disturbance to the BMP, prevent harm to the public, and provide connections for future utilities. It is also important that sections of the BMP remain hydraulically connected to fully use as much of the BMP as possible. BMPs should be connected by open channels covered with an appropriate grate to allow visual inspection of the channel and ease of maintenance. Culverts can be used for larger

Appendix B. BMP Design Guidance

facilities, but they should be inspected regularly for blockages. Figure B-11-23 shows pedestrian access over BMPs while maintaining appropriate hydraulic connectivity.



(Top left) Los Angeles, California. Source: Tetra Tech, Inc. (Top right) Bender Wells Clark Design, San Antonio, Texas. (Bottom) Raleigh, North Carolina. Source: Tetra Tech, Inc.

Figure B-11-23. Access over linear BMPs.

11.10 ADA Requirements

BMPs typically require surfaces with little to no slope, therefore, Americans with Disabilities Act (ADA) requirements are rarely an issue. However, in areas with high levels of pedestrian traffic, some effort should be made to delineate the BMP. Several options—including low-level and decorative fencing, such as the one shown in Figure B-11-24, or a low-profile curb, as shown in Figure B-11-25, can often be used to delineate the space around the BMP and alert pedestrians of the change in grade.



Portland, Oregon. Source: Portland BES

Figure B-11-24. Low-level fencing.



Greensboro, North Carolina. Source: Tetra Tech

Figure B-11-25. Low-profile curbing.

11.11 References

Barrett, M.E. 2005. *Complying with the Edwards Aquifer Rules. Technical Guidance on Best Management Practices*. RG-348. Prepared for Texas Commission on Environmental Quality, Field Operations Division, Austin, TX.

Fassman, E.A. and S. Blackbourn. 2010. Urban runoff mitigation by a permeable pavement system over impermeable soils. *Journal of Hydrologic Engineering* 15(6):475-485.

TxDOT (Texas Department of Transportation). 2011. Chapter 13, Section 2. Soil Erosion Control Considerations. *Hydraulic Design Manual*. Austin, TX.

UDFCD (Urban Drainage and Flood Control District). 2010. T-12 Outlet Structures. *Urban Storm Drainage Criteria Manual, Volume 3 – Best Management Practices*. Denver, CO.
http://www.udfcd.org/downloads/down_critmanual_volIII.htm.

Appendix C. BMP Design Templates

NOTE: IF NO IMPERMEABLE LINER IS REQUIRED, ENSURE THAT SUBGRADE COMPACTION IS MINIMIZED DURING CONSTRUCTION. SCARIFY OR RIP SUBGRADE TO A DEPTH OF 9-12".

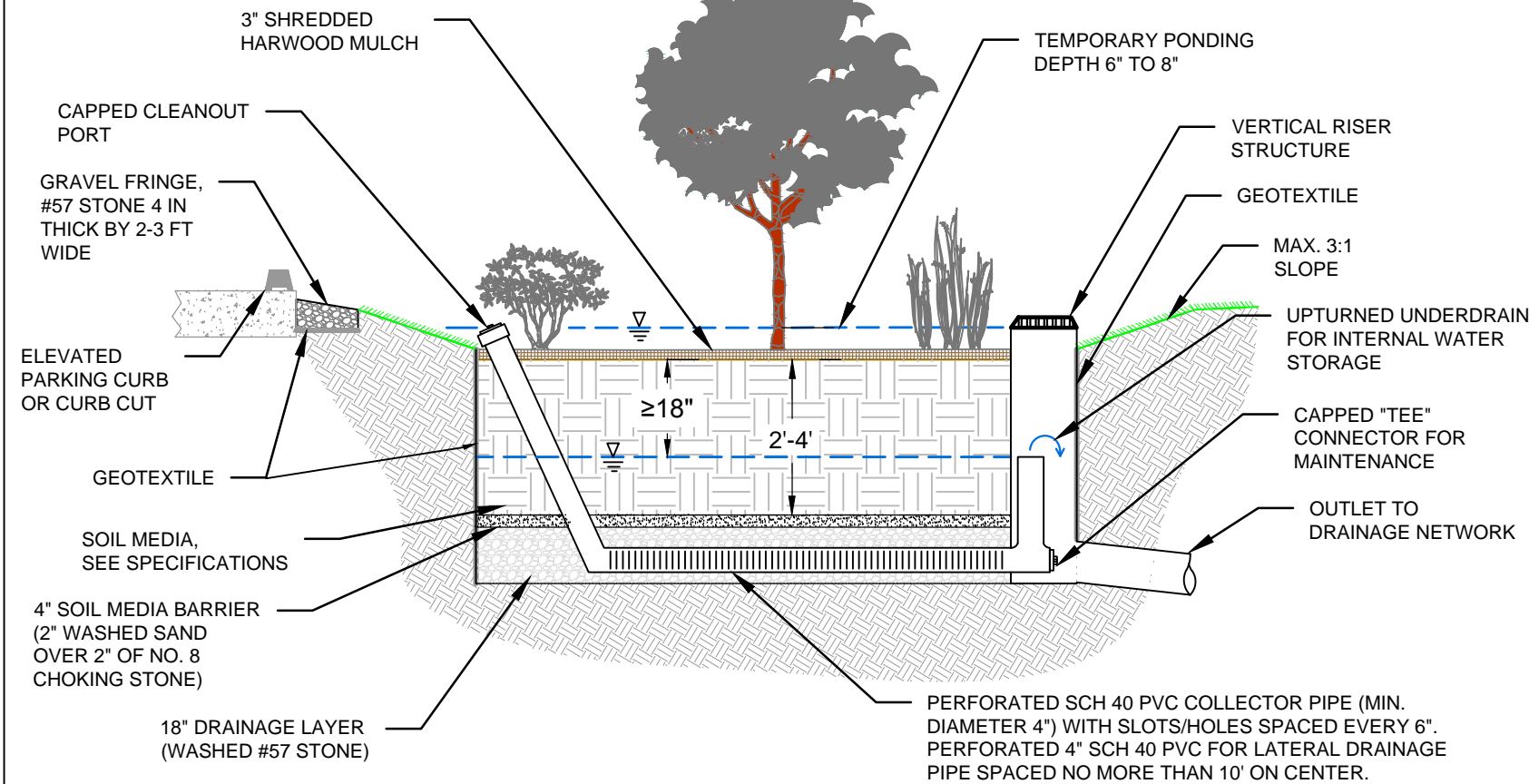

PROFILE W/ INTERNAL WATER STORAGE PROFILE (TYP.)

NTS

SOIL MEDIA SPECIFICATIONS

TEXTURE AND COMPOSITION (BY VOLUME):

SOIL MEDIA SHOULD CONSIST OF A LOAMY SAND CONFORMING TO THE FOLLOWING SPECIFICATIONS:

- 85-88% WASHED COARSE SAND (CONCRETE SAND PASSING A 1/2" SIEVE OR THOROUGHLY WASHED MORTAR SAND PASSING A 3/8" SIEVE)
- 8-12% FINES PASSING A #270 SIEVE
- 2-5% ORGANIC MATTER

ORGANIC MATTER MATERIAL:

AGED BARK FINES, HARDWOOD CHIPS, OR SIMILAR PLANT-DERIVED ORGANIC MATERIAL. ORGANIC MATTER SHOULD INCLUDE NO ANIMAL MANURE OR BYPRODUCTS.

INFILTRATION RATES:

0.5 TO 6 IN/HR (1-2 IN/HR RECOMMENDED FOR COMPREHENSIVE POLLUTANT TREATMENT AND HYDROLOGIC BENEFIT)

PH:

6 TO 8

CATION EXCHANGE CAPACITY (CEC):

GREATER THAN 5 MILLIEQUIVALENTS (MEQ)/100 G SOIL

PHOSPHORUS:

TOTAL PHOSPHORUS SHOULD NOT EXCEED 15 PPM

VEGETATION SPECIFICATIONS

FOR BIOSWALES TO FUNCTION PROPERLY AS STORMWATER TREATMENT AND BLEND INTO THE LANDSCAPING, VEGETATION SELECTION IS CRUCIAL. APPROPRIATE VEGETATION WILL HAVE THE FOLLOWING CHARACTERISTICS:

1. PLANT MATERIALS MUST BE TOLERANT OF SUMMER DROUGHT, PONDING FLUCTUATIONS, AND SATURATED SOIL CONDITIONS FOR 10 TO 48 HOURS.
2. IT IS RECOMMENDED THAT A MINIMUM OF THREE TREE, THREE SHRUBS, AND THREE HERBACEOUS GROUNDCOVER SPECIES BE INCORPORATED TO PROTECT AGAINST FACILITY FAILURE FROM DISEASE AND INSECT INFESTATIONS OF A SINGLE SPECIES. PLANT ROOTING DEPTHS MUST NOT DAMAGE THE UNDERDRAIN, IF PRESENT. SLOTTED OR PERFORATED UNDERDRAIN PIPE MUST BE MORE THAN 5 FEET FROM TREE LOCATIONS (IF SPACE ALLOWS).
3. NATIVE PLANT SPECIES THAT ARE NOT INVASIVE AND DO NOT REQUIRE CHEMICAL INPUTS ARE RECOMMENDED TO BE USED TO THE MAXIMUM EXTENT PRACTICABLE.
4. SHADE TREES SHOULD BE FREE OF BRANCHES FOR THE BOTTOM 1/3 OF THEIR TOTAL HEIGHT AND LINES OF SITE SHOULD BE MAINTAINED WITH PLANTING ALONG THE TRANSPORTATION CORRIDOR.

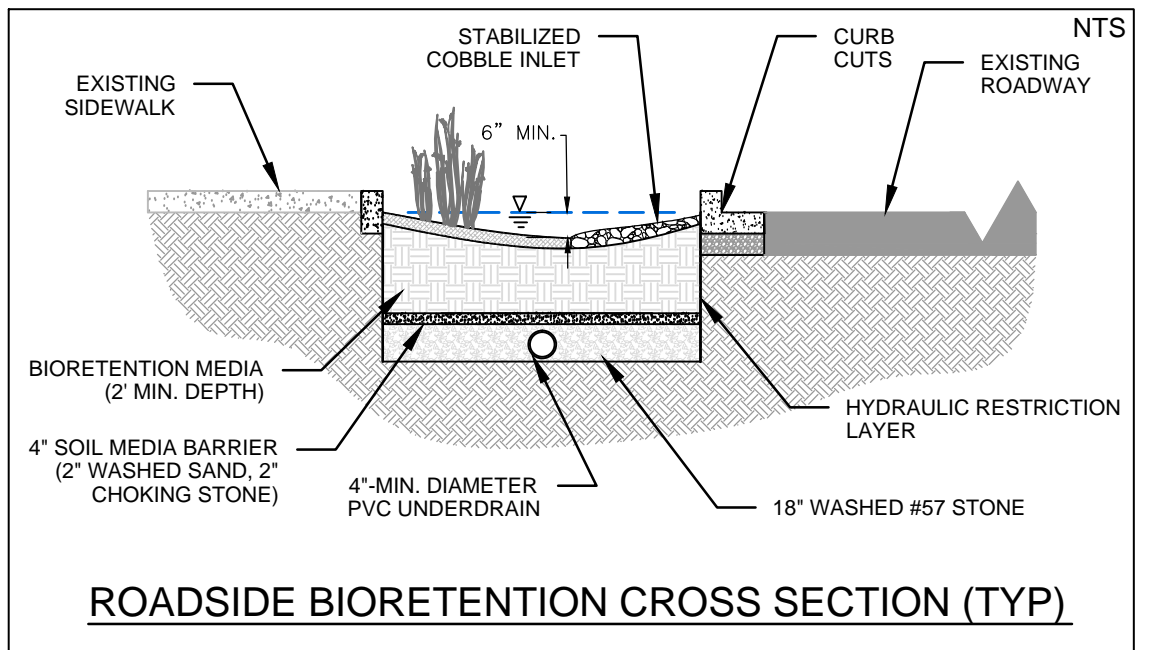

ROADSIDE BIORETENTION CROSS SECTION (TYP)

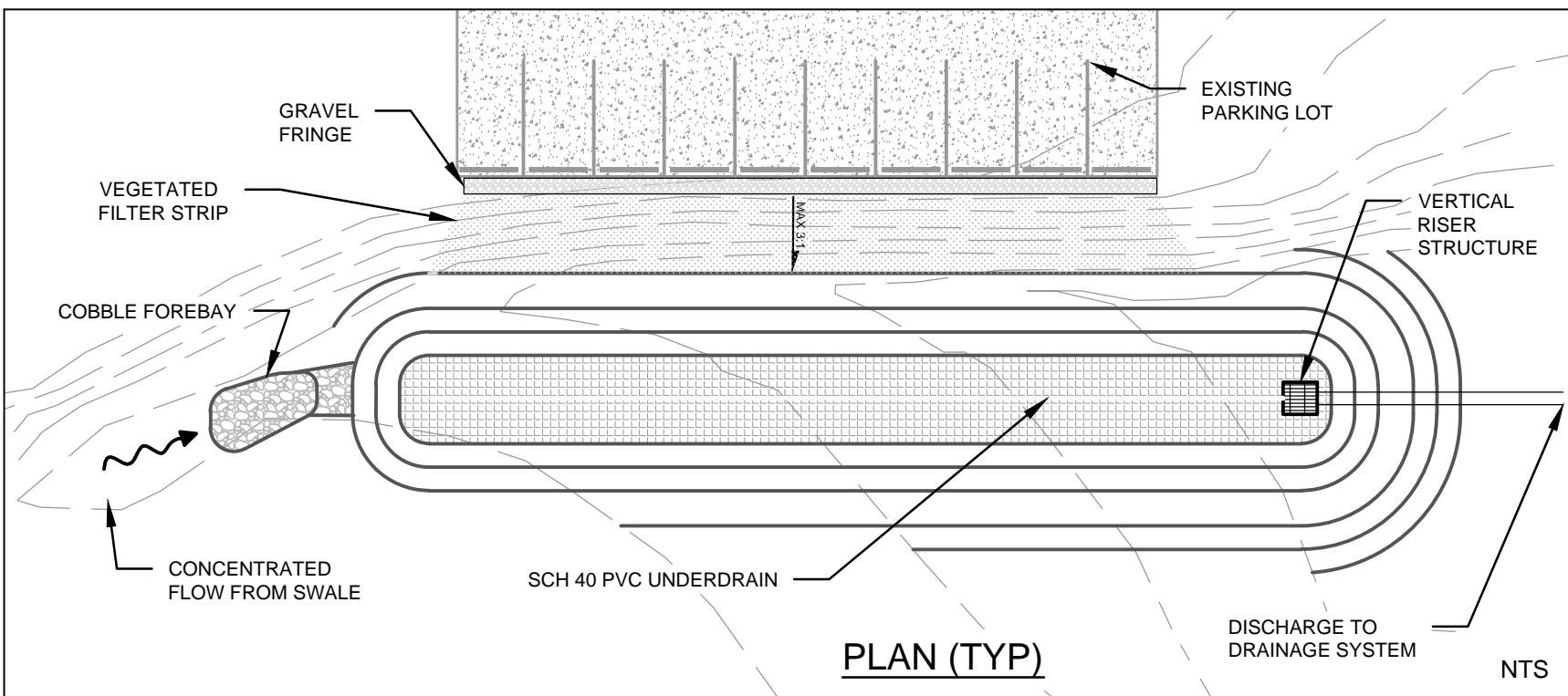

PLAN (TYP)

NTS

CONSULTANT NAME
STREET NUMBER AND ADDRESS

SAN ANTONIO RIVER AUTHORITY
CAPITAL IMPROVEMENTS MANAGEMENT SERVICES DEPARTMENT

BIORETENTION

% SUBMITTAL	PROJECT NO.:	DATE:
DRWN. BY:	DSGN. BY:	CHKD. BY:
		SHEET NO.: OF

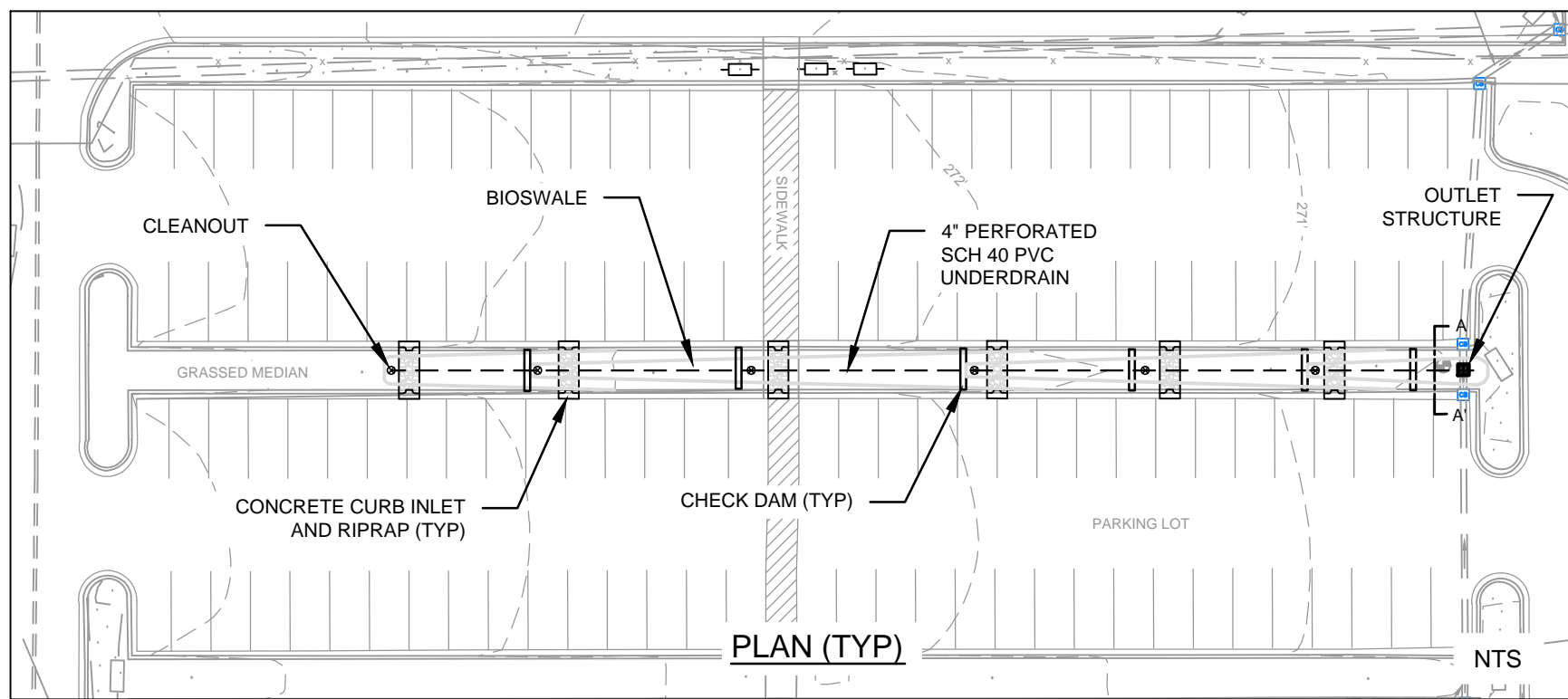
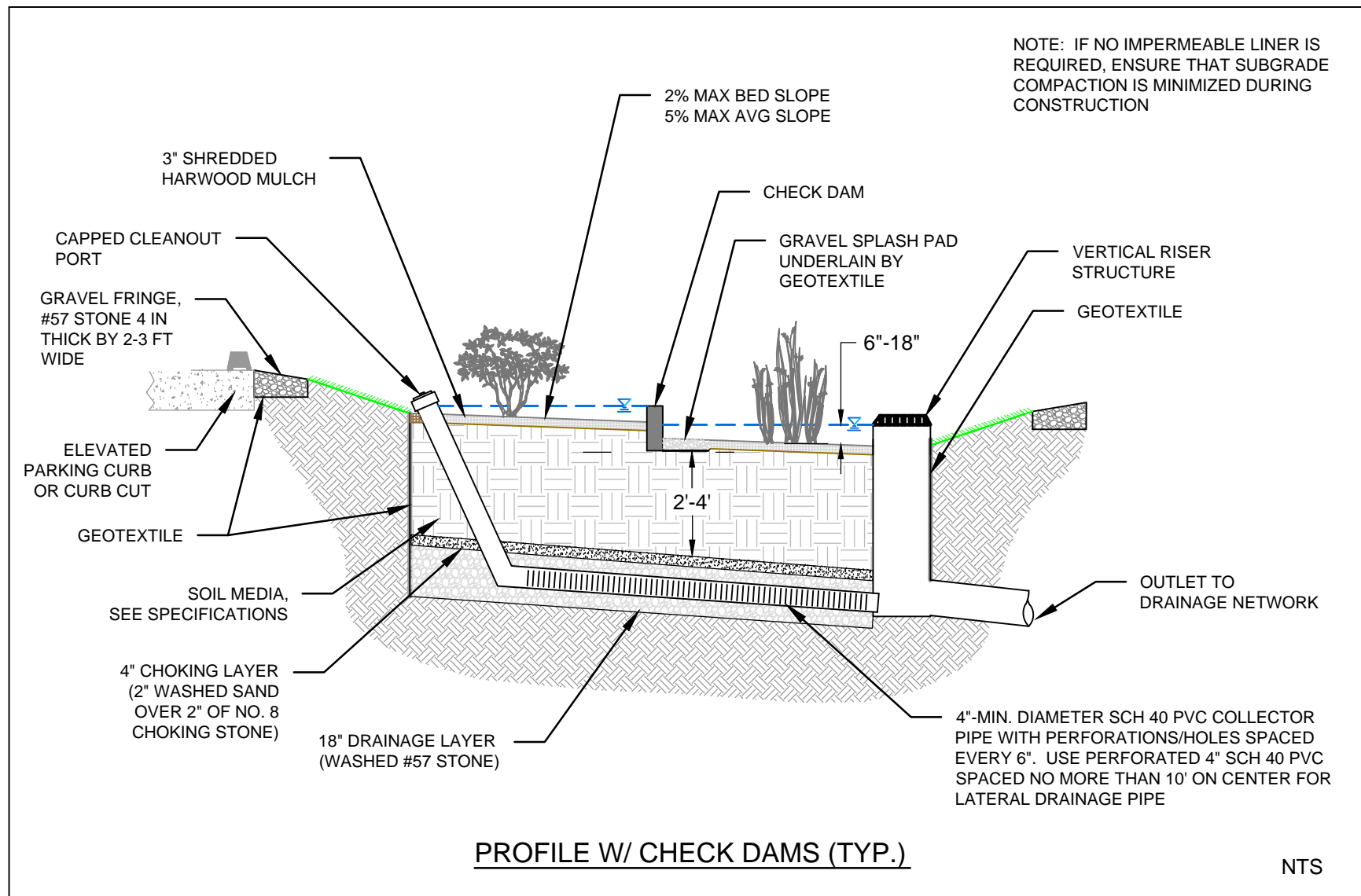

SOIL MEDIA SPECIFICATIONS

TEXTURE AND COMPOSITION (BY VOLUME):
 SOIL MEDIA SHOULD CONSIST OF A LOAMY SAND CONFORMING TO THE FOLLOWING SPECIFICATIONS:
 • 85-88% WASHED COARSE SAND (CONCRETE SAND PASSING A 1/4" SIEVE OR THOROUGHLY WASHED MORTAR SAND PASSING A 3/8" SIEVE)
 • 8-12% FINES PASSING A #270 SIEVE
 • 2-5% ORGANIC MATTER

ORGANIC MATTER MATERIAL:
 AGED BARK FINES, HARDWOOD CHIPS, OR SIMILAR PLANT-DERIVED ORGANIC MATERIAL. ORGANIC MATTER SHOULD INCLUDE NO ANIMAL MANURE OR BYPRODUCTS.

INFILTRATION RATES:
 0.5 TO 6 IN/HR (1-2 IN/HR RECOMMENDED FOR COMPREHENSIVE POLLUTANT TREATMENT AND HYDROLOGIC BENEFIT)

PH:
 6 TO 8

CATION EXCHANGE CAPACITY (CEC):
 GREATER THAN 5 MILLIEQUIVALENTS (MEQ)/100 G SOIL

PHOSPHORUS:
 TOTAL PHOSPHORUS SHOULD NOT EXCEED 15 PPM

VEGETATION SPECIFICATIONS

FOR BIOSWALES TO FUNCTION PROPERLY AS STORMWATER TREATMENT AND BLEND INTO THE LANDSCAPING, VEGETATION SELECTION IS CRUCIAL. APPROPRIATE VEGETATION WILL HAVE THE FOLLOWING CHARACTERISTICS:

1. PLANT MATERIALS MUST BE TOLERANT OF SUMMER DROUGHT, PONDING FLUCTUATIONS, AND SATURATED SOIL CONDITIONS FOR 10 TO 48 HOURS.
2. IT IS RECOMMENDED THAT A MINIMUM OF THREE TREE, THREE SHRUBS, AND THREE HERBACEOUS GROUNDCOVER SPECIES BE INCORPORATED TO PROTECT AGAINST FACILITY FAILURE FROM DISEASE AND INSECT INFESTATIONS OF A SINGLE SPECIES. PLANT ROOTING DEPTHS MUST NOT DAMAGE THE UNDERDRAIN, IF PRESENT. SLOTTED OR PERFORATED UNDERDRAIN PIPE MUST BE MORE THAN 5 FEET FROM TREE LOCATIONS (IF SPACE ALLOWS).
3. NATIVE PLANT SPECIES THAT ARE NOT INVASIVE AND DO NOT REQUIRE CHEMICAL INPUTS ARE RECOMMENDED TO BE USED TO THE MAXIMUM EXTENT PRACTICABLE.
4. SHADE TREES SHOULD BE FREE OF BRANCHES FOR THE BOTTOM 1/3 OF THEIR TOTAL HEIGHT AND LINES OF SITE SHOULD BE MAINTAINED WHEN PLANTING ALONG TRANSPORTATION CORRIDORS.

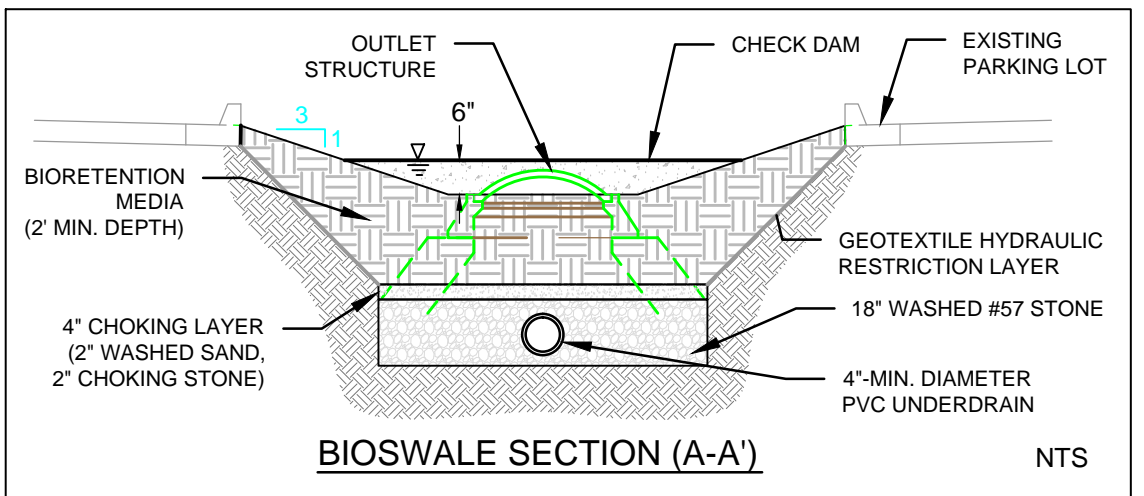

CONSULTANT NAME		
STREET NUMBER AND ADDRESS		
SAN ANTONIO RIVER AUTHORITY		
CAPITAL IMPROVEMENTS MANAGEMENT SERVICES DEPARTMENT		
BIOSWALE		
% SUBMITTAL	PROJECT NO.:	DATE:
DRWN. BY:	DSGN. BY:	CHKD. BY:
		SHEET NO.: OF

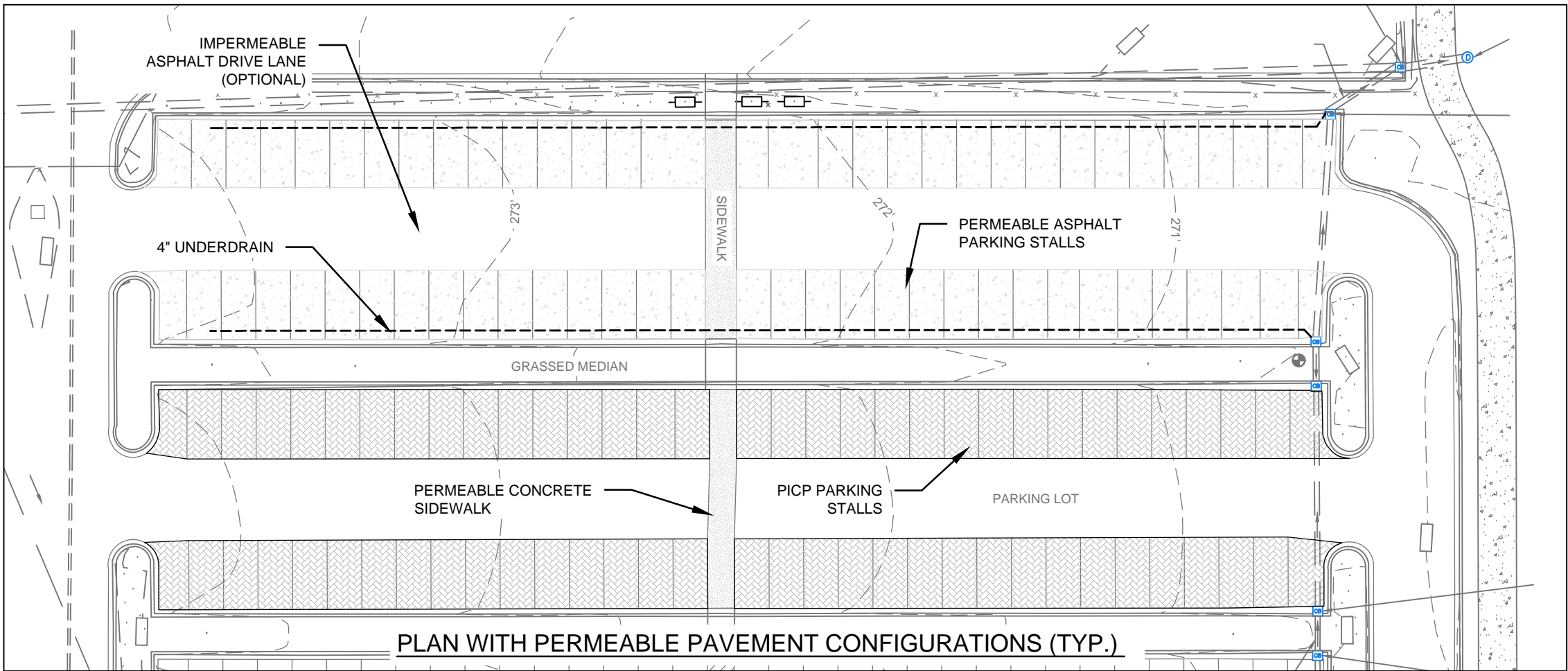
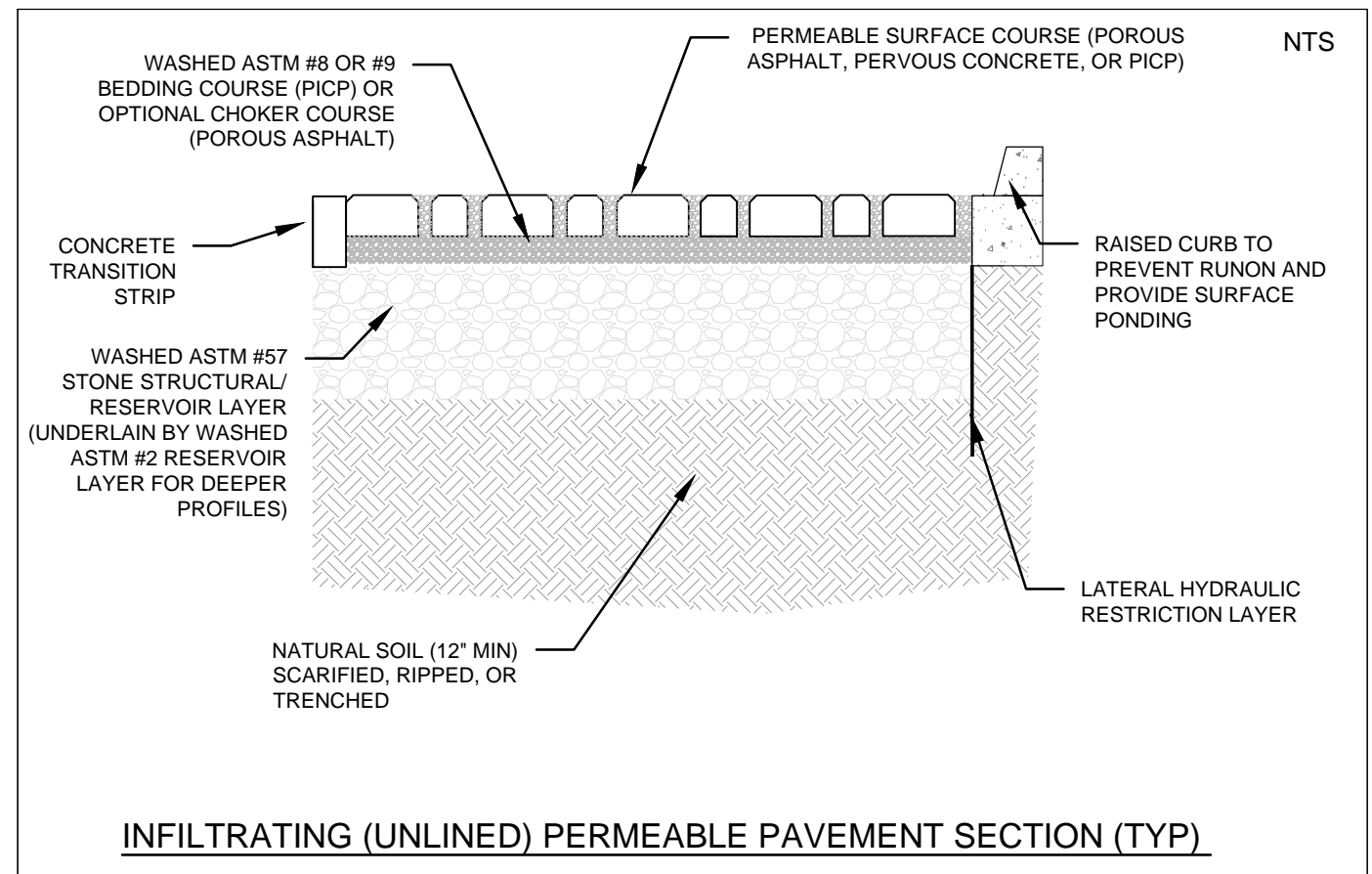
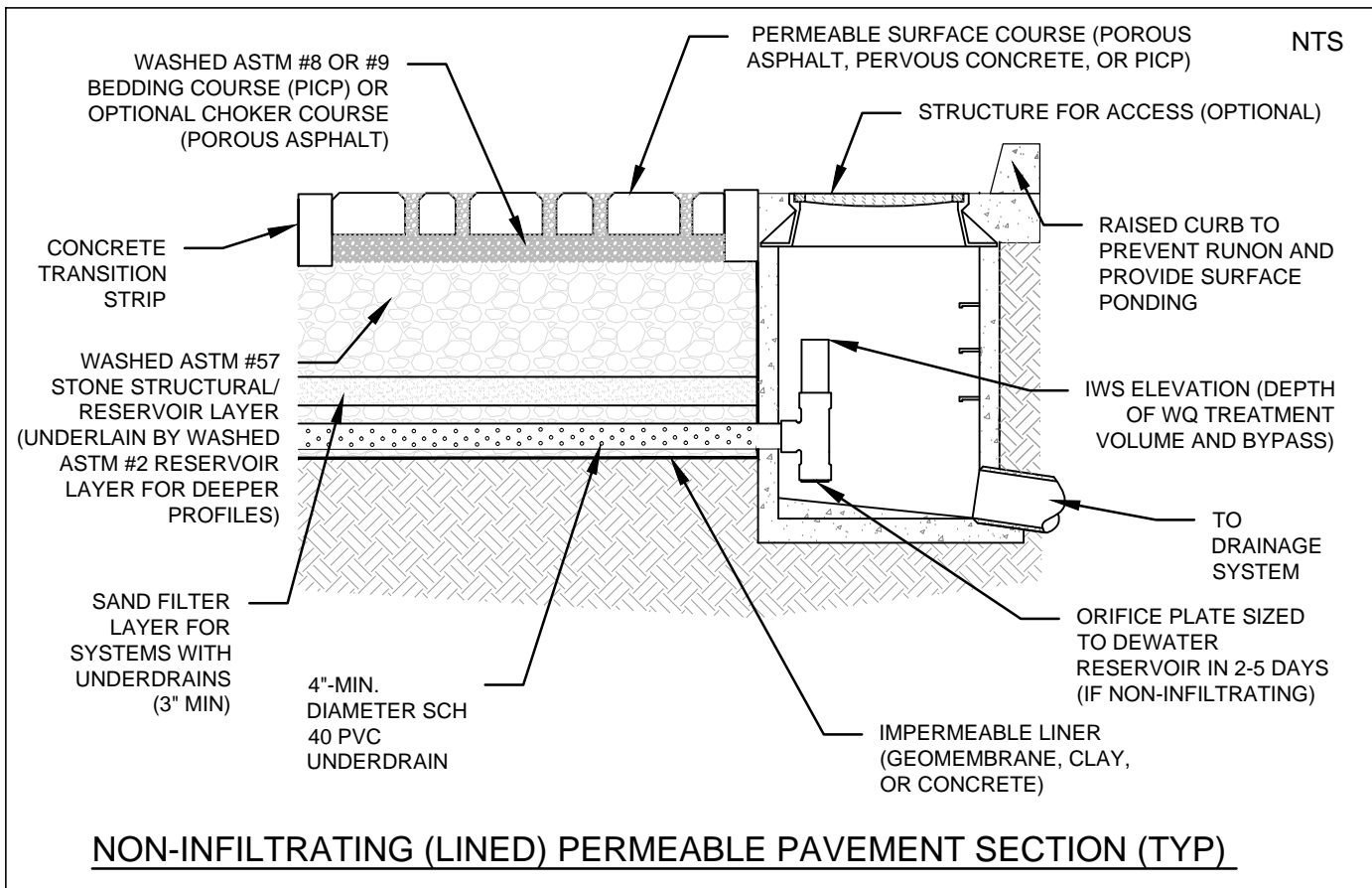

- NOTES:**
1. ALL AGGREGATE SHOULD BE WASHED, ANGULAR, CRUSHED STONE.
 2. OBSERVATION WELLS SHOULD BE CONSTRUCTED OF PERFORATED 4" SCH 40 AND CAPPED TO PREVENT INJURY OR VEHICULAR DAMAGE.
 3. SUBGRADE SLOPES SHOULD NOT EXCEED 0.5% WITHOUT ANALYSIS BY A STRUCTURAL ENGINEER. BAFFLES SHOULD BE INSTALLED IN SLOPED SYSTEMS TO RETAIN THE DESIGN VOLUME.
 4. SYSTEMS WITH PICP SHOULD PROVIDE INTERNAL BYPASS FOR HIGH FLOWS TO PREVENT UPLIFT AND TRANSPORT OF BEDDING COURSE. PERVIOUS CONCRETE AND POROUS ASPHALT MAY BYPASS ON THE SURFACE.

GEOTEXTILE SPECIFICATIONS:
(FOR PROTECTION OF GEOMEMBRANES)

Geotextile property	Value	Test method
Grab tensile strength (lbs)	≥ 120	ASTM D4632
Mullen burst strength (lbs/sq. in.)	≥ 225	ASTM D3786
Permeability (gpm/sq. ft.)	≥ 125	ASTM D4491
Apparent opening size (sieve size)	#70-#80 (min)	ASTM D4751

CONSULTANT NAME STREET NUMBER AND ADDRESS		
SAN ANTONIO RIVER AUTHORITY CAPITAL IMPROVEMENTS MANAGEMENT SERVICES DEPARTMENT		
PERMEABLE PAVEMENT		
% SUBMITTAL	PROJECT NO.:	DATE:
DRWN. BY:	DSGN. BY:	CHKD. BY:
		SHEET NO.: OF

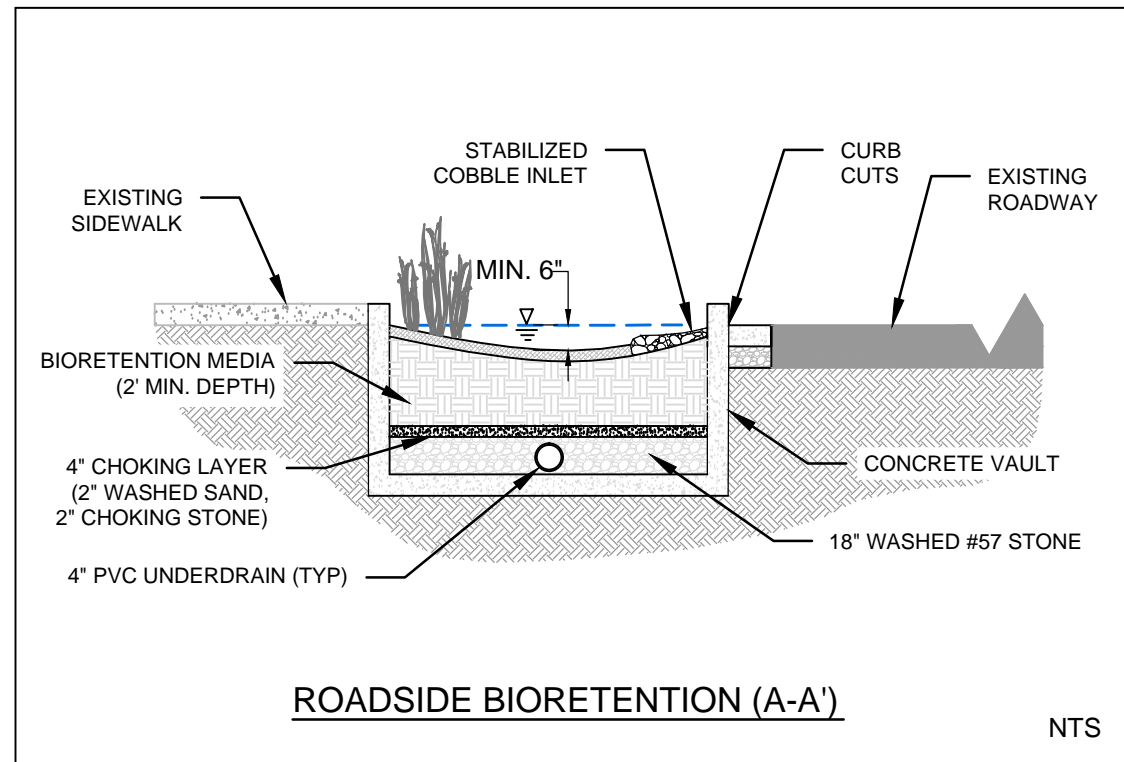
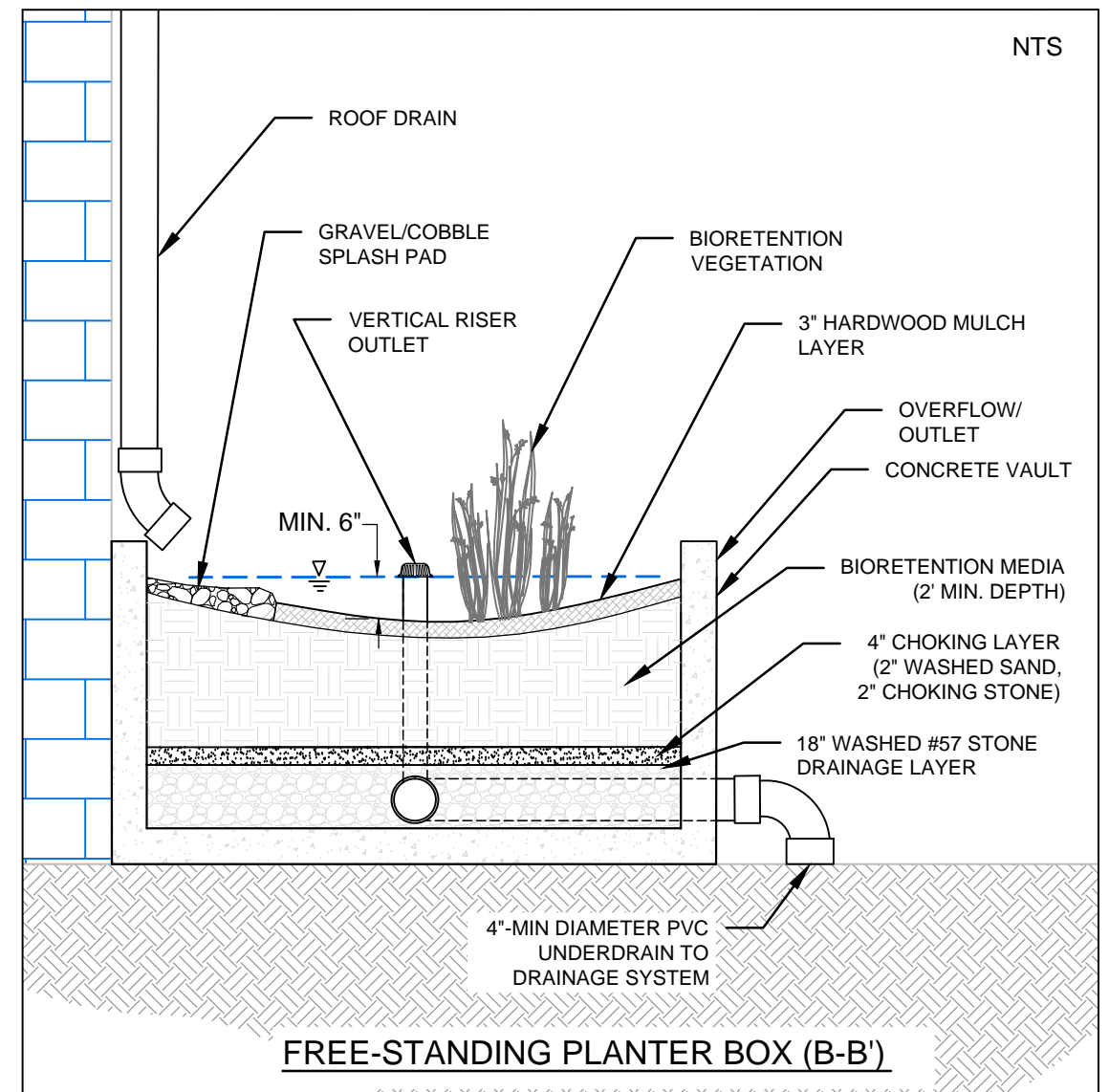
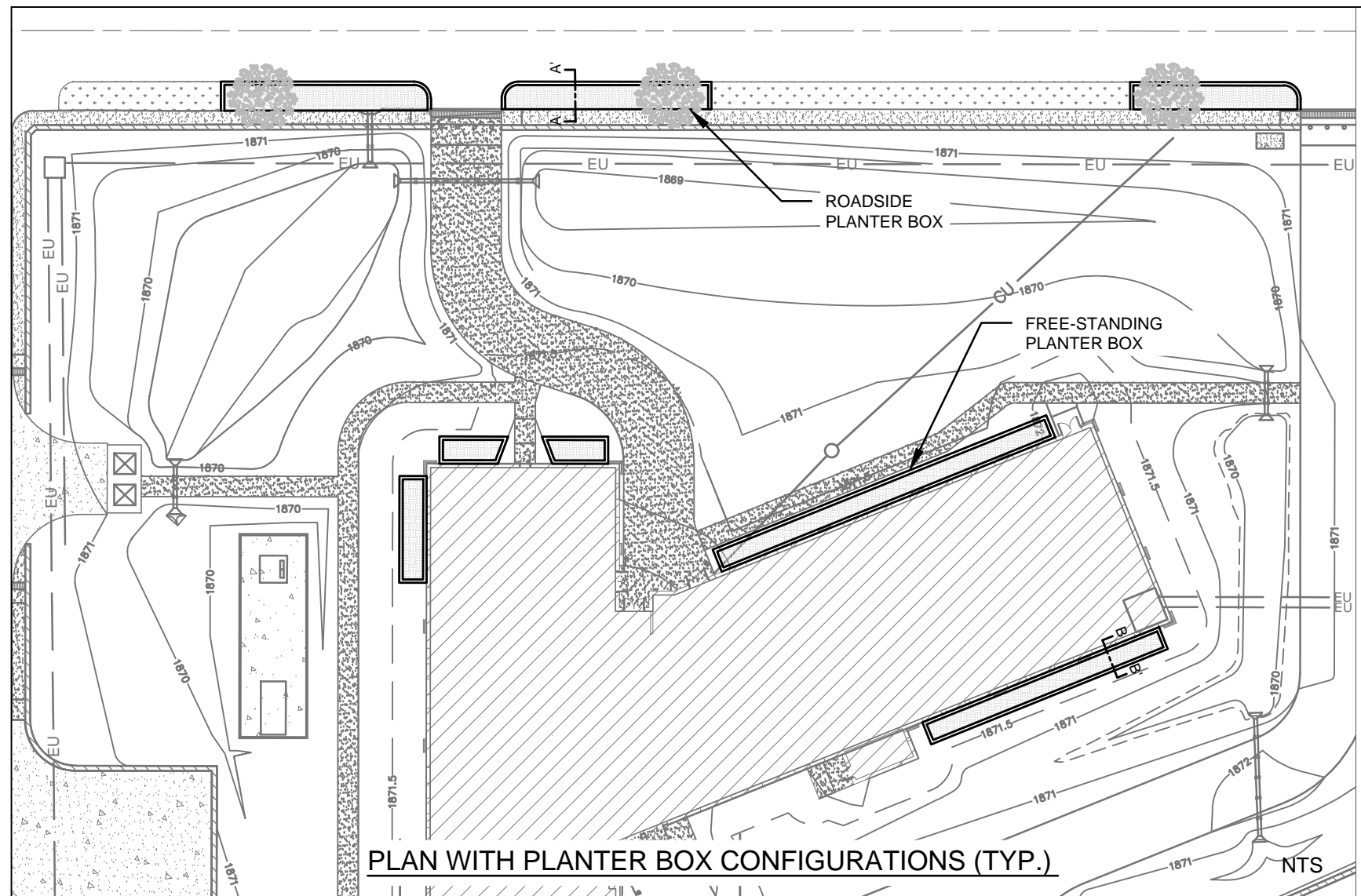

SOIL MEDIA SPECIFICATIONS

TEXTURE AND COMPOSITION (BY VOLUME):

SOIL MEDIA SHOULD CONSIST OF A LOAMY SAND CONFORMING TO THE FOLLOWING SPECIFICATIONS:

- 85-88% WASHED COARSE SAND (CONCRETE SAND PASSING A 1/4" SIEVE OR THOROUGHLY WASHED MORTAR SAND PASSING A 1/8" SIEVE)
- 8-12% FINES PASSING A #270 SIEVE
- 2-5% ORGANIC MATTER

ORGANIC MATTER MATERIAL:

AGED BARK FINES, HARDWOOD CHIPS, OR SIMILAR PLANT-DERIVED ORGANIC MATERIAL. ORGANIC MATTER SHOULD INCLUDE NO ANIMAL MANURE OR BYPRODUCTS.

INFILTRATION RATES:

0.5 TO 6 IN/HR (1-2 IN/HR RECOMMENDED FOR COMPREHENSIVE POLLUTANT TREATMENT AND HYDROLOGIC BENEFIT)

PH:

6 TO 8

CATION EXCHANGE CAPACITY (CEC):

GREATER THAN 5 MILLIEQUIVALENTS (MEQ)/100 G SOIL

PHOSPHORUS:

TOTAL PHOSPHORUS SHOULD NOT EXCEED 15 PPM

VEGETATION SPECIFICATIONS

FOR BIOSWALES TO FUNCTION PROPERLY AS STORMWATER TREATMENT AND BLEND INTO THE LANDSCAPING, VEGETATION SELECTION IS CRUCIAL. APPROPRIATE VEGETATION WILL HAVE THE FOLLOWING CHARACTERISTICS:

1. PLANT MATERIALS MUST BE TOLERANT OF SUMMER DROUGHT, PONDING FLUCTUATIONS, AND SATURATED SOIL CONDITIONS FOR 10 TO 48 HOURS.
2. IT IS RECOMMENDED THAT A MINIMUM OF THREE TREE, THREE SHRUBS, AND THREE HERBACEOUS GROUNDCOVER SPECIES BE INCORPORATED TO PROTECT AGAINST FACILITY FAILURE FROM DISEASE AND INSECT INFESTATIONS OF A SINGLE SPECIES. PLANT ROOTING DEPTHS MUST NOT DAMAGE THE UNDERDRAIN, IF PRESENT. SLOTTED OR PERFORATED UNDERDRAIN PIPE MUST BE MORE THAN 5 FEET FROM TREE LOCATIONS (IF SPACE ALLOWS).
3. NATIVE PLANT SPECIES THAT ARE NOT INVASIVE AND DO NOT REQUIRE CHEMICAL INPUTS ARE RECOMMENDED TO BE USED TO THE MAXIMUM EXTENT PRACTICABLE.
4. SHADE TREES SHOULD BE FREE OF BRANCHES FOR THE BOTTOM 1/3 OF THEIR TOTAL HEIGHT AND LINES OF SITE SHOULD BE MAINTAINED WITH PLANTING ALONG THE TRANSPORTATION CORRIDOR.

CONSULTANT NAME STREET NUMBER AND ADDRESS		
SAN ANTONIO RIVER AUTHORITY CAPITAL IMPROVEMENTS MANAGEMENT SERVICES DEPARTMENT		
PLANTER BOX		
DATE: _____	PROJECT NO.: _____	% SUBMITTAL _____
SHEET NO.: ____ OF ____	CHKD. BY: _____	DRWN. BY: _____

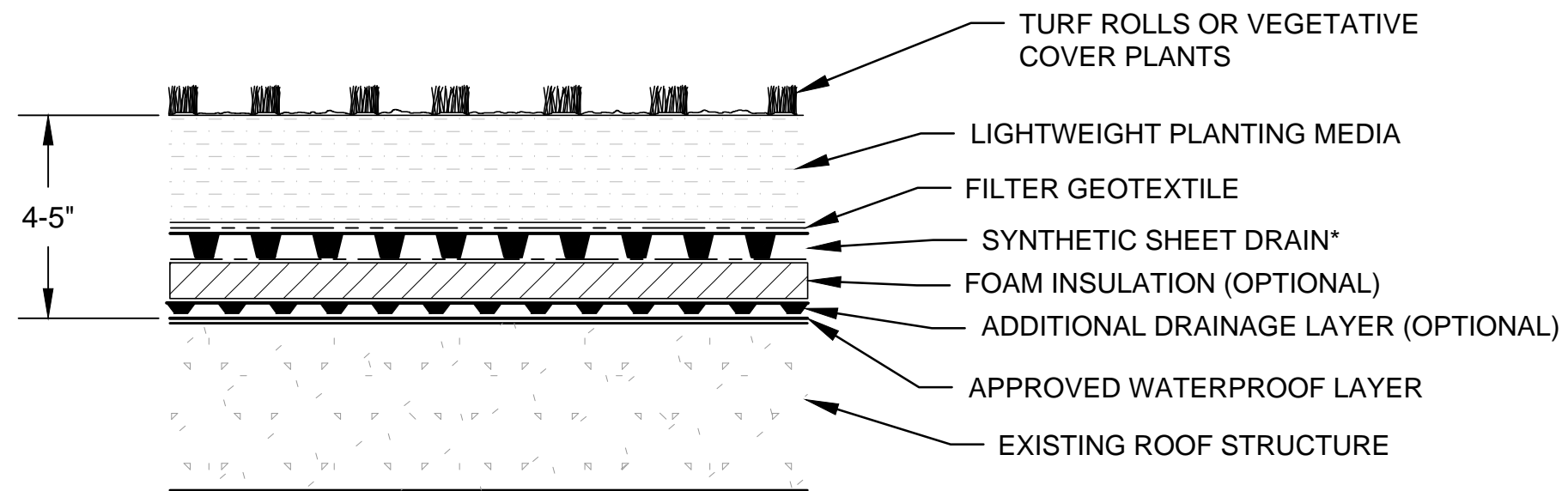

*TO GUTTERS OR ROOF DRAINS

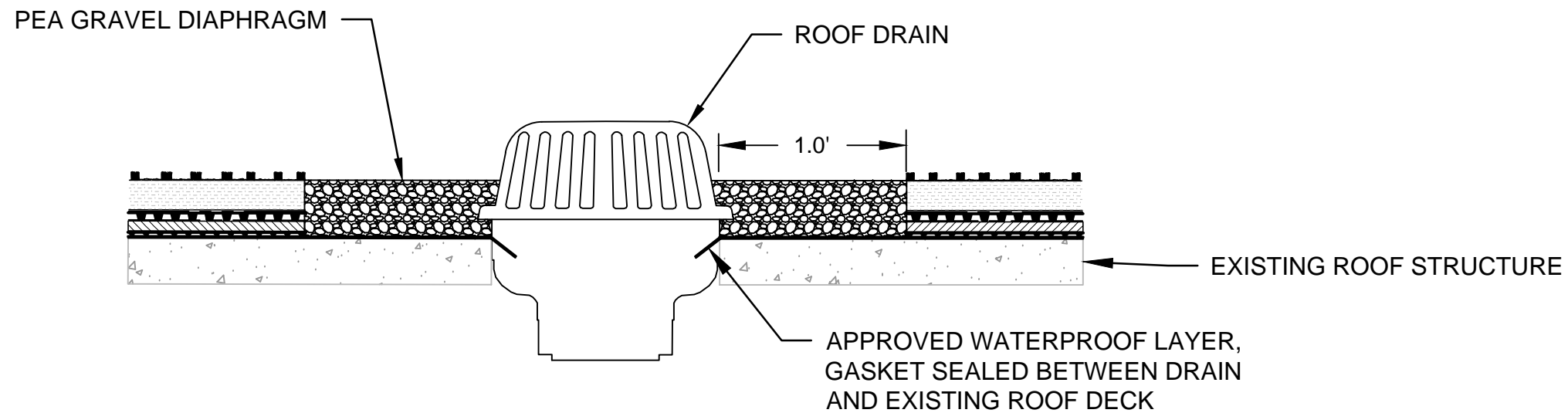

CONSULTANT NAME <small>STREET NUMBER AND ADDRESS</small>		
CITY OF SAN ANTONIO CAPITAL IMPROVEMENTS MANAGEMENT SERVICES DEPARTMENT		
GREEN ROOF		
____% SUBMITTAL	PROJECT NO.: _____	DATE: _____
DRWN. BY: _____	DSGN. BY: _____	CHKD. BY: _____
		SHEET NO.: ____ OF ____

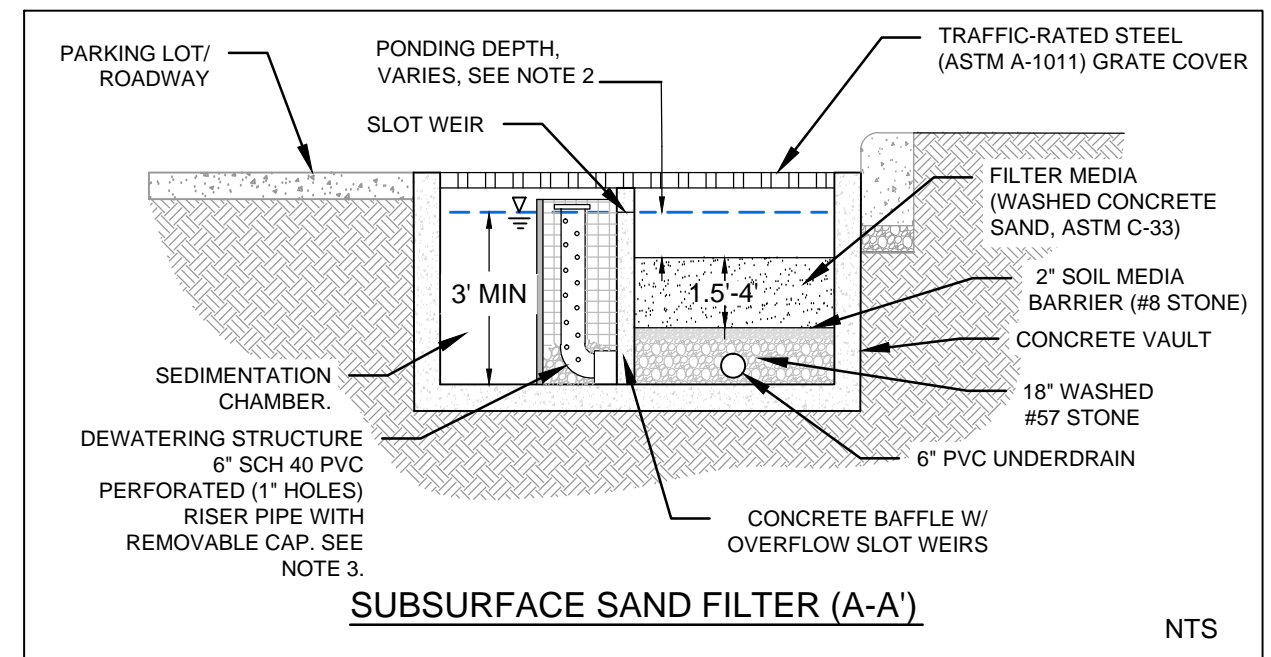
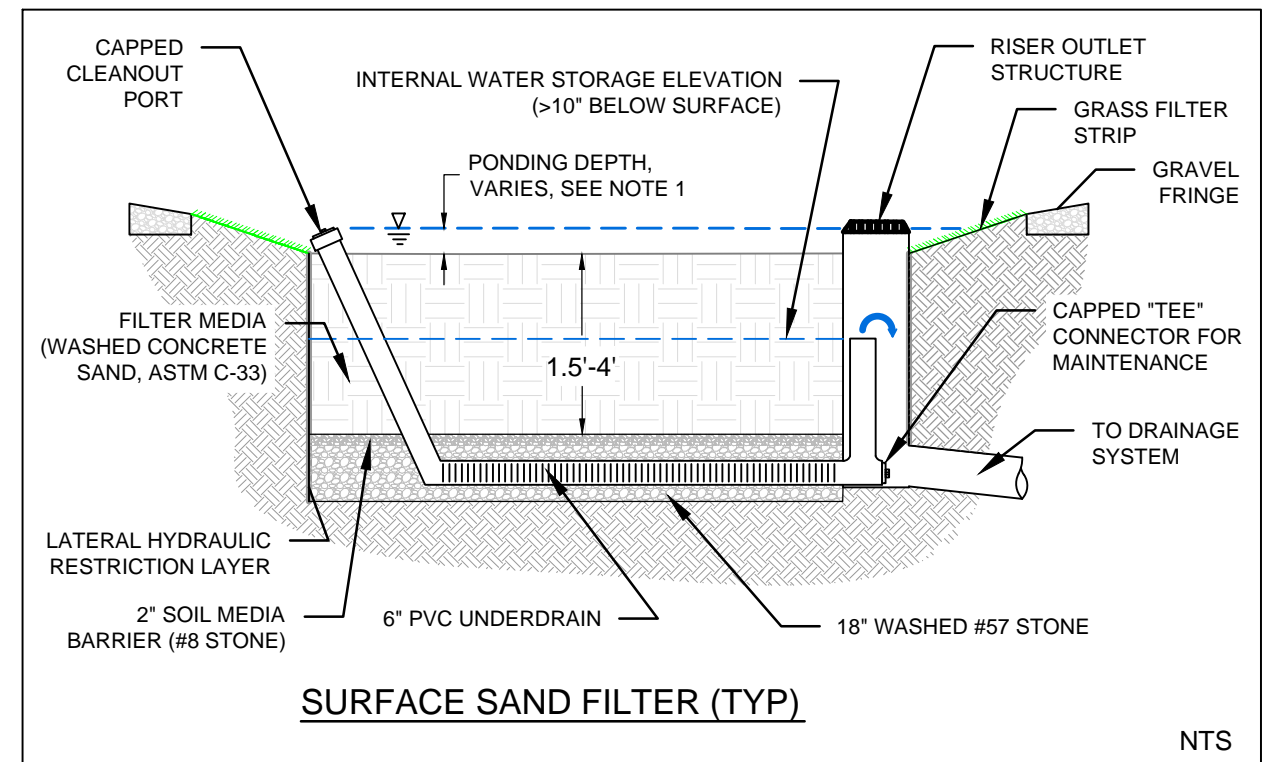
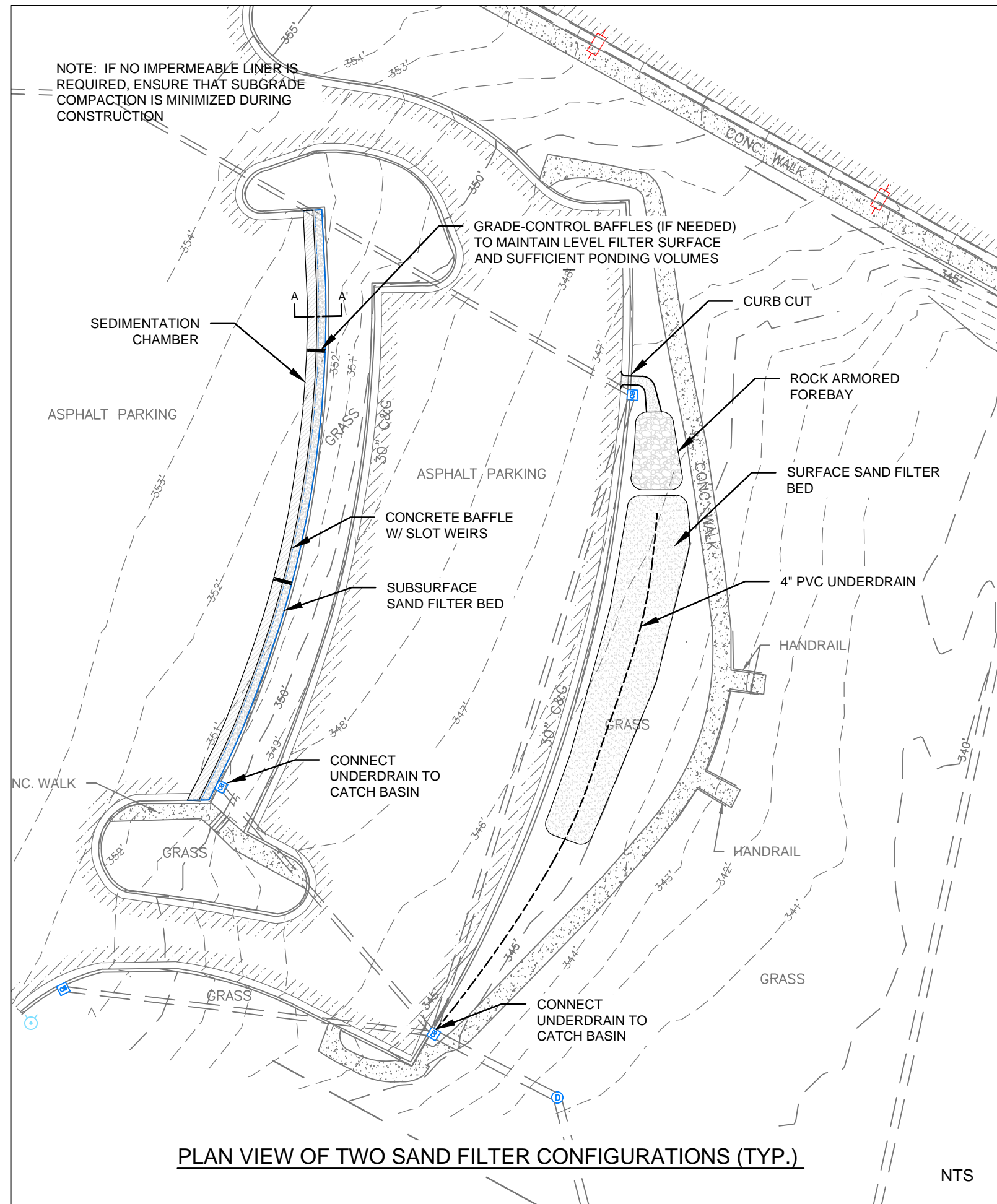

NOTE 1:

PONDING DEPTHS WILL VARY ACCORDING TO SITE CONDITIONS AND REQUIRED TREATMENT VOLUMES. TCEQ ALLOWS MAXIMUM PONDING DEPTHS OF 8 FEET, ALTHOUGH SHALLOWER DEPTHS (BELOW 3 FT) SHOULD BE USED IN RESIDENTIAL AREAS OR NEAR SCHOOLS OR PARKS.

NOTE 2:

PONDING DEPTHS WILL VARY ACCORDING TO SITE CONDITIONS AND REQUIRED TREATMENT VOLUMES, BUT SHOULD BE LIMITED TO 1'-2' FOR SUBSURFACE SAND FILTERS.

NOTE 3:

RISER PIPE SHOULD BE PROTECTED BY REMOVABLE GALVANIZED WELDED WIRE TRASH RACK (1"X1" OPENINGS) INSTALLED ON AN ANGLE IRON FRAME. A CONE OF ASTM #57 STONE SHOULD BE PLACED AROUND THE BASE OF THE RISER. AN ORIFICE PLATE OR VALVE SHOULD BE USED TO REGULATE DEWATERING RATE.

CONSULTANT NAME		
STREET NUMBER AND ADDRESS		
SAN ANTONIO RIVER AUTHORITY		
SAND FILTER		
% SUBMITTAL	PROJECT NO.:	DATE:
DRWN. BY:	DSGN. BY:	CHKD. BY:
		SHEET NO.: OF

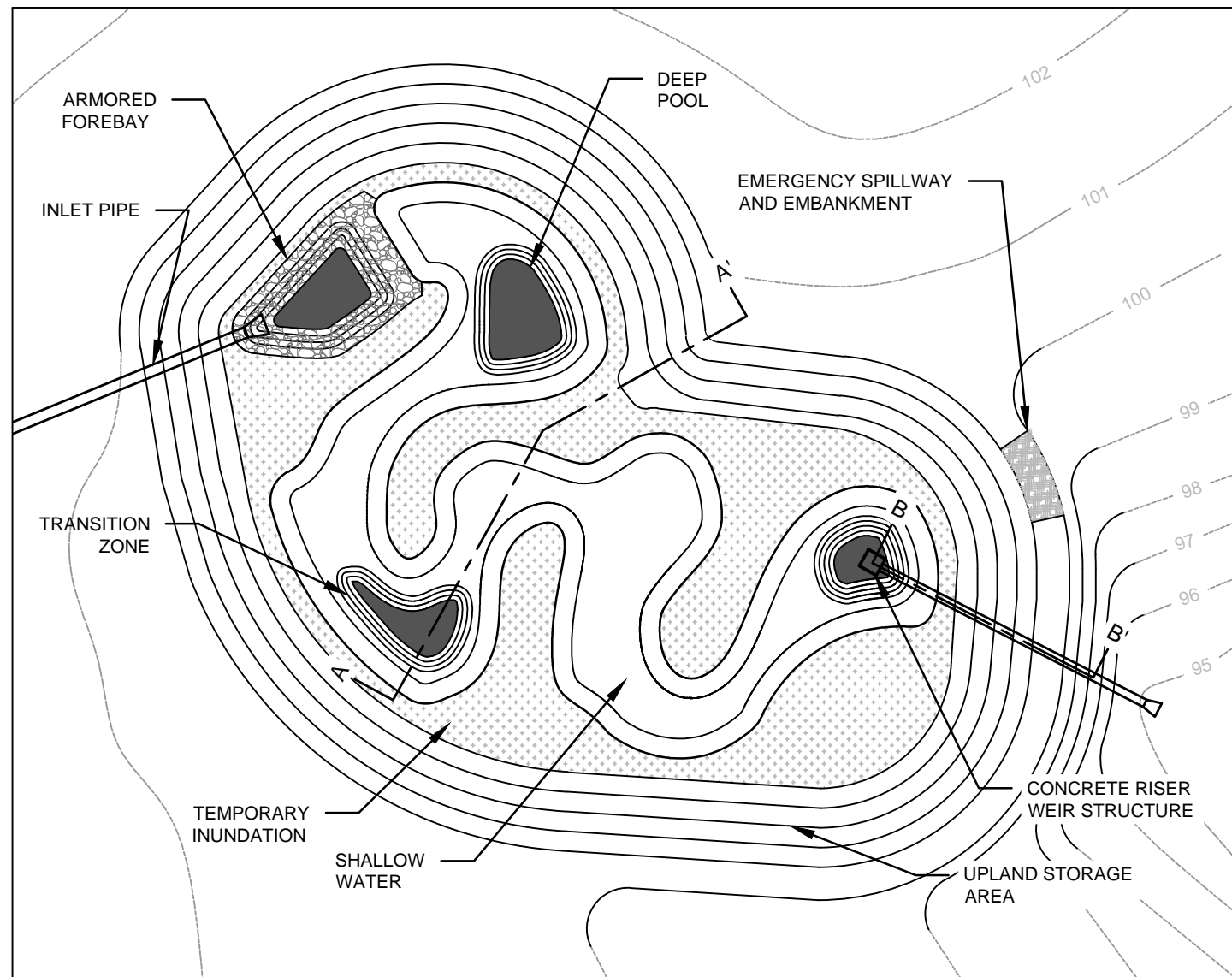

PLAN VIEW (TYP.)

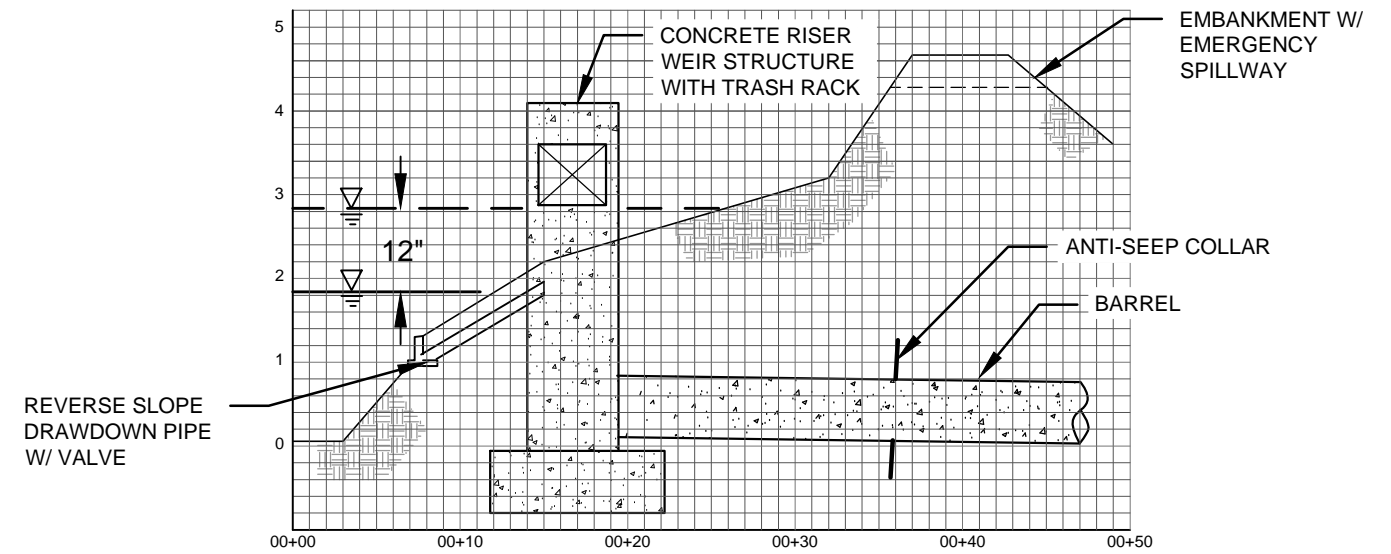

PROFILE B-B'

WETLAND ZONES

- DEEP POOLS: 15-20% OF WETLAND SURFACE AREA (INCLUDING FOREBAY), 18- TO 36-INCHES-DEEP
- TRANSITION: 10-15% OF WETLAND SURFACE AREA, TRANSITION BETWEEN DEEP POOL AND SHALLOW WATER, 12-18 INCHES DEEP, MAXIMUM SLOPES OF 1.5:1.
- SHALLOW WATER: 40% OF WETLAND SURFACE AREA, 3- TO 6-INCHES-DEEP, FLAT OR 6:1 SLOPE (AT LEAST 6-FOOT RADIUS AROUND ALL TRANSITION ZONES/DEEP POOLS TO PROVIDE SAFETY SHELF)
- TEMPORARY PONDING: 30-40% OF WETLAND SURFACE AREA, UP TO 12-INCHES-DEEP, 3:1 SLOPES
- DETENTION STORAGE/UPLAND: ADDITIONAL PONDING DEPTH CAN BE PROVIDED FOR PEAK FLOW MITIGATION, AS NEEDED, BUT DEPTH SHOULD GENERALLY NOT EXCEED 4 FEET ABOVE THE PERMANENT POOL ELEVATION

TOPSOIL

1-4 INCHES OF TOPSOIL SHOULD BE APPLIED TO SUPPORT PLANT GROWTH. DEPTH DEPENDS ON SPECIFIED PLANTINGS AND UNDERLYING SOIL CHARACTERISTICS. TOPSOIL NATURAL, FRIABLE SOIL REPRESENTATIVE OF PRODUCTIVE, WELL-DRAINED SOILS IN THE AREA. IT SHALL BE FREE OF SUBSOIL, STUMPS, ROCKS LARGER THAN 1-INCH DIAMETER, BRUSH WEEDS, TOXIC SUBSTANCES, AND OTHER MATERIAL DETRIMENTAL TO PLANT GROWTH. LOW PHOSPHORUS (TP < 15 PPM) WITH PH 5.5-7.

BMP FUNCTION

- FOREBAY SHOULD CONSTITUTE 10% OF THE TOTAL PERMANENT POOL SURFACE AREA.
- RATE OF WATER LOSS DURING DRY MONTHS SHOULD NOT EXCEED SUPPLY FROM GROUNDWATER, BASEFLOW, OR RUNOFF TO ENSURE WATER IS MAINTAINED IN PERMANENT POOLS
- THE MINIMUM LENGTH-TO-WIDTH (L:W) RATIO SHOULD BE 2:1, BUT L:W SHOULD BE MAXIMIZED BY CREATING A SINUOUS FLOW PATH AND PLACING THE OUTLET AS FAR FROM THE INLET AS POSSIBLE
- 6-12 INCHES OF TEMPORARY PONDING SHALL BE PROVIDED ABOVE THE NORMAL POOL ELEVATION
- DRAW DOWN ORIFICE IS DESIGNED TO DISCHARGE THE WATER QUALITY VOLUME IN 2 TO 5 DAYS (LONGER TIMES MAXIMIZE TREATMENT EFFICIENCY).

SECTION A-A'

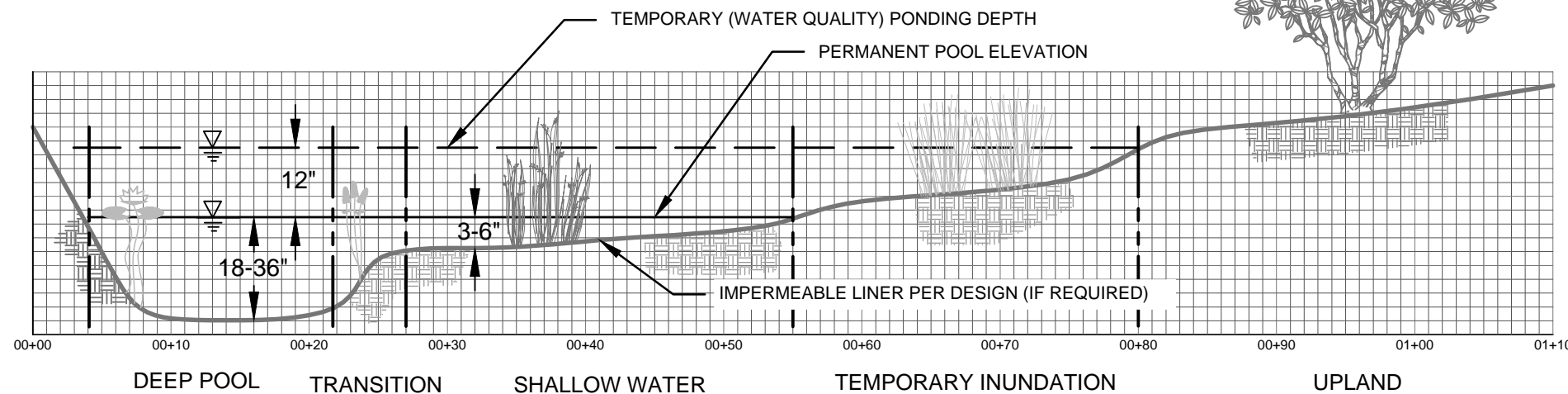

CONSULTANT NAME STREET NUMBER AND ADDRESS		
SAN ANTONIO RIVER AUTHORITY		
CONSTRUCTED WETLAND		
% SUBMITTAL	PROJECT NO.:	DATE:
DRWN. BY:	DSGN. BY:	CHKD. BY:
		SHEET NO.: OF

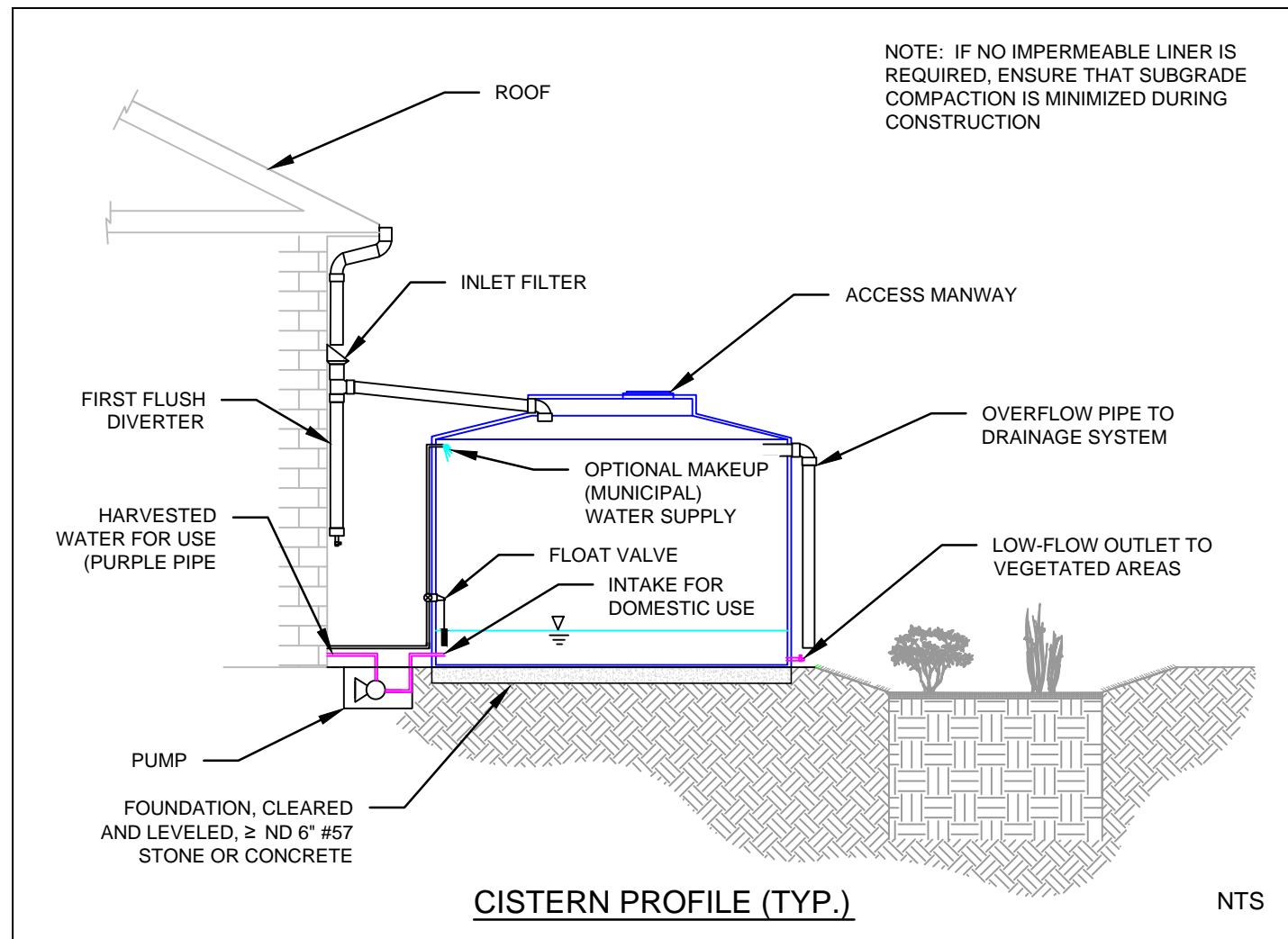

NOTES: CAUTIONARY SIGNAGE, PIPE COLOR, AND LOCKING FEATURES

PER SECTION 608.8 AND SECTION C104.4 OF THE CITY OF SAN ANTONIO AMENDMENTS TO THE INTERNATIONAL PLUMBING CODE, CLEAR AND OBVIOUS SIGNAGE MUST BE PROVIDED WHEREVER HARVESTED RAINWATER IS USED. SIGNS WITH PURPLE BACKGROUND (PANTONE COLOR #512) AND BLACK LETTERING SHOULD READ: "CAUTION: RECLAIMED WATER, DO NOT DRINK" IN ENGLISH AND SPANISH. AREAS REQUIRING SIGNAGE INCLUDE ENTRANCES TO ROOMS (INCLUDING MECHANICAL ROOMS) WHERE HARVESTED WATER IS PIPED OR USED, IRRIGATION AND AUTOMOBILE WASHING HOSES, LOW-FLOW OUTLET ORIFICES, TOILET TANKS THAT USE HARVESTED WATER FOR FLUSHING, AND ANY SPIGOTS, DRAWDOWN PIPES, OR ACCESS HATCHES. SPECIFIC SIGNAGE LANGUAGE FOR THESE USES IS PROVIDED IN SECTION C104.7 OF THE CITY OF SAN ANTONIO AMENDMENTS TO THE INTERNATIONAL PLUMBING CODE.

ALL PIPES AND HOSES USED TO CONVEY HARVESTED WATER SHOULD BE PURPLE IN COLOR (PANTONE COLOR #512) OR CONTINUOUSLY WRAPPED WITH PURPLE MYLAR TAPE (PER SECTION C104.4 OF THE CITY OF SAN ANTONIO AMENDMENTS TO THE INTERNATIONAL PLUMBING CODE) TO INDICATE THAT THE WATER IS NOT SAFE TO DRINK. TAPE-WRAPPED PIPE SHALL DISPLAY THE WARNING PROVIDED ABOVE IN NOMINAL 1/2-INCH BLACK, UPPERCASE LETTERING IN TWO PARALLEL LINES SUCH THAT AFTER WRAPPING THE PIPE A FULL LINE OF TEXT IS VISIBLE. PIPES THAT ARE COMPLETELY COLORED PURPLE SHALL DISPLAY THE WARNING ON BOTH SIDES AT INTERVALS NOT EXCEEDING 3 FEET. ADDITIONALLY, ALL VALVES (EXCEPT FIXTURE SUPPLY CONTROL VALVES) MUST BE EQUIPPED WITH LOCKING FEATURES.

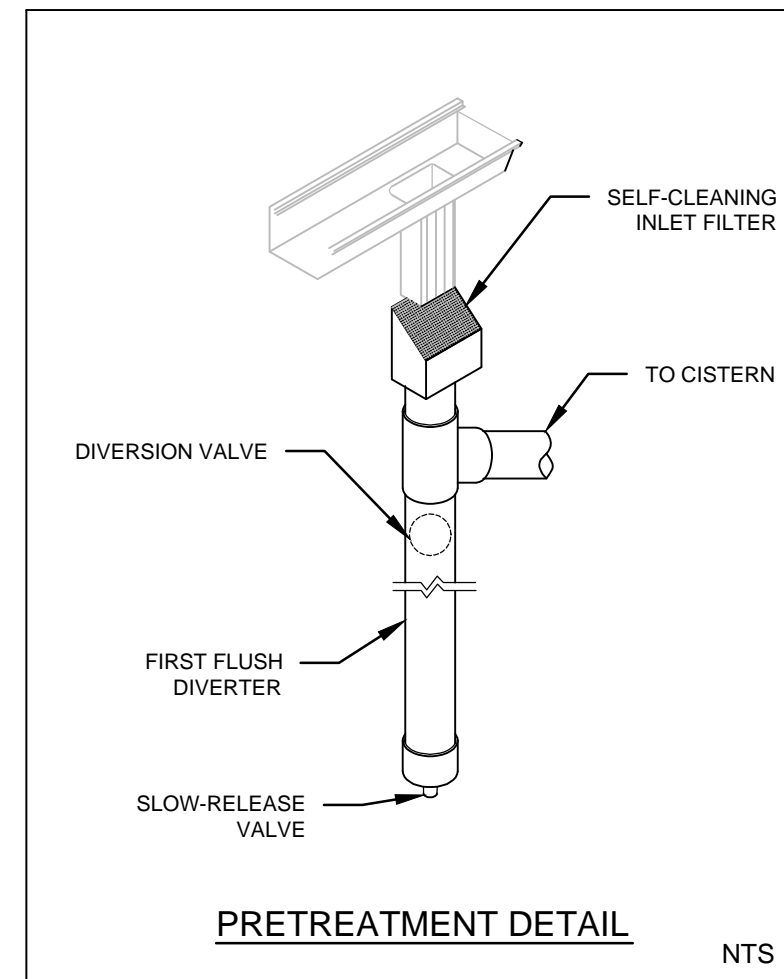
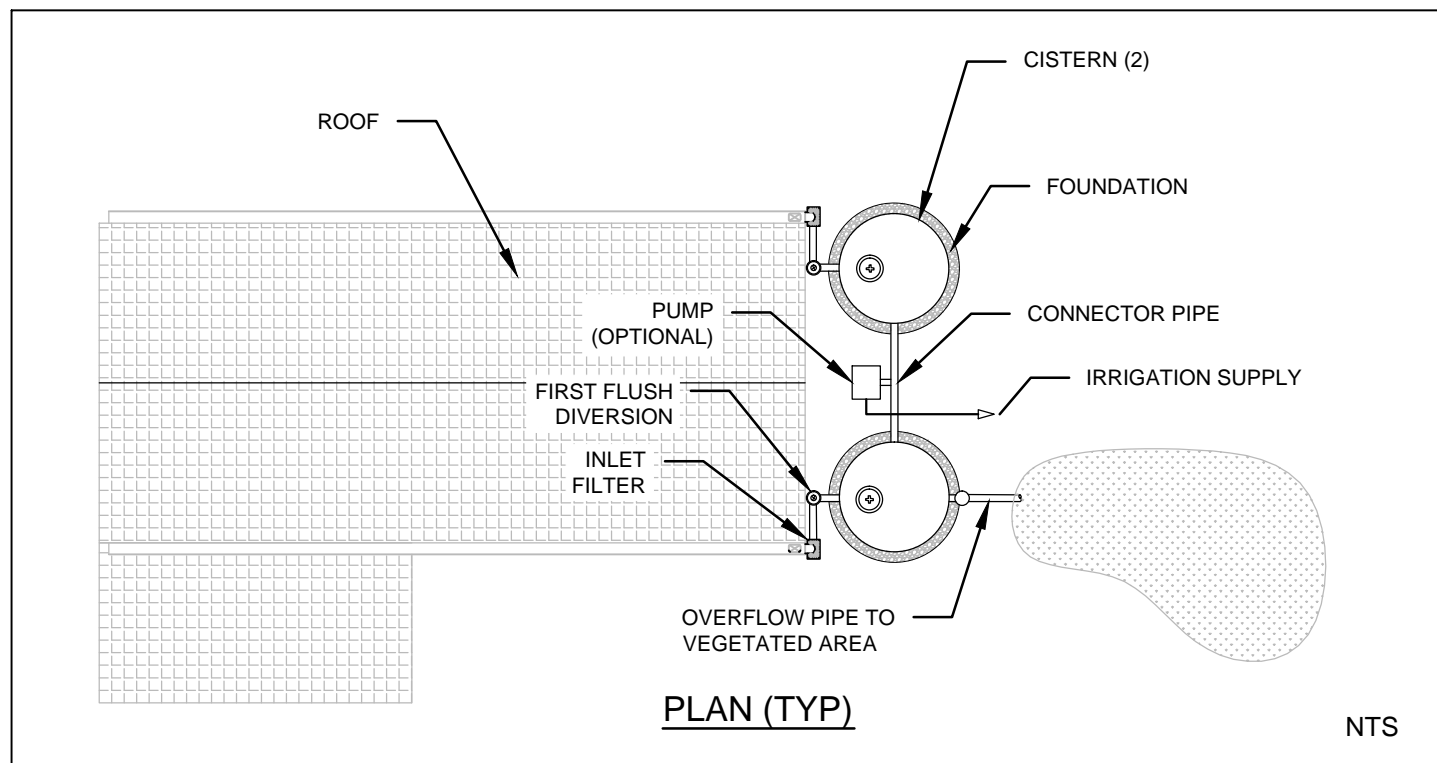

CONSULTANT NAME		
STREET NUMBER AND ADDRESS		
SAN ANTONIO RIVER AUTHORITY		
CAPITAL IMPROVEMENTS MANAGEMENT SERVICES DEPARTMENT		
CISTERN		
% SUBMITTAL	PROJECT NO.:	DATE:
DRWN. BY:	DSGN. BY:	CHKD. BY:
		SHEET NO.: OF

Appendix D. Fact Sheets

Siting and Suitability

Bioretention areas offer flexibility in design and can easily be incorporated into new or existing infrastructure such as parking lot islands and edges, street rights-of-way and medians, roundabouts, pedestrian walkways, public transit stops, or building drainage areas. The available space and site topography often dictate the geometry and size of the bioretention areas. Additional site objectives include incorporation into the site's natural hydrologic regime and further enhancement of natural landscape features in an urban setting. See Chapter 3 for details.

Drainage Area: Less than 5 acres and fully stabilized.

Aquifer Protection Zones and Karst: Use impermeable liner to protect subsurface resources and prevent sinkholes.

Head Requirements: Bioretention typically requires a minimum of 2.5 to 3.5 ft of elevation difference between the inlet and outlet to the receiving storm drain network.

Slopes: Slopes draining to bioretention should be 15% or less, side slopes should be 3:1 (H:V) or flatter, and internal longitudinal slope should be 2% or less.

Setbacks: Provide 10-ft setback from structures/foundations, 100-ft setback from septic fields and water supply wells, and 50-ft setback from steep slopes.

Water Table & Bedrock: At least 3 ft separation must be provided between bottom of cut (subgrade) and seasonal high water table, bedrock, or other restrictive features.

Soil Type: Bioretention can be used in any soils. If subsoil infiltration is less than 0.5 in/hr, an underdrain should be installed. A liner may be needed if subsoils contain expansive clays or calcareous minerals.

Areas of Concern: Infiltration is not allowed at sites with known soil contamination or *hot spots*, such as gas stations. An appropriate impermeable liner must be used in areas of concern.

Design Considerations & Specifications

(see Appendix B for details)

Design Component	General Specification
Drainage Design	1 Impermeable liner If non-infiltrating (per geotechnical investigation), use clay liner, geomembrane liner, or concrete.
	2 Lateral hydraulic restriction barriers May use concrete or geomembrane to restrict lateral flows to adjacent subgrades, foundations, or utilities.
	3 Underdrain/Infiltration Underdrain required if subsoil infiltration < 0.5 in/hr. Schedule 40 PVC pipe with perforations (slots or holes) every 6 inches. 4-inch diameter lateral pipes spaced no more than 10 ft on center should join a 6-inch collector pipe. If design is fully-infiltrating, ensure that subgrade compaction is minimized.
	4 Cleanouts/Observation Wells Provide cleanout ports/observation wells for each underdrain pipe at spacing consistent with local regulations.
	5 Internal Water Storage (IWS) If using underdrain, the underdrain outlet can be elevated to create a sump for additional moisture retention to promote plant survival and treatment. Top of IWS should be greater than 18 inches below surface.
	6 Temporary Ponding Depth 6–18 inches (6–12 inches near schools or in residential areas); average ponding depth of 9 inches is recommended.
	7 Drawdown Time Surface drawdown: 12–24 hrs. Subsurface dewatering: 48 hrs.
Soil Media	8 Soil Media Depth 2–4 feet (deeper for better pollutant removal, hydrologic benefits, and deeper rooting depths).
	9 Soil Media Composition 85–88% sand, 8–12% fines, 2–5% plant-derived organic matter (animal wastes or byproducts should never be applied).
	10 Media Permeability 1–6 in/hr infiltration rate (1–2 in/hr recommended).
	11 Chemical Analysis Total phosphorus < 15 ppm, pH 6–8, CEC > 5 meq/100 g soil.
	12 Drainage Layer Separate media from underdrain with 2 to 4 inches of washed sand (ASTM C-33), followed by 2 inches of choking stone (ASTM No. 8) over a 1.5 ft envelope of ASTM No. 57 stone.
Routing	13 Inlet Provide stabilized inlets and energy dissipation.
	14 Pretreatment Rock armored forebay (concentrated flow), gravel fringe and vegetated filter strip (sheet flow), or vegetated swale.
	15 Outlet Configuration Online: All runoff is routed through system—install an elevated overflow structure or weir at the elevation of maximum ponding. Offline: Only treated volume is diverted to system—install a diversion structure or allow bypass of high flows.
Landscape	16 Mulch Dimensional chipped hardwood or triple shredded, well-aged hardwood mulch 3-inches-deep.
	17 Vegetation Native, deep rooting, drought tolerant plants.
	18 Multi-Use Benefits Provide educational signage, artwork, or wildlife amenities.



This schematic represents an offline situation where higher flows bypass the system to the existing downstream network. Infiltration is restricted due to hypothetical subsurface conflicts and adjacency to infrastructure.

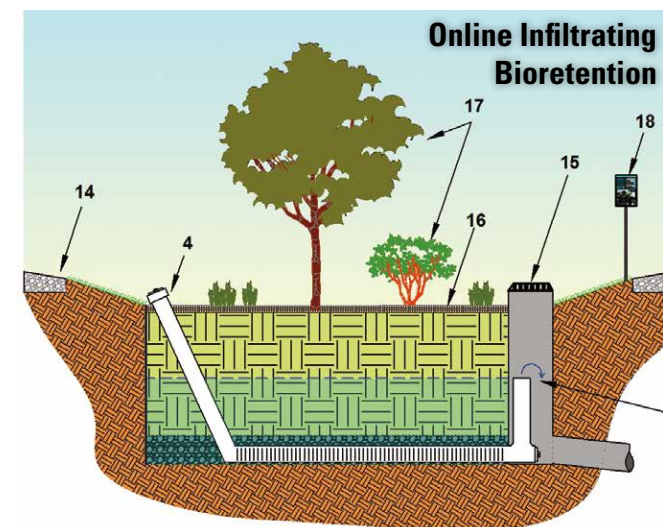

This schematic represents an online situation where all flow is routed through the system—an outlet structure is provided to allow overflow during higher flow events. The underdrain is upturned to enhance capture and infiltration of runoff and to improve soil moisture for plant survival.

Maintenance Considerations (see Appendix F for detailed checklist)

Task	Frequency	Indicator Maintenance is Needed	Maintenance Notes
Catchment inspection	Weekly or biweekly with routine property maintenance	Excessive sediment, trash, and/or debris accumulation on the surface of bioretention	Permanently stabilize any exposed soil and remove any accumulated sediment. Adjacent pervious areas may need to be regraded.
Inlet inspection		Internal erosion or excessive sediment, trash, and/or debris accumulation	Check for sediment accumulation to ensure that flow into the bioretention is as designed. Remove any accumulated sediment.
Litter/leaf removal and misc. upkeep		Accumulation of litter and debris within bioretention area, mulch around outlet, internal erosion	Litter, leaves, and debris should be removed to reduce the risk of outlet clogging, reduce nutrient inputs to the bioretention area, and to improve facility aesthetics. Erosion should be repaired and stabilized.
Pruning	1–2 times/year	Overgrown vegetation that interferes with access, lines of sight, or safety	Nutrients in runoff often cause bioretention vegetation to flourish.
Mowing	2–12 times/year	Overgrown vegetation that interferes with access, lines of sight, or safety	Frequency depends on location and desired aesthetic appeal and type of vegetation.
Outlet inspection	1 time/year	Erosion at outlet	Remove any accumulated mulch or sediment.
Mulch removal and replacement	1 time/2–3 years	Less than 3 inches of mulch remaining	Remove decomposed fraction and top off with fresh mulch to a total depth of 3 inches
Remove and replace dead plants	1 time/year	Dead plants	Plant die-off tends to be highest during the first year (commonly 10% or greater). Survival rates increase with time.
Temporary Watering	1 time/2–3 days for first 1–2 months	Until establishment and during severely-droughty weather	Watering after the initial year might be required.
Fertilization	1 time initially	Upon planting	One-time spot fertilization for first year vegetation.

Description

Bioretention areas are small-scale, vegetated depressions designed to provide stormwater storage and filtration through engineered media. Using detention, sedimentation, filtration and adsorption, bioretention enhances the removal of contaminants from stormwater by both plants and soils.

Bioretention can also incorporate pretreatment (i.e., vegetated filter strips, vegetated swales or settling forebays), allowing increased sedimentation and capture of debris from heavily trafficked areas. Finally, bioretention can be used in-line with traditional stormwater conveyance systems.

Treatment Efficiency

Parameter	Efficiency
Runoff Volume	High (unlined)/Low (lined)
Sediment	High
Nutrients	Medium
Pathogens	High
Metals	High
Oil & Grease	High
Organics	High



Siting and Suitability

Bioswales are highly versatile stormwater BMPs that effectively reduce pollutants. With a narrow width, bioswales can be integrated into site plans with various configurations and components. Ideal sites for bioswales include the right-of-way of linear transportation corridors and along borders or medians of parking lots. In heavily trafficked areas, curb cuts can be used to delineate boundaries. Bioswales can be combined with other basic and stormwater runoff BMPs to form a treatment train, reducing the required size of a single BMP unit.

Drainage Area: Less than 2 acres and fully stabilized.

Aquifer Protection Zones and Karst: Use impermeable liner to protect subsurface resources and prevent sinkholes.

Head Requirements: Bioswale typically requires a minimum of 2.5 to 3.5 ft of elevation difference between the inlet and outlet to the receiving storm drain network.

Slopes: Slopes draining to bioswale should be 15% or less, side slopes should be 3:1 (H:V) or flatter, and check dams should be used to provide longitudinal bed slopes of 2% (average slope should not exceed 5% from inlet to outlet).

Setbacks: Provide 10-ft setback from structures/foundations, 100-ft setback from septic fields and water supply wells, and 50-ft setback from steep slopes.

Water Table & Bedrock: At least 3 ft separation must be provided between bottom of cut (subgrade) and seasonal high water table, bedrock, or other restrictive features.

Soil Type: Bioswale can be used in any soils. If subsoil infiltration is less than 0.5 in/hr, an underdrain should be installed. A liner may be needed if subsoils contain expansive clays or calcareous minerals.

Areas of Concern: Infiltration is not allowed at sites with known soil contamination or *hot spots*, such as gas stations. An appropriate impermeable liner must be used in areas of concern.

Design Considerations & Specifications (see Appendix B for details)

Design Component	General Specification	
BMP Function	1 Impermeable liner	If non-infiltrating (per geotechnical investigation), use clay liner, geomembrane liner, or concrete.
	2 Lateral hydraulic restriction barriers	May use concrete or geomembrane to restrict lateral seepage to adjacent subgrades, foundations, or utilities.
	3 Underdrain/Infiltration	Underdrain required if subsoil infiltration < 0.5 in/hr. Schedule 40 PVC pipe with perforations (slots or holes) every 6 inches. 4-inch diameter lateral pipes spaced no more than 10 ft on center should join a 6-inch collector pipe. If design is fully-infiltrating, ensure that subgrade compaction is minimized.
	4 Cleanouts/Observation Wells	Provide cleanout ports/observation wells for each underdrain pipe at spacing consistent with local regulations.
	5 Internal Water Storage (IWS)	If using underdrain, the underdrain outlet can be elevated to create a sump for additional moisture retention to promote plant survival and treatment. Top of IWS should be greater than 18 inches below surface.
	6 Temporary Ponding Depth	Use check dams to provide 6–18 inches (6–12 inches near schools or in residential areas); average ponding depth of 9 inches is recommended.
	7 Drawdown Time	Surface drawdown: 12–24 hrs Subsurface dewatering: 48 hrs.
Soil Media	8 Soil Media Depth	2–4 feet (deeper for better pollutant removal, hydrologic benefits, and deeper rooting depths).
	9 Soil Media Composition	85–88% sand, 8–12% fines, 2–5% plant-derived organic matter (animal wastes or byproducts should never be applied).
	10 Media Permeability	1–6 in/hr infiltration rate (1–2 in/hr recommended).
	11 Chemical Analysis	Total phosphorus < 15 ppm, pH 6–8, CEC > 5 meq/100 g soil.
	12 Drainage Layer	Separate media from underdrain with 2 to 4 inches of washed concrete sand (ASTM C-33), followed by 2 inches of choking stone (ASTM No. 8) over a 1.5 ft envelope of ASTM No. 57 stone.
Routing	13 Inlet/Pretreatment	Provide stabilized inlets and energy dissipation. Install rock armored forebay for concentrated flows, gravel fringe and vegetated filter strip for sheet flows.
	14 Slope and Grade Control	If necessary, use check dams to maintain maximum 2% bed slope. Check dams should extend sufficiently deep to prevent piping (undercutting) below the check dam.
	15 Outlet Configuration	Online: All runoff is routed through system—install an elevated overflow structure or weir at the elevation of maximum ponding. Offline: Only treated volume is diverted to system—install a diversion structure or allow bypass of high flows.
Landscape	16 Mulch	Dimensional chipped hardwood or triple shredded, well-aged hardwood mulch 3-inches-deep.
	17 Vegetation	Native, deep rooting, drought tolerant plants.
18 Multi-Use Benefits	Provide educational signage, artwork, or wildlife amenities.	

Maintenance Considerations (see Appendix F for detailed checklist)

Task	Frequency	Indicator Maintenance is Needed	Maintenance Notes
Catchment inspection	Weekly or biweekly with routine property maintenance	Excessive sediment, trash, and/or debris accumulation on the surface of bioswale	Permanently stabilize any exposed soil and remove any accumulated sediment. Adjacent pervious areas may need to be regraded.
Inlet inspection		Internal erosion or excessive sediment, trash, and/or debris accumulation	Check for sediment accumulation to ensure that flow into the bioswale is as designed. Remove any accumulated sediment.
Litter/leaf removal and misc. upkeep		Accumulation of litter and debris within bioswale area, mulch around outlet, internal erosion	Litter, leaves, and debris should be removed to reduce the risk of outlet clogging, reduce nutrient inputs to the bioretention area, and to improve facility aesthetics. Erosion should be repaired and stabilized.
Pruning	1–2 times/year	Overgrown vegetation that interferes with access, lines of sight, or safety	Nutrients in runoff often cause bioretention vegetation to flourish.
Mowing	2–12 times/year	Overgrown vegetation that interferes with access, lines of sight, or safety	Frequency depends on location and desired aesthetic appeal and type of vegetation.
Outlet inspection	1 time/year	Erosion at outlet	Remove any accumulated mulch or sediment.
Mulch removal and replacement	1 time/2–3 years	Less than 3 inches of mulch remaining	Remove decomposed fraction and top off with fresh mulch to a total depth of 3 inches
Remove and replace dead plants	1 time/year	Dead plants	Plant die-off tends to be highest during the first year (commonly 10% or greater). Survival rates increase with time.
Temporary Watering	1 time/2–3 days for first 1–2 months	Until establishment and during severely-droughty weather	Watering after the initial year might be required.
Fertilization	1 time initially	Upon planting	One-time spot fertilization for first year vegetation.

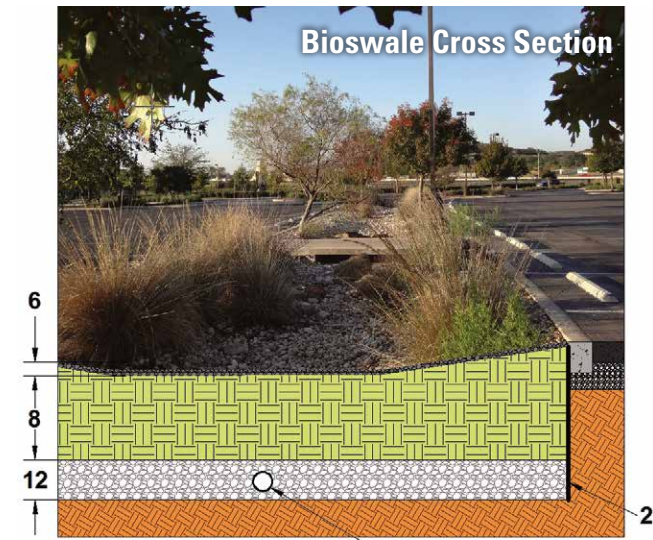

A bioswale captures, conveys, and filters runoff at the Rim Retail Center. Lateral hydraulic restriction barriers protect the adjacent pavement subgrade while allowing vertical infiltration.

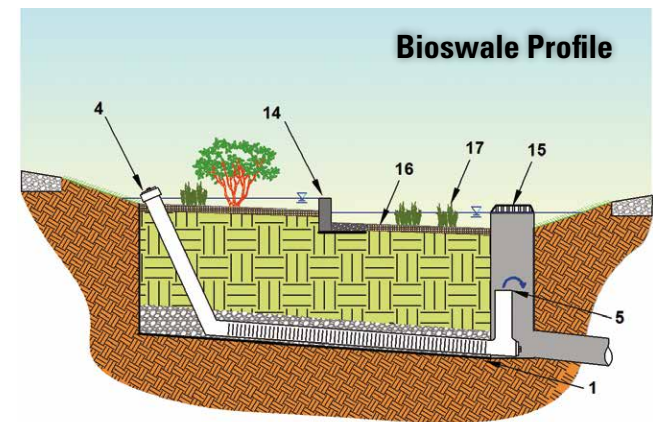

This schematic represents an online, infiltrating bioswale where all flow is routed through the system—check dams control the longitudinal slope and ensure capture of the design storm volume. Internal water storage is provided to enhance water retention and plant survival by upturning the underdrain.

Description

Bioswales are shallow, open channels that are designed to reduce runoff volume through infiltration. Additionally, bioswales remove pollutants such as trash and debris by filtering water through vegetation within the channel. Swales can serve as conveyance for stormwater and can be used in place of traditional curbs and gutters; however, when compared to traditional conveyance systems the primary objective of a bioswale is infiltration and water quality enhancement rather than conveyance. In addition to reducing the mass of pollutants in runoff, properly maintained bioswales can enhance the aesthetics of a site.

Treatment Efficiency

Runoff Volume	High (unlined)/ Low (lined)	Bacteria	High
Sediment	High	Nutrients	Medium
Trash/debris	High	Heavy Metals	High
Organics	High	Oil & Grease	High

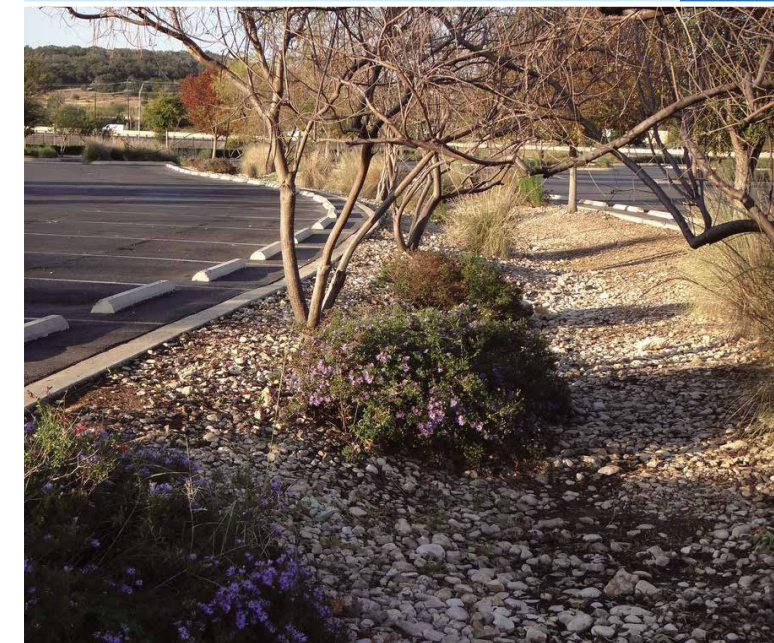

Siting and Suitability

The use of permeable pavement is encouraged for sites such as parking lots, driveways, pedestrian plazas, rights-of-way, and other lightly traveled areas. Numerous types and forms of permeable pavers exist and offer a range of utility, strength, and permeability. Permeable pavement must be designed to support the maximum anticipated traffic load but should not be used in highly trafficked areas. For designs that include infiltration, surrounding soils must allow for adequate infiltration. Precautions must be taken to protect soils from compaction during construction.

Aquifer Protection Zones and Karst:

Permeable pavement can be used in sensitive geology if impermeable liners and a sand filter layer are used. In areas outside the Edwards Aquifer Recharge and Transition Zones, infiltration into native subsoils is encouraged.

Available Space: Permeable pavement is typically designed to treat storm water that falls on the pavement surface area and runoff from other impervious surfaces. It is most commonly used at commercial, institutional, and residential locations in area that are traditionally impervious. Permeable pavement should not be used in high-traffic areas.

Underground Utilities: Complete a utilities inventory to ensure that site development will not interfere with or affect utilities.

Existing Buildings: Assess building effects on the site. Permeable pavement must be set away from building foundations at least 10 feet and 50 feet from steep slopes.

Water Table and Bedrock: Permeable pavement is applicable where depth from subgrade to seasonal high water table, bedrock, or other restrictive feature is 3 feet or greater.

Soil Type: Examine site compaction and soil characteristics. Minimize compaction during construction; do not place the bed bottom on compacted fill. Determine site-specific permeability; it is ideal to have well-drained soils.

Areas of Concern: Permeable pavement that includes infiltration in design is not recommended for sites with known soil contamination or *hot spots* such as gas stations. Impermeable membrane can be used to contain flow within areas of concern.

Design Considerations & Specifications

(see Appendix B for details)

Design Component	General Specification		
BMP Function	1	Impermeable liner	If non-infiltrating (per geotechnical investigation), use clay liner, geomembrane liner, or concrete.
	2	Lateral hydraulic restriction barriers	May use concrete or geomembrane to restrict lateral seepage to adjacent subgrades, foundations, or utilities.
	3	Underdrain/Infiltration	Underdrain required if subsoil infiltration < 0.5 in/hr. Schedule 40 PVC pipe with perforations (slots or holes) every 6 inches. 4-inch diameter lateral pipes should join a 6-inch collector pipe. If design is fully infiltrating, ensure that subgrade compaction is minimized.
	4	Observation Wells	Provide capped observation wells to monitor drawdown.
	5	Internal Water Storage (IWS)	If using underdrain in infiltrating systems, the underdrain outlet can be elevated to create a sump to enhance infiltration and treatment.
	6	Drawdown Time	If using fully-lined system, provide orifice at underdrain outlet sized to release water quality volume over 2–5 days.
	7	Subgrade Slope and Geotextile	Subgrade slope should be 0.5% or flatter. Baffles should be used to ensure water quality volume is retained. Geotextile should be used along perimeter of cut to prevent soil from entering the aggregate voids.
Profile	8	Surface Course	Pervious concrete, porous asphalt, and permeable interlocking concrete pavers (PICP) are the preferred types of permeable pavement because detailed industry standards and certified installers are available.
	9	Temporary Ponding Depth (in Edwards Aquifer Zones)	Surface ponding should be provided (by curb and gutter) to capture the design storm in the event that the permeable pavement surface clogs.
	10	Bedding Course (for PICP)	Use a 2-inch bedding course of ASTM No. 8 stone.
	11	Reservoir Layer	Base layer should be washed ASTM No. 57 stone (washed ASTM No. 2 may be used as a subbase layer for additional storage).
	12	Soil/Sand Filter Layer	With underdrains or when subsoils are not suitable for filtration (per geotechnical investigation: min. 4-inch layer of ASTM C-33 washed sand above gravel of underdrain drainage layer. No underdrains: min. 12-inch of native subsoil as subgrade.
Routing	13	Structural Design	A pavement structural analysis should be completed by a qualified and licensed professional.
	14	Large Storm Routing	For poured in place systems (pervious concrete or porous asphalt): system can overflow internally or on the surface. For modular/paver-type systems (PICP): internal bypass is required to prevent upflow and transport of bedding course.
Other	15	Edge Restraints and Dividers	Provide a concrete divider strip between any permeable and impermeable surfaces and around the perimeter of PICP installations.
	16	Signage	Signage should prohibit activities that cause premature clogging and indicate to pedestrians and maintenance staff that the surface is intended to be permeable.
	17	Multi-Use Benefits	Provide educational signage, enhanced pavement colors, or stormwater reuse systems.

Permeable Pavement Cross Section

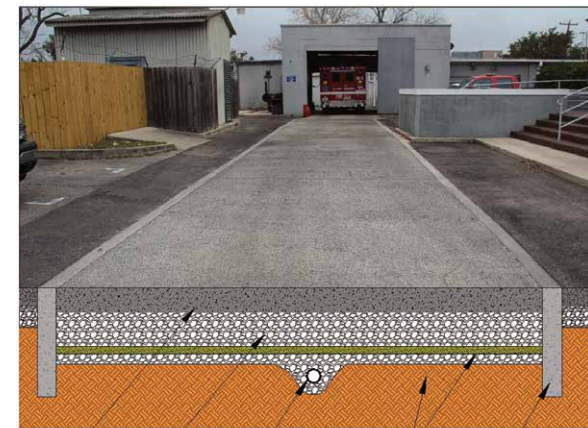

Pervious concrete captures runoff from the Alamo Heights Fire Station. An impermeable concrete transition strip delineates the pervious concrete for maintenance personnel and functions as a hydraulic restriction barrier to protect adjacent pavement and infrastructure from lateral seepage.

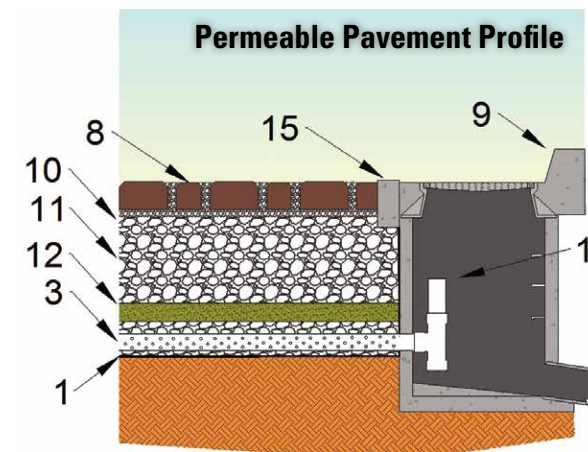

This schematic represents a typical permeable pavement profile with internal water storage to enhance capture and infiltration of the design storm volume. An orifice can be provided at the invert of the underdrain to slowly dewater captured runoff in non-infiltrating systems.

Maintenance Considerations (see Appendix F for detailed checklist)

Task	Frequency	Indicator Maintenance is Needed	Maintenance Notes
Catchment inspection	Weekly or biweekly during routine property maintenance	Sediment accumulation on adjacent impervious surfaces or in voids/joints of permeable pavement	Stabilize any exposed soil and remove any accumulated sediment. Adjacent pervious areas may need to be graded to drain away from permeable pavement.
Miscellaneous upkeep	Weekly or biweekly during routine property maintenance	Trash, leaves, weeds, or other debris accumulated on permeable pavement surface	Immediately remove debris to prevent migration into permeable pavement voids. Identify source of debris and remedy problem to avoid future deposition.
Preventative vacuum/regenerative air street sweeping	Twice a year in higher sediment areas	N/A	Pavement should be swept with a vacuum power or regenerative air street sweeper at least twice per year to maintain infiltration rates.
Replace fill materials	As needed	For paver systems, whenever void space between joints becomes apparent or after vacuum sweeping	Replace bedding fill material to keep fill level with the paver surface.
Restorative vacuum/regenerative air street sweeping	As needed	Surface infiltration test indicates poor performance or water is ponding on pavement surface during rainfall	Pavement should be swept with a vacuum power or regenerative air street sweeper to restore infiltration rates.

Description

Permeable pavement allows for percolation of stormwater through subsurface aggregate and offers an alternative to conventional concrete and asphalt paving. Typically, stormwater that drains through the permeable surface is allowed to infiltrate underlying soils and excess runoff drains through perforated underdrain pipes.

Treatment Efficiency

Parameter	Efficiency
Runoff Volume	High (unlined)/Low (lined)
Sediment	High
Nutrients	Low
Pathogens	Medium
Metals	Medium
Oil & Grease	Medium
Organics	Low



Siting and Suitability

Planter boxes require relatively little space and can be easily adapted for urban retrofits such as building and rooftop runoff catchments or into new street and sidewalk designs. Because planter boxes are typically fully-contained systems, available space presents the most significant limitation. To ensure healthy vegetation in the planter box, proper plant and media selection are important considerations for accommodating the drought, ponding fluctuations, and brief periods of saturated soil conditions.

Drainage Area: To be less than 0.35 acres and fully stabilized.

Aquifer Protection Zones and Karst: Planter boxes can be used in areas with sensitive geology, but outflow should be directed to the storm drain network or used for irrigation (per geotechnical investigation).

Underground Utilities: Complete a utilities inventory to ensure that site development will not interfere with or affect the utilities.

Existing Buildings: Assess building effects (runoff, solar shadow) on the site. When completely contained, building setbacks are less of a concern.

Water Table: Seasonal high water table should be located below the bottom of the box.

Soil Type: Soils within the drainage area must be stabilized. If planter boxes are fully contained, local soils must provide structural support.

Areas of Concern: Fully-contained planter boxes can be used in areas with known soil contamination or in *hot spots*.

Design Considerations & Specifications

(see Appendix B for details)

Design Component/Consideration	General Specification		
BMP Function	1	Impermeable liner	Planter boxes are typically contained within a concrete vault.
	2	Underdrain (required)	Underdrain required if subsoil infiltration < 0.5 in/hr. Schedule 40 PVC pipe with perforations (slots or holes) every 6 inches. 4-inch diameter lateral pipes spaced no more than 10 ft on center should join a 6-inch collector pipe. If design is fully infiltrating, ensure that subgrade compaction is minimized.
	3	Cleanouts/Observation Wells	Provide cleanout ports/observation wells for each underdrain pipe at spacing consistent with local regulations.
	4	Internal Water Storage (IWS)	With careful plant selection, the outlet can be slightly elevated to create a sump for additional moisture retention to promote plant survival and enhanced treatment. Top of IWS should be greater than 18 inches below surface.
	5	Temporary Ponding Depth	Provide 6–18 inches surface ponding (6–12 inches near schools or in residential areas); average ponding depth of 9 inches is recommended.
	6	Drawdown Time	Surface drawdown: 12–24 hrs, Subsurface dewatering: 48 hrs.
Soil Media	7	Soil Media Depth	2–4 feet (deeper for better pollutant removal, hydrologic benefits, and deeper rooting depths).
	8	Soil Media Composition	85–88% sand, 8–12% fines, 2–5% plant-derived organic matter (animal wastes or byproducts should never be applied).
	9	Media Permeability	1–6 in/hr infiltration rate (1–2 in/hr recommended).
	10	Chemical Analysis	Total phosphorus < 15 ppm, pH 6–8, CEC > 5 meq/100 g soil.
	11	Drainage Layer	Separate soil media from underdrain with 2 to 4 inches of washed concrete sand (ASTM C33), followed by 2 inches of choking stone (ASTM No. 8) over a 1.5 ft envelope of ASTM No. 57 stone.
Routing	12	Inlet/ Pretreatment	Provide stabilized inlets and energy dissipation. Install rock armored forebay, gravel splash pad, or upturn incoming pipes.
	13	Outlet Configuration	Online: All runoff is routed through system—install an elevated overflow structure or weir at the elevation of maximum ponding. Offline: Only treated volume is diverted to system—install a diversion structure or allow bypass of high flows.
Landscape	14	Mulch	Dimensional chipped hardwood or triple shredded, well-aged hardwood mulch 3-inches-deep.
	15	Vegetation	Native, deep rooting, drought tolerant plants.
	16	Multi-Use Benefits	Provide educational signage, artwork, or wildlife habitat.

Planter Box at Sunset Depot (rendering)



This rendering illustrates an example of a planter box retrofit to an existing historical building.

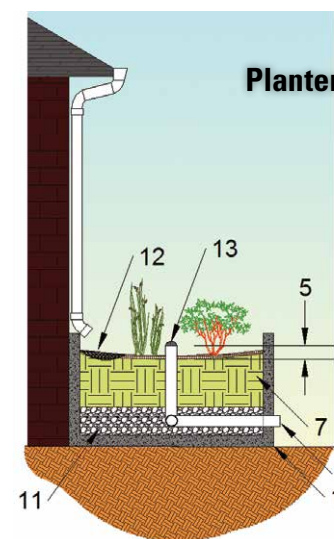

Planter Box Cross Section

This figure shows the major components of a planter box.

Maintenance Considerations (see Appendix F for detailed checklist)

Task	Frequency	Indicator Maintenance is Needed	Maintenance Notes
Catchment inspection	Weekly or biweekly with routine property maintenance	Excessive sediment, trash, and/or debris accumulation on the surface of bioswale	Permanently stabilize any exposed soil and remove any accumulated sediment. Adjacent pervious areas may need to be regraded.
Inlet inspection		Internal erosion or excessive sediment, trash, and/or debris accumulation	Check for sediment accumulation to ensure that flow into the bioswale is as designed. Remove any accumulated sediment.
Litter/leaf removal and misc. upkeep		Accumulation of litter and debris within bioswale area, mulch around outlet, internal erosion	Litter, leaves, and debris should be removed to reduce the risk of outlet clogging, reduce nutrient inputs to the bioretention area, and to improve facility aesthetics. Erosion should be repaired and stabilized.
Pruning	1–2 times/year	Overgrown vegetation that interferes with access, lines of sight, or safety	Nutrients in runoff often cause bioretention vegetation to flourish.
Mowing	2–12 times/year	Overgrown vegetation that interferes with access, lines of sight, or safety	Frequency depends on location and desired aesthetic appeal and type of vegetation.
Outlet inspection	1 time/year	Erosion at outlet	Remove any accumulated mulch or sediment.
Mulch removal and replacement	1 time/2–3 years	Less than 3 inches of mulch remaining	Remove decomposed fraction and top off with fresh mulch to a total depth of 3 inches
Remove and replace dead plants	1 time/year	Dead plants	Plant die-off tends to be highest during the first year (commonly 10% or greater). Survival rates increase with time.
Temporary Watering	1 time/2–3 days for first 1–2 months	Until establishment and during severely-droughty weather	Watering after the initial year might be required.
Fertilization	1 time initially	Upon planting	One-time spot fertilization for first year vegetation.

Description

Planter boxes are vegetated BMP units that capture, temporarily store, and filter storm water runoff. The vegetation, ponding areas, and soil media in the planter boxes remove contaminants and retain storm water flows from small drainage areas before directing the treated storm water to an underdrain system. Typically, planter boxes are completely contained systems; for this reason, they can be used in areas where geotechnical constraints prevent or limit infiltration or in areas of concern where infiltration should be avoided. Planter boxes offer considerable flexibility and can be incorporated into small spaces, enhancing natural aesthetics of the landscape.

Planter boxes are effective for removing

Treatment Efficiency			
Runoff Volume	Low	Metals	High
Sediment	High	Oil & Grease	High
Nutrients	Medium	Organics	High
Pathogens	High		

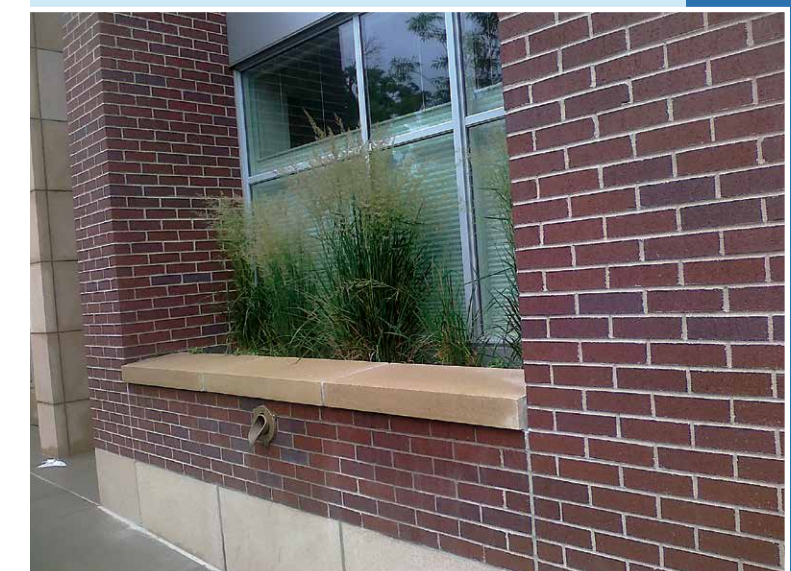

Siting and Suitability

Greenroofs are typically constructed on flat or gently sloped rooftops of a wide variety of shapes and sizes. Where installed on new construction, building structural design should consider the additional load of the greenroof. Where installed on existing buildings the structure should be evaluated by a structural engineer to determine suitability. Greenroofs can be implemented on a wide range of building types and settings and can integrate with other roof infrastructure such as HVAC components, walkways, and solar panels.

Drainage Area: Varies widely from a few square feet to several acres.

Aquifer Protection Zones and Karst: Not applicable. The use of greenroofs may reduce the need for downstream components to address these issues.

Head Requirements: Not applicable

Slopes: Green roofs can be installed on roof surfaces that are flat or are sloped.

Setbacks: Not applicable

Structural Requirements: a structural engineer should evaluate the structure to ensure that it is capable of supporting the greenroof.

Areas of Concern: In areas of significant wind loads design considerations may be necessary to ensure security of media or a greenroof may not be suitable.

Design Considerations & Specifications (see Appendix B for details)

Design Component		General Specification
BMP Function	1 Roof Slope	Greenroofs may be constructed on slopes from 1% to 30%. Where slopes approach 30% media retention practices such as baffles or geo-grids should be incorporated into the design.
	2 Waterproof Liner	All greenroof systems should incorporate a waterproof liner to protect the roof deck and underlying structure from leaks.
	3 Insulation (optional)	Insulation may be placed either above or below the waterproof liner to enhance the energy efficiency of the building and to provide additional protection of the roof deck.
	4 Root Barrier	Root barrier is placed directly above the waterproof liner, or insulation as appropriate, to prevent plant roots from impacting the integrity of the liner
	5 Drainage Layer	Aggregate: Minimum of 2 inches of clean washed synthetic or inorganic aggregate material such as no 8 stone or suitable alternatives. Manufactured: A wide range of prefabricated drainage layers are available which incorporate drainage and storage or rainfall. Minimum storage capacity should be 0.8 inches.
	6 Root Permeable Filter Fabric	A semipermeable filter fabric is placed between the drainage layer and growth media to prevent migration of the media into the drainage layer.
Growth Media	7 Media Depth	Minimum 4 inches of growth media.
	8 Media Composition	80–90% lightweight inorganic materials such as expanded slates, shales, or pumice. No more than 20% organic materials with a low potential for leaching nutrients.
Other Considerations	9 Roof Drains and Scuppers	Setback greenroof media and drainage layers a minimum of 12 inches from all roof drains and scupper and fill these areas with washed no. 57 stone to a depth equal to or greater than the depth of the greenroof components.
	10 Other Infrastructure	Separate greenroof 24 inches from other rooftop infrastructure such as vents, HVAC components, etc. Setback areas may be filled with washed no. 57 gravel or suitable alternative.
	11 Access	Adequate access to the roof must be provided to allow routine maintenance.
Landscape	12 Vegetation	Primarily drought tolerant species which can thrive in a rooftop environment without supplemental irrigation; see Plant List (Appendix E).
	13 Multi-Use Benefits	Include features to enhance habitat, aesthetics, recreation, and public education as desired.

Maintenance Considerations (see Appendix F for detailed checklist)

Task	Frequency	Indicator Maintenance is Needed	Maintenance Notes
Media Inspection	2 times/year	Internal erosion of media from runoff or wind scour, exposed underlayment components	Replace eroded media and vegetation. Adopt additional erosion prevention practices as appropriate.
Liner Inspection	1 time/year	Liner is exposed or tenants have experienced leaks	Evaluate liner for cause of leaks. Repair or replace as necessary.
Outlet Inspection	2 times/year	Accumulation of litter and debris around the roof drain or scupper or standing water in adjacent areas.	Litter, leaves, and debris should be removed to reduce the risk of outlet clogging. If sediment has accumulated in the gravel drain buffers remove and replaces the gravel.
Vegetation Inspection	1 time/year	Dead plants or excessive open areas on greenroof	Within the first year, 10 percent of plants can die. Survival rates increase with time.
Invasive Vegetation	2 times/year	Presence of unwanted or undesirable species	Remove undesired vegetation. Evaluate greenroof for signs of excessive water retention.
Temporary Watering	1 time/2–3 days for first 1–2 months	Until establishment and during severely-droughty weather	Watering after the initial year might be required.

Extensive Green Roof



A modular extensive green roof in Fallbrook, California, was installed on the roof of a public library. Prefabricated plastic trays were planted with colorful varieties of stonecrop.

Extensive Green Roof Cross Section

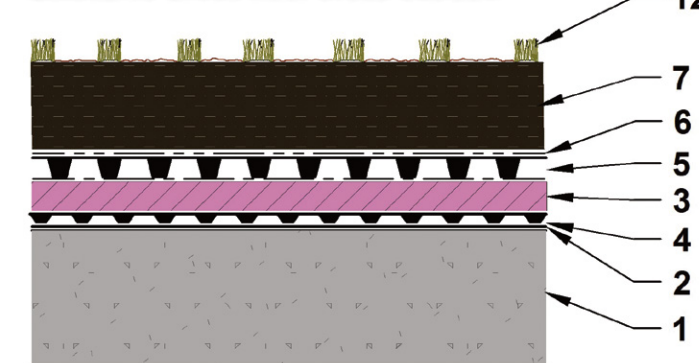

Typical components of an extensive green roof. The cross section of intensive green roofs will be deeper and vary from site to site based on desired functions and structural capacity of the underlying structure.

Description

Greenroofs are vegetated surfaces generally installed on flat or gently sloped rooftops. They consist of drought tolerant vegetation grown in a thin layer of media underlain by liner and drainage components. They reduce stormwater runoff volume and improve water quality by intercepting rainfall which is either filtered by the media, evaporated from the roof surface or utilized by the vegetation. Greenroofs can be installed on a wide range of building types and may provide additional functions such as extending roof-life and reducing energy requirements of the building. Research has shown that Greenroofs also may improve property values of adjacent buildings and provide air quality benefits. In addition to these functions greenroofs can serve as passive recreation areas and provide wildlife habitat.

Treatment Efficiency

	High	Bacteria	Medium
Runoff Volume	High	Bacteria	Medium
TSS	Medium	Nutrients	Medium
Trash/debris	Medium	Heavy Metals	High
Organics	Medium	Oil & Grease	NA



Siting and Suitability

Sand filters require less space than many LID BMPs and are typically used in areas with restricted space such as parking lots or other highly impervious areas. Sizing should be based on the desired water quality treatment volume the *Storm Water Design Standards Manual* specifications and should take into account all runoff at ultimate build-out, including off-site drainage. The design phase should also identify where pretreatment will be needed. Aboveground units should be designed with a vegetated filter strip or forebay as a pretreatment element, and belowground units should incorporate a forebay sediment chamber.

Aquifer Protection Zones and Karst: Sand filters can be used in sensitive geology if impermeable liners are used.

Underground Utilities: A complete utilities inventory should be done to ensure that site development will not interfere with or affect the utilities.

Existing Buildings: If used underground, ensure that the sand filter will not interfere with existing foundations.

Water Table and Bedrock: Sand filters are applicable where depth from subgrade to seasonal high water table, bedrock, or other restrictive feature is 3 ft or greater.

Soil Type: If infiltration is planned to existing soils, examine site compaction and soil characteristics. Determine site-specific permeability. It is ideal to have well-drained soils. If native soils show less than 0.5 in/hr infiltration rate, underdrains should be included.

Areas of Concern: Sand filters, if lined, can be used for sites with known soil contamination or *hot spots* such as gas stations. Impermeable membranes must be used to contain infiltration within areas of concern.

Design Considerations & Specifications

(see Appendix B for details)

Design Component	General Specification
BMP Function	1 BMP Type Surface sand filters: installed in shallow depressions on surface. Require pretreatment by vegetated swales, filter strip, or forebay. Subsurface sand filters: can be installed along the edges of roads and parking lots to conserve space. Must include a sedimentation chamber for pretreatment.
	2 Impermeable liner If non-infiltrating (per geotechnical investigation), use clay liner, geomembrane liner, or concrete.
	3 Lateral hydraulic restriction barriers May use concrete or geomembrane to restrict lateral seepage to adjacent subgrades, foundations, or utilities.
	4 Underdrain/Infiltration Underdrain required if subsoil infiltration < 0.5 in/hr. Schedule 40 PVC pipe with perforations (slots or holes) every 6 inches. 4-inch diameter lateral pipes should join a 6-inch collector pipe. If design is fully infiltrating, ensure that subgrade compaction is minimized.
	5 Cleanouts/Observation Wells Provide cleanout ports/observation wells for each underdrain pipe at spacing consistent with local regulations.
	6 Internal Water Storage (IWS) If using underdrain in infiltrating systems, the underdrain outlet can be elevated to create a sump for enhanced infiltration and treatment. Top of IWS should be greater than 10 inches below surface.
	7 Temporary Ponding Depth No greater than 8 feet (shallower depth should be used in residential areas or near schools and parks).
	8 Drawdown Time Surface drawdown: 12–24 hrs.
Soil Media	9 Soil Media Depth 1.5–4 feet (deeper for better pollutant removal, hydrologic benefits, and deeper rooting depths).
	10 Gradation Washed concrete sand (ASTM C-33) free of fines, stones, and other debris.
	11 Chemical Analysis Total phosphorus < 15 ppm.
Routing	12 Drainage Layer Separate soil media from underdrain with 2 to 4 inches of washed concrete sand (ASTM C-33), followed by 2 inches of choking stone (ASTM No. 8) over a 1.5 ft envelope of ASTM No. 57 stone.
	13 Inlet/Pretreatment Provide stabilized inlets and energy dissipation. Install rock armored forebay for concentrated flows, gravel fringe and vegetated filter strip for sheet flows to surface sand filters. For subsurface sand filters, a sedimentation chamber is provided (should be dewatered between storm events).
Other	14 Outlet Configuration Online: All runoff is routed through system—install an elevated overflow structure or weir at the elevation of maximum ponding. Offline: Only treated volume is diverted to system—install a diversion structure or allow bypass of high flows.
	15 Multi-Use Benefits Provide features to enhance aesthetics and public education.



A surface sand filter captures and filters runoff diverted from a parking lot at the University of Texas at San Antonio.

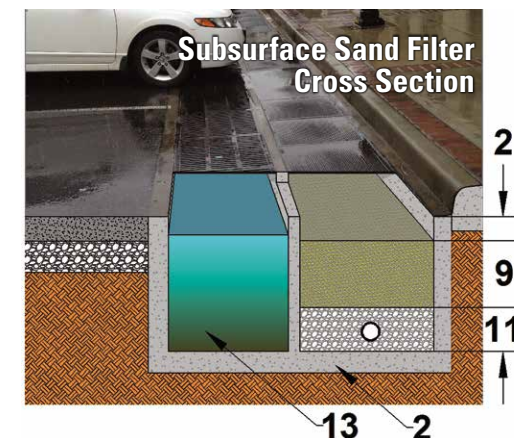

A subsurface sand filter captures parking lot runoff in a sedimentation chamber for pretreatment. Flow then passes through slots in the divider wall into the sand filter chamber.

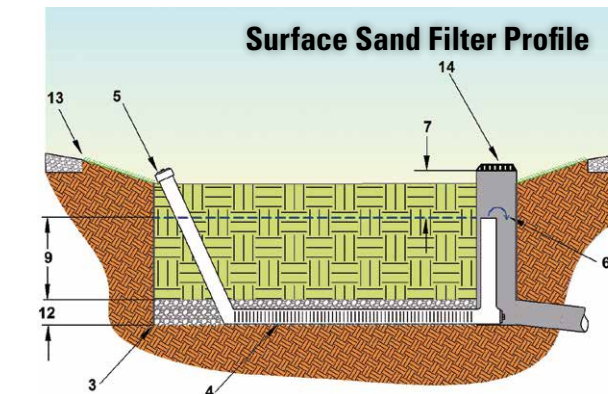

Maintenance Considerations (see Appendix F for detailed checklist)

Task	Frequency	Indicator Maintenance is Needed	Maintenance Notes
Catchment inspection	Weekly or biweekly with routine property maintenance	Excessive sediment, trash, and/or debris accumulation on the surface of sand filter.	Permanently stabilize any exposed soil and remove any accumulated sediment. Adjacent pervious areas may need to be regarded.
Inlet inspection	Once after first major rain of the season, then every 2 to 3 months depending on observed sediment and debris loads	Debris or sediment has blocked inlets.	Remove any accumulated material.
Sedimentation chamber/forebay inspection	Every two months	Sediment has reached 6-inches-deep (install a fixed vertical sediment depth marker) or litter and debris has clogged weirs between sedimentation chamber and sand filter chamber (for subsurface filters).	Remove accumulated material from sedimentation chamber. Remove and replace top 2 to 3 inches of sand filter if necessary.
Sand filter surface infiltration inspection	After major storm events or biannually	Surface ponding draws down in greater than 48 hours.	Remove and replace top 2 to 3 inches of sand filter, or as needed to restore infiltration capacity. Inspect watershed for sediment sources.
Outlet inspection	Once after first major rain of the season, then monthly	Erosion or sediment deposition at outlet.	Check for erosion at the outlet and remove any accumulated sediment.
Miscellaneous upkeep	12 times/year		Tasks include trash collection, spot weeding, soil media replacement, and removal of visual contamination.

Description

Sand filters are filtering BMPs that can be installed on the surface or subsurface. They remove pollutants by filtering stormwater vertically through a sand media and can also be designed for infiltration. Although they function similar to bioretention, sand filters lack the pollutant removal mechanisms provided by the biological activity and fine clay particles found in bioretention media.

Treatment Efficiency

Runoff Volume	Low
Sediment	High
Nutrients	Low
Pathogens	Medium
Metals	Low
Oil & Grease	Medium
Organics	Medium



Siting and Suitability

Stormwater wetlands are typically constructed in the lowest elevation of a site to convey runoff via gravity flow and to minimize excavation requirements. However, sufficient elevation gradient to the existing stormwater network is required to discharge effluent. Constructed wetlands can be incorporated along the perimeter of a site by designing a long, linear footprint, or can serve as an attractive amenity in common areas of developments. If the entire design volume cannot be stored in a single location or if utility conflicts are apparent, wetland pockets can be distributed between several locations and connected with vegetated channels and/or buried conduit. Most importantly, proper function of stormwater wetlands relies on the adequate supply of groundwater, baseflow, or runoff to maintain permanent pools during dry periods. Stormwater wetlands can provide additional site benefits, such as public/youth education and wildlife habitat, and be incorporated as part of open space plans across various land uses.

Drainage Area: A 10-acre minimum drainage area is recommended.

Aquifer Protection Zones and Karst: Use impermeable liner to protect subsurface resources and prevent sinkholes.

Head Requirements: Wetlands typically require a minimum of 3.0 ft of elevation difference.

Slopes: Interior side slopes above the shallow water zone should be 3:1 (H:V) or flatter. 2:1 side slopes are appropriate within the deep pool zones.

Setbacks: Provide 10-ft setback from structures/foundations, 100-ft setback from septic fields and water supply wells, and 50-ft setback from steep slopes.

Areas of Concern: Within residential, school, and other uncontrolled public areas, safety measures such as a protective perimeter fence should be considered.

Design Considerations & Specifications (see Appendix B for details)

Design Component	General Specification
BMP Function	1 Water Balance: Evapotranspiration/Infiltration Rate of water loss during dry months should not exceed supply from groundwater, baseflow, or runoff to ensure water is maintained in permanent pools.
	2 Sediment Forebay Forebay should be 18- to 36-inches-deep, 10% of the temporary ponding surface area, and should be lined with riprap for energy dissipation.
	3 Maximum Flow Path The minimum length-to-width (L:W) ratio should be 2:1, but L:W should be maximized by creating a sinuous flow path and placing the outlet as far from the inlet as possible.
	4a Wetland Zones Deep Pools: 15–20% of wetland surface area (including forebay), 18- to 36-inches-deep.
	4b Transition: 10–15% of wetland surface area, transition between deep pool and shallow water, 12–18 inches deep, maximum slopes of 1.5:1.
	4c Shallow Water: 40% of wetland surface area, 3- to 6-inches-deep, flat or 6:1 slope (at least 6-foot radius around all deep pools to provide safety shelf).
4d Temporary Ponding: 30–40% of wetland surface area, up to 12-inches-deep, 3:1 slopes.	
4e Detention Storage/Upland: Additional ponding depth can be provided for peak flow mitigation, as needed, but depth should generally not exceed 4 feet above the permanent pool elevation.	
5 Temporary Ponding Depth Provide 6–12 inches temporary ponding above normal pool.	
6 Drawdown Time Drawdown orifice is designed to discharge the water quality volume in 2 to 5 days (longer times maximize treatment efficiency).	
Topsoil	7 Topsoil Depth 1–4 inches of topsoil should be applied to support plant growth. Depth depends on specified plantings and underlying soil characteristics.
	8 Topsoil Composition Natural, friable soil representative of productive, well-drained soils in the area. It shall be free of subsoil, stumps, rocks larger than 1-inch diameter, brush weeds, toxic substances, and other material detrimental to plant growth. Low phosphorus (TP < 15 ppm) with pH 5.5–7.
Routing	9 Outlet Configuration Online: All runoff is routed through the wetland basin—install an elevated riser structure or weir with an orifice at the permanent pool elevation and an overflow at the maximum temporary ponding elevation. Offline: Runoff in excess of the design water quality volume bypasses the wetland.
	10 Design Drawdown Orifice Non-clogging orifices should feature a downturned pipe that extends 6 to 12 inches below the permanent pool elevation in an area of open water (deep pool).
	11 Outfall Pipe and Emergency Overflow The outlet barrel should incorporate an anti-seepage device as appropriate to prevent lateral seepage, and discharge to an adequately stabilized area; an emergency spillway should be provided to safely bypass extreme flood flows.
Landscape	12 Maintenance/Emergency Dewatering Design A protected inlet should be provided near the base of the outlet structure with a tamper-proof manual valve (intake should be sized one standard pipe size larger than needed to dewater the basin in 24 hours).
	13 Vegetation Primarily annual and perennial wetland plants specified by zones.
14 Multi-Use Benefits Include features to enhance habitat, aesthetics, recreation, and public education as desired.	

Maintenance Considerations (see Appendix F for detailed checklist)

Task	Frequency	Indicator Maintenance is Needed	Maintenance Notes
Forebay Inspection	Weekly or biweekly	Internal erosion or excessive sediment, trash, and/or debris accumulation	Check for sediment accumulation to ensure that forebay capacity is as designed. Remove any accumulated sediment.
Basin Inspection	1 time/year	Excessive sediment, trash, and/or debris accumulation in the wetland	Remove any accumulated sediment. Adjacent pervious areas may need to be re-graded.
Outlet Inspection	Weekly or biweekly with routine property maintenance	Accumulation of litter and debris within wetland area, large debris around outlet, internal erosion	Litter, leaves, and debris should be removed to reduce the risk of outlet clogging and to improve facility aesthetics. Erosion should be repaired and stabilized.
Mowing	2-12 times/year	Overgrown vegetation on embankment or adjacent areas	Frequency depends on location and desired aesthetic appeal.
Embankment Inspection	1 time/year	Erosion at embankment	Repair eroded areas and re-vegetate.
Remove and Replace Dead Vegetation	1 time/year	Dead plants or excessive open areas in wetland	Within the first year, 10 percent of plants can die. Survival rates increase with time.
Temporary Watering	1 time/2–3 days for first 1–2 months	Until establishment and during severely-droughty weather	Watering after the initial year might be required.

Typical Wetland Plan

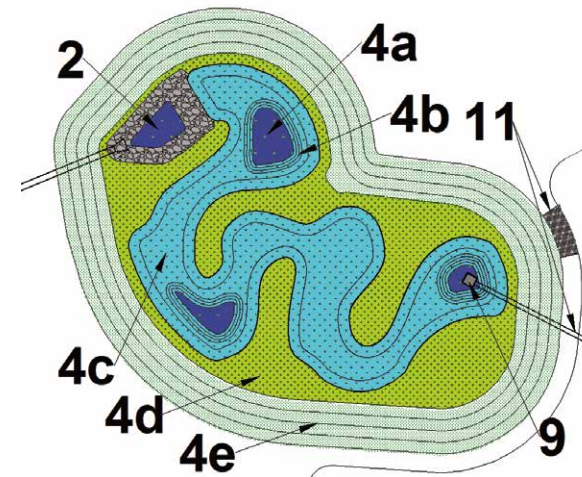

Typical Stormwater Wetland Profile

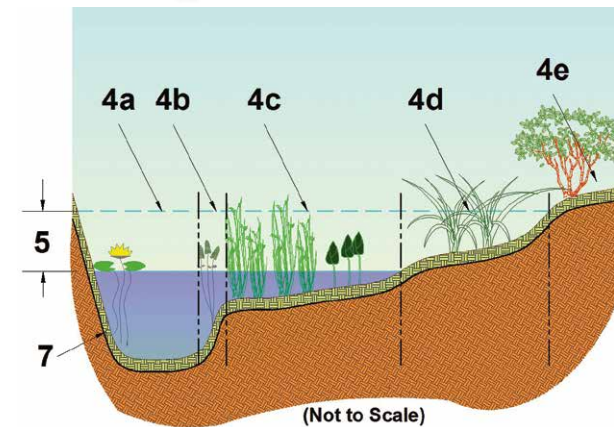

Diverse wetland zones provide important water quality functions and ecosystem services. To enhance plant survival, vegetation should be carefully selected for the water depth and hydroperiod of each zone.

Description

Constructed stormwater wetlands are basins that retain a permanent body of shallow water that facilitates the growth of a range of dense wetland vegetation. Constructed to mimic the functions of natural wetlands, stormwater wetlands are a multi-functional, bio-diverse BMP that employ a range of pollutant removal mechanisms. Wetlands create a shallow matrix of sediment, plants, water, and detritus that collectively remove multiple pollutants through a series of complementary physical, chemical, and biological processes. Despite having a higher land requirement as compared to other detention-based BMPs, stormwater wetlands are one of the best practices for removing TSS, nitrogen, and phosphorus while also providing stormwater peak flow attenuation. In addition to their water quality function, stormwater wetlands can also improve site aesthetics and provide an excellent habitat for wildlife and waterfowl.

Treatment Efficiency

Runoff Volume	Low	Bacteria	High
TSS	High	Nutrients	Medium
Trash/debris	High	Heavy Metals	High
Organics	High	Oil & Grease	High



TETRA TECH



SAN ANTONIO
RIVER AUTHORITY
Leaders in Watershed Solutions

Siting and Suitability

Cisterns should be placed near a roof downspout, but can also be located remotely if a “wet conveyance” configuration is used. The structural capacity of soils should be investigated to determine whether a footer is needed. Cisterns are available commercially in numerous sizes, shapes, and materials. The configuration will be determined by available space, intended reuse strategy, and aesthetic preference. An overflow mechanism is important to prevent water from backing up onto rooftops—overflow should be conveyed in a safe direction away from building foundations.

Drainage Area: Rooftop area.

Aquifer Protection Zones and Karst:

Harvested water may be used for irrigation only if irrigated area contains at least 12 inches of native soil. No runoff should result from irrigation.

Existing Buildings: Ideally, cistern overflows should be set away from building foundations at least 5 feet.

Water Table: The seasonal high water table should be located below the bottom of the cistern, particularly underground cisterns, to prevent buoyant forces from affecting the cistern.

Soil Type: Ensure that the cistern is securely mounted on stable soils. If structural capacity of the site is in question, complete a geotechnical report to determine the structural capacity of soils.

Areas of Concern: Overflow volume or outflow volume should not be directed to areas where infiltration is not desired. Such areas may include *hot spots*, where soils can be contaminated.

Design Considerations & Specifications

(see Appendix B for details)

Design Component	General Specification
Configuration and Function	1 Cistern material and foundation Tanks should typically be opaque to prevent algal growth. A foundation of gravel should be provided if the weight of the cistern at capacity is less than 2000 pounds, otherwise a concrete foundation should be provided.
	2 Conveyance configuration Runoff should be conveyed to the cistern such that no backwater onto roofs occurs during the 100-yr event. Two types of inlet configurations are available: • Dry conveyance: conduit freely drains to cistern with no water storage in pipe • Wet conveyance: a bend in the conduit retains water between rainfall events (allows cistern to be placed further from buildings)
	3 Inlet filter A self-cleaning inlet filter should be provided to strain out large debris such as leaves. Some systems incorporate built-in bypass mechanisms to divert high flows.
	4 First flush diverter A passive first flush diverter should be incorporated in areas with high pollutant loads to capture the first washoff of sediment, debris, and pollen during a rainfall event. First flush diverters are typically manually dewatered between events.
	5 Low-flow outlet An outlet should be designed to dewater the water quality storage volume to a vegetated area in no less than 2 days. The elevation of the outlet depends on the volume of water stored for alternative purposes.
	6 Overflow or bypass Emergency overflow (set slightly below the inlet elevation) or bypass must be provided to route water safely out of the cistern when it reaches full capacity.
Reuse and Safety	7 Signage Signage indicating: “Caution: Reclaimed Water, Do Not Drink” (preferably in English and Spanish) must be provided anywhere cistern water is piped or outlets.
	8 Pipe color and locking features All pipes conveying harvested rainwater should be Pantone color #512 and be labeled as reclaimed water. All valves should feature locking features.
	9 Routing water for use Regardless of gravity or pumped flow, adequate measures must be taken to prevent contamination of drinking water supplies.
	10 Makeup water supply A makeup water supply can be provided to refill the cistern to a desired capacity when harvested water has a dedicated use.
	11 Vector control All inlets and outlets to the cistern must be covered with a 1-mm or smaller mesh to prevent mosquito entry/egress.
Other	12 Multi-use benefits Harvested rainwater should be used to offset potable water uses, such as irrigation, toilet flushing, car washing, etc. Additionally, educational signage and aesthetically-pleasing facades should be specified.

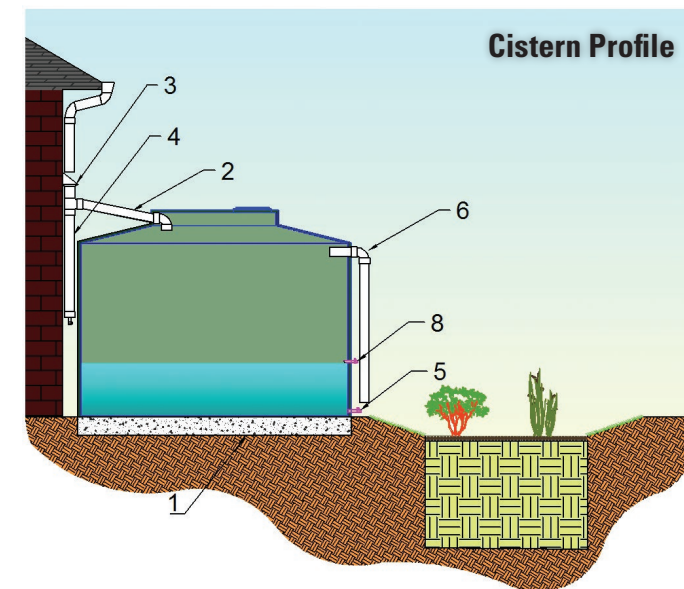

This schematic represents a water harvesting system with dry conveyance (water freely drains from the roof gutter to tank). Water from the low flow drawdown and the overflow are directed away from the building to an adjacent irrigation area.

Maintenance Considerations (see Appendix F for detailed checklist)

Task	Frequency	Indicator Maintenance is Needed	Maintenance Notes
Gutter and rooftop inspection	Biannually and before heavy rains	Inlet clogged with debris	Clean gutters and roof of debris that have accumulated, check for leaks
Remove accumulated debris	Monthly	Inlet clogged with debris	Clean debris screen to allow unobstructed stormwater flow into the cistern
Structure inspection	Biannually	Cistern leaning or soils slumping/eroding	Check cistern for stability, anchor system if necessary
Structure inspection	Annually	Leaks	Check pipe, valve connections, and backflow preventers for leaks
Add ballast	Before any major wind-related storms	Tank is less than half-full	Add water to half full
Miscellaneous upkeep	Annually		Make sure cistern manhole is accessible, operational, and secure

Description

Cisterns are storage vessels that can collect and store rooftop runoff from a downspout for later use. Sized according to rooftop area and desired volume, cisterns can be used to collect both residential and commercial building runoff. By temporarily storing the runoff, less runoff enters the storm water drainage system, thereby reducing the amount of pollutants discharged to surface waters. Additionally, cisterns and their smaller counterpart referred to as rain barrels are typically used in a treatment train system where collected runoff is slowly released into another BMP or landscaped area for infiltration. Because of the peak-flow reduction and storage for potential beneficial uses, subsequent treatment train BMPs can be reduced in size. Cisterns can collect and hold water for commercial uses, most often for non-potable uses such as irrigation or toilet flushing.

Treatment Efficiency

Runoff Volume	Varies based on cistern size and drawdown mechanisms
Water Quality	Water quality improvements depend on downstream practices—high pollutant removal can be achieved if paired with an infiltrating or filtering practice



Appendix E. Plant List

The following plant list was created to guide users of this manual in general selection of appropriate plants for the region. However, plant species commonly grown in landscape areas in San Antonio will grow differently in BMP applications, especially where amended or engineered soils are used. Please see the individual BMP design guidance in Appendix B before selecting plants. Plant selection and care is also dependent upon other factors such as microclimate, soil, rainfall, season, placement (e.g., north side of building), density, efficiency, and use. A knowledgeable landscape architect, horticulturalist, botanist, ecologist or arborist, preferably with experience in the San Antonio area, should be consulted for final plant selection. In addition, local tree preservation and landscaping regulations may limit the use of certain species.

Detailed information about native plants is available from the Native Plant Information Network (NPIN) at <http://www.wildflower.org/explore/>. To find a plant's county-by-county distribution, please search the USDA's Plants Database at: <http://plants.usda.gov/>. To find native plant suppliers in your area, visit <http://www.wildflower.org/suppliers/>.

Common name	Scientific name	Native to Central TX ¹	Size		Evergreen (E) or Deciduous (D)	Lifespan / Duration (Annual [A], Perennial [P], Biennial [B])	Light			Drought tolerant	Soil Moisture				Irrigation ²	Comments
			Height	Spread			Sun	Part sun/shade	Shade		Dry	Moist	Wet	Shallow water		
SHADE TREES															1/4" - 3/4"	
American elm	<i>Ulmus americana</i>	✓	72'-90'	50'-70'	D	200+ yrs	✓	✓		Semi						
American sycamore	<i>Platanus occidentalis</i>		75'-100'	50'-70'	D	200+ yrs	✓	✓	✓	Semi						
Arizona ash	<i>Fraxinus velutina</i>		36'-72'	45'-60'	D	30+ yrs	✓			✓					-	Fast-growing
Bald cypress	<i>Taxodium distichum</i>	✓	50'-75'	30'-60'	D	600+ yrs	✓	✓		Semi					+	
Black walnut	<i>Juglans nigra</i>	✓	72'-100'	72'-100'	D	100+ yrs	✓	✓		Semi						Certain plants sensitive to tannins from walnut husks
Black willow	<i>Salix nigra</i>	✓	36'-72'	36'-72'	D	65+ yrs	✓	✓	✓	Semi					+	Fast-growing
Box elder	<i>Acer Negundo</i>		35'-50'	30'-40'	D	75+ yrs	✓	✓		✓						Fast-growing, susceptible to breakage
Bur oak	<i>Quercus macrocarpa</i>	✓	36'-100'	36'-100'	D	200+ yrs	✓	✓	✓	✓					+	
Canby oak	<i>Quercus canbyi</i>		20'-35'	20'-35'	E	100+ yrs	✓			✓						
Cedar elm	<i>Ulmus crassifolia</i>	✓	50'-70'	40'-60'	D	100+ yrs		✓		✓						Fast growing, long-living
Cottonwood	<i>Populus deltoides</i>	✓	12'-36'	12'-30'	D	100+ yrs	✓	✓	✓	✓					+	Fast-growing, susceptible to breakage
Honey mesquite	<i>Prosopis glandulosa</i>	✓	12'-36'	12'-36'	D	75+ yrs	✓			✓					-	Thorny
Mexican sycamore	<i>Platanus mexicana</i>		40'-50'	30'-35'	D	70+ yrs	✓	✓		✓						Benefits from occasional deep soakings
Montezuma cypress	<i>Taxodium mucronatum</i>		36'-72'	30'-60'	E	700+ yrs		✓		Semi					+	Deciduous in colder climates
Pecan	<i>Carya illinoensis</i>	✓	70'-100'	50'-70'	D	200+ yrs	✓			Semi						Edible fruit, prune to maintain strong branching
Sugarberry/Hackberry	<i>Celtis laevigata</i>	✓	60'-80'	60'-70'	D	60+ yrs		✓		✓					-	
UNDERSTORY & SMALL TREES															1/4" - 3/4"	
Anaqua	<i>Ehretia anacua</i>	✓	20'-45'	20'-45'	E	60+ yrs	✓	✓		✓					-	Edible fruit for wildlife
Guajillo	<i>Acacia berlandieri</i>		3'-15'	3'-15'	D	15+ yrs	✓	✓		✓					-	

Common name	Scientific name	Native to Central TX ¹	Size		Evergreen (E) or Deciduous (D)	Lifespan / Duration (Annual [A], Perennial [P], Biennial [B])	Light			Drought tolerant	Soil Moisture				Irrigation ²	Comments
			Height	Spread			Sun	Part sun/shade	Shade		Dry	Moist	Wet	Shallow water		
Huisache	<i>Acacia farnesiana</i>	✓	15'-25'	15'-25'	D	30+ yrs	✓			✓					-	Thorny, forms dense thickets through suckers
Mexican buckeye	<i>Ungnadia speciosa</i>	✓	20'-30'	15'-20'	E	60+ yrs		✓		✓						Seeds toxic if eaten
Mexican plum	<i>Prunus mexicana</i>	✓	15'-35'	15'-35'	D	25+ yrs	✓	✓		✓						Edible fruit
Red mulberry	<i>Morus rubra</i>	✓	12'-36'	10'-30'		50+ yrs	✓	✓	✓	✓						Ripened fruit edible, toxic: leaves, stems, unripened fruit
Retama	<i>Parkinsonia aculeata</i>	✓	12'-36'	15'-40'	D	15+ yrs	✓			✓						Thorny, self-seeds aggressively in moist soils
TX or Mexican redbud	<i>Cercis canadensis</i>	✓	10'-20'	10'-20'	D	20+ yrs	✓	✓		✓					-	
Texas persimmon	<i>Diospyrus texana</i>	✓	15'-35'	15'-35'	E	50+ yrs	✓	✓		✓					-	Edible fruit
SHRUBS											1/4" - 1/2"					
American beautyberry	<i>Callicarpa americana</i>	✓	3'-5'	3'-5'	D	P		✓		Semi						
Black brush acacia	<i>Acacia rigidula</i>	✓	5'-15'	5'-15'	D	P	✓	✓		✓					-	Thorny, suckers readily, often used for erosion control
Buttonbush	<i>Cephalanthus occidentalis</i>	✓	6'-12'	6'-10'	D	P		✓	✓						+	
Chile pequin	<i>Capsicum annuum</i>	✓	1'-2'	1'-2'	D	P	✓	✓	✓	✓						Edible fruit (hot pepper)
Common elderberry	<i>Sambucus nigra ssp. Canadensis</i>	✓	6'-12'	6'-12'	D	P		✓							+	Ripened fruit edible, toxic: leaves, stems, unripened fruit
Dwarf palmetto	<i>Sabal minor</i>	✓	5'-10'	5'-10'	E	P	✓	✓	✓	✓						
False willow	<i>Baccharis neglecta</i>	✓	6'-12'	6'-12'	E	P		✓		✓					-	Semi-evergreen
Illinois bundleflower	<i>Desmanthus illinoensis</i>	✓	2'-3'	1'-2'	D	P	✓			Semi						
Indigo spires salvia	<i>Salvia 'Indigo Spires'</i>		3.5'	3.5'	D	P	✓			✓						

Common name	Scientific name	Native to Central TX ¹	Size		Evergreen (E) or Deciduous (D)	Lifespan / Duration (Annual [A], Perennial [P], Biennial [B])	Light			Drought tolerant	Soil Moisture				Irrigation ²	Comments
			Height	Spread			Sun	Part sun/shade	Shade		Dry	Moist	Wet	Shallow water		
Narrow-leaf water primrose	<i>Ludwigia octovalvis</i>	✓	3'-6'	2'-4'	D	P	✓	✓							+	Fast-growing, reseeds readily
River fern	<i>Thelypteris kunthii</i>	✓	2.5'	1'	E	P		✓	✓	Semi						
Rock rose	<i>Pavonia lasiopetala</i>	✓	4'	4'	D	P	✓	✓		✓					-	
Texas lantana	<i>Lantana urticoides</i> (L. horrida)	✓	2'-6'	2'-6'	E	P	✓	✓		✓					-	Stems become thorny with age
Texas sage	<i>Leucophyllum frutescens</i>	✓	2'-8'	2'-8'	E	P	✓	✓		✓					-	
Texas star hibiscus	<i>Hibiscus coccineus</i>		3'-6'	3'-6'	D	P	✓			Semi					+	
Turk's cap	<i>Malvaviscus arboreus</i> var. <i>drummondii</i>	✓	3'-5'	3'-5'	E	P		✓	✓	✓						
GRASSES & GRASS-LIKE FORBS											1/4"–1/2"³					
Big bluestem	<i>Andropogon gerardii</i>	✓	4'-8'	spreads	E*	P	✓	✓		✓						Droops with high soil moisture
Buffalograss	<i>Bouteloua dactyloides</i>	✓	6"-12"	spreads	E	P	✓			✓					-	Semi-evergreen, spreads by rhizomes
Bushy bluestem	<i>Andropogon glomeratus</i>		2'-5'	spreads	E*	P	✓								+	
Canada wildrye	<i>Elymus canadensis</i>	✓	2'-4'	spreads	E*	P	✓	✓		✓						Establishes quickly
Cane Bluestem	<i>Bothriochloa barbinodis</i>	✓	1'-3'	spreads	E*	P	✓			✓						
Eastern gamagrass	<i>Tripsacum dactyloides</i>	✓	3'-6'	spreads	E	P		✓							+	
Fringed windmillgrass	<i>Chloris ciliata</i>		1'-3'	spreads	E*	P		✓		Semi						
Green sprangletop	<i>Leptochloa dubia</i>	✓	2'-3'	spreads	E*	P	✓	✓		✓						
Gulf Coast muhly grass	<i>Muhlenbergia capillaris</i>	✓	1.5'-3'	1.5'-3'	E*	P	✓			Semi						
Hairy grama	<i>Bouteloua hirsuta</i>	✓	6"-18"	spreads	E*	P		✓		✓					-	

Common name	Scientific name	Native to Central TX ¹	Size		Evergreen (E) or Deciduous (D)	Lifespan / Duration (Annual [A], Perennial [P], Biennial [B])	Light			Drought tolerant	Soil Moisture				Irrigation ²	Comments
			Height	Spread			Sun	Part sun/shade	Shade		Dry	Moist	Wet	Shallow water		
Hooded windmillgrass	<i>Chloris cucullata</i>	✓	6"-24"	spreads	E*	P	✓	✓		Semi						
Indiangrass	<i>Sorghastrum nutans</i>	✓	3'-6'	spreads	E*	P	✓	✓		✓						
Inland sea oats	<i>Chasmanthium latifolium</i>	✓	2'-4'	spreads	E*	P		✓	✓	Semi						Spreads aggressively, often used for erosion control
Horsetail (Scouringrush)	<i>Equisetum hyemale var. affine</i>	✓	2'-4'	spreads	E	P	✓	✓		Semi				+		Spreads aggressively
Lindheimer's muhly	<i>Muhlenbergia lindheimeri</i>	✓	2'-5'	2'-5'	E	P	✓			✓						Semi-evergreen
Liriope	<i>Liriope muscari</i> 'Big Blue'		12"-18"	12"-18"	E	P		✓	✓	✓						
Little bluestem	<i>Schizachyrium scoparium</i>	✓	1.5'-2'	spreads	E*	P	✓	✓		✓						Will not tolerate wetlands
Needle spikerush	<i>Eleocharis acicularis</i>	✓	6"	spreads	E*	A	✓							+		
Plains bristlegrass	<i>Setaria leucopila</i>	✓	3'-6'	spreads	E*	P	✓			✓				-		
Purple threeawn	<i>Aristida purpurea</i>	✓	12"-18"	spreads	E*	A	✓			✓				-		Good for erosion control
Purpletop	<i>Tridens flavus</i>	✓	2'-6'	spreads	E*	P	✓	✓		✓						
Sand lovegrass	<i>Eragrostis trichodes</i>	✓	1'-3'	spreads	E*	P		✓		✓						Adapts to heavier soils
Seep muhly	<i>Muhlenbergia reverchonii</i>	✓	1'-3.5'	1'-3.5'	E	P	✓			✓						
Sideoats grama	<i>Bouteloua curtipendula</i>	✓	1'-3'	spreads	E*	P	✓	✓		✓						State grass of Texas
Slender spikerush	<i>Eleocharis tenuis</i>	✓	1'-3'	spreads	E*	P	✓							+		
Softstem bulrush	<i>Schoenoplectus/Scirpus tabernaemontani</i>	✓	3'-6'	spreads	E*	P	✓							+		Good for habitat reconstruction
Squarestem spikerush	<i>Eleocharis quadrangulata</i>	✓	1.5'-4'	spreads	E*	P	✓							+		
Switchgrass	<i>Panicum virgatum</i>	✓	3'-6'	spreads	E*	P	✓	✓		✓				+		

Common name	Scientific name	Native to Central TX ¹	Size		Evergreen (E) or Deciduous (D)	Lifespan / Duration (Annual [A], Perennial [P], Biennial [B])	Light			Drought tolerant	Soil Moisture				Irrigation ²	Comments
			Height	Spread			Sun	Part sun/shade	Shade		Dry	Moist	Wet	Shallow water		
Texas cupgrass	<i>Eriochloa sericea</i>	✓	1'-2'	spreads	E*	P	✓	✓		✓						Does not grow rhizomously
Texas grama	<i>Bouteloua rigidiseta</i>	✓	6"-12"	spreads	E*	P	✓			✓					-	
Vine mesquite	<i>Panicum obtusum</i>	✓	1'-2'	spreads	E*	P		✓		✓						
Western wheatgrass	<i>Pascopyrum smithii</i>	✓	1'-2.5'	spreads	E*	P	✓	✓		✓						Turf grass, can crowd out other grasses
VINES												1/4"-1/2"				
Alamo vine	<i>Merremia dissecta</i>	✓	6'-12'	4'-10'	D	P	✓	✓		✓						Twining climber, can be aggressive
Carolina snailseed	<i>Cocculus carolinus</i>	✓	3'-15'	3'-15'	D	P		✓		Semi						Spreads vigorously, fast-growing
Mustang grape	<i>Vitis mustangensis</i>	✓	36'-72'	36'-72'	D	P		✓		✓					-	Twining climber, edible fruit
Old man's beard	<i>Clematis drummondii</i>	✓	20'-25'	3'-6'	D	P		✓		✓						
Passionflower	<i>Passiflora foetida v. hirsuta</i>	✓	15'-20'	3'-6'	D	A	✓	✓		✓					-	Twining climber, edible fruit, suckers vigorously
Peppervine	<i>Ampelopsis arborea</i>		30'-40'	30'-40'	E	P	✓	✓		Semi						Semi-evergreen, aggressive, climbing and/or trailing
Trumpet creeper	<i>Campsis Radicans</i>		25'-35'	6'-8'	D	P	✓			✓						Climbs by aerial rootlets, aggressive
Virginia creeper	<i>Parthenocissus quinquefolia</i>	✓	12'-36'	12'-36'	D	P	✓	✓	✓	Semi						High climbing or trailing with tendrils, toxic berries
SMALL FORBS & GROUND COVER												1/2"-1 1/2"				
American basketflower	<i>Centaurea americana</i>	✓	2'-5'	2'-5'	D	A	✓			✓						
American water-willow	<i>Justicia americana</i>	✓	1'-3'	1'-3'	D	P	✓	✓	✓						+	
Annual sunflower	<i>Helianthus annuus</i>	✓	2'-8'	1'-2'	D	A	✓	✓		✓						Spreads rapidly by seed

Common name	Scientific name	Native to Central TX ¹	Size		Evergreen (E) or Deciduous (D)	Lifespan / Duration (Annual [A], Perennial [P], Biennial [B])	Light			Drought tolerant	Soil Moisture				Irrigation ²	Comments
			Height	Spread			Sun	Part sun/shade	Shade		Dry	Moist	Wet	Shallow water		
Autumn sage (salvia)	<i>Salvia gregii</i>	✓	2.5'	2.5'	E	P	✓			✓					-	Stems brittle - avoid foot traffic
Bee blossom	<i>Gaura suffulta</i>	✓	1'-3'	1'-2'	D	A	✓			Semi						
Black-eyed Susan	<i>Rudbeckia hirta</i>	✓	1'-3'	1.5'-2'	D	A	✓	✓		✓						
Blackfoot daisy	<i>Melampodium leucanthum</i>	✓	6"-12"	1'-2'	D	P	✓	✓		✓						
Blue curls	<i>Phacelia congesta</i>	✓	1'-3'	2'-3'	D	A	✓	✓	✓	✓						Best if sheltered from west sun, stem is brittle
Broadleaf arrowhead	<i>Sagittaria latifolia</i>		1'-3'	1'-3'	D	P	✓	✓							+	
Bulbine	<i>Bulbine frutescens</i>		1'-2'	2'-3'	E	P	✓	✓		✓					-	
Bush sunflower	<i>Simsia calva</i>	✓	1'-3'	1'-3'	D	P	✓			✓					-	
Butterflyweed	<i>Asclepias tuberosa</i>		1'-2'	1'-2'	D	P	✓	✓		✓						Roots and plant sap are toxic
Clasping leaf coneflower	<i>Dracopis amplexicaulis</i>	✓	1'-2'	1'-2'	D	A	✓	✓		Semi						
Cowpen daisy	<i>Verbesina encelioides</i>	✓	1'-3'	1'-2'	D	A	✓			✓					-	
Drummond phlox	<i>Phlox drummondii</i>	✓	6"-18"	6"-18"	D	A	✓	✓		✓						
Drummond's woodsorrel	<i>Oxalis drummondii</i>	✓	6"-12"	6"-12"	D	P	✓	✓		✓						
Engelmann's daisy	<i>Engelmannia peristenia</i>	✓	1.5'-2'	1'-3'	E	P		✓	✓	✓						
Foxglove	<i>Penstemon cobaea</i>	✓	1'-2'	1'-2'	D	P	✓	✓		✓						May go dormant during summer
Frogfruit	<i>Phyla nodiflora</i>	✓	3"-6"	3"-6"	E	P	✓	✓	✓	✓					+	Semi-evergreen, tolerates drought and flooding
Gayfeather	<i>Liatris mucronata</i>	✓	1'-3'	1'-2'	D	P	✓	✓		✓					-	Excessive water causes root rot
Golden wave	<i>Coreopsis basilis</i>	✓	6"-18"	6"-18"	D	A	✓	✓		✓						

Common name	Scientific name	Native to Central TX ¹	Size		Evergreen (E) or Deciduous (D)	Lifespan / Duration (Annual [A], Perennial [P], Biennial [B])	Light			Drought tolerant	Soil Moisture				Irrigation ²	Comments
			Height	Spread			Sun	Part sun/shade	Shade		Dry	Moist	Wet	Shallow water		
Greenthread	<i>Thelesperma filifolium</i>	✓	1'-3'	1'-2'	D	A	✓			✓					-	
Hill Country rain lily	<i>Cooperia pedunculata</i>	✓	6"-12"	3"-6"	D	P	✓			Semi						Blooms after rain
Horsemint	<i>Monarda citriodora</i>	✓	1'-2'	1'-2'	D	A	✓	✓		✓						
Huisache daisy	<i>Amblyolepis setigera</i>	✓	6"-15"	6"-15"	D	A	✓	✓		✓						
Indian blanket	<i>Gaillardia pulchella</i>	✓	12"-18"	12"-18"	D	A	✓	✓		✓						
Indian paintbrush	<i>Castilleja coccinea</i>		1'-2'	6"-9"	D	A	✓			Semi						
Lanceleaf coreopsis	<i>Coreopsis lanceolata</i>		1'-2.5'	1'-2'	E	P	✓	✓	✓	✓						Not reliably perennial, but self-sows readily
Lindheimers senna	<i>Senna lindheimeriana</i>	✓	1'-3'	3'-6'	D	P	✓	✓		✓					-	
Maximilian sunflower	<i>Helianthus maximiliani</i>	✓	4'-6'	3'-6'	D	P	✓	✓		Semi						
Mealy blue sage	<i>Salvia farinacea</i>	✓	2'-3'	1'-2'	D	P	✓	✓		✓					-	
Mexican hat	<i>Ratibida columnifera</i>	✓	1'-3'	1'-2'	D	P	✓	✓		✓						Can be aggressive
Money plant, water pennywort	<i>Hydrocotyle umbellata</i>		3"-10"	3"-10"	D	P	✓	✓	✓						+	Can absorb pollutants
Obedient plant	<i>Physostegia intermedia</i>	✓	1'-5'	1'-3'	D	P	✓	✓	✓						+	
Partridge pea	<i>Cassia/Chamaecrista fasciculata</i>		1'-3'	1'-3'	D	A	✓	✓		✓						
Pickerelweed	<i>Pontederia cordata</i>	·	3'-4'	2'-3'		P	✓	✓							+	
Pigeonberry	<i>Rivina humilis</i>	✓	6"-18"	2'-3'	D	P		✓		Semi						Toxic if ingested
Pink evening primrose	<i>Oenothera speciosa</i>	✓	1'-2'	1'-2'	E	P	✓	✓		✓						Semi-evergreen
Pitcher sage	<i>Salvia azurea</i>	✓	2'-4'	1'-3'	D	P	✓	✓		✓						
Plains coreopsis	<i>Coreopsis tinctoria</i>	✓	1'-2'	6"-12"	D	A	✓	✓		Semi						
Prairie verbena	<i>Glandularia bipinnatifida</i>	✓	6"-12"	6"-12"	D	P	✓	✓		✓						
Purple coneflower	<i>Echinacea purpurea</i>		2'-4'	2'-4'	D	P	✓	✓		✓					-	
Purple Iris	<i>Iris brevicaulis</i>		1'-2'	1'-2'	D	P		✓	✓	Semi					+	

Common name	Scientific name	Native to Central TX ¹	Size		Evergreen (E) or Deciduous (D)	Lifespan / Duration (Annual [A], Perennial [P], Biennial [B])	Light			Drought tolerant	Soil Moisture				Irrigation ²	Comments
			Height	Spread			Sun	Part sun/shade	Shade		Dry	Moist	Wet	Shallow water		
Purple prairie clover	<i>Dalea purpurea</i>	✓	1'-3'	1'-2'	D	P	✓			✓						
River primrose	<i>Oenothera jamesii</i>	✓	3'-6'	3'-6'	D	B	✓							+		
Scarlet sage	<i>Salvia coccinea</i>	✓	6"-24"	6"-24"	E	P	✓	✓		Semi						Semi-evergreen
Scrambled eggs	<i>Corydalis aurea</i>		6"-12"	9"-24"	D	A	✓			Semi						
Standing cypress	<i>Ipomopsis rubra</i>	✓	2'-4'	1'-2'	D	B	✓	✓		✓				-		
Straggler daisy	<i>Calyptocarpus vialis</i>	✓	6"-12"	2'-3'	E	P	✓	✓	✓	✓						Semi-evergreen
Texas betony	<i>Stachys coccinea</i>		2.5'	2.5'	D	P		✓		Semi						
Texas bluebonnet	<i>Lupinus texensis</i>	✓	6"-18"	6"-18"	D	A	✓			✓						State flower of Texas
Texas vervain	<i>Verbena halei</i>	✓	1'-3'	15"	D	P	✓			✓				-		
Water hyssop	<i>Bacopa monnieri</i>	✓	6"-12"	6"-12"	D	P	✓	✓						+		
White guara	<i>Gaura lindheimeri</i>		2'-5'	1'-3'	D	P	✓	✓		Semi						Can aggressively overtake other plants
White prairie clover	<i>Dalea candida</i>	✓	1'-2'	1'-2'	D	P	✓			✓						
White pricklypoppy	<i>Argemone albiflora</i>	✓	2'-4'	2'-4'	D	A	✓	✓		✓						Toxic foliage, can absorb pollutants
Widow's tears	<i>Commelina erecta</i>	✓	6"-18"	6"-18"	D	P		✓		✓						
Wild petunia	<i>Ruellia nudiflora</i>	✓	1'-2'	1'-2'	D	P	✓	✓	✓	✓						
Winecup	<i>Callirhoe involucrata</i>	✓	6"-12"	1'-2'	E	P	✓	✓		✓						Semi-evergreen

* Year-round leaf retention, but foliage loses color during dormancy

¹ Designates species definitively native to Central Texas. All other species listed are native to at least one region in the State of Texas. Exceptions: Canby Oak, Texas Star Hibiscus, Indigo Spires, Bulbine, and Liriope

² For establishment estimate purposes. Does not account for possible rainfall. + /- indicates individual species demands relative to noted categorical range and is dependent upon other factors such as microclimate, soil, rainfall, season, placement, density, efficiency, and use.

³ Turf grasses have significantly higher water demands at 3/4" - 2" (weekly).

This page is intentionally blank.

Appendix F. Inspection and Maintenance Checklists

Infiltration BMPs

Bioretention
Bioswale
Permeable Pavement

Filtration BMPs

Planter Box
Green Roof
Sand Filter

Volume-Storage and Reuse BMPs

Cistern
Stormwater Wetland

Connectivity

Vegetated Filter Strip
Vegetated Swale

<h2 style="margin: 0;">Inspection and Maintenance Checklist</h2> <h1 style="margin: 10px 0 0 0;">BIORETENTION</h1>	Property Address _____
	Property Owner _____
	Treatment Measure No. _____ Inspection Date _____
	Inspector(s) _____
	Type of Inspection: <input type="checkbox"/> Monthly <input type="checkbox"/> Pre-wet season <input type="checkbox"/> Post-wet season <input type="checkbox"/> After heavy runoff <input type="checkbox"/> Other: _____

Defect	Conditions when maintenance is needed	Maintenance needed?	Comments ^a	Results expected when maintenance is performed
1. Standing water	Water stands in the bioretention area between storms and does not drain within 24 hours after rainfall.			There should be no areas of standing water once inflow has ceased. Any of the following could apply: sediment or trash blockages removed, grade from head to foot of bioretention area improved, media surface scarified, underdrains flushed.
2. Trash and debris	Trash and debris accumulated in the bioretention area and around the inlet and outlet.			Trash and debris removed from the bioretention area and disposed of properly.
3. Sediment	Evidence of accumulated sediment in the bioretention area.			Material removed so that there is no clogging or blockage. Material is disposed of properly.
4. Erosion	Channels have formed around inlets, there are areas of bare soil, or there is other evidence of erosion.			Obstructions and sediment removed so that water flows freely and disperses over a wide area. Obstructions and sediment are disposed of properly.
5. Vegetation	Vegetation is dead, diseased or overgrown.			Vegetation is healthy and attractive. Grass is maintained at least 3 inches in height.
6. Mulch	Mulch is missing or patchy. Areas of bare earth are exposed or mulch layer is less than 3 inches deep.			All bare earth is covered, except mulch is kept 6 inches away from trunks of trees and shrubs. Mulch is even at a depth of 3 inches.
7. Inlet/outlet	Sediment accumulations.			Inlet/outlet is clear of sediment and debris and allows water to flow freely.
8. Miscellaneous	Any condition not covered above that needs attention for the bioretention area to function as designed.			The design specifications are met.

^a Describe the maintenance completed; if the needed maintenance was not conducted, note when it will be done.

<h2 style="margin: 0;">Inspection and Maintenance Checklist</h2> <h1 style="margin: 10px 0 0 0; color: white;">BIOSWALE</h1>	Property Address _____ Property Owner _____ Treatment Measure No. _____ Inspection Date _____ Inspector(s) _____ Type of Inspection: <input type="checkbox"/> Monthly <input type="checkbox"/> Pre-wet season <input type="checkbox"/> Post-wet season <input type="checkbox"/> After heavy runoff <input type="checkbox"/> Other: _____
--	--

Defect	Conditions when maintenance is needed	Maintenance needed?	Comments ^a	Results expected when maintenance is performed
1. Standing water	Water stands in the bioswale between storms and does not drain within 24 hours after rainfall.			There should be no areas of standing water once inflow has ceased. Any of the following could apply: sediment or trash blockages removed, grade from head to foot of bioretention area improved, media surface scarified, underdrains flushed.
2. Trash and debris	Trash and debris accumulated in the bioswale and around the inlet and outlet.			Trash and debris removed from the bioswale and disposed of properly.
3. Sediment	Evidence of accumulated sediment in the bioswale.			Material removed so that there is no clogging or blockage. Material is disposed of properly.
4. Erosion	Channels have formed around inlets, there are areas of bare soil, or there is other evidence of erosion.			Obstructions and sediment removed so that water flows freely and disperses throughout the bioswale. Obstructions and sediment are disposed of properly.
5. Vegetation	Vegetation is dead, diseased, or overgrown.			Vegetation is healthy and attractive. Grass is maintained at least 3 inches in height.
6. Mulch (if used)	Mulch is missing or patchy. Areas of bare earth are exposed or mulch layer is less than 3 inches deep.			All bare earth is covered, except mulch is kept 6 inches away from trunks of trees and shrubs. Mulch is even at a depth of 3 inches.
7. Inlet/outlet	Sediment or debris accumulations.			Inlet/outlet is clear of sediment and debris and allows water to flow freely.
8. Miscellaneous	Any condition not covered above that needs attention for the bioswale to function as designed.			The design specifications are met.

^a Describe the maintenance completed; if the needed maintenance was not conducted, note when it will be done.

<p>Inspection and Maintenance Checklist</p> <p>PERMEABLE PAVEMENT</p>	Property Address _____
	Property Owner _____
	Treatment Measure No. _____ Inspection Date _____
	Inspector(s) _____
	Type of Inspection:
	<input type="checkbox"/> Monthly <input type="checkbox"/> Pre-wet season <input type="checkbox"/> Post-wet season ____ <input type="checkbox"/> After heavy runoff
	<input type="checkbox"/> Other: _____

Defect	Conditions when maintenance is needed	Maintenance needed?	Comments ^a	Results expected when maintenance is performed
1. Standing water	When water stands on the surface of the permeable pavement and 48 hours has passed since the last rainfall.			There should be no areas of ponded/standing water more than 48 hours after a rain event. Any of the following can apply: surface swept or vacuumed, underdrains added, underdrains cleaned.
2. Trash and debris	Leaves, grass clippings, trash, etc., are preventing water from draining into the permeable pavement and are unsightly.			Area is free of all debris and the permeable pavement is draining properly.
3. Vegetation	Vegetation around the perimeter of the permeable pavement is dead, diseased, or overgrown. Weeds are growing on the surface of the permeable pavement.			Area adjacent to pavement is well-maintained and no bare/exposed areas exist; grass is maintained at a height of 3–6 inches. No weeds present in the pavement area.
4. Deteriorating surface	The pavement is cracked; paver blocks are misaligned or have settled.			The surface area is stabilized, exhibiting no signs of cracks or uneven areas in the pavement area.
5. Miscellaneous	Any condition not covered above that needs attention for the permeable pavement area to function as designed.			The design specifications are met.

^a Describe the maintenance completed; if the needed maintenance was not conducted, note when it will be done.

Inspection and Maintenance Checklist

PLANTER BOX

Property Address _____
 Property Owner _____
 Treatment Measure No. _____ Inspection Date _____
 Inspector(s) _____
 Type of Inspection:
 Monthly Pre-wet season Post-wet season After heavy runoff
 Other: _____

Defect	Conditions when maintenance is needed	Maintenance needed?	Comments ^a	Results expected when maintenance is performed
1. Standing water	When water stands in the planter box between storms and does not drain within 24 hours after rainfall.			There should be no areas of standing water after inflow has ceased. Any of the following could apply: sediment or trash blockages removed, mulch replaced, soil media surface scarified, underdrains flushed.
2. Trash and debris	Trash and debris accumulated in the planter box and around the inlet and outlet.			Trash and debris removed and disposed of properly.
3. Sediment	Evidence of accumulated sediment in the planter box.			Material removed so that there is no clogging or blockage. Material is disposed of properly.
4. Erosion	Channels have formed around inlets, there are areas of bare soil, or there is other evidence of erosion.			Obstructions and sediment removed so that water flows freely and disperses over a wide area. Obstructions and sediment are disposed of properly.
5. Vegetation	Vegetation is dead, diseased, or overgrown.			Vegetation is healthy and attractive. Grass maintained at least 3 inches in height.
6. Mulch	Mulch is missing or patchy; areas of bare earth are exposed, or mulch layer is less than 3 inches deep.			All bare earth is covered, except mulch is kept 6 inches away from trunks of trees and shrubs. Mulch is even at a depth of 3 inches.
7. Inlet/outlet	Sediment or debris accumulations.			Inlet/outlet is clear of sediment and debris and allows water to flow freely.
8. Affected impervious areas or structures	Obvious effects on surrounding impervious areas or structures.			Hydraulic restriction layers prevent impacts from infiltration to surrounding structures.
9. Miscellaneous	Any condition not covered above that needs attention for the planter box to function as designed.			The design specifications are met.

^a Describe the maintenance completed; if the needed maintenance was not conducted, note when it will be done.

<h2 style="margin: 0;">Inspection and Maintenance Checklist</h2> <h1 style="margin: 20px 0 0 0;">GREEN ROOF</h1>	Property Address _____
	Property Owner _____
	Treatment Measure No. _____ Inspection Date _____
	Inspector(s) _____
	Type of Inspection: <input type="checkbox"/> Monthly <input type="checkbox"/> Pre-wet season <input type="checkbox"/> Post-wet season ____ <input type="checkbox"/> After heavy runoff <input type="checkbox"/> Other: _____

Defect	Conditions when maintenance is needed	Maintenance needed?	Comments ^a	Results expected when maintenance is performed
1. Standing water	Roof drainage system is clogged.			There should be no areas of standing water on the green roof. The drainage system is inspected for clogging conditions and repaired or replaced as needed.
2. Erosion	Areas of scoured media or bare roof.			Green roof media stays in place and does not migrate across or erode from roof surface. Eroded media replaced and re-vegetated. If problem is recurrent, consider media more resistant to wind erosion or installing media retention components.
3. Vegetation	Vegetation is dead, missing, incorrect or unwanted.			Areas of missing vegetation replanted. Plant species are appropriate to conditions and drainage system is functioning properly. If problem is recurrent, consider irrigation during establishment or use alternative species. Unwanted vegetation removed and replaced with appropriate species. Evaluate growing conditions for cause of invasive vegetation.
4. Leaking roof	Roof liner has failed.			Evaluate liner for cause of leaks. Repair or replace as necessary.

^a Describe the maintenance completed; if the needed maintenance was not conducted, note when it will be done.

<h2 style="margin: 0;">Inspection and Maintenance Checklist</h2> <h1 style="margin: 10px 0 0 0; font-size: 2em;">SAND FILTER</h1>	Property Address _____ Property Owner _____ Treatment Measure No. _____ Inspection Date _____ Inspector(s) _____ Type of Inspection: <input type="checkbox"/> Monthly <input type="checkbox"/> Pre-wet season <input type="checkbox"/> Post-wet season <input type="checkbox"/> After heavy runoff <input type="checkbox"/> Other: _____
---	--

Defect	Conditions when maintenance is needed	Maintenance needed?	Comments ^a	Results expected when maintenance is performed
1. Standing water	When water stands over the sand filter media between storms and does not drain within 24 hours after rainfall.			There should be no areas of standing water after inflow has ceased. Any of the following could apply: sediment or trash blockages removed, filter media surface scarified, underdrains flushed, media replaced.
2. Trash and debris	Trash and debris accumulated in the sand filter and around the inlet and outlet.			Trash and debris removed from filter and disposed of properly.
3. Sediment	Evidence of accumulated sediment in the sand filter.			Material removed so that there is no clogging or blockage. Material is disposed of properly.
4. Erosion	Channels have formed around inlets, there are areas of bare soil, or there is other evidence of erosion.			Obstructions and sediment removed so that water flows freely and disperses throughout the sand filter media. Obstructions and sediment are disposed of properly.
5. Inlet/outlet	Sediment or debris accumulations.			Inlet/outlet is clear of sediment and debris and allows water to flow freely.
6. Miscellaneous	Any condition not covered above that needs attention for the sand filter to function as designed.			The design specifications are met.

^a Describe the maintenance completed; if the needed maintenance was not conducted, note when it will be done.

<h2 style="margin: 0;">Inspection and Maintenance Checklist</h2> <h1 style="margin: 20px 0 0 0;">CISTERN</h1>	Property Address _____
	Property Owner _____
	Treatment Measure No. _____ Inspection Date _____
	Inspector(s) _____
	Type of Inspection: <input type="checkbox"/> Monthly <input type="checkbox"/> Pre-wet season <input type="checkbox"/> Post-wet season ____ <input type="checkbox"/> After heavy runoff <input type="checkbox"/> Other: _____

Defect	Conditions when maintenance is needed	Maintenance needed?	Comments ^a	Results expected when maintenance is performed
1. Low flow	Gutters are full of debris and overflowing.			Gutters should be clear and free-flowing when gutters are cleaned and gutter guards or screens are installed.
2. Inlet	Filters are clogged or full.			Filters are clean and free of trash and debris.
3. First flush diverter	First flush filter is full or clogged causing permanent flow to the cistern.			First flush is diverted away from the cistern when the first flush diverter valve is removed and cleaned.
4. Cistern does not drain within 48 hours	Outlet is clogged.			Cistern completely drains in less than 48 hours.
5. Cistern drains in less than 24 hours	Cistern leaks or outlet allows excessive flows.			Cistern drains in 24 to 48 hours.
6. Miscellaneous	Any condition not covered above that needs attention for the cistern to function as designed.			The design specifications are met.

^a Describe the maintenance completed; if the needed maintenance was not conducted, note when it will be done.

<h2 style="margin: 0;">Inspection and Maintenance Checklist</h2> <h1 style="margin: 10px 0 0 0; color: white;">STORMWATER WETLAND</h1>	Property Address _____ Property Owner _____ Treatment Measure No. _____ Inspection Date _____ Inspector(s) _____ Type of Inspection: <input type="checkbox"/> Monthly <input type="checkbox"/> Pre-wet season <input type="checkbox"/> Post-wet season <input type="checkbox"/> After heavy runoff <input type="checkbox"/> Other: _____
--	--

Defect	Conditions when maintenance is needed	Maintenance needed?	Comments ^a	Results expected when maintenance is performed
1. Sediment	Evidence of accumulated sediment in the forebay or wetland body.			Accumulated sediment is excavated and disposed of properly.
2. Erosion	Evidence of erosion or sloughing on embankment.			Eroded areas filled with suitable material and vegetation established.
3. Vegetation	Embankment vegetation is dead, diseased, or overgrown; trees or shrubbery are growing on the embankment; there are areas of unwanted or inappropriate vegetation.			Vegetation reestablished, trees or shrubs removed from the embankment and replaced with grass; embankment vegetation is mowed, invasive vegetation removed.
	There are visible dead plants or extensive bare areas in the wetland area.			Dead or missing wetland plants replaced with appropriate species.
4. Clogged orifice	Debris or vegetation is restricting flow through the orifice.			Debris is removed from orifice to allow desired drawdown.
5. Clogged riser or bypass structure	Debris or vegetation is impeding flow.			Debris is removed from the riser; consider trash rack installation.
6. Riser, barrel, or embankment failure	Separation of structural components.			Professional Engineer should conduct analysis of structural condition and recommend repairs.
7. Low water level	Low-level release valve is leaking or liner has failed.			Low-level release valve replaced or repaired; liner repaired.
8. Outfall	Outfall exhibits erosion and scour.			Scoured areas repaired.

^a Describe the maintenance completed; if the needed maintenance was not conducted, note when it will be done.

<h2 style="margin: 0;">Inspection and Maintenance Checklist</h2> <h1 style="margin: 10px 0 0 0;">VEGETATED FILTER STRIP</h1>	Property Address _____
	Property Owner _____
	Treatment Measure No. _____ Inspection Date _____
	Inspector(s) _____
	Type of Inspection: <input type="checkbox"/> Monthly <input type="checkbox"/> Pre-wet season <input type="checkbox"/> Post-wet season ____ <input type="checkbox"/> After heavy runoff <input type="checkbox"/> Other: _____

Defect	Conditions when maintenance is needed	Maintenance needed?	Comments ^a	Results expected when maintenance is performed
1. Sediment	Sediment depth exceeds 2 inches or covers vegetation.			Sediment deposits removed and surface re-leveled to maintain sheet flow over the filter strip.
2. Erosion	Eroded or scoured areas due to flow channelization or high flows.			No erosion or scouring evident. For ruts or bare areas less than 12 inches wide, damaged areas repaired by filling with crushed gravel. Over time the grass will start to cover the rock.
3. Trash and debris	Trash and debris accumulated on the filter strip.			Trash and debris removed from filter strip and flow spreading devices.
4. Visual contaminants and pollution	Any visual evidence of oil, gasoline contaminants, or other pollutants.			No visual contaminants or pollutants present.
5. Vegetation	When grass becomes excessively tall (greater than 10 inches). Evidence of nuisance weeds and other unwanted vegetation. Vegetation seems crowded or overgrown.			Grass mowed to a height of 2–5 inches and clippings removed. Nuisance vegetation controlled such that flow is not impeded using Integrated Pest Management (IPM) techniques if applicable. For more information, see http://www.ipm.ucdavis.edu . Minor vegetation removal and thinning. Mowing berms and surroundings. Facility looks well kept.
6. Flow spreader	Flow spreader uneven or clogged so that flows are not uniformly distributed through the entire filter width.			No visual erosion in the filter strip or ponding behind the flow spreader.

^a Describe the maintenance completed; if the needed maintenance was not conducted, note when it will be done.

<h2 style="margin: 0;">Inspection and Maintenance Checklist</h2> <h1 style="margin: 10px 0 0 0; color: white;">VEGETATED SWALE</h1>	Property Address _____ Property Owner _____ Treatment Measure No. _____ Inspection Date _____ Inspector(s) _____ Type of Inspection: <input type="checkbox"/> Monthly <input type="checkbox"/> Pre-wet season <input type="checkbox"/> Post-wet season <input type="checkbox"/> After heavy runoff <input type="checkbox"/> Other: _____
---	--

Defect	Conditions when maintenance is needed	Maintenance needed?	Comments ^a	Results expected when maintenance is performed
1. Standing water	When water stands in the swale between storms and does not drain freely.			There should be no areas of standing water after inflow has ceased. Outlet structures and underdrain (if installed) should drain freely.
2. Trash and debris	Trash and debris that exceeds 5 cubic feet per 1,000 square feet (one standard garbage can).			Trash and debris are removed from the swale.
3. Visual contaminants and pollution	Visual evidence of oil, gasoline, contaminants, or other pollutants.			No visual evidence of contaminants or pollutants present.
4. Sediment	Sediment depth exceeds 2 inches or covers vegetation.			Sediment deposits removed without significant disturbance of the vegetation. Swale is level from side to side and drains freely toward outlet.
5. Erosion	Eroded or scoured areas due to flow channelization or high flows.			No erosion or scouring in swale bottom. For ruts or bare areas less than 12 inches wide, damaged areas repaired by filling with crushed gravel. Over time the grass will start to cover the rock.
6. Vegetation	Grass is sparse or bare or eroded patches occur in more than 10% of the swale bottom.			Vegetation coverage is in more than 90% of the swale bottom. Poorly vegetated areas of the swale bottom are re-planted with plugs of grass from the upper slope and reseeded in locations where plugs were taken. Plugs are planted in the swale bottom with no gaps, or reseeded into loosened, fertile soil.

Defect	Conditions when maintenance is needed	Maintenance needed?	Comments ^a	Results expected when maintenance is performed
	<p>Grass is excessively tall (greater than 10 inches) or nuisance weeds and other vegetation start to take over.</p> <p>Vegetation growth is poor because sunlight does not reach swale.</p>			<p>Vegetation trimmed or mowed, and nuisance vegetation removed so that flow is not impeded. Vegetation/grass maintained at a height of 4–6 inches (depending on landscape requirements). Grass clippings removed.</p> <p>Overhanging limbs and brushy vegetation on side slopes are trimmed back.</p>
7. Inlet/outlet	Sediment or debris accumulations.			Inlet/outlet is clear of sediment and debris and allows water to flow freely.
8. Flow spreader	Flow spreader uneven or clogged so that flows are not uniformly distributed through entire swale width.			Spreader leveled and cleaned such that flows are distributed evenly over the entire swale width.
9. Low-flow channel overflow	Nuisance flows are ponding, swale is continually wet.			Low-flow channel media is renewed to adequately convey nuisance flows.
10. Constant baseflow	When small quantities of water continually flow through the swale, even when it has been dry for weeks, and an eroded muddy channel has formed in the swale bottom.			A low-flow pea gravel drain can be added to the length of the swale or an underdrain can be installed to prevent an eroded or muddy channel.

^a Describe the maintenance completed; if the needed maintenance was not conducted, note when it will be done.

Appendix G. Cost Estimates and Regulatory Guidance

Contents

G.1	Cost Estimates	G-1
G.2	Regulatory Guidance	G-5
G.3	Bexar County	G-5
G.3.1	Bexar County Regulations	G-5
G.3.2	City of San Antonio Unified Development Code	G-5
G.3.3	City of San Antonio Master Plan	G-7
G.3.4	Edwards Aquifer Recharge and Contributing Zones	G-7
G.3.5	Endangered Species	G-8
G.3.6	Suburban Community Ordinances	G-8
G.4	Goliad County	G-10
G.4.1	Goliad County Regulations	G-10
G.4.2	City of Goliad Regulations	G-10
G.5	Karnes County	G-11
G.6	Wilson County	G-11
G.6.1	City of La Vernia	G-11
G.6.2	City of Floresville	G-11
G.6.3	City of Poth	G-11
G.6.4	City of Stockdale	G-12
G.6.5	Wilson County	G-12
G.7	References	G-12

Appendix G. Cost Estimates and Regulatory Guidance

Tables

Table G-1. Common cost considerations in LID planning and design.....G-1
Table G-2. Detailed cost estimates of LID installation and maintenance by practice type.....G-2

G.1 Cost Estimates

Planning-level cost estimates were developed for each BMP type from the latest unit bid costs from the City of San Antonio (2013), TxDOT (2013), the City of Austin (2013) and estimates from local vendors. Estimates for each cost component were developed on the basis of the design standards provided in the previous sections. Costs are based on local information and recommendations compiled from local vendors. The range in cost estimates reflects the recommended ranges in the design specifications for each component. For example, a range in media depth of 2 to 4 feet results in a cost range of \$1.75 to \$3.75 per square foot. Table G-1 summarizes common cost elements associated with the planning and design of LID BMPs. Total project costs include construction costs, bonding, and mobilization that would be part of a contractor's bid.

Table G-1: Common cost considerations in LID planning and design

Common cost elements	
Planning	10% of total project costs
Design	30% of total project costs
Mobilization	11% of total project costs
Contingency	20% of total project costs
Site Preparation	
Clearing and grubbing	\$0.24-0.50/ft ²
Asphalt removal	\$2.32/ft ²
Concrete removal	\$2.39/ft ²
Sidewalk removal	\$1.21-2.39/ft ²

The project manager must refine these numbers throughout the phases of design to prepare a more accurate project construction estimate for bidding purposes. The inclusion of various sizes of projects in the maintenance costs attempts to include those costs in which an economy of scale has been observed. The sizes selected for this analysis were:

- Large LID BMP systems = 4000 ft²
- Medium LID BMP system = 2000 ft²
- Small LID BMP system = 500 ft²

These categories are based on typically sized LID BMPs. Treatment can be provided by a system of multiple different LID BMP types depending on the configuration of the site. Detailed information on installation and maintenance costs based on the frequency and type of maintenance required are presented in Table G-2. The information is broken into three categories

- Routine maintenance (costs associated with maintenance required monthly up to every 2 years).
- Intermediate maintenance (costs associated with maintenance required every 6 to 10 years).
- Replacement maintenance (costs associated with replacement of the system; estimated as a service life of 20 years). Replacement cost is based on removing/replacing all components of a BMP that would potentially fail in 20 years but does not include relocation of a BMP.

These unit costs can be multiplied by the size of each BMP to assist in providing full lifecycle cost analyses for these LID BMPs. Additional information on the recommended maintenance intervals for each type of BMP was provided in Appendix B. Maintenance costs are based on Water Environment Federation (WERF 2009) research that documented labor and equipment usage from other LID programs across the country. Local labor and equipment operating costs were collected from TxDOT and municipalities to determine cost structures.

Table G-2: Detailed cost estimates of LID installation and maintenance by practice type

Components/Activities	LID practice type								
	Bioretention	Bioswale	Permeable pavement	Stormwater wetlands	Planter boxes	Sand filter	Vegetated filter strip	Vegetated swale	Cisterns/ rain barrels
Installation									
Excavation			\$1.10–\$2.25/ft ²		\$3.90–\$6.15/ft ²			\$0.80/ft ³	
Without underdrains	\$2.75–\$5.00/ft ²	\$2.75–\$5.00/ft ²		\$5.00–\$15.00/ft ²					
With underdrains	\$3.90–\$6.15/ft ²	\$3.90–\$6.15/ft ²				\$2.80–\$5.05/ft ²			
2 feet (min) to 3 feet						\$1.60–\$3.20/ft ²			
Fine Grading				\$0.25/ft ²				\$0.25/ft ²	
Soil Media						\$1.90–\$5.05/ft ²			
Topsoil				\$1.35/ft ²					
Recommended mix	\$2.40–\$4.75/ft ²	\$2.40–\$4.75/ft ²			\$2.40–\$4.75/ft ²				
With engineered media	\$3.40–\$6.80/ft ²	\$3.40–\$6.80/ft ²			\$3.40–\$6.80/ft ²				
Soil Media Barrier									
Geotextile	\$0.45/ft ²	\$0.45/ft ²			\$0.45/ft ²	\$0.45/ft ²			
Washed sand (2-inch layer)	\$0.20/ft ²	\$0.20/ft ²			\$0.20/ft ²	\$0.20/ft ²			
No. 8 aggregate (min 2 inches thick)	\$0.28/ft ²	\$0.28/ft ²			\$0.28/ft ²	\$0.28/ft ²			
Underdrain Pipe (includes drainage stone, assumes 5-foot spacing)	\$3.60/ft ²	\$3.60/ft ²			\$3.60/ft ²	\$3.60/ft ²			

Components/Activities	LID practice type								
	Bioretention	Bioswale	Permeable pavement	Stormwater wetlands	Planter boxes	Sand filter	Vegetated filter strip	Vegetated swale	Cisterns/ rain barrels
Curb and Gutter	\$18/ft	\$18/ft			\$18/ft				
Mulch (native hardwood)	\$0.24– \$0.39/ft ²	\$0.24– \$0.39/ft ²			\$0.24– \$0.39/ft ²				
Hydraulic Restriction Layer									
Filter fabric	\$0.45/ft ²	\$0.45/ft ²		\$0.45/ft ²					
Clay	\$0.65/ft ²	\$0.65/ft ²		\$0.65/ft ²					
30-mil liner	\$0.35/ft ²	\$0.35/ft ²	\$0.35/ft ²	\$0.35/ft ²	\$0.35/ft ²	\$0.35/ft ²			
Concrete barrier	\$12.00/ft ²	\$12.00/ft ²	\$12.00/ft ²	\$12.00/ft ²	\$12.00/ft ²	\$12.00/ft ²			
Vegetation	\$0.20–\$3.50/ft ²	\$0.20–\$3.50/ft ²		\$1.25– \$3.50/ft ²	\$0.50–\$3.50/ft ²				
Sod (buffalo)							\$0.67/ft ²	\$0.67/ft ²	
Seeding							\$0.15– \$0.22/ft ²	\$0.15– \$0.22/ft ²	
Permeable Pavement Materials									
Pervious asphalt			\$2.00/ft ²						
Pervious concrete			\$6.00/ft ²						
PICP			\$3.00/ft ²						
Plastic grid pavers			\$2.50/ft ²						
Bedding Layer									
Washed sand (2-inch layer)			\$0.20/ft ²						
No. 8 aggregate (min 2 inches thick)			\$0.22/ft ²						
No. 57 stone (min 6 inches to 1 foot)			\$0.83–\$1.67/ft ²						

Components/Activities	LID practice type								
	Bioretention	Bioswale	Permeable pavement	Stormwater wetlands	Planter boxes	Sand filter	Vegetated filter strip	Vegetated swale	Cisterns/ rain barrels
Tanks/Cisterns									\$0.60– \$2.25/gal
Filter									\$40.00– \$400.00
Foundation									
Gravel (assume 6-in. depth)									\$0.75/ft ²
Concrete (assume 6-in. depth)									\$13.50/ft ²
Maintenance									
Routine Maintenance (maintenance required monthly to every 2 years)									
Routine (small)	\$7.62/ft ²	\$7.62/ft ²	\$5.32/ft ²	\$0.44/ft ²	\$7.62/ft ²	\$1.87/ft ²	\$3.73/ft ²	\$3.73/ft ²	
Routine (medium)	\$1.91/ft ²	\$1.91/ft ²	\$1.33/ft ²	\$0.34/ft ²	\$1.91/ft ²	\$0.62/ft ²	\$1.40/ft ²	\$1.40/ft ²	
Routine (large)	\$1.91/ft ²	\$1.91/ft ²	\$0.67/ft ²	\$0.24/ft ²	\$1.91/ft ²	\$0.31/ft ²	\$1.01/ft ²	\$1.01/ft ²	
Intermediate Maintenance (maintenance required every 6 to 10 years)									
Intermediate (small)	\$5.62/ft ²	\$5.62/ft ²	\$3.71/ft ²	\$1.47/ft ²	\$5.62/ft ²	\$2.61/ft ²			
Intermediate (medium)	\$2.94/ft ²	\$2.94/ft ²	\$1.85/ft ²	\$1.41/ft ²	\$2.94/ft ²	\$1.36/ft ²			
Intermediate (large)	\$2.50/ft ²	\$2.50/ft ²	\$1.85/ft ²	\$1.40/ft ²	\$2.50/ft ²	\$1.05/ft ²			
Replacement (service life of 20 years)									
Replacement (small)	\$10.52/ft ²	\$10.52/ft ²	\$6.50– \$9.50/ft ²	\$8.19/ft ²	\$10.52/ft ²	\$6.46/ft ²	\$4.17/ft ²	\$4.17/ft ²	
Replacement (medium)	\$10.17/ft ²	\$10.17/ft ²	\$6.50– \$9.50/ft ²	\$6.43/ft ²	\$10.17/ft ²	\$5.21/ft ²	\$2.33/ft ²	\$2.33/ft ²	
Replacement (large)	\$10.11/ft ²	\$10.11/ft ²	\$6.50– \$9.50/ft ²	\$5.99/ft ²	\$10.11/ft ²	\$4.90/ft ²	\$2.02/ft ²	\$2.02/ft ²	

Note: Small System = 500 ft²; Medium System = 2000 ft²; Large System = 4000 ft²

G.2 Regulatory Guidance

The general regulatory guidance given in Chapter 2 is broadened in Appendix G to cover each county and municipality in the San Antonio River Basin (SARB). This appendix serves as a point of reference for designers to research and review the master plan, land use, land development, environmental, stormwater, and utility regulations that define how LID is currently (2013) regulated within each jurisdiction. The designer should meet with the development review staff in the particular city or county of interest prior to beginning site design. The regulations are grouped by county and then further subdivided by municipality.

G.3 Bexar County

Bexar County is comprised of 21 cities with multiple unincorporated areas or Extraterritorial Jurisdictions (ETJs).

G.3.1 Bexar County Regulations

Bexar County is responsible for enforcing development and construction standards within unincorporated areas and ETJs of the member cities. Bexar County has an interlocal agreement with the City of San Antonio to apply the City's development regulations within the ETJ.

G.3.2 City of San Antonio Unified Development Code

The City of San Antonio regulates public infrastructure and land development through the Unified Development Code (UDC), which also applies to much of the surrounding ETJs. In the 2010 revision to the UDC, the timeline for regularly scheduled revisions was changed from every two years to every five years. The UDC is divided into eight major articles; however, only the articles that most affect use of LID or stormwater management are discussed below.

G.3.2.1 Article III – Zoning

Local zoning regulations define base uses (commercial, residential, etc.) as well as lot sizes, building setbacks, and individual lot open space. LID approaches can employ a number of flexible zoning options to meet the environmental objectives of a site while allowing for the most efficient use of property. The use of these options provides added environmental sensitivity to the zoning and subdivision process over and above what conventional zoning can achieve. Alternative zoning options, some of which are already used in San Antonio, include overlay districts, performance zoning, incentive zoning, impervious overlay zoning, and watershed-based zoning to allow for the introduction of innovative development, site layout, and design techniques.

G.3.2.2 Article V – Development Standards

The development standards section provides most of the regulations covering infrastructure and land development in San Antonio and Bexar County. The sections below discuss the specific codes relevant to LID.

G.3.2.2.1 Parkland Dedication Requirement 35-503

Dedicated park space or payment of a fee in lieu of (FILO) parkland is required for all new residential development. Preservation of native vegetation is encouraged by the tree preservation ordinance, but open space or constructed features are generally preferred. Detention areas are allowed to meet up to 50% of the park dedication requirement if they drain within 24 hours. Preserved floodplain and riparian areas can count toward park space but no specific stormwater management goals are required.

Appendix G. Cost Estimates and Regulatory Guidance

G.3.2.2.2 Stormwater Management 35-504

The City of San Antonio gives developers the option of providing onsite detention to return post-development peak flows to pre-development conditions or paying a FILO detention. The 5-, 25- and 100-year storms are analyzed for each site's Stormwater Management Plan (SWMP) submittal. The standard of care requires assessing impacts to habitable structures or public roads within 2,000 feet downstream of a site. Typically, San Antonio uses streets for drainage conveyance. Section 35-504 (g) from the UDC discusses allowing the 25-year storm to flow in the road as long as one lane in each direction remains passable. This design approach makes it important to encourage LID water quantity and quality mitigation features within the street right-of-way.

No specific permanent BMPs are required to mitigate high frequency flow increase, sediment discharge or other water quality components of concern. However, Section 35-504 (b) (8) states:

The City of San Antonio (COSA) encourages the installation of low impact development (LID) features such as engineered swales, engineered infiltration storm sewer systems, bioretention, and engineered wetlands. For all developments proposed within the COSA jurisdictional boundaries, these features may be considered on-site detention features to the extent that they reduce the stormwater runoff expected downstream as a result of such developments. It shall be the developer's responsibility to demonstrate that said LID features provide such benefit. Credit toward Regional Stormwater Management Participation fees will be considered and approved on a case by case basis by the department of public works.

This section from the UDC along with the River Improvement Overlay design language (G.3.2.3.1) is an important first step in encouraging LID implementation.

G.3.2.2.3 Transportation and Street Design 35-506

The street design criteria include standards specific to grade, pavement composition, drainage, rights-of-way, sidewalks, medians, and such. Pavement width and design speed are specified for each street category based on the type of use and connectivity within the transportation network. No specific stormwater quality requirements are included. All street classifications can incorporate LID measures that vary depending on use, design speed, and character of the neighborhood and that are compatible with complete streets policies, such as the City of San Antonio's. These policies promote safe and convenient access and travel for all users including pedestrians, bicyclists, transit riders, and people of all abilities. The City of San Antonio's policy specifically encourages LID to help manage stormwater runoff.

G.3.2.2.4 Landscaping 35-511

The City of San Antonio has mandatory landscaping requirements for new development, redevelopment, and additions (including new parking lots). A landscaping plan is generally required to define how the site will achieve conformance with the ordinance. However, if all landscape buffer, landscape and tree preservation requirements have been met by the utilization of existing trees and vegetation, the plan only has to show the layout of the preservation areas. This approach is consistent with LID principles that seek to preserve natural areas. If new landscape areas are required for a site, LID BMPs that utilize vegetation (bioretention, bioswales, planter boxes) can be used to meet the landscaping ordinance. For example, bioretention areas within parking lots can be planted with trees to meet parking lot shading requirements.

G.3.2.2.5 Tree Preservation 35-523

The Tree Preservation ordinance is primarily designed to preserve or enhance tree canopy throughout San Antonio and its ETJ. There are existing incentives in the UDC for the implementation of LID features

since the canopy requirement can be reduced by lowering the impervious cover below conventional development. One incentive for LID practices is that a “canopy cover credit of one and one-half (1.5) times the existing canopy cover of trees [is] provided for areas where tree preservation is maintained in conjunction with LID practices such as the use of structured soils including infiltration trenches, bioswales, micro-bioretenment areas and where such locations receive appropriate amounts of stormwater runoff” (Sec. 35-523 (i) (13)).

G.3.2.3 Article VI – Historic Preservation and Urban Design

G.3.2.3.1 River Improvement Overlay Districts (RIO) 35-670

During the 2010-11 Rio District amendment process, reference to LID features was added under Sec. 35-670(b)(3). Sec. 35-670 encourages LID features in all six RIO districts and allows them to “be considered on-site detention features to the extent that they reduce the stormwater runoff expected downstream as a result of such developments.” However, Sec. 35-673(7) requires roof drainage into storm drains or other stormwater detention facilities and these cannot discharge above the normal water level of the river.

G.3.3 City of San Antonio Master Plan

The City of San Antonio’s Comprehensive Master Plan and associated sector plans provide guidance to regulators and developers about desired uses for specific areas of the City and ETJ. For example, the City South Management Area and Heritage South Sector Plan document the desired feel and long-term redevelopment goals based on community input. Currently LID is included in the Master Plan goals as part of watershed protection but is not tied to specific criteria. Implementing LID concepts incorporates higher dwelling unit densities (e.g. clustering of houses) balanced with natural habitat preservation. LID is generally compatible with the sector plan goals, and if properly implemented with good site planning, would provide protection of cultural resources, riparian and aquatic habitat, encourage onsite stormwater controls, and protect watershed-scale hydrologic processes. In addition, LID, when incorporated with transportation networks, can be a facet of complete streets that encourage alternative modes of transportation.

G.3.4 Edwards Aquifer Recharge and Contributing Zones

The Edwards Aquifer Recharge and Contributing Zones are subject to additional regulations because of the potential for development activities to pollute the Edwards Aquifer, which is the main water supply for much of the San Antonio Region. The regulations originating from SAWS are explained below. The TCEQ regulations were discussed previously.

G.3.4.1 SAWS Aquifer Protection Ordinance

Pollution Prevention Criteria Sec. 34-925: SAWS limits maximum impervious cover percentage requirements based on land use types. The regulations become stricter within the recharge zone. For example, impervious cover may not exceed 15% for single-family residential, multi-family residential, or commercial unless it can be proved that additional impervious cover will not cause degradation.

Pollution Prevention Criteria Sec. 34-913: Buffer zones are required adjacent to streams, where 80% of trees must be preserved and the buffer zone should maintain hydraulic and water quality functions. In the code, buffer zones do not require establishment of vegetation if the area is already denuded.

G.3.4.2 SAWS Drought Restrictions

SAWS regulates outside water use during periods of low Edwards Aquifer levels and, during these periods, generally limits landscape watering to one day per week. A variance process exists for new

Appendix G. Cost Estimates and Regulatory Guidance

landscaping that allows more frequent watering for up to five weeks (see <http://www.saws.org/conservation/droughtrestrictions/>). The variance only applies to new landscaping projects that meet SAWS' WaterSaver Landscape requirements. SAWS also limits the type of turf grass that builders are allowed to install in yards. LID designers should select plants based on drought resistance and be aware of the current and likely drought restrictions during planting periods. Appendix E provides further information on drought tolerant vegetation appropriate for LID implementation.

G.3.5 Endangered Species

The City of San Antonio requires submission of a Habitat Compliance Form for all projects requiring a development services permit. The Edwards Aquifer Recharge Zone and adjacent karst geologic layers (see Figure 2-2) have been identified as habitat for endangered karst invertebrates that are listed by the U.S. Fish and Wildlife Service. Similarly, the Golden-Cheeked Warbler is an endangered species that nests in the Ashe-juniper and oak woodlands in ravines and canyons found in north Bexar County. Habitat conservation and recovery plans for all species are on file with the USFWS.

G.3.6 Suburban Community Ordinances

The ordinances for the suburban communities in Bexar County do not directly address LID/GI. Alamo Heights, Castle Hills, Converse, Helotes, Kirby, Leon Valley, Live Oak, Shavano Park, and Terrell Hills regulate and/or incentivize tree preservation. Many of the communities model their regulations after City of San Antonio and/or TxDOT standards with modifications to fit their particular community. Table G-3 lists ordinances with web addresses for the jurisdictions within Bexar County.

Table G-3: Suburban City Ordinances in Bexar County

Agency/City Name	Document Type	Reference Location
Alamo Heights	Code of Ordinances – Including zoning, streets, parking, and subdivision standards	http://library.municode.com/index.aspx?clientId=14492&stateId=43&stateName=Texas
	City Codes – newly adopted changes	http://www.alamoheightstx.gov/government/government-citycodes.php
Balcones Heights	Code of Ordinances – Chapter 152	http://www.balconesheights.org/zoning_map.htm
Castle Hills	Code of Ordinances - Including zoning, streets, parking, and subdivision standards	http://www.cityofcastlehills.com/government/codes-ordinances/
	Zoning – Ordinances and Map	http://www.cityofcastlehills.com/government/zoning-planning/
Converse	Code of Ordinances - Including zoning, streets, parking, drainage, landscaping and subdivision standards.	http://library.municode.com/index.aspx?clientId=14701&stateId=43&stateName=Texas
Elmendorf		Contact 210-635-8210
Fair Oaks Ranch	Code of Ordinances - Including zoning, streets, parking, drainage, landscaping and subdivision standards.	http://z2.franklinlegal.net/franklin/Z2Browser2.html?shows_et=fairoaksranchset
	Un-codified Ordinances	http://www.fairoaksranchtx.org/Archive.aspx?AMID=45&Type=&ADID=

Appendix G. Cost Estimates and Regulatory Guidance

Agency/City Name	Document Type	Reference Location
Grey Forest	Ordinances – 45B - Zoning/Building	http://greyforest-tx.gov/citizen-information/ordinances/
Helotes	Ordinance – Chap 34 Environment, Chapter 78 Subdivisions, Chapter 94 Vegetation	http://www.helotes-tx.gov/index.asp?Type=B_BASIC&SEC={4C051190-DF9A-444C-AFB8-831CD2A4EAA8}
Hill Country Village	Code of Ordinances – Chapter 62 Subdivisions	http://library.municode.com/index.aspx?clientId=14034
Kirby	Code of Ordinances – Including zoning, streets, parking, drainage and subdivision standards	http://www.amlegal.com/nxt/gateway.dll/Texas/kirby/cityofkirbytexascodeofordinances?f=templates\$fn=default.htm\$3.0\$vid=amlegal:kirby_tx
Leon Valley	Code of Ordinances - Including zoning, streets, parking, drainage, landscaping and subdivision standards.	http://z2codes.franklinlegal.net/franklin/Z2Browser2.html?showset=leonvalleyset
Live Oak	Code of Ordinances - Including zoning, streets, parking, drainage, landscaping and subdivision standards.	http://library.municode.com/index.aspx?clientID=14582&stateID=43&statename=Texas
Olmos Park	Code of Ordinances - Including zoning, streets, parking, drainage, landscaping and subdivision standards. Follows typical design criteria of other cities in Bexar County	http://library.municode.com/index.aspx?clientId=15097
San Antonio	Unified Development Code	http://library.municode.com/index.aspx?clientId=14228
SAWS	Aquifer Protection Ordinance	http://www.saws.org/environment/ResourceProtComp/aquifer_protection/ordinance.cfm
	Water Conservation Ordinance	http://www.saws.org/conservation/ordinance/
Schertz	Code of Ordinances – Water Conservation, Drainage Utility	http://library.municode.com/index.aspx?clientId=13783&stateId=43&stateName=Texas
	Comprehensive Land Use Plan – Community Vision, Land Use, Transportation, Parks, Community Enhancement, Growth Capacity – Smart Growth	http://laserfiche.schertzweb.com/Weblink7/Browse.aspx?dbid=1&startid=54103
	Unified Development Code – Zoning, Parking, Subdivisions, Drainage, Transportation, Site Design, Landscaping	http://laserfiche.schertzweb.com/Weblink7/Browse.aspx?dbid=1&startid=54103
Shavano Park	Code of Ordinances – generally mirrors COSA regulations	http://library.municode.com/index.aspx?clientId=14473
Somerset		Contact (830) 429-3639
Terrell Hills	Code of Ordinances – Chapter 13 Traffic and Streets, Chapter 14 Zoning	http://www.terrell-hills.com/thco.html
Town of Hollywood Park	Recent Ordinances	http://hollywoodpark-tx.gov/ordinance/
	Code of Ordinances – Comprehensive Ordinances, Zoning, Parking, Subdivisions, Parks, Drainage, Streets	http://library.municode.com/index.aspx?clientId=14200

Appendix G. Cost Estimates and Regulatory Guidance

Agency/City Name	Document Type	Reference Location
Universal City	Code of Ordinances – Ch. 4-2 Planning - Subdivisions, Streets, Drainage, Parks; Ch. 4-5 Zoning –Use Table, Landscaping, Parking	http://library.municode.com/index.aspx?clientId=10332
Windcrest	Code of Ordinances - Including zoning, streets, parking, drainage and subdivision standards.	http://www.windcrest-tx.gov/?nid=453
	Walzem Road Area Revitalization Plan	http://www.windcrest-tx.gov/DocumentCenter/Home/View/461

G.4 Goliad County

Goliad County contains one incorporated city, which is the county seat Goliad. The County government regulates development in the majority of this mostly rural county.

G.4.1 Goliad County Regulations

Goliad County publishes development codes in a set of subdivision regulations available from the website at http://www.co.goliad.tx.us/default.aspx?Goliad_County/County.News. Article III defines the platting procedure as the process for subdividing land in Goliad County and includes the requirement for a pre-submittal meeting with the Precinct Commissioner and a Registered Engineer or Surveyor. Section V specifies minimum road widths of 20 feet and allow rural street cross-sections with borrow ditches to convey flow. Section VII – Drainage and Flood Control provides design guidance for stormwater runoff management for new subdivisions. Streets and drainage structures are designed for 10-yr to 25-yr storms unless all residential lots are larger than 5-acres. In that case, local and collector streets can be designed for a 5-yr storm. In all cases, the 100-year storm must be contained within the right-of-way. Drainage calculations must be based on the fully developed conditions and use commonly accepted engineering practices used within the area (Section 7.6).

G.4.2 City of Goliad Regulations

The City of Goliad publishes regulations in a code of ordinances available from the website at <http://www.goliadtx.net/default.asp>. Chapter 10 – Subdivision Regulation defines the procedures for creating a subdivision with the City’s jurisdiction. A pre-application conference is necessary for new major subdivision applications with the goal of familiarizing the applicant with city requirements and for city officials to provide guidance for preparing a preliminary plat (Sec. 10.02.006 Procedures). Design requirements for residential subdivision layouts, street widths, drainage, and sidewalks are included in Section 10.02.012 and group housing and commercial development in Section 10.02.013. No specific requirements for water quality, native vegetation preservation, tree canopy, or onsite stormwater management were noted (Accessed May 8, 2013). However, the code does provide considerable flexibility and pre-application conference provides a good opportunity to discuss implementing LID BMPs for a retrofit or new development.

G.4.2.1 Zoning

The City regulates land use through Section 14 –Zoning and provides a map of the approved uses that is available from the web address <http://www.goliadtx.net/docs/ZoningMap.pdf>. The City’s website recommends coordinating with City personnel to verify zoning for individual properties. Minimum parking requirements are included in the Zoning regulations under Section 14.02.353. Parking for mixed

use areas is generally required as the sum of all parking spaces required for all uses. However, the board of adjustments may reduce the total number of parking stalls for reasons such as:

- Joint uses that generate demands at different hours of the day
- Facilities served by publicly available parking capacity
- Facilities primarily served by public transportation, bicycles or pedestrians

G.5 Karnes County

Karnes County is home to three incorporated communities: Karnes City (county seat), Falls City, and Kennedy.

G.6 Wilson County

Wilson County has four incorporates cities: Floresville (county seat), La Vernia, Poth and Stockdale.

G.6.1 City of La Vernia

The City of La Vernia publishes regulations in a Code of Ordinances available at <http://library.municode.com/index.aspx?clientId=14626>. Chapter 30 – Subdivisions discusses the requirements for platting, streets, drainage, and sidewalks. Chapter 38 – Zoning cover acceptable uses, parking and landscaping. The requirements generally follow ordinances described previously for Bexar County and the San Antonio River Basin.

G.6.2 City of Floresville

The City of Floresville publishes regulations in a Code of Ordinances that can be obtained from City Hall by calling (830) 393-3105. Chapter 152: Subdivisions defines the procedures for creating a subdivision including preliminary and final platting requirements in Sections 152.20 and 152.35. Standards and specifications are detailed in Sections 152.50 through 152.61. The sections define lot sizes, street sizing and a requirement for adequate storm drainage. There is considerable flexibility within the ordinance to implement roadside and onsite BMP's in new subdivisions.

G.6.3 City of Poth

The City of Poth publishes regulations in separate ordinances available from the website at <http://www.cityofpoth.org/blog/ordinances/>. The Subdivision Ordinance defines the procedures for creating a subdivision with the City's jurisdiction. Poth requires submittal of preliminary and final plats along with construction plans and plat fees. General requirements for residential subdivision layouts, street widths, drainage, and sidewalks are included in Section 10 and specific requirements for streets and drainage are provide in Exhibit A – Technical Specifications. Floodplain management criteria are provided in a separate Flood Damage Prevention Ordinance which includes Exhibit A - Hydrologic and Hydraulic Design Criteria as No specific requirements for water quality, native vegetation preservation, tree canopy, or onsite stormwater management were noted (Accessed May 8, 2013). However, the code does provide considerable flexibility for drainage design and street requirements and the pre-application conference provides a good opportunity to discuss implementing LID BMPs for a retrofit or new development.

Appendix G. Cost Estimates and Regulatory Guidance

G.6.4 City of Stockdale

The City of Stockdale regulates development through a Subdivision Ordinance No. 297-010801-01 that can be obtained from City Hall by calling (830) 996-3128. The ordinance defines the procedures for creating a subdivision including preliminary and final platting requirements in Sections III and IV. Section VII – General Requirements and Design Standards defines lot sizes, street sizing and design, curb and gutter, sidewalks and storm drainage. Section VII-7(a) requires storm drainage facilities when “prevention of erosion cannot be accomplished satisfactorily by surface drainage.” LID BMPs are very effective at preventing onsite erosion and channel erosion. Stockdale allows streets to carry up to the 10-year storm and storm drains must be sized for the 25-year storm. Detention is not required by the ordinance but is left to the City or City Engineer’s discretion.

G.6.5 Wilson County

Wilson County government ordinances are available from the web address http://www.co.wilson.tx.us/default.aspx?Wilson_County/Ordinances. The Subdivision and Development Rules and Regulations - Article II defines the platting procedure as the process for subdividing land in Wilson County and includes the recommendation for a meeting with the Precinct Commissioner and a Registered Engineer or Surveyor. Lot density is defined based on availability of water and sewer service from centralized systems or individual onsite facilities. Article V specifies drainage requirements for roadways, channels and stream crossings with the FEMA Special Flood Hazard Area. Article VII – Road Construction and Drainage Requirements defines Right-of-Way dedication, street widths and drainage design methods.

G.7 References

- City of Austin (COA). 2013. Average Bid Prices 05-09-13 Excel Spreadsheet. <http://austintexas.gov/page/average-bid-prices>. Accessed May 2, 2013.
- COSA (City of San Antonio). 2013. Unit Price List 09-2012 PDF, <http://www.sanantonio.gov/CIMS/CurrentVendorResources/UnitPriceList.aspx>. Accessed April 30, 2013.
- TxDOT (Texas Department of Transportation). 2013 *February 2013 – April 2013 Average Low Bid Unit Price*. <http://www.txdot.gov/business/letting-bids/average-low-bid-unit-prices.html>. Accessed May 1, 2013.
- Water Environment Research Foundation (WERF). 2009. BMP and LID Whole Life Cost Models Version 2.0. SW2R08. www.werf.org.