

**Compendium of Methods  
for the Determination of  
Toxic Organic Compounds  
in Ambient Air**

**Second Edition**

**Compendium Method TO-9A**

**Determination Of Polychlorinated,  
Polybrominated And  
Brominated/Chlorinated  
Dibenzo-p-Dioxins And Dibenzofurans In  
Ambient Air**

**Center for Environmental Research Information  
Office of Research and Development  
U.S. Environmental Protection Agency  
Cincinnati, OH 45268**

**January 1999**

## Method TO-9A Acknowledgements

This Method was prepared for publication in the *Compendium of Methods for the Determination of Toxic Organic Compounds in Ambient Air, Second Edition* (EPA/625/R-96/010b), which was prepared under Contract No. 68-C3-0315, WA No. 3-10, by Midwest Research Institute (MRI), as a subcontractor to Eastern Research Group, Inc. (ERG), and under the sponsorship of the U.S. Environmental Protection Agency (EPA). Justice A. Manning, John Burckle, and Scott Hedges, Center for Environmental Research Information (CERI), and Frank F. McElroy, National Exposure Research Laboratory (NERL), all in the EPA Office of Research and Development, were responsible for overseeing the preparation of this method. Additional support was provided by other members of the Compendia Workgroup, which include:

- John O. Burckle, U.S. EPA, ORD, Cincinnati, OH
- James L. Cheney, Corps of Engineers, Omaha, NB
- Michael Davis, U.S. EPA, Region 7, KC, KS
- Joseph B. Elkins Jr., U.S. EPA, OAQPS, RTP, NC
- Robert G. Lewis, U.S. EPA, NERL, RTP, NC
- Justice A. Manning, U.S. EPA, ORD, Cincinnati, OH
- William A. McClenny, U.S. EPA, NERL, RTP, NC
- Frank F. McElroy, U.S. EPA, NERL, RTP, NC
- Heidi Schultz, ERG, Lexington, MA
- William T. "Jerry" Winberry, Jr., EnviroTech Solutions, Cary, NC

Method TO-9 was originally published in March of 1989 as one of a series of peer reviewed methods in the second supplement to "*Compendium of Methods for the Determination of Toxic Organic Compounds in Ambient Air*," EPA 600/4-89-018. In an effort to keep these methods consistent with current technology, Method TO-9 has been revised and updated as Method TO-9A in this Compendium to incorporate new or improved sampling and analytical technologies.

This Method is the result of the efforts of many individuals. Gratitude goes to each person involved in the preparation and review of this methodology.

### Author(s)

- Bob Harless, U.S. EPA, NERL, RTP, NC
- William T. "Jerry" Winberry, Jr., EnviroTech Solutions, Cary, NC
- Gil Radolovich, Midwest Research Institute, KC, MO
- Mark Horrigan, Midwest Research Institute, KC, MO

### Peer Reviewers

- Audrey E. Dupuy, U.S. EPA, NSTL Station, MS
- Greg Jungclaus, Midwest Research Institute, KC, MO
- Stan Sleva, TRC, RTP, NC
- Robert G. Lewis, U.S. EPA, NERL, RTP, NC
- Lauren Drees, U.S. EPA, NRMRL, Cincinnati, OH

Finally, recognition is given to Frances Beyer, Lynn Kaufman, Debbie Bond, Cathy Whitaker, and Kathy Johnson of Midwest Research Institute's Administrative Services staff whose dedication and persistence during the development of this manuscript has enabled it's production.

### DISCLAIMER

*This Compendium has been subjected to the Agency's peer and administrative review, and it has been approved for publication as an EPA document. Mention of trade names or commercial products does not constitute endorsement or recommendation for use.*

## Method TO-9A

### Determination Of Polychlorinated, Polybrominated And Brominated/Chlorinated Dibenzo-p-Dioxins And Dibenzofurans In Ambient Air

#### TABLE OF CONTENTS

	<u>Page</u>
1. Scope .....	9A-1
2. Summary of Method .....	9A-2
3. Significance .....	9A-3
4. Safety .....	9A-3
5. Applicable Documents .....	9A-4
5.1 ASTM Standards .....	9A-4
5.2 EPA Documents .....	9A-4
5.3 Other Documents .....	9A-5
6. Definitions .....	9A-5
7. Interferences And Contamination .....	9A-9
8. Apparatus .....	9A-9
8.1 High-Volume Sampler .....	9A-9
8.2 High-Volume Sampler Calibrator .....	9A-9
8.3 High Resolution Gas Chromatograph-High Resolution Mass Spectrometer-Data System (HRGC-HRMS-DS) .....	9A-10
9. Equipment And Materials .....	9A-10
9.1 Materials for Sample Collection .....	9A-10
9.2 Laboratory Equipment .....	9A-11
9.3 Reagents and Other Materials .....	9A-11
9.4 Calibration Solutions and Solutions of Standards Used in the Method .....	9A-12
10. Preparation Of PUF Sampling Cartridge .....	9A-12
10.1 Summary of Method .....	9A-12
10.2 Preparation of Sampling Cartridge .....	9A-13
10.3 Procedure for Certification of PUF Cartridge Assembly .....	9A-13
10.4 Deployment of Cartridges for Field Sampling .....	9A-14
11. Assembly, Calibration And Collection Using Sampling System .....	9A-14
11.1 Description of Sampling Apparatus .....	9A-14
11.2 Calibration of Sampling System .....	9A-15
11.3 Sample Collection .....	9A-21

## TABLE OF CONTENTS (continued)

	<u>Page</u>
12. Sample Preparation . . . . .	9A-23
12.1 Extraction Procedure for Quartz Fiber Filters and PUF Plugs . . . . .	9A-23
12.2 Cleanup Procedures . . . . .	9A-23
12.3 Glassware Cleanup Procedures . . . . .	9A-25
13. HRGC-HRMS System Performance . . . . .	9A-25
13.1 Operation of HRGC-HRMS . . . . .	9A-25
13.2 Colum Performance . . . . .	9A-26
13.3 SIM Cycle Time . . . . .	9A-26
13.4 Peak Separation . . . . .	9A-26
13.5 Initial Calibration . . . . .	9A-26
13.6 Criteria Required for Initial Calibration . . . . .	9A-27
13.7 Continuing Calibration . . . . .	9A-28
14. HRGC-HRMS Analysis And Operating Parameters . . . . .	9A-28
14.1 Sample Analysis . . . . .	9A-28
14.2 Identification Criteria . . . . .	9A-29
14.3 Quantification . . . . .	9A-29
14.4 Calculations . . . . .	9A-30
14.5 Method Detection Limits (MDLs) . . . . .	9A-31
14.6 2,3,7,8-TCDD Toxic Equivalents . . . . .	9A-31
15. Quality Assurance/Quality Control (QA/QC) . . . . .	9A-32
16. Report Format . . . . .	9A-33
17. References . . . . .	9A-34

## METHOD TO-9A

### Determination Of Polychlorinated, Polybrominated And Brominated/Chlorinated Dibenzo-p-Dioxins And Dibenzofurans In Ambient Air

#### 1. Scope

**1.1** This document describes a sampling and analysis method for the quantitative determination of polyhalogenated dibenzo-p-dioxins and dibenzofurans (PHDDs/PHDFs) in ambient air, which include the polychlorinated dibenzo-p-dioxins and dibenzofurans (PCDDs/PCDFs), polybrominated dibenzo-p-dioxins and dibenzofurans (PBDDs/PBDFs), and bromo/chloro dibenzo-p-dioxins and dibenzofurans (BCDDs/BCDFs). The method uses a high volume air sampler equipped with a quartz-fiber filter and polyurethane foam (PUF) adsorbent for sampling 325 to 400 m<sup>3</sup> ambient air in a 24-hour sampling period. Analytical procedures based on high resolution gas chromatography-high resolution mass spectrometry (HRGC-HRMS) are used for analysis of the sample.

**1.2** The sampling and analysis method was evaluated using mixtures of PHDDs and PHDFs, including the 2,3,7,8-substituted congeners (1,2). It has been used extensively in the U.S. Environmental Protection Agency (EPA) ambient air monitoring studies (3,4) for determination of PCDDs and PCDFs.

**1.3** The method provides accurate quantitative data for tetra- through octa-PCDDs/PCDFs (total concentrations for each isomeric series).

**1.4** Specificity is attained for quantitative determination of the seventeen 2,3,7,8-substituted PCDDs/PCDFs and specific 2,3,7,8-substituted PBDD/PBDF and BCDD/BCDF congeners.

**1.5** Minimum detection limits (MDLs) in the range of 0.01 to 0.2 picograms/meter<sup>3</sup> (pg/m<sup>3</sup>) can be achieved for these compounds in ambient air.

**1.6** Concentrations as low as 0.2 pg/m<sup>3</sup> can be accurately quantified.

**1.7** The method incorporates quality assurance/quality control (QA/QC) measures in sampling, analysis, and evaluation of data.

**1.8** The analytical procedures also have been used for the quantitative determination of these types of compounds in sample matrices such as stack gas emissions, fly ash, soil, sediments, water, and fish and human tissue (5-9).

**1.9** The method is similar to methods used by other EPA, industry, commercial, and academic laboratories for determining PCDDs and PCDFs in various sample matrices (10-25). This method is an update of the original EPA Compendium Method TO-9, originally published in 1989 (26).

**1.10** The method does not separately quantify gaseous PHDDs and PHDFs and particulate-associated PHDDs and PHDFs because some of the compounds volatilize from the filter and are collected by the PUF adsorbent. For example, most of the OCDD is collected by the filter and most of the TCDDs are collected by the PUF during sampling. PCDDs/PCDFs may be distributed between the gaseous and particle-adsorbed phases in ambient air. Therefore, the filter and PUF are combined for extraction in this method.

**1.11** The sampling and analysis method is very versatile and can be used to determine other brominated and chlorinated dioxins and furans in the future when more analytical standards become available for use in the method. A recent modification of the sample preparation procedure provides the capability required to determine PCDDs, PCDFs, PCBs, and PAHs in the same sample (27).

## 2. Summary of Method

**2.1** Quartz-fiber filters and glass adsorbent cartridges are pre-cleaned with appropriate solvents and dried in a clean atmosphere. The PUF adsorbent plugs are subjected to 4-hour Soxhlet extraction using an oversized extractor to prevent distortion of the PUF plug. The PUF plugs are then air dried in a clean atmosphere and installed in the glass cartridges. A 50 microliter ( $\mu\text{L}$ ) aliquot of a 16 picogram/microliter ( $\text{pg}/\mu\text{L}$ ) solution of  $^{37}\text{Cl}_4$ -2,3,7,8-TCDD is spiked to the PUF in the laboratory prior to field deployment. (Different amounts and additional  $^{13}\text{C}_{12}$ -labeled standards such as  $^{13}\text{C}_{12}$ -1,2,3,6,7,8-HxCDF may also be used if desired.) The cartridges are then wrapped in aluminum foil to protect from light, capped with Teflon® end caps, placed in a cleaned labeled shipping container, and tightly sealed with Teflon® tap until needed.

**2.2** For sampling, the quartz-fiber filter and glass cartridge containing the PUF are installed in the high-volume air sampler.

**2.3** The high-volume sampler is then immediately put into operation, usually for 24 hours, to sample 325 to 400  $\text{m}^3$  ambient air.

*[Note: Significant losses were not detected when duplicate samplers were operated 7 days and sampled 2660  $\text{m}^3$  ambient air (1-4).]*

**2.4** The amount of ambient air sampled is recorded at the end of the sampling session. Sample recovery involves placing the filter on top of the PUF. The glass cartridge is then wrapped with the original aluminum foil, capped with Teflon® end caps, placed back into the original shipping container, identified, and shipped to the analytical laboratory for sample processing.

**2.5** Sample preparation typically is performed on a "set" of 12 samples, which consists of 9 test samples, a field blank, a method blank, and a matrix spike.

**2.6** The filter and PUF are combined for sample preparation, spiked with 9  $^{13}\text{C}_{12}$ -labeled PCDD/PCDF and 4 PBDD/PBDF internal standards (28), and Soxhlet extracted for 16 hours. The extract is subjected to an acid/base clean-up procedure followed by clean-up on micro columns of silica gel, alumina, and carbon. The extract is then spiked with 0.5 ng  $^{13}\text{C}_{12}$ -1,2,3,4-TCDD (to determine extraction efficiencies achieved for the  $^{13}\text{C}$ -labeled internal standards) and then concentrated to 10  $\mu\text{L}$  for HRGC-HRMS analysis in a 1 mL conical reactival.

**2.7** The set of sample extracts is subjected to HRGC-HRMS selected ion monitoring (SIM) analysis using a 60-m DB-5 or 60-m SP-2331 fused silica capillary column to determine the sampler efficiency, extraction efficiency, and the concentrations or the MDLs achieved for the PHDDs/PHDFs (28). Defined identification criteria and QA/QC criteria and requirements are used in evaluating the analytical data. The analytical results along with the volume of air sampled are used to calculate the concentrations of the respective tetra- through octa-isomers, the concentrations of the 2,3,7,8-chlorine or -bromine substituted isomers, or the MDLs. The concentrations and/or

MDLs are reported in  $\text{pg}/\text{m}^3$ . The EPA toxicity equivalence factors (TEFs) can be used to calculate the 2,3,7,8-TCDD toxicity equivalents (TEQs) concentrations, if desired (18).

### 3. Significance

**3.1** The PHDDs and PHDFs may enter the environment by two routes: (1) manufacture, use and disposal of specific chemical products and by-products and (2) the emissions from combustion and incineration processes. Atmospheric transport is considered to be a major route for widespread dispersal of these compounds in stack gas emissions throughout the environment. The PCDDs/PCDFs are found as complex mixtures of all isomers in emissions from combustion sources. The isomer profiles of PCDDs/PCDFs found in ambient air are similar to those found in combustion sources. Isomer profiles of PCDDs/PCDFs related to chemical products and by-products are quite different in that only a few specific and characteristic isomers are detectable, which clearly indicate they are not from a combustion source.

**3.2** The 2,3,7,8-substituted PCDDs/PCDFs are considered to be the most toxic isomers. Fortunately, they account for the smallest percentage of the total PCDD/PCDF concentrations found in stack gas emissions from combustion sources and in ambient air. The 2,3,7,8-tetrachlorodibenzo-p-dioxin (2,3,7,8-TCDD), 1 of 22 TCDD isomers and the most toxic member of PCDDs/PCDFs, is usually found as a very minor component in stack gas emissions (0.5 to 10 percent of total TCDD concentration) and is seldom found in ambient air samples. All of the 2,3,7,8-substituted PCDDs/PCDFs are retained in tissue of life-forms such as humans, fish, and wildlife, and the non 2,3,7,8-substituted PCDDs/PCDFs are rapidly metabolized and/or excreted.

**3.3** Attention has been focused on determining PHDDs/PHDFs in ambient air only in recent years. The analyses are time-consuming, complex, difficult, and expensive. Extremely sensitive, specific, and efficient analytical procedures are required because the analysis must be performed for very low concentrations in the  $\text{pg}/\text{m}^3$  and sub  $\text{pg}/\text{m}^3$  range. The MDLs, likewise, must be in the range of 0.01 to 0.2  $\text{pg}/\text{m}^3$  for the results to have significant meaning for ambient air monitoring purposes. The background level of total PCDDs/PCDFs detected in ambient air is usually in the range of 0.5 to 3  $\text{pg}/\text{m}^3$ , and the PBDFs is in the range of 0.1 to 0.2  $\text{pg}/\text{m}^3$  (2,3,14). Because PCDDs/PCDFs, PBDDs/PBDFs, and BCDDs/BCDFs can be formed by thermal reactions, there has been an increasing interest in ambient air monitoring, especially in the vicinities of combustion and incineration processes such as municipal waste combustors and resource recovery facilities (19,20). PBDDs/PBDFs can be created thermally (22,23), and they may also be formed in certain chemical processes (21). BCDDs/BCDFs have been detected in ash from combustion/incineration processes (9). The sampling and analysis method described here can be used in monitoring studies to accurately determine the presence or absence of  $\text{pg}/\text{m}^3$  and sub  $\text{pg}/\text{m}^3$  levels of these compounds in ambient air (26,27).

### 4. Safety

**4.1** The 2,3,7,8-TCDD and other 2,3,7,8-chlorine or bromine substituted isomers are toxic and can pose health hazards if handled improperly. Techniques for handling radioactive and infectious materials are applicable to 2,3,7,8-TCDD and the other PHDDs and PHDFs. Only highly trained individuals who are thoroughly versed in appropriate laboratory procedures and familiar with the hazards of 2,3,7,8-TCDD should handle these substances. A good laboratory practice involves routine physical examinations and blood checks of employees working with 2,3,7,8-TCDD. It is the responsibility of the laboratory personnel to ensure that safe handling procedures are employed.

4.2 The toxicity or carcinogenicity of the other penta-, hexa-, hepta-, and octa-PHDDs/PHDFs with chlorine or bromine atoms in positions 2,3,7,8 are known to have similar, but lower, toxicities. However, each compound should be treated as a potential health hazard and exposure to these compounds must be minimized.

4.3 While the procedure specifies benzene as the extraction solution, many laboratories have substituted toluene for benzene (28). This is due to the carcinogenic nature of benzene. The EPA is presently studying the replacement of benzene with toluene.

4.4 A laboratory should develop a strict safety program for working with these compounds, which would include safety and health protocols; work performed in well ventilated and controlled access laboratory; maintenance of current awareness file of OSHA regulations regarding the safe handling of chemicals specified in the method; protective equipment; safety training; isolated work area; waste handling and disposal procedures; decontamination procedures; and laboratory wipe tests. Other safety practices as described in EPA Method 613, Section 4, July 1982 version, EPA Method 1613 Revision A, April 1990, Office of Water and elsewhere (29,30).

## 5. Applicable Documents

### 5.1 ASTM Standards

- Method D1365 *Definitions of Terms Relating to Atmospheric Sampling and Analysis*.
- Method E260 *Recommended Practice for General Gas Chromatography Procedures*.
- Method E355 *Practice for Gas Chromatography Terms and Relationships*.

### 5.2 EPA Documents

- *Quality Assurance Handbook for Air Pollution Measurement Systems, Volume II*, U. S. Environmental Protection Agency, EPA 600/R-94-038b, May 1994.
- *Protocol for the Analysis of 2,3,7,8-Tetrachlorodibenzo-p-Dioxin by High Resolution Gas Chromatography-High Resolution Mass Spectrometry*, U. S. Environmental Protection Agency, EPA 600/40-86-004, January 1986.
- "Evaluation of an EPA High Volume Air Sampler for Polychlorinated Dibenzo-p-Dioxins and Polychlorinated Dibenzofurans," undated report by Battelle under Contract No. 68-02-4127, Project Officers Robert G. Lewis and Nancy K. Wilson, U. S. Environmental Protection Agency, Research Triangle Park, North Carolina.
- *Compendium of Methods for the Determination of Toxic Organic Compounds in Ambient Air: Method TO-9, Second Supplement*, U. S. Environmental Protection Agency, EPA 600/4-89-018, March 1989.
- *Technical Assistance Document for Sampling and Analysis of Toxic Organic Compounds in Ambient Air*, U. S. Environmental Protection Agency, EPA 600/4-83-027, June 1983.
- "Analytical Procedures and Quality Assurance for Multimedia Analysis of Polychlorinated Dibenzo-p-Dioxins and Dibenzofurans by High Resolution Gas Chromatography - Low Resolution Mass Spectrometry," U. S. Environmental Protection Agency/OSW, SW-846, RCRA 8280 HRGC-LRMS, January 1987.
- "Analytical Procedures and Quality Assurance for Multimedia Analysis of Polychlorinated Dibenzo-p-Dioxins and Dibenzofurans by High Resolution Gas Chromatography - High Resolution Mass Spectrometry," U. S. Environmental Protection Agency/OSW, SW-846, RCRA 8290 HRGC-HRMS, June 1987.



- Harless, R., "Analytical Procedures and Quality Assurance Plan for the Determination of PCDDs and PCDFs Ambient Air near the Rutland, Vermont Municipal Incinerator," Final Report, U. S. Environmental Protection Agency, AREAL, RTP, NC, 1988.
- *Feasibility of Environmental Monitoring and Exposure Assessment for a Municipal Waste Combustor: Rutland, Vermont Pilot Study*, U. S. Environmental Protection Agency, EPA 600/8-91/007, March 1991.
- "Method 23, Determination of Polychlorinated Dibenzo-p-Dioxins (PCDDs) and Dibenzofurans (PCDFs) from Stationary Sources." *Federal Register*, Vol. 56, No. 30, February 13, 1991.
- *Method 1613 Tetra- through Octa-Chlorinated Dioxins and Furans by Isotope Dilution HRGC-HRMS*, U. S. Environmental Protection Agency, Office of Solid Waste, Washington, DC, April 1990.

### 5.3 Other Documents

- "Operating Procedures for Model PS-1 Sampler," Graseby/General Metal Works, Inc., Village of Cleves, OH 45002 (800-543-7412).
- "Chicago Air Quality: PCB Air Monitoring Plan, Phase 2," IEAP/APC/86-011, Illinois Environmental Protection Agency, Division of Air Pollution Control, April 1986.
- "Operating Procedures for the Thermo Environmental Semi-volatile Sampler," Thermo Environmental Instruments, Inc. (formerly Wedding and Associates), 8 West Forge Parkway, Franklin, MA 02038 (508-520-0430).

## 6. Definitions

*[Note: Definitions used in this document and any user-prepared Standard Operating Procedures (SOPs) should be consistent with those used in ASTM D1356. All abbreviations and symbols are defined within this document at the point of first use.]*

**6.1 Polychlorinated dibenzo-p-dioxins (PCDDs) and polychlorinated dibenzofurans (PCDFs)**—compounds that contain from 1 to 8 chlorine atoms, resulting in a total of 75 PCDDs and 135 PCDFs. The structures are shown in Figure 1. The numbers of isomers at different chlorination levels are shown in Table 1. The seventeen 2,3,7,8-substituted PCDDs/PCDFs are shown in Table 2.

**6.2 Polybrominated dibenzo-p-dioxins (PBDDs) and polybrominated dibenzofurans (PBDFs)**—compounds that have the same structure and contain from 1 to 8 bromine atoms, resulting in a total of 75 PBDDs and 135 PBDFs. The structures and isomers are the same as those of the PCDDs/PCDFs shown in Figure 1 and Tables 1 and 2.

**6.3 Brominated/chlorinated dibenzo-p-dioxins (BCDDs) and brominated/chlorinated dibenzofurans (BCDFs)**—compounds with the same structures and may contain from 1 to 8 chlorine and bromine atoms, resulting in 1550 BCDD congeners and 3050 BCDF congeners.

**6.4 Polyhalogenated dibenzo-p-dioxins (PHDDs) and polyhalogenated dibenzofurans (PHDFs)**—dibenzo-p-dioxins and dibenzofurans substituted with 1 or more halogen atoms.

**6.5 Isomer**—compounds having the same number and type of halogen atoms, but substituted in different positions. For example, 2,3,7,8-TCDD and 1,2,3,4-TCDD are isomers. Additionally, there are 22 isomers that constitute the homologues of TCDDs.

**6.6 Isomeric group**—a group of dibenzo-p-dioxins or dibenzofurans having the same number of halogen atoms. For example, the tetra-chlorinated dibenzo-p-dioxins.

**6.7 Internal Standard**—is an isotopically-labeled analog that is added to all samples, including method blanks (process and field) and quality control samples, before extraction. They are used along with response factors to measure the concentration of the analytes. Nine PCDD/PCDF and 4 PBDD/PBDF internal standards are used in this method. There is one for each of the chlorinated dioxin and furan isomeric groups with a degree of halogenation ranging from four to eight, with the exception of OCDF.

**6.8 High-Resolution Calibration Solutions (see Table 3)**—solutions in tridecane containing known amounts of 17 selected PCDDs and PCDFs, 9 internal standards ( $^{13}\text{C}_{12}$ -labeled PCDDs/PCDFs), 2 field standards, 4 surrogate standards, and 1 recovery standard. The set of 5 solutions is used to determine the instrument response of the unlabeled analytes relative to the  $^{13}\text{C}_{12}$ -labeled internal standards and of the  $^{13}\text{C}_{12}$ -labeled internal standards relative to the surrogate, field and recovery standards. Different concentrations and other standards may be used, if desired. Criteria for acceptable calibration as outlined in Section 13.5 should be met in order to use the analyte relative response factors.

**6.9 Sample Fortification Solutions (see Table 4)**—solutions (in isooctane) containing the  $^{13}\text{C}_{12}$ -labeled internal standards that are used to spike all samples, field blanks, and process blanks before extraction. Brominated standards used only when desired.

**6.10 Recovery Standard Solution (see Table 5)**—Recovery Standard Solution (see Table 5)—an isooctane solution containing the  $^{13}\text{C}_{12}$ -1,2,3,4-TCDD ( $^{13}\text{C}_{12}$ -2,3,7,8,9-HxDD optional) recovery standards that are added to the extract before final concentration for HRGC-HRMS analysis to determine the recovery efficiencies achieved for the  $^{13}\text{C}_{12}$ -labeled internal standards.

**6.11 Air Sampler Field Fortification Solution (see Table 6)**—an isooctane solution containing the  $^{37}\text{Cl}_4$ -2,3,7,8-TCDD standard that is spiked to the PUF plugs prior to shipping them to the field for air sampling.

**6.12 Surrogate Standard Solution (see Table 7)**—an isooctane solution containing 4  $^{13}\text{C}_{12}$ -labeled standards that may be spiked to the filter or PUF prior to air sampling, to the sample prior to extraction, or to the sample extract before cleanup or before HRGC-HRMS analysis to determine sampler efficiency method efficiency or for identification purposes (28). Other standards and different concentrations may be used, if desired.

**6.13 Matrix Spike and Method Spike Solutions (see Table 8)**—isooctane solutions of native (non-labeled) PCDDs and PCDFs and PBDDs and PBDFs that are spiked to a clean PUF prior to extraction.

**6.14 Sample Set**—consists of nine test samples, field blank, method blank, and matrix spiked with native PHDDs/PHDFs. Sample preparation, HRGC-HRMS analysis, and evaluation of data is performed on a sample set.

**6.15 Lab Control Spike**—standard that is prepared during sample preparation and that contains exactly the same amounts of all of the labeled and unlabeled standards that were used in extraction and cleanup of the sample set for HRGC-HRMS analysis.

**6.16 Field Blank**—consists of a sample cartridge containing PUF and filter that is spiked with the field fortification solution, shipped to the field, installed on the sampler, and passively exposed at the sampling area (the sampler is not operated). It is then sealed and returned to the laboratory for extraction, cleanup, and HRGC-HRMS analysis. It is treated in exactly the same manner as a test sample. A field blank is processed with each sampling episode. The field blank represents the background contributions from passive exposure to ambient air, PUF, quartz fiber filter, glassware, and solvents.

**6.17 Laboratory Method Blank**—represents the background contributions from glassware, extraction and cleanup solvents. A Soxhlet extractor is spiked with a solution of  $^{13}\text{C}_{12}$ -labeled internal standards, extracted, cleaned up, and analyzed by HRGC-HRMS in exactly the same manner as the test samples.

**6.18 Solvent Blank**—an aliquot of solvent (the amount used in the method) that is spiked with the  $^{13}\text{C}_{12}$ -labeled internal standards and concentrated to  $60\ \mu\text{L}$  for HRGC-HRMS analysis. The analysis provides the background contributions from the specific solvent.

**6.19 GC Column Performance Evaluation Solution (see Table 9)**—a solution containing a mixture of selected PCDD/PCDF isomers, including the first and last chromatographic eluters for each isomeric group. Used to demonstrate continued acceptable performance of the capillary column and to define the PCDD/PCDF retention time windows. Also includes a mixture of tetradioxin isomers that elute closest to 2,3,7,8-TCDD.

**6.20 QA/QC Audit Samples**—samples of PUF that contain known amounts of unlabeled PCDDs and PCDFs. These samples are submitted as "blind" test samples to the analytical laboratory. The analytical results can then be used to determine and validate the laboratory's accuracy, precision and overall analytical capabilities for determination of PCDDs/PCDFs.

**6.21 Relative Response Factor**—response of the mass spectrometer to a known amount of an analyte relative to a known amount of a labeled internal standard.

**6.22 Method Blank Contamination**—the method blank should be free of interferences that affect the identification and quantification of PHDDs and PHDFs. A valid method blank is an analysis in which all internal standard signals are characterized by S/N ratio greater than 10:1 and the MDLs are adequate for the study. The set of samples must be extracted and analyzed again if a valid method blank cannot be achieved.

**6.23 Sample Rerun**—additional cleanup of the extract and reanalysis of the extract.

**6.24 Extract Reanalysis**—analysis by HRGC-HRMS of another aliquot of the final extract.

**6.25 Mass Resolution Check**—a standard method used to demonstrate a static HRMS resolving power of 10,000 or greater (10 percent valley definition).

**6.26 Method Calibration Limits (MCLs)**—for a given sample size, a final extract volume, and the lowest and highest calibration solutions, the lower and upper MCLs delineate the region of quantitation for which the HRGC-HRMS system was calibrated with standard solutions.

**6.27 HRGC-HRMS Solvent Blank**—a 1 or 2  $\mu\text{L}$  aliquot of solvent that is analyzed for tetra- through octa-PCDDs and PCDFs following the analysis of a sample that contains high concentrations of these compounds.

An acceptable solvent blank analysis (free of PHDDs/PHDFs) should be achieved before continuing with analysis of the test samples.

**6.28 Sampler Spike (SS)**—a sampler that is spiked with known amounts of the air sampler field fortification solution (see Table 6) and the matrix spike solutions (see Table 8) prior to operating the sampler for 24 hours to sample 325-400 std m<sup>3</sup> ambient air. The results achieved for this sample can be used to determine the efficiency, accuracy and overall capabilities of the sampling device and analytical method.

**6.29 Collocated Samplers (CS)**—two samplers installed close together at the same site that can be spiked with known amounts of the air sampler field fortification solution (see Table 6) prior to operating the samplers for 24 hours to sample 325-400 std m<sup>3</sup> ambient air. The analytical results for these two samples can be used to determine and evaluate efficiency, accuracy, precision, and overall capabilities of the sampling device and analytical method.

**6.30 Congener**—a term which refers to any one particular member of the same chemical family. As an example, there are 75 congeners of chlorinated dibenzo-p-dioxins. A specific congener is denoted by unique chemical notations. For example, 2,4,8,9-tetrachlorodibenzofuran is referred to as 2,4,8,9-TCDF.

**6.31 Homologue**—a term which refers to a group of structurally related chemicals that have the same degree of chlorination. For example, there are eight homologues of CDDs, monochlorinated through octochlorinated. Notation for homologous classes is as follows:

Class	Acronym	
Dibenzo-p-dioxin	D	
Dibenzofuran	F	
No. of halogens	Acronym	Example
1	M	
2	D	2,4-DCDD
3	Tr	
4	T	1,4,7,8-TCDD
5	Pe	
6	Hx	
7	Hp	
8	O	
1 through 8	CDDs and CDFs	

## 7. Interferences And Contamination

**7.1** Any compound having a similar mass and mass/charge (m/z) ratio eluting from the HRGC column within  $\pm 2$  seconds of the PHDD/PHDF of interest is a potential interference. Also, any compound eluting from the HRGC column in a very high concentration will decrease sensitivity in the retention time frame. Some commonly encountered interferences are compounds that are extracted along with the PCDDs and PCDFs or other PHDDs/PHDFs, e.g., polychlorinated biphenyls (PCBs), methoxybiphenyls, polychlorinated diphenylethers, polychlorinated naphthalenes, DDE, DDT, etc. The cleanup procedures are designed to eliminate the majority of these substances. The capillary column resolution and mass spectrometer resolving power are extremely helpful in segregating any remaining interferences from PCDDs and PCDFs. The severity of an interference

problem is usually dependent on the concentrations and the mass spectrometer and chromatographic resolutions. However, polychlorinated diphenylethers are extremely difficult to resolve from PCDFs because they elute in retention time windows of PCDFs, and their fragment ion resulting from the loss of 2 chlorine atoms is identical to that of the respective PCDF. For example, the molecular ions of hexachlorodiphenylethers must be monitored to confirm their presence or absence in the analysis for TCDFs. This requirement also applies to the other PCDFs and PBDFs.

**7.2** Since very low levels of PCDDs and PCDFs must be determined, the elimination of interferences is essential. High purity reagents and solvents must be used, and all equipment must be scrupulously cleaned. All materials, such as PUF, filter solvents, etc., used in the procedures are monitored and analyzed frequently to ensure the absence of contamination. Cleanup procedures must be optimized and performed carefully to minimize the loss of analyte compounds during attempts to increase their concentrations relative to other sample components. The analytical results achieved for the field blank, method blank, and method spike in a "set" of samples is extremely important in evaluating and validating the analytical data achieved for the test samples.

## 8. Apparatus

*[Note: This method was developed using the PS-1 semi-volatile sampler provided by General Metal Works, Village of Cleves, OH as a guideline. EPA has experience in use of this equipment during various field monitoring programs over the last several years. Other manufacturers' equipment should work as well. However, modifications to these procedures may be necessary if another commercially available sampler is selected.]*

**8.1 High-Volume Sampler (see Figure 2).** Capable of pulling ambient air through the filter/adsorbent cartridge at a flow rate of approximately 8 standard cubic feet per minute (scfm) ( $0.225 \text{ std m}^3/\text{min}$ ) to obtain a total sample volume of greater than 325 scm over a 24-hour period. Major manufacturers are:

- Tisch Environmental, Village of Cleves, OH
- Andersen Instruments Inc., 500 Technology Ct., Smyrna, GA
- Thermo Environmental Instruments, Inc., 8 West Forge Parkway, Franklin, MA

**8.2 High-Volume Sampler Calibrator.** Capable of providing multipoint resistance for the high-volume sampler. Major manufacturers are:

- Tisch Environmental, Village of Cleves, OH
- Andersen Instruments Inc., 500 Technology Ct., Smyrna, GA
- Thermo Environmental Instruments, Inc., 8 West Forge Parkway, Franklin, MA

## 8.3 High Resolution Gas Chromatograph-High Resolution Mass Spectrometer-Data System (HRGC-HRMS-DS)

**8.3.1** The GC should be equipped for temperature programming and all of the required accessories, such as gases and syringes, should be available. The GC injection port should be designed for capillary columns. Splitless injection technique, on-column injections, or moving needle injectors may be used. It is important to use the same technique and injection volume at all times.

**8.3.2** The HRGC-HRMS interface, if used, should be constructed of fused silica tubing or all glass or glass lined stainless steel and should be able to withstand temperatures up to 340°C. The interface should not degrade the separation of PHDD/PHDF isomers achieved by the capillary column. Active sites or cold spots in the interface can cause peak broadening and peak tailing. The capillary column should be fitted directly into the HRMS ion source to avoid these types of problems. Graphite ferrules can adsorb PHDDs/PHDFs and cause problems. Therefore, Vespel® or equivalent ferrules are recommended.

**8.3.3** The HRMS system should be operated in the electron impact ionization mode. The static resolving power of the instrument should be maintained at 10,000 or greater (10% valley definition). The HRMS should be operated in the selected ion monitoring (SIM) mode with a total cycle time of one second or less. At a minimum, the ions listed in Tables 10, 11, and 12 for each of the select ion monitoring (SIM) descriptors should be monitored. It is important to use the same set of ions for both calibration and sample analysis.

**8.3.4** The data system should provide for control of mass spectrometer, data acquisition, and data processing. The data system should have the capability to control and switch to different sets of ions (descriptors/mass menus shown in Tables 10, 11, and 12) at different times during the HRGC-HRMS SIM analysis. The SIM traces/displays of ion signals being monitored can be displayed on the terminal in real time and sorted for processing. Quantifications are reported based on computer generated peak areas. The data system should be able to provide hard copies of individual ion chromatograms for selected SIM time intervals, and it should have the capability to allow measurement of noise on the baseline. It should also have the capability to acquire mass-spectral peak profiles and provide hard copies of the peak profiles to demonstrate the required mass resolution.

**8.3.5** HRGC columns, such as the DB-5 (28) and SP-2331 fused silica capillary columns, and the operating parameters known to produce acceptable results are shown in Tables 13 and 14. Other types of capillary columns may also be used as long as the performance requirements can be successfully demonstrated.

## 9. Equipment And Materials

### 9.1 Materials for Sample Collection (see Figure 3a)

**9.1.1 Quartz fiber filter.** 102 millimeter bindless quartz microfiber filter, Whatman International Ltd, QMA-4.

**9.1.2 Polyurethane foam (PUF) plugs.** 3-inch thick sheet stock polyurethane type (density 0.022 g/cm<sup>3</sup>). The PUF should be of the polyether type used for furniture upholstery, pillows, and mattresses. The PUF cylinders (plugs) should be slightly larger in diameter than the internal diameter of the cartridge. Sources of equipment are Tisch Environmental, Village of Cleves, OH; University Research Glassware, 116 S. Merritt Mill Road, Chapel Hill, NC; Thermo Environmental Instruments, Inc., 8 West Forge Parkway, Franklin, MA; Supelco, Supelco Park, Bellefonte, PA; and SKC Inc., 334 Valley View Road, Eighty Four, PA (see Figure 3b).

**9.1.3 Teflon® end caps.** For sample cartridge. Sources of equipment are Tisch Environmental, Village of Cleves, OH; and University Research Glassware, 116 S. Merritt Mill Road, Chapel Hill, NC (see Figure 3b).

**9.1.4 Sample cartridge aluminum shipping containers.** For sample cartridge shipping. Sources of equipment are Tisch Environmental, Village of Cleves, OH; and University Research Glassware, 116 S. Merritt Mill Road, Chapel Hill, NC (see Figure 3b).

**9.1.5 Glass sample cartridge.** For sample collection. Sources of equipment are Tisch Environmental, Village of Cleves, OH; Thermo Environmental Instruments, Inc., 8 West Forge, Parkway, Franklin, MA; and University Research Glassware, 116 S. Merritt Mill Road, Chapel Hill, NC (see Figure 3b).

## 9.2 Laboratory Equipment

- 9.2.1 **Laboratory hoods.**
- 9.2.2 **Drying oven.**
- 9.2.3 **Rotary evaporator.** With temperature-controlled water bath.
- 9.2.4 **Balances.**
- 9.2.5 **Nitrogen evaporation apparatus.**
- 9.2.6 **Pipettes.** Disposal Pasteur, 150-mm long x 5-mm i.d.
- 9.2.7 **Soxhlet apparatus.** 500-mL.
- 9.2.8 **Glass funnels.**
- 9.2.9 **Desiccator.**
- 9.2.10 **Solvent reservoir.** 125-mL, Kontes, 12.35-cm diameter.
- 9.2.11 **Stainless steel spoons and spatulas.**
- 9.2.12 **Glass wool.** Extracted with methylene chloride, stored in clean jar.
- 9.2.13 **Laboratory refrigerator.**
- 9.2.14 **Chromatographic columns.**
- 9.2.15 **Perfluorokerosenes.**

## 9.3 Reagents and Other Materials

- 9.3.1 **Sulfuric acid.** Ultrapure, ACS grade, specific gravity 1.84, acid silica.
- 9.3.2 **Sodium hydroxide.** Potassium hydroxide, reagent grade, base silica.
- 9.3.3 **Sodium sulfate.**
- 9.3.4 **Anhydrous, reagent grade.**
- 9.3.5 **Glass wool.** Silanized, extracted with methylene chloride and hexane, and dried.
- 9.3.6 **Diethyl ether.** High purity, glass distilled.
- 9.3.7 **Isooctane.** Burdick and Jackson, glass-distilled.
- 9.3.8 **Hexane.** Burdick and Jackson, glass-distilled.
- 9.3.9 **Toluene.** Burdick and Jackson, glass-distilled, or equivalent.
- 9.3.10 **Methylene chloride.** Burdock and Jackson, chromatographic grade, glass distilled.
- 9.3.11 **Acetone.** Burdick and Jackson, high purity, glass distilled.
- 9.3.12 **Tridecane.** Aldrich, high purity, glass distilled.
- 9.3.13 **Isooctane.** Burdick and Jackson, high purity, glass distilled.
- 9.3.14 **Alumina.** Acid, pre-extracted (16-21 hours) and activated.
- 9.3.15 **Silica gel.** High purity grade, type 60, 70-230 mesh; extracted in a Soxhlet apparatus with methylene chloride (see Section 8.18) for 16-24 hours (minimum of 3 cycles per hour) and activated by heating in a foil-covered glass container for 8 hours at 130°C.
- 9.3.16 **18 percent Carbopack C/Celite 545.**
- 9.3.17 **Methanol.** Burdick and Jackson, high purity, glass distilled.
- 9.3.18 **Nonane.** Aldrich, high purity, glass distilled.
- 9.3.19 **Benzene.** High purity, glass distilled.

## 9.4 Calibration Solutions and Solutions of Standards Used in the Method

**9.4.1 HRGC-HRMS Calibration Solutions (see Table 3).** Solutions containing  $^{13}\text{C}_{12}$ -labeled and unlabeled PCDDs and PCDFs at known concentrations are used to calibrate the instrument. These standards can be obtained from various commercial sources such as Cambridge Isotope Laboratories, 50 Frontage Road, Andover, MA 01810, 508-749-8000.

**9.4.2 Sample Fortification Solutions (see Table 4).** An isooctane solution (or nonane solution) containing the  $^{13}\text{C}_{12}$ -labeled PCDD/PCDF and PBDD/PBDF internal standards at the listed concentrations. The internal standards are spiked to all samples prior to extraction and are used to measure the concentration of the unlabeled native analytes and to determine MDLs.

**9.4.3 Recovery Standard Spiking Solution (see Table 5).** An isooctane solution containing  $^{13}\text{C}_{12}$ -1,2,3,4-TCDD at a concentration of 10 pg/ $\mu\text{L}$ . Additional recovery standards may be used if desired.

**9.4.4 Sampler Field Fortification Solution (see Table 6).** An isooctane solution containing 10 pg/ $\mu\text{L}$   $^{37}\text{Cl}_4$ -2,3,7,8-TCDD.

**9.4.5 Surrogate Standards Solution (see Table 7).** An isooctane solution containing the four  $^{13}\text{C}_{12}$ -labeled standards at a concentration of 100 pg/ $\mu\text{L}$ .

**9.4.6 Matrix/Method Spike Solution (see Table 8).** An isooctane solution containing the unlabeled PCDDs/PCDFs and PBDDs/PBDFs at the concentrations listed.

*[Note: All PHDD/PHDF solutions listed above should be stored in a refrigerator at less than or equal to 4°C in the dark. Exposure of the solutions to light should be minimized.]*

**9.4.7 Column Performance Evaluation Solutions (see Table 9).** Isooctane solutions of first and last chromatographic eluting isomers for each isomeric group of tetra- through octa-CDDs/CDFs. Also includes a mixture of tetradoxin isomers that elute closest to 2,3,7,8-TCDD.

## 10. Preparation Of PUF Sampling Cartridge

### 10.1 Summary of Method

**10.1.1** This part of the procedure discusses pertinent information regarding the preparation and cleaning of the filter, adsorbents, and filter/adsorbent cartridge assembly. The separate batches of filters and adsorbents are extracted with the appropriate solvent.

**10.1.2** At least one PUF cartridge assembly and one filter from each batch, or 10 percent of the batch, whichever is greater, should be tested and certified before the batch is considered for field use.

**10.1.3** Prior to sampling, the cartridges are spiked with surrogate compounds.

### 10.2 Preparation of Sampling Cartridge

**10.2.1** Bake the quartz filters at 400°C for 5 hours before use.

**10.2.2** Set aside the filters in a clean container for shipment to the field or prior to combining with the PUF glass cartridge assembly for certification prior to field deployment.

**10.2.3** The PUF plugs are 6.0-cm diameter cylindrical plugs cut from 3-inch sheet stock and should fit, with slight compression, in the glass cartridge, supported by the wire screen (see Figure 2). During cutting, rotate the die at high speed (e.g., in a drill press) and continuously lubricate with deionized or distilled water. Pre-cleaned PUF plugs can be obtained from commercial sources (see Section 9.1.2).



**10.2.4** For initial cleanup, place the PUF plugs in a Soxhlet apparatus and extract with acetone for 16 hours at approximately 4 cycles per hour. When cartridges are reused, use diethyl ether/hexane (5 to 10 percent volume/volume [v/v]) as the cleanup solvent.

*[Note: A modified PUF cleanup procedure can be used to remove unknown interference components of the PUF blank. This method consists of rinsing 50 times with toluene, acetone, and diethyl ether/hexane (5 to 10 percent v/v), followed by Soxhlet extraction. The extracted PUF is placed in a vacuum oven connected to a water aspirator and dried at room temperature for approximately 2 to 4 hours (until no solvent odor is detected). The extract from the Soxhlet extraction procedure from each batch may be analyzed to determine initial cleanliness prior to certification.]*

**10.2.5** Fit a nickel or stainless steel screen (mesh size 200/200) to the bottom of a hexane-rinsed glass sampling cartridge to retain the PUF adsorbents, as illustrated in Figure 2. Place the Soxhlet-extracted, vacuum-dried PUF (2.5-cm thick by 6.5-cm diameter) on top of the screen in the glass sampling cartridge using polyester gloves.

**10.2.6** Wrap the sampling cartridge with hexane-rinsed aluminum foil, cap with the Teflon® end caps, place in a cleaned labeled aluminum shipping container, and seal with Teflon® tape. Analyze at least 1 PUF plug from each batch of PUF plugs using the procedures described in Section 10.3, before the batch is considered acceptable for field use. A level of 2 to 20 pg for tetra-, penta-, and hexa- and 40 to 150 pg for hepta- and octa-CDDs similar to that occasionally detected in the method blank (background contamination) is considered to be acceptable. Background levels can be reduced further, if necessary. Cartridges are considered clean for up to 30 days from date of certification when stored in their sealed containers.

### 10.3 Procedure for Certification of PUF Cartridge Assembly

**10.3.1** Extract 1 filter and PUF adsorbent cartridge by Soxhlet extraction and concentrate using a Kuderna-Danish (K-D) evaporator for each lot of filters and cartridges sent to the field.

**10.3.2** Assemble the Soxhlet apparatus. Charge the Soxhlet apparatus with 300 mL of the extraction solvent (10 percent v/v diethyl ether/hexane) and reflux for 2 hours. Let the apparatus cool, disassemble it, and discard the used extraction solvent. Transfer the filter and PUF glass cartridge to the Soxhlet apparatus (the use of an extraction thimble is optional).

*[Note: The filter and adsorbent assembly are tested together in order to reach detection limits, to minimize cost and to prevent misinterpretation of the data. Separate analyses of the filter and PUF would not yield useful information about the physical state of most of the PHDDs and PHDFs at the time of sampling due to evaporative losses from the filter during sampling.]*

**10.3.3** Add 300 mL of diethyl ether/hexane (10 percent v/v) to the Soxhlet apparatus. Reflux the sample for 18 hours at a rate of at least 3 cycles per hour. Allow to cool; then disassemble the apparatus.

**10.3.4** Assemble a K-D concentrator by attaching a 10-mL concentrator tube to a 500-mL evaporative flask.

**10.3.5** Transfer the extract by pouring it through a drying column containing about 10 cm of anhydrous granular sodium sulfate and collect the extract in the K-D concentrator. Rinse the Erlenmeyer flask and column with 20 to 30 mL of 10 percent diethylether/hexane to complete the quantitative transfer.

**10.3.6** Add 1 or 2 clean boiling chips and attach a 3-ball Snyder column to the evaporative flask. Pre-wet the Snyder column by adding about 1 mL of the extraction solvent to the top of the column. Place the K-D apparatus on a hot water bath (50°C) so that the concentrator tube is partially immersed in the hot water, and the entire lower rounded surface of the flask is bathed with hot vapor. Adjust the vertical position of the apparatus

and the water temperature as required to complete the concentration in one hour. At the proper rate of distillation, the balls of the column will actively chatter but the chambers will not flood with condensed solvent. When the apparent volume of liquid reaches approximately 5 mL, remove the K-D apparatus from the water bath and allow it to drain and cool for at least 5 minutes. Remove the Snyder column and rinse the flask and its lower joint into the concentrator tube with 5 mL of hexane. A 5-mL syringe is recommended for this operation.

**10.3.7** Concentrate the extract to 1 mL, cleanup the extract (see Section 12.2.2), and analyze the final extract using HRGC-HRMS.

**10.3.8** The level of target compounds must be less than or equal to 2 to 20 pg for tetra-, penta-, and hexa- and 40 to 150 pg for hepta- and octa-CDDs for each pair of filter and adsorbent assembly analyzed is considered to be acceptable.

#### 10.4 Deployment of Cartridges for Field Sampling

**10.4.1** Prior to field deployment, add surrogate compounds (i.e., chemically inert compounds not expected to occur in an environmental sample) to the center bed of the PUF cartridge, using a microsyringe. The surrogate compounds (see Table 3) must be added to each cartridge assembly.

**10.4.2** Use the recoveries of the surrogate compounds to monitor for unusual matrix effects and gross sampling processing errors. Evaluate surrogate recovery for acceptance by determining whether the measured concentration falls within the acceptance limits.

### 11. Assembly, Calibration And Collection Using Sampling System

*[Note: This method was developed using the PS-1 semi-volatile sampler provided by General Metal Works, Village of Cleves, OH as a guideline. EPA has experience in use of this equipment during various field monitoring programs over the last several years. Other manufacturers' equipment should work as well. However, modifications to these procedures may be necessary if another commercially available sampler is selected.]*

#### 11.1 Description of Sampling Apparatus

The entire sampling system is diagrammed in Figure 1. This apparatus was developed to operate at a rate of 4 to 10 scfm (0.114 to 0.285 std m<sup>3</sup>/min) and is used by EPA for high-volume sampling of ambient air. The method write-up presents the use of this device.

The sampling module (see Figure 2) consists of a filter and a glass sampling cartridge containing the PUF utilized to concentrate dioxins/furans from the air. A field portable unit has been developed by EPA (see Figure 4).

#### 11.2 Calibration of Sampling System

Each sampler should be calibrated (1) when new, (2) after major repairs or maintenance, (3) whenever any audit point deviates from the calibration curve by more than 7 percent, (4) before/after each sampling event, and (5) when a different sample collection media, other than that which the sampler was originally calibrated to, will be used for sampling.

**11.2.1 Calibration of Orifice Transfer Standard.** Calibrate the modified high volume air sampler in the field using a calibrated orifice flow rate transfer standard. Certify the orifice transfer standard in the laboratory against a positive displacement rootsmeter (see Figure 5). Once certified, the recertification is performed rather

infrequently if the orifice is protected from damage. Recertify the orifice transfer standard performed once per year utilizing a set of five multiple resistance plates.

*[Note: The set of five multihole resistance plates are used to change the flow through the orifice so that several points can be obtained for the orifice calibration curve. The following procedure outlines the steps to calibrate the orifice transfer standard in the laboratory.]*

**11.2.1.1** Record the room temperature ( $T_1$  in °C) and barometric pressure ( $P_b$  in mm Hg) on the Orifice Calibration Data Sheet (see Figure 6). Calculate the room temperature in K (absolute temperature) and record on Orifice Calibration Data Sheet.

$$T_1 \text{ in K} = 273^\circ + T_1 \text{ in } ^\circ\text{C}$$

**11.2.1.2** Set up laboratory orifice calibration equipment as illustrated in Figure 5. Check the oil level of the rootsmeter prior to starting. There are 3 oil level indicators, 1 at the clear plastic end and 2 site glasses, 1 at each end of the measuring chamber.

**11.2.1.3** Check for leaks by clamping both manometer lines, blocking the orifice with cellophane tape, turning on the high volume motor, and noting any change in the rootsmeter's reading. If the rootsmeter's reading changes, there is a leak in the system. Eliminate the leak before proceeding. If the rootsmeter's reading remains constant, turn off the hi-vol motor, remove the cellophane tape, and unclamp both manometer lines.

**11.2.1.4** Install the 5-hole resistance plate between the orifice and the filter adapter.

**11.2.1.5** Turn manometer tubing connectors 1 turn counter-clockwise. Make sure all connectors are open.

**11.2.1.6** Adjust both manometer midpoints by sliding their movable scales until the zero point corresponds with the meniscus. Gently shake or tap to remove any air bubbles and/or liquid remaining on tubing connectors. (If additional liquid is required for the water manometer, remove tubing connector and add clean water.)

**11.2.1.7** Turn on the high volume motor and let it run for 5 minutes to set the motor brushes. Turn the motor off. Insure manometers are set to zero. Turn the high volume motor on.

**11.2.1.8** Record the time, in minutes, required to pass a known volume of air (approximately 200 to 300 ft<sup>3</sup> of air for each resistance plate) through the rootsmeter by using the rootsmeter's digital volume dial and a stopwatch.

**11.2.1.9** Record both manometer readings— orifice water manometer ( $\Delta H$ ) and rootsmeter mercury manometer ( $\Delta P$ ) on Orifice Calibration Data Sheet (see Figure 6).

*[Note:  $\Delta H$  is the sum of the difference from zero (0) of the two column heights.]*

**11.2.1.10** Turn off the high volume motor.

**11.2.1.11** Replace the 5-hole resistance plate with the 7-hole resistance plate.

**11.2.1.12** Repeat Sections 11.2.1.3 through 11.2.1.11.

**11.2.1.13** Repeat for each resistance plate. Note results on Orifice Calibration Data Sheet (see Figure 6). Only a minute is needed for warm-up of the motor. Be sure to tighten the orifice enough to eliminate any leaks. Also check the gaskets for cracks.

*[Note: The placement of the orifice prior to the rootsmeter causes the pressure at the inlet of the rootsmeter to be reduced below atmospheric conditions, thus causing the measured volume to be incorrect. The volume measured by the rootsmeter must be corrected.]*

**11.2.1.14** Correct the measured volumes on the Orifice Calibration Data Sheet:

$$V_{\text{std}} = V_{\text{m}} \left( \frac{P_{\text{a}} - \Delta P}{P_{\text{std}}} \right) \left( \frac{T_{\text{std}}}{T_{\text{a}}} \right)$$

where:

- $V_{\text{std}}$  = standard volume, std m<sup>3</sup>
- $V_{\text{m}}$  = actual volume measured by the rootsmeter, m<sup>3</sup>
- $P_{\text{a}}$  = barometric pressure during calibration, mm Hg
- $\Delta P$  = differential pressure at inlet to volume meter, mm Hg
- $P_{\text{std}}$  = 760 mm Hg
- $T_{\text{a}}$  = ambient temperature during calibration, K.

**11.2.1.15** Record standard volume on Orifice Calibration Data Sheet.

**11.2.1.16** The standard flow rate as measured by the rootsmeter can now be calculated using the following formula:

$$Q_{\text{std}} = \frac{V_{\text{std}}}{\theta}$$

where:

- $Q_{\text{std}}$  = standard volumetric flow rate, std m<sup>3</sup>/min
- $\theta$  = elapsed time, min

**11.2.1.17** Record the standard flow rates to the nearest 0.01 std m<sup>3</sup>/min.

**11.2.1.18** Calculate and record  $\sqrt{\Delta H (P_1/P_{\text{std}})(298/T_1)}$  value for each standard flow rate.

**11.2.1.19** Plot each  $\sqrt{\Delta H (P_1/P_{\text{std}})(298/T_1)}$  value (y-axis) versus its associated standard flow rate (x-axis) on arithmetic graph paper and draw a line of best fit between the individual plotted points.

*[Note: This graph will be used in the field to determine standard flow rate.]*

## **11.2.2 Calibration of the High Volume Sampling System Utilizing Calibrated Orifice Transfer Standard**

For this calibration procedure, the following conditions are assumed in the field:

- The sampler is equipped with an valve to control sample flow rate.
- The sample flow rate is determined by measuring the orifice pressure differential, using a magnehelic gauge.
- The sampler is designed to operate at a standardized volumetric flow rate of 8 ft<sup>3</sup>/min (0.225 m<sup>3</sup>/min), with an acceptable flow rate range within 10 percent of this value.
- The transfer standard for the flow rate calibration is an orifice device. The flow rate through the orifice is determined by the pressure drop caused by the orifice and is measured using a "U" tube water manometer or equivalent.
- The sampler and the orifice transfer standard are calibrated to standard volumetric flow rate units (scfm or scmm).

- An orifice transfer standard with calibration traceable to NIST is used.
- A "U" tube water manometer or equivalent, with a 0- to 16-inch range and a maximum scale division of 0.1 inch, will be used to measure the pressure in the orifice transfer standard.
- A magnehelic gauge or equivalent, with a 9- to 100-inch range and a minimum scale division of 2 inches for measurements of the differential pressure across the sampler's orifice is used.
- A thermometer capable of measuring temperature over the range of 32° to 122°F (0° to 50°C) to  $\pm 2^\circ\text{F}$  ( $\pm 1^\circ\text{C}$ ) and referenced annually to a calibrated mercury thermometer is used.
- A portable aneroid barometer (or equivalent) capable of measuring ambient barometric pressure between 500 and 800 mm Hg (19.5 and 31.5 in. Hg) to the nearest mm Hg and referenced annually to a barometer of known accuracy is used.
- Miscellaneous handtools, calibration data sheets or station log book, and wide duct tape are available.

**11.2.2.1** Monitor the airflow through the sampling system with a venturi/Magnehelic assembly, as illustrated in Figure 7. Set up the calibration system as illustrated in Figure 7. Audit the field sampling system once per quarter using a flow rate transfer standard, as described in the EPA *High Volume-Sampling Method, 40 CFR 50, Appendix B*. Perform a single-point calibration before and after each sample collection, using the procedures described in Section 11.2.3.

**11.2.2.2** Prior to initial multi-point calibration, place an empty glass cartridge in the sampling head and activate the sampling motor. Fully open the flow control valve and adjust the voltage variator so that a sample flow rate corresponding to 110 percent of the desired flow rate (typically 0.20 to 0.28 m<sup>3</sup>/min) is indicated on the Magnehelic gauge (based on the previously obtained multipoint calibration curve). Allow the motor to warm up for 10 minutes and then adjust the flow control valve to achieve the desired flow rate. Turn off the sampler. Record the ambient temperature and barometric pressure on the Field Calibration Data Sheet (see Figure 8).

**11.2.2.3** Place the orifice transfer standard on the sampling head and attach a manometer to the tap on the transfer standard, as illustrated in Figure 7. Properly align the retaining rings with the filter holder and secure by tightening the three screw clamps. Connect the orifice transfer standard by way of the pressure tap to a manometer using a length of tubing. Set the zero level of the manometer or magnehelic. Attach the magnehelic gauge to the sampler venturi quick release connections. Adjust the zero (if needed) using the zero adjust screw on face of the gauge.

**11.2.2.4** To leak test, block the orifice with a rubber stopper, wide duct tape, or other suitable means. Seal the pressure port with a rubber cap or similar device. Turn on the sampler.

*Caution: Avoid running the sampler from too long a time with the orifice blocked. This precaution will reduce the chance that the motor will be overheated due to the lack of cooling air. Such overheating can shorten the life of the motor.*

**11.2.2.5** Gently rock the orifice transfer standard and listen for a whistling sound that would indicate a leak in the system. A leak-free system will not produce an upscale response on the sampler's magnehelic. Leaks are usually caused either by damaged or missing gaskets by cross-threading and/or not screwing sample cartridge together tightly. All leaks must be eliminated before proceeding with the calibration. When the sample is determined to be leak-free, turn off the sampler and unblock the orifice. Now remove the rubber stopper or plug from the calibrator orifice.

**11.2.2.6** Turn the flow control valve to the fully open position and turn the sampler on. Adjust the flow control valve until a Magnehelic reading of approximately 70 in. is obtained. Allow the Magnehelic and manometer readings to stabilize and record these values on the Field Calibration Data Sheet (see Figure 8).

**11.2.2.7** Record the manometer reading under Y1 and the Magnehelic reading under Y2 on the Field Calibration Data Sheet. For the first reading, the Magnehelic should still be at 70 inches as set above.

**11.2.2.8** Set the magnehelic to 60 inches by using the sampler's flow control valve. Record the manometer (Y1) and Magnehelic (Y2) readings on the Field Calibration Data Sheet.

**11.2.2.9** Repeat the above steps using Magnehelic settings of 50, 40, 30, 20, and 10 inches.

**11.2.2.10** Turn the voltage variator to maximum power, open the flow control valve, and confirm that the Magnehelic reads at least 100 inches. Turn off the sampler and confirm that the magnehelic reads zero.

**11.2.2.11** Read and record the following parameters on the Field Calibration Data Sheet. Record the following on the calibration data sheet:

Data, job number, and operator's signature;

- Sampler serial number;
- Ambient barometric pressure; and
- Ambient temperature.

**11.2.2.12** Remove the "dummy" cartridge and replace with a sample cartridge.

**11.2.2.13** Obtain the Manufacturer High Volume Orifice Calibration Certificate.

**11.2.2.14** If not performed by the manufacturer, calculate values for each calibrator orifice static pressure (Column 6, inches of water) on the manufacturer's calibration certificate using the following equation:

$$\sqrt{\Delta H(P_a/760)(298/[T_a + 273])}$$

where:

$P_a$  = the barometric pressure (mm Hg) at time of manufacturer calibration, mm Hg

$T_a$  = temperature at time of calibration, °C

**11.2.2.15** Perform a linear regression analysis using the values in Column 7 of the manufacturer High Volume Orifice Calibration Certificate for flow rate ( $Q_{STD}$ ) as the "X" values and the calculated values as the Y values. From this relationship, determine the correlation (CC1), intercept (B1), and slope (M1) for the Orifice Transfer Standard.

**11.2.2.16** Record these values on the Field Calibration Data Sheet (see Figure 8).

**11.2.2.17** Using the Field Calibration Data Sheet values (see Figure 8), calculate the Orifice Manometer Calculated Values (Y3) for each orifice manometer reading using the following equation:

#### **Y3 Calculation**

$$Y3 = [Y1(P_a/760)(298/\{T_a + 273\})]^{1/2}$$

**11.2.2.18** Record the values obtained in Column Y3 on the Field Calibration Data Sheet (see Figure 8).

**11.2.2.19** Calculate the Sampler Magnehelic Calculate Values (Y4) using the following equation:

#### **Y4 Calculation**

$$Y4 = [Y2(P_a/760)(298/\{T_a + 273\})]^{1/2}$$

**11.2.2.20** Record the value obtained in Column Y4 on the Field Calibration Data Sheet (see Figure 8).

**11.2.2.21** Calculate the Orifice Flow Rate (X1) in scm, using the following equation:

#### **X1 Calculation**

$$X1 = \frac{Y3 - B1}{M1}$$

**11.2.2.22** Record the values obtained in Column X1, on the Field Calibration Data Sheet (see Figure 8).

**11.2.2.23** Perform a linear regression of the values in Column X1 (as X) and the values in Column Y4 (as Y). Record the relationship for correlation (CC2), intercept (B2), and slope (M2) on the Field Calibration Data Sheet.

**11.2.2.24** Using the following equation, calculate a set point (SP) for the manometer to represent a desired flow rate:

$$\text{Set point (SP)} = [(\text{Expected } P_a)/(\text{Expected } T_a)(T_{\text{std}}/P_{\text{std}})][M2 (\text{Desired flow rate}) + B2]^2$$

where:

- $P_a$  = Expected atmospheric pressure ( $P_a$ ), mm Hg
- $T_a$  = Expected atmospheric temperature ( $T_a$ ), °C
- M2 = Slope of developed relationship
- B2 = Intercept of developed relationship
- $T_{\text{std}}$  = Temperature standard, 25°C
- $P_{\text{std}}$  = Pressure standard, 760 mm Hg

**11.2.2.25** During monitoring, calculate a flow rate from the observed Magnehelic reading using the following equations:

$$Y5 = [\text{Average Magnehelic Reading } (\Delta H) (P_a/T_a)(T_{\text{std}}/P_{\text{std}})]^{1/2}$$

$$X2 = \frac{Y5 - B2}{M2}$$

where:

- Y5 = Corrected Magnehelic reading
- X2 = Instant calculated flow rate, scm

**11.2.2.26** The relationship in calibration of a sampling system between Orifice Transfer Standard and flow rate through the sampler is illustrated in Figure 9.

### **11.2.3 Single-Point Audit of the High Volume Sampling System Utilizing Calibrated Orifice Transfer Standard**

Single point calibration checks are required as follows:

- Prior to the start of each 24-hour test period.
- After each 24-hour test period. The post-test calibration check may serve as the pre-test calibration check for the next sampling period if the sampler is not moved.
- Prior to sampling after a sample is moved.

For samplers, perform a calibration check for the operational flow rate before each 24-hour sampling event and when required as outlined in the user quality assurance program. The purpose of this check is to track the sampler's calibration stability. Maintain a control chart presenting the percentage difference between a sampler's indicated and measured flow rates. This chart provides a quick reference of sampler flow-rate drift problems and is useful for tracking the performance of the sampler. Either the sampler log book or a data sheet will be used

to document flowcheck information. This information includes, but is not limited to, sampler and orifice transfer standard serial number, ambient temperature, pressure conditions, and collected flow-check data.

In this subsection, the following is assumed:

- The flow rate through a sampler is indicated by the orifice differential pressure;
- Samplers are designed to operate at an actual flow rate of 8 scfm, with a maximum acceptable flow-rate fluctuation range of  $\pm 10$  percent of this value;
- The transfer standard will be an orifice device equipped with a pressure tap. The pressure is measured using a manometer; and
- The orifice transfer standard's calibration relationship is in terms of standard volumetric flow rate ( $Q_{std}$ ).

**11.2.3.1** Perform a single point flow audit check before and after each sampling period utilizing the Calibrated Orifice Transfer Standard (see Section 11.2.1).

**11.2.3.2** Prior to single point audit, place a "dummy" glass cartridge in the sampling head and activate the sampling motor. Fully open the flow control valve and adjust the voltage variator so that a sample flow rate corresponding to 110 percent of the desired flow rate (typically 0.19 to 0.28 m<sup>3</sup>/min) is indicated on the Magnehelic gauge (based on the previously obtained multipoint calibration curve). Allow the motor to warm up for 10 minutes and then adjust the flow control valve to achieve the desired flow rate. Turn off the sampler. Record the ambient temperature and barometric pressure on a Field Test Data Sheet (see Figure 10).

**11.2.3.3** Place the flow rate transfer standard on the sampling head.

**11.2.3.4** Properly align the retaining rings with the filter holder and secure by tightening the 3 screw clamps. Connect the flow rate transfer standard to the manometer using a length of tubing.

**11.2.3.5** Using tubing, attach 1 manometer connector to the pressure tap of the transfer standard. Leave the other connector open to the atmosphere.

**11.2.3.6** Adjust the manometer midpoint by sliding the movable scale until the zero point corresponds with the water meniscus. Gently shake or tap to remove any air bubbles and/or liquid remaining on tubing connectors. (If additional liquid is required, remove tubing connector and add clean water.)

**11.2.3.7** Turn on high-volume motor and let run for 5 minutes.

**11.2.3.8** Record the pressure differential indicated,  $\Delta H$ , in inches of water, on the Field Test Data Sheet. Be sure stable  $\Delta H$  has been established.

**11.2.3.9** Record the observed Magnehelic gauge reading, in inches of water, on the Field Test Data Sheet. Be sure stable  $\Delta M$  has been established.

**11.2.3.10** Using previous established Orifice Transfer Standard curve, calculate  $Q_{ss}$  (see Section 11.2.2.23).

**11.2.3.11** This flow should be within  $\pm 10$  percent of the sampler set point, normally, 8 ft<sup>3</sup>. If not, perform a new multipoint calibration of the sampler.

**11.2.3.12** Remove Flow Rate Transfer Standard and dummy adsorbent cartridge.

### 11.3 Sample Collection

#### 11.3.1 General Requirements

**11.3.1.1** The sampler should be located in an unobstructed area, at least 2 meters from any obstacle to air flow. The exhaust hose should be stretched out in the downwind direction to prevent recycling of air into the sample head.

**11.3.1.2** All cleaning and sample module loading and unloading should be conducted in a controlled environment, to minimize any chance of potential contamination.



**11.3.1.3** When new or when using the sampler at a different location, all sample contact areas need to be cleared. Use triple rinses of reagent grade hexane or methylene chloride contained in Teflon® rinse bottles. Allow the solvents to evaporate before loading the PUF modules.

### **11.3.2 Preparing Cartridge for Sampling**

**11.3.2.1** Detach the lower chamber of the cleaned sample head. While wearing disposable, clean, lint-free nylon, or powder-free surgical gloves, remove a clean glass adsorbent module from its shipping container. Remove the Teflon® end caps. Replace the end caps in the sample container to be reused after the sample has been collected.

**11.3.2.2** Insert the glass module into the lower chamber and tightly reattach the lower chambers to the module.

**11.3.2.3** Using clean rinsed (with hexane) Teflon-tipped forceps, carefully place a clean conditioned fiber filter atop the filter holder and secure in place by clamping the filter holder ring over the filter. Place the aluminum protective cover on top of the cartridge head. Tighten the 3 screw clamps. Ensure that all module connections are tightly assembled. Place a small piece of aluminum foil on the ball-joint of the sample cartridge to protect from back-diffusion of semi-volatile into the cartridge during transporting to the site.

*[Note: Failure to do so could result in air flow leaks at poorly sealed locations which could affect sample representativeness.]*

**11.3.2.4** Place in a carrying bag to take to the sampler.

### **11.3.3 Collection**

**11.3.3.1** After the sampling system has been assembled, perform a single point flow check as described in Sections 11.2.3.

**11.3.3.2** With the empty sample module removed from the sampler, rinse all sample contact areas using reagent grade hexane in a Teflon® squeeze bottle. Allow the hexane to evaporate from the module before loading the samples.

**11.3.3.3** With the sample cartridge removed from the sampler and the flow control valve fully open, turn the pump on and allow it to warm-up for approximately 5 minutes.

**11.3.3.4** Attach a "dummy" sampling cartridge loaded with the exact same type of filter and PUF media to be used for sample collection.

**11.3.3.5** Turn the sampler on and adjust the flow control valve to the desired flow as indicated by the Magnehelic gauge reading determined in Section 11.2.2.4. Once the flow is properly adjusted, take extreme care not to inadvertently alter its setting.

**11.3.3.6** Turn the sampler off and remove both the "dummy" module. The sampler is now ready for field use.

**11.3.3.7** Check the zero reading of the sampler Magnehelic. Record the ambient temperature, barometric pressure, elapsed time meter setting, sampler serial number, filter number, and PUF cartridge number on the Field Test Data Sheet (see Figure 10). Attach the loaded sampler cartridge to the sampler.

**11.3.3.8** Place the voltage variator and flow control valve at the settings used in Section 11.3.2, and the power switch. Activate the elapsed time meter and record the start time. Adjust the flow (Magnehelic setting), if necessary, using the flow control valve.

**11.3.3.9** Record the Magnehelic reading every 6 hours during the sampling period. Use the calibration factors (see Section 11.2.2.3) to calculate the desired flow rate. Record the ambient temperature, barometric pressure, and Magnehelic reading at the beginning and during sampling period.

### 11.3.4 Sample Recovery

**11.3.4.1** At the end of the desired sampling period, turn the power off. Carefully remove the sampling head containing the filter and adsorbent cartridge to a clean area.

**11.3.4.2** While wearing disposable lint free nylon or surgical gloves, remove the PUF cartridge from the lower module chamber and lay it on the retained aluminum foil in which the sample was originally wrapped.

**11.3.4.3** Carefully remove the glass fiber filter from the upper chamber using clean Teflon®-tipped forceps.

**11.3.4.4** Fold the filter in half twice (sample side inward) and place it in the glass cartridge atop the PUF.

**11.3.4.5** Wrap the combined samples in the original hexane rinsed aluminum foil, attached Teflon® end caps and place them in their original aluminum sample container. Complete a sample label and affix it to the aluminum shipping container.

**11.3.4.6** Chain-of-custody should be maintained for all samples. Store the containers at <4°C and protect from light to prevent possibly photo-decomposition of collected analytes. If the time span between sample collection and laboratory analysis is to exceed 24 hours, refrigerate sample.

**11.3.4.7** Perform a final calculated sample flow check using the calibration orifice, as described in Section 11.3.2. If calibration deviates by more than 10 percent from the initial reading, mark the flow data for that sample as suspect and inspect and/or remove from service.

**11.3.4.8** Return at least 1 field filter/PUF blank to the laboratory with each group of samples. Treat a field blank exactly as the sample except that no air is drawn through the filter/adsorbent cartridge assembly.

**11.3.4.9** Ship and store samples under ice (<4°C) until receipt at the analytical laboratory, after which it should be refrigerated at less than or equal to 4°C. Extraction must be performed within seven days of sampling and analysis within 40 days after extraction.

## 12. Sample Preparation

### 12.1 Extraction Procedure for Quartz Fiber Filters and PUF Plugs

**12.1.1** Take the glass sample cartridge containing the PUF plug and quartz fiber filter out of the shipping container and place it in a 43-mm x 123-mm Soxhlet extractor. Add 10 µL of <sup>13</sup>C<sub>12</sub>-labeled sample fortification solution (see Table 4) to the sample. Put the thimble into a 50 mm Soxhlet extractor fitted with a 500 mL boiling flask containing 275 mL of benzene.

*[Note: While the procedure specifies benzene as the extraction solution, many laboratories have substituted toluene for benzene because of the carcinogenic nature of benzene (28). The EPA is presently studying the replacement of benzene with toluene.]*

**12.1.2** Place a small funnel in the top of the Soxhlet extractor, making sure that the top of the funnel is inside the thimble. Rinse the inside of the corresponding glass cylinder into the thimble using approximately 25 mL of benzene. Place the extractor on a heating mantel. Adjust the heat until the benzene drips at a rate of 2 drops per second and allow to flow for 16 hours. Allow the apparatus to cool.

**12.1.3** Remove the extractor and place a 3-bulb Snyder column onto the flask containing the benzene extract. Place on a heating mantel and concentrate the benzene to 25 mL (do not let go to dryness). Add 100 ml of hexane and again concentrate to 25 mL. Add a second 100 mL portion of hexane and again concentrate to 25 mL.

**12.1.4** Let cool and add 25 mL hexane. The extract is ready for acid/base cleanup at this point.

## 12.2 Cleanup Procedures

**12.2.1 Acid/Base Cleanup.** Transfer the hexane extract to a 250 mL separatory funnel with two 25-mL portions of hexane. Wash the combined hexane with 30 ml of 2 N potassium hydroxide. Allow layers to separate and discard the aqueous layer. Repeat until no color is visible in the aqueous layer, up to a maximum of 4 washes. Partition the extract against 50 ml of 5% sodium chloride solution. Discard the aqueous layer. Carefully add 50 mL of concentrated sulfuric acid. Shake vigorously for 1 minute, allow layers to separate, and discard the acid layer. Repeat the acid wash until no color is visible in the aqueous layer, up to a maximum of 4 washes. Partition the extract against 50 ml of 5% sodium chloride solution. Discard the aqueous layer. Transfer the hexane through a 42-mm x 160-mm filter funnel containing a plug of glass wool and 3-cm of sodium sulfate into a 250-mL Kuderna-Danish (KD) concentrator fitter with a 15-mL catch tube. Rinse the filter funnel with two 25 mL portions of hexane. Place a 3-bulb Snyder column on the KD concentrator and concentrate on a steam bath to 1-2 mL. The extract is ready for the alumina column cleanup at this point, but it can be sealed and stored in the dark, if necessary. An extract that contains obvious contamination, such as yellow or brown color, is subjected to the silica column cleanup prior to the alumina cleanup.

**12.2.2 Silica Column Preparation.** Gently tamp a plug of glass wool into the bottom of a 5.75-inch (14.6 cm) disposable Pasteur pipette. Pour prewashed 100-200 mesh Bio-Sil®A (silica gel) into the pipette until a height of 3.0 cm of silica gel is packed into the column. Top the silica gel with 0.5 cm of anhydrous granular sodium sulfate. Place columns in an oven set at 220°C. Store columns in the oven until ready for use, at least overnight. Remove only the columns needed and place them in a desiccator until they have equilibrated to room temperature. Use immediately.

**12.2.3 Silica Column Cleanup.** Position the silica column over the alumina column so the eluent will drip onto the alumina column. Transfer the 2 mL hexane extract from the Acid/Base Cleanup onto the silica column with two separate 0.5-mL portions of hexane. Elute the silica column with an additional 4.0 mL of hexane. Discard the silica column and proceed with the alumina column cleanup at the point where the column is washed with 6.0 mL of carbon tetrachloride.

**12.2.4 Alumina Column Preparation.** Gently tamp a plug of glass wool into the bottom of a 5.75-inch (14.6 cm) disposable Pasteur pipette. Pour WOELM neutral alumina into the pipette while tapping the column with a pencil or wooden dowel until a height of 4.5 cm of alumina is packed into the column. Top the alumina with a 0.5 cm of anhydrous granular sodium sulfate. Prewash the column with 3 mL dichloromethane. Allow the dichloromethane to drain from the column; then force the remaining dichloromethane from the column with a stream of dry nitrogen. Place prepared columns in an oven set at 225°C. Store columns in the oven until ready for use, at least overnight. Remove only columns needed and place them in a desiccator over anhydrous calcium sulfate until they have equilibrated to room temperature. Use immediately.

**12.2.5 Alumina Column Cleanup.** Prewet the alumina column with 1 mL of hexane. Transfer the 2 mL hexane extract from acid/base cleanup into the column. Elute the column with 6.0 mL of carbon tetrachloride and archive. Elute the column with 4.0 mL of dichloromethane and catch the eluate in a 12- mL distillation receiver. Add 3 µL tetradecane, place a micro-Snyder column on the receiver and evaporate the dichloromethane just to dryness by means of a hot water bath. Add 2 mL of hexane to the receiver and evaporate just to dryness. Add another 2-mL portion of hexane and evaporate to 0.5 mL. The extract is ready for the carbon column cleanup at this point.

**12.2.6 Carbon Column Preparation.** Weigh 9.5 g of Bio-Sil®A (100-200 mesh) silica gel, which has been previously heated to 225°C for 24 hours, into a 50-mL screw cap container. Weigh 0.50 g of Amoco PX-21 carbon onto the silica gel cap and shake vigorously for 1 hour. Just before use, rotate the container by hand for at least 1 minute. Break a glass graduated 2.0-mL disposal pipette at the 1.8 mL mark and fire polish the end. Place a small plug of glass wool in the pipette and pack it at the 0.0 mL mark using two small solid glass rods. Add 0.1 mL of Bio-Sil®A 100-200 mesh silica gel. If more than 1 column is to be made at a time, it is best to

add the silica gel to all the columns and then add the carbon-silica gel mixture to all columns. Add 0.40 mL of the carbon silica gel mixture to the column; the top of the mixture will be at the 0.55-mL mark on the pipette. Top the column with a small plug of glass wool.

**12.2.7 Carbon Column Cleanup.** Place the column in a suitable clamp with the silica gel plug up. Add approximately 0.5 mL of 50 percent benzene-methylene chloride (v/v) to the top of the column. Fit a 10 mL disposable pipette on the top of the carbon column with a short piece of extruded teflon tubing. Add an additional 9.5 mL of the 50 percent benzene-methylene chloride. When approximately 0.5 mL of this solvent remains, add 10 mL of toluene. After all the toluene has gone into the column, remove the 10-mL reservoir and add at least 2.0 mL of hexane to the column. When approximately 0.1 mL of the hexane is left on the top of the column, transfer the sample extract onto the column with a Pasteur pipette. Rinse the distillation receiver column that contained the extract with two separate 0.2 mL portions of hexane and transfer each rinse onto the column. Allow the top of each transfer layer to enter the glass wool before adding the next one. When the last of the transfer solvent enters the glass wool, add 0.5 mL of methylene chloride, replace the 10-mL reservoir, and add 4.5 mL of methylene chloride to it. When approximately 0.5 mL of this solvent remains, add 10 mL of 50 percent benzene-methylene chloride. When all this solvent has gone onto the column, remove the reservoir, take the column out of the holder and rinse each end with toluene, turn the column over, and put it back in the holder. All previous elution solvents are archived. Place a suitable receiver tube under the column and add 0.5 mL of toluene to the top of the column. Fit the 10 mL reservoir on the column and add 9.5 mL of toluene to it. When all toluene has eluted through the column and has been collected in the receiving tube, add 5 mL of tetradecane and concentrate to 0.5 mL using a stream of nitrogen and water bath maintained at 60°C. Transfer the toluene extract to a 2.0 mL graduated Chromoflex® tube with two 0.5-mL portions of benzene. Add 0.5 ng of <sup>13</sup>C<sub>12</sub>-1,2,3,4-TCDD and store the extracts in the dark at room temperature. Concentrate the extract to 30 µL using a stream of nitrogen at room temperature just prior to analysis or shipping. Transfer the extracts that are to be shipped to a 2 mm i.d. x 75 mm glass tube that has been fire sealed on one end with enough benzene to bring the total volume of the extract to 100 µL. Then fire seal other end of the tube.

### 12.3 Glassware Cleanup Procedures

In this procedure, take each piece of glassware through the cleaning separately except in the oven baking process. Wash the 100-mL round bottom flasks, the 250 mL separatory funnels, the KD concentrators, etc., that were used in the extraction procedures three times with hot tap water, two times with acetone and two times with hexane. Then bake this glassware in a forced air oven that is vented to the outside for 16 hours at 450°C. Clean the PFTE stopcocks as above except for the oven baking step. Rinse all glassware with acetone and hexane immediately before use.

## 13. HRGC-HRMS System Performance

### 13.1 Operation of HRGC-HRMS

Operate the HRMS in the electron impact (EI) ionization mode using the selected ion monitoring (SIM) detection technique. Achieve a static mass resolution of 10,000 (10% valley) before analysis of a set of samples is begun. Check the mass resolution at the beginning and at the end of each day. (Corrective actions should be implemented whenever the resolving power does not meet the requirement.) Chromatography time required for PCDDs and PCDFs may exceed the long-term stability of the mass spectrometer because the instrument is operated in the high-resolution mode and the mass drifts of a few ppm (e.g., 5 ppm in mass) can have adverse effects on the analytical results. Therefore, a mass-drift correction may be required. Use a lock-mass ion for the reference

compound perfluorokerosene (PFK) to tune the mass spectrometer. The selection of the SIM lock-mass ions of PFK shown in the descriptors (see Tables 10, 11 and 12) is dependent on the masses of the ions monitored within each descriptor. An acceptable lock-mass ion at any mass between the lightest and heaviest ion in each descriptor can be used to monitor and correct mass drifts. Adjust the level of the reference compound (PFK) metered inside the ion chamber during HRGC-HRMS analyses so that the amplitude of the most intense selected lock-mass ion signal is kept to a minimum. Under those conditions, sensitivity changes can be more effectively monitored. Excessive use of PFK or any reference substance will cause high background signals and contamination of the ion source, which will result in an increase in "downtime" required for instrument maintenance.

Tune the instrument to a mass resolution of 10,000 (10% valley) at  $m/z$  292.9825 (PFK). By using the peak matching unit (manual or computer simulated) and the PFK reference peak, verify that the exact  $m/z$  392.9761 (PFK) is within 3 parts per million (ppm) of the required value.

Document the instrument resolving power by recording the peak profile of the high mass reference signal ( $m/z$  392.9761) obtained during the above peak matching calibration experiment by using the low mass PFK ion at  $m/z$  292.9825 as a reference. The minimum resolving power of 10,000 should be demonstrated on the high mass ion while it is transmitted at a lower accelerating voltage than the low mass reference ion, which is transmitted at full voltage and full sensitivity. There will be little, if any, loss in sensitivity on the high mass ion if the source parameters are properly tuned and optimized. The format of the peak profile representation should allow for computer calculated and manual determination of the resolution, i.e., the horizontal axis should be a calibrated mass scale (amu or ppm per division). Detailed descriptions for mass resolution adjustments are usually found in the instrument operators manual or instructions.

### 13.2 Column Performance

After the HRMS parameters are optimized, analyze an aliquot of a column performance solution containing the first and last eluting compounds (see Table 9), or a solution containing all congeners, to determine and confirm SIM parameters, retention time windows, and HRGC resolution of the compounds. Adjustments can be made at this point, if necessary. Some PeCDFs elute in the TCDD retention time window when using the 60 m DB-5 column. The PeCDF masses can be included with the TCDD/TCDF masses in Descriptor 1. Include the PeCDD/PeCDF masses with the TCDD/TCDF masses when using the 60 m SP-2331 polar column. The HRGC-HRMS SIM parameters and retention time windows can be rapidly and efficiently determined and optimized by analysis of a window defining solution of PCDDs/PCDFs using one mass for each isomer for the complete analysis of tetra- through octa- compounds, as illustrated in Figure 11.

### 13.3 SIM Cycle Time

The total time for each SIM cycle should be 1 second or less for data acquisition, which includes the sum of the mass ion dwell times and ESA voltage reset times.

### 13.4 Peak Separation

Chromatographic peak separation between 2,3,7,8-TCDD and the co-eluting isomers should be resolved with a valley of 25% or more (see Figure 12).

### 13.5 Initial Calibration

After the HRGC-HRMS SIM operating conditions are optimized, perform an initial calibration using the 5 calibration solutions shown in Table 3. The quantification relationships of labeled and unlabeled standards are illustrated in Tables 15, 16, 17, and 18. Figures 13 through 22 represent the extracted ion current profiles (EICP) for specific masses for 2,3,7,8-TCDF, 2,3,7,8-TCDD and other 2,3,7,8-substituted PCDF/PCDD (along with their labeled standards) through OCDF and OCDD respectively.

*[Note: Other solutions containing fewer or different congeners and at different concentrations may also be used for calibration purposes.]*

Referring to Tables 10, 11, or 12, calculate (1) the relative response factors (RRFs) for each unlabeled PCDD/PCDF and PBDD/PBDF [RRF (I)] relative to their corresponding  $^{13}\text{C}_{12}$ -labeled internal standard and (2) the RRFs for the  $^{13}\text{C}_{12}$ -labeled PCDD/PCDF and PBDD/PBDF internal standards [RRF (II)] relative to  $^{37}\text{Cl}_4$ -2,3,7,8-TCDD recovery standard using the following formulae:

$$\text{RRF(I)} = \frac{(A_x \times Q_{is})}{(Q_x \times A_{is})}$$

$$\text{RRF(II)} = \frac{(A_{is} \times Q_{rs})}{(Q_{is} \times A_{rs})}$$

where:

$A_x$  = the sum of the integrated ion abundances of the quantitation ions (see Tables 10, 11 or 12) for unlabeled PCDDs/PCDFs, and PBDDs/PBDFs and BCDDs/BCDFs.

$A_{is}$  = the sum of the integrated ion abundances of the quantitation ions for the  $^{13}\text{C}_{12}$ -labeled internal standards (see Table 10, 11 or 12).

*[Note: Other  $^{13}\text{C}_{12}$ -labeled analytes may also be used as the recovery standard(s)]*

$A_{rs}$  = the integrated ion abundance for the quantitation ion of the  $^{37}\text{Cl}_4$ -2,3,7,8-TCDD recovery standard.

$Q_{is}$  = the quantity of the  $^{13}\text{C}_{12}$ -labeled internal standard injected, pg.

$Q_x$  = the quantity of the unlabeled PCDD/PCDF analyte injected, pg.

$Q_{rs}$  = the quantity of the  $^{37}\text{Cl}_4$ -2,3,7,8-TCDD injected, pg.

RRF(I) and RRF(II) = dimensionless quantities. The units used to express  $Q_{is}$  and  $Q_x$  must be the same.

*[Note:  $^{13}\text{C}_{12}$ -1,2,3,7,8-PeBDF is used to determine the response factor for the unlabeled 2,3,7,8-substituted, PeBDD, HxBDF and HxBDD.]*

Calculate the average RRFs for the 5 concentration levels of unlabeled and  $^{13}\text{C}_{12}$ -labeled PCDDs/PCDFs and PBDDs/PBDFs for the initial calibration using the following equation:

$$\overline{\text{RRF}} = \frac{\text{RRF1} + \text{RRF2} + \text{RRF3} + \text{RRF4} + \text{RRF5}}{5}$$

### 13.6 Criteria Required for Initial Calibration

The analytical data must satisfy certain criteria for acceptable calibration. The isotopic ratios must be within the acceptable range (see Tables 19 and 20). The percent relative standard deviation for the response factors should be less than the values presented in Table 21. The signal-to-noise ratio for the  $^{13}\text{C}_{12}$ -labeled standards must be 10:1 or more and 5:1 or more for the unlabeled standards.

### 13.7 Continuing Calibration

Conduct an analysis at the beginning of each day to check and confirm the calibration using an aliquot of the calibration solution. This analysis should meet the isotopic ratios and signal to noise ratios of the criteria stated in Section 13.6 (see Table 21 for daily calibration percent difference criteria). It is good practice to confirm the calibration at the end of the day also. Calculate the daily calibration percent difference using the following equation.

$$\% \text{RRF} = \frac{\text{RRF}_{\text{cc}} - \overline{\text{RRF}}}{\overline{\text{RRF}}} \times 100$$

$\text{RRF}_{\text{cc}}$  = the relative response factor for a specific analyte in the continuing calibration standard.

## 14. HRGC-HRMS Analysis And Operating Parameters

### 14.1 Sample Analysis

Sample Analysis. An aliquot of the sample extract is analyzed with the HRGC-HRMS system using the instrument parameters illustrated in Tables 13 and 14 and the SIM descriptors and masses shown in Tables 10, 11, and 12. A 30-m SE-54 fused silica capillary column is used to determine the concentrations of total tetra-, penta-, hexa-, hepta- and octa-CDDs/CDFs and/or to determine the minimum limits of detections (MLDs) for the compounds. If the tetra-, penta-, and hexa-CDDs/CDFs were detected in a sample and isomer specific analyses are required, then an aliquot of the sample extract is analyzed using the 60 m SP-2331 fused silica capillary column to provide a concentration for each 2,3,7,8-substituted PCDD/PCDF and concentrations for total PCDDs and PCDFs also.

*[Note: Other capillary columns such as the DB-5, SE-30, and DB-225 may be used if the performance satisfies the specifications for resolution of PCDDs/PCDFs. The SE-54 column resolves the four HpCDF isomers, two HpCDD isomers, OCDF and OCDD for isomer specific analysis. It does not resolve the tetra-, penta-, and hexa-2,3,7,8-substituted isomers. The SE-54 column is used for the analysis of PBDDs and PBDFs.]*

Isomer specificity for all 2,3,7,8-substituted PCDDs/PCDFs cannot be achieved on a single HRGC capillary column at this time. However, many types of HRGC capillary columns are available and can be used for these analyses after their resolution capabilities are confirmed to be adequate using appropriate standards.

Two HRGC columns shown in Table 13 have been used successfully since 1984 (27, 28). The 60-m DB-5 provides an efficient analysis for total concentrations of PCDDs/PCDFs, specific isomers (total tetra-, penta-, hexa-CDDs/CDFs, four HpCDF isomers, two HpCDD isomers, OCDD and OCDF), PBDDs/PBDFs, and/or determination of MDLs. The 60 m SP-2331 column provides demonstrated and confirmed resolution of 2,3,7,8-substituted tetra-, penta-, and hexa-PCDDs/PCDFs (14). The descriptors and masses shown in Tables 10, 11 and 12 must be modified to take into account the elution of some of the PeCDDs and PeCDFs in the tetra retention time window using the SP-2331 column.

## 14.2 Identification Criteria

Criteria used for identification of PCDDs and PCDFs in samples are as follows:

- The integrated ion abundance ratio  $M/(M+2)$  or  $(M+2)/(M+4)$  shall be within 15 percent of the theoretical value. The acceptable ion abundance ranges are shown in Tables 19 and 20.
- The ions monitored for a given analyte, shown in Tables 10, 11, and 12, shall reach their maximum within 2 seconds of each other.
- The retention time for the 2,3,7,8-substituted analytes must be within 3 seconds of the corresponding  $^{13}\text{C}_{12}$ -labeled internal standard, surrogate, or alternate standard.
- The identification of 2,3,7,8-substituted isomers that do not have corresponding  $^{13}\text{C}_{12}$ -labeled standards is done by comparison to the analysis of a standard that contains the specific congeners. Comparison of the relative retention time (RRT) of the analyte to the nearest internal standard with reference (i.e., within 0.005 RRT time units to the comparable RRTs found in the continuing calibration or literature).
- The signal-to-noise ratio for the monitored ions must be greater than 2.5.
- The analysis shall show the absence of polychlorinated diphenyl-ethers (PCDPEs). Any PCDPEs that co-elute ( $\pm 2$  seconds) with peaks in the PCDF channels indicates a positive interference, especially if the intensity of the PCDPE peak is 10 percent or more of the PCDF.

Use the identification criteria in Section 14.2 to identify and quantify the PCDDs and PCDFs in the sample. Figure 23 illustrates a reconstructed EICP for an environmental sample, identifying the presence of 2,3,7,8-TCDF as referenced to the labeled standard.

## 14.3 Quantification

The peak areas of ions monitored for  $^{13}\text{C}_{12}$ -labeled PCDDs/PCDFs and  $^{37}\text{Cl}_4$ -2,3,7,8-TCDD, unlabeled PCDDs/PCDFs, and respective relative response factors are used for quantification. The  $^{37}\text{Cl}_4$ -2,3,7,8-TCDD, spiked to extract prior to final concentration, and respective response factors are used to determine the sample extraction efficiencies achieved for the nine  $^{13}\text{C}_{12}$ -labeled internal standards, which are spiked to the sample prior to extraction (% recovery). The  $^{13}\text{C}_{12}$ -labeled PCDD/PCDF internal standards and response factors are used for quantification of unlabeled PCDDs/PCDFs and for determination of the minimum limits of detection with but one exception:  $^{13}\text{C}_{12}$ -OCDD is used for OCDF. Each  $^{13}\text{C}_{12}$ -labeled internal standard is used to quantify all of the PCDDs/PCDFs in its isomeric group. For example,  $^{13}\text{C}_{12}$ -2,3,7,8-TCDD and the 2,3,7,8-TCDD response factor are used to quantify all of the 22 tetra-chlorinated isomers. The quantification relationships of these standards are shown in Tables 15, 16, 17, and 18. The  $^{37}\text{Cl}_4$ -2,3,7,8-TCDD spiked to the filter of the sampler



prior to sample collection is used to determine the sampler retention efficiency, which also indicates the collection efficiency for the sampling period.

#### 14.4 Calculations

**14.4.1 Extraction Efficiency.** Calculate the extraction efficiencies (percent recovery) of the 9  $^{13}\text{C}_{12}$ -labeled PCDD/PCDF or the 3  $^{13}\text{C}_{12}$ -labeled PBDD/PBDF internal standards measured in the extract using the formula:

$$\%R_{\text{is}} = \frac{[A_{\text{is}} \times Q_{\text{rs}} \times 100]}{[Q_{\text{is}} \times A_{\text{rs}} \times \text{RRF(II)}]}$$

where:

$\%R_{\text{is}}$  = percent recovery (extraction efficiency).

$A_{\text{is}}$  = the sum of the integrated ion abundances of the quantitation ions (see Tables 10, 11 or 12) for the  $^{13}\text{C}_{12}$ -labeled internal standard.

$A_{\text{rs}}$  = the sum of the integrated ion abundances of the quantitation ions (see Table 10, 11 or 12) for the  $^{37}\text{Cl}_4$ - or  $^{13}\text{C}_{12}$ -labeled recovery standard; the selection of the recovery standard(s) depends on the type of homologues.

$Q_{\text{is}}$  = quantity of the  $^{13}\text{C}_{12}$ -labeled internal standard added to the sample before extraction, pg.

$Q_{\text{rs}}$  = quantity of the  $^{37}\text{Cl}_4$ - or  $^{13}\text{C}_{12}$ -labeled recovery standard added to the sample extract before HRGC-HRMS analysis, pg.

RRF(II) = calculated mean relative response factor for the labeled internal standard relative to the appropriate labeled recovery standard.

**14.4.2 Calculation of Concentration.** Calculate the concentration of each 2,3,7,8-substituted PCDD/PCDF, other isomers or PBDD/PBDF that have met the criteria described in Sections 14.2 using the following formula:

$$C_x = \frac{[A_x \times Q_{\text{is}}]}{[A_{\text{is}} \times V_{\text{std}} \times \text{RRF(I)}]}$$

where:

$C_x$  = concentration of unlabeled PCDD/PCDF, PBDD/PBDF or BCDD/BCDF congener(s), pg/m<sup>3</sup>.

$A_x$  = the sum of the integrated ion abundances of the quantitation ions (see Table 11, 12 or 13) for the unlabeled PCDDs/PCDFs, or PBDDs/PBDFs or BCDFs.

$A_{\text{is}}$  = the sum of the integrated ion abundances of the quantitation ions (see Table 11, 12 or 13) for the respective  $^{13}\text{C}_{12}$ -labeled internal standard.

$Q_{\text{is}}$  = quantity of the  $^{13}\text{C}_{12}$ -labeled internal standard added to the sample before extraction, pg.

$V_{\text{std}}$  = standard volume of air, std m<sup>3</sup>.

RRF(I) = calculated mean relative response factor for an unlabeled 2,3,7,8-substituted PCDD/PCDF obtained in Section 13.4.

### 14.5 Method Detection Limits (MDLs)

The ambient background levels of total PCDDs/PCDFs are usually found in the range of 0.3 to 2.9 pg/m<sup>3</sup>. Therefore, the MDLs required to generate meaningful data for ambient air should be in the range of 0.02 to 0.15 pg/m<sup>3</sup> for tetra-, penta-, and hexa-CDDs/CDFs. Trace levels, 0.05 to 0.25 pg/m<sup>3</sup>, of HpCDDs and OCDD are usually detected in the method blank (background contamination).

An MDL is defined as the amount of an analyte required to produce a signal with a peak area at least 2.5 x the area of the background signal level measured at the retention time of interest. MDLs are calculated for total PHDDs/PHDFs and for each 2,3,7,8-substituted congener. The calculation method used is dependent upon the type of signal responses present in the analysis. For example:

- Absence of response signals of one or both quantitation ion signals at the retention time of the 2,3,7,8-substituted isomer or at the retention time of non 2,3,7,8-substituted isomers. The instrument noise level is measured at the analyte's expected retention time and multiplied by 2.5, inserted into the formula below and calculated and reported as not detected (ND) at the specific MDL.
- Response signals at the same retention time as the 2,3,7,8-substituted isomers or the other isomers that have a S/N ratio in excess of 2.5:1 but that do not satisfy the identification criteria described in 14.2 are calculated and reported as ND at the elevated MDL and discussed in the narrative that accompanies the analytical results. Calculate the MDLs using the following formula:

$$\text{MDL} = \frac{[2.5 \times A_x \times Q_{is}]}{[A_{is} \times V_{std} \times \overline{\text{RRF}}]}$$

where:

MDL = concentration of unlabeled PHDD/PHDF, pg/m<sup>3</sup>.

$A_x$  = sum of integrated ion abundances of the quantitation ions (see Table 10, 11 or 12) for the unlabeled PHDDs/PHDFs which do not meet the identification criteria or 2.5 x area of noise level at the analyte's retention time.

$A_{is}$  = sum of the integrated ion abundances of the quantitation ions (see Table 10, 11, or 12) for the <sup>13</sup>C<sub>12</sub>-labeled internal standards.

$Q_{is}$  = quantity of the <sup>13</sup>C<sub>12</sub>-labeled internal standard spiked to the sample prior to extraction, pg.

$V_{std}$  = standard volume of ambient air sampled, std m<sup>3</sup>.

$\overline{\text{RRF}}$  = mean relative response factor for the unlabeled PHDD/PHDF.

### 14.6 2,3,7,8-TCDD Toxic Equivalents

Calculate the 2,3,7,8-TCDD toxic equivalents of PCDDs and PCDFs present in a sample according to the method recommended by EPA and the Center for Disease Control (18). This method assigns a 2,3,7,8-TCDD toxicity equivalency factor (TEF) for each of the seventeen 2,3,7,8-substituted PCDDs/PCDFs (see Table 22). The 2,3,7,8-TCDD equivalent of the PCDDs and PCDFs present in the sample is calculated by the respective TEF factors times their concentration for each of the compounds listed in Table 22. The exclusion of the other isomeric groupings (mono-, di-, and tri-chlorinated dibenzodioxins and dibenzofurans) does not mean that they are non-toxic. Their toxicity, as known at this time, is much less than the toxicity of the compounds listed in Table 22. The above procedure for calculating the 2,3,7,8-TCDD toxic equivalents is not claimed to be based on a

thoroughly established scientific foundation. The procedure, rather, represents a "consensus recommendation on science policy." Similar methods are used throughout the world.

### 15. Quality Assurance/Quality Control (QA/QC)

**15.1** Certified analytical standards were obtained from Cambridge Isotope Laboratories, 50 Frontage Road, Andover, MA 01810, 508-749-8000.

**15.2** Criteria used for HRGC-HRMS initial and continuing calibration are defined in Sections 13.5 and 13.6.

**15.3** Analytical criteria used for identification purposes are defined in Section 14.2.

**15.4** All test samples, method blanks, field blanks, and laboratory control samples are spiked with  $^{13}\text{C}_{12}$ -labeled internal standards prior to extraction.

**15.5** Sample preparation and analysis and evaluation of data are performed on a set of 12 samples, which may consist of 9 test samples, field blank, method blank, fortified method blank, or a laboratory control sample.

**15.6** Method evaluation studies were performed to determine and evaluate the overall method capabilities (1, 2).

**15.7** The  $^{13}\text{C}_{12}$ -1,2,3,4-TCDD solution is spiked to filters of all samplers, including field blanks, immediately prior to operation or is spiked to all PUF plugs prior to shipping them to the field for sampling to determine and document the sampling efficiency.

**15.8** Minimum equipment calibration and accuracy requirements achieved are illustrated in Table 23.

**15.9** QA/QC requirements for data:

<u>Criteria</u>	<u>Requirements</u>
The data shall satisfy all indicated identification criteria	Discussed in Section 14.2
Method efficiency achieved for $^{13}\text{C}_{12}$ -labeled tetra-, penta-, hexa-CDDs/CDFs and PBDDs/PBDFs	50 to 120%
Method efficiency achieved for $^{13}\text{C}_{12}$ -labeled HpCDD and OCDD	40 to 120%
Accuracy achieved for PHDDs and PHDFs in method spike at 0.25 to 2.0 $\text{pg}/\text{m}^3$ concentration range	70 to 130%
Precision achieved for duplicate method spikes or QA samples	$\pm 30\%$
Sampler efficiency achieved for $^{13}\text{C}_{12}$ -1,2,3,4-TCDD	50 to 120%
Method blank contamination	Free of contamination that would interfere with test sample results.
Method detection limit range for method blank and field blank (individual isomers)	0.02 to 0.25 $\text{pg}/\text{m}^3$

**16. Report Format**

The analytical results achieved for a set of 12 samples should be presented in a table such as the one shown in Table 24. The analytical results, analysis, QA/QC criteria, and requirements used to evaluate data are discussed in an accompanying analytical report. The validity of the data in regard to the data quality requirements and any qualification that may apply is explained in a clear and concise manner for the user's information.

## 17. References

1. Harless, R. L. et al., "Evaluation of Methodology for Determination of Polyhalogenated Dibenzo-p-Dioxins and Dibenzofurans in Ambient Air," in *Proceedings of the 1991 EPA/A&WMA International Symposium on Measurement of Toxic and Related Air Pollutants*, U. S. Environmental Protection Agency, Research Triangle Park, NC 27711, EPA-600/9-91-018, May 1991.
2. Harless, R. L., et al., "Evaluation of a Sampling and Analysis Method for Determination of Polyhalogenated Dibenzo-p-Dioxins and Dibenzofurans in Ambient Air," in *Proceedings of the 11th International Symposium on Chlorinated Dioxins and Related Compounds*, U. S. Environmental Protection Agency, Research Triangle Park, NC 27711, EPA-600/D-91-106; *Chemosphere*, Vol. 25, (7-10):1317-1322, Oct-Nov 1992.
3. Smith-Mullen, C., et al., *Feasibility of Environmental Monitoring and Exposure Assessment for a Municipal Waste Combustor, Rutland, Vermont Pilot Study*, U. S. Environmental Protection Agency, Research Triangle Park, NC 27711, EPA-600/8-91-007, March 1991.
4. Harless, R. L., et al., *Sampling and Analysis for Polychlorinated Dibenzo-p-Dioxins and Dibenzofurans in Ambient Air*, U. S. Environmental Protection Agency, Research Triangle Park, NC 27711, EPA-600/D-9-172, May 1990.
5. Harless, R. L. et al., *Analytical Procedures and Quality Assurance Plan for the Analysis of 2,3,7,8-TCDD in Tier 3-7 Samples of the U. S. EPA National Dioxin Study*, U. S. Environmental Protection Agency, Research Triangle Park, NC 27711, EPA-600/3-85-019, May 1986.
6. Harless, R. L. et al., *Analytical Procedures and Quality Assurance Plan for the Analysis of Tetra Through Octa Chlorinated Dibenzo-p-Dioxins and Dibenzofurans in Tier 4 Combustion and Incineration Processes*, U. S. Environmental Protection Agency, Research Triangle Park, NC 27711, Addendum to EPA-600/3-85-019, May 1986.
7. Albro, P.W., et al., "Methods for the Quantitative Determination of Multiple Specific Polychlorinated Dibenzo-p-Dioxins and Dibenzofuran Isomers in Human Adipose Tissue in the Parts-Per-Trillion Range. An Interlaboratory Study," *Anal. Chem.*, Vol.57:2717-2725, 1985.
8. O'Keefe, P. W., et al., "Interlaboratory Validation of PCDD and PCDF Concentrations Found in Municipal Incinerator Emissions," *Chemosphere*, Vol. 18:185-192, 1989.
9. Harless, R. L., et al., "Identification of Bromo/Chloro Dibenzo-p-Dioxins and Dibenzofurans in Ash Samples," *Chemosphere*, Vol. 18:201-208, 1989.
10. Lafleur, L.E., and Dodo, G. H., "An Interlaboratory Comparison of Analytical Procedures for the Measurement of PCDDs/PCDFs in Pulp and Paper Industry Solid Wastes," *Chemosphere*, Vol. 18:77-84, 1989.
11. Patterson, D. G. et al., "Levels of Polychlorinated Dibenzo-p-Dioxins and Dibenzofurans in Workers Exposed to 2,3,7,8-TCDD," *American Journal of Industrial Medicine*, Vol. 16:135-146, 1989.

12. Lamparski, L. L. and Nestrick, T. J. "Determination of Tetra-, Hexa-, Hepta- and Octa-chlorodibenzo-p-dioxin isomers in Particulate Samples at Parts-Per-Trillion Levels," *Anal. Chem.*, Vol. 52:2045-2054, 1980.
13. Rappe, C., "Analysis of Polychlorinated Dioxins and Furans," *Environ. Sci. Technol.*, Vol. 18:78A-90A, 1984.
14. Rappe, C., et al., "Identification of PCDDs and PCDFs in Urban Air," *Chemosphere*, Vol. 17:3-20, 1988.
15. Tondeur, Y., et al., "Method 8290: An Analytical Protocol for the Multimedia Characterization of Polychlorinated Dibenzo-p-Dioxins and Dibenzofurans by High Resolution Gas Chromatography/High Resolution Mass Spectrometry," *Chemosphere*, Vol. 18:119-131, 1989.
16. "Method 23, Method for Measurement of Polychlorinated Dibenzo-p-Dioxins and Dibenzofurans from Stationary Sources," *Federal Register*, Vol. 56(30):5758-5770, February 13, 1991.
17. "Method 1613: Tetra- through Octa-Chlorinated Dioxins and Furans by Isotope Dilution HRGC-HRMS," *Federal Register*, Vol. 56(26):5098-5122, February 7, 1991.
18. *Interim Procedures for Estimating Risks Associated with Exposures to Mixtures of Chlorinated Dibenzo-p-Dioxins and Dibenzofurans (CDDs/CDFs)*, U. S. Environmental Protection Agency, Research Triangle Park, NC 27711, EPA-625/3-89-016, March 1989.
19. Tiernan, T., et al., "PCDD/PCDF in the Ambient Air of a Metropolitan Area in the U.S.," *Chemosphere*, Vol. 19:541-546, 1989.
20. Hunt, G., "Measurement of PCDDs/PCDFs in Ambient Air," *J. Air Pollut. Control Assoc.*, Vol. 39:330-331, 1989.
21. "40 CFR Parts 707 and 766, Polyhalogenated Dibenzo-p-Dioxins and Dibenzofurans: Testing and Reporting Requirements: Final Rule," *Federal Register*, Vol. 52 (108):21412-21452, June 5, 1987.
22. Buser, H., "Polybrominated Dibenzo-p-Dioxins and Dibenzofurans: Thermal reaction products of polybrominated diphenyl ether flame retardants," *Environ. Sci. Technol.*, Vol. 20:404-408, 1988.
23. Sovocol, G. W., et al., "Analysis of Municipal Incinerator Fly Ash for Bromo and Bromo/Chloro Dioxins, Dibenzofurans, and Related Compounds," *Chemosphere*, Vol. 18:193-200, 1989.
24. Lewis, R. G., et al., "Modification and Evaluation of a High-Volume Air Sampler for Pesticides and Semivolatile Industrial Organic Chemicals," *Anal. Chem.*, Vol. 54:592-594, 1982.
25. Lewis, R. G., et al., "Evaluation of Polyurethane Foam for Sampling Pesticides, Polychlorinated Biphenyls and Polychlorinated Naphthalenes in Ambient Air," *Anal. Chem.*, Vol. 49:1668-1672, 1977.
26. Winberry, W. T., Jr., et al., *Compendium of Methods for the Determination of Toxic Organic Compounds in Ambient Air, Second Supplement, Method TO-9*, U. S. Environmental Protection Agency, Research Triangle Park, NC 27711, EPA 600/4-89-018, March 1989.

27. "Analysis of Air Samples for PCDDs, PCDFs, PCBs, and PAHs in Support of the Great Lakes Deposition Project," Draft Report, Midwest Research Institute, 425 Volker Boulevard, Kansas City, MO, MRI Project No. 3103-A, April 1990.
28. Boggess, K.E., "Analysis of Air Samples for PCDDs, PCDFs, PCBs and PAHs in Support of the Great Lakes Deposition Project," Final Report, Midwest Research Institute, 425 Volker Boulevard, Kansas City, MO, MRI Project No. 3103-A, April 1993.
29. "Working with Carcinogens," NIOSH, Publication 77-206, August 1977.
30. "Safety in the Academic Chemistry Laboratories," ACS Committee on Chemical Safety, 1979.

TABLE 1. NUMBER OF POLYCHLORINATED DIBENZO-P-DIOXIN AND DIBENZOFURAN (PCDD/PCDF) CONGENERS

No. of Chlorine Atoms	No. of PCDD Isomers	No. of PCDF Isomers
1	2	4
2	10	16
3	14	28
4	22	38
5	14	28
6	10	16
7	2	4
8	1	1
Total	75	135

[*Note:* This also applies for the polybrominated dibenzo-p-dioxins and dibenzofurans (PBDDs/PBDFs).]

TABLE 2. LIST OF 2,3,7,8-CHLORINE SUBSTITUTED PCDD/PCDF CONGENERS

PCDDs	PCDFs
2,3,7,8-TCDD	2,3,7,8-TCDF
1,2,3,7,8-PeCDD	1,2,3,7,8-PeCDF
	2,3,4,7,8-PeCDF
1,2,3,4,7,8-HxCDD	1,2,3,4,7,8-HxCDF
1,2,3,6,7,8-HxCDD	1,2,3,6,7,8-HxCDF
1,2,3,7,8,9-HxCDD	1,2,3,7,8,9-HxCDF
	2,3,4,6,7,8-HxCDF
1,2,3,4,6,7,8-HpCDD	1,2,3,4,6,7,8-HpCDF
	1,2,3,4,7,8,9-HpCDF
1,2,3,4,6,7,8,9-OCDD	1,2,3,4,6,7,8,9-OCDF



TABLE 3. COMPOSITIONS OF THE INITIAL CALIBRATION SOLUTIONS OF LABELED AND UNLABELED PCDDS AND PCDFS

Compound Solution No.	Concentrations (pg/ $\mu$ L)				
	1	2	3	4	5
<b>Unlabeled Analytes</b>					
2,3,7,8-TCDD	0.5	1	5	50	100
2,3,7,8-TCDF	0.5	1	5	50	100
1,2,3,7,8-PeCDD	2.5	5	25	250	500
1,2,3,7,8-PeCDF	2.5	5	25	250	500
2,3,4,7,8-PeCDF	2.5	5	25	250	500
1,2,3,4,7,8-HxCDD	2.5	5	25	250	500
1,2,3,6,7,8-HxCDD	2.5	5	25	250	500
1,2,3,7,8,9-HxCDD	2.5	5	25	250	500
1,2,3,4,7,8-HxCDF	2.5	5	25	250	500
1,2,3,6,7,8-HxCDF	2.5	5	25	250	500
1,2,3,7,8,9-HxCDF	2.5	5	25	250	500
2,3,4,6,7,8-HxCDD	2.5	5	25	250	500
1,2,3,4,6,7,8-HpCDD	2.5	5	25	250	500
1,2,3,4,6,7,8-HpCDF	2.5	5	25	250	500
1,2,3,4,7,8,9-HpCDF	2.5	5	25	250	500
OCDD	5.0	10	50	500	1000
OCDF	5.0	10	50	500	1000
<b>Internal Standards</b>					
<sup>13</sup> C <sub>12</sub> -2,3,7,8-TCDD	100	100	100	100	100
<sup>13</sup> C <sub>12</sub> -1,2,3,7,8-PeCDD	100	100	100	100	100
<sup>13</sup> C <sub>12</sub> -1,2,3,6,7,8-HxCDD	100	100	100	100	100
<sup>13</sup> C <sub>12</sub> -1,2,3,4,6,7,8-HpCDD	100	100	100	100	100
<sup>13</sup> C <sub>12</sub> -OCDD	200	200	200	200	200
<sup>13</sup> C <sub>12</sub> -2,3,7,8-TCDF	100	100	100	100	100

TABLE 3. (continued)

Compound Solution No.	Concentrations (pg/ $\mu$ L)				
	1	2	3	4	5
$^{13}\text{C}_{12}$ -1,2,3,7,8-PeCDF	100	100	100	100	100
$^{13}\text{C}_{12}$ -1,2,3,4,7,8-HxCDF	100	100	100	100	100
$^{13}\text{C}_{12}$ -1,2,3,4,6,7,8-HpCDF	100	100	100	100	100
<b>Surrogate Standards</b>					
$^{13}\text{C}_{12}$ -2,3,4,7,8-PeCDF	60	80	100	120	140
$^{13}\text{C}_{12}$ -1,2,3,4,7,8-HxCDF	60	80	100	120	140
$^{13}\text{C}_{12}$ -1,2,3,6,7,8-HxCDF	60	80	100	120	140
$^{13}\text{C}_{12}$ -1,2,3,6,7,8,9-HpCDF	60	80	100	120	140
<b>Field Standards</b>					
$^{37}\text{Cl}_4$ -2,3,7,8-TCDD	100	100	100	100	100
$^{13}\text{C}_{12}$ -1,2,3,7,8,9-HxCDD	100	100	100	100	100
<b>Recovery Standard</b>					
$^{13}\text{C}_{12}$ -1,2,3,4-TCDD	50	50	50	50	50

[Note: Standards specified in EPA Method 1613 can also be used in this method.]

TABLE 4. COMPOSITION OF THE SAMPLE FORTIFICATION SOLUTIONS

Analyte	Concentration (pg/ $\mu$ L)
<b>Chlorinated Internal Standards</b>	
$^{13}\text{C}_{12}$ -2,3,7,8-TCDD	100
$^{13}\text{C}_{12}$ -1,2,3,7,8-PeCDD	100
$^{13}\text{C}_{12}$ -1,2,3,6,7,8-HxCDD	100
$^{13}\text{C}_{12}$ -1,2,3,4,6,7,8-HpCDD	100
$^{13}\text{C}_{12}$ -OCDD	100
$^{13}\text{C}_{12}$ -2,3,7,8-TCDF	100
$^{13}\text{C}_{12}$ -1,2,3,7,8-PeCDF	100
$^{13}\text{C}_{12}$ -1,2,3,4,7,8-HxCDF	100
$^{13}\text{C}_{12}$ -1,2,3,4,6,7,8-HpCDF	100
<b>Brominated Internal Standards</b>	
$^{13}\text{Cl}_{12}$ -2,3,7,8-TBDD	0.86
$^{13}\text{C}_{12}$ -2,3,7,8-TBDF	0.86
$^{13}\text{C}_{12}$ -1,2,3,7,8-PeBDF	0.86

TABLE 5. COMPOSITION OF RECOVERY STANDARD SOLUTION

Analyte	Concentration (pg/ $\mu$ L)
<b>Recovery Standard</b>	
$^{13}\text{C}_{12}$ -1,2,3,4-TCDD	10

TABLE 6. COMPOSITION OF AIR SAMPLER FIELD FORTIFICATION STANDARD SOLUTION

Analyte	Concentration (pg/ $\mu$ L)
<b>Field Fortification Standard</b>	
$^{37}\text{Cl}_4$ -2,3,7,8-TCDD	10

TABLE 7. COMPOSITION OF SURROGATE STANDARD SOLUTION

Analyte	Concentration (pg/ $\mu$ L)
<b>Surrogate Standards</b>	
$^{13}\text{C}_{12}$ -1,2,3,4,7,8-HxCDD	100
$^{13}\text{C}_{12}$ -2,3,4,7,8-PeCDF	100
$^{13}\text{C}_{12}$ -1,2,3,6,7,8-HxCDF	100
$^{13}\text{C}_{12}$ -1,2,3,4,7,8,9-HpCDF	100

TABLE 8. COMPOSITION OF MATRIX AND METHOD SPIKE AND METHOD SPIKE SOLUTIONS OF PCDDs/PCDFs AND PBDDs/PBDFs<sup>a</sup>

Analyte	Concentration (pg/ $\mu$ L)	Analyte	Concentration (pg/ $\mu$ L)
<b>Native PCDDs and PCDFs</b>		<b>Native PBDDs and PBDFs</b>	
2,3,7,8-TCDD	1	2,3,7,8-TBDD	1
2,3,7,8-TCDF	1	2,3,7,8-TBDF	1
1,2,3,7,8-PeCDD	5	1,2,3,7,8-PeBDD	5
1,2,3,7,8-PeCDF	5	1,2,3,7,8-PeBDF	5
2,3,4,7,8-PeCDF	5	1,2,3,4,7,8-HxBDD	5
1,2,3,4,7,8-HxCDD	5	1,2,3,4,7,8-HxBDF	5
1,2,3,6,7,8-HxCDD	5		
1,2,3,7,8,9-HxCDD	5		
1,2,3,4,7,8-HxCDF	5		
1,2,3,6,7,8-HxCDF	5		
1,2,3,7,8,9-HxCDF	5		
2,3,4,6,7,8-HxCDF	5		
1,2,3,4,6,7,8-HpCDD	5		
1,2,3,4,6,7,8-HpCDF	5		
1,2,3,4,7,8,9-HpCDF	5		
OCDD	10		
OCDF	10		

<sup>a</sup>Solutions at different concentrations and those containing different congeners may also be used.

TABLE 9. HRGC-HRMS COLUMN PERFORMANCE EVALUATION SOLUTIONS

Congener	First Eluted	Last Eluted
SE-54 Column GC Retention Time Window Defining Standard <sup>a</sup>		
TCDF	1,3,6,8-	1,2,8,9-
TCDD	1,3,6,8-	1,2,8,9-
PeCDF	1,3,4,6,8-	1,2,3,8,9-
PeCDD	1,2,4,7,9-	1,2,3,8,9-
HxCDF	1,2,3,4,6,8-	1,2,3,4,8,9-
HxCDD	1,2,4,6,7,9-	1,2,3,4,6,7-
HpCDF	1,2,3,4,6,7,8-	1,2,3,4,7,8,9-
HpCDD	1,2,3,4,6,7,9-	1,2,3,4,6,7,8-
OCDF	OCDF	
OCDD	OCDD	
SE-54 TCDD Isomer Specificity Test Standard <sup>b</sup>		
	1,2,3,4-TCDD	
	1,4,7,8-TCDD	2,3,7,8-TCDD
SP-2331 Column TCDF Isomer Specificity Test Standard <sup>c</sup>		
	2,3,4,7-TCDF	
	2,3,7,8-TCDF	
	1,2,3,9-TCDF	

<sup>a</sup>A solution containing these congeners and the seventeen 2,3,7,8-substituted congeners may also be used for these purposes.

<sup>b</sup>A solution containing the 1,2,3,4,-TCDD and 2,3,7,8-TCDD may also be used for this purpose.

<sup>c</sup>Solution containing all tetra- through octa-congeners may also be used for these purposes.

TABLE 10. DESCRIPTORS, MASSES, M/Z TYPES, AND ELEMENTAL COMPOSITIONS OF THE PCDDS AND PCDFS

Descriptor Number	Accurate Mass	m/z Type	Elemental Composition	Compound <sup>2</sup>	Primary m/z
1	292.9825	Lock	C <sub>7</sub> F <sub>11</sub>	PFK	
	303.9016	M	C <sub>12</sub> H <sub>4</sub> <sup>35</sup> Cl <sub>4</sub> O	TCDF	Yes
	305.8987	M+2	C <sub>12</sub> H <sub>4</sub> <sup>35</sup> Cl <sub>3</sub> <sup>37</sup> ClO	TCDF	
	315.9419	M	<sup>13</sup> C <sub>12</sub> H <sub>4</sub> <sup>35</sup> Cl <sub>4</sub> O	TCDF <sup>3</sup>	Yes
	317.9389	M+2	<sup>13</sup> C <sub>12</sub> H <sub>4</sub> <sup>35</sup> Cl <sub>3</sub> <sup>37</sup> ClO	TCDF <sup>3</sup>	
	319.8965	M	C <sub>12</sub> H <sub>4</sub> <sup>35</sup> Cl <sub>4</sub> O <sub>2</sub>	TCDD	Yes
	321.8936	M+2	C <sub>12</sub> H <sub>4</sub> <sup>35</sup> Cl <sub>3</sub> <sup>37</sup> ClO <sub>2</sub>	TCDD	
	327.8847	M	C <sub>12</sub> H <sub>4</sub> <sup>37</sup> Cl <sub>4</sub> O <sub>2</sub>	TCDD <sup>4</sup>	
	330.9792	QC	C <sub>7</sub> F <sub>13</sub>	PFK	
	331.9368	M	<sup>13</sup> C <sub>12</sub> H <sub>4</sub> <sup>35</sup> Cl <sub>4</sub> O <sub>2</sub>	TCDD <sup>3</sup>	Yes
	333.9339	M+2	<sup>13</sup> C <sub>12</sub> H <sub>4</sub> <sup>35</sup> Cl <sub>3</sub> <sup>37</sup> ClO <sub>2</sub>	TCDD <sup>3</sup>	
	375.8364	M+2	C <sub>12</sub> H <sub>4</sub> <sup>35</sup> Cl <sub>5</sub> <sup>37</sup> ClO	HxCDFE	
2	339.8597	M+2	C <sub>12</sub> H <sub>3</sub> <sup>35</sup> Cl <sub>4</sub> <sup>37</sup> ClO	PeCDF	Yes
	341.8567	M+4	C <sub>12</sub> H <sub>3</sub> <sup>35</sup> Cl <sub>5</sub> <sup>37</sup> Cl <sub>2</sub> O	PeCDF	
	351.9000	M+2	<sup>13</sup> C <sub>12</sub> H <sub>3</sub> <sup>35</sup> Cl <sub>4</sub> <sup>37</sup> ClO	PeCDF <sup>3</sup>	Yes
	353.8970	M+4	<sup>13</sup> C <sub>12</sub> H <sub>3</sub> <sup>35</sup> Cl <sub>3</sub> <sup>37</sup> Cl <sub>2</sub> O	PeCDF <sup>3</sup>	
	354.9792	Lock	C <sub>9</sub> F <sub>13</sub>	PFK	
	355.8546	M+2	C <sub>12</sub> H <sub>3</sub> <sup>35</sup> Cl <sub>4</sub> <sup>37</sup> ClO <sub>2</sub>	PeCDD	Yes
	357.8516	M+4	C <sub>12</sub> H <sub>3</sub> <sup>35</sup> Cl <sub>5</sub> <sup>37</sup> Cl <sub>2</sub> O <sub>2</sub>	PeCDD	
	367.8949	M+2	<sup>13</sup> C <sub>12</sub> H <sub>3</sub> <sup>35</sup> Cl <sub>4</sub> <sup>37</sup> ClO <sub>2</sub>	PeCDD <sup>4</sup>	Yes
	369.8919	M+4	<sup>13</sup> C <sub>12</sub> H <sub>3</sub> <sup>35</sup> Cl <sub>3</sub> <sup>37</sup> Cl <sub>2</sub> O <sub>2</sub>	PeCDD <sup>4</sup>	
	409.7974	M+2	C <sub>12</sub> H <sub>3</sub> <sup>35</sup> Cl <sub>6</sub> <sup>37</sup> ClO	HpCDFE	

TABLE 10. (continued)

Descriptor Number	Accurate Mass	m/z Type	Elemental Composition	Compound <sup>2</sup>	Primary m/z
3	373.8208	M+2	C <sub>12</sub> H <sub>2</sub> <sup>35</sup> Cl <sub>5</sub> <sup>37</sup> Cl O	HxCDF	Yes
	375.8178	M+4	C <sub>12</sub> H <sub>2</sub> <sup>35</sup> Cl <sub>4</sub> <sup>37</sup> Cl <sub>2</sub> O	HxCDF	
	383.8639	M	<sup>13</sup> C <sub>12</sub> H <sub>2</sub> <sup>35</sup> Cl <sub>6</sub> O	HxCDF <sup>3</sup>	Yes
	385.8610	M+2	<sup>13</sup> C <sub>12</sub> H <sub>2</sub> <sup>35</sup> Cl <sub>5</sub> <sup>37</sup> Cl O	HxCDF <sup>3</sup>	
	389.8157	M+2	C <sub>12</sub> H <sub>2</sub> <sup>35</sup> Cl <sub>5</sub> <sup>37</sup> Cl O <sub>2</sub>	HxCDD	Yes
	391.8127	M+4	C <sub>12</sub> H <sub>2</sub> <sup>35</sup> Cl <sub>4</sub> <sup>37</sup> Cl <sub>2</sub> O <sub>2</sub>	HxCDD	
	392.9760	Lock	C <sub>9</sub> F <sub>15</sub>	PFK	
	401.8559	M+2	<sup>13</sup> C <sub>12</sub> H <sub>2</sub> <sup>35</sup> Cl <sub>5</sub> <sup>37</sup> Cl O <sub>2</sub>	HxCDD <sup>3</sup>	Yes
	403.8529	M+4	<sup>13</sup> C <sub>12</sub> H <sub>2</sub> <sup>35</sup> Cl <sub>4</sub> <sup>37</sup> Cl <sub>2</sub> O <sub>2</sub>	HxCDD <sup>3</sup>	
	430.9729	QC	C <sub>9</sub> F <sub>13</sub>	PFK	
	445.7555	M+4	C <sub>12</sub> H <sub>2</sub> <sup>35</sup> Cl <sub>6</sub> <sup>37</sup> Cl <sub>2</sub> O	OCDPE	
4	407.7818	M+2	C <sub>12</sub> H <sup>35</sup> Cl <sub>6</sub> <sup>37</sup> Cl O	H <sub>p</sub> CDF	Yes
	409.7789	M+4	C <sub>12</sub> H <sup>35</sup> Cl <sub>5</sub> <sup>37</sup> Cl <sub>2</sub> O	H <sub>p</sub> CDF	
	417.8253	M	<sup>13</sup> C <sub>12</sub> H <sup>35</sup> Cl <sub>7</sub> O	H <sub>p</sub> CDF <sup>3</sup>	Yes
	419.8220	M+2	<sup>13</sup> C <sub>12</sub> H <sup>35</sup> Cl <sub>6</sub> <sup>37</sup> Cl O	H <sub>p</sub> CDF <sup>3</sup>	
	423.7766	M+2	C <sub>12</sub> H <sup>35</sup> Cl <sub>6</sub> <sup>37</sup> Cl O <sub>2</sub>	H <sub>p</sub> CDD	Yes
	425.7737	M+4	C <sub>12</sub> H <sup>35</sup> Cl <sub>5</sub> <sup>37</sup> Cl <sub>2</sub> O <sub>2</sub>	H <sub>p</sub> CDD	
	430.9729	Lock	C <sub>9</sub> F <sub>17</sub>	PFK	
	435.8169	M+2	<sup>13</sup> C <sub>12</sub> H <sup>35</sup> Cl <sub>6</sub> <sup>37</sup> Cl O <sub>2</sub>	H <sub>p</sub> CDD <sup>3</sup>	Yes
	437.8140	M+4	<sup>13</sup> C <sub>12</sub> H <sup>35</sup> Cl <sub>5</sub> <sup>37</sup> Cl <sub>2</sub> O <sub>2</sub>	H <sub>p</sub> CDD <sup>3</sup>	
479.7165	M+4	C <sub>12</sub> H <sup>35</sup> Cl <sub>7</sub> <sup>37</sup> Cl <sub>2</sub> O	NCDPE		



TABLE 10. (continued)

Descriptor Number	Accurate Mass	m/z Type	Elemental Composition	Compound <sup>2</sup>	Primary m/z
5	441.7428	M+2	C <sub>12</sub> <sup>35</sup> Cl <sub>7</sub> <sup>37</sup> Cl O	OCDF	Yes
	442.9728	Lock	C <sub>10</sub> F <sub>17</sub>	PFK	
	443.7399	M+4	C <sub>12</sub> <sup>35</sup> Cl <sub>6</sub> <sup>37</sup> Cl <sub>2</sub> O	OCDF	
	457.7377	M+2	C <sub>12</sub> <sup>35</sup> Cl <sub>7</sub> <sup>37</sup> Cl O <sub>2</sub>	OCDD	Yes
	459.7348	M+4	C <sub>12</sub> <sup>35</sup> Cl <sub>6</sub> <sup>37</sup> Cl <sub>2</sub> O <sub>2</sub>	OCDD	
	469.7779	M+2	<sup>13</sup> C <sub>12</sub> <sup>35</sup> Cl <sub>7</sub> <sup>37</sup> Cl O <sub>2</sub>	OCDD <sup>3</sup>	Yes
	471.7750	M+4	<sup>13</sup> C <sub>12</sub> <sup>35</sup> Cl <sub>6</sub> <sup>37</sup> Cl <sub>2</sub> O <sub>2</sub>	OCDD <sup>3</sup>	
	513.6775	M+4	C <sub>12</sub> <sup>35</sup> Cl <sub>8</sub> <sup>37</sup> Cl <sub>2</sub> O	DCDPE	

<sup>1</sup>Nuclidic masses used:

H = 1.007825    C = 12.00000    <sup>13</sup>C = 13.003355    F = 18.9984  
 O = 15.994915    <sup>35</sup>Cl = 34.968853    <sup>37</sup>Cl = 36.965903

<sup>2</sup>Compound abbreviations:

Polychlorinated dibenzo-p-dioxins

TCDD = Tetrachlorodibenzo-p-dioxin  
 PeCDD = Pentachlorodibenzo-p-dioxin  
 HxCDD = Hexachlorodibenzo-p-dioxin  
 HpCDD = Heptachlorodibenzo-p-dioxin  
 OCDD = Octachlorodibenzo-p-dioxin

Polychlorinated dibenzofurans

TCDF = Tetrachlorodibenzofuran  
 PeCDF = Pentachlorodibenzofuran  
 HxCDF = Hexachlorodibenzofuran  
 HpCDF = Heptachlorodibenzofuran

Polychlorinated diphenyl ethers

HxCdPE = Hexachlorodiphenyl ether  
 HpCDPE = Heptachlorodiphenyl ether  
 OCDPE = Octachlorodiphenyl ether  
 NCDPE = Nonachlorodiphenyl ether  
 DCDPE = Decachlorodiphenyl ether

Lock mass and QC compound

PFK = Perfluorokerosene

<sup>3</sup>Labeled compound

<sup>4</sup>There is only one m/z for <sup>37</sup>Cl<sub>4</sub>-2,3,7,8-TCDD (recovery standard).

TABLE 11. DESCRIPTORS, M/Z TYPES, EXACT MASSES AND ELEMENTAL COMPOSITIONS OF THE PBDDS AND PBDFS

Descriptor Number	Accurate Mass <sup>1</sup>	Ion Type	Elemental Composition	Compound <sup>2</sup>
1	327.8847	M	C <sub>12</sub> H <sub>4</sub> <sup>37</sup> Cl <sub>4</sub> O <sub>2</sub>	TCDD <sup>4</sup>
	330.9792	QC	C <sub>7</sub> F <sub>13</sub>	PFK
	331.9368	M	C <sub>12</sub> H <sub>4</sub> <sup>35</sup> Cl <sub>4</sub> O <sub>2</sub>	TCDD <sup>3</sup>
	333.9339	M+2	C <sub>12</sub> H <sub>4</sub> <sup>35</sup> Cl <sub>3</sub> <sup>37</sup> ClO <sub>2</sub>	TCDD <sup>3</sup>
2	417.825	M	<sup>13</sup> C <sub>12</sub> H <sup>35</sup> Cl <sub>7</sub> O	HpCDF <sup>3</sup>
	419.822	M+2	<sup>13</sup> C <sub>12</sub> H <sup>35</sup> Cl <sub>6</sub> <sup>37</sup> ClO	HpCDF <sup>3</sup>
	466.973	QC		PFK
	481.698	M+2	C <sub>12</sub> H <sub>4</sub> <sup>79</sup> Br <sub>3</sub> <sup>81</sup> BrO	TBDF
	483.696	M+4	C <sub>12</sub> H <sub>4</sub> <sup>79</sup> Br <sub>2</sub> <sup>81</sup> Br <sub>2</sub> O	TBDF
	485.694	M+6	C <sub>12</sub> H <sub>4</sub> <sup>79</sup> Br <sup>81</sup> Br <sub>3</sub> O	TBDF
	492.970	LOCK MASS		PFK
	493.738	M+2	<sup>13</sup> C <sub>12</sub> H <sub>4</sub> <sup>79</sup> Br <sub>3</sub> <sup>81</sup> BrO	TBDF <sup>3</sup>
	495.736	M+4	<sup>13</sup> C <sub>12</sub> H <sub>4</sub> <sup>79</sup> Br <sub>2</sub> <sup>81</sup> Br <sub>2</sub> O	TBDD <sup>3</sup>
	497.692	M+2	C <sub>12</sub> H <sub>4</sub> <sup>79</sup> Br <sub>3</sub> <sup>81</sup> BrO <sub>2</sub>	TBDD
	499.690	M+4	C <sub>12</sub> H <sub>4</sub> <sup>79</sup> Br <sub>2</sub> <sup>81</sup> Br <sub>2</sub> O <sub>2</sub>	TBDD
	501.689	M+6	C <sub>12</sub> H <sub>4</sub> <sup>79</sup> Br <sup>81</sup> Br <sub>3</sub> O	TBDD
	509.733	M+2	<sup>13</sup> C <sub>12</sub> H <sub>4</sub> <sup>79</sup> Br <sub>3</sub> <sup>81</sup> BrO <sub>2</sub>	TBDD <sup>3</sup>
	511.731	M+4	<sup>13</sup> C <sub>12</sub> H <sub>4</sub> <sup>79</sup> Br <sub>2</sub> <sup>81</sup> Br <sub>2</sub> O <sub>2</sub>	TBDD <sup>3</sup>
	565.620	M+6	C <sub>12</sub> H <sub>5</sub> <sup>79</sup> Br <sub>2</sub> <sup>81</sup> Br <sub>3</sub> O	PeBDPO
	643.530	M+6	C <sub>12</sub> H <sub>4</sub> <sup>79</sup> Br <sub>3</sub> <sup>81</sup> Br <sub>3</sub> O	HxBDPO

TABLE 11. (continued)

Descriptor Number	Accurate Mass <sup>1</sup>	Ion Type	Elemental Composition	Compound <sup>2</sup>
3	469.778	M+2	$^{13}\text{C}_{12} \text{ } ^{35}\text{Cl}_7 \text{ } ^{37}\text{Cl} \text{ O}_2$	OCDD <sup>3</sup>
	471.775	M+4	$^{13}\text{C}_{12} \text{ } ^{35}\text{Cl}_6 \text{ } ^{37}\text{Cl} \text{ O}_2$	OCDD <sup>3</sup>
	559.608	M+2	$\text{C}_{12} \text{ H}_3 \text{ } ^{79}\text{Br}_4 \text{ } ^{81}\text{Br} \text{ O}$	PeBDF
	561.606	M+4	$\text{C}_{12} \text{ H}_3 \text{ } ^{79}\text{Br}_3 \text{ } ^{81}\text{Br}_2 \text{ O}$	PeBDF
	563.604	M+6	$\text{C}_{12} \text{ H}_3 \text{ } ^{79}\text{Br}_2 \text{ } ^{81}\text{Br}_3 \text{ O}$	PeBDF
	566.966	LOCK MASS		PFK
	573.646	M+4	$^{13}\text{C}_{12} \text{ H}_3 \text{ } ^{79}\text{Br}_3 \text{ } ^{81}\text{Br}_2 \text{ O}$	PeBDF <sup>3</sup>
	575.644	M+6	$^{13}\text{C}_{12} \text{ H}_3 \text{ } ^{79}\text{Br}_2 \text{ } ^{81}\text{Br}_3 \text{ O}$	PeBDF <sup>3</sup>
	575.603	M+2	$\text{C}_{12} \text{ H}_3 \text{ } ^{79}\text{Br}_4 \text{ } ^{81}\text{Br} \text{ O}_2$	PeBDD
	577.601	M+4	$\text{C}_{12} \text{ H}_3 \text{ } ^{79}\text{Br}_3 \text{ } ^{37}\text{Br}_2 \text{ O}_2$	PeBDD
	579.599	M+6	$\text{C}_{12} \text{ H}_3 \text{ } ^{79}\text{Br}_2 \text{ } ^{81}\text{Br}_3 \text{ O}_2$	PeBDD
	589.641	M+4	$^{13}\text{C}_{12} \text{ H}_3 \text{ } ^{79}\text{Br}_3 \text{ } ^{37}\text{Br}_2 \text{ O}_2$	PeBDD <sup>3</sup>
	591.639	M+6	$^{13}\text{C}_{12} \text{ H}_3 \text{ } ^{79}\text{Br}_3 \text{ } ^{81}\text{Br}_2 \text{ O}_2$	PeBDD <sup>3</sup>
	616.963	QC		PFK

TABLE 11. (continued)

Descriptor Number	Accurate Mass <sup>1</sup>	Ion Type	Elemental Composition	Compound <sup>2</sup>
4	643.530	M+6	C <sub>12</sub> H <sub>4</sub> <sup>79</sup> Br <sub>3</sub> <sup>81</sup> Br <sub>3</sub> O	HxBDPO
	721.441	M+6	C <sub>12</sub> H <sub>3</sub> <sup>79</sup> Br <sub>4</sub> <sup>81</sup> Br <sub>3</sub> O	HpBDPO
	616.963	QC		PFK
	639.517	M+4	C <sub>12</sub> H <sub>2</sub> <sup>79</sup> Br <sub>4</sub> <sup>81</sup> Br <sub>2</sub> O	HxBDF
	641.514	M+6	C <sub>12</sub> H <sub>2</sub> <sup>79</sup> Br <sub>3</sub> <sup>81</sup> Br <sub>3</sub> O	HxBDF
	643.512	M+8	C <sub>12</sub> H <sub>2</sub> <sup>79</sup> Br <sub>2</sub> <sup>81</sup> Br <sub>4</sub> O	HxBDF
	655.511	M+4	C <sub>12</sub> H <sub>2</sub> <sup>79</sup> Br <sub>4</sub> <sup>81</sup> Br <sub>2</sub> O <sub>2</sub>	HxBDD
	657.509	M+6	C <sub>12</sub> H <sub>2</sub> <sup>79</sup> Br <sub>3</sub> <sup>81</sup> Br <sub>3</sub> O <sub>2</sub>	HxBDD
	659.507	M+8	C <sub>12</sub> H <sub>2</sub> <sup>79</sup> Br <sub>2</sub> <sup>81</sup> Br <sub>4</sub> O <sub>2</sub>	HxBDD
	666.960	LOCK MASS		PFK
	721.441	M+6	C <sub>12</sub> H <sub>3</sub> <sup>79</sup> Br <sub>4</sub> <sup>81</sup> Br <sub>3</sub> O	HpBDPO
	801.349	M+8	C <sub>12</sub> H <sub>2</sub> <sup>79</sup> Br <sub>4</sub> <sup>81</sup> Br <sub>4</sub> O	OBDPO

TABLE 11. (continued)

Descriptor Number	Accurate Mass <sup>1</sup>	Ion Type	Elemental Composition	Compound <sup>2</sup>
5	717.427	M+4	C <sub>12</sub> H <sup>79</sup> Br <sub>5</sub> <sup>81</sup> Br <sub>2</sub> O	HpBDF
	719.425	M+6	C <sub>12</sub> H <sup>79</sup> Br <sub>4</sub> <sup>81</sup> Br <sub>3</sub> O	HpBDF
	721.423	M+8	C <sub>12</sub> H <sup>79</sup> Br <sub>3</sub> <sup>81</sup> Br <sub>4</sub> O	HpBDF
	733.422	M+4	C <sub>12</sub> H <sup>79</sup> Br <sub>5</sub> <sup>81</sup> Br <sub>2</sub> O <sub>2</sub>	HpBDD
	735.420	M+6	C <sub>12</sub> H <sup>79</sup> Br <sub>4</sub> <sup>81</sup> Br <sub>3</sub> O <sub>2</sub>	HpBDD
	737.418	M+4	C <sub>12</sub> H <sup>79</sup> Br <sub>3</sub> <sup>81</sup> Br <sub>4</sub> O <sub>2</sub>	HpBDD
	754.954	QC		PFK
	770.960	LOCK MASS ALTERNATE		HpTriazine
	801.349	M+8	C <sub>12</sub> H <sub>2</sub> <sup>79</sup> Br <sub>4</sub> <sup>81</sup> Br <sub>4</sub> O	OBDPO
	816.951	LOCK MASS		PFK
	879.260	M+8	C <sub>12</sub> H <sup>79</sup> Br <sub>5</sub> <sup>81</sup> Br <sub>4</sub> O	NBDPO
	865.958	QC ALTERNATE		HpTriazine

<sup>1</sup>Nuclidic masses used: H = 1.007825 C = 12.000000 <sup>13</sup>C = 13.003355  
O = 15.994915 <sup>79</sup>Br = 78.91834 <sup>81</sup>Br = 80.91629  
<sup>19</sup>F = 18.9984

<sup>2</sup>Compound abbreviations:

Polybrominated dibenzo-p-dioxins

TBDD = Tetrabromodibenzo-p-dioxin  
PeBDD = Pentabromodibenzo-p-dioxin  
HxBDD = Hexabromodibenzo-p-dioxin  
HpBDD = Heptabromodibenzo-p-dioxin  
OBDD = Octabromodibenzo-p-dioxin

Polybrominated dibenzofurans

TBDF = Tetrabromodibenzofuran  
PeBDF = Pentabromodibenzofuran  
HxBDF = Hexabromodibenzofuran  
HpBDF = Heptabromodibenzofuran  
OBDF = Octabromodibenzofuran

Polybrominated diphenyl ethers

HxBDPE = Hexabromodiphenyl ether  
HpBDPE = Heptabromodiphenyl ether  
OBDPE = Octabromodiphenyl ether  
NBDPE = Nonabromodiphenyl ether  
DBDPE = Decabromodiphenyl ether  
PFK = Perfluorokerosene  
HpTriazine = Tris-(perfluoroheptyl)-s-Triazine

<sup>3</sup>Labeled Compound

<sup>4</sup>There is only one m/z for <sup>37</sup>Cl<sub>4</sub>-2378-TCDD (recovery standard).

TABLE 12. DESCRIPTORS, MASSES, M/Z TYPES, AND ELEMENTAL COMPOSITIONS OF THE BCDDS AND BCDFS

Descriptor Number	Accurate mass <sup>1</sup>	m/z Type	Elemental Composition	Compound <sup>2</sup>	Primary m/z
1	315.942	M	$^{13}\text{C}_{12}\text{H}_4\text{ }^{35}\text{Cl}_4\text{O}$	TCDF <sup>4</sup>	
	317.939	M+2	$\text{C}_{12}\text{H}_4\text{ }^{35}\text{Cl}_3\text{ }^{37}\text{Cl}\text{O}$	TCDF <sup>4</sup>	Yes
	327.885	M	$\text{C}_{12}\text{H}_4\text{ }^{35}\text{Cl}_4\text{O}_2$	TCDD <sup>3</sup>	Yes
	330.979	Lock	$\text{C}_7\text{F}_{13}$	PFK	
	331.937	M	$^{13}\text{C}_{12}\text{H}_4\text{ }^{35}\text{Cl}_4\text{O}_2$	TCDD <sup>4</sup>	
	333.934	M+2	$^{13}\text{C}_{12}\text{H}_4\text{ }^{35}\text{Cl}_3\text{ }^{37}\text{Cl}\text{O}_2$	TCDD <sup>4</sup>	Yes
	347.851	M	$\text{C}_{12}\text{H}_4\text{ }^{35}\text{Cl}_3\text{ }^{79}\text{Br}\text{O}$	Br Cl <sub>3</sub> DF	
	349.849	M+2	$\text{C}_{12}\text{H}_4\text{ }^{35}\text{Cl}_2\text{ }^{37}\text{Cl}\text{ }^{79}\text{Br}\text{O}$	Br Cl <sub>3</sub> DF	Yes
	363.846	M	$\text{C}_{12}\text{H}_4\text{ }^{35}\text{Cl}_3\text{ }^{79}\text{Br}\text{O}_2$	Br Cl <sub>3</sub> DD	
	365.844	M+2	$\text{C}_{12}\text{H}_4\text{ }^{35}\text{Cl}_2\text{ }^{37}\text{Cl}\text{ }^{79}\text{Br}\text{O}_2$	Br Cl <sub>3</sub> DD	Yes

TABLE 12. (continued)

Descriptor Number	Accurate mass <sup>1</sup>	m/z Type	Elemental Composition	Compound <sup>2</sup>	Primary m/z
2	351.900	M+2	<sup>13</sup> C <sub>12</sub> H <sub>3</sub> <sup>35</sup> Cl <sub>5</sub> O	PeCDF <sub>4</sub>	
	353.897	M+4	<sup>13</sup> C <sub>12</sub> H <sub>3</sub> <sup>35</sup> Cl <sub>4</sub> <sup>37</sup> Cl O	PeCDF <sup>4</sup>	
	354.979	Lock	C <sub>9</sub> F <sub>3</sub>	PFK	
	367.895	M+2	<sup>13</sup> C <sub>12</sub> H <sub>3</sub> <sup>35</sup> Cl <sub>5</sub> O <sub>2</sub>	PeCDD <sup>4</sup>	Yes
	369.892	M+4	<sup>13</sup> C <sub>12</sub> H <sub>3</sub> <sup>35</sup> Cl <sub>4</sub> <sup>37</sup> Cl O <sub>2</sub>	PeCDD <sup>4</sup>	
	381.812	M	C <sub>12</sub> H <sub>3</sub> <sup>35</sup> Cl <sub>4</sub> <sup>79</sup> Br O	Br Cl <sub>4</sub> DF	
	383.809	M+2	C <sub>12</sub> H <sub>3</sub> <sup>35</sup> Cl <sub>3</sub> <sup>37</sup> Cl <sup>79</sup> Br O	Br Cl <sub>4</sub> DF	Yes
	397.807	M	C <sub>12</sub> H <sub>3</sub> <sup>35</sup> Cl <sub>4</sub> <sup>79</sup> Br O <sub>2</sub>	Br Cl <sub>4</sub> DD	
	399.804	M+2	C <sub>12</sub> H <sub>3</sub> <sup>35</sup> Cl <sub>3</sub> <sup>37</sup> Cl <sup>79</sup> Br O <sub>2</sub>	Br Cl <sub>4</sub> DD	Yes

<sup>1</sup>Nuclidic masses used:

H = 1.007825

C = 12.00000

<sup>13</sup>C = 13.003355

O = 15.994915

<sup>35</sup>Cl = 34.968853

<sup>37</sup>Cl = 36.965903

F = 18.9984

<sup>79</sup>Br = 78.91834

<sup>81</sup>Br = 80.91629

<sup>2</sup>Compound abbreviations:

Polychlorinated dibenzo-p-dioxins

TCDD = Tetrachlorodibenzo-p-dioxin

PeCDD = Pentachlorodibenzo-p-dioxin

HxCDD = Hexachlorodibenzo-p-dioxin

HpCDD = Heptachlorodibenzo-p-dioxin

OCDD = Octachlorodibenzo-p-dioxin

Polychlorinated dibenzofurans

TCDF = Tetrachlorodibenzofuran

PeCDF = Pentachlorodibenzofuran

HxCDF = Hexachlorodibenzofuran

HpCDF = Heptachlorodibenzofuran

Brominated/Chlorinated

dibenzo-p-dioxins and dibenzofurans

BrCl<sub>3</sub>DD = Bromotrichloro dibenzo-p-dioxin

BrCl<sub>4</sub>DD = Bromotetrachloro dibenzo-p-dioxin

BrCl<sub>3</sub>DF = Bromotrichloro dibenzofuran

BrCl<sub>4</sub>DF = Bromotetrachloro dibenzofuran

Lock mass and QC compound

PFK = Perfluorokerosene

<sup>3</sup>There is only one m/z for <sup>37</sup>Cl<sub>4</sub>-2,3,7,8-TCDD (recovery standard).

<sup>4</sup>Labeled compound

TABLE 13. HRGC OPERATING CONDITIONS

Column Type	DB-5	SE-54	SP-2331
Length (m)	60	30	60
i.d. (mm)	0.25	0.25	0.25
Film Thickness ( $\mu\text{m}$ )	0.25	0.25	0.20
Carrier Gas	Helium	Helium	Helium
Carrier Gas Flow (mL/min)	1-2	1-2	1-2
Injector temperature ( $^{\circ}\text{C}$ )	290	308	308
Injection Mode	Splitless	<--- Moving needle --->	
Initial Temperature ( $^{\circ}\text{C}$ )	200	170.0	150.0
Initial Time (min)	2	7.0	7.0
Rate 1 ( $^{\circ}\text{C}/\text{min}$ )	5	8.0	10.0
Temperature ( $^{\circ}\text{C}$ )	220		
Hold Time (min)	16		
Rate 2 (deg. C/min)	5		
Temperature ( $^{\circ}\text{C}$ )	235		
Hold Time (min)	7		
Rate 2 (deg. C/min)	5		
Final Temperature ( $^{\circ}\text{C}$ )	330	300.0	250.0
Hold Time (min)	5		

TABLE 14. HRMS OPERATING CONDITIONS

Electron impact ionization	25-70 eV
Mass resolution	>10,000 (10% Valley Definition)
Analysis	Selected ion monitoring (SIM)
Exact masses monitored	Masses shown in Tables 10, 11, 12



TABLE 15. UNLABELED AND LABELED  
ANALYTE QUANTIFICATION RELATIONSHIPS

Analyte	Internal Standard Used During Quantification
2,3,7,8-TCDD	<sup>13</sup> C <sub>12</sub> -2,3,7,8-TCDD
Other TCDDs	<sup>13</sup> C <sub>12</sub> -2,3,7,8-TCDD
<sup>37</sup> Cl <sub>4</sub> -2,3,7,8-TCDD	<sup>13</sup> C <sub>12</sub> -2,3,7,8-TCDD
1,2,3,7,8-PeCDD	<sup>13</sup> C <sub>12</sub> -1,2,3,7,8-PeCDD
Other PeCDDs	<sup>13</sup> C <sub>12</sub> -1,2,3,7,8-PeCDD
1,2,3,4,7,8-HxCDD	<sup>13</sup> C <sub>12</sub> -1,2,3,6,7,8-HxCDD
1,2,3,6,7,8-HxCDD	<sup>13</sup> C <sub>12</sub> -1,2,3,6,7,8-HxCDD
1,2,3,7,8,9-HxCDD	<sup>13</sup> C <sub>12</sub> -1,2,3,6,7,8-HxCDD
Other HxCDDs	<sup>13</sup> C <sub>12</sub> -1,2,3,6,7,8-HxCDD
1,2,3,4,6,7,8-HpCDD	<sup>13</sup> C <sub>12</sub> -1,2,3,4,6,7,8-HpCDD
Other HpCDDs	<sup>13</sup> C <sub>12</sub> -1,2,3,4,6,7,8-HpCDD
OCDD	<sup>13</sup> C <sub>12</sub> -OCDD
2,3,7,8-TCDF	<sup>13</sup> C <sub>12</sub> -2,3,7,8-TCDF
Other TCDFs	<sup>13</sup> C <sub>12</sub> -2,3,7,8-TCDF
1,2,3,7,8-PeCDF	<sup>13</sup> C <sub>12</sub> -1,2,3,7,8-PeCDF
2,3,4,7,8-PeCDF	<sup>13</sup> C <sub>12</sub> -1,2,3,7,8-PeCDF
Other PeCDFs	<sup>13</sup> C <sub>12</sub> -1,2,3,7,8-PeCDF
1,2,3,4,7,8-HxCDF	<sup>13</sup> C <sub>12</sub> -1,2,3,4,7,8-HxCDF
1,2,3,6,7,8-HxCDF	<sup>13</sup> C <sub>12</sub> -1,2,3,4,7,8-HxCDF
1,2,3,7,8,9-HxCDF	<sup>13</sup> C <sub>12</sub> -1,2,3,4,7,8-HxCDF
2,3,4,6,7,8-HxCDF	<sup>13</sup> C <sub>12</sub> -1,2,3,4,7,8-HxCDF
Other HxCDFs	<sup>13</sup> C <sub>12</sub> -1,2,3,4,7,8-HxCDF
1,2,3,4,6,7,8-HpCDF	<sup>13</sup> C <sub>12</sub> -1,2,3,4,6,7,8-HpCDF
1,2,3,4,7,8,9-HpCDF	<sup>13</sup> C <sub>12</sub> -1,2,3,4,6,7,8-HpCDF
Other HpCDFs	<sup>13</sup> C <sub>12</sub> -1,2,3,4,6,7,8-HpCDF
OCDF	<sup>13</sup> C <sub>12</sub> -OCDD

TABLE 16. INTERNAL STANDARDS QUANTIFICATION RELATIONSHIPS

Internal Standard	Standard Used During Percent Recovery Determination <sup>a</sup>
<sup>13</sup> C <sub>12</sub> -2,3,7,8-TCDD	<sup>13</sup> C <sub>12</sub> -1,2,3,4-TCDD
<sup>13</sup> C <sub>12</sub> -1,2,3,7,8-PeCDD	<sup>13</sup> C <sub>12</sub> -1,2,3,4-TCDD
<sup>13</sup> C <sub>12</sub> -1,2,3,6,7,8-HxCDD	<sup>13</sup> C <sub>12</sub> -1,2,3,7,8,9-HxCDD
<sup>13</sup> C <sub>12</sub> -1,2,3,4,6,7,8-HpCDD	<sup>13</sup> C <sub>12</sub> -1,2,3,7,8,9-HxCDD
<sup>13</sup> C <sub>12</sub> -OCDD	<sup>13</sup> C <sub>12</sub> -1,2,3,7,8,9-HxCDD
<sup>13</sup> C <sub>12</sub> -2,3,7,8-TCDF	<sup>13</sup> C <sub>12</sub> -1,2,3,4-TCDD
<sup>13</sup> C <sub>12</sub> -1,2,3,7,8-PeCDF	<sup>13</sup> C <sub>12</sub> -1,2,3,4-TCDD
<sup>13</sup> C <sub>12</sub> -1,2,3,4,7,8-HxCDF	<sup>13</sup> C <sub>12</sub> -1,2,3,7,8,9-HxCDD
<sup>13</sup> C <sub>12</sub> -1,2,3,4,6,7,8-HpCDF	<sup>13</sup> C <sub>12</sub> -1,2,3,7,8,9-HxCDD

<sup>a</sup>Surrogate standards shown in Table 7 may also be used.

TABLE 17. SURROGATE/ALTERNATE STANDARDS QUANTIFICATION RELATIONSHIPS

Surrogate Standard	Standard Used During Percent Recovery Determination
<sup>13</sup> C <sub>12</sub> -2,3,4,7,8-PeCDF	<sup>13</sup> C <sub>12</sub> -1,2,3,7,8-PeCDF
<sup>13</sup> C <sub>12</sub> -1,2,3,4,7,8-HxCDD	<sup>13</sup> C <sub>12</sub> -1,2,3,6,7,8-HxCDD
<sup>13</sup> C <sub>12</sub> -1,2,3,6,7,8-HxCDF	<sup>13</sup> C <sub>12</sub> -1,2,3,4,7,8-HxCDF
<sup>13</sup> C <sub>12</sub> -1,2,3,4,7,8,9-HpCDF	<sup>13</sup> C <sub>12</sub> -1,2,3,4,6,7,8-HpCDF

[Note: Other surrogate standards may be used instead]

TABLE 18. QUANTIFICATION RELATIONSHIPS OF THE CARBON-LABELED STANDARDS AND THE ANALYTES

Analytes	Quantification Standard
2,3,7,8-TBDD	$^{13}\text{C}_{12}$ -2,3,7,8-TBDD
2,3,7,8-TBDF	$^{13}\text{C}_{12}$ -2,3,7,8-TBDF
1,2,3,7,8-PeBDD	$^{13}\text{C}_{12}$ -1,2,3,7,8-PeBDD
1,2,3,7,8-PeBDF	$^{13}\text{C}_{12}$ -1,2,3,7,8-PeBDF
2,3,4,7,8-PeBDF	$^{13}\text{C}_{12}$ -1,2,3,7,8-PeBDF
1,2,3,4,7,8-HxBDD	$^{13}\text{C}_{12}$ -1,2,3,7,8-PeBDD

[Note: 0.5 ng  $^{37}\text{Cl}_4$ -2,3,7,8-TCDD spiked to the extract prior to final concentration to 60  $\mu\text{L}$  was used to determine the method efficiency (% recovery of the  $^{13}\text{C}_{12}$ -labeled PBDDs/PBDFs).

- Additional 2,3,7,8-substituted PBDDs/PBDFs are now commercially available.
- Retention Index for the PBDDs/PBDFs were published by Sovocool, et al., *Chemosphere* 16, 221-114, 1987; and Donnelly, et al., *Biomedical Environmental Mass Spectrometry*, 14, pp. 465-472, 1987.]

TABLE 19. THEORETICAL ION ABUNDANCE RATIOS AND CONTROL LIMITS FOR PCDDS AND PCDFS

No. of Chlorine Atoms	m/z's Forming Ratio	Theoretical Ratio	Control Limits <sup>1</sup>	
			Lower	Upper
4 <sup>2</sup>	M/M+2	0.77	0.65	0.89
5	M+2/M+4	1.55	1.32	1.78
6	M+2/M+4	1.24	1.05	1.43
6 <sup>3</sup>	M/M+2	0.51	0.43	0.59
7	M+2/M+4	1.04	0.88	1.20
7 <sup>4</sup>	M/M+2	0.44	0.37	0.51
8	M+2/M+4	0.89	0.76	1.02

<sup>1</sup>Represent  $\pm 15\%$  windows around the theoretical ion abundance ratios.

<sup>2</sup>Does not apply to  $^{37}\text{Cl}_4$ -2,3,7,8-TCDD (cleanup standard).

<sup>3</sup>Used for  $^{13}\text{C}_{12}$ -HxCDF only.

<sup>4</sup>Used for  $^{13}\text{C}_{12}$ -HpCDF only.

TABLE 20. THEORETICAL ION ABUNDANCE RATIOS AND CONTROL LIMITS FOR PBDDS AND PBDfs

Number of Bromine Atoms	Ion Type	Theoretical Ratio	Control Limits	
			Lower	Upper
4	M+2/M+4	0.68	0.54	0.82
4	M+4/M+6	1.52	1.22	1.82
5	M+2/M+4	0.51	0.41	0.61
5	M+4/M+6	1.02	0.82	1.22
6	M+4/M+6	0.77	0.62	0.92
6	M+6/M+8	1.36	1.09	1.63
7	M+4/M+6	0.61	0.49	0.73
7	M+6/M+8	1.02	0.82	1.22

TABLE 21. MINIMUM REQUIREMENTS FOR INITIAL AND DAILY CALIBRATION RESPONSE FACTORS

Compound	Relative Response Factors	
	Initial Calibration RSD	Daily Calibration % Difference
<b>Unlabeled Analytes</b>		
2,3,7,8-TCDD	25	25
2,3,7,8-TCDF	25	25
1,2,3,7,8-PeCDD	25	25
1,2,3,7,8-PeCDF	25	25
2,3,4,7,8-PeCDF	25	25
1,2,4,5,7,8-HxCDD	25	25
1,2,3,6,7,8-HxCDD	25	25
1,2,3,7,8,9-HxCDD	25	25
1,2,3,4,7,8-HxCDF	25	25
1,2,3,6,7,8-HxCDF	25	25
1,2,3,7,8,9-HxCDF	25	25
2,3,4,6,7,8-HxCDF	25	25
1,2,3,4,6,7,8-HpCDD	25	25
1,2,3,4,6,7,8-HpCDF	25	25
OCDD	25	25
OCDF	30	30
<b>Internal Standards</b>		
<sup>13</sup> C <sub>12</sub> -2,3,7,8-TCDD	25	25
<sup>13</sup> C <sub>12</sub> -1,2,3,7,8-PeCDD	30	30
<sup>13</sup> C <sub>12</sub> -1,2,3,6,7,8-HxCDD	25	25
<sup>13</sup> C <sub>12</sub> -1,2,3,4,6,7,8-HpCDD	30	30

TABLE 21. (continued)

Compound	Relative Response Factors	
	Initial Calibration RSD	Daily Calibration % Difference
<sup>13</sup> C <sub>12</sub> -OCDD	30	30
<sup>13</sup> C <sub>12</sub> -2,3,7,8-TCDF	30	30
<sup>13</sup> C <sub>12</sub> -1,2,3,7,8-PeCDF	30	30
<sup>13</sup> C <sub>12</sub> -1,2,3,4,7,8-HxCDF	30	30
<sup>13</sup> C <sub>12</sub> -1,2,3,4,6,7,8-HpCDF	30	30
Surrogate Standards		
<sup>37</sup> Cl <sub>4</sub> -2,3,7,8-TCDD	25	25
<sup>13</sup> C <sub>12</sub> -2,3,4,7,8-PeCDF	25	25
<sup>13</sup> C <sub>12</sub> -1,2,3,4,7,8-HxCDD	25	25
<sup>13</sup> C <sub>12</sub> -1,2,3,4,7,8-HxCDF	25	25
<sup>13</sup> C <sub>12</sub> -1,2,3,4,7,8,9-HpCDF	25	25

TABLE 22. 2,3,7,8-TCDD EQUIVALENT FACTORS (TEFs)<sup>1</sup>  
FOR THE POLYCHLORINATED DIBENZODIOXINS  
AND POLYCHLORINATED DIBENZOFURANS

Number	Compound	TEF
1	2,3,7,8-TCDD	1.00
2	1,2,3,7,8-PeCDD	0.50
3	1,2,3,4,7,8-HxCDD	0.1
4	1,2,3,6,7,8-HxCDD	0.1
5	1,2,3,7,8,9-HxCDD	0.1
6	1,2,3,4,6,7,8-HpCDD	0.01
7	OCDD	0.001
8	2,3,4,7,8-TCDF	0.10
9	1,2,3,7,8-PeCDF	0.05
10	2,3,4,7,8-PeCDF	0.5
11	1,2,3,4,7,8-HxCDF	0.1
12	1,2,3,6,7,8-HxCDF	0.1
13	1,2,3,7,8,9-HxCDF	0.1
14	2,3,4,6,7,8-HxCDF	0.1
15	1,2,3,4,6,7,8-HpCDF	0.01
16	1,2,3,4,7,8,9-HpCDF	0.01
17	OCDF	0.001

<sup>1</sup>Interim procedures for Estimating Risks associated with Exposures to mixtures of Chlorinated Dibenzo-p-Dioxins and Dibenzofurans (CDDs/CDFs), WPA-625/3-89-016, March 1989.

[*Note: The same TEFs are assigned to the PBDDs/PBDFs and BCDDs/BCDFs.*]

TABLE 23. MINIMUM SAMPLING EQUIPMENT CALIBRATION AND ACCURACY REQUIREMENTS

Equipment	Acceptance limits	Frequency and method of measurement	Action if requirements are not met
<u>Sampler</u>	Indicated flow rate = true flow rate $\pm 10\%$ .	Calibrate with certified transfer standard on receipt, after maintenance on sampler, and any time audits or flow checks deviate more than $\pm 10\%$ from the indicated flow rate or $\pm 10\%$ from the design flow rate.	Recalibrate
<u>Associated equipment</u>			
Sampler on/off timer	$\pm 30$ min/24 hour	Check at purchase and routinely on sample-recovery days	Adjust or replace
Elapsed-time meter	$\pm 30$ min/24 hour	Compare with a standard time-piece of known accuracy at receipt and at 6-month intervals	Adjust or replace
Flowrate transfer standard (orifice device)	Check at receipt for visual damage	Recalibrate annually against positive displacement standard volume meter	Adopt new calibration curve



TABLE 24. FORMAT FOR TABLE OF ANALYTICAL RESULTS

IDENTIFICATION					
AIR SAMPLER EFFICIENCY (% RECOVERY)					
<sup>13</sup> C <sub>12</sub> -1,2,3,4,-TCDD					
METHOD EFFICIENCY (% RECOVERY)					
<sup>13</sup> C <sub>12</sub> -2,3,7,8-TCDF					
<sup>13</sup> C <sub>12</sub> -2,3,7,8-TCDD					
<sup>13</sup> C <sub>12</sub> -1,2,3,7,8-PeCDF					
<sup>13</sup> C <sub>12</sub> -1,2,3,7,8-PeCDD					
<sup>13</sup> C <sub>12</sub> -1,2,3,4,7,8-HxCDF					
<sup>13</sup> C <sub>12</sub> -1,2,3,6,7,8-HxCDD					
<sup>13</sup> C <sub>12</sub> -1,2,3,4,6,7,8-HpCDD					
<sup>13</sup> C <sub>12</sub> -OCDD					
CONCENTRATIONS DETECTED or MDL (pg/m <sup>3</sup> )					
TCDDs (TOTAL) <sup>1</sup>					
2,3,7,8-TCDD					
PeCDDs (TOTAL)					
1,2,3,7,8-PeCDD					
HxCDDs (TOTAL)					
1,2,3,4,7,8-HxCDD					
1,2,3,6,7,8-HxCDD					
1,2,3,7,8,9-HxCDD					
HpCDDs (TOTAL)					
1,2,3,4,6,7,8-HpCDD					

TABLE 24. (continued)

IDENTIFICATION					
OCDD					
TCDFs (TOTAL)					
2,3,7,8-TCDF					
PeCDFs (TOTAL)					
1,2,3,7,8-PeCDF					
2,3,4,7,8-PeCDF					
HxCDFs (TOTAL)					
1,2,3,4,7,8-HxCDF					
1,2,3,6,7,8-HxCDF					
1,2,3,7,8,9-HxCDF					
2,3,4,6,7,8-HxCDF					
HpCDFs (TOTAL)					
1,2,3,4,6,7,8-HpCDF					
1,2,3,4,7,8,9-HpCDF					
OCDF					

<sup>1</sup>(TOTAL) = All congeners, including the 2,3,7,8-substituted congeners.

ND = Not detected at specified minimum detection limit (MDL).

[*Note: Please refer to text for discussion and qualification that must accompany the results.*]

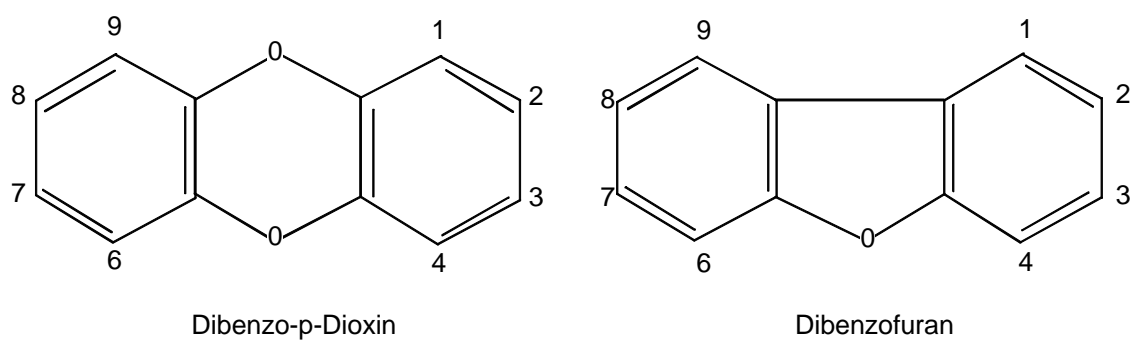

Figure 1. Dibenzo-p-dioxin and dibenzofuran structures.

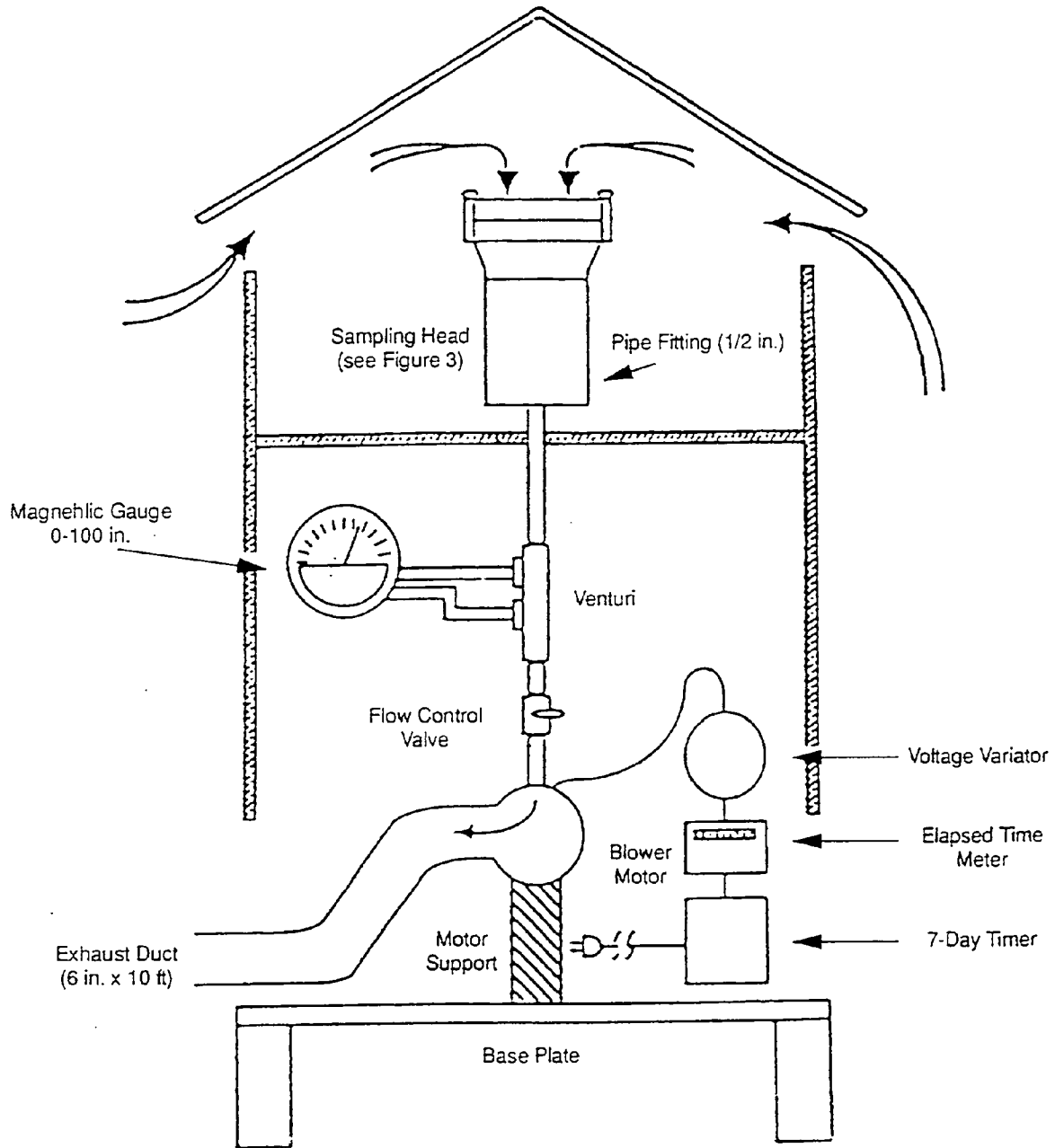

Figure 2. Typical dioxins/furan high volume air sampler.

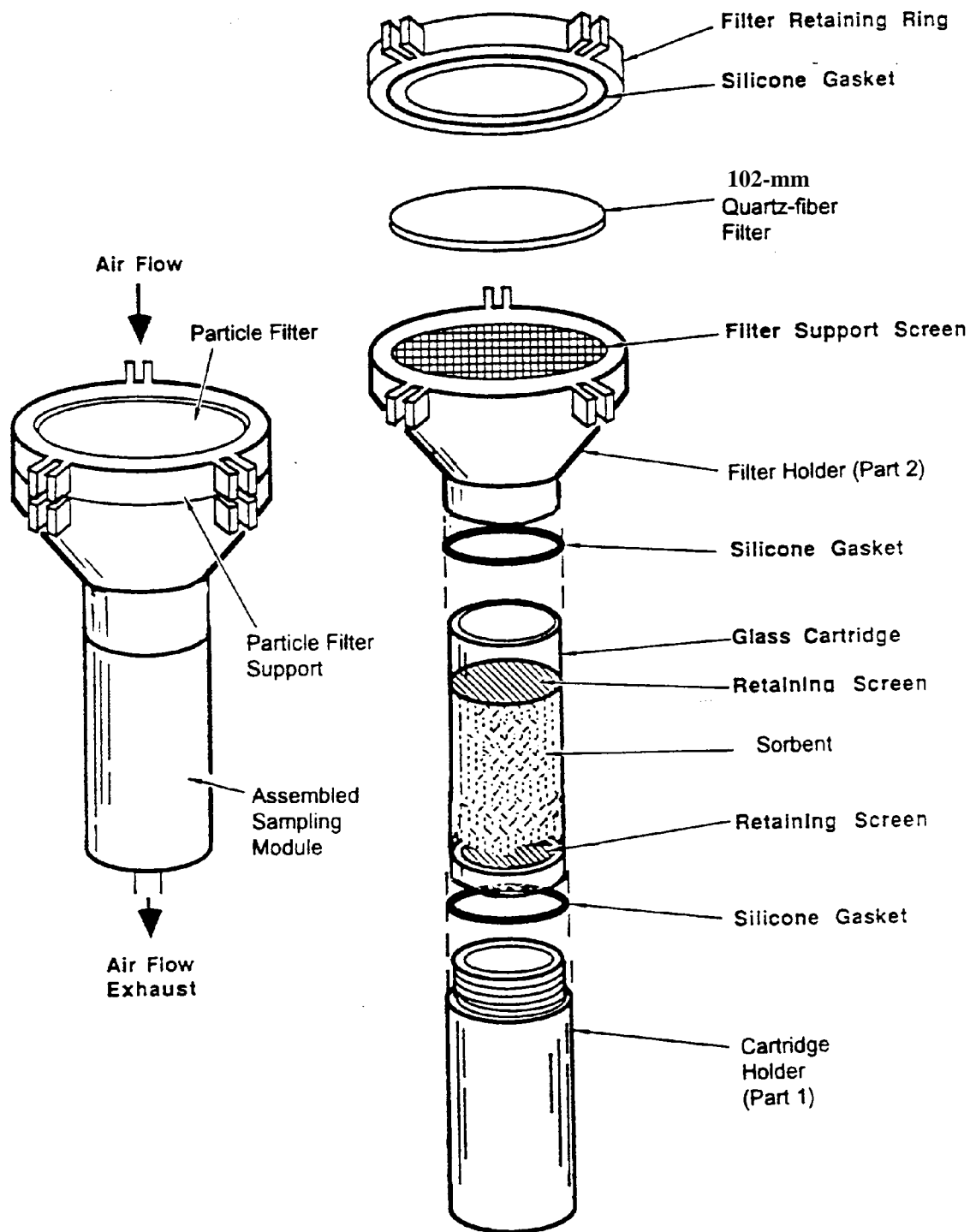
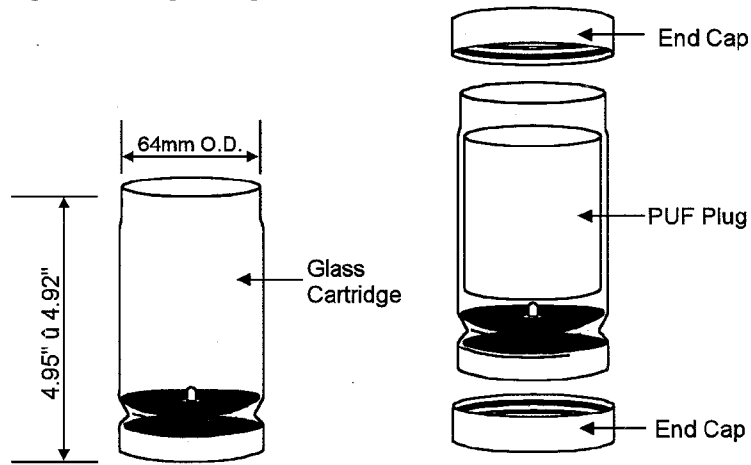
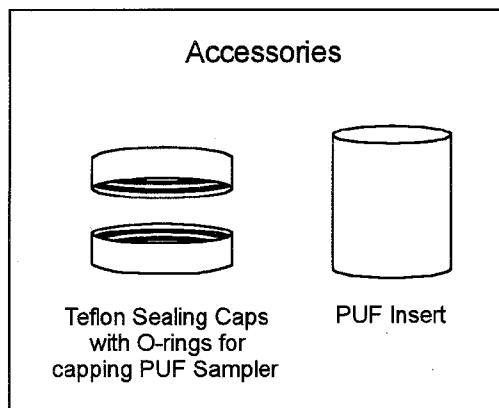

Figure 3a. Typical absorbent cartridge assembly for sampling dioxin/furans.

Glass PUF Sampler with  
Stainless Steel Screens



(1) Glass PUF cartridge, plug, and end caps.



(2) PUF shipping container.

Figure 3b. Typical glass PUF cartridge (1) and shipping container (2) for use with hi-vol sampling systems.

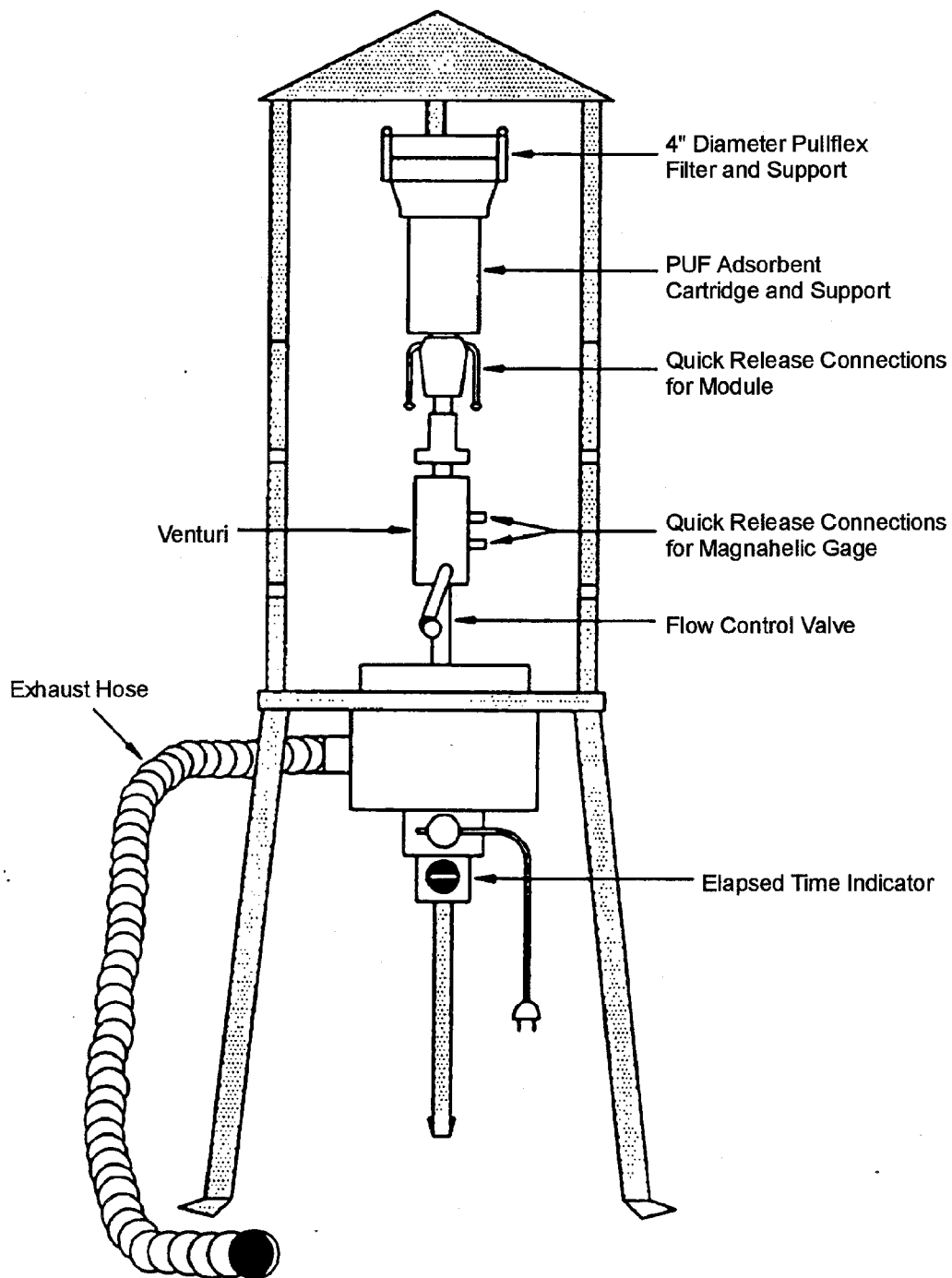

Figure 4. Portable high volume air sampler developed by EPA.

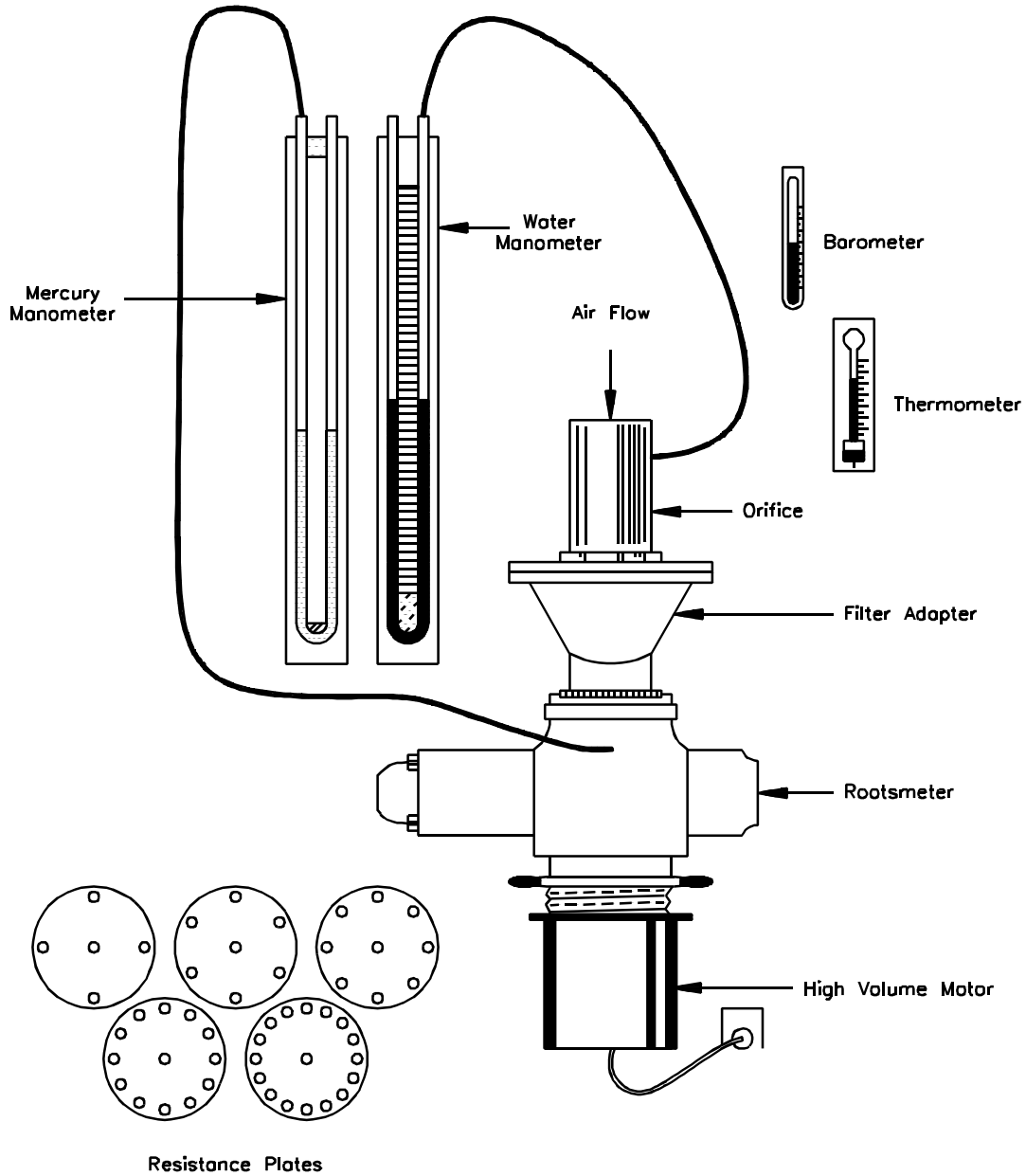

Figure 5. Positive displacement rootsmeter used to calibrate orifice transfer standard.



COMPENDIUM METHOD TO-9A  
ORIFICE CALIBRATION DATA SHEET

T<sub>1</sub> \_\_\_\_\_ Name \_\_\_\_\_  
 P<sub>1</sub> \_\_\_\_\_ Date \_\_\_\_\_  
 Orifice No. \_\_\_\_\_ mmHg  
 Rootsmer No. \_\_\_\_\_

Resistance Platis (No. of holes)	Air Volume Measured by Rootsmer V <sub>m</sub>		Standard Volume, V <sub>std</sub> (std m <sup>3</sup> )	Time for Air Volume to Pass Through Rootsmer, θ (min)	Rootsmer Pressure Differential, ΔP (mm Hg)	Pressure Drop Across Orifice, ΔH (in. H <sub>2</sub> O)	x-Axis Standard Flowrate, Q <sub>std</sub> (std m <sup>3</sup> /min)	Y - axis $\sqrt{\Delta H(P_1/P_{std})(298/T_1)}$ value
	(R <sup>3</sup> )	(m <sup>3</sup> )						
5	200	5.66						
7	200	5.66						
10	300	8.50						
13	300	8.50						
18	300	8.50						

Factors: (R<sup>3</sup>)(0.02832  $\frac{m^3}{R^3}$ ) = m<sup>3</sup> and (in. Hg) 25.4 ( $\frac{mm\ Hg}{in.\ Hg}$ ) = mm Hg

Calculation Equations:

$$1. V_{std} = V_m \left( \frac{P_1 - \Delta P}{P_{std}} \right) \left( \frac{T_{std}}{T_1} \right)$$

where:

$$T_{std} = 296^\circ K$$

$$P_{std} = 760.0\ mm\ Hg$$

$$2. Q_{std} = \frac{V_{std}}{\theta}$$

Figure 6. Orifice calibration data sheet.

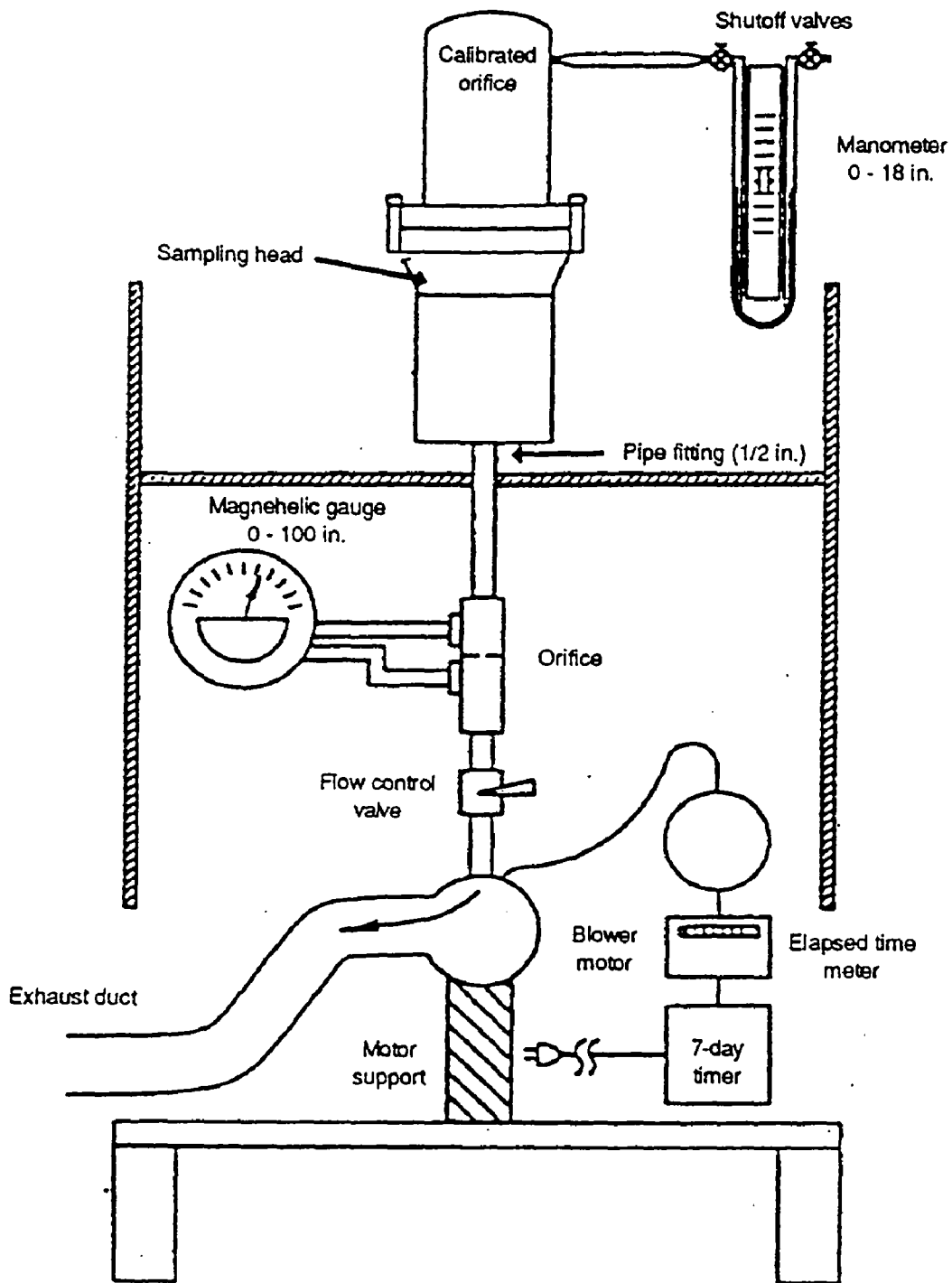

Figure 7. Field calibration configuration of the dioxin/furan sampler.

COMPENDIUM METHOD TO-9A  
 FIELD CALIBRATION DATA SHEET DIOXIN/FURAN SAMPLER CALIBRATION

Sampler ID: \_\_\_\_\_ Calibration Orifice ID: \_\_\_\_\_  
 Sampler Location: \_\_\_\_\_ Job No.: \_\_\_\_\_  
 High Volume Transfer Orifice Data:  
 Correlation Coefficient (CC1): \_\_\_\_\_ Slope (M1): \_\_\_\_\_  
 (CC2): \_\_\_\_\_ (M2): \_\_\_\_\_  
 Intercept (B1): \_\_\_\_\_  
 (B2): \_\_\_\_\_

Calibration Date: \_\_\_\_ Time: \_\_\_\_\_  
 Calibration Ambient Temperature: \_\_\_\_ °F \_\_\_\_ °C CALIBRATOR'S SIGNATURE  
 Calibration Ambient Barometric Pressure: \_\_\_\_ "Hg \_\_\_\_ mm Hg  
 Calibration set point (SP): \_\_\_\_\_

SAMPLER CALIBRATION

Actual values from calibration		Calibrated values		
Orifice manometer, inches (Y1)	Monitor magnehelic, inches (Y2)	Orifice manometer (Y3)	Monitor magnehelic (Y4)	Calculated value orifice flow, scm (X1)
	70			
	60			
	50			
	40			
	30			
	20			
	10			

Definitions

- |   |  |
|---|--|
| Y1 = Calibration orifice reading, in. H <sub>2</sub> O  | Y4 = Calculated value for magnehelic                       |
| Y2 = Monitor magnehelic reading, in. H <sub>2</sub> O   | = [Y2(Pa/760)(298/{Ta + 273})] <sup>1/2</sup>              |
| P <sub>a</sub> = Barometric pressure actual, mm Hg      | X1 = Calculated value orifice flow, scm                    |
| B1 = Manufacturer's Calibration orifice Intercept       | = $\frac{Y3 - B1}{M1}$                                     |
| M1 = Manufacturer's Calibration orifice manometer slope | P <sub>std</sub> = Barometric pressure standard, 760 mm Hg |
| Y3 = Calculated value for orifice manometer             | T <sub>a</sub> = Temperature actual, °C                    |
| = [Y1(Pa/760)(298/{Ta + 273})] <sup>1/2</sup>           | T <sub>std</sub> = Temperature standard, 25°C              |

Figure 8. Orifice transfer field calibration data sheet.

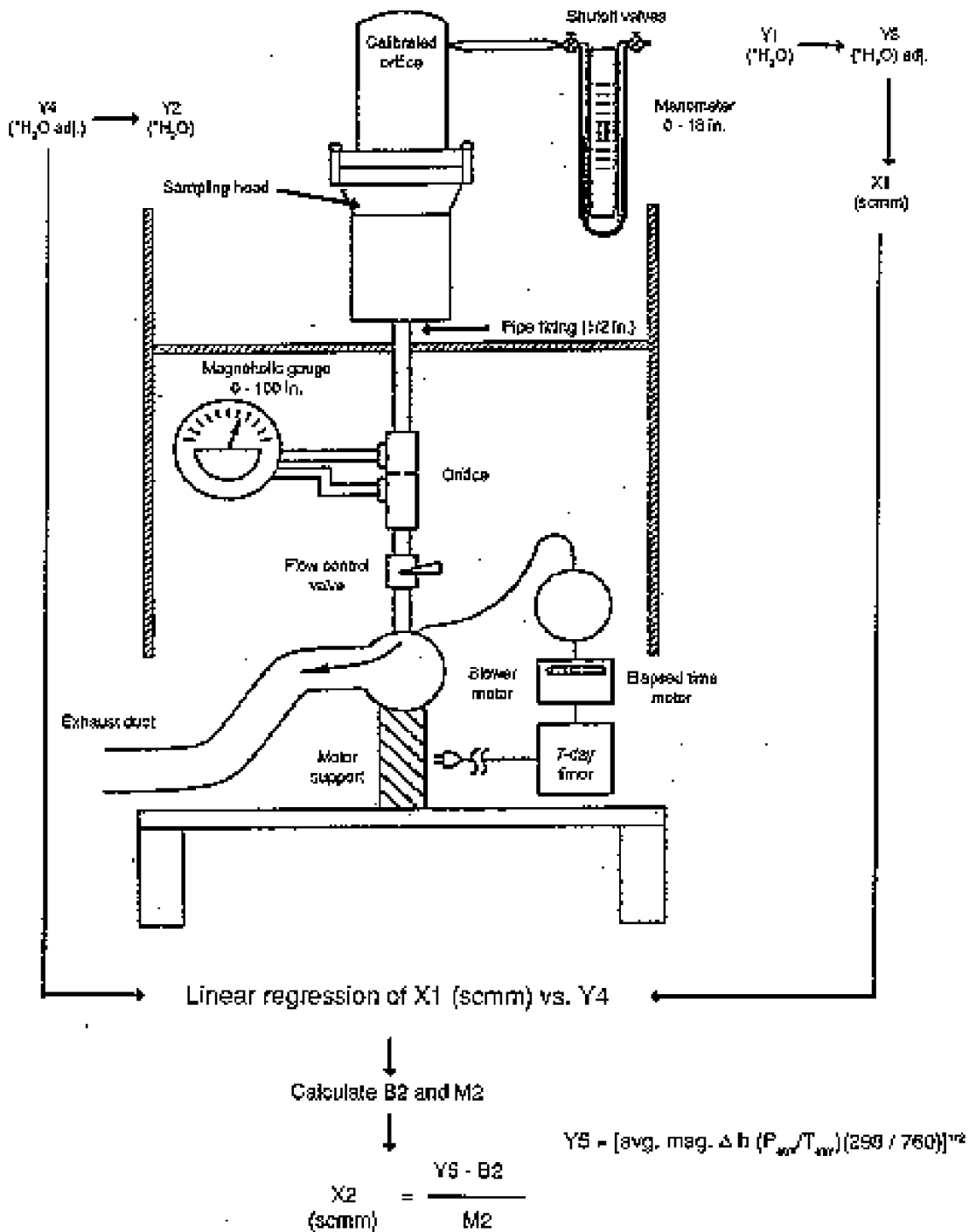

Figure 9. Relationship between orifice transfer standard and flow rate through sampler.

**COMPENDIUM METHOD TO-9A  
FIELD TEST DATA SHEET  
GENERAL INFORMATION**

**Sampler I.D. No.:** \_\_\_\_\_  
**Lab PUF Sample No.:** \_\_\_\_\_  
**Sample location:** \_\_\_\_\_  
 \_\_\_\_\_  
 \_\_\_\_\_

**Operator:** \_\_\_\_\_  
**Other:** \_\_\_\_\_  
 \_\_\_\_\_  
 \_\_\_\_\_

**PUF Cartridge Certification Date:** \_\_\_\_\_  
**Date/Time PUF Cartridge Installed:** \_\_\_\_\_  
**Elapsed Timer:** \_\_\_\_\_  
 Start \_\_\_\_\_  
 Stop \_\_\_\_\_  
 Diff. \_\_\_\_\_

	<b>Start</b>	<b>Stop</b>
<b>Barometric pressure ("Hg)</b>	_____	_____
<b>Ambient Temperature (°F)</b>	_____	_____
<b>Rain</b>	Yes _____	Yes _____
	No _____	No _____

**Sampling**

<b>M1</b> _____	<b>B1</b> _____
<b>M2</b> _____	<b>B2</b> _____

**Sampling time**

Start \_\_\_\_\_  
 Stop \_\_\_\_\_  
 Diff. \_\_\_\_\_

**Audit flow check within ±10 of set point**

\_\_\_\_\_ Yes  
 \_\_\_\_\_ No

TIME	TEMP	BAROMETRIC PRESSURE	MAGNEHELIC READING	CALCULATED FLOW RATE (scmm)	READ BY
<b>Avg.</b>					

Comments

\_\_\_\_\_

\_\_\_\_\_

\_\_\_\_\_

Figure 10. Field test data sheet.

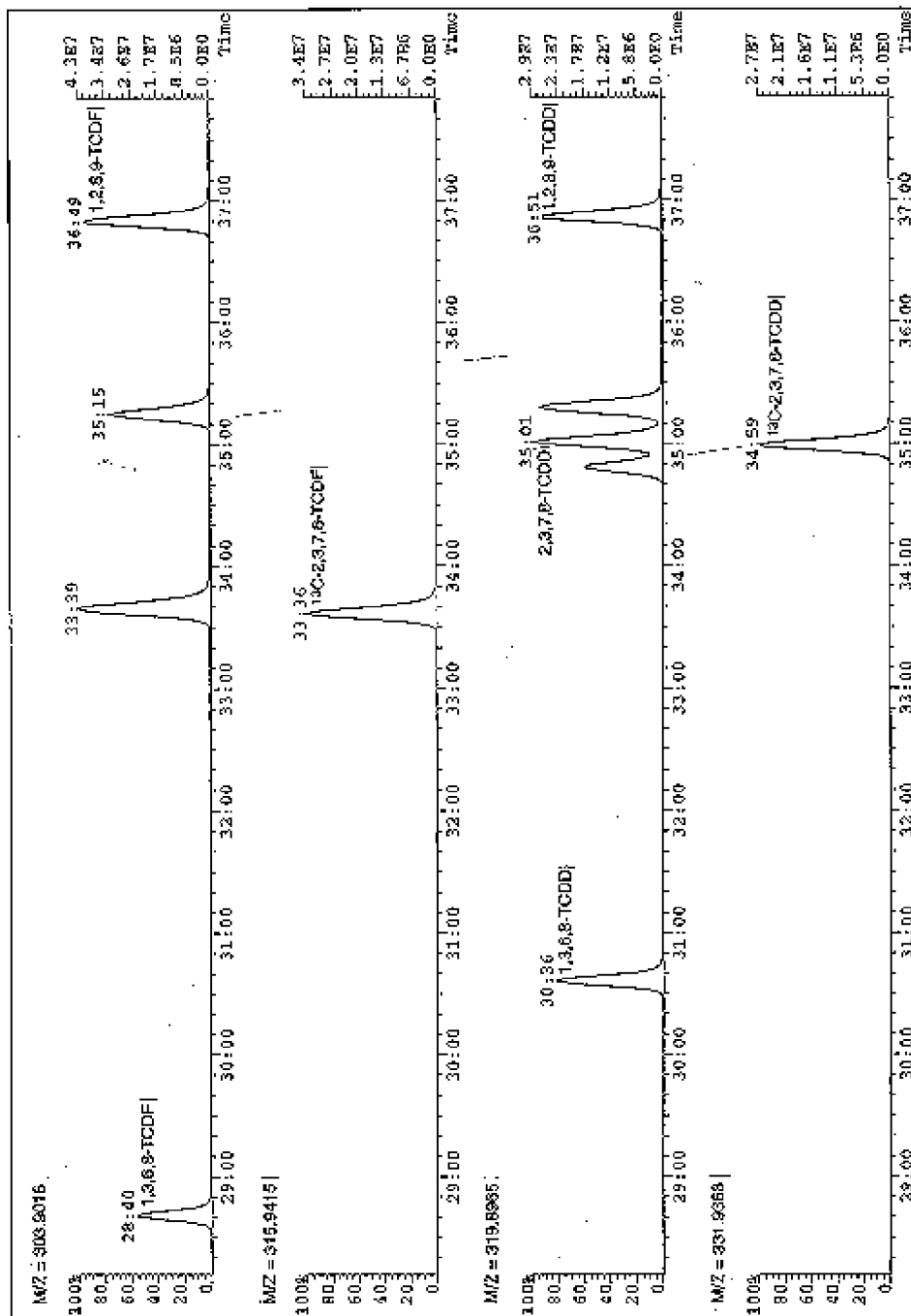

Figure 11. Chromatograms showing the window defining mix. First and last eluting PCDF and PCDD isomer in each group are shown above the respective internal quantification standard (IQS).

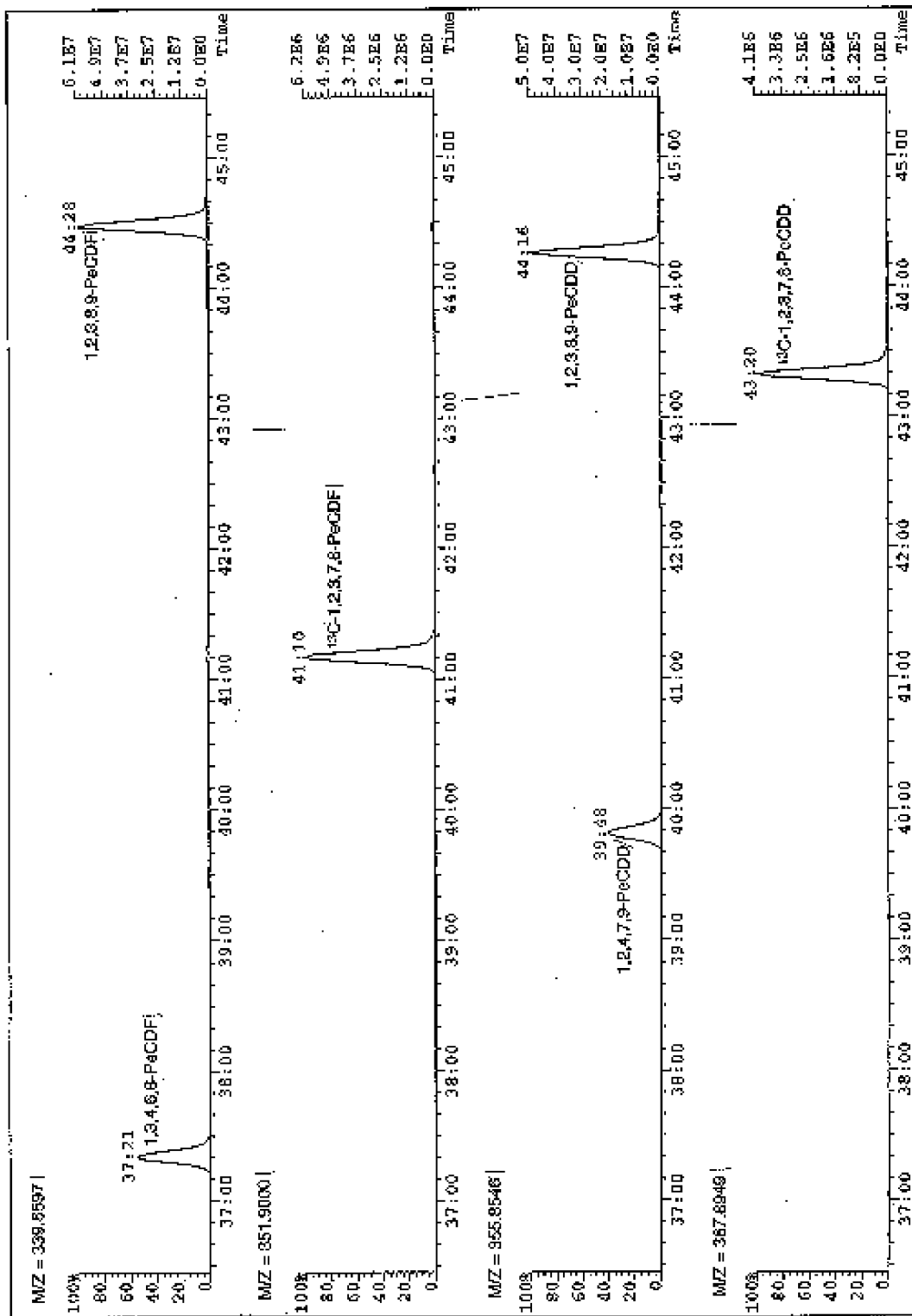

Figure 11. (continued)

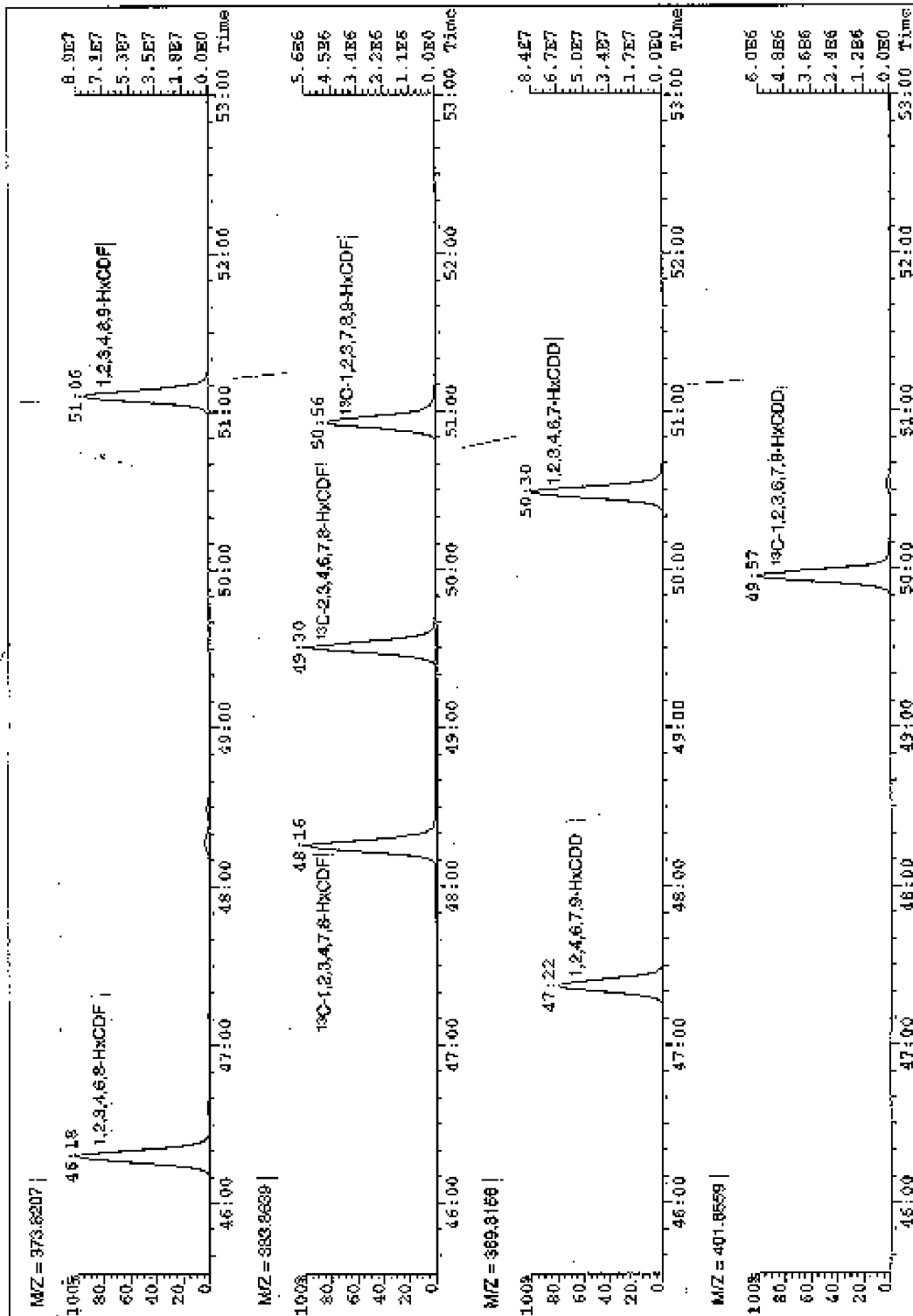

Figure 11. (continued)



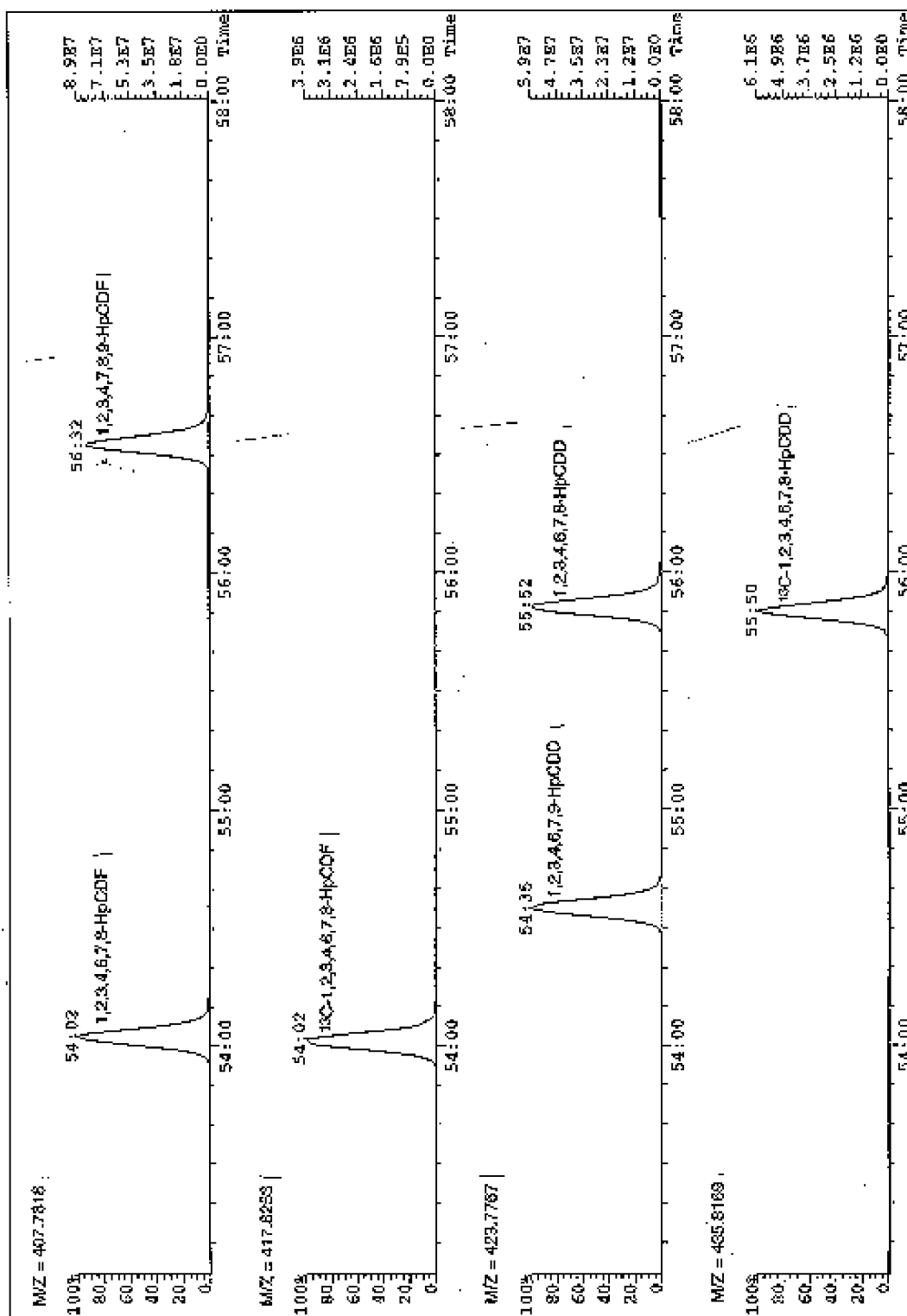

Figure 11. (continued)

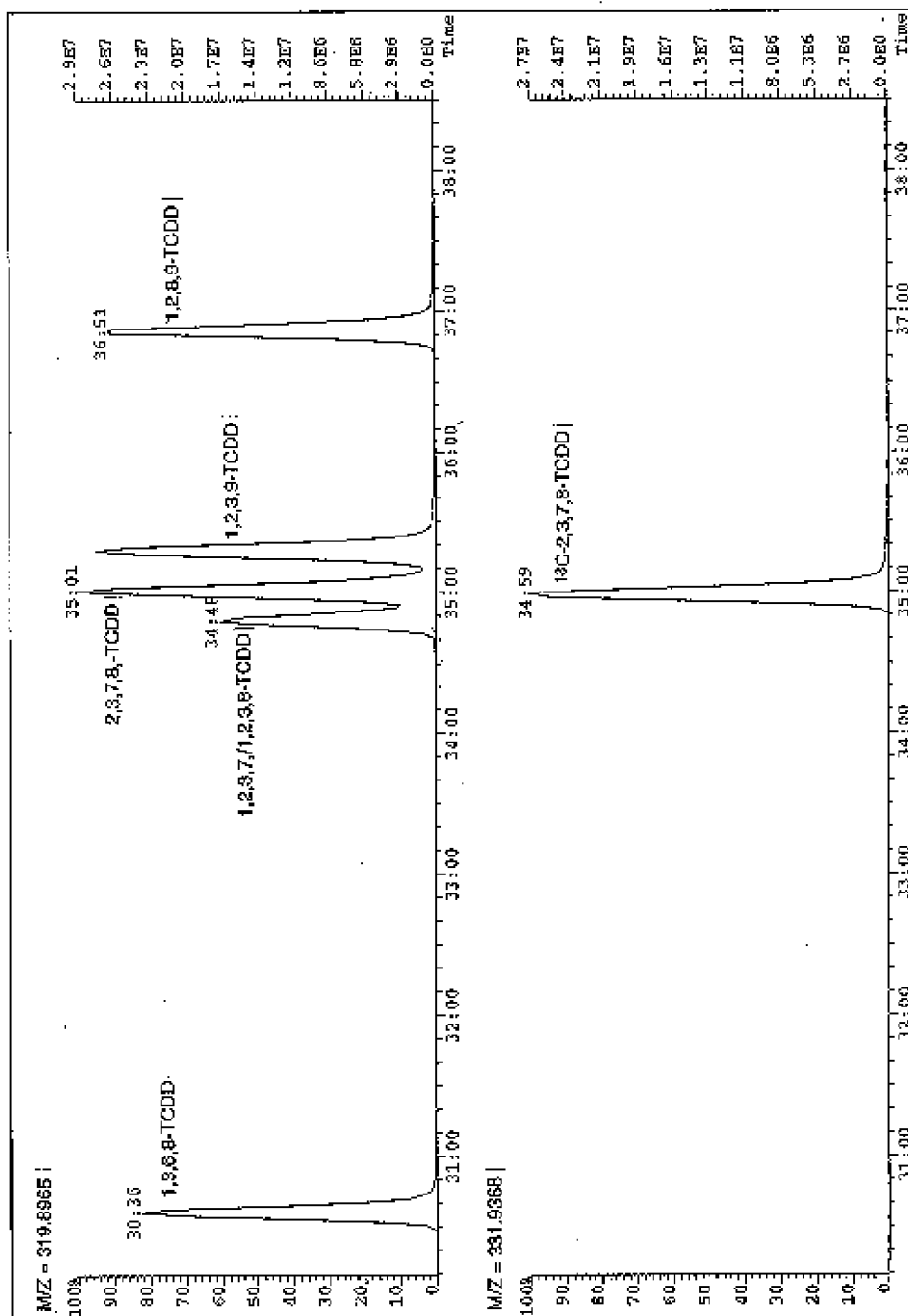

Figure 12. HRGC-HRMS column performance mix showing acceptable separation of 2,3,7,8-TCDD from the adjacent isomers.

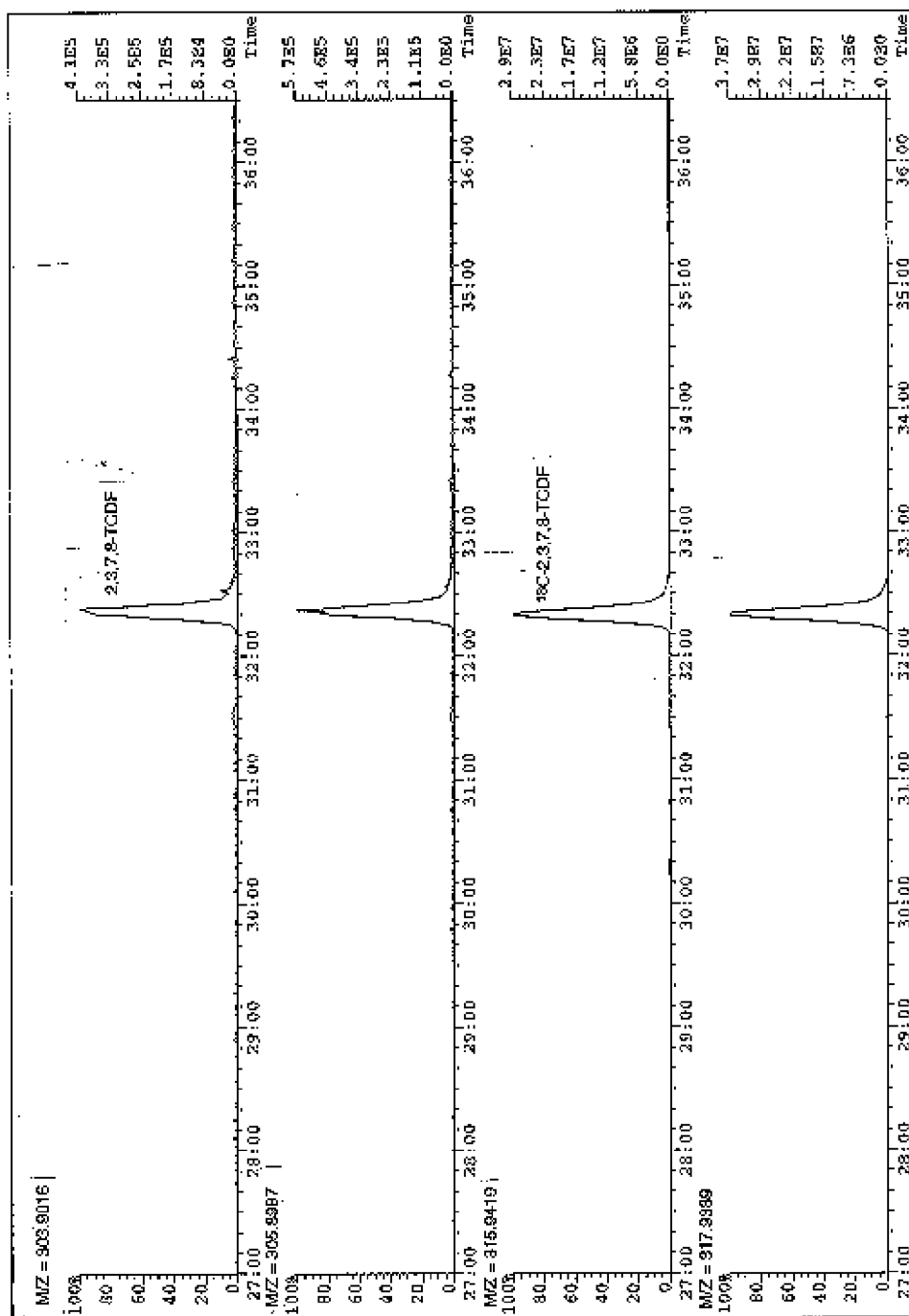

Figure 13. Extracted ion current profiles (EICP) for 2,3,7,8-TCDF and labeled standard.

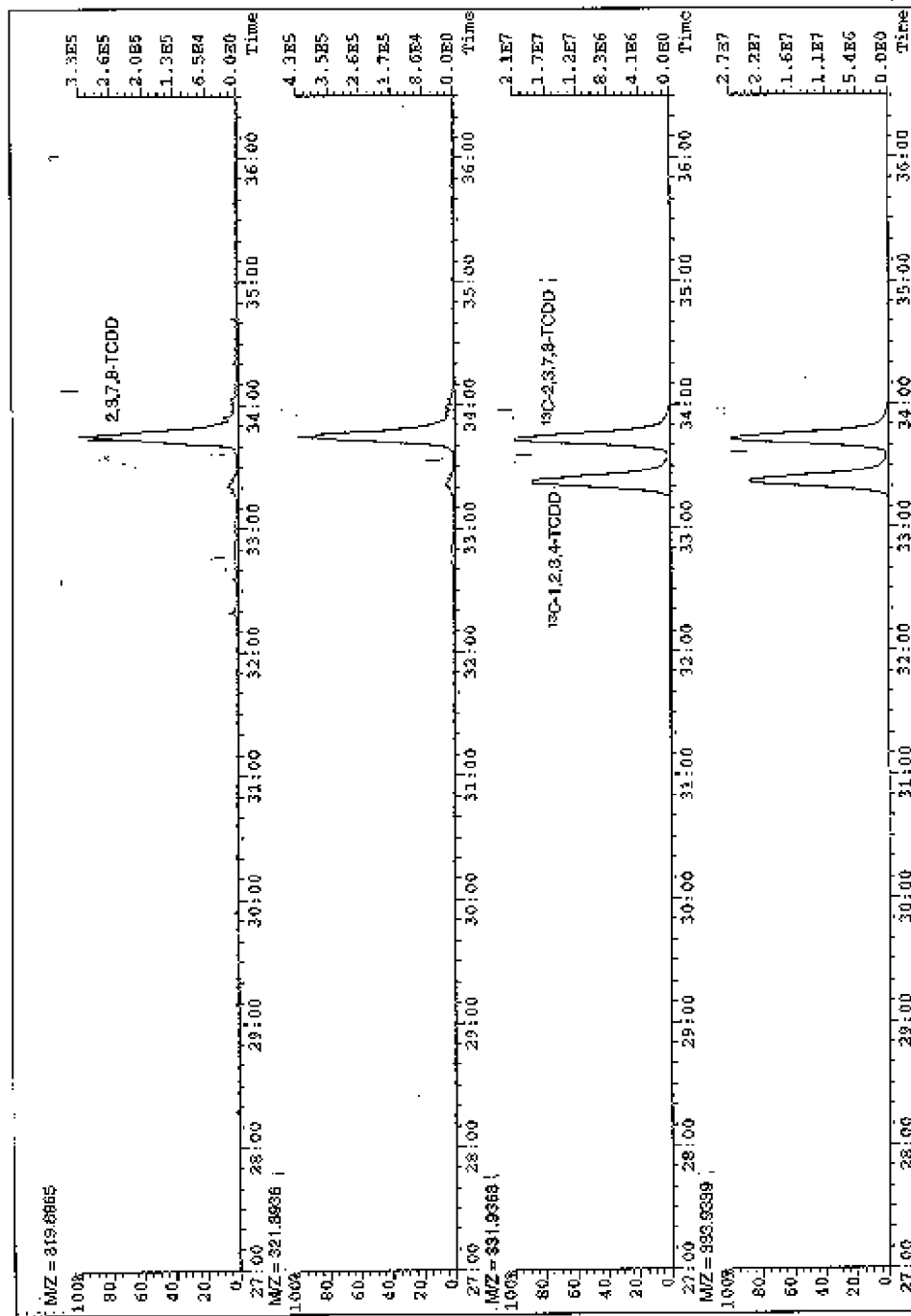

Figure 14. Extracted ion current profiles (HLCP) for 2,3,7,8-TCDD and labeled standard.

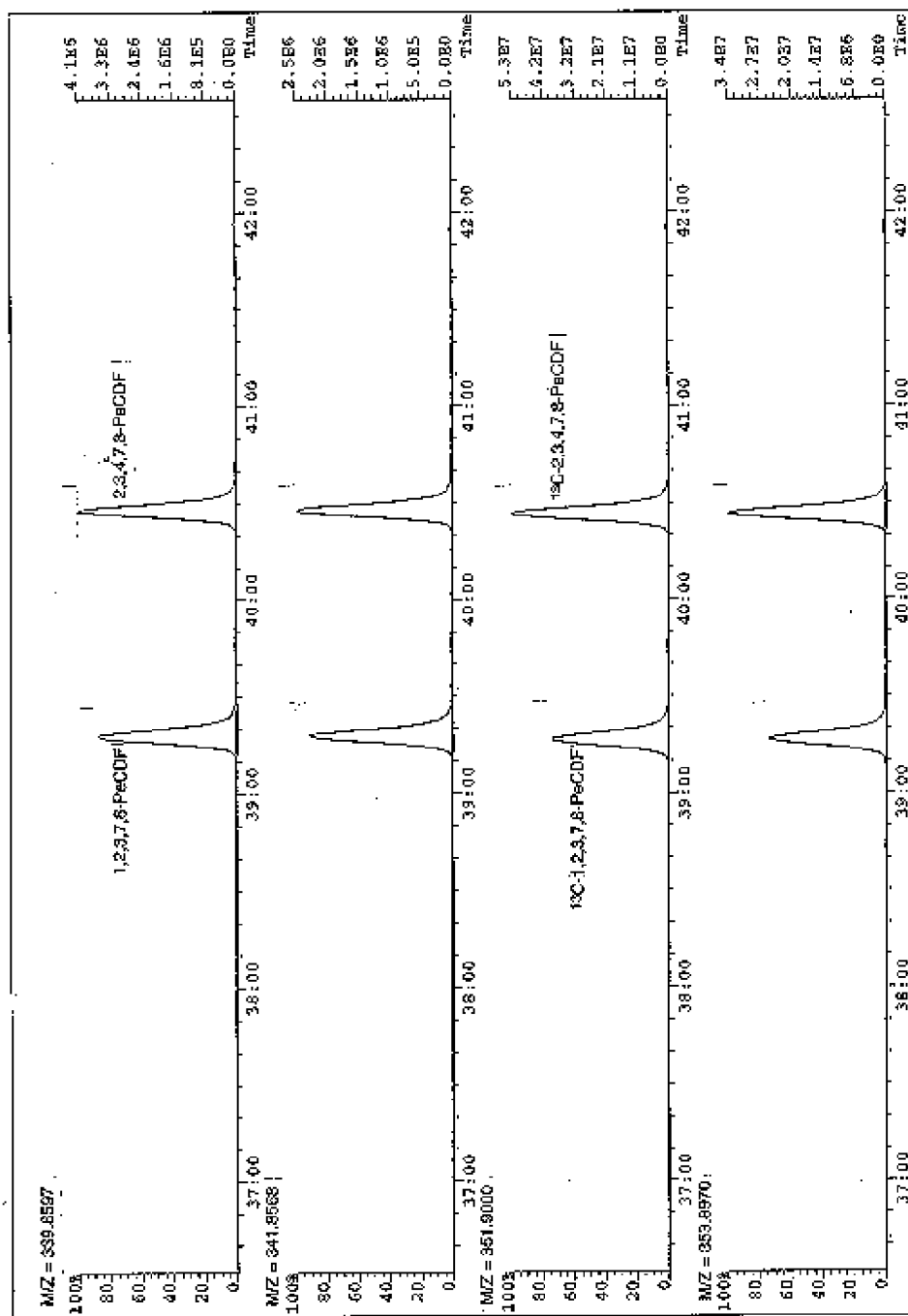

Figure 15. Extracted ion current profiles (ELCP) for 2,3,7,8-substituted PeCDF and labeled standard.

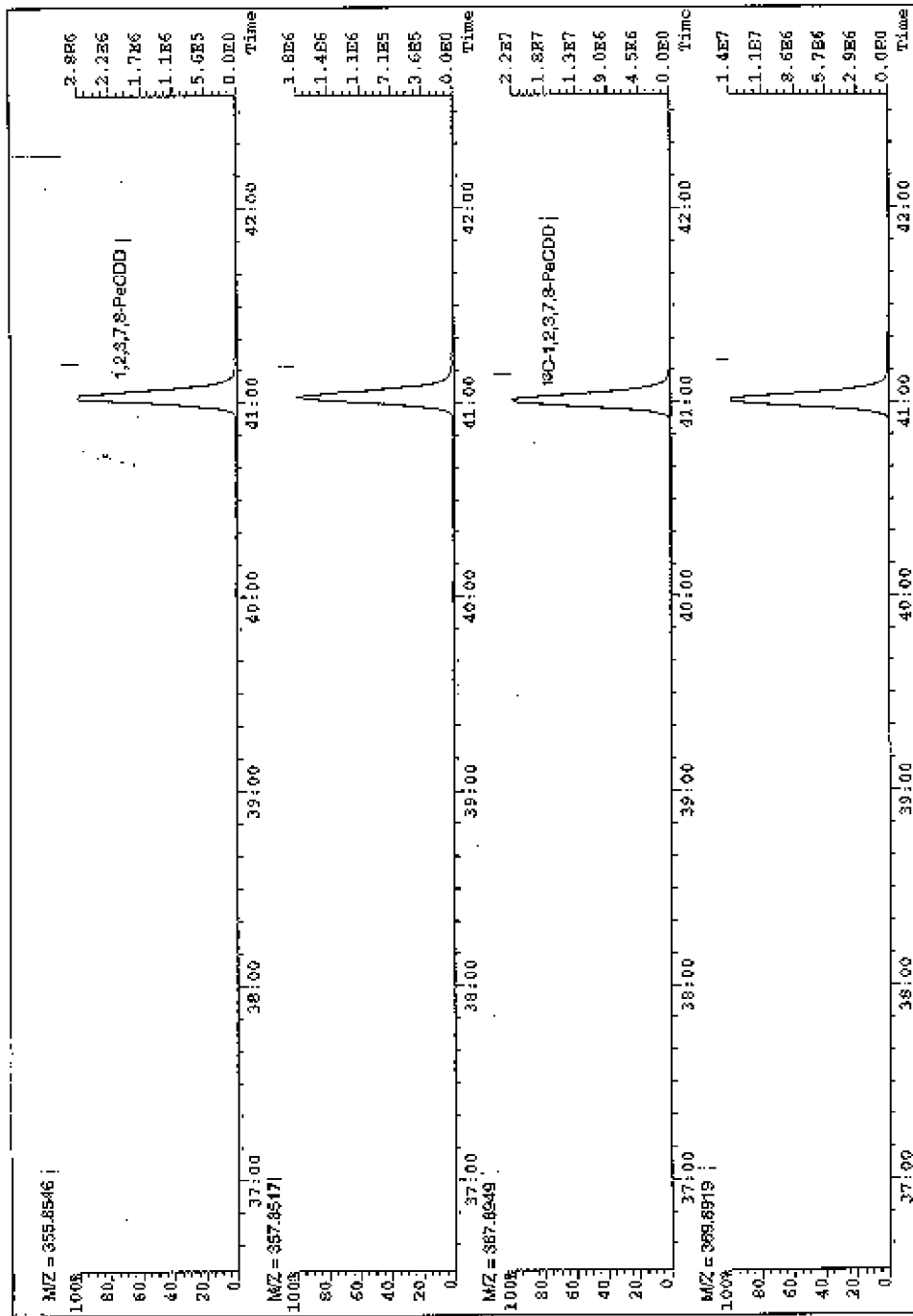

Figure 16. Extracted ion current profiles (EICP) for 2,3,7,8-substituted PeCDD and labeled standard.

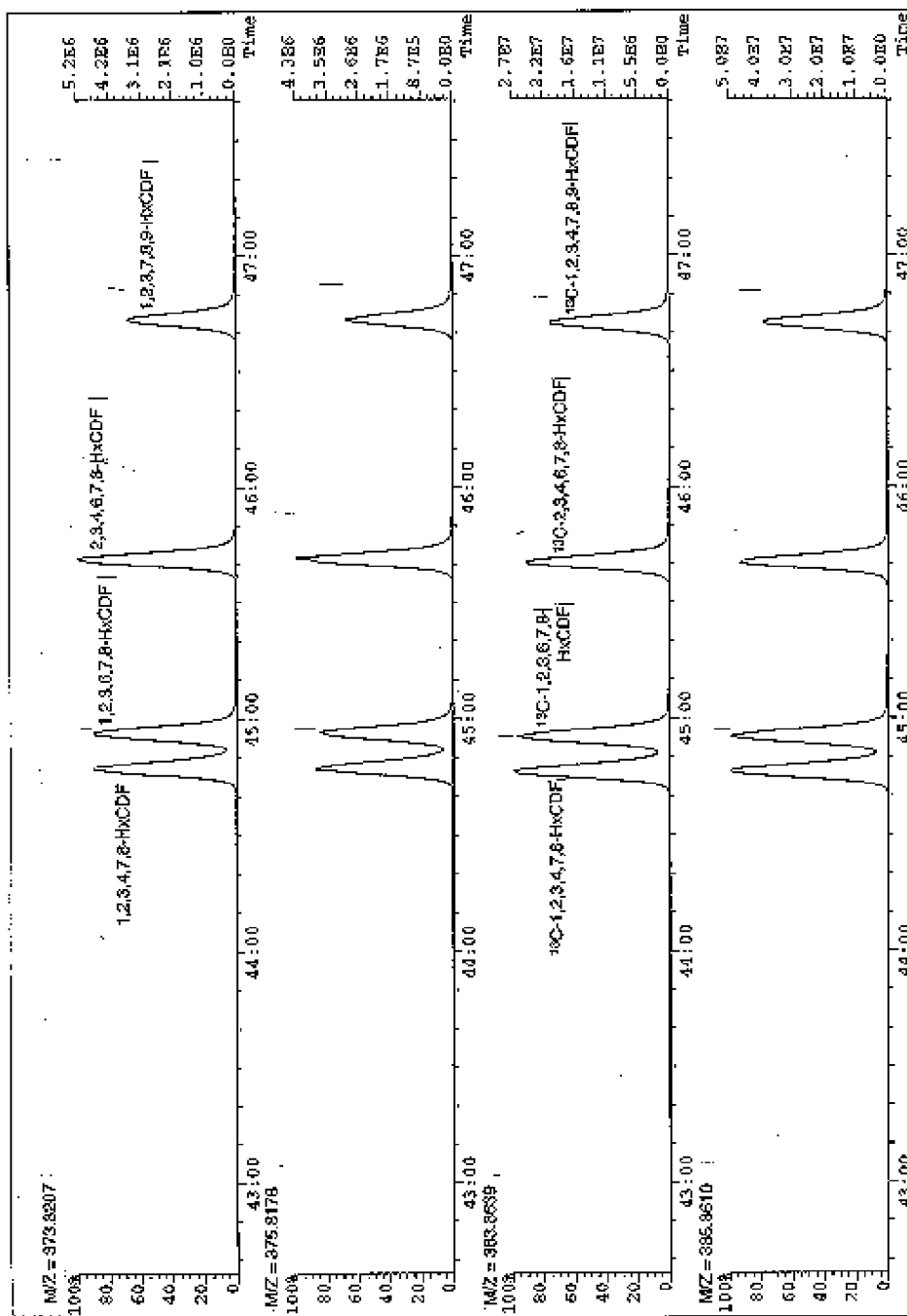

Figure 17. Extracted ion current profiles (EICP) for 2,3,7,8-substituted HxCDF and labeled standard.

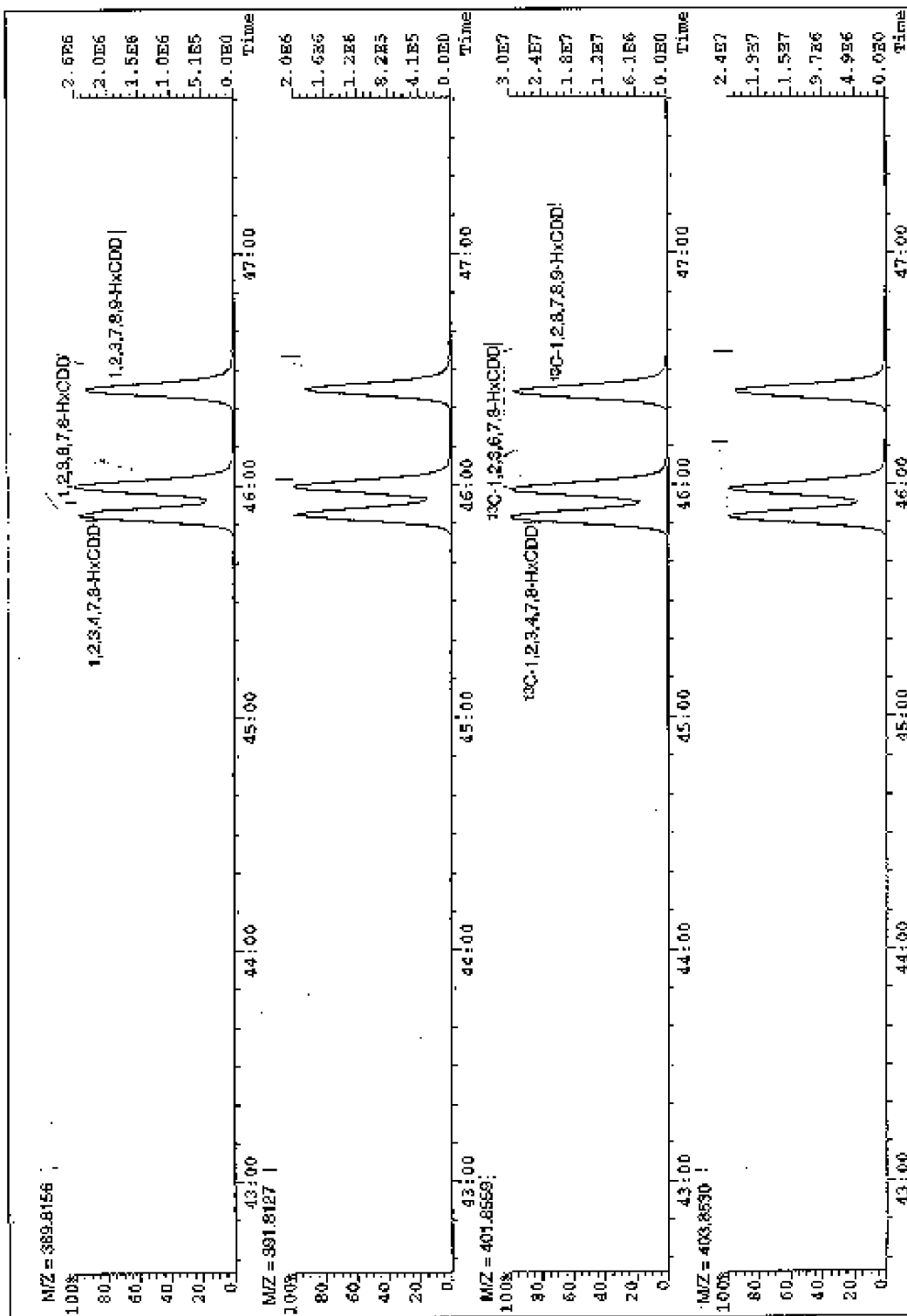

Figure 18. Extracted ion current profiles (EICP) for 2,3,7,8-substituted HxCDD and labeled standard.



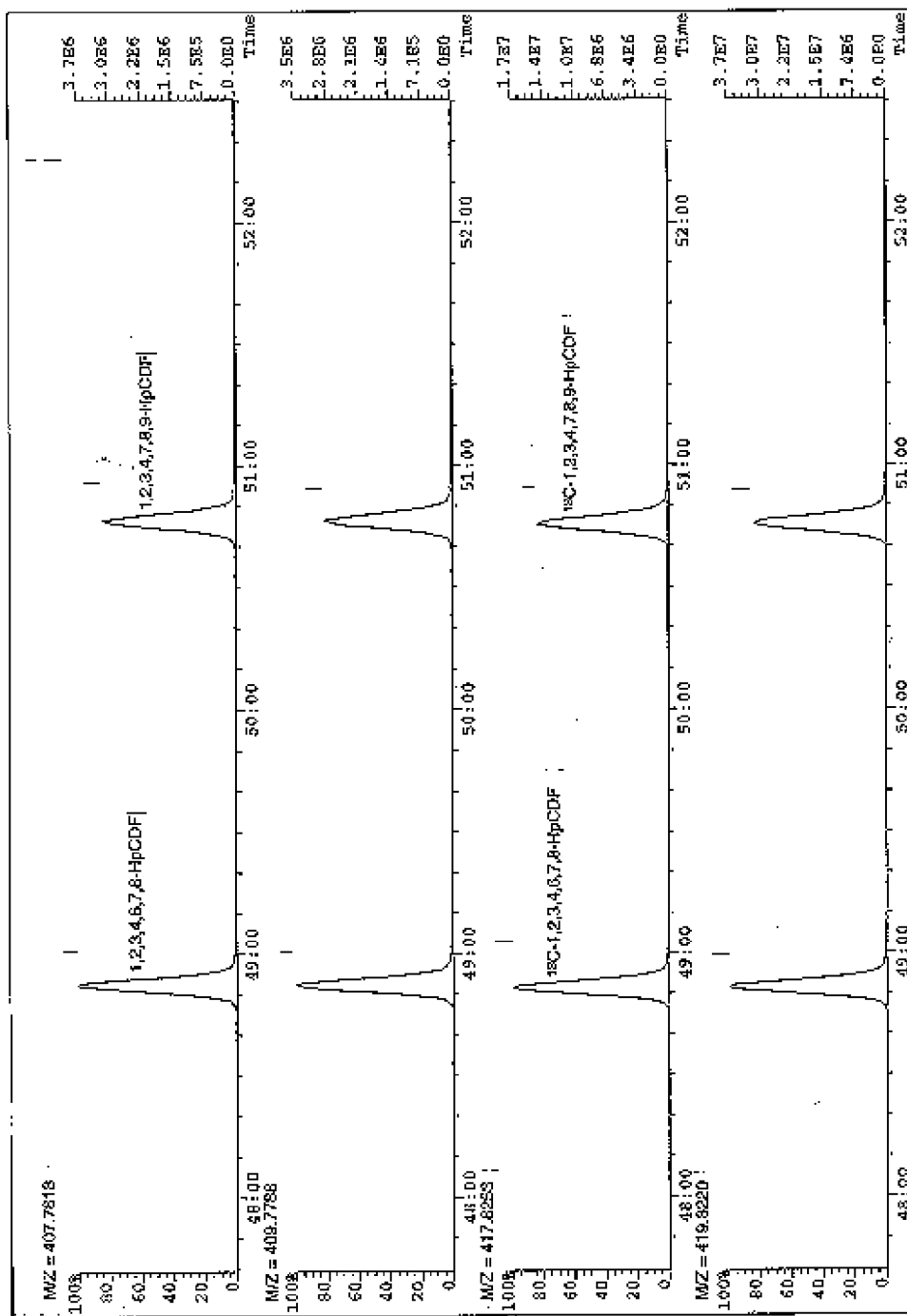

Figure 19. Extracted ion current profiles (EICP) for 2,3,7,8-substituted HpCDF and labeled standard.

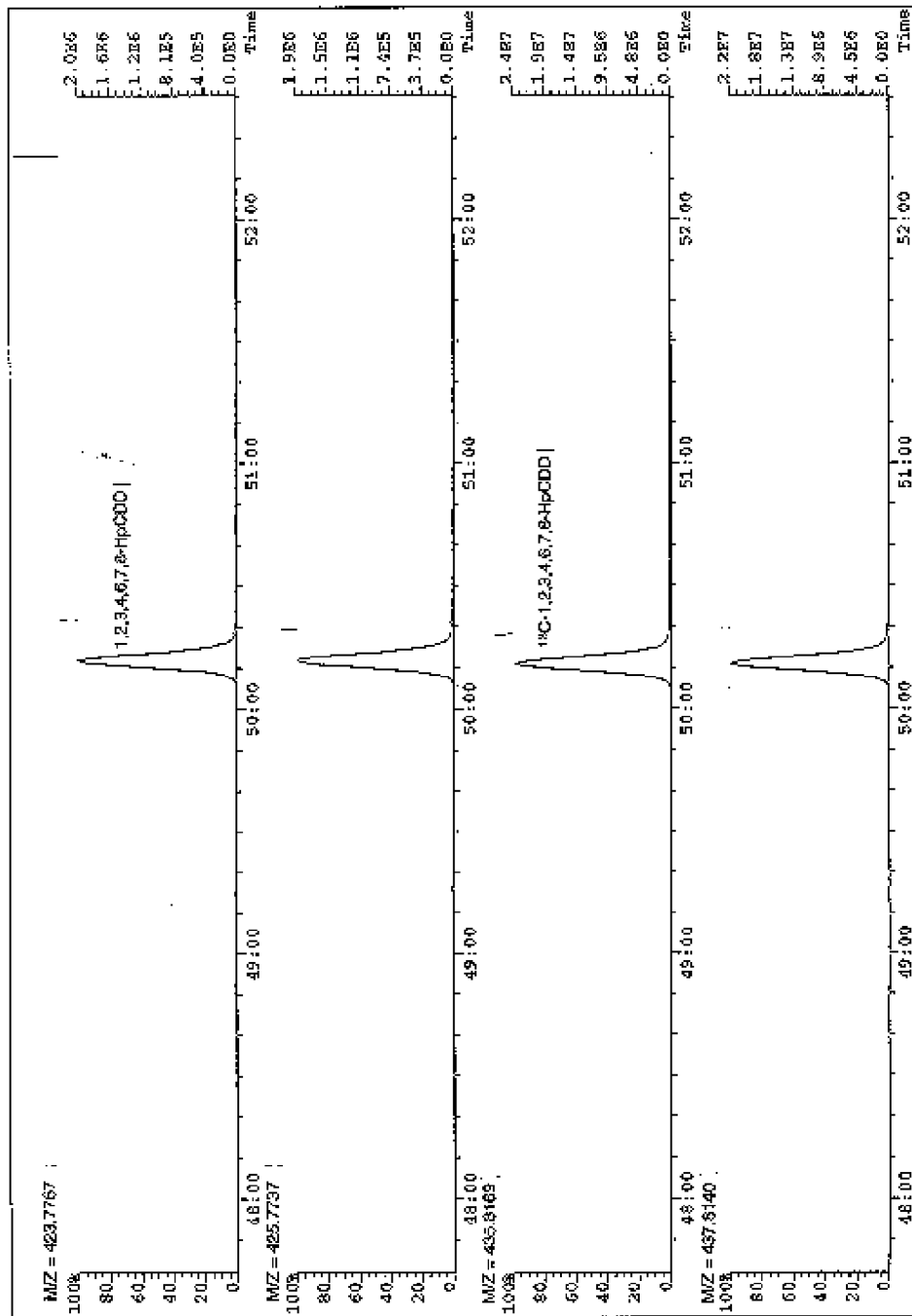

Figure 20. Extracted ion current profiles (EICP) for 2,3,7,8-substituted HpCDD and labeled standard.

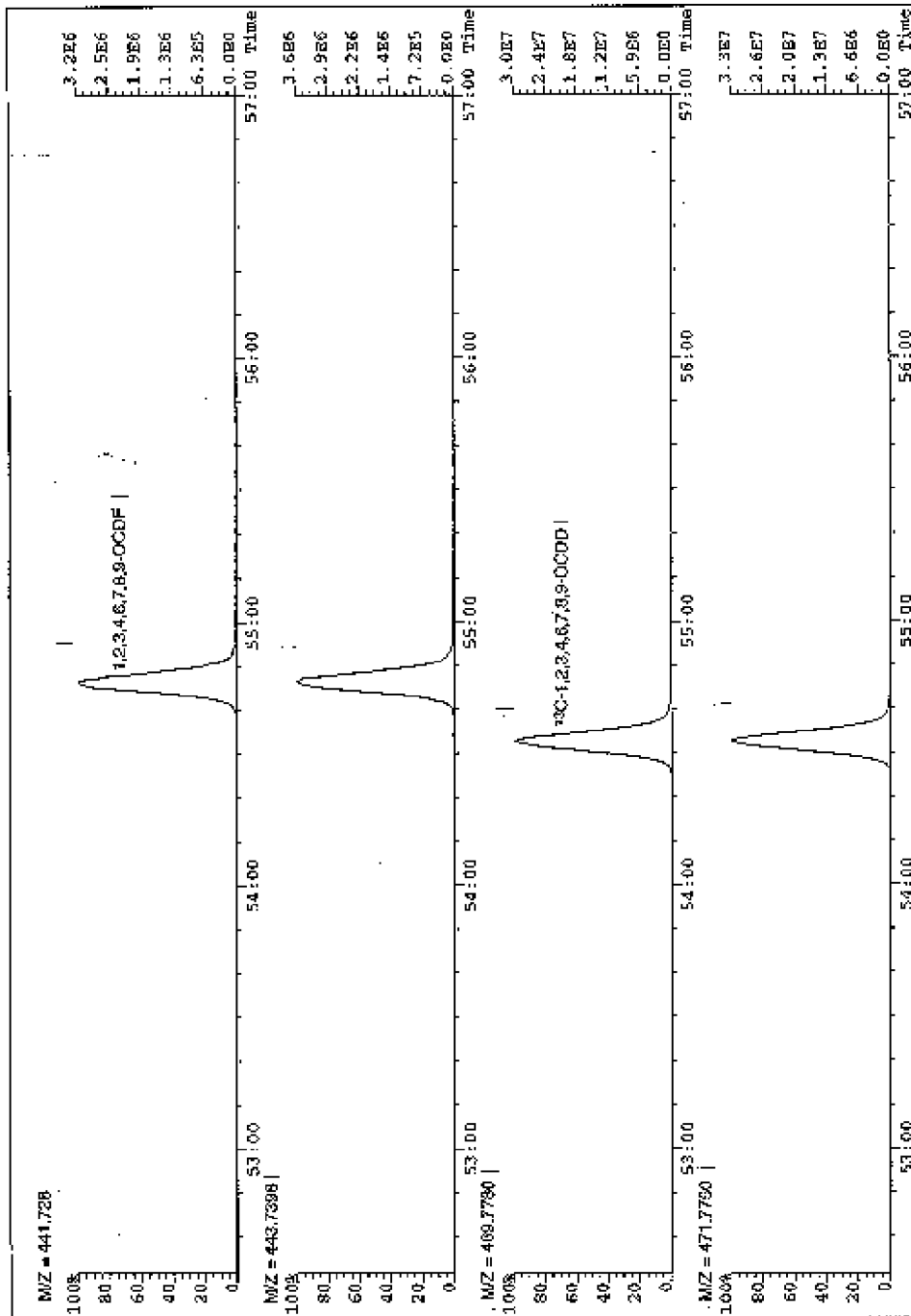

Figure 21. Extracted ion current profiles (EICP) for OCDF and labeled standard.

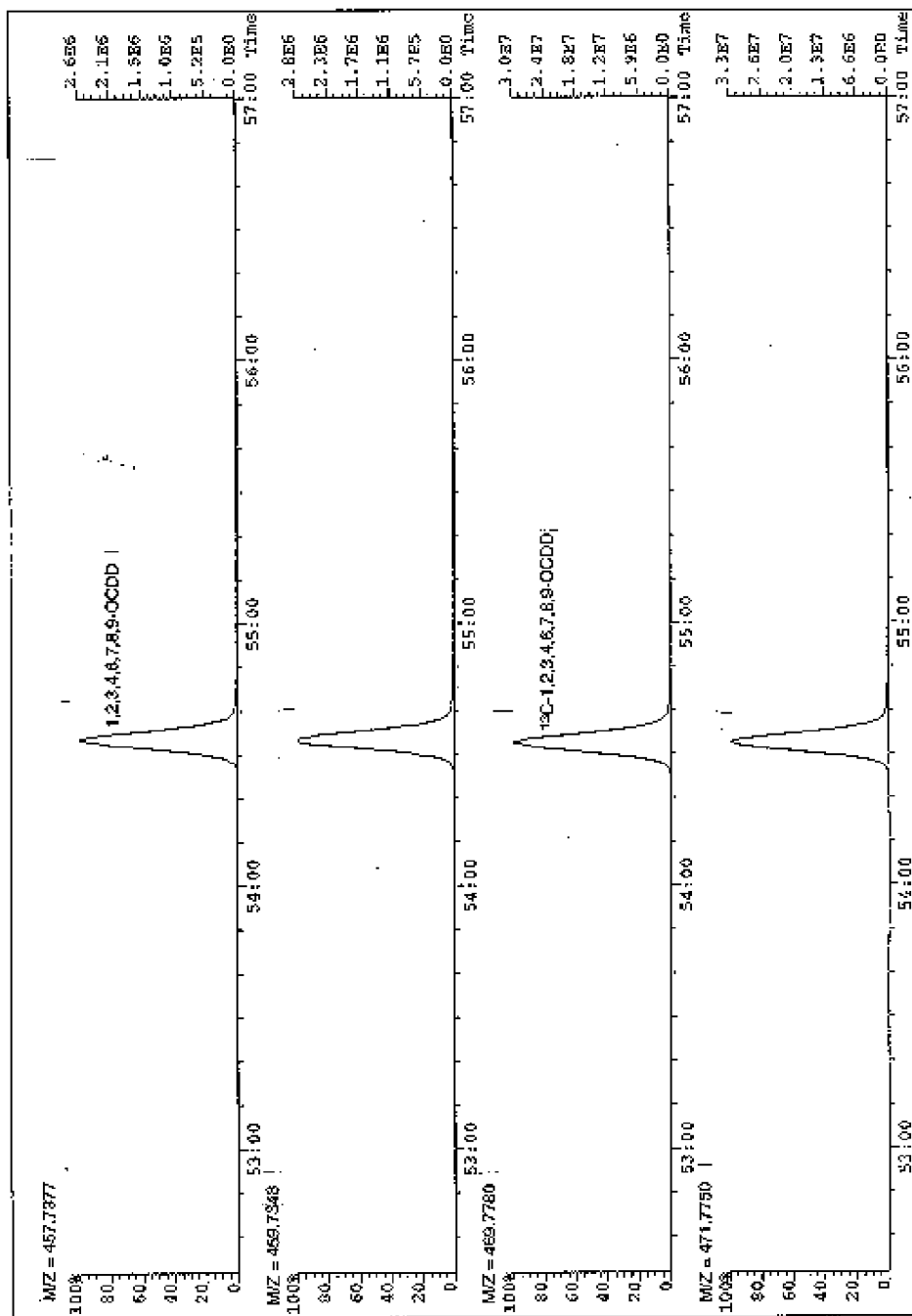

Figure 22. Extracted ion current profiles (EICP) for OCDD and labeled standard.

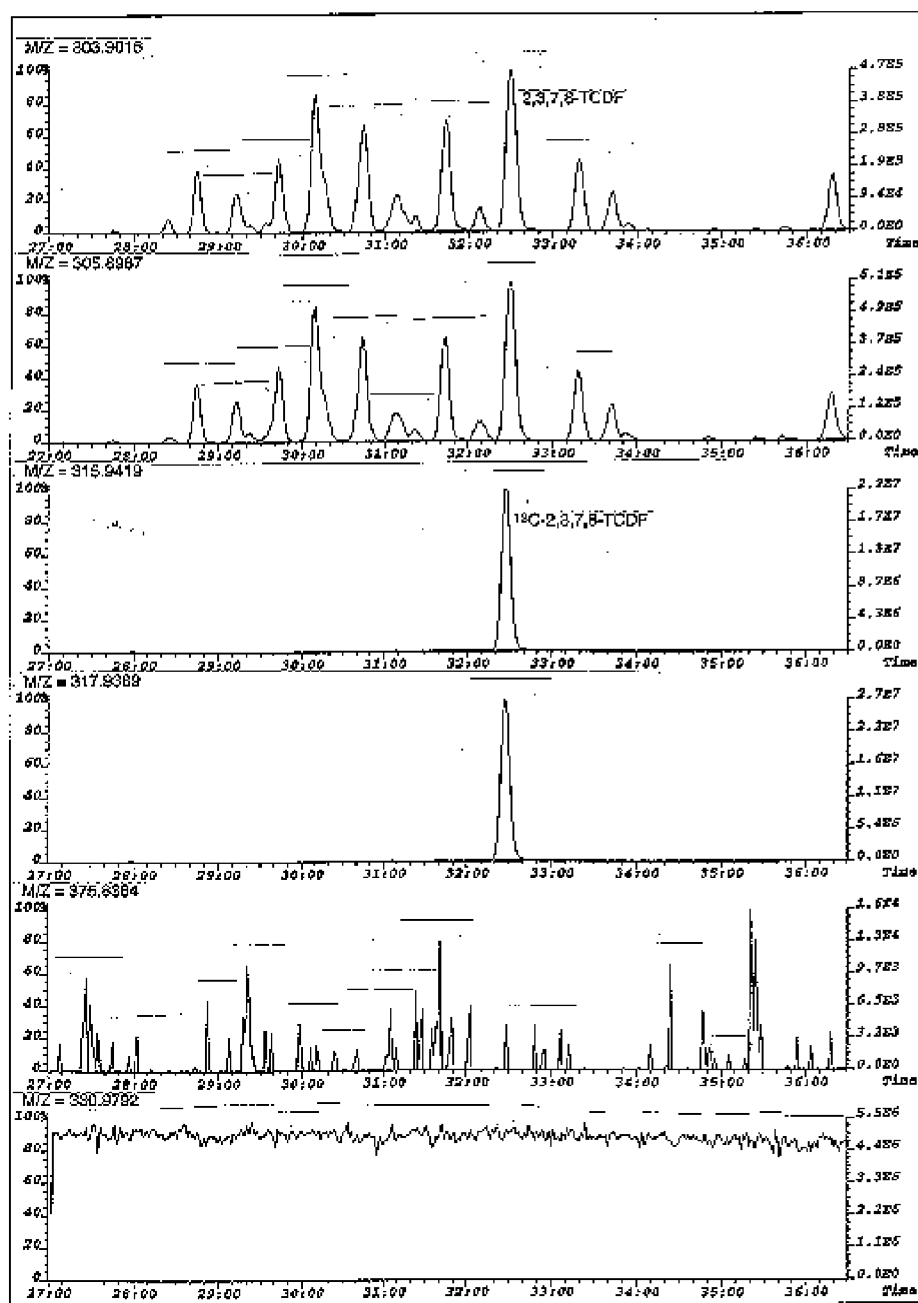

Figure 23. Extracted ion current profiles (EICP) for 2,3,7,8-TCDF and labeled standard in a complex environmental sample showing presence of other TCDF isomers.

This Page Intentionally Left Blank