



ORNL-5786

**OAK RIDGE
NATIONAL
LABORATORY**

MARTIN MARIETTA

A Review and Analysis of
Parameters for Assessing Transport
of Environmentally Released
Radionuclides through Agriculture

C. F. Baes III
R. D. Sharp
A. L. Sjoreen
R. W. Shor

MANAGED BY
MARTIN MARIETTA ENERGY SYSTEMS, INC.
FOR THE UNITED STATES
DEPARTMENT OF ENERGY

Health and Safety Research Division

**A Review and Analysis of Parameters for Assessing Transport
of Environmentally Released Radionuclides through
Agriculture**

C. F. Baes III

Environmental Sciences Division

R. D. Sharp

Computer Sciences

A. L. Sjoreen

Computer Sciences

R. W. Shor

Health and Safety Research Division

Date Published: September 1984

Research Sponsored by the Office of Radiation Programs, U. S.
Environmental Protection Agency under Interagency Agreement
AD-89-F-2-A106 (formerly EPA-78-D-X0394)

Prepared by the

Oak Ridge National Laboratory

Oak Ridge, Tennessee 37831

operated by

Martin Marietta Energy Systems, Inc.

for the

U. S. DEPARTMENT OF ENERGY

under contract No. DE-AC05-84OR21400

DISCLAIMER

Although the research described in this report has been funded by the United States Environmental Protection Agency through Interagency Agreement Number AD-89-F-2-A106 (formerly EPA-78-D-X0394) with Oak Ridge National Laboratory, it has not been subjected to the Agency's required peer and policy review and therefore does not necessarily reflect the views of the Agency and no official endorsement should be inferred.

CONTENTS

	Page
DISCLAIMER	ii
LIST OF FIGURES	v
LIST OF TABLES	xi
PARAMETER SYMBOLS AND DEFINITIONS	xiii
ACKNOWLEDGMENT	xvii
HIGHLIGHTS	xvii
1. INTRODUCTION	1
2. ELEMENT-SPECIFIC TRANSPORT PARAMETERS	4
2.1 Soil-to-Plant Uptake Parameters B_v and B_r	4
2.1.1 Protocols for determination of parameter values	5
2.1.2 Group IA and IIA elements	9
2.1.3 Group IIIA, IVA, and VA elements	20
2.1.4 Group VIA and VIIA elements	24
2.1.5 Group IIIB and the rare earth elements	26
2.1.6 Period IV transition elements	27
2.1.7 Period V transition elements	30
2.1.8 Period VI transition elements	40
2.1.9 The actinide elements	45
2.1.10 Comparison of default estimates with previously published values	47
2.2 Ingestion-to-Milk Parameter, F_m	47
2.3 Ingestion-to-Beef Parameter, F_m^b	49
2.4 The Distribution Coefficient, K_d	53
2.4.1 Variability in K_d	53
2.4.2 Estimates of K_d based on default B_v values	63
3. INTERCEPTION FRACTION FOR VEGETATION	65
3.1 Pasture Grasses and Hay	65
3.2 Leafy Vegetables	65
3.3 Silage	71
3.4 Exposed Produce	73
3.5 Correlation Between Interception Fraction and Standing Crop Biomass	75
4. SITE-SPECIFIC PARAMETERS	80
4.1 Agricultural Parameters	84
4.2 Climatological Parameters	109
4.3 Demographic and Miscellaneous SITE Parameters	114
5. MISCELLANEOUS PARAMETERS	124
5.1 The Weathering Removal Loss Constant, λ_w	124
5.2 The Metabolic Turnover Constant For Milk, λ_m	124
5.3 The Metabolic Turnover Constant For Beef, λ_f	125
5.4 Lifetime Grain and Forage Requirements For Cattle On Feed, Q_g^{fc} and Q_f^{fc} Respectively	127
5.5 The Carbon and Water Content of Foods	127
5.6 Coarse (2.5 - 15 μ m) Suspended Particulate Matter	128
6. SUMMARY	133
7. REFERENCES	134

LIST OF FIGURES

Figure	Page
1.1. The categorization of all vegetable crops and animal feeds in the TERRA code based on radionuclide transport and agricultural pathway characteristics	2
2.1. Values of the soil-to-plant concentration factor B_v adopted as default estimates in the computer code TERRA	10
2.2. Values of the soil-to-plant concentration factor B_r adopted as default estimates in the computer code TERRA	11
2.3. Lognormal probability plot of geometric means of B_v for cesium (calculated from references 26, 34, and 55-71), including one geometric standard deviation of the mean	12
2.4. Assumed systematic trends in for Group IA and IIA elements. Solid dots and error bars represent geometric means and standard deviations determined from available references	15
2.5. Correlation between soil potassium concentration and the soil-to-plant concentration factor, B_v , for potassium based on references 16 and 65	16
2.6. Assumed systematic trends in (B_r/B_v) ratio for Group IA and IIA elements. Solid dots and error bars represent geometric means and standard deviations determined from available references	17
2.7. Lognormal probability plot of geometric means of B_v for strontium (calculated from references 11, 16, 17, 21, 31, 33, 59, 60, 62-70, 72, 74-76, 78, 81-83, 85, and 86), including one geometric standard deviation of the mean	18
2.8. Correlation between soil boron concentration and the soil-to-plant concentration factor, B_v , for boron based on references 16, 65, and 76	21
2.9. Correlation between soil phosphorus concentration and the soil-to-plant concentration factor, B_v , for phosphorus based on reference 16	23
2.10. Assumed systematic trends in (B_r/B_v) ratio for aluminum, scandium, and yttrium. Solid dots and error bars represent geometric means and standard deviations of the mean determined from available references	28
2.11. Correlation between soil chromium concentration and the soil-to-plant concentration factor, B_v , for chromium based on references 16 and 65	31

LIST OF FIGURES (continued)

Figure	Page
2.12. Correlation between soil manganese concentration and the soil-to-plant concentration factor, B_v , for manganese based on references 16, 36, 37, 104, 112, and 113	32
2.13. Correlation between soil iron concentration and the soil-to-plant concentration factor, B_v , for iron based on references 16, 65, and 104	33
2.14. Correlation between soil cobalt concentration and the soil-to-plant concentration factor, B_v , for cobalt based on references 16 and 65	34
2.15. Correlation between soil copper concentration and the soil-to-plant concentration factor, B_v , for copper based on references 16, 104, and 115	35
2.16. Correlation between soil zinc concentration and the soil-to-plant concentration factor, B_v , for zinc based on references 16, 35, 37, 67, 97, 104, 114, 115, and 119	36
2.17. Assumed systematic trend in B_v for Period IV elements based on default estimates. Solid dots and error bars represent geometric means and standard deviations determined from available references	37
2.18. Assumed systematic trend in (B_p / B_v) ratio for Period IV elements. Solid dots and error bars represent geometric means and standard deviations of the mean determined from available references	38
2.19. Assumed systematic trends in the ratio of for Period V and IV elements (Nb/V, Rh/Co, Pd/Ni, and Ag/Cu) based on the ratios of default B_v estimates for other elements in the periods	41
2.20. Assumed systematic trend in B_v for Period V transition elements based on default B_v estimates. Solid dots and error bars represent geometric means and standard deviations determined from available references	42
2.21. Assumed systematic trend in for Period VI elements based on assumed systematic trends in Period IV and V elements	44
2.22. Lognormal probability plot of geometric means of B_v for plutonium (calculated from references 8-10, 30, 59, 101, 129, 131, 132, and 134-138), including one geometric standard deviation of the mean	46

LIST OF FIGURES (continued)

Figure	Page
2.23. Comparison of soil-to-plant concentration factor default values reported in this report and derived from reference 15. The “+” and “-” signs indicate whether our estimates are greater or less than, respectively, those derived from reference 15. The values indicated are the difference factor, and circled elements indicate a difference of at least an order of magnitude	48
2.24. Values of the ingestion-to-milk transfer coefficient F_m adopted as default estimates in the computer code TERRA	50
2.24. Values of the ingestion-to-beef transfer coefficient F_f adopted as default estimates in the computer code TERRA	51
2.25. Systematic trends in the ratio of default estimates for B_v and F_m for successive elements and corresponding assumed ratios for F_f for successive elements used to determine default F_f estimates	52
2.26. Systematic variations in default estimates for Period II, III, IV, and V elements	54
2.27. Systematic variations in default estimates for Period VI and VII elements	55
2.28. Systematic variations in default and F_f estimates for Period II, III, IV, and V elements	56
2.29. Systematic variations in default and F_f estimates for Period VI and VII elements	57
2.30. Values of the soil-water distribution coefficient K_d adopted as default estimates in the computer code TERRA	58
2.31. Percent error in K_d estimation from one to five percent overestimates of soil concentration or underestimates of water concentration in a 10g-100mL batch-type K_d experiment	60
2.32. Lognormal probability plots of for cesium and strontium in soils of pH 4.5 to 9 based on available references	62
2.33. Correlation between and based on geometric means of available reference geometric means	64
3.1. Relationship between interception fraction and productivity for forage grasses (pasture and hay)	66
3.2. Model of field geometry of leafy vegetable spacings	67

LIST OF FIGURES (continued)

Figure	Page
3.3. Hypothetical growth curve for plants. Leafy vegetables are harvested at the time of maximum growth, and silage is harvested at grain maturity	70
3.4. Model of field geometry of silage plant spacings	72
3.5. Three plots of equal area containing hypothetical crops of varying size and planting density	77
3.6. Assumed relationships between interception fraction and fresh weight productivity for exposed produce and leafy vegetables and between interception fraction and dry weight productivity for silage	78
3.7. The ratio of interception fraction to productivity (r^i/Y_i) as a function of interception fraction dependent on (A) and independent of (B) productivity of silage, exposed produce, and leafy vegetables. The ranges of productivity found in the U.S., based on reference 7, are shown at the bottom of the figure	79
4.1. Map of the conterminous United States showing county delineations	81
4.2. Map of the conterminous United States with half degree longitude-latitude grid indicated	82
4.3. Geographic distribution of SITE parameter leafy vegetable production, P_{lv}	86
4.4. Geographic distribution of SITE parameter leafy vegetable productivity, Y_{lv}	87
4.5. Geographic distribution of SITE parameter exposed produce production, P_e	88
4.6. Geographic distribution of SITE parameter exposed produce productivity, Y_e	89
4.7. Geographic distribution of SITE parameter protected produce production, P_{pp}	90
4.8. Geographic distribution of SITE parameter protected produce productivity, Y_{pp}	91
4.9. Geographic distribution of SITE parameter grain food production, P_{gh}	92

LIST OF FIGURES (continued)

Figure	Page
4.10. Geographic distribution of SITE parameter grain food productivity, Y_{gh}	93
4.11. Geographic distribution of SITE parameter grain feed production, P_{gf}	94
4.12. Geographic distribution of SITE parameter grain feed productivity, Y_{gf}	95
4.13. Geographic distribution of SITE parameter silage feed production, P_s	96
4.14. Geographic distribution of SITE parameter silage feed productivity, Y_s	97
4.15. Geographic distribution of SITE parameter hay feed production, P_h	98
4.16. Geographic distribution of SITE parameter hay feed areal yield, Y_h^a	99
4.17. Geographic distribution of SITE parameter number of frost-free days, d_{ff}	101
4.18. Geographic distribution of SITE parameter cattle and calves inventory, n_{cc}	102
4.19. Geographic distribution of SITE parameter milk cow inventory, n_m	103
4.20. Geographic distribution of SITE parameter annual number of cattle on feed sold, s_g	104
4.21. Geographic distribution of SITE parameter sheep inventory, n_s	105
4.22. Geographic distribution of SITE parameter pasture area, A_p , shown as a fraction of total cell area	106
4.23. Geographic distribution of SITE parameter beef cows inventory, n_b	108
4.24. Geographic distribution of SITE parameter estimated annual average evapotranspiration, E	111
4.25. Geographic distribution of SITE parameter estimated annual average irrigation, I	112

LIST OF FIGURES (continued)

Figure	Page
4.26. Geographic distribution of SITE parameter estimated annual average precipitation, P	113
4.27. Geographic distribution of SITE parameter estimated annual average morning mixing height, M_{am}	115
4.28. Geographic distribution of SITE parameter estimated annual average afternoon (evening) mixing height, M_{pm}	116
4.29. Geographic distribution of SITE parameter estimated annual average absolute humidity, H	117
4.30. Geographic distribution of SITE parameter (estimated 1980) U.S. Population, pop_t	118
4.31. Geographic distribution of SITE parameter fraction of (1970) population classified as urban, pop_u	119
4.32. Geographic distribution of SITE parameter fraction of (1970) population classified as rural-farm, pop_{rf}	120
4.33. Geographic distribution of SITE parameter fraction of (1970) population classified as rural-nonfarm, pop_{nf}	121
4.34. Geographic distribution of SITE parameter dominant land feature, L_{df}	122
5.1. Metabolic half-times for the elements in milk (days), based on reference 145	126
5.2. Lognormal probability plot of coarse suspended particulate Matter (2.5 - 15 μm)	131

LIST OF TABLES

Table	Page
2.1. Examples of non-uniform elemental distribution in plants	6
2.2. Relative importance of food crop categories in selected states and the conterminous U. S.	7
2.3. Dry-to-wet weight conversion factors for exposed produce, protected produce, and grains	8
2.4. Comparison of observed and predicted concentrations of Group IA and IIA elements in produce and plants	14
2.5. Literature values of B_v , B_r , and the (C_r/C_v) ratio for radium	19
2.6. Comparison of observed and predicted concentrations of Group IIIA, IVA, and VA elements in produce and plants	22
2.7. Comparison of observed and predicted concentrations of Group VIA and VIIA elements in produce and plants	25
2.8. Comparison of observed and predicted concentrations of Group IIIB and the rare earth elements in produce and plants	27
2.9. Comparison of observed and predicted concentrations of Period IV transition elements in produce and plants	30
2.10. Comparison of observed and predicted concentrations of Period V transition elements in produce and plants	40
2.11. Comparison of observed and predicted concentrations of Period VI transition elements in produce and plants	43
2.12. Comparison of observed and predicted concentrations of actinide elements in produce and plants	47
2.13. Estimates of distribution of K_d for various elements in agricultural soils of pH 4.5 to 9.0	61
3.1. Weighting factors for leafy vegetable interception fraction model simulation	69
3.2. Relative importance of various exposed produce in the U.S.	74
3.3. Values of interception fraction for five important crops in the exposed produce category	76
4.1. Example derivation of agricultural parameters for SITE cell #3284 from county-averaged parameters	83

LIST OF TABLES (continued)

Table		Page
4.2.	Derivation of number of frost-free days for half degree cells from values for the three nearest weather stations to the centroid of the cell	85
4.3.	Agricultural and climatological parameters for seven selected SITE cells and parameters derived from them in TERRA	109
5.1.	Water content of produce, beef, and cow's milk	129
5.2.	Carbon content of produce, beef, and cow's milk	130

PARAMETER SYMBOLS AND DEFINITIONS

Symbol	Definition
A_{hi}	The area allocated to crop i which is harvested or harvest area (m^2).
A_i	The inventory area allocated to crop i (m^2).
A_p	The area of pasture (m^2).
B_r	Soil-to-plant concentration factor which is the ratio of activity concentration in plant parts usually associated with reproductive or storage functions (fruits, seeds, tubers, etc.) in dry weight to the dry weight activity concentration in root zone soil at edible maturity or time of harvest (unitless).
B_v	Soil-to-plant concentration factor which is the ratio of activity concentration in plant parts usually associated with vegetative functions (leaves, stems, straw, etc.) in dry weight to the dry weight activity concentration in root zone soil at edible maturity or time of harvest (unitless).
C_a^{C14}	Carbon-14 activity concentration in air (Bq or Ci/ m^3).
C_a^{H3}	Tritium activity concentration in air (Bq or Ci/ m^3).
C_a^r	Resuspension air concentration (Bq or Ci/ m^3).
C_{cd}^{C14}	Carbon-14 activity concentration in atmospheric carbon dioxide (Bq or Ci/kg).
C_{food}^{H3}	Tritium activity concentration in food (Bq or Ci/ m^3).
C_p	The annual consumption of pasture by livestock (kg/yr).
C_r	Activity concentration in plant parts usually associated with reproductive or storage functions (fruits, seeds, tubers, etc.) in dry weight (Bq or Ci/kg).
C_s	Activity concentration in dry weight in root zone soil (Bq or Ci/kg).
C_s^t	Activity concentration in dry weight in average or typical root zone soil (Bq or Ci/kg).
C_v	Activity concentration in plant parts usually associated with vegetative functions (leaves, stems, straw, etc.) in dry weight (Bq or Ci/kg).
C_{wv}^{H3}	Tritium activity concentration in atmospheric water vapor (Bq or Ci/kg).
C^{ps}	The activity concentration on the surfaces of plants (Bq or Ci/kg).
D_r^r	The deposition rate of resuspended material (Bq or Ci/ m^2/s).
d	Depth of the soil layer of interest, e.g., root zone (cm).
d_{ff}	Average annual number of frost-free days (d).
d_l	The linear distance between a weather station and the centroid of the SITE cell (km).
d_p	The distance between plants in a row in a field of row crops (cm).
d_r	The distance between rows of plants in a field of row crops (cm).
E	Average annual evapotranspiration (cm).
F_f	The fraction of daily ingested activity concentration (from feeding) which is transferred to and remains in a kilogram of muscle at equilibrium (d/kg).
f_{gi}	The fraction of grain which is imported from outside of the assessment area (unitless).
F_m	The fraction of daily ingested activity concentration (from feeding) which is transferred to and remains in a kilogram of milk at equilibrium (d/kg).
f_{ff}	The fractional transfer of ingested activity to beef (unitless).

PARAMETER SYMBOLS AND DEFINITIONS (Continued)

Symbol	Definition
f_m	The fractional transfer of ingested activity to milk (unitless).
f_w^a	The fraction of water in vegetation derived from atmospheric sources (unitless).
f^m	The fraction of maximum growth attained by plants (unitless).
g_{pg}	The number of successive grazings of pasture by cattle (yr^{-1}).
H	Average annual absolute humidity (g/m^3).
h_h	The number of hay harvests in a year (yr^{-1}).
I	Average annual irrigation (cm).
i	Identification number for each SITE cell based on the longitude and latitude of the southeastern corner of the cell (unitless).
K_d	The soil-water distribution coefficient which is the ratio of activity or elemental concentration in soil to that in water at equilibrium (mL/g).
L_{df}	Dominant land feature of the assessment area (unitless).
l	The length of a unit area (cm).
M_{am}	Average annual morning mixing height (m).
M_{pm}	Average annual afternoon mixing height (m).
m_m	The muscle mass of a cow (kg).
m_p	The quantity of milk produced from a milk cow per milking (kg).
n	The number of fruit per plant or tree (unitless).
n_a	The inventory of "all other cattle" (head).
n_b	The inventory of "beef cattle" (head).
n_{cc}	The inventory of cattle and calves (head).
n_g	The inventory of grain-fattened cattle (head).
n_m	The inventory of milk cows (head).
n_r	The number of plants in a row in a field of row crops (unitless).
n_s	The inventory of sheep (head).
P	Average annual total precipitation (cm).
P_{ai}	The annual yield or production of crop i (kg/yr).
P_e	The annual production of exposed produce (kg).
P_{gf}	The annual production of grain feed (kg).
P_{gh}	The annual production of grain food (kg).
P_h	The annual production of hay (kg).
P_{hf}	The annual production of harvested forage or hay + silage (kg).
P_{hi}	The harvest yield or production of crop i per harvest (kg).
P_{lv}	The annual production of leafy vegetables (kg).
P_{pg}	The annual production (equal to consumption by livestock inventory) of pasture grass (kg).
P_{pp}	The annual production of protected produce (kg).
P_s	The annual production of silage (kg).
P_{sl}	Pressure corrected to sea level (mb).

PARAMETER SYMBOLS AND DEFINITIONS (Continued)

Symbol	Definition
P_{sus}	Suspended particulate matter in the range of 2.0-15 μm from resuspension processes ($\mu\text{g}/\text{m}^3$).
p_c	The parameter value for a SITE cell (variable).
p_1	The parameter value for the nearest weather station to the centroid of a SITE cell (variable).
p_2	The parameter value for the second nearest weather station to the centroid of a SITE cell (variable).
p_3	The parameter value for the third nearest weather station to the centroid of a SITE cell (variable).
pop_{nf}	The fraction of the population classified as “rural-non-farm” (unitless).
pop_{rf}	The fraction of the population classified as “rural-farm” (unitless).
pop_t	The total population of the assessment area (unitless).
pop_u	The fraction of the population classified as “urban” (unitless).
Q_f^{fc}	The lifetime forage requirement of grain-fed cattle (kg/yr).
Q_{feed}	Feed ingestion rate by cattle used in meat and milk concentration calculations (k/s).
Q_g^{fc}	The lifetime grain requirement of grain-fed cattle (kg/yr).
R_f	The collective forage requirement by livestock (kg/yr).
R_g	The collective grain requirement by livestock (kg/yr).
r_f	The radius of an individual fruit or plant (cm).
r_n	The number of rows of plants in a field of row crops (unitless).
r^e	The average interception fraction for exposed produce (unitless).
r^{ef}	The average interception fraction for exposed fruit (unitless).
r^h	The interception fraction for hay (unitless).
r^i	The interception fraction for plant i (unitless).
r^{lv}	The interception fraction for leafy vegetables (unitless).
r^{mf}	The interception fraction for mature tree fruit (unitless).
r^{mlv}	The interception fraction for mature leafy vegetables (unitless).
r^{ms}	The interception fraction for mature silage (unitless).
r^{msb}	The interception fraction for mature snap beans (unitless).
r^{mt}	The interception fraction for mature tomatoes (unitless).
r^{pg}	The interception fraction for pasture grass (unitless).
r^s	The interception fraction for silage (unitless).
s_g	The annual sales of grain-fattened cattle (head/yr).
T_f	The metabolic half-time for material in beef (s).
T_m	The metabolic half-time for material in milk (s).
T_w	The weathering removal half-time for material deposited on plant surfaces (s).
t_i	The time of interest (d).
t_m	The time at which milk is sampled (s).

PARAMETER SYMBOLS AND DEFINITIONS (Continued)

Symbol	Definition
t_{\max}	The time at which maximum plant growth occurs (d).
t_s	The time at which cattle are slaughtered (s).
V_d^r	The deposition velocity of resuspended material (cm/s).
V_i	The velocity of a migrating material in a soil column (cm/s).
V_w	The velocity of water in a soil column (cm/s).
w	The width of a unit area (cm).
w_1	The weighting factor (inversely proportional to distance) used with the nearest weather station to the centroid of a SITE cell (unitless).
w_2	The weighting factor (inversely proportional to distance) used with the second nearest weather station to the centroid of a SITE cell (unitless).
w_3	The weighting factor (inversely proportional to distance) used with the third nearest weather station to the centroid of a SITE cell (unitless).
X	Longitude ($^{\circ}$ W)
Y	Latitude ($^{\circ}$ N)
Y_e	The productivity of exposed produce (kg/m ²).
Y_{gf}	The productivity of grain feed (kg/m ²).
Y_{gh}	The productivity of grain food (kg/m ²).
Y_h	The productivity of hay (kg/m ²).
Y_i	The productivity of plant i based on the ratio of production to area harvested (kg/m ²).
Y_i^a	The area1 yield of crop i (kg/yr/m ²).
Y_{lv}	The productivity of leafy vegetables (kg/m ²).
Y_{pg}	The productivity of pasture grass (kg/m ²).
Y_{pg}^a	The area1 yield of pasture grass (kg/yr/m ²).
Y_{pp}	The productivity of protected produce (kg/m ²).
Y_s	The productivity of silage (kg/m ²).
z	Altitude (m).
λ_g	The turnover rate of cattle in the “cattle on feed” category (yr ⁻¹).
λ_f	The metabolic removal rate constant for beef (s ⁻¹).
λ_m	The metabolic removal rate constant for milk (s ⁻¹).
λ_w	The weathering removal constant for plant surfaces (s ⁻¹).
ρ	Soil bulk density (g/cm ³).
θ	Volumetric water content of the soil [mL (equal to cm ³ H ₂ O) /cm ³].

ACKNOWLEDGMENT

We wish to express our deepest gratitude to C. B. Nelson, C. W. Miller, S. Y. Ohr, B. D. Murphy, O. W. Hermann, and C. L. Begovich for their cooperation, suggestions, help, and encouragement in producing the TERRA computer code. We also wish to acknowledge G. G. Killough for his assistance in the Monte Carlo simulations which were essential to some of our analyses and P. E. Johnson and R. C. Durfec for their assistance in creating the SITE data base. Finally, we wish to recognize Y. C. Ng, C. A. Little, D. E. Fields, A. P. Watson, and R. J. Raridon for their time and effort in reviewing this manuscript.

HIGHLIGHTS

Assessment models of radionuclide transport through terrestrial agricultural systems rely on input parameters to describe transport behavior and define interrelationships among the agricultural ecosystem compartments. Often a single set of default parameters, such as those given in the USNRC Reg. Guide I. 109, is recommended for use in generic assessments in lieu of site specific information. These parameters are often based on an incomplete knowledge of transport processes, on readily available literature references, and on generalized or idealized conceptualizations of common agricultural practice. Usually, in lieu of solid experimental, observational, or theoretical support, parameters are chosen to provide conservative results. Further, inconsistencies may occur between experimental determination of the parameter and its use in the assessment model.

The above-mentioned limitations in model input parameters are usually unavoidable and seem to be inherent in the assessment modeling process, but are usually acceptable (in many applications) within the context of overall uncertainty in assessment methodology. However, in some assessment applications, including comparisons among various facilities and source terms in a variety of geographical locations, many of these limitations are not acceptable. This report describes an evaluation of terrestrial transport parameters designed to address many of the above-mentioned limitations and provides documentation of default parameters incorporated into the food-chain-transport assessment code TERRA.

The parameters discussed in this report are divided into five categories: agricultural, climatological, demographic, element-specific, and miscellaneous. The climatological, demographic, and many of the agricultural parameters have been determined on a location-specific basis for the conterminous United States with a resolution of $\frac{1}{2} \times \frac{1}{2}$ degree longitude-latitude. These parameters include various land use and geographic information, population and its distribution in rural and urban settings, agricultural production and productivity, precipitation, and estimates of evapotranspiration, morning and afternoon mixing heights, absolute humidity, and number of frost-free days. These location-specific parameters have been stored in computer readable format and are collectively referred to as the Specific-Information on the Terrestrial Environment (SITE) data base. This report describes the SITE data base and the protocols used in its generation.

The element-specific parameters include soil-to-plant concentration factors, B_v , and B_r , ingestion-to-milk and ingestion-to-beef transfer parameters, F_m and F_f , respectively, and the soil-water distribution coefficient, K_d . The report describes the available literature references, the protocols and assumptions made, and correlations between parameters used to determine these default parameters and compares concentrations predicted using them with experimentally measured concentrations.

1. INTRODUCTION

Under Task I of contract EPA-AD-89-F-2-A106 (formerly EPA-78-D-X0394), the Health and Safety Research Division (HASRD) of the Oak Ridge National Laboratory (ORNL) prepared the AIRDOS-EPA¹ and DARTAB² computer codes to provide the Environmental Protection Agency (EPA) with an integrated set of codes and data bases to simulate atmospheric and terrestrial transport of radionuclides routinely released to the atmosphere and to calculate resulting health impacts to man consequent from these releases. Under Task II of the project an integrated set of computer codes and data bases is being designed to replace the AIRDOS-EPA and DARTAB system. This report describes the Specific Information on the Terrestrial Environment (SITE) computerized data base, element-specific transport parameters, and other parameters used in lieu of user input in the terrestrial transport code TERRA³ or accessed by the atmospheric transport code ANEMOS⁴ and/or the dose and risk code ANDROS.⁵

The terrestrial transport and agricultural parameters reviewed and documented by Moore et al.¹ represented an attempt to update and reevaluate parameters previously recommended in USNRC Regulatory Guide 1.109.⁶ Experience with the AIRDOS-EPA computer code has highlighted several problems in the modeling approach and certain limitations in the assessment methodology which are addressed under Task II. One problem occurs in the protocols used in reviewing literature values for soil-to-plant concentration factors. Other limitations apparent in the AIRDOS-EPA computer code are the absence of transport parameters for many elements and the incorporation of a single set of default agricultural parameters to describe a highly diverse agricultural system in the United States.

Much of the effort under Task II has been directed towards resolution of these problems or inconsistencies and construction of a location-specific data base of default agricultural, meteorological, and demographic parameters for use in generic assessments. Element-specific transport parameters have been reevaluated with regard to their use in the model TERRA, literature references given by Moore et al.¹ have been reevaluated, and new references have been added. For those elements for which experimental experience has been slight, systematic assumptions based on their location in the periodic table of the elements have been used to estimate default values. Theoretical models based on two- and three-dimensional geometries of food and feed crops have been used to suggest default values of the interception fraction, r .

It is beyond the scope of this report to detail the TERRA computer code, but a general understanding of the simulation of transport in vegetable and feed crops is prerequisite to interpretation of our analyses. All vegetable and feed crops have been assigned to seven categories based on their phenotypic and agricultural transport characteristics.⁷ These categories are leafy vegetables, exposed produce, protected produce, grains, pasture, hay, and silage (Fig. 1.1). The first three are classed as human foods and the last three as livestock feeds. Grains are classed as both. Leafy vegetables present a broad flat leaf surface for direct interception of atmospherically depositing material. Furthermore, the edible portion of the plant is primarily concerned with vegetative growth (leaves and stems). Exposed produce (snap beans, tomatoes, apples, etc.) intercept atmospherically depositing material on edible surfaces, but surface areas for exposure are relatively small compared to leafy vegetables. Additionally, edible portions are typically concerned with reproductive functions (fruits and seeds). Protected produce (potatoes, peanuts, citrus fruits, etc.) are not directly exposed to atmospherically depositing material because their growth habit is underground, or if aboveground, the edible portions are protected by pods, shells, or nonedible skins or peels. Typically, edible portions are reproductive or storage organs.

Grains are similar to protected produce, but their use as both livestock feeds and food for man necessitates a separate category. The other three categories of livestock feeds are pasture, hay, and (corn and sorghum) silage. All of these feeds are composed, primarily, of vegetative growth. Silage is categorized separately from hay and pasture based on its interception characteristics. Hay and pasture are separated because their residence times in the field are significantly different, and therefore, parent nuclide decay and ingrowth of daughters calculated in TERRA for these two

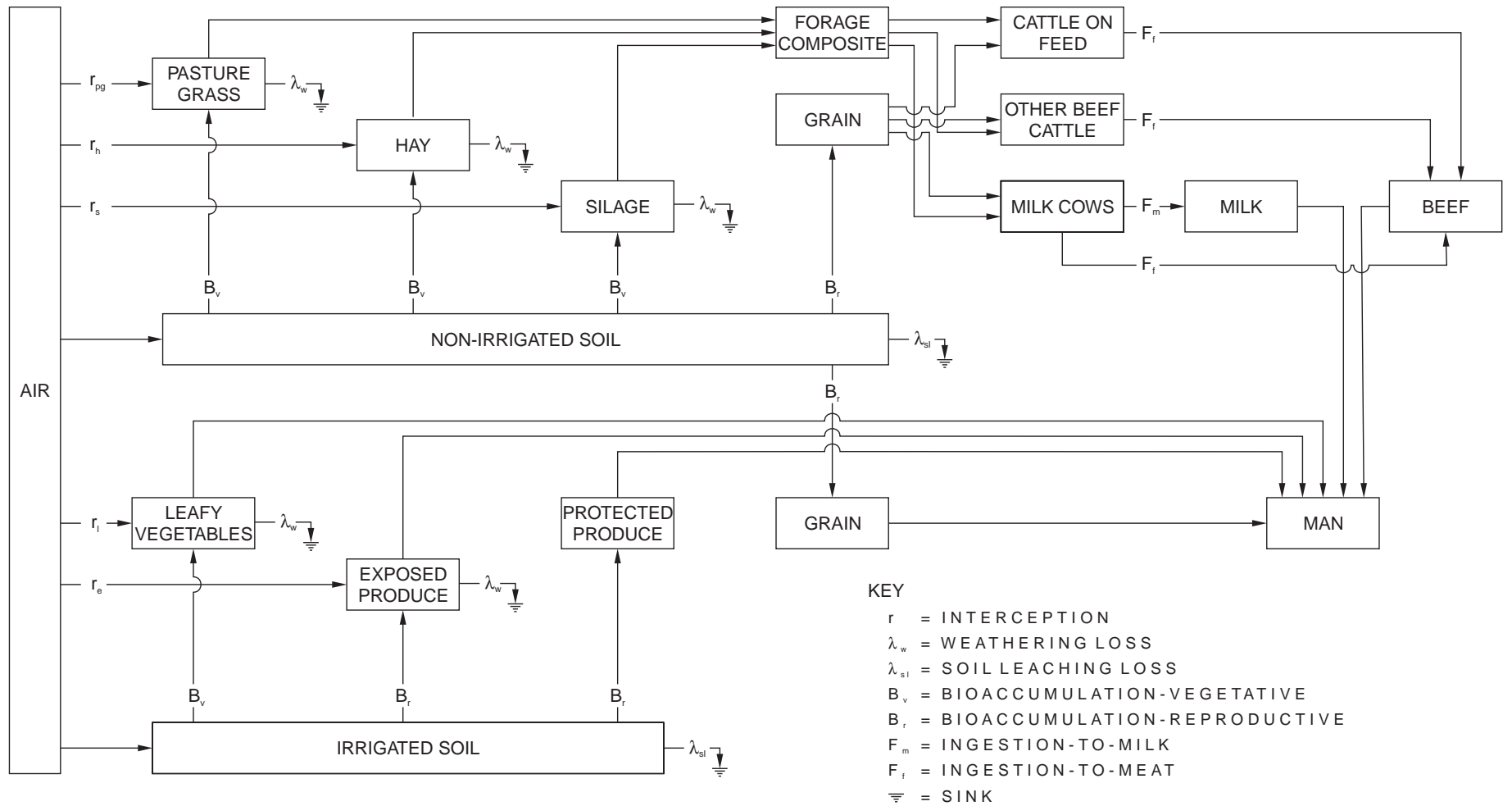

Figure 1.1. The categorization of all vegetable crops and animal feeds in the TERRA code based on radionuclide transport and agricultural pathway characteristics.

categories may be significantly different. Furthermore, hay is easily imported and exported from a location and pasture is not. This difference between the two is important in the calculation of location-specific estimates of pasture productivity and feed fractions based on livestock inventories (Section 4.1).

The elaboration of vegetation into seven categories has been determined chiefly by the protocols necessary in analyzing transport behavior, allowing for location-specific variability in agricultural practice, and simulating radiological decay in the TERRA code. Similarly, for all parameters the following analyses reflect our intent towards “reasonable estimates” based on unbiased approaches, parameter correlations, and theoretical or systematic models when available information is limited. We will attempt to estimate distributions of these parameters whenever possible to allow the reader to select more or less conservative parameter estimates than those used as default in TERRA. Finally, any changes in parameter definitions from those given by Moore et al.,¹ or listed in the USNRC Regulatory Guide 1.109,⁶ have not been made capriciously, but reflect responses to limitations or inconsistencies of past approaches.

2. ELEMENT-SPECIFIC TRANSPORT PARAMETERS

Quantification of nuclide transport through agricultural systems in TERRA involves the parameters describing soil-to-plant uptake for vegetative growth (leaves and stems), B_v ; and nonvegetative growth (fruits, seeds, and tubers), B_r ; ingestion-to-milk transfer, F_m ; ingestion-to-meat transfer for beef cattle, F_f ; and the soil-water distribution coefficient, K_d . Ideally, these transport parameters should be nuclide-specific. For example, isotopic differences in plant availability have been shown for plutonium.⁸⁻¹⁰ However, available information for other elements and the lack of compelling theory for a nuclide-specific approach necessitates an element-specific determination for these parameters. Thus, it is assumed here that variability among isotopes of the same element is insignificant compared to variability among different elements and the overall variability inherent in the parameters themselves. For soil-plant uptake of strontium, available information supports this assumption.¹¹

2.1 Soil-to-Plant Uptake Parameters B_v and B_r

Root uptake of radionuclides incorporated into surface horizons of soil is parameterized by the transfer coefficients B_v and B_r , representing the ratio of elemental concentrations in plant and soil at harvestable maturity. The parameters B_v and B_r are given by

$$B_v = \frac{C_v}{C_s} \text{ and} \quad (1)$$

$$B_r = \frac{C_r}{C_s} \quad (2)$$

where

- B_v = soil-to-plant elemental transfer coefficient for vegetative portions of food crops and feed plants,
- B_r = soil-to-plant elemental transfer coefficient for nonvegetative (reproductive) portions of food crops and feed plants,
- C_v = elemental concentration in vegetative portions of food crops and feed plants (dry weight) at edible maturity,
- C_r = elemental concentration in nonvegetative (reproductive) portions of food crops and feed plants (dry weight) at edible maturity, and
- C_s = elemental concentration in root zone soil (dry weight).

This approach to concentration ratios is significantly different from the B_{iv1} and B_{iv2} approach used by Moore et al.¹ and is in response to some inconsistencies and inadequacies experienced with the AIRDOS-EPA approach.¹² In Moore et al.,¹ B_{iv1} values were calculated from dry plant/dry soil concentration ratios for livestock feeds, and B_{iv2} values were calculated from fresh weight plant/dry soil concentration ratios for food crops. This approach was used because information on feed and food crops is customarily reported in dry and fresh weights, respectively. In analysis of available literature for these concentration ratios, all data in a reference were divided into "animal feeds" and "direct consumption by man" categories, corresponding to B_{iv1} and B_{iv2} , respectively. A literature reference could be used for B_{iv1} or B_{iv2} or both. Conversely, B_{iv1} and B_{iv2} for an element might be derived from two sets of data and references which could be equal, share common elements, or be disjointed. For most elements, $B_{iv2} \leq B_{iv1}$ was observed. This result is logical because the concentration of a finite quantity of material in a plant decreases as plant weight increases. However, if two disjointed sets of references were used, $B_{iv2} \geq B_{iv1}$ for an element could occur. The resultant

values of B_{iv1} and B_{iv2} were appropriate with respect to the references used to generate them, but were not directly comparable with each other. In the approach used here, classification of references is based on physiologic plant characteristics, and not upon ultimate fate of the plant in the human food chain.

Also, in the Moore et al.¹ approach, any statistical analysis of B_{iv2} would have to be based on “converted” parameter values because they are usually reported in dry weight. Because very few references include dry-to-wet weight conversion factors, general references such as Morrison (1959)¹³ and Spector (1959)¹⁴ were used for generation of B_{iv2} . In some cases a value of 25% dry matter^{1,6,15} was used to convert to wet weight. These transformations of reported data added unnecessary uncertainty to parameter estimates, and statistical analysis would be less precise than analysis of original data. Thus, the adoption of dry weight concentration ratios here reduces additional imprecision in parameter estimates and facilitates a more direct comparison between the two concentration factors (B_v and B_r).

Adoption of B_v and B_r over B_{iv1} and B_{iv2} is based on an evaluation of literature references for root uptake and distribution of elements in plants. Nonuniform elemental distributions in food and feed crops has been widely observed (Table 2.1). Typically, nonnutritional elemental concentrations in agricultural plants are generally ordered as roots > leaves \geq stems > tubers \geq fruits \geq seeds.^{10,17,31-37} Variations in the relative distribution of elements among plant parts occur with species, variety, growth conditions, and element, but in general for most elements, $C_v > C_r$.

Analysis of food and feed production in the conterminous United States suggests that B_v and B_r are analogous to B_{iv1} and B_{iv2} , respectively. Leafy vegetables are the only group of food crops for which B_v is the appropriate transfer parameter. Nationally, leafy vegetables comprise a relatively small portion of food crop production (Table 2.2). Thus, major portions of food crops in the United States are associated with the transport parameter B_r . For feed crops, grains are the only category associated with B_r . Although the relative importance of grain feeds varies considerably by state and county, in most areas nongrain feeds dominate. Therefore, the use of default soil-to-plant transport parameters (reviewed in the following sections) in the computer code AIRDOS-EPA merely requires substitution of B_v for B_{iv1} and substitution of a B_r , converted from dry weight to wet weight, for B_{iv2} . Appropriate generic factors for conversion of B_r to B_{iv2} , based on relative importance of various nonleafy vegetables in the United States, are 0.126, 0.222, and 0.888 for exposed produce, protected produce, and grains, respectively (Table 2.3). Weighting these conversion factors by the relative importance (based on production in kilograms) of each category in the United States (Table 2.2) yields an overall average value of 0.428. However, regional differences in the relative importance of the food categories and assessment requirements may require the selection of more appropriate conversion factors from Tables 2.2 and 2.3.

2.1.1 Protocols for determination of parameter values

All estimates of B_v and B_r are based on any combination of 1) analysis of literature references, 2) correlations with other parameters, 3) elemental systematics, or 4) comparisons of observed and predicted elemental concentrations in foods. In general, no *a priori* biases or protocols were used to produce conservative values.

Analysis of literature references required subjective evaluation of the experimental techniques, reliability of reported data, and appropriateness of reported values to the parameters. Practically, when many references were available for an element, subjective standards were relatively high; when only one or a few references were available, standards were less rigorous, and alternative approaches became increasingly important. Occasionally, reported data was not amenable for direct calculation of B_v or B_r based on Eqs. (1) and (2). If such corollary information such as soil bulk density, crop yield, background concentration, counting efficiency, and specific activities were not reported or easily available from other references, estimates of them were made for indirect

Table 2.1. Examples of nonuniform elemental distribution in plants

Element	$(C_r/C_v)^a$	Plant	Reference
Li	1.6×10^{-1}	pumpkin	16
Be	1.4×10^{-1}	pumpkin	16
B	3.1×10^{-1}	various vegetables	17
Na	6.8×10^{-1}	pumpkin	16
Mg	6.6×10^{-1}	grain and root crops	18
Ca	1.6×10^{-1}	grain and root crops	18
Ti	5.3×10^{-1}	sedge and nut grasses	19
Cr	5.7×10^{-1}	pumpkin	16
Mn	2.0×10^{-1}	various vegetables	17
Fe	1.1×10^{-1}	pumpkin	16
Co	2.7×10^{-1}	sedge and nut grasses	19
Zn	3.5×10^{-1}	corn	20
Sr	8.7×10^{-2}	oats	21
Y	1.3×10^{-1}	beans	22
Mo	1.2×10^{-1}	various vegetables	17
Tc	1.9×10^{-2}	wheat	23
Cd	7.0×10^{-2}	various vegetables	24
I	4.9×10^{-1}	various vegetables	25
Cs	2.6×10^{-1}	wheat	26
Ba	9.6×10^{-2}	pumpkin	16
Ce	3.4×10^{-1}	beans	22
Pb	4.2×10^{-2}	various vegetables	27
Po	1.5×10^{-1}	various vegetables	28
U	5.0×10^{-1}	various grain and root crops	29
Np	3.5×10^{-2}	wheat	30
Pu	1.2×10^{-2}	various vegetables	10
Am	4.2×10^{-3}	various vegetables	10
Cm	6.7×10^{-3}	various vegetables	10

^a (C_r/C_v) ratios were determined when pairs of observations were reported for a plant type. values in the table are the geometric mean of these ratios for the given reference.

calculation of B_v or B_r . Acceptance or rejection of such references was subjective, depending on the number and quality of other available references and comparison of indirect estimates with direct estimates from reliable sources. Often reported data were presented graphically. When such references were used, some error from visual interpretation of the graphs is inherent in resultant parameter estimates.

Although past estimates of plant uptake parameters have been based on the assumption of equilibrium,^{39,40} studies in which the concentration of polonium,⁴¹ radium,⁴² cesium,⁴³ a mixture of fission products,⁴⁴ or strontium^{43,45-51} in assorted plants has been repeatedly measured indicate that concentration factors for radionuclides change with time. If equilibrium or near-equilibrium conditions are achieved, they occur late in plant ontogeny. Because the transport parameters are used to generate plant concentrations at edible maturity for all vegetative categories, except pasture, an attempt was made to use references in which plant and soil concentrations were measured at edible maturity of the plant. In a majority of references, soil concentrations are given for the beginning of the experiment and plant concentrations are usually measured several weeks or months later. Because for most elements concentration factors are small and removal mechanisms from soil are controlled, only slight error is introduced in using such references. Also, concentration factors determined before edible maturity were used if subjective evaluation of the experiment suggested only slight error would be introduced from using these references. However, most references in which concentration factors were measured within three weeks of seed germination were rejected. For experimental determination of concentration factors for technetium, the above considerations severely limited the available data base.

Table 2.2. Relative importance of food crop categories in selected states and the conterminous U.S.^a

	Percent of total			
	Leafy vegetables	Exposed produces	Protected produce	Grains
California				
Area harvested	8.1	32.7	42.6	16.5
Production	14.4	52.3	29.7	3.5
Florida				
Area harvested	2.8	6.8	87.0	3.5
Production	4.9	7.2	87.4	0.6
Maine				
Area harvested	0.1	14.9	83.1	2.0
Production	0.1	3.1	96.6	0.2
Minnesota				
Area harvested	<0.1	0.4	25.2	74.3
Production	0.2	1.3	46.6	51.9
Montana				
Area harvested	<0.1	<0.1	4.1	95.9
Production	<0.1	0.1	12.0	87.9
Texas				
Area harvested	1.4	1.8	33.1	63.7
Production	10.3	5.2	55.1	29.4
Virginia				
Area harvested	1.5	14.6	32.1	51.8
Production	4.7	31.7	34.9	28.6
Conterminous U.S.				
Area harvested	1.2	6.1	23.3	69.4
Production	5.8	20.0	42.2	32.0

^aReference: Shor, Baes, and Sharp⁷, Appendix B.

If a reference was judged appropriate, analysis of the reported values was done in a manner similar to that of Moore et al.¹ with several modifications. First, all reported values were divided into those for vegetative growth (leaves, stems, straws) or nonvegetative growth (reproductive and storage parts such as fruits, seeds, and tubers). Plant concentrations for the former were used in calculation of B_v and the latter for B_r . Also, if C_v and C_r were reported for a single plant type (e.g., wheat straw and grain or carrot top and root), the ratio (C_r/C_v) was calculated. The geometric mean of all reported values applied to B_v , B_r , or (C_r/C_v) ratio was calculated for each reference. For some references the (C_r/C_v) ratio could be calculated, but B_v , and B_r could not because hydroponic solutions were used to grow plants or C_s was not reported. Finally, the geometric means for each reference were used to construct a distribution for B_v , B_r , or (C_r/C_v) ratio. The geometric means of these (inter-reference) distributions were taken to be the best unbiased estimates of the parameters, because reported values often spanned more than an order of magnitude, and because the distributions for elements strontium, cesium, and plutonium (for which there were numerous references) appeared to be lognormally distributed.

Table 2.3. Dry-to-wet weight conversion factors for exposed produce, protected produce, and grains

Vegetable	Conversion factor ^a	Weighting factor ^b	Reference	Vegetable	Conversion factor	Weighting factor	Reference
Exposed produce				Protected produce			
Apple	0.159	15.4	14	Onion	0.125	3.6	14
Asparagus	0.070	0.6	14	Orange	0.128	22.8	14
Bushberries	0.151	1.6	14	Peanut	0.920	3.4	38
Cherry	0.170	0.7	14	Peas	0.257	0.4	14
Cucumber	0.039	4.0	14	Potato	0.222	33.7	14
Eggplant	0.073	0.1	14	Sugarbeet	0.164	6.5	13
Grape	0.181	20.2	14	Sugarcane	0.232	5.5	13
Peach	0.131	6.9	14	Sweet corn	0.261	6.0	14
Pear	0.173	3.5	14	Sweet potato	0.315	1.5	14
Plums and prunes	0.540	3.1	14	Tree nuts	0.967	0.4	14
Sweet pepper	0.074	1.3	14	Watermelon	0.079	2.6	14
Snap bean	0.111	0.7	14				
Squash	0.082	1.8	14	Weighted average	0.222		
Strawberry	0.101	1.3	14				
Tomato	0.059	38.8	14	Grains			
				Barley	0.889	10.1	14
Weighted average	0.126			Corn (for meal)	0.895	37.7	38
Protected produce				Oats	0.917	2.3	14
Bean (dry)	0.878	2.2	14	Rye	0.890	0.5	14
Cantaloupe	0.060	1.1	14	Soybean	0.925	5.3	14
Carrot	0.118	2.4	14	Wheat	0.875	44.0	14
Grapefruit	0.112	5.5	14				
Lemon	0.107	2.4	14	Weighted average	0.888		

^aConversion factor = grams dry/grams wet.

^bRelative importance based on production in kilograms (percent of total) in the United States based on reference 7.

When only a few literature references were available, alternatives or supplements to the geometric means of distributions method were employed. For example, it was found that B_v was correlated with C_s for several elements, e.g., B, P, Cu, and Zn. That is, entry of the element into the plant appeared to be regulated rather than a constant fraction of the soil concentration. Therefore, studies employing highly enriched soil concentrations might yield inappropriate concentration factors for model calculations. Such correlations were combined with average or typical observed soil concentrations⁵² to generate appropriate concentration factors.

Another approach to determination of concentration factors was to compare plant concentrations surveyed in the literature^{53,54} with those generated by the equations

$$C_v = B_v C_s^t \text{ and} \quad (3)$$

$$C_r = B_r C_s^t, \quad (4)$$

where C_s^t is an average or typical soil concentration reported in the literature.⁵² If predicted plant concentrations were clearly atypical of reported values, the concentration factors were revised accordingly. In general, this method served as a critique of, or supplement to, other methods because of the uncertainties in values for “average” soil and plant concentrations. Typically, these values ranged over two orders of magnitude.

Finally, for rare elements and elements with little or no experimental information available, elemental systematics were used to derive best estimates when no other method or information was available. That is, relationships established between concentration factors for an element and those for other elements of the same or adjacent periods or groups were examined for trends. Such trends were extrapolated to the element in question, with the implication that chemically similar elements act similarly in the soil-plant environment. This elemental analog approach was extremely useful when support information for B_r was unavailable or meager. Systematic trends in observed (C_r/C_v) ratios were often used to predict B_r from B_v when the support data for the former was lacking, but relatively good for the latter.

Selection of values used as default in the TERRA code involved all of the above procedures. The final value selected as default was estimated to two significant digits rounded off to the nearest 0.5 decimal place (Figs. 2.1 and 2.2). That is, if a value of 1.3 was determined from the various above-outlined procedures a value of 1.5 was adopted. A determined value of 1.2 was rounded off to 1.0. The values of B_v and B_r in Figures 2.1 and 2.2 are further discussed in the following sections (2.1.2 through 2.1.10).

2.1.2 Group IA and IIA elements

The Group IA or alkali metals (Li, Na, K, Rb, Cs, and Fr) and the Group IIA or alkaline earth metals (Be, Mg, Ca, Sr, Ba, and Ra) are, generally, relatively easily taken up from soil by plants. Many of the lighter of these elements are essential plant nutrients and some, including isotopes of cesium, strontium, and radium, are extremely important radiologically. Literature references for calculation of B_v and B_r for cesium^{26,34,55-71} and strontium^{11,16-19,21,31-33,59-86} are quite abundant. Available references for the rest of the elements in these two groups are less numerous. References were available for lithium,¹⁶ sodium,^{16,17,65} potassium,^{16-18,65,71,84} rubidium,⁶⁵ beryllium,¹⁶ magnesium,^{16,18,65,71} calcium,^{16,18,65,71,72,84,85} and radium.⁸⁷⁻⁹³ No references were found for francium.

Cesium is the best documented of the Group IA elements. Analysis of the 18 references from which B_v estimates were taken suggests that the distribution of geometric means is lognormal (Fig. 2.3). The geometric means established for each of the 18 references ranged from 0.018 to 0.52 with a geometric mean of the means = 0.078. This value was rounded off to 0.08 for use in TERRA. Half of the B_v references included information pertinent to B_r , yielding a geometric mean of 0.018 for B_r . Ten of the references yielded (C_r/C_v) ratios, suggesting a value of 0.49 for this ratio. Using this ratio value with the B_r estimate previously mentioned yields a second estimate of B_r of 0.038 by the equation

$$B_r = B_v \left[\frac{C_r}{C_v} \right] \quad (5)$$

Thus, an estimate of $B_r = 0.03$, which is near the midpoint of the range (0.018 to 0.038), was adopted. The ratio of default values of B_r and B_v (B_r/B_v) is within one standard deviation of the (C_r/C_v) ratio distribution determined from the 10 references. Comparison of observed concentrations of cesium in plant foods with those predicted using the default estimate for B_r (Fig. 2.2) suggests that the default value is not unreasonable (Table 2.4). No information on naturally occurring cesium in vegetation applicable to B_v was available, but a radiological survey of the Marshall Islands⁹⁴ indicates that predicted Cs-137 concentrations in plants using the default estimate of B_v and measured soil concentrations are less than observed concentrations (which include resuspended material).

The B_v and B_r values chosen for lithium are derived from an unpublished study by Baes and Katz of natural variations in elemental concentrations in associated pumpkins and soils.¹⁶

	I A	II A											III A	IV A	V A	VI A	VII A
II	Li 0.025	Be 0.010											B 4.0		N 30		F 0.060
III	Na 0.075	Mg 1.0	III B	IV B	V B	VI B	VII B	VIII		I B	II B	Al 4.0×10^{-3}	Si 0.35	P 3.5	S 1.5	Cl 70	
IV	K 1.0	Ca 3.5	Sc 6.0×10^{-3}	Ti 5.5×10^{-3}	V 5.5×10^{-3}	Cr 7.5×10^{-3}	Mn 0.25	Fe 4.0×10^{-3}	Co 0.020	Ni 0.060	Cu 0.40	Zn 1.5	Ga 4.0×10^{-3}	Ge 0.40	As 0.040	Se 0.025	Br 1.5
V	Rb 0.15	Sr 2.5	Y 0.015	Zr 2.0×10^{-3}	Nb 0.020	Mo 0.25	Tc 9.5	Ru 0.075	Rh 0.15	Pd 0.15	Ag 0.40	Cd 0.55	In 4.0×10^{-3}	Sn 0.030	Sb 0.20	Te 0.025	I 0.15
VI	Cs 0.080	Ba 0.15		Hf 3.5×10^{-3}	Ta 0.010	W 0.045	Re 1.5	Os 0.015	Ir 0.055	Pt 0.095	Au 0.40	Hg 0.90	Tl 4.0×10^{-3}	Pb 0.045	Bi 0.035	Po 2.5×10^{-3}	At 1.0
VII	Fr 0.030	Ra 0.015															
Lanthanides	La 0.010	Ce 0.010	Pr 0.010	Nd 0.010	Pm 0.010	Sm 0.010	Eu 0.010	Gd 0.010	Tb 0.010	Dy 0.010	Ho 0.010	Er 0.010	Tm 0.010	Yb 0.010	Lu 0.010		
Actinides	Ac 3.5×10^{-3}	Th 8.5×10^{-4}	Pa 2.5×10^{-3}	U 8.5×10^{-3}	Np 0.10	Pu 4.5×10^{-4}	Am 5.5×10^{-3}	Cm 8.5×10^{-4}									
Key:	Li 0.025	— Symbol		— Transfer Coefficient, B_v													

Figure 2.1. Values of the soil-to-plant concentration factor B_v , adopted as default estimates in the computer code TERRA.

	I A	II A											III A	IV A	V A	VI A	VII A
II	Li 4.0×10^{-3}	Be 1.5×10^{-3}											B 2.0		N 30		F 6.0×10^{-3}
III	Na 0.055	Mg 0.55	III B	IV B	V B	VI B	VII B	VIII		I B	II B	Al 6.5×10^{-4}	Si 0.070	P 3.5	S 1.5	Cl 70	
IV	K 0.55	Ca 0.35	Sc 1.0×10^{-3}	Ti 3.0×10^{-3}	V 3.0×10^{-3}	Cr 4.5×10^{-3}	Mn 0.050	Fe 1.0×10^{-3}	Co 7.0×10^{-3}	Ni 0.060	Cu 0.25	Zn 0.90	Ga 4.0×10^{-4}	Ge 0.080	As 6.0×10^{-3}	Se 0.025	Br 1.5
V	Rb 0.070	Sr 0.25	Y 6.0×10^{-3}	Zr 5.0×10^{-4}	Nb 5.0×10^{-3}	Mo 0.060	Tc 1.5	Ru 0.020	Rh 0.040	Pd 0.040	Ag 0.10	Cd 0.15	In 4.0×10^{-4}	Sn 6.0×10^{-3}	Sb 0.030	Te 4.0×10^{-3}	I 0.050
VI	Cs 0.030	Ba 0.015		Hf 8.5×10^{-4}	Ta 2.5×10^{-3}	W 0.010	Re 0.35	Os 3.5×10^{-3}	Ir 0.015	Pt 0.025	Au 0.10	Hg 0.20	Tl 4.0×10^{-4}	Pb 9.0×10^{-3}	Bi 5.0×10^{-3}	Po 4.0×10^{-4}	At 0.15
VII	Fr 0.030	Ra 0.015															

Lanthanides	La 4.0×10^{-3}	Ce 4.0×10^{-3}	Pr 4.0×10^{-3}	Nd 4.0×10^{-3}	Pm 4.0×10^{-3}	Sm 4.0×10^{-3}	Eu 4.0×10^{-3}	Gd 4.0×10^{-3}	Tb 4.0×10^{-3}	Dy 4.0×10^{-3}	Ho 4.0×10^{-3}	Er 4.0×10^{-3}	Tm 4.0×10^{-3}	Yb 4.0×10^{-3}	Lu 4.0×10^{-3}
Actinides	Ac 3.5×10^{-4}	Th 8.5×10^{-5}	Pa 2.5×10^{-4}	U 4.0×10^{-3}	Np 0.010	Pu 4.5×10^{-5}	Am 2.5×10^{-4}	Cm 1.5×10^{-5}							

Key:

Li	—	Symbol
4.0×10^{-3}	—	Transfer Coefficient, B_f

Figure 2.2. Values of the soil-to-plant concentration factor B_f , adopted as default estimates in the computer code TERRA.

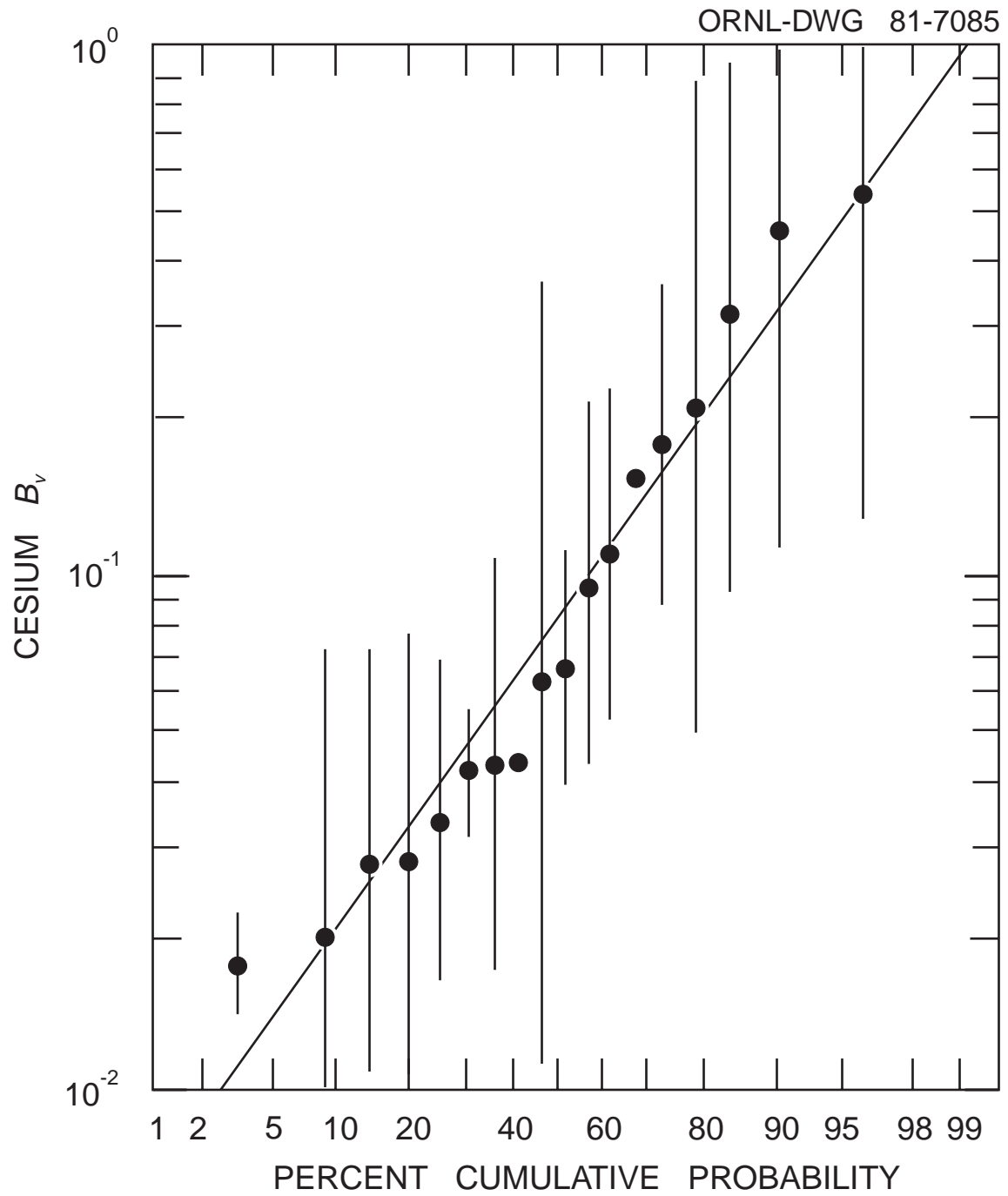

Figure 2.3. Lognormal probability plot of geometric means of B_v for cesium (calculated from references 26, 34, and 55-71), including one geometric standard deviation of the mean.

Comparison of observed and predicted plant concentrations in Table 2.4 indicates that both default B_v and B_r predict plant concentrations which are within observed ranges.

The B_v for sodium (0.075) was also derived from reference 16. Reference 65 reported soil and plant concentrations from which a lower estimate of B_v for sodium was derived, but systematic trends observed by plotting B_v against atomic number for Group IA and IIA elements (Fig. 2.4). suggest the rejection of this lower value. Comparison of observed and predicted plant sodium using the higher value supports its selection, because the predicted value is slightly below the reported range.

An estimate of the (C_r/C_v) ratio for sodium of 0.74 was derived from references 16 and 17. One and two standard deviations of the data reported in references 17 and 16, respectively, include the value 1.0. Thus, $B_v = B_r$ for sodium is quite likely for many plants. However, reported values of C_r for sodium are generally less than C_v . Thus, the derived ratio of 0.74 was judged acceptable, yielding a default value of 0.055 for sodium B_r using Eq. (5). This estimate of B_r appears reasonable (Table 2.4).

The default value of B_v for potassium was determined to be 1.0. This value is based on the geometric mean of values determined for two references (16 and 65), the correlation between B_v and C_s for potassium observed from these references (Fig. 2.5), and the assumption that typical agricultural practice includes soil fertilization with potassium.

The (C_r/C_v) ratio based on literature references is quite variable for potassium. Values at or near 1.0 were found for pumpkin¹⁶ and many common vegetables,¹⁷ including root crops.⁷¹ Lower ratios near 0.4 have been observed for grains.^{18,71,84} From Table 2.4, $C_r < C_v$ appears to apply to potassium, and thus the geometric mean of values determined for references 16-18, 71, and 84 was used to generate a value of $B_r = 0.55$. This estimate yields predicted C_r for potassium which agrees well with the observed range (Table 2.4).

One reference was found for rubidium B_v , but both default B_v and B_r values were derived by assuming systematic trends in B_v (Fig. 2.4) and (B_r/B_v) ratio (Fig. 2.6) for Group IA and IIA elements and comparing observed and predicted C_v and C_r . No references were found for francium B_v , B_r , C_v , or C_r ; and therefore, assumed systematic trends in B_v and (B_r/B_v) ratio were used exclusively for default estimates of the concentration factors. The B_v of 0.03 determined here for francium compares well with the value of 0.04 derived from Ng et al.¹⁵ (assuming 25% dry matter).

Strontium is perhaps the best studied of all elements in the periodic table with respect to plant uptake. As for cesium, analysis of the references for B_v indicates that this parameter is lognormally distributed (Fig. 2.7). The range of reference mean values, 0.077 to 17, is larger than the range for cesium, but the number of references is also greater. The geometric mean of the reference means = 2.7, and it was rounded off to 2.5 for use in TERRA. Fifteen references applicable to B_r yielded a value of 0.25. Twenty-five references yielded estimates of (C_r/C_v) , which when multiplied by the default value of B_v also gave a $B_r = 0.25$.

A $B_v = 0.01$ for beryllium was derived from reference 16. That reference also yielded a $B_r = 0.0028$ for pumpkin, but examination of Figs. 2.4 and 2.6 suggest that a value of 0.0015 is more reasonable. Adoption of this value yields a predicted C_r value which is approximately an order of magnitude higher than reported values (Table 2.4). However, as noted by Shacklette et al.,⁵³ toxicity to plants is severe and measurable amounts are rarely observed in plants.

The B_v for magnesium (1.0) was determined from references 16 and 65. The geometric mean of values of (C_r/C_v) ratio for references 16, 18, and 71 was used to derive a $B_r = 0.55$. Predicted and observed C_v and C_r for magnesium agree well (Table 2.4).

Calcium B_v (3.5) was derived from references 16, 65, 71, and 72. Comparison of predicted and observed C_v values using this B_v value (Table 2.4) and comparison among other Group IIA elements for B_v in Fig. 2.4 support the reasonableness of this value. Calculated mean (C_r/C_v) ratios for calcium, strontium, barium, and radium, 0.081, 0.13, 0.18, and 0.095, respectively, suggested the adoption of a value of 0.1 for all Group IIA elements below magnesium. Thus, $B_r = 0.35$ for calcium is used in TERRA. Comparison of predicted and observed C_r values using this B_r (Table 2.4) is good.

Table 2.4. Comparison of observed and predicted concentrations of Group I A and II A elements in produce and plants (ppm, dry wt.)

Element	Average concentration in soil (C_s) ^a	Vegetative growth (C_v)		Fruits and tubers (C_r)	
		Observed range ^b	Predicted ^c	Observed range ^b	Predicted ^d
Group IA					
Li	30	0.15 to 55	0.75	0.010 to 9.8	0.12
Na	6,300	700 to 20,000	470	15 to 3,500	350
K	14,000	1,000 to 77,000 ^{e,f}	14,000	7,800 to 28,000 ^e	7,500
Rb	100	18 to 400	15	1.0 to 50	7.0
Cs	5.0		0.40	2.0×10^{-3} to 0.35	0.15
Fr					
Group IIA					
Be	6.0	0.090	0.060	1.0×10^{-3}	9.0×10^{-3}
Mg	6,300	110 to 14,000 ^{f,g}	6,300	200 to 11,000 ^{f,g}	3,500
Ca	14,000	1,000 to 78,000 ^f	48,000	71 to 6,400 ^{f,g}	4,800
Sr	300	13 to 1,900	750	0.060 to 40	75
Ba	500	28 to 80	75	0.30 to 86	7.5
Ra	8.0×10^{-7}	2.6×10^{-9}	1.2×10^{-8}	1.1×10^{-9}	1.2×10^{-9}

^aReference 52.

^bTaken or calculated from values in reference 53 assuming ash wt./dry wt. = .128 and .057 for vegetative growth and fruits and tubers, respectively

^cThe product, $B_v \times C_s$.

^dThe product, $B_r \times C_s$.

^eReference 13.

^fReference 14.

^gReference 54.

The B_v for barium (0.15) was determined from references 16, 59, and 65. The default B_v value was calculated in a manner similar to that for calcium using Eq. (5). Observed and predicted C_v and C_r agree well (Table 2.4).

Because of its importance radiologically, the concentration factors for radium used in AIRDOS-EPA have been both highly scrutinized and criticized.⁹⁵ Reevaluations of the B_{iv1} and B_{iv2} values listed in Moore et al.¹ have been based on corrections of values reported in the literature¹² and subjective evaluation of the quality of the references.⁹⁵ Unfortunately, available references for calculation of soil-to-plant concentration factors for radium must all be judged subjectively (Table 2.5). However, separation of plants into the two categories in association with B_v and B_r eliminates inconsistencies in the B_{iv1} and B_{iv2} approach and suggests that only one available reference reports questionable results. The earliest reference found for radium soil-plant concentration factors, reported by Kirchmann and Boulenger in 1968,⁸⁷ has not been used in support of B_v and B_r here because their analytical technique is questionable⁹⁵ and yields extremely high values. Furthermore, the experimental technique for determination of radium used by Kirchmann and Boulenger has been questioned.⁹⁵ However, reference 87 does yield a (B_r/B_v) ratio consistent with those for calcium, strontium, and barium. Insufficient criteria have been found for rejection of any of the remaining references.

ORNL-DWG 81-7093R

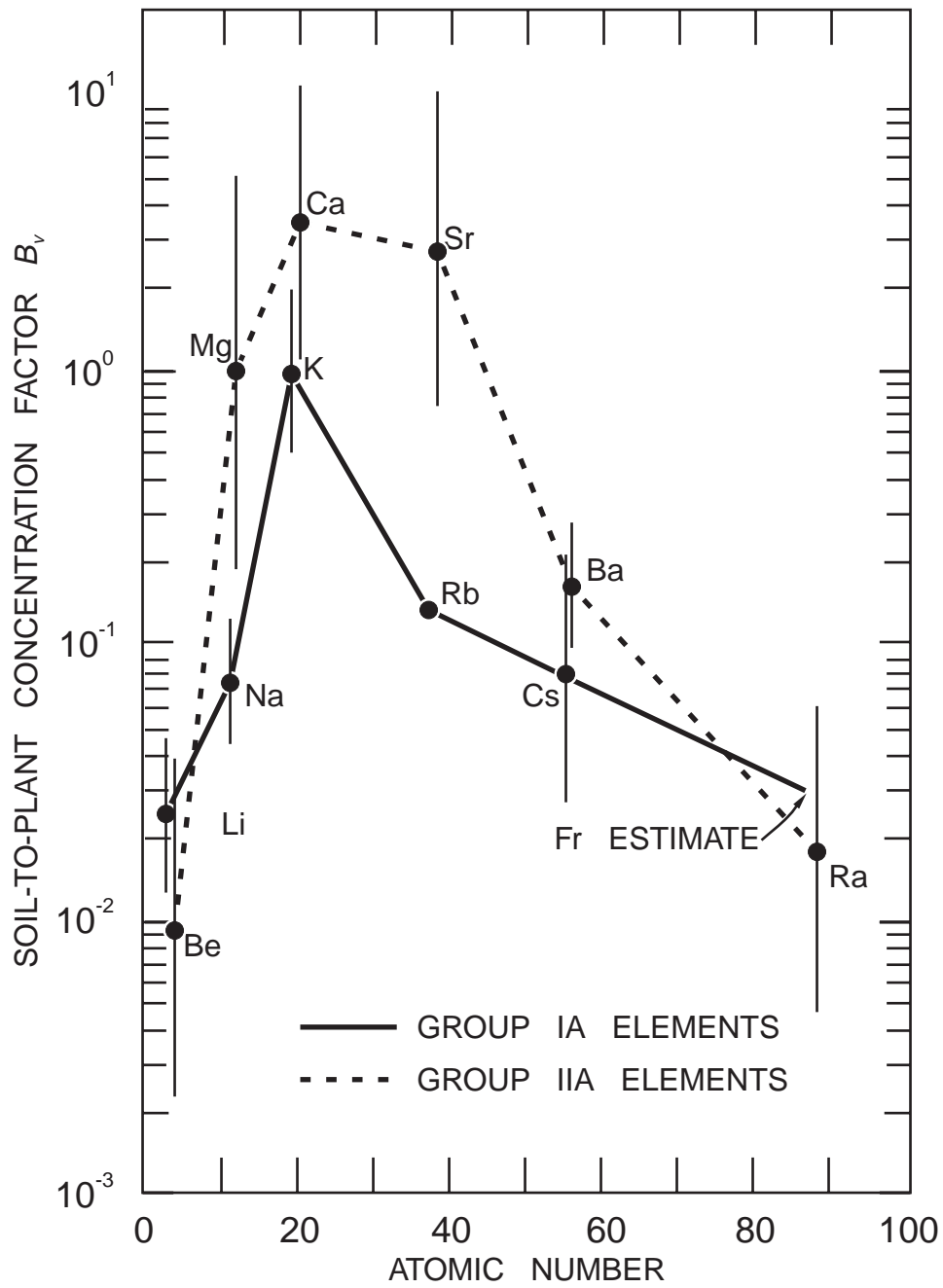

Figure 2.4. Assumed systematic trends in B_v for Group IA and IIA elements. Solid dots and error bars represent geometric means and standard deviations determined from available references.

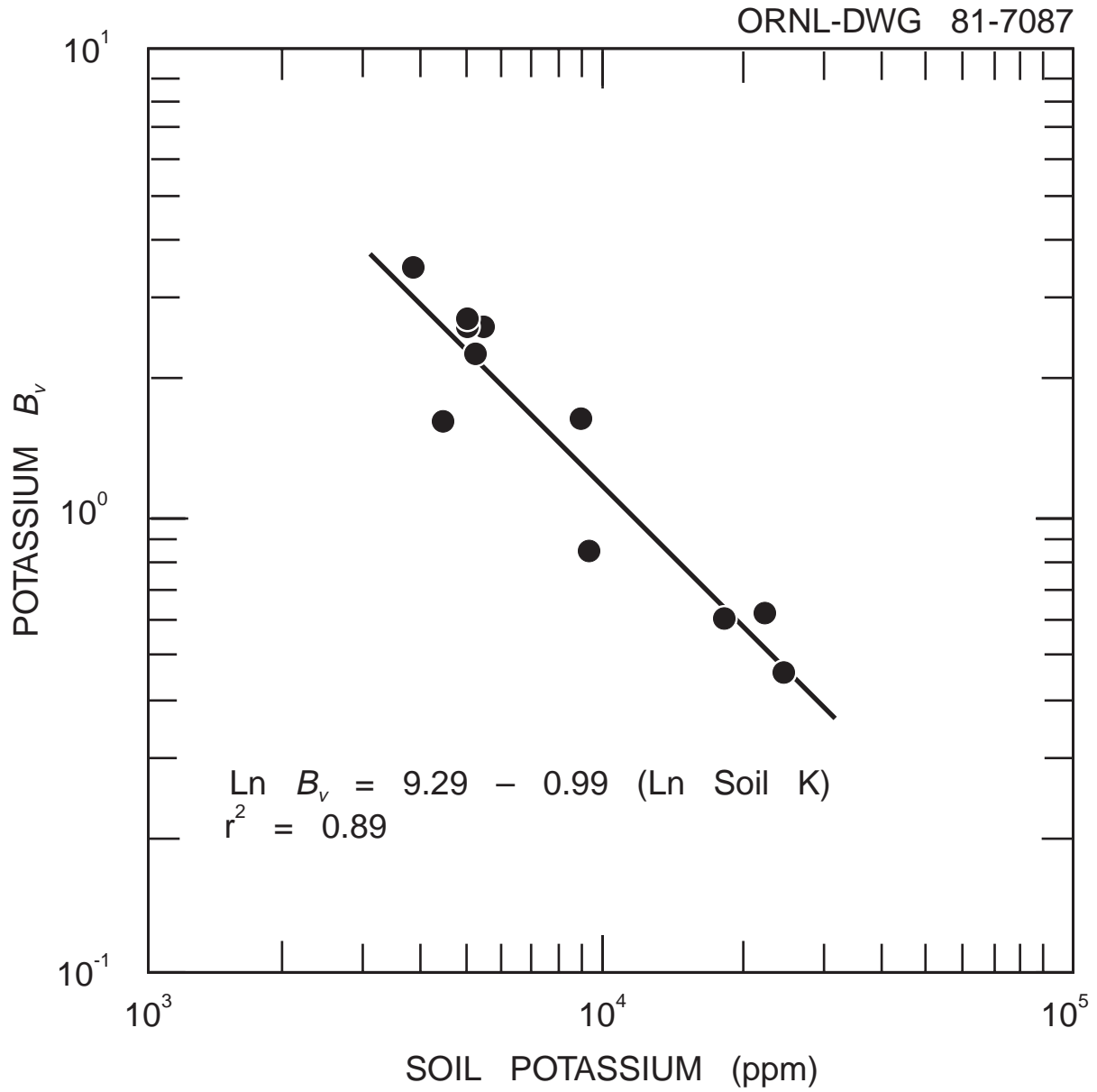

Figure 2.5. Correlation between soil potassium concentration and the soil-to-plant concentration factor, B_v , for potassium based on references 16 and 65.

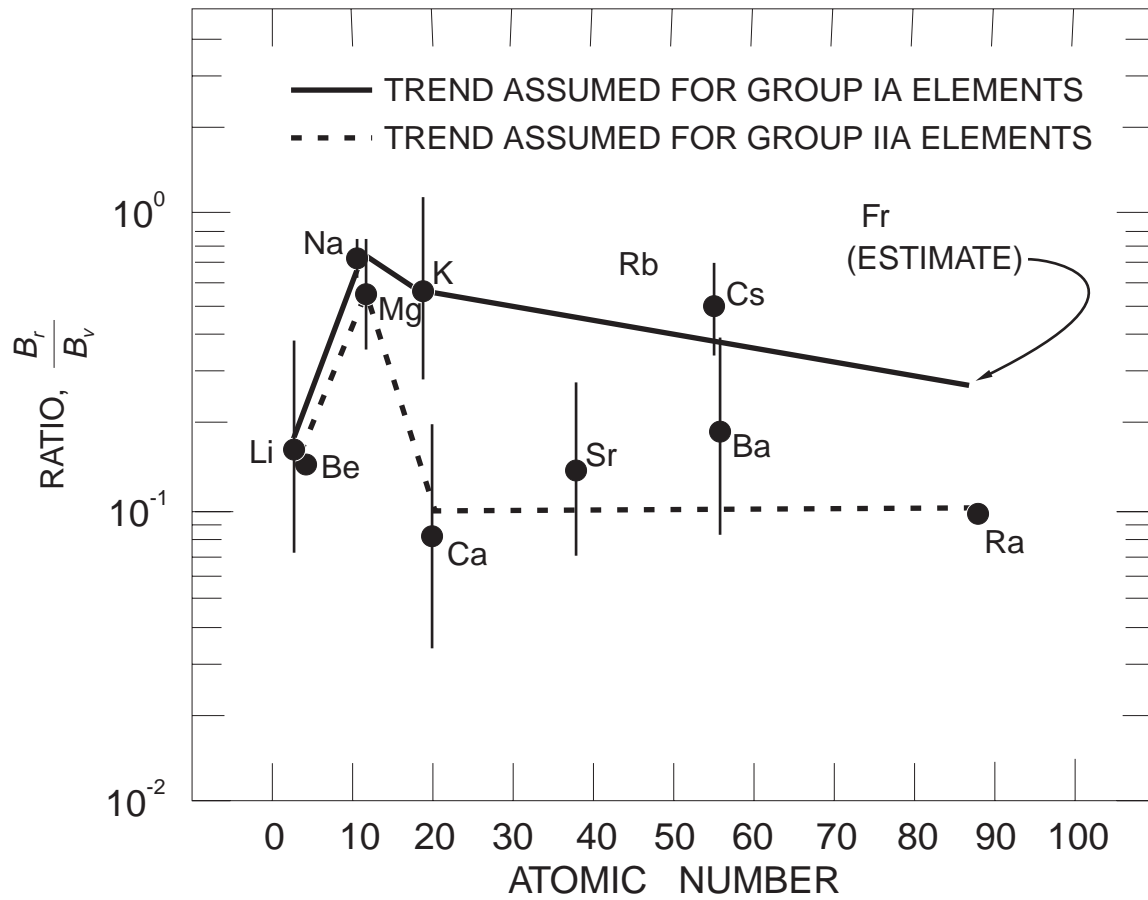

Figure 2.5. Assumed systematic trends in (B_r/B_v) ratio for Group IA and IIA elements. Solid dots and error bars represent geometric means and standard deviations determined from available references.

ORNL-DWG 81-7084

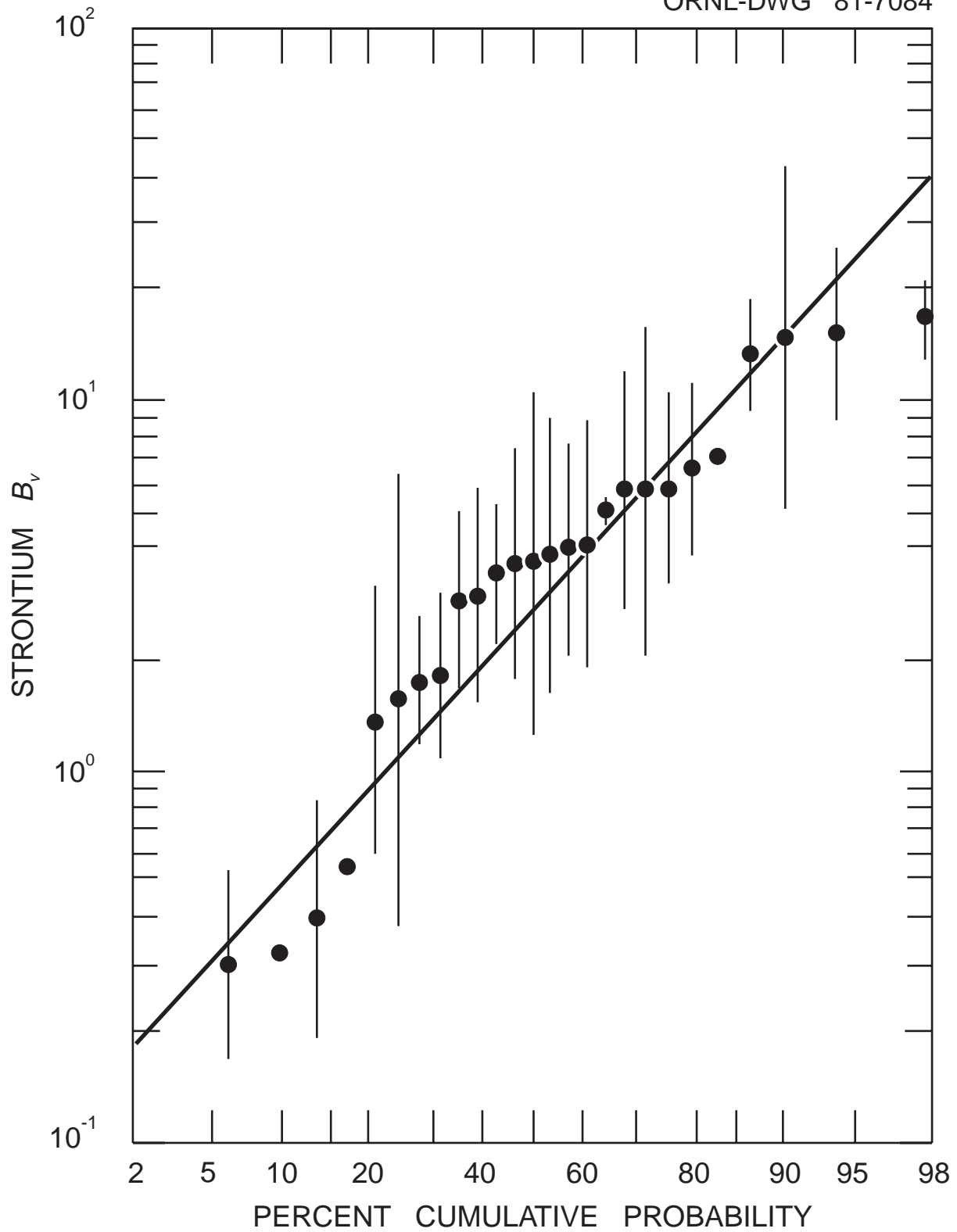

Figure 2.7. Lognormal probability plot of geometric means of B_v for strontium (calculated from references 11, 16, 17, 21, 31, 33, 59, 60, 62-70, 72, 74-76, 78, 81-83, 85, and 86), including one geometric standard deviation of the mean.

Table 2.5. Literature values of B_v , B_r , and the (C_r/C_v) ratio for radium^a

B_v	B_r	(C_r/C_v)	Reference	Comments
0.71	0.10	0.95	87	Ra-226 measurement technique questionable. Estimates of B_v and B_r not used in present analysis.
	5.0×10^{-4}		90	Reported wet weight plant concentrations converted to dry weight using reference 13.
0.045	3.2×10^{-3}		88	Values reported for "herbage and fruit" required assumptions as to exact makeup. Wet weight plant concentrations converted to dry weight using reference 14.
0.060		1.8	93	Vegetation sampled inappropriate to human pathways. Resuspension of soil onto plant surfaces suspected.
0.012			89	Pot geometry and soil bulk density assumed in order to estimate soil radium concentrations. Ash weight plant concentrations converted to dry weight using reference 13.
0.020			91	
2.4×10^{-3}	8.2×10^{-4}		92	"Salad" was assumed to be lettuce. Ash weight plant concentrations converted to dry weight using reference 14.

^aGeometric means of all values reported.

In a review of Ra-226 transport by McDowell-Boyer, Watson, and Travis,⁹⁶ a value of 0.09 was recommended for a radium forage and hay concentration factor. The authors recommended a value of 0.02 for vegetables, fruit, and grain. The dry weight equivalent of this value would be a factor of 4 to 10 higher, depending on the assumed water content of vegetables, fruit, and grains. The value for B_v derived from five references listed in Table 2.5 is 0.017, which is roughly a factor of 5 lower than the value recommended in reference 96. This value has been rounded off to 0.015. The B_r value derived from three references listed in Table 2.5 is 0.0011, which is much lower than the value recommended in reference 96. The (B_r/B_v) ratio obtained from reference 87 and similar ratios found for calcium, strontium, and barium suggest that a $B_r = 0.0015$ is reasonable. These default B_v and B_r values appear to be acceptable based on systematic trends (Figs. 2.4 and 2.6) for Group IIA elements and comparison of observed and predicted C_v and C_r values (Table 2.4).

Much work has been done on the effect of available soil calcium on the uptake of strontium by plants,^{18,21,33,71,78,79,81,82} and this subject has been thoroughly reviewed by Francis;²³³ in general, plant uptake of strontium is inversely proportional to the amount of exchangeable calcium in the soil. The same effect of soil calcium on plant uptake of radium has also been suggested.⁸⁸ Therefore, it is likely that plant uptake of all Group IIA elements will be negatively affected by increasing soil calcium. The exact relationships between calcium and other IIA elements will be affected by plant type, plant part, and soil characteristics; therefore, in the TERRA computer code, soil calcium influence on B_v and B_r for Group IIA elements is not considered. However, a user of the code may wish to select higher B_v and B_r values than the defaults (Figs. 2.1 and 2.2) for Group IIA elements for pasture pathways and lower values for food crop pathways, assuming that in the latter case soils are more intensively prepared and amended (including liming).

2.1.3 Group IIIA, IVA, and VA elements

Groups IIIA, IVA, and VA contain elements which are essential plant nutrients, elements for which some isotopes are important radiologically, and elements for which experimental evidence for B_v and B_r is scanty. By far, the best documented element of these groups for B_v and B_r is lead,^{16,20,27,91,99-105} followed by arsenic,^{16,19,98} boron,^{16,17,65,76} aluminum,^{16,17,19,65} phosphorus,^{16,17,97} indium,⁶⁵ tin,⁶⁵ and antimony.⁶⁵ No references were readily obtainable for nitrogen, silicon, gallium, germanium, thallium, and bismuth. Corollary information was used to estimate transfer parameters for these elements.

The B_v value of 4.0 adopted for boron is based on the relationship between soil boron concentration and boron B_v determined from references 16, 65, and 76 (Fig. 2.8), and an assumed average soil boron concentration of 10 ppm (Table 2.6).⁵² The (B_r/B_v) ratio as determined from references 16 and 17 is approximately 0.5, and a B_r value of 2.0 was adopted. Comparison of observed and predicted boron food concentrations (Table 2.6) indicates that the default B_v and B_r values are reasonable.

The B_r estimate of 0.004 for aluminum is based on references 16 and 65. The (B_r/B_v) ratio of 0.167 determined from reference 17 was used to generate a default value for B_r of 6.5×10^{-4} . This value is a factor of 2.5 greater than the single value of 2.6×10^{-4} found by Baes and Katz,¹⁶ but comparison of observed and predicted aluminum concentrations in produce (Table 2.6) indicates the default B_v and B_r estimates give reasonable predictions which are near the low end of reported ranges.

The B_v for indium was taken from a single value determined from reference 65. Because the default B_v estimate for indium equals the default B_v estimate for aluminum, a gallium B_v of 0.004 was also assumed for this Period IV element. Since no data were available for thallium B_v , its value was set equal to that for aluminum, gallium, and indium. A (B_r/B_v) ratio of 0.1 was assumed for gallium, indium, and thallium, yielding a B_r of 4.0×10^{-4} for these elements. Unfortunately, elemental concentrations of gallium, indium, and thallium in soils and a variety of produce are not well-documented. However, the values assumed here are consistent with the fragmentary information of observed plant concentrations of these elements.

Of the Group IVA elements, lead is the best documented with respect to B_v and B_r . The default B_v value of 0.045 is the geometric mean of values determined for nine references. A (B_r/B_v) ratio of 0.2 based on references 16, 20, 27, 99 and 102 yields a B_r estimate of 0.009. Table 2.6 shows that these B_v and B_r default values yield appropriate estimates of lead concentrations in produce.

No references for the direct measurement of B_v or B_r for silicon were found. Ng et al.¹⁵ provide data from which a dry weight transfer factor of 6.1×10^{-4} can be derived. Menzel,¹⁰⁶ however, reported that the transfer coefficient for soluble forms of silicon ranged between 0.1 and 1.0. Using the 330,000 ppm (33%) value for silicon in soil reported by Vinogradov⁵² and the C_v range reported by Shacklette et al.,⁵³ the Ng et al. value is approximately an order of magnitude too low and the range reported by Menzel is too high. Therefore, for a B_v estimate, the C_v value reported for grasses of 110,000 ppm silicon (plant concentrations for other produce or vegetables were reported in wet or ash weight) was combined with the reported average soil concentration according to Eq. (3) to give a $B_v = 0.35$ for silicon. The (B_r/B_v) ratio for silicon was assumed to be the same as for lead, generating a B_r estimate of 0.07.

Reference 15 yields a dry weight transfer factor of 0.4 for germanium. This value appears to be slightly low when predicted and measured C_v values are compared (Table 2.6). However, in the absence of experimental evidence and because the value agrees well with the default B_v estimate for silicon, it is used for germanium B_v also. The (B_r/B_v) ratio is also assumed to be 0.2 as for lead and silicon, yielding a B_r estimate of 0.08.

The B_v for tin of 0.03 is based on reference 65, and the B_r value of 0.006 is based on an assumed (B_r/B_v) ratio of 0.2. Comparison of observed and predicted C_v and C_r values in Table 2.6 indicates that the default B_v and B_r values are reasonable.

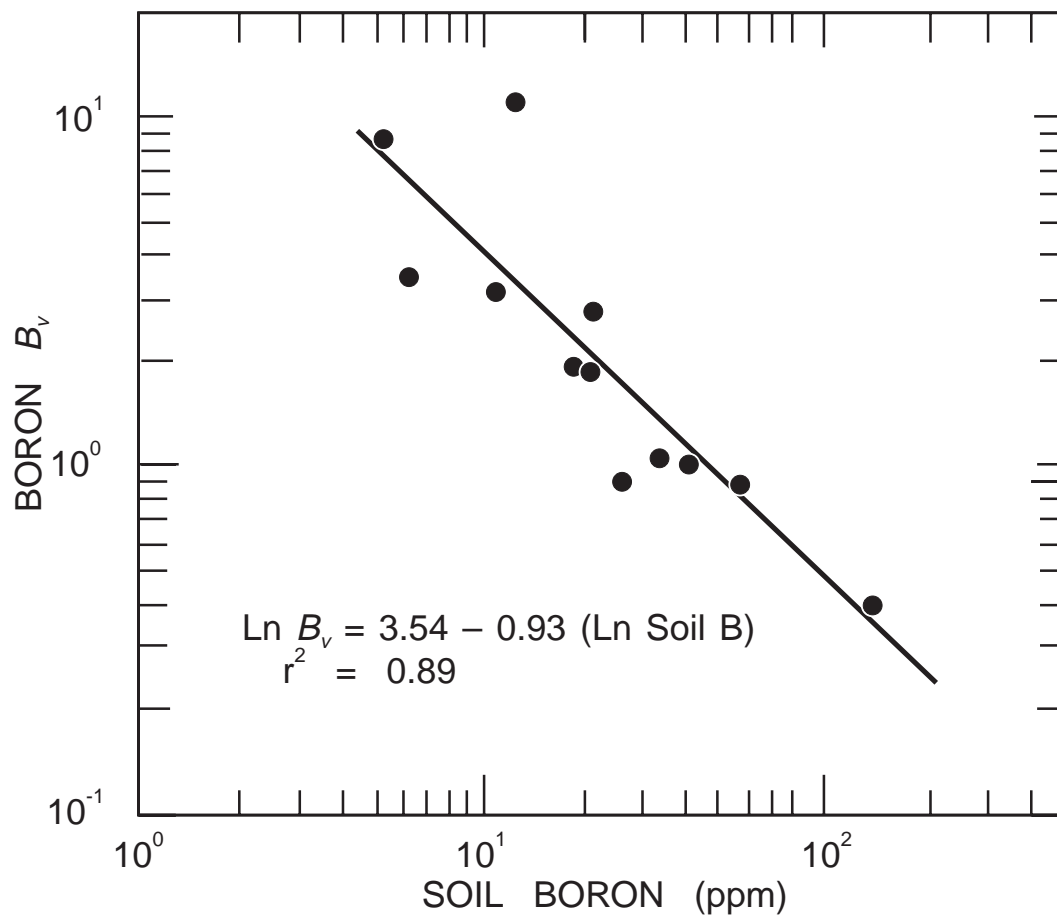

Figure 2.8. Correlation between soil boron concentration and the soil-to-plant concentration factor, B_v , for boron based on references 16, 65, and 76.

Table 2.6. Comparison of observed and predicted concentrations of Group III A, IV A, and V A elements in produce and plants (ppm, dry wt.)

Element	Average concentration in soil (C_s) ^a	Vegetative growth (C_v)		Fruits and tubers (C_r)	
		Observed range ^b	Predicted ^c	Observed range ^b	Predicted ^d
Group III A					
B	10	4.0 to 2,100	40	66 to 520	20
Al	71,000	900	280	11 to 86	46
Ga	30	0.13	0.12		0.012
In					
Tl		0.26 to 0.90			
Group IV A					
Si	330,000	24,000 to 110,000	120,000		23,000
Ge	1.0	0.64 to 13	0.40		0.080
Sn	10	0.13	0.30	0.10 to 1.8	0.060
Pb	10	0.13 to 9.0	0.45	0.015 to 1.0	0.090
Group V A					
N	1,000	16,000 to 43,000 ^e	30,000	4,500 to 29,000 ^{e,f}	30,000
P	800	600 to 9,800 ^e	2,800	630 to 52,000 ^f	2,800
As	5.0	<0.05 to 0.25	0.20	<0.05 to 3.9	0.030
Sb	0.10	<0.056 ^g	0.020	1.3×10^{-4} to 0.039 ^g	3.0×10^{-3}
Bi	1.0	0.15	0.035	0.068	5.0×10^{-3}

^aReference 52.

^bTaken or calculated from values in reference 53 assuming ash wt./dry wt. = .128 and .057 for vegetative growth and fruits and tubers, respectively

^cThe product, $B_v \times C_s$.

^dThe product, $B_r \times C_s$.

^eReference 14.

^fReference 13.

^gReference 54.

No references for experimental determination of B_v for the essential plant nutrient nitrogen were readily available. The review reference 15 yields a default value of 30, which gives a predicted C_v in the midrange of reported values (Table 2.6). Thus, this value was adopted for use in TERRA. Comparison of observed C_v and C_r ranges indicates that nitrogen uptake in vegetative and reproductive plant parts is approximately the same. In the absence of evidence to the contrary, $B_v = B_r$ was assumed.

The B_v for phosphorus is based on the relationship between soil phosphorus concentration and B_v found from data in reference 16 (Fig. 2.9), assuming an average soil concentration of phosphorus of 800 ppm.⁵² Three references yield estimates of (B_r/B_v) ratio. Two references (16 and 97) yield estimates greater than 1.0. Reference 17 yields a value of 0.78, but one standard deviation of the mean includes 1.0. Thus as for nitrogen, $B_v = B_r$ was adopted. Comparison of observed and predicted C_v and C_r indicates that default values of B_v and B_r for phosphorus are reasonable.

The B_v for arsenic of 0.04 was determined from references 16 and 98. References 16 and 19 both indicate that, unlike the lighter members of Group VA elements, the accumulation of arsenic in nonvegetative plant parts is less than for vegetative parts. A (B_r/B_v) ratio for arsenic of 0.15 was used to calculate a default $B_r = 0.006$. Comparison of observed and predicted C_v and C_r values (Table 2.6) shows that the default B_v predicts C_v values near the high end of the observed range and the B_r predicts C_r values near the low end of the observed range.

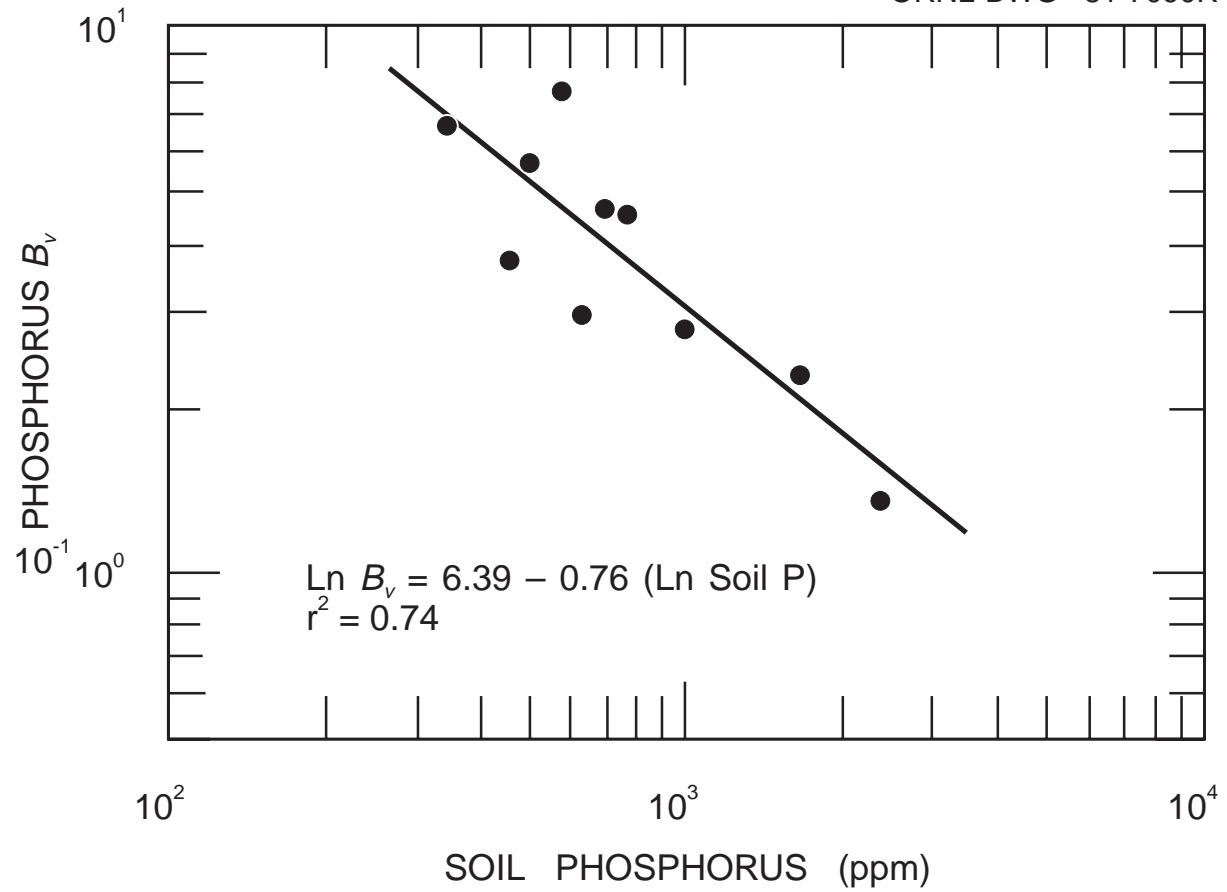

Figure 2.9. Correlation between soil phosphorus concentration and the soil-to-plant concentration factor, B_v , for phosphorus based on reference 16.

The B_v for antimony was taken from reference 65. The (B_r/B_v) ratio for arsenic was also used for antimony. Comparisons of observed and predicted C_v and C_r for arsenic (Table 2.6) are reasonably good.

The B_v for bismuth was determined from the B_v estimates for lead and polonium (discussed in Sec. 2.1.4). The B_r estimate was generated from the default B_v of 0.035 and the (B_r/B_v) ratio used for arsenic and antimony. Comparison of observed and predicted C_v and C_r , although not definitive, are relatively good (Table 2.6).

2.1.4 Group VIA and VIIA elements

The Group VIA and VIIA elements include the relatively mobile anions and the radiologically important elements polonium and iodine. Of these elements the best documented are iodine,^{25,59,65,107,234,235} selenium,^{19,65,76} and polonium.^{28,91} Single references were available for fluorine,¹⁰⁸ chlorine,⁶⁵ and bromine,⁶⁵ and no references were readily available for sulfur, tellurium, and astatine.

No references on direct determination of soil-to-plant transfer coefficients for sulfur were readily available. However, assuming an average sulfur concentration of 1400 ppm in vegetative portions of plants¹⁴ and 850 ppm in soil,⁵² a B_v of 1.5 results. Comparison of observed C_v and C_r for sulfur indicate that $B_v = B_r$ for this element (Table 2.7).

The default B_v value for selenium of 0.025 was determined via several approaches. The value obtained from references 65 and 76 (0.032) was compared with values given by Ng et al.¹⁵ and Menzel.¹⁰⁶ The latter two estimates were several orders of magnitude higher than the value obtained from references 65 and 76. Although B_v for plant-fly ash relationships^{19,65,76} is comparable to B_v estimates given by Ng et al.¹⁵ and Menzel,¹⁰⁶ their estimates, when combined with an average selenium soil concentration of 1 ppm, tend to over-predict observed C_v values (Table 2.7). Therefore, as a model for selenium the As/P and Br/Cl B_v ratios were used as analogs for the Se/S B_v ratio. If such ratios are assumed to change systematically, then the Se/S ratio may be assumed to be 0.016. This value, multiplied by the B_v for sulfur, yields a default selenium B_v estimate of 0.025. Comparison of observed and predicted selenium C_v using this default value (Table 2.7) suggests that the default value is reasonable. Although the (B_r/B_v) ratio for selenium taken from reference 19 is less than 1.0, comparison of observed C_v and C_r ranges suggest that $B_v = B_r$ for selenium also.

The B_v for polonium based on references 28 and 91 is 2.5×10^{-3} . The (B_r/B_v) ratio taken from reference 28 is 0.15. This ratio generates a default B_r value of 4.0×10^{-4} . Unfortunately, no references for comparison of observed C_v and C_r were immediately available for comparison with predicted values.

No references were found for tellurium. The default B_v values determined for selenium and polonium suggest that a reasonable assumption for tellurium B_v is also a value of 0.025. Correspondingly, the (B_r/B_v) ratio of 0.15 for polonium was used to predict a B_r for tellurium of 0.004. As for polonium, no observed C_v and C_r values were available. Furthermore, no average tellurium soil concentrations were available either.

The B_v for fluorine is based on reference 108. The value of 0.06 generates a predicted C_v value which falls within the range of observed values (Table 2.7). Comparison of observed C_v and C_r ranges suggest a discrimination factor of approximately an order of magnitude. Thus, a (B_r/B_v) ratio of 0.1 was assumed and $B_r = 0.006$.

The B_v and B_r for chlorine were determined through comparison of observed C_v and C_r and average C_s for chlorine (Table 2.7). Both the resulting B_v and $B_r = 70$, the highest concentration factors for any element reviewed here. Reference 65 yielded a B_v of 2.1 and a value of 20 was obtained from reference 15, but the C_v predicted with these factors are well below the reported range. Thus the more indirect method was deemed more appropriate for chlorine.

**Table 2.7. Comparison of observed and predicted concentrations of Group VI A
VII A elements in produce and plants (ppm, dry wt.)**

Element	Average concentration in soil (C_s) ^a	Vegetative growth (C_v)		Fruits and tubers (C_r)	
		Observed range ^b	Predicted ^c	Observed range ^b	Predicted ^d
Group VI A					
S	850	100 to 17,000 ^e	1,300	200 to 450 ^e	1,300
Se	1.0 ^f	<0.01 to 0.35	0.025	<0.01 to 0.50	0.025
Te					
Po	1.0×10^{-11}		2.5×10^{-14}		4.0×10^{-15}
Group VII A					
F	200	1.3 to 28	12	0.020 to 8.4	1.2
Cl	100	2,000 to 23,000	7,000	300 to 8,500	7,000
Br	5.0	0.31 to 4.9	7.5	0.20 to 260	7.5
I	5.0	4.3 to 10	0.75	2.8 to 10	0.25
At					

^aReference 52.

^bTaken or calculated from values in reference 53 assuming ash wt./dry wt. = .128 and .057 for vegetative growth and fruits and tubers, respectively

^cThe product, $B_v \times C_s$.

^dThe product, $B_r \times C_s$.

^eReference 14.

^fBased on values given in references 65 and 76.

The B_v for bromine is based on reference 65. Although the corresponding predicted C_v is slightly high with respect to the observed C_v range, comparison of observed C_v and C_r ranges suggest that the reported C_v range may be low (the upper end of the C_r range is higher than that for the C_v range and a discrimination factor of greater than 1.0 for C_r appears unlikely). In lieu of contrary information, a (B_r / B_v) ratio of 1.0 was assumed for bromine, and thus $B_v = B_r$ was assumed.

The B_v for iodine (0.15) is the geometric mean of values determined for references 25, 59, 65, 107, 234, and 235. References 59 and 107 indicate that B_v for iodine ranges between 1.0 to 2.0. However, references 65, 234, and 235 indicate a much lower B_v for iodine (0.04 to 0.10). Menzel¹⁰⁶ reports that the concentration factor for bromine is greater than that for iodine, and examination of Table 2.7 shows that the adopted B_v for iodine does not predict a C_v value greater than observed. Thus, the default value adopted in the TERRA code seems reasonable.

The B_v value of 0.050, adopted as a default in TERRA, is based on a compromise between the value of 0.02 derived from reference 234 and the product of the B_r/B_v ratio (0.5) derived from references 25 and 234 and the default B_v of 0.15. Examination of Table 2.7 shows that the default B_r value does not over-predict observed C_r values reported in the literature.

No references were found for astatine. A value of 1.0 for B_v is derived from Ng et al.,¹⁵ and this value is adopted as a default value for TERRA. Using polonium as an analog, the assumed (B_r/B_v) ratio is 0.15, producing a $B_r = 0.15$.

2.1.5 Group IIIB and the rare earth elements

The Group IIIB and the rare earth or lanthanide series elements are generally not important for plant nutrition, nor do they accumulate to any large extent in plants. Radiologically, isotopes of cerium are important. In our analysis, we found yttrium^{16,22,59,60,67} and cerium^{22,59,60,65} to be the best documented of these elements, followed by scandium,⁶⁵ lanthanum,⁶⁵ promethium,^{22,59} samarium,⁶⁵ and ytterbium.⁶⁵ No references were obtained for praseodymium, neodymium, europium, gadolinium, terbium, dysprosium, holmium, erbium, and thulium. However, because of the similarity of chemical behavior of all the lanthanides,^{110,111} soil-to-plant concentration factors for these undocumented elements are based on our analysis of cerium. The B_v for yttrium of 0.015 was derived from references 16, 22, 59, 60, and 67. A (C_r/C_v) ratio of 0.29 was determined from references 16, 22, and 60 and compared with a (B_r/B_v) ratio of 0.46 which was based on a B_r derived from these same references. A (B_r/B_v) ratio midway between these two estimates (0.36) was used to derive a default $B_r = 0.006$. Comparison of observed and predicted C_v and C_r for yttrium (Table 2.8) indicate that the default B_v and B_r values are perhaps slightly low, but not unreasonable.

The B_v for scandium of 0.006 is based on the observation by Baes and Mesmer¹¹⁰ that the chemistry of scandium is between that for aluminum (Sect. 2.1.3) and that for yttrium, but surprisingly more like that for aluminum. A value of 0.0078 was taken from reference 65, and data from Ng et al.¹⁵ yields a value of 0.0043. The mean of these two values corresponds well with the value of 0.006 determined through systematic interpretation of Baes and Mesmer's observation (Fig. 2.10). The (B_r/B_v) ratio was determined in a similar manner to B_v assuming a systematic variation in this parameter. The ratio value of 0.2 was used to calculate a default $B_r = 0.001$. Comparison of observed and predicted scandium food concentrations (Table 2.8) are difficult because of the uncertainty in the observed range values. However, if the observed C_r range reported is reasonable, then both predicted C_r and C_v values are not unreasonable.

The B_v for cerium of 0.01 was derived from references 22, 59, 60, and 65. Because of the similarity in the lanthanide elements, the B_v values from references 22, 59, and 65 for other members of the series were pooled with and without those for cerium to estimate B_v for all of the lanthanides. Both sets of pooled references yielded a $B_v = 0.01$. Thus, this value was adopted for elements 57 through 71. Pooling of references for (B_r/B_v) ratio^{22,60} yielded a value of 0.4. This value was also used for elements 57 through 71.

Comparisons of observed and predicted lanthanide concentrations in produce and plants is difficult because of the paucity of good experimental information. However, examination of Table 2.8 shows that for elements in which comparisons can be made, our soil-to-plant transfer coefficients tend to slightly underpredict reported food concentrations. Although some underpredictions are by more than an order of magnitude, the uncertainty involved in a typical soil concentration or the applicability of a few measurements to the true range of food concentrations does not warrant revision of the estimates.

Table 2.8. Comparison of observed and predicted concentrations of Group IIIB and the rare earth elements in produce and plants (ppm, dry wt.)

Element	Average concentration in soil (C_s) ^a	Vegetative growth (C_v)		Fruits and tubers (C_r)	
		Observed range ^b	Predicted ^c	Observed range ^b	Predicted ^d
Sc	7.0	1.0×10^{-4e}	0.042	5.0×10^{-5} to $0.10^{b,e}$	7.0×10^{-3}
Y	50	2.7 to 9.1	0.75	0.40 to 4.5	0.30
La	40	<0.074	0.40	0.052 to 0.31^e	0.16
Ce	50	0.084	0.50	0.033 to $0.10^{b,e}$	0.20
Pr	4.5		0.045		0.18
Nd	18		0.18	0.080	0.072
Pm				0.080	
Sm	4.9		0.049	0.080	0.020
Eu	0.39	$<5.3 \times 10^{-3e}$	3.9×10^{-3}	0.080	1.6×10^{-3}
Gd	5.5		0.055	0.080	0.022
Tb	0.85		8.5×10^{-3}	0.080	3.4×10^{-3}
Dy	6.0		0.060	0.080	0.024
Ho	0.95		9.5×10^{-3}	0.080	3.8×10^{-3}
Er	4.5		0.045	0.080	0.018
Tm	0.45		4.5×10^{-3}	0.080	1.8×10^{-3}
Yb	4.6	0.53 to 3.2	0.046	0.080 to 13	0.018
Lu	1.2		0.012	0.080	4.8×10^{-3}

^aSc-Ce from reference 52; Pr-Lu estimated from ranges reported by Gibson et al.¹¹¹

^bTaken or calculated from values in reference 53 assuming ash wt./dry wt. = .128 and .057 for vegetative growth and fruits and tubers, respectively

^cThe product, $B_v \times C_s$.

^dThe product, $B_r \times C_s$.

^eReference 54.

2.1.6 Period IV transition elements

Elements of atomic number 22 through 30 (titanium through zinc) are perhaps the best documented for plant uptake from soil. Several of these elements, including manganese, iron, and zinc are generally accepted as essential plant micronutrients.⁵³ Others, including chromium and cobalt, are recognized as essential for animal nutrition and are suspected as plant nutrients, although their essentiality has not been established. Stable isotopes of these elements have been extensively studied because most are toxic to plants and animals at sufficient concentrations, although radiologically they are relatively unimportant. As the following discussion will show, the concept of a single equilibrium concentration factor for many of these elements can be questioned. For those elements which are essential to plant nutrition, and thus are likely to be regulated by the plant, correlations between soil concentrations and B_v have been established in a manner similar to those for potassium, phosphorus, and nitrogen.

Available references for B_v , B_r , and (B_r/B_v) ratio numbered 16 for zinc;^{16,17,19,20,35,37,65,67,97,104,114-119} nine for manganese;^{16,17,19,36,37,65,104,112,113} eight for copper;^{16,17,19,20,65,104,114,115} five for nickel,^{16,20,102,104,114} iron,^{16,17,19,65,104} and cobalt;^{16,17,19,65,104} four for chromium;^{16,19,65,102} three for titanium;^{16,19,65} and two for vanadium.^{16,65} Correlations between soil concentrations and B_v were found for all but vanadium, titanium, and nickel. These correlations were often used in lieu of the geometric means approach to define default B_v values.

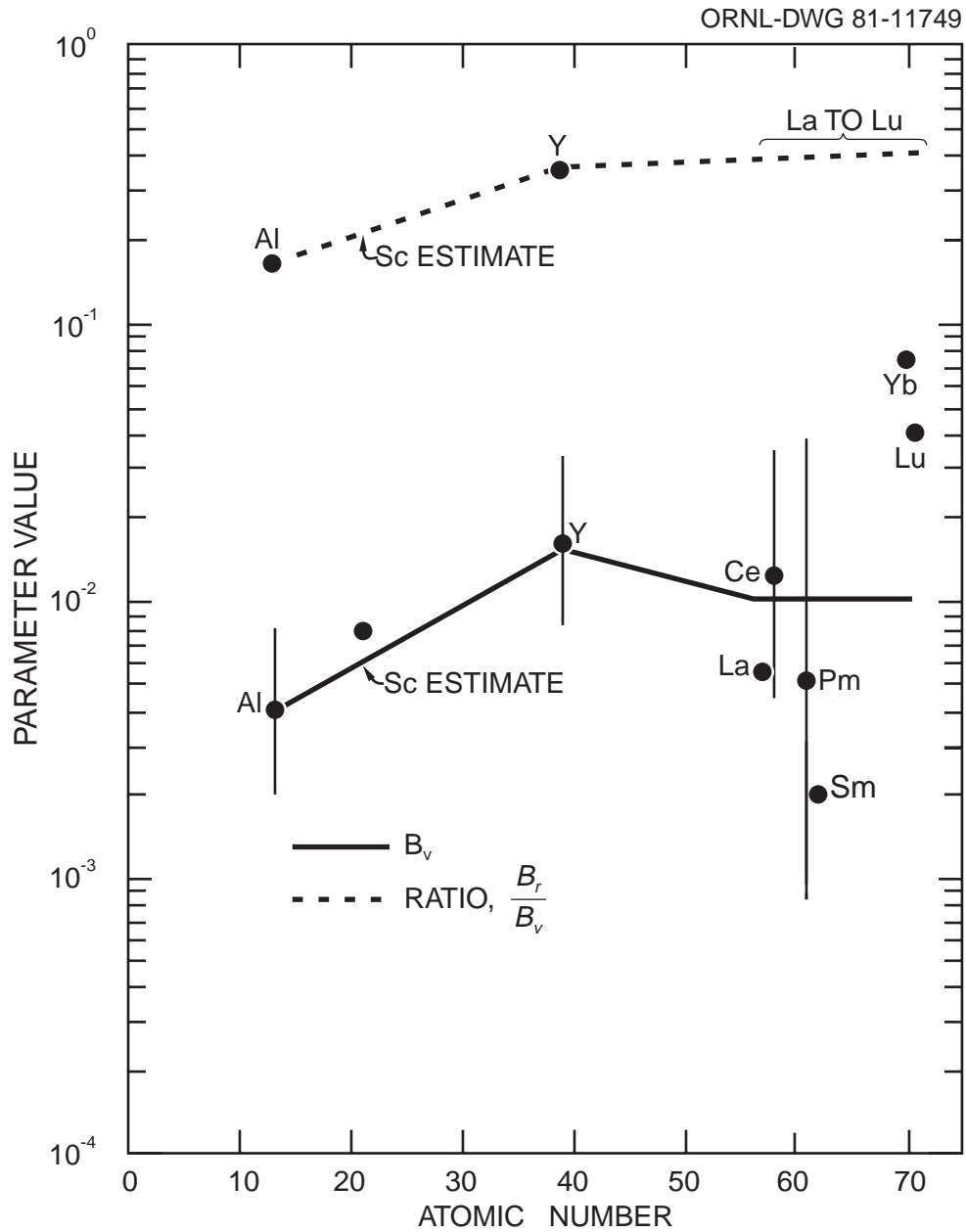

Figure 2.10. Assumed systematic trends in B_v and (B_r/B_v) ratio for aluminum, scandium, and yttrium. Solid dots and error bars represent geometric means and standard deviations of the mean determined from available references.

As before, predicted plant concentrations were compared with observed values in order to assure reasonable B_v and B_r estimates. These approaches were used in lieu of elemental systematics because subsequent analyses (see Sec. 2.1.7 and 2.1.8) depended heavily on the values obtained for these Period IV elements.

The B_v for titanium of 0.0055 is the geometric mean derived from references 16 and 65. The B_r value was generated from a (B_r/B_v) ratio derived from reference 19. Both soil-to-plant concentration factors predict plant concentrations from typical soil titanium concentrations which agree well with observed plant concentrations (Table 2.9).

The B_v for vanadium was also derived from references 16 and 65, and it is numerically equal to the B_v for titanium. No information was available on the (B_r/B_v) ratio for vanadium, and therefore, it was assumed equal to that for titanium, yielding a $B_r = 0.003$. Comparison of observed and predicted C_v and C_r for vanadium (Table 2.9) is also good.

References 16 and 65 yield a B_v by the geometric means method of 0.03 for chromium. However, a correlation between soil chromium concentration and chromium B_v was observed from the data in these two references (Fig. 2.11). Although this correlation is weak, the B_v determined by geometric means predicts C_v for chromium greater than the observed range. Therefore, the relationship in Fig. 2.11 was used to predict a chromium B_v of 0.0075 at a soil chromium concentration of 200 ppm.⁵² This value of B_v does predict a reasonable C_v , (Table 2.9).

A (B_r/B_v) ratio of 0.6 for chromium was determined from references 16, 19, and 102. This value generates a $B_r = 0.0045$, which predicts a C_r within the reported range of observed C_r values (Table 2.9).

The B_v for manganese generated by the geometric means method is 0.41. However, from data in references 16, 36, 37, 104, 112, and 113 a strong correlation between B_v and soil manganese concentration was observed (Fig. 2.12). At a typical soil manganese concentration of 850 ppm,⁵² the corresponding $B_v = 0.25$. This latter value was adopted for TERRA. Although this latter B_v value for manganese overpredicts C_v with respect to the reported observed range, the former value overpredicts C_v by an even larger factor.

The (B_r/B_v) ratio for manganese of 0.2 was determined from references 16, 17, and 19. This ratio generates a $B_r = 0.05$. Comparison of observed and predicted C_r using this B_r value (Table 2.9) indicates that the default B_r is reasonable.

Iron is an essential plant nutrient, and therefore, root uptake is probably regulated by the plant. It is not surprising that the relationship between soil iron concentration and B_v shown in Fig. 2.13 was found. At a typical soil iron concentration of 3.8%,⁵² the corresponding $B_v = 0.004$. The (B_r/B_v) ratio based on references 16, 17, and 19 = 0.25, yielding a B_r of 0.001. Comparison of observed and predicted C_v and C_r (Table 2.9) for iron indicates the reasonableness of the default B_v , and B_r .

The B_v for cobalt of 0.02 is based on the weak correlation between soil cobalt concentration and B_v (Fig. 2.14) and a typical soil cobalt concentration of 8 ppm.⁵² A (B_r/B_v) ratio of 0.35 was derived from references 16, 17, and 19. This ratio generates a $B_r = 0.007$. Predicted C_v and C_r using these default concentration factors for cobalt agree well with observed C_v and C_r ranges (Table 2.9).

The B_v for nickel is based on references 16 and 104. Unlike chromium, manganese, iron, and cobalt, no clear relationship between soil nickel concentration and B_v was indicated from the available data. Also, unlike the other Period IV transition elements no discrimination factor between vegetative and nonvegetative plant parts was found. In fact, the geometric mean of references 16, 20, 102, and 114 for (B_r/B_v) ratio was 1.2. Therefore, a (B_r/B_v) ratio of 1.0 was assumed and $B_v = B_r$ for nickel. Examination of Table 2.9 indicates that the observed C_r range includes the C_v range, supporting this assumption. Predicted C_v and C_r values agree well with reported observed ranges.

The B_v for copper is based on the strong correlation between soil copper concentration and B_v shown in Fig. 2.15 and an average soil copper concentration of 20 ppm.⁵² The (B_r/B_v) ratio, as

Table 2.9. Comparison of observed and predicted concentrations of Group IV transition elements in produce and plants (ppm, dry wt.)

Element	Average concentration in soil (C_s) ^a	Vegetative growth (C_v)		Fruits and tubers (C_r)	
		Observed range ^b	Predicted ^c	Observed range ^b	Predicted ^d
Ti	4,600	1.6 to 160	25	0.087 to 80	14
V	100	<0.091 to 21	0.55	4.60×10^{-4} to 47	0.30
Cr	200	0.18 to 2.9	1.5	0.030 to 8.0	0.90
Mn	850	1.9 to 16	210	8.0 to 80	43
Fe	38,000	6.5 to 410 ^e	150	10 to 160 ^e	38
Co	8.0	0.010 to 0.54	0.16	6.0×10^{-3} to 0.36	0.056
Ni	40	0.23 to 5.2 ^{b,f}	2.4	0.028 to 10	2.4
Cu	20	1.7 to 11	8.0	0.80 to 27	5.0
Zn	50	2.5 to 630	75	0.50 to 110	45

^aReference 52.

^bTaken or calculated from values in reference 53 assuming ash wt./dry wt. = .128 and .057 for vegetative growth and fruits and tubers, respectively

^cThe product, $B_v \times C_s$.

^dThe product, $B_r \times C_s$.

^eReference 14.

^fReference 54.

determined from references 16, 17, 19, 20, and 114, equals 0.63. This ratio yields a $B_r = 0.25$. Both soil-to-plant concentration factors yield reasonable predicted plant copper concentrations (Table 2.9).

The B_v for zinc was determined from the strong correlation between soil zinc concentration and B_v determined from references 16, 35, 37, 67, 97, 104, 114, 115, 117, and 119 (Fig. 2.16) and an average zinc soil concentration of 50 ppm.⁵² The (B_r/B_v) ratio of 0.6 was determined from references 16, 17, 19, 20, 67, 97, 114, and 116. Combining this ratio with the default B_v value generates a $B_r = 0.9$. Examination of Table 2.9 shows that predicted plant concentrations using these default concentration factors fall well within observed ranges.

Figures 2.17 and 2.18 show the default B_v and (B_r/B_v) ratios, respectively, for Period IV transition elements used in the TERRA computer code. The solid lines in the figures show the systematic trends in these parameters defined by the default estimates. The dots represent the parameter values as determined from the geometric means method. The error bars represent one geometric standard deviation. With the exception of chromium, all B_v default values fall within one standard deviation of the mean. For all elements except nickel, the (B_r/B_v) ratio is the geometric mean of the reference values.

2.1.7 Period V transition elements

The Period V transition elements contain the controversial and radiologically important element technetium and the toxic metal cadmium. Additionally, this period includes the element ruthenium which is also important radiologically. For concentration factors, cadmium,^{16,17,19,20,24,65,97,102,104,105,114,116,124-126} molybdenum,^{16,17,19,65,76,120,121} technetium^{23,107,122,123,127} and are the best documented, followed by ruthenium^{22,59,60,63} and zirconium.¹⁶ No references were found for niobium, rhodium, palladium, and silver.

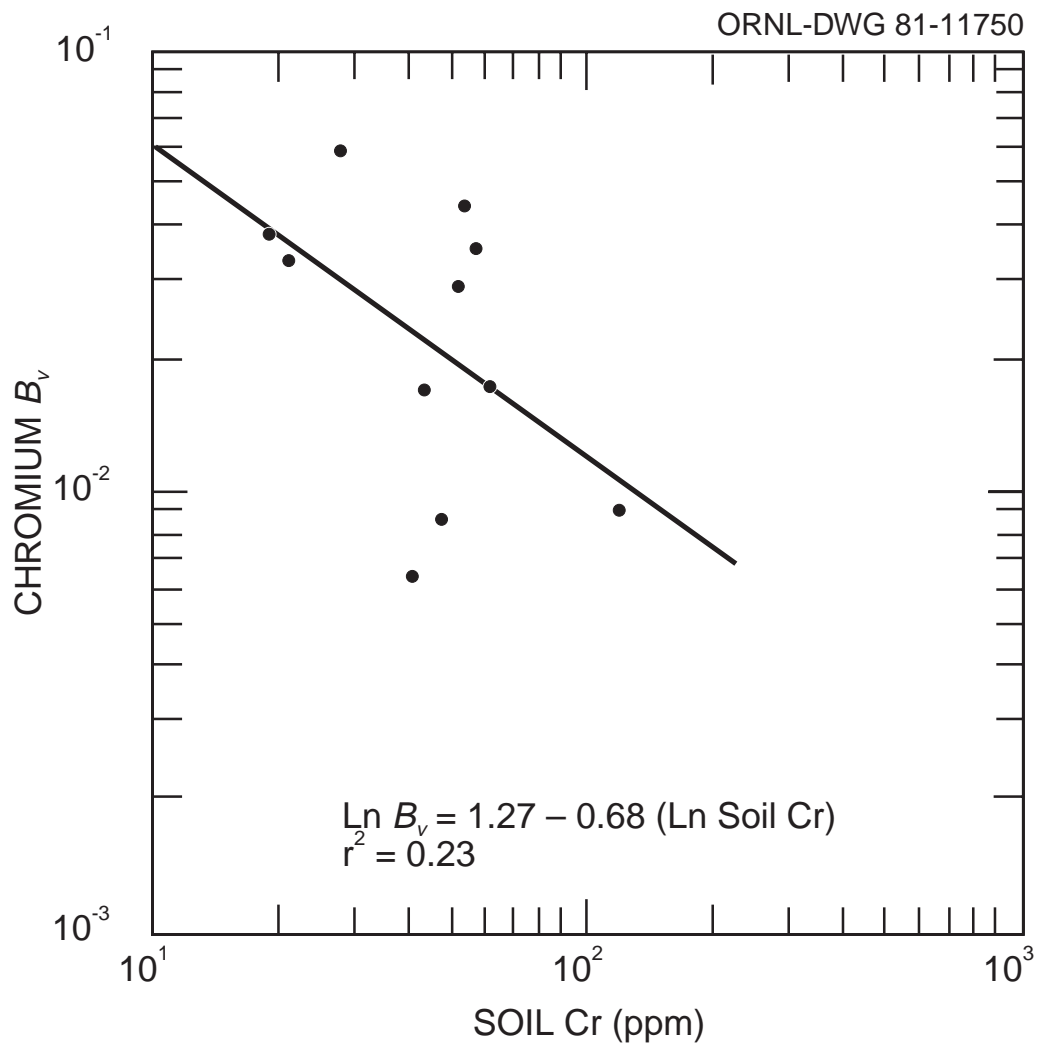

Figure 2.11. Correlation between soil chromium concentration and the soil-to-plant concentration factor, B_v , for chromium based on references 16 and 65.

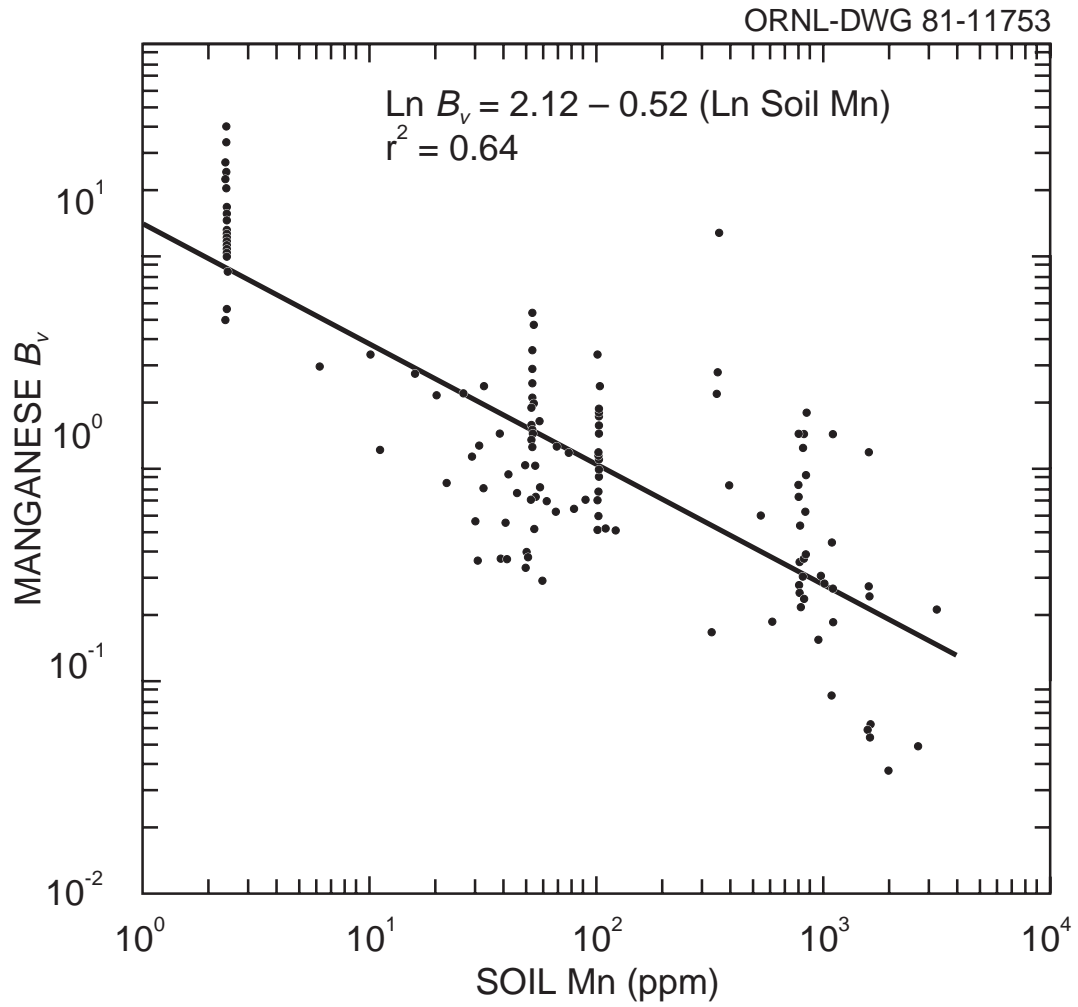

Figure 2.12. Correlation between soil manganese concentration and the soil-to-plant concentration factor, B_v , for manganese based on references 16, 36, 37, 104, 112, and 113.

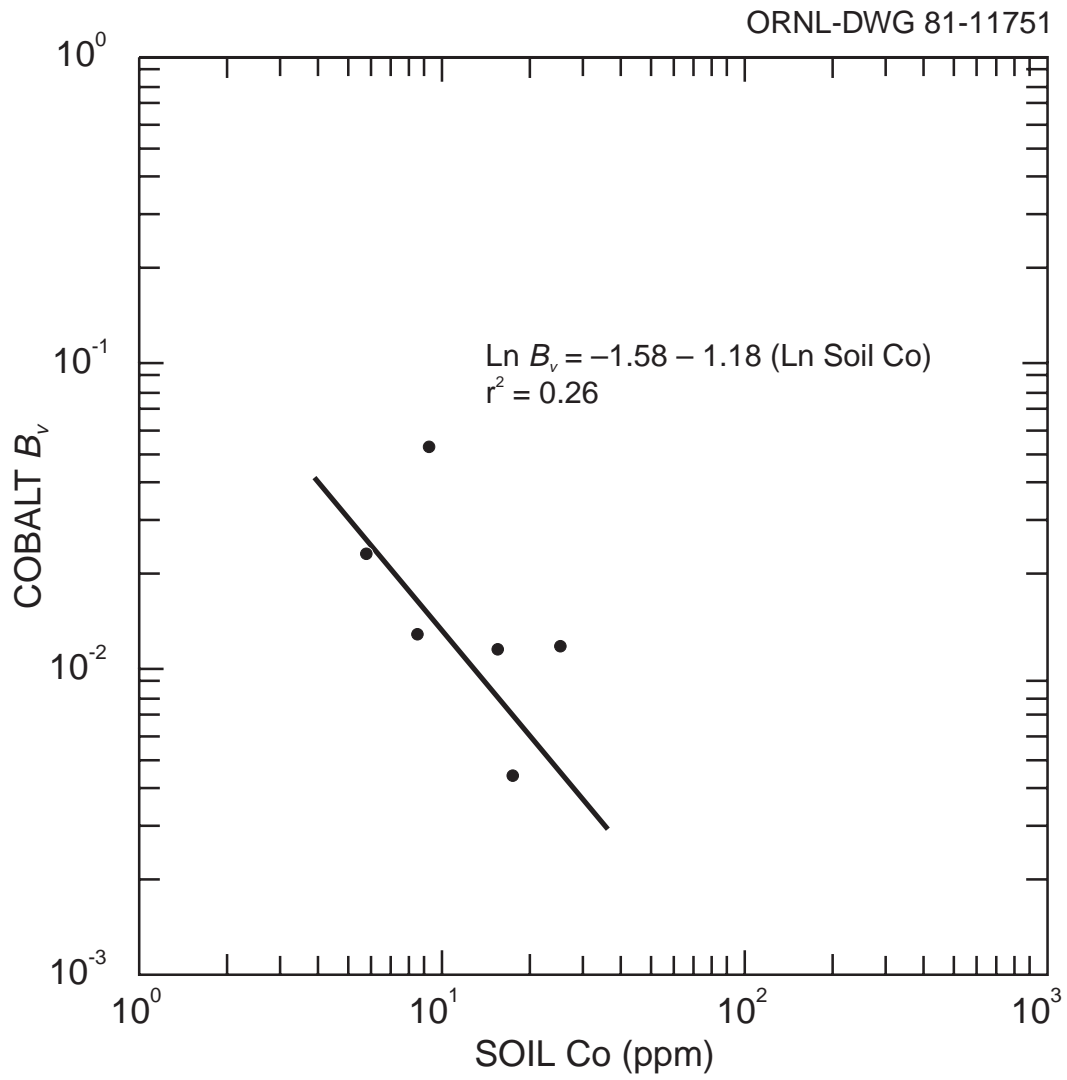

Figure 2.14. Correlation between soil cobalt concentration and the soil-to-plant concentration factor, B_v , for cobalt based on references 16 and 65.

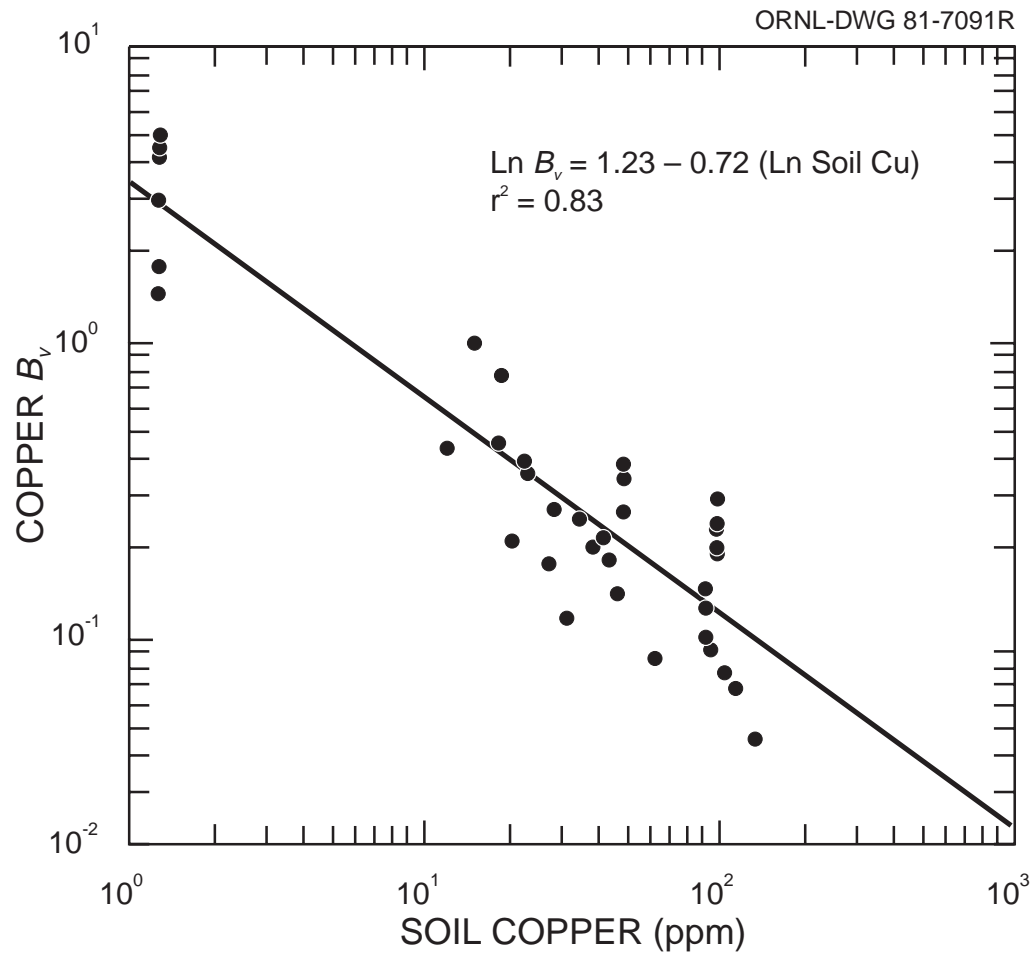

Figure 2.15. Correlation between soil copper concentration and the soil-to-plant concentration factor, B_v , for copper based on references 16, 104, and 115.

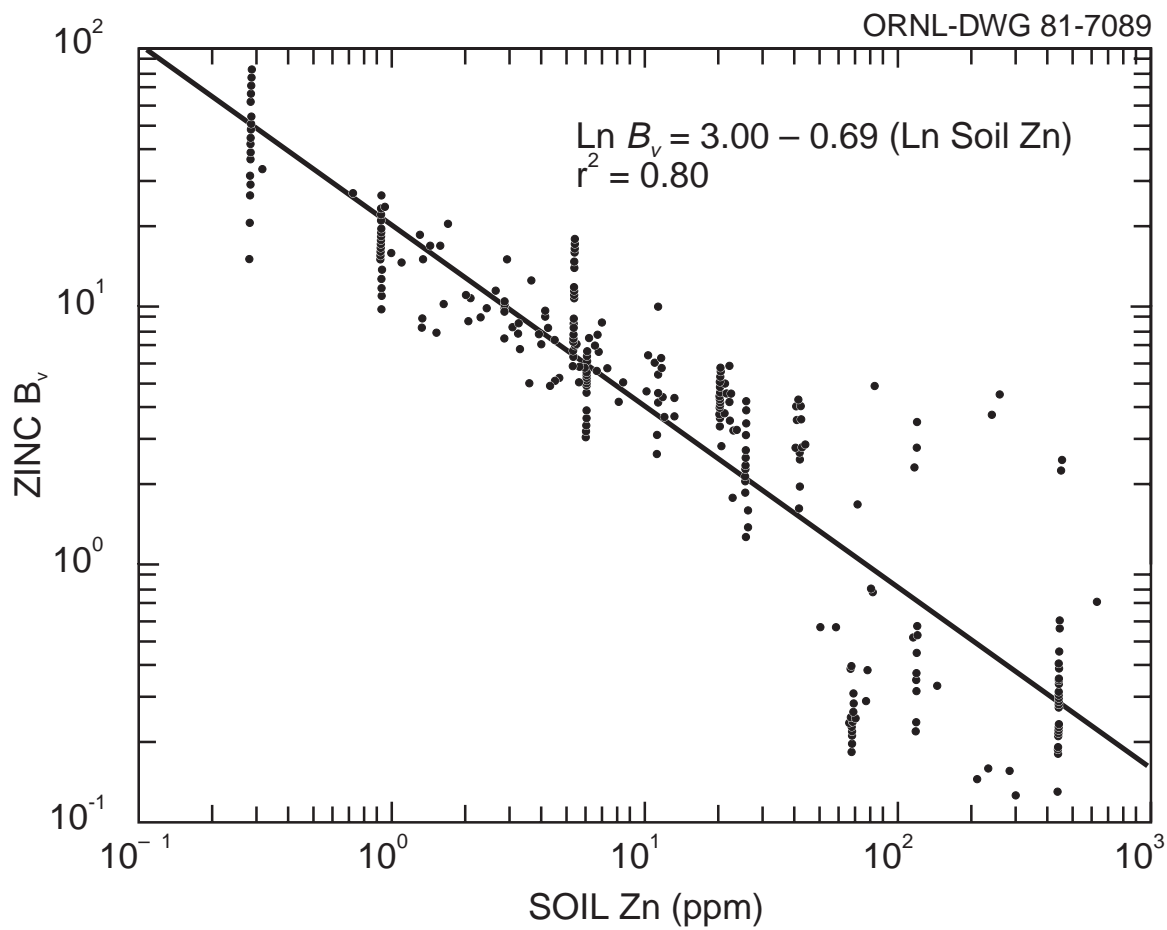

Figure 2.16. Correlation between soil zinc concentration and the soil-to-plant concentration factor, B_v , for zinc based on references 16, 35, 37, 67, 97, 104, 114, 115, and 119.

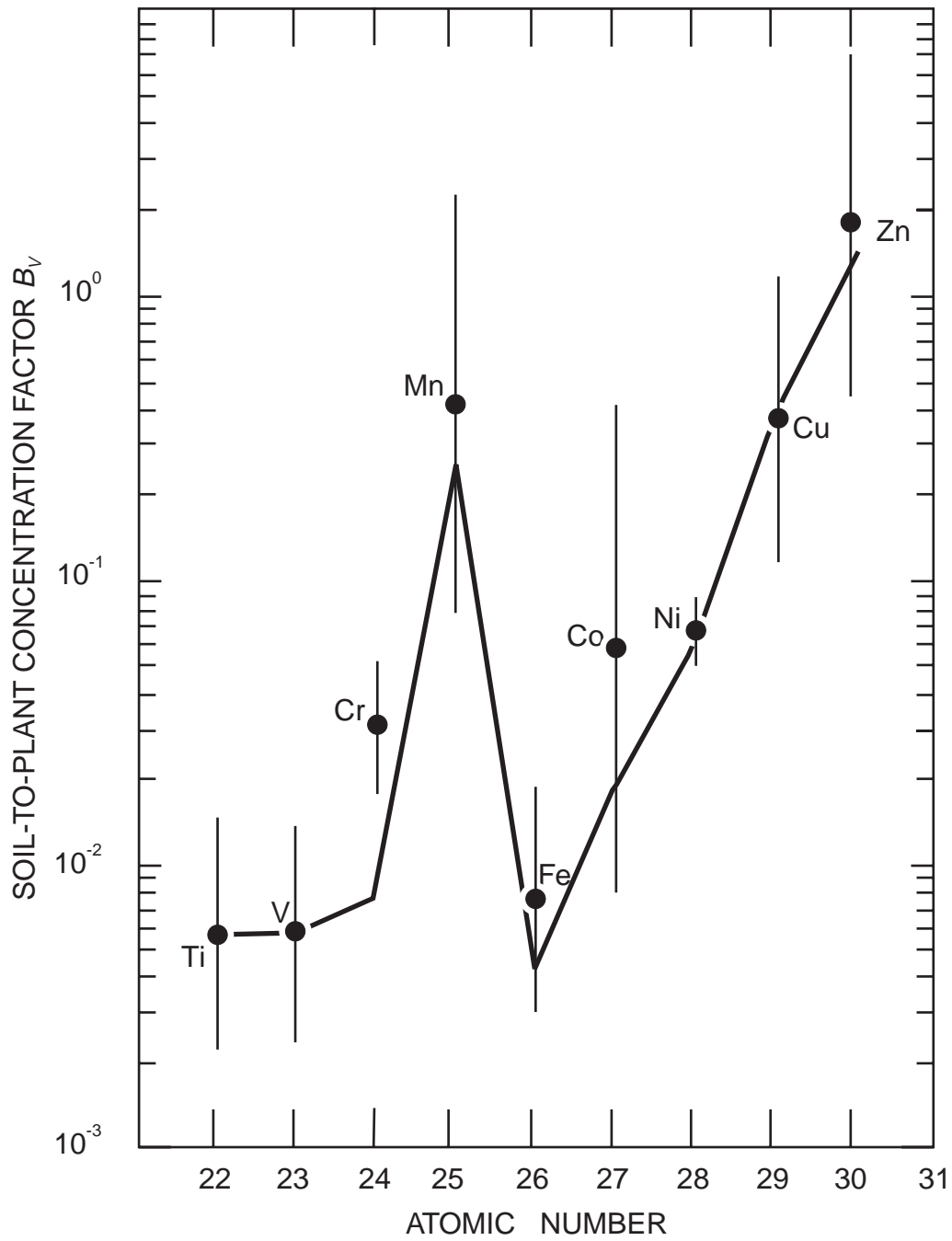

Figure 2.17. Assumed systematic trends in B_v for Period IV elements based on default B_v estimates. Solid dots and error bars represent geometric means and standard deviations determined from available references.

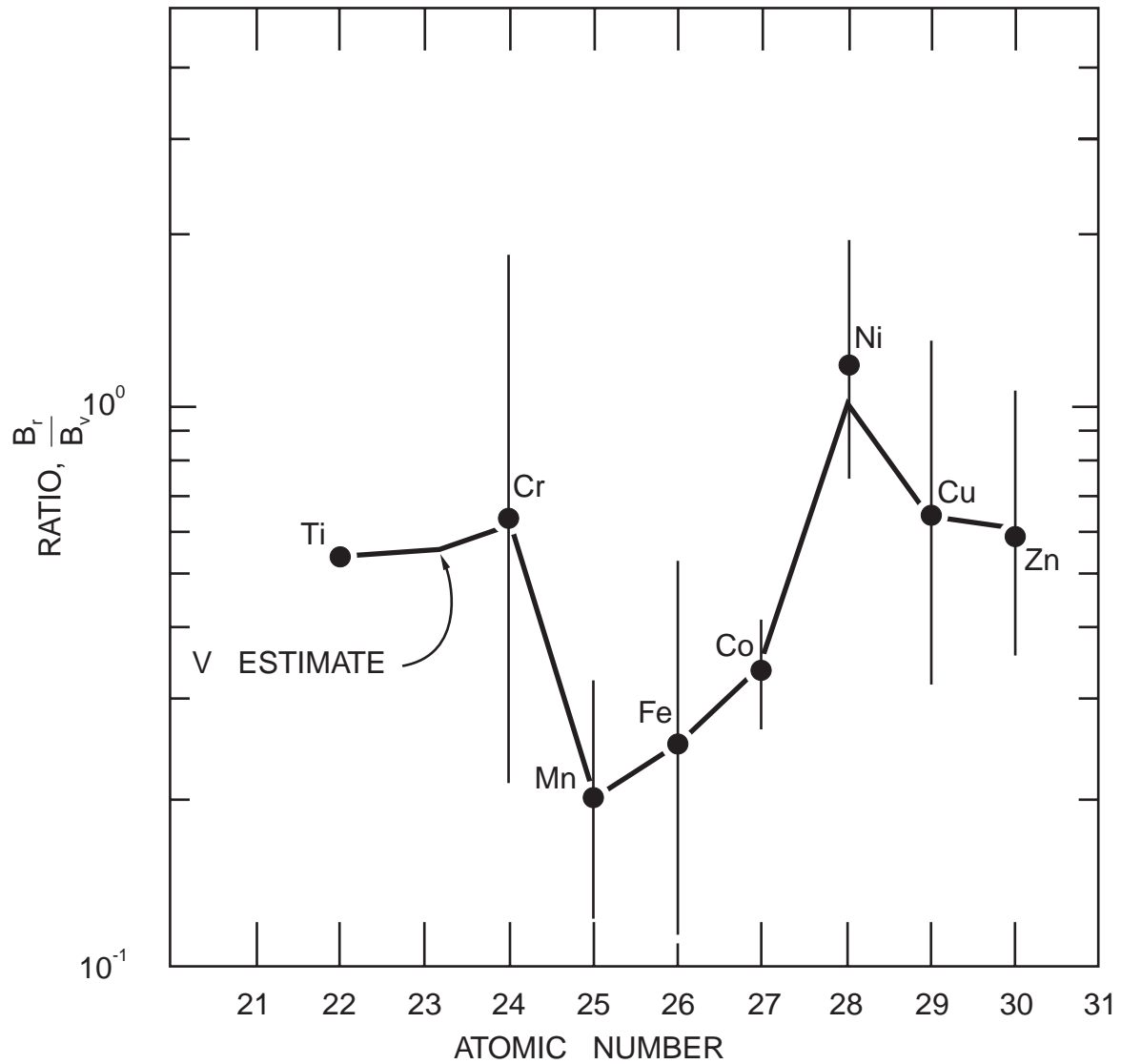

Figure 2.18. Assumed systematic trends in (B_r/B_v) ratio for Period IV elements. Solid dots and error bars represent geometric means and standard deviations of the mean determined from available references.

Because of its importance radiologically and because of the high concentration factors previously reported for technetium,^{23,107,122} it will be given special attention. Hoffman et al.¹²³ critiqued past studies of technetium uptake using the pertechnetate anion (TcO_4^-) and concluded that the concentration factors of 100-1000 derived from these studies were inappropriate because of the high levels of technetium added to the soils and the measurement of concentration factors before plant maturity. Evidence further suggests that technetium in soil becomes increasingly sorbed and thus is less available for plant uptake with time.^{23,128} Aging of soils over 100 days decreased observed concentration ratios by factors of 1.5 to 5.1 in one study by Cataldo.¹⁰⁷ Thus, the application of short-term pot studies to long-term assessments is clearly inappropriate for technetium. Therefore, the concentration factors representing field measurements of long-term technetium uptake in plants reported by Hoffman et al.¹²³ were adopted for the TERRA code, and references 23, 107, and 122 were used only for calculation of B_r or were excluded from our analyses.

The geometric mean of the B_v values reported by Hoffman et al.¹²³ is 9.5. The geometric mean for B_r derived from references 23 and 122 is 1.3. This value was rounded to 1.5 for use as a default value in TERRA. The (B_r/B_v) ratio generated by the two default values is 0.16 which compares favorably with the observed (B_r/B_v) ratios for molybdenum and ruthenium. It is interesting that a $B_{iv,2}$ generated from B_r (see Sect. 2.1) is roughly an order of magnitude less than the value suggested in Moore et al.¹ which takes into account successive harvesting of food crops. No information is available on average technetium concentrations in typical soils and vegetation. Until such information becomes available the B_v and B_r for technetium remain suspect.

The B_v for molybdenum of 0.25 is based on references 16, 65, 76, and 120. Although Singh and Kumar¹²¹ reported soybean grain and leaf molybdenum concentrations from which a (B_r/B_v) ratio of 2.2 was derived, the (B_r/B_v) ratio for determination of B_r was derived from references 16, 17, and 19. This (B_r/B_v) ratio is 0.25 and yields a B_r estimate of 0.06. These B_v and B_r estimates predict vegetable and produce concentrations which agree well with observed concentrations (Table 2.10).

The B_v estimate of 0.002 for zirconium is based on the data on pumpkin leaves and vines by Baes & Katz.¹⁶ A value of 0.25 was chosen for the default (B_r/B_v) ratio for zirconium based on the above analysis for molybdenum. The resultant B_r estimate of 5.0×10^{-4} yields predicted plant concentrations which are consistent with observed concentrations (Table 2.10). Observed zirconium concentrations in vegetative growth in Table 2.10 are based on a range of values reported for cabbage. Shacklette et al.⁵³ report that zirconium is "infrequently detected in food plants." Thus, the "observed" plant concentrations in Table 2.10 for zirconium may not be entirely representative of actual produce concentration. Therefore, agreement of observed and predicted concentrations in Table 2.10 was not considered essential to acceptance or rejection of B_v and B_r values. Thus, although the predicted C_v is below the reported C_v for zirconium the default B_v for zirconium based on reference 16 is used as default in TERRA.

The B_v for ruthenium of 0.075 is based on references 22, 59, 60, and 63. The (B_r/B_v) ratio from references 22, 60, and 63 is 0.26, yielding a B_r estimate of 0.02. Unfortunately, no estimate of ruthenium in typical soils was available for comparison of observed and predicted plant concentrations.

The occurrence of cadmium in soils and plants has been well studied. The B_v for cadmium was determined from eleven references (16, 17, 24, 65, 97, 104, 105, 114, and 124-126). The geometric mean of the eleven geometric means is 0.55. A (B_r/B_v) ratio of 0.26 was derived from references 16, 19, 20, 24, 97, 102, 105, 114, 116, 125, and 126, yielding an estimate of $B_r = 0.15$. Agreement between observed and predicted cadmium concentrations in plants is excellent (Table 2.10).

Default values of B_v and B_r for niobium, rhodium, palladium, and silver were determined primarily through elemental systematic approaches, because no references on direct determination of B_v or B_r for these elements were available. The assumption that Period V transition elements

Table 2.10. Comparison of observed and predicted concentrations of Period V transition elements in produce and plants (ppm, dry wt.)

Element	Average concentration in soil (C_s) ^a	Vegetative growth (C_v)		Fruits and tubers (C_r)	
		Observed range ^b	Predicted ^c	Observed range ^b	Predicted ^d
Zr	300	53 to 74	0.60	5.0×10^{-3} to 11	0.15
Nb		0.038		0.017	
Mo	2.0	0.35 to 2.9	0.50	0.060 to 13	0.12
Tc					
Ru				1.0×10^{-4} to 4.0×10^{-3}	
Rh					
Pd					
Ag	0.10	0.13	0.040	0.057	0.010
Cd	0.50	0.13 to 2.4	0.28	0.013 to 0.82	0.075

^aReference 52.

^bTaken or calculated from values in reference 53 assuming ash wt./dry wt. = .128 and .057 for vegetative growth and fruits and tubers, respectively

^cThe product, $B_v \times C_s$.

^dThe product, $B_r \times C_s$.

are natural analogs of Period IV transition elements suggested that the ratio of B_v estimates for these periods might vary systematically from Group IVB to Group IIB. Examination of these ratios for which B_v estimates had been made via other approaches (Fig. 2.19) yielded estimates of B_v ratio for Nb/V by linear extrapolation between the Zr/Ti ratio and the Mo/Cr ratio. Likewise the Rh/Co, Pd/Ni, and Ag/Cu ratios were extrapolated from the Ru/Fe and Cd/Zn ratios. These estimated ratios, when multiplied by default B_v estimates for Period IV elements (Sect. 2.1.6), yielded B_v estimates for the Period V elements niobium, rhodium, cobalt, palladium, and silver. Plotting of the resultant Period V transition element B_v estimates by atomic number (Fig. 2.20) yields results somewhat similar to the same plot for Period IV transition elements (Fig. 2.17). Unfortunately, comparison of observed and predicted C_v and C_r for niobium, rhodium, and palladium is not possible until more information is available. Some comparison for silver is possible (Table 2.10), although typical silver concentrations in plants are only approximates. The systematics approach seems to underpredict B_v for silver, but by less than an order of magnitude. The default B_r estimates for niobium, rhodium, palladium, and silver used in Fig. 2.2 were derived from an assumed (B_r/B_v) value of 0.25, which is consistent with observations for molybdenum and cadmium.

2.1.8 Period VI transition elements

Very few references for plant uptake of the Period VI transition elements were available. Also, comparisons between observed and predicted produce and plant concentrations were difficult to make because of the uncertainty in typical soil and plant concentrations (Table 2.11). Therefore, B_v and B_r default estimates for Period VI transition elements are mostly based on their Period IV and V analogs.

Single measurements of associated soil and plant concentrations applicable to B_v were found in reference 65 for hafnium, tantalum, and tungsten. Three additional measurements were found in reference 101 for tungsten. The geometric means approach for tungsten indicates a B_v which is

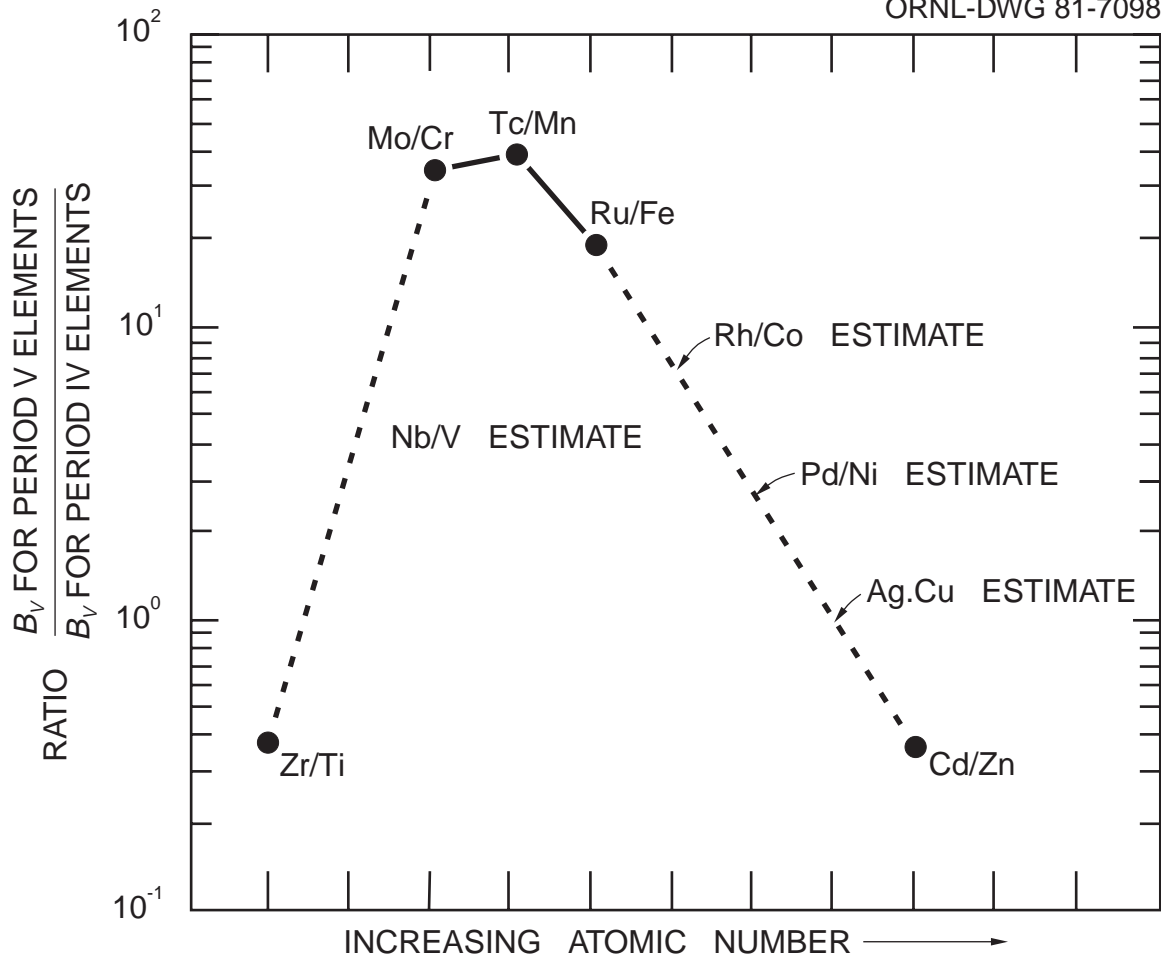

Figure 2.19. Assumed systematic trends in the ratio of B_V for Period V and IV elements (Nb/V, Rh/Co, Pd/Ni, and Ag/Cu) based on the ratios of default B_V estimates for other elements in the periods.

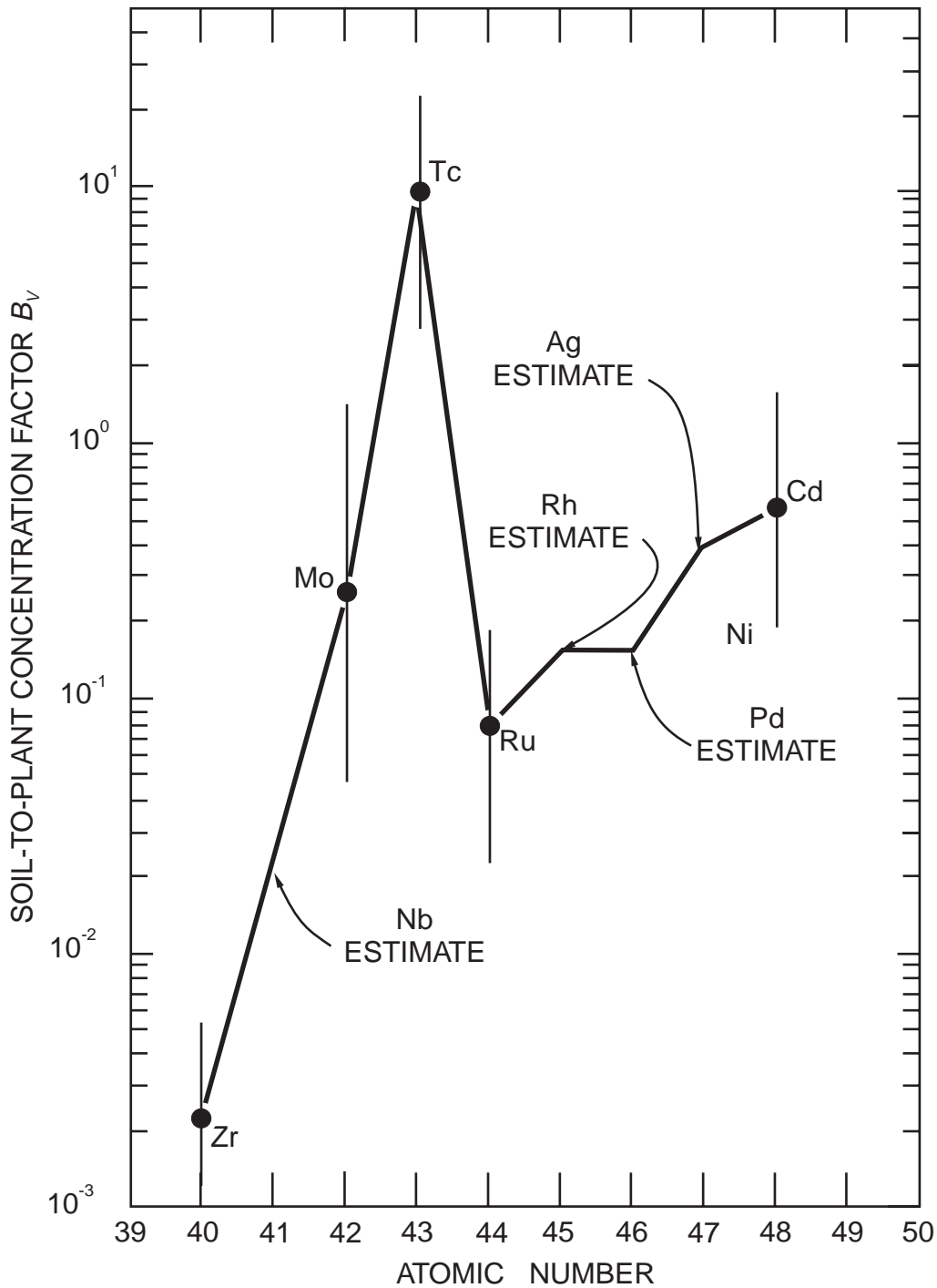

Figure 2.20. Assumed systematic trend in B_v for Period V transition elements based on default B_v estimates. Solid dots and error bars represent geometric means and standard deviations determined from available references.

Table 2.11. Comparison of observed and predicted concentrations of Period VI transition elements in produce and plants (ppm, dry wt.)

Element	Average concentration in soil (C_s) ^a	Vegetative growth (C_v)		Fruits and tubers (C_r)	
		Observed range ^b	Predicted ^c	Observed range ^b	Predicted ^d
Hf	6.0	<6.3×10 ^{-3e}	0.021	2.3×10 ⁻³ to 2.0 ^e	5.1×10 ⁻³
Ta					
W		0.064		0.029	
Re		6.4×10 ⁻⁴		2.9×10 ⁻⁴	
Os					
Ir					
Pt					
Au		<1.1×10 ⁻⁴ to 5.3×10 ^{-3e}		1.0×10 ⁻⁵ to 1.1×10 ^{-3e}	
Hg	0.010	<0.01 to 0.020	9.0×10 ⁻³	<0.010 to 0.020	2.0×10 ⁻³

^aReference 52.

^bTaken or calculated from values in reference 53 assuming ash wt./dry wt. = .128 and .057 for vegetative growth and fruits and tubers, respectively

^cThe product, $B_v \times C_s$.

^dThe product, $B_r \times C_s$.

^eReference 54.

much greater than that for chromium and more nearly equal to that for molybdenum, although in reference 65 the derived molybdenum B_v exceeds the derived tungsten B_v by a factor of approximately three. Comparison of B_v values derived from reference 65 for hafnium and tantalum with their respective Period IV and V analogs indicates that if the single derived values are appropriate, the Period VI transition element concentration factors exceed those for their Period IV analogs, but are less than their Period V analogs.

While the above observations lend insight into the concentration factors for some Period VI transition elements, concentration factors for the rest must rely on supposition until further experimental evidence is available. Figure 2.21 represents the methodology used in determination of default B_v estimates for Period VI transition elements. To derive these, B_v default estimates for Period IV transition elements (Sect. 2.1.6) and Period V transition elements (Sect. 2.1.7) were plotted by increasing atomic number. The default B_v estimate for the Period VI elements were simply the log-averages of the two other elements within each group rounded to the nearest 0.5 decimal place. This method insures that trends observed in Periods IV and V are generally repeated in Period VI (increasing B_v for the first four members of the period, decrease in the fifth, etc.). While such repetition of trends may be acceptable if general chemical properties are assumed to be an important basis for B_v behavior, our method has serious limitations. Our procedure implies that, except for Groups IVB and IIB, Period VI element B_v values exceed those for Period IV and are exceeded by those for Period V. Such an implication is unfounded and may be a serious limitation to our approach. However, determination of the most appropriate default estimates of B_v for Period VI transition elements will require direct experimental measurement of them.

There were no available references for the (B_r/B_v) ratio or for B_r for the Period VI elements. Therefore, a value of 0.25 for the (B_r/B_v) ratio was assumed, based on analysis of Period V transition elements. This value was used with the default B_v estimates to generate default B_r estimates.

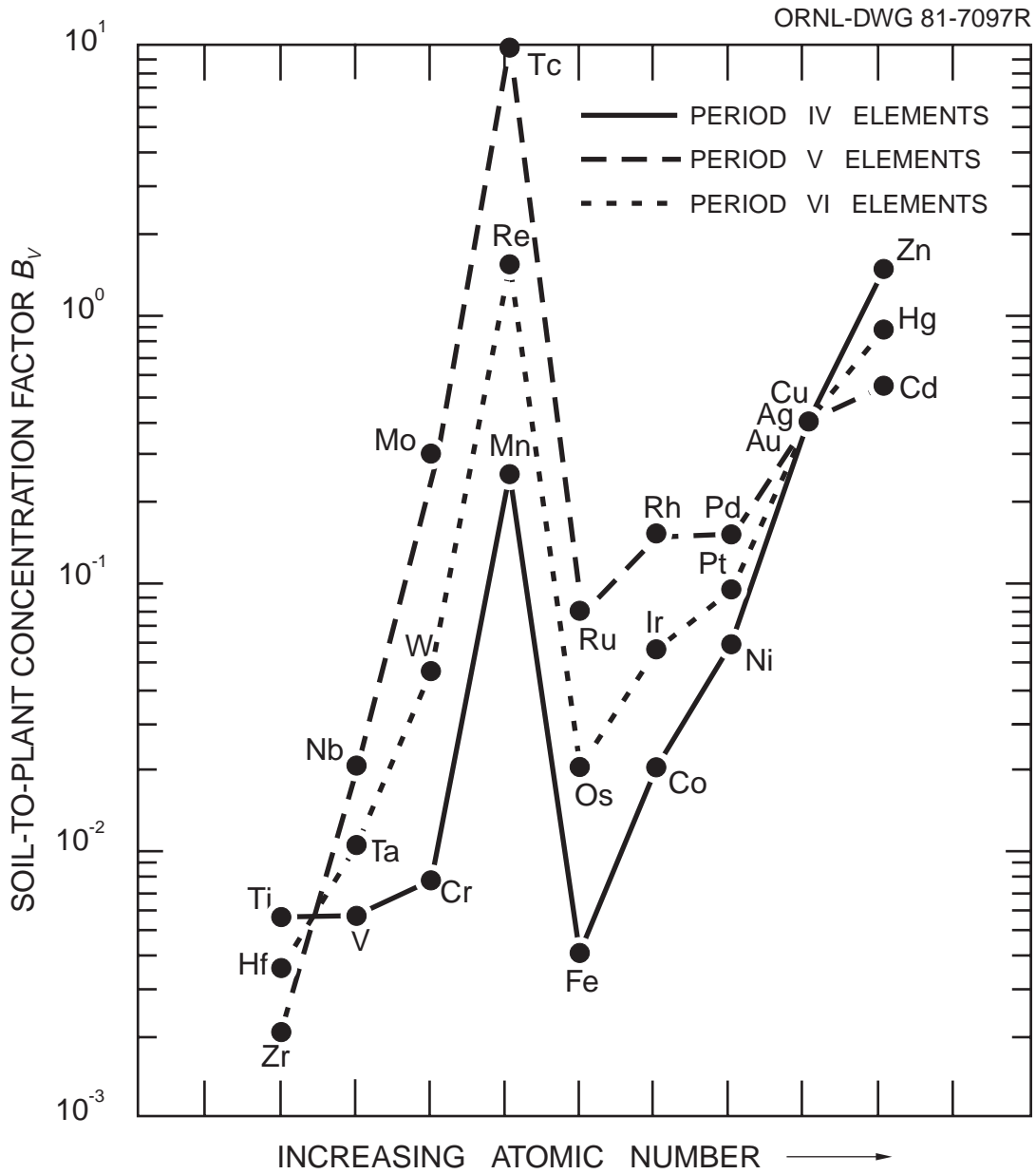

Figure 2.21. Assumed systematic trend in B_v for Period VI elements based on assumed systematic trends in Period IV and V elements.

Comparisons of observed and predicted plant concentrations were possible only for hafnium and mercury. For these elements predicted values were always within an order of magnitude of the observed ranges. However, observed ranges were usually bounded on the low sides by detection limits of the analysis procedures.⁵⁴

2.1.9 The actinide elements

The actinide elements have been extensively studied with respect to plant uptake from soil. The greatest number of references were found for plutonium^{8-10,30,59,101,129-138} and americium,^{10,30,129,131,133,136,137,139-142} with fewer references for uranium,^{29,65,90,91,143} thorium,^{65,90,91} neptunium, and curium.^{10,30,131} No literature references were found for actinium, protactinium, or any elements of atomic number greater than 96.

The B_v for plutonium appears to be lognormally distributed and reported values range from 10^{-6} to 10^{-2} (Fig. 2.22). The fourteen references used to determine B_v for plutonium yielded a geometric mean of 4.5×10^{-4} . The (B_r/B_v) ratio of 0.1 was calculated from references 8, 10, 30, 129, 130, 134, and 136. This value produces a $B_r = 4.5 \times 10^{-5}$ which agrees well with the geometric mean of B_r derived from references 8, 10, 30, 129, 133, 134, 136, and 138. No measurements of typical or average concentrations of plutonium in soils or vegetable produce were available for comparison between predicted and observed concentrations. Comparisons of predicted and observed actinide concentrations were only possible for thorium and uranium (Table 2.12).

The B_v for americium of 0.0055 was derived from references 10, 30, 129, 131, 136, 137, and 139-142. A B_r of 2.5×10^{-4} was derived from references 10, 30, 129, and 136 by selecting a value midway between the range defined by the geometric mean of B_r and the product of the default B_v estimate and the geometric mean for (B_r/B_v) ratio.

The B_v for uranium of 0.0085 was determined from references 29, 65, and 91. The (B_r/B_v) ratios derived from data reported by Prister²⁹ and Fedorov and Romanov¹⁴³ both equaled a value of 0.5, and this value was used to determine a default B_r estimate of 0.004. Comparison of predicted and observed vegetable concentrations supports the default concentration factors, although typical uranium concentrations in vegetative portions of produce are unavailable.

The B_v for thorium of 8.5×10^{-4} was determined from references 65 and 91. No references were available for a thorium (B_r/B_v) ratio, and thus the value of 0.1 used for radium was assumed, yielding a default B_r estimate of 8.5×10^{-5} . Comparisons of observed and predicted vegetation concentrations are hampered by the uncertainty in thorium concentrations in vegetation. In the food surveys carried out by Oakes et al.⁵⁴ and Monford et al.¹⁴⁴ most thorium concentrations in food items were at or below detection limits. However, it may be concluded that the default B_v and B_r estimates assumed here do not overpredict observed food concentrations.

The default B_v estimates for actinium and protactinium were determined from those of radium and thorium and thorium and uranium, respectively, by assuming systematic variation in B_v with atomic number in a manner similar to that used for radium and francium (see Sect. 2.1.2). Such a procedure implies that thorium has the lowest B_v of the actinides of atomic number 89 through 92. This implication has yet to be tested, but examination of our default estimates of the ingestion-to-cow's milk (F_m) transfer coefficient shows that it is less than or equal to those for actinium, protactinium, and uranium (see Sect. 2.2 for the milk transfer coefficient). The B_r for actinium and protactinium was determined by assumption of a (B_r/B_v) ratio of 0.1 as for radium and thorium.

The B_v for neptunium of 0.1 is based on references 10, 30, and 131. The B_r default estimate of 0.01 is based on the geometric means of B_r values from references 10 and 30. This value suggests that a (B_r/B_v) ratio of 0.1 is appropriate for neptunium also.

The B_v for curium of 8.5×10^{-4} is based on references 10, 30, and 141. The B_r estimate of 1.5×10^{-5} is based on the geometric means of B_r from references 10 and 30, suggesting an appropriate (B_r/B_v) ratio of less than 0.1. In the TERRA code B_v and B_r estimates for elements of atomic number greater than 96 are set equal to those for curium (element 96).

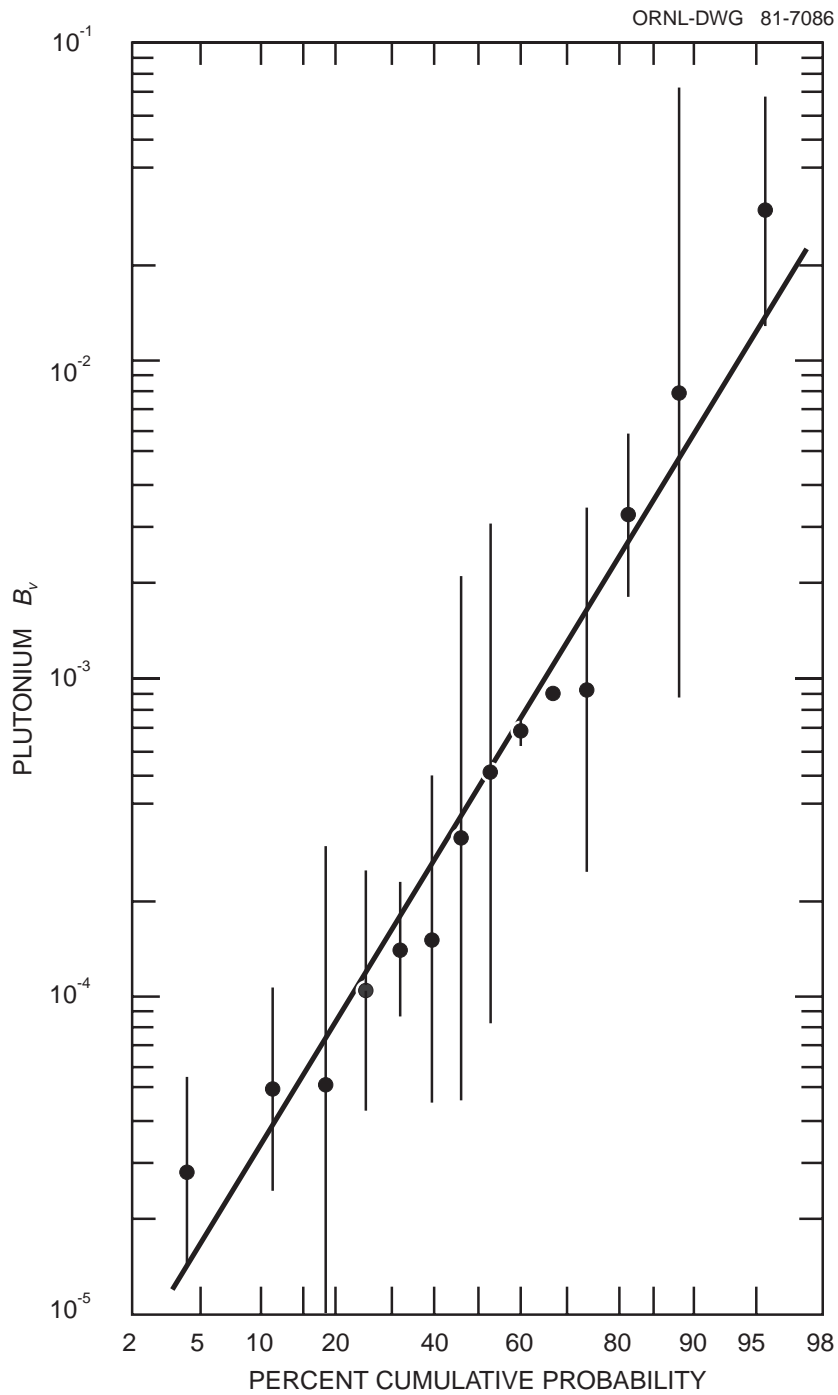

Figure 2.22. Lognormal probability plot of geometric means of B_v for plutonium (calculated from references 8-10, 30, 59, 101, 129, 131, 132, and 134-138), including one geometric standard deviation of the mean.

Table 2.12. Comparison of observed and predicted concentrations of actinide elements in produce and plants (ppm, dry wt.)

Element	Average concentration in soil (C_s) ^a	Vegetative growth (C_v)		Fruits and tubers (C_r)	
		Observed range ^b	Predicted ^c	Observed range ^b	Predicted ^d
Actinide elements					
Ac					
Th	6.0	<0.032	5.1×10^{-3}	$<2.5 \times 10^{-3}$ to 0.12	5.1×10^{-4}
Pa					
U	1.0		8.5×10^{-3}	3.8×10^{-4} to 0.020	4.0×10^{-3}
Np					
Pu					
Am					
Cm					

^aReference 52.

^bTaken or calculated from values reported in reference 144.

^cThe product, $B_v \times C_s$.

^dThe product, $B_r \times C_s$.

2.1.10 Comparison of default estimates with previously published values

Comparisons of our default estimates of B_v and B_r with previously used or reported values is difficult because the parameter definitions used here differ somewhat from past soil-plant uptake parameter definitions. However, general comparisons may be made. The most useful comparison is with the soil-to-plant uptake parameter B_{iv} in Table E-1 of the NRC Reg. Guide 1.109.⁶ Most of these values of B_{iv} were, in turn, taken from reference 15 by dividing the “concentration in terrestrial plants” (Table 10A) by the “elemental composition of typical agricultural soil” (Table 4). In reference 15 the plant concentrations were converted to a wet or fresh weight basis by assuming 25% dry matter in plants. Thus, the B_{iv} values generated from Tables 10A and 4 may be converted to a dry weight basis by multiplying by a factor of four. The resultant dry weight B_{iv} values may be directly compared with our B_v estimates (Fig. 2.23).

In comparing plant uptake parameters it should be remembered that the criteria for B_v and B_{iv} definition are comparable, but not equivalent. Also, as evidenced by figures 2.3, 2.7, and 2.22, each default estimate is representative of a distribution of values. Thus, a factor of 2 or 3 difference between B_v and B_{iv} should not be considered significant. Therefore, in Fig. 2.23 we have highlighted those elements for which an order of magnitude difference or greater occurs between our numbers and those in reference 15. These elements include fluorine, silicon, calcium, titanium, selenium, strontium, rhodium, palladium, indium, tellurium, osmium, iridium, platinum, gold, thallium, bismuth, polonium, radium, thorium, neptunium, and curium. Our approaches to determination of B_v estimates have led to lower estimates than those derived from reference 15 for more than half of these elements. For elements calcium, strontium, and neptunium, numerous experimental results indicate higher default values than those derived from reference 15.

2.2 Ingestion-to-Milk Parameter, F_m

The ingestion-to-milk transfer coefficients for milk cows used in TERRA are representative of the fraction of the daily elemental intake in feed which is transferred to a kilogram of milk. The

	I A	II A											III A	IV A	V A	VI A	VII A
II	Li + 8	Be + 6											B + 5		N		F + 100
III	Na - 3	Mg	III B	IV B	V B	VI B	VII B	VIII		I B	II B	Al + 5	Si + 600	P	S	Cl + 4	
IV	K	Ca + 100	Sc	Ti + 25	V	Cr + 7.5	Mn	Fe	Co	Ni	Cu	Zn	Ga + 4	Ge	As	Se - 200	Br - 2
V	Rb - 3.5	Sr + 38	Y	Zr + 3	Nb	Mo - 2	Tc + 9.5	Ru - 3	Rh - 350	Pd - 133	Ag	Cd - 2	In - 250	Sn + 3	Sb + 5	Te - 200	I + 2
VI	Cs + 2	Ba + 7.5		Hf + 5	Ta + 4	W	Re	Os - 13	Ir - 950	Pt - 21	Au + 40	Hg	Tl - 250	Pb - 6	Bi - 17	Po - 1600	At
VII	Fr	Ra + 12															
Lanthanides			La	Ce	Pr	Nd	Pm	Sm	Eu	Gd	Tb	Dy	Ho	Er	Tm	Yb	Lu
Actinides			Ac - 3	Th - 20	Pa - 4	U	Np + 10	Pu - 2	Am + 5.5	Cm - 12							

Figure 2.23. Comparison of soil-to-plant concentration factor default values reported in this report and derived from reference 15. The “+” and “-” signs indicate whether our estimates are greater or less than, respectively, those derived from reference 15. The values indicated are the difference factor, and circled elements indicate a difference factor of at least an order of magnitude.

elemental values for this parameter (Fig. 2.24) were taken from the extensive review in 1977 by Ng et al.,¹⁴⁵ except for the elements chromium, manganese, iron, nickel, zirconium, antimony, mercury, polonium, and americium which were taken from a later (1979) reference.⁴⁰ The protocol for rounding adopted for B_v and B_r was used also for F_m . The error introduced in defining the parameter in days/kilogram (here) rather than days/liter (as by Ng and his associates) is much less than that introduced by the rounding protocol, because the density of milk ranges from 1.028 to 1.035 kg/L.¹⁴⁶

2.3 Ingestion-to-Beef Parameter, F_f

The ingestion-to-beef parameters in TERRA are representative of the fraction of the daily elemental intake in feed which is transferred to and remains in a kilogram of beef until slaughter. The elemental values for this parameter (Fig. 2.25) were either taken from several reviews published by Ng and his coworkers^{15,39,40} or determined from elemental systematic assumptions. Estimates of F_f for 32 elements were available from the more recent reviews (references 39 and 40). Values for sodium, phosphorus, potassium, calcium, manganese, iron, zinc, strontium, niobium, antimony, and cerium were taken from reference 40, and values for chromium, cobalt, nickel, copper, rubidium, yttrium, zirconium, molybdenum, technetium, ruthenium, rhodium, silver, tellurium, iodine, cesium, barium, lanthanum, praseodymium, neodymium, tungsten, and americium were taken from reference 39. The F_f estimates for the remaining elements were derived from reference 15, except for those which exceeded a theoretical maximum value of 1.0 day/kg.

A theoretical maximum F_f value may be calculated by assuming a 1 unit/kg (wet) concentration of an element in feed. If an extremely conservative 100% efficiency in transfer from feed to muscle is assumed, and beef cattle consume 50 kg (wet) feed per day,¹⁵ and the average muscle mass per head of beef cattle is 200 kg,¹³ then the average daily increase in elemental concentration in beef muscle is given by

$$\frac{(1 \text{ unit / kg})(50 \text{ kg / head / day})}{200 \text{ kg beef / head}} = 0.25 \text{ unit / kg beef / day.} \quad (6)$$

Further, if a second extremely conservative assumption that there is no biological turnover of the element from the muscle is made, then assuming that the average beef cow is fed for 200 days before slaughter¹³ gives a value of 50 units/kg beef at slaughter. Relating this value to the daily consumption of feed yields a conservative maximum F_f of (50 units/kg)/(50 units/day) or 1.0 days/kg. Clearly, default estimates near or exceeding this value are highly suspect.

Review of the F_f values derived from reference 15 indicates that estimates for gallium, germanium, tantalum, polonium, astatine, francium, actinium, thorium, protactinium, neptunium, plutonium, and curium all exceed the above-calculated theoretical maximum. Because of the radiological importance of elements of atomic number greater than 82, a systematic approach based on elemental variation of B_v and F_m was used to determine default F_f estimates (Fig. 2.26). A similar approach using systematic trends observed in F_m for Period IV elements was used to determine F_f estimates for gallium and germanium.

The approach used for elements of atomic number greater than 82 was to observe ratios of default B_v (Fig. 2.1) and F_m (Fig. 2.24) values for successive elements (Fig. 2.26). The ratios determined for both parameters were log-transformed and averaged. The exponentials of these averages were used to define a default ratio value for successive F_f default estimates. The F_f value for americium was then used to determine the default F_f estimates for curium and plutonium. In turn, each default F_f estimate was calculated by multiplication with the proper ratio, i.e., $\text{Pu } F_f = (\text{Pu/Am}) \text{ ratio} \times (\text{Am } F_f)$, $\text{Np } F_f = (\text{Np/Pu}) \text{ ratio} \times (\text{Pu } F_f)$, and so on. Implicit in such an argument is the assumption that the availability of an element for plant uptake and transportability to milk is indicative of its availability or transportability to beef. Some support for this argument is

	I A	II A											III A	IV A	V A	VI A	VII A
II	Li 0.020	Be 9.0×10^{-7}											B 1.5×10^{-3}		N 0.025		F 1.0×10^{-3}
III	Na 0.035	Mg 4.0×10^{-3}	III B	IV B	V B	VI B	VII B	VIII		I B	II B	Al 2.0×10^{-4}	Si 2.0×10^{-5}	P 0.015	S 0.015	Cl 0.015	
IV	K 7.0×10^{-3}	Ca 0.010	Sc 5.0×10^{-6}	Ti 0.010	V 2.0×10^{-5}	Cr 1.5×10^{-3}	Mn 3.5×10^{-4}	Fe 2.5×10^{-4}	Co 2.0×10^{-3}	Ni 1.0×10^{-3}	Cu 1.5×10^{-3}	Zn 0.010	Ga 5.0×10^{-5}	Ge 0.070	As 6.0×10^{-5}	Se 4.0×10^{-3}	Br 0.020
V	Rb 0.010	Sr 1.5×10^{-3}	Y 2.0×10^{-5}	Zr 3.0×10^{-5}	Nb 0.020	Mo 1.5×10^{-3}	Tc 0.010	Ru 6.0×10^{-7}	Rh 0.010	Pd 0.010	Ag 0.020	Cd 1.0×10^{-3}	In 1.0×10^{-4}	Sn 1.0×10^{-3}	Sb 1.0×10^{-4}	Te 2.0×10^{-4}	I 0.010
VI	Cs 7.0×10^{-3}	Ba 3.5×10^{-4}		Hf 5.0×10^{-6}	Ta 3.0×10^{-6}	W 3.0×10^{-4}	Re 1.5×10^{-3}	Os 5.0×10^{-3}	Ir 2.0×10^{-6}	Pt 5.0×10^{-3}	Au 5.5×10^{-6}	Hg 4.5×10^{-4}	Tl 2.0×10^{-3}	Pb 2.5×10^{-4}	Bi 5.0×10^{-4}	Po 3.5×10^{-4}	At 0.010
VII	Fr 0.020	Ra 4.5×10^{-4}															

Lanthanides	La 2.0×10^{-5}	Ce 2.0×10^{-5}	Pr 2.0×10^{-5}	Nd 2.0×10^{-5}	Pm 2.0×10^{-5}	Sm 2.0×10^{-5}	Eu 2.0×10^{-5}	Gd 2.0×10^{-5}	Tb 2.0×10^{-5}	Dy 2.0×10^{-5}	Ho 2.0×10^{-5}	Er 2.0×10^{-5}	Tm 2.0×10^{-5}	Yb 2.0×10^{-5}	Lu 2.0×10^{-5}
Actinides	Ac 2.0×10^{-5}	Th 5.0×10^{-6}	Pa 5.0×10^{-6}	U 6.0×10^{-4}	Np 5.0×10^{-6}	Pu 1.0×10^{-7}	Am 4.0×10^{-7}	Cm 2.0×10^{-5}							

Key:

Li	—	Symbol
0.020	—	Transfer Coefficient, F_m

Figure 2.24. Values of the ingestion-to-milk transfer coefficient F_m adopted as default estimates in the computer code TERRA.

	I A	II A										III A	IV A	V A	VI A	VII A	
II	Li 0.010	Be 1.0×10^{-3}										B 8.0×10^{-4}		N 0.075		F 0.15	
III	Na 0.055	Mg 5.0×10^{-3}	III B	IV B	V B	VI B	VII B	VIII		I B	II B	Al 1.5×10^{-3}	Si 4.0×10^{-5}	P 0.055	S 0.10	Cl 0.080	
IV	K 0.020	Ca 7.0×10^{-4}	Sc 0.015	Ti 0.030	V 2.5×10^{-3}	Cr 5.5×10^{-3}	Mn 4.0×10^{-4}	Fe 0.020	Co 0.020	Ni 6.0×10^{-3}	Cu 0.010	Zn 0.10	Ga 5.0×10^{-4}	Ge 0.70	As 2.0×10^{-3}	Se 0.015	Br 0.025
V	Rb 0.015	Sr 3.0×10^{-4}	Y 3.0×10^{-4}	Zr 5.5×10^{-3}	Nb 0.25	Mo 6.0×10^{-3}	Tc 8.5×10^{-3}	Ru 2.0×10^{-3}	Rh 2.0×10^{-3}	Pd 4.0×10^{-3}	Ag 3.0×10^{-3}	Cd 5.5×10^{-4}	In 8.0×10^{-3}	Sn 0.080	Sb 1.0×10^{-3}	Te 0.015	I 7.0×10^{-3}
VI	Cs 0.020	Ba 1.5×10^{-4}		Hf 1.0×10^{-3}	Ta 6.0×10^{-4}	W 0.045	Re 8.0×10^{-3}	Os 0.40	Ir 1.5×10^{-3}	Pt 4.0×10^{-3}	Au 8.0×10^{-3}	Hg 0.25	Tl 0.040	Pb 3.0×10^{-4}	Bi 4.0×10^{-4}	Po 9.5×10^{-5}	At 0.010
VII	Fr 2.5×10^{-3}	Ra 2.5×10^{-4}															
Lanthanides	La 3.0×10^{-4}	Ce 7.5×10^{-4}	Pr 3.0×10^{-4}	Nd 3.0×10^{-4}	Pm 5.0×10^{-3}	Sm 5.0×10^{-3}	Eu 5.0×10^{-3}	Gd 3.5×10^{-3}	Tb 4.5×10^{-3}	Dy 5.5×10^{-3}	Ho 4.5×10^{-3}	Er 4.0×10^{-3}	Tm 4.5×10^{-3}	Yb 4.0×10^{-3}	Lu 4.5×10^{-3}		
Actinides	Ac 2.5×10^{-5}	Th 6.0×10^{-6}	Pa 1.0×10^{-5}	U 2.0×10^{-4}	Np 5.5×10^{-5}	Pu 5.0×10^{-7}	Am 3.5×10^{-6}	Cm 3.5×10^{-6}									

Key:	Li 0.010	— Symbol
		— Transfer Coefficient, F_f

Figure 2.25. Values of the ingestion-to-beef transfer coefficient F_f adopted as default estimates in the computer code TERRA.

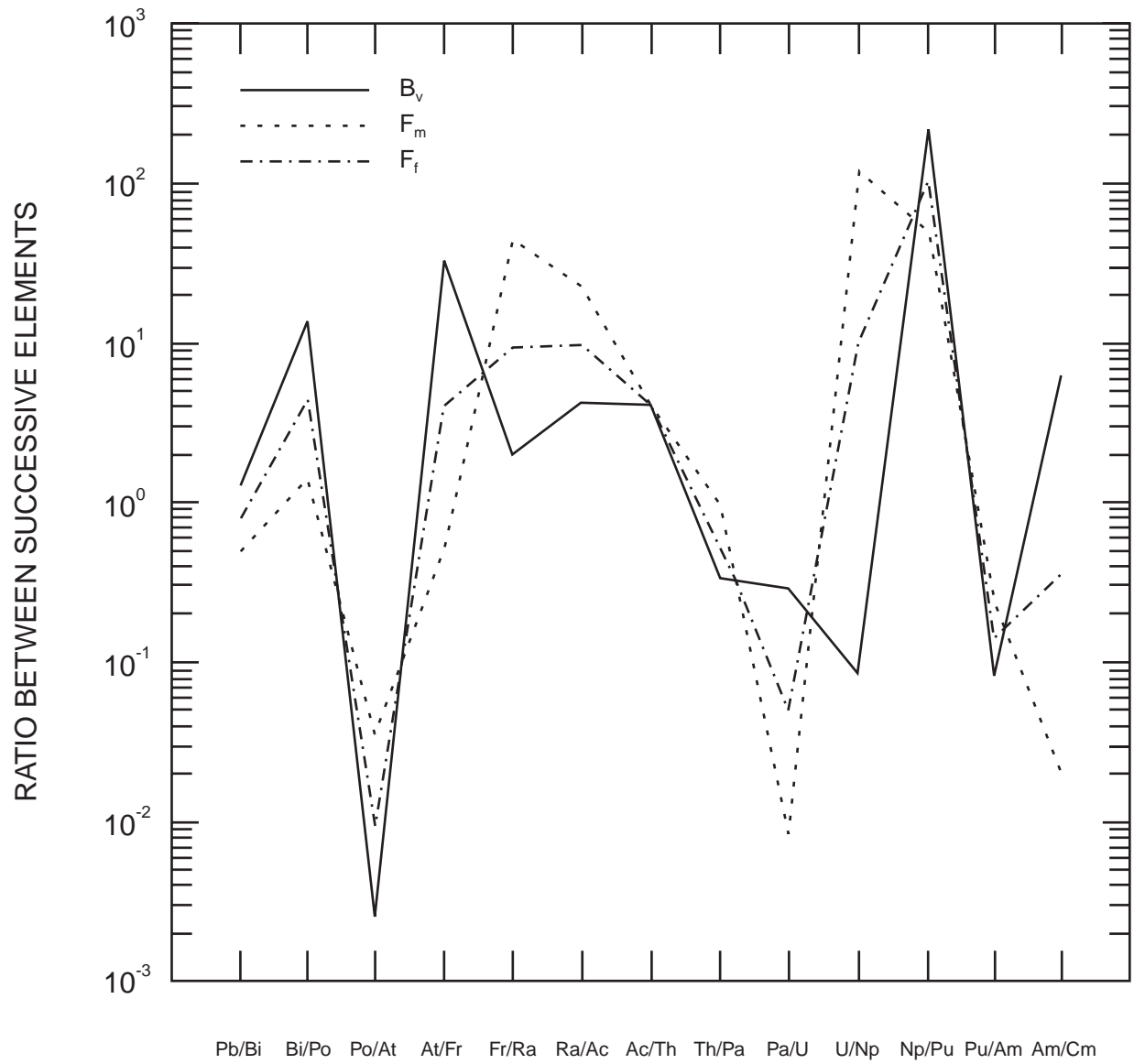

Figure 2.26. Systematic trends in the ratio of default estimates for B_v and F_m for successive elements and corresponding assumed ratios for F_f for successive elements used to determine default F_f estimates.

seen in the systematic variability of our B_v estimates (Figs. 2.27 and 2.28) and F_m estimates (Figs. 2.29 and 2.30). However, experimental determination of F_f for elements of atomic number greater than 82 would be preferable to our present approach, if available.

2.4 The Distribution Coefficient, K_d

The distribution coefficient, K_d is the ratio of elemental concentration in soil to that in water in a soil-water system at equilibrium. In general, K_d is measured in terms of gram weights of soil and milliliter volumes of water. In TERRA the distribution coefficient is used in the following equation to determine a location-specific leaching constant for elemental removal from a given soil depth,

$$\lambda_l = \frac{P + I - E}{\theta d [1 + (\frac{\rho}{\theta} K_d)]} \quad (7)$$

where

- P = annual average total precipitation (cm),
- E = annual average evapotranspiration (cm),
- I = annual average irrigation (cm),
- d = depth of soil layer from which leaching occurs (cm),
- ρ = soil bulk density (g/cm^3),
- θ = volumetric water content of the soil [$\text{mL}(=\text{cm}^3)/\text{cm}^3$], and
- K_d = the distribution coefficient (mL/g).

Default estimates of K_d used in the TERRA code are presented in Fig. 2.31. The mantissa of these values has been rounded off to the nearest 0.5 decimal place as for the other element specific transport parameters. The values for magnesium, potassium, calcium, manganese, iron, cobalt, copper, zinc, strontium, yttrium, molybdenum, technetium, ruthenium, cesium, lead, polonium, cerium, thorium, uranium, neptunium, plutonium, americium, and curium were determined through a review of the K_d literature. The estimates for the remaining elements were determined by a correlation of K_d with B_v . Because of the inherent uncertainties in estimates of K_d for various materials, a brief discussion of the parameter and its determination is appropriate.

2.4.1 Variability in K_d

The first source of variability in the parameter is associated with the laboratory methods used to determine K_d . Generally, the two most common techniques for determination of K_d are the column and batch methods, although other methods have been employed to measure distributions of chemical forms¹⁴⁷ or distribution among soil fractions.¹⁴⁸ In the column method a solution of material in water is applied to a column containing uniformly packed soil. The K_d of the material is determined from comparison of the 50% breakthrough curves for the water and material according to the equation

$$\frac{V_i}{V_w} = \frac{1}{1 + \frac{\rho}{\theta} K_d}, \quad (8)$$

where

- V_i = the velocity of the migrating material (determined from the 50% breakthrough curve) and
- V_w = the velocity of the water.

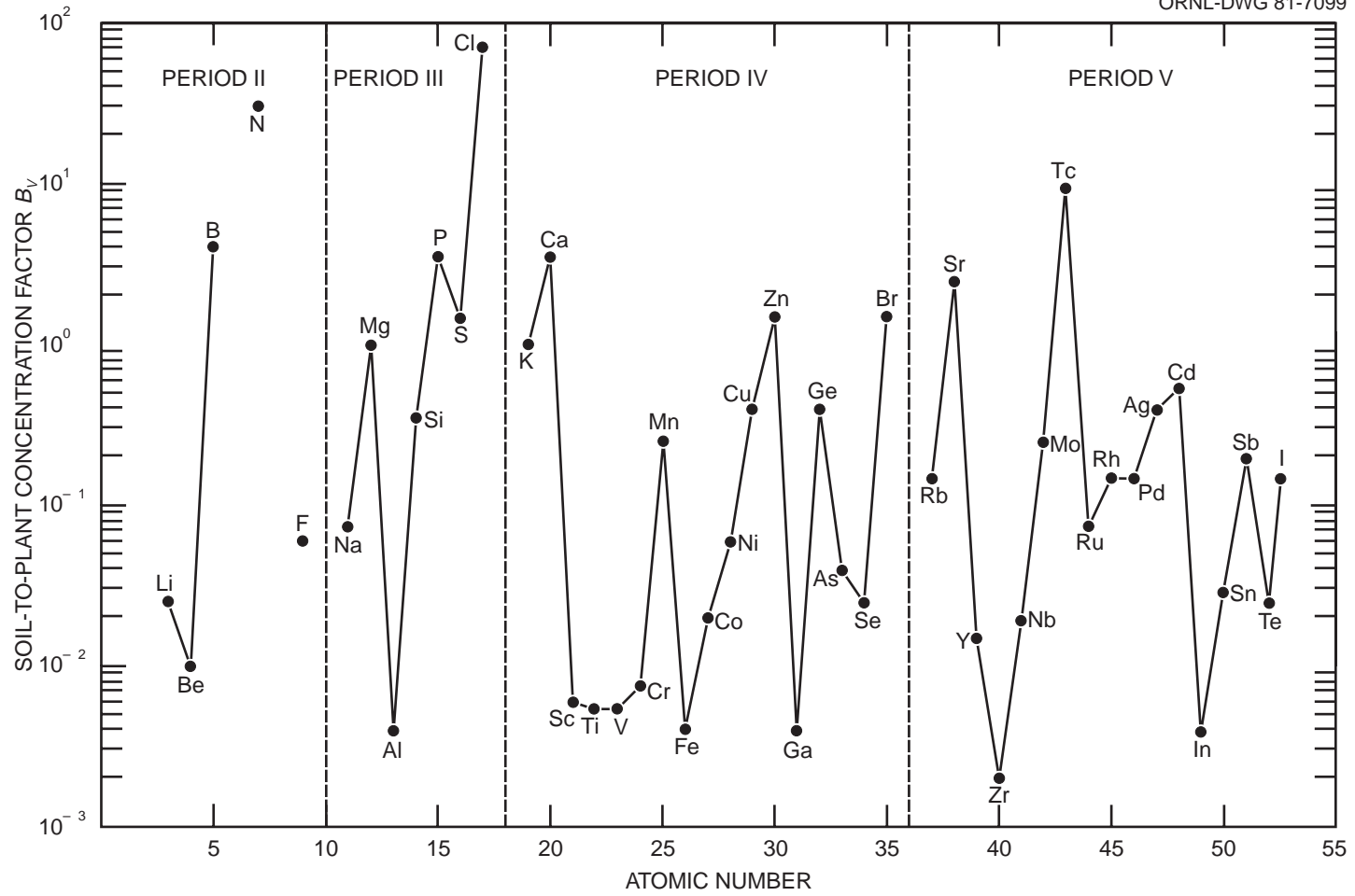

Figure 2.27. Systematic variations in default B_v estimates for Period II, III, IV, and V elements.

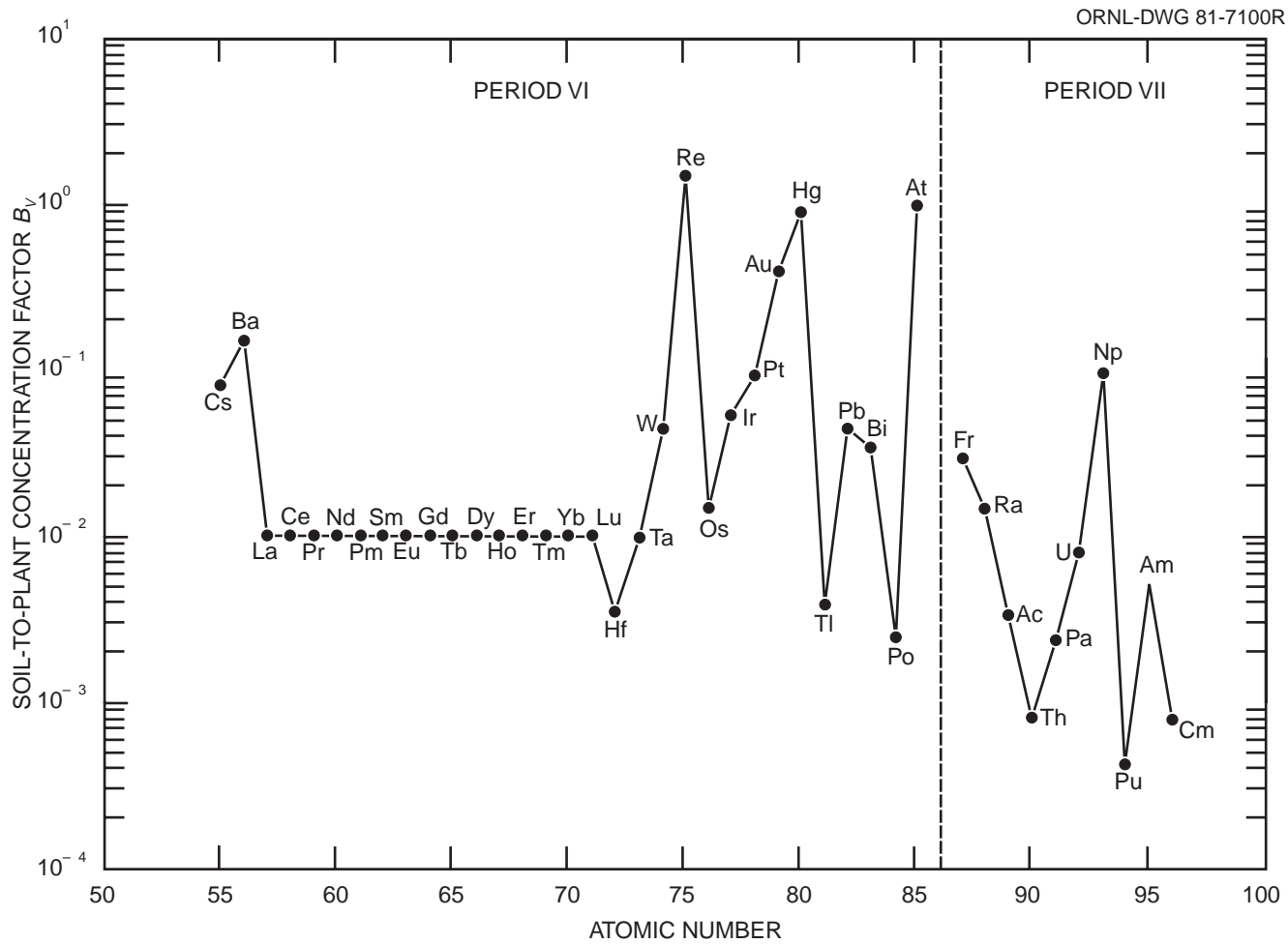

Figure 2.28. Systematic variations in default B_v estimates for Period VI and VII elements.

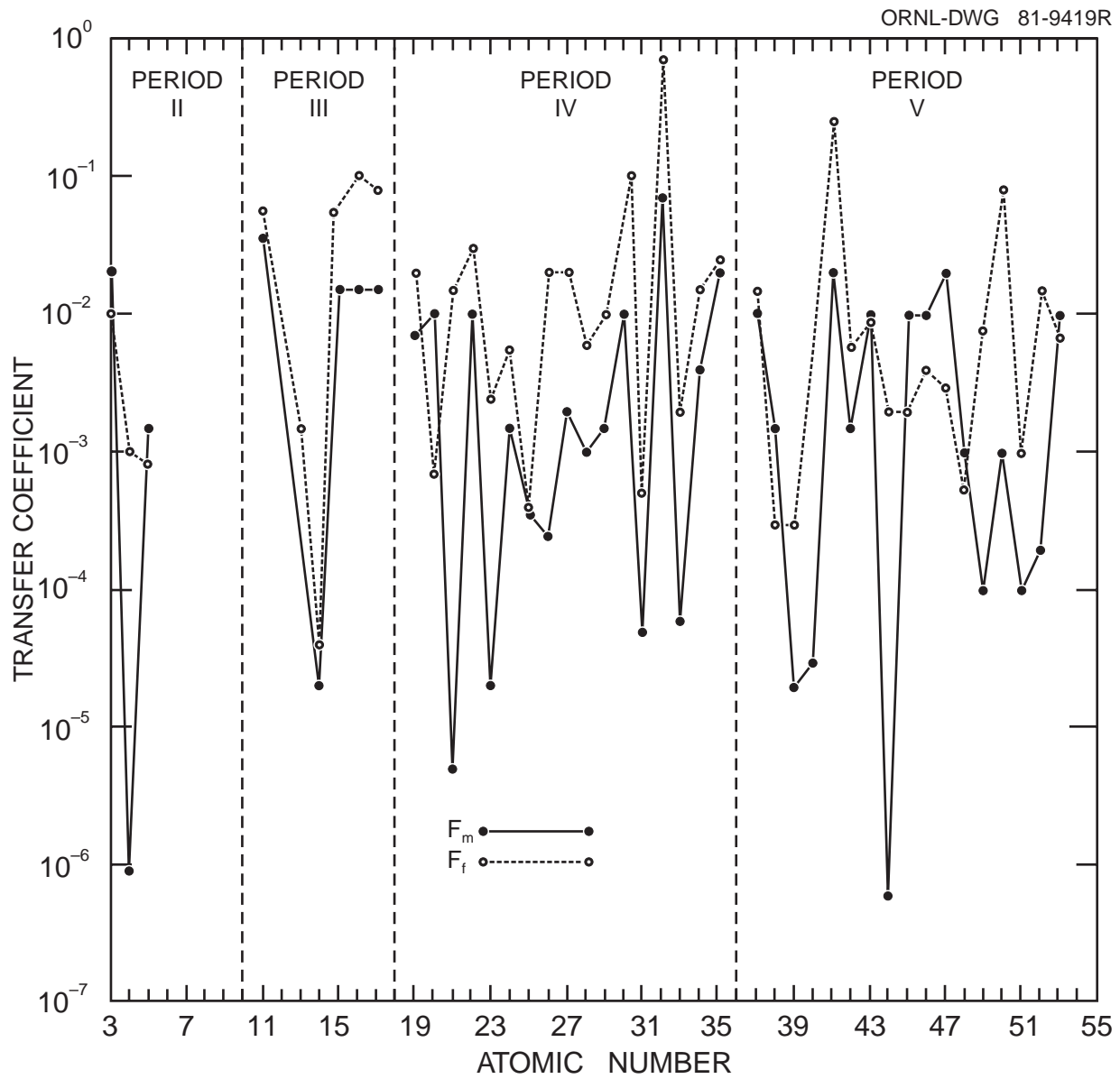

Figure 2.29. Systematic variations in default F_m and F_f estimates for Period II, III, IV, and V elements.

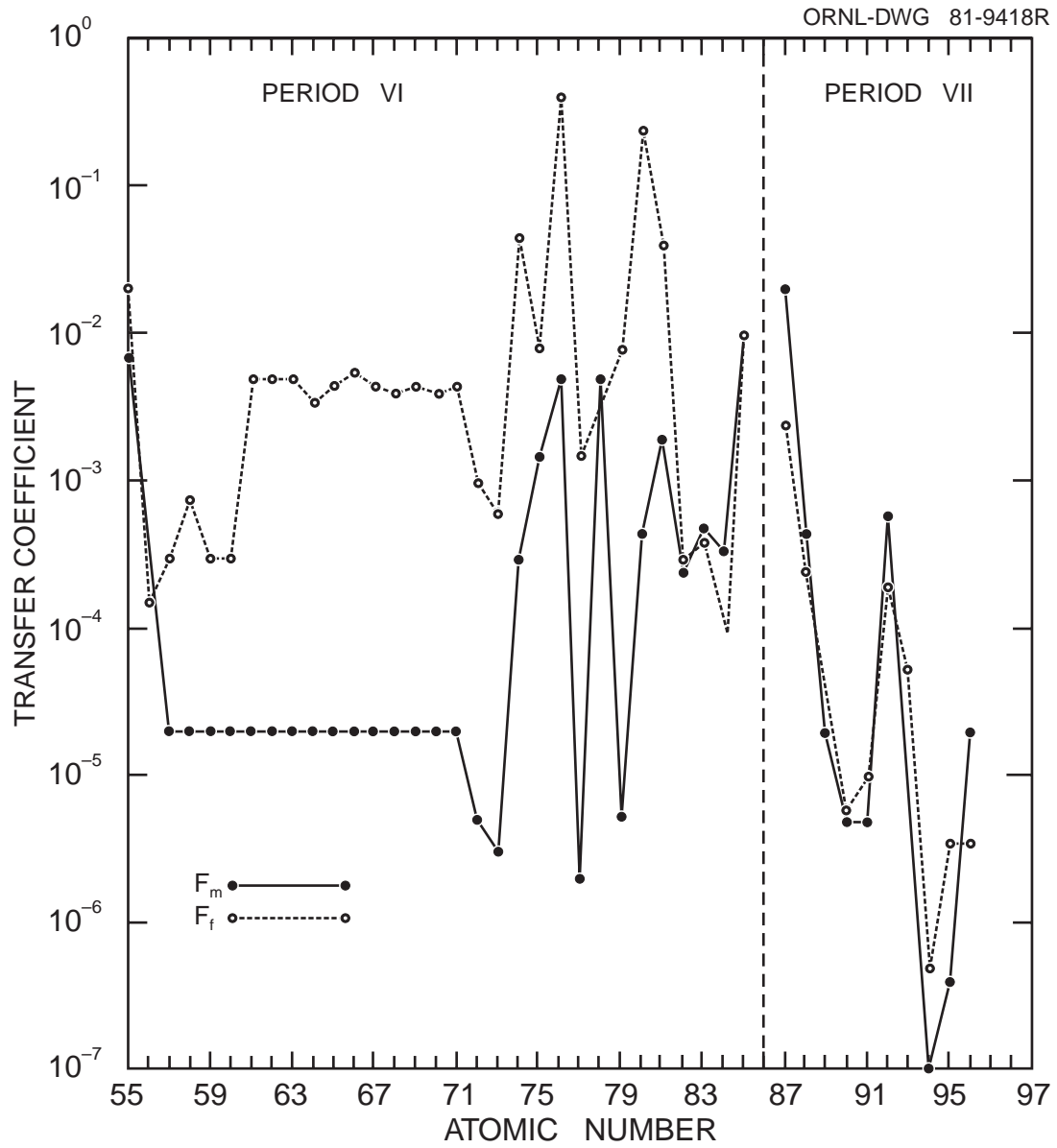

Figure 2.30. Systematic variations in default F_m and F_f estimates for Period VI and VII elements.

	I A	II A											III A	IV A	V A	VI A	VII A
II	Li 300	Be 650											B 3.0		N 0.50		F 150
III	Na 100	Mg 4.5	III B	IV B	V B	VI B	VII B	VIII		I B	II B	Al 1500	Si 30	P 3.5	S 7.5	Cl 0.25	
IV	K 5.5	Ca 4.0	Sc 1000	Ti 1000	V 1000	Cr 850	Mn 65	Fe 25	Co 45	Ni 150	Cu 35	Zn 40	Ga 1500	Ge 25	As 200	Se 300	Br 7.5
V	Rb 60	Sr 35	Y 500	Zr 3000	Nb 350	Mo 20	Tc 1.5	Ru 350	Rh 60	Pd 60	Ag 45	Cd 6.5	In 1500	Sn 250	Sb 45	Te 300	I 60
VI	Cs 1000	Ba 60		Hf 1500	Ta 650	W 150	Re 7.5	Os 450	Ir 150	Pt 90	Au 25	Hg 10	Tl 1500	Pb 900	Bi 200	Po 500	At 10
VII	Fr 250	Ra 450															

Lanthanides	La 650	Ce 850	Pr 650	Nd 650	Pm 650	Sm 650	Eu 650	Gd 650	Tb 650	Dy 650	Ho 650	Er 650	Tm 650	Yb 650	Lu 650
Actinides	Ac 1500	Th 1.5×10^5	Pa 2500	U 450	Np 30	Pu 4500	Am 700	Cm 2000							

Key:

Li 300

 — Symbol
— Transfer Coefficient, K_d

Figure 2.31. Values of the soil-water distribution coefficient K_d adopted as default estimates in the computer code TERRA.

In the batch method, soil and water are shaken with the material for a period of time until equilibrium distribution between soil and water is achieved or assumed. Because of nonequilibrium or the influences of convection and diffusion in the column method, these two techniques may give different results for nonionic elemental forms.¹⁴⁹ Thus, in searching the literature for K_d values, various biases and confounding factors inherent in the laboratory methods used to determine K_d are reflected in the values reported.

A second factor responsible for variation or imprecision in K_d measurement is a result of the parameter being a ratio of two concentrations. A small amount of error in measurement of either the soil or water concentration of material may produce a large amount of error in the resultant ratio. For example, in a batch-type experimental system of 10 g soil, 100 mL H₂O, and 100 µg of material for which the true K_d is 190 mL/g, a 1% overestimate of the soil concentration (95.95 µg in soil) yields a K_d of 237 mL/g, or approximately a 25% overestimate of K_d . The relative error in K_d estimate from a given percent error in measurement of soil concentration increases rapidly with increasing K_d (Fig. 2.32). The same is true with a given percent underestimate of the water concentration as the true K_d of the material decreases. Thus, if an investigator measures only one fraction of the soil-water system and determines the concentration of the other fraction by default, significant errors may be introduced into the K_d estimate from very small experimental errors of measurement. This magnification of experimental error undoubtedly contributes a significant amount of variability to K_d estimates for materials which are highly soluble or insoluble.

A third source of variability in K_d is its variation with soil type. Soils with different pH, clay content, organic matter content, free iron and manganous oxide contents, or particle size distributions will likely yield different K_d values. For example, in a study by Griffin and Shimp¹⁵⁰ of lead absorption by clay minerals, pH was shown to be an extremely important determinant of K_d . From their data, an exponential relationship between K_d and pH of the clays was found. At pH > 7.0, lead K_d is on the order of 10³, and below this pH, K_d ranges from 10¹ to 10². Soil pH has also been shown to influence K_d for plutonium and curium;¹⁵¹⁻¹⁵³ ruthenium, yttrium, zirconium, niobium, and cerium;¹⁵⁴ arsenic and selenium;^{155,156} and manganese, iron, zinc, cobalt, copper, cadmium, and calcium.¹⁵⁷⁻¹⁵⁹

Another source of variation in K_d is the time factor involved with its determination. Batch-type K_d determinations are usually made over a period of a few to several hours until equilibrium is achieved or assumed. If equilibrium does not occur within this short time period, some error is introduced. Errors from nonequilibrium K_d determinations made after 24 hours, however, are relatively insignificant.^{151,152,160} A more significant error may be introduced by using short term K_d determinations to simulate leaching over time periods of months or years. Gast et al.²³ found that sorption of Tc-99 by low organic soils tended to significantly increase over a 5-6 week period. Treatments of the soil with dextrose, H₂O₂, and steam sterilization, and sorption variation with temperature—all indicated that microbiota played either a direct or indirect role in sorption. Heterotrophic bacteria capable of solubilizing PbS, ZnS, and CdS have been reported by Cole,¹⁶¹ and microbial influences on the solubility of transuranics has also been suggested by Wildung and Garland.¹⁶² If microbial action is, indeed, important over the long term, then the applicability of K_d experiments carried out with oven dried and sieved soil to models of leaching in agricultural soils over long time periods must be questioned.

An analysis of the literature was performed to ascertain appropriate distributions of K_d for various elements (Table 2.13). Because of the variation of K_d with soil pH, an analysis of 222 agricultural soils^{163,164} was used to determine a typical range of pH for agricultural soils. In these soils, pH was found to be normally distributed with a mean pH of 6.7 and 95% of the values between a pH of 4.7 to 8.7. Thus, the criterion was adopted of discarding K_d values which were measured in soils outside of the pH range of 4.5 to 9. The K_d determinations used to generate Table 2.13 represent a diversity of soils, pure clays (pure minerals were excluded), extracting solutions (commonly H₂O, CaCl₂, or NaCl), laboratory techniques, and magnification of experimental error. Also, unavoidably, single measurements have been combined with replicates, means, and means of means to derive K_d distributions. When many references have been used to

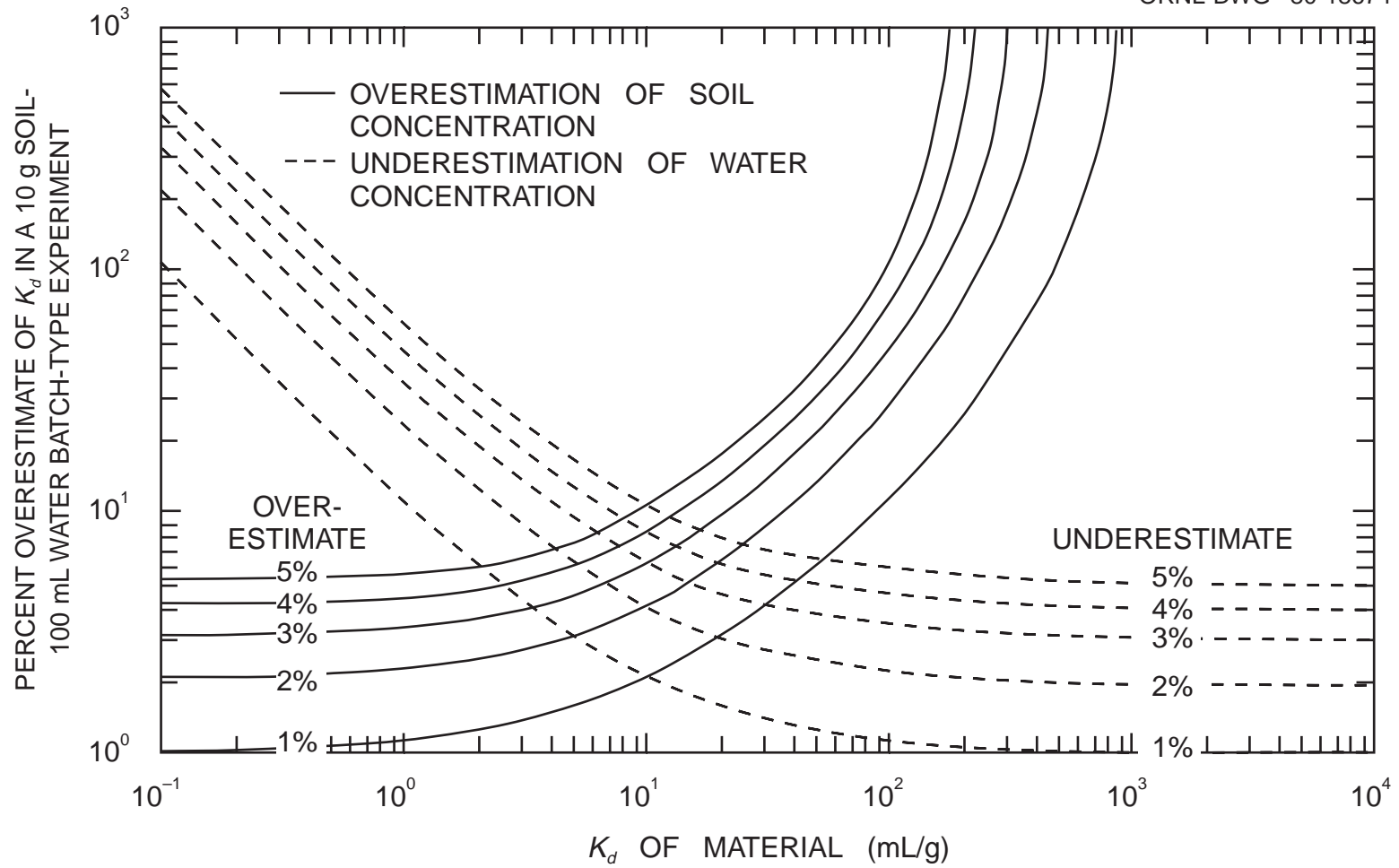

Figure 2.32. Percent error in K_d estimation from one to five percent overestimates of soil concentration or underestimates of water concentration in a 10 g-100 mL batch-type K_d experiment.

Table 2.13. Estimates of the distribution of K_d for various elements in agricultural soils of pH 4.5 to 9.0

Element	# Obs.	μ^a	σ^b	Exp(μ) ^c	Observed range ^b	References
					— mL/g —	
Mg	58	1.5	0.40	4.6	1.6 to 13.5	165, 166
K	10	1.7	0.49	5.6	2.0 to 9.0	165
Ca	10	1.4	0.78	4.1	1.2 to 9.8	165
Mn	45	4.2	2.5	65	0.2 to 10,000	149, 158, 167, 168
Fe	30	3.2	2.0	25	1.4 to 1,000	149, 158, 167, 169
Co	57	3.9	1.1	47	0.2 to 3,800	149, 158, 160, 167, 169–171
Cu	55	3.6	0.97	35	1.4 to 333	157, 158
Zn	146	3.6	1.8	38	0.1 to 8,000	149, 157–159, 167
Sr	218	3.6	1.6	37	0.15 to 3,300	149, 152, 154, 160, 167, 169, 171–180
Y	2	6.2	1.7	510	160 to 1,640	154
Mo	17	2.9	2.2	18	0.37 to 400	149
Tc	24	-3.4	1.1	0.033	0.0029 to 0.28	23
Ru	17	5.9	0.75	350	48 to 1,000	154, 160
Ag	16	3.8	1.5	46	10 to 1,000	149, 167
Cd	28	1.9	0.86	6.4	1.26 to 26.8	157
Cs	135	6.9	1.8	1,000	10 to 52,000	149, 160, 167, 169, 171, 173, 175, 177, 178, 180–183
Ce	16	6.7	0.54	840	58 to 6,000	154, 160
Pb	125	6.0	2.1	400	4.5 to 7,640	150, 184
Po	6	6.3	0.65	520	196 to 1,063	184
Th	17	12	0.57	150,000	2,000 to 510,000	185–187
U	24	6.1	2.5	450	10.5 to 4,400	185–187
Np	44	3.4	2.5	29	0.16 to 929	148, 186, 188, 189
Pu	40	8.4	2.4	4,500	11 to 300,000	151, 152–154, 177, 182, 186, 187, 189
Am	46	6.5	2.4	680	1.0 to 47,230	148, 188–190
Cm	31	7.6	1.6	1,900	99.3 to 51,900	148, 153, 189

^aThe mean of the logarithms of the observed values.

^bThe standard deviation of the logarithms of the observed values.

^cGeometric mean (50% cumulative probability).

generate the distribution, greater assurance can be given that the distribution is a representative distribution because it is not heavily biased by one or two experimental designs or techniques. Where a single or a few references were used, less assurance can be given.

On the basis of distributions computed for cesium and strontium (Fig. 2.33), a lognormal distribution for K_d has been assumed for all elements. Thus, the median value of the assumed lognormal distribution is used as a best estimate default K_d for TERRA (except for lead, and technetium where judgement was exercised). However, if the distribution of K_d computed for cesium and strontium are typical, then K_d may vary by as much as three orders of magnitude in soils of pH 4.5 to 9.0. Such variation in K_d is greater than or equal to the variation in B_v observed for cesium, strontium, and plutonium (Figs. 2.3, 2.7, and 2.22) and suggests the advisability of using site-specific values when available.

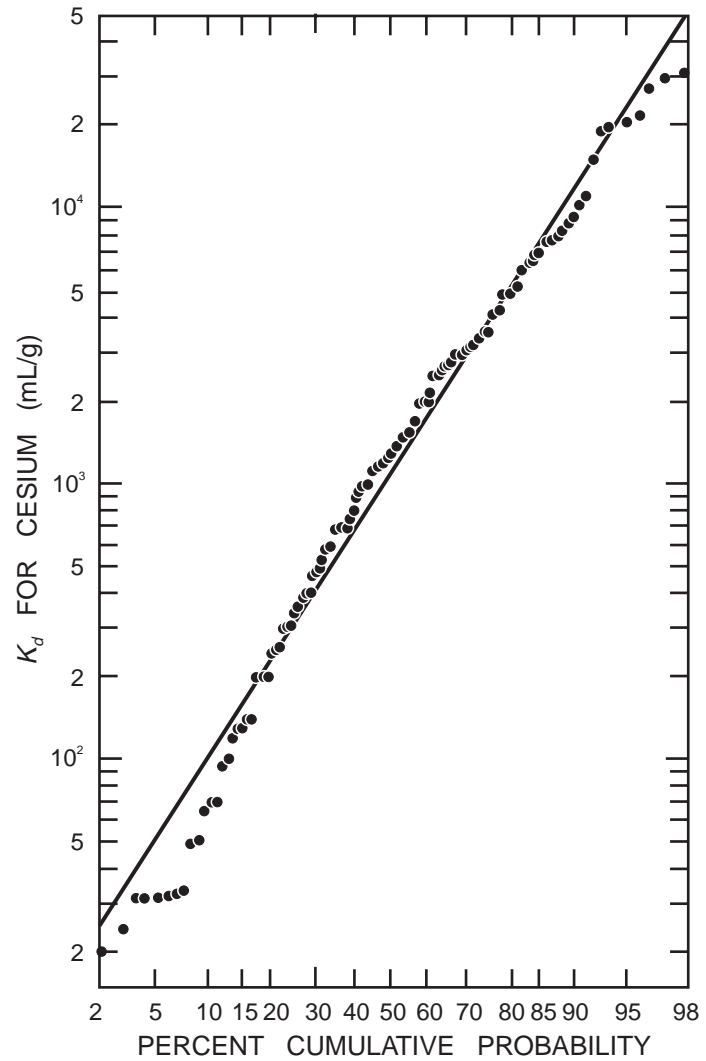
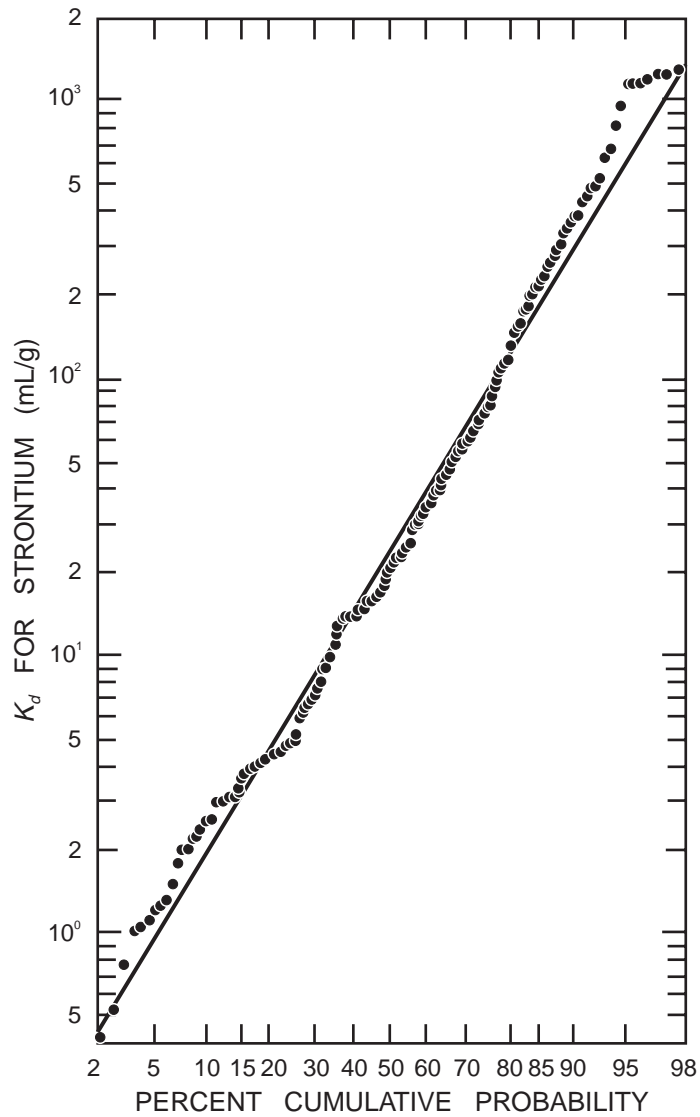

Figure 2.33. Lognormal probability plots of K_d for cesium and strontium in soils of pH 4.5 to 9 based on available references.

2.4.2 Estimates of K_d based on default B_v values

Although K_d estimates for the 23 above-mentioned elements are subject to great uncertainty, they are based on values reported in the literature. No references are immediately available for the remaining elements of the periodic table. In order to provide a default estimate for these elements, an alternative method is used. In 1979, Van Dorp, Eleveld, and Frissel¹⁹¹ proposed a model for estimation of the soil-plant concentration factor. Their approach was to calculate the solubility of a nuclide in soil water, its ability to transfer across root membranes, and its upward movement with the transpiration stream. They reasoned that measured values of K_d , root selectivity coefficient (S), and transpiration coefficient (T_c) would allow them to predict the soil-plant concentration factor from soil-radionuclide concentration. Their model has not become generally used or accepted for dose calculations, but their implied dependency of B_v on K_d is the basis of our approach for estimating default K_d estimates in lieu of experimental determinations.

Our approach is to presume that the default K_d estimates for elements in Sect. 2.4.1 and their corresponding B_v estimates represent a wide variety of soils and plants. Therefore, a single default estimate for B_v and K_d will reflect soils, plants, and experimental conditions which are “averaged” or “generalized.” Thus, any relationship observed between K_d and B_v may be used to predict “average” or “generalized” K_d estimates from our default B_v estimates.

Figure 2.34 shows the correlation found between B_v and K_d . It should be noted that the B_v estimates in Fig. 2.34 are the geometric means determined directly through analysis of reviewed literature, and not necessarily the default values from Fig. 2.1. Technetium is an example. The technetium B_v of 89 is the geometric mean of the geometric means of references 23, 107, 122, and 123. It was felt that although the short-term plant uptake studies represented in references 23, 107, and 122 were inappropriate for long-term B_v estimates, they were appropriately associated with the short-term K_d determinations for technetium (because B_v decreases and K_d increases with time). Thus, these two short-term parameters were used in the definition of the B_v - K_d relationship. However, in Fig. 2.31 we used our best estimate of technetium B_v and the regression equation

$$K_d = \exp(2.38 - 0.89(\ln B_v)) \quad (9)$$

to determine our best estimate of technetium K_d of 1.5. In addition to technetium the K_d default estimates for elements not mentioned in Sect. 2.4.1 were determined via Eq. (9) and the best estimate B_v default values in Fig. 2.1.

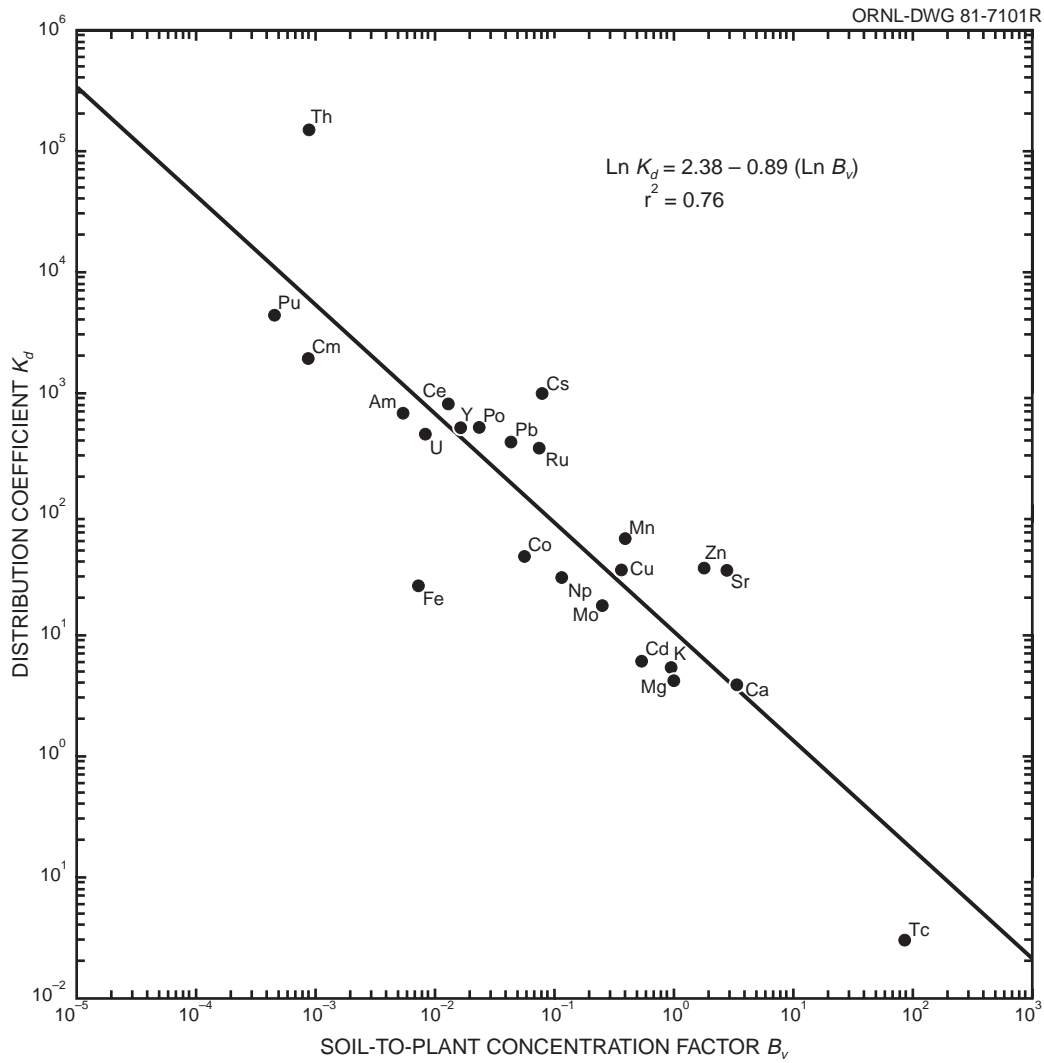

Figure 2.34. Correlation between B_v , and K_d based on geometric means of available reference geometric means.

3. INTERCEPTION FRACTION FOR VEGETATION

The interception fraction for a given vegetation type, r^i , is a factor which accounts for the fact that not all of the airborne material depositing within a unit area will initially deposit on edible vegetation surfaces. The fraction of the total deposit which is initially intercepted by vegetation is the interception fraction, r^i , such that $0 \leq r^i \leq 1$. In the TERRA code, as in other food chain transport models,⁶ the processes of initial deposition and weathering removal with time are treated separately. In the NRC Regulatory Guide 1.109 model, separate interception fractions are suggested for iodines and other particulate types.⁶ The analysis of agricultural food and feed crops in the United States by Shor, Baes, and Sharp⁷ suggests that the diversity of growth forms necessitates vegetation-specific estimates of interception fraction as well. The following sections outline a theoretical approach to vegetation-specific interception fractions. The results of such approaches have been used as default estimates in lieu of user-input values in the TERRA computer code. Variation of interception fraction with element, chemical form, and deposition process (e.g., wet, dry) will require further research.

In Section 3 pasture, hay, and silage productivities are considered to be on an air-dry weight basis as reported in reference 7. Vegetable and produce productivities are in fresh weight as reported in reference 7.

3.1 Pasture Grasses and Hay

The interception fraction for pasture grasses and hay are modeled in a different manner than for other vegetation types because experimental determinations of interception fractions for grasses have been performed.¹⁹²⁻¹⁹⁸ In these studies a correlation between initial interception fraction and productivity (standing crop biomass) has been found. This relationship and an empirical fit of the available data (summarized in Table 3.5 of reference 199) is shown in Figure 3.1. The empirical relationship is given by

$$r^{pg} = 1 - \exp(-2.88Y_{pg}) \quad (10)$$

where

$$\begin{aligned} r^{pg} &= \text{the interception fraction for pasture grass and} \\ Y_{pg} &= \text{the productivity of pasture grass (kg/m}^2, \text{ dry).} \end{aligned}$$

This relationship has been assumed to apply to hay as well as pasture grasses in the computer code TERRA.

3.2 Leafy Vegetables

There are no readily available literature references for the interception fraction for leafy vegetables. Therefore, the interception fraction for leafy vegetables is based on a theoretical model (Fig. 3.2). With this model a range of possible interception fractions may be generated if the following assumptions are made:

1. On a two-dimensional basis the fractional area represented by leafy vegetables is equal to the interception fraction;
2. leafy vegetables may be represented by circles on a two-dimensional basis (Fig. 3.2);
3. leafy vegetables are planted in rows;

ORNL-DWG 80 - 14273

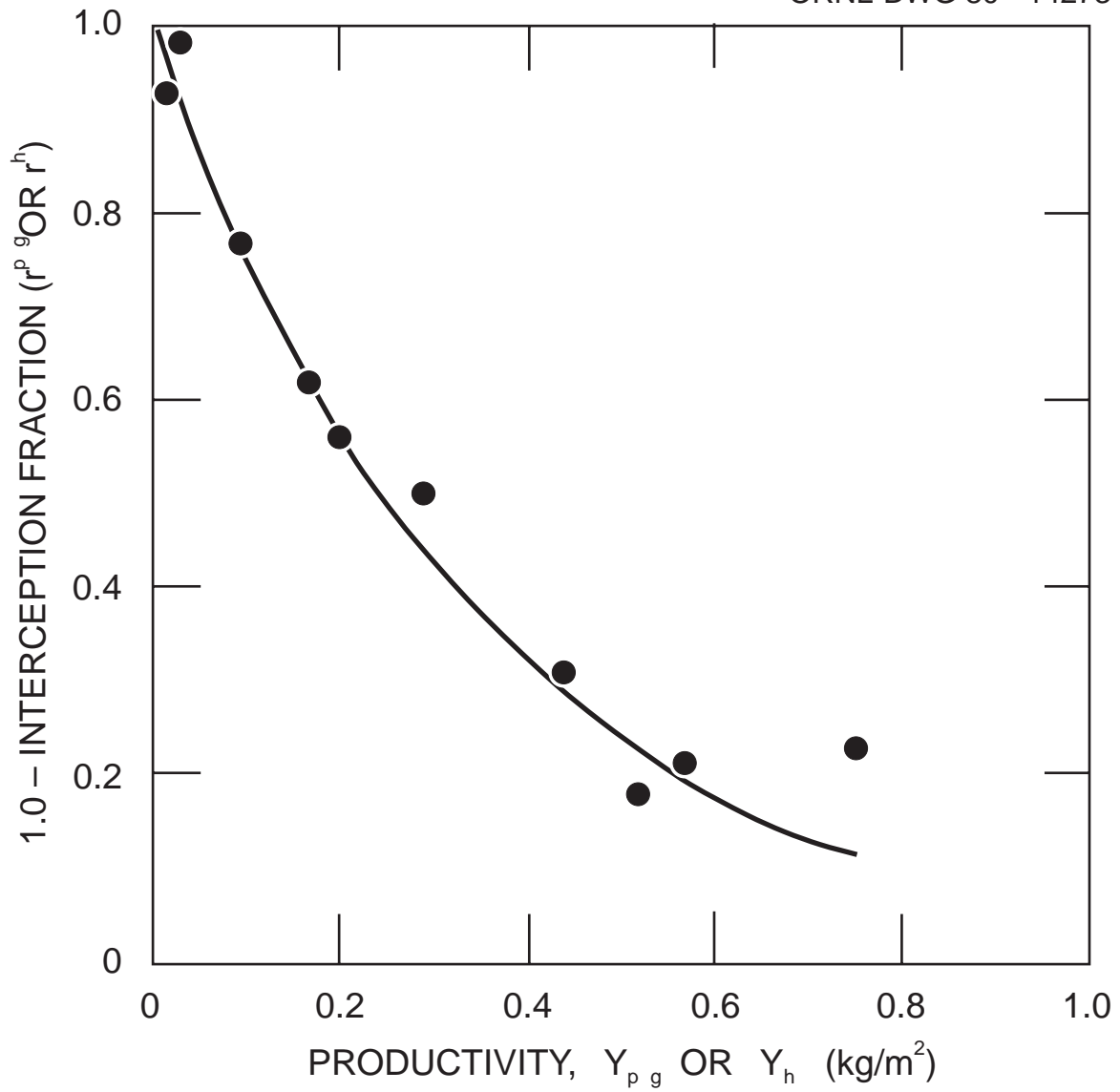

Figure 3.1. Relationship between interception fraction and productivity (in dry weight) for forage grasses (pasture and hay).

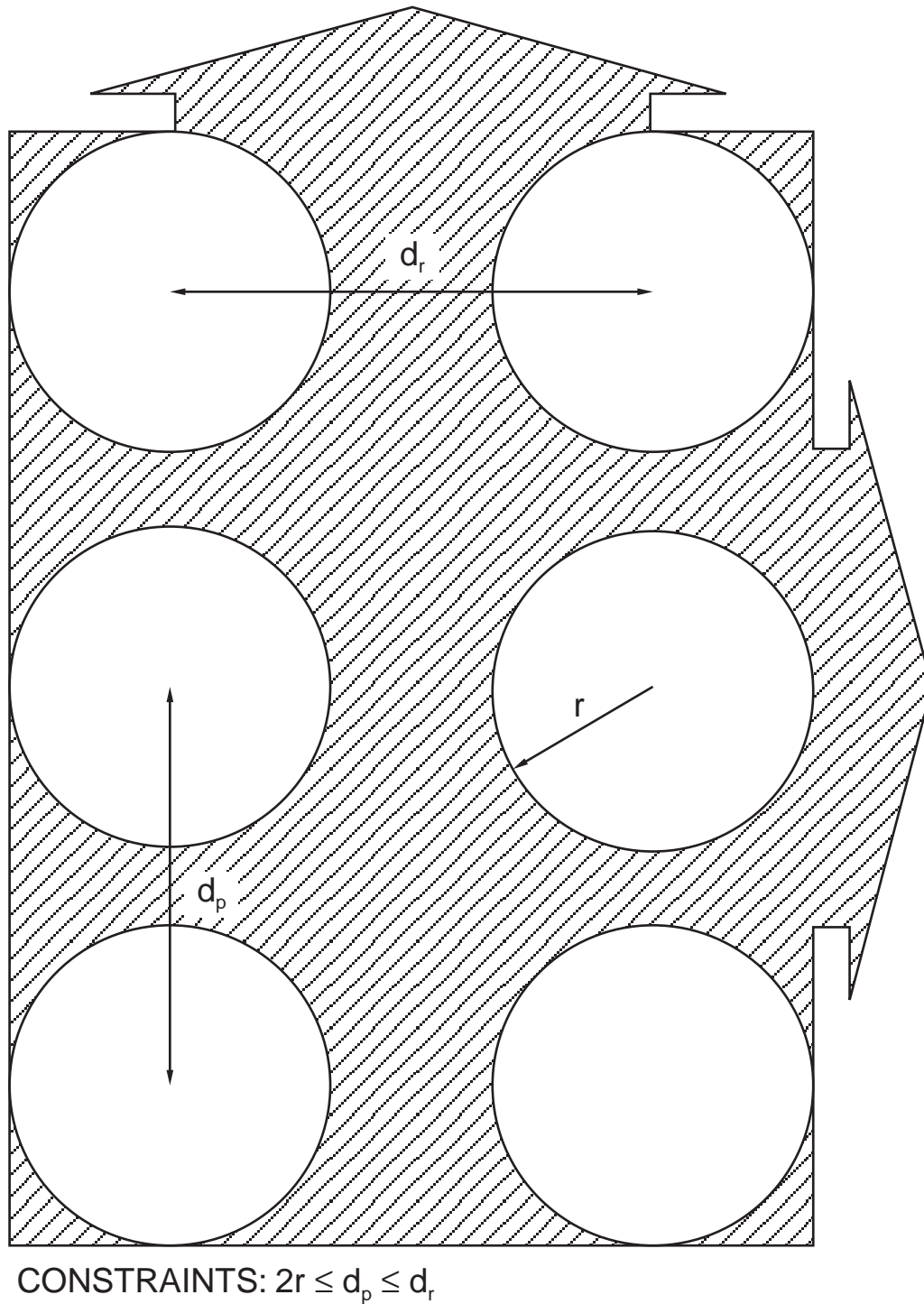

Figure 3.2. Model of field geometry of leafy vegetable spacings.

4. the ranges of between-plant and between-row spacings in the United States are approximately equal to the minima and maxima recommended by Knott;²⁰⁰
5. a farmer will not plant individual leafy vegetables so close together that leaves from adjacent plants overlap (thereby decreasing yield);
6. rows will generally be spaced farther apart than individual plants in a row; and
7. harvest of leafy vegetables occurs at the time of maximum yield, and maximum yield corresponds to maximum plant diameter.

With the above assumptions, the model given by Fig. 3.2 predicts that the fraction of planted area occupied by leafy vegetables, equivalent to the interception fraction at harvestable maturity, is given by

$$r^{mlv} = \frac{n_r r_n \pi r_f^2}{[(n_r - 1)d_p + 2r_f][(r_n - 1)d_r + 2r_f]}, \quad (11)$$

where

- r^{mlv} = the interception fraction for mature leafy vegetables,
- n_r = the number of plants per row,
- r_n = the number of rows of plants,
- r_f = the radius of an individual fruit or plant,
- d_p = the distance between plants in a row, and
- d_r = the distance between rows of plants.

The constraints on the model are

$$2r_f \leq d_p \leq d_r. \quad (12)$$

As the land area planted becomes infinitely large, Eq. (11) becomes

$$r^{mlv} = \frac{\pi r_f^2}{d_p d_r}. \quad (13)$$

If a farmer maximizes the number of plants per row such that $d_p = 2r_f$, then Eq. (13) becomes

$$r^{mlv} = \frac{\pi r_f}{2d_r}. \quad (14)$$

When $2r_f = d_p = d_r$ (maximum utilization of planted land), then the interception fraction for mature leafy vegetables is 0.785.

In order to predict an average interception fraction for the mature leafy vegetable, recommended field spacings²⁰⁰ for leafy vegetables were assumed to represent typical spacings actually encountered in American agriculture. A distribution of field spacings was determined by obtaining a range of recommended spacings for each leafy vegetable and weighting each vegetable according to its importance (by area planted) in the United States (Table 3.1). By determining distributions of typical d_r spacings and values of r_f , a Monte Carlo technique was used to produce a distribution of solutions to Eq. (14). The mean value of this distribution is $r^{mlv} = 0.30$. In this simulation the average d_r was 73.5 cm (28.7 inches).

Table 3.1. Weighting factors for leafy vegetable interception fraction model simulation

Leafy vegetable	Quantity planted (km ²)	Percent	Weight factor
Lettuce	948	42	
cos			14
head			14
leaf			14
Cabbage	367	16	
early			6
late			5
Chinese			5
Greens	246	11	
collards			3
kale			3
spinach			3
New Zealand spinach			2
Broccoli	176	8	
sprouting			4
raab			4
Mint	160	7	7
Celery	140	6	6
Cauliflower	113	5	5
Green onions	59.3	3	3
Escarole	33.6	2	
chicory			1
endive			1
Brussels sprouts	24.8	1	1
Total	2267.7	100	100

From the theoretical interception fraction for mature leafy vegetables of 0.30 it is possible to generate an average interception fraction over the time in the field by taking into account the logistic growth characteristics of plants (Fig. 3.3). It is commonly known that plants (and many living organisms) have growth patterns which follow a logistic growth pattern.²⁰¹⁻²⁰⁵ Logistic growth curves have been defined by various equations which yield the appropriate shape. For our analysis the following equation was used:

$$f^m = \frac{1 - \cos\left[180\left(\frac{t_i}{t_m}\right)\right]}{2}, \quad (15)$$

where

- f^m = the fraction of maximum growth,
- t_i = the time of interest, and
- t_m = the time at which maximum growth normally occurs

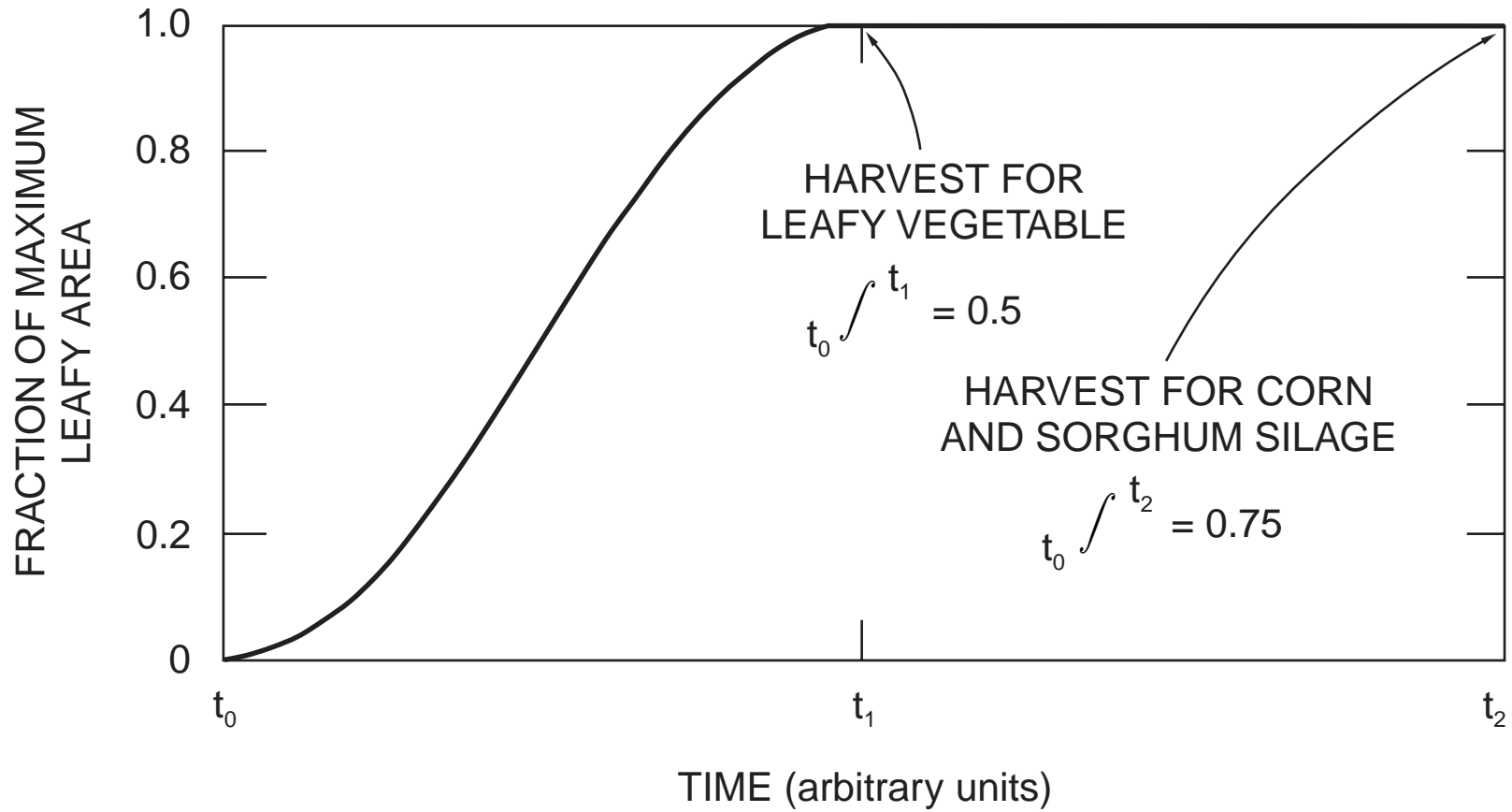

Figure 3.3. Hypothetical growth curve for plants. Leafy vegetables are harvested at the time of maximum growth, and silage is harvested at grain maturity.

Equation (15) was chosen because at time = $t_m/2$, $f^m = 0.5$ and integration of Eq. (15) from t_0 to t_m yields 0.5. Thus, an average interception fraction for leafy vegetables over the time in the field is equal to 0.5×0.30 or 0.15. It must be emphasized that the value of 0.15 represents a theoretical average over the United States for leafy vegetables. A corresponding theoretical maximum would be 0.5×0.785 or 0.39.

3.3 Silage

The analysis of silage interception fraction is based on an approach similar to that for leafy vegetables. A modification of the two-dimensional model was made to allow for overlap of leaves from adjacent plants (as seen in aerial views of corn and sorghum fields). However, no overlap was allowed between leaves from adjacent rows (Fig. 3.4). It was assumed in our analyses that the silage is not harvested until the grain has matured. This period of maturity corresponds to the period t_1 to t_2 in Fig. 3.3. According to descriptions of growth stages in corn by Hanaway²⁰⁶ and Norman,²⁰⁷ grain maturity occurs at a time approximately equal to twice the time to maximum plant growth (and thus maximum surface area). Accordingly, the integral of plant surface area from t_0 to t_2 in Fig. 3.3 is 0.75.

From Fig. 3.4, the fraction of total area occupied by the silage at maturity is given by

$$r^{ms} = \frac{r_f^2 \left[\frac{4\pi}{3} + (n_r - 1) \frac{\sqrt{3}}{2} + (n_r - 2) \frac{\pi}{3} \right] r_n}{[d_r (r_n - 1) + 2r_f][d_p (n_r + 1)]}. \quad (16)$$

The model constraints are

$$r_f = d_p \leq \frac{d_r}{2}. \quad (17)$$

As the planted area becomes infinitely large, Eq. (16) approaches

$$r^{ms} = \frac{r_f^2 \left[\frac{\pi}{3} + \frac{\sqrt{3}}{2} \right]}{d_r \cdot d_p}. \quad (18)$$

Since $d_p = r_f$, Eq. (18) becomes

$$r^{ms} = \frac{d_p \left[\frac{\pi}{3} + \frac{\sqrt{3}}{2} \right]}{d_r}. \quad (19)$$

At maximum silage density ($d_r = 2d_p$) Eq. (19) becomes a value of 0.96. Correspondingly, the maximum average interception fraction is equal to 0.72.

The average interception fraction was derived from average values of d_r and d_p for corn and sorghum plantings. An average d_p of 30.5 cm (12 inches) and d_r of 99 cm (39 inches) was taken from Knott²⁰⁰ and Rutledge.²⁰⁸ Using these values, an interception fraction at maturity of 0.59 was determined from Eq. (19). This value yields an average interception fraction of 0.44.

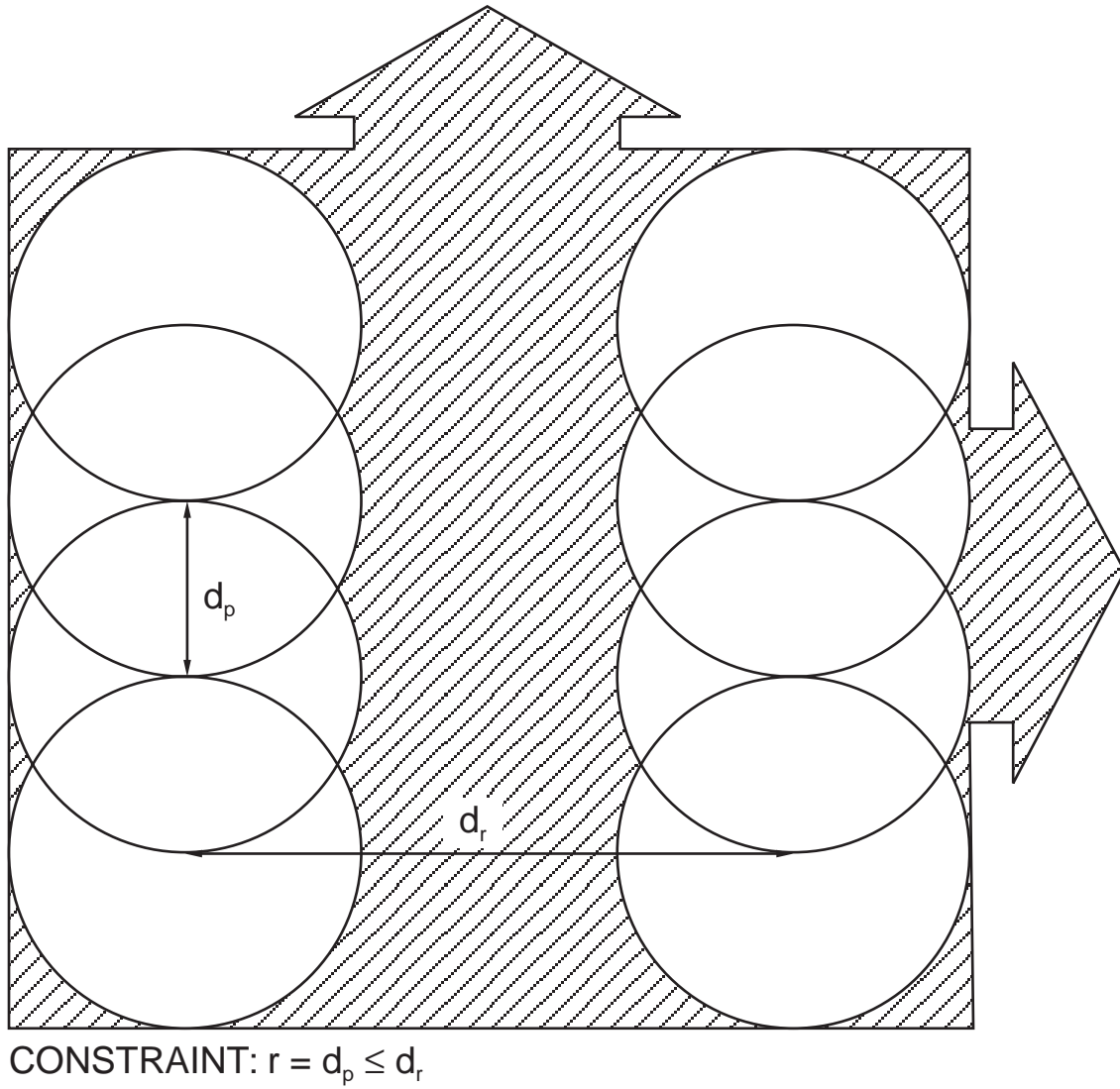

Figure 3.4. Model of field geometry of silage plant spacings.

3.4 Exposed Produce

The exposed produce category includes 31 commercially important fruits and vegetables in the United States.⁷ These produce may be broadly classified as noncitrus fruits, berries, and important field crops. Because of the diversity of growth forms in the exposed produce category, our analysis is based on five of the most important noncitrus fruits and field crops in the category—apples, snap beans, tomatoes, peaches, and cherries. For this analysis, importance is defined in terms of area planted (see Table 3.2).

For noncitrus fruits and tomatoes, as with leafy vegetables and silage, it is assumed that the fruits can be represented by circles on a two-dimensional basis. The interception fraction is calculated by determining the total fruit cross-sectional area per square meter which is given by

$$r^{mf} = \frac{n\pi r_f^2}{lw}, \quad (20)$$

where

- r^{mf} = the interception fraction of the mature fruit,
- n = the number of fruit per square meter
- r_f = the radius of the fruit (mm),
- l = the length of the unit area (1000 mm), and
- w = the width of the unit area (1000 mm).

It is assumed that an average interception fraction over the lifetime of the fruit is provided for by the model of logistic growth and maturity used for silage. That is, half of the fruit's residence time in the tree or on the plant is assumed to be for growth and development, and one half of the time is assumed to be for maturing or ripening before harvest. Thus, Eq. (20) becomes

$$r^{ef} = \frac{0.75n\pi r_f^2}{lw}, \quad (21)$$

where

- r^{ef} = average interception fraction for exposed fruit.

For snap beans the same approach as for round fruits is used, except that the effective surface area of a snap bean is modeled in two dimensions as a rectangle—a two dimensional view of a cylinder on its side. For mature snap beans

$$r^{msb} = \frac{n2r_f l_f}{lw}, \quad (22)$$

where

- l_f = the length of the snap bean.

As with tree fruits and tomatoes, the average interception fraction over the time in the field is 0.75 times the value of the mature interception fraction.

A search of the literature was performed to determine values of n , r_f , r_l , and l_f or collateral information from which to deduce them. Empirical measurements of r_f and r_l were combined with literature values to determine default values. Fruit weights were compared with estimated weights of spheres of water of the same radius to check default estimates. Information from the 1974

Table 3.2. Relative importance of various exposed produce in the U.S.

Vegetable	Quantity planted (km ²)	Percent of category	Percent of sub- category
Non-citrus tree fruits			
Apple	1960	27.2	57.3
Apricot	6.00	0.1	0.2
Cherry	429	6.0	12.5
Date	0.101	≤0.1	≤0.1
Fig	0.0647	≤0.1	≤0.1
Mango	4.86	≤0.1	0.1
Nectarine	3.63	≤0.1	0.1
Peach	644	9.0	18.8
Pear	229	3.2	6.7
Hot Pepper	48.2	0.7	1.4
Plum	36.6	0.5	1.1
Prune	61.4	0.9	1.8
Total	3423	47.6	
Berries & vine fruits			
Blackberry	94.5	1.3	10.6
Blueberry	154	2.1	17.3
Boysenberry	4.75	≤0.1	0.5
Cranberry	91.2	1.3	10.2
Currant	1.12	≤0.1	0.1
Gooseberry	0.348	≤0.1	≤0.1
Grape	411	5.7	46.1
Pimento	1.64	≤0.1	0.2
Raspberry	29.9	0.4	3.4
Strawberry	104	1.5	11.7
Total	892	12.4	
Field crops			
Asparagus	269	3.7	9.3
Cucumber	380	5.3	13.2
Eggplant	16.0	0.2	0.6
Okra	16.7	0.2	0.6
Rhubarb	6.80	0.1	0.2
Sweet pepper	155	2.2	5.4
Snap bean	1250	17.4	43.4
Squash	133	1.9	4.6
Tomato	655	9.1	22.7
Total	2880	40.0	

Census of Agriculture²⁰⁹ was used to calculate values of n for each fruit or vegetable. Estimated interception fractions for mature apples, snap beans, tomatoes, peaches, and cherries were calculated according to Eqs. (21) and (22) and weighted to derive a default interception fraction estimate of 0.052 for exposed produce (Table 3.3). Surprisingly, the values for the noncitrus fruits (apples, peaches, and cherries) are within approximately a factor of 1.3 of each other, and the values for the field crops are approximately equal to each other.

3.5 Correlation Between Interception Fraction and Standing Crop Biomass

As mentioned in Sect. 3.1, Chamberlain found a relationship between standing crop biomass or productivity and the interception fraction for pasture grasses. This relationship [Eq. (10)] is used in the TERRA code to calculate the interception fraction for pasture grasses and hay. The analyses of interception fraction for leafy vegetables, silage, and exposed produce (Sect. 3.2, 3.3, and 3.4, respectively) are based on generalized or average crops. Use of the interception fraction values for these categories as default estimates independent of complementary values of productivity (Y_i) could result in unreasonable overestimates of surface plant concentrations, c^{ps} , because

$$c^{ps} \propto \frac{r^i}{Y_i}. \quad (23)$$

That is, low values of Y_i coupled with values of r^i for average crops (represented by average Y_i values) could produce high values of r^i/Y_i . As Y_i approaches zero, the r^i/Y_i ratio approaches infinity.

Figure 3.3 indicates that leaf (or edible produce) surface area increases with time as the plant grows. Clearly, since interception fraction is proportional to surface area, the interception fraction for very young plants is less than that for mature plants, and r^i is a function of Y_i for the individual plant. However, it is not clear whether r^i is a function of Y_i for the mature plant in the field. Figure 3.5 illustrates the problem.

Figure 3.5 presents three plots of equal area with hypothetical crops represented by spheres. The relative ordering of productivity is $A > B > C$. In plots A and B planting geometry (packing) has been maximized (without staggering) by planting individual plants within a row and rows of plants adjacent to one another. The difference between the two crops is that the crop in plot A is of greater size (radius, r_f) than the crop in plot B. In plots B and C the crop radii are equal, but planting geometry is less efficient in plot C. In all plots the interception characteristics of the individual crops are equal.

It can be shown mathematically that the total surface area of crops in plots A and B are equal. That is, the decrease in surface area per plant as plant radius is reduced is exactly counterbalanced by the increase in number of plants per unit area. Therefore, the interception fraction for crops A and B should be the same. The productivity, however, is dependent on the volume multiplied by the number of plants per unit area. Since volume is proportional to the cube of plant radius, the productivity of plot A is greater than that of plot B. In this example, regardless of plant size the interception fraction is a constant value which is independent of productivity.

In plots B and C the interception fraction is a function of productivity. The surface area per plant is constant, and as planting geometry becomes less efficient, both productivity and interception fraction decrease proportionately.

The above examples illustrate that interception fraction for nongrasslike plants may or may not be a function of productivity, depending on whether a difference in productivity reflects a difference in plant size or a difference in plant spacings. This dilemma has been addressed in TERRA. As mentioned in the introduction to this report (and as will be discussed later), the TERRA code allows input of location-specific agricultural parameters, including location-specific productivity

Table 3.3. Values of the interception fraction for five important crops in the exposed produce category

Produce	r_i	r_f	n	l_f	Interception fraction	Weighting factor ^a
Apples	4.2 m	38 mm	10/m ²		0.034 ^b	0.29
Snap beans		4 mm	220/m ²	55 mm	0.073 ^c	0.21
Tomatoes		38 mm	20/m ²		0.068 ^b	0.29
Peaches	1.8 m	31.8 mm	15/m ²		0.036 ^b	0.14
Cherries	5.3 m	8.5 mm	160/m ²		0.027 ^b	0.07
Weighted average					0.052	

^aBased on values in Table 3.2.

^bEq.(21).

^c0.75 × Eq. (22).

estimates. In TERRA the location-specific productivity estimate determines a corresponding interception fraction. In other words, it has been assumed that location-specific variations in productivity are more reflective of the differences in plots B and C than in A and B.

Since observed relationships between interception fraction and productivity are unavailable for nongrasslike plants, the relationship shown in Fig. 3.1 has been assumed to apply to nongrasslike plants also. The coefficients of the exponential terms for exposed produce, leafy vegetables, and silage have been determined by fitting an exponential regression equation, forced through the point $[(1-r^i = 0), (Y_i = 0)]$ to the points representing the United States average productivity-average interception fraction and maximum observed productivity-theoretical maximum interception fraction. The average and maximum productivities are taken from Appendices B and C of reference 7. The resulting relationships are (Fig. 3.6),

$$r^e = 1 - \exp(-0.0324Y_e), \quad (24)$$

$$r^{lv} = 1 - \exp(-0.0846Y_{lv}), \text{ and} \quad (25)$$

$$r^s = 1 - \exp(-0.769Y_s), \quad (26)$$

where the superscripts and subscripts “e,” “lv,” and “s” are for exposed produce, leafy vegetables, and silage, respectively.

Although this approach is at best *ad hoc*, the consequences of setting the interception fraction at a constant value and allowing productivity to vary over its reported range are serious. Figure 3.7 compares the method of using Eqs. (24)-(26), case A, and using a single interception fraction, case B, over the observed productivity range shown at the bottom of the figure. At the extremes of the ranges, especially at productivities less than 0.1 kg/m², the ratio of r^i/Y_i is particularly suspect.

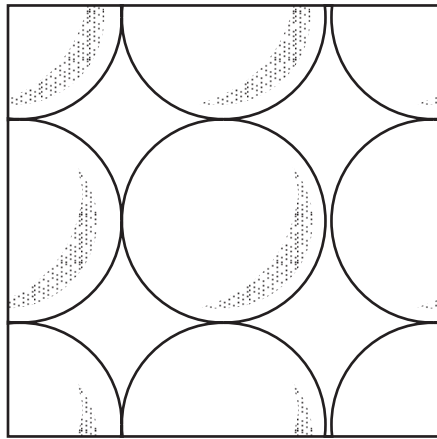

PLOT A

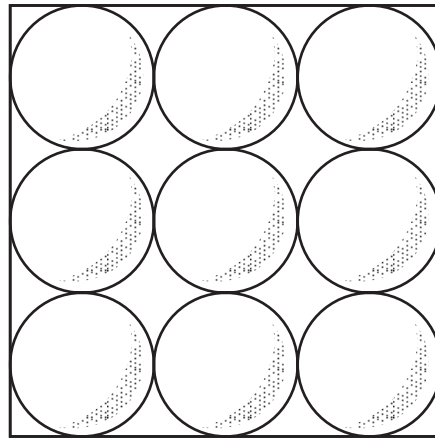

PLOT B

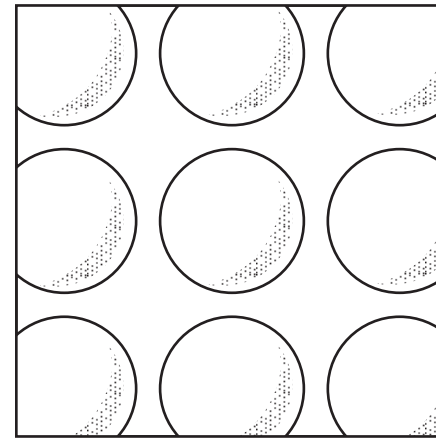

PLOT C

Figure 3.5. Three plots of equal area containing hypothetical crops of varying size and planting density.

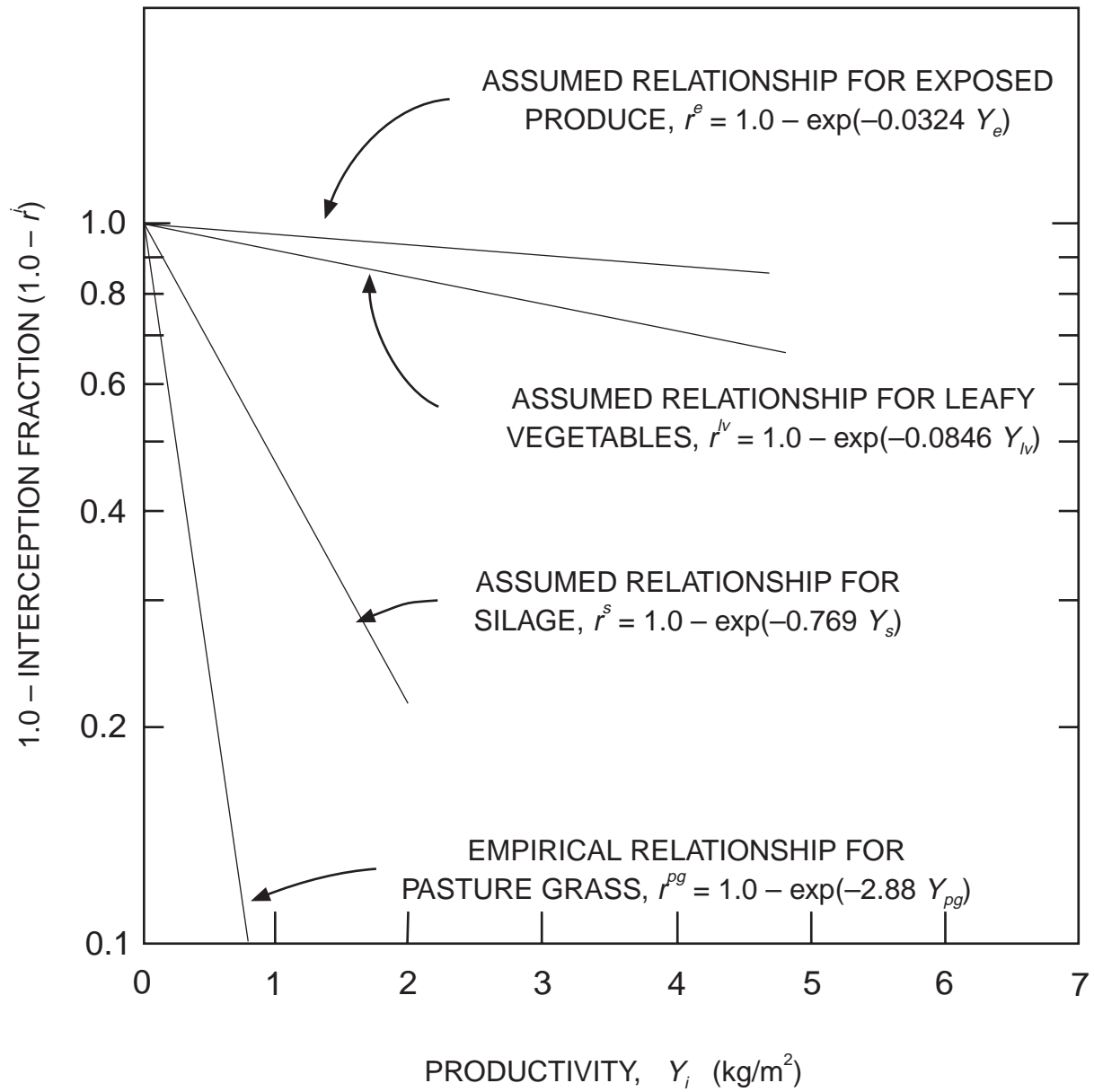

Figure 3.6. Assumed relationships between interception fraction and fresh weight productivity for exposed produce and leafy vegetables and between interception fraction and dry weight productivity for silage.

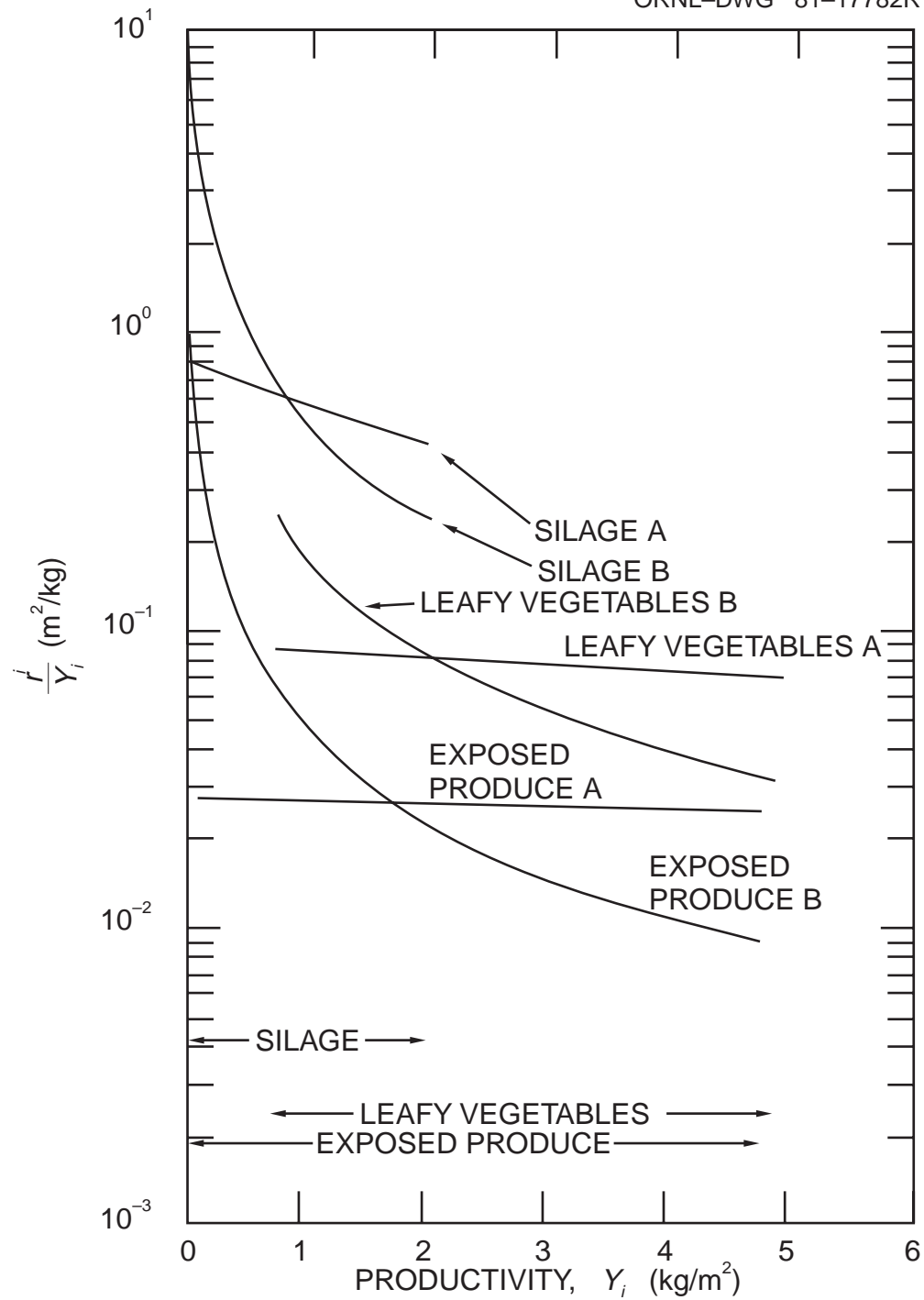

Figure 3.7. The ratio of interception fraction to productivity (r^i/Y_i) as a function of interception fraction dependent on (A) and independent of (B) productivity of silage, exposed produce, and leafy vegetables. The ranges of productivity found in the U.S., based on reference 7, are shown at the bottom of the figure.

4. SITE-SPECIFIC PARAMETERS

For a given location, as specified by a longitude-latitude coordinate (X, Y), TERRA simulates terrestrial transport by incorporating 21 site-specific agricultural and climatological parameters into its calculations. These parameters are available on a $\frac{1}{2} \times \frac{1}{2}$ degree longitude-latitude basis and are part of a data base, called SITE, which includes 36 agricultural, climatological, demographic, and other parameters. The remaining 15 parameters not used by the TERRA code are either used by or are available for use by the other codes of the CRRIS system. The agricultural parameters were derived from the report by Shor, Baes, and Sharp⁷, which analyzes the 1974 Census of Agriculture.²⁰⁹ Climatological parameters were interpolated from long-term averages recorded by United States weather stations as reported in several sources.²¹⁰⁻²¹² Demographic parameters describing the fraction of the population in various urbanization categories were available on a half-degree cell basis from the analyses of the 1970 U.S. Census by Haaland and Heath.^{213,214} Estimates of population were taken from the 1980 U.S. Census.

The half-degree cell grid was preferred over the United States county resolution because of the variation in county area (Fig. 4.1). Bristol county, Rhode Island, the smallest county, is 64.5 km², and San Bernardino county, California, the largest, is 52,100 km², a range of over 800 fold. Half-degree cells provide a more uniform grid (Fig. 4.2). The areas of the cells vary from 2,030 km² at 49°N latitude to 2,810 km² at 25°N latitude—a variation of less than 30% over the conterminous United States. Half-degree cell areas are comparable to the areas of counties in northeast Texas (Fig. 4.1).

Each SITE cell is defined by an identification number, i , such that

$$i = 2[(X - 66.5) + 116(Y - 24.5)], \quad (27)$$

where

- X = the longitude (in degrees W) of the southeast corner of the cell and
- Y = the latitude (in degrees N) of the southeast corner of the cell.

Equation (27) is based on the reference point 66.5°W, 24.5°N and the fact that the conterminous United States lies between 66.5°W and 125°W. One hundred and sixteen half-degree cells define this span, horizontally.

Two methods were needed to convert county data to half-degree cell data because some data were stored per unit area and others were stored as a total count. The data stored as a total count was distributed according to the fraction of each county included in the individual cell (method A). The data stored per unit area was distributed according to the fraction of each cell included in the appropriate counties (method B). Both of these transformation fractions were determined for each SITE cell and each United States county using the IUCALC program which calculates polygon-polygon intersections, unions, and relative differences.²¹⁵ Table 4.1 shows the derivation of the number of cattle and calves, n_{cc} , and productivity of protected produce, Y_p , for SITE cell #3284, which has coordinates at the southeast corner of 84.5°W, 38.5°N. Three counties in Indiana and nine counties in Kentucky overlap this cell.

Method A is used for all parameters representing discrete entities, e.g., head of livestock, numbers of people, kilograms of produce. The assumption in effect is that number distribution is uniform throughout the county. The proportion of the county total within the cell is proportional to the area of the county within the cell. Method B is used for all parameters representing densities and representative averages, e.g., productivities and climatic variables. The effective assumption here is that the contribution from the county to the cell is proportional to the fraction of the cell which coincides with the county.

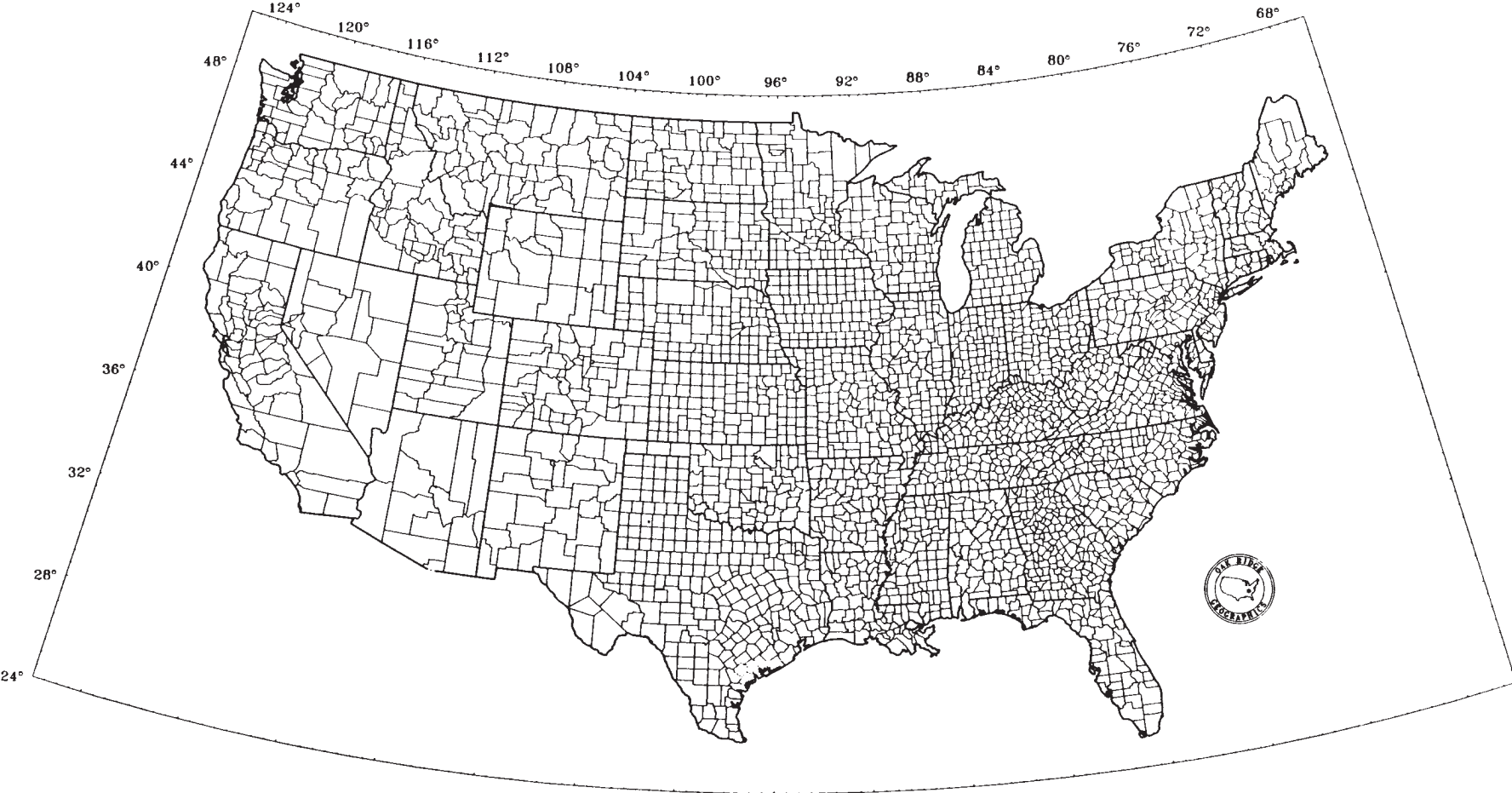

Figure 4.1. Map of the conterminous United States showing county delineations.

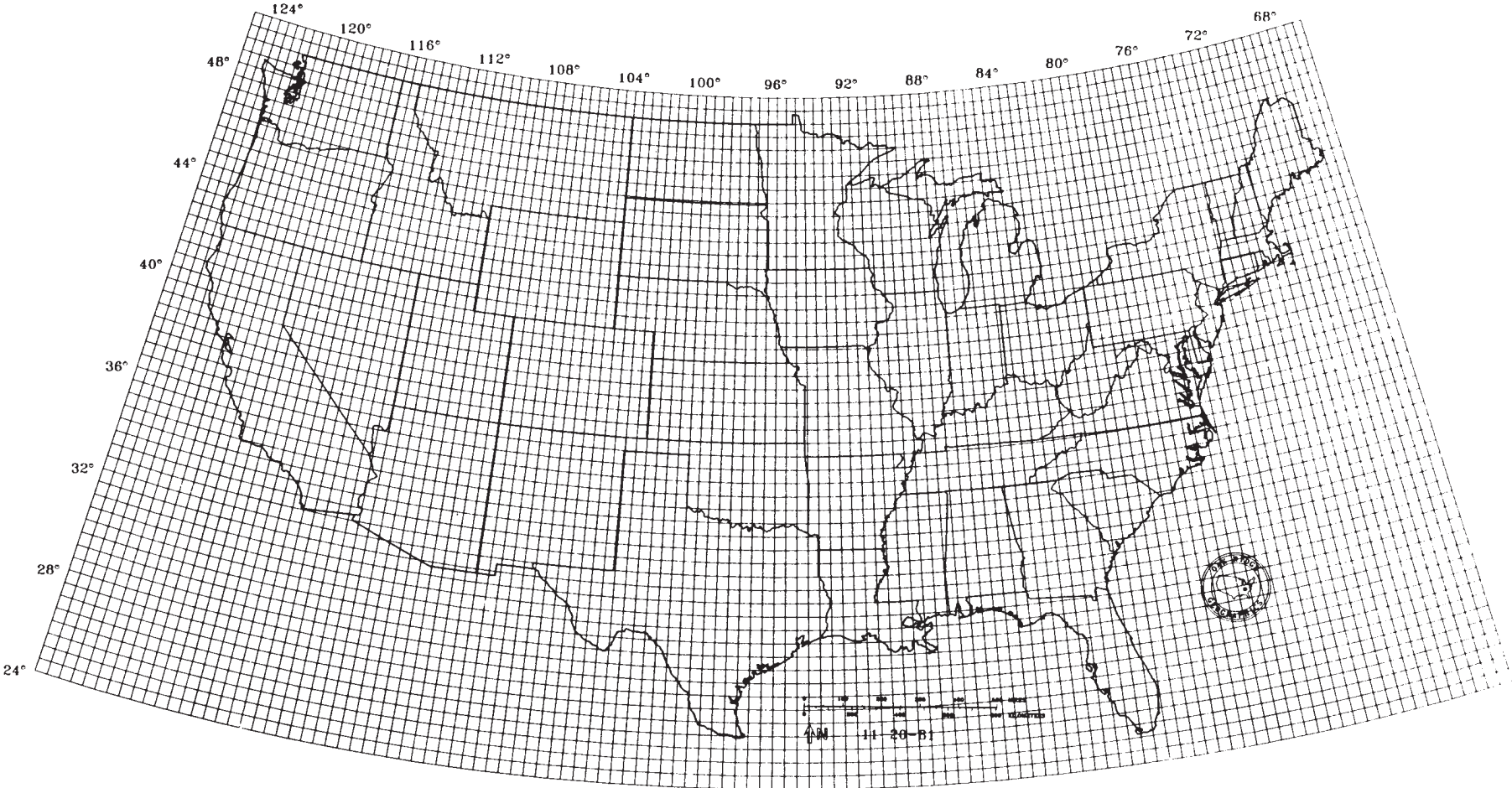

Figure 4.1. Map of the conterminous United States with half degree longitude-latitude grid indicated.

Table 4.1. Example derivation of agricultural parameters for SITE cell #3284 from county-averaged parameters

County, state ^a	— Transfer parameter ^b —		n_{cc}^c (head)	Y_{pp}^d (kg/m ²)
	Method A	Method B		
Dearborn, In	3.60×10 ⁻³	1.25×10 ⁻³	17288	1.52
Ohio, In	5.59×10 ⁻¹	5.51×10 ⁻²	7111	0.060
Switzerland, In	3.74×10 ⁻¹	9.38×10 ⁻²	12863	0.060
Boone, Ky	6.18×10 ⁻¹	1.75×10 ⁻¹	20926	1.42
Carroll, Ky	8.45×10 ⁻²	1.25×10 ⁻²	11370	0.040
Gallatin, Ky	9.71×10 ⁻¹	1.10×10 ⁻¹	7512	2.12
Grant, Ky	9.31×10 ⁻¹	2.63×10 ⁻¹	22148	0.61
Harrison, Ky	9.00×10 ⁻⁴	3.14×10 ⁻⁴	44345	1.22
Henry, Ky	2.60×10 ⁻³	8.52×10 ⁻⁴	36319	0.78
Kenton, Ky	4.74×10 ⁻¹	8.88×10 ⁻²	10633	1.18
Owen, Ky	4.91×10 ⁻¹	1.96×10 ⁻¹	26555	0.75
Pendleton, Ky	1.32×10 ⁻²	4.18×10 ⁻³	24125	0.82
Total or average			69190	0.99

^aAll counties which share area with SITE cell #3284 which has coordinates of southeast corner of 84.5°W, 38.5°N.

^bFor method A parameter is fraction of each county within the cell. For method B parameter is fraction of cell within each county.

^cNumber of cattle and calves.

^dYield of protected produce.

Climatological parameters were determined on a half degree cell basis by selecting the three United States weather stations nearest the centroid of the cell. The three parameter values for the weather stations were weighted according to distance from the weather station to the cell centroid such that

$$p_c = w_1 p_1 + w_2 p_2 + w_3 p_3, \quad (28)$$

where

- p_c = the parameter value for the half degree cell,
 w_1, w_2, w_3 = the weighting factors for the first, second, and third nearest weather stations, respectively, and
 p_1, p_2, p_3 = the parameter values for the first, second, and third nearest weather stations, respectively.

The weighting factors were defined such that

$$w_1 + w_2 + w_3 = 1 \text{ and} \quad (29)$$

$$w = \frac{1}{d_l}, \quad (30)$$

where

d_i = the linear distance between the weather station and the centroid of the cell.

The linear distance between weather stations and the centroid of the cell was determined by

$$\frac{\text{kilometers}}{1.0^\circ \text{ longitude}} = A \cos Y + B + CY + DY^2 \text{ and} \quad (31)$$

$$\frac{\text{kilometers}}{1.0^\circ \text{ latitude}} = \frac{\text{Eq. (31)}}{\cos Y} + E + FY + GY^2 . \quad (32)$$

where

$$\begin{aligned} A &= 1.113 \times 10^2, \\ B &= -9.855 \times 10^{-2}, \\ C &= 7.789 \times 10^{-3}, \\ D &= -5.894 \times 10^{-5}, \\ E &= -8.570 \times 10^{-1}, \\ F &= 7.927 \times 10^{-1}, \text{ and} \\ G &= 5.888 \times 10^{-5}. \end{aligned}$$

Table 4.2 shows example derivations of cell-averaged values of frost-free days from values from the three nearest United States weather stations.

4.1 Agricultural Parameters

The SITE data base contains 21 parameters describing location-specific agricultural practice, 14 of which are used by TERRA in simulating terrestrial transport of radionuclides. In addition, the climatic parameter, number of frost-free days, is used to estimate the number of harvests of hay and grazings of pasture by cattle. These parameters are described in detail in the report by Shor, Baes, and Sharp⁷. It is beyond the scope of this report to detail their derivation, but a brief description of their use in TERRA follows.

As discussed in Sect. 3., atmospheric deposition on edible portions of food and feed crops is inversely proportional to standing crop biomass. The best estimate of standing crop biomass at harvest is given by the productivity, defined as

$$Y_i = \frac{P_{hi}}{A_{hi}}, \quad (33)$$

where

$$\begin{aligned} Y_i &= \text{the productivity (yield) of crop } i \text{ (kg/m}^2\text{)}, \\ P_{hi} &= \text{the harvest yield (production) of crop } i \text{ (kg) per harvest, and} \\ A_{hi} &= \text{the area planted to crop } i \text{ which is harvested or harvest area (m}^2\text{)}. \end{aligned}$$

For leafy vegetables, exposed and protected produce, grains, and silage, harvest yields and areas were obtained directly from the 1974 Census of Agriculture. However, for hay and pasture only, annual yields (summed over all harvests) and areas allocated for hay and pasture (not necessarily

Table 4.2. Derivation of number of frost-free days for half-degree cells from values for the three nearest weather stations to the centroid of the cell^a

Cell#	Longitude ^b	Latitude ^c	Stations	Weighting factors ^d			Frost-free days
				w ₁	w ₂	w ₃	
3615	76.0	40.0	B, A, C	0.462	0.287	0.251	203
3616	75.5	40.0	B, F, E	0.858	0.074	0.067	201
3617	77.0	40.0	B, F, E	0.612	0.225	0.163	201
3618	77.5	40.0	B, F, E	0.436	0.342	0.222	200
3731	76.0	40.5	A, B, D	0.372	0.334	0.294	185
3732	76.5	40.5	B, A, D	0.489	0.262	0.249	189
3733	77.0	40.5	B, F, D	0.525	0.241	0.234	189
3847	76.0	41.0	D, A, B	0.508	0.279	0.213	181

^aThe following weather station values were used:

- A = Allentown, Pa: 180 frost-free days
- B = Harrisburg, Pa: 201 frost-free days
- C = Philadelphia, Pa: 232 frost-free days
- D = Scranton, Pa: 174 frost-free days
- E = Baltimore, Md: 234 frost-free days
- F = Frederick, Md: 176 frost-free days.

^bSoutheast corner of cell.

^cFirst, second, and third nearest weather station, respectively.

^dGiven by Eqs. (30) and (31).

areas actually harvested) were given or derived from census information. Thus, for hay and pasture Shor, Baes, and Sharp⁷ calculated “areal yields” defined by

$$Y_i^a = \frac{P_{ai}}{A_i}, \quad (34)$$

where

- Y_i^a = the areal yield of crop i (kg/yr/m²),
- P_{ai} = the annual yield of crop i (kg/yr), and
- A_i = the inventory area for crop i (m²).

The sum of all harvest yields (production) and productivity estimates for leafy vegetables (Figs. 4.3 and 4.4), exposed produce (Figs. 4.5 and 4.6), protected produce (Figs. 4.7 and 4.8), grain for food (Figs. 4.9 and 4.10), grain for feed (Figs. 4.11 and 4.12), and silage (Figs. 4.13 and 4.14) are included in the SITE data base. Also included are the annual yield (production) of hay (Fig. 4.15) and areal yield estimate for hay (Fig. 4.16). The areal yield of pasture estimate is not included in the SITE data base, but is calculated in TERRA from information contained in SITE (as discussed below). The productivity estimates for hay and pasture are calculated by dividing areal yields by the estimated numbers of hay harvests and successive pasture grazings by cattle, respectively.

Number of harvests per year for hay is initially estimated by

$$h_h = \frac{d_{ff}}{60 \text{ days}}, \quad (35)$$

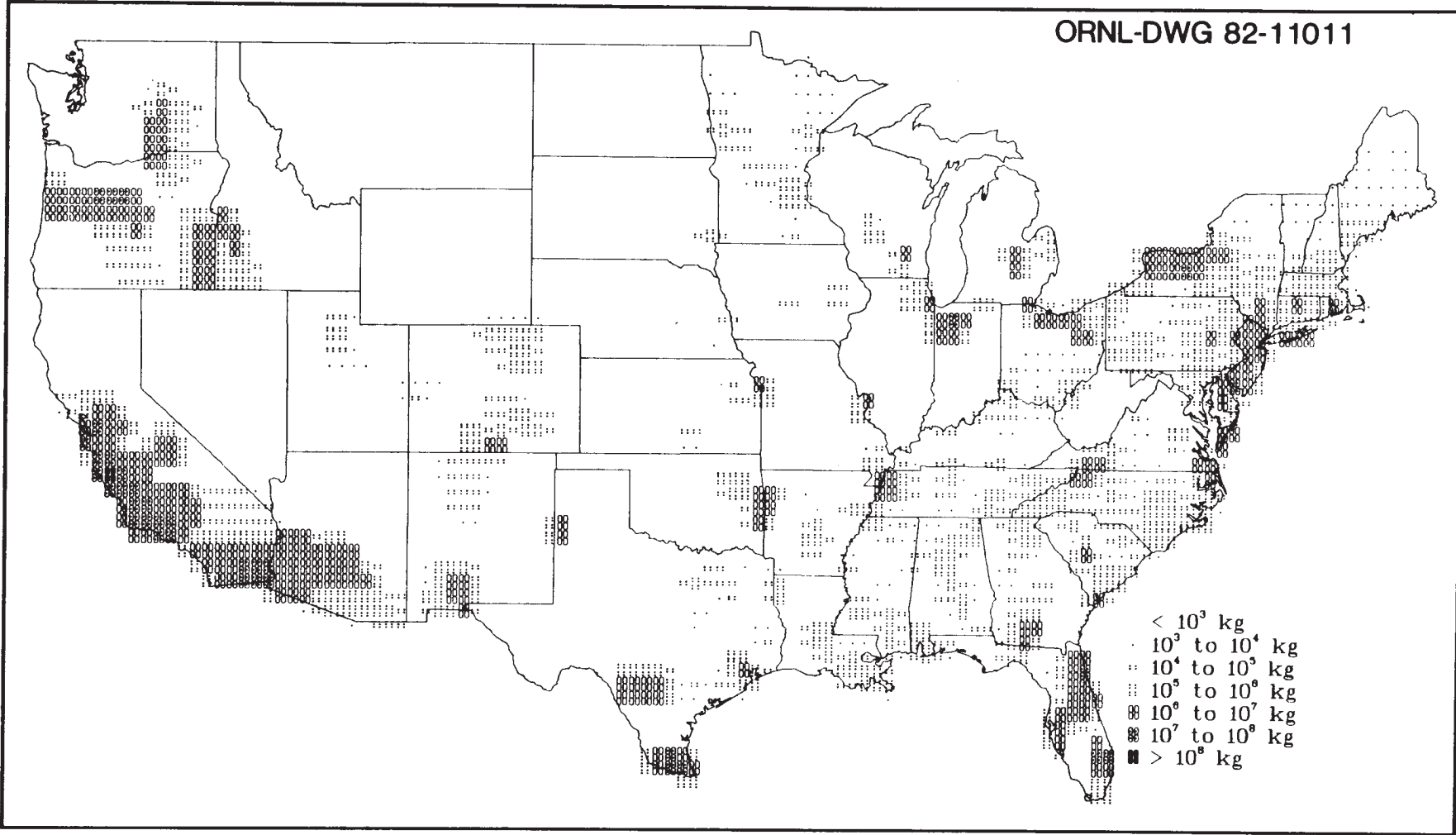

Figure 4.3. Geographic distribution of SITE parameter leafy vegetable production, P_{lv}

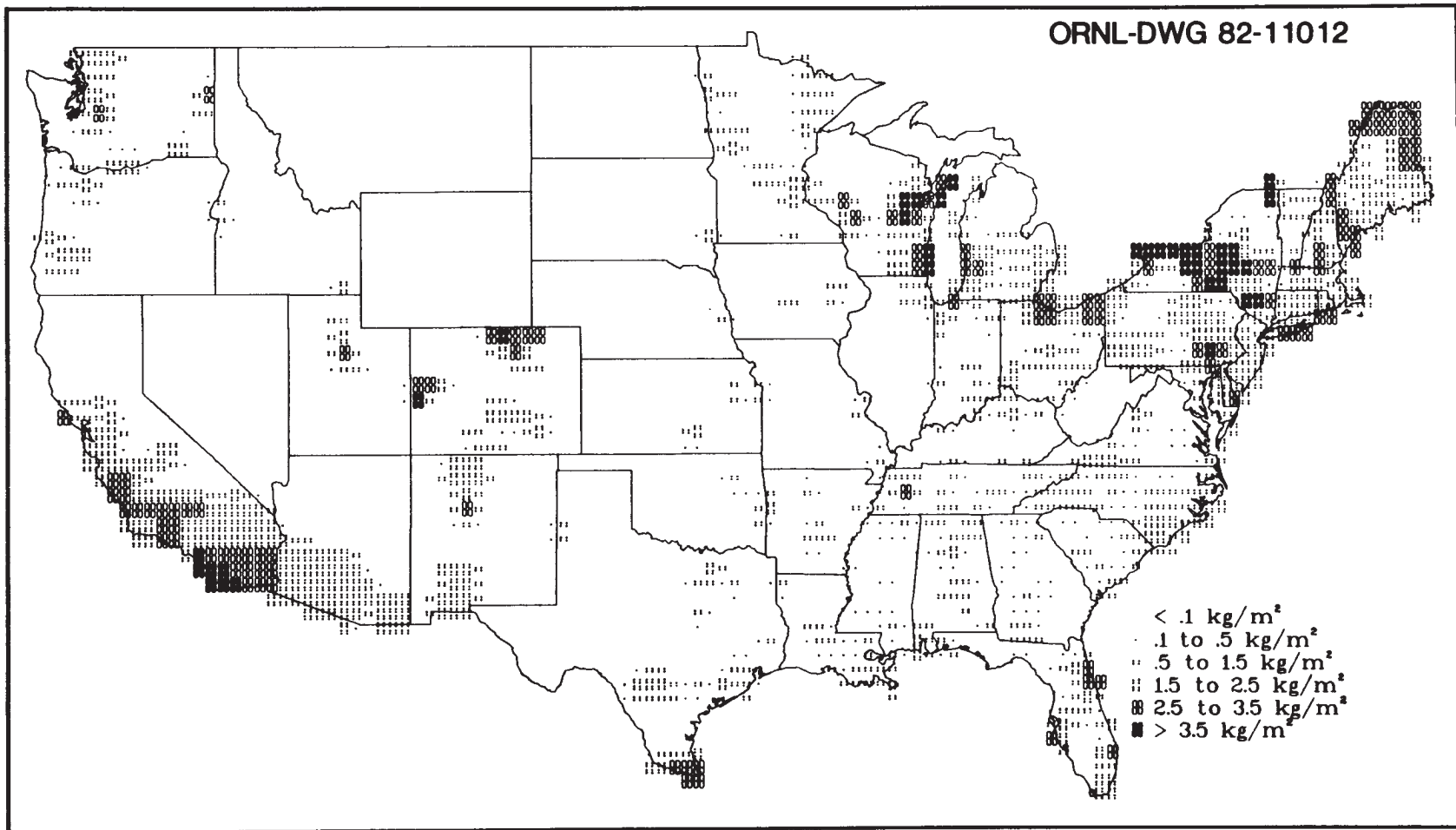

Figure 4.4. Geographic distribution of SITE parameter leafy vegetable productivity, Y_{lv}

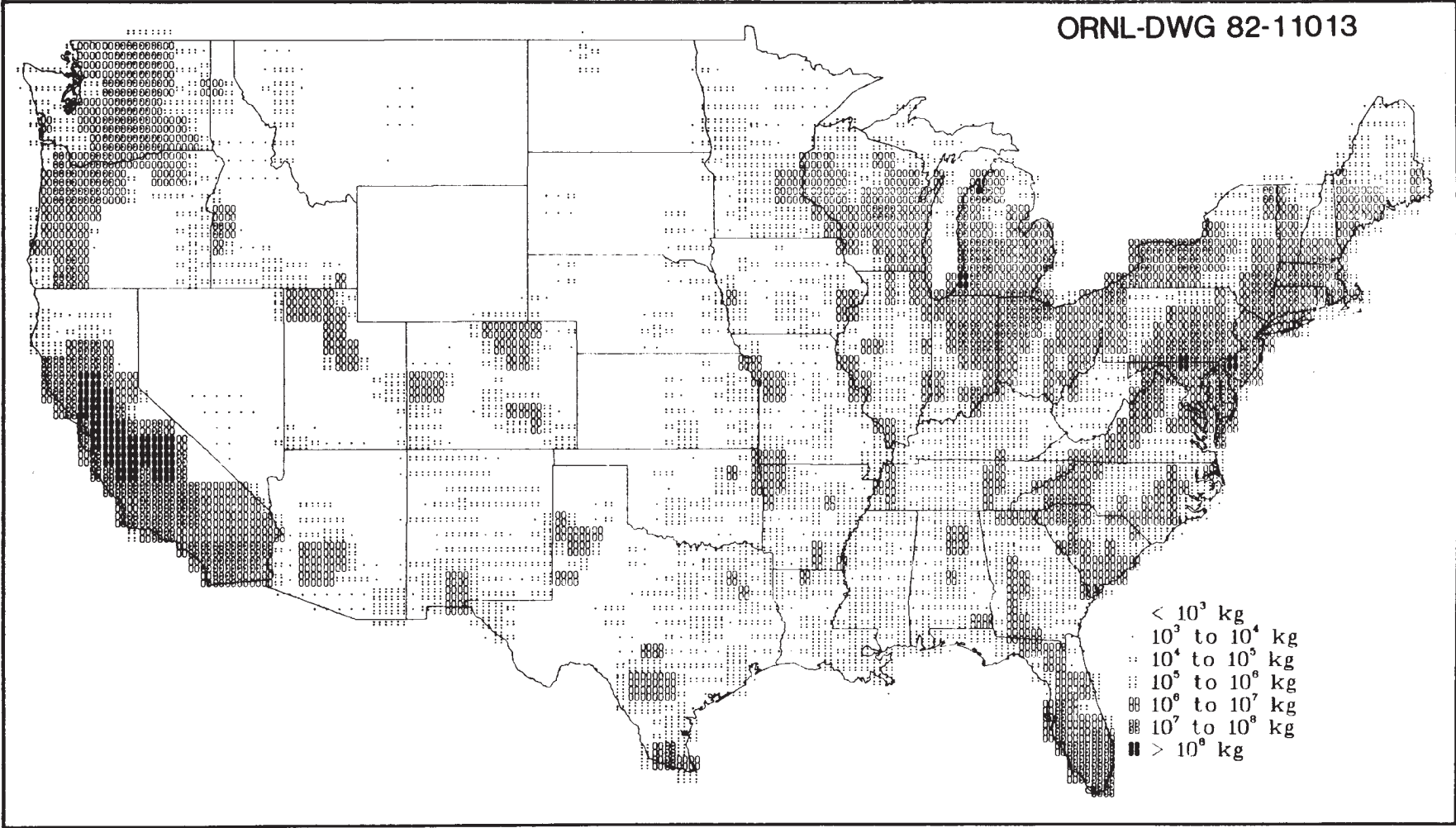

Figure 4.5. Geographic distribution of SITE parameter exposed produce production, P_e

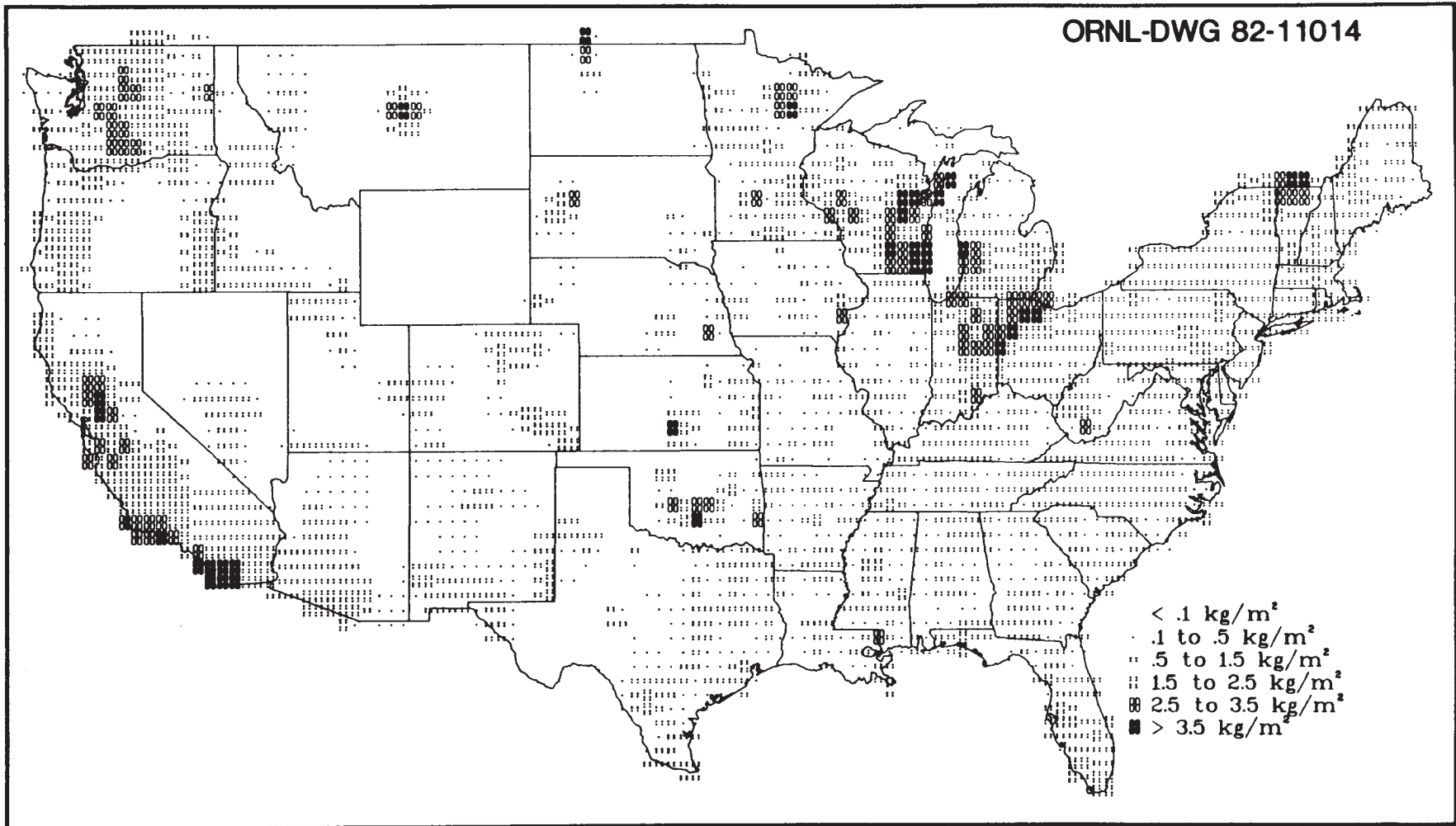

Figure 4.6. Geographic distribution of SITE parameter exposed produce productivity, Y_e

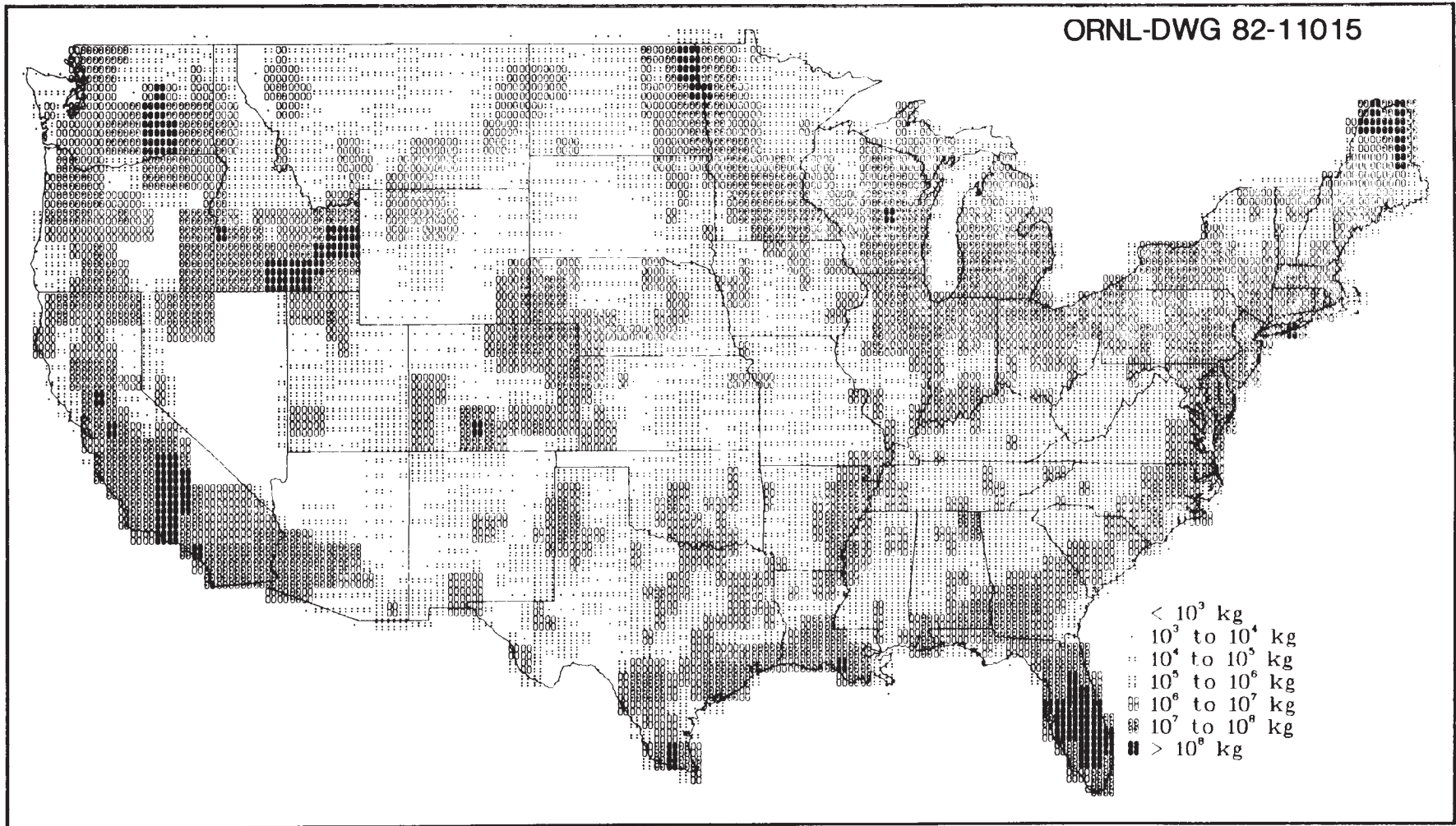

Figure 4.7. Geographic distribution of SITE parameter protected produce production, $P_{p p}$

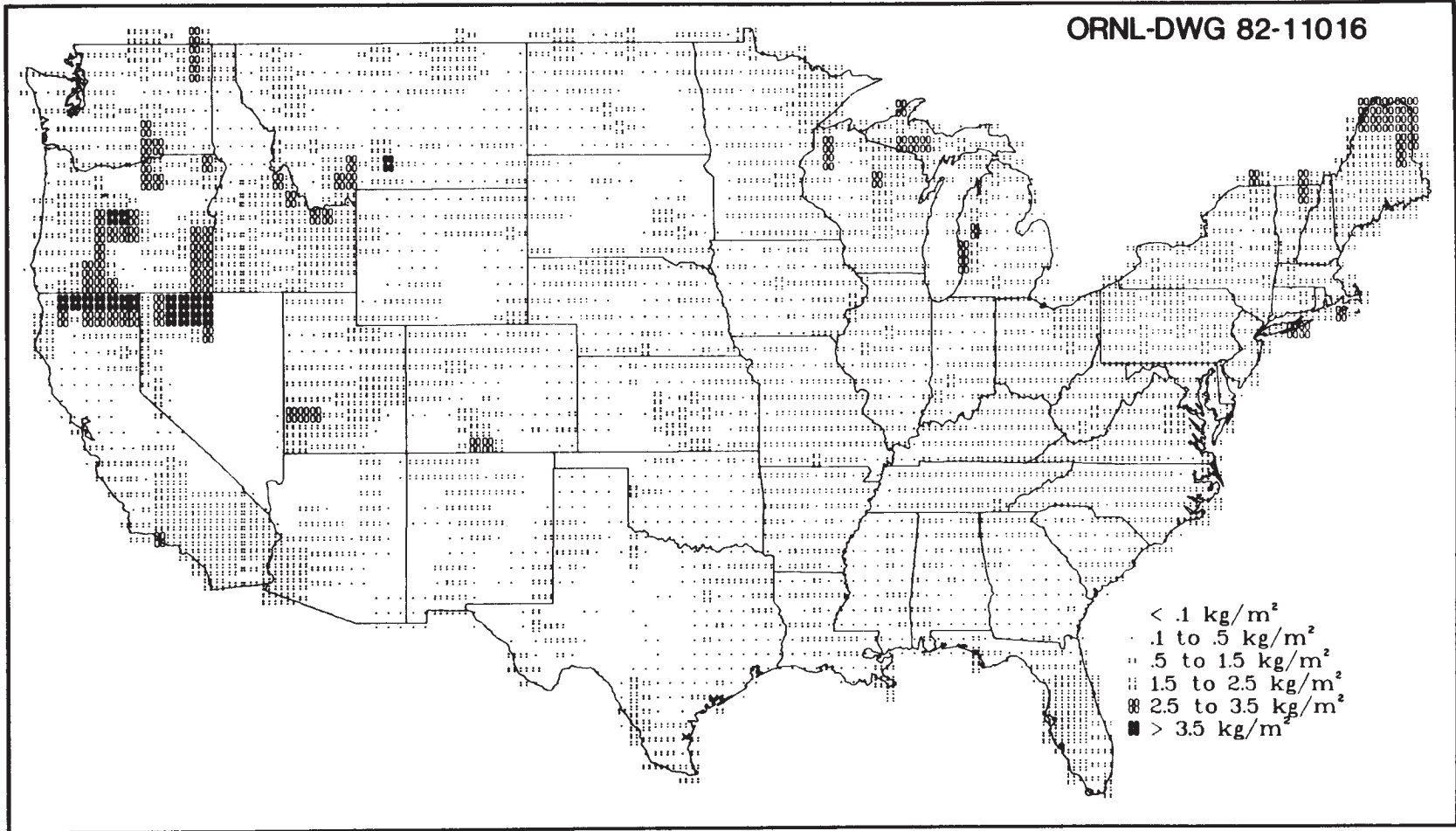

Figure 4.8. Geographic distribution of SITE parameter protected produce productivity, $Y_{p p}$

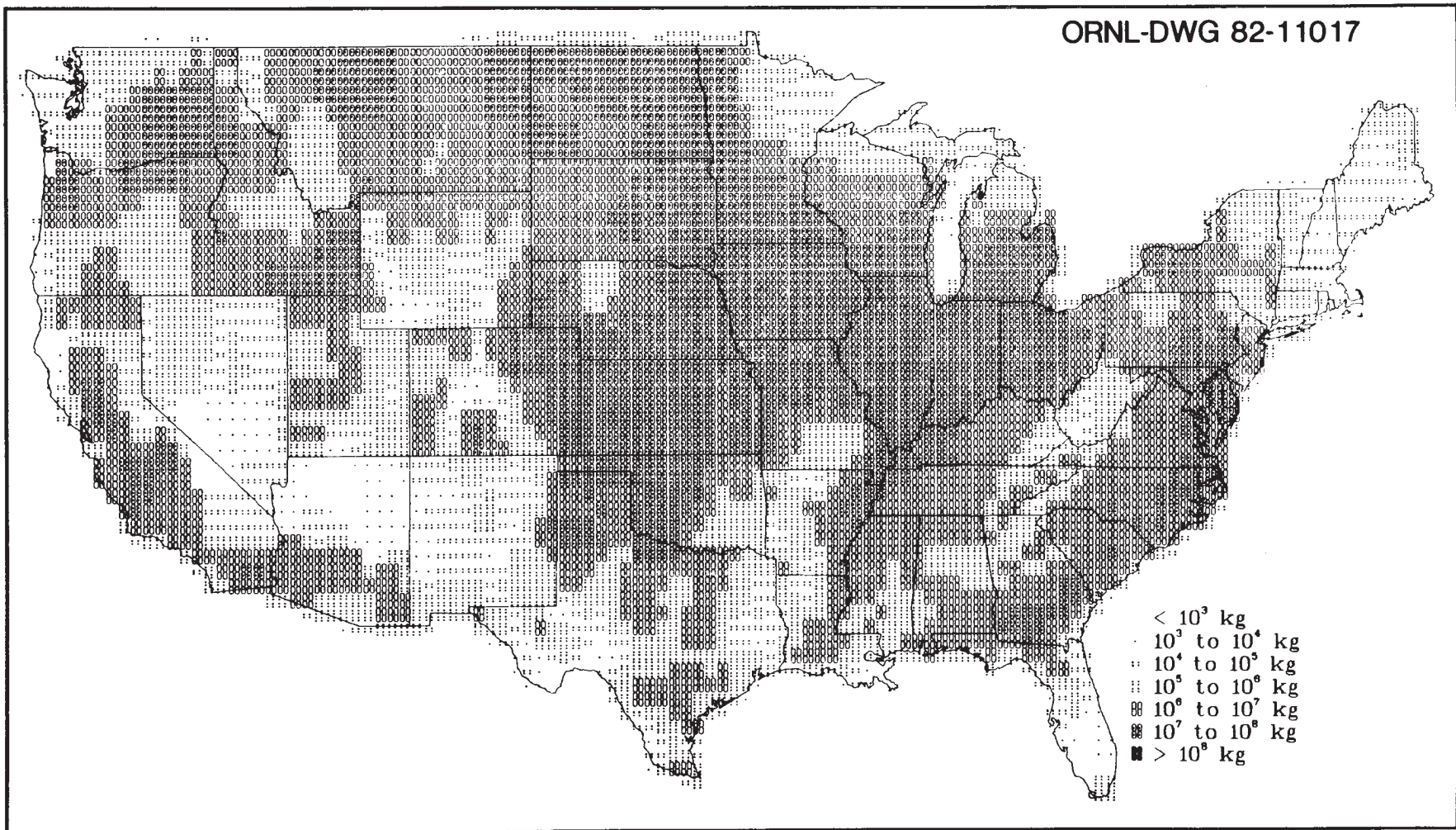

Figure 4.9. Geographic distribution of SITE parameter grain food production, $P_{g h}$

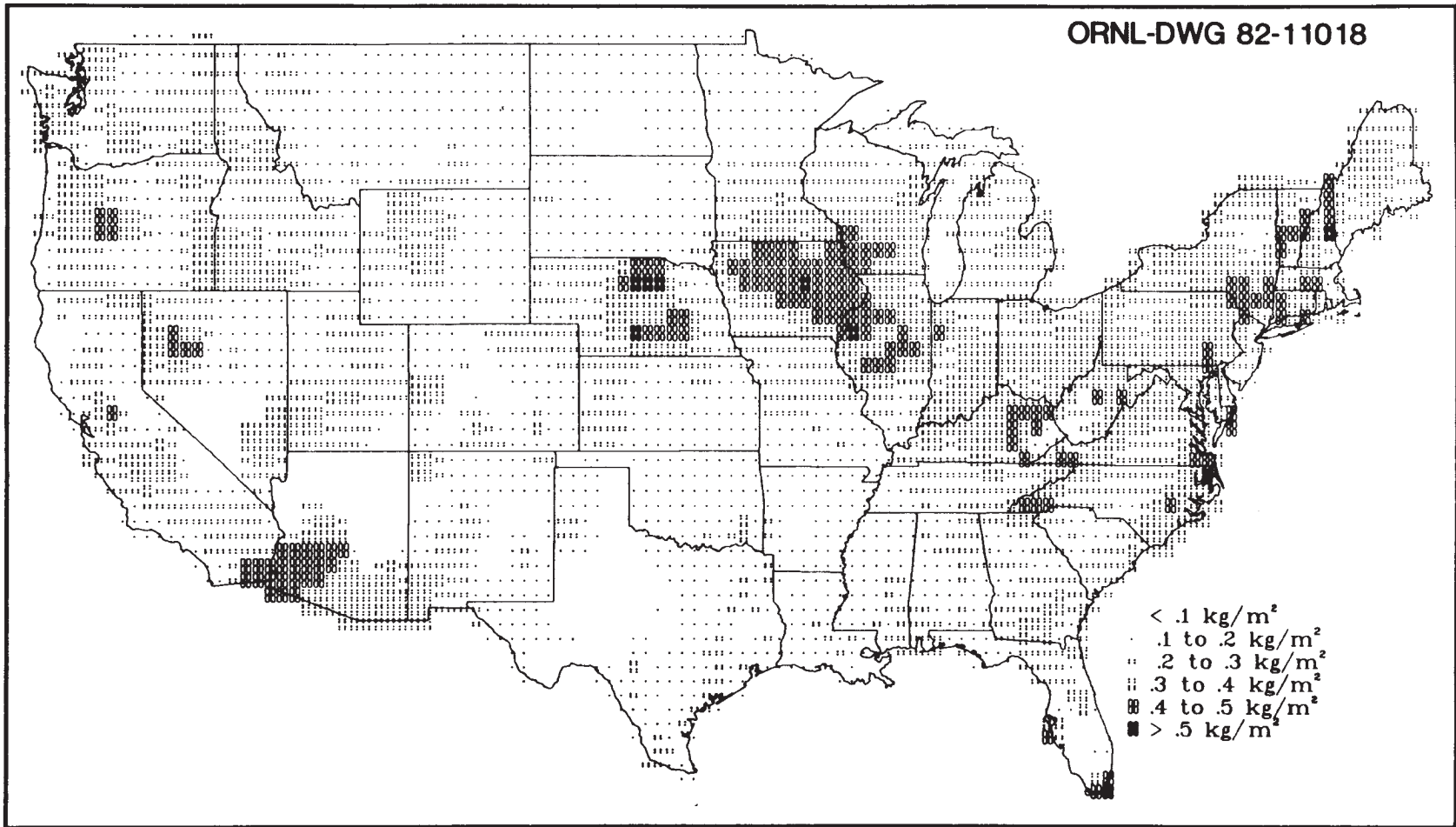

Figure 4.10. Geographic distribution of SITE parameter grain food productivity, $Y_{g h}$

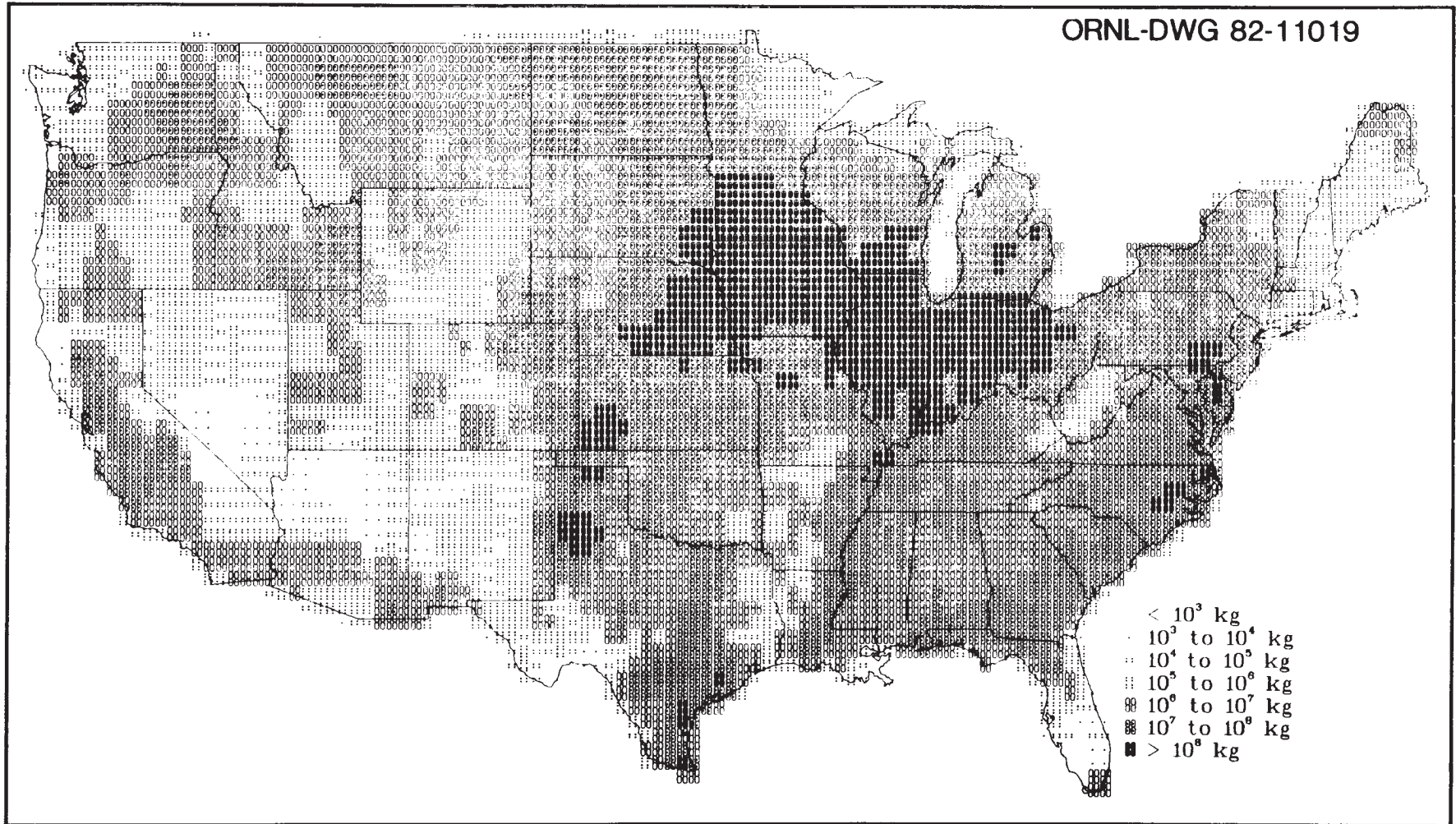

Figure 4.11. Geographic distribution of SITE parameter grain feed production, P_{gf}

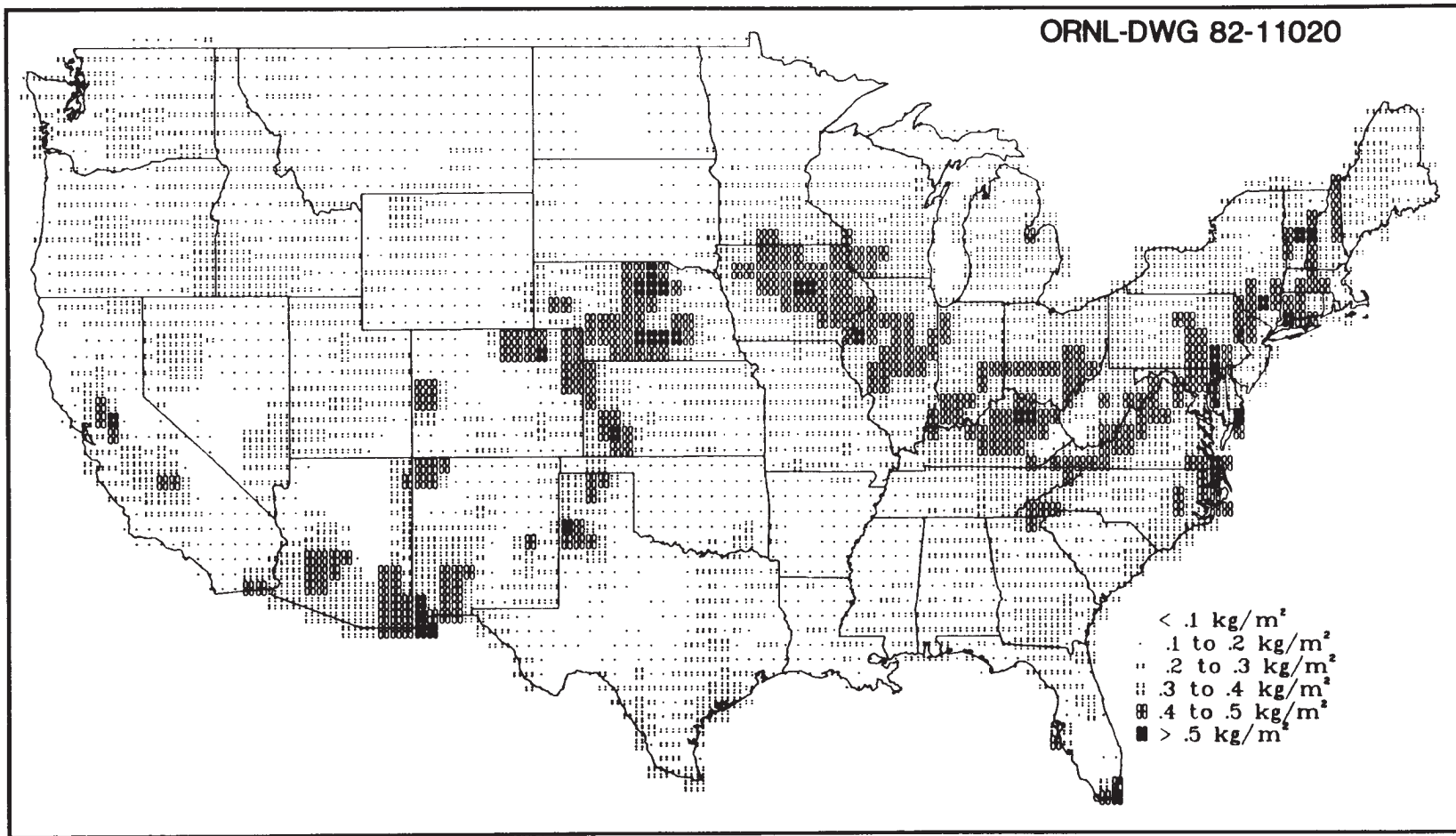

Figure 4.12. Geographic distribution of SITE parameter grain feed productivity, Y_{gf}

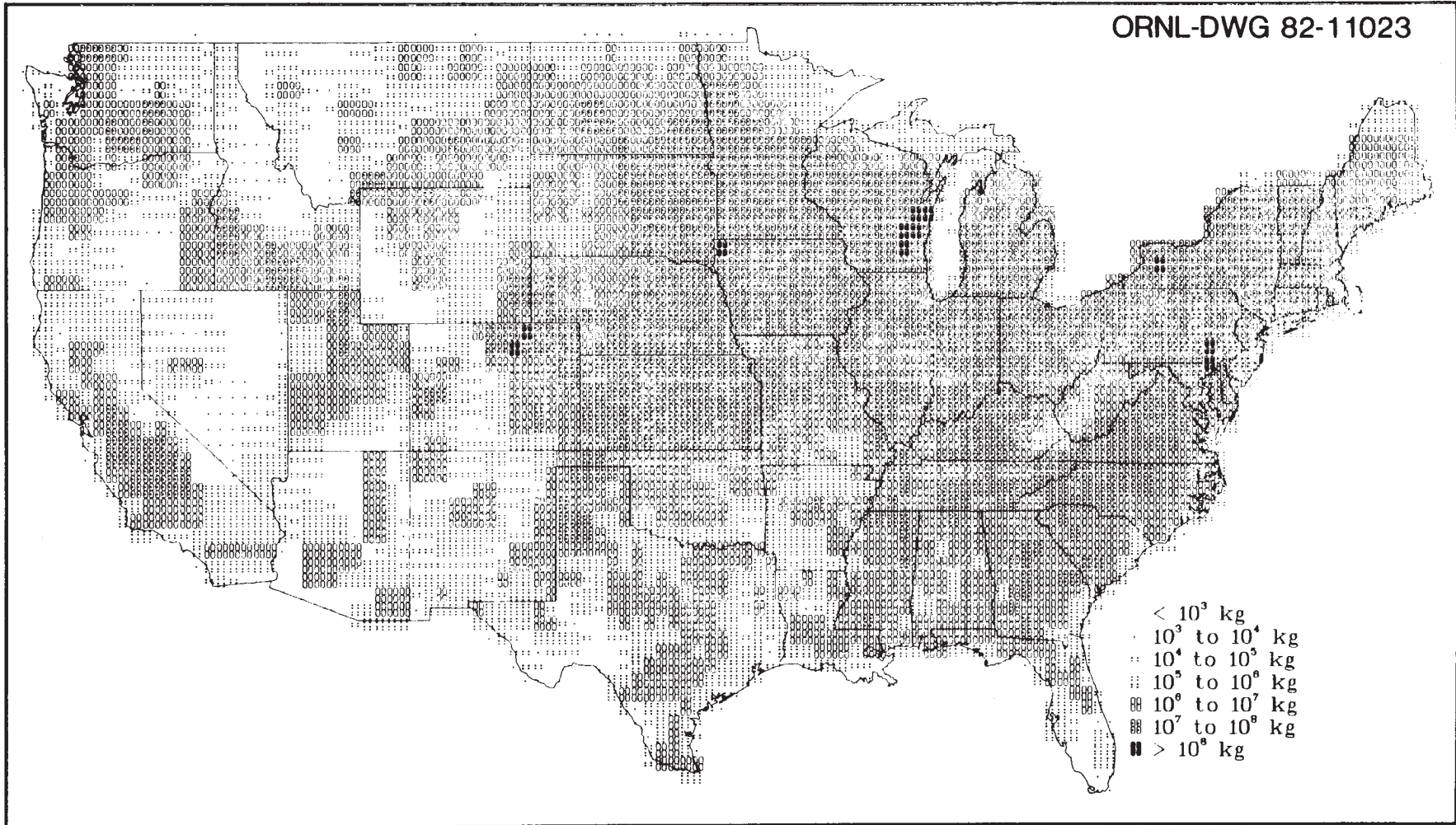

Figure 4.13. Geographic distribution of SITE parameter silage feed production, P_s

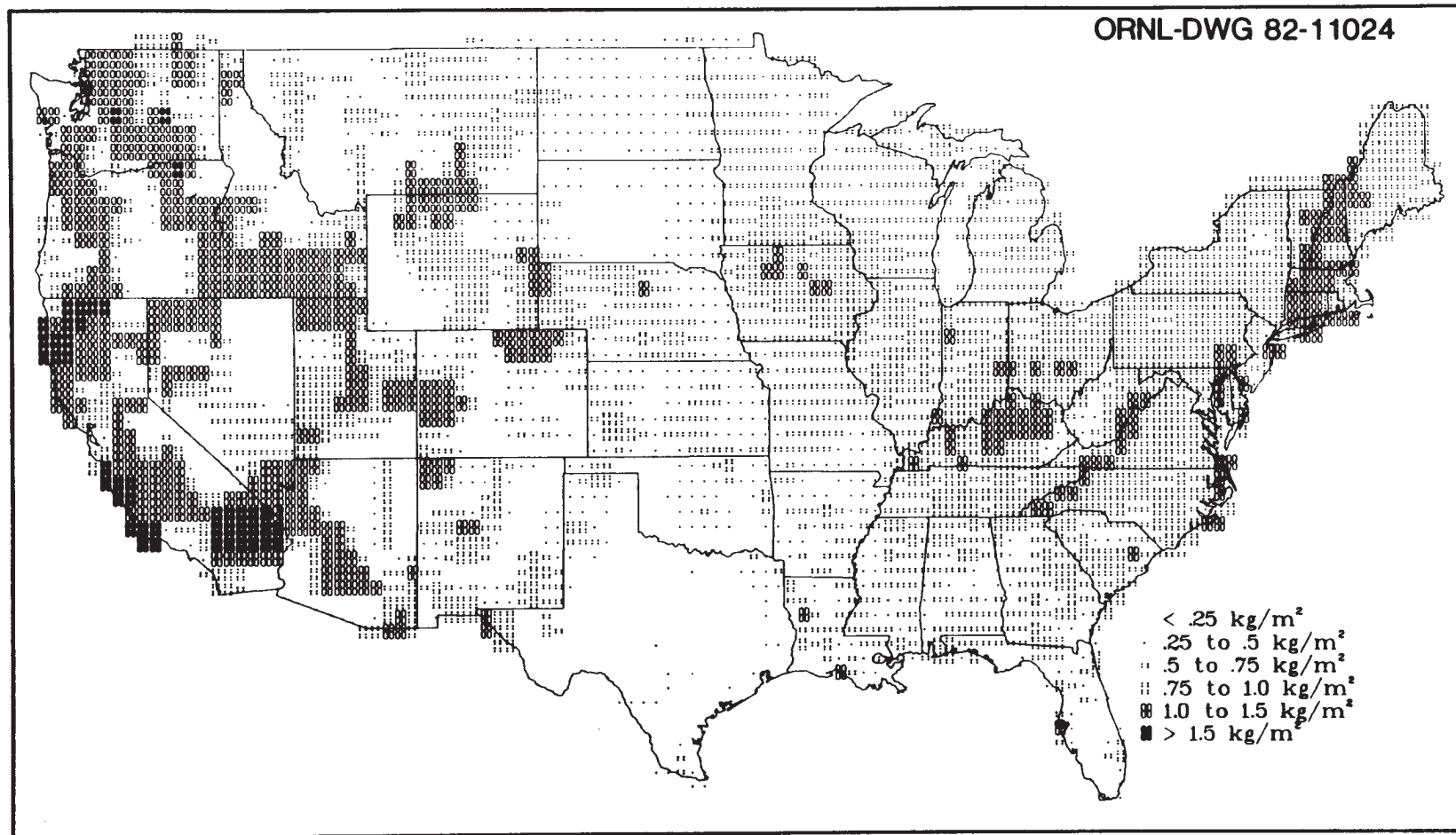

Figure 4.14. Geographic distribution of SITE parameter silage feed productivity, Y_s

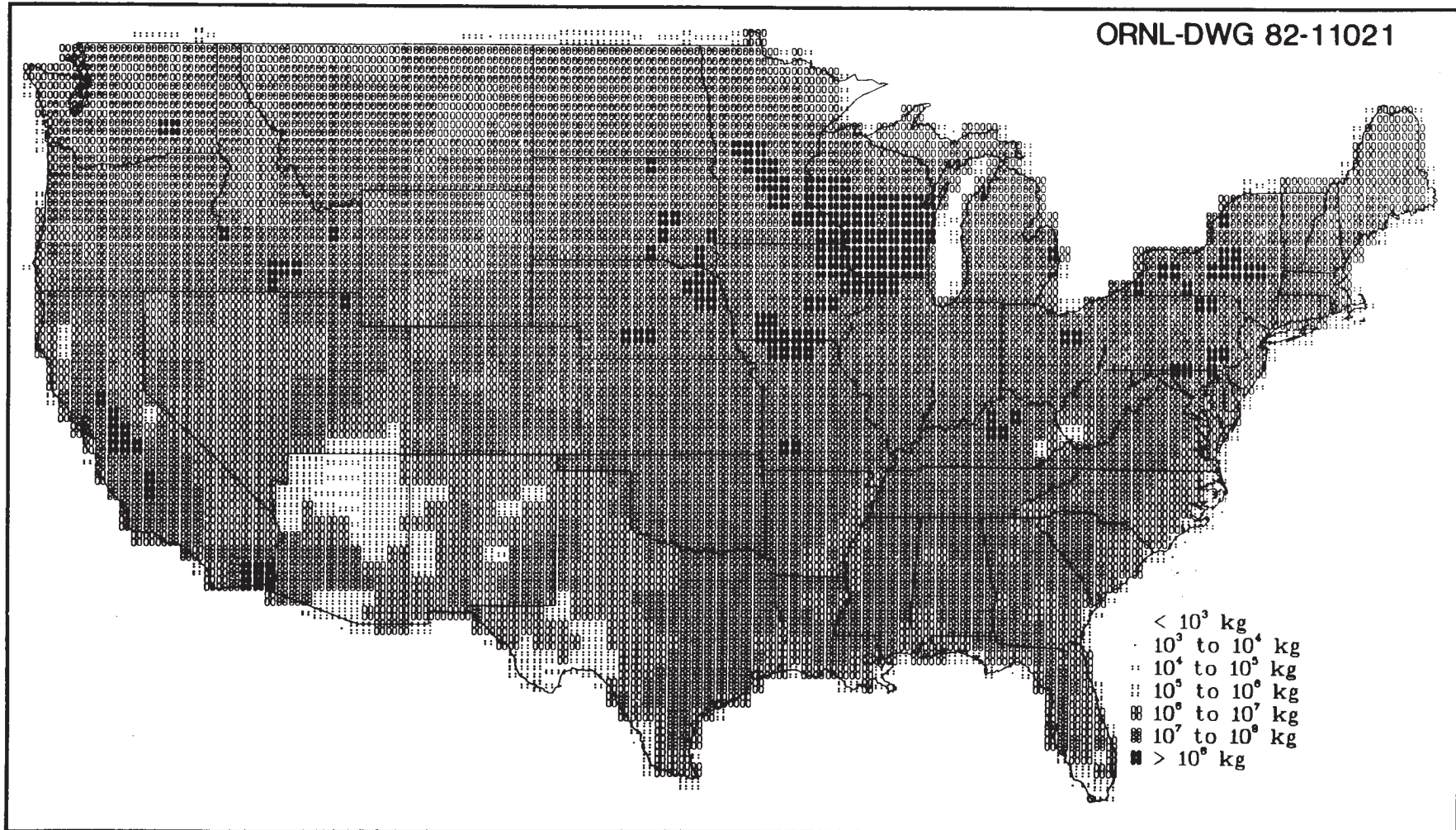

Figure 4.15. Geographic distribution of SITE parameter hay feed production, P_h

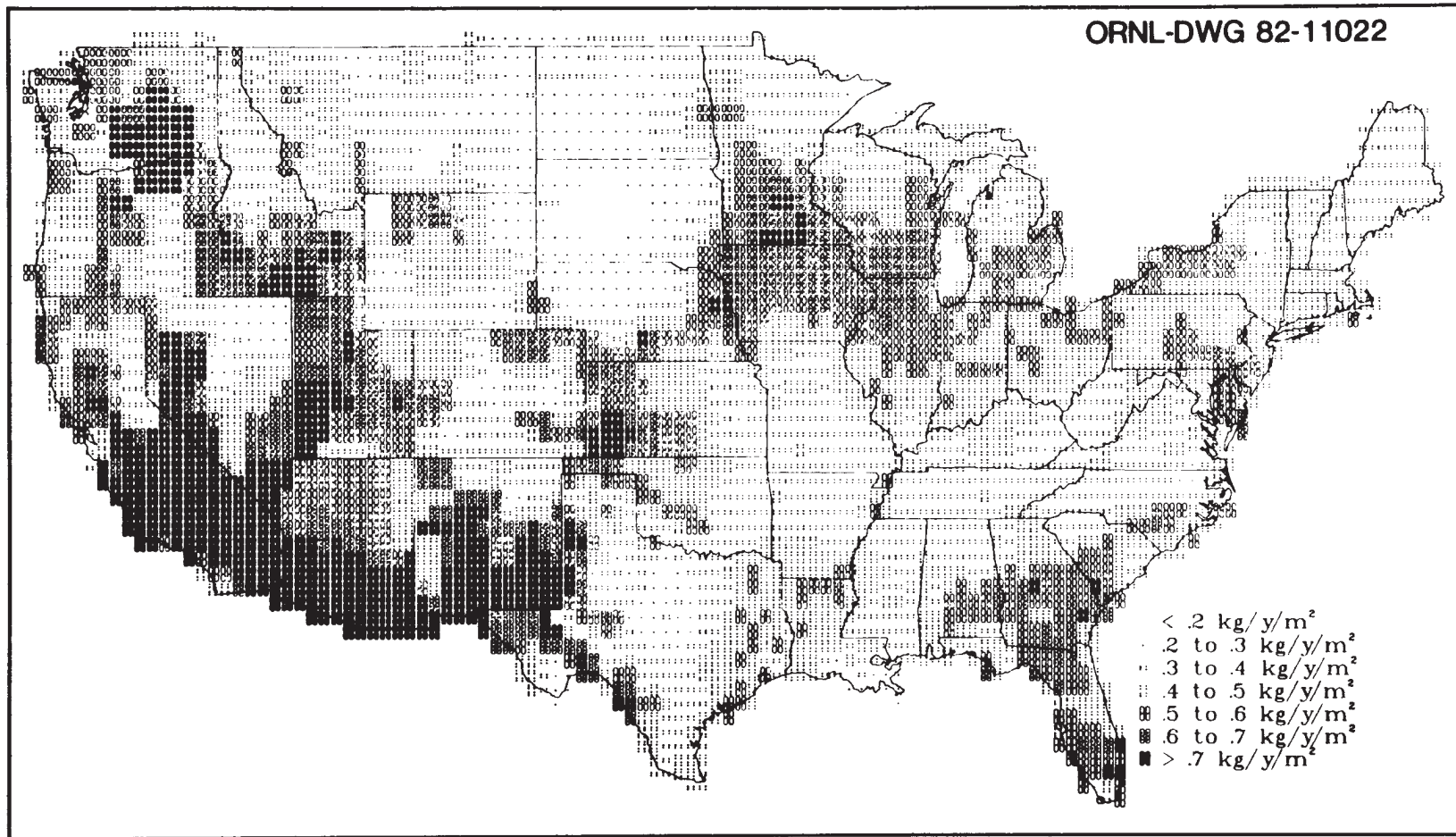

Figure 4.16. Geographic distribution of SITE parameter hay feed areal yield, Y_h^a

where

- h_h = the number of hay harvests (yr^{-1}),
- d_{ff} = the number of frost-free days (day/yr), and
- 60 days = the average time between successive hay harvests.⁷

The initial estimate of h_h is rounded off to the nearest integer and hay productivity, Y_h , is calculated according to

$$Y_h = \frac{P_h}{h_h} . \quad (36)$$

If $Y_h < 0.10 \text{ kg/m}^2$, then the initial estimate of h_h is reduced to the largest integer for which $Y_h > 0.10 \text{ kg/m}^2$. The value of 0.10 kg/m^2 is considered the minimum productivity at which hay harvesting is economically feasible.⁷ The same general procedure is followed for calculation of pasture grass productivity, Y_{pg} , except that the initial estimate of successive grazings (harvests) by cattle, g_{pg} , is given by

$$g_{pg} = \frac{d_{ff}}{30 \text{ days}} , \quad (37)$$

where

- 30 days = the average time between successive grazings by cattle.⁶

and the minimum productivity is 0.005 kg/m^2 .⁷ The SITE data base includes estimated number of frost-free days in a year (Fig. 4.17).

In TERRA the area1 yield of pasture grass, from which pasture grass productivity is calculated, is estimated from the cattle and calf inventory, n_{cc} (Fig. 4.18), the inventory of milk cows, n_m (Fig. 4.19), the annual sales of cattle on grain, s_g (Fig. 4.20), and the inventory of sheep, n_s (Fig. 4.21), in the manner described in Section 5.1 of the report by Shor, Baes, and Sharp.⁷ Briefly, annual consumption of pasture grass is defined by a mass balance of livestock forage requirement or need and harvested supply. The difference between need and supply is assumed to be pasture consumption. The harvested supply is defined as 75% of hay and silage production, and need is defined according to the numbers and types of forage consuming livestock. The following equations are used to calculate pasture grass area1 yield Y_{pg}^a in TERRA:

$$Y_{pg}^a = \frac{C_p}{A_p} , \quad (38)$$

where

- C_p = the annual consumption of pasture in a half-degree cell by livestock (kg/yr) and
- A_p = the area of pasture (Fig. 4.22) in the cell (m^2).

Pasture consumption is calculated according to

$$C_p = R_f - 0.75P_{hf} , \text{ and} \quad (39)$$

$$P_{hf} = P_s + P_h ,$$

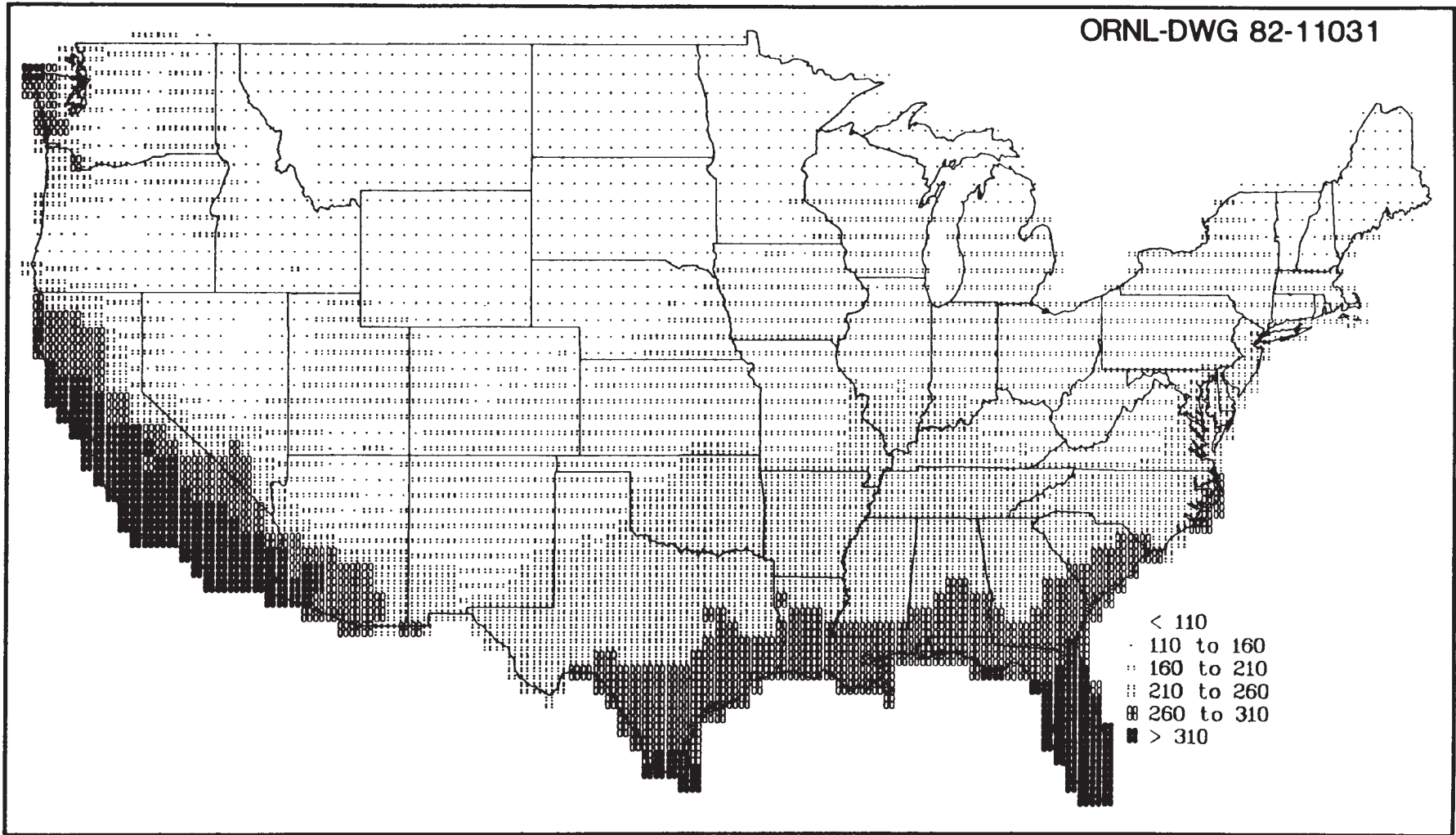

Figure 4.17. Geographic distribution of SITE parameter number of frost-free days, d_{ff}

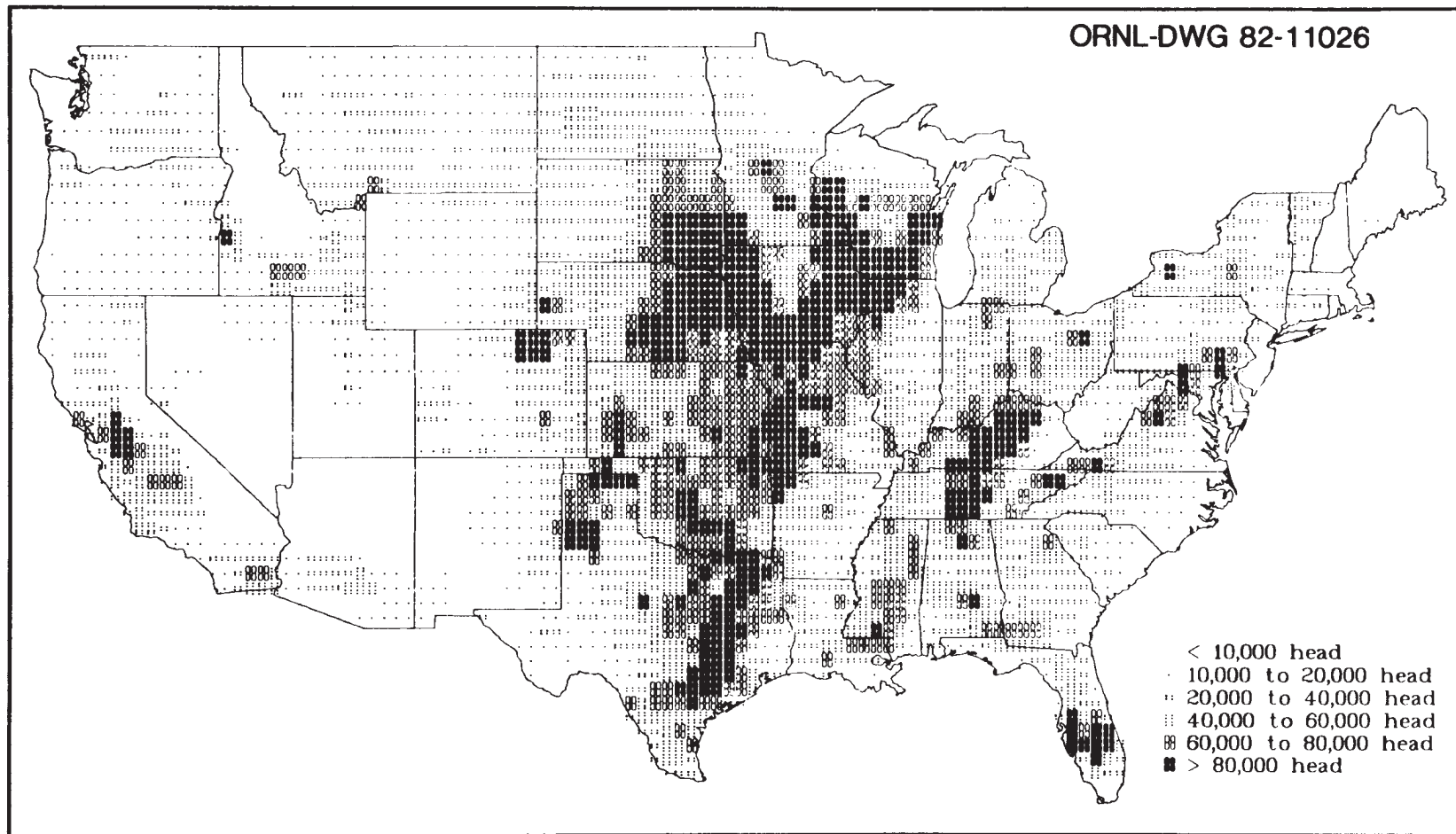

Figure 4.18. Geographic distribution of SITE parameter number cattle and calves inventory, n_{cc}

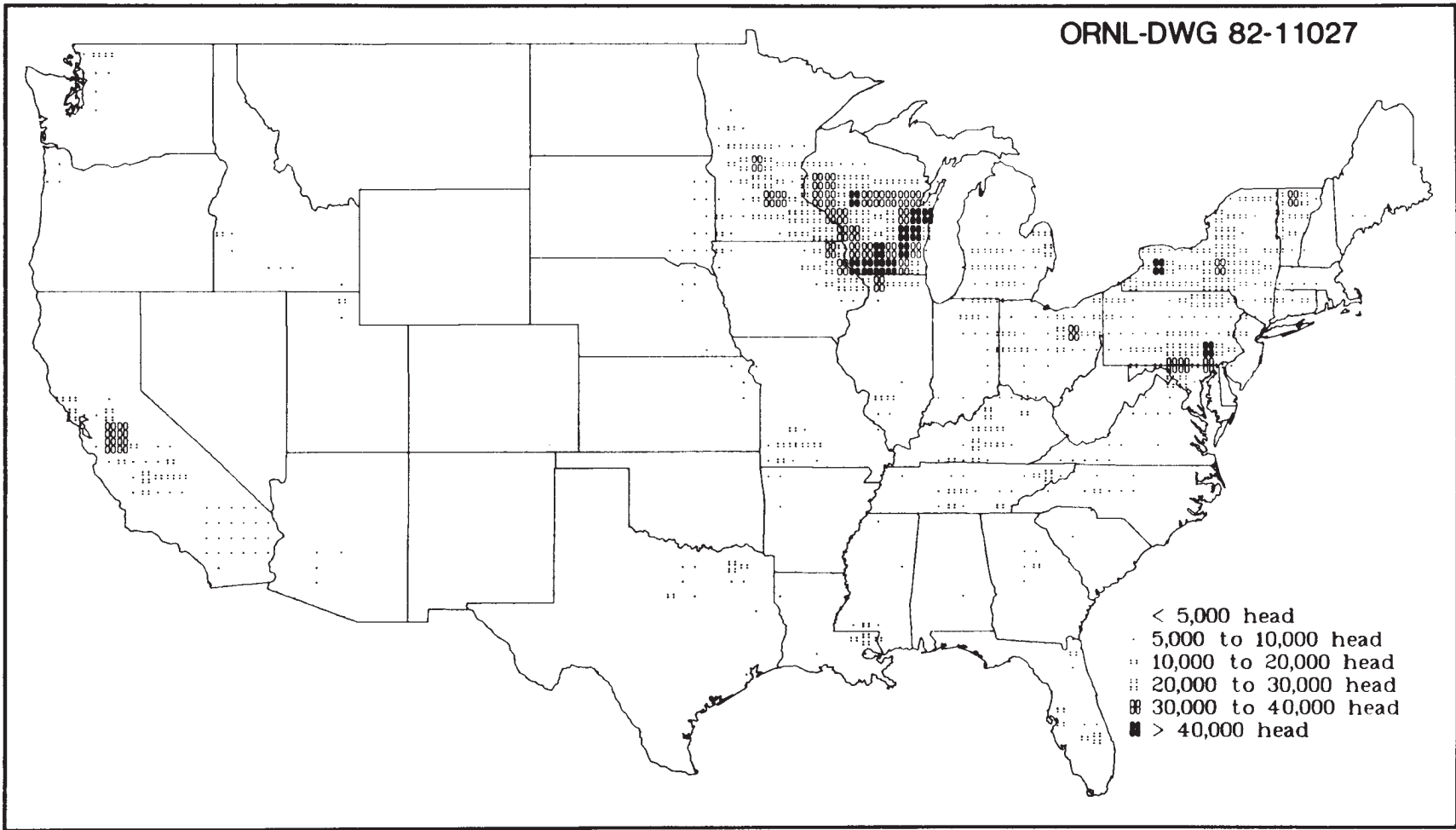

Figure 4.19. Geographic distribution of SITE parameter milk cow inventory, n_m

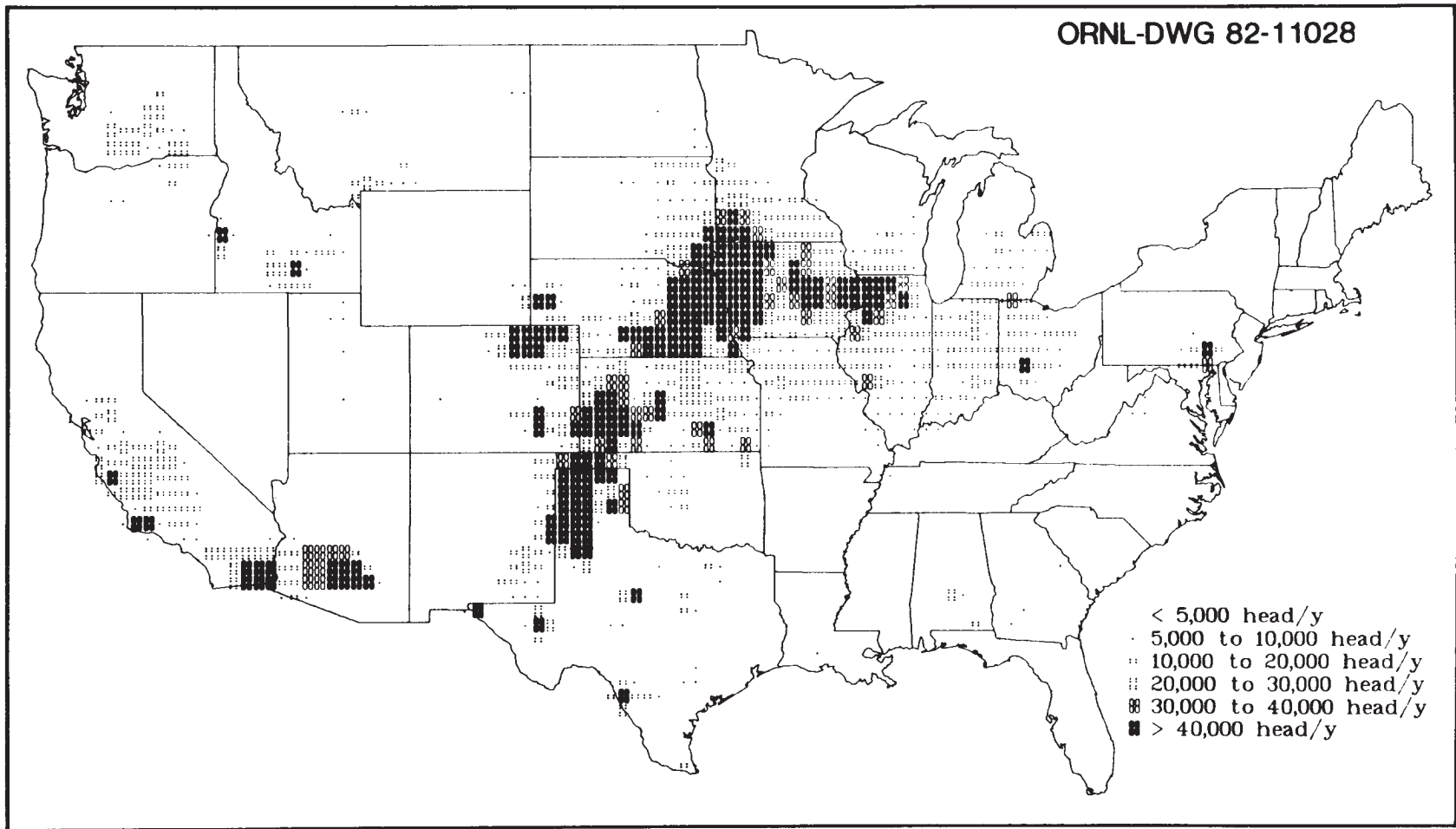

Figure 4.20. Geographic distribution of SITE parameter annual number of cattle on feed sold, s_g

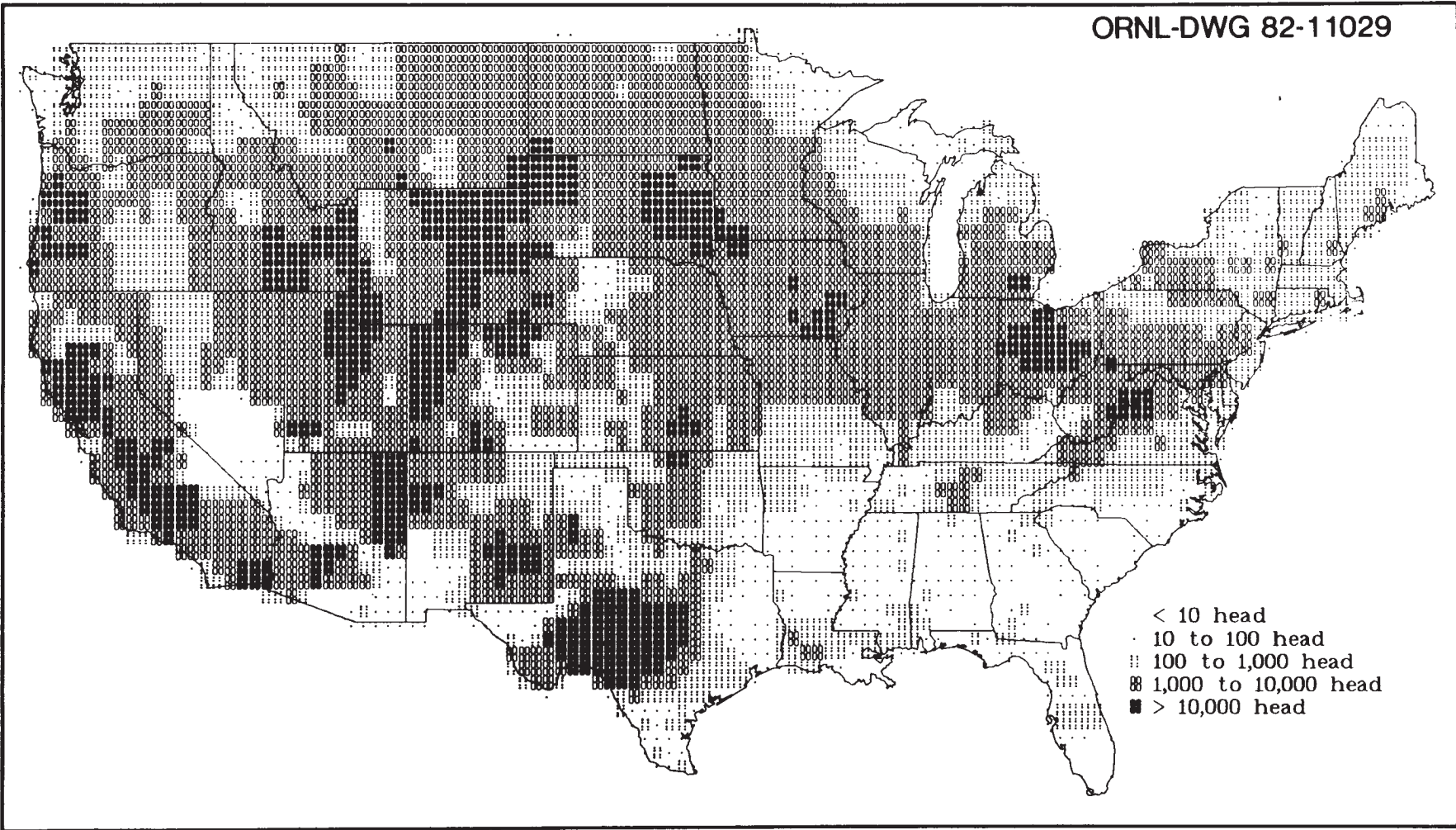

Figure 4.21. Geographic distribution of SITE parameter sheep inventory, n_s

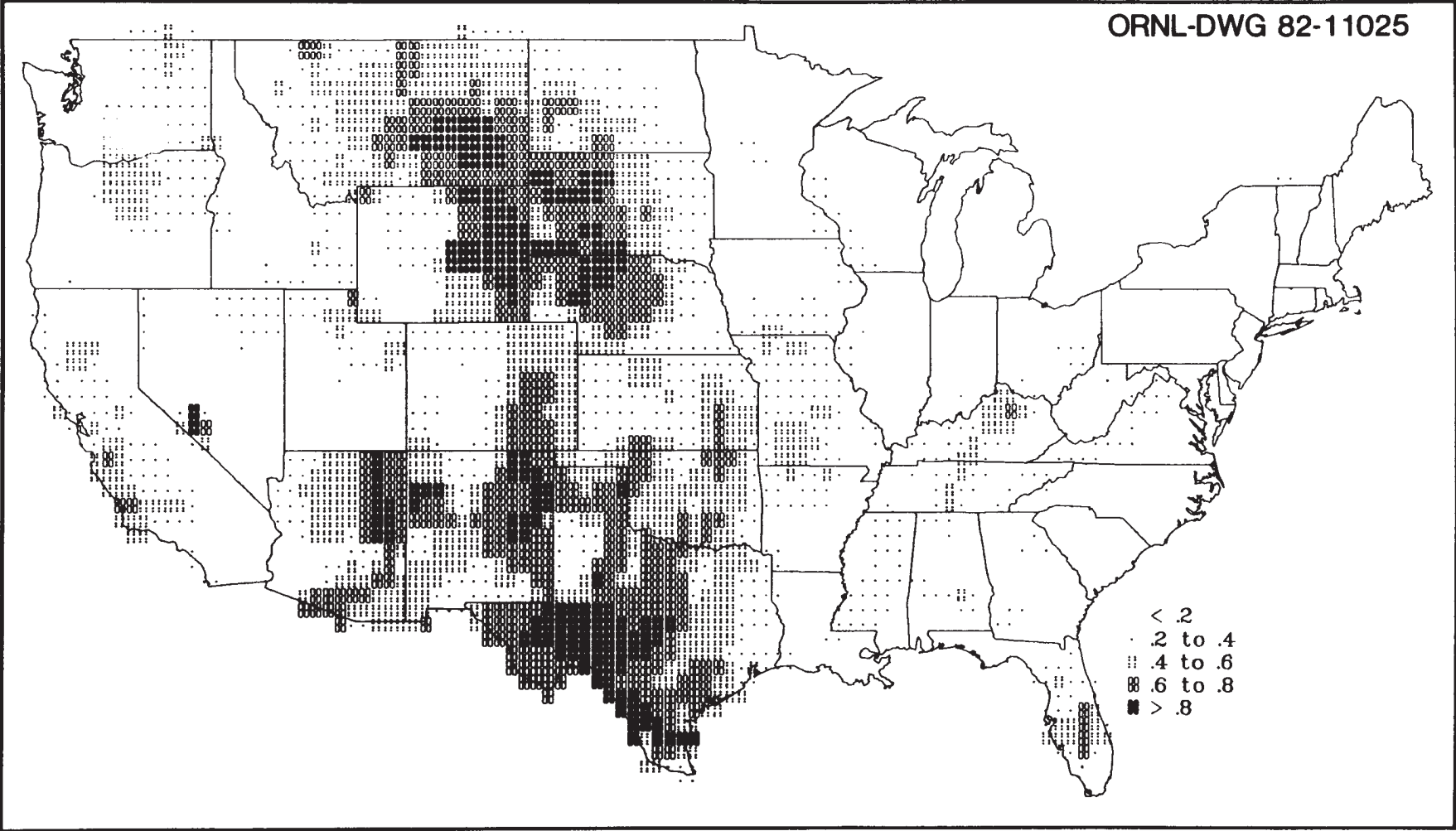

Figure 4.22. Geographic distribution of SITE parameter pasture area, A_p , shown as a fraction of total cell area.

where

- R_f = the collective forage requirement by forage-consuming livestock in the cell (kg/yr),
 P_{hf} = annual production of harvested forage in the cell (kg/yr),
 P_s = the annual production of silage in the cell (kg/yr), and
 P_h = the annual production of hay in the cell (kg/yr).

The collective livestock forage requirement is given by

$$R_f = 4010n_m + 970n_g + 3030n_a + 600n_s, \quad (41)$$

where

- n_g = the inventory of cattle on grain (head) in the cell,
 n_a = the average annual inventory of “all other cattle” (neither milk cows or cattle on feed) in the cell (head), and

the coefficients are annual forage requirements for each livestock category (kg/head/yr).⁷ Inventory numbers of milk cows, n_m , and sheep, n_s , are given in SITE, and n_g and n_a are calculated by

$$n_g = \frac{s_g}{\lambda_g}, \text{ and} \quad (42)$$

$$n_a = n_{cc} - n_m - \frac{3}{2}n_g, \quad (43)$$

where

- λ_g = the turnover rate of cattle on feed grain (1/yr).

The number of cattle and calves in the cell, n_{cc} , is given in SITE. The turnover rate λ_g is assumed to be 2.0/yr.⁷

In some states, notably Texas, Oklahoma, Nebraska, and Kansas, large numbers of cattle are imported and placed on feedlots for fattening. In these areas Eq. (43) may produce a negative value due to the high value of n_g . This possibility is tested for in the TERRA code, and when Eq. (43) is negative the value of n_a is set equal to the SITE parameter beef cow inventory, n_b (Fig. 4.23).

As shown in Eq. (39), all forage consumed by livestock in a cell is assumed to be produced locally within the cell in TERRA. This type of assumption is not applied to grain. That is, a grain requirement for all livestock in the cell is calculated according to

$$R_g = 2600n_m + 1820n_g + 150n_a, \quad (44)$$

where

- R_g = the collective grain requirement of all grain-consuming livestock in the cell (kg/yr)
 and

the coefficients are the annual grain requirements for each livestock category (kg/head/yr).⁷ Sheep are assumed to consume forage only. The grain requirement is compared to the SITE parameter, annual harvest yield or production of grain feed, P_{gf} (kg), and the fraction of grain imported from outside of the cell, f_{gi} , is calculated according to

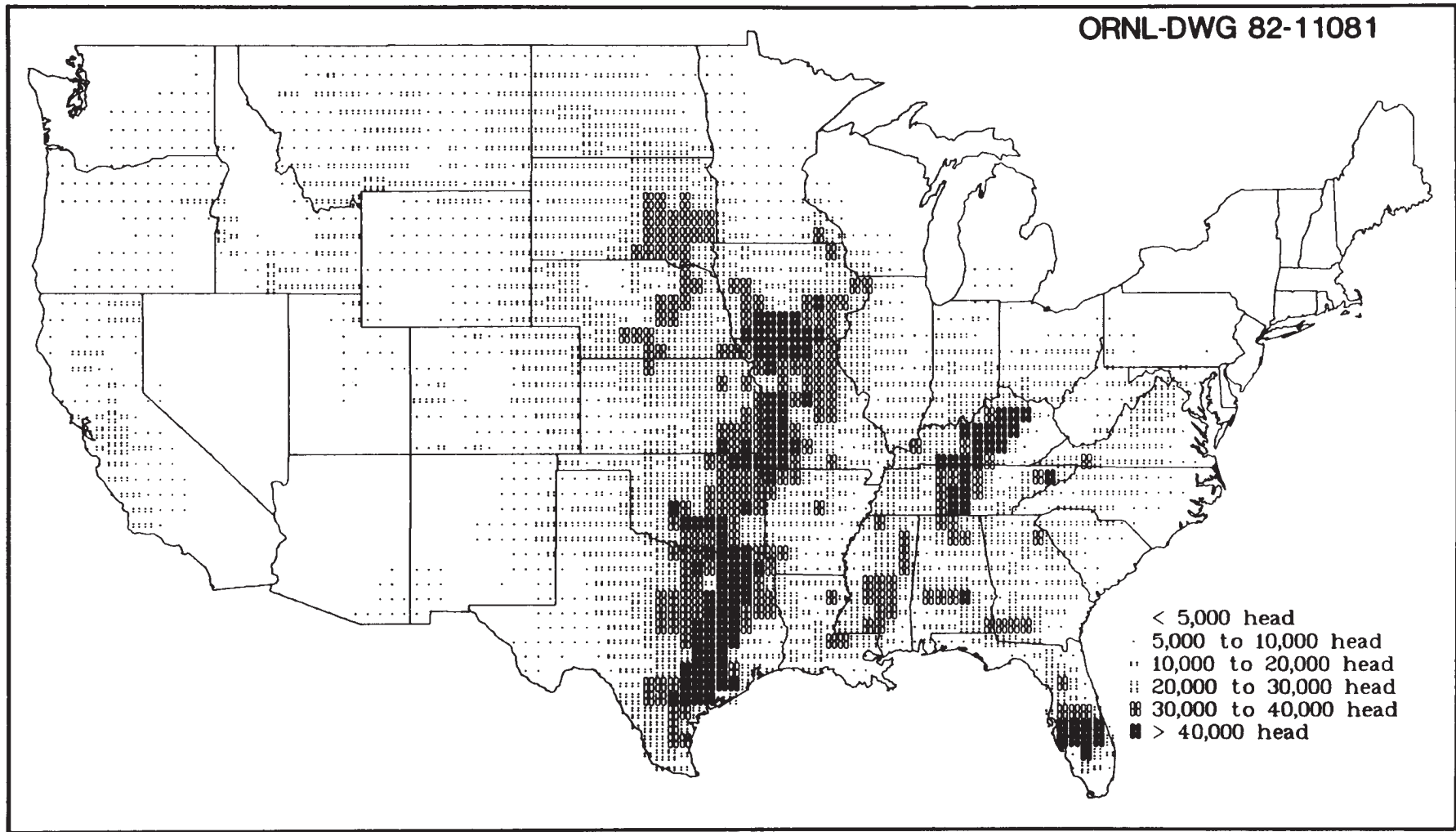

Figure 4.23. Geographic distribution of SITE parameter beef cows inventory, n_b .

Table 4.3. Agricultural and climatological parameters for seven selected SITE cells and parameters derived from them in TERRA

Parameter	Cell number; (X,Y); state						
	#1655 (82,31.5) GA	#2069 (115,33) CA	#2273 (101,34) TX	#3051 (84,37.5) KY	#3182 (91.5,38) MO	#3628 (82.5,40) OH	#4541 (75,44) NY
SITE Parameter							
Y_e (kg/m ²)	0.536	2.28	0.577	0.721	0.154	1.13	1.29
Y_{lv} (kg/m ²)	0.0	2.84	0.0	0.209	0.0	2.06	0.177
Y_s (kg/m ²)	0.843	0.187	0.391	1.04	0.591	0.847	0.917
Y_h^a (kg/m ²)	0.540	1.40	0.365	0.397	0.394	0.495	0.441
d_{ff} (day/yr)	287	357	209	201	206	191	162
A_p (m ²)	2.73×10 ⁸	4.00×10 ⁷	9.18×10 ⁸	1.28×10 ⁹	1.06×10 ⁹	3.10×10 ⁸	2.24×10 ⁸
P_s (kg/yr)	6.42×10 ⁶	2.36×10 ⁵	4.43×10 ⁶	1.75×10 ⁷	5.52×10 ⁶	1.88×10 ⁷	3.38×10 ⁷
P_h (kg/yr)	8.54×10 ⁶	1.61×10 ⁸	4.01×10 ⁶	6.97×10 ⁷	5.70×10 ⁷	5.97×10 ⁷	7.22×10 ⁷
n_{cc}	29,536	72,784	35,451	124,414	67,263	42,645	27,564
n_m (head)	2,446	1,460	40	3,504	2,250	8,907	15,125
n_s (head)	1	34,385	1,776	3,184	444	22,226	280
n_b (head)	12,543	2,334	13,265	52,694	32,797	10,748	817
s_g (head)	2,117	136,978	1,391	3,856	2,437	6,279	127
P_{gf} (kg)	8.64×10 ⁷	9.32×10 ⁶	1.05×10 ⁸	2.23×10 ⁷	1.47×10 ⁷	1.24×10 ⁸	1.83×10 ⁶
Parameters calculated in TERRA							
h_h (1/yr)	5	6	3	3	3	3	3
Y_h (kg/m ²)	0.108	0.233	0.122	0.132	0.131	0.165	0.147
n_g (head)	1,059	68,489	696	1,592	1,219	3,140	64
n_a (head)	25,502	2334 ^a	34,367	119,522	63,184	29,028	12,343
R_f (kg/yr)	8.81×10 ⁷	1.00×10 ⁸	1.06×10 ⁸	3.80×10 ⁸	2.02×10 ⁸	1.40×10 ⁸	9.83×10 ⁷
C_p (kg/yr)	7.69×10 ⁷	0	9.97×10 ⁷	3.15×10 ⁸	1.55×10 ⁸	8.11×10 ⁷	1.88×10 ⁷
Y_{pg}^a (kg/yr/m ²)	0.282	0	0.109	0.246	0.146	0.262	0.084
g_{pg} (1/yr)	10	0	7	7	7	6	5
Y_{pg} (kg/m ²)	0.028	0	0.016	0.035	0.021	0.044	0.017

^aSet equal to inventory of beef cattle in this SITE cell.

$$f_{gi} = 1 - \frac{P_{gf}}{R_g}, \quad (45)$$

unless $P_{gf}/R_g > 1.0$, in which case f_{gi} is set to 1.0.

Table 4.3 lists 13 of the 14 agricultural parameters in SITE and number of frost-free days, which is used by TERRA for selected SITE cells in the United States. The 14th agricultural parameter, irrigation, is discussed in Sect. 4.2. The other seven parameters—annual yields (production) of leafy vegetables, P_{lv} , exposed produce, P_e , protected produce, P_{pp} , grains consumed by man, P_{gh} , and productivity estimates for protected produce, Y_{pp} , grain feeds, Y_{gf} , and grain foods consumed by man, Y_{gh} ,—are not currently used by TERRA.

4.2 Climatological Parameters

The SITE data base contains six climatological parameters—precipitation, evapotranspiration, absolute humidity, morning mixing height, afternoon mixing height, and number of frost-free days. All except evapotranspiration have been calculated according to the method described in Sect. 4. for climatological parameters (interpolation among the three nearest weather stations).

Evapotranspiration was calculated by United States county and converted to SITE cell basis according to Method B. Of the six, only precipitation, evapotranspiration, absolute humidity, and frost-free days are used by TERRA. Frost-free days has been discussed in Sect. 4.1. The following discussion will detail the derivation and use of the remaining five climatological parameters and the agricultural parameter irrigation.

Evapotranspiration (Fig. 4.24), irrigation (Fig. 4.25) and precipitation (Fig. 4.26) are used in the calculation of leaching constants [Eq. (7)] as described in Sect. 2.4. Leaching constants are calculated for both irrigated and nonirrigated soils in TERRA. Food crops (except grains) are assumed to be grown on irrigated soils and all livestock feeds are assumed to be grown on nonirrigated soils. The numerator of Eq. (7), $(P + I - E)$, is assumed to be a mass balance of water inputs and outputs for a given agricultural area. Surface runoff and storage of water in surface agricultural soils is not considered in TERRA.

Evapotranspiration was calculated according to a model proposed by Morton.²¹⁶ The model requires as input annual precipitation, sea level pressure (or altitude), monthly dew point, monthly ambient air temperatures, and monthly fraction of maximum possible sunshine. Annual precipitation was taken from Olson, Emerson, and Nungesser²¹⁷ by county in eastern states and by state climatic division in western states. Conversion of precipitation by state climatic division to a county basis was achieved using the IUCALC code.²¹⁵ The altitude of each county centroid in meters was estimated using the TERGHT code.²¹⁸ Each altitude was converted to sea level pressure in millibars using²¹⁹

$$P_{sl} = \left[\frac{z - 44308}{-11876.94} \right]^{5.25679}, \quad (46)$$

where

$$\begin{aligned} P_{sl} &= \text{sea level pressure (mb) and} \\ z &= \text{altitude (m).} \end{aligned}$$

Monthly dew point and ambient air temperatures were taken from references 210, 211, and 212 for various United States weather stations. The monthly fractions of maximum possible sunshine were taken from references 211 and 212 for various weather stations. All parameters derived from weather station data were interpolated to county centroids and finally to the half degree cells using methods previously described.

Annual irrigation in centimeters was taken from information reported in the 1974 Census of Agriculture. For each county the 1974 Census reports total land irrigated in acres and the estimated quantity of irrigation water applied in acre-feet. The latter was divided by the former and the quotient was converted to centimeters.

Irrigation was not included with precipitation in the model input parameters, although it is considered in Eq. (7). This discrepancy will add a small amount of error to the evapotranspiration by county calculation. Because the Morton model is designed for large land areas and does not provide for local discontinuities, it was assumed that irrigation water is an insignificant fraction of total precipitation over the entire county or cell. This assumption is supported by the observation that nationally only 3-4% of all farmland is irrigated. However, in some counties irrigated land may be a significant fraction of the total land area and our calculations inappropriate.

According to Morton, the evapotranspiration model has been verified over a wide range of environments and compares satisfactorily with annual precipitation less runoff for 81 river basins in Canada, 36 river basins in the southern United States, three river basins in Ireland, and two river basins in Kenya. Wallace²²⁰ compared the model with the Thornthwaite-Mather²²¹ and Penman²²² approaches to modeling evapotranspiration and found the Morton model to be superior in modeling arid environments. Morton, however, warns against use of the model near sharp environmental discontinuities. Therefore, estimates of evapotranspiration near coast-lines and mountain ranges are suspect.

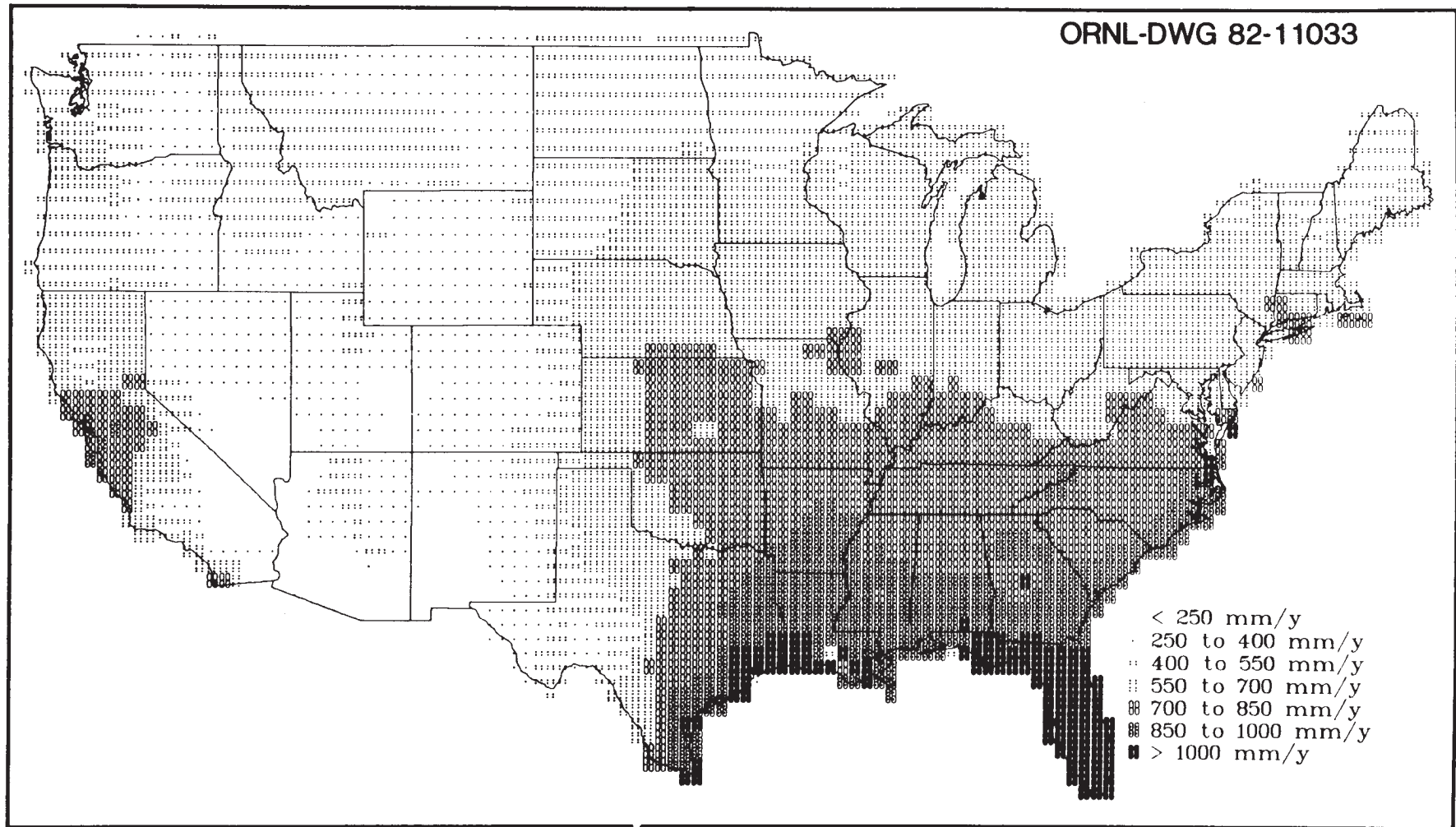

Figure 4.24. Geographic distribution of SITE parameter estimated annual average evapotranspiration, E .

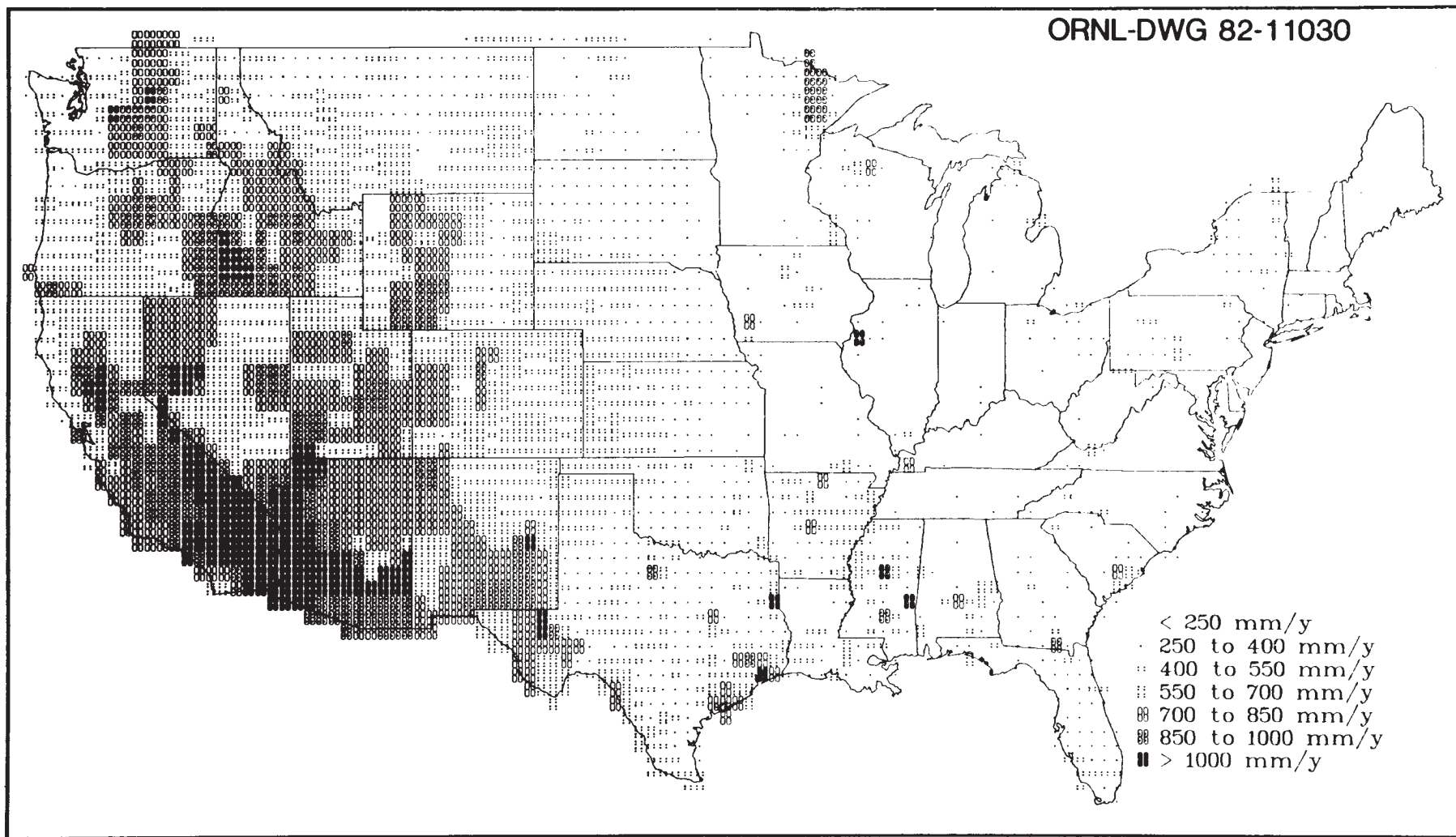

Figure 4.25. Geographic distribution of SITE parameter estimated annual average irrigation, *I*.

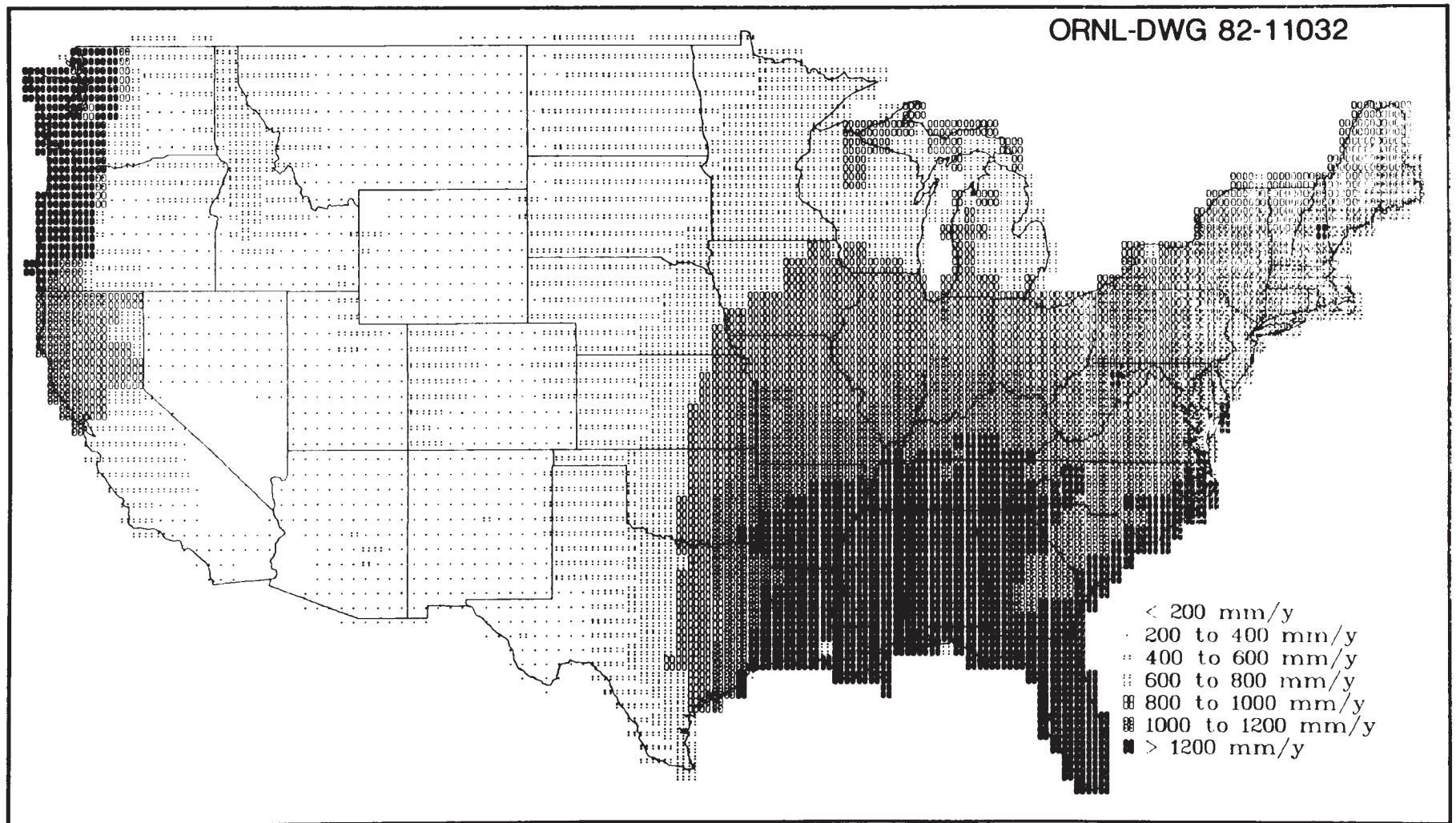

Figure 4.26. Geographic distribution of SITE parameter estimated annual average precipitation, P .

Morning and afternoon mixing heights in meters (Figs. 4.27 and 4.28, respectively) were taken from the annual average tabulation for 62 United States weather stations reported by Holzworth²²³ under both precipitation and nonprecipitation conditions. Cell values are interpolations among the three nearest weather stations. Currently, morning and afternoon mixing height estimations are not used in TERRA. However, they may be of use to atmospheric dispersion computer codes and models which calculate dispersion of elevated releases.

The estimates of absolute humidity (Fig. 4.29) were taken from the annual averages for 218 United States weather stations calculated by Etnier²²⁴ from annual-average temperature and relative humidity data. The cell-averaged values were interpolated from the three nearest weather stations as previously described.

4.3 Demographic and Miscellaneous SITE Parameters

In addition to the 29 parameters previously discussed, SITE includes seven parameters describing the population of the cell and cell characteristics. These parameters include the estimated 1980 population and fractions (based on the 1970 Census) which are classified as urban, rural-farm, and rural-nonfarm, the actual land area of the cell, the dominant land feature in the cell, and the coarse suspended particulate matter due to resuspension.

The 1980 population estimate for half degree cells (Fig. 4.30) was determined from data by enumeration district as described in references 213 and 214. The definitions of "urban," "rural-farm," and "rural-nonfarm" are as follows. The urban population (Fig. 4.31) comprises all persons living in (1) places of 2,500 inhabitants or more incorporated as cities, boroughs, villages, and towns (except towns in New England, New York, and Wisconsin); (2) the densely settled urban fringe, whether incorporated or unincorporated, of urbanized areas; (3) towns in New England and townships in New Jersey and Pennsylvania which contain no incorporated municipalities as subdivisions and have either 25,000 inhabitants or more or a population of 2,500 to 25,000 and a density of 580 persons or more per square kilometer (1,500 persons per square mile); (4) counties in states other than the New England States, New Jersey, and Pennsylvania that have no incorporated municipalities within their boundaries and have a density of 580 persons or more per square kilometer (1,500 persons per square mile); and (5) unincorporated places of 2,500 inhabitants or more. The rural population is divided into "rural-farm," (Fig. 4.32) comprising all persons living on farms, and "rural-nonfarm," (Fig. 4.33) comprising the remainder. According to the 1970 Census definition, the farm population consists of all persons living in rural territory on places of less than 0.04 km² yielding agricultural products which sold for \$250 or more in the previous year, or on places of 0.04 km² (10 acres) or more yielding agricultural products which sold for \$50 or more in the previous year.

The land area of the cell in square meters is less than or equal to the theoretical area of the cell, depending on the area of surface waters in the cell. The actual area of the cell was determined from the county areas reported in the 1974 Census of Agriculture. "Land areas" includes land temporarily or partially covered by water (marshlands, swamps, etc); canals under 201 m (one eighth statute mile) wide; and lakes, reservoirs, and ponds under 0.16 km² (40 acres).

The SITE data base contains a coded number which describes the dominant land feature of the cell (Fig. 4.34). The dominant land feature may be useful to atmospheric dispersion calculations requiring location-specific surface roughness correction factors. The dominant land features considered are

- 1) Tall row crops,
- 2) Short row crops,
- 3) Hay or tall grass,
- 4) Urban areas,
- 5) Small lakes,
- 6) Short grass, and
- 7) Forest.

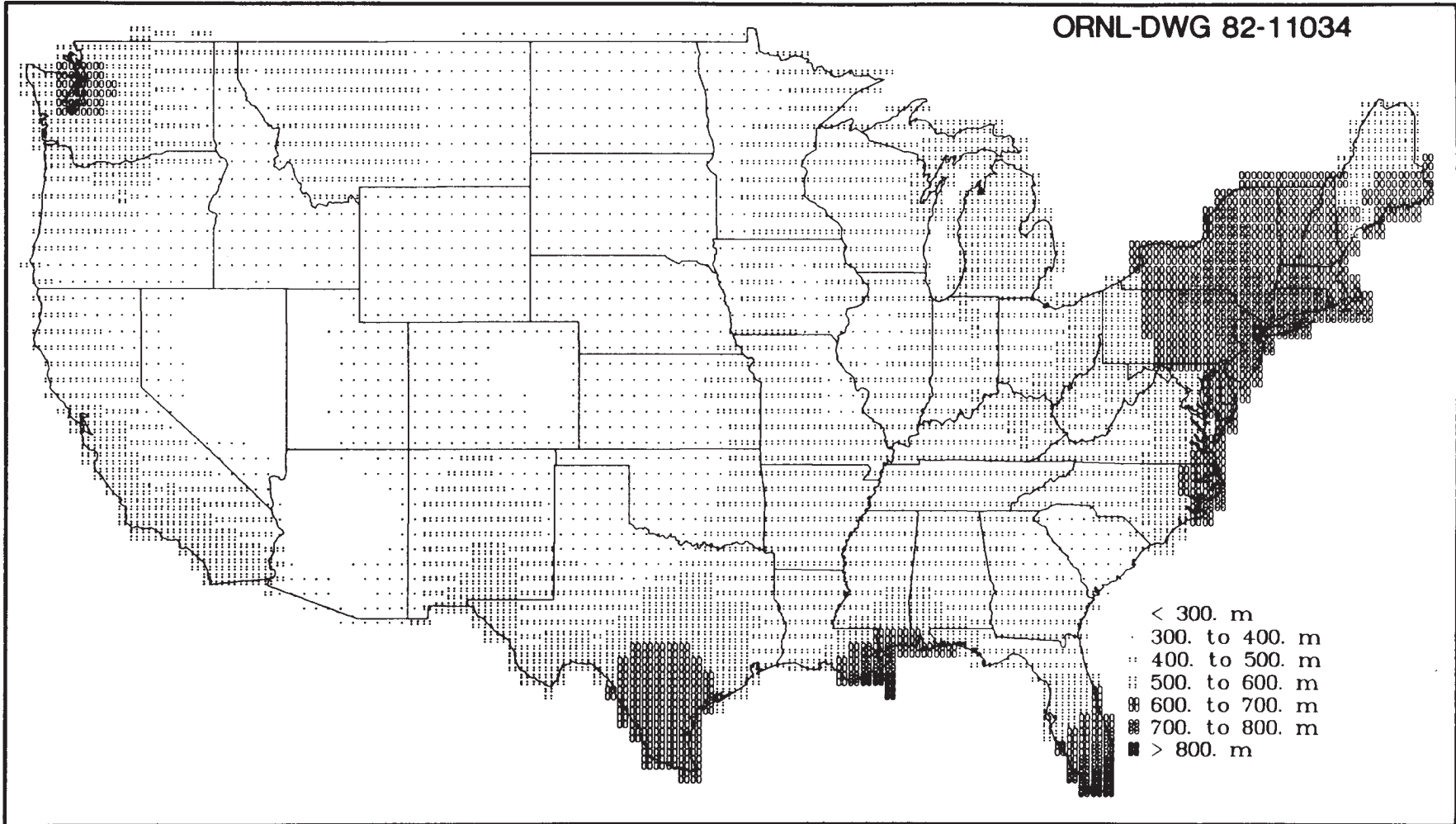

Figure 4.27. Geographic distribution of SITE parameter estimated annual average morning mixing height, $M_{a,m}$

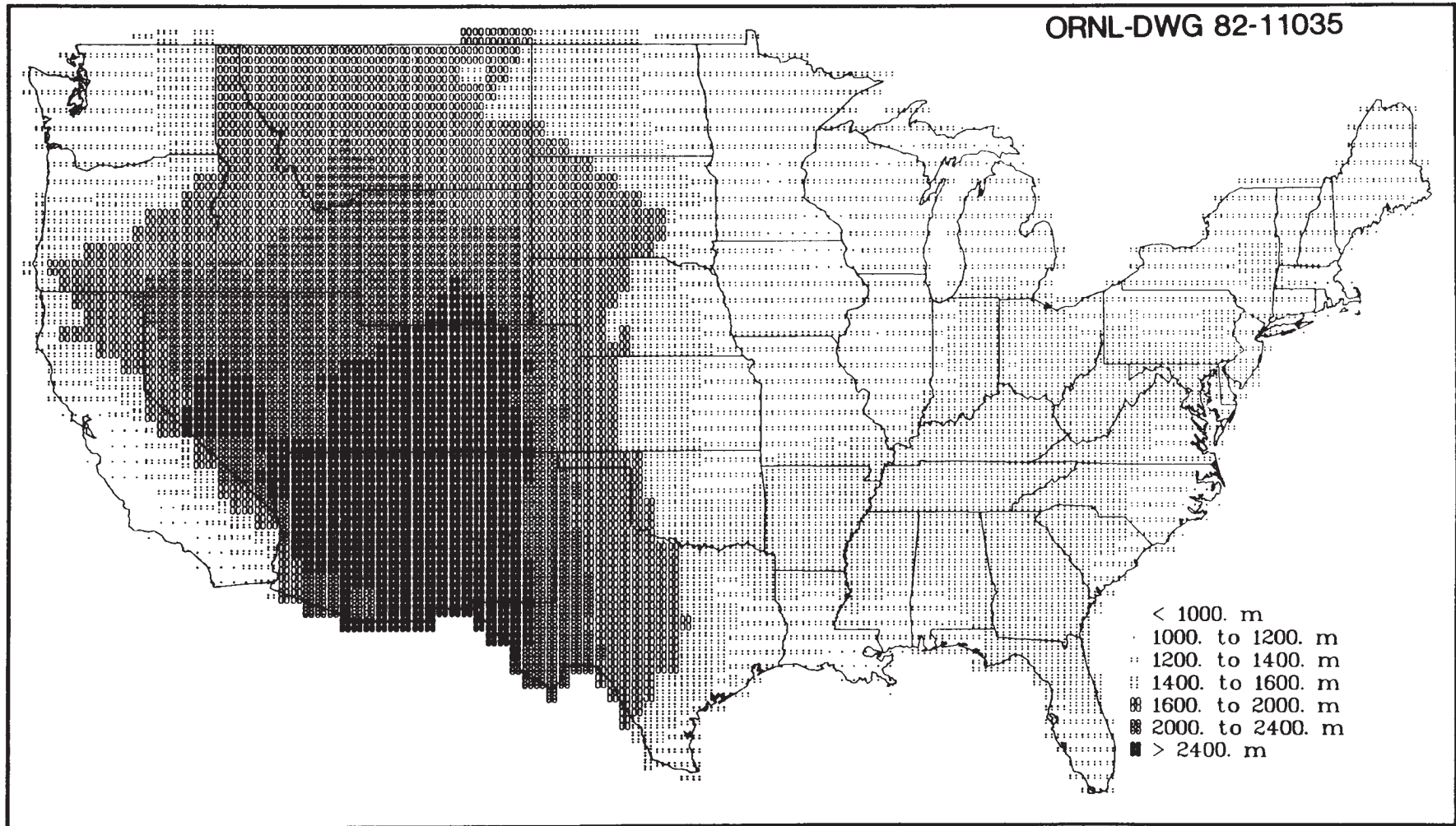

Figure 4.28. Geographic distribution of SITE parameter estimated annual average afternoon (evening) mixing height, $M_{p,n}$

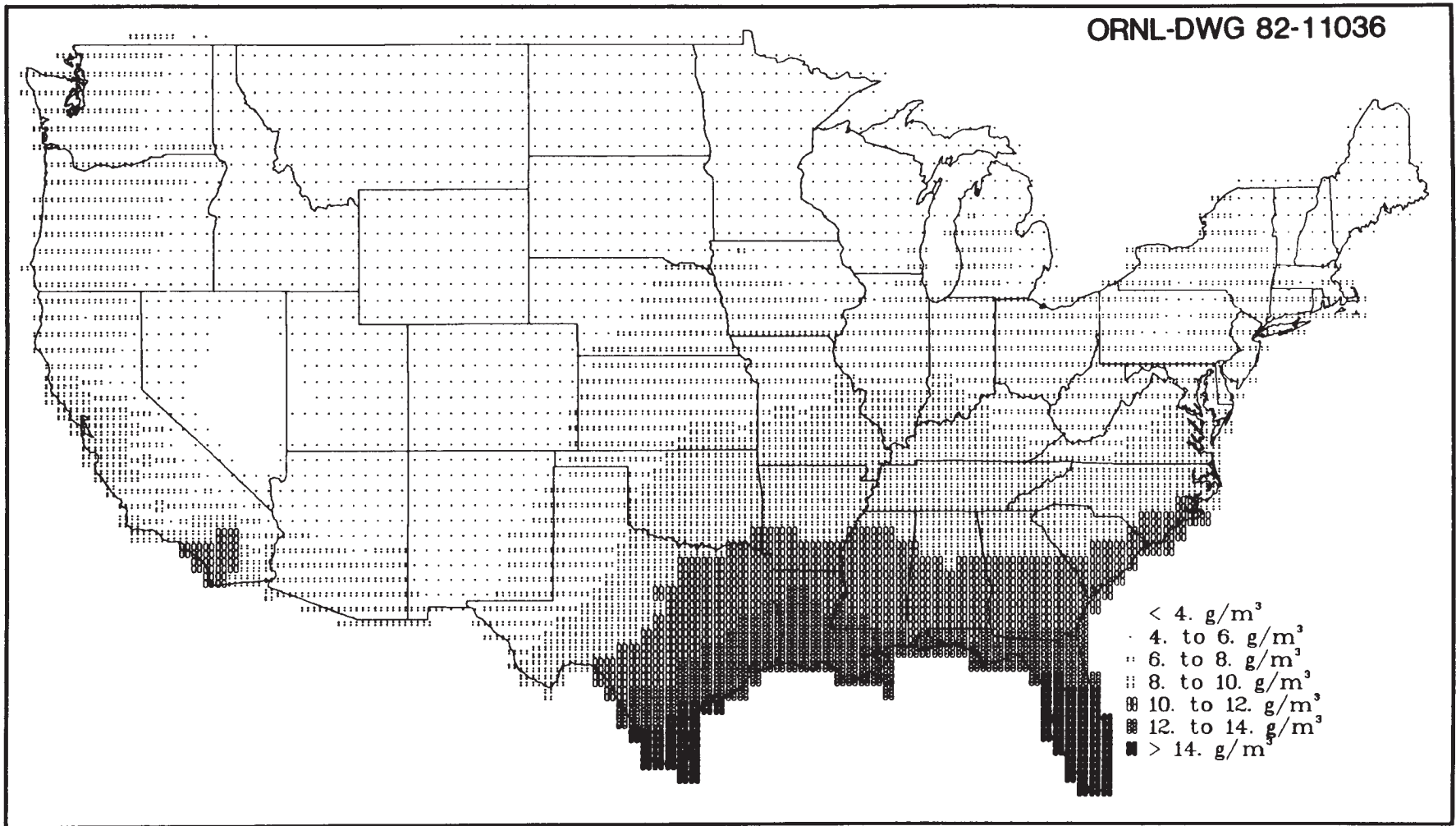

Figure 4.29. Geographic distribution of SITE parameter estimated annual average absolute humidity, H .

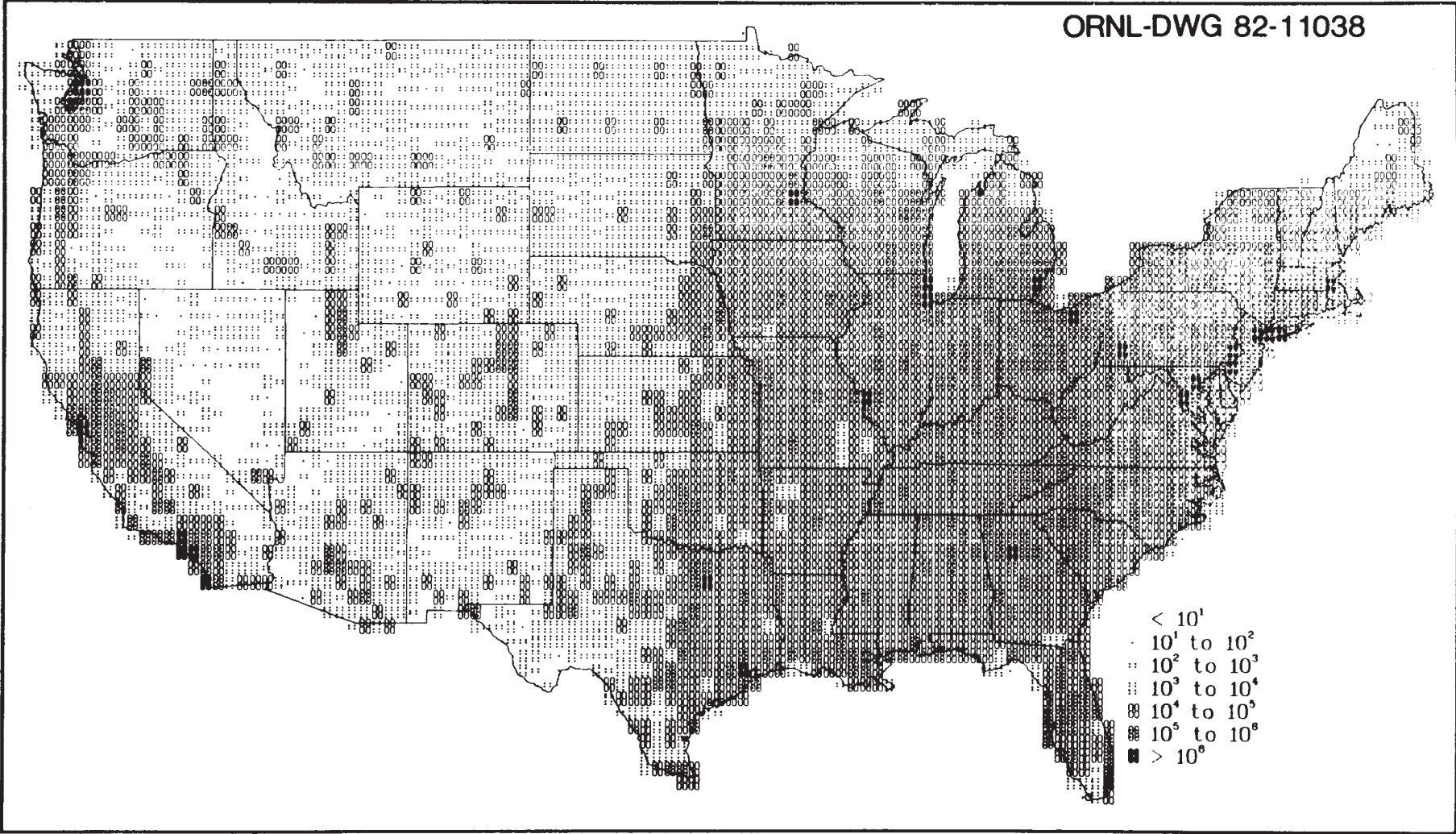

Figure 4.30. Geographic distribution of SITE parameter (estimated 1980) U.S. population, *pop.*

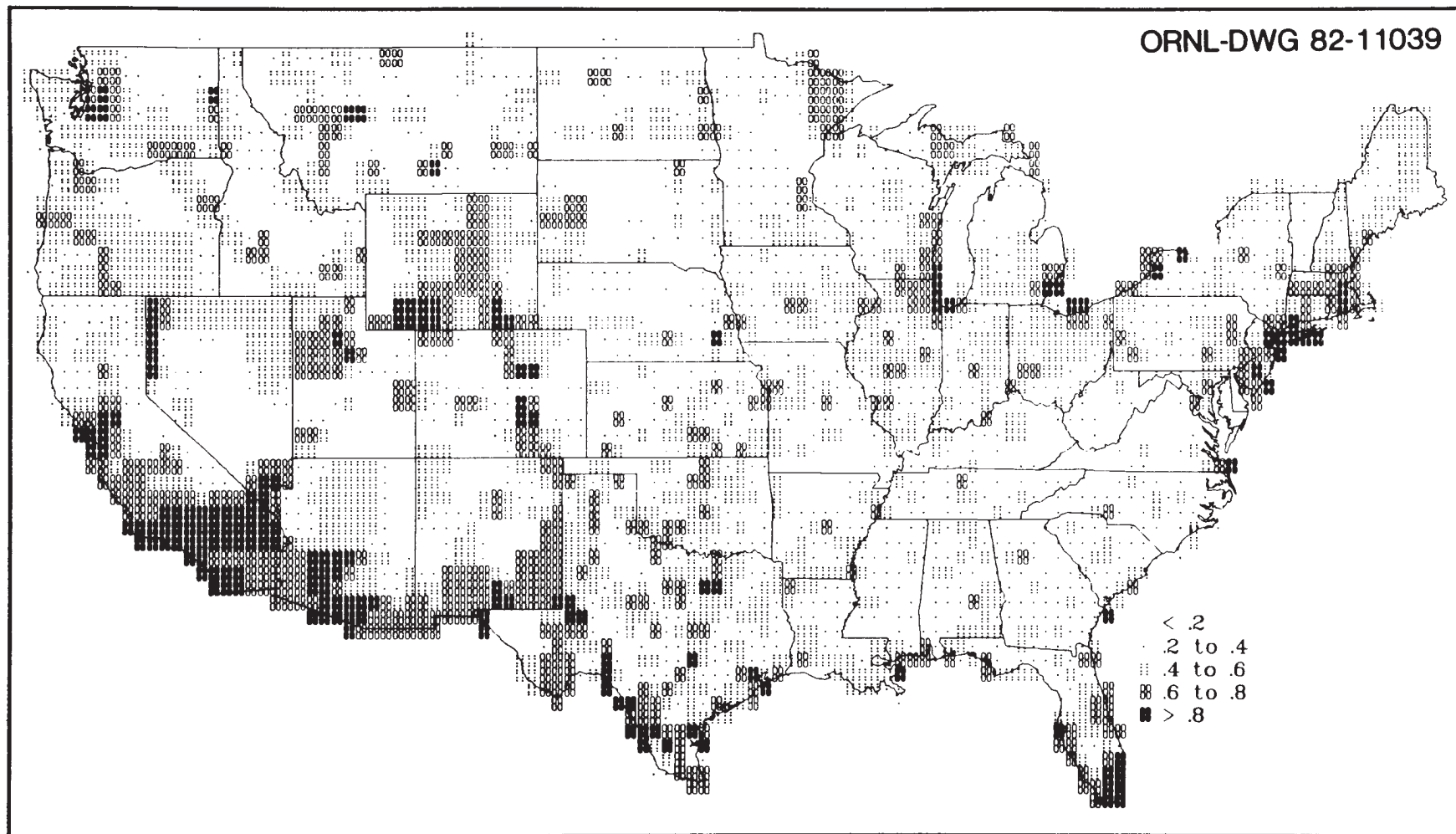

Figure 4.31. Geographic distribution of SITE parameter fraction of (1970) population classified as urban, pop_u .

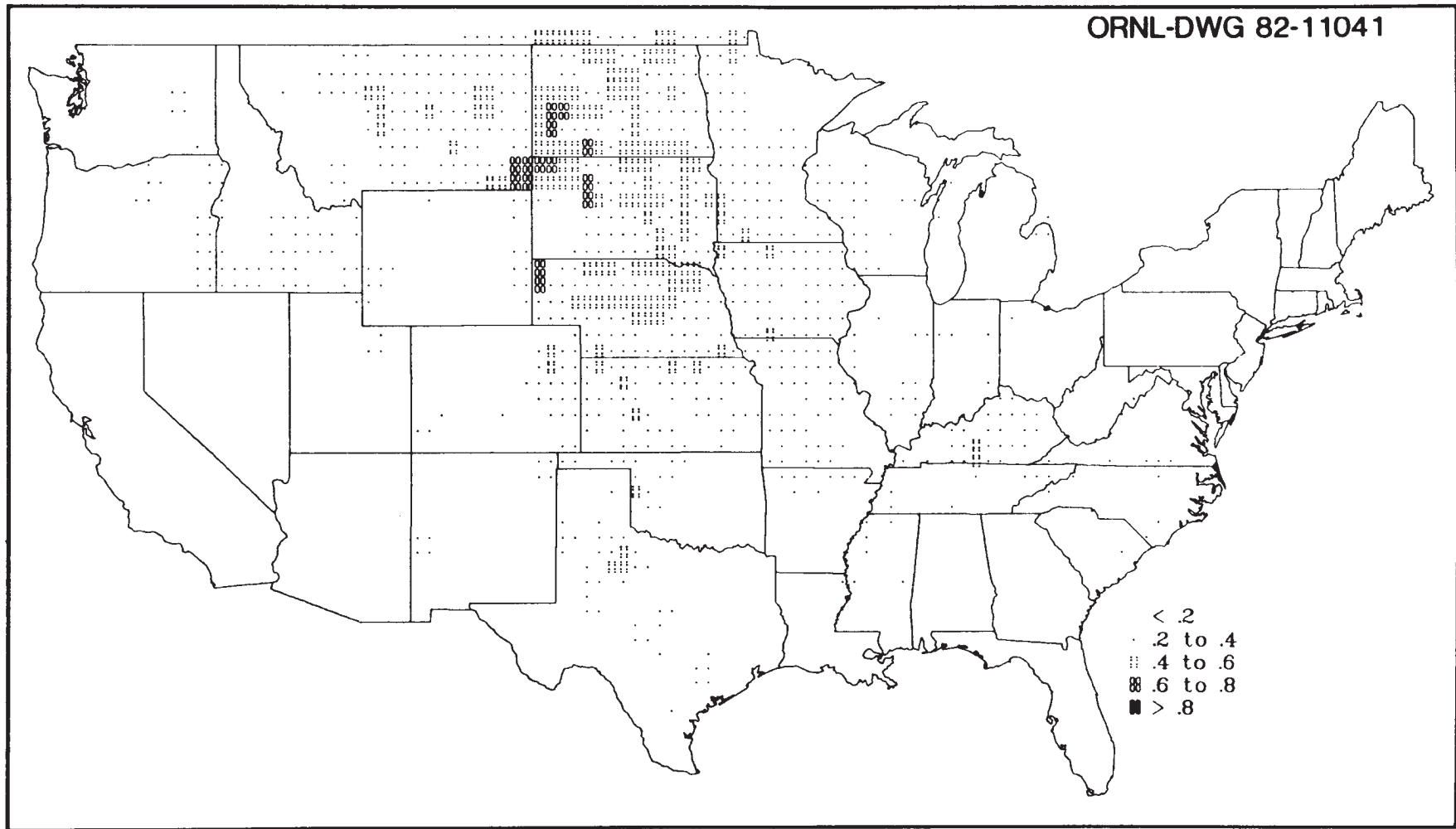

Figure 4.32. Geographic distribution of SITE parameter fraction of (1970) population classified as rural-farm, pop_r

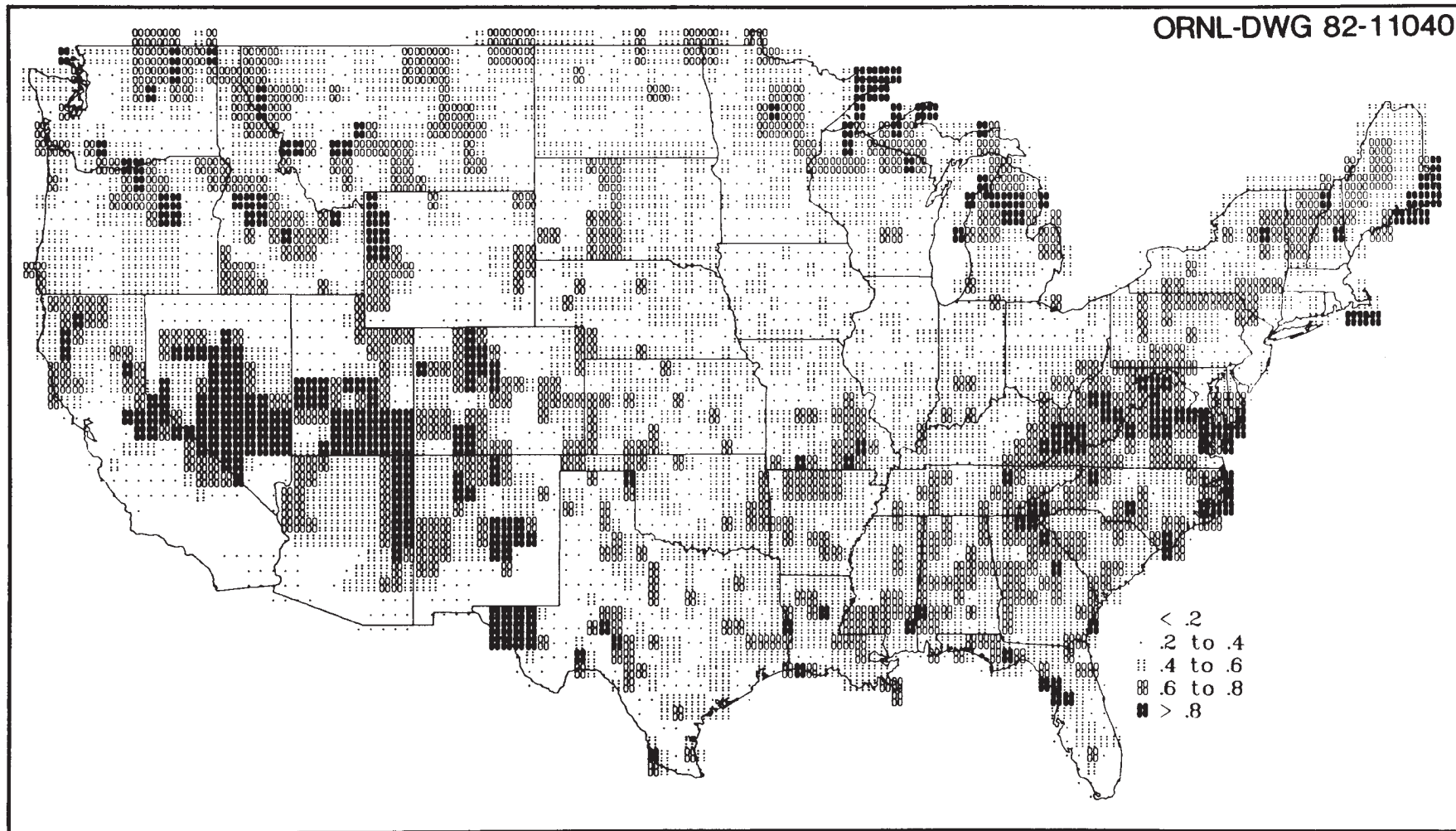

Figure 4.33. Geographic distribution of SITE parameter fraction of (1970) population classified as rural-nonfarm, pop_{nf}

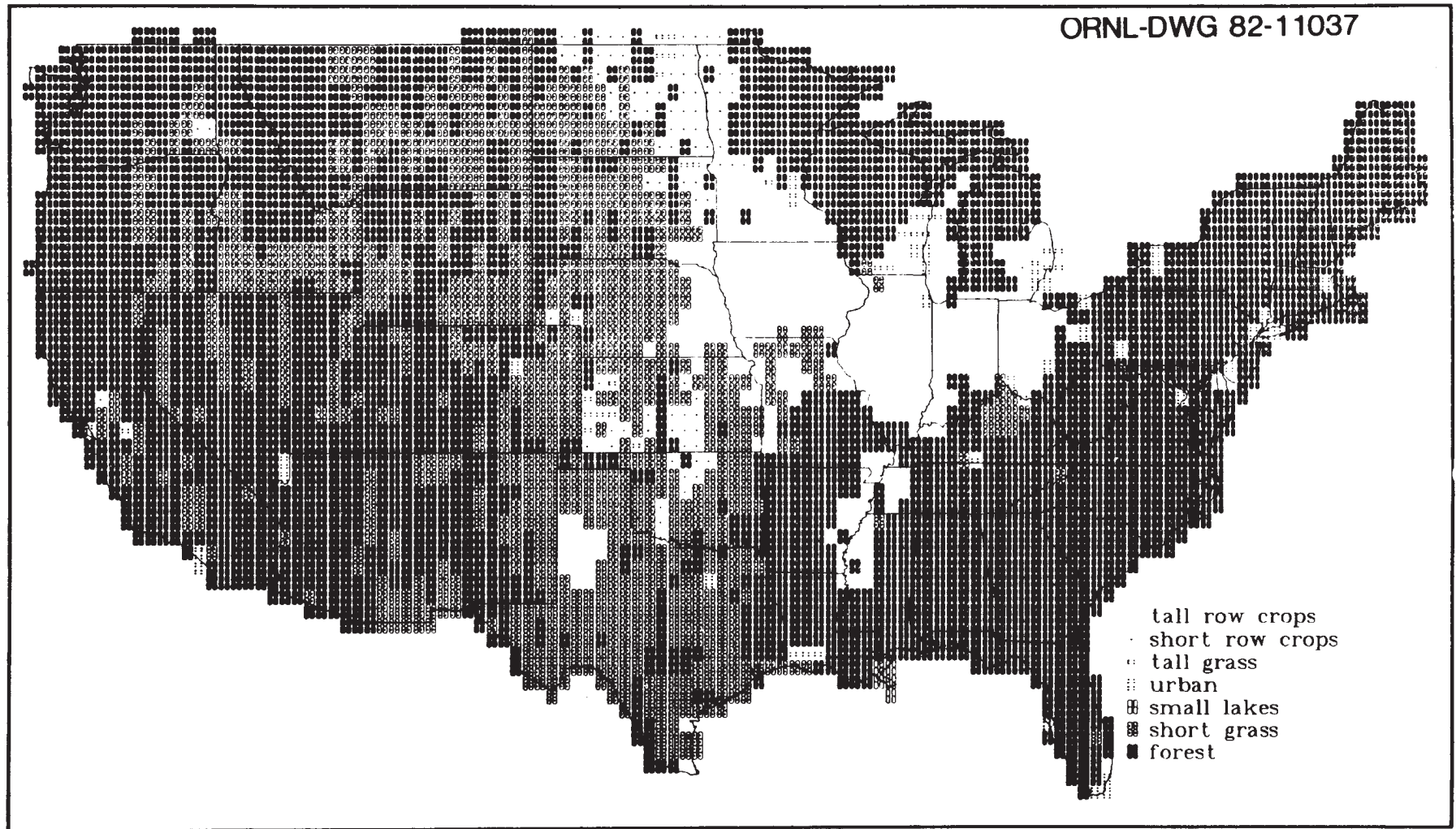

Figure 4.34. Geographic distribution of SITE parameter dominant land feature, L_{df}

The dominant land features were determined from data gathered by Olson, Emerson, and Nungesser.²¹⁷ They reported areas for each land feature by county. The county areas were converted to cell areas by methods previously described. The land feature with the largest area is considered the dominant land feature.

The dominant land feature is expressed as a code of the form FLPPP. The “F” value is either “0” or “1,” for less than or more than 50% of the total area in the cell classified as Federal land, respectively. Federal land was not subclassified as to land use in data gathered by Olson, Emerson, and Nungesser.²¹⁷ Therefore, an assumption inherent in our estimation of dominant land feature is that Federal and privately owned lands are similar in land feature make up. This assumption may be incorrect, especially when Federal lands are protected forest or wildlife areas. The “L” value corresponds to the seven land features previously given. The “PPP” value indicates the percentage of the total area of the cell corresponding to the “L” category.

5. MISCELLANEOUS PARAMETERS

Other default parameters included in the TERRA code are the weathering removal constant, λ_w , the metabolic removal rate constants from milk and beef, λ_m and λ_f , respectively, and the lifetime grain and forage requirements of cattle on feed, Q_g^{fc} and Q_f^{fc} , respectively. The weathering removal constant is extremely important in calculating surface plant concentrations due to direct deposition processes, and the latter four parameters are utilized in calculating beef and milk concentrations.

5.1 The Weathering Removal Loss Constant, λ_w

After radionuclides are initially deposited on vegetation surfaces environmental processes (in addition to radiological decay) will begin to remove the deposited material. Miller and Hoffman²²⁵ have reviewed the literature on weathering removal of radionuclides from vegetation. They classify the environmental removal processes as wind removal, water removal, growth dilution, and herbivorous grazing. Wind removal may be very effective in removal of freshly deposited large particles ($> 1 \mu\text{m}$ diameter), but not nearly as effective after the first few days. Submicron particles may be released from plant surfaces during periods of rapid growth and high transpiration rates. Also, surface abrasion from wind action may dislodge salt particles, wax, and other surface fragments. Radioactivity associated with these components would also be removed from the vegetation.

Precipitation, fog, dew, and mist—all may remove surface-deposited radionuclides via direct washoff and leaching. Leaching, in addition, may remove radionuclides incorporated into plants through root uptake. Wash-off, like wind removal, seems to be most effective on freshly deposited material. Precipitation falling as a light, continuous drizzle is more efficient than a large quantity of precipitation falling over a much shorter period.²²⁵

Removal due to growth dilution and grazing by herbivores may vary considerably by plant and location. Produce growth characteristics may be quite varied. Slow-growing varieties may be expected to be less affected by growth dilution than faster growing varieties. Grazing by herbivores may be particularly hard to predict. Weathering removal tends to occur in an exponential manner with a characteristic half-time, T_w .²²⁵ From this half-time a weathering removal constant, λ_w , may be derived according to

$$\lambda_w = \frac{\ln 2}{T_w}. \quad (47)$$

In the TERRA code the value of λ_w adopted by the USNRC⁶ of 5.73×10^{-7} (equal to a T_w of 14 d) is used for all radionuclides (except for iodine) on all plant surfaces. This value is somewhat arbitrary, but is within the range of reported values in the literature. In their literature review Miller and Hoffman²²⁵ found measured values of T_w to range between 2.8 to 34 days with a geometric mean of all reported values of 10 days. For I_2 vapor, iodine particulates, and other particulates on herbaceous vegetation the geometric means of reported values of T_w are 7.2, 8.8, and 17 days, respectively. The value of T_w used in TERRA is $1.0 \times 10^{-6} \text{ s}^{-1}$, which corresponds to a T_w of 8 days.

5.2 The Metabolic Turnover Constant For Milk, λ_m

In the TERRA code radionuclide transfers to beef and milk are modeled via a single compartment model whereby the radionuclide is transferred from feed directly to milk and beef. This approach differs from the approach taken by the USNRC⁶ in that isotopes of the same

element with significantly different half-lives may yield different milk and beef concentrations, even though the milk and beef transfer coefficients (F_m and F_f , respectively) are the same for the isotopes. Such one-compartment models require quantification of all inputs and outputs from the compartment. For milk and beef the metabolic removal constants must be known.

The model for radionuclide transfer to milk is given by

$$C_m = \frac{C_{feed} Q_{feed} f_{im} (1 - \exp(-\lambda_m t_m))}{m_p \lambda_m}, \quad (48)$$

where

- C_m = the radionuclide concentration in milk (Bq or Ci/kg),
- C_{feed} = the radionuclide concentration in feed (Bq or Ci/kg),
- Q_{feed} = the ingestion rate of feed (kg/s),
- f_{im} = the fractional transfer from ingested feed to milk (unitless),
- λ_m = the metabolic turnover constant for milk (s^{-1}),
- t_m = the time at which milk is sampled (s), and
- m_p = the quantity of milk collected per milking (kg).

At equilibrium Eq. (48) reduces to

$$C_m = \frac{C_{feed} Q_{feed} f_{im}}{m_p \lambda_m}. \quad (49)$$

Since by the USNRC⁶ approach,

$$C_m = 86,400 C_{feed} Q_{feed} F_m, \quad (50)$$

where 86,400 = the number of seconds in a day, then

$$f_{im} = 86,400 F_m m_p \lambda_m. \quad (51)$$

Since F_m and m_p are already known (from reference 7 $m_p = 13.4$ kg), then the only parameter which needs to be defined is λ_m .

Ng and his associates¹⁴⁵ have determined values of metabolic halftimes, T_m , for various elements in milk (Fig. 5.1: note that these values of T_m are in terms of days rather than seconds). They consider a value of T_m of 0.693 d (equal to $\ln 2$) to be conservative. Such a value of T_m is equivalent to a λ_m of 1.0/d or $1.16 \times 10^{-5}/s$. This latter value is adopted for calculation of milk concentrations in the TERRA code. Using this value in Eqs. (49) and (51) allows for an equilibrium milk concentration to be achieved within approximately seven days.

5.3 The Metabolic Turnover Constant For Beef, X,

The metabolic turnover constant for beef is determined in a manner similar to that for milk by substituting the fractional transfer to beef, f_{if} , the time to slaughter, t_s , the muscle mass of beef cattle, m_m , the metabolic turnover constant for beef, λ_f , and the beef transfer coefficient, F_f for the respective parameters f_{im} , t_m , m_p , λ_m , and F_m in Eqs. (49)-(51). However, estimates of λ_f do not appear to be available in the literature. In fact, the question of whether equilibrium beef concentration ever occurs for some radionuclides has never been completely resolved. As default in

	I A	II A											III A	IV A	V A	VIA	VII A
II	Li 0.693	Be 0.80											B 0.693		N 0.693		F 0.693
III	Na 17	Mg 0.693	III B	IV B	V B	VI B	VII B	VIII		I B	II B		Al 0.693	Si 0.693	P 1.97	S 0.693	Cl 0.693
IV	K 5.3	Ca 1.01	Sc 0.693	Ti 0.693	V 0.693	Cr 0.693	Mn 0.693	Fe 0.693	Co 0.693	Ni 0.693	Cu 0.693	Zn 2.71	Ga 0.693	Ge 0.693	As 0.693	Se 2.21	Br 0.693
V	Rb 0.54	Sr 2.11	Y 0.693	Zr 0.693	Nb 0.693	Mo 0.89	Tc 0.693	Ru 0.693	Rh 0.693	Pd 0.693	Ag 0.693	Cd 0.693	In 0.693	Sn 0.693	Sb 0.693	Te 1.35	I 1.01
VI	Cs 0.93	Ba 1.58		Hf 0.693	Ta 0.693	W 0.863	Re 0.67	Os 0.693	Ir 0.693	Pt 0.693	Au 0.693	Hg 0.693	Tl 2.19	Pb 3.33	Bi 0.693	Po 1.15	At 0.693
VII	Fr 0.693	Ra 1.97															
Lanthanides	La 0.693	Ce 0.693	Pr 0.693	Nd 0.693	Pm 0.693	Sm 0.693	Eu 0.693	Gd 0.693	Tb 0.693	Dy 0.693	Ho 0.693	Er 0.693	Tm 0.693	Yb 0.693	Lu 0.693		
Actinides	Ac 0.693	Th 0.693	Pa 0.693	U 0.693	Np 0.693	Pu 0.693	Am 0.693	Cm 0.693									
Key:	Li 0.693	— Symbol		— Transfer Coefficient, T_m													

Figure 5.1. Metabolic half-times for the elements in milk (days), based on reference 145.

TERRA we have assumed that equilibrium does, indeed, occur, and a λ_f of $5.73 \times 10^{-7}/s$ (equal to a T_f of 14 d) is reasonable. Such a turnover rate constant allows for equilibrium to be achieved after approximately 90 days.

5.4 Lifetime Grain and Forage Requirements For Cattle On Feed, Q_g^{fc} and Q_f^{fc} , Respectively

In calculating radionuclide transport into beef the average annual lifetime feeding schedule of the cattle is combined with the predicted radionuclide concentrations in the feed to predict average annual intake of radionuclides by the cattle. For milk cows and “all other” cattle the inventory feeding schedules may be used in the calculation because slaughtered individuals from these categories may be assumed to have always resided in their respective category. However, lifetime grain and forage requirements for cattle on feed are different from the inventory grain and forage requirements (discussed in the report by Shor, Baes, and Sharp⁷) which are used in the calculation of pasture production (Sect. 4.1) because they take into account the movement of the individuals from one inventory category to another. These lifetime average feeding rates are used in the calculation of beef concentrations in the TERRA code.

Since the cattle in feedlots are slaughtered after an average occupancy of six months, and since they enter and leave the feedlot throughout the year, the lifetime feeding rate of grain and forage is a mix of the feeding schedules in the inventory categories “all other cattle” and “cattle on feed.” For example, an animal entering the feedlot at the beginning of the year would have been fed on the feedlot schedule only before slaughter, but those entering thereafter until the end of the year would have been fed a combination of the feedlot and “all other cattle” schedules before slaughter. In determining the lifetime feeding schedule of slaughtered cattle from feedlots, we assume that entry and exit from the feedlot is at a constant rate equal to $s_g/365$ or $n_g/182.5$. The ideal animal entering the lot is 9 months old and is fed for 6 months or 182.5 days. In order to find an average feeding rate for this animal, his feed is added over the last 13.5 months of his life (the first 1.5 months is assumed to be on milk) and 12/13.5 of this amount is his annual rate of feeding. From Table 17 of reference 7 the daily grain consumption rate for cattle on grain is 5.0 kg/d (equal to 1820/365). The comparable rate for forage is 2.7 kg/d. The respective rates for the “all other cattle” category are 0.4 kg/d for grain and 8.3 kg/d for forage. Therefore the totals for grain and forage for the last 13.5 months of life are 910 kg and 1003 kg, respectively. The annual rates are 891 kg and 2108 kg for grain and forage, respectively. These rates are used in the TERRA code in the calculation of radionuclide concentrations in beef from slaughtered feedlot cattle.

5.5 The Carbon and Water Content of Foods

In the TERRA code concentrations of tritium (H-3) and carbon-14 in foods are calculated according to a model which assumes that the specific activities of tritium and carbon-14 in foods at a given location are the same as the specific activities of H-3 and C-14 in atmospheric H₂O and CO₂, respectively (equilibrium is assumed). Thus, the first step in calculating activity concentrations of tritium and carbon-14 in food is calculating their respective activity concentrations in atmospheric water vapor and carbon dioxide. For tritium, this calculation is made by utilizing the SITE parameter, absolute humidity, H , by the equation

$$C_{ww}^{H3} = 1000 \frac{C_a^{H3}}{H}, \quad (52)$$

where

- C_{ww}^{H3} = the activity concentration of tritium in atmospheric water vapor (Bq or Ci/kg),
- C_a^{H3} = the activity concentration of tritium in air based on the atmospheric dispersion calculation (Bq or Ci/m³), and
- H = the absolute humidity (g/m³).

Once the specific activity of H-3 in atmospheric water vapor is calculated, then the same activity in the atmospherically derived water of vegetable produce, beef, and milk is assumed. That is

$$C_{food}^{H3} = C_a^{H3} \cdot f_w^a, \quad (53)$$

where

$$\begin{aligned} C_{food}^{H3} &= \text{The tritium activity concentration in food (Bq or Ci/kg) and} \\ f_w^a &= \text{the fraction of water in food derived from atmospheric sources (unitless).} \end{aligned}$$

Traditionally, the tritium concentration in food has been assumed to be 50% of tritium concentration in air ($f_w^a = 0.5$) based on a model by Anspaugh, et al.²²⁶ However, recent empirical evidence suggests that tritium concentration in vegetation under chronic exposure conditions is nearly equal to the tritium air concentration ($f_w^a = 1.0$).²²⁷ In the TERRA code the default is the latter assumption.

The water content of the produce categories may be derived from the dry-to-wet weight conversion factors presented in Table 2.3. The value (1.0 – the listed conversion factor) gives the kilograms of H₂O per kilogram fresh produce. For beef and milk, reference 14 yields 0.615 and 0.87 kilograms of water per kilogram of fresh, uncooked food, respectively. The water content of leafy vegetables is assumed to be 0.934 (Table 5.1).

A specific activity approach, analogous to that for tritium, is used for carbon-14. The specific activity of C-14 in atmospheric CO₂ is given by

$$C_{cd}^{C14} = 1000 \frac{C_a^{C14}}{0.18}, \quad (54)$$

where

$$\begin{aligned} C_{cd}^{C14} &= \text{the activity concentration of carbon-14 in atmospheric CO}_2 \text{ (Bq or Ci/kg),} \\ C_a^{C14} &= \text{the activity concentration of carbon-14 in air based on the atmospheric dispersion} \\ &\quad \text{calculation (Bq or Ci/m}^3\text{), and} \\ 0.18 &= \text{the average concentration of CO}_2 \text{ in the atmosphere (g/m}^3\text{), corresponding to 330} \\ &\quad \text{ppm by volume.}^{228} \end{aligned}$$

The carbon content of the food categories in TERRA, based on a recent review by Killough²²⁹ and supplemental information from reference 14, is given in Table 5.2.

5.6 Coarse (2.5 - 15 m) Suspended Particulate Matter

Resuspension of material deposited on surface soils is calculated in TERRA via a mass loading approach.²³⁰ In such an approach the specific activity of a radionuclide in resuspended material is assumed to be the same as the specific activity of surface soil. Thus, the calculation of surface soil concentration is used together with the quantity of resuspended material in the air (mass loading) to calculate an air concentration due to resuspension. This air concentration is given by

$$C_a^r = \frac{C_s^s P_{sus}}{1 \times 10^9}, \quad (55)$$

Table 5.1. Water content of produce, beef, and cow's milk

Food	Water content ^a	Weighting factor ^b	Food	Water content
Leafy vegetables			Beef	
Broccoli	0.899	3.7	Chuck	0.65
Brussel sprouts	0.849	0.6	Flank	0.61
Cabbage	0.924	22.0	Hamburger	0.55
Cauliflower	0.917	2.8	Liver	0.697
Celery	0.937	15.5	Porterhouse	0.58
Escarole	0.866	1.1	Rib roast	0.59
Green onions	0.876	2.6	Round	0.69
Lettuce	0.948	46.0	Rump	0.55
Spinach greens	0.927	5.7	Sirloin	0.62
Weighted average	0.934		Average	0.615
Exposed produce ^c	0.874		Whole cow's milk	0.870
Protected produce ^c	0.778			
Grain foods ^c	0.112			

^aKilograms of water per kilograms fresh, unprepared produce or edible portions of uncooked food (reference 14)

^bRelative importance based on production in kilograms (% of total) in the conterminous United States.

^cBased on values given in Table 2.3.

where

$$\begin{aligned}
 C_s^s &= \text{surface soil (depth = 1 cm) concentration (Bq or Ci/kg),} \\
 1 \times 10^9 &= \text{the number of micrograms per kilogram (}\mu\text{g/kg),} \\
 C_a^r &= \text{resuspension air concentration (Bq or Ci/m}^3\text{), and} \\
 P_{sus} &= \text{suspended particulate matter (}\mu\text{g/m}^3\text{).}
 \end{aligned}$$

In TERRA the mass loading value P_{sus} is based on data reported by the EPA.²³¹ This parameter represents the 2.5-15 μm diameter particle fraction collected by either the Size-Selective Inlet (SSI) hi vol or the dichotomous samplers operated as part of the Inhalable Particulate Network (IPN) operated by EPA's Environmental Monitoring and Support Laboratory, Research Triangle Park. Inhalable suspended particulate matter appears to be bimodally distributed into fine and coarse particle sizes. The fine fraction (<0.1-2 μm) are mostly generated by fossil fuel combustion and atmospheric photochemistry processes. The coarse fraction (2.5-15 μm) is primarily a result of windblown dusts, mechanical processes, and pollen.

The value of P_{sus} of 15.5 $\mu\text{g/m}^3$ used as default in TERRA is the geometric mean of values taken from the April 1979-June 1980 IPN summary (Fig. 5.2). The data are reported for 46 sampling locations in the conterminous United States, and represent annual arithmetic averages for each station. As shown in Fig. 5.2, the parameter P_{sus} is lognormally distributed. The range of measured values is from 3.2 to 52.4 $\mu\text{g/m}^3$.

Table 5.2. Water content of produce, beef, and cow's milk

Food	Carbon content ^a	Weighting factor ^b	Reference	Food	Carbon content	Weighting factor	Reference
Leafy vegetables				Protected produce			
Broccoli	0.042	3.7	229	Bean (dry)	0.198	2.2	229
Brussel sprouts	0.065	0.6	229	Cantaloupe	0.025	1.1	229
Cabbage	0.032	22.0	229	Carrot	0.049	2.4	229
Cauliflower	0.035	2.8	229	Grapefruit	0.048	5.5	14
Celery	0.024	15.5	229	Lemon	0.047	2.4	14
Escarole	0.056	1.1	14	Onion	0.054	3.6	14
Green onions	0.053	2.6	14	Orange	0.055	22.8	229
Lettuce	0.020	46.0	229	Peanut	0.574	3.4	229
Spinach greens	0.028	5.7	229	Peas	0.114	0.4	14
Weighted average	0.026			Potato	0.095	33.7	229
Exposed produce ^c				Sugarbeet	0.051	6.5	14
Apple	0.070	15.4	229	Sugarcane	0.438	5.5	229
Asparagus	0.030	0.6	229	Sweet corn	0.118	6.0	229
Bushberries	0.070	1.6	229	Sweet potato	0.137	1.5	229
Cherry	0.074	0.7	14	Tree nuts	0.659	0.4	229
Cucumber	0.016	4.0	14	Watermelon	0.034	2.6	14
Eggplant	0.031	0.1	14	Weighted average	0.116		
Grape	0.083	20.2	229	Grains			
Peach	0.056	6.9	229	Barley	0.395	10.1	229
Pear	0.076	3.5	229	Corn (for meal)	0.118	37.7	229
Plums and prunes	0.062	3.1	229	Oats	0.431	2.3	229
Sweet pepper	0.033	1.3	14	Rye	0.396	0.5	229
Snap bean	0.047	0.7	229	Soybean	0.465	5.3	229
Squash	0.021	1.8	229	Wheat	0.391	44.0	229
Strawberry	0.044	1.3	229	Weighted average	0.293		
Tomato	0.025	38.8	229	Beef			
Weighted average	0.050			Whole cow's milk	0.069		14

^aKilograms of carbon per kilograms fresh, unprepared produce. Based on protein, fat, and carbohydrate content of 50, 76, and 44%, respectively.

^bRelative importance based on production in kilograms (% of total) in the conterminous United States.

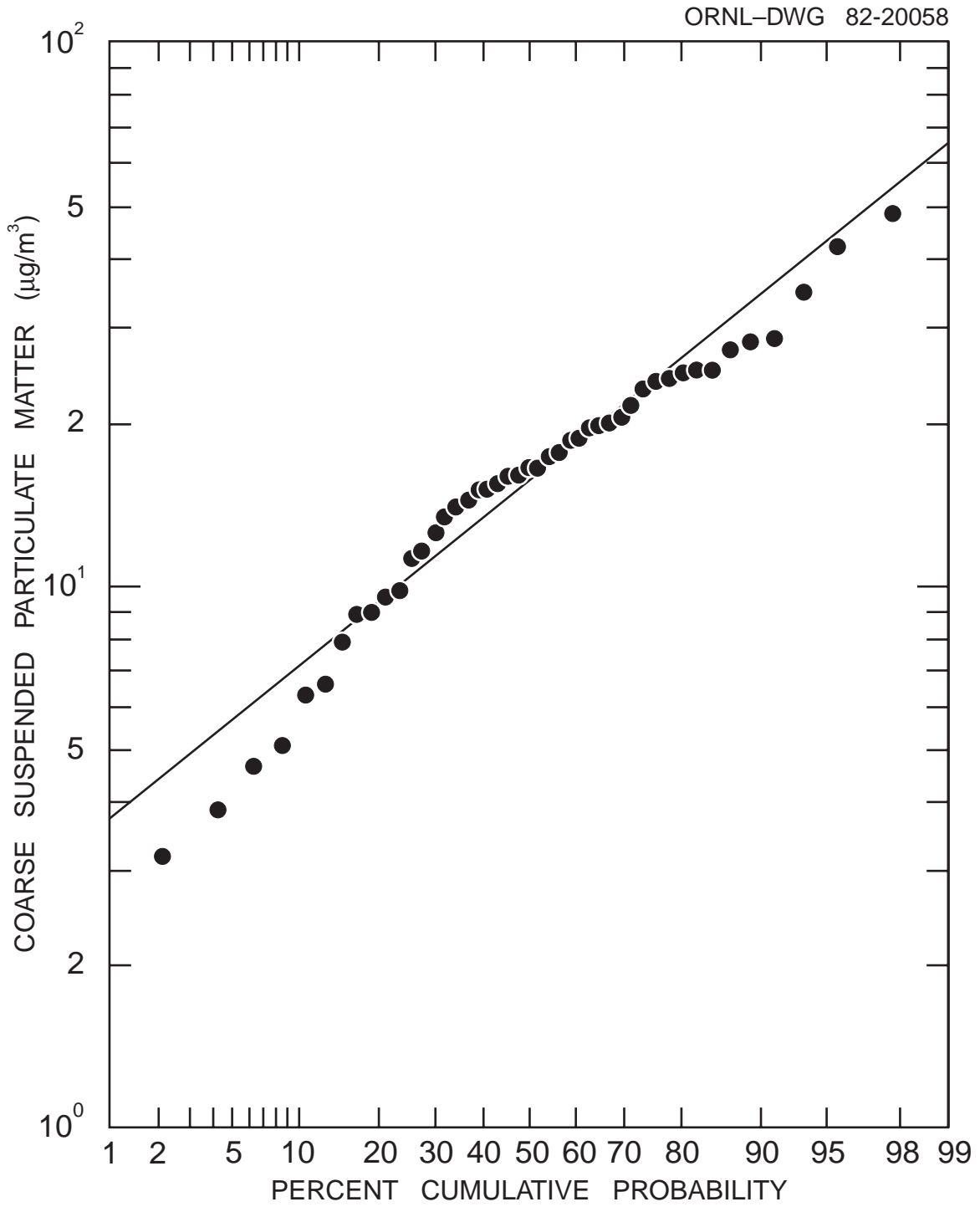

Figure 5.23. Lognormal probability plot of coarse suspended particulate matter (2.5 – 15 μm).

Resuspended material may contribute to plant surface concentrations before and after termination of the atmospheric source term. In TERRA a deposition rate of the resuspended activity is calculated according to

$$D_r^r = \frac{C_a^r V_d^r}{100}, \quad (56)$$

where

- D_r^r = the deposition rate of resuspended material (Bq or Ci/m²/s),
- V_d^r = deposition velocity of the resuspended material (cm/s), and
- 100 = the number of centimeters in a meter (cm/m).

The value of V_d^r used in TERRA is 0.1 cm/s, which is a reasonable estimate for particle diameters between 2 and 15 μm , a friction velocity of 30 cm/s, and particle densities $>1 \text{ g/cm}^3$ as shown by Sehmel²³² (Figure 5 in reference 232).

6. SUMMARY

In this report we have documented most of the default parameters incorporated into the TERRA computer code. Especially, we have presented a literature review and systematic analysis of element-specific transfer parameters B_v , B_r , F_m , F_f , and K_d . This review and analysis merely suggests default values which are consistent with the modeling approaches taken in TERRA and may be acceptable for most assessment applications of the computer code. However, particular applications of the code and additional analysis of elemental transport may require alternative values to the default values in TERRA. Also, use of the values reported herein in other computer codes simulating terrestrial transport is not advised without careful interpretation of the limitations and scope of our analyses.

In addition to the default elemental transport parameters, we have discussed an approach to determination of vegetation-specific interception fractions. The limitations of this approach are many, and its use indicates the need for analysis of deposition, interception, and weathering processes. Judgement must be exercised in interpretation of plant surface concentrations generated through use of our approach.

Finally, we have documented the location-specific agricultural, climatological, and population parameters in the default SITE data base. These parameters are intended as alternatives to “average” values currently used in assessment models. Indeed, areas in the United States where intensive crop, milk, or beef production occurs will be reflected in the parameter values as will areas where little agricultural activity occurs. However, the original information sources contained some small error and the interpolation and conversion methods used will add more. Therefore, our values should be regarded as default best estimates, not absolute “correct” values. As with any assessment, site-specific information is recommended over default values.

Parameters used in TERRA not discussed herein are discussed in the companion report to this one—ORNL-5785.³ In the companion report the models employed in and the coding of TERRA are discussed. These reports together provide documentation of the TERRA code and its use in assessments.

7. REFERENCES

- [1] Moore, R. E., C. F. Baes, III, L. M. McDowell-Boyer, A. P. Watson, F. O. Hoffman, J. C. Pleasant, and C. W. Miller. 1979. *AIRDOS-EPA: A Computerized Methodology for Estimating Environmental Concentrations and Dose to Man from Airborne Releases of Radionuclides*. ORNL-5532. Oak Ridge National Laboratory.
- [2] Begovich, C. L., K. F. Eckerman, E. C. Schlatter, S. Y. Ohr, and R. O. Chester. 1981. *DARTAB: A Program to Combine Airborne Radionuclide Environmental Exposure Data with Dosimetric and Health Effects Data to Generate Tabulations of Predicted Impacts*. ORNL-5692. Oak Ridge National Laboratory.
- [3] Baes, C. F., III, R. D. Sharp, A. L. Sjoreen, and O. W. Hermann. In press. *TERRA: A Computer Code for Calculation of the Transport of Environmentally Released Radionuclides Through Agriculture*. ORNL-5785. Oak Ridge National Laboratory.
- [4] Miller, C. W., C. L. Begovich, O. W. Hermann and A. L. Sjoreen. In press. *ANEMOS: A Computer Code to Estimate Air Concentrations and Ground Deposition Rates for Atmospheric Nuclides Emitted from Multiple Operating Sources*. ORNL-5913. Oak Ridge National Laboratory.
- [5] Begovich, C. L., S. Y. Ohr, R. O. Chester, and A. L. Sjoreen. In press. *ANDROS: A Code for Assessment of Nuclide Doses and Risks with Option Selection*. ORNL-5889. Oak Ridge National Laboratory.
- [6] U.S. Nuclear Regulatory Commission. 1977. Regulatory Guide 1.109, *Calculation of Annual Doses to Man from Routine Releases of Reactor Effluents for the Purpose of Evaluating Compliance with 10 CFR Part 50 Appendix Z (Revision I)*. Office of Standards Development.
- [7] Shor, R. W., Baes, C. F., III, and R. D. Sharp. 1982. *Agricultural Production in the United States by County: A Compilation of Information from the 1974 Census of Agriculture for Use in Terrestrial Food Chain Transport and Assessment Models*. ORNL-5768. Oak Ridge National Laboratory.
- [8] Gibbons, J. W., D. C. Adriano, J. J. Alberts, and K. W. McLeod. 1978. *Critical Pathways of Radionuclides to Man from Agro-Ecosystems*. NUREG/CR-0536.
- [9] Hersloff, L. W. and J. C. Corey. 1978. "Uptake of three isotopes of plutonium from soil by sweet corn grown in a growth chamber." In Adriano, D. C. and I. L. Brisbin, Jr., (eds.) *Environmental Chemistry and Cycling Process*. Proceedings of a symposium held at Augusta, Ga. April 28-May 1, 1976. pp. 622-627.
- [10] Schreckhise, R. G. and J. F. Cline. 1980. "Comparative uptake and distribution of plutonium, americium, curium, and neptunium in four plant species." *Health Phys.* **38**: 817-824.
- [11] Morgan, A. 1959. "The uptake of ⁹⁰Sr by rye grass." *J. Nucl. Energy Part A: Reactor Sci.* **11**: 8-13.
- [12] Baes, C. F., III and R. D. Sharp. 1981. *A Directory of Parameters Used in a Series of Assessment Applications of the AIRDOS-EPA and DARTAB Computer Codes*. ORNL-5710. Oak Ridge National Laboratory.
- [13] Morrison, F. B. 1956. *Feeds and Feeding. A Handbook for the Student and Stockman*. 22nd ed. The Morrison Publishing Co., Ithaca, New York.
- [14] Spector, W. S. 1956. *Handbook of Biological Data*. W. B. Saunders Co., Philadelphia. p. 187.

- [15] Ng, Y. C., C. A. Burton, S. E. Thompson, R. K. Tandy, H. K. Kretner, and M. W. Pratt. 1968. "Prediction of the maximum dosage to man from the fallout of nuclear devices." In *Handbook for Estimating the Maximum Internal Dose from Radionuclides Released to the Biosphere*. UCRL-50163, Pt. IV. Lawrence Radiation Laboratory.
- [16] Baes, C. F., III and J. A. Katz. Unpublished analysis of East Tennessee pumpkins, vines, and soils.
- [17] Haghiri, F. 1964. "Strontium-90 accumulation by some vegetable crops." *Ohio J. Sci.* **64**(5): 371-374.
- [18] Fredriksson, L. and Å. Eriksson. 1970. "Plant uptake of fission products I. Uptake of ⁹⁰Sr in pot experiments in relation to uptake under field conditions." *Lantbrökögsk. Annlr.* **36**: 3-18.
- [19] Cherry, D. S. and R. K. Guthrie. 1979. "The uptake of chemical elements from coal ash and settling basin effluent by primary producers II. Relation between concentrations in ash deposits and tissues of grasses growing on the ash." *Sci. Tot. Environ.* **13**: 27-31.
- [20] Sheaffer, C. C., A. M. Decker, R. L. Chaney, and L. W. Douglass. 1979. "Soil temperature and sewage sludge effects on metals in crop tissue and soils." *J. Environ. Qual.* **8**(4): 455-459.
- [21] Andersen, A. J. 1971. "Influence of phosphorus and nitrogen nutrition on uptake and distribution of strontium and calcium in oat plants." *Soil Sci. Soc. Am. Proc.* **35**: 108-111.
- [22] Essington, E., H. Nishita, and A. Wallace. 1963. "Effect of chelating agents on the uptake of Y-91, Ru-106, Ce-144, and Pm-147 by beans grown in a calcareous soil." *Soil. Sci.* **95**: 331-337.
- [23] Gast, R. G., E. R. Landa, L. J. Thorvig, D. F. Grigal, and J. C. Balogh. 1979. *The behavior of technetium-99 in soils and plants: Final Report for the period April 1, 1974 to December 31, 1978*. COO-2447-6. National Technical Information Service, Springfield, Virginia.
- [24] Schroeder, H. A. and J. J. Balassa. 1963. "Cadmium: uptake by vegetables from superphosphate in soil." *Science* **140**: 819-820.
- [25] Orr, J. B., F. C. Kelly, and G. L. Stuart. 1978. "The effect of iodine maturing on the iodine content of plants." *J. Agri. Sci.* **18**: 159-161.
- [26] Haak, E. and Å. Eriksson. 1973. *Studies on Plant Accumulation of Fission Products under Swedish Conditions XIV Uptake of ¹³⁷Cs by Wheat and Timothy from Six Different Soils as Influenced by Rate of K-Fertilization and by Type and Rate of N-Fertilization in Pot Experiments*. FOA 4 Rapport. C4557-A3. October, 1973. 36 pp.
- [27] Ter Haar, G. 1970. "Air as a source of lead in edible crops." *Environ. Sci. Technol.* **4**(3): 226-30.
- [28] Watters, R. L., J. E. Johnson, and W. R. Hansen. 1969. *A Study of Unsupported Polonium-210 for Ion Exchange in Soil and Uptake in Vegetation*. Second Technical Progress Report of the Department of Radiology and Radiation Biology, Colorado State University, Fort Collins, Colorado. 8052 1. COO-1733-3.
- [29] Prister, B. S. 1970. "Behavior of uranium in the biologic chain." In *USSR Reports on Natural and Fallout Radioactivity*. pp. 194-207. AEC-tr-7128, USAEC/HSL.
- [30] Wallace, A., E. M. Romney, H. Nishita, and E. K. Schulz. 1979. *Preliminary Analysis of First Crop of Plants Grown in Seven Soils Uniformly Contaminated with Four Transuranic Elements Simultaneously*. University of California, L.A. NUREG/CR-0700.136

- [31] Romney, E. M., W. L. Ehrler, A. H. Lange, and K. H. Larson. 1960. "Some environmental factors influencing radiostrontium uptake by plants." *Plant and Soil* **12**(1): 41-48.
- [32] Duckworth, R. B. and J. Hawthorn. 1960. "Uptake and distribution of strontium in vegetables and cereals." *J. Sci. Food Agric.* **11**: 218-225.
- [33] Evans, E. J. and A. J. Dekker. 1962. "Comparative Sr-90 content of agricultural crops grown in a contaminated soil." *Can. J. Plant Sci.* **42**: 252-258.
- [34] Evans, E. J. and A. J. Dekker. 1968. "Comparative Cs-137 content of agricultural crops grown in a contaminated soil." *Can. J. Plant Sci.* **48**: 183-188.
- [35] Singh, B. R. and K. Steenberg. 1974. "Plant response to micronutrients I. Uptake, distribution and translocation of zinc in maize and barley plants." *Plant and Soil* **40**: 637-646.
- [36] Singh, B. R. and K. Steenberg. 1974. "Plant response to micronutrients II. Uptake, distribution and translocation of manganese in maize and barley plants." *Plant and Soil* **40**: 647-654.
- [37] Singh, B. R. and K. Steenberg. 1974. "Plant response to micronutrients III. Interaction between manganese and zinc in maize and barley plants." *Plant and Soil* **40**: 655-667.
- [38] National Academy of Sciences. 1971. *Nutrient Requirements of Dairy Cattle* (fourth ed.). ISBN 0-309-01916-8.
- [39] Ng, Y. C., C. S. Colsher, and S. E. Thompson. 1979. "Transfer coefficients for terrestrial food chains — their derivation and limitations." In Kellermann, H. J. (ed.) *Radioaktivitat and Umwelt*. Proceedings of the 12th Annual Conference of the Fachverband fur Strahlenschutz, Norderney, West Germany, 2-6 October 1978. Band I. pp. 455-481.
- [40] Ng, Y. C., C. S. Colsher, and S. E. Thompson. 1979 "Transfer factors for assessing the dose from radionuclides in agricultural products." In *Biological Implications of Radionuclides Released from Nuclear Industries, Vol. II*. Proceedings of an International Symposium on Biological Implications of Radionuclides Released from Nuclear Industries, Vienna, 26-30 March 1979. pp. 295-318 (IAEA-SM-237/54).
- [41] Hansen, W. R. and R. L. Watters. 1970. "Plant uptake of ²¹⁰Po from soil." *Rad. Bot.* **10**(4): 371-375.
- [42] Vavilov, P. P., I. N. Verkhovskaya, O. N. Popova, and R. P. Kodaneva. 1972. "Conditions of radium accumulation by plants from the soil." *Radioekologicheskie Issledovaniya v Prirodnykh Biogeotsenozakh* (Verkhovskaya, I. N., ed.) pp. 95-103. Moscow: Izdatel'stvo Nauka.
- [43] Routson, R. C. and D. A. Cataldo. 1978. "A growth chamber study of the effect of soil concentration and plant age on the uptake of Sr and Cs by tumbleweed." *Comm. Soil Sci. Pt. Anal.* **9**(3): 215-30.
- [44] Il'ina, G. V. and S. G. Rydkii. 1965. "Uptake of radioactive fission products by field crops. Report 1: Accumulation of radioactive fission products by grain and oil-bearing crops." *Fed. Am. Soc. Exp. Bio. Proc.* **25**: T123-T127.
- [45] Andersen, A. J. 1971. "The uptake and distribution of strontium in oat as influenced by the time of supply." *Soil Sci.* **111**(6): 379-81.
- [46] Baranova, Z. A. and A. S. Frid. 1975. "Absorption of strontium-90, potassium and calcium by oat plants from soil during ontogenesis." *Soviet Ph. Phys. (tr.)* **22**(6): 1173-1176.137

- [47] Myttenaere, C. 1965. "The influence of the strontium/calcium ratio of the nutrient solution on the translocation and chemical forms of strontium and calcium in *Pisum sativum*." *Rad. Bot.* **5**: 1143-151.
- [48] Ringoet, A. and D. de Zeeuw. 1968. "Discrimination between calcium and strontium in oat plants. I. Influence of the growth stage of the plants and of the osmotic potential of the root medium." *Z. Phlan. Bd.* **59**(3): 238-248.
- [49] Ringoet, A. and D. de Zeeuw. 1968. "Discrimination between calcium and strontium in oat plants. II. Relation to the differential chemical binding of both ions." *Z. Phlan. Bd.* **59**(3): 249-257.
- [50] Soileau, J. M. 1973. "Activity of barley seedling roots as measured by strontium uptake." *Agron. J.* **65**(4): 625-628.
- [51] Kodaira, K., A. Tsumura, and H. Kobayashi. 1973. "Uptake of radioactive strontium and cesium in rice plants. (1) Accumulation of Sr and Cs in rice grains through roots." *J. Radial. Res.* **14**: 31-39.
- [52] Vinogradov, A. P. 1959. *The Geochemistry of Rare and Dispersed Elements in Soils*, 2nd ed. Consultants Bureau, Inc., New York.
- [53] Shacklette, H. T., J. A. Erdman, T. F. Harms, and C. S. E. Papp. 1978. "Trace elements in plant foodstuffs." In Dehme, F. W. (ed.). *Toxicity of Heavy Metals in the Environment Part 1*. Marcel Dekker, Inc., New York. pp. 25-68.
- [54] Oakes, T. W., K. E. Shank, C. E. Easterly, and L. R. Quintana. 1977. "Concentrations of radionuclides and selected stable elements in fruits and vegetables." In *Environmental Health, 11th Annual Conference on Trace Substances*.
- [55] Barber, D. A. 1964. "Influence of soil organic matter on the entry of cesium-137 into plants." *Nature* **204**: 1326-1327. Schulz, R. K. 1965. "Soil chemistry of radionuclides." *Health Phys.* **11**: 1317-1324.
- [56] Fredriksson, L., Å. Eriksson, and H. Lönsjö. 1966. *Studies on Plant Accumulation of Fission Products under Swedish Conditions. VIII. Uptake of ¹³⁷Cs in Agricultural Crops as Influenced by Soil Characteristics, and Rate of Potassium Fertilization in a Three Year Micro Plot Experiment*. Research Institute of National Defense, Stockholm, Sweden. FOA 4 Rapport A 4486-4623.
- [57] Fredriksson, L., H. Lönsjö and Å. Eriksson. 1969. *Studies on Plant Accumulation of Fission Products under Swedish Conditions. X. Absorption of ⁹⁰Sr and ¹³⁷Cs from Soil by Vegetable Crops*. Research Institute of National Defense, Stockholm, Sweden. FOA 4 Rapport C 4387-28.
- [58] Fredriksson, L., H. Lönsjö, and Å. Eriksson. 1969. *Studies on Plant Accumulation of Fission Products under Swedish Conditions. XII. Uptake of ¹³⁷Cs by Barley and Peas from 12 Different Top Soils Combined with 2 Sub-soils in a Long Term Micro Plot Experiment*. Research Institute of National Defense, Stockholm, Sweden. FOA 4 Rapport C 4405-4428.
- [59] Rediske, J. H., J. F. Cline, and A. A. Selders. 1955. *The Absorption of Fission Products by Plants*. HW-36734.
- [60] Romney, E. M., J. W. Neel, H. Nishita, J. H. Olafson, and K. H. Larson. 1957. "Plant uptake of ⁹⁰Sr, ⁹¹Y, ¹⁰⁶Ru, ¹³⁷Cs, and ¹⁴⁴Ce from soils." *Soil Sci.* **83**: 369-376.
- [61] Fredriksson, L., H. Lönsjö, and Å. Eriksson. 1969. *Studies on Plant Accumulation of Fission Products Under Swedish Conditions. X. Absorption of ⁹⁰Sr and ¹³⁷Cs from Soil by Vegetable Crops*. Research Institute of National Defense, Stockholm, Sweden. FOA 4 Rapport C 4387-28.

- [62] Andersen, A. J. 1967. *Investigations on the Plant Uptake of Fission Products from Contaminated Soils. I. Influence of Plant Species and Soil Types on the Uptake of Radioactive Strontium and Caesium*. Danish Atomic Energy Commission, Research Establishment Risø. Risø Report No. 170. November, 1967.
- [63] Neel, J. W., J. H. Olafson, A. J. Steen, B. E. Gillooly, H. Nishita, and K. H. Larson. 1953. *Soil-Plant Interrelationships with Respect to the Uptake of Fission Products: I. The Uptake of Sr⁹⁰, Cs¹³⁷, Ru¹⁰⁶, Ce¹⁴⁴, and Y⁹⁰*. The University of California. UCLA-247.
- [64] Routson, R. C. 1975. *The Effect of Soil Concentration on the Tumbleweed Uptake of ⁹⁰Sr and ¹³⁷Cs from a Burbank Sand*. Battelle-Pacific Northwest Laboratories. BNWL-1905.
- [65] Furr, A. K., T. F. Parkinson, C. L. Heffron, J. T. Reid, W. M. Haschek, W. H. Gutenmann, C. A. Bathe, L. E. St. John, Jr., and D. J. Lisk. 1978. "Elemental content of tissues and excreta of lambs, goats, and kids fed white sweet clover growing on fly ash." *J. Agric. Food Chem.* **26**(4): 847-851.
- [66] Cataldo, D. A. 1979. *Comparative Availability of Cesium and Strontium for Plant Absorption from Amended Rupert Surface Soil and Associated Subsoil: Influence of Growth Conditions*. Pacific Northwest Laboratory PNL-2741.
- [67] Essington, E., H. Nishita, and A. Wallace. 1962. "Influence of chelates on availability of fission products to plants grown in a contaminated soil." *Soil Sci.* **94**: 96-105.
- [68] Nishita, H., A. J. Steen, and K. H. Larson. 1958. "Release of Sr90 and Cs137 from Vina loam upon prolonged cropping." *Soil Sci.* **86**: 195-201.
- [69] Nishita, H., R. M. Haug, and M. Hamilton. 1968. "Influence of minerals on Sr90 and Cs137 uptake by bean plants." *Soil Sci.* **105**: 237-243.
- [70] Nishita, H. and R. M. Haug. 1972. "Influence of clinoptilolite on Sr90 and Cs 137 uptakes by plants." *Soil Sci.* **114**(2): 149-157.
- [71] Fredriksson, L., B. Eriksson, B. Rasmuson, B. Gahne, K. Edvarson, and K. Löw. 1958. "Plant uptake of Sr⁹⁰ and Cs¹³⁷ from soils." In *Proceedings of the Second United Nations International Conference on the Peaceful Uses of Atomic Energy Vol. 18*, held in Geneva 1-13, September, 1958. pp. 449-470.
- [72] Vose, P. B. and Koontz, H. V. 1959. "Uptake of strontium by pasture plants and its possible significance in relation to the fall-out of strontium." *Nature* **183**: 1447-1448.
- [73] Milbourn, G. M., F. B. Ellis, and R. S. Russell. 1959. "The absorption of radioactive strontium by plants under field conditions in the United Kingdom." *J. Nucl. Energy Part A: Reactor Sci.* **10**: 116-132.
- [74] Ralls, J. W., S. Primbsch, T. R. Guckeen, H. J. Maagdenberg, J. Rinehart, F. C. Lamb, and W. A. Mercer. 1967. "Distribution of strontium and calcium in major vegetable and fruit crops and criteria for use of fallout-contaminated foods." *Radiol. Health Data Rep.* **8**(7): 355-358.
- [75] Andersen, A. J. 1965. "Uptake by plants of radionuclides from contaminated soils." *Nature* **208**(5006): 195-196.
- [76] Furr, A. K., T. F. Parkinson, R. A. Hinrichs, D. R. Van Campen, C. A. Bathe, W. H. Gutenmann, L. E. St. John, Jr., I. S. Pakkala, and D. J. Lisk. 1977. "National survey of elements, and radioactivity in fly ashes and absorption of elements by cabbage grown in fly ash-soil mixtures." *Environ. Sci. Technol.* **11**(3): 1194-1201.
- [77] Arkhipov, N. P., Y. A. Fedorov, E. F. Bondar, R. M. Aleksakhin, G. N. Romanov, and L. T. Feuraleva. 1974. "Predicting ⁹⁰Sr accumulation in the crop harvest as a result of its uptake from the soil." *Soviet Soil Sci.* **6**(4): 412-419.

- [78] Fredriksson, L., Å. Eriksson, and E. Haak. 1961. *Studies on Plant Accumulation of Fission Products Under Swedish Conditions. II. Influence of Lime and Phosphate Fertilizer on the Accumulation of Sr-89 in Red Clover Grown in 29 Different Swedish Soils*. Research Institute of National Defense. Stockholm, Sweden. FOA 5 Rapport A4188-4626.
- [79] Fredriksson, L., E. Haak, and Å. Eriksson. 1969. *Studies on Plant Accumulation of Fission Products Under Swedish Conditions. XI. Uptake of ⁹⁰Sr by Different Crops as Influenced by Liming and Soil Tillage Operations*. Research Institute of National Defense. Stockholm, Sweden. FOA Rapport C 4395-28.
- [80] Haak, E. and H. Lönsjö. 1975. *Studies on Plant Accumulation of Fission Products Under Swedish Conditions. XVI. Uptake of ⁹⁰Sr by Barley and Peas from 12 Different Topsoils Combined with 2 Subsoils in a Long Term Microplot Experiment*. Department of Radiobiology, Agricultural College of Sweden. S-750 07 UPPSALA 7.
- [81] Romney, E. M., G. V. Alexander, G. M. LeRoy, and K. H. Larson. 1959. "Influence of stable Sr on plant uptake of Sr90 from soils." *Soil Sci.* **87**: 42-45.
- [82] Lee, C. C. 1961. "Effects of plant nutrients on uptake of radiostrontium by thatcher wheat." *Science* **133**: 1921-1922.
- [83] Andersen, A. J., G. Gissel-Nielsen, and G. Nielsen. 1967. "Effects of fertilization on the strontium-calcium and cesium-potassium relationships in plants. I. The uptake and distribution of radioactive strontium and calcium in oats." *Kgl. Vet.-og. Landbohøjskoles Arsskrift* **1967**: 154-167.
- [84] Shirshova, R. A. 1962. "Effect of potassium fertilizers on the uptake of radioactive strontium by plants." *Pochvovedenie* **1962**(3): 36-43.
- [85] Mel'nikova, M. K. and Z. A. Baranova. 1969. "The mechanism of radiostrontium intake in potato tubers." In *USSR Reports on Natural and Fallout Radioactivity*. U.S. Atomic Energy Commission, Health and Safety Laboratory. UNSCLEAR Number A/AC.82/G/L.-1288. pp. 127-142.
- [86] Wallace, A., R. K. Schulz, E. M. Romney, and H. Nishita. 1979. *Biological Transport of Radionuclides at Low Level Waste Storage Sites*. Laboratory of Nuclear Medicine and Radiation Biology, University of California. NUREG/CR-0701.
- [87] Kirchmann, R., R. Boulenger, and A. LaFontaine. 1968. "Absorption of ²²²Ra in cultivated plants." pp. 1045-1051. In W. S. Synder et al., (eds.). *Proceedings of the IRPA Congress on Radiation Protection, Vol. II*. Rome, 1966. Pergamon Press.
- [88] DeBortoli, M. and P. Gaglione. 1972. "Radium-226 in environmental materials and foods." *Health Phys.* **22**(1): 43-48.
- [89] Grzybowska, D. 1974. "Uptake of ²²⁶Ra by plants from contaminated soils." *Nukleonika* **19**: 71-78.
- [90] Mordberg, E. L., V. M. Aliksandruk, G. F. Kovygin, I. I. Shevckenko, V. M. Blyumshtein, and G. F. Yushkevich. 1976. "Translocation of isotopes of the uranium-radium series into the grain of some agricultural crops." *Gig. Sanit.* **2**: 58-61.
- [91] Moffett, D. and M. Tellier. 1977. "Uptake of radioisotopes by vegetation growing on uranium tailings." *Can. J. Soil. Sci.* **56**: 417-424.
- [92] Khademi, B., A. Alemi, and A. Nasserli. 1980. "Transfer of radium from soil to plants in the area of high natural radioactivity in Iran (Ramsar)." In Gesell, T. F., W. M. Lowder, and J. E. McLaughlin. (eds.) *The Natural Radiation Environment III, Vol. I*. CONF-78422.

- [93] Marple, M. L. 1980. *Radium-224 in Vegetation and Substrates at Inactive Uranium Mill Sites*. Ph.D. Thesis. University of New Mexico, Albuquerque, New Mexico. LA-8183-T.
- [94] Nelson, V. A. 1979. *Radiological Survey of Plants, Animals, and Soil at Five Atolls in the Marshall Islands September - October 1976*. University of Washington, College of Fisheries, Laboratory of Radiation Ecology, Seattle, Washington. NVO-269-36.
- [95] Fowler, T. W. 1980. "Comments on Ra-226 edible plant/soil bioaccumulation factor recommended by ORNL in the AIRDOS-EPA manual." Letter to Christopher B. Nelson, May 21, 1980.
- [96] McDowell-Boyer, L. M., A. P. Watson, and C. C. Travis. 1979. *Review and Recommendations of Dose Conversion Factors and Environmental Transport Parameters for ^{210}Pb and ^{226}Ra . Final Report* Oak Ridge National Laboratory. NUREG/CR-0574. ORNL/NUREG-56.
- [97] Mulla, D. J., A. L. Page, and T. J. Ganje. 1980. "Cadmium accumulations and bioavailability in soils from long-term phosphorus fertilization." *J. Environ. Qual.* **9**(3): 408-412.
- [98] Isaac, R. A., S. R. Wilkinson, and J. A. Stuedemann. 1978. "Analysis and fate of arsenic in broiler litter applied to coastal Bermuda grass and Kentucky-31 tall fescue." In Adriano, D. C. and I. L. Brisbin, Jr. (eds.), *Environmental Chemistry and Cycling Processes*. Proceedings of a symposium held at Augusta, Georgia April 28-May 1, 1976. pp. 207-220.
- [99] Dedolph, R., Ter Haar, G., Holtzman, R., and Lucas, H., Jr. 1970. "Sources of Pb in perennial ryegrass and radishes." *Environ. Sci. Technol.* **4**(3): 217-225.
- [100] Rabinowitz, M. 1972. "Plant uptake of soil and atmospheric lead in southern California." *Chemosphere* **1**(4): 175-180.
- [101] Wilson, D. O. and J. F. Cline. 1966. "Removal of plutonium-239, tungsten-185, and lead-210 from soils." *Nature* **209**: 941-942.
- [102] Keefer, R. F., R. M. Singh, D. J. Horvath, and A. R. Khawaja. 1979. "Heavy metal availability to plants from sludge application." *Compost. Sci.* **20**(3): 31-34.
- [103] Karamanos, R. E., J. R. Bettany, and J. W. B. Stewart. 1976. "The uptake of native and applied lead by alfalfa and bromegrass from soil." *Can. J. Soil Sci.* **56**: 485-494.
- [104] Okamoto, K., Y. Yamamoto, and K. Fuwa. 1978. "Accumulation of manganese, zinc, cobalt, nickel, and cadmium by *Clethra barbinervis*." *Agric. Biol. Chem.* **42**(3): 663-664.
- [105] Preer, J. R., H. S. Sekhon, B. R. Stephens, and M. S. Collins. 1980. "Factors affecting heavy metal content of garden vegetables." *Environ. Pollut. B* **1**: 95-104.
- [106] Menzel, R. G. 1965. "Soil-plant relationships of radioactive elements." *Health Phys.* **11**: 1325-1332.
- [107] Cataldo, D. A. 1979. *Behavior of Technetium and Iodine in a Hanford Sand and Associated Subsoil: Influence of Soil Aging on Uptake by Cheatgrass and Tumbleweed*. Pacific Northwest Laboratory. PNL-2740. March 1979.
- [108] Davis, R. D. 1980. "Uptake of flouride by ryegrass grown in soil treated with sewage sludge." *Environ. Pollut. B* **1**: 277-284.
- [109] Nishita, H., A. Wallace, and E. M. Romney. 1978. *Radionuclide Uptake by Plants*. Laboratory of Nuclear Medicine and Radiation Biology, University of California, Los Angeles. NUREG/CR-0336. UCLA 12-1 158.
- [110] Baes, C. F., Jr. and R. E. Mesmer. 1976. *The Hydrolysis of Cations*. John Wiley & Sons, New York. 489 pp.

- [111] Gibson, J. A., J. F. Miller, P. S. Kennedy, and G. W. P. Rengstorff. 1959. *The Properties of the Rare Earth Metals and Compounds*. Prepared for the Rare Earth Research Group. Battelle Memorial Institute.
- [112] Salcedo, I. H., B. G. Ellis, and R. E. Lucas. 1979. "Studies in soil manganese: II. Extractable manganese and plant uptake." *Soil Sci. Soc. Am. J.* **43**: 138-141.
- [113] Shuman, L. M. and O. E. Anderson. 1974. "Evaluation of six extractants for their ability to predict manganese concentrations in wheat and soybeans." *Soil. Sci. Amer. Proc.* **38**: 788-790.
- [114] Sommers, L. E. 1980. "Toxic metals in agricultural crops." In Britton, G., B. L. Damron, G. T. Edds, and J. M. Davidson (eds.) *Sludge - Health Risks of Land Application*. Ann Arbor, Michigan. pp. 105-140.
- [115] Safaya, N. M. 1976. "Phosphorus-zinc interaction in relation to absorption rates of phosphorus, zinc, copper, manganese, and iron in corn." *Soil Sci. Soc. Am. J.* **40**: 1976.
- [116] Giordano, P. M., D. A. Mays, and A. D. Behel, Jr. 1979. "Soil temperature effects on uptake of cadmium and zinc by vegetables grown on sludge-amended soil." *J. Environ. Qual.* **8**(2): 233-236.
- [117] Shukla, U. C. and H. Raj. 1974. "Influence of genetic variability on zinc response in wheat." *Soil Sci. Soc. Amer. Proc.* **38**: 477-479.
- [118] MacClean, A. J. 1974. "Effects of soil properties and amendments on the availability of zinc in soils." *Can. J. Soil. Sci.* **54**: 369-378.
- [119] Coffman, C. B. and J. R. Miller. 1973. "Response of corn in the greenhouse to soil applied zinc and a comparison of three chemical extractions for determining available zinc." *Soil. Sci. Soc. Amer. Proc.* **37**: 721-724.
- [120] Gammon, N., Jr., G. M. Volk, E. N. McCubbin, and A. H. Eddins. 1954. "Soil factors affecting molybdenum uptake by cauliflower." *Soil Sci. Soc. Amer. Proc.* **18**: 302-305.
- [121] Singh, M. and V. Kumar. 1979. "Sulfur, phosphorus, and molybdenum interactions on the concentration and uptake of molybdenum in soybean plants (*Glycine max*)." *Soil Sci.* **127**(5): 307-312.
- [122] Wildung, R. E., T. R. Garland, and D. A. Cataldo. 1977. "Accumulation of technetium by plants." *Health Phys.* **32**: 315-317.
- [123] Hoffman, F. O., J. W. Huckabee, D. M. Lucas, C. T. Garten, Jr., T. G. Scott, R. L. Walker, P. S. Gouge, and C. V. Holmes. 1980. *Sampling of Technetium-99 in Vegetation and Soils in the Vicinity of Operating Gaseous Diffusion Facilities*. ORNL/TM-7386. Oak Ridge National Laboratory. October, 1980.
- [124] Mahler, R. J., F. T. Bingham, G. Sposito, and A. L. Page. 1980. "Cadmium-enriched sewage sludge application to acid and calcareous soils: relation between treatment, cadmium in saturation extracts, and cadmium uptake." *J. Environ. Qual.* **9**(3): 359-364.
- [125] Peel, J. W., R. J. Vetter, J. E. Christian, W. V. Kessler, and W. W. McFee. 1978. "The uptake and distribution of cadmium in corn." In Adriano, D. C. and I. L. Brisbin, Jr., (eds.) *Environmental Chemistry and Cycling Processes*. Proceedings of a symposium held at Augusta, Georgia April 28-May 1, 1976. pp. 628-636.
- [126] Haghiri, F. 1973. "Cadmium uptake by plants." *J. Environ. Qual.* **2**(1):93-95.
- [127] Gast, R. G., E. R. Landa, and L. J. Thorvig. 1976. *The Behavior of Technetium-99 in Soils and Plants: Progress Report for the Period April 1, 1974-March 31, 1977*. COO-2447-5.

- [128] Landa, E. R., L. H. Thorvig, and R. G. Gast. 1977. "Effect of selective dissolution, electrolytes, aeration, and sterilization on technetium-99 sorption by soils." *J. Environ. Qual.* **6**: 181-187.
- [129] Romney, E. M., A. Wallace, and J. E. Kinnear. 1978. *Plant Uptake of Pu and Am Through Roots in Nevada Test Site Soils, Vol. I*. Laboratory of Nuclear Medicine and Radiation Biology, University of California, Los Angeles. NVO-192. June 1978.
- [130] Crawford, T. V. 1977. *Savannah River Laboratory Environmental Transport and Effects Research, Annual Report-1977*. Savannah River Laboratory, Aiken, South Carolina. DP-1489. pp. 25-28.
- [131] Price, K. R. 1972. *Uptake of ²³⁷Np, ²³⁹Pu, ²⁴¹Am, and ²⁴⁴Cm from Soil by Tumbleweed and Cheatgrass*. Battelle Pacific Northwest Laboratories, Richland, Washington. BNWL-1688.
- [132] Romney, E. M., H. M. Mork, and K. H. Larson. 1970. "Persistence of plutonium in soil, plants, and small mammals." *Health Phys.* **19**: 487-491.
- [133] Schulz, P. K., G. A. Tompkins, and K. J. Babock. 1976. "Uptake of plutonium and americium by plants from soil: uptake by wheat from various soils and effect of oxidation of plutonium added to soil." In *Proc. Int. Symp. Transuranium Nuclides in the Environment*. San Francisco, 17-21 November 1975, Vienna. IAEA.
- [134] Gnevshva, G. I. 1971. "Uptake of plutonium-239 into agriculture plants from soil." *Biol. Nauki.* **14**: 60 (*Chemical Abstracts*) **76**: 1446f.
- [135] Lipton, W. V. and A. S. Goldin. 1976. "Some factors influencing the uptake of plutonium-239 by pea plants." *Health Phys.* **31**: 425-430.
- [136] Au, F. H. F., V. D. Leavitt, W. F. Becker, and J. C. McFarlane. 1977. "Incorporation of transuranics into vegetable and field crops grown at the Nevada Test Site." pp. 1-16. In White, M. G. and P. B. Dunaway (eds.) *Transuranics in Desert Ecosystems*. Nevada Applied Ecology Group. NVO-181. November, 1977.
- [137] Cline, J. F. 1968. "Uptake of ²⁴¹Am and ²³⁹Pu by plants." pp. 8.24-8.25. In Thompson, R. C., P. Teal, and E. G. Swazi (eds.) *Pacific Northwest Laboratory Annual Report for 1967 to the USAEC Division of Biology and Medicine, Vol. I*, Biological Sciences. BNWL-714. May 1968.
- [138] Dahlman, R. C., E. A. Bondietti, and L. D. Eyman. 1976. "Biological pathways and chemical behavior of plutonium and other actinides in the environment." pp. 47-80. In Friedman, A. M. (ed.) *Actinides in the Environment*. ACS Symposium Series, No. 35.
- [139] Wallace, A., R. T. Mueller, and E. M. Romney. 1978. "Variable ²⁴¹Am concentration in soil uptake and C. R. in barley plants." pp. 629-635. In White M. G. and P. B. Dunaway (eds.) *Selected Environmental Plutonium Research Reports of the NAEG*. Nevada Applied Ecology Group. NVO-192.
- [140] Wallace, A. 1972. "Effect of soil pH and chelating agent (DTPA) on uptake by and distributions of ²⁴¹Am in plant parts of bush beans." *Rad. Bot.* **12**: 433-435.
- [141] Wallace, A. 1972. "Increased uptake of ²⁴¹Am by plants caused by the chelating agent DTPA." *Health Phys.* **22**: 559-562.
- [142] Wallace, A., R. K. Schulz, E. M. Romney, and H. Nishita. 1979. *Biological Transport of Radionuclides at Low Level Waste Storage Sites, Annual Report, October 1, 1977-September 30, 1978*. Laboratory of Nuclear Medicine and Radiation Biology, University of California. NUREG 1 CR-0701.

- [143] Fedorov, Ye. A. and G. N. Romanov. 1969. "Quantitative characteristics of the relation between the environmental contamination levels and radioisotope concentrations in selected types of farm produce." pp. 112-126. In *USSR Reports on Natural and Fallout Radioactivity*. U.S. Atomic Energy Commission, Health and Safety Laboratory.
- [144] Montford, M. A., K. E. Shank, C. Hendricks, and T. W. Oakes. 1980. "Concentration of stable elements in food products." In *Proceedings of the 14th Annual Conference on Trace Substances in Environmental Health*. University of Missouri, June 3-6, 1980.
- [145] Ng, Y. C., C. S. Colsher, D. J. Quinn, and S. E. Thompson. 1977. *Transfer Coefficients for the Predictions of Dose to Man Via the Forage-Cow-Milk Pathway from Radionuclides Released to the Biosphere*. Lawrence Livermore Laboratory. UCRL-51939.
- [146] Weast, R. C. and M. J. Astle (eds.). 1979. *CRC Handbook of Chemistry and Physics 60th Ed.* CRC Press, Inc., Boca Raton, Florida. p. F-3.
- [147] Francis, C. W., M. Reeves III, R. S. Fisher, and B. A. Smith. 1977. "Soil chromatograph k_d values." In *Waste Isolation Safety Assessment Program, Task 4. Contractor Information Meeting Proceedings*. September 23-23, 1977. Battelle Memorial Institute. Human Affairs Research Centers, Seattle, Washington. PNL-SA-6957. pp. 403-431
- [148] Sheppard, J. C., J. A. Kittrick, M. J. Campbell, and T. L. Hardt. 1977. *Determination of Distribution Ratios and Diffusion Coefficients of Neptunium, Americium and Curium in Soil-Aquatic Environments*. Washington State University, Pullman, Washington. RLO-2221-T-12-3.
- [149] Inoue, Y. and S. Morisawa. 1976. "Distribution coefficient k_d of radionuclide between sample soil and water." *Nippon Genshiryoku Gakkai Shi* **18**(8): 525-534.
- [150] Griffin, R. A. and N. F. Shimp. 1976. "Effect of pH on exchange-adsorption or precipitation of lead from landfill leachates by clay minerals." *Environ. Sci. Technol.* **10**(13): 1256-1261.
- [151] Relyea, J. F. and D. A. Brown. 1978. "Adsorption and diffusion of plutonium in soil." In Adriano, D. C. and I. L. Brisbin, Jr. (eds.) *Environmental Chemistry and Cycling Processes*. Proceedings of a symposium held at Augusta, Georgia, April 28-May 1, 1976. Technical Information Center, U.S. Department of Energy. pp. 479-495.
- [152] Rhodes, D. W. 1957. "Adsorption of plutonium by soil." *Soil Sci.* **84**: 465-471.
- [153] Nishita, H. 1978. "Extractability of plutonium-238 and curium-242 from a contaminated soil as a function of pH and certain soil components. $\text{CH}_3\text{COOH-NH}_4\text{OH}$ " In Adriano, D. C. and I. L. Brisbin, Jr. (eds.) *Environmental Chemistry and Cycling Processes*. Proceedings of a symposium held at Augusta, Georgia, April 28-May 1, 1976. Technical Information Center, U.S. Department of Energy. pp. 403-416.
- [154] Rhodes, D. W. 1957. "The effect of pH on the uptake of radioactive isotopes from solution by a soil." *Soil Sci. Soc. Am. Proc.* **21**: 389-392.
- [155] Bishop, R. F. and D. Chisholm. 1962. "Arsenic accumulation in Annapolis Valley orchard soils." *Can. J. Soil Sci.* **42**: 77-80.
- [156] Frost, R. R. and R. A. Griffin. 1977. "Effect of pH on adsorption of arsenic and selenium from landfill leachate by clay minerals." *Soil Sci. Soc. Am. J.* **41**: 53-57.
- [157] Frost, R. R. and R. A. Griffin. 1977. "Effect of pH on adsorption of copper, zinc, and cadmium from landfill leachate by clay minerals." *J. Environ. Sci. Health.* **A12**(4&5): 139-156.
- [158] Graham, E. R. 1973. "Selective distribution and labile pools of micro-nutrient elements as factors affecting plant uptake." *Soil Sci. Soc. Am. Proc.* **37**: 70-74.

- [159] Reddy, M. R. and H. F. Perkins. 1974. "Fixation of zinc by clay minerals." *Soil Sci. Soc. Amer. Proc.* **38**: 229-231.
- [160] Wildung, M. W. and D. W. Rhodes. 1963. *Removal of Radioisotopes from Solution by Earth Materials from Eastern Idaho*. Phillips Petroleum Company, Atomic Energy Division. National Reactor Testing Station. U.S. Atomic Energy Commission. IDO-14624, November 1963.
- [161] Cole, M. A. 1979. "Solubilization of heavy metal sulfides by heterotrophic soil bacteria." *Soil Sci.* **127**(5): 313-317.
- [162] Wildung, R. E. and J. R. Garland. 1977. *The Relationship of Microbial Processes to the Fate and Behavior of Transuranic Elements in Soils, Plants, and Animals*. Battelle Pacific Northwest Laboratories. PNL-2416, October 1977. 45 pp.
- [163] Holtan, H. N., C. B. England, G. P. Lawless, and G. A. Schumaker. 1968. *Moisture-Tension Data for Selected Soils on Experimental Watersheds*. U.S. Department of Agriculture, Agricultural Research Service. ARS 41-144.
- [164] Free, G. R., G. M. Browning, and G. W. Musgrave. 1940. "Relative infiltration and related physical characteristics of certain soils." *U.S. Department of Agriculture Technical Bulletin 729*. U.S. Department of Agriculture. 52 pp.
- [165] Graham, E. R. and C. G. Silva. 1979. "Labile pools and distribution coefficients for soil calcium, magnesium, and potassium determined with exchange equilibria and radioisotopes." *Soil Sci.* **128**(1): 17-22.
- [166] Mokwunye, A. U. and S. W. Melsted. 1973. "Magnesium fixation and release in soils of temperate and tropical origins." *Soil Sci.* **116**(5): 349-362.
- [167] Inoue, Y. and S. Morisawa. 1976. "Migration of radionuclides in a model saturated zone, (1)." *Nippon Genshiryoku Gakkai Shi* **18**(5): 42-50.
- [168] Sims, J. L., P. Duangpatra, J. H. Ellis, and R. E. Phillips. 1979. "Distribution of available manganese in Kentucky soils." *Soil Sci.* **127**(5): 270-274.
- [169] Rancon, D. 1972. *Utilisation Pratique du Coefficient de Distribution pour la Mesure de la Contamination Radioactive des Mineraux, des Roches, du sol et des Eaux Souterraines*. Department de Surete Nucleaire, Centre d'Etudes Nucleaires de Cadarache, Saclay, France. Rapport CEA-R-4274. 35 pp.
- [170] Graham, E. R. and D. D. Killion. 1962. "Soil colloids as a factor in the uptake of cobalt, cesium, and strontium by plants." *Soil Sci. Soc. Am. Proc.* **26**: 545-547.
- [171] Schmalz, B. L. 1972. *Radionuclide Distribution in Soil Mantle of the Lithosphere as a Consequence of Waste Disposal at the National Reactor Testing Station*. Idaho Operations Office. U.S. Atomic Energy Commission. IDO-10049. 62 pp.
- [172] Inoue, Y., S. Morisawa, and Y. Mahara. 1975. "Radionuclide migration in aerated zones, (1). Migration characteristics of nuclides contained in percolating water." *Nippon Genshiryoku Gakkai Shi* **17**(7): 376-384.
- [173] Klechkovskii, V. M. 1957. *On the Behavior of Radioactive Fission Products in Soil, their Absorption by Plants and their Accumulation in Crops* (Translated from Russian). U.S. Atomic Energy Commission, Washington, DC.
- [174] Gailledreau, C. 1963. "Reactions physico-chimiques lors du mouvement souterrain des radioisotopes." In *The International Symposium on the Retention and Migration of Radioactive Ions in Soils*. Saclay, 16, 17, and 18 October, 1962. Center for Nuclear Studies, Saclay, The University Press of France. pp. 270-275.

- [175] Jacobs, D. G. 1963. "Ion exchange in the deep-well disposal of radioactive wastes." In *International Symposium on the Retention and Migration of Radioactive Ions in Soils*. Saclay, 16, 17, and 18 October, 1962. Center for Nuclear Studies, Saclay, The University Press of France. pp. 43-54.
- [176] McHenry, J. R. 1958. "Ion-exchange properties of strontium in a calcareous soil." *Soil Sci. Soc. Amer. Proc.* **22**: 514-518.
- [177] Tamura, T. 1972. "Sorption phenomena significant in radioactive-waste-disposal." In Cook, T. D. (ed.) *Underground Waste Management and Environmental Implications*. Proceedings of a Symposium 6-9 December, 1971. Houston, Texas, American Association of Petroleum Geologists and United States Geological Survey. pp. 318-330.
- [178] Nishita, H., B. W. Kowalewsky, A. J. Steen, and K. H. Larson. 1956. "Fixation and extractability of fission products contaminating various soils and clays: I. Sr⁹⁰, Y⁹¹, Ru¹⁰⁶, Cs¹³⁷, and Ce¹⁴⁴." *Soil Sci.* **81**: 317-326.
- [179] Juo, A. S. R. and S. A. Barber. 1970. "The retention of strontium by soils as influenced by pH, organic matter and saturation cations." *Soil Sci.* **109**(3): 143-148.
- [180] Dames and Moore. 1977. *Assessment of the Levels, Potential Origins and Transport Routes of the Radioactivity Measured in the Vicinity of the Maxey Flat Low-Level Radioactive Waste Disposal Site*. March 1977 report.
- [181] Rogowski, A. S. and T. Tamura. 1965. "Movement of ¹³⁷Cs by runoff, erosion and infiltration on the alluvial caprina silt loam." *Health Phys.* **11**: 1333-1340.
- [182] Prout, N. E. 1958. "Adsorption of radioactive wastes by Savannah River Plant soil." *Soil Sci.* **85**(1): 13-17.
- [183] Tamura, T. 1966. "Development and applications of minerals in radioactive waste disposal." In *Proceedings of the International Clay Conference*. Jerusalem, Israel. Vol. 1. pp. 425-439.
- [184] Tso, T. C. 1970. "Limited removal of Po²¹⁰ and Pb²¹⁰ from soil and fertilizer by leaching." *Agron. J.* **62**: 663-664.
- [185] Rancon, D. 1973. "Comportement dans les milieux souterrains de l'uranium et du thorium rejetes par l'industrie nucleaire." pp. 333-346. In *Environmental Behavior of Radionuclides Released in the Nuclear Industry*. Proceedings of a Symposium. Aix-en-Provence. 14-18 May 1973. IAEA-SM-172/55.
- [186] Dahlman, R. C., E. A. Bondiotti, and L. D. Eyman. 1976. "Biological pathways and chemical behavior of plutonium and other actinides in the environment." In A. M. Friedman (ed.) *Environmental Behavior of the Actinide Elements*. American Chemical Society Symposium Series 35. pp. 47-80.
- [187] Bondiotti, E. A., S. A. Reynolds, and M. H. Shanks. 1976. "Interaction of plutonium with complexing substances in soils and natural waters" (IAEA-SM-199/51). In *Transuranium Nuclides in the Environment*. Proceedings of the Symposium Held in San Francisco, 17-21 November 1975. International Atomic Energy Agency, Vienna, 1976. pp. 273-287.
- [188] Routson, R. C., G. Jansen, and A. V. Robinson. 1975. *Sorption of ⁹⁹Tc, ²³⁷Np and ²⁴¹Am on Two Subsoils from Differing Weathering Intensity Areas*. Battelle Pacific Northwest Laboratories. Richland, Washington. BNWL-1889. 13 pp.
- [189] Nishita, H., A. Wallace, E. M. Romney, and R. K. Schulz. 1979. *Effect of Soil Type on the Extractability of ²³⁷Pu, ²⁴¹Am and ²⁴⁴Cm as a Function of pH*. Laboratory of Nuclear Medicine and Radiation Biology, University of California at Los Angeles. UCLA 12-1192. 32 pp.

- [190] Nishita, H. and M. Hamilton. 1977. "Factors influencing the chemical extractability of ^{24}Am from a contaminated soil." In White, M. G. and P. B. Dunaway (eds.) *Transuranics in Natural Environments*. A Symposium at Gatlinburg, Tennessee, October 1976. Nevada Applied Ecology Group, U.S. Energy Research and Development Administration, Las Vegas, Nevada. NVO-178. pp. 77-96.
- [191] Van Dorp, F., R. Eleveld, and M. J. Frissel. 1979. "A new approach for soil-plant transfer calculations." In *International Symposium on Biological Implications of Radionuclides Released from Nuclear Industries*. Vienna, 26-30 March 1979. IAEA-SM-237134.
- [192] Chamberlain, A. C. 1967. "Transport of Lycopodium spores and other small particles to rough surfaces." *Proc. R. Soc. London* **A296**: 45-70.
- [193] Chamberlain, A. C. 1970. "Interception and retention of radioactive aerosols by vegetation." *Atmos. Environ.* **4**: 57-78.
- [194] Chamberlain, A. C. and R. C. Chadwick. 1966. "Transport of iodine from atmosphere to ground." *Tellus* **XVIII**(2): 226-237.
- [195] Chadwick, R. C. and A. C. Chamberlain. 1970. "Field loss of radionuclides from grass." *Atmos. Environ.* **4**: 51-56.
- [196] Mibourn, G. M. and R. Taylor. 1965. "The contamination of grassland with radioactive strontium. I. Initial retention and loss." *Radiat. Bot.* **5**: 337-47.
- [197] Peters, L. N. and J. P. Witherspoon. 1972. "Retention of 44-88 μ simulated fallout particles by grasses." *Health Phys.* **22**: 261-266.
- [198] Witherspoon, J. P. and F. G. Taylor, Jr. 1970. "Interception and retention of a simulated fallout by agricultural plants." *Health Phys.* **19**: 493-499.
- [199] Hoffman, F. O. and C. F. Baes, III (eds.). 1979. *A Statistical Analysis of Selected Parameters for Predicting Food Chain Transport and Internal Dose of Radionuclides. Final Report*. ORNL/NUREG/TM-282. Oak Ridge National Laboratory
- [200] Knott, J. E. 1957. *Handbook for Vegetable Growers*. J. Wiley and Sons, Inc., New York.
- [201] Brenchley, W. E. and V. G. Jackson. 1921. "Root development in barley and wheat under different conditions of growth." *Ann. Bot.* **XXXV**: 533-556.
- [202] Watson, D. J., G. N. Thorne, and S. A. W. French. 1958. "Physiological causes of differences in grain yield between varieties of barley." *Ann. Bot.* **22**: 321-352.
- [203] Thorne, G. N. 1961. "Effects of age and environment on net assimilation rate of barley." *Ann. Bot.* **25**: 29-38.
- [204] Crow, J. F. and M. Kimura. 1970. *An Introduction to Population Genetics Theory*. Harper and Row, publishers, New York.
- [205] Ryan, J. W., P. A. Garza, and S. L. Brown. 1974. *A Damage Assessment Model for Agricultural Crops*. Stanford Research Institute. AD/A-002.
- [206] Hanaway, J. J. 1963. "Growth stages of corn (*Zea mays, l.*)." *Agron. J.* **55**: 487-492.
- [207] Norman, A. G. 1956. *Advances in Agronomy*. Academic Press Inc., New York.
- [208] Rutledge, A. D. 1979. "Vegetable garden guide." Publication 447 (Revised) University of Tennessee Agricultural Extension Service, The University of Tennessee.
- [209] U.S. Department of Commerce, Bureau of the Census. 1977. *The 1974 Census of Agriculture, United States Summary and State Data*. Vol. 1, Part 51. U.S. Government Printing Office, Washington, D.C.

- [210] U.S. Department of Commerce. 1968. *Climatic Atlas of the United States*. Environmental Science Services Administration, Environmental Data Service. Reprinted by the National Oceanic and Atmospheric Administration. 1977.
- [211] U.S. Department of Commerce. 1979. *Comparative Climatic Data for the United States through 1978*. Environmental Data and Information Service, National Climatic Center, Asheville, N.C.
- [212] Ruffner, J. A. 1978. *Climates of the States*. Vols. 1&2. Gale Research Company. Book Tower, Detroit, Michigan.
- [213] Haaland, C. M. and M. T. Heath. 1973. *Mapping of Population Density*. ORNL-TM-4246. Oak Ridge National Laboratory.
- [214] Haaland, C. M. and M. T. Heath. 1974. "Mapping of population density." *Demography* **11**(2): 321-336.
- [215] Edwards, R. G. and P. R. Coleman. 1976. *IUCALC-A FORTRAN Subroutine for Calculating Polygon-Line Intersections, and Polygon-Polygon Intersections, Unions, and Relative Differences*. ORNL/CSD/TM-12. Oak Ridge National Laboratory.
- [216] Morton, F. I. 1978. "Estimating evapotranspiration from potential evaporation: practicality of an iconoclastic approach." *J. Hydro.* **38**: 1-32.
- [217] Olson, R. J., C. J. Emerson, and M. K. Nungesser. 1980. *GEOECOLOGY A County-Level Environmental Data Base for the Conterminous United States*. ORNL/TM-7351. Environmental Sciences Division Publication No. 1537. Oak Ridge National Laboratory.
- [218] Taylor, A. B. TERHGT program. Air Sources Laboratory, NOAA, Rockville, Md. 20852.
- [219] Haltiner, G. J. and F. L. Martin. 1957. *Dynamical and Physical Meteorology*. McGraw-Hill Book Co., Inc. New York.
- [220] Wallace, R. W. 1978. *A Comparison of Evapotranspiration Estimates Using DOE Hanford Climatological Data*. Pacific Northwest Laboratory. Richland, Washington. PNL-2698. 20 pp.
- [221] Thornthwaite, C. W. and J. R. Mather. 1955. "The water balance." *Climatol.* **8**(1); Laboratory of Climatology, Drexel Institute. 104 pp.
- [222] Penman, H. L. 1948. "Natural evaporation from open water, bare soil and grass." *Proc. Royal Soc. London, Series A* **193**: 120-145.
- [223] Holzworth, G. C. 1972. *Mixing Heights, Wind Speeds, and Potential for Urban Air Pollution Throughout the Contiguous United States*. PB-207 103. Environmental Protection Agency, Research Triangle Park, North Carolina. U.S. Department of Commerce. National Technical Information Service. January 1972.
- [224] Etnier E. L. 1980. "Regional and site-specific absolute humidity data for use in tritium dose calculations." *Health Phys.* **39**: 318-320.
- [225] Miller, C. W. and F. O. Hoffman. (Submitted to *Health Phys.*) "An examination of the environmental half-time for radionuclides deposited on vegetation."
- [226] Anspaugh, L. R., J. J. Koranda, W. L. Robison, and J. R. Martin. 1972. *Dose to Man via the Food-Chain Transfer Resulting from Exposure to Tritiated Water Vapor*. USAEC Report UCRL-73195, Rev. 1.
- [227] Murphy, C. E., Jr. and M. M. Pendergast. 1979. "Environmental transport and cycling of tritium in the vicinity of atmospheric releases." pp. 361-371. In Freeman, S. (ed.) *Symposium on the Behavior of Tritium in the Environment*. IAEA, Vienna.

- [228] Baes, C. F., Jr., H. E. Goeller, J. S. Olson, and R. M. Rotty. 1976. *The Global Carbon Dioxide Problem*. ORNL-5194. Oak Ridge National Laboratory.
- [229] Killough, G. G., J. E. Till, E. L. Etnier, and B. D. Murphy. In press. "Dose equivalent due to atmospheric releases of carbon-14." In Miller, C. W. (ed.). *Models and Parameters for Environmental Radiological Assessments*. DOE/TIC-11468. Department of Energy Technical Information Center, Oak Ridge, Tennessee.
- [230] Linsley, G. S. 1978. *Resuspension of the Transuranium Elements - A Review of Existing Data*. NRPB-R75. National Radiological Protection Board. Harwell, Didcot, Oxon OX11 ORQ.
- [231] Suggs, J. C., C. E. Rodes, E. G. Evans, and R. E. Bumgardner. 1981. *Inhalable Particulate Network Annual Report: Operation and Data Summary (Mass Concentrations Only)* April 1979-June 1980. EPA-600/4-81-037. United States Environmental Protection Agency. May 1981.
- [232] Sehmel, G. A. 1980. "Particle and gas dry deposition: a review." *Atmos. Environ.* **14**: 983-1011
- [233] Francis, C. W. 1978. *Radiostrontium Movement in Soils and Uptake in Plants*. DOE Critical Review Series. Technical Information Center. U. S. Department of Energy.
- [234] Klepper, B., D. G. Watson, and J. F. Cline. 1976. "Iodine-129 concentration factors for food products." In *Pacific Northwest Laboratory Annual Report for 1975 to the USERDA Division of Biomedical and Environmental Research Part 2 Ecological Sciences*. BNWL-2000 PT2.
- [235] Johnson, J. M. and G. W. Butler. 1957. "Iodine content of pasture plants I. Method of determination and preliminary investigation of species and strain differences." *Physiol. Plant.* **10**: 100-111.

INTERNAL DISTRIBUTION

- | | |
|------------------------|------------------------------|
| 1. S. I. Auerbach | 27. D. C. Parzyck |
| 2-6. C. F. Baes III | 28. H. A. Pfuderer |
| 7. L. W. Barnthouse | 29. R. M. Reed |
| 8. E. A. Bondietti | 30. D. E. Reichle |
| 9. R. O. Chester | 31. C. R. Richmond |
| 10. W. D. Cottrell | 32. P. S. Rohwer |
| 11. C. C. Coutant | 33. T. H. Row |
| 12. K. E. Cowser | 34. R. D. Sharp |
| 13. A. G. Croff | 35. R. W. Shor |
| 14. B. S. Ellis | 36. A. L. Sjoreen |
| 15. W. R. Emanuel | 37. S. H. Stow |
| 16. J. T. Ensminger | 38. G. W. Suter |
| 17. W. Fulkerson | 39. C. C. Travis |
| 18. R. H. Gardner | 40. R. I. Van Hook, Jr. |
| 19. W. R. Garrett | 41. W. Van Winkle |
| 20. C. T. Garten, Jr. | 42. P. J. Walsh |
| 21. H. B. Gerstner | 43. A. P. Watson |
| 22. S. G. Hildebrand | 44. Central Research Library |
| 23. F. O. Hoffman, Jr. | 45. Y- 12 Technical Library |
| 24. S. V. Kaye | 46-47. Laboratory Records |
| 25. C. W. Miller | 48. ORNL Patent Office |
| 26. T. W. Oakes | |

EXTERNAL DISTRIBUTION

49. L. R. Anspaugh, Lawrence Livermore Laboratory, P.O. Box 808, Livermore, California 94550
50. J. A. Auxier, Applied Science Laboratory, Inc., P.O. Box 549, Oak Ridge, Tennessee 37830
51. D. A. Baker, Battelle-Pacific Northwest Laboratories, P.O. Box 999, Richland, Washington 99352
52. P. Cho, HHAD/OHER/ER, U.S. Department of Energy, Washington, D.C. 20545
53. Hugh W. Church, Sandia Laboratory, Division 5333, Albuquerque, New Mexico 87115
54. Bernard L. Cohen, Department of Physics and Astronomy, University of Pittsburg, Pittsburg, Pennsylvania 15260
55. Frank J. Congel, U.S. Nuclear Regulatory Commission, Washington, D.C. 20555
56. T. V. Crawford, Savannah River Laboratory, Aiken, South Carolina 29801
57. R. G. Cuddihy, Inhalation Toxicology Research Institute, 5200 Gibson Blvd., SE., Albuquerque, New Mexico 87108

58. F. L. Culler, Electric Power Research Institute, P.O. Box 10412, Palo Alto, California 94303
59. Ray Dickson, National Oceanic and Atmospheric Administration, 550 Second Street, Idaho Falls, Idaho 93401
60. G. G. Eichholz, School of Nuclear Engineering, Georgia Institute of Technology, Atlanta, Georgia 30332
61. J. Falco, ORD, U.S. Environmental Protection Agency, 401 M Street, SW, Washington, D.C. 20460
62. Mike Smith, EERF, U.S. Environmental Protection Agency, P.O. Box 3009, Montgomery, Alabama 36193
63. Carl V. Gogolak, U. S. Department of Energy, Environmental Measurement Laboratory, 376 Hudson Street, New York, New York 10014
64. J. W. Healy, Health Physics Division, Los Alamos Scientific Laboratory, P.O. Box 1663, Los Alamos, New Mexico 97544
65. Bruce Hicks, Director, Air Resources Atmospheric Turbulence and Diffusion Laboratory, National Oceanic and Atmospheric Administration, Oak Ridge, Tennessee 37830
66. Wayne Lowder, U.S. Department of Energy, Washington, D.C. 20545
67. W. A. Mills, U.S. Nuclear Regulatory Commission, Washington, D.C. 20555
68. Dade Moeller, School of Public Health, Harvard University, 677 Huntington Ave., Boston, Massachusetts 02115
69. A. A. Moghissi, ORD, U.S. Environmental Protection Agency, 401 M Street, SW, Washington, D.C. 20460
70. Sam Morris, Brookhaven National Laboratory, Building 475, Upton, New York 11973
71. Paul Moskowitz, Brookhaven National Laboratory, Building 475, Upton, New York 11973
- 72.-76. Christopher B. Nelson, Office of Radiation Programs, U.S. Environmental Protection Agency, Washington, D.C. 20460
77. Yook C. Ng, Biomedical and Environmental Research Division, Lawrence Livermore Laboratory, P.O. Box 808, Livermore, California 94550
78. J. K. Soldat, Pacific Northwest Laboratories, Battelle Memorial Institute, Richland, Washington 99352
79. W. L. Templeton, Ecosystems Department, Battelle-Pacific Northwest Laboratories, Richland, Washington 99352
80. E. C. Watson, Battelle-Pacific Northwest Laboratories, P.O. Box 999, Richland, Washington 99352
81. F. W. Whicker, Department of Radiology and Radiation Biology, Colorado State University, Fort Collins, Colorado 80521
82. W. H. Wilkie, Tennessee Valley Authority, River Oaks Building, Muscle Shoals, Alabama 35660
83. Office of Assistant Manager, Energy Research and Development, Department of Energy, Oak Ridge Operations Office, Oak Ridge, Tennessee 37830
- 84-96. Technical Information Center, P.O. Box 62, Oak Ridge, Tennessee 37831