

**NASEO** National  
Association

of State Energy Officials

ENERGY'S WASHINGTON VOICE



# State Energy Assurance Guidelines

**Version 3.1**  
**December 2009**

## **ACKNOWLEDGEMENTS**

---

The National Association of State Energy Officials (NASEO) Energy Data and Security Committee greatly appreciate the assistance of those individuals who have made contributions to these guidelines. In particular, we recognize the contributions of the National Association of Regulatory Utility Commissioners, the National Conference of State Legislatures, the National Governors Association—Center for Best Practices and the many states that provided detailed information regarding their programs and contingency plans. Development of these state guidelines was made possible by the ongoing support of the U.S. Department of Energy Office of Electricity Delivery and Energy Reliability (OE) and its Infrastructure Security and Energy Restoration Division.

Alice Lippert of OE has been a key supporter of this effort and strengthened the relationship between the states and the federal government in energy emergency preparedness and has facilitated numerous training, exercises, and planning efforts. Dr. Kenneth Friedman also with OE has help to assure that state concerns have been reflected in the Energy Sector Specific Plan of the National Infrastructure Protection Plan. The work of the Department of Energy on critical infrastructure protection and energy emergency preparedness needs to be closely coordinated with state and local governments to assure they are complementary and supportive.

It is important to acknowledge individuals who contributed to these guidelines over the years. Jeffrey R. Pillon as Chair of the NASEO Energy Data and Security Committee has provided leadership in the development of the Guidelines since their inception, serving as a principal author and editor and ensuring the incorporation of the contributions from many organizations and individuals. NASEO's first Executive Director, Frank Bishop, was a major force in helping to make the first version of the Guidelines, released in June of 2004, a reality. Diane Shea, former executive director of NASEO, made substantial contributions to the second version of the Guidelines that was released in November of 2005.

Dr. Donald Milsten, the first chair to the NASEO Energy Data & Security Committee has made substantial contributions to each of the versions including the third version. Additionally he has assisted many states in developing and updating their energy emergency plans based on the Guidelines. The work of Jeffrey Genzer, NASEO's Legal Council, in promoting energy assurance policies and actions at the state and federal levels has greatly contributed to this effort. Shemika Spenser of the NASEO Staff has made important contributions as has Tracey Kohler, currently working with NASEO and formerly with NARUC. John Cuttica, with the University of Illinois at Chicago, contributed to the sections dealing with Combined Heat and Power.

NARUC, through its critical infrastructure committee, has also provided substantial input in the development of the Guidelines. The efforts of NARUC Staff Miles Keogh, and Julia Friedman, Thomas Pearce of Public Utilities Commission of Ohio and the current Chair of the Staff Subcommittee on Critical Infrastructure, and Katie Rich, Public Utility Commission of Texas, are acknowledged.

It is the responsibility of local, state and federal governments to be prepared to respond to a serious disruption in energy supply. We must also work to strengthen and enhance the resiliency of our energy infrastructure to assure that it is protected and can better withstand the full range of hazards, from deliberate attacks to the impacts of hurricanes and other natural disasters.

David Terry, Executive Director  
National Association of State Energy Officials

# TABLE OF CONTENTS

<b>I. INTRODUCTION</b> .....	<b>6</b>
A. Organization of the Guidelines .....	8
B. The Nature of Energy Assurance Planning.....	9
<b>II. ENERGY ASSURANCE CONSIDERATIONS</b> .....	<b>12</b>
A. Defining Critical Infrastructure and Energy Emergency Preparedness .....	12
B. Components of Critical Infrastructure Protection.....	13
C. Energy Assurance Planning for Utilities.....	25
D. Cyber Security .....	26
<b>III. DEFINE AND CLARIFY ORGANIZATIONAL RELATIONSHIPS &amp; RESPONSIBILITIES</b> .....	<b>34</b>
A. Who has Legal Authority in the State During an Energy Emergency? .....	34
B. What is the Relationship of Legal Authorities to the State’s Emergency Plans? .....	34
C. Roles and Relationships among Federal, State, Regional and Local Authorities .....	40
<b>IV. PRINCIPAL STRATEGIES FOR MANAGING ENERGY SHORTAGES</b> .....	<b>45</b>
A. Finding Information .....	45
B. Energy Emergency Assurance Coordinators System .....	45
C. Understanding a State’s Energy Profile and Vulnerabilities .....	47
D. Defining the Stages of an Energy Emergency .....	49
E. Assessing the Severity of an Energy Emergency .....	53
F. Important Elements in the Design of Emergency Response Measures .....	53
<b>V. RESPONSE MEASURES</b> .....	<b>56</b>
A. Electricity .....	56
B. Natural Gas .....	64
C. Petroleum .....	70
<b>VI. PUBLIC INFORMATION</b> .....	<b>80</b>
A. Public Information Programs .....	80
B. Coordination .....	81
C. Operational Considerations.....	82
D. Data and Information Acquisition and Dissemination.....	83
E. Equipment Requirements.....	84
<b>VII. CONCLUSION</b> .....	<b>85</b>
<b>VIII. APPENDICES</b> .....	<b>86</b>
Appendix A—Quick Guidelines: Ten Things You Should Know to be Prepared for Energy Emergencies.....	87
Appendix B—Additional Information Pertaining to Federal Agencies .....	92
Appendix C—Federal Energy Emergency Authorities .....	96
Appendix D—Monitoring Energy Supplies .....	110
Appendix E—Essential Pre-Crisis and Background Information for State Energy Emergency Responders.....	117
Appendix F—Petroleum Fuel Set-Aside .....	123
Appendix G—The Role of Energy Efficiency and Renewable Energy Resources in Energy Assurance Planning.....	127
Appendix H—References and Resources.....	138

## **Executive Summary**

---

The State Energy Assurance Guidelines were developed by the National Association of State Energy Officials (NASEO) with the assistance of the National Association of Regulatory Utility Commissioners (NARUC) under the direction of the U.S. Department of Energy's Office of Electricity Delivery and Energy Reliability (OE). The guidelines integrate the lessons learned from responding to energy emergencies in recent years and from the dialogue that has occurred at conferences, exercises and meetings on energy assurance. They encompass many topics that states may wish to consider incorporating into their plans. Foremost among these is how energy assurance can improve: planning and responding quickly and effectively to energy emergencies, enhancing the resiliency of our response capability, reductions in the risk and vulnerability of critical energy infrastructure, and investments in the resiliency of the energy infrastructure.

OE is a key player at the federal level in mitigating energy emergencies, defining the components of critical energy infrastructure, and taking a lead in the protection of our nation's energy assets. OE also recognizes the major role states play in protecting energy assets within and beyond their borders, as well as the states' central role in responding to energy shortages, disruptions, and emergencies. As a result OE has facilitated state energy emergency planning by providing guidance on state energy emergency preparedness plans and sponsoring energy emergency training. These guidelines are a component of this ongoing support.

There are several key components discussed in these guidelines that enhance the resiliency of our response capability, and which are prerequisites to effective planning. These include the following and are discussed in further detail in Appendix A.

1. Make sure you and your staff are prepared and trained to meet the needs of policy makers.
2. Know your state's energy profile and interdependencies.
3. Know the geography and demographics of your energy infrastructure.
4. Know your key government and industry contacts.
5. Maintain a good working relationship with the private and public sector contacts.
6. Be prepared to work with the media.
7. Know the legal authorities that support your response.
8. Understand how you can effectively respond (increasing supply, reducing demand and other actions).
9. Maintain an alternative budget for emergencies.
10. Keep your energy assurance plan up to date.

The guidelines comprise the states' overall role in energy assurance, including organizing and building response mechanisms; coordination with stakeholders; operating within the federal emergency support function structure; planning response strategies; profiling energy use and vulnerability; and identifying fuel-related response measures. Extensive appendices further detail several topics and include relevant federal statutes, energy supply monitoring, and other useful information for state energy emergency assurance planning.

It is also important to stress that states need to work closely in planning and coordinating energy assurance efforts with the energy industries and other units of government in their state and region. It is the energy industry that will first respond to a disruption in their supply. If they can manage the disruption, and reduce the consequences, then actions by the states and locals may not be as critical. However, in a major disaster, when the disruption threatens the public health safety or welfare, or when the energy industry turns to a state or local government for assistance, that is when these energy assurance plans are intended to be used. In addition, efforts to protect critical energy infrastructure and build its resilience is the goal of the National Infrastructure Protection Plan. This plan is clearly defined as a public and private sector partnership, recognizing that these goals can only be achieved by working together.

These guidelines are intended to serve as a yardstick to which states' plans can be compared and improved. Each state possesses a unique set of energy infrastructure, energy usage patterns and the energy supply network designed to service these needs. These guidelines offer direction, but cannot substitute for necessary planning and the effort required to assemble state-specific authorities organizational structures, strategic needs, and plan for events and contingencies that will minimize consequences that may adversely affect the public's welfare and safety.

## I. INTRODUCTION

---

During any given year, states and territories face a variety of energy supply disruptions. Where these disruptions are limited in scope, and addressed quickly by energy providers, they are barely newsworthy. If, however, these disruptions extend over wide areas and last more than several hours they may become “energy emergencies” requiring the intervention of government emergency responders. Disruptions can result from many factors, including: spikes in demand during peak energy use; unanticipated power plant or refinery shutdowns; transmission system congestion; and natural disasters.

This document has two purposes. First, it provides state energy and emergency officials with a standard set of guidelines for understanding and reviewing how their jurisdictions respond to energy outages. With this knowledge, officials will be able to review and improve the components of their energy emergency response plans. These guidelines are a compilation of information from many state energy and emergency officials who have experienced and responded to energy emergencies. In brief, the guidelines:

- List state actions that will ease the impacts of short-term energy disruptions;
- Recommend long-term strategies and options for dealing with sustained disruptions or outages;
- Define critical infrastructure protection and set context for energy assurance;
- Describe coordination of state organizational relationships and responsibilities;
- Identify information that states need to know about specific fuels as well as pertinent government and industry contacts;
- Identify steps that state and territory officials can take to work with industry to minimize and resolve the impacts of an energy supply disruption; and
- Describe public information and crisis communication plans.

One of the primary challenges in energy emergency preparedness is to meet the needs and concerns of all affected parties in both the public and private sectors, while the objectives and policies being considered are assessed in light of their mutual impacts. These guidelines are intended to assist planners with identifying the key elements needed to craft a workable preparedness plan while avoiding potential conflicts among stakeholders. Additionally, these guidelines should assist officials with establishing priorities for various services and functions and helping to mitigate the impact of any energy shortage on society.

The second purpose of this document is to address the protection of critical energy infrastructure and the means by which its resilience can be enhanced. Critical Infrastructure Protection (CIP) is the shared responsibility of the private sector, local and state governments, and the federal government. The *Homeland Security Act of 2002*, and the subsequent Presidential strategies on CIP, defined what must be done to protect the

nation's infrastructure. These efforts are now detailed in the National Infrastructure Protection Plan updated in 2009<sup>1</sup> and the Energy Sector Specific Plan issued in 2007. "Critical" infrastructure is infrastructure that, if disrupted, would significantly impact public health and safety, the economy, and/or national security. Any prolonged interruption of the supply of basic energy - whether it is electricity, natural gas, or petroleum products - would do considerable harm to the United States economy and the American people. No single government agency, industry group, or company can secure the energy infrastructure. Collaboration at all levels is essential for securing an interdependent infrastructure that is owned, operated, hosted, and regulated by many entities, all of which have limited resources and expertise for infrastructure protection. Voluntary partnerships help leverage resources, facilitate the useful exchange of security-related information, and maximize the effectiveness of infrastructure protection efforts. The U.S. Department of Energy (DOE) is working to coordinate CIP efforts in the energy sector and with private, federal, state, and local partners.

CIP includes proactive measures for protecting physical and cyber systems so vital to the operations of the United States that their incapacity or destruction will seriously weaken national security, economic stability, or public safety. CIP methods and resources deter or prevent attacks against critical infrastructures by people (e.g., terrorists, other criminals, hackers, etc.), by nature (e.g., hurricanes, tornadoes, earthquakes, floods, etc.), and by hazardous material accidents involving nuclear, biological, or chemical substances. The U.S. is in the process of identifying and prioritizing the most critical assets in each sector of the economy and developing sustainable programs to protect these assets.<sup>2</sup>

Figure 1 summarizes the relationship between energy emergency preparedness and responses while protecting critical energy infrastructure and enhancing resiliency. The former is reactive, the latter is prospective. One cannot protect everything from every hazard or threat, so good response plans are needed that can effectively and quickly move to recovery and, by so doing, reduce the consequences of the event. This is the very definition of "resilience", which is an ability to recover from or adjust easily to misfortune or change. In addition, as the lessons are learned from prior emergencies and disasters, actions can be taken in the short- and long-term to mitigate these risks. In some cases the risk could be entirely mitigated and in most cases the risk will be reduced. In Figure 1, security generally refers to the threat component and in this example shows threats related to deliberate actions by those that intend to do harm. It also equally applies to other threats. There are four specific groups of threats:

- *Deliberate attacks* caused by people (e.g., terrorists, criminals, hackers delinquents, employees);
- *Natural attacks* caused by nature (e.g., hurricanes, tornadoes, floods, wildfires, earthquakes):

---

<sup>1</sup> See: [http://www.dhs.gov/xprevprot/programs/editorial\\_0827.shtm](http://www.dhs.gov/xprevprot/programs/editorial_0827.shtm)

<sup>2</sup> NARUC Committee on Critical Infrastructure Technical Briefs. *Paper 1: Issue Paper on Critical Infrastructure Protection*. April 2005. The federal and state roles in critical infrastructure protection are introduced and explored, with a special focus on the role of the state agencies and public utility commissions. [http://www.naruc.org/Publications/CIP\\_Issues\\_1.pdf](http://www.naruc.org/Publications/CIP_Issues_1.pdf)

- *Accidental attacks* caused by technological failure (e.g., pipeline rupture, levee breaches, chemical spills, power outages, nuclear or biological contamination); and
- *Systemic threats* caused by the physical inability of energy delivery systems to meet demand.

Figure 1

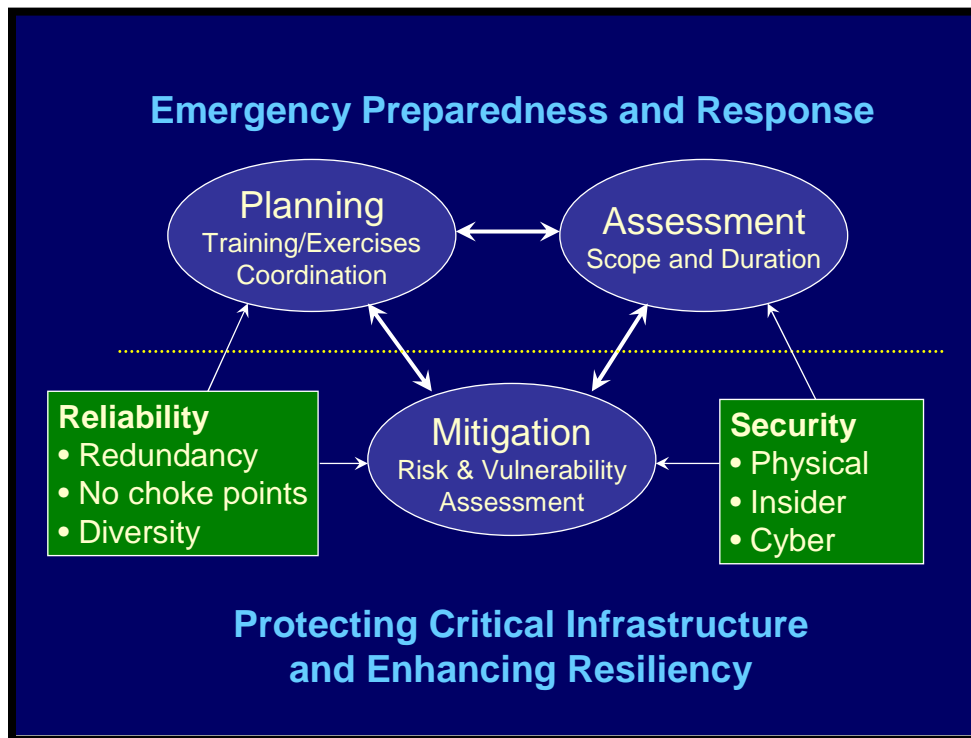

### A. Organization of the Guidelines

In recognition of assurance planning as a dynamic process, this document outlines and details information for assessing, updating, and revising all current state and territory energy emergency plans. These guidelines tie concerns for the protection of critical infrastructure and concepts of energy assurance with the traditional energy emergency response planning undertaken by state energy offices, energy restoration responsibilities supported by public utility commissions, and state and local emergency plans developed by emergency and homeland security agencies.<sup>3</sup>

This document is designed to guide the user through the logical steps suggested for reviewing the effectiveness of a state plan. Thus, it does not necessarily outline how a particular state plan should be written. The intent of the guidelines is to provide states

<sup>3</sup> NARUC Committee on Critical Infrastructure Technical Briefs. *Paper 6: Critical Infrastructure Information Sharing Rules: Model Protocols for States*. April 2005. The paper discusses both federal and state actions to date regarding the sharing of critical infrastructure information and provides a framework for future cooperation and efforts to harmonize information sharing among state commissions, the FERC and the Department of Homeland Security. [http://www.naruc.org/Publications/CIP\\_CEIIProtocolPaper\\_6.pdf](http://www.naruc.org/Publications/CIP_CEIIProtocolPaper_6.pdf)



with strategies for addressing such items as: how to identify an energy emergency, what questions to ask, what resources to access, a general order of response, and other useful outlining and ordering issues pertaining to plan development.

Organizational information is followed by several sections that discuss suggested plan elements such as a vulnerability assessment, energy profile, response measures, public information, and energy supply monitoring. Appendices with additional detail follow the main text of the guidelines.

The major sections of this document include:

- I. Introduction
- II. Energy Assurance Considerations
- III. Organizational Relationships and Responsibilities
- IV. Principal Strategies for Managing Energy Shortages
- V. Response Measures
- VI. Public Information
- VII. Conclusion
- VIII. Appendices

## **B. The Nature of Energy Assurance Planning**

The concept of energy assurance has evolved significantly since the early 1970s. During the era of embargoes, federal and state energy emergency planners focused on petroleum shortages. Electricity and natural gas contingencies have addressed shortage and the response planning process, typically as part of the regulation of electric and gas utilities. Some states also considered integrating energy efficiency/assurance options into their plans. Since the September 11, 2001 attack on the nation, the Northeast Blackout of 2003, the devastation caused by Hurricanes Katrina and Rita in 2005, and the petroleum supply disruptions caused by the Hurricanes Gustav and Ike in 2008 in the Southeastern states, federal, state and local governments have placed greater emphasis on assurance and included within it the need to address the protection of energy infrastructure.

Any energy emergency planning effort should be based on good data acquisition and information management. However, the response to an energy shortage—no matter how it is caused—is as much an art as it is a science. Hence, the nature of energy emergency preparedness is seen as good data management and response planning as well as the identification of multiple stakeholders, their interests, and the definition of how their energy interests affect energy emergency planning.

Energy planning is resource intensive. Costs will constrain continuous changes in any plan. Nevertheless, regular review should be undertaken to accommodate basic changes such as turnover in emergency response personnel. In general, plans should be updated about every five years to make certain that active stakeholders and changes in market forces are identified. Plans should also be updated in whole or in part as energy markets change, and simultaneously, emergency responders should train regularly in order to keep their knowledge fresh and their contacts “warm.”

**Getting Started**—There are a series of critical first steps to beginning energy assurance planning that should be considered by a state at the onset of the planning process. These steps can be almost as important as the plan itself.

An energy assurance planning effort—whether to write a new plan or update an existing plan—must first begin by forming a “planning team.” The team should include all of the key individuals and agencies that have responsibilities for select elements of the entire effort. As a first step this team should be identified, and each of the individual members must have the time available to commit to the effort. A coordinator should then be identified with the primary responsibility of ensuring that tasks are completed and that the effort is moving forward in accordance with an agreed to schedule. In addition to the core team, outside support may also be needed if the available state resources are not sufficient to undertake the scope of work required.

A state may have one plan or several plans that encompass one or more elements of energy assurance. For example, some states have an energy emergency plan in addition to the state’s overall emergency or disaster plan that would also address energy emergencies. The energy emergency plan may provide for a greater level of detail than may be found in the emergency or disaster plan, yet both may need to be updated. In addition to these plans, there may be energy specific plans dealing individually with electricity, natural gas, petroleum, or other energy resources. Other contingencies, such as pandemic response, may be considered as part of a state’s overall pandemic plan and also as part of Continuity of Operations Plans (COOP). It is critical for states to account for COOP and Continuity of Government (COG) plans as listed under the Federal Preparedness Circular (FPC) 65. Plans for addressing critical energy infrastructure may be part of the state homeland security strategy or part of a specific state infrastructure protection plan. Regardless of the specific state plan, the state must clearly define the planning effort recognizing that different plans, which are interdependent, need to be addressed through the process.

Any energy assurance planning effort should also involve the public and private stakeholders that will be affected or required to take action under the plans. They should be included in the initial process and in the review and refinement phase of the plan development. Planning coordination should also ideally extend to localities within the states and the multi-state region that rely on an integrated energy supply and distribution network.

Lastly, all plans will require training on their implementation and exercises to assess how well they work. Future efforts to update the plans should be considered as part of the planning cycle.

For more information about this critical planning process phase, please see, *Developing and Maintaining State, Territorial, Tribal, and Local Government Emergency Plans* (March 2009) developed by the Department of Homeland Security, FEMA. The document promotes a common understanding of the fundamentals of planning and decision making to help emergency planners examine a hazard and produce integrated, coordinated, and synchronized plans. It provides emergency and homeland security managers and other emergency services personnel with FEMA’s recommendations on how to address the entire planning process — from forming a planning team, through writing and maintaining the plan, to executing the plan. It also encourages

emergency and homeland security managers to follow a process that addresses all of the hazards and threats that might impact their jurisdiction through a suite of operations plans (OPLANs) connected to a single, integrated concept plan (CONPLAN). You can find the document at [http://www.fema.gov/pdf/about/divisions/npd/cpg\\_101\\_layout.pdf](http://www.fema.gov/pdf/about/divisions/npd/cpg_101_layout.pdf).

## What is Resilience?

---

The Merriam-Webster Online Dictionary: <http://www.m-w.com/dictionary> defines “resilience” as: an ability to recover from or adjust easily to misfortune or change.

In the context of Energy Assurance Planning resilience can be achieved through various strategies. These can be divided into two groups of actions. The first is emergency response. How can one create effective responses that minimize consequences and provide a rapid recovery and a return to normal conditions? Energy assurance encompasses preparedness activities that enhance the ability to more quickly return to normal following an energy disruption. These efforts are focused on responses after a disruptive event. The second group are actions taken before a disruption that prevent them from occurring (reduce threats) and defend against those disruptions (reduce vulnerabilities). Disruptions are those that result from all hazards whether they are deliberate attacks, technological failures or natural disasters.

The first group is addressed through energy emergency preparedness (planning, training and exercises) and the integration of those efforts with other disaster response plans at the local, state and federal levels. The second group is pursued through the efforts undertaken in the mid to long-term as part of the National Infrastructure Protection Plan (NIPP) and the Energy Sector Specific Plan (SSP) and other interdependent SSPs. The NIPP uses the word resilience 27 times in describing the objectives and various initiatives contained in the plan.

Resilience can have four infrastructural qualities:

- **Robustness** - *the inherent strength or resistance in a system to withstand external demands without degradation or loss of functionality*
- **Redundancy** - *system properties that allow for alternate options, choices, and substitutions under stress*
- **Resourcefulness** - *the capacity to mobilize needed resources and services in emergencies*
- **Rapidity** - *the speed with which disruption can be overcome and safety, services, and financial stability restored*

For more information see:

- Homeland Security Advisory Council, Report of the Critical Infrastructure Task Force January 2006, which can be found at: [http://www.dhs.gov/xlibrary/assets/HSAC\\_CITF\\_Report\\_v2.pdf](http://www.dhs.gov/xlibrary/assets/HSAC_CITF_Report_v2.pdf)
- Critical Infrastructure, Interdependencies, and Resilience, T.D. O’Rourke. The Bridge, Volume 37, No. 1 spring 2007. National Academy <http://www.nae.edu/cms/Publications/TheBridge/Archives/7404.aspx>

## II. ENERGY ASSURANCE CONSIDERATIONS

---

This section addresses issues that impact how states conduct energy assurance planning. In particular, this section addresses including critical infrastructure protection in emergency planning and how this, and energy alternatives, contribute to energy assurance. Because this section examines factors that logically precede a disruption, the information may or may not be included in an energy emergency response plan.

Depending on the individual needs of each state, some will choose to include this information in their energy emergency plans while others may prefer to place it within a statewide energy plan or as part of the state's homeland security strategy. In any case, an understanding of infrastructure and assurance will help in updating an emergency plan.

### A. Defining Critical Infrastructure and Energy Emergency Preparedness

DOE's Office of Electricity Delivery and Energy Reliability leads the federal government's effort to ensure a robust, secure, and reliable energy infrastructure in the contemporary energy environment. This includes malevolent threats and increasing complexity due to interdependencies. As the sector specific agency for energy, as defined by the Department of Homeland Security National Infrastructure Protection Plan, OE worked closely with DHS and dozens of government and industry security partners to create an Energy Sector Specific Plan.

The Energy Sector Specific Plan (SSP) is intended to help DOE in the prioritization of its protection and preparedness initiatives and in investments within and across sectors and ultimately to ensure that government resources are applied where they offer the most benefit for mitigating risk. This can be done by lowering vulnerabilities, deterring threats, minimizing the consequences of attacks and other incidences, and enhancing recovery. The SSP combined with the National Response Framework, which is described in more detail below, aided the development of these guidelines for states as well as provided the essential groundwork for collaboration among federal, state and local partners.

DOE has reached out to the states and territories through state government associations. The National Association of State Energy Officials represents state energy offices that are required by law to develop state energy emergency plans. State energy offices are often at the center of efforts to mitigate the impact of energy shortages. The National Association of State Regulatory Utility Commissions represents public utility commissions, and in 2005 undertook two major surveys of state utility agencies to inventory their energy assurance planning and related efforts.<sup>4</sup> The National Governors Association (NGA) and the National Conference of State Legislatures also developed

---

<sup>4</sup> NARUC Committee on Critical Infrastructure Technical Briefs. *Paper 3: Primer on Energy Assurance for Public Utility Commissions*. April 2005. The paper addresses energy assurance planning, including critical infrastructure protection and energy mitigation.  
[http://www.naruc.org/Publications/CIP\\_EnergyAssurancePrimer\\_3.pdf](http://www.naruc.org/Publications/CIP_EnergyAssurancePrimer_3.pdf)

policies related to energy assurance and guidance. Attachment D of the 2009 Sector Critical Infrastructure and Key Resources (CIKR) Protection Annual Report for the Energy Sector outlines the specific initiatives that NASEO, NARUC, NGA and the National Conference of State Legislatures (NCSL) embarked on to achieve the goals and objectives of the Energy SSP.

To help states meet the objectives of the Energy SSP, NARUC encourages public utility commissions to “assure that their regulated industries take appropriate, cost-effective measures to improve” critical infrastructure. The box below includes a list of insights endorsed by NARUC.

#### **Six Insights Endorsed by NARUC**

- Consider cost recovery and prudence of investment;
- Examine exceptions from *Freedom of Information Act* provisions for proprietary utility security information;
- Include rapid sharing of information and clear communication channels during threats and for warnings;
- Continue to coordinate with other state agencies in maintaining current emergency planning;
- Pay attention to interdependencies as they relate to protecting critical infrastructure and vital assets; and
- Consider regional coordination and the impact of the interstate location of critical facilities.

While DOE continues its work with energy stakeholders these guidelines provide some insight into critical infrastructure and how infrastructure relates to state energy emergency preparedness planning. Ultimately, protection of critical infrastructure will help to mitigate the effects of an emergency.

## **B. Components of Critical Infrastructure Protection**

As described above, both DHS and DOE have worked together to develop a collection of key resources<sup>5</sup> to aid in protecting critical infrastructure and preparing, preventing and responding to energy emergencies. As part of the NIPP, the National Response Framework (NRF) was developed as a guide to conducting all-hazards response. There are many elements of the NIPP, the Energy SSP, and the NRF that will be incorporated throughout these guidelines to aid states in developing the most effective and thorough energy emergency plans and risk mitigation strategies. All states are encouraged to review the available resources along with these guidelines as they develop and refine their energy emergency plans.

---

<sup>5</sup> In September 2008, DHS published *A Guide to Critical Infrastructure and Key Resources Protection at the State, Regional, Local, Tribal, and Territorial Level*. This document contains a great deal of useful information and can be found online at: [http://www.naseo.org/eaguidelines/documents/Guide\\_to\\_CI\\_and\\_Key\\_Resources\\_Protection\\_at\\_the\\_State,\\_R.L.T&T\\_Level\\_September\\_2008.pdf](http://www.naseo.org/eaguidelines/documents/Guide_to_CI_and_Key_Resources_Protection_at_the_State,_R.L.T&T_Level_September_2008.pdf)

The cornerstone of the NIPP is the Risk Management Framework, as depicted below. The framework establishes the processes for combining consequence, vulnerability, and threat information to produce a comprehensive and systematic assessment of risks to assets, systems, networks, and functions of potential interest. The Risk Management Framework has six main steps: 1) set goals and objectives; 2) identify assets, systems, and networks; 3) assess risk based on consequences, vulnerability and threats; 4) establish priorities based on risk results; 5) develop and implement protective programs and resiliency strategies; and 6) measure effectiveness. This framework results in the identification and development of prioritized protective measures and resiliency strategies, and helps enhance critical infrastructure protection and resiliency through continuous improvements over time.

Figure 2

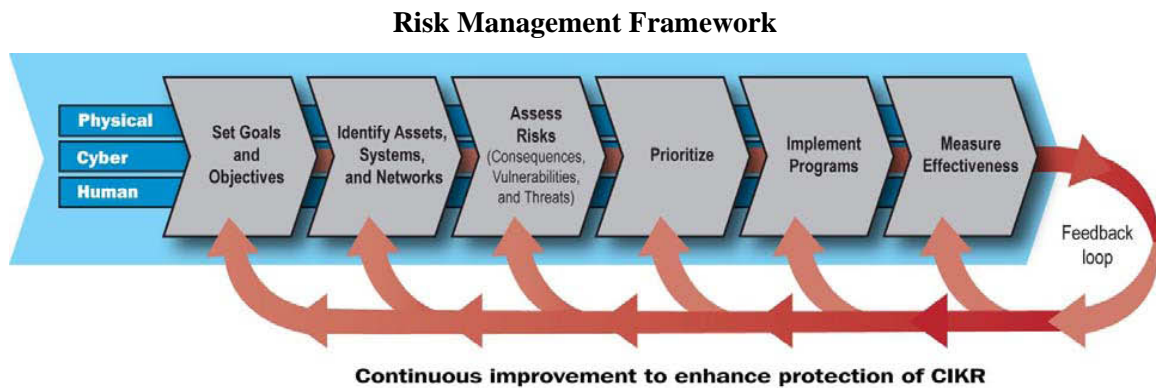

Developing State Energy Assurance Plans entails developing both a state energy emergency plan, (i.e. responding to an event) and a plan that addresses how a state is implementing the risk management framework of the NIPP, (i.e. preventing or reducing the risk of an event). Since one cannot protect or eliminate the risk of all hazards, good emergency plans are needed to ensure an effective and rapid response that reduces the negative outcomes of any given event. Some of the common components also overlap with energy emergency planning. These components include:

- |  |   |
|--|---|
| 1. Critical (physical) Assets                                      | 8. Risk Characterization  |
| 2. Threat Environment  | 9. Defining State & Territory, Regional, Local, and Tribal Roles and Responsibilities         |
| 3. Policies, Procedures and Plans                                  | 10. Protection of Sensitive Information   |
| 4. Physical and Cyber Security                                     | 11. The Role of Energy Efficiency and Renewable Energy Resources in Energy Assurance Planning |
| 5. Operations Security   |   |
| 6. Information System Network Architecture and Penetration Testing |   |
| 7. Consequence Analysis  |   |

**1. Critical (physical) Assets**

The primary assets ordinarily identified for energy preparedness include energy generation and delivery infrastructure. Some examples of these include:

- Electric generation, transmission and local distribution facilities;
- Natural gas wells, collection systems, gas processing plants, inter- and intra-state pipelines and storage; and
- Petroleum production, refining, inter- and intra-state pipelines plus over-the-road delivery systems and storage.

Ordinarily, state governments do not own or control physical energy assets. However, in a few states municipal governments own and operate utilities and, in some cases, states own or exercise authority over energy production facilities. Opinions vary about what level of detail government needs to know with regard to physical assets, however, from an emergency planning perspective, knowledge of major assets, location, and impact on the delivery of energy helps preparedness and a state's ability to respond.

## ***2. Threat Environment***

Threat has many meanings in preparedness. While following September 11<sup>th</sup> much of the focus was on the threat of terrorism, the national strategy for the physical protection of critical infrastructure takes an all hazards approach. Understanding these threats is a part of a sound vulnerability analysis and helps guide both emergency response plans and critical infrastructure risk mitigation efforts. Knowing what may cause a disruption can increase defensive steps to enhance assurance as well as create a more efficient response. Categories of attacks or threats to consider in an all-hazards approach include:

- *Deliberate attacks* caused by people (e.g. terrorists, criminals, hackers, employees);
- *Natural attacks* caused by nature (e.g., hurricanes, tornadoes, floods, wildfires, earthquakes);
- *Accidental attacks* caused by technological failure (e.g., pipeline rupture, levee breaches, chemical spills, nuclear or biological contamination); and
- *Systemic threats* caused by the physical inability of energy delivery systems to meet demand.

## ***3. Policies, Procedures and Plans***

Refining policies as well as understanding and practicing procedures are all traditional components of comprehensive energy preparedness planning. All viable energy emergency plans should be updated regularly to ensure that current policies are included and that all responders are acquainted with how response and mitigation systems are designed to work. To properly measure progress, metric goals and objectives are necessary components as well.

## ***4. Physical and Cyber Security***

Lack of sound physical and cyber security creates increased vulnerability. Energy providers are primarily responsible for their own security; however, government can help by working with energy industries to understand the extent of need, the constraints to improvement, and the costs of developing adequate security. Government can then have an effect on viable policies and rules for support. Some examples are:

- Government has existing natural gas pipeline safety rules. Continuing to work with the industry to assure that these rules are followed increases energy assurance.
- Government has extensive rules pertaining to the reliable delivery of electricity. Energy emergency planning can include general descriptions of existing physical security measures as well as illustrative descriptions of the steps energy companies take to restore power or supply. This information will help planners respond to a disruption efficiently and assist officials with their explanation to the public.
- The infrastructure of the petroleum markets is often understood in general terms only. However, the more a state knows about the location of pipelines, storage, loading terminals, preferred highway delivery routes, and the nature and location of retail outlets, the more it can do to assist in a shortage. Knowledge of regional refining facilities and competing finished product markets are other pieces of the physical structure with potential security issues affecting vulnerability.

The four main areas of cyber vulnerability are people, policy, procedure and platforms. Most security threats will originate from one of these areas. Threats from people involve social engineering, phishing schemes, and insider threats. Some examples of insufficient policies include: an inadequate security policy, an inadequate privacy policy, unnecessary system access, inadequate continuity of operations or disaster recovery plan, lax or nonexistent policies for replacing/updating network and local equipment, and an inadequate security oversight by management. A breakdown in procedures sometimes entails inadequate risk assessment process, inadequate risk management process, and inadequate incident response process. However, procedures breakdowns can also involve failures in sharing or communicating emerging threats and means to address emerging and existing threats. Platform issues include exploits of configuration, hardware, and software/firmware vulnerabilities, whether from current arrangements or upgrades. Sometimes the attacks are multipronged, exploiting multiple seemingly unrelated vulnerabilities. These are all vulnerabilities that contribute to the overall level of security threats.

### ***5. Operations Security***

State program developers are unlikely to need extensive knowledge of energy company operations security. However, it is useful to know that this security is in place and that energy companies train personnel in its implementation. Regarding operational security, the role of government is to ask questions and insist upon site-specific security measures. Public Utility Commissions (PUC) may include operational security requirements in a Certificate of Convenience and Necessity, or other similar rules, for



energy entities regulated by the state. PUC Staff needs to be up-to-date on cyber security requirements, potential threats, and understand the National Strategy for Critical Infrastructure. In some states this effort may be limited to issues that arise only in cases before the Commission that involve meeting cyber standards, issue of prudency and cost recovery. In other states this may be addressed more informally as general oversight by Commission Staff and may be a part of the state's homeland security strategy. PUC Staff should be involved in plans for changes to operations security and should have a role in examining the need for and likely results of any proposed changes.

Industry can assist state emergency responders by explaining their operations security process and practices. This will help public officials plan and respond accordingly during a shortage.

### ***6. Information System Network Architecture and Penetration Testing***

The realization that delicate and expensive critical infrastructure computerized support systems are vulnerable, clearly focuses the need to ensure that cyber security concerns are an integral part of the planning process. Fortunately, many utilities, petroleum production companies and local delivery companies use proprietary software or systems that are less vulnerable than off-the-shelf software. Several of the nation's major software companies have acknowledged this risk and have cautiously suggested that the U.S. Department of Homeland Security "should examine whether tailored government action is necessary."<sup>6</sup>

States may wish to have their own information technology specialists work with the energy industry and the federal government to improve such systems to increase energy assurance. Due to the sensitivity of such detailed information it may not be prudent to include such information in an emergency plan; however, policy makers and planners will benefit by having up-to-date knowledge of information networks and their operating characteristics (architecture). In addition, PUCs may wish to consider rules for improved information system architecture and adequate penetration testing.

### ***7. Consequence Analysis***

Consequence analysis means understanding the effects of an energy disruption. Some consequences are impacts on related energy systems while others are societal impacts such as people displaced from their homes, costs to state and local government, and loss of business income.

Widespread energy outages, such as the power failure in the Midwest and Northeast in August 2003, and the petroleum shortage that impacted southeast states following Gustav and Ike in the fall of 2008, clearly highlight the need to consider the consequences of not only energy disruptions, but also actions taken to alleviate them. It is suggested that up-to-date state plans contain sufficient information about current energy infrastructure and operations to help predict possible shortage impacts. This

---

<sup>6</sup> Associated Press in *The Baltimore Sun*, Thursday, April 1, 2004, p. 2D.

should be part of a thorough vulnerability assessment. Beyond this, planners may wish to assess the operational characteristics of downstream critical infrastructure and account for these when responding to an emergency. *It is strongly recommended that this be undertaken in close coordination with large power and energy providers whose emergency response actions can lead to devastating downstream system failure.* Some potential downstream effects might be:

- Failure of petroleum supply infrastructure to function when electric power is interrupted;
- Failure of water supply and purification systems to operate when power is lost;
- Loss of power to buildings, critical air handling, or environmental equipment;
- Outages at refineries and gas processing plants due to electric outages or curtailments in natural gas supply;
- Secondary utility system time-to-failure when back-up storage is exhausted; and
- Failure of information system networks.

The response to downstream impacts may be to alter operational and emergency procedures, provide alerts and warnings where none have been given in the past, or seek to assure that automatic alternatives and backup are understood and acquired.

## **8. Risk Characterization**

Up-to-date energy emergency plans often contain a vulnerability analysis associating state energy infrastructure with demographics. Risk is also associated with operating any type of energy power system or energy delivery system, and better understanding of this will allow planners to pre-determine the magnitude of possible damage for any given geographical area of impact. Planners should also take into consideration the manner in which the affected demographics will respond to an emergency and the risks associated with those responses.

Most states already prioritize energy user risk through utility outage and restoration rules or through a critical user list contained in a state petroleum set-aside. *It is suggested that planners re-examine existing priorities, make them current, and update them periodically.* Adequate planning may also determine which prioritized energy end-users can best protect themselves with backup supply or access to energy alternatives.

## **9. Defining State & Territory, Regional, Local, and Tribal Roles and Responsibilities**

*This section was abstracted verbatim from “A Guide to Critical Infrastructure and Key Resources Protection at the State, Regional, Local, Tribal, and Territorial Level” September 2008, U.S. Department of Homeland Security.*

In order to effectively mitigate risk, the NIPP sets out a number of responsibilities for state, local, tribal, and territorial governments and regional organizations. These are

summarized below. Collectively, these efforts create a protective envelope for our Nation's Critical Infrastructure and Key Resources (CIKR). These non-federal efforts are the most visible and tangible to many of the owners and operators—as well as to the public in general. Further increasing partnerships among these organizational levels is crucial towards achieving the highest level of preparedness and risk mitigation.

**State (and territorial) governments**—should establish CIKR partnerships; facilitate coordinated information sharing, and enable planning and preparedness for CIKR protection within their jurisdictions. They serve as crucial coordination hubs, bringing together prevention, protection, response, and recovery authorities, capacities; and resources among local jurisdictions, across sectors, and between regional entities. States and territories also act as conduits for requests for federal assistance when the threat or incident situation exceeds the capabilities of public and private sector CIKR partners at lower jurisdictional levels. States receive CIKR information from the federal government to support national and state CIKR protection and resiliency programs.

State and territorial governments should develop and implement state- or territory-wide CIKR protection programs that reflect the full range of NIPP-related activities. State/territorial programs should address all relevant aspects of CIKR protection, leverage support from homeland security assistance programs that apply across the homeland security mission area, and reflect priority activities in their strategies to ensure that resources are effectively allocated. Effective statewide and regional CIKR protection efforts should be integrated into the over-arching homeland security program framework at the state or territory level to ensure that prevention, protection, response, and recovery efforts are synchronized and mutually supportive. CIKR protection at the state/territory level cuts across all sectors present within the state/territory and should support national, state, and local priorities. The program should also explicitly address unique geographical issues, including trans-border concerns, as well as interdependencies among sectors and jurisdictions within those geographical boundaries.

Specific CIKR protection-related activities at the state/territorial level include:

- Acting as a focal point for and promoting the coordination of protective and emergency response activities, preparedness programs, and resource support among local jurisdictions and regional partners;
- Developing a consistent approach to CIKR identification, risk determination, mitigation planning, and prioritized security investment, and exercising preparedness among all relevant stakeholders within their jurisdictions;
- Identifying, implementing, and monitoring a risk management plan and taking corrective actions as appropriate;
- Participating in significant national, regional, and local awareness programs to encourage appropriate management and security of cyber systems;
- Acting as conduits for requests for federal assistance when the threat of current situation exceeds the capabilities of state and local jurisdictions and private entities resident within them;
- Facilitating the exchange of security information, including threat assessments and other analysis, attack indications and warning, and advisories, within and across jurisdictions and sectors therein;

- Participating in and coordinating with the existing NIPP sector partnership model, including Government Coordinating Councils (GCCs) like the state, local, tribal, and territorial GCC; Sector Coordinating Councils (SCCs); and other CIKR governance efforts and SSP planning efforts relevant to the given jurisdiction to include the state's or jurisdiction's customized version of a sector partnership model, such as combined GCCs/SCCs which demand less support [Note: it is not necessary to create parallel councils at the state level, although this may be desired in some states or regions];
- Ensuring that funding priorities are addressed and that resources are allocated efficiently and effectively to achieve the CIKR protection mission in accordance with relevant plans and strategies;
- Sharing information on CIKR deemed critical from national, state, regional, local, tribal, and/or territorial perspectives to enable prioritized protection and restoration of critical public services, facilities, utilities, and processes within the jurisdiction;
- Addressing unique geographical issues, including trans-border concerns, dependencies, and interdependencies among the sectors within the jurisdiction;
- Identifying and implementing plans and processes for increases in protective measures that align to all-hazards warnings, specific threat vectors as appropriate, and each level of the Homeland Security Advisory System (HSAS);
- Documenting lessons learned from pre-disaster mitigation efforts, exercises, and actual incidents, and apply that learning, where applicable, to CIKR protection;
- Providing response and protection where there are gaps and local entities lack resources to address these gaps;
- Identifying and communicating state and territorial needs or requirements for CIKR-related R&D to DHS; and
- Providing information, as part of the grants process and/or homeland security strategy updates, regarding state priorities, requirements, and CIKR-related funding projections.

**Regional CIKR partnerships**—include a variety of public-private sector initiatives that cross jurisdictional and/or sector boundaries and focus on homeland security preparedness, protection, response, and recovery within or serving the population of a defined geographical area. Specific regional initiatives range in scope from organizations that include multiple jurisdictions and industry partners within a single state to groups that involve jurisdictions and enterprises in more than one state and across international borders. In many cases, state governments also collaborate through adoption of interstate compacts to formalize regionally based partnerships regarding CIKR protection.

CIKR partners leading or participating in regional initiatives are encouraged to capitalize on the larger area- and sector-specific expertise and relationships to:

- Promote collaboration among CIKR partners in implementing NIPP-related CIKR risk assessment and protection activities;
- Facilitate education and awareness of CIKR protection efforts occurring within their geographical areas;

- Coordinate regional exercise and training programs, including a focus on CIKR protection collaboration across jurisdictional and sector boundaries;
- Support threat-initiated and ongoing operation-based activities to enhance protection and preparedness, as well as to support mitigation, response, and recovery;
- Work with state, local, tribal, territorial, and international governments and the private sector, as appropriate, to evaluate regional and cross-sector CIKR interdependencies, including cyber considerations;
- Conduct appropriate regional planning efforts and undertake appropriate partnership agreements to enable regional CIKR protection activities and enhanced response to emergencies;
- Facilitate information sharing and data collection between and among regional initiative members and external partners;
- Share information on progress and CIKR protection requirements with DHS, the SSAs, the states, and other CIKR partners, as appropriate; and
- Participate in the NIPP sector partnership model, as appropriate.

Local governments represent the front lines for homeland security and, more specifically, for CIKR protection and implementation of the NIPP risk management framework and sector partnership model. They provide critical public services and functions in conjunction with private sector owners and operators. In some sectors, local government entities own and operate CIKR such as water, storm water, and gas and electric utilities. Most disruptions or malevolent acts that impact CIKR begin and end as local situations. Local authorities typically shoulder the weight of initial prevention, response, and recovery operations until coordinated support from other sources becomes available, regardless of who owns or operates the affected asset, system, or network. Local governments drive emergency preparedness, lead and support NIPP and SSP implementation activities, and encourage the participation of local CIKR partners; including government agencies, owners and operators, and private citizens in the communities they serve.

CIKR protection focus at the local level includes, but is not limited to:

- Acting as a focal point for and promoting the coordination of protective and emergency response activities, preparedness programs, and resource support among local agencies, businesses, and citizens;
- Developing a consistent approach at the local level to CIKR identification, risk determination, mitigation planning, and prioritized security investment, and exercising preparedness among all relevant CIKR partners within the jurisdiction;
- Identifying, implementing, and monitoring a risk management plan, and taking corrective actions as appropriate;
- Participating in significant national, regional, and local awareness programs to encourage appropriate management and security of cyber systems;
- Facilitating the exchange of security information, including threat assessments, attack indications and warnings, and advisories, among CIKR partners within the jurisdiction;

- Participating in the NIPP sector partnership model, including GCCs, SCCs, State Local, Tribal and Territorial Government Coordinating Council (SLTTGCC) and other CIKR governance efforts and SSP planning efforts relevant to the given jurisdiction, through direct participation, coordination, or establishment of local coordinating councils as appropriate;
- Ensuring that funding priorities are addressed and that resources are allocated efficiently and effectively to achieve the CIKR protection mission in accordance with those plans and strategies in effect at the national, state, and local levels;
- Sharing information with CIKR partners, as appropriate through Homeland Security Information Network (HSIN) and other channels, on CIKR deemed critical from the local perspective to enable prioritized protection and restoration of critical public services, facilities, utilities, and processes within the jurisdiction;
- Addressing unique geographical issues, including trans-border concerns, dependencies, and interdependencies among agencies and enterprises within the jurisdiction;
- Identifying and implementing plans and processes for step-ups in protective measures that align to all-hazard warnings, specific threat vectors as appropriate, and each level of the HSAS;
- Integrating CIKR protection into existing plans, such as hazard mitigation plans, emergency operations plans, and contingency plans;
- Documenting lessons learned from pre-disaster mitigation efforts, exercises, and actual incidents, and applying that learning, where applicable, to the CIKR protection context;
- Conducting CIKR protection public awareness activities;
- Conducting CIKR exercises and training; and
- Assuring energy resilience through energy self reliance.

**Tribal government**—roles and responsibilities regarding CIKR protection generally mirror those of state and local governments as detailed above. Tribal governments are accountable for the public health, welfare, and safety of tribal members, as well as the protection of CIKR and continuity of essential services under their jurisdiction. Under the NIPP partnership model, tribal governments ensure close coordination with federal, state, local, and international counterparts to achieve synergy in the implementation of the NIPP and SSP frameworks within their jurisdictions. This is particularly important in the context of information sharing, risk analysis and management, awareness, preparedness planning, protective program investments and initiatives, and resource allocation.

### ***10. Protecting Sensitive Information***

Much of the information for critical infrastructure preparedness will either be proprietary for private companies or sensitive for the protection of the nation. Common sense dictates not publishing detailed location maps that could be used by criminals and terrorists. Less apparent is imparting too much detail about information system architecture, consequence analysis, or other vulnerability assessments that seem less

direct. A state energy emergency plan may be developed with more knowledge about these characteristics than actually needs to appear in the plan. Most of the emergency protocols contained in a state energy emergency plan are already public knowledge. Since a major purpose of such a plan is to organize these items in a meaningful way for efficient response it may be prudent to keep some response information general rather than specific. It may also be better to keep secure information stored outside of the plan in more than one location for use by authorized individuals only. For additional information on this issue see the NARUC [Information Sharing Practices In Regulated Critical Infrastructure States: Analysis & Recommendations](http://naruc.org/cipbriefs/) that can be found at <http://naruc.org/cipbriefs/>.

In addition, because of the *Freedom of Information Act* and sunshine laws in many states, there is a question as to whether sensitive information can be protected from disclosure. In the final analysis accomplishing this is a delicate task and will require careful coordination and cooperation among stakeholders.

### **11. *The Role of Energy Efficiency and Renewable Energy Resources in Energy Assurance Planning***

States have promoted energy efficiency and the use of renewable energy since the early 1970's. Renewable energy and energy efficiency approaches can be linked in strategic ways with state and regional energy assurance planning to help build resiliency. This would involve two approaches. First is a tactical project approach that could include renewable back-up power to support critical facilities in the event of an outage. The second is a longer-term resource planning approach that diversifies energy sources by increasing the use of renewable resources and energy efficiency. There are three primary reasons for considering the impact of alternative energy sources on energy assurance: 1) more accurate assessment of energy assurance risk reduction, 2) understanding the potential risks and benefits in displacing conventional energy, and 3) knowing where alternatives can provide immediate protection and safety while buying time for response and repair while energy supplies are restored.

**Reducing Risk**—The use of various alternatives to conventional electricity, petroleum, and natural gas has the potential to enhance energy security by helping to distribute generation and diversify supply among various locations. This can reduce, but not eliminate, the risk of relying on the concentrated power production or energy acquisition from relatively few locations such as power plants, pipelines, and grids. In other cases, when conventional gasoline and diesel fuel are in short supply, it may be possible to obtain a variety of local and regional alternative fuels such as ethanol or biodiesel.

Risk can best be understood by examining energy supply and demand at various times. Risk reduction is best accomplished as a result of longer term investment and changes to the energy infrastructure. In addition, because it is impractical to eliminate all risk, effective short-term responses are also needed to reduce the consequences and allow for more rapid recovery. Efforts to both assure effective emergency response, and reduce risks in the long-term, need to be considered. A simple example is a home located in a northern climate that is well insulated. It can tolerate a winter power outage longer

because of reduced heat loss allowing more time for power restoration. With the inclusion of a supplemental source of heating, one further reduces the degree of the potentially harmful impacts.

**Understanding the Advantages and Disadvantages**—In utilizing alternatives it is important to understand advantages and disadvantages offered by different forms of alternative energy. For further details see Appendix G.

Table 1 outlines energy alternatives divided into three types under a supply and demand classification. These categories are illustrative only.

<b>Table 1: Types and Examples of Energy Alternatives that May Lower Energy Assurance Risk from Conventional Energy Sources</b>		
<i>Supply Side</i>		<i>Demand Side</i>
<i>Renewable Resources</i>	<i>Supplemental Resources</i>	<i>Crossover Resources</i>
Wind Energy	Combined Heat and Power	Energy Efficiency and Smart Grid Programs
Solar & Wind Energy Renewable Energy Portfolio Standards	Distributed Generation	Load Management and Smart Grid
Biomass <ul style="list-style-type: none"> <li>• Ethanol/Biodiesel</li> <li>• Waste <ul style="list-style-type: none"> <li>○ Landfill gas</li> <li>○ Anaerobic Digestion</li> </ul> </li> </ul>	Hybrid Transportation Technology <ul style="list-style-type: none"> <li>• Electric Hybrid</li> <li>• Fuel Cells <ul style="list-style-type: none"> <li>○ Natural gas</li> <li>○ Hydrogen</li> </ul> </li> </ul>	Demand Response Management <ul style="list-style-type: none"> <li>• Smart Grid</li> <li>• Time-of-Day Pricing</li> <li>• Remote Switching</li> </ul>
Hydropower	Enhanced Battery Technology	Energy Building Codes
Geothermal		Energy Star Appliances and Standards

Supply side renewable resources include wind, solar, biomass, hydro- and geothermal power. Wind and biomass especially, have become prominent in recent years. Renewable energy portfolios (REP) further support the integration of these technologies as part of the nation’s energy systems.

**What States Can Do to Enhance Alternatives in Energy Assurance Planning**—Here are some suggestions to consider when assessing alternatives in energy assurance planning:

1. *Create and maintain a statewide inventory of energy alternatives.* Energy alternatives will inevitably reduce risk whether or not their existence is identified. However, in order to make the best use of them, officials should know what they are and where they are located.
2. *Calculate the potential contribution to state energy supply from power-producing alternatives and demand reduction programs.* This is the next logical step if states want to know how much conventional power alternatives may displace. Knowing the energy value of alternative energy fuels and infrastructure allows for more accurate assessment of energy assurance risk.
3. *Work with alternative energy supply companies to assure emergency safety protection while conventional power is restored.* Knowledge of the location and



4. *Assure that renewable energy sources are grid connected.*

Energy efficiency, renewable energy, and CHP systems can help diversify and improve the resiliency of energy supply and utilization. It is essential that the facilities and infrastructures responding to an emergency (e.g., “911” and state emergency communication centers) have reliable secondary energy sources and backup power systems. The installation of resources such as PV, fuel cells, wind power, and CHP, which can operate independently from the grid to supplement or replace conventional generation, is vital to ensure alternatives to transportation fuels and enhance the resiliency of the end use sectors in weathering the effects of disasters, whether natural or manmade. Appendix G provides additional detail on how some states are diversifying energy resources as part of their overall approach to energy assurance and emergency preparedness.

**Examples of Incorporating Renewable Energy into Energy Assurance Planning**

***The Use of Renewable Energy for Disaster Recovery***

November 2008: Two new alternative energy products shepherded by NextEnergy are being tested and refined. The first is Titan Energy Worldwide’s REMUS unit (Renewable Energy Mobile Utility System) now being tested on NextEnergy’s Alternative Fuels Platform. REMUS is a 7-ton rechargeable battery pack used to supply computer-grade electricity in the field for military applications. REMUS can recharge its batteries in numerous ways; via fossil fuel generation, portable solar panels, even wind power. Once it fulfills its military obligations, REMUS can then be mass produced in high quantities for many other non-military applications in the future.

A third example being tested in Israel by ZenithSolar is a Combined Heat and Power (CHP) concentrated photovoltaic (CPV) system that is providing 75 percent of its power output as heat and 25 percent as electricity. These units are relatively inexpensive, presently starting at around \$20,000 for one 4 foot by 4 foot CPV module. See Appendix G.

The fourth example is the City of Troy, New York, which operates radio communications systems for police, fire, and general government functions. These systems utilize remote receiver locations to relay the transmissions from low power handheld radios back to the communications center. A 10 kW UNI-SOLAR System was installed in 2004 at a relay location and is capable of fully powering this location with the power grid serving as the back-up power to the solar system.

**C. Energy Assurance Planning for Utilities**

Taken from the perspective of electric and gas utilities, NARUC has suggested a list of planning criteria that incorporate many of the critical infrastructure considerations

suggested by DOE as well as state energy office planners. While there is no national government-based organization as closely tied to the petroleum industry as NARUC is to the utility industry, these criteria may also be applied to the protection of petroleum assets.<sup>7</sup> For example, state planners may wish to ask local petroleum delivery companies, as well as national entities who produce and transport finished oil products, if they have made appropriate business decisions regarding investments in enhanced asset security.

#### Questions to Explore Concerning Critical Infrastructure:

- Have key energy assets been identified, digitally mapped, and ranked from a security and vulnerability perspective?
- Have critical physical, cyber, and vulnerability risks been identified?
- Have interdependencies, such as the linkage between natural gas supply and the reliability of gas-fired generation, been quantified?
- What is the planning horizon and geographic scope of the energy assessment process? Does it accurately characterize and quantify extended and multiple contingencies?
- Have appropriate options for response to these vulnerabilities been developed and tested?
- Have downstream impacts on other sectors (e.g., water, transportation, and telecommunications) and societal impacts been identified?
- Has the energy sector presented an appropriate business case for making security investments and sought to recover prudent critical infrastructure investments?
- Has the energy sector implemented changes that will enhance reliability and security, including business continuity?
- How has security been integrated into the ongoing business strategy of the energy sector?
- Have investments in utility and end-user efficiencies or alternative energy sources been investigated to minimize the adverse impacts resulting from an energy shortage or emergency?
- Has a mechanism been established to update planning and response plans?
- Has there been a “post-event” activity to improve the energy sector’s best practices?

#### **D. Cyber Security**

In recent years, the necessity for enhanced cyber security has become an increasingly high priority for the public and the private sectors. The threat of a cyber attack is present within any system that relies on information communication technology and can be detrimental on many levels to consumers, business owners, government, and infrastructure. With a continual and ever-growing dependence on information technology throughout the world, appropriate attention to creating sound cyber security

---

<sup>7</sup> NARUC Committee on Critical Infrastructure Technical Briefs. *Paper 3: A Primer on Energy Assurance for Public Utility Commissions*. April 2005, p. 11-12. The paper discusses both federal and state actions to date regarding the sharing of critical infrastructure information and provides a framework for future cooperation and efforts to harmonize information sharing among state commissions, the FERC and the Department of Homeland Security. [http://www.naruc.org/Publications/CIP\\_EnergyAssurancePrimer\\_3.pdf](http://www.naruc.org/Publications/CIP_EnergyAssurancePrimer_3.pdf)

is a critical element of a robust state energy assurance plan. This section provides an overview of what a state should consider in energy emergency planning, including available cyber security resources to assist in planning, prevention, and recovery.

### 1. Cyber Security Threats

- In 2001, hackers penetrated the California Independent System Operator, which oversees most of the state's electricity transmission grid; attacks were routed through California, Oklahoma, and China.
- Ohio Davis-Besse nuclear power plant safety monitoring system was offline for 5 hours due to Slammer worm in January 2003.
- Aaron Caffrey, 19, brought down the Port of Houston in October, 2003. This is thought to be the first well-documented attack on critical U.S. infrastructure.
- In March 2005, security consultants within the electric industry reported that hackers were targeting the U.S. electric power grid and had gained access to U.S. utilities electronic control systems. In a few cases, these intrusions had “caused an impact.”
- In April 2009, the Wall Street Journal reported that spies hacked into the U.S. electric grid and left behind computer programs that could allow them to disrupt service.

#### Primary Types of Cyber Threats

Type of Threats	Description	Impacts if Successful
Modification of data in transit	Modification of transactions across networks.	Financial losses, inconsistent data, breakdown in public trust.
Denial of service	Attacks that slow servers or networks down or bring them to a halt.	Prevent business transactions, frustrate potential users, and damage credibility.
Theft of information /espionage	Penetration attacks resulting in theft of information / intelligence.	Breach of legal and regulatory requirements to maintain confidentiality, financial impacts, breakdown of public trust, damage credibility.
Unauthorized use of resources	Penetration of systems to allow attackers to utilize services—computers, phones, and data. This can also include taking control of servers using them to send spam or launch distributed denial of services attacks.	Financial loss, potential liability, compromise of systems and networks, potential “leapfrogging” (moving ahead in order of service).
Data tampering	Modification of content / format of web pages, data (e.g. tax, medical, criminal records).	Damage credibility, legal ramifications of falsification of data.
“Spoofing”	Impersonating an address internal to a network to gain access. E-mail impersonation.	Potential compromise or destruction of system, damage credibility.
“Sniffing”	Monitoring network traffic for information (passwords, credit card numbers, etc.)	Compromise or damage of systems and credibility.
Viruses / Internet vandals	Malicious programs and code capable of damage and self-replication.	Business expenses, system down time, lost productivity.
Disasters (natural, technological, human-caused)	Floods, fires, severe storms, act of sabotage / terrorism.	Loss of life and/or critical resources, services to the public, and property.
Physical intruders, vandalism, and theft of equipment	Destruction or theft of resources.	Business expenses, system down time, lost productivity.
Cyber intrusions, of control systems*	This can potentially destroy equipment or disable control systems that could result in infrastructure failures or the use of infrastructure as vehicles of attack	Loss of life and/or critical resources, services to the public, and property damage to critical control systems and equipment.
“Information Warfare”	Deliberate offensive and defensive use of information and information systems to deny, exploit, corrupt, or destroy an adversary’s information, information-based processes, information systems, and computer-based	(Information warfare could utilize any of the threats listed in this table, conceivably achieving any or all of the impacts listed. Information warfare is most often used between nations or between major business competitors

	<p>networks while protecting one's own. Primary means of conducting information warfare include:</p> <ul style="list-style-type: none"> <li>➤ Psychological operations to affect the adversary's reasoning.</li> <li>➤ Electronic operations to deny accurate information to the adversary.</li> <li>➤ Deception operations to mislead about one's own capabilities or intentions.</li> <li>➤ Physical destruction of the adversary's information networks and systems.</li> <li>➤ Security measures to keep adversaries from learning about one's own capabilities and intentions.</li> <li>➤ Information attack to directly corrupt an adversary's information without being detected.</li> </ul>	<p>to gain an advantage in a major military operation or business competition.)</p>
--	---	---

Sources: Michigan Department of Information Technology web site; Center for Strategic and International Studies web site; Institute for the Advanced Study of Information Warfare web site. \*Category added to reflect control system exploits.

## ***2. Cyber Security Considerations in Energy Assurance Planning***

The following is a list of some, but not all, considerations a state should incorporate into developing an energy assurance planning document to address cyber security issues.

- Consider vulnerabilities to cyber attacks and establish communication lines early among the appropriate parties;
- Familiarize yourself with available cyber security resources at the state and federal level as well as within the private sector;
- Educate and train employees about cyber preparedness and good information technology practices;
- Ensure home and office electronic filing systems are backed-up on a regular basis and have up-to-date virus protection;
- Insist that key emergency responders have hard copies of contact information and response plans are readily available;
- Prepare a response plan that includes a provision that assumes the federal government may also be under a cyber attack, and ensure that it is updated regularly; and
- Similar to electricity power emergencies, cyber systems should have “black start” capability. That is, a backup should be available that is outside of, but capable of connecting to, and repairing any compromised IT system that is critical to energy delivery, safety, and security.

## ***3. Federal and State Cyber Security Resources***

There is much being done to address cyber security and it is important that states familiarize themselves with the activities underway and resources available at both the federal and state level to address cyber attacks.

*U.S. Department of Homeland Security*—the Homeland Security Act of 2002 required the first-ever all-encompassing coordinated national critical infrastructure and key resources protection effort. As part of this effort, the Information Technology Sector Specific Plan (IT SSP) was collaboratively developed by the Department of Homeland

Security's National Cyber Security Division as the Sector Specific Agency for the IT Sector and sector security partners, including the IT Sector Coordinating Council and IT Government Coordinating Council. The IT SSP does not provide specific procedures for individual Sector entities operations and is not designed to guide federal or state government efforts to respond to events; rather it is a planning document that provides guidance on how public and private partners will work together to protect IT Sector CI/KR. The IT SSP is a living document—designed to evolve with the ever-present threats and vulnerabilities faced by our nation. <http://www.dhs.gov/xlibrary/assets/nipp-ssp-information-tech.pdf>

*The United States Computer Emergency Readiness Team (US-CERT)*— Established in 2003, as a partnership between the Department of Homeland Security and the public and private sectors to protect the nation's internet infrastructure by coordinating defense against and response to cyber attacks, US-CERT is responsible for:

- Analyzing and reducing cyber threats and vulnerabilities;
- Disseminating cyber threat warning information; and
- Coordinating incident response activities.

US-CERT interacts with federal agencies, industry, the research community, state and local governments, and others to disseminate reasoned and actionable cyber security information to the public—providing a way for citizens, businesses, and other institutions to communicate and coordinate directly with the United States government about cyber security. <http://www.us-cert.gov/aboutus.html>

*U.S. Department of Energy* -- The Cyber Security Office within the U.S. Department of Energy's Office of the Chief Information Officer is responsible for implementing and maintaining a comprehensive cyber security program that is effective across its diverse missions and large array of interdependent networks and information systems. The Office published a revitalization plan in 2006 designed to strengthen the Department's networks and establish a vital, institutionalized cyber security program. <http://cio.energy.gov/cybersecurity.htm>  
<http://cio.energy.gov/documents/2006DOECyberSecurityRevitalizationPlan.pdf>

*The North American Electric Reliability Corporation (NERC)*— Standards CIP-002 through CIP-009 (the Critical Cyber Asset Identification portion of the Critical Infrastructure Protection standards) provide a cyber security framework for the identification and protection of Critical Cyber Assets to support reliable operation of the Bulk Electric System. These are mandatory and enforceable standards that entail a comprehensive compliance program that includes periodic reporting, self-certification spot check, and compliance audits.

- CIP-002-1—Critical Cyber Asset Identification, requires the identification and documentation of the Critical Cyber Assets associated with the Critical Assets that support the reliable operation of the Bulk Electric System. These Critical Assets are to be identified through the application of a risk-based assessment.

- CIP-003-1—Security Management Controls, requires that Responsible Entities have minimum security management controls in place to protect Critical Cyber Assets.
- CIP-004-1—Personnel and Training, requires that personnel having authorized cyber or authorized unescorted physical access to Critical Cyber Assets, including contractors and service vendors, have an appropriate level of personnel risk assessment, training, and security awareness.
- CIP-005-1—Electronic Security Perimeter(s), requires identification and protection of the Electronic Security Perimeter(s) inside which all Critical Cyber Assets reside, as well as all access points on the perimeter.
- CIP-006-1—Physical Security of Critical Cyber Assets, is intended to ensure the implementation of a physical security program for the protection of Critical Cyber Assets.
- CIP-007-1—System Security Management, requires Responsible Entities to define methods, processes, and procedures for securing those systems determined to be Critical Cyber Assets, as well as the non-critical Cyber Assets within the Electronic Security Perimeter(s).
- CIP-008-1—Incident Reporting and Response Planning, ensures the identification, classification, response, and reporting of Cyber Security incidents related to Critical Cyber Assets.
- CIP-009-1—Recovery Plans for Critical Cyber Assets, ensures that recovery plan(s) are put in place for Critical Cyber Assets and that these plans follow established business continuity and disaster recovery techniques and practices.

NERC developed these standards to recognize the differing roles each entity plays in the operation of the Bulk Electric System, the criticality and vulnerability of the assets needed to manage Bulk Electric System reliability, and the risks to which they are exposed. The Standards are available at: <http://www.nerc.com/page.php?cid=2|20>

In October 2007, US House of Representative, Subcommittee on Emerging Threats, Cyber security, and Science and Technology held a hearing on the cyber threat to control systems, focusing specifically on the susceptibility to the Bulk Power System discovered by engineers at the Idaho National Laboratory. The vulnerability, known as “Aurora,” could enable a targeted attack on infrastructure connected to the electric grid, potentially destroying the machines and causing catastrophic losses of power for an undeterminable amount of time. Since the hearing NERC has been working to reduce the risk of this vulnerability to power systems.

*Federal Bureau of Investigation (FBI)*—InfraGard is a program that began in 1996 as a local effort to gain support from the information technology industry and academia for the FBI’s investigative efforts in the cyber arena. The program expanded over time and exists today as an association of businesses, academic institutions, state and local law enforcement agencies, and other participants dedicated to sharing information and intelligence to prevent hostile acts against the United States. The goal of InfraGard is to promote ongoing dialogue and timely communication between members and the FBI.

InfraGard members gain access to information that enables them to protect their assets and in turn give information to government that facilitates its responsibilities to prevent and address terrorism and other crimes. <http://www.infragard.net/>

Multi-State Information Sharing and Analysis Center (MS-ISAC) is a collaborative organization with participation from all fifty states, the District of Columbia, local governments, and U.S. Territories with a mission to provide a common mechanism for raising the level of cyber security readiness and response in each state and with local governments and the territories. The MS-ISAC provides a central resource for gathering information on cyber threats to critical infrastructure from the states and providing two-way sharing of information between and among the states and with local government. <http://www.msisac.org/>

National Institute of Standards and Technology (NIST)— the Energy Independence and Security Act (EISA) of 2007, assigned NIST the primary responsibility to coordinate development of a framework that includes protocols and model standards for information management to achieve interoperability and assure cyber security of the smart grid devices and systems. NIST has established itself as an agency that is technically knowledgeable and able to work collectively with industry and other government agencies, including the Department of Energy (DOE) and the Federal Energy Regulatory Commission (FERC). <http://nist.gov/smartgrid/>

#### ***4. State Role in Cyber Security in the Energy Sector***

States can play a supportive role in assuring adequate levels of cyber security in the energy sector. In the petroleum area, the American Petroleum Institute has adopted guidelines<sup>8</sup> that address the needs of the petroleum sector and it is important that states that have responsibilities for petroleum are aware of those standards. In the area of gas and electric, Public Utility Commissions (PUC) have a role in assuring the adequacy and reliability of natural gas and electricity and this extends to cyber security which, if breached, could impact the reliability of supply. In some PUCs this activity may be limited to actions taken as part of formal proceedings. In other states, in addition to case work, more informal discussions occur between PUC and utilities and such efforts may be tied to the state's homeland security and critical infrastructure efforts. Efforts underway to implement the Smart Grid will mean a substantial increase in the amount of cyber-based communications within the Power Grid. It will be important that various standards under development are properly implemented and maintained as an integral component of an overall cyber security effort. The cyber security strategy for the Smart Grid must examine both domain-specific and common requirements when developing a mitigation strategy to ensure interoperability of solutions across different parts of the infrastructure. The primary goal is to ensure that a comprehensive evaluation of the systems and components of the Smart Grid is completed.

---

<sup>8</sup> Security Guidelines for the Petroleum Industry, American Petroleum Institute, April 2005, *second edition*. See Section 7.0: <http://www.api.org/policy/otherissues/upload/Security.pdf>

Public Utility Commissions may have a significant role to play in implementing a secure Smart Grid, incorporating cost recovery in rates, assuring necessary cyber security standards have been implemented, and assuring that investments made with federal matching Smart Grid funding meet the federal requirements. It is important that PUCs, in states where it is allowed, work with the private sectors to ensure that there are measures in place that will protect critical energy systems, as well as both water and telecommunications facilities, in the event of an emergency. It is essential that PUCs help to create networks among utility regulators and other federal, state, local, and private sectors to address cross-sector issues. As part of this effort NIST has developed a three phase plan to help implement the Smart Grid. Phase One will identify an initial set of existing consensus standards and develop a roadmap to help fill the gaps. Phase Two establishes public and private Standards Panels to provide ongoing recommendations for new or revised standards. Finally, Phase Three is designed to test and certify the framework.

Working with industry, government, and consumer stakeholders, NIST is expediting the development of standards critical to achieving a reliable and interoperable Smart Grid. The interoperability of the Smart Grid is extremely important to its performance, given that it enables both integration and two-way communication among the many interconnected elements of the electric power grid. The accelerated development of the Smart Grid technology is one of the primary objectives of the American Recovery and Reinvestment Act. However, it can be argued that by moving too quickly there are some vital points that could be overlooked. For example, the risks are similar to what happens when computers are linked over the internet in that certain weaknesses can be exploited in the way computers talk to each other, and hackers can seize control of computers. In the case of the Smart Grid, better communication between utilities and the meters at individual homes and businesses increases the risk that someone could control the power supply for a single building, or an entire neighborhood, leaving customers vulnerable to attacks.

While there are many requirements that may be applicable to the Smart Grid, currently only the NERC Critical Infrastructure Protection (CIP) documents are mandatory for a specific domain of the Smart Grid. Because the cyber security requirements are not unique across the documents, a cross-reference matrix is being developed, to help assist in assessing and selecting the requirements necessary. This matrix will map the requirements and controls listed in the Catalog of Control Systems Security: Recommendations for Standards Developers, which was published by the Department of Homeland Security in 2008.

State agencies and the private sector are increasingly relying on web and internet based services to conduct business operations. Cyber security must be an integral component of these efforts. In addition, plans for disaster recovery, business continuity and Continuity of Operations Plans (COOP) are an important aspect to assure that these systems can be rapidly returned to service if attacked or physically destroyed, especially if they support critical functions. By addressing essential employees, required facilities, computer system records and back-up data systems, agencies are able to minimize the damages and losses in the event of an attack. State agencies are encouraged to assure



that cyber security, critical cyber systems, and their recovery are incorporated within their Continuity of Operations Plans and should encourage businesses they work with as partners in critical infrastructure protection to also address this area of need.

Finally, state agencies should have, or develop some level of, in-house understanding and expertise on cyber security. By doing so as they prepare assurance plans, or related response documents, they can work to assure that these requirements are met. Becoming familiar with the various standards that are in place, and those that might be developed, that govern cyber security requirements is important to adequately carry out regulatory and programmatic responsibilities. This is clearly an area for which attention is growing and one that needs to be the focus of attention by the staff of energy offices and Public Utility Commissions. Those agencies that do not currently have individuals assigned to this responsibility should give serious consideration to assuring that they have some level of knowledge to address this important issue.

### **III. DEFINE AND CLARIFY ORGANIZATIONAL RELATIONSHIPS & RESPONSIBILITIES**

---

This section discusses federal, state, and local government roles in energy emergency planning and outlines questions to consider when defining these roles in a state's plan.

#### **A. Who has Legal Authority in the State During an Energy Emergency?**

All states are presumed to have legal authority for general emergencies and most have laws pertaining to energy emergencies; however, confirming the roles of your state in both general and energy emergencies is a crucial first step in planning. Many states depend upon their emergency management (e.g. homeland security or civil defense) organization for energy emergency planning and response. Others may focus energy emergency responsibilities on some or all of several groups that might be involved. These responsibilities can be grouped into four broad categories:

1. Monitoring the energy supply system in order to detect any unusual imbalances that indicate the potential for an energy emergency and, if so, to advise the appropriate state officials.
2. Developing, administering, or coordinating energy emergency contingency plans.
3. Communicating with federal, state, and local agencies related to energy emergency planning and management.
4. Maintaining ongoing contact with components of the energy industry including regulated utilities, cooperatives, municipally-owned, and unregulated providers.

#### **B. What is the Relationship of Legal Authorities to the State's Emergency Plans?**

State emergency or disaster plans are designed to delineate responsibilities among state agencies and between the state and local jurisdictions. Beyond this definition, these plans seek to define the relationship of both state and local response mechanisms to the federal emergency management system. The *Emergency Support Functions* under the *National Response Framework* provide guidance on these relationships.

The *NRF* is an all-discipline, all-hazards plan that establishes a single, comprehensive framework for the management of domestic incidents. It provides the structure and mechanisms for the coordination of federal support to state, local, and tribal incident managers and for exercising direct federal authorities and responsibilities. The *NRF* assists in the homeland security mission of preventing terrorist attacks within the United States, reducing the vulnerability to all natural and man-made hazards, and minimizing the damage and assisting in the recovery from any type of incident that occurs.

The *NRF* establishes a comprehensive approach to enhance the ability of the United States to manage domestic incidents. The plan incorporates best practices and

procedures from incident management disciplines—homeland security, emergency management, law enforcement, firefighting, public works, public health, responder and recovery worker health and safety, emergency medical services, and the private sector, and integrates them into a unified structure. It forms the basis of how the federal government coordinates with state, local, and tribal governments and the private sector during incidents.

The *NRF* is built on the template of the *National Incident Management System (NIMS)*, which provides a consistent framework for incident management at all jurisdictional levels, regardless of the cause, size, or complexity of the incident. The activation of the *NRF* and its coordinating structures and protocols—either partially or fully—for specific “Incidents of National Significance” provides mechanisms for the coordination and implementation of a wide variety of incident management and emergency assistance activities. Included in these activities are federal support to state, local, and tribal authorities; interaction with nongovernmental, private donor, and private-sector organizations; and the coordinated, direct exercise of federal authorities, when appropriate.

The *NRF* contains five sections—one of which is crucial for state energy emergency planning. These include: the *Basic Plan*, *Appendices*, the *Emergency Support Function Annexes*, *Support Annexes* and *Incident Annexes*. The *Basic Plan* presents the policies and concept of operations that guide how the federal government will respond and coordinate with state and local governments and provides a compendium of National Interagency Plans. *Appendices* provide more detailed supporting information, including terms, definitions, acronyms, authorities, and a compendium of national interagency plans. *The Emergency Support Function Annexes* describe the roles and responsibilities of primary and support agencies for key response functions, such as energy, transportation and communications, which supplement state and local activities.

The *Emergency Support Function Annexes* group capabilities and resources into functions most likely needed during an incident and describe the responsibilities of primary and support agencies involved. The key response function of energy is outlined in [Emergency Support Function 12](#) (ESF-12). *Support Annexes* provide the procedures and specific administrative requirements common to most incidents (e.g. Public Affairs, Financial Management, and Worker Safety and Health and includes an [Annex on Critical Infrastructure and Key Resources](#)). *Incident Annexes* describe protocols and agency roles and responsibilities for specific contingencies (e.g. biological, cyber,

***The NRF establishes protocols to help:***

- Save lives and protect the health and safety of the public, responders, and recovery workers;
- Ensure security of the homeland;
- Prevent an imminent incident, including acts of terrorism, from occurring;
- Protect and restore critical infrastructure and key resources;
- Conduct law enforcement investigations to resolve the incident, apprehend the perpetrators, and collect and preserve evidence for prosecution and/or attribution;
- Protect property and mitigate damages and impacts to individuals, communities, and the environment; and
- Facilitate recovery of individuals, families, businesses, governments, and the

nuclear/radiological, food and agriculture, catastrophic and terrorism incidents). In many cases, these annexes are supported by more detailed operational supplements or standard operating procedures.

Most up-to-date state emergency plans parallel the NRF; hence, they contain an ESF-12. The degree to which a state ESF-12 assigns responsibility to agencies varies among states. Typically, roles will be assigned to several state stakeholders. It is recommended that each state’s energy emergency plan delineate the energy interest and response activity associated with the state’s ESF-12.

More than one state agency may have ESF-12 responsibilities for an energy emergency. Local governments also play important roles during an energy emergency and need to be considered in the planning process. Some of the key agencies summarized in Figure 3 are described in more detail below.

Figure 3

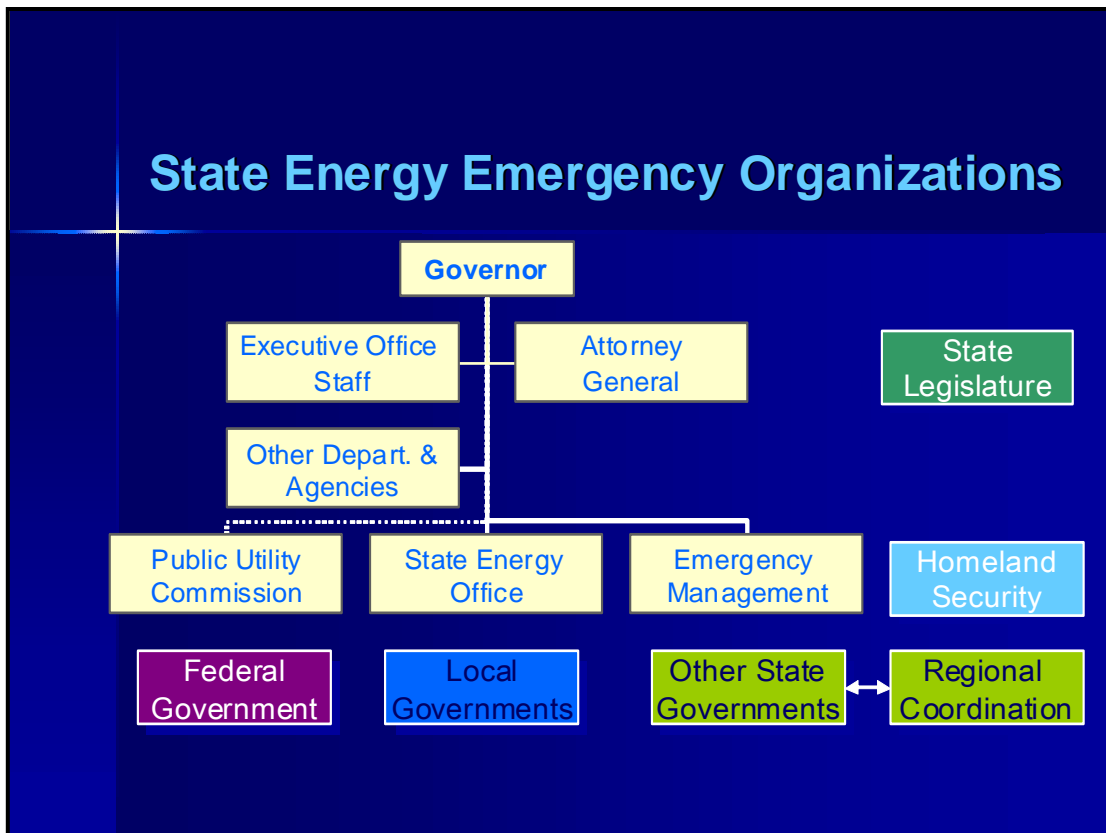

### ***1. Governor's Office***

Governors and the governors' offices have the ultimate responsibility for energy emergency planning. In December 2006, the National Governors Association—Center for Best Practices released the *Governor's Guide to Energy Assurance* to assist governors in protecting their states' critical energy infrastructure and effectively responding to energy emergencies.

The level of involvement of a Governor's Office during an energy emergency varies from state to state based on the severity of the situation and the roles assigned in the state's emergency plan. Regardless of the hierarchy or degree of problem, the Governor's Office will want to be informed expeditiously.

### ***2. State Energy Offices (SEOs)***

Most SEOs were established during the early 1970s in response to the Arab oil embargo. As a result, most SEOs are involved with petroleum issues. Also, the State Heating Oil and Propane Program, sponsored by DOE and NASEO, has provided a consistent framework for twenty-four states to monitor prices and market conditions of home heating oil and propane.

Since the late 1980s, many SEOs have been placed within other state agencies that may or may not have the responsibility for energy emergency management. Under the State Energy Program (SEP), which provides grants to states and directs funding to State Energy Offices, states are required by law to prepare a state energy emergency plan. While DOE does not formally review these required plans, OE does provide guidance in their development.

### ***3. Emergency Management Agencies***

The primary emergency response agency in most states is the state emergency management agency, homeland security, or civil defense office, or similar authority. Since the federal deregulation of petroleum prices, several state ESF-12 annexes assigned the energy emergency functions to the Public Service Commission because planners perceived energy issues to be associated with regulated utility power. However, the ESF-12 function may be shared by multiple agencies. In some states such operations are assigned to the state police or other civil defense-related agencies.

### ***4. Public Utilities Commissions***

PUCs are regulatory agencies which monitor regulated utilities and associated energy supply. States with non-regulated rural electric cooperatives and/or municipally-owned utilities may also develop reporting requirements for such systems. Most utilities fall under some regulation, either by the PUC, a county or municipal government that owns and operates a municipal utility, or other officials likely to sit on the board of a rural electric cooperative. Electric and gas utilities are generally required to have up-to-date emergency response and power restoration plans. These plans may or may not have to

be filed with a public authority but are almost universally required for licensing purposes.

Most state emergency management agencies now incorporate utility and PUC responders in their emergency response. This enhances the ability of the agency, as well as the Governor’s office, to explain what is happening to the public and makes it easier to provide governmental assistance if needed. The quality of this cooperation varies among states.

One set of questions in the 2005 NARUC survey (see pp. 17 of the NARUC study) focused on the state utility commission’s role in energy emergency preparedness. Table 2 summarizes the findings.

Table 2

<b><i>Energy Assurance Planning Authority (35 State PUCs Responding)</i></b>	
<b>Emergency Preparedness Role</b>	<b>Number of States</b>
PUC is <i>actively involved</i> in energy preparedness planning	31
PUC has <i>primary authority</i> over energy preparedness planning	6
PUC is <i>the lead coordinating</i> agency over energy preparedness planning	6
PUC has an active role in planning through <i>state emergency operations set-up</i>	19
PUC is a <i>member of an Energy Emergency Assurance Coordinator Committee</i>	7
PUC has <i>lead role in state-wide communications</i> during energy emergency	1
<i>Source: NARUC Technical Assistance Briefs: NARUC Inventory on State Energy Assurance Planning, pp. vii-viii.</i>	

### **5. Other State Agencies**

In some cases, the SEO is not the lead agency for petroleum matters. Instead, the state agriculture or other office responsible for weights and measures is assigned because that agency verifies the octane of gasoline and assures the quantity sold and often price posting requirements.

A state or local social or human services department is typically responsible for assisting with human needs when energy for seasonal heating and cooling is short or prices are extremely high. Such agencies typically manage the federal low-income heating programs, or oversee a state’s federal Weatherization Assistance Program. In several states, the SEO is responsible for these programs. Such agencies can help provide financial and social relief to low-income energy users, but they are not equipped to implement emergency mitigation measures designed to curtail or redistribute limited petroleum products.

State transportation departments may be assigned a high level of responsibility because lawmakers associate petroleum use with highways and roads. A state transportation

department can also help clear fuel delivery routes and typically approaches the Federal Motor Carrier Administration (FMCA) when driver hour waivers are needed. Law enforcement is involved whenever there is a potential for public disturbances or imminent danger to public welfare due to an energy shortage.

The assignment of responsibilities in oil-producing states may also present some confusing management patterns. Some petroleum and gas producing states consolidate the oversight of petroleum and gas production with energy efficiency and energy emergency response.

## **6. *Homeland Security***

The most recent addition to state emergency response concerns is terrorism. The creation of the federal DHS prompted states to create additional functions within their existing emergency management structure or parallel to it. These agencies have been crucial players in updating the *NRF* and continue to refine the nation's approach to emergency response. Subject to many variations among the states, one might expect a state DHS to coordinate many emergency functions while bringing additional attention to prevention while subordinate or allied agencies continue to focus on response. As agencies become increasingly comfortable with their respective roles the interrelationships between prevention and response may grow closer and become relatively seamless. One example may be the growing need to improve the nation's aging, and increasingly inadequate, electric power transmission grid. The prevention of major electricity outages would protect large numbers of customers while enhancing the ability of emergency responders to rapidly mitigate such outages as they occur.

## **7. *Local Government (Counties and Municipalities)***

Even if a state maintains active emergency management function, local authorities are likely to be the first to learn of, and respond to, an emergency—including an energy problem. Not every local jurisdiction has an emergency response entity. Where these are absent, the first agency to be notified is likely the local police or sheriff's department. State planners should ensure a coordinated effort between the state and local plans.

Larger cities and counties throughout the U.S. have emergency response agencies that parallel and coordinate closely with the State Emergency Operations Center (SEOC). Where such agencies exist, one can expect them to be tied closely to the state emergency management preparedness and to train regularly on resolving state-wide and inter-jurisdictional issues caused by emergencies, including an energy shortage.

The Public Technology Institute (PTI) has developed a set of *Local Government Energy Assurance Guidelines* (September 2008). These local government guidelines address community energy self-reliance by enhancing the resiliency of local government-owned/operated assets from natural and human-caused disasters. They also encourage local governments to be vigilant and aware of the interdependencies of the larger energy system, which consists of energy production, transmission, and distribution and their important role in maintaining these systems.

PTI is now working with their network of over 30,000 local governments nation-wide and piloting the development of Energy Assurance Plans using these Guidelines.

### **C. Roles and Relationships among Federal, State, Regional and Local Authorities**

States, usually through the SEOs, have worked closely with DOE since the oil crises of the 1970s. When federal petroleum regulations ended, the relationship matured into a mutually-supportive response effort involving training and support for enhancing plans and mitigating shortages. Today, states interact with a variety of federal and regional agencies to help protect citizens during energy emergencies. Important factors relating to the major federal and regional agencies with which states coordinate are described below:

#### ***1. Primary DOE Energy Emergency Offices***

SEOs work with DOE more than any other federal agency. States interact with several units of DOE; however, the Office of Electricity Delivery and Energy Reliability and the Energy Information Administration dominate energy emergency planning. The OE, as noted above, is the primary DOE office which deals with energy emergency planning and response. It is also responsible under the *National Infrastructure Protection Plan* for formulating strategies to protect critical energy infrastructure as described in the Energy Sector Specific Plan.

EIA is the primary federal agency providing energy data, statistics and analysis. States also submit completed energy plans to the Office of Energy Efficiency and Renewable Energy (EERE), meet with officials from fuel-related units, and, primarily through their PUC, interact with the Federal Energy Regulatory Commission on matters pertaining to electricity and natural gas.

#### ***2. Emergency Support Function 12***

DOE/OE is the lead federal agency when the federal ESF-12 is activated. States work closely with DOE in sharing energy emergency and shortage information as well as seeking technical support. Within the ESF-12, DOE is responsible for:

- Serving as the focal point for issues and policy decisions relating to energy response and restoration efforts;
- Assessing energy system damage and monitoring repair work;
- Collecting, assessing, and providing information on energy supply, demand, and market impacts; and contribute to situation and after-action reports;
- Identifying supporting resources needed to restore energy systems;
- Deploying DOE response teams as needed to affected area(s) to assist in response and restoration efforts; and



- Reviewing and sponsoring the energy industry’s requests for Telecommunications Service Priority (TSP) assignments to provision new services.

DOE is the Sector-Specific Agency for the energy sector under Homeland Security Presidential Directive 7, “Critical Infrastructure Identification, Prioritization, and Protection.”

DOE maintains the following capabilities to meet ESF-12 requirements:

- Collects and reports to Congress information filed by electric energy generators, transmitters and distributors on loss of firm load, system voltage reductions or public appeals, bulk system operational actions and fuel supply emergencies;
- Assists in the development of state and local energy recovery priorities;
- Assists affected energy stakeholders in dealing with the Federal Emergency Management Agency (FEMA) by coordinating with publicly-owned electric, gas, and lifeline utilities in applying for FEMA cost sharing for repairs;
- Assists affected energy stakeholders in obtaining repair crews and materials from outside the affected areas;
- Acts as an ombudsman in conjunction with state energy and emergency agencies to obtain electric power restoration priority to communications, public works (water, sewage), and ancillary energy facilities (e.g., fuel transportation/distribution systems, pipeline pump stations, refineries);
- Handles requests for unique department assets to support an energy emergency response; and
- Maintains the DOE Emergency Operations Center (EOC). The EOC is open twenty-four hours per day, seven days a week and can be reached by telephone Voice: (202) 586-8100, FAX: (202) 586-8485, or by E-mail at [hqdoe@oem.doe.gov](mailto:hqdoe@oem.doe.gov).

### **3. Other Federal Agencies**

Other federal agencies and their roles regarding energy emergencies include:

#### **U.S. Department of Agriculture**

The U.S. Department of Agriculture (USDA) is best accessed via the state’s agriculture agency. Issues that may need to be addressed include propane for crop drying, protecting livestock, and supporting accurate weights and measures. In addition, the **Rural Utilities Service (RUS)** is housed at USDA. RUS is responsible for funding and tracking energy consumption information for rural electric cooperatives. <http://www.usda.gov/rus/>

#### **U.S. Department of Commerce**

The U.S. Department of Commerce (DOC) has excellent data resources for developing emergency plan demographics. In addition, the **Mineral**

**Management Service (MMS)** and the **National Oceanic & Atmospheric Administration (NOAA)** are part of DOC. MMS oversees the oil and gas production fields in the Gulf of Mexico <http://www.mms.gov>, and NOAA provides up-to-the-minute tracking for hurricanes, wildfires, winter storms, and other weather-related emergencies <http://www.noaa.gov>.

### **U.S. Environmental Protection Agency**

The U.S. Environmental Protection Agency (EPA) should be contacted through a state's environmental agency. EPA may need to be contacted if waivers are sought for fuels that do not meet national and local air quality requirements. A fuel waiver can be issued only when the criteria specified in the Clean Air Act Section 211(c)(4)(C) have been met. In general, these criteria allow a fuels waiver only to address a temporary emergency fuel supply shortage that exists throughout a state or region that was caused by an unusual situation such as an act of God, and that could not have been avoided by prudent planning.

### **U.S. Department of Homeland Security**

DHS leads the unified national effort to secure the country. Several states have developed homeland security agencies. States should expect to contact DHS through their state's DHS, emergency management agency, or law enforcement. During an emergency coordination will likely occur through the state's emergency operations center.

### **Federal Energy Management Agency**

The Federal Energy Management Agency, which is an agency within DHS, supports states with general emergency backup and processes requests for disaster reimbursement. The bulk of a state's relationship with FEMA will be handled through the state's emergency management agency. DOE can also help states coordinate with FEMA on energy emergency issues.

### **U.S. Coast Guard**

The U.S. Coast Guard (USCG) oversees the nation's ports and waterways accessible by tankers and barges, essential for the delivery of petroleum and liquefied natural gas supplies. <http://www.uscg.mil/>

### **U.S. Department of Transportation**

The U.S. Department of Transportation (DOT) has several sub-agencies that may relate to an energy emergency, including:

**Pipeline and Hazardous Materials Safety Administration (PHMSA)**  
PHMSA rules apply to inter- and intra-state pipelines. State regulations for natural gas generally reinforce the federal requirements. The state's PUC is ordinarily the primary point of contact in the event of a pipeline problem. If the loss of gas is sufficiently severe, states should anticipate a coordinated response through the state emergency operations center.

### **Federal Highway Administration (FHWA)**

FHWA has excellent data for transportation-related energy issues. In an emergency, responders will ordinarily work through the state highway agency for road-related assistance.

### **Federal Maritime Administration**

In the event that a state requires long distance waterborne fuel delivery (usually heating oil or gasoline) aboard an international shipping carrier not registered in the United States, a waiver from the federal act requiring the use of US-flagged vessels (the *Jones Act*) would be sought through the Federal Maritime Administration (FMA) and with DOE assistance.

### **Federal Motor Carrier Safety Administration**

Limits on the number of hours a truck driver can operate a vehicle fall under requirements of the Federal Motor Carrier Safety Administration (FMCSA). These limits can be waived under two conditions. First, if an emergency has been declared by the President of the United States, the Governor of a state, or their authorized representative; and second, if the FMCSA Field Administrator has declared that a regional emergency exists that justifies an exemption. This exemption cannot exceed the duration of the motor carrier's or driver's direct assistance in providing emergency relief to the affected area, or 30 days from the date of the initial declaration of the emergency or the exemption, whichever is less.

390.23 Relief from regulations which includes Parts 390 to 399 can be found at: <http://www.fmcsa.dot.gov/rules-regulations/administration/fmcsr/fmcsrruletext.asp?chunkKey=090163348002389c>

Limits on Hours of Service of Drive can be found at: <http://www.fmcsa.dot.gov/rules-regulations/administration/fmcsr/FmcsrGuideDetails.asp?menukey=395>

Detailed instructions for this are contained on the NASEO website at: [http://naseo.org/committees/energysecurity/archive/documents/Driver\\_Hours\\_Waivers\\_Request\\_Procedures.pdf](http://naseo.org/committees/energysecurity/archive/documents/Driver_Hours_Waivers_Request_Procedures.pdf)

### **Federal Aviation Administration**

The Federal Aviation Administration (FAA) supports the nation's airports. In the event of an aviation fuel shortage it may be necessary to coordinate with the agency. This would most likely be handled through the state's transportation agency and coordinated at the state emergency operation center. The FAA also has air transportation data useful for planning purposes.

#### ***4. Regional Agencies***

States should become familiar with the variety of regional energy organizations affecting them. PUCs often deal with the Electric Reliability Councils, the Regional Transmission Operators (RTOs), and Independent System Operators (ISOs) that coordinate the distribution of electricity and handle multi-state emergency electrical procedures.

Other examples of regional organizations are the Power Marketing Administrations (PMAs) that operate large hydropower dams under DOE jurisdiction. Bonneville Power Administration in the Northwest and the Tennessee Valley Authority in the Southeast are two such PMAs. In addition, state energy policy organizations such as the Southern States Energy Board and the Western Energy Board may provide coordination during emergencies.

##### **North American Electric Reliability Corporation**

The North American Electric Reliability Corporation ensures the reliability of the bulk power system in the U.S. and is divided into eight regional entities. Membership in the regional entities is comprised of individuals from investor-owned utilities; federal power agencies; rural electric cooperatives; state, municipal and provincial utilities; independent power producers; power marketers; and end-use customers.

##### **The ISO/RTO Council**

The ISO/RTO Council (IRC) is an industry organization founded in 2003 and is comprised of ten Independent System Operators and Regional Transmission Organizations in North America. The IRC works collaboratively to develop effective processes, tools, and methods for improving competitive electricity markets across the U.S.

#### ***5. International Issues***

Cross border fuel delivery issues may arise with Canada and Mexico. Border states may have organizations designed to deal with these issues. The DOE can also assist with cross border energy issues.

## **IV. PRINCIPAL STRATEGIES FOR MANAGING ENERGY SHORTAGES**

---

There is no perfect formula for drafting an energy assurance preparedness plan or implementing a response to an emergency. This section suggests the basic pieces of information planners should obtain and suggests key considerations needed for a successful response.

### **A. Finding Information**

These guidelines contain many references for updating an energy assurance preparedness plan. A good place to begin is in Appendix A, which contains NASEO's list of ten basic things needed for dealing with energy emergencies. In addition Appendix H References and Resources have a number of references to additional planning documents and guides.

Within that short guide, and elsewhere in these guidelines, the importance of ongoing energy supply monitoring is stressed. This means remaining abreast of data on the [Energy Information Administration website](#) pertaining to the state and maintaining contact with representatives from the state's principal energy companies and suppliers. OE and EIA are valuable sources of information for state energy officials and their staff.

In order to obtain information, it is critical to establish a liaison with other agencies that have responsibilities in this area, such as the public utility commission and emergency management agency. It is also important to maintain contact with state petroleum-related associations as a valuable source of information. Having working relationships with people in the industry can provide a valuable "heads up" in many cases.

Participation in DOE/OE sponsored meetings, such as both the Winter and Summer Fuels Outlook conferences will also help state officials remain up-to-date on seasonal energy markets.

### **B. Energy Emergency Assurance Coordinators System**

OE maintains a password-protected Energy Emergency Assurance Coordinators (EEAC) website through which authorized state energy emergency coordinators may access valuable energy security information, including daily news summaries, emergency situation reports, lessons learned from other states, links to outage and curtailment information, and the ability to email messages to colleagues in other jurisdictions.

The EEAC is a cooperative effort among NASEO, NARUC, NCSL, NGA—Center for Best Practices, Public Technology Institute, and OE's ISER Division. It establishes a secure cooperative communications environment for state and local government personnel with access to information on energy supply, demand, pricing, and infrastructure. Designated members have expertise in electricity, petroleum, and natural gas. The current membership of approximately nearly 200 people is made up of

representatives from state energy offices, public utility organizations, state legislators, emergency management agencies, homeland security offices, local governments, and governors' offices.

Each state has designated at least one primary and one secondary designee per energy source (electricity, natural gas, and petroleum), which provides up to six individuals per state for the EEAC list. In the event of an energy supply disruption or emergency, OE relies upon the EEAC contacts to provide an up-to-date assessment of energy markets in the effected states. During these emergency situations, as well as other non-emergency situations in which the list may be used, the EEAC serves as the link between the state, industry, and OE.

In an energy emergency, OE may need to disclose sensitive and privileged information, and in these situations, may contact only the primary coordinator. From that point, it is the primary coordinator's responsibility to follow the state's plan for disclosure of information. In most other non-emergency or less sensitive emergency or disruption situations, both the primary and secondary coordinators may be contacted. Communications can be sent directly to the OE via email and an EEAC can use the listservs to send information to different regions. In addition, the EEAC bulletin board provides a great way for coordinators to share information and best practices.

An EEAC should keep in touch with the state's key energy sector contacts, including key players in the state's primary energy supply and energy consuming sectors, as well as key emergency or energy-related personnel in other agencies of state government and local governments. Additionally, it is important to keep in contact with other EEACs in the state—if a responder's first contact with other EEACs is during an emergency, it is already too late.

The types of events that warrant communication with the EEAC network include:

- Large scale events, such as an attack on the power grid, international oil disruption, hurricane, major ice storm;
- Emerging problems, such as the spring gasoline change in non-attainment air quality areas that cause a significant increase in the number of terminals without a supply, severe cold weather with requests for fuel driver hour waivers, price spikes, and other indicators of stress on the supply/distribution system's ability to supply fuel;
- Routine summer and winter energy assessments; and
- Simulations and exercises.

The types of *non-proprietary* information that should be shared include:

- Information that quantifies the size, scope and potential duration of the problem;
- Geographic area affected;
- Effects upstream and downstream in the energy supply/distribution system;
- Public statements by state officials;

- Specific actions taken by state or local governments to mitigate impacts;
- Requests from industry for assistance and response; and
- In-state media reports that accurately describe the problem.

An EEAC should consider sending information to the EEAC list when market indicators suggest the potential for supply problems and monitoring will be increased. In addition, information should be sent when an event occurs that affects energy supply, demand, or price or when an energy emergency or state of disaster is declared that affects energy supply. In the case of an international event that affects energy supply, OE will likely communicate its analysis to the EEAC list and the states, or states may request such information from OE.

The EEAC list may also be used by OE to request information from a state in which there are reports of energy problems. States should use the list to communicate regionally to counterparts, because problems are often not limited to a single jurisdiction. Too much information is often better than little or no information—if in doubt use the list. A brief message can go a long way and communication is key.

If a message is received from another EEAC, and your state has information to lend further insights to the problem, all those who received the message should receive a response. The response should indicate whether or not similar problems are being observed. The information should be verified—it is probably not wise to rely solely on personal knowledge.

An EEAC must be a credible and timely source of information. If answers are immediately available they need to be obtained from previously-established contacts in state government and industry. The EEAC website needs to be checked regularly for postings on the bulletin boards and additional information should be added as warranted. An EEAC should also “exercise” the list periodically by sending status information to states in the region, just to get in the habit of using it. It is also a good idea to check contact information on the list and update it as necessary. It is important to know the EEACs in the region and have their names and numbers on an emergency contact list rather than relying solely on the website.

On the secure ISERnet website (<http://www.oe.netl.doe.gov/isernet>) there are several communications tools for exchanging information, including the EEAC listservs, the EEAC member list, and the bulletin board. Only designated EEACs have access to the secure website; designation determinations should be reviewed with the SEO, or by contacting the OE’s ISER Division. Designated EEACs can obtain the URL for the website by contacting EOs for assistance.

### **C. Understanding a State’s Energy Profile and Vulnerabilities**

In addition to understanding the general response stages for dealing with an emergency, and the possible levels of severity encountered, there are two pieces of information energy emergency planners should understand before choosing response measures: 1)

understanding the state's energy profile and 2) assessing the vulnerabilities. Within these elements of the planning process, it is critical to look at the demographics of the affected population. Planners should have a thorough understanding of both how the population and the infrastructure will respond to emergency events. These items may be covered within the body of a plan, or, if preferred, set out in appendices. For purposes of these guidelines, these items are discussed in greater detail in *Appendix D* and *Appendix E*.

### ***1. Understanding the States Energy Profile***

The state's energy profile is composed of two elements. The first is a description of the state's energy provider industry by energy sources and stakeholder and as much relevant energy emergency-related information as planners deem pertinent. The second is a description of how and where energy is used in the state including an assessment of vulnerability associated with that use and its location. A good source of information for this element is the state energy profiles on the EIA's website.

An energy profile includes time series of a state's energy usage by energy source and sector, the sources of supply, volume of throughput, system capacity, and interstate routing of these fuels. The EIA's fuel use data is an important source for much of this information. At a minimum, a state's energy profile should cover:

- Electric power generation capacity and output, transmission, end-uses, and prices;
- Natural gas, transmission, distribution, storage, end-uses, and prices; and
- Petroleum product, refining, distribution, storage, pipeline movement, end-uses, and prices.

States will need to communicate with the other stakeholders, including:

- Power generation and delivery companies, such as:
  - Investor-Owned Utilities
  - Electric Cooperatives
  - Municipal Utilities
  - Power Marketing Agencies (if applicable)
  - Regional Transmission Operators/Independent Systems Operators
  - Generation, transmission, distribution, and retail entities, if the state electric sector is restructured
- Petroleum product refiners, suppliers, distributors, and associations
- Local governments and regional entities—particularly those functions that provide essential public services (including police, fire, 911 communications, emergency medical, and water)
- Other public sector stakeholders with relevant responsibilities. This would include, especially, most of the agencies listed in ESF-12

An energy emergency plan's energy profile may parallel some of the information contained in a more general State Energy Plan. However, the energy emergency plan



will differ because it focuses on emergency-related conditions and how energy providers respond to shortage. So as to not reveal the specific locations of critical energy assets information pertaining to energy providers may be general rather than specific.

## ***2. Vulnerabilities***

Vulnerability also relates to international, national, regional and jurisdictional markets. Thus a vulnerability analysis might include an assessment of electrical transmission and gas transmission while coastal states may also include a discussion of water-borne fuel transport along with overland pipelines.

Other areas that may affect vulnerability include electric generation capacity and location, petroleum and natural gas pipeline capacity, proximity to refineries, competing demand portals along pipelines and both age and protection of infrastructure. Some of this information could very well be proprietary so parts of a vulnerability assessment may require only the most general level of discussion.

While considering shortage impacts on consumption as one form of vulnerability, the reverse is also true. Hence planners should look at potential consumption patterns as a source of vulnerability. Examples might include major interstate highway networks running through populated areas, electricity, natural gas and petroleum flow controls that are outside of a jurisdiction's oversight, and the impact of ISOs on monitoring and managing electric transmission.

### **D. Defining the Stages of an Energy Emergency**

The response of state government, including the SEO, PUC, and other responders, can be described in four phases. Each phase describes an appropriate level of mobilization required to address a potential or developing emergency situation (see Figure 4).

#### **Phase I - Monitor and Alert**

Phase I involves the normal ongoing energy supply, demand and price monitoring. State agencies regularly monitor data and information as it becomes available through energy supply reporting systems (see *Appendix D* on Supply Monitoring) and pay special attention to supply and distribution problems.

#### **Phase II - Assess and Determine Action**

In Phase II, having noticed early signs of what might become an energy emergency, responding agencies intensify data and information collection efforts and ensure that the most recent information is available. This information is analyzed to evaluate potential outcomes and assess possible courses of action.

- Appropriate contacts throughout state government should be informed of the results of this assessment.
- Appropriate action can then be determined. If no action is required, monitoring and evaluation continue and further updates are made as changes occur.

### **Phase III - Actions and Feedback**

Once a decision has been made that specific state government action is necessary to assure the health, welfare, and safety of citizens, and the continued economic well-being of the state, Phase III activity begins. This includes:

- Implementing programs to maximize available supplies and/or to minimize existing demand levels and monitoring these activities to determine their effectiveness;
- Increasing the level of communication among state agencies and others;
- If the nature of the problem involves multiple states, information sharing among state energy coordinators, using the EEAC website, should begin;
- Convening emergency planning and response organizations to consider actions that might be taken by the various state departments and agencies;
- If implementation of voluntary programs or other emergency deterrent actions fail to mitigate the emergency, begin implementing additional actions;
- If the situation continues to deteriorate, recommending that a “State of Energy Emergency” be declared (usually by the Governor). The Governor may also be called upon to declare a “State of Disaster.” State legislation regarding “State of Energy Emergency” and/or “State of Disaster” will dictate further action and assign responsibility among pertinent parties; and
- If it appears that all other options available to the state prove inadequate, the next level of mobilization is to request federal assistance.
  - Federal assistance would generally be available in the case of a national/international energy emergency;
  - The emergency planning agencies and representatives from other state departments, as appropriate, would be responsible for coordinating and monitoring federal programs;
  - Federal assistance may be requested sooner without a declaration of a national emergency to provide the following;
    - Waiver federal driver hour requirements;
    - Waiver vehicle fuel air quality standards;
    - Request Coast Guard to intensify ice breaking; and
    - Request Strategic Petroleum Reserve (SPR) or the Northeast Heating Oil Reserves.

### **Phase IV - Review Lessons Learned**

As emergency operations are phased out, responding state agencies should evaluate the emergency preparedness programs and activities that were implemented and report the results to interested parties such as the Governor’s Office, cabinet level officers, legislative committees and energy policy councils. Evaluation activities should include:

- Reports describing the nature of the energy emergency and a chronology of the actions taken to respond to it;
- Evaluation of mitigation actions results and of the effectiveness of specific actions taken to respond to the emergency; and

- Critical reviews of the overall performance of the state's energy emergency plans in addressing an emergency.

It should be noted that movement from one phase to another is as much a matter of judgment as it is a matter of objective definition.

Figure 4

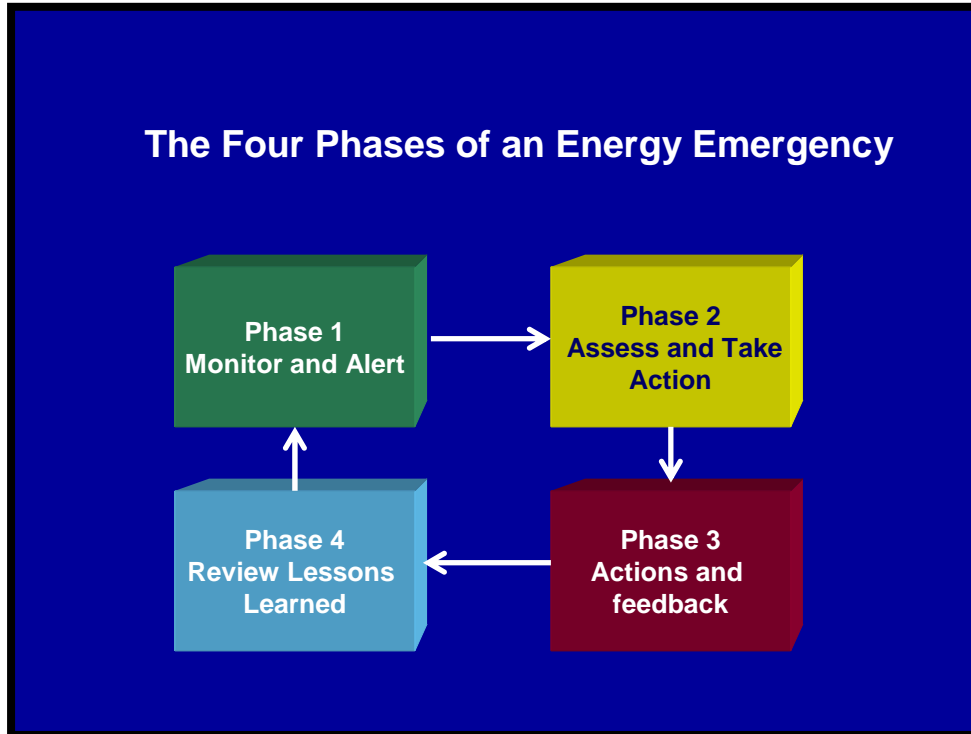
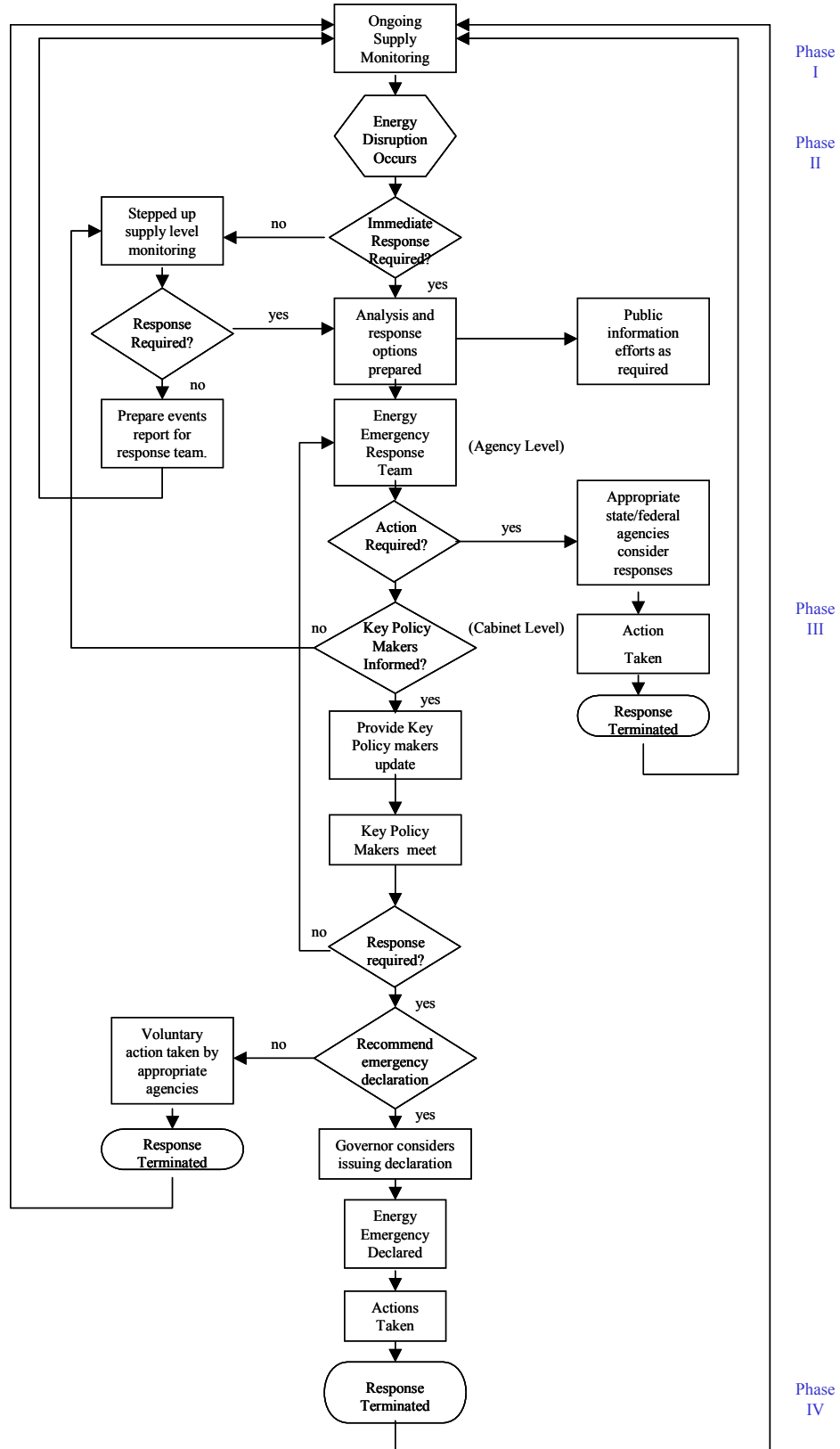

Figure 5

**Energy Emergency Response Flow Chart**

Once an energy emergency has been identified and responders have been notified, the following response flow chart illustrates the suggested steps that should be taken.



## E. Assessing the Severity of an Energy Emergency

Actions to mitigate an energy emergency generally track the severity of a crisis. State officials must decide appropriate actions within any level of severity; hence, it is useful to have some guidance regarding the seriousness of an emergency in order to consider appropriate response measures. For purposes of planning, four levels of shortage are suggested:

Table 3

<p><u>Normal Conditions Level 1</u> <i>Monitor and Alert</i></p>	<ul style="list-style-type: none"> <li>◆ No discernable shortage.</li> <li>◆ Possible shortages elsewhere.</li> </ul>
<p><u>Shortage Level 2</u> <i>Mild Shortage</i></p>	<ul style="list-style-type: none"> <li>◆ 5-10%* reductions in petroleum supply for a week or more, estimated by the days a port or terminal is closed or the number of substitutions of truck deliveries instead of normal pipeline supply.</li> <li>◆ 5-10%* reduction in natural gas nominations on interstate pipelines or pipelines on allocation for up to 2 weeks.</li> <li>◆ Localized storm damage causing short-term electric transmission/distribution loss.</li> </ul>
<p><u>Shortage Level 3</u> <i>Moderate Shortage</i></p>	<ul style="list-style-type: none"> <li>◆ 10-15%* reductions in petroleum products for three weeks or more.</li> <li>◆ 10 to 15%* reduction in natural gas supply nominations on interstate pipelines plus inside City Gate (the point at which gas moves from the pipeline to local distribution lines).</li> <li>◆ Curtailments by local gas distribution companies for two weeks or more.</li> <li>◆ Severe storm damage to electric transmission/distribution infrastructure.</li> </ul>
<p><u>Shortage Level 4</u> <i>Severe Shortage</i></p>	<ul style="list-style-type: none"> <li>◆ Greater than 15%* reduction in availability of petroleum products and/or natural gas for more than two weeks.</li> <li>◆ Natural gas nominations fall severely due to weather, interstate pipeline failure or production problems.</li> <li>◆ Electricity outages extend for several weeks.</li> </ul>

\*Percentage reductions are illustrative only and power outage severity is often based on the number of effected customers.

## F. Important Elements in the Design of Emergency Response Measures

There are a variety of measures that the energy industry and government can take to mitigate an energy shortage. It is useful for state coordinators to understand both. Depending upon the level of severity, energy industry measures may be sufficient. The art of energy emergency management is understanding when it is necessary and prudent for government to intervene. This section covers the necessary program elements that can be used in developing response measures; the necessity of cooperation within the state when considering response measures; implementation; and the evaluation of the effect of the measures.

### 1. Program Elements

The following short list of program elements provides a good starting point and template for evaluating each potential response measure:

- Description of the Measure
  - Provide a short narrative of the measure and actions to be taken.
- Intent of the Measure
  - Explain how energy demand will be reduced, or supply enhanced, as a result of the measure's implementation.
- Conditions Under Which the Measure May be Used and the Duration That it May be in Effect.
  - Consider the level(s) of severity in which the measure is appropriate. The description should estimate if and how the measure(s) should be used in conjunction with other measures.
- Legal Authority
  - Any regulatory or mandatory measure should include the legal basis of the measure's implementation. These include:
    - Existing legal documents
    - Other documents required to initiate an action should be prepared
    - Legal constraints

## ***2. Coordination***

- Consider the combination of private and public sector entities that are needed to perform a measure successfully;
- Plan to coordinate through the state's emergency management system (including ESF-12) even if proposed measures are to be implemented outside of government and especially outside of the Emergency Operations Center structure;
- When considering measures, also take into account the possible actions of neighboring jurisdictions, regional entities and the federal government; and
- Many local governments also have ESP-12 planners and plans that could add value to any emergency preparedness and response event.

## ***3. Implementation***

This list includes identification of specific start-up actions, plus associated costs for start-up and deployment.

- Budget
  - Estimate a 90-day budget. Include cost of operations and administration (overhead).
- Procedures

- Identify each step needed to implement a mitigation measure. Include items such as lead time, agency responsibilities, staffing requirements, and possible constraints.
- Implementation lead time
  - Estimate how long it will take to put the measure in place.
- Operations and administration
  - Identify lines of authority, management responsibilities, and administration procedures.
- Evaluation mechanisms
  - Describe evaluation mechanisms to measure the effectiveness of the action.

#### **4. Impact Assessment**

Estimate the fiscal savings, social, and economic impacts. The methodology and assumptions used should be explicitly stated. To the extent practical, the response measure impacts should be separated from the effects of the shortage itself. Post-action evaluation is valuable; hence, the following steps for monitoring impacts should be considered up front:

- *Demand reductions*—estimate reductions such as voluntary conservation measures taken by citizens or mandatory measures requiring thermostat set-backs or government facility closings;
- *Reductions in fuel consumption*—estimate reductions based on accepted demand measurement formulas such as those used by the Federal Energy Management Program (e.g., *Federal Measurement and Verification Guidelines V. 2.2*, Federal Energy Management Program);
- *Supply enhancement*—inquire if there is additional supply that might be made available;
- *Interdependency effects*—discuss how the change in supply of one type of energy might affect the supply of other forms of energy;
- *Social impacts*—identify measure impacts on subgroups as defined by income, housing density or region;
- *Economic impacts*—estimate program impacts on the state’s economy. The analysis could include effects on employment, productivity, and revenues; and
- *Information management*—some measures may be purely informational. All other measures could be accompanied by an explanation. Planning should identify who communicates with media and who prepares the information.

## V. RESPONSE MEASURES

This section discusses response measures by major energy groups: electricity, natural gas, and petroleum. Coal is not separately addressed and is suggested to be treated as part of the electric sector plans unless there is a large amount of non-utility coal usage in the state. This section also provides general information on certain response measures, but does not offer specifications for detailed response measure planning and development.

### A. *Electricity*

Energy emergencies involving the electric power system place special burdens on involved electric utility and the state to implement appropriate and effective control measures. The electric power system is subject to numerous technical constraints restricting what can or cannot be done to prevent power outages. The system also contains many automatic control devices that respond almost instantaneously to perturbations in supply, demand, and other system conditions. Hence, some measures taken to prevent outages can actually increase risk and, in some cases, create cascading effects that can collapse the entire system in a matter of minutes. There have been enough episodes of this type of catastrophic, widespread system failure to warrant care in the exercise of measures under emergency conditions. The role of ISOs in identifying and mitigating electricity problems is becoming increasingly important in many states. Additional technical information concerning electricity can be found in *Appendices C, D, and E*.

#### U.S. Electricity Flows 2008

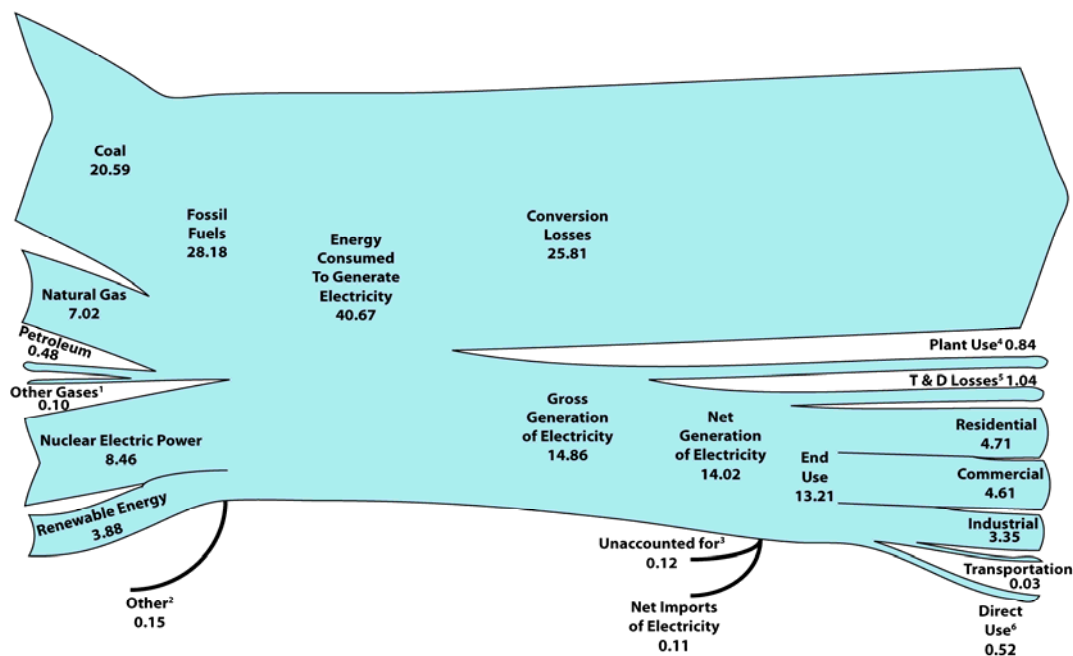

Source: Annual Energy Review, Energy Information Administration, DOE June 2009.



## ***1. Power Generation, Transmission, and System Ownership***

Traditionally, electricity in the United States has been generated primarily by in-state or relatively nearby power generation facilities. Investor-owned, rural cooperative, or municipal electric companies generate and transmit the power they produce. States regulate the industry for price, reliability, and safety through a PUC.

The advent of electricity restructuring in many states is changing the way electricity is produced and sold. Consumers are increasingly reliant on the purchase of power from a variety of in- and out-of-state sources. In several states company-owned generating and transmission assets have been "unbundled", thereby creating separate generating and transmission entities. As ownership of some assets moves out of state, or if assets fall outside of PUC purview, a state's ability to regulate them diminishes.

Only about a third of the states have deregulated (or restructured) their traditional regulated electric markets. In addition, as local companies buy, and become reliant on, purchased power from out of their immediate area, market forces play an increasingly important role. Market forces can create risk for consumers that neither they, nor the PUC, can control. One solution to this problem is the RTO/ISO structure that FERC is working to broaden. Some RTOs/ISOs have been successful in matching market supply to local needs and coordinating regional utility energy management in order to avoid massive power loss. In some states that are not under the control of an RTO/ISO, the electric control area dispatchers perform many of these same functions, albeit over a smaller area, necessitating more coordination.

## ***2. RTO/ISO Emergency Response***

RTO/ISO function as the independent electric transmission operators, balancing authorities, and reliability coordinators for a single state or multi-state region. RTOs/ISOs operate the electrical power system in accordance with NERC standards and regional coordinating council standards. RTOs/ISOs may also operate market systems that solicit sales for various services. Pricing structures developed for such services may also affect the use of power in OSO member states. As regional transmission operators, they possess real-time knowledge of the status of the electric system within their operating area and adjacent operating areas. Such knowledge includes power plant availability and fuel type, as well as predictive models that describe the stability of forecasted and current operations. These operators have established emergency plans for dealing with conditions where the power system is under stress. Such conditions may exist when there is either an abundance or shortage of power within the immediate control area and may include events ranging from a system-wide reserve shortage to localized voltage problems. Below are steps that RTO/ISO operators may take before and during system emergencies:

- ***Continually monitor system operations and conditions***  
RTOs/ISOs continually monitor system needs and the resources available to meet such needs. When the RTO/ISO identifies a power situation that could limit or prevent the ability to safely and reliably operate the system under normal protocols,

it will declare a system emergency. When time permits, an announcement of a system emergency is typically preceded by a system alert and a system warning. Notice of such events is provided to market participants as well as to relevant state entities. System emergencies are often identified in stages by the RTO/ISO with each stage indicating the progressively serious nature of the situation. In the Electric Reliability Council of Texas (ERCOT) region, the issuance of an advisory may not require any action on the part of market participants. If the situation deteriorates and adjusted responsive reserves drop below a certain threshold, an alert will be issued, which may require procurement of additional ancillary services (i.e. responsive reserves and non-spin responsive reserves—generating capacity which is capable of being brought online within 10 minutes if it is offline, or interrupted within 10 minutes if it is online, and which is capable of either being operated or interrupted for at least two hours). The need for additional resources is communicated to transmission and distribution service providers (TDSPs) and qualified scheduling entities (QSEs) who in turn provide notification to generation owners and other resources.<sup>9</sup>

- ***Discontinue Outside Sales Of Power/Increase Power Imports***  
If emergency conditions warrant, an RTO/ISO can direct that the sales to areas outside of the control area be curtailed in order to meet in-market requirements. Contract arrangements by market participants must reflect the ability to use this procedure. Likewise, when conditions warrant, the RTO/ISO may solicit power from outside its control area to relieve emergency conditions. For example, in the ERCOT region, instability of the frequency of the system and/or a drop in adjusted responsive reserves may trigger the need to activate the emergency electric curtailment plan (EECP). One option for procuring additional generation is utilizing DC tie connections to other regions such as the Southwest Power Pool (SPP).<sup>10</sup>
- ***Modify Operation of Generating Units for Emergency Relief***  
Once an emergency is declared an RTO/ISO may bypass normal market operations and purchase energy or ancillary services needed to correct the situation through “out of market” transactions. An RTO/ISO may take such actions throughout the entire control area or only within a specific sub-area or service territory. When operating reserves drop below minimum reliability criteria, an RTO/ISO will typically first alert market participants and post notice of the conditions on its web site and then will take various actions to contain and correct the situation. For example, units that normally operate at close to full output capacity may be asked by the RTO/ISO to increase their output to emergency operating levels. This procedure can damage equipment if not properly implemented so is normally deployed only for a short time.

During the course of regular operations some generating units may be called upon and compensated to provide spinning reserve for the RTO/ ISO area. Spinning

---

<sup>9</sup> ERCOT. Protocols, Section 5: Dispatch. October 2007.  
<http://www.ercot.com/mktrules/protocols/current/05-100107.doc>

<sup>10</sup> Id.

reserve capability involves a quick response capability to manage contingencies on the system. During an emergency, an RTO/ISO may convert non-spinning reserves to spinning reserves. Reactive power services are monitored as well and additional units can be secured to provide reactive power to maintain system stability under emergency conditions. Other generating units are typically dedicated to provide black start capability for the electric system should system-wide restoration be necessary. In the ERCOT region, procuring additional generation is one of the components of EECF Step 1. This may include dispatching Reliability Must Run [?] (RMR) units and non-spin reserve services. ERCOT may also notify QSEs for additional generation capacity that is capable of coming online within thirty minutes.<sup>11</sup>

- ***Request Selected Customers To Reduce Load***

In many regions RTOs/ISOs have worked with state regulators to develop demand response programs that can be used in emergency situations. RTOs/ISOs, either directly or through their members, can deploy demand side response resources where end-use customers are compensated to reduce their demand on the system upon notice by the system operator. Such programs can be active load management with direct control of equipment or voluntary response where the customer selects equipment to be controlled based upon current operations. Some of these programs can provide emergency response in as little as thirty minutes to help maintain the reliability of the bulk power system during a capacity deficiency. ERCOT has developed a program for commercial loads that are willing to reduce load when called upon, i.e. when it enters into EECF Step 2. Loads acting as a Resource (LaaRs) account for 1,750 megawatts (MW) of adjusted responsive reserves and must meet a number of technical requirements to participate in the program. Once instructed by a QSE to reduce load, LaaRs must respond within ten minutes.<sup>12</sup>

- ***Request All Customers To Voluntarily Reduce Load***

RTOs/ISOs can develop media communications either directly or through their members to request voluntary load reduction from all customers. Such communications should be coordinated with state emergency management offices, PUCs, and media where possible. In addition, agencies should have draft press releases prepared that may be adapted for these circumstances. For example, ERCOT may issue a media appeal for voluntary load reduction prior to or during the implementation of the EECF, as the situation warrants.<sup>13</sup>

- ***Reduce Voltage***

An RTO/ISO either directly or through its members can reduce operational voltage, usually by less than five-six percent, in order to mitigate system contingencies. At this level, most customers will not notice a change, however public notification should accompany such action as certain electrical equipment may be adversely

---

<sup>11</sup> ERCOT. Operating Guides, Section 4: Emergency Operations. July 2007.  
<http://www.ercot.com/mktrules/guides/operating/2007/07/04/04-070107.doc>

<sup>12</sup> Id.

<sup>13</sup> ERCOT. Protocols, Section 5: Dispatch. October 2007.  
<http://www.ercot.com/mktrules/protocols/current/05-100107.doc>

affected by this action. In the ERCOT region, system voltage instability may lead to firm load shed if all of the other previous resources have been dispatched and the frequency continues to deteriorate.<sup>14</sup>

- ***Implement Controlled Rotating Interruptions***

This is generally the last step taken by an RTO/ISO to control a system emergency and is implemented after all other attempts to control the emergency have failed to contain the problem. Also called “rolling blackouts”, this technique involves the interruption of portions of the grid for a period of time, usually for two hours or less. As one section is restored, another is taken off-line to reduce total system load. There is often a tiered protocol for rotating interruptions. For example, the California ISO (CAISO) will allocate reductions first to utilities that failed to schedule enough power for the day and if additional reductions are needed, the CAISO will allocate those reductions based on historic peak demand. Customers interrupted in this manner generally do not receive compensation. Where practical, public notification should be utilized to permit customers to protect sensitive operations during such interruptions. If ERCOT determines that it is necessary to shed firm load, it will instruct TDSPs to begin rotating outages. TDSPs will shed 100 MW of firm load in their service territories for a period of 10 minutes. Once ERCOT receives sufficient bids and/or the system returns to its normal frequency, it will begin notifying market participants that the EECPP has been cancelled.<sup>15</sup>

In addition to the steps that RTOs/ISOs can take to mitigate system contingencies, some further steps they may employ on a regular basis include:

- ***Assure System Reliability***

Implement all prudent prevention and maintenance measures to assure system reliability. This may include the training of all operating personnel in appropriate emergency procedures, including the conduct of drills. Perform system analysis of future conditions including forecasts of demand requirements, available and planned capacity, transmission flows and operating performance on both a real time and multi-year future time period basis. Require members to operate within standards established for reliability in support of short term and long term operations. Require members to make improvements to their transmission systems in order to ensure reliable, safe and secure operations.

- ***Emergency Communications Protocols with State Regulatory Agencies***

Many RTOs/ISOs utilize formal communications protocols to keep state regulatory agencies abreast of any emergency actions identified by the RTO/ISO. These protocols are updated on a regular basis. The objective of these protocols is to ensure that state decision makers receive information about power system emergencies in a timely manner. For example, in New York, the New York ISO shift supervisor is required to contact the New York Public Service Commission (NYPSC) when unusual operating conditions occur. The NYPSC then performs a

---

<sup>14</sup> Id.

<sup>15</sup> Id.

technical evaluation of system conditions and advises elected officials and state agencies of the situation. If service disruption has or is likely to occur, state emergency management may become involved. To the extent these do not already exist, RTOs/ISOs should establish liaisons with responsible state officials for the communication of system conditions. ERCOT has developed Crisis Communications Procedures that work in conjunction with its EECF. The purpose of the procedures is to provide necessary notifications to the Public Utility Commission of Texas (PUCT), the State Operations Center (SOC), state legislators, market participants, the media, and the public. ERCOT will use a variety of mediums for communicating with the appropriate parties, including automated messages and press releases.

- ***Join in Mutual Aid Agreements***

Enter into mutual aid agreements and memoranda with other system operators in order to provide improved performance in meeting contingencies. This may also include agreements for sharing real time operational information that permits the RTO/ISO to observe conditions inside another's control area, which could lead to contingency conditions within their own operating area.

- ***Cooperate with State Emergency and Homeland Security Authorities***

Work with state emergency management and homeland security authorities to assure the safety and integrity of the transmission infrastructure and associated components. The state of Texas created the Private Sector Advisory Council (the Council), which is comprised of representatives from ERCOT, transmission and distribution utilities (TDUs), electric utilities, electric cooperatives, and municipally-owned utilities. The Council meets quarterly to discuss topics relating to critical infrastructure protection and homeland security/border security that affects each of the critical infrastructure and key resource sectors. During an emergency event in Texas, energy representatives would likely be working alongside members of the PUCT's emergency response team (EMRT) to facilitate the efficient restoration of service.<sup>16</sup>

- ***Inform the Public***

Provide accurate and useful information to public officials, members and the public so there is an understanding of the operating and emergency procedures used by the RTO/ISO. For example, ERCOT has achieved this goal through the development and implementation of its Crisis Communications Procedures.

### ***3. State Response—RTOs/ISOs and Legal Authorities***

The manner in which a state agency works with an RTO/ISO in the implementation of some or all of these measures depends on the legal authorities that are in place. In most instances, a cooperative working relationship is the cornerstone, as a state will have no legal authority over an RTO/ISO. However, a state may possess legal authority over the members of the RTO/ISO and can therefore augment the actions taken by an RTO/ISO in assuring cooperative participation of the members. The most common arrangement is

---

<sup>16</sup> Texas Government Code, Chapter 421. June 2005.

for the RTO/ISO to develop collaborative working protocols that will keep the states informed under any system-wide emergency condition identified by the regional power entity. Most RTOs/ISOs maintain emergency protocol manuals and other supporting documentation on their web sites.

State agencies should make sure that they have copies of all of the RTO/ISO website addresses, as well as ensuring that the RTOs/ISOs have current and twenty-four hour contact names for state agency representatives and vice versa.

#### ***4. State Emergency Agency Response***

In the event of an electricity emergency, the state agency responsible for responding to this type of occurrence can refer to these response procedures:

- Monitor Conditions  
A state can monitor the condition of the electric power system to determine appropriate actions. A state may rely on information provided by an electric utility and upon information collected by officials. ISOs may provide access to real-time operations data on its website, including short-term load forecasts, current load, system frequency, and DC tie flows. Many TDUs and electric utilities have included outage data on their websites. In the ERCOT region, twice daily notifications are provided to market participants and the PUCT regarding generation available for peak hour demand, the forecasted peak hour demand, and the potential for entering into EECF. More frequent notifications are issued if real-time operations reveal the need for an advisory, alert, or the implementation of the EECF.<sup>17</sup>
- Assist in the Arrangement of Special Electricity Purchase Contracts  
A state can, under special circumstances, work with an electric utility to arrange special contracts for the purchase of additional power or transmission services. The objective of this is to leverage a state's influence in order to encourage sales agreements designed for emergency conditions.
- Issue Public Request for Load Reduction  
In coordination with an electric utility a state can request that public reduce electricity consumption and shift consumption to off-peak hours.
- Implement Load Reduction Measures at State Facilities  
Some state-owned facilities consume enough electricity to impact overall system load. A state can direct such facilities to reduce load by turning down air conditioning and water heating settings, as well as turning off unnecessary electrical equipment and lighting. Under severe conditions, a state may adjust the working hours at its facilities or even close them temporarily.  
In order for this approach to work, a state must inventory facilities to learn about their electricity consumption. In many states that implement energy efficiency

---

<sup>17</sup> For more information regarding real-time operations in the ERCOT region, use the following link:  
<http://www.ercot.com/index.html>.

programs, this may have already been accomplished. This information may also identify where load reductions can occur without jeopardizing critical missions. Working with the electric utilities, this inventory can also identify where a load reduction would provide the most relief during an emergency.

- Declare State of Emergency

If the electric power situation threatens to result in serious public health and safety impacts, a state can declare a State of Emergency, allowing special measures to be implemented. In some states, there is a single “State of Emergency” condition. Others have several emergency stages, each of which triggers different responses. Ordinarily, the governor issues the declaration. Some states have authorities to declare an energy emergency under which the Governor may be able to order a specific set of responses within the authorities specified in the Act. For example, Michigan has an energy emergency statute which was used during the 2003 blackout.

- Other Special Emergency Measures

A number of additional measures can be taken under emergency conditions. These would be governed by legal authorities granted to a state. Implementation should be coordinated with electric utilities to maximize effectiveness and efficiency.

Examples include:

- Impose restrictions on the hours during which commercial, industrial, public, and school buildings may be open;
- Impose restrictions on lighting levels in commercial, industrial, public, and school buildings;
- Impose restrictions on interior temperature in commercial, industrial, public, and school buildings;
- Impose restrictions on the use of display and decorative lighting;
- Require mandatory interruption of selected customers;
- Curtail sales of electricity outside the utility service areas;
- Grant waivers to utilities that have generators operating at less than their technical limits due to environmental or other restrictions;
- Start up state-owned backup generators to provide additional capacity; and
- Direct utilities to use pre-determined customer restoration priority lists to the degree the physical distribution system permits.

- Request Federal Assistance

Severe electricity emergencies can overwhelm state resources. At this point, a state may consider a request for assistance from the federal government.

**B. Natural Gas**

Due to system design, disruptions in natural gas delivery are less frequent than those affecting electricity. Most natural gas systems have multiple pipeline interconnection rerouting capabilities and are buried underground. State laws require contractors to know where they are digging thus reducing (but certainly not eliminating) construction-related ruptures. Furthermore, problems with a gas system generally take longer to develop and therefore provide more opportunity for response.

**Natural Gas Flows, 2008**

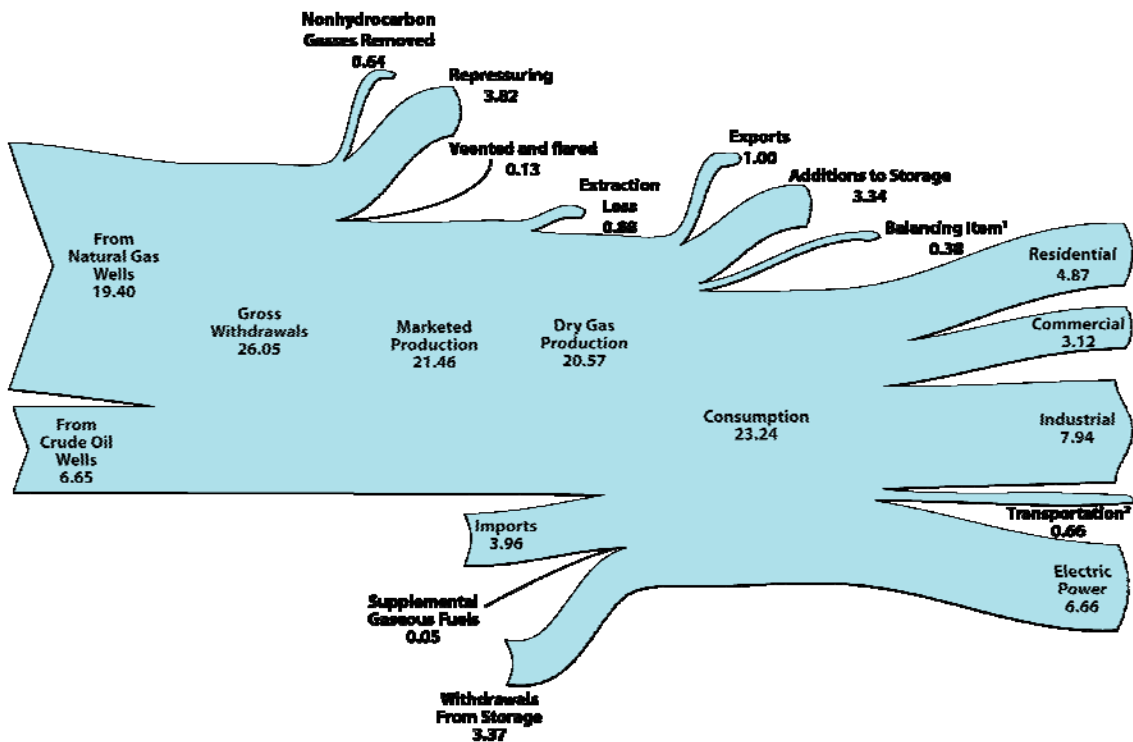

Source: Annual Energy Review, Energy Information Administration, DOE June 2009.

However, when disruptions do occur, there can be substantial risk to public health and safety. A break in a natural gas pipeline can lead to fires and/or explosions. A total loss of gas supply in a region can take weeks, even months, to restore as crews must purge air from the entire system, re-pressure it, and then manually re-light all of the customers that have been shut off. A loss of gas in winter can create serious public health impacts in a short period of time. Additional technical information concerning natural gas can be found in *Appendices C, D, and E*.

This section provides an overview of natural gas, as well as response considerations for emergencies.



## ***1. Gas Production and Supply***

The majority of natural gas used in the U.S. originates in the southern part of the country (Texas, Louisiana, Oklahoma, New Mexico, and the Gulf of Mexico), Wyoming, and Alaska. A sizable quantity of gas is also imported from Canada. Most states import gas that is transported via high-capacity, high-pressure pipelines owned by interstate gas transmission companies. Within a state, gas is provided via a local distribution company (LDC) that operates intra-state and local service lines. An LDC may also own or rent gas storage facilities that are an important component of the gas supply system. Many large commercial or industrial customers buy gas directly from producers, or interstate suppliers, and use the interstate transmission and LDC lines simply as freight transporters.

## ***2. System Ownership***

The natural gas business structure is very complex. Gas production resources, transmission systems, and the local distribution systems are usually owned by different companies. The “gas utility” from which most customers buy is most often an LDC that generally does not own out-of-state gas supplies or interstate transmission pipelines. As such, the LDC may have fewer options for reacting to natural gas emergencies than would a vertically integrated utility.

## ***3. Local Gas Company Response***

Local gas distribution companies are required by federal law to have emergency plans for dealing with gas infrastructure disruptions. In addition, federal pipeline safety rules apply to both local distribution companies and interstate pipelines. The emergency steps that gas companies generally take during a shortage include:

- ***Purchase and Transport Additional Gas***

Depending on the availability of gas and transmission line capacity, an LDC may arrange to buy additional gas to meet demand. The price of this purchased gas, contract details, the availability of gas transmission capacity, and the ability of the company’s system to accept additional supply may limit the amount that can be purchased.

- ***Increase Withdrawals from Storage***

Gas companies that own or rent storage can increase the rate of withdrawal in order to meet increased short-term demand, subject to operational constraints. This option must be exercised in relation to the impact of short-term withdrawals on longer-term supplies.

- ***Increase Withdrawals from Other Operating System Sources***

Most gas companies have access to other supply sources such as liquefied natural gas (LNG), propane air stations, and/or synthetic natural gas plants. However, these options are not always available (i.e., they may also be in short supply), are

expensive, and may not be in the appropriate locations to help in an emergency.

- ***Increase Pipeline Pressure***

In some pipeline systems, it is possible to increase the pressure (referred to as “increasing line pack”) to effectively store additional gas. This is usually done in anticipation of high demand levels. Allowable pipeline pressure increases are regulated by federal law.

- ***Request that Customers Voluntarily Reduce Gas Demand***

Large commercial and industrial customers may be asked to reduce gas use by decreasing thermostat settings or reducing gas-consuming industrial processes. Residential customers may be asked to lower thermostat and water heating settings, reduce hot water demand, and defer using gas appliances.

- ***Arrange for Import of Compressed Natural Gas or Liquefied Petroleum Gas***

Compressed natural gas (CNG) and liquefied petroleum gas (LPG or propane) can be moved by rail or truck to supplement natural gas supplies. The quantity of these substitutes is limited by the capacity of processing and transport facilities. These are expensive options.

- ***Interrupt Selected Customers***

Some customers choose “interruptible” gas service, which allows an LDC to cut their supply in times of high gas demand. These arrangements, which provide significant financial incentives to customers, usually require advance notice of interruption and limit the total number of hours in a year that service can be interrupted.

Interruptible customers must have fuel switching capability—usually oil or LPG. Since interruption is normally a wintertime event and other fuels are also in high demand, interruptible customers should be encouraged to acquire pre-season alternative fuel.

- ***Implement Gas Cutoffs***

In times of severe system stress a local gas company can cut off customers, including those who are not on interruptible service contracts. This is a “last resort” measure to avoid loss of pressure in the entire system. Due to the extensive effort required to restore service, and relight all customer pilot lights, this measure is rarely implemented. The determination of which customers to cut off is based on the configuration of the gas network and on customer priorities. In general, every attempt is made to maintain service to residential customers and special facilities (e.g., hospitals) and to impose cutoffs on lower priority customers. However, the configuration of a gas system sometimes means that customers at the end of radial pipelines are the first to lose service, independent of their priority. In general, customers that are interrupted by the imposition of such a measure do not receive compensation.

#### **4. State Response—Gas Companies and Legal Authorities.**

The manner in which a state agency works with a gas company depends upon the legal authorities in place. Steps that a state can take include:

- ***Review Gas Company Emergency Plans***  
The state should review gas emergency plans. These plans are normally on file with the PUC where they are reviewed and generally approved. Exercises to test the plans should be conducted annually. The state should participate with the LDC in these exercises to better define roles and highlight deficiencies.
- ***Review County and Municipal Natural Gas Emergency Plans***  
Analogous to electricity emergency plans, states may require that county and municipal agencies have plans for dealing with natural gas disruptions. These plans should be reviewed and tested.
- ***Monitor Conditions***  
States need to monitor the condition of the natural gas system to determine appropriate actions. States can generally rely on information provided by the gas company and on information collected on its own.
- ***Assist in the Arrangement of Special Gas Purchase Contracts***  
Under certain circumstances, most states can work with a gas company to arrange for special purchase contracts to obtain additional supplies and transmission services. The objective of this intervention is to leverage a state's influence and encourage the execution of sales agreements that would not be employed except during emergency conditions.
- ***Issue Requests for a Reduction in Gas Use***  
In coordination with a gas company, a state can issue requests for the public to reduce natural gas consumption and to shift consumption to off-peak hours.
- ***Implement Gas Demand Reduction Measures at State Facilities***  
A state can direct its own facilities to reduce demand for gas by turning down space heating settings and turning off non-critical gas-consuming equipment. Under severe conditions, a state may adjust the working hours at its facilities or even close them temporarily. In order for this approach to be effective, a state must inventory its facilities and their natural gas consumption patterns. It is desirable that this inventory be done prior to the onset of emergency conditions.
- ***Declare State of Emergency***  
If the natural gas situation deteriorates to a level that threatens serious public health and safety, a state can declare a "State of Emergency" that allows special measures to be implemented. The Governor ordinarily issues the declaration.
- ***Implement Additional Emergency Measures***  
There are a number of additional measures a state can use under emergency

- Impose restrictions on the hours that commercial, industrial, public, and school buildings may be open;
  - Impose restrictions on interior temperature in commercial, industrial, public, and school buildings;
  - Require mandatory interruption of selected customers; and
  - Require retention, or later, restoration, of approved lists of priority customers as the physical structure of the system permits.
- ***Request Federal Assistance***  
Severe natural gas emergencies can overwhelm state resources. At this point, a state can request assistance from the federal government.
  - ***Establish Notification Protocols***  
In a fashion similar to electricity, the procedures by which the state receives notification of an impending or actual natural gas emergency should be established. The procedures include:
    - Identify conditions requiring notification;
    - Identify agency(ies) and individuals to be notified;
    - Select manner of notification; and
    - Indicate information to be communicated. (Gas companies are already required by federal law to report certain emergency conditions that have safety implications to the U.S. DOT Office of Pipeline Safety. State officials can use this notification network as a start.)

## ***5. Gas Curtailment Responses***

States plan to curtail (reduce usage including cut-offs, noted above) in a variety of ways. As noted in Chapter II, NARUC's Committee on Critical Infrastructure conducted two major surveys of state utilities commissions in 2005. The first catalogued current energy assurance programs and policies implemented by state public utility agencies. The second documented state natural gas curtailment policies. Thirty states plus the District of Columbia responded to the natural gas survey. While this study revealed considerable differences among the respondents, it also showed that "primary authority to respond—was evenly divided among the commissions, Governors, and shared authority."<sup>18</sup> Overall, the study found "a strong collaborative process" existing among state government stakeholders.

- ***Curtailment Plan Proceedings***

---

<sup>18</sup> NARUC Committee on Critical Infrastructure Technical Briefs. *Paper 8: NARUC Inventory on Gas Curtailment Planning*. April 2005. The NARUC paper reports in detail the findings of a 2004 assessment of state commissions regarding gas curtailment planning and related policy issues.  
[http://www.naruc.org/Publications/CIP\\_GasCurtailmentInventoryReport\\_8.pdf](http://www.naruc.org/Publications/CIP_GasCurtailmentInventoryReport_8.pdf)

The decision to curtail gas is preceded in most states by some sort of information gathering process such as a formal hearing or intensive staff review. The curtailment plans in most states are a part of the LDC's tariff filing. Some states responded that they also could levy fines or penalties if LDCs failed to file curtailment plans in a timely manner.

- ***Curtailment Priorities***

Approximately half of the states have authority to require specific actions of LDCs in order to respond to a shortage. However, a few states have no such authority. The study notes that all curtailment plans "placed a priority on protecting human health and safety." Generally, "priorities are implemented to ensure continued service to residential customers and other critical loads."

- ***Gas in Generating Electricity***

In general, the NARUC study revealed that the use of natural gas for electricity generation has not reached a point that concerns many utility commissions. A majority of the states responding in the study indicated that "electric generation with non-firm customers have no priority of use during gas curtailment and are generally curtailed prior to other users."

The most important lesson learned from the gas curtailment survey is that the bulk of state public utility commissions join with other state agencies in responding to energy shortages. Gas curtailment policies are usually reflected within the tariffs submitted by LDCs and most curtailment plans thus submitted are required under state law. Finally, it is important to remember that utility rules vary among states. Therefore, energy officials in each state must find out exactly how their state utility policies are implemented. An understanding of the rules in neighboring and regional states is also useful because many LDCs are either owned or coordinate with out-of-state entities and some or all of a state's gas supply may cross state lines to reach customers.

**C. Petroleum**

There are several essential petroleum products used by different sectors of a state's economy. The ones of most importance from the perspective of energy emergency planning include:

- Gasoline for transportation;
- Heating (or No. 2 Distillate) oil for residential and commercial heating;
- Diesel fuel for transportation and in some industrial applications;
- Jet fuel and aviation gasoline;
- Liquefied petroleum gas (propane) for space heating and cooking; and
- Fuel oil: used for industrial boilers, space heating, and electric power generation

**U.S Petroleum Flows, 2008**

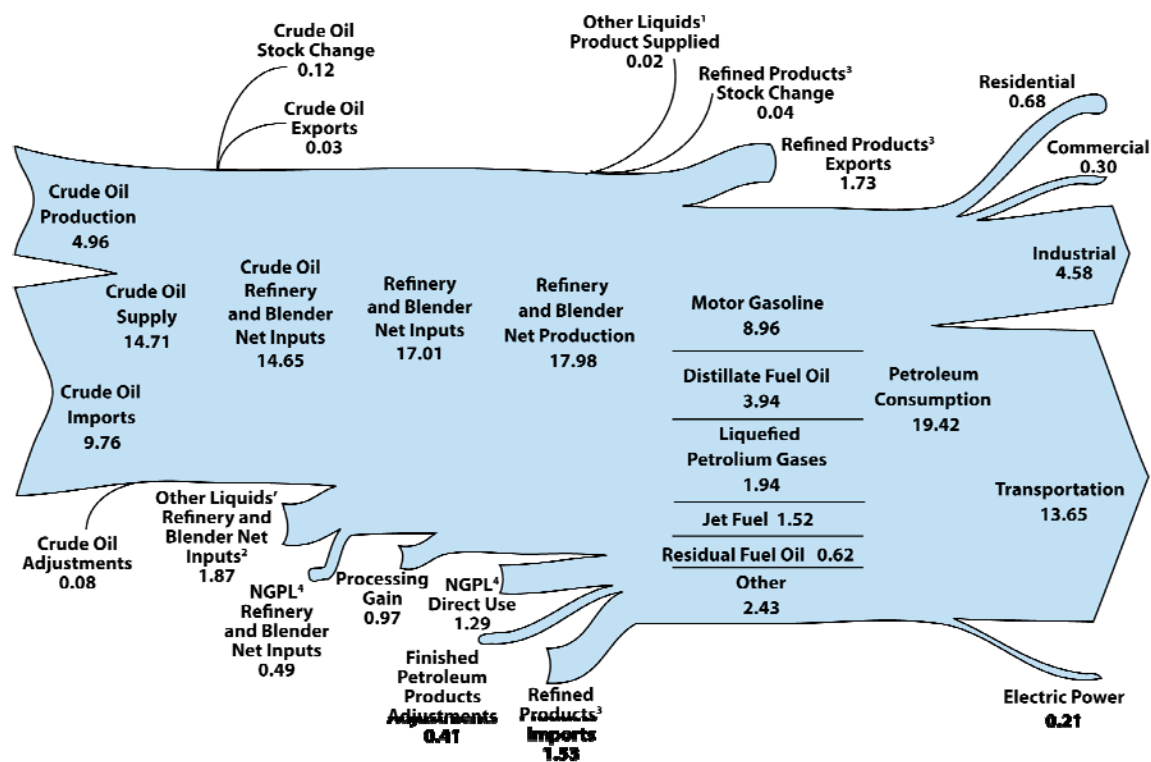

Source: Annual Energy Review, Energy Information Administration, DOE June 2009.

There are numerous other petroleum products, but shortages in their supply are generally not considered to affect public health and safety and so are not usually considered in energy emergency planning. Additional information on petroleum can be found in *Appendices C, D, and E*.

## ***1. Ownership***

The petroleum market involves numerous companies, both domestic and foreign. Unlike the electric and natural gas systems, there is no “utility” that can exercise substantial control over the petroleum product system and be a primary partner in managing any emergency response. While several major oil companies are vertically integrated, managing oil from exploration and production through retail marketing, the market also contains many companies that specialize. At the retail level the petroleum "industry" is heavily weighted toward middle level suppliers (jobbers) and retail outlets. As a result, energy emergencies involving petroleum products are complex and require states to work with multiple organizations to develop effective actions.

## ***2. Production and Supply***

Electricity and natural gas are essentially "domestic" forms of energy (even though there are significant imports from Mexico and Canada). Oil is an international commodity and the U.S. imports more than half of the oil it consumes. Thus, in addition to the usual supply and demand factors influencing any commodity, oil is also subject to international policy decisions or events that exist outside of the nation's control. Domestic oil production is enhanced as much as improving technology allows, but the amount of "proven" oil reserves available within the US (and Canada) continues to diminish.

## ***3. Refining and Delivery***

Two other major factors affect the availability and the price of oil products: 1) the refining system and 2) the delivery system. At the refining level, the availability of oil products depends on the maintenance and repair of an aging system of refineries. Notwithstanding advances in refining chemistry, technology, and safety, no new refineries have been constructed within the U.S. in more than twenty years, although plant expansions have occurred. When refineries suffer outages of any kind, product supply is restricted and prices increase.

The national oil product delivery system is highly reliable. Major underground pipelines provide the bulk of the oil to end users. Regional and local storage supplements pipeline supply and the entire network is managed by sophisticated computer controls. Locally, oil products are transferred from inter- and intra-state pipelines (or, for many coastal areas, ships and barges) to motor carriers. During natural disasters and extreme weather, problems with this transfer can occur. While there is virtually nothing a state can do to influence foreign oil markets, and refinery problems, a state can help facilitate in-state transfers when the need arises.

## ***4. Market Forces***

The market forces that affect the petroleum industry include:

- *International Market Economics*

Shortages resulting from major oil supplier closures can drive prices up nationwide. Actual and predicted international events can affect world oil prices. The expected impact of international events is a rapid increase in the price of crude oil and petroleum products with a potential surge in demand caused by purchasers anticipating even higher prices. For example, a reduction in Organization of Petroleum Exporting Countries (OPEC) supply targets, or a political intervention in export from one country such as Venezuela or Nigeria, increases price as major suppliers place limits on the quantities delivered to jobbers and retailers. Conversely, when falling prices are expected, some purchasers may liquidate inventories purchased at higher prices in order to avoid even greater losses from lower prices. This, in turn, compounds downward pressures on prices.

- *Price Volatility*

Petroleum prices are often discussed in terms of rapid changes. These products are commodities and when demand for a commodity exceeds its supply, prices rise. Analysts call this ‘price volatility’. Consumers are not interested in volatility when the price is going down (although suppliers are). Higher prices both increase the incentive to find new supply and, if sufficiently severe, curtail demand. Economic theory predicts an eventual balance, and less volatility, as reduced demand caused by higher prices comes in line with supply. Such balance is not easy to achieve due to a variety of factors such as: seasonal use patterns across international oil markets, random weather issues, supply manipulation by various market players for proprietary reasons, and unreliable supply and consumption data.

- *Seasonality*

Petroleum product prices in the U.S. have historically changed with the seasons. They rose when seasonal demand increased and retreated when seasonal demand diminished. For example, gasoline prices rose in the summer because of summer vacation travel and, if left to market forces, retreat in the winter. Heating oil and propane prices usually increase as winter approaches. This is true even though propane is a make-up fuel for certain industrial processes, as well as a staple for various agriculture needs such as crop drying, that do not necessarily coincide with winter. Seasonal changes have become less predictable as market volatility increases. For example, petroleum prices crashed in response to the recession in 2008 and began to rebound in the first half of 2009 as refining problems and investment in commodity markets rose.

- *Other Curtailment*

In spite of seasonality, petroleum product supply can be curtailed in any season. When this happens prices rise outside of normal expectations and consumers perceive that the market is out of balance. This can result from regional incidents with respect to pipelines or refineries serving a state or region,



unusually high levels of demand for a parallel fuel,<sup>19</sup> or refiner or major supplier volume limitations. Increasingly, even the suggestion of problems precipitates volatility in commodity markets driving up prices ahead of actual shortage.

If problems occur in production, refining, or transportation, the result is often a spot outage. Spot shortages are short-term events often focused in one area. When the localized problem ends, such as the outage of a regional refinery, the spot shortage ends and prices return to a lower level.

## ***5. Gasoline Pricing***

Nearly half of U.S. petroleum use is gasoline. The transportation sector's dependence on gasoline suggests that contingency planning should focus on the needs of motorists and on alternative strategies for meeting transportation demand. [Motor vehicle registrations](#) in the United States increased from 108 million in 1970 to 244 million in 2006. When estimating petroleum needs in most states, transportation usage vastly exceeds other uses for oil products.

The relationship of transportation demand to gasoline prices appears to be changing. Basic economics illustrates that supply and demand govern prices. However, when a commodity becomes so embedded in the lives of buyers that they appear to consume at any price, that commodity is said to be highly inelastic. In the past, consumers have reacted to higher gasoline prices by reducing demand, although the speed and degree to which this demand reduction takes place is influenced by other economic factors and consumer choices. In recent years there appears to be less demand sensitivity to prices than has been seen in the past, however when price exceeded \$4.00 per gallon in 2008 the economy moved into a recession and demand fell.

A spokesman for the U.S. petroleum industry has argued that the basic economic rules of supply and demand still control the oil markets. Perhaps this is true over time. However, recent events suggest that the varieties of factors affecting petroleum product prices are capable of creating rapid dislocations in price and supply. It has become increasingly difficult to predict oil product prices and this increases risk and vulnerability from the perspective of energy emergency planning.

## ***6. State Actions***

Given the complexity of the international and national petroleum markets, and the many regional sub-sets of these markets, there are steps a state can take in responding to an emergency situation, including:

- ***Require County and Municipal Petroleum Product Emergency Plans***  
As with electricity and natural gas, states may require that county and municipal agencies have plans for dealing with petroleum product supply disruptions.

---

<sup>19</sup> The nature of crude oil is such that a refinery can produce more gasoline and less heating oil or vice versa. Refineries "tilt" production in the spring to produce more gasoline for summer driving and in late summer and early fall to refine more distillate for winter heating.

These county and municipal plans should be coordinated with the state plans to ensure effective operation.

- ***Monitor Conditions***

A state should monitor the supply of petroleum products to determine appropriate actions.

- ***Issue Public Request for Demand Reduction***

A state can issue requests to the public and industry to reduce petroleum consumption. In addition to requesting public participation, the state can implement a number of voluntary and mandatory programs to encourage participation in demand reduction. Examples include:

- Increase promotion of the use of public transportation and encourage employer support for mass transit versus parking subsidies;
- Increase promotion of telecommuting and teleconferencing to minimize travel;
- Expand carpooling and vanpooling programs, both individual- and employer-based;
- Increase enforcement of highway speed limits;
- Promote flex-time work schedules to reduce congestion;
- Encourage reduction in industrial processes requiring diesel fuel or fuel oil;
- Encourage reduction in space heating using propane;
- Assist LPG and heating oil consumers in locating alternate suppliers;
- Work with industry associations to obtain support for proposed measures from their membership; and
- Assist low-income customers in obtaining emergency supply or other help in obtaining product.

- ***Enhance Supply***

States can boost supply by following these recommendations:

- Facilitate the movement of petroleum products to disaster areas by coordinating needs with the state highway agency and police units. (In most states, this would be done through the SEOC);
- Act as a liaison among energy industries to facilitate communications and verify requests for assistance;
- Coordinate the process of acquiring waivers of federal and state driver hour limitations as needed to increase bulk highway fuel transport;
- Reduce demand at state-owned facilities in the same manner as recommended with electricity and natural gas;
- Request waivers from the U.S. Environmental Protection Agency for the import of gasoline that does not meet local air quality requirements; and
- Work through the DOE to obtain *Jones Act* waivers for the import of petroleum products on non-US flag vessels.

The threat of hurricanes in coastal areas has in some cases required large scale evacuations. This has required efforts to assure that gas stations along evacuation routes have sufficient gasoline and diesel fuel supplies to meet this surge in demand. To address this need the State of Texas formed a State Fuel Team under the State Emergency Management Plan. This team is composed of not-for-profit trade associations and works with the State Emergency Operations Center. Their role begins before a hurricane makes landfall by coordinating deliveries of additional supplies of gasoline and diesel fuel along evacuation routes. The State Fuel Team also assists with damage assessment after the hurricane has passed, checking on refineries, pipelines, terminals, and gas stations to determine the level of damage and the level of effort required to safely return to normal operations.

Another approach to this can be seen in Florida that also has had considerable experience with hurricanes. This effort is coordinated through the State Energy Operations Center to assess supply and to coordinate with petroleum suppliers to assure essential needs are met. The Florida Energy and Climate Commission (Governor's Energy Office) has designated an Emergency Coordinating Officer (ECO) who is responsible for monitoring the prices and availability of petroleum products. In the event of a shortage the ECO will consult with various state departments as part of their Energy Support Function 12 (ESF-12 - Fuels). These departments included: Environmental Protection, Transportation, Management Services, and Florida Division of Emergency Management. The ECO will also contact the Florida Petroleum Council, the Florida Petroleum Marketers and Convenience Store Association, and petroleum suppliers. Upon a determination that a shortage is anticipated or exists an executive order of the Governor can be executed that will work through the state's purchase order process to procure additional supplies from emergency fuel providers. This is defined under contract provisions for specific deliverables and performance objectives to provide a minimum of 100,000 gallons of bulk fuel daily to city and county sites designated by ESF-12—Fuels under mutually acceptable terms and conditions.

- ***Mandatory Emergency Measures States May Consider***

If the petroleum situation deteriorates to a level that threatens public health, safety, and welfare and causes significant economic impacts, a state can declare a "State of Emergency" that allows the implementation of mandatory measures. These measures should be considered when petroleum supplies are forced to significantly restrict supply.

In a serious petroleum shortage, provisions of the Uniform Commercial Code may apply, including Section 2-615.<sup>20</sup> The code covers commercial transactions and has provisions that address conditions when a supplier is unable to meet its supply obligations. Section 2-615 permits a seller to breach its

---

<sup>20</sup> Uniform Commercial Code—Article 2. Part 1. Short Title, General Construction and Subject Matter. Legal Information Institute Web site.  
<http://www.law.cornell.edu/ucc/search/display.html?terms=Allocations&url=/ucc/2/article2.htm#s2-615>

contract with a buyer if delivery “has been made impracticable by the occurrence of a contingency,” caused by events outside of the supplier’s direct control. States should review the adoption of this code under state statute to understand specifically how these provisions might apply in their states.

Note that under Section 2-615 the seller must allocate available supply in a fair and reasonable manner. Historically, when this provision triggered allocations of petroleum products, supplies were either allocated as a percentage of contractual volumes or based on the prior year’s actual purchases. Should such a condition occur, suppliers may not be able to discriminate within a class of accounts to give priority to one user over another. This may require state action under emergency authority to specify those uses that should be given priority attention to assure essential public needs are met. States should discuss this issue with their suppliers to determine how they would address this situation and contingencies can be crafted to assure that essential public needs are met. Two potential options are:

- Establish a “Priority End User Program” which requires that suppliers provide police, fire, and emergency medical services one hundred percent of their current requirement upon certification to their suppliers. The list of priority users should be kept as short and clear cut as possible to avoid disputes on the question of whether some service is a priority. The priority users may also need to be tailored to the particulars of an event. For example, diesel fuel for backup generators to support water systems may need to be included in the priority list in the event the petroleum shortage is coupled with a power outage. This action can be done quickly and should be done before initiating a full-scale set-aside.
- In the event of petroleum shortages where suppliers are allocating supply for an extended duration (for example, two months or longer), a state set-aside program could be implemented. (See *Appendix F: Petroleum Fuel Set-Aside*) This program would require petroleum companies delivering fuel into the state to set aside a percentage of their projected deliveries (usually gasoline, propane, liquefied petroleum gas, and diesel fuel) for subsequent allocation by the state authorities. In these cases, a list of priority uses should be identified to guide the decision process. This could include:
  - Police, fire, and emergency response units;
  - Life and health care facilities;
  - Water and sanitation services;
  - Telecommunications;
  - Mass transit;
  - Agriculture and food services;
  - Critical industry and commerce; and
  - Other priority users as determined by the state.

Other special measures that could be used to manage supply or curb demand include the following:

- Purchase restrictions on petroleum (primarily gasoline) products, including minimum purchase requirements, odd/even license plate purchase authorizations, staggered days of operation, and others;
- Reductions of highway speed limits;
- Exemptions to driver and/or vehicle restrictions to allow increased shipments of fuels; and
- Restrictions on the hours during which commercial, industrial, and public facilities may operate.

### ***7. Request for Federal Assistance***

Severe petroleum product emergencies usually result from national or international events that are beyond the ability of state agencies to influence. At this point, the state can request assistance from the federal government.

Two actions, noted throughout these Guidelines, which can be taken by the federal government or initiated by a state request include: Fuel Waivers and Driver Hours of Service Waivers.

- ***Fuel Waivers***

A fuel waiver can be granted in the event of a gasoline or diesel fuel supply emergency by the Environmental Protection Agency with the agreement of the Department of Energy. Fuel or fuel additive requirements may be temporarily waived if doing so will alleviate the fuel supply emergency. In addition, in some states actions might be taken to suspend state rules and regulations that mirror federal requirements. In such cases, the Governor may also need to take action under state authority. Alternatively, if the state's rules on fuel requirements include waiver provisions, these may be used.

When fuel waivers are under consideration at a state level, it is important to ensure coordination between the various state agencies. These agencies would include: the state agency responsible for air quality standards, agencies responsible for enforcement of fuel quality standards, and the office that monitors petroleum supply.

A fuel waiver can be issued only when the criteria specified in the Clean Air Act Section 211(c)(4)(C) have been met. In general, these criteria allow a fuels waiver only to address a temporary emergency fuel supply shortage that exists throughout a state or region that was caused by an unusual situation such as an Act of God, and that could not have been avoided by prudent planning. "Spot" or localized shortages generally are not fuel supply disruptions for which a waiver may be issued. A fuel supply disruption that meets the criteria for a waiver must be one that results in a generalized supply emergency. For example, in 2008 EPA issued fuel waivers in those areas of the southeast that experienced fuel shortages as a result of the damage

and refinery shut-downs caused by Hurricanes Gustav and Ike. Fuels waivers cannot be issued to address concerns regarding the price of fuel.

EPA has promulgated various requirements for motor vehicle fuel under the Clean Air Act, which applies to both gasoline and diesel fuel. However, most of these requirements apply only during part of the year or to designated geographic areas. If the fuel waiver criteria have been met, EPA may waive time and type fuel restrictions for a designated area and period of time. This provides petroleum suppliers with added supply flexibility during a shortage.

For example, the volatility of gasoline is controlled each year during the high ozone season of June 1st through September 15th. In addition, the gasoline used in certain urban areas is subject to volatility standards that are more stringent than in surrounding rural areas. A fuel waiver may allow use of higher volatility gasoline from rural areas to address a fuel supply shortage in an urban area. Similarly, a waiver of the summer volatility requirements could allow winter grade gasoline to be used during the summer high ozone season. However, gasoline volatility standards are necessary to control the emissions of volatile organic compounds (VOC), which contribute to ozone pollution. Fuel waivers that allow use of gasoline with higher volatility may result in increased VOC emissions. For this reason, the Clean Air Act provides strict criteria for when fuel waivers may be granted, and requires that waivers be limited as much as possible in terms of their geographic scope and duration.

**Process for Requesting a Fuel Waiver.** EPA works closely with state officials especially during emergencies. Except in unusual or emergency circumstances, a formal request for a fuel waiver is made by, or on behalf of, the Governor of an affected state after consultation with EPA. During normal business hours (Monday through Friday, 8 am to 5 pm Eastern Time) the first point of contact for obtaining information about a fuel waiver request is the EPA Air Enforcement Division, at 202-564-2260, or the Transportation and Regional Programs Division, at 734-214-4956. Outside of normal business hours, the point of contact is the EPA Emergency Operations Center, at 202-564-3850, which is able to communicate with the EPA officials who provide assistance regarding fuel waiver requests.

For a list of Fuel Waivers that have been granted see:

<http://www.epa.gov/compliance/civil/caa/fuelwaivers/>

Source Document See: Frequently asked question on Fuel Waivers

<http://www.epa.gov/compliance/resources/faqs/civil/fuelwaiver.html>

- ***Waivers for Driver Hours of Service Restrictions***

Limits on the number of hours a truck driver can operate a vehicle fall under requirements of the Federal Motor Carrier Safety Administration (FMCSA). These limits can be waived under two conditions. First, if an emergency has been declared by the President of the United States, the governor of a state, or by their authorized representatives having authority to declare emergencies; and second, if the FMCSA Field Administrator has declared that a regional emergency exists which justifies an

exemption. This exemption cannot exceed the duration of the motor carrier's or driver's direct assistance in providing emergency relief to the affected area, or 30 days from the date of the initial declaration of the emergency or the exemption from the regulations by the FMCSA Field Administrator, whichever is less.

This means, for example, that if a governor has declared an emergency in all or any part of the state, driver hours of service are automatically waived for drivers making deliveries to provide emergency relief to the affected area. In a declared energy emergency, such as a severe propane shortage, propane delivery drivers are exempted. This permits them to drive additional hours for delivery or to reach distant supply terminals and return expeditiously. In a natural disaster, such as a hurricane and declared emergency, drivers can work additional hours needed to resupply fuel and other goods. Drivers passing through multiple states do not require that waivers be in effect in those states if they are providing supplies to an area where an emergency has been declared.

390.23 Relief from regulations which includes Parts 390 to 399 can be found at:  
<http://www.fmcsa.dot.gov/rules-regulations/administration/fmcsr/fmcsrruletext.asp?chunkKey=090163348002389c>

Limits on Hours of Service of Drive can be found at:  
<http://www.fmcsa.dot.gov/rules-regulations/administration/fmcsr/FmcsrGuideDetails.asp?menukey=395>

## VI. PUBLIC INFORMATION

---

This section outlines the information to share with the public and how the information should be disseminated in the event of an energy emergency.

### A. Public Information Programs

A strong public information program is a key crisis management tool. Timely and accurate information helps prevent confusion and uncertainty and enlists public support and cooperation. Participants in an effective public information program include the Governor's Office, state agencies, local governments, energy providers, local businesses, state legislature, and the federal government. It is essential to provide stakeholders and the public with information about the nature, severity, and duration of an emergency because inadequate understanding and awareness can lead to counterproductive reactions that may exacerbate the situation. Before state government can provide information to the public, it must gather information, describe the emergency accurately, and develop recommendations to manage the situation. It is assumed that state resources for these purposes would be more readily available during an emergency than in non-crisis times. Caution should be exercised to comply with state information protocols when receiving direct requests from the media.

- **Functions**

Public information programs have two primary functions in an energy emergency. The first is to help the public understand the nature of the problem and prevent panic. The second is to encourage appropriate responses including conservation and energy use reduction programs.

- **Problems to Avoid**

Experience reveals two major risks due to poor communications: 1) multiple authorities may inadvertently release information that appears to be contradictory because they use different technical terms; and 2) some groups will take advantage of a shortage by characterizing it in ways that further their self interest. It is critical to work closely with media outlets and trade associations to ensure a consistent, concise and well-informed message is distributed by all parties.

- **Types of Public Information Campaigns**

- ***Informational Campaign***

The governor or other state officials provide recurring communication through television, radio, and printed media, as appropriate. This campaign should provide clear and concise updates of the situation and the steps being taken to provide relief.

- ***Education Campaign***



An education campaign informs citizens on ways to minimize energy usage and the inconvenience experienced due to a disruption. Key elements of the educational campaign include:

- Use of the Internet, in addition to other media, to expand coverage;
- Electric and natural gas utilities are responsible for making emergency information available to their customers;
- Natural gas and electric utilities, whose emergency procedures call for public relations, should coordinate closely with the PUC and state emergency management to deliver a unified message;
- When state action is required, releases to the public should come from a designated state spokesperson. In many states this person will be at the SEOC. It may also include the SEO and the PUC; and
- Antitrust laws prohibit oil companies from sharing information among themselves, so companies are unlikely to inform the public during shortages. As a result, the lead agency concerned with petroleum may be asked to explain the adequacy and availability of oil product supplies.

## **B. Coordination**

Coordinating public information requires a mechanism for interagency cooperation and procedures to assure that public statements are timely, accurate, and consistent. As part of the planning process, a specific office should be assigned the responsibility for the public information program. This assigned office, depending on the energy resource in question, could be located within the Governor's Office, PUC, SEO, or emergency management agency. Recommended public information coordinating activities for various phases of energy emergency management include:

- **Preparation**

In preparing for an impending energy emergency the SEO should review public information plans and briefing materials and revise them as needed. Contact should be made with the state emergency management agency to assure that information protocols are coordinated and understood.

- **Location**

Assuming most communications will come from the SEOC, energy office officials should make provisions for the use of data sets, charts, and related displays on-site or by remote means. An example is to make sure that projection equipment is available and operable for displaying computer-generated slides.

- **Responsibility**

A public information program will be implemented at the discretion of the Governor and managed by an assigned individual or office. Since the media is not required to contact designated public information officers, agency officials may be queried directly. In order to be prepared, agency officials should seek

guidance about state media relation protocols in advance. Also, pre-crisis coordination and media response training are advised.

- **Effective Communications**

An effective emergency response plan involves continuous coordination and two-way communication with all levels of government, private industry, and the public.

- **Special Responsibility of Assigned Office**

The office providing public information needs to assure that necessary personnel, equipment, and facilities are on hand, and that procedures allow it to function as a central clearinghouse for gathering and disseminating energy information, whether or not it actually makes presentations to media.

### C. **Operational Considerations**

The following are guiding principles for implementing public information programs during an energy emergency:

- ***Designate Contacts***

Maintain an up-to-date 24 hour telephone and address directory of key staff and other stakeholders, such as ESF-12 state agencies, local governments, federal government agencies, and energy industry representatives.

- ***Ensure Accuracy***

Information must be verified before release. Regularly scheduled meetings with the press help relieve any pressure to answer questions prematurely without adequate verification.

- ***Include Local Officials***

Make certain that local officials receive at least as much information as the media.

- ***Prepare Press Kits***

Handouts for press conferences and written statements for broadcast appearances are excellent tools for disseminating information, such as fuel supply and use issues, data, responder actions, and comparisons with previous emergencies. Written statements provide a record of what was said.

- ***Use National and State Information***

Use data from EIA and/or OE, plus other sources, to describe the external forces (e.g., international markets, shipping issues, transportation, refinery outages, and weather) that might affect a state's energy situation. Use industry experts in the interpretation of events.

- ***Don't Rush to Conclusions***

Use *extreme* caution when drawing conclusions with media present. Energy emergencies usually involve complex factors and media are under pressure to simplify information and provide headlines. Public opinion can be swayed by fragmented data and unsupported opinions. Information and conclusions should be balanced and accurate.

- ***Access Key Policy Makers***  
Use access to key policy makers and experts from various state agencies as needed. Ask these persons, when possible, to answer substantive questions from the media.
- ***Inform the Public***  
Assist the media in informing the public in every way possible. The objective is to provide authoritative, accurate, and timely information in order to avert the spread of rumors and inappropriate private and public response.
- ***Use Contacts in Private Organizations and Industry Associations***  
Enlist private organizations to distribute information. For example, the Automobile Association of America distributes information about gasoline and diesel fuel prices.<sup>21</sup> Fuel oil and propane dealer associations are invaluable for providing information and speaking on behalf of the petroleum industry.

#### **D. Data and Information Acquisition and Dissemination**

Public information requires access to data about the cause of, and recovery from, an energy emergency. The assigned office should draw data from well-established, credible sources. The following are guidelines for linking information regarding the progress of an energy emergency to public information efforts:

- Use existing organizational data structures and procedures to the maximum extent possible;
- Identify the type and sources of information needed and the level of detail and analysis required by decision makers;
- Designate media contact(s) with the requisite technical knowledge and communication skills to summarize the energy situation;
- Develop a rapid management review and approval process for public information material prior to transmitting any information outside of the office; and
- Maintain a file of all news articles on the energy emergency for recordkeeping and review purposes.

---

<sup>21</sup> Daily Fuel Gauge Report. American Automobile Association.  
<http://news.hospitality-1st.com/AAA-2009.html>

## **E. Equipment Requirements**

Additional communication equipment may be needed and obtained on loan from other state agencies. For example, if a state police or emergency management division has an SEOC, it is typically equipped to handle public information needs.

## VII. CONCLUSION

---

The ongoing threat from “all hazards” within our nation, our aging energy infrastructure, and the enormous economic loss associated with intentional or unintentional energy outages and natural disasters highlight the need for states to be prepared for all hazards as identified in the *National Response Framework*, the *National Infrastructure Protection Plan* and the *Energy Sector Specific Plan*. States and local government will continue to be on the front line when emergencies occur, and the public will expect that states know how to effectively respond in a coordinated fashion to mitigate the consequences and assure a rapid recovery.

The guidelines discussed in this document can serve as an important starting point for a state’s energy emergency planning effort. They are not a substitute for a good, well-developed state plan that reflects the unique elements of a state’s energy use, legal foundations, and organizational structure. These Guidelines provide a wealth of information and insights that can and should be considered in any well-developed energy emergency plan. The process of developing a comprehensive plan, including the involvement of all the stakeholders, is nearly as important as the final document. Relationships established during the preparation of a state planning effort should also be reinforced and strengthened using exercises and training opportunities to sustain the capabilities developed in the planning process. Such efforts will produce invaluable results when an emergency occurs.

The Office of Electricity Delivery and Energy Reliability, the National Association of State Energy Officials and the National Association of Regulatory Utility Commissioners remain committed to assisting states with energy emergency planning and to protecting critical energy infrastructure now and in the future.

\* \* \*

## **VIII. APPENDICES**

---

Appendix A—Quick Guidelines: Ten Things You Should Know to be Prepared for Energy Emergencies

Appendix B—Additional Information Pertaining to Federal Agencies

Appendix C—Federal Energy Emergency Authorities

Appendix D—Monitoring Energy Supplies

Appendix E—Essential Pre-Crisis and Background Information for State Energy Emergency Responders

Appendix F— Petroleum Fuel Set-Aside

Appendix G—The Role of Energy Efficiency and Renewable Energy Resources in Energy Assurance Planning

Appendix H—References and Resources

## **Appendix A—Quick Guidelines: Ten Things You Should Know to be Prepared for Energy Emergencies**

---

### **1. Make sure you and your staff are prepared to deal with the needs of policy makers**

#### *In Summary:*

Be familiar with state procedures for declaring emergencies and with National Governor's Association, Energy Emergency Preparedness Policy which is as follows:

#### **18.6 Energy Emergency Preparedness**

*States have played a unique and important role in response to past energy crises and must maintain their ability to meet their responsibilities to mitigate the effects of future supply disruptions or shortages. It is imperative that states and the federal government develop strategies for responding to a broad variety of possible energy and electricity emergencies. Initial efforts should focus on strategies to prevent emergencies from occurring. Efforts to diversify our energy systems while maximizing our use of cost-effective domestic energy resources are part of this long-term effort. Additional efforts must focus on planning the response federal and state governments would take if an energy or electricity emergency occurs. Any federal actions must give consideration to existing state laws and programs, and state and local officials must be included in any federal planning process.*

*Voluntary conservation should be preferred to mandatory measures whenever possible. Any mandatory response should be phased in, beginning with the least stringent measures, with rationing reserved for only the most severe shortage.*

*To facilitate emergency preparedness, Governors support the following measures.*

- *There must be improved coordination among DOE, the Department of Homeland Security (DHS), the Department of Transportation (DOT), and the states in overseeing the security of the nation's energy infrastructure.*
- *Integrated emergency response plans and procedures should be developed and well tested to ensure the coordination and flow of information among energy suppliers, consumers, and federal, state, and local governments.*
- *Fuel switching capability for large energy users to reduce dependence upon a single fuel source should be encouraged.*
- *A timely official review of the Strategic Petroleum Reserve (SPR) should be undertaken by Congress and the Administration to determine its ideal size. The Administration also should establish more specific criteria for determining when the SPR should be filled and tapped, taking into account regional reserves.*
- *Upon a Governor's declaration of an energy or electricity emergency, non-exempt federal facilities within a state should be required to reduce their energy consumption by at least 10 percent from the previous year's consumption, for the duration of the emergency.*

#### **18.7 Energy Infrastructure Security**

*Energy infrastructure - power plants, refineries, and transmission and distribution networks - share the vulnerability of all types of critical infrastructures to risks associated with*

*threats from terrorist attacks and weapons of mass destruction. Managing the vulnerability of energy infrastructure is a necessary element of our national security, economic well-being, and environmental protection. Based on the level of vulnerability and risk, measures should be taken to detect, prevent, control, and manage the consequences of terrorism directed toward energy infrastructure. Governors also support the principles outlined in NGA policy EC-5, Homeland Security Policy, and NGA policy NR-20, Improved Pipeline Safety, and support the use of those principles in the implementation of this provision.*

*Time limited (effective Annual Meeting 2007–Annual Meeting 2009). Adopted Annual Meeting 2001; revised Winter Meeting 2002, Winter Meeting 2003, Annual Meeting 2003, Annual Meeting 2005, Annual Meeting 2007, and Annual Meeting 2008.*

## 2. **Know Your State’s Energy Profile and Interdependencies**

Useful energy emergency planning begins with knowledge of the fuels used within your state. Someone in the agency should understand the sources, volume, and import routing of these fuels. Once you know the state’s fuel profile, you can gauge the most vulnerable consumption sectors or you can readily identify the impacts of inclement weather, pipeline or power outages, etc.

*In summary:*

- Understand the state and local energy markets
- Know the relationship of local markets to regional and national markets
- Stay current with EIA State Energy Data pertaining to your state
- Cover all of the energy and fuel types:
  - Electricity
  - Natural Gas
  - Motor Gasoline
  - Aviation Fuels
  - Propane
  - Heavy industrial fuels
  - Distillates
  - Renewables
  - Nuclear
  - Know how much energy your state consumes on a monthly basis (*Note: most data is published monthly and you can divide by the days in a month to get daily average*).

Interdependencies are the degree to which one infrastructure depends on one another for operations. A coal-fired power plant, for example, is dependent on rail or water-borne shipments. A disruption to either could eventually lead to curtailment of power production. Many petroleum refineries rely on electric power to operate and, in the event of a blackout, may not be able to execute a controlled shut down. This, in turn, can damage equipment, further aggravating a bad situation.

There are four types of infrastructure interdependencies:

- Physical (e.g., inputs and outputs of one infrastructure used by another)
- Cyber (e.g., electronic, informational linkages)
- Geographic (e.g., common corridor or location)
- Logical (e.g., dependency through financial markets)

## 3. **Know the Geography and Demographics of your Energy Infrastructure**



Geography is an important component of emergency preparedness. Most states have distinct regions with parochial supply requirements. These must be understood in order to craft an appropriate response. Knowing import and supply geography will help officials focus on the supply and retail facilities closest to a problem. Knowing how the regional energy supply network works is especially important.

*In summary:*

- Know the sources of energy imported into your state and how it moves into the state:
  - Pipelines
  - Major electric transmission facilities
  - Trucking
  - Rail
  - Ports
- Know the electric utilities and gas distribution company service areas
- Locate all major petroleum import terminals for your state
- Know the routes of your state's major highways
- Understand the distribution of all major fuel retail outlets

Demographics relates to population and density and who and how many individuals might be effected by infrastructure failures e.g., how many customers may be without power, size of residential population near critical infrastructure that could suffer fire, explosion, toppling, electrocution or other hazard. Proximity to potential hazards leads to questions about evacuation, other facilities that may be affected, and public reaction. So, while you need to know the locations of energy infrastructure, you also need to know about the areas in which they are located in order to assess consequences in an event of damage or destruction.

#### 4. **Know your Key Government and Industry Contacts**

Energy emergency preparedness is highly dependent on knowing who is responsible for what. Many, if not most, energy shortage situations can be resolved with a telephone call or direct communication with a key industry or state stakeholder. Most shortages or supply disruptions are resolved without an emergency ever being declared. In addition, knowledge of your state's demographics is a must for understanding the impacts of shortages.

*In summary:*

- Understand the relationship of population centers to rural areas
- Have good demographic information for your state
- Know key persons in your state's key energy supply sectors
  - Petroleum
  - Natural gas
  - Electricity
  - Coal
  - Other
- Know key players in the various energy consuming sectors. This could be associations or other groups:
  - Residential
  - Commercial
  - Industrial
  - Governmental

- Know the key emergency and energy-related personnel in other agencies of state government (including the Governor’s Office and state emergency management agency) and major local governments
- Know key personnel in neighboring state energy offices
- Understand the role of your PUC in safeguarding electric and natural gas operations and energy pricing
- Have a current emergency personnel contact list for all utilities, public, private, large and small. Have a current e-mail distribution list of the EEAC [DEFINE] contacts and secondary contacts in surrounding states

**5. Maintain a Good Working Relationship with Private and Public Sector Contacts**

Remember, various segments of the fuel industry compete for customers. It is in their interest to provide seamless, reliable service. All segments of the fuel industry are covered by one or more rules pertaining to such factors as price, territory, supply obligations or safety. Given this, you can rely on the private sector as the “first line of defense” in mitigating a fuel shortage. Notwithstanding bad press, coordinate with the private sector to handle most mild and moderate supply problems and make the administration of mandatory measures, when necessary, efficient.

*In summary:*

- Understand the energy shortage mitigation plans of local distribution companies
- Know the executive director of the local petroleum, propane, and related professional associations
- Maintain current contacts and communications

**6. Be Prepared to Work With The Media**

Being the “expert” places a special burden on the state’s energy emergency information contact. Given the tendency to work closely with emergency management agencies, it is important to clarify which agency is the official spokesperson for the emergency. And remember the first commandment—no matter where an energy office is located, the Governor will become involved. Know the Governor’s Press Office protocols before the first reporter calls.

It almost goes without saying, knowing the numbers will enable the spokesperson to say something intelligent without venturing into the dangerous, but media-preferred, waters of speculation. Keep the report simple, number-driven, upbeat and short. Answer baited or antagonistic (or baited seemingly friendly) questions with the numbers. Try to think ahead of the questions.

*In summary:*

- Understand the Governor’s Press Office communication protocol
- Know your state government’s communications hierarchy
- Know when to speak and who is responsible for saying it
- Stay abreast of events
- Make sure the director is briefed daily, or more often, on the numbers as well as the situation
- Practice responding to hostile questions
- Know when to *hold ‘em* and know when to *fold ‘em*

**7. Know the Legal Authorities which Support your Response**

Responding to an energy shortage has many legal implications and the private sector stakeholders with whom you must work are very much aware of this. Avoid the temptation to do things the law will not allow.

*In summary:*

- Know informal “pecking” order for dealing with emergencies
- Understand the rules promulgated by your public utility commission pertaining to local distribution company power restoration and safety

#### 8. **Understand How You can Effectively Respond**

The tools of response are most often called measures. Various measures are appropriate for different levels of response. Ideally, a state will have passive and voluntary measures to mitigate minor problems and an increasing scale of active and mandatory measures for more severe stages of supply disruption. In addition there are measures that can work to increase or supplement supply and other measures that are intended to reduce demand. In both cases the efforts are intended to move toward supply/demand equilibrium.

*In summary:*

- Understand what is and is not possible in your state
- Be prepared to explain how measures work and why they might be recommended.
- Be prepared to recommend measures to the Governor including:
  - Voluntary
  - Mandatory
  - Supply enhancement
  - Demand restraint

#### 9. **Maintain an Alternative Budget for Emergencies**

Plan to defend some politically acceptable maintenance budget for routine monitoring and plan updates and have a short-term, augmented budget ready to present when an emergency occurs.

*In summary:*

- Understand your budget for emergencies
- Strive to maintain some amount of contingency planning funds to defray the costs of gearing up for any fuel shortage that affects your state

#### 10. **Keep Your Energy Assurance Plans Up-to-Date**

The energy supply industry is dynamic. Mergers, technology, changes in consumption patterns and political events all impact a state’s energy profile. Assume that some of your plan’s information will be questionable within two to three years and significantly out-of-date in five to seven years. States should budget money and staff for plan upgrades.

*In summary:*

- Review the State’s Energy Emergency Preparedness Plan on a regular basis
- Assess changes in local and national energy markets as they impact your state
- Coordinate your planning with your state’s emergency agency

## **Additional Information Pertaining to Federal Agencies**

### **A. U.S. Department of Energy**

DOE's energy emergency support responsibilities and capabilities are distributed among several divisions within the Department. DOE sets forth the missions of the key elements as follows:

1. **Office of Policy and International Affairs**  
This Office is the principal advisor to the Secretary, Deputy Secretary, and Under Secretary on energy and technology policy issues, including the environmental consequences of energy use. This Office has primary responsibility for the formulation and development of national energy policy and for the conduct of policy analyses. The Office analyzes, develops, and coordinates departmental science and technology policy, environmental policy including global climate change policy, and economic policy. It is also responsible for advising the Department's senior management on issues related to the Department's environmental security and energy emergency policies.
2. **Office of Electricity Delivery and Energy Reliability**  
This Office operates DOE's Emergency Management System, Headquarters Emergency Operations Center (Forrestal Building), the Technical Support Center (Germantown, Maryland) and ensures integration and compatibility of all departmental emergency operations facilities. OE ensures integration and compatibility of all Departmental emergency operations facilities. In order to meet its national security requirements and responsibilities as set forth in the *National Response Framework*, DOE has established mandatory reporting requirements for electric power system incidents or possible incidents. Such incidents are to be reported to the Department through its EOC on a timely basis.

The OE is also responsible for Critical Infrastructure Protection. It manages departmental activities that support DOE's role as lead agency for government interaction with the nation's energy sectors regarding critical infrastructure protection. In this role, OE develops and manages the critical infrastructure protection R&D program, and leads and coordinates departmental efforts to work with industry, state and local governments and national and international entities in accordance with *Presidential Decision Directive 63* (Policy on Critical Infrastructure Protection). This *Directive* calls for a series of actions that are designed to defend critical infrastructure from various threats. The *Directive* also identifies lead federal agencies for each critical infrastructure in the U.S.

3. **Energy Information Administration**  
EIA was created by Congress in 1977. It is a statistical agency of DOE that provides policy-independent data, forecasts, and analyses to promote sound policy making, efficient markets, and public understanding regarding energy and its interaction with the economy and the environment. EIA distributes four types of information products: energy data, analyses, forecasts, and descriptive information

about its products. Many of the products, such as the *Petroleum Supply Monthly*, deal with specific industries.

Of particular value to a broad range of customers are products that contain data on all fuel types presented in an integrated manner. Some key releases of integrated information are the *Monthly Energy Review*, the *Annual Energy Review*, the *Short-Term Energy Outlook*, and the *Annual Energy Outlook*.

Most of the energy data are collected by EIA staff who design and send out statistical surveys to energy producers, users, transporters, and certain other businesses. Companies and households report directly to EIA. EIA also obtains energy data from other sources, such as trade associations and other government agencies.

EIA's analysis products are technical reports and articles that analyze issues about energy including economics, technology, energy production, prices, distribution, storage, consumption, and environmental effects. The Administration's forecasts cover all energy types, and include forecasts of supply, consumption, prices, and other important factors. There is a short-term forecast that goes out six to eight quarters in the future, and a midterm forecast that goes out twenty years. Some of EIA's forecasting models are available on their website at <http://www.eia.doe.gov>.

Other EIA products are descriptions of information products that include directories of survey forms, lists of publications, electronic products and models, a guide to energy education resources, and complete lists of energy data contacts to call who have answers to energy questions.

#### 4. Additional Activities

The following actions are taken in an emergency that requires activation of the *Federal Response Plan* and ESF-12.

- DOE Headquarters will establish the Headquarters Emergency Management Team and assign personnel to temporary duty at the FEMA Headquarters, Regional Operations Center, and Disaster Field Office as needed;
- The ESF-12 priority will be to save lives, protect property, and assist other ESFs by aiding in the restoration of damaged energy systems; and
- Within twenty four hours of implementation of the *Federal Response Plan* or upon instruction from FEMA, DOE Headquarters will start submitting situation reports to FEMA Headquarters.

### B. **Federal Emergency Management Agency and the *Federal Response Framework***

#### 1. FEMA Role and Responsibility

Under the *Stafford Act* and *Executive Orders 12148, Federal Emergency Management, and 12656, Assignment of Emergency Preparedness Responsibilities*, FEMA has been delegated primary responsibility for coordinating federal emergency preparedness, planning, management, and disaster assistance functions. FEMA also has been delegated responsibility for establishing federal disaster assistance policy.

2. **Federal Response Framework**

FEMA has the lead in developing and maintaining the *Federal Response Framework* which describes the structure for organizing, coordinating, and mobilizing federal resources to augment state and local efforts under the *Stafford Act* and its implementing regulations that appear in 44 CFR 206. The *NRF* also may be used in conjunction with federal agency emergency operations plans developed under other statutory authorities as well as memorandums of understanding among various federal agencies. The *NRF* is implemented through regional supplements developed by FEMA, and the regional offices of other federal agencies, that describe specific actions, operating locations, and relationships to address the unique needs of the region and states. From time to time, operations supplements to the *NRF* may be issued to address special events that merit advanced planning, such as the Olympics or presidential inaugurations.
3. **Organization of the *NRF***

The *NRF* is comprised of three core documents: the Emergency Support Functions (ESF); Support and Incident Annexes; and the Partner Guides. It also summarizes federal planning assumptions, response and recovery actions, and responsibilities. Separate *Emergency Support Function Annexes* describe the mission, policies, concept of operations, and responsibilities of the primary and support agencies involved in the implementation of key response functions that supplement state and local activities. Energy is ESF-12.
4. **State Assistance**

Under the *Stafford Act*, a Governor may request that the President declare a major disaster or an emergency if an event is beyond the combined response capabilities of a state and affected local governments. Based upon the findings of a joint federal-state-local Preliminary Damage Assessment indicating the damages are sufficient to warrant assistance under the Act, the President may grant a major disaster or emergency declaration. No direct federal assistance is authorized prior to a presidential declaration. However, FEMA can use limited pre-declaration authorities to move Initial Response Resources (critical goods typically needed in the immediate aftermath of a disaster, e.g., food, water, emergency generators) and emergency teams closer to potentially affected areas. FEMA also can activate essential command and control structures to lessen or avert the effects of a disaster and to improve the timeliness of disaster operations.
5. **Additional Assistance**

Under the *Stafford Act*, when an incident poses a threat to life and property that cannot be effectively dealt with by state or local governments, FEMA can request that the Department of Defense (DOD) to utilize its resources prior to a declaration to perform any emergency work “essential for the preservation of life and property” under the *Stafford Act*. Following a declaration, the President may direct any federal agency to use its authorities and resources in support of state and local assistance efforts to the extent that provision of the support does not conflict with other agency emergency missions. A state must commit to pay a share of the cost to receive certain types of federal assistance under the *Stafford Act*. In extraordinary cases, the President can choose to adjust the cost share or waive it for a specified time period. The presidential declaration notes any cost-share waiver, and a FEMA-State Agreement is signed that stipulates the division of costs among federal, state, and local governments and other conditions for receiving assistance.

6. Energy Consequences

A natural disaster, such as an earthquake, may produce energy consequences such as pipeline ruptures disrupting petroleum transmission and natural gas or transmission tower collapses interrupting gas flow and electric transmission. Conversely, failure of a primary transmission line may result in an energy emergency in its own right.

## **Authorities Affecting Multiple Segments of the Energy Sector**

### **American Recovery and Reinvestment Act of 2009, Public Law 111-5**

The ARRA granted supplemental appropriations for FY2009 to the Department of Energy for, among other things, programs for energy efficiency and renewable energy, electricity delivery and energy reliability, and fossil energy research and development. Section 405 specifically provides financial support for smart grid demonstration projects in urban, suburban, tribal, and rural areas, as well as to electric utilities who invest in advanced grid technology. This section also requires the Secretary of Energy to establish and maintain a smart grid information clearinghouse which will make data from smart grid demonstration projects and other sources available to the public. The ARRA provides a number of additional financial incentives for renewable energy, energy efficiency, and biomass projects on a State, local and individual level.

### **Homeland Security Presidential Directive 5 (HSPD - 5)**

This directive enhances the ability of the United States to manage domestic incidents by establishing a single, comprehensive national incident management system. It requires all federal departments and agencies to cooperate with the Secretary of Homeland Security by providing their full and prompt cooperation, resources, and support as appropriate and consistent with their own responsibilities for protecting the nation's security. The directive provides for federal assistance to state and local authorities when their resources are overwhelmed, or when federal interests are involved.

### **Homeland Security Presidential Directive 7 (HSPD - 7)**

This directive establishes a national policy for federal departments and agencies to identify and prioritize U.S. critical infrastructure/key resources CIKR and to protect them from terrorist attacks. Federal departments and agencies are required to: (1) identify, prioritize, and coordinate CI/KR protection in order to prevent, deter, and mitigate the effects of deliberate efforts to destroy, incapacitate, or exploit them; and (2) work with state and local governments and the private sector to accomplish this objective. Federal departments and agencies are directed to protect information associated with carrying out this directive, including handling voluntarily provided information and information that would facilitate terrorist targeting of CIKR consistent with the Homeland Security Act of 2002 and other applicable legal authorities.

### **Federal Information Security Management Act of 2002 (FISMA); E-Authentication Guidance for Federal Agencies, Office of Management and Budget (OMB) (December 16, 2003); FIPS Publication 199, Standards for Security Categorization of Federal Information and Information Systems (February 10, 2004); National Information Assurance Acquisition Policy for National Security Systems (NSTISSP 11); Federal Preparedness Circular 65, Federal Executive Branch Continuity of Operations (June 2004)**

DOE, like other Federal agencies, is responsible for complying with FISMA as well as guidelines and practices developed by OMB that implement the law. While FISMA applies strictly to federal government agencies, DOE has carefully implemented requirements that support protection of the energy infrastructure. These include, for example, OMB's e-authentication guidance for remote authentication, National Institute of Standards and



Technology guidelines for securing and procuring national security systems, and other related guidance.

**Protected Critical Infrastructure Information (PCII) Program of the Critical Infrastructure Information (CII) Act of 2002, 6 U.S.C. §§ 131-134**

The PCII Program, established pursuant to the CII Act, creates a framework that enables members of the private sector to voluntarily submit sensitive information to the Department of Homeland Security (DHS) regarding the nation's critical infrastructure with the assurance that the information, if it satisfies the requirements of the CII Act, will be protected from public disclosure. To implement and manage the program, DHS has created the PCII Program Office within DHS's National Protection and Programs Directorate. The PCII Program Office or other Federal agencies designated by the PCII program manager can receive critical infrastructure information to be validated as PCII if such information qualifies for protection under the CII Act. On September 1, 2006, DHS issued a Final Rule on Procedures for Handling Critical Infrastructure Information.

**Chemical Facility Anti-Terrorism Standards ("CFATS"), 6 C.F.R. Part 27**

In Section 550 of the Department of Homeland Security Appropriations Act of 2007, Public Law 109-295, Congress gave DHS the authority to require high-risk chemical facilities to complete vulnerability assessments, develop site security plans, and implement protective measures necessary to meet DHS-defined performance standards. In accordance with this authority, on April 2, 2007, DHS released the Chemical Facility Anti-Terrorism Standards as an interim final rule.

Through the CFATS, DHS established risk-based performance standards for the security of the Nation's chemical facilities. The CFATS requires covered chemical facilities to prepare Security Vulnerability Assessments (SVA), which identifies facility security vulnerabilities, and to develop and implement Site Security Plans, which include measures that satisfy the identified risk-based performance standards. It also allows certain covered chemical facilities, in specified circumstances, to submit Alternate Security Programs (ASPs) in lieu of an SVA, Site Security Plan, or both.

CFATS also contains associated provisions addressing inspections and audits, recordkeeping, and the protection of information that constitutes Chemical-terrorism Vulnerability Information (CVI). Finally, the rule provides the Department with authority to seek compliance through the issuance of Orders, including Orders Assessing Civil Penalty and Orders for the Cessation of Operations.

**Bonneville Project Act of 1937, 16 U.S.C. 832 et seq.; Reclamation Act of 1939, as amended, 43 U.S.C. 584 et seq.; Flood Control Act of 1944, 16 U.S.C. 825(s); Colorado River Storage Act of 1956, 43 U.S.C. 620 et seq.; Pacific Northwest Preferences Act of 1964, 16 U.S.C. 837; Federal Columbia River Transmission System Act of 1974, 16 U.S.C. 838; Department of Energy Organization Act, Section 302, 42 U.S.C. 7152; Pacific Northwest Electric Planning and Conservation Act of 1980, 16 U.S.C. 839; and Energy and Water Development Appropriation Act of 1985, 16 U.S.C. 837g-1**

DOE's power marketing associations have general powers under enabling legislation to manage multiple areas of critical infrastructure protection. These range from protection to response and restoration covering generation, transmission, and related facilities. Congress provides similar

authority to the Tennessee Valley Authority (TVA) to protect and reconstitute TVA generation, transmission, and related facilities.

**Federal Power Act (FPA), 16 U.S.C. 791a-825r; Public Utility Regulatory Policies Act (PURPA) of 1978, codified in 16 U.S.C. 2601 et seq.; Energy Policy Act of 1992, 42 U.S.C. 13201 note**

Congress provides a statutory foundation for the Federal Energy Regulatory Commission's (FERC) oversight of power markets. While generation siting, intrastate transportation, and retail sales are generally regulated by state or local entities, wholesale sales and interstate transportation generally fall under federal regulation, primarily by FERC.

One of FERC's strategic goals is to protect customers and market participants through vigilant and fair oversight of energy markets in transition. To pursue this goal, the Commission promotes understanding of energy market operations and assesses market conditions using objective benchmarks to create pro-competitive market structure. FERC's Office of Market Oversight and Investigations is charged with assessing the competitive performance and efficiency of U.S. wholesale natural gas and electricity markets.

**Federal Power Act, as amended, 202(a) (16 U.S.C. 791a), and the Public Utility Regulatory Policies Act, Section 209(b) (16 U.S.C. 824a-2)**

The Secretary of Energy has authority with regard to reliability of the interstate electric power transmission system. DOE has the authority to define reliability regions and encourage interconnection and coordination within and between regions. DOE also has the authority to gather information regarding reliability issues and to make recommendations regarding industry security and reliability standards.

**Defense Production Act (DPA) of 1950, as amended, 101(a), 101 (b), 101(c), and 708 (50 U.S.C. 2071 (a), (c), and 2158)**

The Secretaries of Energy and Commerce have been delegated the President's authorities under sections 101(a) and 101(c) of DPA to require the priority performance of contracts or orders relating to materials (including energy sources), equipment, or services, including transportation, or to issue allocation orders, as necessary or appropriate for the national defense or to maximize domestic energy supplies. DPA section 101(a) permits the priority performance of contracts or orders necessary or appropriate to promote the national defense. "National defense" is defined in DPA section 702(13) to include "emergency preparedness activities conducted pursuant to title VI of the Robert T. Stafford Disaster Relief and Emergency Act and critical infrastructure protection and assurance." The Secretary of Energy has been delegated (Executive Orders 12919 and 11790) the DPA section 101(a) authority with respect to all forms of energy. The Secretary of Commerce has been granted (Executive Order 12919) the section 101(a) authority over most materials, equipment, and services relevant to repair of damaged energy facilities. Section 101(c) of the DPA authorizes contract priority ratings relating to contracts for materials (including energy sources), equipment, or services in order to maximize domestic energy supplies, if the Secretaries of Commerce and Energy, exercising their authorities delegated by Executive Order 12919, make certain findings with respect to the need for the material, equipment, or services for the exploration, production, refining, transportation, or conservation of energy supplies.

The DPA priority contracting and allocation authorities could be used to expedite repairs to damaged energy facilities, and for other purposes, including directing the supply or

transportation of petroleum products, to maximize domestic energy supplies, meet defense energy needs, or support emergency preparedness activities. In the case of both the section 101(a) and 101(c) authorities, if there are contracts in place between the entity requiring priority contracting assistance and one or more suppliers of the needed good or service, DOE (with respect to the section 101(c) authority) or DOC (with respect to the section 101(a) authority) would issue an order requiring suppliers to perform under the contract on a priority basis before performing other non-rated commercial contracts. If no contracts are in place, DOE or DOC would issue a directive authorizing an entity requiring the priority contracting assistance to place a rated order with a supplier able to provide the needed materials, equipment, or services. That contractor would be required to accept the order and place it ahead of other nonrated commercial orders.

Section 101(b) provides authority to facilitate transportation of energy supplies during an emergency by requiring pipelines, marine terminals, and other facilities to perform transportation contracts to promote national defense. The authority to control the general distribution of petroleum supplies in the civilian market can be used if a finding is made that supplies are “scarce and critical” and defense needs cannot be met without causing dislocations that will create appreciable hardship.

DPA section 708 provides a limited antitrust defense for industry participating in voluntary agreements “to help provide for the defense of the United States through the development of preparedness programs and the expansion of productive capacity and supply beyond levels needed to meet essential civilian demand in the United States.” In the event of widespread damage to energy production or delivery systems, this authority, for example, could be used to establish a voluntary agreement of service companies to coordinate the planning of the restoration of the facilities.

**Robert T. Stafford Disaster Relief and Emergency Assistance Act, as amended, 42 U.S.C. 5121 et seq.**

The Federal Emergency Management Agency (FEMA), following a presidential declaration of emergency or major disaster, provides assistance and may require other Federal agencies to provide resources and personnel to support state and local emergency and disaster assistance efforts. Requests for a presidential declaration of an emergency or major disaster must be made by the Governor of the affected state based on a finding by the Governor that the situation is of such severity and magnitude that effective response is beyond the capabilities of the State. DOE supports DHS/ FEMA relief efforts by assisting federal, state, and local government and industry with their efforts to restore energy systems in disaster areas. When necessary, DOE also may deploy response staff to disaster sites. DOE is the lead agency directing Emergency Support Function-12 (Energy), which assists the restoration of energy systems and provides an initial point-of-contact for the activation and deployment of DOE resources. These activities are performed pursuant to the Stafford Act and HSPD-5 (Management of Domestic Incidents) and National Response Plan (NRP).

**Executive Order 11912, Department of Energy Organization Act, Sections 102 and 203 (42 U.S.C. 7112, 7133); Energy Policy and Conservation Act (EPCA), Sections 251-254 (42 U.S.C. 6271-6274); Agreement on an International Energy Program (IEP)**

The DOE and the Department of State share responsibility for U.S. participation in the energy emergency preparedness activities of the International Energy Agency (IEA). IEA, consisting of 26 member countries, was established by IEP following the 1973 oil crisis with the goal of

developing and maintaining cooperative oil emergency response policies and programs. DOE leads U.S. participation in IEA's oil emergency response programs. The Department develops plans for U.S. emergency response actions, develops the U.S. position on an appropriate international response, and makes recommendations for action to the President.

**Section 27 of the Merchant Marine Act of 1920, as amended (Jones Act), 46 U.S.C. 883**

Public Law 81-891(64 Stat. 1120) directs the Secretary of Homeland Security to waive the provisions of section 27 of the Merchant Marine Act of 1920 ("Jones Act") which requires the use of U.S.-flag, U.S.-built, and U.S.-crewed vessels in coastwise trade, upon the request of the Secretary of Defense to the extent the Secretary of Defense deems necessary in the interest of the national defense. Public Law 81-891 authorizes the Secretary of Homeland Security to waive compliance with the Jones Act either upon his own initiative or upon the written recommendation of the head of another agency whenever the Secretary determines that waiver is necessary in the interest of the national defense. In the event of a drawdown of SPR, the President may direct the Secretary of Homeland Security to waive the Jones Act, if the volume of crude oil to be moved is significantly greater than the capacity of the existing, available U.S.-flag "Jones Act" crude oil tanker fleet. Interagency procedures have been established to expedite actions on Jones Act waiver requests during a petroleum supply disruption

**Interstate Commerce Commission Termination Act of 1995 (Pub. L. No. 104-88, 109 Stat.803)**

This authorizes the Surface Transportation Board and the Department of Transportation to issue priority orders during an emergency situation for rail movement of commodities including petroleum. (49 U.S.C. Section 11123)

**Federal Motor Carrier Safety Administration 49 C.F.R. 390.23**

This provides for waiver of federal motor carrier safety regulations to provide emergency relief during a regional or local emergency declared by the President, governor of a state, or the Regional Director of Motor Carriers. An emergency is defined to include natural disasters, explosions, blackouts or other occurrences, natural or man-made, which interrupts the delivery of essential services such as electricity, medical care, sewer, water, telecommunications and telecommunications transmission or essential supplies such as food and fuel, or otherwise immediately threaten human life or public welfare. For example, the waivers may exempt motor carriers and drivers from limits on on-duty hours when providing direct assistance in such emergencies and provides exemptions from inspections, record keeping, hazardous materials, and other requirements.

**Department of Energy Organization Act, Section 205 and Federal Energy Administration Act of 1974, Sections 51 to 59**

The DOE and the National Association of State Energy Offices (NASEO) agreed that the DOE will develop, maintain, and distribute a contact list of state and federal individuals responsible for energy market assessment and energy emergency responses. The states will participate in the effort by providing timely assessments of energy markets to the DOE and other states in the event of an energy supply disruption. In support of this effort, each state identified one or more Energy Emergency Assurance Coordinators (EEACs).

**Community Opportunities, Accountability and Training and Educational Services Act of 1998, Title III, Sec 301-309, and the Low Income Home Energy Assistance Act of 1981**

The Department of Health and Human Services (HHS) can make the Low Income Home Energy Assistance Program (LIHEAP) emergency contingency funds available to help eligible low income households meet their home heating and/or cooling needs arising from a natural disaster or other emergency such as extremely high energy prices. The DOE may advise HHS on the fuel supply situation for such emergency funding.

In addition to the availability of discretionary emergency funds, HHS also annually awards energy assistance block grants to the 50 states, the District of Columbia, eligible Indian tribes/tribal organizations, and insular territory areas, who in turn make payments directly to eligible households to help meet the costs of home energy.

**Ports and Waterways Safety Act, Natural Gas Pipeline Safety Act, and the Hazardous Liquids Pipeline Safety Act, 33 U.S.C. 1221 et seq.**

The Ports and Waterways Safety Act authorizes the Secretary of Transportation to establish vessel traffic systems for ports, harbors, and other navigable waters and control vessel traffic in areas determined to be hazardous (e.g., because of conditions of reduced visibility, adverse weather, vessel congestion, etc.) (33 U.S.C. 1223).

Two statutes provide the framework for the federal pipeline safety program. The Natural Gas Pipeline Safety Act of 1968 as amended authorizes DOT to regulate pipeline transportation of natural (flammable, toxic, or corrosive) gas and other gases as well as the transportation and storage of liquid natural gas (LNG). Similarly, the Hazardous Liquid Pipeline Safety Act of 1979 as amended authorizes DOT to regulate pipeline transportation of hazardous liquids (crude oil, petroleum products, anhydrous ammonia, and carbon dioxide). Both of these Acts have been recodified as 49 U.S.C. Chapter 601. The federal pipeline safety regulations (1) assure safety in design, construction, inspection, testing, operation, and maintenance of pipeline facilities in the location, construction, operation and maintenance of LNG facilities; (2) set out parameters for administering the pipeline safety program; and (3) delineate requirements for onshore oil pipeline response plans. The regulations are written as minimum performance standards.

The Magnuson Act (50 U.S.C. 191 et seq.) directs the Secretary of Transportation to issue regulations governing the movement of any vessel within U.S. Territorial waters, upon a presidential declaration of a national emergency by reasons of actual or threatened war, insurrection or invasion, or disturbance or threatened disturbance of the international relations of the United States (50 U.S.C. 191).

**Maritime Transportation Security Act (MTSA), Public Law 107-295, 46 U.S.C. 2101 note**

MTSA, which amended the Merchant Marine Act of 1936, requires implementation of regulations for improving the security of ports, waterfront facilities, and vessels, including those involved with the oil and gas sectors. Most energy sites with waterfront facilities are impacted by MTSA and must conduct vulnerability assessments and develop security plans to be approved by the U.S. Coast Guard (USCG).

**Aviation and Transportation Security Act (ATSA), Public Law 107-71, 115 Stat. 597, November 19, 2001**

As established by ATSA, TSA is responsible for security in all modes of transportation. The six modes of transportation include mass transit, aviation, maritime, highway, rail, and pipeline systems. As further noted in NIPP, TSA is the sector specific agency (SSA) for all modes of transportation except maritime, for which the USCG is the SSA.

### **Critical Energy Infrastructure Information, FERC Orders 630 and 630A**

FERC issued a final rule restricting access to Critical Energy Infrastructure Information and establishing new procedures for requesting access to Critical Energy Infrastructure Information.

### **International Emergency Economic Powers Act (IEEPA) (50 U.S.C. Section 1701 et seq.)**

The IEEPA authorizes the president to declare a national emergency to deal with a threat to the national security, foreign policy, or economy of the United States that originates in whole or substantial part outside the United States. Upon declaration of a national emergency, it further authorizes the president, after such a declaration, to block transactions and freeze assets to deal with the threat. In the event of an actual attack on the United States, the president can also confiscate property connected with a country, group, or person that aided in the attack. For instances, if a petroleum shortage is sufficiently severe to invoke a presidentially declared emergency, the IEEPA could be used to control supplies of petroleum products in which foreign countries or foreign nationals have an “interest”.

### **Federal Energy Management Program (FEMP)**

The Department of Energy's Federal Energy Management Program (FEMP) works to reduce the cost and environmental impact of the federal government by advancing energy efficiency and water conservation, promoting the use of distributed and renewable energy, and improving utility management decisions at federal sites. In a severe emergency, the President may order increased conservation in federal facilities and operations, including the federal vehicle fleet. The FEMP helps federal agencies reach their energy savings goals by aggressively raising awareness of energy efficiency activities and making it easier for agencies and utilities to save energy and money.

### **Authorities Affecting Electric Power**

#### **Energy Policy Act of 2005, Public Law 109-58, Title XII: Electricity, Subtitle A: Reliability Standards, Section 1211: Electric Reliability Standards; Electricity Modernization Act of 2005, August 5, 2005, 42 U.S.C. 15801 note; 16 U.S.C. 824o**

This subtitle provides for federal jurisdiction over certain activities that are required to support reliability of the U.S. bulk power system. Title XII authorizes FERC to certify a national electric reliability organization to enforce mandatory reliability standards for the bulk power system. FERC will oversee the electric reliability organization in the U.S. and all electric reliability organization standards must be approved by FERC. The electric reliability organization can impose penalties on a user, owner, or operator of the bulk power system for violations of any FERC-approved reliability standard, but such penalties are subject to FERC review and potential change.

#### **FERC Order Issued in Docket No. RR06-1-000, Certifying the North American Electric Reliability Council (NERC) as the Electric Reliability Organization (ERO), July 20, 2006**

Pursuant to the Energy Policy Act of 2005, FERC conditionally certified NERC as the Nation's ERO. NERC must make specified changes to the electric reliability organization and file those changes with FERC in order to continue as the electric reliability organization.

As the electric reliability organization, NERC will be responsible for developing and enforcing mandatory electric reliability standards under the FERC's oversight. The standards will apply to all users, owners, and operators of the bulk power system.

**FERC Order 706 Issued in Docket No. RM06-22-000, Mandatory Reliability Standards for Critical Infrastructure Protection, January 18, 2008**

Pursuant to section 215 of the Federal Power Act (FPA), FERC approved eight Critical Infrastructure Protection (CIP) Reliability Standards submitted to FERC for approval by the North American Electric Reliability Corporation (NERC). The CIP Reliability Standards require certain users, owners, and operators of the Bulk-Power System to comply with specific requirements to safeguard critical cyber assets.

**FERC Order Issued in Docket No. RD09-7-000, Approving Revised Reliability Standards for Critical Infrastructure Protection and Requiring Compliance Filing, September 30, 2009**

Pursuant to section 215(d)(5) of the Federal Power Act, FERC in Order 706 directed NERC to develop modifications to the eight Critical Infrastructure Protection (CIP) Reliability Standards using its Reliability Standards Development Process. On May 22, 2009, NERC filed revised Reliability Standards for Critical Infrastructure Protection. In its filing, NERC indicates that it is developing responsive modifications in multiple phases, and the instant filing represents the results of the first phase of the initiative. The revised CIP Reliability Standards will become effective on April 1, 2010.

**Federal Power Act, 16 U.S.C. 791a-825r; Public Utility Regulatory Policies Act, 16 U.S.C. 2705; DOE Organization Act, 42 U.S.C. 7101-7352; 18 CFR Parts 4, 12, and 16; MOU between FERC and U.S Army Corps of Engineers (USACE) and Bureau of Reclamation (BOR)**

Congress authorizes FERC to oversee the nation's nonfederal hydropower infrastructure. Congressional and other legal delegations also define hydropower responsibilities among FERC and other agencies, such as USACE and BOR.

With regard to FERC authorities, delegations in FPA include a range of activities, such as issuing licenses for nonfederal hydropower projects; requiring safety and operating conditions; investigating and taking over facilities (or levying fines) for administrative violations, such as safety and security; defining construction, maintenance, and operation requirements by licensees; and other acts to carry out the purposes of the Federal Power Act. In addition, section 405(d) of PURPA, 16 U.S.C. 2705, authorizes a hydropower project's exemption from licensing under certain conditions. Finally, DOE Organization Act, 42 U.S.C. 7101-7352: Title IV establishes FERC (as the successor agency to the Federal Power Commission) and enumerates FERC's authority regarding hydropower facilities.

In addition to congressional delegations, regulations further define FERC authorities over hydropower facilities. These rules address such issues as project safety and security, procedures for relicensing or Federal takeover of licensed hydropower projects, and investigations.

FERC has several Memorandums Of Understandings (MOUs) with regard to hydropower facilities:

- **USACE**, which has responsibility for ownership and operation of federal dams for electric power production and other purposes. This MOU describes procedures for agency cooperation during the processing of hydropower applications to facilitate the investigation, construction, operation, and maintenance of FERC-licensed hydro projects at USACE dams.
- **BOR**, which has responsibility for ownership and operation of dams for electric power production and other purposes. This MOU describes procedures for agency cooperation during the processing of hydropower applications to facilitate the investigation, construction, operation, and maintenance of FERC-licensed hydro projects at BOR dams.

**Executive Order 10485, Providing for the Performance of Certain Functions Heretofore Performed by the President with Respect to Electric Power and Natural Gas Facilities Located on the Borders of the United States, September 3, 1953, as amended by Executive Order 12038, Relating to Certain Functions Transferred to the Secretary of Energy by the Department of Energy Organization Act, February 3, 1978**

DOE is authorized to issue presidential permits for the construction, operation, maintenance, and connection of electric transmission facilities at U.S. international borders if it determines that the issuance of such a permit is in the public interest. In determining whether issuance of the permit is consistent with the public interest, DOE considers the impact the proposed project would have on the operating reliability of the U.S. electric power supply and the environmental impacts of the proposed project pursuant to the National Environmental Policy Act (NEPA) of 1969, and any other factors that DOE may also consider relevant to the public interest. DOE must also obtain favorable recommendations from the Secretary of State and the Secretary of Defense before issuing a permit.

**Department of Energy Organization Act, Federal Power Act, 10 CFR Sections 205.350—205.353**

The DOE has the authority to obtain current information regarding emergency situations on the electric supply systems. It may establish mandatory reporting requirements for electric power system incidents or possible incidents. This reporting is required to meet national security requirements and other responsibilities contained in the NRP for emergencies.

**Federal Power Act, as amended, 202(c), 16 U.S.C. 824a(c)**

The Secretary of Energy has authority in time of war or other emergencies to order temporary interconnections of facilities and generation, delivery, interchange, or transmission of electric energy that the Secretary deems necessary to meet an emergency.

This authority may be utilized upon receipt of a petition from a party requesting the emergency action or it may be initiated by DOE on its own initiative.

**Federal Power Act, as amended, 202(e), 16 U.S.C. 824a(e)**



Exports of electricity from the United States to a foreign country are regulated by DOE pursuant to sections 301(b) and 402(f) of the Department of Energy Organization Act (42 U.S.C. 7151(b), 7172(f)) and require authorization under section 202(e) of FPA (16 U.S.C. 824a(e)).

**Federal Power Act, as amended, 210 and 211, (16 U.S.C. 791a et seq.)**

These sections authorize the FERC to order interconnections and wheeling transmission services, if such actions are in the public interest and would promote efficient use of the facilities in question, conserve energy, or improve system reliability.

**Department of Energy Organization Act and FPA, 10 CFR 205.350-205.353**

DOE has authority to obtain current information regarding emergency situations on the electric supply systems in the United States. DOE has established mandatory reporting requirements for electric power system incidents or possible incidents. This reporting is required to meet DOE's national security requirements and other responsibilities contained in NRP.

**Power Plant and Industrial Fuel Use Act (FUA), 404(a), 42 U.S.C. 8374(a)**

Under section 404(a), the President has authority by order to allocate coal (and require the transportation of coal) for use by any power plant or major fuel-burning installation during a declared severe energy supply interruption as defined by section 3(8) of the Energy Policy and Conservation Act, 42 U.S.C. 6202(8). The President may also exercise such allocation authority upon a published finding that a national or regional fuel supply shortage exists or may exist that the President determines is, or is likely to be, of significant scope and duration, and of an emergency nature; causes, or may cause, major adverse impact on public health, safety, welfare or on the economy; and results, or is likely to result, from an interruption in the supply of coal or from sabotage, or from an act of God. Section 404(e) stipulates that the President may not delegate his authority to issue orders under this authority. It does not, however, prevent the President from directing any federal agency to issue rules or regulations, or take other action consistent with section 404, in the implementation of such order.

The FUA section 404(a) authority could be used to help provide coal as an alternative fuel source to electric power plants and other major fuel-burning installations that have received orders prohibiting the burning of natural gas or petroleum as a primary energy source, assuming these facilities actually have the capability to burn coal. Many likely do not, so the authority may be of limited utility. This authority also could be used during a coal supply shortage to ensure that coal-burning electric power plants or major fuel-burning installations have adequate supplies of coal.

As an alternative to the use of FUA section 404(a), the President, or the President's delegate(s), could allocate coal supplies under the authority of section 101(a) of the Defense Production Act, 50 U.S.C. App. 2071(a) and Executive Order 12919 (1994).

**Clean Air Act, 42 U.S.C. 7401 et seq.**

Section 110(f) of the Clean Air Act permits a state governor to issue an emergency temporary suspension of any part of a State Implementation Plan (SIP) (as well as a temporary waiver of penalties for excess SO<sub>x</sub> or NO<sub>x</sub> emissions) in accordance with the following: (1) the owner/operator of a fuel-burning source petitions the state for relief; (2) the governor gives notice and opportunity for public hearing on the petition; (3) the governor finds that an

emergency exists in the vicinity of the source involving high levels of unemployment or loss of necessary energy supplies for residential dwellings, and that the unemployment or loss can be totally or partially alleviated by an emergency suspension of SIP requirements applicable to the petitioning source; (4) the President, in response to the governor's request, declares a national or regional emergency exists of such severity that a temporary SIP suspension may be necessary and other means of responding to the energy emergency may be inadequate; and (5) the governor issues an emergency suspension to the source. DOE may be asked to advise the President of fuel supply situations regarding requests for presidential emergency declarations for SIP relief.

## **Authorities Affecting Natural Gas**

### **Natural Gas Act, Sections 3 and 7, 15 U.S.C. 717 et seq.**

DOE has authority under section 3 to issue orders, upon application, to authorize imports and exports of natural gas. Section 3 requires DOE to approve, without modification or delay, applications to import LNG and applications to import and export natural gas from and to countries with which there is a free-trade agreement in effect requiring national treatment for trade in natural gas. Section 7 provides FERC the authority to approve the siting of and abandonment of interstate natural gas facilities, including pipelines, storage, and LNG facilities. FERC authority under the Natural Gas Act is to review and evaluate certificate applications for facilities to transport, exchange, or store natural gas; acquire, construct, and operate facilities for such service; and to extend or abandon such facilities. In this context, FERC approvals include the siting of said facilities and evaluation of alternative locations. FERC jurisdiction does not include production, gathering, or distribution facilities, or those strictly for intrastate service. In reference to regulating imports and exports of natural gas under section 3 of the Natural Gas Act, Executive Order 10485, as amended by Executive Order 12038, and sections 301(b), 402(e), and (f) of the Department of Energy Organization Act (42 U.S.C. 7101 et seq.), the Secretary has delegated to FERC authority over the construction, operation, and siting of particular facilities, and with respect to natural gas, that involves the construction of new domestic facilities, the place of entry for imports or exit for exports. FERC also has authority to approve or deny an application for the siting, construction, expansion, and operation of an LNG terminal under section 3 of the Natural Gas Act.

### **Natural Gas Policy Act, Title III, Sections 301-303, 15 U.S.C. 717 et seq.**

DOE may order any interstate pipeline or local distribution company served by an interstate pipeline to allocate natural gas in order to assist in meeting the needs of high-priority consumers during a natural gas emergency. DOE has delegated authority (Executive Order 12235) under sections 302 and 303, respectively, of the Natural Gas Policy Act, to authorize purchases of natural gas and to allocate supplies of natural gas in interstate commerce to assist in meeting natural gas requirements for high priority uses, upon a finding by the President under section 301 of an existing or imminent natural gas supply emergency (15 U.S.C. 3361-3363). The declaration of a natural gas supply emergency is the legal precondition for the emergency purchase and allocation authority in sections 302 and 303, respectively, of the Natural Gas Policy Act.

Although Executive Order 12235 delegates to the Secretary of Energy the emergency purchase and allocation authorities in sections 302 and 303, respectively, the President has not delegated his authority to declare a natural gas supply emergency. Nothing in the Natural Gas Policy Act would preclude such a presidential delegation.

Under section 301 of the Natural Gas Policy Act, the President may declare a natural gas supply emergency if he makes certain findings. The President must find that a severe natural gas shortage, endangering the supply of natural gas for high-priority uses, exists or is imminent in the United States or in any region of the country. Further, the President must find that the exercise of the emergency natural gas purchase authority under section 302 of the Natural Gas Policy Act, of the emergency allocation authority under section 303 of the Natural Gas Policy Act, or of the emergency conversion authority of section 607 of PURPA is reasonably necessary, having exhausted other alternatives to the maximum extent practicable, to assist in meeting natural gas requirements for high-priority uses. The emergency terminates on the date the President finds that a shortage either no longer exists or is not imminent, or 120 days after the date of the emergency declaration, whichever is earlier.

#### **Public Utility Regulatory Policies Act of 1978, Section 607, 15 U.S.C. 717z, and Section 404(b) of the Power Plant and Industrial Fuel Use Act, 42 U.S.C. 8374(b)**

There are two authorities that can be used in emergency situations to require utilities to switch from natural gas and petroleum for electric power generation. DOE has delegated authority (Executive Order 12235) under section 607(a) of PURPA, following the President's finding of a natural gas supply emergency, to prohibit the burning of natural gas by any electric power plant or major fuel-burning installation. The required emergency finding is identical to that in the Natural Gas Policy Act (15 U.S.C. 717z). As explained in the previous section discussing the Natural Gas Policy Act, under section 301 of the Natural Gas Policy Act and 607(a) of PURPA, the President may declare a natural gas supply emergency if he makes certain findings. The President must find that a severe natural gas shortage, endangering the supply of natural gas for high-priority uses, exists or is imminent in the United States. The PURPA fuel-switching authority is similar to the presidential authority contained in section 404(b) of the Power Plant and Industrial Fuel Use Act (FUA), 42 U.S.C. 8374(b), to prohibit the burning of natural gas or petroleum by electric power plants or major fuel-burning installations.

Section 404(b) of FUA provides that the President may by order prohibit the use by any power plant or major fuel-burning installation of petroleum or natural gas, or both, as a primary energy source. A legal precondition to such a presidential order is the President's finding of a severe energy supply interruption, as defined by section 3(8) of EPCA, 42 U.S.C. 6202(8). Section 404(e) stipulates that the President may not delegate his authority to issue orders under this authority. It does not, however, prevent the President from directing any Federal agency to issue rules or regulations, or take other action consistent with section 404, in the implementation of such order.

#### **Emergency Reconstruction, FERC Order 633**

Amended FERC regulations enable interstate natural gas pipeline companies to replace mainline facilities using, if necessary, a route other than the existing right-of-way and waiving the 45-day prior notice requirement and cost constraints, when immediate action is required to restore service in an emergency because of a sudden unanticipated loss of natural gas or capacity in order to prevent loss of life, impairment of health, or damage to property. In such emergencies, the amended regulations allow pipeline companies to proceed with construction before the end of the separate 30-day prior notice period to landowners if all necessary easements have been obtained. This initiative was implemented in the wake of the events of September 11, 2001, to help ensure the security of the natural gas pipeline infrastructure without compromising the FERC's responsibilities under the NEPA.

## **Authorities Affecting Petroleum**

### **Energy Policy and Conservation Act, Sections 151-180, 42 U.S.C. 6231-6251**

Sections 151-191 of EPCA authorize DOE to establish and operate the Strategic Petroleum Reserve (SPR). Section 161(d)(1) authorizes the President to order drawdown and sale of products from the SPR upon a finding that drawdown is required either by a “severe energy supply interruption” or obligations of the United States under the Agreement on an International Energy Program (42 U.S.C. 6241(d)(1)).

Section 161(h) empowers the President to drawdown the SPR in circumstances other than a “severe energy supply interruption” or a need to meet U.S. obligations under IEP, if the President finds that a circumstance “exists that constitutes, or is likely to become, a domestic or international energy supply shortage of significant scope and duration” and the President determines that drawdown “would assist directly or significantly in preventing or reducing the adverse impact of such a shortage” and the Secretary of Defense has found that the action taken will not impair national security. However, there are several limitations on the use of this authority: The reserve may not be drawn down for more than 30 million barrels or for longer than 60 days with respect to a single event, or if the reserve would be reduced below the level of 500 million barrels (42. U.S.C. 6241(h)). EPCA gives the President authority to authorize the export of crude oil withdrawn from the SPR during a drawdown for refining or exchange outside the United States in connection with an arrangement for the delivery of refined petroleum products to the United States (42. U.S.C. 6241(i)). In recognition of this authority, DOC has provided for automatic approval for export of SPR oil for these purposes in its Export Administration Regulations at 15 CFR Part 754.

The sale of oil withdrawn from the SPR would be in accordance with the SPR competitive sales procedures in 10 CFR Part 625.

### **Energy Policy and Conservation Act (EPCA), Sections 103, 42 U.S.C. 6201 et seq.**

This section delegates broad authority to the Department of Commerce (E.O. 11912) to limit exports of crude oil and refined petroleum products (as well as coal, natural gas, petrochemical feed stocks and energy-related materials and equipment).

### **Energy Policy and Conservation Act, Sections 181-184, 42 U.S.C. 6250-6250c**

Pursuant to section 181 of EPCA, 42 U.S.C. 6250, the Secretary established and maintains a 2 million barrel home heating oil reserve in the Northeast. This reserve is not part of the SPR. The Secretary may sell products from the Northeast Home Oil Reserve dependent on a presidential finding that there is a “severe energy supply interruption” in accordance with section 183(a) of the EPCA, based upon a finding that a dislocation in the heating oil market has resulted from such interruption or the existence of a regional supply shortage of significant size and duration, and that action under this section would assist directly and significantly in reducing the adverse impact of such shortage.

### **Energy Policy and Conservation Act, Section 363, 42 U.S.C. 6322(e)**

To be eligible for financial assistance to assist in the development and implementation of energy conservation plans, a State must submit to the Secretary of Energy, as a supplement to its energy

conservation plan, an energy emergency planning program for an energy supply disruption as designated by the State consistent with applicable Federal and State law. The contingency plan, "... shall include an implementation strategy or strategies (including regional coordination) for dealing with energy emergencies."

## Appendix D—Monitoring Energy Supplies

---

### Monitoring Energy Supplies

Energy supply monitoring should take place regularly. SEOs and PUCs keep track of energy developments pertaining to the state, its region, and the nation through industry contacts, trade publications, and statistical reports. The EIA website (<http://www.eia.doe.gov/>) and the Monthly Energy Review (<http://www.eia.doe.gov/emeu/mer/contents.html>) provides an abundance of reports and statistics on all types of energy, arranged in a variety of ways to make the data easy to find.

#### I. Monitoring Electricity

##### A. General Information

Day-to-day electricity supply and demand are monitored on a routine basis by operating companies. Utilities generally prepare annual forecasts estimating demand for electricity and the means to satisfy it for the following five years. Other forecasted information includes:

- expected price for fuel and other necessary purchases;
- expected fuel and purchased power availability; and
- plant status and similar data.

##### B. Reporting to the DOE

Utilities are also required to report to the DOE EOC any of the following events:

- loss of firm system loads;
- voltage reductions;
- requests to the public to reduce usage;
- vulnerabilities that could impact system adequacy or reliability; and
- fuel supply emergencies (see Power System Emergency Reporting Procedures, May 1989, DOE).

##### C. Data Sources

###### 1. Electricity Sales

Monthly sales of electricity are published by state, month, and sector by the EIA in the *Electric Power Monthly* (found at [http://www.eia.doe.gov/cneaf/electricity/epm/epm\\_sum.html](http://www.eia.doe.gov/cneaf/electricity/epm/epm_sum.html)).

###### 2. Electricity Production by Fuel Source

This information is published in the EIA *Electric Power Monthly* ([http://www.eia.doe.gov/cneaf/electricity/epm/epm\\_sum.html](http://www.eia.doe.gov/cneaf/electricity/epm/epm_sum.html)) that includes, in English units (tons and barrels):

- the quantity of fuel used;
- kilowatt-hour produced; and
- fuel costs by state.
  - The source of this information is the *Monthly Report of Cost and Quality of Fuels for Electric Plants*, FERC-423.

###### 3. Levels of Fuel Inventories Available for Generation

Coal inventories and prices are published in the EIA *Quarterly Coal Report* [http://www.eia.doe.gov/cneaf/coal/quarterly/qcr\\_sum.html](http://www.eia.doe.gov/cneaf/coal/quarterly/qcr_sum.html)),

that lists the amount of coal consumed in each state and the price paid by each sector. Levels of fuel inventories will be estimated by each utility and reported by the number of days of supply on hand at each location for coal- and oil-fired plants.

4. Generation Capacity and Plant Availability  
This information can be obtained from the *Inventory of Power Plants in the United States* (<http://www.eia.doe.gov/cneaf/electricity/ipp/ippbackissues.html> discontinued) published by the EIA. Additional information can be found at: <http://www.eia.doe.gov/cneaf/electricity/epa/epa2p2.html>
5. Regional System Reliability Forecast  
NERC (<http://www.nerc.com/>) publishes annual reports of regional system reliability. These reports assess regional reserve margins by comparing net system availability with peak load projections and system-pool reserve availability.
6. Coal Distribution  
This data is published in the EIA *Quarterly Coal Distribution Report* ([http://www.eia.doe.gov/cneaf/coal/quarterly/qcr\\_sum.html](http://www.eia.doe.gov/cneaf/coal/quarterly/qcr_sum.html)) and is a source of information regarding the origin and method of shipping coal.
7. Cooling and Heating Degree Days  
Cooling and heating degree day data are available from the National Weather Service and National Oceanic and Atmospheric Administration (NOAA). [http://www.cpc.ncep.noaa.gov/products/analysis\\_monitoring/cdus/degree\\_days/](http://www.cpc.ncep.noaa.gov/products/analysis_monitoring/cdus/degree_days/). This data may be used to describe extreme weather conditions that create peak loads on the electrical generation system.
8. Contact Names, Addresses, and Telephone Numbers  
It is important to maintain a list of key utility personnel involved with emergency operations at key locations.

Exercise caution when using and integrating data from these various sources. Direct communication with electric utilities and the state agencies will be helpful in avoiding inaccurate conclusions.

## II. Monitoring Natural Gas

- A. Complexities in Monitoring Natural Gas  
Natural gas markets have become more complex to monitor in recent years as a result of the direct purchase agreements between large users and wellhead producers. This decentralization has resulted in a significant decrease in available data. Adequate monitoring of natural gas requires information covering:
  - the quantity of interstate deliveries to LDC;
  - storage levels;
  - gas injection rates into storage;
  - projected system send-outs;
  - spot market and contract prices;
  - curtailment notices; and
  - heating degree days.
- B. Data Sources
  1. Interstate Deliveries to LDC

- Natural gas deliveries by sector are shown in the EIA *Natural Gas Monthly* ([http://www.eia.doe.gov/oil\\_gas/natural\\_gas/data\\_publications/natural\\_gas\\_monthly/ngm.html](http://www.eia.doe.gov/oil_gas/natural_gas/data_publications/natural_gas_monthly/ngm.html)), that shows the amount of natural gas delivered into the state for sale.
2. **Storage Levels and Injection Rates**  
State natural gas inventories are reported in the EIA *Natural Gas Monthly*, ([http://www.eia.doe.gov/oil\\_gas/natural\\_gas/data\\_publications/natural\\_gas\\_monthly/ngm.html](http://www.eia.doe.gov/oil_gas/natural_gas/data_publications/natural_gas_monthly/ngm.html)). From this information the percentage of storage capacity being used at any time can be calculated.
  3. **Projected System Send-Outs**  
Natural gas demand and supply projections are provided by the LDC as part of their annual GCR filings. These projections include storage field inventory balances. Potential shortages can be identified when long-term supply is inadequate to meet projected demand.
  4. **Spot and Contract Prices**  
Average city gate prices (price to the LDC as gas is received), and prices by sector, for each state are published in the EIA *Natural Gas Monthly*. ([http://www.eia.doe.gov/oil\\_gas/natural\\_gas/data\\_publications/natural\\_gas\\_monthly/ngm.html](http://www.eia.doe.gov/oil_gas/natural_gas/data_publications/natural_gas_monthly/ngm.html)). Price is an indicator of aggregate supply. When short-term prices are lower than long-term contract prices, supplies are generally judged to be in excess of demand. Conversely, when long-term contract prices are lower, spot markets are assumed to be tight, indicating that demand may be exceeding supply.
  5. **Curtailement Notices**  
Interstate pipelines provide notices of curtailments to FERC. Notices of curtailment are early indicators of reduced supply. The supplementary supply required to offset the reduction in deliveries may need to be calculated and perhaps satisfied from other in-state supplies, depending upon the current levels of storage volumes, actual system send outs, and inter-tie exchanges.
  6. **Heating Degree Days**  
Heating degree-day information is provided the National Weather Service on a daily and monthly basis, [http://www.epc.ncep.noaa.gov/products/analysis\\_monitoring/cdus/degree\\_days/](http://www.epc.ncep.noaa.gov/products/analysis_monitoring/cdus/degree_days/). Statistics can often be obtained through local or regional weather stations. These values indicate periods of extreme cold weather that bring on increases in demand for natural gas for space heating.
  7. **Contact Names, Addresses and Telephone Numbers**  
A list of individuals that are involved with emergency-related activities and planning in state government, at local distribution companies, and interstate pipeline companies is needed in any plan.

### **III. Monitoring Petroleum**

- A. **Monitoring Petroleum Markets**  
Petroleum markets are monitored continuously by marketers and commercial buyers. Statistical organizations such as the EIA maintain databases containing information used to determine recent market behavior and anticipate supply



disruptions. EIA has numerous publications which provide a wealth of information available at [http://tonto.eia.doe.gov/dnav/pet/pet\\_pub\\_publist.asp](http://tonto.eia.doe.gov/dnav/pet/pet_pub_publist.asp). The American Petroleum Institute (API) (<http://www.api.org/statistics/>) is another source of information. While it is relatively easy to obtain aggregate petroleum data, the nature of the petroleum market, and the lack of regulation, makes learning about individual companies relatively difficult. Following are some suggestions for working with the industry to obtain information.

1. Liaison

To ensure proper interpretation of the data, contact is maintained with liaisons within the petroleum industry. Monitoring requires a variety of data, including:

- petroleum product use;
- prices;
- inventories;
- production; and
- sources of crude oil.

2. Infrastructure

Petroleum supply infrastructure information is useful. Examples include:

- marine and pipeline terminals;
- locations of terminals;
- terminal capacity; and
- terminal product transfer capability (e.g., number of loading rack positions).

Most important, monitoring also requires accurate and timely information about:

- petroleum supply;
- wholesale and retail prices;
- inventories; and
- production rates for state and regional refineries.

3. Decentralized Delivery Network

Because petroleum is distributed through a decentralized network, there is no single source of information by which to assess or characterize emerging problems. Anti-trust laws also prohibit oil companies from sharing information regarding supply availability and price.

Consequently, petroleum information is either published by a third party that can maintain the anonymity of sources or is confidential and not available. Therefore, the state's role in developing data and assessing supply is more critical for petroleum products than it is for electricity or natural gas, where utilities control supply and distribution within franchised, and often regulated, service territories.

4. Estimating the Severity of a Shortage

The severity of a fuel shortage can be estimated by reference to various indicators, but to quantify a statewide shortage in terms of an accurate percentage of shortfalls is difficult. Further, due to the variety of supply arrangements, distribution systems, and local consumption patterns, some communities may experience a more serious shortfall than others. Therefore, it is not always useful to tie the phases of a flexible energy emergency plan to specific percentage shortage levels.

B. Supply and Demand:

The following sources provide information useful in monitoring petroleum supply and demand.

1. Motor Gasoline Consumption  
The total number of gallons of gasoline used is provided on a monthly and annual basis of motor gasoline sales revenue by the FHA. The data can be found on at: <http://www.fhwa.dot.gov/policy/ohpi/qffuel.cfm>
2. Petroleum Product Demand  
Monthly deliveries of petroleum products to states by primary suppliers are reported in the EIA *Monthly Report of Petroleum Products Sold into States For Consumption*,  
[http://tonto.eia.doe.gov/dnav/pet/pet\\_cons\\_prim\\_dcunus\\_m.htm](http://tonto.eia.doe.gov/dnav/pet/pet_cons_prim_dcunus_m.htm)
3. Form EIA-782C.  
[http://www.eia.doe.gov/pub/oil\\_gas/petroleum/survey\\_forms/eia782ci.pdf](http://www.eia.doe.gov/pub/oil_gas/petroleum/survey_forms/eia782ci.pdf). This report contains actual delivered volumes for the preceding month for each petroleum product supplied and projected deliveries for the upcoming month. This information is necessary in order to determine the severity of a petroleum shortage and to calculate the amount of petroleum product to be set aside for emergency hardships. Monthly historical sales of all petroleum products by state are also reported in the EIA C-007 Report, *First Sales of Petroleum Products into States for Consumption*.  
[http://www.eia.doe.gov/pub/oil\\_gas/petroleum/data\\_publications/prime\\_supplier\\_report/current/pdf/c007.pdf](http://www.eia.doe.gov/pub/oil_gas/petroleum/data_publications/prime_supplier_report/current/pdf/c007.pdf).
4. Wholesale and Retail Prices  
Wholesale and retail prices are available on the EIA website at: [http://tonto.eia.doe.gov/dnav/pet/pet\\_pri\\_top.asp](http://tonto.eia.doe.gov/dnav/pet/pet_pri_top.asp) under the Refiner, Reseller, and Retail Monthly Prices heading. The page also includes data on weekly and monthly prices such as the EIA *Petroleum Marketing Monthly*, that provides monthly information regarding wholesale and retail prices at the state-level and the *Weekly Petroleum Status Report*  
[http://www.eia.doe.gov/oil\\_gas/petroleum/data\\_publications/weekly\\_petroleum\\_status\\_report/wpsr.html](http://www.eia.doe.gov/oil_gas/petroleum/data_publications/weekly_petroleum_status_report/wpsr.html), that provides information on national and international prices and inventory information. In an emergency, more timely information is needed and may be obtained through industry publications such as Oil Price Information Service's OPIS-Alerts or the *Oil Daily*. Special state-conducted telephone surveys of petroleum distributors and retailers are also conducted.
5. Inventories and Production  
Inventory (stocks) and production data can be found on the EIA website at: [http://tonto.eia.doe.gov/dnav/pet/pet\\_stoc\\_top.asp](http://tonto.eia.doe.gov/dnav/pet/pet_stoc_top.asp) and [http://tonto.eia.doe.gov/dnav/pet/pet\\_crd\\_top.asp](http://tonto.eia.doe.gov/dnav/pet/pet_crd_top.asp). Data are presented weekly and monthly by region. Data are reported by regional areas known as Petroleum Administration for Defense Districts (PADD). State level monthly inventories are also published in this report. Weekly data are also available through the API *Weekly Statistical Bulletin* (<http://www.api.org/statistics/>) at PADD level aggregations.
6. Infrastructure Information

Relevant information includes a listing of refineries serving the state, their production and storage capacities, the location and capacities of pipelines and terminals, and marine terminals. This information is compiled from various sources including state, industry and other private sources. A list of operable refineries can be found in EIA *Petroleum Supply Annual* at:

[http://tonto.eia.doe.gov/dnav/pet/pet\\_pub\\_publist.asp](http://tonto.eia.doe.gov/dnav/pet/pet_pub_publist.asp)

7. Source of Crude Oil  
The source and volumes of crude oil supply used by regional refineries may be found in the EIA *Petroleum Supply Monthly* [http://www.eia.doe.gov/oil\\_gas/petroleum/data\\_publications/petroleum\\_supply\\_monthly/psm.html](http://www.eia.doe.gov/oil_gas/petroleum/data_publications/petroleum_supply_monthly/psm.html). This information is needed to estimate the extent to which refiners may need to shift supplies if any given source of crude oil is disrupted.
  - For example, when crude oil was embargoed from Iraq and Kuwait in 1990, the effects of this action on Midwest supplies was able to be determined.
8. Heating Degree Days  
Heating degree-day information is provided by the National Weather Service on a daily and monthly basis, [http://www.cpc.ncep.noaa.gov/products/analysis\\_monitoring/cdus/degree\\_days/](http://www.cpc.ncep.noaa.gov/products/analysis_monitoring/cdus/degree_days/). Statistics can often be obtained through local or regional weather stations. These values indicate periods of extreme cold weather, which bring on increases in demand for heating fuels for space heating.
9. Contact Names, Addresses, and Telephone Numbers  
This information is obtained directly from the oil companies or their various associations and is periodically updated. State petroleum and dealer associations are excellent sources for the names of jobbers and distributors involved with the sale and distribution of gasoline, distillate, LPG and other petroleum products.
10. Gas Prices  
GasBuddy.com provides a visual representation of average unleaded fuel prices by county across the U.S. [http://www.gasbuddy.com/gb\\_gastemperaturemap.aspx](http://www.gasbuddy.com/gb_gastemperaturemap.aspx)

In addition to the information above, the Infrastructure Security and Energy Restoration Division of OE (ISER) within the U.S. Department of Energy Office of Electricity Delivery and Energy Reliability (OE) provides information and critical updates during energy emergencies.

The following are useful sites on energy resiliency:

1. Energy Assurance Daily  
Provides a summary of public information concerning current energy issues. Published Monday through Friday to inform stakeholders of developments affecting energy systems, flows, and markets, it provides highlights of energy issues rather than a comprehensive coverage. The Energy Assurance Daily covers: major energy developments in Electricity, petroleum, and natural

gas industries; energy prices; and other relevant news.

<http://www.oe.netl.doe.gov/ead.aspx>

2. Emergency Situation Reports  
Contains impact studies on the disruption to energy infrastructure caused by major disasters such as hurricanes, the 2003 blackout, west coast wildfires, etc.  
[http://www.oe.netl.doe.gov/emergency\\_sit\\_rpt.aspx](http://www.oe.netl.doe.gov/emergency_sit_rpt.aspx)
3. Electric Disturbance Events (OE-417)  
The Electric Emergency Incident and Disturbance Report provides information on electric emergency incidents and disturbances. The Department of Energy uses the information to fulfill its overall national security and other energy emergency management responsibilities, as well as for analytical purposes.  
<http://www.oe.netl.doe.gov/oe417.aspx>
4. Analysis & Outreach  
ISER works closely with state and local governments - hosting conferences, preparing briefs, analyzing state or local plans, and developing tools to ensure a process that is both fluid and effective. This site contains some lessons learned through those events.  
<http://www.oe.netl.doe.gov/outreach.aspx>

## *Appendix E—Essential Pre-Crisis and Background Information for State Energy Emergency Responders*

---

### **Essential Pre-Crisis and Background Information for State Energy Emergency Responders**

#### I. State Energy Profile

A state energy profile should contain the elements of a state's energy industry so that responders will know how various energy supply systems work and whom to contact during a shortage.

#### A. The Basics of a State Electricity Industry

##### 1. Investor Owned Utilities

Investor owned utilities (IOUs), dominate the nation's electricity industry. They own most of the generating plants and transmission lines. In states with a strong cooperative or municipal system, the local IOU still provides most of the generated power resold to consumers. IOUs are regulated by the state's utility regulatory body for tariff, reliability, safety, consumer priorities, growth and emergencies. IOUs have been traditionally owned by local investors but in several regions of the nation, they have merged into regional investor owned entities and become local subsidiaries.

##### 2. Electric Membership Cooperatives (EMC)

Most states have electrical cooperatives that originally served rural customers. The growth of suburbs, towns and cities has blurred this distinction. Cooperatives typically own and maintain significant local delivery capacity through less populated areas. They usually belong to a state-wide electric membership cooperative association, or corporation, that acts on their behalf in many intra- and inter-state matters, helps them purchase power, manages safety training and assists during emergencies by receiving and transferring information, coordinating repair crews and helping companies exercise mutual aid agreements if needed. Cooperatives generally have mutual aid agreements with other cooperatives—in state and in neighboring states. Most cooperatives manage their own affairs and answer to a board of directors. PUCs do not generally regulate their rates but it is not uncommon to see some linkage between the PUC and cooperatives on safety and emergency matters.

##### 3. Municipal Electric Utilities

Municipalities throughout the U.S. own and operate their own utilities. These utilities account for a smaller percentage of delivered electricity than IOU and EMC. Most belong to state associations, or corporations, that provide services to their members similar to those offered by EMC associations. Some municipal utilities (and cooperatives) also own generating plants and transmission lines or participate in larger organizations that do this for them. Municipals rarely fall under PUC jurisdiction for either rates or safety and emergencies. Like EMC, they do have extensive mutual aid agreements. For all three of the ownership types it is useful to know:

- who owns the utility;

- where the utility is located and the area(s) it serves;
  - how the utilities manage outages including mutual aid agreements, and restoration priorities;
  - to whom and how utilities report emergencies;
  - what steps utilities take to prevent and or mitigate the loss of power and the failure of infrastructure;
  - what public laws and regulations apply; and
  - the typical restoration sequence they employ to restore power in various areas—urban, sub-urban and rural.
4. **Generation Plants**  
 The first place a state energy planner looks for electrical generation is the IOU. As noted in the body of the guide, electric restructuring is pushing many IOU to break up vertically integrated assets so that planners should look for generating capacity owned and delivered from out-of-state companies as well as those owned and operated by in-state IOU. States should also identify independent sources of power such as merchant plans, co-generation plants and large industries that sell excess power.
5. **Interstate Sales**  
 Utilities have long shopped for lower cost power if available outside of their own systems. Deregulation, combined with economic competition, the growth of large interstate transmission grids and a growing number of interstate marketing entities, has encouraged large end users to purchase power from many available sources for the best price in addition to, or instead of, locally-generated power.
6. **Desired Data**  
 The best places to search for data are the state PUC and EIA. Even if a PUC does not regulate all generation or transmission affecting a state, it is likely to know who sells power, where it is located and what it costs. EIA data also will help determine where the bulk of a state's power comes from and in what sectors it is consumed. Information to examine includes:
- megawatts generated;
  - megawatts imported;
  - reserve capacity;
  - exports;
  - principal facilities and location;
  - ownership;
  - customers served (preferably broken out by type); and
  - Infrastructure failure prevention and back up.
7. **Transmission**  
 Vertically integrated Investor Owned Utilities own the bulk of U.S. transmission lines. Electric restructuring is beginning to change this. Divestiture of vertically-owned assets has resulted in independently-owned (usually conglomerate) transmission systems. As the interstate sale of power has increased, so has the complexity of transmission. Hence, electric problems in one area have caused outages in other systems hundreds of miles away.

It is recommended that states look for sources of major power transmission as well as in-state delivery systems. Precise trunk and

branch line location may not be necessary, but a general knowledge of where they are, and what external conditions may affect them, is useful to have.

Many state power systems fall within RTO and that are committed to improve reliability. States should get to know the RTO, if one exists, and understand what it does to distribute and route power and prevent failures. State officials should also understand the role of the Electric Reliability Councils and how their impact.

The same two sources a state needs for generation apply to transmission as well. Start with the PUC and EIA when seeking information. Useful information to cover includes;

- line location;
- line capacity;
- ownership; and
- Infrastructure protection and restoration protocols.

## B. The Basics of the State's Natural Gas Industry

### 1. Structure and Ownership in the Gas Industry

The natural gas industry can be roughly divided into three categories: production, transmission and distribution. In states with gas production, gas can be supplied to consumers directly from the well-head, or going through gas processing units where liquids are removed. Most states, buy gas from inter-state transmission lines.

Gas is produced by large national oil and gas companies plus a myriad of relatively small owners and operators who sell their gas to processing plants or transmission companies. The major transmission companies, such as Columbia, may also have an interest in local distribution companies.

### 2. Local Distribution Companies (LDCs)

The primary companies delivering gas to consumers are called LDCs. They obtain gas from various producers or interstate transmission pipelines. LDCs are regulated by PUCs for the same factors found in the electric market. LDCs, like electric utilities, are investor owned and also, like electric companies, subject to consolidation. In some states, the same company sells both electricity and natural gas. Additionally, independent companies have emerged that are not regulated for tariff by PUCs, but must comply with various operating, safety and environmental regulations. It is useful to know:

- millions of cubic feet imported;
- how much each company nominates (contracts to buy);
- volume of cubic feet produced if applicable;
- storage capacity available to the state (both in- and out-of-state);
- export volume if applicable;
- principal facilities and location;
- ownership;
- customers served (preferably broken out by type); and

- infrastructure failure prevention and back up.

### 3. The Impact of Deregulation

Natural gas companies, like electricity companies, have always sold to a wide variety of end users. Large volume energy buyers can obtain an industrial or commercial rate that is more closely attuned to the market than residential rates that are adjusted to provide predictable and manageable prices for home consumption. Many states have allowed large industrial, commercial and institutional consumers to buy natural gas directly from producers while the LDC serves as a transmission company delivering gas to the end use for what is basically a freight rate plus certain fees. Many states have now extended open market purchase to residential users as well. The result is that many users of natural gas now purchase gas at market, rather than tariff-controlled rates. At least one state has basically deregulated its natural gas market so that the long-standing LDCs became a wholesale distributor to several independent, market based, companies. For LDCs and other ownership types it is useful to know:

- who owns the companies;
- where the companies are located and who they serve;
- how the companies manage storage;
- how the companies manage supply shortage;
- how the companies repair pipeline ruptures and restore gas, including their mutual aid agreements and restoration priorities;
- to whom and how do they report emergencies;
- what they typically do to prevent the loss of gas and mitigate infrastructure failure or damage;
- what public laws and regulations apply; and
- their typical restoration sequence to various areas—urban, sub-urban and rural.

## C. Basics of the State's Petroleum Industry

### 1. Ownership Structure

A typical state petroleum industry is composed of several layers of ownership. Whether produced in or out-of-state, the produced oil must be refined before it is sold to consumers. States closest to refineries may enjoy lower pipeline transportation costs. In some cases, ownership may be wholly, or partially, vertically integrated from production through retail sales; hence the levels listed below may overlap. Levels of ownership pertinent to state petroleum consumption include:

- a. Production Companies  
Identifying these companies is "nice to know" but not critical for state planning purposes.
- b. Refineries  
It is useful, but not absolutely necessary, to know which refineries supply a state's petroleum. If known, potential shortages can be identified early when a supplying refinery curtails production or shuts down for any reason.



- c. **Primary Suppliers**  
The SEO should identify every company that brings petroleum supplies into the state so that it can maintain volume information and know whom to contact if a state Set Aside is necessary.
- d. **Pipeline Companies**  
Each state should identify the owners/operators of inter- and intra-state pipelines importing and shipping petroleum to and within the state.
- e. **Wholesale Distributors (or Jobbers)**  
These companies may be subsidiaries of national or regional entities, or they may be independent. They are key players in the transfer of petroleum products from pipelines (or from barges and ships, if applicable) to retailers. They generally operate facilities, called terminals, at which product is transferred from interstate carrier for local delivery. State officials should know who these jobbers are, or at a minimum, be in contact with the state organization that represents them. It is also useful to know the location of various terminals throughout the state as well as the volume per day transfer capacity of each facility. Other information a state can try to obtain from jobbers includes:
  - o areas served;
  - o principal roadways used;
  - o numbers of residential, commercial, institutional and industrial customers;
  - o access to, and volume of, available storage;
  - o emergency plans if any;
  - o volume of product delivery (per specified period of time); and
  - o names of non-oil company transporters who may be hired to deliver product.

Remember, petroleum companies are unregulated and are not obligated to provide information. Various petroleum associations may be a better source for some or all of this data.
- f. **Retailers**
  - o Motor gasoline is sold primarily through retail gasoline outlets. While it is useful to know the number and location of operating outlets on a yearly basis, these outlets change hands often. Knowing the total number of state retail outlets is usually sufficient.
  - o Home heating oil and LPG retailers will be significantly fewer in number than motor gasoline service stations. A list of these companies is very important for providing assistance to low income customers during a shortage. Knowledge of what jobber terminals they use is helpful. Note: in some states a terminal is a major wholesale facility. In others, it may include every retail heating oil company with a truck. There is no standard for this.

2. Consumption Profile  
EIA provides relatively up-to-date data for in-state sales of all retail petroleum products. Charts and graphs from the EIA provide valuable information for understanding how various shortages impact different consuming sectors and the relative importance of each type of petroleum product within a state's economy.

## II. Vulnerability Assessment

A vulnerability assessment will help state energy emergency planners understand the relationship between the state's energy providers, energy imported and customers. The aim of an assessment is to associate geographic and consumption patterns with energy supply in order to predict the impact of a shortage on various customers and areas within a state.

### A. Demographics

Some of the demographic factors planners should consider exploring in order to do a vulnerability assessment are:

1. Population.
2. Housing profile.
3. Employment profile.
4. Sector energy use (or include in Energy Profile).

### B. Energy Emergency Stakeholders

Stakeholders are those entities who participate in a state's energy marketplace in some manner. Obvious stakeholders are the various energy companies that generate, transmit and sell power or fuel. Others include agencies identified in ESF-12. Clearly, the SEO should be a stakeholder even if it is not specifically identified as one because of its location within state government. One could argue that the public is a stakeholder as well. For the purpose of emergency planning, the public's interest is identified through the energy use profile and the demographics contained in the vulnerability assessment. A plan should contain the following:

1. State energy providers identified and described.
2. State agencies identified in ESF-12, the SEO and others as applicable. (e.g., Attorney General, People's Counsel).
3. Energy, company and dealer associations and related organizations.
4. County and municipal government organizations including:
  - Emergency management.
  - State-wide government associations.
5. Out-of-state stakeholders including:
  - Interstate energy holding companies doing business in state.
  - Federal agencies.
  - Regional entities.
6. Cross cutting organizations including:
  - Social service agencies assisting consumers.
  - Private and non-profit relief agencies.

### C. Assessment

Evaluate potential vulnerability to energy shortages for various end users and locations, and for a variety of reasons, in light of the state's energy profile, its demographics and the interests of its stakeholders.

## **I. Overview**

### **What Is the Purpose of the Set-Aside?**

Typically, a state Petroleum Fuel Set-Aside is a mandatory program designed to provide “hardship” assistance to designated petroleum customers based on the availability, not price, of refined petroleum products. A Set-Aside would ordinarily be implemented when the amount of liquid petroleum fuels stocked in a state or entering a state is inadequate to meet demand for a sustained period. These conditions are manifest when wholesaler-resellers (major, often national, suppliers) of petroleum commodities cannot obtain and resell sufficient product and there is a need to ration supply in order to serve priority customers. Price is not an issue in this type of emergency; the problem a Set-Aside is designed to meet arises when price can no longer attract product for sale.

This condition may also exist when wholesaler-resellers find it necessary to reduce the amount or allocation of product supply to local retailers due to conditions such as insufficient supply of crude oil or refined petroleum products (e.g., gasoline, diesel fuel, and home heating oil), extended maintenance or repair of refineries, or other large-scale problems. If this happens, a Governor may declare an energy emergency, or designate certain geographic areas as suffering from supply imbalance and redirect product to those areas as needed.

Most Petroleum Set-Asides are designed to interfere with the petroleum market as little as possible. A Petroleum Set-Aside allocates limited volumes of fuel to designated priority users in order to maintain vital services. They are not intended to control consumption, reduce queues, and provide relief for routine uses such as driving (including commuting to and from work). A Set-Aside does not dictate cost. All fuels delivered through the program are purchased at the market price and, ordinarily, through the priority customer’s usual supplier(s). The volume of fuel allocated, or released for purchase to designated users, is designed to achieve maximum flexibility in the distribution of shortage fuels and to minimize government interference with the petroleum market.

## **II. How Does the Set-Aside Work?**

In most states, emergency management is coordinated through the state emergency management agency and a state emergency plan that designates one or more agencies to lead energy emergency responses under Emergency Support Function 12 (ESF-12). The agency most likely to have the lead in a liquid fuels shortage is the department in which State Energy Office (SEO) is housed or the SEO itself if it stands alone. Within that office, a set Set-Aside program generally assigns responsibility to a Fuel Allocation Manager. This manager, in consultation with higher authority and representatives of the petroleum industry, allocates fuel up to a set percentage of the total monthly supply of the fuel available for sale in the state. Set Aside regulations usually designate a percent of the volume for each fuel to be adjusted within a maximum parameter (e.g., five percent) according to the severity of the shortage. No supplier would be required to set aside more than the percentage designated for any single fuel. The wholesaler-retailer (or prime supplier) retains the physical volume designated to be set aside for release as ordered by the State Energy Office.

### **The key steps in operating a Petroleum Fuel Set-Aside:**

- End-users on the list of qualified priority customers who experience a hardship obtaining adequate supply file a pre-prepared Hardship Application with the State Energy Office for relief.
- Each potential applicant must judge whether or not to apply for hardship relief based on monthly fuel needs.
- The application must be filed within a certain number of days at the beginning of each period (e.g., seven business days).
- At the beginning of each period the Fuel Allocation Manager, using information on the federal EIA 782C form<sup>22</sup> for each primary petroleum supplier shipping fuel into the state, determines the volume of each fuel available for assignment.
- The Fuel Allocation Manager makes hardship assignments from the monthly available volume of set aside fuel.
- The Fuel Allocation Manager orders wholesaler-resellers to supply the retail dealer normally used by priority customers (usually an established or contractual customer) whose applications are approved.
- The retailer receiving this supply then sells the product to the applicant at the market or other price negotiated between them.
- Assigned fuel is sold only to approved applicants in accordance with the Set-Aside regulations. Applicants are, of course, free to purchase whatever fuel they can on the open market.
- The Fuel Allocation Manager may base the decision to assign fuel on a variety of factors depending upon the severity of the shortage, the time of year, the number of applications received from other priority customers within and outside of a specific applicant's area, the actual volume of fuel available for the month, or any other orderly and equitable distribution process (e.g., first come, first served).
- Applicants may appeal decisions to some higher authority, usually the state Attorney General. If relief is granted, the relief is most likely to be assigned at the beginning of the following month before other assignments are made. Of course if the program ends in the month following an order for relief, the order would be invalid.
- Trades between prime suppliers could be used to balance the burden of set-aside among the prime suppliers, if needed.

### **How Is the Need for Set-Aside Identified?**

The conditions suggesting the use of a Set-Aside occur when retail dealers report to their various retail associations that the amount of product allocated to them by wholesaler-resellers, major petroleum companies, or various market intermediaries has been severely reduced compared to their normal allocation.

### **What Fuel Sectors Are Involved?**

The fuel sectors most likely to be affected by the above conditions include all liquid fuels such as distillate (heating oil, diesel and kerosene), motor gasoline, propane, aviation fuels, and boiler fuel.

### **Percent of Petroleum Product to Set Aside**

Typically, the maximum monthly percentages of incoming product set aside by major suppliers, and reallocated to priority users for a specified period of time are:

- Motor gasoline: up to 5%

---

<sup>22</sup> <http://www.eia.doe.gov/oss/forms.html#eia-782c>

- Middle distillate (diesel & heating oil): 4%
- Boiler Fuel (#4 and heavy industrial fuel oil): 3%
- Propane: 3%
- Aviation gasoline: 5%
- Kerosene: 2%.

**Note:** The percentage should be no larger than what is expected to be required to meet emergency supply needs. The percentage is based on the amount of fuel already in the state in storage and the amount estimated to enter the state from the prime suppliers. To calculate emergency supply needs:

1. Ask for the prior year's monthly consumption from potential essential users.
2. Total the consumption of potential essential users by month.
3. Subtract the specific month's consumption from the state's supply.
4. Divide the shortfall by the total prime suppliers' sales for the specific month to get an estimated percentage of emergency supply needs.

### **Who Can Apply for Hardship Relief?**

The potential applicants for the Set-Aside include businesses, groups, institutions and governments included within the list of priority customers whose goods and services are needed for the welfare of the public and may include wholesale purchaser-resellers for sale to wholesale purchaser-consumers (retailers) and their customers (end-users). These priority categories are similar to those used for allocating fuel in other energy areas—especially electricity:

- agricultural production and distribution;
- aviation including ground support;
- cargo, freight & mail;
- emergency services;
- energy production;
- government/sanitation;
- health care;
- public passenger transportation;
- telecommunications;
- utility services (including water); and
- non-military shipping.

### **III. Steps for Implementing a Set-Aside**

#### **Monitoring**

- The State Energy Office (SEO) monitors petroleum fuel supply imported into its state using state, federal and private sector data. It does this continuously and remains in close touch with state petroleum fuel associations and others who can provide timely data. If fuel monitoring, or requests received from retail dealers or associations, indicate a shortage of sufficient magnitude to require hardship relief, the SEO should:
  - Verify these reports using the EIA 782C reporting forms and other sources of energy data including regional, private sector and anecdotal information;
  - Identify the geographic area(s) affected; and
  - Call the prime suppliers for real-time data.

#### **Notification**

- In many states, the SEO notifies the State Emergency Operation Center (SEOC) and, through the SEOC, the Governor’s Office about the shortage and its potential impact on petroleum product users in the affected areas. This will vary depending on legal authorities.
- The SEO also notifies petroleum companies importing and selling fuel within the state.
- Where possible, SEO staff often meets with petroleum suppliers to review Set-Aside procedures. States with up-to-date state energy emergency plans will usually have ongoing relationships with the industry and may have worked out Set-Aside issues as part of overall emergency planning.
- The SEO may consider holding public meetings with groups of priority customers to explain the application form and process.

**Program Preparation**

Most often, an SEO would be responsible for carrying out or at least overseeing the following:

- Prepare fact sheets and information for the media and public;
- Test receipt and notification systems (manual and electronic);
- Review and, in consultation with higher authority as required, set procedures for disbursing unallocated product at the end of each month;
- Review the appeals process and notify the state Attorney General of the impending Set-Aside; and
- Set-Aside duties are assigned by management to members of the agency staff. Management provides rapid program review and training.

**IV. The Hardship Application**

It is helpful for the agency managing a Set-Aside to produce a Hardship Application form and “Handbook” for distribution to priority end-users, the media, wholesaler-resellers, and retailers. An SEO would review the format and content of the application form and manual whenever a Petroleum Fuel Set-Aside is contemplated to assure that needs of the energy crisis at hand are met. If so approved, the SEO would consider placing the application form in HTML format and posting it on a web site for completion and return via E-mail.

**Appendix G—The Role of Energy Efficiency and Renewable Energy Resources in Energy Assurance Planning**

Emergency mitigation is a combination of advanced planning, preparedness and response capability. Energy shortage, as a component of broad emergency considerations, follows the same formula. Plans assist stakeholders in knowing what to do before an event occurs. Energy preparedness means having adequate supply resources on hand, knowing where and how to obtain response-related assistance (e.g., personnel, emergency generation, repair equipment and communications), and training stakeholders to use them. Response capability is the sum of all efforts to end an emergency.

Alternative energy is a component of overall supply resources. Alternatives offer options, provide back-up, and buy time for restoration. Thus, they add value to the entire emergency response effort by providing additional reliability and resiliency. Another way to put this is to say that having alternative energy resources on hand reduces energy assurance risk.

Examples of valuable alternative energy resources are listed in the Tables G-1 and G-2. The availability and scope of alternative resources will vary among regions of the country—from state-to-state and local jurisdiction-to-local jurisdiction. Alternatives not only reduce the risk of losing conventional energy sources, they also enhance life cycle assurance by providing additional emergency equipment such as temporary generation for health and water facilities, power for communications, and potential alternatives for conventional fuel.

Energy efficiency is a form of alternative energy that can be seen as the “silent partner” of energy resources. Energy not used accomplishes the same goal as energy consumed. Efficiency measures such as insulation help retain heat or cooling while buying time for repair. Energy efficient motors reduce the load on grids faced with potential overload and failure.

It is widely understood that alternatives cannot replace conventional energy supply. But energy shortages come in many shapes and sizes. Alternatives may buy more or less time depending on when, where, and how a shortage occurs. But, in most cases, they can reduce consumption at the margins while giving response teams more time to complete repairs or find new sources of short supply.

**What Factors May Planners Consider When Evaluating Energy Alternatives?**

There are a number of ways to evaluate alternative energy sources for enhancing energy assurance. Tables G-1 and G-2 build on Table 1 in Section 10 and illustrate some possibilities states may wish to consider.

**Table G-1**

Types and Examples of Energy Alternatives that May Lower Energy Assurance Risk from Conventional Energy Sources			
<i>Supply Side</i>			
<i>Renewable Resources</i>		<i>Supplemental Resources</i>	
<b>Wind Energy</b>		<b>Combined Heat and Power (Cogeneration)</b>	
Advantages	Disadvantages	Advantages	Disadvantages
<ul style="list-style-type: none"> <li>Increasing market share</li> </ul>	<ul style="list-style-type: none"> <li>Utilities and Independent</li> </ul>	<ul style="list-style-type: none"> <li>Systems can support site</li> </ul>	<ul style="list-style-type: none"> <li>Many exiting units not set</li> </ul>

<ul style="list-style-type: none"> <li>• Meets Renewable Portfolio requirements</li> <li>• Active industry group advocates</li> <li>• Potential offshore (coastal) growth</li> <li>• KWh costs increasingly competitive</li> <li>• Can lower need for building additional conventional electric generation capacity</li> </ul>	<ul style="list-style-type: none"> <li>• Onshore wind production is less reliable than offshore generation</li> <li>• Environmental community concerns <ul style="list-style-type: none"> <li>○ Avian fly ways</li> <li>○ Effect on habitat of tower base construction and footprint</li> </ul> </li> </ul>	<ul style="list-style-type: none"> <li>• Fits well with distributed generation</li> <li>• Environmentally friendly by recycling waste heat</li> <li>• Can serve all aspects of space conditioning</li> <li>• Can support “mission critical” facilities during power outage</li> <li>• Can be installed with black start capability</li> <li>• “Island mode” units operate independently of electric grid</li> <li>• Primarily for industrial or institutional use</li> <li>• Safety issues are generally mitigated in that units are operated by professionals</li> </ul>	<ul style="list-style-type: none"> <li>• May operate on conventional fuel, thus not necessarily reducing fuel risk</li> <li>• On site redundancy for “Island mode” increases capital cost</li> <li>• May not be coordinated with emergency and assurance agencies and thus, while reducing risk, cannot be readily called upon for assistance</li> </ul>
<b>Solar Energy</b>		<b>Distributed Generation</b>	
Advantages	Disadvantages	Advantages	Disadvantages
<ul style="list-style-type: none"> <li>• Can mitigate summer peak in many locations</li> <li>• Newer technology with improved efficiency available</li> <li>• New types of solar cells are more adaptable for existing structures</li> <li>• Reduces need for transmission lines</li> <li>• Multiple use</li> </ul>	<ul style="list-style-type: none"> <li>• Very long payback for residential retrofit</li> <li>• Subject to time-of-day and seasonal sun light variation</li> <li>• Large-scale parabolic generation units are feasible only in the US Southwest and, while promising, would require extensive</li> </ul>	<ul style="list-style-type: none"> <li>• Units provide assurance through decentralization of generation capacity</li> <li>• Power that is remote from central production can be generated by a variety of energy sources.</li> <li>• May be found in residential as</li> </ul>	<ul style="list-style-type: none"> <li>• See coordination comment above</li> <li>• Use of conventional fuels provides less assurance protection</li> <li>• Safety issues for utility restoration teams must be addressed when units are</li> </ul>



<ul style="list-style-type: none"> <li>• Can provide portable back-up generation for critical communications, and emergency power</li> <li>• PV becoming attractive for “Big Box” commercial roof installation</li> </ul>			
<b>Biomass - Ethanol</b>		<b>Hybrid Transportation Technology Electric Hybrid</b>	
Advantages	Disadvantages	Advantages	Disadvantages
<ul style="list-style-type: none"> <li>• Can offset use of conventional petroleum motor fuel</li> <li>• High level of subsidies reduces cost to consumer</li> <li>• Extensive research promises wider raw material options for biomass fuel production</li> <li>• Relatively compatible with many existing vehicles</li> <li>• Does not require all new, capital intensive, fueling facilities</li> </ul>	<ul style="list-style-type: none"> <li>• Less energy efficient than conventional motor fuel</li> <li>• Production raises issues for food supply when relying on corn as source</li> <li>• Federal subsidies may be reduced</li> <li>• May create operational issues (e.g., corrosion of certain vehicle parts)</li> <li>• Cannot be shipped via conventional pipeline thus potentially reducing availability and gasoline-risk mitigation</li> <li>• Value for energy assurance is concentrated in reducing dependency on imported petroleum, not in reducing overall fuel use</li> </ul>	<ul style="list-style-type: none"> <li>• Extensive market penetration in 2007–2008 reduces conventional fuel risk</li> <li>• No additional refueling infrastructure is required</li> <li>• Federal and state purchase subsidies have been and may continue to be available</li> </ul>	<ul style="list-style-type: none"> <li>• Long-term reliability and resale value is still being established as of 2009</li> <li>• If plug-in electric hybrids are marketed, they may create issues relating to electric generation risk</li> <li>• Cost of vehicles is high relative to conventionally-powered units</li> <li>• Long-term acceptance is more closely related to national vehicle buying trends than to energy assurance</li> </ul>
<b>Biomass—Waste (Landfill gas)</b>		<b>Natural gas or Propane (Vehicles)</b>	

<b>(Anaerobic Digestion)</b>			
Advantages	Disadvantages	Advantages	Disadvantages
<ul style="list-style-type: none"> <li>• Can reduce dependence on conventional fuels while reducing environmental risk</li> <li>• Requires capital commitment, licensing, and possibly extensive local community support</li> <li>• Waste fuel availability should hold up through the duration of facility amortization</li> </ul>	<ul style="list-style-type: none"> <li>• Expensive to develop</li> <li>• Often requires willingness of local jurisdictions to develop in competition with public projects that may be more well understood by the public</li> <li>• Gas and waste resources are, ultimately, not guaranteed</li> </ul>	<ul style="list-style-type: none"> <li>• Both fuels back out motor gasoline and diesel and thus diversify fuel options</li> <li>• Both fuels have record of reducing vehicle maintenance cost</li> <li>• Both fuels pollute less than motor gasoline or diesel</li> <li>• Both fuels may be especially beneficial for industrial, commercial, and governmental operations where centralized fuel capacity is cost effective</li> </ul>	<ul style="list-style-type: none"> <li>• Both require expensive new infrastructure</li> <li>• Efforts to create and expand natural gas and propane vehicle use in the 1990s and early 2000s failed to provide significant market penetration</li> <li>• Federal government support for this technology has significantly diminished</li> <li>• Neither technology proved practical for general consumer use</li> </ul>
<b>Hydropower</b>		<b>Fuel Cells Hydrogen</b>	
Advantages	Disadvantages	Advantages	Disadvantages
<ul style="list-style-type: none"> <li>• Wide spread use in states with sufficient flowing water resources provides the broadest non-conventional fuel footprint in the USA</li> <li>• Has extensive track record for reliable alternative power provision</li> <li>• Provides</li> </ul>	<ul style="list-style-type: none"> <li>• Can be subject to seasonal weather impacts affecting water flow</li> <li>• Has been challenged where dams have destroyed habitat</li> <li>• Water supply issues in various states, combined with high capital costs limit expansion</li> </ul>	<ul style="list-style-type: none"> <li>• Beneficiary of significant federal government research and development effort</li> <li>• Provides promise of clean fuel alternative</li> <li>• Can be produced from natural gas, thus reducing dependency on</li> </ul>	<ul style="list-style-type: none"> <li>• Has been undergoing research and development for many years without significant marketable results</li> <li>• Successful adaptation could complicate use of natural gas for space</li> </ul>

<ul style="list-style-type: none"> <li>Enhances flood control in certain locations</li> </ul>		<ul style="list-style-type: none"> <li>Has promise of being combined with electric hybrid to create petroleum-free fuel, thus reducing fuel risk</li> </ul>	<ul style="list-style-type: none"> <li>Significant vehicle unit cost anticipated</li> </ul>
<b>Geothermal</b>		<b>Enhanced Battery Technology</b>	
Advantages	Disadvantages	Advantages	Disadvantages
<ul style="list-style-type: none"> <li>Reduces use of conventional fossil fuels for space conditioning</li> </ul>	<ul style="list-style-type: none"> <li>Capital intensive</li> <li>Issues of long-term maintenance and reliability</li> </ul>	<ul style="list-style-type: none"> <li>Has benefited hybrid vehicle technology</li> <li>Has promise of increasing dispatchability for both wind- and solar-generated power</li> </ul>	<ul style="list-style-type: none"> <li>Battery technology to enhance large-scale applications suitable for vehicles and large motor operation is still under development</li> </ul>

**Table G 2**

Types and Examples of Energy Alternatives that May Lower Energy Assurance Risk from Conventional Energy Sources	
<i>Demand Side</i>	
<i>Crossover Resources</i>	
<b>Energy Efficiency Programs</b>	
Advantages	Disadvantages
<ul style="list-style-type: none"> <li>Most effective non-fuel means for providing energy assurance</li> <li>Well developed and has track record of reducing power consumption</li> <li>Technological advances have secured constant yielding benefit</li> </ul>	<ul style="list-style-type: none"> <li>Much of the advantage gained from efficiency has been mitigated by demand growth</li> <li>Human equation can reduce value of efficiency and conservation</li> <li>Major industries (e.g., automobile) have resisted maximizing energy efficient technology</li> </ul>
<b>Renewable Energy Portfolio Standards</b>	
Advantages	Disadvantages
<ul style="list-style-type: none"> <li>May encourage large fuel consumers to reduce purchase of carbon-based fuels through combination of regulations and credits</li> </ul>	<ul style="list-style-type: none"> <li>Long-term benefits are still to be measured</li> <li>May take time to develop where not authorized as jurisdictional political process proceeds</li> </ul>
<b>Demand Response Management Smart Grid—Time-of-Day Pricing—Remote Switching</b>	
Advantages	Disadvantages
<ul style="list-style-type: none"> <li>Offers advantage of creating wide-spread efficiency gains thus reducing risk</li> </ul>	<ul style="list-style-type: none"> <li>Any form of external (especially centralized) control raises issues of privacy</li> </ul>

<ul style="list-style-type: none"> <li>• Participating consumers can see money saving results rapidly</li> <li>• Time-of-day pricing is generally accepted by many industrial, commercial and institutional users</li> <li>• Major federal support has been obtained from some Federal Energy Regulatory Commission members</li> <li>• Pilot programs show promising results for risk mitigation</li> </ul>	<ul style="list-style-type: none"> <li>• Smart grid technology may have serious technological challenges in scaling up from demonstration and pilot programs to large-scale use</li> <li>• Utilities can be expected to weigh capital costs of implementation v. profitability</li> <li>• Long-range benefits are still being debated</li> </ul>
<b>Energy Codes</b>	
Advantages	Disadvantages
<ul style="list-style-type: none"> <li>• Can create common responsibility (“level the playing field”) among classes of consumers for costly energy consumption reduction strategies</li> <li>• Once in place, and properly monitored, codes can create permanent technological solutions for energy assurance</li> <li>• Properly administered energy codes enhance environmental benefit as well as energy assurance</li> </ul>	<ul style="list-style-type: none"> <li>• Code development is a complex political process involving debate about energy efficiency benefits v. project costs and supplier profit</li> <li>• Local code enforcement officials often resist any state initiatives perceived to challenge local political responsibility</li> <li>• Industries that must incur capital costs can be expected to resist code development</li> </ul>

### **What Have States Done to Enhance Energy Alternative Options?**

- **Renewable and Alternative Transportation Fuels Programs**

Minnesota has one of the oldest and most successful alternative transportation fuel programs and emphasizes the use of E-85 and flex-fuel vehicles. In 2007, the state’s fleet purchases of E-85 increase to 412,483 gallons from 165,526 gallons in 2006. The state’s purchases of flex-fuel capable vehicles able to run on E85, gasoline, or intermediate blends has increased dramatically as well, with fully half of the state-owned passenger vehicles being flex-fuel capable. The state also has the most robust offering of E-85 refueling stations—320 and growing.

The Illinois Green Fleets Program provides businesses, government units, and other organizations in Illinois recognition and marketing opportunities to add clean, domestic, renewable fuel vehicles in their fleet. The program recognizes a fleet manager's progressive efforts in using environmentally friendly vehicles and fuels to improve air quality while promoting domestic fuels for greater national energy security. An Illinois Green Fleet is one that acquires vehicles using natural gas, propane, E-85, electricity, biodiesel, or other clean, domestically produced fuels. In addition to the Green Fleets Program, Illinois Governor Rod Blagojevich signed legislation requiring state agencies to purchase Flexible Fuel Vehicles that can run on E-85. The bill also encourages state agencies to purchase fuel-efficient hybrid vehicles.

Since 2006, Oregon's Portland Water Bureau (PWB) has been using B99 (99 percent biodiesel, 1 percent diesel) in its city-owned, diesel-powered vehicles and equipment from spring through fall and B50 (50 percent biodiesel, 50 percent diesel) in the winter. The biodiesel used by PWB is locally produced. The city's partners in the —effort, Oregon-based Star Oil and Sequential Pacific —Biofuels, blend and distribute the fuel, while regional farmers (from Oregon, Washington, Idaho, and Montana) grow the seed crops that eventually become the feedstock for

B99. With PWB's approximately 144 vehicles—ranging from backhoes and forklifts to dump trucks and tractors—running on B99, the emissions benefits are adding up.

These are just three examples of how renewable and alternative fuels programs can improve air quality while enhancing energy assurance and resiliency.

- **Photovoltaics**

The use of photovoltaic continues to play an important role in responding to emergency energy scenarios. In fact, photovoltaic is the renewable resource most commonly used during disaster relief efforts to supply electricity. During Hurricane Katrina, the Florida Solar Energy Center (FSEC) provided a photovoltaic option for HAM radio backup during their support of recovery efforts in the aftermath of the storm. In addition, the National Energy Foundation and FSEC have formed the Renewable Energy Disaster Relief Fund to provide renewable energy resource powered equipment needed by survivors of a disaster in the United States. The Fund was formed to combat the lack of energy resources and services so often available during emergency response efforts. The funds raised by REDRF will be used to purchase renewable energy hardware (such as photovoltaic panels and wind generators) to power necessary equipment for first response efforts after a disaster, ideally within the first 3 weeks after an event until utility services are restored.

Biloxi, Mississippi used two small photovoltaic systems mounted on wheels to power fans and lights at a distribution center during the aftermath of Hurricane Katrina. The Point of Distribution provided food, water, ice, clothing, and other supplies using the photovoltaic systems, which were made by a New York church group and had a 75-watt photovoltaic module, battery, charge controller, and 700-watt inverters.

As a result of Katrina, eighteen solar lighting systems were installed at the Louisiana State Police Headquarters—providing lighting for the hub of the state's hurricane recovery efforts. And in Pennsylvania, the Sustainable Development Fund provided support for the installation of a photovoltaic array at the residence of the governor to provide a portion of daily primary power for the residence as well as reliable backup power for critical state government services.

The events of Hurricane Katrina left many states examining their critical infrastructures and supplies of backup power. The above are just a sampling of the many examples of photovoltaic use in response to emergency scenarios.

- **Fuel Cells**

Some states and cities see fuel cells as an option for emergency preparedness and public safety. There are an array of security or energy assurance applications for clean energy including building and facility backup power, emergency response (in field), low-power protection, infrastructure area support, transportation, and telecommunications. These energy sources can operate independent of the grid and can continue to provide electricity when the grid is down. Whether it is providing power to communications centers, heating a facility, or keeping traffic signals running, these additional measures can be critical in emergency response and preparedness.

During the August 2003 blackout in New York City, the New York Police Department Central Park Police Station remained in operation because it is powered by an on-site fuel cell that is grid independent. And the Verizon 911 call center in Long Island and the East Anaheim Police

Department and Community Center in California both installed a fuel cell system to provide power for its operations.

- **Wind Power**

According to a report recently released by the U.S. Department of Energy and Lawrence Berkeley National Laboratory, the U.S. was the fastest-growing wind power market in the world in 2007, for the third consecutive year. Wind projects accounted for 35 percent of all new electric generating capacity added in the U.S. in 2007, and more than 200 GW of wind are in various stages of development throughout the country. This kind of development is a good indicator that wind will play an increasingly important role in the nation's utility scale electricity generation mix. However, small-scale wind generation (e.g., residential, institutional) at specific locations can offer communities with a power alternative during larger scale electricity outages. Small wind electric systems are one of the most cost-effective, home-based or site specific renewable energy systems. A small wind electric system can lower utility bills in some cases, and can help provide power supplies during extended utility outages. The American Wind Energy Association has developed a guide to small-scale wind applications ([www.awea.org/smallwind/](http://www.awea.org/smallwind/)) that could help in evaluating its application in particular areas.

- **Demand Response Programs**

Demand response programs offer a variety of potential benefits including financial (reducing energy cuts costs) and environmental (cutting electricity is the most environmentally sound way of securing power) in addition to the reliability that reducing peak energy use can provide to allow the power to stay on during emergency situations. Demand response programs have been credited with helping to avoid blackouts by providing needed supply during a power emergency, while also generating revenues totaling millions of dollars for the commercial, industrial, and residential buildings that participate.

One example of a state demand response program is the New York State Energy Research & Development Authority (NYSERDA) Peak-Load Reduction Program, which is designed to improve the reliability of New York's electric grid while helping businesses and industries reduce operating costs. Any company with a large electric load on summer afternoons (when the electric grid is most stressed) may be eligible for incentives to offset the costs of up to 65 percent of energy saving capital improvements. The program is split into two components—Permanent Demand Reduction and Demand Response—with incentives available for both.

PJM Interconnection, a regional transmission organization, offers three demand response program options to end-users. The Emergency Load Response Program offers end-users financial incentives for agreeing to reduce a set amount of electricity consumption during system emergencies; the Economic Load Response Program offers end-users financial incentives for voluntarily reducing electricity consumption during times of high wholesale prices; and finally, the Synchronized Reserves Market offers end-users financial incentives for reducing electricity consumption on short notice in case of an unexpected emergency event (e.g. power plant outage or transmission line failure).

In 2007, California launched a revised version of its demand response energy curtailment program, formerly known as the Demand Reserves Partnership, under the new name Capacity Bidding Program. The goal of the program is simply to leverage proven demand response strategies that have helped other cities and states keep the electricity on when the threat of a power failure loomed. The program, run under Southern California Edison, is an internet-based

program that offers financial incentives to customers agreeing to reduce their energy use when a critical event is forecast.

### Combined Heat and Power (CHP)

A typical CHP system is summarized in Figure G-1

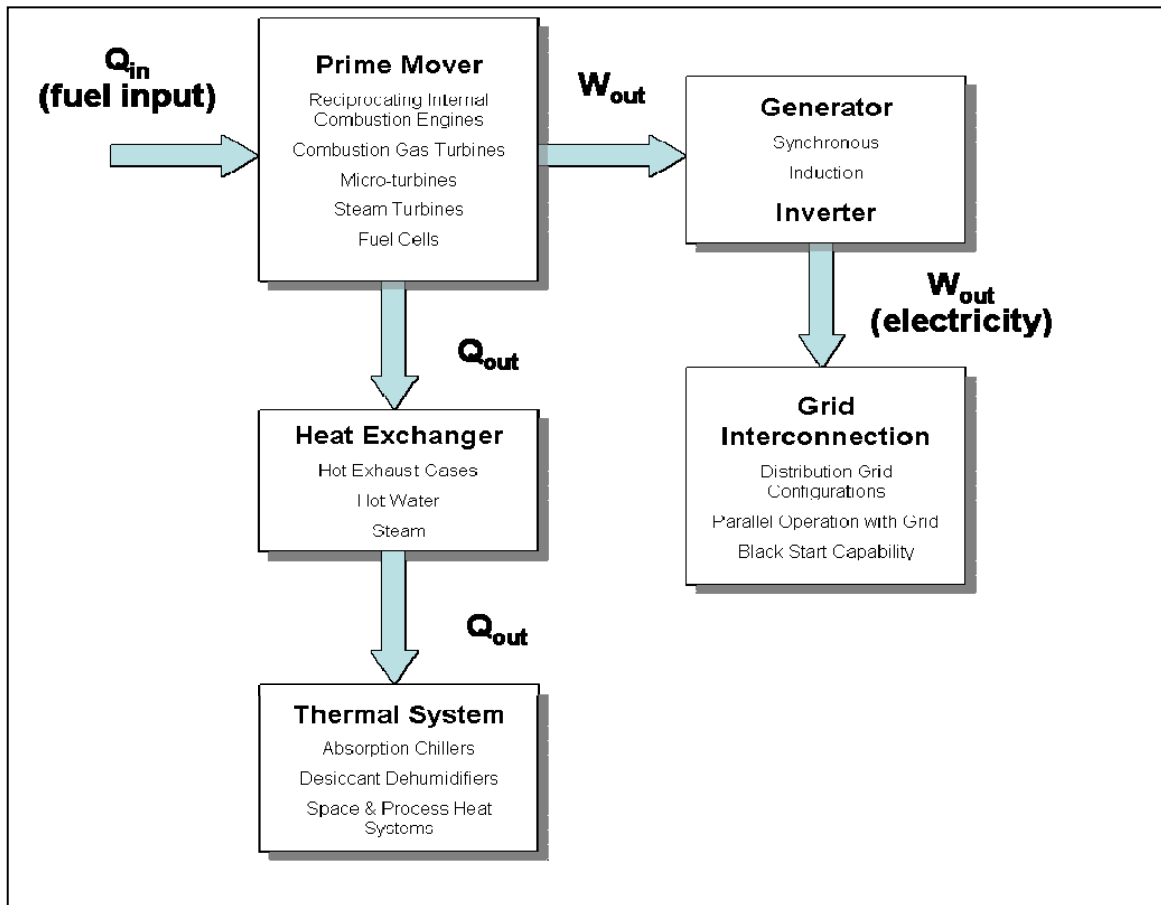

### CHP as Part of a State’s Energy Assurance System

One of the main contributions CHP technologies can make to energy assurance is the capability, **under certain configurations**, to continue to safely operate and provide electric service to a facility during emergency situations (extended electric utility outages). The following paragraphs describe the CHP system configurations and conditions that must exist for these capabilities to be realized. Please refer to the CHP Basics section above for an explanation of terms.

#### 1) CHP System Operates in Parallel with a De-energized Grid

- The CHP system must be configured to operate in the Non-Export mode—not capable of exporting power to the grid at any time.
- The CHP system must be configured with a synchronous generator.
- The CHP system must have “Black Start” capability.
- The CHP system must be sized (capacity) to either handle the full electric load of the facility or the system must be equipped with a transfer switch

(automated or manual) capable of shedding enough of the facility's electric load to allow the CHP system capacity to meet the needs of the facility. If the building load placed on the CHP system exceeds the capacity of the CHP system, it will shut down due to overload conditions.

**2) CHP System Disconnects from the Grid When the Grid De-energizes but Continues to Serve the Facility Load**

- The CHP system can be configured to operate in either the Export or Non Export mode—since the system will be physically disconnected from the de-energized grid, the export versus non export configuration is irrelevant.
- The CHP system must be configured with either an inverter or a synchronous generator.
- The CHP system must have “Black Start” capability.
- The CHP system must be sized (capacity) to either handle the full electric load of the facility or the system must be equipped with a transfer switch (automated or manual) capable of shedding enough of the facility's load to allow the CHP system capacity to meet the needs of the facility.

*It should be noted that some CHP systems are installed totally independent of the grid (non parallel operation). This is referred to as “Islanding or Isolated Mode”. In this situation, the CHP system is never operated in parallel with the grid and therefore the operating status of the grid is irrelevant. However, to ensure reliability of service, redundancy is normally built into the CHP system in the form of multiple engines/generators. This normally tends to be an expensive option and is not seen very often.*

• **Steps to Including CHP in Energy Assurance Planning**

- 1) Determine where CHP systems are presently installed and operating within your area. This can be found at the DOE sponsored website:  
[www.eea-inc.com/chpdata/index.html](http://www.eea-inc.com/chpdata/index.html)
- 2) Determine which of those sites meet the criteria for operating during times of emergency (de-energized electric utility grid).
- 3) Determine which of the facilities could be utilized to meet the energy assurance plan needs during an emergency (hospitals, schools etc).
- 4) Determine the ease and cost of modifying existing CHP sites to meet the needs of the energy assurance plan (e.g., adding black start capability may be economically justified).
- 5) Examine whether adding CHP to a select few key facilities is desirable and affordable as part of the energy assurance plan.

• **Emergency/Backup Generators Versus CHP Systems**

Often times, commercial and industrial facilities will have emergency or backup generators on-site. These systems are normally installed to assist the facility maintain electric service during electric outages. The chart below illustrates the difference between emergency/backup generators and the CHP systems described above.



Figure G 1

<b>Emergency Generators vs. CHP Systems</b>	
<p style="text-align: center;"><u>Emergency Generators</u></p> <ul style="list-style-type: none"> <li>- Diesel fueled—high emissions and limited amount of stored fuel (limited to hours versus days of operation)</li> <li>- Sized to meet limited critical loads only</li> <li>- Not designed or capable of continuous operation for long periods of time</li> <li>- Rarely operates (will the engines start when required?)</li> <li>- Financial payback only in times of emergency</li> </ul>	<p style="text-align: center;"><u>CHP System</u></p> <ul style="list-style-type: none"> <li>- Natural gas fueled—low emissions and continuous supply of fuel</li> <li>- Operates in parallel with the utility grid to continuously provide electric and thermal requirements of the facility</li> <li>- Designed and capable of continuous operation – capable of operating with or without an energized grid</li> <li>- CHP provides backup to the grid; grid supplies backup to the CHP system</li> <li>- Potential for good financial return due to long operating hours</li> </ul>

- **A Possible Alternative to conventional CHP—Solar-Powered CHP**

ZenithSolar, located in *Nes Tziona*, Israel, is testing a prototype concentrated photovoltaic (CPV) solar installation that aims to produce up to 75 percent heat output and 25 percent electric output per unit. Each 4 foot by 4 foot CPV unit has an approximate instantaneous power rating of 2kWp and an associated 5kWp thermal rating (from unit cooling water). The company has engineered the systems for easy upgrade with the potential for ultimate electrical ratings of 4 to 5kWp. These units may offer potential for small commercial and institutional back-up and, in arrays, may provide significant alternative energy benefits for wider applications.



Photograph by Donald Milsten March 2009.

## ***Appendix H—References and Resources***

---

This Appendix is a Quick Reference and URL locator for major energy stakeholders and additional information sources. Much of this information is covered in the body of the Guidelines and other appendices; however, it is provided here as an additional aid for state energy emergency and other personnel.

### **Agencies and Organizations**

- U.S. Department of Energy Office of Electricity Delivery and Energy Reliability (Responsible for Critical Energy Infrastructure Protection and Energy Emergency Preparedness <http://oe.energy.gov/>
  - Infrastructure Security & Energy Restoration (ISER) Division is responsible for ensuring the security, resiliency and survivability of key energy assets and critical energy infrastructure at home and abroad. [http://www.oe.energy.gov/our\\_organization/iser.htm](http://www.oe.energy.gov/our_organization/iser.htm)
- U.S. Department of Homeland Security <http://www.dhs.gov/>
- National Association of State Energy Officials (NASEO), Energy Data & Security Committee <http://naseo.org/committees/energysecurity/>
- National Association of Regulatory Utility Commissioners (NARUC) Committee on Critical Infrastructure <http://www.naruc.org/committees.cfm?c=46>
- National Governors' Association (NGA) Center of Best Practices Homeland Security & Technology <http://www.nga.org/portal/site/nga/menuitem.8274ad9c70a7bd616adcbeeb501010a0/?vgnextoid=e9a4d9b834420010VgnVCM1000001a01010aRCRD>
- National Conference of State Legislatures (NCSL) Task Force on Homeland Security and Emergency Preparedness <http://www.ncsl.org/Default.aspx?TabID=773&tabs=855,106,702#855>
- Public Technology Institute (PTI) works with local governments on developing and implementing local Energy Assurance Plans. <http://www.pti.org/>

### **Documents and Reports**

- *National Response Framework* (January 2008) Department of Homeland Security (DHS)—is the successor to the National Response Plan and focuses on response and short-term recovery. <http://www.fema.gov/emergency/nrf/mainindex.htm#>
  - Emergency Support Function #12—Energy Annex <http://www.fema.gov/pdf/emergency/nrf/nrf-esf-12.pdf>
  - Critical Infrastructure and Key Resources Support Annex <http://www.fema.gov/pdf/emergency/nrf/nrf-esf-12.pdf>

- *The National Infrastructure Protection Plan*, (2009) Department of Homeland Security (DHS)—provides a coordinated approach to critical infrastructure and key resources (CI/KR) protection roles and responsibilities for governmental agencies and private sector security partners. <http://www.dhs.gov/nipp>
  - *Energy Sector Specific Plan (Energy SSP) Redacted* (May 2007) Department of Homeland Security (DHS) and Department of Energy (DOE)—provides means to implement the NIPP for critical energy infrastructure/key resources <http://www.dhs.gov/xlibrary/assets/nipp-ssp-energy-redacted.pdf>
- *A Guide to Critical Infrastructure and Key Resources Protection at the State, Regional, Local, Tribal, and Territorial Level* (September 2008), Department of Homeland Security (DHS)—contains a wealth of information on CIKR issues and organizational structures. [http://www.naseo.org/eaguidelines/documents/Guide\\_to\\_CI\\_and\\_Key\\_Resources\\_Protection\\_at\\_the\\_State,R,L,T&T\\_Level\\_September\\_2008.pdf](http://www.naseo.org/eaguidelines/documents/Guide_to_CI_and_Key_Resources_Protection_at_the_State,R,L,T&T_Level_September_2008.pdf)
- *Developing and Maintaining State, Territorial, Tribal, and Local Government Emergency Plans* (March 2009) Department of Homeland Security, FEMA—promotes a common understanding of the fundamentals of planning and decision making to help emergency planners examine a hazard and produce integrated, coordinated, and synchronized plans. [http://www.fema.gov/pdf/about/divisions/npd/cpg\\_101\\_layout.pdf](http://www.fema.gov/pdf/about/divisions/npd/cpg_101_layout.pdf)
- *The Governors Guide to Energy Assurance* (December, 2006) NGA Center of Best Practices Homeland Security & Technology—roles and responsibilities for ensuring a robust, secure and reliable energy infrastructure. <http://www.nga.org/portal/site/nga/menuitem.6c9a8a9ebc6ae07eee28aca9501010a0/?vgnextoid=35fe91e19877f010VgnVCM1000001a01010aRCRD>
- *Local Government Energy Assurance Guidelines* (September 2008) Public Technology Institute (PTI). Protecting and enhancing the resiliency of the energy sector from natural and human-caused disasters requires local governments to be vigilant and aware of the interdependencies of the system. This guide provides a valuable resource for local governments as they examine and enhance their energy assurance efforts. <http://www.pti.org/index.php/ptiee1/more/410/>
- The National Strategy for Homeland Security provides a common framework for the prevention and disruption of terrorist attacks; protection of the American people, our critical infrastructure, and key resources; response to and recovery from incidents; and strengthening the foundation to ensure long-term success. [http://www.dhs.gov/xabout/history/gc\\_1193938363680.shtm](http://www.dhs.gov/xabout/history/gc_1193938363680.shtm)
- *The Role of State Public Utility Commissions in Protecting the National Utility Infrastructure*, National Regulatory Research Institute, (March 2005). <http://nrri.org/pubs/multiutility/05-03.pdf>
- DHS Daily Open Source Infrastructure Report [http://www.dhs.gov/xinfoshare/programs/editorial\\_0542.shtm](http://www.dhs.gov/xinfoshare/programs/editorial_0542.shtm)
- *National Association of Regulatory Utility Commissioners Technical Briefs* <http://www.naruc.org/cipbriefs>

- *Information Technology for Counterterrorism: Immediate Actions and Future Possibilities* (book) (2003) Computer Science and Telecommunications Board  
<http://www.nap.edu/catalog/10640.html>
- *Planning for Government Continuity* (November, 2003) National Governors Association (NGA) Center for Best Practices  
<http://www.nga.org/portal/site/nga/menuitem.9123e83a1f6786440ddcbeeb501010a0/?vgnextoid=ed74303cb0b32010VgnVCM1000001a01010aRCRD>
- *Establishing State Intelligence Fusion Centers* (July, 2005) National Governors Association (NGA) Center for Best Practices—Guidance for setting up and operating an intelligence fusion center  
<http://www.nga.org/Files/pdf/FusionCenterIB.pdf>
- *Critical Infrastructure Protection: Significant Challenges Need to be Addressed* (July, 2002) General Accounting Office  
<http://www.gao.gov/new.items/d02961t.pdf>
- *Making the Nation Safer* (book) (2002)—National Academies Press  
<http://search.nap.edu/nap/cgi/napsearch.cgi?term=making+the+nation+safer>
- *States' Homeland Security Priorities* (August, 2002) National Governors Association (NGA) Center for Best Practices—  
<http://www.nga.org/portal/site/nga/menuitem.9123e83a1f6786440ddcbeeb501010a0/?vgnextoid=d9fc5aa265b32010VgnVCM1000001a01010aRCRD>
- *Interstate Strategies for Transmission Planning and Expansion* (2002) Task Force on Electricity Infrastructure, The National Governor's Association (NGA)—report recommending the creation of Multi-State Entities (MSEs) to facilitate state coordination on transmission planning, certification, and siting at a regional level.  
<http://www.nga.org/portal/site/nga/menuitem.9123e83a1f6786440ddcbeeb501010a0/?vgnextoid=07f1303cb0b32010VgnVCM1000001a01010aRCRD>
- *Electrical Energy Security* (April 2002) The Regulatory Assistance Project
  - *Part I: Assessing Security Risk*  
<http://www.raonline.org/Pubs/IssueLtr/ElecSec1.pdf>
  - *Part II: Policies for a Resilient Network'*  
[http://www.raonline.org/docs/RAP\\_IssuesLetter-ElectricalEnergySecurityPolicies\\_2002\\_04.pdf](http://www.raonline.org/docs/RAP_IssuesLetter-ElectricalEnergySecurityPolicies_2002_04.pdf)
- *Emergency Planning and Preparedness: Securing Oil and Natural Gas Infrastructures In the New Economy* (June, 2001)—National Petroleum Council  
<http://www.npc.org/reports/rby.html>

### **Renewable Energy, Energy Efficiency, and CHP:**

- For information on CHP market studies including qualitative and quantitative assessments of national, state, regional, and local trends related to clean heat and power deployment, please see <http://www.uschpa.org/i4a/pages/index.cfm?pageid=3308>.

- For more information on the operation of the CHP system at the Mississippi Baptist Medical Center during Hurricane Katrina, see:  
<http://www.chpcenterse.org/reports/CHP-MBMC.pdf>
- For more information on CHP, please see the Combined Heat and Power Resource Guide, September 2005 at  
[http://www.chpcentermw.org/pdfs/Resource\\_Guide\\_10312005\\_Final\\_Rev5.pdf](http://www.chpcentermw.org/pdfs/Resource_Guide_10312005_Final_Rev5.pdf)
- For more information on Illinois Green Fleets, see:  
<http://www.illinoisgreenfleets.org/fuels/e-85.html>.
- For more information on alternative fuels programs, see:  
<http://www.eere.energy.gov/afdc/about.html>.
- For more information about the California demand response programs, please see  
<http://www.fypower.org/>.
- For more information about the Renewable Energy Disaster Relief Fund (REDRF), please visit  
<http://www.fsec.ucf.edu/en/publications/pdf/FSEC-PF-431-08.pdf>
- For more information about one example of the Florida Solar Energy Center response to Hurricane Katrina, see:  
<http://www.fsec.ucf.edu/en/media/newsletters/echron/archives/2005/Q4/disaster-relief.htm>.
- Annual Report on U.S. Wind Power Installation, Cost and Performance Trends: 2007,” see: <http://eetd.lbl.gov/ea/ems/re-pubs.html>.
- To access America Wind Energy Association fact sheets, please visit,  
<http://www.awea.org/pubs/factsheets.html>.
- To view program details for the NYSERDA Peak-Load Reduction Program, please visit  
<http://www.nyserda.org/programs/PeakLoad/default.asp>.
- For more information on Southern California Edison Capacity Bidding Program, see:  
<http://www.sce.com/cbp>.
- For a full list of demand response programs in California, please visit  
[http://www.fypower.org/pdf/Calif\\_DemandResp\\_FYP\\_Final.pdf](http://www.fypower.org/pdf/Calif_DemandResp_FYP_Final.pdf)

### **Pandemic Influenza Resources and Reports**

- US Department of Health and Human Service Pandemic Web site  
<http://www.pandemicflu.gov>
- US Department of Health and Human Service 2009 H1N1 Flu (Swine Flu)  
<http://www.cdc.gov/H1N1FLU/>
- World Health Organization Web site  
<http://www.who.int/topics/influenza/en/>

- Center for Disease Control Site Web site  
<http://www.cdc.gov/flu/avian/index.htm>
- *Interim Pre-pandemic Planning Guidance* (February 2007) Centers for Disease Control  
<http://www.cominit.com/en/node/265484>
- *National Strategy for Pandemic Influenza* (November 2005) Office of Homeland Security—intended to guide U.S. preparedness and response activities to mitigate the impact of a pandemic.  
<http://www.flu.gov/professional/federal/pandemic-influenza.pdf>
- *Pandemic Influenza Preparedness, Response, and Recovery Guide for Critical Infrastructure And Key Resources* (September 2003) Department of Homeland Security (DHS)—A practical tool developed for business owner-operators and their contingency planners to enhance pandemic planning.  
<http://www.flu.gov/professional/pdf/cikrpandemicinfluenzaguide.pdf>