



NOAA Technical Memorandum NMFS-AFSC-224

Results of the 2010 Eastern Bering Sea Upper Continental Slope Survey of Groundfish and Invertebrate Resources

by
G. R. Hoff and L. L. Britt

U.S. DEPARTMENT OF COMMERCE
National Oceanic and Atmospheric Administration
National Marine Fisheries Service
Alaska Fisheries Science Center

May 2011

NOAA Technical Memorandum NMFS

The National Marine Fisheries Service's Alaska Fisheries Science Center uses the NOAA Technical Memorandum series to issue informal scientific and technical publications when complete formal review and editorial processing are not appropriate or feasible. Documents within this series reflect sound professional work and may be referenced in the formal scientific and technical literature.

The NMFS-AFSC Technical Memorandum series of the Alaska Fisheries Science Center continues the NMFS-F/NWC series established in 1970 by the Northwest Fisheries Center. The NMFS-NWFSC series is currently used by the Northwest Fisheries Science Center.

This document should be cited as follows:

Hoff, G. R., and L. L. Britt. 2011. Results of the 2010 eastern Bering Sea upper continental slope survey of groundfish and invertebrate resources. U.S. Dep. Commer., NOAA Tech. Memo. NMFS-AFSC-224, 300 p.

Reference in this document to trade names does not imply endorsement by the National Marine Fisheries Service, NOAA.



NOAA Technical Memorandum NMFS-AFSC-224

Results of the 2010 Eastern Bering Sea Upper Continental Slope Survey of Groundfish and Invertebrate Resources

by
G. R. Hoff and L. L. Britt

Alaska Fisheries Science Center
7600 Sand Point Way N.E.
Seattle, WA 98115
www.afsc.noaa.gov

U.S. DEPARTMENT OF COMMERCE

Gary F. Locke, Secretary

National Oceanic and Atmospheric Administration

Jane Lubchenco, Under Secretary and Administrator

National Marine Fisheries Service

Eric C. Schwaab, Assistant Administrator for Fisheries

May 2011

This document is available to the public through:

National Technical Information Service
U.S. Department of Commerce
5285 Port Royal Road
Springfield, VA 22161

www.ntis.gov

ABSTRACT

The results of the 2010 Alaska Fisheries Science Center's (AFSC) bottom trawl survey of the groundfish and invertebrate resources of the eastern Bering Sea upper continental slope (EBSS) is presented. The 2010 EBSS survey is the fourth standardized biennial groundfish bottom trawl survey of this region.

Two hundred successful survey bottom trawls were conducted from 200 to 1,200 m on the eastern Bering Sea slope. The survey area stretched from Unalaska and Akutan Island in Alaska (54° N) to the U.S-Russian border at 61° N. Sampling was stratified by six subareas running south to north and by five depth strata within each subarea. Stations were chosen randomly and target sampling density was proportional to the area (km²) in each subarea and depth stratum. Mean sampling density was approximately one tow per 204 km².

This report provides estimates of biomass in metric tons (t), population number, and catch per unit effort (CPUE; no./ha and kg/ha) for all species identified on the survey. Size frequencies (42 species) and CPUE distribution plots (43 species) are presented for the most abundant species or species of commercial and ecological interest. The largest biomass of fish and invertebrate species, respectively, were the giant grenadier (*Albatrossia pectoralis*), Pacific ocean perch (*Sebastes alutus*), arrowtooth flounder (*Atheresthes stomias*), popeye grenadier (*Coryphaenoides cinereus*), shortspine thornyhead (*Sebastolobus alascanus*), deep sea papillate sea cucumber (*Pannychia moseleyi*), the brittlestar (*Ophiacantha normani*), and the claypipe sponge (*Aphrocallistes vastus*).

CONTENTS

ABSTRACT.....	iii
CONTENTS.....	v
LIST OF FIGURES	vi
LIST OF TABLES	xii
INTRODUCTION	1
METHODS	2
Survey Area and Sampling Design.....	2
Survey Agenda and Personnel	3
Vessel, Scientific Gear and Procedures	3
Catch Processing and Collection of Biological Data.....	5
Abundance Estimates.....	7
RESULTS	18
Haul, Catch, and Biological Data	18
Distribution Length Frequencies and Abundance Estimates	19
CITATIONS	265
ACKNOWLEDGMENTS	266
APPENDICES	267
Haul Log	271

LIST OF FIGURES

Figure 1. Map showing subareas used for the 2010 Eastern Bering Sea slope Survey	8
Figure 2. Diagram of the Poly Nor’eastern high opening bottom trawl net and bottom contact sensor.....	9-14
Figure 3. Relationship between temperature, latitude and bottom depth collected from trawl stations during the 2010 EBSS survey	15
Figure 4. Distribution and relative abundance of Pacific sleeper shark (<i>Somniosus pacificus</i>) from the 2010 EBSS survey	95-96
Figure 5. Size composition of the estimated Pacific sleeper shark (<i>Somniosus pacificus</i>) population from the 2010 EBSS survey for all subareas by depth	97
Figure 6. Distribution and relative abundance of Alaska skate (<i>Bathyraja parmifera</i>) from the 2010 EBSS survey.....	99-100
Figure 7. Size composition of the estimated Alaska skate (<i>Bathyraja parmifera</i>) population from the 2010 EBSS survey for all subareas by depth	101
Figure 8. Distribution and relative abundance of Aleutian skate (<i>Bathyraja aleutica</i>) from the 2010 EBSS survey.....	103-104
Figure 9. Size composition of the estimated Aleutian skate (<i>Bathyraja aleutica</i>) population from the 2010 EBSS survey for all subareas by depth	105
Figure 10. Distribution and relative abundance of Bering skate (<i>Bathyraja interrupta</i>) from the 2010 EBSS survey.....	107-108
Figure 11. Size composition of the estimated Bering skate (<i>Bathyraja interrupta</i>) population from the 2010 EBSS survey for all subareas by depth	109
Figure 12. Distribution and relative abundance of Commander skate (<i>Baythraja lindbergi</i>) from the 2010 EBSS survey	111-112
Figure 13. Size composition of the estimated Commander skate (<i>Baythraja lindbergi</i>) population from the 2010 EBSS survey for all subareas by depth	113
Figure 14. Distribution and relative abundance of whiteblotched skate (<i>Bathyraja maculata</i>) from the 2010 EBSS survey	115-116

Figure 15. Size composition of the estimated whiteblotched skate (<i>Bathyraja maculata</i>) population from the 2010 EBSS survey for all subareas by depth	117
Figure 16. Distribution and relative abundance of whitebrow skate (<i>Bathyraja minispinosa</i>) from the 2010 EBSS survey.....	119-120
Figure 17. Size composition of the estimated whitebrow skate (<i>Bathyraja minispinosa</i>) population from the 2010 EBSS survey for all subareas by depth	121
Figure 18. Distribution and relative abundance of rougtail skate (<i>Bathyraja trachura</i>) from the 2010 EBSS survey	123-124
Figure 19. Size composition of the estimated rougtail skate (<i>Bathyraja trachura</i>) population from the 2010 EBSS survey for all subareas by depth..	125
Figure 20. Distribution and relative abundance of mud skate (<i>Bathyraja taranetzi</i>) from the 2010 EBSS survey.....	127-128
Figure 21. Size composition of the estimated mud skate (<i>Bathyraja taranetzi</i>) population from the 2010 EBSS survey for all subareas by depth	129
Figure 22. Distribution and relative abundance of giant grenadier (<i>Albatrossia pectoralis</i>) from the 2010 EBSS survey.....	131-132
Figure 23. Size composition of the estimated giant grenadier (<i>Albatrossia pectoralis</i>) population from the 2010 EBSS survey for all subareas by depth	133
Figure 24. Distribution and relative abundance of Pacific grenadier (<i>Coryphaenoides acrolepis</i>) from the 2010 EBSS survey	135-136
Figure 25. Size composition of the estimated Pacific grenadier (<i>Coryphaenoides acrolepis</i>) population from the 2010 EBSS survey for all subareas by depth	137
Figure 26. Distribution and relative abundance of popeye grenadier (<i>Coryphaenoides cinereus</i>) from the 2010 EBSS survey	139-140
Figure 27. Size composition of the estimated popeye grenadier (<i>Coryphaenoides cinereus</i>) population from the 2010 EBSS survey for all subareas by depth	141
Figure 28. Distribution and relative abundance of walleye pollock (<i>Theragra chalcogramma</i>) from the 2010 EBSS survey	143-144
Figure 29. Size composition of the estimated walleye pollock (<i>Theragra chalcogramma</i>) population from the 2010 EBSS survey for all subareas by depth	145

Figure 30. Distribution and relative abundance of Pacific cod (<i>Gadus macrocephalus</i>) from the 2010 EBSS survey	147-148
Figure 31. Size composition of the estimated Pacific cod (<i>Gadus macrocephalus</i>) population from the 2010 EBSS survey for all subareas by depth	149
Figure 32. Distribution and relative abundance of shortspine thornyhead (<i>Sebastolobus alascanus</i>) from the 2010 EBSS survey	151-152
Figure 33. Size composition of the estimated shortspine thornyhead (<i>Sebastolobus alascanus</i>) population from the 2010 EBSS survey for all subareas by depth.....	153
Figure 34. Distribution and relative abundance of Pacific ocean perch (<i>Sebastes alutus</i>) from the 2010 EBSS survey.....	155-156
Figure 35. Size composition of the estimated Pacific ocean perch (<i>Sebastes alutus</i>) population from the 2010 EBSS survey for all subareas by depth	157
Figure 36. Distribution and relative abundance of rougheyeye rockfish (<i>Sebastes aleutianus</i>) from the 2010 EBSS survey.....	159-160
Figure 37. Size composition of the estimated rougheyeye rockfish (<i>Sebastes aleutianus</i>) population from the 2010 EBSS survey for all subareas by depth	161
Figure 38. Distribution and relative abundance of blackspotted rockfish (<i>Sebastes melanostictus</i>) from the 2010 EBSS survey	163-164
Figure 39. Size composition of the estimated blackspotted rockfish (<i>Sebastes melanostictus</i>) population from the 2010 EBSS survey for all subareas by depth	165
Figure 40. Distribution and relative abundance of shorttraker rockfish (<i>Sebastes borealis</i>) from the 2010 EBSS survey	167-168
Figure 41. Size composition of the estimated shorttraker rockfish (<i>Sebastes borealis</i>) population from the 2010 EBSS survey for all subareas by depth	169
Figure 42. Distribution and relative abundance of sablefish (<i>Anoplopoma fimbria</i>) from the 2010 EBSS survey.....	171-172
Figure 43. Size composition of the estimated sablefish (<i>Anoplopoma fimbria</i>) population from the 2010 EBSS survey for all subareas by depth	173
Figure 44. Distribution and relative abundance of bigmouth sculpin (<i>Hemitripterus bolini</i>) from the 2010 EBSS survey	175-176

Figure 45. Size composition of the estimated bigmouth sculpin (<i>Hemitripterus bolini</i>) population from the 2010 EBSS survey for all subareas by depth	177
Figure 46. Distribution and relative abundance of spinyhead sculpin (<i>Dasycottus setiger</i>) from the 2010 EBSS survey	179-180
Figure 47. Size composition of the estimated spinyhead sculpin (<i>Dasycottus setiger</i>) population from the 2010 EBSS survey for all subareas by depth	181
Figure 48. Distribution and relative abundance of darkfin sculpin (<i>Malacocottus zonurus</i>) from the 2010 EBSS survey.....	183-184
Figure 49. Size composition of the estimated darkfin sculpin (<i>Malacocottus zonurus</i>) population from the 2010 EBSS survey for all subareas by depth	185
Figure 50. Distribution and relative abundance of blob sculpin (<i>Psychrolutes phrictus</i>) from the 2010 EBSS survey	187-188
Figure 51. Size composition of the estimated blob sculpin (<i>Psychrolutes phrictus</i>) population from the 2010 EBSS survey for all subareas by depth	189
Figure 52. Distribution and relative abundance of blacktail snailfish (<i>Careproctus melanurus</i>) from the 2010 EBSS survey	191-192
Figure 53. Size composition of the estimated blacktail snailfish (<i>Careproctus melanurus</i>) population from the 2010 EBSS survey for all subareas by depth	193
Figure 54. Distribution and relative abundance of Bering eelpout (<i>Lycodes beringi</i>) from the 2010 EBSS survey	195-196
Figure 55. Size composition of the estimated Bering eelpout (<i>Lycodes beringi</i>) population from the 2010 EBSS survey for all subareas by depth	197
Figure 56. Distribution and relative abundance of ebony eelpout (<i>Lycodes concolor</i>) from the 2010 EBSS survey.....	199-200
Figure 57. Size composition of the estimated ebony eelpout (<i>Lycodes concolor</i>) population from the 2010 EBSS survey for all subareas by depth	201
Figure 58. Distribution and relative abundance of twoline eelpout (<i>Bothrocara brunneum</i>) from the 2010 EBSS survey	203-204
Figure 59. Size composition of the estimated twoline eelpout (<i>Bothrocara brunneum</i>) population from the 2010 EBSS survey for all subareas by depth	205

Figure 60. Distribution and relative abundance of western eelpout (<i>Bothrocara zestum</i>) from the 2010 EBSS survey.....	207-208
Figure 61. Size composition of the estimated western eelpout (<i>Bothrocara zestum</i>) population from the 2010 EBSS survey for all subareas by depth.	209
Figure 62. Distribution and relative abundance of Pacific halibut (<i>Hippoglossus stenolepis</i>) from the 2010 EBSS survey	211-212
Figure 63. Size composition of the estimated Pacific halibut (<i>Hippoglossus stenolepis</i>) population from the 2010 EBSS survey for all subareas by depth	213
Figure 64. Distribution and relative abundance of flathead sole (<i>Hippoglossoides elassodon</i>) from the 2010 EBSS survey	215-216
Figure 65. Size composition of the estimated flathead sole (<i>Hippoglossoides elassodon</i>) population from the 2010 EBSS survey for all subareas by depth	217
Figure 66. Distribution and relative abundance of Greenland turbot (<i>Reinhardtius hippoglossoides</i>) from the 2010 EBSS survey	219-220
Figure 67. Size composition of the estimated Greenland turbot (<i>Reinhardtius hippoglossoides</i>) population from the 2010 EBSS survey for all subareas by depth	221
Figure 68. Distribution and relative abundance of arrowtooth flounder (<i>Atheresthes stomias</i>) from the 2010 EBSS survey	223-224
Figure 69. Size composition of the estimated arrowtooth flounder (<i>Atheresthes stomias</i>) population from the 2010 EBSS survey for all subareas by depth	225
Figure 70. Distribution and relative abundance of Kamchatka flounder (<i>Atheresthes evermanni</i>) from the 2010 EBSS survey	227-228
Figure 71. Size composition of the estimated Kamchatka flounder (<i>Atheresthes evermanni</i>) population from the 2010 EBSS survey for all subareas by depth	229
Figure 72. Distribution and relative abundance of rex sole (<i>Glyptocephalus zachirus</i>) from the 2010 EBSS survey.....	231-232
Figure 73. Size composition of the estimated rex sole (<i>Glyptocephalus zachirus</i>) population from the 2010 EBSS survey for all subareas by depth	233
Figure 74. Distribution and relative abundance of triangle Tanner crab (<i>Chionoecetes angulatus</i>) from the 2010 EBSS survey.....	235-236

Figure 75. Size composition of the estimated triangle Tanner crab (<i>Chionoecetes angulatus</i>) population from the 2010 EBSS survey for all subareas by depth	237
Figure 76. Distribution and relative abundance of Tanner crab (<i>Chionoecetes bairdi</i>) from the 2010 EBSS survey.....	239-240
Figure 77. Size composition of the estimated Tanner crab (<i>Chionoecetes bairdi</i>) population from the 2010 EBSS survey for all subareas by depth	241
Figure 78. Distribution and relative abundance of snow crab (<i>Chionoecetes opilio</i>) from the 2010 EBSS survey.....	243-244
Figure 79. Size composition of the estimated snow crab (<i>Chionoecetes opilio</i>) population from the 2010 EBSS survey for all subareas by depth	245
Figure 80. Distribution and relative abundance of grooved Tanner crab (<i>Chionoecetes tanneri</i>) from the 2010 EBSS survey.....	247-248
Figure 81. Size composition of the estimated grooved Tanner crab (<i>Chionoecetes tanneri</i>) population from the 2010 EBSS survey for all subareas by depth	249
Figure 82. Distribution and relative abundance of golden king crab (<i>Lithodes aequispinus</i>) from the 2010 EBSS survey	251-252
Figure 83. Size composition of the estimated golden king crab (<i>Lithodes aequispinus</i>) population from the 2010 EBSS survey for all subareas by depth	253
Figure 84. Distribution and relative abundance of scarlet king crab (<i>Lithodes couesi</i>) from the 2010 EBSS survey.....	255-256
Figure 85. Size composition of the estimated scarlet king crab (<i>Lithodes couesi</i>) population from the 2010 EBSS survey for all subareas by depth	257
Figure 86. Distribution and relative abundance of magistrate armhook squid (<i>Berryteuthis magister</i>) from the 2010 EBSS survey	259-260
Figure 87. Size composition of the estimated magistrate armhook squid (<i>Berryteuthis magister</i>) population from the 2010 EBSS survey for all subareas by depth	261
Figure 88. Distribution and relative abundance of Alaskan pink shrimp (<i>Pandalus eous</i>) from the 2010 EBSS survey.....	263-264

LIST OF TABLES

Table 1. Sampling effort and density for each subarea and depth stratum completed during the 2010 EBSS survey	16
Table 2. Survey leg calendar, research staff and their affiliations during the 2010 EBSS survey	17
Table 3. Details of sampling and data recording gear used during the 2010 EBSS survey	20
Table 4. Collection requests completed or attempted during the 2010 EBSS survey	21-22
Table 5. List of all species of fishes and invertebrates encountered on the 2010 EBSS survey.	23-42
Table 6. All species encountered in the 2010 EBSS survey with depth range and frequency of occurrence. Species are listed in descending order by total catch weight.	43-52
Table 7. Summary of biological data (lengths, otoliths, individual weights, and stomach samples) collected during the 2010 EBSS survey	53-54
Table 8. Summary of voucher specimens collected during the 2010 EBSS survey	55
Table 9. Abundance and density estimates for all fishes and invertebrates encountered by depth range during the 2010 EBSS survey.	56-92
Table 10. Abundance estimates by subarea and depth stratum for Pacific sleeper shark (<i>Somniosus pacificus</i>) from the 2010 EBSS survey	94
Table 11. Abundance estimates by subarea and depth stratum for Alaska skate (<i>Bathyraja parmifera</i>) from the 2010 EBSS survey	98
Table 12. Abundance estimates by subarea and depth stratum for Aleutian skate (<i>Bathyraja aleutica</i>) from the 2010 EBSS survey	102
Table 13. Abundance estimates by subarea and depth stratum for Bering skate (<i>Bathyraja interrupta</i>) from the 2010 EBSS survey	106
Table 14. Abundance estimates by subarea and depth stratum for Commander skate (<i>Bathyraja lindbergi</i>) from the 2010 EBSS survey	110

Table 15. Abundance estimates by subarea and depth stratum for whiteblotched skate (<i>Bathyraja maculata</i>) from the 2010 EBSS survey	114
Table 16. Abundance estimates by subarea and depth stratum for whitebrow skate (<i>Bathyraja minispinosa</i>) from the 2010 EBSS survey.....	118
Table 17. Abundance estimates by subarea and depth stratum for rougetail skate (<i>Bathyraja trachura</i>) from the 2010 EBSS survey	122
Table 18. Abundance estimates by subarea and depth stratum for mud skate (<i>Bathyraja taranetzi</i>) from the 2010 EBSS survey.....	126
Table 19. Abundance estimates by subarea and depth stratum for giant grenadier (<i>Albatrossia pectoralis</i>) from the 2010 EBSS survey.....	130
Table 20. Abundance estimates by subarea and depth stratum for Pacific grenadier (<i>Coryphaenoides acrolepis</i>) from the 2010 EBSS survey.....	134
Table 21. Abundance estimates by subarea and depth stratum for popeye grenadier (<i>Coryphaenoides cinereus</i>) from the 2010 EBSS survey	138
Table 22. Abundance estimates by subarea and depth stratum for walleye pollock (<i>Theragra chalcogramma</i>) from the 2010 EBSS survey.....	142
Table 23. Abundance estimates by subarea and depth stratum for Pacific cod (<i>Gadus macrocephalus</i>) from the 2010 EBSS survey	146
Table 24. Abundance estimates by subarea and depth stratum for shortspine thornyhead (<i>Sebastolobus alascanus</i>) from the 2010 EBSS survey.....	150
Table 25. Abundance estimates by subarea and depth stratum for Pacific ocean perch (<i>Sebastes alutus</i>) from the 2010 EBSS survey	154
Table 26. Abundance estimates by subarea and depth stratum for rougheye rockfish (<i>Sebastes aleutianus</i>) from the 2010 EBSS survey.....	158
Table 27. Abundance estimates by subarea and depth stratum for blackspotted rockfish (<i>Sebastes melanostictus</i>) from the 2010 EBSS survey	162
Table 28. Abundance estimates by subarea and depth stratum for shorttraker rockfish (<i>Sebastes borealis</i>) from the 2010 EBSS survey	166
Table 29. Abundance estimates by subarea and depth stratum for sablefish (<i>Anoplopoma fimbria</i>) from the 2010 EBSS survey.....	170

Table 30. Abundance estimates by subarea and depth stratum for bigmouth sculpin (<i>Hemitripterus bolini</i>) from the 2010 EBSS survey	174
Table 31. Abundance estimates by subarea and depth stratum for spinyhead sculpin (<i>Dasycottus setiger</i>) from the 2010 EBSS survey	178
Table 32. Abundance estimates by subarea and depth stratum for darkfin sculpin (<i>Malacocottus zonurus</i>) from the 2010 EBSS survey.....	182
Table 33. Abundance estimates by subarea and depth stratum for blob sculpin (<i>Psychrolutes phrictus</i>) from the 2010 EBSS survey	186
Table 34. Abundance estimates by subarea and depth stratum for blacktail snailfish (<i>Careproctus melanurus</i>) from the 2010 EBSS survey	190
Table 35. Abundance estimates by subarea and depth stratum for Bering eelpout (<i>Lycodes beringi</i>) from the 2010 EBSS survey	194
Table 36. Abundance estimates by subarea and depth stratum for ebony eelpout (<i>Lycodes concolor</i>) from the 2010 EBSS survey.....	198
Table 37. Abundance estimates by subarea and depth stratum for twoline eelpout (<i>Bothrocara brunneum</i>) from the 2010 EBSS survey	202
Table 38. Abundance estimates by subarea and depth stratum for western eelpout (<i>Bothrocara zestum</i>) from the 2010 EBSS survey.....	206
Table 39. Abundance estimates by subarea and depth stratum for Pacific halibut (<i>Hippoglossus stenolepis</i>) from the 2010 EBSS survey	210
Table 40. Abundance estimates by subarea and depth stratum for flathead sole (<i>Hippoglossoides elassodon</i>) from the 2010 EBSS survey	214
Table 41. Abundance estimates by subarea and depth stratum for Greenland turbot (<i>Reinhardtius hippoglossoides</i>) from the 2010 EBSS survey	218
Table 42. Abundance estimates by subarea and depth stratum for arrowtooth flounder (<i>Atheresthes stomias</i>) from the 2010 EBSS survey	222
Table 43. Abundance estimates by subarea and depth stratum for Kamchatka flounder (<i>Atheresthes evermanni</i>) from the 2010 EBSS survey	226
Table 44. Abundance estimates by subarea and depth stratum for rex sole (<i>Glyptocephalus zachirus</i>) from the 2010 EBSS survey	230

Table 45. Abundance estimates by subarea and depth stratum for triangle Tanner crab (<i>Chionoecetes angulatus</i>) from the 2010 EBSS survey.....	234
Table 46. Abundance estimates by subarea and depth stratum for Tanner crab (<i>Chionoecetes bairdi</i>) from the 2010 EBSS survey.....	238
Table 47. Abundance estimates by subarea and depth stratum for snow crab (<i>Chionoecetes opilio</i>) from the 2010 EBSS survey	242
Table 48. Abundance estimates by subarea and depth stratum for grooved Tanner crab (<i>Chionoecetes tanneri</i>) from the 2010 EBSS survey	246
Table 49. Abundance estimates by subarea and depth stratum for golden king crab (<i>Lithodes aequispinus</i>) from the 2010 EBSS survey	250
Table 50. Abundance estimates by subarea and depth stratum for scarlet king crab (<i>Lithodes couesi</i>) from the 2010 EBSS survey	254
Table 51. Abundance estimates by subarea and depth stratum for magistrate armhook squid (<i>Berryteuthis magister</i>) from the 2010 EBSS survey.....	258
Table 52. Abundance estimates by subarea and depth stratum for Alaskan pink shrimp (<i>Pandalus eous</i>) from the 2010 EBSS survey.....	262
Appendix A. Scope ratio table used during the 2010 EBSS survey	270
Appendix B. Performance codes of trawl hauls conducted on the 2010 EBSS survey	271
Appendix C. Haul log for all trawls completed during the 2010 EBSS survey.....	272

INTRODUCTION

The Alaska Fisheries Science Center's (AFSC) Resource Assessment and Conservation Engineering Division (RACE) conducted a bottom trawl survey from 27 May to 21 July 2010 to assess the groundfish and invertebrate resources on the eastern Bering Sea upper continental slope (EBSS). The survey area extended from Unalaska and Akutan Islands to the U.S.-Russian border near the International Date Line (166° E to 180° W) at depths from 200 to 1,200 m.

Prior to the current standardized EBSS biennial surveys (2002, 2004, 2008, 2010) a pilot survey was conducted in 2000 which tested two versions of the Poly Nor'eastern bottom trawl gear (mud-sweep and rockhopper footropes). The pilot study showed that the Poly Nor'eastern net with mud sweep gear was more efficient and robust for sampling the EBSS survey area bottom than the rockhopper gear (Mark Wilkins, AFSC, pers. comm.). Eastern Bering Sea Slope surveys were conducted in 2002, 2004, and 2008, and the results are detailed in NOAA Technical Memoranda (Hoff and Britt 2003, 2005, 2009). The slope survey was not conducted in 2006 due to budget limitations. The 2010 EBSS trawl survey is the fourth in this series of biennial groundfish surveys that incorporate the AFSC's latest sampling technologies and protocols for survey design, catch data gathering, species identification, and net mensuration monitoring.

Triennial surveys were conducted from 1979 to 1991 on the EBSS using a variety of nets, methods, vessels, and sampling locations. The results from these surveys have been summarized in numerous data reports (Bakkala et al. 1985a, Bakkala et al. 1985b, Sample et al. 1985, Walters et al. 1988, Bakkala et al. 1992, Goddard and Zimmermann 1993). Comparisons between the post-2000 surveys and those conducted from 1979 to 1991 remain confounded due to the differences in sampling gear, survey design, sampling methodology, and species identification.

This report summarizes the survey design, sampling gear, and survey logistics used as well as the personnel that participated in this survey. Estimates of abundance, distribution, and size frequency are presented for commercially and ecologically important species. The purpose of this report is to provide information on the biological resources encountered to the scientific community, the fishing industry, and the general public. The results presented herein represent the exclusive report prepared from the EBSS survey conducted in 2010. For additional information from this survey please contact the authors (G.R. Hoff email: *jerry.hoff@noaa.gov* or L.L. Britt email: *lyle.britt@noaa.gov*).

METHODS

Survey Area and Sampling Design

The EBSS survey area was divided into six geographic subareas (1-6) running south to north along the upper continental slope (Fig. 1) to assist in the distribution of trawl effort in relation to estimated habitat area. The subareas were based on distinct bathymetric types and underwater features: broad low slope areas, canyon areas, and steep slope inter-canyon faces. Subareas 1 and 6 consist of broad low slope areas with wide bathymetric contours in the 200-600 m depth range followed by a gradual slope to 1,200 m. Subareas 2 and 4 consist of Pribilof and Zhemchug canyons, respectively, which are characterized by semi-enclosed basins with steep walls and narrow bathymetric contours below 600 m. Subareas 3 and 5 are steep slope inter-canyon “faces” with narrow bathymetric contours throughout most of their depths.

Geographic subareas were stratified by depth every 200 m from 200 to 1,200 m resulting in five depth strata for each geographic subarea (200-400 m; 400-600 m; 600-800 m; 800-1,000 m;

1,000-1,200 m). The total area of each substratum (km^2) was calculated using known bathymetry contour lines (Table 1) and used to determine sampling density. Two-hundred survey stations were selected using a stratified random sampling design from a pool of over 200 successful stations completed between 2000 and 2008 as well as additional stations added randomly in most strata. Stratum sampling densities ranged from one haul per 112.39 km^2 to one haul per 368.96 km^2 with a mean sampling density of one haul per 204.48 km^2 . Sampling densities varied due to difficulties in successfully completing all planned stations in some deep strata due to areas with untrawlable bottom.

Survey Agenda and Personnel

The EBSS survey began on 27 May 2010 near Zhemchug Canyon and concluded on 21 July 2010 in the south-western eastern Bering Sea. Mobilization and demobilization of the survey took place in Dutch Harbor, Alaska. There was one mid-survey exchange of scientific crews on St. Paul Island on 24 June 2010. Research personnel for the survey were primarily AFSC staff and two graduate students (Table 2).

Vessel, Scientific Gear, and Procedures

The F/V *Vesteraalen*, a 38-m commercial stern trawler powered by twin engines with 1,725 continuous horsepower, was chartered for the survey. Electronic navigation and fishing equipment on the vessel included global positioning system (GPS) receivers, video position plotters, radar, single sideband and VHF transmitter-receivers, an EC-150 color video depth sounder, and auto-pilots. The vessel was operated by Captain Tim Cosgrove during the entire slope survey. A four-member crew aided in the operation of the vessel and in the use of the fishing gear.

The standard RACE Division fishing gear included trawls, bridles, and trawl doors. A Poly Nor' eastern high-opening bottom trawl equipped with mud-sweep roller gear was used to sample all stations (Fig. 2). This sampling trawl had a 27.2 m headrope with twenty-one 30 cm floats and a 24.3 m long-link chain fishing line attached to a 24.9 m footrope. The body of the net was constructed of 127 mm stretched-mesh polyethylene netting, with 89 mm stretched-mesh polyethylene netting in the codend, and a 32 mm stretched-mesh nylon codend liner. The mud-sweep roller gear was constructed of 203 mm solid rubber disks strung over 16 mm high-tensile chain. The net was fished with 1.83 m × 2.75 m (6 ft × 9 ft; 1,000 kg) steel V-doors rigged with four-point bridles to enhance their stability at slow towing speeds and 55 m bridles between the doors and wingtips. This trawl is a modified version of the standard trawl used for the RACE Division's West Coast Upper Continental Slope survey (Lauth 2000). During fishing the height and width of the trawl were measured using a Scanmar (Scanmar, Asgardstrand, Norway) net measurement system. The GPS system recorded vessel location recording tow duration, distance fished, and precise location. A tilt sensor (bottom contact sensor) attached to the footrope recorded bottom contact which was used to determine the precise beginning and end of the tow. Bottom depth and water temperature profiles were recorded using a Sea-Bird SBE-39 microbathythermograph (Sea-Bird Electronics Inc., Bellevue, Washington). All net configuration measurements were recorded electronically as well as on paper. The Haul Log (Appendix C) details net performance for each tow.

Each station was surveyed with echosounding over a 1.5-2.0 nautical mile (nmi) horizontal distance. A site was considered towable when the depth changed less than 50 m over the 2-nmi transect and there were no detectable obstacles in the trawl path. Trawl operations

followed Stauffer (2004). Standard tow speed was 2.5 knots and standard tow duration was 30 minutes at all depths. For each tow the following data was recorded: date, time, latitude, longitude, gear depth, surface temperature, bottom temperature, water column temperature profile, net spread, net height, and bottom contact. At the end of each tow, haul data were plotted and examined for appropriate distance, bottom contact, and depth range. Each tow, the tow was scored on a graded scale: successful tows were given a positive score, whereas unsuccessful tows received a negative score. In general, a positive tow was considered valid and used for survey abundance estimates, while a negative tow was not used in the analysis. Table 3 lists the specific models, versions, serial numbers, and RACE numbers for most sampling tools used for this survey.

Catch Processing and Collection of Biological Data

Catches were sorted, weighed, and enumerated for all species of fishes and invertebrates. The catch was processed in one of two ways: either by sorting the entire catch and weighing each species in aggregate or by weighing the net codend and discarding the predominant species (except for a weighed and sexed random length frequency sample) and the rest of the catch sorted and weighed by species. Random samples of species that were designated for biological data collection were set aside after weighing. Total weight and numbers for each species were recorded onto a paper on-deck catch form. In cases where individuals could not be reasonably enumerated (i.e., corals, sponges, bryozoans, ascidians) only total weight was recorded. For large numbers of an individual species in a single haul, the total number was extrapolated from subsample weight and count of 50-200 individuals. In most cases fish length frequency subsamples were used for extrapolation of the total haul count for individual species.

A random subsample of 100-150 fish, depending on the size range for the species, was selected for length frequency measurements. The sex of each individual was determined by internal examination of the gonads or by external characters (e.g., claspers for elasmobranchs), and specimens were sorted into baskets of males, females, or undetermined sex. Fork length (FL) was measured for most fishes, except for elasmobranchs which were measured to total length (TL) and macrourids to preanal-fin length (PAFL). Fishes and cephalopods were measured to the nearest centimeter on a bar-coded length board using a Juniper LS 600 Polycorder, which uses a bar-code reader wand and species-specific numerical codes. Data from polycorders were downloaded into a database, examined for accuracy, and paper copies printed. All crab species were measured to the nearest 1.0 mm using vernier calipers and recorded on an on-deck paper form.

Otoliths (age structures) were collected from commercially and ecologically important fish species utilizing a stratified sampling regime based on geographic subarea and length. Otoliths of each species were collected from 1 to 3/cm/sex/subarea with the exception of roughey rockfish (*S. aleutianus*) and blackspotted rockfish (*S. melanostictus*) for which there was an attempt to collect otoliths from all fish encountered. At the time of otolith collection, the sex, fork length (cm) or pre-anal fin length (PAFL), and weight (kg) of each specimen were recorded on on-deck paper forms.

Stomach samples were collected from selected fish species for the AFSC's Resource Ecology and Ecosystem Modeling Program. Many commercial and ecologically important species were targeted for food habits including walleye pollock (*Theragra chalcogramma*), arrowtooth flounder (*Atheresthes stomias*), Pacific ocean perch (*Sebastes alutus*), and

Pacific cod (*Gadus macrocephalus*). Specimens were chosen at random and only intact stomachs (non-regurgitated) were chosen for collection. Stomachs were excised and preserved in 10% buffered formalin at sea for later examination. Species, haul number, fish length, weight, and sex were recorded on specimen forms at the time of collection.

Voucher specimens were collected from species that are rare, of taxonomic interest, or were unidentifiable at the time of encounter. Collections were labeled with a cruise number, vessel number, haul number, species, voucher number, preservative, and collector's name or initials. Voucher specimens were preserved in 10% buffered formalin (most fishes and non-calcareous invertebrates) or 95% ethanol for calcareous invertebrates. A few specimens were stored frozen and returned to Seattle, Washington. Additional biological samples were collected for study per investigators' requests. Table 4 details the investigators, samples collected, and study purposes.

Abundance Estimates

Catch per unit effort (CPUE) was calculated by dividing catch weight or number for each species by the estimated area swept of the trawl. CPUE is expressed in kilograms per hectare (kg/ha) and number of individuals per hectare (no./ha). Population and biomass (metric tons) estimates were calculated using mean CPUE and extrapolated into the area for each stratum and subsequently summed for all strata. Fish length frequencies were used to estimate the proportion of fish at each length interval weighted by the CPUE (number of fish/ha) and then expanded to the depth stratum population. For details on these methods see Wakabayashi (et al. 1985) and Alverson and Pereyra (1969).

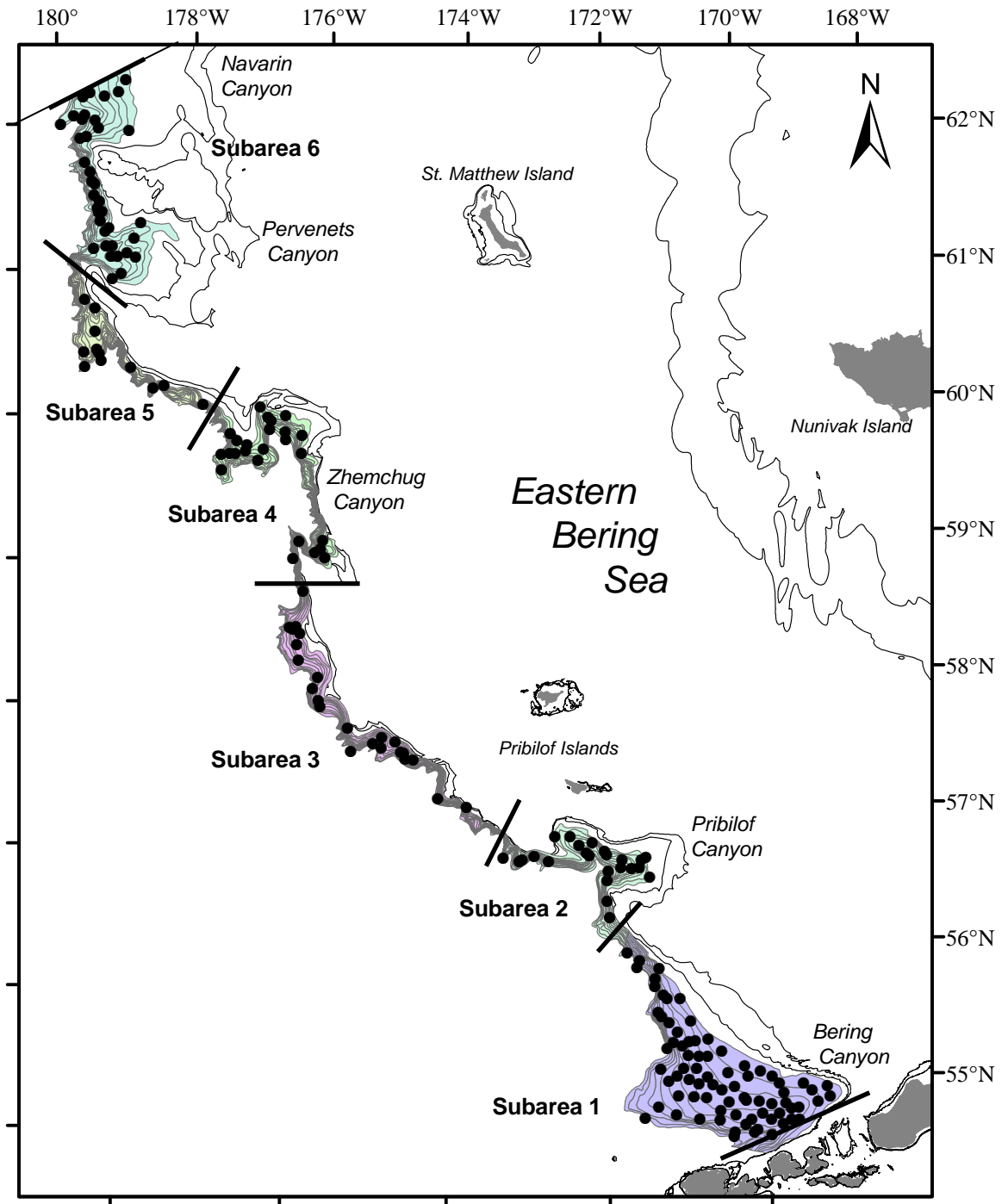

Figure 1. -- Map of standard survey area and the six subareas. Indicated are the 200 successful trawl stations (black dots) completed during the 2010 EBSS survey.

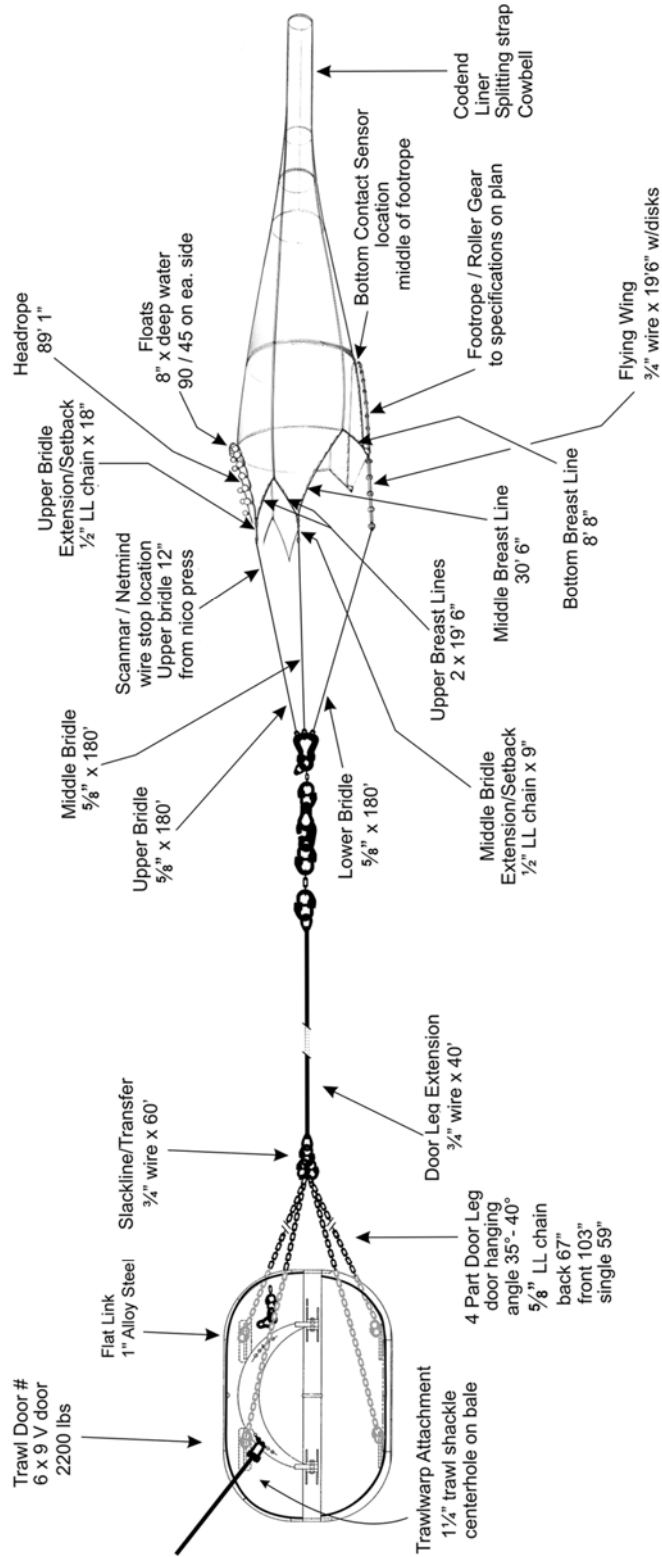
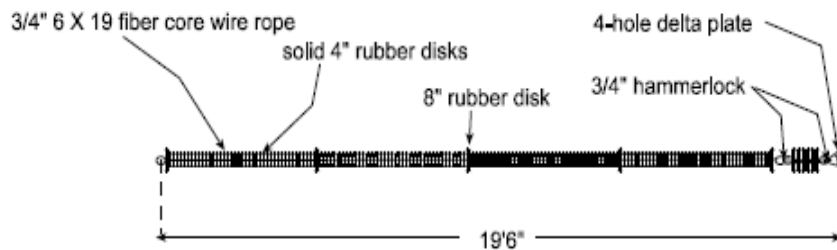
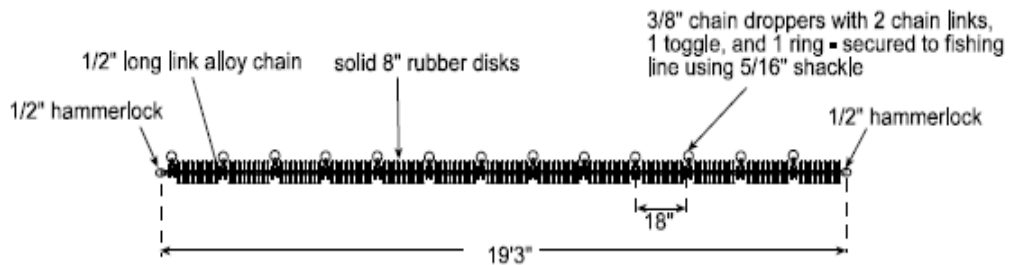

Figure 2a. - - Diagram of the Poly Nor'eastern high-rise opening bottom trawl net used during the 2010 EBSS survey. Diagram includes a general schematic of the trawl doors, rigging, and trawl configuration.

Outboard section



Middle section



Inboard section

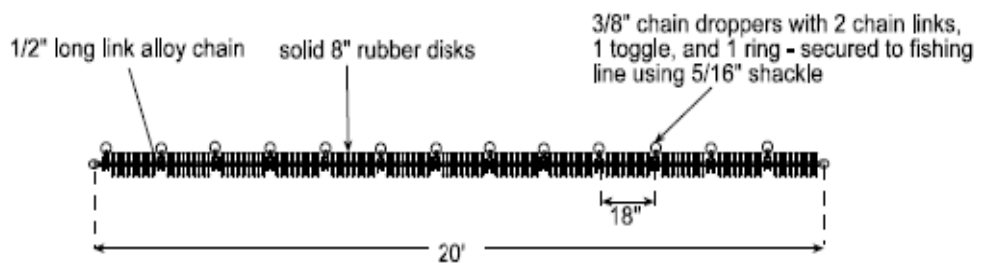

Figure 2b. - - Detailed diagram of the ground sections of the Poly Nor' eastern net used during the 2010 EBSS survey.

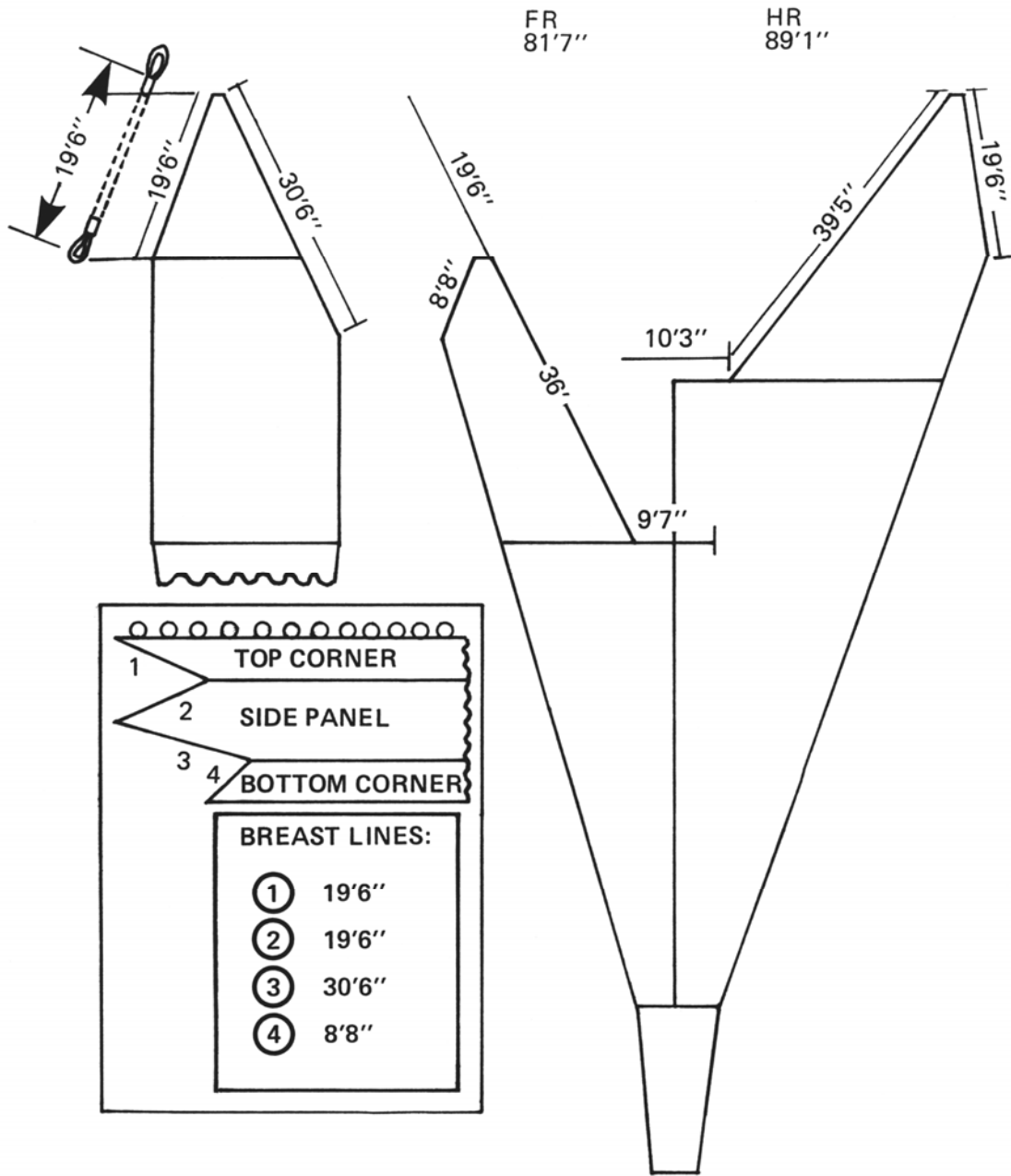

Figure 2c. - - Detailed diagram and dimensions of the Poly Nor' eastern net used during the 2010 EBSS survey.

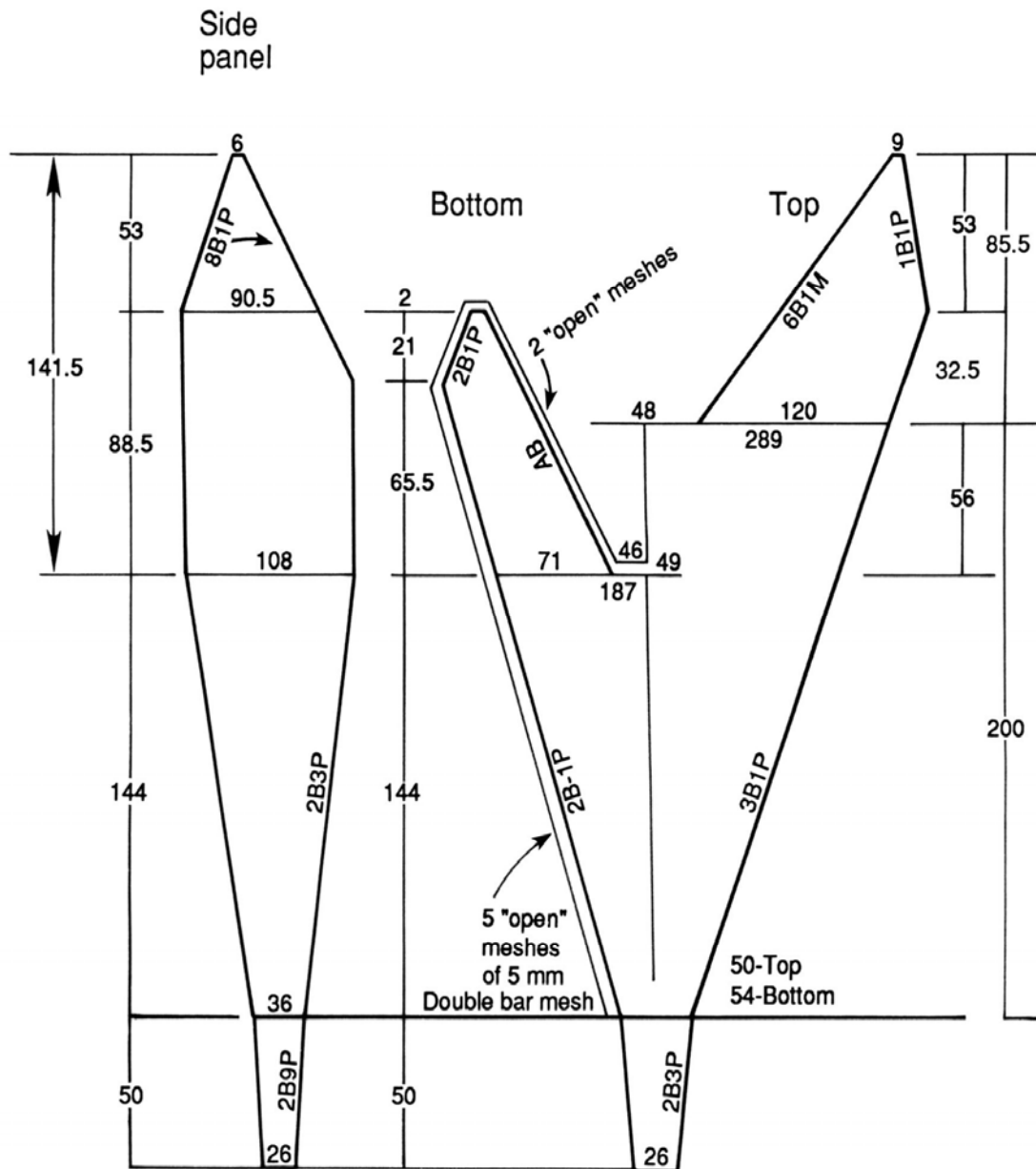

Figure 2d. - - Detailed diagram and dimensions of the Poly Nor' eastern net used during the 2010 EBSS survey.



Figure 2f. - - Photo of the bottom contact sensor and its footrope attachment configuration to the ground gear used during the 2010 EBSS survey.

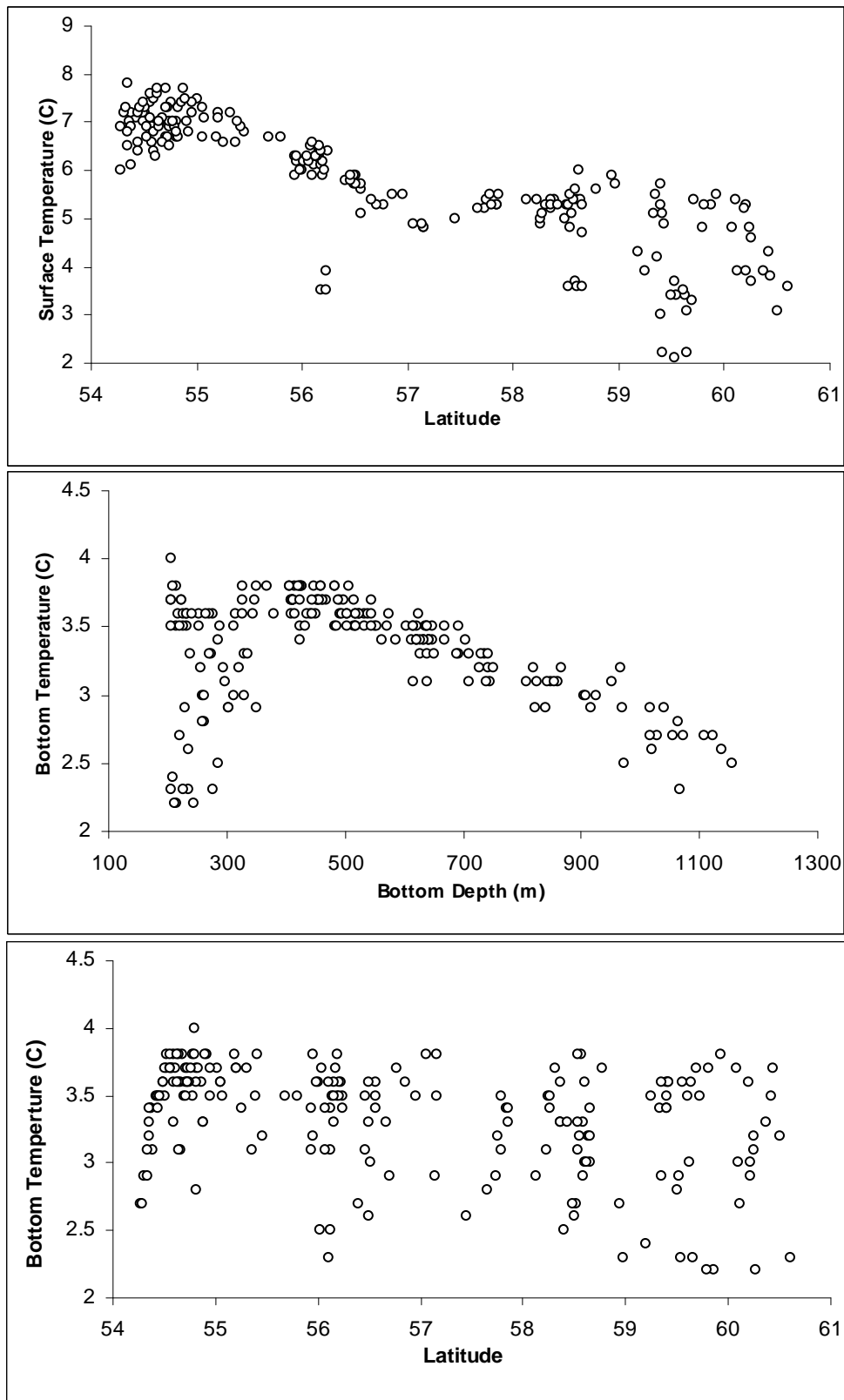

Figure 3. - - Relationship between temperature, latitude ($^{\circ}$ N), and bottom depth collected from trawl stations during the 2010 EBSS survey.

Table 1. - - Sampling effort and density for each subarea and depth stratum completed during the 2010 EBSS survey.

Subarea	Depth stratum (m)	Stratum area estimate (km²)	Effort target (%)	Hauls completed (n)	Effort achieved (%)	Sampling density (km²/haul)
1	200-400	4012.41	12.26	21	10.50	191.07
	400-600	4062.77	12.42	36	18.00	112.85
	600-800	1741.66	5.32	13	6.50	133.97
	800-1000	1354.74	4.14	5	2.50	270.95
	1000-1200	1106.89	3.38	3	1.50	368.96
2	200-400	1157.64	3.54	7	3.50	165.38
	400-600	705.08	2.15	8	4.00	88.13
	600-800	591.27	1.81	5	2.50	118.25
	800-1000	552.73	1.69	2	1.00	276.37
	1000-1200	535.67	1.64	2	1.00	267.84
3	200-400	903.78	2.76	10	5.00	90.38
	400-600	886.11	2.71	4	2.00	221.53
	600-800	910.26	2.78	6	3.00	151.71
	800-1000	732.35	2.24	2	1.00	366.18
	1000-1200	675.52	2.06	2	1.00	337.76
4	200-400	1236.27	3.78	11	5.50	112.39
	400-600	730.35	2.23	4	2.00	182.59
	600-800	693.95	2.12	4	2.00	173.49
	800-1000	707.59	2.16	4	2.00	176.90
	1000-1200	662.42	2.02	2	1.00	331.21
5	200-400	423.71	1.29	3	1.50	141.24
	400-600	425.73	1.30	3	1.50	141.91
	600-800	431.83	1.32	2	1.00	215.91
	800-1000	551.99	1.69	2	1.00	276.00
	1000-1200	570.14	1.74	2	1.00	285.07
6	200-400	2595.79	7.93	12	6.00	216.32
	400-600	1705.76	5.21	12	6.00	142.15
	600-800	917.49	2.80	8	4.00	114.69
	800-1000	645.17	1.97	3	1.50	215.06
	1000-1200	496.42	1.52	2	1.00	248.21
Totals	200-1200	32723.49	100	200	100.00	mean 204.48

Table 2. - - Vessel itinerary and scientists participating during the 2010 EBSS survey.

<u>Name</u>	<u>Survey Position</u>	<u>Affiliation</u>
<u>Leg 1: 5/28 - 6/23</u>		
Lyle Britt	Chief Scientist	AFSC, Seattle
Duane Stevenson	Fishery Biologist	AFSC, Seattle
Roger Clark	Fishery Biologist	AFSC, Seattle
Jared Guthridge	Fishery Biologist	ASLC, Seward
Christian Gredzens	Fishery Biologist	AFSC, Seattle
Scott Van Sant	Crab Biologist	AFSC, Kodiak
<u>Leg 2: 6/24 - 7/21</u>		
Gerald R. Hoff	Chief Scientist	AFSC, Seattle
Stan Kotwicki	Fishery Biologist	AFSC, Seattle
Roger Clark	Fishery Biologist	AFSC, Seattle
Pam Goddard	Fishery Biologist	AFSC, Seattle
Grace Hutton	Feeding Ecology	NEU, Intern
Dennis Benjamin	Fishery Biologist	AFSC, Seattle

*AFSC-Alaska Fisheries Science Center, Seattle WA.

*ASLC-Alaska Sea Life Center, Seward AK.

*NEU-Northeastern University, Boston MA.

For further information, contact: Russ Nelson, Director, Resource Assessment and Conservation Engineering Division, Alaska Fisheries Science Center, National Marine Fisheries Service, 7600 Sand Point Way NE, Bldg. 4, Seattle, WA, 98115. Telephone (206)526-4170.

RESULTS

Haul, Catch, and Biological Data

During the 2010 EBSS survey, 200 tows were completed successfully and were used for abundance estimates (Fig. 1). Nine tows were considered unsatisfactory in meeting survey standards and were recorded, but in most cases the location was resampled to obtain a successful tow at that station (see Appendix B).

The EBSS survey sampling was designed to distribute trawling effort in proportion to the total area (km²) of each stratum. A comparison of the planned total effort distribution by stratum to that actually achieved is shown in Table 1. In general, sampling effort in the deepest strata (1,000-1,200 m) was under-represented due to the difficulty in finding trawlable grounds. Shallow strata more commonly received the prescribed sampling density, where on average each tow represented 204 km² of area. The Haul Log (Appendix C) details date, exact location, depth of all hauls attempted, net parameters during the tow, environmental conditions, and catch weights for all hauls attempted.

Bottom temperatures recorded during the survey ranged from 2.2 °C to 4.0 °C and were correlated with depth below approximately 400 m. Between 200 and 400 m, bottom temperature was highly variable and showed no direct relationship with depth (Fig. 3). Surface temperatures ranged from 2.1°C to 7.8 °C, and were related to latitude, with cooler surface waters at higher latitudes. Bottom temperatures showed no relationship with latitude.

Approximately 145 fish species and 334 invertebrate species were identified during the 2010 EBSS survey. The actual number of species encountered may be slightly higher or lower given inadequate field identification characteristics for some species. Tables 5a and 5b list all species of fishes and invertebrates encountered and identified on the 2010 EBSS survey

alphabetized by common name or scientific name, respectively.

The giant grenadier (*Albatrossia pectoralis*) represented the largest biomass estimated on the 2010 EBSS survey followed by Pacific ocean perch (*Sebastes alutus*), and arrowtooth flounder (*Atheresthes stomias*). The most abundant fish species was the popeye grenadier (*Coryphaenoides cinereus*). The deep sea papillate cucumber (*Pannychia moseleyi*) had the largest estimated biomass for invertebrates and the brittle star (*Ophiacantha normani*) was the most abundant. Table 6 lists all species encountered during the survey in descending order of total weight, with details on the depth distribution and the frequency of occurrence for each species. Tables 7 and 8 detail the biological data collected for selected species.

Population, biomass, and CPUE estimates and variance of the estimates were calculated for every species encountered on the 2010 EBSS survey and are presented in Table 9. The estimates are reported by: shallow strata (200-600 m), deep strata (600-1,200 m), and all strata combined.

Distributions, Length Frequencies, and Abundance Estimates

Abundance estimates, population size estimates, CPUE distribution plots, and estimates of population length frequencies are presented in Tables 10-52 and Figures 5-89 for 43 of the most abundant and commercially important fish and invertebrate species. Abundance estimates were calculated for each subarea and each 200-m stratum within each subarea, and all subareas and strata combined. CPUE distribution plots represent the abundance of the species for each haul. Fishes are presented in phylogenetic order (Nelson 1994).

Table 3. - Details of sampling and data recording gear used during the 2010 EBSS survey.

Net & mensuration gear	Data type/function	Model/Version/serial #
Poly Nor'Eastern trawl	research sampling tool	Net #15 Hauls 1-31, 47, 83; Net #5 Hauls 32-46, 48-63, 154-175, 191-192 Net#11 Hauls 64-82, 84-92, 111, 113, 176-189, 193-209 Net #16 Hauls 94-110, 112, 114-153, 190
Doors	spread the net	Doors # 885 Hauls 1-209
Vessel skipper and trawl master	conduct trawling operations	Tim Cosgrove-hauls 1-209
Scanmar height sensor	measure net height	Model HC4-HT60 Serial #'s T254C5, T1340C5
Scanmar slave spread sensor	measure net spread	Model MTR serial # 2759, 4295
Scanmar master spread sensor	measure net spread	Model HC4 serial # 2495, A3654
Scanmar receiver cabinets	spread and height signal	Model 4002 RSST946, 1400
Scanmar hydrophone	spread and height signal	Serial # 841
Scanmar program	records data input from net mensuration gear	AFSC (menu) version 5.8 Hoboware Lite-2.5, Convert-5.1, Haulpos-8.4, Haultime-6.83, Scangraf-3.54, Scanplot-13.0, SBELob-1.8, Setclock-3.31, Speedplot-2.42
Vessel depth sounder	record depth soundings	Simrad ES60 software 1.5.2.77 1998
Furuno GPS	determine latitude and longitude	
SeaBird SBE-39 V1.8	depth and water temperature	Serial # 384, 642, 857
Bottom contact sensor (HOBO Pendant G accelerometer)	record footrope bottom contact	Serial # 237095
Olympic wire counter	measure trawl cable	Olympic wire counter 750-N cable meter #505
Catch processing	Data type/function	Model/Version/serial #
Marel basket scale	weigh baskets of catch	Model 1100 Type U-2
Marel specimen scale	weigh individual specimens	Model 2000 Type M60
Measurement Systems International (MSI) load cell	weigh cod end with catch	Model 4300
Catch data entry program	onboard catch database	Written in Access 2003 AFSC version no. 20090324
Juniper systems LS 600 Polycorder	record fish length data	Serial #'s 818-3227, 603-3330, P60-5396, 630-3317
Dell computer	data recording	Optiplex 745 Windows XP Service Pack 3
Laser printers	produce hard copy of data	HP Laserjet 1012
Digital camera	photograph specimens	Pentax 4.3v 7.1 megapixel OPTIO W30 Serial 9336240
Federal Scientific Research Permit	allows research sampling	SRP # 2010-08
State of Alaska Research Permit	allows research sampling	CF-10-038

Species identification guides

Clark, R.N. 2006. *Field Guide to the Benthic Marine Invertebrates of Alaska's Shelf and Upper Slope*. AFSC unpublished manuscript.

Jorgenson, E.M. 2009. *Field Guide to the Squids and Octopods of the Eastern North Pacific and Bering Sea*. Alaska Sea Grant College Program. University of Alaska Fairbanks. 100 p.

Kessler, D. 2002. *A Working Field Guide to Trawl Caught Animals*. AFSC unpublished manuscript.

Mecklenburg, C.W., T. A. Mecklenburg, and L. K. Thorsteinson 2002. *Fishes of Alaska*. American Fisheries Society. 1,037 p.

Orr, J.W., M.A. Brown and D. Baker 2000. *Guide to rockfishes (Scorpaenidae) of the genera Sebastes, Sebastolobus, and Adelosebastes of the Northeast Pacific Ocean*, 2nd Edition, NOAA Tech. Memo. NMFS-AFSC-117, 47 p.

Stevenson, D.E., J. W. Orr, G. R. Hoff and J. D. McEachran 2007. *Field Guide to Sharks, Skates, and Ratfish of Alaska* Alaska Sea Grant College Program. University of Alaska Fairbanks. 77 p.

Table 4. - - Projects and collections completed or attempted during the 2010 EBSS survey.

Project title	Project description	Investigator (s) & affiliation	Data/samples collected
Age structures for critical species	collection of otoliths from selected fish species for current stock assessment models	Anne Hollowed (AFSC)	see Table 7 for details on otolith collection numbers
Age structures of giant grenadier	collection of otoliths from giant grenadiers for future stock assessment models	Dave Clausen (AFSC)	see Table 7 for details on otolith collection numbers
Age structures for selected species	collection of otoliths from a selected group of fishes for future stock assessment models	Gerald Hoff (AFSC)	see Table 7 for details on otolith collection numbers
Biological data on crab	collection of carapace size, weight, and shell condition on selected crab species	Robert Foy, Jan Haaga (AFSC-Kodiak)	see Table 7 for details on species, length and weight collection numbers. Shell conditions were also recorded
Light profiles	collection of light profiles with light meter to study influence of light on pollock distribution	Stan Kotwicki (AFSC)	Light, depth, temperature, conductivity profiles were collected for 209 bottom trawls
Rougeye & Blackspotted rockfish tissues	collection of tissue samples of shorttraker rockfish in conjunction with otolith collections for population genetic study	Tony Gharret (UAF), Paul Spencer (AFSC)	262 tissue samples collected
Sleeper shark life history	tag and release of sleeper shark for life history information, growth and movement	Gerald Hoff (AFSC), Robert Foy (AFSC-Kodiak)	Spaghetti tags (n = 21) were deployed and tissue samples (n = 21) collected from sleeper sharks
Alaska skate tagging	tagging and release of all Alaska skates	Olav Ormseth (AFSC)	44 Alaska skates were tagged and released
Skate eggs & juvenile data	measure juvenile skates & retain and preserve selected skate egg cases.	Gerald Hoff (AFSC)	142 juvenile skates were measured identified to <i>B. trachura</i> (n = 2), <i>B. minispinosa</i> (n = 15), <i>B. lindbergi</i> (n = 34), <i>B. maculata</i> (n = 4), <i>B. taranetzi</i> (n = 4), <i>B. aleutica</i> (n = 6), <i>B. interrupta</i> (n = 47), approximately 100 skate egg cases were collected
Live skate eggs	collect live skate eggs for development study	Gerald Hoff (AFSC), Jared Guthridge (ASLC)	19 live skate eggs were collected and transported to the Alaska Sealife Center for development studies. <i>B. trachura</i> (n = 6), <i>B. taranetzi</i> (n = 6), <i>B. aleutica</i> (n = 2), <i>B. interrupta</i> (n = 2), <i>B. parmifera</i> (n = 3)
Octopus data collection	collection of lengths and sex on octopus species	Liz Connors (AFSC)	Mantle lengths and sex were taken on >200 octopus. The dominant species were <i>Benthioctopus leioderma</i> (n = 62), <i>Sasakiotopus salebrosus</i> (n = 93), <i>Octopus dofleini</i> (n = 54)

Table 4. - - continued.

Project title	Project description	Investigators & affiliation	Data/samples collected
Squid data collection	collection of mantle lengths on all squid species	Olav Ormseth (AFSC)	Mantle lengths were collected on >2000 squid with the dominant species being <i>Berryteuthis magister</i> . (n = 1,704)
Outreach/fishermans festival	collection of slected fish and invertebrate specimens used for public outreach and teaching and display at Fishermans festival	Jason Connor, Mark Wilkins (AFSC)	Two specimens each of a variety of commercial and unusual fish and invertebrate species were frozen
Survey operations photos	photograph standard trawl survey operations for use in presentations and outreach events	Rebecca Reuter (AFSC)	41 usable digital photographs were taken during the survey of deck and survey operations
Sightings of short-tail albatross	report sightings of endangered short-tail	Shannon Fitzgerald (AFSC), Greg Balogh (USFWS)	Seven sightings of short-tail albatross were reported
Trophic interactions feeding ecology	collections of stomach contents of selected fish species and preserved at sea for later analysis	Kerim Aydin, Troy Buckley (AFSC)	see Table 7 for numbers by species of stomach samples that were collected during the survey
Fish photos	collect high quality digital photos of selected fishes for use in a new publication on North Pacific fishes	Gerald Hoff (AFSC) & Milton Love (UCSB)	approximately five photos were taken that fulfilled this project
Hydroacoustic data	used to estimate biomass of pelagic fishes	Patrick Ressler, Taina Honkalehto (AFSC)	ES60 Hydroacoustic data was collected during each trawl
Snailfish collections	collect snailfish for taxonomic studies	Jay Orr (AFSC)	approximately 76 lots of snailfish were collected
Snailfish eggs from Lithodids	life history of parasitic snailfishes on crabs	Jay Orr (AFSC)	approximately three snailfish egg specimens were collected
Coral collections	identification and systematics of corals	Ewann Bernston (NWFSC)	approximately 25 coral specimens were collected
Zoaroid fish collections	taxonomic studies on this group	Eric Hilton (VIMS)	approximately 10 zoaroid specimens were collected
Myctophid fish collections	forage fishes for fatty acid analysis	Alan Springer (UAF)	approximately 100 myctophid specimens were collected
Assorted fish collections	reference collection of mammal prey items	Bill Walker (AFSC-NMML)	approximately 10 fish specimens were collected

AFSC-Alaska Fisheries Science Center, Seattle WA.

NWFSC-Northwest Fisheries Science Center, Seattle WA.

UAF-University of Fairbanks, Fairbanks AK.

UCSB-University of California Santa Barbara, Santa Barbara CA.

NMML-National Marine Mammal Laboratory, Seattle WA.

VIMS-Virginia Institute of Marine Science, Gloucester MA.

USFWS-United States Fish and Wildlife Service, Anchorage AK.

Table 5a. - Alphabetical list by common name of all fishes and invertebrates encountered on the 2010 EBSS survey.

Common name	Species/Taxon
Alaska eelpout	<i>Bothrocara pusillum</i>
Alaska skate	<i>Bathyraja parmifera</i>
Alaska skate egg case	<i>Bathyraja parmifera</i> egg case
Alaska snailfish	<i>Careproctus colletti</i>
Alaska volute	<i>Arctomelon stearnsii</i>
Alaska volute species	<i>Arctomelon</i> species cf. <i>stearnsii</i> (Clark & McLean)
Alaskan hermit	<i>Pagurus ochotensis</i>
Alaskan pink (=northern) shrimp	<i>Pandalus eous</i> (=borealis)
Alaskan trophon	<i>Boreotrophon alaskanus</i>
Aleutian alligatorfish	<i>Aspidophoroides bartoni</i>
Aleutian hermit	<i>Pagurus aleuticus</i>
Aleutian moonsnail	<i>Cryptonatica</i> (=Natica) <i>aleutica</i>
Aleutian skate	<i>Bathyraja aleutica</i>
Aleutian skate egg case	<i>Bathyraja aleutica</i> egg case
amphipod species	<i>Amphiodia</i> species
amphipod species	Amphipoda
Arctic argid	<i>Argis dentata</i>
Arctic moonsnail	<i>Cryptonatica affinis</i>
arrowtooth flounder	<i>Atheresthes stomias</i>
articulated bamboo coral	<i>Isidella</i> species
Atka mackerel	<i>Pleurogrammus monopterygius</i>
barbed eualid	<i>Eualus barbatus</i>
barnacle species	Thoracica
barrel sponge	<i>Halichondria panicea</i>
barrel sponge species	<i>Halichondria</i> species
barreleye	<i>Macropinna microstoma</i>
baseball sponge	<i>Craniella cranium</i>
basketstar	<i>Gorgonocephalus eucnemis</i>
basketstar species	<i>Gorgonocephalus</i> species
bat sea star species	<i>Ceramaster</i> species
beautiful sun star	<i>Solaster</i> species C (Clark)
Bering eelpout	<i>Lycodes beringi</i>
Bering Henricia	<i>Henricia beringiana</i>
Bering skate	<i>Bathyraja interrupta</i>
Bering skate egg case	<i>Bathyraja interrupta</i> egg case
Bering spiny star	<i>Hippasteria</i> species C (Clark)
bigmouth sculpin	<i>Hemitripteris bolini</i>
bigmouth sculpin eggs	<i>Hemitripteris bolini</i> eggs
bigscale species	Melamphaidae
bivalve species	<i>Acharax johnsoni</i>
bivalve species	Bivalvia
blackfaced red snailfish	<i>Paraliparis ulochir</i>
blackfin poacher	<i>Bathyagonus nigripinnis</i>
blackfin snailfish	<i>Careproctus cypselurus</i>
blackline snipe eel	<i>Avocettina infans</i>
blacklip snailfish	<i>Elassodiscus tremebundus</i>
blacknose sculpin	<i>Icelus canaliculatus</i>
blacksmelt species	<i>Bathylagus</i> species
blackspined sea star	<i>Lethasterias nanimensis</i>

Table 5a. - - Continued.

Common name	Species/Taxon
blackspotted rockfish	<i>Sebastes melanostictus</i>
blacktail snailfish	<i>Careproctus melanurus</i>
blob sculpin	<i>Psychrolutes phricus</i>
blotched snailfish	<i>Crystallichthys cyclospilus</i>
boreopacific armhook squid	<i>Gonatopsis borealis</i>
Bowers Bank snailfish	<i>Careproctus bowersianus</i>
brachiopod species	<i>Frieleia halli</i>
brisingid sea star	Brisingidae
bristlemouth species	Gonostomatidae
brittlestarfish species	<i>Ophiacantha cataleimmoidea</i>
brittlestarfish species	<i>Ophiacantha normani</i>
brittlestarfish species	<i>Ophiopholis longispina</i>
brittlestarfish species	<i>Ophioscolex</i> species
brittlestarfish species	Ophiuroidea
brittlestarfish species	<i>Stegophiura ponderosa</i>
brokenline lampfish	<i>Lampanyctus jordani</i>
bryozoan species	<i>Alcyonidium pedunculatum</i>
California headlightfish	<i>Diaphus theta</i>
cannonball sun star	<i>Heterozonias alternatus</i>
chestnut whelk	<i>Buccinum castaneum</i>
chevron-tentacled anemone	<i>Cribrinopsis fernaldi</i>
Chinook salmon	<i>Oncorhynchus tshawytscha</i>
chiton species	<i>Leptochiton</i> species
chiton species	<i>Placiphorella pacifica</i>
chiton species	<i>Placiphorella</i> species
Chrysaora jellyfish	<i>Chrysaora melanaster</i>
chum salmon	<i>Oncorhynchus keta</i>
clawed armhook squid	<i>Gonatus onyx</i>
clay pipe sponge	<i>Aphrocallistes vastus</i>
comb jelly species	<i>Beroe abyssicola</i>
comb jelly species	<i>Beroe</i> species
Commander skate	<i>Bathyraja lindbergi</i>
Commander skate egg case	<i>Bathyraja lindbergi</i> egg case
common mud star	<i>Ctenodiscus crispatus</i>
coral eelpout	<i>Puzanovia rubra</i>
coral species	<i>Amphilaphis</i> species
coral species	<i>Muriceides</i> species cf. <i>cylindrica</i> (Bayer et al.)
coral species	<i>Primnoa</i> species
costate whelk	<i>Buccinum costatum</i>
crab species	<i>Oregonia bifurca</i>
crangonid shrimp species	<i>Crangon</i> species
crangonid shrimp species	Crangonidae
crested bigscale	<i>Poromitra curilensis</i> (=crassiceps)
crested sea star	<i>Lophaster furcilliger</i>
crested star	<i>Lophaster vexator</i>
crimson pasiphaeid	<i>Pasiphaea tarda</i>
crinoid species	<i>Florometra inexpectata</i>
crinoid species	<i>Florometra</i> species
crinoid species	Crinoidea species
darkfin sculpin	<i>Malacocottus zonurus</i>

Table 5a. - - Continued.

Common name	Species/Taxon
deep sea papillate cucumber	<i>Pannychia moseleyi</i>
deepsea eualid	<i>Eualus biunguis</i>
deepsea skate	<i>Bathyraja abyssicola</i>
deepsea sole	<i>Embassichthys bathybius</i>
deepsea spinyhead	<i>Metacrangon variabilis</i>
divaricate nutclam	<i>Acila castrensis</i>
dorid species	<i>Dendronotus</i> species
Dover sole	<i>Microstomus pacificus</i>
dreamer species	<i>Oneirodes</i> species
dreamer species	<i>Oneirodes thompsoni</i>
dusky rockfish	<i>Sebastes variabilis</i>
eared barnacle	<i>Scalpellum cornutum</i>
eastern Pacific bobtail	<i>Rossia pacifica</i>
ebony eelpout	<i>Lycodes concolor</i>
echiuroid worm species	Echiura
eelpout species	<i>Bothrocarra</i> species
eelpout species	<i>Lycenchelys</i> species
eelpout species	<i>Lycodapus</i> species
eelpout species	<i>Lycodes</i> species
egg yolk jelly	<i>Phacellophora camtschatica</i>
emarginate snailfish	<i>Careproctus furcellus</i>
empty clam shells	Bivalvia shells
empty snail shells	Gastropoda shells
encrusting coral	<i>Clavularia incrustans</i>
eulachon	<i>Thaleichthys pacificus</i>
eualid shrimp species	<i>Eualus</i> species
Evermann's seastar	<i>Zoroaster evermanni</i>
feathery shipworm	<i>Bankia setacea</i>
Fisher sun star	<i>Solaster</i> species F (Clark)
flabby sculpin	<i>Zesticelus profundorum</i>
flapjack devilfish	<i>Opisthoteuthis californiana</i>
flathead sole	<i>Hippoglossoides elassodon</i>
four spined brittle star	<i>Ophiura quadrispina</i>
fragile moonsnail	<i>Bulbus fragilis</i>
fragile sea star	<i>Cheiraster dawsoni</i>
funnel sponge	<i>Phakellia cribrosa</i>
fuzzy hermit crab	<i>Pagurus trigonocheirus</i>
garnet lampfish	<i>Stenobranchius nannochir</i>
gastropod species	<i>Antiplanes thalea</i>
gastropod species	<i>Puncturella rothi</i>
giant barnacle	<i>Balanus evermanni</i>
giant grenadier	<i>Albatrossia pectoralis</i>
giant octopus	<i>Octopus dofleini</i>
giant red mysid	<i>Neognathophausia gigas</i>
gigantic anemone	<i>Metridium farcimen</i> (= <i>Metridium giganteum</i>)
glass sponge species	Hexactinellida
golden king crab	<i>Lithodes aequispinus</i>
gorgonian coral species	Gorgonacea
grape anemone	<i>Oractis diomedea</i>
gravel tube worm	<i>Onuphis conchylega</i>

Table 5a. - - Continued.

Common name	Species/Taxon
gray starsnout poacher	<i>Bathyagonus alascanus</i>
great sculpin	<i>Myoxocephalus polyacanthocephalus</i>
green sea urchin	<i>Strongylocentrotus droebachiensis</i>
Greenland cockle	<i>Serripes groenlandicus</i>
Greenland turbot	<i>Reinhardtius hippoglossoides</i>
Greenland wentletrap	<i>Boreoscala greenlandica</i>
grooved sea star	<i>Crossaster borealis</i>
grooved Tanner crab	<i>Chionoecetes tanneri</i>
hairy-lure dreamer	<i>Oneirodes bulbosus</i>
hat sponge	<i>Phakellia beringensis</i>
heart urchin	<i>Brisaster latifrons</i>
heart urchin species	<i>Brisaster owstoni</i>
hermit species	<i>Pagurus cornutus</i>
hermit species	<i>Pagurus</i> species
highsnout bigscale	<i>Melamphaes lugubris</i>
Korean horsehair crab	<i>Erimacrus isenbeckii</i>
hot dog sea anemone	<i>Bathypheilia australis</i>
humpback snailfish	<i>Elassodiscus caudatus</i>
hybrid Tanner crab	<i>Chionoecetes</i> hybrid
isopod species	<i>Rocinella angusta</i>
jellyfish species	<i>Aequorea</i> species
jellyfish species	<i>Atolla</i> species
jellyfish species	<i>Aurelia</i> species
jellyfish species	<i>Periphylla periphylla</i>
jellyfish species	Scyphozoa
Kamchatka coral	<i>Paragorgia arborea</i>
Kamchatka flounder	<i>Atheresthes evermanni</i>
keeled aforia	<i>Aforia circinata</i>
Kessler sun star	<i>Solaster</i> species E (Clark)
king crab species	<i>Paralomis multispina</i>
king crab species	<i>Paralomis</i> species A (Clark 2006)
king crab species	<i>Paralomis verrilli</i>
knobbyhand hermit	<i>Pagurus confragosus</i>
ladder whelk	<i>Buccinum scalariforme</i>
lampfish species	<i>Lampanyctus</i> species
lampfish species	<i>Stenobranchius</i> species
lamprey species	Petromyzontidae
lebbeid shrimp species	<i>Lebbeus</i> species
lion's mane	<i>Cyanea capillata</i>
long nipped sponge	<i>Polymastia robusta</i>
longfin grenadier	<i>Coryphaenoides longifilis</i>
longfinger hermit	<i>Pagurus rathbuni</i>
longhand hermit	<i>Pagurus tanneri</i>
longhorned decorator crab	<i>Chorilia longipes</i>
longnose lancetfish	<i>Alepisaurus ferox</i>
longsnout prickleback	<i>Lumpenella longirostris</i>
longspine thornyhead	<i>Sebastolobus altivelis</i>
magistrate armhook squid	<i>Berryteuthis magister</i>
majestic sea star	<i>Pedicellaster magister</i>
mollusk species	<i>Neomenia</i> cf. <i>yamamoti</i> (Clark 2006)

Table 5a. - - Continued.

Common name	Species/Taxon
mollusk species	<i>Neomenia</i> species
mollusk species	<i>Onchidiopsis</i> species
mottled anemone	<i>Urticina crassicornis</i>
mud skate	<i>Bathyraja taranetzi</i>
mud skate egg case	<i>Bathyraja taranetzi</i> egg case
Murray sea pen	<i>Anthoptilum murrayi</i>
Mysidae shrimp species	Mysidae
Nodal bamboo coral species	<i>Keratoisis</i> species
North Pacific sea star	<i>Leptychaster arcticus</i>
northern carditid	<i>Cyclocardia</i> species cf. <i>borealis</i> (Clark 2006)
northern horsemussel	<i>Modiolus modiolus</i>
northern lampfish	<i>Stenobranchius leucopsarus</i>
northern pearleye	<i>Benthalbella dentata</i>
northern rock sole	<i>Lepidopsetta polyxystra</i>
northern rockfish	<i>Sebastes polyspinis</i>
northern sea star	<i>Dipsacaster borealis</i>
northern smoothtongue	<i>Leuroglossus schmidti</i>
notched brittlestar	<i>Ophiura sarsi</i>
nudibranch species	Nudibranchia
oblique smoothcockle	<i>Serripes notabilis</i>
octopus species	<i>Benthoctopus oregonensis</i>
octopus species	<i>Benthoctopus</i> species
octopus species	<i>Graneledone</i> species cf. <i>boreopacifica</i> (Nesis)
octopus species	<i>Japetella diaphana</i>
octopus species	Octopodidae
octopus species	<i>Opisthoteuthis</i> species cf. <i>californiana</i> (Jorgensen)
octopus species	<i>Sasakiopus salebrosus</i>
orange bat sea star	<i>Ceramaster patagonicus</i>
orange-pink sea urchin	<i>Allocentrotus fragilis</i>
Oregon triton	<i>Fusitriton oregonensis</i>
Pacific ambereye	<i>Hymenodora frontalis</i>
Pacific blacksmelt	<i>Bathylagus pacificus</i>
Pacific cod	<i>Gadus macrocephalus</i>
Pacific Colga	<i>Colga pacifica</i>
Pacific flatnose	<i>Antimora microlepis</i>
Pacific glass shrimp	<i>Pasiphaea pacifica</i>
Pacific grenadier	<i>Coryphaenoides acrolepis</i>
Pacific hake	<i>Merluccius productus</i>
Pacific halibut	<i>Hippoglossus stenolepis</i>
Pacific herring	<i>Clupea pallasii</i>
Pacific lamprey	<i>Lampetra tridentata</i>
Pacific lyre crab	<i>Hyas lyratus</i>
Pacific ocean perch	<i>Sebastes alutus</i>
Pacific sergestid	<i>Sergestes similis</i>
Pacific sleeper shark	<i>Somniosus pacificus</i>
Pacific viperfish	<i>Chauliodus macouni</i>
pale mammilated sponge	<i>Weberella bursa</i>
pale moonsnail	<i>Euspira pallida</i>
peaked shrimp	<i>Acantheephyra curtirostris</i>
peanut worm unid.	Sipuncula

Table 5a. - - Continued.

Common name	Species/Taxon
pearly prickleback	<i>Bryozoichthys marjorius</i>
pinch bug species	<i>Munidopsis</i> species
pincushion sea star	<i>Diplopteraster multipes</i>
pink rose star	<i>Crossaster</i> species B (Clark)
pinpoint lampfish	<i>Nannobrachium regale</i>
polychaete worm species	Polychaeta
polychaete worm tubes	Polychaete tubes
popeye blacksmelt	<i>Bathylagus ochotensis</i>
popeye grenadier	<i>Coryphaenoides cinereus</i>
Pribilof whelk	<i>Neptunea pribiloffensis</i>
proboscis snailfish	<i>Careproctus simus</i>
prowfish	<i>Zaprora silenus</i>
puncterellas	<i>Cranopsis</i> species
purple hermit	<i>Elassochirus cavimanus</i>
purple striated sea anemone	Actiniaria species
red bat star	<i>Ceramaster japonicus</i>
red snailfish	<i>Paraliparis dactylosus</i>
redbanded rockfish	<i>Sebastes babcocki</i>
reticulate anemone	<i>Actinauge verrilli</i>
rex sole	<i>Glyptocephalus zachirus</i>
ribbed bryozoan	<i>Rhamphostomella costata</i>
ridged blood star	<i>Henricia aspera</i>
ridged crangon	<i>Crangon dalli</i>
robust blacksmelt	<i>Bathylagus milleri</i>
rockfish species	<i>Sebastes</i> species
rose sea star	<i>Crossaster papposus</i>
rosy tritonia	<i>Tritonia diomedea</i>
rotund trophon	<i>Boreotrophon rotundatus</i>
rough China hat sponge	<i>Neoesperiopsis infundibula</i>
rough purple sea anemone	<i>Paractinostola faeculenta</i>
rougheyed rockfish	<i>Sebastes aleutianus</i>
rougtail skate	<i>Bathyraja trachura</i>
rougtail skate egg case	<i>Bathyraja trachura</i> egg case
rusty snailfish	<i>Paraliparis</i> species cf. <i>pectoralis</i> (Orr and Baldwin)
sablefish	<i>Anoplopoma fimbria</i>
salmon snailfish	<i>Careproctus rastrinus</i>
sandy sea cucumber	<i>Pseudostichopus mollis</i>
sawback poacher	<i>Leptagonus frenatus</i>
scaly paperbone	<i>Scopelosaurus harryi</i>
scarlet king crab	<i>Lithodes couesi</i>
scarlet sea star	<i>Pseudarchaster parelii</i>
sea anemone species	<i>Actinernus</i> species
sea anemone species	Actiniaria
sea anemone species	<i>Actinistola</i> species A (Clark 2006)
sea anemone species	<i>Actinoscyphia</i> species
sea anemone species	Actinostolidae
sea anemone species	<i>Actinurnis</i> species
sea anemone species	Hormathiidae
sea anemone species	<i>Stomphia</i> species
sea anemone species	<i>Urticina</i> species

Table 5a. - - Continued.

Common name	Species/Taxon
sea cucumber species	<i>Bathyploetes</i> species
sea cucumber species	Holothuroidea
sea cucumber species	<i>Pannychia</i> species
sea cucumber species	<i>Psolus</i> species
sea cucumber species	<i>Scotoplanes</i> species
sea cucumber species	<i>Synallactes challengerii</i>
sea cucumber species	<i>Synallactes</i> species
sea mouse species	<i>Aphrodita negligens</i>
sea mouse species	<i>Aphrodita</i> species
sea raspberry	<i>Gersemia</i> species
sea spider species	<i>Colossendeis</i> species
sea spider species	Pycnogonida
sea star species	<i>Asteronyx</i> species
sea star species	<i>Brisingella exilis</i>
sea star species	<i>Brisingella</i> species
sea star species	<i>Henricia asthenactis</i>
sea star species	<i>Henricia derjugini</i>
sea star species	<i>Henricia longispina</i>
sea star species	<i>Henricia</i> species
sea star species	<i>Leptychaster anomalus</i>
sea star species	<i>Lophaster</i> species
sea star species	<i>Mediaster tenellus</i>
sea star species	<i>Myxoderma sacculatum</i>
sea star species	<i>Nearchaster</i> species
sea star species	<i>Nearchaster variabilis</i>
sea star species	<i>Odontohenricia fisheri</i>
sea star species	<i>Odontohenricia</i> species
sea star species	<i>Odontohenricia</i> species A (Clark)
sea star species	<i>Pteraster jordani</i>
sea star species	<i>Pteraster marssipus</i>
sea star species	<i>Pteraster</i> species
sea star species	<i>Pteraster tessellatus</i>
sea star species	<i>Solaster hypothrissus</i>
sea star species	<i>Solaster</i> species
sea star species	<i>Solaster</i> species A (Clark 1997)
sea star species	<i>Stephanasterias albula</i>
sea urchin species	<i>Strongylocentrotus</i> species
searcher	<i>Bathymaster signatus</i>
seaslug species	<i>Tritonia</i> species
seawhip species	<i>Halipterus</i> species
seawhip species	<i>Halipterus willemoesi</i>
serpent sea star	<i>Asteronyx loveni</i>
shadow eelpout	<i>Bothrocara nyx</i>
shell shrimp	<i>Crangon alaskensis</i>
shortfin eelpout	<i>Lycodes brevipes</i>
shortraker rockfish	<i>Sebastes borealis</i>
shortscale eualid	<i>Eualus suckleyi</i>
shortspine thornyhead	<i>Sebastolobus alascanus</i>
shrew whelk	<i>Colus halli</i>
shrimp species	<i>Bentheogennema borealis</i>

Table 5a. - - Continued.

Common name	Species/Taxon
shrimp species	<i>Pandalopsis aleutica</i>
shrimp species	<i>Pandalopsis ampla</i>
shrimp species	<i>Pandalopsis longirostris</i>
shrimp species	<i>Pandalopsis</i> species
sidestripe shrimp	<i>Pandalopsis dispar</i>
silvergray rockfish	<i>Sebastes brevispinis</i>
skate species	<i>Bathyraja</i> species
skate species egg case	<i>Bathyraja</i> species egg case
slender codling	<i>Halargyreus johnsonii</i>
slender seawhips	<i>Stylatula</i> species
slim snailfish	<i>Rhinoliparis attenuatus</i>
smalldisk snailfish	<i>Careproctus gilberti</i>
smooth green sponge	<i>Latrunculia</i> species B (Clark 2006)
smooth lump sucker	<i>Aptocyclus ventricosus</i>
smoothskin octopus	<i>Benthoctopus leioderma</i>
smoothstem seawhip	<i>Virgularia</i> species
snail eggs	gastropod eggs
snail species	<i>Beringius frielei</i>
snail species	<i>Beringius undatus</i>
snail species	<i>Buccinum</i> species
snail species	<i>Colus</i> species
snail species	<i>Otukaia kiheiziebisu</i>
snail species	<i>Volutomitra alaskana</i>
snail species egg case	<i>Beringius</i> species eggs
snail species egg case	<i>Buccinum</i> species eggs
snailfish species	<i>Careproctus</i> species
snailfish species	<i>Elassodiscus</i> species
snailfish species	Liparidinae
snailfish species	<i>Paraliparis</i> species
snailfish species	<i>Paraliparis</i> species cf. <i>dactylosus</i> (Orr and Baldwin)
snailfish species	<i>Paraliparis</i> species cf. <i>ulochir</i> (Orr and Baldwin)
snailfish species	<i>Rhinoliparis</i> species
snakehead eelpout	<i>Lycenchelys crotalinus</i>
snakeshead brachiopod	<i>Terebratulina unguicula</i>
snow crab	<i>Chionoecetes opilio</i>
soft coral species	<i>Anthomastus</i> species
softskin slickhead	<i>Rouleina attrita</i>
spectacled sculpin	<i>Triglops scepticus</i>
spiny eel species	<i>Polyacanthonotus challengeri</i>
spiny henricia	<i>Henricia spiculifera</i>
spiny lebbeid	<i>Lebbeus groenlandicus</i>
spiny red sea star	<i>Hippasteria spinosa</i>
spiny sea star speices	<i>Hippasteria armata</i>
spiny sea star speices	<i>Hippasteria californica</i>
spiny sea star speices	<i>Hippasteria heathi</i>
spiny sea star speices	<i>Hippasteria</i> species
spiny trophon	<i>Scabrotrophon scitulus</i>
spinyhead sculpin	<i>Dasycottus setiger</i>
spinyridge shrimp	<i>Notostomus japonicus</i>
splendid hermit	<i>Labidochirus splendescens</i>

Table 5a. - - Continued.

Common name	Species/Taxon
sponge hermit	<i>Pagurus brandti</i>
sponge species	<i>Neoesperiopsis digitata</i>
sponge species	<i>Phakellia</i> species
sponge species	<i>Polymastia</i> species
sponge species	Porifera
sponge species	<i>Staurocalyptus</i> species
sponge species	<i>Suberites ficus</i>
sponge species	<i>Swiftia</i> species
squid species	<i>Chiroteuthis calyx</i>
squid species	<i>Galiteuthis phyllura</i>
squid species	<i>Gonatus madokai</i>
squid species	<i>Gonatus middendorffi</i>
squid species	<i>Gonatus</i> species
squid species	<i>Taonius pavo</i>
squid species	Teuthoidea
starsnout poacher species	<i>Bathyagonus</i> species
striped sea leech	<i>Notostomobdella cyclostoma</i>
sweet sea potato	<i>Molpadia intermedia</i>
swellhead snailfish	<i>Paraliparis cephalus</i>
Swift's sea star	<i>Gephyreaster swifti</i>
swimming anemone	<i>Stomphia coccinea</i>
swimming sea cucumber	<i>Paelopatides confundens</i>
swollen whelk	<i>Buccinum oedematum</i>
Tanner crab	<i>Chionoecetes bairdi</i>
tentacle-shedding anemone	<i>Liponema brevicornis</i>
thick spined brittle star	<i>Ophiolebes pachybacra</i>
thin-ribbed whelk	<i>Colus herendeenii</i>
thorny sculpin	<i>Icelus spiniger</i>
three-ribbed whelk	<i>Ancistrolepis eucosmius</i>
tomato snailfish	<i>Careproctus</i> species G (Orr)
toothless snailfish	<i>Paraliparis paucidens</i>
Townsend hermit crab	<i>Pagurus townsendi</i>
tree sponge	<i>Mycale loveni</i>
tree sponge species	<i>Mycale</i> species
triangle Tanner crab	<i>Chionoecetes angulatus</i>
tubeshoulder species	Platytroctidae
tunicate species	Ascidacea
tunicate species	<i>Boltenia</i> species
twoline eelpout	<i>Bothrocara brunneum</i>
two-ribbed whelk	<i>Ancistrolepis bicinctus</i>
twospine crangon	<i>Crangon communis</i>
ubiquitous brittle star	<i>Ophiopholis aculeata</i>
vampire squid	<i>Vampyroteuthis infernalis</i>
Vancouver lampshell	<i>Laqueus vancouverensis</i>
Vancouver scallop	<i>Delectopecten vancouverensis</i>
vase sponge	<i>Aulosaccus schulzei</i>
Verrill pinch bug	<i>Munidopsis verrilli</i>
walleye pollock	<i>Theragra chalcogramma</i>
warped whelk	<i>Pyrulofusus deformis</i>
western eelpout	<i>Bothrocara zestum</i>

Table 5a. - - Continued.

Common name	Species/Taxon
whelk species	<i>Neptunea insularis</i>
whelk species	<i>Neptunea</i> species
whelk species	<i>Neptunea</i> species F (Clark & McLean)
whelk species	<i>Pyrulofusus dexius</i>
whelk species	<i>Pyrulofusus melonis</i>
whelk species	<i>Pyrulofusus</i> species eggs
whelk species egg case	<i>Neptunea</i> species eggs
white henricia	<i>Henricia</i> species B (Clark 2006)
white neptune	<i>Neptunea amianta</i>
white night doris	<i>Archidoris odhneri</i>
white rose star	<i>Crossaster</i> species A (Clark)
white scallop	<i>Chlamys albida</i>
white sea urchin	<i>Strongylocentrotus pallidus</i>
whiteblotched skate	<i>Bathyraja maculata</i>
whiteblotched skate egg case	<i>Bathyraja maculata</i> egg case
whitebrow skate	<i>Bathyraja minispinosa</i>
whitebrow skate egg case	<i>Bathyraja minispinosa</i> egg case
whiteknee hermit	<i>Pagurus dalli</i>
whitescaled sea cucumber	<i>Psolus squamatus</i>
wide-eye sculpin	<i>Icelus euryops</i>
worm species	<i>Cerebratulus californienesis</i>
worm species	<i>Emplectonema</i> species
worm species	Phascolosomatidae
worm species	<i>Serpula</i> species
worm species	<i>Spinther</i> species A (Clark 2006)
worm species	Polychaeta species
wrinkled star	<i>Pteraster militaris</i>
yellow Irish lord	<i>Hemilepidotus jordani</i>
yellow leafy sponge	<i>Leucosolenia blanca</i>
yellowleg pandalid	<i>Pandalus tridens</i>
yellowmouth rockfish	<i>Sebastes reedi</i>

Table 5b. - - Alphabetical list by scientific name of all fishes and invertebrates on the 2010 EBSS survey.

Species/Taxon	Common name
<i>AcanthePHYra curtirostris</i>	peaked shrimp
<i>Acharax johnsoni</i>	bivalve species
<i>Acila castrensis</i>	divaricate nutclam
<i>Actinauge verrilli</i>	reticulate anemone
<i>Actinernus</i> species	sea anemone species
Actiniaria	sea anemone species
<i>Actinistola</i> species A (Clark 2006)	sea anemone species
<i>Actinoscyphia</i> species	sea anemone species
Actinostolidae	sea anemone species
<i>Actinurnis</i> species	sea anemone species
<i>Aequorea</i> species	jellyfish species
<i>Aforia circinata</i>	keeled aforia
<i>Albatrossia pectoralis</i>	giant grenadier
<i>Alcyonidium pedunculatum</i>	bryozoan species
<i>Alepisaurus ferox</i>	longnose lancetfish
<i>Allocentrotus fragilis</i>	orange-pink sea urchin
<i>Amphilaphis</i> species	coral species
<i>Amphiodia</i> species	amphipod species
Amphipoda	amphipod species
<i>Ancistrolepis bicinctus</i>	two-ribbed whelk
<i>Ancistrolepis eucosmius</i>	three-ribbed whelk
<i>Anoplopoma fimbria</i>	sablefish
<i>Anthomastus</i> species	soft coral species
<i>Anthoptilum murrayi</i>	Murray sea pen
<i>Antimora microlepis</i>	Pacific flatnose
<i>Antiplanes thalea</i>	gastropod species
<i>Aphrocallistes vastus</i>	clay pipe sponge
<i>Aphrodita negligens</i>	sea mouse species
<i>Aphrodita</i> species	sea mouse species
<i>Aptocyclus ventricosus</i>	smooth lumpsucker
<i>Archidoris odhneri</i>	white night doris
<i>Arctomelon</i> species cf. <i>stearnsii</i> (Clark & McLean)	Alaska volute species
<i>Arctomelon stearnsii</i>	Alaska volute
<i>Argis dentata</i>	Arctic argid
Asciacea	tunicate species
<i>Aspidophoroides bartoni</i>	Aleutian alligatorfish
<i>Asteronyx loveni</i>	serpent sea star
<i>Asteronyx</i> species	sea star species
<i>Atheresthes evermanni</i>	Kamchatka flounder
<i>Atheresthes stomias</i>	arrowtooth flounder
<i>Atolla</i> species	jellyfish species
<i>Aulosaccus schulzei</i>	vase sponge
<i>Aurelia</i> species	jellyfish species
<i>Avocettina infans</i>	blackline snipe eel
<i>Balanus evermanni</i>	giant barnacle
<i>Bankia setacea</i>	feathery shipworm
<i>Bathyagonus alascanus</i>	gray starsnout poacher
<i>Bathyagonus nigripinnis</i>	blackfin poacher
<i>Bathyagonus</i> species	starsnout poacher species

Table 5b. - - Continued.

Species/Taxon	Common name
<i>Bathylagus milleri</i>	robust blacksmelt
<i>Bathylagus ochotensis</i>	popeye blacksmelt
<i>Bathylagus pacificus</i>	Pacific blacksmelt
<i>Bathylagus</i> species	blacksmelt species
<i>Bathymaster signatus</i>	searcher
<i>Bathyphelia australis</i>	hot dog sea anemone
<i>Bathyplotes</i> species	sea cucumber species
<i>Bathyraja abyssicola</i>	deepsea skate
<i>Bathyraja aleutica</i>	Aleutian skate
<i>Bathyraja aleutica</i> egg case	Aleutian skate egg case
<i>Bathyraja interrupta</i>	Bering skate
<i>Bathyraja interrupta</i> egg case	Bering skate egg case
<i>Bathyraja lindbergi</i>	Commander skate
<i>Bathyraja lindbergi</i> egg case	Commander skate egg case
<i>Bathyraja maculata</i>	whiteblotched skate
<i>Bathyraja maculata</i> egg case	whiteblotched skate egg case
<i>Bathyraja minispinosa</i>	whitebrow skate
<i>Bathyraja minispinosa</i> egg case	whitebrow skate egg case
<i>Bathyraja parmifera</i>	Alaska skate
<i>Bathyraja parmifera</i> egg case	Alaska skate egg case
<i>Bathyraja</i> species	skate species
<i>Bathyraja</i> species egg case	skate species egg case
<i>Bathyraja taranetzi</i>	mud skate
<i>Bathyraja taranetzi</i> egg case	mud skate egg case
<i>Bathyraja trachura</i>	rougtail skate
<i>Bathyraja trachura</i> egg case	rougtail skate egg case
<i>Benthalbella dentata</i>	northern pearleye
<i>Bentheogennema borealis</i>	shrimp species
<i>Benthoctopus leioderma</i>	smoothskin octopus
<i>Benthoctopus oregonensis</i>	octopus species
<i>Benthoctopus</i> species	octopus species
<i>Beringius frielei</i>	snail species
<i>Beringius</i> species eggs	snail species egg case
<i>Beringius undatus</i>	snail species
<i>Beroe abyssicola</i>	comb jelly species
<i>Beroe</i> species	comb jelly species
<i>Berryteuthis magister</i>	magistrate armhook squid
<i>Bivalvia</i>	bivalve species
<i>Boltenia</i> species	tunicate species
<i>Boreoscala greenlandica</i>	Greenland wentletrap
<i>Boreotrophon alaskanus</i>	Alaskan trophon
<i>Boreotrophon rotundatus</i>	rotund trophon
<i>Bothrocara brunneum</i>	twoline eelpout
<i>Bothrocara nyx</i>	shadow eelpout
<i>Bothrocara pusillum</i>	Alaska eelpout
<i>Bothrocara</i> species	eelpout species
<i>Bothrocara zestum</i>	western eelpout
<i>Brisaster latifrons</i>	heart urchin
<i>Brisaster owstoni</i>	heart urchin species
<i>Brisingella exilis</i>	sea star species

Table 5b. - - Continued.

Species/Taxon	Common name
<i>Brisingella</i> species	sea star species
Brisingidae	brisingid sea star
<i>Bryozoichthys marjorius</i>	pearly prickleback
<i>Buccinum castaneum</i>	chestnut whelk
<i>Buccinum costatum</i>	costate whelk
<i>Buccinum oedematum</i>	swollen whelk
<i>Buccinum scalariforme</i>	ladder whelk
<i>Buccinum</i> species	snail species
<i>Buccinum</i> species eggs	snail species egg case
<i>Bulbus fragilis</i>	fragile moonsnail
<i>Careproctus bowersianus</i>	Bowers Bank snailfish
<i>Careproctus colletti</i>	Alaska snailfish
<i>Careproctus cypselurus</i>	blackfin snailfish
<i>Careproctus furcellus</i>	emarginate snailfish
<i>Careproctus gilberti</i>	smalldisk snailfish
<i>Careproctus melanurus</i>	blacktail snailfish
<i>Careproctus rastrinus</i>	salmon snailfish
<i>Careproctus simus</i>	proboscis snailfish
<i>Careproctus</i> species	snailfish species
<i>Careproctus</i> species G (Orr)	tomato snailfish
<i>Ceramaster japonicus</i>	red bat star
<i>Ceramaster patagonicus</i>	orange bat sea star
<i>Ceramaster</i> species	bat sea star species
<i>Cerebratulus californienesis</i>	worm species
<i>Chauliodus macouni</i>	Pacific viperfish
<i>Cheiraster dawsoni</i>	fragile sea star
<i>Chionoecetes angulatus</i>	triangle Tanner crab
<i>Chionoecetes bairdi</i>	Tanner crab
<i>Chionoecetes</i> hybrid	hybrid Tanner crab
<i>Chionoecetes opilio</i>	snow crab
<i>Chionoecetes tanneri</i>	grooved Tanner crab
<i>Chiroteuthis calyx</i>	squid species
<i>Chlamys albida</i>	white scallop
<i>Chorilia longipes</i>	longhorned decorator crab
<i>Chrysaora melanaster</i>	Chrysaora jellyfish
<i>Clavularia incrustans</i>	encrusting coral
<i>Clupea pallasii</i>	Pacific herring
<i>Colga pacifica</i>	Pacific Colga
<i>Colossendeis</i> species	sea spider species
<i>Colus halli</i>	shrew whelk
<i>Colus herendeenii</i>	thin-ribbed whelk
<i>Colus</i> species	snail species
<i>Coryphaenoides acrolepis</i>	Pacific grenadier
<i>Coryphaenoides cinereus</i>	popeye grenadier
<i>Coryphaenoides longifilis</i>	longfin grenadier
<i>Crangon alaskensis</i>	shell shrimp
<i>Crangon communis</i>	twospine crangon
<i>Crangon dalli</i>	ridged crangon
<i>Crangon</i> species	crangonid shrimp species
Crangonidae	crangonid shrimp species

Table 5b. - - Continued.

Species/Taxon	Common name
<i>Craniella cranium</i>	baseball sponge
<i>Cranopsis</i> species	puncterellas
<i>Cribrinopsis fernaldi</i>	chevron-tentacled anemone
<i>Crossaster borealis</i>	grooved sea star
<i>Crossaster papposus</i>	rose sea star
<i>Crossaster</i> species A (Clark)	white rose star
<i>Crossaster</i> species B (Clark)	pink rose star
<i>Cryptonatica</i> (= <i>Natica</i>) <i>aleutica</i>	Aleutian moonsnail
<i>Cryptonatica affinis</i>	Arctic moonsnail
<i>Crystallichthys cyclospilus</i>	blotched snailfish
<i>Ctenodiscus crispatus</i>	common mud star
<i>Cyanea capillata</i>	lion's mane
<i>Cyclocardia</i> species cf. <i>borealis</i> (Clark 2006)	northern carditid
<i>Dasycottus setiger</i>	spinyhead sculpin
<i>Delectopecten vancouverensis</i>	Vancouver scallop
<i>Dendronotus</i> species	dorid species
<i>Diaphus theta</i>	California headlightfish
<i>Diplopteraster multipes</i>	pincushion sea star
<i>Dipsacaster borealis</i>	northern sea star
Echiura	echiuroid worm species
<i>Elassochirus cavimanus</i>	purple hermit
<i>Elassodiscus caudatus</i>	humpback snailfish
<i>Elassodiscus</i> species	snailfish species
<i>Elassodiscus tremebundus</i>	blacklip snailfish
<i>Embassichthys bathybius</i>	deepsea sole
<i>Emplectonema</i> species	worm species
<i>Erimacrus isenbeckii</i>	Korean horsehair crab
<i>Eualus barbatus</i>	barbed eualid
<i>Eualus biunguis</i>	deepsea eualid
<i>Eualus</i> species	eualid shrimp species
<i>Eualus suckleyi</i>	shortscale eualid
<i>Euspira pallida</i>	pale moonsnail
<i>Florometra inexpectata</i>	crinoid species
<i>Florometra</i> species	crinoid species
<i>Frieleia halli</i>	brachiopod species
<i>Fusitriton oregonensis</i>	Oregon triton
<i>Gadus macrocephalus</i>	Pacific cod
<i>Galiteuthis phyllura</i>	squid species
gastropod eggs	snail eggs
<i>Gephyreaster swifti</i>	Swift's sea star
<i>Gersemia</i> species	sea raspberry
<i>Glyptocephalus zachirus</i>	rex sole
<i>Gonatopsis borealis</i>	boreopacific armhook squid
<i>Gonatus madokai</i>	squid species
<i>Gonatus middendorffi</i>	squid species
<i>Gonatus onyx</i>	clawed armhook squid
<i>Gonatus</i> species	squid species
Gonostomatidae	bristlemouth species
Gorgonacea	gorgonian coral species
<i>Gorgonocephalus eucnemis</i>	basketstar

Table 5b. - - Continued.

Species/Taxon	Common name
<i>Gorgonocephalus</i> species	basketstar species
<i>Graneledone</i> species cf. <i>boreopacifica</i> (Nesis)	octopus species
<i>Halargyreus johnsonii</i>	slender codling
<i>Halichondria panicea</i>	barrel sponge
<i>Halichondria</i> species	barrel sponge species
<i>Halipteris</i> species	seawhip species
<i>Halipteris willemoesi</i>	seawhip species
<i>Hemilepidotus jordani</i>	yellow Irish lord
<i>Hemitripteris bolini</i>	bigmouth sculpin
<i>Hemitripteris bolini</i> eggs	bigmouth sculpin eggs
<i>Henricia aspera</i>	ridged blood star
<i>Henricia asthenactis</i>	sea star species
<i>Henricia beringiana</i>	Bering <i>Henricia</i>
<i>Henricia derjugini</i>	sea star species
<i>Henricia longispina</i>	sea star species
<i>Henricia</i> species	sea star species
<i>Henricia</i> species B (Clark 2006)	white <i>henricia</i>
<i>Henricia spiculifera</i>	spiny <i>henricia</i>
<i>Heterozonias alternatus</i>	cannonball sun star
Hexactinellida	glass sponge species
<i>Hippasteria armata</i>	spiny sea star species
<i>Hippasteria californica</i>	spiny sea star species
<i>Hippasteria heathi</i>	spiny sea star species
<i>Hippasteria</i> species	spiny sea star species
<i>Hippasteria</i> species C (Clark)	Bering spiny star
<i>Hippasteria spinosa</i>	spiny red sea star
<i>Hippoglossoides elassodon</i>	flathead sole
<i>Hippoglossus stenolepis</i>	Pacific halibut
Holothuroidea	sea cucumber species
Hormathiidae	sea anemone species
<i>Hyas lyratus</i>	Pacific lyre crab
<i>Hymenodora frontalis</i>	Pacific ambereye
<i>Icelus canaliculatus</i>	blacknose sculpin
<i>Icelus euryops</i>	wide-eye sculpin
<i>Icelus spiniger</i>	thorny sculpin
<i>Isidella</i> species	articulated bamboo coral
<i>Japetella diaphana</i>	octopus species
<i>Keratoisis</i> species	Nodal bamboo coral species
<i>Labidochirus splendescens</i>	splendid hermit
<i>Lampanyctus jordani</i>	brokenline lampfish
<i>Lampanyctus</i> species	lampfish species
<i>Lampetra tridentata</i>	Pacific lamprey
<i>Laqueus vancouverensis</i>	Vancouver lampshell
<i>Latrunculia</i> species B (Clark 2006)	smooth green sponge
<i>Lebbeus groenlandicus</i>	spiny lebbeid
<i>Lebbeus</i> species	lebbeid shrimp species
<i>Lepidopsetta polyxystra</i>	northern rock sole
<i>Leptagonus frenatus</i>	sawback poacher
<i>Leptochiton</i> species	chiton species
<i>Leptychaster anomalus</i>	sea star species

Table 5b. - - Continued.

Species/Taxon	Common name
<i>Leptychaster arcticus</i>	North Pacific sea star
<i>Lethasterias nanimensis</i>	blackspined sea star
<i>Leucosolenia blanca</i>	yellow leafy sponge
<i>Leuroglossus schmidti</i>	northern smoothtongue
Liparidinae	snailfish species
<i>Liponema brevicornis</i>	tentacle-shedding anemone
<i>Lithodes aequispinus</i>	golden king crab
<i>Lithodes couesi</i>	scarlet king crab
<i>Lophaster furcilliger</i>	crested sea star
<i>Lophaster</i> species	sea star species
<i>Lophaster vexator</i>	crested star
<i>Lumpenella longirostris</i>	longsnout prickleback
<i>Lycenchelys crotalinus</i>	snakehead eelpout
<i>Lycenchelys</i> species	eelpout species
<i>Lycodapus</i> species	eelpout species
<i>Lycodes beringi</i>	Bering eelpout
<i>Lycodes brevipes</i>	shortfin eelpout
<i>Lycodes concolor</i>	ebony eelpout
<i>Lycodes</i> species	eelpout species
<i>Macropinna microstoma</i>	barreleye
<i>Malacocottus zonurus</i>	darkfin sculpin
<i>Mediaster tenellus</i>	sea star species
<i>Melamphaes lugubris</i>	highsnout bigscale
Melamphaidae	bigscale species
<i>Merluccius productus</i>	Pacific hake
<i>Metacrangon variabilis</i>	deepsea spinyhead
<i>Metridium farcimen</i> (= <i>Metridium giganteum</i>)	gigantic anemone
<i>Microstomus pacificus</i>	Dover sole
<i>Modiolus modiolus</i>	northern horsemussel
<i>Molpadia intermedia</i>	sweet sea potato
<i>Munidopsis</i> species	pinch bug species
<i>Munidopsis verrilli</i>	Verrill pinch bug
<i>Muriceides</i> species cf. <i>cylindrica</i> (Bayer et al.)	coral species
<i>Mycale loveni</i>	tree sponge
<i>Mycale</i> species	tree sponge species
<i>Myoxocephalus polyacanthocephalus</i>	great sculpin
Mysidae	Mysidae shrimp species
<i>Myxoderma sacculatum</i>	sea star species
<i>Nannobrachium regale</i>	pinpoint lampfish
<i>Nearchaster</i> species	sea star species
<i>Nearchaster variabilis</i>	sea star species
<i>Neoesperiopsis digitata</i>	sponge species
<i>Neoesperiopsis infundibula</i>	rough China hat sponge
<i>Neognathophausia gigas</i>	giant red mysid
<i>Neomenia</i> cf. <i>yamamoti</i> (Clark 2006)	mollusk species
<i>Neomenia</i> species	mollusk species
<i>Neptunea amianta</i>	white neptune
<i>Neptunea insularis</i>	whelk species
<i>Neptunea pribiloffensis</i>	Pribilof whelk
<i>Neptunea</i> species	whelk species

Table 5b. - - Continued.

Species/Taxon	Common name
<i>Neptunea</i> species eggs	whelk species egg case
<i>Neptunea</i> species F (Clark & McLean)	whelk species
<i>Notostomobdella cyclostoma</i>	striped sea leech
<i>Notostomus japonicus</i>	spinyridge shrimp
Nudibranchia	nudibranch species
Octopodidae	octopus species
<i>Octopus dofleini</i>	giant octopus
<i>Odontohenricia fisheri</i>	sea star species
<i>Odontohenricia</i> species	sea star species
<i>Odontohenricia</i> species A (Clark)	sea star species
<i>Onchidiopsis</i> species	mollusk species
<i>Oncorhynchus keta</i>	chum salmon
<i>Oncorhynchus tshawytscha</i>	Chinook salmon
<i>Oneiodes bulbosus</i>	hairy-lure dreamer
<i>Oneiodes</i> species	dreamer species
<i>Oneiodes thompsoni</i>	dreamer species
<i>Onuphis conchylega</i>	gravel tube worm
<i>Ophiacantha cataleimmoida</i>	brittlestarfish species
<i>Ophiacantha normani</i>	brittlestarfish species
<i>Ophiolebes pachybaetra</i>	thick spined brittle star
<i>Ophiopholis aculeata</i>	ubiquitous brittle star
<i>Ophiopholis longispina</i>	brittlestarfish species
<i>Ophioscolex</i> species	brittlestarfish species
<i>Ophiura quadrispina</i>	four spined brittle star
<i>Ophiura sarsi</i>	notched brittlestar
Ophiuroidea	brittlestarfish species
<i>Opisthoteuthis californiana</i>	flapjack devilfish
<i>Opisthoteuthis</i> species cf. <i>californiana</i> (Jorgensen)	octopus species
<i>Oractis diomedea</i>	grape anemone
<i>Oregonia bifurca</i>	crab species
<i>Otukaia kiheiziebisu</i>	snail species
<i>Paelopatides confundens</i>	swimming sea cucumber
<i>Pagurus aleuticus</i>	Aleutian hermit
<i>Pagurus brandti</i>	sponge hermit
<i>Pagurus confragosus</i>	knobbyhand hermit
<i>Pagurus cornutus</i>	hermit species
<i>Pagurus dalli</i>	whiteknee hermit
<i>Pagurus ochotensis</i>	Alaskan hermit
<i>Pagurus rathbuni</i>	longfinger hermit
<i>Pagurus</i> species	hermit species
<i>Pagurus tanneri</i>	longhand hermit
<i>Pagurus townsendi</i>	Townsend hermit crab
<i>Pagurus trigonocheirus</i>	fuzzy hermit crab
<i>Pandalopsis aleutica</i>	shrimp species
<i>Pandalopsis ampla</i>	shrimp species
<i>Pandalopsis dispar</i>	sidestripe shrimp
<i>Pandalopsis longirostris</i>	shrimp species
<i>Pandalopsis</i> species	shrimp species
<i>Pandalus eous</i> (= <i>borealis</i>)	Alaskan pink (=northern) shrimp
<i>Pandalus tridens</i>	yellowleg pandalid

Table 5b. - - Continued.

Species/Taxon	Common name
<i>Pannychia moseleyi</i>	deep sea papillate cucumber
<i>Pannychia</i> species	sea cucumber species
<i>Paractinostola faeculenta</i>	rough purple sea anemone
<i>Paragorgia arborea</i>	Kamchatka coral
<i>Paraliparis cephalus</i>	swellhead snailfish
<i>Paraliparis dactylosus</i>	red snailfish
<i>Paraliparis paucidens</i>	toothless snailfish
<i>Paraliparis</i> species	snailfish species
<i>Paraliparis</i> species cf. <i>dactylosus</i> (Orr and Baldwin)	snailfish species
<i>Paraliparis</i> species cf. <i>pectoralis</i> (Orr and Baldwin)	rusty snailfish
<i>Paraliparis</i> species cf. <i>ulochir</i> (Orr and Baldwin)	snailfish species
<i>Paraliparis ulochir</i>	blackfaced red snailfish
<i>Paralomis multispina</i>	king crab species
<i>Paralomis</i> species A (Clark 2006)	king crab species
<i>Paralomis verrilli</i>	king crab species
<i>Pasiphaea pacifica</i>	Pacific glass shrimp
<i>Pasiphaea tarda</i>	crimson pasiphaeid
<i>Pedicellaster magister</i>	majestic sea star
<i>Periphylla periphylla</i>	jellyfish species
Petromyzontidae	lamprey species
<i>Phacellophora camtschatica</i>	egg yolk jelly
<i>Phakellia beringensis</i>	hat sponge
<i>Phakellia cribrosa</i>	funnel sponge
<i>Phakellia</i> species	sponge species
Phascolosomatidae	worm species
<i>Placiphorella pacifica</i>	chiton species
<i>Placiphorella</i> species	chiton species
Platyroctidae	tubeshoulder species
<i>Pleurogrammus monopterygius</i>	Atka mackerel
<i>Polyacanthonotus challengerii</i>	spiny eel species
Polychaeta	polychaete worm species
Polychaete tubes	polychaete worm tubes
<i>Polymastia robusta</i>	long nipped sponge
<i>Polymastia</i> species	sponge species
Porifera	sponge species
<i>Poromitra curilensis</i> (= <i>crassiceps</i>)	crested bigscale
<i>Primnoa</i> species	coral species
<i>Pseudarchaster parelii</i>	scarlet sea star
<i>Pseudostichopus mollis</i>	sandy sea cucumber
<i>Psolus</i> species	sea cucumber species
<i>Psolus squamatus</i>	whitescaled sea cucumber
<i>Psychrolutes phrictus</i>	blob sculpin
<i>Pteraster jordani</i>	sea star species
<i>Pteraster marssipus</i>	sea star species
<i>Pteraster militaris</i>	wrinkled star
<i>Pteraster</i> species	sea star species
<i>Pteraster tessellatus</i>	sea star species
<i>Puncturella rothi</i>	gastropod species
<i>Puzanovia rubra</i>	coral eelpout
Pycnogonida	sea spider species

Table 5b. - - Continued.

Species/Taxon	Common name
<i>Pyrulofusus deformis</i>	warped whelk
<i>Pyrulofusus dexius</i>	whelk species
<i>Pyrulofusus melonis</i>	whelk species
<i>Pyrulofusus</i> species eggs	whelk species
<i>Reinhardtius hippoglossoides</i>	Greenland turbot
<i>Rhamphostomella costata</i>	ribbed bryozoan
<i>Rhinoliparis attenuatus</i>	slim snailfish
<i>Rhinoliparis</i> species	snailfish species
<i>Rocinella angusta</i>	isopod species
<i>Rossia pacifica</i>	eastern Pacific bobtail
<i>Rouleina attrita</i>	softskin slickhead
<i>Sasakiopus salebrosus</i>	octopus species
<i>Scabrotrophon scitulus</i>	spiny trophon
<i>Scalpellum cornutum</i>	eared barnacle
<i>Scopelosaurus harryi</i>	scaly paperbone
<i>Scotoplanes</i> species	sea cucumber species
Scyphozoa	jellyfish species
<i>Sebastes aleutianus</i>	roughey rockfish
<i>Sebastes alutus</i>	Pacific ocean perch
<i>Sebastes babcocki</i>	redbanded rockfish
<i>Sebastes borealis</i>	shortraker rockfish
<i>Sebastes brevispinis</i>	silvergray rockfish
<i>Sebastes melanostictus</i>	blackspotted rockfish
<i>Sebastes polyispinis</i>	northern rockfish
<i>Sebastes reedi</i>	yellowmouth rockfish
<i>Sebastes</i> species	rockfish species
<i>Sebastes variabilis</i>	dusky rockfish
<i>Sebastolobus alascanus</i>	shortspine thornyhead
<i>Sebastolobus altivelis</i>	longspine thornyhead
<i>Sergestes similis</i>	Pacific sergestid
<i>Serpula</i> species	worm species
<i>Serripes groenlandicus</i>	Greenland cockle
<i>Serripes notabilis</i>	oblique smoothcockle
Sipuncula	peanut worm unid.
<i>Solaster hypothrissus</i>	sea star species
<i>Solaster</i> species	sea star species
<i>Solaster</i> species A (Clark 1997)	sea star species
<i>Solaster</i> species C (Clark)	beautiful sun star
<i>Solaster</i> species E (Clark)	Kessler sun star
<i>Solaster</i> species F (Clark)	Fisher sun star
<i>Somniosus pacificus</i>	Pacific sleeper shark
<i>Spinther</i> species A (Clark 2006)	worm species
<i>Staurocalyptus</i> species	sponge species
<i>Stegophiura ponderosa</i>	brittlestarfish species
<i>Stenobranchius leucopsarus</i>	northern lampfish
<i>Stenobranchius nannochir</i>	garnet lampfish
<i>Stenobranchius</i> species	lampfish species
<i>Stephanasterias albula</i>	sea star species
<i>Stomphia coccinea</i>	swimming anemone
<i>Stomphia</i> species	sea anemone species

Table 5b. - - Continued.

Species/Taxon	Common name
<i>Strongylocentrotus droebachiensis</i>	green sea urchin
<i>Strongylocentrotus pallidus</i>	white sea urchin
<i>Strongylocentrotus</i> species	sea urchin species
<i>Stylatula</i> species	slender seawhips
<i>Suberites ficus</i>	sponge species
<i>Swiftia</i> species	sponge species
<i>Synallactes challengerii</i>	sea cucumber species
<i>Synallactes</i> species	sea cucumber species
<i>Taonius pavo</i>	squid species
<i>Terebratulina unguicula</i>	snakeshead brachiopod
Teuthoidea	squid species
<i>Thaleichthys pacificus</i>	eulachon
<i>Theragra chalcogramma</i>	walleye pollock
Thoracica	barnacle species
<i>Triglops scepticus</i>	spectacled sculpin
<i>Tritonia diomedea</i>	rosy tritonia
<i>Tritonia</i> species	seaslug species
<i>Urticina crassicornis</i>	mottled anemone
<i>Urticina</i> species	sea anemone species
<i>Vampyroteuthis infernalis</i>	vampire squid
<i>Virgularia</i> species	smoothstem seawhip
<i>Volutomitra alaskana</i>	snail species
<i>Weberella bursa</i>	pale mammilated sponge
<i>Zaprora silenus</i>	prowfish
<i>Zesticelus profundorum</i>	flabby sculpin
<i>Zoroaster evermanni</i>	Evermann's seastar
Actiniaria species	purple striated sea anemone
Polychaeta species	worm species
Crinoidea species	crinoid species
Bivalvia shells	empty clam shells
Gastropoda shells	empty snail shells

Table 6. - - All species encountered on the 2010 EBSS survey with depth range and frequency of occurrence. Species are listed in descending order by total catch weight.

Species name	Total weight (kg)	Total number	Min-Max depth encountered (m)	Mean depth encountered (m)	Frequency of occurrence (hauls)
<i>Albatrossia pectoralis</i>	137,010.71	39,057	296-1149	620	141
<i>Sebastes alutus</i>	45,990.34	55,001	207-580	348	86
<i>Atheresthes stomias</i>	15,894.82	14,608	201-735	398	134
<i>Coryphaenoides cinereus</i>	11,664.71	66,084	449-1149	733	88
<i>Sebastolobus alascanus</i>	8,416.37	12,897	206-1149	568	132
<i>Bothrocara zestum</i>	7,900.03	11,252	398-1149	597	75
<i>Atheresthes evermanni</i>	7,225.01	5,578	202-1149	492	169
<i>Reinhardtius hippoglossoides</i>	5,040.14	1,477	206-1149	547	139
<i>Hippoglossoides elassodon</i>	4,761.21	11,292	201-567	357	103
<i>Bathyraja aleutica</i>	4,511.84	1,485	202-1149	524	156
<i>Pannychia moseleyi</i>	3,322.12	40,103	220-1132	614	76
<i>Glyptocephalus zachirus</i>	2,616.81	3,946	202-637	363	95
<i>Anoplopoma fimbria</i>	2,336.96	697	398-1059	634	96
<i>Theragra chalcogramma</i>	1,783.62	1,271	202-510	305	56
<i>Gadus macrocephalus</i>	1,407.96	538	201-420	256	40
<i>Hippoglossus stenolepis</i>	1,238.44	193	201-616	380	57
<i>Ophiacantha normani</i>	1,194.12	1,287,848	403-1149	656	51
<i>Bathyraja maculata</i>	1,093.46	393	214-1059	451	64
<i>Aphrocallistes vastus</i>	1,025.32	4	202-965	520	60
<i>Sebastes borealis</i>	951.52	301	225-737	430	37
<i>Bathyraja lindbergi</i>	840.20	396	215-1149	648	73
<i>Ceramaster japonicus</i>	814.93	8,317	208-1116	505	127
<i>Paractinostola faeculenta</i>	797.22	2,810	206-1132	591	38
<i>Coryphaenoides acrolepis</i>	743.12	2,406	629-1149	935	29
<i>Hemitripterus bolini</i>	738.63	186	202-629	373	67
<i>Liponema brevicornis</i>	673.28	6,395	201-1149	451	132
<i>Brisaster latifrons</i>	671.24	35,976	206-1116	457	28
<i>Bathyraja interrupta</i>	644.19	521	201-1065	403	93
<i>Lithodes aequispinus</i>	616.21	789	202-1059	448	90
<i>Lycodes concolor</i>	589.00	664	398-1149	584	53
Hexactinellida	498.22	1	202-901	548	11
<i>Berryteuthis magister</i>	488.21	1,802	202-1149	466	141
<i>Bathyraja minispinosa</i>	486.79	305	214-1149	581	98
<i>Chionoecetes angulatus</i>	475.98	5,058	247-1149	694	77
<i>Psychrolutes phrictus</i>	402.04	129	747-1149	966	20
<i>Dipsacaster borealis</i>	347.24	1,834	206-1065	434	72
<i>Chionoecetes tanneri</i>	334.68	1,396	279-1149	650	85
<i>Crossaster borealis</i>	332.93	2,827	202-1149	506	154
<i>Bathyraja trachura</i>	315.78	154	597-1149	864	36
crinoid unidentified	290.32	18,691	565-1009	752	5
<i>Neptunea</i> sp.	251.62	2,419	201-1116	527	89
<i>Bothrocara brunneum</i>	229.81	415	425-1116	684	43
<i>Somniosus pacificus</i>	227.41	22	220-965	505	19
<i>Chionoecetes bairdi</i>	221.98	1,451	201-737	326	56
<i>Bathyraja parmifera</i>	220.19	35	206-416	271	15
Porifera	212.59	2	202-1149	448	85
<i>Gorgonocephalus eucnemis</i>	209.68	1,472	214-965	412	16
<i>Malacocottus zonurus</i>	199.64	1,994	202-1058	402	108
<i>Nearchaster variabilis</i>	198.54	5,847	336-1149	666	75
Polychaete tubes	196.57	2,770	909-1116	1011	3

Table 6. - - Continued.

Species name	Total weight (kg)	Total number	Min-Max depth caught (m)	Mean bottom depth (m)	Frequency of occurrence (hauls)
<i>Zaprora silenus</i>	193.33	55	215-253	227	7
<i>Pandalus eous</i>	181.20	30,587	201-425	273	56
<i>Embassichthys bathybius</i>	152.92	139	616-901	721	18
<i>Sebastes melanostictus</i>	143.76	182	215-512	344	28
<i>Asteronyx loveni</i>	135.38	4,014	214-511	343	24
<i>Bathyraja taranetzi</i>	127.49	138	202-965	437	40
<i>Lithodes couesi</i>	124.67	182	510-1149	762	32
<i>Microstomus pacificus</i>	118.92	109	202-580	387	36
<i>Careproctus melanurus</i>	117.16	273	296-1065	675	59
<i>Careproctus furcellus</i>	97.12	269	206-1065	531	49
<i>Virgularia</i> sp.	95.73	10,783	220-847	460	9
<i>Pagurus cornutus</i>	84.78	1,991	206-637	408	53
<i>Actinostolidae</i>	84.45	2,540	201-1035	420	55
<i>Aulosaccus schulzei</i>	77.98	9	296-738	530	7
<i>Sebastes aleutianus</i>	71.42	75	201-439	294	22
<i>Myxoderma sacculatum</i>	66.48	532	430-1132	775	19
<i>Dasycottus setiger</i>	65.27	558	201-645	360	65
<i>Ophiacantha cataleimmoidea</i>	64.48	25,092	296-635	505	18
<i>Zoroaster evermanni</i>	61.90	597	492-1132	802	26
<i>Aphrodita negligens</i>	61.61	3,717	206-1116	487	106
<i>Chrysaora melanaster</i>	60.97	99	215-1102	484	49
<i>Lepidopsetta polyxystra</i>	55.98	71	202-322	258	4
<i>Paragorgia arborea</i>	48.96	8	517-1035	819	6
<i>Leptagonus frenatus</i>	46.79	1,027	202-725	287	39
<i>Bathyraja abyssicola</i>	46.53	3	687-1014	904	3
<i>Aptocyclus ventricosus</i>	44.95	54	313-1149	641	34
<i>Octopus dofleini</i>	44.80	54	202-735	370	30
<i>Fusitriton oregonensis</i>	42.80	599	201-631	332	60
<i>Pyrulofusus melonis</i>	42.18	399	207-664	435	46
<i>Lycodes beringi</i>	41.81	765	219-1065	526	89
<i>Pandalopsis dispar</i>	40.01	2,613	206-909	398	48
<i>Thaleichthys pacificus</i>	39.97	957	201-608	326	19
<i>Anthoptilum murrayi</i>	38.28	5,406	1132-1132	1132	1
<i>Paralomis multispina</i>	36.78	77	632-1149	939	13
<i>Diplopteraster multipes</i>	35.19	146	202-1149	388	40
<i>Antimora microlepis</i>	34.66	83	631-1149	975	19
<i>Allocentrotus fragilis</i>	33.74	260	208-543	343	31
<i>Buccinum oedematum</i>	31.22	901	236-1116	651	85
<i>Isidella</i> sp.	30.90		703-960	841	4
<i>Careproctus colletti</i>	28.14	109	323-1059	613	26
<i>Solaster</i> sp. F	26.77	175	219-1149	513	36
<i>Actinauge verrilli</i>	26.59	1,501	206-1132	469	51
<i>Beringius frielei</i>	24.88	237	215-735	440	48
<i>Careproctus rastrinus</i>	24.32	63	201-440	261	23
<i>Sebastes variabilis</i>	23.37	16	215-244	228	3
<i>Leuroglossus schmidti</i>	22.63	3,282	226-1149	584	119
<i>Ophiopholis aculeata</i>	21.66	6,243	202-1149	508	44
<i>Opisthoteuthis californiana</i>	20.55	37	406-687	520	17
<i>Actinoscyphia</i> sp.	20.41	1,201	909-1132	1042	4
<i>Benthoctopus leioderma</i>	18.87	62	233-1065	553	36
<i>Chionoecetes opilio</i>	18.23	140	201-639	336	30

Table 6. - - Continued.

Species name	Total weight (kg)	Total number	Min-Max depth caught (m)	Mean bottom depth (m)	Frequency of occurrence (hauls)
<i>Bathylagus</i> sp.	17.24	439	498-1149	800	35
<i>Myoxocephalus polyacanthocephalus</i>	16.69	5	206-305	239	3
<i>Elassodiscus tremebundus</i>	16.63	112	303-1149	873	24
<i>Synallactes</i> sp.	16.15	532	207-1065	456	38
<i>Staurocalyptus</i> sp.	15.93	1	526-1048	849	6
<i>Rossia pacifica</i>	14.72	142	202-322	247	26
Petromyzontidae	13.87	43	201-853	434	28
<i>Bathymaster signatus</i>	13.60	68	207-253	227	9
<i>Bathyagonus nigripinnis</i>	13.34	1,078	226-1116	550	101
<i>Graneledone</i> sp. cf. <i>boreopacifica</i>	12.49	33	901-1132	1020	7
<i>Anthomastus</i> sp.	12.25	152	847-853	850	2
<i>Hippasteria spinosa</i>	11.78	25	215-555	349	9
<i>Phacellophora camtschatica</i>	11.49	28	202-1102	546	28
<i>Elassodiscus caudatus</i>	11.44	168	496-1102	777	38
<i>Neptunea amianta</i>	10.90	201	403-1102	664	18
<i>Sebastes polyspinis</i>	10.61	10	215-253	231	3
<i>Careproctus cypselurus</i>	10.00	84	417-1149	924	21
<i>Pteraster tesselatus</i>	9.87	25	206-318	249	4
<i>Benthoctopus</i> sp.	9.62	18	452-1132	765	10
<i>Pagurus trigonocheirus</i>	9.34	374	202-637	287	12
<i>Sasakiopus salebrosus</i>	9.13	93	220-1059	525	54
<i>Oncorhynchus keta</i>	8.74	5	419-735	600	3
<i>Pteraster jordani</i>	8.52	190	220-1132	709	29
<i>Heterozonias alternatus</i>	8.38	46	616-1059	751	6
Empty gastropod shell	8.04	20	226-1102	431	12
<i>Lampetra tridentata</i>	7.93	27	214-1132	516	21
<i>Pagurus townsendi</i>	7.87	296	420-1149	715	48
<i>Strongylocentrotus pallidus</i>	7.83	100	208-622	362	11
<i>Pyrulofusus deformis</i>	7.67	37	202-430	279	12
<i>Neoesperiopsis infundibula</i>	7.19	32	217-965	518	7
Scyphozoa	7.05	28	202-1149	589	52
<i>Clupea pallasii</i>	6.83	16	233-439	307	5
<i>Lophaster furcilliger</i>	6.68	339	362-1132	620	38
<i>Primnoa</i> sp.	6.59	3	328-1048	607	3
<i>Buccinum scalariforme</i>	6.38	184	206-697	395	17
<i>Stomphia</i> sp.	6.23	247	219-619	410	17
<i>Ceramaster patagonicus</i>	6.11	101	207-837	439	7
<i>Triglops scepticus</i>	5.90	125	201-286	226	12
<i>Pasiphaea pacifica</i>	5.60	2,162	398-1065	501	45
<i>Bathyraja parmifera</i> egg case	5.47	204	207-631	364	28
<i>Hippasteria armata</i>	5.46	11	305-721	530	6
<i>Stenobrachius</i> sp.	5.30	734	233-1149	633	89
<i>Aphrodita</i> sp.	5.27	130	322-460	416	4
<i>Pandalopsis aleutica</i>	5.13	282	226-1116	784	24
<i>Opisthoteuthis</i> sp. cf. <i>californiana</i>	4.96	2	453-453	453	1
<i>Pagurus tanneri</i>	4.76	117	616-1021	773	5
<i>Solaster</i> sp. C	4.65	14	207-322	250	7
<i>Hippasteria</i> sp.	4.63	7	372-372	372	1
<i>Icelus canaliculatus</i>	4.49	281	215-965	548	32
<i>Cribrinopsis fernaldi</i>	4.48	37	215-244	228	3
<i>Mycale loveni</i>	4.38	11	207-965	358	7

Table 6. - - Continued.

Species name	Total weight (kg)	Total number	Min-Max depth caught (m)	Mean bottom depth (m)	Frequency of occurrence (hauls)
<i>Pannychia</i> sp.	4.25	84	683-1012	847	3
<i>Bathyploetes</i> sp.	3.91	125	226-417	296	4
<i>Neptunea pribiloffensis</i>	3.89	37	206-305	250	6
<i>Mycale</i> sp.	3.70	1	226-247	237	2
<i>Mediaster tenellus</i>	3.65	49	597-1014	782	8
<i>Hemilepidotus jordani</i>	3.60	3	220-244	232	2
<i>Strongylocentrotus droebachiensis</i>	3.59	136	207-425	264	10
<i>Florometra</i> sp.	3.28	660	410-1132	607	7
<i>Halichondria panicea</i>	3.26	2	206-526	366	2
<i>Amphilaphis</i> sp.	3.19	4	215-555	371	5
<i>Hippasteria californica</i>	3.18	13	460-847	670	3
<i>Pteraster marssipus</i>	3.11	49	206-425	275	14
<i>Pseudarchaster parelii</i>	3.05	105	217-1116	591	41
<i>Henricia</i> sp.	3.04	208	201-1065	439	71
<i>Benthoctopus oregonensis</i>	3.04	3	733-1058	896	2
<i>Pteraster militaris</i>	3.03	51	207-965	506	12
<i>Ctenodiscus crispatus</i>	3.02	206	220-616	369	5
<i>Bathyraja aleutica</i> egg case	3.00	54	244-747	440	11
<i>Bathylagus pacificus</i>	2.87	120	632-1132	898	13
<i>Onchidiopsis</i> sp.	2.85	319	236-1132	457	29
<i>Gephyreaster swifti</i>	2.85	1	226-226	226	1
<i>Sebastobus altivelis</i>	2.82	6	847-853	850	2
<i>Buccinum</i> sp. eggs	2.79		227-1012	560	33
<i>Lycenchelys crotalinus</i>	2.78	28	440-901	653	6
<i>Neptunea</i> sp. eggs	2.61		328-960	581	12
<i>Aequorea</i> sp.	2.41	17	201-901	398	17
<i>Hemitripteris bolini</i> eggs	2.37		226-226	226	1
<i>Eualus biunguis</i>	2.35	1,013	406-1149	728	44
<i>Swiftia</i> sp.	2.28	9	207-853	529	10
<i>Lampanyctus jordani</i>	2.27	67	406-733	528	19
<i>Solaster</i> sp.	2.25	11	228-444	332	4
<i>Brisingella exilis</i>	2.24	24	410-629	514	6
<i>Bathyraja interrupta</i> egg case	2.11	139	202-1058	468	37
<i>Elassochirus cavimanus</i>	2.03	29	207-425	270	13
<i>Paralomis verrilli</i>	2.03	5	1059-1149	1104	2
<i>Bothrocaris</i> sp.	2.01	6	629-1065	768	4
<i>Bathyraja trachura</i> egg case	1.98	138	509-1012	730	13
<i>Lumpenella longirostris</i>	1.97	29	406-637	520	5
Ophiuroidea	1.97	3,247	406-632	485	5
<i>Brisaster owstoni</i>	1.96	59	279-512	365	3
<i>Gonatopsis borealis</i>	1.88	18	320-1012	568	16
<i>Arctomelon stearnsii</i>	1.87	33	224-664	456	25
<i>Pagurus confragosus</i>	1.84	38	207-492	267	7
<i>Atolla</i> sp.	1.73	75	405-1149	802	33
gastropod eggs	1.72	4	217-1059	586	22
<i>Lophaster vexator</i>	1.66	45	413-1132	645	16
<i>Crystallichthys cyclospilus</i>	1.53	1	244-244	244	1
<i>Stenobrachius leucopsarus</i>	1.52	222	345-1132	648	36
<i>Tritonia diomedea</i>	1.50	20	256-1132	642	3
<i>Icelus spiniger</i>	1.45	44	201-345	243	18
Empty bivalve shell	1.44		227-256	242	2

Table 6. - - Continued.

Species name	Total weight (kg)	Total number	Min-Max depth caught (m)	Mean bottom depth (m)	Frequency of occurrence (hauls)
<i>Chauliodus macouni</i>	1.39	47	247-1116	752	31
<i>Chionoecetes hybrid</i>	1.39	39	206-433	301	10
<i>Merluccius productus</i>	1.33	1	416-416	416	1
<i>Neptunea insularis</i>	1.32	12	403-853	601	7
<i>Aurelia</i> sp.	1.32	5	286-497	437	4
<i>Bathyraja minispinosa</i> egg case	1.25	70	208-1059	574	18
<i>Coryphaenoides longifilis</i>	1.15	2	725-801	763	2
<i>Hippasteria</i> sp.	1.14	2	297-965	631	2
<i>Halipteris willemoesi</i>	1.08	19	297-297	297	1
<i>Psolus squamatus</i>	1.04	34	847-1035	942	7
<i>Rhamphostomella costata</i>	1.00		960-960	960	1
<i>Halipteris</i> sp.	1.00	22	214-526	335	5
<i>Bathylagus milleri</i>	0.93	28	597-1132	945	8
<i>Pyrulofusus dexius</i>	0.92	4	226-226	226	1
<i>Strongylocentrotus</i> sp.	0.92	20	444-444	444	1
<i>Polyacanthonotus challengerii</i>	0.90	1	962-962	962	1
<i>Oneirodes thompsoni</i>	0.88	6	597-962	799	6
<i>Careproctus gilberti</i>	0.87	94	444-628	542	3
<i>Bothrocarus nyx</i>	0.85	76	842-1149	988	6
<i>Buccinum</i> sp.	0.83	12	637-1102	947	6
<i>Henricia beringiana</i>	0.81	30	224-547	419	20
<i>Stylatula</i> sp.	0.78	169	219-498	410	10
<i>Crossaster</i> sp. B	0.77	74	425-965	627	8
<i>Sebastes</i> sp.	0.77	1	208-208	208	1
<i>Oneirodes</i> sp.	0.76	5	747-1059	916	4
<i>Stomphia coccinea</i>	0.75	14	215-233	227	3
<i>Buccinum costatum</i>	0.74	15	608-1149	823	10
<i>Pagurus</i> sp.	0.74	13	279-555	423	4
<i>Pyrulofusus</i> sp. eggs	0.73	14	214-616	398	10
<i>Henricia asthenactis</i>	0.72	17	226-291	259	2
<i>Tritonia</i> sp.	0.71	19	403-1009	681	6
<i>Sebastes reedi</i>	0.70	1	372-372	372	1
Polychaeta	0.69	175	225-1132	584	10
<i>Balanus evermanni</i>	0.68	5	207-453	292	3
<i>Taonius pavo</i>	0.66	5	449-1102	865	4
<i>Phakellia cribrata</i>	0.62	1	512-512	512	1
<i>Puzanovia rubra</i>	0.61	11	847-847	847	1
<i>Weberella bursa</i>	0.60	18	207-215	211	2
<i>Alepisaurus ferox</i>	0.59	1	425-425	425	1
<i>Careproctus simus</i>	0.56	31	313-853	624	7
<i>Bankia setacea</i>	0.56	100	540-1058	799	2
Liparidinae	0.53	73	279-1048	619	26
<i>Erimacrus isenbeckii</i>	0.53	5	219-244	230	3
<i>Ceramaster</i> sp.	0.52	9	322-622	472	2
<i>Hyas lyratus</i>	0.52	29	206-454	278	20
<i>Polymastia</i> sp.	0.52	10	215-244	228	3
<i>Neomenia</i> cf. <i>yamamotoi</i>	0.51	11	538-945	739	4
<i>Solaster hypothrissus</i>	0.49	6	444-543	494	2
<i>Halargyreus johnsonii</i>	0.48	3	1012-1132	1072	2
Brisingiidae	0.48	8	440-637	556	8
<i>Lycodapus</i> sp.	0.45	148	207-1149	589	44

Table 6. - - Continued.

Species name	Total weight (kg)	Total number	Min-Max depth caught (m)	Mean bottom depth (m)	Frequency of occurrence (hauls)
<i>Gonatus</i> sp.	0.45	9	410-747	569	6
<i>Actinurnis</i> sp.	0.45	3	703-703	703	1
<i>Solaster</i> sp. A	0.43	2	226-509	368	2
<i>Neptunea</i> sp. F	0.41	4	206-227	218	3
<i>Scotoplanes</i> sp.	0.40	54	1102-1102	1102	1
<i>Melamphaes lugubris</i>	0.40	14	226-664	505	10
<i>Pedicellaster magister</i>	0.39	40	206-1102	541	26
<i>Chiroteuthis calyx</i>	0.39	1	664-664	664	1
<i>Henricia aspera</i>	0.36	15	207-444	256	6
<i>Periphylla periphylla</i>	0.36	41	401-1149	726	27
<i>Gonatus onyx</i>	0.36	2	362-664	513	2
<i>Leucosolenia blanca</i>	0.36	3	244-438	341	2
<i>Argis dentata</i>	0.35	91	206-622	347	31
<i>Galiteuthis phyllura</i>	0.33	3	526-812	639	3
<i>Ophioscolex</i> sp.	0.32	434	909-1132	1025	4
<i>Lycodes brevipes</i>	0.31	5	215-227	221	3
<i>Laqueus vancouverensis</i>	0.30	36	207-616	390	9
<i>Nearchaster</i> sp.	0.29	6	635-1021	828	2
<i>Urticina</i> sp.	0.29	15	201-406	273	7
Amphipoda	0.29	238	406-406	406	1
Actiniaria	0.28	11	219-1102	470	8
<i>Metridium farcimen</i>	0.26	2	233-305	269	2
<i>Sebastes babcocki</i>	0.26	1	320-320	320	1
<i>Molpadia intermedia</i>	0.26	11	430-449	440	2
<i>Hippasteria heathi</i>	0.25	3	418-853	636	2
<i>Gonatus madokai</i>	0.24	2	419-738	579	2
Teuthoidea	0.24	2	1058-1058	1058	1
<i>Odontohenricia</i> sp.	0.24	7	226-512	353	3
<i>Onuphis conchylega</i>	0.23		233-233	233	1
<i>Modiolus modiolus</i>	0.22	3	398-446	422	2
<i>Latrunculia</i> sp. B	0.22	5	616-616	616	1
<i>Clavularia incrustans</i>	0.22		847-1048	938	3
<i>Elassodiscus</i> sp.	0.21	1	1116-1116	1116	1
<i>Brisingella</i> sp.	0.21	3	497-847	672	2
<i>Pasiphaea tarda</i>	0.21	13	226-1149	875	9
<i>Paraliparis</i> sp.	0.20	12	632-1065	804	6
<i>Paraliparis</i> sp. cf. <i>dactylosus</i>	0.20	21	526-733	627	5
<i>Oregonia bifurca</i>	0.20	10	847-960	903	3
<i>Gonatus middendorffi</i>	0.20	1	509-509	509	1
<i>Beringius</i> sp. eggs	0.20	25	215-683	410	6
<i>Paelopatides confundens</i>	0.18	1	1059-1059	1059	1
<i>Bathylagus ochotensis</i>	0.17	6	487-901	705	6
<i>Stenobranchius nanochir</i>	0.17	28	1048-1132	1090	2
<i>Phakellia beringensis</i>	0.17	1	512-512	512	1
<i>Crossaster</i> sp. A	0.17	11	296-703	529	5
<i>Scopelosaurus harryi</i>	0.16	2	538-733	636	2
<i>Macropinna microstoma</i>	0.16	6	687-1149	980	6
Asciacea	0.15	8	226-847	537	2
<i>Boltenia</i> sp.	0.14	1	487-1012	750	2
<i>Paraliparis</i> sp. cf. <i>pectoralis</i>	0.14	6	1014-1048	1031	2
<i>Oractis diomedea</i>	0.14	9	214-320	256	6

Table 6. - - Continued.

Species name	Total weight (kg)	Total number	Min-Max depth caught (m)	Mean bottom depth (m)	Frequency of occurrence (hauls)
<i>Nannobrachium regale</i>	0.14	5	632-1102	827	3
<i>Labidochirus splendescens</i>	0.14	11	206-410	261	5
<i>Alcyonidium pedunculatum</i>	0.14		244-438	341	2
<i>Oneirodes bulbosus</i>	0.13	2	812-1009	911	2
<i>Actinistola</i> sp. A	0.13	1	256-256	256	1
<i>Pleurogrammus monopterygius</i>	0.13	1	801-801	801	1
<i>Archidoris odhneri</i>	0.12	7	215-217	216	2
<i>Cyanea capillata</i>	0.12	2	233-438	336	2
<i>Pagurus aleuticus</i>	0.12	2	225-622	424	2
<i>Cheiraster dawsoni</i>	0.12	6	217-628	379	4
<i>Urticina crassicornis</i>	0.11	7	398-438	418	2
<i>Keratosis</i> sp.	0.11	1	853-853	853	1
<i>Crangon dalli</i>	0.11	57	201-286	233	11
<i>Careproctus</i> sp.	0.11	9	221-555	410	5
<i>Melamphaidae</i>	0.11	4	1065-1065	1065	1
<i>Paraliparis cephalus</i>	0.11	27	628-1116	850	6
<i>Bathyraja</i> sp.	0.11	1	1059-1059	1059	1
<i>Arctomelon</i> sp. cf. <i>stearnsii</i>	0.10	2	526-526	526	1
<i>Rouleina attrita</i>	0.10	1	1012-1012	1012	1
<i>Pandalus tridens</i>	0.10	29	214-444	326	4
<i>Buccinum castaneum</i>	0.10	3	737-1058	898	2
<i>Phakellia</i> sp.	0.10	1	733-733	733	1
<i>Rhinoliparis attenuatus</i>	0.10	12	410-1065	881	8
<i>Bathypheia australis</i>	0.09	60	215-444	281	4
<i>Actinernus</i> sp.	0.09	1	703-703	703	1
<i>Japetella diaphana</i>	0.09	1	202-202	202	1
<i>Lampanyctus</i> sp.	0.09	1	834-834	834	1
<i>Craniella cranium</i>	0.09	4	215-217	216	2
<i>Ophiura quadrispina</i>	0.09	363	406-406	406	1
<i>Serripes groenlandicus</i>	0.09	1	305-305	305	1
<i>Lophaster</i> sp.	0.09	3	487-619	553	2
<i>Pagurus rathbuni</i>	0.08	6	631-631	631	1
<i>Pseudostichopus mollis</i>	0.08	1	538-538	538	1
<i>Neoesperiopsis digitata</i>	0.08	1	258-258	258	1
<i>Emplectonema</i> sp.	0.08	3	207-567	364	3
<i>Neognathophausia gigas</i>	0.08	22	547-1132	871	13
<i>Chorilia longipes</i>	0.07	10	217-628	433	8
<i>Henricia</i> sp. B	0.07	2	208-444	326	2
<i>Bathyraja taranetzi</i> egg case	0.07	6	215-1059	608	4
<i>Muriceides</i> sp. cf. <i>cylindrica</i>	0.07	1	1048-1048	1048	1
<i>Notostomus japonicus</i>	0.07	3	488-1149	901	3
<i>Pteraster</i> sp.	0.07	4	215-1149	832	3
<i>Cyclocardia</i> sp. cf. <i>borealis</i>	0.06	16	452-452	452	1
<i>Terebratulina unguicula</i>	0.06	8	217-226	222	2
<i>Lebbeus groenlandicus</i>	0.06	6	616-847	695	3
<i>Polymastia robusta</i>	0.06	2	207-207	207	1
<i>Poromitra curilensis</i>	0.06	3	609-733	655	3
<i>Acharax johnsoni</i>	0.05	5	430-637	561	3
<i>Bathyagonus</i> sp.	0.05	2	547-547	547	1
Gorgonacea	0.05	1	608-608	608	1
<i>Diaphus theta</i>	0.05	3	405-737	588	3

Table 6. - - Continued.

Species name	Total weight (kg)	Total number	Min-Max depth caught (m)	Mean bottom depth (m)	Frequency of occurrence (hauls)
<i>Bivalvia</i>	0.05	7	1102-1102	1102	1
<i>Zesticelus profundorum</i>	0.05	18	747-1149	963	9
<i>Notostomobdella cyclostoma</i>	0.05	13	207-737	470	9
<i>Careproctus bowersianus</i>	0.04	3	444-847	646	2
<i>Serripes notabilis</i>	0.04	1	258-258	258	1
<i>Solaster</i> sp. E	0.04	1	518-518	518	1
<i>Crossaster papposus</i>	0.04	2	244-244	244	1
Thoracica	0.04	1	320-320	320	1
<i>Ancistrolepis eucosmius</i>	0.04	9	221-452	313	5
<i>Asteronyx</i> sp.	0.04	1	413-413	413	1
Pycnogonida	0.04	18	296-965	584	11
<i>Henricia derjugini</i>	0.04	1	732-732	732	1
<i>Synallactes challengerii</i>	0.04	1	252-252	252	1
<i>Icelus euryops</i>	0.03	6	296-440	379	3
<i>Chlamys albida</i>	0.03	2	217-217	217	1
Holothuroidea	0.03	3	401-628	515	2
<i>Bothrocara pusillum</i>	0.03	5	286-305	296	2
<i>Beroe</i> sp.	0.03	1	410-410	410	1
<i>Colus herendeenii</i>	0.03	2	236-305	271	2
<i>Odontohenricia fisheri</i>	0.03	1	965-965	965	1
<i>Cerebratulus californienesis</i>	0.03	3	454-475	465	2
<i>Bentheogennema borealis</i>	0.03	13	597-1132	883	10
<i>Colossendeis</i> sp.	0.03	11	475-1065	697	6
<i>Florometra inexpectata</i>	0.03	3	413-413	413	1
<i>Bulbus fragilis</i>	0.03	4	236-256	249	3
<i>Eualus</i> sp.	0.03	11	416-725	575	5
Hormathiidae	0.03	3	406-410	408	2
<i>Rhinoliparis</i> sp.	0.03	6	416-919	669	5
<i>Benthalbella dentata</i>	0.03	1	814-814	814	1
<i>Vampyroteuthis infernalis</i>	0.03	1	608-608	608	1
<i>Stegophiura ponderosa</i>	0.03	2	215-488	352	2
<i>Paraliparis dactylosus</i>	0.02	3	628-834	731	2
<i>Delectopecten vancouverensis</i>	0.02	7	683-1065	899	4
<i>Gorgonocephalus</i> sp.	0.02	1	847-847	847	1
<i>Placiphorella pacifica</i>	0.02	3	444-847	646	2
<i>Bathyraja</i> sp. egg case	0.02	1	1059-1059	1059	1
<i>Paraliparis ulochir</i>	0.02	2	859-859	859	1
<i>Hymenodora frontalis</i>	0.02	9	820-1059	996	4
<i>Dendronotus</i> sp.	0.02	1	256-256	256	1
<i>Ophiolebes pachybactra</i>	0.02	11	444-444	444	1
<i>Bathyraja lindbergi</i> egg case	0.02	2	449-449	449	1
Sipuncula	0.02	2	629-1065	847	2
<i>Bathyagonus alascanus</i>	0.02	2	201-220	211	2
<i>Careproctus</i> sp. G	0.02	1	1149-1149	1149	1
<i>Avocettina infans</i>	0.02	1	801-801	801	1
<i>Bryozoichthys marjorius</i>	0.02	1	226-226	226	1
<i>Pandalopsis</i> sp.	0.02	3	444-637	541	2
Phascolosomatidae	0.02	3	320-737	529	2
Polychaeta	0.01	1	497-497	497	1
<i>Pandalopsis ampla</i>	0.01	2	738-837	788	2
<i>Paralomis</i> sp. A	0.01	1	945-945	945	1

Table 6. - - Continued.

Species name	Total weight (kg)	Total number	Min-Max depth caught (m)	Mean bottom depth (m)	Frequency of occurrence (hauls)
<i>Neomenia</i> sp.	0.01	1	345-345	345	1
<i>Euspira pallida</i>	0.01	1	449-449	449	1
<i>Aforia circinata</i>	0.01	2	201-452	327	2
<i>Otukaia kiheiziebisu</i>	0.01	1	901-901	901	1
<i>Lycodes</i> sp.	0.01	1	945-945	945	1
<i>Serpula</i> sp.	0.01	1	215-215	215	1
<i>Eualus barbatus</i>	0.01	4	286-425	361	3
<i>Munidopsis verrilli</i>	0.01	2	418-847	633	2
Gonostomatidae	0.01	2	413-1116	765	2
<i>Aspidophoroides bartoni</i>	0.01	1	227-227	227	1
<i>Paraliparis</i> sp. cf. <i>ulochir</i>	0.01	2	687-1048	868	2
<i>Beroe abyssicola</i>	0.01	1	889-889	889	1
<i>Rocinella angusta</i>	0.01	3	308-416	348	3
<i>Pandalopsis longirostris</i>	0.01	3	425-555	490	2
<i>Cranopsis</i> sp.	0.01	6	613-613	613	1
<i>Colus halli</i>	0.01	1	398-398	398	1
<i>Antiplanes thalea</i>	0.01	4	258-452	381	4
<i>Bathyraja maculata</i> egg case	0.01	1	512-512	512	1
<i>Lycenchelys</i> sp.	0.01	1	1058-1058	1058	1
<i>Scalpellum cornutum</i>	0.01	2	297-297	297	1
<i>Sergestes similis</i>	0.01	5	419-509	464	2
<i>Leptochiton</i> sp.	0.01	2	616-1021	819	2
<i>Cryptonatica aleutica</i>	0.01	3	208-256	233	3
<i>Boreotrophon alaskanus</i>	0.01	3	362-1012	707	3
Echiura	0.01	1	619-619	619	1
<i>Paraliparis paucidens</i>	0.01	1	687-687	687	1
purple striated sea anemone	0.01	1	834-834	834	1
<i>Eualus suckleyi</i>	0.01	2	555-555	555	1
<i>Pagurus ochotensis</i>	0.01	1	225-225	225	1
<i>Colus</i> sp.	0.01	2	511-847	679	2
<i>Boreoscala greenlandica</i>	0.01	1	296-296	296	1
<i>Volutomitra alaskana</i>	0.01	1	258-258	258	1
Octopodidae	0.01	1	446-446	446	1
<i>Leptychaster arcticus</i>	0.01	1	208-208	208	1
<i>Ophiura sarsi</i>	0.01	2	406-526	466	2
<i>Lethasterias nanimensis</i>	>0.01	1	281-281	281	1
<i>Crangon alaskensis</i>	>0.01	1	268-268	268	1
<i>Crangon communis</i>	>0.01	3	214-214	214	1
<i>Acanthephyra curtirostris</i>	>0.01	4	889-889	889	1
Nudibranchia	>0.01	2	406-416	411	2
<i>Colga pacifica</i>	>0.01	1	616-616	616	1
<i>Scabrotrophon scitulus</i>	>0.01	1	233-233	233	1
Platyroctidae	>0.01	1	419-419	419	1
Mysidae	>0.01	2	1012-1012	1012	1
<i>Lebbeus</i> sp.	>0.01	1	1149-1149	1149	1
<i>Gersemia</i> sp.	>0.01	1	853-853	853	1
<i>Spinther</i> sp. A	>0.01	1	416-416	416	1
<i>Crangon</i> sp.	>0.01	3	279-279	279	1
<i>Metacrangon variabilis</i>	>0.01	1	279-279	279	1
<i>Pagurus brandti</i>	>0.01	1	207-207	207	1
<i>Pagurus dalli</i>	>0.01	1	244-244	244	1

Table 6. - - Continued.

Species name	Total weight (kg)	Total number	Min-Max depth caught (m)	Mean bottom depth (m)	Frequency of occurrence (hauls)
<i>Munidopsis</i> sp.	>0.01	1	847-847	847	1
<i>Placiphorella</i> sp.	>0.01	1	853-853	853	1
<i>Puncturella rothi</i>	>0.01	1	847-847	847	1
<i>Boreotrophon rotundatus</i>	>0.01	1	362-362	362	1
<i>Ancistrolepis bicinctus</i>	>0.01	1	901-901	901	1
<i>Acila castrensis</i>	>0.01	1	1065-1065	1065	1
<i>Leptychaster anomalus</i>	>0.01	1	267-267	267	1
<i>Ophiopholis longispina</i>	>0.01	2	1048-1048	1048	1
<i>Psolus</i> sp.	>0.01	1	416-416	416	1
<i>Frieleia halli</i>	>0.01	1	837-837	837	1
<i>Cryptonatica affinis</i>	>0.01	1	398-398	398	1
<i>Amphiodia</i> sp.	>0.01	3	512-512	512	1

Table 7. - - Summary of biological data collected during the 2010 EBSS survey.

Scientific name	Individuals measured	Otoliths collected	Individual weights	Stomach samples	Tag & release
<i>Albatrossia pectoralis</i>	8,990	516	515		
<i>Hippoglossoides elassodon</i>	7,269				
<i>Sebastolobus alascanus</i>	6,823			108	
<i>Atheresthes stomias</i>	6,662	777	773	387	
<i>Coryphaenoides cinereus</i>	6,333	99	110		
<i>Atheresthes evermanni</i>	4,903				
<i>Glyptocephalus zachirus</i>	3,708				
<i>Sebastes alutus</i>	3,348	442	442		
<i>Chionoectes angulatus</i>	3,137				
<i>Bothrocara zestum</i>	3,073				
<i>Chionoectes bairdi</i>	2,195				
<i>Berryteuthis magister</i>	1,704				
<i>Coryphaenoides acrolepis</i>	1,680	235	235		
<i>Theragra chalcogramma</i>	1,585			182	
<i>Malacocottus zonurus</i>	1,538				
<i>Bathyraja aleutica</i>	1,492		95		
<i>Reinhardtius hippoglossoides</i>	1,485	522	521	203	
<i>Chionoectes tanneri</i>	1,389				
<i>Lithodes aequispinus</i>	803				
<i>Lycodes beringi</i>	778				
<i>Anoplopoma fimbria</i>	700				
<i>Dasycottus setiger</i>	639	118	118		
<i>Lycodes concolor</i>	631	183	183		
<i>Bathyraja interrupta</i>	572		20		
<i>Gadus macrocephalus</i>	535			142	
<i>Bothrocara brunneum</i>	410				
<i>Bathyraja maculata</i>	395		196		
<i>Bathyraja lindbergi</i>	389		267		
<i>Sebastes borealis</i>	295	244	245	46	
<i>Bathyraja minispinosa</i>	295		135		
<i>Careproctus melanurus</i>	269				
<i>Chionoectes opilio</i>	254				
<i>Hemitripteris bolini</i>	187		112		
<i>Sebastes melanostictus</i>	182	176	176	8	
<i>Hippoglossus stenolepis</i>	169				
<i>Lithodes couesi</i>	168				
<i>Bathyraja trachura</i>	154		66		
<i>Embassichthys bathybius</i>	135				
<i>Rossia pacifica</i>	134				

Table 7. - - Continued.

Scientific name	Individuals measured	Otoliths collected	Individual weights	Stomach samples	Tag & release
<i>Psychrolutes phrictus</i>	129		81		
<i>Bathyraja taranetzi</i>	127		58		
<i>Microstomus pacificus</i>	121				
<i>Sasakiopus salebrosus</i>	106				
<i>Sebastes aleutianus</i>	85	86	86	11	
<i>Antimora microlepis</i>	83		45		
<i>Paralomis multispina</i>	77				
<i>Lepidopsetta polyxystra</i>	71				
<i>Enteroctopus dofleini</i>	61				
<i>Benthoctopus leioderma</i>	59				
<i>Zaprora silenus</i>	57				
<i>Bathyraja parmifera</i>	48				44
<i>Aptocyclus ventricosus</i>	48		28		
<i>Opisthoteuthis californiana</i>	34				
<i>Graneledone boreopacifica</i>	33				
<i>Lycenchelys crotalinus</i>	22		3		
<i>Somniosus pacificus</i>	21		21		21
<i>Gonatopsis borealis</i>	18				
<i>Sebastes variabilis</i>	16			5	
<i>Benthoctopus</i> species	13				
<i>Sebastes polyspinis</i>	10			3	
<i>Benthoctopus oregonensis</i>	5				
<i>Myoxocephalus polyacanthocephalus</i>	5				
<i>Oncorhynchus keta</i>	5				
<i>Paralomis verrilli</i>	5				
<i>Erimacrus isenbeckii</i>	5				
<i>Bathyraja abyssicola</i>	3				
<i>Gonatus</i> species	3				
Teuthoidea	2				
<i>Gonatus onyx</i>	2				
<i>Gonatus madokai</i>	2				
<i>Galiteuthis phyllura</i>	2				
<i>Oncorhynchus tshawytscha</i>	1				
octopus species	1				
<i>Japetella diaphana</i>	1				
<i>Vampyroteuthis infernalis</i>	1				
<i>Gonatus middendorffi</i>	1				
<i>Chiroteuthis calyx</i>	1				
<i>Taonius pavo</i>	1				
Totals	76,693	3,398	4,531	1,095	65

Table 8. - - Summary of vouchers specimens collected during the 2010 EBSS survey.
One lot consists of an individual or group of individuals of a single species.

Species name	Lots	Species name	Lots
<i>Bathyraja</i> species	1	<i>Paraliparis</i> species cf. <i>pectoralis</i>	1
<i>Bathyraja taranetzi</i>	1	<i>Poromitra curilensis</i>	1
<i>Bathyraja taranetzi</i> egg case	5	<i>Melamphaes lugubris</i>	1
<i>Bathyraja trachura</i> egg case	8	<i>Nannobrachium regale</i>	1
<i>Bathyraja lindbergi</i> egg case	1	<i>Polyacanthonotus challengerii</i>	1
<i>Bathyraja minispinosa</i> egg case	15	<i>Benthalbella dentata</i>	1
Gonostomatidae	1	<i>Scopelosaurus harryi</i>	1
Liparidinae	26	<i>Lumpenella longirostris</i>	1
<i>Merluccius productus</i>	1	<i>Bryozoichthys marjorius</i>	1
<i>Sebastes reedi</i>	1	<i>Zaprora silenus</i>	2
<i>Neptunea</i> species	1	<i>Bothrocara pusillum</i>	1
Ophiuroidea	1	<i>Bothrocara nyx</i>	5
<i>Bathygonus alascanus</i>	1	<i>Lycenchelys</i> species	1
<i>Rouleina attrita</i>	1	<i>Lycodes</i> species	1
<i>Bathylagus ochotensis</i>	2	<i>Bothrocara</i> species	4
<i>Bathymaster signatus</i>	4	<i>Lycodapus</i> species	39
<i>Coryphaenoides acrolepis</i>	2	<i>Puzanovia rubra</i>	1
<i>Coryphaenoides longifilis</i>	1	<i>Sebastolobus altivelis</i>	1
<i>Halargyreus johnsonii</i>	1	<i>Sebastes babcocki</i>	1
<i>Elassodiscus</i> species	1	<i>Onchidiopsis</i> species	1
<i>Elassodiscus caudatus</i>	2	<i>Beringius frielei</i>	1
<i>Elassodiscus tremebundus</i>	1	<i>Neptunea amianta</i>	4
<i>Careproctus</i> species	6	<i>Neptunea insularis</i>	3
<i>Careproctus bowersianus</i>	2	<i>Buccinum</i> species	1
<i>Careproctus simus</i>	4	<i>Buccinum oedematum</i>	1
<i>Careproctus gilberti</i>	3	<i>Benthooctopus</i> species	1
<i>Careproctus rastrinus</i>	2	<i>Henricia</i> species	1
<i>Paraliparis dactylosus</i>	2	<i>Henricia asthenactis</i>	1
<i>Paraliparis cephalus</i>	1	<i>Odontohenricia fisheri</i>	1
<i>Careproctus</i> species	1	<i>Henricia beringiana</i>	1
<i>Paraliparis</i> species	6	<i>Hippasteria</i> species	1
<i>Paraliparis paucidens</i>	1	<i>Hippasteria armata</i>	1
<i>Rhinoliparis</i> species	5	<i>Mediaster tenellus</i>	1
<i>Rhinoliparis attenuatus</i>	5	<i>Solaster</i> species C	2
<i>Paraliparis</i> species cf. <i>dactylosus</i>	5	<i>Crossaster</i> species A	1
<i>Paraliparis</i> species cf. <i>ulochir</i>	2	<i>Nearchaster</i> species	1

Table 9. - - Biomass, population, CPUE and variance estimates of all fishes and invertebrates encountered during the 2010 EBSS survey. Species are listed alphabetically by scientific name.

Species	Stratum		Biomass		Population		CPUE		CPUE	
	(m)	(t)	Variance	Number	Variance	kg/ha	Variance	no./ha	Variance	
<i>Acanthephyra curtirostris</i>	200-600	0.00E+00	0.00E+00	0.00E+00	0.00E+00	0.00E+00	0.00E+00	0.00E+00	0.00E+00	
	600-1200	3.30E-02	0.00E+00	0.00E+00	1.09E+09	2.22E-05	3.40E-08	2.22E-02	3.40E-02	
	All Depths	3.30E-02	1.09E-03	3.30E+04	1.09E+09	7.66E-06	1.17E-08	7.66E-03	1.17E-02	
<i>Acharax johnsoni</i>	200-600	2.63E-02	6.94E-04	3.29E+03	1.08E+07	1.42E-05	2.62E-08	1.77E-03	4.10E-04	
	600-1200	1.16E-01	9.14E-03	1.05E+04	6.50E+07	1.47E-04	1.06E-06	1.33E-02	7.73E-03	
	All Depths	1.43E-01	9.84E-03	1.38E+04	7.59E+07	6.00E-05	3.84E-07	5.75E-03	2.94E-03	
<i>Acila castrensis</i>	200-600	0.00E+00	0.00E+00	0.00E+00	0.00E+00	0.00E+00	0.00E+00	0.00E+00	0.00E+00	
	600-1200	2.05E-02	0.00E+00	0.00E+00	1.05E+08	8.06E-06	4.48E-09	4.03E-03	1.12E-03	
	All Depths	2.05E-02	4.21E-04	1.03E+04	1.05E+08	2.78E-06	1.55E-09	1.39E-03	3.87E-04	
Actinariidae	200-600	0.00E+00	0.00E+00	0.00E+00	0.00E+00	0.00E+00	0.00E+00	0.00E+00	0.00E+00	
	600-1200	0.00E+00	0.00E+00	0.00E+00	0.00E+00	0.00E+00	0.00E+00	0.00E+00	0.00E+00	
	All Depths	4.53E-02	2.05E-03	7.55E+03	5.70E+07	8.36E-06	1.40E-08	1.39E-03	3.88E-04	
<i>Actinauge verrilli</i>	200-600	6.29E+01	5.47E+02	9.16E+05	1.37E+11	3.02E-02	1.33E-02	4.32E-01	3.18E+00	
	600-1200	6.09E+01	1.45E+03	5.71E+06	2.19E+13	4.33E-02	5.49E-02	4.45E+00	9.91E+02	
	All Depths	1.24E+02	2.00E+03	6.63E+06	2.20E+13	3.47E-02	2.75E-02	1.82E+00	3.44E+02	
Actinernus species	200-600	0.00E+00	0.00E+00	0.00E+00	0.00E+00	0.00E+00	0.00E+00	0.00E+00	0.00E+00	
	600-1200	2.72E-01	0.00E+00	0.00E+00	9.10E+06	3.43E-04	8.12E-06	3.81E-03	1.00E-03	
	All Depths	2.72E-01	7.37E-02	3.02E+03	9.10E+06	1.18E-04	2.80E-06	1.32E-03	3.46E-04	
Actiniaria	200-600	1.67E+00	8.97E-01	5.15E+04	4.16E+08	6.69E-04	1.68E-05	2.08E-02	9.86E-03	
	600-1200	6.93E-01	3.95E-01	1.36E+04	9.21E+07	4.00E-04	9.25E-06	7.52E-03	1.93E-03	
	All Depths	2.36E+00	1.29E+00	6.51E+04	5.08E+08	5.76E-04	1.41E-05	1.62E-02	7.14E-03	
<i>Actinistola</i> species A	200-600	6.86E-01	0.00E+00	0.00E+00	2.87E+07	2.42E-04	7.68E-06	1.89E-03	4.68E-04	
	600-1200	0.00E+00	0.00E+00	0.00E+00	0.00E+00	0.00E+00	0.00E+00	0.00E+00	0.00E+00	
	All Depths	6.86E-01	4.70E-01	5.36E+03	2.87E+07	1.59E-04	5.03E-06	1.24E-03	3.07E-04	
<i>Actinoscyphia</i> species	200-600	0.00E+00	0.00E+00	0.00E+00	0.00E+00	0.00E+00	0.00E+00	0.00E+00	0.00E+00	
	600-1200	2.17E+02	0.00E+00	0.00E+00	1.01E+14	1.06E-01	4.35E-01	6.38E+00	1.73E+03	
	All Depths	2.17E+02	2.59E+04	1.29E+07	1.01E+14	3.64E-02	1.51E-01	2.20E+00	6.02E+02	
Actinostolidae	200-600	3.93E+02	6.46E+04	1.22E+07	6.57E+13	1.48E-01	1.13E+00	4.43E+00	1.15E+03	
	600-1200	3.24E+01	7.10E+02	8.08E+05	4.21E+11	3.80E-02	7.93E-02	9.49E-01	4.68E+01	
	All Depths	4.25E+02	6.53E+04	1.30E+07	6.61E+13	1.11E-01	7.72E-01	3.24E+00	7.72E+02	
<i>Actinurnis</i> species	200-600	0.00E+00	0.00E+00	0.00E+00	0.00E+00	0.00E+00	0.00E+00	0.00E+00	0.00E+00	
	600-1200	1.35E+00	0.00E+00	0.00E+00	8.19E+07	1.70E-03	2.00E-04	1.14E-02	9.03E-03	
	All Depths	1.35E+00	1.81E+00	9.05E+03	8.19E+07	5.87E-04	6.88E-05	3.95E-03	3.11E-03	
<i>Aequorea</i> species	200-600	1.15E+01	9.76E+00	7.97E+04	3.68E+08	5.72E-03	2.67E-04	4.08E-02	1.08E-02	
	600-1200	4.65E-01	2.16E-01	6.12E+03	3.74E+07	2.44E-04	4.11E-06	3.21E-03	7.12E-04	
	All Depths	1.19E+01	9.98E+00	8.58E+04	4.05E+08	3.83E-03	1.83E-04	2.78E-02	7.64E-03	

Table 9. - - Continued.

Species	Stratum		Biomass		Population		CPUE		CPUE	
	(meters)	(t)	Variance	Number	Variance	kg/ha	Variance	no./ha	Variance	
<i>Aforia circinata</i>	200-600	9.35E-02	0.00E+00	0.00E+00	5.44E+07	4.43E-05	8.87E-08	5.95E-03	1.54E-03	
	600-1200	0.00E+00	0.00E+00	0.00E+00	0.00E+00	0.00E+00	0.00E+00	0.00E+00	0.00E+00	
	All Depths	9.35E-02	3.03E-03	1.27E+04	5.44E+07	2.90E-05	5.84E-08	3.90E-03	1.02E-03	
<i>Albatrossia pectoralis</i>	200-600	1.42E+05	5.59E+08	3.38E+07	3.87E+13	7.98E+01	3.69E+04	1.83E+01	1.92E+03	
	600-1200	5.19E+05	4.31E+09	1.59E+08	4.50E+14	3.85E+02	2.45E+05	1.17E+02	2.22E+04	
	All Depths	6.61E+05	4.86E+09	1.93E+08	4.89E+14	1.85E+02	1.29E+05	5.24E+01	1.10E+04	
<i>Alcyonidium pedunculatum</i>	200-600	6.11E-01	1.69E-01	2.99E+03	8.69E+06	3.19E-05	1.32E-07	2.00E-03	5.14E-04	
	600-1200	0.00E+00	0.00E+00	0.00E+00	0.00E+00	0.00E+00	0.00E+00	0.00E+00	0.00E+00	
	All Depths	6.11E-01	1.69E-01	2.99E+03	8.69E+06	3.19E-05	1.32E-07	2.00E-03	5.14E-04	
<i>Alepisaurus ferrox</i>	200-600	1.49E+00	0.00E+00	0.00E+00	6.31E+06	1.29E-03	2.17E-04	2.18E-03	6.20E-04	
	600-1200	0.00E+00	0.00E+00	0.00E+00	0.00E+00	0.00E+00	0.00E+00	0.00E+00	0.00E+00	
	All Depths	1.49E+00	2.21E+00	2.51E+03	6.31E+06	8.44E-04	1.42E-04	1.43E-03	4.06E-04	
<i>Allocentrotus fragilis</i>	200-600	1.48E+02	0.00E+00	0.00E+00	1.19E+11	6.67E-02	4.68E-02	5.16E-01	3.12E+00	
	600-1200	0.00E+00	0.00E+00	0.00E+00	0.00E+00	0.00E+00	0.00E+00	0.00E+00	0.00E+00	
	All Depths	1.48E+02	1.42E+03	1.15E+06	1.19E+11	4.37E-02	3.16E-02	3.38E-01	2.10E+00	
<i>Amphilaphis species</i>	200-600	2.73E+01	0.00E+00	0.00E+00	1.05E+08	4.77E-04	9.65E-06	9.04E-03	3.70E-03	
	600-1200	0.00E+00	0.00E+00	0.00E+00	0.00E+00	0.00E+00	0.00E+00	0.00E+00	0.00E+00	
	All Depths	2.73E+01	4.29E+02	1.66E+04	1.05E+08	3.10E-04	6.30E-06	5.88E-03	2.42E-03	
<i>Amphiodia species</i>	200-600	3.06E-03	9.34E-06	9.17E+03	8.41E+07	2.07E-06	5.60E-10	6.20E-03	5.04E-03	
	600-1200	0.00E+00	0.00E+00	0.00E+00	0.00E+00	0.00E+00	0.00E+00	0.00E+00	0.00E+00	
	All Depths	3.06E-03	9.34E-06	9.17E+03	8.41E+07	2.07E-06	5.60E-10	6.20E-03	5.04E-03	
Amphipoda	200-600	8.79E-01	0.00E+00	0.00E+00	5.39E+11	5.94E-04	4.63E-05	4.96E-01	3.23E+01	
	600-1200	0.00E+00	0.00E+00	0.00E+00	0.00E+00	0.00E+00	0.00E+00	0.00E+00	0.00E+00	
	All Depths	8.79E-01	7.72E-01	7.34E+05	5.39E+11	3.89E-04	3.03E-05	3.25E-01	2.11E+01	
<i>Ancistrolepis bicornis</i>	200-600	0.00E+00	0.00E+00	0.00E+00	0.00E+00	0.00E+00	0.00E+00	0.00E+00	0.00E+00	
	600-1200	1.22E-02	0.00E+00	0.00E+00	3.74E+07	6.43E-06	2.85E-09	3.21E-03	7.12E-04	
	All Depths	1.22E-02	1.50E-04	6.12E+03	3.74E+07	2.22E-06	9.83E-10	1.11E-03	2.46E-04	
<i>Ancistrolepis euosmius</i>	200-600	1.23E-01	0.00E+00	0.00E+00	1.91E+08	7.70E-05	2.25E-07	1.77E-02	1.39E-02	
	600-1200	0.00E+00	0.00E+00	0.00E+00	0.00E+00	0.00E+00	0.00E+00	0.00E+00	0.00E+00	
	All Depths	1.23E-01	3.48E-03	2.73E+04	1.91E+08	5.05E-05	1.48E-07	1.16E-02	9.18E-03	
<i>Anoplopoma fimbria</i>	200-600	2.36E+03	2.82E+05	8.36E+05	3.10E+10	1.55E+00	1.96E+01	5.50E-01	2.21E+00	
	600-1200	7.31E+03	1.50E+06	2.01E+06	9.73E+10	6.35E+00	9.89E+01	1.76E+00	6.44E+00	
	All Depths	9.67E+03	1.78E+06	2.85E+06	1.28E+11	3.21E+00	5.18E+01	9.68E-01	3.98E+00	
<i>Anthomastus species</i>	200-600	0.00E+00	0.00E+00	0.00E+00	0.00E+00	0.00E+00	0.00E+00	0.00E+00	0.00E+00	
	600-1200	1.08E+02	0.00E+00	0.00E+00	1.78E+12	5.79E-02	2.31E-01	7.18E-01	3.52E+01	
	All Depths	1.08E+02	1.17E+04	1.34E+06	1.78E+12	2.00E-02	7.97E-02	2.48E-01	1.21E+01	
<i>Anthoptilum murrayi</i>	200-600	0.00E+00	0.00E+00	0.00E+00	0.00E+00	0.00E+00	0.00E+00	0.00E+00	0.00E+00	
	600-1200	3.01E+02	0.00E+00	0.00E+00	1.81E+15	1.53E-01	1.62E+00	2.16E+01	3.23E+04	
	All Depths	3.01E+02	9.07E+04	4.25E+07	1.81E+15	5.28E-02	5.58E-01	7.46E+00	1.11E+04	

Table 9. -- Continued.

Species	Stratum			Biomass			Population			CPUE		
	(meters)	(t)	Variance	Number	Variance	kg/ha	Variance	no./ha	Variance			
<i>Antimora microlepis</i>	200-600	0.00E+00	0.00E+00	0.00E+00	0.00E+00	0.00E+00	0.00E+00	0.00E+00	0.00E+00	0.00E+00	0.00E+00	
	600-1200	2.66E+02	0.00E+00	0.00E+00	1.50E+10	1.38E-01	8.87E-02	3.32E-01	5.38E-01			
	All Depths	2.66E+02	2.77E+03	6.38E+05	1.50E+10	4.75E-02	3.46E-02	1.15E-01	2.09E-01			
<i>Antiplanes thalea</i>	200-600	3.38E-02	0.00E+00	0.00E+00	4.88E+07	2.03E-05	1.49E-08	8.08E-03	2.09E-03			
	600-1200	0.00E+00	0.00E+00	0.00E+00	0.00E+00	0.00E+00	0.00E+00	0.00E+00	0.00E+00			
	All Depths	3.38E-02	3.01E-04	1.39E+04	4.88E+07	1.33E-05	9.82E-09	5.29E-03	1.38E-03			
<i>Aphrocallistes vastus</i>	200-600	8.21E+02	5.80E+04	1.23E+04	3.54E+07	1.27E-03	5.92E-05	8.38E-03	2.14E-03			
	600-1200	6.65E+03	4.32E+07	5.07E+03	2.57E+07	2.92E-04	4.27E-06	4.72E-03	1.11E-03			
	All Depths	7.47E+03	4.33E+07	1.74E+04	6.11E+07	1.56E-03	6.35E-05	1.31E-02	3.25E-03			
<i>Aphrodita negligens</i>	200-600	2.33E+02	4.63E+03	1.35E+07	1.44E+13	1.08E-01	1.43E-01	6.68E+00	4.84E+02			
	600-1200	2.94E+01	8.40E+01	1.60E+06	2.68E+11	2.97E-02	7.02E-03	1.60E+00	2.35E+01			
	All Depths	2.63E+02	4.71E+03	1.51E+07	1.46E+13	8.08E-02	9.70E-02	4.93E+00	3.30E+02			
<i>Aphrodita</i> species	200-600	1.84E+01	0.00E+00	0.00E+00	1.26E+11	9.43E-03	8.88E-03	2.36E-01	4.29E+00			
	600-1200	0.00E+00	0.00E+00	0.00E+00	0.00E+00	0.00E+00	0.00E+00	0.00E+00	0.00E+00			
	All Depths	1.84E+01	2.38E+02	4.90E+05	1.26E+11	6.18E-03	5.82E-03	1.54E-01	2.81E+00			
<i>Aptocyclus ventricosus</i>	200-600	1.10E+02	1.98E+03	1.30E+05	2.99E+09	5.39E-02	4.68E-02	5.69E-02	6.62E-02			
	600-1200	1.21E+02	1.50E+03	1.74E+05	2.60E+09	8.68E-02	4.41E-02	1.25E-01	7.73E-02			
	All Depths	2.32E+02	3.48E+03	3.04E+05	5.58E+09	6.53E-02	4.59E-02	8.03E-02	7.07E-02			
<i>Archidoris odhneri</i>	200-600	6.47E-01	0.00E+00	0.00E+00	6.37E+08	2.99E-04	6.46E-06	1.78E-02	2.10E-02			
	600-1200	0.00E+00	0.00E+00	0.00E+00	0.00E+00	0.00E+00	0.00E+00	0.00E+00	0.00E+00			
	All Depths	6.47E-01	2.02E-01	3.86E+04	6.37E+08	1.96E-04	4.24E-06	1.17E-02	1.38E-02			
<i>Arctomelon species cf. stearnsii</i>	200-600	2.84E-01	0.00E+00	0.00E+00	3.11E+07	1.92E-04	4.84E-06	3.77E-03	1.86E-03			
	600-1200	0.00E+00	0.00E+00	0.00E+00	0.00E+00	0.00E+00	0.00E+00	0.00E+00	0.00E+00			
	All Depths	2.84E-01	8.08E-02	5.57E+03	3.11E+07	1.26E-04	3.17E-06	2.47E-03	1.22E-03			
<i>Arctomelon stearnsii</i>	200-600	5.90E+00	1.64E+00	1.07E+05	4.89E+08	3.29E-03	7.68E-05	6.11E-02	2.68E-02			
	600-1200	1.29E+00	2.88E-01	2.25E+04	9.14E+07	1.42E-03	2.84E-05	2.47E-02	8.97E-03			
	All Depths	7.19E+00	1.93E+00	1.29E+05	5.80E+08	2.64E-03	6.07E-05	4.85E-02	2.09E-02			
<i>Argis dentata</i>	200-600	1.43E+00	1.09E-01	3.59E+05	7.20E+09	6.91E-04	3.49E-06	1.78E-01	2.50E-01			
	600-1200	1.25E-02	1.56E-04	3.12E+03	9.73E+06	1.35E-05	1.26E-08	3.37E-03	7.86E-04			
	All Depths	1.44E+00	1.09E-01	3.62E+05	7.21E+09	4.57E-04	2.39E-06	1.18E-01	1.71E-01			
Ascidiacea	200-600	2.16E-01	4.66E-02	1.20E+04	1.44E+08	1.82E-04	4.35E-06	1.01E-02	1.34E-02			
	600-1200	3.71E-01	1.38E-01	1.77E+04	3.13E+08	1.99E-04	2.72E-06	9.46E-03	6.17E-03			
	All Depths	5.87E-01	1.84E-01	2.97E+04	4.56E+08	1.88E-04	3.77E-06	9.90E-03	1.09E-02			
<i>Aspidophoroides bartoni</i>	200-600	5.60E-02	0.00E+00	0.00E+00	3.14E+07	1.98E-05	5.12E-08	1.98E-03	5.12E-04			
	600-1200	0.00E+00	0.00E+00	0.00E+00	0.00E+00	0.00E+00	0.00E+00	0.00E+00	0.00E+00			
	All Depths	5.60E-02	3.14E-03	5.60E+03	3.14E+07	1.29E-05	3.35E-08	1.29E-03	3.35E-04			
<i>Asteronyx loveni</i>	200-600	6.84E+02	0.00E+00	0.00E+00	1.72E+14	2.62E-01	3.02E+00	7.81E+00	3.08E+03			
	600-1200	0.00E+00	0.00E+00	0.00E+00	0.00E+00	0.00E+00	0.00E+00	0.00E+00	0.00E+00			
	All Depths	6.84E+02	1.63E+05	2.09E+07	1.72E+14	1.72E-01	1.99E+00	5.11E+00	2.02E+03			

Table 9. -- Continued.

Species	Stratum		Biomass		Population		CPUE		CPUE	
	(meters)	(t)	Variance	Number	Variance	kg/ha	Variance	no./ha	Variance	
<i>Asteronyx</i> species	200-600	1.08E+01	0.00E+00	0.00E+00	8.11E+06	7.32E+05	7.02E-07	1.93E-03	4.86E-04	
	600-1200	0.00E+00	0.00E+00	0.00E+00	0.00E+00	0.00E+00	0.00E+00	0.00E+00	0.00E+00	
	All Depths	1.08E-01	1.17E-02	2.85E+03	8.11E+06	4.80E-05	4.60E-07	1.26E-03	3.18E-04	
<i>Atheresthes evermanni</i>	200-600	2.13E+04	7.13E+06	1.84E+07	5.23E+12	1.23E+01	3.77E+02	1.00E+01	2.20E+02	
	600-1200	6.55E+03	6.90E+05	3.59E+06	2.95E+11	6.51E+00	9.21E+01	3.71E+00	4.15E+01	
	All Depths	2.79E+04	7.82E+06	2.20E+07	5.53E+12	1.03E+01	2.85E+02	7.85E+00	1.67E+02	
<i>Atheresthes stomias</i>	200-600	7.35E+04	1.19E+08	7.05E+07	1.05E+14	3.57E+01	4.01E+03	3.31E+01	3.56E+03	
	600-1200	5.50E+02	3.18E+04	2.95E+05	9.62E+09	6.46E-01	4.34E+00	3.48E-01	1.34E+00	
	All Depths	7.41E+04	1.19E+08	7.08E+07	1.05E+14	2.35E+01	2.89E+03	2.18E+01	2.57E+03	
<i>Arolla</i> species	200-600	4.29E-01	6.28E-02	1.91E+04	8.21E+07	2.79E-04	2.85E-06	1.33E-02	4.92E-03	
	600-1200	1.15E+01	1.54E+01	4.48E+05	4.33E+09	6.28E-03	2.83E-04	2.69E-01	1.65E-01	
	All Depths	1.19E+01	1.54E+01	4.67E+05	4.42E+09	2.35E-03	1.07E-04	1.02E-01	7.45E-02	
<i>Aulosaccus schulzei</i>	200-600	2.37E+02	2.94E+04	2.52E+04	2.24E+08	5.69E-02	2.74E-01	1.91E-02	1.89E-02	
	600-1200	9.73E+00	4.44E+01	8.49E+03	5.76E+07	3.69E-03	9.26E-04	8.44E-03	4.85E-03	
	All Depths	2.47E+02	2.94E+04	3.36E+04	2.82E+08	6.06E-02	2.75E-01	2.76E-02	2.37E-02	
<i>Aurelia</i> species	200-600	5.12E+00	0.00E+00	0.00E+00	1.77E+08	2.60E-03	2.70E-04	9.83E-03	3.49E-03	
	600-1200	0.00E+00	0.00E+00	0.00E+00	0.00E+00	0.00E+00	0.00E+00	0.00E+00	0.00E+00	
	All Depths	5.12E+00	7.40E+00	2.27E+04	1.77E+08	1.70E-03	1.78E-04	6.44E-03	2.30E-03	
<i>Avocettina infans</i>	200-600	0.00E+00	0.00E+00	0.00E+00	0.00E+00	0.00E+00	0.00E+00	0.00E+00	0.00E+00	
	600-1200	1.05E-01	0.00E+00	0.00E+00	4.32E+07	5.63E-05	2.18E-07	3.52E-03	8.53E-04	
	All Depths	1.05E-01	1.11E-02	6.57E+03	4.32E+07	1.94E-05	7.53E-08	1.21E-03	2.94E-04	
<i>Balanus evermanni</i>	200-600	5.10E+00	0.00E+00	0.00E+00	6.03E+08	2.40E-03	6.23E-04	1.54E-02	1.80E-02	
	600-1200	0.00E+00	0.00E+00	0.00E+00	0.00E+00	0.00E+00	0.00E+00	0.00E+00	0.00E+00	
	All Depths	5.10E+00	2.20E+01	3.20E+04	6.03E+08	1.57E-03	4.08E-04	1.01E-02	1.18E-02	
<i>Bankia setacea</i>	200-600	4.73E-01	2.23E-01	0.00E+00	0.00E+00	0.00E+00	0.00E+00	0.00E+00	0.00E+00	
	600-1200	3.70E+00	1.37E+01	9.24E+05	8.54E+11	1.45E-03	1.45E-04	3.63E-01	9.09E+00	
	All Depths	4.17E+00	1.39E+01	9.24E+05	8.54E+11	5.03E-04	5.04E-05	1.26E-01	3.15E+00	
<i>Bathylagonus alascanus</i>	200-600	7.99E-02	0.00E+00	0.00E+00	4.52E+07	2.90E-05	7.06E-08	3.53E-03	8.13E-04	
	600-1200	0.00E+00	0.00E+00	0.00E+00	0.00E+00	0.00E+00	0.00E+00	0.00E+00	0.00E+00	
	All Depths	7.99E-02	4.27E-03	9.45E+03	4.52E+07	1.90E-05	4.63E-08	2.31E-03	5.34E-04	
<i>Bathylagonus nigripinnis</i>	200-600	2.41E+01	2.69E+01	1.68E+06	1.36E+11	1.38E-02	1.26E-03	9.59E-01	5.81E+00	
	600-1200	2.90E+01	1.88E+01	2.63E+06	1.75E+11	2.35E-02	1.10E-03	2.17E+00	9.99E+00	
	All Depths	5.31E+01	4.57E+01	4.32E+06	3.11E+11	1.71E-02	1.22E-03	1.38E+00	7.55E+00	
<i>Bathylagonus</i> species	200-600	1.65E-01	0.00E+00	0.00E+00	4.37E+07	1.12E-04	1.64E-06	4.47E-03	2.62E-03	
	600-1200	0.00E+00	0.00E+00	0.00E+00	0.00E+00	0.00E+00	0.00E+00	0.00E+00	0.00E+00	
	All Depths	1.65E-01	2.73E-02	6.61E+03	4.37E+07	7.32E-05	1.07E-06	2.93E-03	1.71E-03	
<i>Bathylagus milleri</i>	200-600	0.00E+00	0.00E+00	0.00E+00	0.00E+00	0.00E+00	0.00E+00	0.00E+00	0.00E+00	
	600-1200	7.15E+00	0.00E+00	0.00E+00	8.09E+09	4.28E-03	2.71E-04	1.27E-01	2.62E-01	
	All Depths	7.15E+00	8.29E+00	2.10E+05	8.09E+09	1.48E-03	9.69E-05	4.39E-02	9.32E-02	

Table 9. - - Continued.

Species	Stratum			Biomass			Population			CPUE			CPUE		
	(meters)	(t)	Variance	Number	Variance	kg/ha	Variance	no./ha	Variance						
<i>Bathylagus ochotensis</i>	200-600	2.09E+01	1.51E+02	1.14E+04	4.17E+07	1.01E+04	4.45E+07	5.60E+03	1.35E-03						
	600-1200	1.01E+00	5.53E-01	2.32E+04	1.84E+08	5.68E-04	1.13E-05	1.35E-02	4.26E-03						
	All Depths	1.22E+00	5.68E-01	3.46E+04	2.25E+08	2.62E-04	4.20E-06	8.33E-03	2.35E-03						
<i>Bathylagus pacificus</i>	200-600	0.00E+00	0.00E+00	0.00E+00	0.00E+00	0.00E+00	0.00E+00	0.00E+00	0.00E+00						
	600-1200	2.05E+01	0.00E+00	0.00E+00	4.63E+10	1.28E-02	1.23E-03	5.40E-01	1.92E+00						
	All Depths	2.05E+01	3.47E+01	8.60E+05	4.63E+10	4.43E-03	4.59E-04	1.86E-01	7.22E-01						
<i>Bathylagus species</i>	200-600	1.98E+00	2.86E+00	4.68E+04	1.44E+09	1.34E-03	1.73E-04	3.17E-02	8.72E-02						
	600-1200	1.29E+02	2.89E+03	3.11E+06	9.07E+11	6.59E-02	4.67E-02	1.65E+00	1.99E+01						
	All Depths	1.31E+02	2.89E+03	3.16E+06	9.09E+11	2.36E-02	1.70E-02	5.91E-01	7.46E+00						
<i>Bathymaster signatus</i>	200-600	4.97E+01	0.00E+00	0.00E+00	1.03E+10	3.23E-02	2.57E-02	1.68E-01	6.89E-01						
	600-1200	0.00E+00	0.00E+00	0.00E+00	0.00E+00	0.00E+00	0.00E+00	0.00E+00	0.00E+00						
	All Depths	4.97E+01	3.71E+02	2.59E+05	1.03E+10	2.12E-02	1.70E-02	1.10E-01	4.57E-01						
<i>Bathypheila australis</i>	200-600	6.59E-01	0.00E+00	0.00E+00	6.83E+10	3.22E-04	6.17E-06	2.05E-01	2.23E+00						
	600-1200	0.00E+00	0.00E+00	0.00E+00	0.00E+00	0.00E+00	0.00E+00	0.00E+00	0.00E+00						
	All Depths	6.59E-01	1.93E-01	4.14E+05	6.83E+10	2.11E-04	4.05E-06	1.34E-01	1.47E+00						
<i>Bathyploetes species</i>	200-600	2.69E+01	3.40E+02	5.12E+05	1.03E+11	1.43E-02	1.03E-02	3.22E-01	6.07E+00						
	600-1200	0.00E+00	0.00E+00	0.00E+00	0.00E+00	0.00E+00	0.00E+00	0.00E+00	0.00E+00						
	All Depths	2.69E+01	3.40E+02	5.12E+05	1.03E+11	1.43E-02	1.03E-02	3.22E-01	6.07E+00						
<i>Bathyraja abyssicola</i>	200-600	0.00E+00	0.00E+00	0.00E+00	0.00E+00	0.00E+00	0.00E+00	0.00E+00	0.00E+00						
	600-1200	3.45E+02	0.00E+00	0.00E+00	1.65E+08	1.63E-01	6.27E-01	1.05E-02	2.46E-03						
	All Depths	3.45E+02	4.81E+04	2.09E+04	1.65E+08	5.63E-02	2.20E-01	3.62E-03	8.66E-04						
<i>Bathyraja aleutica</i>	200-600	1.51E+04	1.64E+07	2.73E+06	2.12E+11	7.71E+00	3.98E+02	1.47E+00	7.08E+00						
	600-1200	3.62E+03	1.91E+05	4.36E+06	2.52E+11	3.09E+00	1.31E+01	3.20E+00	2.29E+01						
	All Depths	1.87E+04	1.66E+07	7.09E+06	4.64E+11	6.11E+00	2.69E+02	2.07E+00	1.31E+01						
<i>Bathyraja aleutica</i> egg case	200-600	1.79E+01	1.99E+02	3.17E+05	5.86E+10	8.04E-03	4.33E-03	1.44E-01	1.29E+00						
	600-1200	5.97E-02	3.57E-03	3.32E+03	1.10E+07	6.46E-05	2.88E-07	3.59E-03	8.89E-04						
	All Depths	1.79E+01	1.99E+02	3.21E+05	5.86E+10	5.29E-03	2.84E-03	9.56E-02	8.45E-01						
<i>Bathyraja interrupta</i>	200-600	2.67E+03	2.04E+05	2.32E+06	1.21E+11	1.37E+00	7.15E+00	1.15E+00	3.84E+00						
	600-1200	1.08E+02	1.93E+03	7.34E+04	8.59E+08	1.06E-01	1.53E-01	6.21E-02	4.13E-02						
	All Depths	2.78E+03	2.06E+05	2.39E+06	1.22E+11	9.37E-01	5.09E+00	7.75E-01	2.79E+00						
<i>Bathyraja interrupta</i> egg case	200-600	7.08E+00	4.69E+00	4.49E+05	1.59E+10	3.32E-03	1.41E-04	2.05E-01	4.48E-01						
	600-1200	4.27E+00	3.02E+00	3.26E+05	1.30E+10	3.08E-03	1.38E-04	2.28E-01	5.88E-01						
	All Depths	1.13E+01	7.71E+00	7.75E+05	2.89E+10	3.24E-03	1.39E-04	2.13E-01	4.93E-01						
<i>Bathyraja lindbergi</i>	200-600	1.01E+03	3.74E+04	2.83E+05	2.96E+09	5.82E-01	2.11E+00	1.62E-01	1.62E-01						
	600-1200	2.38E+03	2.17E+05	1.51E+06	7.26E+10	2.34E+00	2.54E+01	1.33E+00	6.92E+00						
	All Depths	3.39E+03	2.55E+05	1.79E+06	7.56E+10	1.19E+00	1.08E+01	5.64E-01	2.78E+00						
<i>Bathyraja lindbergi</i> egg case	200-600	5.55E-02	0.00E+00	0.00E+00	4.81E+07	2.98E-05	1.16E-07	3.72E-03	1.82E-03						
	600-1200	0.00E+00	0.00E+00	0.00E+00	0.00E+00	0.00E+00	0.00E+00	0.00E+00	0.00E+00						
	All Depths	5.55E-02	3.08E-03	6.94E+03	4.81E+07	1.95E-05	7.62E-08	2.44E-03	1.19E-03						

Table 9. -- Continued.

Species	Stratum		Biomass		Population		CPUE		CPUE	
	(meters)	(t)	Variance	Number	Variance	kg/ha	Variance	no./ha	Variance	
<i>Bathyraja maculata</i>	200-600	3.34E+03	2.31E+05	8.82E+05	1.92E+10	1.90E+00	1.39E+01	5.07E-01	1.46E+00	
	600-1200	7.20E+02	9.86E+04	5.28E+05	5.09E+10	8.78E-01	1.35E+01	6.27E-01	6.65E+00	
	All Depths	4.06E+03	3.30E+05	1.41E+06	7.00E+10	1.55E+00	1.39E+01	5.49E-01	3.23E+00	
<i>Bathyraja maculata</i> egg case	200-600	2.45E-02	0.00E+00	0.00E+00	9.34E+06	1.65E-05	3.58E-08	2.07E-03	5.60E-04	
	600-1200	0.00E+00	0.00E+00	0.00E+00	0.00E+00	0.00E+00	0.00E+00	0.00E+00	0.00E+00	
	All Depths	2.45E-02	5.98E-04	3.06E+03	9.34E+06	1.08E-05	2.35E-08	1.35E-03	3.67E-04	
<i>Bathyraja minispinosa</i>	200-600	1.25E+03	1.27E+05	5.20E+05	1.67E+10	7.13E-01	7.02E+00	2.93E-01	9.11E-01	
	600-1200	6.55E+02	8.94E+03	9.06E+05	1.58E+10	5.52E-01	5.76E-01	6.44E-01	8.37E-01	
	All Depths	1.91E+03	1.36E+05	1.43E+06	3.25E+10	6.57E-01	4.79E+00	4.14E-01	9.09E-01	
<i>Bathyraja minispinosa</i> egg case	200-600	1.35E+00	2.21E-01	7.98E+04	7.80E+08	9.20E-04	1.67E-05	5.47E-02	6.13E-02	
	600-1200	3.53E+00	3.26E+00	2.05E+05	9.64E+09	3.17E-03	2.20E-04	1.73E-01	5.32E-01	
	All Depths	4.88E+00	3.48E+00	2.85E+05	1.04E+10	1.70E-03	8.74E-05	9.57E-02	2.25E-01	
<i>Bathyraja parmifera</i>	200-600	1.30E+03	0.00E+00	0.00E+00	6.48E+09	5.78E-01	4.30E+00	1.03E-01	1.49E-01	
	600-1200	0.00E+00	0.00E+00	0.00E+00	0.00E+00	0.00E+00	0.00E+00	0.00E+00	0.00E+00	
	All Depths	1.30E+03	1.71E+05	2.42E+05	6.48E+09	3.79E-01	2.89E+00	6.76E-02	9.98E-02	
<i>Bathyraja parmifera</i> egg case	200-600	2.08E+01	7.46E+01	8.36E+05	1.36E+11	1.04E-02	2.67E-03	4.03E-01	4.65E+00	
	600-1200	3.22E+00	4.87E+00	9.11E+04	4.58E+09	3.47E-03	3.80E-04	1.06E-01	4.69E-01	
	All Depths	2.40E+01	7.95E+01	9.27E+05	1.40E+11	7.98E-03	1.88E-03	3.00E-01	3.22E+00	
<i>Bathyraja</i> species	200-600	0.00E+00	0.00E+00	0.00E+00	0.00E+00	0.00E+00	0.00E+00	0.00E+00	0.00E+00	
	600-1200	8.43E-01	0.00E+00	0.00E+00	6.32E+07	4.56E-04	1.44E-05	4.30E-03	1.28E-03	
	All Depths	8.43E-01	7.10E-01	7.95E+03	6.32E+07	1.57E-04	4.95E-06	1.48E-03	4.41E-04	
<i>Bathyraja</i> species egg case	200-600	0.00E+00	0.00E+00	0.00E+00	0.00E+00	0.00E+00	0.00E+00	0.00E+00	0.00E+00	
	600-1200	1.43E-01	0.00E+00	0.00E+00	6.32E+07	7.74E-05	4.14E-07	4.30E-03	1.28E-03	
	All Depths	1.43E-01	2.05E-02	7.95E+03	6.32E+07	2.67E-05	1.43E-07	1.48E-03	4.41E-04	
<i>Bathyraja taranetzi</i>	200-600	5.46E+02	2.00E+04	5.32E+05	1.60E+10	2.96E-01	7.67E-01	2.93E-01	6.28E-01	
	600-1200	3.06E+01	1.23E+02	9.19E+04	9.23E+08	3.07E-02	1.00E-02	8.21E-02	6.51E-02	
	All Depths	5.76E+02	2.01E+04	6.24E+05	1.69E+10	2.05E-01	5.21E-01	2.20E-01	4.43E-01	
<i>Bathyraja taranetzi</i> egg case	200-600	2.35E-01	4.21E-02	2.85E+04	4.78E+08	1.24E-04	1.57E-06	1.47E-02	1.73E-02	
	600-1200	1.82E-01	2.03E-02	1.21E+04	8.08E+07	1.38E-04	9.08E-07	7.81E-03	2.09E-02	
	All Depths	4.17E-01	6.24E-02	4.06E+04	5.58E+08	1.29E-04	1.34E-06	1.23E-02	1.20E-02	
<i>Bathyraja trachura</i>	200-600	0.00E+00	0.00E+00	0.00E+00	0.00E+00	0.00E+00	0.00E+00	0.00E+00	0.00E+00	
	600-1200	2.10E+03	0.00E+00	0.00E+00	2.89E+10	1.21E+00	3.05E+00	5.92E-01	6.59E-01	
	All Depths	2.10E+03	1.15E+05	1.06E+06	2.89E+10	4.19E-01	1.38E+00	2.04E-01	3.05E-01	
<i>Bathyraja trachura</i> egg case	200-600	1.28E-01	1.03E-02	9.13E+03	4.54E+07	8.66E-05	6.24E-07	6.18E-03	2.77E-03	
	600-1200	1.48E+01	1.27E+02	1.02E+06	5.61E+11	8.44E-03	2.71E-03	5.83E-01	1.21E+01	
	All Depths	1.49E+01	1.27E+02	1.03E+06	5.61E+11	2.97E-03	9.43E-04	2.05E-01	4.21E+00	
<i>Benthalbella dentata</i>	200-600	0.00E+00	0.00E+00	0.00E+00	0.00E+00	0.00E+00	0.00E+00	0.00E+00	0.00E+00	
	600-1200	1.83E-01	0.00E+00	0.00E+00	4.94E+07	9.78E-05	6.60E-07	3.76E-03	9.76E-04	
	All Depths	1.83E-01	3.34E-02	7.03E+03	4.94E+07	3.37E-05	2.28E-07	1.30E-03	3.37E-04	

Table 9. -- Continued.

Species	Stratum		Biomass		Population		CPUE		CPUE	
	(meters)	(t)	Variance	Number	Variance	kg/ha	Variance	no./ha	Variance	
<i>Bentheogennema borealis</i>	200-600	0.00E+00	0.00E+00	0.00E+00	0.00E+00	0.00E+00	0.00E+00	0.00E+00	0.00E+00	
	600-1200	1.59E-01	0.00E+00	0.00E+00	4.71E+08	1.10E-04	9.77E-08	4.83E-02	1.70E-02	
	All Depths	1.59E-01	2.97E-03	6.80E+04	4.71E+08	3.81E-05	3.62E-08	1.67E-02	6.35E-03	
<i>Benthoctopus leioderma</i>	200-600	3.72E+01	9.82E+01	1.12E+05	5.85E+08	2.32E-02	5.10E-03	6.83E-02	3.29E-02	
	600-1200	4.94E+01	2.38E+02	1.86E+05	1.45E+09	2.93E-02	6.76E-03	1.10E-01	7.66E-02	
	All Depths	8.66E+01	3.36E+02	2.98E+05	2.03E+09	2.53E-02	5.65E-03	8.27E-02	4.81E-02	
<i>Benthoctopus oregonensis</i>	200-600	0.00E+00	0.00E+00	0.00E+00	0.00E+00	0.00E+00	0.00E+00	0.00E+00	0.00E+00	
	600-1200	2.78E+01	0.00E+00	0.00E+00	1.44E+08	1.10E-02	8.08E-03	1.19E-02	5.58E-03	
	All Depths	2.78E+01	7.59E+02	1.69E+04	1.44E+08	3.81E-03	2.79E-03	4.11E-03	1.94E-03	
<i>Benthoctopus species</i>	200-600	5.29E-01	1.62E-01	1.21E+04	5.16E+07	2.09E-04	2.74E-06	5.46E-03	1.28E-03	
	600-1200	7.63E+01	2.97E+02	1.01E+05	1.03E+09	3.39E-02	1.73E-02	5.70E-02	3.81E-02	
	All Depths	7.69E+01	2.98E+02	1.13E+05	1.08E+09	1.18E-02	6.17E-03	2.33E-02	1.45E-02	
<i>Beringius frielei</i>	200-600	8.78E+01	3.37E+02	8.03E+05	2.94E+10	5.26E-02	2.27E-02	4.86E-01	1.98E+00	
	600-1200	2.51E+00	1.01E+00	3.28E+04	1.54E+08	2.75E-03	9.30E-05	3.56E-02	1.41E-02	
	All Depths	9.03E+01	3.38E+02	8.36E+05	2.96E+10	3.54E-02	1.54E-02	3.31E-01	1.34E+00	
<i>Beringius species eggs</i>	200-600	1.15E+00	6.49E-01	7.67E+04	2.43E+09	9.80E-05	6.86E-07	3.50E-02	6.12E-02	
	600-1200	5.37E-02	2.88E-03	2.68E+04	7.21E+08	5.81E-05	2.33E-07	2.90E-02	5.82E-02	
	All Depths	1.20E+00	6.52E-01	1.04E+05	3.15E+09	8.41E-05	5.27E-07	3.29E-02	5.98E-02	
<i>Beringius undatus</i>	200-600	7.57E-01	0.00E+00	0.00E+00	2.62E+07	3.03E-04	1.20E-05	2.04E-03	5.48E-04	
	600-1200	0.00E+00	0.00E+00	0.00E+00	0.00E+00	0.00E+00	0.00E+00	0.00E+00	0.00E+00	
	All Depths	7.57E-01	5.74E-01	5.12E+03	2.62E+07	1.98E-04	7.86E-06	1.34E-03	3.59E-04	
<i>Beroe abyssicola</i>	200-600	0.00E+00	0.00E+00	0.00E+00	0.00E+00	0.00E+00	0.00E+00	0.00E+00	0.00E+00	
	600-1200	8.24E-02	0.00E+00	0.00E+00	6.79E+07	5.55E-05	2.13E-07	5.55E-03	2.13E-03	
	All Depths	8.24E-02	6.79E-03	8.24E+03	6.79E+07	1.92E-05	7.34E-08	1.92E-03	7.34E-04	
<i>Beroe species</i>	200-600	8.50E-02	0.00E+00	0.00E+00	7.06E+06	5.75E-05	4.33E-07	1.80E-03	4.23E-04	
	600-1200	0.00E+00	0.00E+00	0.00E+00	0.00E+00	0.00E+00	0.00E+00	0.00E+00	0.00E+00	
	All Depths	8.50E-02	7.23E-03	2.66E+03	7.06E+06	3.77E-05	2.84E-07	1.18E-03	2.77E-04	
<i>Berryteuthis magister</i>	200-600	1.62E+03	3.49E+04	6.60E+06	1.25E+12	9.32E-01	1.40E+00	3.47E+00	2.87E+01	
	600-1200	2.12E+02	1.19E+03	5.51E+05	6.75E+09	1.93E-01	1.07E-01	4.99E-01	6.40E-01	
	All Depths	1.83E+03	3.61E+04	7.15E+06	1.26E+12	6.77E-01	1.07E+00	2.45E+00	2.10E+01	
Bivalvia	200-600	0.00E+00	0.00E+00	0.00E+00	0.00E+00	0.00E+00	0.00E+00	0.00E+00	0.00E+00	
	600-1200	3.12E-01	0.00E+00	0.00E+00	2.26E+09	1.82E-04	2.30E-06	2.78E-02	5.32E-02	
	All Depths	3.12E-01	9.76E-02	4.76E+04	2.26E+09	6.29E-05	7.92E-07	9.58E-03	1.84E-02	
Bivalvia empty shell	200-600	8.22E+00	4.20E+01	1.92E+04	3.06E+08	1.53E-04	3.00E-06	5.72E-03	4.22E-03	
	600-1200	0.00E+00	0.00E+00	0.00E+00	0.00E+00	0.00E+00	0.00E+00	0.00E+00	0.00E+00	
	All Depths	8.22E+00	4.20E+01	1.92E+04	3.06E+08	1.53E-04	3.00E-06	5.72E-03	4.22E-03	
<i>Bolteria species</i>	200-600	3.36E-02	1.13E-03	0.00E+00	0.00E+00	0.00E+00	0.00E+00	0.00E+00	0.00E+00	
	600-1200	1.24E+00	1.53E+00	9.38E+03	8.79E+07	4.86E-04	1.63E-05	3.68E-03	9.36E-04	
	All Depths	1.27E+00	1.53E+00	9.38E+03	8.79E+07	1.69E-04	5.65E-06	1.28E-03	3.24E-04	

Table 9. - - Continued.

Species	Stratum			Biomass			Population			CPUE			CPUE			
	(meters)	(t)	Variance	Number	Variance	kg/ha	Variance	no./ha	Variance	no./ha	Variance					
<i>Boreoscala greenlandica</i>	200-600	1.35E+02	0.00E+00	0.00E+00	5.07E+06	1.14E+05	1.71E-08	1.90E-03	4.74E-04	0.00E+00	0.00E+00	0.00E+00	0.00E+00	0.00E+00	0.00E+00	
	600-1200	0.00E+00	0.00E+00	0.00E+00	0.00E+00	0.00E+00	0.00E+00	0.00E+00	0.00E+00	0.00E+00	0.00E+00	0.00E+00	0.00E+00	0.00E+00	0.00E+00	
	All Depths	1.35E-02	1.83E-04	2.25E+03	5.07E+06	7.48E-06	1.12E-08	1.25E-03	3.10E-04	1.98E-03	5.15E-04	1.80E-03	3.81E-03	9.58E-04	1.98E-03	5.15E-04
<i>Boreotrophon alaskanus</i>	200-600	9.93E-03	9.86E-05	4.96E+03	2.46E+07	3.97E-06	2.06E-09	1.98E-03	5.15E-04	1.80E-03	7.27E-03	1.80E-03	3.81E-03	9.58E-04	1.98E-03	5.15E-04
	600-1200	4.41E-02	1.45E-03	1.27E+04	9.89E+07	2.19E-05	1.83E-08	7.27E-03	1.80E-03	7.27E-03	1.80E-03	3.81E-03	9.58E-04	1.98E-03	5.15E-04	1.80E-03
	All Depths	5.41E-02	1.55E-03	1.77E+04	1.24E+08	1.02E-05	7.68E-09	3.81E-03	9.58E-04	3.81E-03	9.58E-04	1.98E-03	5.15E-04	1.80E-03	7.27E-03	1.80E-03
<i>Boreotrophon rotundatus</i>	200-600	9.93E-03	0.00E+00	0.00E+00	2.46E+07	3.97E-06	2.06E-09	1.98E-03	5.15E-04	1.80E-03	7.27E-03	1.80E-03	3.81E-03	9.58E-04	1.98E-03	5.15E-04
	600-1200	0.00E+00	0.00E+00	0.00E+00	0.00E+00	0.00E+00	0.00E+00	0.00E+00	0.00E+00	0.00E+00	0.00E+00	0.00E+00	0.00E+00	0.00E+00	0.00E+00	0.00E+00
	All Depths	9.93E-03	9.86E-05	4.96E+03	2.46E+07	2.60E-06	1.35E-09	1.30E-03	3.38E-04	1.30E-03	3.38E-04	1.30E-03	3.38E-04	1.30E-03	3.38E-04	1.30E-03
<i>Bothrocara brunneum</i>	200-600	2.11E+02	2.93E+03	9.48E+04	7.15E+08	3.13E-01	2.38E-01	1.36E-01	4.75E-02	1.36E-01	4.75E-02	1.36E-01	4.75E-02	1.36E-01	4.75E-02	1.36E-01
	600-1200	9.96E+02	4.73E+04	9.44E+05	6.87E+10	5.65E-01	1.48E+00	5.15E-01	7.68E+01	5.15E-01	7.68E+01	5.15E-01	7.68E+01	5.15E-01	7.68E+01	5.15E-01
	All Depths	1.21E+03	5.02E+04	1.04E+06	6.95E+10	4.64E-01	7.32E-01	3.64E-01	2.68E+01	3.64E-01	2.68E+01	3.64E-01	2.68E+01	3.64E-01	2.68E+01	3.64E-01
<i>Bothrocara nyx</i>	200-600	0.00E+00	0.00E+00	0.00E+00	0.00E+00	0.00E+00	0.00E+00	0.00E+00	0.00E+00	0.00E+00	0.00E+00	0.00E+00	0.00E+00	0.00E+00	0.00E+00	0.00E+00
	600-1200	1.17E+01	0.00E+00	0.00E+00	9.70E+11	6.32E-03	2.51E-03	5.63E-01	1.96E+01	5.63E-01	1.96E+01	5.63E-01	1.96E+01	5.63E-01	1.96E+01	5.63E-01
	All Depths	1.17E+01	1.24E+02	1.04E+06	9.70E+11	2.18E-03	8.67E-04	1.94E-01	6.75E+00	1.94E-01	6.75E+00	1.94E-01	6.75E+00	1.94E-01	6.75E+00	1.94E-01
<i>Bothrocara pusillum</i>	200-600	1.65E-01	0.00E+00	0.00E+00	3.08E+08	5.82E-05	2.20E-07	9.03E-03	5.46E-03	9.03E-03	5.46E-03	9.03E-03	5.46E-03	9.03E-03	5.46E-03	9.03E-03
	600-1200	0.00E+00	0.00E+00	0.00E+00	0.00E+00	0.00E+00	0.00E+00	0.00E+00	0.00E+00	0.00E+00	0.00E+00	0.00E+00	0.00E+00	0.00E+00	0.00E+00	0.00E+00
	All Depths	1.65E-01	1.24E-02	2.56E+04	3.08E+08	3.81E-05	1.45E-07	5.92E-03	3.58E-03	5.92E-03	3.58E-03	5.92E-03	3.58E-03	5.92E-03	3.58E-03	5.92E-03
<i>Bothrocara species</i>	200-600	0.00E+00	0.00E+00	0.00E+00	0.00E+00	0.00E+00	0.00E+00	0.00E+00	0.00E+00	0.00E+00	0.00E+00	0.00E+00	0.00E+00	0.00E+00	0.00E+00	0.00E+00
	600-1200	6.66E+00	0.00E+00	0.00E+00	4.83E+08	7.19E-03	2.90E-03	2.25E-02	9.60E-03	2.25E-02	9.60E-03	2.25E-02	9.60E-03	2.25E-02	9.60E-03	2.25E-02
	All Depths	6.66E+00	3.59E+01	3.35E+04	4.83E+08	2.48E-03	1.00E-03	7.75E-03	3.39E-03	7.75E-03	3.39E-03	7.75E-03	3.39E-03	7.75E-03	3.39E-03	7.75E-03
<i>Bothrocara zestum</i>	200-600	1.66E+04	3.92E+07	2.04E+07	5.10E+13	1.12E+01	2.60E+03	1.39E+01	3.43E+03	1.39E+01	3.43E+03	1.39E+01	3.43E+03	1.39E+01	3.43E+03	1.39E+01
	600-1200	1.08E+04	1.86E+07	2.01E+07	3.73E+13	9.98E+00	1.48E+03	1.80E+01	3.06E+03	1.80E+01	3.06E+03	1.80E+01	3.06E+03	1.80E+01	3.06E+03	1.80E+01
	All Depths	2.74E+04	5.78E+07	4.05E+07	8.83E+13	1.08E+01	2.21E+03	1.53E+01	3.29E+03	1.53E+01	3.29E+03	1.53E+01	3.29E+03	1.53E+01	3.29E+03	1.53E+01
<i>Brisaster latifrons</i>	200-600	1.77E+03	1.19E+06	9.58E+07	3.18E+15	9.23E-01	4.55E+01	5.23E+01	1.28E+05	5.23E+01	1.28E+05	5.23E+01	1.28E+05	5.23E+01	1.28E+05	5.23E+01
	600-1200	4.41E+02	1.54E+05	2.06E+07	3.20E+14	5.57E-01	1.75E+01	2.60E+01	3.65E+04	2.60E+01	3.65E+04	2.60E+01	3.65E+04	2.60E+01	3.65E+04	2.60E+01
	All Depths	2.22E+03	1.34E+06	1.16E+08	3.50E+15	7.97E-01	3.57E+01	4.33E+01	9.60E+04	4.33E+01	9.60E+04	4.33E+01	9.60E+04	4.33E+01	9.60E+04	4.33E+01
<i>Brisaster owestoni</i>	200-600	9.72E+00	0.00E+00	0.00E+00	8.11E+10	3.45E-03	1.53E-03	1.04E-01	1.32E+00	1.04E-01	1.32E+00	1.04E-01	1.32E+00	1.04E-01	1.32E+00	1.04E-01
	600-1200	0.00E+00	0.00E+00	0.00E+00	0.00E+00	0.00E+00	0.00E+00	0.00E+00	0.00E+00	0.00E+00	0.00E+00	0.00E+00	0.00E+00	0.00E+00	0.00E+00	0.00E+00
	All Depths	9.72E+00	9.37E+01	2.89E+05	8.11E+10	2.26E-03	1.00E-03	6.84E-02	8.66E-01	6.84E-02	8.66E-01	6.84E-02	8.66E-01	6.84E-02	8.66E-01	6.84E-02
<i>Brisingella exilis</i>	200-600	2.09E+00	2.45E+00	1.70E+04	9.51E+07	1.41E-03	1.49E-04	1.15E-02	5.94E-03	1.15E-02	5.94E-03	1.15E-02	5.94E-03	1.15E-02	5.94E-03	1.15E-02
	600-1200	4.83E+00	1.93E+01	5.65E+04	1.50E+09	5.22E-03	1.58E-03	6.11E-02	1.30E-01	6.11E-02	1.30E-01	6.11E-02	1.30E-01	6.11E-02	1.30E-01	6.11E-02
	All Depths	6.91E+00	2.17E+01	7.35E+04	1.59E+09	2.73E-03	6.40E-04	2.86E-02	4.87E-02	2.86E-02	4.87E-02	2.86E-02	4.87E-02	2.86E-02	4.87E-02	2.86E-02
<i>Brisingella species</i>	200-600	6.27E-01	3.93E-01	5.97E+03	3.57E+07	4.24E-04	2.36E-05	4.04E-03	2.14E-03	4.04E-03	2.14E-03	4.04E-03	2.14E-03	4.04E-03	2.14E-03	4.04E-03
	600-1200	3.54E-02	1.25E-03	8.84E+03	7.82E+07	1.89E-05	2.47E-08	4.73E-03	1.54E-03	4.73E-03	1.54E-03	4.73E-03	1.54E-03	4.73E-03	1.54E-03	4.73E-03
	All Depths	6.62E-01	3.95E-01	1.48E+04	1.14E+08	2.84E-04	1.54E-05	4.28E-03	1.92E-03	4.28E-03	1.92E-03	4.28E-03	1.92E-03	4.28E-03	1.92E-03	4.28E-03
Brisingidae	200-600	1.09E+00	5.23E-01	1.74E+04	6.94E+07	6.55E-04	2.86E-05	9.79E-03	3.59E-03	9.79E-03	3.59E-03	9.79E-03	3.59E-03	9.79E-03	3.59E-03	9.79E-03
	600-1200	5.65E-01	1.21E-01	1.14E+04	4.68E+07	5.46E-04	7.34E-06	1.11E-02	2.78E-03	1.11E-02	2.78E-03	1.11E-02	2.78E-03	1.11E-02	2.78E-03	1.11E-02
	All Depths	1.65E+00	6.44E-01	2.89E+04	1.16E+08	6.17E-04	2.12E-05	1.02E-02	3.29E-03	1.02E-02	3.29E-03	1.02E-02	3.29E-03	1.02E-02	3.29E-03	1.02E-02

Table 9. - - Continued.

Species	Stratum		Biomass		Population		CPUE		CPUE	
	(meters)	(t)	Variance	Number	Variance	kg/ha	Variance	no./ha	Variance	
<i>Bryozoaichthys marjorius</i>	200-600	3.20E+02	0.00E+00	0.00E+00	3.99E+06	2.70E+05	9.55E+08	1.69E+03	3.73E+04	
	600-1200	0.00E+00	0.00E+00	0.00E+00	0.00E+00	0.00E+00	0.00E+00	0.00E+00	0.00E+00	
	All Depths	3.20E+02	1.02E+03	2.00E+03	3.99E+06	1.77E+05	6.26E+08	1.11E+03	2.44E+04	
<i>Buccinum castaneum</i>	200-600	0.00E+00	0.00E+00	0.00E+00	0.00E+00	0.00E+00	0.00E+00	0.00E+00	0.00E+00	
	600-1200	7.01E+01	0.00E+00	0.00E+00	3.55E+08	3.77E+04	4.95E+06	1.12E+02	4.67E+03	
	All Depths	7.01E+01	3.29E+01	2.22E+04	3.55E+08	1.30E+04	1.72E+06	3.88E+03	1.62E+03	
<i>Buccinum costatum</i>	200-600	0.00E+00	0.00E+00	0.00E+00	0.00E+00	0.00E+00	0.00E+00	0.00E+00	0.00E+00	
	600-1200	4.53E+00	0.00E+00	0.00E+00	2.25E+09	3.06E+03	1.01E+04	6.46E+02	4.96E+02	
	All Depths	4.53E+00	3.82E+00	1.01E+05	2.25E+09	1.06E+03	3.66E+05	2.23E+02	1.79E+02	
<i>Buccinum oedematum</i>	200-600	2.92E+01	4.78E+01	9.48E+05	4.80E+10	1.72E+02	2.48E+03	5.85E+01	2.95E+00	
	600-1200	1.05E+02	4.37E+02	2.87E+06	2.81E+11	8.28E+02	1.67E+02	2.24E+00	1.08E+01	
	All Depths	1.34E+02	4.84E+02	3.82E+06	3.29E+11	3.96E+02	8.24E+03	1.15E+00	6.22E+00	
<i>Buccinum scalariforme</i>	200-600	2.26E+01	8.22E+01	6.20E+05	5.74E+10	1.31E+02	4.73E+03	3.72E+01	3.47E+00	
	600-1200	6.25E+01	3.91E+01	2.48E+04	6.16E+08	4.20E+04	1.22E+05	1.67E+02	1.91E+02	
	All Depths	2.33E+01	8.26E+01	6.45E+05	5.80E+10	8.74E+03	3.13E+03	2.49E+01	2.30E+00	
<i>Buccinum species</i>	200-600	0.00E+00	0.00E+00	0.00E+00	0.00E+00	0.00E+00	0.00E+00	0.00E+00	0.00E+00	
	600-1200	8.77E+00	0.00E+00	0.00E+00	2.37E+09	4.58E+03	9.93E+04	5.07E+02	5.13E+02	
	All Depths	8.77E+00	5.58E+01	8.64E+04	2.37E+09	1.58E+03	3.44E+04	1.75E+02	1.81E+02	
<i>Buccinum species eggs</i>	200-600	7.52E+00	4.34E+00	0.00E+00	0.00E+00	0.00E+00	0.00E+00	0.00E+00	0.00E+00	
	600-1200	3.86E+00	1.61E+00	0.00E+00	0.00E+00	0.00E+00	0.00E+00	0.00E+00	0.00E+00	
	All Depths	1.14E+01	5.95E+00	0.00E+00	0.00E+00	0.00E+00	0.00E+00	0.00E+00	0.00E+00	
<i>Bulbus fragilis</i>	200-600	1.26E+01	0.00E+00	0.00E+00	1.40E+08	5.04E+05	1.11E+07	7.28E+03	2.64E+03	
	600-1200	0.00E+00	0.00E+00	0.00E+00	0.00E+00	0.00E+00	0.00E+00	0.00E+00	0.00E+00	
	All Depths	1.26E+01	5.12E+03	1.89E+04	1.40E+08	3.30E+05	7.30E+08	4.77E+03	1.74E+03	
<i>Careproctus bowersianus</i>	200-600	2.99E+02	8.92E+04	2.99E+03	8.92E+06	2.59E+05	8.76E+08	2.59E+03	8.76E+04	
	600-1200	2.83E+01	8.00E+02	1.77E+04	3.13E+08	1.51E+04	1.58E+06	9.46E+03	6.17E+03	
	All Depths	3.13E+01	8.09E+02	2.07E+04	3.22E+08	6.91E+05	6.01E+07	4.96E+03	2.69E+03	
<i>Careproctus colletti</i>	200-600	9.12E+01	5.35E+02	2.55E+05	4.17E+09	4.51E+02	2.38E+02	1.27E+01	2.03E+01	
	600-1200	2.82E+01	1.23E+02	2.14E+05	1.21E+10	2.44E+02	6.80E+02	1.89E+01	7.14E+01	
	All Depths	1.19E+02	6.58E+02	4.69E+05	1.63E+10	3.80E+02	1.80E+02	1.48E+01	3.78E+01	
<i>Careproctus cypselurus</i>	200-600	5.78E+00	2.15E+01	2.63E+04	3.72E+08	3.10E+03	8.47E+04	1.41E+02	1.50E+02	
	600-1200	7.45E+01	5.42E+02	5.98E+05	1.51E+10	3.55E+02	9.24E+03	3.09E+01	4.64E+01	
	All Depths	8.03E+01	5.64E+02	6.24E+05	1.55E+10	1.43E+02	3.95E+03	1.16E+01	1.88E+01	
<i>Careproctus furcellus</i>	200-600	3.31E+02	7.08E+03	8.15E+05	8.92E+10	1.69E+01	2.83E+01	3.82E+01	2.15E+00	
	600-1200	4.87E+01	2.17E+02	4.67E+05	1.85E+10	3.17E+02	6.51E+03	3.05E+01	5.71E+01	
	All Depths	3.80E+02	7.30E+03	1.28E+06	1.08E+11	1.22E+01	1.92E+01	3.55E+01	1.60E+00	
<i>Careproctus gilberti</i>	200-600	1.60E+00	2.43E+00	1.76E+05	2.86E+10	1.39E+03	2.40E+04	1.52E+01	2.84E+00	
	600-1200	1.46E+00	2.12E+00	1.56E+05	2.43E+10	1.78E+03	2.20E+04	1.91E+01	2.52E+00	
	All Depths	3.06E+00	4.55E+00	3.32E+05	5.29E+10	1.52E+03	2.32E+04	1.66E+01	2.72E+00	

Table 9. -- Continued.

Species	Stratum (meters)	Biomass		Population		CPUE		CPUE	
		(t)	Variance	Number	Variance	kg/ha	Variance	no./ha	Variance
<i>Careproctus melanurus</i>	200-600	1.20E+02	1.46E+03	2.03E+05	7.04E+09	7.64E-02	8.24E-02	1.18E-01	2.84E-01
	600-1200	3.45E+02	4.19E+03	9.39E+05	1.59E+10	3.05E-01	2.80E-01	7.86E-01	1.27E+00
	All Depths	4.64E+02	5.65E+03	1.14E+06	2.30E+10	1.55E-01	1.61E-01	3.49E-01	7.21E-01
<i>Careproctus rastrinus</i>	200-600	1.38E+02	0.00E+00	0.00E+00	9.47E+09	5.47E-02	1.80E-01	1.61E-01	2.51E-01
	600-1200	0.00E+00	0.00E+00	0.00E+00	0.00E+00	0.00E+00	0.00E+00	0.00E+00	0.00E+00
	All Depths	1.38E+02	8.45E+03	3.97E+05	9.47E+09	3.58E-02	1.18E-01	1.06E-01	1.70E-01
<i>Careproctus simus</i>	200-600	1.34E-01	1.03E-02	1.14E+04	8.04E+07	1.08E-04	9.52E-07	9.31E-03	7.56E-03
	600-1200	1.68E+00	8.26E-01	8.91E+04	2.28E+09	1.95E-03	1.01E-04	1.04E-01	2.98E-01
	All Depths	1.82E+00	8.36E-01	1.00E+05	2.36E+09	7.42E-04	3.60E-05	4.18E-02	1.09E-01
<i>Careproctus</i> species	200-600	2.75E-01	0.00E+00	0.00E+00	1.70E+08	2.25E-04	3.61E-06	1.95E-02	1.52E-02
	600-1200	0.00E+00	0.00E+00	0.00E+00	0.00E+00	0.00E+00	0.00E+00	0.00E+00	0.00E+00
	All Depths	2.75E-01	3.82E-02	2.49E+04	1.70E+08	1.48E-04	2.37E-06	1.28E-02	9.99E-03
<i>Careproctus</i> species G	200-600	0.00E+00	0.00E+00	0.00E+00	0.00E+00	0.00E+00	0.00E+00	0.00E+00	0.00E+00
	600-1200	2.28E-01	0.00E+00	0.00E+00	2.03E+08	1.23E-04	1.05E-06	7.72E-03	4.11E-03
	All Depths	2.28E-01	5.21E-02	1.43E+04	2.03E+08	4.26E-05	3.63E-07	2.66E-03	1.42E-03
<i>Ceramaster japonicus</i>	200-600	2.58E+03	8.59E+04	2.46E+07	5.64E+12	1.52E+00	5.04E+00	1.50E+01	5.26E+02
	600-1200	2.83E+02	2.57E+03	4.23E+06	7.41E+11	2.51E-01	2.51E-01	3.83E+00	7.60E+01
	All Depths	2.87E+03	8.85E+04	2.88E+07	6.38E+12	1.08E+00	3.74E+00	1.11E+01	3.98E+02
<i>Ceramaster patagonicus</i>	200-600	2.00E+00	8.20E-01	3.77E+04	3.29E+08	1.29E-03	5.71E-05	2.21E-02	1.73E-02
	600-1200	2.16E+01	3.54E+02	3.42E+05	9.52E+10	2.15E-02	2.81E-02	3.49E-01	7.62E+00
	All Depths	2.36E+01	3.54E+02	3.80E+05	9.55E+10	8.27E-03	9.73E-03	1.35E-01	2.64E+00
<i>Ceramaster</i> species	200-600	2.38E+00	5.65E+00	3.89E+04	1.51E+09	8.39E-04	9.21E-05	1.37E-02	2.46E-02
	600-1200	2.87E-01	8.24E-02	6.24E+03	3.89E+07	3.11E-04	6.65E-06	6.75E-03	3.14E-03
	All Depths	2.66E+00	5.73E+00	4.51E+04	1.55E+09	6.56E-04	6.25E-05	1.13E-02	1.72E-02
<i>Cerebratulus californienesis</i>	200-600	1.69E-01	1.44E-02	2.64E+04	5.48E+08	8.33E-05	4.76E-07	1.01E-02	8.93E-03
	600-1200	0.00E+00	0.00E+00	0.00E+00	0.00E+00	0.00E+00	0.00E+00	0.00E+00	0.00E+00
	All Depths	0.00E+00	0.00E+00	0.00E+00	0.00E+00	0.00E+00	0.00E+00	0.00E+00	0.00E+00
<i>Chauliodus macouni</i>	200-600	5.28E-01	6.92E-02	2.56E+04	1.19E+08	2.97E-04	2.64E-06	1.38E-02	4.26E-03
	600-1200	6.90E+00	2.61E+00	2.20E+05	2.14E+09	4.75E-03	7.51E-05	1.53E-01	6.62E-02
	All Depths	7.43E+00	2.68E+00	2.46E+05	2.25E+09	1.83E-03	3.19E-05	6.18E-02	2.98E-02
<i>Cheiraster dawsoni</i>	200-600	2.97E-01	4.13E-02	1.68E+04	1.18E+08	1.89E-04	2.05E-06	1.09E-02	5.98E-03
	600-1200	9.59E-02	9.19E-03	3.00E+03	8.98E+06	1.18E-04	9.53E-07	3.67E-03	9.31E-04
	All Depths	3.93E-01	5.05E-02	1.98E+04	1.27E+08	1.64E-04	1.67E-06	8.43E-03	4.24E-03
<i>Chionoecetes angulatus</i>	200-600	8.25E+01	5.66E+02	7.72E+05	4.92E+10	3.92E-02	3.33E-02	4.14E-01	2.63E+00
	600-1200	3.15E+03	2.63E+05	3.60E+07	3.56E+13	2.43E+00	2.03E+01	2.57E+01	1.64E+03
	All Depths	3.23E+03	2.63E+05	3.68E+07	3.57E+13	1.47E+00	7.72E+00	1.56E+01	6.38E+02
<i>Chionoecetes bairdi</i>	200-600	2.20E+03	3.99E+05	1.11E+07	5.08E+12	5.63E-01	1.08E+01	3.67E+00	1.44E+02
	600-1200	1.33E+00	7.21E-01	1.84E+04	9.85E+07	1.15E-03	3.48E-05	1.36E-02	6.74E-03
	All Depths	2.20E+03	3.99E+05	1.11E+07	5.08E+12	2.26E-01	7.21E+00	1.47E+00	9.86E+01

Table 9. - - Continued.

Species	Stratum		Biomass		Population		CPUE		CPUE	
	(meters)	(t)	Variance	Number	Variance	kg/ha	Variance	no./ha	Variance	
<i>Chionoecetes hybrid</i>	200-600	1.91E+01	9.95E+01	3.70E+05	3.17E+10	8.23E-03	1.78E-03	2.10E-01	7.30E-01	
	600-1200	0.00E+00	0.00E+00	0.00E+00	0.00E+00	0.00E+00	0.00E+00	0.00E+00	0.00E+00	
	All Depths	1.91E+01	9.95E+01	3.70E+05	3.17E+10	3.29E-03	1.17E-03	8.41E-02	4.82E-01	
<i>Chionoecetes opilio</i>	200-600	4.45E+02	4.94E+04	1.29E+06	1.72E+11	1.04E-01	1.12E+00	4.74E-01	3.87E+00	
	600-1200	8.03E-02	6.45E-03	2.68E+03	7.17E+06	4.86E-05	7.11E-07	1.62E-03	7.90E-04	
	All Depths	4.45E+02	4.94E+04	1.29E+06	1.72E+11	4.16E-02	7.40E-01	1.91E-01	2.59E+00	
<i>Chionoecetes tanneri</i>	200-600	3.22E+02	4.35E+03	1.25E+06	1.28E+11	2.93E-01	3.11E-01	1.17E+00	5.49E+00	
	600-1200	1.06E+03	3.72E+04	5.26E+06	9.18E+11	7.20E-01	2.02E+00	3.69E+00	4.19E+01	
	All Depths	1.38E+03	4.15E+04	6.51E+06	1.05E+12	5.49E-01	1.01E+00	2.68E+00	2.05E+01	
<i>Chiroteuthis calyx</i>	200-600	0.00E+00	0.00E+00	0.00E+00	0.00E+00	0.00E+00	0.00E+00	0.00E+00	0.00E+00	
	600-1200	1.25E+00	0.00E+00	0.00E+00	1.05E+07	1.35E-03	1.26E-04	3.50E-03	8.47E-04	
	All Depths	1.25E+00	1.56E+00	3.24E+03	1.05E+07	4.67E-04	4.35E-05	1.21E-03	2.92E-04	
<i>Chlamys albid</i>	200-600	1.50E-01	0.00E+00	0.00E+00	7.79E+07	6.93E-05	6.28E-07	4.07E-03	2.17E-03	
	600-1200	0.00E+00	0.00E+00	0.00E+00	0.00E+00	0.00E+00	0.00E+00	0.00E+00	0.00E+00	
	All Depths	1.50E-01	2.25E-02	8.83E+03	7.79E+07	4.54E-05	4.12E-07	2.67E-03	1.42E-03	
<i>Chorilia longipes</i>	200-600	1.83E-01	5.65E-03	2.55E+04	9.13E+07	1.41E-04	5.36E-07	1.86E-02	7.57E-03	
	600-1200	1.80E-02	3.23E-04	3.00E+03	8.98E+06	2.20E-05	3.35E-08	3.67E-03	9.31E-04	
	All Depths	2.01E-01	5.97E-03	2.85E+04	1.00E+08	9.98E-05	3.65E-07	1.34E-02	5.32E-03	
<i>Chysaora melanaster</i>	200-600	2.02E+02	3.21E+03	2.90E+05	2.93E+09	1.02E-01	9.03E-02	1.58E-01	1.21E-01	
	600-1200	4.92E+01	2.71E+02	1.52E+05	2.19E+09	4.34E-02	1.73E-02	1.20E-01	9.09E-02	
	All Depths	2.51E+02	3.49E+03	4.42E+05	5.12E+09	8.19E-02	6.57E-02	1.45E-01	1.11E-01	
<i>Clavularia incrustans</i>	200-600	0.00E+00	0.00E+00	0.00E+00	0.00E+00	0.00E+00	0.00E+00	0.00E+00	0.00E+00	
	600-1200	1.91E+00	2.54E+00	0.00E+00	0.00E+00	0.00E+00	0.00E+00	0.00E+00	0.00E+00	
	All Depths	0.00E+00	0.00E+00	0.00E+00	0.00E+00	0.00E+00	0.00E+00	0.00E+00	0.00E+00	
<i>Clupea pallas</i>	200-600	2.75E+01	0.00E+00	0.00E+00	1.41E+09	1.56E-02	1.39E-02	3.78E-02	7.92E-02	
	600-1200	0.00E+00	0.00E+00	0.00E+00	0.00E+00	0.00E+00	0.00E+00	0.00E+00	0.00E+00	
	All Depths	2.75E+01	2.54E+02	6.61E+04	1.41E+09	1.02E-02	9.14E-03	2.47E-02	5.21E-02	
<i>Colga pacifica</i>	200-600	0.00E+00	0.00E+00	0.00E+00	0.00E+00	0.00E+00	0.00E+00	0.00E+00	0.00E+00	
	600-1200	9.98E-03	0.00E+00	0.00E+00	6.22E+06	1.26E-05	1.10E-08	3.15E-03	6.86E-04	
	All Depths	9.98E-03	9.96E-05	2.49E+03	6.22E+06	4.35E-06	3.79E-09	1.09E-03	2.37E-04	
<i>Colossendeis species</i>	200-600	8.26E-02	1.95E-03	2.85E+04	2.16E+08	5.59E-05	1.23E-07	1.93E-02	1.37E-02	
	600-1200	3.64E-02	6.74E-04	1.82E+04	1.69E+08	1.67E-05	9.45E-09	8.33E-03	2.36E-03	
	All Depths	1.19E-01	2.62E-03	4.67E+04	3.84E+08	4.23E-05	8.38E-08	1.55E-02	9.76E-03	
<i>Colus halli</i>	200-600	2.98E-02	0.00E+00	0.00E+00	8.88E+06	2.02E-05	5.32E-08	2.02E-03	5.32E-04	
	600-1200	0.00E+00	0.00E+00	0.00E+00	0.00E+00	0.00E+00	0.00E+00	0.00E+00	0.00E+00	
	All Depths	2.98E-02	8.88E-04	2.98E+03	8.88E+06	1.32E-05	3.48E-08	1.32E-03	3.48E-04	
<i>Colus herendeenii</i>	200-600	1.60E-01	0.00E+00	0.00E+00	4.54E+07	5.64E-05	3.68E-07	3.53E-03	8.08E-04	
	600-1200	0.00E+00	0.00E+00	0.00E+00	0.00E+00	0.00E+00	0.00E+00	0.00E+00	0.00E+00	
	All Depths	1.60E-01	2.23E-02	9.99E+03	4.54E+07	3.69E-05	2.41E-07	2.31E-03	5.31E-04	

Table 9. -- Continued.

Species	Stratum		Biomass		Population		CPUE		CPUE	
	(meters)	(t)	Variance	Number	Variance	kg/ha	Variance	no./ha	Variance	
<i>Colus</i> species	200-600	1.15E-02	1.33E-04	2.88E+03	8.28E+06	7.79E-06	7.94E-09	1.95E-03	4.96E-04	
	600-1200	1.77E-02	3.13E-04	8.84E+03	7.82E+07	9.46E-06	6.17E-09	4.73E-03	1.54E-03	
	All Depths	2.92E-02	4.45E-04	1.17E+04	8.64E+07	8.36E-06	7.30E-09	2.91E-03	8.53E-04	
<i>Coryphaenoides acrolepis</i>	200-600	0.00E+00	0.00E+00	0.00E+00	0.00E+00	0.00E+00	0.00E+00	0.00E+00	0.00E+00	
	600-1200	6.58E+03	0.00E+00	0.00E+00	1.27E+13	3.32E+00	9.69E+01	9.60E+00	4.16E+02	
	All Depths	6.58E+03	1.55E+06	1.91E+07	1.27E+13	1.14E+00	3.56E+01	3.31E+00	1.63E+02	
<i>Coryphaenoides cinereus</i>	200-600	2.33E+03	6.56E+05	1.05E+07	1.54E+13	1.33E+00	3.25E+01	5.77E+00	6.74E+02	
	600-1200	6.79E+04	5.95E+07	3.74E+08	1.60E+15	4.36E+01	1.72E+03	2.46E+02	4.96E+04	
	All Depths	7.02E+04	6.01E+07	3.84E+08	1.62E+15	1.59E+01	1.02E+03	8.85E+01	3.05E+04	
<i>Coryphaenoides longifilis</i>	200-600	0.00E+00	0.00E+00	0.00E+00	0.00E+00	0.00E+00	0.00E+00	0.00E+00	0.00E+00	
	600-1200	6.38E+00	0.00E+00	0.00E+00	7.13E+07	4.09E-03	7.94E-04	7.07E-03	1.70E-03	
	All Depths	6.38E+00	2.65E+01	1.19E+04	7.13E+07	1.41E-03	2.75E-04	2.44E-03	5.92E-04	
<i>Crangon alaskensis</i>	200-600	2.11E-02	0.00E+00	0.00E+00	2.78E+07	8.42E-06	9.29E-09	2.11E-03	5.81E-04	
	600-1200	0.00E+00	0.00E+00	0.00E+00	0.00E+00	0.00E+00	0.00E+00	0.00E+00	0.00E+00	
	All Depths	2.11E-02	4.44E-04	5.27E+03	2.78E+07	5.52E-06	6.09E-09	1.38E-03	3.80E-04	
<i>Crangon communis</i>	200-600	1.54E-02	0.00E+00	0.00E+00	1.33E+08	8.32E-06	9.06E-09	6.24E-03	5.10E-03	
	600-1200	0.00E+00	0.00E+00	0.00E+00	0.00E+00	0.00E+00	0.00E+00	0.00E+00	0.00E+00	
	All Depths	1.54E-02	2.37E-04	1.15E+04	1.33E+08	5.45E-06	5.93E-09	4.08E-03	3.34E-03	
<i>Crangon dalli</i>	200-600	6.45E-01	0.00E+00	0.00E+00	1.26E+10	2.47E-04	8.86E-07	1.32E-01	2.65E-01	
	600-1200	0.00E+00	0.00E+00	0.00E+00	0.00E+00	0.00E+00	0.00E+00	0.00E+00	0.00E+00	
	All Depths	6.45E-01	4.31E-02	3.42E+05	1.26E+10	1.62E-04	5.93E-07	8.64E-02	1.77E-01	
<i>Crangon</i> species	200-600	4.34E-03	0.00E+00	0.00E+00	4.24E+07	3.67E-06	1.76E-09	5.50E-03	3.96E-03	
	600-1200	0.00E+00	0.00E+00	0.00E+00	0.00E+00	0.00E+00	0.00E+00	0.00E+00	0.00E+00	
	All Depths	4.34E-03	1.89E-05	6.51E+03	4.24E+07	2.40E-06	1.15E-09	3.60E-03	2.60E-03	
Crangonidae	200-600	3.07E-02	0.00E+00	0.00E+00	2.62E+07	1.23E-05	1.97E-08	2.04E-03	5.48E-04	
	600-1200	0.00E+00	0.00E+00	0.00E+00	0.00E+00	0.00E+00	0.00E+00	0.00E+00	0.00E+00	
	All Depths	3.07E-02	9.43E-04	5.12E+03	2.62E+07	8.04E-06	1.29E-08	1.34E-03	3.59E-04	
<i>Craniella cranium</i>	200-600	5.11E-01	1.09E-01	2.15E+04	2.07E+08	2.36E-04	3.62E-06	9.92E-03	6.74E-03	
	600-1200	0.00E+00	0.00E+00	0.00E+00	0.00E+00	0.00E+00	0.00E+00	0.00E+00	0.00E+00	
	All Depths	0.00E+00	0.00E+00	0.00E+00	0.00E+00	0.00E+00	0.00E+00	0.00E+00	0.00E+00	
<i>Cranopsis</i> species	200-600	0.00E+00	0.00E+00	0.00E+00	0.00E+00	0.00E+00	0.00E+00	0.00E+00	0.00E+00	
	600-1200	2.73E-02	0.00E+00	0.00E+00	2.68E+08	3.45E-05	8.19E-08	2.07E-02	2.95E-02	
	All Depths	2.73E-02	7.43E-04	1.64E+04	2.68E+08	1.19E-05	2.83E-08	7.13E-03	1.02E-02	
<i>Cribrinopsis fernaldi</i>	200-600	3.58E+01	0.00E+00	0.00E+00	3.21E+10	1.69E-02	1.67E-02	1.40E-01	1.06E+00	
	600-1200	0.00E+00	0.00E+00	0.00E+00	0.00E+00	0.00E+00	0.00E+00	0.00E+00	0.00E+00	
	All Depths	3.58E+01	5.03E+02	2.90E+05	3.21E+10	1.11E-02	1.10E-02	9.18E-02	7.00E-01	
Crinoidea	200-600	4.95E-01	2.45E-01	5.97E+04	3.56E+09	2.07E-04	5.62E-06	2.50E-02	8.16E-02	
	600-1200	1.51E+03	2.24E+06	9.90E+07	8.97E+15	1.26E+00	1.08E+02	8.14E+01	4.31E+05	
	All Depths	1.51E+03	2.24E+06	9.91E+07	8.97E+15	4.34E-01	3.73E+01	2.81E+01	1.49E+05	

Table 9. -- Continued.

Species	Stratum			Biomass			Population			CPUE		
	(meters)	(t)	Variance	Number	Variance	kg/ha	Variance	no./ha	Variance			
<i>Crossaster borealis</i>	200-600	8.30E+02	1.01E+04	7.15E+06	4.93E+11	4.57E-01	4.28E-01	4.08E+00	3.13E+01			
	600-1200	4.83E+02	1.14E+04	3.68E+06	5.28E+11	4.29E-01	8.05E-01	3.28E+00	3.81E+01			
	All Depths	1.31E+03	2.15E+04	1.08E+07	1.02E+12	4.47E-01	5.55E-01	3.80E+00	3.36E+01			
<i>Crossaster papposus</i>	200-600	8.70E-01	0.00E+00	0.00E+00	1.37E+09	3.48E-04	9.53E-06	1.88E-02	2.93E-02			
	600-1200	0.00E+00	0.00E+00	0.00E+00	0.00E+00	0.00E+00	0.00E+00	0.00E+00	0.00E+00			
	All Depths	8.70E-01	4.43E-01	4.70E+04	1.37E+09	2.28E-04	6.25E-06	1.23E-02	1.92E-02			
<i>Crossaster species A</i>	200-600	1.02E+00	9.50E-01	5.81E+04	3.13E+09	5.61E-04	3.60E-05	3.19E-02	1.18E-01			
	600-1200	1.16E-01	4.37E-03	1.11E+04	3.44E+07	1.47E-04	5.94E-07	1.41E-02	4.90E-03			
	All Depths	1.13E+00	9.54E-01	6.92E+04	3.16E+09	4.18E-04	2.37E-05	2.57E-02	7.90E-02			
<i>Crossaster species B</i>	200-600	1.19E+00	7.70E-01	1.21E+05	6.95E+09	1.03E-03	8.32E-05	1.05E-01	7.72E-01			
	600-1200	1.75E+00	9.97E-01	1.39E+05	4.97E+09	1.51E-03	4.26E-05	1.40E-01	4.80E-01			
	All Depths	2.95E+00	1.77E+00	2.60E+05	1.19E+10	1.20E-03	6.90E-05	1.17E-01	6.68E-01			
<i>Cryptonatica aleutica</i>	200-600	3.94E-02	0.00E+00	0.00E+00	6.77E+07	1.48E-05	1.04E-08	5.66E-03	1.38E-03			
	600-1200	0.00E+00	0.00E+00	0.00E+00	0.00E+00	0.00E+00	0.00E+00	0.00E+00	0.00E+00			
	All Depths	3.94E-02	5.51E-04	1.47E+04	6.77E+07	9.72E-06	6.81E-09	3.71E-03	9.09E-04			
<i>Cryptonatica affinis</i>	200-600	2.98E-03	0.00E+00	0.00E+00	8.88E+06	2.02E-06	5.32E-10	2.02E-03	5.32E-04			
	600-1200	0.00E+00	0.00E+00	0.00E+00	0.00E+00	0.00E+00	0.00E+00	0.00E+00	0.00E+00			
	All Depths	2.98E-03	8.88E-06	2.98E+03	8.88E+06	1.32E-06	3.48E-10	1.32E-03	3.48E-04			
<i>Crystallichthys cyclospilus</i>	200-600	8.58E+00	0.00E+00	0.00E+00	3.14E+07	3.43E-03	1.54E-03	2.24E-03	6.57E-04			
	600-1200	0.00E+00	0.00E+00	0.00E+00	0.00E+00	0.00E+00	0.00E+00	0.00E+00	0.00E+00			
	All Depths	8.58E+00	7.36E+01	5.61E+03	3.14E+07	2.24E-03	1.01E-03	1.47E-03	4.30E-04			
<i>Ctenodiscus crispatus</i>	200-600	1.50E+01	1.96E+02	1.01E+06	8.93E+11	5.28E-03	3.23E-03	3.58E-01	1.47E+01			
	600-1200	1.45E-01	2.09E-02	1.25E+04	1.56E+08	1.83E-04	2.31E-06	1.58E-02	1.71E-02			
	All Depths	1.51E+01	1.96E+02	1.02E+06	8.93E+11	3.52E-03	2.12E-03	2.40E-01	9.64E+00			
<i>Cyanea capillata</i>	200-600	1.59E+00	0.00E+00	0.00E+00	5.49E+07	6.46E-04	2.81E-05	5.92E-03	1.51E-03			
	600-1200	0.00E+00	0.00E+00	0.00E+00	0.00E+00	0.00E+00	0.00E+00	0.00E+00	0.00E+00			
	All Depths	1.59E+00	1.30E+00	1.28E+04	5.49E+07	4.23E-04	1.84E-05	3.88E-03	9.94E-04			
<i>Cyclocardia species cf. borealis</i>	200-600	1.94E-01	0.00E+00	0.00E+00	2.49E+09	1.31E-04	2.24E-06	3.38E-02	1.49E-01			
	600-1200	0.00E+00	0.00E+00	0.00E+00	0.00E+00	0.00E+00	0.00E+00	0.00E+00	0.00E+00			
	All Depths	1.94E-01	3.74E-02	4.99E+04	2.49E+09	8.57E-05	1.47E-06	2.21E-02	9.79E-02			
<i>Dasycottus setiger</i>	200-600	3.71E+02	4.40E+03	2.83E+06	2.00E+11	1.56E-01	1.51E-01	1.26E+00	6.67E+00			
	600-1200	1.11E+00	6.57E-01	2.07E+04	2.04E+08	1.21E-03	5.61E-05	2.24E-02	1.76E-02			
	All Depths	3.72E+02	4.40E+03	2.85E+06	2.01E+11	1.02E-01	1.04E-01	8.31E-01	4.71E+00			
<i>Delectopecten vancouverensis</i>	200-600	0.00E+00	0.00E+00	0.00E+00	0.00E+00	0.00E+00	0.00E+00	0.00E+00	0.00E+00			
	600-1200	1.60E-01	0.00E+00	0.00E+00	8.79E+08	6.79E-05	1.18E-07	2.47E-02	1.18E-02			
	All Depths	1.60E-01	1.01E-02	5.67E+04	8.79E+08	2.34E-05	4.13E-08	8.51E-03	4.19E-03			
<i>Dendronotus species</i>	200-600	9.65E-02	0.00E+00	0.00E+00	2.87E+07	3.40E-05	1.52E-07	1.89E-03	4.68E-04			
	600-1200	0.00E+00	0.00E+00	0.00E+00	0.00E+00	0.00E+00	0.00E+00	0.00E+00	0.00E+00			
	All Depths	9.65E-02	9.30E-03	5.36E+03	2.87E+07	2.23E-05	9.94E-08	1.24E-03	3.07E-04			

Table 9. - - Continued.

Species	Stratum			Biomass			Population			CPUE		
	(meters)	(t)	Variance	Number	Variance	kg/ha	Variance	no./ha	Variance			
<i>Diaphus theta</i>	200-600	5.41E-02	2.93E-03	2.71E+03	7.32E+06	3.66E-05	1.76E-07	1.83E-03	4.39E-04			
	600-1200	9.40E-02	4.07E-03	6.79E+03	2.13E+07	1.02E-04	3.53E-07	7.35E-03	1.85E-03			
	All Depths	1.48E-01	7.00E-03	9.50E+03	2.86E+07	5.91E-05	2.36E-07	3.73E-03	9.25E-04			
<i>Diplopteraster multipes</i>	200-600	1.31E+02	1.12E+03	5.18E+05	1.34E+10	7.51E-02	6.58E-02	2.92E-01	6.49E-01			
	600-1200	1.31E+01	1.03E+02	1.06E+05	4.84E+09	8.16E-03	2.03E-03	6.58E-02	9.47E-02			
	All Depths	1.44E+02	1.22E+03	6.25E+05	1.83E+10	5.20E-02	4.47E-02	2.14E-01	4.68E-01			
<i>Dipsacaster borealis</i>	200-600	1.20E+03	1.34E+05	5.98E+06	2.42E+12	6.61E-01	3.74E+00	3.37E+00	7.68E+01			
	600-1200	4.53E+01	4.37E+02	6.28E+05	9.77E+10	3.91E-02	2.95E-02	5.08E-01	4.74E+00			
	All Depths	1.24E+03	1.34E+05	6.61E+06	2.51E+12	4.45E-01	2.53E+00	2.38E+00	5.35E+01			
<i>Echiura</i> species	200-600	0.00E+00	0.00E+00	0.00E+00	0.00E+00	0.00E+00	0.00E+00	0.00E+00	0.00E+00			
	600-1200	1.73E-02	0.00E+00	0.00E+00	8.32E+06	2.19E-05	3.30E-08	3.64E-03	9.17E-04			
	All Depths	1.73E-02	3.00E-04	2.88E+03	8.32E+06	7.55E-06	1.14E-08	1.26E-03	3.16E-04			
<i>Elassochirus cavimanus</i>	200-600	8.69E+00	0.00E+00	0.00E+00	2.20E+09	4.57E-03	4.34E-04	7.81E-02	7.96E-02			
	600-1200	0.00E+00	0.00E+00	0.00E+00	0.00E+00	0.00E+00	0.00E+00	0.00E+00	0.00E+00			
	All Depths	8.69E+00	7.13E+00	1.66E+05	2.20E+09	2.99E-03	2.88E-04	5.12E-02	5.34E-02			
<i>Elassodiscus caudatus</i>	200-600	1.22E+00	6.70E-01	1.25E+04	5.61E+07	8.25E-04	4.11E-05	8.45E-03	3.48E-03			
	600-1200	6.63E+01	1.35E+02	1.02E+06	2.12E+10	4.14E-02	6.36E-03	6.10E-01	8.22E-01			
	All Depths	6.75E+01	1.36E+02	1.03E+06	2.12E+10	1.48E-02	2.57E-03	2.16E-01	3.65E-01			
<i>Elassodiscus</i> species	200-600	0.00E+00	0.00E+00	0.00E+00	0.00E+00	0.00E+00	0.00E+00	0.00E+00	0.00E+00			
	600-1200	1.88E+00	0.00E+00	0.00E+00	7.74E+07	8.24E-04	4.68E-05	3.85E-03	1.02E-03			
	All Depths	1.88E+00	3.55E+00	8.80E+03	7.74E+07	2.84E-04	1.62E-05	1.33E-03	3.53E-04			
<i>Elassodiscus trenebundus</i>	200-600	4.05E-01	1.64E-01	5.06E+03	2.56E+07	3.42E-04	1.53E-05	4.27E-03	2.39E-03			
	600-1200	1.35E+02	1.60E+03	8.62E+05	5.07E+10	7.60E-02	3.83E-02	4.74E-01	1.30E+00			
	All Depths	1.35E+02	1.60E+03	8.67E+05	5.07E+10	2.65E-02	1.44E-02	1.66E-01	4.98E-01			
<i>Embassichthys bathybius</i>	200-600	0.00E+00	0.00E+00	0.00E+00	0.00E+00	0.00E+00	0.00E+00	0.00E+00	0.00E+00			
	600-1200	7.67E+02	0.00E+00	0.00E+00	8.66E+10	6.07E-01	3.94E+00	5.57E-01	3.34E+00			
	All Depths	7.67E+02	7.81E+04	7.41E+05	8.66E+10	2.10E-01	1.43E+00	1.92E-01	1.21E+00			
<i>Emplectonema</i> species	200-600	3.50E-01	6.74E-02	1.43E+04	6.89E+07	1.55E-04	1.81E-06	6.06E-03	1.59E-03			
	600-1200	0.00E+00	0.00E+00	0.00E+00	0.00E+00	0.00E+00	0.00E+00	0.00E+00	0.00E+00			
	All Depths	3.50E-01	6.74E-02	1.43E+04	6.89E+07	1.55E-04	1.81E-06	6.06E-03	1.59E-03			
<i>Erimacrus isenbeckii</i>	200-600	2.32E+00	0.00E+00	0.00E+00	1.29E+08	1.29E-03	1.01E-04	1.09E-02	5.65E-03			
	600-1200	0.00E+00	0.00E+00	0.00E+00	0.00E+00	0.00E+00	0.00E+00	0.00E+00	0.00E+00			
	All Depths	2.32E+00	2.83E+00	1.95E+04	1.29E+08	8.44E-04	6.64E-05	7.17E-03	3.72E-03			
<i>Eualus barbatus</i>	200-600	4.85E-02	0.00E+00	0.00E+00	7.19E+07	2.41E-05	2.51E-08	8.21E-03	3.41E-03			
	600-1200	0.00E+00	0.00E+00	0.00E+00	0.00E+00	0.00E+00	0.00E+00	0.00E+00	0.00E+00			
	All Depths	4.85E-02	8.47E-04	1.46E+04	7.19E+07	1.58E-05	1.66E-08	5.38E-03	2.25E-03			
<i>Eualus biunguis</i>	200-600	5.16E-01	6.29E-02	1.89E+05	8.01E+09	3.41E-04	3.85E-06	1.26E-01	4.94E-01			
	600-1200	1.53E+01	5.88E+01	6.53E+06	9.18E+12	8.60E-03	1.04E-03	3.75E+00	1.98E+02			
	All Depths	1.58E+01	5.89E+01	6.72E+06	9.19E+12	3.19E-03	3.73E-04	1.38E+00	7.08E+01			

Table 9. - - Continued.

Species	Stratum			Biomass			Population			CPUE			CPUE		
	(meters)	(t)	Variance	Number	Variance	kg/ha	Variance	no./ha	Variance						
<i>Eualus</i> species	200-600	5.86E-02	1.51E-03	1.90E+04	1.90E+08	3.28E-05	4.95E-08	1.00E-02	5.28E-03						
	600-1200	5.38E-02	2.31E-03	2.95E+04	7.11E+08	3.95E-05	7.40E-08	2.15E-02	2.26E-02						
	All Depths	1.12E-01	3.82E-03	4.86E+04	9.01E+08	3.51E-05	5.77E-08	1.40E-02	1.12E-02						
<i>Eualus suckleyi</i>	200-600	2.55E-02	0.00E+00	0.00E+00	7.22E+07	2.21E-05	6.39E-08	7.36E-03	7.10E-03						
	600-1200	0.00E+00	0.00E+00	0.00E+00	0.00E+00	0.00E+00	0.00E+00	0.00E+00	0.00E+00						
	All Depths	2.55E-02	6.50E-04	8.50E+03	7.22E+07	1.45E-05	4.18E-08	4.82E-03	4.65E-03						
<i>Euspira pallida</i>	200-600	4.86E-02	0.00E+00	0.00E+00	1.20E+07	2.61E-05	8.91E-08	1.86E-03	4.54E-04						
	600-1200	0.00E+00	0.00E+00	0.00E+00	0.00E+00	0.00E+00	0.00E+00	0.00E+00	0.00E+00						
	All Depths	4.86E-02	2.36E-03	3.47E+03	1.20E+07	1.71E-05	5.83E-08	1.22E-03	2.98E-04						
<i>Florometra inexpectata</i>	200-600	8.54E-02	0.00E+00	0.00E+00	7.30E+07	5.78E-05	4.38E-07	5.78E-03	4.38E-03						
	600-1200	0.00E+00	0.00E+00	0.00E+00	0.00E+00	0.00E+00	0.00E+00	0.00E+00	0.00E+00						
	All Depths	8.54E-02	7.30E-03	8.54E+03	7.30E+07	3.79E-05	2.87E-07	3.79E-03	2.87E-03						
<i>Florometra</i> species	200-600	3.21E-01	2.07E-02	3.49E+04	2.65E+08	2.17E-04	1.34E-06	2.36E-02	1.70E-02						
	600-1200	2.49E+01	6.01E+02	5.07E+06	2.48E+13	1.26E-02	1.07E-02	2.58E+00	4.42E+02						
	All Depths	2.52E+01	6.01E+02	5.11E+06	2.48E+13	4.50E-03	3.70E-03	9.06E-01	1.53E+02						
<i>Frieleia halli</i>	200-600	0.00E+00	0.00E+00	0.00E+00	0.00E+00	0.00E+00	0.00E+00	0.00E+00	0.00E+00						
	600-1200	1.56E-02	2.45E-04	7.82E+03	6.12E+07	6.19E-06	2.65E-09	3.10E-03	6.61E-04						
	All Depths	1.56E-02	2.45E-04	7.82E+03	6.12E+07	6.19E-06	2.65E-09	3.10E-03	6.61E-04						
<i>Fusitriton oregonensis</i>	200-600	2.13E+02	2.82E+03	3.11E+06	5.64E+11	9.94E-02	7.88E-02	1.47E+00	1.62E+01						
	600-1200	7.59E-01	2.03E-01	1.07E+04	3.79E+07	8.19E-04	1.58E-05	1.16E-02	3.05E-03						
	All Depths	2.13E+02	2.82E+03	3.12E+06	5.64E+11	6.54E-02	5.37E-02	9.64E-01	1.10E+01						
<i>Gadus macrocephalus</i>	200-600	6.83E+03	0.00E+00	0.00E+00	3.30E+11	3.57E+00	1.11E+02	1.39E+00	1.59E+01						
	600-1200	0.00E+00	0.00E+00	0.00E+00	0.00E+00	0.00E+00	0.00E+00	0.00E+00	0.00E+00						
	All Depths	6.83E+03	2.26E+06	2.73E+06	3.30E+11	2.34E+00	7.54E+01	9.10E-01	1.09E+01						
<i>Galiteuthis phyllura</i>	200-600	2.06E-01	2.43E-02	5.94E+03	1.72E+07	1.40E-04	1.48E-06	4.02E-03	1.05E-03						
	600-1200	1.68E+00	2.83E+00	6.32E+03	4.00E+07	8.83E-04	5.38E-05	3.32E-03	7.61E-04						
	All Depths	1.89E+00	2.85E+00	1.23E+04	5.72E+07	3.96E-04	1.95E-05	3.78E-03	9.49E-04						
gastropod eggs	200-600	4.42E+00	4.73E+00	9.84E+03	8.35E+07	6.26E-05	4.70E-07	6.26E-03	4.70E-03						
	600-1200	2.00E+00	4.09E-01	5.11E+03	1.61E+07	1.19E-04	8.42E-07	3.98E-03	9.35E-04						
	All Depths	6.42E+00	5.14E+00	1.50E+04	9.96E+07	8.13E-05	5.89E-07	5.51E-03	3.45E-03						
Gastropoda empty shell	200-600	2.83E+01	1.05E+02	1.18E+05	6.46E+09	1.33E-03	8.01E-05	4.55E-02	1.15E-01						
	600-1200	3.53E-01	1.25E-01	7.47E+04	5.58E+09	2.06E-04	2.94E-06	4.36E-02	1.31E-01						
	All Depths	2.87E+01	1.05E+02	1.93E+05	1.20E+10	1.54E-03	8.30E-05	8.92E-02	2.46E-01						
<i>Gephyreaster swifti</i>	200-600	1.03E+01	0.00E+00	0.00E+00	1.03E+07	8.73E-03	5.01E-03	4.00E-03	1.07E-03						
	600-1200	0.00E+00	0.00E+00	0.00E+00	0.00E+00	0.00E+00	0.00E+00	0.00E+00	0.00E+00						
	All Depths	1.03E+01	4.81E+01	4.74E+03	1.03E+07	5.72E-03	3.29E-03	2.62E-03	7.01E-04						
<i>Gersemia</i> species	200-600	0.00E+00	0.00E+00	0.00E+00	0.00E+00	0.00E+00	0.00E+00	0.00E+00	0.00E+00						
	600-1200	1.36E-02	0.00E+00	0.00E+00	4.60E+07	7.11E-06	3.49E-09	3.56E-03	8.73E-04						
	All Depths	1.36E-02	1.84E-04	6.78E+03	4.60E+07	2.45E-06	1.20E-09	1.23E-03	3.01E-04						

Table 9. - - Continued.

Species	Stratum		Biomass		Population		CPUE		CPUE	
	(meters)	(t)	Variance	Number	Variance	kg/ha	Variance	no./ha	Variance	
<i>Glyptocephalus zachirus</i>	200-600	1.07E+04	1.69E+06	1.62E+07	3.11E+12	5.82E+00	6.70E+01	8.66E+00	1.26E+02	
	600-1200	1.13E+02	7.47E+03	1.49E+05	1.31E+10	1.30E-01	7.25E-01	1.72E-01	1.29E+00	
	All Depths	1.08E+04	1.70E+06	1.63E+07	3.12E+12	3.86E+00	5.14E+01	5.73E+00	9.88E+01	
<i>Gonatopsis borealis</i>	200-600	3.11E+00	1.27E+00	3.27E+04	1.15E+08	1.92E-03	6.79E-05	2.01E-02	5.82E-03	
	600-1200	4.99E+00	5.31E+00	4.60E+04	4.76E+08	3.75E-03	1.44E-04	3.30E-02	1.17E-02	
	All Depths	8.11E+00	6.58E+00	7.87E+04	5.91E+08	2.55E-03	9.42E-05	2.45E-02	7.85E-03	
<i>Gonatus madokai</i>	200-600	3.45E-02	1.19E-03	2.87E+03	8.26E+06	2.33E-05	7.13E-08	1.94E-03	4.95E-04	
	600-1200	7.74E-01	5.99E-01	3.40E+03	1.15E+07	9.49E-04	6.21E-05	4.16E-03	1.19E-03	
	All Depths	8.09E-01	6.00E-01	6.27E+03	1.98E+07	3.43E-04	2.15E-05	2.71E-03	7.33E-04	
<i>Gonatus middendorffi</i>	200-600	6.04E-01	0.00E+00	0.00E+00	9.32E+06	4.09E-04	2.19E-05	2.06E-03	5.58E-04	
	600-1200	0.00E+00	0.00E+00	0.00E+00	0.00E+00	0.00E+00	0.00E+00	0.00E+00	0.00E+00	
	All Depths	6.04E-01	3.65E-01	3.05E+03	9.32E+06	2.68E-04	1.43E-05	1.35E-03	3.66E-04	
<i>Gonatus onyx</i>	200-600	1.46E+00	2.13E+00	4.96E+03	2.46E+07	5.83E-04	4.45E-05	1.98E-03	5.15E-04	
	600-1200	2.20E-01	4.85E-02	3.24E+03	1.05E+07	2.38E-04	3.92E-06	3.50E-03	8.47E-04	
	All Depths	1.68E+00	2.18E+00	8.20E+03	3.51E+07	4.64E-04	3.05E-05	2.51E-03	6.27E-04	
<i>Gonatus species</i>	200-600	3.18E-01	4.52E-02	2.02E+04	1.85E+08	1.71E-04	1.87E-06	1.09E-02	7.65E-03	
	600-1200	1.18E+00	9.28E-01	1.05E+04	3.15E+07	1.25E-03	7.39E-05	1.04E-02	2.43E-03	
	All Depths	1.50E+00	9.74E-01	3.07E+04	2.17E+08	5.43E-04	2.68E-05	1.07E-02	5.83E-03	
<i>Gonostomatidae</i>	200-600	2.28E-02	5.19E-04	2.85E+03	8.11E+06	1.54E-05	3.11E-08	1.93E-03	4.86E-04	
	600-1200	1.76E-02	3.10E-04	8.80E+03	7.74E+07	7.70E-06	4.09E-09	3.85E-03	1.02E-03	
	All Depths	4.04E-02	8.29E-04	1.16E+04	8.55E+07	1.28E-05	2.17E-08	2.59E-03	6.68E-04	
<i>Gorgonacea</i>	200-600	5.80E-02	1.14E-03	2.04E+04	1.63E+08	2.05E-05	2.58E-08	6.44E-03	1.69E-03	
	600-1200	1.59E-01	0.00E+00	0.00E+00	1.10E+07	1.72E-04	2.04E-06	3.58E-03	8.86E-04	
	All Depths	1.59E-01	2.53E-02	3.31E+03	1.10E+07	5.93E-05	7.04E-07	1.24E-03	3.06E-04	
<i>Gorgonocephalus eucnemis</i>	200-600	6.04E+02	9.03E+04	5.73E+06	8.24E+12	4.86E-01	1.06E+01	3.14E+00	2.77E+02	
	600-1200	1.66E+00	1.47E+00	1.33E+04	6.91E+07	1.12E-03	3.81E-05	1.04E-02	2.42E-03	
	All Depths	6.06E+02	9.03E+04	5.74E+06	8.24E+12	3.19E-01	7.00E+00	2.06E+00	1.83E+02	
<i>Gorgonocephalus species</i>	200-600	0.00E+00	0.00E+00	0.00E+00	0.00E+00	0.00E+00	0.00E+00	0.00E+00	0.00E+00	
	600-1200	1.77E-01	0.00E+00	0.00E+00	7.82E+07	9.46E-05	6.17E-07	4.73E-03	1.54E-03	
	All Depths	1.77E-01	3.13E-02	8.84E+03	7.82E+07	3.26E-05	2.13E-07	1.63E-03	5.32E-04	
<i>Granelledone species cf. boreopacifica</i>	200-600	0.00E+00	0.00E+00	0.00E+00	0.00E+00	0.00E+00	0.00E+00	0.00E+00	0.00E+00	
	600-1200	9.61E+01	0.00E+00	0.00E+00	8.63E+09	5.01E-02	3.91E-02	1.34E-01	2.34E-01	
	All Depths	9.61E+01	1.94E+03	2.54E+05	8.63E+09	1.73E-02	1.39E-02	4.61E-02	8.41E-02	
<i>Halargyreus johnsonii</i>	200-600	0.00E+00	0.00E+00	0.00E+00	0.00E+00	0.00E+00	0.00E+00	0.00E+00	0.00E+00	
	600-1200	3.95E+00	0.00E+00	0.00E+00	3.35E+08	1.88E-03	1.56E-04	1.17E-02	5.29E-03	
	All Depths	3.95E+00	9.33E+00	2.51E+04	3.35E+08	6.49E-04	5.42E-05	4.03E-03	1.84E-03	
<i>Halichondria panicea</i>	200-600	1.01E+01	6.79E+01	1.07E+04	1.15E+08	7.75E-04	7.82E-05	3.82E-03	1.90E-03	
	600-1200	0.00E+00	0.00E+00	0.00E+00	0.00E+00	0.00E+00	0.00E+00	0.00E+00	0.00E+00	
	All Depths	1.01E+01	6.79E+01	1.07E+04	1.15E+08	7.75E-04	7.82E-05	3.82E-03	1.90E-03	

Table 9. -- Continued.

Species	Stratum		Biomass		Population		CPUE		CPUE	
	(meters)	(t)	Variance	Number	Variance	kg/ha	Variance	no./ha	Variance	
<i>Halichondria</i> species	200-600	2.26E+00	5.10E+00	0.00E+00	0.00E+00	0.00E+00	0.00E+00	0.00E+00	0.00E+00	
	600-1200	0.00E+00	0.00E+00	0.00E+00	0.00E+00	0.00E+00	0.00E+00	0.00E+00	0.00E+00	
	All Depths	2.26E+00	5.10E+00	0.00E+00	0.00E+00	0.00E+00	0.00E+00	0.00E+00	0.00E+00	
<i>Halipteris</i> species	200-600	3.53E+00	0.00E+00	0.00E+00	2.15E+09	1.94E-03	2.00E-04	4.25E-02	1.07E-01	
	600-1200	0.00E+00	0.00E+00	0.00E+00	0.00E+00	0.00E+00	0.00E+00	0.00E+00	0.00E+00	
	All Depths	3.53E+00	4.41E+00	7.51E+04	2.15E+09	1.27E-03	1.31E-04	2.78E-02	7.03E-02	
<i>Halipteris willemoesi</i>	200-600	6.09E+00	0.00E+00	0.00E+00	1.15E+10	2.15E-03	6.05E-04	3.78E-02	1.87E-01	
	600-1200	0.00E+00	0.00E+00	0.00E+00	0.00E+00	0.00E+00	0.00E+00	0.00E+00	0.00E+00	
	All Depths	6.09E+00	3.71E+01	1.07E+05	1.15E+10	1.41E-03	3.96E-04	2.48E-02	1.23E-01	
<i>Hemilepidotus jordani</i>	200-600	2.00E+01	0.00E+00	0.00E+00	1.53E+08	7.89E-03	6.64E-03	6.34E-03	3.06E-03	
	600-1200	0.00E+00	0.00E+00	0.00E+00	0.00E+00	0.00E+00	0.00E+00	0.00E+00	0.00E+00	
	All Depths	2.00E+01	3.19E+02	1.65E+04	1.53E+08	5.17E-03	4.35E-03	4.15E-03	2.01E-03	
<i>Hemitripterus bolini</i>	200-600	3.15E+03	1.97E+05	7.73E+05	1.06E+10	1.68E+00	9.06E+00	4.09E-01	4.63E-01	
	600-1200	3.95E+01	7.11E+02	1.65E+04	1.04E+08	4.91E-02	7.49E-02	2.06E-02	1.12E-02	
	All Depths	3.19E+03	1.98E+05	7.90E+05	1.07E+10	1.12E+00	6.54E+00	2.75E-01	3.41E-01	
<i>Hemitripterus bolini</i> eggs	200-600	4.74E+00	2.25E+01	0.00E+00	0.00E+00	0.00E+00	0.00E+00	0.00E+00	0.00E+00	
	600-1200	0.00E+00	0.00E+00	0.00E+00	0.00E+00	0.00E+00	0.00E+00	0.00E+00	0.00E+00	
	All Depths	4.74E+00	2.25E+01	0.00E+00	0.00E+00	0.00E+00	0.00E+00	0.00E+00	0.00E+00	
<i>Henricia aspera</i>	200-600	1.68E+00	0.00E+00	0.00E+00	5.45E+08	1.03E-03	3.50E-05	3.92E-02	3.66E-02	
	600-1200	0.00E+00	0.00E+00	0.00E+00	0.00E+00	0.00E+00	0.00E+00	0.00E+00	0.00E+00	
	All Depths	1.68E+00	7.79E-01	6.18E+04	5.45E+08	6.72E-04	2.31E-05	2.57E-02	2.43E-02	
<i>Henricia asthenactis</i>	200-600	2.39E+00	0.00E+00	0.00E+00	4.32E+09	1.74E-03	2.16E-04	4.95E-02	2.62E-01	
	600-1200	0.00E+00	0.00E+00	0.00E+00	0.00E+00	0.00E+00	0.00E+00	0.00E+00	0.00E+00	
	All Depths	2.39E+00	3.31E+00	7.15E+04	4.32E+09	1.14E-03	1.42E-04	3.24E-02	1.72E-01	
<i>Henricia beringiana</i>	200-600	2.68E+00	0.00E+00	0.00E+00	6.98E+08	1.63E-03	2.08E-05	5.96E-02	2.59E-02	
	600-1200	0.00E+00	0.00E+00	0.00E+00	0.00E+00	0.00E+00	0.00E+00	0.00E+00	0.00E+00	
	All Depths	2.68E+00	4.22E-01	1.06E+05	6.98E+08	1.07E-03	1.42E-05	3.91E-02	1.77E-02	
<i>Henricia derjugini</i>	200-600	0.00E+00	0.00E+00	0.00E+00	0.00E+00	0.00E+00	0.00E+00	0.00E+00	0.00E+00	
	600-1200	1.09E-01	0.00E+00	0.00E+00	9.21E+06	1.38E-04	1.32E-06	3.84E-03	1.02E-03	
	All Depths	1.09E-01	1.19E-02	3.04E+03	9.21E+06	4.76E-05	4.54E-07	1.32E-03	3.50E-04	
<i>Henricia longispina</i>	200-600	2.19E-02	0.00E+00	0.00E+00	7.51E+06	1.85E-05	4.49E-08	2.31E-03	7.02E-04	
	600-1200	0.00E+00	0.00E+00	0.00E+00	0.00E+00	0.00E+00	0.00E+00	0.00E+00	0.00E+00	
	All Depths	2.19E-02	4.81E-04	2.74E+03	7.51E+06	1.21E-05	2.94E-08	1.52E-03	4.60E-04	
<i>Henricia</i> species	200-600	1.49E+01	6.59E+00	1.05E+06	3.39E+10	7.25E-03	1.82E-04	4.95E-01	1.10E+00	
	600-1200	1.53E+00	2.66E-01	1.70E+05	3.61E+09	1.14E-03	7.85E-06	1.15E-01	8.52E-02	
	All Depths	1.64E+01	6.85E+00	1.23E+06	3.76E+10	5.14E-03	1.30E-04	3.64E-01	7.83E-01	
<i>Henricia</i> species B	200-600	2.67E-01	0.00E+00	0.00E+00	2.78E+07	1.72E-04	2.00E-06	4.59E-03	1.39E-03	
	600-1200	0.00E+00	0.00E+00	0.00E+00	0.00E+00	0.00E+00	0.00E+00	0.00E+00	0.00E+00	
	All Depths	2.67E-01	3.61E-02	7.33E+03	2.78E+07	1.12E-04	1.31E-06	3.01E-03	9.14E-04	

Table 9. -- Continued.

Species	Stratum		Biomass		Population		CPUE		CPUE	
	(meters)	(t)	Variance	Number	Variance	kg/ha	Variance	no./ha	Variance	
<i>Henricia spiculifera</i>	200-600	1.24E+01	0.00E+00	0.00E+00	2.43E+08	5.94E+05	2.62E-07	8.45E-03	5.60E-03	
	600-1200	0.00E+00	0.00E+00	0.00E+00	0.00E+00	0.00E+00	0.00E+00	0.00E+00	0.00E+00	
	All Depths	1.24E-01	1.10E-02	1.81E+04	2.43E+08	3.89E-05	1.72E-07	5.53E-03	3.68E-03	
<i>Heterozonias alternatus</i>	200-600	0.00E+00	0.00E+00	0.00E+00	0.00E+00	0.00E+00	0.00E+00	0.00E+00	0.00E+00	
	600-1200	2.55E+01	0.00E+00	0.00E+00	9.68E+09	2.93E-02	3.39E-02	1.60E-01	1.10E+00	
	All Depths	2.55E+01	3.02E+02	1.36E+05	9.68E+09	1.01E-02	1.18E-02	5.52E-02	3.82E-01	
Hexactinellida	200-600	1.66E+03	7.99E+05	0.00E+00	0.00E+00	0.00E+00	0.00E+00	0.00E+00	0.00E+00	
	600-1200	4.73E+02	2.17E+05	1.26E+04	0.00E+00	1.59E-03	1.65E-04	3.52E-03	8.08E-04	
	All Depths	2.13E+03	1.02E+06	1.26E+04	0.00E+00	5.48E-04	5.67E-05	1.21E-03	2.78E-04	
<i>Hippasteria armata</i>	200-600	1.41E+01	9.32E+01	1.77E+04	1.09E+08	6.36E-03	2.02E-03	1.03E-02	5.13E-03	
	600-1200	5.91E+00	1.18E+01	1.76E+04	1.19E+08	7.43E-03	1.45E-03	2.21E-02	1.33E-02	
	All Depths	2.00E+01	1.05E+02	3.54E+04	2.28E+08	6.73E-03	1.81E-03	1.44E-02	7.92E-03	
<i>Hippasteria californica</i>	200-600	3.34E+00	1.11E+01	7.60E+03	5.78E+07	1.79E-03	4.21E-04	4.08E-03	2.18E-03	
	600-1200	1.21E+01	7.98E+01	4.48E+04	1.05E+09	9.59E-03	3.18E-03	4.38E-02	8.68E-02	
	All Depths	1.55E+01	9.10E+01	5.24E+04	1.11E+09	4.48E-03	1.37E-03	1.78E-02	3.14E-02	
<i>Hippasteria heathi</i>	200-600	2.29E-01	5.24E-02	2.54E+03	6.47E+06	1.55E-04	3.14E-06	1.72E-03	3.88E-04	
	600-1200	1.06E+00	1.12E+00	1.36E+04	1.84E+08	5.55E-04	2.12E-05	7.11E-03	3.49E-03	
	All Depths	1.29E+00	1.17E+00	1.61E+04	1.90E+08	2.93E-04	9.34E-06	3.58E-03	1.45E-03	
<i>Hippasteria species</i>	200-600	5.93E+00	3.52E+01	5.64E+03	3.18E+07	2.09E-03	5.74E-04	1.99E-03	5.19E-04	
	600-1200	6.45E-01	4.16E-01	7.01E+03	4.91E+07	3.38E-04	7.89E-06	3.68E-03	9.32E-04	
	All Depths	6.58E+00	3.56E+01	1.26E+04	8.09E+07	1.49E-03	3.78E-04	2.57E-03	6.58E-04	
<i>Hippasteria species C</i>	200-600	1.99E+01	0.00E+00	0.00E+00	9.05E+08	9.19E-03	1.11E-02	1.39E-02	2.53E-02	
	600-1200	0.00E+00	0.00E+00	0.00E+00	0.00E+00	0.00E+00	0.00E+00	0.00E+00	0.00E+00	
	All Depths	1.99E+01	3.96E+02	3.01E+04	9.05E+08	6.02E-03	7.24E-03	9.10E-03	1.66E-02	
<i>Hippasteria spinosa</i>	200-600	6.20E+01	0.00E+00	0.00E+00	1.62E+09	2.87E-02	2.26E-02	6.57E-02	8.25E-02	
	600-1200	0.00E+00	0.00E+00	0.00E+00	0.00E+00	0.00E+00	0.00E+00	0.00E+00	0.00E+00	
	All Depths	6.20E+01	1.02E+03	1.12E+05	1.62E+09	1.88E-02	1.50E-02	4.30E-02	5.49E-02	
<i>Hippoglossoides elassodon</i>	200-600	2.05E+04	0.00E+00	0.00E+00	3.37E+13	1.01E+01	1.56E+02	2.41E+01	1.04E+03	
	600-1200	0.00E+00	0.00E+00	0.00E+00	0.00E+00	0.00E+00	0.00E+00	0.00E+00	0.00E+00	
	All Depths	2.05E+04	5.54E+06	5.14E+07	3.37E+13	6.61E+00	1.25E+02	1.58E+01	8.09E+02	
<i>Hippoglossus stenolepis</i>	200-600	4.73E+03	6.53E+05	7.30E+05	1.87E+10	2.53E+00	2.84E+01	3.98E-01	1.17E+00	
	600-1200	8.77E+01	7.69E+03	7.48E+03	5.60E+07	1.11E-01	8.47E-01	9.46E-03	6.17E-03	
	All Depths	4.82E+03	6.61E+05	7.38E+05	1.88E+10	1.69E+00	2.02E+01	2.64E-01	8.01E-01	
Holothuroidea	200-600	2.01E-02	4.05E-04	3.35E+03	1.13E+07	1.36E-05	2.43E-08	2.27E-03	6.74E-04	
	600-1200	7.79E-02	6.07E-03	5.99E+03	3.59E+07	9.55E-05	6.29E-07	7.34E-03	3.72E-03	
	All Depths	9.80E-02	6.47E-03	9.35E+03	4.72E+07	4.19E-05	2.32E-07	4.02E-03	1.72E-03	
Hormathiidae	200-600	7.59E-02	0.00E+00	0.00E+00	4.42E+07	5.13E-05	1.87E-07	5.97E-03	2.69E-03	
	600-1200	0.00E+00	0.00E+00	0.00E+00	0.00E+00	0.00E+00	0.00E+00	0.00E+00	0.00E+00	
	All Depths	7.59E-02	3.07E-03	8.82E+03	4.42E+07	3.36E-05	1.23E-07	3.91E-03	1.76E-03	

Table 9. - - Continued.

Species	Stratum		Biomass		Population		CPUE		CPUE	
	(meters)	(t)	Variance	Number	Variance	kg/ha	Variance	no./ha	Variance	
<i>Hyas lyratus</i>	200-600	6.02E+00	0.00E+00	0.00E+00	4.77E+10	2.59E-03	2.46E-04	1.55E-01	1.03E+00	
	600-1200	0.00E+00	0.00E+00	0.00E+00	0.00E+00	0.00E+00	0.00E+00	0.00E+00	0.00E+00	
	All Depths	6.02E+00	1.13E+01	3.57E+05	4.77E+10	1.70E-03	1.62E-04	1.02E-01	6.79E-01	
<i>Hymenodora frontalis</i>	200-600	0.00E+00	0.00E+00	0.00E+00	0.00E+00	0.00E+00	0.00E+00	0.00E+00	0.00E+00	
	600-1200	1.46E-01	0.00E+00	0.00E+00	1.82E+09	6.42E-05	8.48E-08	3.21E-02	2.12E-02	
	All Depths	1.46E-01	7.30E-03	7.29E+04	1.82E+09	2.22E-05	2.99E-08	1.11E-02	7.48E-03	
<i>Icelus canaliculatus</i>	200-600	6.18E+00	5.99E+00	3.42E+05	1.97E+10	4.56E-03	6.57E-04	2.59E-01	2.25E+00	
	600-1200	1.04E+01	1.85E+01	6.73E+05	8.05E+10	1.22E-02	2.34E-03	7.99E-01	1.05E+01	
	All Depths	1.65E+01	2.45E+01	1.01E+06	1.00E+11	7.19E-03	1.24E-03	4.46E-01	5.12E+00	
<i>Icelus euryops</i>	200-600	1.36E-01	0.00E+00	0.00E+00	1.65E+08	7.96E-05	2.44E-07	1.39E-02	7.45E-03	
	600-1200	0.00E+00	0.00E+00	0.00E+00	0.00E+00	0.00E+00	0.00E+00	0.00E+00	0.00E+00	
	All Depths	1.36E-01	6.14E-03	2.27E+04	1.65E+08	5.21E-05	1.61E-07	9.10E-03	4.91E-03	
<i>Icelus spiniger</i>	200-600	8.20E+00	0.00E+00	0.00E+00	3.63E+09	3.07E-03	8.95E-05	8.99E-02	8.92E-02	
	600-1200	0.00E+00	0.00E+00	0.00E+00	0.00E+00	0.00E+00	0.00E+00	0.00E+00	0.00E+00	
	All Depths	8.20E+00	3.13E+00	2.37E+05	3.63E+09	2.01E-03	6.06E-05	5.89E-02	6.01E-02	
<i>Isidella species</i>	200-600	0.00E+00	0.00E+00	0.00E+00	0.00E+00	0.00E+00	0.00E+00	0.00E+00	0.00E+00	
	600-1200	2.39E+02	2.64E+04	0.00E+00	0.00E+00	0.00E+00	0.00E+00	0.00E+00	0.00E+00	
	All Depths	2.39E+02	2.64E+04	0.00E+00	0.00E+00	0.00E+00	0.00E+00	0.00E+00	0.00E+00	
<i>Japetella diaphana</i>	200-600	5.17E-01	0.00E+00	0.00E+00	3.29E+07	1.82E-04	4.35E-06	2.03E-03	5.38E-04	
	600-1200	0.00E+00	0.00E+00	0.00E+00	0.00E+00	0.00E+00	0.00E+00	0.00E+00	0.00E+00	
	All Depths	5.17E-01	2.67E-01	5.74E+03	3.29E+07	1.19E-04	2.85E-06	1.33E-03	3.52E-04	
<i>Keratois species</i>	200-600	0.00E+00	0.00E+00	0.00E+00	0.00E+00	0.00E+00	0.00E+00	0.00E+00	0.00E+00	
	600-1200	7.46E-01	0.00E+00	0.00E+00	4.60E+07	3.91E-04	1.06E-05	3.56E-03	8.73E-04	
	All Depths	7.46E-01	5.56E-01	6.78E+03	4.60E+07	1.35E-04	3.64E-06	1.23E-03	3.01E-04	
<i>Labidochirus splendescens</i>	200-600	7.30E-01	0.00E+00	0.00E+00	8.29E+08	2.78E-04	2.33E-06	2.50E-02	1.64E-02	
	600-1200	0.00E+00	0.00E+00	0.00E+00	0.00E+00	0.00E+00	0.00E+00	0.00E+00	0.00E+00	
	All Depths	7.30E-01	1.20E-01	6.39E+04	8.29E+08	1.82E-04	1.54E-06	1.64E-02	1.09E-02	
<i>Lampanyctus jordani</i>	200-600	5.58E+00	8.39E+00	1.69E+05	7.53E+09	3.68E-03	5.15E-04	1.11E-01	4.61E-01	
	600-1200	2.39E+00	4.42E+00	6.87E+04	3.31E+09	2.55E-03	3.59E-04	7.28E-02	2.68E-01	
	All Depths	7.96E+00	1.28E+01	2.37E+05	1.08E+10	3.29E-03	4.59E-04	9.80E-02	3.93E-01	
<i>Lampanyctus species</i>	200-600	0.00E+00	0.00E+00	0.00E+00	0.00E+00	0.00E+00	0.00E+00	0.00E+00	0.00E+00	
	600-1200	6.64E-01	0.00E+00	0.00E+00	5.70E+07	3.55E-04	8.72E-06	4.04E-03	1.13E-03	
	All Depths	6.64E-01	4.41E-01	7.55E+03	5.70E+07	1.23E-04	3.01E-06	1.39E-03	3.88E-04	
<i>Lampetra tridentata</i>	200-600	1.98E+01	2.72E+01	6.80E+04	2.88E+08	1.01E-02	1.12E-03	3.42E-02	1.13E-02	
	600-1200	1.31E+01	2.77E+01	4.87E+04	4.26E+08	1.13E-02	1.35E-03	3.97E-02	1.57E-02	
	All Depths	3.28E+01	5.48E+01	1.17E+05	7.14E+08	1.06E-02	1.19E-03	3.61E-02	1.27E-02	
<i>Laqueus vancouverensis</i>	200-600	4.67E-01	3.70E-02	3.90E+04	2.49E+08	2.34E-04	1.49E-06	1.92E-02	9.08E-03	
	600-1200	7.30E-01	2.74E-01	1.08E+05	6.06E+09	9.23E-04	3.34E-05	1.37E-01	7.37E-01	
	All Depths	1.20E+00	3.11E-01	1.47E+05	6.31E+09	1.16E-03	3.49E-05	1.56E-01	7.46E-01	

Table 9. - - Continued.

Species	Stratum		Biomass		Population		CPUE		CPUE	
	(meters)	(t)	Variance	Number	Variance	kg/ha	Variance	no./ha	Variance	
<i>Latrunclia</i> species B	200-600	0.00E+00	0.00E+00	0.00E+00	0.00E+00	0.00E+00	0.00E+00	0.00E+00	0.00E+00	
	600-1200	6.99E-01	4.88E-01	1.57E+04	2.48E+08	7.56E-04	3.94E-05	1.70E-02	2.00E-02	
	All Depths	6.99E-01	4.88E-01	1.57E+04	2.48E+08	7.56E-04	3.94E-05	1.70E-02	2.00E-02	
<i>Lebbeus groenlandicus</i>	200-600	0.00E+00	0.00E+00	0.00E+00	0.00E+00	0.00E+00	0.00E+00	0.00E+00	0.00E+00	
	600-1200	2.96E-01	0.00E+00	0.00E+00	3.94E+08	3.46E-04	4.58E-06	3.42E-02	3.54E-02	
	All Depths	2.96E-01	4.33E-02	3.24E+04	3.94E+08	1.19E-04	1.59E-06	1.18E-02	1.24E-02	
<i>Lebbeus</i> species	200-600	0.00E+00	0.00E+00	0.00E+00	0.00E+00	0.00E+00	0.00E+00	0.00E+00	0.00E+00	
	600-1200	2.85E-02	0.00E+00	0.00E+00	2.03E+08	1.54E-05	1.64E-08	7.72E-03	4.11E-03	
	All Depths	2.85E-02	8.14E-04	1.43E+04	2.03E+08	5.33E-06	5.67E-09	2.66E-03	1.42E-03	
<i>Lepidopsetta polyxystra</i>	200-600	3.12E+02	0.00E+00	0.00E+00	1.37E+11	1.25E-01	1.85E+00	1.58E-01	2.86E+00	
	600-1200	0.00E+00	0.00E+00	0.00E+00	0.00E+00	0.00E+00	0.00E+00	0.00E+00	0.00E+00	
	All Depths	3.12E+02	8.87E+04	3.95E+05	1.37E+11	8.16E-02	1.21E+00	1.03E-01	1.88E+00	
<i>Leptagonus frenatus</i>	200-600	2.95E+02	1.28E+04	6.61E+06	8.56E+12	1.27E-01	2.92E-01	2.79E+00	1.91E+02	
	600-1200	1.30E+00	1.68E+00	2.65E+04	7.02E+08	8.71E-04	5.24E-05	1.78E-02	2.18E-02	
	All Depths	2.98E+02	1.28E+04	6.64E+06	8.56E+12	8.32E-02	1.94E-01	1.83E+00	1.27E+02	
<i>Leptoichiton</i> species	200-600	0.00E+00	0.00E+00	0.00E+00	0.00E+00	0.00E+00	0.00E+00	0.00E+00	0.00E+00	
	600-1200	5.42E-02	0.00E+00	0.00E+00	1.49E+08	5.04E-05	1.21E-07	1.16E-02	4.71E-03	
	All Depths	5.42E-02	1.52E-03	1.63E+04	1.49E+08	1.74E-05	4.18E-08	4.00E-03	1.64E-03	
<i>Leptychaster anomalus</i>	200-600	1.63E-02	0.00E+00	0.00E+00	3.55E+07	8.23E-06	4.40E-09	4.12E-03	1.10E-03	
	600-1200	0.00E+00	0.00E+00	0.00E+00	0.00E+00	0.00E+00	0.00E+00	0.00E+00	0.00E+00	
	All Depths	1.63E-02	1.42E-04	8.17E+03	3.55E+07	5.39E-06	2.89E-09	2.70E-03	7.23E-04	
<i>Leptychaster arcticus</i>	200-600	8.75E-02	0.00E+00	0.00E+00	4.50E+07	3.66E-05	9.72E-08	4.05E-03	1.07E-03	
	600-1200	0.00E+00	0.00E+00	0.00E+00	0.00E+00	0.00E+00	0.00E+00	0.00E+00	0.00E+00	
	All Depths	8.75E-02	4.45E-03	9.46E+03	4.50E+07	2.39E-05	6.38E-08	2.65E-03	7.00E-04	
<i>Lethasterias nanimensis</i>	200-600	1.83E-02	0.00E+00	0.00E+00	2.09E+07	8.45E-06	9.35E-09	2.11E-03	5.84E-04	
	600-1200	0.00E+00	0.00E+00	0.00E+00	0.00E+00	0.00E+00	0.00E+00	0.00E+00	0.00E+00	
	All Depths	1.83E-02	3.35E-04	4.58E+03	2.09E+07	5.53E-06	6.13E-09	1.38E-03	3.83E-04	
<i>Leucosolenia blanca</i>	200-600	2.03E+00	1.45E+00	1.80E+04	1.05E+08	1.04E-03	5.85E-05	8.82E-03	3.56E-03	
	600-1200	0.00E+00	0.00E+00	0.00E+00	0.00E+00	0.00E+00	0.00E+00	0.00E+00	0.00E+00	
	All Depths	2.03E+00	1.45E+00	1.80E+04	1.05E+08	1.04E-03	5.85E-05	8.82E-03	3.56E-03	
<i>Leuroglossus schmidti</i>	200-600	7.00E+01	5.82E+02	1.07E+07	1.36E+13	3.79E-02	1.32E-02	5.72E+00	3.11E+02	
	600-1200	2.05E+01	1.76E+01	2.37E+06	2.26E+11	1.61E-02	1.02E-03	1.88E+00	1.45E+01	
	All Depths	9.05E+01	6.00E+02	1.31E+07	1.38E+13	3.04E-02	9.09E-03	4.40E+00	2.11E+02	
Liparidinae	200-600	6.73E-01	1.24E-01	7.57E+04	1.02E+09	3.93E-04	4.05E-06	4.51E-02	4.03E-02	
	600-1200	2.17E+00	6.98E-01	3.05E+05	1.12E+10	1.30E-03	1.03E-05	1.93E-01	2.10E-01	
	All Depths	2.84E+00	8.22E-01	3.81E+05	1.22E+10	7.05E-04	6.34E-06	9.60E-02	1.03E-01	
<i>Liponema brevicornis</i>	200-600	2.96E+03	1.76E+05	2.94E+07	2.46E+13	1.57E+00	7.49E+00	1.50E+01	8.09E+02	
	600-1200	6.66E+01	2.70E+02	1.64E+06	2.54E+11	5.39E-02	1.92E-02	1.11E+00	8.15E+00	
	All Depths	3.02E+03	1.77E+05	3.10E+07	2.49E+13	1.05E+00	5.42E+00	1.02E+01	5.75E+02	

Table 9. -- Continued.

Species	Stratum			Biomass			Population			CPUE		
	(meters)	(t)	Variance	Number	Variance	kg/ha	Variance	no./ha	Variance			
<i>Lithodes aequispinus</i>	200-600	2.16E+03	2.63E+05	2.53E+06	2.85E+11	1.59E+00	1.28E+01	1.96E+00	1.93E+01			
	600-1200	1.40E+02	3.19E+03	2.97E+05	9.10E+09	1.31E-01	4.48E-01	2.54E-01	1.04E+00			
	All Depths	2.30E+03	2.67E+05	2.83E+06	2.95E+11	7.16E-01	8.79E+00	9.36E-01	1.33E+01			
<i>Lithodes couesi</i>	200-600	4.29E+01	3.23E+02	4.58E+04	3.49E+08	4.33E-02	3.43E-02	4.48E-02	3.31E-02			
	600-1200	5.90E+02	3.79E+04	8.71E+05	6.45E+10	4.99E-01	1.73E+00	7.36E-01	3.24E+00			
	All Depths	6.33E+02	3.82E+04	9.17E+05	6.48E+10	3.17E-01	6.52E-01	4.59E-01	1.23E+00			
<i>Lophaster furcilliger</i>	200-600	7.48E+00	4.79E+00	4.26E+05	1.05E+10	4.79E-03	3.19E-04	2.68E-01	6.79E-01			
	600-1200	3.78E+01	1.02E+03	1.64E+06	1.34E+12	1.75E-02	1.10E-02	8.67E-01	1.59E+01			
	All Depths	4.52E+01	1.03E+03	2.07E+06	1.35E+12	9.17E-03	4.00E-03	4.74E-01	5.95E+00			
<i>Lophaster species</i>	200-600	1.21E-01	1.47E-02	3.36E+03	1.13E+07	6.50E-05	5.54E-07	1.81E-03	4.27E-04			
	600-1200	1.44E-01	2.08E-02	5.77E+03	3.33E+07	1.82E-04	2.29E-06	7.29E-03	3.67E-03			
	All Depths	2.65E-01	3.55E-02	9.13E+03	4.46E+07	1.05E-04	1.15E-06	3.70E-03	1.54E-03			
<i>Lophaster vexator</i>	200-600	8.65E-01	1.79E-01	3.42E+04	2.61E+08	6.16E-04	1.33E-05	2.34E-02	2.04E-02			
	600-1200	8.21E+00	1.44E+01	2.17E+05	7.85E+09	5.83E-03	7.32E-04	1.55E-01	4.05E-01			
	All Depths	9.08E+00	1.45E+01	2.51E+05	8.12E+09	2.41E-03	2.65E-04	6.87E-02	1.56E-01			
<i>Lumpenella longirostris</i>	200-600	3.57E+00	4.94E+00	4.76E+04	1.09E+09	1.97E-03	2.05E-04	2.60E-02	4.38E-02			
	600-1200	2.47E+00	4.34E+00	4.06E+04	1.19E+09	3.12E-03	5.00E-04	5.13E-02	1.37E-01			
	All Depths	6.04E+00	9.28E+00	8.82E+04	2.28E+09	2.37E-03	3.05E-04	3.47E-02	7.54E-02			
<i>Lycenchelys croatalinus</i>	200-600	5.52E-01	3.05E-01	3.63E+03	1.32E+07	2.97E-04	1.16E-05	1.96E-03	5.01E-04			
	600-1200	8.23E+00	1.42E+01	8.88E+04	1.93E+09	9.08E-03	1.40E-03	9.41E-02	1.64E-01			
	All Depths	8.78E+00	1.45E+01	9.24E+04	1.94E+09	3.33E-03	5.04E-04	3.38E-02	5.83E-02			
<i>Lycenchelys species</i>	200-600	0.00E+00	0.00E+00	0.00E+00	0.00E+00	0.00E+00	0.00E+00	0.00E+00	0.00E+00			
	600-1200	7.39E-02	0.00E+00	0.00E+00	8.54E+07	2.90E-05	5.82E-08	3.63E-03	9.09E-04			
	All Depths	7.39E-02	5.46E-03	9.24E+03	8.54E+07	1.00E-05	2.01E-08	1.25E-03	3.14E-04			
<i>Lycodapus species</i>	200-600	7.28E-01	2.35E-02	2.96E+05	5.02E+09	4.81E-04	1.71E-06	2.05E-01	4.05E-01			
	600-1200	1.06E+00	1.01E-01	2.32E+05	4.21E+09	8.43E-04	5.89E-06	1.85E-01	1.96E-01			
	All Depths	1.78E+00	1.24E-01	5.28E+05	9.24E+09	6.06E-04	3.16E-06	1.98E-01	3.32E-01			
<i>Lycodes beringi</i>	200-600	8.32E+01	1.63E+02	1.38E+06	4.35E+10	5.18E-02	1.05E-02	8.73E-01	2.96E+00			
	600-1200	7.77E+01	2.02E+02	1.68E+06	9.32E+10	6.72E-02	1.60E-02	1.37E+00	5.71E+00			
	All Depths	1.61E+02	3.65E+02	3.06E+06	1.37E+11	5.71E-02	1.24E-02	1.04E+00	3.94E+00			
<i>Lycodes brevipes</i>	200-600	2.39E+00	0.00E+00	0.00E+00	4.27E+08	9.29E-04	3.47E-05	1.53E-02	1.04E-02			
	600-1200	0.00E+00	0.00E+00	0.00E+00	0.00E+00	0.00E+00	0.00E+00	0.00E+00	0.00E+00			
	All Depths	2.39E+00	1.60E+00	3.83E+04	4.27E+08	6.09E-04	2.28E-05	1.00E-02	6.84E-03			
<i>Lycodes concolor</i>	200-600	1.16E+03	1.05E+05	1.09E+06	1.02E+11	7.14E-01	5.93E+00	6.62E-01	5.46E+00			
	600-1200	1.31E+03	1.11E+05	1.98E+06	3.20E+11	1.06E+00	5.50E+00	1.49E+00	1.23E+01			
	All Depths	2.46E+03	2.16E+05	3.06E+06	4.22E+11	8.32E-01	5.78E+00	9.48E-01	7.94E+00			
<i>Lycodes species</i>	200-600	0.00E+00	0.00E+00	0.00E+00	0.00E+00	0.00E+00	0.00E+00	0.00E+00	0.00E+00			
	600-1200	5.48E-02	0.00E+00	0.00E+00	2.09E+07	4.49E-05	1.39E-07	3.74E-03	9.66E-04			
	All Depths	5.48E-02	3.00E-03	4.57E+03	2.09E+07	1.55E-05	4.80E-08	1.29E-03	3.33E-04			

Table 9. -- Continued.

Species	Stratum		Biomass		Population		CPUE		CPUE	
	(meters)	(t)	Variance	Number	Variance	kg/ha	Variance	no./ha	Variance	
<i>Macropinna microstoma</i>	200-600	0.00E+00	0.00E+00	0.00E+00	0.00E+00	0.00E+00	0.00E+00	0.00E+00	0.00E+00	
	600-1200	1.28E+00	0.00E+00	0.00E+00	4.68E+08	6.64E-04	6.41E-06	2.80E-02	9.37E-03	
	All Depths	1.28E+00	4.09E-01	4.94E+04	4.68E+08	2.29E-04	2.29E-06	9.67E-03	3.38E-03	
<i>Malacocottus zonurus</i>	200-600	1.06E+03	2.31E+05	8.24E+06	4.27E+12	5.65E-01	7.27E+00	4.90E+00	2.20E+02	
	600-1200	2.11E+01	8.47E+01	4.76E+05	3.69E+10	1.93E-02	3.75E-03	4.90E-01	3.17E+00	
	All Depths	1.08E+03	2.31E+05	8.71E+06	4.31E+12	3.77E-01	4.82E+00	3.38E+00	1.49E+02	
<i>Mediaster tenellus</i>	200-600	0.00E+00	0.00E+00	0.00E+00	0.00E+00	0.00E+00	0.00E+00	0.00E+00	0.00E+00	
	600-1200	2.04E+01	0.00E+00	0.00E+00	3.44E+10	1.34E-02	9.41E-03	1.91E-01	1.01E+00	
	All Depths	2.04E+01	3.05E+02	2.96E+05	3.44E+10	4.63E-03	3.26E-03	6.60E-02	3.55E-01	
<i>Melamphaea lugubris</i>	200-600	8.94E-01	2.39E-01	2.64E+04	8.64E+07	6.14E-04	1.50E-05	1.82E-02	5.88E-03	
	600-1200	3.37E-01	5.65E-02	1.59E+04	1.21E+08	3.65E-04	4.86E-06	1.72E-02	1.04E-02	
	All Depths	1.23E+00	2.96E-01	4.23E+04	2.07E+08	5.28E-04	1.15E-05	1.79E-02	7.41E-03	
Melamphaidae	200-600	0.00E+00	0.00E+00	0.00E+00	0.00E+00	0.00E+00	0.00E+00	0.00E+00	0.00E+00	
	600-1200	1.11E+00	0.00E+00	0.00E+00	1.69E+09	4.35E-04	1.31E-05	1.61E-02	1.79E-02	
	All Depths	1.11E+00	1.23E+00	4.10E+04	1.69E+09	1.50E-04	4.51E-06	5.56E-03	6.19E-03	
<i>Merluccius productus</i>	200-600	3.86E+00	0.00E+00	0.00E+00	8.38E+06	2.61E-03	8.91E-04	1.96E-03	5.02E-04	
	600-1200	0.00E+00	0.00E+00	0.00E+00	0.00E+00	0.00E+00	0.00E+00	0.00E+00	0.00E+00	
	All Depths	3.86E+00	1.49E+01	2.90E+03	8.38E+06	1.71E-03	5.84E-04	1.28E-03	3.29E-04	
<i>Metacrangon variabilis</i>	200-600	4.34E-03	0.00E+00	0.00E+00	4.71E+06	3.67E-06	1.76E-09	1.83E-03	4.41E-04	
	600-1200	0.00E+00	0.00E+00	0.00E+00	0.00E+00	0.00E+00	0.00E+00	0.00E+00	0.00E+00	
	All Depths	4.34E-03	1.89E-05	2.17E+03	4.71E+06	2.40E-06	1.15E-09	1.20E-03	2.89E-04	
<i>Metridium farcimen</i>	200-600	1.28E+00	0.00E+00	0.00E+00	4.75E+07	4.86E-04	1.61E-05	3.66E-03	8.72E-04	
	600-1200	0.00E+00	0.00E+00	0.00E+00	0.00E+00	0.00E+00	0.00E+00	0.00E+00	0.00E+00	
	All Depths	1.28E+00	8.40E-01	9.74E+03	4.75E+07	3.19E-04	1.06E-05	2.40E-03	5.73E-04	
<i>Microstomus pacificus</i>	200-600	4.63E+02	0.00E+00	0.00E+00	7.23E+09	2.67E-01	4.81E-01	2.49E-01	3.27E-01	
	600-1200	0.00E+00	0.00E+00	0.00E+00	0.00E+00	0.00E+00	0.00E+00	0.00E+00	0.00E+00	
	All Depths	4.63E+02	8.47E+03	4.57E+05	7.23E+09	1.75E-01	3.31E-01	1.63E-01	2.28E-01	
<i>Modiolus modiolus</i>	200-600	6.63E-01	0.00E+00	0.00E+00	4.26E+07	4.48E-04	1.74E-05	6.00E-03	2.60E-03	
	600-1200	0.00E+00	0.00E+00	0.00E+00	0.00E+00	0.00E+00	0.00E+00	0.00E+00	0.00E+00	
	All Depths	6.63E-01	2.88E-01	8.88E+03	4.26E+07	2.94E-04	1.14E-05	3.93E-03	1.71E-03	
<i>Molpadia intermedia</i>	200-600	8.47E-01	5.99E-01	3.64E+04	1.08E+09	4.55E-04	2.30E-05	1.95E-02	4.14E-02	
	600-1200	0.00E+00	0.00E+00	0.00E+00	0.00E+00	0.00E+00	0.00E+00	0.00E+00	0.00E+00	
	All Depths	8.47E-01	5.99E-01	3.64E+04	1.08E+09	4.55E-04	2.30E-05	1.95E-02	4.14E-02	
<i>Munidopsis species</i>	200-600	0.00E+00	0.00E+00	0.00E+00	0.00E+00	0.00E+00	0.00E+00	0.00E+00	0.00E+00	
	600-1200	1.77E-02	0.00E+00	0.00E+00	7.82E+07	9.46E-06	6.17E-09	4.73E-03	1.54E-03	
	All Depths	1.77E-02	3.13E-04	8.84E+03	7.82E+07	3.26E-06	2.13E-09	1.63E-03	5.32E-04	
<i>Munidopsis verrilli</i>	200-600	1.53E-02	2.33E-04	2.54E+03	6.47E+06	1.03E-05	1.40E-08	1.72E-03	3.88E-04	
	600-1200	5.30E-02	2.81E-03	8.84E+03	7.82E+07	2.84E-05	5.55E-08	4.73E-03	1.54E-03	
	All Depths	6.83E-02	3.05E-03	1.14E+04	8.46E+07	1.66E-05	2.82E-08	2.76E-03	7.83E-04	

Table 9. -- Continued.

Species	Stratum		Biomass		Population		CPUE		CPUE	
	(meters)	(t)	Variance	Number	Variance	kg/ha	Variance	no./ha	Variance	
<i>Muriceides</i> species cf. <i>cylindrica</i>	200-600	0.00E+00	0.00E+00	0.00E+00	0.00E+00	0.00E+00	0.00E+00	0.00E+00	0.00E+00	
	600-1200	5.14E-01	0.00E+00	0.00E+00	6.06E+07	2.20E-04	3.35E-06	3.34E-03	7.70E-04	
	All Depths	5.14E-01	2.64E-01	7.79E+03	6.06E+07	7.61E-05	1.16E-06	1.15E-03	2.66E-04	
<i>Mycale loveni</i>	200-600	1.99E+01	6.77E+01	4.70E+04	3.97E+08	9.24E-03	2.82E-03	2.44E-02	1.71E-02	
	600-1200	6.17E-01	3.80E-01	7.01E+03	4.91E+07	3.23E-04	7.22E-06	3.68E-03	9.32E-04	
	All Depths	2.05E+01	6.80E+01	5.40E+04	4.46E+08	9.56E-03	2.83E-03	2.81E-02	1.80E-02	
<i>Mycale</i> species	200-600	7.69E+00	5.29E+01	2.88E+03	8.32E+06	9.55E-05	1.18E-06	1.99E-03	5.10E-04	
	600-1200	0.00E+00	0.00E+00	0.00E+00	0.00E+00	0.00E+00	0.00E+00	0.00E+00	0.00E+00	
	All Depths	7.69E+00	5.29E+01	2.88E+03	8.32E+06	9.55E-05	1.18E-06	1.99E-03	5.10E-04	
<i>Myoxocephalus polyacanthocephalus</i>	200-600	8.81E+01	0.00E+00	0.00E+00	2.79E+08	3.11E-02	6.16E-02	9.38E-03	5.08E-03	
	600-1200	0.00E+00	0.00E+00	0.00E+00	0.00E+00	0.00E+00	0.00E+00	0.00E+00	0.00E+00	
	All Depths	8.81E+01	3.45E+03	2.66E+04	2.79E+08	2.04E-02	4.05E-02	6.14E-03	3.34E-03	
Mysidae	200-600	0.00E+00	0.00E+00	0.00E+00	0.00E+00	0.00E+00	0.00E+00	0.00E+00	0.00E+00	
	600-1200	1.88E-02	0.00E+00	0.00E+00	3.52E+08	7.37E-06	3.74E-09	7.37E-03	3.74E-03	
	All Depths	1.88E-02	3.52E-04	1.88E+04	3.52E+08	2.54E-06	1.29E-09	2.54E-03	1.29E-03	
<i>Myxoderma sacculatum</i>	200-600	4.43E+00	9.97E+00	3.44E+04	5.92E+08	2.15E-03	3.19E-04	1.63E-02	1.75E-02	
	600-1200	2.94E+02	1.43E+04	2.62E+06	1.55E+12	2.33E-01	8.14E-01	1.88E+00	6.84E+01	
	All Depths	2.99E+02	1.43E+04	2.65E+06	1.55E+12	8.19E-02	2.90E-01	6.60E-01	2.42E+01	
<i>Nannobranchium regale</i>	200-600	0.00E+00	0.00E+00	0.00E+00	0.00E+00	0.00E+00	0.00E+00	0.00E+00	0.00E+00	
	600-1200	9.04E-01	0.00E+00	0.00E+00	4.81E+08	6.18E-04	1.17E-05	2.17E-02	1.30E-02	
	All Depths	9.04E-01	4.22E-01	3.11E+04	4.81E+08	2.13E-04	4.10E-06	7.47E-03	4.55E-03	
<i>Nearchaster</i> species	200-600	0.00E+00	0.00E+00	0.00E+00	0.00E+00	0.00E+00	0.00E+00	0.00E+00	0.00E+00	
	600-1200	1.54E+00	0.00E+00	0.00E+00	7.90E+08	1.26E-03	1.04E-04	2.64E-02	3.37E-02	
	All Depths	1.54E+00	2.17E+00	3.68E+04	7.90E+08	4.34E-04	3.59E-05	9.11E-03	1.17E-02	
<i>Nearchaster variabilis</i>	200-600	4.45E+01	2.70E+02	9.55E+05	1.02E+11	2.99E-02	1.73E-02	6.38E-01	6.54E+00	
	600-1200	8.42E+02	3.85E+04	2.77E+07	7.86E+13	6.51E-01	2.40E+00	1.99E+01	2.41E+03	
	All Depths	8.87E+02	3.88E+04	2.86E+07	7.87E+13	2.44E-01	9.20E-01	7.30E+00	9.12E+02	
<i>Neoesperiopsis digitata</i>	200-600	3.71E-01	1.37E-01	4.75E+03	2.26E+07	1.48E-04	2.87E-06	1.90E-03	4.72E-04	
	600-1200	0.00E+00	0.00E+00	0.00E+00	0.00E+00	0.00E+00	0.00E+00	0.00E+00	0.00E+00	
	All Depths	3.71E-01	1.37E-01	4.75E+03	2.26E+07	1.48E-04	2.87E-06	1.90E-03	4.72E-04	
<i>Neoesperiopsis infundibula</i>	200-600	2.57E+01	4.82E+02	1.10E+05	7.95E+09	2.17E-02	4.78E-02	9.11E-02	7.88E-01	
	600-1200	3.42E+00	6.25E+00	2.09E+04	2.44E+08	2.50E-03	2.14E-04	1.48E-02	7.42E-03	
	All Depths	2.91E+01	4.89E+02	1.31E+05	8.20E+09	2.42E-02	4.81E-02	1.06E-01	7.95E-01	
<i>Neognathophausia gigas</i>	200-600	1.92E-02	1.98E-04	6.46E+03	2.03E+07	1.30E-05	1.21E-08	4.37E-03	1.24E-03	
	600-1200	4.01E-01	1.32E-02	1.18E+05	1.29E+09	2.49E-04	8.54E-07	7.15E-02	5.48E-02	
	All Depths	4.20E-01	1.34E-02	1.24E+05	1.31E+09	9.43E-05	3.12E-07	2.75E-02	2.06E-02	
<i>Neoromia</i> cf. <i>yamamoti</i>	200-600	4.80E-01	1.15E-01	1.33E+04	8.92E+07	2.30E-04	3.48E-06	6.43E-03	2.82E-03	
	600-1200	1.71E+00	1.26E+00	3.32E+04	7.56E+08	1.40E-03	7.66E-05	2.72E-02	3.89E-02	
	All Depths	2.19E+00	1.37E+00	4.65E+04	8.45E+08	6.34E-04	2.88E-05	1.36E-02	1.52E-02	

Table 9. -- Continued.

Species	Stratum		Biomass		Population		CPUE		CPUE	
	(meters)	(t)	Variance	Number	Variance	kg/ha	Variance	no./ha	Variance	
Neoromia species	200-600	7.05E-02	0.00E+00	0.00E+00	2.53E+07	2.82E-05	1.04E-07	2.01E-03	5.30E-04	
	600-1200	0.00E+00	0.00E+00	0.00E+00	0.00E+00	0.00E+00	0.00E+00	0.00E+00	0.00E+00	
	All Depths	7.05E-02	4.97E-03	5.03E+03	2.53E+07	1.84E-05	6.80E-08	1.32E-03	3.47E-04	
Neptunea amianta	200-600	2.00E+01	1.07E+02	3.35E+05	2.42E+10	9.59E-03	3.06E-03	1.65E-01	8.11E-01	
	600-1200	2.69E+01	1.06E+02	5.22E+05	3.79E+10	2.18E-02	4.38E-03	4.22E-01	1.57E+00	
	All Depths	4.70E+01	2.13E+02	8.57E+05	6.21E+10	1.38E-02	3.53E-03	2.54E-01	1.08E+00	
Neptunea insularis	200-600	3.50E+00	4.18E+00	2.44E+04	1.94E+08	1.36E-03	9.15E-05	9.41E-03	4.15E-03	
	600-1200	2.56E+00	1.58E+00	2.95E+04	2.07E+08	2.15E-03	8.96E-05	2.46E-02	1.20E-02	
	All Depths	6.06E+00	5.76E+00	5.39E+04	4.01E+08	1.63E-03	9.05E-05	1.47E-02	6.86E-03	
Neptunea pribiloffensis	200-600	2.97E+01	0.00E+00	0.00E+00	1.49E+10	1.05E-02	2.71E-03	1.10E-01	3.45E-01	
	600-1200	0.00E+00	0.00E+00	0.00E+00	0.00E+00	0.00E+00	0.00E+00	0.00E+00	0.00E+00	
	All Depths	2.97E+01	1.07E+02	3.11E+05	1.49E+10	6.86E-03	1.80E-03	7.19E-02	2.28E-01	
Neptunea species	200-600	7.78E+02	3.11E+04	6.46E+06	2.07E+12	4.87E-01	2.22E+00	4.10E+00	1.53E+02	
	600-1200	1.28E+02	4.88E+02	2.73E+06	2.21E+11	9.18E-02	2.28E-02	1.86E+00	1.00E+01	
	All Depths	9.06E+02	3.16E+04	9.19E+06	2.29E+12	3.50E-01	1.50E+00	3.33E+00	1.04E+02	
Neptunea species eggs	200-600	4.95E+00	1.19E+01	0.00E+00	0.00E+00	0.00E+00	0.00E+00	0.00E+00	0.00E+00	
	600-1200	6.12E+00	1.83E+01	0.00E+00	0.00E+00	0.00E+00	0.00E+00	0.00E+00	0.00E+00	
	All Depths	1.11E+01	3.02E+01	0.00E+00	0.00E+00	0.00E+00	0.00E+00	0.00E+00	0.00E+00	
Neptunea species F	200-600	2.19E+00	0.00E+00	0.00E+00	1.45E+08	7.72E-04	3.77E-05	7.62E-03	2.77E-03	
	600-1200	0.00E+00	0.00E+00	0.00E+00	0.00E+00	0.00E+00	0.00E+00	0.00E+00	0.00E+00	
	All Depths	2.19E+00	2.11E+00	2.16E+04	1.45E+08	5.06E-04	2.47E-05	4.99E-03	1.82E-03	
Notostomobdella cyclostoma	200-600	1.24E-01	2.54E-03	4.20E+04	4.10E+08	6.30E-05	7.68E-08	1.99E-02	8.98E-03	
	600-1200	5.24E-02	1.28E-03	1.12E+04	6.40E+07	5.66E-05	1.11E-07	1.21E-02	5.48E-03	
	All Depths	1.76E-01	3.82E-03	5.31E+04	4.74E+08	6.08E-05	8.80E-08	1.72E-02	7.75E-03	
Notostomus japonicus	200-600	9.37E-02	8.79E-03	2.93E+03	8.58E+06	6.34E-05	5.27E-07	1.98E-03	5.14E-04	
	600-1200	3.65E-01	9.80E-02	2.45E+04	3.09E+08	1.52E-04	1.07E-06	1.17E-02	5.17E-03	
	All Depths	4.59E-01	1.07E-01	2.75E+04	3.17E+08	9.39E-05	7.10E-07	5.35E-03	2.12E-03	
Nudibranchia	200-600	1.20E-02	0.00E+00	0.00E+00	1.74E+07	8.09E-06	4.26E-09	4.04E-03	1.06E-03	
	600-1200	0.00E+00	0.00E+00	0.00E+00	0.00E+00	0.00E+00	0.00E+00	0.00E+00	0.00E+00	
	All Depths	1.20E-02	6.95E-05	5.98E+03	1.74E+07	5.30E-06	2.80E-09	2.65E-03	6.99E-04	
Octopodidae	200-600	1.77E-02	0.00E+00	0.00E+00	8.69E+06	1.20E-05	1.88E-08	1.99E-03	5.21E-04	
	600-1200	0.00E+00	0.00E+00	0.00E+00	0.00E+00	0.00E+00	0.00E+00	0.00E+00	0.00E+00	
	All Depths	1.77E-02	3.13E-04	2.95E+03	8.69E+06	7.84E-06	1.23E-08	1.31E-03	3.41E-04	
Octopus dofleini	200-600	2.08E+02	5.18E+03	1.99E+05	1.55E+09	1.31E-01	3.78E-01	1.11E-01	7.43E-02	
	600-1200	8.12E+00	2.87E+01	1.16E+04	4.60E+07	8.36E-03	2.02E-03	1.14E-02	2.94E-03	
	All Depths	2.16E+02	5.21E+03	2.11E+05	1.60E+09	8.84E-02	2.51E-01	7.67E-02	5.18E-02	
Odontohenricia fisheri	200-600	1.53E-01	2.36E-02	5.48E+03	3.00E+07	1.30E-04	2.20E-06	4.63E-03	2.81E-03	
	600-1200	2.24E-01	5.03E-02	7.01E+03	4.91E+07	1.18E-04	9.54E-07	3.68E-03	9.32E-04	
	All Depths	3.78E-01	7.39E-02	1.25E+04	7.92E+07	1.25E-04	1.76E-06	4.30E-03	2.15E-03	

Table 9. -- Continued.

Species	Stratum		Biomass		Population		CPUE		CPUE	
	(meters)	(t)	Variance	Number	Variance	kg/ha	Variance	no./ha	Variance	
<i>Odontohenricia</i> species	200-600	8.26E+01	0.00E+00	0.00E+00	2.16E+08	4.26E-04	9.96E-06	1.25E-02	8.34E-03	
	600-1200	0.00E+00	0.00E+00	0.00E+00	0.00E+00	0.00E+00	0.00E+00	0.00E+00	0.00E+00	
	All Depths	8.26E-01	2.59E-01	2.45E+04	2.16E+08	2.79E-04	6.55E-06	8.21E-03	5.48E-03	
<i>Odontohenricia</i> species A	200-600	1.04E-01	0.00E+00	0.00E+00	7.51E+06	8.80E-05	1.01E-06	2.31E-03	7.02E-04	
	600-1200	0.00E+00	0.00E+00	0.00E+00	0.00E+00	0.00E+00	0.00E+00	0.00E+00	0.00E+00	
	All Depths	1.04E-01	1.08E-02	2.74E+03	7.51E+06	5.76E-05	6.64E-07	1.52E-03	4.60E-04	
<i>Onchidiopsis</i> species	200-600	8.84E+00	8.04E+00	9.29E+05	1.24E+11	4.92E-03	3.59E-04	5.32E-01	6.11E+00	
	600-1200	2.10E+00	3.76E+00	2.97E+05	7.60E+10	1.16E-03	6.74E-05	1.62E-01	1.36E+00	
	All Depths	1.09E+01	1.18E+01	1.23E+06	2.00E+11	3.62E-03	2.61E-04	4.04E-01	4.49E+00	
<i>Oncorhynchus keta</i>	200-600	3.74E+00	1.40E+01	2.87E+03	8.26E+06	2.53E-03	8.36E-04	1.94E-03	4.95E-04	
	600-1200	3.17E+01	7.34E+02	1.68E+04	1.92E+08	3.10E-02	4.64E-02	1.65E-02	1.22E-02	
	All Depths	3.55E+01	7.48E+02	1.97E+04	2.00E+08	1.23E-02	1.66E-02	6.98E-03	4.55E-03	
<i>Oncorhynchus tshawytscha</i>	200-600	1.40E+01	0.00E+00	0.00E+00	1.73E+07	5.59E-03	4.09E-03	1.66E-03	3.62E-04	
	600-1200	0.00E+00	0.00E+00	0.00E+00	0.00E+00	0.00E+00	0.00E+00	0.00E+00	0.00E+00	
	All Depths	1.40E+01	1.96E+02	4.16E+03	1.73E+07	3.66E-03	2.68E-03	1.09E-03	2.37E-04	
<i>Oneirodes bulbosus</i>	200-600	0.00E+00	0.00E+00	0.00E+00	0.00E+00	0.00E+00	0.00E+00	0.00E+00	0.00E+00	
	600-1200	1.31E+00	0.00E+00	0.00E+00	1.83E+08	6.72E-04	1.91E-05	9.41E-03	3.28E-03	
	All Depths	1.31E+00	1.07E+00	1.83E+04	1.83E+08	2.32E-04	6.62E-06	3.25E-03	1.14E-03	
<i>Oneirodes</i> species	200-600	0.00E+00	0.00E+00	0.00E+00	0.00E+00	0.00E+00	0.00E+00	0.00E+00	0.00E+00	
	600-1200	5.44E+00	0.00E+00	0.00E+00	4.59E+08	3.00E-03	2.27E-04	1.87E-02	6.40E-03	
	All Depths	5.44E+00	1.19E+01	3.63E+04	4.59E+08	1.03E-03	7.97E-05	6.44E-03	2.27E-03	
<i>Oneirodes thompsoni</i>	200-600	0.00E+00	0.00E+00	0.00E+00	0.00E+00	0.00E+00	0.00E+00	0.00E+00	0.00E+00	
	600-1200	3.36E+00	0.00E+00	0.00E+00	8.79E+07	3.24E-03	1.47E-04	2.37E-02	6.21E-03	
	All Depths	3.36E+00	2.12E+00	2.64E+04	8.79E+07	1.12E-03	5.24E-05	8.17E-03	2.25E-03	
<i>Onuphis conchylega</i>	200-600	1.17E+00	1.38E+00	0.00E+00	0.00E+00	0.00E+00	0.00E+00	0.00E+00	0.00E+00	
	600-1200	0.00E+00	0.00E+00	0.00E+00	0.00E+00	0.00E+00	0.00E+00	0.00E+00	0.00E+00	
	All Depths	1.17E+00	1.38E+00	0.00E+00	0.00E+00	0.00E+00	0.00E+00	0.00E+00	0.00E+00	
<i>Ophiacantha cataleimmoidea</i>	200-600	2.45E+02	1.48E+04	9.05E+07	1.68E+15	1.65E-01	9.40E-01	6.12E+01	1.09E+05	
	600-1200	3.32E+00	9.96E+00	1.67E+06	2.50E+12	2.81E-03	4.79E-04	1.42E+00	1.20E+02	
	All Depths	2.48E+02	1.48E+04	9.22E+07	1.69E+15	1.09E-01	6.21E-01	4.06E+01	7.19E+04	
<i>Ophiacantha normani</i>	200-600	1.97E+03	4.88E+05	2.29E+09	8.10E+17	1.33E+00	3.33E+01	1.55E+03	5.39E+07	
	600-1200	1.87E+03	5.69E+05	1.86E+09	7.18E+17	1.99E+00	5.70E+01	1.97E+03	6.85E+07	
	All Depths	3.84E+03	1.06E+06	4.15E+09	1.53E+18	1.56E+00	4.13E+01	1.69E+03	5.87E+07	
<i>Ophiolebes pachybaetra</i>	200-600	5.37E-02	2.89E-03	3.28E+04	1.08E+09	4.66E-05	2.84E-07	2.84E-02	1.06E-01	
	600-1200	0.00E+00	0.00E+00	0.00E+00	0.00E+00	0.00E+00	0.00E+00	0.00E+00	0.00E+00	
	All Depths	5.37E-02	2.89E-03	3.28E+04	1.08E+09	4.66E-05	2.84E-07	2.84E-02	1.06E-01	
<i>Ophiopholis aculeata</i>	200-600	5.82E+01	1.69E+03	1.72E+07	1.52E+14	3.92E-02	1.03E-01	1.16E+01	9.26E+03	
	600-1200	1.46E+01	9.26E+01	3.14E+06	3.55E+12	9.84E-03	2.17E-03	2.16E+00	8.87E+01	
	All Depths	7.28E+01	1.78E+03	2.04E+07	1.56E+14	4.90E-02	1.05E-01	1.37E+01	9.35E+03	

Table 9. -- Continued.

Species	Stratum		Biomass		Population		CPUE		CPUE	
	(meters)	(t)	Variance	Number	Variance	kg/ha	Variance	no./ha	Variance	
<i>Ophiopholis longispina</i>	200-600	0.00E+00	0.00E+00	0.00E+00	0.00E+00	0.00E+00	0.00E+00	0.00E+00	0.00E+00	
	600-1200	1.56E-02	2.42E-04	1.56E+04	2.42E+08	6.68E-06	3.08E-09	6.68E-03	3.08E-03	
	All Depths	1.56E-02	2.42E-04	1.56E+04	2.42E+08	6.68E-06	3.08E-09	6.68E-03	3.08E-03	
<i>Ophioscolex</i> species	200-600	0.00E+00	0.00E+00	0.00E+00	0.00E+00	0.00E+00	0.00E+00	0.00E+00	0.00E+00	
	600-1200	3.25E+00	2.60E+00	4.30E+06	3.34E+12	1.68E-03	1.10E-04	2.23E+00	1.80E+02	
	All Depths	3.25E+00	2.60E+00	4.30E+06	3.34E+12	1.68E-03	1.10E-04	2.23E+00	1.80E+02	
<i>Ophiura quadrispina</i>	200-600	2.68E-01	0.00E+00	0.00E+00	1.25E+12	1.81E-04	4.31E-06	7.57E-01	7.51E+01	
	600-1200	0.00E+00	0.00E+00	0.00E+00	0.00E+00	0.00E+00	0.00E+00	0.00E+00	0.00E+00	
	All Depths	2.68E-01	7.20E-02	1.12E+06	1.25E+12	1.19E-04	2.83E-06	4.96E-01	4.92E+01	
<i>Ophiura sarsi</i>	200-600	1.70E-02	0.00E+00	0.00E+00	1.58E+07	1.15E-05	9.44E-09	3.86E-03	9.70E-04	
	600-1200	0.00E+00	0.00E+00	0.00E+00	0.00E+00	0.00E+00	0.00E+00	0.00E+00	0.00E+00	
	All Depths	1.70E-02	1.55E-04	5.71E+03	1.58E+07	7.53E-06	6.20E-09	2.53E-03	6.37E-04	
Ophiuroidea	200-600	5.74E+00	1.20E+01	9.50E+06	2.97E+13	3.88E-03	7.42E-04	6.42E+00	1.85E+03	
	600-1200	4.80E-02	2.31E-03	3.43E+03	1.18E+07	5.19E-05	1.86E-07	3.71E-03	9.50E-04	
	All Depths	5.78E+00	1.20E+01	9.50E+06	2.97E+13	2.56E-03	4.88E-04	4.21E+00	1.22E+03	
<i>Opisthoteuthis californiana</i>	200-600	6.83E+01	2.84E+02	1.09E+05	8.90E+08	4.13E-02	2.35E-02	5.93E-02	5.70E-02	
	600-1200	2.10E+00	2.41E+00	2.03E+04	1.19E+08	2.19E-03	1.87E-04	2.03E-02	8.62E-03	
	All Depths	7.04E+01	2.87E+02	1.30E+05	1.01E+09	2.78E-02	1.58E-02	4.58E-02	4.06E-02	
<i>Opisthoteuthis</i> species cf. <i>californiana</i>	200-600	1.46E+01	0.00E+00	0.00E+00	3.48E+07	9.88E-03	1.28E-02	3.99E-03	2.08E-03	
	600-1200	0.00E+00	0.00E+00	0.00E+00	0.00E+00	0.00E+00	0.00E+00	0.00E+00	0.00E+00	
	All Depths	1.46E+01	2.14E+02	5.90E+03	3.48E+07	6.47E-03	8.38E-03	2.61E-03	1.37E-03	
<i>Oractis diomedea</i>	200-600	5.57E-01	0.00E+00	0.00E+00	1.76E+08	2.76E-04	3.11E-06	1.77E-02	8.67E-03	
	600-1200	0.00E+00	0.00E+00	0.00E+00	0.00E+00	0.00E+00	0.00E+00	0.00E+00	0.00E+00	
	All Depths	5.57E-01	1.26E-01	3.15E+04	1.76E+08	1.81E-04	2.05E-06	1.16E-02	5.73E-03	
<i>Oregonia bifurca</i>	200-600	0.00E+00	0.00E+00	0.00E+00	0.00E+00	0.00E+00	0.00E+00	0.00E+00	0.00E+00	
	600-1200	1.63E+00	0.00E+00	0.00E+00	2.11E+09	9.09E-04	3.60E-05	4.15E-02	5.03E-02	
	All Depths	1.63E+00	1.79E+00	7.02E+04	2.11E+09	3.14E-04	1.25E-05	1.43E-02	1.76E-02	
<i>Otukaita kiiheiziebisu</i>	200-600	0.00E+00	0.00E+00	0.00E+00	0.00E+00	0.00E+00	0.00E+00	0.00E+00	0.00E+00	
	600-1200	8.57E-02	0.00E+00	0.00E+00	3.74E+07	4.50E-05	1.40E-07	3.21E-03	7.12E-04	
	All Depths	8.57E-02	7.34E-03	6.12E+03	3.74E+07	1.55E-05	4.82E-08	1.11E-03	2.46E-04	
<i>Paelopatides confundens</i>	200-600	0.00E+00	0.00E+00	0.00E+00	0.00E+00	0.00E+00	0.00E+00	0.00E+00	0.00E+00	
	600-1200	1.40E+00	1.96E+00	7.95E+03	6.32E+07	7.57E-04	3.96E-05	4.30E-03	1.28E-03	
	All Depths	1.40E+00	1.96E+00	7.95E+03	6.32E+07	7.57E-04	3.96E-05	4.30E-03	1.28E-03	
<i>Pagurus aleuticus</i>	200-600	1.61E+00	9.78E-01	2.95E+04	4.39E+08	6.43E-04	2.18E-05	1.18E-02	9.55E-03	
	600-1200	2.81E-01	7.91E-02	3.70E+03	1.37E+07	3.45E-04	8.20E-06	4.54E-03	1.42E-03	
	All Depths	1.89E+00	1.06E+00	3.32E+04	4.53E+08	5.40E-04	1.71E-05	9.28E-03	6.74E-03	
<i>Pagurus brandti</i>	200-600	3.94E-02	0.00E+00	0.00E+00	1.24E+08	1.63E-05	2.17E-08	6.09E-03	2.70E-03	
	600-1200	0.00E+00	0.00E+00	0.00E+00	0.00E+00	0.00E+00	0.00E+00	0.00E+00	0.00E+00	
	All Depths	3.94E-02	1.02E-03	1.46E+04	1.24E+08	1.07E-05	1.43E-08	3.99E-03	1.77E-03	

Table 9. -- Continued.

Species	Stratum			Biomass			Population			CPUE			CPUE		
	(meters)	(t)	Variance	Number	Variance	kg/ha	Variance	no./ha	Variance						
<i>Pagurus confragosus</i>	200-600	1.07E+01	0.00E+00	0.00E+00	1.37E+10	4.23E-03	3.95E-04	9.06E-02	2.38E-01						
	600-1200	0.00E+00	0.00E+00	0.00E+00	0.00E+00	0.00E+00	0.00E+00	0.00E+00	0.00E+00						
	All Depths	1.07E+01	1.96E+01	2.34E+05	1.37E+10	2.77E-03	2.62E-04	5.93E-02	1.58E-01						
<i>Pagurus cornutus</i>	200-600	3.10E+02	1.04E+04	7.24E+06	9.60E+12	1.64E-01	4.00E-01	3.82E+00	3.73E+02						
	600-1200	2.14E-02	4.59E-04	2.68E+03	7.17E+06	2.71E-05	5.06E-08	3.38E-03	7.90E-04						
	All Depths	3.10E+02	1.04E+04	7.25E+06	9.60E+12	1.07E-01	2.67E-01	2.50E+00	2.47E+02						
<i>Pagurus dalli</i>	200-600	1.55E-02	0.00E+00	0.00E+00	5.99E+07	7.15E-06	6.69E-09	3.57E-03	1.67E-03						
	600-1200	0.00E+00	0.00E+00	0.00E+00	0.00E+00	0.00E+00	0.00E+00	0.00E+00	0.00E+00						
	All Depths	1.55E-02	2.40E-04	7.74E+03	5.99E+07	4.68E-06	4.38E-09	2.34E-03	1.10E-03						
<i>Pagurus ochotensis</i>	200-600	2.91E-02	0.00E+00	0.00E+00	2.36E+07	1.16E-05	1.78E-08	1.94E-03	4.93E-04						
	600-1200	0.00E+00	0.00E+00	0.00E+00	0.00E+00	0.00E+00	0.00E+00	0.00E+00	0.00E+00						
	All Depths	2.91E-02	8.49E-04	4.86E+03	2.36E+07	7.62E-06	1.16E-08	1.27E-03	3.23E-04						
<i>Pagurus rathbuni</i>	200-600	2.87E-01	8.26E-02	1.06E+04	1.13E+08	1.01E-04	1.35E-06	3.76E-03	1.85E-03						
	600-1200	2.84E-01	8.06E-02	2.18E+04	4.77E+08	2.71E-04	5.07E-06	2.09E-02	3.00E-02						
	All Depths	5.71E-01	1.63E-01	3.25E+04	5.90E+08	1.60E-04	2.62E-06	9.66E-03	1.15E-02						
<i>Pagurus species</i>	200-600	3.34E+00	0.00E+00	0.00E+00	2.56E+09	1.49E-03	1.92E-04	2.78E-02	5.54E-02						
	600-1200	0.00E+00	0.00E+00	0.00E+00	0.00E+00	0.00E+00	0.00E+00	0.00E+00	0.00E+00						
	All Depths	3.34E+00	9.04E+00	5.92E+04	2.56E+09	9.78E-04	1.26E-04	1.82E-02	3.64E-02						
<i>Pagurus tanneri</i>	200-600	0.00E+00	0.00E+00	0.00E+00	0.00E+00	0.00E+00	0.00E+00	0.00E+00	0.00E+00						
	600-1200	1.44E+01	0.00E+00	0.00E+00	4.12E+10	1.58E-02	8.07E-03	3.94E-01	4.16E+00						
	All Depths	1.44E+01	8.12E+01	3.68E+05	4.12E+10	5.46E-03	2.82E-03	1.36E-01	1.46E+00						
<i>Pagurus townsendi</i>	200-600	6.00E+00	9.32E+00	2.49E+05	1.76E+10	4.06E-03	5.75E-04	1.69E-01	1.09E+00						
	600-1200	2.44E+01	3.36E+01	9.07E+05	3.08E+10	2.14E-02	2.77E-03	7.73E-01	2.49E+00						
	All Depths	3.04E+01	4.29E+01	1.16E+06	4.84E+10	1.00E-02	1.39E-03	3.78E-01	1.65E+00						
<i>Pagurus trigonocheirus</i>	200-600	6.16E+01	4.81E+02	2.32E+06	7.26E+11	2.18E-02	1.19E-02	8.23E-01	1.75E+01						
	600-1200	1.18E-01	1.39E-02	1.07E+04	1.15E+08	1.49E-04	1.53E-06	1.35E-02	1.26E-02						
	All Depths	6.17E+01	4.81E+02	2.33E+06	7.26E+11	1.44E-02	7.87E-03	5.43E-01	1.16E+01						
<i>Pandalopsis aleutica</i>	200-600	9.70E-02	7.36E-03	6.25E+03	2.20E+07	8.37E-05	7.22E-07	5.37E-03	2.13E-03						
	600-1200	3.45E+01	1.88E+02	1.92E+06	5.38E+11	1.84E-02	4.04E-03	1.01E+00	1.15E+01						
	All Depths	3.46E+01	1.88E+02	1.93E+06	5.38E+11	6.40E-03	1.46E-03	3.51E-01	4.17E+00						
<i>Pandalopsis ampla</i>	200-600	0.00E+00	0.00E+00	0.00E+00	0.00E+00	0.00E+00	0.00E+00	0.00E+00	0.00E+00						
	600-1200	9.18E-02	0.00E+00	0.00E+00	7.27E+07	4.76E-05	8.42E-08	7.26E-03	1.83E-03						
	All Depths	9.18E-02	6.30E-03	1.12E+04	7.27E+07	1.64E-05	2.93E-08	2.50E-03	6.37E-04						
<i>Pandalopsis dispar</i>	200-600	1.44E+02	1.22E+03	9.57E+06	5.43E+12	7.31E-02	4.43E-02	4.84E+00	1.87E+02						
	600-1200	9.22E+00	8.39E+01	4.75E+05	2.22E+11	7.56E-03	3.88E-03	3.89E-01	1.03E+01						
	All Depths	1.53E+02	1.31E+03	1.00E+07	5.65E+12	5.05E-02	3.12E-02	3.31E+00	1.30E+02						
<i>Pandalopsis longirostris</i>	200-600	3.90E-02	0.00E+00	0.00E+00	7.24E+07	3.38E-05	1.16E-07	9.54E-03	7.68E-03						
	600-1200	0.00E+00	0.00E+00	0.00E+00	0.00E+00	0.00E+00	0.00E+00	0.00E+00	0.00E+00						
	All Depths	3.90E-02	1.13E-03	1.10E+04	7.24E+07	2.21E-05	7.59E-08	6.25E-03	5.04E-03						

Table 9. - - Continued.

Species	Stratum		Biomass		Population		CPUE		CPUE	
	(meters)	(t)	Variance	Number	Variance	kg/ha	Variance	no./ha	Variance	
<i>Pandalopsis</i> species	200-600	1.79E+02	3.21E+04	2.99E+03	8.92E+06	1.55E+05	3.15E+08	2.59E+03	8.76E-04	
	600-1200	2.68E+02	7.17E+04	5.36E+03	2.87E+07	3.38E+05	7.90E+08	6.77E+03	3.16E-03	
	All Depths	4.47E+02	1.04E+03	8.34E+03	3.76E+07	2.18E+05	4.77E+08	4.03E+03	1.66E-03	
<i>Pandalus</i> eous	200-600	9.39E+02	0.00E+00	0.00E+00	4.75E+14	4.15E+01	6.16E-01	7.08E+01	1.80E+04	
	600-1200	0.00E+00	0.00E+00	0.00E+00	0.00E+00	0.00E+00	0.00E+00	0.00E+00	0.00E+00	
	All Depths	9.39E+02	1.41E+04	1.61E+08	4.75E+14	2.72E-01	4.42E-01	4.63E+01	1.29E+04	
<i>Pandalus</i> tridens	200-600	2.88E+01	0.00E+00	0.00E+00	5.09E+09	2.46E+04	5.94E+06	7.20E-02	5.08E-01	
	600-1200	0.00E+00	0.00E+00	0.00E+00	0.00E+00	0.00E+00	0.00E+00	0.00E+00	0.00E+00	
	All Depths	2.88E+01	5.96E-02	8.47E+04	5.09E+09	1.61E+04	3.89E+06	4.71E-02	3.33E-01	
<i>Pannychia</i> moseleyi	200-600	7.60E+03	1.81E+06	7.64E+07	1.81E+14	4.96E+00	1.47E+02	5.12E+01	1.72E+04	
	600-1200	2.99E+03	9.92E+05	5.26E+07	2.43E+14	3.06E+00	9.84E+01	5.37E+01	2.70E+04	
	All Depths	1.06E+04	2.80E+06	1.29E+08	4.25E+14	8.03E+00	2.46E+02	1.05E+02	4.42E+04	
<i>Pannychia</i> species	200-600	0.00E+00	0.00E+00	0.00E+00	0.00E+00	0.00E+00	0.00E+00	0.00E+00	0.00E+00	
	600-1200	3.91E+01	1.41E+03	7.59E+05	4.61E+11	1.58E-02	1.50E-02	3.18E-01	4.94E+00	
	All Depths	3.91E+01	1.41E+03	7.59E+05	4.61E+11	1.58E-02	1.50E-02	3.18E-01	4.94E+00	
<i>Paractinostola</i> faeulentata	200-600	3.12E+03	2.84E+06	1.04E+07	2.74E+13	1.49E+00	9.96E+01	5.13E+00	1.02E+03	
	600-1200	4.66E+02	4.41E+04	2.29E+06	5.31E+11	2.67E-01	1.12E+00	1.17E+00	2.48E+01	
	All Depths	3.58E+03	2.88E+06	1.27E+07	2.79E+13	1.07E+00	6.58E+01	3.77E+00	6.81E+02	
<i>Paragorgia</i> arborea	200-600	6.77E+00	4.59E+01	0.00E+00	0.00E+00	0.00E+00	0.00E+00	0.00E+00	0.00E+00	
	600-1200	2.96E+02	4.00E+04	4.92E+04	1.84E+09	3.41E-02	7.16E-02	2.96E-02	4.49E-02	
	All Depths	3.03E+02	4.00E+04	4.92E+04	1.84E+09	1.15E-02	2.41E-02	9.97E-03	1.52E-02	
<i>Paraliparis</i> cephalus	200-600	0.00E+00	0.00E+00	0.00E+00	0.00E+00	0.00E+00	0.00E+00	0.00E+00	0.00E+00	
	600-1200	4.49E-01	0.00E+00	0.00E+00	5.11E+09	4.03E-04	2.96E-06	1.01E-01	2.12E-01	
	All Depths	4.49E-01	4.79E-02	1.29E+05	5.11E+09	1.39E-04	1.05E-06	3.49E-02	7.47E-02	
<i>Paraliparis</i> dactylosus	200-600	0.00E+00	0.00E+00	0.00E+00	0.00E+00	0.00E+00	0.00E+00	0.00E+00	0.00E+00	
	600-1200	1.08E-01	0.00E+00	0.00E+00	9.29E+07	9.11E-05	3.06E-07	1.14E-02	4.79E-03	
	All Depths	1.08E-01	5.95E-03	1.35E+04	9.29E+07	3.14E-05	1.07E-07	3.93E-03	1.67E-03	
<i>Paraliparis</i> paucidens	200-600	0.00E+00	0.00E+00	0.00E+00	0.00E+00	0.00E+00	0.00E+00	0.00E+00	0.00E+00	
	600-1200	2.11E-02	0.00E+00	0.00E+00	1.23E+07	2.01E-05	2.80E-08	3.36E-03	7.77E-04	
	All Depths	2.11E-02	4.44E-04	3.51E+03	1.23E+07	6.95E-06	9.65E-09	1.16E-03	2.68E-04	
<i>Paraliparis</i> species	200-600	0.00E+00	0.00E+00	0.00E+00	0.00E+00	0.00E+00	0.00E+00	0.00E+00	0.00E+00	
	600-1200	1.54E+00	0.00E+00	0.00E+00	2.47E+09	7.68E-04	1.31E-05	4.47E-02	3.39E-02	
	All Depths	1.54E+00	1.02E+00	8.33E+04	2.47E+09	2.65E-04	4.61E-06	1.54E-02	1.21E-02	
<i>Paraliparis</i> species cf. <i>dactylosus</i>	200-600	9.53E-02	4.59E-03	5.97E+03	1.78E+07	5.71E-05	2.12E-07	3.63E-03	8.70E-04	
	600-1200	5.78E-01	1.78E-01	6.19E+04	2.47E+09	6.97E-04	1.80E-05	7.49E-02	2.53E-01	
	All Depths	6.73E-01	1.82E-01	6.78E+04	2.49E+09	2.78E-04	6.39E-06	2.82E-02	8.82E-02	
<i>Paraliparis</i> species cf. <i>pectoralis</i>	200-600	0.00E+00	0.00E+00	0.00E+00	0.00E+00	0.00E+00	0.00E+00	0.00E+00	0.00E+00	
	600-1200	1.12E+00	0.00E+00	0.00E+00	1.05E+09	4.81E-04	1.18E-05	2.06E-02	2.12E-02	
	All Depths	1.12E+00	6.05E-01	4.80E+04	1.05E+09	1.66E-04	4.07E-06	7.11E-03	7.34E-03	

Table 9. - - Continued.

Species	Stratum		Biomass		Population		CPUE		CPUE	
	(meters)	(t)	Variance	Number	Variance	kg/ha	Variance	no./ha	Variance	
<i>Paraliparis</i> species cf. <i>ulochir</i>	200-600	0.00E+00	0.00E+00	0.00E+00	0.00E+00	0.00E+00	0.00E+00	0.00E+00	0.00E+00	
	600-1200	6.08E-02	0.00E+00	0.00E+00	7.30E+07	3.35E-05	3.96E-08	6.70E-03	1.52E-03	
	All Depths	6.08E-02	2.38E-03	1.13E+04	7.30E+07	1.15E-05	1.38E-08	2.31E-03	5.31E-04	
<i>Paraliparis ulochir</i>	200-600	0.00E+00	0.00E+00	0.00E+00	0.00E+00	0.00E+00	0.00E+00	0.00E+00	0.00E+00	
	600-1200	1.40E-01	0.00E+00	0.00E+00	2.44E+08	1.15E-04	9.14E-07	1.28E-02	1.13E-02	
	All Depths	1.40E-01	1.97E-02	1.56E+04	2.44E+08	3.97E-05	3.15E-07	4.41E-03	3.89E-03	
<i>Paralomis multispina</i>	200-600	0.00E+00	0.00E+00	0.00E+00	0.00E+00	0.00E+00	0.00E+00	0.00E+00	0.00E+00	
	600-1200	3.34E+02	1.92E+04	7.24E+05	1.06E+11	3.12E-01	4.16E-01	6.59E-01	2.17E+00	
	All Depths	3.34E+02	1.92E+04	7.24E+05	1.06E+11	1.87E-01	1.49E-01	3.96E-01	7.76E-01	
<i>Paralomis</i> species A	200-600	0.00E+00	0.00E+00	0.00E+00	0.00E+00	0.00E+00	0.00E+00	0.00E+00	0.00E+00	
	600-1200	6.39E-02	0.00E+00	0.00E+00	2.09E+07	5.24E-05	1.89E-07	3.74E-03	9.66E-04	
	All Depths	6.39E-02	4.09E-03	4.57E+03	2.09E+07	1.81E-05	6.53E-08	1.29E-03	3.33E-04	
<i>Paralomis verrilli</i>	200-600	0.00E+00	0.00E+00	0.00E+00	0.00E+00	0.00E+00	0.00E+00	0.00E+00	0.00E+00	
	600-1200	2.67E+01	0.00E+00	0.00E+00	2.41E+09	1.45E-02	1.17E-02	3.52E-02	6.68E-02	
	All Depths	2.67E+01	4.50E+02	6.50E+04	2.41E+09	4.99E-03	4.05E-03	1.21E-02	2.31E-02	
<i>Pasiphaea pacifica</i>	200-600	1.82E+01	2.33E+01	7.05E+06	3.83E+12	1.22E-02	1.65E-03	4.68E+00	2.60E+02	
	600-1200	5.30E-01	4.65E-02	2.09E+05	9.99E+09	5.45E-04	4.62E-06	2.12E-01	9.07E-01	
	All Depths	1.88E+01	2.34E+01	7.26E+06	3.84E+12	8.15E-03	1.11E-03	3.14E+00	1.75E+02	
<i>Pasiphaea tarda</i>	200-600	3.79E-02	6.58E-04	4.74E+03	1.03E+07	3.20E-05	6.83E-08	4.00E-03	1.07E-03	
	600-1200	1.57E+00	4.40E-01	9.58E+04	1.25E+09	7.65E-04	6.51E-06	4.96E-02	2.15E-02	
	All Depths	1.61E+00	4.40E-01	1.01E+05	1.26E+09	2.85E-04	2.39E-06	1.97E-02	8.50E-03	
<i>Pedicellaster magister</i>	200-600	2.87E+00	2.49E+00	2.02E+05	1.02E+10	1.40E-03	6.29E-05	9.61E-02	2.55E-01	
	600-1200	7.19E-01	4.36E-02	9.22E+04	7.36E+08	5.79E-04	1.86E-06	6.94E-02	2.21E-02	
	All Depths	3.59E+00	2.53E+00	2.95E+05	1.09E+10	1.11E-03	4.19E-05	8.69E-02	1.74E-01	
<i>Periphylla periphylla</i>	200-600	3.01E-01	1.32E-02	2.75E+04	8.51E+07	2.12E-04	8.85E-07	2.04E-02	7.26E-03	
	600-1200	1.59E+00	1.69E-01	1.78E+05	2.21E+09	9.82E-04	3.82E-06	1.23E-01	6.14E-02	
	All Depths	1.89E+00	1.82E-01	2.05E+05	2.29E+09	4.75E-04	2.01E-06	5.55E-02	2.79E-02	
Petromyzontidae	200-600	4.94E+01	1.01E+02	1.53E+05	9.95E+08	2.87E-02	5.12E-03	8.88E-02	4.40E-02	
	600-1200	3.90E+00	5.08E+00	1.40E+04	6.98E+07	3.30E-03	2.53E-04	1.14E-02	2.88E-03	
	All Depths	5.33E+01	1.06E+02	1.67E+05	1.07E+09	2.00E-02	3.58E-03	6.21E-02	3.11E-02	
<i>Phacellophora camtschatica</i>	200-600	5.07E+01	1.86E+02	8.94E+04	3.40E+08	2.07E-02	5.40E-03	4.02E-02	1.39E-02	
	600-1200	2.13E+01	6.04E+01	7.29E+04	5.65E+08	1.52E-02	1.95E-03	5.15E-02	1.57E-02	
	All Depths	7.19E+01	2.46E+02	1.62E+05	9.05E+08	1.88E-02	4.20E-03	4.41E-02	1.45E-02	
<i>Phakellia beringensis</i>	200-600	5.32E+01	2.83E-01	3.06E+03	9.34E+06	3.60E-04	1.70E-05	2.07E-03	5.60E-04	
	600-1200	0.00E+00	0.00E+00	0.00E+00	0.00E+00	0.00E+00	0.00E+00	0.00E+00	0.00E+00	
	All Depths	5.32E+01	2.83E-01	3.06E+03	9.34E+06	3.60E-04	1.70E-05	2.07E-03	5.60E-04	
<i>Phakellia cribrosa</i>	200-600	1.88E+00	3.55E+00	3.06E+03	9.34E+06	1.27E-03	2.13E-04	2.07E-03	5.60E-04	
	600-1200	0.00E+00	0.00E+00	0.00E+00	0.00E+00	0.00E+00	0.00E+00	0.00E+00	0.00E+00	
	All Depths	1.88E+00	3.55E+00	3.06E+03	9.34E+06	1.27E-03	2.13E-04	2.07E-03	5.60E-04	

Table 9. - - Continued.

Species	Stratum		Biomass		Population		CPUE		CPUE	
	(meters)	(t)	Variance	Number	Variance	kg/ha	Variance	no./ha	Variance	
<i>Phakellia</i> species	200-600	0.00E+00	0.00E+00	0.00E+00	0.00E+00	0.00E+00	0.00E+00	0.00E+00	0.00E+00	
	600-1200	3.75E-01	1.41E-01	3.83E+03	1.47E+07	4.06E-04	1.14E-05	4.14E-03	1.18E-03	
	All Depths	3.75E-01	1.41E-01	3.83E+03	1.47E+07	4.06E-04	1.14E-05	4.14E-03	1.18E-03	
Phascolosomatidae	200-600	6.36E-02	4.05E-03	1.06E+04	1.12E+08	2.54E-05	8.46E-08	4.24E-03	2.35E-03	
	600-1200	1.47E-02	2.16E-04	3.67E+03	1.35E+07	1.59E-05	1.74E-08	3.97E-03	1.09E-03	
	All Depths	7.83E-02	4.26E-03	1.43E+04	1.26E+08	4.13E-05	1.02E-07	8.21E-03	3.44E-03	
<i>Placiphorella pacifica</i>	200-600	2.99E-03	8.92E-06	2.99E+03	8.92E+06	2.59E-06	8.76E-10	2.59E-03	8.76E-04	
	600-1200	1.59E-01	2.53E-02	1.77E+04	3.13E+08	8.51E-05	5.00E-07	9.46E-03	6.17E-03	
	All Depths	1.62E-01	2.53E-02	2.07E+04	3.22E+08	3.11E-05	1.73E-07	4.96E-03	2.69E-03	
<i>Placiphorella</i> species	200-600	0.00E+00	0.00E+00	0.00E+00	0.00E+00	0.00E+00	0.00E+00	0.00E+00	0.00E+00	
	600-1200	1.36E-02	0.00E+00	0.00E+00	4.60E+07	7.11E-06	3.49E-09	3.56E-03	8.73E-04	
	All Depths	1.36E-02	1.84E-04	6.78E+03	4.60E+07	2.45E-06	1.20E-09	1.23E-03	3.01E-04	
Platyroctidae	200-600	5.75E-03	0.00E+00	0.00E+00	8.26E+06	3.89E-06	1.98E-09	1.94E-03	4.95E-04	
	600-1200	0.00E+00	0.00E+00	0.00E+00	0.00E+00	0.00E+00	0.00E+00	0.00E+00	0.00E+00	
	All Depths	5.75E-03	3.30E-05	2.87E+03	8.26E+06	2.55E-06	1.30E-09	1.27E-03	3.24E-04	
<i>Pleurogrammus monoptyerygius</i>	200-600	0.00E+00	0.00E+00	0.00E+00	0.00E+00	0.00E+00	0.00E+00	0.00E+00	0.00E+00	
	600-1200	8.28E-01	0.00E+00	0.00E+00	4.32E+07	4.43E-04	1.35E-05	3.52E-03	8.53E-04	
	All Depths	8.28E-01	6.86E-01	6.57E+03	4.32E+07	1.53E-04	4.67E-06	1.21E-03	2.94E-04	
<i>Polyacanthonotus challengerii</i>	200-600	0.00E+00	0.00E+00	0.00E+00	0.00E+00	0.00E+00	0.00E+00	0.00E+00	0.00E+00	
	600-1200	4.54E+00	0.00E+00	0.00E+00	2.57E+07	3.06E-03	6.47E-04	3.42E-03	8.06E-04	
	All Depths	4.54E+00	2.06E+01	5.07E+03	2.57E+07	1.06E-03	2.23E-04	1.18E-03	2.78E-04	
Polychaeta	200-600	1.49E+00	1.22E+00	2.70E+05	6.74E+10	7.69E-04	6.61E-05	1.83E-01	4.07E+00	
	600-1200	1.27E+00	7.21E-01	5.12E+05	1.58E+11	9.29E-04	2.16E-05	3.32E-01	3.35E+00	
	All Depths	2.76E+00	1.94E+00	7.82E+05	2.25E+11	1.70E-03	8.77E-05	5.15E-01	7.42E+00	
Polychaete tubes	200-600	0.00E+00	0.00E+00	0.00E+00	0.00E+00	0.00E+00	0.00E+00	0.00E+00	0.00E+00	
	600-1200	1.94E+03	2.35E+06	2.44E+07	5.94E+14	1.25E-01	1.05E+00	1.10E+01	8.08E+03	
	All Depths	1.94E+03	2.35E+06	2.44E+07	5.94E+14	1.25E-01	1.05E+00	1.10E+01	8.08E+03	
<i>Polymastia robusta</i>	200-600	2.52E-01	6.35E-02	8.69E+03	7.55E+07	1.16E-04	1.77E-06	4.01E-03	2.11E-03	
	600-1200	0.00E+00	0.00E+00	0.00E+00	0.00E+00	0.00E+00	0.00E+00	0.00E+00	0.00E+00	
	All Depths	2.52E-01	6.35E-02	8.69E+03	7.55E+07	1.16E-04	1.77E-06	4.01E-03	2.11E-03	
<i>Polymastia</i> species	200-600	4.02E+00	1.11E+01	7.29E+04	2.91E+09	1.83E-03	3.26E-04	3.46E-02	9.01E-02	
	600-1200	0.00E+00	0.00E+00	0.00E+00	0.00E+00	0.00E+00	0.00E+00	0.00E+00	0.00E+00	
	All Depths	4.02E+00	1.11E+01	7.29E+04	2.91E+09	1.83E-03	3.26E-04	3.46E-02	9.01E-02	
Porifera	200-600	9.43E+02	3.19E+05	1.14E+04	3.58E+07	5.22E-04	1.67E-05	4.58E-03	1.28E-03	
	600-1200	1.61E+02	6.86E+03	3.57E+03	9.56E+06	2.45E-03	3.18E-04	4.41E-03	1.03E-03	
	All Depths	1.10E+03	3.26E+05	1.49E+04	4.54E+07	1.42E-03	1.56E-04	4.50E-03	1.15E-03	
<i>Poromitra curilensis</i>	200-600	0.00E+00	0.00E+00	0.00E+00	0.00E+00	0.00E+00	0.00E+00	0.00E+00	0.00E+00	
	600-1200	1.94E-01	0.00E+00	0.00E+00	3.34E+07	2.05E-04	1.07E-06	1.07E-02	2.58E-03	
	All Depths	1.94E-01	1.30E-02	1.03E+04	3.34E+07	7.07E-05	3.75E-07	3.68E-03	9.09E-04	

Table 9. -- Continued.

Species	Stratum			Biomass			Population			CPUE		
	(meters)	(t)	Variance	Number	Variance	kg/ha	Variance	no./ha	Variance			
<i>Primnoa</i> species	200-600	1.87E+01	3.47E+02	2.99E+03	8.92E+06	6.78E-05	5.97E-07	2.61E-03	8.83E-04			
	600-1200	9.34E-01	8.73E-01	1.56E+04	2.42E+08	4.01E-04	1.11E-05	6.68E-03	3.08E-03			
	All Depths	1.96E+01	3.48E+02	1.86E+04	2.51E+08	1.83E-04	4.22E-06	4.02E-03	1.64E-03			
<i>Pseudarchaster parelii</i>	200-600	8.23E+00	8.81E+00	1.75E+05	1.86E+09	3.98E-03	2.12E-04	1.00E-01	7.43E-02			
	600-1200	8.64E+00	7.06E+00	3.27E+05	8.04E+09	5.43E-03	1.75E-04	2.22E-01	2.83E-01			
	All Depths	1.69E+01	1.59E+01	5.02E+05	9.90E+09	4.48E-03	1.99E-04	1.42E-01	1.49E-01			
<i>Pseudostichopus mollis</i>	200-600	2.41E-01	5.82E-02	3.09E+03	9.56E+06	1.63E-04	3.49E-06	2.09E-03	5.73E-04			
	600-1200	0.00E+00	0.00E+00	0.00E+00	0.00E+00	0.00E+00	0.00E+00	0.00E+00	0.00E+00			
	All Depths	2.41E-01	5.82E-02	3.09E+03	9.56E+06	1.63E-04	3.49E-06	2.09E-03	5.73E-04			
<i>Psolus</i> species	200-600	7.60E-03	5.77E-05	3.80E+03	1.44E+07	4.08E-06	2.18E-09	2.04E-03	5.45E-04			
	600-1200	0.00E+00	0.00E+00	0.00E+00	0.00E+00	0.00E+00	0.00E+00	0.00E+00	0.00E+00			
	All Depths	7.60E-03	5.77E-05	3.80E+03	1.44E+07	4.08E-06	2.18E-09	2.04E-03	5.45E-04			
<i>Psolus squamatus</i>	200-600	0.00E+00	0.00E+00	0.00E+00	0.00E+00	0.00E+00	0.00E+00	0.00E+00	0.00E+00			
	600-1200	7.37E+00	1.25E+01	2.50E+05	1.11E+10	4.05E-03	2.55E-04	1.35E-01	2.15E-01			
	All Depths	7.37E+00	1.25E+01	2.50E+05	1.11E+10	4.05E-03	2.55E-04	1.35E-01	2.15E-01			
<i>Psychrolutes phrictus</i>	200-600	0.00E+00	0.00E+00	0.00E+00	0.00E+00	0.00E+00	0.00E+00	0.00E+00	0.00E+00			
	600-1200	3.32E+03	0.00E+00	0.00E+00	8.54E+10	1.55E+00	1.04E+01	4.80E-01	1.69E+00			
	All Depths	3.32E+03	5.00E+05	9.87E+05	8.54E+10	5.34E-01	4.09E+00	1.66E-01	6.30E-01			
<i>Pteraster jordanii</i>	200-600	5.24E+00	4.25E+00	1.01E+05	1.37E+09	3.24E-03	2.32E-04	6.45E-02	8.25E-02			
	600-1200	4.78E+01	3.09E+02	1.00E+06	1.38E+11	2.88E-02	8.75E-03	6.43E-01	4.22E+00			
	All Depths	5.30E+01	3.13E+02	1.10E+06	1.39E+11	1.20E-02	3.29E-03	2.64E-01	1.57E+00			
<i>Pteraster marssipus</i>	200-600	1.35E+01	0.00E+00	0.00E+00	4.30E+09	8.85E-03	1.62E-03	1.36E-01	3.47E-01			
	600-1200	0.00E+00	0.00E+00	0.00E+00	0.00E+00	0.00E+00	0.00E+00	0.00E+00	0.00E+00			
	All Depths	1.35E+01	2.02E+01	2.09E+05	4.30E+09	5.80E-03	1.08E-03	8.91E-02	2.31E-01			
<i>Pteraster militaris</i>	200-600	1.60E+01	5.44E+01	2.11E+05	7.94E+09	1.12E-02	4.34E-03	1.49E-01	6.67E-01			
	600-1200	1.83E+00	1.06E+00	5.20E+04	6.95E+08	1.38E-03	4.59E-05	3.98E-02	3.62E-02			
	All Depths	1.78E+01	5.54E+01	2.63E+05	8.64E+09	7.78E-03	2.87E-03	1.11E-01	4.51E-01			
<i>Pteraster species</i>	200-600	1.32E-01	1.74E-02	8.24E+03	6.80E+07	6.09E-05	4.86E-07	3.80E-03	1.90E-03			
	600-1200	5.72E-01	1.89E-01	3.00E+04	4.51E+08	3.04E-04	3.72E-06	1.57E-02	8.40E-03			
	All Depths	7.04E-01	2.07E-01	3.82E+04	5.19E+08	1.45E-04	1.60E-06	7.91E-03	4.14E-03			
<i>Pteraster tessellatus</i>	200-600	5.36E+01	0.00E+00	0.00E+00	1.13E+10	2.15E-02	3.31E-02	8.60E-02	2.49E-01			
	600-1200	0.00E+00	0.00E+00	0.00E+00	0.00E+00	0.00E+00	0.00E+00	0.00E+00	0.00E+00			
	All Depths	5.36E+01	1.98E+03	1.91E+05	1.13E+10	1.41E-02	2.17E-02	5.63E-02	1.65E-01			
<i>Puncturella rothi</i>	200-600	0.00E+00	0.00E+00	0.00E+00	0.00E+00	0.00E+00	0.00E+00	0.00E+00	0.00E+00			
	600-1200	1.77E-02	0.00E+00	0.00E+00	7.82E+07	9.46E-06	6.17E-09	4.73E-03	1.54E-03			
	All Depths	1.77E-02	3.13E-04	8.84E+03	7.82E+07	3.26E-06	2.13E-09	1.63E-03	5.32E-04			
<i>Puzanovia rubra</i>	200-600	0.00E+00	0.00E+00	0.00E+00	0.00E+00	0.00E+00	0.00E+00	0.00E+00	0.00E+00			
	600-1200	5.37E+00	0.00E+00	0.00E+00	9.46E+09	2.88E-03	5.70E-04	5.20E-02	1.87E-01			
	All Depths	5.37E+00	2.89E+01	9.72E+04	9.46E+09	9.92E-04	1.97E-04	1.79E-02	6.44E-02			

Table 9. -- Continued.

Species	Stratum		Biomass		Population		CPUE		CPUE	
	(meters)	(t)	Variance	Number	Variance	kg/ha	Variance	no./ha	Variance	
Pycnogonida	200-600	3.88E-02	3.24E-04	2.20E+04	1.47E+08	2.33E-05	1.94E-08	1.50E-02	9.07E-03	
	600-1200	1.17E-01	2.80E-03	5.48E+04	4.92E+08	9.60E-05	1.16E-07	4.77E-02	2.83E-02	
	All Depths	1.56E-01	3.12E-03	7.68E+04	6.39E+08	4.85E-05	5.36E-08	2.63E-02	1.59E-02	
<i>Pyrulofusus deformis</i>	200-600	3.00E+01	0.00E+00	0.00E+00	1.73E+09	1.62E-02	4.42E-03	7.94E-02	9.94E-02	
	600-1200	0.00E+00	0.00E+00	0.00E+00	0.00E+00	0.00E+00	0.00E+00	0.00E+00	0.00E+00	
	All Depths	3.00E+01	6.70E+01	1.51E+05	1.73E+09	1.06E-02	2.95E-03	5.20E-02	6.64E-02	
<i>Pyrulofusus dexius</i>	200-600	1.85E+00	0.00E+00	0.00E+00	6.39E+07	1.56E-03	3.19E-04	6.75E-03	5.97E-03	
	600-1200	0.00E+00	0.00E+00	0.00E+00	0.00E+00	0.00E+00	0.00E+00	0.00E+00	0.00E+00	
	All Depths	1.85E+00	3.41E+00	7.99E+03	6.39E+07	1.02E-03	2.09E-04	4.42E-03	3.91E-03	
<i>Pyrulofusus melonis</i>	200-600	1.33E+02	1.24E+03	1.24E+06	7.28E+10	8.56E-02	8.50E-02	8.06E-01	5.68E+00	
	600-1200	2.58E+00	3.02E+00	2.54E+04	2.48E+08	2.79E-03	2.62E-04	2.75E-02	2.21E-02	
	All Depths	1.36E+02	1.24E+03	1.26E+06	7.30E+10	5.70E-02	5.72E-02	5.37E-01	3.85E+00	
<i>Pyrulofusus</i> species eggs	200-600	2.44E+00	6.42E-01	5.10E+04	4.69E+08	9.77E-04	2.46E-05	3.13E-02	2.51E-02	
	600-1200	2.58E-01	6.66E-02	0.00E+00	0.00E+00	0.00E+00	0.00E+00	0.00E+00	0.00E+00	
	All Depths	2.70E+00	7.09E-01	5.10E+04	4.69E+08	6.38E-04	1.62E-05	2.05E-02	1.66E-02	
<i>Reinhardtius hippoglossoides</i>	200-600	1.15E+04	2.00E+06	3.85E+06	2.53E+11	6.76E+00	1.32E+02	2.23E+00	1.57E+01	
	600-1200	8.36E+03	1.80E+06	1.99E+06	1.08E+11	7.58E+00	1.23E+02	1.87E+00	9.59E+00	
	All Depths	1.99E+04	3.80E+06	5.84E+06	3.60E+11	7.04E+00	1.28E+02	2.11E+00	1.36E+01	
<i>Rhamphostomella costata</i>	200-600	0.00E+00	0.00E+00	0.00E+00	0.00E+00	0.00E+00	0.00E+00	0.00E+00	0.00E+00	
	600-1200	5.76E+00	3.32E+01	0.00E+00	0.00E+00	0.00E+00	0.00E+00	0.00E+00	0.00E+00	
	All Depths	5.76E+00	3.32E+01	0.00E+00	0.00E+00	0.00E+00	0.00E+00	0.00E+00	0.00E+00	
<i>Rhinoliparis attenuatus</i>	200-600	1.06E-02	1.13E-04	2.66E+03	7.06E+06	7.19E-06	6.77E-09	1.80E-03	4.23E-04	
	600-1200	7.14E-01	3.12E-02	8.35E+04	6.51E+08	3.84E-04	1.71E-06	4.84E-02	3.47E-02	
	All Depths	7.24E-01	3.13E-02	8.61E+04	6.59E+08	1.37E-04	6.20E-07	1.79E-02	1.26E-02	
<i>Rhinoliparis</i> species	200-600	1.77E-02	1.67E-04	5.95E+03	1.72E+07	1.20E-05	1.02E-08	4.02E-03	1.05E-03	
	600-1200	1.54E-01	1.16E-04	2.76E+04	5.86E+07	6.55E-05	1.19E-07	1.31E-02	4.20E-03	
	All Depths	1.72E-01	2.83E-04	3.35E+04	7.58E+07	3.04E-05	4.81E-08	7.17E-03	2.14E-03	
<i>Rocinella angusta</i>	200-600	4.67E-02	0.00E+00	0.00E+00	5.94E+07	2.03E-05	2.34E-08	6.10E-03	1.60E-03	
	600-1200	0.00E+00	0.00E+00	0.00E+00	0.00E+00	0.00E+00	0.00E+00	0.00E+00	0.00E+00	
	All Depths	4.67E-02	1.03E-03	1.33E+04	5.94E+07	1.33E-05	1.54E-08	3.99E-03	1.05E-03	
<i>Rossia pacifica</i>	200-600	7.23E+01	0.00E+00	0.00E+00	2.78E+10	3.12E-02	8.52E-03	3.02E-01	8.02E-01	
	600-1200	0.00E+00	0.00E+00	0.00E+00	0.00E+00	0.00E+00	0.00E+00	0.00E+00	0.00E+00	
	All Depths	7.23E+01	3.16E+02	6.72E+05	2.78E+10	2.05E-02	5.78E-03	1.98E-01	5.44E-01	
<i>Rouleina attrita</i>	200-600	0.00E+00	0.00E+00	0.00E+00	0.00E+00	0.00E+00	0.00E+00	0.00E+00	0.00E+00	
	600-1200	9.38E-01	0.00E+00	0.00E+00	8.79E+07	3.68E-04	9.36E-06	3.68E-03	9.36E-04	
	All Depths	9.38E-01	8.79E-01	9.38E+03	8.79E+07	1.27E-04	3.23E-06	1.27E-03	3.23E-04	
<i>Sasakiopus salebrosus</i>	200-600	1.86E+01	1.54E+01	2.07E+05	1.59E+09	1.12E-02	6.70E-04	1.27E-01	6.60E-02	
	600-1200	1.36E+01	1.55E+01	1.26E+05	6.84E+08	1.35E-02	1.53E-03	1.16E-01	5.41E-02	
	All Depths	3.22E+01	3.09E+01	3.34E+05	2.27E+09	1.20E-02	9.63E-04	1.23E-01	6.16E-02	

Table 9. - - Continued.

Species	Stratum		Biomass		Population		CPUE		CPUE	
	(meters)	(t)	Variance	Number	Variance	kg/ha	Variance	no./ha	Variance	
<i>Scabrotrophon scitulus</i>	200-600	2.08E+02	0.00E+00	0.00E+00	2.70E+07	8.31E-06	9.04E-09	2.08E-03	5.65E-04	
	600-1200	0.00E+00	0.00E+00	0.00E+00	0.00E+00	0.00E+00	0.00E+00	0.00E+00	0.00E+00	
	All Depths	2.08E-02	4.32E-04	5.20E+03	2.70E+07	5.44E-06	5.92E-09	1.36E-03	3.70E-04	
<i>Scalpellum cornutum</i>	200-600	4.51E-02	0.00E+00	0.00E+00	1.27E+08	1.59E-05	3.32E-08	3.98E-03	2.07E-03	
	600-1200	0.00E+00	0.00E+00	0.00E+00	0.00E+00	0.00E+00	0.00E+00	0.00E+00	0.00E+00	
	All Depths	4.51E-02	2.03E-03	1.13E+04	1.27E+08	1.04E-05	2.17E-08	2.61E-03	1.36E-03	
<i>Scopelosaurus harrisi</i>	200-600	4.10E-01	1.68E-01	3.66E+03	1.34E+07	2.20E-04	6.34E-06	1.96E-03	5.06E-04	
	600-1200	1.99E-01	3.96E-02	3.83E+03	1.47E+07	2.15E-04	3.20E-06	4.14E-03	1.18E-03	
	All Depths	6.09E-01	2.08E-01	7.49E+03	2.81E+07	2.18E-04	5.24E-06	2.72E-03	7.36E-04	
<i>Scotoplanes</i> species	200-600	0.00E+00	0.00E+00	0.00E+00	0.00E+00	0.00E+00	0.00E+00	0.00E+00	0.00E+00	
	600-1200	2.73E+00	7.46E+00	3.67E+05	1.35E+11	1.59E-03	1.75E-04	2.14E-01	3.17E+00	
	All Depths	2.73E+00	7.46E+00	3.67E+05	1.35E+11	1.59E-03	1.75E-04	2.14E-01	3.17E+00	
Scyphozoa	200-600	7.98E+00	6.21E+00	9.23E+04	5.26E+08	1.85E-03	1.05E-04	3.75E-02	1.28E-02	
	600-1200	3.19E+01	9.23E+01	8.67E+04	9.75E+08	4.38E-03	2.03E-04	6.92E-02	2.52E-02	
	All Depths	3.99E+01	9.85E+01	1.79E+05	1.50E+09	2.62E-03	1.35E-04	4.71E-02	1.67E-02	
<i>Sebastes aleutianus</i>	200-600	3.74E+02	0.00E+00	0.00E+00	4.36E+09	1.61E-01	2.33E-01	1.69E-01	1.97E-01	
	600-1200	0.00E+00	0.00E+00	0.00E+00	0.00E+00	0.00E+00	0.00E+00	0.00E+00	0.00E+00	
	All Depths	3.74E+02	7.24E+03	4.01E+05	4.36E+09	1.05E-01	1.58E-01	1.11E-01	1.35E-01	
<i>Sebastes alutus</i>	200-600	2.03E+05	0.00E+00	0.00E+00	7.73E+15	1.27E+02	3.53E+05	1.50E+02	4.74E+05	
	600-1200	0.00E+00	0.00E+00	0.00E+00	0.00E+00	0.00E+00	0.00E+00	0.00E+00	0.00E+00	
	All Depths	2.03E+05	6.12E+09	2.35E+08	7.73E+15	8.33E+01	2.34E+05	9.83E+01	3.15E+05	
<i>Sebastes babcocki</i>	200-600	1.21E+00	0.00E+00	0.00E+00	2.22E+07	4.82E-04	3.04E-05	1.88E-03	4.64E-04	
	600-1200	0.00E+00	0.00E+00	0.00E+00	0.00E+00	0.00E+00	0.00E+00	0.00E+00	0.00E+00	
	All Depths	1.21E+00	1.45E+00	4.71E+03	2.22E+07	3.15E-04	1.99E-05	1.23E-03	3.04E-04	
<i>Sebastes borealis</i>	200-600	4.30E+03	1.51E+06	1.13E+06	8.88E+10	2.81E+00	8.72E+01	7.57E-01	5.58E+00	
	600-1200	6.94E+01	1.79E+03	2.13E+04	1.55E+08	7.90E-02	1.73E-01	2.43E-02	1.49E-02	
	All Depths	4.37E+03	1.51E+06	1.15E+06	8.90E+10	1.87E+00	5.87E+01	5.04E-01	3.77E+00	
<i>Sebastes brevispinis</i>	200-600	3.35E+00	0.00E+00	0.00E+00	1.89E+07	1.55E-03	3.14E-04	2.00E-03	5.26E-04	
	600-1200	0.00E+00	0.00E+00	0.00E+00	0.00E+00	0.00E+00	0.00E+00	0.00E+00	0.00E+00	
	All Depths	3.35E+00	1.12E+01	4.34E+03	1.89E+07	1.01E-03	2.05E-04	1.31E-03	3.45E-04	
<i>Sebastes melanostictus</i>	200-600	6.25E+02	0.00E+00	0.00E+00	2.28E+11	3.45E-01	1.86E+00	4.68E-01	7.46E+00	
	600-1200	0.00E+00	0.00E+00	0.00E+00	0.00E+00	0.00E+00	0.00E+00	0.00E+00	0.00E+00	
	All Depths	6.25E+02	5.63E+04	8.77E+05	2.28E+11	2.26E-01	1.24E+00	3.06E-01	4.92E+00	
<i>Sebastes polyspinis</i>	200-600	4.23E+01	0.00E+00	0.00E+00	7.59E+08	2.24E-02	2.48E-02	2.09E-02	2.17E-02	
	600-1200	0.00E+00	0.00E+00	0.00E+00	0.00E+00	0.00E+00	0.00E+00	0.00E+00	0.00E+00	
	All Depths	4.23E+01	8.18E+02	4.00E+04	7.59E+08	1.46E-02	1.63E-02	1.37E-02	1.43E-02	
<i>Sebastes reedi</i>	200-600	3.00E+00	0.00E+00	0.00E+00	1.85E+07	1.38E-03	2.51E-04	1.98E-03	5.16E-04	
	600-1200	0.00E+00	0.00E+00	0.00E+00	0.00E+00	0.00E+00	0.00E+00	0.00E+00	0.00E+00	
	All Depths	3.00E+00	9.00E+00	4.30E+03	1.85E+07	9.07E-04	1.65E-04	1.30E-03	3.38E-04	

Table 9. -- Continued.

Species	Stratum			Biomass			Population			CPUE			CPUE		
	(meters)	(t)	Variance	Number	Variance	kg/ha	Variance	no./ha	Variance						
<i>Sebastes variabilis</i>	200-600	1.17E+02	0.00E+00	0.00E+00	4.91E+09	4.88E-02	2.18E-01	3.31E-02	1.03E-01						
	600-1200	0.00E+00	0.00E+00	0.00E+00	0.00E+00	0.00E+00	0.00E+00	0.00E+00	0.00E+00						
	All Depths	1.17E+02	1.04E+04	7.94E+04	4.91E+09	3.19E-02	1.43E-01	2.17E-02	6.76E-02						
<i>Sebastolobus alascanus</i>	200-600	2.11E+04	1.10E+07	3.71E+07	1.75E+13	1.37E+01	8.48E+02	2.33E+01	1.30E+03						
	600-1200	8.21E+03	6.51E+05	6.20E+06	4.95E+11	7.63E+00	6.92E+01	5.90E+00	5.47E+01						
	All Depths	2.93E+04	1.17E+07	4.33E+07	1.80E+13	1.16E+01	5.86E+02	1.73E+01	9.39E+02						
<i>Sebastolobus altivelis</i>	200-600	0.00E+00	0.00E+00	0.00E+00	0.00E+00	0.00E+00	0.00E+00	0.00E+00	0.00E+00						
	600-1200	2.27E+01	0.00E+00	0.00E+00	1.43E+09	1.21E-02	5.66E-03	2.60E-02	2.79E-02						
	All Depths	2.27E+01	2.92E+02	4.89E+04	1.43E+09	4.17E-03	1.97E-03	8.98E-03	9.69E-03						
<i>Sergestes similis</i>	200-600	2.37E-02	0.00E+00	0.00E+00	1.09E+08	1.60E-05	1.67E-08	9.96E-03	6.64E-03						
	600-1200	0.00E+00	0.00E+00	0.00E+00	0.00E+00	0.00E+00	0.00E+00	0.00E+00	0.00E+00						
	All Depths	2.37E-02	2.73E-04	1.47E+04	1.09E+08	1.05E-05	1.10E-08	6.52E-03	4.36E-03						
<i>Serpula</i> species	200-600	1.26E+00	1.43E+00	0.00E+00	0.00E+00	0.00E+00	0.00E+00	0.00E+00	0.00E+00						
	600-1200	0.00E+00	0.00E+00	0.00E+00	0.00E+00	0.00E+00	0.00E+00	0.00E+00	0.00E+00						
	All Depths	1.26E+00	1.43E+00	0.00E+00	0.00E+00	0.00E+00	0.00E+00	0.00E+00	0.00E+00						
<i>Serripes groenlandicus</i>	200-600	4.30E-01	0.00E+00	0.00E+00	2.49E+07	1.52E-04	3.01E-06	1.76E-03	4.07E-04						
	600-1200	0.00E+00	0.00E+00	0.00E+00	0.00E+00	0.00E+00	0.00E+00	0.00E+00	0.00E+00						
	All Depths	4.30E-01	1.84E-01	4.99E+03	2.49E+07	9.93E-05	1.97E-06	1.15E-03	2.67E-04						
<i>Serripes notabilis</i>	200-600	2.00E-01	0.00E+00	0.00E+00	2.26E+07	7.97E-05	8.33E-07	1.90E-03	4.72E-04						
	600-1200	0.00E+00	0.00E+00	0.00E+00	0.00E+00	0.00E+00	0.00E+00	0.00E+00	0.00E+00						
	All Depths	2.00E-01	3.98E-02	4.75E+03	2.26E+07	5.22E-05	5.45E-07	1.24E-03	3.09E-04						
Sipuncula	200-600	0.00E+00	0.00E+00	0.00E+00	0.00E+00	0.00E+00	0.00E+00	0.00E+00	0.00E+00						
	600-1200	1.04E-01	0.00E+00	0.00E+00	1.13E+08	5.93E-05	1.21E-07	7.42E-03	1.88E-03						
	All Depths	1.04E-01	7.23E-03	1.30E+04	1.13E+08	2.05E-05	4.20E-08	2.56E-03	6.56E-04						
<i>Solaster hypothirissus</i>	200-600	1.43E+00	0.00E+00	0.00E+00	2.18E+08	1.24E-03	1.55E-04	1.51E-02	2.25E-02						
	600-1200	0.00E+00	0.00E+00	0.00E+00	0.00E+00	0.00E+00	0.00E+00	0.00E+00	0.00E+00						
	All Depths	1.43E+00	1.51E+00	1.75E+04	2.18E+08	8.14E-04	1.02E-04	9.91E-03	1.47E-02						
<i>Solaster</i> species	200-600	8.29E+00	0.00E+00	0.00E+00	7.87E+08	5.90E-03	1.90E-03	3.01E-02	7.13E-02						
	600-1200	0.00E+00	0.00E+00	0.00E+00	0.00E+00	0.00E+00	0.00E+00	0.00E+00	0.00E+00						
	All Depths	8.29E+00	2.57E+01	3.86E+04	7.87E+08	3.86E-03	1.25E-03	1.97E-02	4.68E-02						
<i>Solaster</i> species A	200-600	1.11E+00	0.00E+00	0.00E+00	1.33E+07	8.18E-04	4.51E-05	3.75E-03	9.25E-04						
	600-1200	0.00E+00	0.00E+00	0.00E+00	0.00E+00	0.00E+00	0.00E+00	0.00E+00	0.00E+00						
	All Depths	1.11E+00	6.72E-01	5.05E+03	1.33E+07	5.36E-04	2.96E-05	2.46E-03	6.07E-04						
<i>Solaster</i> species C	200-600	2.27E+01	0.00E+00	0.00E+00	6.13E+08	1.32E-02	6.43E-03	3.86E-02	5.09E-02						
	600-1200	0.00E+00	0.00E+00	0.00E+00	0.00E+00	0.00E+00	0.00E+00	0.00E+00	0.00E+00						
	All Depths	2.27E+01	7.87E+01	6.26E+04	6.13E+08	8.62E-03	4.23E-03	2.52E-02	3.35E-02						
<i>Solaster</i> species E	200-600	9.13E-02	0.00E+00	0.00E+00	4.72E+06	7.90E-05	8.19E-07	1.88E-03	4.64E-04						
	600-1200	0.00E+00	0.00E+00	0.00E+00	0.00E+00	0.00E+00	0.00E+00	0.00E+00	0.00E+00						
	All Depths	9.13E-02	8.33E-03	2.17E+03	4.72E+06	5.18E-05	5.36E-07	1.23E-03	3.04E-04						

Table 9. -- Continued.

Species	Stratum		Biomass		Population		CPUE		CPUE	
	(meters)	(t)	Variance	Number	Variance	kg/ha	Variance	no./ha	Variance	
<i>Solaster</i> species F	200-600	6.79E+01	5.08E+02	3.90E+05	1.13E+10	3.99E-02	1.90E-02	2.38E-01	5.18E-01	
	600-1200	4.31E+01	2.68E+02	3.46E+05	1.95E+10	3.36E-02	1.44E-02	2.68E-01	9.20E-01	
	All Depths	1.11E+02	7.76E+02	7.37E+05	3.09E+10	3.77E-02	1.73E-02	2.48E-01	6.53E-01	
<i>Somniosus pacificus</i>	200-600	5.80E+02	3.60E+04	5.55E+04	2.56E+08	3.56E-01	1.65E+00	3.53E-02	1.39E-02	
	600-1200	2.53E+02	1.42E+04	2.28E+04	1.11E+08	2.25E-01	9.04E-01	1.83E-02	4.39E-03	
	All Depths	8.33E+02	5.03E+04	7.83E+04	3.67E+08	3.11E-01	1.39E+00	2.94E-02	1.07E-02	
<i>Spinther</i> species A	200-600	7.60E-03	0.00E+00	0.00E+00	1.44E+07	4.08E-06	2.18E-09	2.04E-03	5.45E-04	
	600-1200	0.00E+00	0.00E+00	0.00E+00	0.00E+00	0.00E+00	0.00E+00	0.00E+00	0.00E+00	
	All Depths	7.60E-03	5.77E-05	3.80E+03	1.44E+07	2.67E-06	1.43E-09	1.34E-03	3.57E-04	
<i>Staurocalyptus</i> species	200-600	4.24E-01	1.79E-01	2.79E+03	7.77E+06	2.87E-04	1.08E-05	1.89E-03	4.66E-04	
	600-1200	1.01E+02	2.19E+03	0.00E+00	0.00E+00	0.00E+00	0.00E+00	0.00E+00	0.00E+00	
	All Depths	1.02E+02	2.19E+03	2.79E+03	7.77E+06	2.87E-04	1.08E-05	1.89E-03	4.66E-04	
<i>Stegophiura ponderosa</i>	200-600	1.72E-01	0.00E+00	0.00E+00	7.65E+07	8.43E-05	6.45E-07	5.79E-03	2.40E-03	
	600-1200	0.00E+00	0.00E+00	0.00E+00	0.00E+00	0.00E+00	0.00E+00	0.00E+00	0.00E+00	
	All Depths	1.72E-01	2.26E-02	1.12E+04	7.65E+07	5.52E-05	4.23E-07	3.79E-03	1.57E-03	
<i>Stenobranchius leucopsarus</i>	200-600	3.98E+00	1.32E+00	5.66E+05	3.04E+10	1.97E-03	6.17E-05	2.81E-01	1.40E+00	
	600-1200	3.84E+00	5.51E-01	5.95E+05	1.20E+10	2.72E-03	2.86E-05	4.24E-01	6.93E-01	
	All Depths	7.82E+00	1.87E+00	1.16E+06	4.24E+10	2.23E-03	5.02E-05	3.30E-01	1.16E+00	
<i>Stenobranchius nannochir</i>	200-600	0.00E+00	0.00E+00	0.00E+00	0.00E+00	0.00E+00	0.00E+00	0.00E+00	0.00E+00	
	600-1200	1.36E+00	0.00E+00	0.00E+00	3.36E+10	6.08E-04	1.54E-05	9.68E-02	4.32E-01	
	All Depths	1.36E+00	1.19E+00	2.18E+05	3.36E+10	2.10E-04	5.36E-06	3.34E-02	1.50E-01	
<i>Stenobranchius</i> species	200-600	7.64E+00	2.25E+00	9.34E+05	3.11E+10	4.90E-03	1.64E-04	6.01E-01	2.24E+00	
	600-1200	1.64E+01	4.53E+00	2.48E+06	1.10E+11	1.14E-02	1.74E-04	1.74E+00	4.64E+00	
	All Depths	2.40E+01	6.78E+00	3.41E+06	1.41E+11	7.13E-03	1.76E-04	9.96E-01	3.35E+00	
<i>Stephanasterias albula</i>	200-600	2.05E-02	0.00E+00	0.00E+00	2.62E+07	8.18E-06	8.76E-09	2.04E-03	5.48E-04	
	600-1200	0.00E+00	0.00E+00	0.00E+00	0.00E+00	0.00E+00	0.00E+00	0.00E+00	0.00E+00	
	All Depths	2.05E-02	4.19E-04	5.12E+03	2.62E+07	5.36E-06	5.74E-09	1.34E-03	3.59E-04	
<i>Stomphia coccinea</i>	200-600	2.49E+01	0.00E+00	0.00E+00	1.46E+11	9.95E-03	9.46E-03	1.81E-01	3.09E+00	
	600-1200	0.00E+00	0.00E+00	0.00E+00	0.00E+00	0.00E+00	0.00E+00	0.00E+00	0.00E+00	
	All Depths	2.49E+01	4.46E+02	4.53E+05	1.46E+11	6.52E-03	6.21E-03	1.19E-01	2.03E+00	
<i>Stomphia</i> species	200-600	1.91E+01	6.01E+01	2.49E+05	7.97E+09	1.01E-02	2.60E-03	1.26E-01	2.37E-01	
	600-1200	6.95E+00	3.90E+01	5.50E+05	2.70E+11	8.78E-03	4.41E-03	6.96E-01	3.02E+01	
	All Depths	2.61E+01	9.91E+01	8.00E+05	2.78E+11	9.64E-03	3.20E-03	3.22E-01	1.05E+01	
<i>Strongylocentrotus droebachiensis</i>	200-600	2.31E+01	0.00E+00	0.00E+00	9.17E+10	1.07E-02	2.39E-03	2.98E-01	2.79E+00	
	600-1200	0.00E+00	0.00E+00	0.00E+00	0.00E+00	0.00E+00	0.00E+00	0.00E+00	0.00E+00	
	All Depths	2.31E+01	9.62E+01	5.91E+05	9.17E+10	7.03E-03	1.59E-03	1.95E-01	1.84E+00	
<i>Strongylocentrotus pallidus</i>	200-600	2.90E+02	6.09E+04	3.51E+06	8.66E+12	1.16E-01	1.29E+00	1.41E+00	1.83E+02	
	600-1200	2.37E-01	5.61E-02	7.40E+03	5.48E+07	2.90E-04	5.81E-06	9.07E-03	5.68E-03	
	All Depths	2.91E+02	6.09E+04	3.51E+06	8.66E+12	7.62E-02	8.47E-01	9.25E-01	1.20E+02	

Table 9. - - Continued.

Species	Stratum		Biomass		Population		CPUE		CPUE	
	(meters)	(t)	Variance	Number	Variance	kg/ha	Variance	no./ha	Variance	
<i>Strongylocentrotus</i> species	200-600	2.76E+00	0.00E+00	0.00E+00	3.57E+09	2.39E-03	7.48E-04	5.17E-02	3.50E-01	
	600-1200	0.00E+00	0.00E+00	0.00E+00	0.00E+00	0.00E+00	0.00E+00	0.00E+00	0.00E+00	
	All Depths	2.76E+00	7.61E+00	5.97E+04	3.57E+09	1.57E-03	4.90E-04	3.39E-02	2.30E-01	
<i>Stylatula</i> species	200-600	2.49E+00	0.00E+00	0.00E+00	1.76E+11	1.64E-03	1.76E-04	3.57E-01	1.07E+01	
	600-1200	0.00E+00	0.00E+00	0.00E+00	0.00E+00	0.00E+00	0.00E+00	0.00E+00	0.00E+00	
	All Depths	2.49E+00	2.90E+00	5.38E+05	1.76E+11	1.08E-03	1.16E-04	2.34E-01	6.99E+00	
<i>Suberites ficus</i>	200-600	4.51E-01	9.68E-02	1.17E+04	6.58E+07	1.80E-04	2.11E-06	4.66E-03	1.44E-03	
	600-1200	0.00E+00	0.00E+00	0.00E+00	0.00E+00	0.00E+00	0.00E+00	0.00E+00	0.00E+00	
	All Depths	4.51E-01	9.68E-02	1.17E+04	6.58E+07	1.80E-04	2.11E-06	4.66E-03	1.44E-03	
<i>Swiftia</i> species	200-600	9.53E-01	5.62E-01	2.33E+04	1.19E+08	6.06E-04	3.31E-05	1.20E-02	4.11E-03	
	600-1200	1.59E+01	2.01E+02	1.28E+04	8.19E+07	2.89E-04	3.01E-06	1.14E-02	4.75E-03	
	All Depths	1.68E+01	2.02E+02	3.61E+04	2.01E+08	5.00E-04	2.30E-05	1.18E-02	4.30E-03	
<i>Synallactes challengerii</i>	200-600	2.38E-01	5.66E-02	6.61E+03	4.37E+07	1.62E-04	3.42E-06	4.49E-03	2.64E-03	
	600-1200	0.00E+00	0.00E+00	0.00E+00	0.00E+00	0.00E+00	0.00E+00	0.00E+00	0.00E+00	
	All Depths	2.38E-01	5.66E-02	6.61E+03	4.37E+07	1.62E-04	3.42E-06	4.49E-03	2.64E-03	
<i>Synallactes</i> species	200-600	5.35E+01	1.75E+02	1.71E+06	2.15E+11	3.35E-02	1.03E-02	1.06E+00	1.27E+01	
	600-1200	8.98E+00	2.24E+01	3.42E+05	3.75E+10	9.26E-03	2.18E-03	3.77E-01	4.15E+00	
	All Depths	6.24E+01	1.98E+02	2.05E+06	2.53E+11	4.27E-02	1.25E-02	1.44E+00	1.68E+01	
<i>Taonius pavo</i>	200-600	7.71E-01	3.47E-01	9.68E+03	5.56E+07	5.81E-04	2.94E-05	6.04E-03	2.50E-03	
	600-1200	6.23E+00	2.68E+01	2.49E+04	2.27E+08	3.23E-03	4.77E-04	1.33E-02	4.24E-03	
	All Depths	7.00E+00	2.71E+01	3.46E+04	2.83E+08	1.50E-03	1.84E-04	8.53E-03	3.10E-03	
<i>Terebratulina unguicula</i>	200-600	1.30E-01	1.28E-02	1.84E+04	2.15E+08	1.03E-04	1.18E-06	1.39E-02	1.88E-02	
	600-1200	0.00E+00	0.00E+00	0.00E+00	0.00E+00	0.00E+00	0.00E+00	0.00E+00	0.00E+00	
	All Depths	1.30E-01	1.28E-02	1.84E+04	2.15E+08	1.03E-04	1.18E-06	1.39E-02	1.88E-02	
Teuthoidea	200-600	0.00E+00	0.00E+00	0.00E+00	0.00E+00	0.00E+00	0.00E+00	0.00E+00	0.00E+00	
	600-1200	2.20E+00	0.00E+00	0.00E+00	3.41E+08	8.64E-04	5.15E-05	7.26E-03	3.64E-03	
	All Depths	2.20E+00	4.84E+00	1.85E+04	3.41E+08	2.98E-04	1.78E-05	2.50E-03	1.25E-03	
<i>Thaleichthys pacificus</i>	200-600	1.98E+02	1.14E+04	4.75E+06	5.92E+12	7.95E-02	2.61E-01	1.91E+00	1.37E+02	
	600-1200	8.12E-01	6.60E-01	2.83E+04	7.98E+08	8.79E-04	5.33E-05	3.06E-02	6.44E-02	
	All Depths	1.99E+02	1.14E+04	4.78E+06	5.92E+12	5.24E-02	1.72E-01	1.26E+00	9.05E+01	
<i>Theragra chalcogramma</i>	200-600	1.44E+04	0.00E+00	0.00E+00	1.33E+13	6.32E+00	5.31E+02	4.84E+00	3.15E+02	
	600-1200	0.00E+00	0.00E+00	0.00E+00	0.00E+00	0.00E+00	0.00E+00	0.00E+00	0.00E+00	
	All Depths	1.44E+04	2.36E+07	1.07E+07	1.33E+13	4.14E+00	3.56E+02	3.17E+00	2.11E+02	
Thoracica	200-600	2.12E-01	0.00E+00	0.00E+00	2.81E+07	8.47E-05	9.40E-07	2.12E-03	5.88E-04	
	600-1200	0.00E+00	0.00E+00	0.00E+00	0.00E+00	0.00E+00	0.00E+00	0.00E+00	0.00E+00	
	All Depths	2.12E-01	4.50E-02	5.30E+03	2.81E+07	5.55E-05	6.16E-07	1.39E-03	3.85E-04	
<i>Triglops scepcticus</i>	200-600	2.87E+01	0.00E+00	0.00E+00	1.22E+11	1.34E-02	9.46E-03	2.78E-01	4.45E+00	
	600-1200	0.00E+00	0.00E+00	0.00E+00	0.00E+00	0.00E+00	0.00E+00	0.00E+00	0.00E+00	
	All Depths	2.87E+01	2.58E+02	5.94E+05	1.22E+11	8.80E-03	6.22E-03	1.82E-01	2.93E+00	

Table 9. - - Continued.

Species	Stratum		Biomass		Population		CPUE		CPUE	
	(meters)	(t)	Variance	Number	Variance	kg/ha	Variance	no./ha	Variance	
<i>Tritonia diomedea</i>	200-600	3.55E+00	7.23E+00	2.34E+04	3.12E+08	1.46E-03	1.43E-04	9.60E-03	6.19E-03	
	600-1200	5.84E+00	3.41E+01	1.18E+05	1.39E+10	2.97E-03	6.08E-04	6.00E-02	2.48E-01	
	All Depths	9.39E+00	4.13E+01	1.41E+05	1.42E+10	1.98E-03	3.01E-04	2.70E-02	8.95E-02	
<i>Tritonia</i> species	200-600	5.46E-01	8.92E-02	2.27E+04	1.64E+08	3.90E-04	6.90E-06	1.55E-02	1.01E-02	
	600-1200	5.04E+00	8.86E+00	1.28E+05	5.84E+09	2.64E-03	1.64E-04	6.70E-02	1.08E-01	
	All Depths	5.58E+00	8.95E+00	1.51E+05	6.01E+09	1.16E-03	6.15E-05	3.32E-02	4.39E-02	
<i>Urticina crassicornis</i>	200-600	3.88E-01	0.00E+00	0.00E+00	2.38E+08	2.62E-04	3.82E-06	1.79E-02	1.48E-02	
	600-1200	0.00E+00	0.00E+00	0.00E+00	0.00E+00	0.00E+00	0.00E+00	0.00E+00	0.00E+00	
	All Depths	3.88E-01	6.19E-02	2.65E+04	2.38E+08	1.72E-04	2.51E-06	1.17E-02	9.76E-03	
<i>Urticina</i> species	200-600	2.03E+00	0.00E+00	0.00E+00	2.47E+09	8.80E-04	1.66E-05	4.85E-02	6.01E-02	
	600-1200	0.00E+00	0.00E+00	0.00E+00	0.00E+00	0.00E+00	0.00E+00	0.00E+00	0.00E+00	
	All Depths	2.03E+00	6.36E-01	1.14E+05	2.47E+09	5.77E-04	1.10E-05	3.18E-02	3.98E-02	
<i>Vampyroteuthis infernalis</i>	200-600	0.00E+00	0.00E+00	0.00E+00	0.00E+00	0.00E+00	0.00E+00	0.00E+00	0.00E+00	
	600-1200	9.18E-02	0.00E+00	0.00E+00	1.25E+07	9.93E-05	6.81E-07	3.82E-03	1.01E-03	
	All Depths	9.18E-02	8.43E-03	3.53E+03	1.25E+07	3.43E-05	2.35E-07	1.32E-03	3.47E-04	
<i>Virgularia</i> species	200-600	4.06E+02	8.08E+04	3.34E+07	5.69E+14	1.43E-01	1.42E+00	1.18E+01	9.96E+03	
	600-1200	1.82E+02	3.31E+04	4.07E+07	1.65E+15	9.75E-02	6.54E-01	2.18E+01	3.26E+04	
	All Depths	5.88E+02	1.14E+05	7.40E+07	2.22E+15	1.28E-01	1.15E+00	1.52E+01	1.77E+04	
<i>Volutomitra alaskana</i>	200-600	2.85E-02	0.00E+00	0.00E+00	2.26E+07	1.14E-05	1.70E-08	1.90E-03	4.72E-04	
	600-1200	0.00E+00	0.00E+00	0.00E+00	0.00E+00	0.00E+00	0.00E+00	0.00E+00	0.00E+00	
	All Depths	2.85E-02	8.13E-04	4.75E+03	2.26E+07	7.46E-06	1.11E-08	1.24E-03	3.09E-04	
<i>Weberella bursa</i>	200-600	4.78E+00	2.11E+01	1.44E+05	1.95E+10	2.21E-03	5.95E-04	6.67E-02	5.48E-01	
	600-1200	0.00E+00	0.00E+00	0.00E+00	0.00E+00	0.00E+00	0.00E+00	0.00E+00	0.00E+00	
	All Depths	4.78E+00	2.11E+01	1.44E+05	1.95E+10	2.21E-03	5.95E-04	6.67E-02	5.48E-01	
<i>Zaprora silenus</i>	200-600	7.57E+02	0.00E+00	0.00E+00	7.29E+09	4.55E-01	6.06E+00	1.24E-01	5.03E-01	
	600-1200	0.00E+00	0.00E+00	0.00E+00	0.00E+00	0.00E+00	0.00E+00	0.00E+00	0.00E+00	
	All Depths	7.57E+02	1.12E+05	1.94E+05	7.29E+09	2.98E-01	4.00E+00	8.13E-02	3.32E-01	
<i>Zesticelus profundorum</i>	200-600	0.00E+00	0.00E+00	0.00E+00	0.00E+00	0.00E+00	0.00E+00	0.00E+00	0.00E+00	
	600-1200	3.94E-01	0.00E+00	0.00E+00	2.38E+09	1.85E-04	3.32E-07	6.98E-02	4.09E-02	
	All Depths	3.94E-01	1.79E-02	1.50E+05	2.38E+09	6.39E-05	1.21E-07	2.41E-02	1.51E-02	
<i>Zoroaster evermanni</i>	200-600	1.37E+00	1.03E+00	2.15E+04	3.45E+08	7.38E-04	3.89E-05	1.16E-02	1.30E-02	
	600-1200	3.74E+02	6.78E+03	3.85E+06	1.75E+12	2.38E-01	5.02E-01	2.33E+00	6.31E+01	
	All Depths	3.75E+02	6.78E+03	3.87E+06	1.75E+12	8.28E-02	1.85E-01	8.11E-01	2.28E+01	

This page left intentionally blank

Table 10. - Abundance estimates by subarea and depth strata for Pacific sleeper shark (*Somniosus pacificus*) from the 2010 EBSS survey.

<i>Somniosus pacificus</i>		Pacific sleeper shark					
Subarea	Depth strata (m)	Biomass (t)	Population	Biomass variance	Population variance	Average CPUE (kg/ha)	Average CPUE (no./ha)
1	200-400	1.02E+02	5.55E+03	1.05E+04	3.08E+07	2.55E-01	1.38E-02
	400-600	2.20E+02	2.83E+04	1.02E+04	1.47E+08	5.42E-01	6.95E-02
	600-800	1.29E+02	7.50E+03	8.95E+03	2.58E+07	7.41E-01	4.31E-02
	800-1,000	0.00E+00	0.00E+00	0.00E+00	0.00E+00	0.00E+00	0.00E+00
	1,000-1,200	0.00E+00	0.00E+00	0.00E+00	0.00E+00	0.00E+00	0.00E+00
2	200-400	5.13E+01	4.30E+03	2.63E+03	1.85E+07	4.43E-01	3.71E-02
	400-600	2.87E+01	4.13E+03	8.26E+02	1.70E+07	4.08E-01	5.86E-02
	600-800	0.00E+00	0.00E+00	0.00E+00	0.00E+00	0.00E+00	0.00E+00
	800-1,000	4.42E+01	7.01E+03	1.96E+03	4.91E+07	8.00E-01	1.27E-01
	1,000-1,200	0.00E+00	0.00E+00	0.00E+00	0.00E+00	0.00E+00	0.00E+00
3	200-400	2.76E+01	2.30E+03	7.64E+02	5.31E+06	3.06E-01	2.55E-02
	400-600	0.00E+00	0.00E+00	0.00E+00	0.00E+00	0.00E+00	0.00E+00
	600-800	3.09E+01	3.31E+03	9.53E+02	1.10E+07	3.39E-01	3.64E-02
	800-1,000	0.00E+00	0.00E+00	0.00E+00	0.00E+00	0.00E+00	0.00E+00
	1,000-1,200	0.00E+00	0.00E+00	0.00E+00	0.00E+00	0.00E+00	0.00E+00
4	200-400	9.89E+01	3.72E+03	9.78E+03	1.38E+07	8.00E-01	3.01E-02
	400-600	0.00E+00	0.00E+00	0.00E+00	0.00E+00	0.00E+00	0.00E+00
	600-800	0.00E+00	0.00E+00	0.00E+00	0.00E+00	0.00E+00	0.00E+00
	800-1,000	0.00E+00	0.00E+00	0.00E+00	0.00E+00	0.00E+00	0.00E+00
	1,000-1,200	0.00E+00	0.00E+00	0.00E+00	0.00E+00	0.00E+00	0.00E+00
5	200-400	0.00E+00	0.00E+00	0.00E+00	0.00E+00	0.00E+00	0.00E+00
	400-600	0.00E+00	0.00E+00	0.00E+00	0.00E+00	0.00E+00	0.00E+00
	600-800	4.87E+01	4.96E+03	2.37E+03	2.46E+07	1.13E+00	1.15E-01
	800-1,000	0.00E+00	0.00E+00	0.00E+00	0.00E+00	0.00E+00	0.00E+00
	1,000-1,200	0.00E+00	0.00E+00	0.00E+00	0.00E+00	0.00E+00	0.00E+00
6	200-400	0.00E+00	0.00E+00	0.00E+00	0.00E+00	0.00E+00	0.00E+00
	400-600	5.13E+01	7.27E+03	1.33E+03	2.41E+07	3.00E-01	4.26E-02
	600-800	0.00E+00	0.00E+00	0.00E+00	0.00E+00	0.00E+00	0.00E+00
	800-1,000	0.00E+00	0.00E+00	0.00E+00	0.00E+00	0.00E+00	0.00E+00
	1,000-1,200	0.00E+00	0.00E+00	0.00E+00	0.00E+00	0.00E+00	0.00E+00
1-6	200-1,200	8.33E+02	7.83E+04	5.03E+04	3.67E+08	3.11E-01	2.94E-02

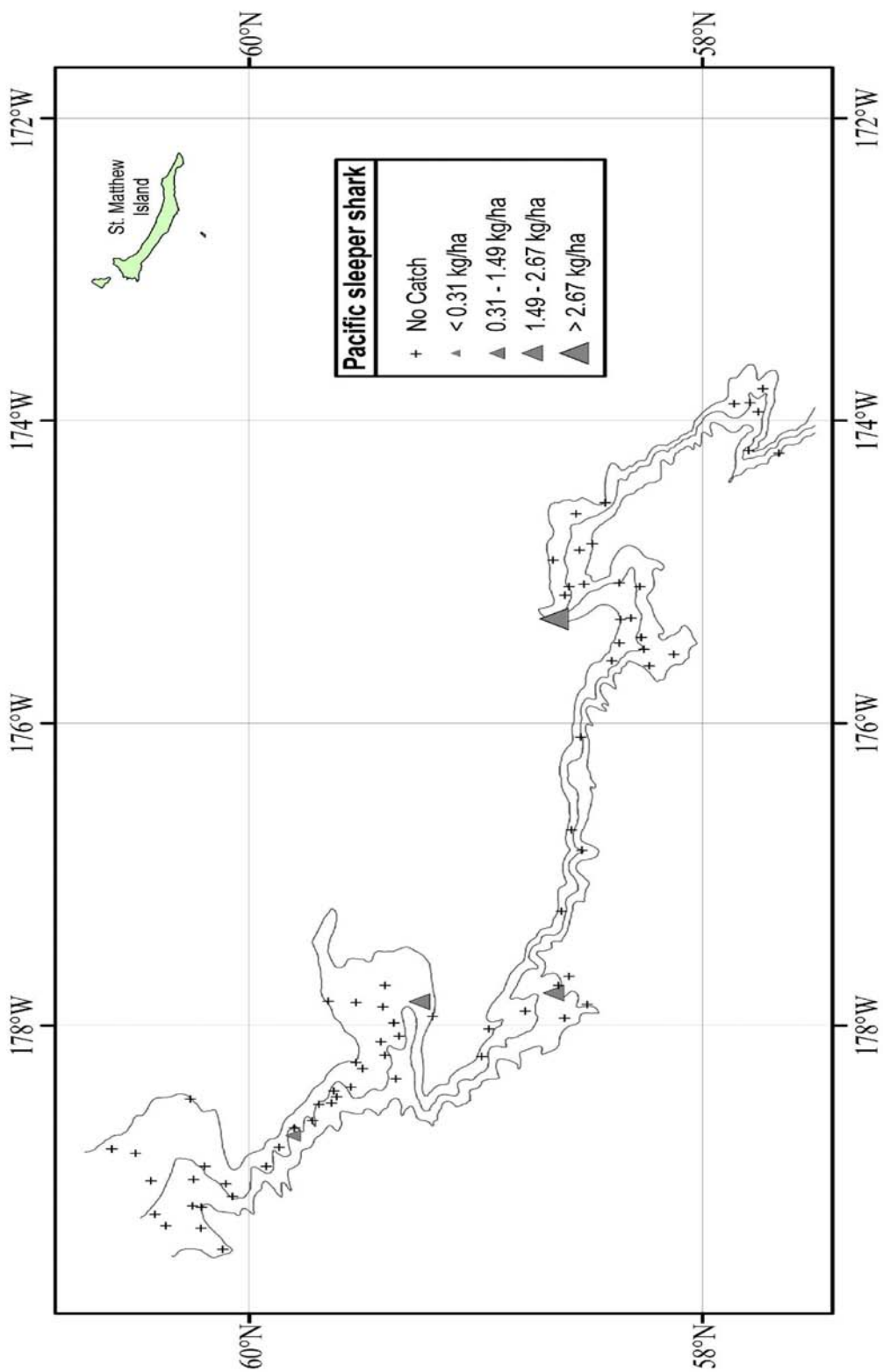

Figure 4. - - Distribution and relative abundance of Pacific sleeper shark from the 2010 EBSS survey. Relative abundance is categorized by no catch, sample CPUE less than the mean CPUE, between the mean CPUE and one standard deviation above the mean, between one and two standard deviations above the mean CPUE, and greater than two standard deviations above the mean CPUE.

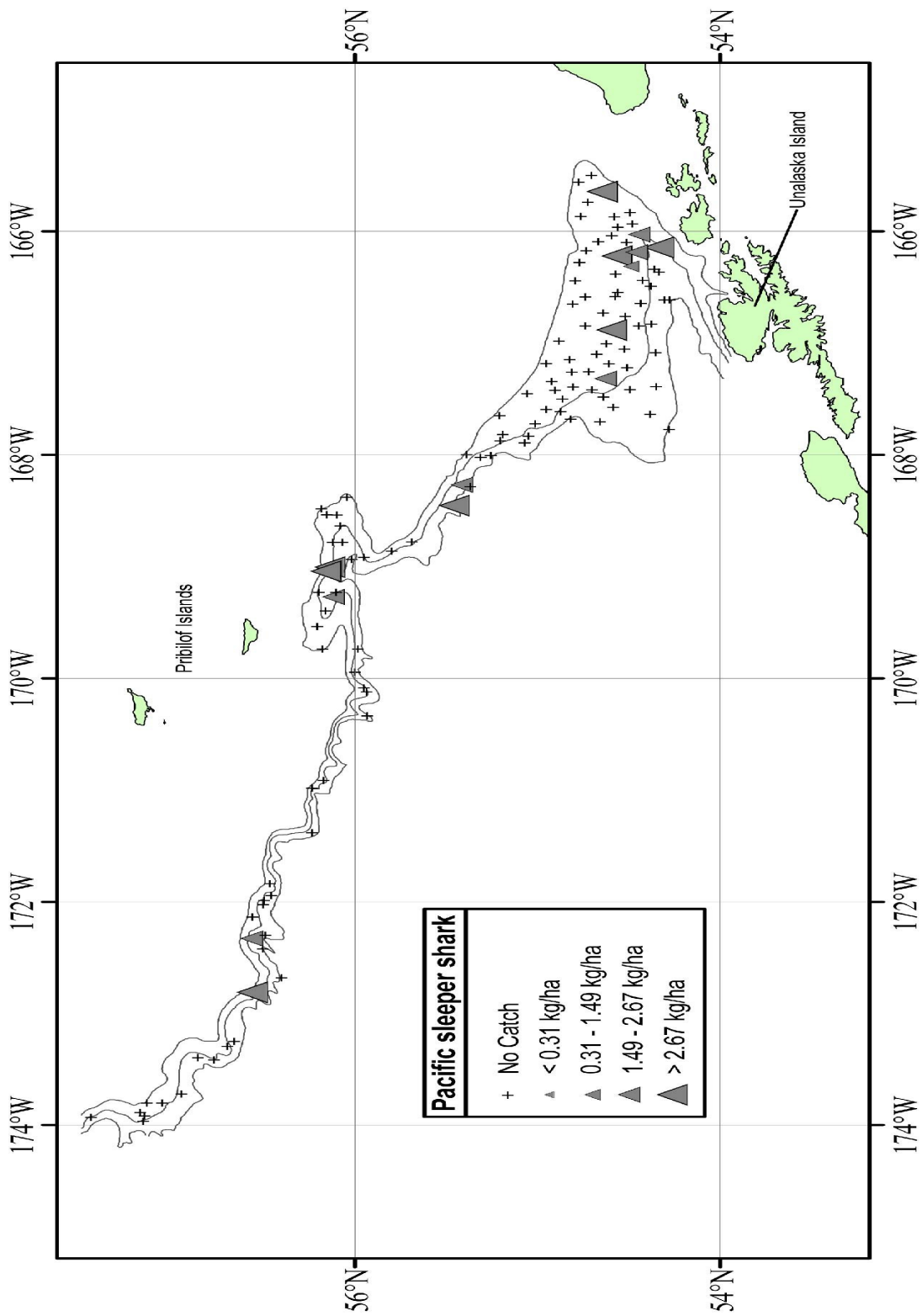

Figure 4. - - Continued.

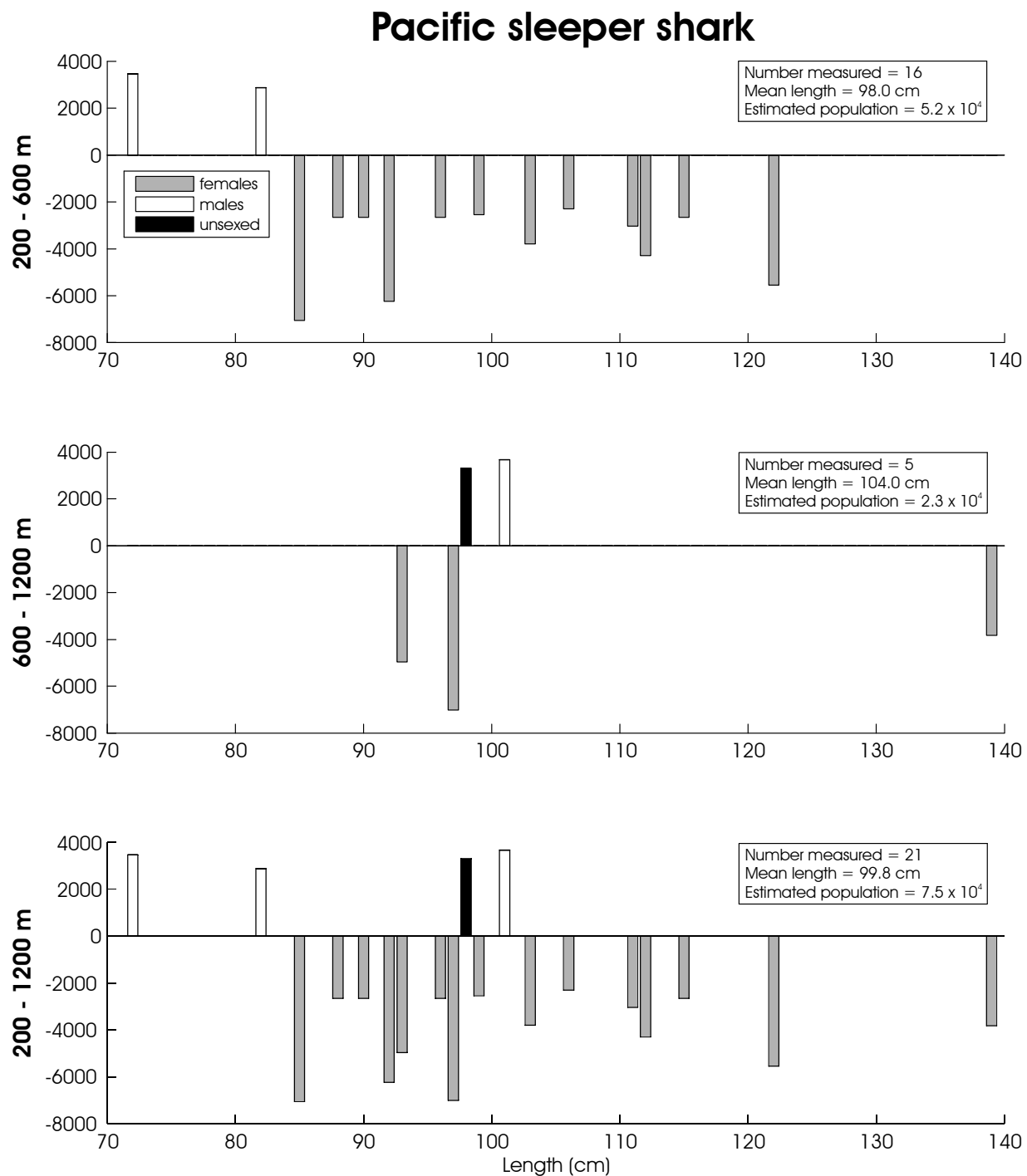

Figure 5. - - Size composition of the estimated Pacific sleeper shark population from the 2010 EBSS survey for all subareas by depth. The abscissa is scaled as total length in centimeters while the ordinate represents the estimated total population.

Table 11. - Abundance estimates by subarea and depth strata for Alaska skate
(*Bathyraja parmifera*) from the 2010 EBSS survey.

<i>Bathyraja parmifera</i>		Alaska skate					
Subarea	Depth strata (m)	Biomass (t)	Population	Biomass variance	Population variance	Average CPUE (kg/ha)	Average CPUE (no./ha)
1	200-400	1.05E+02	3.36E+04	5.29E+03	5.64E+08	2.62E-01	8.37E-02
	400-600	0.00E+00	0.00E+00	0.00E+00	0.00E+00	0.00E+00	0.00E+00
	600-800	0.00E+00	0.00E+00	0.00E+00	0.00E+00	0.00E+00	0.00E+00
	800-1,000	0.00E+00	0.00E+00	0.00E+00	0.00E+00	0.00E+00	0.00E+00
	1,000-1,200	0.00E+00	0.00E+00	0.00E+00	0.00E+00	0.00E+00	0.00E+00
2	200-400	7.02E+01	8.24E+03	4.93E+03	6.80E+07	6.07E-01	7.12E-02
	400-600	0.00E+00	0.00E+00	0.00E+00	0.00E+00	0.00E+00	0.00E+00
	600-800	0.00E+00	0.00E+00	0.00E+00	0.00E+00	0.00E+00	0.00E+00
	800-1,000	0.00E+00	0.00E+00	0.00E+00	0.00E+00	0.00E+00	0.00E+00
	1,000-1,200	0.00E+00	0.00E+00	0.00E+00	0.00E+00	0.00E+00	0.00E+00
3	200-400	8.53E+01	1.02E+04	4.76E+03	6.79E+07	9.44E-01	1.13E-01
	400-600	0.00E+00	0.00E+00	0.00E+00	0.00E+00	0.00E+00	0.00E+00
	600-800	0.00E+00	0.00E+00	0.00E+00	0.00E+00	0.00E+00	0.00E+00
	800-1,000	0.00E+00	0.00E+00	0.00E+00	0.00E+00	0.00E+00	0.00E+00
	1,000-1,200	0.00E+00	0.00E+00	0.00E+00	0.00E+00	0.00E+00	0.00E+00
4	200-400	8.86E+01	1.25E+04	2.13E+03	4.60E+07	7.17E-01	1.01E-01
	400-600	3.56E+02	6.47E+04	1.27E+05	4.18E+09	4.87E+00	8.85E-01
	600-800	0.00E+00	0.00E+00	0.00E+00	0.00E+00	0.00E+00	0.00E+00
	800-1,000	0.00E+00	0.00E+00	0.00E+00	0.00E+00	0.00E+00	0.00E+00
	1,000-1,200	0.00E+00	0.00E+00	0.00E+00	0.00E+00	0.00E+00	0.00E+00
5	200-400	5.87E+01	7.06E+03	8.71E+02	1.28E+07	1.39E+00	1.67E-01
	400-600	0.00E+00	0.00E+00	0.00E+00	0.00E+00	0.00E+00	0.00E+00
	600-800	0.00E+00	0.00E+00	0.00E+00	0.00E+00	0.00E+00	0.00E+00
	800-1,000	0.00E+00	0.00E+00	0.00E+00	0.00E+00	0.00E+00	0.00E+00
	1,000-1,200	0.00E+00	0.00E+00	0.00E+00	0.00E+00	0.00E+00	0.00E+00
6	200-400	5.15E+02	1.02E+05	2.57E+04	1.53E+09	1.98E+00	3.92E-01
	400-600	1.68E+01	3.80E+03	2.81E+02	1.44E+07	9.82E-02	2.23E-02
	600-800	0.00E+00	0.00E+00	0.00E+00	0.00E+00	0.00E+00	0.00E+00
	800-1,000	0.00E+00	0.00E+00	0.00E+00	0.00E+00	0.00E+00	0.00E+00
	1,000-1,200	0.00E+00	0.00E+00	0.00E+00	0.00E+00	0.00E+00	0.00E+00
1-6	200-1,200	1.30E+03	2.42E+05	1.71E+05	6.48E+09	3.79E-01	6.76E-02

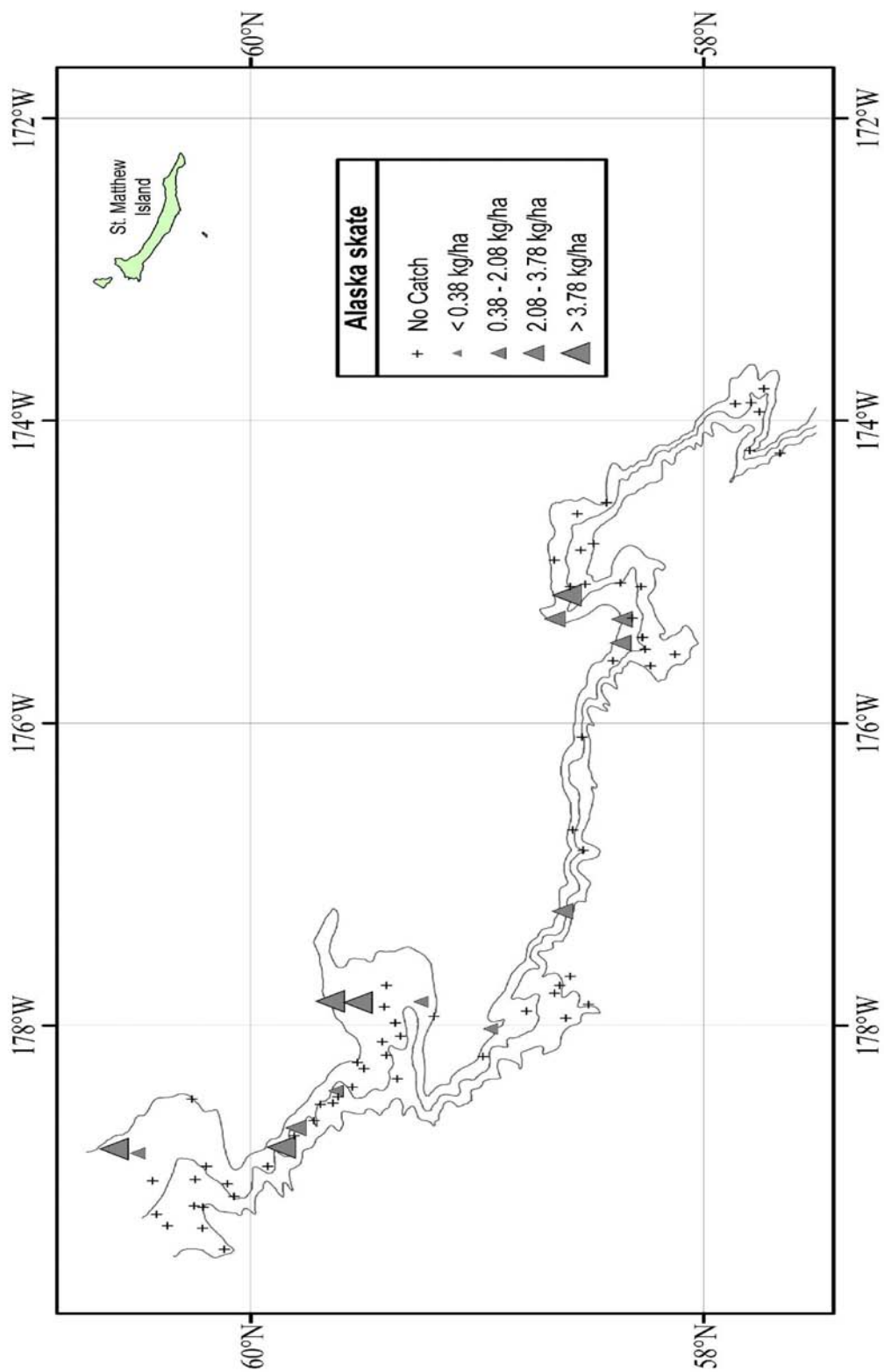

Figure 6. - - Distribution and relative abundance of Alaska skate from the 2010 EBSS survey. Relative abundance is categorized by no catch, sample CPUE less than the mean CPUE, between the mean CPUE and one standard deviation above the mean, between one and two standard deviations above the mean CPUE, and greater than two standard deviations above the mean CPUE.

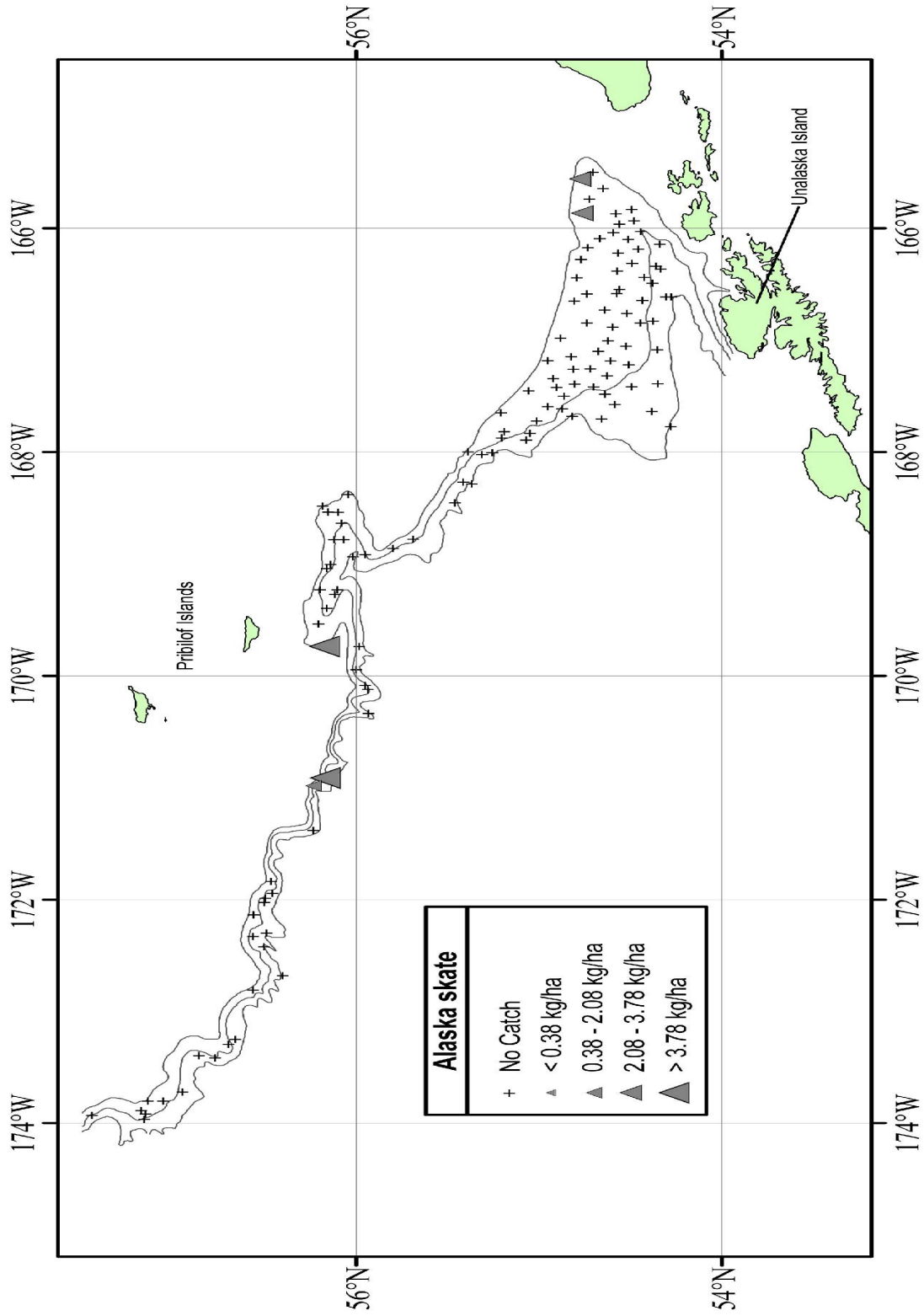

Figure 6. - - Continued.

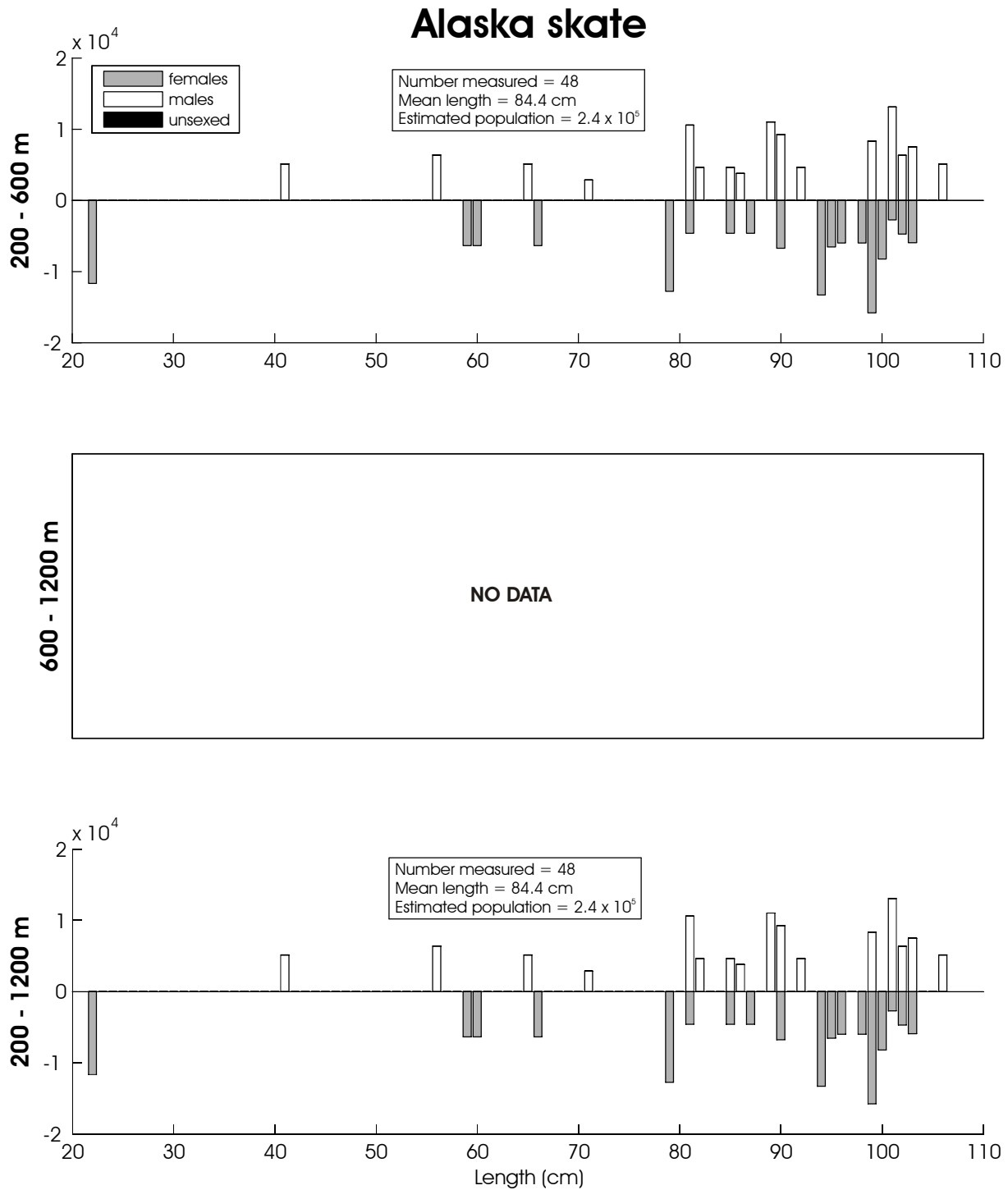

Figure 7. - - Size composition of the estimated Alaska skate population from the 2010 EBSS survey for all subareas by depth. The abscissa is scaled as total length in centimeters while the ordinate represents the estimated total population.

Table 12. - - Abundance estimates by subarea and depth strata for Aleutian skate (*Bathyraja aleutica*) from the 2010 EBSS survey.

<i>Bathyraja aleutica</i>		Aleutian skate					
Subarea	Depth strata (m)	Biomass (t)	Population	Biomass variance	Population variance	Average CPUE (kg/ha)	Average CPUE (no./ha)
1	200-400	2.53E+03	2.83E+05	3.04E+05	3.62E+09	6.31E+00	7.06E-01
	400-600	1.72E+03	4.08E+05	2.13E+05	1.71E+10	4.23E+00	1.00E+00
	600-800	5.02E+02	3.66E+05	4.70E+04	3.20E+10	2.88E+00	2.10E+00
	800-1,000	2.06E+02	1.67E+05	6.92E+03	2.22E+09	1.52E+00	1.23E+00
	1,000-1,200	2.64E+01	1.60E+05	2.34E+02	1.20E+10	2.39E-01	1.45E+00
2	200-400	8.10E+02	1.20E+05	2.47E+05	5.35E+09	6.99E+00	1.04E+00
	400-600	6.10E+02	1.97E+05	2.58E+04	1.79E+09	8.66E+00	2.79E+00
	600-800	3.89E+02	2.26E+05	1.34E+04	5.18E+09	6.57E+00	3.83E+00
	800-1,000	5.50E+02	3.85E+05	2.59E+04	8.13E+09	9.95E+00	6.96E+00
	1,000-1,200	4.16E+02	1.32E+06	4.79E+04	7.15E+10	7.76E+00	2.47E+01
3	200-400	2.00E+02	3.06E+04	7.06E+03	1.48E+08	2.21E+00	3.39E-01
	400-600	1.09E+02	3.83E+04	2.44E+03	3.40E+08	1.23E+00	4.32E-01
	600-800	4.59E+02	3.23E+05	1.07E+04	7.67E+09	5.04E+00	3.55E+00
	800-1,000	2.34E+01	1.21E+05	3.44E+02	1.11E+10	3.20E-01	1.65E+00
	1,000-1,200	2.74E+00	2.34E+04	7.51E+00	5.46E+08	4.06E-02	3.46E-01
4	200-400	1.10E+03	1.43E+05	2.51E+05	2.45E+09	8.94E+00	1.15E+00
	400-600	3.99E+03	5.29E+05	1.48E+07	1.64E+11	5.46E+01	7.24E+00
	600-800	1.71E+02	1.38E+05	2.98E+03	9.29E+08	2.46E+00	1.99E+00
	800-1,000	2.25E+02	3.21E+05	1.33E+04	3.12E+10	3.18E+00	4.53E+00
	1,000-1,200	8.48E+01	2.16E+05	6.79E+03	3.96E+10	1.28E+00	3.27E+00
5	200-400	1.93E+02	3.83E+04	5.08E+03	2.00E+08	4.55E+00	9.04E-01
	400-600	4.66E+02	8.15E+04	9.21E+04	2.08E+09	1.10E+01	1.91E+00
	600-800	3.78E+01	3.47E+04	1.43E+03	1.21E+09	8.76E-01	8.04E-01
	800-1,000	9.99E+00	6.32E+03	9.98E+01	4.00E+07	1.81E-01	1.15E-01
	1,000-1,200	0.00E+00	0.00E+00	0.00E+00	0.00E+00	0.00E+00	0.00E+00
6	200-400	8.57E+02	1.59E+05	9.31E+04	2.18E+09	3.30E+00	6.12E-01
	400-600	2.51E+03	7.06E+05	4.39E+05	1.35E+10	1.47E+01	4.14E+00
	600-800	4.15E+02	3.72E+05	3.92E+03	3.14E+09	4.52E+00	4.05E+00
	800-1,000	1.05E+02	1.75E+05	1.04E+04	2.56E+10	1.63E+00	2.71E+00
	1,000-1,200	0.00E+00	0.00E+00	0.00E+00	0.00E+00	0.00E+00	0.00E+00
1-6	200-1,200	1.87E+04	7.09E+06	1.66E+07	4.64E+11	6.11E+00	2.07E+00

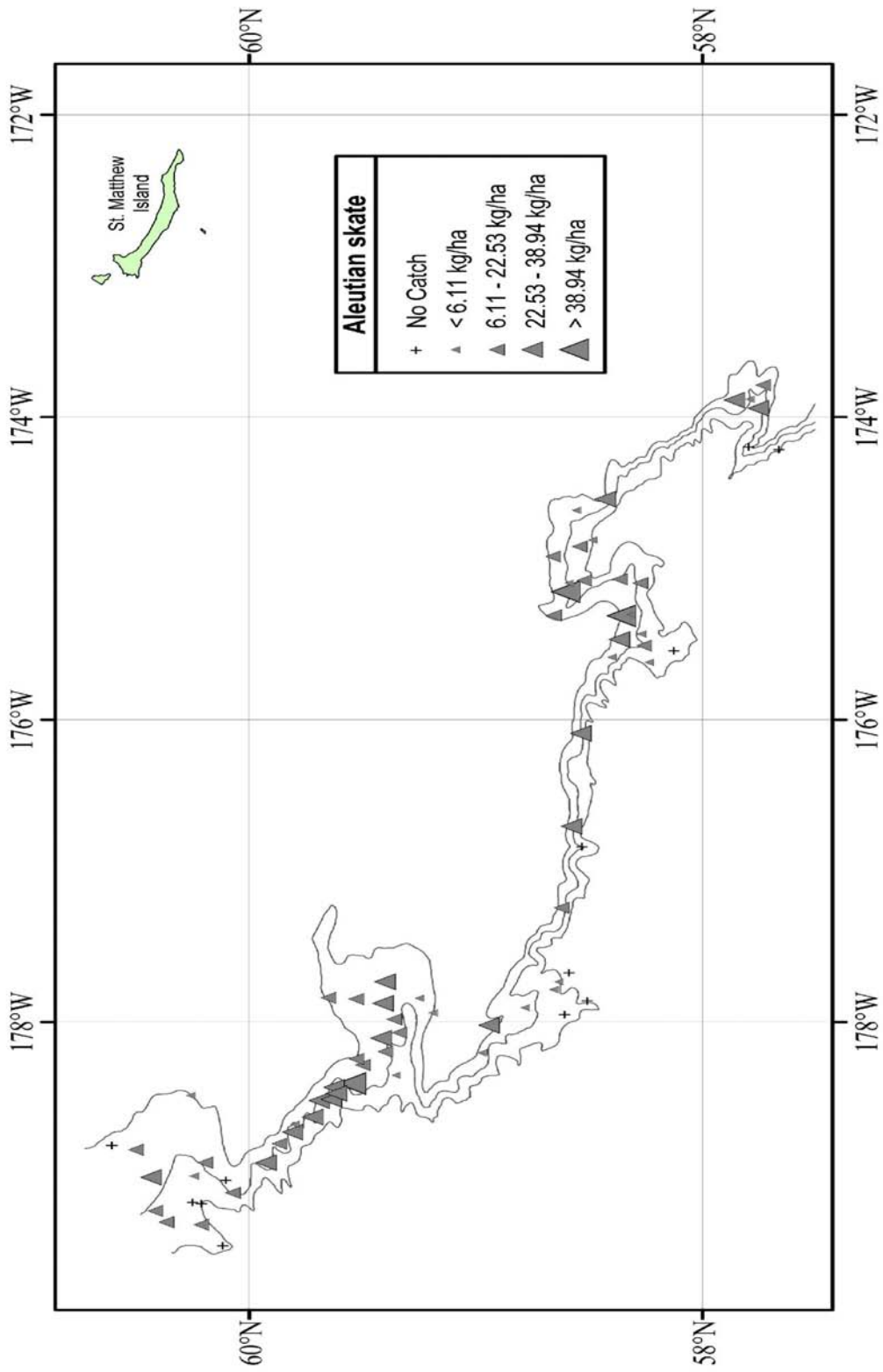

Figure 8. - - Distribution and relative abundance of Aleutian skate from the 2010 EBSS survey. Relative abundance is categorized by no catch, sample CPUE less than the mean CPUE, between the mean CPUE and one standard deviation above the mean, between one and two standard deviations above the mean CPUE, and greater than two standard deviations above the mean CPUE.

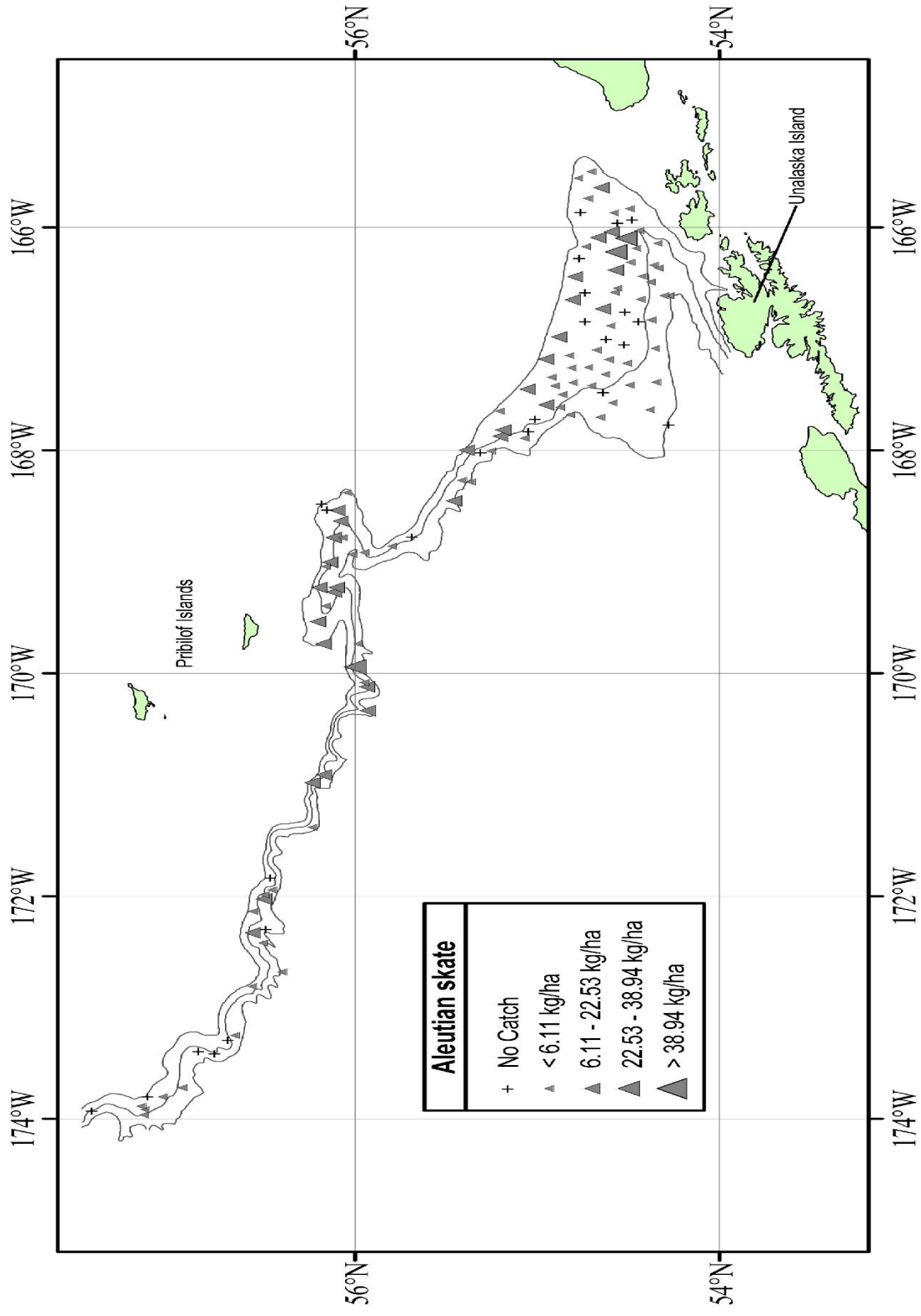

Figure 8. - - Continued.

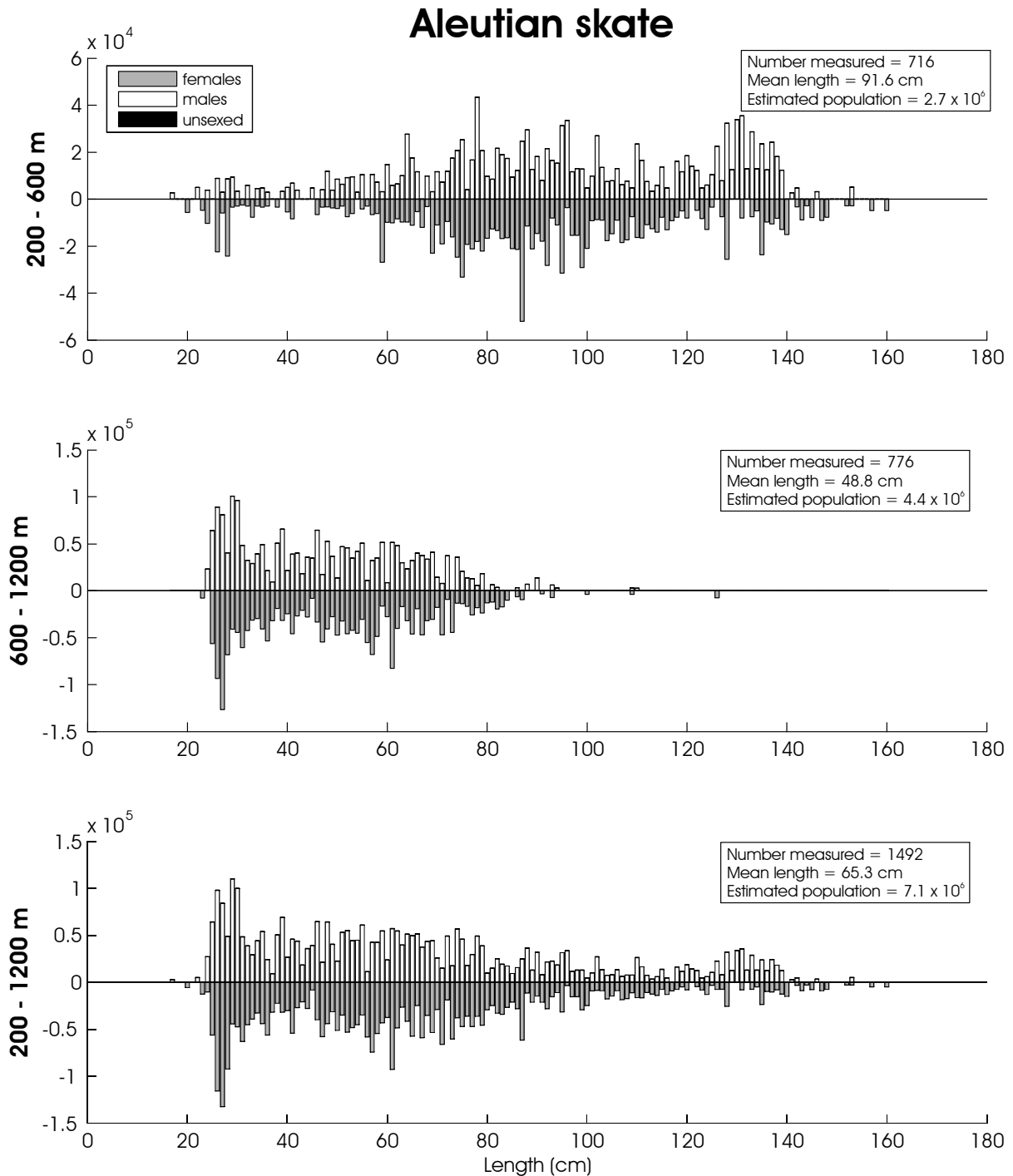

Figure 9. - - Size composition of the estimated Aleutian skate population from the 2010 EBSS survey for all subareas by depth. The abscissa is scaled as total length in centimeters while the ordinate represents the estimated total population.

Table 13. - - Abundance estimates by subarea and depth strata for Bering skate
(*Bathyraja interrupta*) from the 2010 EBSS survey.

<i>Bathyraja interrupta</i>		Bering skate					
Subarea	Depth strata (m)	Biomass (t)	Population	Biomass variance	Population variance	Average CPUE (kg/ha)	Average CPUE (no./ha)
1	200-400	7.07E+02	6.31E+05	2.25E+04	2.02E+10	1.76E+00	1.57E+00
	400-600	5.66E+02	3.29E+05	5.30E+04	1.68E+10	1.39E+00	8.11E-01
	600-800	8.11E+01	4.01E+04	1.48E+03	3.69E+08	4.66E-01	2.30E-01
	800-1,000	2.05E+01	7.55E+03	4.22E+02	5.70E+07	1.52E-01	5.57E-02
	1,000-1,200	1.19E+00	2.05E+04	1.42E+00	4.21E+08	1.08E-02	1.85E-01
2	200-400	2.75E+01	3.96E+04	7.07E+02	9.45E+08	2.38E-01	3.42E-01
	400-600	6.34E+00	2.49E+03	4.02E+01	6.19E+06	8.99E-02	3.53E-02
	600-800	0.00E+00	0.00E+00	0.00E+00	0.00E+00	0.00E+00	0.00E+00
	800-1,000	0.00E+00	0.00E+00	0.00E+00	0.00E+00	0.00E+00	0.00E+00
	1,000-1,200	0.00E+00	0.00E+00	0.00E+00	0.00E+00	0.00E+00	0.00E+00
3	200-400	1.80E+02	1.79E+05	7.67E+03	6.95E+09	1.99E+00	1.98E+00
	400-600	3.68E+01	3.31E+04	2.87E+02	1.22E+08	4.15E-01	3.74E-01
	600-800	0.00E+00	0.00E+00	0.00E+00	0.00E+00	0.00E+00	0.00E+00
	800-1,000	0.00E+00	0.00E+00	0.00E+00	0.00E+00	0.00E+00	0.00E+00
	1,000-1,200	0.00E+00	0.00E+00	0.00E+00	0.00E+00	0.00E+00	0.00E+00
4	200-400	1.11E+02	1.21E+05	7.08E+02	1.08E+09	9.01E-01	9.75E-01
	400-600	3.32E+02	2.27E+05	9.38E+04	4.30E+10	4.54E+00	3.11E+00
	600-800	0.00E+00	0.00E+00	0.00E+00	0.00E+00	0.00E+00	0.00E+00
	800-1,000	0.00E+00	0.00E+00	0.00E+00	0.00E+00	0.00E+00	0.00E+00
	1,000-1,200	0.00E+00	0.00E+00	0.00E+00	0.00E+00	0.00E+00	0.00E+00
5	200-400	3.19E+01	1.37E+04	2.72E+02	4.71E+07	7.52E-01	3.22E-01
	400-600	1.15E+02	7.47E+04	7.37E+03	2.96E+09	2.70E+00	1.75E+00
	600-800	0.00E+00	0.00E+00	0.00E+00	0.00E+00	0.00E+00	0.00E+00
	800-1,000	0.00E+00	0.00E+00	0.00E+00	0.00E+00	0.00E+00	0.00E+00
	1,000-1,200	0.00E+00	0.00E+00	0.00E+00	0.00E+00	0.00E+00	0.00E+00
6	200-400	3.64E+02	5.01E+05	9.86E+03	2.48E+10	1.40E+00	1.93E+00
	400-600	1.94E+02	1.70E+05	7.75E+03	3.80E+09	1.14E+00	9.95E-01
	600-800	5.35E+00	5.17E+03	2.71E+01	1.15E+07	5.83E-02	5.64E-02
	800-1,000	0.00E+00	0.00E+00	0.00E+00	0.00E+00	0.00E+00	0.00E+00
	1,000-1,200	0.00E+00	0.00E+00	0.00E+00	0.00E+00	0.00E+00	0.00E+00
1-6	200-1,200	2.78E+03	2.39E+06	2.06E+05	1.22E+11	9.37E-01	7.75E-01

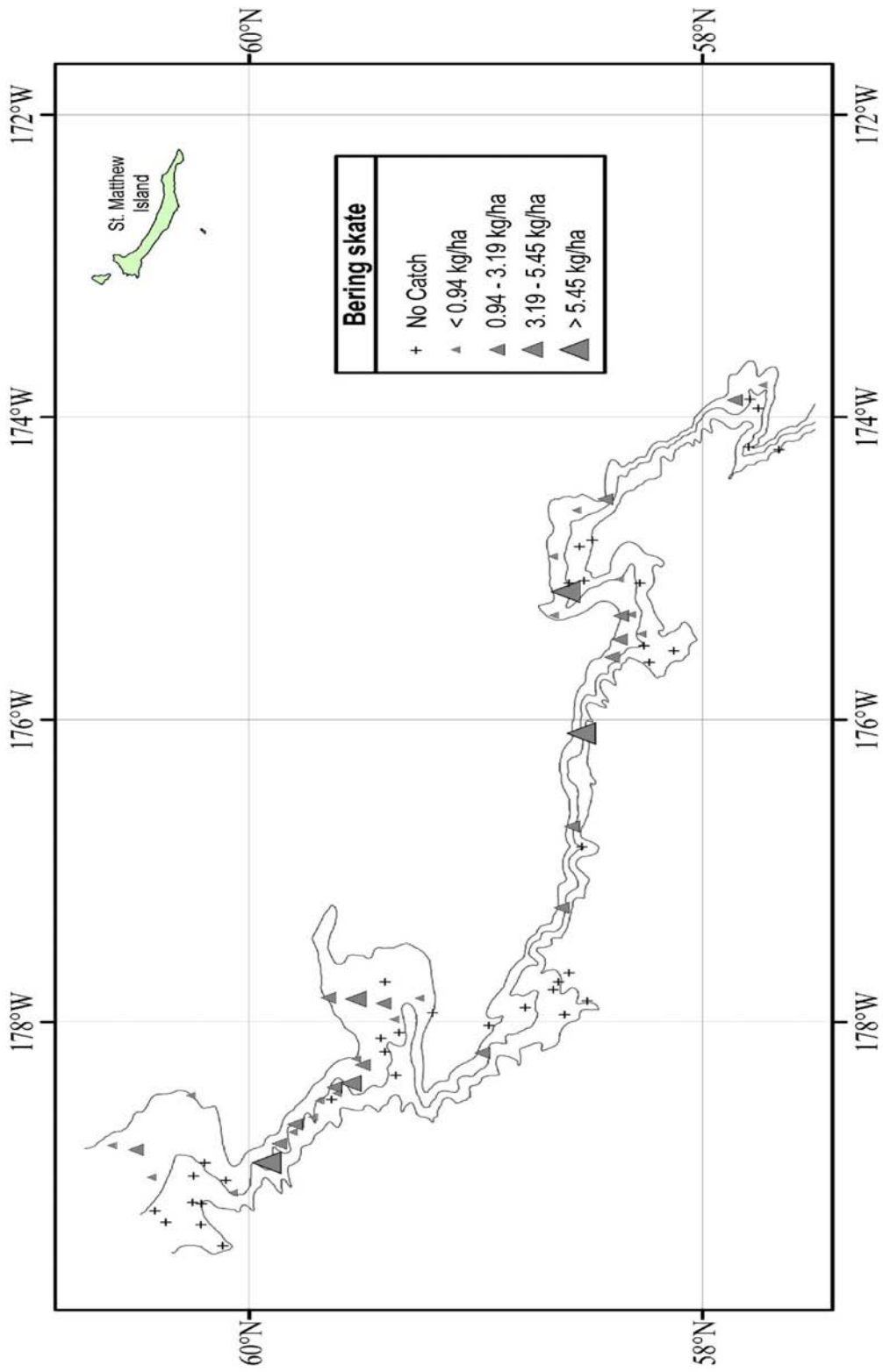

Figure 10. - - Distribution and relative abundance of Bering skate from the 2010 EBSS survey. Relative abundance is categorized by no catch, sample CPUE less than the mean CPUE, between the mean CPUE and one standard deviation above the mean, between one and two standard deviations above the mean CPUE, and greater than two standard deviations above the mean CPUE.

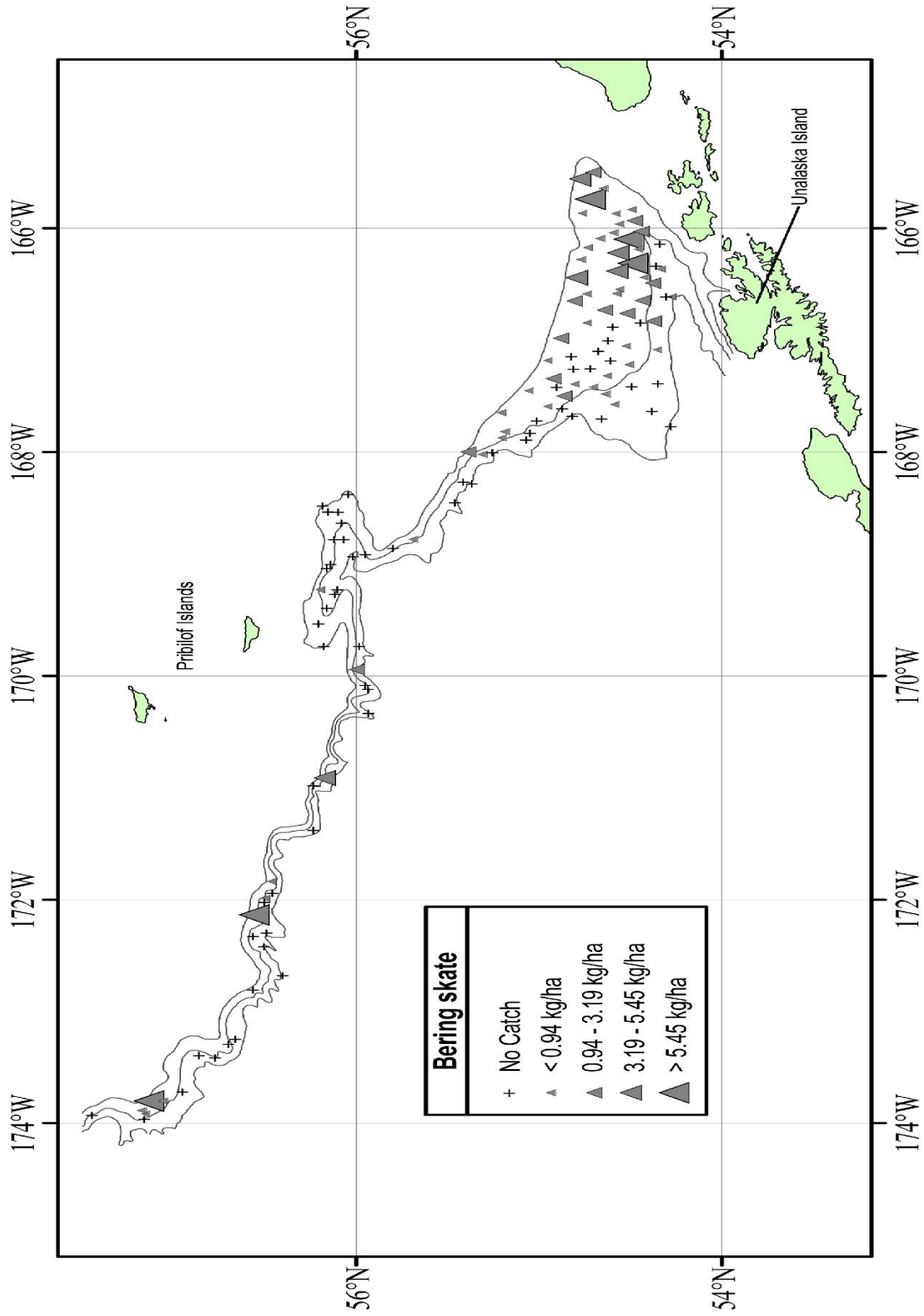

Figure 10. - - Continued.

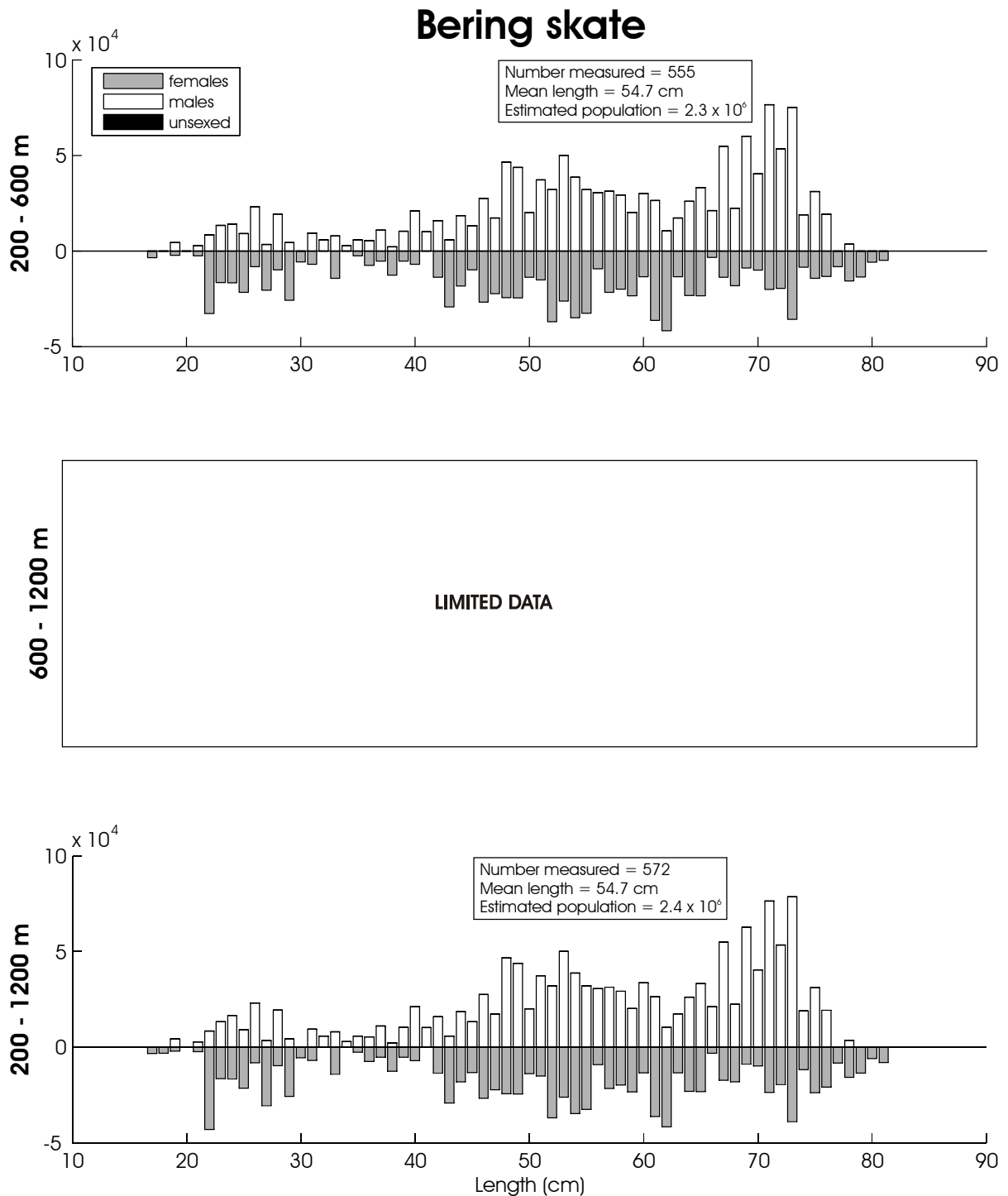

Figure 11. - - Size composition of the estimated Bering skate population from the 2010 EBSS survey for all subareas by depth. The abscissa is scaled as total length in centimeters while the ordinate represents the estimated total population.

Table 14. - - Abundance estimates by subarea and depth strata for Commander skate (*Bathyraja lindbergi*) from the 2010 EBSS survey.

<i>Bathyraja lindbergi</i>		Commander skate					
Subarea	Depth strata (m)	Biomass (t)	Population	Biomass variance	Population variance	Average CPUE (kg/ha)	Average CPUE (no./ha)
1	200-400	0.00E+00	0.00E+00	0.00E+00	0.00E+00	0.00E+00	0.00E+00
	400-600	3.12E+02	6.96E+04	2.00E+04	1.05E+09	7.68E-01	1.71E-01
	600-800	8.76E+01	2.07E+04	1.92E+03	9.41E+07	5.03E-01	1.19E-01
	800-1,000	0.00E+00	0.00E+00	0.00E+00	0.00E+00	0.00E+00	0.00E+00
	1,000-1,200	1.83E+00	2.05E+04	3.34E+00	4.21E+08	1.65E-02	1.85E-01
2	200-400	6.18E+01	1.65E+04	3.82E+03	2.72E+08	5.34E-01	1.42E-01
	400-600	8.18E+01	2.68E+04	1.30E+03	1.30E+08	1.16E+00	3.80E-01
	600-800	6.51E+02	2.16E+05	1.49E+05	2.04E+10	1.10E+01	3.65E+00
	800-1,000	1.54E+02	4.88E+04	1.40E+04	1.24E+09	2.79E+00	8.83E-01
	1,000-1,200	2.74E+00	1.43E+04	7.50E+00	2.03E+08	5.11E-02	2.66E-01
3	200-400	0.00E+00	0.00E+00	0.00E+00	0.00E+00	0.00E+00	0.00E+00
	400-600	6.65E+01	1.62E+04	1.92E+03	1.07E+08	7.50E-01	1.83E-01
	600-800	1.22E+02	3.86E+04	2.83E+03	2.55E+08	1.34E+00	4.24E-01
	800-1,000	9.27E+01	3.22E+04	1.94E+03	2.18E+08	1.27E+00	4.39E-01
	1,000-1,200	4.90E+01	3.92E+04	1.00E+03	5.34E+08	7.26E-01	5.80E-01
4	200-400	0.00E+00	0.00E+00	0.00E+00	0.00E+00	0.00E+00	0.00E+00
	400-600	1.11E+02	3.59E+04	1.43E+03	2.14E+08	1.52E+00	4.92E-01
	600-800	2.53E+02	9.63E+04	1.00E+04	1.39E+09	3.65E+00	1.39E+00
	800-1,000	1.36E+02	3.84E+04	6.22E+03	5.27E+08	1.93E+00	5.43E-01
	1,000-1,200	1.58E+01	8.74E+04	2.51E+02	7.65E+09	2.39E-01	1.32E+00
5	200-400	0.00E+00	0.00E+00	0.00E+00	0.00E+00	0.00E+00	0.00E+00
	400-600	6.68E+01	1.71E+04	1.30E+02	1.30E+07	1.57E+00	4.02E-01
	600-800	1.19E+02	4.53E+04	2.56E+03	5.83E+08	2.76E+00	1.05E+00
	800-1,000	2.83E+01	1.84E+04	7.99E+02	3.37E+08	5.12E-01	3.33E-01
	1,000-1,200	0.00E+00	0.00E+00	0.00E+00	0.00E+00	0.00E+00	0.00E+00
6	200-400	0.00E+00	0.00E+00	0.00E+00	0.00E+00	0.00E+00	0.00E+00
	400-600	3.10E+02	1.01E+05	8.80E+03	1.18E+09	1.81E+00	5.91E-01
	600-800	5.39E+02	3.62E+05	2.52E+04	1.70E+10	5.88E+00	3.95E+00
	800-1,000	1.17E+02	3.88E+05	8.26E+02	1.99E+10	1.82E+00	6.01E+00
	1,000-1,200	1.28E+01	4.24E+04	1.63E+02	1.80E+09	2.58E-01	8.54E-01
1-6	200-1,200	3.39E+03	1.79E+06	2.55E+05	7.56E+10	1.19E+00	5.64E-01

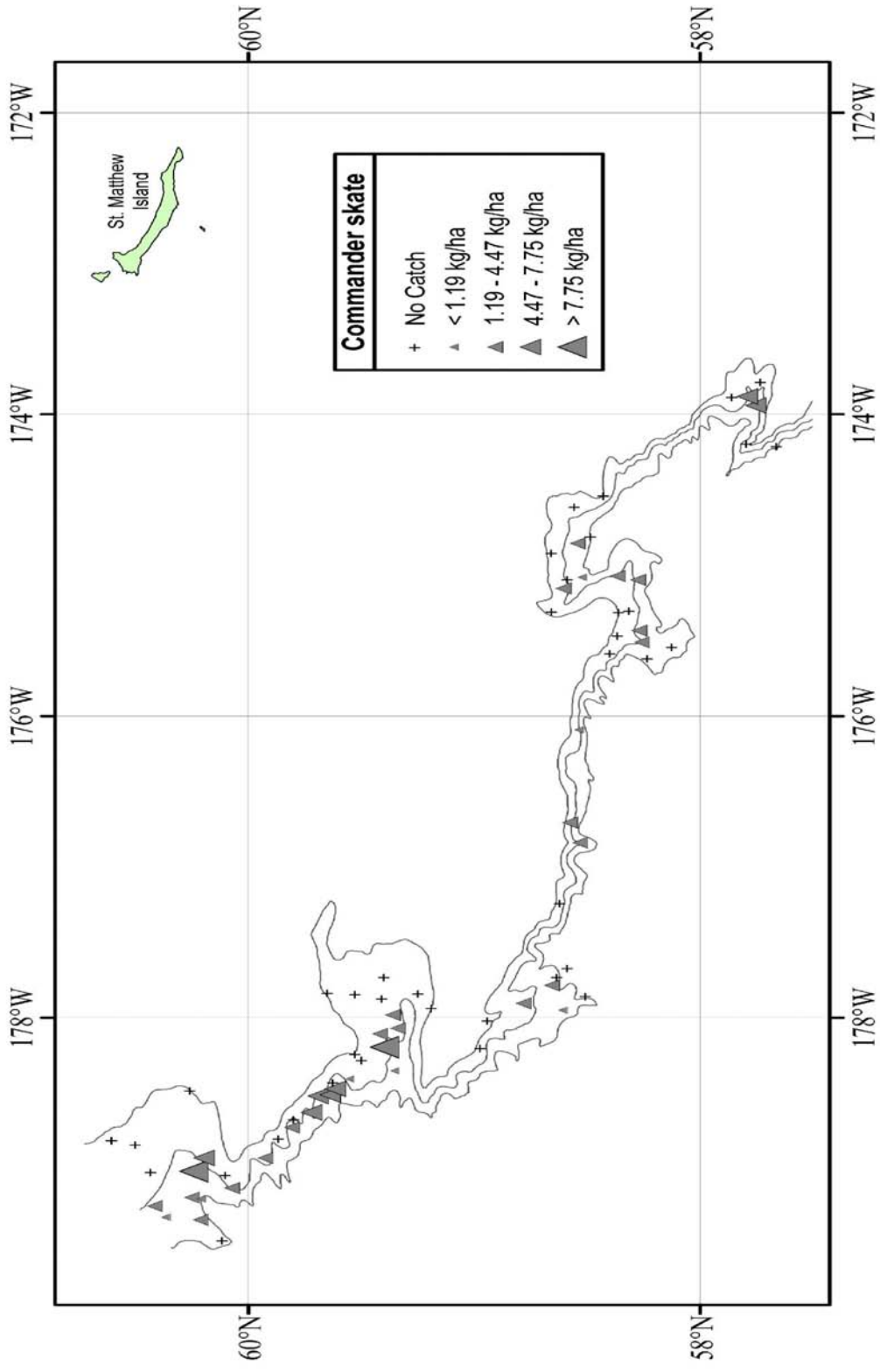

Figure 12. - - Distribution and relative abundance of Commander skate from the 2010 EBSS survey. Relative abundance is categorized by no catch, sample CPUE less than the mean CPUE, between the mean CPUE and one standard deviation above the mean, between one and two standard deviations above the mean CPUE, and greater than two standard deviations above the mean CPUE.

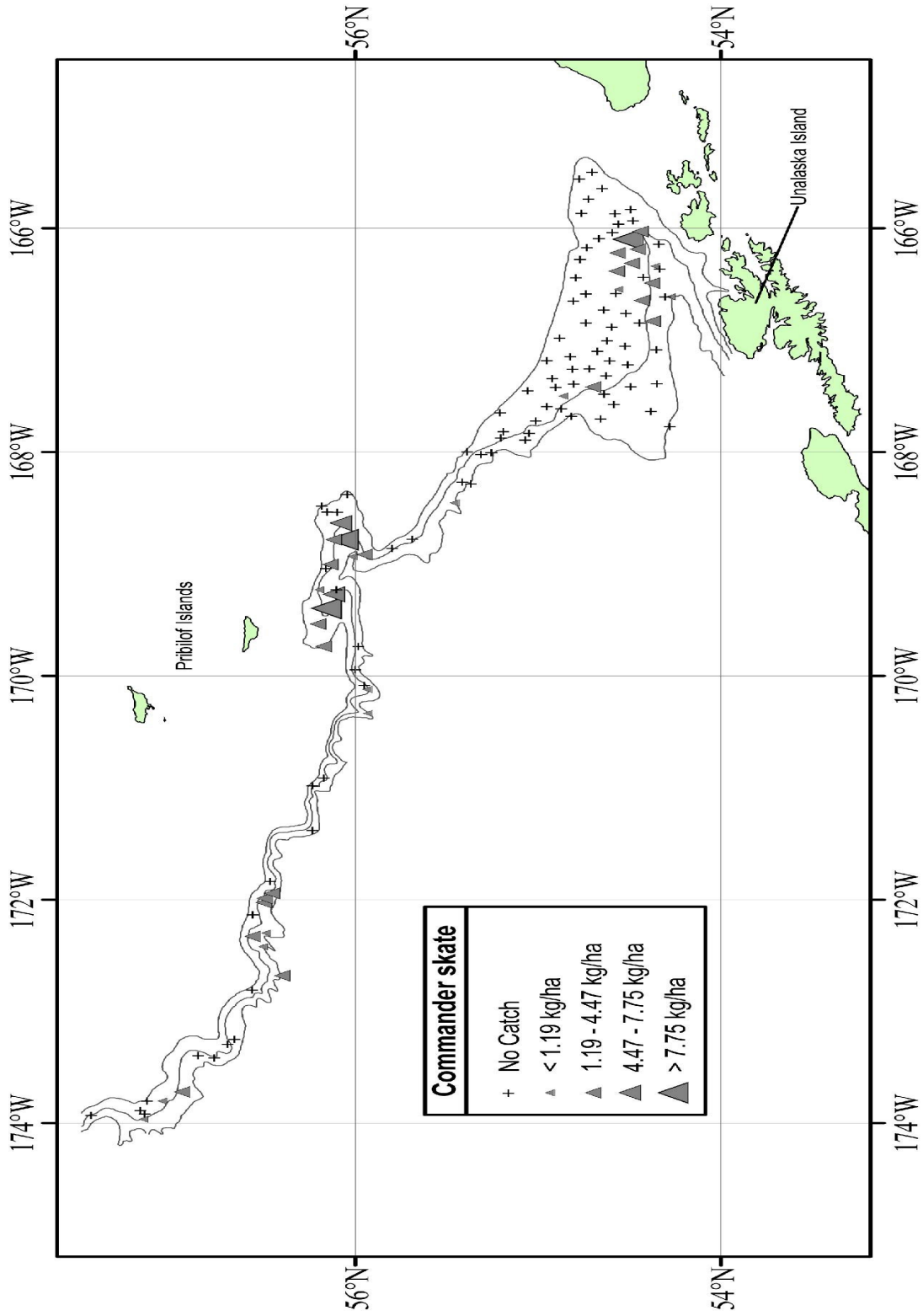

Figure 12. - - Continued.

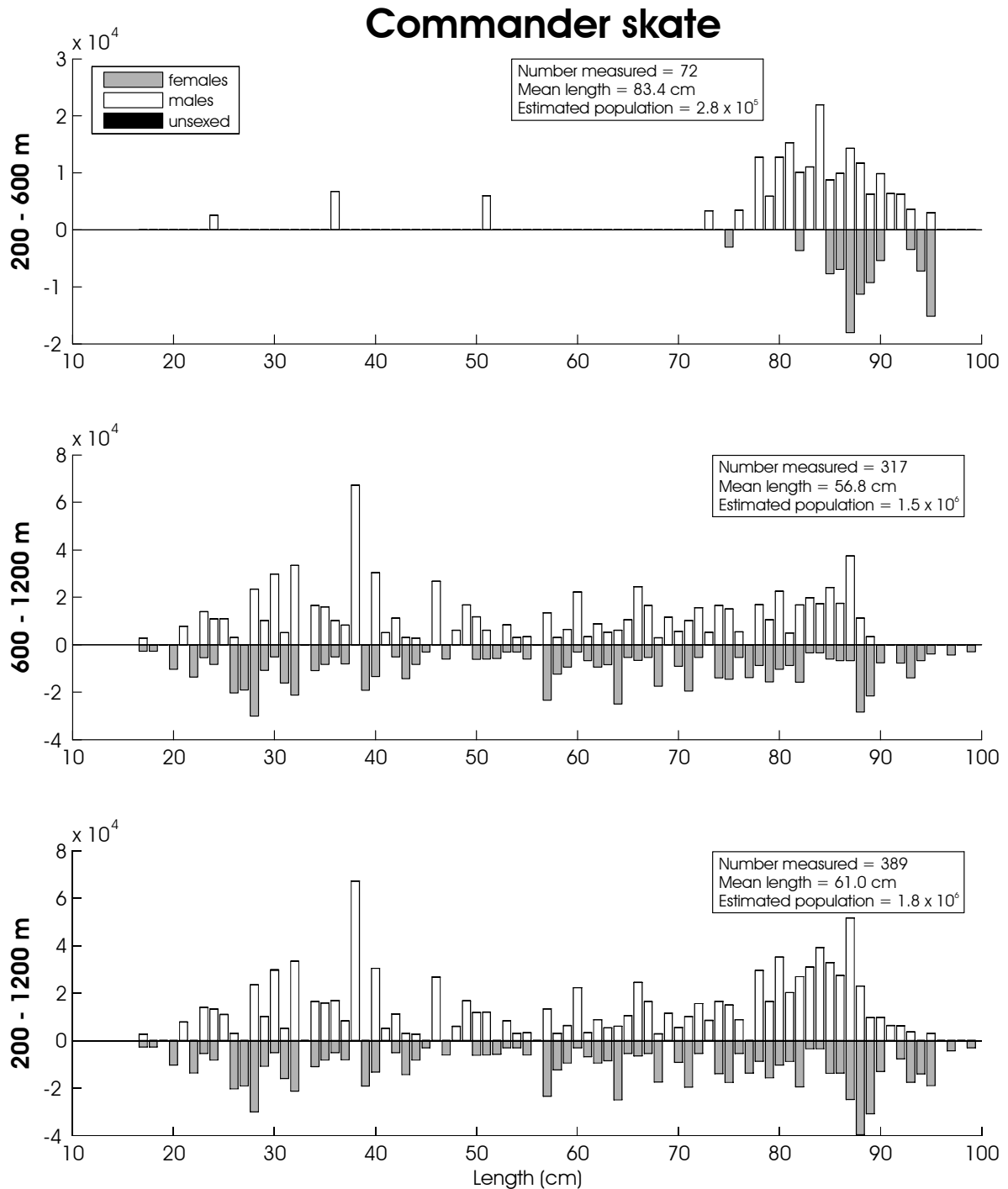

Figure 13. -- Size composition of the estimated Commander skate population from the 2010 EBSS survey for all subareas by depth. The abscissa is scaled as total length in centimeters while the ordinate represents the estimated total population.

Table 15. - Abundance estimates by subarea and depth strata for whiteblotched skate (*Bathyraja maculata*) from the 2010 EBSS survey.

<i>Bathyraja maculata</i>		whiteblotched skate					
Subarea	Depth strata (m)	Biomass (t)	Population	Biomass variance	Population variance	Average CPUE (kg/ha)	Average CPUE (no./ha)
1	200-400	2.45E+02	3.50E+04	2.70E+04	6.54E+08	6.10E-01	8.72E-02
	400-600	5.32E+02	9.80E+04	1.11E+04	4.22E+08	1.31E+00	2.41E-01
	600-800	0.00E+00	0.00E+00	0.00E+00	0.00E+00	0.00E+00	0.00E+00
	800-1,000	0.00E+00	0.00E+00	0.00E+00	0.00E+00	0.00E+00	0.00E+00
	1,000-1,200	0.00E+00	0.00E+00	0.00E+00	0.00E+00	0.00E+00	0.00E+00
2	200-400	4.43E+02	5.60E+04	6.06E+04	1.05E+09	3.83E+00	4.84E-01
	400-600	3.70E+02	9.89E+04	2.84E+04	1.42E+09	5.25E+00	1.40E+00
	600-800	4.84E+02	3.07E+05	6.26E+04	2.20E+10	8.18E+00	5.19E+00
	800-1,000	7.61E+00	1.40E+04	5.79E+01	1.96E+08	1.38E-01	2.54E-01
	1,000-1,200	6.22E+00	2.39E+04	3.87E+01	5.69E+08	1.16E-01	4.45E-01
3	200-400	0.00E+00	0.00E+00	0.00E+00	0.00E+00	0.00E+00	0.00E+00
	400-600	0.00E+00	0.00E+00	0.00E+00	0.00E+00	0.00E+00	0.00E+00
	600-800	9.41E+00	3.31E+03	8.85E+01	1.10E+07	1.03E-01	3.64E-02
	800-1,000	0.00E+00	0.00E+00	0.00E+00	0.00E+00	0.00E+00	0.00E+00
	1,000-1,200	0.00E+00	0.00E+00	0.00E+00	0.00E+00	0.00E+00	0.00E+00
4	200-400	3.82E+01	8.20E+03	6.96E+02	3.36E+07	3.09E-01	6.63E-02
	400-600	1.75E+01	4.57E+03	3.07E+02	2.08E+07	2.40E-01	6.25E-02
	600-800	0.00E+00	0.00E+00	0.00E+00	0.00E+00	0.00E+00	0.00E+00
	800-1,000	0.00E+00	0.00E+00	0.00E+00	0.00E+00	0.00E+00	0.00E+00
	1,000-1,200	0.00E+00	0.00E+00	0.00E+00	0.00E+00	0.00E+00	0.00E+00
5	200-400	1.70E+02	2.50E+04	7.24E+02	1.54E+07	4.02E+00	5.89E-01
	400-600	1.09E+02	2.43E+04	3.23E+03	1.52E+08	2.57E+00	5.70E-01
	600-800	0.00E+00	0.00E+00	0.00E+00	0.00E+00	0.00E+00	0.00E+00
	800-1,000	0.00E+00	0.00E+00	0.00E+00	0.00E+00	0.00E+00	0.00E+00
	1,000-1,200	0.00E+00	0.00E+00	0.00E+00	0.00E+00	0.00E+00	0.00E+00
6	200-400	1.23E+02	2.13E+04	2.80E+03	8.24E+07	4.74E-01	8.19E-02
	400-600	1.29E+03	5.10E+05	9.66E+04	1.53E+10	7.54E+00	2.99E+00
	600-800	2.13E+02	1.80E+05	3.58E+04	2.81E+10	2.32E+00	1.96E+00
	800-1,000	0.00E+00	0.00E+00	0.00E+00	0.00E+00	0.00E+00	0.00E+00
	1,000-1,200	0.00E+00	0.00E+00	0.00E+00	0.00E+00	0.00E+00	0.00E+00
1-6	200-1,200	4.06E+03	1.41E+06	3.30E+05	7.00E+10	1.55E+00	5.49E-01

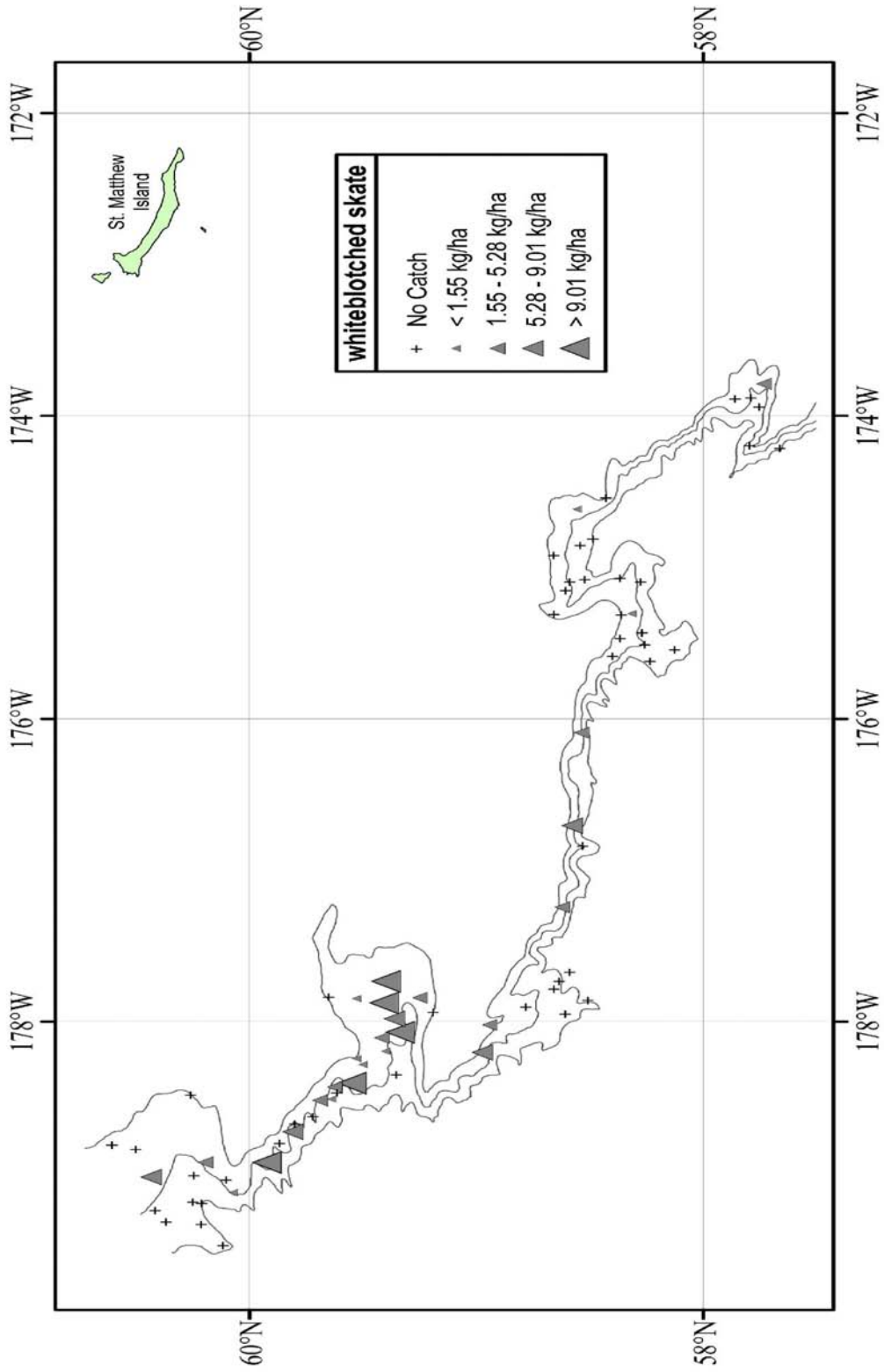

Figure 14. - - Distribution and relative abundance of whiteblotched skate from the 2010 EBSS survey. Relative abundance is categorized by no catch, sample CPUE less than the mean CPUE, between the mean CPUE and one standard deviation above the mean, between one and two standard deviations above the mean CPUE, and greater than two standard deviations above the mean CPUE.

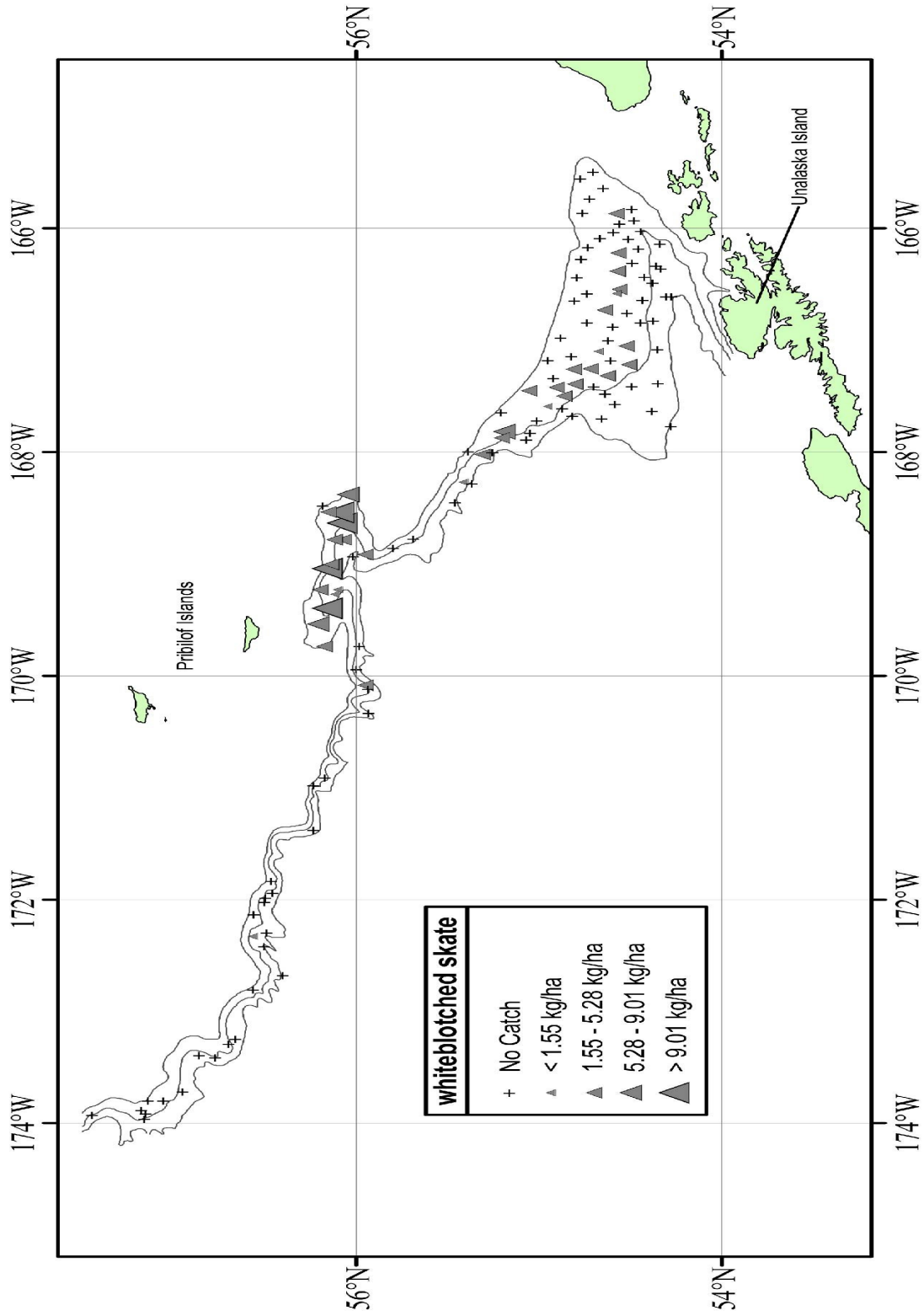

Figure 14. - - Continued.

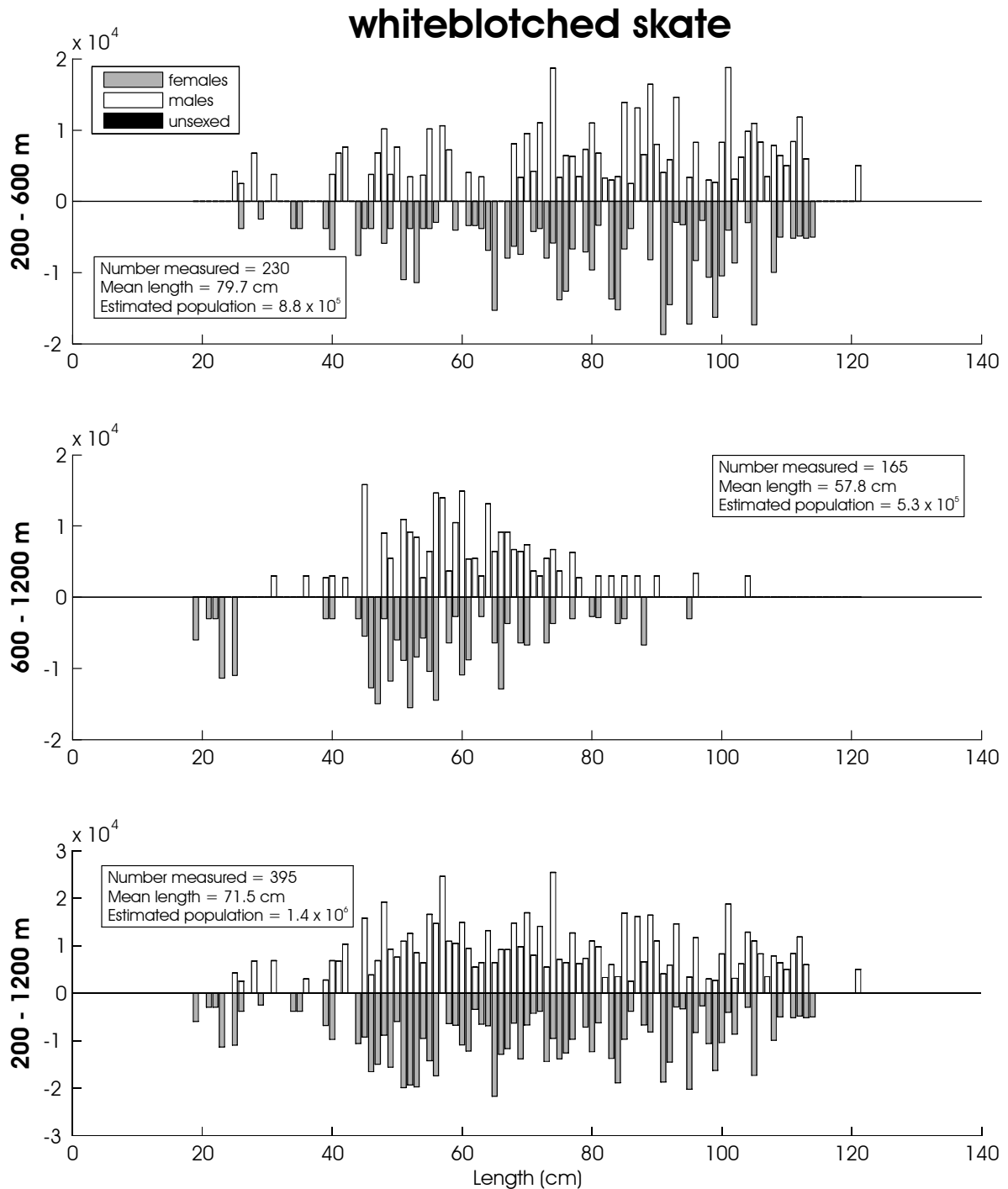

Figure 15. -- Size composition of the estimated whiteblotched skate population from the 2010 EBSS survey for all subareas by depth. The abscissa is scaled as total length in centimeters while the ordinate represents the estimated total population.

Table 16. - - Abundance estimates by subarea and depth strata for whitebrow skate
(*Bathyraja minispinosa*) from the 2010 EBSS survey.

<i>Bathyraja minispinosa</i>					whitebrow skate		
Subarea	Depth strata (m)	Biomass (t)	Population	Biomass variance	Population variance	Average CPUE (kg/ha)	Average CPUE (no./ha)
1	200-400	2.14E+02	7.12E+04	6.94E+03	7.69E+08	5.34E-01	1.78E-01
	400-600	5.40E+02	2.00E+05	1.08E+05	1.34E+10	1.33E+00	4.92E-01
	600-800	1.20E+02	8.38E+04	1.70E+03	1.05E+09	6.87E-01	4.81E-01
	800-1,000	7.96E+01	8.66E+04	9.15E+02	7.32E+08	5.88E-01	6.39E-01
	1,000-1,200	1.42E+01	1.28E+05	9.08E+01	5.08E+09	1.29E-01	1.16E+00
2	200-400	0.00E+00	0.00E+00	0.00E+00	0.00E+00	0.00E+00	0.00E+00
	400-600	5.44E+01	2.32E+04	1.18E+03	2.12E+08	7.72E-01	3.29E-01
	600-800	9.05E+01	5.14E+04	1.06E+03	2.25E+08	1.53E+00	8.70E-01
	800-1,000	6.52E+01	7.53E+04	2.70E+03	1.10E+09	1.18E+00	1.36E+00
	1,000-1,200	1.03E+02	2.21E+05	1.37E+02	2.46E+09	1.93E+00	4.12E+00
3	200-400	3.35E+01	1.13E+04	4.11E+02	4.57E+07	3.71E-01	1.25E-01
	400-600	4.76E+01	1.62E+04	2.27E+03	2.62E+08	5.37E-01	1.83E-01
	600-800	5.46E+01	4.90E+04	3.76E+02	1.57E+08	6.00E-01	5.38E-01
	800-1,000	0.00E+00	0.00E+00	0.00E+00	0.00E+00	0.00E+00	0.00E+00
	1,000-1,200	2.34E-01	7.79E+03	5.46E-02	6.06E+07	3.46E-03	1.15E-01
4	200-400	1.98E+01	8.62E+03	1.16E+02	1.99E+07	1.60E-01	6.97E-02
	400-600	5.87E+01	3.41E+04	5.34E+02	2.41E+08	8.03E-01	4.67E-01
	600-800	3.79E+01	5.89E+04	1.44E+03	3.47E+09	5.46E-01	8.49E-01
	800-1,000	2.47E+01	3.98E+04	2.47E+02	9.16E+08	3.49E-01	5.62E-01
	1,000-1,200	8.45E+00	8.80E+03	7.14E+01	7.74E+07	1.28E-01	1.33E-01
5	200-400	1.03E+01	3.85E+03	1.06E+02	1.48E+07	2.43E-01	9.08E-02
	400-600	0.00E+00	0.00E+00	0.00E+00	0.00E+00	0.00E+00	0.00E+00
	600-800	2.97E-01	5.30E+03	8.80E-02	2.81E+07	6.87E-03	1.23E-01
	800-1,000	0.00E+00	0.00E+00	0.00E+00	0.00E+00	0.00E+00	0.00E+00
	1,000-1,200	5.51E-01	7.87E+03	3.03E-01	6.19E+07	9.66E-03	1.38E-01
6	200-400	1.15E+02	5.16E+04	5.01E+03	1.05E+09	4.44E-01	1.99E-01
	400-600	1.59E+02	1.00E+05	2.54E+03	7.64E+08	9.34E-01	5.89E-01
	600-800	4.64E+01	6.09E+04	1.49E+02	1.32E+08	5.06E-01	6.64E-01
	800-1,000	9.11E+00	2.16E+04	5.13E+01	2.14E+08	1.41E-01	3.34E-01
	1,000-1,200	0.00E+00	0.00E+00	0.00E+00	0.00E+00	0.00E+00	0.00E+00
1-6	200-1,200	1.91E+03	1.43E+06	1.36E+05	3.25E+10	6.57E-01	4.14E-01

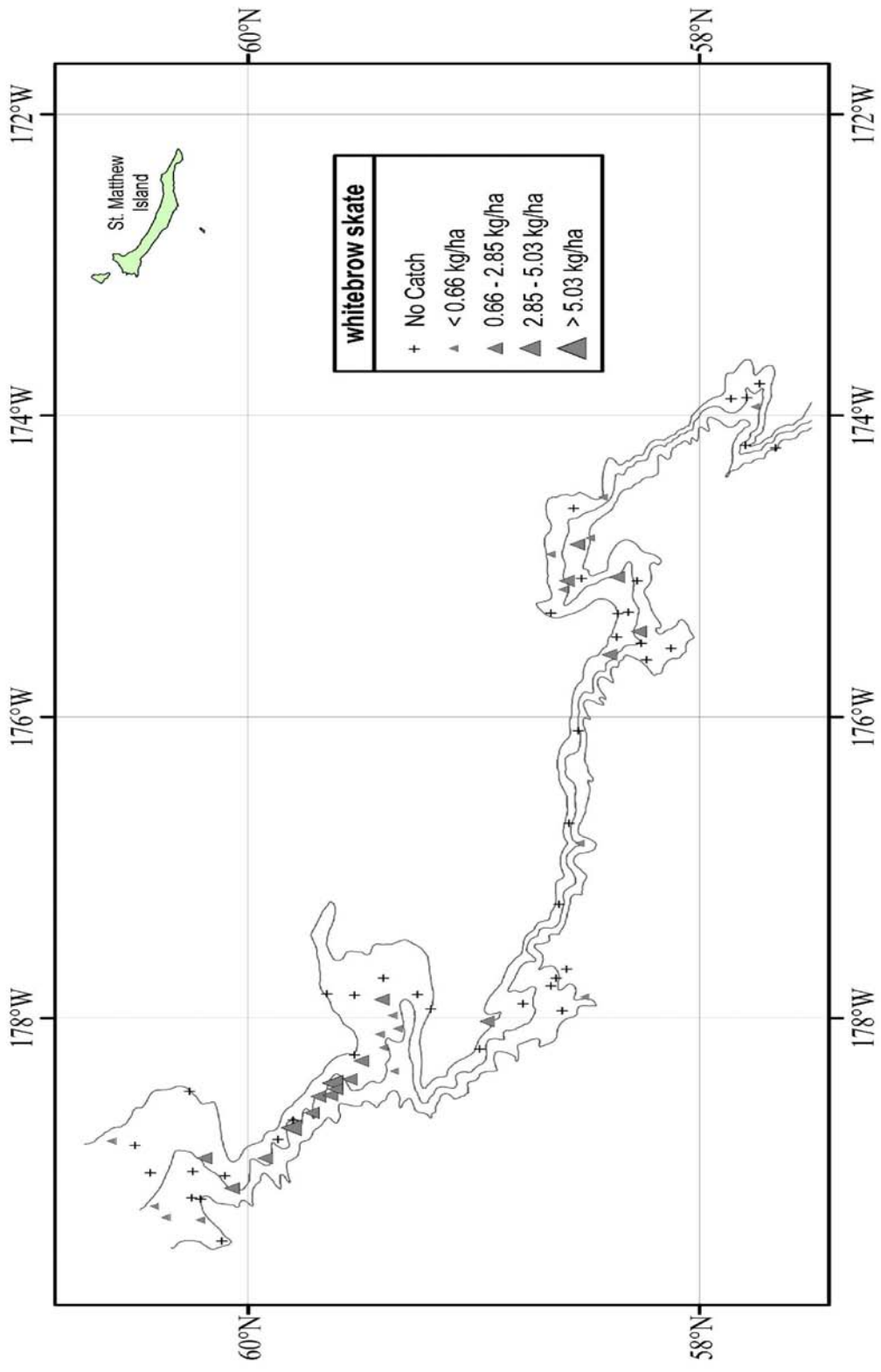

Figure 16. - - Distribution and relative abundance of whitebrow skate from the 2010 EBSS survey. Relative abundance is categorized by no catch, sample CPUE less than the mean CPUE, between the mean CPUE and one standard deviation above the mean, between one and two standard deviations above the mean CPUE, and greater than two standard deviations above the mean CPUE.

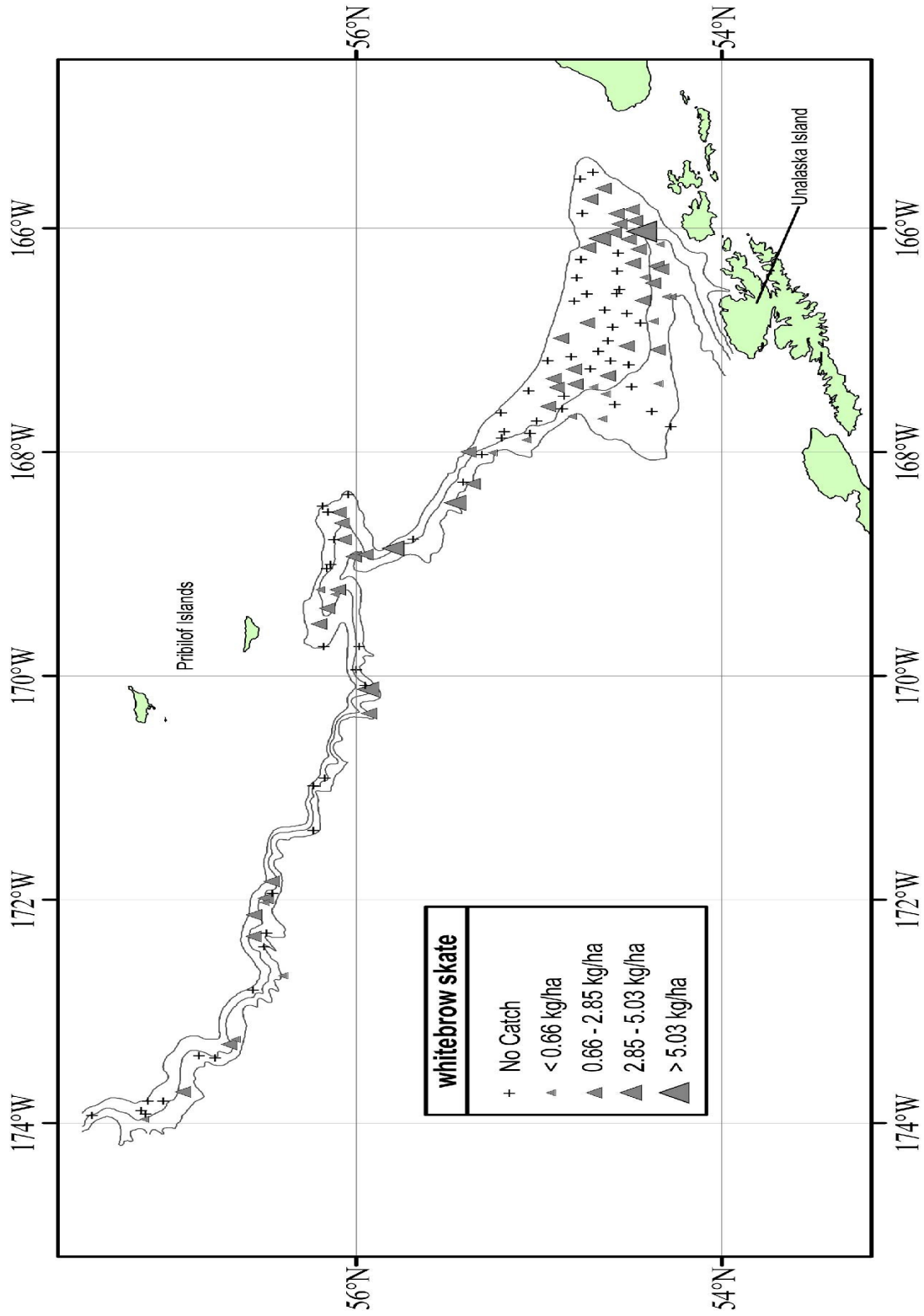

Figure 16. - - Continued.

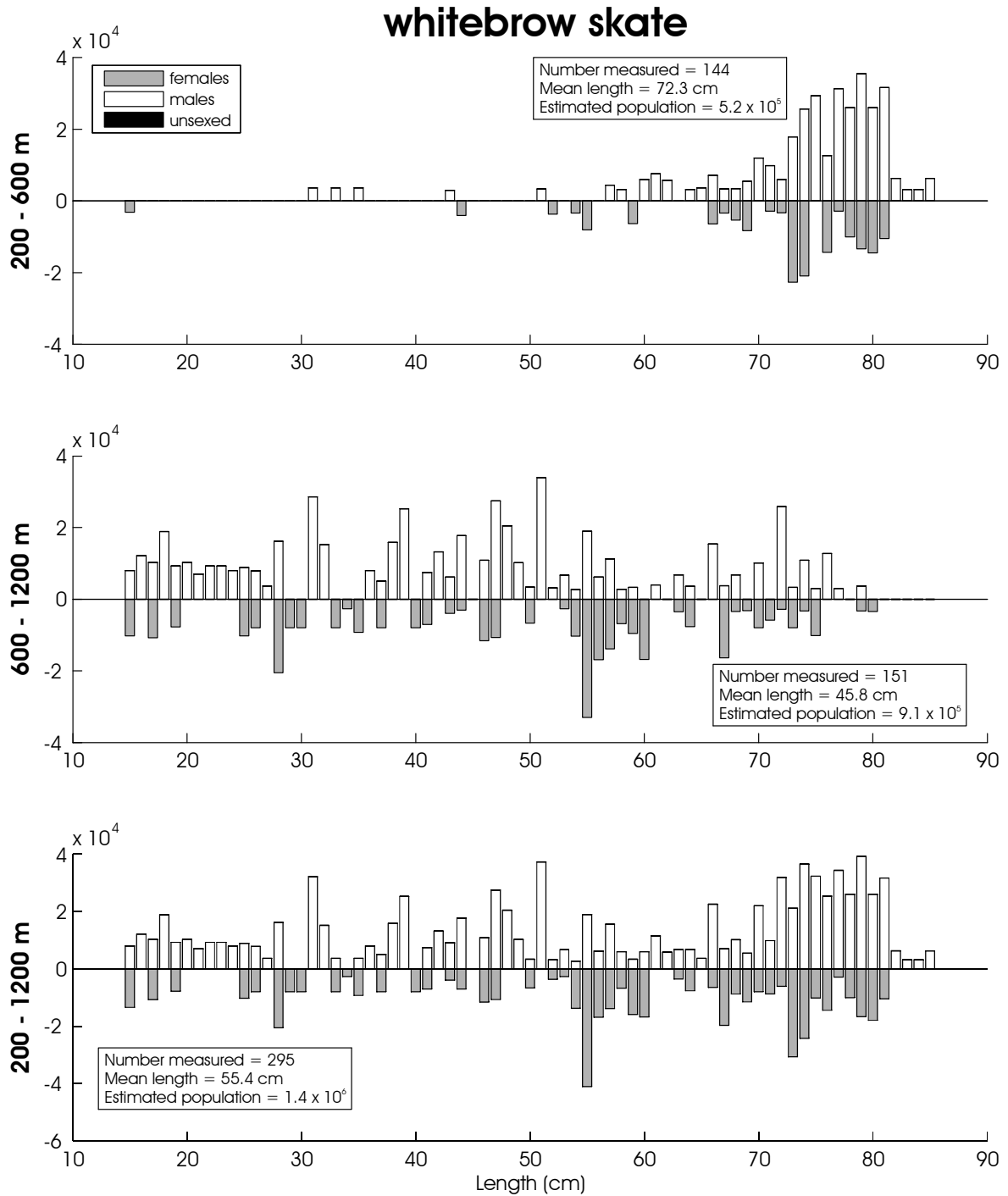

Figure 17. -- Size composition of the estimated whitebrow skate population from the 2010 EBSS survey for all subareas by depth. The abscissa is scaled as total length in centimeters while the ordinate represents the estimated total population.

Table 17. - - Abundance estimates by subarea and depth strata for roughtail skate (*Bathyraja trachura*) from the 2010 EBSS survey.

<i>Bathyraja trachura</i>		roughtail skate					
Subarea	Depth strata (m)	Biomass (t)	Population	Biomass variance	Population variance	Average CPUE (kg/ha)	Average CPUE (no./ha)
1	200-400	0.00E+00	0.00E+00	0.00E+00	0.00E+00	0.00E+00	0.00E+00
	400-600	0.00E+00	0.00E+00	0.00E+00	0.00E+00	0.00E+00	0.00E+00
	600-800	9.02E+01	3.07E+04	2.52E+03	2.66E+08	5.18E-01	1.76E-01
	800-1,000	5.39E+02	2.23E+05	2.91E+04	4.15E+09	3.98E+00	1.65E+00
	1,000-1,200	2.23E+02	1.46E+05	2.44E+03	2.22E+09	2.01E+00	1.32E+00
2	200-400	0.00E+00	0.00E+00	0.00E+00	0.00E+00	0.00E+00	0.00E+00
	400-600	0.00E+00	0.00E+00	0.00E+00	0.00E+00	0.00E+00	0.00E+00
	600-800	0.00E+00	0.00E+00	0.00E+00	0.00E+00	0.00E+00	0.00E+00
	800-1,000	4.00E+01	1.36E+04	1.60E+03	1.84E+08	7.24E-01	2.45E-01
	1,000-1,200	7.11E+01	3.65E+04	3.15E+03	4.23E+08	1.33E+00	6.81E-01
3	200-400	0.00E+00	0.00E+00	0.00E+00	0.00E+00	0.00E+00	0.00E+00
	400-600	0.00E+00	0.00E+00	0.00E+00	0.00E+00	0.00E+00	0.00E+00
	600-800	1.00E+01	3.51E+03	1.00E+02	1.23E+07	1.10E-01	3.86E-02
	800-1,000	8.41E+01	8.71E+04	7.07E+03	7.58E+09	1.15E+00	1.19E+00
	1,000-1,200	1.96E+02	9.63E+04	3.47E+04	6.51E+09	2.90E+00	1.43E+00
4	200-400	0.00E+00	0.00E+00	0.00E+00	0.00E+00	0.00E+00	0.00E+00
	400-600	0.00E+00	0.00E+00	0.00E+00	0.00E+00	0.00E+00	0.00E+00
	600-800	1.80E+01	5.18E+03	3.25E+02	2.68E+07	2.60E-01	7.46E-02
	800-1,000	1.38E+02	7.09E+04	4.30E+03	7.37E+08	1.95E+00	1.00E+00
	1,000-1,200	2.90E+01	8.80E+03	8.43E+02	7.74E+07	4.38E-01	1.33E-01
5	200-400	0.00E+00	0.00E+00	0.00E+00	0.00E+00	0.00E+00	0.00E+00
	400-600	0.00E+00	0.00E+00	0.00E+00	0.00E+00	0.00E+00	0.00E+00
	600-800	1.17E+02	4.63E+04	1.08E+03	4.41E+07	2.71E+00	1.07E+00
	800-1,000	2.24E+02	9.26E+04	9.64E+03	1.77E+09	4.05E+00	1.68E+00
	1,000-1,200	1.23E+02	4.79E+04	1.52E+04	2.30E+09	2.16E+00	8.40E-01
6	200-400	0.00E+00	0.00E+00	0.00E+00	0.00E+00	0.00E+00	0.00E+00
	400-600	0.00E+00	0.00E+00	0.00E+00	0.00E+00	0.00E+00	0.00E+00
	600-800	3.70E+01	1.19E+04	3.60E+02	4.13E+07	4.03E-01	1.30E-01
	800-1,000	1.41E+02	9.35E+04	1.91E+03	3.06E+08	2.19E+00	1.45E+00
	1,000-1,200	2.21E+01	4.76E+04	4.87E+02	2.26E+09	4.45E-01	9.58E-01
1-6	200-1,200	2.10E+03	1.06E+06	1.15E+05	2.89E+10	4.19E-01	2.04E-01

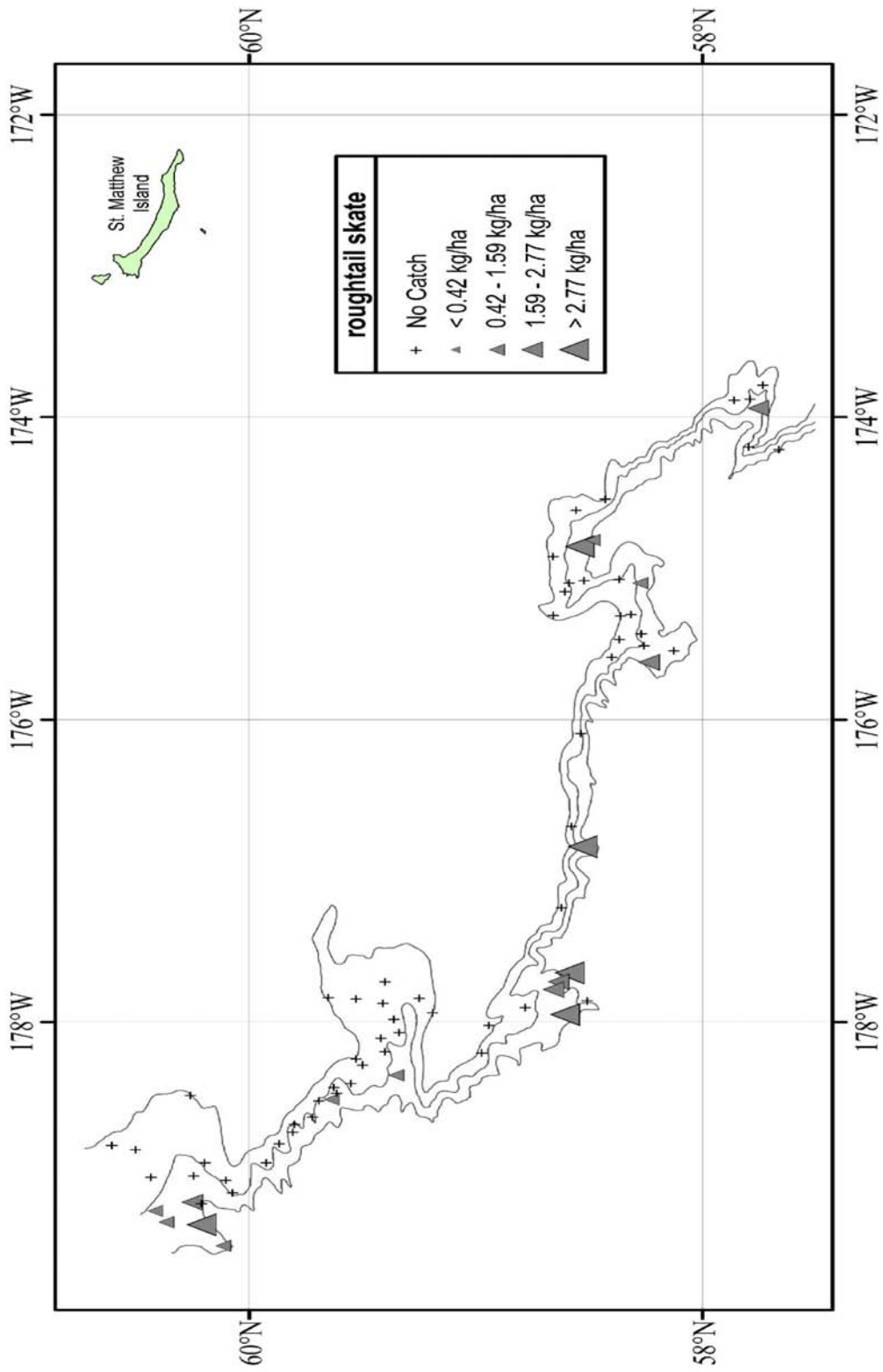

Figure 18. - - Distribution and relative abundance of roughtail skate from the 2010 EBSS survey. Relative abundance is categorized by no catch, sample CPUE less than the mean CPUE, between the mean CPUE and one standard deviation above the mean, between one and two standard deviations above the mean CPUE, and greater than two standard deviations above the mean CPUE.

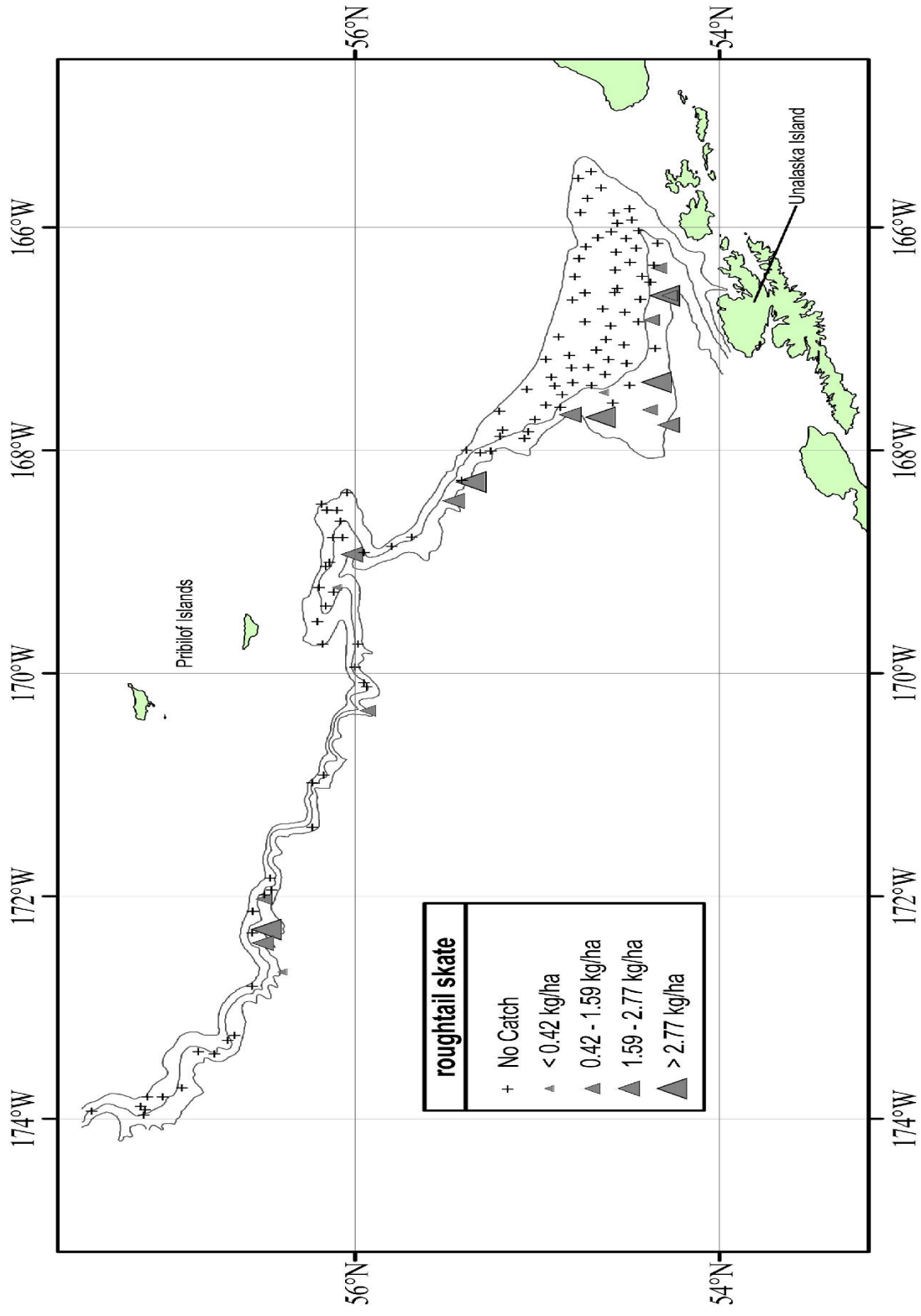

Figure 18. - - Continued.

rougtail skate

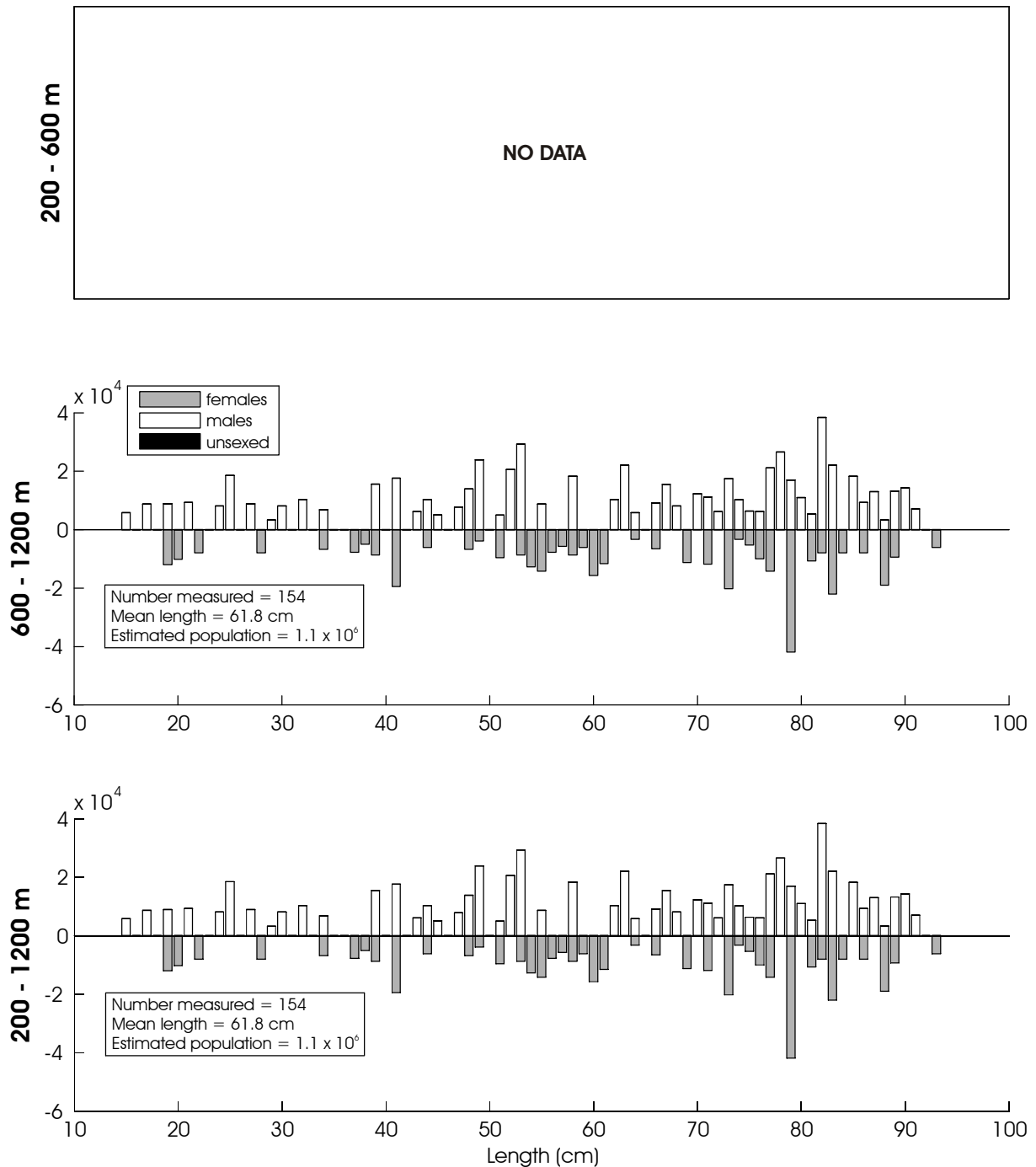

Figure 19. - Size composition of the estimated rougtail skate population from the 2010 EBSS survey for all subareas by depth. The abscissa is scaled as total length in centimeters while the ordinate represents the estimated total population.

Table 18. - Abundance estimates by subarea and depth strata for mud skate
(*Bathyraja taranetzi*) from the 2010 EBSS survey.

<i>Bathyraja taranetzi</i>		mud skate					
Subarea	Depth strata (m)	Biomass (t)	Population	Biomass variance	Population variance	Average CPUE (kg/ha)	Average CPUE (no./ha)
1	200-400	2.80E+01	1.68E+04	4.81E+02	1.50E+08	6.98E-02	4.18E-02
	400-600	9.71E+00	5.83E+03	5.55E+01	1.65E+07	2.39E-02	1.44E-02
	600-800	2.07E+00	3.67E+03	4.29E+00	1.35E+07	1.19E-02	2.11E-02
	800-1,000	0.00E+00	0.00E+00	0.00E+00	0.00E+00	0.00E+00	0.00E+00
	1,000-1,200	0.00E+00	0.00E+00	0.00E+00	0.00E+00	0.00E+00	0.00E+00
2	200-400	1.17E+02	9.00E+04	5.83E+03	3.34E+09	1.01E+00	7.78E-01
	400-600	5.96E+01	7.48E+04	3.81E+02	6.38E+08	8.46E-01	1.06E+00
	600-800	1.05E+01	3.32E+04	2.56E+01	2.10E+08	1.77E-01	5.61E-01
	800-1,000	5.02E+00	3.48E+04	3.21E+00	4.52E+08	9.08E-02	6.30E-01
	1,000-1,200	0.00E+00	0.00E+00	0.00E+00	0.00E+00	0.00E+00	0.00E+00
3	200-400	1.33E+01	1.26E+04	8.64E+01	7.50E+07	1.48E-01	1.39E-01
	400-600	2.87E+00	1.09E+04	8.22E+00	1.18E+08	3.24E-02	1.23E-01
	600-800	0.00E+00	0.00E+00	0.00E+00	0.00E+00	0.00E+00	0.00E+00
	800-1,000	0.00E+00	0.00E+00	0.00E+00	0.00E+00	0.00E+00	0.00E+00
	1,000-1,200	0.00E+00	0.00E+00	0.00E+00	0.00E+00	0.00E+00	0.00E+00
4	200-400	1.17E+02	1.00E+05	5.80E+03	4.05E+09	9.48E-01	8.10E-01
	400-600	0.00E+00	0.00E+00	0.00E+00	0.00E+00	0.00E+00	0.00E+00
	600-800	8.12E+00	1.48E+04	6.59E+01	2.18E+08	1.17E-01	2.13E-01
	800-1,000	0.00E+00	0.00E+00	0.00E+00	0.00E+00	0.00E+00	0.00E+00
	1,000-1,200	0.00E+00	0.00E+00	0.00E+00	0.00E+00	0.00E+00	0.00E+00
5	200-400	4.31E+00	3.85E+03	1.86E+01	1.48E+07	1.02E-01	9.08E-02
	400-600	0.00E+00	0.00E+00	0.00E+00	0.00E+00	0.00E+00	0.00E+00
	600-800	0.00E+00	0.00E+00	0.00E+00	0.00E+00	0.00E+00	0.00E+00
	800-1,000	0.00E+00	0.00E+00	0.00E+00	0.00E+00	0.00E+00	0.00E+00
	1,000-1,200	0.00E+00	0.00E+00	0.00E+00	0.00E+00	0.00E+00	0.00E+00
6	200-400	1.36E+02	1.38E+05	6.54E+03	6.52E+09	5.26E-01	5.32E-01
	400-600	5.70E+01	7.92E+04	8.11E+02	1.10E+09	3.34E-01	4.64E-01
	600-800	4.91E+00	5.45E+03	2.41E+01	2.97E+07	5.35E-02	5.94E-02
	800-1,000	0.00E+00	0.00E+00	0.00E+00	0.00E+00	0.00E+00	0.00E+00
	1,000-1,200	0.00E+00	0.00E+00	0.00E+00	0.00E+00	0.00E+00	0.00E+00
1-6	200-1,200	5.76E+02	6.24E+05	2.01E+04	1.69E+10	2.05E-01	2.20E-01

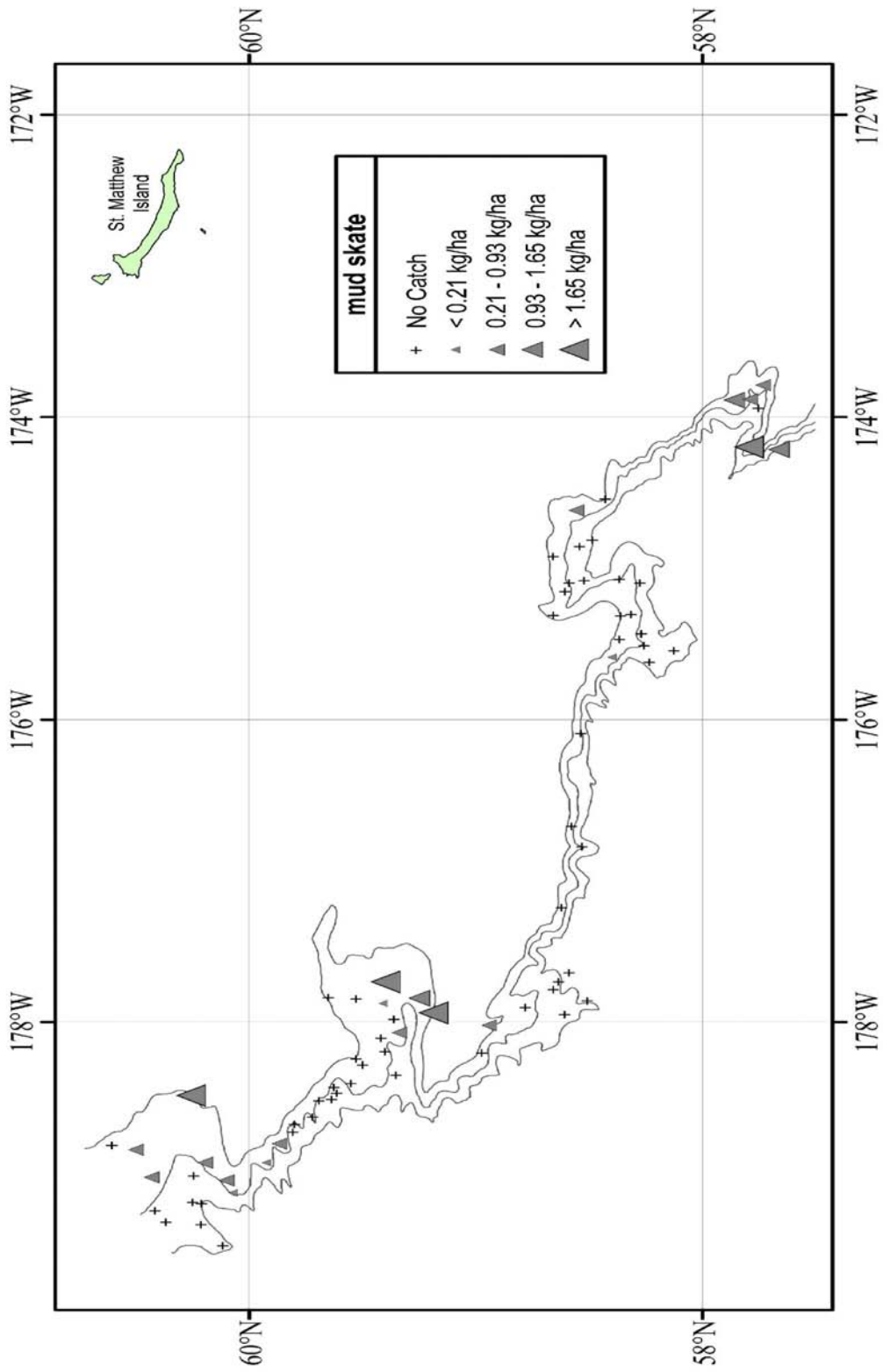

Figure 20. - - Distribution and relative abundance of mud skate from the 2010 EBSS survey. Relative abundance is categorized by no catch, sample CPUE less than the mean CPUE, between the mean CPUE and one standard deviation above the mean, between one and two standard deviations above the mean CPUE, and greater than two standard deviations above the mean CPUE.

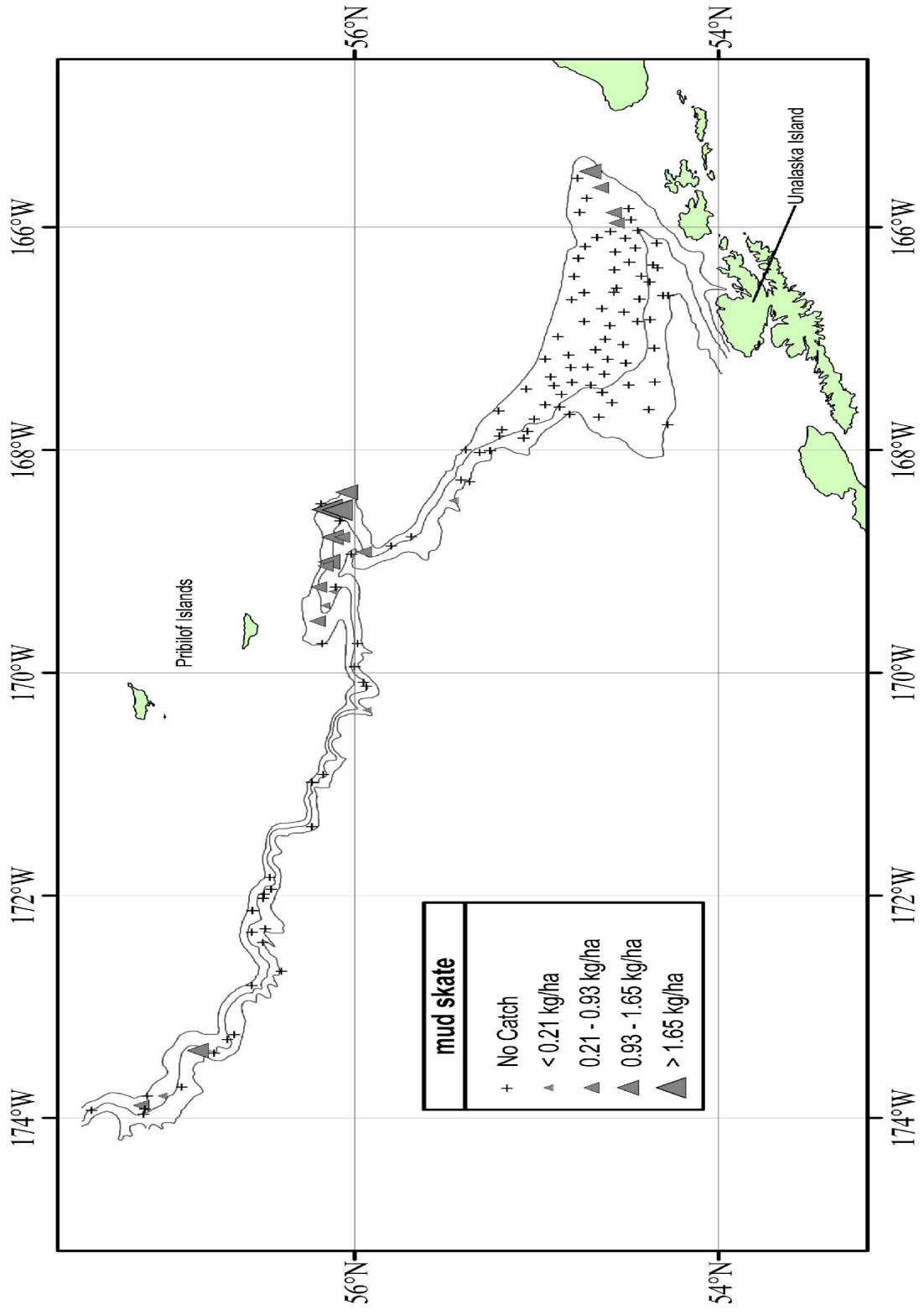

Figure 20. - - Continued.

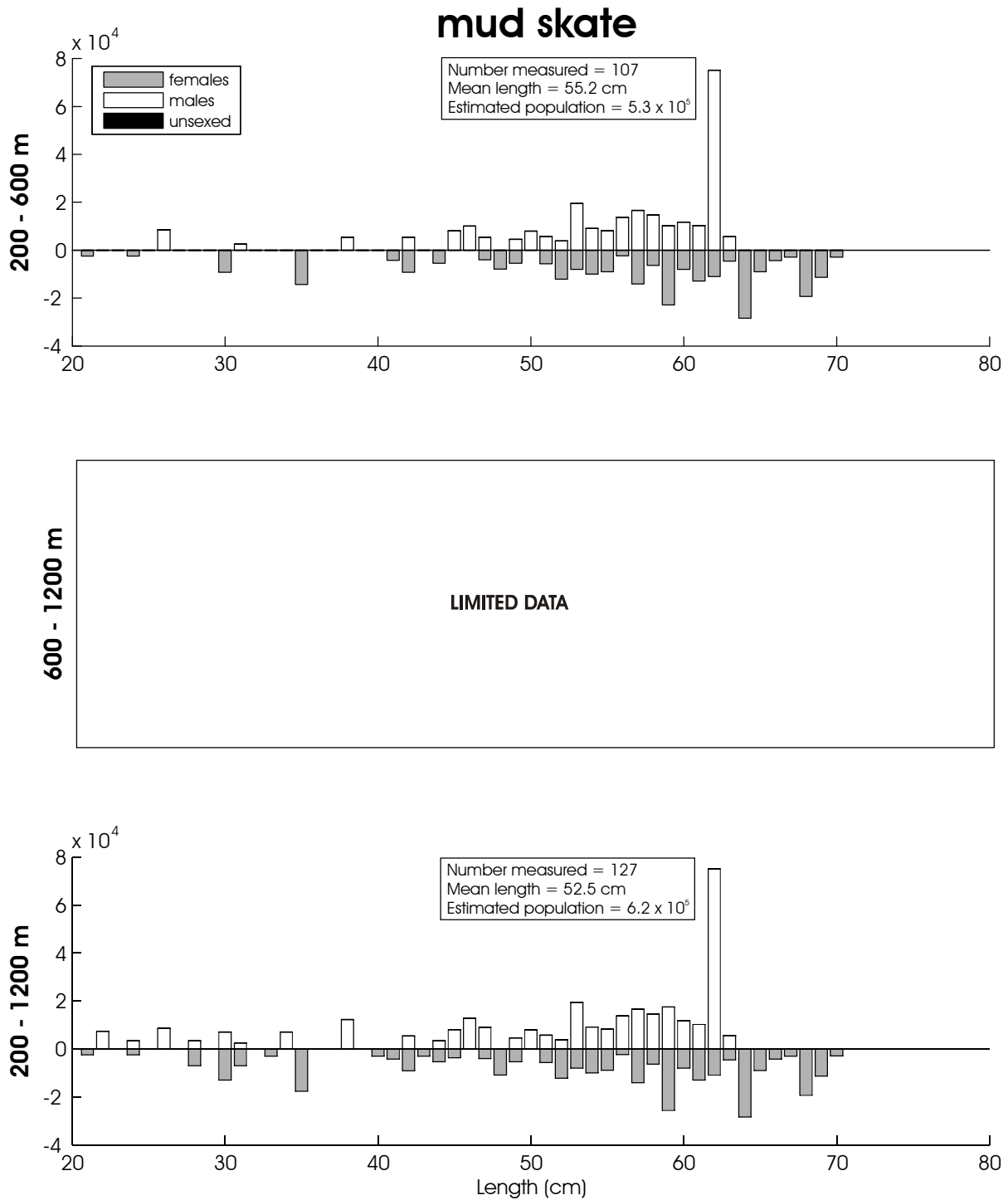

Figure 21. - - Size composition of the estimated mud skate population from the 2010 EBSS survey for all subareas by depth. The abscissa is scaled as total length in centimeters while the ordinate represents the estimated total population.

Table 19. - - Abundance estimates by subarea and depth strata for giant grenadier (*Albatrossia pectoralis*) from the 2010 EBSS survey.

<i>Albatrossia pectoralis</i>						giant grenadier	
Subarea	Depth strata (m)	Biomass (t)	Population	Biomass variance	Population variance	Average CPUE (kg/ha)	Average CPUE (no./ha)
1	200-400	0.00E+00	0.00E+00	0.00E+00	0.00E+00	0.00E+00	0.00E+00
	400-600	1.78E+04	4.67E+06	1.21E+07	1.10E+12	4.39E+01	1.15E+01
	600-800	1.32E+04	5.44E+06	9.71E+06	2.74E+12	7.56E+01	3.12E+01
	800-1,000	2.13E+04	7.00E+06	9.06E+07	5.19E+12	1.57E+02	5.17E+01
	1,000-1,200	1.06E+04	3.74E+06	4.36E+06	1.37E+10	9.57E+01	3.38E+01
2	200-400	3.00E+02	3.87E+04	8.99E+04	1.50E+09	2.59E+00	3.34E-01
	400-600	1.96E+04	3.25E+06	1.03E+08	2.37E+12	2.78E+02	4.61E+01
	600-800	6.03E+03	1.73E+06	1.40E+07	1.60E+12	1.02E+02	2.93E+01
	800-1,000	1.25E+04	2.92E+06	2.05E+07	8.16E+11	2.26E+02	5.29E+01
	1,000-1,200	1.91E+03	4.42E+05	6.61E+05	5.86E+10	3.56E+01	8.25E+00
3	200-400	1.59E+03	2.71E+05	1.53E+06	4.44E+10	1.75E+01	3.00E+00
	400-600	1.60E+04	5.38E+06	1.83E+07	6.11E+12	1.81E+02	6.07E+01
	600-800	3.65E+04	1.21E+07	6.25E+07	6.29E+12	4.01E+02	1.33E+02
	800-1,000	1.52E+04	5.68E+06	8.08E+07	1.32E+13	2.08E+02	7.76E+01
	1,000-1,200	8.89E+03	2.08E+06	1.87E+07	1.11E+12	1.32E+02	3.08E+01
4	200-400	2.17E+03	3.89E+05	4.16E+06	1.36E+11	1.76E+01	3.15E+00
	400-600	2.46E+04	5.92E+06	5.75E+07	5.81E+12	3.37E+02	8.11E+01
	600-800	5.51E+04	1.53E+07	1.24E+09	1.11E+14	7.94E+02	2.20E+02
	800-1,000	2.70E+04	7.72E+06	5.83E+07	3.16E+12	3.82E+02	1.09E+02
	1,000-1,200	1.52E+04	2.79E+06	2.33E+07	2.77E+10	2.29E+02	4.21E+01
5	200-400	0.00E+00	0.00E+00	0.00E+00	0.00E+00	0.00E+00	0.00E+00
	400-600	1.80E+04	3.90E+06	8.75E+05	5.67E+10	4.23E+02	9.17E+01
	600-800	6.55E+04	1.56E+07	3.49E+07	6.39E+12	1.52E+03	3.60E+02
	800-1,000	1.95E+04	7.60E+06	8.51E+07	1.58E+13	3.54E+02	1.38E+02
	1,000-1,200	2.97E+04	1.17E+07	1.04E+08	2.60E+13	5.21E+02	2.06E+02
6	200-400	1.93E+01	5.55E+03	3.71E+02	3.08E+07	7.42E-02	2.14E-02
	400-600	4.14E+04	9.95E+06	3.61E+08	2.31E+13	2.43E+02	5.83E+01
	600-800	5.94E+04	1.70E+07	1.64E+08	1.14E+13	6.47E+02	1.85E+02
	800-1,000	5.89E+04	1.83E+07	1.43E+09	1.66E+14	9.13E+02	2.83E+02
	1,000-1,200	6.26E+04	2.21E+07	8.55E+08	7.87E+13	1.26E+03	4.44E+02
1-6	200-1,200	6.61E+05	1.93E+08	4.86E+09	4.89E+14	1.85E+02	5.24E+01

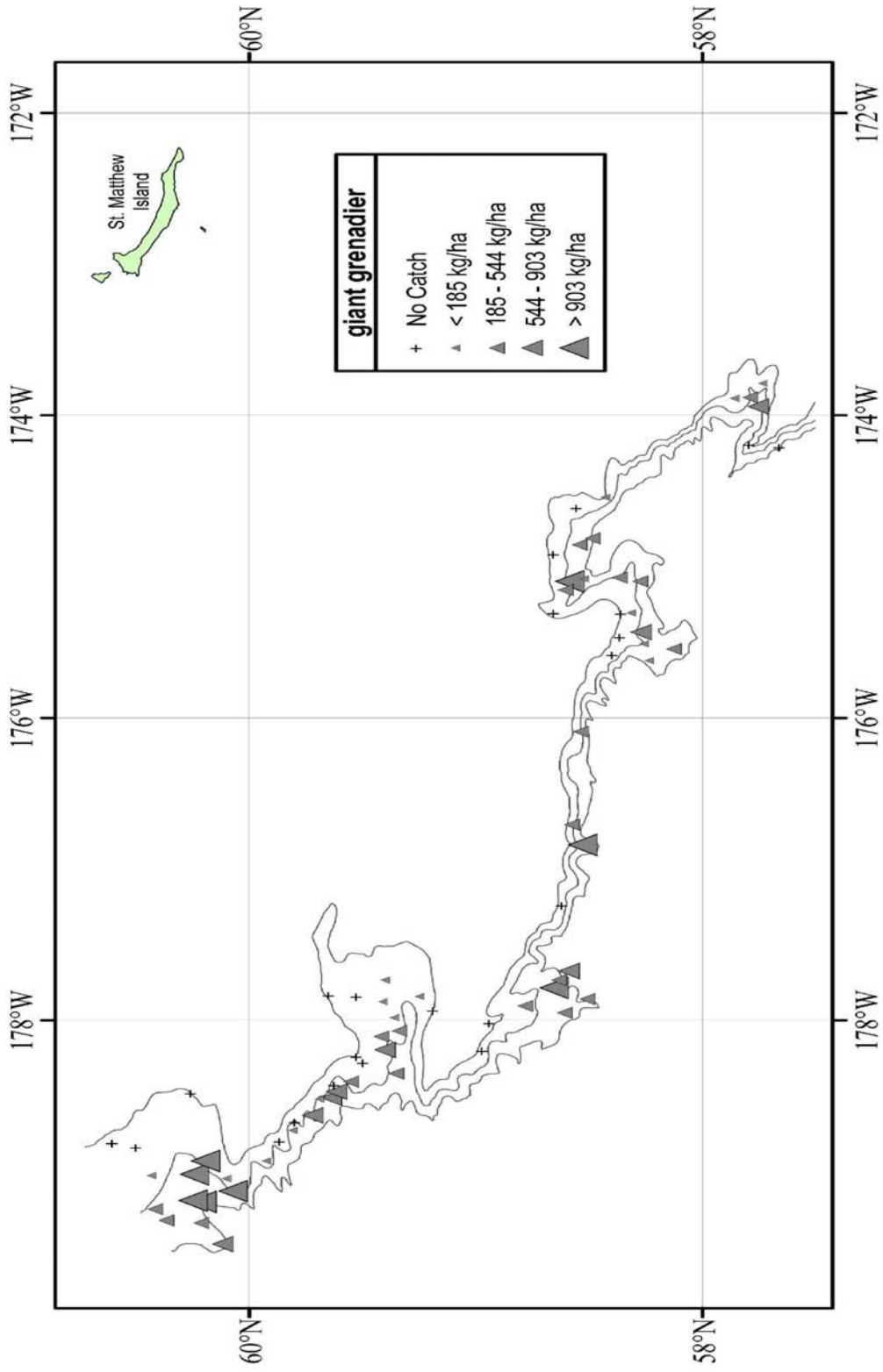

Figure 22. - - Distribution and relative abundance of giant grenadier from the 2010 EBSS survey. Relative abundance is categorized by no catch, sample CPUE less than the mean CPUE, between the mean CPUE and one standard deviation above the mean, between one and two standard deviations above the mean CPUE, and greater than two standard deviations above the mean CPUE.

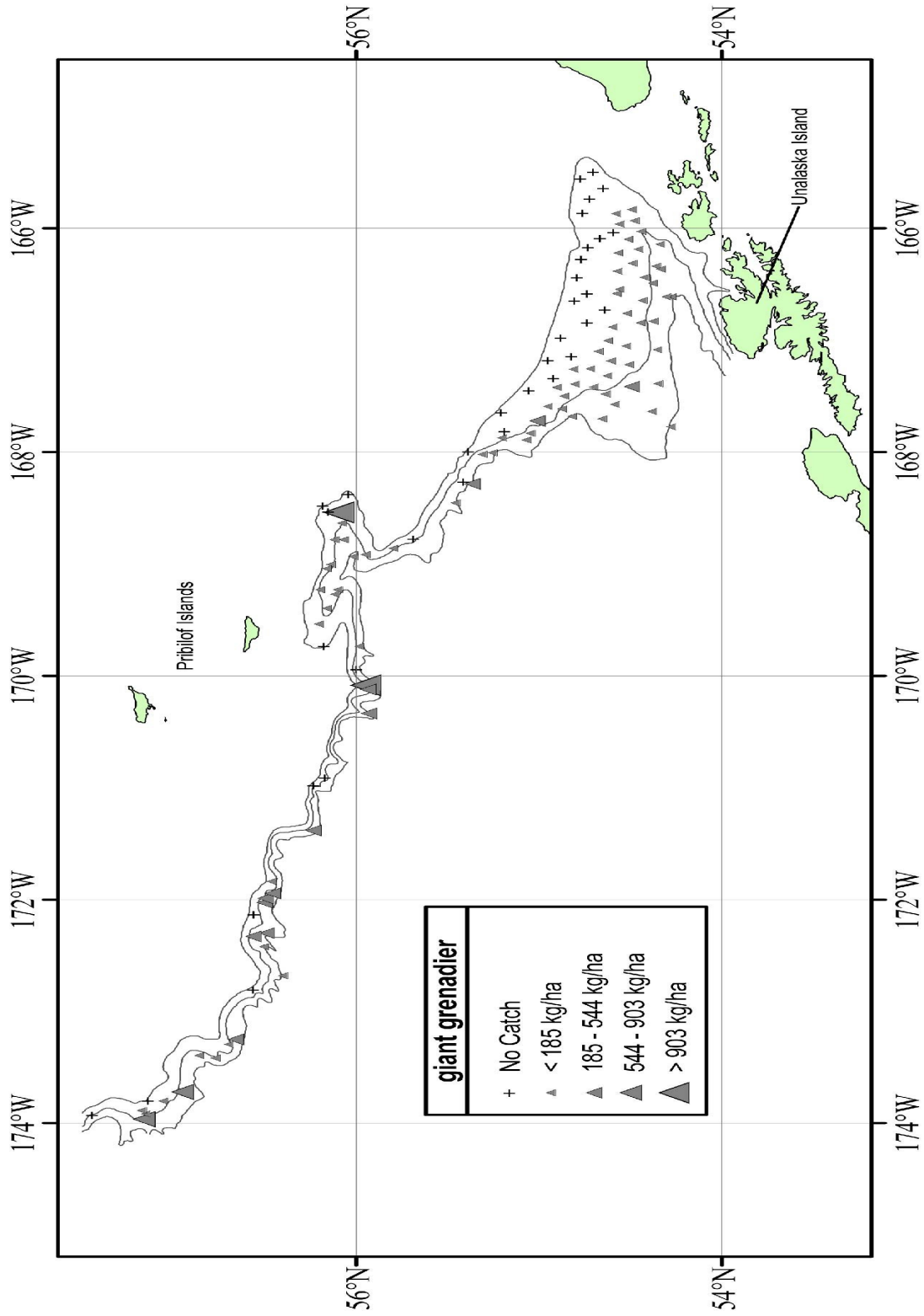

Figure 22. - - Continued.

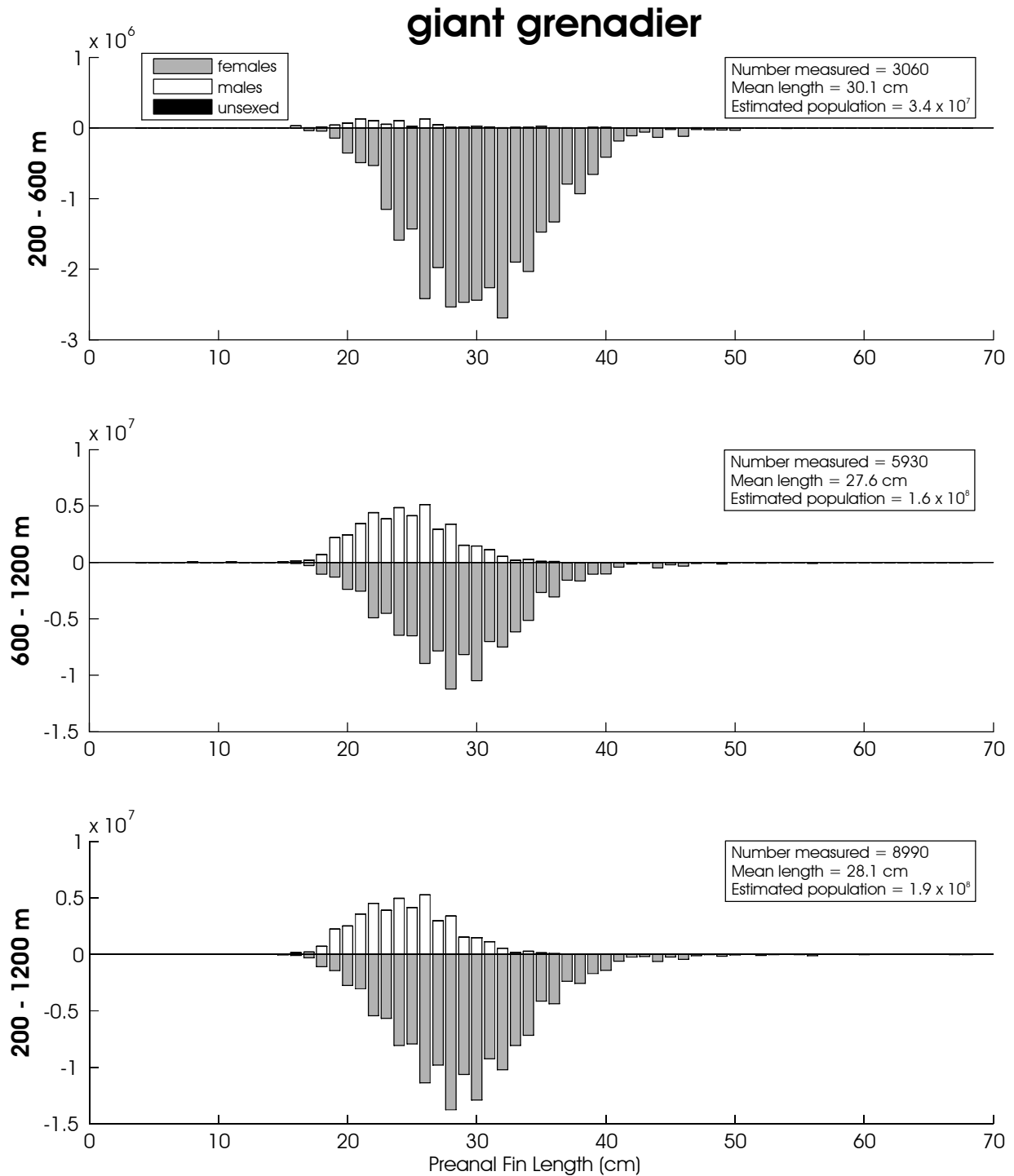

Figure 23. - Size composition of the estimated giant grenadier population from the 2010 EBSS survey for all subareas by depth. The abscissa is scaled as total length in centimeters while the ordinate represents the estimated total population.

Table 20. - - Abundance estimates by subarea and depth strata for Pacific grenadier
(*Coryphaenoides acrolepis*) from the 2010 EBSS survey.

<i>Coryphaenoides acrolepis</i>					Pacific grenadier		
Subarea	Depth strata (m)	Biomass (t)	Population	Biomass variance	Population variance	Average CPUE (kg/ha)	Average CPUE (no./ha)
1	200-400	0.00E+00	0.00E+00	0.00E+00	0.00E+00	0.00E+00	0.00E+00
	400-600	0.00E+00	0.00E+00	0.00E+00	0.00E+00	0.00E+00	0.00E+00
	600-800	1.04E+01	1.53E+04	1.08E+02	2.35E+08	5.98E-02	8.79E-02
	800-1,000	1.86E+01	2.43E+04	3.01E+02	2.98E+08	1.38E-01	1.79E-01
	1,000-1,200	2.47E+02	1.14E+06	2.88E+04	1.15E+12	2.23E+00	1.03E+01
2	200-400	0.00E+00	0.00E+00	0.00E+00	0.00E+00	0.00E+00	0.00E+00
	400-600	0.00E+00	0.00E+00	0.00E+00	0.00E+00	0.00E+00	0.00E+00
	600-800	4.14E+00	2.76E+03	1.72E+01	7.63E+06	7.01E-02	4.67E-02
	800-1,000	1.56E+01	7.69E+04	2.52E+01	4.01E+09	2.82E-01	1.39E+00
	1,000-1,200	2.70E+03	2.76E+06	1.27E+05	6.13E+10	5.04E+01	5.15E+01
3	200-400	0.00E+00	0.00E+00	0.00E+00	0.00E+00	0.00E+00	0.00E+00
	400-600	0.00E+00	0.00E+00	0.00E+00	0.00E+00	0.00E+00	0.00E+00
	600-800	0.00E+00	0.00E+00	0.00E+00	0.00E+00	0.00E+00	0.00E+00
	800-1,000	6.25E+01	1.89E+05	3.05E+03	2.14E+08	8.53E-01	2.58E+00
	1,000-1,200	1.07E+03	3.75E+06	1.92E+05	1.26E+12	1.59E+01	5.56E+01
4	200-400	0.00E+00	0.00E+00	0.00E+00	0.00E+00	0.00E+00	0.00E+00
	400-600	0.00E+00	0.00E+00	0.00E+00	0.00E+00	0.00E+00	0.00E+00
	600-800	0.00E+00	0.00E+00	0.00E+00	0.00E+00	0.00E+00	0.00E+00
	800-1,000	8.49E+01	4.66E+05	1.50E+03	1.17E+11	1.20E+00	6.59E+00
	1,000-1,200	1.24E+03	3.40E+06	1.13E+06	8.40E+12	1.87E+01	5.13E+01
5	200-400	0.00E+00	0.00E+00	0.00E+00	0.00E+00	0.00E+00	0.00E+00
	400-600	0.00E+00	0.00E+00	0.00E+00	0.00E+00	0.00E+00	0.00E+00
	600-800	3.23E+01	4.38E+05	3.76E+01	7.78E+09	7.48E-01	1.01E+01
	800-1,000	1.46E+02	1.22E+06	4.80E+03	1.40E+11	2.65E+00	2.21E+01
	1,000-1,200	5.39E+02	3.42E+06	2.58E+02	3.32E+11	9.45E+00	6.01E+01
6	200-400	0.00E+00	0.00E+00	0.00E+00	0.00E+00	0.00E+00	0.00E+00
	400-600	0.00E+00	0.00E+00	0.00E+00	0.00E+00	0.00E+00	0.00E+00
	600-800	0.00E+00	0.00E+00	0.00E+00	0.00E+00	0.00E+00	0.00E+00
	800-1,000	1.83E+02	8.82E+05	3.35E+04	7.79E+11	2.84E+00	1.37E+01
	1,000-1,200	2.25E+02	1.30E+06	2.39E+04	4.32E+11	4.53E+00	2.62E+01
1-6	200-1,200	6.58E+03	1.91E+07	1.55E+06	1.27E+13	1.14E+00	3.31E+00

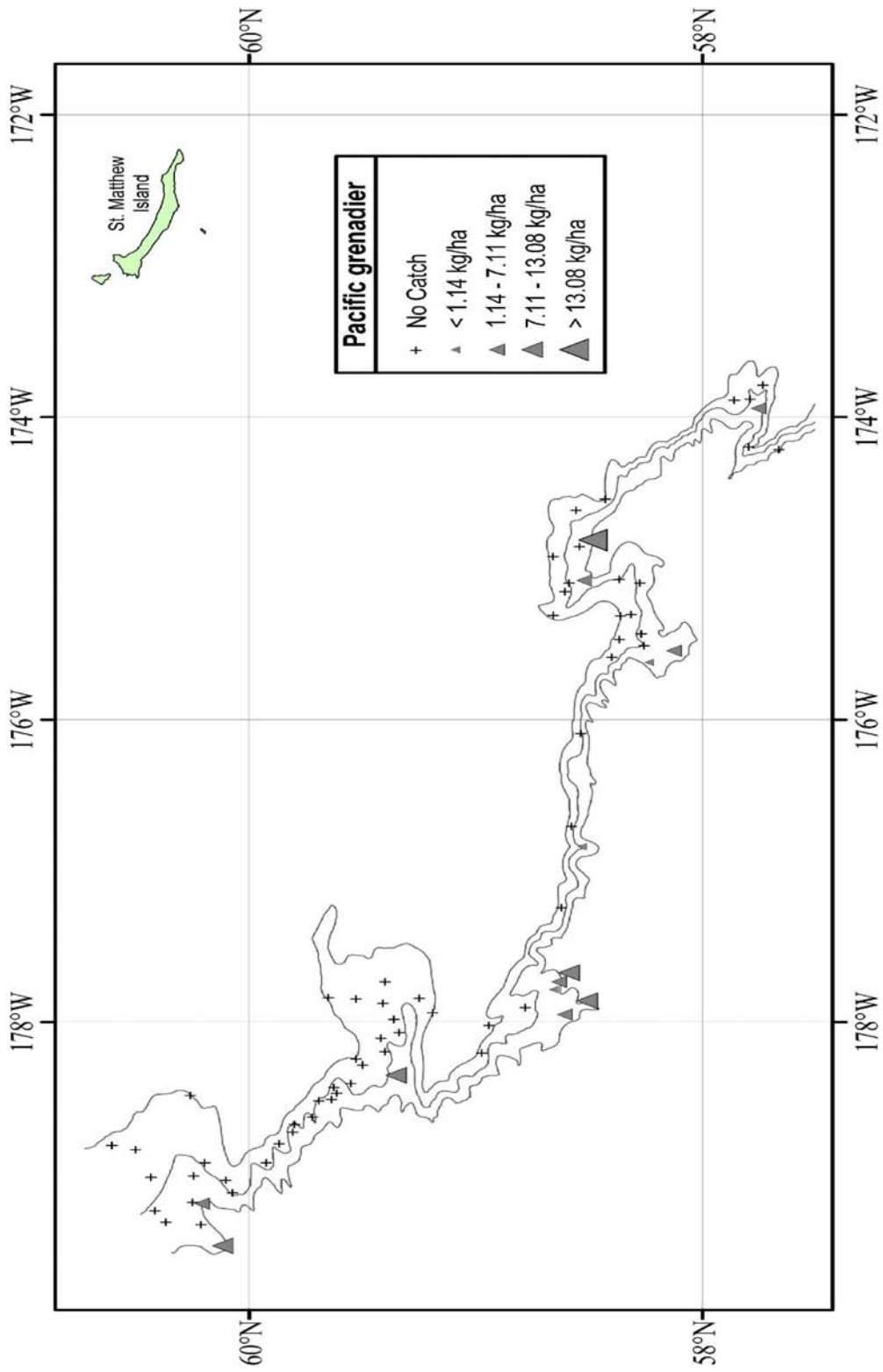

Figure 24. - - Distribution and relative abundance of Pacific grenadier from the 2010 EBSS survey. Relative abundance is categorized by no catch, sample CPUE less than the mean CPUE, between the mean CPUE and one standard deviation above the mean, between one and two standard deviations above the mean CPUE, and greater than two standard deviations above the mean CPUE.

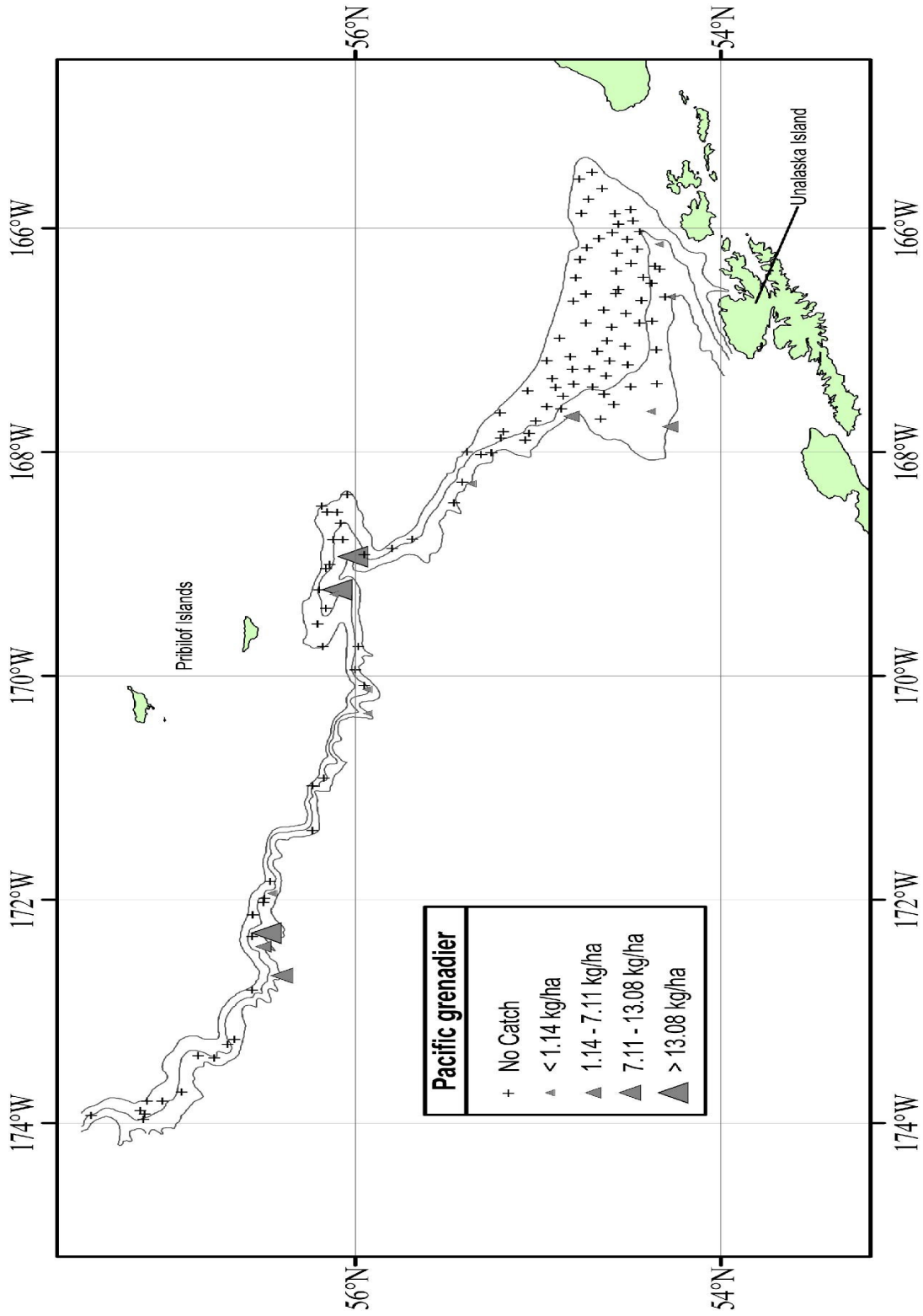

Figure 24. - - Continued.

Pacific grenadier

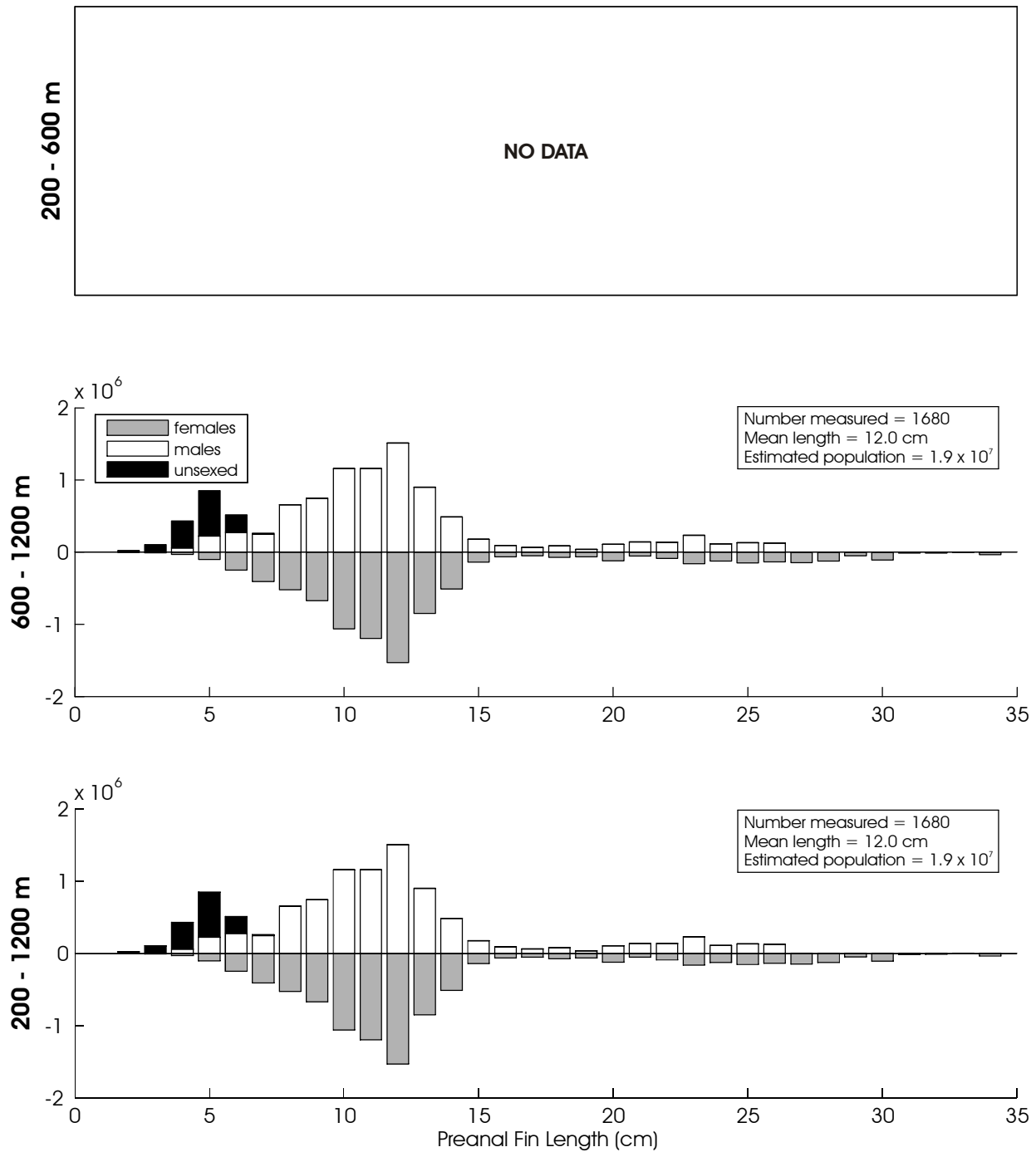

Figure 25. - Size composition of the estimated Pacific grenadier population from the 2010 EBSS survey for all subareas by depth. The abscissa is scaled as total length in centimeters while the ordinate represents the estimated total population.

Table 21. - - Abundance estimates by subarea and depth strata for popeye grenadier (*Coryphaenoides cinereus*) from the 2010 EBSS survey.

<i>Coryphaenoides cinereus</i>				popeye grenadier			
Subarea	Depth strata (m)	Biomass (t)	Population	Biomass variance	Population variance	Average CPUE (kg/ha)	Average CPUE (no./ha)
1	200-400	0.00E+00	0.00E+00	0.00E+00	0.00E+00	0.00E+00	0.00E+00
	400-600	2.05E+02	6.23E+05	2.54E+04	2.49E+11	5.05E-01	1.53E+00
	600-800	2.36E+03	9.19E+06	6.24E+05	9.85E+12	1.35E+01	5.28E+01
	800-1,000	8.71E+03	4.40E+07	9.72E+06	2.42E+14	6.43E+01	3.25E+02
	1,000-1,200	6.72E+03	3.04E+07	7.71E+06	1.98E+14	6.07E+01	2.75E+02
2	200-400	0.00E+00	0.00E+00	0.00E+00	0.00E+00	0.00E+00	0.00E+00
	400-600	4.27E+02	1.37E+06	9.88E+04	9.59E+11	6.06E+00	1.95E+01
	600-800	1.78E+03	6.40E+06	2.74E+06	3.54E+13	3.02E+01	1.08E+02
	800-1,000	6.48E+03	3.26E+07	1.28E+07	3.43E+14	1.17E+02	5.89E+02
	1,000-1,200	7.07E+03	2.81E+07	1.18E+07	1.02E+14	1.32E+02	5.25E+02
3	200-400	0.00E+00	0.00E+00	0.00E+00	0.00E+00	0.00E+00	0.00E+00
	400-600	1.19E+02	4.81E+05	6.72E+03	1.01E+11	1.34E+00	5.43E+00
	600-800	4.31E+03	2.97E+07	4.76E+05	2.47E+13	4.73E+01	3.26E+02
	800-1,000	2.25E+03	1.45E+07	5.93E+05	2.99E+13	3.08E+01	1.98E+02
	1,000-1,200	3.50E+03	1.71E+07	8.66E+05	1.28E+13	5.18E+01	2.53E+02
4	200-400	0.00E+00	0.00E+00	0.00E+00	0.00E+00	0.00E+00	0.00E+00
	400-600	5.22E+02	2.56E+06	9.50E+04	2.23E+12	7.15E+00	3.50E+01
	600-800	1.97E+03	1.11E+07	5.48E+05	2.56E+13	2.84E+01	1.60E+02
	800-1,000	3.38E+03	2.43E+07	7.30E+05	4.88E+13	4.78E+01	3.43E+02
	1,000-1,200	3.96E+03	2.39E+07	6.64E+05	8.41E+12	5.98E+01	3.60E+02
5	200-400	0.00E+00	0.00E+00	0.00E+00	0.00E+00	0.00E+00	0.00E+00
	400-600	2.24E+00	9.74E+03	5.02E+00	9.48E+07	5.26E-02	2.29E-01
	600-800	2.95E+03	1.94E+07	1.97E+06	6.65E+13	6.83E+01	4.49E+02
	800-1,000	2.00E+03	1.50E+07	1.32E+06	9.59E+13	3.63E+01	2.71E+02
	1,000-1,200	2.20E+03	1.25E+07	5.31E+05	2.56E+13	3.85E+01	2.18E+02
6	200-400	0.00E+00	0.00E+00	0.00E+00	0.00E+00	0.00E+00	0.00E+00
	400-600	1.05E+03	5.43E+06	4.30E+05	1.19E+13	6.16E+00	3.18E+01
	600-800	3.65E+03	2.59E+07	1.02E+06	7.11E+13	3.98E+01	2.82E+02
	800-1,000	2.67E+03	1.85E+07	2.28E+06	1.52E+14	4.14E+01	2.86E+02
	1,000-1,200	1.96E+03	1.16E+07	3.06E+06	1.10E+14	3.95E+01	2.34E+02
1-6	200-1,200	7.02E+04	3.84E+08	6.01E+07	1.62E+15	1.59E+01	8.85E+01

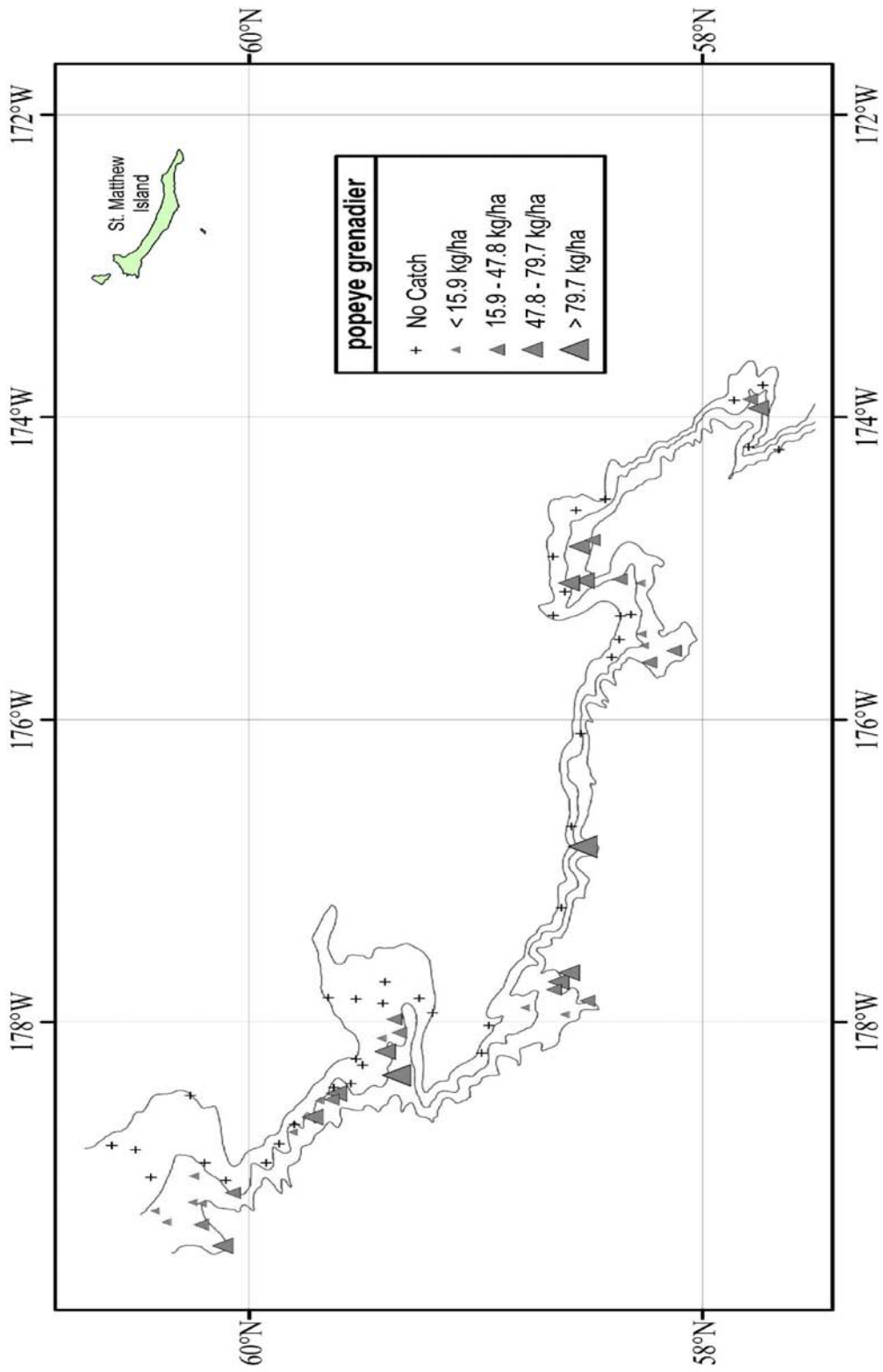

Figure 26. - - Distribution and relative abundance of popeye grenadier from the 2010 EBSS survey. Relative abundance is categorized by no catch, sample CPUE less than the mean CPUE, between the mean CPUE and one standard deviation above the mean, between one and two standard deviations above the mean CPUE, and greater than two standard deviations above the mean CPUE.

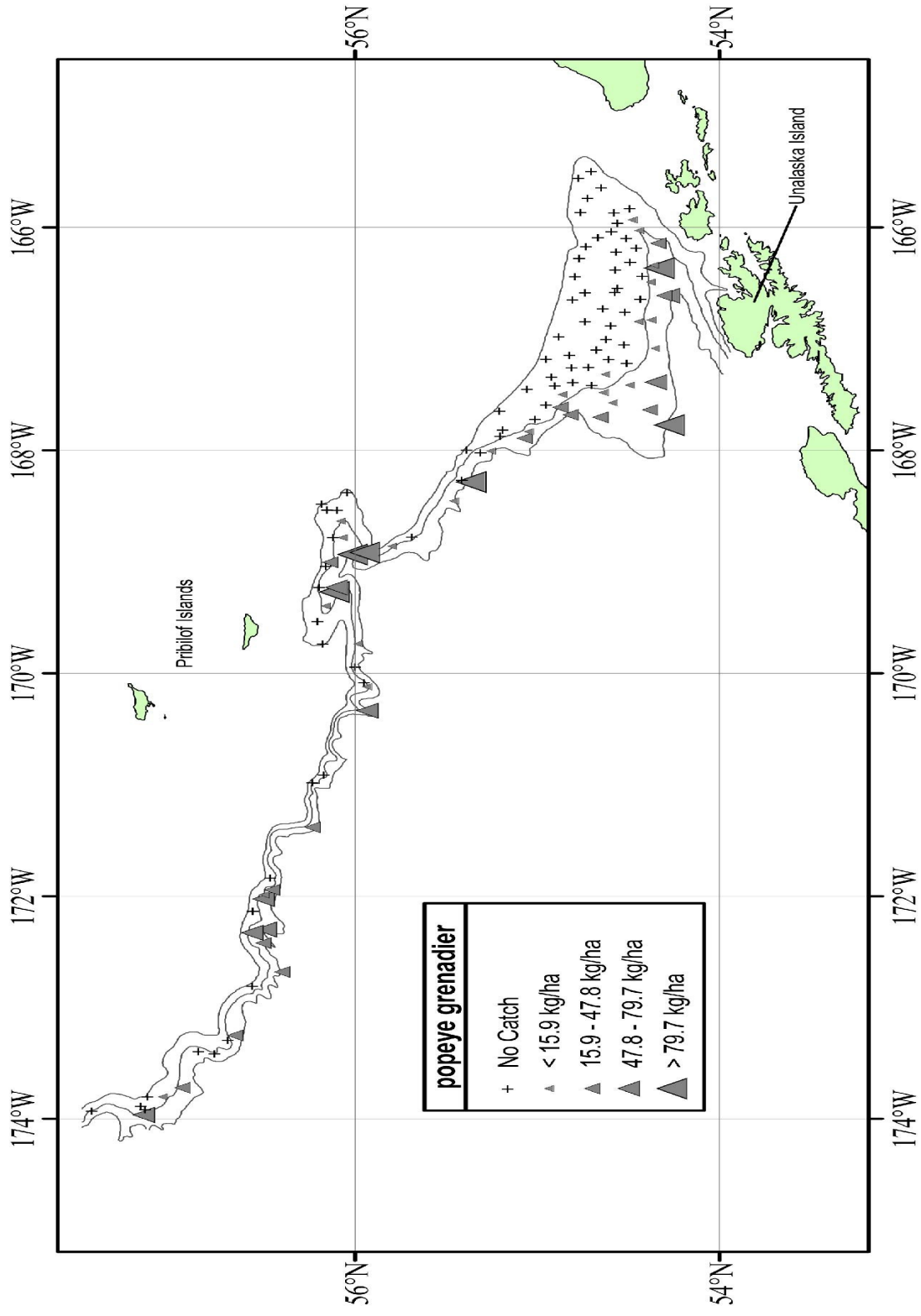

Figure 26. - - Continued.

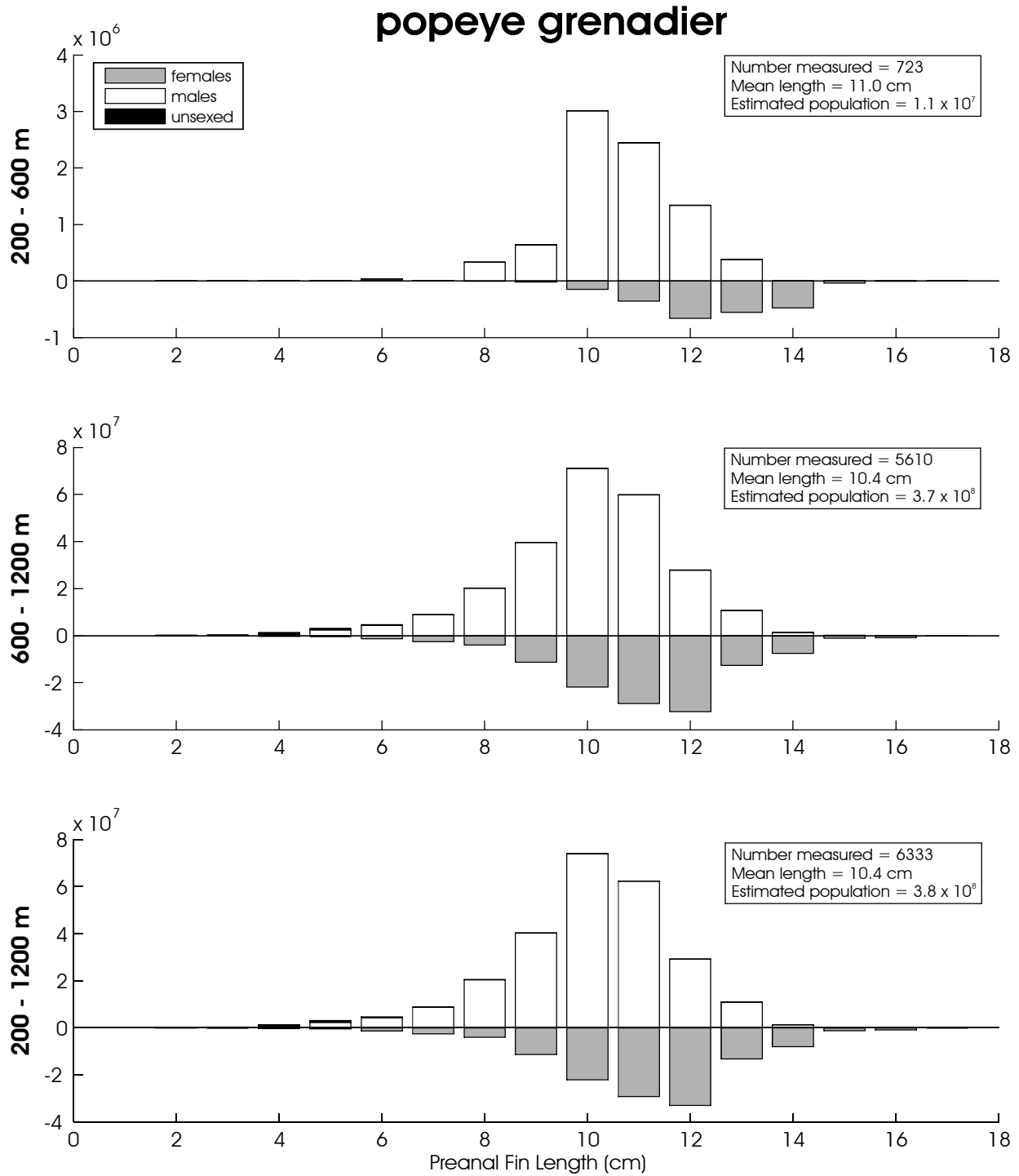

Figure 27. - - Size composition of the estimated popeye grenadier population from the 2010 EBSS survey for all subareas by depth. The abscissa is scaled as total length in centimeters while the ordinate represents the estimated total population.

Table 22. - - Abundance estimates by subarea and depth strata for walleye pollock (*Theragra chalcogramma*) from the 2010 EBSS survey.

<i>Theragra chalcogramma</i>						walleye pollock	
Subarea	Depth strata (m)	Biomass (t)	Population	Biomass variance	Population variance	Average CPUE (kg/ha)	Average CPUE (no./ha)
1	200-400	7.52E+03	5.55E+06	2.02E+07	1.11E+13	1.87E+01	1.38E+01
	400-600	1.19E+03	1.30E+06	5.47E+05	7.56E+11	2.93E+00	3.21E+00
	600-800	0.00E+00	0.00E+00	0.00E+00	0.00E+00	0.00E+00	0.00E+00
	800-1,000	0.00E+00	0.00E+00	0.00E+00	0.00E+00	0.00E+00	0.00E+00
	1,000-1,200	0.00E+00	0.00E+00	0.00E+00	0.00E+00	0.00E+00	0.00E+00
2	200-400	1.02E+03	9.59E+05	3.62E+05	3.66E+11	8.77E+00	8.28E+00
	400-600	3.07E+01	2.36E+04	6.36E+02	4.17E+08	4.35E-01	3.35E-01
	600-800	0.00E+00	0.00E+00	0.00E+00	0.00E+00	0.00E+00	0.00E+00
	800-1,000	0.00E+00	0.00E+00	0.00E+00	0.00E+00	0.00E+00	0.00E+00
	1,000-1,200	0.00E+00	0.00E+00	0.00E+00	0.00E+00	0.00E+00	0.00E+00
3	200-400	4.00E+02	2.46E+05	2.61E+04	9.72E+09	4.43E+00	2.72E+00
	400-600	0.00E+00	0.00E+00	0.00E+00	0.00E+00	0.00E+00	0.00E+00
	600-800	0.00E+00	0.00E+00	0.00E+00	0.00E+00	0.00E+00	0.00E+00
	800-1,000	0.00E+00	0.00E+00	0.00E+00	0.00E+00	0.00E+00	0.00E+00
	1,000-1,200	0.00E+00	0.00E+00	0.00E+00	0.00E+00	0.00E+00	0.00E+00
4	200-400	5.64E+02	3.63E+05	3.07E+04	1.44E+10	4.56E+00	2.94E+00
	400-600	1.50E+01	9.24E+03	2.24E+02	8.53E+07	2.05E-01	1.26E-01
	600-800	0.00E+00	0.00E+00	0.00E+00	0.00E+00	0.00E+00	0.00E+00
	800-1,000	0.00E+00	0.00E+00	0.00E+00	0.00E+00	0.00E+00	0.00E+00
	1,000-1,200	0.00E+00	0.00E+00	0.00E+00	0.00E+00	0.00E+00	0.00E+00
5	200-400	4.60E+01	4.29E+04	4.18E+01	5.76E+07	1.09E+00	1.01E+00
	400-600	0.00E+00	0.00E+00	0.00E+00	0.00E+00	0.00E+00	0.00E+00
	600-800	0.00E+00	0.00E+00	0.00E+00	0.00E+00	0.00E+00	0.00E+00
	800-1,000	0.00E+00	0.00E+00	0.00E+00	0.00E+00	0.00E+00	0.00E+00
	1,000-1,200	0.00E+00	0.00E+00	0.00E+00	0.00E+00	0.00E+00	0.00E+00
6	200-400	3.56E+03	2.25E+06	2.48E+06	9.74E+11	1.37E+01	8.67E+00
	400-600	8.58E+00	3.80E+03	7.37E+01	1.44E+07	5.03E-02	2.23E-02
	600-800	0.00E+00	0.00E+00	0.00E+00	0.00E+00	0.00E+00	0.00E+00
	800-1,000	0.00E+00	0.00E+00	0.00E+00	0.00E+00	0.00E+00	0.00E+00
	1,000-1,200	0.00E+00	0.00E+00	0.00E+00	0.00E+00	0.00E+00	0.00E+00
1-6	200-1,200	1.44E+04	1.07E+07	2.36E+07	1.33E+13	4.14E+00	3.17E+00

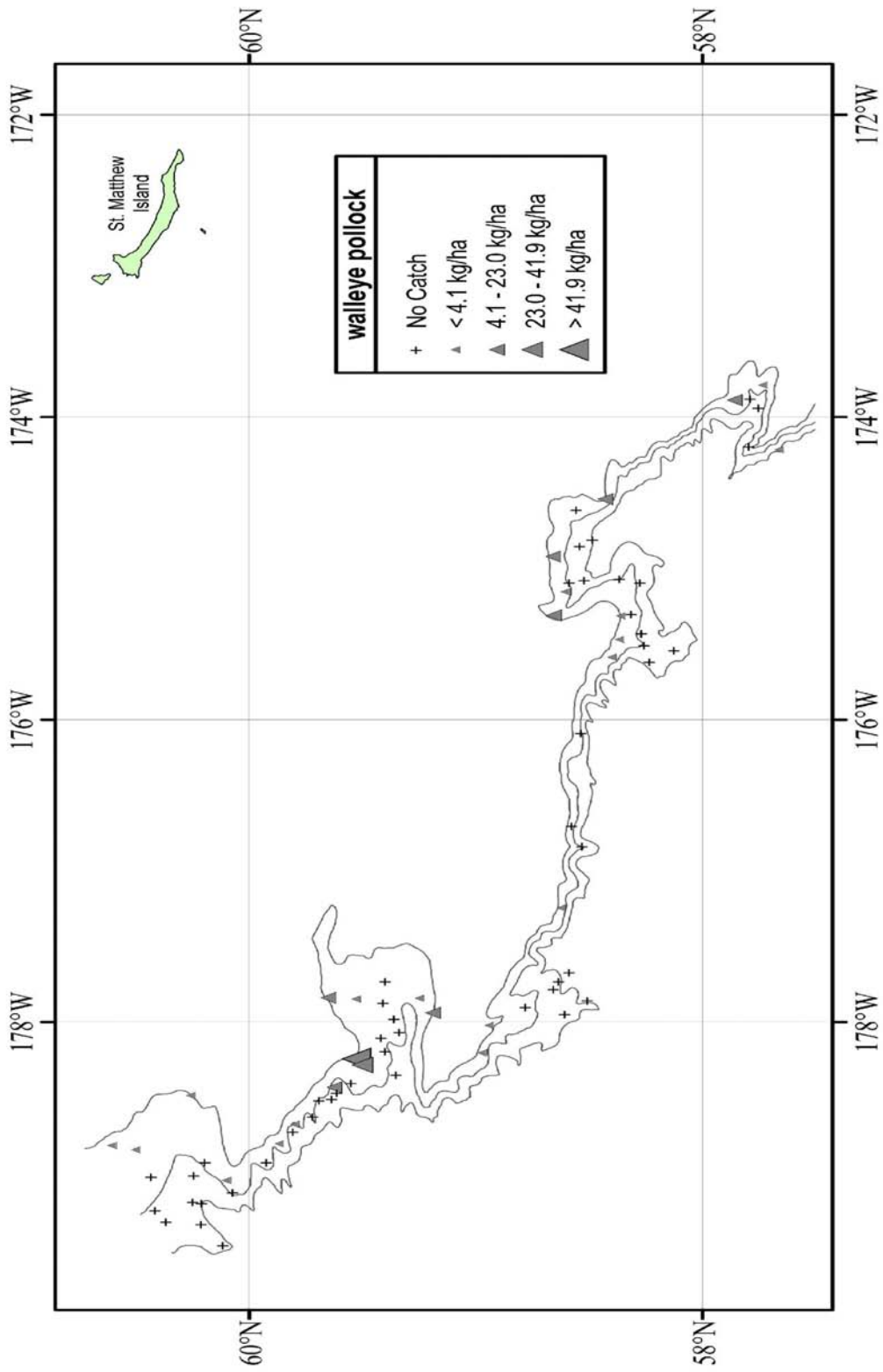

Figure 28. - - Distribution and relative abundance of walleye pollock from the 2010 EBSS survey. Relative abundance is categorized by no catch, sample CPUE less than the mean CPUE, between the mean CPUE and one standard deviation above the mean, between one and two standard deviations above the mean CPUE, and greater than two standard deviations above the mean CPUE.

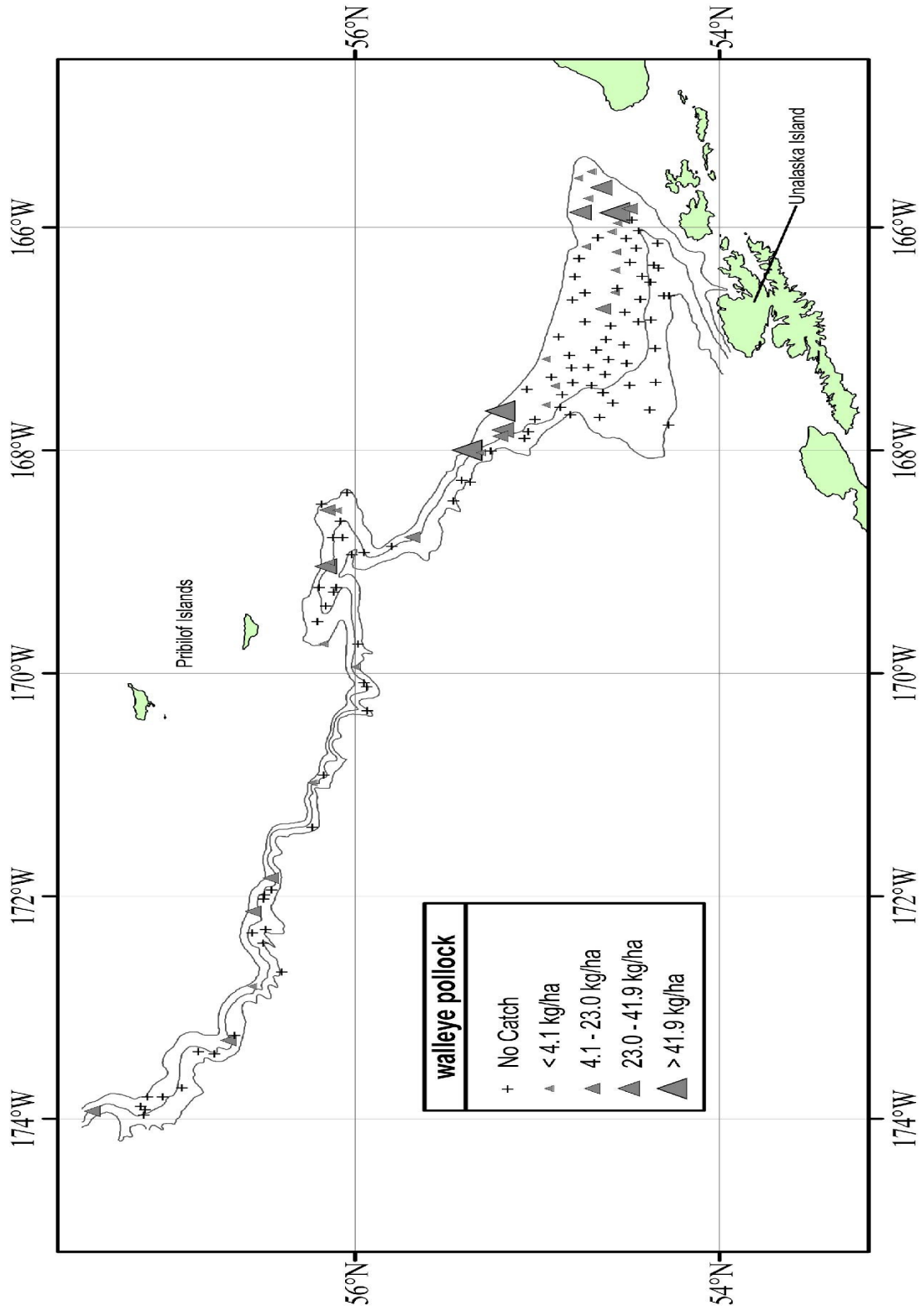

Figure 28. - - Continued.

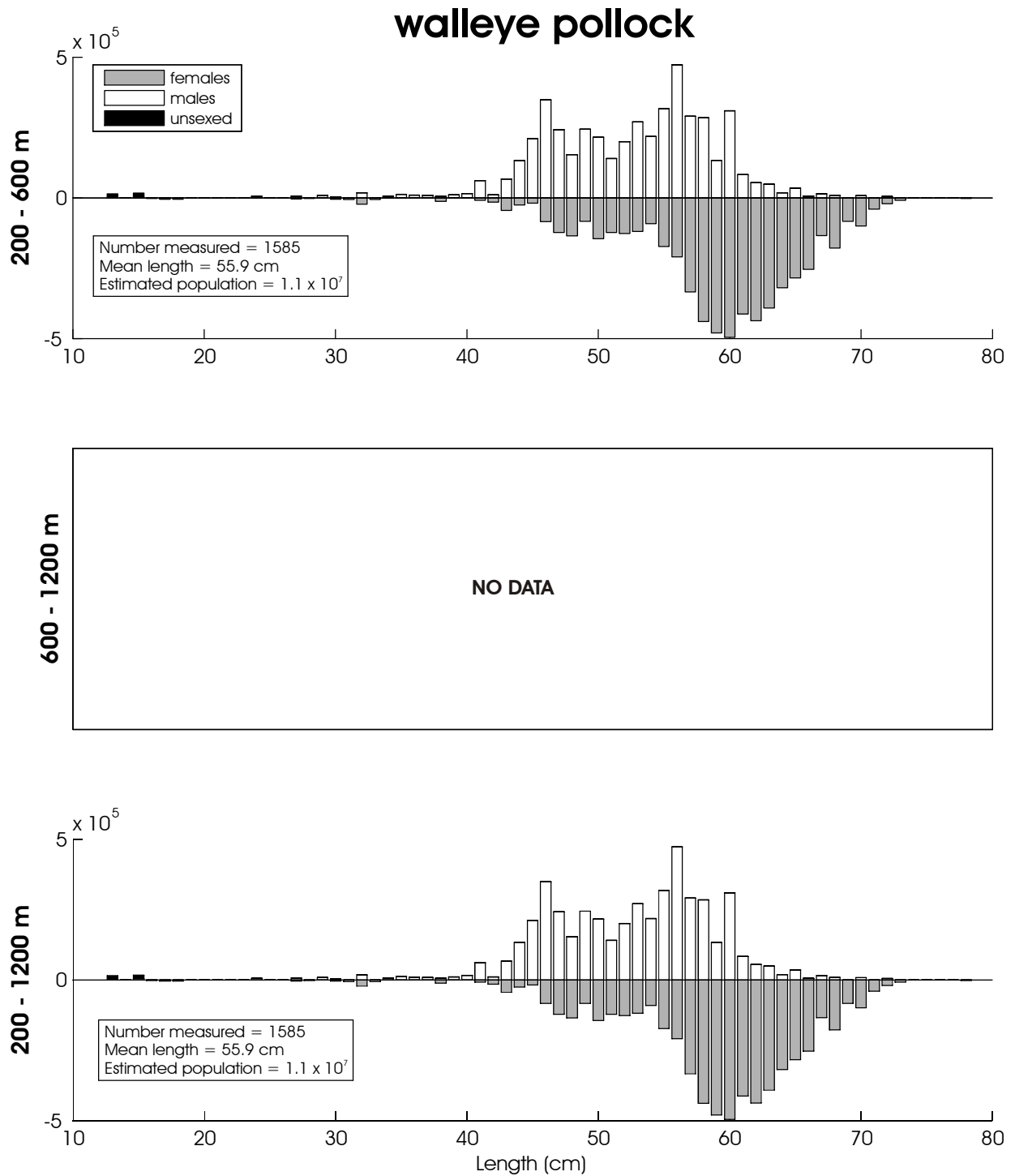

Figure 29. - Size composition of the estimated walleye pollock population from the 2010 EBSS survey for all subareas by depth. The abscissa is scaled as total length in centimeters while the ordinate represents the estimated total population.

Table 23. - - Abundance estimates by subarea and depth strata for Pacific cod
(*Gadus macrocephalus*) from the 2010 EBSS survey.

<i>Gadus macrocephalus</i>						Pacific cod	
Subarea	Depth strata (m)	Biomass (t)	Population	Biomass variance	Population variance	Average CPUE (kg/ha)	Average CPUE (no./ha)
1	200-400	1.13E+03	5.79E+05	1.82E+05	4.14E+10	2.81E+00	1.44E+00
	400-600	0.00E+00	0.00E+00	0.00E+00	0.00E+00	0.00E+00	0.00E+00
	600-800	0.00E+00	0.00E+00	0.00E+00	0.00E+00	0.00E+00	0.00E+00
	800-1,000	0.00E+00	0.00E+00	0.00E+00	0.00E+00	0.00E+00	0.00E+00
	1,000-1,200	0.00E+00	0.00E+00	0.00E+00	0.00E+00	0.00E+00	0.00E+00
2	200-400	3.35E+03	1.33E+06	1.74E+06	2.52E+11	2.89E+01	1.15E+01
	400-600	1.91E+01	7.73E+03	3.63E+02	5.97E+07	2.70E-01	1.10E-01
	600-800	0.00E+00	0.00E+00	0.00E+00	0.00E+00	0.00E+00	0.00E+00
	800-1,000	0.00E+00	0.00E+00	0.00E+00	0.00E+00	0.00E+00	0.00E+00
	1,000-1,200	0.00E+00	0.00E+00	0.00E+00	0.00E+00	0.00E+00	0.00E+00
3	200-400	8.65E+02	3.16E+05	1.01E+05	1.26E+10	9.57E+00	3.49E+00
	400-600	0.00E+00	0.00E+00	0.00E+00	0.00E+00	0.00E+00	0.00E+00
	600-800	0.00E+00	0.00E+00	0.00E+00	0.00E+00	0.00E+00	0.00E+00
	800-1,000	0.00E+00	0.00E+00	0.00E+00	0.00E+00	0.00E+00	0.00E+00
	1,000-1,200	0.00E+00	0.00E+00	0.00E+00	0.00E+00	0.00E+00	0.00E+00
4	200-400	8.27E+02	2.60E+05	1.96E+05	1.74E+10	6.69E+00	2.10E+00
	400-600	0.00E+00	0.00E+00	0.00E+00	0.00E+00	0.00E+00	0.00E+00
	600-800	0.00E+00	0.00E+00	0.00E+00	0.00E+00	0.00E+00	0.00E+00
	800-1,000	0.00E+00	0.00E+00	0.00E+00	0.00E+00	0.00E+00	0.00E+00
	1,000-1,200	0.00E+00	0.00E+00	0.00E+00	0.00E+00	0.00E+00	0.00E+00
5	200-400	1.87E+02	5.58E+04	2.20E+04	1.78E+09	4.41E+00	1.32E+00
	400-600	0.00E+00	0.00E+00	0.00E+00	0.00E+00	0.00E+00	0.00E+00
	600-800	0.00E+00	0.00E+00	0.00E+00	0.00E+00	0.00E+00	0.00E+00
	800-1,000	0.00E+00	0.00E+00	0.00E+00	0.00E+00	0.00E+00	0.00E+00
	1,000-1,200	0.00E+00	0.00E+00	0.00E+00	0.00E+00	0.00E+00	0.00E+00
6	200-400	4.50E+02	1.83E+05	1.88E+04	4.40E+09	1.73E+00	7.07E-01
	400-600	0.00E+00	0.00E+00	0.00E+00	0.00E+00	0.00E+00	0.00E+00
	600-800	0.00E+00	0.00E+00	0.00E+00	0.00E+00	0.00E+00	0.00E+00
	800-1,000	0.00E+00	0.00E+00	0.00E+00	0.00E+00	0.00E+00	0.00E+00
	1,000-1,200	0.00E+00	0.00E+00	0.00E+00	0.00E+00	0.00E+00	0.00E+00
1-6	200-1,200	6.83E+03	2.73E+06	2.26E+06	3.30E+11	2.34E+00	9.10E-01

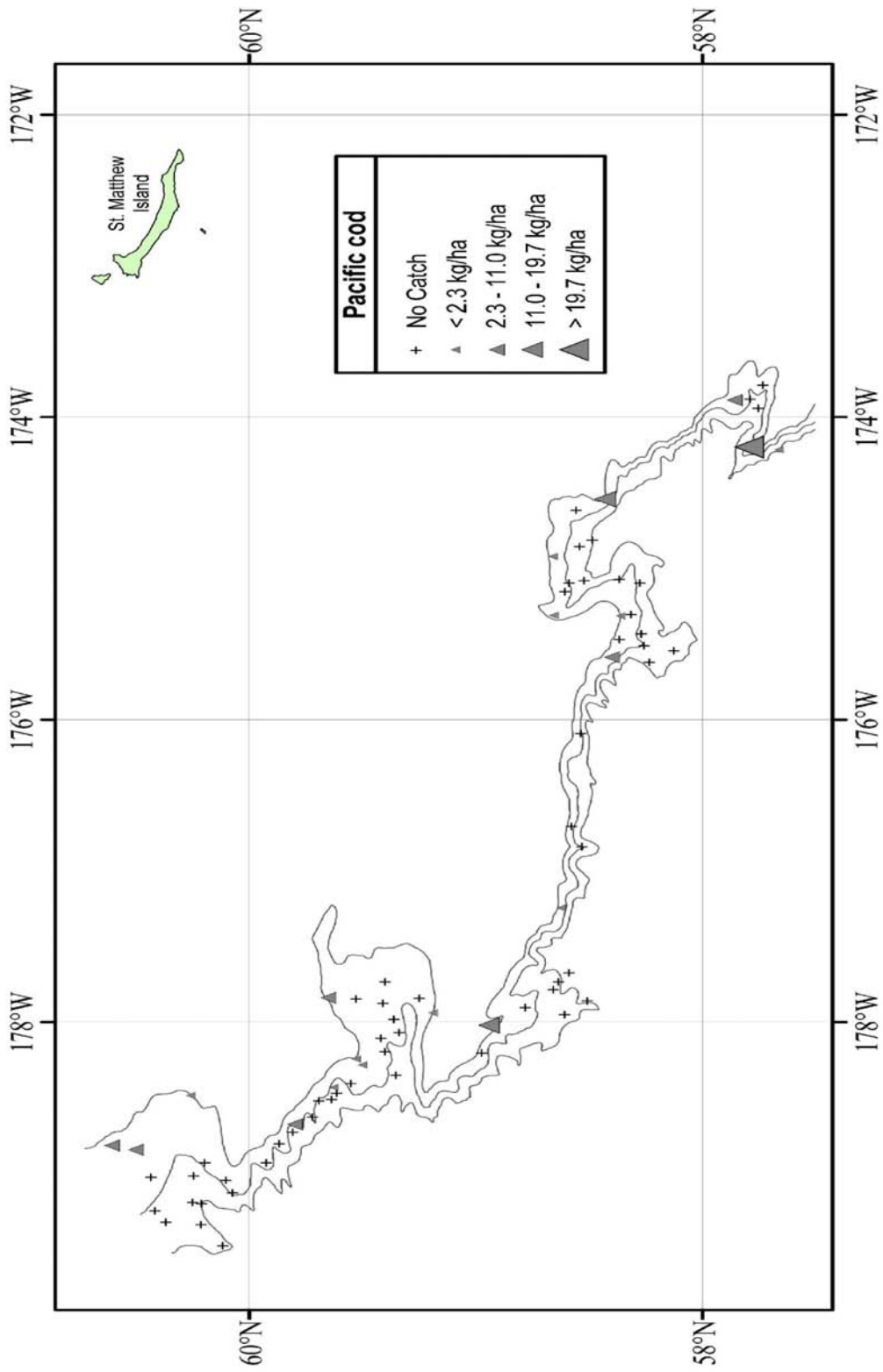

Figure 30. - - Distribution and relative abundance of Pacific cod from the 2880 EBSS survey. Relative abundance is categorized by no catch, sample CPUE less than the mean CPUE, between the mean CPUE and one standard deviation above the mean, between one and two standard deviations above the mean CPUE, and greater than two standard deviations above the mean CPUE.

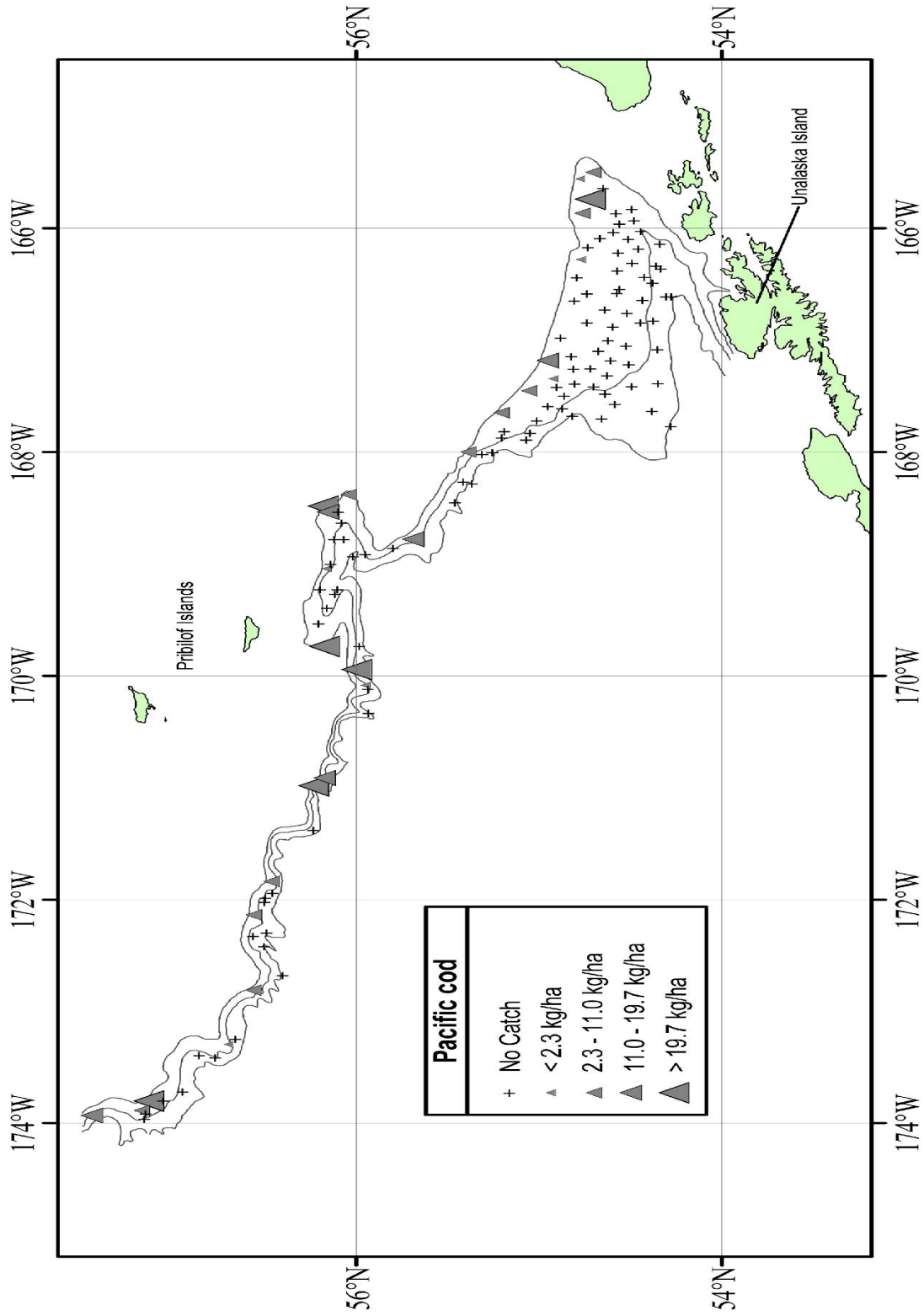

Figure 30. - - Continued.

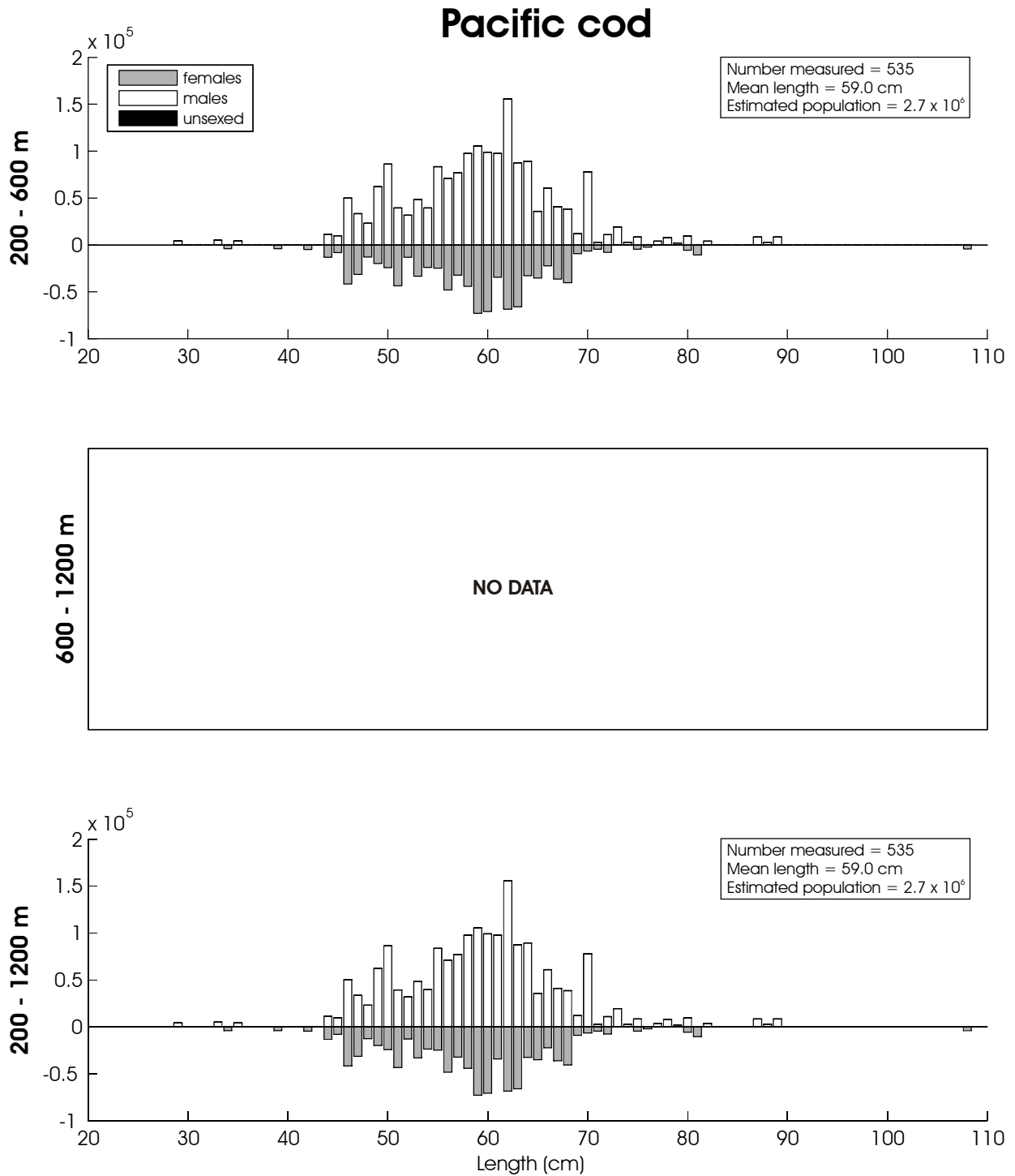

Figure 31. - Size composition of the estimated Pacific cod population from the 2010 EBSS survey for all subareas by depth. The abscissa is scaled as total length in centimeters while the ordinate represents the estimated total population.

Table 24. - - Abundance estimates by subarea and depth strata for shortspine thornyhead (*Sebastolobus alascanus*) from the 2010 EBSS survey.

<i>Sebastolobus alascanus</i>		shortspine thornyhead					
Subarea	Depth strata (m)	Biomass (t)	Population	Biomass variance	Population variance	Average CPUE (kg/ha)	Average CPUE (no./ha)
1	200-400	1.01E+03	3.88E+06	2.99E+05	4.42E+12	2.52E+00	9.68E+00
	400-600	1.23E+04	2.11E+07	8.75E+06	8.39E+12	3.02E+01	5.20E+01
	600-800	1.89E+03	1.84E+06	1.02E+05	1.52E+11	1.09E+01	1.06E+01
	800-1,000	1.47E+03	1.05E+06	1.43E+05	9.30E+10	1.08E+01	7.72E+00
	1,000-1,200	6.47E+01	3.90E+04	1.10E+03	3.83E+08	5.85E-01	3.52E-01
2	200-400	1.42E+02	4.56E+05	1.79E+04	2.03E+11	1.23E+00	3.94E+00
	400-600	3.09E+03	3.50E+06	9.64E+05	1.25E+12	4.38E+01	4.97E+01
	600-800	1.00E+03	7.27E+05	8.70E+04	6.44E+10	1.70E+01	1.23E+01
	800-1,000	3.00E+02	1.79E+05	1.66E+04	1.48E+09	5.42E+00	3.23E+00
	1,000-1,200	1.54E+01	2.22E+04	2.32E+01	3.98E+07	2.87E-01	4.15E-01
3	200-400	5.98E+02	1.19E+06	2.81E+05	1.21E+12	6.62E+00	1.32E+01
	400-600	1.76E+03	2.09E+06	5.90E+05	9.14E+11	1.99E+01	2.36E+01
	600-800	1.32E+03	1.11E+06	1.10E+05	9.47E+10	1.45E+01	1.22E+01
	800-1,000	1.15E+02	8.69E+04	9.00E+03	4.83E+09	1.57E+00	1.19E+00
	1,000-1,200	0.00E+00	0.00E+00	0.00E+00	0.00E+00	0.00E+00	0.00E+00
4	200-400	2.70E+00	6.61E+03	7.27E+00	4.37E+07	2.18E-02	5.35E-02
	400-600	7.13E+02	1.49E+06	3.35E+04	2.86E+11	9.76E+00	2.04E+01
	600-800	7.02E+02	2.96E+05	5.68E+04	6.03E+09	1.01E+01	4.26E+00
	800-1,000	7.47E+01	2.02E+04	1.51E+03	5.44E+07	1.06E+00	2.85E-01
	1,000-1,200	3.16E+01	1.09E+04	9.98E+02	1.19E+08	4.77E-01	1.65E-01
5	200-400	0.00E+00	0.00E+00	0.00E+00	0.00E+00	0.00E+00	0.00E+00
	400-600	6.65E+02	1.83E+06	2.26E+04	4.12E+11	1.56E+01	4.30E+01
	600-800	1.54E+02	5.46E+04	2.36E+04	2.98E+09	3.56E+00	1.26E+00
	800-1,000	5.40E+01	3.73E+04	2.27E+02	3.75E+05	9.78E-01	6.76E-01
	1,000-1,200	0.00E+00	0.00E+00	0.00E+00	0.00E+00	0.00E+00	0.00E+00
6	200-400	1.82E+01	4.59E+04	2.40E+02	1.27E+09	7.02E-02	1.77E-01
	400-600	8.61E+02	1.51E+06	8.23E+04	4.07E+11	5.05E+00	8.83E+00
	600-800	1.02E+03	7.26E+05	9.93E+04	7.57E+10	1.11E+01	7.91E+00
	800-1,000	0.00E+00	0.00E+00	0.00E+00	0.00E+00	0.00E+00	0.00E+00
	1,000-1,200	0.00E+00	0.00E+00	0.00E+00	0.00E+00	0.00E+00	0.00E+00
1-6	200-1,200	2.93E+04	4.33E+07	1.17E+07	1.80E+13	1.16E+01	1.73E+01

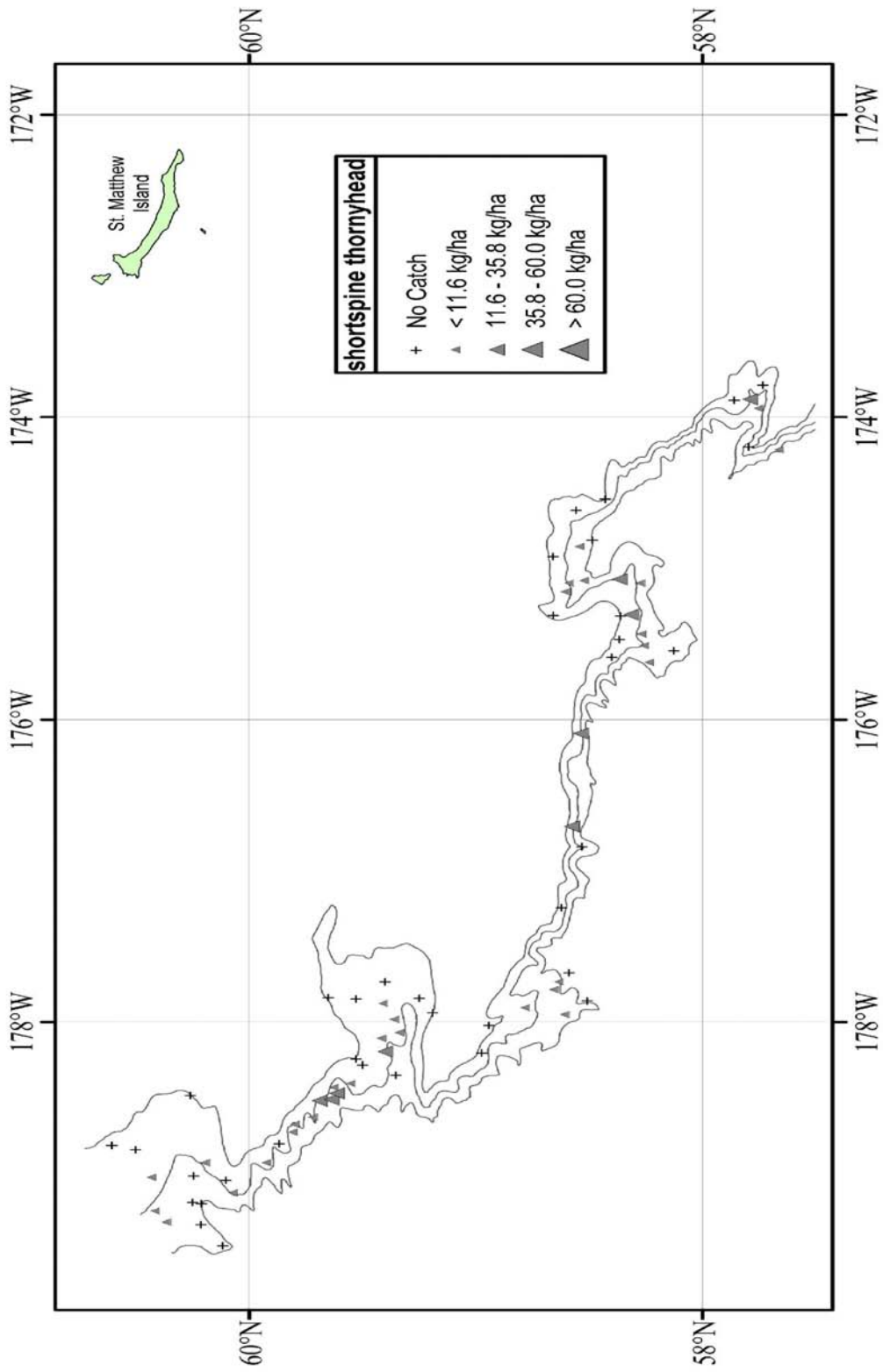

Figure 32. - - Distribution and relative abundance of shortspine thornyhead from the 2010 EBSS survey. Relative abundance is categorized by no catch, sample CPUE less than the mean CPUE, between the mean CPUE and one standard deviation above the mean, between one and two standard deviations above the mean CPUE, and greater than two standard deviations above the mean CPUE.

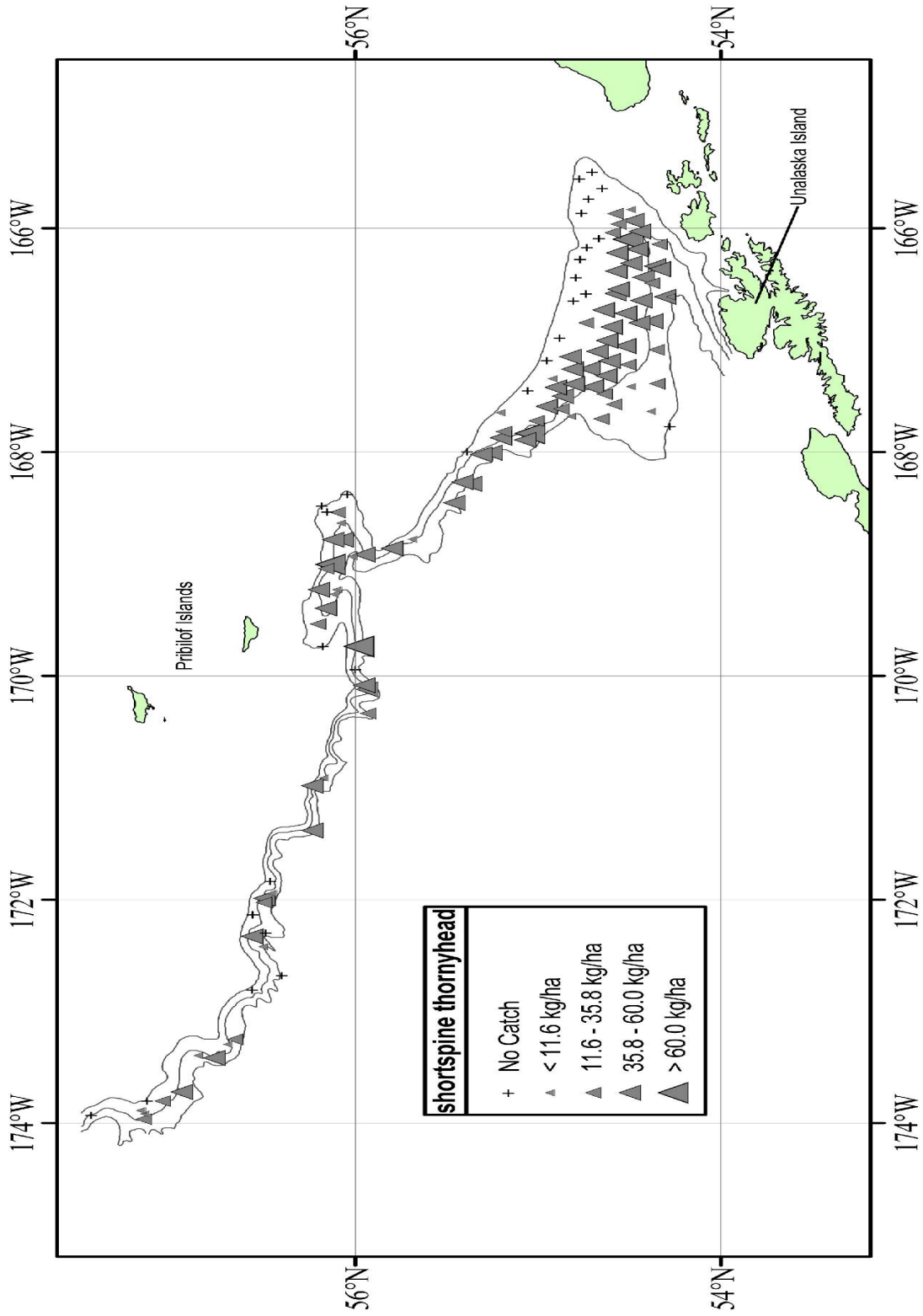

Figure 32. - - Continued.

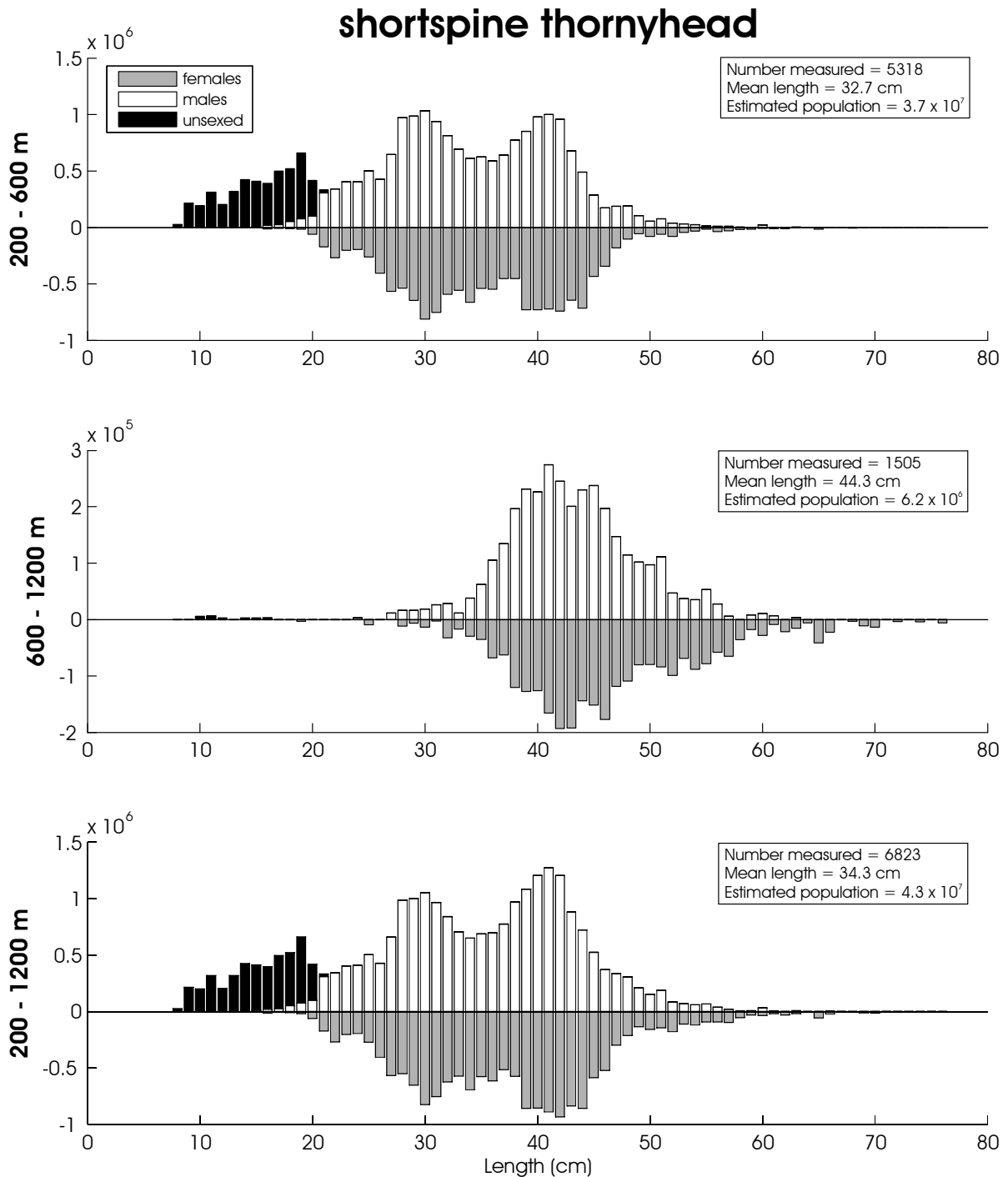

Figure 33. -- Size composition of the estimated shortspine thornyhead population from the 2010 EBSS survey for all subareas by depth. The abscissa is scaled as total length in centimeters while the ordinate represents the estimated total population.

Table 25. - Abundance estimates by subarea and depth strata for Pacific ocean perch (*Sebastes alutus*) from the 2010 EBSS survey.

<i>Sebastes alutus</i>		Pacific ocean perch					
Subarea	Depth strata (m)	Biomass (t)	Population	Biomass variance	Population variance	Average CPUE (kg/ha)	Average CPUE (no./ha)
1	200-400	2.32E+04	2.39E+07	5.04E+08	5.22E+14	5.79E+01	5.94E+01
	400-600	3.12E+02	3.98E+05	3.12E+03	4.97E+09	7.69E-01	9.79E-01
	600-800	0.00E+00	0.00E+00	0.00E+00	0.00E+00	0.00E+00	0.00E+00
	800-1,000	0.00E+00	0.00E+00	0.00E+00	0.00E+00	0.00E+00	0.00E+00
	1,000-1,200	0.00E+00	0.00E+00	0.00E+00	0.00E+00	0.00E+00	0.00E+00
2	200-400	4.91E+04	4.99E+07	1.00E+09	1.01E+15	4.24E+02	4.31E+02
	400-600	1.72E+01	2.29E+04	6.33E+01	1.14E+08	2.44E-01	3.25E-01
	600-800	0.00E+00	0.00E+00	0.00E+00	0.00E+00	0.00E+00	0.00E+00
	800-1,000	0.00E+00	0.00E+00	0.00E+00	0.00E+00	0.00E+00	0.00E+00
	1,000-1,200	0.00E+00	0.00E+00	0.00E+00	0.00E+00	0.00E+00	0.00E+00
3	200-400	3.87E+04	5.24E+07	3.43E+08	6.78E+14	4.29E+02	5.80E+02
	400-600	0.00E+00	0.00E+00	0.00E+00	0.00E+00	0.00E+00	0.00E+00
	600-800	0.00E+00	0.00E+00	0.00E+00	0.00E+00	0.00E+00	0.00E+00
	800-1,000	0.00E+00	0.00E+00	0.00E+00	0.00E+00	0.00E+00	0.00E+00
	1,000-1,200	0.00E+00	0.00E+00	0.00E+00	0.00E+00	0.00E+00	0.00E+00
4	200-400	9.06E+04	1.06E+08	4.27E+09	5.52E+15	7.33E+02	8.58E+02
	400-600	8.87E+01	1.10E+05	4.43E+03	6.72E+09	1.22E+00	1.50E+00
	600-800	0.00E+00	0.00E+00	0.00E+00	0.00E+00	0.00E+00	0.00E+00
	800-1,000	0.00E+00	0.00E+00	0.00E+00	0.00E+00	0.00E+00	0.00E+00
	1,000-1,200	0.00E+00	0.00E+00	0.00E+00	0.00E+00	0.00E+00	0.00E+00
5	200-400	8.81E+02	1.03E+06	4.62E+05	6.32E+11	2.08E+01	2.42E+01
	400-600	3.95E+00	6.98E+03	3.99E+00	1.22E+07	9.27E-02	1.64E-01
	600-800	0.00E+00	0.00E+00	0.00E+00	0.00E+00	0.00E+00	0.00E+00
	800-1,000	0.00E+00	0.00E+00	0.00E+00	0.00E+00	0.00E+00	0.00E+00
	1,000-1,200	0.00E+00	0.00E+00	0.00E+00	0.00E+00	0.00E+00	0.00E+00
6	200-400	3.59E+02	7.68E+05	7.25E+04	2.40E+11	1.38E+00	2.96E+00
	400-600	8.96E+00	1.50E+04	2.71E+01	7.24E+07	5.25E-02	8.77E-02
	600-800	0.00E+00	0.00E+00	0.00E+00	0.00E+00	0.00E+00	0.00E+00
	800-1,000	0.00E+00	0.00E+00	0.00E+00	0.00E+00	0.00E+00	0.00E+00
	1,000-1,200	0.00E+00	0.00E+00	0.00E+00	0.00E+00	0.00E+00	0.00E+00
1-6	200-1,200	2.03E+05	2.35E+08	6.12E+09	7.73E+15	8.33E+01	9.83E+01

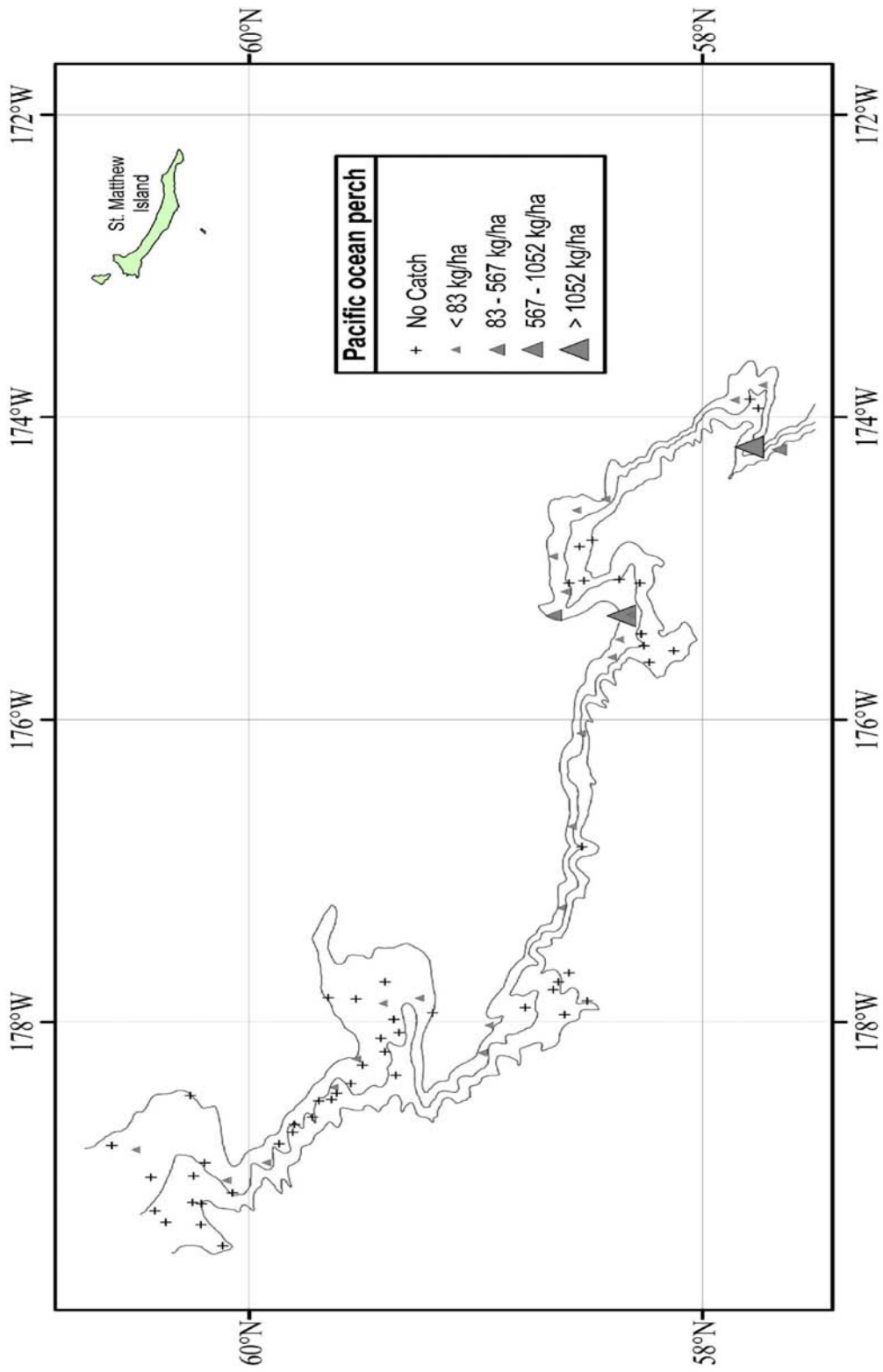

Figure 34. - - Distribution and relative abundance of Pacific ocean perch from the 2010 EBSS survey. Relative abundance is categorized by no catch, sample CPUE less than the mean CPUE, between the mean CPUE and one standard deviation above the mean, between one and two standard deviations above the mean CPUE, and greater than two standard deviations above the mean CPUE.

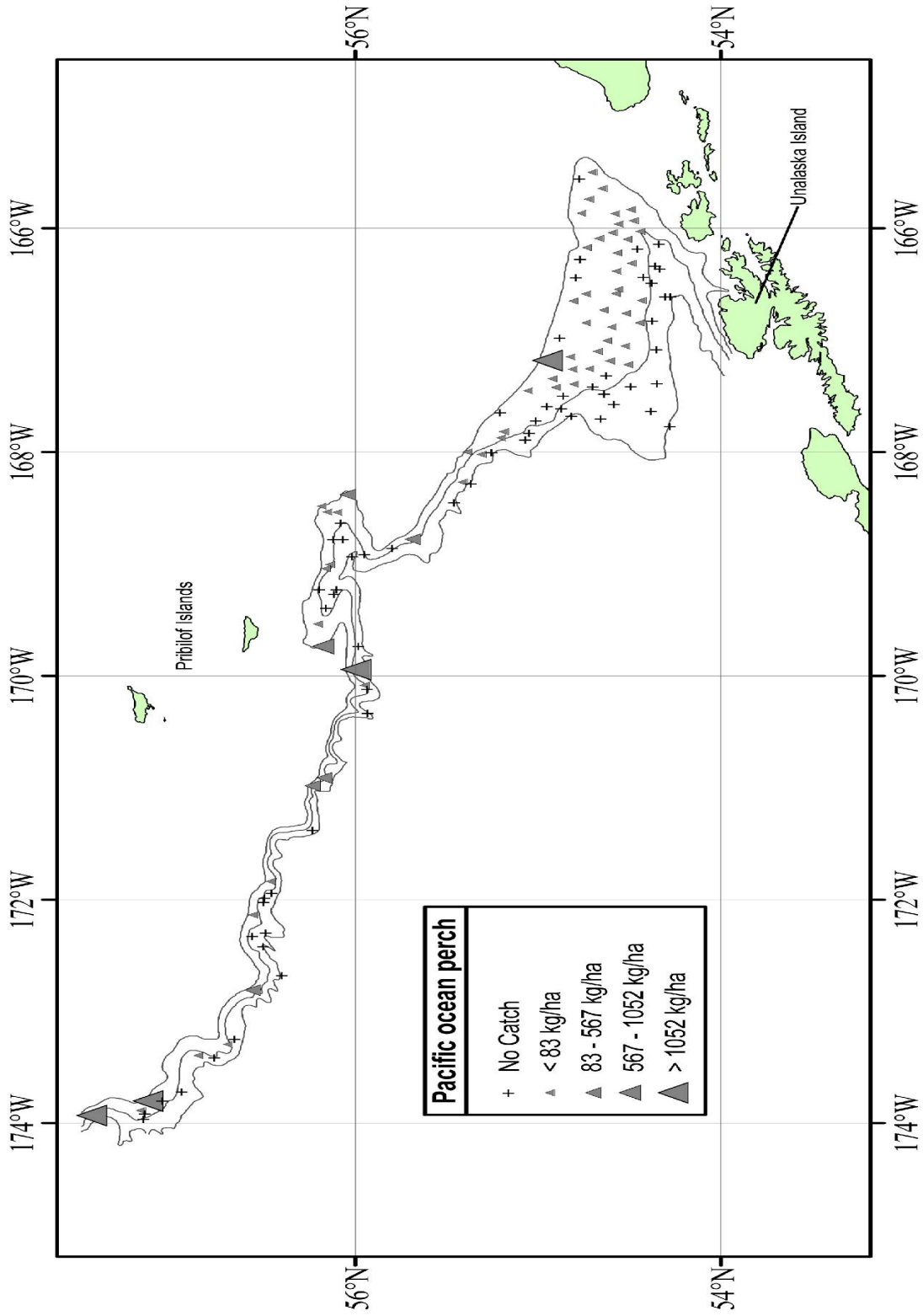

Figure 34. - - Continued.

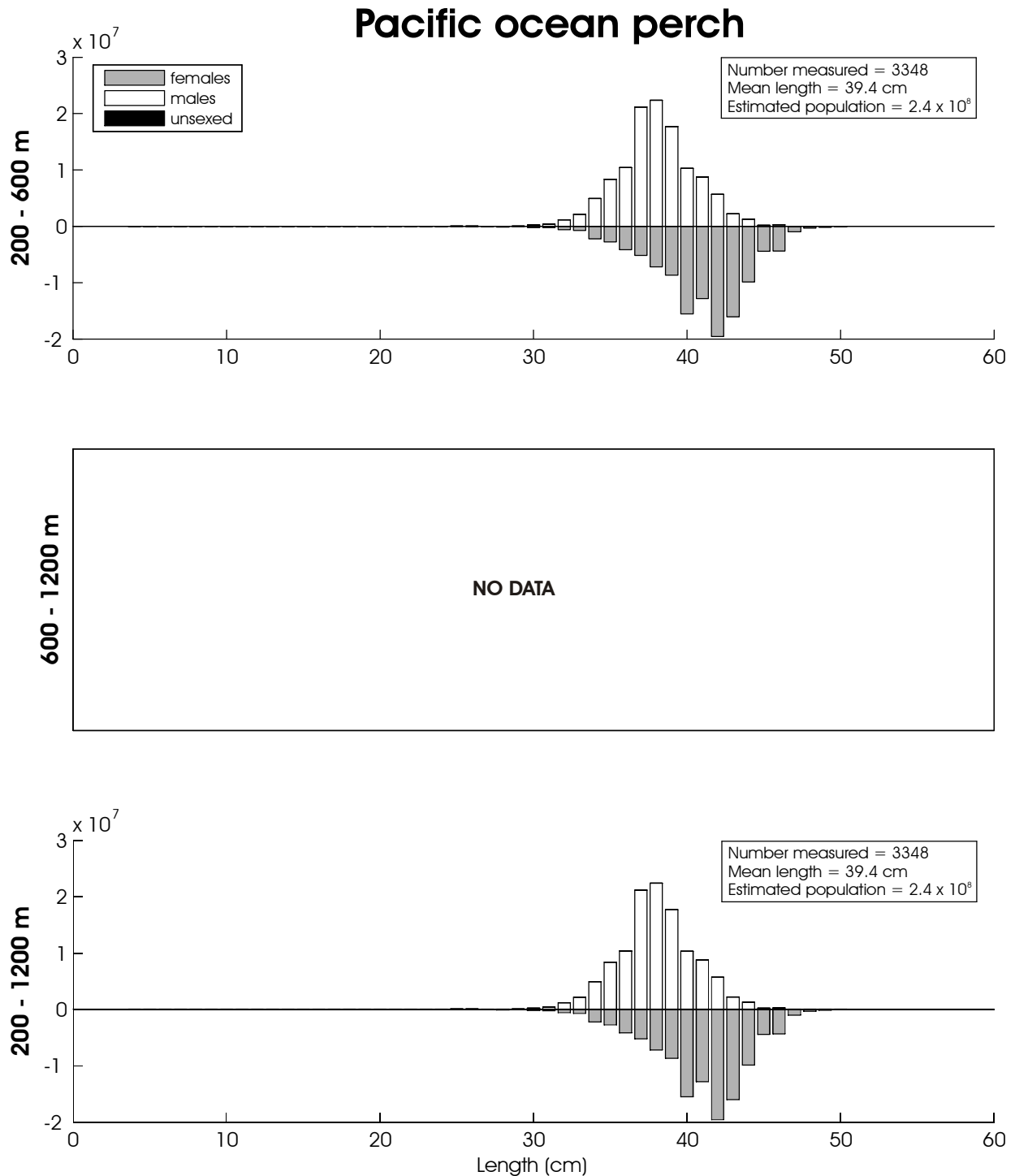

Figure 35. - Size composition of the estimated Pacific ocean perch population from the 2010 EBSS survey for all subareas by depth. The abscissa is scaled as total length in centimeters while the ordinate represents the estimated total population.

Table 26. - Abundance estimates by subarea and depth strata for roughey rockfish (*Sebastes aleutianus*) from the 2010 EBSS survey.

<i>Sebastes aleutianus</i>		roughey rockfish					
Subarea	Depth strata (m)	Biomass (t)	Population	Biomass variance	Population variance	Average CPUE (kg/ha)	Average CPUE (no./ha)
1	200-400	3.13E+02	3.62E+05	6.00E+03	4.04E+09	7.81E-01	9.03E-01
	400-600	1.08E+01	8.78E+03	3.76E+01	2.45E+07	2.65E-02	2.16E-02
	600-800	0.00E+00	0.00E+00	0.00E+00	0.00E+00	0.00E+00	0.00E+00
	800-1,000	0.00E+00	0.00E+00	0.00E+00	0.00E+00	0.00E+00	0.00E+00
	1,000-1,200	0.00E+00	0.00E+00	0.00E+00	0.00E+00	0.00E+00	0.00E+00
2	200-400	3.35E+01	1.55E+04	1.12E+03	2.40E+08	2.90E-01	1.34E-01
	400-600	0.00E+00	0.00E+00	0.00E+00	0.00E+00	0.00E+00	0.00E+00
	600-800	0.00E+00	0.00E+00	0.00E+00	0.00E+00	0.00E+00	0.00E+00
	800-1,000	0.00E+00	0.00E+00	0.00E+00	0.00E+00	0.00E+00	0.00E+00
	1,000-1,200	0.00E+00	0.00E+00	0.00E+00	0.00E+00	0.00E+00	0.00E+00
3	200-400	9.68E+00	8.70E+03	3.21E+01	2.17E+07	1.07E-01	9.62E-02
	400-600	0.00E+00	0.00E+00	0.00E+00	0.00E+00	0.00E+00	0.00E+00
	600-800	0.00E+00	0.00E+00	0.00E+00	0.00E+00	0.00E+00	0.00E+00
	800-1,000	0.00E+00	0.00E+00	0.00E+00	0.00E+00	0.00E+00	0.00E+00
	1,000-1,200	0.00E+00	0.00E+00	0.00E+00	0.00E+00	0.00E+00	0.00E+00
4	200-400	6.98E+00	5.43E+03	4.87E+01	2.95E+07	5.65E-02	4.39E-02
	400-600	0.00E+00	0.00E+00	0.00E+00	0.00E+00	0.00E+00	0.00E+00
	600-800	0.00E+00	0.00E+00	0.00E+00	0.00E+00	0.00E+00	0.00E+00
	800-1,000	0.00E+00	0.00E+00	0.00E+00	0.00E+00	0.00E+00	0.00E+00
	1,000-1,200	0.00E+00	0.00E+00	0.00E+00	0.00E+00	0.00E+00	0.00E+00
5	200-400	0.00E+00	0.00E+00	0.00E+00	0.00E+00	0.00E+00	0.00E+00
	400-600	0.00E+00	0.00E+00	0.00E+00	0.00E+00	0.00E+00	0.00E+00
	600-800	0.00E+00	0.00E+00	0.00E+00	0.00E+00	0.00E+00	0.00E+00
	800-1,000	0.00E+00	0.00E+00	0.00E+00	0.00E+00	0.00E+00	0.00E+00
	1,000-1,200	0.00E+00	0.00E+00	0.00E+00	0.00E+00	0.00E+00	0.00E+00
6	200-400	0.00E+00	0.00E+00	0.00E+00	0.00E+00	0.00E+00	0.00E+00
	400-600	0.00E+00	0.00E+00	0.00E+00	0.00E+00	0.00E+00	0.00E+00
	600-800	0.00E+00	0.00E+00	0.00E+00	0.00E+00	0.00E+00	0.00E+00
	800-1,000	0.00E+00	0.00E+00	0.00E+00	0.00E+00	0.00E+00	0.00E+00
	1,000-1,200	0.00E+00	0.00E+00	0.00E+00	0.00E+00	0.00E+00	0.00E+00
1-6	200-1,200	3.74E+02	4.01E+05	7.24E+03	4.36E+09	1.05E-01	1.11E-01

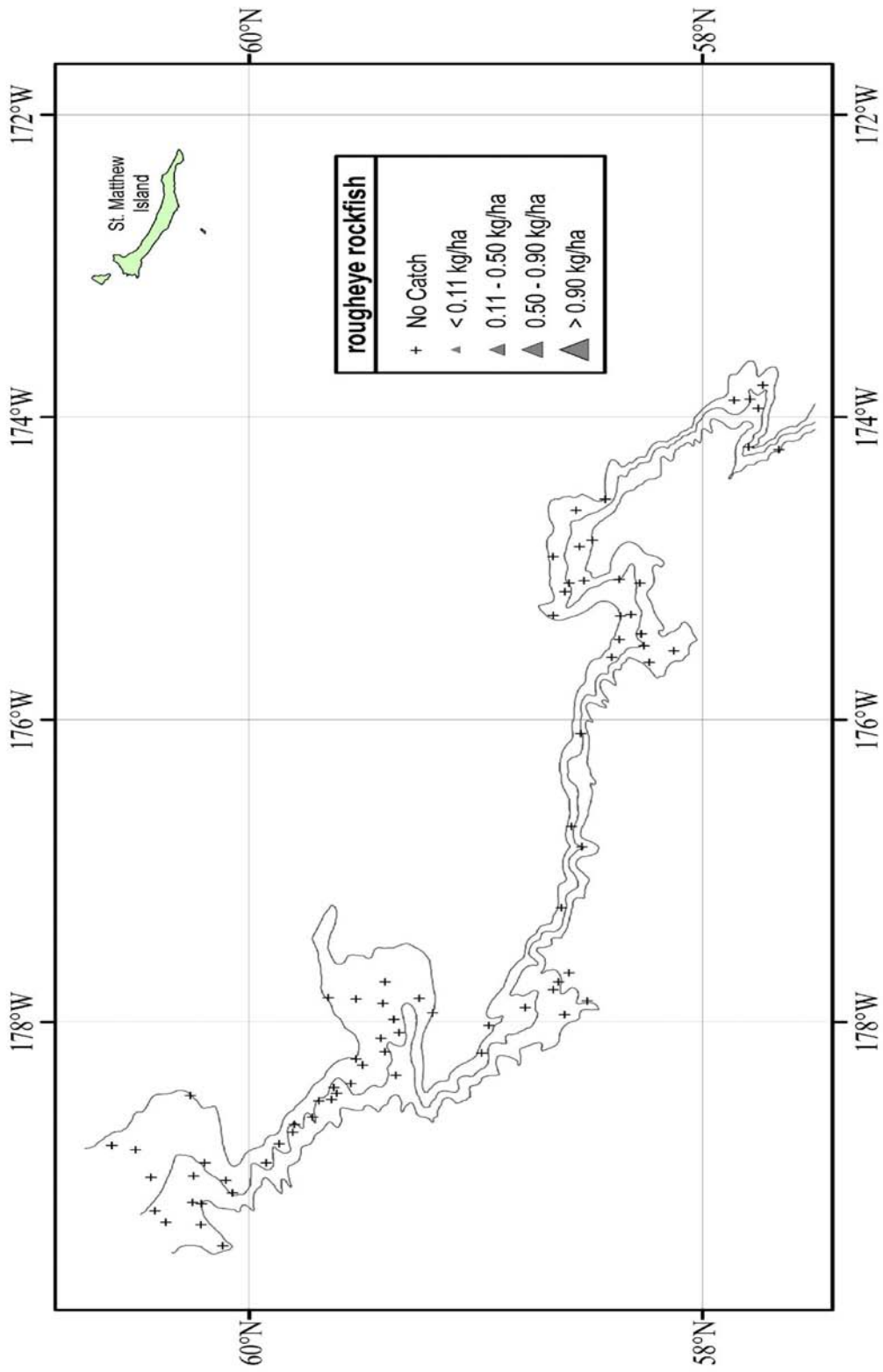

Figure 36. - - Distribution and relative abundance of rougheye rockfish from the 2010 EBSS survey. Relative abundance is categorized by no catch, sample CPUE less than the mean CPUE, between the mean CPUE and one standard deviation above the mean, between one and two standard deviations above the mean CPUE, and greater than two standard deviations above the mean CPUE.

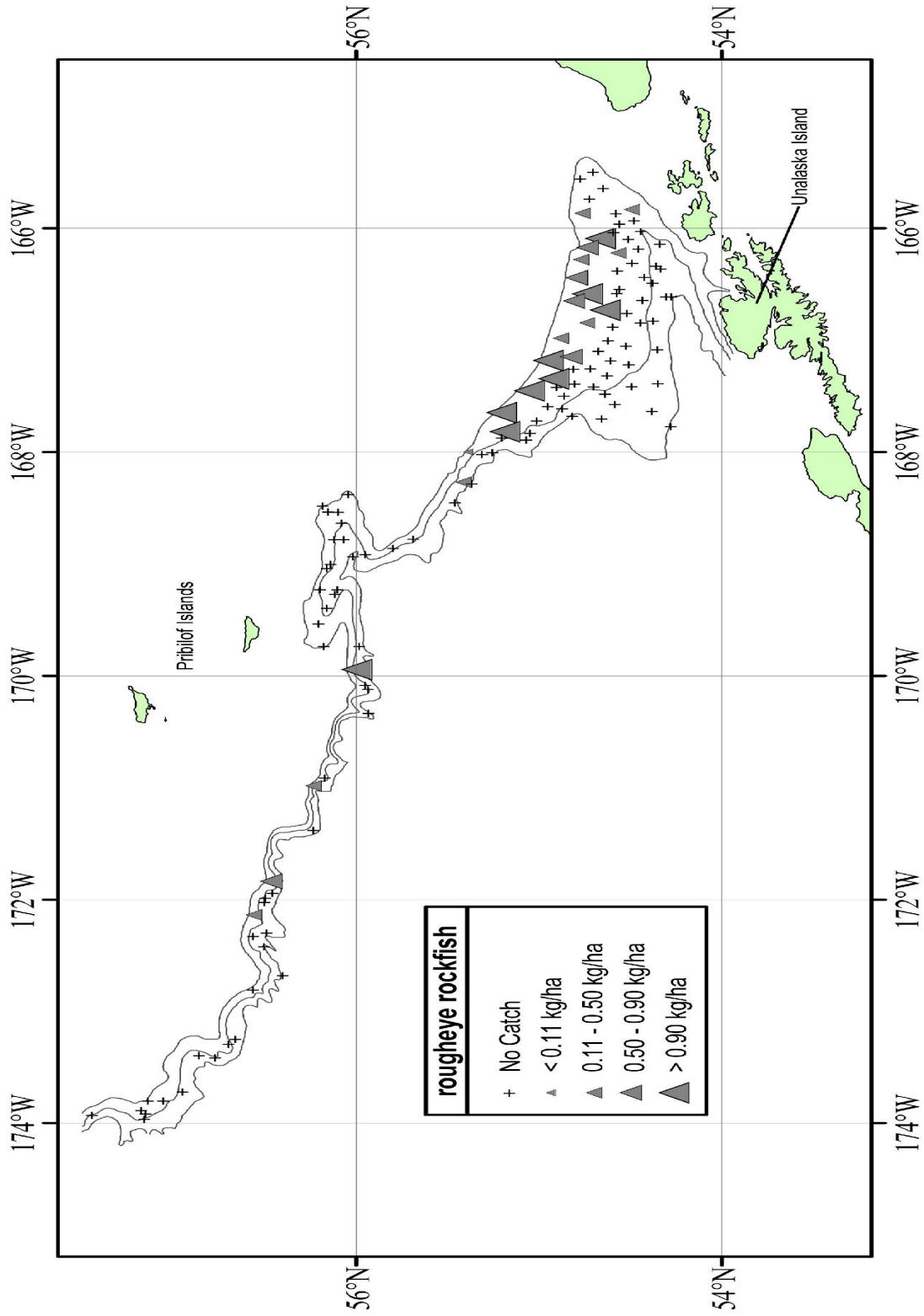

Figure 36.- - Continued.

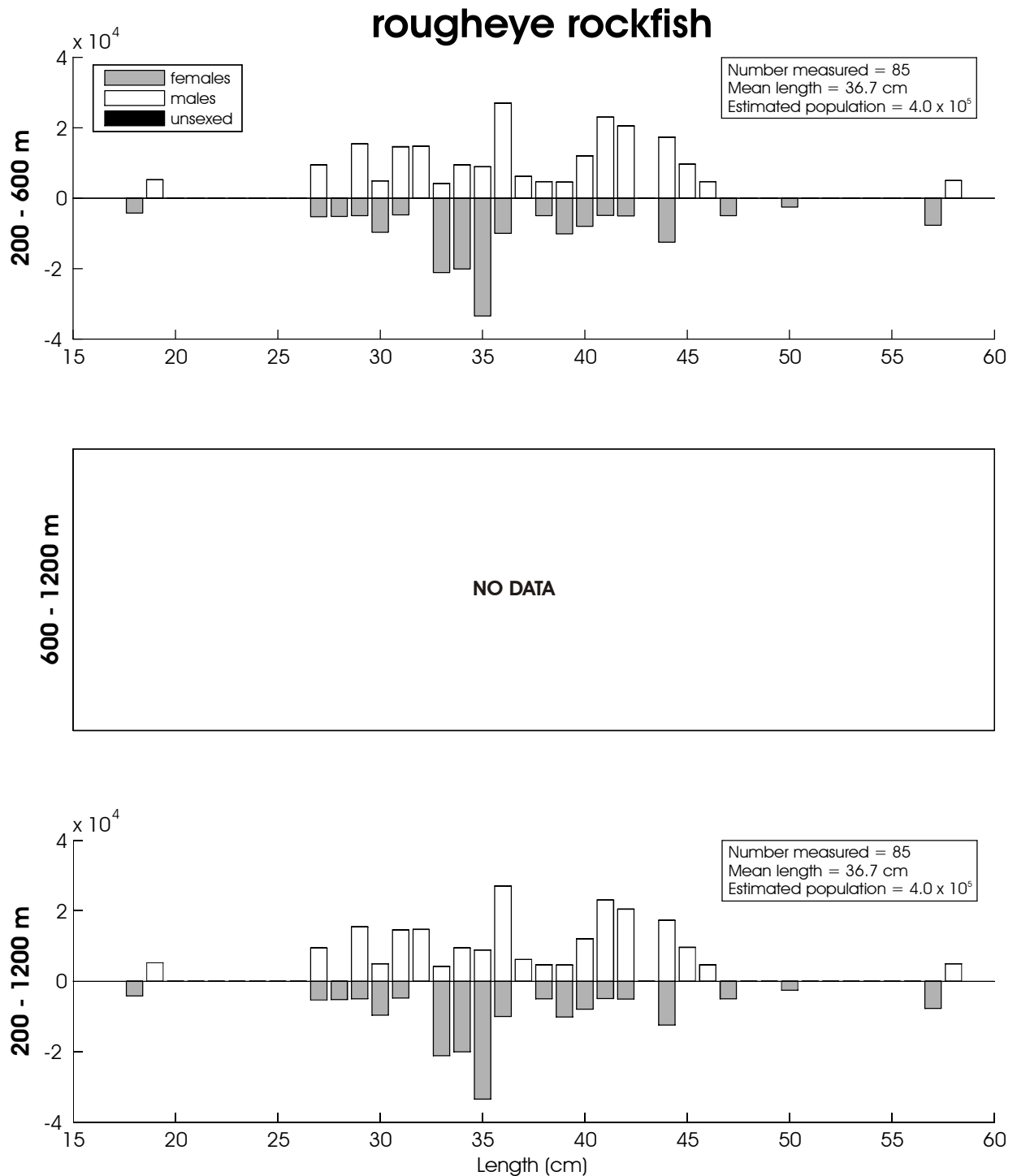

Figure 37. - - Size composition of the estimated roughey rockfish population from the 2010 EBSS survey for all subareas by depth. The abscissa is scaled as total length in centimeters while the ordinate represents the estimated total population.

Table 27. - - Abundance estimates by subarea and depth strata for blackspotted rockfish (*Sebastes melanostictus*) from the 2010 EBSS survey.

<i>Sebastes melanostictus</i>		blackspotted rockfish					
Subarea	Depth strata (m)	Biomass (t)	Population	Biomass variance	Population variance	Average CPUE (kg/ha)	Average CPUE (no./ha)
1	200-400	8.99E+01	9.49E+04	3.08E+03	2.93E+09	2.24E-01	2.36E-01
	400-600	1.26E+02	6.94E+04	1.61E+03	4.91E+08	3.11E-01	1.71E-01
	600-800	0.00E+00	0.00E+00	0.00E+00	0.00E+00	0.00E+00	0.00E+00
	800-1,000	0.00E+00	0.00E+00	0.00E+00	0.00E+00	0.00E+00	0.00E+00
	1,000-1,200	0.00E+00	0.00E+00	0.00E+00	0.00E+00	0.00E+00	0.00E+00
2	200-400	2.93E+02	5.60E+05	4.93E+04	2.12E+11	2.53E+00	4.84E+00
	400-600	7.08E+00	5.15E+03	5.02E+01	2.65E+07	1.00E-01	7.31E-02
	600-800	0.00E+00	0.00E+00	0.00E+00	0.00E+00	0.00E+00	0.00E+00
	800-1,000	0.00E+00	0.00E+00	0.00E+00	0.00E+00	0.00E+00	0.00E+00
	1,000-1,200	0.00E+00	0.00E+00	0.00E+00	0.00E+00	0.00E+00	0.00E+00
3	200-400	8.20E+01	1.33E+05	2.10E+03	1.21E+10	9.07E-01	1.47E+00
	400-600	0.00E+00	0.00E+00	0.00E+00	0.00E+00	0.00E+00	0.00E+00
	600-800	0.00E+00	0.00E+00	0.00E+00	0.00E+00	0.00E+00	0.00E+00
	800-1,000	0.00E+00	0.00E+00	0.00E+00	0.00E+00	0.00E+00	0.00E+00
	1,000-1,200	0.00E+00	0.00E+00	0.00E+00	0.00E+00	0.00E+00	0.00E+00
4	200-400	8.95E+00	5.56E+03	3.81E+01	1.39E+07	7.24E-02	4.50E-02
	400-600	0.00E+00	0.00E+00	0.00E+00	0.00E+00	0.00E+00	0.00E+00
	600-800	0.00E+00	0.00E+00	0.00E+00	0.00E+00	0.00E+00	0.00E+00
	800-1,000	0.00E+00	0.00E+00	0.00E+00	0.00E+00	0.00E+00	0.00E+00
	1,000-1,200	0.00E+00	0.00E+00	0.00E+00	0.00E+00	0.00E+00	0.00E+00
5	200-400	0.00E+00	0.00E+00	0.00E+00	0.00E+00	0.00E+00	0.00E+00
	400-600	0.00E+00	0.00E+00	0.00E+00	0.00E+00	0.00E+00	0.00E+00
	600-800	0.00E+00	0.00E+00	0.00E+00	0.00E+00	0.00E+00	0.00E+00
	800-1,000	0.00E+00	0.00E+00	0.00E+00	0.00E+00	0.00E+00	0.00E+00
	1,000-1,200	0.00E+00	0.00E+00	0.00E+00	0.00E+00	0.00E+00	0.00E+00
6	200-400	1.09E+01	5.55E+03	1.20E+02	3.08E+07	4.22E-02	2.14E-02
	400-600	6.97E+00	3.32E+03	4.86E+01	1.10E+07	4.09E-02	1.95E-02
	600-800	0.00E+00	0.00E+00	0.00E+00	0.00E+00	0.00E+00	0.00E+00
	800-1,000	0.00E+00	0.00E+00	0.00E+00	0.00E+00	0.00E+00	0.00E+00
	1,000-1,200	0.00E+00	0.00E+00	0.00E+00	0.00E+00	0.00E+00	0.00E+00
1-6	200-1,200	6.25E+02	8.77E+05	5.63E+04	2.28E+11	2.26E-01	3.06E-01

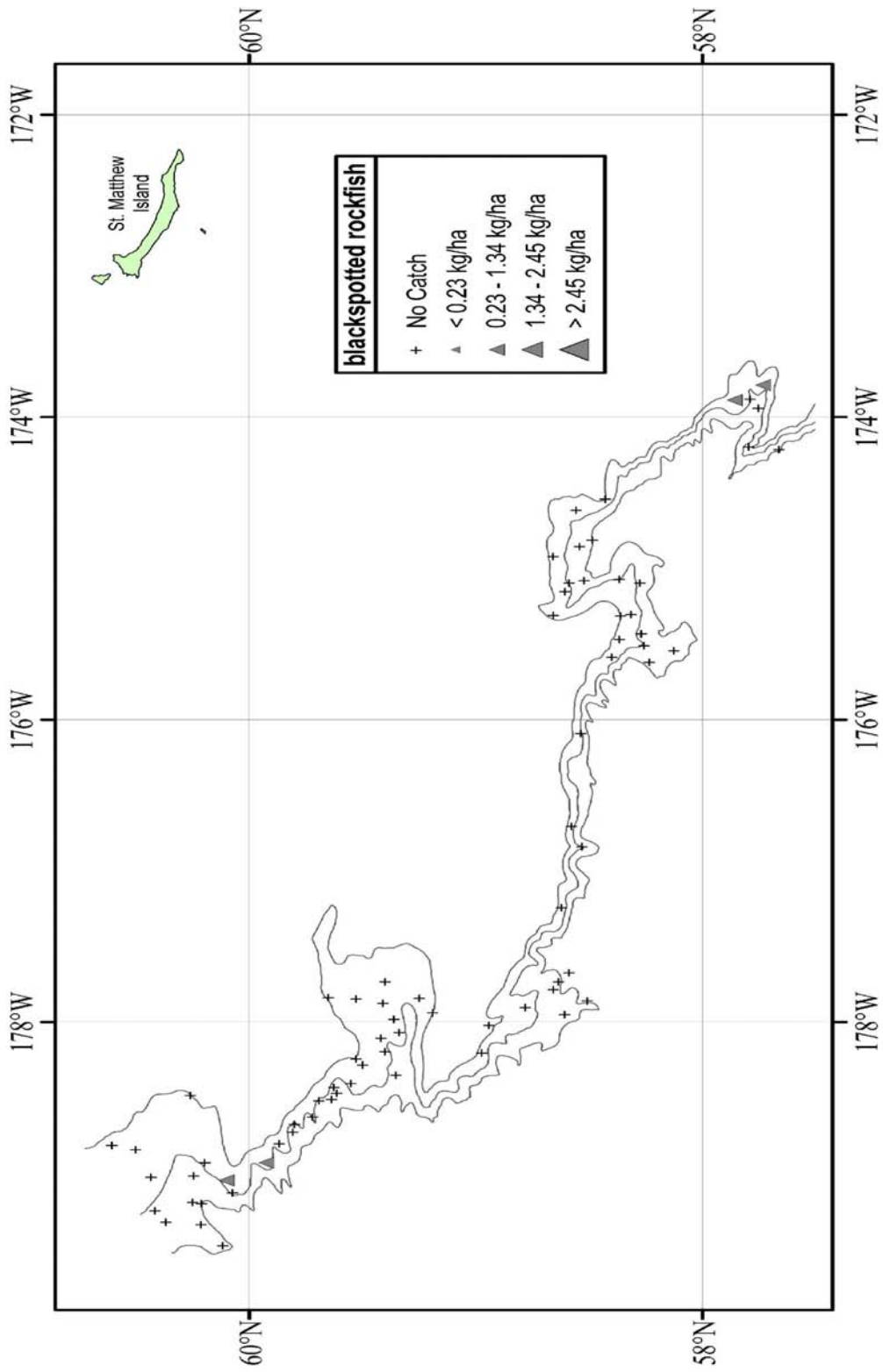

Figure 38. - - Distribution and relative abundance of blackspotted rockfish from the 2010 EBSS survey. Relative abundance is categorized by no catch, sample CPUE less than the mean CPUE, between the mean CPUE and one standard deviation above the mean, between one and two standard deviations above the mean CPUE, and greater than two standard deviations above the mean CPUE.

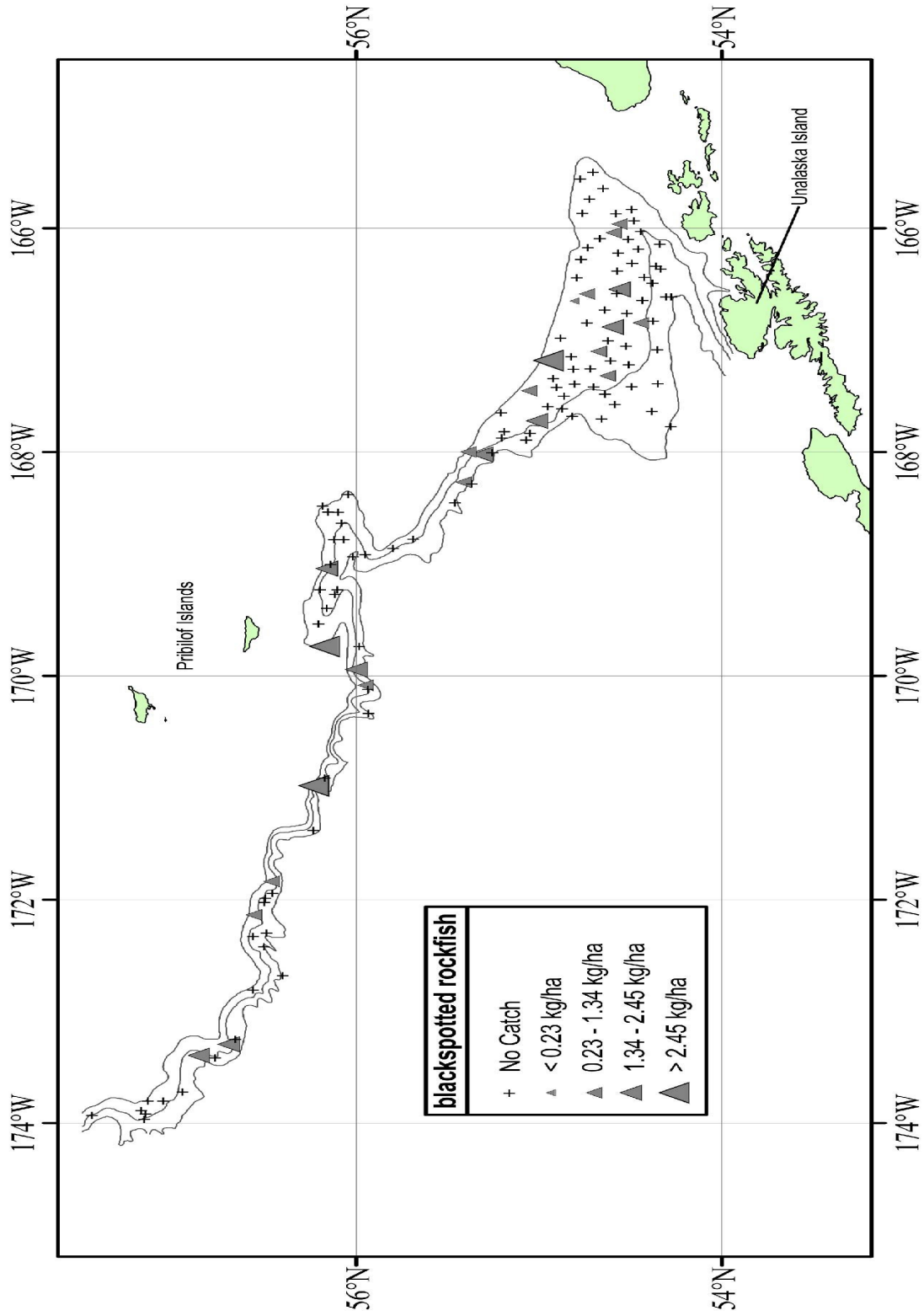

Figure 38. - - Continued.

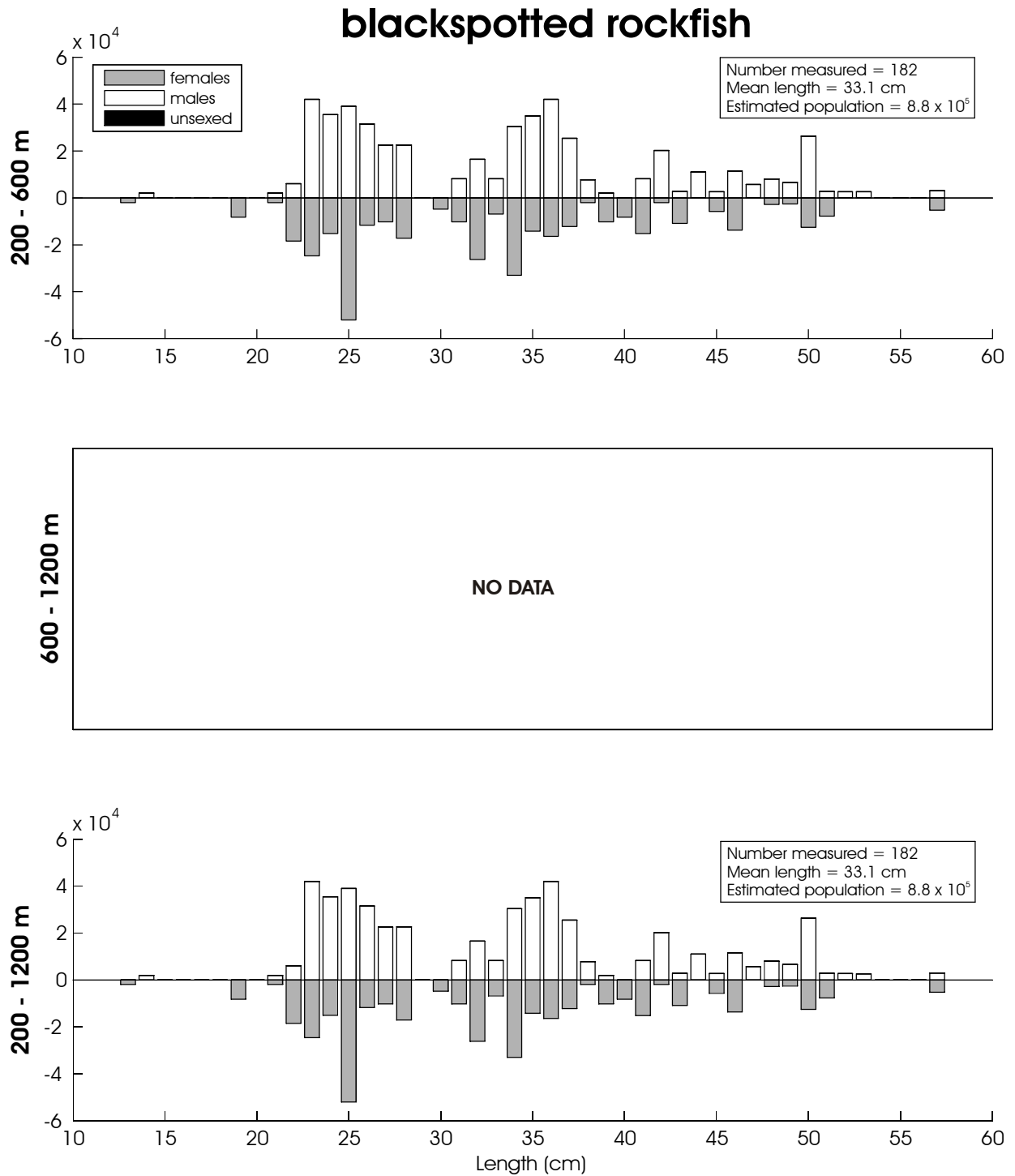

Figure 39. - - Size composition of the estimated blackspotted rockfish population from the 2010 EBSS survey for all subareas by depth. The abscissa is scaled as total length in centimeters while the ordinate represents the estimated total population.

Table 28. - - Abundance estimates by subarea and depth strata for shortraker rockfish (*Sebastes borealis*) from the 2010 EBSS survey.

<i>Sebastes borealis</i>		shortraker rockfish					
Subarea	Depth strata (m)	Biomass (t)	Population	Biomass variance	Population variance	Average CPUE (kg/ha)	Average CPUE (no./ha)
1	200-400	4.01E+01	9.89E+03	9.64E+02	4.65E+07	1.00E-01	2.46E-02
	400-600	3.84E+02	8.24E+04	1.26E+05	4.63E+09	9.45E-01	2.03E-01
	600-800	1.84E+01	6.99E+03	1.64E+02	2.24E+07	1.06E-01	4.01E-02
	800-1,000	0.00E+00	0.00E+00	0.00E+00	0.00E+00	0.00E+00	0.00E+00
	1,000-1,200	0.00E+00	0.00E+00	0.00E+00	0.00E+00	0.00E+00	0.00E+00
2	200-400	1.39E+03	2.27E+05	8.25E+05	2.33E+10	1.20E+01	1.96E+00
	400-600	4.28E+02	2.11E+05	4.45E+04	7.74E+09	6.07E+00	3.00E+00
	600-800	3.84E+01	1.10E+04	1.47E+03	1.22E+08	6.49E-01	1.87E-01
	800-1,000	0.00E+00	0.00E+00	0.00E+00	0.00E+00	0.00E+00	0.00E+00
	1,000-1,200	0.00E+00	0.00E+00	0.00E+00	0.00E+00	0.00E+00	0.00E+00
3	200-400	1.16E+03	1.64E+05	3.71E+05	4.44E+09	1.29E+01	1.81E+00
	400-600	1.43E+02	5.72E+04	1.18E+04	1.86E+09	1.61E+00	6.46E-01
	600-800	1.26E+01	3.31E+03	1.59E+02	1.10E+07	1.39E-01	3.64E-02
	800-1,000	0.00E+00	0.00E+00	0.00E+00	0.00E+00	0.00E+00	0.00E+00
	1,000-1,200	0.00E+00	0.00E+00	0.00E+00	0.00E+00	0.00E+00	0.00E+00
4	200-400	6.23E+02	3.39E+05	1.27E+05	4.64E+10	5.04E+00	2.74E+00
	400-600	3.67E+01	1.39E+04	1.35E+03	1.92E+08	5.03E-01	1.90E-01
	600-800	0.00E+00	0.00E+00	0.00E+00	0.00E+00	0.00E+00	0.00E+00
	800-1,000	0.00E+00	0.00E+00	0.00E+00	0.00E+00	0.00E+00	0.00E+00
	1,000-1,200	0.00E+00	0.00E+00	0.00E+00	0.00E+00	0.00E+00	0.00E+00
5	200-400	0.00E+00	0.00E+00	0.00E+00	0.00E+00	0.00E+00	0.00E+00
	400-600	1.12E+01	6.68E+03	1.25E+02	4.47E+07	2.62E-01	1.57E-01
	600-800	0.00E+00	0.00E+00	0.00E+00	0.00E+00	0.00E+00	0.00E+00
	800-1,000	0.00E+00	0.00E+00	0.00E+00	0.00E+00	0.00E+00	0.00E+00
	1,000-1,200	0.00E+00	0.00E+00	0.00E+00	0.00E+00	0.00E+00	0.00E+00
6	200-400	0.00E+00	0.00E+00	0.00E+00	0.00E+00	0.00E+00	0.00E+00
	400-600	7.34E+01	2.21E+04	1.34E+03	1.03E+08	4.31E-01	1.29E-01
	600-800	0.00E+00	0.00E+00	0.00E+00	0.00E+00	0.00E+00	0.00E+00
	800-1,000	0.00E+00	0.00E+00	0.00E+00	0.00E+00	0.00E+00	0.00E+00
	1,000-1,200	0.00E+00	0.00E+00	0.00E+00	0.00E+00	0.00E+00	0.00E+00
1-6	200-1,200	4.37E+03	1.15E+06	1.51E+06	8.89E+10	1.87E+00	5.04E-01

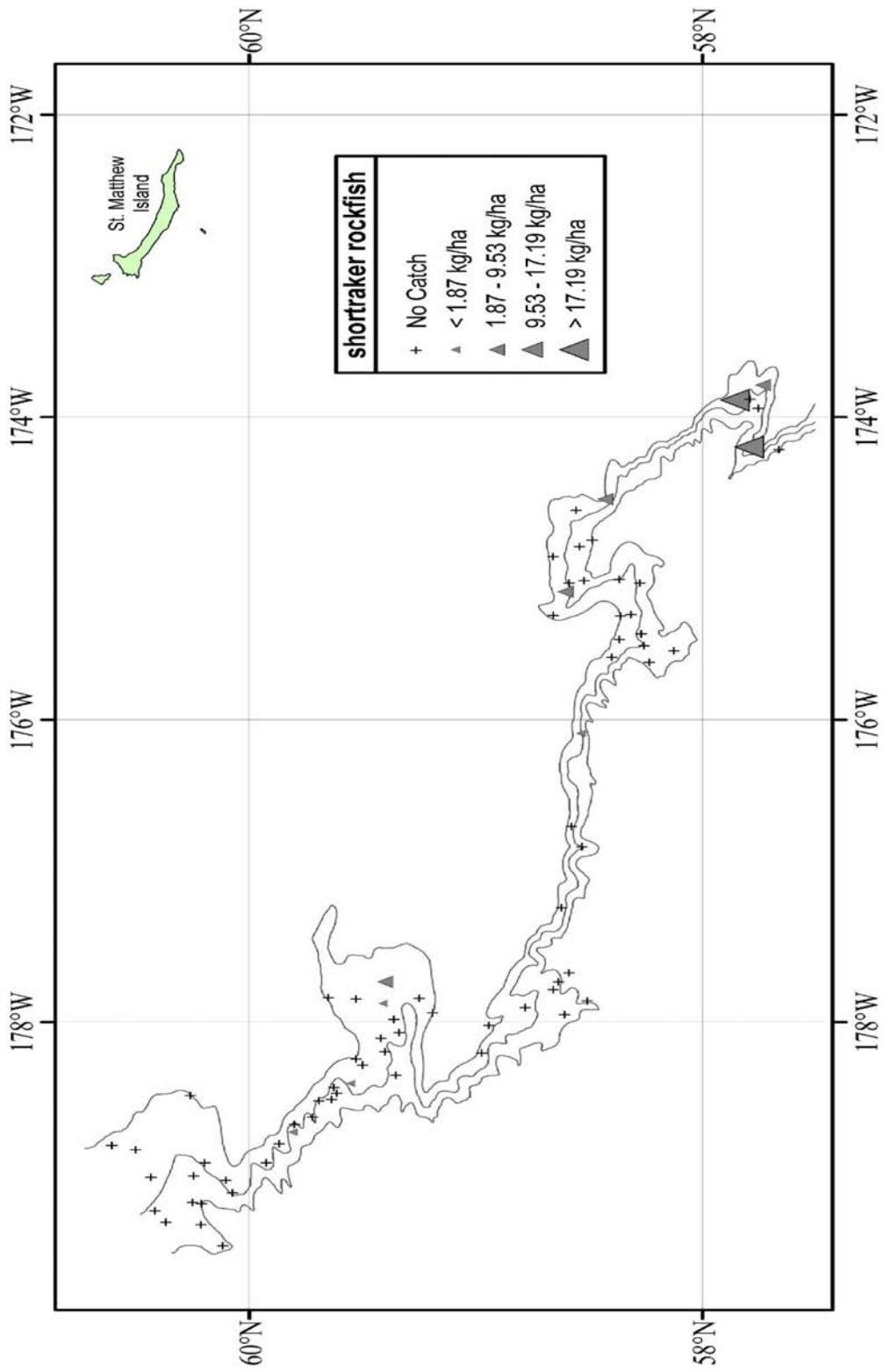

Figure 40. - - Distribution and relative abundance of shorttraker rockfish from the 2010 EBSS survey. Relative abundance is categorized by no catch, sample CPUE less than the mean CPUE, between the mean CPUE and one standard deviation above the mean, between one and two standard deviations above the mean CPUE, and greater than two standard deviations above the mean CPUE.

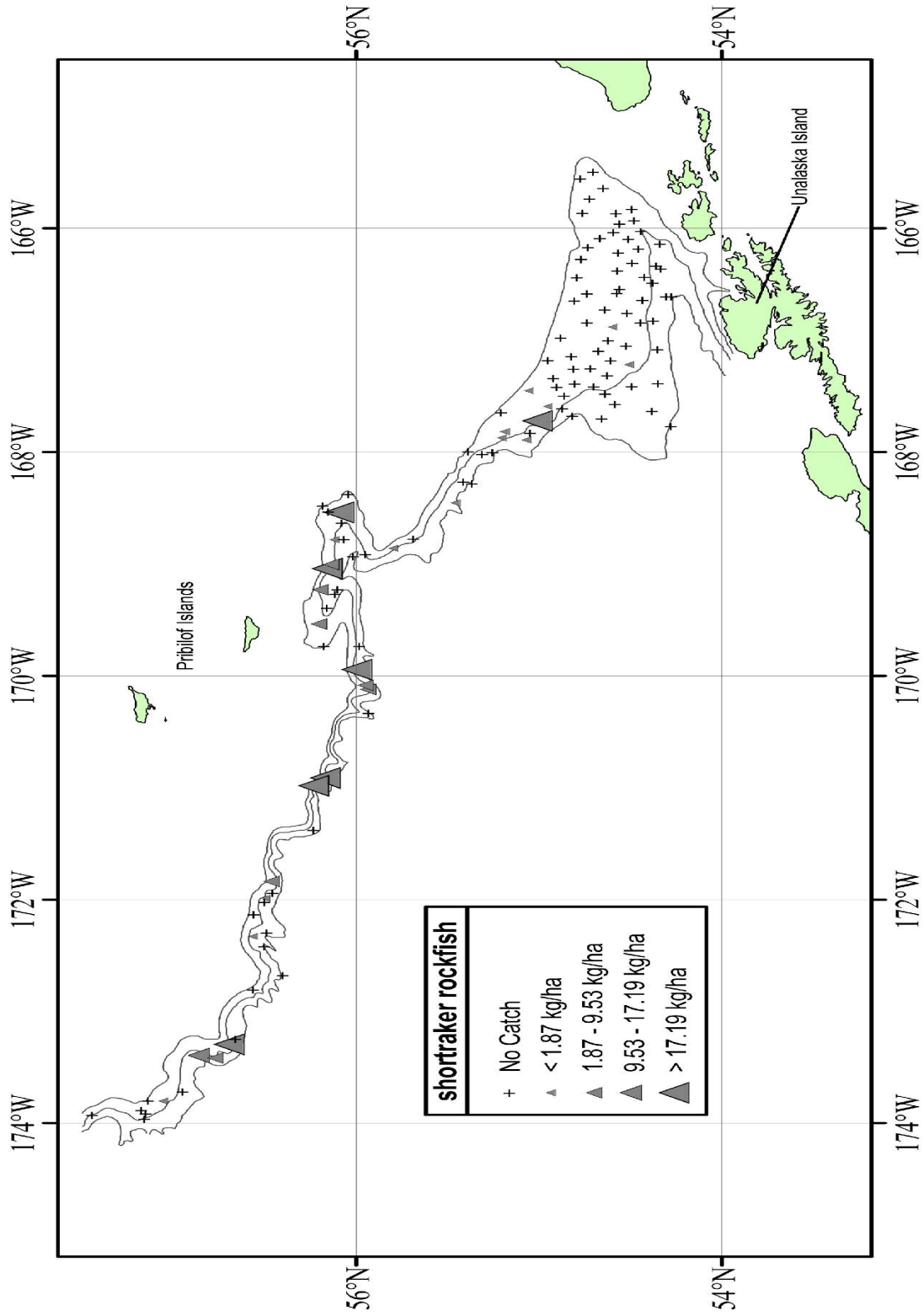

Figure 40. - - Continued.

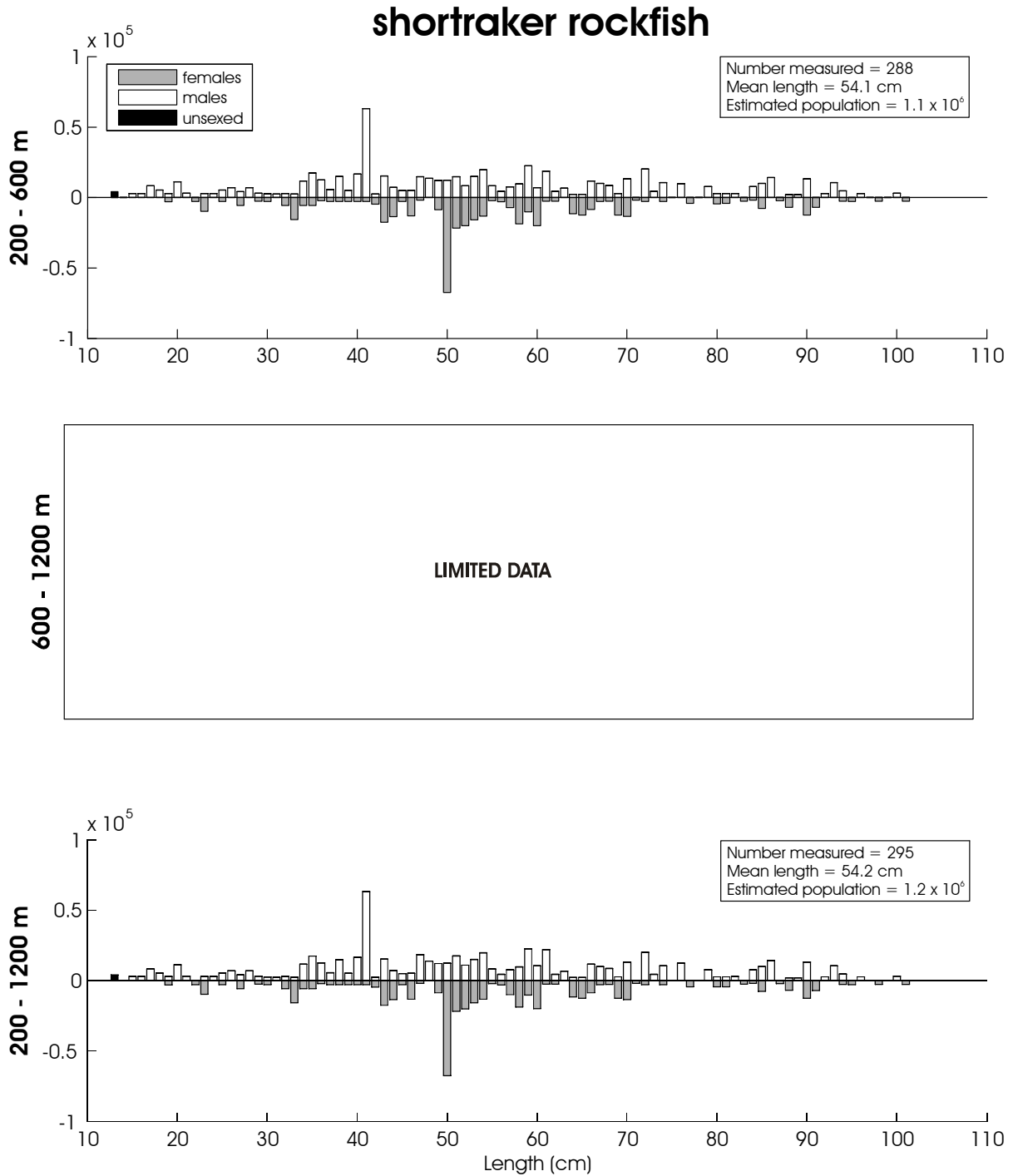

Figure 41. - - Size composition of the estimated shortraker rockfish population from the 2010 EBSS survey for all subareas by depth. The abscissa is scaled as total length in centimeters while the ordinate represents the estimated total population.

Table 29. - - Abundance estimates by subarea and depth strata for sablefish
(*Anoplopoma fimbria*) from the 2010 EBSS survey.

<i>Anoplopoma fimbria</i>						sablefish	
Subarea	Depth strata (m)	Biomass (t)	Population	Biomass variance	Population variance	Average CPUE (kg/ha)	Average CPUE (no./ha)
1	200-400	0.00E+00	0.00E+00	0.00E+00	0.00E+00	0.00E+00	0.00E+00
	400-600	1.27E+03	5.07E+05	2.01E+05	2.38E+10	3.13E+00	1.25E+00
	600-800	2.18E+03	5.97E+05	7.82E+05	4.43E+10	1.25E+01	3.43E+00
	800-1,000	8.25E+02	2.29E+05	1.09E+05	8.04E+09	6.09E+00	1.69E+00
	1,000-1,200	1.85E+02	4.63E+04	1.74E+04	1.11E+09	1.67E+00	4.19E-01
2	200-400	0.00E+00	0.00E+00	0.00E+00	0.00E+00	0.00E+00	0.00E+00
	400-600	4.63E+02	1.38E+05	4.24E+04	4.01E+09	6.56E+00	1.96E+00
	600-800	9.61E+02	2.80E+05	1.94E+04	1.40E+09	1.62E+01	4.74E+00
	800-1,000	7.29E+02	1.96E+05	3.25E+05	2.40E+10	1.32E+01	3.54E+00
	1,000-1,200	1.61E+02	4.77E+04	2.58E+04	2.28E+09	3.00E+00	8.91E-01
3	200-400	0.00E+00	0.00E+00	0.00E+00	0.00E+00	0.00E+00	0.00E+00
	400-600	1.98E+02	6.01E+04	2.78E+04	2.12E+09	2.23E+00	6.79E-01
	600-800	3.31E+02	9.41E+04	2.31E+04	1.73E+09	3.63E+00	1.03E+00
	800-1,000	3.40E+02	8.18E+04	3.28E+03	1.47E+08	4.64E+00	1.12E+00
	1,000-1,200	3.19E+01	8.04E+03	1.01E+03	6.47E+07	4.72E-01	1.19E-01
4	200-400	0.00E+00	0.00E+00	0.00E+00	0.00E+00	0.00E+00	0.00E+00
	400-600	7.92E+01	2.95E+04	2.32E+03	3.10E+08	1.08E+00	4.04E-01
	600-800	2.19E+02	6.48E+04	1.22E+04	1.07E+09	3.15E+00	9.34E-01
	800-1,000	4.74E+02	1.31E+05	1.11E+05	8.60E+09	6.70E+00	1.85E+00
	1,000-1,200	1.49E+02	4.37E+04	2.22E+04	1.91E+09	2.25E+00	6.60E-01
5	200-400	0.00E+00	0.00E+00	0.00E+00	0.00E+00	0.00E+00	0.00E+00
	400-600	4.11E+01	1.09E+04	1.69E+03	1.19E+08	9.65E-01	2.56E-01
	600-800	1.35E+02	2.65E+04	1.83E+04	7.02E+08	3.13E+00	6.13E-01
	800-1,000	1.93E+01	6.12E+03	3.74E+02	3.74E+07	3.50E-01	1.11E-01
	1,000-1,200	0.00E+00	0.00E+00	0.00E+00	0.00E+00	0.00E+00	0.00E+00
6	200-400	0.00E+00	0.00E+00	0.00E+00	0.00E+00	0.00E+00	0.00E+00
	400-600	3.08E+02	9.08E+04	6.94E+03	6.33E+08	1.81E+00	5.32E-01
	600-800	4.24E+02	1.16E+05	1.94E+04	1.36E+09	4.62E+00	1.27E+00
	800-1,000	1.52E+02	4.40E+04	6.54E+03	6.20E+08	2.36E+00	6.81E-01
	1,000-1,200	0.00E+00	0.00E+00	0.00E+00	0.00E+00	0.00E+00	0.00E+00
1-6	200-1,200	9.67E+03	2.85E+06	1.78E+06	1.28E+11	3.21E+00	9.68E-01

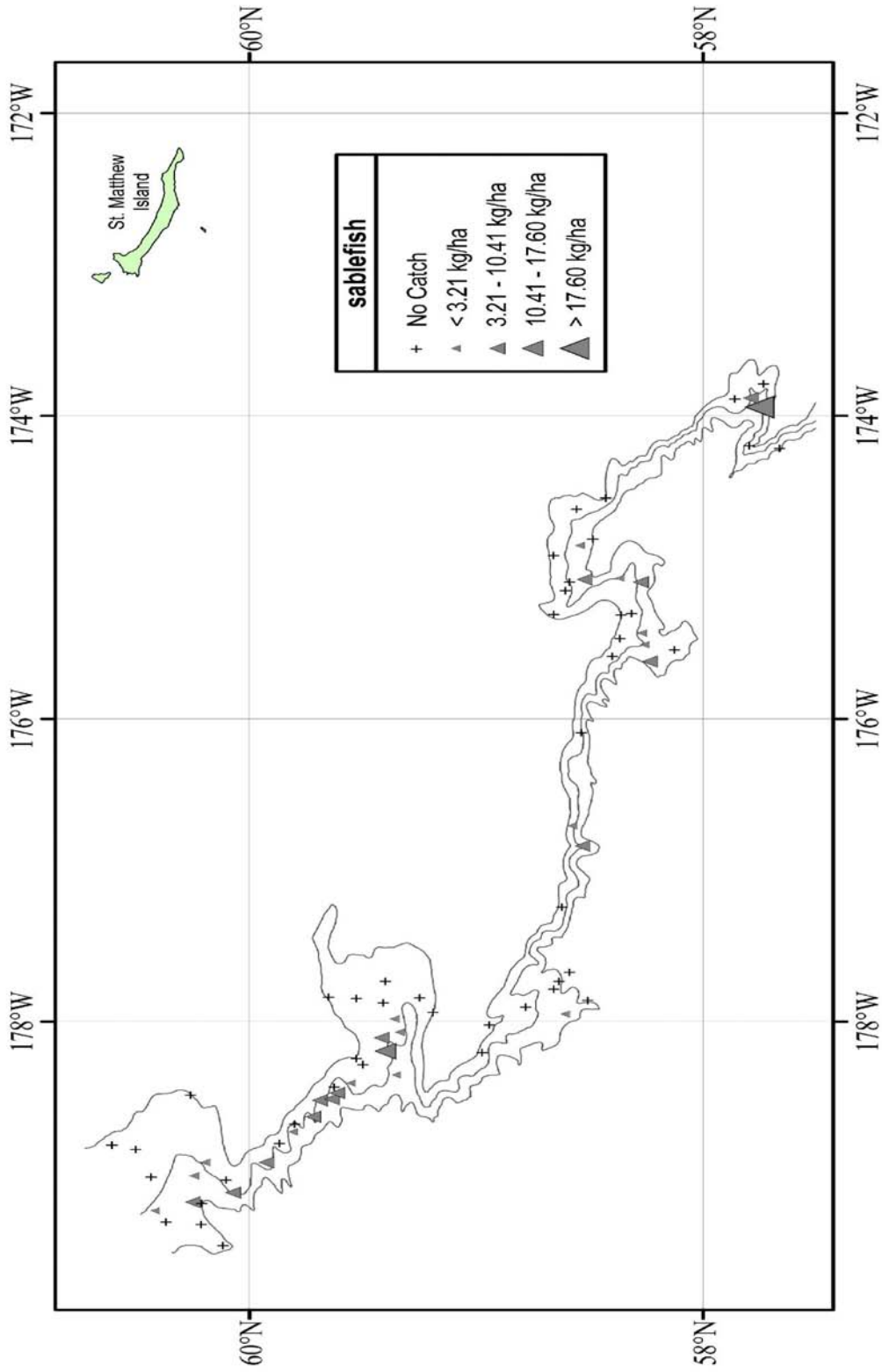

Figure 42. - - Distribution and relative abundance of sablefish from the 2010 EBSS survey. Relative abundance is categorized by no catch, sample CPUE less than the mean CPUE, between the mean CPUE and one standard deviation above the mean, between one and two standard deviations above the mean CPUE, and greater than two standard deviations above the mean CPUE.

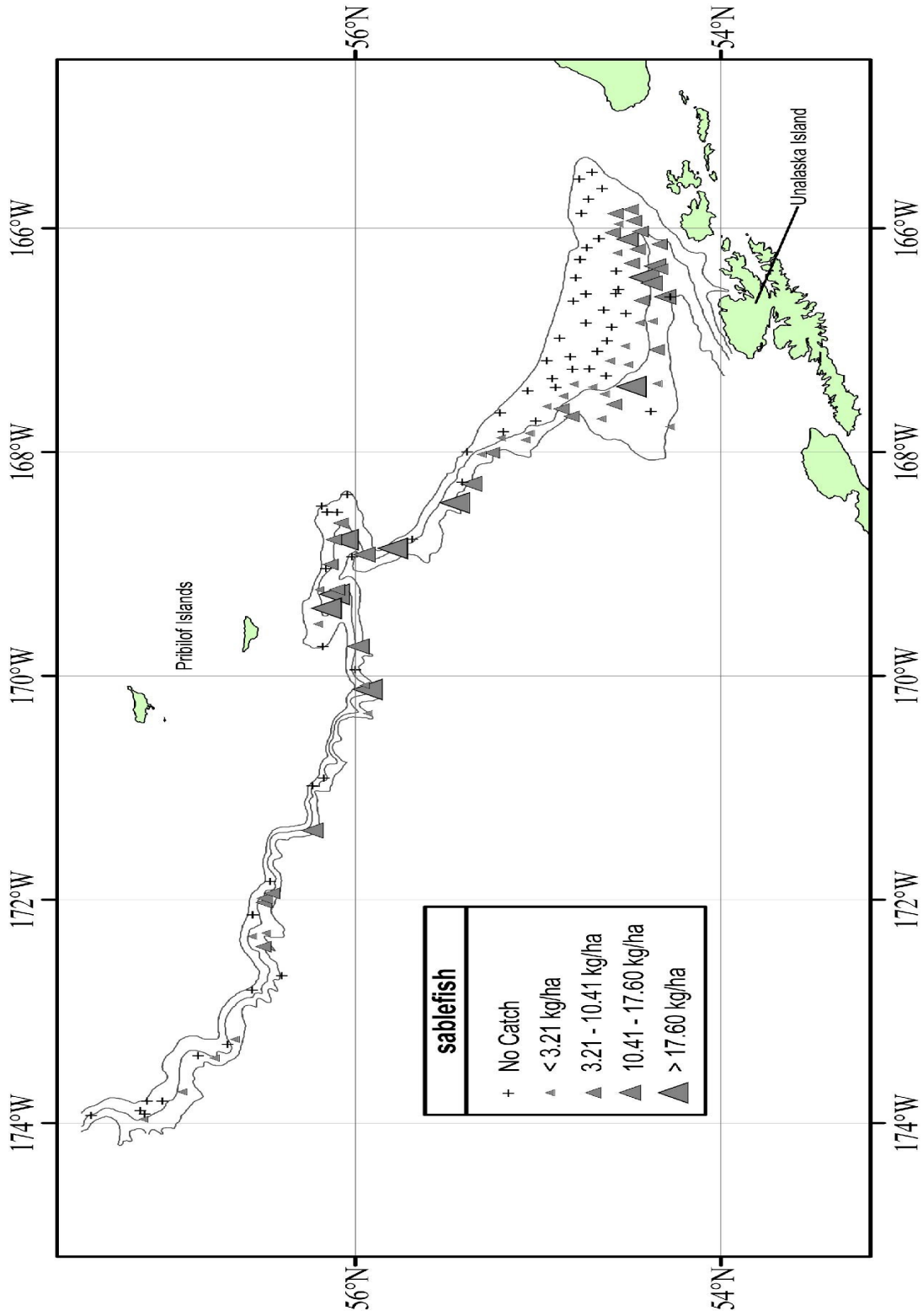

Figure 42. - - Continued.

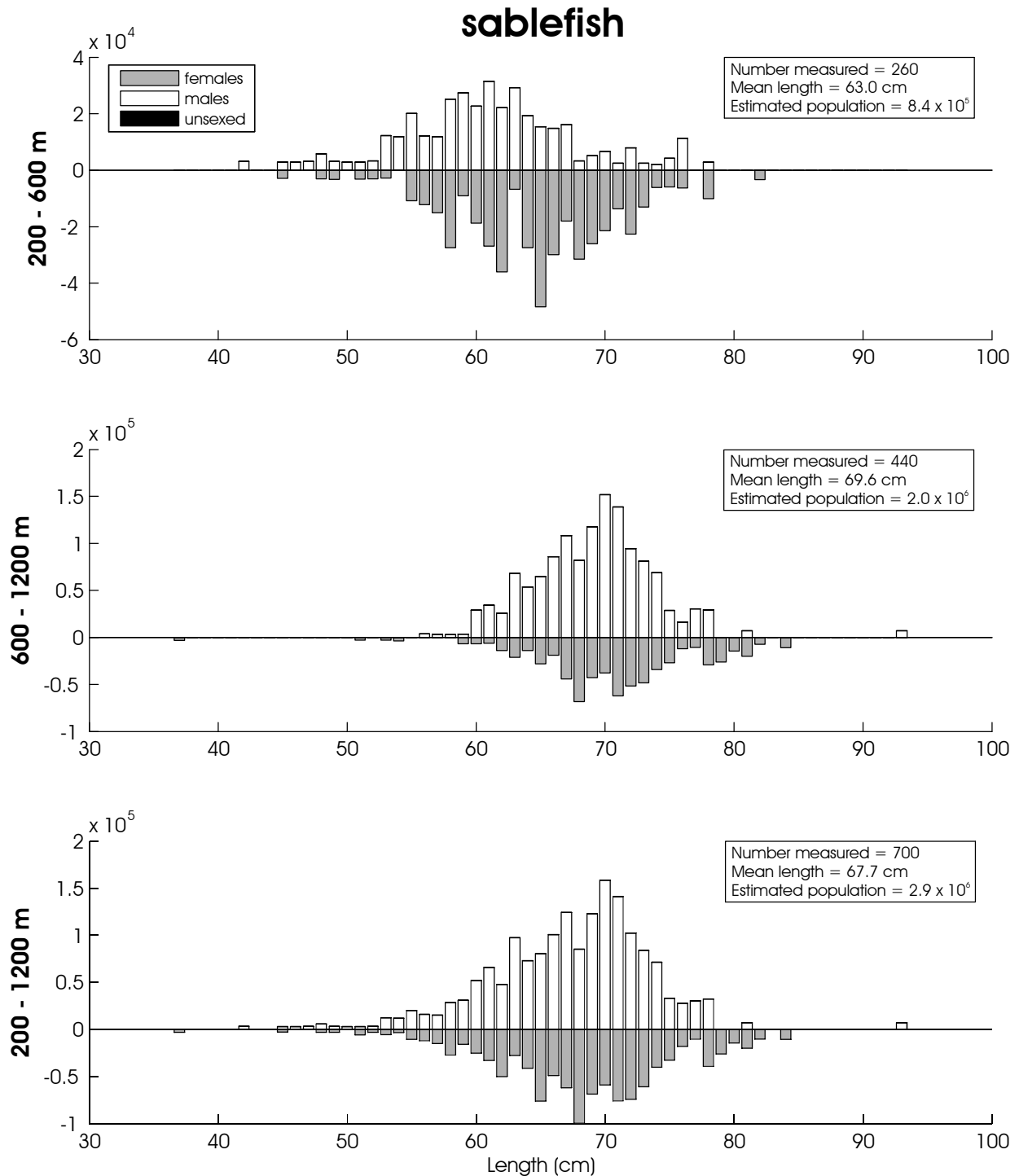

Figure 43. - Size composition of the estimated sablefish population from the 2010 EBSS survey for all subareas by depth. The abscissa is scaled as total length in centimeters while the ordinate represents the estimated total population.

Table 30. - Abundance estimates by subarea and depth strata for bigmouth sculpin (*Hemitripteris bolini*) from the 2010 EBSS survey.

<i>Hemitripteris bolini</i>		bigmouth sculpin					
Subarea	Depth strata (m)	Biomass (t)	Population	Biomass variance	Population variance	Average CPUE (kg/ha)	Average CPUE (no./ha)
1	200-400	1.10E+02	2.00E+04	3.16E+03	8.61E+07	2.74E-01	4.98E-02
	400-600	1.31E+02	2.96E+04	2.64E+03	8.48E+07	3.23E-01	7.28E-02
	600-800	0.00E+00	0.00E+00	0.00E+00	0.00E+00	0.00E+00	0.00E+00
	800-1,000	0.00E+00	0.00E+00	0.00E+00	0.00E+00	0.00E+00	0.00E+00
	1,000-1,200	0.00E+00	0.00E+00	0.00E+00	0.00E+00	0.00E+00	0.00E+00
2	200-400	2.79E+02	6.17E+04	1.20E+04	8.20E+08	2.41E+00	5.33E-01
	400-600	3.40E+02	7.82E+04	7.00E+03	3.30E+08	4.82E+00	1.11E+00
	600-800	2.26E+01	8.29E+03	5.12E+02	6.87E+07	3.83E-01	1.40E-01
	800-1,000	0.00E+00	0.00E+00	0.00E+00	0.00E+00	0.00E+00	0.00E+00
	1,000-1,200	0.00E+00	0.00E+00	0.00E+00	0.00E+00	0.00E+00	0.00E+00
3	200-400	1.15E+02	4.07E+04	3.07E+03	2.80E+08	1.28E+00	4.50E-01
	400-600	2.91E+02	6.17E+04	5.03E+03	1.30E+08	3.28E+00	6.97E-01
	600-800	0.00E+00	0.00E+00	0.00E+00	0.00E+00	0.00E+00	0.00E+00
	800-1,000	0.00E+00	0.00E+00	0.00E+00	0.00E+00	0.00E+00	0.00E+00
	1,000-1,200	0.00E+00	0.00E+00	0.00E+00	0.00E+00	0.00E+00	0.00E+00
4	200-400	4.32E+02	9.68E+04	2.87E+04	8.63E+08	3.49E+00	7.83E-01
	400-600	5.82E+01	1.36E+04	3.32E+03	7.75E+07	7.97E-01	1.86E-01
	600-800	0.00E+00	0.00E+00	0.00E+00	0.00E+00	0.00E+00	0.00E+00
	800-1,000	0.00E+00	0.00E+00	0.00E+00	0.00E+00	0.00E+00	0.00E+00
	1,000-1,200	0.00E+00	0.00E+00	0.00E+00	0.00E+00	0.00E+00	0.00E+00
5	200-400	5.73E+01	1.11E+04	1.22E+03	3.92E+07	1.35E+00	2.61E-01
	400-600	6.94E+01	1.34E+04	4.81E+03	1.79E+08	1.63E+00	3.14E-01
	600-800	0.00E+00	0.00E+00	0.00E+00	0.00E+00	0.00E+00	0.00E+00
	800-1,000	0.00E+00	0.00E+00	0.00E+00	0.00E+00	0.00E+00	0.00E+00
	1,000-1,200	0.00E+00	0.00E+00	0.00E+00	0.00E+00	0.00E+00	0.00E+00
6	200-400	7.81E+02	2.26E+05	3.63E+04	3.40E+09	3.01E+00	8.69E-01
	400-600	4.88E+02	1.21E+05	8.95E+04	4.27E+09	2.86E+00	7.07E-01
	600-800	1.69E+01	8.26E+03	1.99E+02	3.54E+07	1.84E-01	9.01E-02
	800-1,000	0.00E+00	0.00E+00	0.00E+00	0.00E+00	0.00E+00	0.00E+00
	1,000-1,200	0.00E+00	0.00E+00	0.00E+00	0.00E+00	0.00E+00	0.00E+00
1-6	200-1,200	3.19E+03	7.90E+05	1.98E+05	1.07E+10	1.12E+00	2.75E-01

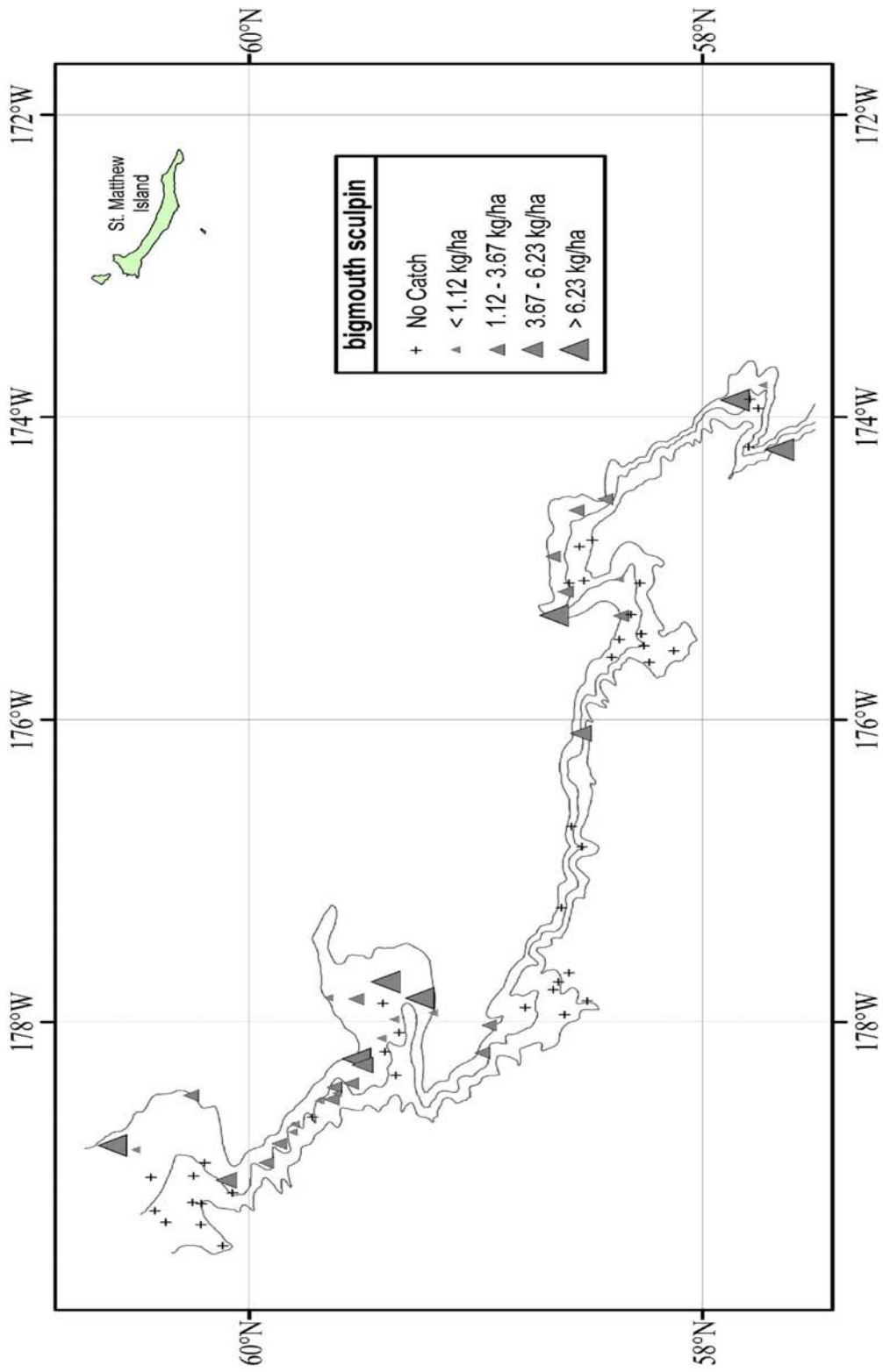

Figure 44. - - Distribution and relative abundance of bigmouth sculpin from the 2010 EBSS survey. Relative abundance is categorized by no catch, sample CPUE less than the mean CPUE, between the mean CPUE and one standard deviation above the mean, between one and two standard deviations above the mean CPUE, and greater than two standard deviations above the mean CPUE.

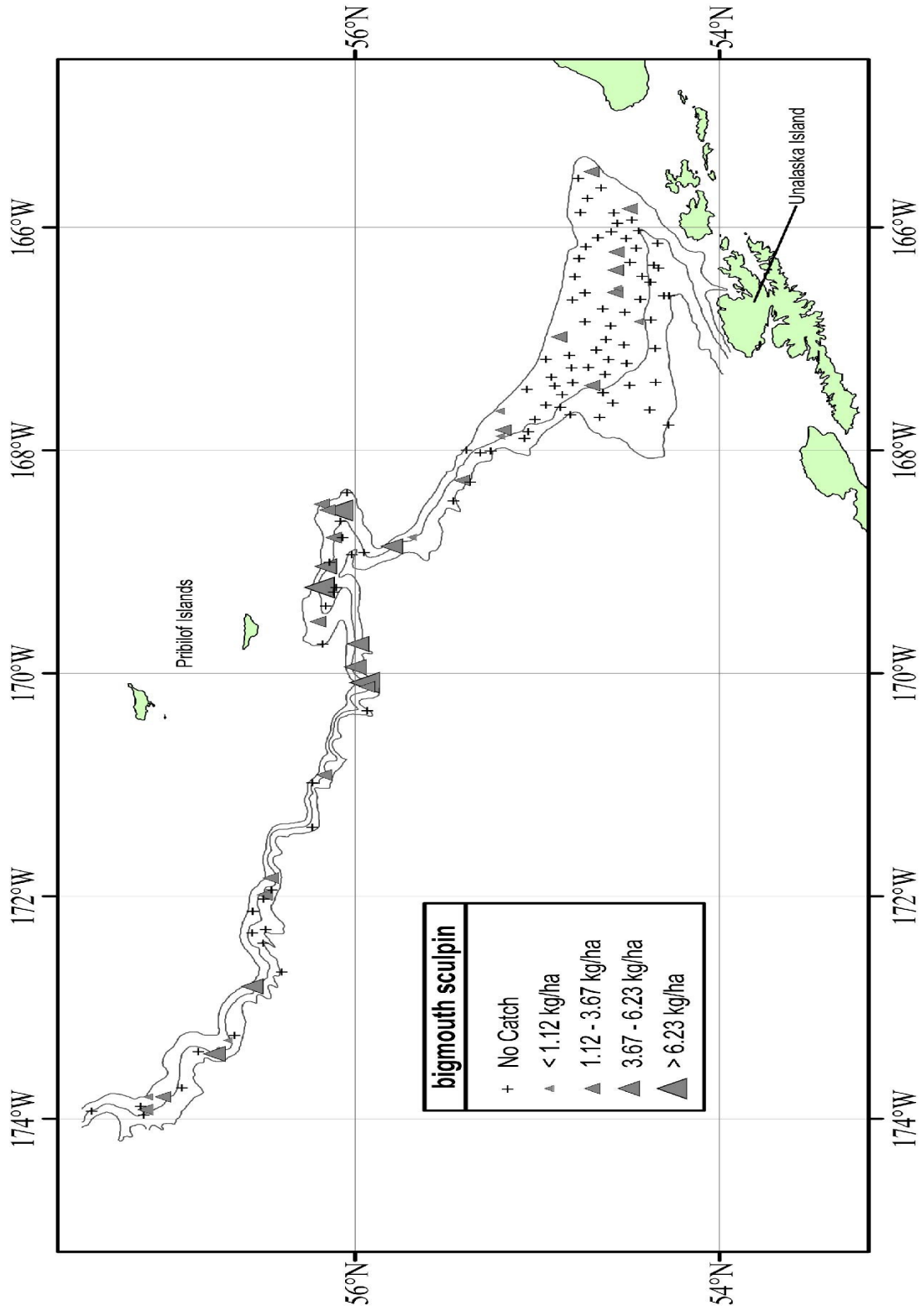

Figure 44. - - Continued.

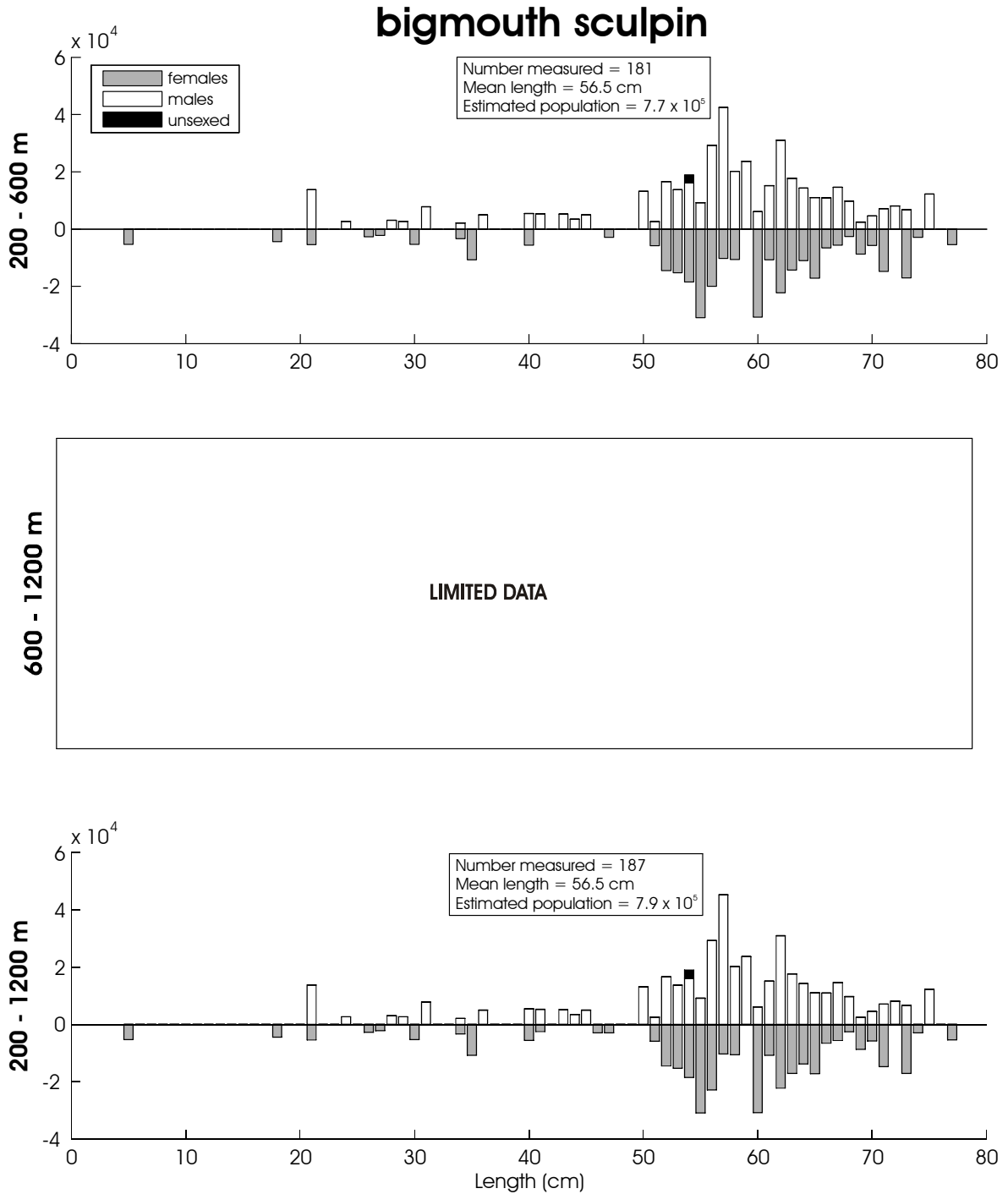

Figure 45. -- Size composition of the estimated bigmouth sculpin population from the 2010 EBSS survey for all subareas by depth. The abscissa is scaled as total length in centimeters while the ordinate represents the estimated total population.

Table 31. - - Abundance estimates by subarea and depth strata for spinyhead sculpin (*Dasycottus setiger*) from the 2010 EBSS survey.

<i>Dasycottus setiger</i>		spinyhead sculpin					
Subarea	Depth strata (m)	Biomass (t)	Population	Biomass variance	Population variance	Average CPUE (kg/ha)	Average CPUE (no./ha)
1	200-400	2.87E+02	1.82E+06	4.16E+03	1.68E+11	7.15E-01	4.54E+00
	400-600	2.02E+01	2.61E+05	2.89E+01	5.12E+09	4.96E-02	6.43E-01
	600-800	1.11E+00	2.07E+04	6.57E-01	2.04E+08	6.40E-03	1.19E-01
	800-1,000	0.00E+00	0.00E+00	0.00E+00	0.00E+00	0.00E+00	0.00E+00
	1,000-1,200	0.00E+00	0.00E+00	0.00E+00	0.00E+00	0.00E+00	0.00E+00
2	200-400	2.80E+00	8.24E+03	7.86E+00	6.80E+07	2.42E-02	7.12E-02
	400-600	9.13E-02	2.54E+03	8.33E-03	6.43E+06	1.29E-03	3.60E-02
	600-800	0.00E+00	0.00E+00	0.00E+00	0.00E+00	0.00E+00	0.00E+00
	800-1,000	0.00E+00	0.00E+00	0.00E+00	0.00E+00	0.00E+00	0.00E+00
	1,000-1,200	0.00E+00	0.00E+00	0.00E+00	0.00E+00	0.00E+00	0.00E+00
3	200-400	2.81E+00	7.44E+04	4.74E+00	3.83E+09	3.11E-02	8.23E-01
	400-600	4.10E-01	1.08E+04	1.68E-01	1.16E+08	4.63E-03	1.22E-01
	600-800	0.00E+00	0.00E+00	0.00E+00	0.00E+00	0.00E+00	0.00E+00
	800-1,000	0.00E+00	0.00E+00	0.00E+00	0.00E+00	0.00E+00	0.00E+00
	1,000-1,200	0.00E+00	0.00E+00	0.00E+00	0.00E+00	0.00E+00	0.00E+00
4	200-400	5.33E+00	4.55E+04	5.78E+00	5.29E+08	4.31E-02	3.68E-01
	400-600	5.44E-01	1.84E+04	1.54E-01	1.71E+08	7.44E-03	2.52E-01
	600-800	0.00E+00	0.00E+00	0.00E+00	0.00E+00	0.00E+00	0.00E+00
	800-1,000	0.00E+00	0.00E+00	0.00E+00	0.00E+00	0.00E+00	0.00E+00
	1,000-1,200	0.00E+00	0.00E+00	0.00E+00	0.00E+00	0.00E+00	0.00E+00
5	200-400	3.80E+00	4.10E+04	8.08E+00	4.24E+08	8.96E-02	9.67E-01
	400-600	8.06E-01	4.61E+04	2.29E-01	8.12E+08	1.89E-02	1.08E+00
	600-800	0.00E+00	0.00E+00	0.00E+00	0.00E+00	0.00E+00	0.00E+00
	800-1,000	0.00E+00	0.00E+00	0.00E+00	0.00E+00	0.00E+00	0.00E+00
	1,000-1,200	0.00E+00	0.00E+00	0.00E+00	0.00E+00	0.00E+00	0.00E+00
6	200-400	4.34E+01	4.19E+05	1.78E+02	1.91E+10	1.67E-01	1.61E+00
	400-600	3.76E+00	8.51E+04	4.98E+00	2.53E+09	2.20E-02	4.99E-01
	600-800	0.00E+00	0.00E+00	0.00E+00	0.00E+00	0.00E+00	0.00E+00
	800-1,000	0.00E+00	0.00E+00	0.00E+00	0.00E+00	0.00E+00	0.00E+00
	1,000-1,200	0.00E+00	0.00E+00	0.00E+00	0.00E+00	0.00E+00	0.00E+00
1-6	200-1,200	3.72E+02	2.85E+06	4.40E+03	2.01E+11	1.02E-01	8.31E-01

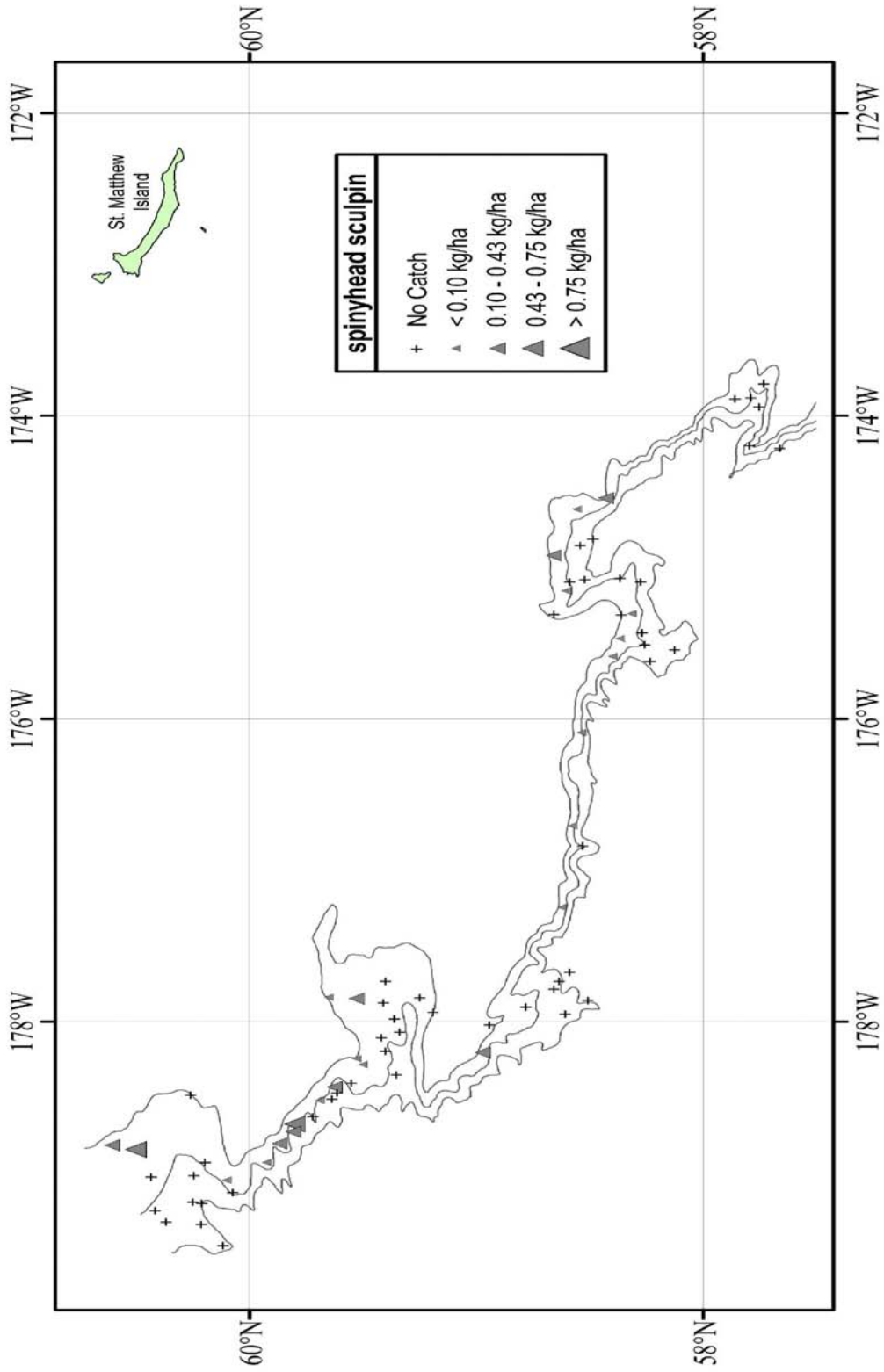

Figure 46. - - Distribution and relative abundance of spinyhead sculpin from the 2010 EBSS survey. Relative abundance is categorized by no catch, sample CPUE less than the mean CPUE, between the mean CPUE and one standard deviation above the mean, between one and two standard deviations above the mean CPUE, and greater than two standard deviations above the mean CPUE.

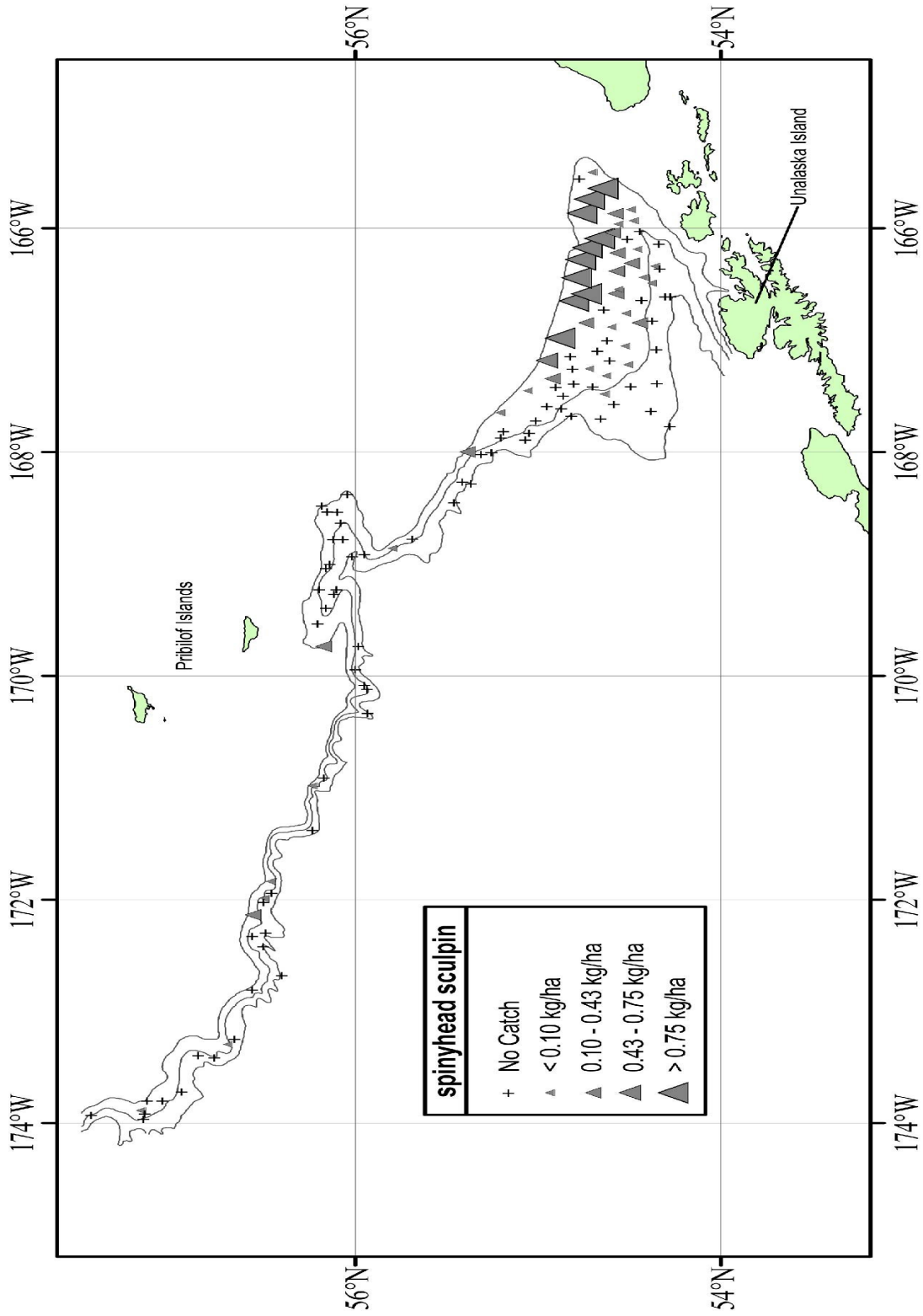

Figure 46. - - Continued.

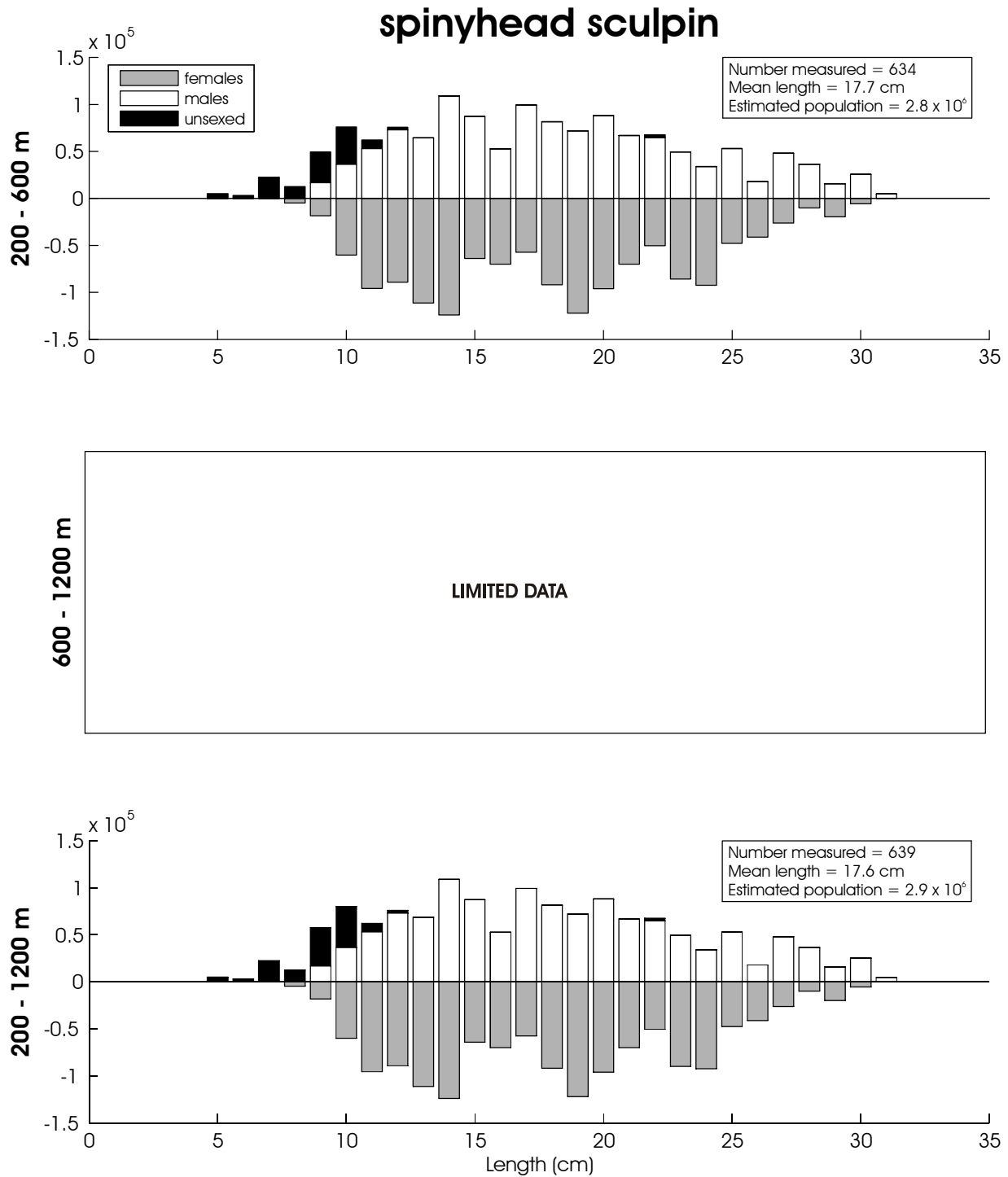

Figure 47. - - Size composition of the estimated spinyhead sculpin population from the 2010 EBSS survey for all subareas by depth. The abscissa is scaled as total length in centimeters while the ordinate represents the estimated total population.

Table 32. - - Abundance estimates by subarea and depth strata for darkfin sculpin
(*Malacocottus zonurus*) from the 2010 EBSS survey.

<i>Malacocottus zonurus</i>						darkfin sculpin	
Subarea	Depth strata (m)	Biomass (t)	Population	Biomass variance	Population variance	Average CPUE (kg/ha)	Average CPUE (no./ha)
1	200-400	6.91E+01	5.16E+05	1.16E+03	6.82E+10	1.72E-01	1.29E+00
	400-600	1.02E+01	4.33E+05	3.79E+00	6.15E+09	2.51E-02	1.07E+00
	600-800	7.88E+00	1.77E+05	1.25E+01	5.01E+09	4.53E-02	1.01E+00
	800-1,000	7.69E+00	9.72E+04	5.92E+01	9.46E+09	5.68E-02	7.18E-01
	1,000-1,200	3.33E-01	9.24E+03	1.11E-01	8.54E+07	3.01E-03	8.35E-02
2	200-400	5.75E+02	2.38E+06	2.18E+05	2.42E+12	4.97E+00	2.06E+01
	400-600	7.48E+01	1.23E+06	3.95E+03	1.04E+12	1.06E+00	1.74E+01
	600-800	2.44E-01	1.22E+04	5.96E-02	1.49E+08	4.13E-03	2.06E-01
	800-1,000	0.00E+00	0.00E+00	0.00E+00	0.00E+00	0.00E+00	0.00E+00
	1,000-1,200	0.00E+00	0.00E+00	0.00E+00	0.00E+00	0.00E+00	0.00E+00
3	200-400	7.09E+01	8.34E+05	1.39E+03	1.52E+11	7.85E-01	9.22E+00
	400-600	3.99E-01	1.08E+04	1.59E-01	1.16E+08	4.50E-03	1.22E-01
	600-800	0.00E+00	0.00E+00	0.00E+00	0.00E+00	0.00E+00	0.00E+00
	800-1,000	0.00E+00	0.00E+00	0.00E+00	0.00E+00	0.00E+00	0.00E+00
	1,000-1,200	0.00E+00	0.00E+00	0.00E+00	0.00E+00	0.00E+00	0.00E+00
4	200-400	1.04E+02	9.56E+05	4.74E+03	1.95E+11	8.37E-01	7.73E+00
	400-600	1.83E+00	2.30E+04	2.54E+00	1.91E+08	2.50E-02	3.15E-01
	600-800	0.00E+00	0.00E+00	0.00E+00	0.00E+00	0.00E+00	0.00E+00
	800-1,000	0.00E+00	0.00E+00	0.00E+00	0.00E+00	0.00E+00	0.00E+00
	1,000-1,200	0.00E+00	0.00E+00	0.00E+00	0.00E+00	0.00E+00	0.00E+00
5	200-400	5.02E+00	7.90E+04	3.31E+00	3.45E+08	1.19E-01	1.87E+00
	400-600	3.87E+00	1.12E+05	5.30E+00	2.80E+09	9.08E-02	2.64E+00
	600-800	0.00E+00	0.00E+00	0.00E+00	0.00E+00	0.00E+00	0.00E+00
	800-1,000	0.00E+00	0.00E+00	0.00E+00	0.00E+00	0.00E+00	0.00E+00
	1,000-1,200	0.00E+00	0.00E+00	0.00E+00	0.00E+00	0.00E+00	0.00E+00
6	200-400	7.57E+01	6.61E+05	5.74E+02	3.10E+10	2.92E-01	2.55E+00
	400-600	7.03E+01	1.00E+06	1.54E+03	3.52E+11	4.12E-01	5.89E+00
	600-800	4.93E+00	1.81E+05	1.29E+01	2.22E+10	5.37E-02	1.97E+00
	800-1,000	0.00E+00	0.00E+00	0.00E+00	0.00E+00	0.00E+00	0.00E+00
	1,000-1,200	0.00E+00	0.00E+00	0.00E+00	0.00E+00	0.00E+00	0.00E+00
1-6	200-1,200	1.08E+03	8.71E+06	2.31E+05	4.31E+12	3.77E-01	3.38E+00

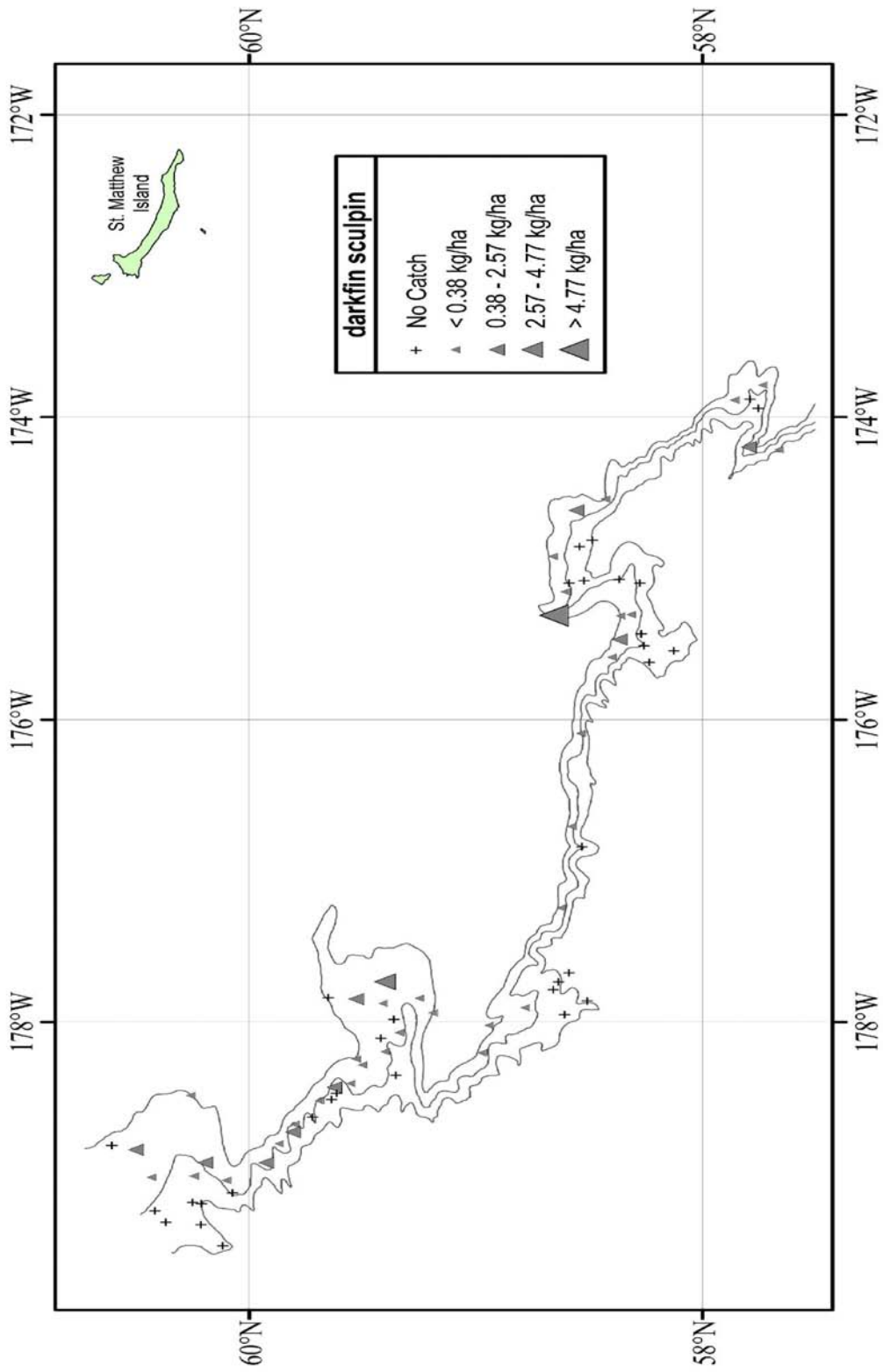

Figure 48. - - Distribution and relative abundance of darkfin sculpin from the 2010 EBSS survey. Relative abundance is categorized by no catch, sample CPUE less than the mean CPUE, between the mean CPUE and one standard deviation above the mean, between one and two standard deviations above the mean CPUE, and greater than two standard deviations above the mean CPUE.

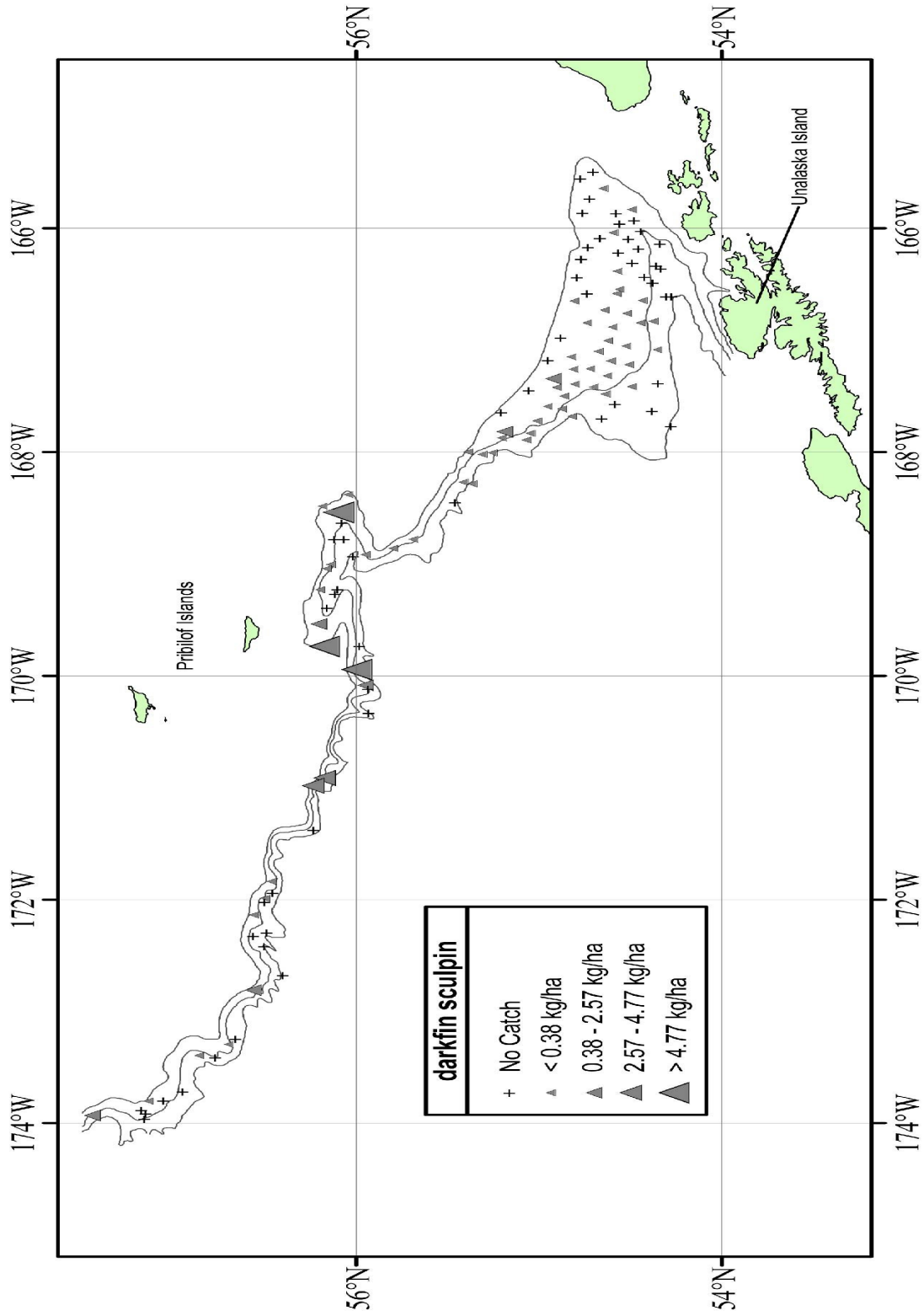

Figure 48. - - Continued.

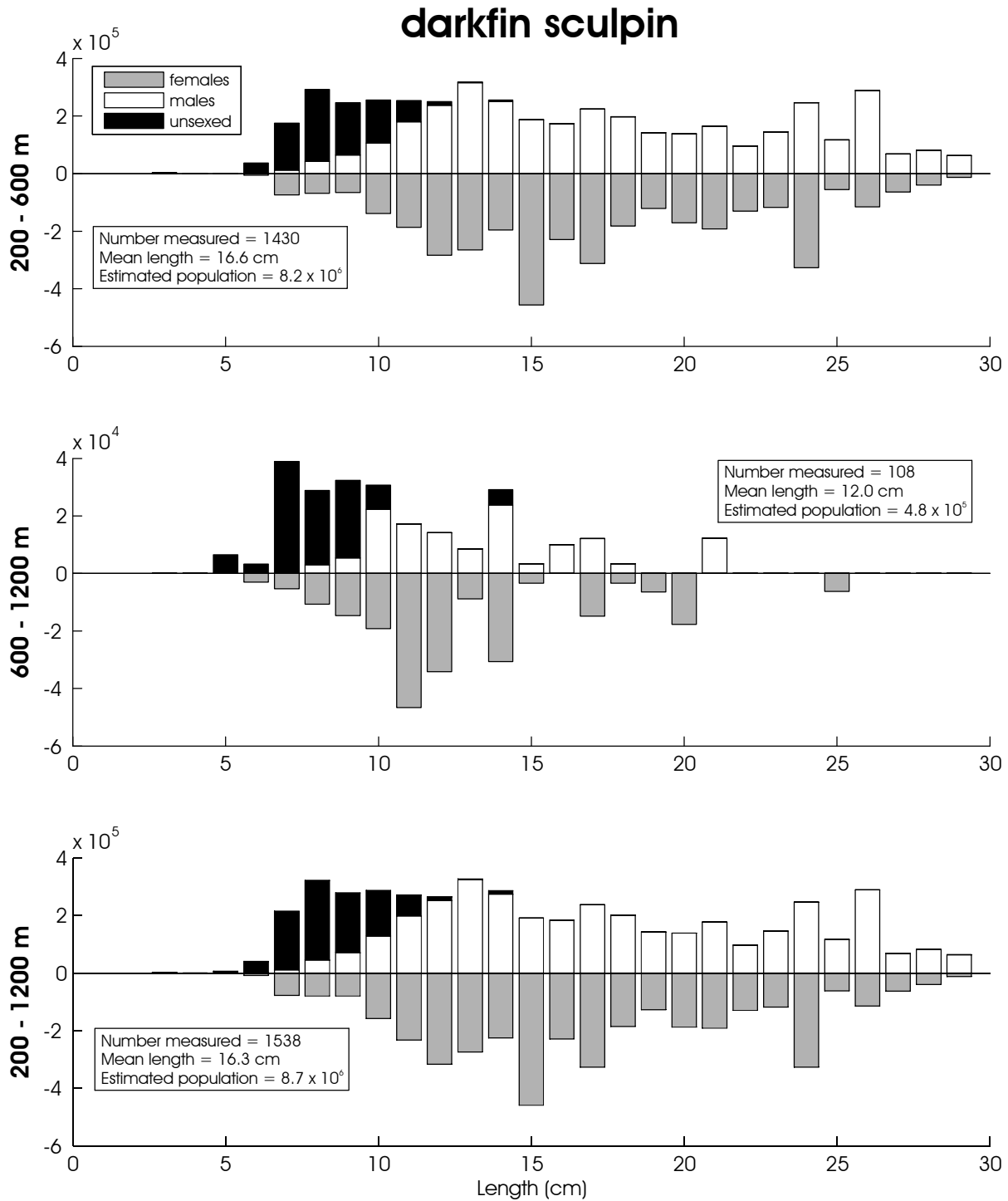

Figure 49. - - Size composition of the estimated darkfin sculpin population from the 2010 EBSS survey for all subareas by depth. The abscissa is scaled as total length in centimeters while the ordinate represents the estimated total population.

Table 33. - - Abundance estimates by subarea and depth strata for blob sculpin
(*Psychrolutes phrictus*) from the 2010 EBSS survey.

<i>Psychrolutes phrictus</i>		blob sculpin					
Subarea	Depth strata (m)	Biomass (t)	Population	Biomass variance	Population variance	Average CPUE (kg/ha)	Average CPUE (no./ha)
1	200-400	0.00E+00	0.00E+00	0.00E+00	0.00E+00	0.00E+00	0.00E+00
	400-600	0.00E+00	0.00E+00	0.00E+00	0.00E+00	0.00E+00	0.00E+00
	600-800	1.06E+01	3.32E+03	1.11E+02	1.10E+07	6.06E-02	1.91E-02
	800-1,000	2.19E+02	6.66E+04	2.44E+04	2.52E+09	1.61E+00	4.92E-01
	1,000-1,200	8.55E+02	1.55E+05	1.35E+05	2.62E+09	7.72E+00	1.40E+00
2	200-400	0.00E+00	0.00E+00	0.00E+00	0.00E+00	0.00E+00	0.00E+00
	400-600	0.00E+00	0.00E+00	0.00E+00	0.00E+00	0.00E+00	0.00E+00
	600-800	0.00E+00	0.00E+00	0.00E+00	0.00E+00	0.00E+00	0.00E+00
	800-1,000	0.00E+00	0.00E+00	0.00E+00	0.00E+00	0.00E+00	0.00E+00
	1,000-1,200	2.20E+02	5.07E+04	1.05E+04	1.21E+09	4.10E+00	9.47E-01
3	200-400	0.00E+00	0.00E+00	0.00E+00	0.00E+00	0.00E+00	0.00E+00
	400-600	0.00E+00	0.00E+00	0.00E+00	0.00E+00	0.00E+00	0.00E+00
	600-800	0.00E+00	0.00E+00	0.00E+00	0.00E+00	0.00E+00	0.00E+00
	800-1,000	3.80E+02	7.82E+04	1.44E+05	6.12E+09	5.19E+00	1.07E+00
	1,000-1,200	5.16E+02	1.35E+05	2.46E+04	6.73E+08	7.64E+00	2.00E+00
4	200-400	0.00E+00	0.00E+00	0.00E+00	0.00E+00	0.00E+00	0.00E+00
	400-600	0.00E+00	0.00E+00	0.00E+00	0.00E+00	0.00E+00	0.00E+00
	600-800	0.00E+00	0.00E+00	0.00E+00	0.00E+00	0.00E+00	0.00E+00
	800-1,000	1.41E+02	4.52E+04	5.27E+03	3.13E+08	1.99E+00	6.38E-01
	1,000-1,200	3.90E+02	1.14E+05	1.05E+04	7.11E+08	5.88E+00	1.72E+00
5	200-400	0.00E+00	0.00E+00	0.00E+00	0.00E+00	0.00E+00	0.00E+00
	400-600	0.00E+00	0.00E+00	0.00E+00	0.00E+00	0.00E+00	0.00E+00
	600-800	0.00E+00	0.00E+00	0.00E+00	0.00E+00	0.00E+00	0.00E+00
	800-1,000	3.23E+02	2.63E+05	1.04E+05	6.92E+10	5.85E+00	4.77E+00
	1,000-1,200	2.72E+02	7.56E+04	4.04E+04	1.95E+09	4.76E+00	1.33E+00
6	200-400	0.00E+00	0.00E+00	0.00E+00	0.00E+00	0.00E+00	0.00E+00
	400-600	0.00E+00	0.00E+00	0.00E+00	0.00E+00	0.00E+00	0.00E+00
	600-800	0.00E+00	0.00E+00	0.00E+00	0.00E+00	0.00E+00	0.00E+00
	800-1,000	0.00E+00	0.00E+00	0.00E+00	0.00E+00	0.00E+00	0.00E+00
	1,000-1,200	0.00E+00	0.00E+00	0.00E+00	0.00E+00	0.00E+00	0.00E+00
1-6	200-1,200	3.32E+03	9.87E+05	5.00E+05	8.54E+10	5.34E-01	1.66E-01

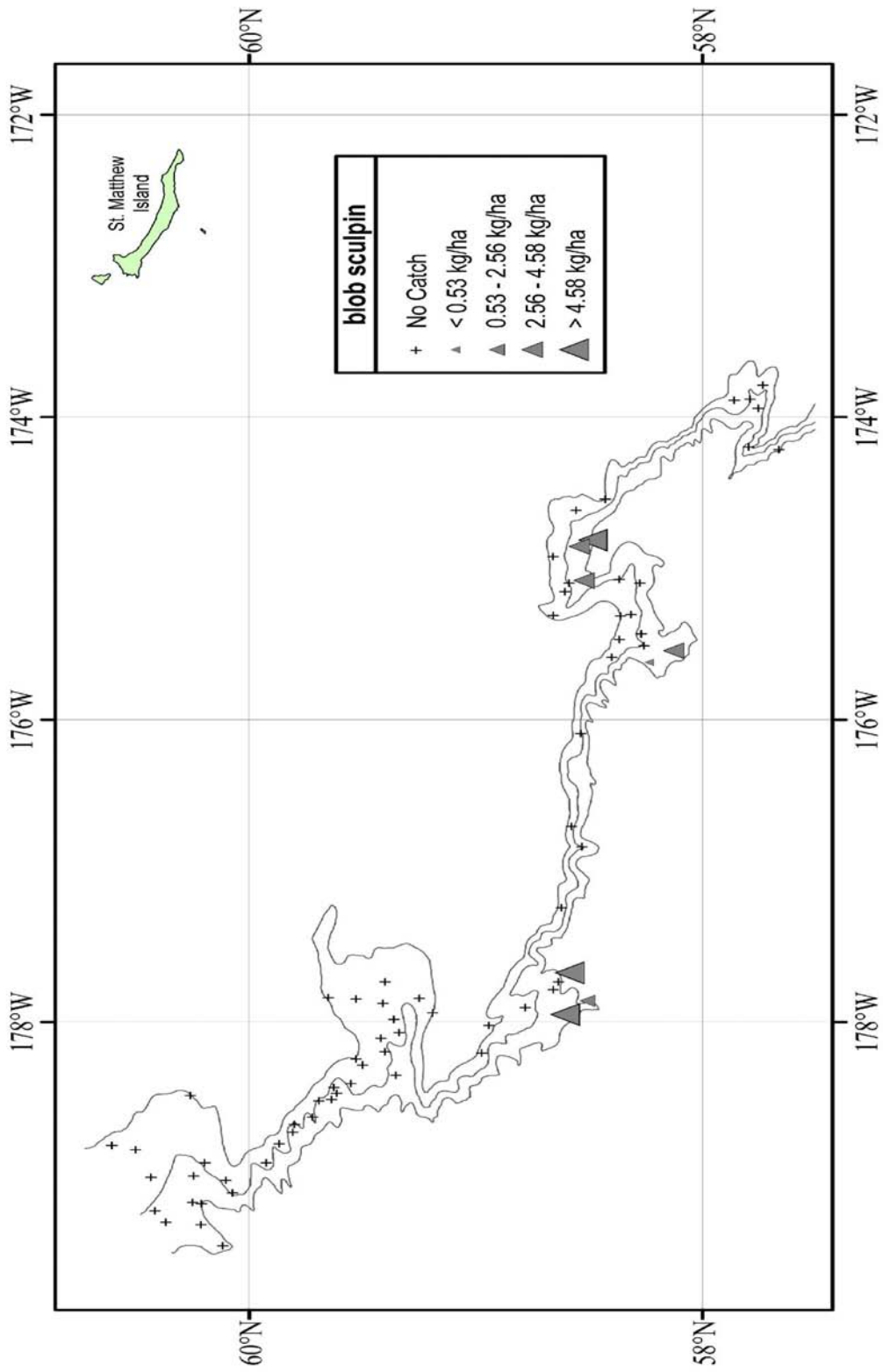

Figure 50. - - Distribution and relative abundance of blob sculpin from the 2010 EBSS survey. Relative abundance is categorized by no catch, sample CPUE less than the mean CPUE, between the mean CPUE and one standard deviation above the mean, between one and two standard deviations above the mean CPUE, and greater than two standard deviations above the mean CPUE.

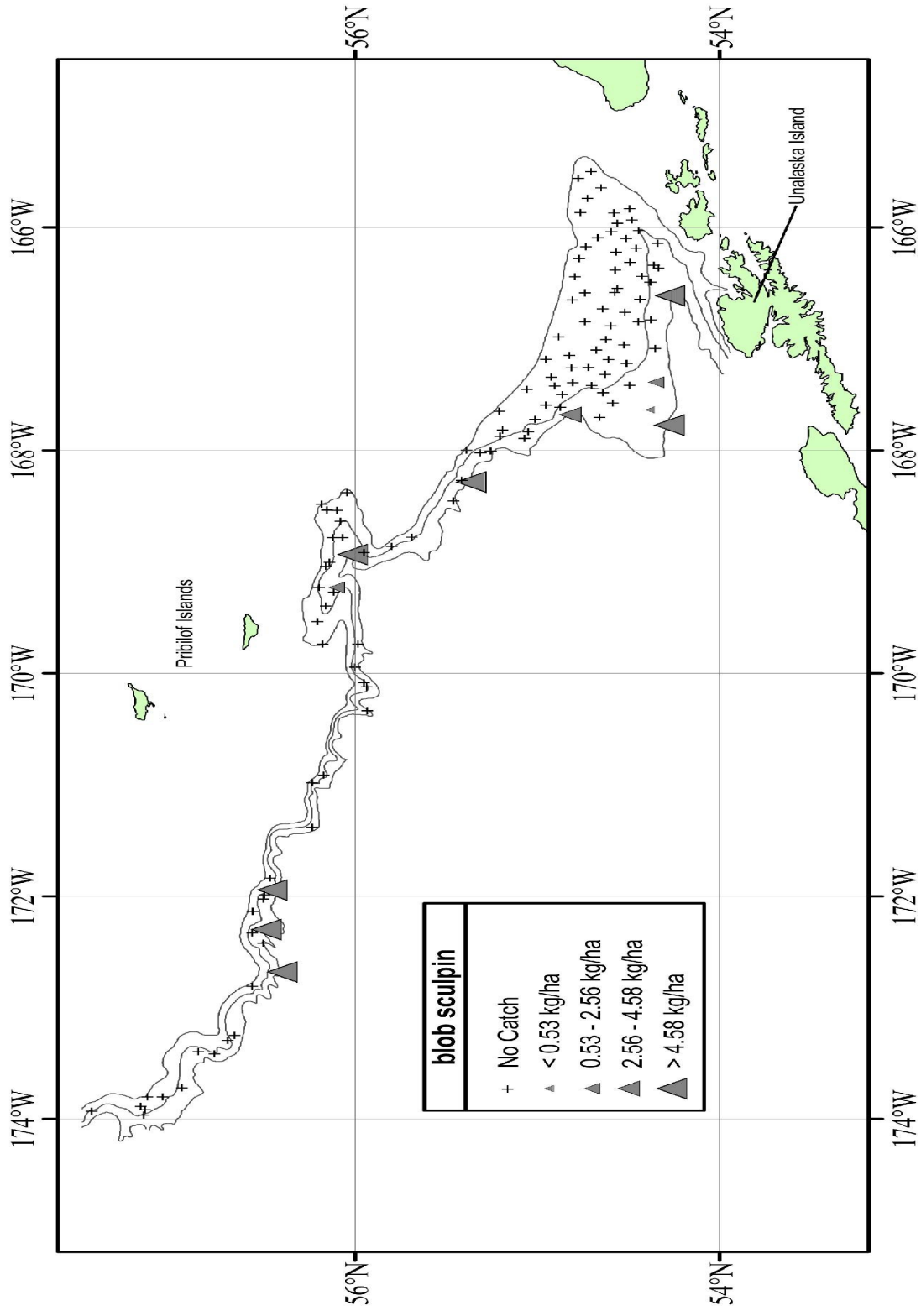

Figure 50. - - Continued.

blob sculpin

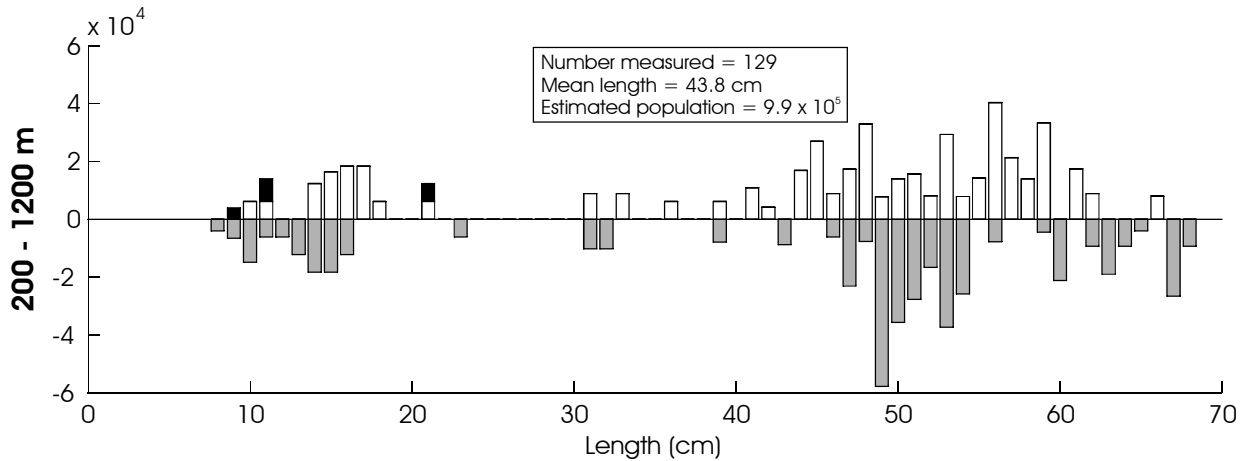
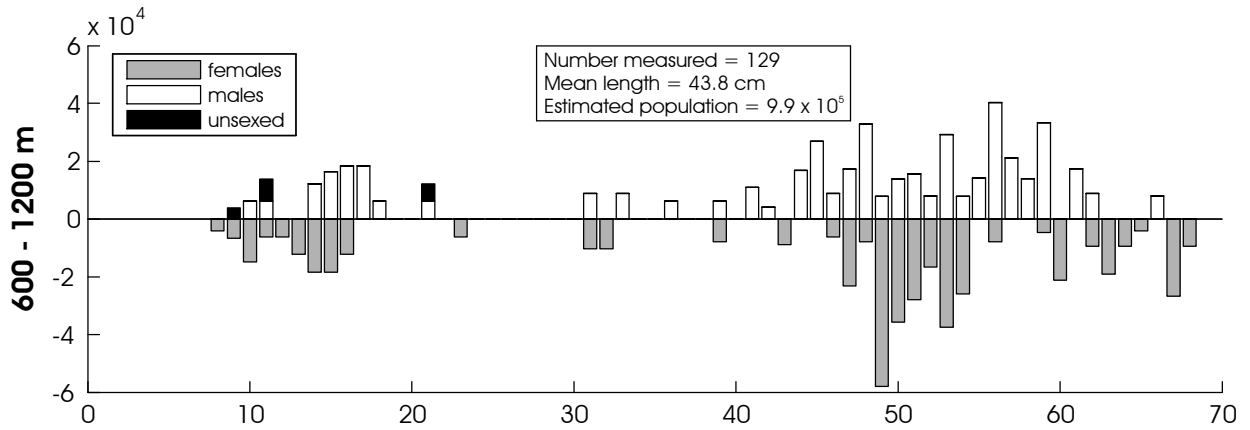
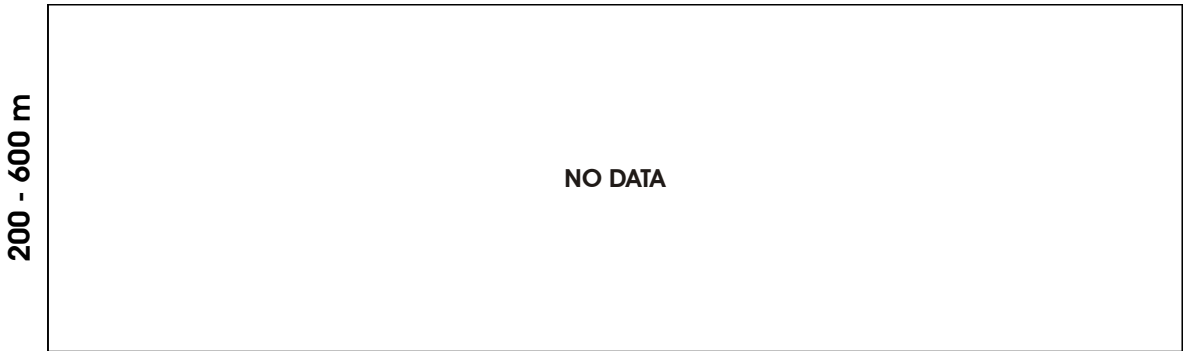

Figure 51. - - Size composition of the estimated blob sculpin population from the 2010 EBSS survey for all subareas by depth. The abscissa is scaled as total length in centimeters while the ordinate represents the estimated total population.

Table 34. - - Abundance estimates by subarea and depth strata for blacktail snailfish (*Careproctus melanurus*) from the 2010 EBSS survey.

<i>Careproctus melanurus</i>		blacktail snailfish					
Subarea	Depth strata (m)	Biomass (t)	Population	Biomass variance	Population variance	Average CPUE (kg/ha)	Average CPUE (no./ha)
1	200-400	0.00E+00	0.00E+00	0.00E+00	0.00E+00	0.00E+00	0.00E+00
	400-600	6.74E+00	8.79E+03	1.62E+01	2.44E+07	1.66E-02	2.16E-02
	600-800	5.63E+01	1.04E+05	3.03E+02	9.08E+08	3.23E-01	5.99E-01
	800-1,000	3.15E+01	9.27E+04	1.85E+02	6.48E+08	2.33E-01	6.84E-01
	1,000-1,200	5.73E+00	2.89E+04	3.63E+00	9.25E+05	5.18E-02	2.61E-01
2	200-400	0.00E+00	0.00E+00	0.00E+00	0.00E+00	0.00E+00	0.00E+00
	400-600	3.48E+01	3.27E+04	3.65E+02	3.02E+08	4.93E-01	4.63E-01
	600-800	1.30E+01	3.40E+04	9.80E+01	5.24E+08	2.20E-01	5.74E-01
	800-1,000	2.70E+00	2.71E+04	7.28E+00	7.36E+08	4.88E-02	4.91E-01
	1,000-1,200	0.00E+00	0.00E+00	0.00E+00	0.00E+00	0.00E+00	0.00E+00
3	200-400	2.38E+00	2.25E+03	5.68E+00	5.07E+06	2.64E-02	2.49E-02
	400-600	0.00E+00	0.00E+00	0.00E+00	0.00E+00	0.00E+00	0.00E+00
	600-800	9.17E+01	1.97E+05	9.94E+02	3.44E+09	1.01E+00	2.16E+00
	800-1,000	1.89E+01	1.06E+05	3.40E+01	3.63E+08	2.58E-01	1.45E+00
	1,000-1,200	4.04E+00	1.61E+04	1.63E+01	2.59E+08	5.98E-02	2.38E-01
4	200-400	1.41E+01	8.67E+03	1.99E+02	7.52E+07	1.14E-01	7.02E-02
	400-600	2.54E+01	3.97E+04	5.88E+02	1.14E+09	3.48E-01	5.43E-01
	600-800	1.50E+01	1.88E+04	7.88E+01	1.20E+08	2.16E-01	2.70E-01
	800-1,000	5.96E+01	1.14E+05	2.13E+03	3.80E+09	8.42E-01	1.61E+00
	1,000-1,200	6.43E+00	1.09E+04	4.13E+01	1.19E+08	9.70E-02	1.65E-01
5	200-400	0.00E+00	0.00E+00	0.00E+00	0.00E+00	0.00E+00	0.00E+00
	400-600	1.50E+01	3.02E+04	1.34E+00	8.59E+07	3.53E-01	7.09E-01
	600-800	2.49E-01	2.65E+04	6.20E-02	7.02E+08	5.77E-03	6.13E-01
	800-1,000	1.24E+00	1.26E+04	1.54E+00	1.60E+08	2.25E-02	2.29E-01
	1,000-1,200	0.00E+00	0.00E+00	0.00E+00	0.00E+00	0.00E+00	0.00E+00
6	200-400	0.00E+00	0.00E+00	0.00E+00	0.00E+00	0.00E+00	0.00E+00
	400-600	2.14E+01	8.06E+04	2.80E+02	5.41E+09	1.25E-01	4.73E-01
	600-800	3.43E+01	1.36E+05	2.85E+02	3.90E+09	3.73E-01	1.48E+00
	800-1,000	3.97E+00	1.52E+04	1.57E+01	2.31E+08	6.15E-02	2.36E-01
	1,000-1,200	0.00E+00	0.00E+00	0.00E+00	0.00E+00	0.00E+00	0.00E+00
1-6	200-1,200	4.64E+02	1.14E+06	5.65E+03	2.30E+10	1.55E-01	3.49E-01

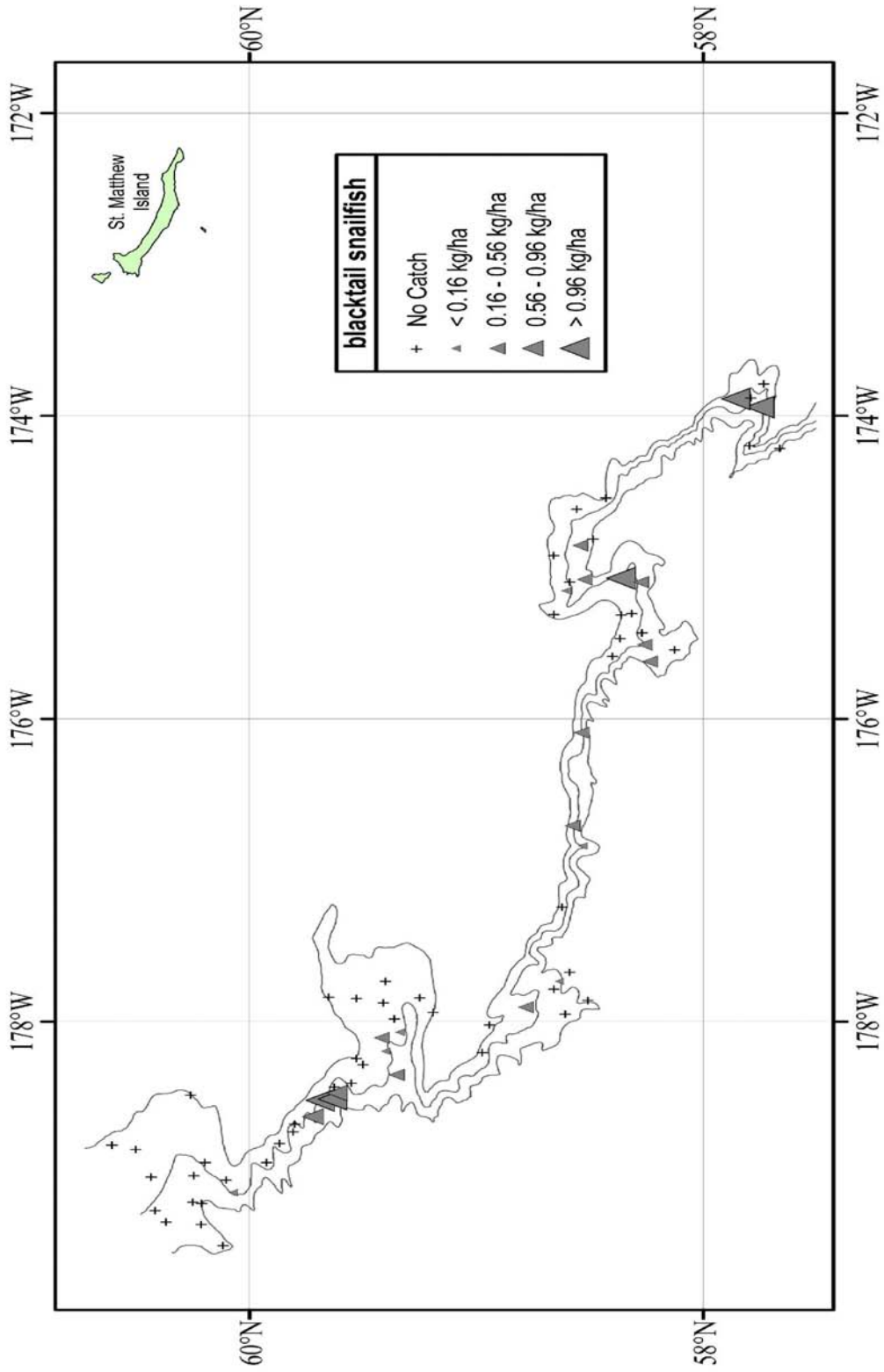

Figure 52. - - Distribution and relative abundance of blacktail snailfish from the 2010 EBSS survey. Relative abundance is categorized by no catch, sample CPUE less than the mean CPUE, between the mean CPUE and one standard deviation above the mean, between one and two standard deviations above the mean CPUE, and greater than two standard deviations above the mean CPUE.

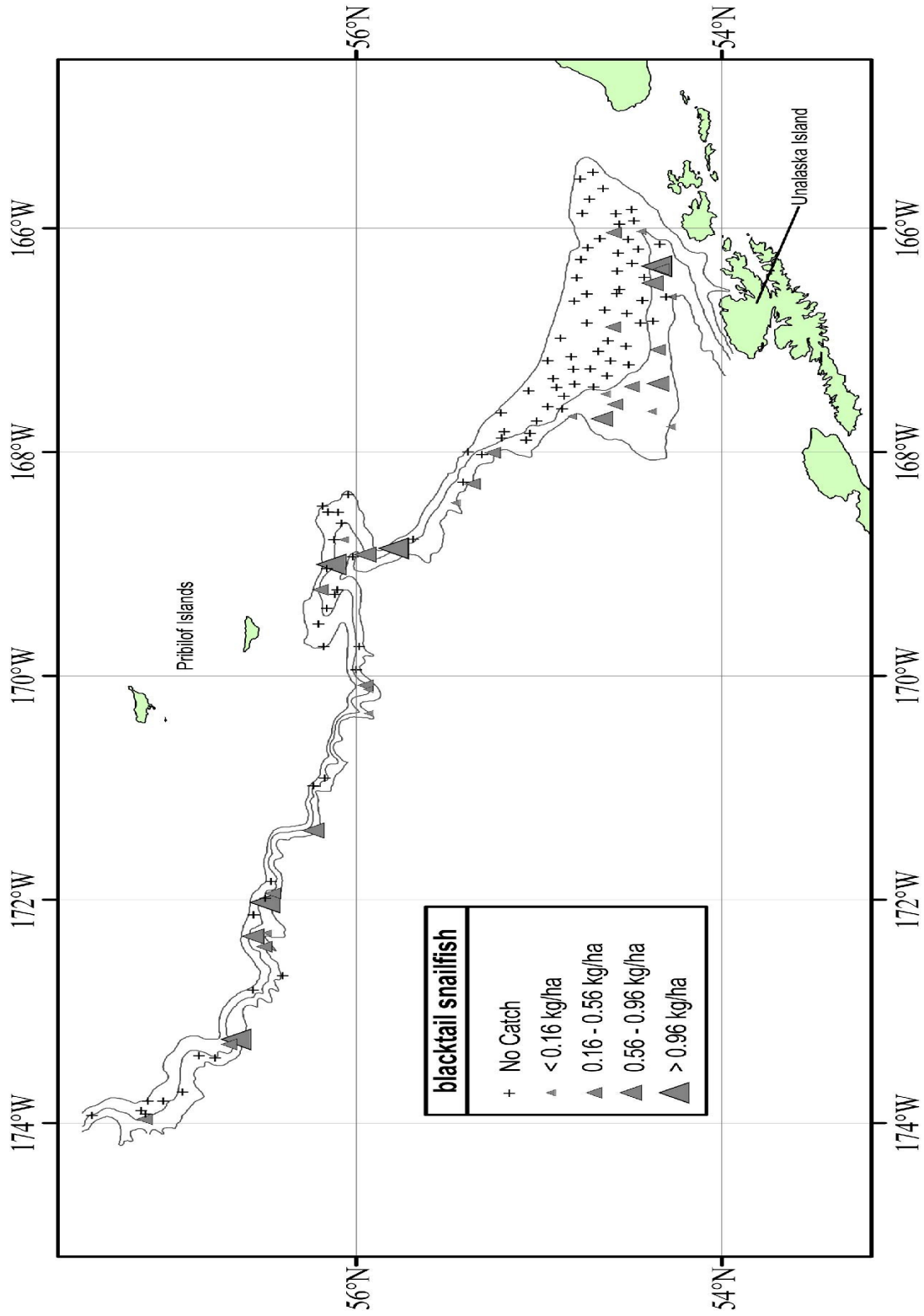

Figure 52. - - Continued.

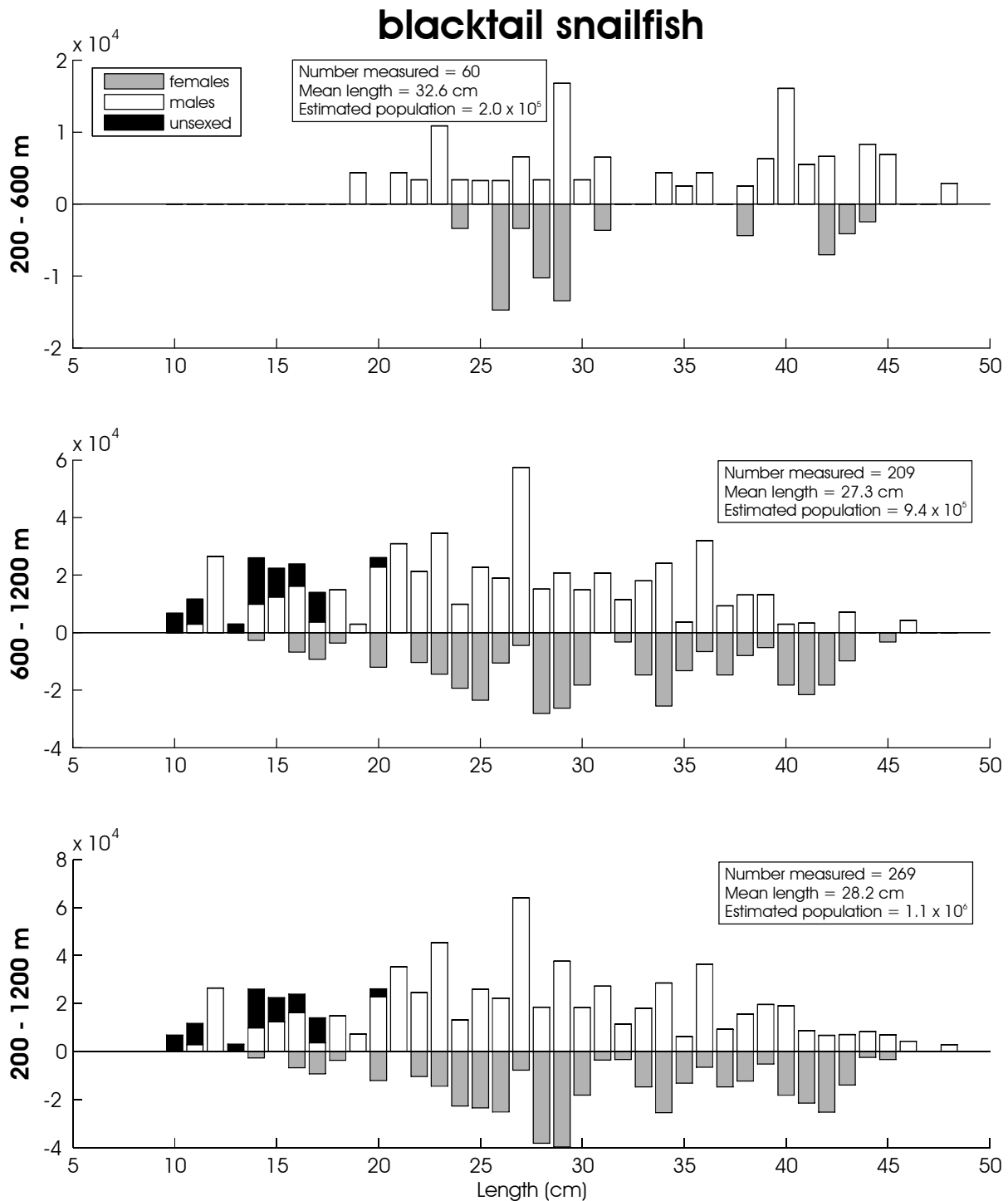

Figure 53. - Size composition of the estimated blacktail snailfish population from the 2010 EBSS survey for all subareas by depth. The abscissa is scaled as total length in centimeters while the ordinate represents the estimated total population.

Table 35. - Abundance estimates by subarea and depth strata for Bering eelpout (*Lycodes beringi*) from the 2010 EBSS survey.

<i>Lycodes beringi</i>		Bering eelpout					
Subarea	Depth strata (m)	Biomass (t)	Population	Biomass variance	Population variance	Average CPUE (kg/ha)	Average CPUE (no./ha)
1	200-400	4.19E+00	6.06E+04	2.97E+00	6.68E+08	1.04E-02	1.51E-01
	400-600	3.42E+01	5.99E+05	6.67E+01	1.89E+10	8.41E-02	1.47E+00
	600-800	9.51E+00	2.89E+05	1.17E+01	8.31E+09	5.46E-02	1.66E+00
	800-1,000	2.93E+01	7.19E+05	8.16E+01	4.72E+10	2.16E-01	5.31E+00
	1,000-1,200	4.56E+00	1.23E+05	2.08E+01	1.52E+10	4.12E-02	1.11E+00
2	200-400	3.95E+00	6.02E+04	1.56E+01	3.62E+09	3.42E-02	5.20E-01
	400-600	1.55E+01	2.75E+05	2.26E+01	5.67E+09	2.20E-01	3.89E+00
	600-800	2.01E+00	3.66E+04	1.16E+00	2.51E+08	3.40E-02	6.19E-01
	800-1,000	0.00E+00	0.00E+00	0.00E+00	0.00E+00	0.00E+00	0.00E+00
	1,000-1,200	0.00E+00	0.00E+00	0.00E+00	0.00E+00	0.00E+00	0.00E+00
3	200-400	4.07E-01	7.13E+03	7.70E-02	2.62E+07	4.51E-03	7.89E-02
	400-600	1.57E+00	2.24E+04	8.27E-01	1.67E+08	1.77E-02	2.52E-01
	600-800	1.20E+01	2.11E+05	3.42E+01	9.02E+09	1.32E-01	2.31E+00
	800-1,000	0.00E+00	0.00E+00	0.00E+00	0.00E+00	0.00E+00	0.00E+00
	1,000-1,200	0.00E+00	0.00E+00	0.00E+00	0.00E+00	0.00E+00	0.00E+00
4	200-400	0.00E+00	0.00E+00	0.00E+00	0.00E+00	0.00E+00	0.00E+00
	400-600	2.02E-01	4.38E+03	4.07E-02	1.92E+07	2.76E-03	6.00E-02
	600-800	4.87E-01	1.04E+04	2.37E-01	1.07E+08	7.01E-03	1.49E-01
	800-1,000	0.00E+00	0.00E+00	0.00E+00	0.00E+00	0.00E+00	0.00E+00
	1,000-1,200	0.00E+00	0.00E+00	0.00E+00	0.00E+00	0.00E+00	0.00E+00
5	200-400	0.00E+00	0.00E+00	0.00E+00	0.00E+00	0.00E+00	0.00E+00
	400-600	1.95E-01	3.25E+03	3.79E-02	1.05E+07	4.58E-03	7.63E-02
	600-800	0.00E+00	0.00E+00	0.00E+00	0.00E+00	0.00E+00	0.00E+00
	800-1,000	0.00E+00	0.00E+00	0.00E+00	0.00E+00	0.00E+00	0.00E+00
	1,000-1,200	0.00E+00	0.00E+00	0.00E+00	0.00E+00	0.00E+00	0.00E+00
6	200-400	9.00E+00	1.41E+05	3.95E+01	1.02E+10	3.47E-02	5.43E-01
	400-600	1.40E+01	2.07E+05	1.43E+01	4.28E+09	8.19E-02	1.21E+00
	600-800	1.99E+01	2.89E+05	5.22E+01	1.31E+10	2.17E-01	3.15E+00
	800-1,000	0.00E+00	0.00E+00	0.00E+00	0.00E+00	0.00E+00	0.00E+00
	1,000-1,200	0.00E+00	0.00E+00	0.00E+00	0.00E+00	0.00E+00	0.00E+00
1-6	200-1,200	1.61E+02	3.06E+06	3.65E+02	1.37E+11	5.71E-02	1.04E+00

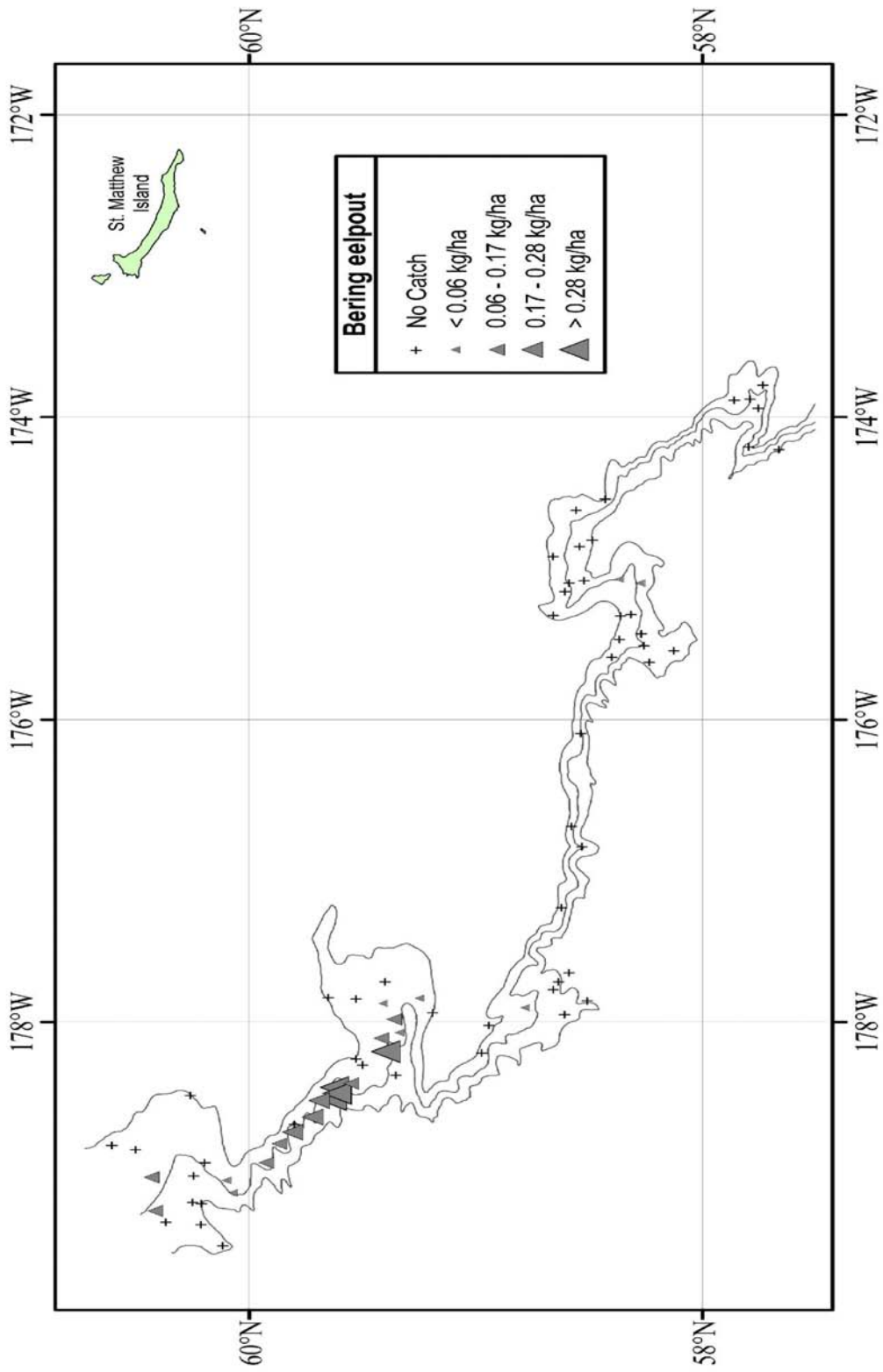

Figure 54. - - Distribution and relative abundance of Bering eelpout from the 2010 EBSS survey. Relative abundance is categorized by no catch, sample CPUE less than the mean CPUE, between the mean CPUE and one standard deviation above the mean, between one and two standard deviations above the mean CPUE, and greater than two standard deviations above the mean CPUE.

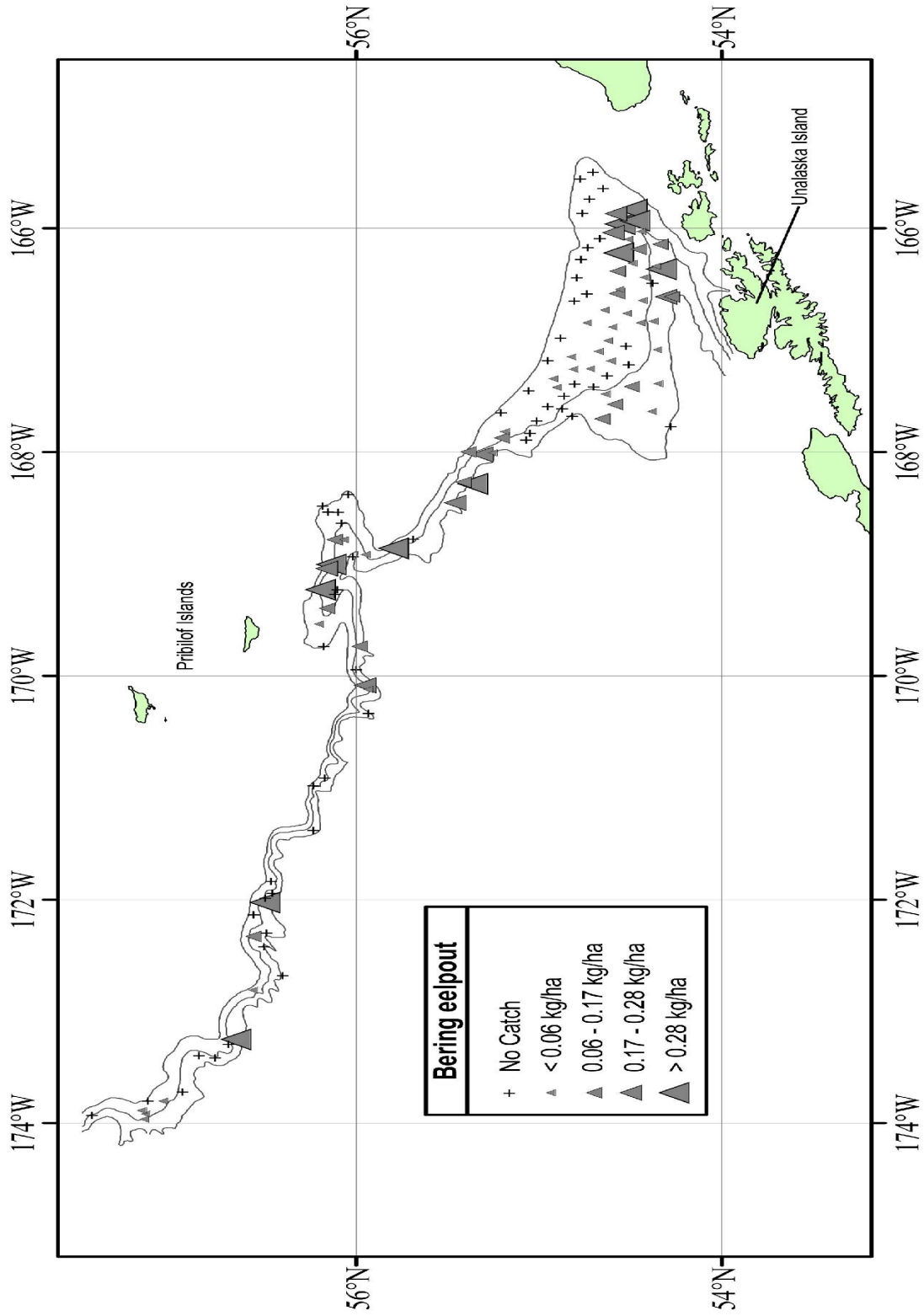

Figure 54. - - Continued.

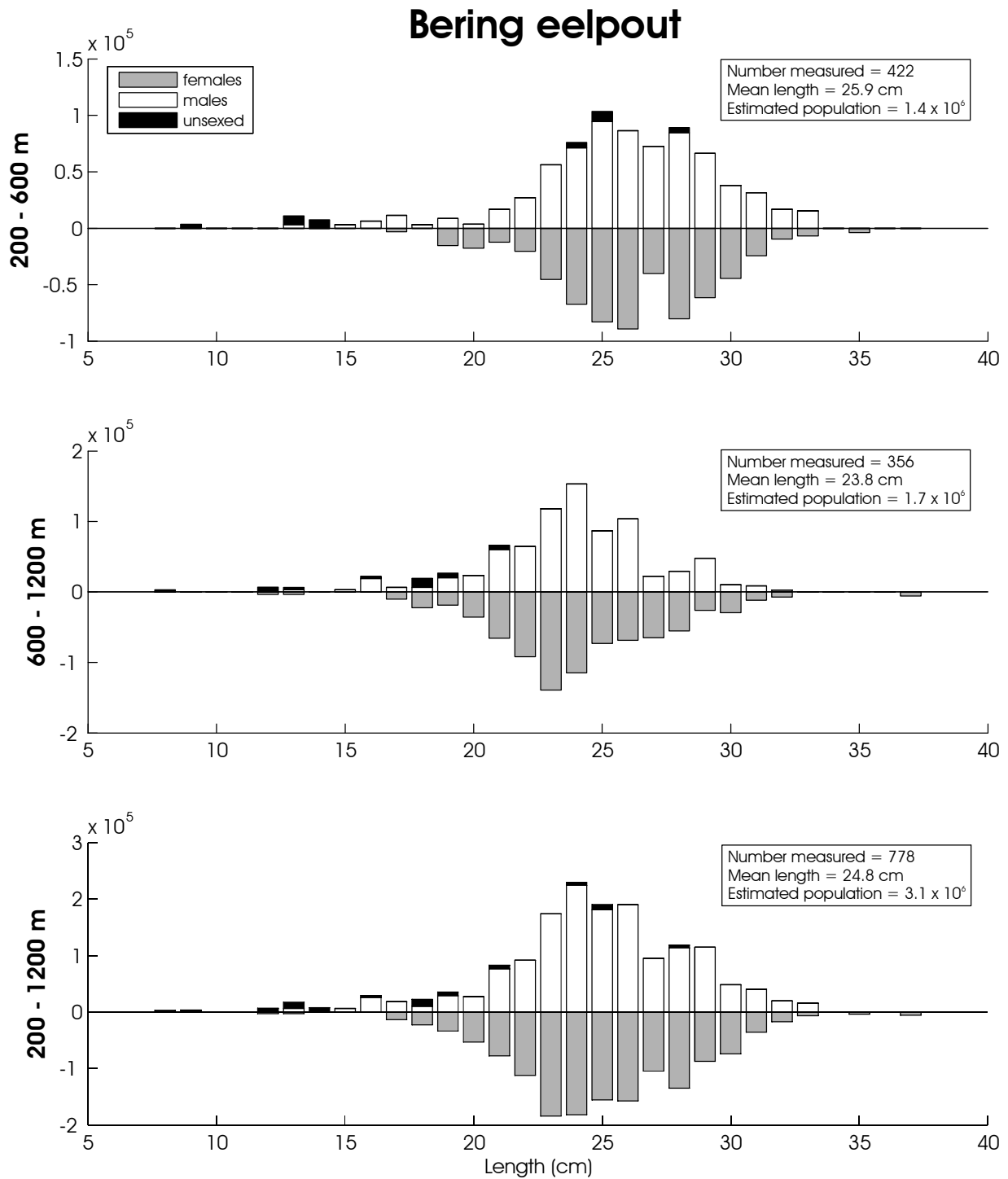

Figure 55. - - Size composition of the estimated Bering eelpout population from the 2010 EBSS survey for all subareas by depth. The abscissa is scaled as total length in centimeters while the ordinate represents the estimated total population.

Table 36. - Abundance estimates by subarea and depth strata for ebony eelpout (*Lycodes concolor*) from the 2010 EBSS survey.

<i>Lycodes concolor</i>		ebony eelpout					
Subarea	Depth strata (m)	Biomass (t)	Population	Biomass variance	Population variance	Average CPUE (kg/ha)	Average CPUE (no./ha)
1	200-400	0.00E+00	0.00E+00	0.00E+00	0.00E+00	0.00E+00	0.00E+00
	400-600	4.47E+02	3.81E+05	5.40E+04	4.92E+10	1.10E+00	9.38E-01
	600-800	7.63E+01	8.71E+04	8.46E+02	7.83E+08	4.38E-01	5.00E-01
	800-1,000	0.00E+00	0.00E+00	0.00E+00	0.00E+00	0.00E+00	0.00E+00
	1,000-1,200	0.00E+00	0.00E+00	0.00E+00	0.00E+00	0.00E+00	0.00E+00
2	200-400	0.00E+00	0.00E+00	0.00E+00	0.00E+00	0.00E+00	0.00E+00
	400-600	1.40E+02	1.29E+05	8.63E+03	6.37E+09	1.99E+00	1.83E+00
	600-800	1.37E+02	2.09E+05	4.63E+03	8.55E+09	2.31E+00	3.54E+00
	800-1,000	2.40E+02	5.05E+05	5.76E+04	2.55E+11	4.34E+00	9.13E+00
	1,000-1,200	3.02E+02	5.73E+05	5.47E+03	9.70E+08	5.65E+00	1.07E+01
3	200-400	0.00E+00	0.00E+00	0.00E+00	0.00E+00	0.00E+00	0.00E+00
	400-600	2.41E+00	5.75E+03	5.83E+00	3.30E+07	2.72E-02	6.49E-02
	600-800	1.64E+02	1.90E+05	2.70E+04	3.59E+10	1.81E+00	2.08E+00
	800-1,000	0.00E+00	0.00E+00	0.00E+00	0.00E+00	0.00E+00	0.00E+00
	1,000-1,200	0.00E+00	0.00E+00	0.00E+00	0.00E+00	0.00E+00	0.00E+00
4	200-400	0.00E+00	0.00E+00	0.00E+00	0.00E+00	0.00E+00	0.00E+00
	400-600	1.19E+02	1.32E+05	1.42E+04	1.73E+10	1.63E+00	1.80E+00
	600-800	2.96E+02	3.20E+05	1.29E+04	1.61E+10	4.27E+00	4.62E+00
	800-1,000	0.00E+00	0.00E+00	0.00E+00	0.00E+00	0.00E+00	0.00E+00
	1,000-1,200	0.00E+00	0.00E+00	0.00E+00	0.00E+00	0.00E+00	0.00E+00
5	200-400	0.00E+00	0.00E+00	0.00E+00	0.00E+00	0.00E+00	0.00E+00
	400-600	0.00E+00	0.00E+00	0.00E+00	0.00E+00	0.00E+00	0.00E+00
	600-800	0.00E+00	0.00E+00	0.00E+00	0.00E+00	0.00E+00	0.00E+00
	800-1,000	0.00E+00	0.00E+00	0.00E+00	0.00E+00	0.00E+00	0.00E+00
	1,000-1,200	0.00E+00	0.00E+00	0.00E+00	0.00E+00	0.00E+00	0.00E+00
6	200-400	0.00E+00	0.00E+00	0.00E+00	0.00E+00	0.00E+00	0.00E+00
	400-600	4.46E+02	4.39E+05	2.83E+04	2.87E+10	2.61E+00	2.57E+00
	600-800	8.92E+01	9.30E+04	2.71E+03	3.11E+09	9.72E-01	1.01E+00
	800-1,000	0.00E+00	0.00E+00	0.00E+00	0.00E+00	0.00E+00	0.00E+00
	1,000-1,200	0.00E+00	0.00E+00	0.00E+00	0.00E+00	0.00E+00	0.00E+00
1-6	200-1,200	2.46E+03	3.06E+06	2.16E+05	4.22E+11	8.32E-01	9.48E-01

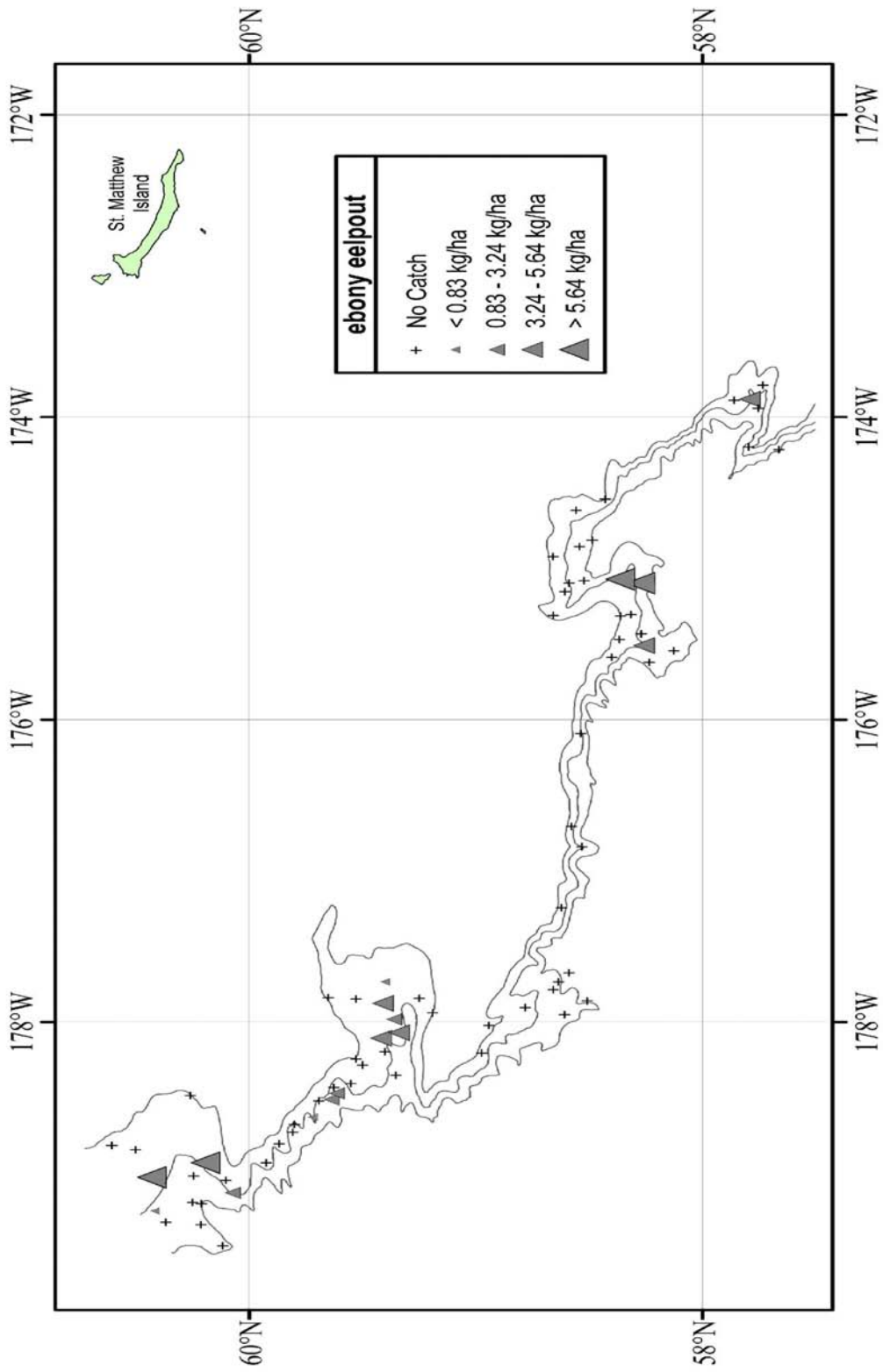

Figure 56. - - Distribution and relative abundance of ebony eelpout from the 2010 EBSS survey. Relative abundance is categorized by no catch, sample CPUE less than the mean CPUE, between the mean CPUE and one standard deviation above the mean, between one and two standard deviations above the mean CPUE, and greater than two standard deviations above the mean CPUE.

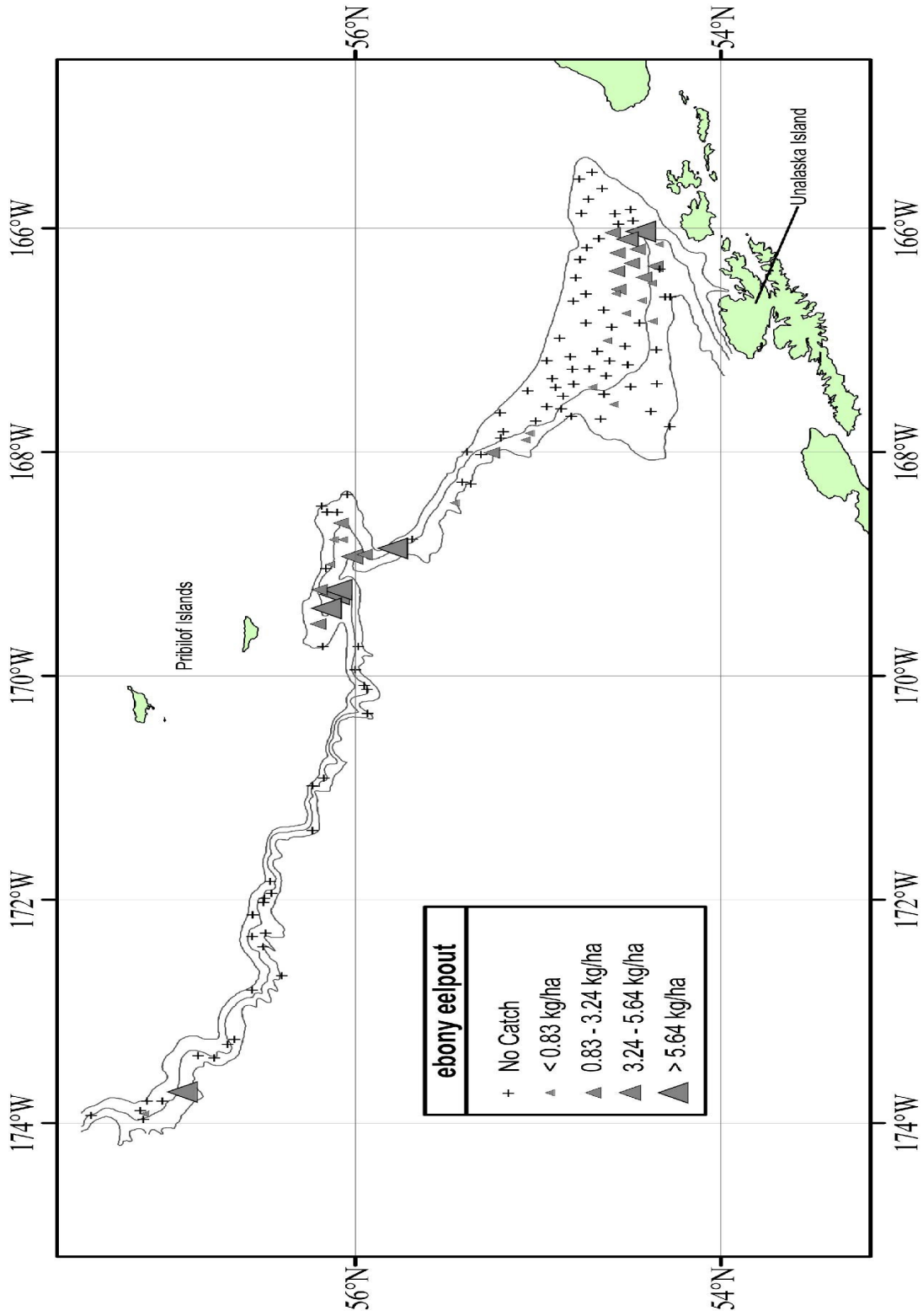

Figure 56. - - Continued.

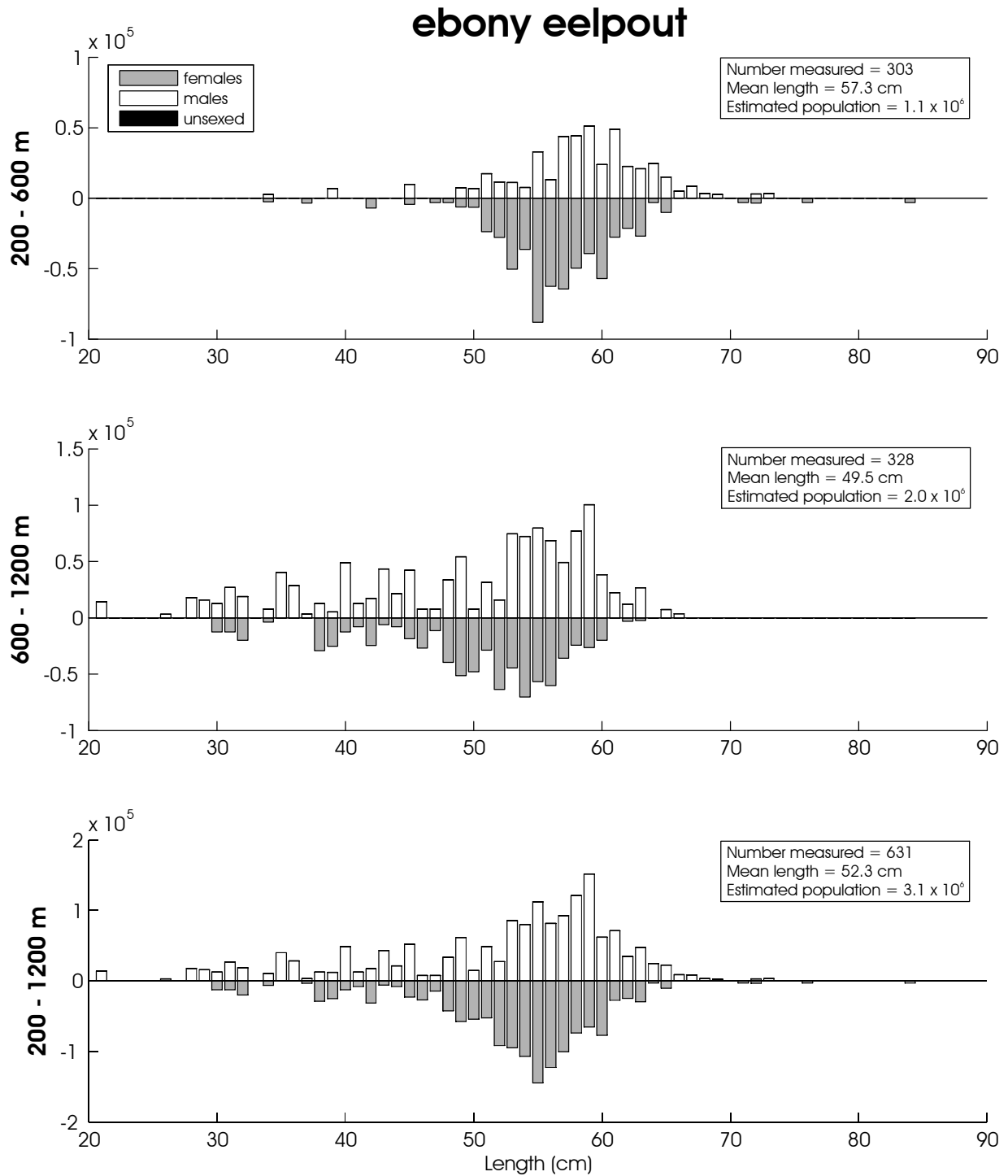

Figure 57. -- Size composition of the estimated ebony eelpout population from the 2010 EBSS survey for all subareas by depth. The abscissa is scaled as total length in centimeters while the ordinate represents the estimated total population.

Table 37. - - Abundance estimates by subarea and depth strata for twoline eelpout (*Bothrorcara brunneum*) from the 2010 EBSS survey.

<i>Bothrorcara brunneum</i>						twoline eelpout	
Subarea	Depth strata (m)	Biomass (t)	Population	Biomass variance	Population variance	Average CPUE (kg/ha)	Average CPUE (no./ha)
1	200-400	0.00E+00	0.00E+00	0.00E+00	0.00E+00	0.00E+00	0.00E+00
	400-600	0.00E+00	0.00E+00	0.00E+00	0.00E+00	0.00E+00	0.00E+00
	600-800	8.30E+01	7.15E+04	9.97E+02	1.07E+09	4.77E-01	4.10E-01
	800-1,000	4.45E+02	3.68E+05	2.27E+04	1.40E+10	3.28E+00	2.72E+00
	1,000-1,200	9.09E+01	2.05E+05	8.27E+03	4.21E+10	8.21E-01	1.85E+00
2	200-400	0.00E+00	0.00E+00	0.00E+00	0.00E+00	0.00E+00	0.00E+00
	400-600	2.61E+01	1.17E+04	2.13E+02	3.65E+07	3.71E-01	1.66E-01
	600-800	4.62E+01	2.74E+04	3.99E+02	1.65E+08	7.81E-01	4.64E-01
	800-1,000	0.00E+00	0.00E+00	0.00E+00	0.00E+00	0.00E+00	0.00E+00
	1,000-1,200	4.42E+00	1.59E+04	1.95E+01	2.53E+08	8.25E-02	2.97E-01
3	200-400	0.00E+00	0.00E+00	0.00E+00	0.00E+00	0.00E+00	0.00E+00
	400-600	7.60E+00	5.39E+03	5.78E+01	2.91E+07	8.58E-02	6.09E-02
	600-800	9.59E+01	7.19E+04	1.58E+03	1.01E+09	1.05E+00	7.89E-01
	800-1,000	9.08E+01	9.39E+04	8.25E+03	8.81E+09	1.24E+00	1.28E+00
	1,000-1,200	0.00E+00	0.00E+00	0.00E+00	0.00E+00	0.00E+00	0.00E+00
4	200-400	0.00E+00	0.00E+00	0.00E+00	0.00E+00	0.00E+00	0.00E+00
	400-600	4.58E+01	1.91E+04	8.17E+02	1.56E+08	6.27E-01	2.62E-01
	600-800	3.10E+01	1.55E+04	9.59E+02	2.41E+08	4.46E-01	2.24E-01
	800-1,000	9.52E+00	7.80E+03	9.07E+01	6.09E+07	1.35E-01	1.10E-01
	1,000-1,200	3.17E+00	1.76E+04	1.00E+01	3.10E+08	4.78E-02	2.66E-01
5	200-400	0.00E+00	0.00E+00	0.00E+00	0.00E+00	0.00E+00	0.00E+00
	400-600	1.07E+02	4.56E+04	1.66E+03	4.43E+08	2.52E+00	1.07E+00
	600-800	6.03E+01	2.48E+04	3.64E+03	6.16E+08	1.40E+00	5.75E-01
	800-1,000	0.00E+00	0.00E+00	0.00E+00	0.00E+00	0.00E+00	0.00E+00
	1,000-1,200	0.00E+00	0.00E+00	0.00E+00	0.00E+00	0.00E+00	0.00E+00
6	200-400	0.00E+00	0.00E+00	0.00E+00	0.00E+00	0.00E+00	0.00E+00
	400-600	2.43E+01	1.30E+04	1.84E+02	5.00E+07	1.43E-01	7.62E-02
	600-800	3.57E+01	1.92E+04	3.93E+02	1.07E+08	3.89E-01	2.09E-01
	800-1,000	6.80E-01	5.07E+03	4.62E-01	2.57E+07	1.05E-02	7.86E-02
	1,000-1,200	0.00E+00	0.00E+00	0.00E+00	0.00E+00	0.00E+00	0.00E+00
1-6	200-1,200	1.21E+03	1.04E+06	5.02E+04	6.95E+10	4.64E-01	3.64E-01

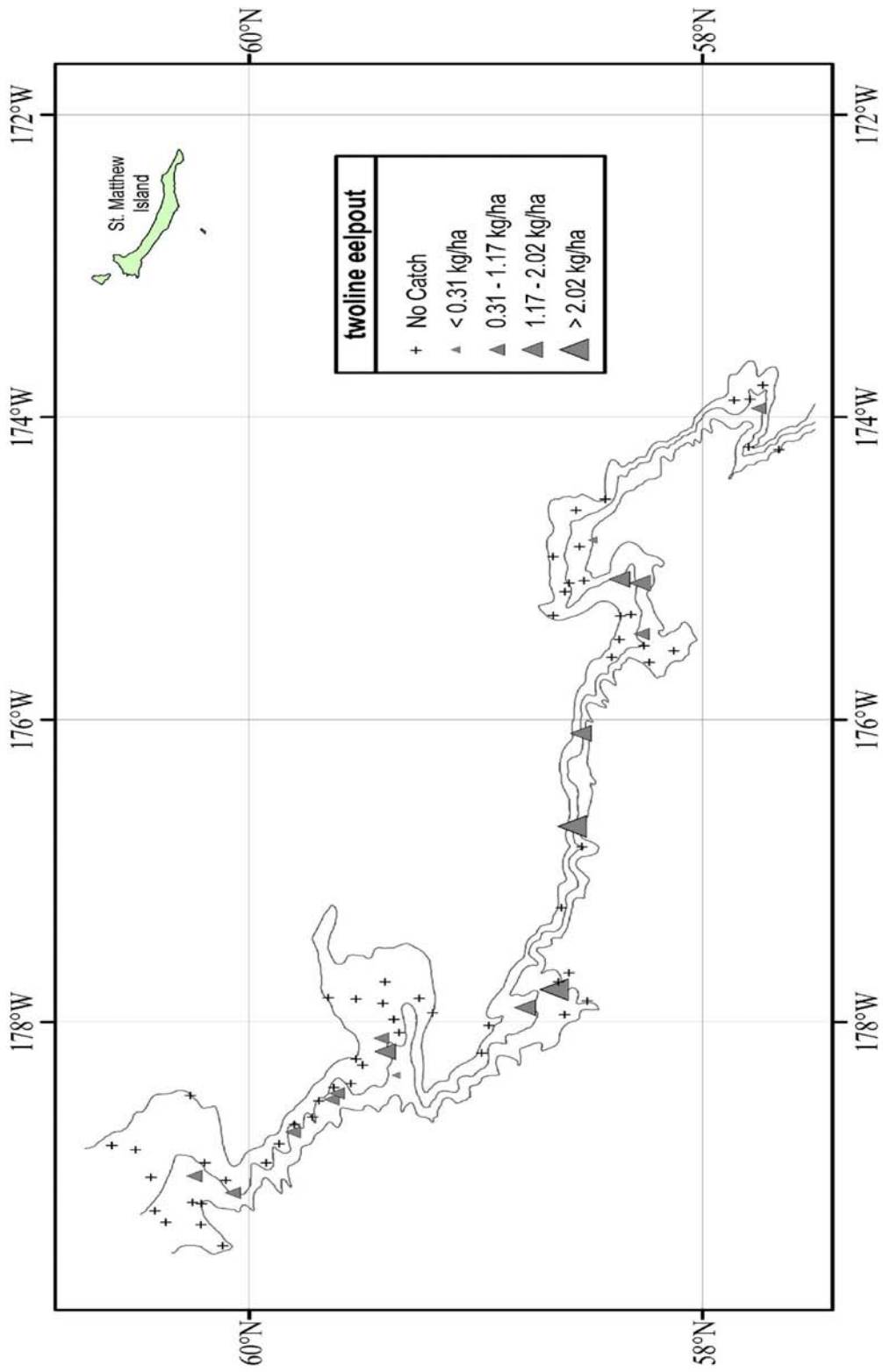

Figure 58. - - Distribution and relative abundance of twoline eelpout from the 2010 EBSS survey. Relative abundance is categorized by no catch, sample CPUE less than the mean CPUE, between the mean CPUE and one standard deviation above the mean, between one and two standard deviations above the mean CPUE, and greater than two standard deviations above the mean CPUE.

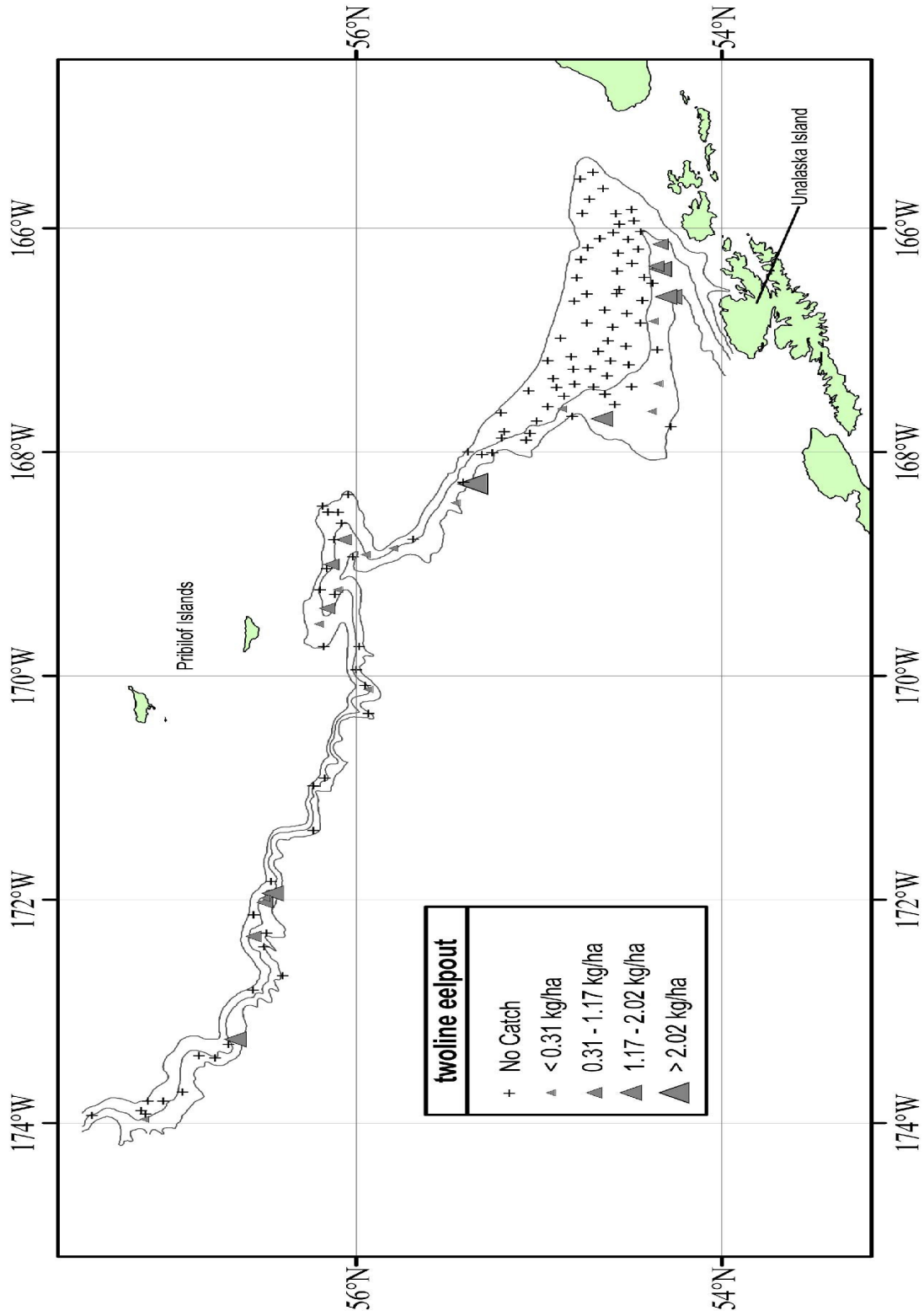

Figure 58. - - Continued.

twoline eelpout

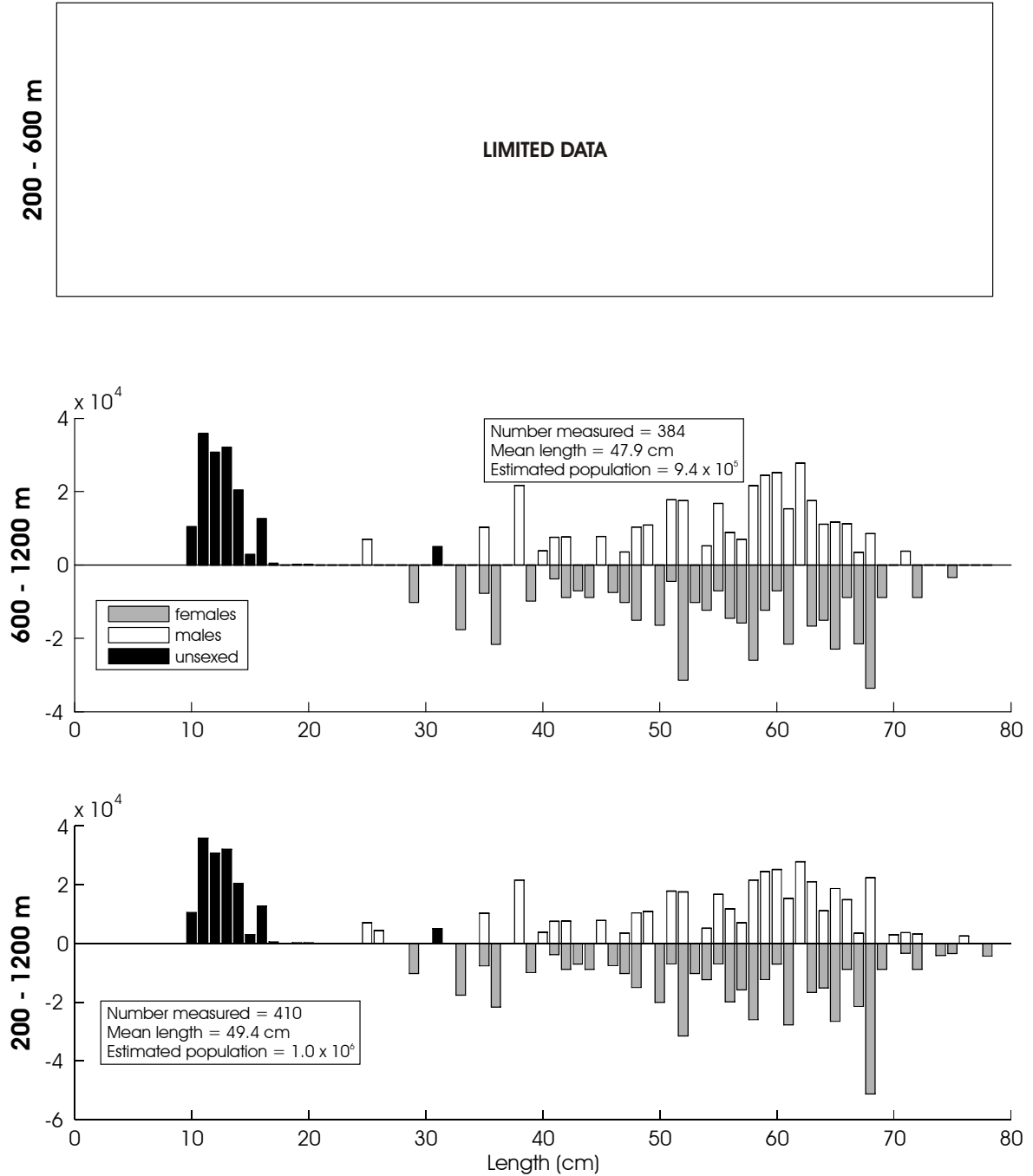

Figure 59. - - Size composition of the estimated twoline eelpout population from the 2010 EBSS survey for all subareas by depth. The abscissa is scaled as total length in centimeters while the ordinate represents the estimated total population.

Table 38. - - Abundance estimates by subarea and depth strata for western eelpout (*Bothrocara zestum*) from the 2010 EBSS survey.

<i>Bothrocara zestum</i>						western eelpout	
Subarea	Depth strata (m)	Biomass (t)	Population	Biomass variance	Population variance	Average CPUE (kg/ha)	Average CPUE (no./ha)
1	200-400	0.00E+00	0.00E+00	0.00E+00	0.00E+00	0.00E+00	0.00E+00
	400-600	1.60E+04	1.91E+07	3.91E+07	5.03E+13	3.94E+01	4.69E+01
	600-800	7.59E+03	1.29E+07	1.48E+07	2.71E+13	4.36E+01	7.43E+01
	800-1,000	2.93E+03	5.23E+06	3.74E+06	9.08E+12	2.17E+01	3.86E+01
	1,000-1,200	1.60E+01	6.74E+04	2.52E+02	1.66E+09	1.45E-01	6.09E-01
2	200-400	0.00E+00	0.00E+00	0.00E+00	0.00E+00	0.00E+00	0.00E+00
	400-600	2.56E+02	7.37E+05	6.10E+04	5.23E+11	3.63E+00	1.04E+01
	600-800	2.80E+01	2.21E+05	7.17E+02	4.55E+10	4.74E-01	3.73E+00
	800-1,000	9.68E+01	1.01E+06	9.34E+03	9.91E+11	1.75E+00	1.83E+01
	1,000-1,200	7.56E+01	5.02E+05	2.30E+02	6.02E+10	1.41E+00	9.37E+00
3	200-400	0.00E+00	0.00E+00	0.00E+00	0.00E+00	0.00E+00	0.00E+00
	400-600	6.15E+00	5.39E+03	3.78E+01	2.91E+07	6.94E-02	6.09E-02
	600-800	2.68E+01	2.69E+04	9.25E+01	1.24E+08	2.95E-01	2.96E-01
	800-1,000	3.86E+00	7.82E+03	1.49E+01	6.12E+07	5.28E-02	1.07E-01
	1,000-1,200	0.00E+00	0.00E+00	0.00E+00	0.00E+00	0.00E+00	0.00E+00
4	200-400	0.00E+00	0.00E+00	0.00E+00	0.00E+00	0.00E+00	0.00E+00
	400-600	4.05E+01	3.07E+04	1.64E+03	9.42E+08	5.55E-01	4.20E-01
	600-800	0.00E+00	0.00E+00	0.00E+00	0.00E+00	0.00E+00	0.00E+00
	800-1,000	0.00E+00	0.00E+00	0.00E+00	0.00E+00	0.00E+00	0.00E+00
	1,000-1,200	0.00E+00	0.00E+00	0.00E+00	0.00E+00	0.00E+00	0.00E+00
5	200-400	0.00E+00	0.00E+00	0.00E+00	0.00E+00	0.00E+00	0.00E+00
	400-600	6.02E+00	3.34E+03	3.62E+01	1.12E+07	1.41E-01	7.85E-02
	600-800	0.00E+00	0.00E+00	0.00E+00	0.00E+00	0.00E+00	0.00E+00
	800-1,000	0.00E+00	0.00E+00	0.00E+00	0.00E+00	0.00E+00	0.00E+00
	1,000-1,200	0.00E+00	0.00E+00	0.00E+00	0.00E+00	0.00E+00	0.00E+00
6	200-400	0.00E+00	0.00E+00	0.00E+00	0.00E+00	0.00E+00	0.00E+00
	400-600	3.07E+02	5.88E+05	2.29E+04	1.26E+11	1.80E+00	3.45E+00
	600-800	2.88E+01	5.93E+04	3.54E+02	9.28E+08	3.14E-01	6.46E-01
	800-1,000	0.00E+00	0.00E+00	0.00E+00	0.00E+00	0.00E+00	0.00E+00
	1,000-1,200	0.00E+00	0.00E+00	0.00E+00	0.00E+00	0.00E+00	0.00E+00
1-6	200-1,200	2.74E+04	4.05E+07	5.78E+07	8.83E+13	1.08E+01	1.53E+01

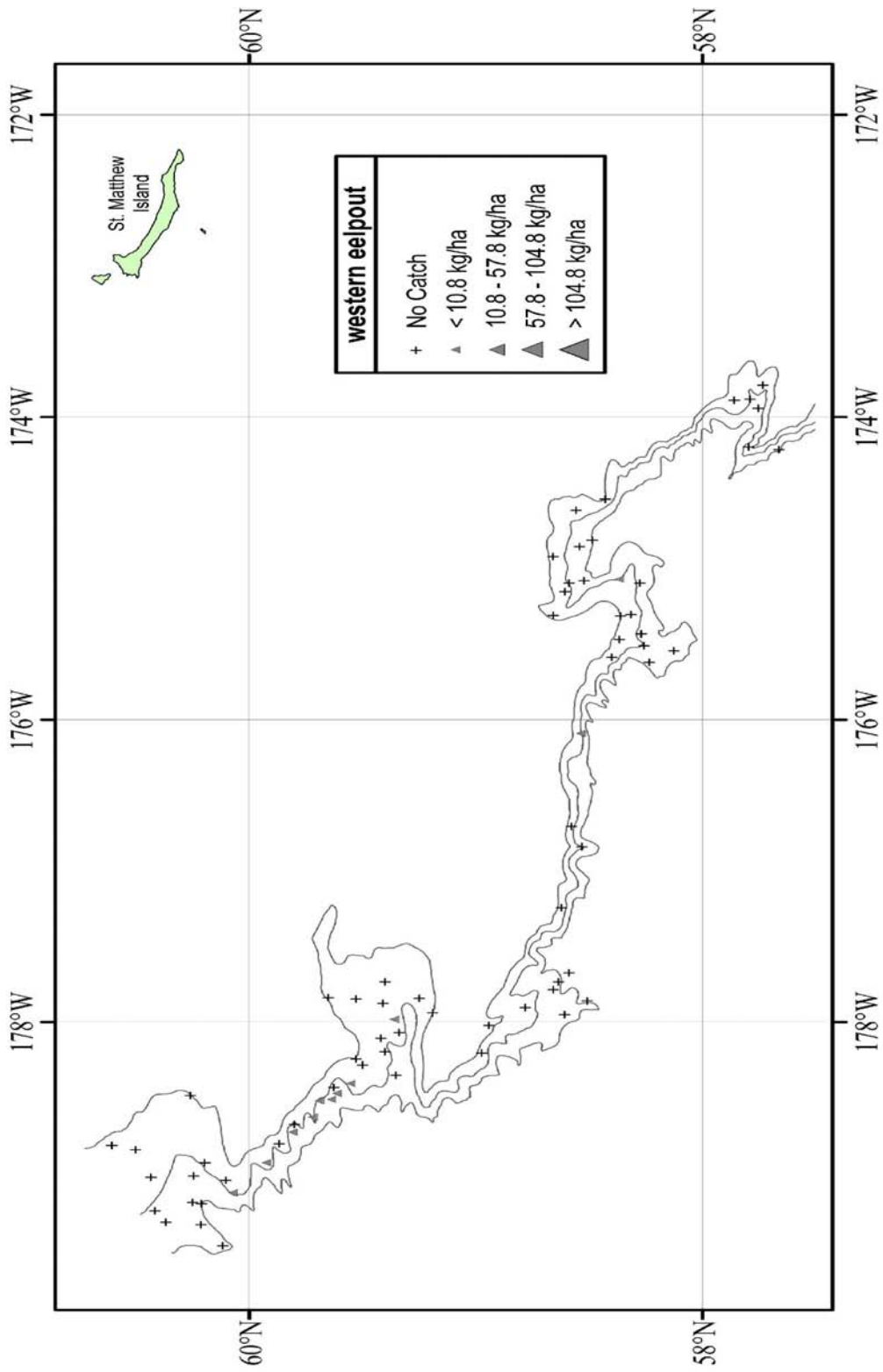

Figure 60. - - Distribution and relative abundance of western eelpout from the 2010 EBSS survey. Relative abundance is categorized by no catch, sample CPUE less than the mean CPUE, between the mean CPUE and one standard deviation above the mean, between one and two standard deviations above the mean CPUE, and greater than two standard deviations above the mean CPUE.

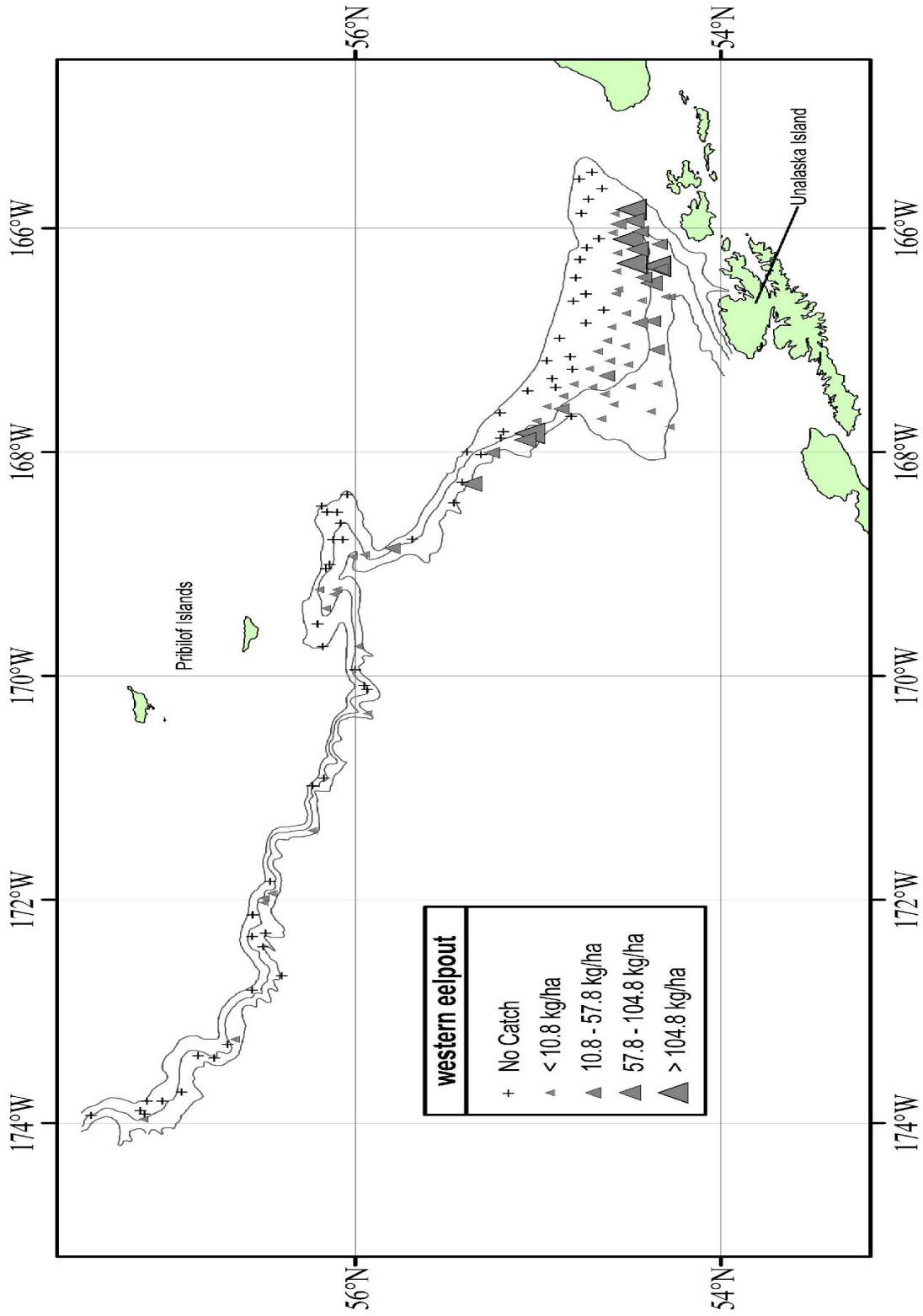

Figure 60. - - Continued.

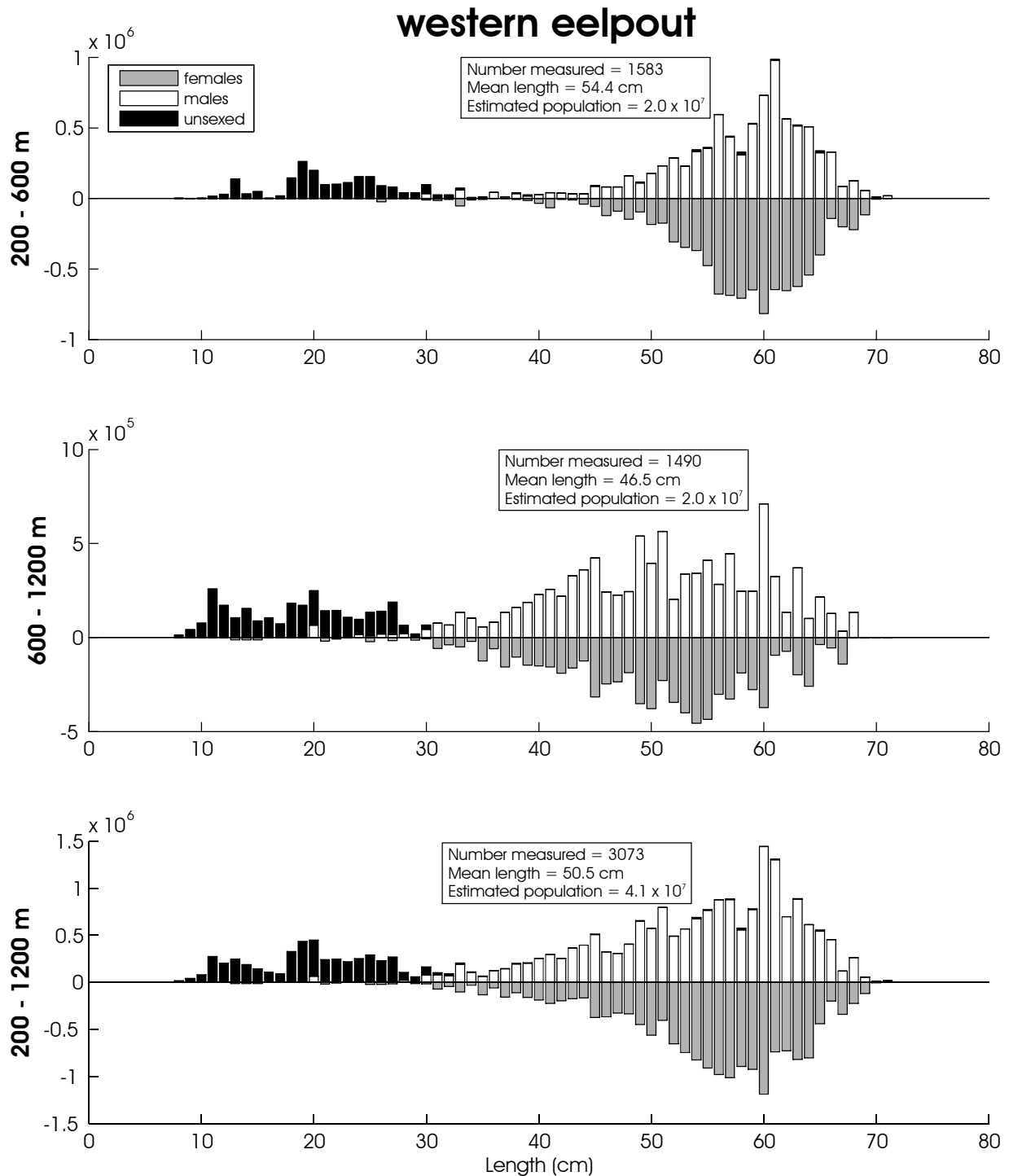

Figure 61. - - Size composition of the estimated western eelpout population from the 2010 EBSS survey for all subareas by depth. The abscissa is scaled as total length in centimeters while the ordinate represents the estimated total population.

Table 39. - Abundance estimates by subarea and depth strata for Pacific halibut (*Hippoglossus stenolepis*) from the 2010 EBSS survey.

<i>Hippoglossus stenolepis</i>						Pacific halibut	
Subarea	Depth strata (m)	Biomass (t)	Population	Biomass variance	Population variance	Average CPUE (kg/ha)	Average CPUE (no./ha)
1	200-400	1.01E+03	1.53E+05	1.11E+05	2.12E+09	2.51E+00	3.82E-01
	400-600	6.17E+02	8.62E+04	2.68E+04	5.28E+08	1.52E+00	2.12E-01
	600-800	0.00E+00	0.00E+00	0.00E+00	0.00E+00	0.00E+00	0.00E+00
	800-1,000	0.00E+00	0.00E+00	0.00E+00	0.00E+00	0.00E+00	0.00E+00
	1,000-1,200	0.00E+00	0.00E+00	0.00E+00	0.00E+00	0.00E+00	0.00E+00
2	200-400	0.00E+00	0.00E+00	0.00E+00	0.00E+00	0.00E+00	0.00E+00
	400-600	9.28E+01	7.64E+03	6.31E+03	2.91E+07	1.32E+00	1.08E-01
	600-800	0.00E+00	0.00E+00	0.00E+00	0.00E+00	0.00E+00	0.00E+00
	800-1,000	0.00E+00	0.00E+00	0.00E+00	0.00E+00	0.00E+00	0.00E+00
	1,000-1,200	0.00E+00	0.00E+00	0.00E+00	0.00E+00	0.00E+00	0.00E+00
3	200-400	3.99E+02	1.07E+05	8.21E+04	9.28E+09	4.41E+00	1.18E+00
	400-600	2.76E+02	2.89E+04	3.85E+04	4.82E+08	3.12E+00	3.27E-01
	600-800	0.00E+00	0.00E+00	0.00E+00	0.00E+00	0.00E+00	0.00E+00
	800-1,000	0.00E+00	0.00E+00	0.00E+00	0.00E+00	0.00E+00	0.00E+00
	1,000-1,200	0.00E+00	0.00E+00	0.00E+00	0.00E+00	0.00E+00	0.00E+00
4	200-400	1.65E+02	2.38E+04	4.82E+03	5.82E+07	1.33E+00	1.93E-01
	400-600	3.55E+02	5.06E+04	4.20E+04	9.85E+08	4.85E+00	6.93E-01
	600-800	0.00E+00	0.00E+00	0.00E+00	0.00E+00	0.00E+00	0.00E+00
	800-1,000	0.00E+00	0.00E+00	0.00E+00	0.00E+00	0.00E+00	0.00E+00
	1,000-1,200	0.00E+00	0.00E+00	0.00E+00	0.00E+00	0.00E+00	0.00E+00
5	200-400	8.37E+01	1.29E+04	7.01E+03	1.66E+08	1.98E+00	3.04E-01
	400-600	1.89E+02	1.76E+04	1.61E+04	9.07E+07	4.44E+00	4.13E-01
	600-800	0.00E+00	0.00E+00	0.00E+00	0.00E+00	0.00E+00	0.00E+00
	800-1,000	0.00E+00	0.00E+00	0.00E+00	0.00E+00	0.00E+00	0.00E+00
	1,000-1,200	0.00E+00	0.00E+00	0.00E+00	0.00E+00	0.00E+00	0.00E+00
6	200-400	2.21E+02	6.59E+04	1.24E+04	7.97E+08	8.53E-01	2.54E-01
	400-600	1.33E+03	1.77E+05	3.06E+05	4.20E+09	7.77E+00	1.04E+00
	600-800	8.77E+01	7.48E+03	7.69E+03	5.60E+07	9.56E-01	8.16E-02
	800-1,000	0.00E+00	0.00E+00	0.00E+00	0.00E+00	0.00E+00	0.00E+00
	1,000-1,200	0.00E+00	0.00E+00	0.00E+00	0.00E+00	0.00E+00	0.00E+00
1-6	200-1,200	4.82E+03	7.38E+05	6.61E+05	1.88E+10	1.69E+00	2.64E-01

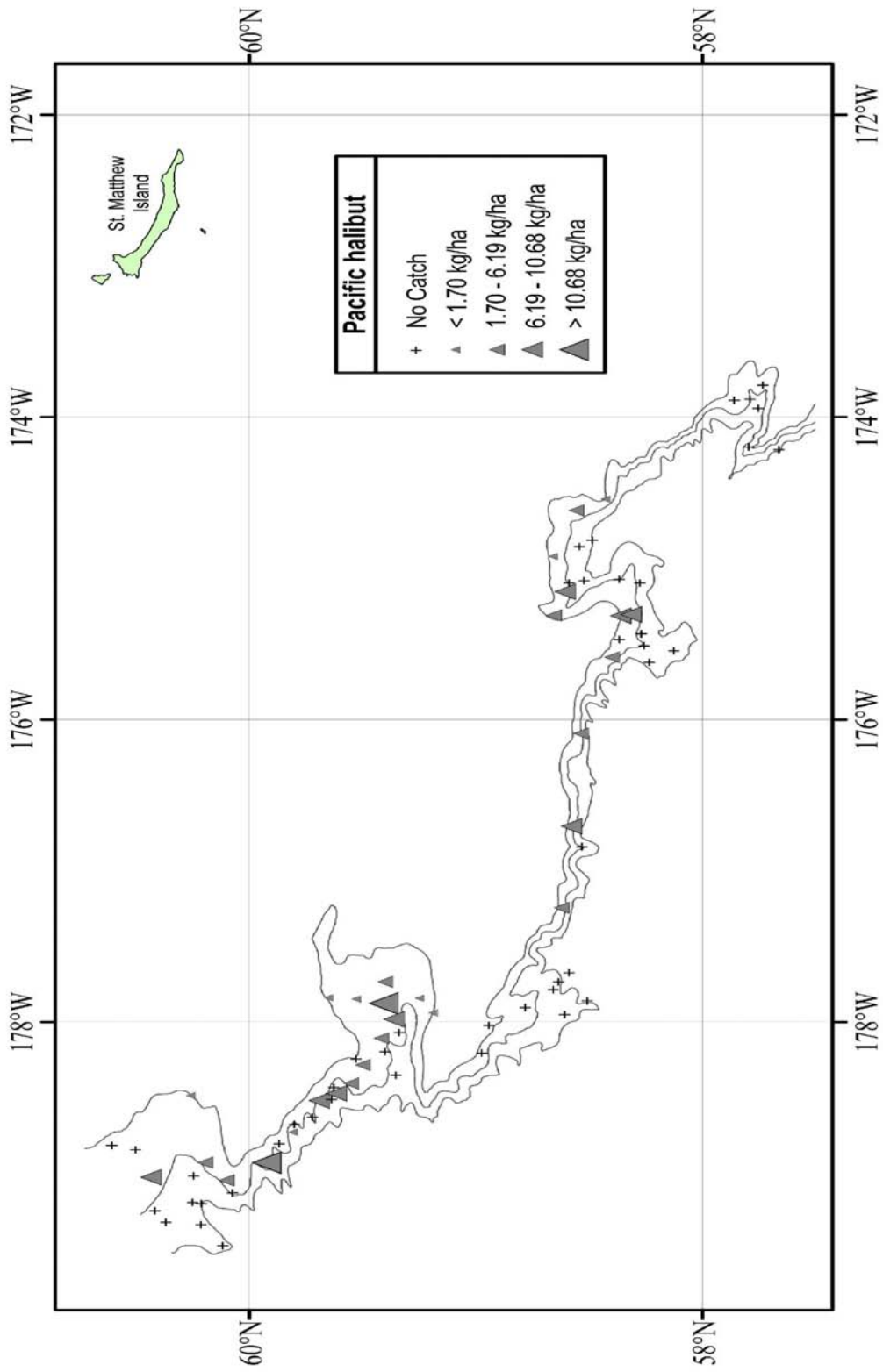

Figure 62. - - Distribution and relative abundance of Pacific halibut from the 2010 EBSS survey. Relative abundance is categorized by no catch, sample CPUE less than the mean CPUE, between the mean CPUE and one standard deviation above the mean, between one and two standard deviations above the mean CPUE, and greater than two standard deviations above the mean CPUE.

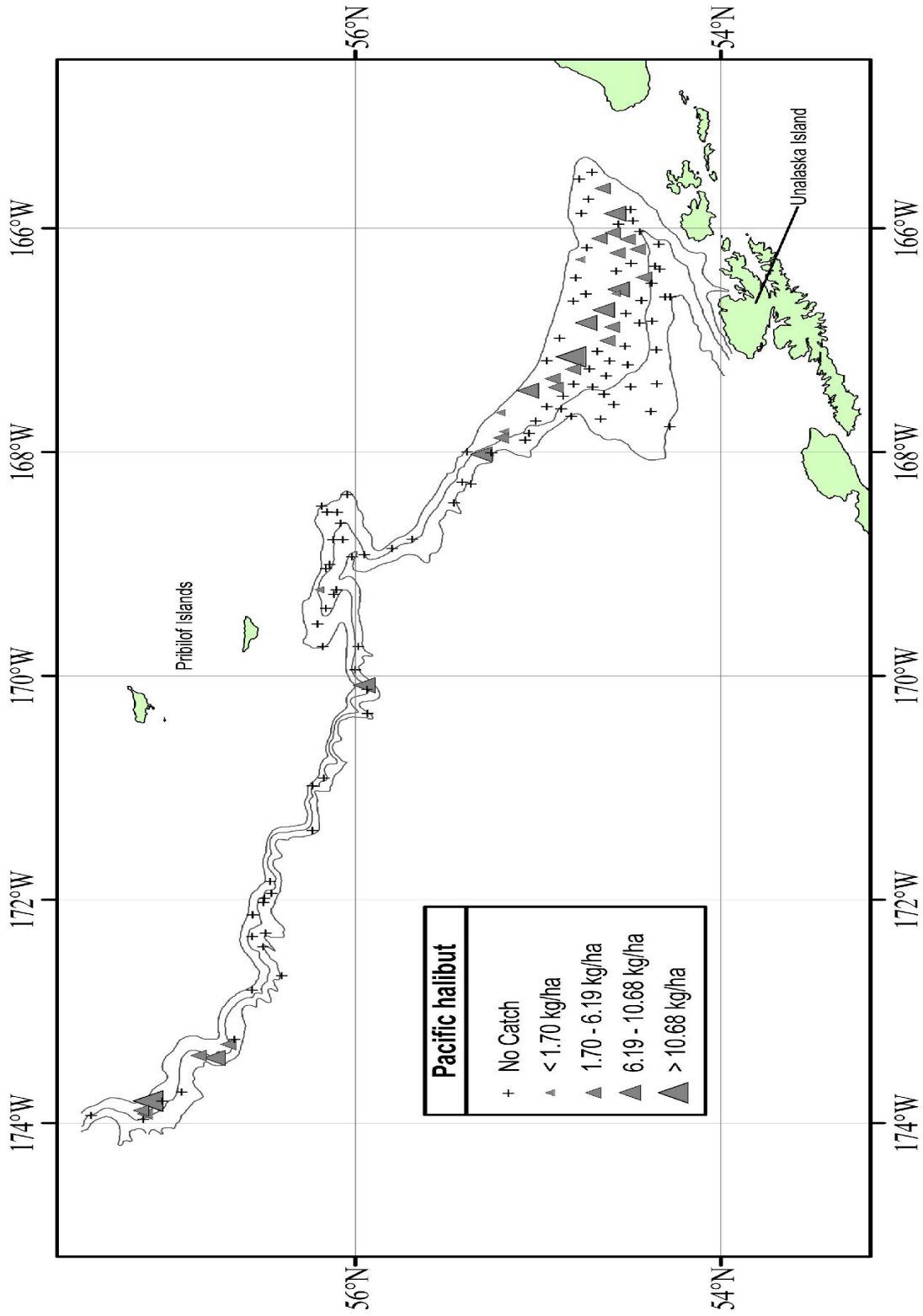

Figure 62. - - Continued.

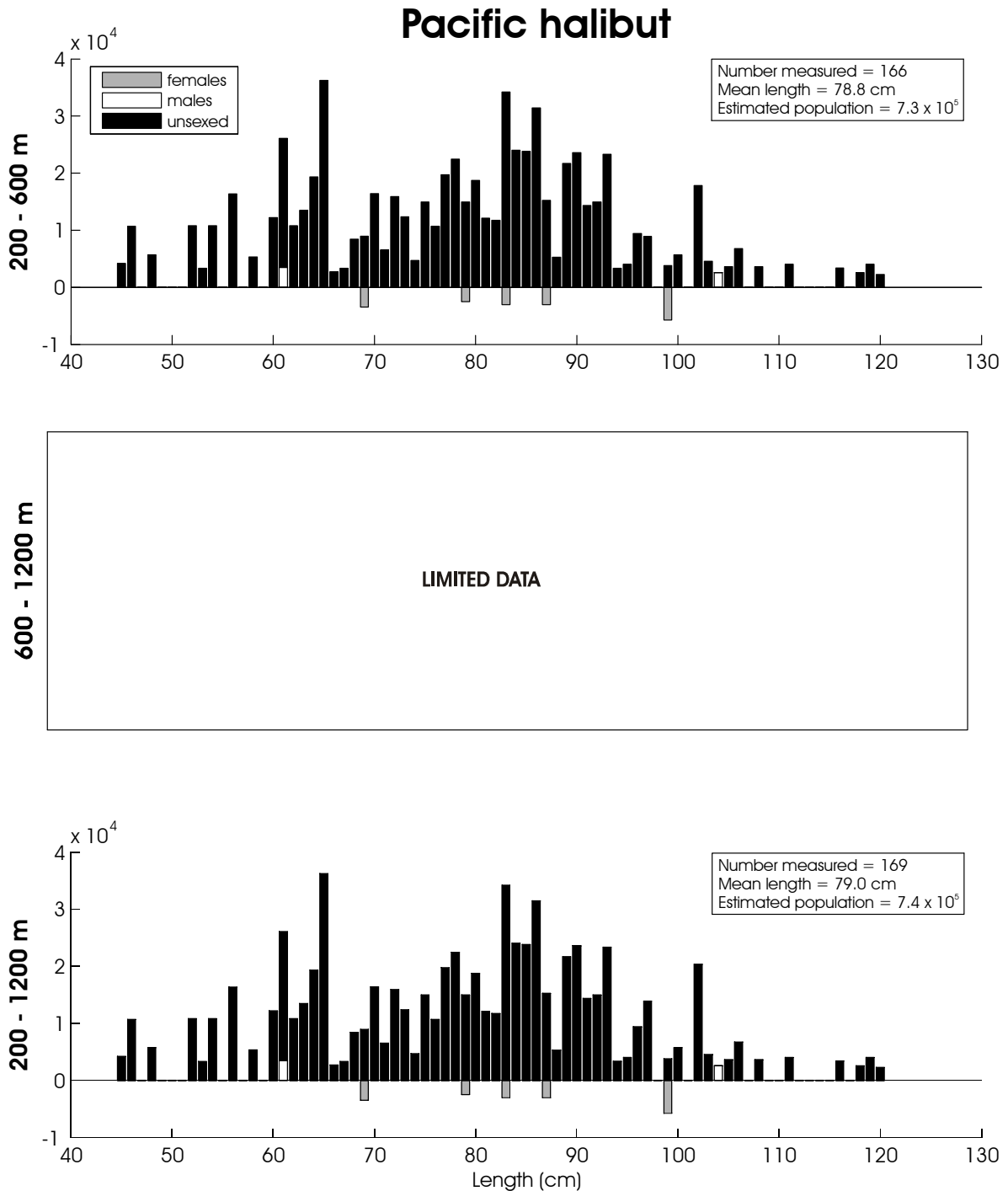

Figure 63. -- Size composition of the estimated Pacific halibut population from the 2010 EBSS survey for all subareas by depth. The abscissa is scaled as total length in centimeters while the ordinate represents the estimated total population.

Table 40. - Abundance estimates by subarea and depth strata for flathead sole
(*Hippoglossoides elassodon*) from the 2010 EBSS survey.

<i>Hippoglossoides elassodon</i>						flathead sole	
Subarea	Depth strata (m)	Biomass (t)	Population	Biomass variance	Population variance	Average CPUE (kg/ha)	Average CPUE (no./ha)
1	200-400	5.11E+03	1.52E+07	7.87E+05	9.22E+12	1.27E+01	3.78E+01
	400-600	3.15E+03	4.89E+06	2.90E+05	7.16E+11	7.75E+00	1.20E+01
	600-800	0.00E+00	0.00E+00	0.00E+00	0.00E+00	0.00E+00	0.00E+00
	800-1,000	0.00E+00	0.00E+00	0.00E+00	0.00E+00	0.00E+00	0.00E+00
	1,000-1,200	0.00E+00	0.00E+00	0.00E+00	0.00E+00	0.00E+00	0.00E+00
2	200-400	7.84E+02	1.26E+06	2.40E+05	7.04E+11	6.77E+00	1.09E+01
	400-600	2.55E+01	3.14E+04	2.71E+02	4.87E+08	3.61E-01	4.46E-01
	600-800	0.00E+00	0.00E+00	0.00E+00	0.00E+00	0.00E+00	0.00E+00
	800-1,000	0.00E+00	0.00E+00	0.00E+00	0.00E+00	0.00E+00	0.00E+00
	1,000-1,200	0.00E+00	0.00E+00	0.00E+00	0.00E+00	0.00E+00	0.00E+00
3	200-400	1.33E+03	3.04E+06	3.23E+05	1.96E+12	1.47E+01	3.36E+01
	400-600	2.13E+03	2.82E+06	7.40E+05	1.28E+12	2.40E+01	3.19E+01
	600-800	0.00E+00	0.00E+00	0.00E+00	0.00E+00	0.00E+00	0.00E+00
	800-1,000	0.00E+00	0.00E+00	0.00E+00	0.00E+00	0.00E+00	0.00E+00
	1,000-1,200	0.00E+00	0.00E+00	0.00E+00	0.00E+00	0.00E+00	0.00E+00
4	200-400	1.47E+03	3.59E+06	1.75E+05	7.78E+11	1.19E+01	2.90E+01
	400-600	7.89E+02	1.37E+06	2.12E+05	6.68E+11	1.08E+01	1.88E+01
	600-800	0.00E+00	0.00E+00	0.00E+00	0.00E+00	0.00E+00	0.00E+00
	800-1,000	0.00E+00	0.00E+00	0.00E+00	0.00E+00	0.00E+00	0.00E+00
	1,000-1,200	0.00E+00	0.00E+00	0.00E+00	0.00E+00	0.00E+00	0.00E+00
5	200-400	6.17E+02	2.05E+06	1.31E+05	1.10E+12	1.46E+01	4.83E+01
	400-600	5.39E+02	9.65E+05	6.45E+04	2.16E+11	1.27E+01	2.27E+01
	600-800	0.00E+00	0.00E+00	0.00E+00	0.00E+00	0.00E+00	0.00E+00
	800-1,000	0.00E+00	0.00E+00	0.00E+00	0.00E+00	0.00E+00	0.00E+00
	1,000-1,200	0.00E+00	0.00E+00	0.00E+00	0.00E+00	0.00E+00	0.00E+00
6	200-400	3.87E+03	1.48E+07	2.54E+06	1.69E+13	1.49E+01	5.68E+01
	400-600	6.98E+02	1.45E+06	4.46E+04	1.94E+11	4.09E+00	8.50E+00
	600-800	0.00E+00	0.00E+00	0.00E+00	0.00E+00	0.00E+00	0.00E+00
	800-1,000	0.00E+00	0.00E+00	0.00E+00	0.00E+00	0.00E+00	0.00E+00
	1,000-1,200	0.00E+00	0.00E+00	0.00E+00	0.00E+00	0.00E+00	0.00E+00
1-6	200-1,200	2.05E+04	5.14E+07	5.54E+06	3.37E+13	6.61E+00	1.58E+01

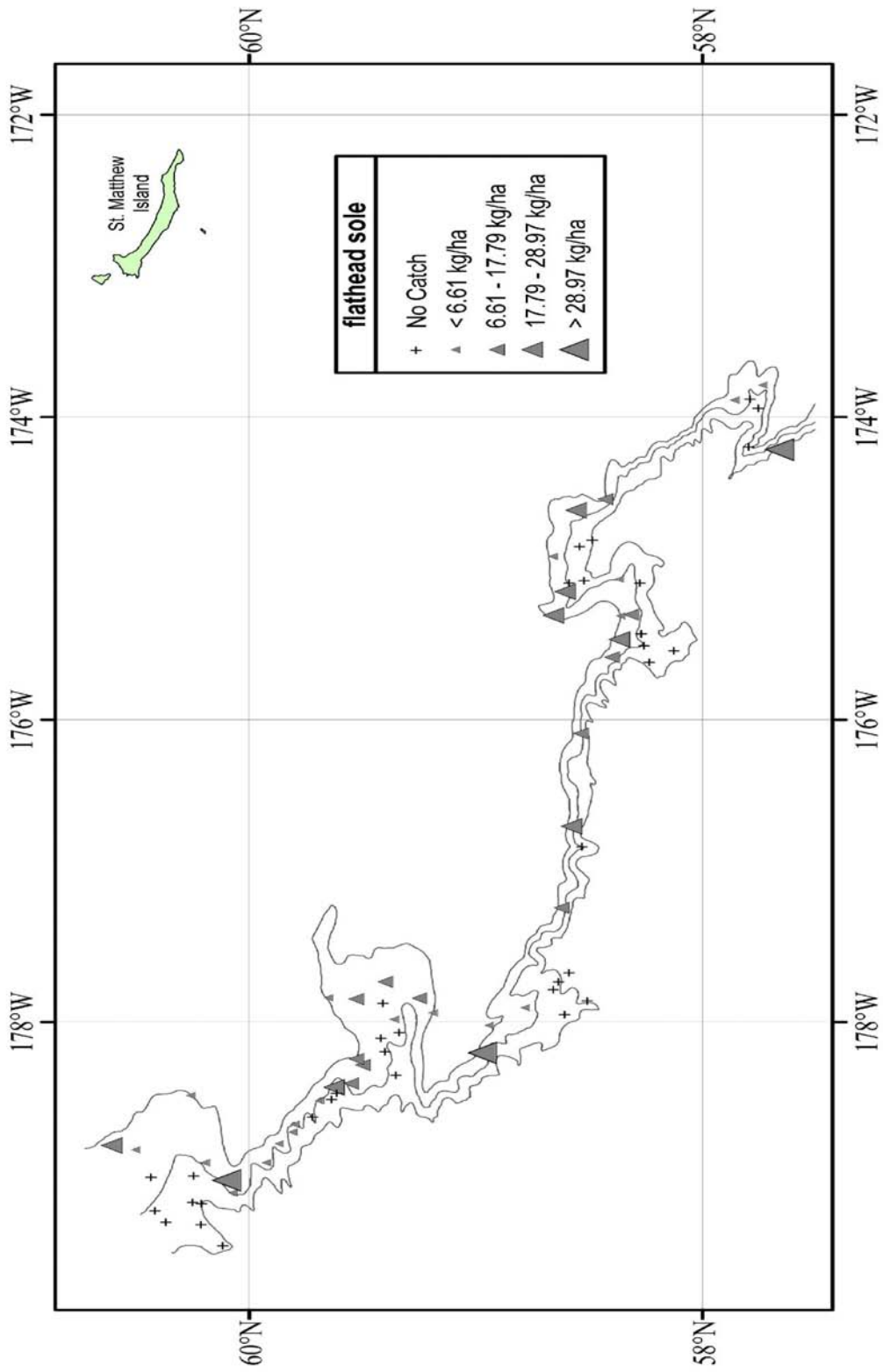

Figure 64. - - Distribution and relative abundance of flathead sole from the 2010 EBSS survey. Relative abundance is categorized by no catch, sample CPUE less than the mean CPUE, between the mean CPUE and one standard deviation above the mean, between one and two standard deviations above the mean CPUE, and greater than two standard deviations above the mean CPUE.

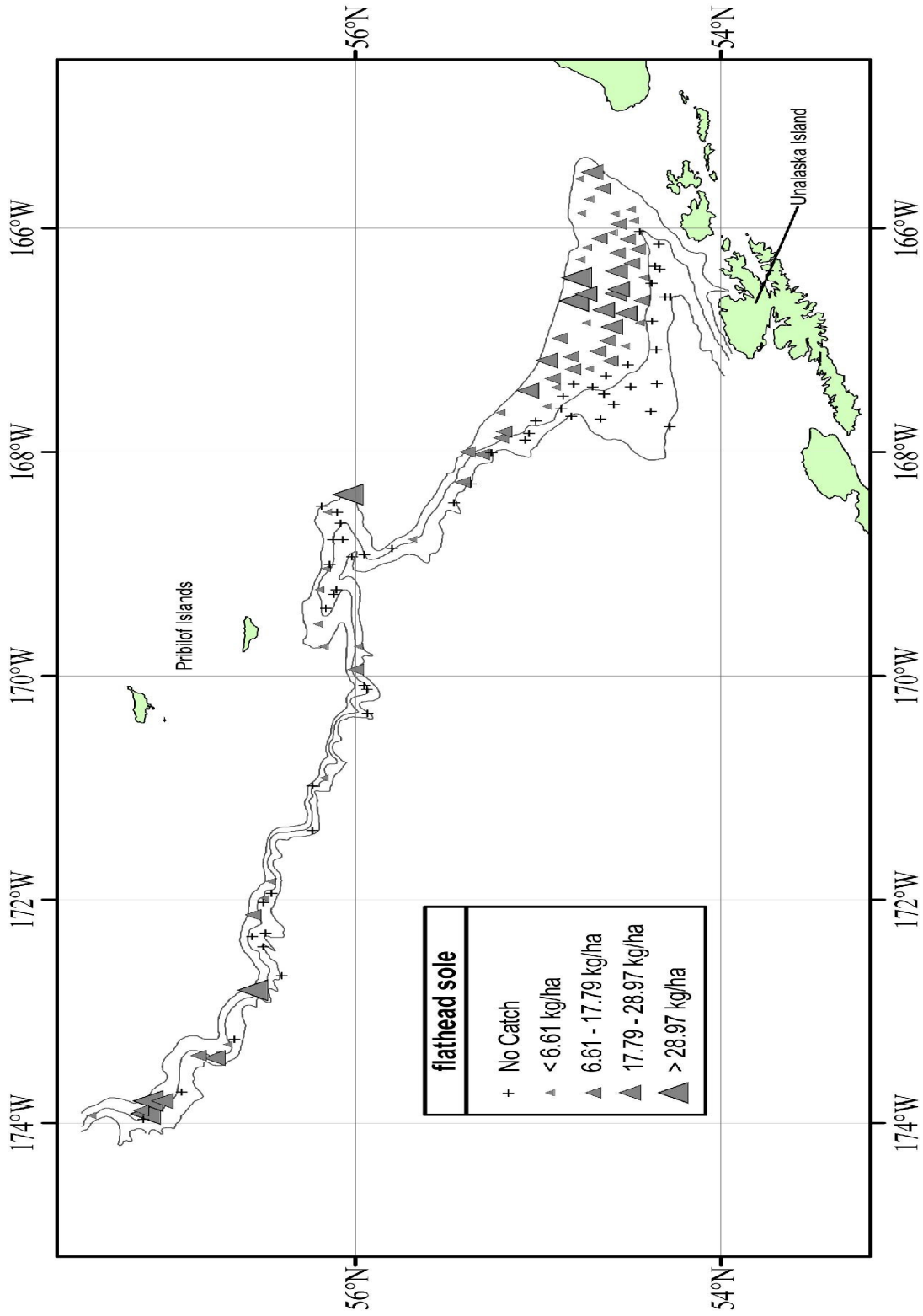

Figure 64. - - Continued.

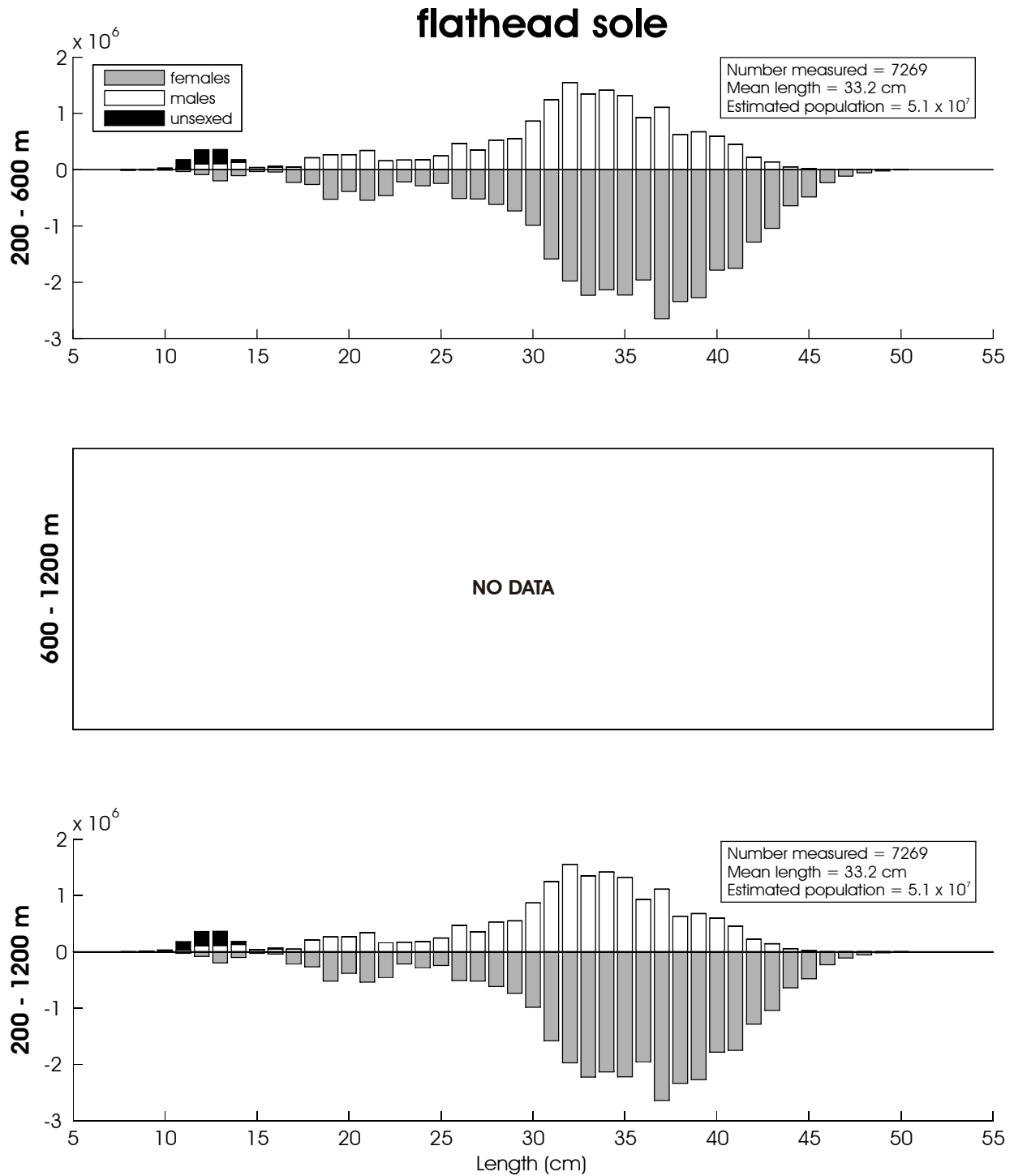

Figure 65. - - Size composition of the estimated flathead sole population from the 2010 EBSS survey for all subareas by depth. The abscissa is scaled as total length in centimeters while the ordinate represents the estimated total population.

Table 41. - - Abundance estimates by subarea and depth strata for Greenland turbot (*Reinhardtius hippoglossoides*) from the 2010 EBSS survey.

<i>Reinhardtius hippoglossoides</i>		Greenland turbot					
Subarea	Depth strata (m)	Biomass (t)	Population	Biomass variance	Population variance	Average CPUE (kg/ha)	Average CPUE (no./ha)
1	200-400	2.34E+02	5.40E+04	3.89E+04	1.75E+09	5.83E-01	1.35E-01
	400-600	3.92E+03	1.21E+06	3.82E+05	3.55E+10	9.65E+00	2.98E+00
	600-800	1.77E+03	3.73E+05	1.32E+05	6.06E+09	1.01E+01	2.14E+00
	800-1,000	1.08E+03	2.33E+05	3.75E+05	1.43E+10	7.94E+00	1.72E+00
	1,000-1,200	4.65E+02	9.91E+04	5.76E+04	2.89E+09	4.20E+00	8.95E-01
2	200-400	4.35E+01	1.29E+04	1.89E+03	1.66E+08	3.76E-01	1.11E-01
	400-600	6.82E+02	2.17E+05	4.64E+04	2.93E+09	9.67E+00	3.08E+00
	600-800	9.99E+02	3.27E+05	3.72E+05	4.28E+10	1.69E+01	5.53E+00
	800-1,000	7.26E+01	1.38E+04	1.19E+03	5.17E+04	1.31E+00	2.49E-01
	1,000-1,200	3.74E+02	8.89E+04	6.12E+03	6.37E+08	6.99E+00	1.66E+00
3	200-400	1.16E+02	4.12E+04	3.60E+03	6.02E+08	1.29E+00	4.56E-01
	400-600	2.79E+02	8.34E+04	4.07E+03	1.75E+08	3.15E+00	9.41E-01
	600-800	3.72E+02	1.01E+05	1.62E+04	1.10E+09	4.09E+00	1.11E+00
	800-1,000	7.00E+01	2.61E+04	4.90E+03	6.82E+08	9.56E-01	3.57E-01
	1,000-1,200	0.00E+00	0.00E+00	0.00E+00	0.00E+00	0.00E+00	0.00E+00
4	200-400	1.65E+02	4.43E+04	2.86E+03	2.31E+08	1.34E+00	3.58E-01
	400-600	6.46E+02	2.34E+05	4.06E+04	7.61E+09	8.85E+00	3.20E+00
	600-800	7.30E+02	1.44E+05	3.82E+05	1.23E+10	1.05E+01	2.08E+00
	800-1,000	3.82E+02	7.16E+04	3.63E+04	1.39E+09	5.40E+00	1.01E+00
	1,000-1,200	1.32E+02	1.76E+04	1.74E+04	3.10E+08	1.99E+00	2.66E-01
5	200-400	9.45E+01	3.53E+04	5.54E+03	6.90E+08	2.23E+00	8.34E-01
	400-600	3.89E+02	1.43E+05	4.97E+04	6.27E+09	9.13E+00	3.37E+00
	600-800	0.00E+00	0.00E+00	0.00E+00	0.00E+00	0.00E+00	0.00E+00
	800-1,000	2.28E+01	6.32E+03	5.21E+02	4.00E+07	4.14E-01	1.15E-01
	1,000-1,200	0.00E+00	0.00E+00	0.00E+00	0.00E+00	0.00E+00	0.00E+00
6	200-400	5.12E+02	2.34E+05	5.51E+04	8.14E+09	1.97E+00	9.00E-01
	400-600	4.44E+03	1.54E+06	1.36E+06	1.89E+11	2.60E+01	9.03E+00
	600-800	1.37E+03	3.86E+05	3.09E+05	2.22E+10	1.49E+01	4.21E+00
	800-1,000	4.19E+02	8.22E+04	7.79E+04	2.49E+09	6.49E+00	1.27E+00
	1,000-1,200	1.08E+02	2.04E+04	1.16E+04	4.15E+08	2.17E+00	4.11E-01
1-6	200-1,200	1.99E+04	5.84E+06	3.80E+06	3.60E+11	7.04E+00	2.11E+00

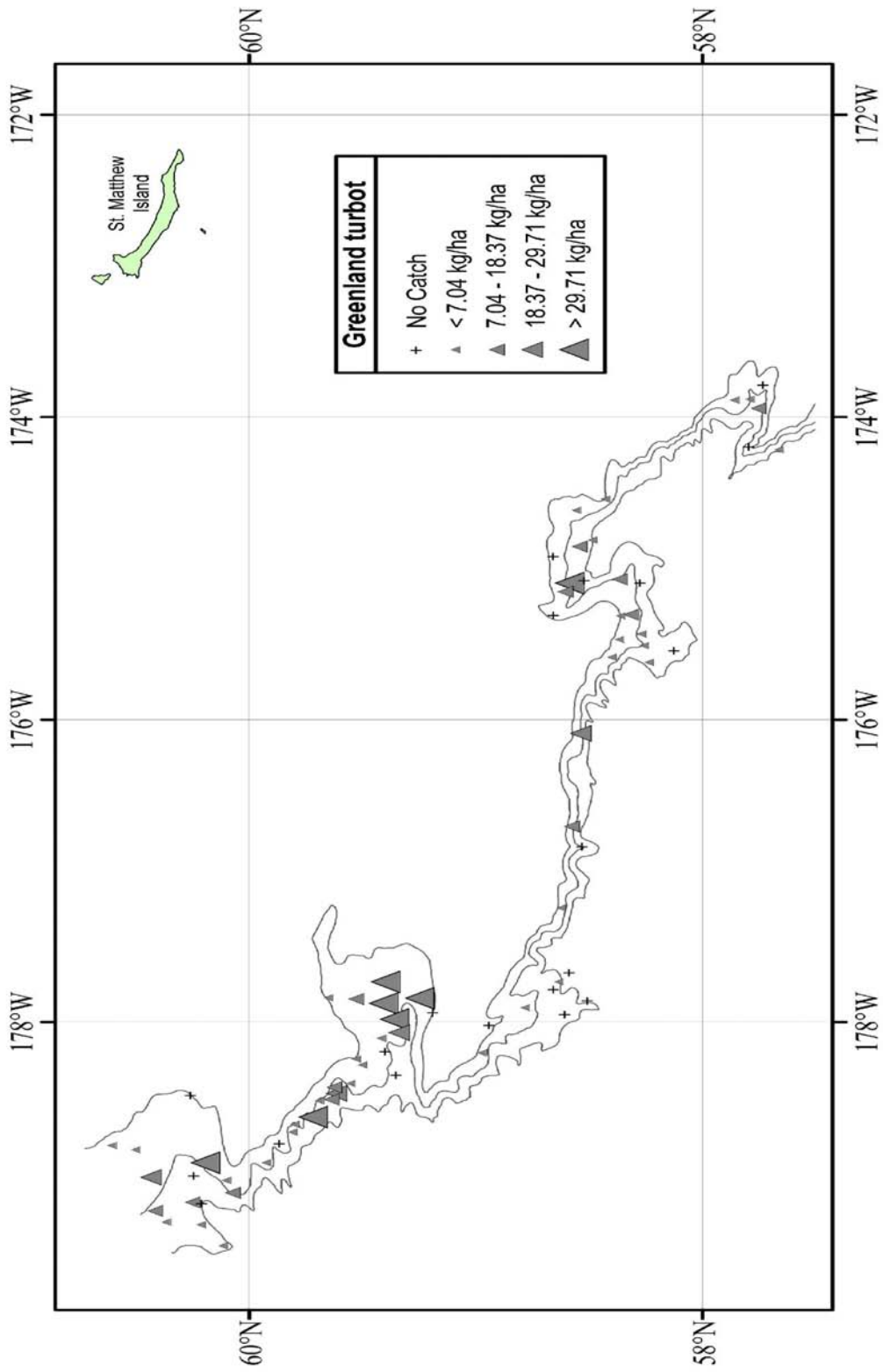

Figure 66. - - Distribution and relative abundance of Greenland turbot from the 2010 EBSS survey. Relative abundance is categorized by no catch, sample CPUE less than the mean CPUE, between the mean CPUE and one standard deviation above the mean, between one and two standard deviations above the mean CPUE, and greater than two standard deviations above the mean CPUE.

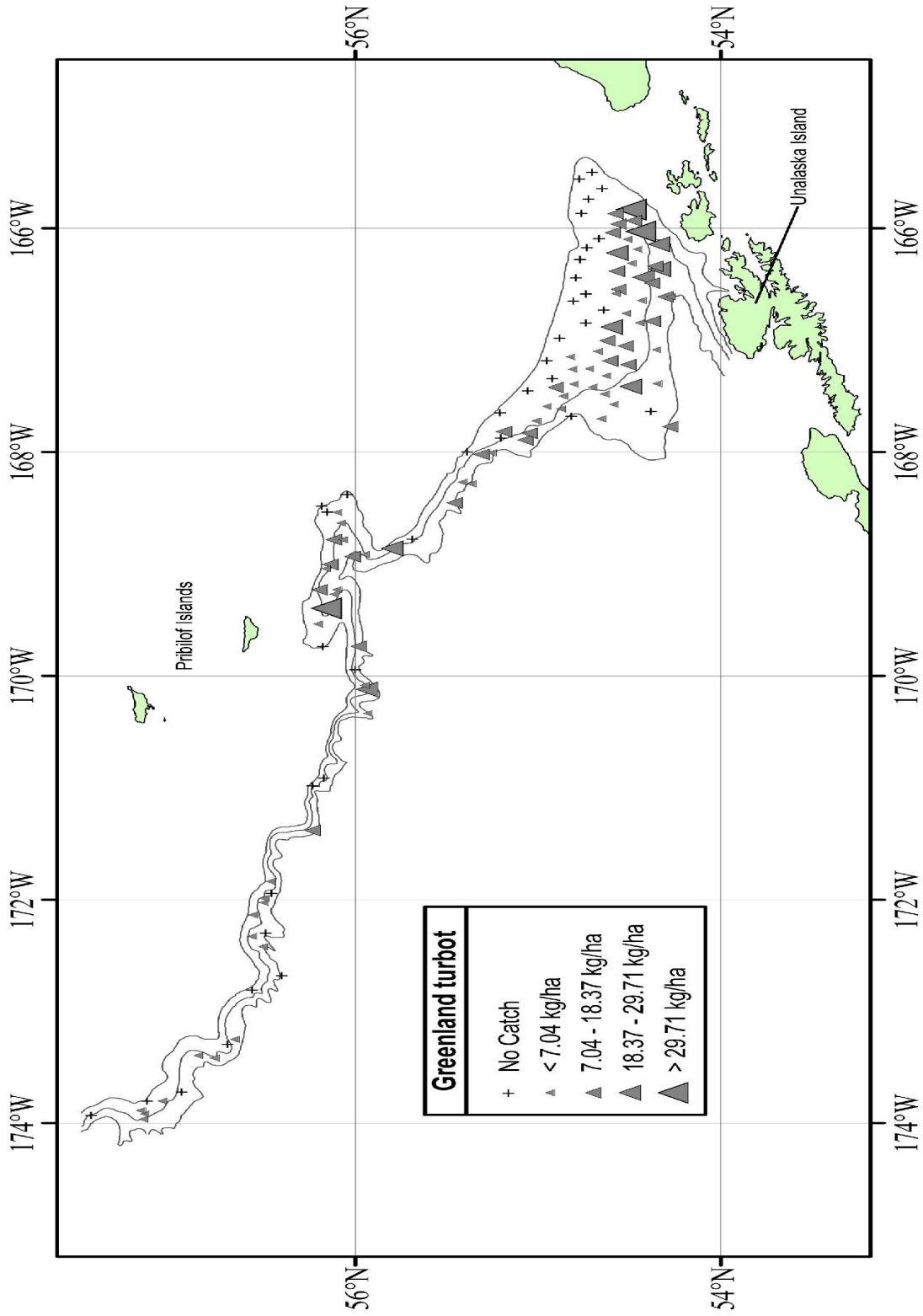

Figure 66. - - Continued.

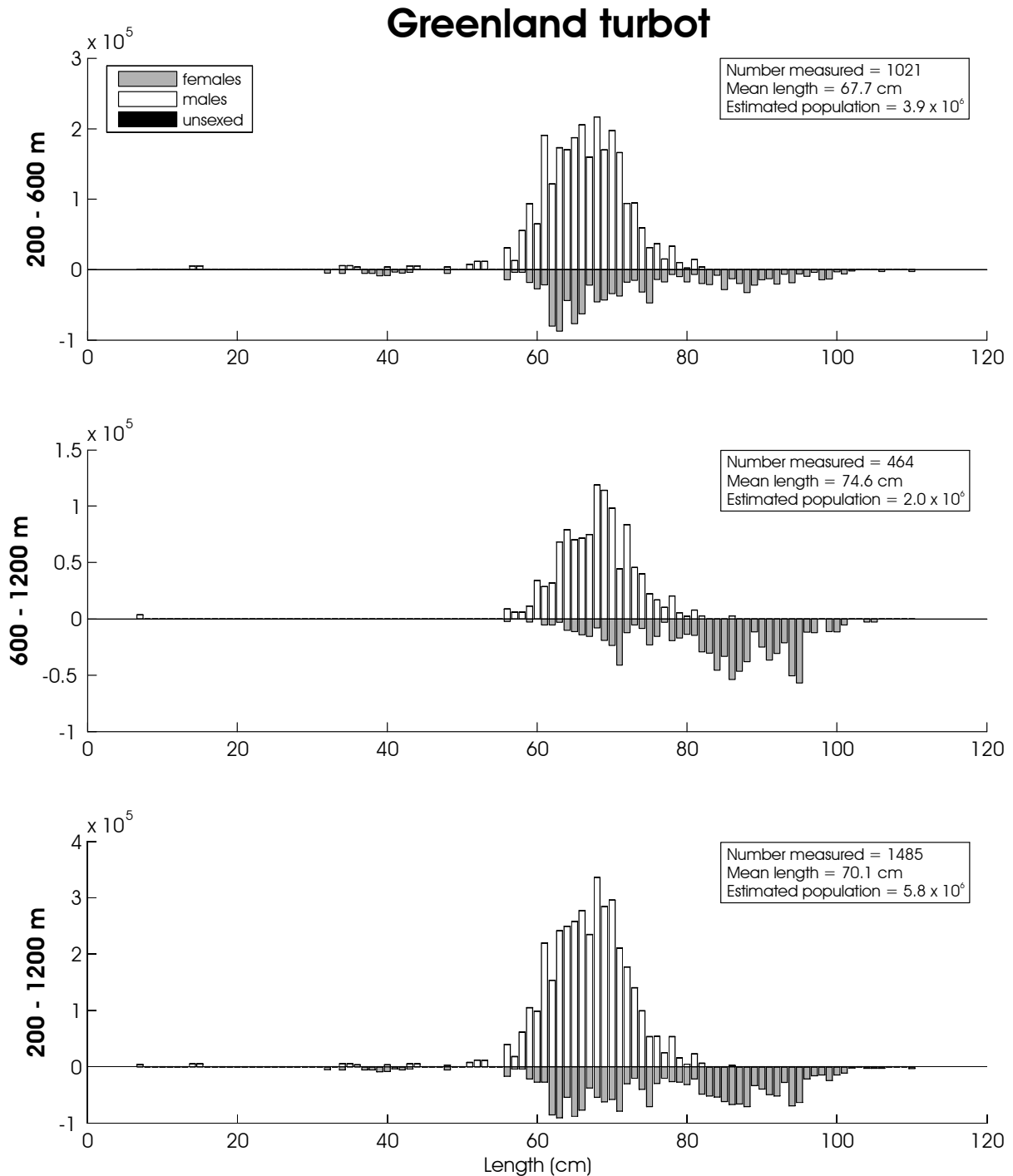

Figure 67. -- Size composition of the estimated Greenland turbot population from the 2010 EBSS survey for all subareas by depth. The abscissa is scaled as total length in centimeters while the ordinate represents the estimated total population.

Table 42. - - Abundance estimates by subarea and depth strata for arrowtooth flounder (*Atheresthes stomias*) from the 2010 EBSS survey.

<i>Atheresthes stomias</i>		arrowtooth flounder					
Subarea	Depth strata (m)	Biomass (t)	Population	Biomass variance	Population variance	Average CPUE (kg/ha)	Average CPUE (no./ha)
1	200-400	3.05E+04	3.68E+07	4.74E+07	6.34E+13	7.59E+01	9.17E+01
	400-600	5.62E+03	4.70E+06	7.08E+06	7.45E+12	1.38E+01	1.16E+01
	600-800	1.10E+02	5.05E+04	3.01E+03	6.72E+08	6.34E-01	2.90E-01
	800-1,000	0.00E+00	0.00E+00	0.00E+00	0.00E+00	0.00E+00	0.00E+00
	1,000-1,200	0.00E+00	0.00E+00	0.00E+00	0.00E+00	0.00E+00	0.00E+00
2	200-400	8.71E+03	7.92E+06	1.99E+07	1.34E+13	7.52E+01	6.84E+01
	400-600	1.80E+03	8.35E+05	5.31E+05	9.53E+10	2.55E+01	1.18E+01
	600-800	4.83E+00	2.76E+03	2.34E+01	7.63E+06	8.17E-02	4.67E-02
	800-1,000	0.00E+00	0.00E+00	0.00E+00	0.00E+00	0.00E+00	0.00E+00
	1,000-1,200	0.00E+00	0.00E+00	0.00E+00	0.00E+00	0.00E+00	0.00E+00
3	200-400	1.42E+03	1.54E+06	1.03E+05	1.37E+11	1.57E+01	1.52E+01
	400-600	3.83E+03	2.85E+06	7.63E+06	5.08E+12	4.32E+01	3.21E+01
	600-800	9.21E+01	4.96E+04	1.87E+03	4.63E+08	1.01E+00	5.45E-01
	800-1,000	0.00E+00	0.00E+00	0.00E+00	0.00E+00	0.00E+00	0.00E+00
	1,000-1,200	0.00E+00	0.00E+00	0.00E+00	0.00E+00	0.00E+00	0.00E+00
4	200-400	2.76E+03	2.99E+06	4.84E+05	8.42E+11	2.23E+01	2.42E+01
	400-600	1.31E+03	8.96E+05	5.65E+05	3.22E+11	1.80E+01	1.23E+01
	600-800	0.00E+00	0.00E+00	0.00E+00	0.00E+00	0.00E+00	0.00E+00
	800-1,000	0.00E+00	0.00E+00	0.00E+00	0.00E+00	0.00E+00	0.00E+00
	1,000-1,200	0.00E+00	0.00E+00	0.00E+00	0.00E+00	0.00E+00	0.00E+00
5	200-400	1.28E+02	8.82E+04	2.62E+02	1.28E+08	3.01E+00	2.08E+00
	400-600	4.30E+03	2.45E+06	6.89E+06	2.25E+12	1.01E+02	5.76E+01
	600-800	0.00E+00	0.00E+00	0.00E+00	0.00E+00	0.00E+00	0.00E+00
	800-1,000	0.00E+00	0.00E+00	0.00E+00	0.00E+00	0.00E+00	0.00E+00
	1,000-1,200	0.00E+00	0.00E+00	0.00E+00	0.00E+00	0.00E+00	0.00E+00
6	200-400	2.53E+03	2.20E+06	7.85E+05	6.50E+11	9.76E+00	8.48E+00
	400-600	1.06E+04	7.26E+06	2.80E+07	1.11E+13	6.24E+01	4.26E+01
	600-800	3.42E+02	1.92E+05	2.69E+04	8.48E+09	3.73E+00	2.09E+00
	800-1,000	0.00E+00	0.00E+00	0.00E+00	0.00E+00	0.00E+00	0.00E+00
	1,000-1,200	0.00E+00	0.00E+00	0.00E+00	0.00E+00	0.00E+00	0.00E+00
1-6	200-1,200	7.41E+04	7.08E+07	1.19E+08	1.05E+14	2.35E+01	2.18E+01

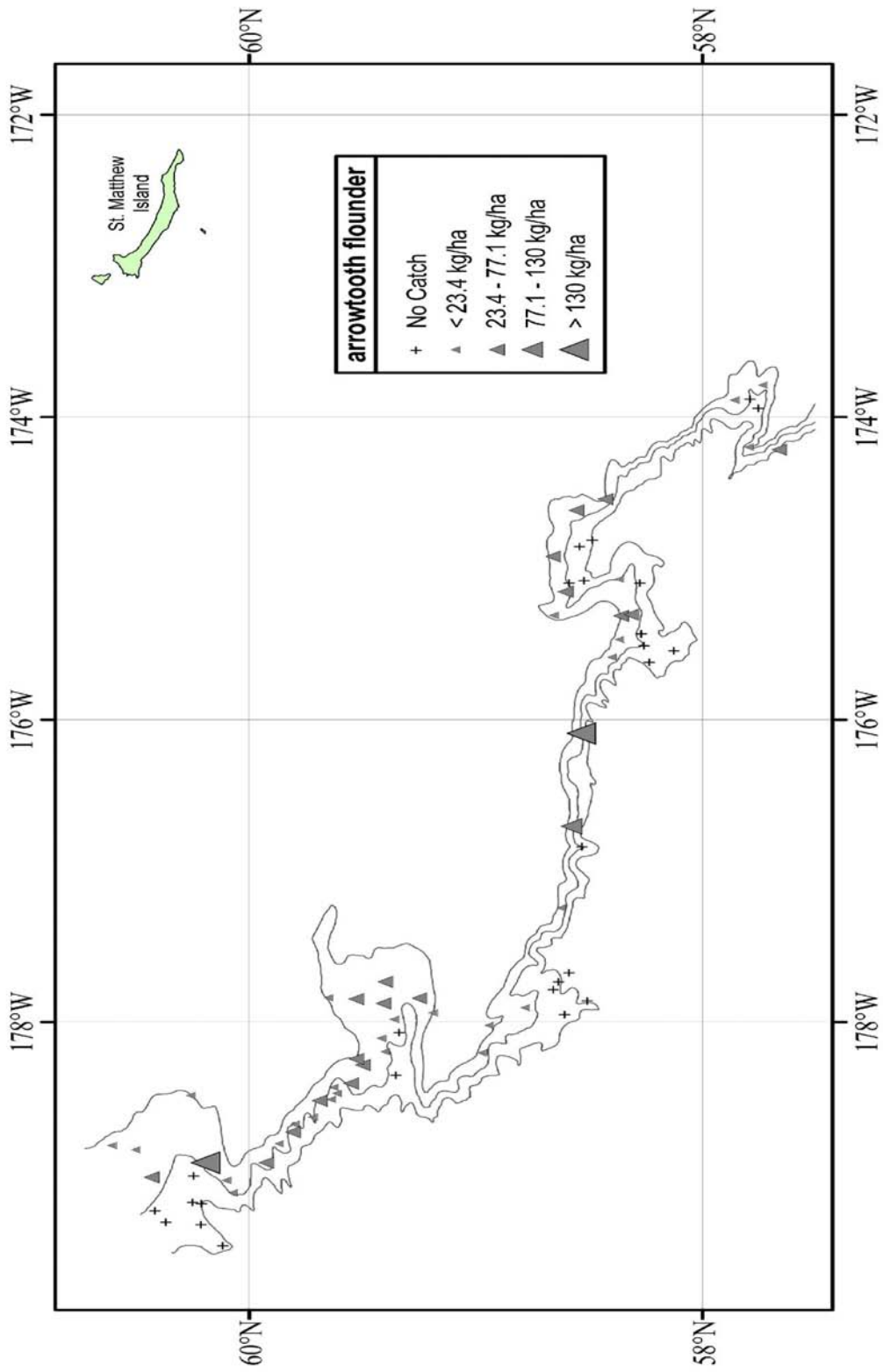

Figure 68. - - Distribution and relative abundance of arrowtooth flounder from the 2010 EBSS survey. Relative abundance is categorized by no catch, sample CPUE less than the mean CPUE, between the mean CPUE and one standard deviation above the mean, between one and two standard deviations above the mean CPUE, and greater than two standard deviations above the mean CPUE.

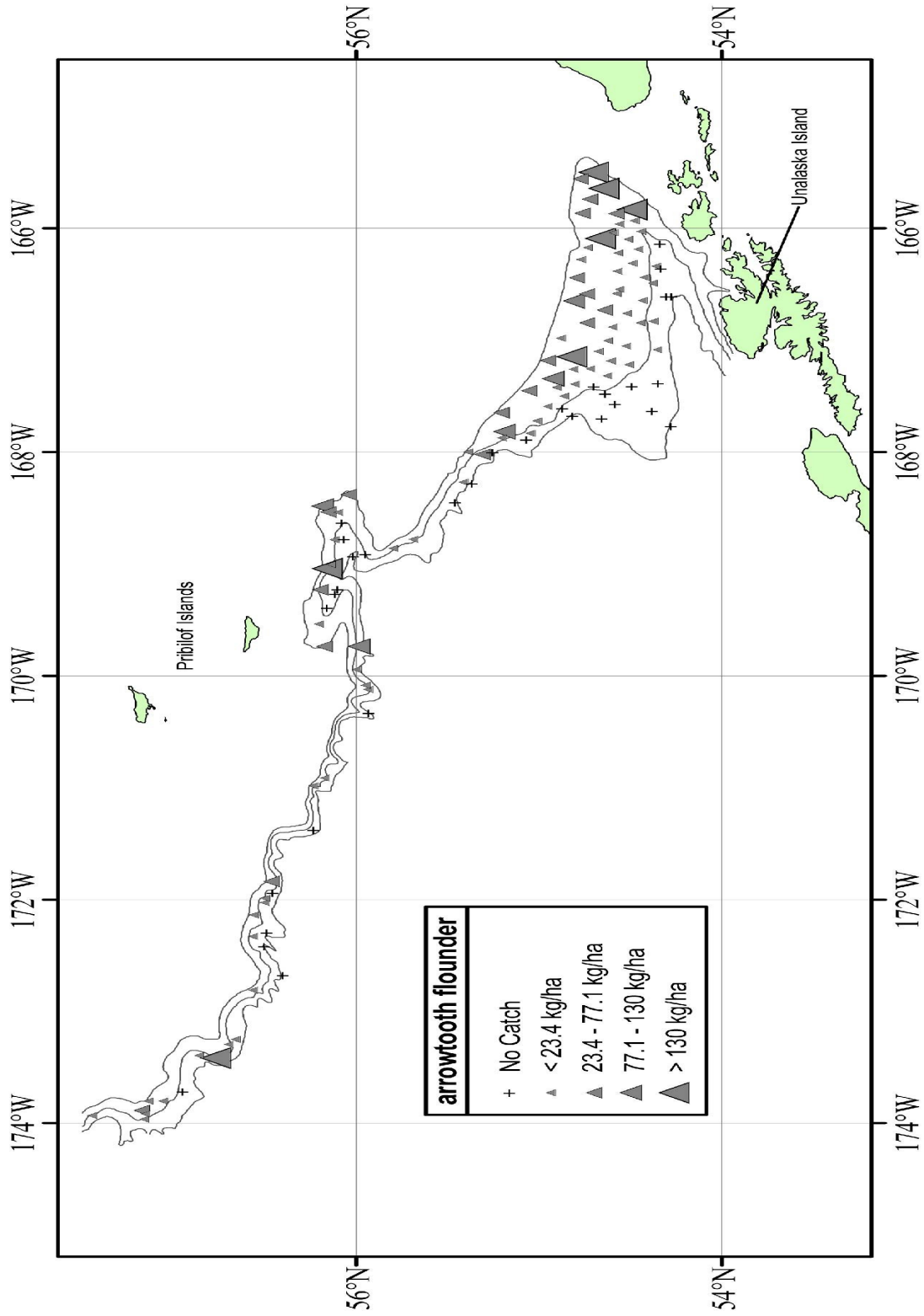

Figure 68. - - Continued.

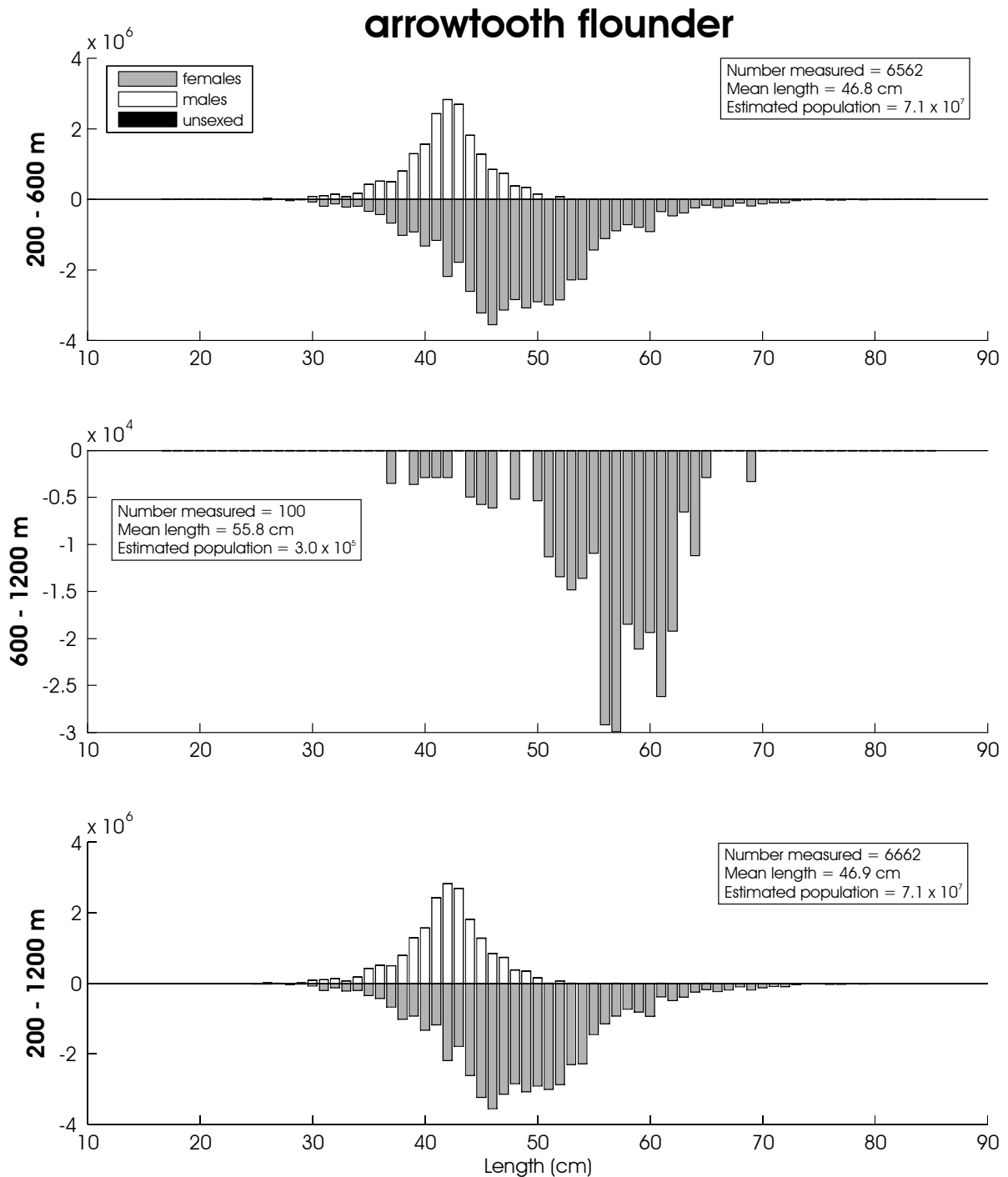

Figure 69. -- Size composition of the estimated arrowtooth flounder population from the 2010 EBSS survey for all subareas by depth. The abscissa is scaled as total length in centimeters while the ordinate represents the estimated total population.

Table 43. - - Abundance estimates by subarea and depth strata for Kamchatka flounder (*Atheresthes evermanni*) from the 2010 EBSS survey.

<i>Atheresthes evermanni</i>		Kamchatka flounder					
Subarea	Depth strata (m)	Biomass (t)	Population	Biomass variance	Population variance	Average CPUE (kg/ha)	Average CPUE (no./ha)
1	200-400	1.34E+03	1.53E+06	9.60E+04	9.18E+10	3.34E+00	3.82E+00
	400-600	6.60E+03	4.87E+06	5.85E+05	4.07E+11	1.62E+01	1.20E+01
	600-800	1.30E+03	6.23E+05	7.13E+04	1.23E+10	7.46E+00	3.58E+00
	800-1,000	6.06E+02	2.56E+05	3.17E+04	3.88E+09	4.47E+00	1.89E+00
	1,000-1,200	2.38E+02	9.78E+04	2.25E+03	8.49E+08	2.15E+00	8.83E-01
2	200-400	5.86E+02	6.18E+05	1.02E+04	3.49E+09	5.06E+00	5.34E+00
	400-600	2.63E+03	1.67E+06	8.66E+05	4.38E+11	3.73E+01	2.37E+01
	600-800	1.01E+03	5.73E+05	2.83E+04	7.59E+09	1.71E+01	9.69E+00
	800-1,000	2.03E+02	1.04E+05	2.21E+02	1.31E+09	3.67E+00	1.88E+00
	1,000-1,200	9.55E+01	3.02E+04	4.43E+03	2.69E+06	1.78E+00	5.63E-01
3	200-400	2.42E+02	2.67E+05	7.31E+03	1.29E+10	2.67E+00	2.96E+00
	400-600	1.30E+03	1.12E+06	1.94E+04	5.47E+10	1.47E+01	1.26E+01
	600-800	8.27E+02	5.27E+05	3.02E+04	1.21E+10	9.08E+00	5.79E+00
	800-1,000	4.60E+01	1.56E+04	2.12E+03	2.45E+08	6.28E-01	2.14E-01
	1,000-1,200	4.72E+01	1.58E+04	3.62E-03	6.70E+04	6.99E-01	2.34E-01
4	200-400	3.24E+02	3.60E+05	9.06E+03	1.51E+10	2.62E+00	2.92E+00
	400-600	5.11E+02	4.64E+05	2.63E+04	3.42E+10	7.00E+00	6.36E+00
	600-800	3.83E+02	1.87E+05	1.49E+04	1.63E+09	5.53E+00	2.69E+00
	800-1,000	1.38E+02	6.24E+04	1.91E+04	3.90E+09	1.95E+00	8.82E-01
	1,000-1,200	0.00E+00	0.00E+00	0.00E+00	0.00E+00	0.00E+00	0.00E+00
5	200-400	9.55E+01	9.60E+04	5.88E+02	2.90E+08	2.25E+00	2.27E+00
	400-600	2.05E+02	1.50E+05	1.13E+02	1.62E+08	4.81E+00	3.52E+00
	600-800	9.59E+01	4.77E+04	9.19E+03	2.27E+09	2.22E+00	1.10E+00
	800-1,000	1.32E+01	6.32E+03	1.73E+02	4.00E+07	2.38E-01	1.15E-01
	1,000-1,200	0.00E+00	0.00E+00	0.00E+00	0.00E+00	0.00E+00	0.00E+00
6	200-400	3.00E+03	3.68E+06	1.27E+06	1.81E+12	1.16E+01	1.42E+01
	400-600	4.47E+03	3.57E+06	4.24E+06	2.37E+12	2.62E+01	2.09E+01
	600-800	1.54E+03	1.05E+06	4.76E+05	2.49E+11	1.68E+01	1.14E+01
	800-1,000	0.00E+00	0.00E+00	0.00E+00	0.00E+00	0.00E+00	0.00E+00
	1,000-1,200	0.00E+00	0.00E+00	0.00E+00	0.00E+00	0.00E+00	0.00E+00
1-6	200-1,200	2.79E+04	2.20E+07	7.82E+06	5.53E+12	1.03E+01	7.85E+00

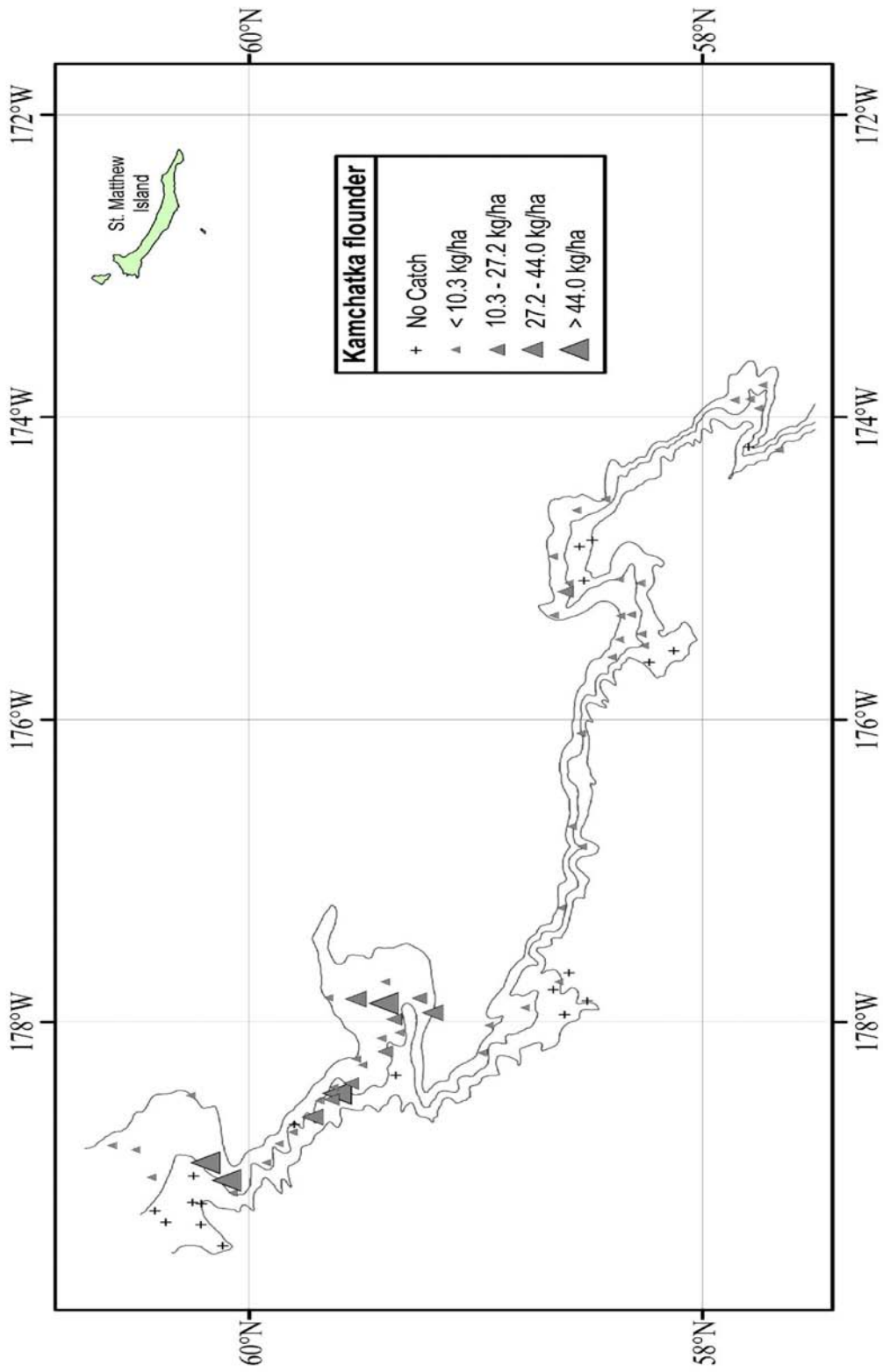

Figure 70. - - Distribution and relative abundance of Kamchatka flounder from the 2010 EBSS survey. Relative abundance is categorized by no catch, sample CPUE less than the mean CPUE, between the mean CPUE and one standard deviation above the mean, between one and two standard deviations above the mean CPUE, and greater than two standard deviations above the mean CPUE.

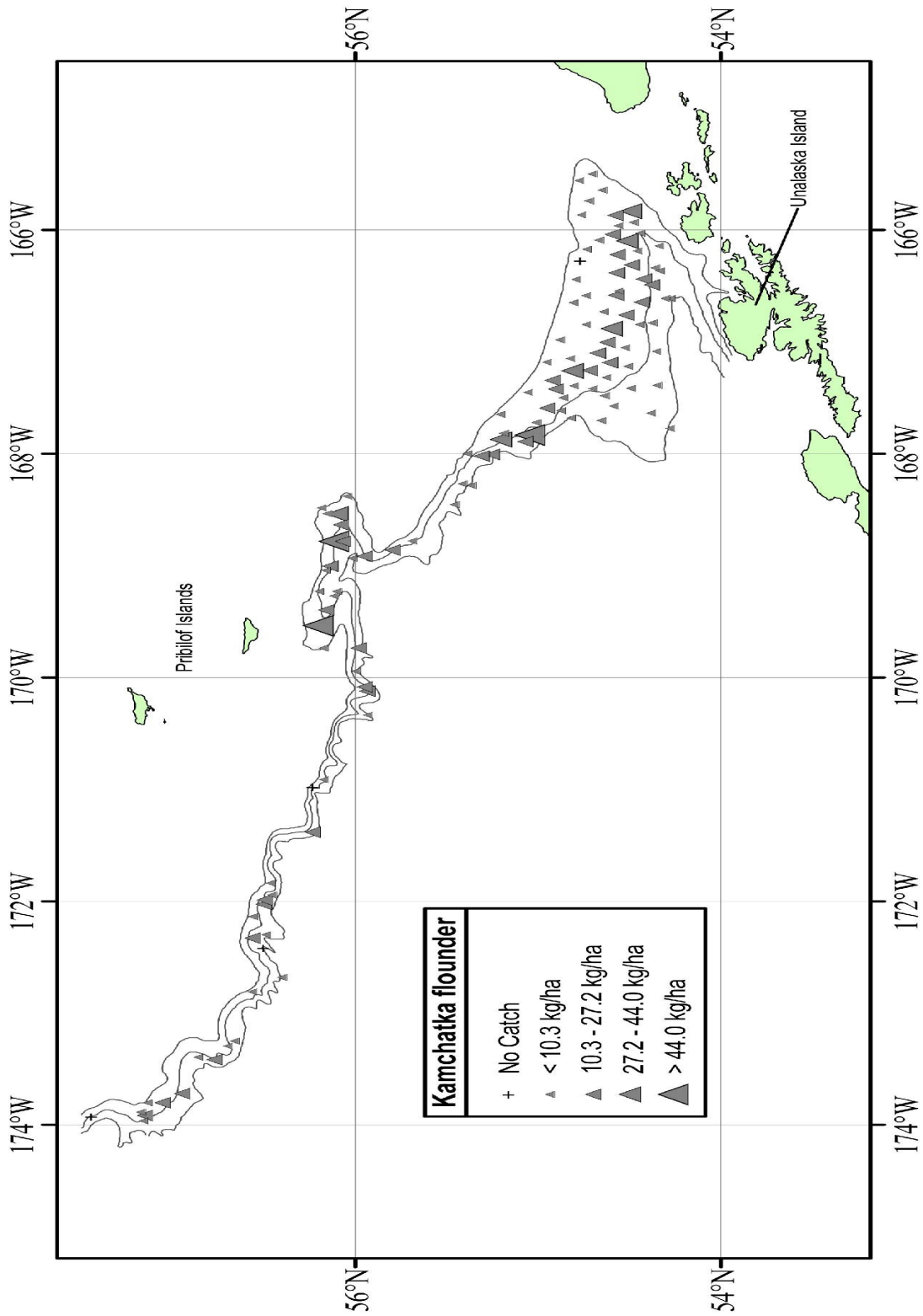

Figure 70. - - Continued.

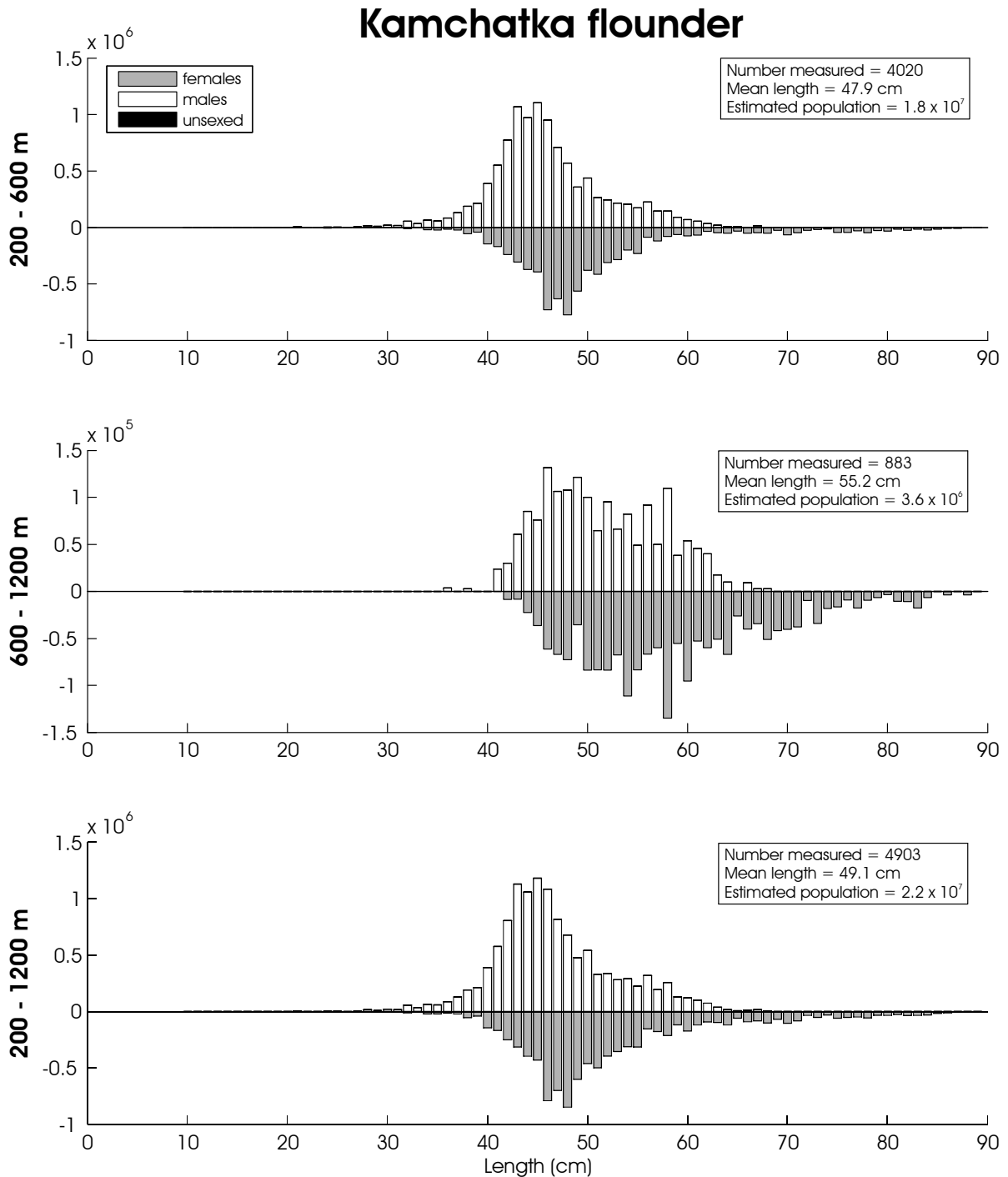

Figure 71. -- Size composition of the estimated Kamchatka flounder population from the 2010 EBSS survey for all subareas by depth. The abscissa is scaled as total length in centimeters while the ordinate represents the estimated total population.

Table 44. - - Abundance estimates by subarea and depth strata for rex sole
(*Glyptocephalus zachirus*) from the 2010 EBSS survey.

<i>Glyptocephalus zachirus</i>						rex sole	
Subarea	Depth strata (m)	Biomass (t)	Population	Biomass variance	Population variance	Average CPUE (kg/ha)	Average CPUE (no./ha)
1	200-400	3.66E+03	5.20E+06	8.77E+05	1.43E+12	9.13E+00	1.30E+01
	400-600	1.53E+03	2.20E+06	7.02E+04	1.43E+11	3.75E+00	5.41E+00
	600-800	2.69E-01	3.05E+03	7.21E-02	9.32E+06	1.54E-03	1.75E-02
	800-1,000	0.00E+00	0.00E+00	0.00E+00	0.00E+00	0.00E+00	0.00E+00
	1,000-1,200	0.00E+00	0.00E+00	0.00E+00	0.00E+00	0.00E+00	0.00E+00
2	200-400	1.09E+03	1.37E+06	3.24E+05	5.18E+11	9.37E+00	1.18E+01
	400-600	7.32E+02	9.72E+05	4.53E+04	1.02E+11	1.04E+01	1.38E+01
	600-800	8.00E+01	1.08E+05	6.41E+03	1.16E+10	1.35E+00	1.82E+00
	800-1,000	0.00E+00	0.00E+00	0.00E+00	0.00E+00	0.00E+00	0.00E+00
	1,000-1,200	0.00E+00	0.00E+00	0.00E+00	0.00E+00	0.00E+00	0.00E+00
3	200-400	1.02E+03	1.45E+06	1.74E+05	3.72E+11	1.13E+01	1.60E+01
	400-600	6.08E+02	7.93E+05	3.12E+04	4.45E+10	6.86E+00	8.95E+00
	600-800	3.27E+01	3.86E+04	1.07E+03	1.49E+09	3.59E-01	4.24E-01
	800-1,000	0.00E+00	0.00E+00	0.00E+00	0.00E+00	0.00E+00	0.00E+00
	1,000-1,200	0.00E+00	0.00E+00	0.00E+00	0.00E+00	0.00E+00	0.00E+00
4	200-400	8.29E+02	1.31E+06	7.68E+04	1.71E+11	6.71E+00	1.06E+01
	400-600	3.79E+02	5.37E+05	5.69E+04	1.07E+11	5.18E+00	7.35E+00
	600-800	0.00E+00	0.00E+00	0.00E+00	0.00E+00	0.00E+00	0.00E+00
	800-1,000	0.00E+00	0.00E+00	0.00E+00	0.00E+00	0.00E+00	0.00E+00
	1,000-1,200	0.00E+00	0.00E+00	0.00E+00	0.00E+00	0.00E+00	0.00E+00
5	200-400	6.40E+01	3.16E+05	1.61E+03	5.50E+10	1.51E+00	7.45E+00
	400-600	3.68E+02	4.81E+05	2.30E+04	3.53E+10	8.64E+00	1.13E+01
	600-800	0.00E+00	0.00E+00	0.00E+00	0.00E+00	0.00E+00	0.00E+00
	800-1,000	0.00E+00	0.00E+00	0.00E+00	0.00E+00	0.00E+00	0.00E+00
	1,000-1,200	0.00E+00	0.00E+00	0.00E+00	0.00E+00	0.00E+00	0.00E+00
6	200-400	3.97E+02	1.35E+06	7.61E+03	1.14E+11	1.53E+00	5.21E+00
	400-600	5.23E+01	1.85E+05	1.27E+03	1.38E+10	3.07E-01	1.08E+00
	600-800	0.00E+00	0.00E+00	0.00E+00	0.00E+00	0.00E+00	0.00E+00
	800-1,000	0.00E+00	0.00E+00	0.00E+00	0.00E+00	0.00E+00	0.00E+00
	1,000-1,200	0.00E+00	0.00E+00	0.00E+00	0.00E+00	0.00E+00	0.00E+00
1-6	200-1,200	1.08E+04	1.63E+07	1.70E+06	3.12E+12	3.86E+00	5.73E+00

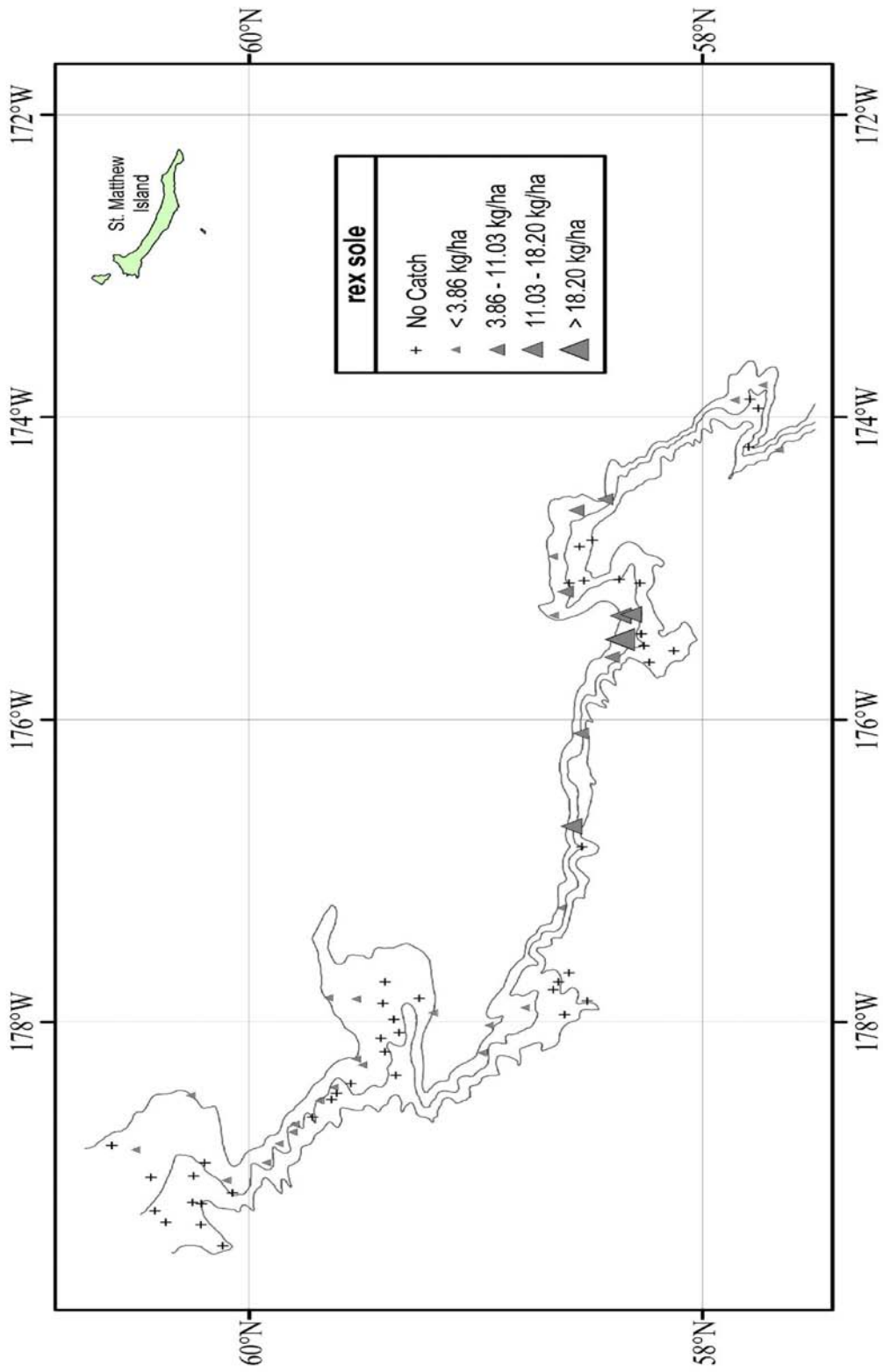

Figure 72. - - Distribution and relative abundance of rex sole from the 2010 EBSS survey. Relative abundance is categorized by no catch, sample CPUE less than the mean CPUE, between the mean CPUE and one standard deviation above the mean, between one and two standard deviations above the mean CPUE, and greater than two standard deviations above the mean CPUE.

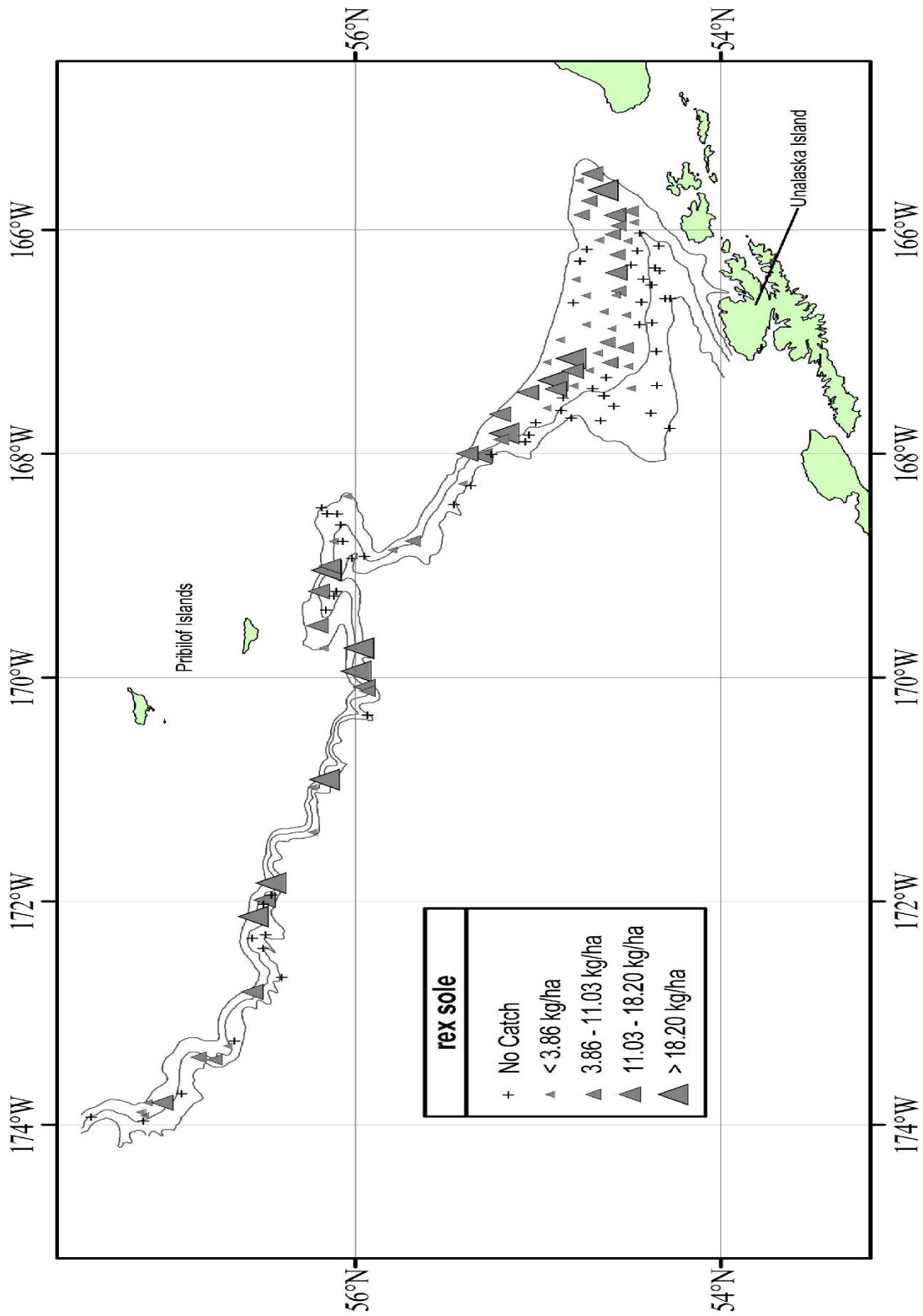

Figure 72. - - Continued.

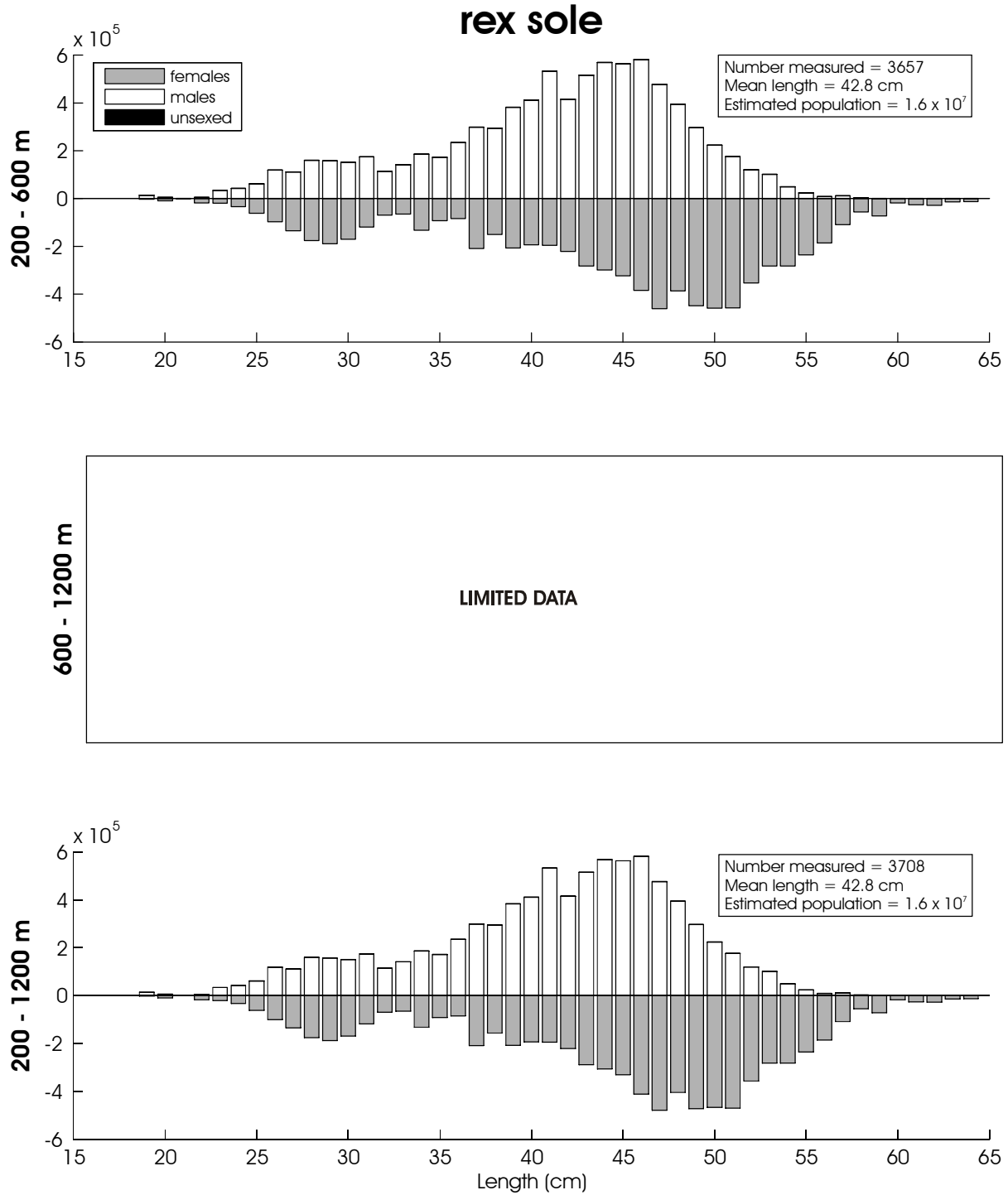

Figure 73. - - Size composition of the estimated rex sole population from the 2010 EBSS survey for all subareas by depth. The abscissa is scaled as total length in centimeters while the ordinate represents the estimated total population.

Table 45. - - Abundance estimates by subarea and depth strata for triangle Tanner crab (*Chionoecetes angulatus*) from the 2010 EBSS survey.

<i>Chionoecetes angulatus</i>		triangle Tanner crab					
Subarea	Depth strata (m)	Biomass (t)	Population	Biomass variance	Population variance	Average CPUE (kg/ha)	Average CPUE (no./ha)
1	200-400	3.97E-02	4.96E+03	1.58E-03	2.46E+07	9.90E-05	1.24E-02
	400-600	3.85E+01	2.90E+05	2.85E+02	1.94E+10	9.48E-02	7.13E-01
	600-800	1.18E+02	2.01E+06	7.36E+03	2.66E+12	6.77E-01	1.15E+01
	800-1,000	6.36E+02	8.74E+06	2.33E+04	1.35E+13	4.70E+00	6.45E+01
	1,000-1,200	5.18E+02	7.52E+06	3.63E+04	3.94E+12	4.68E+00	6.80E+01
2	200-400	0.00E+00	0.00E+00	0.00E+00	0.00E+00	0.00E+00	0.00E+00
	400-600	9.14E+00	4.45E+04	4.98E+01	1.37E+09	1.30E-01	6.31E-01
	600-800	1.36E+01	4.22E+04	1.68E+02	1.08E+09	2.30E-01	7.14E-01
	800-1,000	5.45E+01	2.03E+05	2.97E+03	4.13E+10	9.86E-01	3.68E+00
	1,000-1,200	1.23E+03	8.06E+06	1.88E+05	1.47E+13	2.29E+01	1.50E+02
3	200-400	0.00E+00	0.00E+00	0.00E+00	0.00E+00	0.00E+00	0.00E+00
	400-600	1.87E+00	1.62E+04	3.48E+00	2.62E+08	2.11E-02	1.83E-01
	600-800	2.69E+00	2.20E+04	2.01E+00	1.19E+08	2.95E-02	2.42E-01
	800-1,000	6.99E+00	5.63E+05	4.89E+01	3.17E+11	9.55E-02	7.69E+00
	1,000-1,200	7.43E+00	4.91E+05	5.52E+01	2.41E+11	1.10E-01	7.26E+00
4	200-400	1.04E-01	1.15E+04	1.08E-02	1.33E+08	8.40E-04	9.33E-02
	400-600	1.67E-01	1.19E+04	2.79E-02	1.43E+08	2.29E-03	1.63E-01
	600-800	1.04E-02	5.18E+03	1.07E-04	2.68E+07	1.49E-04	7.46E-02
	800-1,000	3.81E+01	4.88E+05	6.12E+02	5.74E+09	5.38E-01	6.90E+00
	1,000-1,200	2.64E-01	1.76E+04	6.97E-02	3.10E+08	3.98E-03	2.66E-01
5	200-400	0.00E+00	0.00E+00	0.00E+00	0.00E+00	0.00E+00	0.00E+00
	400-600	1.73E+00	4.95E+04	2.03E+00	1.53E+09	4.07E-02	1.16E+00
	600-800	1.75E+01	1.64E+05	3.08E+02	2.70E+10	4.06E-01	3.80E+00
	800-1,000	2.09E+02	6.51E+06	4.68E+02	1.40E+11	3.78E+00	1.18E+02
	1,000-1,200	3.80E+01	3.21E+05	2.95E+01	9.03E+07	6.66E-01	5.63E+00
6	200-400	0.00E+00	0.00E+00	0.00E+00	0.00E+00	0.00E+00	0.00E+00
	400-600	3.10E+01	3.44E+05	2.26E+02	2.63E+10	1.81E-01	2.02E+00
	600-800	4.49E+01	2.04E+05	4.36E+02	1.03E+10	4.89E-01	2.22E+00
	800-1,000	2.00E+02	5.54E+05	2.73E+03	6.78E+09	3.10E+00	8.58E+00
	1,000-1,200	1.46E+01	1.20E+05	2.93E+01	1.44E+09	2.95E-01	2.41E+00
1-6	200-1,200	3.23E+03	3.68E+07	2.63E+05	3.57E+13	1.47E+00	1.56E+01

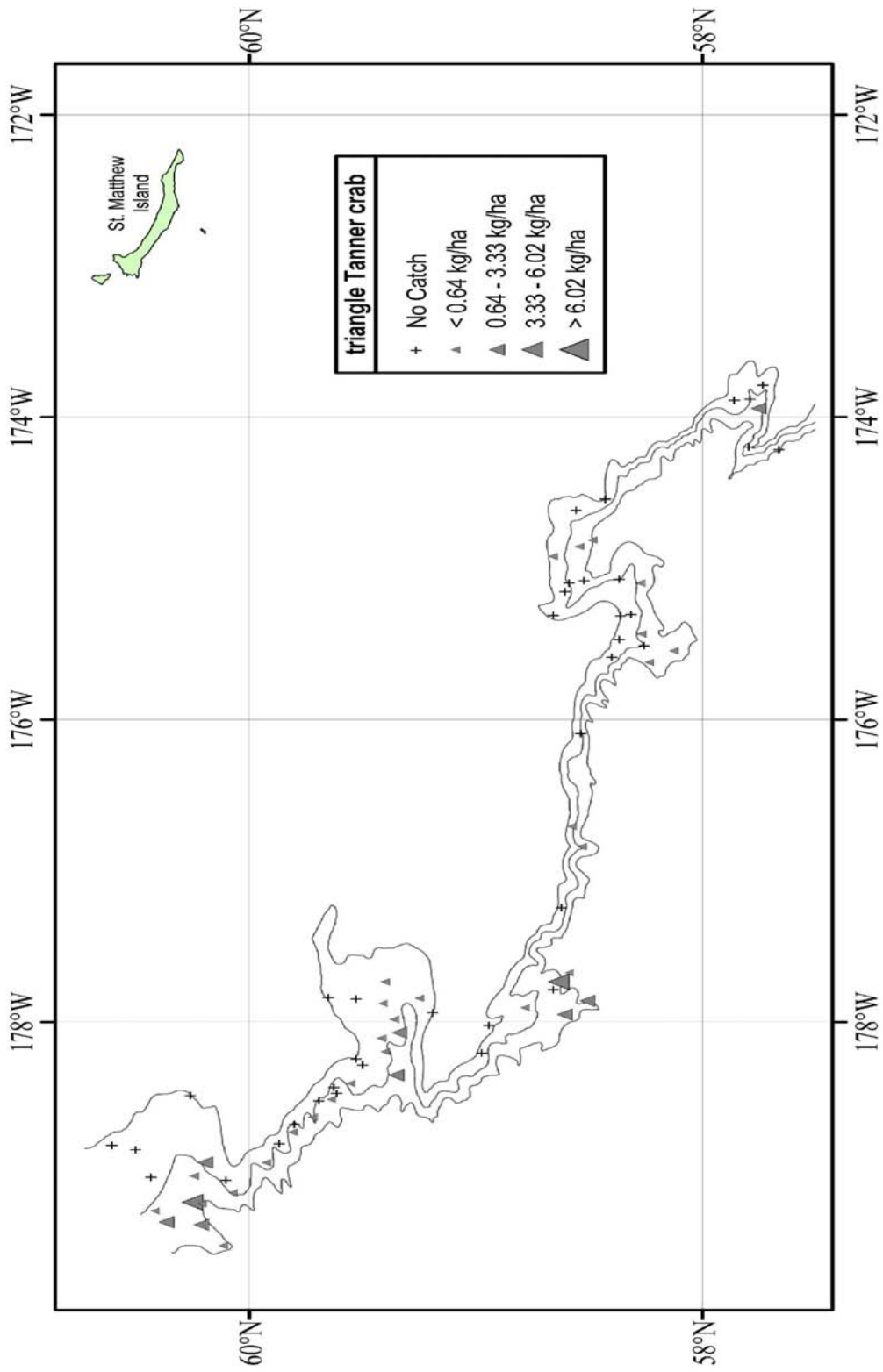

Figure 74. - - Distribution and relative abundance of triangle Tanner crab from the 2010 EBSS survey. Relative abundance is categorized by no catch, sample CPUE less than the mean CPUE, between the mean CPUE and one standard deviation above the mean, between one and two standard deviations above the mean CPUE, and greater than two standard deviations above the mean CPUE.

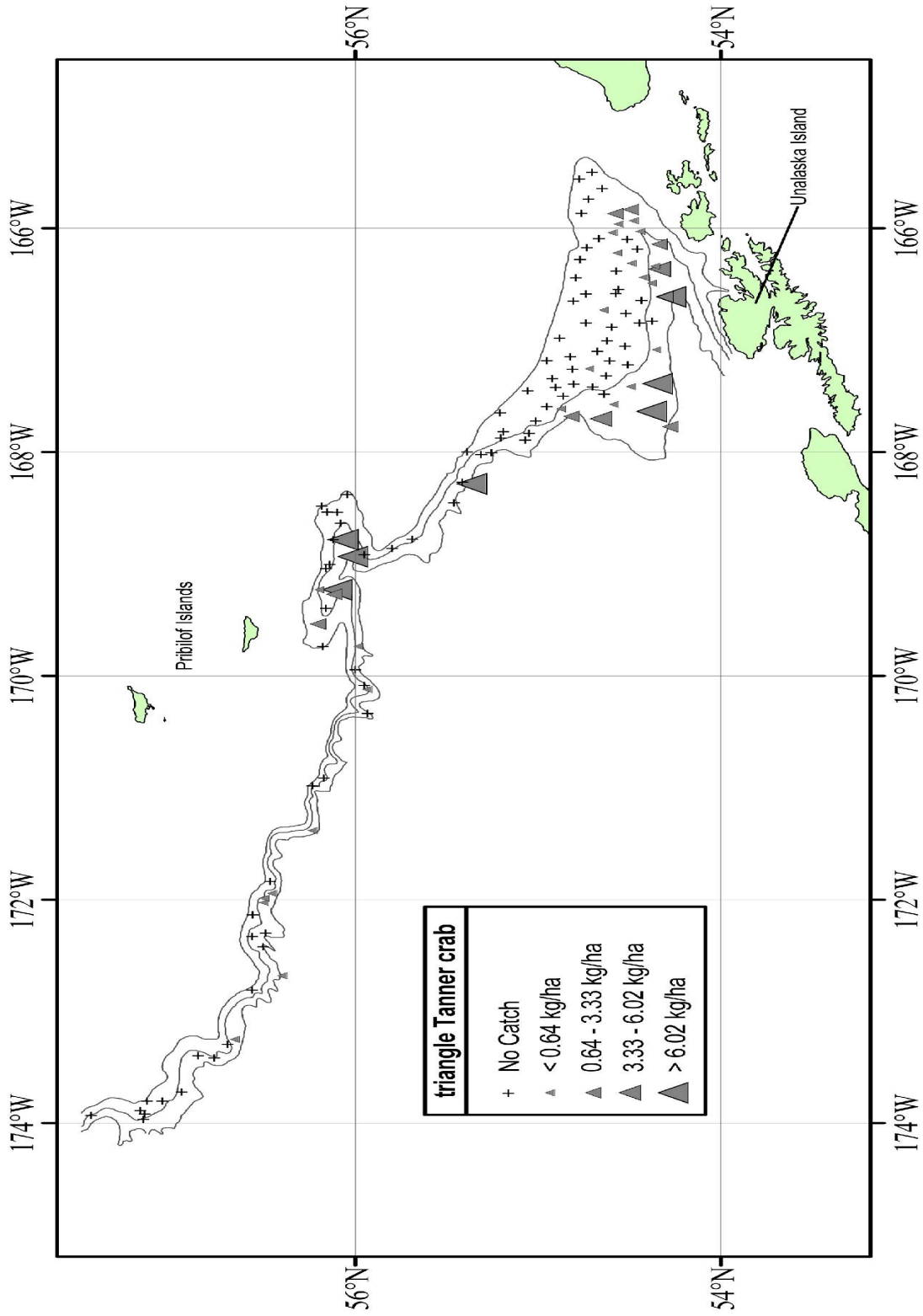

Figure 74. - - Continued.

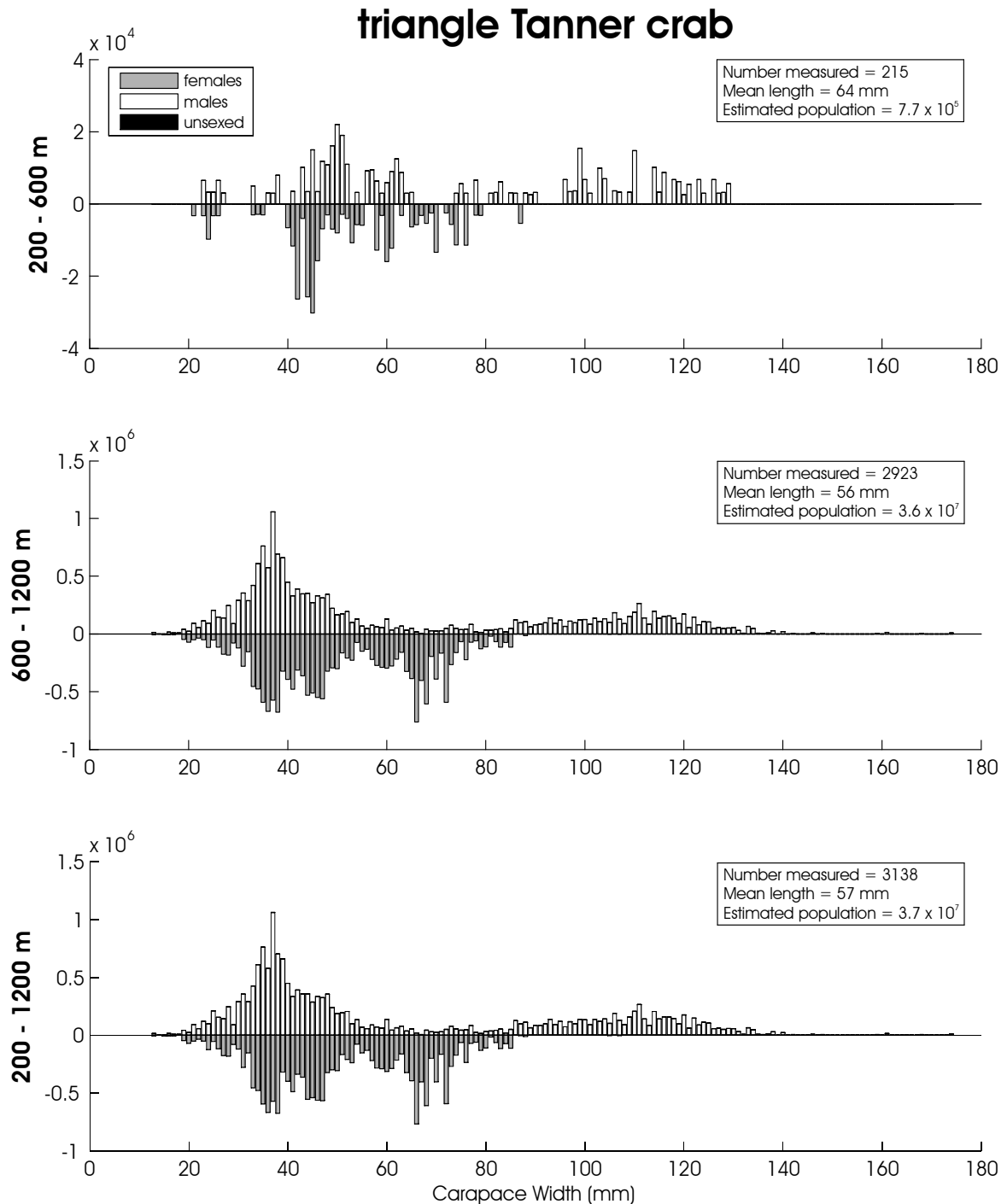

Figure 75. - Size composition of the estimated triangle Tanner crab population from the 2010 EBSS survey for all subareas by depth. The abscissa is scaled as total carapace width in millimeters while the ordinate represents the estimated total population.

Table 46. - Abundance estimates by subarea and depth strata for Tanner crab (*Chionoecetes bairdi*) from the 2010 EBSS survey.

<i>Chionoecetes bairdi</i>		Tanner crab					
Subarea	Depth strata (m)	Biomass (t)	Population	Biomass variance	Population variance	Average CPUE (kg/ha)	Average CPUE (no./ha)
1	200-400	1.85E+03	6.84E+06	3.93E+05	4.31E+12	4.61E+00	1.70E+01
	400-600	1.00E+00	2.35E+04	4.46E-01	2.28E+08	2.47E-03	5.77E-02
	600-800	5.00E-01	7.35E+03	2.50E-01	5.40E+07	2.87E-03	4.22E-02
	800-1,000	0.00E+00	0.00E+00	0.00E+00	0.00E+00	0.00E+00	0.00E+00
	1,000-1,200	0.00E+00	0.00E+00	0.00E+00	0.00E+00	0.00E+00	0.00E+00
2	200-400	7.01E+00	6.41E+04	1.33E+01	5.91E+08	6.05E-02	5.54E-01
	400-600	1.17E+00	2.25E+04	6.13E-01	2.19E+08	1.66E-02	3.19E-01
	600-800	8.54E-02	3.05E+03	7.30E-03	9.31E+06	1.44E-03	5.16E-02
	800-1,000	0.00E+00	0.00E+00	0.00E+00	0.00E+00	0.00E+00	0.00E+00
	1,000-1,200	0.00E+00	0.00E+00	0.00E+00	0.00E+00	0.00E+00	0.00E+00
3	200-400	3.61E+00	5.36E+04	2.60E+00	7.79E+08	3.99E-02	5.93E-01
	400-600	0.00E+00	0.00E+00	0.00E+00	0.00E+00	0.00E+00	0.00E+00
	600-800	0.00E+00	0.00E+00	0.00E+00	0.00E+00	0.00E+00	0.00E+00
	800-1,000	0.00E+00	0.00E+00	0.00E+00	0.00E+00	0.00E+00	0.00E+00
	1,000-1,200	0.00E+00	0.00E+00	0.00E+00	0.00E+00	0.00E+00	0.00E+00
4	200-400	9.04E+00	1.55E+05	1.92E+01	4.52E+09	7.31E-02	1.26E+00
	400-600	0.00E+00	0.00E+00	0.00E+00	0.00E+00	0.00E+00	0.00E+00
	600-800	0.00E+00	0.00E+00	0.00E+00	0.00E+00	0.00E+00	0.00E+00
	800-1,000	0.00E+00	0.00E+00	0.00E+00	0.00E+00	0.00E+00	0.00E+00
	1,000-1,200	0.00E+00	0.00E+00	0.00E+00	0.00E+00	0.00E+00	0.00E+00
5	200-400	3.39E+01	4.50E+05	5.08E+02	2.34E+10	7.99E-01	1.06E+01
	400-600	0.00E+00	0.00E+00	0.00E+00	0.00E+00	0.00E+00	0.00E+00
	600-800	6.78E-01	5.30E+03	4.60E-01	2.81E+07	1.57E-02	1.23E-01
	800-1,000	0.00E+00	0.00E+00	0.00E+00	0.00E+00	0.00E+00	0.00E+00
	1,000-1,200	0.00E+00	0.00E+00	0.00E+00	0.00E+00	0.00E+00	0.00E+00
6	200-400	2.85E+02	3.41E+06	5.95E+03	7.35E+11	1.10E+00	1.31E+01
	400-600	9.52E+00	6.81E+04	3.01E+01	1.72E+09	5.58E-02	3.99E-01
	600-800	6.43E-02	2.68E+03	4.13E-03	7.17E+06	7.00E-04	2.92E-02
	800-1,000	0.00E+00	0.00E+00	0.00E+00	0.00E+00	0.00E+00	0.00E+00
	1,000-1,200	0.00E+00	0.00E+00	0.00E+00	0.00E+00	0.00E+00	0.00E+00
1-6	200-1,200	2.20E+03	1.11E+07	3.99E+05	5.08E+12	2.26E-01	1.47E+00

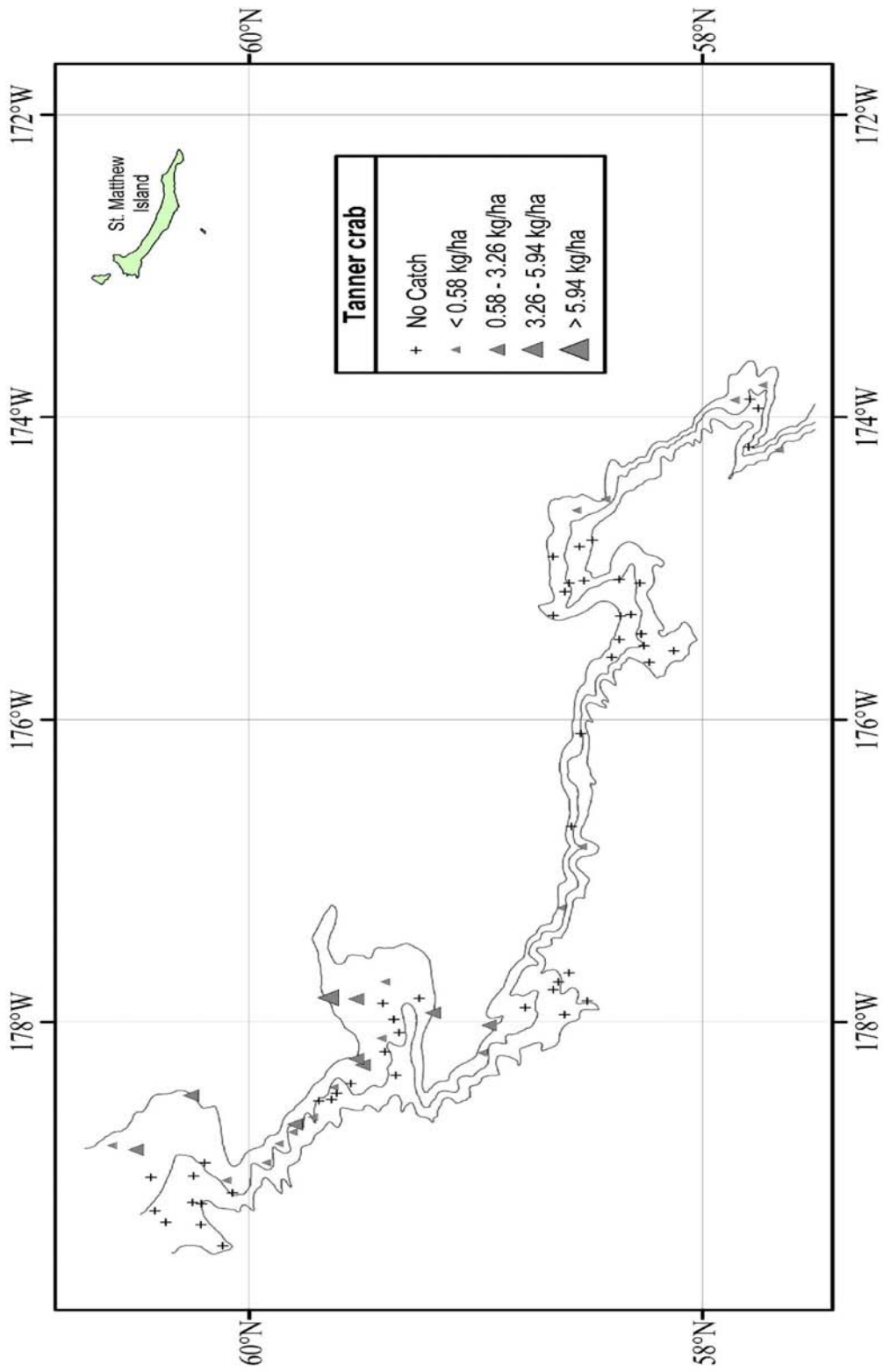

Figure 76. - - Distribution and relative abundance of Tanner crab from the 2010 EBSS survey. Relative abundance is categorized by no catch, sample CPUE less than the mean CPUE, between the mean CPUE and one standard deviation above the mean, between one and two standard deviations above the mean CPUE, and greater than two standard deviations above the mean CPUE.

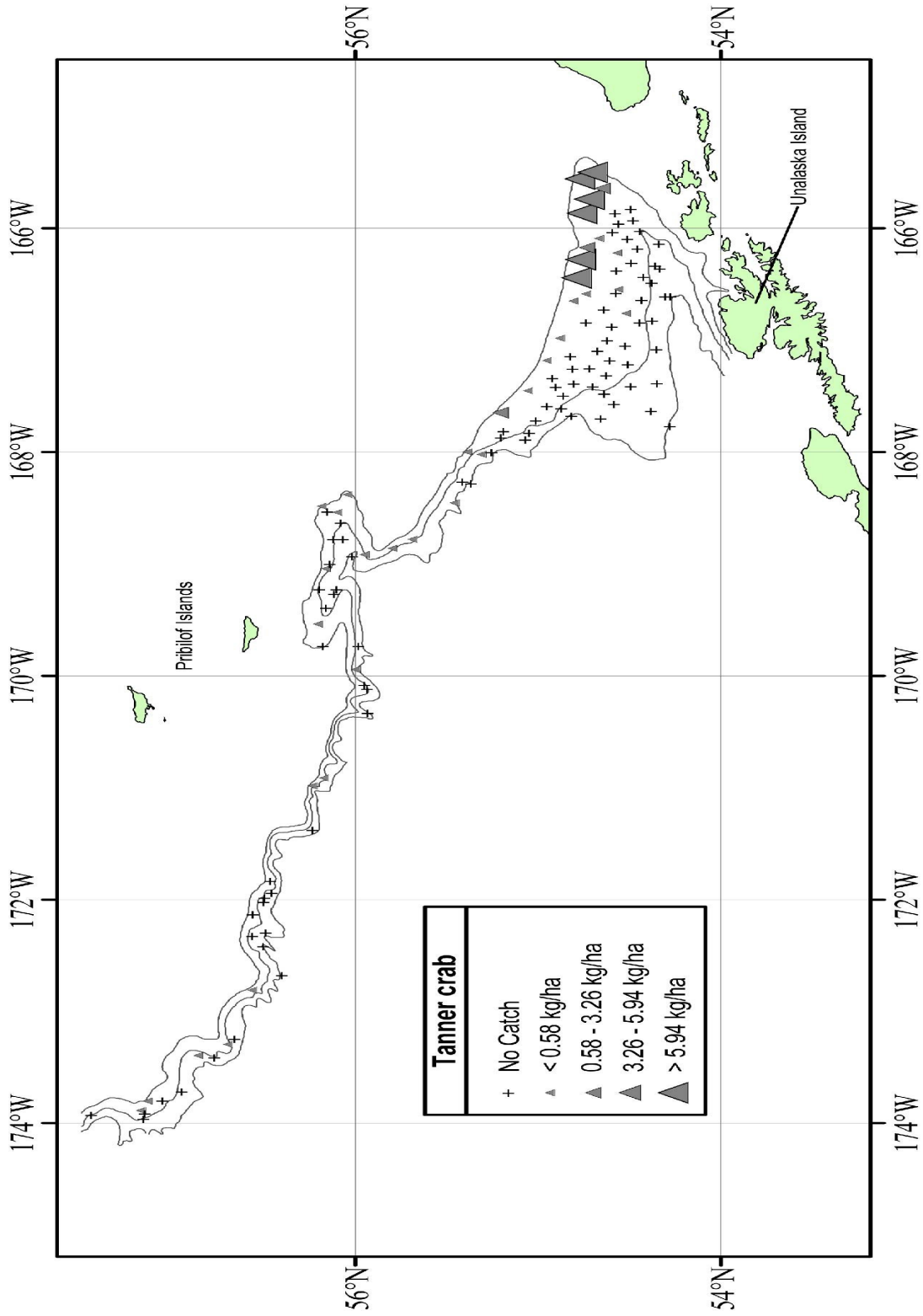

Figure 76. - - Continued.

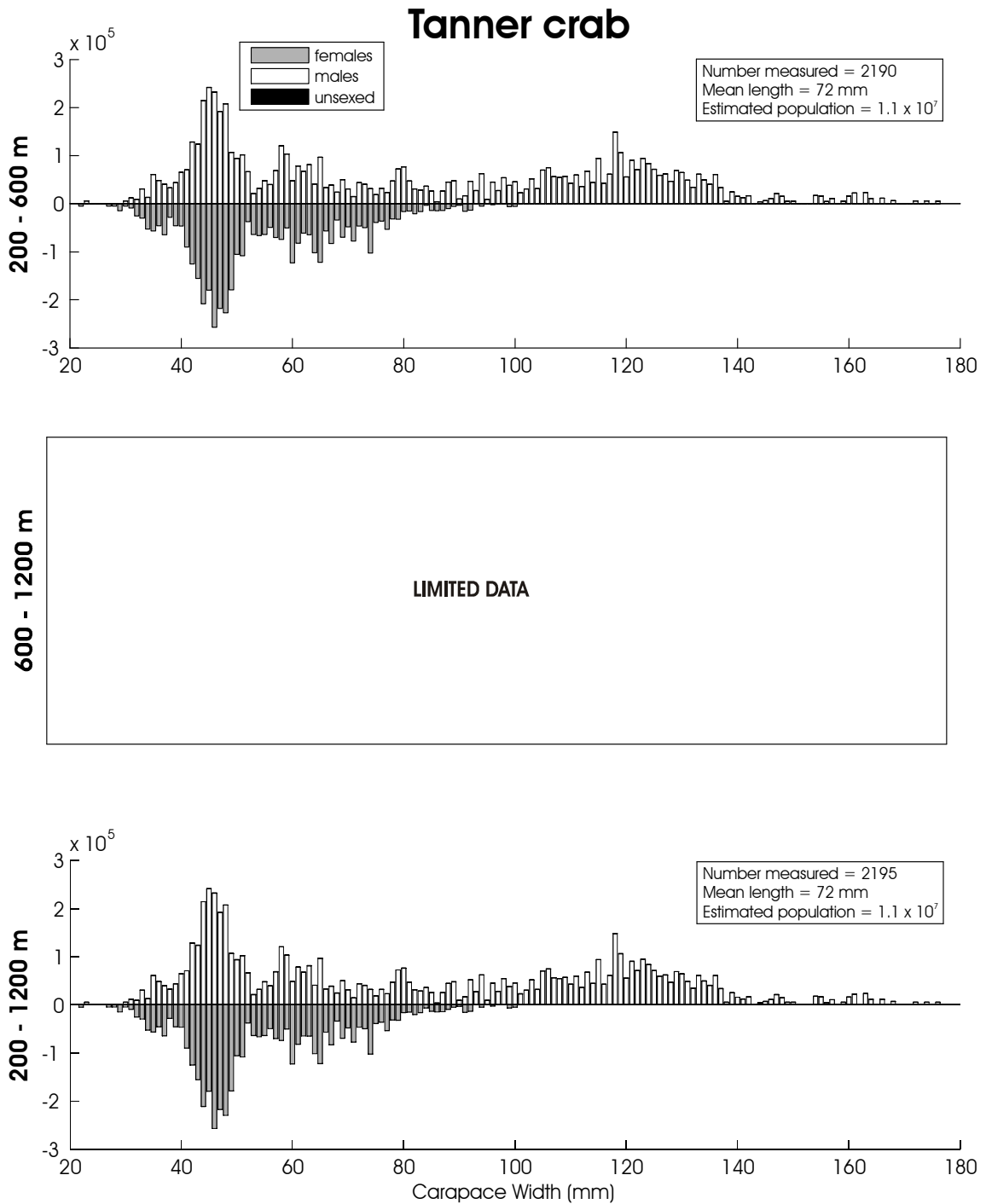

Figure 77. - - Size composition of the estimated Tanner crab population from the 2010 EBSS survey for all subareas by depth. The abscissa is scaled as total carapace width in millimeters while the ordinate represents the estimated total population.

Table 47. - - Abundance estimates by subarea and depth strata for snow crab
(*Chionoecetes opilio*) from the 2010 EBSS survey.

<i>Chionoecetes opilio</i>						snow crab	
Subarea	Depth strata (m)	Biomass (t)	Population	Biomass variance	Population variance	Average CPUE (kg/ha)	Average CPUE (no./ha)
1	200-400	4.01E+02	6.77E+05	4.92E+04	1.42E+11	9.99E-01	1.69E+00
	400-600	2.60E+00	1.24E+04	3.48E+00	5.48E+07	6.41E-03	3.05E-02
	600-800	0.00E+00	0.00E+00	0.00E+00	0.00E+00	0.00E+00	0.00E+00
	800-1,000	0.00E+00	0.00E+00	0.00E+00	0.00E+00	0.00E+00	0.00E+00
	1,000-1,200	0.00E+00	0.00E+00	0.00E+00	0.00E+00	0.00E+00	0.00E+00
2	200-400	0.00E+00	0.00E+00	0.00E+00	0.00E+00	0.00E+00	0.00E+00
	400-600	0.00E+00	0.00E+00	0.00E+00	0.00E+00	0.00E+00	0.00E+00
	600-800	0.00E+00	0.00E+00	0.00E+00	0.00E+00	0.00E+00	0.00E+00
	800-1,000	0.00E+00	0.00E+00	0.00E+00	0.00E+00	0.00E+00	0.00E+00
	1,000-1,200	0.00E+00	0.00E+00	0.00E+00	0.00E+00	0.00E+00	0.00E+00
3	200-400	2.05E+00	7.11E+03	3.60E+00	2.45E+07	2.27E-02	7.86E-02
	400-600	0.00E+00	0.00E+00	0.00E+00	0.00E+00	0.00E+00	0.00E+00
	600-800	0.00E+00	0.00E+00	0.00E+00	0.00E+00	0.00E+00	0.00E+00
	800-1,000	0.00E+00	0.00E+00	0.00E+00	0.00E+00	0.00E+00	0.00E+00
	1,000-1,200	0.00E+00	0.00E+00	0.00E+00	0.00E+00	0.00E+00	0.00E+00
4	200-400	6.80E+00	4.21E+04	2.50E+01	1.05E+09	5.50E-02	3.40E-01
	400-600	1.56E-01	9.18E+03	9.61E-03	2.81E+07	2.14E-03	1.26E-01
	600-800	0.00E+00	0.00E+00	0.00E+00	0.00E+00	0.00E+00	0.00E+00
	800-1,000	0.00E+00	0.00E+00	0.00E+00	0.00E+00	0.00E+00	0.00E+00
	1,000-1,200	0.00E+00	0.00E+00	0.00E+00	0.00E+00	0.00E+00	0.00E+00
5	200-400	1.73E+00	6.43E+04	1.72E+00	1.47E+09	4.08E-02	1.52E+00
	400-600	7.35E-02	3.34E+03	5.40E-03	1.12E+07	1.73E-03	7.85E-02
	600-800	0.00E+00	0.00E+00	0.00E+00	0.00E+00	0.00E+00	0.00E+00
	800-1,000	0.00E+00	0.00E+00	0.00E+00	0.00E+00	0.00E+00	0.00E+00
	1,000-1,200	0.00E+00	0.00E+00	0.00E+00	0.00E+00	0.00E+00	0.00E+00
6	200-400	3.00E+01	4.70E+05	1.02E+02	2.76E+10	1.16E-01	1.81E+00
	400-600	3.85E-01	3.32E+03	1.49E-01	1.10E+07	2.26E-03	1.95E-02
	600-800	8.03E-02	2.68E+03	6.45E-03	7.17E+06	8.76E-04	2.92E-02
	800-1,000	0.00E+00	0.00E+00	0.00E+00	0.00E+00	0.00E+00	0.00E+00
	1,000-1,200	0.00E+00	0.00E+00	0.00E+00	0.00E+00	0.00E+00	0.00E+00
1-6	200-1,200	4.45E+02	1.29E+06	4.94E+04	1.72E+11	4.16E-02	1.91E-01

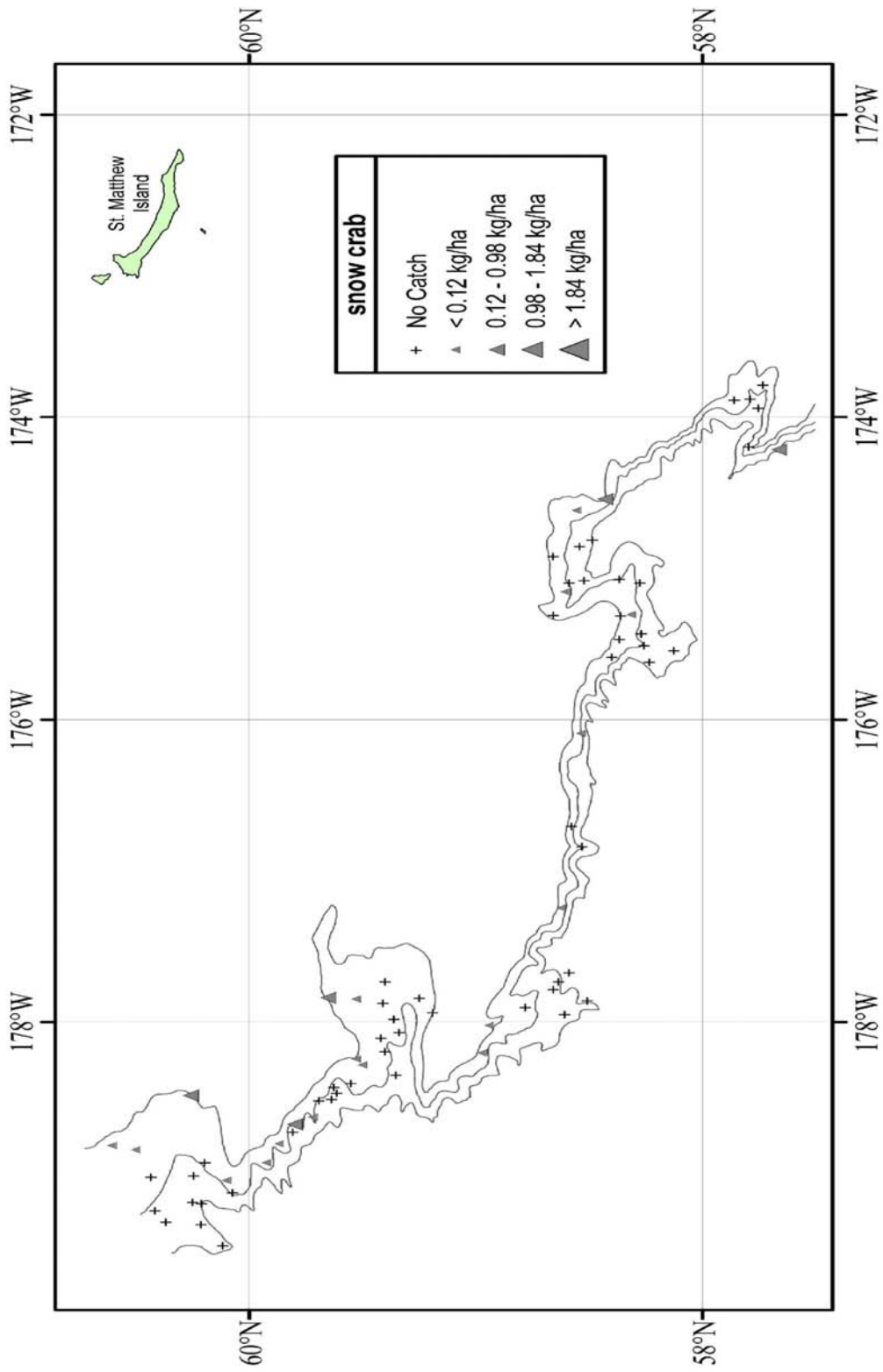

Figure 78. - - Distribution and relative abundance of snow crab from the 2010 EBSS survey. Relative abundance is categorized by no catch, sample CPUE less than the mean CPUE, between the mean CPUE and one standard deviation above the mean, between one and two standard deviations above the mean CPUE, and greater than two standard deviations above the mean CPUE.

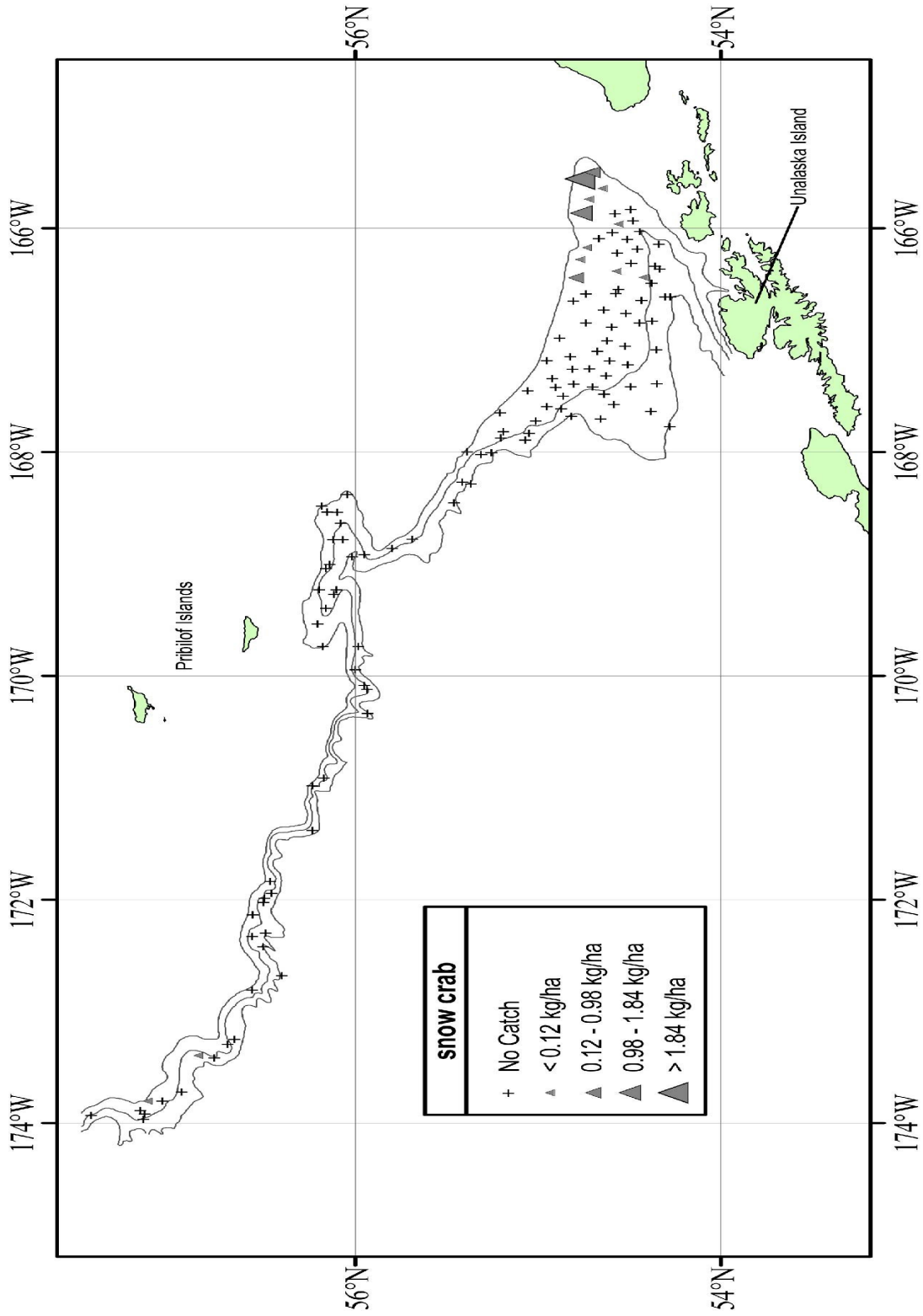

Figure 78. - - Continued.

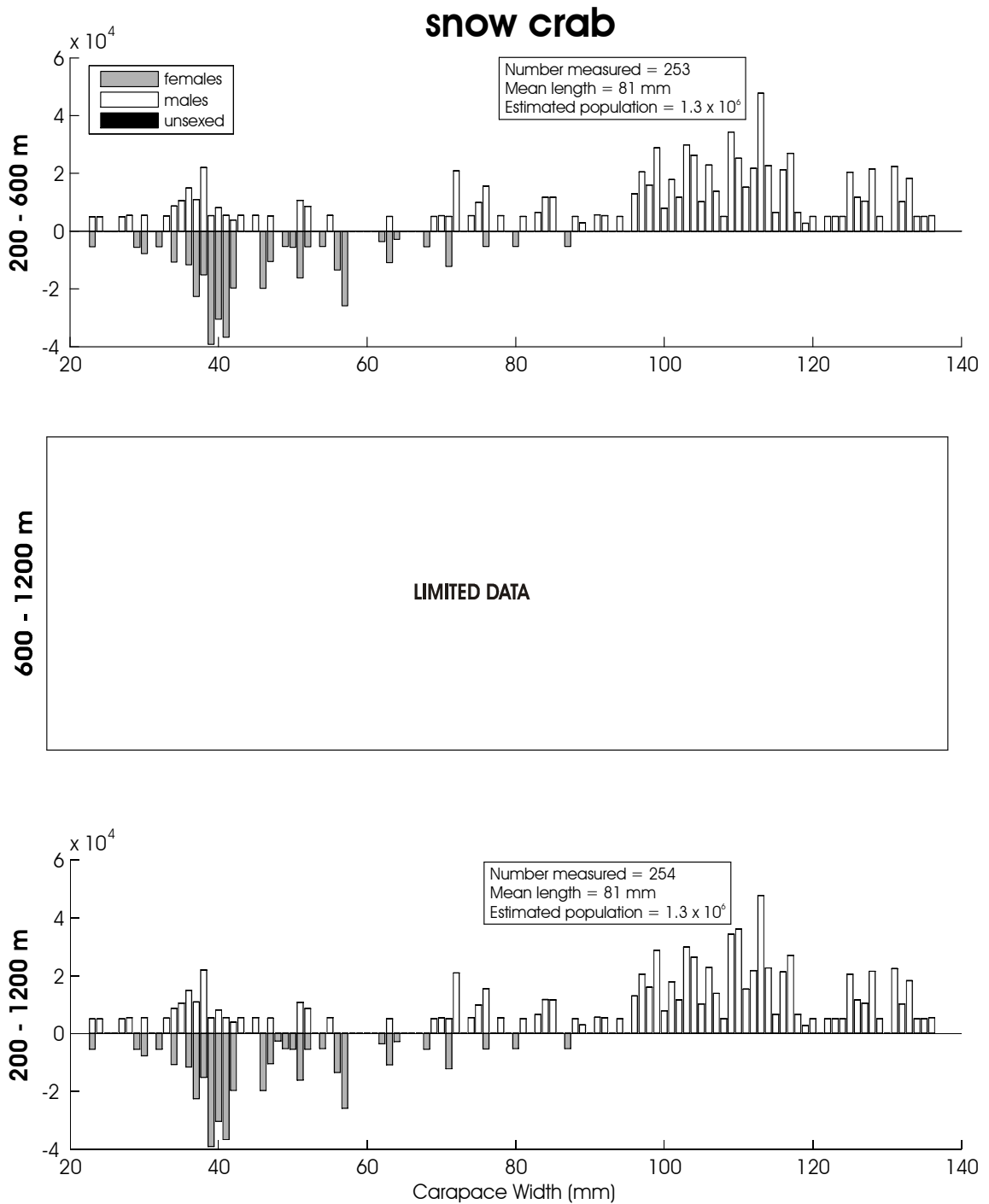

Figure 79. - - Size composition of the estimated snow crab population from the 2010 EBSS survey for all subareas by depth. The abscissa is scaled as total carapace width in millimeters while the ordinate represents the estimated total population.

Table 48. - - Abundance estimates by subarea and depth strata for grooved Tanner crab (*Chionoecetes tanneri*) from the 2010 EBSS survey.

<i>Chionoecetes tanneri</i>		grooved Tanner crab					
Subarea	Depth strata (m)	Biomass (t)	Population	Biomass variance	Population variance	Average CPUE (kg/ha)	Average CPUE (no./ha)
1	200-400	0.00E+00	0.00E+00	0.00E+00	0.00E+00	0.00E+00	0.00E+00
	400-600	2.41E+01	6.46E+04	1.28E+02	6.30E+08	5.93E-02	1.59E-01
	600-800	1.61E+02	7.10E+05	7.26E+03	2.42E+11	9.23E-01	4.08E+00
	800-1,000	9.09E+01	4.87E+05	2.57E+03	1.96E+11	6.71E-01	3.60E+00
	1,000-1,200	0.00E+00	0.00E+00	0.00E+00	0.00E+00	0.00E+00	0.00E+00
2	200-400	3.01E-01	4.30E+03	9.05E-02	1.85E+07	2.60E-03	3.71E-02
	400-600	9.34E+01	3.47E+05	1.19E+03	2.02E+10	1.32E+00	4.92E+00
	600-800	5.29E+01	1.59E+05	3.87E+02	3.21E+09	8.94E-01	2.69E+00
	800-1,000	9.21E+01	3.60E+05	7.09E+03	9.26E+10	1.67E+00	6.52E+00
	1,000-1,200	6.17E+01	3.79E+05	2.46E+03	1.32E+11	1.15E+00	7.07E+00
3	200-400	4.17E-01	4.34E+03	1.74E-01	1.89E+07	4.61E-03	4.80E-02
	400-600	4.57E+01	3.14E+05	9.32E+02	6.86E+10	5.15E-01	3.55E+00
	600-800	2.49E+02	8.85E+05	1.21E+04	7.23E+10	2.73E+00	9.73E+00
	800-1,000	1.61E+01	7.48E+04	2.28E+02	1.50E+08	2.20E-01	1.02E+00
	1,000-1,200	3.99E+00	1.52E+05	2.70E+00	1.11E+10	5.91E-02	2.25E+00
4	200-400	0.00E+00	0.00E+00	0.00E+00	0.00E+00	0.00E+00	0.00E+00
	400-600	3.39E+01	1.45E+05	5.02E+02	1.62E+10	4.65E-01	1.99E+00
	600-800	6.15E+01	2.81E+05	1.31E+03	1.67E+10	8.86E-01	4.05E+00
	800-1,000	6.17E+01	6.36E+05	9.98E+02	1.30E+11	8.72E-01	8.98E+00
	1,000-1,200	5.93E+01	6.34E+05	1.66E+03	4.77E+04	8.95E-01	9.57E+00
5	200-400	0.00E+00	0.00E+00	0.00E+00	0.00E+00	0.00E+00	0.00E+00
	400-600	2.36E+01	6.75E+04	1.41E+02	1.73E+09	5.54E-01	1.59E+00
	600-800	2.87E+01	9.53E+04	4.50E+02	4.03E+09	6.65E-01	2.21E+00
	800-1,000	0.00E+00	0.00E+00	0.00E+00	0.00E+00	0.00E+00	0.00E+00
	1,000-1,200	6.66E+00	3.18E+04	3.41E+01	2.59E+08	1.17E-01	5.58E-01
6	200-400	0.00E+00	0.00E+00	0.00E+00	0.00E+00	0.00E+00	0.00E+00
	400-600	1.00E+02	3.07E+05	1.45E+03	2.08E+10	5.87E-01	1.80E+00
	600-800	1.11E+02	3.73E+05	6.63E+02	1.83E+10	1.21E+00	4.06E+00
	800-1,000	0.00E+00	0.00E+00	0.00E+00	0.00E+00	0.00E+00	0.00E+00
	1,000-1,200	0.00E+00	0.00E+00	0.00E+00	0.00E+00	0.00E+00	0.00E+00
1-6	200-1,200	1.38E+03	6.51E+06	4.15E+04	1.05E+12	5.49E-01	2.68E+00

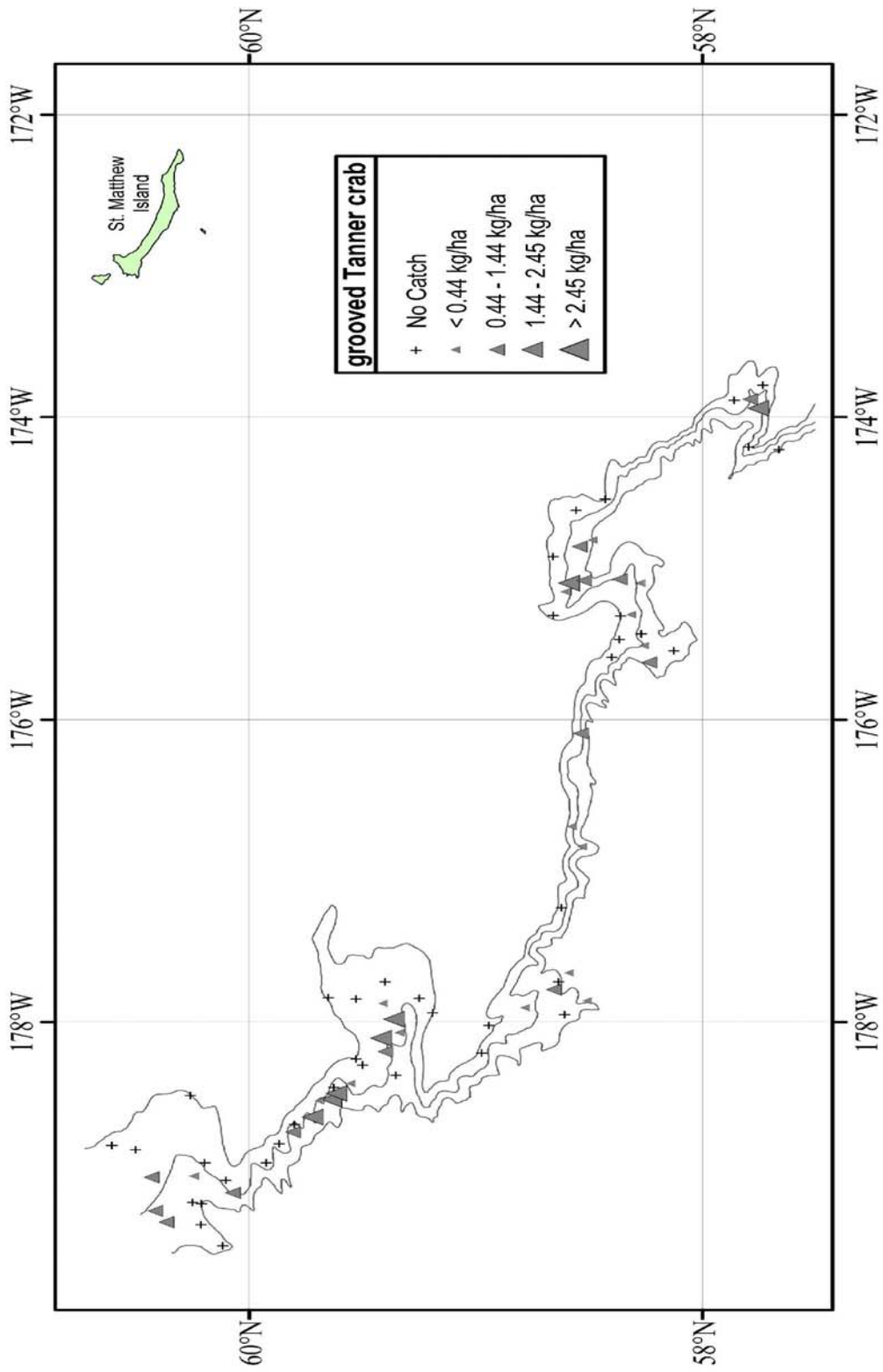

Figure 80. - - Distribution and relative abundance of grooved Tanner crab from the 2010 EBSS survey. Relative abundance is categorized by no catch, sample CPUE less than the mean CPUE, between the mean CPUE and one standard deviation above the mean, between one and two standard deviations above the mean CPUE, and greater than two standard deviations above the mean CPUE.

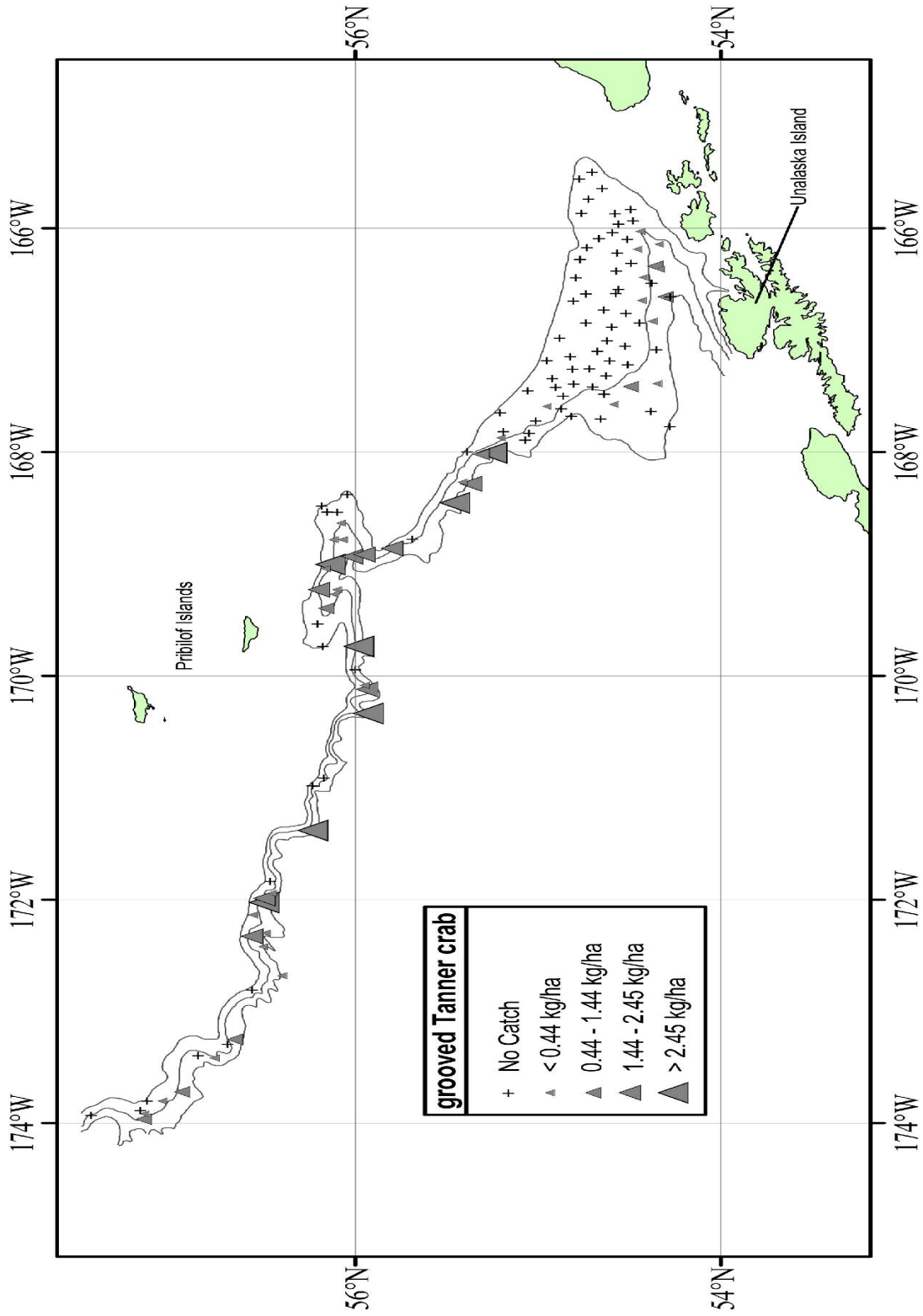

Figure 80. - - Continued.

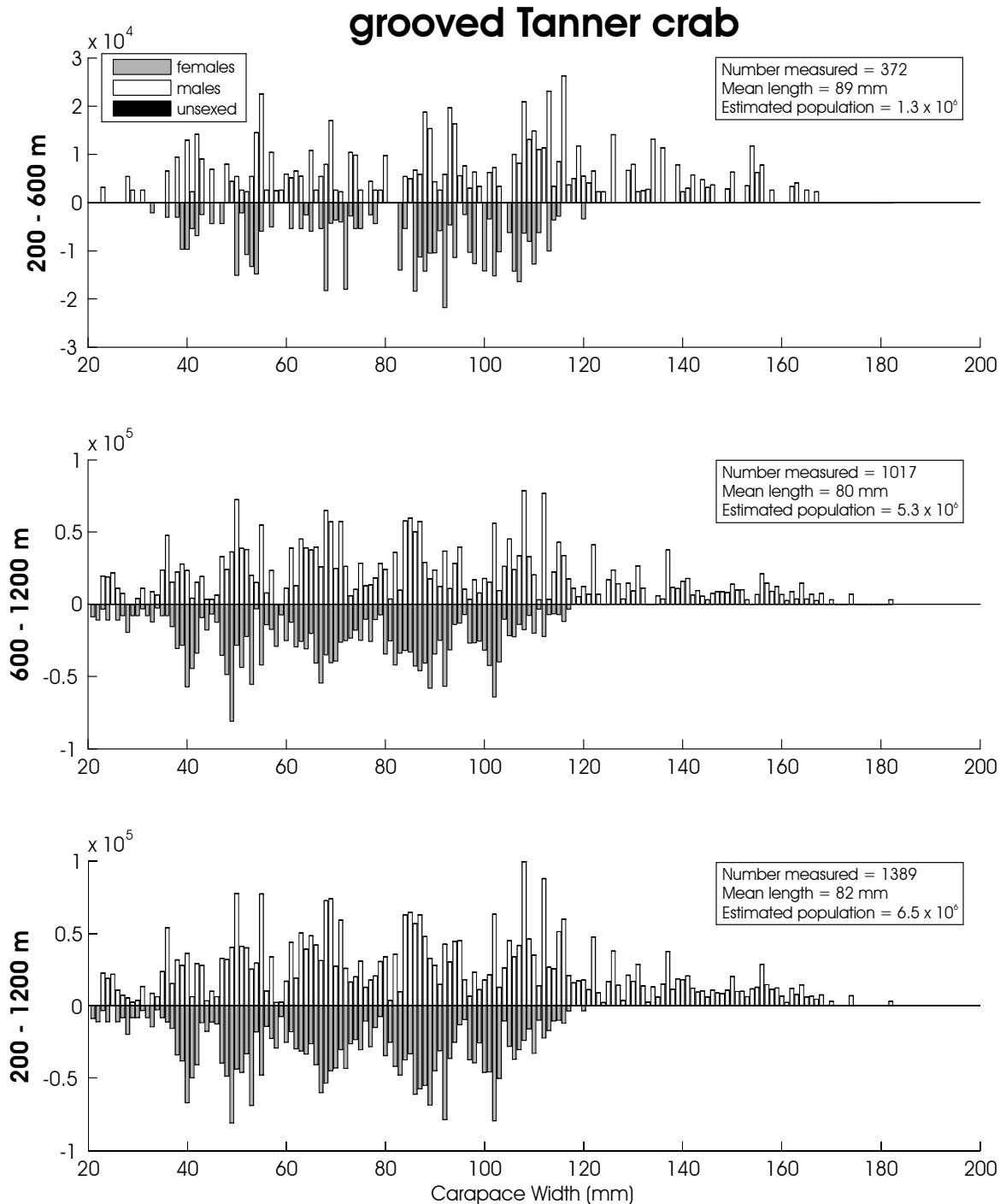

Figure 81. - Size composition of the estimated grooved Tanner crab population from the 2010 EBSS survey for all subareas by depth. The abscissa is scaled as total carapace width in millimeters while the ordinate represents the estimated total population.

Table 49. - - Abundance estimates by subarea and depth strata for golden king crab (*Lithodes aequispinus*) from the 2010 EBSS survey.

<i>Lithodes aequispinus</i>		golden king crab					
Subarea	Depth strata (m)	Biomass (t)	Population	Biomass variance	Population variance	Average CPUE (kg/ha)	Average CPUE (no./ha)
1	200-400	1.16E+02	8.82E+04	3.80E+03	2.47E+09	2.89E-01	2.20E-01
	400-600	2.46E+02	3.01E+05	1.25E+03	1.61E+09	6.06E-01	7.41E-01
	600-800	4.41E-01	3.67E+03	1.94E-01	1.35E+07	2.53E-03	2.11E-02
	800-1,000	9.72E-01	2.65E+04	9.46E-01	7.03E+08	7.18E-03	1.96E-01
	1,000-1,200	0.00E+00	0.00E+00	0.00E+00	0.00E+00	0.00E+00	0.00E+00
2	200-400	1.05E+03	9.27E+05	2.39E+05	1.97E+11	9.09E+00	8.01E+00
	400-600	4.32E+02	7.78E+05	1.27E+04	5.04E+10	6.13E+00	1.10E+01
	600-800	1.04E+02	1.61E+05	2.76E+03	5.43E+09	1.76E+00	2.72E+00
	800-1,000	1.18E+01	1.40E+04	1.40E+02	1.96E+08	2.14E-01	2.54E-01
	1,000-1,200	1.65E+01	4.77E+04	2.74E+02	2.28E+09	3.09E-01	8.91E-01
3	200-400	8.48E+01	5.86E+04	3.11E+03	1.22E+09	9.39E-01	6.48E-01
	400-600	4.01E+00	5.75E+03	1.61E+01	3.30E+07	4.53E-02	6.49E-02
	600-800	7.29E-02	3.31E+03	5.31E-03	1.10E+07	8.00E-04	3.64E-02
	800-1,000	0.00E+00	0.00E+00	0.00E+00	0.00E+00	0.00E+00	0.00E+00
	1,000-1,200	0.00E+00	0.00E+00	0.00E+00	0.00E+00	0.00E+00	0.00E+00
4	200-400	7.24E+01	5.98E+04	8.99E+02	6.81E+08	5.85E-01	4.84E-01
	400-600	0.00E+00	0.00E+00	0.00E+00	0.00E+00	0.00E+00	0.00E+00
	600-800	0.00E+00	0.00E+00	0.00E+00	0.00E+00	0.00E+00	0.00E+00
	800-1,000	0.00E+00	0.00E+00	0.00E+00	0.00E+00	0.00E+00	0.00E+00
	1,000-1,200	0.00E+00	0.00E+00	0.00E+00	0.00E+00	0.00E+00	0.00E+00
5	200-400	3.41E+01	2.97E+04	2.61E+02	2.08E+08	8.04E-01	7.00E-01
	400-600	2.65E+00	3.34E+03	7.04E+00	1.12E+07	6.23E-02	7.85E-02
	600-800	0.00E+00	0.00E+00	0.00E+00	0.00E+00	0.00E+00	0.00E+00
	800-1,000	0.00E+00	0.00E+00	0.00E+00	0.00E+00	0.00E+00	0.00E+00
	1,000-1,200	0.00E+00	0.00E+00	0.00E+00	0.00E+00	0.00E+00	0.00E+00
6	200-400	5.31E+01	6.01E+04	8.26E+02	1.13E+09	2.05E-01	2.32E-01
	400-600	6.37E+01	2.20E+05	1.87E+03	3.11E+10	3.73E-01	1.29E+00
	600-800	5.61E+00	4.09E+04	1.15E+01	4.72E+08	6.12E-02	4.46E-01
	800-1,000	0.00E+00	0.00E+00	0.00E+00	0.00E+00	0.00E+00	0.00E+00
	1,000-1,200	0.00E+00	0.00E+00	0.00E+00	0.00E+00	0.00E+00	0.00E+00
1-6	200-1,200	2.30E+03	2.83E+06	2.67E+05	2.95E+11	7.16E-01	9.36E-01

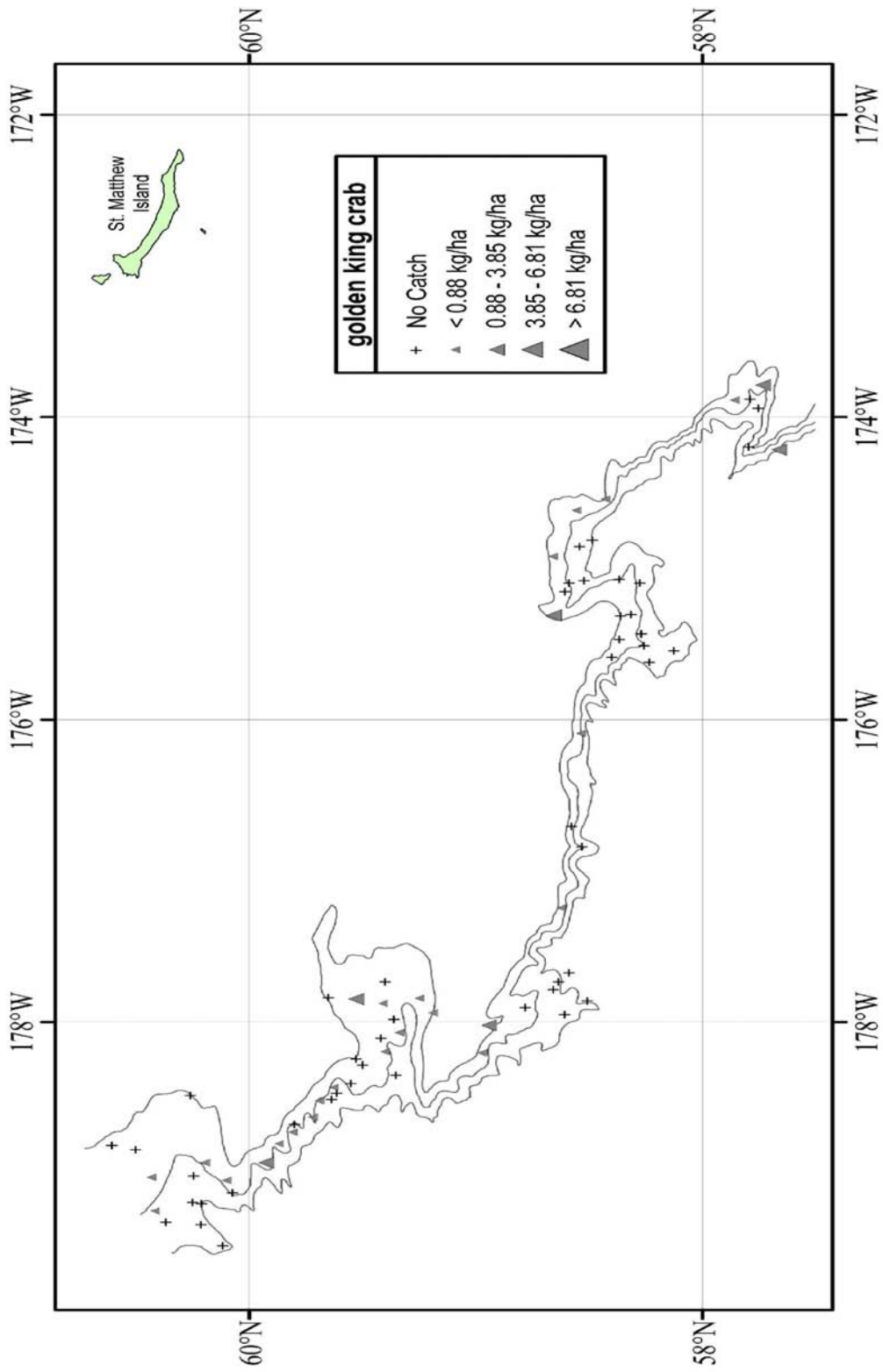

Figure 82. - - Distribution and relative abundance of golden king crab from the 2010 EBSS survey. Relative abundance is categorized by no catch, sample CPUE less than the mean CPUE, between the mean CPUE and one standard deviation above the mean, between one and two standard deviations above the mean CPUE, and greater than two standard deviations above the mean CPUE.

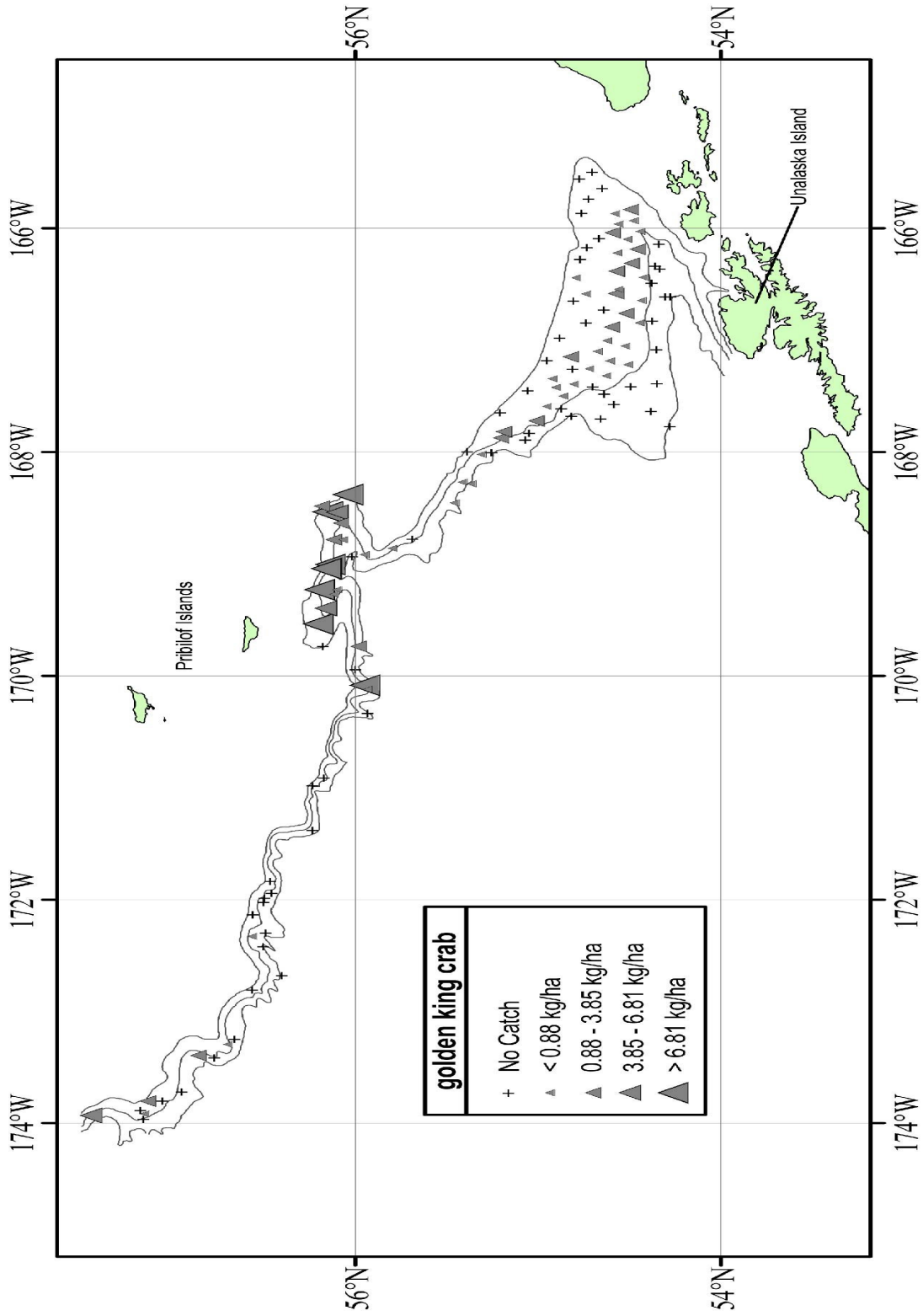

Figure 82. - - Continued.

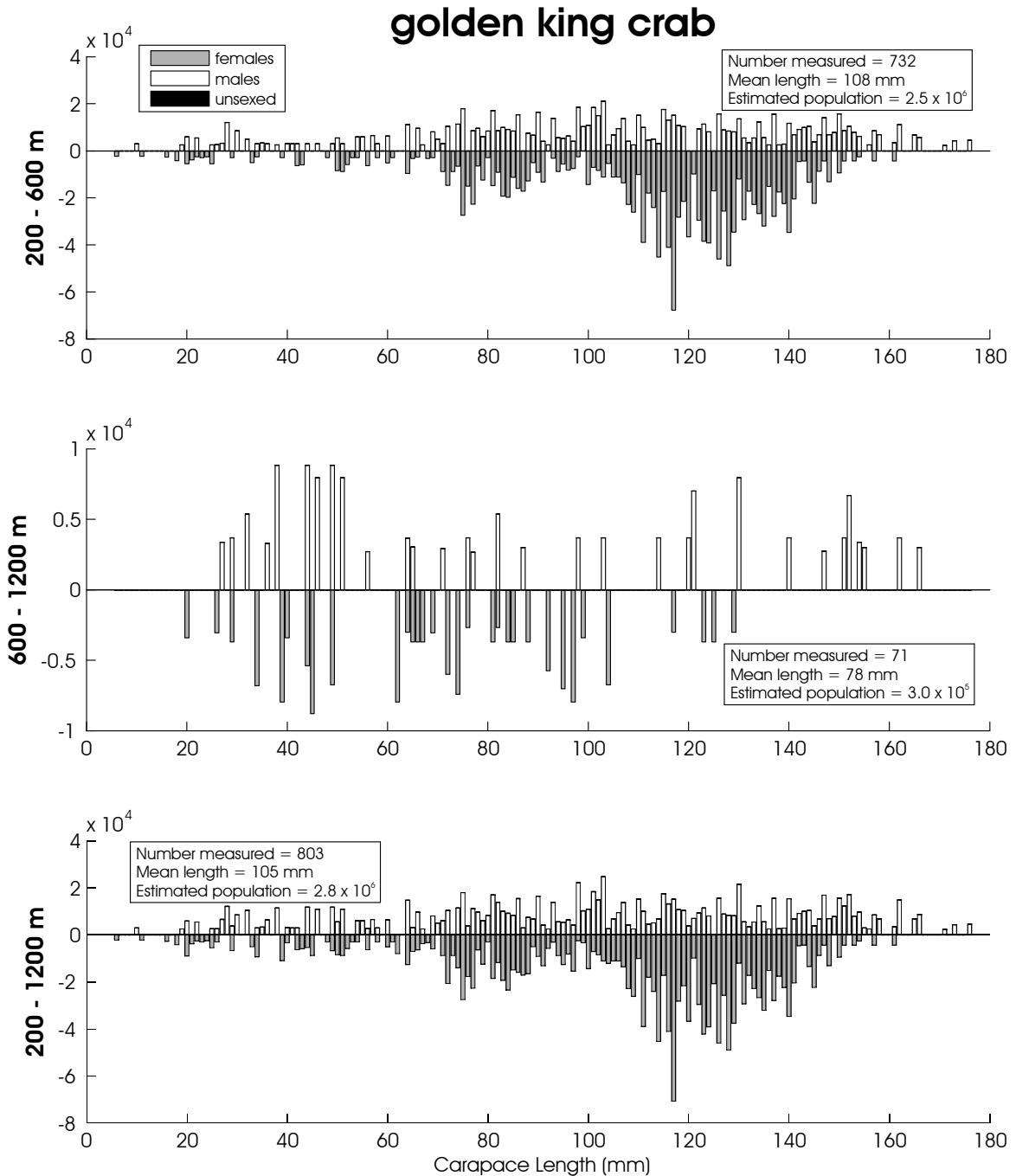

Figure 83. - Size composition of the estimated golden king crab population from the 2010 EBSS survey for all subareas by depth. The abscissa is scaled as total carapace length from the eye socket in millimeters while the ordinate represents the estimated total population.

Table 50. - - Abundance estimates by subarea and depth strata for scarlet king crab (*Lithodes couesi*) from the 2010 EBSS survey.

<i>Lithodes couesi</i>		scarlet king crab					
Subarea	Depth strata (m)	Biomass (t)	Population	Biomass variance	Population variance	Average CPUE (kg/ha)	Average CPUE (no./ha)
1	200-400	0.00E+00	0.00E+00	0.00E+00	0.00E+00	0.00E+00	0.00E+00
	400-600	0.00E+00	0.00E+00	0.00E+00	0.00E+00	0.00E+00	0.00E+00
	600-800	6.99E+00	1.49E+04	4.80E+01	1.37E+08	4.01E-02	8.57E-02
	800-1,000	1.91E+01	4.94E+04	1.76E+02	1.20E+09	1.41E-01	3.65E-01
	1,000-1,200	0.00E+00	0.00E+00	0.00E+00	0.00E+00	0.00E+00	0.00E+00
2	200-400	0.00E+00	0.00E+00	0.00E+00	0.00E+00	0.00E+00	0.00E+00
	400-600	3.22E+01	3.23E+04	2.09E+02	1.67E+08	4.57E-01	4.59E-01
	600-800	5.95E+01	1.41E+05	2.75E+03	1.23E+10	1.01E+00	2.39E+00
	800-1,000	1.48E+01	6.10E+04	2.19E+02	3.72E+09	2.68E-01	1.10E+00
	1,000-1,200	6.46E+01	1.08E+05	2.66E+03	8.44E+09	1.21E+00	2.01E+00
3	200-400	0.00E+00	0.00E+00	0.00E+00	0.00E+00	0.00E+00	0.00E+00
	400-600	0.00E+00	0.00E+00	0.00E+00	0.00E+00	0.00E+00	0.00E+00
	600-800	1.60E+01	1.89E+04	1.11E+02	1.56E+08	1.76E-01	2.07E-01
	800-1,000	1.01E+01	7.82E+03	1.03E+02	6.12E+07	1.38E-01	1.07E-01
	1,000-1,200	4.17E+00	8.04E+03	1.74E+01	6.47E+07	6.17E-02	1.19E-01
4	200-400	0.00E+00	0.00E+00	0.00E+00	0.00E+00	0.00E+00	0.00E+00
	400-600	0.00E+00	0.00E+00	0.00E+00	0.00E+00	0.00E+00	0.00E+00
	600-800	0.00E+00	0.00E+00	0.00E+00	0.00E+00	0.00E+00	0.00E+00
	800-1,000	6.30E+00	1.24E+04	1.42E+01	5.80E+07	8.91E-02	1.75E-01
	1,000-1,200	2.12E+01	3.28E+04	4.50E+02	1.08E+09	3.20E-01	4.95E-01
5	200-400	0.00E+00	0.00E+00	0.00E+00	0.00E+00	0.00E+00	0.00E+00
	400-600	0.00E+00	0.00E+00	0.00E+00	0.00E+00	0.00E+00	0.00E+00
	600-800	2.08E+01	2.48E+04	4.34E+02	6.16E+08	4.82E-01	5.75E-01
	800-1,000	1.36E+00	6.12E+03	1.85E+00	3.74E+07	2.46E-02	1.11E-01
	1,000-1,200	0.00E+00	0.00E+00	0.00E+00	0.00E+00	0.00E+00	0.00E+00
6	200-400	0.00E+00	0.00E+00	0.00E+00	0.00E+00	0.00E+00	0.00E+00
	400-600	1.07E+01	1.35E+04	1.14E+02	1.82E+08	6.26E-02	7.91E-02
	600-800	9.10E+01	1.29E+05	2.29E+03	4.70E+09	9.92E-01	1.41E+00
	800-1,000	2.33E+02	2.32E+05	2.82E+04	3.14E+10	3.61E+00	3.60E+00
	1,000-1,200	2.10E+01	2.42E+04	4.42E+02	5.87E+08	4.24E-01	4.88E-01
1-6	200-1,200	6.33E+02	9.17E+05	3.82E+04	6.48E+10	3.17E-01	4.59E-01

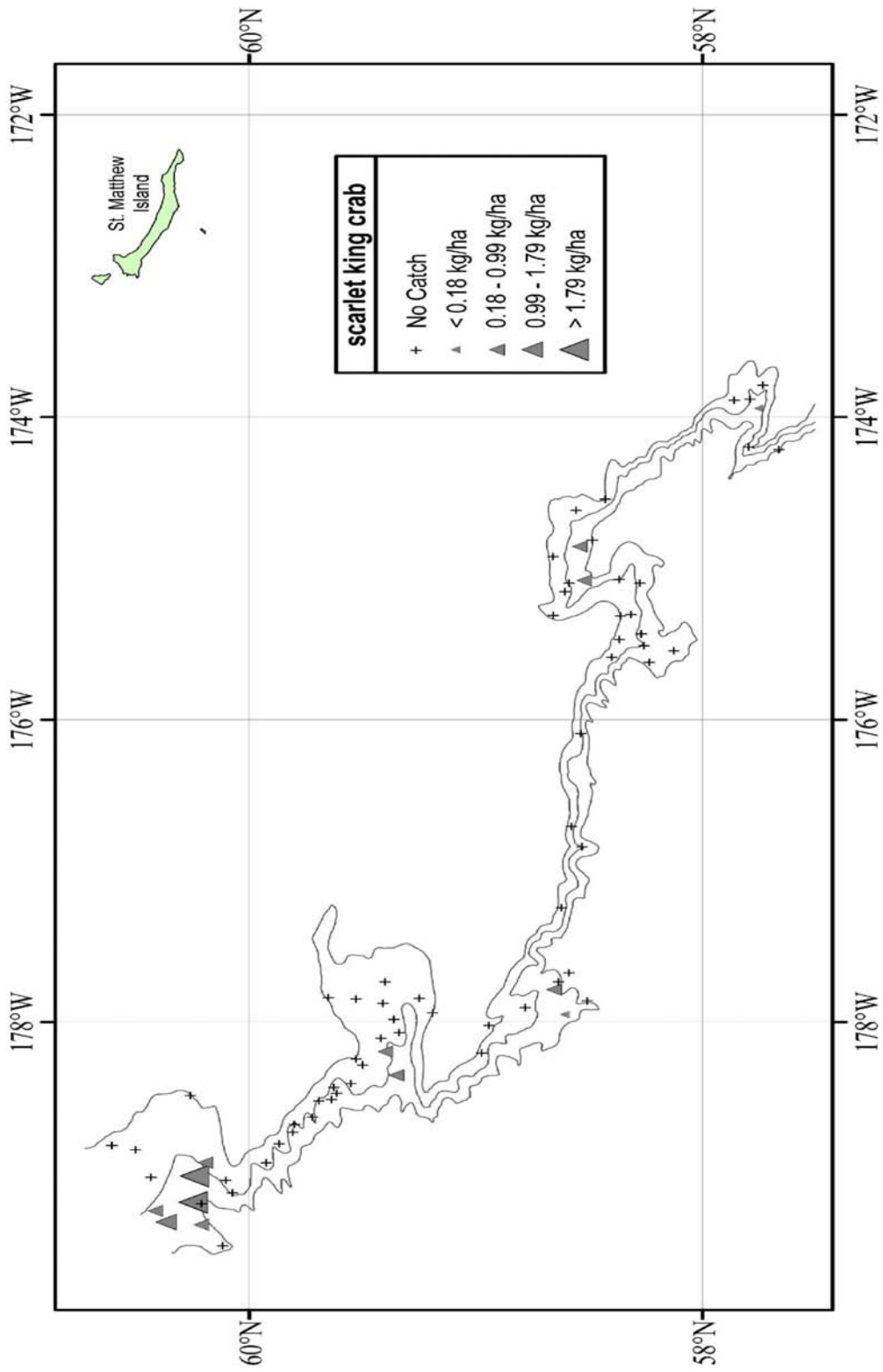

Figure 84. - - Distribution and relative abundance of scarlet king crab from the 2010 EBSS survey. Relative abundance is categorized by no catch, sample CPUE less than the mean CPUE, between the mean CPUE and one standard deviation above the mean, between one and two standard deviations above the mean CPUE, and greater than two standard deviations above the mean CPUE.

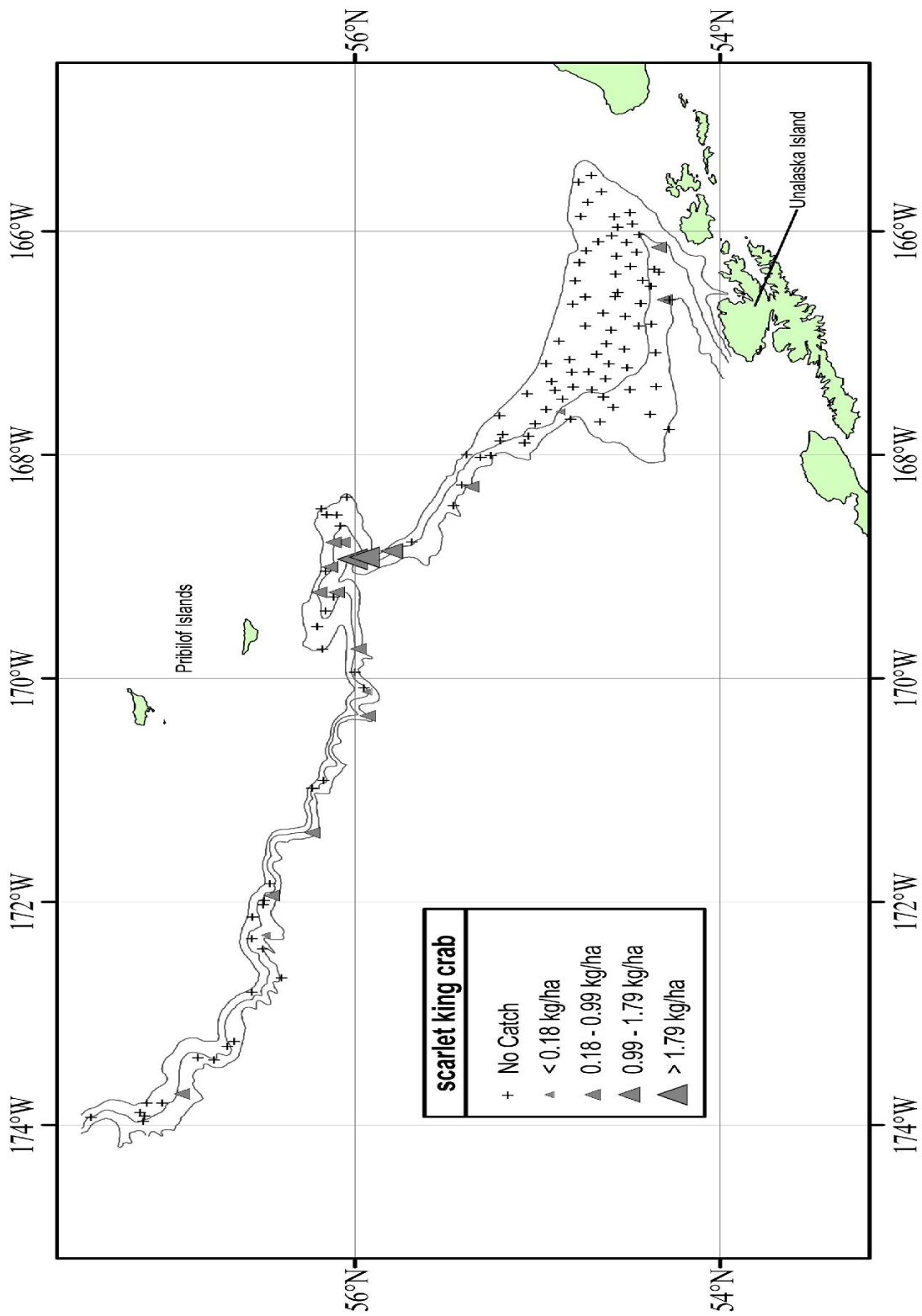

Figure 84. - - Continued.

scarlet king crab

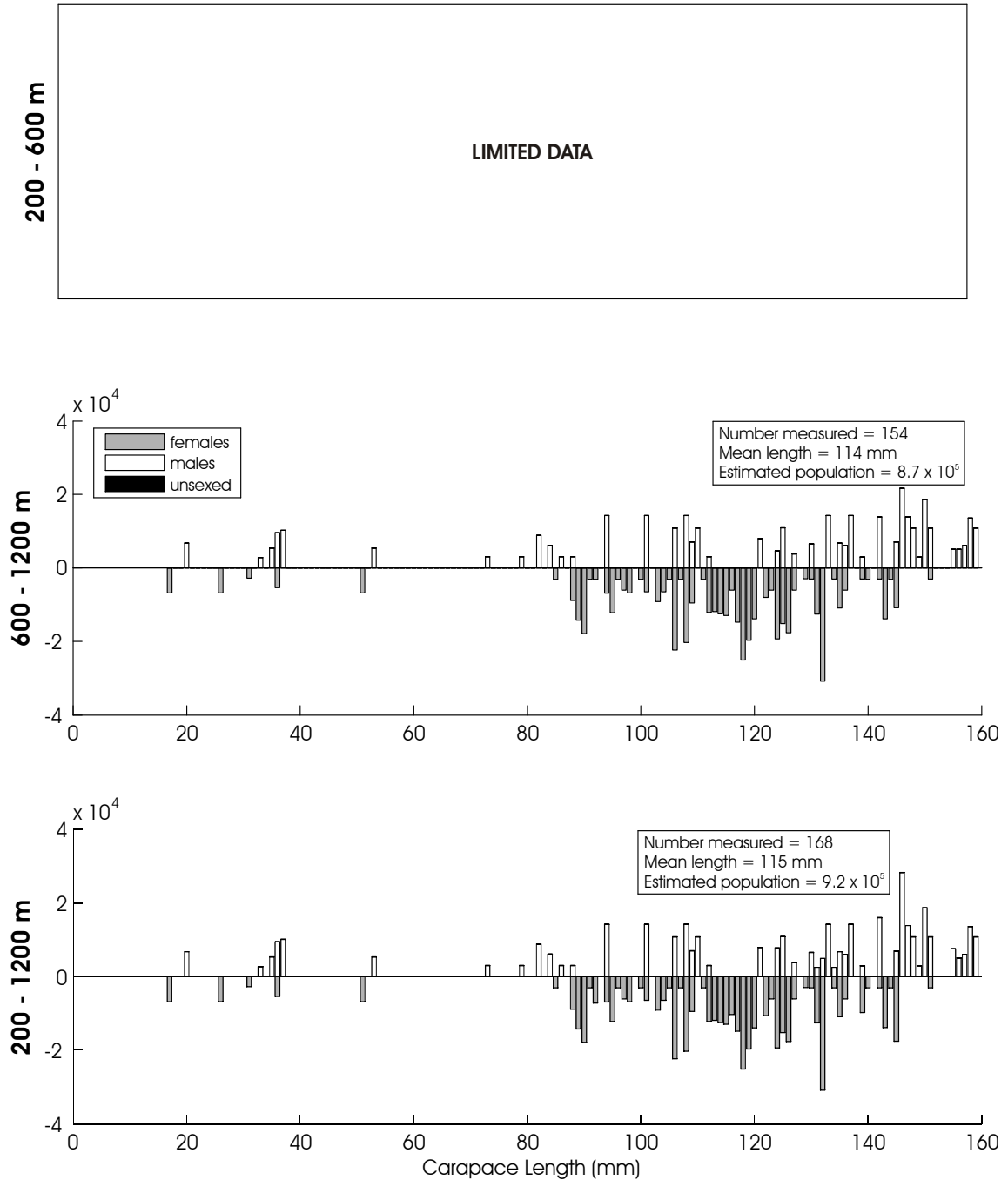

Figure 85. - Size composition of the estimated scarlet king crab population from the 2010 EBSS survey for all subareas by depth. The abscissa is scaled as total carapace

Table 51. - - Abundance estimates by subarea and depth strata for magistrate armhook squid (*Beryteuthis magister*) from the 2010 EBSS survey.

<i>Beryteuthis magister</i>		magistrate armhook squid					
Subarea	Depth strata (m)	Biomass (t)	Population	Biomass variance	Population variance	Average CPUE (kg/ha)	Average CPUE (no./ha)
1	200-400	2.71E+02	1.56E+06	1.35E+04	4.25E+11	6.76E-01	3.88E+00
	400-600	6.00E+02	1.41E+06	1.20E+04	4.31E+10	1.48E+00	3.46E+00
	600-800	1.05E+02	2.63E+05	5.17E+02	3.05E+09	6.03E-01	1.51E+00
	800-1,000	2.65E+01	6.92E+04	2.30E+02	7.28E+08	1.95E-01	5.11E-01
	1,000-1,200	2.01E+01	4.95E+04	1.08E+02	7.22E+08	1.82E-01	4.48E-01
2	200-400	4.89E+01	1.86E+05	1.02E+03	1.54E+10	4.22E-01	1.61E+00
	400-600	7.78E+01	2.09E+05	4.68E+02	2.18E+09	1.10E+00	2.97E+00
	600-800	1.49E+01	4.59E+04	3.45E+01	2.61E+08	2.52E-01	7.76E-01
	800-1,000	0.00E+00	0.00E+00	0.00E+00	0.00E+00	0.00E+00	0.00E+00
	1,000-1,200	1.14E+01	2.22E+04	1.80E+01	3.98E+07	2.13E-01	4.15E-01
3	200-400	8.54E+01	3.76E+05	5.29E+02	1.21E+10	9.45E-01	4.16E+00
	400-600	2.30E+01	6.17E+04	6.23E+01	2.83E+08	2.59E-01	6.96E-01
	600-800	3.66E+00	1.05E+04	1.34E+01	1.11E+08	4.02E-02	1.16E-01
	800-1,000	0.00E+00	0.00E+00	0.00E+00	0.00E+00	0.00E+00	0.00E+00
	1,000-1,200	0.00E+00	0.00E+00	0.00E+00	0.00E+00	0.00E+00	0.00E+00
4	200-400	1.01E+02	4.30E+05	6.73E+02	1.22E+10	8.16E-01	3.48E+00
	400-600	4.07E+01	9.19E+04	1.12E+03	4.05E+09	5.58E-01	1.26E+00
	600-800	1.45E+01	3.17E+04	2.11E+02	1.01E+09	2.09E-01	4.57E-01
	800-1,000	3.42E+00	2.75E+04	6.12E+00	5.01E+08	4.83E-02	3.89E-01
	1,000-1,200	2.05E+00	1.09E+04	4.22E+00	1.19E+08	3.10E-02	1.65E-01
5	200-400	4.71E+01	5.32E+05	5.07E+02	5.97E+10	1.11E+00	1.26E+01
	400-600	1.47E+01	3.18E+04	6.13E+01	3.57E+08	3.46E-01	7.48E-01
	600-800	0.00E+00	0.00E+00	0.00E+00	0.00E+00	0.00E+00	0.00E+00
	800-1,000	0.00E+00	0.00E+00	0.00E+00	0.00E+00	0.00E+00	0.00E+00
	1,000-1,200	0.00E+00	0.00E+00	0.00E+00	0.00E+00	0.00E+00	0.00E+00
6	200-400	2.01E+02	1.43E+06	4.08E+03	6.72E+11	7.73E-01	5.50E+00
	400-600	1.08E+02	2.86E+05	8.32E+02	5.87E+09	6.35E-01	1.67E+00
	600-800	1.08E+01	2.05E+04	5.02E+01	2.14E+08	1.17E-01	2.24E-01
	800-1,000	0.00E+00	0.00E+00	0.00E+00	0.00E+00	0.00E+00	0.00E+00
	1,000-1,200	0.00E+00	0.00E+00	0.00E+00	0.00E+00	0.00E+00	0.00E+00
1-6	200-1,200	1.83E+03	7.15E+06	3.61E+04	1.26E+12	6.77E-01	2.45E+00

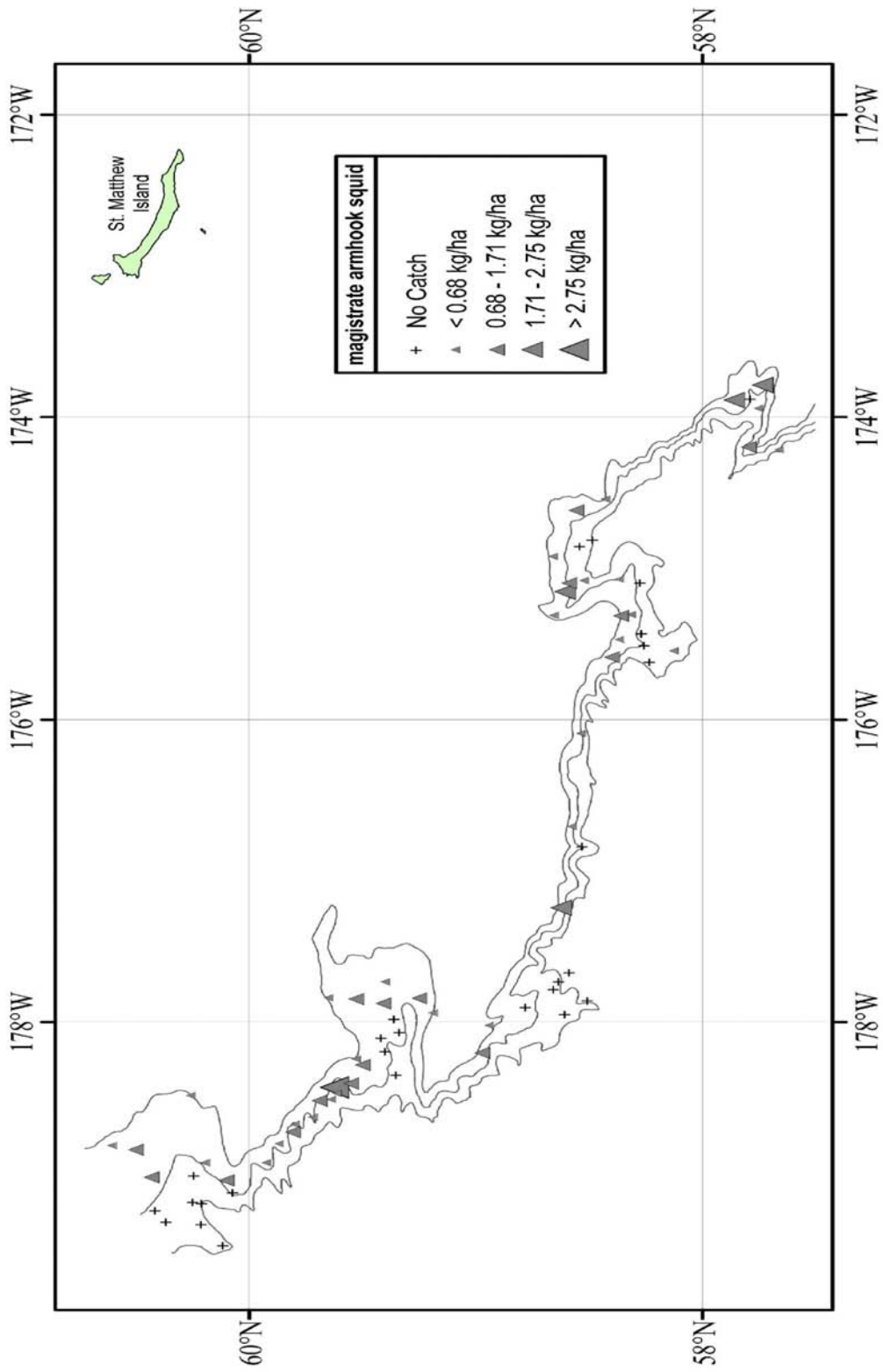

Figure 86. - - Distribution and relative abundance of magistrate armhook squid from the 2010 EBSS survey. Relative abundance is categorized by no catch, sample CPUE less than the mean CPUE, between the mean CPUE and one standard deviation above the mean, between one and two standard deviations above the mean CPUE, and greater than two standard deviations above the mean CPUE.

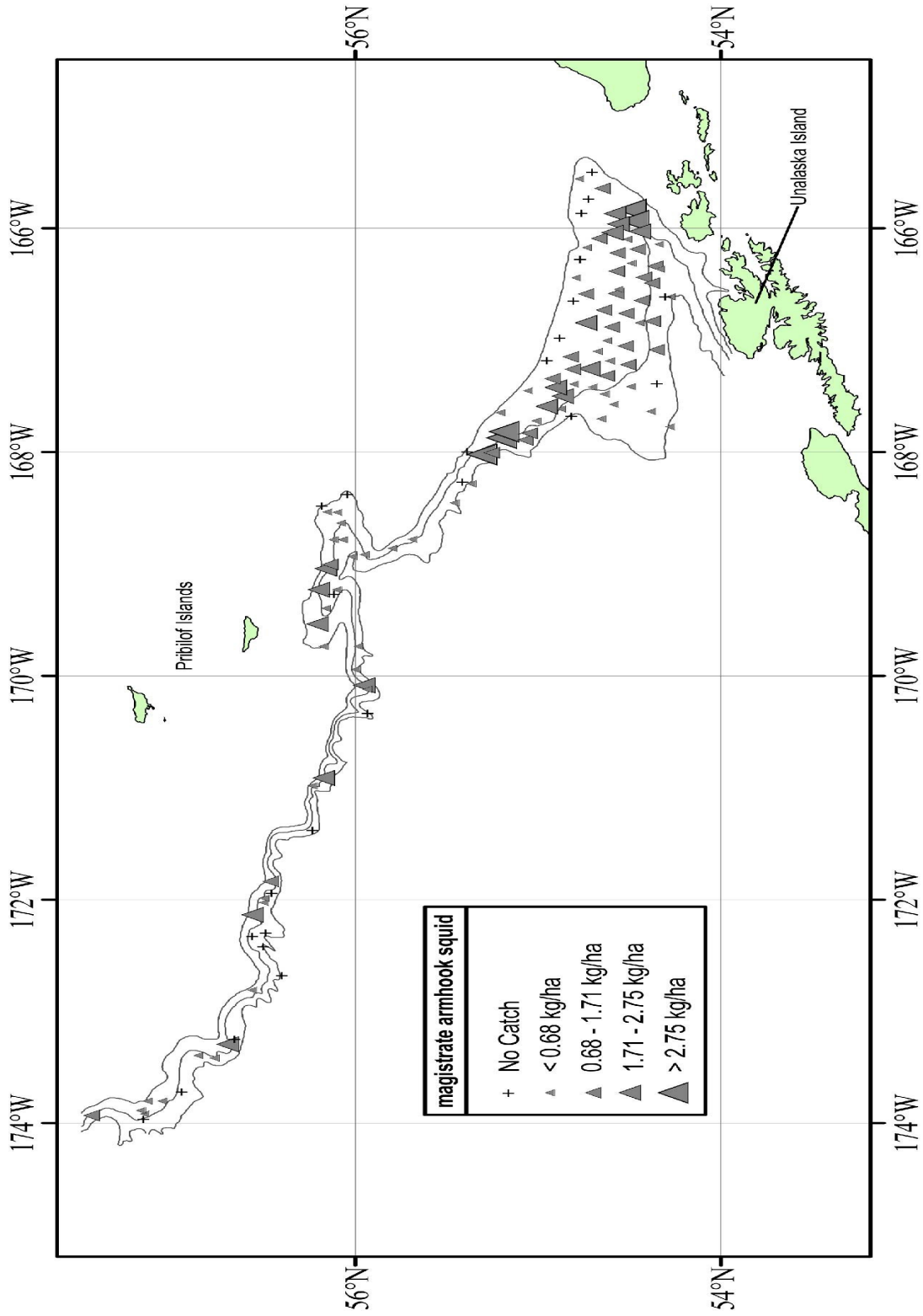

Figure 86. - - Continued.

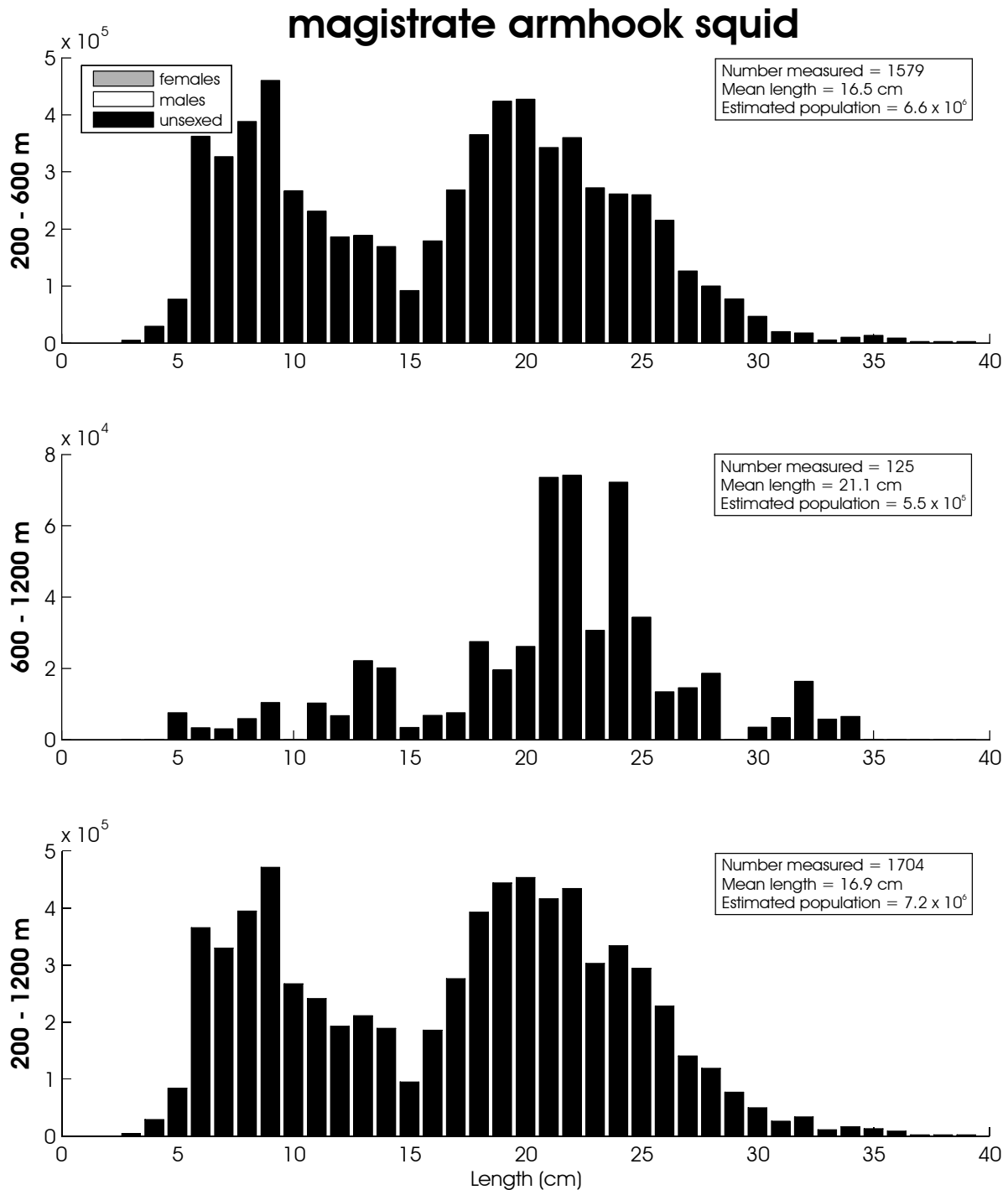

Figure 87. - Size composition of the estimated magistrate armhook squid population from the 2010 EBSS survey for all subareas by depth. The abscissa is scaled as total mantle length in centimeters while the ordinate represents the estimated total population.

Table 52. - - Abundance estimates by subarea and depth strata for Alaskan shrimp
(*Pandalus eous*) from the 2010 EBSS survey.

<i>Pandalus eous</i>				Alaskan pink shrimp			
Subarea	Depth strata (m)	Biomass (t)	Population	Biomass variance	Population variance	Average CPUE (kg/ha)	Average CPUE (no./ha)
1	200-400	4.19E+02	8.14E+07	7.52E+03	3.46E+14	1.04E+00	2.03E+02
	400-600	0.00E+00	0.00E+00	0.00E+00	0.00E+00	0.00E+00	0.00E+00
	600-800	0.00E+00	0.00E+00	0.00E+00	0.00E+00	0.00E+00	0.00E+00
	800-1,000	0.00E+00	0.00E+00	0.00E+00	0.00E+00	0.00E+00	0.00E+00
	1,000-1,200	0.00E+00	0.00E+00	0.00E+00	0.00E+00	0.00E+00	0.00E+00
2	200-400	5.04E+01	9.29E+06	4.30E+02	1.72E+13	4.36E-01	8.02E+01
	400-600	1.36E-01	2.26E+04	1.84E-02	5.11E+08	1.92E-03	3.21E-01
	600-800	0.00E+00	0.00E+00	0.00E+00	0.00E+00	0.00E+00	0.00E+00
	800-1,000	0.00E+00	0.00E+00	0.00E+00	0.00E+00	0.00E+00	0.00E+00
	1,000-1,200	0.00E+00	0.00E+00	0.00E+00	0.00E+00	0.00E+00	0.00E+00
3	200-400	2.05E+01	3.58E+06	6.40E+01	1.95E+12	2.26E-01	3.96E+01
	400-600	0.00E+00	0.00E+00	0.00E+00	0.00E+00	0.00E+00	0.00E+00
	600-800	0.00E+00	0.00E+00	0.00E+00	0.00E+00	0.00E+00	0.00E+00
	800-1,000	0.00E+00	0.00E+00	0.00E+00	0.00E+00	0.00E+00	0.00E+00
	1,000-1,200	0.00E+00	0.00E+00	0.00E+00	0.00E+00	0.00E+00	0.00E+00
4	200-400	1.38E+02	2.14E+07	2.82E+03	4.33E+13	1.12E+00	1.73E+02
	400-600	1.50E+00	2.40E+05	2.24E+00	5.77E+10	2.05E-02	3.29E+00
	600-800	0.00E+00	0.00E+00	0.00E+00	0.00E+00	0.00E+00	0.00E+00
	800-1,000	0.00E+00	0.00E+00	0.00E+00	0.00E+00	0.00E+00	0.00E+00
	1,000-1,200	0.00E+00	0.00E+00	0.00E+00	0.00E+00	0.00E+00	0.00E+00
5	200-400	1.86E+01	2.87E+06	8.30E+01	2.03E+12	4.38E-01	6.78E+01
	400-600	0.00E+00	0.00E+00	0.00E+00	0.00E+00	0.00E+00	0.00E+00
	600-800	0.00E+00	0.00E+00	0.00E+00	0.00E+00	0.00E+00	0.00E+00
	800-1,000	0.00E+00	0.00E+00	0.00E+00	0.00E+00	0.00E+00	0.00E+00
	1,000-1,200	0.00E+00	0.00E+00	0.00E+00	0.00E+00	0.00E+00	0.00E+00
6	200-400	2.91E+02	4.18E+07	3.22E+03	6.42E+13	1.12E+00	1.61E+02
	400-600	3.80E-02	1.14E+04	1.44E-03	1.30E+08	2.23E-04	6.68E-02
	600-800	0.00E+00	0.00E+00	0.00E+00	0.00E+00	0.00E+00	0.00E+00
	800-1,000	0.00E+00	0.00E+00	0.00E+00	0.00E+00	0.00E+00	0.00E+00
	1,000-1,200	0.00E+00	0.00E+00	0.00E+00	0.00E+00	0.00E+00	0.00E+00
1-6	200-1,200	9.39E+02	1.61E+08	1.41E+04	4.75E+14	2.72E-01	4.63E+01

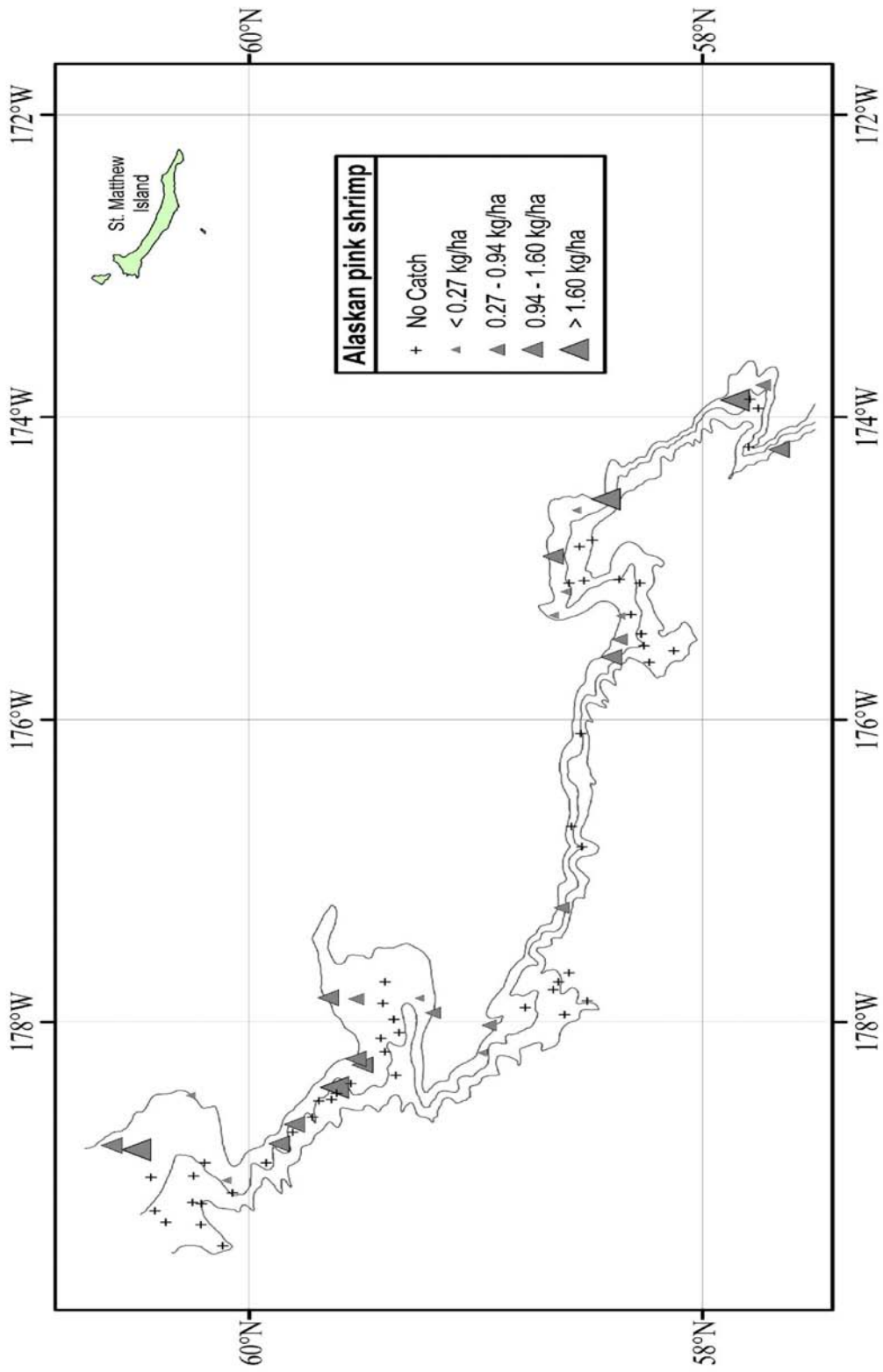

Figure 88. - - Distribution and relative abundance of Alaskan pink shrimp from the 2010 EBSS survey. Relative abundance is categorized by no catch, sample CPUE less than the mean CPUE, between the mean CPUE and one standard deviation above the mean, between one and two standard deviations above the mean CPUE, and greater than two standard deviations above the mean CPUE.

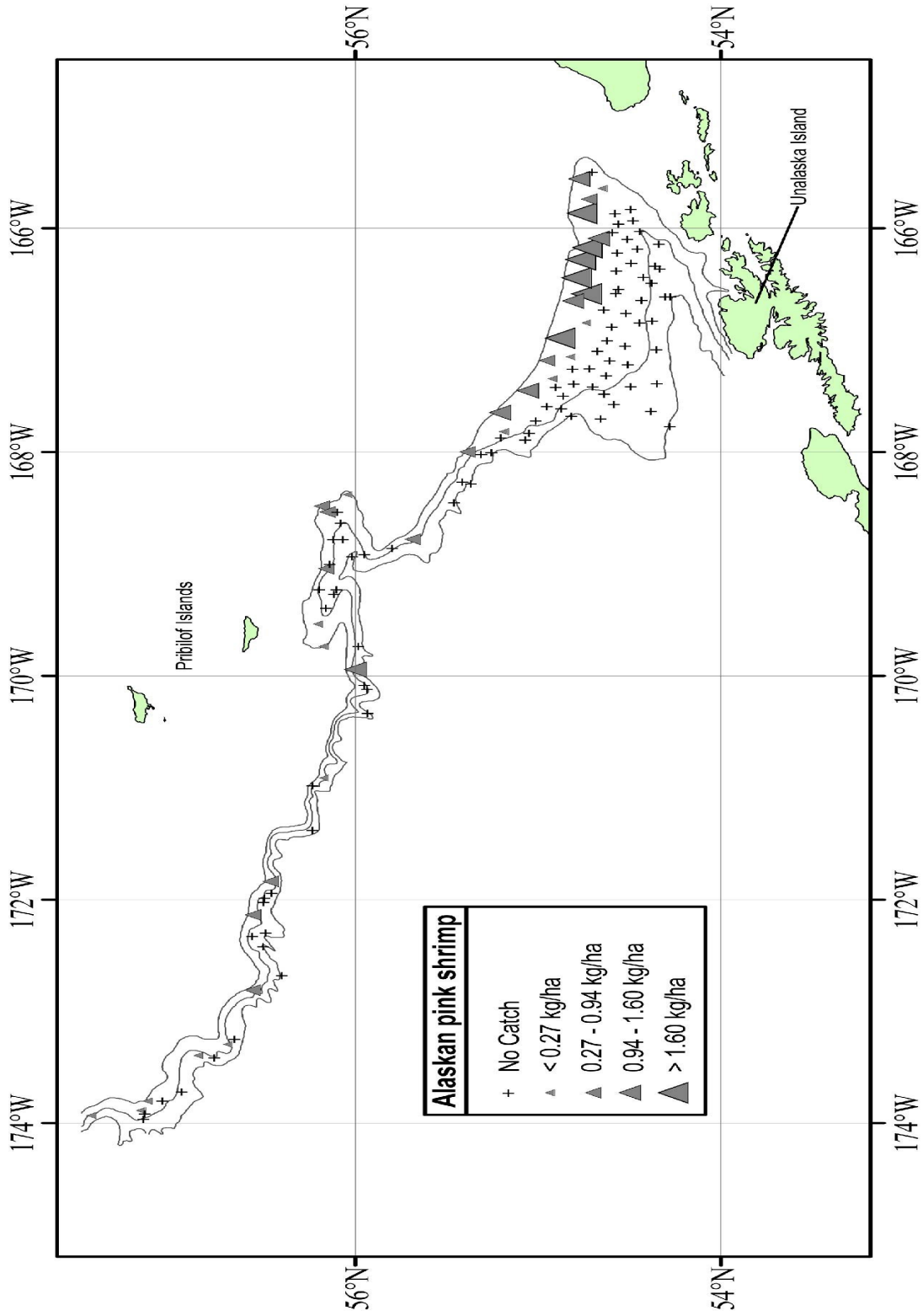

Figure 88. - - Continued.

CITATIONS

- Alverson, D.L., and W.T. Pereyra. 1969. Demersal fish explorations in the northeast Pacific Ocean—An evaluation of exploratory fishing methods and analytical approaches to stock sizes and yield forecasts. *J. Fish. Res. Board Can.* 26:1985-2001.
- Bakkala, R.G., W.A. Karp, G.E. Walters, T. Sasaki, M.T. Wilson, T.M. Sample, A.M. Shimada, D. Adams, and C.E. Armistead. 1992. Distribution, abundance, and biological characteristics of groundfish in the eastern Bering Sea based on results of U.S.-Japan bottom trawl and hydroacoustic surveys during June-September 1988. U.S. Dep. Commer., NOAA Tech. Memo. NMFS F/NWC-213, 372 p.
- Bakkala, R.G., K. Wakabayashi, K. Okada, J.J. Traynor, T.M. Sample, H. Yamaguchi, M.S. Alton, and M.O. Nelson. 1985a. Results of cooperative U.S.-Japan groundfish investigations in the Bering Sea during May-August 1979. *Int. N. Pac. Fish. Comm. Bull.* 44, 252 p.
- Bakkala, R.G., J.J. Traynor, T. Kazuyuki, A.M. Shimada, and H. Yamaguchi 1985b. Results of cooperative U.S.-Japan groundfish investigations in the Eastern Bering Sea during June-November 1982. U.S. Dep. Commer., NOAA Tech. Memo. NMFS F/NWC-87, 448 p.
- Goddard, P., and M. Zimmermann. 1993. Distribution, abundance, and biological characteristics of groundfish in the Eastern Bering Sea based on results of the U.S. bottom trawl survey during June-September 1991. AFSC Processed Rep. 93-15, 338 p. Alaska Fish. Sci. Cent., Natl. Mar. Fish. Serv., NOAA, 7600 Sand Point Way NE Seattle WA 98115.
- Hoff, G.R., and L.L. Britt. 2003. The 2002 eastern Bering Sea upper continental slope survey of groundfish and invertebrate resources. U.S. Dep. Commer., NOAA. Tech. Memo. NMFS-AFSC-141, 261 p.
- Hoff, G.R., and L.L. Britt. 2005. Results of the 2004 eastern Bering Sea upper continental slope survey of groundfish and invertebrate resources. U.S. Dep. Commer., NOAA. Tech. Memo. NMFS-AFSC-156, 276 p.
- Hoff, G.R., and L.L. Britt. 2009. Results of the 2008 eastern Bering Sea upper continental slope survey of groundfish and invertebrate resources. U.S. Dep. Commer., NOAA. Tech. Memo. NMFS-AFSC-197, 294 p.

- Lauth, R.R. 2000. The 1999 Pacific west coast upper continental slope trawl survey of groundfish resources off Washington, Oregon, and California: Estimates of distribution, abundance, and length composition. U.S. Dep. Commer., NOAA Tech. Memo. NMFS-AFSC-115, 287 p.
- Nelson, J.S. 1994. Fishes of the World. 3rd edition. John Wiley & Sons. New York, 600 p.
- Sample, T.M., K. Wakabayashi, R.G. Bakkala, and H. Yamaguchi. 1985. Report of the 1981 cooperative U.S.-Japan bottom trawl survey of the Eastern Bering Sea continental shelf and slope. U.S. Dep. Commer., NOAA Tech. Memo. NMFS F/NWC-88, 338 p.
- Stauffer, G. 2004. NOAA Protocols for groundfish bottom trawl surveys of the nation's fishery resources. U.S. Dep. Commer., NOAA Tech. Memo. NMFS-SPO-65, 205 p.
- Wakabayashi, K., R.G. Bakkala, and M.S. Alton. 1985. Methods of the U.S.-Japan demersal trawl surveys, p. 7-29. *In* R.G. Bakkala and K. Wakabayashi (editors), Results of cooperative U.S.-Japan groundfish investigations in the Bering Sea during May-August 1979. Int. North Pac. Fish. Comm. Bull. 44.
- Walters, G.E., K. Teshima, J.J. Traynor, R.G. Bakkala, J.A. Sassano, K.L. Halliday, W.A. Karp, K. Mito, N.J. Williamson, and D. M. Smith. 1988. Distribution, abundance, and biological characteristics of groundfish in the Eastern Bering Sea based on results of the U.S.-Japan triennial bottom trawl and hydroacoustic surveys during May-September, 1985. U.S. Dep. Commer., NOAA Tech. Memo. NMFS F/NWC-154, 400 p.

ACKNOWLEDGMENTS

We would like to sincerely thank all the scientific survey participants for all their hard work during the 2010 EBSS survey. Thanks also go to the skipper and crew of the F/V *Vesteraalen*. Their cooperation and knowledge was greatly appreciated.

APPENDICES

Haul Log

The haul log details the location, depth, time, temperature and net mensuration parameters of each haul conducted during the 2010 EBSS survey as well as each haul's catch by weight (kg) with a breakdown of the species composition and the individual species weight or a grouped weight for less abundant species. Appendix A describes the trawl warp/bottom depth ratio used for each trawl. Appendix B lists the number of hauls completed by trawl performance code during the survey. Zero and positive performance codes are considered successful tows and were used for the standard abundance estimates and negative performance tows were not included in the estimates of abundance. Appendix C is the detailed haul log for every haul completed with data during the survey. For quick reference, the unsuccessful tows not used for abundance estimates are shaded in gray.

Appendix A. - - Scope ratio table used during
the 2010 EBSS survey.

Bottom Depth		Warp Length	
Minimum (m)	Maximum (m)	Meters	Fathoms
146	176	550	301
177	206	600	328
207	237	650	355
238	267	700	383
269	298	750	410
299	328	800	437
330	358	850	465
360	389	900	492
390	420	950	519
421	450	1000	547
451	481	1050	574
482	511	1100	601
512	542	1150	628
543	572	1200	656
573	603	1250	683
604	633	1300	710
634	664	1350	738
665	694	1400	765
695	725	1450	792
726	755	1500	820
756	786	1550	847
787	816	1600	874
817	847	1650	901
848	877	1700	930
878	908	1750	957
909	938	1800	984
939	969	1850	1012
970	999	1900	1039
1000	1030	1950	1066
1031	1060	2000	1094
1061	1091	2050	1121
1091	1121	2100	1148
1122	1152	2150	1176
1152	1182	2200	1203
1183	1213	2250	1230
1213	1243	2300	1258
1244	1274	2350	1285

Appendix B. - - Performance codes assigned to trawl hauls conducted on the 2010 EBSS survey. Performance codes zero or greater are considered successful hauls, and codes less than zero are unsuccessful hauls.

Performance Code	Description	Number of Hauls
6.24	Satisfactory performance, scope changed during tow	1
6	Satisfactory performance, unspecified problem	1
5.8	Satisfactory performance, light footrope contact	1
5.2	Satisfactory performance, net improperly configured, unspecified reason	1
5	Satisfactory performance, unspecified gear performance problem	4
4.4	Satisfactory performance, large fish catch affected net performance	5
4.2	Satisfactory performance, caught large quantity of mud	1
4.1	Satisfactory performance, caught large rock	4
4	Satisfactory performance, caught unspecified object	3
3.2	Satisfactory performance, caught longline gear	1
3.11	Satisfactory performance, caught sabelfish pot	1
2.4	Satisfactory performance, belly damage	1
2.1	Satisfactory performance, wing damage	2
1.2	Satisfactory performance, major hang, stopped forward progress of vessel	1
1.12	Satisfactory performance, hauled back early due to hang(s)	1
1.1	Satisfactory performance, minor hang(s)	3
0	Good performance	169
-2.4	Unsatisfactory performance, belly damage	4
-6	Unsatisfactory performance, unspecified problem	5

This page left intentionally blank

Appendix C. - - Haul Log.

Haul	1	2	3	4	5	6	7
Date	3-Jun-2010	3-Jun-2010	3-Jun-2010	4-Jun-2010	4-Jun-2010	4-Jun-2010	4-Jun-2010
Stratum	31	31	31	33	32	32	31
Station ID	31-10	31-01	31-11	33-08	32-07	32-05	31-08
Performance	1.1	-2.4	0	0	0	0	0
Bottom depth	229	219	232	638	483	507	333
Tow start latitude (N)	56.1752	56.23365	56.23642	57.16045	57.15443	57.05687	57.17705
Tow start longitude (W)	-170.9138	-170.9758	-170.9845	-173.96503	-173.91672	-173.80387	-173.88653
Tow end latitude (N)	56.16817	56.2107	56.24537	57.13915	57.1339	57.07305	57.15602
Tow end longitude (W)	-170.88175	-170.95723	-171.02592	-173.9509	-173.90155	-173.83152	-173.87597
Tow duration (Hour)	0.496	0.61	0.583	0.545	0.521	0.587	0.532
Distance of tow (nmi)	2.18	2.89	2.82	2.54	2.47	2.61	2.44
Mean net width (m)	15.163	15.16	16.056	16.443	15.615	15.636	15.321
Surface temperature (°C)	3.5	3.9	3.5	4.8	4.8	4.9	
Bottom temperature (°C)		3.6	3.5	3.5	3.8	3.8	
Pacific sleeper shark							
Bering skate	14.82				0.84	2.37	1.66
mud skate						0.53	2.02
rougthead skate							
Alaska skate	25.11	29.18	8.26				
Aleutian skate	20.66		35.21	13.99	2.24	8.52	7.84
Commander skate				2.62		3.73	
whiteblotched skate							
whitebrow skate				1.84			
other skates & skate eggs		0.59	0.03	0.48		0.02	
arrowtooth flounder	27.14	39.82	30.82	6.84	15.70	68.30	110.64
Kamchatka flounder	2.71	12.29		19.36	69.23	52.02	7.34
Greenland turbot				11.13	5.06	11.15	23.25
Pacific halibut					11.82		15.14
flathead sole	1.07				190.51	103.13	34.98
rex sole	91.32	4.72	12.26		4.38	34.92	5.98
other flatfish				0.76			
Pacific grenadier							
giant grenadier				2505.70	448.66	650.37	28.42
popeye grenadier				229.79		5.84	
Pacific cod	41.58	49.91	149.06				9.19
walleye pollock		3.13	1.38				
blob sculpin							
bigmouth sculpin	12.08	15.15			8.85	13.16	
other sculpins	8.85	14.76	19.38				0.04
twoline eelpout				2.05			
western eelpout				1.48			
ebony eelpout					0.42		
other eelpouts				0.14	0.15	0.13	0.10
sablefish				2.02			
searcher	0.87	2.88	4.33				
blacktail snailfish				1.62			
other snailfishes					0.76	0.75	0.35
poachers	0.19	0.29	0.09	0.22			0.18
mesopelagic fishes			0.03	0.08	0.02	0.13	
other fishes	4.46	31.12	92.72	1.75	0.42	0.54	0.37
shortspine thornyhead	10.67	54.22	268.22	29.12	13.48	25.70	2.73
roughey rockfish			1.61				
blackspotted rockfish		17.16	23.20				
Pacific ocean perch	1632.08	2191.59	1946.93				22.44
shortraker rockfish	219.55	185.51	131.24			0.92	
grooved Tanner crab				3.84	0.85	0.82	
Tanner crab	0.24	0.56	0.10				0.21
triangle Tanner crab							
snow crab							
scarlet king crab							
golden king crab					0.70		
hermit crabs	0.04	0.10	0.91	0.08			
other crabs	0.03		0.30				
snails	1.55	1.73	6.43	2.14			
bivalves		0.01					
octopus	20.99	1.54	6.20				
squid	7.87	5.07	2.34	0.01	1.50	1.12	2.23
sea anemones & corals	2.29	1.15	1.73		3.56	3.25	3.13
jellyfish	0.85	0.79		3.94	7.02	0.11	0.17
shrimps	0.03	0.05	0.18		0.08	0.04	0.46
seastars & sea cucumbers	9.39	8.26	16.30	9.01	1.16	1.96	
sponges	160.39	28.29	318.35				
other invertebrates		0.11	0.40		0.01		0.01
Haul Total Weight (kg)	2316.84	2700.00	3078.00	2850.00	787.41	989.54	278.88

Appendix C. - - Haul Log.

Haul	8	9	10	11	12	13	14
Date	4-Jun-2010	5-Jun-2010	5-Jun-2010	5-Jun-2010	5-Jun-2010	6-Jun-2010	6-Jun-2010
Stratum	31	45	43	42	41	61	61
Station ID	31-12	45-04	43-02	42-03	41-08	61-03	61-04
Performance	0	4.1	4.4	0	2.4	0	0
Bottom depth	229	1028	709	410	260	206	304
Tow start latitude (N)	57.13883	58.52187	58.58597	58.60373	58.65732	59.6534	59.52867
Tow start longitude (W)	-173.80358	-175.0781	-175.09708	-175.15255	-175.30887	-177.84743	-177.85475
Tow end latitude (N)	57.1597	58.5093	58.58892	58.61705	58.64007	59.6393	59.50885
Tow end longitude (W)	-173.82208	-175.10127	-175.05843	-175.11773	-175.31447	-177.88305	-177.83828
Tow duration (Hour)	0.526	0.465	0.516	0.547	0.439	0.536	0.541
Distance of tow (nmi)	2.59	1.96	2.33	2.57	1.97	2.57	2.45
Mean net width (m)	15.426	15.46	16.469	15.365	15.378	15.835	15.692
Surface temperature (°C)	4.9	3.6	3.7	3.6	3.6	2.2	2.1
Bottom temperature (°C)	2.9	2.7	3.3	3.6	3	2.3	2.9
Pacific sleeper shark					26.60		
Bering skate	25.96			67.69	2.67	8.52	16.85
mud skate							
rougthead skate							
Alaska skate				77.08	8.00	19.05	17.19
Aleutian skate		7.65	6.41	839.77	10.16	9.36	22.86
Commander skate		1.45		7.19			
whiteblotched skate							4.94
whitebrow skate			8.37	2.42			
other skates & skate eggs							0.04
arrowtooth flounder	47.99			172.66	43.31	13.16	132.06
Kamchatka flounder	37.09		18.11	48.63	3.66	13.71	106.66
Greenland turbot			142.36	53.59		1.16	30.03
Pacific halibut	129.36			37.27	5.63	3.33	3.85
flathead sole	199.10			107.12	82.38	10.37	56.19
rex sole	3.66			28.30	0.95	6.60	3.60
other flatfish							
Pacific grenadier		8.06					
giant grenadier		474.10	8843.78	796.81			
pop-eye grenadier		218.33	228.18				
Pacific cod	98.34				4.98	9.45	
walleye pollock				3.24	36.60	92.76	5.82
blob sculpin		13.14					
bigmouth sculpin	0.67			12.50	41.84	1.20	6.38
other sculpins	0.21	0.01		0.53	19.26	0.84	3.89
twoline eelpout							
western eelpout							
ebony eelpout							
other eelpouts		0.02	0.55			0.08	
sablefish		13.62					
searcher					3.80		
blacktail snailfish		0.59		0.19			
other snailfishes	0.09	1.17		1.67		0.84	3.09
poachers			0.14	0.32	0.11	0.38	1.61
mesopelagic fishes				0.03			0.02
other fishes				0.35	46.83		0.23
shortspine thornyhead		2.89	21.18	35.92			
rougheye rockfish							
blackspotted rockfish							
Pacific ocean perch	4878.90			3.97	842.44		
shortraker rockfish				7.95			
grooved Tanner crab		4.13	8.89	1.61			
Tanner crab	0.74					14.28	2.77
triangle Tanner crab							
snow crab	0.35	0.49		0.02		1.56	0.15
scarlet king crab		1.94					
golden king crab	5.70				5.66		4.81
hermit crabs		0.06	0.92	0.68		2.57	0.22
other crabs						1.88	0.06
snails	2.21	0.40	3.44	2.33	0.18	3.53	0.60
bivalves							
octopus		1.29			0.01		
squid	1.25	0.19	3.20	7.63	0.96	2.31	4.91
sea anemones & corals	0.62	4.51	16.99	15.47	1.70	0.45	5.85
jellyfish			0.42	1.43	1.66	1.77	0.70
shrimps	0.64			5.14	0.60	4.74	3.52
seastars & sea cucumbers	2.78	1.18	1.84	11.76	1.45	0.09	35.51
sponges					3.27	0.01	
other invertebrates		0.01	1.05	0.22		2.50	0.32
Haul Total Weight (kg)	5435.64	755.23	9305.80	2351.50	1194.72	226.51	474.73

Appendix C. - - Haul Log.

Haul	15	16	17	18	19	20	21
Date	6-Jun-2010	6-Jun-2010	6-Jun-2010	6-Jun-2010	7-Jun-2010	7-Jun-2010	7-Jun-2010
Stratum	62	62	62	61	65	64	63
Station ID	62-03	62-02	62-01	61-01	65-03	64-06	63-06
Performance	4	0	0	0	0	0	0
Bottom depth	425	441	424	210	1109	906	737
Tow start latitude (N)	59.40045	59.40963	59.25077	59.19055	60.11902	60.21517	60.37077
Tow start longitude (W)	-177.74183	-177.884	-177.84935	-177.94617	-179.49085	-179.3531	-179.33367
Tow end latitude (N)	59.41127	59.39593	59.26198	59.18328	60.1004	60.20537	60.3556
Tow end longitude (W)	-177.74922	-177.8531	-177.88572	-177.90412	-179.47663	-179.38048	-179.30287
Tow duration (Hour)	0.341	0.573	0.552	0.57	0.476	0.427	0.513
Distance of tow (nmi)	1.28	2.33	2.45	2.56	2.22	1.89	2.41
Mean net width (m)	13.971	15.12	15.256	14.732	16.466	13.83	15.703
Surface temperature (°C)	3	2.2	3.9	4.3	3.9	3.9	3.9
Bottom temperature (°C)	3.4	3.6	3.5	2.4	2.7	3	3.3
Pacific sleeper shark			8.82				
Bering skate		4.90	1.74				
mud skate	3.28	0.48	4.30	12.56			
rougthead skate					3.25	8.64	5.52
Alaska skate			4.41				
Aleutian skate	24.65	36.82	2.44	2.43		12.50	10.98
Commander skate						6.53	0.19
whiteblotched skate	39.92	55.00	7.10				
whitebrow skate		2.90				0.94	0.89
other skates & skate eggs	0.18			0.03		0.02	0.01
arrowtooth flounder	132.48	93.24	170.96	10.94			
Kamchatka flounder	10.38	310.19	47.24	106.67			
Greenland turbot	53.34	205.08	154.53		15.86	12.46	8.23
Pacific halibut	3.20	144.90	3.05	1.25			
flathead sole	16.32		38.25	18.43			
rex sole				14.12			
other flatfish				3.13			
Pacific grenadier					27.91		
giant grenadier	32.84	167.34	5.76		2453.25	1168.67	1182.54
pop-eye grenadier					272.99	60.19	20.27
Pacific cod				7.40			
walleye pollock			2.26	27.33			
blob sculpin							
bigmouth sculpin	37.34		28.01	2.82			
other sculpins	5.02	0.16	0.54	0.55			
twoline eelpout							
western eelpout							
ebony eelpout	1.16	18.03					
other eelpouts		0.06	0.09				
sablefish							
searcher							
blacktail snailfish							
other snailfishes	0.15	2.58			1.18	0.63	
poachers	0.14		0.06	0.56			
mesopelagic fishes	0.11	0.13	0.01		0.84	1.25	0.36
other fishes					2.05	1.01	
shortspine thornyhead		6.66					6.75
rougthead rockfish							
blackspotted rockfish							
Pacific ocean perch		0.56	1.25				
shortraker rockfish	3.87	1.34					
grooved Tanner crab		1.10					2.54
Tanner crab	0.16			7.33			
triangle Tanner crab	0.06	1.38	0.09		1.54	8.42	3.08
snow crab							
scarlet king crab						2.72	6.72
golden king crab		2.58	0.72	2.51			
hermit crabs				0.03		0.01	
other crabs		0.07					
snails		0.65	0.01	0.27	2.46	0.06	0.04
bivalves					0.05		
octopus	0.26			0.24			
squid	0.83	3.10	3.43	0.47	0.11		
sea anemones & corals	19.26	386.86	1.27	3.55	3.40		
jellyfish	0.20		1.52	0.88	0.19	0.21	0.22
shrimps	0.14	0.13	0.26	2.53	0.01	0.03	0.01
seastars & sea cucumbers	4.95	3.38	1.97	1.28	6.84	4.17	0.31
sponges			4.94	4.53			
other invertebrates	0.03	0.13	0.03		0.07	0.01	
Haul Total Weight (kg)	390.26	1449.76	495.06	231.85	2792.00	1288.46	1248.66

Appendix C. - - Haul Log.

Haul	22	23	24	25	26	27	28
Date	7-Jun-2010	8-Jun-2010	8-Jun-2010	8-Jun-2010	8-Jun-2010	8-Jun-2010	9-Jun-2010
Stratum	63	61	61	61	62	63	65
Station ID	63-07	61-13	61-15	61-16	62-12	63-05	65-02
Performance	0	0	0	0	0	0	0
Bottom depth	604	214	294	235	468	711	1042
Tow start latitude (N)	60.41807	60.26228	60.50263	60.60875	60.43463	60.24587	60.21188
Tow start longitude (W)	-179.25965	-178.49468	-178.85597	-178.8252	-179.03682	-179.03032	-179.21137
Tow end latitude (N)	60.43453	60.23848	60.4848	60.58738	60.42485	60.26722	60.2345
Tow end longitude (W)	-179.28957	-178.49588	-178.82478	-178.81365	-178.99688	-179.01972	-179.21592
Tow duration (Hour)	0.6	0.571	0.569	0.557	0.544	0.537	0.554
Distance of tow (nmi)	2.51	2.65	2.63	2.5	2.49	2.47	2.53
Mean net width (m)	15.53	15.182	15.521	15.433	15.041	15.415	16.194
Surface temperature (°C)	4.3	3.7	3.1	3.6	3.8	4.8	5.3
Bottom temperature (°C)	3.5	2.2	3.2	2.3	3.7	3.1	2.9
Pacific sleeper shark							
Bering skate		1.21	4.53	0.66	2.12		
mud skate		8.83	0.88		1.08		
rougthead skate	3.33						
Alaska skate			7.58	17.83			
Aleutian skate	20.14	4.27	15.69		39.76	3.43	
Commander skate	4.85					45.32	2.11
whiteblotched skate					26.72		
whitebrow skate	1.06			2.46			
other skates & skate eggs		0.01	0.28	0.02	0.01	0.05	0.07
arrowtooth flounder		4.21	22.23	12.28	117.27		
Kamchatka flounder		3.45	6.62	36.37	32.54		
Greenland turbot	61.18		0.65	3.38	86.86		
Pacific halibut		1.09			28.54		
flathead sole		6.18	4.43	70.24			
rex sole		2.02	0.21				
other flatfish						0.96	
Pacific grenadier							5.80
giant grenadier	1399.38				6.68	5552.09	7578.74
popeye grenadier	5.31					49.51	17.18
Pacific cod		4.64	24.62	11.70			
walleye pollock		0.08	13.73	15.04			
blob sculpin							
bigmouth sculpin		12.32	3.60	31.04			
other sculpins		11.67	5.96	0.67	0.11	1.77	
twoline eelpout						1.46	
western eelpout							
ebony eelpout	0.92				28.10		
other eelpouts	0.49		0.02	0.17	0.35		
sablefish	2.34					7.22	
searcher							
blacktail snailfish							
other snailfishes			3.37	0.17	0.01	3.57	0.61
poachers		0.29	0.21	0.01			
mesopelagic fishes	0.30				0.20	0.21	
other fishes	1.96						4.55
shortspine thornyhead	17.33				0.63		
rougthead rockfish							
blackspotted rockfish							
Pacific ocean perch			14.77				
shortraker rockfish							
grooved Tanner crab	4.42				3.39	0.23	
Tanner crab		8.95	6.01	0.53			
triangle Tanner crab	0.79					1.02	0.76
snow crab		0.99	0.10	0.33			
scarlet king crab	3.53					16.62	
golden king crab	0.43				0.13		
hermit crabs		0.08	0.07	0.74	0.03		
other crabs		0.18	0.53				
snails			0.40	0.71	0.01	0.03	
bivalves							
octopus			0.09				
squid		0.21	3.57	1.20	2.63		
sea anemones & corals		8.90	80.96	45.48	1.01	1.06	9.18
jellyfish	0.01	0.31	0.17	0.03	0.59		
shrimps	0.01	0.86	12.75	4.96	0.02	0.08	0.03
seastars & sea cucumbers	2.43	9.04	71.60	61.80	2.84	3.08	3.75
sponges		1.80	0.22	2.27		0.29	
other invertebrates			1.22	0.85	0.07		
Haul Total Weight (kg)	1530.22	91.59	307.08	320.93	381.70	5688.00	7622.78

Appendix C. - - Haul Log.

Haul	29	30	31	32	33	34	35
Date	9-Jun-2010	9-Jun-2010	9-Jun-2010	10-Jun-2010	10-Jun-2010	10-Jun-2010	10-Jun-2010
Stratum	64	62	62	61	62	61	62
Station ID	64-04	62-10	62-09	61-21	62-08	61-09	62-07
Performance	4.4	0	0	0	0	0	0
Bottom depth	968	525	545	329	416	243	455
Tow start latitude (N)	60.2532	60.19757	60.07535	60.10278	59.92587	59.86932	59.81075
Tow start longitude (W)	-179.20368	-178.9412	-179.13965	-179.05655	-178.94088	-178.8157	-178.73883
Tow end latitude (N)	60.26972	60.20688	60.05415	60.08202	59.90723	59.85093	59.8263
Tow end longitude (W)	-179.21877	-178.92118	-179.1423	-179.06837	-178.9164	-178.78737	-178.77098
Tow duration (Hour)	0.642	0.35	0.535	0.551	0.541	0.545	0.559
Distance of tow (nmi)	2.47	1.52	2.4	2.44	2.54	2.62	2.55
Mean net width (m)	15.13	13.843	16.167	15.942	16.85	16.555	16.08
Surface temperature (°C)	4.6	5.2	4.8	5.4	5.5	5.3	5.3
Bottom temperature (°C)	3.2	3.6	3.7	3	3.8	2.2	3.7
Pacific sleeper shark							5.12
Bering skate			0.11		24.62	8.02	3.51
mud skate		0.92	0.19	1.25	0.47	1.06	
rougthead skate	8.55						
Alaska skate						21.66	
Aleutian skate		6.24	17.23		103.19	10.98	141.51
Commander skate	7.35	12.31	6.36		13.68		6.38
whiteblotched skate		5.45	4.25		39.04		32.10
whitebrow skate		2.41	3.82		9.14		13.33
other skates & skate eggs		0.07		0.01	0.03		0.02
arrowtooth flounder		835.03	4.00	17.12	144.11	2.98	156.42
Kamchatka flounder		288.16	25.33	185.84	24.30	2.43	23.32
Greenland turbot	54.95	159.70	68.45	6.52	26.85		23.54
Pacific halibut		7.63		17.38	50.09		6.47
flathhead sole		12.24	12.46	297.13	22.48	6.03	9.66
rex sole				9.14	4.70	8.22	0.85
other flatfish				1.09			
Pacific grenadier							
giant grenadier	7779.21	2360.70	3774.91	3.47	19.17		130.18
popeye grenadier	49.60		131.36				2.87
Pacific cod							
walleye pollock				1.32		3.34	
blob sculpin							
bigmouth sculpin				16.52	4.94	9.52	1.74
other sculpins		1.22		1.29	2.51	1.38	3.95
twoline eelpout			1.69				1.83
western eelpout			18.55		2.96		32.61
ebony eelpout		21.08	3.56				
other eelpouts			0.08	0.11	0.64	0.45	1.02
sablefish	16.00	3.20	15.09		19.25		11.26
searcher							
blacktail snailfish			0.39				
other snailfishes	1.77	1.93	2.47	0.32	8.89	3.09	7.46
poachers		0.03	0.03		0.08	0.88	0.31
mesopelagic fishes			0.16		0.27		0.11
other fishes			0.23	1.63	2.10		0.76
shortspine thornyhead		5.72	6.14		10.16		22.72
roughey rockfish							
blackspotted rockfish				1.97	2.10		
Pacific ocean perch				47.96	0.58		
shortraker rockfish							5.83
grooved Tanner crab			1.79				1.85
Tanner crab				0.95	1.47	2.15	1.26
triangle Tanner crab	16.63	2.19	1.70		0.44		0.02
snow crab				0.05	0.12	0.41	
scarlet king crab	32.97	1.60					
golden king crab		0.23		0.43	13.54	1.06	0.67
hermit crabs			0.10	0.12	2.10	2.44	26.95
other crabs	0.05				0.08		
snails	1.68	0.09	0.23	0.39	0.99	1.32	3.03
bivalves							
octopus					0.51		2.10
squid		0.23		6.42	1.91	4.48	7.00
sea anemones & corals	36.27	2.15	3.56	139.86	44.58	3.14	12.12
jellyfish		0.03			0.28	0.81	1.14
shrimps		0.17		0.98	3.11	4.45	4.69
seastars & sea cucumbers	2.38	0.63	7.15	1.57	14.22	3.12	321.80
sponges		4.24		0.80		0.19	
other invertebrates	1.00		0.61	0.43		2.44	14.62
Haul Total Weight (kg)	8008.41	3735.60	4112.00	762.07	619.68	106.05	1042.12

Appendix C. - - Haul Log.

Haul	36	37	38	39	40	41	42
Date	10-Jun-2010	11-Jun-2010	11-Jun-2010	11-Jun-2010	11-Jun-2010	12-Jun-2010	12-Jun-2010
Stratum	61	63	62	63	61	63	62
Station ID	61-08	63-04	62-06	63-09	61-07	63-03	62-05
Performance	0	0	0	0	0	0	0
Bottom depth	212	639	493	625	312	622	437
Tow start latitude (N)	59.80195	59.72	59.6934	59.63983	59.62662	59.61488	59.55408
Tow start longitude (W)	-178.68562	-178.63787	-178.52937	-178.52085	-178.4405	-178.4816	-178.41383
Tow end latitude (N)	59.78457	59.70258	59.70952	59.65375	59.64573	59.59732	59.5751
Tow end longitude (W)	-178.65783	-178.61168	-178.55832	-178.55037	-178.46448	-178.45613	-178.42837
Tow duration (Hour)	0.552	0.541	0.568	0.505	0.567	0.641	0.541
Distance of tow (nmi)	2.51	2.48	2.47	2.31	2.59	2.77	2.52
Mean net width (m)	15.77	17.263	17.088	17.22	16.735	16.596	17.12
Surface temperature (°C)	4.8	5.4	3.3	3.1	3.4	3.5	3.4
Bottom temperature (°C)	2.2	3.5	3.7	3.6	3	3.5	3.6
Pacific sleeper shark							
Bering skate	3.92	1.95	3.82		11.74	0.05	15.90
mud skate							
rougthead skate				3.62			
Alaska skate	8.75				4.08		
Aleutian skate	7.50	27.17	69.78	24.94	65.09	28.99	193.33
Commander skate		19.42	17.92	27.26		21.82	3.71
whiteblotched skate			11.20	4.18	6.92		45.24
whitebrow skate		2.86	3.36	4.84	12.85	3.48	7.72
other skates & skate eggs					0.05		
arrowtooth flounder	3.67	46.59	153.84	44.65	40.99	30.78	252.29
Kamchatka flounder		125.05	14.92	92.52	20.08	281.53	75.32
Greenland turbot	0.48	218.75	28.62	29.32	38.53	97.91	10.86
Pacific halibut			42.72			35.15	9.09
flathead sole	6.20		5.74		125.22		50.28
rex sole	4.74		10.02		4.12		
other flatfish							
Pacific grenadier							
giant grenadier		2667.63	452.92	3047.92		3078.79	1140.41
popeye grenadier		298.08	8.30	183.60		364.45	
Pacific cod	15.06				2.63		
walleye pollock	4.79				74.57		
blob sculpin							
bigmouth sculpin	1.12		2.82	4.94	13.54	1.06	10.58
other sculpins	4.74		0.49		8.99		0.04
twoline eelpout				2.04		1.91	
western eelpout		0.15	31.56	5.73		4.75	1.52
ebony eelpout		0.43		7.54		4.41	
other eelpouts		1.69	0.74	2.83	1.25	2.65	0.34
sablefish		34.36	14.26	22.84		31.14	3.17
searcher							
blacktail snailfish		3.77	5.00	5.46		2.67	
other snailfishes	0.95	0.13	4.77	0.63	11.61	0.64	1.28
poachers	1.68	0.40	0.54	0.23	0.73	0.24	0.27
mesopelagic fishes		0.08	0.08	0.04	1.65	0.01	0.18
other fishes		2.46	3.17	1.92	0.15		0.21
shortspine thornyhead	0.50	40.70	83.07	68.47	3.10	115.84	40.74
rougheye rockfish							
blackspotted rockfish							
Pacific ocean perch					2.93		
shortraker rockfish							5.14
grooved Tanner crab		6.86	1.27	8.12		10.37	1.87
Tanner crab	3.51	0.02			0.02		
triangle Tanner crab		1.76		0.57			0.02
snow crab	1.35	0.03					
scarlet king crab							
golden king crab		1.29	0.70		0.79		
hermit crabs	3.66	0.59	8.80	1.54	4.55	3.23	2.78
other crabs					0.01		
snails	1.35	2.85	3.10	2.12	7.75	2.75	2.16
bivalves		0.04			0.09	0.01	0.01
octopus	2.93	0.29	1.88	0.83			0.39
squid	3.06	0.35	3.51	0.96	13.57	2.83	6.92
sea anemones & corals	5.55	0.66	1.88	4.36	63.73	1.71	10.28
jellyfish	0.16	0.98	0.59	0.54	6.96		0.11
shrimps	4.33	0.04	4.40	0.01	8.78	0.02	0.88
seastars & sea cucumbers	1.20	13.86	36.53	37.31	62.43	167.80	68.33
sponges	0.79	0.56			1.93		
other invertebrates	6.71	0.15	0.12	0.12	1.65		4.63
Haul Total Weight (kg)	98.69	3522.01	1032.45	3642.00	623.08	4296.99	1966.00

Appendix C. - - Haul Log.

Haul	43	44	45	46	47	48	49
Date	12-Jun-2010	12-Jun-2010	12-Jun-2010	13-Jun-2010	13-Jun-2010	13-Jun-2010	13-Jun-2010
Stratum	61	61	62	62	64	63	62
Station ID	61-06	61-05	62-04	62-13	64-01	63-01	62-15
Performance	0	0	0	-2.4	0	3.11	0
Bottom depth	263	227	533	492	969	621	540
Tow start latitude (N)	59.50043	59.53132	59.41792	59.42415	59.35348	59.33947	59.36003
Tow start longitude (W)	-178.29215	-178.25332	-178.11428	-178.2185	-178.36085	-178.07783	-177.98793
Tow end latitude (N)	59.48233	59.5147	59.41883	59.42743	59.35712	59.33598	59.3716
Tow end longitude (W)	-178.26887	-178.22435	-178.1594	-178.17652	-178.40798	-178.12462	-178.02878
Tow duration (Hour)	0.571	0.549	0.563	0.565	0.623	0.588	0.588
Distance of tow (nmi)	2.45	2.48	2.83	2.45	2.73	2.71	2.67
Mean net width (m)	16.51	16.6	17.083	16.694	15.557	15.55	15.617
Surface temperature (°C)	3.4	3.7	5.1	4.9	5.5	5.1	4.2
Bottom temperature (°C)	2.8	2.3	3.6	3.6	2.9	3.4	3.6
Pacific sleeper shark							
Bering skate	9.30	3.70		0.03			0.03
mud skate						1.80	
rougthead skate					4.12		
Alaska skate							
Aleutian skate	12.51	13.30	41.58	8.62	0.38	16.58	22.00
Commander skate			6.69	12.79	4.16	15.26	12.77
whiteblotched skate	5.16	6.29	16.49	13.87		70.30	26.27
whitebrow skate	6.96		0.32	3.65	0.27	1.67	0.90
other skates & skate eggs			0.03	0.04			
arrowtooth flounder	99.77	109.98	14.13	16.92			15.58
Kamchatka flounder	34.96	23.77	28.24	34.62		19.04	74.48
Greenland turbot	12.88	2.68	24.36	8.52		90.52	165.82
Pacific halibut	13.54		15.58	15.93			40.05
flathead sole	65.28	47.96		8.32			0.35
rex sole	12.74	7.92					
other flatfish							
Pacific grenadier					36.10		
giant grenadier			903.20	1265.80	896.96	842.81	656.18
pop-eye grenadier			9.65	2.30	372.41	142.24	147.86
Pacific cod	4.28	3.38					
walleye pollock	146.30	287.95					
blob sculpin							
bigmouth sculpin	19.28	27.94	2.39	3.44			2.76
other sculpins	0.84	1.53		0.56		0.23	0.01
twoline eelpout			4.02	11.36	0.13		
western eelpout							1.52
ebony eelpout			20.09	2.87		19.28	12.52
other eelpouts		0.05	0.51	0.57	0.03	0.18	0.32
sablefish			16.00	5.65	11.85	7.06	6.74
searcher							
blacktail snailfish			1.06	1.07	0.78	0.28	
other snailfishes	0.94	0.54	0.02	3.42	0.26	0.03	1.83
poachers	0.31	0.17	0.03	0.14		0.09	0.11
mesopelagic fishes			0.05	0.12	1.01	0.02	0.05
other fishes	0.28				5.88		
shortspine thornyhead			49.75	172.42		30.12	29.00
roughey rockfish							
blackspotted rockfish							
Pacific ocean perch		0.01					
shortraker rockfish				3.64			
grooved Tanner crab			9.40	1.22		1.50	9.77
Tanner crab	2.42	3.84	0.08				
triangle Tanner crab			0.07		6.98	8.24	0.65
snow crab	0.22	0.49					
scarlet king crab					4.05		
golden king crab				7.94		0.07	
hermit crabs	5.45	1.16		0.32		0.06	0.04
other crabs	0.11	0.12					
snails	4.00	1.82	0.42	0.13	0.06	0.05	0.38
bivalves							
octopus	0.01		0.40	1.81			
squid	4.34	2.31					
sea anemones & corals	28.25	4.22	10.30	21.11	0.59	4.31	15.23
jellyfish		0.62	0.24		0.15	0.20	0.03
shrimps	5.73	4.13	0.01	0.15	0.01		0.03
seastars & sea cucumbers	28.55	10.79	32.19	11.40	1.17	2.37	1.83
sponges	0.32	0.24		0.34	0.06	3.59	0.16
other invertebrates	3.03	1.36	0.06	0.35		0.09	0.09
Haul Total Weight (kg)	527.76	568.27	1207.36	1641.44	1347.41	1278.00	1245.36

Appendix C. - - Haul Log.

Haul	50	51	52	53	54	55	56
Date		14-Jun-2010	14-Jun-2010	14-Jun-2010	14-Jun-2010	15-Jun-2010	15-Jun-2010
Stratum		63	51	51	52	54	54
Station ID		63-02	51-03	51-02	52-03	54-04	54-01
Performance		4.1	0	0	0	0	0
Bottom depth		623	277	222	498	907	818
Tow start latitude (N)		59.4006	58.97228	58.94123	58.78207	58.60733	58.63205
Tow start longitude (W)		-178.20392	-178.2116	-178.0292	-177.91113	-177.95763	-177.7422
Tow end latitude (N)		59.3996	58.98913	58.94335	58.79873	58.60657	58.63087
Tow end longitude (W)		-178.18068	-178.2351	-178.07118	-177.94225	-177.9118	-177.78402
Tow duration (Hour)		0.323	0.533	0.557	0.58	0.602	0.599
Distance of tow (nmi)		1.34	2.36	2.45	2.6	2.68	2.5
Mean net width (m)		15.857	16.573	14.994	16.833	16.83	17.487
Surface temperature (°C)		5.3	5.7	5.9	5.6	5.4	5.4
Bottom temperature (°C)		3.4	2.3	2.7	3.7	3	3.2
Pacific sleeper shark							
Bering skate			5.10				
mud skate				1.12			
rougthead skate						26.30	9.92
Alaska skate				7.16			
Aleutian skate		9.23	5.30	25.92	4.86		1.58
Commander skate		29.88			6.67	4.62	
whiteblotched skate		1.68	20.31	14.13			
whitebrow skate		1.06		2.68			
other skates & skate eggs			0.12	0.18			
arrowtooth flounder		2.21	9.16	13.46	4.04		
Kamchatka flounder		34.64	8.85	11.90	22.94		2.08
Greenland turbot			22.28		4.19		3.61
Pacific halibut							
flathead sole			123.63	17.35	4.68		
rex sole			2.78	12.48	8.86		
other flatfish		1.07				2.40	
Pacific grenadier						6.28	17.03
giant grenadier		1670.85			1850.43	842.43	2273.96
popeye grenadier		148.39			0.69	69.71	249.20
Pacific cod				41.60			
walleye pollock			4.06	3.12			
blob sculpin						52.80	
bigmouth sculpin			11.14	4.45			
other sculpins		0.98	1.45	4.66	0.07		
twoline eelpout		3.83			5.75		
western eelpout							
ebony eelpout							
other eelpouts		0.75			0.06	0.06	
sablefish		26.04				3.16	
searcher				0.29			
blacktail snailfish		0.18			1.77		0.20
other snailfishes		0.16	1.53	5.33	0.45	1.03	0.13
poachers		0.11	0.15	2.40	0.53		
mesopelagic fishes					0.06	0.67	0.35
other fishes				0.65	0.48	0.37	
shortspine thornyhead		49.85			37.40	3.18	5.46
rougthead rockfish							
blackspotted rockfish							
Pacific ocean perch			6.18	193.40			
shortraker rockfish							
grooved Tanner crab		2.92			1.03		
Tanner crab			0.58	6.82			
triangle Tanner crab		0.24			0.07	15.53	18.20
snow crab			0.33	0.04			
scarlet king crab		2.10				0.22	
golden king crab		0.13	2.37	5.66			
hermit crabs			0.07	0.20	0.30	0.02	0.02
other crabs			0.18	0.03		0.01	0.48
snails		0.03	1.33	1.62	0.13	0.02	0.83
bivalves							
octopus		0.07			4.12	0.52	
squid			5.80	0.88		0.06	0.27
sea anemones & corals		5.04	0.17	3.91	5.57	1.42	2.85
jellyfish		0.26	1.19	0.23		1.34	0.04
shrimps		0.15	0.03	2.51	0.06	2.18	0.08
seastars & sea cucumbers		2.52	14.49	11.80	10.01	2.35	3.27
sponges			0.40	0.62		0.56	0.45
other invertebrates		0.14	0.03		0.79	0.01	
Haul Total Weight (kg)		1994.52	249.00	396.60	1976.00	1037.25	2590.00

Appendix C. - - Haul Log.

Haul	57	58	59	60	61	62	63
Date	15-Jun-2010	15-Jun-2010	15-Jun-2010	16-Jun-2010	16-Jun-2010	16-Jun-2010	16-Jun-2010
Stratum	55	53	51	53	52	52	55
Station ID	55-02	53-03	51-06	53-02	52-02	52-01	55-01
Performance	0	0	0	0	0	0	0
Bottom depth	1138	703	262	732	447	459	1016
Tow start latitude (N)	58.50765	58.65557	58.62095	58.53065	58.57545	58.5365	58.58722
Tow start longitude (W)	-177.86783	-177.79355	-177.24833	-176.84407	-176.70998	-176.09385	-177.68088
Tow end latitude (N)	58.4968	58.65547	58.62882	58.51995	58.5682	58.53818	58.59863
Tow end longitude (W)	-177.89775	-177.7494	-177.29327	-176.80447	-176.6723	-176.1371	-177.68943
Tow duration (Hour)	0.557	0.56	0.586	0.725	0.576	0.541	0.401
Distance of tow (nmi)	2.13	2.57	2.77	2.82	2.36	2.56	1.43
Mean net width (m)	16.981	16.91	15.871	14.443	16.578	16.588	16.668
Surface temperature (°C)	5.3	5.3	6	5.3	5.4	5.5	5.6
Bottom temperature (°C)	2.6	3.4	3	3.3	3.8	3.8	2.9
Pacific sleeper shark		9.82					
Bering skate			4.18		5.64	28.20	
mud skate							
rougthead skate		8.48		14.14			10.30
Alaska skate			9.68				
Aleutian skate		7.62	22.98		27.14	105.34	
Commander skate		17.12		6.48	8.02	4.80	
whiteblotched skate			13.22		17.50	13.69	
whitebrow skate	0.07			0.06			
other skates & skate eggs		0.32	0.06	0.06	0.06	0.01	
arrowtooth flounder			13.29		347.05	906.39	
Kamchatka flounder			5.52	18.10	17.11	20.40	
Greenland turbot			4.37		29.47	80.24	
Pacific halibut			26.02		39.41	13.68	
flathead sole			32.30		81.64	67.95	
rex sole			1.85		55.60	40.96	
other flatfish				5.82			
Pacific grenadier	33.22	3.87		2.47			23.16
giant grenadier	1240.48	5999.53		6735.21	1504.64	1959.84	1667.28
popeye grenadier	93.28	155.73		410.69			122.12
Pacific cod			8.35				
walleye pollock			6.02				
blob sculpin	4.48						19.73
bigmouth sculpin						20.76	
other sculpins			0.36		0.94	0.36	
twoline eelpout		12.15			17.22	7.84	
western eelpout						1.80	
ebony eelpout							
other eelpouts					0.15		0.01
sablefish				25.54	11.30		
searcher							
blacktail snailfish				0.05	1.22	1.45	
other snailfishes	0.27		3.69	0.02	0.33		1.93
poachers		0.26	1.24	0.34	0.14	0.05	
mesopelagic fishes	0.84				0.01	0.01	0.36
other fishes	5.31			0.93			4.07
shortspine thornyhead		30.99			73.75	82.32	
rougthead rockfish							
blackspotted rockfish							
Pacific ocean perch			35.79		0.49	0.64	
shortraker rockfish						3.34	
grooved Tanner crab	0.05	5.03		0.72	1.29	4.77	0.51
Tanner crab			1.65	0.13			
triangle Tanner crab	2.76			2.13	0.43		1.35
snow crab			0.04			0.02	
scarlet king crab		4.20					
golden king crab			1.17			0.81	
hermit crabs		0.06		0.21	0.01		
other crabs	0.82						3.03
snails	0.25	0.13	0.03	0.88	0.35	0.27	0.96
bivalves							
octopus	1.49		9.30	1.26	3.99	1.23	1.93
squid			8.81		2.45	1.74	0.43
sea anemones & corals	40.17	2.35	7.12	0.89	34.48	27.17	13.35
jellyfish	0.47		0.26				0.38
shrimps	0.03		2.81	0.01	4.49	0.41	0.02
seastars & sea cucumbers	34.11	46.72	3.32	59.20	6.38	8.97	7.91
sponges	8.57				1.07	0.39	
other invertebrates	0.84		0.06		0.22	0.14	125.17
Haul Total Weight (kg)	1467.51	6304.37	223.49	7285.31	2294.00	3406.00	2004.00

Appendix C. - - Haul Log.

Haul	64	65	66	67	68	69	70
Date	17-Jun-2010	17-Jun-2010	17-Jun-2010	17-Jun-2010	18-Jun-2010	18-Jun-2010	18-Jun-2010
Stratum	44	44	43	42	41	41	41
Station ID	44-03	44-04	43-04	42-01	41-10	41-15	41-09
Performance	0	0	0	0	0	0	0
Bottom depth	916	849	649	573	287	274	272
Tow start latitude (N)	58.12353	58.23203	58.25565	58.26695	58.39932	58.36457	58.35805
Tow start longitude (W)	-175.54335	-175.62145	-175.50897	-175.43348	-175.58733	-175.4698	-175.3135
Tow end latitude (N)	58.1426	58.25153	58.27637	58.27282	58.38387	58.3573	58.3543
Tow end longitude (W)	-175.56877	-175.64168	-175.52323	-175.46538	-175.5598	-175.43238	-175.3558
Tow duration (Hour)	0.608	0.639	0.561	0.436	0.548	0.551	0.555
Distance of tow (nmi)	2.67	2.72	2.52	1.99	2.36	2.34	2.54
Mean net width (m)	16.18	16.719	16.412	15.355	15.749	15.728	15.453
Surface temperature (°C)	5.4	5.4	4.9	5	5.4	5.4	5.2
Bottom temperature (°C)	2.9	3.1	3.5	3.5	2.5	3.3	3.3
Pacific sleeper shark							
Bering skate				0.10	5.66	5.70	7.49
mud skate					0.02		
rougthead skate		7.33					
Alaska skate						8.38	11.61
Aleutian skate		3.50	16.50	4.14	7.90	23.18	173.00
Commander skate			15.72	7.07			
whiteblotched skate							
whitebrow skate				3.64	2.86		
other skates & skate eggs	0.03		0.06		0.11	0.01	0.04
arrowtooth flounder					40.94	17.56	150.20
Kamchatka flounder			7.48	4.42	2.00	10.98	4.68
Greenland turbot		8.14	7.27	2.75	1.82	13.28	11.76
Pacific halibut					7.09		24.38
flathead sole					31.48	69.93	18.78
rex sole					36.66	83.92	63.86
other flatfish			15.58				0.72
Pacific grenadier	9.72	2.50					
giant grenadier	1339.00	669.26	680.36	1889.24			
popeye grenadier	128.60	119.12	59.80	37.04			
Pacific cod					10.51		5.56
walleye pollock					9.05	11.07	1.95
blob sculpin	17.96	2.24					
bigmouth sculpin							5.21
other sculpins					0.89	1.70	0.68
twoline eelpout				2.72			
western eelpout							
ebony eelpout			17.94				
other eelpouts		0.01					
sablefish		14.66	3.40	5.08			
searcher							
blacktail snailfish		0.90	2.08				
other snailfishes	0.78	0.31		0.07	0.03	0.03	0.45
poachers			0.04	0.01	0.92	0.51	0.36
mesopelagic fishes	0.53	0.19	0.14	0.01			
other fishes	0.34		1.44				
shortspine thornyhead		11.46	19.16	8.94			
rougheye rockfish							
blackspotted rockfish							
Pacific ocean perch					6.83	169.02	5536.73
shortraker rockfish							
grooved Tanner crab		4.31	0.56				
Tanner crab							
triangle Tanner crab	0.78	0.81		0.02			
snow crab							
scarlet king crab							
golden king crab							
hermit crabs	0.03			0.03			
other crabs					0.04		
snails	0.65	0.59	0.07		0.13	0.02	0.13
bivalves							
octopus	3.71		0.25			0.51	
squid	0.19				2.99	0.28	4.60
sea anemones & corals	8.42	0.26	0.05	0.31	1.89	1.88	0.75
jellyfish	1.54	0.46	1.31	0.33	0.01	0.27	1.19
shrimps	2.25	0.17			3.51	1.53	0.50
seastars & sea cucumbers	2.44	0.78	3.77	20.69	6.14	39.23	51.48
sponges						0.04	
other invertebrates	40.23			1.39	0.18	0.01	0.06
Haul Total Weight (kg)	1557.18	846.99	852.97	1988.01	179.66	459.02	6076.18

Appendix C. - - Haul Log.

Haul	71	72	73	74	75	76	77
Date	18-Jun-2010	18-Jun-2010	18-Jun-2010	19-Jun-2010	19-Jun-2010	19-Jun-2010	19-Jun-2010
Stratum	42	43	42	45	44	41	41
Station ID	42-05	43-03	42-04	45-02	44-02	41-07	41-06
Performance	0	0	0	0	0	0	0
Bottom depth	410	642	574	1123	952	255	321
Tow start latitude (N)	58.31198	58.2727	58.36572	58.48552	58.54118	58.65852	58.55582
Tow start longitude (W)	-175.30507	-175.09717	-175.0705	-174.80918	-174.85337	-174.91793	-174.61198
Tow end latitude (N)	58.31172	58.29032	58.34277	58.46887	58.52235	58.65807	58.57802
Tow end longitude (W)	-175.34767	-175.08877	-175.07027	-174.79035	-174.8351	-174.87393	-174.60062
Tow duration (Hour)	0.542	0.479	0.568	0.569	0.593	0.546	0.548
Distance of tow (nmi)	2.52	2.19	2.58	2.19	2.38	2.57	2.59
Mean net width (m)	15.869	15.325	16.149	17.188	16.283	15.189	15.114
Surface temperature (°C)	5.3	5.1	5.3	5	4.8	4.7	5.1
Bottom temperature (°C)	3.7	3.4	3.6	2.7	3.1	3.2	3.2
Pacific sleeper shark							
Bering skate	2.42		1.74			2.18	1.24
mud skate							0.90
rougthead skate		3.48		3.30	17.30		
Alaska skate							
Aleutian skate	3.06	11.88	16.26	0.14	21.51	12.10	1.34
Commander skate		12.56	8.14		14.38		
whiteblotched skate	3.84						5.20
whitebrow skate			5.88	0.96	3.59	2.44	
other skates & skate eggs		0.21	0.03		0.01	0.22	0.05
arrowtooth flounder	101.62		11.42			106.02	104.15
Kamchatka flounder	29.30	17.68	28.90			11.06	9.14
Greenland turbot	39.30		46.26	15.00	43.94		13.21
Pacific halibut	39.95					6.09	9.09
flathead sole	57.26		7.40			1.76	75.48
rex sole	54.30					10.74	16.71
other flatfish		25.20					
Pacific grenadier				130.90			
giant grenadier	640.25	901.56	1538.70	1137.00	1577.79		
popeye grenadier		49.60	68.62	178.63	224.79		
Pacific cod						3.46	
walleye pollock						45.39	
blob sculpin				27.98	12.78		
bigmouth sculpin			0.10			7.95	6.00
other sculpins	0.08				0.01	1.29	2.35
twoline eelpout		5.98	6.74	0.36			
western eelpout			9.24				
ebony eelpout		26.72	27.18				
other eelpouts		0.09	0.05		0.02		
sablefish		20.34	11.14		11.14		
searcher						3.41	
blacktail snailfish		1.20	5.60		1.49		
other snailfishes		0.23	1.92	0.84	1.91		0.02
poachers	0.04	0.08	0.71	0.05		1.13	0.83
mesopelagic fishes	0.06	0.08	0.13	0.24	0.24	0.05	0.02
other fishes			0.48	1.29			0.23
shortspine thornyhead	53.34	35.90	56.98		1.89		
rougthead rockfish							
blackspotted rockfish							
Pacific ocean perch	15.42					1.58	17.92
shortraker rockfish							
grooved Tanner crab	0.43	0.32	5.62	1.05	1.74		
Tanner crab							0.62
triangle Tanner crab		0.00		0.03	0.75	0.04	
snow crab	0.01						0.08
scarlet king crab					0.84		
golden king crab						2.40	0.25
hermit crabs		0.08	0.04		0.11		0.08
other crabs					1.39	0.01	0.01
snails		0.18	1.03	0.24	0.89	0.85	0.03
bivalves							
octopus		0.07	1.82	4.31	0.29	1.23	
squid	0.73		0.49			0.78	4.88
sea anemones & corals	8.10	0.05	46.54	35.27	9.56	0.69	10.97
jellyfish			0.42	0.34	0.01	8.49	0.08
shrimps	1.41	0.61	0.03	0.04	0.12	5.75	2.41
seastars & sea cucumbers	2.82	314.46	159.30	3.74	5.39	7.96	2.65
sponges		0.09	1.06			0.05	0.25
other invertebrates	0.03	0.14	0.04	31.67	0.12	0.11	0.06
Haul Total Weight (kg)	1053.76	1428.78	2070.00	1573.39	1954.01	245.22	286.24

Appendix C. - - Haul Log.

Haul	78	79	80	81	82	83	84
Date	19-Jun-2010	20-Jun-2010	20-Jun-2010	20-Jun-2010	20-Jun-2010	20-Jun-2010	21-Jun-2010
Stratum	41	44	43	43	43	41	41
Station ID	41-05	44-01	43-01	43-06	43-06	41-04	41-03
Performance	0	0	2.1	-2.4	-2.4	0	0
Bottom depth	330	866	640	648	642	335	351
Tow start latitude (N)	58.42662	57.75128	57.787	57.8408	57.8488	57.85577	57.73185
Tow start longitude (W)	-174.53808	-173.93773	-173.8765	-173.9497	-173.95417	-173.88137	-173.78347
Tow end latitude (N)	58.4098	57.74897	57.77677	57.8639	57.86087	57.84628	57.74778
Tow end longitude (W)	-174.50778	-173.91552	-173.89132	-173.9633	-173.96417	-173.84468	-173.81638
Tow duration (Hour)	0.549	0.356	0.335	0.59	0.331	0.539	0.581
Distance of tow (nmi)	2.66	1.41	1.46	2.76	1.48	2.45	2.66
Mean net width (m)	15.547	16.11	16.059	15.691	15.478	15.9	15.824
Surface temperature (°C)	5.3	5.4	5.5	5.3	5.3	5.5	5.2
Bottom temperature (°C)	3.3	3.2	3.5	3.4	3.4	3.3	2.9
Pacific sleeper shark							
Bering skate	6.81					5.10	0.92
mud skate			1.10	3.02		5.18	3.28
rougthead skate		3.87					
Alaska skate							
Aleutian skate	87.98	14.50	1.52	12.48	2.78	56.16	13.60
Commander skate		9.06	16.58	36.28	16.24		
whiteblotched skate							8.74
whitebrow skate	1.51	1.06		0.04	4.82		
other skates & skate eggs				0.14			
arrowtooth flounder	274.28			1.76	2.20	62.04	23.92
Kamchatka flounder	30.27	17.71	24.18	27.28	10.96	3.36	8.46
Greenland turbot	5.24	19.21	7.44	70.54		3.58	
Pacific halibut	3.35						
flathead sole	57.95					9.32	12.12
rex sole	45.26					13.52	12.80
other flatfish							
Pacific grenadier		4.53					
giant grenadier	27.80	1502.25	1013.34	877.23	123.40	708.84	17.24
popeye grenadier		174.57	58.04	138.22	53.46		
Pacific cod	79.45					31.12	
walleye pollock	39.53					27.72	3.01
blob sculpin							
bigmouth sculpin	9.60					32.16	3.98
other sculpins	1.23		0.07	0.04	0.08	0.54	0.28
twoline eelpout		1.22		9.58			
western eelpout				2.38			
ebony eelpout			11.22	2.07	1.34		
other eelpouts		0.01		0.12	0.07		
sablefish		46.89	13.46	79.90	36.98		
searcher							
blacktail snailfish		6.31		2.35	1.96	4.88	
other snailfishes	16.54	1.20	2.63	0.43	0.41	0.62	0.34
poachers	0.50	0.01	0.04	0.01	0.03	0.27	
mesopelagic fishes	0.01	0.29	0.29	0.13	0.15		
other fishes	0.98	0.73	0.21	0.68	2.14		0.28
shortspine thornyhead		2.76	46.10	39.64	27.20		
roughey rockfish	2.57						
blackspotted rockfish						1.88	1.32
Pacific ocean perch	6.93					107.94	75.26
shortraker rockfish	13.00			6.66		107.46	19.76
grooved Tanner crab		4.70	2.36	8.56	1.52		
Tanner crab	0.42					0.01	1.51
triangle Tanner crab		3.60					
snow crab	1.81						
scarlet king crab		0.33		3.46	0.03		
golden king crab	0.01					1.61	6.29
hermit crabs	0.62		0.02	0.04	0.07		
other crabs						0.06	
snails	0.54				0.02	0.41	0.08
bivalves							
octopus	2.41						
squid	2.23	0.34				6.89	8.64
sea anemones & corals	1.42					7.72	16.40
jellyfish	0.57	0.29	0.62	0.28	0.38		0.29
shrimps	20.96			0.02	0.02	9.07	4.91
seastars & sea cucumbers	5.48	0.57		1.14		5.48	0.45
sponges	3.27		0.10	7.39	9.90		
other invertebrates	0.27			0.14			0.04
Haul Total Weight (kg)	750.80	1816.00	1199.32	1332.00	296.15	1212.94	243.91

Appendix C. - - Haul Log.

Haul	85	86	87	88	89	90	91
Date	21-Jun-2010	22-Jun-2010	22-Jun-2010	22-Jun-2010	22-Jun-2010	23-Jun-2010	23-Jun-2010
Stratum	41	41	31	33	31	32	31
Station ID	41-01	41-12	31-13	33-07	31-05	32-03	31-09
Performance	4.4	0	0	0	0	0	0
Bottom depth	299	260	236	694	344	462	303
Tow start latitude (N)	57.79428	57.66027	57.44552	56.94935	56.86233	56.77333	56.7013
Tow start longitude (W)	-174.19353	-174.20972	-173.93283	-173.71943	-173.39687	-173.41807	-173.29597
Tow end latitude (N)	57.79872	57.65088	57.43237	56.9572	56.84655	56.76222	56.71457
Tow end longitude (W)	-174.21843	-174.20498	-173.92072	-173.75605	-173.41845	-173.41272	-173.32893
Tow duration (Hour)	0.339	0.268	0.382	0.529	0.498	0.295	0.555
Distance of tow (nmi)	1.59	1.11	1.7	2.43	2.25	1.35	2.51
Mean net width (m)	15.086	15.267	15.636	15.813	15.527	14.161	15.983
Surface temperature (°C)	5.3	5.2	5	5.5	5.5	5.3	5.3
Bottom temperature (°C)	3.1	2.8	2.6	3.5	3.6	3.7	2.9
Pacific sleeper shark							
Bering skate							
mud skate	16.62	1.98			3.28		
rougthead skate							
Alaska skate							
Aleutian skate				14.44			
Commander skate				7.80			
whiteblotched skate							
whitebrow skate				3.02			2.74
other skates & skate eggs				0.01	0.04		
arrowtooth flounder	9.05	54.12	20.21		65.48	260.32	17.85
Kamchatka flounder		12.82		39.70	0.69	21.71	17.13
Greenland turbot		3.46			3.42	7.72	
Pacific halibut					8.19	17.95	21.49
flathead sole		54.51	11.04		49.50	35.62	18.36
rex sole		0.12			21.65	14.26	5.58
other flatfish				3.60		1.38	
Pacific grenadier							
giant grenadier				2693.88	487.82	236.82	29.88
popeye grenadier				147.64			
Pacific cod	91.60	2.57	30.84				3.31
walleye pollock		5.29	23.62				48.98
blob sculpin							
bigmouth sculpin		13.84				10.62	2.92
other sculpins	1.73	0.60	1.19		0.26		1.30
twoline eelpout							
western eelpout							
ebony eelpout				41.62			
other eelpouts							
sablefish				2.68		2.12	
searcher							
blacktail snailfish							1.06
other snailfishes				0.04			
poachers				0.01	0.03	0.01	0.07
mesopelagic fishes				0.07		0.08	
other fishes				0.96		3.51	
shortspine thornyhead		0.41		56.79	0.48	66.74	11.26
rougheye rockfish							
blackspotted rockfish					5.48		6.02
Pacific ocean perch	14092.73	696.25	5074.90		10.88		159.18
shortraker rockfish	47.99				37.06	10.00	74.66
grooved Tanner crab				4.30		0.19	
Tanner crab		0.32			0.04		0.10
triangle Tanner crab							
snow crab		0.25			0.06		
scarlet king crab				2.49			
golden king crab		3.41	16.30		6.52		0.01
hermit crabs				0.03		0.07	
other crabs						0.03	0.05
snails		0.18	0.05		0.07		0.24
bivalves							
octopus					0.04		0.97
squid	2.33	0.28	2.80		0.41	0.71	8.29
sea anemones & corals		1.75	0.85		0.32	5.96	2.16
jellyfish				0.72	0.37	1.09	2.93
shrimps		1.76	0.21		0.86	0.02	0.73
seastars & sea cucumbers	0.36	1.55	2.81	4.18	1.19	1.87	0.84
sponges	112.44		0.93		0.48		10.02
other invertebrates					0.01	0.01	4.23
Haul Total Weight (kg)	14374.84	855.48	5185.75	3024.00	704.64	698.82	452.36

Appendix C. - - Haul Log.

Haul	92	93	94	95	96	97	98
Date	23-Jun-2010	25-Jun-2010	25-Jun-2010	26-Jun-2010	26-Jun-2010	26-Jun-2010	26-Jun-2010
Stratum	33	35	31	35	34	33	31
Station ID	33-05	35-04	31-04	35-02	34-03	33-03	31-03
Performance	0	0	0	0	5	6.24	0
Bottom depth	742	1055	227	1020	926	616	286
Tow start latitude (N)	56.66105	56.40367	56.56607	56.49245	56.50857	56.56612	56.5615
Tow start longitude (W)	-173.25078	-172.68077	-172.8118	-172.29922	-172.42363	-172.33032	-172.13913
Tow end latitude (N)	56.65285	56.3901	56.55155	56.49485	56.5124	56.56715	56.55543
Tow end longitude (W)	-173.22028	-172.65022	-172.77975	-172.33825	-172.38445	-172.37368	-172.10108
Tow duration (Hour)	0.462	0.61	0.554	0.569	0.588	0.566	0.51
Distance of tow (nmi)	2.1	2.57	2.56	2.47	2.51	2.69	2.53
Mean net width (m)	16.166	16.893	15.355	17.012	16.777	17.055	16.434
Surface temperature (°C)	5.4	5.8	5.1	5.7	5.9	5.6	5.7
Bottom temperature (°C)	3.3	2.7	3.6	2.6	3	3.5	3.4
Pacific sleeper shark			12.00			9.32	
Bering skate							32.54
mud skate							
rougthead skate		0.60		23.74	9.66		
Alaska skate							
Aleutian skate	11.32	0.35	5.61		2.41	29.52	18.74
Commander skate		5.18		1.08	2.80	16.95	
whiteblotched skate						2.84	
whitebrow skate	1.24	0.03				7.02	9.04
other skates & skate eggs			0.01	19.44			
arrowtooth flounder	2.28		83.62			13.95	39.26
Kamchatka flounder	6.54	3.03	4.09	2.94		59.10	19.54
Greenland turbot	18.22				8.04	30.28	9.61
Pacific halibut							
flathead sole			208.61				33.18
rex sole			38.01				76.93
other flatfish	1.17		0.43				
Pacific grenadier		40.83		93.97	6.76		
giant grenadier	1438.37	293.30		820.85	357.98	893.91	
popeye grenadier	157.82	164.80		275.20	85.14	324.80	
Pacific cod			20.25				11.61
walleye pollock			2.87				55.35
blob sculpin		23.07		41.82			
bigmouth sculpin			20.51				
other sculpins		0.01	1.70			0.01	1.53
twoline eelpout	9.04					6.73	
western eelpout	2.28						
ebony eelpout							
other eelpouts	1.22		0.07		0.01	0.49	
sablefish	8.90			3.96	16.23	10.70	
searcher			0.06				
blacktail snailfish	5.18			0.50	0.75	4.04	
other snailfishes	0.34	0.24		0.55	0.35	0.02	10.27
poachers	0.07		1.06			0.22	1.51
mesopelagic fishes	0.09	0.33		0.16	0.21	0.02	0.06
other fishes	9.26	2.02	4.46	1.69	1.35		0.04
shortspine thornyhead	18.36				1.15	136.22	
rougthead rockfish							0.62
blackspotted rockfish							1.90
Pacific ocean perch			649.89				22.80
shortraker rockfish						3.81	
grooved Tanner crab	4.32	0.36		0.15	0.06	8.07	0.19
Tanner crab			0.11				
triangle Tanner crab	0.30	0.95					
snow crab							
scarlet king crab				0.52			
golden king crab						0.02	
hermit crabs	0.07	0.07	0.05		0.03	0.18	0.08
other crabs		2.19		3.73			0.02
snails	0.32	0.04	0.38	0.10	0.21	0.42	0.22
bivalves							
octopus	1.05		0.04	0.47	2.53	0.19	3.41
squid			0.95				7.85
sea anemones & corals	0.30	0.20	3.29	0.07	0.03	0.16	0.41
jellyfish	0.83	0.27	2.23	0.11	0.41		
shrimps		0.05	2.00	0.01	0.04	0.01	4.32
seastars & sea cucumbers	0.34	4.34	13.01	15.83	7.75	88.49	11.30
sponges	5.93	1.37	0.26	2.52	2.32		0.47
other invertebrates		0.01		0.01		0.53	0.84
Haul Total Weight (kg)	1705.16	543.65	1075.57	1309.41	506.21	1648.03	373.64

Appendix C. - - Haul Log.

Haul	99	100	101	102	103	104	105
Date	26-Jun-2010	27-Jun-2010	27-Jun-2010	27-Jun-2010	27-Jun-2010	28-Jun-2010	28-Jun-2010
Stratum	33	32	34	31	33	24	23
Station ID	33-02	32-01	34-11	31-02	33-09	24-04	23-04
Performance	3.2	0	4.1	0	0	5	0
Bottom depth	694	519	843	311	643	860	635
Tow start latitude (N)	56.50177	56.501	56.46043	56.46775	56.23752	55.93368	55.93918
Tow start longitude (W)	-172.02737	-171.98913	-171.9469	-171.83762	-171.38498	-170.33702	-170.12158
Tow end latitude (N)	56.4876	56.49373	56.44963	56.46318	56.24535	55.94787	55.94313
Tow end longitude (W)	-171.99402	-171.95143	-171.90978	-171.80347	-171.4226	-170.30732	-170.08113
Tow duration (Hour)	0.541	0.585	0.573	0.525	0.546	0.574	0.552
Distance of tow (nmi)	2.62	2.55	2.66	2.29	2.57	2.53	2.61
Mean net width (m)	16.472	16.096	17.611	15.603	16.815	16.083	16.43
Surface temperature (°C)	5.7	5.9	5.8	5.9	6.4	5.9	6.3
Bottom temperature (°C)	3.3	3.6	3.1	3.5	3.4	3.1	3.4
Pacific sleeper shark							
Bering skate		3.54		2.30			
mud skate						0.24	
rougthead skate	2.85					5.90	
Alaska skate							
Aleutian skate	43.84	9.28	0.31		13.82	52.42	53.62
Commander skate	7.20	8.57	8.74			2.66	2.99
whiteblotched skate							
whitebrow skate	2.05	8.83		3.04		8.64	15.71
other skates & skate eggs	11.23						
arrowtooth flounder	3.07	64.02		137.72			1.75
Kamchatka flounder	49.73	68.62	5.88	15.97	56.86	16.06	48.88
Greenland turbot	4.47	18.57		12.05	38.17	2.81	97.38
Pacific halibut							
flathead sole		11.05		11.11			
rex sole		42.24		157.18	9.31		28.98
other flatfish	1.36		1.12			11.00	
Pacific grenadier			0.46			1.52	1.50
giant grenadier	889.45	1324.56	1547.65	75.19	1204.83	1254.79	1389.70
popeye grenadier	243.14	16.11	193.23		71.56	214.26	9.53
Pacific cod				9.65			
walleye pollock				31.50			
blob sculpin			48.56				
bigmouth sculpin		8.41		10.60			8.19
other sculpins		0.15	0.01	0.05	0.01	0.05	0.01
twoline eelpout	7.30	1.41	11.61				1.24
western eelpout	1.44	1.14	0.49		1.76	0.01	
ebony eelpout							
other eelpouts	1.27	0.01					0.26
sablefish	17.85	32.12	25.38		49.80	11.74	76.30
searcher							
blacktail snailfish	10.29		1.58		3.73	0.40	0.40
other snailfishes	0.19	2.37	1.36	5.26	0.02	1.31	1.17
poachers	0.15			0.14	0.17	0.04	0.10
mesopelagic fishes	0.07	0.05	0.16		0.08	0.39	0.02
other fishes			2.61			1.31	1.78
shortspine thornyhead	49.06	142.91	13.41		79.96	31.60	62.20
roughey rockfish				2.02			
blackspotted rockfish				1.50			
Pacific ocean perch				24.76			
shortraker rockfish		4.04		14.50			13.89
grooved Tanner crab	37.24	6.35	1.99		11.70	13.00	6.71
Tanner crab							
triangle Tanner crab	0.27	0.35	0.89		0.11		0.19
snow crab							
scarlet king crab			1.30		1.75	2.18	0.04
golden king crab							1.52
hermit crabs	0.28	0.27			0.05	0.11	0.43
other crabs						2.06	
snails	0.33	0.79	0.42	0.13	0.31	0.42	0.69
bivalves			0.01				
octopus	0.12	1.97	3.60	1.93			
squid	1.10	0.01		3.36	0.18		0.33
sea anemones & corals	0.09	14.62	0.22	0.34	0.30	10.94	3.76
jellyfish		0.48			1.51	0.27	0.03
shrimps	0.04	0.32	0.11	2.46		0.03	
seastars & sea cucumbers	1.00	5.08	0.72	1.25	83.57	7.12	42.26
sponges	0.21	0.09	1.03	0.72		7.83	0.23
other invertebrates	0.10	0.08	0.01	0.12		0.18	0.67
Haul Total Weight (kg)	1386.79	1798.41	1872.87	524.86	1629.56	1661.29	1872.46

Appendix C. - - Haul Log.

Haul	106	107	108	109	110	111	112	
Date	28-Jun-2010	28-Jun-2010	28-Jun-2010	29-Jun-2010	INCOMPLETE TOW	29-Jun-2010	INCOMPLETE TOW	
Stratum	22	21	22	24		23		
Station ID	22-06	21-11	22-05	24-06		23-09		
Performance	0	4.4	0	4		0		
Bottom depth	427	252	525	972		629		
Tow start latitude (N)	55.95217	56.0019	55.98572	56.11942		56.16445		
Tow start longitude (W)	-170.08547	-169.94537	-169.73902	-169.27305		-169.39617		
Tow end latitude (N)	55.94917	56.00468	55.98298	56.10235		56.15295		
Tow end longitude (W)	-170.12003	-169.96518	-169.77653	-169.25132		-169.4213		
Tow duration (Hour)	0.492	0.307	0.563	0.593		0.466		
Distance of tow (nmi)	2.21	1.35	2.5	2.53		2.03		
Mean net width (m)	15.511	15.872	16.237	15.561		15.756		
Surface temperature (°C)	6.2	6	6	6.1		6.3		
Bottom temperature (°C)	3.8	3.6	3.6	2.5		3.3		
Pacific sleeper shark				6.31				
Bering skate		3.45						
mud skate				0.49				0.51
rougthead skate								
Alaska skate								
Aleutian skate	3.92	66.11	5.44	27.77				7.75
Commander skate				19.46				27.64
whiteblotched skate	10.24			1.09				56.62
whitebrow skate				0.95				3.96
other skates & skate eggs			0.02					0.01
arrowtooth flounder	77.52	36.52	359.43					
Kamchatka flounder	53.10	12.42	105.46	13.42		85.58		
Greenland turbot	5.60		54.94	7.64		175.62		
Pacific halibut	31.16							
flathead sole		22.78	2.79					
rex sole	52.68	46.26	96.30					
other flatfish		0.55	0.61					
Pacific grenadier				0.75				
giant grenadier	3265.32		450.26	567.78		24.60		
pop-eye grenadier			3.62	717.79		1.13		
Pacific cod	7.40	191.82						
walleye pollock		5.80						
blob sculpin								
bigmouth sculpin	24.82	13.00	16.51					
other sculpins	1.44	10.63	0.01	0.05		0.12		
twoline eelpout						5.17		
western eelpout			1.39	13.80		7.30		
ebony eelpout				34.24		21.01		
other eelpouts	0.69		0.53	0.03		0.33		
sablefish	4.41		42.54	92.69		60.84		
searcher		0.38						
blacktail snailfish	0.76							
other snailfishes	0.03		0.61	1.93		0.02		
poachers	0.02	1.43	0.02					
mesopelagic fishes				0.13		0.03		
other fishes		12.73						
shortspine thornyhead	104.06		321.38	12.20		105.58		
rougthead rockfish		4.33						
blackspotted rockfish	2.75	4.86						
Pacific ocean perch	3.00	4085.90						
shortraker rockfish	20.61	100.98						
grooved Tanner crab	0.57		14.23	0.56		1.50		
Tanner crab		0.06						
triangle Tanner crab			0.81	7.77				
snow crab								
scarlet king crab			1.24					
golden king crab	29.35		4.50	1.69		16.05		
hermit crabs	0.06	0.05		0.37		0.08		
other crabs	0.02	0.20	0.03	10.26				
snails	0.01	0.30	0.03	1.69		0.19		
bivalves								
octopus	0.30		0.05	0.13				
squid	6.77	0.94	2.57			1.85		
sea anemones & corals	2.01	2.95	18.71	0.21		0.12		
jellyfish		0.49		0.07		0.05		
shrimps	0.04	3.11	0.01	0.01		0.05		
seastars & sea cucumbers	23.02	4.26	8.27	11.97		0.59		
sponges	0.43	1.67	0.22	1.99		1.21		
other invertebrates	0.08			0.03		1.83		
Haul Total Weight (kg)	3732.20	4633.97	1512.52	1555.28		607.32		

Appendix C. - - Haul Log.

Haul	113	114	115	116	117	118	119
Date	29-Jun-2010	30-Jun-2010	30-Jun-2010	30-Jun-2010	30-Jun-2010	30-Jun-2010	1-Jul-2010
Stratum	21	25	22	22	22	21	25
Station ID	21-06	25-05	22-09	22-03	22-07	21-05	25-02
Performance	4.4	0	0	6	4	0	5
Bottom depth	223	1066	432	519	517	379	1157
Tow start latitude (N)	56.17833	56.10387	56.20725	56.20097	56.14202	56.16188	56.02063
Tow start longitude (W)	-169.73705	-169.22955	-169.5374	-169.23233	-169.00543	-169.0434	-168.93595
Tow end latitude (N)	56.18933	56.08857	56.20937	56.19402	56.13887	56.15452	56.01782
Tow end longitude (W)	-169.74363	-169.21143	-169.57257	-169.19892	-168.98452	-169.00653	-168.9133
Tow duration (Hour)	0.278	0.493	0.482	0.481	0.329	0.518	0.418
Distance of tow (nmi)	1.3	2.05	2.25	2.23	1.37	2.44	1.52
Mean net width (m)	15.48	16.44	15.605	15.927	15.57	15.768	12.338
Surface temperature (°C)	6.1	5.9	6	6.2	6.3	6.4	6.2
Bottom temperature (°C)	3.7	2.3	3.5	3.6	3.5	3.6	2.5
Pacific sleeper shark					6.96	11.93	
Bering skate				2.55			
mud skate			3.18	3.15	3.28	3.07	
rougtail skate		0.95					4.46
Alaska skate	8.52						
Aleutian skate	23.18	39.90	51.83	71.24	15.51	7.54	6.90
Commander skate	7.50		6.09	3.60	6.58		0.19
whiteblotched skate	6.65	0.78	27.50	13.05	6.68	60.24	
whitebrow skate		7.23	2.47	2.29			3.21
other skates & skate eggs	0.06	0.20	0.06	0.04			
arrowtooth flounder	71.62		68.24	167.09	19.12	1139.38	
Kamchatka flounder	17.50	1.82	426.01	33.24	34.00	15.72	5.68
Greenland turbot		18.61	18.58	35.98	15.29	10.12	15.86
Pacific halibut				5.06			
flathead sole	7.50		1.14	6.65		1.99	
rex sole	5.51		29.42	49.87	36.68	127.36	
other flatfish				20.62		9.60	
Pacific grenadier		147.36					107.17
giant grenadier		171.08	205.99	151.30	278.51	69.74	38.36
pop-eye grenadier		228.59			75.79		368.44
Pacific cod	88.11					4.68	
walleye pollock	0.99				6.16	141.90	
blob sculpin		7.37					11.30
bigmouth sculpin			12.23	27.35		19.74	
other sculpins	58.21		2.65	0.24	0.02	0.18	0.01
twoline eelpout		0.55	1.71		3.31		
western eelpout		5.71		1.91			2.12
ebony eelpout		23.67	6.92	7.11	1.40		8.01
other eelpouts	0.09	0.01	0.20	1.90	0.96	0.92	0.79
sablefish		20.20	4.03	9.28	10.75		
searcher	0.35						
blacktail snailfish				1.32	2.80		
other snailfishes		2.32	0.05		0.02	0.10	1.10
poachers	0.06		0.09	0.02	0.04		
mesopelagic fishes		1.47	0.74	0.19	0.26	0.81	0.29
other fishes	25.82	1.04				0.99	2.01
shortspine thornyhead		1.27	23.87	92.65	262.80	31.40	0.37
rougheye rockfish							
blackspotted rockfish	27.76					6.06	
Pacific ocean perch	1716.02		0.73		0.92	4.01	
shortraker rockfish			12.27	13.20	19.01	142.08	
grooved Tanner crab		0.76		5.58	5.59	0.07	3.90
Tanner crab			0.30			0.10	
triangle Tanner crab		104.33	2.84	0.10			27.78
snow crab							
scarlet king crab		0.82		2.01	1.64		4.07
golden king crab		2.08	40.39	38.28	19.39	101.24	
hermit crabs	0.14		0.10	0.05		0.13	0.06
other crabs	0.04	0.35					10.11
snails	3.24	0.28	0.10	0.07		0.12	0.03
bivalves							
octopus	0.16	0.02		1.95		0.63	
squid	0.35	0.45	8.26	7.08	1.96	7.82	0.55
sea anemones & corals	4.76	0.20	0.06	42.97	15.18	9.99	0.37
jellyfish	0.13	0.33	2.34			1.16	0.23
shrimps	0.58	0.01	0.17	0.03	0.01	1.95	0.01
seastars & sea cucumbers	1.72	0.98	83.57	3.07	1.70	14.88	1.40
sponges	69.31		4.15			1.78	1.14
other invertebrates	0.06	0.01	0.01			0.01	
Haul Total Weight (kg)	2145.94	790.74	1048.27	822.08	852.32	1949.42	625.92

Appendix C. - - Haul Log.

Haul	120	121	122	123	124	125	126
Date	1-Jul-2010	1-Jul-2010	1-Jul-2010	1-Jul-2010	2-Jul-2010	2-Jul-2010	2-Jul-2010
Stratum	23	22	21	21	23	21	22
Station ID	23-02	22-08	21-10	21-03	23-08	21-04	22-10
Performance	0	2.1	0	0	0	0	1.12
Bottom depth	745	563	214	225	635	290	451
Tow start latitude (N)	56.07105	56.12333	56.18373	56.04677	56.08093	56.1545	56.10033
Tow start longitude (W)	-168.78432	-168.78442	-168.48543	-168.38043	-168.63585	-168.53738	-168.53975
Tow end latitude (N)	56.07362	56.12608	56.1687	56.0675	56.08668	56.16502	56.10617
Tow end longitude (W)	-168.74758	-168.805	-168.45413	-168.36563	-168.67275	-168.57007	-168.56555
Tow duration (Hour)	0.478	0.355	0.529	0.541	0.498	0.53	0.351
Distance of tow (nmi)	2.32	1.34	2.57	2.48	2.4	2.36	1.74
Mean net width (m)	15.025	15.446	14.811	15.085	16.471	15.32	16.964
Surface temperature (°C)	6.2	6.3	6.4	6.3	6.5	6.5	6.6
Bottom temperature (°C)	3.1	3.4	3.8	3.7	3.4	3.5	3.6
Pacific sleeper shark							
Bering skate							
mud skate	0.96	2.99		5.84		17.09	5.88
rougthead skate							
Alaska skate							
Aleutian skate	10.09	17.52		16.88	37.95		30.43
Commander skate	127.62	7.16			21.35		
whiteblotched skate	7.90	7.30		21.08	76.02	7.95	61.56
whitebrow skate	2.31				5.31		2.20
other skates & skate eggs	0.01	0.02	1.64	1.32	0.46	0.10	0.54
arrowtooth flounder		1.51	388.52	107.20		132.08	25.40
Kamchatka flounder	70.88	123.04	12.47	11.64	53.48	26.88	92.78
Greenland turbot	2.86	19.29			8.24		5.15
Pacific halibut							
flathead sole				115.04		4.68	
rex sole		4.30		1.78			
other flatfish				0.66		0.92	
Pacific grenadier							
giant grenadier	568.37	8.28			5.77		2698.69
pop-eye grenadier	16.04				6.49		
Pacific cod			104.60	37.52		51.42	
walleye pollock						15.75	1.76
blob sculpin							
bigmouth sculpin		3.06	4.49			12.94	29.74
other sculpins	0.41	0.34	0.56	1.31		0.82	22.15
twoline eelpout	5.44						
western eelpout							
ebony eelpout	2.12	0.68			8.90		
other eelpouts	0.04	0.22	0.00		0.00		
sablefish	72.96	14.17			29.08		
searcher			0.62	0.36			
blacktail snailfish	0.43						
other snailfishes	0.25	0.40		0.15	0.69	0.33	0.02
poachers		0.04	0.20			0.19	
mesopelagic fishes	0.33	0.10			0.14		0.49
other fishes	1.38					0.51	
shortspine thornyhead	60.12	86.40			6.85		18.92
rougthead rockfish							
blackspotted rockfish							
Pacific ocean perch			0.32	394.66		9.66	1.30
shortraker rockfish		1.35					75.47
grooved Tanner crab	1.39	0.71			0.83		
Tanner crab			0.78	0.04			0.12
triangle Tanner crab	3.85						
snow crab							
scarlet king crab	1.71	0.63					
golden king crab	2.58	3.28	10.19	78.66	9.07	49.21	17.37
hermit crabs	0.05	0.01	0.32	0.18	0.02	0.03	
other crabs	0.84			0.00	0.01		0.01
snails			0.92	0.41			0.03
bivalves				0.03			
octopus	0.09	2.38		0.01	0.09		0.06
squid	0.44	0.48			0.64	1.80	1.08
sea anemones & corals		0.53	0.01	0.43	0.17	5.75	1.29
jellyfish	0.02	0.09			0.97	1.98	
shrimps	0.22	0.04	1.59	0.45		1.51	0.09
seastars & sea cucumbers	0.12	0.92	4.14	5.03	0.20	2.72	88.54
sponges	13.62	8.63	2.16	4.18	0.68	0.41	0.79
other invertebrates	0.87	12.23	0.08	0.18			57.14
Haul Total Weight (kg)	976.32	328.11	533.61	805.04	273.40	344.72	3239.00

Appendix C. - - Haul Log.

Haul	127	128	129	130	131	132	133
Date	2-Jul-2010	2-Jul-2010	3-Jul-2010	3-Jul-2010	3-Jul-2010	3-Jul-2010	4-Jul-2010
Stratum	23	22	21	13	14	12	13
Station ID	23-01	22-01	21-01	13-15	14-11	12-13	13-09
Performance	0	5	0	0	4.1	5.2	1.1
Bottom depth	728	550	215	744	854	425	628
Tow start latitude (N)	55.95125	55.7991	55.6882	55.45953	55.36698	55.41812	55.25792
Tow start longitude (W)	-168.91817	-168.85963	-168.78118	-168.45537	-168.2841	-168.27098	-168.00567
Tow end latitude (N)	55.94912	55.8145	55.7063	55.45443	55.381	55.40677	55.27632
Tow end longitude (W)	-168.95662	-168.88033	-168.80327	-168.42433	-168.30032	-168.23835	-168.02833
Tow duration (Hour)	0.513	0.518	0.511	0.507	0.393	0.508	0.523
Distance of tow (nmi)	2.43	2.2	2.46	2.34	1.9	2.43	2.51
Mean net width (m)	15.931	15.816	15.513	15.591	16.114	18.266	17.115
Surface temperature (°C)	6.3	6.7	6.7	6.8	6.6	6.9	6.6
Bottom temperature (°C)	3.2	3.5	3.5	3.2	3.1	3.8	3.4
Pacific sleeper shark				10.82		6.64	
Bering skate			0.18				
mud skate	1.74			0.56			
rougthead skate				8.64	14.54		
Alaska skate							
Aleutian skate	20.98	20.45		62.00	5.42	3.55	9.10
Commander skate	14.07			3.66			
whiteblotched skate	6.48					6.55	
whitebrow skate	2.84	14.18		11.08	3.81		1.16
other skates & skate eggs	0.06	0.13	0.03	0.12	1.40		
arrowtooth flounder		27.31	39.38			46.88	
Kamchatka flounder	52.60	67.74	11.32	31.62	27.20	39.82	53.22
Greenland turbot	14.94	99.12		54.22	11.01	21.40	12.51
Pacific halibut							
flathead sole			1.81			34.14	
rex sole		7.75	29.10			16.72	
other flatfish		1.16		47.32	18.60	0.62	
Pacific grenadier					1.99		
giant grenadier	51.84	41.47		79.31	1304.12		82.28
pop-eye grenadier	550.73	41.89		20.40	449.83		3.22
Pacific cod			60.94				
walleye pollock			64.60				
blob sculpin					18.15		
bigmouth sculpin		15.46	3.47			6.02	
other sculpins	0.35	0.10	1.05		0.87	0.20	0.65
twoline eelpout	1.68	3.23		3.00	22.82		
western eelpout	0.33	97.82			226.66		46.81
ebony eelpout	8.18	38.16		0.18			6.62
other eelpouts	0.22	1.03		0.96	1.92	0.68	0.21
sablefish	62.28	87.28		251.32	34.82		20.98
searcher							
blacktail snailfish	3.42	7.08		0.31	0.96		1.95
other snailfishes	1.00	0.31		0.24	2.36		0.01
poachers	0.07	0.18	0.41	0.11	0.13		0.18
mesopelagic fishes	0.52	0.39		0.39	0.38	0.05	0.48
other fishes		2.74	0.77	0.28	1.76	0.49	
shortspine thornyhead	70.58	126.48	1.64	60.04	42.36	61.00	121.74
rougthead rockfish						1.27	
blackspotted rockfish						2.45	
Pacific ocean perch			353.53			0.89	
shortraker rockfish		0.70		1.99			
grooved Tanner crab	7.08	8.29		21.49	6.07	1.46	14.84
Tanner crab	0.03	0.02	0.59	0.14			
triangle Tanner crab					21.55		
snow crab							
scarlet king crab	17.57	5.95			1.53		
golden king crab	1.55	1.64		0.12	0.11	0.67	
hermit crabs	0.07	0.10		0.13	0.10		0.59
other crabs			0.01		1.48	0.01	
snails		0.11	0.15	0.57	0.34	0.04	2.23
bivalves							
octopus		0.07		0.27	0.72		0.91
squid	1.47	1.44	0.37	1.10	0.11		3.82
sea anemones & corals		4.61	5.54	0.07	57.04	3.81	
jellyfish	0.03	0.01		0.05	0.01	0.06	0.05
shrimps	0.01	0.05	1.53	0.03	0.25	0.03	0.00
seastars & sea cucumbers	0.74	10.34	6.98	14.17	6.22	3.35	16.50
sponges		0.04		0.37	796.42		
other invertebrates		0.03	0.01	0.01	0.30		0.14
Haul Total Weight (kg)	893.46	734.87	583.40	687.10	3083.35	258.79	400.21

Appendix C. - - Haul Log.

Haul	134	135	136	137	138	139	140
Date	4-Jul-2010	4-Jul-2010	4-Jul-2010	4-Jul-2010	5-Jul-2010	5-Jul-2010	5-Jul-2010
Stratum	12	11	12	11	13	12	11
Station ID	12-12	11-10	12-16	11-40	13-08	12-17	11-28
Performance	0	0	0	0	0	0	0
Bottom depth	409	226	412	206	615	545	352
Tow start latitude (N)	55.31425	55.39217	55.20512	55.20958	55.07165	55.04998	55.19
Tow start longitude (W)	-168.02205	-167.99772	-167.87223	-167.64843	-167.8926	-167.83462	-167.81785
Tow end latitude (N)	55.33043	55.40215	55.22563	55.22823	55.09158	55.0687	55.17342
Tow end longitude (W)	-168.04938	-168.02577	-167.89	-167.67907	-167.90837	-167.85052	-167.79488
Tow duration (Hour)	0.532	0.525	0.506	0.562	0.517	0.525	0.489
Distance of tow (nmi)	2.51	2.11	2.56	2.87	2.52	2.34	2.36
Mean net width (m)	15.93	15.704	16.274	16.023	16.054	15.579	16.092
Surface temperature (°C)	7.2	7	7.2	7.1	7.1	6.7	6.7
Bottom temperature (°C)	3.7	3.5	3.7	3.7	3.5	3.6	3.8
Pacific sleeper shark							
Bering skate	2.34	8.68	2.46	3.09			3.06
mud skate							
rougthead skate							
Alaska skate							
Aleutian skate		64.32	47.80	3.94	3.51		67.11
Commander skate							
whiteblotched skate	14.28		20.34				31.26
whitebrow skate		2.64			1.10		
other skates & skate eggs				0.05	0.05	0.08	0.04
arrowtooth flounder	98.16	22.94	59.18	123.78		7.73	446.26
Kamchatka flounder	73.12	4.79	115.87	9.26	87.91	161.24	32.42
Greenland turbot	41.06				68.62	65.30	38.80
Pacific halibut	30.46		16.60	6.30			6.26
flathead sole	68.72	31.88	37.78	30.08			44.60
rex sole	34.26	46.44	21.88	76.90			86.42
other flatfish	2.82	0.35	4.06	0.46			4.12
Pacific grenadier							
giant grenadier	30.40		63.56		181.78	145.72	
popeye grenadier					130.93	50.14	
Pacific cod		16.60		19.77			
walleye pollock	14.66	169.29	86.54	1066.26			105.32
blob sculpin							
bigmouth sculpin			0.32	3.66			4.26
other sculpins	0.39	2.05	0.34	0.54	0.65	0.10	6.41
twoline eelpout							
western eelpout					252.14	461.24	
ebony eelpout					2.72	0.77	
other eelpouts	1.10	0.22	0.67				0.18
sablefish	2.72		2.64		12.44	1.80	
searcher				0.82			
blacktail snailfish							
other snailfishes		0.31		0.23	0.35	0.13	3.12
poachers	0.03	0.52	0.03	0.13	0.01	0.02	0.12
mesopelagic fishes	0.69	0.06	0.91	0.95	0.09	0.86	4.42
other fishes	0.24	0.57	3.03	3.36			0.89
shortspine thornyhead	55.80		154.00	6.64	53.96	909.86	18.72
roughey rockfish		0.36		5.15			4.54
blackspotted rockfish	6.70	1.35					
Pacific ocean perch	4.98	0.34	5.02				13.64
shortraker rockfish			4.16		3.36		5.92
grooved Tanner crab	3.63		0.63				
Tanner crab	0.05	0.14		3.56			
triangle Tanner crab							
snow crab							
scarlet king crab							
golden king crab	1.34		3.79				10.40
hermit crabs		0.08	0.17	0.47		0.35	0.60
other crabs		0.03		0.01			
snails	1.55	3.06	1.47	3.70	1.32	2.26	1.08
bivalves							
octopus				1.52	0.18		0.40
squid	13.90	1.00	12.05	0.06	4.80	6.06	22.60
sea anemones & corals	17.88	1.41	21.62	7.61	0.39		8.67
jellyfish	0.04		0.01	0.23			0.03
shrimps	0.04	2.43	0.02	4.66	0.01	1.18	0.24
seastars & sea cucumbers	5.60	12.18	7.76	3.24	174.48	114.96	13.91
sponges	0.04	0.04			0.19	1.86	
other invertebrates	0.07		0.01	0.40	0.17	0.35	0.02
Haul Total Weight (kg)	527.08	394.07	694.71	1386.83	981.16	1932.00	985.85

Appendix C. - - Haul Log.

Haul	141	142	143	144	145	146	147	
Date	5-Jul-2010	5-Jul-2010	6-Jul-2010	6-Jul-2010	6-Jul-2010	INCOMPLETE TOW	6-Jul-2010	
Stratum	12	11	15	13	12		12	
Station ID	12-46	11-27	15-07	13-07	12-36		12-40	
Performance	1.2	0	0	0	0		0	
Bottom depth	489	232	1065	639	504		453	
Tow start latitude (N)	55.0133	55.05765	54.82018	54.87565	54.8641		54.95548	
Tow start longitude (W)	-167.7218	-167.45113	-167.68265	-167.61338	-167.49865		-167.59335	
Tow end latitude (N)	55.01802	55.04258	54.80167	54.85537	54.88015		54.97102	
Tow end longitude (W)	-167.72883	-167.42257	-167.67433	-167.60047	-167.52173		-167.61693	
Tow duration (Hour)	0.149	0.549	0.507	0.542	0.531		0.524	
Distance of tow (nmi)	0.69	2.49	2.28	2.43	2.33		2.3	
Mean net width (m)	16.725	15.795	17.499	16.082	16.206		16.626	
Surface temperature (°C)	7.5	7.3	7.3	7.7	7.4		7.4	
Bottom temperature (°C)	3.7	3.6	2.8	3.3	3.6		3.7	
Pacific sleeper shark								
Bering skate		0.94			5.60			2.02
mud skate								
rougthead skate			9.96					
Alaska skate								
Aleutian skate		47.28	0.95	3.43	3.45			28.08
Commander skate					4.03			
whiteblotched skate		9.37			7.14			4.92
whitebrow skate			0.37					5.85
other skates & skate eggs			0.03	0.52				
arrowtooth flounder	6.46	156.92			8.76			10.00
Kamchatka flounder	8.44	9.26	7.46	17.94	22.90		90.88	
Greenland turbot	5.92			11.52	10.28		16.70	
Pacific halibut		35.60						
flathead sole		88.57					13.36	
rex sole		70.58					7.93	
other flatfish				8.44			3.20	
Pacific grenadier			4.93					
giant grenadier	318.54		486.36	167.46	310.53		235.10	
pop-eye grenadier			80.10	63.93	0.73			
Pacific cod		20.36						
walleye pollock							2.10	
blob sculpin			11.18					
bigmouth sculpin								
other sculpins	0.04	0.26	0.05	0.74	0.18		0.08	
twoline eelpout				2.25				
western eelpout	8.54			224.64	19.38		4.11	
ebony eelpout								
other eelpouts			0.01	0.02	0.01			
sablefish			15.89	19.51	10.78		7.58	
searcher								
blacktail snailfish			0.12					
other snailfishes		0.02	1.90	0.13				
poachers				0.03	0.03			
mesopelagic fishes	0.17	0.41	1.52	0.10	0.12		0.52	
other fishes			4.64				0.42	
shortspine thornyhead	11.82		3.06	41.42	63.32		208.00	
rougthead rockfish		5.12						
blackspotted rockfish	2.21	1.85						
Pacific ocean perch		5.03						
shortraker rockfish	36.52	2.13					4.86	
grooved Tanner crab							0.82	
Tanner crab		0.85						
triangle Tanner crab			11.84	0.00				
snow crab								
scarlet king crab				0.02				
golden king crab	1.25				0.34		1.91	
hermit crabs		0.05	0.04					
other crabs		0.01	1.52	0.72				
snails	1.13	1.80	0.85	1.77	0.53		0.13	
bivalves			0.40				0.05	
octopus			3.56	1.53			0.01	
squid	0.10	0.21	0.24	1.26	9.13		6.68	
sea anemones & corals	0.88	9.51	0.23	0.01	0.31		32.40	
jellyfish	0.67		0.08	0.04	0.33			
shrimps	0.11	4.19	0.43	0.01	0.27			
seastars & sea cucumbers	21.65	10.76	1.32	179.50	315.05		5.03	
sponges	0.14			0.62	12.81			
other invertebrates	0.03	0.07		0.19	0.83		0.02	
Haul Total Weight (kg)	424.63	481.17	649.03	747.74	806.86		692.73	

Appendix C. - - Haul Log.

Haul	148	149	150	151	152	153	154
Date	6-Jul-2010	7-Jul-2010	7-Jul-2010	7-Jul-2010	7-Jul-2010	7-Jul-2010	9-Jul-2010
Stratum	11	15	12	13	13	14	13
Station ID	11-41	15-01	12-30	13-02	13-01	14-01	13-03
Performance	0	0	0	0	0	0	0
Bottom depth	327	1072	553	614	651	821	622
Tow start latitude (N)	54.92483	54.27885	54.4266	54.37928	54.3609	54.30827	54.3755
Tow start longitude (W)	-167.34555	-166.61277	-166.43698	-166.4915	-166.33857	-166.61223	-166.83103
Tow end latitude (N)	54.9379	54.27875	54.42787	54.37627	54.36098	54.31247	54.37407
Tow end longitude (W)	-167.37593	-166.58193	-166.46803	-166.52698	-166.37417	-166.57787	-166.79342
Tow duration (Hour)	0.498	0.504	0.497	0.497	0.515	0.529	0.522
Distance of tow (nmi)	2.44	2.06	2.04	2.34	2.32	2.3	2.47
Mean net width (m)	16.665	17.436	16.746	16.248	16.907	16.79	17.258
Surface temperature (°C)	6.8	6.9	7.1	7.2	7	7.2	6.9
Bottom temperature (°C)	3.8	2.7	3.5	3.4	3.3	2.9	3.4
Pacific sleeper shark							
Bering skate	4.76	0.12	3.07	7.72			9.78
mud skate							
rougthead skate		4.03				28.14	5.54
Alaska skate							
Aleutian skate	1.94	1.72	3.78	7.60	8.82	5.40	9.66
Commander skate		0.18		10.84	3.53		7.58
whiteblotched skate							
whitebrow skate	3.10	1.05	1.07	5.24	5.73	1.14	0.52
other skates & skate eggs	0.01						
arrowtooth flounder	506.33		17.38	5.54	14.62		6.12
Kamchatka flounder	53.34	10.75	42.30	48.40	16.50	21.36	18.52
Greenland turbot		19.35	64.86	33.60	56.94	39.72	53.02
Pacific halibut	7.37		7.36				
flathead sole	40.76		0.68				
rex sole	163.44						
other flatfish	5.46						
Pacific grenadier		0.81					
giant grenadier		212.32	97.38	137.42	687.83	138.54	222.80
pop-eye grenadier		199.88		0.57	19.35	98.52	0.48
Pacific cod	4.28						
walleye pollock							
blob sculpin		22.73				8.25	
bigmouth sculpin							
other sculpins	3.32	0.01	0.20	0.09	0.23		0.01
twoline eelpout		8.86			7.88	10.26	1.68
western eelpout		0.01	59.20	286.34	1157.62	12.57	89.84
ebony eelpout			3.40	2.95	6.81		2.48
other eelpouts	0.19	0.46	0.05		0.07	0.80	0.06
sablefish			128.63	44.52	45.46	45.08	11.50
searcher							
blacktail snailfish		0.14		2.21	4.32		
other snailfishes	0.34	0.87		0.02	0.23	0.73	
poachers	0.20	0.03	0.08	0.12	0.37	0.40	0.15
mesopelagic fishes	22.04	5.96	0.38	0.41	0.27	0.36	0.22
other fishes	1.81	0.42	0.50	0.36	1.50		
shortspine thornyhead	7.52	3.55	65.88	43.15	53.36	52.12	50.74
rougthead rockfish	5.48						
blackspotted rockfish							
Pacific ocean perch	11.00						
shortraker rockfish							
grooved Tanner crab			0.29		2.34	3.80	1.38
Tanner crab							
triangle Tanner crab		29.21	2.03	1.40	0.81	2.72	
snow crab			0.51				
scarlet king crab						0.80	
golden king crab	2.32		1.57				
hermit crabs	0.51	0.03	0.38	0.12		0.21	0.01
other crabs	0.02						
snails	3.28	2.07	7.13	2.24	2.55	1.79	1.97
bivalves		0.01					
octopus	0.02	1.25	0.77	0.72	1.63	0.23	
squid	3.91	1.13	3.01	6.02	2.68		3.10
sea anemones & corals	3.72	0.23	0.02				
jellyfish	0.18	0.68	0.02	0.02	0.42	0.01	
shrimps	1.06	0.93	0.09	0.06	0.03	0.10	0.06
seastars & sea cucumbers	13.32	4.91	207.29	159.98	31.45	1.58	297.12
sponges			12.44	0.26	2.32		2.96
other invertebrates	0.03	0.01	0.40	2.17	0.31	0.01	0.29
Haul Total Weight (kg)	871.06	533.69	732.17	810.09	2135.97	474.66	797.60

Appendix C. - - Haul Log.

Haul	155	156	157	158	159	160	161
Date	9-Jul-2010	10-Jul-2010	10-Jul-2010	10-Jul-2010	10-Jul-2010	10-Jul-2010	11-Jul-2010
Stratum	12	12	12	12	12	12	15
Station ID	12-04	12-15	12-18	12-19	12-10	12-05	15-10
Performance	0	0	0	0	4.2	0	0
Bottom depth	518	416	412	412	458	532	1018
Tow start latitude (N)	54.447	54.59837	54.57655	54.57293	54.52168	54.43778	54.28202
Tow start longitude (W)	-166.84532	-166.88198	-166.58148	-166.38452	-166.76223	-166.64477	-167.77395
Tow end latitude (N)	54.44245	54.5766	54.57255	54.57323	54.52603	54.43635	54.27877
Tow end longitude (W)	-166.87903	-166.8869	-166.61652	-166.41837	-166.72667	-166.60808	-167.73853
Tow duration (Hour)	0.511	0.521	0.502	0.502	0.506	0.512	0.494
Distance of tow (nmi)	2.28	2.46	2.32	2.2	2.36	2.45	2.35
Mean net width (m)	16.193	17.284	16.657	16.637	15.295	16.526	16.725
Surface temperature (°C)	6.6	6.4	6.6	6.9	6.7	6.4	6
Bottom temperature (°C)	3.5	3.6	3.7	3.7	3.7	3.5	2.7
Pacific sleeper shark		34.14					
Bering skate			2.32	15.12	4.28	5.84	
mud skate							
rougthead skate							9.54
Alaska skate							
Aleutian skate		12.23	12.14	53.74		0.09	
Commander skate				4.58		9.97	
whiteblotched skate			5.26	6.42			
whitebrow skate						3.90	
other skates & skate eggs	0.01	0.02					15.90
arrowtooth flounder	10.60	54.30	12.78	46.68	24.68	6.10	
Kamchatka flounder	18.54	144.54	52.08	76.05	41.86	72.74	6.24
Greenland turbot	16.06	82.98	12.96	57.00	7.23	12.66	28.46
Pacific halibut		7.48	2.36				
flathead sole	2.10	85.04	96.14	94.12	81.80	29.22	
rex sole		11.09	14.27	32.00	3.12		
other flatfish			0.92	2.03		1.54	
Pacific grenadier							20.64
giant grenadier	99.98	123.24	55.30	161.10	95.72	82.14	417.90
pop-eye grenadier	0.04						419.10
Pacific cod							
walleye pollock			3.70	2.51			
blob sculpin							55.30
bigmouth sculpin	0.31		7.26	12.02			
other sculpins	0.41	0.30	0.69	0.75	0.22	0.02	
twoline eelpout							
western eelpout	43.61	6.62	14.55	36.62	28.28	31.00	1.70
ebony eelpout			1.11	7.10	1.62	2.50	
other eelpouts	0.07	0.10	0.37	0.36	0.17	0.09	
sablefish	8.90					20.40	4.07
searcher							
blacktail snailfish		0.74					0.34
other snailfishes		0.00					5.65
poachers	0.11	0.18	0.11	0.03	0.09	0.11	
mesopelagic fishes	0.58	0.42	0.13	0.35	0.05	0.37	1.11
other fishes			0.27	0.74		0.42	0.98
shortspine thornyhead	46.68	115.72	74.52	124.23	56.58	70.38	
rougthead rockfish							
blackspotted rockfish	1.32	8.25					
Pacific ocean perch	0.72	6.62	5.32	9.20	3.88	1.70	
shortraker rockfish		0.52					
grooved Tanner crab						0.23	
Tanner crab					0.09		
triangle Tanner crab							11.66
snow crab				0.02			
scarlet king crab							
golden king crab	0.64	4.62	4.61	8.48	5.21	1.45	
hermit crabs	0.11	0.65	1.36	3.56	0.87	0.94	
other crabs	0.01						
snails	7.47	3.76	10.66	30.78	6.13	3.51	0.84
bivalves					0.06		0.00
octopus	0.75	1.43	1.64	0.76	0.40	0.52	
squid	1.56	3.86	4.05	5.23	4.38	3.34	1.12
sea anemones & corals		0.16	0.10	7.99	0.50	0.01	
jellyfish	0.05	0.01	0.03	0.08			0.08
shrimps	0.37	0.01	0.05	0.07		0.09	0.76
seastars & sea cucumbers	288.67	143.10	224.43	65.04	112.77	70.68	5.07
sponges	60.28	2.24	3.16	1.06	20.28	23.51	
other invertebrates	2.18	0.04	0.13	2.84	2.34	0.77	0.14
Haul Total Weight (kg)	612.12	854.42	624.76	868.68	502.61	456.22	1006.61

Appendix C. - - Haul Log.

Haul	162	163	164	165	166	167	168
Date	11-Jul-2010	11-Jul-2010	11-Jul-2010	11-Jul-2010	12-Jul-2010	12-Jul-2010	12-Jul-2010
Stratum	14	13	14	13	13	13	13
Station ID	14-03	13-12	14-06	13-06	13-11	13-13	13-04
Performance	0	0	0	0	0	0	0
Bottom depth	807	689	826	616	635	753	670
Tow start latitude (N)	54.3851	54.58887	54.65923	54.63782	54.4952	54.35117	54.35352
Tow start longitude (W)	-167.63647	-167.57242	-167.70475	-167.48238	-167.41603	-167.38847	-167.08617
Tow end latitude (N)	54.36457	54.5684	54.63787	54.6597	54.51433	54.34557	54.35832
Tow end longitude (W)	-167.62663	-167.56412	-167.716	-167.4788	-167.43745	-167.3527	-167.1231
Tow duration (Hour)	0.521	0.504	0.512	0.526	0.523	0.514	0.52
Distance of tow (nmi)	2.41	2.34	2.52	2.45	2.55	2.42	2.48
Mean net width (m)	17.14	17.048	17.397	17.052	17.2	16.687	16.712
Surface temperature (°C)	6.1	6.8	7	7	7	6.5	6.8
Bottom temperature (°C)	3.1	3.3	3.1	3.1		3.2	3.4
Pacific sleeper shark							
Bering skate		2.28		2.45			2.34
mud skate							
rougthead skate	5.18		25.08	0.15		12.22	
Alaska skate							
Aleutian skate	0.09	1.35	3.30		1.53	22.16	3.34
Commander skate							
whiteblotched skate							
whitebrow skate			2.03	2.18		2.15	2.81
other skates & skate eggs	0.05		0.18	0.13	0.01	0.02	0.10
arrowtooth flounder							6.72
Kamchatka flounder	9.80	10.82	6.02	24.75	33.08	30.62	5.26
Greenland turbot		6.76	5.34	5.81	85.35	26.75	19.55
Pacific halibut							
flathead sole							
rex sole					0.09		
other flatfish			4.08		1.59		2.85
Pacific grenadier	0.16						
giant grenadier	334.08	280.84	344.60	254.68	1055.60	352.70	404.29
popeye grenadier	107.53	39.16	180.55	2.08	30.74	207.38	44.05
Pacific cod							
walleye pollock							
blob sculpin	0.02					3.18	
bigmouth sculpin							
other sculpins	0.01			0.33	0.03	0.01	0.01
twoline eelpout	3.72		9.36			4.49	
western eelpout	0.05	18.16	1.41	7.16	9.18	3.37	75.96
ebony eelpout		0.91					
other eelpouts	0.18	0.31	0.51	0.20	0.41	2.03	0.08
sablefish		27.68	6.11	9.24	123.12	8.91	25.50
searcher							
blacktail snailfish	0.25	1.94	2.48	0.07	0.79	3.21	2.08
other snailfishes	0.30	0.28	1.35	0.01	0.02	0.75	0.18
poachers	0.12	0.25	0.32	0.07	0.21	0.19	0.22
mesopelagic fishes	0.83	0.44	0.58	0.30	0.37	2.10	0.45
other fishes	0.35	0.21					
shortspine thornyhead	6.47	37.48	33.82	25.12	14.16	20.42	29.88
rougthead rockfish							
blackspotted rockfish							
Pacific ocean perch							
shortraker rockfish							
grooved Tanner crab		1.72			4.34	0.05	
Tanner crab							
triangle Tanner crab	26.83	1.65	22.83		1.41	26.40	0.93
snow crab							
scarlet king crab							
golden king crab							
hermit crabs	0.02	0.43	0.04		0.03	0.11	0.03
other crabs							
snails	1.13	1.44	0.79	1.96	1.66	1.78	1.35
bivalves		0.00					
octopus	1.49	0.05	1.25	0.01	0.15		0.12
squid	2.44	1.85	1.35	1.97	0.43	0.43	4.86
sea anemones & corals							
jellyfish	0.47	0.04	0.19	0.10		0.32	0.08
shrimps	0.34	0.01	0.20	0.04	0.09	0.21	0.08
seastars & sea cucumbers	1.07	6.37	4.94	239.79	58.97	0.85	225.48
sponges		1.07		0.67	0.40		2.00
other invertebrates		0.49	0.05	0.29	0.17	0.02	1.12
Haul Total Weight (kg)	502.97	444.00	658.77	579.54	1423.96	732.83	861.71

Appendix C. - - Haul Log.

Haul	169	170	171	172	173	174	175
Date	12-Jul-2010	12-Jul-2010	13-Jul-2010	13-Jul-2010	13-Jul-2010	13-Jul-2010	13-Jul-2010
Stratum	12	12	12	12	12	11	11
Station ID	12-02	12-42	12-41	12-01	12-32	11-26	11-30
Performance	0	0	0	0	0	0	0
Bottom depth	515	546	464	458	414	348	221
Tow start latitude (N)	54.51118	54.7027	54.60935	54.72142	54.81388	54.82585	54.95407
Tow start longitude (W)	-167.21773	-167.4187	-167.18763	-167.25742	-167.25838	-167.14757	-167.18303
Tow end latitude (N)	54.49233	54.6824	54.59067	54.70198	54.80093	54.815	54.94608
Tow end longitude (W)	-167.20458	-167.41352	-167.16817	-167.25087	-167.2317	-167.11397	-167.14977
Tow duration (Hour)	0.505	0.509	0.514	0.495	0.492	0.519	0.518
Distance of tow (nmi)	2.27	2.29	2.46	2.24	2.25	2.48	2.33
Mean net width (m)	16.295	16.274	16.8	16.774	16.485	16.855	16.495
Surface temperature (°C)	7.2	6.7	6.3	6.7	6.7	6.7	7.2
Bottom temperature (°C)	3.7	3.5	3.7	3.7	3.7	3.7	3.5
Pacific sleeper shark							
Bering skate	3.43	2.77					2.74
mud skate							
rougthead skate							
Alaska skate							
Aleutian skate	4.00	4.14	19.11	9.56	4.49	16.10	32.02
Commander skate		6.84					
whiteblotched skate	6.08			10.24	15.85		
whitebrow skate		1.09			5.29		
other skates & skate eggs	0.06	0.01					0.06
arrowtooth flounder	5.00		11.08	6.08	27.60	928.94	114.54
Kamchatka flounder	12.24	19.12	56.74	62.82	157.66	26.78	4.06
Greenland turbot	35.84	22.38	37.62	11.96	21.62	8.48	
Pacific halibut					14.02	47.70	
flathead sole			37.68	18.22	43.44	49.38	98.39
rex sole	1.26		32.24	12.35	34.20	80.92	5.20
other flatfish			1.10			5.82	
Pacific grenadier							
giant grenadier	521.75	437.32	230.24	158.66	122.76		
pop-eye grenadier							
Pacific cod							42.44
walleye pollock							1.50
blob sculpin							
bigmouth sculpin		4.67					
other sculpins	0.17	0.04	0.13	0.28	0.04	0.04	1.77
twoline eelpout							
western eelpout	14.55	22.50	8.11	8.16			
ebony eelpout		1.24					
other eelpouts	0.01	0.01	0.06	0.04	0.06	0.05	
sablefish	5.16	3.92	5.77				
searcher							
blacktail snailfish							
other snailfishes	0.09	0.01				2.97	0.04
poachers	0.27	0.15	0.02	0.08	0.06	0.14	
mesopelagic fishes	0.50	0.23	0.10	0.14	0.24	1.28	0.36
other fishes		0.32			0.24		44.21
shortspine thornyhead	35.02	64.08	61.74	76.82	111.42	60.88	
rougthead rockfish						2.92	4.02
blackspotted rockfish							10.85
Pacific ocean perch	0.60		0.99	1.66	3.06	19.41	4523.34
shortraker rockfish	0.58						
grooved Tanner crab							
Tanner crab							0.66
triangle Tanner crab				0.01			
snow crab							
scarlet king crab							
golden king crab	0.73		0.00	1.44		7.69	
hermit crabs			0.01	1.80	1.81	2.14	0.50
other crabs					0.01	0.02	
snails	3.18	3.62	2.97	3.51	3.83	2.91	2.00
bivalves		0.16					
octopus	0.10	0.47	0.35	0.09	0.59		
squid	4.00	2.24	1.52	6.85	3.54	4.61	
sea anemones & corals	0.24	0.07	0.17	0.26	1.08	9.48	0.75
jellyfish	0.05					0.01	0.05
shrimps	0.01	0.01	0.02		0.01	0.18	1.10
seastars & sea cucumbers	273.76	241.09	86.43	155.41	59.54	81.74	1.28
sponges	40.08	8.57	2.12	0.60	0.87	1.12	0.07
other invertebrates	4.15	2.01	0.01	0.45	0.01	0.32	0.04
Haul Total Weight (kg)	972.92	849.07	596.34	547.52	633.32	1362.03	4891.98

Appendix C. - - Haul Log.

Haul	176	177	178	179	180	181	182
Date	14-Jul-2010	14-Jul-2010	14-Jul-2010	14-Jul-2010	14-Jul-2010	15-Jul-2010	15-Jul-2010
Stratum	12	12	11	11	11	12	11
Station ID	12-43	12-38	11-33	11-11	11-08	12-06	11-24
Performance	0	0	0	0	0	0	0
Bottom depth	460	426	327	240	232	423	369
Tow start latitude (N)	54.52437	54.67638	54.73788	54.88337	54.80985	54.56262	54.6436
Tow start longitude (W)	-167.05193	-167.09913	-166.84728	-166.98167	-166.65038	-166.54667	-166.73152
Tow end latitude (N)	54.519	54.65393	54.72488	54.87615	54.81822	54.56708	54.64
Tow end longitude (W)	-167.01658	-167.09695	-166.82048	-166.94773	-166.68407	-166.51042	-166.69577
Tow duration (Hour)	0.52	0.495	0.471	0.519	0.517	0.488	0.496
Distance of tow (nmi)	2.37	2.5	2.26	2.35	2.4	2.41	2.36
Mean net width (m)	16.143	15.686	15.975	15.658	16.197	16.195	16.322
Surface temperature (°C)	6.9	6.6	6.9	7.5	7	7.1	6.9
Bottom temperature (°C)	3.8	3.8	3.7	3.3	3.6	3.7	3.8
Pacific sleeper shark							
Bering skate	1.66		3.11	7.54	9.83	1.16	9.85
mud skate							
rougthead skate							
Alaska skate							
Aleutian skate		8.30		23.18	66.48	11.03	45.04
Commander skate						4.40	
whiteblotched skate	6.06	5.54				7.62	8.43
whitebrow skate	2.90		2.95	5.58			
other skates & skate eggs					0.01	0.02	
arrowtooth flounder	9.50	12.49	132.84	68.88	311.10	24.74	178.36
Kamchatka flounder	19.90	59.98	23.51	5.14	2.72	38.06	34.34
Greenland turbot	34.80	13.07				27.68	
Pacific halibut			37.46			32.18	24.00
flathead sole	15.10	46.72	16.54	48.38	127.38	89.78	104.24
rex sole	29.08	8.32	11.70	0.82		23.42	13.58
other flatfish			0.74				
Pacific grenadier							
giant grenadier	388.10	99.03				78.11	
popeye grenadier							
Pacific cod							
walleye pollock							17.97
blob sculpin							
bigmouth sculpin				5.06		0.76	
other sculpins	0.15	0.09	2.12	4.63	7.67	0.30	1.09
twoline eelpout							
western eelpout	4.30	7.03				27.46	
ebony eelpout						3.66	
other eelpouts		0.08	0.10			0.16	0.07
sablefish	1.47						
searcher							
blacktail snailfish							
other snailfishes						0.01	1.03
poachers	0.04	0.03				0.04	0.01
mesopelagic fishes	0.11	1.48	7.15	0.47	0.41	0.71	4.01
other fishes	0.32	1.30	0.61	0.35		5.47	
shortspine thornyhead	64.03	78.54	16.88			217.94	98.13
roughey rockfish			0.91	1.03	2.79		15.13
blackspotted rockfish		5.04			0.62	5.65	
Pacific ocean perch	6.45	3.21	6.55		0.83	5.35	8.73
shortraker rockfish							
grooved Tanner crab							
Tanner crab				0.06	1.85	0.08	
triangle Tanner crab							0.01
snow crab							
scarlet king crab							
golden king crab	1.20	1.95				2.64	
hermit crabs	0.17	0.35	1.93	0.13	0.35	0.82	2.76
other crabs				0.01			
snails	2.88	2.22	3.19	1.21	0.94	6.66	2.95
bivalves							
octopus	4.96					0.08	0.29
squid	3.92	2.04	6.69	0.04		2.59	3.70
sea anemones & corals	0.07	0.24	3.47	1.69	1.94	0.65	3.70
jellyfish	1.32		0.18	0.68		0.12	
shrimps	0.07	0.20	1.44	9.93	5.47	0.28	0.05
seastars & sea cucumbers	182.56	98.07	8.58	5.19	0.21	73.44	24.19
sponges	74.85	0.89	1.11	1.54		0.30	0.44
other invertebrates		0.01	0.70	0.40	0.07	0.09	0.02
Haul Total Weight (kg)	855.97	456.22	290.47	191.94	540.69	693.47	602.12

Appendix C. - - Haul Log.

Haul	183	184	185	186	187	188	189
Date	15-Jul-2010	15-Jul-2010	15-Jul-2010	15-Jul-2010	16-Jul-2010	16-Jul-2010	INCOMPLETE TOW
Stratum	11	11	11	11	11	11	
Station ID	11-42	11-32	11-23	11-07	11-22	11-05	
Performance	0	0	0	0	0	0	
Bottom depth	276	207	208	241	315	207	
Tow start latitude (N)	54.74018	54.79538	54.77367	54.7348	54.67092	54.76522	
Tow start longitude (W)	-166.58717	-166.44425	-166.2787	-166.1726	-166.09122	-165.8654	
Tow end latitude (N)	54.73188	54.8	54.77622	54.73512	54.66957	54.76417	
Tow end longitude (W)	-166.55425	-166.47753	-166.32157	-166.21167	-166.12723	-165.893	
Tow duration (Hour)	0.511	0.521	0.563	0.534	0.501	0.384	
Distance of tow (nmi)	2.32	2.21	2.78	2.53	2.34	1.9	
Mean net width (m)	15.642	15.946	16.39	15.915	16.181	15.365	
Surface temperature (°C)	6.5	6.9	7	7	7.1	7.4	
Bottom temperature (°C)	3.6	4	3.8	3.6	3.6	3.7	
Pacific sleeper shark							
Bering skate	2.92	18.48	3.16	1.88	2.82	2.24	
mud skate							
rougthead skate							
Alaska skate						7.37	
Aleutian skate		28.09		3.88	34.10		
Commander skate							
whiteblotched skate							
whitebrow skate				3.08	15.00		
other skates & skate eggs	0.02					0.35	
arrowtooth flounder	138.48	123.64	73.66	24.82	1123.32	104.08	
Kamchatka flounder	9.44	1.33		1.80	9.52	8.45	
Greenland turbot							
Pacific halibut			1.02		18.93		
flathead sole	73.86	105.31	23.24	6.52	32.22	0.51	
rex sole	2.94	0.25			11.28	12.22	
other flatfish					0.57	0.88	
Pacific grenadier							
giant grenadier							
pop-eye grenadier							
Pacific cod			1.93			12.61	
walleye pollock				1.00		105.36	
blob sculpin							
bigmouth sculpin							
other sculpins	3.76	7.82	3.56	3.47	5.42	2.89	
twoline eelpout							
western eelpout							
ebony eelpout							
other eelpouts							
sablefish							
searcher							
blacktail snailfish							
other snailfishes	0.11	0.08	0.33	0.31	0.36	0.77	
poachers			0.01			0.19	
mesopelagic fishes	1.28	0.33	0.84	0.54	0.50		
other fishes	0.53		0.29	1.08	0.36		
shortspine thornyhead							
roughey rockfish	4.31	1.79	1.64	2.62	5.72	0.52	
blackspotted rockfish	3.05						
Pacific ocean perch	10.12			19.63	4.23	1.89	
shortraker rockfish							
grooved Tanner crab							
Tanner crab	0.25	51.65	52.33	6.00	1.05	55.23	
triangle Tanner crab							
snow crab		8.46	1.13	0.40		15.60	
scarlet king crab							
golden king crab	2.08	1.19					
hermit crabs	0.13				0.06	0.05	
other crabs	0.02			0.02	0.03		
snails	3.39	2.24	2.93	1.61	6.60	0.57	
bivalves							
octopus	0.78			0.04	1.02		
squid	4.83	0.01		0.95	2.82		
sea anemones & corals	3.34	43.93	21.36	6.29	3.84	5.07	
jellyfish	0.57	0.05	0.12	0.11	0.27	0.29	
shrimps	5.90	7.45	12.42	11.95	3.97	6.05	
seastars & sea cucumbers	2.74	0.16	0.03	0.33	5.93	0.50	
sponges	0.98			1.07		0.15	
other invertebrates	0.03	0.01		1.12	0.06		
Haul Total Weight (kg)	275.85	402.28	200.01	100.52	1289.99	343.83	

Appendix C. - - Haul Log.

Haul	190	191	192	193	194	195	196
Date	16-Jul-2010	16-Jul-2010	16-Jul-2010	17-Jul-2010	17-Jul-2010	17-Jul-2010	17-Jul-2010
Stratum	11	11	11	11	12	12	12
Station ID	11-04	11-43	11-02	11-15	12-25	12-26	12-09
Performance	1.1	0	0	0	0	0	0
Bottom depth	265	205	252	326	422	446	446
Tow start latitude (N)	54.72368	54.77623	54.70715	54.65058	54.5799	54.56182	54.49638
Tow start longitude (W)	-165.74005	-165.55782	-165.49793	-165.64245	-165.86968	-165.96305	-165.83318
Tow end latitude (N)	54.71957	54.7762	54.71682	54.63073	54.57665	54.55817	54.47768
Tow end longitude (W)	-165.70348	-165.59595	-165.52822	-165.63695	-165.83387	-165.92698	-165.84708
Tow duration (Hour)	0.552	0.557	0.503	0.51	0.501	0.53	0.518
Distance of tow (nmi)	2.5	2.5	2.24	2.24	2.36	2.39	2.27
Mean net width (m)	16.065	14.946	15.243	15.372	16.462	16.099	15.499
Surface temperature (°C)	7.3	7	7.3	7		7.4	7.2
Bottom temperature (°C)	3.6	3.5	3.5	3.6		3.7	3.6
Pacific sleeper shark				18.43			
Bering skate	23.01	19.72	7.24	3.22	2.25	0.48	0.09
mud skate			3.78	1.23	0.92	2.40	
rougthead skate							
Alaska skate		11.10					
Aleutian skate	10.03	5.02	17.32	26.84	15.11		19.53
Commander skate							
whiteblotched skate					13.60		
whitebrow skate	6.54			3.31	3.38	3.18	2.72
other skates & skate eggs	0.13	0.11	0.15	2.53	0.75	0.14	0.06
arrowtooth flounder	104.98	209.22	521.15	624.02	106.56	22.70	842.70
Kamchatka flounder	3.78	3.92	2.80	20.71	81.46	27.76	101.36
Greenland turbot					62.40	29.68	147.74
Pacific halibut				18.98	26.80		
flathead sole	2.06	2.16	60.77	25.14	11.55	28.78	19.04
rex sole	23.80	10.79	58.44	63.00	43.74	20.72	27.54
other flatfish	4.44		53.77	3.38	8.94	5.82	
Pacific grenadier							
giant grenadier					7.04	61.50	68.06
pop-eye grenadier							
Pacific cod	79.22	7.40	20.67				
walleye pollock	8.64	0.76	8.55	124.20	242.44	0.72	40.64
blob sculpin							
bigmouth sculpin			8.36				6.18
other sculpins	8.54		3.37	4.92	0.90	0.23	0.13
twoline eelpout							
western eelpout					1.04	143.18	1656.12
ebony eelpout							
other eelpouts					0.72	1.15	1.14
sablefish					26.88	2.88	16.14
searcher							
blacktail snailfish							
other snailfishes	1.03		1.80	17.53			0.20
poachers	5.76	12.47	16.75	2.93			
mesopelagic fishes					0.07	0.36	0.50
other fishes				0.83	1.81	1.33	4.61
shortspine thornyhead					18.02	31.90	6.27
rougthead rockfish							1.39
blackspotted rockfish						2.85	
Pacific ocean perch	12.65		14.87	19.98	2.09	3.64	4.70
shortraker rockfish							
grooved Tanner crab							
Tanner crab	41.57	75.86	52.56	7.53			
triangle Tanner crab					3.37	0.82	3.84
snow crab	1.21	39.36	6.53	0.41		0.29	
scarlet king crab							
golden king crab					3.42	2.90	3.16
hermit crabs	0.25	0.17			0.64	1.52	0.49
other crabs	0.05	0.66	0.02	0.06			
snails	5.89	0.60	0.11	0.75	4.70	9.87	6.21
bivalves	0.04						
octopus	5.45				0.07	0.99	0.54
squid		0.87		3.04	10.39	8.24	33.27
sea anemones & corals	9.72	0.06	0.05	1.47	41.82	65.94	16.61
jellyfish	1.34	0.21	0.07			1.99	
shrimps	2.32	4.40		0.27	0.28	0.90	
seastars & sea cucumbers	3.98	54.79	6.57	4.70	12.47	15.13	18.91
sponges	0.08	0.59	0.15		0.08	0.98	0.08
other invertebrates	5.41	0.08	0.06	0.25	0.02	1.23	0.01
Haul Total Weight (kg)	371.92	460.34	865.91	999.66	755.72	502.18	3050.00

Appendix C. - - Haul Log.

Haul	197	198	199	200	201	202	203
Date	17-Jul-2010	18-Jul-2010	18-Jul-2010	18-Jul-2010	18-Jul-2010	18-Jul-2010	18-Jul-2010
Stratum	12	12	12	12	12	12	12
Station ID	12-24	12-22	12-44	12-20	12-08	12-28	12-07
Performance	0	0	0	0	0	0	0
Bottom depth	505	406	587	487	518	495	424
Tow start latitude (N)	54.47903	54.59508	54.4418	54.51302	54.4589	54.49002	54.56833
Tow start longitude (W)	-165.93387	-166.04015	-166.0282	-166.09887	-166.18653	-166.3134	-166.2197
Tow end latitude (N)	54.45857	54.59822	54.42837	54.50808	54.45517	54.49018	54.5684
Tow end longitude (W)	-165.93858	-166.00363	-166.05367	-166.12922	-166.22155	-166.34977	-166.25475
Tow duration (Hour)	0.496	0.507	0.506	0.479	0.517	0.489	0.499
Distance of tow (nmi)	2.32	2.4	2.23	2.05	2.34	2.37	2.27
Mean net width (m)	15.702	15.817	16.018	15.893	16.788	16.284	16.364
Surface temperature (°C)	7.3	7.5	7.2	7.3	7.3	7.4	7.6
Bottom temperature (°C)	3.5	3.8	3.4	3.5	3.5	3.6	3.8
Pacific sleeper shark			7.60		6.38	5.36	11.70
Bering skate	4.38	2.22	5.11	63.18	2.42	25.66	17.52
mud skate							
rougthead skate							
Alaska skate							
Aleutian skate		32.84	19.23	96.36	6.62	13.44	100.20
Commander skate			4.37	38.98	10.06	10.14	5.62
whiteblotched skate							11.42
whitebrow skate	6.54	3.60	105.03	7.74	2.76	6.00	
other skates & skate eggs	0.04	0.06	0.11				
arrowtooth flounder	78.64	82.56	11.72	57.60	7.46	27.44	23.36
Kamchatka flounder	24.86	72.36	25.38	132.60	6.78	92.32	58.46
Greenland turbot	44.98	42.30	128.16	14.28	26.00	2.17	75.56
Pacific halibut		15.54		17.32	7.33		8.20
flathead sole	3.38	6.88		23.20	26.24	51.08	46.76
rex sole	1.28	30.80		7.60			28.20
other flatfish	3.95	7.29	0.63	4.04	1.96	4.48	4.81
Pacific grenadier							
giant grenadier	22.76		64.66	86.22	96.72	204.60	24.15
poppeye grenadier	1.22		13.44				
Pacific cod							
walleye pollock		4.62					11.35
blob sculpin							
bigmouth sculpin							6.46
other sculpins	0.21	1.04			0.35	0.71	1.00
twoline eelpout							
western eelpout	327.85	3.82	173.80	800.28	318.60	743.78	18.48
ebony eelpout		8.43	72.38	15.56	8.88	8.14	5.60
other eelpouts	1.12	0.75	0.11	0.05	0.25	0.22	1.86
sablefish	27.00	14.16	28.50	35.16	34.18	18.12	1.75
searcher							
blacktail snailfish		1.11	0.46				
other snailfishes			0.23				0.01
poachers	0.02	0.04	1.14	0.04		0.13	0.07
mesopelagic fishes	0.66	0.42	1.73	0.18	0.14	0.04	0.44
other fishes	0.36		0.30		2.01		1.32
shortspine thornyhead	46.94	26.68	108.28	434.07	89.74	157.90	53.12
rougheye rockfish							1.01
blackspotted rockfish		2.91					
Pacific ocean perch	1.54	8.08	1.52	0.54		1.53	4.48
shortraker rockfish							
grooved Tanner crab			0.98		0.43		
Tanner crab							0.20
triangle Tanner crab	1.23	0.72	0.03			0.04	0.39
snow crab							
scarlet king crab							
golden king crab	3.18	5.19	0.09	2.47	3.81	4.99	2.48
hermit crabs	0.37	1.15	0.02	0.28	0.55	2.96	4.34
other crabs							
snails	8.60	12.80	8.70	39.98	7.34	29.85	38.98
bivalves		0.18					
octopus	1.57		0.62	0.14	2.34	1.29	1.82
squid	10.15	6.81	8.31	1.42	2.71	0.80	3.03
sea anemones & corals	18.26	12.57	0.59	5.83	0.08	0.49	25.86
jellyfish	0.41		0.02		0.63	0.58	
shrimps	0.12	0.18	0.55	0.03	0.05	0.04	0.23
seastars & sea cucumbers	9.04	4.75	114.42	32.58	210.06	185.30	49.91
sponges	1.63		0.70	0.10	27.25	0.28	
other invertebrates	0.21		0.05	0.13	0.27	0.11	0.28
Haul Total Weight (kg)	652.50	412.85	908.95	1917.96	910.40	1600.00	650.43

Appendix C. - - Haul Log.

Haul	204	205	206	207	208	209
Date	19-Jul-2010	19-Jul-2010	19-Jul-2010	19-Jul-2010	20-Jul-2010	20-Jul-2010
Stratum	12	12	12	12	13	14
Station ID	12-47	12-48	12-49	12-50	13-18	14-12
Performance	0	0	0	0	0	5.8
Bottom depth	408	482	503	420	741	841
Tow start latitude (N)	54.90418	54.80477	54.62782	54.62645	54.34163	54.33565
Tow start longitude (W)	-167.42228	-167.39348	-167.32008	-167.00432	-166.14417	-166.3654
Tow end latitude (N)	54.89142	54.78668	54.64753	54.6094	54.332	54.33388
Tow end longitude (W)	-167.39625	-167.37873	-167.3313	-167.02642	-166.17392	-166.3323
Tow duration (Hour)	0.494	0.521	0.487	0.522	0.507	0.486
Distance of tow (nmi)	2.2	2.23	2.31	2.38	2.24	2.24
Mean net width (m)	15.299	16.011	15.824	16.669	15.626	15.992
Surface temperature (°C)	7	6.8	7.6	7.7	7.8	7.3
Bottom temperature (°C)	3.8	3.8	3.6	3.8	3.1	2.9
Pacific sleeper shark			6.16		23.30	
Bering skate		1.43	2.20			2.72
mud skate						
rougthead skate						3.15
Alaska skate						
Aleutian skate	18.07	11.93	1.54		10.89	13.18
Commander skate						
whiteblotched skate	13.35	10.45	14.02			
whitebrow skate	2.95	3.80	5.24		2.28	3.36
other skates & skate eggs					0.01	0.05
arrowtooth flounder	16.73	5.40	5.08	22.72		
Kamchatka flounder	52.28	26.92	13.18	90.68	11.49	15.06
Greenland turbot	38.34	2.76	14.30	34.82	85.70	88.14
Pacific halibut	14.58			7.14		
flathead sole	10.18			58.00		
rex sole	47.94	6.43		17.06		
other flatfish	6.12					
Pacific grenadier					2.72	
giant grenadier	143.72	163.24	328.00	98.24	117.58	586.88
popeye grenadier			0.60		127.04	293.34
Pacific cod						
walleye pollock	1.07					
blob sculpin						
bigmouth sculpin						
other sculpins	0.08	0.12	0.23	0.06		
twoline eelpout					4.50	11.70
western eelpout		21.42	52.46	2.58	59.14	110.26
ebony eelpout				2.94	0.39	
other eelpouts	0.17	0.02	0.01	0.03	0.28	1.02
sablefish		2.64			31.16	21.48
searcher						
blacktail snailfish						0.80
other snailfishes			0.03		0.63	1.51
poachers		0.06	0.09	0.16		0.66
mesopelagic fishes	0.12	0.12	0.33	0.09	2.82	2.13
other fishes	0.77		0.64	0.83		
shortspine thornyhead	90.10	82.18	44.38	93.00	16.13	62.80
rougthead rockfish						
blackspotted rockfish			1.85			
Pacific ocean perch	2.02	1.79		14.62		
shortraker rockfish						
grooved Tanner crab					1.03	1.39
Tanner crab						
triangle Tanner crab					2.55	14.45
snow crab						
scarlet king crab					1.81	
golden king crab	1.10	0.02	0.93	2.28		
hermit crabs	1.90	0.26		0.32		
other crabs						
snails	1.67	1.56	5.95	2.19	0.14	2.75
bivalves						
octopus		0.49			0.19	0.41
squid	7.04	2.38	2.81	1.92	0.58	0.19
sea anemones & corals	7.82	0.82	0.08	0.71	0.13	0.01
jellyfish	0.02	0.16	0.11	0.17	0.08	0.24
shrimps	0.02	0.01	0.27	0.02		0.05
seastars & sea cucumbers	7.93	148.84	183.41	104.97	16.56	6.11
sponges	0.20	8.77	28.49		0.10	
other invertebrates	0.01	0.11	0.64	0.35	0.01	
Haul Total Weight (kg)	486.28	504.13	713.02	555.91	519.24	1243.84

RECENT TECHNICAL MEMORANDUMS

Copies of this and other NOAA Technical Memorandums are available from the National Technical Information Service, 5285 Port Royal Road, Springfield, VA 22167 (web site: www.ntis.gov). Paper and electronic (.pdf) copies vary in price.

AFSC-

- 223 ALLEN, B. M., and R. P. ANGLISS. 2011. Alaska marine mammal stock assessments, 2010, 292 p. NTIS number pending.
- 222 GRAY, A. K., W. T. MCCRANEY, C. T. MARVIN, C. M. KONDZELA, H. T. NGUYEN, and J. R. GUYON. 2011. Genetic stock composition analysis of chum salmon bycatch samples from the 2008 Bering Sea groundfish fisheries, 29 p. NTIS number pending.
- 221 GRAY, A. K., W. T. MCCRANEY, C. T. MARVIN, C. M. KONDZELA, H. T. NGUYEN, and J. R. GUYON. 2011. Genetic stock composition analysis of chum salmon bycatch samples from the 2007 Bering Sea groundfish fisheries, 29 p. NTIS number pending.
- 220 MARVIN, C. T., S. L. WILDES, C. M. KONDZELA, H. T. NGUYEN, and J. R. GUYON. 2011. Genetic stock composition analysis of chum salmon bycatch samples from the 2006 Bering Sea groundfish fisheries, 29 p. NTIS number pending.
- 219 JONES, D. T., A. De ROBERTIS, and N. J. WILLIAMSON. 2011. Statistical combination of multifrequency sounder-detected bottom lines reduces bottom integrations, 13 p. NTIS number pending.
- 218 LANDER, M. E., D. S. JOHNSON, J. T. STERLING, T. S. GELATT, and B. S. FADELY. 2011. Diving behaviors and movements of juvenile Steller sea lions (*Eumetopias jubatus*) captured in the central Aleutian Islands, April 2005, 41 p. NTIS number pending.
- 217 LAZRUS, H. M., J. A. SEPEZ, R. G. FELTHOVEN, and J. C. LEE. 2011. Post-rationalization restructuring of commercial crew member opportunities in Bering Sea and Aleutian Island crab fisheries, 62 p. NTIS No. PB2011-107546.
- 216 CHILTON, E. A., C. E. ARMISTEAD, and R. J. FOY. 2011. The 2010 eastern Bering Sea continental shelf bottom trawl survey: Results for commercial crab species, 101 p. NTIS PB2011-108305.
- 215 VON SZALAY, P. G., C. N. ROOPER, N. W. RARING, and M. H. MARTIN. 2011. Data Report: 2010 Aleutian Islands bottom trawl survey, 153 p. NTIS PB2011-108304.
- 214 LEW, D. K., J. LEE, and D. M. LARSON. 2010. Saltwater sportfishing in Alaska: A summary and description of the Alaska saltwater sportfishing economic survey, 2007, 229 p. NTIS No. PB2011-105279.
- 213 CAHALAN, J. A., B. M. LEAMAN, G. H. WILLIAMS, B. H. MASON, and W. A. KARP. 2010. Bycatch characterization in the Pacific halibut fishery: A field test of electronic monitoring technology, 66 p. NTIS number pending.
- 212 KELLY, B. P., J. L. BENGTON, P. L. BOVENG, M. F. CAMERON, S. P. DAHLE, J. K. JANSEN, E. A. LOGERWELL, J. E. OVERLAND, C. L. SABINE, G. T. WARING, and J. M. WILDER. 2010. Status review of the ringed seal (*Phoca hispida*), 250 p. NTIS number pending.
- 211 CAMERON, M. F., J. L. BENGTON, P. L. BOVENG, J. K. JANSEN, B. P. KELLY, S. P. DAHLE, E. A. LOGERWELL, J. E. OVERLAND, C. L. SABINE, G. T. WARING, and J. M. WILDER. 2010. Status review of the bearded seal (*Erignathus barbatus*), 246 p. NTIS No. PB2011103863.
- 210 JOHNSON, S. W., J. F. THEDINGA, A. D. NEFF, and C. A. HOFFMAN. 2010. Fish fauna in nearshore waters of a barrier island in the western Beaufort Sea, Alaska, 28 p. NTIS No. PB2011-102346.