

# NAVAL RESEARCH LABORATORY

# MAJOR FACILITIES

# 2008

NRL-DC, Washington, DC



NRL-SSC, Mississippi



CBD, Chesapeake Beach, MD



NRL-MRY, Monterey, CA



Ex-USS Shadwell, Mobile, AL



VXS-1, Patuxent River, MD



## EXECUTIVE DIRECTORATE

### Code 1100 – Institute for Nanoscience

- Nanoscience Research Laboratory

### Code 1600 – Scientific Development Squadron ONE (VXS-1)

## BUSINESS OPERATIONS DIRECTORATE

### Code 3400 – Supply and Information Services Division

- Publishing and Graphic Design Support Facilities
- Video Editing Studio
- Photography Studio
- Exhibit Office

### Code 3500 – Research and Development Services Division

- Chesapeake Bay Detachment

## SYSTEMS DIRECTORATE

### Code 5300 – Radar Division

- Advanced Multifunction Radio Frequency Concept Testbed
- Radar Imaging Facility
- Airborne Early Warning Radar Facility
- Radar Signature Calculation Facility
- Compact Range Facility
- Airborne Surveillance Command and Control Research Platform
- Millimeter Wave Radar Facility
- Radar Test Facility
- Microwave Microscope

### Code 5500 – Information Technology Division

- Freespace Communications Testbed
- Robotics and Autonomous Systems Laboratory
- Immersive Simulation Laboratory
- Warfighter Human-Systems Integration Laboratory
- Audio Laboratory
- Mobile and Dynamic Network Laboratory
- Integrated Communications Technology Test Laboratory
- General Electronics Environmental Test Facility
- Key Management Laboratory
- Cryptographic Technology Laboratory
- Navy Cyber Defense Research Laboratory
- Navy Shipboard Communications Testbed
- Virtual Reality Laboratory

### **Information Technology Division, continued**

- Motion Imagery Laboratory
- Global Information Grid Evaluation Facility
- Laboratory for Large Data Research
- Distributed Center for High Performance Computing
- Ruth H. Hooker Research Library

### **Code 5600 – Optical Sciences Division**

- Fiber Fabrication Facility for Non-Oxide and Specialty Glasses
- Nanochannel Glass Technology Facility
- Organic Opto-Electronics Fabrication and Characterization Facility
- Fiber-Optic Optical-Microwave Laboratory
- IRCM Techniques Laboratory
- Missile Warning System Facility
- Infrared Range Facility
- Fiber-Optic Sensor Facility
- Oxide Optical Fiber Fabrication Facility
- Ground Station Exploitation Laboratory
- DIRCM Evaluation Facility

### **Code 5700 – Tactical Electronic Warfare Division**

- Visualization Laboratory
- Transportable Step Frequency Radar
- Vehicle Development Laboratory
- Offboard Test Platform
- Compact Antenna Range Facility
- High-Power Microwave Explosive Laboratory
- RFCM Techniques Chamber Facility
- Search Radar ECM/EA Simulator
- Low-Power Anechoic Chamber
- High-Power Microwave Research Facility
- Electro-Optics Mobile Laboratory
- Infrared/Electro-Optical Calibration and Characterization Laboratory
- Infrared Missile Simulator and Development Laboratory
- Secure Supercomputing Facility
- CBD/Tilghman Island IR Field Evaluation Facility
- Ultra-Short-Pulse Laser Effects Research and Analysis Laboratory
- Central Target Simulator Facility
- Flying Electronic Warfare Laboratory
- Ultra-Near-Field Test Facility



### **Tactical Electronic Warfare Division, continued**

- RF and Millimeter-Wave Laboratory
- Optics Laboratory
- Blackroom Laboratory
- Secure Computational Facility
- Human Perception Laboratory

## **MATERIALS SCIENCE AND COMPONENT TECHNOLOGY DIRECTORATE**

### **Code 6030 – Laboratory for Structure of Matter**

- Automatic X-ray Diffractometers

### **Code 6100 – Chemistry Division**

- Chemical Analysis Facility
- Magnetic Resonance Facility
- Chemical Vapor and Plasma Deposition Facility
- Nanometer Characterization/Manipulation Facility
- Synchrotron Radiation Facility
- Ex-USS *Shadwell* Advanced Fire Research Ship
- Fire Research Enclosure
- Large-Scale Damage Control Facility
- Navy Fuel Research Facility
- Corrosion Engineering and Coatings Characterization Facilities
- Marine Coatings Facility
- Cathodic Protection Model Facility
- Ballast Water Treatment Test Facility
- Antifoulant Coatings Exposure Site
- Sacrificial Anode Qualification Site

### **Code 6300 – Materials Science and Technology Division**

- Materials Processing Facility
- 3 MV Tandem Pelletron Accelerator
- Micro/Nanostructure Characterization Facility
- Mechanical Characterization Facility
- Electrical, Magnetic, and Optical Measurement Facility
- Thin-Film Materials Synthesis and Processing Facility
- Magnetoelectronics Fabrication Facility

### **Code 6400 – Laboratory for Computational Physics and Fluid Dynamics**

- Parallel High Performance Computer Graphics Facility



### **Code 6700 – Plasma Physics Division**

- Nike KrF Laser Facility
- Electra Laser Facility
- Pharos Laser Facility
- Plasma Applications Laboratory
- Space Physics Simulation Chamber
- Gamble II Facility
- Hawk Facility
- Mercury Facility
- High-Frequency Microwave Processing of Materials Laboratory
- T-Cubed Laser System
- TFL Laser System
- Railgun Materials Testing Facility
- Directed Energy Physics Laboratory

### **Code 6800 – Electronics Science and Technology Division**

- Ultrafast Laser Facility
- Space Solar Cell Characterization Laboratory
- Compound Semiconductor Processing Facility
- Laboratory for Advanced Materials Synthesis
- Epicenter for Advanced Materials Growth and Characterization
- Millimeter-Wave Vacuum Electronics Fabrication Facility
- Advanced Silicon Carbide Epitaxial Research Laboratory

### **Code 6900 – Center for Bio/Molecular Science and Engineering**

- Micro Fabrication Facility for Microfluidics
- Quadrupole Time-of-Flight Mass Spectrometer
- Advanced Microscopy Facility

## **OCEAN AND ATMOSPHERIC SCIENCE AND TECHNOLOGY DIRECTORATE**

### **Code 7100 – Acoustics Division**

- Acoustic Communications Measurement Systems
- High-Frequency Acoustic Flow Visualization Sonar Systems
- Instrumentation Suite for Acoustic Propagation Measurements in Complex Shallow Water Environments
- Rail-based Broadband Synthetic Aperture Ocean Measurement System
- Structural Acoustics In-Air Facility
- Laboratory for Structural Acoustics
- Shallow Water Acoustic Laboratory
- Autonomous Acoustic Receiver System
- Salt Water Tank Facility

### **Acoustics Division, continued**

- Underwater Acoustic Time-Reversal Mirror
- Shallow-Water High-Frequency Measurement Systems
- 300 Hz and 500 Hz Autonomous Acoustic Sources
- Sediment Geo-Probe System
- Drifting Echo Repeater
- Shallow Water Ship Acoustic Signature System
- Geoacoustic Physical Model Fabrication Laboratory
- Sono-Magnetic Laboratory

### **Code 7200 – Remote Sensing Division**

- Naval Prototype Optical Interferometer
- Optical Calibration Facility
- Free Surface Hydrodynamics Laboratory

### **Code 7300 – Oceanography Division**

- Ocean Sciences and Remote Sensing Research Facility
- Environmental Microscopy Facility
- Ocean Dynamics and Prediction Network
- Ocean Color Facility
- Littoral Measurements Facility
- Salinity Temperature and Roughness Remote Scanner
- Field Staging Facility
- Ocean Optics Instrumentation Systems
- Autonomous Underwater Vehicle Laboratory
- Real-time Ocean Observations and Forecast Facility

### **Code 7400 – Marine Geosciences Division**

- Transmission Electron Microscopy Facility
- Sediment Physical and Geotechnical Properties Laboratory
- Marine Biogeochemistry Laboratory
- Computed Tomography Scanning Facility
- Moving-Map Composer Facility
- Digital X-Radiography Scanning Laboratory
- Sediment Core Laboratory
- Geospatial Services Laboratory

### **Code 7500 – Marine Meteorology Division**

- Meteorological and Oceanographic Research Library
- Meteorological Archival Facility
- Atmospheric Prediction System Development Laboratory

### **Marine Meteorology Division, continued**

- Mobile Atmospheric Aerosol and Radiation Characterization Observatory
- Satellite Data Ingest and Processing System

### **Code 7600 – Space Science Division**

- Vacuum Ultraviolet Calibration/Testing Facility
- Gamma-Ray Imaging Laboratory
- Cryogenic Sensor Test Facility
- Large Angle and Spectrometric Coronagraph
- Rocket Assembly and Checkout Facility
- Solar Coronagraph Optical Test Chamber
- Space Instrument Test Facility
- EUV/X-Ray Calibration Facility

### **NAVAL CENTER FOR SPACE TECHNOLOGY**

#### **Code 8100 – Space Systems Development Department**

- Precision Radio Frequency Anechoic Chamber Facility
- Satellite Mission Analysis Facility
- Blossom Point Satellite Tracking and Command Station
- Midway Research Center Precision Spacecraft Calibration Facility
- Precision Clock Evaluation Facility
- Maritime Navigation Radar Test Range

#### **Code 8200 – Spacecraft Engineering Department**

- Modal Survey Test Facility
- Static Loads Test Facility
- Payload Processing Facility
- Thermal Vacuum Test Facility
- Spacecraft Acoustic Reverberation Chamber Test Facility
- Spacecraft Spin Test Facility
- Spacecraft Vibration Test Facility
- Spacecraft Thermal Analysis, Fabrication, and Test Facility
- Spacecraft Robotics Engineering and Controls Laboratory
- Class 100 Clean Room Facility
- Radio Frequency Anechoic Chamber Facility
- EMI Test Facility
- Proximity Operations Testbed

### **GENERAL INFORMATION**

- Maps



**Code 1100 – Institute for Nanoscience**

**Code 1600 – Scientific Development Squadron ONE (VXS-1)**

# **EXECUTIVE**

## **DIRECTORATE**

**BACK TO CONTENTS**

# Institute for Nanoscience

- Nanoscience Research Laboratory

# Nanoscience Research Laboratory



**FUNCTION:** Conducts innovative, multidisciplinary research at the intersections of the fields of materials, electronics, and biology in the nanometer size domain. Serves as NRL's nucleus of collaborative activity in this rapidly evolving research area. The current research program emphasizes cross-division efforts in nanomaterials, nanoelectronics, and nanosensors/devices.

**DESCRIPTION:** The Nanoscience Research Laboratory opened in 2003. The central core of this major facility is a 5,000 ft<sup>2</sup> Class 100 fabrication clean room outfitted with tools to permit lithographic fabrication, measurement, and testing of devices. The equipment includes deposition systems for metals and insulators, optical mask aligners, and etching systems. The lithography effort is supported by chemistry stations and fume hoods for spinning on photo resists, baking, and developing the patterns that ultimately result in small devices and circuits. The building also includes 5000 ft<sup>2</sup> of controlled-environment laboratory space (12 laboratories) available to NRL researchers whose experiments are sufficiently demanding to require this space. These laboratories all provide shielding from electromagnetic interference and very low floor vibration and acoustic levels. In addition, eight laboratories control the temperature to within 0.5 °C and four to within 0.1 °C.

**INSTRUMENTATION:** In the nanofabrication facility: atomic force microscope (AFM); benchtop transmission electron microscope (TEM); cascade probe station; critical point dryer; dual beam focused ion beam; e-beam writer

system; e-beam evaporator; ellipsometer; inductively coupled plasma – reactive ion etching systems (Cl, F); ion beam assisted deposition system; ion mill; laser micromachining tool; laser pattern generator; low pressure chemical vapor deposition system optical mask aligners (0.2, 1, 2 micron); optical and fluorescence microscopes; plasma cleaner/etcher/asher; plasma enhanced chemical vapor deposition system; reactive ion etching systems (Cl, F); scanning electron microscope; sputter deposition system; surface profilometer; thermal evaporator; wire bonder.

In the quiet and ultra-quiet measurement laboratories: AFM; laser vibrometer; low temperature transport measurement systems; low temperature magnetic measurement systems; scanning tunneling microscope; nanoindentation and nanomanipulation tools; nanomechanical resonators; nearfield optical microscope; physical vapor deposition system; scanning Auger microscope; surface analysis tools; TEM.

**CONTACT:**

Code 1100 • (202) 767-1803

**LOCATION:**

NRL, Washington, DC



# Scientific Development Squadron ONE (VXS-1)

- Scientific Development Squadron ONE (VXS-1)

# Scientific Development Squadron ONE (VXS-1)



NP-3D Orion aircraft



RC-12 King Air aircraft

**FUNCTION:** Provides airborne research platforms to conduct and support worldwide scientific research projects. Operates and maintains a fleet of five uniquely configured, research modified aircraft.

**DESCRIPTION:** Scientific Development Squadron ONE is the Navy's and DoD's only squadron dedicated to science and technology research. Located on the western shore of the Chesapeake Bay at Naval Air Station Patuxent River, Maryland, the squadron owns and operates three NP-3D Orion aircraft and two RC-12 King Air aircraft configured to perform numerous airborne research projects, including bathymetry, electronic countermeasures, geophysical mapping, and radar development research. Of the three NP-3Ds, VXS-1 flies the Navy's only Rotodome modified P-3 aircraft. The command is the Aircraft Reporting Custodian of four SCAN Eagle Unmanned Aircraft Systems. These platforms primarily support an Office of Naval Research project operated by NAVSEA, but also provide small payload capability to the Naval Research Laboratory through VXS-1.

In addition to aircraft, squadron facilities include 15,300 ft<sup>2</sup> of administrative and work space, a 40,240 ft<sup>2</sup> hangar deck, a 5,240 ft<sup>2</sup> storage facility, and two research projects buildings. The Naval Air Station provides three runways and a large number of aircraft support services. The VXS-1 Commanding Officer is responsible for setting policy, scheduling aircraft assets, managing the daily activities of the squadron, and ensuring the safe and successful execution of worldwide deployed scientific research projects tasked by the Naval Research Laboratory.

**CONTACT:**

Code 1600 • (301) 342-3751

**LOCATION:**

Naval Air Station Patuxent River, MD

**Code 3400 – Supply and Information Services Division**

**Code 3500 – Research and Development Services Division**

# **BUSINESS**

## **OPERATIONS DIRECTORATE**

**BACK TO CONTENTS**



# Supply and Information Services Division

- Publishing and Graphic Design Support Facilities
- Video Editing Studio
- Photography Studio
- Exhibit Office

# Publishing and Graphic Design Support Facilities



**FUNCTION:** Produce NRL's corporate publications, documents, posters, CDs, technical reports, brochures, presentations, framed artwork, and other products using graphic design, image editing, text editing, and layout software in conjunction with various high-speed and large-format printers, copiers, CD duplicators, label makers, binders, laminators, and other equipment.

**DESCRIPTION:** Staff from the Technical Information Services (TIS) Branch provide publication and graphics support to the Laboratory community. Visual information specialists, editors, photographers, and others produce written and visual products for technical reports, conferences, symposia, trade shows, displays, brochures, ceremonies, and more.

High-speed, high-resolution printers and copiers are used to produce color and black-and-white output from digital files or hardcopy originals. Large-format printers are used to produce full-color posters and signs that can be laminated, mounted, or custom framed. Publications can be written, edited, illustrated, printed, and bound, or written to CD/DVD. The facility uses Adobe Creative Suite software and has access to extensive digital image libraries.

**INSTRUMENTATION:** Equipment includes HP and Epson large-format color printers; Xerox and Canon high-speed printer/copiers; matting and framing supplies and equipment; large-format laminator; Rimage CD/DVD duplication system; binding equipment; use of DAPS commercial printers and binders. The main in-house printer/copier used for color publications is the DocuColor 6060, which uses a four-color process and the traditional cyan, magenta, yellow, and black colors found on offset color printing presses. It prints consistent, high-resolution, high-quality color at 600 x 600 dpi.

Web site: <http://tid-www.nrl.navy.mil/>

## CONTACT:

TIS Service Desk (202) 767-3500 • Code 3430 • (202) 404-4963

## LOCATION:

NRL, Washington, DC

# Video Editing Studio



AVID Symphony digital video editing system

**FUNCTION:** Provides the capability to author/produce/edit classified and unclassified multimedia programs for the Laboratory community. Subjects include scientific projects, lectures, seminars, ceremonies, and other events. Videographers work in the studio and on site.

**DESCRIPTION:** This facility features multimedia systems running on software designed to provide the highest quality video postproduction work appropriate for different project needs. In addition to video capture, major capabilities include sound and narration overdubbing, voice enhancement, script reading, color correction, and video nonlinear editing to produce concise, informative, professional quality movies in most every major CD-, DVD-, and Internet-playable format. One system allows on-location editing. Other capabilities include conversion from legacy formats (VHS, Beta, Hi-8) to digital formats.

Web site: <http://tid-www.nrl.navy.mil/>

**INSTRUMENTATION:** Mac-based Avid Symphony and XpressPro DV systems; Boris Red for broadcast quality titling, compositing, and 3D animation; and DVD Studio Pro 3 for DVD authoring. Panasonic Professional Digital Video cameras, soon to transition to HD format.

**CONTACT:**

Code 3432 • (202) 767-3536

**LOCATION:**

NRL, Washington, DC



# Photography Studio



**FUNCTION:** Provides photography of a wide variety of scientific and technical experiments, tests, events, exhibits, portraits, and newsworthy items, and produces high-quality color and black-and-white prints, posters, and other products from digital image files. Photographers work in the studio and on site.

**DESCRIPTION:** This facility maintains a staff of skilled scientific and technical photographers experienced in providing high-quality photographic documentation in high-resolution digital format. Images are produced from digital files that are received from image capture, film negative and hard-copy scans, graphic creation, or the computer network, and are output to various high-resolution printers or storage media.

**EQUIPMENT:** Three 12-megapixel Nikon D3 digital SLR cameras; several MacPro G5 workstations; high-resolution color printers of various sizes; and a Noritsu dDP-411 digital minilab.

Web site: <http://tid-www.nrl.navy.mil/>

**CONTACT:**

Code 3432 • (202) 404-4970 and (202) 767-1978

**LOCATION:**

NRL, Washington, DC

## Exhibit Office



**FUNCTION:** Creates large-format, portable displays of science and technology information for technical conferences, symposia, trade shows, briefings, and other events, and stationary displays for installation in NRL buildings and other locations.

**DESCRIPTION:** Staff from the Exhibit Office design, display, and promote NRL's S&T projects and achievements at conferences, trade shows, and other events locally, nationally, and internationally. The Exhibit Office works with NRL Public Affairs, management, and subject matter experts to design and write text for these displays. TIS then graphically converts this sketched out information into professional, large-format posters that are then mounted on portable, pop-up display structures. These structures are shipped to the conference, where Exhibit staff are present to answer questions about NRL and the technology being exhibited. Accompanying brochures, smaller take-away posters, fact sheets, and informative CDs about NRL or the specific technology are usually available at the booth.

The Exhibit Office is also responsible for stationary displays such as the award cases, history exhibits, and equipment displays on view in NRL Bldgs. 43, 226, and 222.

Web site: <http://tid-www.nrl.navy.mil/>

### EQUIPMENT:

- Pop-up curved and flat, portable aluminum structures for wide-format posters in 8 x 8 ft and 8 x 10 ft sizes.
- Exhibit and display aluminum truss system at 20 ft x 14 ft x 1 ft
- Retractable banner displays at 32 x 88 inches.

### CONTACT:

Code 3430 • (202) 767-3678

### LOCATION:

NRL, Washington, DC

# Research and Development Services Division

- Chesapeake Bay Detachment



# Chesapeake Bay Detachment (CBD)



**FUNCTION:** Operates and maintains a unique land, sea, and air facility for NRL research in areas such as radar, electronic warfare, optical devices, materials, communications, and fire research. It has a variety of plant facilities and specialized equipment to support NRL and tenant research and development projects.

**DESCRIPTION:** The main site at Randle Cliff (Chesapeake Beach), Maryland, covers 157.6 acres contiguous to the Chesapeake Bay with a 0.75-mile waterfront. It is located in a relatively clear area away from congestion and industrial interference. The facility maintains towers for antenna support and a ship motion simulator. Off-site facilities include a 2.6-acre site with a 75-ft tower located 10 nmi east at Tilghman Island, Maryland, and small-craft berthing located in the town of Chesapeake Beach, 2 nmi north of the main site. A test control center for air and sea operations is available to researchers who use the NRL/CBD test range. The test range is a restricted zone directly east of the main site and extending across the bay.

Research watercraft include a 74-ft LCM 8 and a 22-ft Boston Whaler. These are used primarily in support of research projects and secondarily as transport to Tilghman Island.

**INSTRUMENTATION:** The principal investigator is responsible for all instrumentation and test equipment.

**CONTACT:**

Code 3522 • (410) 257-4002

**LOCATION:**

NRL, Chesapeake Beach, MD

# SYSTEMS

## DIRECTORATE

**Code 5300 – Radar Division**

**Code 5500 – Information Technology Division**

**Code 5600 – Optical Sciences Division**

**Code 5700 – Tactical Electronic Warfare Division**

**BACK TO CONTENTS**

## Radar Division

- Advanced Multifunction Radio Frequency Concept Testbed
- Radar Imaging Facility
- Airborne Early Warning Radar Facility
- Radar Signature Calculation Facility
- Compact Range Facility
- Airborne Surveillance Command and Control Research Platform
- Millimeter Wave Radar Facility
- Radar Test Facility
- Microwave Microscope

# Advanced Multifunction Radio Frequency Concept (AMRFC) Testbed



**FUNCTION:** The AMRFC testbed was developed as a proof-of-principle demonstration system that is capable of simultaneously transmitting and receiving multiple beams from common transmit and receive array antennas for radar, electronic warfare, and communications. These RF functions are controlled by common resource allocation manager (RAM) software over a real-time control network. New RF functionality may be readily added to the testbed as required for further demonstrations.

**DESCRIPTION:** Testbed electronics are housed in seven converted 20-ft shipping containers, or trailers. The arrays are mounted on a 15-degree tiltback in the ends of two of the trailers overlooking the Chesapeake Bay, emulating a possible shipboard installation. Packaging the testbed electronics into trailers provides the ability to support laboratory equipment in a protected environment, and provides options to transport testbed assets to other test locations, such as aboard ship. One set of stacked trailers is allocated to the transmit array and associated signal generation electronics. A second stacked trailer pair is allocated to the receive array and associated digital receiver, digital beamforming, and electronic surveillance receive electronics. A fifth trailer houses the testbed communication electronics, and the remaining two trailers provide the central processing, displays, and operations electronics.

Additionally, a portable power plant, dry air supply, and chiller unit provide the testbed power and array cooling.

**INSTRUMENTATION:** The testbed consists of separate active transmit and receive arrays that operate over the 6 to 18 GHz band (nominally). Current functionality includes a multi-mode navigation/surface surveillance Doppler radar, multiple communication links (line of sight and satellite), and passive and active electronic warfare capabilities. Additionally, several fixed dish antennas are located at the site for testing with equipment located at Tilghman Island. An over-the-air Ethernet link was also developed for remote control of Tilghman Island equipment.

## CONTACT:

Code 5303 • (202) 404-1945

## LOCATION:

NRL, Chesapeake Beach, MD

# Radar Imaging Facility



Radar Imaging Facility RAID storage system, real-time processor, and VLDS recorder units

**FUNCTION:** Provides the capability to produce real-time and non-real-time synthetic aperture radar (SAR) and inverse synthetic aperture radar (ISAR) imagery. This facility contains the processing, data storage, and image display and recording resources to handle data from a number of platforms and also serves as an environment for the development of advanced imaging algorithms.

**DESCRIPTION:** The general computing resources available include three Sun workstations, three SGI workstations, and two PC-based workstations (running Linux). In addition, there are two VME-based multiprocessor systems: one system with four I-860 processors and one system with 12 Power-PC processors, which provide real-time processing capability. Data storage is provided by two RAID systems, with a combined storage capacity of 650 GB. All systems are connected by a 100 Mbps network, which also provides connectivity to the other branch facilities. Video scan converters provide the capability to record the video from any of the workstations and real-time processors, and a separate video facility provides video editing capabilities.

**INSTRUMENTATION:** The facility provides very large data store (VLDS) data recorders for playback of data tapes and standard video generation and recording capability for the production of live video recordings. Two VME-based systems are available for interfacing other data recorders, custom interfaces, or other VME-based instrumentation.

**CONTACT:**

Code 5313 • (202) 404-1979

**LOCATION:**

NRL, Washington, DC



# Airborne Early Warning Radar Facility



Ten-element AAFTE airborne radar array antenna

**FUNCTION:** Collects, reduces, and analyzes airborne radar data and identifies, develops, and evaluates new techniques for improving the performance of airborne radars. Nearly all new techniques require radars employing multi-element, multichannel antenna arrays. Of particular interest is Space Time Adaptive Processing (STAP), a technique for optimizing radar detection performance in the presence of jamming and clutter.

**DESCRIPTION:** The facility includes a data and signal processing laboratory, and the 10-element Adaptive Array Flight Test Equipment (AAFTE) airborne radar array antenna and STAP laboratory. Data collected using the AAFTE antenna were used in the first successful demonstration of STAP processing.

**INSTRUMENTATION:** Includes an extensively modified APS-125 radar receiver system; a 10-element AAFTE antenna for collecting multichannel airborne array radar data; a rack-mounted STAP pre- and post-processor; a simulation and evaluation suite; and three UNIX computer workstations.

**CONTACT:**

Code 5313 • (202) 404-1993

**LOCATION:**

NRL, Washington, DC



# Radar Signature Calculation Facility

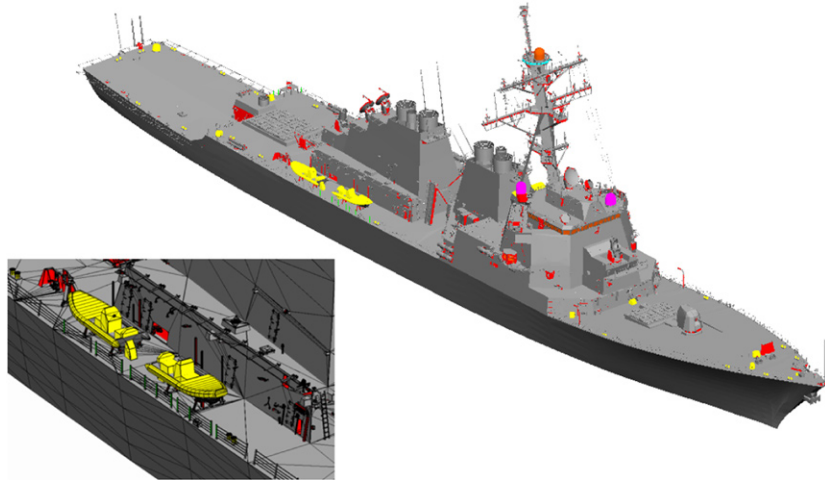

CAD model of USS *The Sullivans* (DDG 68)

**FUNCTION:** The calculation, analysis, and visualization of the spatially extended radar signatures of complex objects such as ships in a sea multipath environment and phased-array antennas. Radar signatures that are typically calculated include total radar cross section (RCS), high range resolution (HRR) profiles, and inverse synthetic aperture radar (ISAR) images. The facility has been used on numerous Navy programs including the design and live fire test and evaluation of the DDG 51 and LPD 71 class ships.

**DESCRIPTION:** The facility consists of several high-performance computers for calculating the radar signatures of complex objects such as ships and phased-array antennas. The radar signatures are calculated from computer-aided design (CAD) models that describe the geometry and material properties of objects. The facility includes models of the FFG 7, DD 963, DDG 51, CG 47, PC 9, LPD 17, and CVN 68 class ships. A large collection of CAD models of individual ship components such as antennas, weapons systems, and deck equipment is also available. The radar signatures of large objects are calculated using the Radar Target Signature (RTS) model. The RTS model is based on high-frequency scattering techniques and was developed by the Radar Division specifically for calculating the radar signature of ships in a sea multipath environment. The radar signature of smaller objects such as phased-array antennas can be accurately calculated using any of several low-frequency computational electromagnetic software packages available within the facility.

**INSTRUMENTATION:** The facility consists of an SGI Origin 2400 parallel computer with 32 processors and 32 GB of physical memory, SGI Fuel and dual-processor Octane graphics workstations with 2 GB of physical memory each, several smaller UNIX workstations and INTEL x86 computers, and a General Dynamics TACLANE KG-175 for secure communications with a shared facility containing two SGI Origin 3800 parallel computers (one with 128 processors and 128 GB of physical memory, the other with 48 processors and 48 GB of physical memory).

**CONTACT:**

Code 5314 • (202) 404-8602

**LOCATION:**

NRL, Washington, DC

# Compact Range Facility

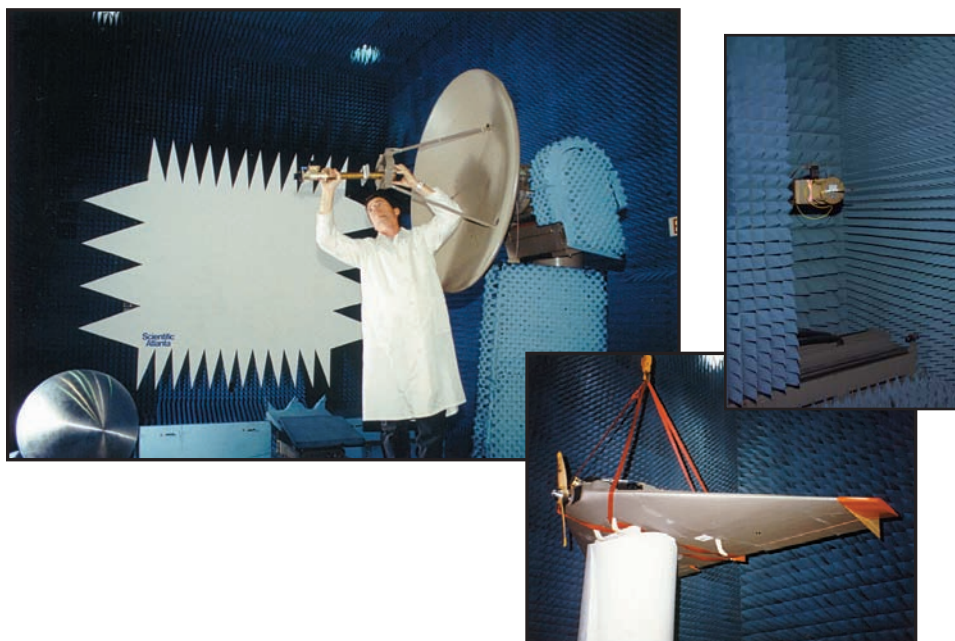

**FUNCTION:** Measures electrical properties and characteristics of antenna systems and performs radar cross section (RCS) measurements of objects. These data are used to verify and optimize the designs of new or existing platforms.

**DESCRIPTION:** The facility contains a Scientific Atlanta Model 5706M compact range reflector that produces simulated farfield conditions from 1 to 110 GHz with a quiet zone (maximum usable size) approximately 7 ft in diameter and 8 ft in length. The compact range reflector is housed in an environmentally and mechanically stable room that measures 20 ft x 20 ft x 40 ft. The chamber also includes a nearfield scanner capable of scanning a 12 ft x 18 ft region and can be configured for planar, cylindrical, or spherical nearfield testing. The system also incorporates a FARO Laser Tracker unit that optically tracks the test probe to within an angular resolution of 0.02 arcseconds. This enables the scanner to be operated at millimeter wavelengths without any performance degradation.

**INSTRUMENTATION:** The facility contains an Agilent E8362A microwave receiver (with external mixers) capable of operating from 1 to 110 GHz, a 5-axis positioner controller, a pulsed continuous-wave system used for RCS measurements, and a 2-axis nearfield scanner positioner unit. The data collection system is controlled by the FR 959 antenna/RCS software package and uses several computer systems for data analysis and acquisition. The software also includes inverse synthetic aperture radar (ISAR) imaging capabilities.

## CONTACT:

Code 5317 • (202) 767-6277

## LOCATION:

NRL, Washington, DC

# Airborne Surveillance Command and Control (ASC<sup>2</sup>) Research Platform



**FUNCTION:** Acts as a surrogate for carrier-based surveillance, engagement, communication relay, combat identification, and command-and-control capable assets of the evolving family of systems warfare architecture. In addition to the integrated AN/APS-145-based airborne early warning/cooperative engagement capability (AEW/CEC) suites, the aircraft is designed to accommodate command and control (C<sup>2</sup>), electronic warfare (EW), radar, and electro-optics (EO) research and development programs well into the next century.

**DESCRIPTION:** The NRL Airborne Surveillance Command and Control (ASC<sup>2</sup>) research aircraft is an NP-3D aircraft integrated with a full E-2C AEW Hawkeye 2000 suite and an Airborne CEC suite to support the Navy's future AEW/CEC network-centric warfare programs. In addition to the AEW/CEC installation, there are floor and ceiling rails to accommodate six additional operator/equipment consoles in the aft crew compartment, a free-fall sonobuoy chute, space for mounting up to 700 lb of equipment in the forward equipment area, and cross-decked Joint Tactical Information Distribution System (JTIDS) Class II equipment. External wing wiring is installed, including fiber optics to support six external electronic pods. The nose radome area has been fitted for a modified Infrared Radiation Detection System (IRDS) turret that can be lowered and raised to support electro-optics projects. Additional structure mountings

are in the nose and tail to accommodate the installation of project antennas. The aircraft can accommodate an additional internal payload of up to 2,800 lb, external payloads of up to 10,000 lb, and a crew of up to 16 people, including military flight crew and project scientists. The avionics suite includes a state-of-the-art, digitally controlled analog ICS system; dual INS; SATCOM; GPS; and seven ultra-high-frequency (UHF), four very-high-frequency (VHF), and two high-power high-frequency (HF) communications systems, all of which are secure communications capable and available for project use. Additionally, it is outfitted with four 90 kVA generators, wired to accommodate future growth of two 120 kVA generators.

**CONTACT:**

Code 5318 • (202) 767-3475

**LOCATION:**

NRL, Washington, DC

# Millimeter Wave Radar Facility



Shelters housing the high-power 94 GHz radar

**FUNCTION:** Experimental high-power 94 GHz tracking radar system (WARLOC) for use in research involving target cross-section measurement, propagation effects, radar imaging, cloud research, and other research that requires very high range and angular resolution.

**DESCRIPTION:** The WARLOC radar is housed in a relocatable radar facility that consists of two equipment shelters, a chiller for cooling the transmitter, and a 175 kVA diesel generator for use at remote sites. A 40-ft-long shelter houses the transmitter power supply, modulator, and gyro-klystron and incorporates structures to provide a pedestal base for the roof-mounted tracking antenna. A second 20-ft shelter contains the receiver, exciter, signal processing, and recording equipment. Data recording at rates up to 80 MB/s and a capacity of more than 80 GB is available. The transmitter is capable of producing 10 kW of average power with a variety of waveforms suitable for precision tracking and imaging of targets at long range. Waveforms with a bandwidth of 600 MHz can be transmitted at full power. A 6-ft Cassegrain antenna is mounted on a precision pedestal and achieves 62 dB of gain.

**INSTRUMENTATION:** Real-time radar control, signal processing, and image formation are accomplished with a VME-based system. An optical tracking system is mounted on the antenna to help in target acquisition at short range.

**CONTACT:**

Code 5306 • (202) 767-0253

**LOCATION:**

NRL, Chesapeake Beach, MD



# Radar Test Facility



Radar antennas in front of and on the roof of the Radar Test Facility

**FUNCTION:** Tests and evaluates basic concepts and engineering developments in connection with target surveillance, tracking, and electronic countermeasures.

**DESCRIPTION:** The Radar Test Facility is situated on top of a cliff, providing a simulated naval scenario overlooking the Chesapeake Bay. Antennas are located on the ground and the roof for the numerous developmental and product-line radar systems. Inside the building are the radar control rooms, transmitters, receivers, and data processing equipment.

**INSTRUMENTATION:** Current instrumentation includes the AN/SPS-49 radar; the AN/SPS-55 and AN/SPS-64 navigation radars; the Senrad radar, which uses a wide-band array mounted back-to-back with the AN/SPS-50 antenna; and antennas for the AN/SPS-40 and AN/SPS-10 radar systems. In front of the building are two precision tracking pedestals that were originally used for the FPS-16 and TPQ-27 radars but now have been modified for research use. Here also are two mobile research radar systems: the EDM version of the AN/SPQ-9B and the engagement radar, an X-band phased-array radar.

**CONTACT:**

Code 5321 • (202) 767-2999

**LOCATION:**

NRL, Chesapeake Beach, MD

# Microwave Microscope

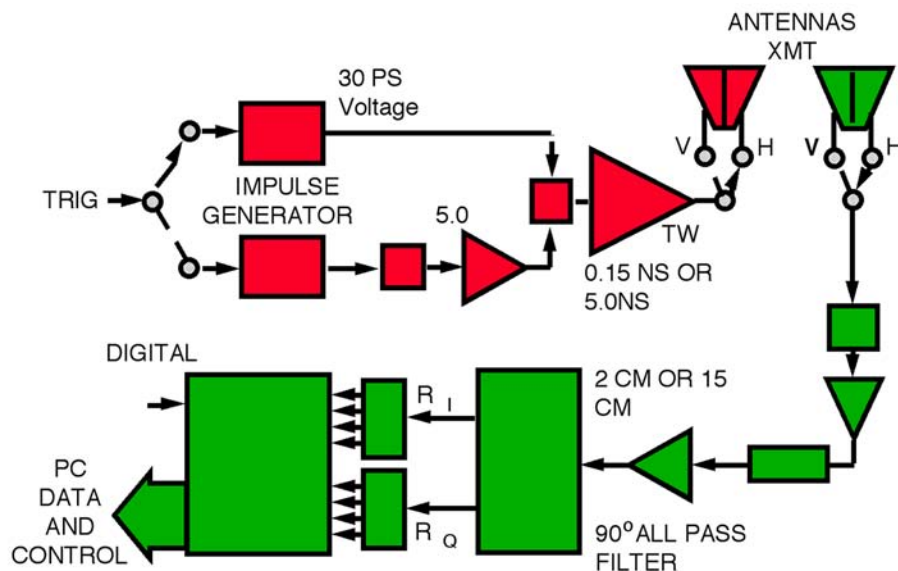

Block diagram of Microwave Microscope

**FUNCTION:** Makes ultra-high-resolution field measurements. The Microwave Microscope (MWM) has been used in support of several NRL experimental programs involving sea scatter and mine detection.

**DESCRIPTION:** The MWM, an ultra-wideband, ultra-high-resolution, dual-polarized measurement radar system, has been designed, implemented, and used in the field to measure ocean surface scattering at X-band frequencies. This experimental system uses a video-excited traveling wave tube (TWT) to produce 2-kW peak power transmit pulses as short as 150 ps in duration. Instantaneous receive bandwidths greater than 8 GHz are supported by a unique direct sampling detector that uses off-the-shelf digital sampling oscilloscope components. Data output consists of coherent I and Q measurements in a fixed number of range cells at re-sample periods as short as 25  $\mu$ s. Final system range resolution is better than 2 cm. The system has been used at a field site at the Atlantic Undersea Test and Evaluation Center (AUTEC), in the Bahamas, to measure ocean surface scatter under high wind and rough sea conditions, and in laboratory buried-object (in sand) identification studies.

**INSTRUMENTATION:** The MWM consists almost entirely of commercial off-the-shelf equipment. Antenna housings and polarization switching logic were designed and built at NRL.

## CONTACT:

Code 5348 • (202) 404-1876

## LOCATION:

NRL, Washington, DC



# Information Technology Division

- Freespace Communications Testbed
- Robotics and Autonomous Systems Laboratory
- Immersive Simulation Laboratory
- Warfighter Human-Systems Integration Laboratory
- Audio Laboratory
- Mobile and Dynamic Network Laboratory
- Integrated Communications Technology Test Laboratory
- General Electronics Environmental Test Facility
- Key Management Laboratory
- Cryptographic Technology Laboratory
- Navy Cyber Defense Research Laboratory
- Navy Shipboard Communications Testbed
- Virtual Reality Laboratory
- Motion Imagery Laboratory
- Global Information Grid Evaluation Facility
- Laboratory for Large Data Research
- Distributed Center for High Performance Computing
- Ruth H. Hooker Research Library

# Freespace Communications Testbed

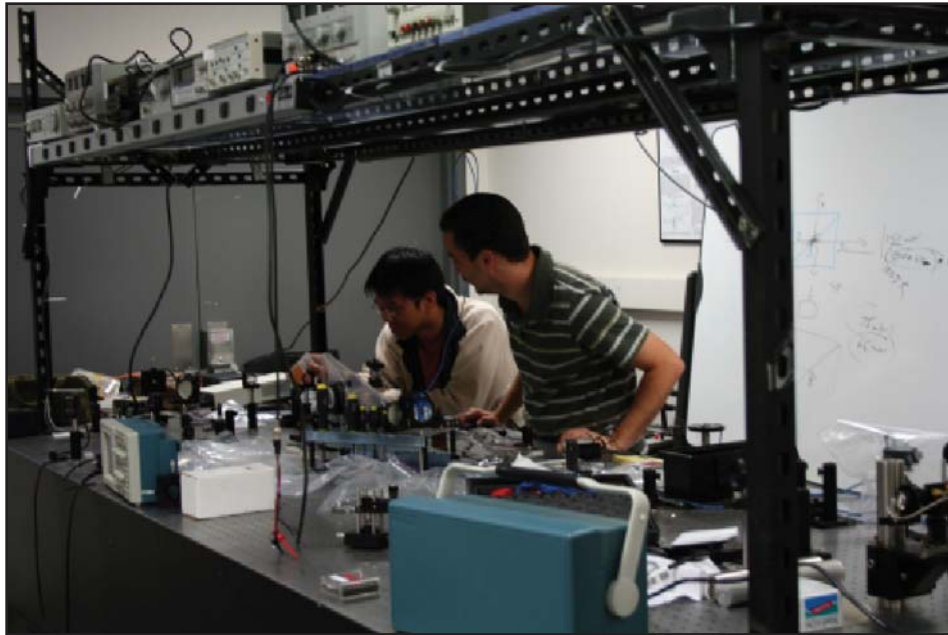

**FUNCTION:** Provides an environment to prototype and study devices and techniques to improve freespace optical and infrared communications. The laboratory is fully equipped with optics, electro-optics, lasers, electronics, and supporting instrumentation needed for automated data acquisition and control. Programs include 6.2 initiatives supported by ONR, DARPA, OSD, and NRL base funds.

**DESCRIPTION:** New concepts and approaches in freespace wireless infrared data links are explored in this lab. Projects include wireless router-based hybrid communications for "last mile" applications; combining adaptive optics with asymmetric retromodulator-based communications to extend range and data rate reliably; modulating retroreflector-based networking; atmospheric studies in a controlled, emulation environment; and analog modulation techniques for freespace optical communications. Subsystems and devices prototyped and tested at this lab are then brought to the NRL Laser Communications Testbed (LCTB) located at Chesapeake Bay Detachment for system tests in realistic marine environments.

**INSTRUMENTATION:** The laboratory is equipped with analog and digital oscilloscopes, function and signal generators, components for adaptive optics and wavefront control, lasers, optics, photometers with heads calibrated at various wavelengths, holders, motorized positioners, and other components required to prototype new ideas.

**CONTACT:**

Code 5505 • (202) 767-0170

**LOCATION:**

NRL, Washington, DC

# Robotics and Autonomous Systems Laboratory



**FUNCTION:** Provides an environment for developing and evaluating intelligent software for both actual and simulated autonomous vehicles. Laboratory computers provide a simulated environment for testing intelligent algorithms for land, air, and sea vehicles. The laboratory's several types of indoor and outdoor robot platforms serve as a testbed for robotics applications. The mobile robots are also available as test platforms for sensors, interfaces, and other technologies being developed by groups within NRL.

**DESCRIPTION:** The robot laboratory is a 1338 ft<sup>2</sup> facility that allows space for indoor operation of mobile robots and can be configured with obstacles or furniture to simulate expected working environments. A large research support vehicle adds the ability to transport mobile robots to offsite or outdoor worksites, provides its own power, and includes computer workstations for work in the field.

The facility maintains 20 mobile robots widely used in the robotics community, enabling the integration of outside research from other government, academic, and industry laboratories. The robots include models from Nomadic Technologies, iRobot, Segway, and ActivMedia. Researchers can assemble homogeneous or heterogeneous robotic teams for use in indoor or outdoor environments.

Proprioceptive sensors on the robots include odometry, a pitch/roll/yaw sensor, compass, GPS,

inertial position tracker, and tactile bumpers. Onboard rangefinders include sonar, active infrared, scanning laser lidar, structured light, and stereovision cameras. In addition to the robots' onboard computers, the lab employs Sun workstations, Linux PCs, Windows PCs, and Macs.

**INSTRUMENTATION:** In addition to the robots' autonomous capabilities, communication with stationary host computers is available via a wireless data network and a wireless video system, permitting distributed computing and feedback to remote users. Sensor data and robot performance can be logged on-board or offboard, tailored to the project as arranged by the principal investigator.

## **CONTACT:**

Code 5510 • (202) 767-2684

## **LOCATION:**

NRL, Washington, DC

# Immersive Simulation Laboratory

**FUNCTION:** Develops and tests novel user interfaces for 3D virtual simulators and first-person shooter games that make user interaction more like natural interaction in the real world. The goal is to design and implement interfaces that give users close to the same ability to move and coordinate actions as they have in the real world. The current emphasis is on developing interfaces to train Marines in tactics, techniques, and procedures for urban combat.



**DESCRIPTION:** The facility supports the development of a range of user interfaces, from high-end body-driven interfaces that fully track the user and present the image through a head-mounted display to device-driven interfaces such as one that customizes the control mapping of a conventional dual joystick game pad to give the user the ability to independently specify direction of viewing and direction of movement. The Immersive Simulation Laboratory (ISL) maintains a distributed simulation system for use as a testbed. It is networked and allows multiple users to interact in the virtual world simultaneously. It was originally developed as part of ONR's VIRTE (Virtual Technologies and Environments) program and is modified in-house as new features are needed. The interface software component is developed in-house and includes a flexible interface that allows for the rapid prototyping of new interface designs.

**INSTRUMENTATION:** Components support the development of new user interfaces that meet the evolving needs of the Navy and Marine Corps. The lab has a variety of motion capture systems, including inertial and passive and active optical; head-mounted displays; large screen displays; input control devices such as game pads and joysticks; graphics and audio rendering computers; and simulation software. ISL also has customized equipment including instrumented Airsoft rifles that register trigger pulls and a custom-built mechanical centering harness that limits the drift of a standing user wearing a head-mounted display.

**CONTACT:**

Code 5511 • (202) 404-8847

**LOCATION:**

NRL, Washington, DC



# Warfighter Human-Systems Integration Laboratory



**FUNCTION:** Develops and evaluates novel computer-based training platforms and approaches designed for the warfighter. The primary emphasis is on virtual environment training technologies and adaptive training techniques. Identification of individual and team performance measures is also a focus and may prove useful for enhancing the ability of autonomous systems to understand and interact with the warfighter in the field.

**DESCRIPTION:** The Warfighter Human-Systems Integration Laboratory (WHSIL) consists of a suite of rooms each containing a different virtual environment (VE) interface. These VE interfaces span the range from desktop PCs to high-end, 3D head-mounted displays with immersive body/head tracked technologies. They all utilize Joint Semi-Automated Forces (JSAF) as a behavior engine for driving the actions of computer-generated forces (CGFs). These systems are networked together providing a shared visual and auditory environment within which training experiments may be conducted. Software being developed in WHSIL will enable both performance metrics and physiologically-based cognitive measures (developed in WHSIL and elsewhere) to be evaluated as drivers for real-time training adaptations.

**INSTRUMENTATION:** The VEs are ONR-developed, government-owned, PC-based applications. VEs in the lab include desktop PCs, a front projection system similar to the Marine Corps' Indoor Simulated Marksmanship Trainer, and the high-end, 3D head-mounted displays with immersive body/head tracked technology. Additional technologies include a prototype multi-wall front projection system and a set of wearable wi-fi-enabled physiological monitors.

**CONTACT:**

Code 5511 • (202) 767-3960

**LOCATION:**

NRL, Washington, DC

# Audio Laboratory

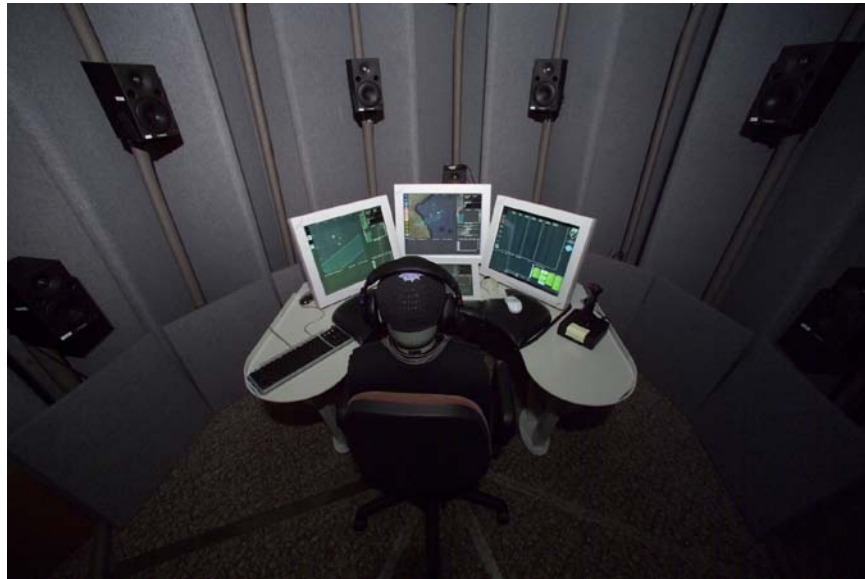

**FUNCTION:** Provides an environment and facilities for auditory display research. A primary focus is the performance use of binaurally rendered 3D sound in conjunction with visual information tasks. Support for personal and free-field (multi-person) virtual sound environments is provided, enabling the simulation of real-world audio information settings, such as Navy combat information centers. Support is also provided for the conceptual design and evaluation of auditory information at various levels of processing.

**DESCRIPTION:** This 300 ft<sup>2</sup> laboratory space incorporates two controlled listening environments. A 121 ft<sup>2</sup> sealed booth allows auditory studies to be carried out in sonic isolation, and a 13 ft circular enclosure allows free-field, immersive aural environments to be rendered for one or more listeners. Audio sources for the circular enclosure can be either pre-recorded or scripted. A number of software tools are available for sound editing and design, and binaural recordings can be made with an instrumented manikin. Software test beds for listening studies involving human subjects are run on Windows and Macintosh workstations maintained in the lab; these platforms function as clients for the laboratory's 3D sound server. An updated prototype of the Navy's four-screen multimodal watchstation is also maintained for use in research involving combined audio and visual information displays. The laboratory is additionally equipped to measure and analyze audio stimuli and ambient sound pressure levels.

**INSTRUMENTATION:** Sound design and real-time spatialization via head-related transfer functions and/or loudspeaker panning techniques are supported with a VR Sonic Sound-Sim rack and studio-quality digital-to-analog signal processing. Sounds are rendered with headphones and/or a circular, 28-unit loudspeaker array in an echo-attenuating enclosure. Additional instrumentation includes an inertial head-tracker, a Brüel & Kjær head-and-torso and Pulse system, an Earscan audiometer, and a fully sound-attenuating booth.

**CONTACT:**

Code 5515 • (202) 767-0491

**LOCATION:**

NRL, Washington, DC



# Mobile and Dynamic Network Laboratory



**FUNCTION:** Supports development and evaluation of next-generation communication technologies for mobile and dynamic data networks. This includes wireless meshes, mobile systems, and other disruptive communication environments relevant to DoD operations. The Mobile and Dynamic Network (MadNet) facility provides simulation, real-time network emulation, and specialized network measurement tools and methods. The facility supports a variety of sponsor organizations by performing research into next-generation networking concepts, including emerging Mobile Ad hoc Networks (MANET) technology and airborne networks.

**DESCRIPTION:** The MadNet Laboratory includes computing assets capable of conducting large-scale simulations of data communication networks, typically concentrating on mobile, wireless scenarios. The facility also uses high performance computer systems to emulate dynamic, wireless networks in a controlled environment. Mobile networks of more than 70 nodes have been emulated and the system can scale to larger network sizes if needed. The laboratory has laptop computers, hand-held personal computing platforms, and embedded systems to support field testing and demonstration of mobile computing environments including vehicular, man-portable, and autonomous (e.g. sensor) systems.

The laboratory also maintains the ability to rapidly prototype working advanced protocols and network communication applications. Laboratory prototypes are generally instrumented with sophisticated data collection and analysis capabilities. Example implementations include protocols for reliable data transport, real-time

communication (including voice, video, and other), collaborative computing, dynamic routing, and network self-configuration and organization.

**INSTRUMENTATION:** The laboratory enables quantitative measurement of protocol and network operation. Software capabilities include dynamic traffic generators capable of emulating characteristics of real network communication applications, and associated data analysis tools to examine different system performance aspects. The laboratory employs a variety of data visualization capabilities for real-time and post-monitoring of dynamic network operation in the test scenario environments. Special hardware instruments such as wireless protocol analyzers are also employed as needed.

**CONTACT:**

Code 5522 • (202) 767-2001

**LOCATION:**

NRL, Washington, DC

# Integrated Communications Technology Test Laboratory

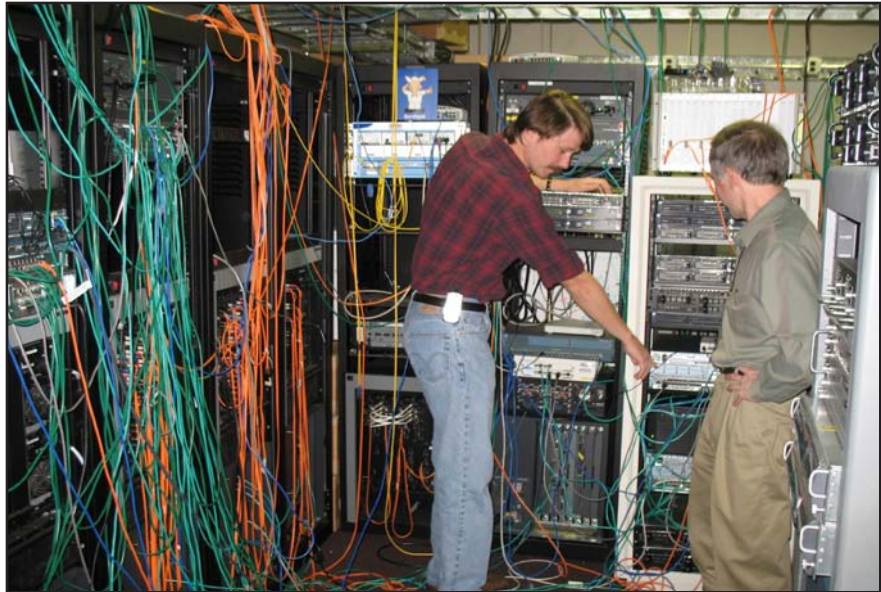

**FUNCTION:** Provides the capability to perform analysis, testing, and prototype development of high-speed wired and wireless networked data communication systems. It provides connectivity to both classified (SIPRNet) and unclassified (NIPRNet) networks through high-speed Ethernet and fiber optic interfaces with connections to the Defense Research and Engineering Network (DREN) to facilitate collaborative efforts with other DoD facilities.

**DESCRIPTION:** The Integrated Communications Technology (ICT) Test Lab provides a rapidly reconfigurable means to perform testing and evaluation of advanced networking technologies. In the past, this has supported multiple DoD programs such as Fleet Battle Experiments, Joint Forces Command Modeling & Simulation, Joint Experimentation, Joint Task Force (JTF) WARNET, and Dragon Warrior. It is an integral part of the Global Information Grid End-to-End Evaluation Facilities (GIG-EF). This facility provides the simulation and test environment required to support the research and development of advanced dynamic networking protocols, wireless communication, and network management for the Navy's future networking needs. This facility offers a unique capability to evaluate vendor capabilities that have potential benefits for Navy systems.

**INSTRUMENTATION:** Test equipment such as network traffic generators and analyzers, signal generators, and spectrum analyzers allow real-time injection and monitoring of wired and wireless (e.g., WiMax, 802.11x) traffic flows from simulated and "real world" data sources. Routers, switches, and interface adapters provide reconfigurable connectivity throughout the facility. Test Lab computers running NRL-developed software test programs tailored to meet specific test requirements can assess the performance of military and commercial off-the-shelf (COTS) equipment such as network radios, routers, and communications security (COMSEC) devices. Network performance parameters such as throughput, latency, jitter, and packet error rates are easily measured and documented.

**CONTACT:**

Code 5523 • (202) 404-2740

**LOCATION:**

NRL, Washington, DC

# General Electronics Environmental Test Facility



Simulation and response measurement equipment

**FUNCTION:** Provides resources for testing the performance and function of electronic equipment under conditions that the equipment could experience during the deployment to and installation in a Naval ship or Marine Corps tactical environment.

**DESCRIPTION:** Several laboratories are available to test electronic equipment to validate performance under the conditions described in MIL-PRF-28800F. The test conditions defined in MIL-PRF-28800F are designed to replicate the variety of environmental conditions that test equipment might experience when deployed to the Fleet.

**INSTRUMENTATION:** This includes automated electronic test equipment and instrumentation, phase noise measurement system, noise figure measurement system, precision spectrum analyzers, wideband signal generators, a 40 ft<sup>3</sup> environmental chamber, and an electromagnetic interference (EMI) test chamber located offsite. A variety of additional test equipment including signal generation, signal analysis, and stimulation and response measurement equipment are used in the performance validation of electronic equipment.

**CONTACT:**

Code 5524 • (202) 767-0327

**LOCATION:**

NRL, Washington, DC



# Key Management Laboratory



**FUNCTION:** Provides a secure environment to research and develop advanced electronic key management and networked key distribution technologies for the Navy and DoD. In conjunction with the Cryptographic Technology Laboratory, this lab also serves as a testbed for new key management components and key delivery protocols developed for the Electronic Key Management System (EKMS) and the emerging Key Management Infrastructure (KMI).

**DESCRIPTION:** The Key Management Laboratory is used to develop networked key distribution architectures, secure key delivery techniques, and protocols for enhanced key delivery to the warfighter. This lab serves as the development site for the Net Key Management Segment (NKMS) key server suite, key distribution guarding techniques, single point keying, and secure wireless key-fill techniques. Powered by a high-performance network of workstations, servers, databases, network security components, and state-of-the-art development tools, the lab supports development of key management applications and a secure client-server framework for netted key distribution. A secure software development environment provides for J2EE programming, web and database applications, XML programming, key distribution guard

development, and modeling of advanced protocols for key/data delivery over Ethernet and secure wireless networks. The lab is also equipped with EKMS components (current and prototype models), legacy and next-generation key-fill devices, and crypto key material to support interoperability testing and validation of new applications.

**CONTACT:**

Code 5541 • (202) 404-4884

**LOCATION:**

NRL, Washington, DC

# Cryptographic Technology Laboratory



**FUNCTION:** Provides a secure environment to research and prototype programmable cryptographic technologies for Navy and DoD applications in support of the Communications Security (COMSEC) Modernization Program. The lab also allows for development of certifiable COMSEC/Information Assurance (IA) products including Type 1 programmable cryptographic devices, cryptographic applications, and high assurance guards.

**DESCRIPTION:** The Cryptographic Technology Laboratory is a secure environment where COMSEC/IA research, development, and testing are conducted. Powered by a classified high-performance network of workstations and state-of-the-art development tools, the lab supports development of software, firmware, and hardware. Software stations provide for embedded software development for real-time cryptographic/guarding technology applications, via the use of computer-aided software engineering tools, embedded integrated development environments (IDE), compilers, real-time code debuggers, simulators, in-circuit emulators, and fabricated development boards. Firmware stations provide support for programmable logic design, VHDL coding and

verification tools for field programmable gate arrays (FPGAs), and other programmable logic devices. Hardware development stations are powered with the Cadence suite of computer-aided engineering tools that support schematic capture, digital design and simulations, printed circuit board (PCB) layout, and testing. The lab is also equipped with a testbed consisting of various end cryptographic units (ECUs) and cryptographic modules used by Fleet systems, useful for interoperability testing.

**CONTACT:**

Code 5541 • (202) 404-4884

**LOCATION:**

NRL, Washington, DC



# Navy Cyber Defense Research Laboratory

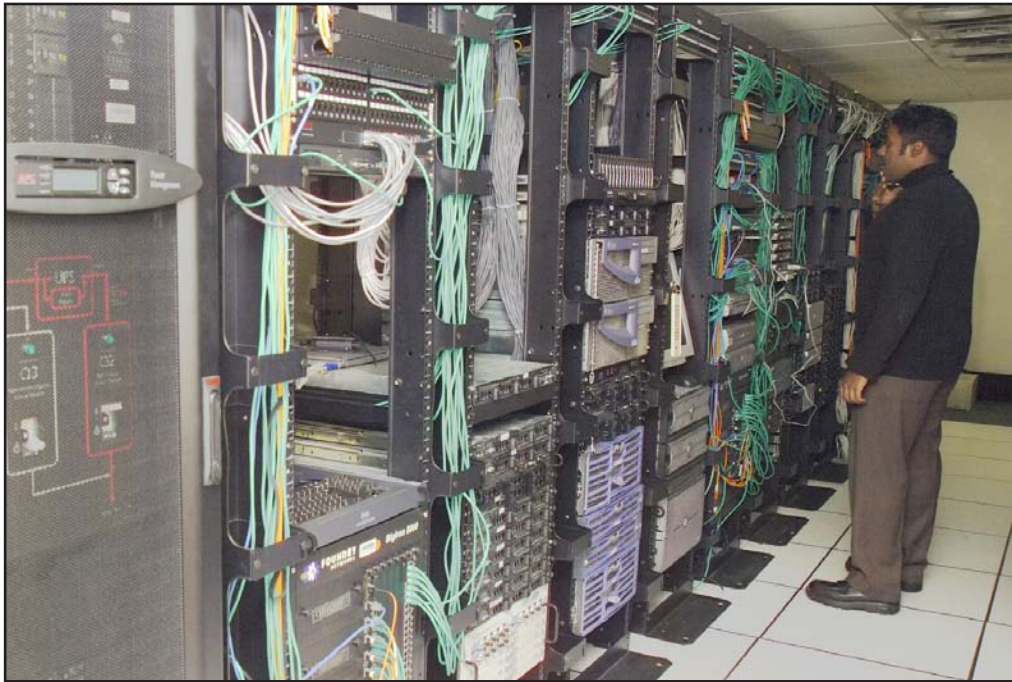

**FUNCTION:** Provides unique facilities for research into various aspects of Information Assurance (IA) and Computer Network Defense (CND). As the Navy's center of excellence for large-scale network security visualization, technological penetration testing, and reverse code engineering, the Navy Cyber Defense Research Laboratory (NCDRL) supports research that augments Navy and DoD network-centric warfare capabilities.

**DESCRIPTION:** NCDRL aims to equip the cyber-warriors at the front lines of defending the network with the tools and capabilities needed to accomplish their mission. NCDRL aims to provide a centralized and unobstructed view of threats and mitigation strategies to the Navy networks by facilitating research and development into CND problems specific to enclaves and applicable to the Navy enterprise as a whole. Fleet and DoD-wide IA initiatives (commercial off-the-shelf and government off-the-shelf) are critically evaluated and assessed prior to production deployment. NCDRL also leads DoD-wide efforts in malicious code analysis and reverse code engineering.

**INSTRUMENTATION:** NCDRL houses virtually every industry-standard security sensor and technology deployed in the Navy enterprise networks (which include ISNS, ONE-NET, and NMCI). The NCDRL research network supports a robust environment enabling the testing of a wide array of developmental security technologies. It can also be dynamically reconfigured to replicate Fleet Network Operations Center architectures.

**CONTACT:**

Code 5544 • (202) 767-9225

**LOCATION:**

NRL, Washington, DC

# Navy Shipboard Communications Testbed



**FUNCTION:** Provides resources for initial development and testing of new secure voice technologies for Navy shipboard applications.

**DESCRIPTION:** This laboratory consists of a suite of rooms configured with Navy shipboard communications systems. By replicating the tactical communications installations aboard ships, this facility provides the means to perform interoperability testing of emerging communications technologies. It also contains workspaces for the development of both the electronic hardware and the various levels of software (embedded to application level) that typically comprise communications devices.

**INSTRUMENTATION:** The core of the laboratory is the shipboard secure voice installation. This equipment consists of a single audio switch (SAS) 2112 Red Switch and the associated analog audio distribution system, which includes red-phone stations and several racks of tactical radios.

The laboratory also contains a Lucent Definity PBX and several stations of digital telephones. Both the red analog and the digital telephony systems are linked to other Navy installations to provide outside connectivity for more extensive testing.

**CONTACT:**

Code 5555 • (202) 404-8842

**LOCATION:**

NRL, Washington, DC

# Virtual Reality Laboratory

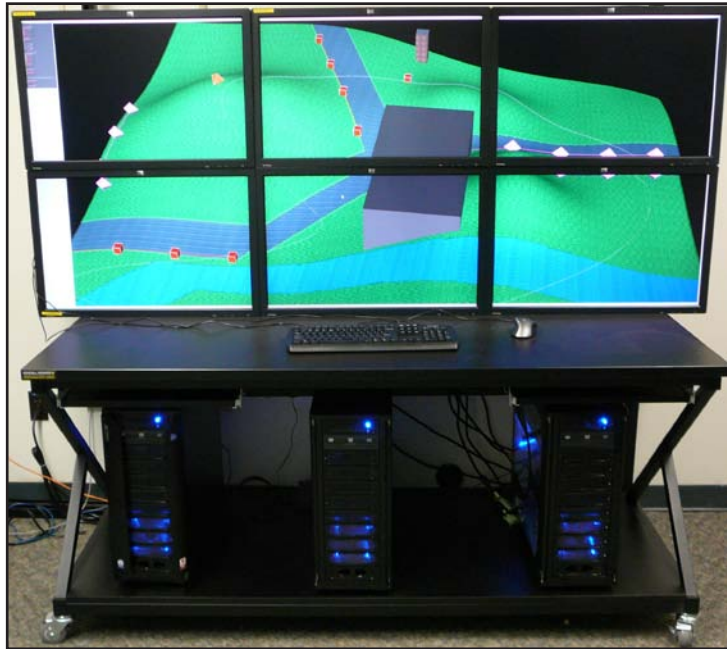

**FUNCTION:** Performs basic and applied research in interactive 3D computer graphics, including visual analytics, virtual environments, and augmented reality (AR). The Virtual Reality (VR) Laboratory is also used to visualize scientific, geospatial, and other databases that are large or contain varied data types. The VR Laboratory is also used to perform research into visualization and interaction techniques.

**DESCRIPTION:** Banks of tiled displays provide low-cost, high-resolution, immersive 3D environments. Our extensible, reconfigurable workbenches each have display areas of 80 x 34 inches. Special operating environments enable a single application to run over all tiles without modifications to the user software. Users may use 3D analogs of traditional interaction devices such as joysticks to control the viewpoint, display parameters, or data content.

The augmented reality system allows multiple users to go outdoors with backpack-worn or vehicle-mounted systems that display situation awareness information (e.g., street names, routes, phase lines, locations of other users) or information inserted by other users (e.g., a selected target). A variation on the software embeds virtual forces controlled by a SAF (semi-automated forces) system. Rooftop-mounted cameras allow users to be forward observers. A 3D command center application and an

indoor demonstration analog of the backpack system distribute real-time updates of information and mission-specific goals to mobile users.

**INSTRUMENTATION:** The VR Laboratory includes several high-resolution display workbenches constructed from multiple display tiles, PC clusters with programmable graphics processing units (GPUs), tracking and interaction devices, and 3D audio and voice recognition packages. The AR hardware includes wearable computers, optical see-through and video-mixing displays, and a wide array of tracking devices (GPS, inertial, ultrasonic, vision-based, and magnetic) suitable for indoor and outdoor uses.

## CONTACT:

Code 5581 • (202) 767-0380

## LOCATION:

NRL, Washington, DC



# Motion Imagery Laboratory



**FUNCTION:** Supports research in leading-edge progressive-scan imaging, high-definition television (HDTV), technology needed to process very high resolution images, and the impact on human perception with various presentation and image capture techniques.

**DESCRIPTION:** The Motion Imagery Laboratory (MIL) is a research environment that leverages high-end computational assets, networks, and applications to take advantage of leading-edge capabilities in state-of-the-art motion imagery with progressive-scan HDTV. The MIL is working with imagery requirements in the near term where multiple 1.5-Gbps data streams are needed to handle the raw output, and is progressing to 100 Gbps and higher in the near future. The MIL is used to assess innovative techniques in next-generation video teleconferencing. Research is conducted on the issue of large single streams on multi-gigabit networks over very long distances in real time, and on the visual tools to support next-generation motion imagery capabilities. The MIL provides an environment to assess collaboration in intelligence, digital Earth model, test and evaluation, and

other DoD needs where very high resolution imagery has an impact. The MIL supports work in compression technology, processing, transmission, and other technologies to allow access to high-resolution imagery by a full spectrum of users from average users at their desktops to those with the most demanding scientific and analytic needs.

**INSTRUMENTATION:** The MIL includes projection facilities for very high definition immersion with surround screens, extremely high resolution micromirror projection, progressive-scan studio cameras, recording/replay capabilities, and other tools for comprehensive work in this area.

**CONTACT:**

Code 5590.3 • (202) 404-7028

**LOCATION:**

NRL, Washington, DC

# Global Information Grid Evaluation Facility

**FUNCTION:** The NRL Global Information Grid Evaluation Facility (GIG-EF) is a federated research and development testbed that provides an unconstrained network infrastructure to demonstrate integration of leading-edge technology for the Navy/Marine/DoD warfighter and the intelligence community. A portion of GIG-EF is a unique, all-optical (OOO) national asset. The GIG-EF remains at the forefront of packet IPv6 technology. It employs a "rapid prototype" process to deploy, stress, and quickly transition hardware and software communications developments to operations by testing in a real-world distributed system engineering testbed. The GIG-EF works in conjunction with federated partners to couple optical switched and routed core paths to emulated TSAT satellite links and mobile JTRS edge assets. GIG-EF collaborators validate desired end-to-end performance of applications within a shared black core net-centric infrastructure.

**DESCRIPTION:** The GIG-EF is unique within DoD and the Federal government. No other test venue offers the ability to bring system and network designers, engineers, and end-users together on either formal evaluation and testing schedules or ad hoc experimentation schedules. The GIG-EF process stresses services to the breaking point and beyond "on a network that exposes interfaces early and often and can break!" The GIG-EF provides a CONUS-wide laboratory that leverages existing DoD operational test facilities that otherwise would remain isolated. The GIG-EF motto is: "One good test is worth a thousand engineering options!"

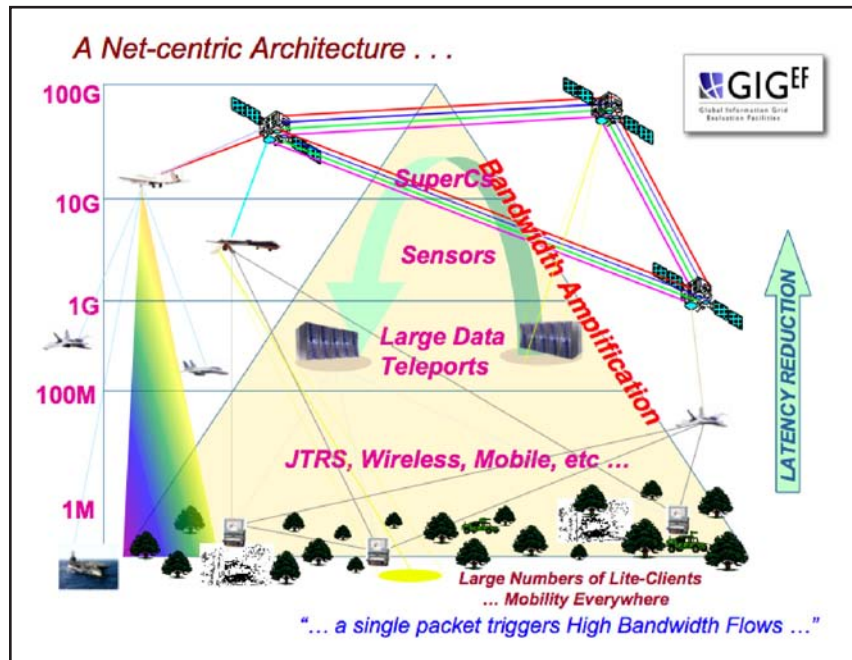

**INSTRUMENTATION:** The GIG-EF supports a variety of systems and instrumentation that can be used to stress and measure net-centric performance. Devices range from actual production network devices (switches, routers, etc.) to computing blade servers on which to develop and test prototype network protocols, delay generators, satellite emulators, edge devices, and encryptors. GIG-EF provides the complete suite of software performance monitoring capabilities that enable IPv4/IPv6 packet capture and analysis from Kbps to 10–40 Gbps. The GIG-EF federation of networks includes the all-optical research core that extends from NRL and the DC metro area to Boston; shared access to HPCMO DREN sites; and by arrangement, connection to DISA DISN CONUS/OCONUS services and National Lambda Rail and Internet2.

## CONTACT:

Code 5591 • (202) 404-7344

## LOCATION:

NRL, Washington, DC



# Laboratory for Large Data Research



**FUNCTION:** The Laboratory for Large Data Research (LDR) addresses a critical need to rapidly prototype shared, unified access to large amounts of data across both the local and the wide area. LDR focuses on developing a global “large data” (LD) cloud along with communications pipes to rapidly access and produce knowledge from the best information available fused from federated, distributed, real-time sensors and archived digital media assets. The LDR utilizes open source agent technology to ingest, store, access, process, fuse, display, and distribute traceback and reachback information over unconstrained lightpaths in real time between producers and consumers without regard to location.

**DESCRIPTION:** The LDR uses a proven “rapid prototype” process model to deploy, stress, debug, and quickly transition data-driven information technology to meet the global operational needs of DoD and the intelligence community. In virtually every data processing domain today, the volumes of data being captured, manipulated, stored, transported, and displayed are increasing superlinearly. Global access to timely information is a key enabler. The LDR goal is to provide coherent virtualization of enterprise services over terabit flows by developing advanced applications and prototypes that cannot be sustained by traditional technology infrastructures. Warehouse-sized facilities and workloads are likely to be common for near-real-time access of operational data across the global AOR, necessitating InfiniBand enable grids, clusters, farms, swarms, manycore processors, 100G networks, exabyte federated and distributed online data storage clouds, and object-based global file systems.

**INSTRUMENTATION:** The LDR is equipped with leading-edge, high-performance, shared and distributed memory processing assets, application-specific servers, massive storage arrays, and visualization systems interconnected seamlessly. Multicore supercomputers and manycore FPGA-enhanced systems and software capture complete transactional or streamed performance and net-ops information, and monitor information assurance end-to-end on a per flow basis. The Session Initiation Protocol (SIP) provides a LDR control plane for authorization and resource access, management of peer-to-peer transactions, end-to-end quality of service guarantees, multi-level precedence and pre-emption, and protocol stack optimization in support of open source service-oriented architectures.

## **CONTACT:**

Code 5591 • (202) 404-3132

## **LOCATION:**

NRL, Washington, DC

# Distributed Center for High Performance Computing



**FUNCTION:** NRL's Center for Computational Science is a Distributed Center (DC) in the DoD High Performance Computing Modernization Program (HPCMP). It supports leading-edge introduction of high performance computing to DoD. The Center makes available a range of shared resources, including massively parallel computer systems and high performance networks, to NRL, Navy, and other DoD scientific users.

**DESCRIPTION:** NRL's Distributed Center for High Performance Computing supports the introduction of a variety of leading-edge technologies in high performance computing (HPC). This includes the introduction or extension of new architectures such as cache-coherent Non-Uniform Memory Access (cc-NUMA) architectures where the application requires access to global shared memory and large single images to achieve results. In addition, large, clustered HPC architectures utilize emerging capabilities such as field programmable gate arrays (FPGAs). The Center not only operates and maintains supercomputers from Silicon Graphics (SGI), Cray, and others, but also supports the scientific users in porting their code to and using these high-end assets. User support includes the computing assets at NRL and the HPCMP assets at 20 other locations across DoD. The Center also has more than 200 terabytes of online shared rotating disk and robotic storage systems for

fileserving and archiving that currently holds 350 terabytes of multimedia data and is scalable to over a petabyte. HPC research extends to the high-performance networks needed for true distributed computing using leading-edge techniques such as InfiniBand across the Defense Research and Engineering Network (DREN) and the Advanced Technology Demonstration network (ATD-net). The networking efforts include transparent and ubiquitous computing, security and work in dense wave division multiplexing (DWDM), and switching in optical networks.

**CONTACT:**

Code 5594 • (202) 767-3885

**LOCATION:**

NRL, Washington, DC

# Ruth H. Hooker Research Library

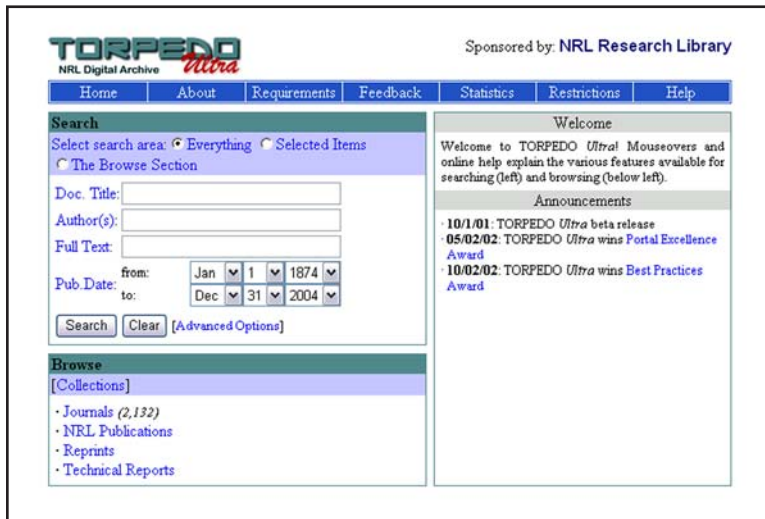

TORPEDO *Ultra*, one of the Web-based services available through the NRL Research Library

**FUNCTION:** NRL's Ruth H. Hooker Research Library offers a full range of traditional and digital library services to enhance and support the research program of the Naval Research Laboratory. Traditional library services include a physical facility for study and research, staffed with subject specialists and information professionals to assist researchers in locating and retrieving published information. A rich and extensive journal, technical report, and book collection has been created and maintained over the 80+-year history of the library. To enhance traditional services, the library is actively expanding the NRL Digital Library (<http://library.nrl.navy.mil>), which provides access to thousands of journals, books, and reference sources at desktops at NRL-DC, NRL-Stennis, NRL-Monterey, and the Office of Naval Research.

**DESCRIPTION:** The Library collections focus on physics, chemistry, electronics, and space sciences. They include 150,000 books and journal volumes, 4,000 current journal subscriptions, and over 2 million technical reports in paper, microfiche, or electronic format. The collections are regularly analyzed, organized, and updated to provide quick and easy retrieval of the most appropriate items. Services include the following: reference assistance in using the collections and locating information from external sources; mediated literature searches of several hundred online databases, including classified databases, to produce on-demand subject bibliographies; circulation of materials from the collection including classified literature up to the SECRET level; interlibrary loan and document delivery to obtain needed items from other scientific and research libraries or from commercial document providers; ordering

all journals for office retention; and user education and outreach to help researchers improve productivity through effective use of both the physical library and the Digital Library resources available through TORPEDO *Ultra* and the World Wide Web. The TORPEDO *Ultra* digital repository provides desktop access to more than 8 million full content items; thousands of research journals; hundreds of technical databases; and reference tools including Web of Science, SCOPUS, and INSPEC.

**EQUIPMENT:** Public access computers, photocopiers, color printer, microform reader/printers, and self-service digital sender.

**CONTACT:**

Code 5596 • (202) 767-2357

**LOCATION:**

NRL, Washington, DC

## Optical Sciences Division

- Fiber Fabrication Facility for Non-Oxide and Specialty Glasses
- Nanochannel Glass Technology Facility
- Organic Opto-Electronics Fabrication and Characterization Facility
- Fiber-Optic Optical-Microwave Laboratory
- IRCM Techniques Laboratory
- Missile Warning System Facility
- Infrared Range Facility
- Fiber-Optic Sensor Facility
- Oxide Optical Fiber Fabrication Facility
- Ground Station Exploitation Laboratory
- DIRCM Evaluation Facility



# Fiber Fabrication Facility for Non-Oxide and Specialty Glasses



**FUNCTION:** Unique facility for the research, development, and fabrication of non-oxide and specialty glasses and fibers in support of Navy/DoD programs.

**DESCRIPTION:** Three Class 100 clean rooms, covering approximately 1500 ft<sup>2</sup>, contain several fume hoods and inert gas dry-boxes for chemical handling. Resistance furnaces and RF induction furnaces are used for chemical purification and glass melting. Two state-of-the-art draw towers are used for fabricating fiber from specialty glasses under controlled atmospheres using two distinctly different techniques, the preform process and the double crucible process. The fibers fabricated at this facility possess low loss, high strength, and high threshold to laser damage. They are enabling many Navy/DoD applications.

**INSTRUMENTATION:** Equipment is available for characterization of glass physical, thermal, and optical properties. Infrared (IR) lasers and spectrometers are routinely used for fiber characterization.

**CONTACT:**

Code 5606 • (202) 767-5836

**LOCATION:**

NRL, Washington, DC



# Nanochannel Glass Technology Facility

Nanochannel glass draw towers housed in a Class 100 clean room



**FUNCTION:** Provides for the fabrication of nanochannel glass, a specialized composite glass material that has regularly spaced features on a nanometer-size scale. Nanochannel glasses are used in the fabrication of nanocomposite and nanopatterned materials.

**DESCRIPTION:** The Nanochannel Glass Technology Facility includes a state-of-the-art, fully automated, glass-fiber draw tower. This draw tower is specially equipped to permit the drawing of multielement fiber bundles. Nanochannel glasses are fabricated by first stacking thousands of composite glass fibers together in hexagonal-shaped bundles. These multielement bundles are drawn, using the draw tower, into boules that contain parallel arrays of fused nanometer-scale fibers or channels. The nanochannel glass boules are processed by slicing the boules into wafers that are subsequently etched, ground, polished, and characterized.

**INSTRUMENTATION:** The Nanochannel Glass Technology Facility is fully equipped to address all aspects of fabrication, processing, and characterization of nanochannel glass. Specific instrumentation includes:

- An 18-ft draw tower contained in a Class 100 clean room
- Computer control of downfeed, furnace temperature, and pinch wheels
- Optical microscopes
- Atomic force microscope
- Thermal analysis instrumentation: thermogravimetric analyzer (TGA), thermomechanical analyzer (TMA), and differential scanning calorimeter (DSC)
- Wafering, grinding, and polishing equipment.

## CONTACT:

Code 5610 • (202) 767-9468

## LOCATION:

NRL, Washington, DC

# Organic Opto-Electronics Fabrication and Characterization Facility



**FUNCTION:** Prepares and spectroscopically characterizes electro- and photo-active organic thin films. Fabricates and evaluates the performance of organic electro-optic, opto-electronic, and electronic devices such as light-emitting diodes, solar cells, and field-effect transistors.

**DESCRIPTION:** This state-of-the-art fabrication and characterization facility develops organic electro-optic, opto-electronic, and electronic prototype devices such as light-emitting diodes, solar cells, and field-effect transistors. Devices are prepared by sequential vacuum vapor deposition of organic and inorganic films on glass or flexible substrates. The deposition processes take place in separate adjacent chambers connected by gate valves. The samples are either rotated from one position to the next, or moved horizontally via magnetic arms. Spectroscopic characterization can take place in situ in vacuum and/or ex situ in a controlled-atmosphere chamber. The facility also provides capabilities for the growth and spectroscopic characterization of high quality electro- and photo-active organic thin films.

**INSTRUMENTATION:** A versatile, high-vacuum, multi-surface film deposition apparatus is available for the preparation of organic films and devices. The chamber

encloses a large, temperature-controlled (10–450 K) wheel that holds 14 substrates and four quartz crystal microbalances, and up to eight resistive heating furnaces for high-vacuum deposition. A Spex 270M monochromator outfitted with a liquid-nitrogen-cooled charge-coupled device (CCD) detector is used for spectroscopic characterization. A computerized, controlled-atmosphere experimental chamber equipped with a freezer and a microscope is available for handling sensitive chemicals, and for fabrication and characterization of prototype devices. The chamber houses several pieces of equipment such as an integrating sphere and a luminance meter for material and device characterization. A newly built ultra-high-vacuum (UHV) multi-chamber deposition apparatus interfaced to a controlled-atmosphere chamber is available for device fabrication (up to 5 in. diagonal) and sealing. This chamber will be soon moved and housed in a clean room at the Nanoscience Research Laboratory.

**CONTACT:**

Code 5611 • (202) 767-9470

**LOCATION:**

NRL, Washington, DC

# Fiber-Optic Optical-Microwave Laboratory

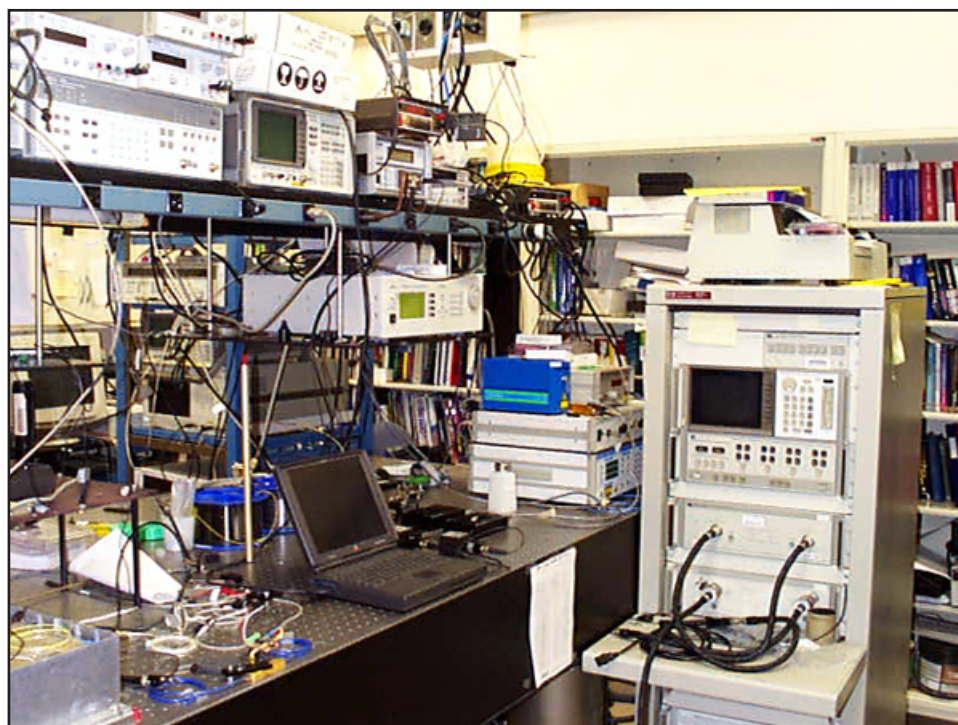

**FUNCTION:** Used to conduct programs of basic science and applied research in the development of laser sources, high-power fiber amplifiers, photonic control of phased arrays, antenna remoting, and microwave frequency conversion.

**DESCRIPTION:** The laboratory is equipped with state-of-the-art microwave and millimeter-wave (MMW) components along with a wide variety of fiber- and free-space optics. Microwave photonics derives its strength from the merger of microwave and fiber-optic techniques for the development of systems with greater than 100 GHz of operational bandwidth. This merger has enabled the development of photonic links for low-loss antenna remoting, true-time delay for squint-free beam steering, microwave frequency conversion, low-noise optical transmitters, and highly efficient photodetectors. In addition, the optical and microwave components used in these systems are commercially available and are improving with advances in the telecommunications industry. Research equipment includes a wide variety of microwave and optical test instruments and components enabling the development of optical techniques valuable for future Navy capabilities.

**INSTRUMENTATION:** The laboratory equipment includes an extensive array of microwave and optical test equipment. Optical and microwave components used in the lab are primarily commercially available and represent the state of the art in microwave photonics technology.

**CONTACT:**

Code 5650 • (202) 767-9360

**LOCATION:**

NRL, Washington, DC



# IRCM Techniques Laboratory



Open-loop rate table for hardware IRCM testing

**FUNCTION:** Assists the Navy and Marine Corps in the development of infrared countermeasure (IRCM) technologies and techniques for Fleet aircraft protection. Specifically, determines requirements for IRCM techniques to defeat infrared threats, imaging and reticle-based surface-to-air and air-to-air IR missiles, and forward-looking infrared (FLIR) devices. IRCM technologies and techniques include sensor damage, coherent and incoherent jamming, and expendable flares.

**DESCRIPTION:** The IRCM Techniques Laboratory performs open-loop hardware testing of “real” missile/sensor threat seekers as well as all-digital missile modeling and simulation analysis to determine countermeasure requirements to defeat the IR threat. The laboratory provides a comprehensive testbed for all types of IR countermeasures against a variety of IR threats. The facility includes advanced countermeasure sources for testing directed IRCM/advanced threat IRCM (DIRCM/ATIRCM) systems and a two-color multiflare/expendable hardware simulator for testing advanced expendable techniques against multispectral threats. The laboratory also has an extensive modeling and simulation capability for testing IRCM against both reticle-based and IR focal plane array based missile seekers.

#### **INSTRUMENTATION:**

- Two open-loop rate tables for IRCM testing of reticle and imaging IR seekers
- A 64-channel analog data acquisition system
- Three multiprocessor simulation workstations – SPARC, ALPHA, and MIPS machines
- One SGI 8-processor simulation super-computer.

#### **CONTACT:**

Code 5660.2 • (202) 767-2115

#### **LOCATION:**

NRL, Washington, DC

## Missile Warning System Facility



**FUNCTION:** Operates a classified facility for research projects dedicated to the development of missile warning systems for the self-protection of Naval aircraft. Participates in exploitation measurements of missile signatures. Simulates the acquisition, guidance, and aerodynamic performance of threat missiles. Measures and models sensor responses to threat signatures as well as the performance of detection and declaration algorithms.

**DESCRIPTION:** An extensive database of threat and background clutter signatures is maintained for developmental and fielded self-protection systems. Participation in field tests (missile live firings and overflights) ensures the data's relevance to the developmental effort. Simulations of threat missile engagements along with simulations of system hardware permit predictions of system performance. Recent activities include support for the AN/AAR-47 Missile Warning Set and the NRL Tactical Aircraft Directed Infrared Countermeasures (TADIRCM) System.

**INSTRUMENTATION:** Principal instrumentation consists of a network of computer workstations capable of hosting system data and the required system software simulations.

**CONTACT:**

Code 5663 • (202) 767-9530

**LOCATION:**

NRL, Washington, DC



# Infrared Range Facility



**FUNCTION:** Enables scientists to measure the infrared (IR) signature of scale aircraft or ship models in a controlled environment, to test the effectiveness of new signature suppression coatings, and to validate IR signature codes against range imagery. Simulates the IR environment from sea level to 30,000-ft altitudes, and provides viewing angles representative of standard IR threats, versatile control of scale model temperatures and orientations, and a low-cost alternative to IR field testing.

**DESCRIPTION:** The NRL Infrared Range Facility is a unique national user facility that serves the IR signature community. The range is a 14-ft-diameter, temperature-controlled, cylindrical enclosure that is treated with high-emittance coatings on the inner walls. The enclosure is surrounded by a 20-ft-diameter thermal chamber. Test articles are inserted through the roof of the chamber and can be viewed over a range of elevation angles from  $-20^{\circ}$  to  $+45^{\circ}$ . The test article itself can be rotated through  $\pm 180^{\circ}$ , tilted through  $\pm 45^{\circ}$ , and temperature-controlled through a variety of heaters and temperature-conditioned fluids. A midwave infrared (MWIR) source is available for semiquantitative solar simulations. The dry air atmosphere within the chamber has a dewpoint of approximately  $-70^{\circ}\text{C}$  and a  $\text{CO}_2$  level of below 1 ppm. Low  $\text{CO}_2$  levels are needed to minimize absorption in the  $\text{CO}_2$  absorption doublet near  $4.2\ \mu\text{m}$ . The low dewpoints are needed to minimize frost formation

on the chamber walls when configured for high-altitude conditions (long-wavelength infrared, LWIR). The chamber walls used to simulate the zenith sky can attain temperatures as low as  $-110^{\circ}\text{C}$ . The sky panels are coated with a new type of flocked black coating with a hemispherical reflectance below 0.2% throughout the IR. Without such a coating, the thermal radiation from the warm Earth panels would reflect from the sky panels and overwhelm the emitted radiation from the sky.

**INSTRUMENTATION:** State-of-the-art focal plane array cameras, low-temperature black-bodies, hemispherical directional reflectometers, and laser-based scatterometers for measuring the bidirectional distribution function.

**CONTACT:**

Code 5662 • (202) 767-3006

**LOCATION:**

NRL, Washington, DC

# Fiber-Optic Sensor Facility

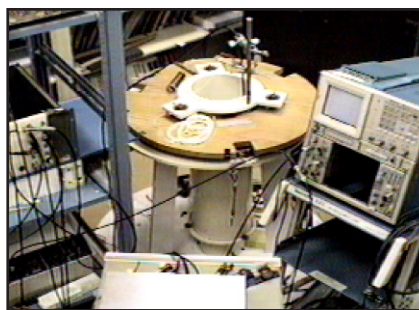
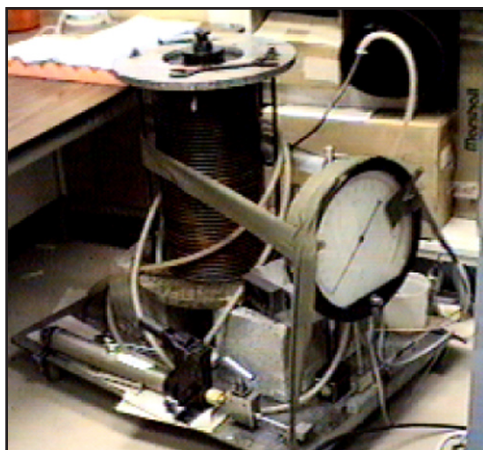

**FUNCTION:** Constructs and evaluates fiber-optic sensors for a variety of measurands. These measurands include acoustic, pressure, magnetic, and electric field as well as strain and rate of rotation.

**DESCRIPTION:** The sensor construction facility includes two Accuwinder coil winding machines, seven optical fiber fusion splicers, annealing facilities for magnetic materials, and facilities for degassing adhesives for potting purposes. The evaluation facilities include two computer-controlled data reduction and analysis stations, one optimized for acoustic sensors and the other optimized for magnetic sensors. There are two environmental chambers that operate from  $-50^{\circ}$  to  $100^{\circ}$  C for life testing of prototype sensors. The acoustic sensor evaluation facility also includes a pressure chamber for determining dc acoustic sensitivity as well as crush performance of prototype fiber-optic hydrophone designs (left figure above). Also available is a G-40 shipboard calibrator, which can operate over a 5 to 1000 Hz frequency range at ambient pressure and between  $4^{\circ}$  and  $35^{\circ}$  C (right figure above). The evaluation facility for rate of rotation sensors includes a Contraves rate table (1000 deg/s to Earth rate) and a suite of measurement equipment. The evaluation facility for magnetic sensors includes MuMetal magnetic shields for low noise measurements and an automated system for dynamic magnetization and Barkhausen noise measurements. The facility has optical test equipment to evaluate optical

sources as well as an optical time domain reflectometer (OTDR) and a Status Monitoring and Reliability Test System (SMARTS) to evaluate fiber-optic circuitry. A number of optical sources at 1.3 and 1.5  $\mu\text{m}$  wavelengths (including a tunable source) are also available.

**INSTRUMENTATION:** The facility uses seven Hewlett Packard 3562A and three Hewlett Packard 3582A dual-channel spectrum analyzers, one Hewlett Packard 3567 modular three-channel spectrum analyzer, three Tektronix single-channel spectrum analyzers, two HP 89410 network analyzers, three TEAC RD-200T 16-channel digital audio-tape recorders, and one RX-800 32-channel DAT recorder. Other instruments include an Anritsu MS 9710B optical spectrum analyzer and an HP 8509B lightwave polarization analyzer.

## CONTACT:

Code 5674 • (202) 767-1316

## LOCATION:

NRL, Washington, DC

# Oxide Optical Fiber Fabrication Facility

**FUNCTION:** Fabricates unique, state-of-the-art optical fibers based on pure or doped silica glass systems. It has the capability of fabricating both single-mode and multimode fibers doped with germanium, phosphorus, and fluorine and holey fibers containing photosensitive and/or laser-active elements. In addition, it can fabricate fibers with cores doped with high concentrations of laser-active ions such as erbium, ytterbium, and neodymium, together with aluminum. The facility supports Navy and DoD programs in fiber-optic sensing, nuclear radiation hardness, optical limiting, fiber-optic tethers, high-power fiber lasers, and small fibers with low visibility.

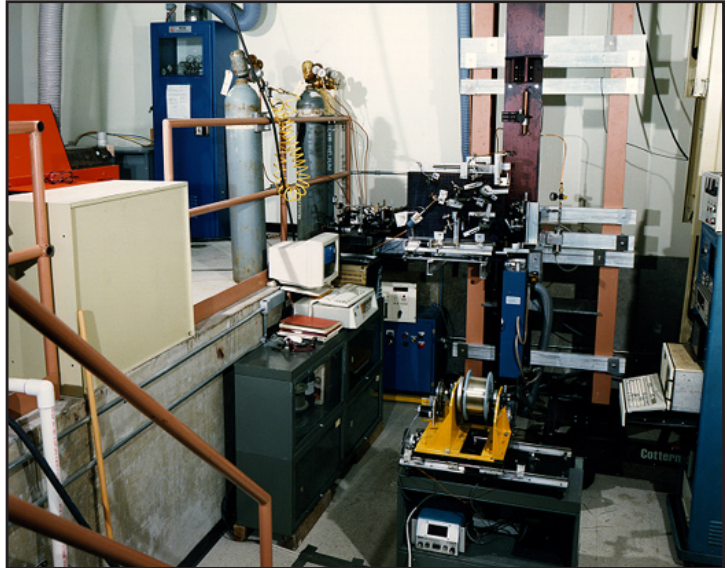

Fiber draw tower showing excimer laser and UV interferometer for fabrication of fiber Bragg grating arrays in line during fiber drawing

**DESCRIPTION:** The facility consists of two parts: the Preform Fabrication Laboratory and the Fiber Draw Laboratory. In the Preform Fabrication Laboratory, optical fiber preforms are fabricated using the modified chemical vapor deposition process. The optical cladding and core are deposited layer by layer, and then the preform is collapsed into a solid rod whose refractive index profile and core/clad ratio are preserved in fiber drawing. In the Fiber Draw Laboratory, the preform is slowly lowered into a high-temperature furnace at the top of the 24-ft draw tower. The glass softens and the optical fiber is drawn out of the bottom of the furnace; the fiber diameter and draw tension are monitored using noncontact techniques. Fiber Bragg gratings may be written into the fiber with short pulses of UV light from an excimer laser. The fiber is coated with a polymer to protect its surface and preserve its intrinsic strength.

**INSTRUMENTATION:** In the Preform Fabrication Laboratory, the reagent gases and rare earth chelate delivery systems are electronically metered. Deposition temperature and preform diameter are monitored, and a computer provides closed-loop control by varying torch temperature and exhaust back pressure. During drawing, the fiber diameter and coating concentricity are monitored with laser-based optical instruments. A non-contact instrument measures draw tension. In the grating writing process, the Bragg wavelength is computer controlled, and the computer also synchronizes the draw process with the firing of the pulsed UV laser to determine the spacing of the gratings along the fiber. The grating positions are marked with an inkjet bar code printer.

**CONTACT:**

Code 5675 • (202) 767-2270

**LOCATION:**

NRL, Washington, DC



# Ground Station Exploitation Laboratory



**FUNCTION:** Operates a facility for research, development, integration, and operation of multi-service/agency exploitation and control station systems. Performs real-time screening, geo-registration, target detection, and data-basing of tactical intelligence, surveillance, and reconnaissance (ISR) data. Simulates real-time concept of operations (CONOPS) environments and networked input and output dissemination interfaces. Provides comparisons of custom and COTS/GOTS exploitation tools and target detection techniques.

**DESCRIPTION:** Multiple databases consisting of deployed and emerging ISR sensor system data are stored for data-mining, target detection processing, and real-time screening/exploitation CONOPS development. Relevant mission data is obtained from national sources as well as from initiated airborne flight tests conducted to obtain specific target/background information. Example hosted exploitation systems include multiple Navy, USMC, Air Force, and other government agency systems.

**INSTRUMENTATION:** Principal instrumentation consists of networked computer workstations capable of real-time receipt of legacy and emerging tactical airborne ISR data acquisition systems. Systems operate at various classification levels.

**CONTACT:**

Code 5661 • (202) 767-9576

**LOCATION:**

NRL, Washington, DC



## *DIRCM Evaluation Facility*

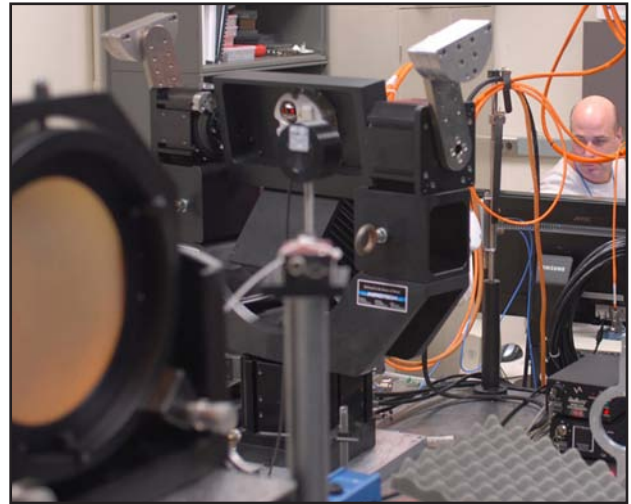

**FUNCTION:** Evaluates smaller Directed Infrared Countermeasure (DIRCM) systems, measuring such performance parameters as response times, field of regard (FoR), tracking sensitivity, laser spatial profile, and various pointing-related accuracies as bias, jitter, handover error, installation repeatability, and far-field divergence, all of which together allow the determination of Energy on Dome (EoD), the prime measure of performance, over a variety of operational conditions.

**DESCRIPTION:** This facility provides end-to-end testing of DIRCM systems, including both the Missile Warning subsystem and the active jammer. The calibrated virtual missile section mimics the signal presented to the system by an actual missile, thus providing an emulated threat to initiate tracking, declaration, and handover functions within the missile warning system, while allowing the stimuli to be tailored to facilitate measurements of particular characteristics. Resultant handovers to the jammer exercise its response, and allow similarly detailed measurements of its characteristics.

**INSTRUMENTATION:** The facility is equipped to support all aspects of DIRCM system evaluation: a two-axis Aerotech motion stage serves as a platform surrogate, providing both platform motion for end-to-end studies, and raster-scanning capability for more specialized investigations. A virtual missile simulator, comprising a blackbody source, an off-axis paraboloidal mirror, and a 124 x 124 broadband pyroelectric array, project an apparent missile into the field of view of the system under test, to probe the response of the system as a whole. Various other optics and additional instrumentation including high-speed detectors and power meters are also available.

**CONTACT:**

Code 5663 • (202) 767-3084 or (202) 767-5899

**LOCATION:**

NRL, Washington, DC

# Tactical Electronic Warfare Division

- Visualization Laboratory
- Transportable Step Frequency Radar
- Vehicle Development Laboratory
- Offboard Test Platform
- Compact Antenna Range Facility
- High-Power Microwave Explosive Laboratory
- RFCM Techniques Chamber Facility
- Search Radar ECM/EA Simulator
- Low-Power Anechoic Chamber
- High-Power Microwave Research Facility
- Electro-Optics Mobile Laboratory
- Infrared/Electro-Optical Calibration and Characterization Laboratory
- Infrared Missile Simulator and Development Laboratory
- Secure Supercomputing Facility
- CBD/Tilghman Island IR Field Evaluation Facility
- Ultra-Short-Pulse Laser Effects Research and Analysis Laboratory
- Central Target Simulator Facility
- Flying Electronic Warfare Laboratory
- Ultra-Near-Field Test Facility
- RF and Millimeter-Wave Laboratory
- Optics Laboratory
- Blackroom Laboratory
- Secure Computational Facility
- Human Perception Laboratory

# Visualization Laboratory

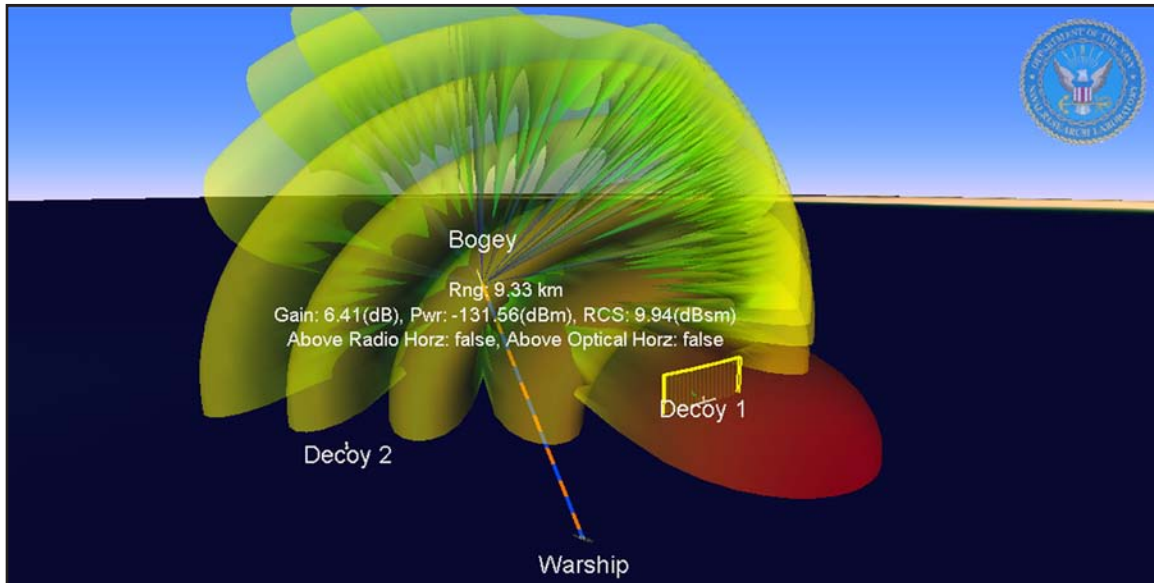

**FUNCTION:** Evaluates and improves the operational effectiveness of existing and emerging electronic warfare systems. By analyzing and visualizing simulation results and test data, the requirements in system design, tactics, and training are addressed.

**DESCRIPTION:** The Visualization Laboratory visualizes and analyzes scenarios to evaluate electronic warfare systems. It uses three-dimensional computer graphics to display parameters in an intuitive manner, providing depth, volume and spatial information. Several analysis routines exist to review the static and dynamic components of the simulation. Static analysis tools convey attributes such as number of platforms, missiles, and emitters used with the scenario, the location of emitters on various platforms, and their characteristics. Dynamic analysis tools convey information about time-variant components, the number of detectable emitters, their bearing, and operation mode. High resolution imagery overlaid on digital elevation data is used to provide an accurate representation of the geographical areas. Live data sources and multimedia interfaces to naval platform and Geospatial Information System (GIS) databases also exist.

**INSTRUMENTATION:** The Visualization Laboratory is equipped with advanced computer graphics workstations, software tools, a high fidelity sound system, acoustic wall panels, and a large video wall consisting of three Clarity Lion UXGA (1600 x 1200) display systems. The facility is supported by workstations running Linux, Solaris, and Windows operating systems.

**CONTACT:**

Code 5770 • (202) 767-6813

**LOCATION:**

NRL, Washington, DC

# Transportable Step Frequency Radar



**FUNCTION:** Provides a mobile facility to characterize and quantify the radar cross section (RCS) signature of ships and electronic warfare (EW) passive and active systems over the 8 to 18 GHz band and at 35 GHz. Additionally, the system can measure the effective radiated power (ERP), sensitivity, and other target signature characteristics of ships and active or passive EW systems over the same frequency range.

**DESCRIPTION:** The Transportable Step Frequency Radar (TSFR) facility consists of an I-band tracking radar, an optical designator to aid in target acquisition, a dual, 1-kW, broadband, traveling-wave-tube-based radar for ERP, RCS, sensitivity and other target characteristic measurements. Similar measurements can be made with the 35 GHz radar. Radar parameters such as pulse repetition frequency, pulse width, frequency, transmit polarization, and receive polarization are programmable. Measurements can be made with a selectable transmit polarization and received with pulse-by-pulse switched received polarization or dual received polarizations if required. The complete self-contained system is controlled from up to three operator workstations in an 8 × 24 ft instrumentation hut with all required antennas, cooling, and generator power mounted on a 45-ft trailer that can be moved to any test range where measurements are to be made.

**INSTRUMENTATION:** The instrumentation radar digitizes and stores on a pulse-by-pulse basis coherent data for a target of interest for post-test data processing. ERP, RCS data, sensitivity and other target characteristics are collected using fast analog-to-digital converters (ADCs) and data collection and storage systems. Data processing is very flexible; the data can be supplied in predetermined processing and display formats or can be tailored to user requirements. The instrumented data radar is calibrated using a combination of automated internal and external procedures.

**CONTACT:**

Code 5715 • (202) 767-1303

**LOCATION:**

NRL, Chesapeake Beach, MD



# Vehicle Development Laboratory



More than 300 prototype vehicles have been developed in the Vehicle Development Laboratory

**FUNCTION:** Supports the development of prototype deployment platform vehicles for offboard countermeasure systems.

**DESCRIPTION:** The Vehicle Development Laboratory is involved in technology development related to offboard countermeasure deployment platforms. This includes research in new airframe materials and fabrication techniques, low-cost flight control sensors and controllers, and low Reynolds number airfoil design. Full-scale and subscale remote control and autonomous prototype vehicles are fabricated and flight tested. Also, avionics subsystems, precision guidance, navigation, control, and deployment mechanisms are refined through flight testing aboard various remotely piloted test aircraft operated by the laboratory.

The Vehicle Development Laboratory has a substantial capability to fabricate airframe and mechanism test articles, light metalwork, and composite structures.

**INSTRUMENTATION:** The Vehicle Development Laboratory has supporting equipment and instrumentation associated with prototype flight testing such as radio control systems, miniature autopilots, video cameras, data collection systems for both onboard and RF telemetry, and a variety of sensors such as accelerometers, gyros, airspeed sensors, and altitude transducers.

**CONTACT:**

Code 5712 • (202) 767-4475

**LOCATION:**

NRL, Washington, DC

# Offboard Test Platform



**FUNCTION:** Measures the aerodynamic forces and moments and studies the airflow characteristics over offboard countermeasures deployment vehicles. Supports the development and testing of propulsion systems for deployment vehicles. This facility is especially suited to the study of subsonic low Reynolds number aerodynamics because of its low turbulence intensity.

**DESCRIPTION:** The Offboard Test Platform (OBTP) is particularly focused on the development of air vehicles designed to operate at low speed, low altitude, and low Reynolds number. The wind tunnel is a continuous flow design that operates over a range of 20 to 200 kts and has two interchangeable test sections. The aerodynamic test section has a 4 ft x 4 ft cross section and a full 3-axis, 6-component strain gauge balance. Models are attached to the balance "sting," which can be manually or automatically controlled to sweep through ranges of angle of attack and sideslip, while force and moment data are collected. The propulsion test section is used to

develop electric, internal combustion, and miniature turbojet engines. It features an open-jet test section and provides a simulation of in-flight airflow conditions.

**INSTRUMENTATION:** The aerodynamic test section has a full 3-axis, 6-component strain gauge balance; a 48-port scanivalve pressure measurement system; and an automated data collection system.

## CONTACT:

Code 5712 • (202) 767-4475

## LOCATION:

NRL, Washington, DC

# Compact Antenna Range Facility

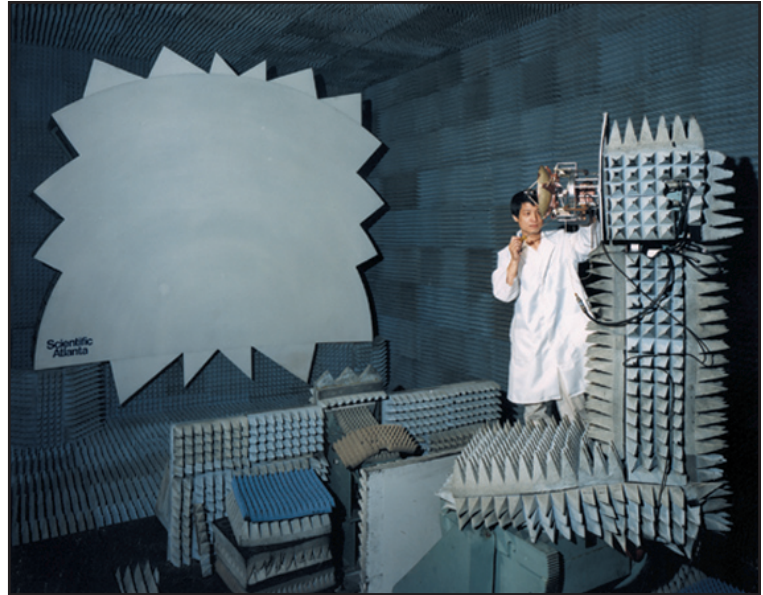

**FUNCTION:** Supports the measurement of phase and amplitude pattern characteristics of devices under test (DUT) over a frequency range of 2.0 to 110.0 GHz in a controlled environment. The facility also provides the capability for radar cross section (RCS) measurements over the same frequency range.

**DESCRIPTION:** The facility is an anechoic chamber that is designed to operate in conjunction with a Scientific Atlanta Compact Range Model 5751 with millimeter-wave (MMW) reflector. The Compact Antenna Range Facility consists of a shielded anechoic chamber (18 ft high x 22 ft wide x 40 ft long) and a geometry that enables farfield radiation patterns to be taken in a small space. Illumination of the MMW reflector at one end of the chamber provides a cylindrical quiet zone (4 ft diameter x 6 ft long) in which all the radiation patterns are measured. The quiet zone is specified to provide at least 45 dB of background noise isolation from 2.0 to 8.0 GHz and at least 50 dB from 8.0 to 94.0 GHz. The amplitude taper is specified to be no more than 0.5 dB over the quiet zone, with a corresponding specification of no more than 10° phase taper. Test antennas or subsystems are positioned by attaching them to an azimuth-over-elevation mount. Further degrees of freedom (DOF) are allowed with the mounting point being on a roll axis and the entire positioner on a slide axis. A second roll axis is provided for source illumination and enables the source polarization to be quickly rotated.

**INSTRUMENTATION:** The Compact Antenna Range Facility uses a complete complement of microwave laboratory instrumentation, including network analyzers, microwave receivers, spectrum analyzers, frequency counters, power meters, function generators, and microwave synthesizers. Antenna and RCS measurements are made using a Hewlett-Packard 8530 microwave receiver coupled with Orbit/Flam & Russell 959 Plus Antenna and RCS Measurement software. RCS measurements are visualized and analyzed using KNOWBELL software from Aeroflex Inc. Four simultaneous channel measurements can be made to characterize an antenna or the RCS of a target from 2.0 to 110 GHz. Broadband, dual-polarized source antennas are available from 2.0 to 26.0 GHz. A high-speed source switch coupled with a 16-channel switch matrix supports 32-channel dual-polarized measurements from 2.0 to 26.0 GHz or 16-channel single-polarized measurements from 2.0 to 50.0 GHz.

**CONTACT:**

Code 5733 • (202) 404-3014

**LOCATION:**

NRL, Washington, DC



# High-Power Microwave Explosive Laboratory



Lexan blast chamber

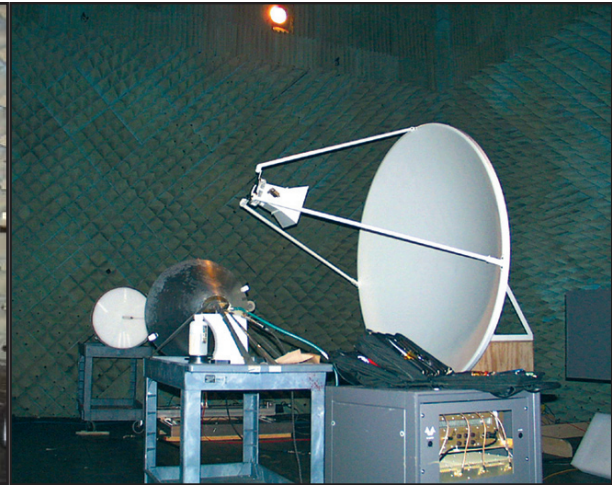

12-ft dish antenna

**FUNCTION:** Develops and evaluates the effectiveness of high-power microwave waveforms for the disruption of electronic systems. Included in the facility are an anechoic chamber, Lexan blast chamber, nearfield focusing dish antenna, and associated RF sources and instruments. High power RF frequencies between 0.6 and 40 GHz may be used inside the anechoic chamber. RF interactions with explosives can be explored using the Lexan blast chamber inside the anechoic facility.

**DESCRIPTION:** The facility is used to explore explosively generated RF systems and the interactions of RF on explosive materials. A storage locker in the facility is cleared to store explosives in small amounts and the blast chamber is rated for up to 0.01lbs of explosive or three blasting caps. Explosives may be characterized using various instruments before and after being exposed to RF. The nearfield focusing antenna allows for high intensity RF fields directed into a spot. This allows component-specific exposure to RF of complex systems. The anechoic chamber is 24 ft wide x 30 ft long x 50 ft high.

**INSTRUMENTATION:** The facility contains sources, RF measurement equipment, and data acquisition instrumentation. Available RF sources include high-power traveling wave tubes (TWTs), solid state devices and magnetrons to provide both continuous and short-pulse high-power RF. Antennas covering multiple frequency ranges are also available. Survey meters are available for measuring RF inside and outside the chamber along with a variety of power meters and associated probes. High-speed scopes and spectrum analyzers are also available for the measurement and analysis of waveforms. A network analyzer may also be used to carry out circuit measurements.

## CONTACT:

Code 5745 • (202) 404-2466

## LOCATION:

NRL, Washington, DC



## *RFCM Techniques Chamber Facility*

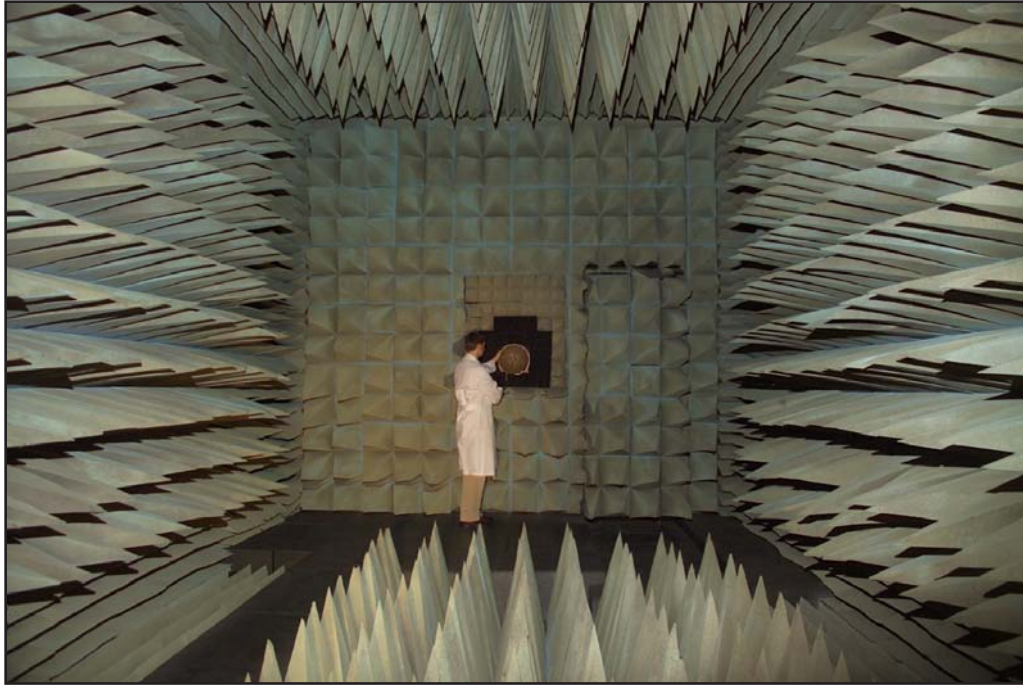

**FUNCTION:** Provides the capability to develop radio-frequency countermeasure (RFCM) techniques in a controlled environment from 2.0 to 40.0 GHz. The configuration of the chamber allows for direct illumination of a target system from an electronic countermeasure (ECM) system.

**DESCRIPTION:** The facility is a shielded anechoic chamber that is 39 ft 3-1/2 in. long x 17 ft 1 in. wide x 16 ft 1-3/8 in. high. This chamber is equipped with a moveable end wall at the east end of the chamber and a single quiet zone located adjacent to the fixed end wall at the west end of the chamber. The quiet zone is 4 ft long x 4 ft wide x 4 ft high. The center of the quiet zone is located on the chamber boresight axis and 2 ft from the absorber tips on the fixed end wall. Target systems are positioned by attaching them to an azimuth-over-elevation mount located in the main control room of the chamber. The system antennas extend through an opening in the wall centered in the quiet zone of the chamber. For servicing, the mount is located on a track that allows it to be rolled back into the control room. The ECM systems are located on the other end of the chamber behind a moveable absorber wall. The ECM antennas are mounted to or placed in front of the opposite wall.

**INSTRUMENTATION:** This facility has no dedicated instrumentation; users supply both the target and ECM systems.

**CONTACT:**

Code 5733 • (202) 404-3014

**LOCATION:**

NRL, Washington, DC

# Search Radar ECM/EA Simulator



Search Radar ECM/EA Simulator (left), AN/SPS-66 PPI (center), and coastal defense radar (right)

**FUNCTION:** Tests the effectiveness of electronic countermeasures/electronic attack (ECM/EA) equipment and techniques for jamming airborne search and targeting radars.

**DESCRIPTION:** The Search Radar ECM/EA Simulator (SRES) is an electronic laboratory for developing EA techniques and for testing EA equipment. It simulates the engagement between an airborne threat search radar and a group of surface ships and aircraft that use EA as part of their defense. The simulation generates RF signals in real time that would be present in the threat radar receiver as measured from the radar echoes and EA. These signals are processed by the radar receivers and presented on radar displays for man-in-the-loop determination of EA effectiveness. An effective EA prevents the radar operator from determining the preferred target's location.

The simulator is housed in a room having both 60- and 400-Hz electrical power. A personal computer interfaces with the microwave attenuators and switches to generate the simulated radar signals and provides the controls for the desired scenario under test. SRES uses human radar operators to achieve actual man-in-the-loop target determination and EA effectiveness.

**INSTRUMENTATION:** Resident EA equipment includes noise sources, false target generators, and AN/SLQ-32 techniques generators. Radar equipment includes a coastal defense radar system, two plan position indicators (PPIs), A and B scopes, and other radar receivers. Additional data recording devices are a radar scan converter (RSC) providing S-VHS video recording and monitoring of radar video presentation, various oscilloscope displays, and microwave spectrum analyzer with plotter for recording its display presentation.

## CONTACT:

Code 5742 • (202) 767-9120

## LOCATION:

NRL, Washington, DC

## Low-Power Anechoic Chamber

**FUNCTION:** Develops and evaluates the effectiveness of electronic attack (EA) techniques against antiship cruise missiles. All terminal countermeasures programmed in the active AN/SLQ-32(V) area threat libraries are developed, tested, and evaluated in this facility in open- and closed-loop test configurations. Measures of effectiveness of the EA waveforms against the missiles are obtained through closed-loop testing.



**DESCRIPTION:** The hardware-in-the-loop facility is instrumented to test antiship missiles operating in the I and J bands of the frequency spectrum with the capability for up to two targets, such as a ship and chaff, in the scenarios. The two targets alternatively can also be implemented to simulate two ships, each having an onboard active electronic warfare (EW) system. Missile radar seekers are mounted on a two-axis pedestal that allows closed-loop evaluation in the azimuth and elevation planes. The engagement and associated kinematics are developed using computer-controlled interactions between the pedestal and fixed and moving horns. The fixed horn is implemented using synthetic line of sight. Signals radiated in the direction of the missile radar seeker simulate targets as seen by the missile seeker, including pulse-by-pulse seeker antenna patterns, ship cross-sectional area, range attenuation, and scintillation effects. EA returns are radiated to also include the effects of seeker antenna patterns, range attenuation, and realistic jamming-to-signal ratios. The missile autopilot aerodynamics modeling is done in real time using

an Applied Dynamics Real-Time System (ADRTS) with the capability of collecting and displaying more than 50 channels of data. The antiship missile model library includes many of today's threats.

**INSTRUMENTATION:** EA equipment includes operational Fleet techniques generators, advanced waveform generators with capability to do cross-pole jamming, and a digital RF memory unit (DRFM) to replicate frequency agile return signals delayed in time and closing at antiship missile velocities. The facility instrumentation assets include an Astro-Med strip-chart recorder, RF spectrum analyzers, oscilloscopes, RF power meters, and microwave sources for generating target signatures, including traveling wave tube (TWT) and solid-state, microwave, and wideband amplifiers.

**CONTACT:**

Code 5743 • (202) 404-7672

**LOCATION:**

NRL, Washington, DC



# High-Power Microwave Research Facility

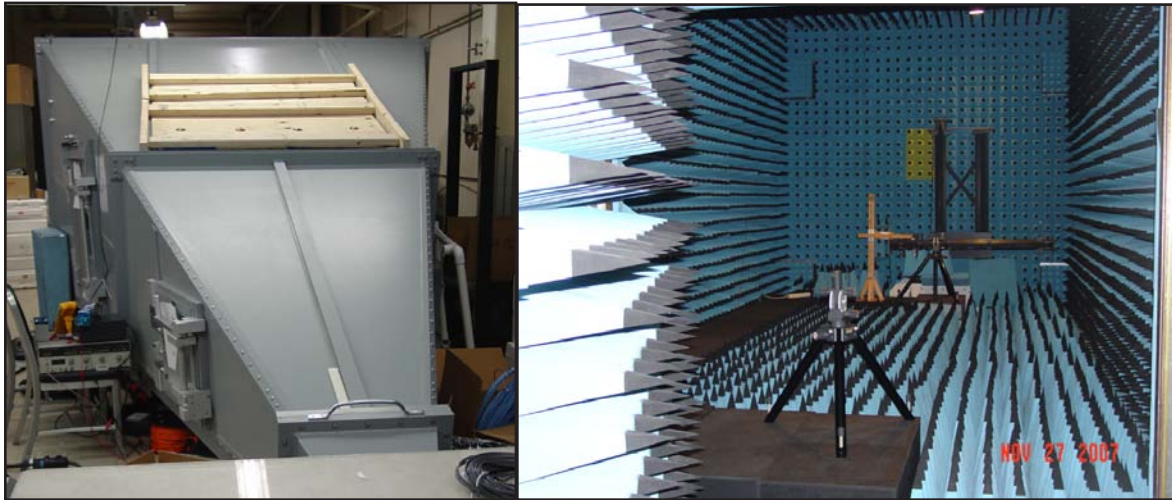

**FUNCTION:** Develops and evaluates the effectiveness of high-power microwave waveforms for the disruption of electronic systems. Included in the facility are an anechoic chamber, gigahertz transverse electromagnetic (GTEM) cell, associated RF sources and instruments, and a 32-processor Beowulf cluster. High-power RF frequencies between 0.6 and 100 GHz may be used inside the anechoic chamber, while frequencies between 0.6 and 20 GHz may be used inside the GTEM cell. Simulation and analysis may be carried out with the Beowulf cluster.

**DESCRIPTION:** The facility is used to test the response of electronic systems to high-power RF waveforms. Primary interest is in the disruption of the function of a system using out-of-band waveforms, i.e., waveforms with frequencies that are not the normal operating frequencies of the device. One of the objectives is to find waveforms that may disrupt a large number of systems with power levels that are as low as possible. Positioners are available to displace device(s) under test or the radiating antenna to obtain angular information. The performance of the system is monitored to determine the portion of the system that was affected by the RF waveform. More invasive instrumentation may also be used to determine point of entry. The facility is also used to develop techniques that will harden systems to RF attack. Once RF susceptibilities and RF entry points are determined, hardening techniques may be evaluated to determine the level of protection provided.

**INSTRUMENTATION:** The facility contains sources, RF measurement equipment, and data acquisition instrumentation. Available RF sources include high-power traveling wave tubes (TWTs), solid-state devices, and magnetrons to provide both continuous and short-pulse high-power RF. Horn antennas covering multiple frequency ranges of interest are also available. Survey meters are available for measuring RF inside and outside the chamber along with a variety of power meters and associated probes. High-speed scopes and spectrum analyzers are also available for the measurement and analysis of waveforms. A network analyzer may also be used to carry out circuit measurements.

## **CONTACT:**

Code 5745 • (202) 767-5746

## **LOCATION:**

NRL, Washington, DC



# Electro-Optics Mobile Laboratory

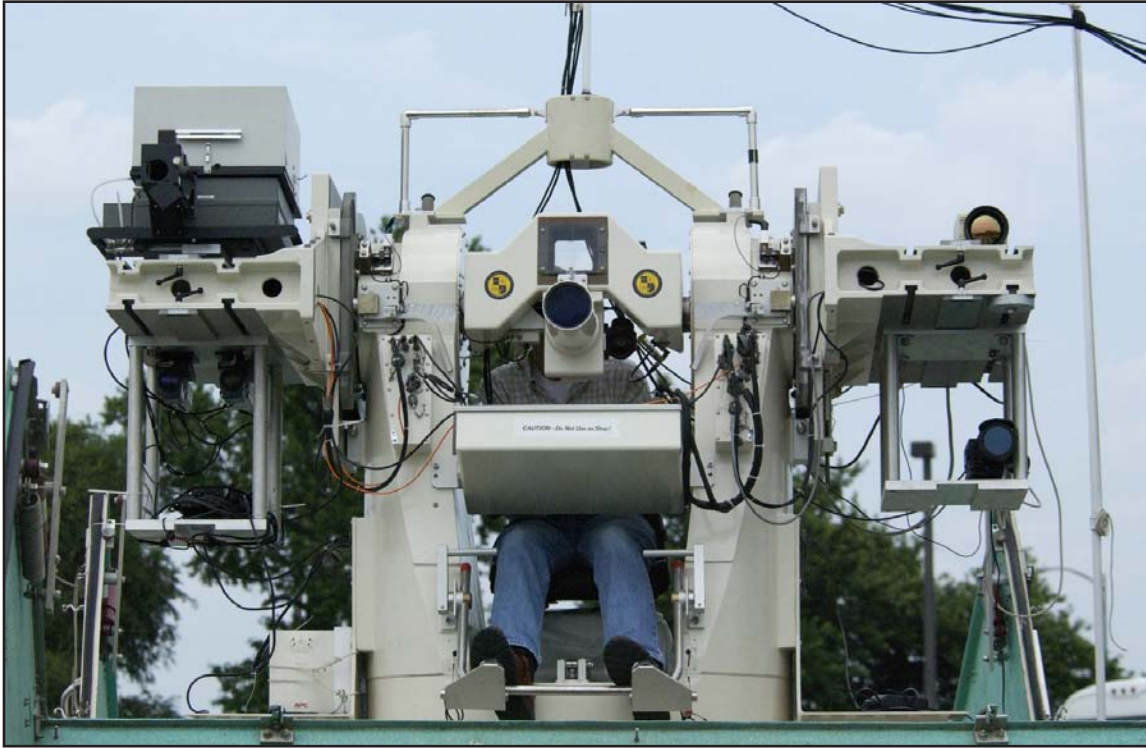

**FUNCTION:** Provides quantifiable IR spatial and spectral radiometric measurements of various types of targets. Typical targets are ships, aircraft, or IR decoys.

**DESCRIPTION:** The Electro-Optics (E/O) Mobile Laboratory is a specially modified, fully instrumented vehicle and a trailer-configured precision tracking mount. This facility provides the work space, storage, and power for instrumentation racks and their operators. Front-end optics and electronics are boresighted on the Kineto tracking mount to provide a stable platform. The mount provides motions of 640° azimuth and 90° elevation at up to 60°/s. Full velocity can be reached within 1 s from a standing position with a full load of 300 lb on each arm along with the operator. This mobile laboratory is outfitted for visual and IR imagery, which can be used for tracking or spatial measurements. High-precision IR radiometers and interferometers provide calibrated measurements in the 3 to 5  $\mu\text{m}$  and 8 to 12  $\mu\text{m}$  bands. A full data acquisition system permits archiving and prompt data reduction.

**INSTRUMENTATION:** E/O Mobile Laboratory test equipment includes weather, ranging, video, and electro-optical instruments. Radiometric and imaging instruments are calibrated and characterized before each test. Equipment currently in use includes a Bomem MR254 high-speed Fourier transform infrared (FTIR) interferometer spectrometer (1.5 to 14  $\mu\text{m}$ ), Indigo Phoenix MW (3 to 5  $\mu\text{m}$ ) and LW (8 to 9  $\mu\text{m}$ ) imagers, and an Indigo Merlin imager (3 to 5  $\mu\text{m}$ ). Calibrations are verified in the field with IR blackbody sources to assure accuracy and consistency.

**CONTACT:**

Code 5750 • (202) 767-3337

**LOCATION:**

NRL, Washington, DC

# *Infrared/Electro-Optical Calibration and Characterization Laboratory*

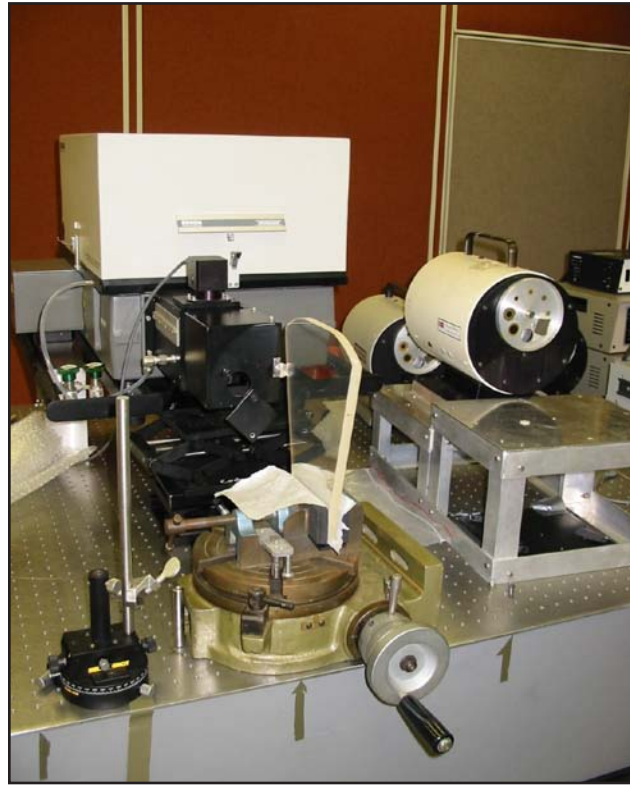

**FUNCTION:** Enables the optical characterization of IR materials and precise calibration of IR radiometric and spectroscopic instrumentation.

**DESCRIPTION:** The Infrared/Electro-Optical Calibration and Characterization Laboratory is an essential element of NRL's IR signature measurement and signature control programs. Naval Sea Systems Command-supported ship signature measurement and ship decoy development programs rely on this laboratory for accurate calibration of instruments such as interferometer spectrometers, circular variable filter radiometers, and IR imaging radiometers. This facility provides the capability for characterizing the surface emissive and reflective properties of IR paints and materials. Measurements are made on transmittance, specular reflectance, diffuse reflectance, and bidirectional reflectance.

**INSTRUMENTATION:** Included are state-of-the-art instruments and devices. Calibration is carried out with precision IR calibration sources and a 24-in.-diameter, 200-in. focal length, off-axis collimator. Equipment currently in use includes a Bomem MR254 Fourier transform infrared (FTIR) spectrometer equipped with multiple detectors allowing measurements in several IR bands. Using integrating spheres for visible and IR bands, values for both total and diffuse reflectance are obtained. The calibrations can be carried out at different ambient temperatures using a Tenny environmentally controlled chamber.

**CONTACT:**

Code 5750 • (202) 767-3337

**LOCATION:**

NRL, Washington, DC

# *Infrared Missile Simulator and Development Laboratory*

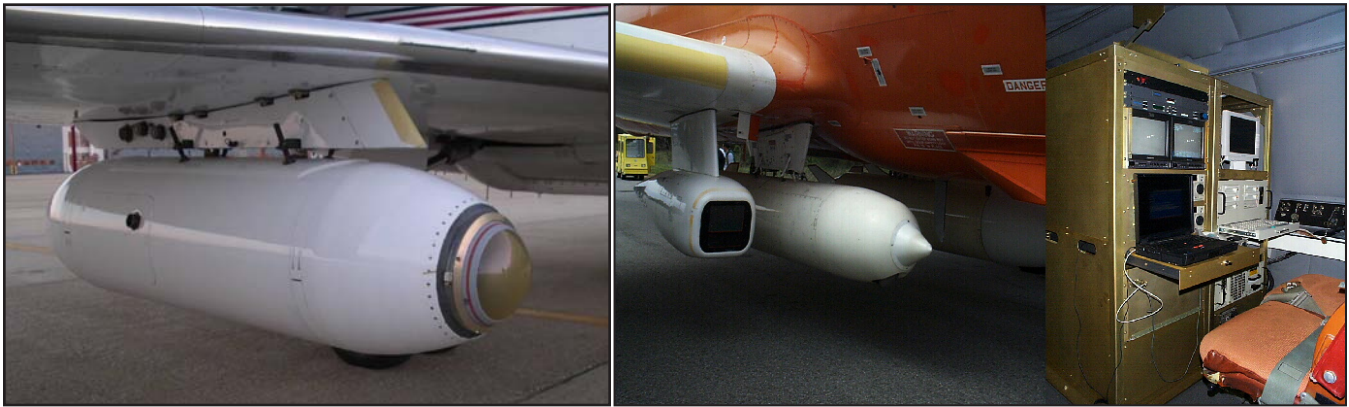

Missile simulators on EP-3 and Learjet

**FUNCTION:** Determines the effectiveness of ship-based IR decoys and IR laser countermeasure (CM) systems against IR-guided antiship missiles (ASM). Develops performance bounds of IR ASMs to detect and engage both conventional and signature-reduced U.S. surface platforms. Evaluates the performance of various infrared countermeasure (IRCM) techniques.

**DESCRIPTION:** The IR Missile Simulator and Development Laboratory includes IR seeker simulators and a fully equipped laboratory for sensor evaluation, processor design and development, flight hardware assembly, algorithm design, and data analysis. The aircraft-mounted systems use fiber-optic communications between the wing pod and the instrumentation/display inside the aircraft. This provides low noise on all data channels. The simulator systems contain an integrated data system for analysis of extensive field trials and allow ready visualization of both the actual tests and post-test data reduction. One simulator is a reprogrammable system permitting evaluation of multiple threats. Detector configurations and algorithms are changed to properly represent the threats. A separate flyable simulator supports research on imaging IR seekers. The large system gimbal accommodates newly developed imaging IR cameras. By using flexible software architecture, a complete missile seeker system with exceptional ability

to incorporate new algorithms and infrared counter-countermeasure (IRCCM) approaches is obtained. Digital data collection allows post-test analysis, system development, and simulation.

**INSTRUMENTATION:** An extensive array of optical and electronic analysis equipment supports the development, test, and operation of the electro-optical (EO)/IR simulators. Test and analysis of much of the electronics are accomplished through custom interfaces coupled to portable computer-based data acquisition subsystems. Software development facilities are a major feature of the simulators, which use both high-level and assembly-level code for real-time operations. A high-performance emulation environment makes development of this complex code possible.

**CONTACT:**

Code 5750 • (202) 767-3337

**LOCATION:**

NRL, Washington, DC



# Secure Supercomputing Facility



**FUNCTION:** Provides NRL, the Navy, and DoD with a high-speed, large-memory computation facility for classified projects. Throughput is comparable to over 500 Cray XMPs with large solid-state disks and represents over 100 teraflops of processing power.

**DESCRIPTION:** The centerpiece of the Secure Supercomputing Facility (SSF) is a 128-processor SGI Origin 3000. Each processor can achieve 500 Mflops and has 128 GB of physical memory and 128 GB of virtual memory. Local disk storage (>360 GB) uses removable Winchester disk cassettes. The facility's computational capability is supplemented by an SGI Origin 3000 system with 64 processors (500 Mflops each) and 64 GB of physical memory. The SSF includes a fully automated, extensible network file server with a storage capacity of 20 terabytes. Access to the SSF is restricted to workspaces within the controlled perimeter of the Tactical Electronic Warfare Division (TEWD) building complex. For more highly controlled projects, normal mode and TEWNET access cease and the SSF and vault enclosure become dedicated to the particular project. Each project uses its own exclusive complement of removable disk cassettes and its own system and application software.

**INSTRUMENTATION:** Secure Supercomputing Facility (SSF) visitors are accommodated in spaces featuring high-performance workstations, X terminals and PCs, and a complement of printers. A rich set of productivity tools is available including X Windows and Motif graphical user interfaces, a full set of UNIX network connectivity tools, industry standard editors, UNIX tools and debuggers, high-performance Math libraries, parallel and distributed programming tools, data visualization, and multimedia tools.

## CONTACT:

Code 5750 • (202) 767-3337

## LOCATION:

NRL, Washington, DC



# CBD/Tilghman Island IR Field Evaluation Facility



CBD test building (above) 16 km across the water from Tilghman Island tower (right)

**FUNCTION:** Research and development facility for electro-optical/infrared (EO/IR) threat simulators including antiship-capable missile seekers. The facility also enables field evaluations of EO/IR countermeasures (decoys and active jamming) in an over-water environment with a focus on the protection of Navy ships.

**DESCRIPTION:** The facility has two components, one at the Chesapeake Bay Detachment (CBD) and one at Tilghman Island. Located at CBD on the western side of the Chesapeake Bay is Building 5, which houses EO/IR sensors, sources, and measurement instrumentation. This building is set on a 30-m-high cliff overlooking the bay. Sixteen km across the bay is the Tilghman Island facility with a tower that contains instrumentation and threat simulators. These facilities enable the research that leads to the development of techniques and systems to defeat anti-ship-capable missile threats. The reference instrumentation quantifies the countermeasure performance and records the environmental conditions. Countermeasures may be deployed from either shore-based location or from one of the support ships attached to the facility.

**INSTRUMENTATION:** The CBD site overlooks the bay and includes instrumentation power and environmental controls in a large space for multiple antiship-capable seeker simulators and reference instrumentation. This site has an environmentally controlled space with optical bench. The Tilghman Island site on the eastern side of the bay features a 100-ft tower, affording a 16-km over-water path to the CBD site. The tower includes instrumentation power and environmental controls for the seeker simulators. Support ships are available as reference targets and to deploy decoys.

**CONTACT:**

Code 5750 • (202) 767-3337

**LOCATION:**

Chesapeake Beach and Tilghman Island, MD

# Ultra-Short-Pulse Laser Effects Research and Analysis Laboratory

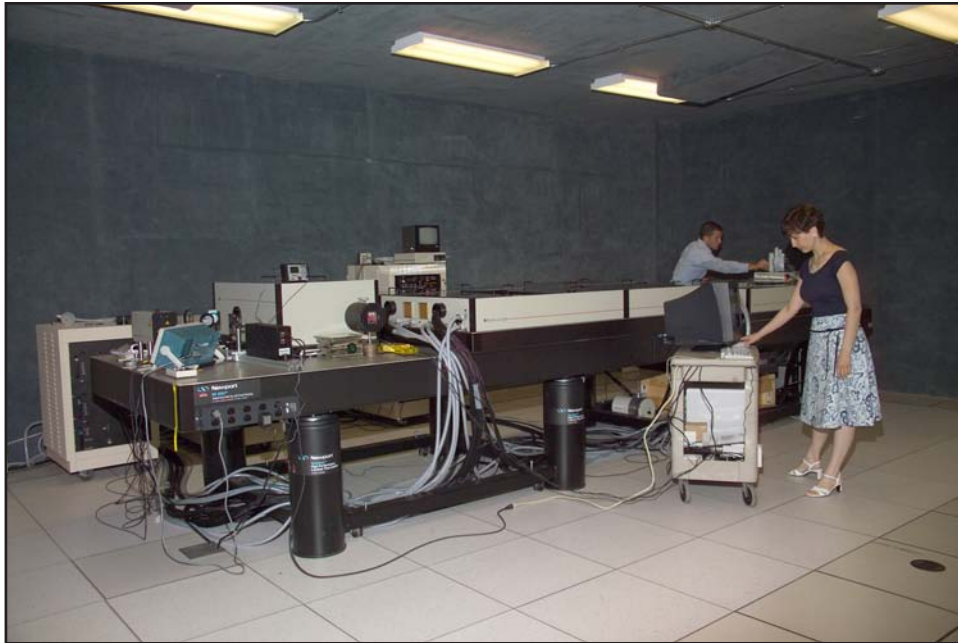

High-power, ultra-short-pulse laser

**FUNCTION:** Enables research into advanced laser countermeasure techniques.

**DESCRIPTION:** This laser facility has a capability to produce very high peak power levels of 27.5 TW while maintaining a low average power of 11 W. This combination keeps the laser physically compact, permitting potential tactical applications. To determine the critical aspects of the laser and test system interaction, the laser facility's temperature is tightly controlled and the humidity is held to a low level. Vibration isolation is also a key feature of the facility.

**INSTRUMENTATION:** The key component in the facility is an ultra-short-pulse laser with very high peak power. The operating environment has a tightly controlled temperature and low-humidity system. A foundation separate from the rest of the building isolates the laser from the normal building vibrations. Measurement instrumentation monitors the performance of the laser and the systems that are excited by the laser.

**CONTACT:**

Code 5750 • (202) 767-3337

**LOCATION:**

NRL, Washington, DC

# Central Target Simulator Facility

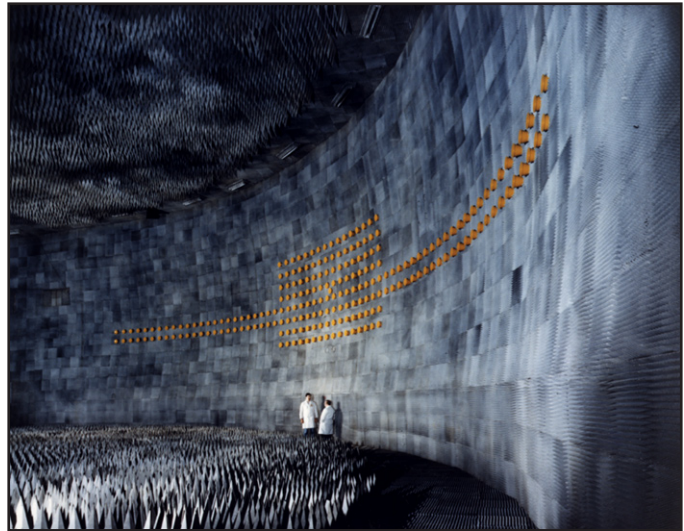

**FUNCTION:** A high-performance, hardware-in-the-loop simulator for real-time closed-loop testing and evaluation of electronic warfare (EW) systems and techniques to counter the antiship missile threat to the U.S. Navy in the 8.0 to 18.0 GHz frequency range. Tests use actual missile hardware and closure rates, enabling test results to be reported in the form of hit/miss distances. In addition, open-loop characterization tests evaluate the capabilities of threat systems and contribute data to the threat simulator validation process.

**DESCRIPTION:** The Central Target Simulator (CTS) Facility is built around a 114 ft x 127 ft x 38 ft high shielded anechoic chamber. A spherical array of 225 dual-polarized antennas is used to simulate the RF environment that the missile encounters in an engagement. Two feed networks distribute time and space coincident signals. The RF generation subsystem is synchronized to the missile radar in time and frequency. State-of-the-art modulation equipment replicates the characteristics of ship and decoy echoes, correctly triggering target discriminants. External inputs allow jamming signals or waveforms to be included. Missile hardware is mounted 75 ft from the array on a three-axis flight motion simulator. The loop between the missile and the facility is closed through a dual Xeon computer. This computer is programmed with a six-degree-of-freedom (6-DOF) aerodynamics/autopilot model that interacts with the guidance hardware in response to the RF stimuli. Simulations run in real time at update rates of up to 200 Hz. A battery of open-loop

characterization tests is used to evaluate the performance of the missile radar subsystems, identifying design features, vulnerabilities, or limitations for potential exploitation by EW tactics and techniques.

**INSTRUMENTATION:** The facility uses general laboratory instrumentation and recording equipment to display and capture information relative to the tests being conducted. The simulation computer stores pertinent information from the scenario, along with 16 analog channels and 32 digital bits captured from the missile radar. A closed circuit television (CCTV) system allows remote displays to be viewed in the control room and throughout the facility, with recording via two VCRs. Communication is provided by a dedicated audio intercom.

**CONTACT:**

Code 5760 • (202) 767-2208

**LOCATION:**

NRL, Washington, DC



# Flying Electronic Warfare Laboratory



**FUNCTION:** Provides NP-3D aircraft host platforms for Effectiveness of Navy Electronic Warfare Systems (ENEWS) Program antiship missile (ASM) seeker simulators used for electronic warfare (EW) effectiveness assessment in an at-sea environment. This capability provides the Navy's research, development, test, and evaluation (RDT&E) and operational communities with unique assets and realistic methods for evaluating surface Navy EW systems.

**DESCRIPTION:** The Flying Electronic Warfare Laboratory provides ASM threat representation through the adaptation of a host of missile seeker simulators. These simulators use a combination of hardware and software to model the external parameters and internal functions of various threat systems. Operational testing against ships' EW assets is enhanced through the unique ability to provide real-time feedback of the effectiveness of electronic attack (EA) responses to the threat seeker's stimuli. Fifteen different simulators representing various ASM threat types are available as part of the ENEWS Program. Up to eight simulators can be operated simultaneously to exercise the onboard/offboard EW assets being tested. Internally mounted equipment racks contain seeker control panels, data displays, data acquisition systems, and communications systems that are organic to each simulator. Special features include the ability to monitor and record simulator status, receiver/processor functions and select decision logic. The

laboratory supports RDT&E and operational activities on a worldwide basis, providing EW testing support to U.S. and NATO programs and those of individual countries.

**INSTRUMENTATION:** Two NP-3D aircraft are configured to carry the simulators. These simulators represent a large cross-section of the threat missile systems available worldwide and are derived from other programs or are hardware systems modified to represent various threat seekers. All of the simulators are one-of-a-kind systems, with the associated instrumentation tailored to the individual simulator. GPS and data link systems allow the collection of aircraft and ship's position information for ground truth determination.

## CONTACT:

Code 5760 • (202) 404-3819

## LOCATION:

Naval Air Warfare Center, Patuxent River, MD



# Ultra-Near-Field Test Facility

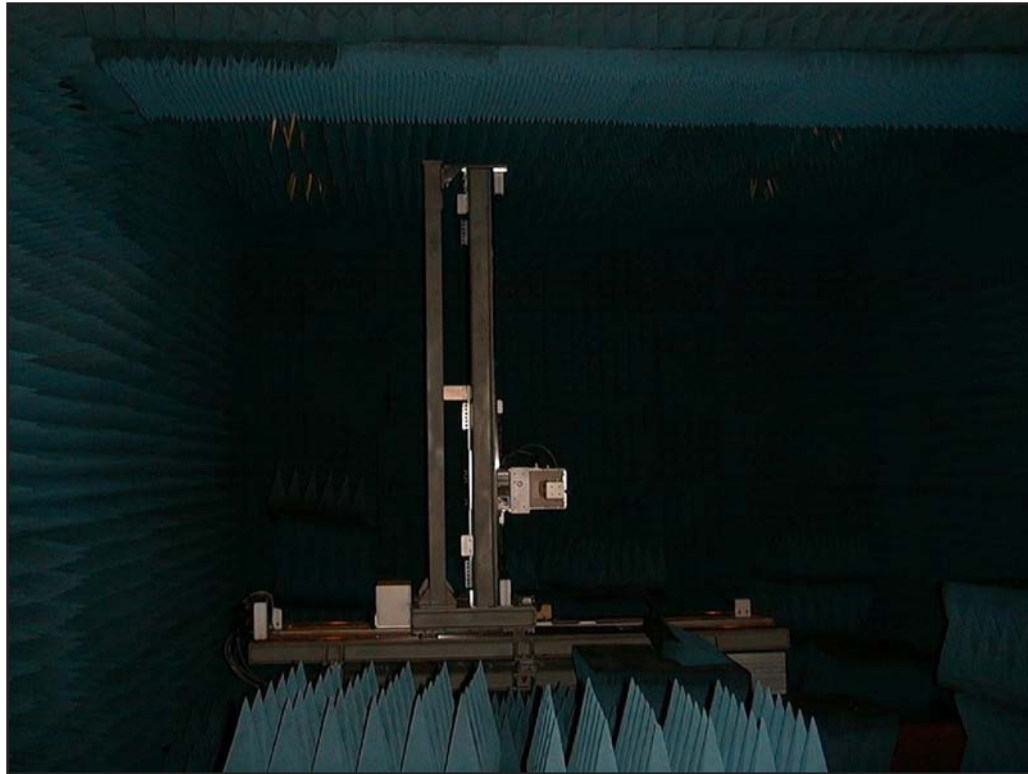

**FUNCTION:** Facilitates state-of-the-art research into the physics of scattering of microwaves from complex bodies in the ultra-near-field.

**DESCRIPTION:** The Ultra-Near-Field Test Facility provides a unique capability to measure and investigate the physics of scattering from within a fraction of a wavelength from the body where evanescent fields enhance the complexity of issues involved. This lab explores rich phenomena associated with periodic structures and the development of new analytical tools for their study.

**INSTRUMENTATION:** Agilent 8530C and 8510C vector network analyzers with measurement capability from 1 to 50 GHz combined with ORBIT/FR AL2000 positioner control provides a complete system for characterizing electromagnetic fields in planar and cylindrical geometries.

**CONTACT:**

Code 5708 • (202) 767-2889

**LOCATION:**

NRL, Washington, DC

# RF and Millimeter-Wave Laboratory



**FUNCTION:** Enables characterization of intrinsic properties of dielectric and magnetic materials, and the evaluation of specular and non-specular properties of absorbers at microwave and millimeter-wave frequencies.

**DESCRIPTION:** The RF and Millimeter-Wave Laboratory is essential to NRL's efforts to develop new materials for microwave applications including signature control where complex designs are developed, tested, and evaluated.

**INSTRUMENTATION:** Multiple vector network analyzers are employed including Agilent E8365B, 8510C, and 85106C models. Multiple waveguides spanning UHF to 100 GHz facilitate materials characterization over these bands. A state-of-the-art NRL Arch, fully computer controlled, enables full evaluation of specular absorbers over all angles from 2 to 50 GHz. Two additional arches are used for millimeter-wave bands up to 100 GHz. A focused lens system enables characterization of samples from 2 to 50 GHz. This system is also configurable as an Arch for specular and non-specular evaluation of absorbers.

**CONTACT:**

Code 5708 • (202) 767-2889

**LOCATION:**

NRL, Washington, DC

## Optics Laboratory

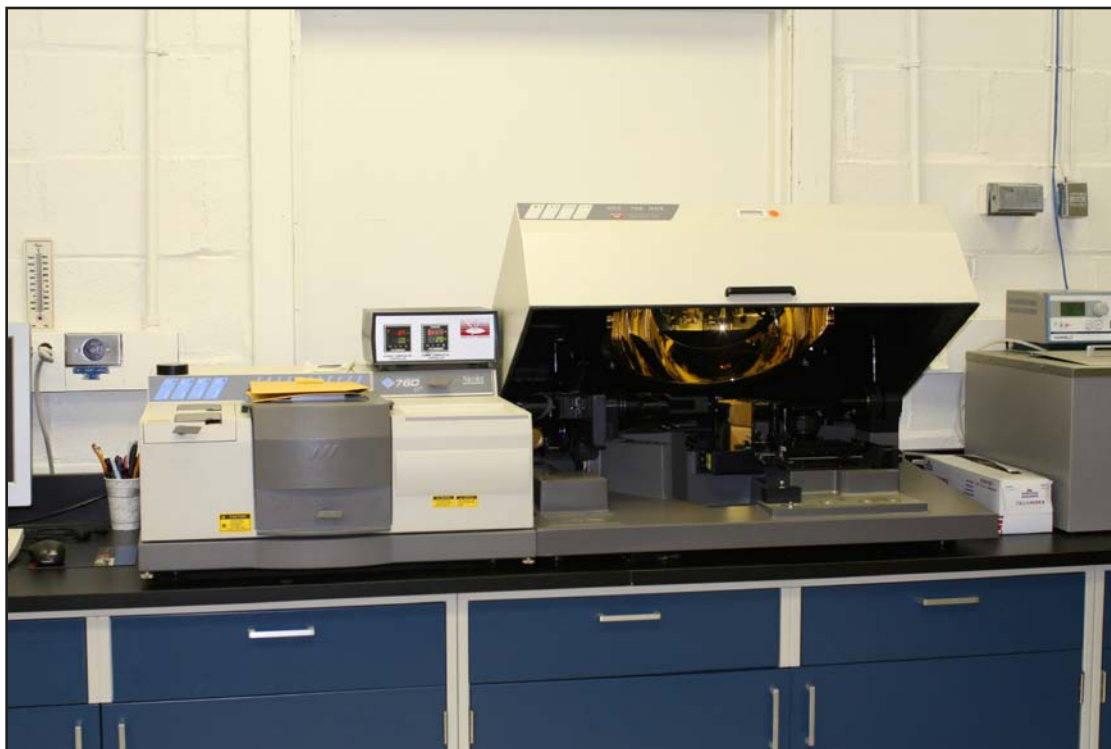

**FUNCTION:** Enables the optical characterization of materials in wavelength regions from the near ultraviolet to the longwave infrared.

**DESCRIPTION:** The Optics Laboratory enables rapid evaluation of the optical properties of materials. Optical characterization is routinely utilized in systematic studies of material treatments and paint pigment, for example. This lab has been essential for NRL's efforts, including in-house research and materials evaluation for signature control.

**INSTRUMENTATION:** Lambda 900 UV/visible/NIR spectrophotometer configurable with an integrating sphere or with a dual beam transmission system. Surface Optics SOC-100 model Hemispherical Directional Reflectometer (HDR) configurable for reflection, both specular and diffuse, and transmission measurements. The SOC-100 is a bench attachment for a Nicolet 760 Fourier transform infrared spectrometer (FTIR) that is used as a stand-alone device for materials evaluation from 2.5 to 25 microns. Additional tools aid in color mapping, useful in visual studies.

**CONTACT:**

Code 5708 • (202) 767-2889

**LOCATION:**

NRL, Washington, DC

# Blackroom Laboratory

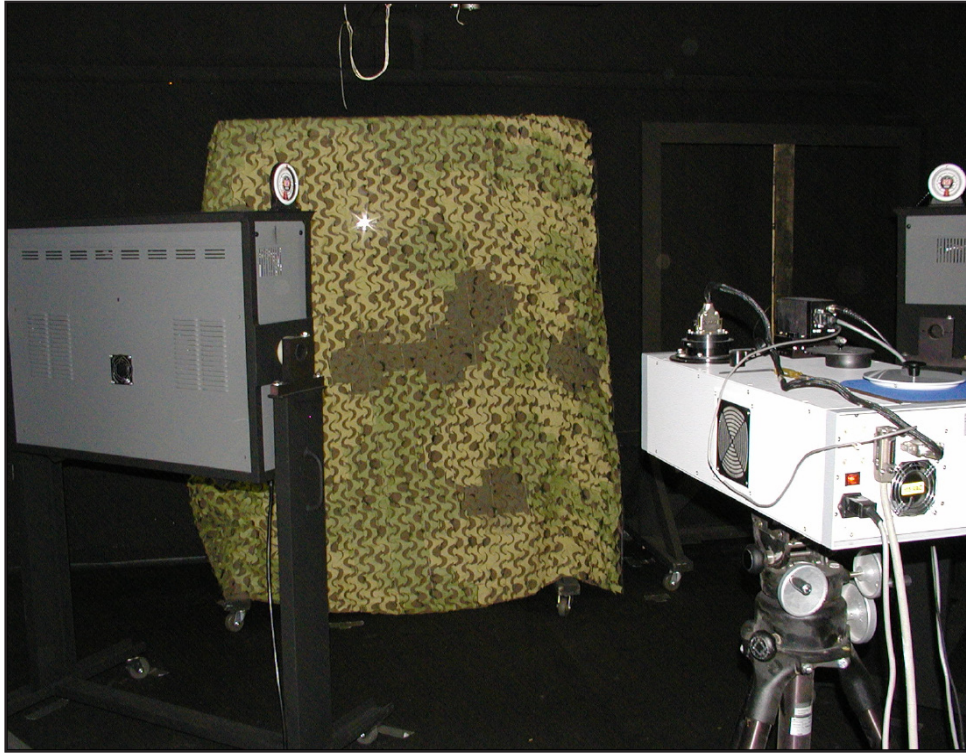

**FUNCTION:** Enables evaluation and characterization of materials ranging from the ultraviolet to the longwave infrared (LWIR).

**DESCRIPTION:** The Blackroom Laboratory is used to conduct radiometry, thermography, and multispectral imaging (UV to LWIR) of materials. The room (25 ft L x 14 ft W x 8 ft 10 in. H) is completely painted with Duron 59-980 flat black to minimize extraneous reflections. This facility meets the performance standard PRF-53134, established by the U.S. Army Night Vision and Electro-Optics Systems Directorate for the measurement of visual camouflage.

**INSTRUMENTATION:** CI Systems SR-5000 Spectroradiometer; AN/PVS-7B and AN/PVS-15B night vision goggles; Toshiba IK-1000 ultra-low-light, color video camera; three Canon digital SLR cameras equipped with Gen III image intensifier units; Indigo Merlin shortwave infrared (SWIR), medium-wave infrared (MWIR), and LWIR cameras; two Gretag-Macbeth Spectralight III sources; CI Systems SR-20 cavity blackbody; Santa Barbara Infrared dual 8-inch blackbodies; Zenith Reflectance Target.

## CONTACT:

Code 5708 • (202) 404-8373

## LOCATION:

NRL, Washington, DC



# Secure Computational Facility



**FUNCTION:** Provides a secure computational modeling environment to support research into novel and better ways to control signatures across the electromagnetic spectrum.

**SOFTWARE:** The RF radar cross section (RCS) of 2D and 3D platforms with material treatments can be accurately predicted and modeled with a number of software tools, including CARLOS, MAXTDA, RTS, XATCH, HYPACED, CADDSCAT, and MOMD. Similarly, codes for signature prediction of treated platforms in the IR spectral region include IRIMAGE, SPIRITS, and SHIPIR/NTCS. A wide variety of material design codes are available to complement the signature codes. These include IRTNEW, OPTRAM, VBROB, and SCATCAD for RF and IR radar absorbing material designs. Performance of frequency selective surfaces and other metamaterials can be made with TENZ3D, MAXTDA, HFSS, and PMM.

**HARDWARE:** The facility includes an SGI Origin 300 server with eight 600 MHz processors and 16 GB RAM, an SGI O2 workstation, and a Mac G4 with SIPPRNET access. Two other Mac G4's and two PC's running Windows XP provide added capability for computational modeling and data analysis.

**CONTACT:**

Code 5708 • (202) 767-0349

**LOCATION:**

NRL, Washington, DC

# Human Perception Laboratory



**FUNCTION:** Enables the study and analysis of human perception.

**DESCRIPTION:** The Human Perception Laboratory facilitates the study of perception, particularly as it relates to visual tasks of a military nature. One of its primary assets is the NRL Eyetracker. The Eyetracker is used to monitor and analyze an observer's visual perception. It tracks the pupil of an observer. The pupil location determines eye movements that in turn indicate areas of attention and cognition. Eyetrackers are portable and do not restrict natural movements and behavior. Among its many applications, the Eyetracker can be used to evaluate search strategies, information display, and camouflage effectiveness.

**INSTRUMENTATION:** Four NRL Eyetrackers; large-screen monitors; video processing and analysis stations.

**CONTACT:**

Code 5708 • (202) 404-8373

**LOCATION:**

NRL, Washington, DC

**Code 6030 – Laboratory for Structure of Matter**

**Code 6100 – Chemistry Division**

**Code 6300 – Materials Science and Technology Division**

**Code 6400 – Laboratory for Computational Physics and Fluid Dynamics**

**Code 6700 – Plasma Physics Division**

**Code 6800 – Electronics Science and Technology Division**

**Code 6900 – Center for Bio /Molecular Science and Engineering**

# **MATERIALS**

**SCIENCE AND COMPONENT TECHNOLOGY**  
**DIRECTORATE**

**BACK TO CONTENTS**

# Laboratory for Structure of Matter

- Automatic X-ray Diffractometers



## Automatic X-ray Diffractometers

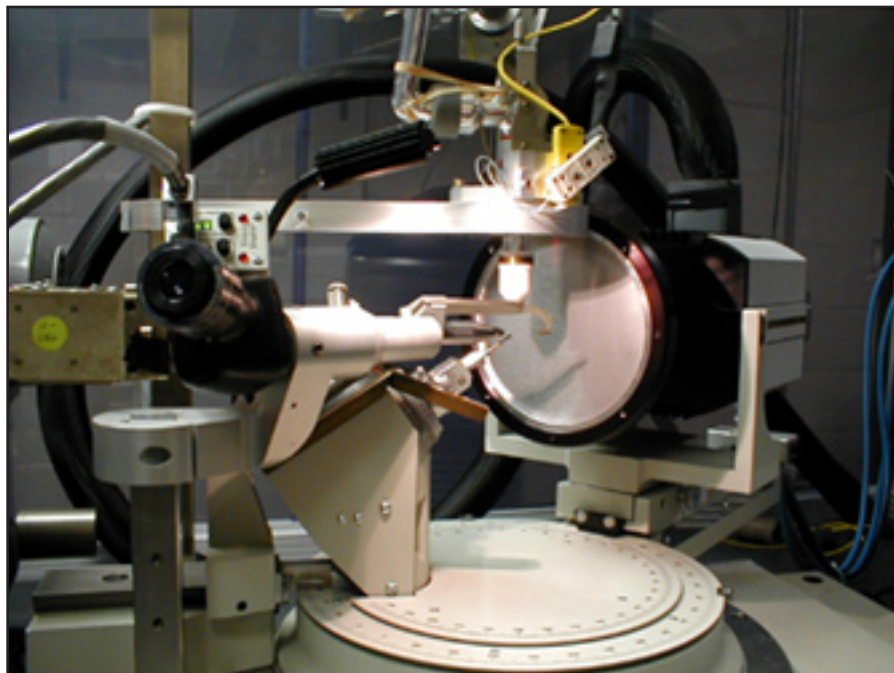

Bruker 6000 CCD X-ray detector mounted on a platform goniometer

**FUNCTION:** Carries out atomic-resolution single-crystal X-ray diffraction analyses. Capabilities exist to examine a wide range of materials from small inorganic molecules to macromolecular biological compounds.

**DESCRIPTION:** The site includes laboratories for sample preparation and purification. Laboratory facilities are also provided for crystal growth. Three automated X-ray diffractometers are available for data acquisition, all of which may be operated over a range of sample temperatures (22° to -180 °C). High-speed computational facilities are in place for structure solution and analyses.

### INSTRUMENTATION:

- A Bruker 6000 charge-coupled device (CCD) area detector mounted on a three-circle goniometer. This equipment is coupled to a rotating anode Cu-K $\alpha$  X-ray source using high brilliance Gobel mirror X-ray optics.
- A Bruker 1000 CCD area detector mounted on a four-circle goniometer using a sealed tube Mo-K $\alpha$  X-ray source and an incident beam graphite monochromator.
- A Bruker P4 serial detector on a four-circle goniometer using a sealed tube Cu-K $\alpha$  X-ray source and an incident beam graphite monochromator.

### CONTACT:

Code 6030 • (202) 767-0656

### LOCATION:

NRL, Washington, DC

# Chemistry Division

- Chemical Analysis Facility
- Magnetic Resonance Facility
- Chemical Vapor and Plasma Deposition Facility
- Nanometer Characterization/Manipulation Facility
- Synchrotron Radiation Facility
- Ex-USS Shadwell Advanced Fire Research Ship
- Fire Research Enclosure
- Large-Scale Damage Control Facility
- Navy Fuel Research Facility
- Corrosion Engineering and Coatings Characterization Facilities
- Marine Coatings Facility
- Cathodic Protection Model Facility
- Ballast Water Treatment Test Facility
- Antifoulant Coatings Exposure Site
- Sacrificial Anode Qualification Site

# Chemical Analysis Facility



**FUNCTION:** Uses state-of-the-art instrumentation for qualitative and quantitative analysis of organic and inorganic compounds, and biomolecules from gas, liquid, and solid samples. Principal functions of the facility include analyzing samples of environmental importance, ranging from the atmospheres of submarines to polycyclic aromatic hydrocarbons in harbor sediments, and characterizing synthetic products and materials (such as polymers).

**DESCRIPTION:** The facility includes instrumentation for characterizing many types of environmental and synthetic samples using a variety of analytical techniques. Environmental samples (air, water, and sediment) are prepared by techniques such as solid-phase extraction, liquid extraction, and thermal desorption. Quantitative and qualitative analytical information is provided by gas chromatography (GC), GC/mass spectrometry (MS), liquid chromatography (LC), LC/MS, inductively coupled plasma MS, capillary electrophoresis, excitation/emission fluorimetry, infrared spectroscopy, and UV-visible spectroscopy. Additional detailed information about molecular structures is obtained by nuclear magnetic resonance (NMR) spectrometry, isotope ratio MS, and matrix-assisted laser desorption MS.

**INSTRUMENTATION:** The facility contains gas chromatographs with flame ionization, thermal conductivity, nitrogen-phosphorous, and mass spectrometer detectors; liquid chromatographs with UV-visible, fluorescence, and mass spectrometer detectors; capillary electrophoresis instruments with UV-visible and conductivity detectors; a thermal desorption-gas chromatograph with tandem infrared and mass spectrometer detectors; an inductively coupled plasma mass spectrometer; a matrix-assisted laser desorption time-of-flight mass spectrometer; Raman, near, and mid-infrared spectrophotometers; UV-visible spectrophotometers; fluorimeters; and NMR spectrometers.

**CONTACT:**

Code 6110 • (202) 404-6392; Code 6181 • (202) 767-3138

**LOCATION:**

NRL, Washington, DC

# Magnetic Resonance Facility



**FUNCTION:** Addresses basic and applied research problems in materials chemistry. Critical Navy problems in materials performance and reliability are stressed, utilizing innovative techniques and approaches, principally in magnetic resonance.

**DESCRIPTION:** Advanced high-resolution solid-state nuclear magnetic resonance (NMR) spectroscopy techniques can be used to observe nuclei across much of the periodic table and provide detailed structural and dynamical information. NMR imaging techniques can also be applied to non-destructive evaluation of materials.

**INSTRUMENTATION:** The facility operates advanced Bruker Fourier transform NMR spectrometers at 11.7 and 7.0 Tesla for solids and liquids, with provisions for variable-temperature multi-nuclear studies, magic-angle spinning, double and triple resonance, high-power decoupling, gradient-enhanced spectroscopy, and liquids micro-imaging. Specialized spectrometers for NMR of solid samples at pressures to 1 GPa, or temperatures to 4.2 K, and for nuclear quadrupole resonance are also available.

**CONTACT:**

Code 6122 • (202) 767-2337

**LOCATION:**

NRL, Washington, DC



# Chemical Vapor and Plasma Deposition Facility

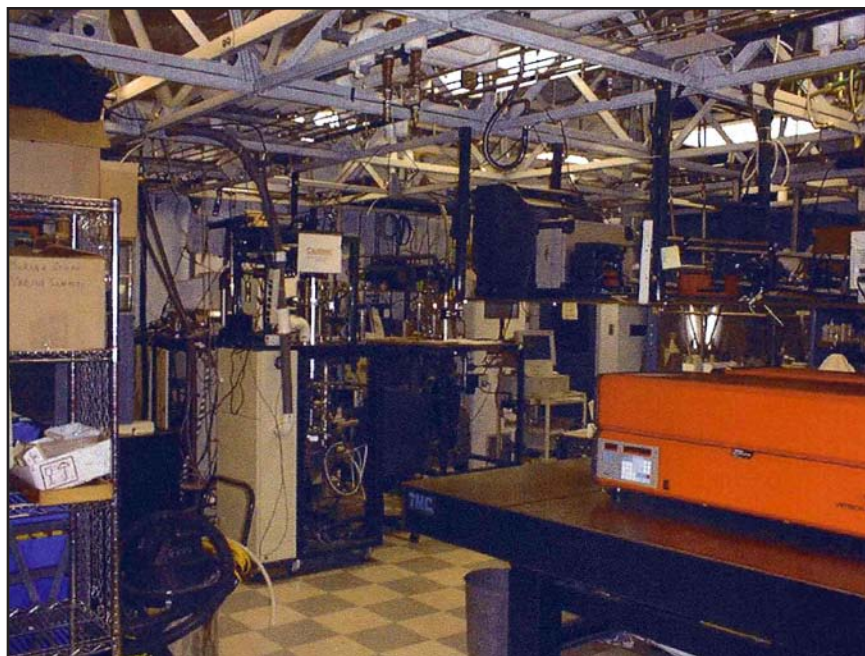

**FUNCTION:** Facility to study and fabricate materials such as diamond by chemical vapor deposition and plasma processing, using in situ diagnostics (laser, Fourier transform infrared, optical emission, and mass spectroscopies), laser machining, and plasma deposition reactors.

**DESCRIPTION:** Fundamental and applied research is conducted in a dedicated laboratory space with single-pass air flow, toxic gas alarm system, and gas scrubbers on exhaust air. The research is directed toward the growth and surface chemistry of advanced materials, the spectroscopy of species at or near interfaces, and the molecular/structural characterization and modification of surfaces and solid-gas interfaces. To this end, techniques involving chemical vapor deposition (CVD), high-temperature environments, photon-assisted processes, and plasma processing and plasma deposition/etching are applied. Such modified surfaces/interfaces impact a broad array of DoD-related problems including plasma modification, electronic device processing, protective coatings, corrosion, and synthetic metastable materials.

**INSTRUMENTATION:** The laboratory features four microwave plasma enhanced deposition facilities (ASTeX HPMM and electron cyclotron resonance plasma deposition chambers); novel inductively coupled plasma research tools; FTIR spectrometers; a triple monochromator, microscope, and optical multichannel channel analyzer for Raman/emission spectroscopy of surface species; a Lambda Physik 2101 excimer laser, a Quantel Nd/YAG laser, a Lambda Physik LPD 3002E dye laser, and an auto-tracking frequency doubling system; quadrupole mass spectrometer in situ sampling system (Hiden) with automated data acquisition; a CW q-switched YAG laser machining facility for cutting diamond films; and a novel RF inductively coupled pulsed plasma source for CVD, etching, and material modification.

**CONTACT:**

Code 6174 • (202) 767-1115

**LOCATION:**

NRL, Washington, DC

# Nanometer Characterization/Manipulation Facility

Close up view of a scanning tunneling microscope used for the study of semiconductor surfaces and interfaces

**FUNCTION:** Characterizes the nanometer scale of biological, chemical, physical, electronic, and mechanical properties of surfaces and thin films using scanning probe microscopies/spectroscopies, and a variety of complementary surface analysis techniques. The limits of materials miniaturization are explored by using the new microscopes to fabricate and manipulate surface structures of nanometer size. This technology is used to investigate new chemical, biological, and magnetic sensors, electronic devices, and nanoscale materials.

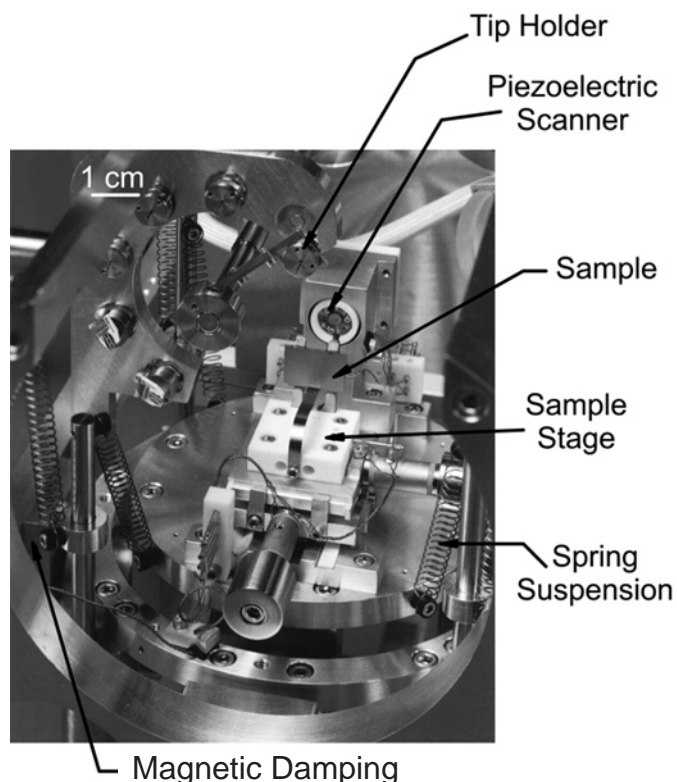

**DESCRIPTION:** Scanning tunneling microscopy/spectroscopy enables observation of the surface topography, chemical reactivity, and electronic structure of conductive substrates with atomic-scale resolution. The atomic force microscope (AFM) provides nanometer-scale resolution of surface topography, mechanical properties, and tip-surface interaction forces on both conductive and insulating substrates. The tip-surface interaction forces, including frictional forces, can be measured with nanonewton (single chemical bond) precision. An ultra-high-vacuum (UHV) system for nanomanipulation and nanoprobe characterization is also available in the Nanoscience Research Laboratory.

**INSTRUMENTATION:** NRL-built UHV scanning tunneling microscope/spectroscopy (STM/S) with facilities for low-energy electron diffraction (LEED) and Auger electron spectroscopy (AES); Omicron UHV variable temperature STM/AFM integrated with a second UHV system housing a multi-tip STM with a scanning electron microscope (5 nm resolution) and scanning Auger

microprobe; Park Scientific Instruments AutoProbe UHV STM/AFM integrated with the NRL Molecular Beam Epitaxy (MBE) Epicenter for characterizing semiconductor surfaces following MBE, including cross-sectional STM; Nanoscope IIIa multimode AFM (lateral force, magnetic force, and tapping modes) equipped with breakout box and force-volume mapping system; TM Microscopes Autoprobe CP AFM used for dip pen nanolithography; Digital Instruments Bioscope AFM integrated with a Zeiss Axiovert 100 inverted optical microscope with fluorescence, micromanipulation, and microinjection capabilities; and Nanoscope IIIa and Multimode AFM, NRL-built lateral-force microscope, and Hysitron scanning-nanoindenters (Triboscope and Bioindenter) with commercial and custom software to measure surface mechanical properties.

## CONTACT:

Code 6177 • (202) 767-2519

## LOCATION:

NRL, Washington, DC

# Synchrotron Radiation Facility

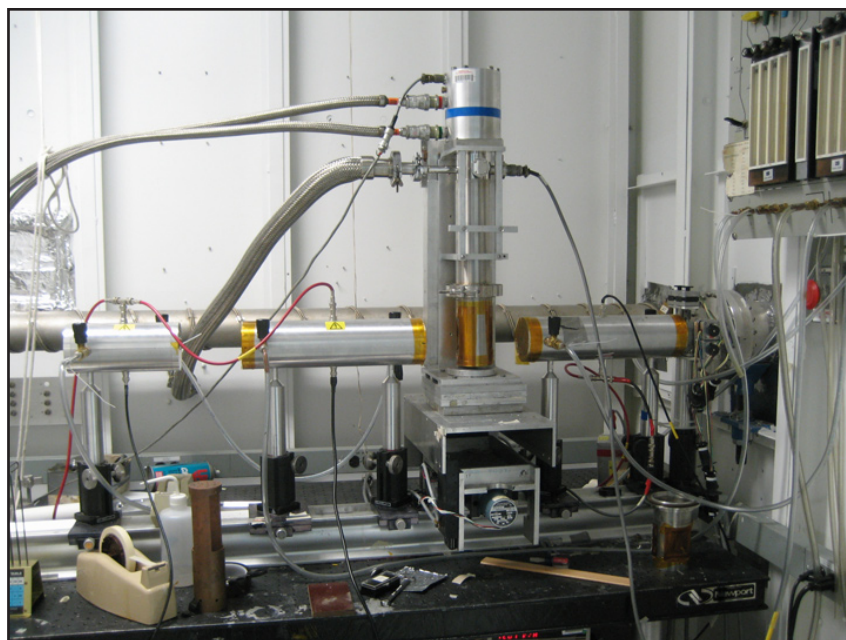

Instrumentation and chamber on the NRL X11A beamline at the National Synchrotron Light Source, Brookhaven National Laboratory

**FUNCTION:** Studies the effects of UV radiation and X rays on solids, and calibrates X-ray optics, detectors, and instruments.

**DESCRIPTION:** Research focuses on applying X rays to chemical and structural analysis of electronic and optical materials. Structural dynamics are monitored by diffraction carried out at the National Synchrotron Light Source (NSLS) or at major laser plasma X-ray sources, over time scales from picoseconds to hours. Synchrotron techniques elucidate the electronic structure of the ground state, transiently excited states, and photo-transformed states in insulators, semiconductors, and molecular films.

**INSTRUMENTATION:**

- Beamlines X11A and X11B provide intense focused and unfocused X-ray fluence from 2 to 35 keV with an energy resolution of  $2 \times 10^{-4}$ . Experimental equipment includes apparatus for transmission and fluorescence extended X-ray absorption fine structure (EXAFS).
- Beamline X23B provides intense, focused X-ray fluences from 3 to 11 keV with an energy resolution of  $3 \times 10^{-4}$ . Experimental equipment includes a four-circle Huber diffractometer and apparatus for transmission, fluorescence, and electron EXAFS.
- Beamline X24C provides intense, focused ultraviolet and X-ray fluences from 1 to 1800 eV with an energy resolution of  $1 \times 10^{-3}$  ( $\Delta E/E$ ). There are two large ultra-high-vacuum (UHV) experimental chambers, a reflectometer, and a Space Science and Plasma Diagnostic Instrument Calibration Facility.
- Beamline U4B provides intense focused UV and fluence from 80 to 1200 keV with an energy resolution from  $10^{-3}$  to  $10^{-4}$ . Equipment includes UHV photoemission and reflectance experimental chambers.

**CONTACT:**

Code 6134 • (202) 767-6327

**LOCATION:**

National Synchrotron Light Source • Long Island, NY



## Ex-USS Shadwell *Advanced Fire Research Ship*



**FUNCTION:** Conducts full-scale fire/damage control experiments in a shipboard environment. This test platform can provide an integrated picture of the interactions of man, equipment, materials, tactics, doctrine, and systems in the development of fire protection/damage control concepts and technology, including the use of chemical simulants.

**DESCRIPTION:** Ex-USS *Shadwell* (LSD 15) has an overall length of 457 ft, beam of 72 ft, and full load displacement of 9000 tons. As a testbed, the ship contains one pressure zone to study smoke management, including a collective protection system (CPS) that has been created on all levels forward of frame 35. Selected ship systems that are important to fire protection and damage control, such as ventilation, electrical power, fluid distribution, fire mains, fire pumps, aqueous film-forming foam (AFFF) proportioning system, and internal communications, have been reactivated. The ship has undergone major automation upgrades to its damage control systems. There is a high-pressure fine water mist system over all decks forward of frame 35. Simulated on the ship are an aircraft carrier hangar bay, the forward section of a SNN 688 submarine, one complete CPS of DDG 51 and its simulated machinery space, LPD 17 well deck with ventilation, DDX flight deck and han-

gar along with Peripheral Vertical Launch Systems (PVLS) and Automatic Gun System (AGS) magazines, and LHA(R) upper and lower vehicle storage area and well deck.

**INSTRUMENTATION:** The facility has extensive sensor and analytical sampling and analysis capabilities for measuring temperature, pressure, smoke obscuration, fluid flow, radiation flux, and total heat flux. There are video recorders for documentation of the fire tests and significant computing facilities for data collection, manipulation, and presentation. There is a 1-gigabit blown fiber network, which is tied into the data system, with 12-node rooms for input, output, and control of ship sensors and functions. This provides video coverage throughout the ship.

**CONTACT:**

Code 6180 • (202) 767-2476

**LOCATION:**

NRL, Mobile, AL



# Fire Research Enclosure



Submarine Fire Research Facility (FIRE I)

**FUNCTION:** Simulates submarine fires, enclosed aircraft fires, and fires in enclosures at shore facilities.

**DESCRIPTION:** FIRE I is a pressurizable, 324 m<sup>3</sup> (11,400 ft<sup>3</sup>) fire test facility that simulates a one-quarter scale submarine compartment capable of pressurization to more than six atmospheres. This facility is used to study large-scale confined fires under controlled conditions and to test prototype equipment and firefighting agents. Two fixed fire-suppression systems for enclosures—nitrogen pressurization and preliminary water mist—have been tested.

**INSTRUMENTATION:** The facility has over 200 sensors measuring pressure, temperature, radiation, total heat flux, and fire byproducts. The data are collected, analyzed, and displayed in real time. Nitrogen suppression pipes are embedded along the chamber walls. Thermocouples in the skin of the chamber record the effect of heat transfer to the chamber wall. The size and complexity of FIRE I require intricate safety considerations with built-in interlock systems. There are several television cameras to visually record the test fires.

**CONTACT:**

Code 6185 • (202) 404-8101

**LOCATION:**

NRL, Chesapeake Beach, MD

# Large-Scale Damage Control Facility



**FUNCTION:** Performs large-scale fire protection experiments that simulate actual Navy platform conditions. Remote control firefighting systems are also tested.

**DESCRIPTION:** The facility consists of five buildings and three testbeds. Two of the buildings are for enclosed fire experiments, qualification of firefighting agents, efficacy of dispensing these agents, and control and visibility through smoke. A third building is a staging area and a fourth is for storage. The fifth building contains a hydraulics laboratory and is equipped with a full-scale shipboard balanced pressure proportioner for aqueous film-forming foam (AFFF). A testbed simulates the lower section of a submarine for studying bilge fires and their extinguishment. A simulated 930 m<sup>2</sup> (10,000 ft<sup>2</sup>) flight testbed is used to develop fire scenarios and suppression technologies. The third testbed has two test compartments, with internal volumes of 28 m<sup>3</sup> and 300 m<sup>3</sup> (1,000 ft<sup>3</sup> and 10,500 ft<sup>3</sup>), that are used for fire suppression experiments.

**INSTRUMENTATION:** Specific instruments for these testbeds are incorporated as a function of the particular experiment, but include sensors, gas sampling, control equipment, mixing vessels, calibrated fuel and aqueous flow metering, and video recording. The fire test building (15 m x 15 m; 50 ft x 50 ft) has a large cone calorimeter for full-scale fire tests of materials and furnishings.

**CONTACT:**

Code 6185 • (202) 404-8101

**LOCATION:**

NRL, Chesapeake Beach, MD

# Navy Fuel Research Facility

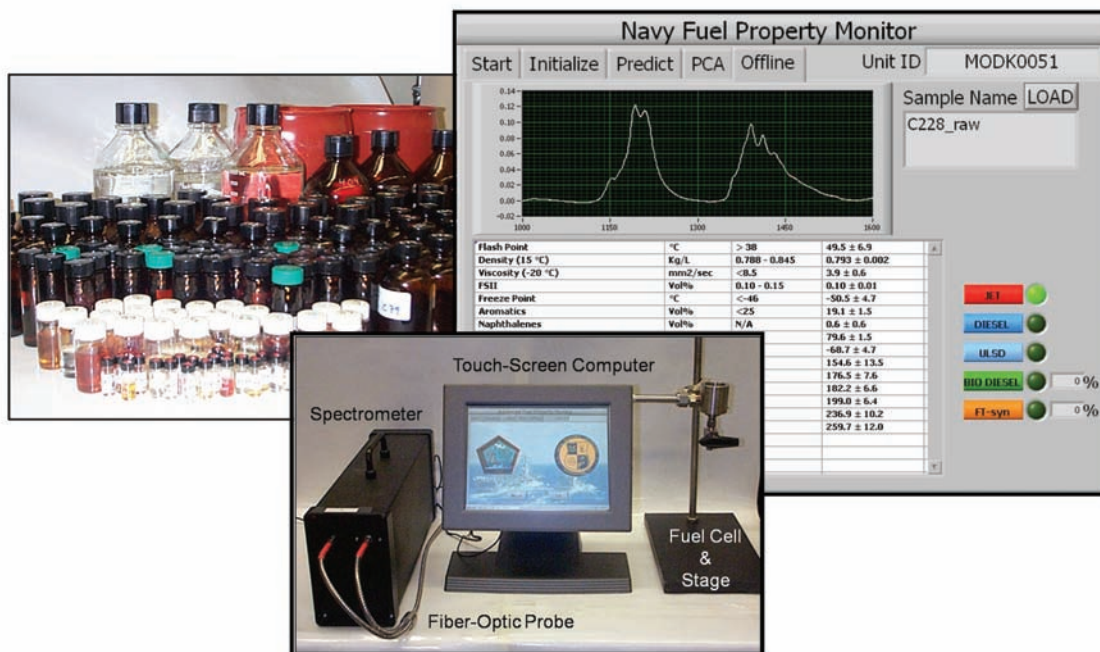

**FUNCTION:** Performs basic and applied research to understand the underlying chemistry that impacts the use, handling, and storage of current and future Navy mobility fuels.

**DESCRIPTION:** The analytical capabilities of the Fuel Research Facility are utilized to correlate the chemical composition of both traditional petroleum-derived and non-petroleum-derived fuels to the critical properties that define their fit for purpose in Navy propulsion systems. Fundamental research is conducted to define the key chemical processes that determine stability and oxidation behavior, rheological properties, and the flammability and ignition hazards of all Navy fuels. Additives used to mitigate undesirable fuel properties are examined for effectiveness and for mechanism of activity. Basic research to develop technologies for strategic synthesis of Navy fuels is also being conducted. The fuel modeling group in the Fuel Research Facility employs state-of-the-art chemometric modeling to extract the critical chemical information from complex analytical data that define fuel structure-performance relationships, and is employed to develop sensor-based instrumentation for rapid ship-board fuel quality surveillance.

**INSTRUMENTATION:** Jet fuel thermal oxidation hot zone reactor with gas chromatography (GC)-helium ionization detection for liquid phase oxidation kinetics; high performance liquid chromatography (HPLC) with electrochemical, fluorescence, ultraviolet, and refractive index detectors (preparative through analytical scale); capillary GC-mass spectrometry; Fourier transform infrared spectroscopy (FTIR) (transmission and attenuated total reflectance [ATR]); near-infrared (NIR), UV-visible, and FT-Raman spectroscopy; a fuel reference library consisting of over 1000 characterized worldwide fuels for chemometric calibration.

## CONTACT:

Code 6181 • (202) 767-3138; Code 6181 • (202) 767-3845

## LOCATION:

NRL, Washington, DC

# Corrosion Engineering and Coatings Characterization Facilities



**FUNCTION:** Perform basic and applied materials development, corrosion engineering, corrosion control, cathodic protection design, marine coatings formulation/characterization, electrochemical systems, seawater sensor systems, and materials failure analysis related to marine environments. Additionally, laboratories support efforts at the NRL Center for Corrosion Science and Engineering in Key West, Florida.

**DESCRIPTION:** Specialized analytical laboratories determine the mechanisms of materials degradation and develop coatings technology for Naval systems. Seawater effects on materials are studied to understand fundamental physical properties of the electrochemical reactions, mechanisms of materials degradations, and the methodology for materials preservation and protection. The facilities and capabilities include basic electrochemical test laboratories, surface chemical analysis, organic coatings properties measurement, mechanical failure analysis, stress corrosion cracking/hydrogen effects instrumentation, and corrosion properties measurement. Marine coatings laboratories enable the analysis of barrier coating properties, surface preparation scenarios, application, and performance testing. Electrochemical facilities enable the theoretical understanding of interfacial processes and surface chemistry and use the

information gained to guide materials development, improve material performance, and reduce maintenance costs.

**INSTRUMENTATION:** Electrochemical testing equipment for ac and dc measurements; Kelvin probe; low-temperature carburization furnace; coatings formulation lab; Fourier transform infrared spectroscopy; gas chromatography/mass spectroscopy; Zeta potential measurement system; Participating Research Team (PRT) member on beamline X11 at the National Synchrotron Light Source (NSLS); fuel cell test station; X-ray photoelectron spectroscopy; and X-ray fluorescence.

**CONTACT:**

Code 6130 • (202) 767-0833

**LOCATION:**

NRL, Washington, DC



# Marine Coatings Facility



**FUNCTION:** Conducts research, development, test and evaluation (RDT&E) in direct support of 21<sup>st</sup>-century Fleet requirements concerning seawater materials performance, corrosion behavior, and marine coatings technology.

**DESCRIPTION:** The Marine Coatings Facility is located at Naval Air Station Key West, Trumbo Point Annex, Florida. The laboratory has an unparalleled database for natural seawater exposure testing and marine-related materials evaluation. It receives a plentiful, unpolluted supply of Gulf of Mexico seawater throughout the year. The tropical climate is ideally suited for marine exposure testing. There is minimal climatic variation and a stable biomass throughout the year. The laboratory has more than 1000 ft of waterfront access, natural "blue" ocean-quality seawater access, a 2500 ft<sup>2</sup> atmospheric test site, and more than 14,000 ft<sup>2</sup> of laboratory facilities.

**INSTRUMENTATION:** Complete state-of-the-art coatings evaluation facilities with 32°–125 °C environmental coatings application chamber, atmospheric exposure site (southernmost site in continental U.S.), complete powder coatings facility, plural component spray capability, natural seawater exposure (open ocean environment), physical analytical properties laboratory, material preparation and application, Fourier transform infrared spectroscopy, seawater flow channel, and Navy antifoulant test site in Miami.

**CONTACT:**

Code 6138 • (305) 293-4214, (202) 404-4132

**LOCATION:**

NRL, Naval Air Station Key West, FL

# Cathodic Protection Model Facility

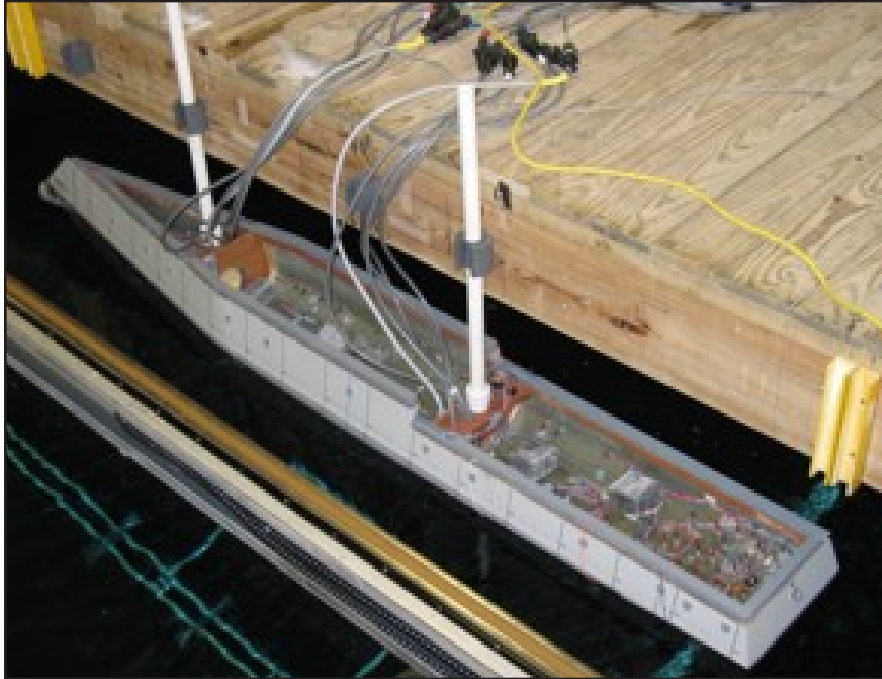

Physical scale modeling facility for design of cathodic protection systems

**FUNCTION:** Performs Navy design and engineering of ship and submarine impressed current cathodic protection (ICCP) systems for underwater hull corrosion control and evaluation/analysis of electric field (EF) and corrosion related magnetic (CRM) signature.

**DESCRIPTION:** The facility consists of 30-ft-diameter modeling tanks with state-of-the-art multi-channel electrochemical controller, sensors, and datalogging capability. The physical models, which range from 1/2 to 1/96<sup>th</sup> scale represent exact geometry and provide data for ICCP system design and for computational science and technology. Capabilities include the ability to control electrolyte conductivity, lifecycle/failure mode analysis, dynamic flow situations, equipment design, and EF signature analysis.

**INSTRUMENTATION:** 50,000-gal and 100,000-gal modeling tanks, 30-zone analog and 60-zone digital controller capability, AISHE Controller (SSN 774), static/dynamic flow simulation, seawater simulation and stabilization, advanced scanning underwater EF/magnetic sensors, scale class models for CG, DDG, LHD, LHA, LCS, LPD, CVN, AOE, MCM, FFG, SSN (688, 21, and 774), and experimental hulls.

**CONTACT:**

Code 6303 • (202) 404-7182; Code 6136 • (305) 293-4214

**LOCATION:**

NRL, Naval Air Station Key West, FL

# Ballast Water Treatment Test Facility



Ship ballast tank mock-up at the Ballast Water Treatment Test Facility

**FUNCTION:** Provides functionality for the full-scale testing and controlled simulation of ship ballasting operations for assessment of aquatic nuisance species (ANS) treatment in accordance with U.S. and International Protocols. The facility conducts research concerning full-scale treatment, organism viability, and biological efficacy. System fully documents process requirements or treatment scenarios and facilitates developing U.S. requirements for Environmental Technology Verification (ETV).

**DESCRIPTION:** The Ballast Water Treatment Test Facility (BWTF) includes land-based ballast tanks (150–300 m<sup>3</sup>), test organism injection systems, pumping capacity >300 m<sup>3</sup>/hr, and in-line pipe sampling. The BWTF is integrated using an industrial plant SCADA system which provides control and feedback of >100 valves, 10 pumps, biological subsystems, physiochemical sensors, and test technologies. The BWTF is sufficiently flexible to allow for the testing of most ballast water treatment systems and also includes a collection tank and waste water treatment capability for management of prepared test waters and treated discharges. Finally, the BWTF incorporates a fully instrumented microbiology laboratory.

**INSTRUMENTATION:** Three 150–300 m<sup>3</sup> test tanks, >300m<sup>3</sup>/hr seawater pumping capacity, advanced sampling/measurement capability, spectrophotometers, flow cytometry, fluorometer, epifluorescent microscopes, and Honeywell process control.

**CONTACT:**

Code 6136 • (305) 293-4214

**LOCATION:**

NRL, Naval Air Station Key West, FL

# Antifoulant Coatings Exposure Site



**FUNCTION:** Provides “real-world” natural seawater exposure capability in support of Navy S&T efforts to develop and evaluate underwater hull antifoulant systems.

**DESCRIPTION:** This tropical exposure site, located on the U.S. Coast Guard station along the intercoastal waterway in Miami, Florida, facilitates long-term specimen exposure with excellent biofouling capability and supports a key part of the qualification process for new technology assessment. The raft holds in excess of 200 6-in. x 24-in. exposure panels and supports natural growth of both micro- and macrofouling organisms within the Biscayne Bay ecosystem.

**INSTRUMENTATION:** Seawater exposure raft, sample exposure system, and seawater physical chemistry monitoring.

**CONTACT:**

Code 6138 • (202) 404-4132

**LOCATION:**

U.S. Coast Guard Station • Miami, FL



## Sacrificial Anode Qualification Site



Sacrificial anode pier test site

**FUNCTION:** Meets testing requirements for qualification of anodes under MIL-A-24779 (aluminum) and MIL-A-18000H (zinc). The site provides natural seawater exposure and represents a large steel cathode specifically instrumented for both S&T and qualification Navy efforts.

**DESCRIPTION:** Located on Pier D-3 at the Naval Trumbo Point Annex in Key West, Florida, the site consists of an 800 ft steel seawall with 60 anode stations and an average seawater depth of 30 feet. Sacrificial anodes can be evaluated for performance, efficiency, passivation potential, and qualification properties. The “real-world” steel bulkhead offers a unique, large, unpolarized cathode surface exposed with flowing natural seawater that is not polarized by the addition of anode test specimens.

**INSTRUMENTATION:** 60 anode stations with enclosed datalogger and control circuitry.

**CONTACT:**

Code 6136 • (305) 293-4214

**LOCATION:**

NRL, Naval Air Station Key West, FL

# Materials Science and Technology Division

- *Materials Processing Facility*
- *3 MV Tandem Pelletron Accelerator*
- *Micro/Nanostructure Characterization Facility*
- *Mechanical Characterization Facility*
- *Electrical, Magnetic, and Optical Measurement Facility*
- *Thin-Film Materials Synthesis and Processing Facility*
- *Magnetoelectronics Fabrication Facility*

# Materials Processing Facility



Isothermal heat treatment facility

**FUNCTION:** Provides a full-spectrum capability to synthesize and process materials, from small to large sizes, by a variety of methods and under varying thermal, mechanical, pressure, and rate-sensitive processes.

**DESCRIPTION:** Fully instrumented materials processing capabilities include facilities for powder production by fluid atomization, thermal evaporation, and arc erosion. These facilities offer the potential to create small particle sizes from 10 nm to 50  $\mu\text{m}$ . The powder synthesis capabilities include a physical vapor deposition system designed to produce and coat submicron powders in situ. Facilities to process powder into bulk specimens by hot and cold isostatic pressing permit a variety of consolidation possibilities. The isothermal heat treatment facility and quenching dilatometer permit accurate determinations of phase relationships in metals. Arc melting facilities permit alloy synthesis and single crystal growth. Bulk alloys can be prepared by induction melting, while rapidly solidified metals of thin cross section can be made by splat quenching and melt spinning. The facility includes rolling mills, swagers,

and wire-drawing facilities. Metal-matrix composites and surface coatings are produced in a variety of computer-controlled, physical vapor deposition systems for coating fibers and surfaces. Ceramic and ceramic-matrix composites processing facilities include a wide variety of conventional, controlled atmospheric furnaces, hot presses, and ball milling apparatus, and have particle size determination and sol-gel and organometallic coating processing capabilities.

**INSTRUMENTATION:** Many of the facilities are modified versions of commercially purchased apparatus that have been adapted to the special needs of our research.

## CONTACT:

Code 6350 • (202) 767-5799

## LOCATION:

NRL, Washington, DC

## 3 MV Tandem Pelletron Accelerator

**FUNCTION:** Generates high-energy ions for accelerator mass spectrometry (AMS), near-surface analysis, high energy ion implantation, and radiation effects studies.

**DESCRIPTION:** Negative ions are generated by Cs sputtering of a solid, or by attaching electrons onto neutral or positive ions by Cs or Rb vapor. Beam currents generated vary from  $\mu\text{A}$  to tens of  $\mu\text{A}$  depending on the source and ion chosen. Two Pelletron charging chains produce a terminal voltage up to 3 MV in the accelerator. Negative ions are injected at 10 to 70 keV, accelerated up to the terminal where they undergo collisions with a stripper gas or a carbon stripper foil and lose electrons, then are accelerated as positive ions back to ground potential. For AMS, the relative intensity of selected ions measures their concentration in the sample of interest located in the ion source. On the analysis beamline, the sample of interest is located at the end of the beamline, and a signal generated by scattering of incident high-energy ions indicates the composition of the sample. Incident high-energy ions can also be used to damage the surface of a sample of interest, or to introduce a dopant.

**INSTRUMENTATION:** Four ion sources: (1) National Electrostatics Corp. (NEC) Mutli-Cathode Source of Negative Ions by Cesium Sputtering (MC-SNICS) 40-cathode ion source; (2) custom multi-cusp gas-feed ion source under development for AMS; (3) front end of Cameca IMS 6f secondary ion mass spectrometer (SIMS); and (4) NEC Alphasross ion source to generate He ion beams. A unique Pretzel magnet coupled with an electrostatic analyzer (ESA) functions as a bandpass mass filter for the ion sources, covering a mass range from 1 to 240 amu. The tandem accelerator is an NEC model 9SDH-2 with a 3 MV terminal potential. An electrostatic bend selects the high-energy-ion charge state to be transmitted



to the AMS beamline. This beamline provides mass-independent parallel transport through use of all-electrostatic components, including a  $45^\circ$  spherical ESA with an  $E/\Delta E$  of 800. Parallel mass analysis is performed with an Enge split-pole spectrograph having a 1.5-m-long focal plane covering a mass range of a factor of 8 with an  $M/\Delta M$  of about 2500. Intense beams are detected by well-shielded Faraday cups, weak beams are detected by position-sensitive microchannel plate detectors and energy detectors. Ions for non-AMS applications are transported through the spectrograph to a switching magnet that selects either (1) an analysis beamline with a variable-angle Si particle detector for Rutherford backscattering and elastic recoil detection analysis, manual and computer-controlled goniometers for ion channeling, and a 0.02 sr acceptance solid-angle, double-focusing,  $180^\circ$  magnetic spectrometer with 0.2% energy resolution; or (2) a high energy ion implantation beamline for uniform ion implantation over a 4-in.-diameter wafer, with heating and water or liquid nitrogen cooling of the sample. All beamlines have cryopumps or turbopumps for clean vacuum conditions.

### CONTACT:

Code 6303 • (202) 767-5738

### LOCATION:

NRL, Washington, DC



# Micro/Nanostructure Characterization Facility



Leo scanning electron microscope (SEM) with electron backscatter diffraction (EBSD) capability

**FUNCTION:** Characterizes the internal micro/nanostructures of metallic, magnetic, electronic, and other multifunctional and structural materials using a variety of electron microscopy techniques.

**INSTRUMENTATION:** (1) JEOL 2010F transmission electron microscope (TEM): A 200 KeV field emission TEM for sub-nanometer-scale analysis of structure and composition. Capabilities include: atomic resolution TEM (ARTEM), electron energy loss spectroscopy (EELS), energy dispersive spectroscopy (EDS), and scanning transmission electron microscopy (STEM) with atomic-resolution Z-contrast imaging, energy filtered imaging, electron holography, and spectrum imaging.

(2) Phillips CM30 TEM: A 300 KeV operating voltage TEM especially utilized for conventional TEM studies of advanced naval steels requiring a large range of tilts for microstructural and defect analyses including conventional bright field and dark field imaging, weak beam dark field analysis, selected area diffraction, EDS, and elemental X-ray mapping using an electron beam/image displacement attachment.

(3) Leo scanning electron microscope (SEM) with electron backscatter diffraction (EBSD) capability: SEM with a field emission gun (FEG) electron source. Capabilities include high-resolution SEM, EDS, and EBSD (TexSem Laboratory system) with automated orientation mapping and quantification.

## CONTACT:

Code 6350 • (202) 767-5799

## LOCATION:

NRL, Washington, DC

# Mechanical Characterization Facility



**FUNCTION:** Characterizes the mechanical behavior of metal, polymer, ceramic, and composite materials under a variety of loading and environmental conditions using servo-hydraulic, electro-mechanical, and creep-load frames for use in advanced material modeling and material response testing under simulated service conditions.

**DESCRIPTION:** The facility consists of various testing systems, many with automated computer control and data acquisition, for determining the mechanical response of materials under controlled loading/deformation and environmental conditions. Basic capabilities include quasi-static tensile and fracture testing; dynamic storage and loss moduli as a function of frequency and temperature; cyclic fatigue crack growth and corrosion fatigue testing; and stress corrosion cracking testing. Fatigue crack growth rates can be determined under constant  $\Delta P$ ,  $\Delta K$ , or  $K_{max}$  conditions. Horizontal 5-kip servo-hydraulic load frames are available for corrosion fatigue and stress corrosion cracking experimentation in liquid environments.

**INSTRUMENTATION:** Various load frames (5 to 550 kN): Instron 1332 (250 kN, 8800 controller), ATS 2330 (60 kN creep), Instron 4201 (5 kN, screw-drive). ATS 3200 furnace (1000 °C), Instron 3119 chamber (-70° to 250 °C). Instron FastTrack (LabVIEW), Fracture Technology Associates (FTA) Crack Growth software. TA Instruments Dynamic Mechanical Analyzer (DMA 2980), Rheometer (AR-600), Differential Scanning Calorimeter/Thermogravimetric Analyzer (DSC/TGA) (SDT-2960), and Dielectric Analyzer (DEA 2970). GOM mbH ESPI 3D laser speckle interferometer for 3D strain measurement over a 2 x 4 in. area with sub-micron displacement resolution.

**CONTACT:**

Code 6350 • (202) 404-8324

**LOCATION:**

NRL, Washington, DC

# Electrical, Magnetic, and Optical Measurement Facility



**FUNCTION:** Provides tools necessary for electrical, magnetic, and optical characterization of bulk and thin-film materials. This includes the ability to determine the resistivity as a function of temperature and magnetic field and the magnetization as a function of temperature using superconducting quantum interference device (SQUID) magnetometry and vibrating sample magnetometry (VSM). Electroluminescence facilities are also available for determining the magneto-optic properties of light-emitting diode structures.

**DESCRIPTION:** This facility comprises several complementary instruments that allow for the magnetic, electrical, optical, and heat capacity characterization of materials and devices. SQUID and vibrating sample magnetometry are used to determine important properties of superconducting, para- and diamagnetic, and ferromagnetic materials. The transport properties of materials, namely the temperature and magnetic field dependent resistivity combined with heat capacity measurements, allow for a fundamental physical understanding of electronic properties. VSM extends the experimental temperature range of magnetic properties characterization to 1000 K. Measurement of luminescence properties of light-emitting devices under varying temperature and magnetic field is also possible in this facility.

**INSTRUMENTATION:** Quantum Design Physical Properties Measurement System (PPMS): Temperature and magnetic field dependent measurements of transport, ac magnetic susceptibility, and heat capacity; temperature range 200 mK to 350 K; magnetic field range  $\pm 8$  T. Quantum Design Magnetic Properties Measurement System (MPMS): Characterization of magnetic properties of materials by SQUID magnetometry; optical-fiber access for magneto-optic characterization; temperature range 1.7 K to 400 K; magnetic field range  $\pm 5$  T; sensitivity less than  $5 \times 10^{-7}$  emu. Digital Measurement Systems VSM: Magnetic materials characterization for magnetic fields up to  $\pm 2$  T; temperature range 110 K to 1000 K. Optical access flow cryostat/electromagnet system for magneto-electroluminescence measurements.

## CONTACT:

Code 6360 • (202) 767-4694

## LOCATION:

NRL, Washington, DC

# Thin-Film Materials Synthesis and Processing Facility



**FUNCTION:** Provides a wide capability for deposition and processing of thin films, including sputter and ion-beam deposition, thermal evaporation, electro-deposition, pulsed laser deposition (PLD), chemical vapor transport, and laser direct-write fabrication. These tools allow for thin-film growth of metals, dielectrics, oxides, and solid electrolyte materials, and for laser patterning of thin-film structures.

**DESCRIPTION:** This facility provides users a wide array of techniques for growth and processing of thin films (thickness 1  $\mu\text{m}$  or less). Sputter deposition offers a versatile method of depositing metallic and dielectric films and is a primary tool of this facility. Thermal evaporation of metals is implemented in both high-vacuum and ultrahigh-vacuum systems. PLD with variable stage temperature and controlled atmosphere allows growth of oxides. Electrolytic deposition offers efficient growth of gold and silver films. Laser direct-write ablation and deposition provide unique methods for imposing computer-aided design (CAD)-defined features via ablation of a substrate film and ablative mass transfer to a substrate.

**INSTRUMENTATION:** Dual-gun sputter system for RF and dc magnetron deposition of metals and dielectrics. Kyocera high-temperature oxide sputtering system. Physical Electronics molecular beam epitaxy system with 8 Knudsen cell sources, quadrupole mass analyzer (QMA) rate-monitor for sub-monolayer control of thickness, and in situ reflection high-energy electron diffraction (RHEED) and Auger analysis. Multi-target PLD system using a 248 nm excimer laser excitation with high-temperature stage and variable chamber atmosphere. Chemical vapor deposition furnace for growth of transition-metal oxides. Laser direct-write system for transfer of CAD-generated features to a wide variety of substrates and printed circuit boards.

**CONTACT:**

Code 6360 • (202) 767-4694 and 767-5653

**LOCATION:**

NRL, Washington, DC



# Magnetolectronics Fabrication Facility



**FUNCTION:** Provides a wide range of lithography tools for construction of micrometer- and nanometer-size devices of interest in the study of magnetolectronics.

**DESCRIPTION:** The Magnetolectronics Fabrication Facility is a Class 1000 clean room facility equipped with tools for lithographic construction of magnetolectronic and spintronic devices. The facility provides pattern definition, metallization, dielectric layer deposition, and reactive and Ar<sup>+</sup> ion etching of wafers and small pieces.

**INSTRUMENTATION:** Karl Suss MJB3 mask aligner/contact printer with mid-ultraviolet (UV) optics capable of optical lithography to 500 nm resolution. Spin/bake/develop equipment for processing of photoresists and e-beam resists. Four-source thermal evaporation system; RF/dc magnetron sputter deposition system; ultra-high-vacuum (UHV) dual ion beam deposition system. CF<sub>4</sub>/O<sub>2</sub> reactive ion etching; Ar<sup>+</sup> ion mill system; wet etch process station. Olympus BX50 optical microscope with differential interference contrast imaging and camera; KLA-Tencor Alpha-step surface profilometer; Cascade Microtech REL-3200 manual probe station and electronic instrumentation rack; Kulicke and Soffa ultrasonic wire bonder. FEI Inc. FIB-200 focused ion beam system equipped with enhanced etch, Pt-metal deposition, and dielectric layer deposition.

## CONTACT:

Code 6360 • (202) 767-4694

## LOCATION:

NRL, Washington, DC

# Laboratory for Computational Physics and Fluid Dynamics

- Parallel High Performance Computer Graphics Facility

# Parallel High Performance Computer Graphics Facility



**FUNCTION:** The Laboratory for Computational Physics and Fluid Dynamics (LCP&FD) is in round-the-clock production for computational studies in the fields of compressible and incompressible fluid dynamics, reactive flows, fluid-structure interaction (including submarine, ship, and aerospace applications), plasma physics, atmospheric and solar magnetoplasma dynamics, application of parallel processing to large-scale problems such as unstructured grid generation for complex flows, and other disciplines of continuum and quantum computational physics.

**DESCRIPTION:** The facility is used to develop and maintain state-of-the-art analytical and computational capabilities in fluid dynamics and related fields of physics, to establish in-house expertise in parallel processing and online graphical rendering for large-scale scientific computing, to perform analyses and computational experiments on specific relevant problems, and to transfer this technology to new and ongoing projects through cooperative programs.

## **INSTRUMENTATION:**

- 1120-core x86 cluster
- Two 64-core SGI Altix systems
- 184-core x86 cluster
- 256-core SGI ICE cluster
- 256-core Opteron cluster
- More than 60 SGI, Apple, and Intel workstations

Each system has on the order of 14 terabytes of disk for storage during a simulation. All computers and workstations have network connections to NICENET and ATDnet allowing access to the NRL Center for Computational Science facilities (including the DoD HPC resources) and many other computer resources both internal and external to NRL.

## **CONTACT:**

Code 6440 • (202) 404-1063

## **LOCATION:**

NRL, Washington, DC

# Plasma Physics Division

- Nike KrF Laser Facility
- Electra Laser Facility
- Pharos Laser Facility
- Plasma Applications Laboratory
- Space Physics Simulation Chamber
- Gamble II Facility
- Hawk Facility
- Mercury Facility
- High-Frequency Microwave Processing of Materials Laboratory
- T-Cubed Laser System
- TFL Laser System
- Railgun Materials Testing Facility
- Directed Energy Physics Facility



# Nike KrF Laser Facility

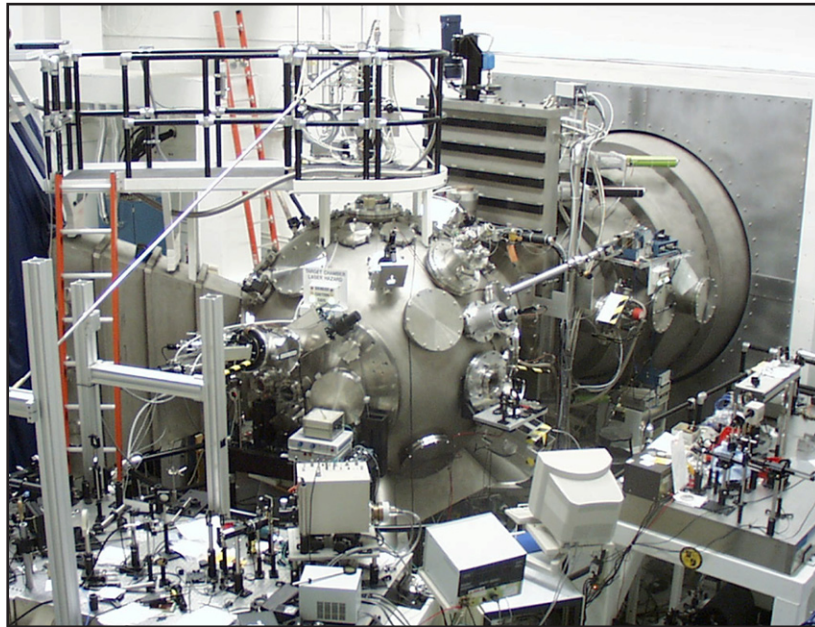

Nike target chamber

**FUNCTION:** Studies the physics and technology issues of direct-drive laser fusion. Primary areas of research include studies of means to reduce hydrodynamic instability in laser-accelerated targets, studies of the response of materials to extreme pressures, and generation of X rays from laser-heated targets. This work supports the Department of Energy's program for science-based stockpile stewardship.

**DESCRIPTION:** The Nike laser is a 56-beam krypton fluoride (KrF) system that provides 3 to 4 kJ of laser energy on targets. The laser uses controlled spatial incoherence to achieve highly uniform focal distributions in each of these beams. Up to 44 of the beams are overlapped onto targets with typical focal diameters of 0.75 mm and peak intensities near  $10^{14}$  W/cm<sup>2</sup>. The combination of uniform individual beams and smoothing from overlapping numerous beams produces extremely uniform illumination of targets. The effective illumination nonuniformity is less than 0.2% when time averaged over a typical 4-ns laser pulse. Nike thereby produces highly uniform ablation pressures on target that allow well-controlled experiments at pressures up to 20 million atmospheres. The remaining 12 laser beams are used to generate diagnostic X rays that radiograph the primary laser-illuminated targets. The facility includes a

front end that generates the desired temporal and spatial laser profiles, two electron-beam-pumped KrF amplifiers of 20 and 60 cm aperture, a computer-controlled optical system consisting of approximately 400 mirrors, and a vacuum target chamber for experiments.

**INSTRUMENTATION:** A computer-controlled data acquisition system, high-speed X-ray and optical cameras, high-resolution X-ray imaging systems, X-ray and visible spectrometers, high-speed digital oscilloscopes, and cryogenic target capability.

**CONTACT:**

Code 6730 • (202) 767-0689

**LOCATION:**

NRL, Washington, DC

# Electra Laser Facility



**FUNCTION:** The Electra Laser Facility is used to develop the science and technology needed to develop a reliable, efficient, high-energy, repetitively pulsed krypton fluoride (KrF) laser. The main application for this laser is a driver for a fusion energy power plant. However, the laser architecture also has defense applications.

**DESCRIPTION:** Electra is an electron-beam-pumped laser. It produces 200- to 700-J, 140-nsec-long laser pulses at rep rates from 1 to 5 Hz. It has run at 2.5 Hz for 16,000 shots (approximately 2 hours). The main amplifier is pumped with two 500,000-V, 100,000-A electron beams. Each beam is 30 cm high by 100 cm long. The pre-amplifier is pumped with two 175,000-V, 80,000-A, 40-nsec-long electron beams. In both cases, the electron beams excite a krypton-fluorine gas mixture inside a laser cell. A thin foil, supported by a structure known as a hibachi, isolates the vacuum regions in which the electron beams are formed, from the gas inside the laser cell. A recirculator both cools and quiets the laser gas between shots. This type of laser is predicted to have total efficiencies of greater than 7%. This is due to advances in the electron beam physics, laser physics, and hibachi. A new solid-state pulsed power

switch has been developed that can become the basis for a durable, efficient, and cost-effective pulsed power system.

**INSTRUMENTATION:** The operation of the Electra facility is carried out through a computerized control system that continually monitors all system parameters. This includes the input, inter-stage, and output voltages, magnetic current, trigger laser operation, and gas, electrolyte, and coolant temperature and flow. A totally separate system is used to acquire data from the experiment, including electron beam voltage and current, laser gas parameters, laser output, and laser pulse shape.

## CONTACT:

Code 6730 • (202) 767-2705

## LOCATION:

NRL, Washington, DC

# Pharos Laser Facility



**FUNCTION:** Conducts high-power, short-pulse laser-plasma and laser-solid interaction studies that include nuclear blast effects simulation, shock wave generation, interaction in solids and plasmas, and shock wave and explosive cavitation interaction in water and water-saturated seabed sands.

**DESCRIPTION:** The facility consists of the Pharos laser with associated target chambers and dedicated diagnostics. Pharos is a Nd:Glass laser that provides two 15-cm clear aperture beams of 1- $\mu\text{m}$  wavelength light. Each beam can deliver more than 500 J of energy on target in a 5-ns pulse. The system repetition rate at full energy is once every 50 minutes. Each of the beams may be independently targeted and independently timed. Harmonic generation crystals can be used to convert the laser's output from 1.0  $\mu\text{m}$  to 0.5  $\mu\text{m}$  wavelength.

**INSTRUMENTATION:** A large variety of laser-plasma diagnostics are available. These include time-integrated visible and X-ray spectrographs and beam diagnostics as well as high-speed drum cameras, ultra-high-speed gated optical imagers, streak cameras, and single-channel detectors sensitive to both visible and X-ray wavelengths. Several specially designed lower-power lasers are also available as probes for optical diagnostics.

**CONTACT:**

Code 6730 • (202) 767-9117

**LOCATION:**

NRL, Washington, DC



# Plasma Applications Laboratory

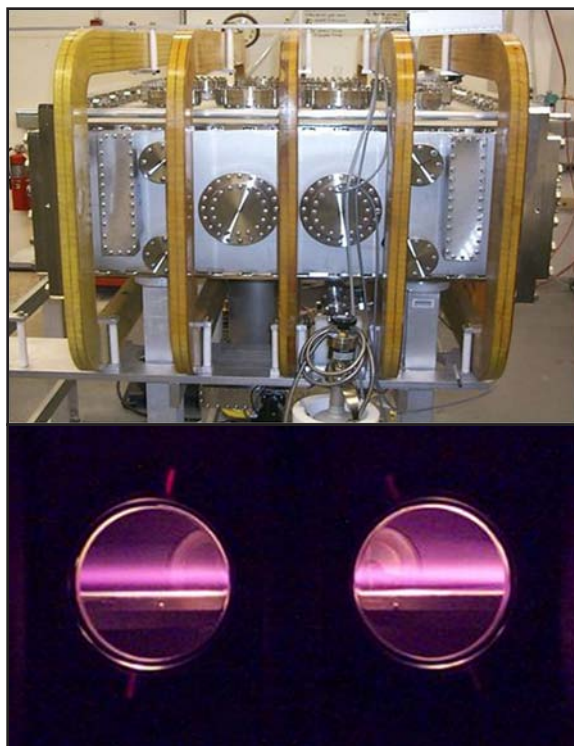

**FUNCTION:** Conducts research related to the production of plasmas, plasma characteristics, and the interaction of plasmas with materials. The research facility is aimed at developing a comprehensive understanding of plasma-based materials applications ranging from etching to deposition to surface activation.

**DESCRIPTION:** The laboratory has several chambers operating under both high and ultrahigh vacuum conditions. The systems have numerous access ports for plasma diagnostics and the ability to accommodate a range of materials processing approaches. Plasma production capabilities include RF-generated sources, magnetrons, and electron beams, including the NRL-developed Large Area Plasma Processing System (LAPPS), which can generate square meter plasma sheets with higher efficiency and better control than other techniques presently used in materials processing. The system shown above is one of the LAPPS chambers where a 1–3 kV electron beam, confined by a 100–300 G magnetic field along the axis, is used to produce plasma in a mixture of argon and nitrogen. A stage located inside the chamber, on which a material can be placed, is moved close to the plasma sheet for processing.

**INSTRUMENTATION:** A variety of plasma and particle collection diagnostics are used. These include Langmuir probes and biased charge collectors to measure plasma density, plasma potential, and temperature; a dual energy analyzer/quadrupole mass analyzer to identify particles and determine their energy; optical diagnostics to measure plasma temperature and composition; and a laser-induced fluorescence system for measuring local particle energies. Numerous transient recorders, power supplies, RF generators, digital multimeters, electrometers, and amplifiers are also available.

**CONTACT:**

Code 6750 • (202) 767-7531

**LOCATION:**

NRL, Washington, DC



# Space Physics Simulation Chamber

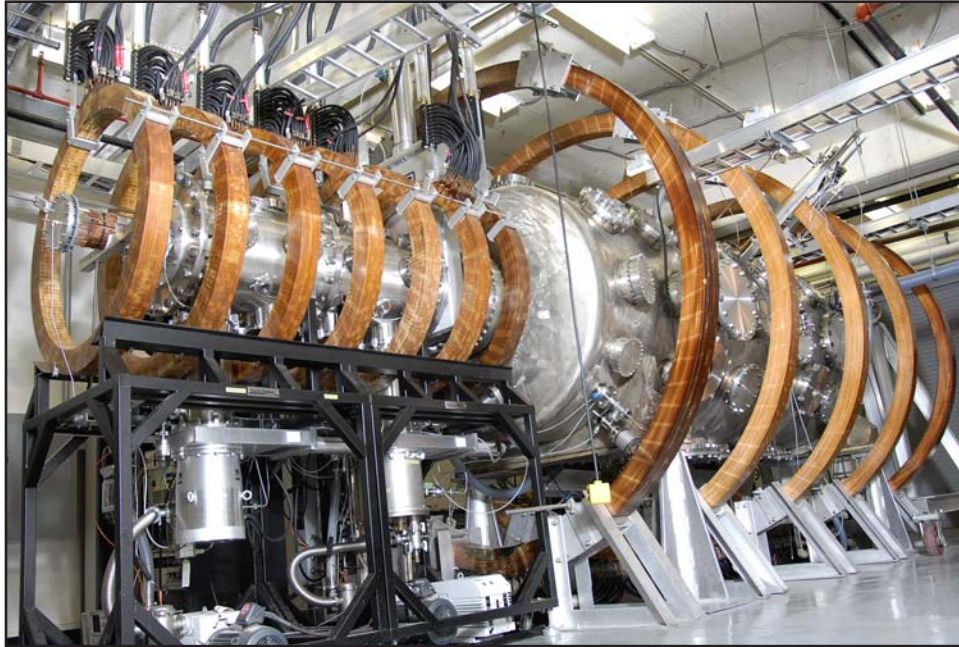

**FUNCTION:** The Space Physics Simulation Chamber (SPSC) is used to create controlled, reproducible conditions representative of the near-Earth space plasma environment. The device is used for the study of ionospheric, magnetospheric, or solar wind plasma phenomena, testing/calibration of space-qualified diagnostic instruments for orbital or suborbital missions, spacecraft charging, large-volume plasma generation, and other topics requiring a low-pressure environment.

**DESCRIPTION:** Plasmas with diameter  $\sim 0.75$  m are produced within two integrated vacuum chamber sections: a 1.8-m-diameter, 5-m-long stainless steel main chamber and a 0.55-m-diameter, 2-m-long source chamber section. Water-cooled electromagnet coils provide an axial magnetic field of up to 250 G in the main chamber and up to 1000 G in the source chamber section. A base pressure near  $10^{-7}$  torr is maintained by pairs of cryogenic and turbomolecular vacuum pumps. Three large-volume plasma sources are available: a microwave discharge plasma source (plasma densities  $n$  ranging from  $10^5$  to  $10^9$   $\text{cm}^{-3}$  and electron temperatures  $T_e \sim 0.5$  eV), a thermionic discharge plasma source ( $n \sim 10^5$ – $10^{12}$   $\text{cm}^{-3}$ ,  $T_e \sim 0.1$ – $2$  eV), and a helicon source ( $n \sim 10^9$ – $10^{13}$   $\text{cm}^{-3}$ ,  $T_e \sim 2$ – $5$  eV). Access for electrical, diagnostic, and manipulator vacuum penetration is available over most of the SPSC volume.

**INSTRUMENTATION:** A full range of plasma diagnostics is available, including internally heated Langmuir probes, emissive probes, ion energy analyzers, impedance probes, ac magnetic field probes, and pressure probes. Numerous transient recorders, power supplies, digital multimeters, electrometers, network and spectrum analyzers, and amplifiers are available. The instrumentation is General Purpose Interface Bus (GPIB)-controlled using LabVIEW™ software.

**CONTACT:**

Code 6755 • (202) 404-1022

**LOCATION:**

NRL, Washington, DC

# Gamble II Facility

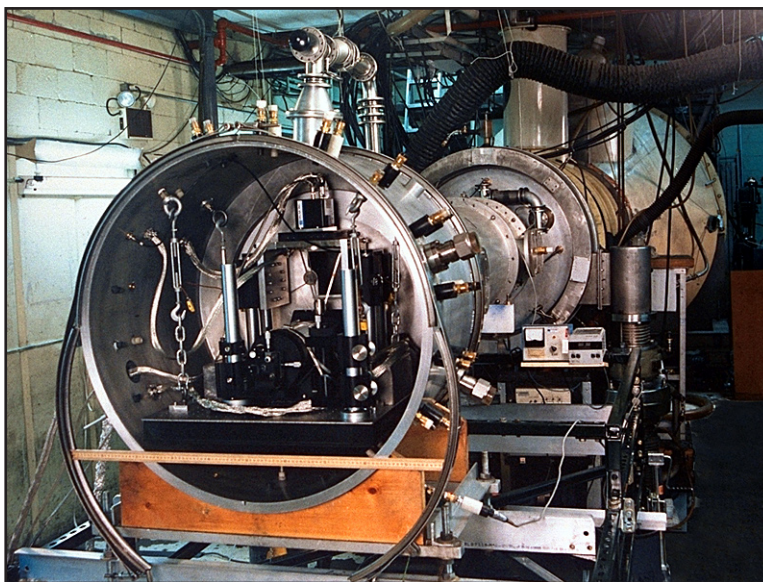

**FUNCTION:** Gamble II produces a high-voltage (2 MV), high-current (1 MA), short (100 ns) pulse of energy of either positive or negative polarity. This terawatt power pulse is used for many Navy, DoD, and Department of Energy research programs including nuclear weapon effects simulation, advanced hydrodynamic radiography, and detection of special nuclear materials. Intense electron beams from Gamble II can interact directly with a target or generate bremsstrahlung to expose test articles to an intense X-ray pulse or to produce a small, intense X-ray source for radiography. Intense ion beams can interact directly with targets or produce characteristic gammas that can be used to probe for special nuclear materials. Another mode of operation uses a plasma opening switch to increase the voltage to 4 MV and reduce the pulse width to 10 ns. The photograph is from an experiment in which a proton beam strikes a support strut of a telescope and induces mechanical vibrations to simulate its response to an intense pulse of  $\sim$ keV X rays in space.

**DESCRIPTION:** The facility's 300-kJ Marx generator is a large capacitor bank capable of producing several-megavolt voltages. The voltage pulse is then compressed in time duration through a succession of water dielectric pulse-forming lines separated by closing switches to eventually arrive as a high-power pulse across a vacuum diode. This pulse can be applied directly across a load (such as a gas column or wire) or can be used to produce powerful electron or ion beams. These high-power beams are then allowed to interact with X-ray converters or to propagate to a variety of targets. The facility is surrounded by thick concrete shielding to contain X rays produced as a result of the high-power pulses.

**INSTRUMENTATION:** Diagnostics for the generator and the beams are monitored in a shielded room located outside the radiation area. Diagnostics include sophisticated computer-controlled transient recorders or oscilloscopes to record analog signals, numerous optical, X-ray, or neutron diagnostics, and nuclear activation monitors.

## CONTACT:

Code 6770 • (202) 767-8373

## LOCATION:

NRL, Washington, DC



# Hawk Facility

**FUNCTION:** Produces a high-current (750 kA) pulse with a microsecond rise time into a vacuum inductor. The energy stored in the inductor is transferred to a radiation or particle-beam load by using a plasma opening switch (POS). These inductive energy store (IES) generators represent a new approach for generating high-power pulses for Navy, DoD, and Department of Energy applications, including nuclear weapons effects simulation, inertial confinement fusion, and dense Z-pinch X-ray and neutron sources. The device is used primarily as a research testbed for IES technology and for fundamental research into the physics of radiation source and POS operation.

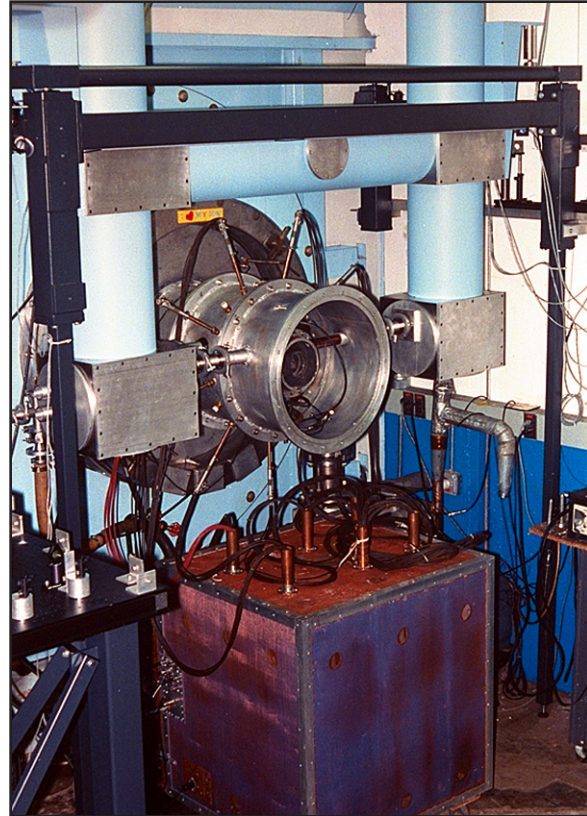

**DESCRIPTION:** The facility consists of four Marx banks in an oil-filled tank, connected in parallel, with an output voltage of 720 kV when the capacitors are charged to 90 kV each. The Marx bank stores 300 kJ of electrical energy. The discharge of the capacitors into the system inductance (700 nH) results in a sinusoidal current with a 1.2  $\mu$ s quarter period and an amplitude of 750 kA. A POS is used to conduct the generator current during most of this rise time (typically for about 1  $\mu$ s) while the energy is transferred from the capacitors to the circuit inductance. The POS then opens quickly (in less than 100 ns) allowing the current to flow to a downstream load, such as an electron-beam diode, for example. The facility is surrounded by thick concrete shielding to contain X rays produced as a result of the high-power pulses.

**INSTRUMENTATION:** Diagnostics for the generator and POS are monitored in a shielded room located outside the radiation area. Diagnostics include sophisticated computer-controlled transient recorders to record analog signals, various optical, X-ray, and nuclear activation monitors, and plasma diagnostics, such as interferometers and charged particle detectors for measuring quantities of interest in the POS.

**CONTACT:**

Code 6770 • (202) 404-8984

**LOCATION:**

NRL, Washington, DC

# Mercury Facility



**FUNCTION:** Mercury is NRL's newest pulsed-power generator facility. It is a state-of-the-art, 6-MV, 375-kA, 50-ns, 2.2-TW magnetically insulated inductive voltage adder (IVA). Mercury is a focal point of research for several areas, including IVA power-flow research and development, X-ray source development for both high-resolution flash radiography (in support of the U.S. Stockpile Stewardship Program) and nuclear weapons effects simulation, and particle-beam source and transport research for various applications.

**DESCRIPTION:** Mercury is a 6-stage IVA. The oil-immersed Marx bank comprises thirty-six 2.2- $\mu$ F, 100-kV capacitors (396 kJ at 100-kV charge). The erected Marx discharges into four parallel coaxial water capacitors, also immersed in oil, that make up the 36-nH intermediate store (IS). Each IS discharges into three 5.5- $\Omega$  coaxial water pulse-forming lines (PFLs) through a laser-triggered gas switch. Each of the twelve 50-ns-long (two-way transit time) PFLs is switched out through self-closing water output switches into a coaxial water output line that connects the PFL to an induction cell through a coaxial oil-filled elbow. Two PFLs feed each of the six induction cells, one from the top and one from the bottom. The voltage on each induction cell is added up in vacuum along a magnetically insulated transmission line to obtain the final voltage. Thick concrete walls surround the generator to contain X rays.

**INSTRUMENTATION:** A full array of electrical diagnostics is monitored on a bank of transient recorders in an electrically shielded room located outside the radiation-shielded area. Complementing the electrical diagnostics is a full set of time-resolved and time-integrated radiation diagnostics, as well as state-of-the-art interferometric diagnostics. The generator operation is computer controlled.

### CONTACT:

Code 6770 • (202) 404-5324

### LOCATION:

NRL, Washington, DC



# High-Frequency Microwave Processing of Materials Laboratory



**FUNCTION:** Conducts research on high-frequency microwave processing of materials using a high-power, continuous-wave (CW), 83-GHz, quasi-optical beam system for rapid, selective sintering, heat treatment, modification, coating, and joining of ceramics and metals, and production of nano-crystalline metals and ceramics.

**DESCRIPTION:** A free-space-propagating, quasi-optical beam of intense polarized millimeter-wave radiation is produced by an 83-GHz, 15-kW, CW industrial gyrotron and injected into a sealed processing chamber (1.5 m long  $\times$  1.2 m high  $\times$  0.9 m wide) where it is focused onto the workpiece. Beam intensities up to 10 kW/cm<sup>2</sup> can be achieved, the beam power is variable up to 15 kW, and the pulse length is variable from 1 s to CW operation. Minimum spot size (0.5 cm), area illumination (20  $\times$  20 cm), and strip illumination (0.5  $\times$  20 cm) of the workpiece can be achieved using focusing mirrors. Various processing atmospheres can be used and workpieces can be heated rapidly to temperatures exceeding 2000 °C.

**INSTRUMENTATION:** The Gycom Ltd. 15 kW gyrotron and associated dc power supply and cryogen-free, superconducting 3 T magnet are controlled and monitored by a LabVIEW™ PC-based system that acquires and analyzes a wide range of instrumentation output and includes a large number of safety interlocks. Workpiece temperature diagnostics include single- and two-color pyrometers, and up to eight K- and S-type thermocouples. Processes can be monitored in real time and recorded via a video camera within the processing chamber.

**CONTACT:**

Code 6793 • (202) 767-2469

**LOCATION:**

NRL, Washington, DC

# T-Cubed Laser System

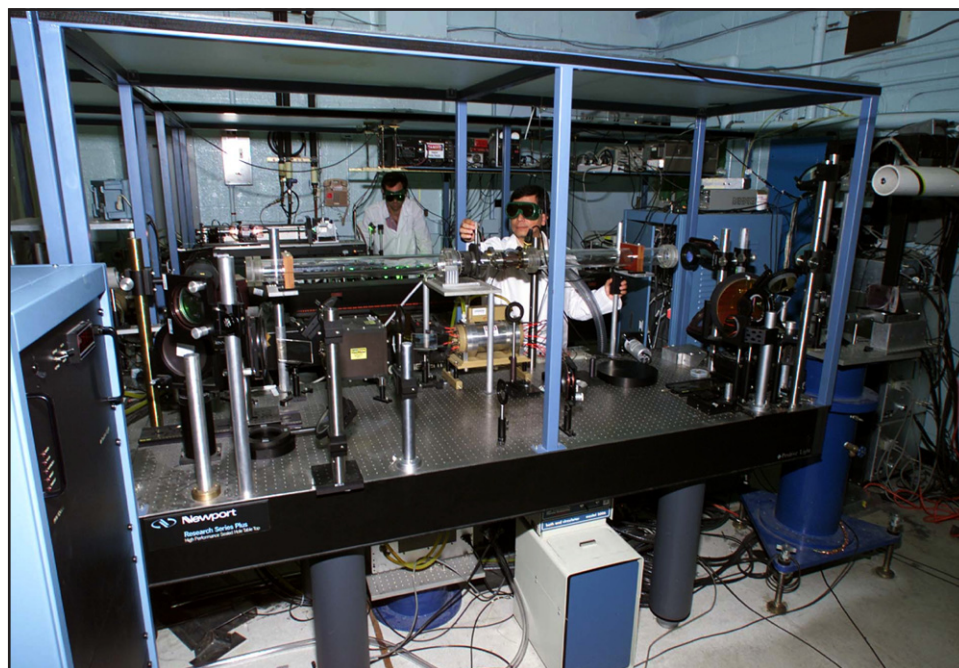

Table-Top Terawatt (T-Cubed) Laser System

**FUNCTION:** Conducts ultra-high-power, ultra-high-intensity laser-plasma, laser-electron beam, and laser-solid interaction studies that include fundamental strong-field physics experiments, and new imaging and diagnostic techniques.

**DESCRIPTION:** The facility consists of the T-Cubed (Table-Top Terawatt) laser with associated target chambers and diagnostics. The T-Cubed Laser System uses chirped pulse amplification of 1.053  $\mu\text{m}$  wavelength light. It can provide  $>8$  J of energy in a 400-fs pulse using a vacuum optical compression chamber, thus providing pulsed power greater than 20 TW. The excellent beam quality of the amplified light provides focused intensities  $\sim 10^{19}$  W/cm<sup>2</sup> on target. The laser pulse also has high contrast ratio so that plasma formation due to prepulse illumination of the target can be minimized. The system repetition rate at full energy is once per 20 min without degrading the beam quality. Optical compression in air can deliver 1-J energy pulses at a rate of once per 5 min. Frequency-doubled pulses at 527 nm wavelength can be obtained at  $\sim 70\%$  efficiencies.

**INSTRUMENTATION:** Several laser plasma and electron beam diagnostic tools and techniques are available. These include laser diagnostics, autocorrelators, FROG (frequency-resolved optical gating), interferometers, optical and X-ray spectrometers, optical and X-ray streak cameras, gated optical imagers, infrared linear and 2D sensor arrays, X-ray diodes, and magnetic electron spectrometers. Several lower-power lasers are also available as probes for optical diagnostics.

**CONTACT:**

Code 6795 • (202) 404-7568

**LOCATION:**

NRL, Washington, DC

# TFL Laser System



Titanium:sapphire Femtosecond Laser (TFL) System

**FUNCTION:** Conducts experimental studies of femtosecond, intense laser pulse interactions with nonlinear media such as propagation and breakdown in air and water, novel radiation generation for remote sensing and countermeasures, and non-thermal material modifications.

**DESCRIPTION:** The facility consists of the Titanium:sapphire Femtosecond Laser (TFL) with the associated interaction chambers and diagnostics. It operates at a repetition rate of 10 Hz and a laser wavelength of 0.8  $\mu\text{m}$ . The laser pulse length is 50 fs and the pulse energy is 500 mJ, providing  $\sim 10$  TW of pulsed laser power. The final compression of the output laser pulse is separated from the laser amplifiers to provide multiple beamlines for convenient switching between experiments. Frequency doubling of the laser provides unique femtosecond laser pulses at 0.4  $\mu\text{m}$  for underwater propagation studies.

**INSTRUMENTATION:** A large variety of laser and plasma diagnostics is available. These include autocorrelators, FROG (frequency-resolved optical gating), a gated optical imager, interferometers, streak cameras, imaging spectrometers, linear and 2D optical image intensifiers, linear and 2D infrared detectors, X-ray spectrometers and detectors, and several pulsed and continuous-wave (CW) probe lasers.

**CONTACT:**

Code 6795 • (202) 404-7568

**LOCATION:**

NRL, Washington, DC



# Railgun Materials Testing Facility



**FUNCTION:** Contributes to the Navy program to develop a high-performance electromagnetic launcher for a future electric warship. This laboratory, together with NRL materials analysis laboratories, focuses on materials aspects of high-power railgun operation. This includes developing high-performance rails, insulators, and armatures that can withstand the megampere currents and thousands of atmospheres of pressure needed to launch projectiles at high velocities. The facility houses a medium-sized railgun, a capacitor bank driver, and multiple diagnostics to measure barrel performance.

**DESCRIPTION:** The high bay laboratory contains a 6-m-long railgun firing into an evacuated transport tube and target chamber. The rails and insulators of the gun are located within a stainless steel containment capable of withstanding the extreme pressures generated during launch. A target chamber is contained within a concrete block house with 18-inch-thick walls on all sides. The gun is powered by 22 half-megajoule capacitor banks, each of which is discharged using high-current solid-state switches. The banks can drive peak currents of up to 1.8 megampere for the 5 msec launch time. Current, pressure, temperature, optical emission, and X-ray imaging diagnostics are mounted on the railgun or along the transport tube. The railgun is designed to be reconfigurable for experimental modification and for ease of diagnostic access. It is capable of producing current densities of hundreds of kA/cm<sup>2</sup>, bore pressures of thousands of atmospheres, and launch velocities of over 2 km/s.

**INSTRUMENTATION:** Projectile velocities are measured using magnetic field probes and voltage probes spaced along the length of the railgun. Thermocouples and pressure diagnostics are mounted on the rails and insulators inside of the containment. Optical spectrometers and fast framing cameras are used to observe the launch. A dual-axis X-ray imager is located in the transport tube to image the projectile before it is destroyed in the multi-layered steel plate target. Signals from the probes are recorded in a multi-channel digitizer system and analyzed using computer software. Rails and insulators are removed from the bore for analysis using scanning electron microscopy, optical imagers, profilometers, X-ray diffraction, and other detailed materials diagnostic tools.

**CONTACT:**

Code 6750 • (202) 767-0335

**LOCATION:**

NRL, Washington, DC



# Directed Energy Physics Facility



**FUNCTION:** Conducts experimental studies of high-energy lasers (HEL) for directed energy (DE) applications. These include the study of HEL beam combining architectures such as the incoherent combining of high-power single-mode fiber lasers; HEL atmospheric propagation physics of turbulence, aerosol scattering and absorption, and thermal blooming effects; HEL interaction with optical components; and the mitigation of atmospheric propagation effects through adaptive optics. Laboratory and field experiments are conducted for these studies.

**DESCRIPTION:** The facility consists of a set of four high-power, single-transverse-mode, continuous-wave (CW) ytterbium fiber lasers, and a CW, high-power (700 W) neodymium yttrium aluminum garnet (Nd:YAG) laser. The power of the four fiber lasers are 1 kW, 1.6 kW, 1.6 kW, and 2 kW, for a total power of 6.2 kW. The excellent beam quality ( $M^2 \sim 1$ ) at these unique and state-of-the-art power levels enables long-range propagation with minimal beam divergence. The facility laboratory has a propagation length of over 20 meters, extendable to longer distances with reflective optics, and has high-power laser and beam diagnostics. The laboratory also has aerosol generation equipment to simulate maritime aerosol conditions for HEL-aerosol interaction experiments. Field experiments at multiple-kilometer ranges are performed at DoD facilities around the country.

**INSTRUMENTATION:** Laser and beam diagnostics include power meters capable of measuring 10 kW beam power, a beam profiling system for precision measurement of  $M^2$ , high-speed video camera for measurement of turbulence- and thermal blooming-induced beam distortions, digital high-speed framing camera for studying aerosol scattering and absorption, spectrometers, gated and un-gated optical image intensifiers, and several pulsed and CW probe lasers. For field experiments, there are mobile laser enclosures, laser cooling water chillers, and remote controls for both laser operation and beam steering.

**CONTACT:**

Code 6795 • (202) 404-7658

**LOCATION:**

NRL, Washington, DC

# Electronics Science and Technology Division

- Ultrafast Laser Facility
- Space Solar Cell Characterization Laboratory
- Compound Semiconductor Processing Facility
- Laboratory for Advanced Materials Synthesis
- Epicenter for Advanced Materials Growth and Characterization
- Millimeter-Wave Vacuum Electronics Fabrication Facility
- Advanced Silicon Carbide Epitaxial Research Laboratory

# Ultrafast Laser Facility

**FUNCTION:** Supports a broad range of basic and applied research that includes understanding primary photophysical processes in molecules, molecular films, and supramolecular systems; characterizing the low-frequency (terahertz) vibrational response of molecules; and simulating the effects of space radiation with state-of-the-art microelectronic circuitry. The Ultrafast Laser Facility (ULF) supports NRL research programs and collaborative research projects with outside universities, industry, and government institutions. Customers from the space electronics industry use the ULF as a tool to optimize circuit designs for space applications.

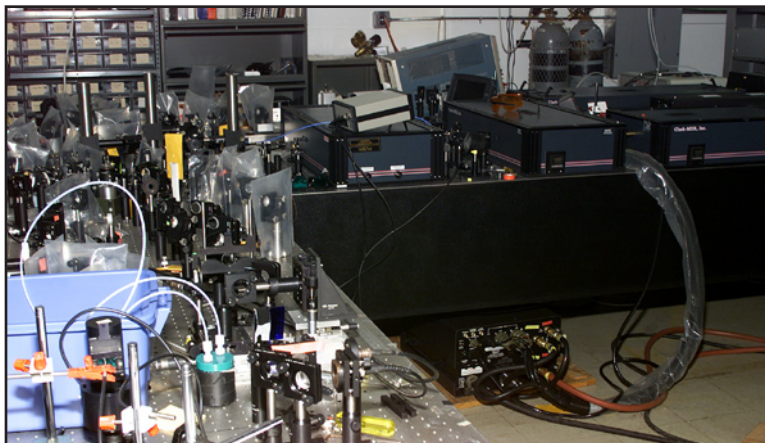

The amplified titanium sapphire system for investigating ultrafast processes in condensed matter systems

**DESCRIPTION:** The ULF's equipment has recently been used to perform experiments that measure ultrafast photophysical processes on organic macromolecules and in organic solid state thin films designed for photonics applications. An optical apparatus has been configured to characterize photophysical mechanisms using transient pump-probe spectroscopy at either a single frequency or using a multicolor continuum. A separate apparatus is used to measure the picosecond timescale photo-induced emission process following ultrashort pulse excitation. An ultrafast terahertz spectrometer is under construction, which will be used to measure the low-frequency vibrational response of organic solids and liquids. The ULF is also devoted to understanding the effects of space radiation on microelectronics circuitry. Sub-picosecond laser pulses are used to simulate the interaction of space radiation with semiconductor material (Si, GaAs, InAs, etc.). The ultrafast pulsed laser permits the study of space radiation effects in microelectronics in a highly controlled manner, and thus complements experiments performed at accelerator facilities. The ULF has proven invaluable to the space industry for troubleshooting microelectronic circuits for space applications.

**INSTRUMENTATION:** The ULF contains laser systems capable of producing laser pulses in a temporal range between 20 fs and 2 ps. The core femtosecond system consists of an amplified titanium sapphire laser that is coupled to two tunable optical parametric amplifiers. This system generates tunable femtosecond pulses from the mid-infrared to the ultraviolet part of the spectrum. A second titanium sapphire oscillator is available for applications requiring high laser pulse repetition rates. The ULF also maintains a synchronously pumped cavity-dumped dye laser system, which produces picosecond laser pulses in the visible. A time-correlated single photon counting apparatus provides a sensitive measurement of fluorescence signals. The ULF contains the optical apparatus and spectroscopic instrumentation to perform a wide variety of ultrafast experiments.

## CONTACT:

Code 6812 • (202) 767-5461

## LOCATION:

NRL, Washington, DC

# Space Solar Cell Characterization Laboratory

Triple junction, amorphous silicon solar cell under colored light bias mounted in the NRL spectral response measurement system

**FUNCTION:** Measures, characterizes, and analyzes photovoltaic materials and devices. The primary focus is the measurement and characterization of solar cell response to exposure to natural and manmade radiation environments. These facilities are used by a range of customers, both commercial and government, for performing experiments ranging from in-depth basic studies of radiation response mechanisms to large-scale product qualification campaigns.

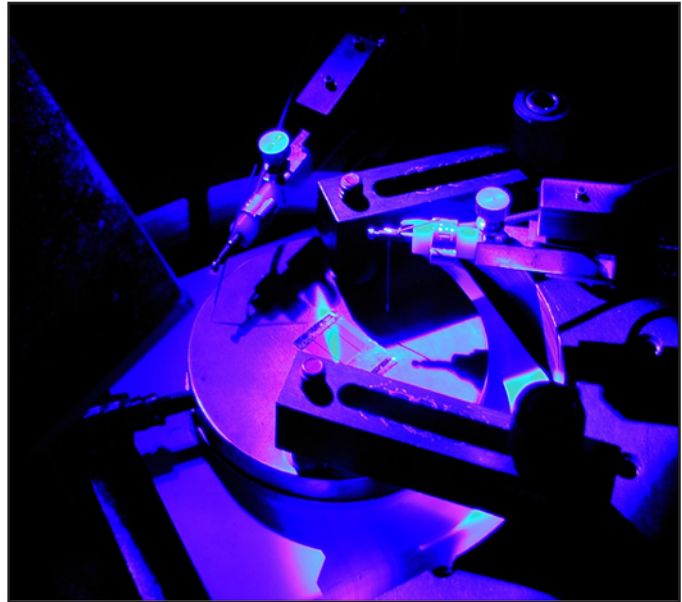

**DESCRIPTION:** This facility is unique in its combination of measurement, analysis, and modeling capabilities. The laboratory contains the in-house expertise to assess a photovoltaic technology, design and implement the most effective characterization test plan, and analyze the results to produce an in-depth materials characterization and device performance evaluation. Furthermore, using the displacement damage dose analysis technique developed within the laboratory, the experimental results can be rapidly translated into accurate predictions of device performance in essentially any radiation environment, particularly that of Earth orbit.

**MEASUREMENT CAPABILITIES:** The solar cell laboratory boasts a wide array of measurement capabilities. The central feature is a TS Space Systems Triple-zone Close Match Simulator that has three independently controllable light zones—300 to 700 nm, 700 to 1200 nm, and 1200 to 2400 nm—and that produces one-sun, air-mass-zero (AM0) illumination with 2% uniformity over a 28 in<sup>2</sup> area with better than 0.5% spectral fidelity from 300 to 2400 nm. In addition, the laboratory contains a Spectrolab X-25 Mark II solar simulator providing one-sun, AM0 illumination with 2% uniformity over a 78 in<sup>2</sup> area with 2% spectral fidelity from 300 to 1600 nm.

The laboratory also contains a custom-built spectral response system ranging in wavelength from 340 to 2400 nm with specialized light and electrical biasing configuration allowing individual subjunction measurements within multijunction devices to be measured. The laboratory also contains diode dark-current measurement systems, a deep-level transient spectrometer, an electrochemical capacitance-voltage profiler, and a state-of-the-art Hall Effect System.

**RADIATION FACILITIES:** NRL maintains in-house radiation facilities and has long-standing relationships with facilities at many other government laboratories, providing access to virtually any desired radiation test environment. Focusing on the natural space radiation environment, NRL has established specialized test chambers enabling exposure of multiple large-area solar cells to electron and proton irradiation over a wide range of particle energies and fluxes.

**CONTACT:**

Code 6818 • (202) 767-2533

**LOCATION:**

NRL, Washington, DC



# Compound Semiconductor Processing Facility



**FUNCTION:** Provides a research environment for hands-on fabrication of novel structures for fundamental investigations of new compound semiconductor materials, devices, and circuit concepts. Also, provides a service facility for electron-beam lithography, scanning electron microscopy, and fabrication of devices and circuits.

**DESCRIPTION:** The facility mostly consists of a 2750 ft<sup>2</sup> clean room area (Class 10,000) with HEPA filtration, temperature/humidity control, and an independent air handling system with single-pass capability. A full-time technician is assigned to the clean facility for maintaining the equipment, training new users, and assisting the hands-on users on specialized runs. State-of-the-art microwave and optoelectronic devices are processed in the clean facility using gallium arsenide, gallium nitride, and indium phosphide material systems. Lines with feature size as small as 20 nm can be fabricated with a Raith electron beam microscope, located in a separate, vibration-free area.

**INSTRUMENTATION:** Principal capabilities include (1) standard photolithography—photoresist spinner and bake ovens, microscope, mask aligners operating in the mid-UV and deep-UV (DUV) range, and a DUV flood exposure system; (2) metallization—e-beam evaporation for standard metals; (3) dry etching—reactive ion etching (RIE), inductively coupled plasma (ICP), and plasma etching; (4) silicon nitride deposition—plasma enhanced chemical vapor deposition; (5) fine line patterning via electron-beam lithography; (6) scanning electron microscopy; and (7) other capabilities—contact alloying, profilometer, rapid thermal annealing (RTA), annealing furnaces, and gold plating.

**CONTACT:**

Code 6852 • (202) 404-4616

**LOCATION:**

NRL, Washington, DC

# Laboratory for Advanced Materials Synthesis

A MOCVD reactor in the Laboratory for Advanced Materials Synthesis

**FUNCTION:** NRL's primary site for the exploration of crystal growth via metal-organic chemical vapor deposition (MOCVD). Current research activities include the growth of wide bandgap semiconductor materials and device structures for use in power electronics, RF communications, radar, and optoelectronics. Materials used in this activity are gallium nitride (GaN) and related alloys such as AlGaN and InGaN. Research activities range from basic research studies of materials and crystal growth to more applied investigations involving devices.



**DESCRIPTION:** The MOCVD growth of homoepitaxial or heteroepitaxial films of GaN, InGaN, and AlGaN is performed on lattice matched and mismatched substrates such as GaN, SiC, sapphire, and silicon. The growth is accomplished by the reaction of metalorganic precursors that typically contain the column III metal, e.g.,  $\text{Ga}(\text{CH}_3)_3$  or  $\text{Al}(\text{CH}_3)_3$ , and the organometallic or hydride precursor of the column V element, e.g.,  $\text{NH}_3$ . Depending on the semiconductor being grown, the reactions take place at pressures 5% to 50% of ambient over a substrate heated in the range of  $500^\circ$  to  $1100^\circ\text{C}$ . Growth rates are typically determined by the column III precursor flux, which is controlled by the temperature and pressure of the sources and the mass flow rate of the high purity carrier gas flowing through the source, and range from  $0.2 \text{ \AA/s}$  to  $10 \text{ \AA/s}$ . The crystal quality is a direct function of growth parameters such as the pressure used for deposition. The epilayers can be doped n- or p-type with dopants such as Si or Mg. Through knowledge and control of the growth process,

different types of structures containing complex heterojunctions can be grown. The equipment is housed in a specially designed and constructed building for the chemicals used in the growth process.

**INSTRUMENTATION:** The facility houses two state-of-the-art reactors for growth of GaN and its technologically important ternary compounds. Each reactor is equipped with in situ process monitoring equipment to aid in the growth of complex device structures. An additional reactor is reserved for gallium arsenide or indium phosphide growth and for growth of the technologically important ternary compounds of gallium arsenide. The laboratory has an integral safety system including gas detectors and alarms.

**CONTACT:**

Code 6882 • (202) 767-3672

**LOCATION:**

NRL, Washington, DC

# *Epicenter for Advanced Materials Growth and Characterization*



**FUNCTION:** Fabricates and analyzes heterostructures that are used in ongoing electronic and optoelectronic device efforts.

**DESCRIPTION:** Advances in molecular beam epitaxy allow the Epicenter to address the control of the structure of solids on the monolayer-length scale. This flexibility in the fabrication of semiconductors allows quantum mechanical control of electronic wave functions, which allows the electronic and optical properties of semiconductors to be engineered for particular device applications. Heterostructures formed from III-V semiconductors with 6.1 Å lattice spacing (GaSb, AlSb, InAs, and related alloys) are grown in the Epicenter. These heterostructures have the potential to define a new state of the art in applications that include >100-GHz high-speed logic circuits, terahertz transistors, sensitive infrared detectors, and mid-infrared semiconductor lasers. III-Mn-V ferromagnetic semiconductors and ZnMnSe, ZnCoSe, and ZnFeSe dilute magnetic semiconductors are also fabricated in the Epicenter. The development of these materials should allow the creation of a new class of devices with operating principles that rely on the spin of the electron, commonly referred to as "spintronics."

**INSTRUMENTATION:** This facility includes five interconnected ultra-high-vacuum systems for molecular beam epitaxy film growth and film analysis. Three of these chambers are used for molecular beam epitaxial growth of III-V semiconductors, II-VI semiconductors, and ferromagnetic semiconductors. Film analysis is accomplished with a scanning tunneling microscope. The fifth chamber is used for etching semiconductor heterostructures.

## **CONTACT:**

Code 6876 • (202) 767-3665

## **LOCATION:**

NRL, Washington, DC



# Millimeter-Wave Vacuum Electronics Fabrication Facility (MMW-VEFF)

High-speed CNC milling machine for fabricating millimeter-wave amplifier structures and components



**FUNCTION:** Fabricates millimeter-wave amplifiers based on vacuum electronics, including traveling wave tubes, klystrons, and gyro-klystrons. The fabricated devices are used for research on new ways of generating broadband, high average power millimeter-wave radiation (30–300 GHz frequencies) for emerging radar, EW, and communications applications. The MMW-VEFF also supports research on high current density electron sources and electron beam propagation.

**DESCRIPTION:** The MMW-VEFF is used to transform theoretical electromagnetic and beam dynamics concepts for devices into functioning real-world prototypes. In a typical process, computer-based solid models of electro-dynamic beam-wave interaction structures are created, based on the theoretical physics design. These solid models are used to generate cutting tool path programs, which in conjunction with the computer-numerically-controlled (CNC) milling machine and lathe, are used to form complex three-dimensional metallic interaction circuits and other component parts. After chemical cleaning, the parts are inspected with a hybrid optical/contact probe coordinate measuring machine. Parts made by CNC mills or lathes are most suitable for Ka-band (26.5–40 GHz) devices. For higher frequencies, including W-band (75–110 GHz), wire and sinker electric discharge machines (EDMs) are typically used in the fabrication process for additional precision. The completed components made by the various techniques

are joined together via hydrogen/vacuum brazing using high-purity noble metal alloys. Completed vacuum electronic devices are evacuated, baked-out, and delivered for high-power electromagnetic testing.

**INSTRUMENTATION:** The MMW-VEFF employs a CNC milling machine and a CNC lathe, both having a cutting accuracy of 5 microns. The facility also utilizes wire and sinker EDMs for force-free cutting of metallic structures with 125 micron feature sizes and 2 micron accuracy. A controlled-atmosphere hydrogen/high-vacuum brazing furnace is used for the contamination-free joining of metallic parts, ceramic metallization, and ceramic-to-metal bonding over the 600° to 1700 °C temperature range.

**CONTACT:**

Code 6843 • (202) 404-2799

**LOCATION:**

NRL, Washington, DC



# Advanced Silicon Carbide Epitaxial Research Laboratory



**FUNCTION:** The premier research laboratory in the DoD for exploration of growth of the wide bandgap semiconductor silicon carbide (SiC) using high-temperature chemical vapor deposition and a hot-walled geometry. Current research aims at establishing tight control of point and extended defects in thick epitaxial layers for use in high-voltage, high-current power electronic devices. Research activities range from basic research studies of materials and crystal growth to more applied investigations involving devices.

**DESCRIPTION:** Homoepitaxial growth of SiC layers on SiC substrates is accomplished by the reaction of silane and propane at temperatures between 1500° and 1800 °C and pressures of 50–200 mbar. Growth rates are varied from 2  $\mu\text{m/hr}$  to 15  $\mu\text{m/hr}$ . The crystal quality is a direct function of the substrate preparation and growth conditions used, such as the ratio of carbon to silicon atoms in the gas phase. The epilayers can be doped either n- or p-type from  $1 \times 10^{14} \text{ cm}^{-3}$  to  $5 \times 10^{18} \text{ cm}^{-3}$  using dopants such as nitrogen or aluminum, respectively. In situ growth monitoring with mass spectrometry and laser-based reflectance techniques permits study of the growth environment. Through knowledge gained from these studies and control of the growth process, different types of complex structures can be grown. The equipment is housed in a specially designed and constructed laboratory space for the chemicals used in the growth process.

**INSTRUMENTATION:** The laboratory comprises two adjacent facilities: the Growth Facility and the Immediate Characterization Facility. The Growth Facility is centered about an Epigress/Aixtron VP508 high-temperature chemical vapor deposition reactor that is widely used in the SiC community to deposit homoepitaxial SiC epilayers on SiC substrates. The Immediate Characterization Facility hosts tools that permit researchers to rapidly characterize epitaxial wafers, providing feedback to growth efforts.

**CONTACT:**

Code 6882 • (202) 767-3098 or 767-3672

**LOCATION:**

NRL, Washington, DC

# Center for Bio/Molecular Science and Engineering

- *Micro Fabrication Facility for Microfluidics*
- *Quadrupole Time-of-Flight Mass Spectrometer*
- *Advanced Microscopy Facility*

## Micro Fabrication Facility for Microfluidics



Haas CNC Minimill



Denkey HM-7 Injection Mold Machine



Potomac Photonics Laser Ablation System

**FUNCTION:** The facility's milling and fabrication machines are used to create micromixing and microfluidic components in glass and plastic for a wide variety of applications. The facility supports projects in the Chemistry Division, the Laboratory for Computational Physics and Fluid Dynamics, and the Center for Bio/Molecular Science and Engineering.

**DESCRIPTION and INSTRUMENTATION:** The facility consists of a 7-ton Denkey HM-7 electric injection mold machine, a Haas CNC Minimill, a Techno-Iseel CNC mill, a Potomac Photonics laser ablation system, and a KLA-Tencor P-15 Profilometer. The Haas Minimill has reproducibility and accuracy to 0.0002 in. The laser ablation system has a user-friendly software interface with vision

and measurement capability. Designs can be imported from Autocad or other computer-aided design (CAD) software. Resolution is 0.25  $\mu\text{m}$  and accuracy is 1–2  $\mu\text{m}$ . Ablation depth can be less than 1  $\mu\text{m}$ , depending on the material.

**CONTACT:**

Code 6910 • (202) 404-6027

**LOCATION:**

NRL, Washington, DC

# Quadrupole Time-of-Flight Mass Spectrometer



API QSTAR® Pulsar i LC/MS/MS System

**FUNCTION:** The system generates superior quality mass spectrometry (MS) and tandem mass spectrometry (MS/MS) data from both atmospheric pressure ionization (API) and matrix-assisted laser desorption ionization (MALDI) techniques.

**DESCRIPTION:** The QSTAR®XL Hybrid LC/MS/MS System is a high-performance, hybrid quadrupole time-of-flight mass spectrometer designed for protein identification and characterization and drug metabolism studies. The unique flexibility to switch between the standard API NanoSpray™ source and the new oMALDI™ 2 ion source makes the QSTAR®XL System the preferred choice for proteomics. Specific scan modes such as precursor ion scanning, enabled by the patented LINAC™ Pulsar collision cell technology, identify the type and location of post-translational modifications or drug metabolites with outstanding specificity and sensitivity.

## FEATURES:

- Enhanced ion optics for highest sensitivity and reliability.
- Excellent mass accuracy and stability yield unequivocal molecular weight and high-quality structural information.
- Unique, patented LINAC™ Pulsar collision cell technology enables the most sensitive product ion and precursor ion scan capabilities for metabolite, protein and peptide, and post-translational modification determination.
- Maximum flexibility with a comprehensive selection of interchangeable, application-specific ion sources; new oMALDI™ 2 source for increased sensitivity.
- Sensitive and rugged IonSpray™, TurbolonSpray®, and atmospheric pressure chemical ionization (APCI) ion sources for routine low-level drug metabolism identification and characterization.
- New NanoSpray™ ion source for capillary liquid chromatography (LC) provides increased sensitivity and throughput for protein and peptide identification and characterization.
- New PhotoSpray™ source for analysis of low-molecular-weight, highly polar compounds via atmospheric pressure photoionization.
- Extended MS and MS/MS mass range (6,000 and 40,000 m/z) expands scope of protein and peptide studies.

## CONTACT:

Code 6910 • (202) 767-0394

## LOCATION:

NRL, Washington, DC



# Advanced Microscopy Facility



**FUNCTION:** Provides a facility for high-resolution studies of complex biomolecular systems. The goal is an understanding of how to engineer biomolecules for various applications, including sensors, self-assembled lipid microstructures, patterned surfaces, and biomaterials.

**DESCRIPTION:** The facility includes electron microscopes, a darkroom, and adjacent biochemical laboratories for sample preparation and additional chemical/physical characterization of proteins, lipids, DNA, and cells.

## INSTRUMENTATION:

- Leo 1455 digital scanning electron microscope
- Hitachi H8100 analytical electron microscope (AEM)
- TopoMetrix Explorer atomic force microscope (AFM)
- Digital Instruments Dimension 3100 AFM
- Zeiss LIBRA-120 energy filtering transmission electron microscope
- Scanning probe microscope capable of multimode atomic force
- Microscopy and scanning tunneling microscopy (STM)
- Nikon C1 Confocal Microscope System
- Scanning-tip AFM capable of imaging large samples using contact mode, non-contact mode, lateral force mode, and force modulation mode
- TopoMetrix Aurora nearfield scanning optical microscope (NSOM)
- Optical equipment
- Confocal fluorescent microscope
- Continuous wave (CW) fluorimeter and microscope
- Optical and fluorescence microscopes
- Balzers BAF400 freeze fracture apparatus
- High-speed ultracentrifuges.

## CONTACT:

Code 6930 • (202) 404-6077

## LOCATION:

NRL, Washington, DC

**Code 7100 – Acoustics Division**

**Code 7200 – Remote Sensing Division**

**Code 7300 – Oceanography Division**

**Code 7400 – Marine Geosciences Division**

**Code 7500 – Marine Meteorology Division**

**Code 7600 – Space Science Division**

# OCEAN

**AND ATMOSPHERIC SCIENCE  
AND TECHNOLOGY DIRECTORATE**

**BACK TO CONTENTS**

# Acoustics Division

- Acoustic Communications Measurement Systems
- High-Frequency Acoustic Flow Visualization Sonar Systems
- Instrumentation Suite for Acoustic Propagation Measurements in Complex Shallow Water Environments
- Rail-based Broadband Synthetic Aperture Ocean Measurement System
- Structural Acoustics In-Air Facility
- Laboratory for Structural Acoustics
- Shallow Water Acoustic Laboratory
- Autonomous Acoustic Receiver System
- Salt Water Tank Facility
- Underwater Acoustic Time-Reversal Mirror
- Shallow-Water High-Frequency Measurement Systems
- 300 Hz and 500 Hz Autonomous Acoustic Sources
- Sediment Geo-Probe System
- Drifting Echo Repeater
- Shallow Water Ship Acoustic Signature System
- Geoacoustic Physical Model Fabrication Laboratory
- Sono-Magnetic Laboratory

# Acoustic Communications Measurement Systems (ACOMMS)

**FUNCTION:** Design and develop adaptive signal processing techniques to improve underwater acoustic communications and networking. Phase coherent and incoherent signal patterns are transmitted from NRL's acoustic projector source systems through the underwater medium to NRL's receiver systems. Improved signal processing techniques are developed and refined to minimize the bit error rate and to evaluate environmental influences on the processor's performance.



ACDS surface unit being deployed from the research vessel *Endeavor*

**DESCRIPTION:** Our acoustic communications research systems enable our team to conduct experiments at frequencies from 3 to 60 kHz. Source signal patterns are designed by NRL, transmitted into the ocean medium, and received at distances out to 15 km. The received signals are processed in situ and recorded for post-experiment data processing. Acoustic Communications Data Storage (ACDS) buoy systems transmit at source levels up to 185 dB. For higher sound pressure levels, an acoustic projector mounted in our 4-ft V-fin towbody develops up to 200 dB. ACDS buoy systems include 8-element vertical line arrays with variable apertures. Our shipboard-based vertical array has a wide aperture of 16 elements and is deployed from a vessel at anchor. Relative position, speed, and depth of our projectors and receiver arrays are carefully controlled throughout the experiments. Impact of Doppler and signal-to-noise ratio on system performance is measured and algorithms developed to improve performance. Our ACDS systems are normally moored to the sea floor with the acoustic elements suspended in the water column. However, one ACDS system has been modified for attachment to a tow frame, and in this configuration it provides a near-ideal autonomous undersea vehicle (AUV) test platform. Each of the ACDS systems provides semi-autonomous opera-

tions for up to 78 hours. Custom-designed software is used for onboard data monitoring and signal processing. Back in the lab, advanced signal processing algorithms are applied to the recorded signals to extract the phase-encoded bit patterns and to improve communication accuracy.

**INSTRUMENTATION:** (1) ACDS buoy systems include three deployed modem systems, a shipboard control station, and wireless local area network (WLAN) communication links. Each deployed modem system includes one acoustic projector (3, 10, or 20 kHz), eight hydrophones, 300 GB of data storage, and three computers. The systems can be moored to the ocean bottom or towed behind a surface vessel. (2) Towed source systems include 3- and 4-ft V-fin towbodies mounted with acoustic projectors, driven by 2-kW power amplifiers. (3) Shipboard-based receiver system includes a custom 16-channel hydrophone array, signal processing electronics, and data monitoring and data recording equipment.

## CONTACT:

Code 7120 • (202) 767-2945

## LOCATION:

NRL, Washington, DC



# High-Frequency Acoustic Flow Visualization (HFAFV) Sonar Systems



HFAFV systems on board the research vessel *Endeavor*

**FUNCTION:** Flow visualization of fluid processes on the continental shelf; e.g., internal tides, ear instabilities, and nonlinear internal gravity waves (solitons).

**DESCRIPTION:** Our HFAFV sonar systems are used to image the fluid processes that perturb the density/sound speed field in the littoral. A patented high-speed transmit-receive switch provides NRL with the receive sensitivity necessary to detect the small-amplitude signals backscattered from particulates and temperature/salinity variability associated with large density gradients in the thermocline. At the laboratory, the data is processed and analyzed with the objective of improving our understanding of the generation and propagation of internal waves and fine structure and their effect on the sound speed field.

**INSTRUMENTATION:** Two similar systems, differing only in operating frequency:

- (1) Matec PR5000 gated sine wave pulse generator and power amplifier, NRL-developed transmit-receive switch, custom-designed transducer (200 kHz)
- (2) Matec PR5000 gated sine wave pulse generator and power amplifier, NRL-developed transmit-receive switch, custom-designed transducer (350 kHz)

Also, a personal computer-based data acquisition system, using off-the-shelf analog-to-digital converters and ISIS software from Triton Elics.

**CONTACT:**

Code 7120 • (202) 767-2945

**LOCATION:**

NRL, Washington, DC

# Instrumentation Suite for Acoustic Propagation Measurements in Complex Shallow Water Environments

**FUNCTION:** Obtain at-sea measurements to test theoretical and modeling predictions of acoustic propagation in dynamic, inhomogeneous, and nonisotropic shallow water environments. The theories and models predict variations of signal amplitude, coherence, and travel time due to interaction of sound with small- to large-scale volume inhomogeneities within the water column and ocean sediment. The instrumentation suite provides calibrated measurements of these acoustic quantities in the frequency range 50 Hz to 20 kHz.



Deployment of instrumentation sled for 96-element acoustic horizontal line array receiver system

**DESCRIPTION:** The multiple sources and receivers in this instrumentation suite allow measurement of acoustic propagation variability as a function of both time and range over horizontal and vertical apertures. The autonomous systems can operate in severe weather conditions since they have no sea-surface expression, while the RF telemetered receiver system can provide real-time information on acoustic propagation. The acoustic receiver systems each have an operational lifetime up to 20 days at a sampling frequency of 4 kHz. The operational lifetime for each acoustic source is ~25 days at 50% duty cycle. Clocks having rubidium-standard accuracy control all timing functions for the acoustic sources and receivers, including waveform synthesis and sampling of the received signals. This feature permits measurement of absolute travel time and its variations to better than millisecond accuracy and allows data from each of the autonomous receiver systems to be time-synced together for phase-coherent processing.

**INSTRUMENTATION:** The instrumentation suite consists of several acoustic sources and receiver array systems, augmented by sensors to characterize the oceanographic environment. The current equipment suite is composed of two autonomous arbitrary waveform acoustic sources, two autonomous continuous-wave acoustic sources, three autonomous 32-element acoustic vertical line array receiver systems, one autonomous 96-element acoustic horizontal line array receiver system, and one 32-element RF telemetered acoustic vertical line array receiver system.

## CONTACT:

Code 7120 • (202) 767-3210

## LOCATION:

NRL, Chesapeake Beach, MD

# Rail-based Broadband Synthetic Aperture Ocean Measurement System

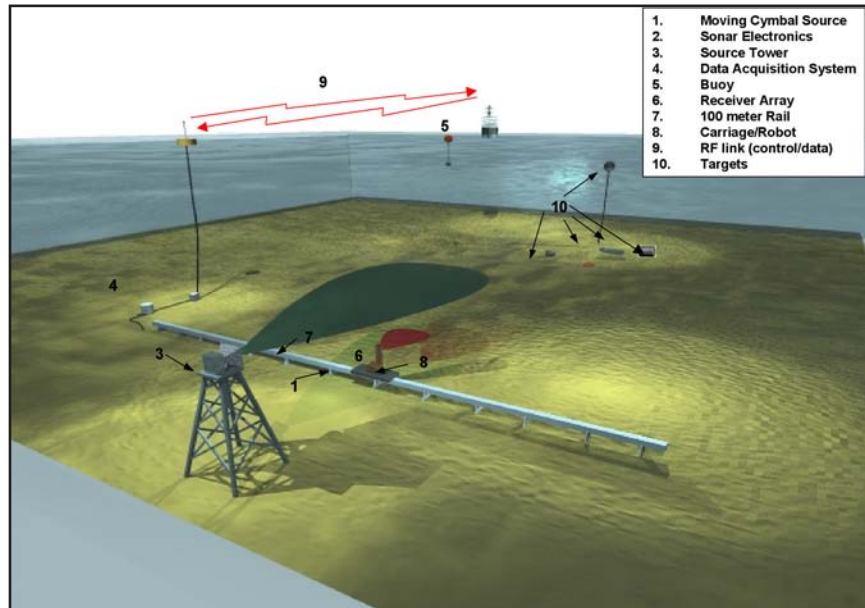

Depiction of the 100-m-long rail deployed in shallow water together with the source tower, data acquisition system, RF link to surface vessel, and scattering targets

**FUNCTION:** Enables collection of broadband acoustic scattering databases where acoustic sources and receivers can be translated on a precise linear path under program control. Further, the phasing of the source and data acquisition is highly coherent such that scattering data can be processed to form synthetic apertures. This facility supports research in the collection of high-quality scattering cross sections of mines and the associated clutter, with the intent of perfecting techniques required for unmanned undersea vehicles (UUVs).

**DESCRIPTION:** The facility is a portable measurement system that can be deployed in an ocean environment. A 100-m-long rail supports a robotic carriage that can be positioned precisely at any point along the rail using an encoder feedback system. The sources and receivers can be attached to the carriage to collect quasi-monostatic data, and a separate source tower enables bistatic scattering data collection. All data acquisition, process control, and signal conditioning are contained within a pressure vessel that sits on the sea floor adjacent to the rail. Bidirectional control and data transfers are made over a dedicated RF link to a surface platform.

**CONTACT:**

Code 7136 • (202) 404-3840

**LOCATION:**

Ocean deployed



# Structural Acoustics In-Air Facility



**FUNCTION:** Supports experimental research where broadband acoustic radiation, reflection, transmission, and surface vibration measurements are required. Typically, ultra-high-precision, highly spatially sampled measurements are conducted on scaled submarine structures, satellite payload fairings, active and passive material systems for sound control, and new transducer and sensor systems.

**DESCRIPTION:** The large, acoustically treated facility is 50 ft x 40 ft x 38 ft high. The laboratory is instrumented with precise acoustic and vibration measurement systems. These include large workspace robotic scanners capable of generating nearfield acoustic holography (NAH) radiation, reflection, and transmission databases. In addition, three-axis laser vibrometers are used to generate very highly sampled surface vibration maps.

**INSTRUMENTATION:** Broadband source/receiver systems; large workspace (3D) robotic scanners for NAH; scanning laser Doppler vibrometry (LDV); multiple workstations to support acquisition, analysis, calculations, and visualization; and structural acoustic codes: SARA2D, SARA3D, ANSYS, NISA, FEMLAB, and SONAX.

**CONTACT:**

Code 7136 • (202) 404-3840

**LOCATION:**

NRL, Washington, DC



## Laboratory for Structural Acoustics

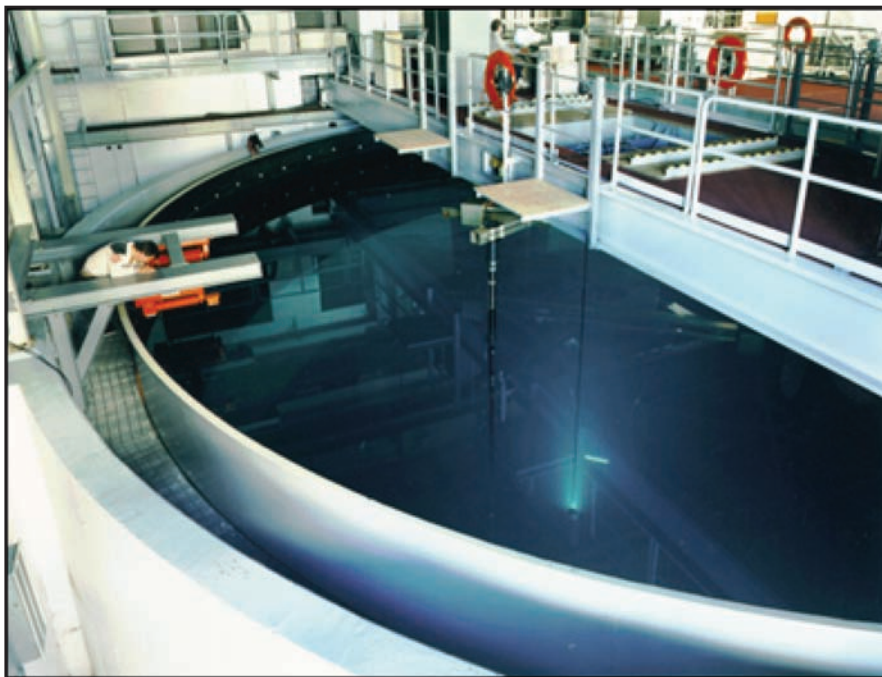

**FUNCTION:** Supports experimental research where acoustic radiation, scattering, and surface vibration measurements of fluid-loaded and non-fluid-loaded structures are required. Typically, ultra-high-precision measurements are conducted in this pristine laboratory environment using submarine hull backing impedance simulators, torpedoes, scale-model submarine structures, and deactivated mine targets.

**DESCRIPTION:** The large acoustic tank—the core research capability for in-water structural acoustics studies—is 55 ft in diameter, 50 ft deep, and contains 800,000 gal of deionized water. The entire tank is vibration and temperature isolated. The laboratory is instrumented with precision measurement systems that include large workspace in-water robotic scanners capable of generating nearfield acoustic holography (NAH) radiation and scattering databases.

**INSTRUMENTATION:** Network-based automated data acquisition and process control including extensive use of robotic scanners. Other attributes and resources include compact measurement ranges using nearfield sources and receivers; multiaxis laser Doppler vibrometry (LDV) for noncontact surface motion measurements; extensive interferometric fiber-optic sensor instrumentation; matrix processors that support MIMO control applications; multiple workstations and file servers to support acquisition, structural acoustics calculations, and visualizations; and structural acoustics codes: SARA2D, SARA3D, ANSYS, NISA, FEMLAB, and SONAX.

**CONTACT:**

Code 7136 • (202) 404-3840

**LOCATION:**

NRL, Washington, DC

# Shallow Water Acoustic Laboratory



**FUNCTION:** Supports experimental research where high-frequency acoustic scattering and surface vibration measurements of fluid-loaded and non-fluid-loaded structures are required. Typically, ultra-high-precision measurements are conducted in this pristine laboratory environment when acoustic interactions with sediments are important.

**DESCRIPTION:** This facility includes a large concrete pool (250,000 gal of deionized water) equipped with high-resolution, computer-controlled target source and receiver manipulators. It is used for high-frequency acoustic scattering characterization of scale-model submarines and deactivated mine targets. The pool has a deep, sandy bottom and a high-resolution Cartesian nearfield acoustic holography (NAH) scanner to accommodate the controlled acoustic study of buried and near-buried mines.

**INSTRUMENTATION:** Network-based automated data acquisition and process control including extensive use of robotic scanners. Other attributes and resources include broadband source/receiver systems; compact measurement ranges using nearfield sources, receivers, and projection algorithms; multiaxis Doppler vibrometers for noncontact surface motion measurements of porous media water interfaces; multiple workstations to support acquisition analysis, calculations, and visualizations; and structural acoustics codes: SARA2D, SARA3D, ANSYS, NISA, FEMLAB, and SONAX.

**CONTACT:**

Code 7136 • (202) 404-3840

**LOCATION:**

NRL, Washington, DC

# Autonomous Acoustic Receiver System



Surface telemetry buoy connected to a 64-element acoustic receiver

**FUNCTION:** Collects underwater acoustic data and oceanographic data. Data are recorded on-board an ocean buoy and can be telemetered to a remote ship or shore station in real time. The system is configured for command-and-control and data download. It can operate unattended for periods of up to one month.

**DESCRIPTION:** The heart of the Autonomous Acoustic Receiver (AAR) system is the data acquisition unit (DAU) containing the analog-to-digital converters for 64 channels at rates up to 8192 samples per second. One 64-element or two 32-element acoustic receive arrays can be attached to this DAU. If used vertically, there is also capability to add four tilt/head/depth sensors spaced throughout the vertical array. Once digitized, the data are sent up a 2000-ft fiber-optic umbilical cable to a surface buoy, where they are stored on hard disk. The data can then be telemetered to another location. The line-of-sight link can also be used to send command-and-control information to the system.

## **INSTRUMENTATION:**

- 16-bit, 64-channel DAU, 8192 sample per second
- 64-element, 1.25-m spacing acoustic receive array
- 32-element, 2.5-m spacing acoustic receive array
- 32-element, 5-m spacing acoustic receive array
- 2000-ft fiber-optic double-armored umbilical cable
- Battery-powered buoy with enhanced line-of-sight capability
- Command-and-control/data downlink station with GPS-linked steerable directional antenna (for remote ship or shore station).

## **CONTACT:**

Code 7145 • (202) 404-4826

## **LOCATION:**

NRL, Chesapeake Beach, MD

# Salt Water Tank Facility

The main salt water tank provides excellent optical access to the controlled saline environment



**FUNCTION:** Provides a controlled environment for studying complex bubble-related processes found in the ocean. It is an experimental pool facility for studies of underwater acoustics, fluid dynamics, and air-sea interface environmental topics, under saline conditions. This facility is currently being used to study the acoustics of bubbly media.

**DESCRIPTION:** The main salt water tank measures 20 ft x 20 ft x 12 ft high, with four 12 x 8 ft windows on each of the vertical walls. The water is recirculated every 10 h through particulate and UV filters, and the tank contains a high-capacity water chiller for controlling temperature. A separate chiller independently handles air temperature. Catwalks and a gantry provide access around and over the main tank, and a three-axis computer-controlled positioning system with four independent stages places and moves equipment within the tank. The tank is contained within a thermally insulated 50 x 26 ft laboratory area furnished with an overhead crane, a staging area, and a 20 x 10 ft room for instrumentation and data analysis.

## INSTRUMENTATION:

- Acoustic sources, amplifiers, and hydrophones spanning 1 Hz to 700 kHz
- Environmental sensors to measure water temperature, salinity, dissolved gas concentrations, and surface tension
- Digital holographic imaging system to size particles down to ~5  $\mu\text{m}$
- Two high-speed digital cameras providing image acquisition up to 2000 full frames per second
- LabVIEW-based data acquisition system with laboratory-wide network access
- Brickwall filters, digital and analog oscilloscopes, data loggers, and power supplies.

## CONTACT:

Code 7145 • (202) 404-4826

## LOCATION:

NRL, Washington, DC



# Underwater Acoustic Time-Reversal Mirror



Preparing 64-element source/receive array for deployment

**FUNCTION:** Records underwater acoustic signals and has the capability to time-reverse and re-broadcast these signals. This provides the ability to focus and scan acoustic energy for the detection of underwater objects. The signals can be emitted from guide sources or received in the form of ocean reverberation.

**DESCRIPTION:** The heart of the system is a 64-element transducer array that can alternately operate as a receiver array or an array of acoustic sources. The time-reversal functionality involves the capability to record signals, reverse them in time, and then re-broadcast them. This provides, for example, the capability to have a received signal returned to its point of origin where it will focus in both time and space. The importance of the concept is that this can be accomplished without detailed knowledge of the complex multipath structure produced by the ocean waveguide. Applications include enhanced echos from target objects, such as submarines or ocean mines, and reduced clutter echos from the ocean bottom or ocean surface.

## **INSTRUMENTATION:**

- 64 6-in. spherical source/receive elements in a linear array with 1.25-m spacing (78.75 m aperture)
- Array elements independently controllable over the 500 to 3500 Hz frequency band
- A data digitization and recording system
- A pressure vessel to enclose system electronics for bottom-moored deployment
- Fiber-optic umbilical cable for connection between pressure vessel and ship/surface buoy.

## **CONTACT:**

Code 7145 • (202) 404-4820

## **LOCATION:**

NRL, Chesapeake Beach, MD

# Shallow-Water High-Frequency Measurement Systems



**FUNCTION:** Supports a broad range of shallow-water high-frequency research programs, from acquiring a fundamental understanding of the physics of shallow-water propagation and boundary interactions to applied mine countermeasure and torpedo issues. The development of these systems has made NRL a leader in high-frequency shallow-water environmental acoustics research. Scattering and propagation measurements have been conducted in areas from the Gulf of Mexico to the Mediterranean. The data have been used in synthetic aperture sonar and torpedo simulations and design.

**DESCRIPTION:** These systems cover the 18 to 200 kHz frequency range. System control and data acquisition are carried by fiber-optic cables that terminate in a portable instrumentation van where the data are digitized and recorded on optical disks.

**INSTRUMENTATION:** These systems include high-resolution source and receiver combinations that operate in shallow to very shallow (7 to 30 m water depth) coastal areas.

**CONTACT:**

Code 7184 • (228) 688-5235

**LOCATION:**

NRL, Stennis Space Center, MS

## 300 Hz and 500 Hz Autonomous Acoustic Sources



**FUNCTION:** Provide acoustic researchers with autonomous, bottom-moored sound sources, which provide precise, highly stable frequency transmissions at GPS trackable times. The accuracy of the sources enables research into environmental perturbations of sound propagated through ocean media.

**DESCRIPTION:** The equipment consists of two sources, one centered at 300 Hz and another at 500 Hz. Each source uses a pressure-compensated flexural bar projector. The sources have a bandwidth of  $\pm 10\%$  about the center frequency. The accuracy of the transmit time and transmit frequency is controlled by a rubidium oscillator that can be disciplined to the GPS satellite system before deployment. The output level is adjustable with a maximum output of 183 dB. Pucks of D-cells contained in two pressure housings provide energy. The systems are rated to 200 meters. A full complement of pucks allows the sources to operate for 21 days at a 50% duty cycle and output level of 181 dB. Each system has an internal rubidium oscillator, and PC-104 electronics for timing and frequency generation. The systems are capable of continuous-wave, frequency modulated (FM) waveforms and arbitrary pseudorandom waveforms. Waveform

types can be mixed within a transmit schedule, being limited only by the projectors, available programmable system memory, and energy levels desired.

**INSTRUMENTATION:** There are two independent systems. Each system consists of an EAI projector, Seascan signal generator/system, PC-104 electronics, and Webb Research assembly. One operates at 300 Hz and the other at 500 Hz. Each system includes a pressure-compensated projector, two pressure housings, and internal programmable electronics for transmit frequency and waveform, plus timing control.

**CONTACT:**

Code 7120 • (202) 767-3210

**LOCATION:**

NRL, Chesapeake Beach, MD

# Sediment Geo-Probe System



Deployment of the geo-probe system

**FUNCTION:** Provides wideband in situ measurement capability of compressional wave speed and attenuation and their spatial variability in marine sediments.

**DESCRIPTION:** In situ ground-truth measurements of sound speed and attenuation are needed to validate geoacoustic inversion algorithms or high-resolution subbottom profiling techniques that are being used for bottom characterization. The wideband capability provides unique measurements of frequency dependency of sound speed and attenuation in various types of marine sediments. In addition, tomographic measurements of sediment sound-speed variability can be used to validate bottom scattering models. The system can be used to characterize large geological provinces in survey mode since the required measurement time per site is about 10 minutes.

**INSTRUMENTATION:** The geo-probe system has four probes populated with 1-inch-diameter ring transducers (Channel Industries) and a data acquisition unit with networking capability. The data acquisition unit can be pre-programmed or controlled through a standard oceanographic CTD cable. Wideband pulses (3–150 kHz) are generated and recorded with a sampling rate of 1 MHz. The system can be deployed at depths up to 1500 m and probe lengths can be varied up to 2 m. The source and receiver arrays on each probe allow spatial variability measurements of compressional wave speed and attenuation by using acoustic tomography.

**CONTACT:**

Code 7120 • (202) 404-8620

**LOCATION:**

NRL, Chesapeake Beach, MD



## Drifting Echo Repeater



Deployment of the drifting echo repeater

**FUNCTION:** Supports low- to mid-frequency active sonar research for target detection and classification in littoral environments. Tests and validates new signal processing algorithms by using simulated targets with proper scattering kernels in multi-static configurations.

**DESCRIPTION:** The drifting echo repeater system is a research tool to simulate targets with pre-defined scattering characteristics. Its in-buoy signal processing capability provides flexibility to perform match-filtering, beamforming, and acoustic time-reversal in real time. Recently, it was used in mid-frequency (1.5–3.5 kHz) bistatic active sonar sea tests at ranges up to 15 km. The system can be used in drifting or moored configurations. The data storage and power budget provide two days of continuous recording of 16 channels and 10% duty-cycle sound transmission.

**INSTRUMENTATION:** The drifting echo repeater system has a wideband (240 Hz to 20 kHz) acoustic source, an 8-element vertical line array, and an 8-element Mills-Cross horizontal array. Acoustic data are sampled at each channel with a 20 kHz sampling rate and monitored in real time by using a wireless local area network (WLAN). High-accuracy GPS positioning is used to track the drifting system location in real time.

**CONTACT:**

Code 7120 • 404-8620

**LOCATION:**

NRL, Chesapeake Beach, MD

# Shallow Water Ship Acoustic Signature System

Shallow Water Ship Acoustic Signature Buoy  
in the Chesapeake Bay between  
Chesapeake Beach and Tilghman Island, MD



**FUNCTION:** Measures ship acoustic signatures in shallow water channels and at port entrances for detection and identification purposes. The system is the acoustics component of NRL's Modular Sensor System (MSS), which is designed to provide track information and local identification of vessels as they approach U.S. ports.

**DESCRIPTION:** The system is composed of two components, a buoy with two acoustic barrier lines and a monitoring system on shore. The acoustic lines contain hydrophones to form a barrier stretching out from the central buoy. The buoy is solar powered but also contains a rechargeable battery pack capable of running the buoy for 1 to 2 weeks; this is inside the central well along with the buoy's electronics. The monitoring system is composed of a computer. Communications are by Ethernet-link radio. The system is composed totally of commercial off-the-shelf (COTS) components with the exception of the NRL-developed array interface electronics. The buoy system is capable of fully independent operation, including detection and acoustic data acquisition of passing ships. More frequently, the onshore monitoring system cues the buoy to acquire data based on information passed to it from the MSS. The hydrophone sensitivities, A/D gains, channel selection, sampling rate, and data acquisition period are all remotely programmable.

**INSTRUMENTATION:** The COTS buoy includes a radar reflector and has an omnidirectional antenna and a self-powered strobe mounted on top. It is two-point moored to prevent twisting the acoustic lines. The lines are each 1 km long and have six hydrophones each. Inside the buoy's central well are power management, array interface, and A/D data acquisition electronics, a computer with a solid-state drive, an Ethernet-link radio, and the battery pack. The monitoring system is composed of a computer, a radio, and a directional antenna.

## CONTACT:

Code 7120 • (202) 404-8149

## LOCATION:

NRL, Chesapeake Beach, MD

# Geoacoustic Physical Model Fabrication Laboratory

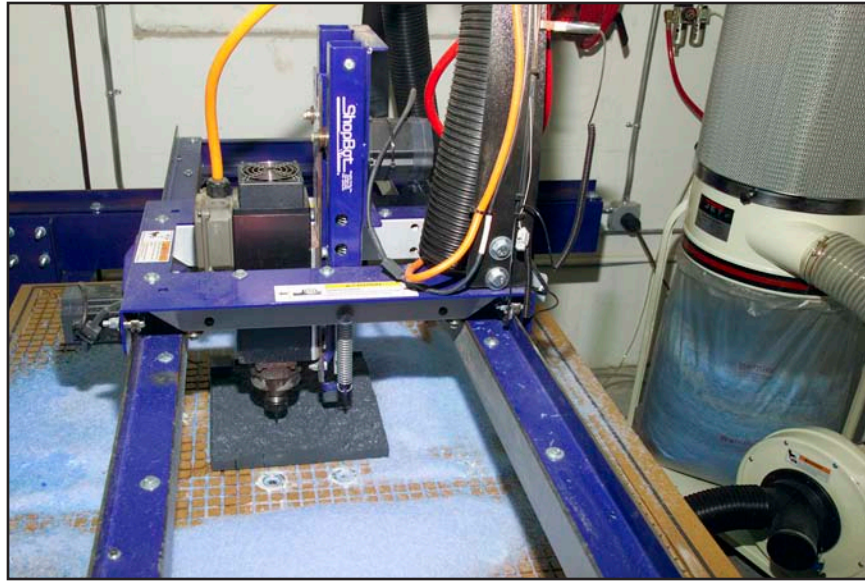

**FUNCTION:** Fabricates three-dimensional rough surfaces (e.g., fractals, ripples) out of materials such as PVC or wax to simulate the roughness properties associated with ocean bottoms. The rough surfaces have been employed in water tank facilities with acoustic sources and receivers to study acoustic scattering and propagation at frequencies up to 500 kHz.

**DESCRIPTION:** The facility enables computer-numerically controlled (CNC) fabrication of arbitrary single-valued topographies with submillimeter precision from machinable materials up to 1.2 m x 1.2 m in size and nominally 0.15 m in thickness. A suite of software allows a surface model and machining strategy to be developed for topography specified either explicitly as a digital elevation map or statistically in terms of spectral parameters. Multiple roughing, re-roughing, and finishing strategies are possible, depending on the nature of the surface to be fabricated. Surfaces are fabricated on a three-axis CNC mill equipped with a precision high-speed spindle, vacuum part fixturing ("hold-down"), liquid-free vortex tool cooling, a retractable ball-transfer system for part alignment, and a vacuum dust-collection system. Materials suitable for fabrication include soft metals, plastics, and wood. The facility also allows for submillimeter precision measurement of topographies of existing surfaces using a kinematic-resistive touch-trigger probe.

## **INSTRUMENTATION:**

- Computer-numerically controlled three-axis milling machine.
- Part fixturing table equipped with a vacuum hold-down system and a retractable ball-transfer system.
- 5 HP precision spindle (0–24,000 rpm) accepting tools up to 0.5 in. (outer diameter).
- Vacuum dust-collection system.
- Liquid-free vortex compressed-air tool cooler.
- Carbide cutting tools as small as 0.01 in. (outer diameter), suitable for metal, plastic, and wood.
- Software suite including CAM and surface-generation programs.
- Touch-trigger measurement probes and control software.

## **CONTACT:**

Code 7144 • (202) 404-4833

## **LOCATION:**

NRL, Washington, DC

# Sono-Magnetic Laboratory (SOMALab)



Experimental chamber of SOMALab under construction in FY07

**FUNCTION:** Conducts research on the interaction between arbitrarily directed magnetic fields and the motion of weakly conducting fluids under the influence of acoustic fields. This interaction causes an induced magnetic field capable of being detected with a flux-gate magnetometer.

**DESCRIPTION:** The facility is a double-hull Faraday cage constructed from steel plate and beam of the very high magnetic- $\mu$  HY-80 steel. The experimental chamber, or inner room, measures 2.5 m x 2.5 m x 4.5 m and is connected by insulated 50-cm-diameter cylindrical waveguide conduit to an external acoustic source chamber that is electromagnetically isolated from the remainder of the facility. Acoustic signals are propagated through the waveguide conduit such that prescribed particle velocities are induced within a 1 m x 1 m x 2 m Plexiglas tank atop a vibration-damped optical bench at the center of the experimental chamber. A set of three-axis Helmholtz coils is used to control the direction and magnitude of magnetic field. Induced magnetic fields from the interaction between the mechanical vibration of a conducting liquid and the Helmholtz coils are detected on a magnetometer.

#### INSTRUMENTATION:

- High- $\mu$  HY-80 Faraday cage
- Acoustic source waveguide
- 1 m x 1 m x 2 m Plexiglas tank
- Non-magnetic vibration-damped optical table
- Flux-gate magnetometer
- Acoustic sources and amplifiers
- Filtration and refrigeration system for experimental fluid

#### CONTACT:

Code 7145 • (202) 767-1741

#### LOCATION:

NRL, Washington, DC



## Remote Sensing Division

- Naval Prototype Optical Interferometer
- Optical Calibration Facility
- Free Surface Hydrodynamics Laboratory

# Naval Prototype Optical Interferometer (NPOI)



The NPOI, located on Anderson Mesa near Flagstaff, AZ, is the largest operating optical telescope in the world

**FUNCTION:** Used for astrometry and astronomical imaging, the Naval Prototype Optical Interferometer (NPOI) is a distributed aperture optical telescope. It is operated for astrometry by the U.S. Naval Observatory. Research into optical imaging and astronomical research is conducted by NRL.

**DESCRIPTION:** The NPOI is a Y configuration of optical sidereostats. The inner fixed stations are used for astrometry while stations on the outer arms, out to an eventual separation of more than 300 m, are used for imaging stars. The stations are connected by vacuum beamlines. Fast delay lines in the main control building and long delay lines outside are used to adjust the optical phases to allow coherent combinations of up to six sidereostats.

**CONTACT:**

Code 7210 • (202) 767-0669

**LOCATION:**

Lowell Observatory, Flagstaff, AZ

# Optical Calibration Facility

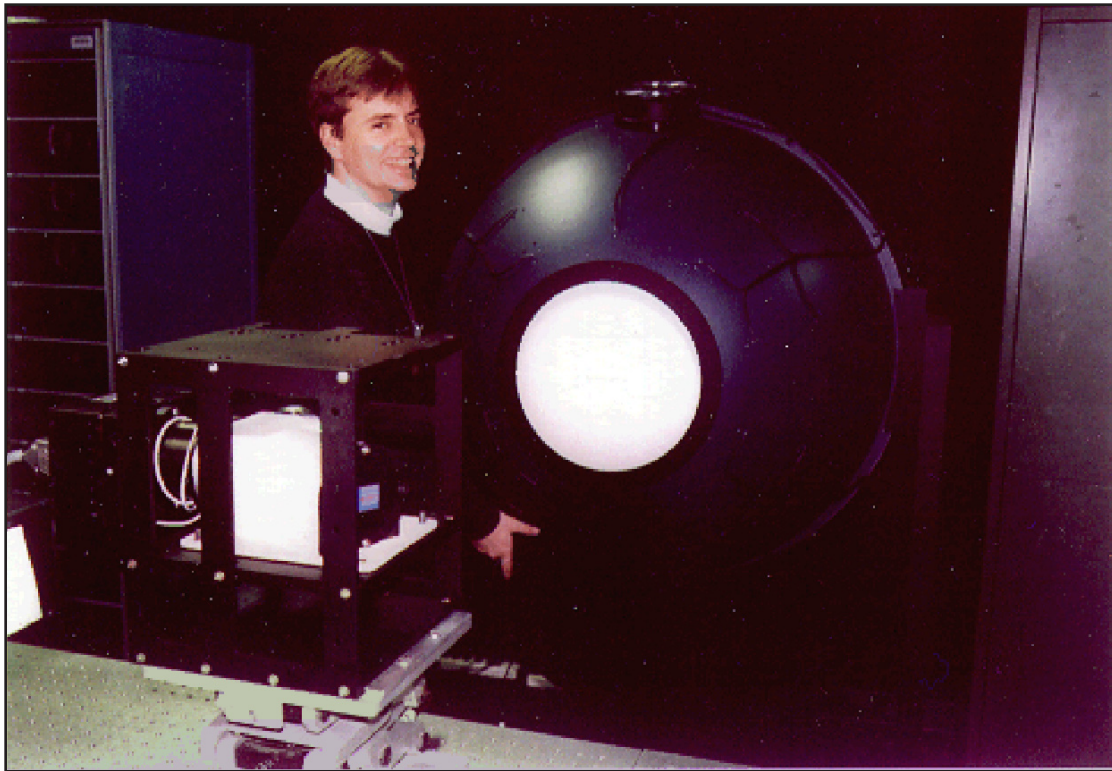

Large black-body calibration sphere

**FUNCTION:** Establishes and maintains procedures for calibrating in-water radiometers and hyperspectral imagers. Such calibration is needed for both research use of the sensors and to maintain traceability to National Institute of Standards and Technology (NIST) calibration devices and standards.

**DESCRIPTION:** The facility consists of a precise optical bench with spectrometers, calibration lamps, and black-body calibration spheres required to establish wavelength and intensity calibration of optical and near-infrared sensors. All components are cross-calibrated to a NIST Standard FEL lamp using a stable reference detector. Calibration procedures meet or exceed NIST and NASA requirements. The laboratory is an official SeaWiFS calibration facility, and participates in NASA "round-robin" calibrations. It has been used to calibrate

all three versions of the PHILLS hyperspectral instruments: Slow Scan Spectrometer, HYCORDER, and Ocean PHILLS. It will be used to calibrate the Hyperspectral Imager for the Coastal Ocean (HICO) space-borne sensor manifested for launch in September 2009.

**CONTACT:**

Code 7230 • (202) 404-2475

**LOCATION:**

NRL, Washington, DC

# Free Surface Hydrodynamics Laboratory

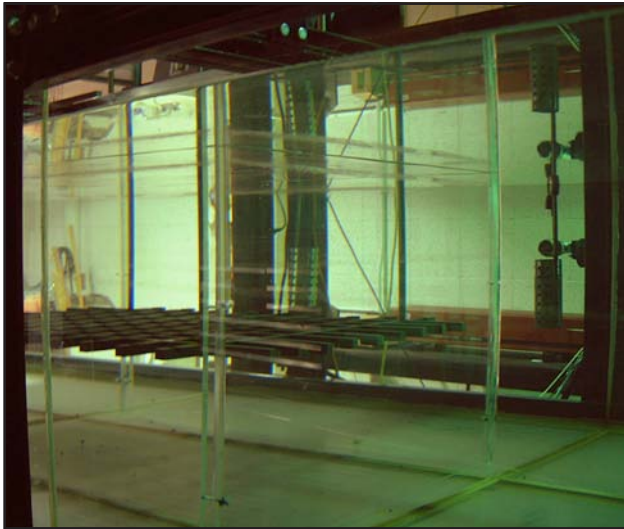

Tank facility with the grid turbulence generator installed

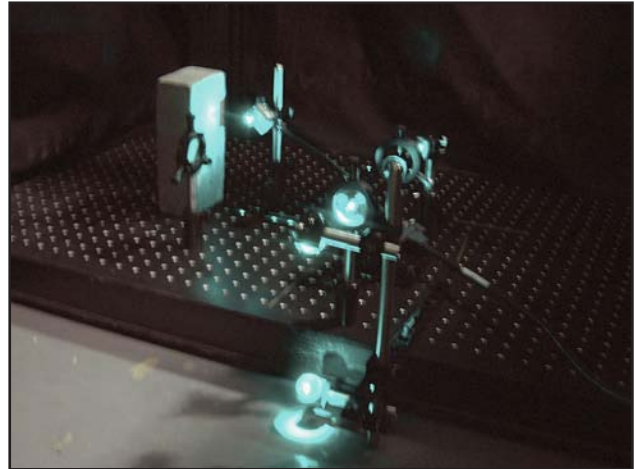

Optics, located under the tank, that illuminate the flow

**FUNCTION:** Investigates processes and interactions at the air-sea interface, and compares measurements to numerical simulations and field data. Typical phenomena of interest include breaking waves, subsurface turbulence, bubble dynamics, aerosol production, surfactant effects, and heat and gas transport. Special emphasis is placed on determining surface expressions of subsurface flows by using infrared methods.

**DESCRIPTION:** The laboratory has a large wave tank with dimensions 10 (L) x 2.5 (W) x 1 (H) meters which is fitted with a computer controlled wavemaker. A grid turbulence generator is also available.

**INSTRUMENTATION:** The lab is equipped with two high sensitivity infrared cameras, a high speed video system, a particle image velocimetry system, and a Langmuir trough.

**CONTACT:**

Code 7253 • (202) 767-2457

**LOCATION:**

NRL, Washington, DC



# Oceanography Division

- Ocean Sciences and Remote Sensing Research Facility
- Environmental Microscopy Facility
- Ocean Dynamics and Prediction Network
- Ocean Color Facility
- Littoral Measurements Facility
- Salinity Temperature and Roughness Remote Scanner
- Field Staging Facility
- Ocean Optics Instrumentation Systems
- Autonomous Underwater Vehicle Laboratory
- Real-time Ocean Observations and Forecast Facility

# *Ocean Sciences and Remote Sensing Research Facility*



**FUNCTION:** A 52,000 ft<sup>2</sup> state-of-the-art building designed to house NRL's Oceanography Division, part of the Ocean and Atmospheric Science and Technology Directorate. The Oceanography Division consists of two branches: (1) Ocean Dynamics and Prediction and (2) Ocean Sciences. The division's mission is to develop oceanographic models of the ocean and littoral areas for operational use; investigate and describe the physical processes that couple and control the ocean; and develop capabilities to use remotely sensed data to describe and measure the oceanographic processes of the open ocean and littoral areas.

**DESCRIPTION:** The building was designed for carrying out research into ocean processes. The laboratories, office spaces, and conference rooms are wired for high-speed computer networking within the building and to the DoD High Performance Computing (HPC) national network. The remote sensing laboratories also have direct access to selected satellite data streams.

**INSTRUMENTATION:** The building contains an environmental scanning electron microscope with an energy dispersive X-ray detector; an Inspect S low vacuum scanning microscope; an advanced seagoing instrumentation and calibration laboratory; a secure data processing laboratory; and a workstation network with multi-tiered storage area networks (SAN) based on performance and availability, totaling approximately 150 TB of immediate and fault-tolerant RAID storage. The building's roof features receivers for the Sea-viewing Wide Field-of-view Sensor (SeaWiFS), Ocean Color Monitor (OCM), Moderate Resolution Imaging Spectroradiometer (MODIS), ocean color sensors, and NOAA polar orbiting satellites.

**CONTACT:**

Code 7300 • (228) 688-4670

**LOCATION:**

NRL, Stennis Space Center, MS

# Environmental Microscopy Facility



**FUNCTION:** Provides high-resolution (5 nm) images and elemental composition (for elements heavier than sodium) of hydrated specimens, including biological materials. The facility is essential for demonstrating spatial relationships between microorganisms and substrata and for investigating biofouling, bioremediation, and biodeterioration.

**DESCRIPTION:** The Environmental Microscopy Facility is equipped to examine the spatial distribution of microorganisms in biofilms and their impact on microbiologically influenced corrosion, biomineralization, and bioaccumulation. The environmental scanning electron microscope (ESEM) with a differential pumping system permits 2D examination of viable cells and precise mapping of associated elements. The ESEM has been used to determine failure mechanisms for welded stainless steels, fiber-reinforced polymers, coatings, sealants, and emulsifiers. The laser confocal scanning microscope provides a 3D examination of microbial substrata relationships. Addition of the Inspect S microscope enables examination of nonconducting samples.

#### **INSTRUMENTATION:**

- ESEM equipped with an energy-dispersive X-ray detector and an image acquisition and archive system
- Laser confocal scanning microscope
- Inspect S low vacuum scanning electron microscope.

#### **CONTACT:**

Code 7303 • (228) 688-5494

#### **LOCATION:**

NRL, Stennis Space Center, MS

# Ocean Dynamics and Prediction Network



**FUNCTION:** Provides general-purpose computer services to branch personnel for program development, graphics, data processing, storage, and backup. Provides network connectivity to other Navy sites, to the DoD High Performance Computing centers, and to the Internet. The computational system enables leading-edge oceanographic numerical prediction research applicable to Navy operations affected by environmental variations at scales of meters to hundreds of kilometers and time scales of seconds to weeks.

**DESCRIPTION:** The computational facilities comprise more than 150 UNIX-based computers, most on a parallel grid engine. Additionally, the infrastructure contains more than 100 Windows-based systems. The core network is supported by Sun Microsystems and Linux based servers, interconnected via redundant gigabit Ethernet and 4-gigabit fiber channel switches, using the latest technology at both the operating system and network layers. Multi-tiered storage area networks (SAN) based on performance and availability total approximately 150 TB of immediate and fault-tolerant RAID storage. Ten-gigabit outside network connectivity between buildings hauls the aggregate traffic. Backups

are performed on site using another tiered solution, SDLT600 and LTO4, all fiber connected. Outside access is protected by real-time adaptive firewalls and RSA SecurID and CAC authentication mechanisms.

**INSTRUMENTATION:**

- AMD Opteron workstations, Sun Solaris servers, Dell Xeon workstations and file-servers
- Quantum ATL four-drive Super DLT and Scaler 12K tape libraries
- 150 terabytes of centralized disk storage.

**CONTACT:**

Code 7320 • (228) 688-4720

**LOCATION:**

NRL, Stennis Space Center, MS



# Ocean Color Facility

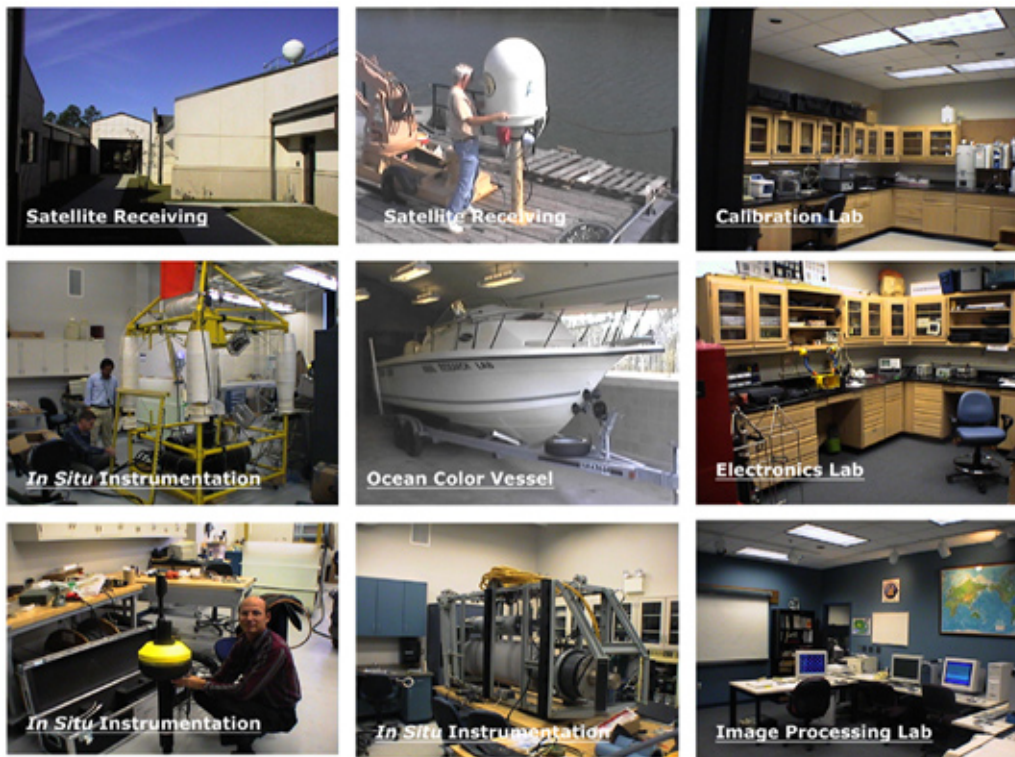

**FUNCTION:** Maintains a state-of-the-art image processing, instrumentation, and satellite receiving capability. The laboratory is developing advanced algorithms for space and aircraft ocean color sensors (SeaWiFS, MODIS, AVHRR, NPOESS, MERIS, OCM, HICO, CASI).

**DESCRIPTION:** The laboratory is currently a SeaWiFS, OCM, and MODIS receive site for real-time data capture and processing of ocean color imagery. Additionally, over 30 GB of satellite imagery is processed daily for areas around the world to support experiments. Real-time ocean color products are used for ship sample collection experiments and integrate with ocean models and forecast systems. These data are used for the development, tuning, and validation of advanced algorithms relating spectral signatures to ocean properties and processes.

**INSTRUMENTATION:** The laboratory has both fixed and shipboard antenna systems to support global experiments. It maintains SAN and Linux clusters and an archive of 50 TB of satellite imagery. The laboratory also maintains an advanced at-sea instrumentation and calibration laboratory specializing in bio-optical properties and coastal ocean color. Facilities include spectral absorption, scattering, and reflectance measurement systems, and laboratory spectrometers.

## CONTACT:

Code 7330 • (228) 688-5268

## LOCATION:

NRL, Stennis Space Center, MS

# Littoral Measurements Facility

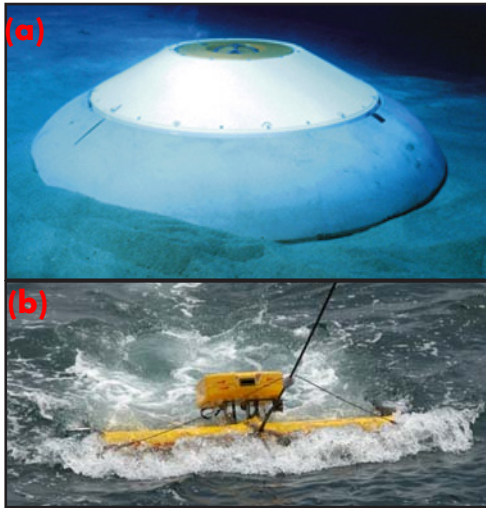

(a) Barny  
(b) ScanFish MKII  
(c) VMP500  
(d) SEPTR

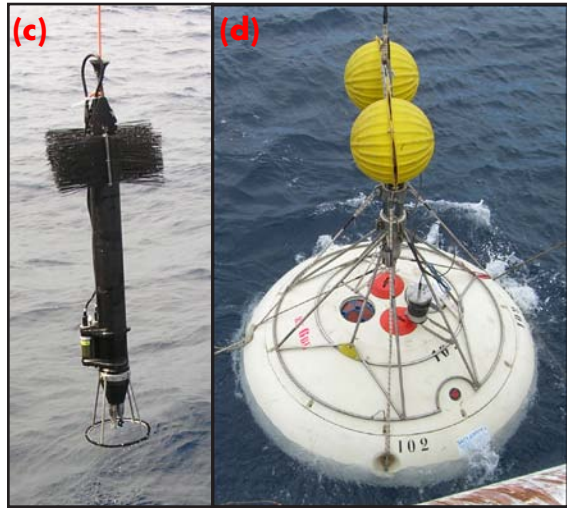

**FUNCTION:** Barny units measure ocean currents and sea surface heights on continental shelves and in ocean straits. SEPTR units are similar to Barnys but also record temperature and salinity (TS) profiles and transmit the data in near real time via satellite. The VMP500 is a vertical microstructure turbulence profiler for the measurement of dissipation-scale turbulence in oceans and lakes up to 500 m in depth. The ScanFish MKII is a towed undulating vehicle system for collecting 3D TS profile data of the water column.

**DESCRIPTION:** Each Barny consists of a circular outer cement ring for ballast and impact protection, a buoyant main instrument housing, and a pop-up float. Each is equipped with an acoustic Doppler current profiler (ADCP) and wave/tide gauge. The pop-up float that contains the ADCP surfaces on an acoustic command, bringing with it a line for recovering the rest of the unit. Barnys are highly trawl-resistant. They were developed through a cooperative agreement between NRL and the NATO Undersea Research Centre (NURC). SEPTRs contain an additional pop-up float and record temperature, salinity, and optical parameters in addition to current profiles and pressure. The VMP500 is a free-falling probe that takes measurements on a downward trajectory and is capable of measuring full-depth profiles of thermal and kinetic energy dissipation rates, in addition to CTD and velocity fine structure in oceans and lakes. It is lightweight and deployable from small boats. The EIVA ScanFish MKII is a wing-shaped hydrofoil that “flies” through the water with ascent/descent controlled remotely; it is designed for high-speed data collection at

either a fixed depth/altitude or on a pre-programmed undulating flight path. This allows for efficient and rapid 3D mapping of mesoscale oceanic features down to 400 m depth with scales ranging from about one meter to many tens of kilometers.

**INSTRUMENTATION:** Each Barny hosts an RDI ADCP and Sea-Bird 026 wave/tide gauge. Each SEPTR contains a CTD, optical sensors, ADCP, and wave/tide gauge. The VMP contains a pressure sensor, 3-axis, high-accuracy accelerometer, SPM-38-1 shear probes, FP07-38-1 fast thermistors, SBE7-38 microstructure conductivity sensor, and SBE-3F/SBE-4C temperature and conductivity sensors. The ScanFish incorporates a Sea-Bird CTD and can host a variety of fast-response temperature and conductivity sensors and standard optics packages that include sensors such as the AC9, BB3, FL3, and transmissometer.

**CONTACT:**

Code 7332 • (228) 688-4734

**LOCATION:**

NRL, Stennis Space Center, MS

# Salinity Temperature and Roughness Remote Scanner (STARRS)

The STARRS system mounts beneath the fuselage on a variety of aircraft

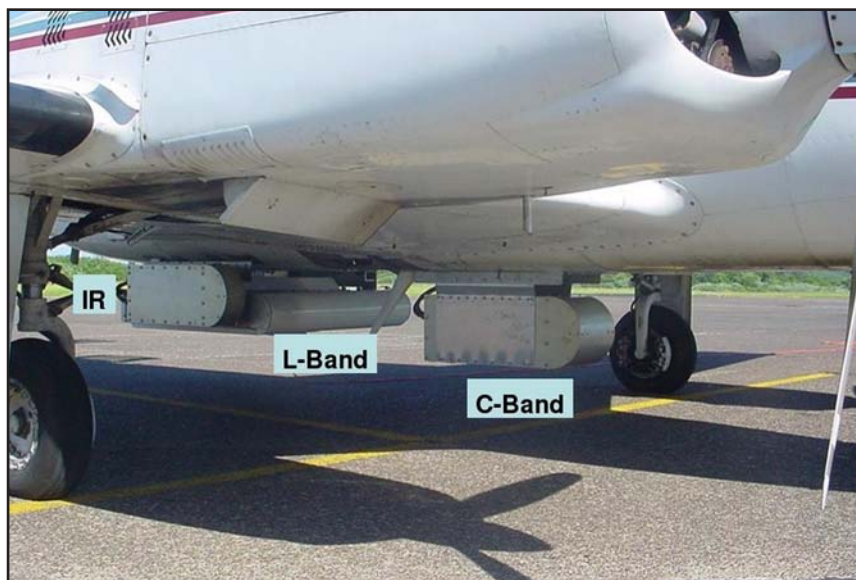

**FUNCTION:** Provides spatially continuous high-resolution surface salinity imagery in a synoptic manner from small aircraft. Its output complements data collected from ship-based and moored systems, puts those data sets into synoptic context, and provides key information for assimilation into predictive models of physical fields including currents, temperature, salinity, and sound speed in the littoral and open oceans.

**DESCRIPTION:** STARRS is an imaging sensor that provides complete areal coverage of surface salinity in a swath twice as wide as the aircraft's altitude. The swath is resolved into six cells, and swaths can be quickly flown adjacent to each other. STARRS includes advanced primary and secondary measurement components to assure salinity retrieval with total noise levels less than a few tenths of one practical salinity unit (psu) under a wide range of environmental conditions. The dominant force driving currents in the littoral is due to density differences between water masses. These are caused by the flux of low salinity waters from bays and rivers to the coastal zone, and the contrasts between shelf and open-ocean waters. Similar contrasts drive large-scale open-ocean currents. STARRS' capabilities allow researchers to routinely obtain high-resolution imagery in a synoptic fashion.

**INSTRUMENTATION:** In the photograph, STARRS is shown mounted to the underside of a Piper Navajo twin engine airplane. In the center is the 1-m-square multibeam 1.4 GHz L-band radiometer; it is based on a low-noise microstrip patch antenna for the primary salinity/brightness/temperature measurement. At left is a two-channel split-window infrared (IR) radiometer for sea surface temperature. At right is a single-beam multichannel C-band radiometer for estimates of sea surface roughness. The IR and C-band secondary subsystems provide useful oceanographic information in their own right, in addition to being key inputs for the retrieval of salinity from the primary L-band system.

## CONTACT:

Code 7332 • (228) 688-5487

## LOCATION:

NRL, Stennis Space Center, MS



# Field Staging Facility



**FUNCTION:** Facilitates routine maintenance for NRL seagoing measurement systems: ocean current (Barny, SEPTR); ocean temperature and salinity (ScanFish); ocean turbulence (VMP); airborne salinity (STARR); and air-sea interaction (WGA/SSS). This facility is equipped with high-precision machinery, calibration chambers, and electronic equipment to adjust, repair, and assemble mechanical and electronic components of the systems.

**DESCRIPTION:** To achieve a consistently high level of data quality from field experiments, seagoing measurement systems are required to endure harsh marine environments and to operate with their designed measurement capability throughout the deployments. This requires continuous maintenance efforts including calibrations, adjustments, tunings, modifications, and storage for electronic and mechanical components of various seagoing systems during the pre- and post-deployment stages. These functions are conducted in this facility, which consists of an electronic assembly and readiness lab, machine and welding lab, sensor calibration lab, 1500 ft<sup>2</sup> experiment staging area (high-bay), and temperature-controlled storage center. The facility is essential for maintaining the readiness and integrity of the NRL measurement systems.

## **INSTRUMENTATION:**

- Bridgeport vertical milling machine; Tradesman bandsaw
- MIG-TIG welding machine (Shopmaster 300)
- Nardini Mascote MS-1440 precision lathe
- 2-ton Presto PSTA2107 pallet stacker
- 2-ton overhead monorail crane.

## **CONTACT:**

Code 7332 • (228) 688-4734

## **LOCATION:**

NRL, Stennis Space Center, MS



# Ocean Optics Instrumentation Systems

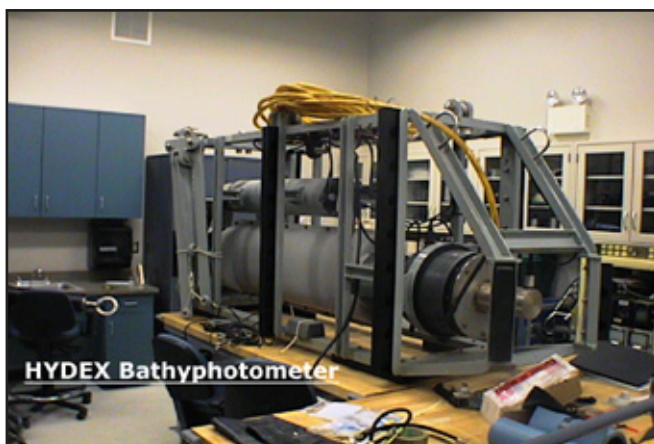

**FUNCTION:** Provides instrumentation suites for a wide variety of measurements to characterize the ocean's optical environment. These packages have been developed to measure optical characteristics from the bioluminescent potential of the depths to the radiometric properties of the sea surface.

**DESCRIPTION:** The ocean surface photic region is of prime interest to the Navy and NASA as it relates to ocean color from satellite and biological application in numerical modeling. Recently, small, lightweight packages have been developed for use in near-shore coastal waters. NRL also maintains capabilities for open-ocean measurements, airborne remote sensing, and airborne expendable optical systems.

**INSTRUMENTATION:** Measurements of the inherent optical properties of attenuation, absorption, and scattering are routinely performed in the field, in addition to the measurement of the apparent radiometric quantities of radiance and irradiance. Instruments include WETLabs AC9 (9 wavelength attenuation and absorption meters); WETLabs ECOVSF and VABAM (angular dependent scattering);

Satlantic SPMR (SeaWiFS wavelength radiance and irradiance profiles); Satlantic HTSRB and K-Chain (near-surface hyperspectral near-surface light field); HYDEX (bioluminescence potential); WETLabs SAFire (multiple wavelength); SeaTech CHL a fluorometers; ASD radiometers (surface-leaving radiance and reflectance).

The integration of these instruments into oceanographic measurement packages and data acquisition systems is an ongoing process at NRL's Ocean Optics facility.

## CONTACT:

Code 7333 • (228) 688-5253

## LOCATION:

NRL, Stennis Space Center, MS

# Autonomous Underwater Vehicle Laboratory

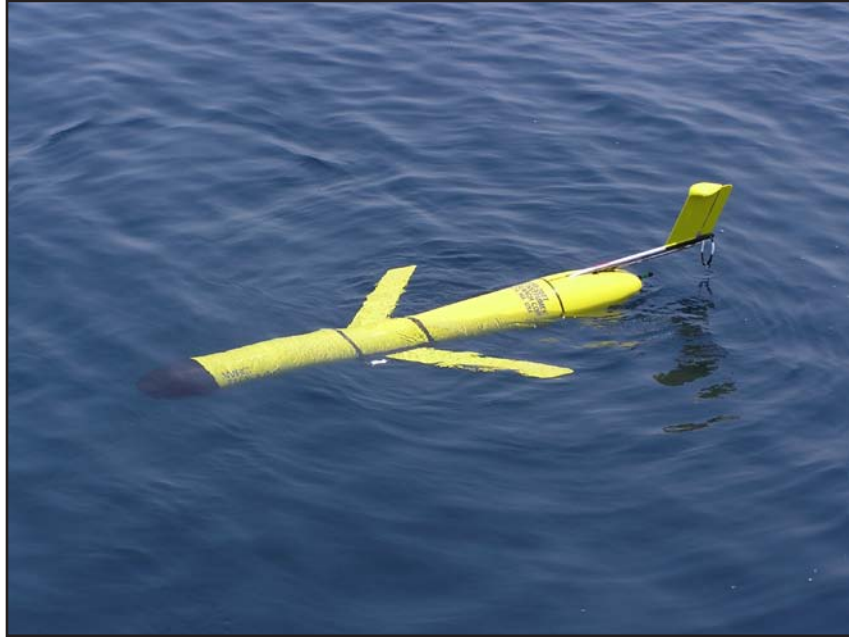

**FUNCTION:** Studies coastal ocean processes with autonomous underwater vehicles (AUVs). Maintains, tests, ballasts, and prepares for deployment the Slocum Electric Glider AUV built by Webb Research Corporation. Slocums are designed to independently perform wide-area ocean surveys of temperature and salinity for up to about one month.

**DESCRIPTION:** Slocum gliders are equipped with temperature/salinity/pressure sensors and with real-time satellite connection to the Iridium network. These gliders, unlike conventional AUVs, have no active propulsion system and instead rely on a battery-induced change of buoyancy and active control surfaces to glide through the coastal ocean from the surface to the bottom and from the bottom to the surface in a saw-tooth pattern. This system requires low amounts of power and therefore the gliders do not need to carry heavy battery payloads and can be deployed over long-duration missions (>30 days). An altimeter is used to prevent bottom collisions. Two-way communication of data/instructions occurs through Iridium satellite or freewave radio when the gliders are on the ocean surface. The central payload of the gliders can be equipped with various instruments for ocean measurements. The coastal gliders can dive to 200 meters depth.

**INSTRUMENTATION:** A Slocum glider typically carries an altimeter and a Sea-Bird CTD (temperature, salinity, and depth) as part of a fundamental sensor faculty. Vertically averaged current velocity can be calculated using the difference of the actual glider track with the programmed track and surface current velocity can be calculated using the consecutive GPS fixes while at surface. Additional sensors include Wetlabs BB3 (optical backscattering), FL3 (fluorescence), and AUVB (total volume scattering).

**CONTACT:**

Code 7332 • (228) 688-5494

**LOCATION:**

NRL, Stennis Space Center, MS

# Real-time Ocean Observations and Forecast Facility (ROOFF)



**FUNCTION:** Provides the capability to visualize “ocean weather” for selected ocean regions. The collection of satellite observations with numerical circulation models is visually animated using daily update of observations systems combined with current ocean conditions derived from numerical models. The ROOFF presents monitoring and ocean tracking for physical and bio-optical conditions. This facility supports Navy programs and experiments by visually assembling new ocean products.

**DESCRIPTION:** New satellite bio-optical and thermal ocean products are fused with different numerical models of physical properties to define the nowcast and forecast of ocean conditions. The room hosts the visualization of both the 2D and 3D ocean conditions for areas in which NRL experiments are being conducted (Gulf of Mexico, South Pacific, U.S. West Coast). The room provides a forum to determine integration of observations and models. The data fusion enables visual testing and validation of ocean products.

**INSTRUMENTATION:** The ROOFF provides multiple large interactive display systems with specialized visualization software allowing scientists to interact with real-time data from satellites, models, and in situ data. These display systems are linked with the Division’s computer systems and updated in real time.

## CONTACT:

Code 7330 • (228) 688-5268

## LOCATION:

NRL, Stennis Space Center, MS

## Marine Geosciences Division

- Transmission Electron Microscopy Facility
- Sediment Physical and Geotechnical Properties Laboratory
- Marine Biogeochemistry Laboratory
- Computed Tomography Scanning Facility
- Moving-Map Composer Facility
- Digital X-Radiography Scanning Laboratory
- Sediment Core Laboratory
- Geospatial Services Laboratory



# Transmission Electron Microscopy Facility



JEOL JEM-3010 TEM

**FUNCTION:** Performs basic and applied research in areas of marine geosciences, geophysics, physics, and microbiology using microanalytical techniques.

**DESCRIPTION:** The Transmission Electron Microscopy Facility has unique instrumentation in its environmental cell transmission electron microscope (EC-TEM) system. The EC is of the closed-cell type and is fully computer-controlled. Unlike EC systems based on the principle of differential pumping, closed-cell EC systems require no modification to the TEM. Confinement of the pressurized environment within the EC is achieved with electron-transparent windows. Since the EC is self-contained within the specimen holder, the TEM can still be used for conventional transmission electron microscopy using conventional specimen holders without compromising resolution and analytical capabilities.

**INSTRUMENTATION:** The facility has a 300 kV JEOL JEM-3010 transmission electron microscope equipped with an energy-dispersive X-ray spectrometer (EDXS), a Gatan Model GIF200 (Gatan Imaging Filter) for energy-filtered imaging and electron energy loss spectroscopy (EELS), and scanning coils for scanning TEM mode. This TEM has a state-of-the-art environmental cell system with two interchangeable EC specimen holders. The center is also equipped with a 100 kV Hitachi H-600 TEM.

**CONTACT:**

Code 7430 • (228) 688-5011

**LOCATION:**

NRL, Stennis Space Center, MS

# *Sediment Physical and Geotechnical Properties Laboratory*



**FUNCTION:** Provides instrumentation and expertise for geotechnical characterization of sediments of all types and origins.

**DESCRIPTION:** Equipment allows for investigations of strength, deformational, and pore pressure response properties of a variety of sediment types. These include uniaxial compressibility, consolidation and creep effects, uniaxial and triaxial strength and deformation properties, viscous and other effects that depend on the rate of deformation and flow.

**INSTRUMENTATION:** Triaxial testing devices, including displacement-controlled and load-controlled systems, oedometers, rheometer, variable-rate vane shear device, drying oven, high-temperature furnace, liquid and plastic limit and hydrometer testing equipment.

**CONTACT:**

Code 7430 • (228) 688-5011

**LOCATION:**

NRL, Stennis Space Center, MS

# Marine Biogeochemistry Laboratory

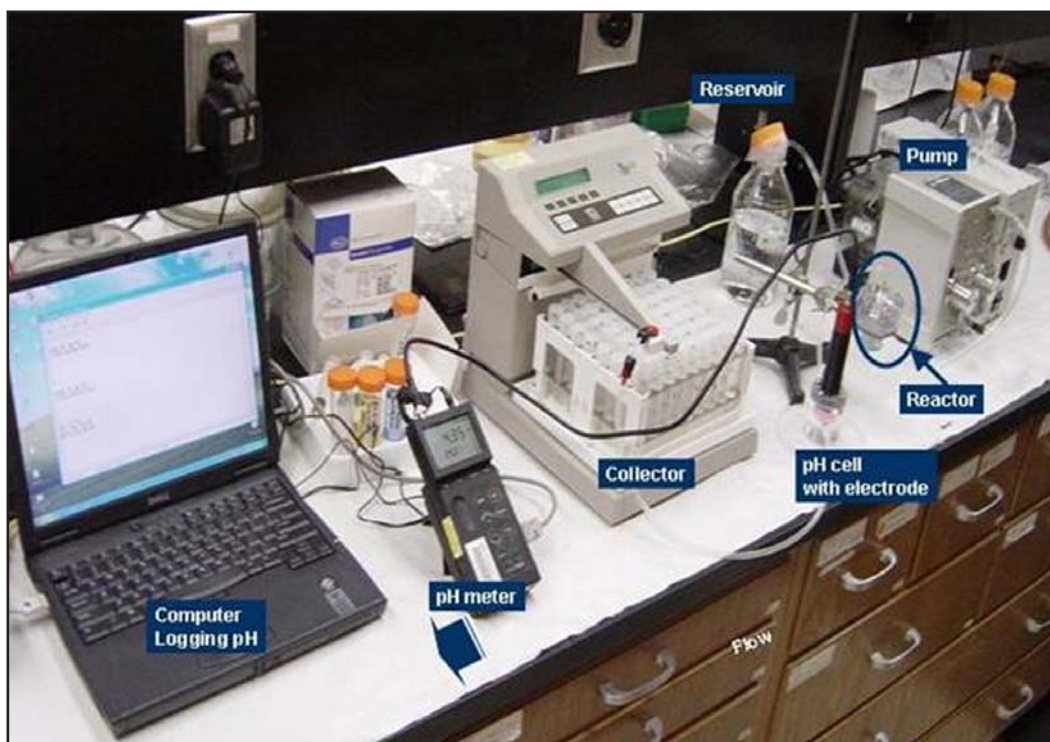

**FUNCTION:** Provides instrumentation and expertise for biogeochemical characterization of aquatic sediments.

**DESCRIPTION:** Benthic mesocosms are used to simulate littoral seabed environments for the analysis of redox gradients in burrowed sediments. A miscible-flow reactor is used to investigate the reaction kinetics of a variety of mineral-microbe-water interactions. Spectrophotometers are used to analyze aqueous samples for the concentrations of dissolved species. Molecular biology systems are used to determine mechanisms for microbe-mineral interactions and microbial diversity in aquatic sediments. The Zetasizer is used for nanoparticle characterization.

**INSTRUMENTATION:** A heparin agarose affinity chromatography (HAAC) spectrophotometer, UV spectrophotometer, molecular biology systems (gel electrophoresis, electroporation, and RNA/DNA hybridization), inductively coupled plasma (ICP) spectrometer, ion chromatograph, Zetasizer NanoZS with titrator, and an anaerobic chamber. A miscible-flow reactor with attached ancillary equipment (see above), centrifuges, and benthic mesocosms.

## CONTACT:

Code 7430 • (228) 688-5474

## LOCATION:

NRL, Stennis Space Center, MS

# Computed Tomography Scanning Facility

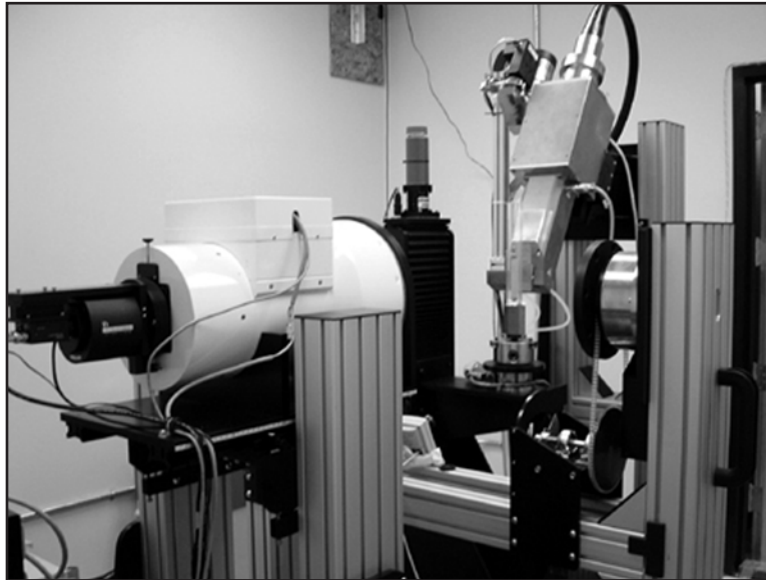

The X-ray system portion of the HD-500 Micro-CT System

**FUNCTION:** Advances research in the areas of marine geosciences, geotechnical, civil, and chemical engineering, physics, and ocean acoustics by using high-resolution, volumetric, X-ray imaging.

**DESCRIPTION:** The Computed Tomography (CT) Scanning Facility has the capability to produce high-quality fine-scale images of Navy relevant materials. This capability is equivalent to that of the synchrotron laboratories ( $\sim 10 \mu\text{m}$  resolution for 1-cm-diameter earth materials). Additionally, this facility can accommodate small to large samples (5 mm to 9 cm diameter with the HD-500). This facilitates the evaluation of similar systems at many scales, in a relatively short period of time. Furthermore, this facility promotes experiments that require weeks to months, so that processes that occur in dynamic systems over extended time periods can be evaluated (e.g., growth and migration of gas bubbles in mud, drainage/imbibition of water from/into beach sand, and evolution of stratigraphy in response to bioturbation). In these cases, the samples are perturbed (physical conditions are altered), allowed to equilibrate, and then CT-scanned.

**INSTRUMENTATION:** The CT facility operates an HD-500 Micro-CT System equipped with a microfocus X-ray tube that operates from 10 to 225 kV and 0 to 3 mA. This state-of-the-art industrial CT enables the production of images with  $10 \mu\text{m}$  resolution for appropriately sized materials. The housing for this system is open, so that large systems (e.g., acoustic impedance tubes, permeameters, compression testers) can be used in conjunction with the CT system. In addition to the high-resolution CT system, the facility is equipped with a Picker Medical CT scanner, which operates at energies to 150 kV, can accommodate large diameter samples (up to  $\sim 0.75$  m in diameter), and is housed in a portable trailer, making the system useful for field experiments. In each case, the energy spectrum is polychromatic.

**CONTACT:**

Code 7430 • (228) 688-5473

**LOCATION:**

NRL, Stennis Space Center, MS



# Moving-Map Composer Facility



**FUNCTION:** Develops, tests, and transitions software and algorithms to perform database design, data compression, change detection, data fusion, archival, retrieval, and display. Demonstrates and evaluates prototype and next-generation digital moving-map capabilities, map design systems, and mission planning systems.

**DESCRIPTION:** The Moving-Map Composer (MMC) Facility is a 32 × 30 ft laboratory. The facility is divided into five primary work areas to support the principal functions of the MMC team:

- Research into data compression and database design
- Research and development of automated algorithms for change detection and object identification
- Development and transition of mission-specific aircraft optical disks for F/A-18 and AV-8B platforms
- Software and algorithm development in support of Naval mission and map planning
- Developing, testing, prototyping, and demonstrating parallel processing techniques to improve efficiency of existing bathymetric data processing systems.

**INSTRUMENTATION:** The MMC Facility includes multiple computer platforms running Unix, Linux, Windows NT, and OpenVMS operating systems.

## CONTACT:

Code 7440 • (228) 688-4611

## LOCATION:

NRL, Stennis Space Center, MS

## Digital X-Radiography Scanning Laboratory



**FUNCTION:** Generates digital X-radiographic images of sediment cores that portray density variations, sediment stratigraphy, bioturbation, and inclusions.

**DESCRIPTION:** The Faxitron 48-in. Cabinet Model 43855C with EZ40M digital line scanner is a fully automated, computer-controlled X-ray system that provides digital X-radiographic images without the need to develop X-ray film, although film can still be used if desired. The cabinet has been customized with ports or tub enclosures on either side to accommodate large core samples approximately 3 meters in length. The system operates with a 130 kV X-ray source and images are automatically imported into a PC desktop system using iX-Pect EZ software.

**CONTACT:**

Code 7430 • (228) 688-5011

**LOCATION:**

NRL, Stennis Space Center, MS

# Sediment Core Laboratory



**FUNCTION:** Provides instrumentation and expertise for physical and geoaoustic characterization of marine sediments.

**DESCRIPTION:** The multisensor core logger measures profiles of compressional wave velocity, wet-bulk density (by gamma-ray attenuation), electrical resistivity, and magnetic susceptibility directly, and acoustic impedance and porosity indirectly. Sediment cores are opened for visual classification, measurement of undrained shear strength via miniature vane and torvane, and subsampling for physical properties tests. Grain-size analyses for coarse sediments are performed by settling tube or standard sieve analysis, and silt and clay particle size distribution is analyzed by the Micromeritics SediGraph. Average grain densities are measured via gas pycnometry using a Quantachrome Penta-Pycnometer.

**INSTRUMENTATION:** A Geotek multisensor core logger, LABCONCO bulk tray freeze dryer, digital macro- and micro-photographic imagery systems, and geotechnical testing instrumentation that includes miniature vane shear and torvane, uni- and triaxial consolidation instruments, geoaoustic Hamilton frame, relative density shaker table, and Quantachrome Penta and Ultra pycnometers. Sediment textural analyses are performed using sieves, pipette analysis, an instrumented settling tube, and a Micromeritics SediGraph, Model 5120.

## CONTACT:

Code 7430 • (228) 688-5011

## LOCATION:

NRL, Stennis Space Center, MS

# Geospatial Services Laboratory



**FUNCTION:** To process, store, and disseminate geospatial data to the Department of Defense and other Federal agencies.

**DESCRIPTION:** The Geospatial Services Laboratory is equipped with 26 Linux servers enabling hundreds of processes to be run simultaneously on geospatial datasets provided by more than 150 terabytes of high performance storage capable of transmitting data at rates in excess of 4 Gbps. The combination of high performance storage and high speed processing enables the rapid processing and dissemination of data to clients and minimizes server idle time. This facility includes several Web servers to provide access to our software and public datasets, as well as internal test and development servers utilizing the latest in virtualization technology. Currently the Geospatial Services Laboratory is split between two server facilities while construction is beginning on its future home: a 1500 ft<sup>2</sup> data center that will host up to 400 servers and as much as 2 petabytes of high performance storage to allow for projected growth requirements over the next five years.

**INSTRUMENTATION:** Twenty-six servers, 11 high performance storage arrays totaling 150 terabytes, multiple user terminals, and an IP-based KVM solution provide user access from anywhere inside the facility with proper authorization.

**CONTACT:**

Code 7440.2 • (228) 688-4197

**LOCATION:**

NRL, Stennis Space Center, MS



# Marine Meteorology Division

- Meteorological and Oceanographic Research Library
- Meteorological Archival Facility
- Atmospheric Prediction System Development Laboratory
- Mobile Atmospheric Aerosol and Radiation Characterization Observatory (MAARCO)
- Satellite Data Ingest and Processing System

# *Meteorological and Oceanographic (METOC) Research Library*



**FUNCTION:** This on-site library provides researchers with complete library functions with emphasis on meteorology and oceanography. Copies of scientific texts, reference books, and journals are on hand for the research needs of NRL and Fleet Numerical Meteorology and Oceanography Center (FNMOC) scientists. Interlibrary loans and online library access functions are also provided by the library.

**DESCRIPTION:** This on-site library maintains current and past copies of most U.S. and many international journals dedicated to the atmospheric, oceanographic, and computational sciences; copies of NRL and FNMOC technical reports and memoranda; and several reference books and hundreds of scientific texts in the mathematical, physical, and Earth sciences. The facility also provides quiet reading and work areas, and online access to the Ruth H. Hooker Research Library, located at NRL's main site in Washington, DC. NRL Monterey scientists are frequent users of the InfoWeb gateway, which provides online access to a large number of journals and other publications.

NRL Monterey shares the scientific library with FNMOC. The library contains many well-known historical and contemporary books on meteorology and

oceanography. The library also serves as a repository for a number of internal technical publications, including technical reports from the laboratories that preceded NRL, namely the Naval Environmental Prediction Research Facility (NEPRF) and the Naval Oceanographic and Atmospheric Research Laboratory (NOARL). The METOC library also maintains historical and current copies of the graduate theses and dissertations written by students in meteorology and oceanography at the Naval Postgraduate School.

## **CONTACT:**

Code 7500 • (831) 656-4721

## **LOCATION:**

Bldg. 702, Rm. 128 • NRL, Monterey, CA

## *Meteorological Archival Facility*



**FUNCTION:** The Bergen Data Center (BDC) provides data archival capability for meteorological and oceanographic data.

**DESCRIPTION:** The BDC operates as a resource for researchers, visiting scientists, and collaborators to access meteorological and oceanographic data. From its initial capacity of 31 TB in 1998, the BDC has grown to its present capacity of 271 TB. It accommodates diverse research requirements, providing archiving of critical data.

**INSTRUMENTATION:** The facility includes a server, SAN switch, tape library, and tape drives. The server, tape library, and tape drives are linked together by Cisco Systems MDS 9216 SAN switch and Cisco Systems MDS 9509 SAN director. The Dell PowerEdge 2850 with the RedHat Enterprise Linux operating system runs Veritas Netbackup Enterprise software for backup, archiving, and tape library management. The tape library has 678 tape slots and 6 tape drives each having a direct connection to the SAN. BDC has a data transfer rate of 1.5 TB per hour. The total online tape storage capacity is 271 TB.

**CONTACT:**

Code 7501.1 • (831) 656-4892

**LOCATION:**

NRL, Monterey, CA

# Atmospheric Prediction System Development Laboratory



**FUNCTION:** Provides connectivity to computational platforms and databases that are necessary for the development, testing, and validation of numerical data assimilation, weather, and ensemble prediction systems. This capability allows for the rapid transition of software development into operations.

**DESCRIPTION:** This laboratory enables scientists at NRL to perform basic and applied research in numerical weather prediction and to take the knowledge learned from this research and quickly apply it to operational data assimilation and prediction systems. The facility allows the scientists to use the same software and databases in all their research that is used in operations at FNMOC, an important component necessary for the improvement of the data assimilation and prediction systems. The high-speed connectivity between the computational resources allows the scientists to share databases, results, and software. Collocation with FNMOC allows developers to access and use computational resources (controlled by operating systems with multilevel security) that will ultimately host the NRL-developed weather prediction systems.

**INSTRUMENTATION:** The laboratory includes an in-house 128-processor computer, a 44-processor Linux cluster, an 88 dual-core processor Linux cluster, individual workstations, and high-speed connectivity which provides direct access to operational supercomputer systems and data, and to the many computational resources at the various Department of Defense High Performance Computing Centers.

**CONTACT:**

Code 7501 • (831) 656-4758

**LOCATION:**

NRL, Monterey, CA



# Mobile Atmospheric Aerosol and Radiation Characterization Observatory (MAARCO)

**FUNCTION:** MAARCO is designed as a stand-alone facility for basic atmospheric research and the collection of data to assist in validating aerosol and weather models. Its purpose is to enable research on atmospheric aerosols, gasses, and radiation (visible and IR light) in areas of key interest, including remote areas, overseas locales, and onboard ships. This complete mobile laboratory facilitates deployment in areas with limited facilities, and provides maximum flexibility for integration of additional instrumentation.



MAARCO

**DESCRIPTION:** MAARCO is a modified 20 ft x 8 ft climate-controlled container, a standard size certified for shipping. Removable scaffolding on the roof, and shelves and racks inside the container facilitate installation, and removal and stowage of instruments for shipping. MAARCO's radiation instruments provide spectral aerosol optical depths and inversion products, direct and diffuse total solar and infrared radiation, and real-time whole-sky images and cloud cover. The aerosol instruments characterize the light-scattering properties of atmospheric aerosols and provide data on aerosol particle sizes, aerodynamic shapes, concentrations, mass, elemental composition, and particle morphology. The gas monitors measure reactive compounds that modify aerosol particles and provide clues to the air mass origin. The lidar and rawinsonde systems display the vertical structure of clouds and aerosols, produce atmospheric extinction and optical depth profiles, and are valuable for locating atmospheric layers for aircraft sampling, and for assisting in interpreting the visible and IR instrument data.

**INSTRUMENTATION:** MAARCO contains an integrated suite of meteorology, aerosol, gas, and radiation instruments, with space maintained for guest instrumentation. The radiation suite includes an AEROSOL ROBOTIC NETWORK (AERONET) Sun Photometer, solar and IR radiometers, a Total Sky Imager, and a Micro-Pulse Lidar. A 3-wavelength nephelometer, Aerodynamic Particle Sizer, total suspended particulate (TSP) filter sampler, tapered element oscillating microbalance (TEOM) sampler, SO<sub>2</sub> and ozone monitors, and a micro-orifice uniform deposit impactor (MOUDI) sampler complete the aerosol and gas suite. Meteorological data are provided by a weather station and a rawinsonde system.

**CONTACT:**

Code 7544 • (831) 656-4725

**LOCATION:**

NRL, Monterey, CA

# Satellite Data Ingest and Processing System



Antenna receiving geostationary satellite data

**FUNCTION:** Collects and processes a unique global digital data set from multiple satellite sensors. The facility enables researchers to rapidly collocate multiple satellite sensors/channels for a wide range of meteorological and oceanographic (METOC) applications anywhere on the globe. Hardware/software compatibility with the Fleet enhances rapid prototyping and transition to operations.

**DESCRIPTION:** The facility includes rooftop antennas to capture real-time Geostationary Operational Environmental Satellite (GOES)-West and GOES-East digital data. The ~30 GB/day/satellite data rate flows through hardware to frame and bit-sync the data located in the computer room. Digital data from three other geostationary satellites (MTSAT and Meteosat-8 and -5) are gathered from the Fleet Numerical Meteorology and Oceanography Center (FNMOC). The five geostationary satellites thus enable true global coverage with visible, infrared, and water vapor channel data using SeaSpace's TeraScan software. Real-time DMSP and NOAA polar orbiter satellite data are captured via an SMQ-11 system. NOAA data are available from a similar system in Norfolk, VA. Global near-real-time DMSP polar orbiter data are also gathered via FNMOC. Near-real-time Tropical Rainfall Measuring Mission (TRMM) and Moderate Resolution Imaging Spectroradiometer (MODIS) polar orbiter data are collected from the NASA Goddard Space Flight Center.

**INSTRUMENTATION:** The facility includes two geostationary receiving systems to capture real-time GOES-West and GOES-East data. A polar orbiter antenna system collects data from NOAA and Defense Meteorological Satellite Program (DMSP) satellites. A suite of Unix workstations and software programs processes these data streams and data from three other geostationary and four global polar orbiter satellite data sets. Collaborative agreements with other government agencies significantly reduce on-site infrastructure needs.

**CONTACT:**

Code 7541 • (831) 656-4833

**LOCATION:**

NRL, Monterey, CA

## Space Science Division

- Vacuum Ultraviolet Calibration/Testing Facility
- Gamma-Ray Imaging Laboratory
- Cryogenic Sensor Test Facility
- Large Angle and Spectrometric Coronagraph
- Rocket Assembly and Checkout Facility
- Solar Coronagraph Optical Test Chamber
- Space Instrument Test Facility
- EUV/X-Ray Calibration Facility

# Vacuum Ultraviolet Calibration/Testing Facility

**FUNCTION:** Provides an oil-free, high-vacuum chamber for vacuum ultraviolet calibration and testing of extreme and far ultraviolet sensors. The system is used to determine an instrument's optical characteristics by simulating the naturally occurring diffuse airglow emissions of the Earth's upper atmosphere. It is also capable of performing component-level testing and characterization of an instrument's individual optical components before instrument assembly.



**DESCRIPTION:** The Vacuum Ultraviolet Calibration/Testing Facility is a series of clean vacuum chambers capable of generating and detecting UV radiation required for optical calibration of space experiments. It was built to support the optical development, testing, and calibration of the Special Sensor Ultraviolet Limb Imager (SSU-LI). It has also been used to test and calibrate the six flight Tiny Ionospheric Photometer (TIP) instruments, the High-resolution Ionospheric and Thermospheric Spectrograph (HITS), the Remote Atmospheric and Ionospheric Detection System (RAIDS), the Ultraviolet Imager (UVI), and others. Using an advanced graphical interface, the facility can be easily reconfigured for a wide variety of UV measurements. A silicon carbide reflection diffuser provides diffuse radiation in the far and extreme UV portions of the spectrum. Calibrated reference detectors monitor the radiation levels during an experiment. Inside the chamber, precision translation and rotation stages allow motion of the test component along four independent axes. To minimize contamination, the end of the vacuum chamber is inside a Class 1000 clean room. The entire facility can be used interactively, and work is in progress to automate the facility to allow remote monitoring via a network connection.

**INSTRUMENTATION:** The facility consists of three vacuum vessels specifically designed for the fabrication and test-

ing of sensors and components operating in the 80 to 170 nm spectrum. The primary vacuum vessel is a 1.67-m-diameter by 2-m-long stainless steel tank. This chamber is evacuated using oil-free cryogenic, turbo, and roughing pumps with a typical operating pressure of  $1 \times 10^{-6}$  Torr. UV radiation is delivered into this system using two gas discharge lamps, which can be configured for directed beam applications or as a diffuse source or for both simultaneously. Inside the chamber are several motion stages for remote positioning of the instrument or components being tested. Positively charged ions can be injected into the chamber with energies up to 3 keV to test an instrument's susceptibility to a charged environment. A rare gas analyzer monitors outgassed contaminants from the items under test. Another vacuum vessel in the facility includes a chamber for independently testing and assembling far UV sealed tube detectors. The facility includes a vacuum chamber dedicated to the deposition of thin-film photocathodes and a 0.6-m-diameter chamber for thermal vacuum testing components or small instruments that require stimulation of UV radiation.

## CONTACT:

Code 7669 • (202) 767-9337

## LOCATION:

NRL, Washington, DC



# Gamma-Ray Imaging Laboratory

**FUNCTION:** The Gamma-Ray Imaging Laboratory is used for designing and testing high-resolution solid-state detectors used in imaging and spectral measurements of X rays and gamma rays. The laboratory facilities include cryostats and electronics to test highly segmented detectors made from silicon or germanium. The segmentation into strips or pixels provides position sensitivity used in reconstruction of the gamma-ray image. The data acquisition system can support test configurations with up to 400 channels of low-noise electronics.

**DESCRIPTION:** The Gamma-Ray Imaging Laboratory provides the resources necessary to test new detector concepts for high-sensitivity measurements of X rays and gamma rays. Much of the work in the laboratory has focused on developing large arrays of intrinsic silicon, lithium-drifted silicon, or germanium detectors that have been segmented into strips or pixels to provide interaction position information necessary for imaging. These detectors provide significantly improved capabilities for detection of natural gamma radiation on Earth as well as in space: for the measurements of X- and gamma-ray emission in solar flares, and astronomical sources of gamma rays such as novae and supernovae and active galactic nuclei; for homeland defense and DoD application in the detection of shielded nuclear materials; and for nuclear medical imaging, both SPECT (Single Photon Emission Computed Tomography) and PET (Positron Emission Tomography).

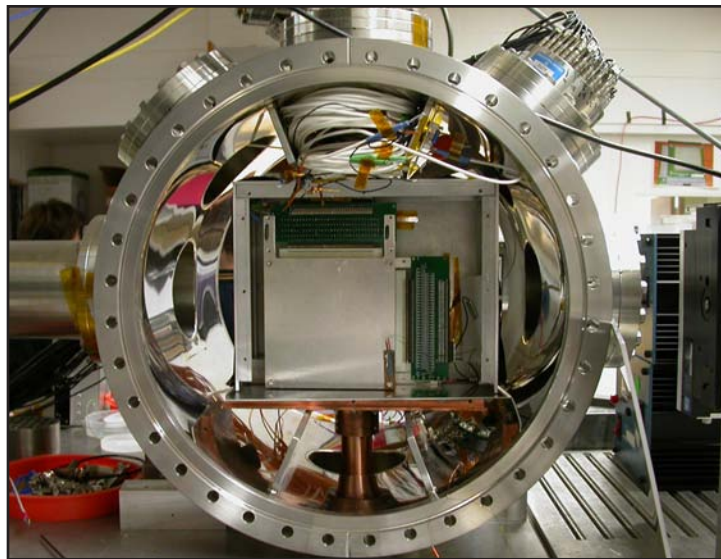

Vacuum test cryostat with a prototype germanium strip detector

**INSTRUMENTATION:** Several cryostats and associated cryogenic systems provide a controlled temperature environment for detector performance testing from 75 K to room temperature. The cryostats provide cold finger mounting of the detector under test and a volume for mounting low-noise electronics at an intermediate temperature. Up to 100 signals can pass through the cryostat wall to a Versamodule Eurocard (VME)-based signal processing and digitization system. Aperture windows in the cryostats permit probing of the detectors using collimated gamma-ray beams from radioactive sources that are mounted on a computer-controlled external positioning system. Two separate large environmental chambers are available to test gamma-ray detectors down to  $-70^{\circ}\text{C}$ .

**CONTACT:**

Code 7651 • (202) 767-3572

**LOCATION:**

NRL, Washington, DC

# Cryogenic Sensor Test Facility

Laser photon source and He-3 cryostat  
in a shielded room



**FUNCTION:** Used for designing and testing hyperspectral (IR to X-rays) single-photon cryogenic detectors. These detectors can measure the “color” (energy) of individual photons without using dispersive elements such as diffraction gratings. The accuracy can be as high as 1 part in 10,000 for a 10 keV photon. The facility provides a cryogenic environment for the detectors, ultra-low-noise electronics, and a fast acquisition system.

**DESCRIPTION:** The Cryogenic Sensor Test Facility is an electromagnetically screened room with a sub-Kelvin temperature cryostat, photon sources (X-ray, UV, optical, and infrared photons), very low noise cryogenic and room temperature electronics, and a signal processing system. It was built to support the development of nondispersive single-photon detectors. These are currently hyperspectral single-photon energy resolving (QVD) detectors, which can cover a wide range of wavelengths from X rays to IR. In the QVD design, the energy deposited by a photon into the detector is thermoelectrically converted into the voltage with subsequent digital readout at the cold stage for a multipixel array configuration. Since the QVD is still at the developmental stage, the facility is very flexible and has tools and equipment that can be easily reconfigured and upgraded.

**INSTRUMENTATION:** The He-3 cryostat provides access to temperatures as low as 0.3 K. An X-ray source (Fe-55) can be placed inside the cryostat and covered or uncovered by external control. The cryostat has windows adjustable to external IR/visible/UV photons. A custom Nd-YAG laser (infrared radiation:  $\lambda=1.06 \mu\text{m}$ ) with frequency doubling (green:  $\lambda=532 \text{ nm}$ ) and tripling (UV:  $\lambda=353 \text{ nm}$ ) produces trains of sub-nanosecond pulses. Cryogenic electronics include Superconducting Quantum Interference Device (SQUID)-array amplifiers, with current noise of  $2 \text{ pA/Hz}^{1/2}$ , bandwidth up to 1 GHz, input impedance of 4 to 250 nH, and trans-impedance gain of 100 to 1000  $\Omega$ .

## CONTACT:

Code 7655 • (202) 767-2506

## LOCATION:

NRL, Washington, DC

# Large Angle and Spectrometric Coronagraph (LASCO)

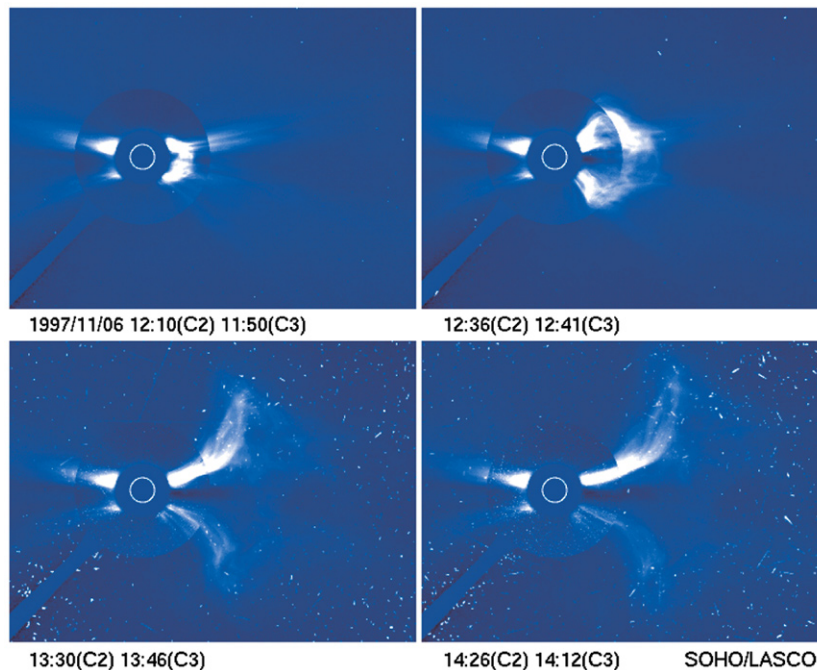

Images of a coronal mass ejection that occurred on November 6, 2000

**FUNCTION:** Designed to answer some fundamental questions: How is the corona heated? Where and how is the solar wind accelerated? What causes coronal mass ejections, and what role do they play in the evolutionary development of large-scale coronal patterns?

**DESCRIPTION:** The LASCO and Extreme-ultraviolet Imaging Telescope (EIT) instruments are two of 11 instruments included on the joint NASA/European Space Agency (ESA) SOHO (Solar and Heliospheric Observatory) spacecraft. SOHO was launched on December 2, 1995, at 0808 UTC (0308 e.s.t.) from the Kennedy Space Center, Cape Canaveral, Florida. The spacecraft is located about 1 million miles from Earth, between Earth and the Sun in a halo orbit about the L1 Lagrangian point. This point is where the gravitational and orbital forces are balanced. About 250 images are returned from LASCO and EIT each day, providing unprecedented views of the Sun and its corona, recording the source of major geomagnetic storms.

**INSTRUMENTATION:** The LASCO instrument is a suite of three coronagraphs that image the solar corona from 1.1 to 32 solar radii (about 1/7 of the distance to Earth). It is convenient to measure distances in terms of solar radii. One solar radius is about 700,000 km, 420,000 miles, or 16 arc min. The EIT instrument images the solar disk to 1.5 solar radii in four narrow wavelength intervals from 17.1 to 30.4 nm. These intervals roughly correspond to ionization temperatures of 60,000 K to 3 MK.

**CONTACT:**

Code 7660 • (202) 767-2263

**LOCATION:**

NRL, Washington, DC



# Rocket Assembly and Checkout Facility

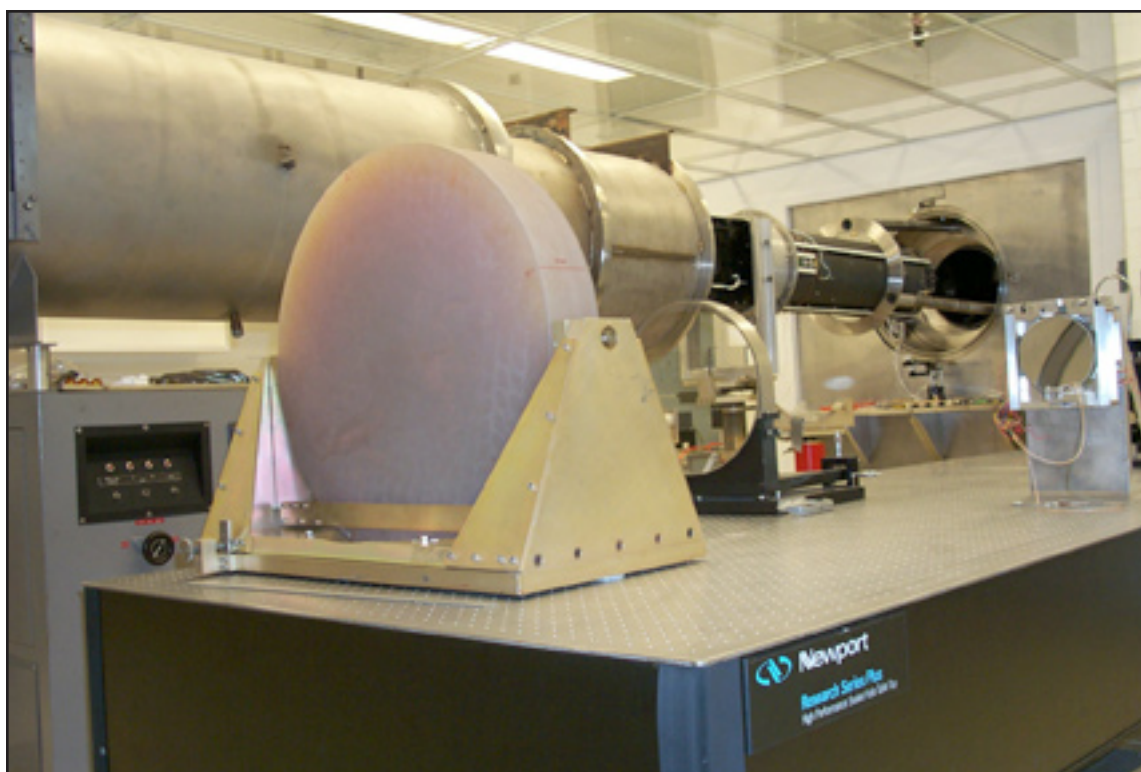

**FUNCTION:** Integrates, tests, and calibrates scientific instruments flown on sounding rocket payloads. The scientific instruments are assembled on an optical bench; the electronic components are installed and tested; and the instrument is moved to the vacuum calibration chamber for spectroradiometric calibration. When removed from the chamber, the payload is ready for shipment to White Sands Missile Range (WSMR), New Mexico, for integration with the spacecraft and launch vehicle.

**DESCRIPTION:** The facility consists of six contiguous laboratory modules subdivided into a storage area, a gray room area, and a clean room. The storage area houses spare instrument components and intermittently used ground support equipment. The gray room area contains facilities to clean components before they enter the clean room and equipment used to ship the instrument to WSMR. The Class 100 cross-flow clean room is separated from the gray room by an air shower. The clean room contains three major stations: a clean bench for assembly of subsystems; a 12 x 4 ft optical bench for instrument assembly and electronic test of the instrument subsystems; and a vacuum chamber for vacuum

focus and spectroradiometric calibration. The cryogenically pumped vacuum chamber is designed with a 30-cm-diameter ultra-violet collimator at one end and a roll-off section that accommodates the entire flight instrument centered in the collimated beam at the other end.

**INSTRUMENTATION:** The facility includes air hood, ultrasonic cleaner, particle counter, oscilloscope, and flight instrument computers.

## CONTACT:

Code 7660 • (202) 767-2093

## LOCATION:

NRL, Washington, DC



# *Solar Coronagraph Optical Test Chamber (SCOTCH)*



**FUNCTION:** Provides a facility for the assembly, test, and vacuum optical characterization of solar and coronal satellite instrumentation under ultraclean conditions.

**DESCRIPTION:** The large SCOTCH is the primary test chamber located within a 400 ft<sup>2</sup> Class 10 clean room. This completely dry-pumped, 550 ft<sup>3</sup> vacuum chamber is maintained at synchrotron levels of cleanliness. Solar instrumentation up to 1 m in diameter and 5 m in length can be physically accommodated in the chamber. An instrument's optical performance is probed and calibrated with a variety of visible and extreme-ultraviolet (XUV) sources mounted on the chamber's 11-m beamline. The instrument is mounted on a precision pointing table equipped with motorized slides, which allows controlled adjustment of instrument pointing with sub-arc-second precision under evacuated conditions. The main beamline is baffled to eliminate stray reflections from the beamline walls and minimize the effect of light scattered off the instrument surfaces. A solar disk stray light rejection of  $10^{-12}$  was successfully measured in the Large Angle Spectrometric Coronagraph (LASCO) C3 channel.

**INSTRUMENTATION:** The SCOTCH is instrumented with temperature-controlled quartz crystal monitors and residual gas analyzers for real-time, quantitative measurements of volatile contamination. Various light sources can be introduced at one end of the 11-m chamber. This includes a solar spectrum simulator as well as other visible and XUV sources. The chamber contains an instrument-pointing table capable of supporting payloads with a mass of 75 kg. The precision of the pointing table is less than 1 arc second.

**CONTACT:**

Code 7660 • (202) 767-3134

**LOCATION:**

NRL, Washington, DC

## Space Instrument Test Facility (SITF)

**FUNCTION:** Enables flight optics and sensors to be assembled and tested under conditions designed to minimize particulate and volatile contamination of the flight hardware. Contamination causes significant optical and detector performance degradation over mission lifetime; by keeping contamination at acceptable levels, we avoid such degradation. The SITF was used for the test and assembly of the Large Angle Spectrometric Coronagraph (LASCO) and is currently being used to develop and test the next generation of space-based solar instrumentation for the NASA Solar Terrestrial Relations Observatory (STEREO) mission.

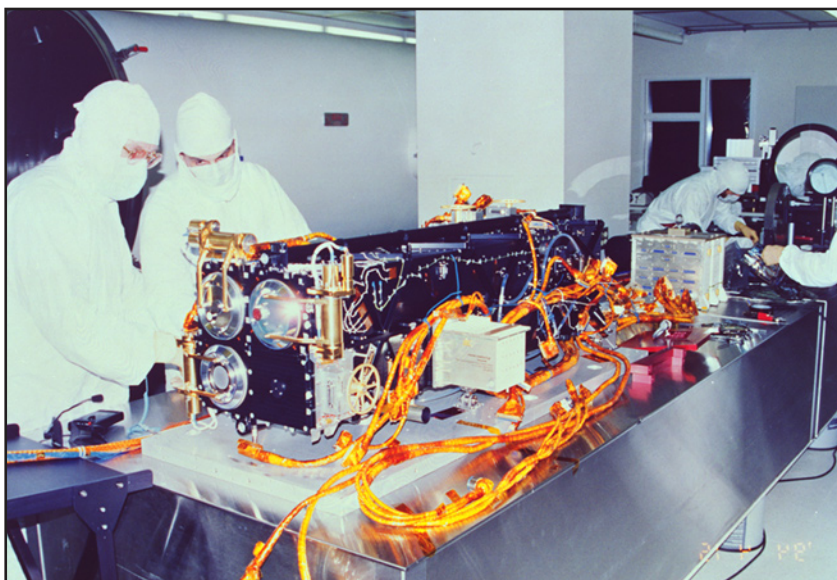

**DESCRIPTION:** The SITF provides a clean, controlled environment for the optical calibration and assembly of modern space-based solar instrumentation. The unique requirements of this instrumentation demand a rigorous approach to contamination control. The instrument vacuum test chamber, the Solar Coronagraph Optical Test Chamber (SCOTCH), forms the primary optical test chamber and is described more fully on the previous page. The instrument handling and assembly is conducted in a Class 10 clean room to reduce particulate generation. Airborne particulate levels are continuously monitored. To prevent hydrocarbon contamination, the clean room air is filtered through activated carbon filters located in the central plenum ducts. The facility also contains a small, well-instrumented thermal vacuum/bake test chamber. This allows characterization of outgassing of components and subassemblies prior to integration in the main instrument structure.

**INSTRUMENTATION:** The SCOTCH is instrumented with a temperature-controlled quartz crystal microbalance and a residual gas analyzer to monitor chamber and instrument outgassing. Various electrical and liquid nitrogen vacuum feed-throughs are available through ports in the tank. A large retractable bell jar pulls back into the Class 10 instrument clean room to provide access to the instrument pointing platform. To facilitate instrument handling, assembly, and alignment operations, the clean room contains a 1.3 x 7-m vibration-isolated optical bench and an overhead crane adapted for clean room use with a 1-ton load capacity. A variety of calibrated optical sources, collimators, and theodolites are available to support in-air optical test, alignment, and assembly operations.

### CONTACT:

Code 7660 • (202) 767-3137

### LOCATION:

NRL, Washington, DC

# EUV/X-Ray Calibration Facility



**FUNCTION:** Provides an ultra-high-vacuum facility for the development and calibration of extreme-ultraviolet (EUV) and X-ray optics and instrumentation using monochromatic synchrotron radiation. Optical components such as mirrors, diffraction gratings, filters, and sensors, as well as complete spaceflight and laboratory instruments, are calibrated.

**DESCRIPTION:** The facility has been used to calibrate EUV and X-ray optical components and complete instruments for spaceflight and laboratory applications. The spaceflight components include multilayer-coated diffraction gratings and mirrors for NASA missions. Instrument calibrations include the EUV spectrometers for the Geostationary Operational Environmental Satellite (GOES) spacecraft. Gratings, mirrors, filters, and sensors have been calibrated for laboratory studies of the EUV and X-ray emissions from laser-produced plasmas at NRL and DOE laser facilities.

**INSTRUMENTATION:** The facility consists of a calibration chamber that is attached to the NRL beamline X24C at the National Synchrotron Light Source at Brookhaven National Laboratory, New York. The chamber's inside dimensions are 63 in. long x 24 in. diameter. It has various computer-controlled translational and rotational mechanisms for the remote manipulation of the test components and detectors. Turbomolecular and ion pumps provide ultra-high-vacuum conditions. The vacuum cleanliness, important for preserv-

ing the functionality of EUV and X-ray optical components, is monitored by a thermoelectric quartz crystal microbalance (TQCM) and residual gas analyzer (RGA). Monochromatic radiation, with wavelengths of 1 nm through the ultraviolet and visible regions, is provided by the X24C beamline monochromator that is located approximately 15 m from the calibration chamber. The radiation beam is several mm in diameter, has low divergence, and has spectral resolution of approximately 400. The beam is polarized with the electric vector in the horizontal plane, and this permits the measurement of the polarization response properties of the EUV and X-ray optics. Absolutely calibrated silicon photodiode detectors measure the incident beam intensity and the beam reflected, diffracted, or transmitted by the optical components. A 2-in.-square Complementary Metal-Oxide Semiconductor (CMOS) sensor provides high-resolution images of the beam. Monochromator wavelength scans and data collection are computer controlled.

**CONTACT:**

Code 7674 • (202) 767-3529

**LOCATION:**

Brookhaven National Laboratory • Upton, NY

**Code 8100 – Space Systems Development Department**

**Code 8200 – Spacecraft Engineering Department**

**NAVAL**  
**CENTER FOR SPACE TECHNOLOGY**

**BACK TO CONTENTS**



# Space Systems Development Department

- Precision Radio Frequency Anechoic Chamber Facility
- Satellite Mission Analysis Facility
- Blossom Point Satellite Tracking and Command Station
- Midway Research Center Precision Spacecraft Calibration Facility
- Precision Clock Evaluation Facility
- Maritime Navigation Radar Test Range

# Precision Radio Frequency Anechoic Chamber Facility

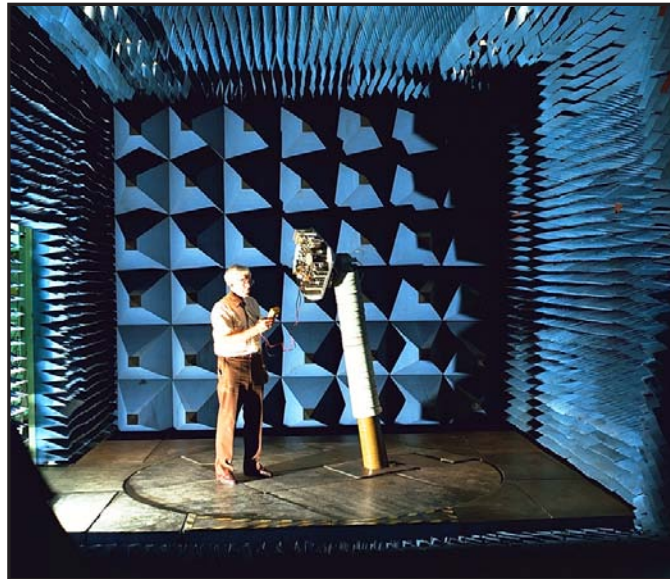

**FUNCTION:** Performs measurements and calibration of antennas for satellites and aircraft or ground-based systems. The chamber is primarily used for optimizing antenna designs, configurations, and performance on satellites and ground planes. It produces 2D and 3D antenna patterns and swept voltage standing wave ratio (VSWR) measurements in both hardcopy and softcopy format. An associated program called STK (Satellite Tool Kit) can also be used to analyze the data in a simulated environment, using the measured antenna patterns.

**DESCRIPTION:** The Precision Radio Frequency Anechoic Chamber is a tapered structure 44 ft long x 14 ft high x 16 ft wide, with a spherical quiet zone 5 ft in diameter. The quiet zone is specified to be isolated from the ambient RF environment outside by 150 dB. The chamber meets the performance specification requirements of free-space voltage standing wave ratio, axial ratio, and reflectivity over the frequency range of 220 MHz to 40 GHz. Reflectivity levels inside the chamber are less than 50 dB from 1 to 40 GHz. The chamber is instrumented for automated measurement capability. The chamber is inside a specially constructed electromagnetic interference facility shielded with 1/8-in.-thick steel plate on all walls, floor, and ceiling. This provides 100 dB attenuation to RF signals from 50 MHz to 100 GHz.

**INSTRUMENTATION:** Antennas under test receive signals transmitted from the opposite end of the chamber by octave-band source antennas. Synthesizers and amplifiers feed the source antennas. Received signals are routed to an HP8510C network analyzer, where they are processed and sent to the control computer. The Flam and Russell 959 Automated Antenna Measurement System is used to control the HP8510C and the positioners and to perform the analysis and plotting.

**CONTACT:**

Code 8122 • (202) 767-6528

**LOCATION:**

NRL, Washington, DC

# Satellite Mission Analysis Facility



**FUNCTION:** Compares the on-orbit performance of complex systems against prelaunch and other baseline data. Supports telemetry, tracking, and control (TT&C) and other ground station requirements that cannot be accomplished by established tracking and control networks. The Pomonkey, Maryland, facility can function semi-autonomously since design, fabrication, test, calibration and support functions are conducted within the facility.

**DESCRIPTION:** Pomonkey is a unique field laboratory with associated platforms. The site, located 25 miles south of NRL near LaPlata, Maryland, occupies approximately 58 acres and is owned by NRL. It contains the largest high-speed tracking antenna in the United States and is suitable for low Earth orbit and deep space mission requirements. Other precision tracking antennas are available with apertures ranging from 1 to 9 m. Using special designs, Pomonkey can support operations over a wide band of frequencies from 50 to 25,000 MHz. Real-time signal enhancement and analysis capability has been developed for the facility, and specific operational analysis tools have been implemented to support a wide range of tasks. Operational systems at the facility are linked through several networks in a peer-to-peer environment. A primary network provides access to key systems at NRL and other agencies, while a second network supports operations conducted at the facility. Firewalls and switches protect the integrity of the systems. Precise ephemeris data of all catalogued objects are obtained from the Naval Network and Space Operations Command through automated communications.

**INSTRUMENTATION:** The facility maintains an inventory of very low noise front-ends, including special feeds, line elements, and amplifiers. These support the standard UHF, L, S, C, X, Ku, and Ka frequency bands as well as deep space frequency assignments. Operation centers house downconverters and other receiving equipment for signal acquisition within these bands. Special radiometric test equipment is used to verify efficiency, gain, and noise temperature of low-noise, high-gain receiving systems. Vector, scalar, and spectrum analyzers are available to ensure performance of newly developed subsystems and components. Fiber-optic links are widely available in support of high-speed connections.

**CONTACT:**

Code 8124 • (202) 767-1750 or (301) 870-3528

**LOCATION:**

Pomonkey, MD

# Blossom Point Satellite Tracking and Command Station



**FUNCTION:** The Blossom Point Satellite Command and Tracking Facility (BP) provides engineering and operational support to several complex space systems for the Navy and other users, enabling cost-effective solutions for all programs. BP provides direct line-of-sight, two-way communications services with spacecraft in multiple bands during all mission phases, including concept, mission, and space segment development, launch, early on-orbit operations, and mission data collection. Additionally, BP's capabilities allow coverage through connectivity to worldwide ground station networks.

**DESCRIPTION:** The 41-acre facility is 40 miles southeast of Washington, D.C. The remote location assures interference-free operations and permits low elevation angle satellite communications. BP consists of a satellite mission operations center, multiple antennas, and an existing infrastructure capable of providing space system command, control, and management for all customer classes. BP provides a single interface point to networked ground stations. BP supports aggregate data rates up to 400 megabits per second with a variety of communication protocols. BP provides high-rate data telecommunications services on a global basis using encrypted DS-3 Asynchronous Transfer Mode (ATM) technology. BP is also accessible from the Internet using TCP/IP protocols and established secured firewall techniques. Selected clients have access to the facility's capabilities via a protected server. BP is a fully certified

external user of the Air Force Satellite Control Network (AFSCN) and has a communications interface into all AFSCN control nodes.

**INSTRUMENTATION:** Eight ground system antennas covering L-, S-, C-, and X-band capability. SGLS, STDN, and CCSDS compatible for extensive customer support flexibility. BP uses the government-owned Common Ground Architecture (CGA) software system as the basis for all ground system and mission operations activities. CGA provides standard ground processing services and employs a reusable code base to develop mission unique requirements. The system runs on SUN platforms under the Solaris UNIX operating system.

## **CONTACT:**

Code 8146 • (301) 870-3582

## **LOCATION:**

NRL, Blossom Point, MD



# Midway Research Center Precision Spacecraft Calibration Facility



**FUNCTION:** The Midway Research Center (MRC) is a worldwide test range that provides accurate, known signals as standards for performance verification, validation, calibration, and anomaly investigation to support national missions and other customers. The MRC ensures responsive and coordinated scheduling, transmission, measurement, and reporting of accurate and repeatable signals.

**DESCRIPTION:** MRC headquarters is located on 162 acres in Stafford County, Virginia, contiguous to Marine Corps Base Quantico. The main site consists of three 18.2-m, radome-enclosed precision tracking antennas and a variety of smaller antennas. It has a large operations building and multiple other equipment and office buildings within a fenced compound. The MRC has the capability to transmit precision test signals, with multiple modulation types, from 20 MHz to 18 GHz (up to 40 GHz in an experimental mode). In addition to the primary site, the MRC is responsible for and controls multiple assets both in the United States and overseas. These assets include Pulstar systems (several worldwide locations), "The Dish" (a 45-m tracking antenna in Palo Alto, California), and "Marlock" (a 25-m tracking antenna system on Guam).

**INSTRUMENTATION:** The MRC system can be configured to support specific customer needs. The MRC instrumentation suite includes nanosecond-level time reference to United States Naval Observatory (USNO), precision frequency standards, accurate RF and microwave power measurement instrumentation, and precision tracking methodologies. The instrumentation has been used for millimeter wave (MMW) projects. Classified and unclassified projects are supported. There is extensive computer control of all assets. The communications system handles wideband data, both classified and unclassified.

**CONTACT:**

Code 8146 • (703) 551-1992

**LOCATION:**

Midway Research Center • Stafford, VA

# Precision Clock Evaluation Facility



**FUNCTION:** Tests and evaluates high-precision atomic clocks for spacecraft, ground, and mobile applications. Supports performance evaluation, environmental testing, including shock and vibration, and anomaly investigation of on-orbit observed performance.

**DESCRIPTION:** The Precision Clock Evaluation Facility (PCEF) consists of time and frequency reference standards for comparison with test units that are made up of five active hydrogen maser frequency standards, three of which are housed in a large environmental chamber for humidity and temperature control. These references provide uninterrupted precise and accurate time/frequency with a stability of about  $1 \times 10^{-15}$  at 1 day. They are maintained in synchronism with coordinated universal time (UTC) as maintained at the United States Naval Observatory (USNO), called UTC(USNO), by several independent means. Eight spacecraft cesium and rubidium atomic clock sized thermal vacuum chambers specially designed for short- and long-term testing are used to simulate a spacelike environment (less than  $1 \times 10^{-6}$  torr) with temperature control of  $0.1 \text{ }^\circ\text{C}$ . To support long-term testing in a space environment, the test chambers and time/frequency standard references are operated on a 125 kW uninterruptible power system with diesel backup. Magnetic sensitivity testing of precision

frequency standards is performed with two Helmholtz coil systems: a three-axis multicoil system and a single-axis 1.5-m Helmholtz coil.

**INSTRUMENTATION:** Four NRL-built data collection systems are used within the PCEF. The primary atomic clock measurement/data collection system is a 48-channel, dual-mixer phase measurement system capable of simultaneous measurements of 48 different clocks at 20-s intervals indefinitely. A single-channel, dual-mixer phase measurement system used for special evaluations is capable of measurements as short as 0.01 s. These data systems each have 2 ps of resolution. Software used in these systems was designed and coded by NRL, and includes analysis software with graphics and networking support for commercial products.

**CONTACT:**

Code 8150.1 • (202) 767-5111

**LOCATION:**

NRL, Washington, DC

# Maritime Navigation Radar Test Range



**FUNCTION:** Provides a Maritime Navigation Radar (MNR) Range consisting of 28 MNRs located 8.75 nautical miles east of the NRL Chesapeake Bay Detachment (CBD) on Tilghman Island, MD. These radars are the same as those used on all merchant vessels and represent a precise cross-section of today's actual MNR environment. The Range provides the emitters and analysis tools to aid the research of new technologies required to understand and exploit this class of emitters essential in developing comprehensive Maritime Domain Awareness.

**DESCRIPTION:** The range includes radars in both S and X bands, radars of nearly every power level and of every antenna size, each fully characterized in terms of detailed signal characteristics, effective radiated power level, antenna size, scan rate, and PRI pattern, and all completely documented and precisely located by means of a differential GPS survey. Available radars include a large selection from both the Furuno and Raytheon families, and somewhat smaller selections from the JRC, Koden, SI-TEX, Anritsu, and BridgeMaster families. Having the ability to quickly, easily, and economically isolate and study any given MNR signal or performance capability, or readily construct and analyze an existing or potential operational scenario, or validate reception or processing capabilities against these low power signals, in an active, real-time environment with accurate ground truth, makes the range a valuable and up-to-date asset for assisting with development of both local and national Maritime Domain Awareness capabilities.

**INSTRUMENTATION:** Selected radars are remotely controllable, some are instrumented with temperature sensors, and all are radiated for extended periods. Monitoring instrumentation at the CBD in Chesapeake Beach, MD, includes precision track-while-scan radar, advanced electronic intelligence analysis system, precision ESM direction finder, precision optical system, sensor fusing and cueing software, specific emitter identification capability, and comprehensive data collection, processing, analysis, and distribution suites, all modular and tailorable to meet user needs.

## CONTACT:

Code 8122 • (202) 767-1930

## LOCATION:

NRL, Chesapeake Beach, MD

# Spacecraft Engineering Department

- Modal Survey Test Facility
- Static Loads Test Facility
- Payload Processing Facility
- Thermal Vacuum Test Facility
- Spacecraft Acoustic Reverberation Chamber Test Facility
- Spacecraft Spin Test Facility
- Spacecraft Vibration Test Facility
- Spacecraft Thermal Analysis, Fabrication, and Test Facility
- Spacecraft Robotics Engineering and Controls Laboratory
- Class 100 Clean Room Facility
- Radio Frequency Anechoic Chamber Facility
- EMI Test Facility
- Proximity Operations Testbed



# Modal Survey Test Facility

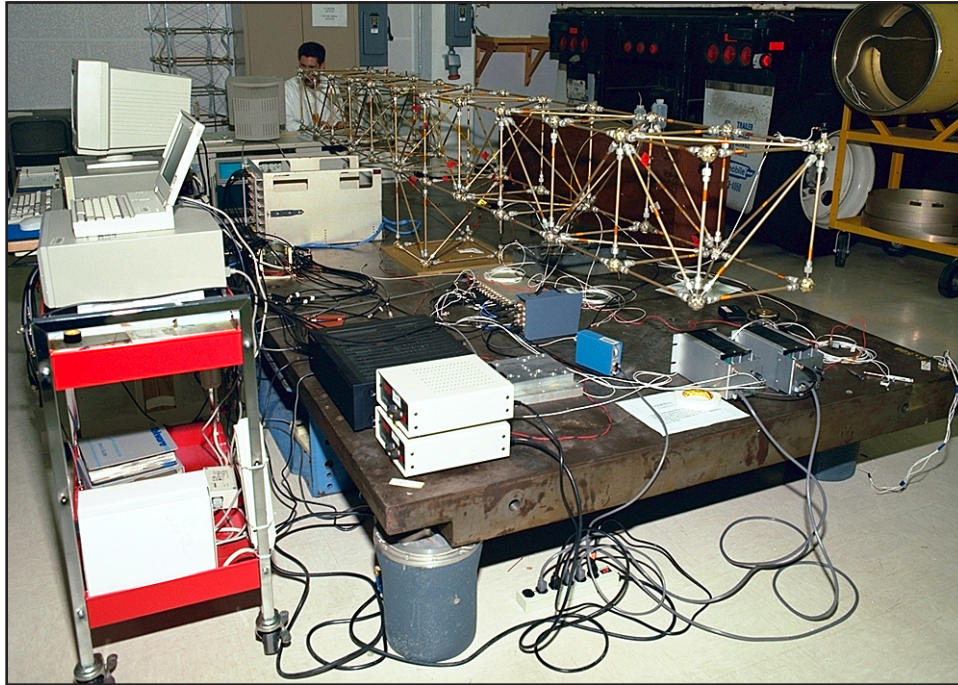

**FUNCTION:** Provides the capability to perform modal survey testing on a wide variety of spacecraft and structures. The data acquired from the test enables the structural analyst to determine the dynamic characteristics of the test article. The test results may be used to correlate finite element models.

**DESCRIPTION:** The Modal Survey Test Facility is located wherever the test article can be set up with appropriate boundary conditions. It depends only on sufficient space for mounting the test article and setting up the data acquisition system. The Naval Center for Space Technology's Environmental Test Facility offers space up to and including a structural test floor large enough to handle space shuttle-size payloads. Electromagnetic shakers of 75 and 250 lbf are available to provide excitation for the test.

**INSTRUMENTATION:** A Hewlett-Packard VXI System with 288 channels of data acquisition provides the means for recording forces and acceleration responses during the modal test. A full complement of accelerometers, force transducers, and signal conditioning is available to support tests of all sizes. Results may be directed to SDRC's I-DEAS®, Matlab®, or other programs for final processing.

**CONTACT:**

Code 8210 • (202) 767-3944

**LOCATION:**

NRL, Washington, DC

# Static Loads Test Facility



**FUNCTION:** Provides the capability to perform large-scale structural loads testing on spacecraft and other structures. Results from these tests can be used to verify strength capabilities of the test article.

**DESCRIPTION:** The Static Loads Test Facility consists of a 40 x 50 ft structural test floor, a structural steel fixture system, and a computer-controlled hydraulic loads application system. The test floor is located in a high-bay facility complete with an overhead crane. The crane has two carriages with 30,000-lb capacity each and approximately 30 ft of hook height. Areas adjacent to the test floor can be used for test article buildup and for test support activities. The test fixture system is an erector-set concept that allows for a wide variety of configurations to fit specific test needs. The load applications system can support up to 20 independent load strings with force capabilities from 3,000 to 100,000 lb.

**INSTRUMENTATION:** Data acquisition is available for strain gages, linear voltage displacement transducers (LVDT), sonar displacement transducers, and load cells. An OPTUM Megadeck 200 data acquisition system provides the capability for collecting up to 400 strain-gage measurements. An OPTUM Megadeck 5733A 72-channel data acquisition system provides high-speed measurement capability. Facilities for light machining are also available. Additional facilities, hardware, and test equipment are available in the Environmental Test Facility to support testing.

**CONTACT:**

Code 8210 • (202) 767-3944

**LOCATION:**

NRL, Washington, DC



# Payload Processing Facility

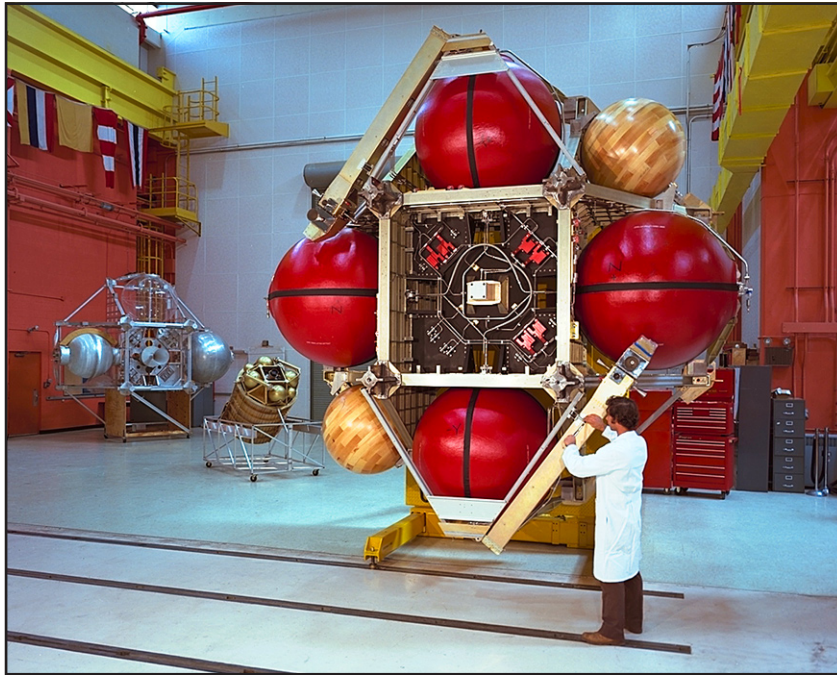

**FUNCTION:** Provides a central location for all equipment and auxiliary machinery used to assemble and test space vehicles, subsystems, experiments, and components.

**DESCRIPTION:** The Payload Processing Facility (PPF) is a comprehensive laboratory complex housing a high-bay assembly area (13,500 ft<sup>2</sup>, 40 ft high), secure assembly support facilities, storage area, lifting equipment, fabrication machinery, and ground transportation equipment. The PPF houses facilities for the following environmental tests: acoustic reverberation, random vibration, thermal vacuum, electromagnetic interference/electromagnetic compatibility/radio frequency (EMI/EMC/RF), optical alignment, modal survey, static loads, and spin balance. In addition, the PPF houses thermal control and reaction control assembly and test facilities, a composites fabrication lab, and a heat pipe lab.

The assembly area serves as the fabrication, assembly, and integration area for spacecraft and flight hardware. Within the assembly area, many activities are performed: structural assembly, wire harness assembly, component and subsystem integration, and mechan-

ical aerospace ground equipment (MAGE) and electrical aerospace ground equipment (EAGE) checkout and debug.

**INSTRUMENTATION:** The PPF has a large array of mechanical aerospace ground equipment, electrical aerospace ground equipment, and spacecraft equipment/special test equipment (SE/STE) to support the myriad tasks performed during spacecraft assembly. The SE/STE include clean rooms (Class 100 to 10,000), large isolated reaction masses, central heating, ventilation, and air conditioning (HVAC)/humidity control, liquid nitrogen and gaseous nitrogen supply, and extensive electrical power distribution and common grounding for equipment and ordnance.

## CONTACT:

Code 8212 • (202) 767-0704

## LOCATION:

NRL, Washington, DC

# Thermal Vacuum Test Facility

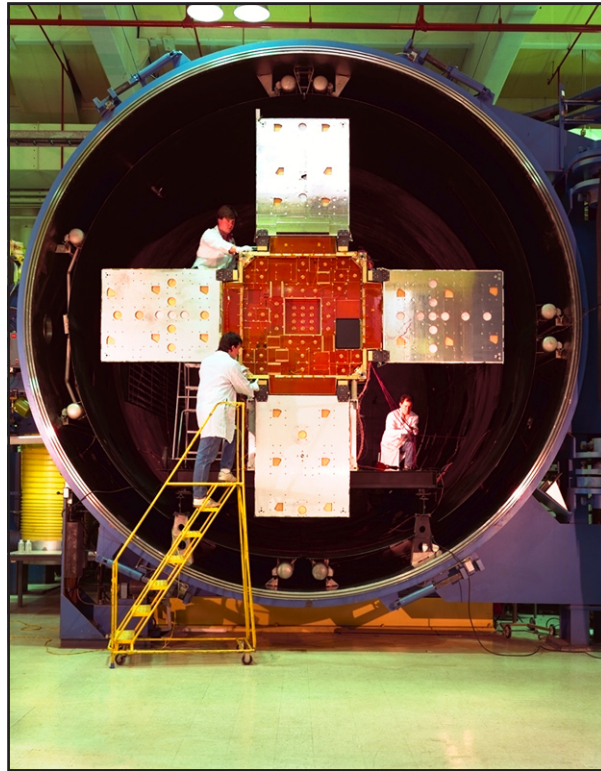

**FUNCTION:** Provides the capability to accurately simulate the space environment for the verification of thermal control system designs and the determination of thermal performance margins and capabilities of space vehicles, experiments, and subsystems.

**DESCRIPTION:** The Thermal Vacuum (TVAC) Test Facility is located within the Payload Processing Facility. It consists of three large chambers and several small chambers, a machinery room, a network of computers, a 26,000-gal liquid nitrogen storage facility, and an assortment of handling and test fixtures.

Of the three large chambers, chamber #1 is a 16-ft-diameter by 30-ft-long horizontal end-loading cylinder, and chambers #2 and #3 are 7-ft-diameter by 8-ft-tall vertical bottom-loading cylinders. Chambers #1 and #2 are cryogenic pumped, providing an oil-free vacuum environment. Chamber #3 has a diffusion pump system capable of evacuation rates similar to the rates that occur during launch ascent. All three chambers are equipped with gaseous nitrogen conditioned thermal shrouds capable of temperatures between  $-150\text{ }^{\circ}\text{C}$  and

$+125\text{ }^{\circ}\text{C}$ . Numerous bulkheads are available for the pass-through of control, communication, power, and telemetry signals to the test setup.

**INSTRUMENTATION:** The facility has both computerized and manual control of the different chambers' thermal environments via the chamber shrouds and heaters, cold plates, and quartz lamps. Separate data acquisition systems exist for monitoring and recording measurements from up to 200 thermocouples, 100 resistance temperature detectors (RTDs), quartz crystal microbalances (QCMs), and residual gas analyzers (RGAs).

**CONTACT:**

Code 8212 • (202) 767-0704

**LOCATION:**

NRL, Washington, DC



# Spacecraft Acoustic Reverberation Chamber Test Facility



**FUNCTION:** Provides the capability to simulate the vibration and high intensity acoustic noise environment experienced by spaceflight hardware during the launch vehicle ascent.

**DESCRIPTION:** The acoustic reverberation chamber is located within the Payload Processing Facility and consists of a 10,000 ft<sup>3</sup> test cell (17.2 ft wide × 21.5 ft long × 27 ft high), a 30,000-lb-force electrodynamic vibration shaker, a machinery room, a network of computers and amplifiers, a 26,000-gal liquid nitrogen storage facility, and an assortment of handling and test fixtures.

A sound pressure level of 153 dB, with a range of 32 to 10,000 Hz, is attainable in the chamber. The 30,000-lb-force shaker has a 2-in. stroke and a 2,000 Hz upper limit and is mounted in the center of the chamber floor to provide mechanical vibration excitation in addition to acoustic excitation of test specimens.

**INSTRUMENTATION:** Control of the chamber sound pressure level (SPL) is provided through a Spectral Dynamics 1500 acoustic controller connected to up to 12 microphones suspended within the chamber. For shaker vibration, a Spectral Dynamics 2550 provides control and limiting of up to 32 channels of accelerometer response. The facility has the capability to perform digital data acquisition of up to 300 channels using a HP VXI E1432 digitizer with I-DEAS<sup>®</sup> postprocessing.

**CONTACT:**

Code 8212 • (202) 767-0704

**LOCATION:**

NRL, Washington, DC

# Spacecraft Spin Test Facility

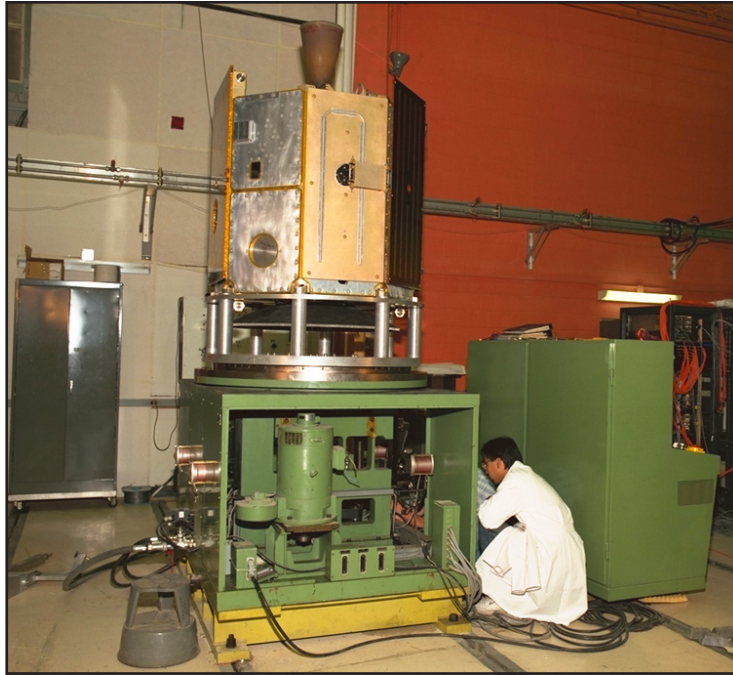

**FUNCTION:** Provides the capability to correct unbalances of spacecraft by using dynamic measurement techniques and static/coupled measurements to provide products of inertia. Moments of inertia (MOI) can be determined on MOI tables of various capacities.

**DESCRIPTION:** The facility contains two spin balancing machines (one horizontal and one vertical) to handle various types of balancing requirements. Both machines are provided with a plane separation network to obtain correction readings directly in the plane of correction. The spin machines require 100 ft<sup>2</sup> of space and are clamped to a slotted 4-ft-thick reinforced concrete floor for stability. Each machine has a remote control console to operate from a distance of 100 ft during hazardous operations. Various capacity MOI tables are used to verify MOI and center of gravity for units under test.

**INSTRUMENTATION:** The vertical spin machine is a Schenk/Trebel model E-6 hydrostatic bearing spin table, has a load capacity up to 18,000 lb, spins at rates of 30 to 300 rpm, and is capable of 2 oz/in. accuracy. The horizontal spin machine is a Schenk/Trebel model FH600 horizontal hard bearing spin table with a capacity of 13 to 1300 lb, spin rates of 50 to 600 rpm, and 100 moz/in. accuracy. MOI tables include Space Electronics models GB8000 (capacity 8,000 lb) and 973-3000 (capacity 3,000 lb). Both have an accuracy of  $\pm 0.5\%$  of total MOI. Other MOI tables are ID models with 5-, 50-, 100-, and 200-lb capacities, and an accuracy of  $\pm 0.005\%$  of total MOI.

**CONTACT:**

Code 8212 • (202) 767-0705

**LOCATION:**

NRL, Washington, DC

# Spacecraft Vibration Test Facility

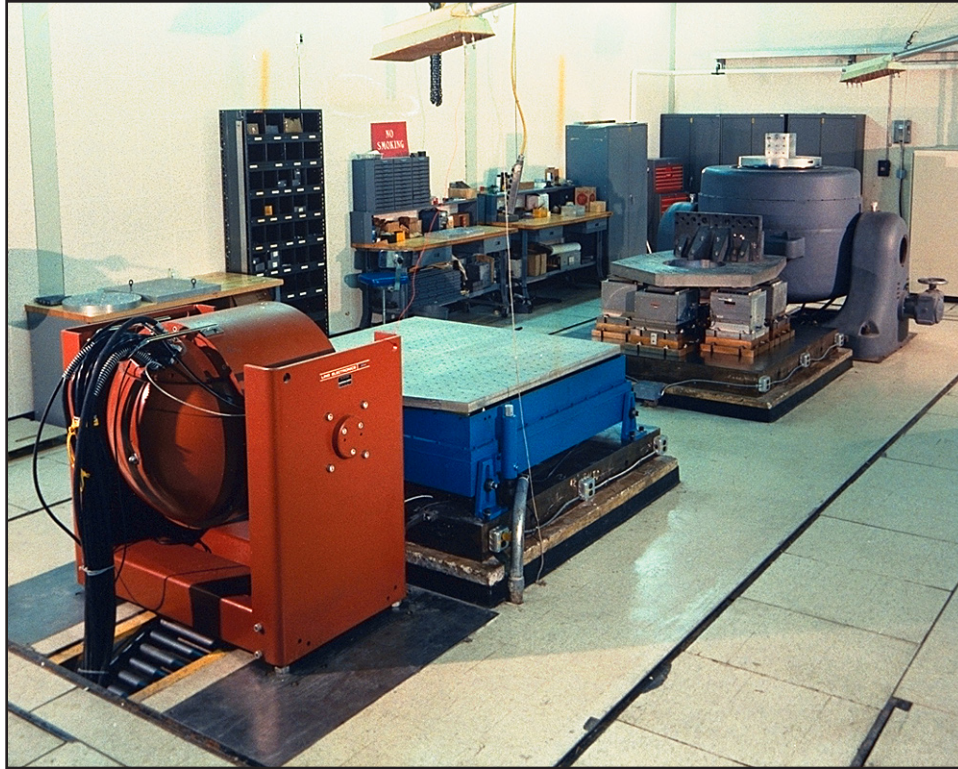

**FUNCTION:** Qualifies and acceptance tests spacecraft and spaceflight components by simulating the various vibration loading environments present during flight operations and demonstrating compliance to design specifications. Using the facility's electrodynamic shakers, an assortment of quasi-static, vibratory, and shock loads can be generated, and test article characteristics can be quantified.

**DESCRIPTION:** The Spacecraft Vibration Test Facility is located within the Payload Processing Facility and consists of four electrodynamic shakers (one 50-klb force, one 30-klb force, two 18-klb force), two slip tables, three individual power amplifiers, and a high-power switching system. One of the 18-klb, the 50-klb, and the 30-klb shakers have an operational range of 5 to 2000 Hz with 2-in. stroke capability.

**INSTRUMENTATION:** A Spectral Dynamics 2550 provides control and limiting of up to 32 channels of accelerometer response. The facility has the capability to perform digital data acquisition of up to 300 channels using an HP VXI E1432 digitizer with I-DEAS® postprocessing.

**CONTACT:**

Code 8214 • (202) 767-0705

**LOCATION:**

NRL, Washington, DC



# Spacecraft Thermal Analysis, Fabrication, and Test Facility

**FUNCTION:** Provides for the analytical thermal design and analysis of any spacecraft. This includes conceptual design, analytical thermal model development, definition of requirements, worst-case environments and design conditions, and temperature predictions for all cases. The facility provides the means to turn an “analytical thermal design” into a working temperature control subsystem ready for flight—i.e., provides the means to go from design and analysis to hardware qualification and acceptance testing and then to orbit.



**DESCRIPTION:** This facility provides computer support to accommodate six thermal analysts. The software required to create and run analytical thermal models includes TRASYS/TSS and Thermal Desktop for radiation exchange and orbital flux determination, and SINDA/FLUINT for thermal model formation and temperature prediction. Thermo-optical surface properties of “real” surfaces must be known accurately for reliable temperature prediction. Thus, two types of reflectometers are used to measure short wavelengths for solar absorptions and long-wave infrared for room-temperature emittance. Detailed thermal design and analysis are followed by fabrication and test phases. Capabilities within the facility include fabrication, assembly, and qualification of flight hardware, and flight support. Technicians have expertise in the manipulation of all contemporary and advanced thermal control hardware including, but not limited to, multilayer insulation materials (for thermal blankets) and flight-qualified temperature sensors, thermostats, and heaters. This facility is capable of and has supported the incorporation of specialty technologies

such as

- Cryogenic thermal blankets and cryo coolers;
- Diode, loop, constant, and variable conductance heat pipes; and
- Capillary pumped loops and other advanced two-phase systems.

**INSTRUMENTATION:** A computerized data acquisition and control system (CDACS) is used during thermal testing for the display, collection, storage, and retrieval of temperature and power data, and for the automated control of all power supplies that feed various simulation heaters. The CDACS consists of

- Two workstations with displays;
- Signal conditioners for over 1,000 thermocouple and low-voltage inputs; and
- 40 rack-mounted, digital power supplies with appropriate bus connectivity for output control.

**CONTACT:**

Code 8221 • (202) 404-7432

**LOCATION:**

NRL, Washington, DC



# Spacecraft Robotics Engineering and Controls Laboratory

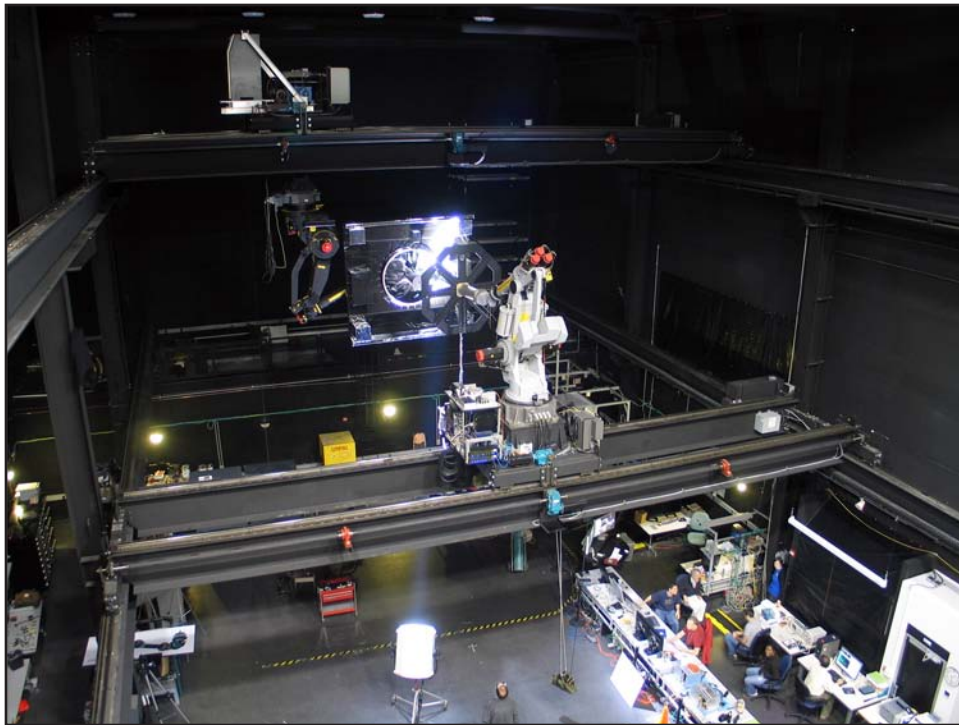

**FUNCTION:** Serves as a national testbed to support research in the emerging field of space robotics including autonomous rendezvous and capture, remote assembly operations, and machine learning.

**DESCRIPTION:** Operated by the Naval Center for Space Technology, with strategic support from the Naval Center for Applied Research in Artificial Intelligence, this is the largest dual-platform motion simulator of its kind. It allows full-scale, hardware-in-the-loop testing of flight mechanisms, sensors, and logic of space robotic systems. The simulator also supports the study of other complex relative motion problems.

Spacecraft orbit parameters, mass properties, and actuators are modeled in the central computer to enable the simulator to replicate vehicle motion response to external disturbances and internal orientation and position commands. Actuator signals normally going to wheels or thrusters are continually processed to compute

incremental force and torque components that force the platform to respond dynamically as a spacecraft would on-orbit.

**INSTRUMENTATION:** A dynamic motion simulator, with dual independent six-degree-of-freedom platforms, provides the ability to test space robotic systems under realistic dynamic and lighting conditions.

## CONTACT:

Code 8231 • (202) 404-3530

## LOCATION:

NRL, Washington, DC

## Class 100 Clean Room Facility



**FUNCTION:** Provides a Class 100 ultra-clean environment for the cleaning, assembly, and acceptance testing of contamination-sensitive spacecraft components and integration of complete spacecraft subsystems. The facility is used primarily to support spacecraft propulsion systems, but has been used to support all spacecraft electrical, electronic, and mechanical subsystems.

**DESCRIPTION:** The facility consists of two self-contained rooms that have a footprint of 44 x 43 x 13 ft and an additional area for mechanical equipment that covers an area 43 x 20 x 13 ft, for a total of 35,776 ft<sup>3</sup>. The entire work area is airtight, pressurized, and dust-, temperature-, and humidity-controlled. It has two laminar flow rooms with an air velocity across the entire room of 100 to 120 ft/min. The air is filtered using HEPA filters to an absolute level of 0.3  $\mu$ m. The rooms are environmentally controlled using air conditioning to achieve 65° to 75 °F and 40% to 60% relative humidity. The rooms are maintained at a minimum 0.15 in. of water pressure differential with existing atmospheric conditions. Connected to the Class 100 clean room is the High Bay Clean Room, a Class 10,000, 35 x 35 x 25 ft room with an 18-ft roll-up door. It supports large spacecraft and propulsion system integration and houses the propulsion orbital tungsten inert gas (TIG) welding operations for plumbing systems.

**INSTRUMENTATION:** The clean rooms are supported by an extensive array of special test equipment (STE) to support the needs of contamination-controlled testing and integration of spaceflight hardware. This STE consists of ultrasonic cleaning equipment, particle counting stations, water purification stations, vacuum drying stations, immersion flush stations, test hardware, electrical checkout stations, rinse stations, inert gas purges, dc power supplies, tooling and fixtures, and high- and low-pressure test panels for helium and nitrogen test gases. This STE has been recently upgraded to include a state-of-the-art spacecraft propulsion testbed with integrated sensor, hardware control, and data acquisition all controlled via a simplified GUI-based user interface. The testbed has over 70 channels of simultaneous data acquisition at rates up to 50,000 Hz for measurement of pressure, temperature, flow rates, and electrical signals.

**CONTACT:**

Code 8232 • (202) 767-9168

**LOCATION:**

NRL, Washington, DC

# Radio Frequency Anechoic Chamber Facility

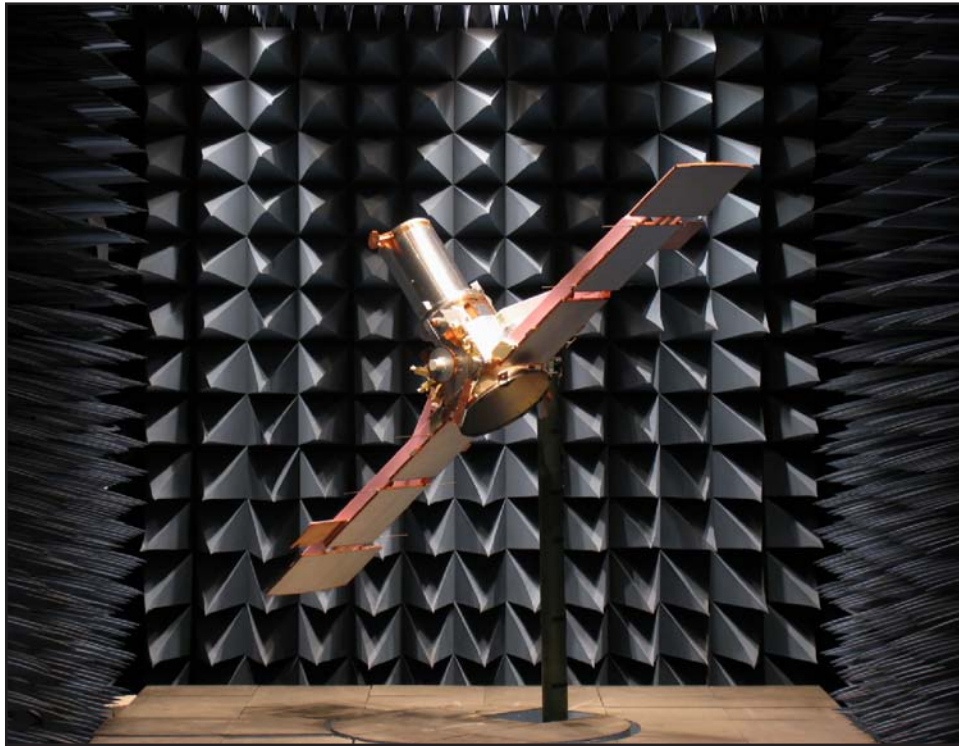

**FUNCTION:** Supports the design, manufacture, and test of antenna systems. The facility is also used as an electromagnetic compatibility/radio frequency interference (EMC/RFI) test chamber.

**DESCRIPTION:** The facility consists of a shielded 31 x 31 x 120 ft tapered anechoic chamber and secondary shielded 12 x 20 x 10 ft rectangular anechoic chamber, both with computer-controlled automated antenna measurement systems and machine shop tool/assembly area. The tapered chamber is pyramidal in shape and transitions to a circular conical section at the transmitting end. The back wall of the chamber is covered with 169 absorbing pyramids that are 9 ft in length. The sides, ceiling, and floor in the quiet zone area are lined with 4-ft absorbing pyramids, and the taper is covered with 2-ft wedge absorber. In the center of the floor is a 9-ft-diameter pit that contains the large model tower. Also in the pit are two scissor lifts that move a section of the floor, allowing the tower to be lowered for mounting models and antennas at ground level.

**INSTRUMENTATION:** The chamber is controlled by an Agilent PNA-based Orbit FR-959 Measurement System, allowing direct measurements from 100 MHz to 6 GHz, remote-mixed measurements from 2 to 18 GHz, and measurements to 110 GHz with appropriate additional mixers. A dual-port high-speed transmit multiplexer allows single- or dual-polarized measurements to be made very quickly, and a high-speed 8-port receive multiplexer allows multiple antennas or antenna configurations to be measured in the same cut.

**CONTACT:**

Code 8241 • (202) 404-5488

**LOCATION:**

NRL, Washington, DC



# EMI Test Facility



**FUNCTION:** Supports electromagnetic interference/radio frequency interference (EMI/RFI) testing of flight hardware. It is also used to support custom RF testing up to 40 GHz.

**DESCRIPTION:** The facility consists of a 23 x 23 ft semi-anechoic main chamber with a 23 x 20 ft ante-chamber. It is a completely welded steel structure that provides a minimum of 120 dB of shielding effectiveness at 18 GHz and 100 dB up to 50 GHz. The main chamber uses a hybrid anechoic material consisting of wideband pyramidal absorbers and ferrite tiles for performance from 20 MHz to 50 GHz. A 10 ft high x 11 ft wide sliding bladder type door allows easy access of large test items to the main chamber. The steel floor rests directly on the concrete slab, so floor loading is not an issue. Filtered and transformer isolated ac electrical power is available in both chambers: 100 A, 120/208 V, 3-phase services, and 60 A, 120/240 V, 1-phase services for each chamber.

**INSTRUMENTATION:** The chamber is equipped with a complete suite of instrumentation to do the full range of MIL-STD-461 EMI qualification testing. Computers with custom-developed software are used for instrumentation control, data handling, and data storage. Additional test equipment is available to do a variety of specialized testing during component design, through system integration and self compatibility.

**CONTACT:**

Code 8241 • (202) 404-4390

**LOCATION:**

NRL, Washington, DC



# Proximity Operations Testbed

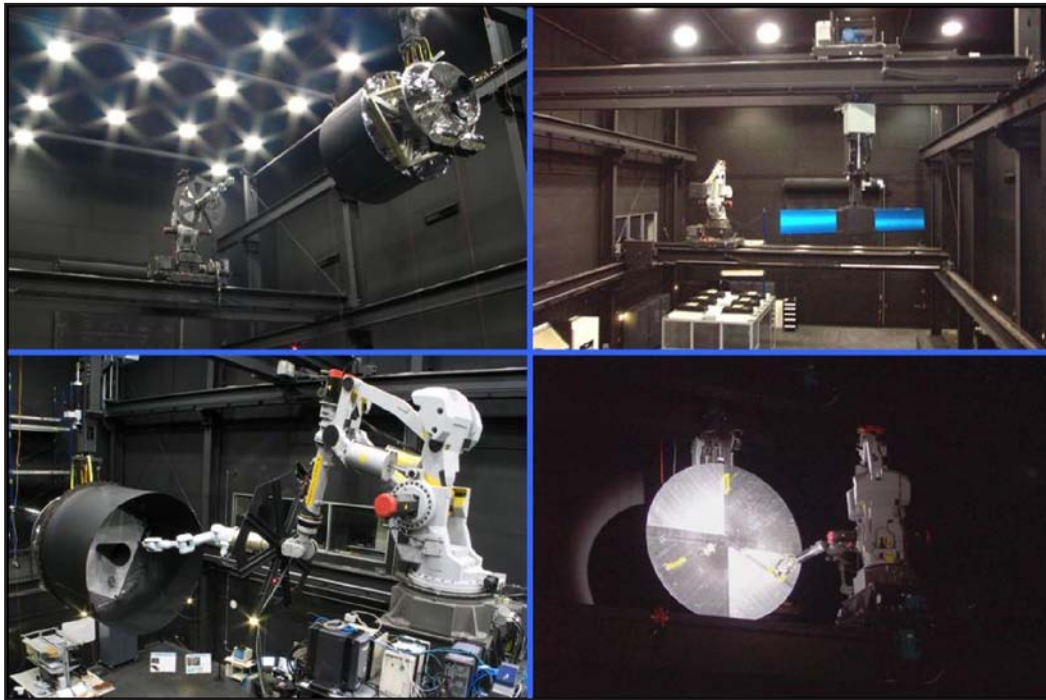

**FUNCTION:** Serves as a national testbed to support research in the emerging field of space robotics including operations in autonomous rendezvous and capture, 3D imaging and inspection, and remote repair and assembly.

**DESCRIPTION:** Operated by the Naval Center for Space Technology, the Proximity Operations Testbed is the largest dual-platform motion simulator of its kind in the U.S. It provides full-scale, hardware-in-the-loop testing of flight mechanisms, sensors, robotic manipulators, and control logic under realistic orbital conditions. It also supports the study of other complex motion problems such as ship dynamics under high sea state conditions.

Spacecraft orbit parameters, mass properties, and actuators are modeled in the central computer to enable the simulator to replicate vehicle motion response to both external and internal disturbances. Reaction wheel torques, thruster on/off logic, and torque coil dipoles are continually processed to provide realistic force and torque commands that drive the simulator to

respond as a spacecraft would on-orbit. Furthermore, sensors detecting contact loads allow realistic response of the platforms to contact dynamics occurring during capture operations.

**INSTRUMENTATION:** The testbed consists of two independent eight-degree-of-freedom platforms for simulation of on-orbit relative dynamics, a force/torque sensor for simulation of contact dynamics, and a high-power spotlight for simulation of solar illumination conditions.

## CONTACT:

Code 8231 • (202) 404-3530

## LOCATION:

NRL, Washington, DC

[Maps](#)

# GENERAL

## INFORMATION

[BACK TO CONTENTS](#)

## General Information

- Naval Research Laboratory (Washington, DC)
- Location of Field Sites in the NRL Washington Area
- Chesapeake Bay Section (Chesapeake Beach, MD)
- John C. Stennis Space Center (Stennis Space Center, MS)
- Naval Research Laboratory Monterey (Monterey, CA)

# Naval Research Laboratory (Washington, DC)

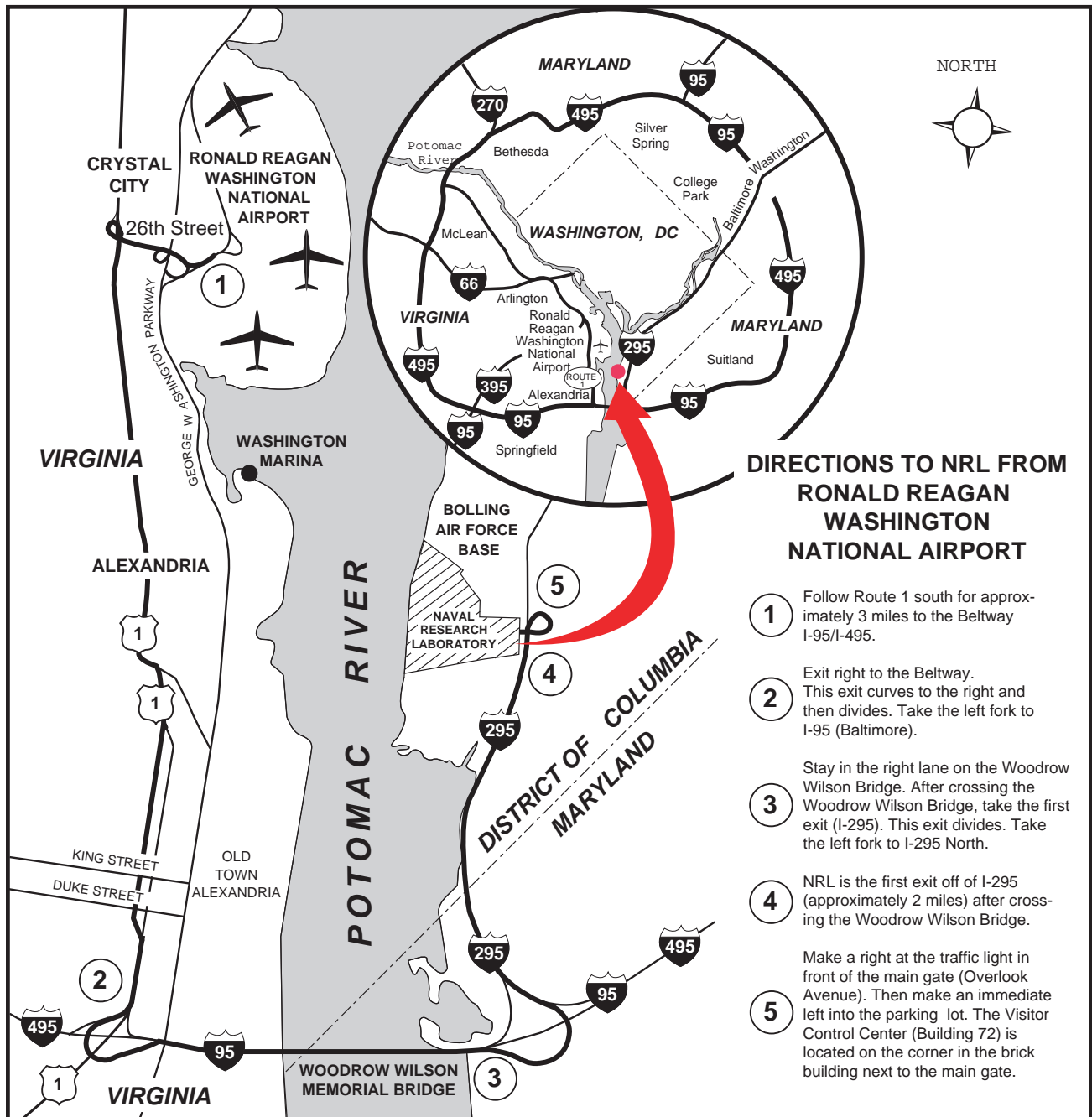

Naval Research Laboratory  
4555 Overlook Avenue, SW  
Washington, DC 20375-5320  
(202) 767-3200



# Location of Field Sites in the NRL Washington Area

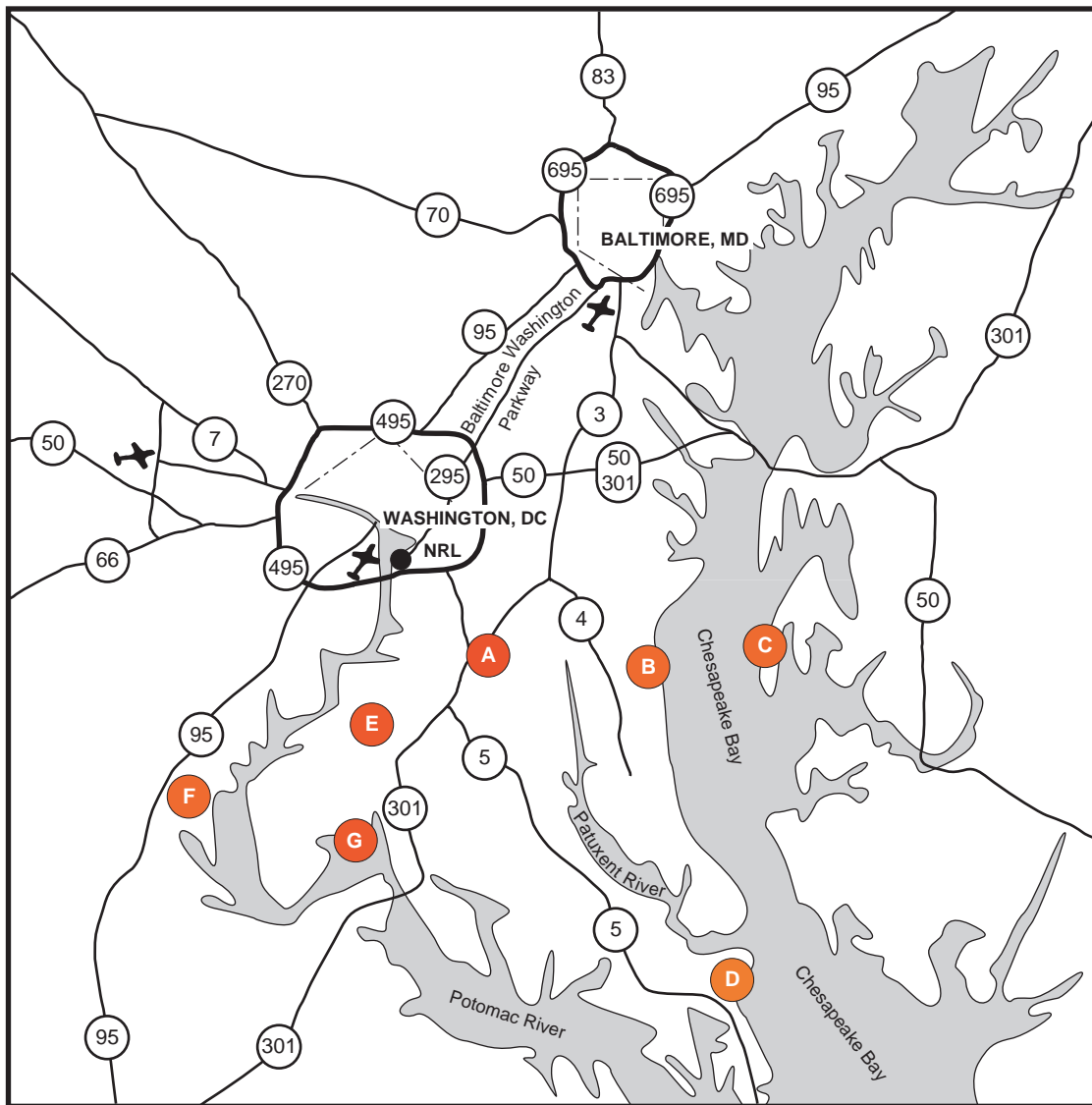

Location	Approximate Mileage from NRL Washington	Cognizant Code
A — Brandywine, MD	28	3520
B — Chesapeake Bay Section, Chesapeake Beach, MD	40	3522
C — Tilghman Island, MD	110	3522
D — Patuxent River (MD) Naval Air Station	64	1600
E — Pomonkey, MD	20	8124
F — Midway Research Center, Quantico, VA	38	8146
G — Blossom Point, MD	40	8146

# Chesapeake Bay Section (Chesapeake Beach, Maryland)

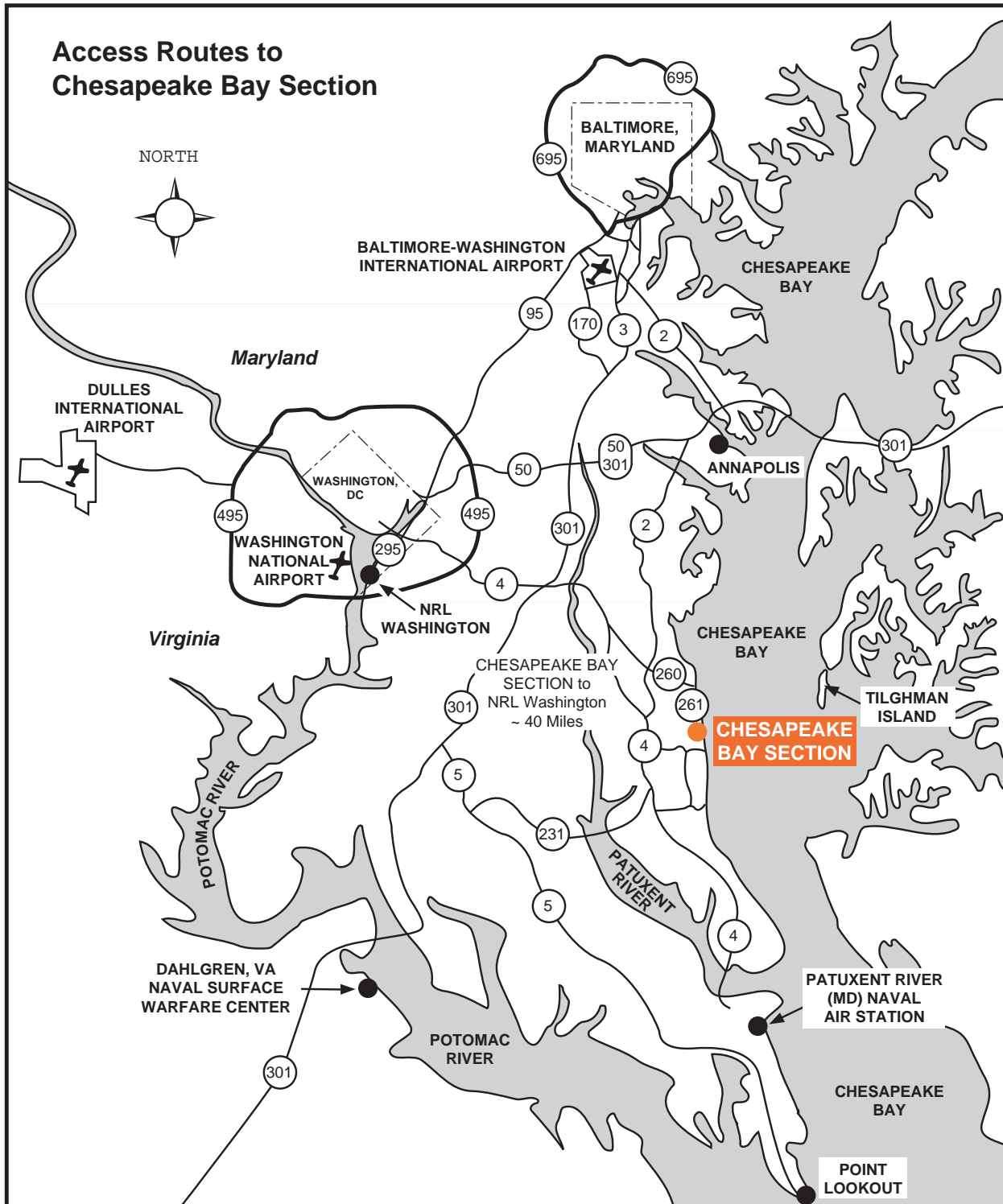

Naval Research Laboratory  
Chesapeake Bay Section  
5813 Bayside Road  
Chesapeake Beach, MD 20732  
(301) 257-4002

# John C. Stennis Space Center (Stennis Space Center, Mississippi)

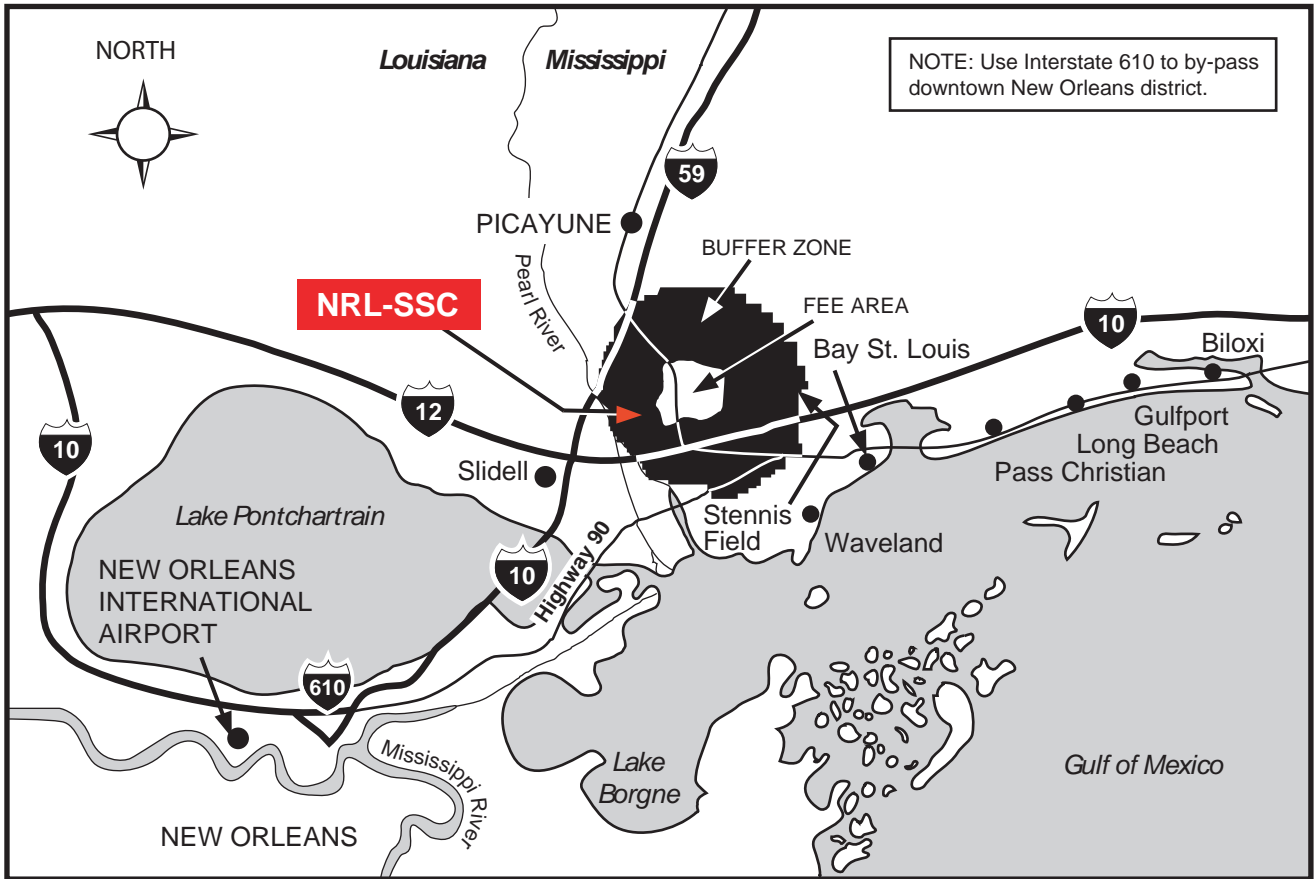

Naval Research Laboratory  
John C. Stennis Space Center  
Stennis Space Center, MS 39529-5004  
(228) 688-3390

# Naval Research Laboratory Monterey (Monterey, California)

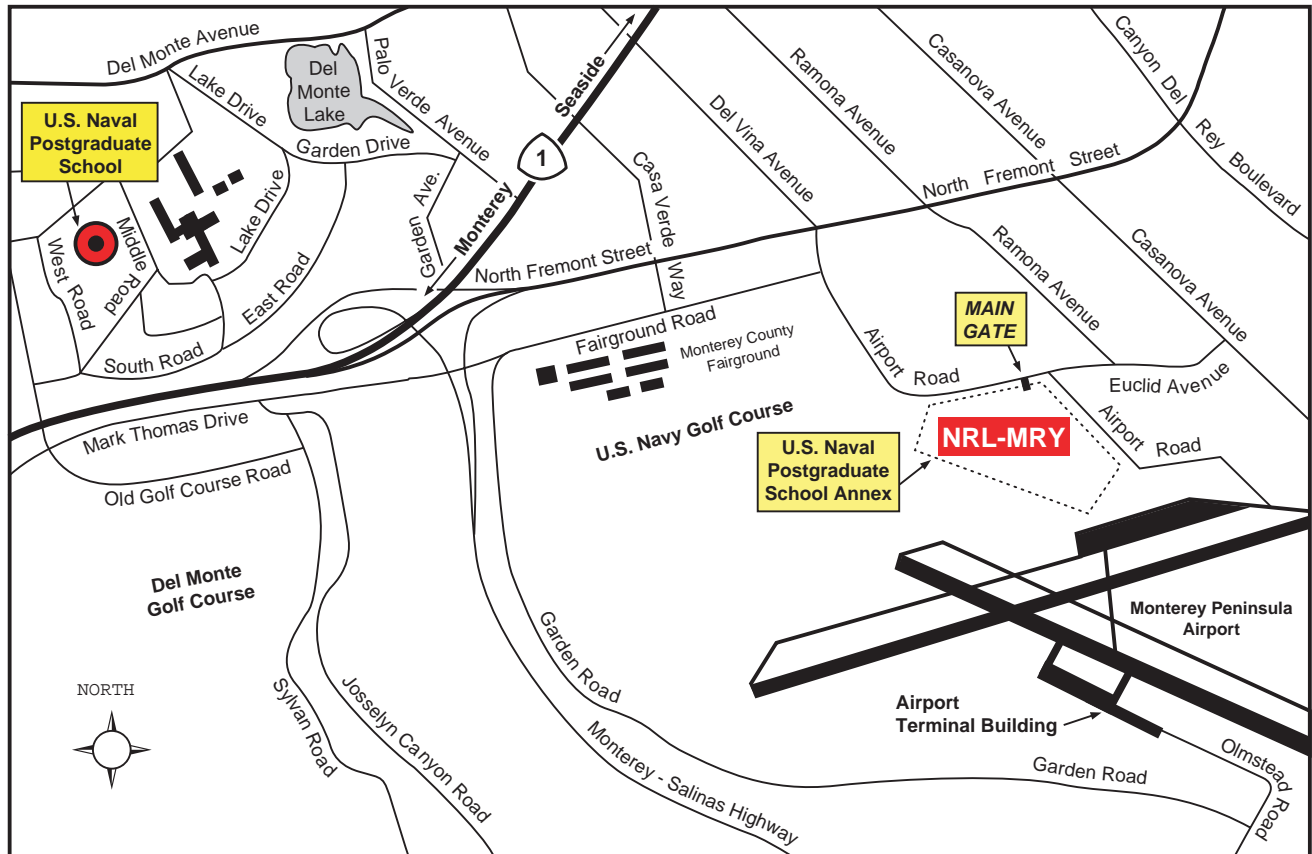

Naval Research Laboratory  
Marine Meteorology Division  
7 Grace Hopper Avenue  
Monterey, CA 93943-5502  
(408) 656-4721



## Credits

Produced by the Supply and Information Services Division  
NAVAL RESEARCH LABORATORY  
4555 Overlook Avenue, SW  
Washington, DC 20375-5320

### Production Staff

#### Editors

Claire Peachey  
Kathy Parrish

#### Graphic Design & Layout

Jonna Atkinson

#### Photographers

Jamie Baker  
William Discher  
Gayle Fullerton  
Michael Savell

REVIEWED AND APPROVED  
NRL/PU/3430-08-502  
October 2008



Paul C. Stewart, Captain, USN  
Commanding Officer

Approved for public release; distribution is unlimited.