



Independent Statistics & Analysis
U.S. Energy Information
Administration

Model Documentation Report: Industrial Demand Module of the National Energy Modeling System

September 2013



This report was prepared by the U.S. Energy Information Administration (EIA), the statistical and analytical agency within the U.S. Department of Energy. By law, EIA's data, analyses, and forecasts are independent of approval by any other officer or employee of the United States Government. The views in this report therefore should not be construed as representing those of the Department of Energy or other Federal agencies.

Table of Contents

1. Introduction	1
Model summary.....	1
Archival media	2
Model contact.....	2
Organization of this report	2
2. Model Purpose.....	3
Interaction with other NEMS modules.....	5
3. Model Rationale.....	7
Theoretical approach.....	7
Modeling approach.....	7
Fundamental assumptions	8
Industry disaggregation.....	10
Energy sources modeled.....	10
Key computations	12
Buildings component UEC	12
Process and assembly component UEC.....	12
Energy-intensive manufacturing industries.....	13
Food products (NAICS 311).....	13
Paper and allied products (NAICS 322).....	15
Bulk chemical industry (parts of NAICS 325)	16
Glass and glass products industry (NAICS 3272)	19
Cement and lime industries (NAICS 32731, 32741).....	21
Iron and steel industry (NAICS 331111).....	24
Alumina and aluminum industry (NAICS 3313)	26
Metal-based durables industry (NAICS 332-336)	28
Other non-energy-intensive manufacturing industries.....	29
Non-manufacturing industries.....	30
Agricultural sub-model	31
Mining sub-model.....	31
Construction sub-model	32

Technology possibility curves, unit energy consumption, and relative energy intensities.....	32
Motor model.....	34
Boiler, steam, cogeneration component.....	36
Model assumptions	40
Capital stock and vintaging	40
Renewable fuels.....	41
Recycling	41
Legislative requirements	41
Cogeneration	42
Benchmarking	42
4. Model Structure	43
Outline of model.....	43
Subroutines and equations.....	45
MECS2006.....	48
FINISH_GRIND_CAP (Node 1)	77
KILN_CAPACITY (Node 2).....	79
KILN_ALLOCATION	83
BURNER_ALLOCATION.....	86
RAW_GRIND_CAP (Node 4).....	86
RAW_GRIND_ALLOC	89
Process Emissions Calculations.....	89
Capacity Determination.....	91
Background on Aluminum Industry	94
Desegregation of Operations.....	95
Aluminum Production.....	95
Primary and Secondary Production Shares	97
AL_PRIM_SMELT	98
AL_SMELT_ALLOC	99
Remaining ALUMINUM_INDUSTRY Submodule Subroutines	100
CALBYPROD	100
MOTORS	105
CALBTOT	112

CALGEN	113
EvalCogen	118
CALSTOT	120
INDTOTAL	123
NATTOTAL	124
CONTAB	124
WRBIN	124
INDCGN	124
WEXOG	125
RDBIN	130
MODCAL	130
CALPROD	130
CALBSC	135
Appendix A. Model Abstract	136
Appendix B. Data Inputs	139
Appendix C. Descriptions of Major Industrial Groups and Selected Industries.....	187
Appendix D. Bibliography.....	196

Tables

Table 1. Census Regions and Census Divisions	2
Table 2. Industry categories, NAICS codes, and IDM industry codes	11
Table 3. Chemical Products in the Bulk Chemical Industry Model	17
Table 4. Components of metal-based durables manufacturing	29
Table 5. Components of other non-energy-intensive manufacturing	29
Table 6. Building weights for TPC index by fuel	52
Table 7. Total cost of selected power, fuels, and lubricants, 2007	54
Table 8. Gasoline/Diesel Volume Allocation	54
Table 9. Regional Share of Employees, by Functional Group	54
Table 10. Construction UEC Weights by Region: -variable Weight_Con	55
Table 11. Functional Groups and Vehicles	56
Table 12. Fuel use weights for buildings	58
Table 13. Relative contribution to total TPC, vehicles and other equipment	58
Table 14. Energy weights for mining equipment	62
Table 15. Census region and coal region mapping	63
Table 16. TPC Equipment Component Weights by Region	64
Table 17. Relative difficulty of extraction of oil and gas	66
Table 18. OGSM and Census region mapping	67
Table 19. TPC Factor Weights by Fuel (<i>TPC_Fac_Wt</i>)	69
Table 20. Metal and Nonmetal Shares by Census region	70
Table 21. Electric Equipment Weights	73
Table 22. Non-Electric Equipment Weights (Metals and Non-Metals)	73
Table 23. TPC Equipment Component Weights by Region -	74
Table 24. Initial allocation of cement kiln burners	86
Table 25. Initial allocations of process grinders	88
Table 26. Initial allocation of lime kilns	93
Table 27. Characteristics of lime kilns	93
Table 28. Aluminum Electrolysis Technologies Using Hall–Héroult Process	99

Appendix B Tables

Table B.1. Building component energy consumption, part 1	139
Table B.2. Building component energy consumption, part 2	141
Table B.3. Food industry national UECs, 2006	143
Table B.4. Pulp and paper industry national UECs. 2006.....	143
Table B.5. Bulk chemical industry total and sub-total national UECs, 2006	144
Table B.6. Glass products industry national UECs, 2006	145
Table B.7. Cement industry national UECs, 2006	146
Table B.8. Iron and steel industry national UECs, 2006	146
Table B.9. Aluminum industry national UECs, 2006	147
Table B.10. Metal-based durables pa component national UECs, 2006.....	148
Table B.11. Other manufacturing sectors pa component national UECs, 2006	149
Table B.12. Non-manufacturing sector pa component national UECs, 2006	150
Table B.13. Regional technology shares	151
Table B. 14. Coefficients for technology possibility curves and retirement rates, Reference case.....	152
Table B.15. National cement industry inputs and UECs for technology choice, 2008, Reference case ...	155
Table B.16. National aluminum industry inputs and UECs for technology choice, 2008, Reference case	155
Table B.17. Coefficients for technology possibility curves, high technology case.....	156
Table B.18. National cement industry inputs and UECs for technology choice, 2008, high technology case	159
Table B.19. Advanced and state of the art technologies	159
Table B.20. Industrial motor characteristics	178
Table B.21. Cost and performance parameters for industrial motor choice model.....	180
Table B.22. Payback acceptance assumptions for motor decisions	181
Table B.23. Energy consumption in boilers.....	182
Table B.24. Boiler population characteristics used for cogeneration system sizing and steam load segmentation	184
Table B. 25. Characteristics of candidate combine heat and power systems, Reference case	184
Table B. 26. Characteristics of candidate combined heat and power systems, high technology case....	185
Table B.27. Payback acceptance rate assumptions for cogeneration market penetration.....	185
Table B.28. Fuel factors for incremental corn- based ethanol production.....	186

Figures

Figure 1. Industrial demand module interactions within NEMS.....	4
Figure 2. Industrial demand module components.....	9
Figure 3. Food industry end uses	14
Figure 4. Paper manufacturing industry process flow	15
Figure 5. Bulk chemical industry end uses	18
Figure 6. Glass industry process flow	20
Figure 7. Cement industry process flow	22
Figure 8. Lime industry process flow	23
Figure 9. Iron and steel industry process flow	25
Figure 10. Aluminum industry process flow	27
Figure 11. Metal-based durables industry end uses.....	28
Figure 12. Flow diagram of module solution	43
Figure 13. AEO Oil and Gas Supply Regions	66
Figure 14. Cement industry detailed process flow	75
Figure 15. Cement Submodule	76
Figure 16. Survival function for new cement capacity.....	79

1. Introduction

This report documents the objectives and analytical approach of the National Energy Modeling System (NEMS) Industrial Demand Module (IDM). The report catalogues and describes model assumptions, computational methodology, parameter estimation techniques, and model source code.

This document serves three purposes. First, it is a reference document providing a detailed description of the NEMS Industrial Demand Module for model analysts, users, and the public. Second, this report meets the legal requirement of the U.S. Energy Information Administration (EIA) to provide adequate documentation in support of its models (Public Law 94-385, section 57.b2). Third, it facilitates continuity in model development by providing documentation from which energy analysts can undertake model enhancements, data updates, and parameter refinements in future projects.

Model summary

The NEMS Industrial Demand Module is a dynamic accounting model, bringing together disparate industries and uses of energy in those industries, and putting them together in an understandable and cohesive framework. The IDM generates long-term (up to the year 2040) projections of industrial sector energy demand as a component of the integrated NEMS. From NEMS, the IDM receives fuel prices, employment data, and the value of industrial shipments. Based on the values of these variables, the IDM passes Table B.1 back to the NEMS estimates of consumption by fuel types.

The NEMS Industrial Demand Module estimates energy consumption by energy source (fuels and feedstocks) for 15 manufacturing and 6 nonmanufacturing industries. The manufacturing industries are classified as energy-intensive manufacturing industries and non-energy-intensive manufacturing industries. The manufacturing industries are modeled through the use of a detailed process flows or end-use accounting procedures. The energy-intensive bulk chemicals industry is subdivided into four components, each with individual detailed process flows. The nonmanufacturing industries are represented in less detail. The IDM projects energy consumption at the Census Region level.; energy consumption at the Census Division level is allocated by using data from the *State Energy Data Report 2009*.¹ The national-level values reported in *Annual Energy Review 2010*² were allocated to the Census Divisions using the *State Energy Data Report 2009*.³ The four Census Regions are divided into nine Census Divisions and are listed in Table 1. They are also mapped in the *Annual Energy Outlook 2013*.⁴

¹ U.S. Energy Information Administration Information, *State Energy Data System Report 2009*, Issued June 30, 2011, <http://www.eia.gov/state/seds/>.

² U.S. Energy Information Administration, *Annual Energy Review 2010*, DOE/EIA-384(2010), October 2011, <http://www.eia.gov/totalenergy/data/annual/>.

³ U.S. Energy Information Administration, *State Energy Data System Report 2009*, <http://www.eia.gov/state/seds/>.

⁴ U.S. Energy Information Administration, *Annual Energy Outlook 2013*, pp. 225-226 <http://www.eia.gov/forecasts/aeo/pdf/f1.pdf>

Table 1. Census Regions and Census Divisions

Census Region	Census Divisions	States
1 (East)	1,2	CT, ME, MA, NH, NJ, NY, PA, RI, VT
2 (Midwest)	3, 4	IL, IN, IA, KS, MI, MN, MO, ND, NE, OH, SD, WI
3 (South)	5, 6, 7	AL, AR, DE, DC, FL, GA, KY, LA, MD, MS, NC, OK, SC, TN, TX, VA, WV
4 (West)	8, 9	AZ, AK, CA, CO, HI, ID, MT, NV, NM, OR, UT, WA, WY

Each industry is modeled as three components consisting of the process/assembly component (PA), the buildings component (BLD), and the boiler/steam/cogeneration component (BSC), unless noted. The non-manufacturing industries (agriculture, construction, and mining), have a different component structure. Agriculture includes the following components: buildings, off-road vehicles, and other produces byproducts that are consumed in the BSC component. For the manufacturing industries, the PA component is separated into the major production processes or end uses.

Archival media

The model is archived as part of the National Energy Modeling System production runs used to generate the Annual Energy Outlook 2013 (AEO2013).

Model contact

Kelly Perl, Industrial Team Lead
 (202) 586-1743
 EIA-OECEAIndustrialTeam@eia.gov
 Office of Energy Analysis
 Office of Energy Consumption & Efficiency Analysis
 Industrial Team
 1000 Independence Avenue, SW
 EI-32, Room 2H-090
 Washington, DC 20585

Organization of this report

Chapter 2 discusses the purpose of the NEMS Industrial Demand Module, detailing its objectives, input and output variables, and the relationship of the IDM to the other modules of NEMS. Chapter 3 describes the rationale behind the IDM design, providing insights into further assumptions utilized in the model. The first section in Chapter 4 provides an outline of the model. The second section in Chapter 4 provides a description of the principal model subroutines, including the key computations performed and key equations solved in each subroutine.

The Appendices to this report provide supporting documentation for the IDM. Appendix A is the model abstract. Appendix B provides the input data for AEO2013. Appendix C provides industrial group descriptions. Appendix D a bibliography of data sources and background materials used in model development.

2. Model Purpose

The NEMS IDM was designed to project industrial energy consumption by fuel type and industry as defined in the NAICS.⁵ The IDM generates long-term (up to the year 2040) projections of industrial sector energy demand as a component of the integrated NEMS. From the other components of NEMS, the IDM receives fuel prices, employment data, and the value of shipments, which are expressed in 2005 dollars, for industrial activity. Based on the values of these variables, the IDM passes back to the NEMS estimates of fuel consumption for 17 main fuels, including feedstocks and renewables, (Figure 1) for each of 21 industry groups. The IDM projects energy consumption at the Census Region level; energy consumption is allocated to the Census Division level based on the latest *State Energy Data System* (SEDS) data.⁶

⁵ Executive Office of the President, Office of Management and Budget, *North American Industry Classification System, United States, 2007*. Washington, DC, 2007

⁶ U.S. Energy Information Administration, *State Energy Data Report 2009*, <http://www.eia.gov/state/seds/>.

Figure 1. Industrial demand module interactions within NEMS

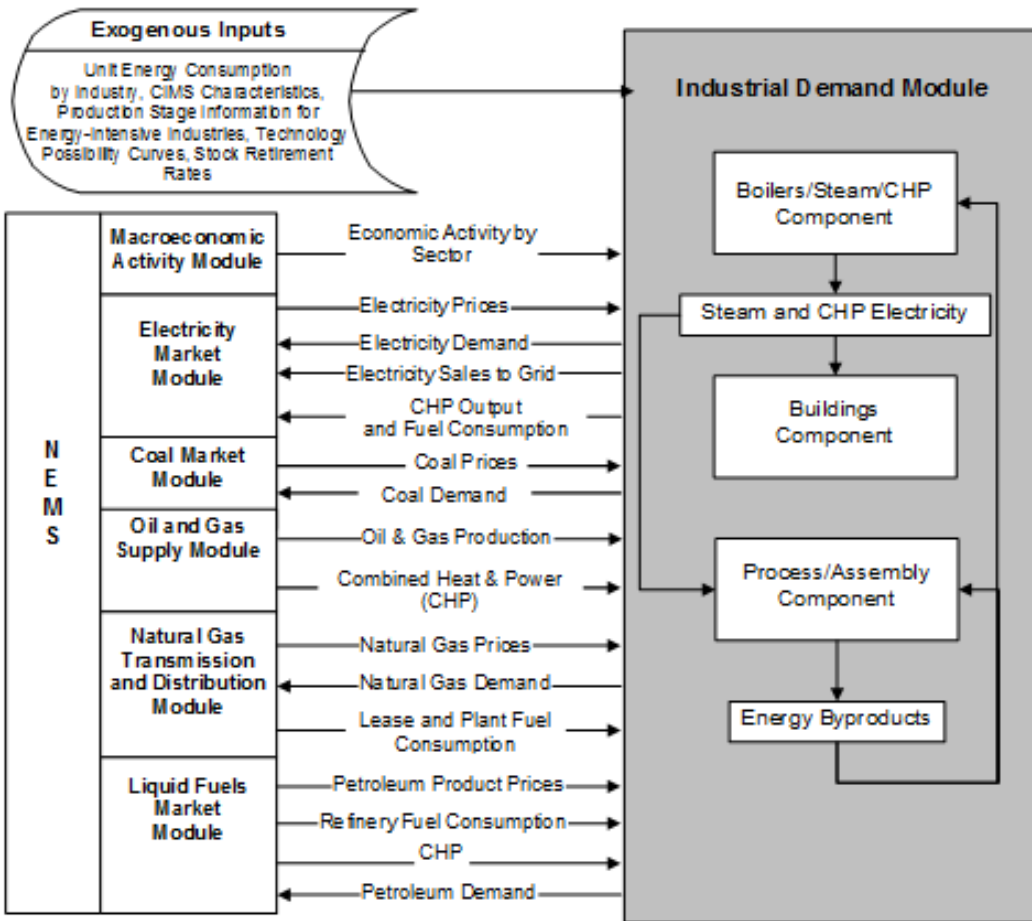

The IDM is an annual energy model; as such, it does not project seasonal or daily variations in fuel demand or fuel prices. The model was designed primarily for use in applications such as the *Annual Energy Outlook (AEO)* and other uses that examine or simulate long-term energy-economy interactions.

The model can also be used to examine various policy, environmental, and regulatory initiatives. For example, energy consumption per dollar of shipments is, in part, a function of energy prices. Therefore, the effect on industrial energy consumption of policies that change relative fuel prices can be analyzed endogenously in the model.

To a lesser extent, the IDM can endogenously analyze specific technology programs or energy standards. The model distinguishes among the energy-intensive manufacturing industries, the non-energy-intensive manufacturing industries, and the non-manufacturing industries.

A process flow approach, represented by the major production processes or end uses, is used to model the manufacturing industries. This approach provides considerable detail about how energy is consumed in a particular industry. The IDM uses “technology bundles” to characterize global technological change. These bundles are defined for each production process step for five of the

manufacturing industries, for each end use in the four remaining manufacturing industry groups, and for whole industries in the nonmanufacturing sub-sector. The industries defined by process steps are pulp and paper, glass, cement and lime, iron and steel, and aluminum. The industries defined by end use are food, bulk chemicals, metal-based durables, and the balance of manufacturing.

The Unit Energy Consumption (UEC) is defined as the energy use per ton of throughput at a process step or as energy use per dollar of shipments for the end-use industries. The “Existing UEC” is the current average installed intensity as of 2006. The “New 2006 UEC” is the intensity expected to prevail for a new, greenfield⁷ installation in 2006. Similarly, the “New 2040 UEC” is the intensity expected to prevail for a new, greenfield installation in 2040. For intervening years, the intensity is interpolated.

A more detailed approach to modeling the process flow of energy intensive manufacturing industries will be incorporated into the IDM over the next few years. For AEO2013, the IDM adopted this approach for the aluminum and cement and lime industries.. Rather than a single point UEC value for the, the new approach represents distinct process steps within an industry. Within these steps are several technology options with their unique UECs, which, when aggregated, represent a means to link technology improvements with an overall UEC. The more detailed submodules are derived from the Consolidated Impacts Modeling System (CIMS) and other reliable data sources.⁸ CIMS is an engineering-economic model based on a similar model developed for the Canadian economy by Energy and Materials Group at Simon Fraser University. Parts of CIMS are also based on the Industrial Sector Technology Use Model (ISTUM), developed by PNNL for the U.S. Department of Energy (DOE) in the 1980s.⁹

The rate at which the average intensity declines is determined by the rate and timing of new additions to capacity. The rate and timing of new additions are a function of retirement rates and industry growth rates.

The model uses a vintage capital stock accounting framework that models energy use in new additions to the stock and in the existing stock. This capital stock is represented as the aggregate vintage of all plants built within an industry and does not imply the inclusion of specific technologies or capital equipment.

Interaction with other NEMS modules

Figure 1 shows the IDM inputs from and outputs to other NEMS modules. The IDM is activated one or more times during the processing for each year of the projection period by the NEMS Integrating Module. On each occurrence of module activation, the processing flow follows the outline shown in Figure 1. Note that all inter-module interactions must pass through the integrating module. For the IDM, the Macroeconomic Activity Module (MAM) is critical. MAM supplies industry value of shipments and employment for the IDM subsectors. Ultimately, these two drivers are major factors influencing industrial energy consumption over time. The second most important influencing factor is the set of energy prices provided by the various supply modules.

⁷ Denotes an investment where no previous investment existed.

⁸ Portland Cement Association and U.S. Department of the Interior, U.S. Geological Survey.

⁹ Roop, Joseph M. and Chris Bataille, “Modeling Climate Change Policies in the US and Canada: A Progress Report,” p. 7. Presentation to 26th USAEE/IAEE North American Conference, September 27, 2006.

Projected industrial sector fuel demands generated by the IDM are used by NEMS in the calculation of the supply and demand equilibrium for individual fuels. In addition, the NEMS supply modules use the industrial sector outputs in conjunction with other projected sectoral demands to determine the patterns of consumption and the resulting amounts and prices of energy delivered to the industrial sector.

3. Model Rationale

Theoretical approach

The IDM can be characterized as a dynamic accounting model, combining economic and engineering data and knowledge. Its architecture brings together the disparate industries,¹⁰ and uses of energy in those industries, combining them in an understandable and cohesive framework. An explicit representation of the varied uses of energy in the industrial sector is used as the framework upon which to base the dynamics of the model.

One of the overriding characteristics of the industrial sector is the heterogeneity of industries, products, equipment, technologies, processes, and energy uses. Adding to this heterogeneity is the inclusion of not only manufacturing, but also the nonmanufacturing industries of agriculture, mining, and construction industries in this sector. These disparate industries range widely from highly energy-intensive activities to non-energy-intensive activities. Energy-intensive industries are modeled at a disaggregate level so that projected changes in composition of the products produced will be automatically taken into account when computing energy consumption.

Modeling approach

A number of considerations have been taken into account in building the Industrial Demand Module. These considerations have been identified largely through experience with current and earlier EIA models, with various EIA analyses, through communication and association with other modelers and analysts, and through literature review. The primary considerations are listed below.

- The Industrial Demand Module incorporates three major industry categories, consisting of energy-intensive manufacturing industries, non-energy-intensive manufacturing industries, and nonmanufacturing industries. The level and type of modeling and the attention to detail is different for each.
- Each manufacturing industry is modeled as three separate, interrelated components, consisting of boilers/steam/cogeneration (BSC), buildings (BLD) and process/assembly (PA) activities.
- The model uses a capital stock vintage accounting framework that models energy use in new additions to the stock and in the existing stock. The existing stock is retired based on retirement rates for each industry.
- The manufacturing industries are modeled with a structure that explicitly describes the major process flows or major consuming uses in the industry.
 - The IDM uses “technology bundles” to characterize technological change. The aluminum and cement and lime industries have been expanded because they utilize technology data found in the Consolidated Impacts Modeling System (CIMS) and allow for more detailed technology modeling. These bundles of specific technology data are defined for each production process step or end use. Technology improvement for each technology bundle for each production

¹⁰ According to the 2007 North American Industry Classification System, there are 596 industries classified as industrial by NEMS.

process step or end use is based upon engineering judgment, with the exception of the energy-intensive industries with submodules that now are CIMS-based.

- The model structure accommodates several industrial sector activities, including: fuel switching, cogeneration, renewables consumption, recycling and byproduct consumption. The principal model calculations are performed at the Census-Region level and aggregated to a national total.

Fundamental assumptions

The industrial sector consists of numerous heterogeneous industries. The IDM classifies these industries into three general groups: energy-intensive manufacturing industries, non-energy-intensive manufacturing industries, and non-manufacturing industries. There are eight energy-intensive manufacturing industries, of which seven are modeled in the IDM. These industries are: food products (NAICS 311); paper and allied products (NAICS 322); bulk chemicals (parts of NAICS 325); glass and glass products (NAICS 3272); cement and lime (NAICS 32731 and 32741);¹¹ iron and steel (NAICS 331111); and aluminum (NAICS 3313). Also within the manufacturing group are eight non-energy-intensive manufacturing industries. These are: fabricated metals (NAICS 332), machinery (NAICS 333), computers and electronics (NAICS 334), electrical equipment and appliances (NAICS 335), transportation equipment (NAICS 336), wood products (NAICS 321), plastic and rubber products (NAICS 326), and the balance of manufacturing (all NAICS manufacturing sectors that are not included elsewhere). The industry categories are also chosen to be as consistent as possible with the categories that are available from the 2006 Manufacturing Energy Consumption Survey (2006 MECS).

The eighth energy-intensive industry, petroleum refining (NAICS 32411) is modeled in detail in the Liquid Fuels Market Module, a separate module of NEMS, and the projected energy consumption is included in the manufacturing total. The projections of lease and plant fuel and cogeneration consumption for Oil and Gas (NAICS 211) are modeled in the Oil and Gas Supply Module and reported in the Industrial Sector energy consumption totals.

For each industry, the flow of energy among the three model components is represented by the arrows in Figure 2. The BSC component satisfies the steam demand from the PA and BLD components. For the manufacturing industries, the PA component is broken down into the major production processes or end uses. Energy consumption in the IDM is primarily a function of the level of industrial economic activity. Industrial economic activity in NEMS is measured by the dollar value of shipments (in constant 2005 dollars) produced by each industry group. The value of shipments by NAICS classification is provided to the IDM by the NEMS Macroeconomic Activity Module. As the level of industrial economic activity increases, energy consumption typically increases, but at a slower rate than the growth in economic activity.

The amount of energy consumption reported by the Industrial Demand Module is also a function of the vintage of the capital stock that produces the shipments. It is assumed that new capital stock will consist of state-of-the-art technologies that are, on average, more energy-efficient than the existing capital stock. Consequently, the amount of energy required to produce a unit of output using new

¹¹ The combination of the cement and lime industries is new in the IDM; hence, there is an incompatibility with any prior AEO that only projects for the cement industry.

capital stock is less than that required using the existing capital stock. The energy intensity of the new capital stock relative to 2006 capital stock is reflected in the parameter of the Technology Possibility Curve (TPC) estimated for each process step or end use. These curves are based on engineering judgments about the likely future path of energy intensity changes. The only exceptions to this methodology are the cement and lime industry process and assembly calculations, which use 2008 capital stock and benchmark the 2006 projections for cement to survey data from the 2006 MECS.¹²

Figure 2. Industrial demand module components

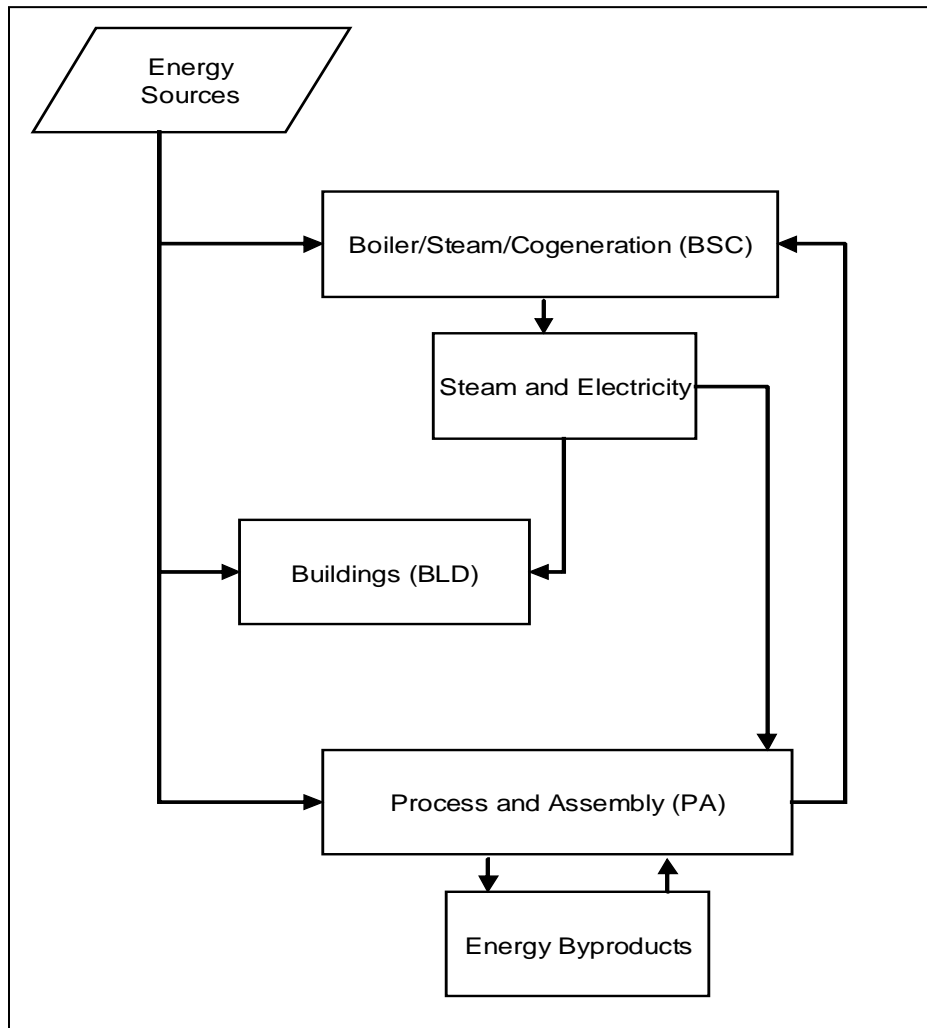

The energy intensity of the existing capital stock also is assumed to decrease over time, but not as rapidly as new capital stock. The decline is due to retrofitting and replacement of equipment from normal wear and tear. It is assumed that retrofitting existing capacity incorporates 50 percent of the improvement that is achieved by installing new capacity. The net effect is that over time the amount of energy required to produce a unit of output declines. Although total energy consumption in the industrial sector is projected to increase, overall energy intensity is projected to decrease.

¹² Note that expected future IDM enhancements in process flow and technology choice modeling will increase the number of industry exceptions to include the remaining energy-intensive industries.

Energy consumption in the buildings component is assumed to grow at the same rate as the average growth rate of employment and output in that industry.¹³ This formulation has been used to account for the countervailing movements in manufacturing employment and value of shipments.

Manufacturing employment falls over the projection, which alone would imply falling building energy use. But, since shipments tend to grow fairly rapidly, that implies that conditioned floor space is increasing. Energy consumption in the BSC is assumed to be a function of the steam demand of the other two components.

Industry disaggregation

Table 1 identifies 6 nonmanufacturing and 15 manufacturing industries modeled in the industrial sector along with their NAICS code coverage. These industry groups have been chosen for a variety of reasons. The primary consideration is the distinction between energy-intensive groups and non-energy-intensive industry groups. The energy-intensive industries are modeled in more detail, with aggregate process flows. The industry categories are also chosen to be as consistent as possible with the categories that are available from 2006 MECS. Of the manufacturing industries, seven of the most energy-intensive are modeled in greater detail in the Industrial Demand Module. Energy consumption for Petroleum Refining (NAICS 32411), also an energy-intensive industry, is modeled by the Liquid Fuels Market Module of NEMS.

Energy sources modeled

The IDM estimates energy consumption by 21 industries for 14 primary and secondary energy sources, some of which have nonfuel uses. The energy sources modeled in the IDM are:

Sources used in fuel applications:

- Electricity
- Natural Gas
- Steam Coal
- Distillate Oil
- Residual Oil
- Liquefied Petroleum Gas (LPG) for heat and power; LPG is also known as Natural Gas Liquids (NGL)
- Motor Gasoline
- Renewables, specifically biomass and hydropower
- Coking Coal, (including net imports)
- Petroleum Coke

¹³ Note that manufacturing employment generally falls in a typical Annual Energy Outlook projection. As a result, buildings' energy consumption declines over time.

Sources used in nonfuel applications:

- Natural Gas Feedstock
- LPG/NGL Feedstock
- Petrochemical Feedstocks
- Asphalt and Road Oil

In the model, byproduct fuels, such as residual fuel oil or petroleum coke, are always consumed before purchased fuels.

Table 2. Industry categories, NAICS codes, and IDM industry codes

Energy-Intensive Manufacturing
Food Products (NAICS 311; IDM industry code 7)
Paper and Allied Products (NAICS 322; IDM industry code 8)
Bulk Chemicals (IDM Industry Code 9)
Inorganic (NAICS 32512 to 32518)
Organic (NAICS 32511, 32519)
Resins (NAICS 3252)
Agricultural (NAICS 3253)
Glass and Glass Products (NAICS 3272; IDM industry code 10)
Cement and Lime (NAICS 32731, 32741; combined IDM industry code 11, Cement only 22, Lime only 23))
Iron and Steel (NAICS 3311; IDM industry code 12)
Aluminum (NAICS 3313; IDM industry code 13)
Non-Energy-Intensive Manufacturing
Metal-Based Durables
Fabricated Metals (NAICS 332; IDM industry code 14)
Machinery (NAICS 333; IDM industry code 15)
Computers and Electronics (NAICS 334; IDM industry code 16)
Electrical Equipment, Appliance and Components (NAICS 335; IDM industry code 18)
Transportation Equipment (NAICS 336; IDM industry code 17)
Wood Products (NAICS 321; IDM industry code 19)
Plastic and Rubber Products (NAICS 326; IDM industry code 20)
Balance of Manufacturing (all remaining manufacturing NAICS, excluding Petroleum Refining (32410); IDM industry code 21)
Non-Manufacturing Industries
Agriculture, Crop Production and Crop Support (NAICS 111, 1151; IDM industry code 1)
Agriculture, Other (NAICS 112-113, 1152-1153; IDM industry code 2)
Coal Mining (NAICS 2121; IDM industry code 3)
Oil and Gas Mining (NAICS 211; IDM industry code 4)
Metal and non-metallic Mining (NAICS 2122-2123; IDM industry code 5)
Construction (NAICS 233-235; IDM industry code 6)

NAICS = North American Industrial Classification System.

Source: Office of Management and Budget, North American Industry Classification System, United States, 2007 (Springfield, VA, National Technical Information Service, 2007).

Key computations

The key computations of the Industrial Demand Module are the Unit Energy Consumption (UEC) estimates made for each NAICS industry group. UEC is defined as the amount of energy required to produce one dollar's worth of shipments or physical output. The distinction between existing and new capital equipment is maintained with a vintage-based accounting procedure. In practice, the fuel use in similar capital equipment is the same across vintages. For example, an electric arc furnace primarily consumes electricity no matter whether it is an old electric arc furnace or a new one.

The modeling approach incorporates technical change in the production process to achieve lower energy intensity. Autonomous technical change can be envisioned as a learning-by-doing process for existing technology. As experience is gained with a technology, the costs of production decline. Autonomous technical change is assumed to be the most important source of energy-related changes in the IDM. Few industrial innovations are adopted solely because of their energy consumption characteristics, but rather for a combination of factors, including process changes to improve product quality, changes made to improve productivity, or changes made in response to the competitive environment. These strategic decisions are not readily amenable to economic or engineering modeling at the current level of disaggregation in the IDM. Instead, the IDM is designed to incorporate overall changes in energy use on a more aggregate and long-term basis using the autonomous technical change parameters.

Buildings component UEC

Buildings are estimated to account for 6 percent of allocated heat and power energy consumption in manufacturing industries.¹⁴ Estimates of 2006 manufacturing sector building energy consumption are presented in Table B.1 and Table B.2. Energy consumption in manufacturing buildings is assumed to grow at the average of the growth rates of employment and shipments in that industry. This assumption appears to be reasonable since lighting and heating, ventilation, and air conditioning (HVAC) are designed primarily for workers rather than machines. However, since value of shipments tends to grow, it is likely that conditioned floor space also grows. The IDM uses an average to account for the contrasting trends in employment and shipment growth rates.

Process and assembly component UEC

The process and assembly component (PA) accounted for the largest share, 62 percent, of direct energy consumption for heat and power in 2006. Of the PA total, natural gas and electricity consumption shares were similar: natural gas accounted for 34 percent and electricity accounted for 32 percent of total energy consumption.

¹⁴ Computed from U.S. Energy Information Administration, *2006 Manufacturing Energy Consumption Survey*, (<http://www.eia.gov/consumption/manufacturing/>), June 2009. Note that byproduct and non-energy use of combustible fuels are excluded from the computation because they are not allocated in the MECS tables.

Energy-intensive manufacturing industries

For nine manufacturing industry groups, energy consumption for the PA component is modeled according to the process flows or end uses in that industry. These industries are food products; paper and allied products; bulk chemicals, namely inorganic, organic, and agricultural chemicals as well as resins; glass and glass products; cement and lime; iron and steel; aluminum, metal-base durables, and balance of manufacturing.

To derive energy use estimates for the process steps, the production process for each industry was first decomposed into its major steps, and then the engineering and product flow relationships among the steps were specified. Process steps for each industry were analyzed using one of the following two methodologies:

Methodology 1. Develop a process flowsheet and estimates of energy use by process step. This was applicable to those industries where the process flows could be well defined for a single broad product line by unit process step: paper and allied products, glass and glass products, cement and lime, iron and steel, and aluminum.

Methodology 2. Develop end-use estimates of energy use by generic process unit as a percentage of total energy use in the PA component. This is especially applicable where the diversity of end products and unit processes is extremely large: food products, bulk chemicals, metal-based durables, and the balance of manufacturing. A motor stock model calculates the electricity consumption for the machine drive end use for these four industries.

In both methodologies, major components of energy consumption by Btu are identified by process for various energy sources:

- Fossil Fuels,
- Electricity (valued at 3,412 Btu/kWh),
- Steam
- Non-fuel energy sources.

The following sections present a more detailed discussion of the process steps and unit energy consumption estimates for each of the energy-intensive industries. The data tables showing the estimates are presented in Appendix B and are referenced in the text as appropriate. The process steps are model inputs with the variable name INDSTEPNAME.

Food products (NAICS 311)

In 2006, the food products industry accounted for 8 percent (\$541 billion) of manufacturing value of shipments and consumed approximately 1,186 trillion Btu of energy.¹⁵ Energy use in the food products industry for the PA component was estimated for each of four major end-use categories:

¹⁵ U.S. Energy Information Administration (EIA), *2006 Manufacturing Energy Consumption Survey*, <http://www.eia.gov/consumption/manufacturing/>, June 2009. Note that the IDM's energy consumption projection for 2006 may vary slightly from the 2006 MECS values due to the inclusion of data from the electricity data forms and model dynamics.

- Process Heating
- Process Cooling
- Machine Drive
- All Other Uses

Figure 3 portrays the PA component's end-use energy flow for the food products industry. A motor stock model, which is described later in this document, calculates electricity consumption for the machine drive end use. The UECs estimated for the remaining end uses in this industry are provided in Table B.3. The dominant end use was direct heat, which accounted for 50 percent of the total PA energy consumption.

Figure 3. Food industry end uses

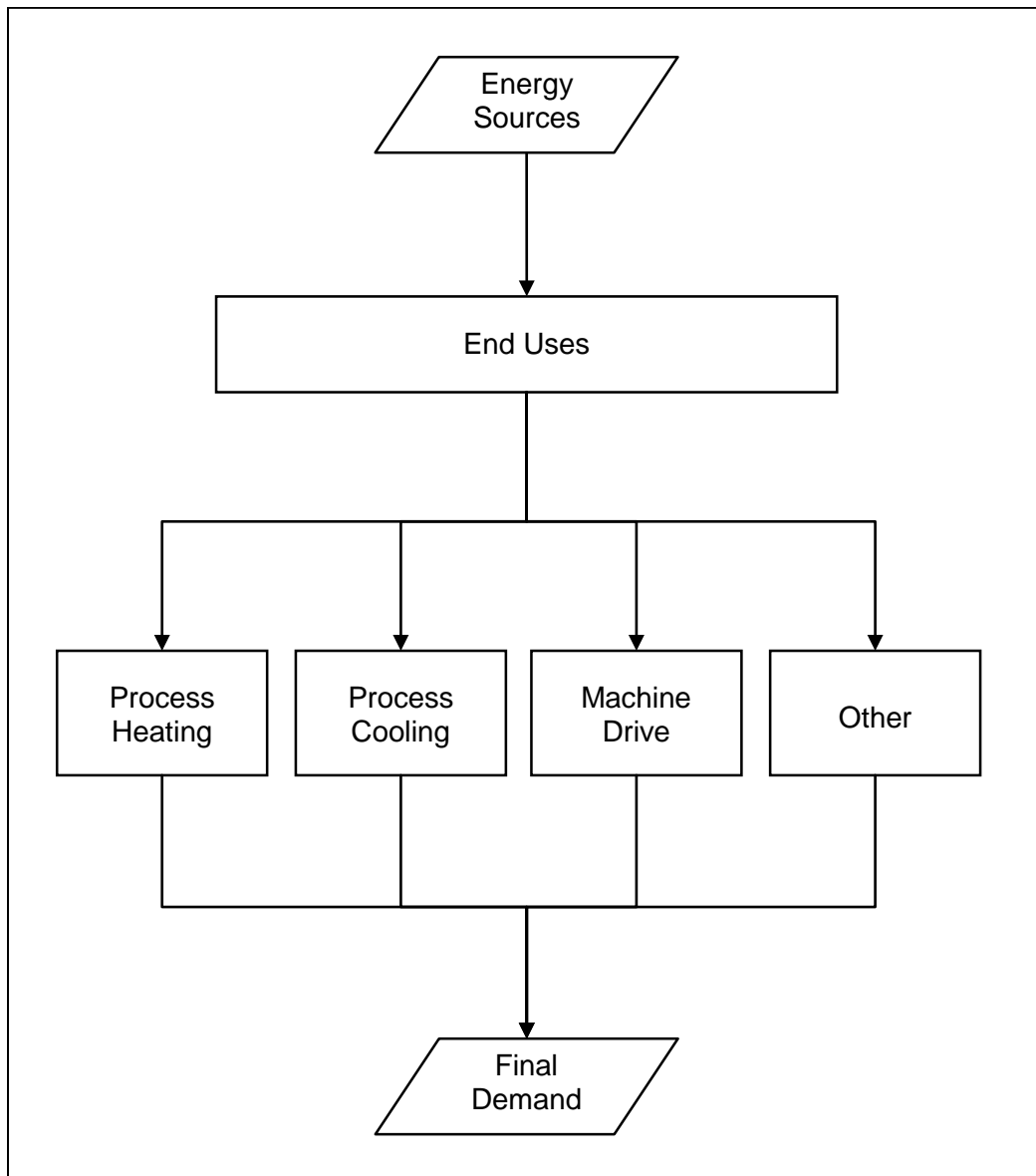

Paper and allied products (NAICS 322)

The paper and allied products industry's principal processes involve the conversion of wood fiber to pulp, and then paper and board to consumer products that are generally targeted at the domestic marketplace. The industry produces a full line of paper and board products, as well as dried pulp, which is sold as a commodity product to domestic and international paper and board manufacturers.

Figure 4 illustrates the major process steps for all pulp and paper manufacturing. The wood is prepared by removing the bark and chipping the whole tree into small pieces. Pulping is the process by which the fibrous cellulose in the wood is removed from the surrounding lignin. Pulping can be conducted with a chemical process (e.g., Kraft, sulfite) or a mechanical process. The pulping step also includes processes such as drying, liquor evaporation, effluent treatment, and miscellaneous auxiliaries. Bleaching is required to produce white paper stock.

Figure 4. Paper manufacturing industry process flow

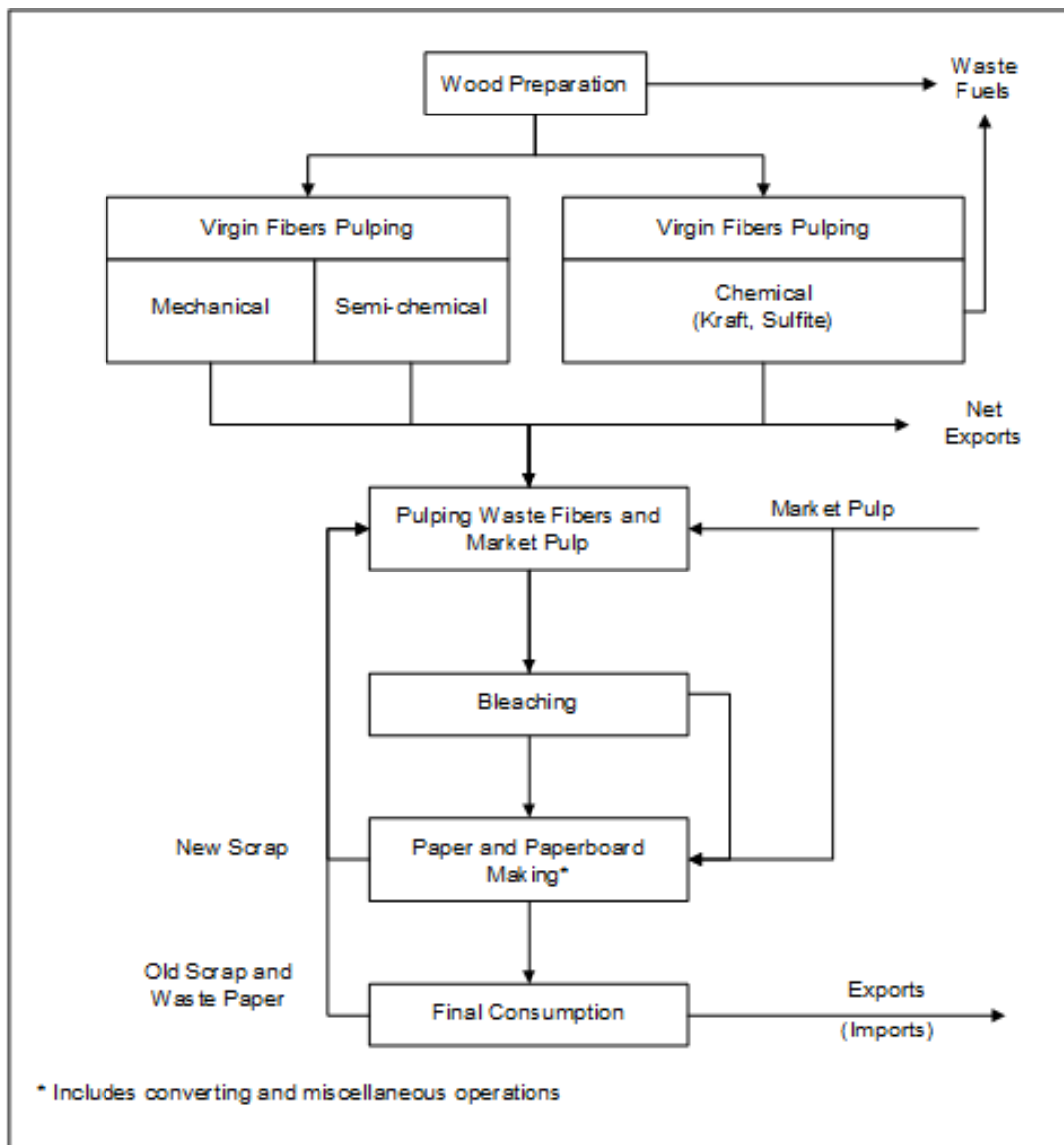

Paper and paperboard making takes the pulp from the above processes and makes the final paper and paperboard products. The manufacturing operations after pulp production are similar for all of the paper end products even though their processes differ. The processes in the paper-making step include papermaking, converting/packaging, coating/re-drying, effluent treatment, and other miscellaneous processes.

In 2006, 96 million tons of paper and paperboard products were produced. The major paper products include wood-free printing paper, ground wood printing paper, newsprint, tissue paper and packaging paper. The major paperboard products include Kraft paperboard, corrugating medium, and recycled paperboard. Of the total pulp production, it is estimated 48 percent was produced with the Kraft chemical process, 3.5 percent from semi-chemical pulping, 4.5 percent from mechanical (ground wood) pulping, and 44 percent from waste fibers. The unit energy consumption estimates for this industry are provided in Table B.4. The largest component of this energy (including steam) use is in the paper and paperboard making process step and Kraft pulping step, accounting for 34 percent and 42 percent, respectively. Use of recycled paper as the feedstock for the waste fiber pulping step is taken into account. The regional distribution for each technology is shown in Table B.13. Future additions to pulping capacity are assumed to reflect a slight relative increase in waste pulping via increased use of market pulp. This assumption reflects recent trends in additional imports of market pulp.

Bulk chemical industry (parts of NAICS 325)

The bulk chemical sector is very complex. Industrial inorganic and organic chemicals are basic chemicals, while plastics, agricultural chemicals, synthetic rubber, pharmaceuticals, and other chemicals are either intermediate chemicals or final products. In 2006, the bulk chemical industry was estimated to consume 24 percent (5.0 quadrillion Btu) of the total energy consumed in the manufacturing sector, while accounting for 7 percent (\$321 billion) of manufacturing value of shipments.¹⁶ This industry is a major energy feedstock user and a major producer of cogeneration power.

The bulk chemical industry's energy consumption patterns are complex, with demands for heat, steam, electricity, and energy feedstocks driven by the demand for production of numerous chemical products, as well as the processes and technologies involved in making these products. Because of this complexity, only ethanol and hydrogen production are singled out for the tracking of specific energy consumption as these chemicals are incorporated directly into the supply modules of NEMS. The rest of the chemicals are aggregated into the four categories as defined by NAICS codes, shown below in Table 2. There are 15 organic, 5 inorganic, 5 resins, and 2 agricultural chemicals, plus 4 aggregate ("other") groups. Modeling of energy consumption within these groups is accomplished by the Technology Possibility Curve (TPC) method used for most other industries as described in Figure 5 and under the "Key Computations" section. However, for since the AEO2012, a limited feedstock selection algorithm was included as well (see below).

It is important to note that the delineation of feedstock demand applies only to the PA component of the bulk chemical energy consumption projections. The PA component also estimates energy consumption for direct process heating, cooling, machine drive (and motors), and other uses. The BSC

¹⁶ This 2006 MECS value does not include 1.1 quadrillion Btu of petrochemical feedstocks which are not assigned directly to the chemical industry.

and BLD components remain the same for this industry as in other models. Thus, steam demand projections are passed from the PA component to the BSC component. The BSC component then calculates fuel consumption to generate the steam. Also, as in the other modules, the BLD component projects energy consumption for this industry's use of its facilities for space heating, space cooling, and lighting.

Table 3. Chemical Products in the Bulk Chemical Industry Model

Organic Chemicals	Inorganic Chemicals	Resins	Agricultural Chemicals
Ethylene	Acetylene	Polyvinyl Chloride	Ammonia
Propylene	Chlorine	Polyethylene	Phosphoric Acid
Butadiene	Oxygen	Polystyrene	Other Agricultural Chemicals
Acetic Acid	Sulfuric Acid	Styrene-Butadiene	
Acrylonitrile	Hydrogen	Rubber	
Ethylbenzene	Other Inorganic Chemicals	Vinyl Chloride	
Ethylene Dichloride		Other Resins	
Ethylene Glycol			
Ethylene Oxide			
Formaldehyde			
Methanol			
Styrene			
Vinyl Acetate			
Ethanol			
On-Purpose Propylene (and byproduct ethylene)			
Other Organic Chemicals			

The feedstock UECs are initialized from the 2006 MECS data the same way the fuel components are (Table B.5), but unlike most fuels the feedstock TPC rates of change are set to zero; in other words, the UECs for feedstocks are assumed not to improve over time. This assumption is based on the inherent stoichiometric relationship between basic chemical products (such as ethylene, propylene, methanol, ammonia) and their feedstock/reactants such as natural gas, NGL/LPG, and petroleum-based naphtha.

To a large degree the NGL/LPG and naphtha petrochemical feedstocks can substitute for one another, especially for the production of commodity chemicals like ethylene, propylene and butadiene. Base year liquid feedstock total has been divided up into the two groups using 2006 MECS data. Over time, as petrochemical shipments grow in the projections, the model splits up incremental petrochemical feedstock demand needed to satisfy growing chemical shipments between LPG and naphtha based upon the relative pricing of the two; i.e., the cheaper LPG is relative to naphtha, the more LPG will dominate in its share of total incremental feedstock demand.

In AEO2013 NGL components (ethane, propane, normal butane, iso-butane, and pentanes plus) were segregated. After making the economic decision between feedstock demand share of LPG vs. naphtha, the LPG demand was filled by the NGL components. All ethane (production plus net imports) was assumed to be consumed in the industrial model. The rest is filled by the other NGLs, proportional to their respective historical feedstock use.

Finally, there is an option to utilize refinery-produced propylene to fulfill some of the incremental organic shipments demand growth. Propylene price is based on production cost from the Liquid Fuels Market Model (LFMM), and this price is competed against feedstock costs (NGL and naphtha).

Figure 5. Bulk chemical industry end uses

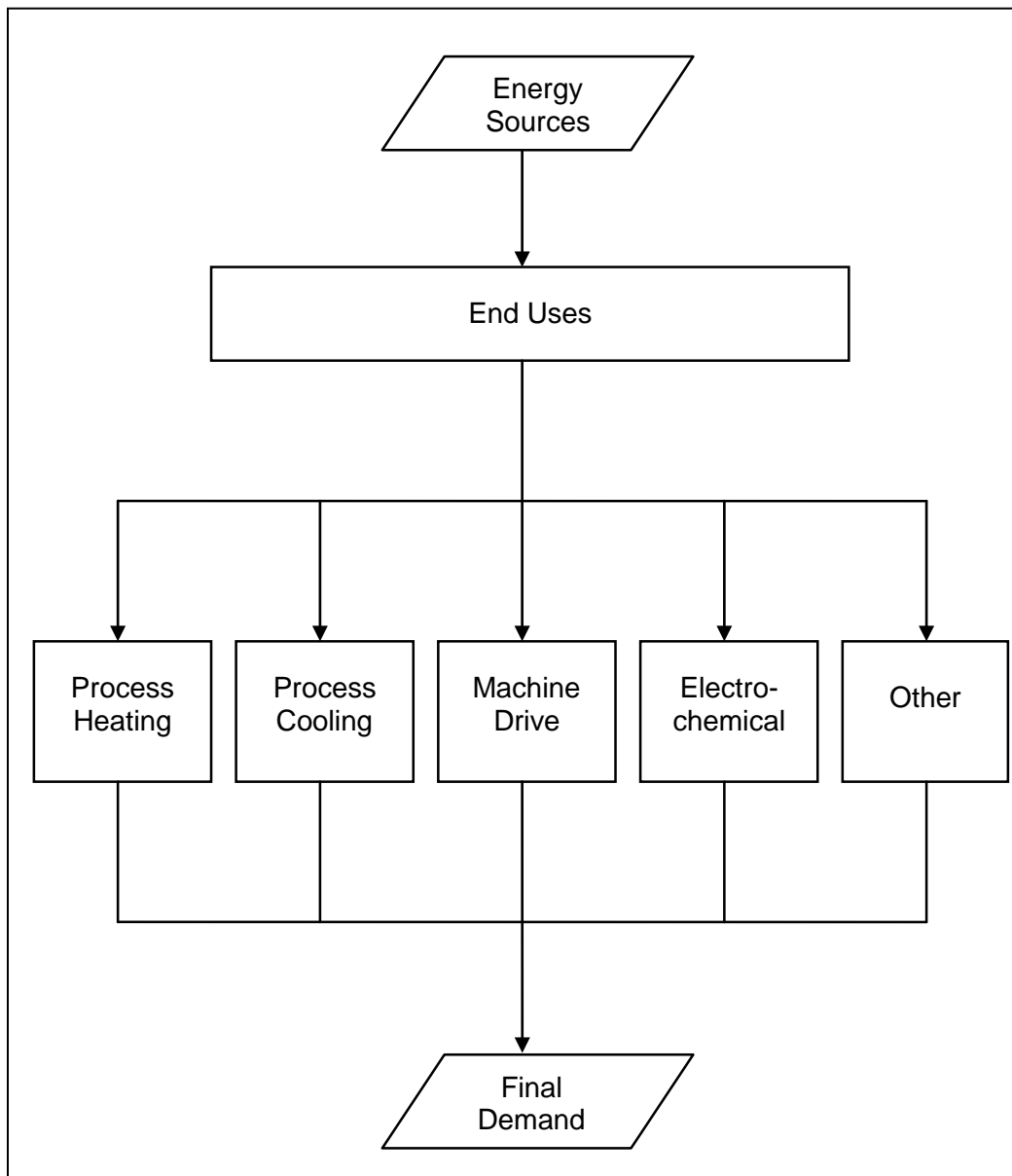

In the United States, the production of ammonia and hydrogen uses primarily natural gas as the feedstock. Nevertheless, there has been some interest in using other feedstocks such as coal and biomass for both ammonia and hydrogen, as well as electrolytic process for hydrogen. EIA performed research analyses on the relative cost-effectiveness of these alternative feedstocks. Cost-effectiveness evaluations for these alternatives were performed for ammonia and hydrogen. The benefits and costs of replacing existing natural gas plants were estimated and compared in the pro forma analysis. The competition between natural gas and the alternatives for a new plant was also analyzed. The costs of using the alternatives were found to be significantly prohibitive, and continue to be in light of continued relatively inexpensive natural gas due to increasing domestic supply. This issue continues to be studied by EIA and will be updated in future projections as appropriate.

Glass and glass products industry (NAICS 3272)

An energy use profile has been developed for the whole glass and glass products industry, NAICS 3272. This industry definition includes glass products made from purchased glass. The glass-making process contains four process steps: batch preparation, melting/refining, forming and post-forming. Figure 6 provides an overview of the process steps involved in the glass and glass products industry. While cullet (scrap) and virgin materials are shown separately to account for the different energy requirements for cullet and virgin material melting, glass makers generally mix cullet with the virgin material. In 2006, the glass and glass products industry produced approximately 20 million tons of glass products.

Figure 6. Glass industry process flow

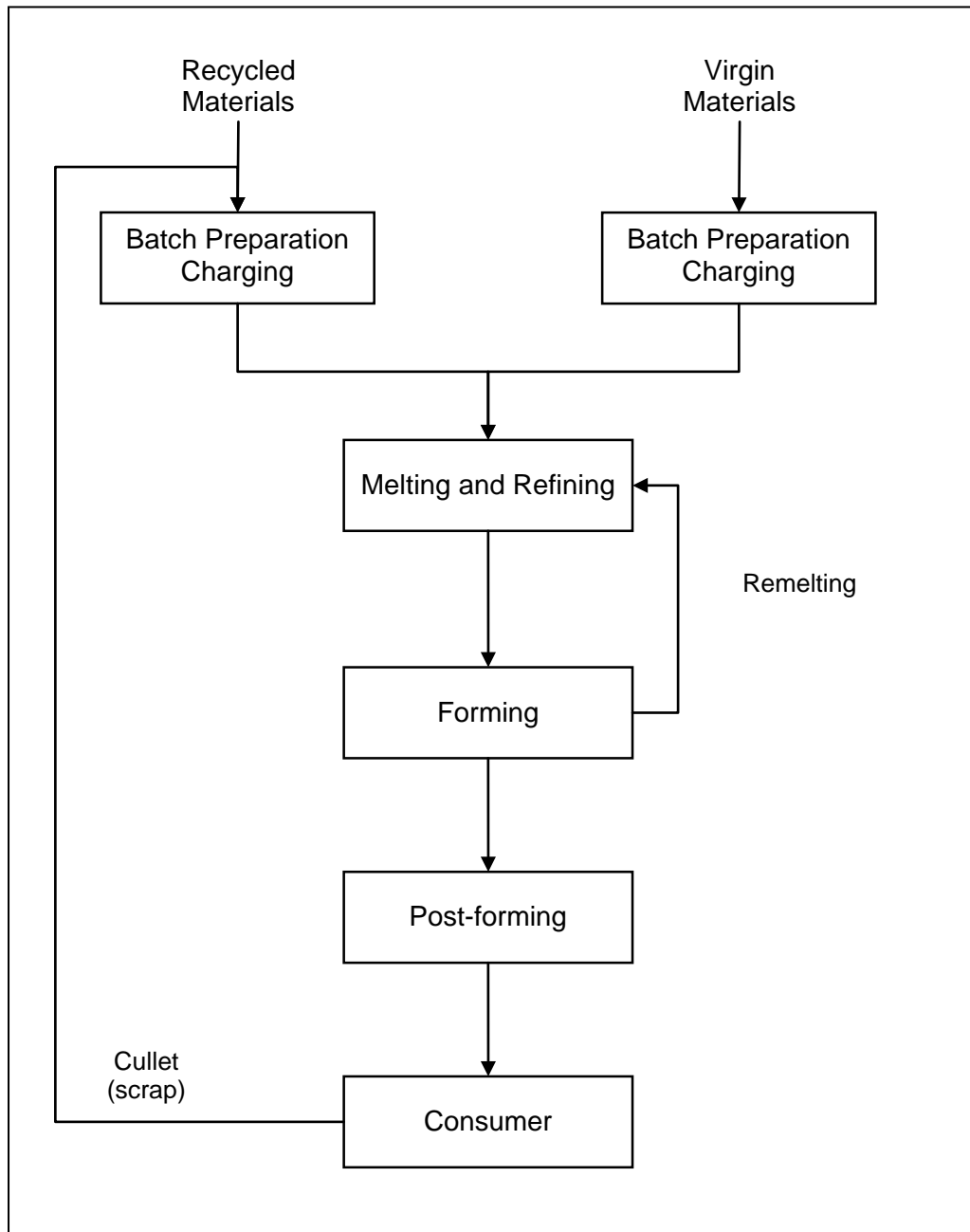

The glass and glass products industry consumed nearly 300 trillion Btu of energy in 2006.¹⁷ This accounts for about a quarter of the total energy consumed in the “stone, clay and glass manufacturing” industry. The fuels consumed are predominantly for direct fuel use, because there is very little steam demand. Direct fuel use is mainly in furnaces for melting. Table B.6 shows the unit energy consumption values for each process step.

¹⁷U.S. Energy Information Administration (EIA), *2006 Manufacturing Energy Consumption Survey*, <http://www.eia.gov/consumption/manufacturing/>, June 2009. Note that the IDM’s energy consumption projection for 2006 may vary slightly from the 2006 MECS values due to the inclusion of data from the electricity data forms and model dynamics.

Cement and lime industries (NAICS 32731, 32741)

The cement (NAICS 32731) and lime (NAICS 32741) industries' energy consumption are reported together in NEMS. Both cement and lime use a new type of process flow model that derives energy use from specific technologies rather than engineering judgment of general energy use. Cement and lime energy use is reported together in NEMS.

The cement industry uses raw materials from non-manufacturing quarrying and mining industries. These materials are sent through crushing and grinding mills and converted to clinker in the clinker producing step. This clinker is then further ground to produce cement. The industry produces cement by two major processes: the wet process and the dry process. Plants using the wet process exclusively accounted for 13 percent of production by weight in 2006, while plants using the dry process exclusively accounted for about 82 percent; plants using both processes accounted for 5 percent of production by weight.¹⁸ The dry process is less energy-intensive than the wet process, and thus the dry process has steadily gained favor in cement production. Even with older facilities and longer kilns, the wet process shows somewhat smaller electric energy consumption because of the use of energy-efficient wet grinding and lack of pre-heaters/pre-calciners found in dry plants. However, total energy use is greater in wet plants due to less-efficient use of sensible energy in the kiln off-gases. As a result, it is assumed in the model that all new plants will be based on the dry process. Figure 7 provides an overview of the process steps involved in the cement industry.

The cement industry produced 98 million metric tons of cement in 2006 and 64 million metric tons in 2010.¹⁹ Since cement is the primary binding ingredient in concrete mixtures, it is used in virtually all types of construction. As a result, the U.S. demand for cement is highly sensitive to the levels of construction activity. The decrease in production illustrates the effects of the 2007-2009 recession, which hit construction particularly hard.

The cement industry exhibits one of the highest unit energy consumption values (MMBtu per dollar value of shipments) in the U.S. industrial sector. The industry consumed nearly 400 trillion Btu of energy in 2006.²⁰ Direct fuel, used in clinker-producing kilns, accounted for 89 percent of the total PA energy consumption.

¹⁸ U.S.G.S. Minerals Yearbook, 2006, Table 7, p. 16.14, <http://minerals.usgs.gov/minerals/pubs/commodity/cement/myb1-2006-cemen.pdf>.

¹⁹ U.S.G.S. Minerals Yearbook, 2010, Table 1, p. 16.7, <http://minerals.usgs.gov/minerals/pubs/commodity/cement/myb1-2010-cemen.pdf>.

²⁰ U.S. Energy Information Administration (EIA), *2006 Manufacturing Energy Consumption Survey*, <http://www.eia.gov/consumption/manufacturing/>, June 2009. Note that the IDM's energy consumption projection for 2006 may vary slightly from the 2006 MECS values due to the inclusion of data from the electricity data forms and model dynamics.

Figure 7. Cement industry process flow

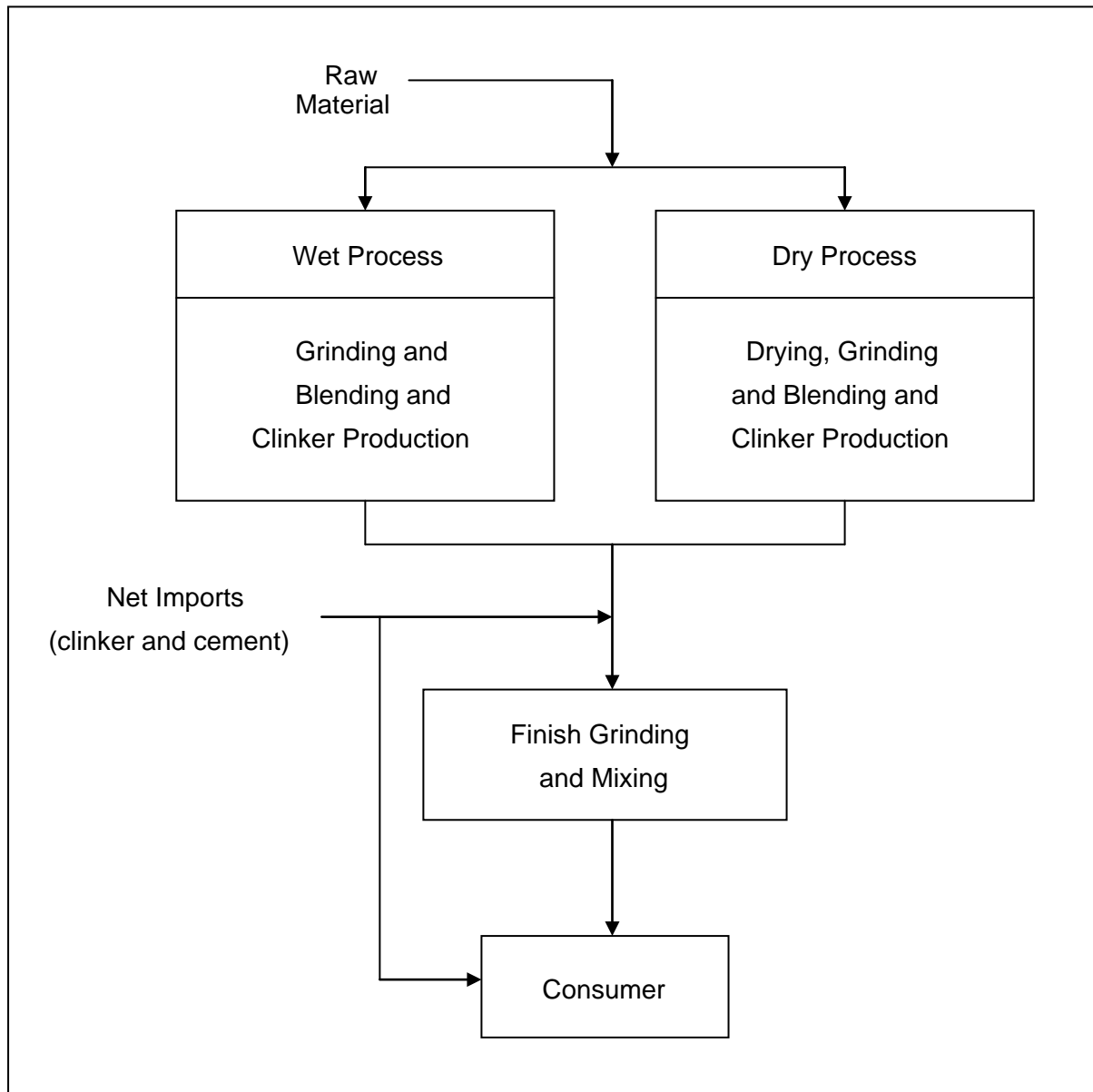

The UEC values for each process in the cement industry are shown in Table B.7. As noted previously, it is assumed that all new cement capacity will be based on the dry process. The regional distribution of cement production processes is presented in Table B.13.

The lime industry produced 21 million metric tons of lime in 2006 and 18 million metric tons in 2010.²¹ Lime is used in a number of ways. Lime's major uses include: metallurgical, primarily iron and steel (35 percent of 2010 use)²²; flue gas desulfurization (21 percent), water treatment (9 percent), construction,

²¹ U.S.G.S. Minerals Yearbook 2010 – Lime, Table 1, p. 43.6, <http://minerals.usgs.gov/minerals/pubs/commodity/lime/myb1-2010-lime.pdf>.

²² U.S.G.S. Minerals Yearbook 2010 – Lime, Table 3, p. 43.8, <http://minerals.usgs.gov/minerals/pubs/commodity/lime/myb1-2010-lime.pdf>.

including cement (8 percent), and pulp and paper (5 percent). Lime is used chemically to make the properties of a product more desirable, such as lowering acidity, as part of a chemical reaction, as in cement; and to remove impurities, such as in metallurgical applications or flue gas desulfurization (see Figure 8 below).

Figure 8. Lime industry process flow

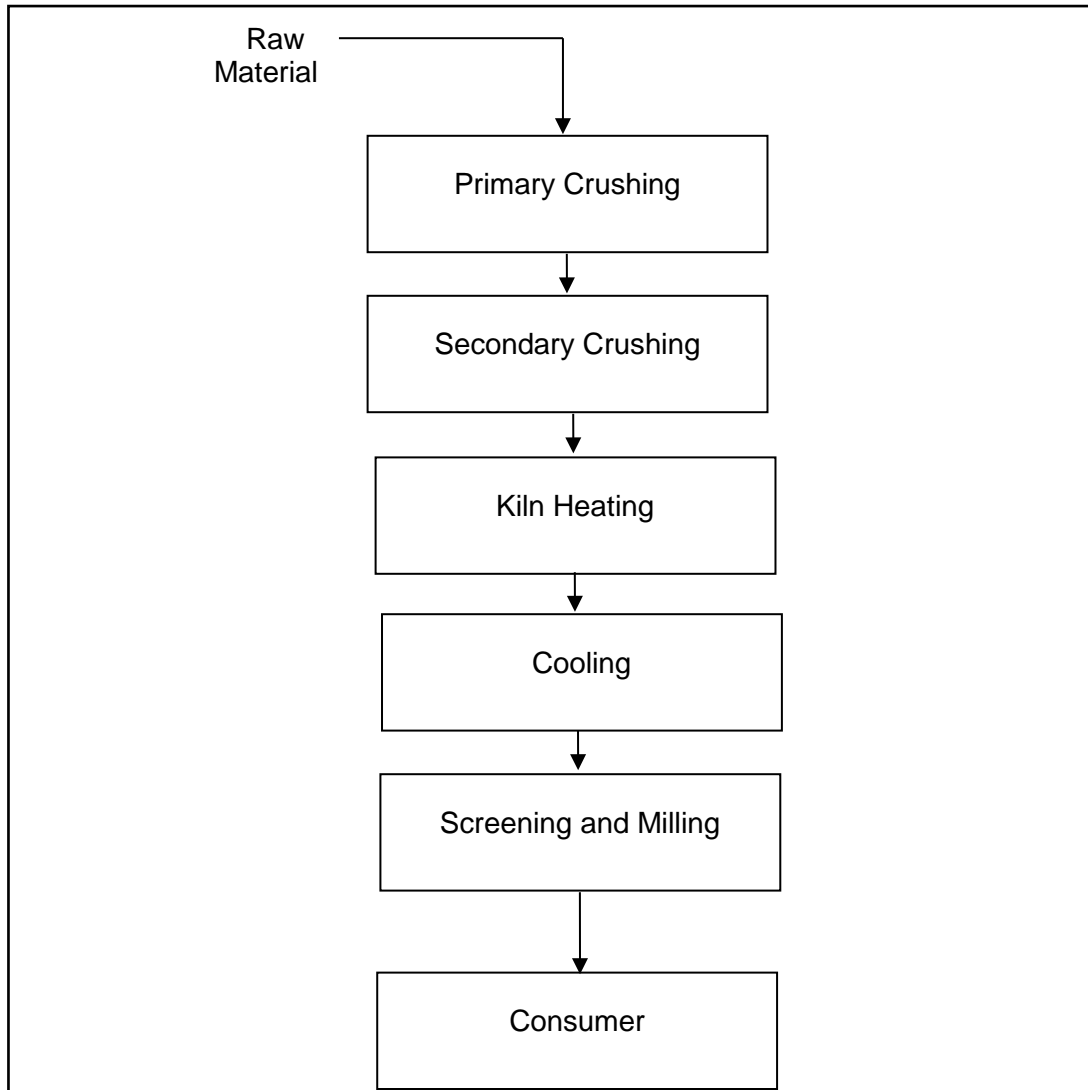

Iron and steel industry (NAICS 331111)

The iron and steel industry includes the following six major process steps:

- Agglomeration
- Coke making
- Iron making
- Steel making
- Steel casting
- Steel forming

Steel manufacturing plants can be classified as integrated or non-integrated. The classification is dependent upon the number of the major process steps that are performed in the facility. Integrated plants perform all the process steps, whereas non-integrated plants, in general, perform only the last three steps.

For the Industrial Demand Module, a process flow was developed to separate the process flow into five process steps around which unit energy consumption values were estimated. Figure 9 shows the process flow diagram used for the analysis. The IDM excludes the agglomeration step because it is part of mining. Iron ore and coal are the basic raw materials that are used to produce iron.

Figure 9. Iron and steel industry process flow

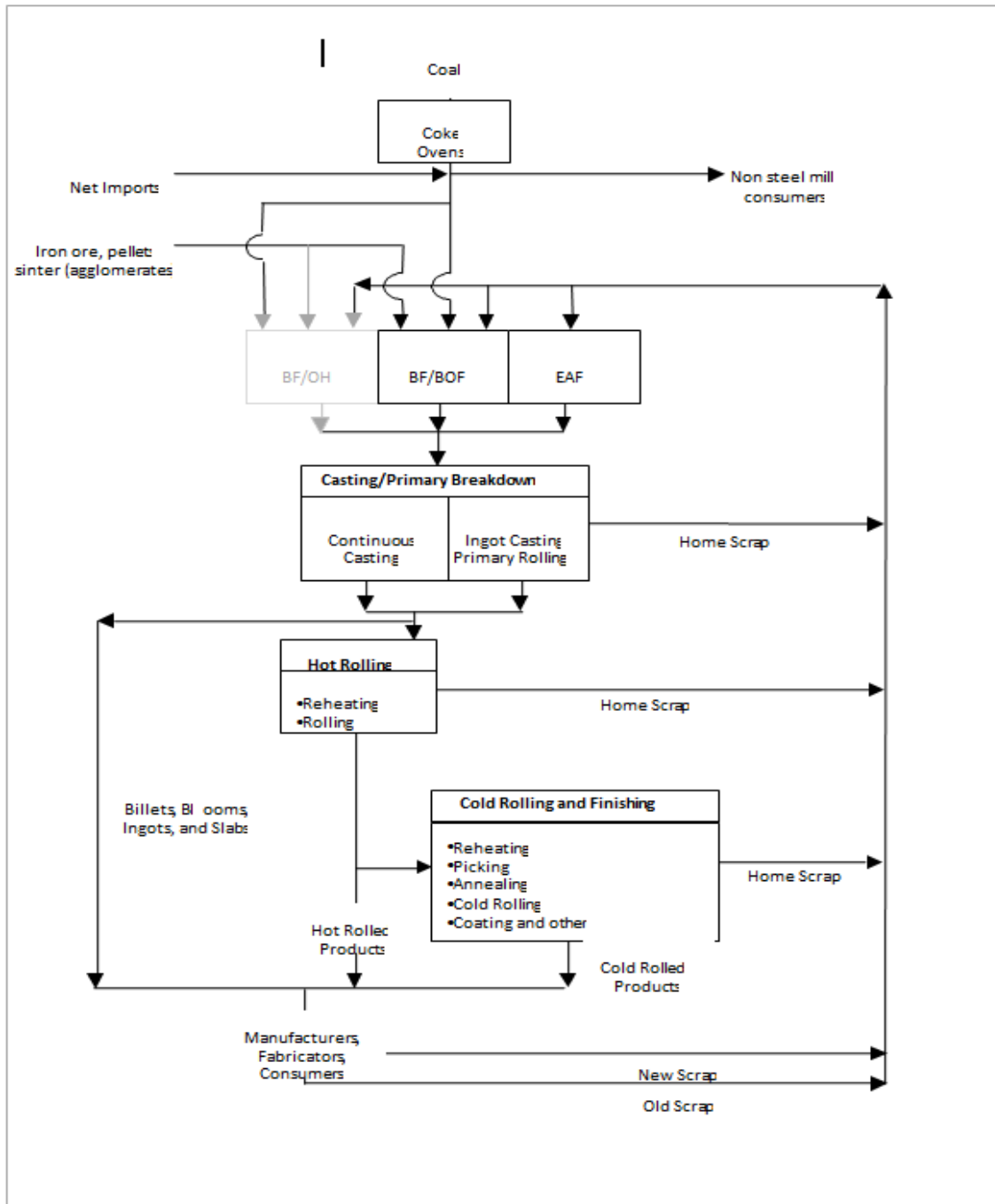

Iron is produced in the Blast Furnace (BF), which is then charged into a Basic Oxygen Furnace (BOF) or Open Hearth (OH) to produce raw steel. The OH is now obsolete in the United States and is not included in new facilities modeled in the IDM. The Electric Arc Furnace (EAF) is utilized to produce raw steel from an all-scrap (recycled materials) charge, sometimes supplemented with direct reduced iron or hot briquetted iron.

The raw steel is cast into ingots or blooms, billets or slabs using continuous casting. Some ingot or cast steel is sold directly (e.g., forging grade billets). The majority is further processed ('hot rolled') into various mill products. Some of these are sold as hot rolled mill products, while others are further cold rolled to impart surface finish or other desirable properties.

In 2006, the U.S. steel industry produced 105 million tons of raw steel utilizing BF, BOF and EAF processes. Taking process yields into account, the total shipments were approximately 104 million tons. EAF accounted for 50 percent of the raw steel production. Continuous casting was the predominant casting process, whereas ingot casting is declining.

Table B.8 summarizes UEC estimates by process step and energy type for the steel industry. The largest category for energy use is coal, followed by liquid and gas fuels. Coke ovens and blast furnaces also produce a significant amount of byproduct fuels, which are used throughout the steel plant. The regional distribution of steel-making technologies is presented in Table B.13.

Alumina and aluminum industry (NAICS 3313)

The U.S. aluminum industry consists of two major sectors: the primary aluminum sector, which uses alumina as raw material; and the secondary sector, which uses collected aluminum scrap as a raw material. The primary and secondary aluminum industries have historically catered to different markets, but these distinctions are fading. Traditionally, the primary industry bought little scrap and supplied wrought products, including sheet, plate, and foil. The secondary industry is scrap-based and has historically supplied foundries that produce die, permanent mold, and sand castings. More recently, secondary aluminum smelters have started supplying wrought (sheet) stock. In addition, in the past decade, the primary producers have been moving aggressively into recycling aluminum, especially used beverage cans.

Figure 10 provides an overview of the process steps involved in the aluminum industry. The energy use analysis accounts for energy used in NAICS 3313 which includes:

- Alumina Refining (NAICS 331311)
- Primary Aluminum Production (NAICS 331312)
- Secondary Smelting and Alloying of Aluminum (NAICS 331314)
- Aluminum Sheet, Plate, Foil Manufacturing (NAICS 331315)
- Aluminum Semi-fabrication of products such as extrusions, tube, cable, and wire (found in NAICS 3316 and NAICS 331319)

Note: aluminum foundry castings (die-casting/permanent mold/other) are not considered as part of NAICS 331311.

The primary sector produced approximately 2.3 million tons of aluminum in 2006. The secondary (scrap-based) sector also recovered 2.3 million tons, exceeding primary production by only 76 thousand tons. Domestic aluminum production plus aluminum semi-finished imports resulted in about 5.4 million tons of mill products like sheet, plate, and foil, cable, and wire.

Figure 10. Aluminum industry process flow

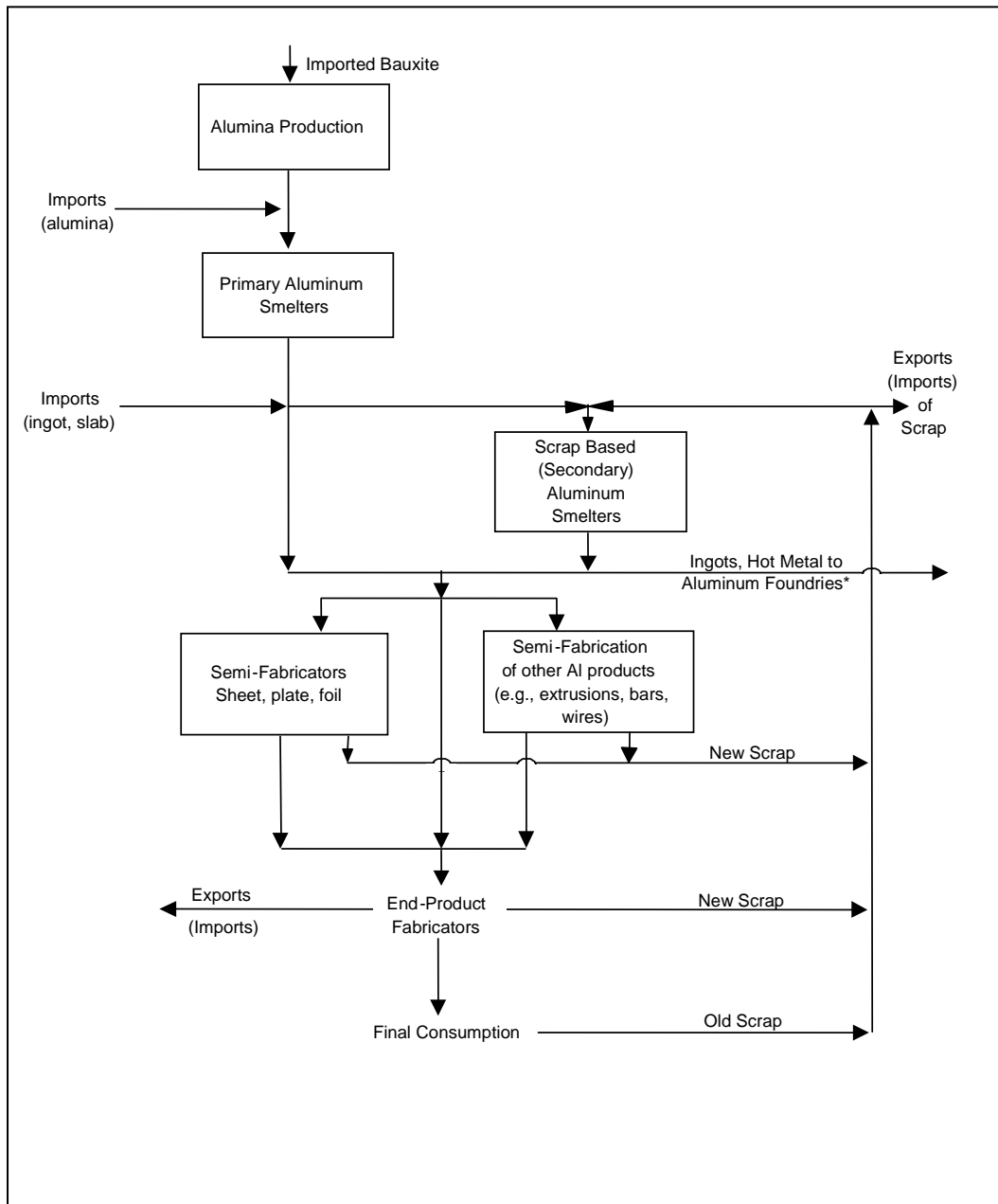

The UEC estimates developed for the process steps are presented in Table B.9 and do not distinguish between the production of primary and secondary aluminum. The principal form of energy used is electricity. The regional distribution of smelters in the aluminum industry is presented in Table B.13.

Metal-based durables industry (NAICS 332-336)

This industry group consists of industries engaged in the manufacture of fabricated metals, machinery, computer and electronic products, transportation equipment, and electrical equipment, appliances, and components. Typical processes found in this group include re-melting operations followed by casting or molding, shaping, heat treating processes, coating, and joining and assembly. Given this diversity of processes, the industry group's energy is characterized by the generic end uses in 2006 MECS.²³ These end-use processes are shown in Figure 11.

Figure 11. Metal-based durables industry end uses

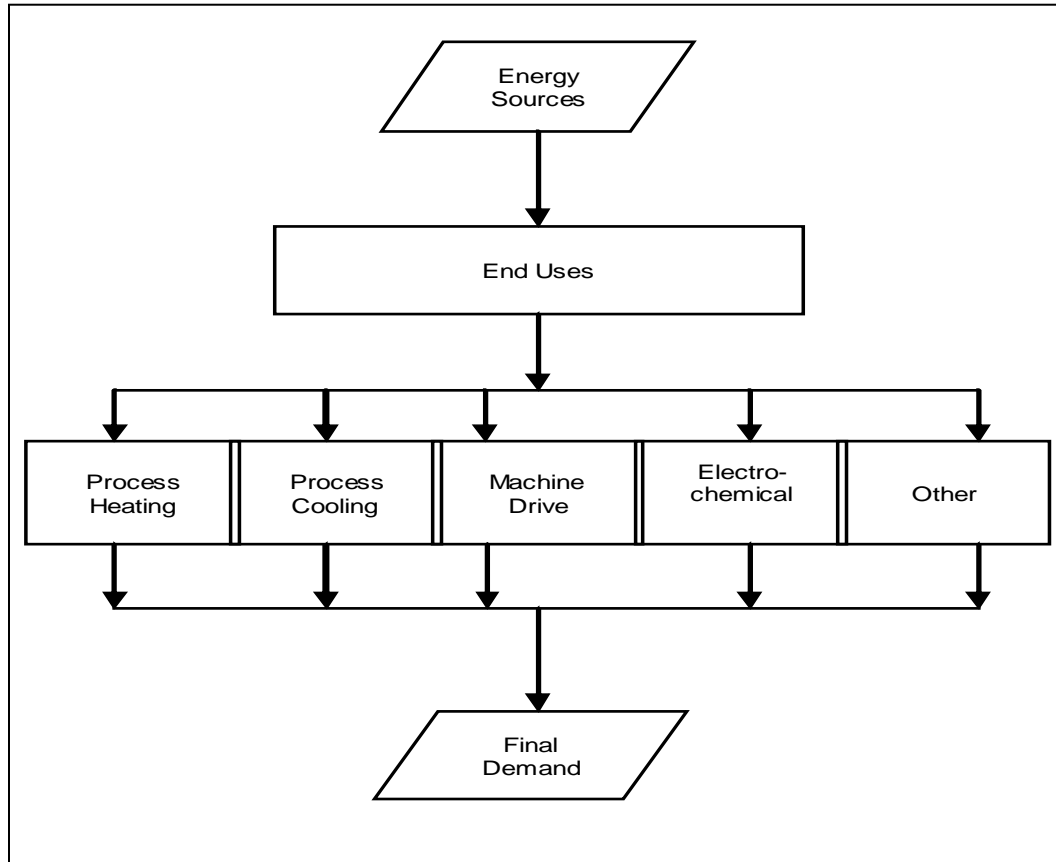

The metal-based durables group has been disaggregated into five component sectors shown in Table 3. In 2006, the metal-based durables industry consumed 1.3 quadrillion Btu of energy.²⁴ A motor stock model, which is described later in this document, calculates electricity consumption for the machine drive end use. Estimated unit energy consumption values for the other end uses in the PA component for the metal-based durables industry are given in Table B.10.

²³ U.S. Energy Information Administration (EIA), *2006 Manufacturing Energy Consumption Survey*, <http://www.eia.gov/consumption/manufacturing/>, June 2009. Note that the IDM's energy consumption projection for 2006 may vary slightly from the 2006 MECS values due to the inclusion of data from the electricity data forms and model dynamics.

²⁴ U.S. Energy Information Administration (EIA), *2006 Manufacturing Energy Consumption Survey*, <http://www.eia.gov/consumption/manufacturing/>, June 2009. Note that the IDM's energy consumption projection for 2006 may vary slightly from the 2006 MECS values due to the inclusion of data from the electricity data forms and model dynamics.

Other non-energy-intensive manufacturing industries

This is a group of miscellaneous industry sectors ranging from the manufacture of tobacco and leather products to furniture and textiles. This industry group's PA energy is characterized by the same generic end uses as the metal-based durables industry. Data limitations and the lack of a dominant energy user limit disaggregation of these industries. Using the 2006 MECS data, wood products (NAICS 321) and plastics manufacturing (NAICS 326) have been separately specified (Table 4). Wood products manufacturing is of interest because the industry derives 52 percent of its energy from biomass in the form of wood waste and residue. The plastics manufacturing industry produces goods by processing goods from plastic materials but does not produce the plastic. Approximately 55 percent of plastics manufacturing's energy consumption is electricity. Together, the wood products and plastics industries account for 788 trillion Btu of energy (4 percent of manufacturing) and 7 percent of manufacturing value of shipments.²⁵ The remaining industries are aggregated into "Balance of Manufacturing."

Table 4. Components of metal-based durables manufacturing

Sectors	NAICS	2006 Unit Energy	Shipments Growth Rate,
		Consumption (thousand Btu per dollar)	Percent (2006-2040)
Fabricated metals	332	1.321	0.8
Machinery	333	0.623	2.1
Computers and electronics	334	0.635	1.9
Transportation equipment	336	0.683	2.3
Electrical equipment, appliances, and components	335	0.526	1.7
Total Metal-Based Durables		0.755	2.0

Table 5. Components of other non-energy-intensive manufacturing

Sectors	NAICS	2006 Unit Energy	Shipments Growth Rate,
		Consumption (thousand Btu per dollar)	Percent (2006-2040)
Wood Products	321	3.630	0.2
Plastics and Rubber Products	326	1.744	0.8
Balance of Manufacturing	NA	1.562	1.6
Total		1.761	1.4

²⁵ U.S. Energy Information Administration (EIA), *2006 Manufacturing Energy Consumption Survey*, <http://www.eia.gov/consumption/manufacturing/>, June 2006.

In 2006, the other non-energy-intensive manufacturing industries consumed over 2 quadrillion Btu of energy.²⁶ A motor stock model, which is described later in this document, calculates electricity consumption for the machine drive end use. Unit energy consumption estimates for the other end uses in the PA component of the balance of manufacturing group are given Table B.11.

Non-manufacturing industries

The non-manufacturing industries do not have a single source for energy consumption data as the manufacturing industries do. Instead, UECs for the agriculture, mining, and construction industries are derived from various sources collected by a number of federal agencies. Furthermore, unlike the majority of manufacturing industries, the TPCs for non-manufacturing are not “fixed” in that they are dynamic and change over time. This dynamic process depends on output from other NEMS modules such as the Buildings Demand Module and on transportation equipment efficiencies, which are employed in the agriculture and construction models, as well as oil and gas well and coal mine productivity which is employed in the mining model.

Energy consumption data for the two agriculture sectors (crops and other agriculture) are largely based on information contained in the Census of Agriculture conducted by the U.S. Department of Agriculture,²⁷ and a special tabulation from the USDA-NASS.²⁸ Expenditures for four energy sources were collected for crop farms and livestock farms. These data were converted from dollar expenditures to energy quantities using prices from the Department of Agriculture and the EIA.

The mining industry is divided into three sectors in the Industrial Demand Module – coal mining, oil and gas extraction, and other mining. The quantities of seven energy types consumed by 29 mining sectors were collected as part of the 2007 Economic Census of Mining by the U.S. Census Bureau.²⁹ The data for the 29 sectors were aggregated into the three sectors included in the Industrial Demand Module and the physical quantities were converted to Btu for use in NEMS.

Only one construction sector is included in the Industrial Demand Module. Detailed statistics for the 31 construction subsectors included in the 2007 Economic Census were aggregated. Expenditure amounts for five energy sources were collected by the U.S. Census Bureau.²⁹ These expenditures were converted from dollars to energy quantities using EIA prices.

These three sources are considered to be the most complete and consistent data available for each of the three non-manufacturing sectors. These data, supplemented by available EIA data, are used to

²⁶ U.S. Energy Information Administration (EIA), *2006 Manufacturing Energy Consumption Survey*, <http://www.eia.gov/consumption/manufacturing/>, June 2006.

²⁷ U.S. Department of Agriculture, National Agricultural Statistical Service, *2007 Census of Agriculture*, February 2009 <http://www.agcensus.usda.gov/Publications/2007/index.asp>.

²⁸ Jim Duffield, USDA-NASS, *2007 Census of Agriculture Special Tabulation*, April 2010, http://www.nass.usda.gov/Data_and_Statistics/Special_Tabulations/index.asp.

²⁹ U.S. Department of Commerce, Census Bureau, *Economic Census 2007: Mining and Construction Industry Series*, 2009, <http://www.census.gov/econ/census07/>.

derive total energy consumption for the non-manufacturing industrial sectors. The additional EIA data sources include the *State Energy Data System 2009*,³⁰ the *2006 MECS*,³¹ and *Fuel Oil and Kerosene Sales 2007*.³² The source data relate to total energy consumption and provide no information on the processes or end uses for which the energy is consumed. Therefore, the UECs for the mining and construction industries relate energy consumption for each fuel type to value of shipments. For the two agricultural industries in IDM a sub-model was implemented and is described below. These UECs are presented in Table B.12 for the non-manufacturing industries.

Agricultural sub-model

U.S. agriculture consists of three major sub-sectors: crop production, which is dependent primarily on regional environments and crops demanded; animal production, which is largely dependent on food demands and feed accessibility; and all remaining agricultural activities, which is primarily composed of forestry and logging. The energy use analysis accounts for energy used in the following categories, with the second and third category combined for modeling purposes:

- Crop Production and Support Activities (NAICS 111 & 1151)
- Animal Production and Support Activities (NAICS 112 & 1152)
- Forestry and Logging and Support Activities (NAICS 113 & 1153)

Consumption in these industries is tied to specialized equipment, which often determines the fuel requirement with little flexibility. Within each of these sub-industries the key energy-using equipment can be broken into three major categories: off-road vehicles, buildings, and other equipment, which is primarily irrigation equipment for crop production. In the IDM, building energy consumption is driven by building characteristics retrieved from the NEMS Commercial Demand Module, and vehicle energy consumption is driven by vehicle efficiencies, by type of fuel, retrieved from the NEMS Transportation Sector Module.³³

Mining sub-model

The mining sector comprises three sectors: coal mining, metal and nonmetal mining, and oil and gas extraction. Energy use is based on what equipment is used at the mine and onsite vehicles used. All mines use extraction equipment and lighting, but only coal and metal and nonmetal mines use grinding and ventilation. Characteristic of the nonmanufacturing sector, TPCs are influenced by efficiency changes in buildings and transportation equipment.

Coal mining production is obtained from the NEMS Coal Market Module (CMM). Currently, it is assumed that 70 percent of the coal is mined at the surface and the rest is mined underground. As these shares evolve, however, so does the energy consumed because surface mines use less energy overall than underground mining. Moreover, the energy consumed for coal mining depends on coal mine

³⁰ Energy Information Administration, *State Energy Data System 2009* (Washington, DC, June 2011).

³¹ Energy Information Administration (EIA), *2006 Manufacturing Energy Consumption Survey*, <http://www.eia.gov/consumption/manufacturing/>, June 2009.

³² Jim Duffield, USDA-NASS, *2007 Census of Agriculture Special Tabulation*, April 2010, http://www.nass.usda.gov/Data_and_Statistics/Special_Tabulations/index.asp.

³³ SAIC Task 1.7 report, TBD.

productivity which is also obtained from the CMM. Diesel fuel and electricity are the predominant fuels used in coal mining. Electricity used for coal grinding is calculated using the raw grinding process step from the cement submodule. In metal and non-metal mining, energy use is similar to coal mining. Output used for metal and non-metal mining is derived from the Macroeconomic Analysis Module's (MAM) variable for "other" mining which also provides the shares of each.

For oil and natural gas extraction, production is derived from the OGSM module. Energy use depends upon the fuel extracted as well as whether the well is conventional or unconventional, e.g. extraction from tight and shale formations, percentage of dry wells, and well depth.

Construction sub-model

Construction uses diesel fuel, gasoline, asphalt and road oil, as well as electricity and natural gas. Asphalt and road oil are tied to state and local government real investment in highways and streets, and this investment is derived from the MAM. TPCs for diesel and gasoline fuels are directly tied to the Transportation Demand Module's heavy- and medium-duty vehicle efficiency projections. For non-vehicular construction equipment, TPCs are a weighted average of vehicular TPCs and highway investment.

Technology possibility curves, unit energy consumption, and relative energy intensities

Technology possibility curves (TPCs) are used to derive future improvements in unit energy consumption (UEC). Future energy improvements were estimated for old (retrofit) and new processes/facilities. The energy improvements for grouped old facilities consist of gradual improvements due to energy conservation measures, retrofit of selected technologies, and the closure of older facilities, leaving the more-efficient plants in operation. The energy savings for old processes/facilities were estimated using engineering judgment regarding how much energy savings could be reasonably achieved in each industry. The estimated annual energy savings for each energy conservation measure are up to 0.5 percent per year.

Unit energy consumption values for the state-of-the-art (SOA) and advanced technologies are also estimated. SOA technologies are the latest proven technologies that are available at the time a commitment is made to build a new plant. These values are then compared to the 2006 unit energy consumption values to develop an index of relative energy intensity (REI). Relative energy intensity is defined as the ratio of energy use in a new or advanced process compared to 2006 average energy use (Table B.14).

The efficiency improvement for new facilities assumes the installation includes the SOA technologies available for that industry. A second and often more important set of substantial improvements is often realized when advanced technologies become available for a specific process. Often one sees a number of technologies being developed and it is difficult to ascertain which specific technologies will be successful. Some judgment is necessary as to the energy-saving potential and the likelihood for such savings to be realistically achieved. All energy improvements in the Industrial Demand Module are based on 2006 energy usage.

Additionally, even SOA technologies and advanced technologies can sometimes be expected to improve after development as the process is improved, optimal residence times and temperatures are found, and better energy recovery techniques are installed. Depending on the process, these are factored into the projections as slow improvements ranging from zero to a maximum of just under 1 percent/year.

Old facilities are assumed to be able to economically justify some retrofits and, for other reasons listed above, show slow improvements over time in their unit energy consumption. It is assumed that by 2035, old equipment (2006 stock) still operating can achieve up to 50 percent of the energy savings of SOA technology due to retrofits and other reasons listed above. Thus, if SOA technology has an REI of 0.80, old equipment operating in the year 2035 will have an REI of 0.90. As a convenience for modeling purposes, the rate of change between the initial and final points is defined as the technology possibility curve (TPC) and used to interpolate for the intervening points. The TPCs for the reference case are given in Table B.14. For scenario analysis, a set of TPCs that reflect more rapid technology changes are also given in Appendix B. The TPCs for the high technology case are given in Table B.16. The list of SOA and advanced technologies considered in the analysis is presented in Table B.18.

Advanced technologies are ones that are still under development and will be available at some time in the future. It is uncertain which specific technologies will be implemented, but it can be assumed with reasonable certainty that at least one of these technologies or a similar technology will be successful. It is also recognized that in some instances thermodynamic limits are being approached, which will prevent further significant improvements in energy savings.

The annual UEC for the old and new vintage is calculated as the product of the previous year's UEC and a factor that reflects the assumed rate of intensity decline over time and the impact of energy price changes on the assumed decline rate:

$$Enpint_{v,f,s} = EnpintLag_{v,f,s} * (1 + TPCRate_v) \quad (1)$$

where

$Enpint_{v,f,s}$ = Unit energy consumption of fuel f at process step s for vintage v ;

$EnpintLag_{v,f,s}$ = Previous year's energy consumption of fuel f at process step s for vintage v ; and

$TPCRate_v$ = Energy intensity decline rate after accounting for the impact of increased energy prices.

The $TPCRate_v$ are calculated using the following relationships if the fuel price is higher than it was in 2006. Otherwise, the default value for the intensity decline rate is used, $BCSC_{v,f,s}$.

$$X = TPCPrat^{TPCBeta}$$

$$TPCPriceFactor = 2 * \frac{X}{(1+X)} \quad (2)$$

$$TPCRate_v = TPCPriceFactor * BCSC_{v,f,s}$$

where

$TPCPrat$ = Ratio of current year average industrial energy price to 2006 price;

$TPC Beta$ = Parameter of logistic function, currently specified as 4;

$TPCPriceFactor$ = TPC price factor, ranging from 0 (no price effect) to 2 for ENPINT

$TPCRate_v$ = Intensity decline rate after accounting for changes due to energy price increases for vintage v ; and

$BCSC_{v,f,s}$ = Default intensity rate for old and new vintage v for each fuel f and step s .

Motor model

Electricity consumption by the machine drive end use for the food, bulk chemicals, metal-based durables, and balance of manufacturing industries is modeled differently than for the other end uses in these industries. Instead of using the TPC approach described above, a motor stock model calculates machine drive electricity consumption. Seven motor size groups are tracked for each industry: 1-5 horsepower (hp), 6-20 hp, 21-50 hp, 51-100 hp, 101-200 hp, 201-500 hp, and >500 hp.

The data for the basic motor stock model were derived from *United States Industrial Electric Motor Systems Market Opportunities Assessment*,³⁴ a report produced for the U.S. Department of Energy's Office of Industrial Technologies (Table B.19). Section 313 of *The Energy Independence and Security Act of 2007* (EISA2007) increased the minimum efficiency of motors to reflect National Electrical Manufacturers Associations Premium Efficiency requirements, effective no later than 2011. These revised standards simplify the model code since only premium efficiency motors can be purchased.

³⁴ U.S. Department of Energy, *United States Industrial Electric Motor Systems Market Opportunities Assessment* (Burlington, MA, December 1998).

The motor stock model can be broken down into five sections. The steps are outlined as follows:

- For each failed motor, evaluate whether the motor is repaired or replaced. The cost and performance characteristics for the motor options are from the MotorMaster+ version 4.0 software (Table B.20).
- Determine the cost differential for replacing the motor. This is the difference between the cost of the new motor meeting minimum efficiency standards and the cost of repairing the motor.
- Determine the annual electricity expenditure savings from replacing the motor. This calculation requires the rated motor horsepower, the average motor part-load, the conversion factor from horsepower to kilowatts, the annual operating hours for the motor, the industrial electricity price, the efficiency rating for minimum efficiency motor, and the efficiency rating for a repaired motor. For purposes of the analysis, the electricity price is assumed to remain constant at the level in the year the choice is made.
- Determine the payback period needed to recover the cost differential for replacing the motor. The payback is determined by dividing the new motor cost differential by the annual electricity expenditure savings.
- Assess the market penetration for replacement motors based on the payback period and the payback acceptance curve.
- Given the payback for each motor size group in each industry, estimate the fraction of replacement motors purchased. This analysis begins with an assumed distribution of required investment payback periods, deemed the payback acceptance curve (Table B.21). In the table, for each integer payback period from 0 to 4 years, a fraction of new motors is specified. This quantifies the notion that the shorter the payback, the greater the fraction of firms that would choose the higher efficiency option, in this case replacing a failed motor.
- Determine the number of new motors purchased as a result of replacements. This is the difference between the total number of motors failed and the number of replacement motors purchased.
- Determine the change in the motor stock for the year. Tracking the number, vintage, and condition of motors in the stock is necessary for calculating average efficiency and average electricity consumption for the machine drive end use.
- Given the value of shipments growth for each industry and the number of new motors purchased to replace failed motors, total purchases of new motors for each size group within each industry can be determined. The new motors will have a higher efficiency than the beginning stock.
- Given the assumed failure rate for the beginning stock of motors and the number of failed motors replaced, the number of rewind motors for each size group within each industry can be determined. Rewinding typically reduces the efficiency of motors.
- Those motors in the beginning stock for the period that were not retired or rewind remain at their previous efficiency.

Calculate the average efficiency of the end-of-year motor stock and the average electricity consumption for machine drive.

- Determine the average electricity consumption for the motor stock as a weighted average of the electricity consumption for new premium efficiency motors, rewind motors, and surviving motors.
- Determine the average efficiency for the motor stock as a weighted average of the efficiency for new premium efficiency motors, rewind motors, and surviving motors.
- Calculate the total electricity consumption for machine drive and the effect of system efficiency improvements. Efficiency improvements in the machine drive end use can be accomplished by modifying the system within which the motor operates as well as by choosing a more efficient motor.
- Determine the total electricity consumption for the motor stock from the stock of motors and the average efficiency.
- Determine the adjusted total electricity consumption for the motor stock. Several parameters may be modified to reflect the assumptions on how the motor systems will change. There are three main types of motor systems: pump systems, fan systems, and compressor systems. For each of these types, there is a parameter that represents the total percentage of motor systems within an industry by type, and one for the amount by which the system efficiency can be improved.

Boiler, steam, cogeneration component

The boiler, steam, cogeneration (BSC) component projects consumption of energy to meet the steam demands from the other two components and to provide internally generated electricity to the buildings and process and assembly components. The BSC component calculates the consumption of fuels and renewable energy to produce the steam and, in appropriate situations, cogenerate electricity.

The use of fuels to produce both heat and electric power in a single unit, the cogeneration element of the BSC component, represents technology implemented in industry for efficiency, which also provides a financial benefit. Some industries have been operating cogeneration plants for more than 40 years; however, due to various incentives and barriers during periods of scarce capital, varying interest rates, and changes in product demands the popularity of cogeneration has grown and declined historically. The modeling approach in the Industrial Demand Module captures both the benefits and risks in determining new capacity, because a well-developed understanding of industrial steam generation is critical, especially under changing outlooks for natural gas and electricity supply and price to industrial end users.

The steam demand and byproducts from the PA and BLD components are passed to the BSC component, which allocates the steam demand to conventional boilers and to cogeneration. The allocation is based upon an estimate of useful thermal energy supplied by cogeneration plants. Energy for cogeneration is subtracted from total indirect fuel use as reported in MECS (given in Table B.22) to obtain conventional boiler fuel use and the associated steam. Assumed average boiler efficiency and a fuel sharing equation are used to estimate the required energy consumption to meet the steam requirement from conventional boilers.

The boiler fuel shares are calculated using a logistic formulation based on data from the 2006 MECS. Waste and byproduct fuels are excluded from the equation because they are assumed to be consumed first. The equation for each industry is as follows:

$$ShareFuel_i = \frac{(P_i^{-1.5} \beta_i)}{\sum_{i=1}^3 P_i^{-1.5} \beta_i} \quad (3)$$

where i is the i^{th} fuel (coal, petroleum, and natural gas). The P_i are the fuel prices relative to 2006 prices; and the exponent on P_i is a sensitivity parameter, assumed equal to -1.5 for all i ; and the β_i are calibrated to reproduce the 2006 fuel shares using the relative prices that prevailed in 2006. The byproduct fuels are consumed before the quantity of purchased fuels is estimated.

Cogeneration capacity, generation, fuel use, and thermal output are determined from exogenous data and new additions are simulated, as needed, using endogenous engineering and economic evaluation. Existing cogeneration capacity and planned additions are derived from EIA's Form 860B (and predecessor) survey. The most recent data used are for 2008, with planned additions (units under construction) through 2012.

The data are processed outside the model to separate industrial cogeneration from commercial sector cogeneration, cogeneration from refineries and enhanced oil recovery operations, and offsite cogeneration. Offsite cogeneration units are primarily merchant power plants selling to the grid, often supplying relatively small amounts of thermal energy available for industrial uses. The remainder, or onsite industrial cogeneration portion, was approximately 41 percent of the total cogeneration capacity in 2006. The cogeneration data are available on a plant basis and include capacity, generation, useful thermal energy, energy use by fuel, and the shares of that energy for electricity and thermal. The data are aggregated by Census region, industry, and fuel type for input to the model.

The modeling of unplanned cogeneration begins with model year 2009, under the assumption that planned units under construction cover only some of the likely additions through 2012. In addition, it is assumed that any existing cogeneration capacity will remain in service throughout the projection, or equivalently, will be refurbished or replaced with like units of equal capacity. The modeling of unplanned capacity additions is done for two capacity types: biomass-fueled and fossil-fueled. Biomass cogeneration is assumed to be added as increments of biomass waste products are produced, primarily in the pulp and paper industry. The amount of biomass cogeneration added is equal to the quantity of new biomass available (in Btu), divided by the total heat rate assumed from biomass steam turbine cogeneration.

Unplanned additions to fossil-fueled cogeneration are projected based on an economic assessment of capacity that could be added to generate the industrial steam requirements that are not already met by existing cogeneration. The driving assumption is that the technical potential for traditional cogeneration is primarily based on supplying thermal requirements. We assume that cogenerated electricity can be used to either reduce purchased electricity or it can be sold to the grid. For simplicity, the approach

adopted is generic and the characteristics of the cogeneration plants are set by the user. The fuel used is assumed to be natural gas based on a study performed for EIA.³⁵

The steps to the approach are outlined as follows:

- Assess the steam requirements that could be met by new cogeneration plants.
- Given total steam load for the industry in each region from the process-assembly and buildings components, subtract steam met by existing cogeneration units.
- Classify non-cogenerated steam uses into six size ranges, or load segments, based on an exogenous data set³⁶ providing the boiler size distribution for each industry and assuming that steam loads are distributed in the same proportions as boiler capacity (Table B.23). Also obtained from the same exogenous data set is the average boiler size (in terms of fuel input per hour) in each load segment, which is used to size the prototypical cogeneration system in each load segment. The prototype cogeneration system sizing is based on the steam generated by the average-sized boiler in each load segment.
- Establish the average hourly steam load in each segment from the aggregate steam load to determine total technical potential for cogeneration (discussed further below).
- Evaluate a gas turbine system prototype for each size range.
- A candidate cogeneration system is established for each load segment with thermal output that matches the steam output of the average-sized boiler in each load segment. To do this, the user-supplied characteristics for eight cogeneration systems are used (Table B.24); the high technology case uses the characteristics in Table B.25. The characteristics used in the calculation include:
 - Net electric generation capacity in kilowatts
 - Total installed cost, in 2005 dollars per kilowatt hour-electric
 - System capacity factor
 - Total fuel use per kilowatt hour
 - Fraction of input energy converted to useful heat and power
- From the above user-supplied characteristics, the following additional parameters for each system are derived:
 - Fraction of input energy converted to electric energy, or electric energy efficiency
 - Electric generation from the cogeneration plant in megawatt hours
 - Cogeneration system fuel use per year in billion Btu
 - Power-steam output ratio
 - Steam output of the cogeneration system

³⁵ SENTECH Inc., *Commercial and Industrial CHP Technology Cost and Performance Data for EIA*, report prepared for the Office of Integrated Analysis and Forecasting, Energy Information Administration, Washington, DC, June 2010.

³⁶ Energy and Environmental Analysis, Inc, *Characterization of the U.S. Industrial Commercial Boiler Population*, submitted to Oak Ridge National Laboratory, May 2005.

- Determine the investment payback period needed to recover the prototypical cogeneration investment for each of the eight system sizes. The analysis considers the annual cash flow from the investment to be equal to the value of the cogenerated electricity, less the cost of the incremental fuel required to generate it discounted using the 10-year Treasury bill rate as projected in the MAM plus a risk premium. For this purpose, the annual cost of fuel (natural gas) and the value of the electricity are based on the prices in effect in the model year in which the evaluation is conducted. The model assumes that the electricity is valued at the average industrial electricity price in the region, net of standby charges that would be incurred after installing cogeneration. The standby charges were assumed to be some fraction of the industrial electricity rate (usually 10 percent). For natural gas, the price of firm-contract natural gas was assumed to apply. Since a simplified representation is required for the broad modeling needs in the IDM, non-fuel operating costs are not included. The costs are small relative to fuel costs and can be difficult to quantify with aggregate, load segment methodology being used as well. The payback is determined by dividing the investment by the average annual cash flow.
- Assess market penetration based on discounted payback and payback acceptance curve.
- Determine the maximum technical potential for cogeneration under the assumption that all non-cogeneration steam for each load segment is converted to cogeneration. This assumes that the technical potential is based on 1) sizing systems, on average, to meet the average hourly steam load in each load segment and 2) the power-steam ratio of the prototype cogeneration system.
- Given the payback for the prototype system evaluated, estimate the fraction of total technical potential that is considered economical. To do this, we start with an assumption about the distribution of required investment payback periods called the payback acceptance curve (Table B.27). For each integer payback period from 0 to 12 years, the table provides a fraction of cogeneration investments that would be considered acceptable. This quantifies the notion that the shorter the payback, the greater the fraction of firms that would be willing to invest. It can also capture the effect that market barriers have in discouraging cogeneration investment.
- Given the total economic potential for cogeneration, estimate the amount of capacity that would be added in the current model year. The annual capacity additions are estimated assuming linear market penetration over a 20-year time period. Thus, 5 percent of the economic potential is adopted each year. Since the amount of technical and economic potential is reevaluated in each model year as economic conditions and steam output change, the annual additions will vary. However, over the 25-year projection horizon, if economic conditions remained constant and steam loads did not increase, the cumulative capacity additions would be equal to the total economic potential determined in the first model projection year.

Model assumptions

Capital stock and vintaging

Industrial energy consumption is affected by increased energy efficiency in new and old plants, the growth rate of the industry, and the retirement rate for old plants. The efficiency changes are captured in the TPCs and the rate of growth is given by the Macroeconomic Activity Module (MAM). The Industrial Demand Module (IDM) capital stock is grouped into three vintages: old, middle, and new. The old vintage consists of capital in production in 2006 and is assumed to retire at a fixed rate each year.

Middle vintage capital is that which is added from 2006 through the Year-1, where Year is the current projection year. New capital is added in the projection years when existing production is less than the output projected by the MAM. Capital stock added during the projection period is retired in subsequent years at the same rate as the pre-2007 capital stock. The retirement rates used in the IDM for the various industries are listed in Table B.14.

Estimates of existing old and middle vintage production are reduced by the retirement rate of capital through the equations below. The retirement rate is posited to be a positive function of energy prices. For years after 2006, the *RetirePrat* is calculated as the greater of 1 or the ratio of the current year's average industrial energy price to the average price in 2006.

$$X = \text{RetirePrat}^{\text{RetireBeta}}$$

$$\text{RetirePriceFactor} = 2 * \frac{X}{(1+X)} \quad (4)$$

$$\text{RetireRate}_s = \text{RetirePriceFactor} * \text{ProdRetr}_s$$

where

RetirePrat = Maximum (1, ratio of current year average industrial energy price to 2006 price),

RetireBeta = Parameter of logistic function, currently specified as 2 for capital stock retirement,

RetirePriceFactor = TPC price factor, ranging from 0 (no price effect) to 2,

RetireRate_s = Retirement rate after accounting for energy price increases for step *s*,
and

ProdRetr_s = Default retirement rate for step *s*

Renewable fuels

Renewable fuels are modeled in the same manner as all other fuels in the IDM. Renewable fuels are modeled both in the PA component and the BSC component. The primary renewable fuels consumed in the industrial sector are pulping liquor, a byproduct of the chemical pulping process in the paper industry, and wood.

Recycling

With projected higher landfill costs, regulatory emphasis on recycling, and potential cost savings, recycling of post-consumer scrap is likely to grow. Projecting such growth, however, is highly dependent on assessing how regulations will be developed, the growth of the economy, and issues related to the quality of recycled materials. Secondary processing of aluminum is now modeled in the Aluminum_Industry submodule as a process flow and investment option.

Legislative requirements

The Energy Policy Act of 1992 (EPACT92) and the Clean Air Act Amendments of 1990 (CAAA) contain requirements that are represented in the Industrial Demand Module. These requirements fall into three main categories: coke oven standards; efficiency standards for boilers, furnaces, and electric motors; and industrial process technologies. The IDM assumes the leakage standards for coke oven doors do not reduce the efficiency of producing coke, or increase unit energy consumption. The IDM uses heat rates of 1.25 (80 percent efficiency) and 1.22 (82 percent efficiency) for gas and oil burners, respectively. These efficiencies meet the EPACT92 standards. The EPACT92 electric motor standards set minimum efficiency levels for all motors up to 200 horsepower purchased after 2002. The EISA2007 increases the motor efficiency standard for all motors up to 500 horsepower purchased after 2011. All motors represented in the motor model are at least as efficient as the standards for a given projection year. The IDM incorporates the necessary reductions in unit energy consumption for the energy-intensive industries.

Section 108 of the Energy Policy Act of 2005 (EPACT05) requires that federally funded projects involving cement or concrete increase the amount of recovered mineral component (e.g., fly ash or blast furnace slag) used in the cement. Such use of mineral components is a standard industry practice, and increasing the amount could reduce both the quantity of energy used for cement clinker production and the level of process-related CO₂ emissions. Because the proportion of mineral component is not specified in the legislation, possible effects of this provision are not currently simulated in the model. When specific regulations are promulgated, their estimated impact may be modeled in NEMS. However, the current cement industry model does include the capability to increase the amount of blended component in the clinker mix.

Section 1321 of EPACT05 extends the Section 29 Production Tax Credit (PTC) for non-conventional fuels to facilities producing coke or coke gas. The credit is available for plants placed in service before 1993 and between 1998 and 2010. Each plant can claim the credit for 4 years; however, the total credit is limited to an annual average of 4,000 barrels of oil equivalent (BOE) per day. The value of the credit is currently \$3.00 per BOE, and will be adjusted for inflation in the future. Because the bulk of the credits will go to plants already operating or under construction, there is likely to be little impact on coke plant capacity.

Cogeneration

The cogeneration assessment described above in the boiler, steam, cogeneration IDM component above requires three basic sets of assumptions: 1) cost and performance characteristics of prototypical facilities in various size ranges; 2) data to disaggregate steam loads by industry into several size ranges, or load segments; and 3) market penetration assumptions to quantify the relationship between the economics of cogeneration and its adoption over time. The cogeneration assumptions used for the AEO are presented in Table B.23, Table B.24, Table B.25, and Table B.26.

Benchmarking

The IDM energy demand projections are benchmarked to historical data values presented in *Annual Energy Review 2010*.³⁷ The national-level values reported in *Annual Energy Review 2010* were allocated to the Census Divisions using the *State Energy Data Report 2009*.³⁸ The benchmark factors are based on the ratio of the SEDS value of consumption for each fuel to the consumption calculated by the model at the Census Division level.

³⁷ U.S. Energy Information Administration, *Annual Energy Review, 2010*, <http://www.eia.gov/state/seds/>.

³⁸ U.S. Energy Information Administration, *State Energy Data System Report 2009*, <http://www.eia.gov/state/seds/>

4. Model Structure

Outline of model

A flow diagram of the Industrial Demand Module solution is provided in Figure 12. The solution outline that follows provides some elaboration of the items in Figure 12. This section is followed by a section covering each subroutine of the solution outline in detail.

Figure 12. Flow diagram of module solution

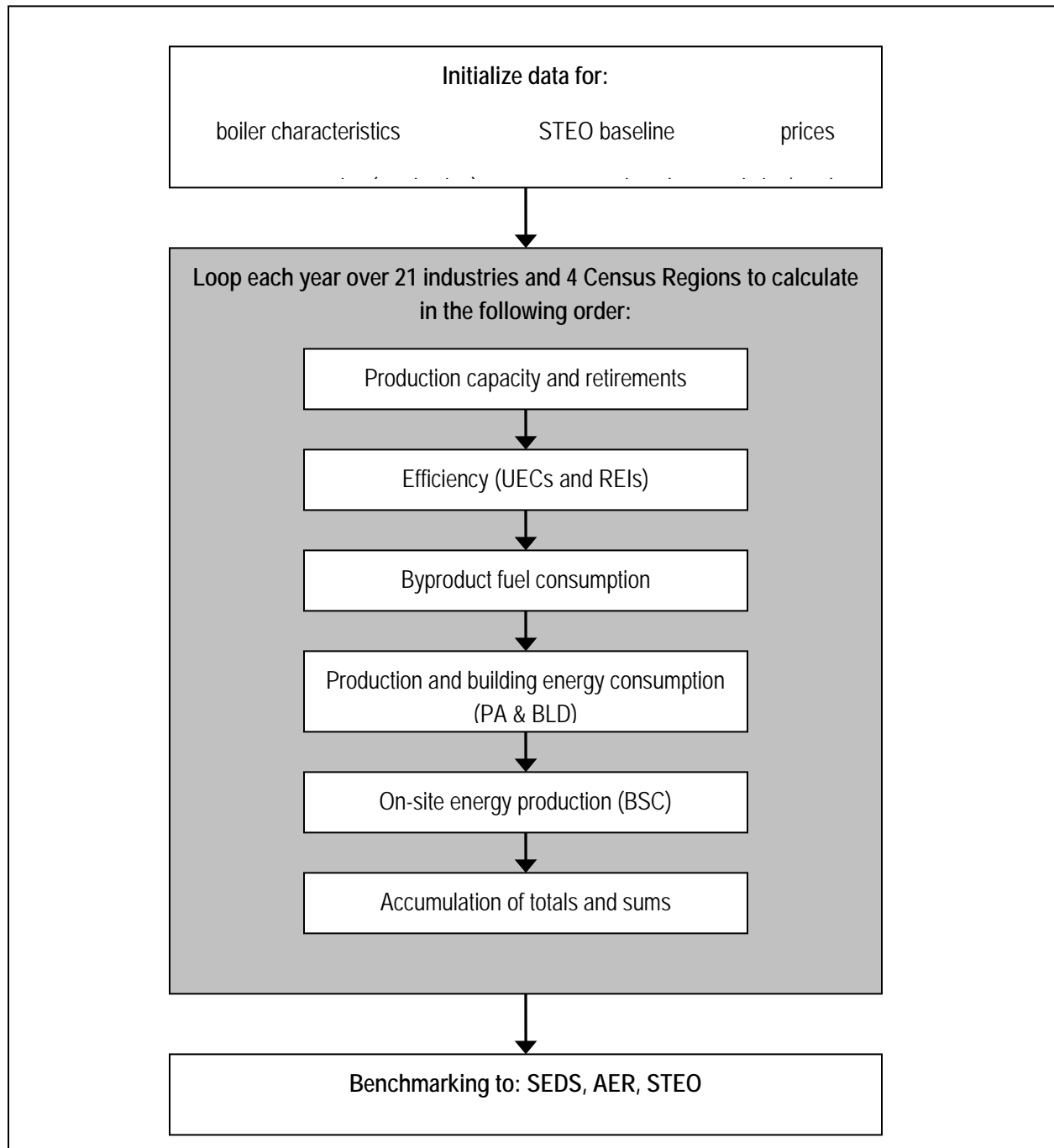

First Year: Initialize Data

- RCNTL: Read Control Options
- IRCOGEN: Read cogeneration data files (called from IND)
- MecLess860B: Calculate 2006 boiler fuel by subtracting Form 906 cogeneration fuel from 2006 MECS indirect fuels
- REXOG: Assign exogenous macroeconomic and energy price variables that come from NEMS.
 - EvalCogen: Evaluate investment payback of a cogeneration system in a given year
- CALBSC: Estimate boiler fuel shares as a function of changing boiler fuel prices
- CALSTOT: Compute energy consumption in the Boiler-Steam-Cogeneration (BSC) component
- WRBIN: Write memory management file with data on current industry, region
- INDTOTAL: Accumulate total energy consumption for the industry
- IEDATA: Read ENPROD file with industry production parameters, base year industrial output, UECs, elasticities and other coefficients; much of the data originally read from ENPROD is now read from two files, ITECH.TXT and PRODFLOW.TXT via subroutines UECTPC and MECS2006, respectively
- MECS2006: Read PRODFLOW.TXT containing process/assembly step definitions and flow rates from most recent MECS data (2006)
- UECTPC: Read ITECH.TXT file with MECS-based UEC rates and the TPC assumptions
- IRSTEO: Read Short Term Energy Outlook file with last available history data and national projections for the next two years

Industry Processing

Loop through each of 21 industry groups, including six non-manufacturing, seven energy-intensive, and eight non-energy-intensive manufacturing industries. For each industry, loop through each of four Census regions

- RDBIN: Read memory management file with previous years' data for this industry and region
- CALPROD: Compute revised productive capacity and throughput by process/assembly step and vintage; implement retirement and vintaging assumptions
- CALCSC: Conservation Supply Curve (CSC): Evaluate changes in UECs based on Technological Possibility
 - AGTPC: Evaluate Technological Possibility for agriculture industries to replace standard CSC values
- LIME_INDUSTY submodule
- CEMENT_INDUSTY submodule, which obtains exogenous inputs from the READ_CEMENT subroutine used by cement and aluminum submodules
- ALUMINUM_INDUSTY submodule, which obtains exogenous inputs from the READ_CEMENT subroutine
- CALBYPROD: Calculate consumption of byproduct fuels
- CALPATOT: Compute consumption of energy in the process assembly component
 - MOTORS: Compute consumption of electricity for machine-drive for end-use industries
- CALBTOT: Compute consumption of energy in the buildings component
- CALGEN: Compute electricity generation for sale and internal use by fuel. Calculates steam for cogeneration and estimates penetration of new builds. Calls the following routines:
 - COGENT: Read cogeneration assumptions spreadsheet (first year)

- SteamSeg: Assign fraction of steam load in current load segment for current industry
- COGINIT: Initialize the cogeneration data arrays with capacity, generation, and fuel use data

National Summaries

- NATTOTAL: Accumulate total energy consumption over all industries
- CONTAB: Accumulate aggregates for non-manufacturing heat and power

Apply exogenous adjustments and assign values to global variables

WEXOG

- SEDS Benchmarking:
 - SEDS years (through 2008): calculate regional benchmark factors as the ratio of actual consumption to model consumption for each fuel in four Census Regions.
 - Post SEDS Years (2009-on): optionally, multiply model consumption by the SEDS benchmark factors.
- Disaggregate energy consumption from four Census Regions to nine Census Divisions using shares from SEDS.
- Calibrate regional energy consumption to match the latest year of national-level history data (from the STEO file).
- STEO Benchmarking
 - STEO years: calculate national benchmark factors as the ratio of model consumption for each fuel to the STEO projection for each fuel.
 - Post-STEO years: optionally, over the period 2010 to 2011, multiply model consumption by the STEO benchmark factors.
- Assign final results to NEMS variables.

Subroutines and equations

This section provides the solution algorithms for the Industrial Demand Module. The order in which the equations are presented follows the logic of the FORTRAN source code very closely to facilitate an understanding of the code and its structure. In several instances, a variable name will appear on both sides of an equation. This is a FORTRAN programming device that allows a previous calculation to be updated (for example, multiplied by a factor) and re-stored under the same variable name. Any calculation (all subroutines) is run for each year, industry, and Census Region unless otherwise indicated. For variables disaggregated to the Census Division level the subscript d will be used to differentiate it from standard regional detail.

IND

IND is the main industrial subroutine called by NEMS. This subroutine calls some data initialization subroutines, including one to retrieve energy price and macroeconomic data (Setup_Mac_and_Price) and routines to solve the model (ISEAM) and to export its results to NEMS global variables (WEXOG).

SETUP_MAC_AND_PRICE

In subroutine "Setup_Mac_and_Price," the value of shipments data from the NEMS MAM is processed. Employment is also obtained from the MAM for each non-agricultural industry. Prices for the various fuels, as well as the previous year's consumption, are obtained from NEMS COMMON blocks. The IDM energy demand projections are benchmarked to values presented in the *Annual Energy Review 2010* in subroutine WEXOG. The national-level values reported in the *Annual Energy Review 2010* are allocated to the Census Divisions using the *State Energy Data Report 2009*. Because detailed data for the IDM are available only for the four Census Regions, the energy prices obtained from NEMS, available for each of the nine Census Divisions, are combined using a weighted average of the fuel prices as shown in the following equation for the first model year. A similar weighted average is used for all other fuels and model years. However, the previous year's consumption is used rather than SEDS consumption.

$$PRCX_{elec} = \frac{\sum_{d=1}^{NUM_r} DPRCX_{elec,d} * QSELIN_{d,2009}}{\sum_{d=1}^{NUM_r} QSELIN_{d,2009}} \quad (5)$$

where

$PRCX_{elec}$ = Price for electricity

NUM_r = Number of Census Divisions in Census Region r ,

$DPRCX_{elec,d}$ = Price of electricity in Census Division d , and

$QSELIN_{d,2009}$ = SEDS consumption of electricity in Census Division d in 2009.

IND calls two subroutines: ISEAM, the subroutine that guides the IDM calculations, and WEXOG, the subroutine that reports the results back to NEMS. The other fuels are calculated in the same manner.

ISEAM

ISEAM controls all of the IDM calculations and initiates some input operations. It opens external files for debugging, binary files for restarting on successive iterations and projection years, and opens the input data files. In the first model year and only on the first iteration, ISEAM calls RCNTRL to read the runtime parameters file (INDRUN.TXT) and base year boiler data (ITLBSHR.TXT). ISEAM also reads a data file, INDBEU.TXT, containing building energy use for lighting, heating, ventilation, and air conditioning. ISEAM calls REXOG to read in exogenous inputs on each model run. For the first model year, ISEAM calls the following subroutines for each Census Region within each industry: IEDATA, UECTPC, CALBYPROD, CALPATOT, CALBTOT, CALGEN, CALBSC, CALSTOT, and INDTOTAL. After the projection for the last Census Region for a particular industry has been calculated, the following two subroutines are called to compute totals: NATTOTAL and CONTAB. After the first model year, ISEAM calls two subroutines, RDBIN to read the restart files, and MODCAL to carry out model calculations. After all model calculations have been completed, ISEAM calculates industry totals and saves information to the restart files in the

subroutine WRBIN. Finally, after each industry has been processed, ISEAM calls the subroutines ADDUPCOGS and INDCGN to aggregate and report industrial cogeneration estimates to NEMS.

RCNTRL

RCNTRL reads data from the input files INDRUN.TXT and ITLBSHR.TXT. The INDRUN.TXT file contains internal control variables for the IDM. Data in this file are based on user defined parameters consisting of indicator variables for subroutine tracing, debugging, writing summary tables, options to calculate model sensitivities, and benchmarking options. The ITLBSHR.TXT data contain estimated 2006 boiler energy use by fuel and is used for calculating boiler fuel shares.

REXOG

REXOG prepares exogenous data obtained from MAM for use in the Industrial Demand Module. Dollar value of shipments and employment are aggregated over the appropriate Census Divisions to obtain data at the Census Region level. The macroeconomic variables used by the IDM are based on NAICS categories beginning with *AEO2006*. Employment data is obtained from NEMS at the three-digit NAICS level. For some industries, employment data must be shared out among industries within a three-digit NAICS level.

IEDATA

IEDATA stands for Industrial ENPROD Data where ENPROD.TXT is the name of the initial industrial input data file. This routine consists of many subprograms designed to retrieve industrial input data.

The call order of these routines is consistent with the data structure of the model. Most of these subroutines perform no calculations and are simply listed with a description of their function. The routines (and replacement routines in parentheses) are as follows:

IRHEADER

The IRHEADER subroutine imports industry and region identifier numbers, base year values of output, physical to dollar output conversion factors, and base year steam demand.

It calculates the ratio of physical output to 2006 value of shipments for pulp and paper, glass, cement, steel and aluminum industries. This constant ratio is applied to value of shipments for subsequent years.

$$PHDRAT = \frac{PHYSICAL}{PRODVX} \quad (6)$$

where

PHDRAT = Ratio of physical units to value of shipments,

PHYSICAL = Physical units of output, and

$PRODVX$ = Value of shipments

If the Unit Energy Consumption (UEC) is in physical units, then the following equation is used.

$$PRODX = PRODVX * PHDRAT \quad (7)$$

where

$PRODX$ = Output in physical units,

$PHDRAT$ = Ratio of physical units to value of shipments, and

$PRODVX$ = Value of shipments.

If the UEC is in dollar units, then the following direct substitution is used:

$$PRODX = PRODVX \quad (8)$$

where

$PRODX$ = Value of shipments, and

$PRODVX$ = Value of shipments.

MECS2006

The MECS2006 subroutine imports production throughput coefficients, process step retirement rates, and other process step flow information from the file PRODFLOW.TXT. Imported process step flow data for each process step include process step number, number of links, the process steps linked to the current step, physical throughput to each process step, retirement rate, and process step name.

A linkage is defined as a link between one or more process steps. The model simulates process steps for five energy-intensive industries: paper, glass, cement, steel, and aluminum; the remaining industries do not have linkages among steps because the steps represent end uses, e.g., refrigeration and freezing in the food products industry, so there is only one down-step throughput. As an example of process step linkage, the wood preparation process step in paper manufacturing is linked to the virgin fibers pulping process step. The down-step throughput is the fraction of total throughput for an industry at a process step if it is linked to the final consumption. If the process step is linked to another process step, then the down-step throughput is the fraction of the linked process step plus the fraction of final consumption. The following example illustrates this procedure.

Let:

Y_1 = Number of tons of paper to be produced.

Y_2 = Number of tons of material to pass through the bleaching process.

Y_3 = Number of tons of material to pass through the waste fiber pulping process.

$Y_4 =$ Number of tons of material to pass through the mechanical pulping process.

$Y_5 =$ Number of tons of material to pass through the semi-mechanical pulping process.

$Y_6 =$ Number of tons of material to pass through the Kraft pulping process.

$Y_7 =$ Number of tons of material to pass through the wood preparation process.

Then, we have the following:

$Y_1 =$ Output, in tons

$Y_2 = 0.502 Y_1$

$Y_3 = 0.317 (Y_1 + Y_2)$

$Y_4 = 0.041 (Y_1 + Y_2)$

$Y_5 = 0.028 (Y_1 + Y_2)$

$Y_6 = 0.377 (Y_1 + Y_2)$

$Y_7 = 1.689 (Y_4 + Y_5 + Y_6)$

If $Y_1 = 96$ million tons of paper produced, then $Y_2 = 48$, $Y_3 = 46$, $Y_4 = 6.5$, $Y_5 = 4$, $Y_6 = 54$, and $Y_7 = 109$.

For the above example, there are 109 million tons of output from the wood preparation process and 46 million tons of output from the waste fiber pulping process. Of the 109 million tons of material passing through the wood preparation process, 10 million tons flow through mechanical pulping, 7 million tons into semi-mechanical pulping, and 92 million tons into the Kraft pulping process. In the IDM, these calculations are performed in an input-output formulation (see CALPROD below for more information).

Physical throughput is obtained for three vintages: old, middle, and new. Old vintage is defined as any capital installed in or before 2006. Middle vintage includes installations from 2007 to the year prior to the current projection year. New vintage includes any capital installed in the current projection year.

In summary, the following subroutines collect data from the input files.

ISEAM

Get building energy use data including lighting, HVAC, facility support, and onsite transportation from INDBEU.TXT.

IRBSCBYP

Get byproduct fuel information for the boiler/steam/cogeneration component. These data consist of fuel identifier numbers of steam intensity values.

RDCNTL

Read INDRUN.TXT and ITLBSHR.TXT. The latter contains base year boiler-fuel use and is used to calculate boiler-fuel shares. Biomass data is retrieved in the IRBSCBYP routine.

IRCOGEN

Get cogeneration information from file EXSTCAP.TXT, including capacity, generation, fuel use, and thermal output from 1990 through 2008. Get corresponding data for planned units from file PLANCAP.TXT.

IRSTEPBYP

Get byproduct data for process and assembly component. These data consist of fuel identifier numbers and heat intensity values.

MECS2006

Get process step data for the energy-intensive industries from PRODFLOW.TXT. These data consist of fuel identifier numbers, base year process step flow rates, and retirement rates.

UECTPC

Read the industrial technology data file (ITECH.TXT) to update the initial ENPROD.TXT data file with 2006 values of UECs and TPCs. The second half of ITECH.TXT is reserved for use in side cases.

IFINLCALC

Calculate initial year values for process step production throughput for the energy-intensive industries.

AGTPC

The AGTPC subroutine calculates the consumption of energy in the agriculture industries by further subdividing consumption in each sub-industry based on the equipment in which the energy is used: off-road vehicles, which are trucks, tractors, and other specialty vehicles; buildings, which require lighting and temperature control; and other equipment, which covers a variety of both common (e.g., pumps) and specialty (e.g., cotton gins) equipment used in all the various types of agricultural production.

Vehicle intensity is calculated as a weighted average using the existing stock of light-, medium-, and heavy-duty trucks. The miles per gallon (MPG) measured by fuel from the Transportation Sector Module is indexed to decline over time.. The TPC for agricultural vehicles is therefore estimated in the model as:

$$VEH_Index_{f,y} = \left(\frac{Trk_Intens_{f,y}}{Trk_Intens_{f,y-1}} \right) - 1 \quad (9)$$

and

$$\text{Trk_Intens}_{f,y} = \frac{1}{\sum_s \text{TFR_TRK_FAS_T}_{s,f,y}} \sum_s \frac{\text{TFR_TRK_FAS_T}_{s,f,y}}{\text{TFR_FTMPG}_{s,f,y}} \quad (10)$$

$\text{VEH_Index}_{f,y}$ = Index used to calculate sub-industry TPC for vehicles for fuel f in year y ,

$\text{Trk_Intens}_{f,y}$ = Average truck energy intensity for fuel f in year y ,

$\text{TFR_TRK_FAS_T}_{s,f,y}$ = Existing truck stock for for fuel f in year y for truck size s , and

$\text{TFR_FTMPG}_{s,f,y}$ = Truck MPG for truck size s for fuel f in year y for truck size s .

Building energy intensity is calculated using an index of heating, lighting, and building shells retrieved from the Commercial Demand Module for warehouses, since this building type is most similar to the types of buildings used in agricultural production. The shares for these three energy users are based on data analysis commissioned by EIA³⁹ and shown in Table 6. The TPC for agricultural buildings is estimated in the model as:

$$\text{BLD_Index}_{r,1,y} = \left(\frac{\text{WHSE_HeatIndex}_{r,f,y}}{\text{WHSE_HeatIndex}_{r,f,y-1}} \right) - 1 \quad (11)$$

$$\text{BLD_Index}_{r,2,y} = \left(\frac{\text{WHSE_LightIndex}_{r,f,y}}{\text{WHSE_LightIndex}_{r,f,y-1}} \right) - 1 \quad (12)$$

$$\text{BLD_Index}_{r,3,y} = \left(\frac{\text{WHSE_ShellIndex}_{r,f,y}}{\text{WHSE_ShellIndex}_{r,f,y-1}} \right) - 1 \quad (13)$$

where

$\text{BLD_Index}_{r,1,y}$ Index, before weighting for heating equipment, used to calculate sub-industry TPC for buildings for region r in year y ,

$\text{BLD_Index}_{r,2,y}$ = Index, before weighting for lighting equipment, used to calculate sub-industry TPC for buildings for region r in year y ,

$\text{BLD_Index}_{r,3,y}$ = Index, before weighting for building shells, used to calculate sub-industry TPC for buildings for region r in year y ,

³⁹ SRA International, "Report on the Analysis and Modeling Approach to Characterize and Estimate Fuel Use by End-Use Applications in the Agriculture and Construction Industries," unpublished report prepared for the U.S. Energy Information Administration, March 2011.

$WHSE_HeatIndex_{r,f,y}$ = Composite of warehouse energy consumption in heating equipment retrieved from the Commercial Demand Module in region r for fuel f in year y ,

$WHSE_LightIndex_{r,f,y}$ = Composite of warehouse energy consumption in lighting equipment retrieved from the Commercial Demand Module in region r for fuel f in year y ,

$WHSE_ShellIndex_{r,f,y}$ = Composite of warehouse energy consumption in building shells retrieved from the Commercial Demand Module in region r for fuel f in year y

Irrigation intensity is computed much the same way as the building intensity, relying on

$WHSE_VentIndex_{r,f,y}$ instead:

$$IRR_Index_{r,f,y} = \left(\frac{WHSE_VentIndex_{r,f,y}}{WHSE_VentIndex_{r,f,y-1}} \right) - 1 \quad (14)$$

where

$WHSE_VentIndex_{r,f,y}$ = Composite of warehouse energy consumption in building vents retrieved from the Commercial Demand Module in region r for fuel f in year y

Table 6. Building weights for TPC index by fuel

Equipment Type	Heating	Lighting	Shell
Electricity	0.25	0.25	0.50
Natural gas	0.25	0.00	0.75
Distillate	0.25	0.00	0.75
LPG	0.25	0.00	0.75
Motor Gasoline	0.25	0.00	0.75

Other equipment is directly indexed to other warehouse equipment using a fourth composite retrieved from the Commercial Demand Module.⁴⁰

⁴⁰ Details of the three warehouse energy consumption variables can be found in U.S. Energy Information Administration, Documentation of the Commercial Sector Demand Module (CSDM), DOE/EIA-M066(2011), Washington, DC, July 2011, pg. 16-39.

CONTPC

The construction industry (NAICS 236-238) encompasses all forms of residential, commercial, and industrial construction activities. It includes road and bridge construction, laying (and consumption) of asphalt, as well as all contractor-related activities. The consumption sector is modeled as one sector, but comprises three subsectors, or functional groups. Functional group weightings are derived by region and fuel, and these are applied to indices of vehicle use derived from the Transportation Sector Module (TSM). These indices of vehicle use are similar to the ones used for agriculture; the mix of vehicles is different. In addition, an investment index of state and local highway investment is the primary factor in determining asphalt demand provided by the Macroeconomic Activity Module (MAM).

The energy demanded for any given fuel is dependent on the value of output in the construction sector, as follows:

$$Q_{r,f,y} = CONSTR_{r,y} * UEC_{r,f,y} \quad (15)$$

$$UEC_{r,f,y} = UEC_{r,f,y-1} * (1 + TPC_{f,y}) \quad (16)$$

where

$Q_{r,f,y}$ = quantity demanded in region r of fuel f for year y

$CONSTR_{r,y}$ = Construction shipments from the MAM for region r and year y

The UEC (for each of the four Census regions) is established for a specific base year (currently 2006), and is calculated using data from the 2006 Census of Employment & Wages, as well as MECS and SEDS. Calculations in years subsequent to the base year recalculate the UECs using a constant factor, the Technology Possibility Curve (TPC), which reflects an assumed improvement in energy intensity (by fuel f) over time (from year $y-1$ to year y):

The TPC, formerly held constant and exogenously supplied to the model, is now calculated through changes in various indices of energy intensity, obtained from other NEMS modules.

The following sections describe the drivers that have a dynamic influence on the TPC, reflecting improvements in technology and energy intensity, and applying them to the construction sector. This has been done by dividing construction energy demand into two categories, Vehicles and Other Equipment, and by looking to the other modules for suitable variables that would guide energy use. In addition, the use of asphalt as a process input requires the use of a measure of economic activity from the MAM: State & Local Highway Investments, changes in which may impact the demand for this product.

Functional Split of the Construction Sector

Although construction is represented as one sector, there are several subsectors within construction that have different energy consumption characteristics. Therefore, in order to calculate aggregate UEC, the Construction sector is divided into three functional groups, as defined by NAICS codes 236, 237, and

238: Buildings, Civil Engineering, and Trade. Energy use is allocated within those groups, by fuel type and region, based on Census estimates of expenditures (apportioned by the number of employees) and regional weighted average fuel prices.

- The following fuel expenditures are obtained from the 2007 Economic Census:

Table 7. Total cost of selected power, fuels, and lubricants, 2007

millions \$2007 U.S. dollars

NAICS	Definition	Total	Electricity	NG	Gasoline & Distillate	Other
236	Building Construction	6,473.0	1,903.0	369.6	4,083.0	117.0
237	Civil Engineering	8,211.0	1,444.0	736.3	5,538.0	492.4
238	Trade	17,680.0	2,426.0	606.7	14,060.0	588.5.

http://factfinder.census.gov/servlet/EconSectorServlet?_lang=en&ds_name=EC0200A1&_SectorId=23

- Because gasoline and distillate (or diesel fuel) expenditures are combined in the Economic Census, it is necessary to split this figure into its components. This is done using SEDS data to construct consumption-weighted estimates of regional shares of gasoline and distillate sales for industrial and commercial consumers:

Table 8. Gasoline/Diesel Volume Allocation

Region	Percentage of Total	
	Gasoline	Distillate
1	12%	88%
2	21%	79%
3	20%	80%
4	17%	83%

- The regional shares of employees by functional group are derived from the 2006 Census of Employment and Wages (<ftp://ftp.bls.gov/pub/special.requests/cew/>):

Table 9. Regional Share of Employees, by Functional Group

Census Region	Buildings	Civil Eng.	Trade
1	15%	11%	15%
2	19%	18%	20%
3	39%	48%	38%
4	27%	23%	28%
Total	100%	100%	100%

These factors inform the allocation of UECs by region, functional group and fuel, displayed in the following table. The current weighting structure is static. These UEC allocation factors are represented in the code as $WEIGHT_CON(r, g, f)$, where the indices represent the region, functional group (buildings, civil engineering, trade), and fuel type, respectively.

Table 10. Construction UEC Weights by Region: -variable Weight_Con

Region 1	Electricity	NG	Distillate	Other	Gasoline
Buildings	35.4%	24.3%	18.5%	11.0%	18.5%
Civil Engineering	20.1%	36.3%	18.8%	34.6%	18.8%
Trade	44.5%	39.4%	62.8%	54.5%	62.8%
Region 2	Electricity	NG	Distillate	Other	Gasoline
Buildings	33.3%	22.1%	17.4%	10.0%	17.4%
Civil Engineering	23.5%	40.9%	21.8%	39.0%	21.8%
Trade	43.2%	36.9%	60.8%	51.0%	60.8%
Region 3	Electricity	NG	Distillate	Other	Gasoline
Buildings	31.7%	19.9%	16.7%	9.1%	16.7%
Civil Engineering	29.3%	48.4%	27.6%	46.7%	27.6%
Trade	39.0%	31.7%	55.7%	44.2%	55.7%
Region 4	Electricity	NG	Distillate	Other	Gasoline
Buildings	33.5%	22.5%	17.3%	10.1%	17.3%
Civil Engineering	22.1%	39.0%	20.5%	37.0%	20.5%
Trade	44.4%	38.5%	62.2%	52.9%	62.2%

Factor Indices for Vehicles and Equipment

As in the AGTPC subroutine, energy consumption is calculated in the agriculture industries by further subdividing consumption in each sub-industry based on shares of equipment use: off-road vehicles, which are trucks, tractors, and other specialty vehicles; buildings, which require lighting and temperature control; and other equipment, which covers a variety of both common (e.g., pumps) and specialty (e.g., cotton gins) equipment used in all the various types of agricultural production.

Vehicle Energy Intensity

The freight truck model generates (at the national level) fuel economy estimates for three classes of truck: Medium, Medium-Heavy, and Heavy. The vehicle component of the TPC trends is based on stock-weighted average fuel economy estimates of the truck population, attributed to the three functional groups as follows:

Table 11. Functional Groups and Vehicles

Function Index (func)	Functional Group	Truck Size Classes Used to Calculate Weighted Average Energy Intensity
1	Buildings	Medium, Medium-Heavy, & Heavy
2	Civil Engineering	Heavy
3	Trade	Medium & Medium-Heavy

Energy intensity is the inverse of the fuel economy for each type of truck. Energy intensity by fuel (f) and year (y) is calculated as a weighted average of the energy intensity across the three functional groups (g):

$$VEH_Index_{f,y} = \left(\frac{Trk_Intens_{f,y}}{Trk_Intens_{f,y-1}} \right) - 1 \quad (17)$$

and

$$Trk_Intens_{f,y} = \frac{1}{\sum_g TFR_TRK_FAS_T_{f,y,g}} \sum_g \frac{TFR_TRK_FAS_T_{f,y,g}}{TFR_FTMPG_{f,y,g}} \quad (18)$$

where

$VEH_Index_{f,y}$ = Index used to calculate sub-industry TPC for vehicles for fuel f in year y ,

$Trk_Intens_{f,y}$ = Average truck energy intensity for fuel f in year y ,

$TFR_TRK_FAS_T_{f,y,g}$ = Existing truck stock for fuel f in year y , and functional group g

$TFR_FTMPG_{f,y,g}$ = Truck MPG for fuel f in year y for functional group g

For each fuel, year, and functional group, marginal change in energy intensity is the following

$$VEH_Index_SC_{f,y,g} = \left(\frac{Trk_Intens_SC_{f,y,g}}{Trk_Intens_SC_{f,y-1,g}} \right) - 1.0 \quad (19)$$

This is converted into a weighted vehicle index (weighted over the three function groups), using the regional UEC weights presented above:

$$Wtd_Veh_Index_{r,f,y} = \sum_{g=1}^3 VEH_Index_SC_{f,y,g} * Weight_Con_{r,f,g} \quad (20)$$

Other Equipment Index

The impact of “Other Equipment” is determined through the use of proxy measures derived from the Commercial Demand Module (CDM) and calculated similarly as the AGTPC procedure. These measures are based on the weighted average efficiency of Heating, Lighting, and Ventilation services provided to the Warehouse building type only (type 10 in the CDM). Heating, lighting, and ventilation variables are expressed in terms of service output per unit of energy input. The reciprocals of these values represent energy intensity, and these are converted to regional estimates, weighted by the level of service demand in the constituent divisions:

$$WHSE_{Index_{r,y,f,s}} = \frac{\sum_{CD} SDbyFuel_{CD,y,f,s}}{\sum_{CD} AverageEfficiency_{CD,f,s} * SDbyFuel_{CD,y,f,s}} \quad (21)$$

where:

SDbyFuel = service demand by fuel (from commercial demand module)

- r represents the Census Regions (1-4)
- d Census divisions within each region
- y year
- f the fuel used for that service
- s the service in question (heating, lighting, or ventilation)

Similar to the AGTPC procedure, these indices are calculated in the CDM, and passed to the IDM under the following variable names, collectively referred to as *WHSE_Index* for brevity:

WHSE_HeatIndex

WHSE_LightIndex

WHSE_VentIndex

These are converted to elements of a new variable, *EQP_Index*, which represents each component’s fractional improvement from the previous year:

$$EQP_{Index_{r,y,f,s}} = \left(\frac{WHSE_{Index_{r,y,f,s}}}{WHSE_{Index_{r,y-1,f,s}}} \right) - 1.0 \quad (22)$$

The collective weighted equipment index is then calculated, based on the contribution each service makes to the consumption of the particular fuel in question.

Wt_Eqp_Index_{r,y,f} =

$$\sum_g \sum_{s=1}^3 EQP_{Index_{r,y,f,s}} * Weight_{Con_{r,,f,g}} * CON_{Proxy_{Wt_{f,s}}} \quad (23)$$

The weights of these contributions are provided in the following table. It should be noted that only electricity demand contains contributions from the lighting and ventilation indices.

Table 12. Fuel use weights for buildings

CON_Proxy_Wt	Heat	Light	Vent
Electricity	20%	20%	60%
Natural Gas	100%	0%	0%
Distillate	100%	0%	0%
LPG	100%	0%	0%
Gasoline	100%	0%	0%

Factor Index for Road Investment

One additional index is necessary for the construction industry for asphalt and road oil consumption. Asphalt is a process input, and is considered to be more closely linked to the MAM's estimate of state and local highway expenditures. Accordingly, this approach considers the annual growth in highway spending as a share of total construction expenditures, weighted by the vehicle energy intensity index to moderate the overall impact on the TPC. The highway index is represented as follows:

$$GI_Hwy_Index_{r,y} = \left(\frac{GI_Hwy_Invest_y}{GI_Hwy_Invest_{2011}} \right) * 0.008 \quad (24)$$

Where: GI_Hwy_Invest = State & Local Highway Investment from the MAM (mc_gslgishwyr), and 0.008 represents the average annual growth in construction expenditures

TPC Calculation

The TPC for each region and fuel type is then calculated. For all fuels except asphalt:

$$TPC_{f,y} = Wt_VEH_Index_{r,y,f} * CON_Equip_Wt_{veh,f} + Wt_EQP_Index_{r,y,f} * CON_Equip_Wt_{Eqp,f} \quad (25)$$

where: CON_Equip_Wt = the relative contribution to the total TPC from Vehicles and Other Equipment, as shown in the following table.

Table 13. Relative contribution to total TPC, vehicles and other equipment

CON_Equip_Wt	Electricity	NG	Diesel	Other	Gasoline
Vehicles	0.0%	20.0%	50.0%	0.0%	25.0%
Other Equipment	100.0%	80.0%	50.0%	100.0%	75.0%

At present, these allocations are based on analyst judgment, and are used to influence the rate of energy intensity improvement within a fuel type.

For asphalt, the TPC is calculated differently, weighing both asphalt and vehicle consumption:

$$TPC_{r,y,f} = 0.3 * GI_Hwy_Index_{r,y} + 0.7 * Wt_VEH_Index_{r,y,f} \quad (26)$$

where the vehicle index corresponds to that for diesel-fueled trucks.

Finally, for every sector and fuel (including the manufacturing sectors), the baseline TPC is also subject to adjustment by increasing fuel prices using the following formulation:

$$TPC_{f,y} = TPC_{f,y} * \frac{2 * \left(\frac{Price_{f,t}}{Price_{f,BaseYr}} \right)^\beta}{1 + \left(\frac{Price_{f,t}}{Price_{f,BaseYr}} \right)^\beta} \quad (27)$$

where the logit coefficient, β , is set in the IDM code to 4.0.

COALTPC

The COALTPC subroutine calculates the consumption of energy in the coal mining industry by further subdividing consumption in each sub-industry based on the equipment in which the energy is used: off-road vehicles, which are trucks, tractors, and other specialty vehicles; various equipment, which encompasses lighting, heating, and ventilation; and grinding equipment.

The most significant determinant of energy use in the coal mining sector is the distinction between underground and surface mining, and thus aggregate production values of underground vs. surface are obtained from the Coal Market Model (CMM) for use in COALTPC.

The amount of fuel (f) demanded by the Coal Mining industry in year (y) is calculated as follows:

$$Q_{f,y} = COALMN_y * UEC_{f,y} \quad (28)$$

where COALMN represents the value of coal mining output, supplied by the Macroeconomic Activity Module(MAM). The IDM calculates this quantity for each of the four Census Regions. The UEC changes from year to year according to the value of the TPC, as follows:

$$UEC_{f,y} = UEC_{f,y-1} * (1 + TPC_{f,y}) \quad (29)$$

where the TPC indicates the marginal change in energy intensity from the previous year. The TPC is calculated as the weighted average of three indices representing the marginal change in three factors: equipment efficiency, the share of underground mining, and labor productivity. These indices are described in detail below.

Factor Indices

Equipment

The weighted equipment index depends on the fuel in question, and is determined through the use of proxy measures derived from the Commercial Demand Module (CDM), the Transportation Sector Module (TSM), and results of the Cement model in the IDM.

Heating, Lighting, and Ventilation

The weighted equipment index depends on the fuel in question, and is determined through the use of proxy measures derived from the Commercial Demand Module (CDM), the Transportation Sector Module (TSM), and results of the Cement model in the IDM.

From the CDM, measures are based on the weighted average efficiency of Heating, Lighting, and Ventilation services provided to the Warehouse building type (type 10 in the CDM). These variables are expressed in terms of service output per unit of energy input. The reciprocals of these values represent energy intensity, and these are converted to regional estimates, weighted by the level of service demand in the constituent divisions:

$$WHSE_{Index_{r,y,f,s}} = \frac{\sum_{CD} SD_{byFuel_{CD,y,f,s}}}{\sum_{CD} AverageEfficiency_{CD,f,s} * SD_{byFuel_{CD,y,f,s}}} \quad (30)$$

where:

SD_{byFuel} = service demand by fuel (from commercial demand module)

- r represents the Census Regions (1-4)
- d Census divisions within each region
- f the fuel used for that service
- s the service in question (heating, lighting, or ventilation)

These indices are calculated in the CDM, and passed to the IDM under the following variable names:

$WHSE_HeatIndex$

$WHSE_LightIndex$

$WHSE_VentIndex$

Vehicle Energy Intensity

From the TSM, the freight truck model generates (at the national level) fuel economy estimates for three classes of truck: Medium, Medium-Heavy, and Heavy. The contribution to the TPC is based on

stock-weighted average fuel economy estimates of the truck population. The average energy intensity is the inverse of the average fuel economy, and is calculated as follows by fuel(f) and year(y):

$$VEH_Index_{f,y} = \left(\frac{Trk_Intens_{f,y}}{Trk_Intens_{f,y-1}} \right) - 1 \quad (31)$$

and

$$Trk_Intens_{f,y} = \frac{1}{\sum_s TFR_TRK_FAS_T_{s,f,y}} \sum_s \frac{TFR_TRK_FAS_T_{s,f,y}}{TFR_FTMPG_{s,f,y}} \quad (32)$$

$VEH_Index_{f,y}$ = Index used to calculate sub-industry TPC for vehicles for fuel f in year y ,

$Trk_Intens_{f,y}$ = Average truck energy intensity for fuel f in year y ,

$TFR_TRK_FAS_T_{s,f,y}$ = Existing truck stock for fuel f in year y for truck size s , and

$TFR_FTMPG_{s,f,y}$ = Truck MPG for truck size s for fuel f in year y for truck size s .

For each fuel, the marginal change in energy intensity is then calculated:

$$VEH_Index_{f,y} = \left(\frac{Trk_Intens_{f,y}}{Trk_Intens_{y-1,f}} \right) - 1.0 \quad (33)$$

Grinding Equipment

From the results of the Cement model, the average efficiency of raw grinding equipment is extracted to use as a proxy for changes in the energy intensity of mining equipment. This factor is only applied to the TPC for electricity.

$$Raw_Grind_Eff_y = \frac{\sum_{type} Elec_Use_Rpt_{type,y}}{\sum_{type} Tot_ProdG_{type,y}} \quad (34)$$

where: $Elec_Use_Rpt$ = Reported electricity consumption for cement grinding, by grinder type; and,

Tot_ProdG = Total grinding output, by grinder type

The weighted equipment index is then calculated.

For Electricity:

$$\begin{aligned}
 Wt_EQP_Index_{f,y} = & \left[\frac{Raw_Grind_Eff_y}{Raw_Grind_Eff_{y-1}} - 1.0 \right] * Elec_Weight_{Grind} \\
 & + \left[\frac{WHSE_LightIndex_y}{WHSE_LightIndex_{y-1}} - 1.0 \right] * Elec_Weight_{Light} \\
 & + \left[\frac{WHSE_VentIndex_y}{WHSE_VentIndex_{y-1}} - 1.0 \right] * Elec_Weight_{Vent}
 \end{aligned} \tag{35}$$

For other fuels:

$$\begin{aligned}
 Wt_EQP_Index_{f,y} = & \left[\frac{WHSE_HeatIndex_{f,y}}{WHSE_HeatIndex_{f,y-1}} - 1.0 \right] * NonEl_Weight_{Heat,f} \\
 & + VEH_Index_{f,y} * NonEl_Weight_{Vehicle,f}
 \end{aligned} \tag{36}$$

where the various weighting factors are input from an exogenous data file:

Table 14. Energy weights for mining equipment

Elec_Weight	Share	NonEl_Weight		
		Fuel	Heat	Vehicle
Grinding	20%	NG	80%	20%
Lighting	20%	DS	70%	30%
Ventilation	60%	GS	0%	100%
		CL	100%	0%
		RS	100%	0%

Surface/Underground Mining Share

This component of the TPC reflects changes in the regional share of coal produced from underground mines. Surface and underground production is reported by the Coal Market Module, and provided to the IDM for this calculation. Production is aggregated from the 14 Coal Regions to the 4 Census Regions, as follows:

$$CL_Surface_{r,y} = \sum_{cr} PMTS_{r,y,cr} \tag{37}$$

$$CL_Underground_{r,y} = \sum_{cr} PMTD_{r,y,cr} \quad (38)$$

where PMTS and PMTD represent the tons of coal produced on the surface and underground, respectively (from the Coal Market Module), and the 14 coal production regions (cr) are mapped to the 4 industrial regions (r) as follows:

Table 15. Census region and coal region mapping

Census Region	Coal Regions
1	1
2	2,3,6
3	4,5,7
4	8-14

The fraction of annual production from underground mines is then:

$$Under_Share_{r,y} = \frac{CL_Underground_{r,y}}{(CL_Underground_{r,y} + CL_Surface_{r,y})} \quad (39)$$

and the marginal change in that share is:

$$Under_Index_{r,y} = \frac{Under_Share_{r,y}}{Under_Share_{r,y-1}} - 1.0 \quad (40)$$

Labor Productivity

Labor productivity is derived from one of the data input files, CLUSER.txt, employed by the Coal Market Module. Each of the production regions has forecasts of productivity by coal type; these are used to construct a production-weighted average productivity forecast, mapped to the Census regions:

$$CL_L_Prod_{r,y,Surf} = \frac{\sum_{cr} B_Prod_{r,Surf,cr} * L_Prod_{r,Surf,cr} * FR_Prod_{r,y,Surf,cr}}{\sum_{cr} B_Prod_{r,Surf,cr} * L_Prod_{r,Surf,cr}} \quad (41)$$

where:

- B_Prod = Base year (2008) coal production by type and supply region
- L_Prod = Base year labor productivity in tons/miner/hour
- FR_Prod = Forecast year labor productivity
- $Surf$ = Mine type: 1 = Surface, 2 = Underground

and the productivity index is:

$$L_Prod_Index_{r,y,Surf} = 1.0 - \frac{CL_L_Prod_{r,y,Surf}}{CL_L_Prod_{r,y-1,Surf}} \quad (42)$$

TPC Calculation

The collective TPC by fuel type and region may now be explicitly calculated:

$$\begin{aligned}
 TPC_{f,y} = & TPC_Weight_{1,f} * Wt_EQP_Index_{f,y} \\
 & + TPC_Weight_{2,f} * Under_Index_{r,y} \\
 & + TPC_Weight_{3,f} * Under_Share_{r,y} * L_Prod_Index_{r,1,y} \\
 + & TPC_Weight_{3,f} * (1.0 - Under_Share_{r,y}) * L_Prod_Index_{r,2,y}
 \end{aligned} \tag{43}$$

where the number index represents the weight associated with either the equipment (1), the underground coal production index (2), or the underground coal share (3).

The factor weights by region and fuel for mining equipment are as follows:

Table 16. TPC Equipment Component Weights by Region

TPC_Weight _{1,f}	Electricity	NG	Distillate	Gasoline	Coal	Residual
Region 1	70%	85%	90%	100%	70%	90%
Region 2	70%	85%	90%	100%	70%	90%
Region 3	70%	85%	90%	100%	70%	90%
Region 4	70%	85%	90%	100%	70%	90%

These weights are based on analyst judgment, and may be changed if desired. The weights for the two remaining factors are then calculated:

$$TPC_Weight_{2,f} = \frac{(1.0 - TPC_Weight_{1,f})}{2} \tag{44}$$

$$TPC_Weight_{3,f} = 1.0 - (TPC_Weight_{1,f} + TPC_Weight_{2,f}) \tag{45}$$

In other words, the difference between 1.0 and the equipment weighting factor is divided between the other two weights.

OGSMTPC

The OGSMTPC subroutine calculates the consumption of energy in the oil and gas extraction industry with the major exception of lease and plant fuel, which is natural gas fuel used for any purpose at the lease (extraction) site and fuel used in gas processing plants (lease and plant fuel is modeled in the Natural Gas Transmission and Distribution Model). All other fuels (residual fuel oil, distillate, motor gasoline, electricity, and LPG) are covered by OGSMTPC, as well as that natural gas that is not used in lease and plant fuel, i.e., in natural gas liquid fractionators.

Energy consumption in this sector is largely driven by the number of wells drilled (related to oil and gas volumes) and their productivity.

The amount of fuel (f) demanded by the Oil and Gas Mining industry in year (y) is calculated as follows:

$$Q_{f,y} = OGMN_y * UEC_{f,y} \quad (46)$$

where OGMN represents the value of domestic onshore oil and gas production, supplied by the Macroeconomic Activity Module (MAM). The IDM calculates this quantity for each of the four Census regions. The UEC (by fuel f) changes from year to year (year y-1 to year y) according to the value of the TPC, as follows:

$$UEC_{f,y} = UEC_{f,y-1} * (1 + TPC_{f,y}) \quad (47)$$

where the TPC indicates the marginal change in energy intensity from the previous year. The TPC is calculated as the weighted average of three indices representing the marginal change in three factors: vehicle energy intensity, the regional productivity of oil and gas wells, and trends in the share of drilling that results in dry wells. Each of these components is described below.

Factor Indices

- **Vehicle Energy Intensity**

As noted in earlier sections, the freight truck model generates fuel economy estimates for three classes of truck. The contribution to the TPC is based on stock-weighted average fuel economy estimates of the truck population. The average energy intensity is the inverse of the average fuel economy, and is calculated as follows, by fuel (f) and year (y):

$$VEH_Index_{f,y} = \left(\frac{Trk_Intens_{f,y}}{Trk_Intens_{f,y-1}} \right) - 1 \quad (48)$$

$$Trk_Intens_{f,y} = \frac{1}{\sum_s TFR_TRK_FAS_T_{s,f,y}} \sum_s \frac{TFR_TRK_FAS_T_{s,f,y}}{TFR_FTMPG_{s,f,y}} \quad (49)$$

$VEH_Index_{f,y}$ = Index used to calculate sub-industry TPC for vehicles for fuel f in year y,

$Trk_Intens_{f,y}$ = Average truck energy intensity for fuel f in year y,

$TFR_TRK_FAS_T_{s,f,y}$ = Existing truck stock for fuel f in year y for truck size s, and

$TFR_FTMPG_{s,f,y}$ = Truck MPG for truck size s for fuel f in year y.

- **Productivity Factors**

The Oil & Gas Supply Module (OGSM)⁴¹ produces estimates of onshore oil and gas production for 6 production regions (PR), and 7 product types (K), as follows (the variable PROD_Wt is a measure of the relative difficulty of extraction, used in subsequent calculations):

Table 17. Relative difficulty of extraction of oil and gas

K	Product Type	PROD_Wt
1	Conventional Oil	1.0
2	Enhanced Oil Recovery	3.0
3	Conventional Shallow Gas	1.0
4	Conventional Deep Gas	1.0
5	Tight Gas	3.0
6	Shale Gas	2.0
7	Coal Bed Methane	3.0

The six production regions are displayed in Figure 13:

Figure 13. AEO Oil and Gas Supply Regions⁴²

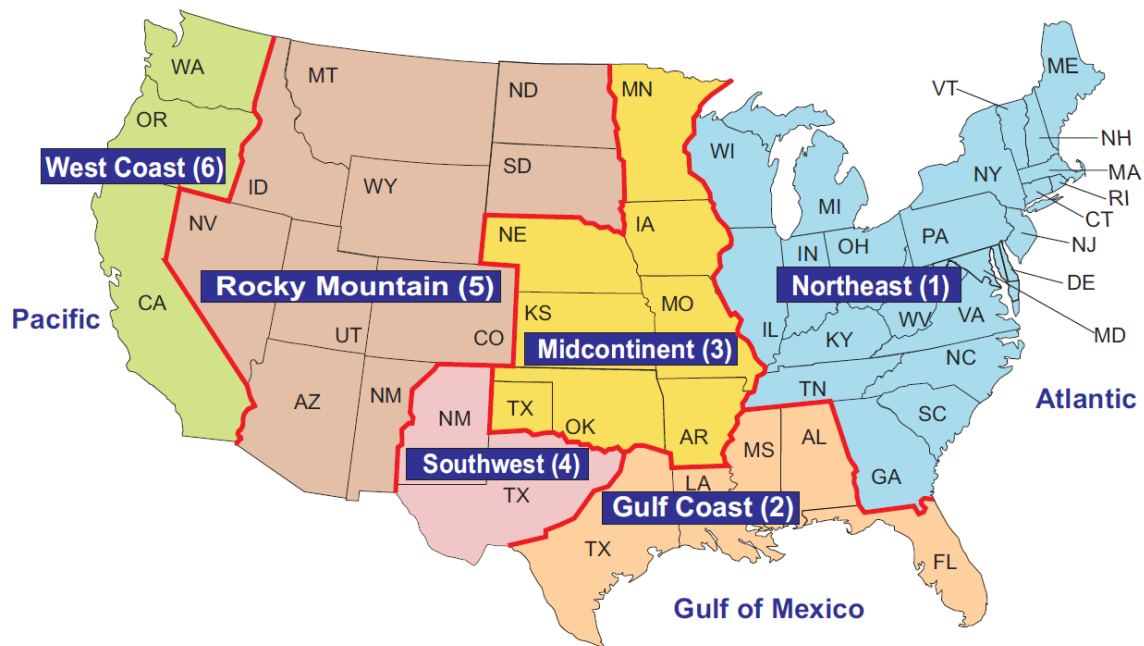

⁴¹ [http://www.eia.gov/forecasts/nemsdoc/ogsm/pdf/m063\(2013\).pdf](http://www.eia.gov/forecasts/nemsdoc/ogsm/pdf/m063(2013).pdf)

⁴² U.S. Energy Information Administration, *Annual Energy Outlook 2013*, p. 229.

The output from the production regions is first mapped to the corresponding Census regions, and converted from MMBbl (for oil) and TCF (for gas) to Trills:

$$OG_Prod_{K,r,y} = \left[\sum_{PR=1}^6 OGREGPRD_{PR,K,y} * OGSM_Map_{PR,r} \right] * Convert_{Type} \quad (50)$$

where: *OGREGPRD* = Regional production by fuel type, from OGSM
OGSM_Map = Regional mapping factors, based on the geographic areas of states in each region, provided in the table below
Convert = Conversion factor for oil (Type=1) and natural gas (Type=2)

Table 18. OGSM and Census region mapping

OGSM_Map Census Region (r)	OGSM Region (PR)					
	Northeast 1	Gulf Coast 2	Midcontinent 3	Southwest 4	Rocky Mountains 5	West Coast 6
1	22.9%	0.0%	0.0%	0.0%	0.0%	0.0%
2	38.0%	0.0%	71.3%	0.0%	15.5%	0.0%
3	39.1%	100.0%	28.7%	57.0%	0.0%	0.0%
4	0.0%	0.0%	0.0%	43.0%	84.5%	100.0%

The share of total production represented by oil is then calculated:

$$Oil_Share_{r,y} = \frac{\sum_{K=1}^2 OG_Prod_{K,r,y}}{\sum_{K=1}^7 OG_Prod_{K,r,y}} \quad (51)$$

Additionally, the Oil & Gas Production factor, *OG_ProdFac*, representing the weighted average difficulty of extraction, is calculated as follows:

$$OG_ProdFac_{Type,r,y} = \frac{\sum_K OG_Prod_{K,r,y} * PROD_Wt_K}{\sum_K OG_Prod_{K,r,y}} \quad (52)$$

where: K = 1,2 for Oil (1 = conventional oil, 2 = enhanced oil recovery)
= 3-7 for Natural Gas (Type = 2) (3 = conventional shallow gas, 4 = conventional deep gas, 5 = tight gas, 6 = shale gas, 7 = coalbed methane)

The Productivity Index is then calculated as:

$$Prod_Index_{r,y} = Oil_Share_{r,y} * \left[\frac{OG_ProdFac_{Type=1,r,y}}{OG_ProdFac_{Type=1,r,y-1}} - 1.0 \right] + (1.0 - Oil_Share_{r,y}) * \left[\frac{OG_ProdFac_{Type=2,r,y}}{OG_ProdFac_{Type=2,r,y-1}} - 1.0 \right] \quad (53)$$

- **Dry Well Index**

Another factor affecting the TPC is the share of drilling that produces dry wells. It is assumed that growth in this factor will correlate with increased energy required for overall extraction. The data for successful and dry wells are obtained from the OGSM, and are mapped from the six Production Regions (PR) to the four Census regions (r).

$$Success_Well_{K,r,y} = \sum_{PR=1}^6 ogsrl48_{PR,K,y} * ogwellsl48_{PR,K,y} * OGSM_Map_{PR,r} \quad (54)$$

$$Dry_Well_{K,r,y} = \sum_{PR=1}^6 (1.0 - ogsrl48_{PR,K,y}) * ogwellsl48_{PR,K,y} * OGSM_Map_{PR,r} \quad (55)$$

$$Total_Well_{K,r,y} = Success_Well_{K,r,y} + Dry_Well_{K,r,y} \quad (56)$$

where: *ogsrl48* = Share of successful wells by production region and product type

ogwellsl48 = Total wells drilled, by region and type

OGSM_Map = Regional mapping factors, based on the geographic areas of states in each region, described above.

The production-weighted average dry well percentage by Census region is then calculated:

$$Wtd_OG_WellFac_{r,y} = \frac{\sum_K Dry_Well_{K,r,y} * OG_Prod_{K,r,y}}{\sum_K Total_Well_{K,r,y} * OG_Prod_{K,r,y}} \quad (57)$$

and the Well Index is expressed as the change in this factor from the previous year:

$$Well_Index_{r,y} = Wtd_OG_WellFac_{r,y} - Wtd_OG_WellFac_{r,y-1} \quad (58)$$

TPC Calculation

The collective TPC by fuel type and region may now be explicitly calculated:

$$\begin{aligned} TPC_{f,y} &= TPC_Fac_Wt_{f,1} * VEH_Index_{f,y} \\ &+ TPC_Fac_Wt_{f,2} * Prod_Index_{r,y} \\ &+ TPC_Fac_Wt_{f,3} * Well_Index_{r,y} \end{aligned} \quad (59)$$

Where *TPC_Fac_Wt* represents ad hoc weighting factors within each fuel type indicating the influence of each of the index factors described above. These assumed factors are provided in the following table.

Table 19. TPC Factor Weights by Fuel (TPC_Fac_Wt)

Fuel	Vehicle Index	Productivity Index	Dry Well Index
Electricity	0.00	0.80	0.20
NG	0.50	0.40	0.10
Diesel	0.50	0.40	0.10
Gasoline	0.50	0.40	0.10
Renewables	0.00	0.80	0.20
Residential	0.00	0.80	0.20

OTH_MINTPC

The OTH_MINTPC subroutine calculates the consumption of energy metals and minerals, which constitute all other mining sub-sectors. As in the COALTPC subroutine, energy usage for grinding equipment used in this sector is evolved parallel to grinding equipment in the cement industry. Also, like the COALTPC subroutine, the distinction between surface and sub-surface mining is made, which governs a large portion of energy consumption patterns in this industry.

The amount of fuel (f) demanded by the Other Mining (Metals & Minerals) industry in year (y) is calculated as follows:

$$Q_{f,y} = OTHMN_y * UEC_{f,y} \quad (60)$$

where OTHMN represents the value of metals and non-metals mining production, supplied by the Macroeconomic Activity Module(MAM). The IDM calculates this quantity for each of the four Census regions. The UEC changes from year to year according to the value of the TPC, as follows:

$$UEC_{f,y} = UEC_{f,y-1} * (1 + TPC_{f,y}) \quad (61)$$

where the TPC indicates the marginal change in energy intensity in year y from the previous year y-1. The TPC is calculated as the weighted average of three indices representing the marginal change in two factors: equipment efficiency, and the labor productivity of surface mining, obtained from the coal model. The TPC is further subdivided between Metal Mining and Non-Metal Mining, in recognition of their different characteristics. These indices are described in detail below.

Metal/Non-Metal Split

Total Mining shipments are reported at the regional level by the MAM, but the metals/non-metals components are available only at the national level within the Global Insight Macroeconomic Model (GI Model). Accordingly, it is necessary to infer what share of regional mining output consists of metals. At present, the national metals share is included as a data statement, but it is possible to extract it from the GI (Global Insights) model as follows:

$$MetlShr_y = \frac{R2122R_{1y}}{R2122R_{1y} + R2123R_{1y}} \quad (62)$$

where: R2122R_1 = Annual value of Metals production from the GI Model
 R2123R_1 = Annual value of Non-Metals production from the GI Model

This share is regionalized by reference to the 2006 Census of Employment and Wages (CEW), which provides estimates of employment in the mining industries, by state. The following data is used to determine what fraction of each region's mining output may be attributed to metals. The variable **Reg_MetIShr** is contained in an input file, and is held static.

Table 20. Metal and Nonmetal Shares by Census region

Census Region	Number of Employees (thousands)			Normalized Share Reg_MetIShr
	Metal	Non-Metal	Metal Share	
1	-	1,807	0.00%	0.0%
2	3,490	19,382	15.26%	21.0%
3	413	27,859	1.46%	2.0%
4	22,491	17,742	55.90%	77.0%

These factors are used in the final calculation of the TPC, below.

Factor Indices

Labor Productivity

Labor productivity is derived from one of the data input files, CLUSER.txt, employed by the CMM. Each of the production regions has forecasts of productivity by coal type; these are used to construct a production-weighted average productivity forecast, mapped to the Census regions:

$$CL_L_Prod_{r,Surf=1,y} = \frac{\sum_{cr} B_Prod_{r,cr,Surf=1} * L_Prod_{r,cr,Surf=1} * FR_Prod_{r,cr,Surf=1,y}}{\sum_{cr} B_Prod_{r,cr,Surf=1} * L_Prod_{r,cr,Surf=1}} \quad (63)$$

where: *B_Prod* = Base year (2008) coal production by type and supply region
L_Prod = Base year labor productivity in tons/miner/hour
FR_Prod = Forecast year labor productivity
Surf = Mine type: 1 = Surface; only Surface mining is used for metal and nonmetal mining.

and the surface mining labor productivity index is:

$$L_Prod_Index_{r,Surf=1,y} = 1.0 - \frac{CL_L_Prod_{r,Surf=1,y}}{CL_L_Prod_{r,Surf=1,y-1}} \quad (64)$$

Equipment

The weighted equipment index depends on the fuel in question, and is determined through the use of proxy measures derived from the Commercial Demand Module (CDM), the Transportation Sector Module (TSM), and results of the Cement model in the IDM.

- **Heating, Lighting, and Ventilation**

From the CDM, measures are based on the weighted average efficiency of Heating, Lighting, and Ventilation services provided to the Warehouse building type (type 10 in the CDM). These variables are expressed in terms of service output per unit of energy input. The reciprocals of these values represent energy intensity, and these are converted to regional estimates, weighted by the level of service demand in the constituent divisions:

$$WHSE_Index_{f,s,r,y} = \frac{\sum_r SDbyFuel_{f,s,r,y}}{\sum_r AverageEfficiency_{r,s,f} * SDbyFuel_{f,s,r,y}} \quad (65)$$

where:

r = represents the divisions within each region

s = the service in question (heating, lighting, or ventilation)

f = the fuel used for that service

These indices are calculated in the CDM, and passed to the IDM under the following variable names:

WHSE_HeatIndex

WHSE_LightIndex

WHSE_VentIndex

- **Grinding Equipment**

From the results of the Cement model, the average efficiency of raw grinding equipment is extracted to use as a proxy for changes in the energy intensity of mining equipment. This factor is only applied to the TPC for electricity.

$$Raw_Grind_Eff_y = \frac{\sum_{type} Elec_Use_Rpt_{type,y}}{\sum_{type} Tot_ProdG_{type,y}} \quad (66)$$

where: Elec_Use_Rpt = Reported electricity consumption for cement grinding, by grinder type;
and,

Tot_ProdG = Total grinding output, by grinder type

- **Vehicle Energy Intensity**

The freight truck model generates fuel economy estimates for three classes of truck. The contribution to the TPC is based on stock-weighted average fuel economy estimates of the truck population. The

average energy intensity is the inverse of the average fuel economy, and is calculated as follows, by fuel (f) and year (y):

$$VEH_Index_{f,y} = \left(\frac{Trk_Intens_{f,y}}{Trk_Intens_{f,y-1}} \right) - 1 \quad (67)$$

and

$$Trk_Intens_{f,y} = \frac{1}{\sum_s TFR_TRK_FAS_{T_{s,f,y}}} \sum_s \frac{TFR_TRK_FAS_{T_{s,f,y}}}{TFR_FTMPG_{s,f,y}} \quad (68)$$

$VEH_Index_{f,y}$ = Index used to calculate sub-industry TPC for vehicles for fuel f in year y ,

$Trk_Intens_{f,y}$ = Average truck energy intensity for fuel f in year y ,

$TFR_TRK_FAS_{T_{s,f,y}}$ = Existing truck stock for fuel f in year y for truck size s , and

$TFR_FTMPG_{s,f,y}$ = Truck MPG for truck size s for fuel f in year y for truck size s .

The weighted equipment index is then calculated for Metals and Non-Metals separately.

For Electricity (Metals Mining):

$$\begin{aligned} Wt_Met_EQP_Index_{f,y} &= \left[\frac{Raw_Grind_Eff_y}{Raw_Grind_Eff_{y-1}} - 1.0 \right] * Elec_Met_Weight_{Grind} \\ &+ \left[\frac{WHSE_LightIndex_{r,y}}{WHSE_LightIndex_{r,y-1}} - 1.0 \right] * Elec_Met_Weight_{Light} \\ &+ \left[\frac{WHSE_VentIndex_{r,y}}{WHSE_VentIndex_{r,y-1}} - 1.0 \right] * Elec_Met_Weight_{Vent} \end{aligned} \quad (69)$$

Similarly, for Non-Metals:

$$\begin{aligned} Wt_NM_EQP_Index_{f,y} &= \left[\frac{Raw_Grind_Eff_y}{Raw_Grind_Eff_{y-1}} - 1.0 \right] * Elec_NM_Weight_{Grind} \\ &+ \left[\frac{WHSE_LightIndex_{r,y}}{WHSE_LightIndex_{r,y-1}} - 1.0 \right] * Elec_NM_Weight_{Light} \\ &+ \left[\frac{WHSE_VentIndex_{r,y}}{WHSE_VentIndex_{r,y-1}} - 1.0 \right] * Elec_NM_Weight_{Vent} \end{aligned} \quad (70)$$

Where the difference in the calculation is in the relative weights ascribed to Grinding, Lighting, and Pumping (through its proxy, ventilation). These factors are as follows:

Table 21. Electric Equipment Weights

	Variable	Grinding	Lighting	Pumping
Metals	Elec_Met_Wt	0.20	0.20	0.60
Non-Metals	Elec_NM_Wt	0.60	0.20	0.20

For Other Fuels (Metals):

$$Wt_Met_EQP_Index_{f,y} = \left[\frac{WHSE_HeatIndex_{f,r,y}}{WHSE_HeatIndex_{f,r,y-1}} - 1.0 \right] * NonEl_Met_Weight_{Heat,f}$$

$$+ VEH_Index_{f,y} * NonEl_Met_Weight_{Vehicle,f} \quad (71)$$

and Non-Metals:

$$Wt_NM_EQP_Index_{f,y} = \left[\frac{WHSE_HeatIndex_{f,r,y}}{WHSE_HeatIndex_{f,r,y-1}} - 1.0 \right] * NonEl_NM_Weight_{Heat,f}$$

$$+ VEH_Index_{f,y} * NonEl_NM_Weight_{Vehicle,f} \quad (72)$$

where the current weighting factors for Metals and Non-Metals are identical. The model assigns the same weights to the two variables in order to make subsequent, user-specified changes easier to implement.

Table 22. Non-Electric Equipment Weights (Metals and Non-Metals)

	TPC_Met_Wt _{r,1,f} & TPC_NM_Wt _{r,1,f}			Coal	Residual
	NG	Diesel	Gasoline		
Heating	80%	70%	0%	100%	100%
Vehicles	20%	30%	100%	0%	0%

TPC Calculation

The collective TPC by fuel type and region may now be explicitly calculated:

$$\begin{aligned}
 TPC_{r,y,ff,y} = & \left[TPC_Met_Wt_{r,1,f} * Wt_Met_EQP_Index_{r,y} \right. \\
 & \left. + TPC_Met_Wt_{r,2,f} * L_Prod_Index_{r,y} \right] * MetlShr_y * Reg_MetlShr_r \\
 + & \left[TPC_NM_Wt_{r,1,f} * Wt_NM_EQP_Index_{r,y} \right. \\
 & \left. + TPC_NM_Wt_{r,2,f} * L_Prod_Index_{r,y} \right] * (1.0 - MetlShr_y * Reg_MetlShr_r) \quad (73)
 \end{aligned}$$

where the TPC Equipment Index weights for both Metals and Non-Metals are provided in the following table:

Table 23. TPC Equipment Component Weights by Region -

TPC_Met_Wt _{r,1,f} & TPC_NM_Wt _{r,1,f}						
Metal & Non-Metal	Electricity	NG	Diesel	Gasoline	Coal	Residual
Region 1	70.0%	85.0%	90.0%	100.0%	90.0%	90.0%
Region 2	70.0%	85.0%	90.0%	100.0%	90.0%	90.0%
Region 3	70.0%	85.0%	90.0%	100.0%	90.0%	90.0%
Region 4	70.0%	85.0%	90.0%	100.0%	90.0%	90.0%

The Non-Equipment (i.e., Labor Productivity) Index weights are then calculated:

$$TPC_Met_Wt_{r,1,f} = 1.0 - TPC_Met_Wt_{r,1,f} \quad (74)$$

As with the Non-Electric equipment weights, above, the factors are identical across regions and for Metals/Non-Metals mining. This explicit separation of the two mine types in the code provides an easily adaptable structure for testing and scenario development.

CEMENT_INDUSTRY Submodule

Figure 14 shows a detailed process flow diagram (PFD) for cement manufacturing. Raw materials containing calcium, silicon, aluminum, iron, gypsum, and small amounts of other ingredients are crushed and ground in ball mills, roller mills, or both. The mining and transport of raw materials to the plant site are excluded in the cement model as these operations are modeled in a separate module of NEMS. Internal submodule calculations are in metric units, which are converted to English units for calculations external to this submodule.

Figure 14. Cement industry detailed process flow

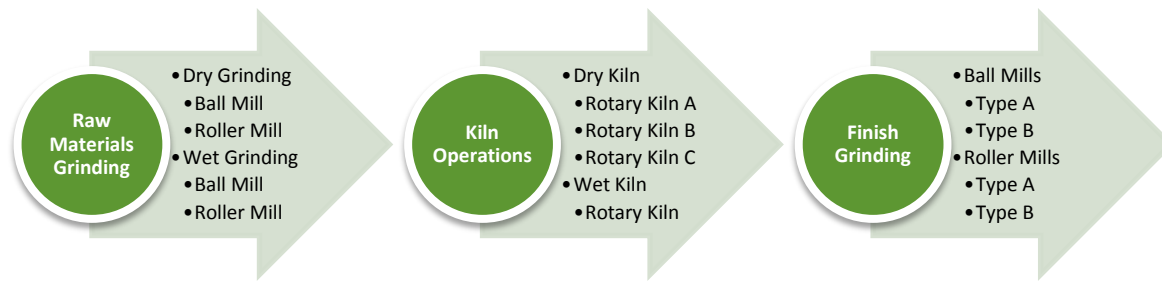

The raw materials are ground dry or combined with water to form slurry (categorized as dry processing or wet processing). Wet grinding reduces grinding energy consumption, but increases the energy consumption for evaporating the added water. The crushed raw materials enter a kiln (often preceded by a pre-heater system) and are exposed to high temperatures (~2,700°F). U.S. kilns are commonly fired by coal, with natural gas and oil as a starter or backup fuel. Recently, alternative fuels such as tires and industrial waste have been used as supplementary fuels. The kiln converts the raw materials mixture into clinker, which is then cooled rapidly to prevent further chemical changes. The cooled clinker is blended with additives and ground into a fine powder that is cement. The cement may be bagged or transported in bulk to retail stores and commercial users.

Due to the chemistry of cement production, mass flows through each major unit operation will not be the same. For this reason, the calculation of mass flows through each unit operation will begin at the end of the PFD -- i.e., the annual production of cement in the finish grinding operation.

Cement production is defined as cement supply *minus* cement imports *plus* cement exports *plus* changes in stocks. These values are obtained exogenously from other NEMS modules or from the United States Geological Survey (USGS).⁴³ The term '*corrected cement production*' will be used in this document to refer to this quantity.

- The total output from the finish grinders equals the corrected cement production. Inputs to the finish grinders consist of (a) clinker from the kiln/clinker cooler (b) additives, such as gypsum and fly ash, and (c) imported clinker. The amount of additives supplied to the fine grinders is calculated as a percentage of the corrected cement production.

$$\begin{aligned} \textit{Grinding_Tonnes} &= \text{Mass flow of output from the finish grinding step, in metric tons} \\ &= C\textit{Supply} - C\textit{Imports} + C\textit{Exports} + C\textit{Stock changes} \end{aligned} \quad (75)$$

The output from the kiln equals the input to the finish grinder *minus* clinker imports.

The greatest loss of material from raw material inputs occurs in the kiln/clinker cooler due to the release of CO₂ and chemical reactions. The calculation of raw material fed to the kiln is obtained by multiplying the kiln's output (after subtracting clinker imports) by

⁴³ U.S. Department of the Interior, U.S. Geological Survey, <http://minerals.usgs.gov/minerals/pubs/commodity/cement/mcs-2006-cement.pdf>

an empirical mass-loss factor that varies between 1.6-1.8, depending on the literature source.

$$\text{Process_OutputK} = \text{Grinding_Tonnes} - \text{Clinker_Imports} \quad (76)$$

$$\text{Raw_Material} = 1.6 \times \text{Process_OutputK}$$

- The input to the raw grinders is the same as the cement kiln input, which is also equal to output of the raw grinding mills.

Figure 15. Cement Submodule

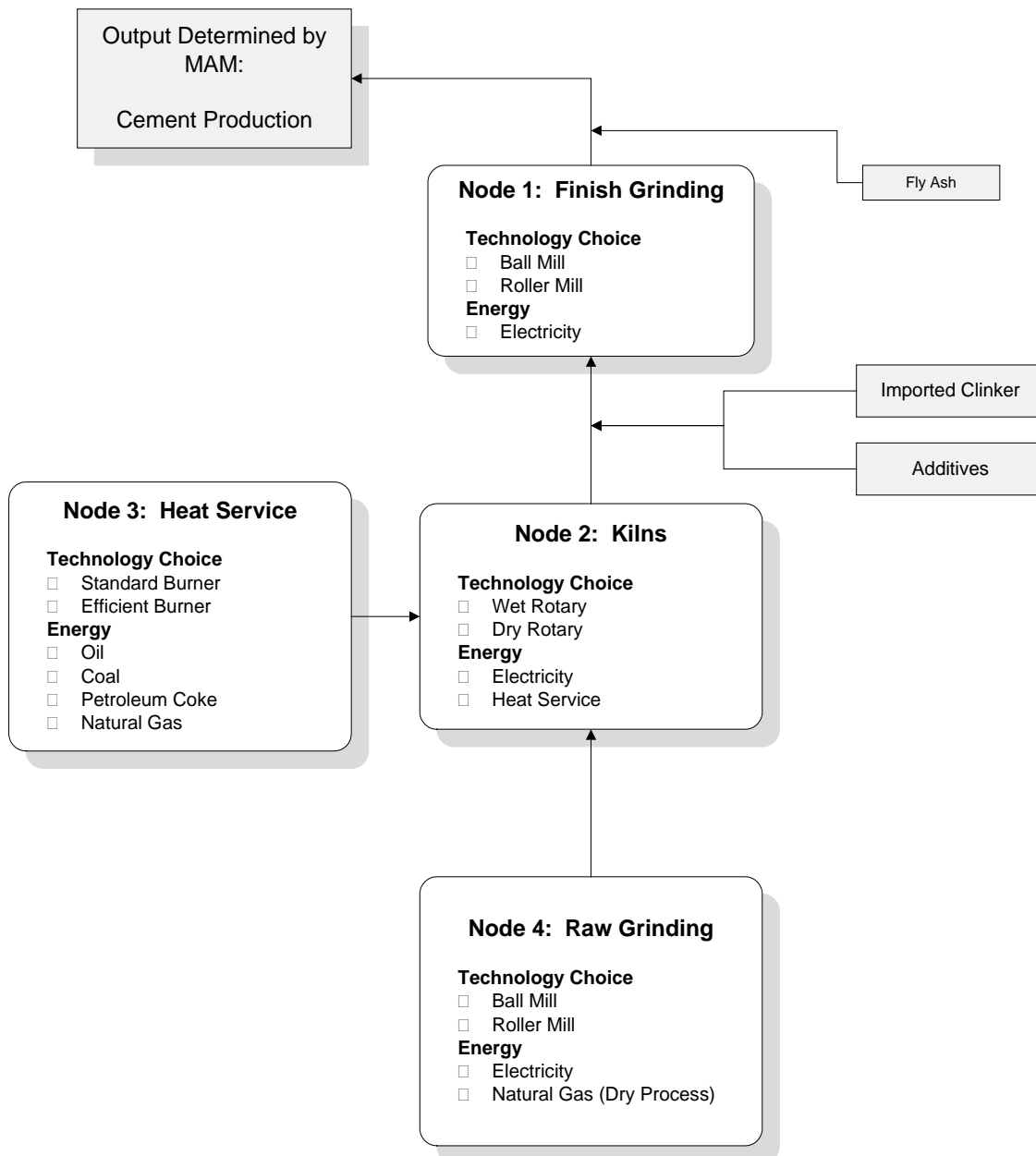

FINISH_GRIND_CAP (Node 1)

The FINISH_GRIND_CAP subroutine represents cement production capacity requirements for IDM.

The output of the Finish Grinding node is the total quantity of cement shipments (in thousand metric tons) in a given year.

$$Shipments = Shipments_IBYR2 * \left[\frac{OUTIND_{22,11}}{CEMENTIBYR} \right] \quad (77)$$

where

Shipments = Physical quantity of cement shipments, in thousands of metric tons, projected for the cement industry

Shipments_IBYR2 = Physical quantity of cement shipments, in thousands of metric tons in 2006, as reported by the U.S. Geological Survey

OUTIND_{22,11} = Gross value of output for the cement industry (IDM industry code of 22) for the nation in the current projection year, as determined by NEMS MAM, and

CEMENTIBYR = Gross value of output for the cement industry for the nation in year 2006, as determined by MAM.

The output requirements of the finish grinders are reduced by the inclusion of certain additives, such as fly-ash, following the grinding step:

$$Grinding_Tonnes = Shipments * (1.0 - FlyAsh) \quad (78)$$

where:

Grinding_Tonnes = Quantity of output from the finish grinding step, in thousands of metric tons

FlyAsh = Percentage of additives, which is currently held constant at 5.0 percent.

Cement production in 2008 represents existing baseline capacity, which is allocated among the four competing types of finish grinders as follows:

$$BaseCapF_{Type} = Grinding_Tonnes * Tech_Share_{Type} \quad (79)$$

where:

BaseCapF_{Type} = Initial baseline capacity, by equipment type

Grinding_Tonnes = Quantity of output from the finish grinding step, in thousands of metric Tons, and

Tech_Share_{Type} = Initial allocation of finish grinding capacity, based on CIMS data, for 2008.

For each year following the base year (i.e., 2008), incremental additions to Finish Grinding capacity are based on the following assumptions:

- Baseline capacity is retired at a linear rate over a fixed time frame (initially set to 20 years)
- Production demand in excess of surviving baseline capacity will be met with replacement equipment, and
- Equipment acquired after 2008 will retire according to a logistic function.

Baseline capacity that survives is computed as follows:

$$BaseCapF_{T_{type}} = BaseCap_Lag_{T_{type}} - \left[\frac{BaseCap_IBYR_{T_{type}}}{BaseLifec} \right] \quad (80)$$

where:

$BaseCapF_{T_{type}}$ = Surviving baseline capacity, by equipment type,

$BaseCap_Lag_{T_{type}}$ = Lagged surviving baseline capacity, by equipment type,

$BaseCap_IBYR_{T_{type}}$ = Baseline capacity in year 2008, by equipment type, and

$BaseLifec$ = Assumed lifetime of baseline capacity.

The survival of any added incremental capacity is based on a logistic function. This function is written as:

$$New_Cap_SurvF_{i+1} = \frac{1}{1 + \exp\left[- Calibrationc * \left(1.0 - \left[\frac{2.0 * (i)}{LifeSpanc}\right]\right)\right]} \quad (81)$$

where

$New_Cap_SurvF_{i+1}$ = Rate of survival for added incremental capacity,

$LifeSpanc$ = Assumed lifetime of added finish grinding capacity,

$Calibrationc$ = Calibration constant for the survival curve of added incremental capacity, and

i = A year index representing the Vintage (i.e., number of years since acquisition of added capacity).

The survival function determines the share of needed capacity added in a given year that survives to the current model year, as shown in Figure 16.

Figure 16. Survival function for new cement capacity

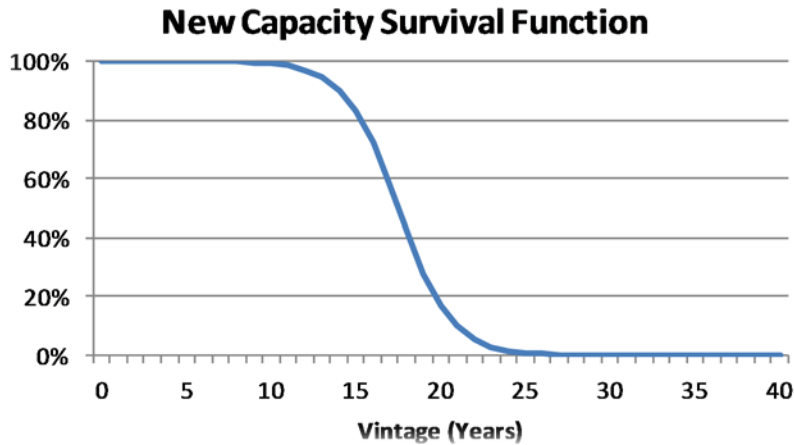

Then, any needed incremental capacity, stored and retained by model year, for the current model year is determined by the both surviving baseline and incrementally added capacity as follows:

$$Needed_Capacity_{Year} = Grinding_Tonnes - Surviving_Capacity \quad (82)$$

$$Incr_AddsF_{Year} = Needed_Capacity_{Year} \quad (83)$$

where

$Needed_Capacity_{Year}$ = Quantity of new capacity production needs in the current model year, in thousands of metric tons

$Grinding_Tonnes$ = Quantity of output from the finish grinding step, in thousands of metric tons

$Surviving_Capacity$ = Surviving incremental capacity added in prior years

$Incr_AddsF_{Year}$ = Variable stored for subsequent use in FINISH_GRIND_ALLOC subroutine.

After establishing the required additions to finish grinding capacity, the CEMENT_INDUSTRY submodule allocates the current model year's added capacity ($Incr_AddsF_{Year}$) among competing technologies.

KILN_CAPACITY (Node 2)

Process heat service required by the kilns is addressed in this node. Wet process and dry process capacity is treated differently, due to the obsolescence of the wet process and the decision not to replace retiring wet capacity. Accordingly, the heating systems associated with the wet process are assumed to be retired at the same rate as the kilns they service.

Kilns provide the clinker for the finish grinding step, so total kiln output/capacity is linked to the previous node.

Historically, a certain fraction of the material proceeding to the finish grinding step consists of imported clinker and other additives. This reduces the needed capacity of kilns, as follows:

$$\text{Process_OutputK} = \text{Grinding_Tonnes} * [1.0 - (\text{Import_Clink} + \text{Additives})] \quad (84)$$

Where:

Process_OutputK = Total output from cement kilns, in thousands of metric tons,

Grinding_Tonnes = Quantity of output from the finish grinding step, in thousands of metric tons,

Import_Clink = Percent of imported clinker, and

Additives = Percent of other additives.

Baseline kiln capacity (i.e., output in 2008 and earlier years) is distributed between “wet” and “dry” processes, and further allocated among different kiln technologies according to historical production shares, from CIMS:

$$\text{Wet}_{\text{ProcessYear}} = \text{Process_OutputK} * p\text{Wet} \quad (85)$$

and

$$\text{Dry}_{\text{Process}} = \text{Process_OutputK} * p\text{Dry} \quad (86)$$

where:

Wet_ProcessYear = Wet process capacity, by *Year*.

pWet = Historical share of wet process output, 13.8%, in 2008,

Dry_Process = Dry process capacity with no *Year* indexing,

Process_OutputK = Total output from cement kilns, in thousands of metric tons, and

pDry = Historical share of dry process output, 86.2%, in 2008.

For the 2008 year, storing of values for subsequent computations occurs as follows:

$$\text{Wet_Rotary}_{2008} = \text{Wet_Process}_{2008} \quad (87)$$

$$\text{Wet_ProcessIBYR} = \text{Wet_Rotary}_{2008} \quad (88)$$

$$\text{Wet_RotaryIBYR}_{2008} = \text{Wet_Rotary}_{2008} \quad (89)$$

and

$$Dry_Rotary_{2008,Type} = Dry_Process * Tech_Share_{Type} \quad (90)$$

$$Dry_Rotary_{IBYR}_{Type} = Dry_Rotary_{2008,Type} \quad (91)$$

where

$Tech_Share_{Type}$ = Allocation shares of dry rotary kilns, CIMS data,

$Wet_Process_{IBYR}$ = Wet process capacity in 2008 base year, and

$Dry_Rotary_{IBYR}_{Type}$ = Dry process capacity, by equipment type in 2008 base year.

For post-2008 year baseline capacities, the baseline capacities, by year are determined as follows:

$$Wet_Process_{Year} = Wet_Process_{Year-1} - \left[\frac{Wet_Process_{IBYR}}{BaseLifec} \right] \quad (92)$$

$$Dry_Rotary_{Year,Type} = Dry_Rotary_{Year-1,Type} * - \left[\frac{Dry_Rotary_{IBYR}_{Type}}{BaseLifec} \right] \quad (93)$$

where

$BaseLifec$ = Retirement span of baseline dry rotary process and wet process capacities.

The survival of any added incremental capacity is based on a logistic function. This function is written as:

$$New_Cap_SurvK_{i+1} = \frac{1}{1 + \exp\left[- Calibrationc * \left(1.0 - \left[\frac{2.0 * (i)}{LifeSpanc}\right]\right)\right]} \quad (94)$$

$New_Cap_SurvK_{i+1}$ = Rate of survival for added incremental capacity,

$LifeSpanc$ = Assumed lifetime of added finish grinding capacity,

$Calibrationc$ = Calibration constant for the survival curve of added incremental capacity, and

i = a year index representing the Vintage (i.e., number of years since acquisition of added incremental capacity) of added capacity.

The survival function determines the share of needed capacity added in a given year that survives to the current model year, as shown in Figure 16.

Then, any needed added incremental capacity, stored and retained by model year, for the current model year is determined by both surviving baseline and surviving incrementally added capacity as follows:

$$Needed_Capacity_{Year} = Process_OutputK - Surviving_Capacity \quad (95)$$

$$Incr_AddsK_{Year} = Needed_Capacity_{Year} \quad (96)$$

where

Needed_Capacity _{Year}	=	Quantity of new capacity production needs in the current model year, in thousands of metric tons,
Process_OutputK	=	Total output from cement kilns, in thousands of metric tons,
Surviving_Capacity	=	Surviving incremental capacity added in prior years,
Incr_AddsK _{Year}	=	Variable for subsequent use in KILN_ALLOCATION subroutine

Incrementally added capacity represents the total productive capacity added in a given year that survives to the current model year. The survival function determines the share of capacity added in a given year that survives to the current year, as shown in Figure 15.

The use of the wet process is considered to be declining, and is consequently not subject to replacement by new, similar technologies. Because of different input process (e.g., raw grinding) requirements associated with the wet process, it needs to be tracked separately, and retirements are accommodated by additions to dry process technology. Any added incremental capacities for dry rotary kilns are subsequently allocated to kiln Type in the KILN_ALLOCATION subroutine.

FINISH_GRIND_ALLOC

New capacity is allocated in the FINISH_GRIND_ALLOC subroutine using a multinomial logit model, in which the characteristics of competing alternatives are assessed. Each alternative technology has identifying characteristics, in this case, the capital cost, O&M cost, fuel use, and particulate emissions associated with the production of a thousand metric tons of cement. These characteristics are extracted from the CIMS database, which contains detailed data for each component in the cement manufacturing process. Each multinomial logit model used in allocating equipment types is initially calibrated to provide the baseline shares of equipment.

For example, the annual market share for each technology is calculated as:

$$Shares_{Type,Year} = \frac{e^{U_{Type,Year}}}{\sum_{Type} e^{U_{Type,Year}}} \quad (97)$$

where the “utility” or $U_{type,year}$ of each equipment type is estimated based on its equipment type attributes. With appropriate constraints, any added production is then allocated among the competing equipment types base on $Shares_{Type,Year}$.

The energy projected and then reported in the IDM for finished grinding is determined from the kiln output and energy intensity of each type of finish grinder, as reported in the CIMS data, which subsequently is partitioned into Census Regions in the CALPATOT subroutine of IDM.

KILN_ALLOCATION

As noted above, all additional kiln capacity is expected to be provided by dry process kilns, and the allocation of incremental demand is governed by the characteristics of the competing dry-process technologies, based on a multinomial logit model. Each multinomial logit model used in allocating equipment types is initially calibrated to provide the baseline shares of equipment.

For example, the annual market share for each dry process kiln technology is calculated as:

$$Shares_{Type,Year} = \frac{e^{U_{Type,Year}}}{\sum_{Type} e^{U_{Type,Year}}} \quad (98)$$

After these market shares are applied to the incrementally added production capacity, coupled with the surviving production capacity from both the wet and dry process kilns, the heat demand in total cement kilns is determined as follows:

$$Heat_Demand = Heat_Demand + \sum_{Type} Heat_Req_{Type'} \quad (99)$$

where

$Heat_Demand$ = Total amount of heat demanded, as expressed in Gigajoules (GJ), to produce $Process_OutputK$, as expressed in thousands of metric tons of clinker and

$Heat_Req_{Type}$ = Heating requirements, by kiln process $Type$, based on clinker production and reported CIMS energy requirements.

The heat (i.e., $Heat_Req_{Type}$) required to produce this output (expressed in GJ) is calculated separately for each process and subsequently totaled and passed to the CEMENT_INDUSTRY’s subroutine BURNER_CAP, as the variable $Heat_Demand$ and $Heat_Req_1$ (i.e., 1 index denotes heating requirement for wet process kilns).

It should be noted that, according to CIMS data, the electricity used in wet process kilns is produced in a CHP system that also provides the required process heat service. Accordingly, these kilns are net producers of electricity, and this component of the electric energy requirement is expressed as a negative in the CEMENT_INDUSTRY submodule’s output.

BURNER_CAP (Node 3)

In the base year, 2008, total process heat requirement, calculated in subroutine KILN_ALLOCATION, is

allocated among the available burner types. For the dry process, the heat requirement is determined as follows:

$$Heat_{Demand} = \sum_{Type} Heat_{Req}_{Type} \quad (100)$$

$$Total_{Heat} = Heat_{Demand} \quad (101)$$

$$Wet_{Heat} = Heat_{Req}_1 \quad (102)$$

$$Dry_{Heat}_{Req} = Total_{Heat} - Wet_{Heat} \quad (103)$$

where

Total_Heat = Total amount of heat demanded,

Heat_Demand = Total amount of heat demanded, as expressed in Gigajoules (GJ) of burner output, to produce *Process_OutputK*, as expressed in thousands of metric tons of clinker,

Heat_Req_{Type} = Heating requirements, by kiln process *Type*, based on clinker production and reported CIMS energy requirements – i.e., wet process is denoted as type 1,

Wet_Heat = Heat demand for wet process kilns, and

Dry_Heat_Req = Total heat demand for dry process kilns.

For 2008, the baseline year in the CEMENT_INDUSTRY submodule, the storing of values for subsequent computations occurs as follows:

$$Baseline_{CapacityIBYR} = Dry_{Heat}_{Req} \quad (104)$$

$$Baseline_{CapacityB}_{2008} = Baseline_{CapacityIBYR} \quad (105)$$

where

Baseline_CapacityIBYR = Baseline heat demand in 2008 for dry process kilns and

Baseline_CapacityB_{Year} = Burner capacity indexed by *Year*.

For post-2008 years, the heat demands are determined from baseline retirements and computed as follows:

$$Baseline_Capacity_{BYR} = Dry_Heat_Req \quad (106)$$

$$Baseline_Capacity_{Year} = Baseline_Capacity_{year-1} - \left[\frac{Baseline_Capacity_{BYR}}{Baselife_c} \right] \quad (107)$$

where

$Baseline_Capacity_{Year}$ = Burner capacity indexed by $Year$ and

$Baselife_c$ = Lifetime of baseline capacity, assumed to be 20 years.

Wet process heating systems are treated differently, in that the allocation of boiler types remains static at 2008 shares because wet process kilns is considered as declining linearly in IDM model projections.

The survival of any added incremental dry process heating capacity is based on a logistic function. This function is written as:

$$New_Cap_Surv_{i+1} = \frac{1}{1 + \exp\left[- Calibration_c * \left(1.0 - \left[\frac{2.0 * (i)}{LifeSpan_c}\right]\right)\right]} \quad (108)$$

where :

$New_Cap_Surv_{i+1}$ = Rate of survival for added incremental dry process heating capacity,

$LifeSpan_c$ = Assumed lifetime of added dry process heating capacity,

$Calibration_c$ = Calibration constant for the survival curve of added incremental dry process heating capacity, and

i = A year index representing the Vintage (i.e., number of years since acquisition of added incremental capacity) of added dry process heating capacity.

The survival function determines the share of needed capacity added in a given year that survives to the current model year, as shown in Figure 15.

Then, any needed added incremental dry heating capacity, stored and retained by model year, for the current model year is determined by both surviving baseline and surviving incrementally added heating capacity as follows:

$$Needed_Capacity_{Year} = Dry_Heat_Req - Surviving_Capacity \quad (109)$$

$$Incr_Adds_{Year} = Needed_Capacity_{Year} \quad (110)$$

where

$Needed_Capacity_{Year}$ = Quantity of new heating capacity needs in the current model year,

$Surviving_Capacity$ = Surviving incremental heating capacity added in prior years, and

$Incr_AddsB_{Year}$ = Variable for subsequent use in BURNER_ALLOCATION subroutine.

Incrementally added capacity represents the total productive capacity added in a given year that survives to the current model year. The survival function determines the share of capacity added in a given year that survives to the current year, as shown in Figure 15.

The initial allocation of burners is defined below.

Table 24. Initial allocation of cement kiln burners

Type	Description	Initial Share
		Shares _{Type, 2008}
Natural Gas 1	Standard Natural Gas-fired Burner	0.6%
Natural Gas 2	Efficient Natural Gas-fired Burner	2.1%
Oil 1	Standard Oil Burner	0.5%
Oil 2	Efficient Oil Burner	1.7%
Coal	Standard Coal Burner	73.1%
Petroleum Coke	Standard Petroleum Coke Burner	22.0%

SAIC, "Model Documentation Report: The U.S. Cement Industry," unpublished data report prepared for the Office of Energy Analysis, U.S. Energy Information Administration, Washington, DC, August 2012.

BURNER_ALLOCATION

The allocation of additional burner heating dry process capacity, $Shares_{Type,Year}$ is determined by the characteristics of the competing technologies, based on a multinomial logit model. Each multinomial logit model used in allocating equipment types is initially calibrated to provide the baseline shares of equipment. In addition, heating demands for each kiln process, by burner type, is converted to fuel input requirements, according to CIMS data on burner coefficients that convert GJ of heating demand into millions of Btu of fuel input.

RAW_GRIND_CAP (Node 4)

The clinker output from the kilns in Node 2 governs the required demand in the Raw Grinding step of the CEMENT_INDUSTRY submodule. The model treats the dry and wet processes separately. The quantity of material passing through the raw grinding step is calculated as follows:

$$Dry_Process_Out = Process_OutputK - Wet_Process_{Year} \quad (111)$$

$$Raw_Material = Dry_Process_Out * MassLoss \quad (112)$$

where:

Dry_Process_Out = Quantity of clinker, in thousand metric tons, produced using dry process, as determined from Node 2,

Process_OutputK = Total quantity of clinker, in thousand metric tons, produced as Determined from Node 2,

Wet_Process_{Year} = Quantity of clinker, in thousand metric tons, produced using wet process, as determined from Node 2,

Raw_Material = Raw material throughput for dry process, in thousands of metric tons, and

MassLoss = .Mass Loss Ratio, set to 1.60.

In 2008, baseline raw grinding capacity is allocated by grinder type in the RAW_GRIND_ALLOC subroutine and computed as follows:

$$Baseline_CapacityIBYR = Raw_Material \quad (113)$$

$$Baseline_CapacityG_{2008} = Baseline_CapacityIBYR \quad (114)$$

where

Baseline_CapacityIBYR = Baseline heat demand in 2008 for dry process kilns

Baseline_CapacityG_{Year} = Burner capacity indexed by *Year*.

For post-2008 years, the raw material throughputs are determined from baseline retirements and computed as follows:

$$Baseline_CapacityG_{Year} = Baseline_CapacityG_{Year-1} - \left[\frac{Baseline_CapacityIBYR}{Baselifec} \right] \quad (115)$$

where

Baseline_CapacityG_{Year} = Raw material throughput capacity indexed by *Year* and

Baselifec = Lifetime of baseline dry process grinding equipment, set to 20 years.

Wet and dry process grinders have different characteristics and initial allocations, as shown in Table 25:

Table 25. Initial allocations of process grinders

Type	Description	Initial Share
Dry Process Grinders		<i>Shares</i> _{Type,2008}
Ball Mill	Dry Raw Grinding Ball Mill	43%
Roller Mill	Dry Raw Grinding Roller Mill	57%
Wet Process Grinders		<i>Tech_Split</i> _{Type}
Ball Mill	Wet Raw Grinding Ball Mill	49%
Autogenous Mill	Wet Raw Grinding Autogenous Mill	51%

SAIC, "Model Documentation Report: The U.S. Cement Industry," unpublished data report prepared for the Office of Energy Analysis, U.S. Energy Information Administration, Washington, DC, August 2012.

As noted previously, wet process capacity is assumed to retire linearly, without replacement, and the demand for associated raw grinding services is directly linked to wet process clinker production. Surviving baseline capacity and incremental additions are then represented with only the dry process kilns.

The survival of any added incremental capacity is based on a logistic function. This function is written as:

$$New_Cap_SurvG_{i+1} = \frac{1}{1 + \exp[-Calibrationc * (1.0 - \frac{2.0 * (i)}{LifeSpanc})]} \quad (116)$$

where

New_Cap_SurvG_{i+1} = Rate of survival for added incremental capacity,

LifeSpanc = Assumed lifetime of added finish grinding capacity,

Calibrationc = Calibration constant for the survival curve of added incremental capacity, and

i = A year index representing the Vintage (i.e., number of years since acquisition of added incremental capacity) of added capacity.

The survival function determines the share of needed capacity added in a given year that survives to the current model year, as shown in Figure 16

Then, any needed added incremental capacity, stored and retained by model year, for the current model year is determined by both surviving baseline and surviving incrementally added capacity as follows:

$$Needed_Capacity_{Year} = Raw_Material - Surviving_Capacity \quad (117)$$

$$Incr_AddsG_{Year} = Needed_Capacity_{Year} \quad (118)$$

where

$Needed_Capacity_{Year}$ = Quantity of new raw grinding capacity production needs in the current model year, in thousands of metric tons,

$Raw_Material$ = Raw material throughput for dry process, in thousands of metric tons ,

$Surviving_Capacity$ = Surviving incremental capacity added in prior years, and

$Incr_AddsG_{Year}$ = Variable for subsequent use in RAW_GRIND_ALLOC subroutine.

Incrementally added capacity represents the total productive capacity added in a given year that survives to the current model year. The survival function determines the share of capacity added in a given year that survives to the current year, as shown in Figure 16.

The use of the wet process is considered to be declining, and is consequently not subject to replacement by new, similar technologies. Because of different input process (e.g., raw grinding) requirements associated with the wet process, it needs to be tracked separately, and retirements are accommodated by additions to dry process technology. Any added incremental capacities for dry rotary kilns are subsequently allocated to raw grinder Type in the RAW_GRIND_ALLOC subroutine.

RAW_GRIND_ALLOC

The allocation of additional raw grinding capacity, $Shares_{Type,Year}$ is determined by the characteristics of the competing technologies, based on a multinomial logit model. Each multinomial logit model used in allocating equipment types is initially calibrated to provide the baseline shares of equipment.

The energy projected and then reported in the IDM for raw grinding is determined from the raw material throughput and energy intensity of each type of raw grinder, as reported in the CIMS data, which subsequently is partitioned into Census Regions in the CALPATOT subroutine of IDM.

Process Emissions Calculations

Process emissions are significant during clinker production at cement manufacturers. IDM computes these process emissions as follows:

- Process-related emissions are calculated using empirical relationships from the U.S. Environmental Protection Agency that link the emissions of CO₂ (process-related) and cement kiln dust (CKD) with the amount of raw material entering the kiln. Process-related CO₂ emissions are computed for each ton of **clinker** produced, while CKD emissions are calculated based on each ton of **cement** produced. Note that CKD emissions are typically recycled with a 2-percent loss.⁴⁴ A standard emissions factor (0.51 tons of carbon dioxide per ton of clinker) is used to calculate process-related CO₂ emissions. When raw material additives, such as blast furnace slag, are used, the emissions factor drops to 0.50 tons of CO₂ per ton of clinker.

⁴⁴ Huntzinger et al, Life Cycle Analyses of Portland Cement Manufacture, J. of Cleaner Production, 17 (2009) pp. 668-675.

Fuel-related CO₂ emissions are calculated from the portfolio of fuels used by the cement industry over a given year. These are calculated in the IDM and added to the amount of process-based CO₂ emissions described above.

LIME_INDUSTRY Submodule

The lime industry submodule calculates lime industry energy consumption. Cement and lime energy shipments and energy consumption are reported together, although they are projected separately. The new process flow model calculates UEC as a function of capital equipment used and updates capital equipment based on demand, capacity surviving, and new capacity. Domestic lime production is not directly estimated by the MAM. However, the MAM macro variable MC_REVIND(11,20,Year), which denotes gross output from “Other Nonmetallic Mineral Products,” is used as a proxy for lime production when calculating CO₂ emissions. Accordingly, this variable is also used to estimate the metric tons of lime production in the projected years. This is done by indexing the macro variable to its 2009 value (the last year for which total lime production was published by USGS), and adjusting the 2009 production value to apply to each projection year, as shown below. This provides a time series estimate of lime production throughout the forecast. Internal submodule calculations are in metric units, which are converted to English units for calculations external to this submodule.

The physical quantity of lime kiln outputs (i.e., shipments) is the total quantity of shipments (in thousand metric tons) in a given year.

$$Demand = Demand_IBYR2 * \left[\frac{OUTIND_{23,11}}{LIMEIBYR} \right] \quad (119)$$

where

Demand = Physical quantity of lime shipments, in thousands of metric tons, projected for the lime industry, as reported by the U.S. Department of Interior, U.S. Geological Survey;

Demand_IBYR2 = Physical quantity of lime shipments, in thousands of metric tons in 2009, as reported by the U.S. Department of Interior, U.S. Geological Survey;

OUTIND_{23,11} = Gross value of output for the lime industry (IDM industry code of 23) for the nation in the current projection year, as determined by NEMS MAM and internally adjusted by IDM; and

LIMEIBYR = Gross value of output for the lime industry for the nation in year 2009, as determined by MAM and internally adjusted by IDM.

The initial, 2009 value of lime production is obtained from the USGS Data Series 140, and is estimated at 15,800 thousand metric tons. Projected values are determined by applying the associated

macroeconomic index. The energy required for processing this output is determined by the existing and projected future stock of lime kilns, as discussed below.

Capacity Determination

Lime production in 2008 represents existing baseline capacity to minimize the need for substantial new capacity based on the relatively low levels of demand (or production) for lime reported by the U.S.

Geological Survey in 2009. Lime demand is subsequently allocated among the three competing types of kilns, per the inputs from the CIMS database.

For 2008, the baseline year in the LIME_INDUSTRY submodule, the storing of values for subsequent computations occurs as follows:

$$Demand_IBYR = 19900 \quad (120)$$

$$Baseline_Capacity_IBYR = Demand_IBYR \quad (121)$$

$$Baseline_Capacity = Demand_IBYR \quad (122)$$

where

Demand_IBYR = Physical lime production (19,900 thousand metric tons) reported by U.S. Department of Interior, U.S. Geological Survey, in 2008 and

Baseline_Capacity_IBYR = Lime kiln capacity in 2008.

For post-2008 years, the lime kiln capacity is determined from baseline retirements and computed as follows:

$$Baseline_Capacity_Lag = Baseline_Capacity \quad (123)$$

$$Baseline_Capacity = Baseline_Capacity_Lag - \left[\frac{Baseline_Capacity_IBYR}{Baselife} \right] \quad (124)$$

where

Baseline_Capacity_Lag = Prior year's lime kiln capacity,

Baseline_Capacity = Surviving baseline kiln capacity,

Baseline_Capacity_IBYR = Initial lime kiln capacity in 2008, and

Baselife = Lifetime of baseline lime kiln capacity, assumed to be 20 years.

The survival of any added incremental lime kiln capacity is based on a logistic function. This function is written as:

$$New_Cap_SurvL_{i+1} = \frac{1}{1 + \exp[-Calibrationc * (1.0 - \frac{2.0 * (i)}{LifeSpan})]} \quad (125)$$

where

$New_Cap_SurvL_{i+1}$ = Rate of survival for added incremental lime kiln capacity,

$LifeSpan$ = Assumed lifetime of added lime kiln capacity,

$Calibrationc$ = Calibration constant for the survival curve of added incremental lime kiln capacity, and

i = A year index representing the vintage (i.e., number of years since acquisition of added incremental capacity) of added lime kiln capacity.

The survival function determines the share of needed capacity added in a given year that survives to the current model year, as shown in Figure 15.

Then, any needed added incremental lime kiln capacity, stored and retained by model year, for the current model year is determined by both surviving baseline and surviving incrementally added lime kiln capacity as follows:

$$Needed_Capacity_{Year} = Demand - Surviving_Capacity \quad (126)$$

$$Incr_Adds_{Year} = Needed_Capacity_{Year} \quad (127)$$

where

$Needed_Capacity_{Year}$ = Quantity of new lime kiln capacity needs in the current model year,

$Surviving_Capacity$ = Surviving incremental lime kiln capacity added in prior years, and

$Incr_Adds_{Year}$ = Variable for subsequent use in allocation added lime kiln capacity.

Incrementally added capacity represents the total productive capacity added in a given year that survives to the current model year. The survival function determines the share of capacity added in a given year that survives to the current year, as shown in Figure 15.

Table 26 displays the initial share of baseline capacity of lime kilns, by fuel.

Table 26. Initial allocation of lime kilns

Type	Description	Initial Share <i>Technology_Share_{Type}</i>
Coal	Rotary Kiln: Coal	73%
Residual Fuel Oil	Rotary Kiln: Residual Fuel Oil	17%
Natural Gas	Vertical Shaft Kiln: Natural Gas	10%

SAIC, "Model Documentation Report: The U.S. Lime Industry," unpublished data report prepared for the Office of Energy Analysis, U.S. Energy Information Administration, Washington, DC, August 2012.

In summary, each year following the base year incremental additions to kiln capacity are based on the following assumptions:

- Baseline capacity is retired at a linear rate over a fixed time frame,
- Production demand in excess of surviving baseline capacity will be met with replacement equipment, and
- Equipment acquired after 2009 will retire according to a logistic decay function, as shown in Figure 15.

After establishing the required additions of kiln capacity, the model allocates the projected new capacity (*Incr_Adds_{Year}*) among the competing technologies.

Capacity Allocation

New capacity is allocated among technologies using a multinomial logit model, in which the characteristics of competing alternatives are assessed. Each alternative technology has identifying characteristics, in this case, the capital cost, O&M cost, fuel use, and CO₂ emissions associated with the production of a thousand metric tons (kT) of lime. These characteristics are extracted from the CIMS database, which contains detailed data for each type of lime kiln, by fuel type, and are shown in Table 27.

Table 27. Characteristics of lime kilns

Technology Type	Technology Attributes		
	Total Fixed Costs (\$/kT)	Fuel Use (MMBtu/kT)	CO ₂ Emissions (Tons/kT)
Coal	36,701	4,893	474.1
Residual Fuel Oil	34,752	5,632	431.9
Natural Gas	31,593	4,931	258.8

SAIC, "Model Documentation Report: The U.S. Lime Industry," unpublished data report prepared for the Office of Energy Analysis, U.S. Energy Information Administration, Washington, DC, August 2012.

The energy projected and then reported in the IDM for lime production is based on the kiln output and energy of each type of kiln and other process and assembly end-use activities, as reported in the CIMS data and latest MECS data. Partitioning of national estimate of energy consumption in the lime industry into Census Regions occurs in the CALPATOT subroutine of IDM.

ALUMINUM_INDUSTRY Submodule

Figure 10 shows a detailed process flow diagram (PFD) for aluminum manufacturing.

Accurate modeling of this heterogeneous and complex industry requires an optimum model from the range of models that simulate this sector. These range from models that require very specific processing details to those that use macroscopic industry representations. In IDM's modeling approach, the process is first broken down into several unit operations using process engineering techniques. The energy consumed by each unit operation and the corresponding mass flow of material (raw materials, intermediates, or final products) through that unit operation are calculated from the data. Their ratio supplies the UEC specific for that unit operation. The energy demands for processing the required mass of material through each unit operation are calculated and aggregated to provide the total energy consumption for the desired amount of the product(s). By virtue of its ability to calculate energy demands at the unit operation level, the aggregated estimate is a more accurate calculation of energy consumption compared with that from a global UEC. This approach is discussed in detail in the ensuing sections, starting with a description of the aluminum manufacturing process.

Background on Aluminum Industry

The U.S. aluminum industry is a broadly diversified industry, starting with ore refining and ending with a wide variety of industrial and consumer products.⁴⁵ Aluminum (Al) is the third most abundant element in the earth's crust, but does not occur in nature as a metal, but only as an oxide (alumina), which in turn, is found in an ore called bauxite. In recent years, aluminum has begun to replace iron and steel in the automotive, electric power, and construction industries owing to its lighter weight, resistance to rust, alloyability, and recyclability. It is popular as a packaging material for beverages and food containers, as well as household and institutional foil.

The supply of aluminum in the United States stems from three basic sources:

- Primary production - domestic production from aluminum ore.
- Secondary production – domestic metal recovered from scrap, a.k.a. recycling
- Imports - primary and secondary ingots and mill products

The end product from the first two sources is molten aluminum metal, which is not in a form suitable for marketing to potential end-users. Instead, ingot casting is the vital conduit between the molten metal and the manufacture of aluminum and aluminum alloy products. Extrusions, forgings, sheet, plate, and foil begin as billet and fabricating ingots. Sand, permanent mold, investment, and pressure die castings typically originate in alloyed remelt ingots. For this modeling effort, it is assumed that aluminum imports are also processed like primary and secondary aluminum into end-use products.

Currently there are over 400 wrought aluminum and wrought aluminum alloys and over 200 aluminum alloys in the form of castings and ingots to match the wide range of material characteristics required by

⁴⁵ All bauxite for primary production is assumed imported to the United States.

end-use manufacturing processes.⁴⁶ In some cases, ingot formation and the manufacture of the final aluminum product for end-use applications are in the same location.

ALUMINUM_INDUSTRY Submodule: Subroutines

For this modeling effort, the boundaries established for the macroscopic modeling of the aluminum industry begin with the delivery of bauxite or scrap aluminum at the plant gate and end with ingot formation and the manufacture of aluminum sheet, plate, foil, and extruded products. Aluminum foundry operations for die and non-die casting are included.

Desegregation of Operations

The total energy consumed by the aluminum industry will be the sum of the energy consumed by the three modeled segments: primary aluminum production, secondary aluminum production, and product formation. Internal submodule calculations are in metric units, which are converted to English units for calculations external to this submodule.

Aluminum Production

Aluminum production is defined as aluminum supply minus aluminum imports plus aluminum exports plus changes in stocks. These values are obtained exogenously from other NEMS modules or from the United States Geological Survey (USGS).

The output of the ALUMINUM_INDUSTRY submodule is the total quantity of aluminum shipments or Gross Output (in thousand metric tons) in a given year. A physical production index is derived as follows:

$$index2006 = \left[\frac{OUTIND_{13,11}}{ALUMIBYR} \right] \quad (128)$$

where

<i>index2006</i> =	Index of Gross Output of aluminum shipments, projected for the aluminum industry
<i>OUTIND</i> _{13,11} =	Gross value of output for the aluminum industry (IDM industry code of 13) for the nation in the current projection year, as determined by NEMS MAM, and
<i>ALUMIBYR</i> =	Gross value of output for the aluminum industry for the nation in year 2006, as determined by MAM.

This index is used to project physical production using a forwarding indexing as follows:

$$domprod = domprod_IBYR2 * index2006 \quad (129)$$

⁴⁶ For aluminum specifications, see the Aluminum Association, http://www.aluminum.org/Content/NavigationMenu/TheIndustry/IndustryStandards/Teal_Sheets.pdf.

where

$domprod =$	Physical output from the aluminum industry (IDM industry code of 13) for the nation in the current projection year, as determined by NEMS MAM and USGS statistics
$index2006 =$	Index of physical quantity of aluminum shipments, projected for the aluminum industry
$domprod_{IBYR2} =$	Physical output for the aluminum industry (IDM industry code of 13) for the nation in 2006, based on USGS statistics.

A further refinement of the IDM allows separation of physical aluminum production into the primary and secondary production industries:

$$AL_{primary_prod} = domprod * primprod_{percent}(year) \quad (130)$$

where

$AL_{primary_prod} =$	Physical output using primary production from the aluminum industry (IDM industry code of 13) for the nation in the current projection year, as determined by NEMS MAM and USGS statistics,
$domprod =$	Physical output from the aluminum industry (IDM industry code of 13) for the nation in the current projection year, as determined by NEMS MAM and USGS statistics, and
$primprod_{percent}(year) =$	Percentage of primary production of aluminum industry (IDM industry code of 13) for the nation in the current projection year, as determined by regressions of endogenous NEMS variables related to fuel prices and USGS production statistics.

The IDM also assumes there is no new primary production capacity greater than surviving primary baseline capacity levels during the projection years, although idled primary capacity can be brought back into production. Secondary production capacity will be increased to meet the macroeconomic outputs prescribed in other modules of NEMS.

For each year following the base year (i.e., 2008), incremental additions to primary aluminum capacity are based on the following assumptions:

- Baseline capacity is retired at a linear rate over a fixed time frame (initially set to 20 years)
- Production demand in excess of surviving baseline capacity will be met with idled equipment, and
- Equipment acquired after 2008 will retire according to a logistic function.

Primary aluminum baseline capacity that survives is computed as follows:

$$SurvBaseCap = SurvBaseCapLag - \frac{SurvBaseCapIBYR}{AL_Base_CapLife} \quad (131)$$

where

$SurvBaseCap =$	Capacity on physical output from the aluminum industry (IDM industry code of 13) for the nation in the current projection year, as determined by the MAM and USGS statistics,
$SurvBaseCapLag =$	Lagged capacity on physical output from the aluminum industry (IDM industry code of 13) for the nation in the current projection year, as determined by the MAM and USGS statistics,
$SurvBaseCapIBYR =$	Baseline capacity cap on physical output from the aluminum industry (IDM industry code of 13) for the nation in the current projection year, as determined by the MAM and USGS statistics in 2011, and
$AL_Base_CapLife =$	Assumed lifetime (30 years) of baseline capacity.

Primary and Secondary Production Shares

The split between primary and secondary production is computed using a system of linear regressions based on historical production and energy prices, all of which is computed in the IDM CALPROD subroutine but implemented in the ALUMINUM_INDUSTRY submodule. Because primary production requires substantial more energy demands than secondary production, this IDM enhancement to MAM Gross Output aluminum projections is a key driver of projected aluminum industry energy consumption.

In addition, primary production, by projection year, is capped as follows:

$$Baseline_Prod_{Type} = MIN[AL_primary_prod, SurvBaseCap] * TechShrSM_{Type} \quad (132)$$

where

$Baseline_Prod_{Type} =$	Physical output, by primary technology, using primary production from the aluminum industry (IDM industry code of 13) for the nation in the current projection year, as determined by NEMS MAM and USGS production statistics,
$AL_primary_prod =$	Total physical output using primary production from the aluminum industry (IDM industry code of 13) for the nation in the current projection year, as determined by NEMS MAM and USGS statistics,
$SurvBaseCap =$	Cap on physical output from the aluminum industry's primary production capacity (IDM industry code of 13) for the nation in the current projection year, as determined by NEMS MAM and USGS statistics,
$TechShrSM_{Type} =$	Logit-derived shares for primary production technologies.

AL_PRIM_SMELT

Primary aluminum production in 2008 represents existing baseline capacity, which is allocated among competing technologies based on either historical data or CIMS data implemented in the AL_SMELT_ALLOC subroutine:

$$AL_baseline_capacity = baseline_capacity_IBYR \quad (133)$$

where:

$$\begin{aligned} AL_baseline_capacity &= \text{Initial baseline capacity} \\ baseline_capacity_IBYR &= \text{Quantity of primary production output in 2008, in thousands of metric tons.} \end{aligned}$$

For each year following the base year (i.e., 2008), incremental additions to primary aluminum production capacity are based on the following assumptions:

- Baseline capacity is retired at a linear rate over a fixed time frame (initially set to 20 years)
- Production demand in excess of surviving baseline capacity will be met with replacement equipment that survives for 30 years, and
- Equipment acquired after 2008 will retire according to a logistic function that has a survival cap of 30 years.

Baseline capacity that survives is computed as follows:

$$AL_BaseLine_Capacity = AL_BaseLine_Capacity_Lag - \left[\frac{BaseLine_Capacity_IBYR}{AL_Base_CapLife} \right] \quad (134)$$

where:

$$AL_BaseLine_Capacity = \text{Surviving baseline capacity,}$$

$$AL_BaseLine_Capacity_Lag = \text{Lagged surviving baseline capacity,}$$

$BaseLine_Capacity_IBYR$ = Baseline capacity in year 2008 or historical capacity from USGS aluminum statistics, and

$$AL_Base_CapLife = \text{Assumed lifetime of baseline capacity.}$$

The survival of any added incremental capacity is based on a logistic function. This function is written as:

$$Surviving_{i+1} = \frac{1}{1 + \exp\left[- CalibrationAL * \left(1.0 - \left[\frac{2.0 * (i)}{LifeTimeAL}\right]\right)\right]} \quad (135)$$

where

$$Surviving_{i+1} = \text{Rate of survival for added incremental capacity,}$$

$LifeTimeAL$ = Assumed lifetime of added finish grinding capacity,

$CalibrationAL$ = Calibration constant for the survival curve of added incremental capacity, and

i = A year index representing the Vintage (i.e., number of years since acquisition of added capacity).

The survival function determines the share of needed capacity added in a given year that survives to the current model year, as shown in these equations:

$$Needed_Capacity_{Year} = AL_Primary_Prod - Surviving_Capacity \quad (136)$$

$$AL_Incr_Adds_{Year} = Needed_Capacity_{Year} \quad (137)$$

where

$Needed_Capacity_{Year}$ = Quantity of new capacity production needs in the current model year, in thousands of metric tons, and

$AL_Incr_Adds_{Year}$ = Variable stored for subsequent use in allocation routines, as modified by the survival function.

As noted earlier, the IDM assumes that no new primary production capacity is built during the projection years. This is accomplished by tracking both the surviving baseline primary production capacity and the total needed primary aluminum production, from which only the minimum of the two values derives primary production demands.

AL_SMELT_ALLOC

The technology shares of the two primary production technologies, $TechShrSM_{Type}$ – are derived based on logistic function of total installation costs, operating and maintenance costs, and environmental considerations. Table 27 presents the two existing aluminum electrolysis technologies based on anode configurations.

Table 28. Aluminum Electrolysis Technologies Using Hall–Héroult Process

Type	$TechShrSM_{Type}$
Prebake	73%
Söderberg	27%

Source: CIMS database

Electrolytic reduction cells differ in the form and configuration of their carbon anodes and alumina feed systems. They belong to one of four types:

- Centre-Worked Prebake (CWPB)
- Side-Worked Prebake (SWPB)

Horizontal Stud Söderberg (HSS), and
Vertical Stud Söderberg (VSS).

Although four types exist today, the CIMS database only provides for two general electrolytic processes shares in current use. It is assumed that the Söderberg technology is no longer used for new capacity. Technology choices for the projection years based on CIMS include:

- Side-Worked Prebake with standard controls
- Side-Worked Prebake with point feeder controls
- Centre-Worked Prebake with point feeder controls
- Centre-Worked Prebake with point feeder controls and also with computer monitoring and automation, and
- Inert anode with wetted cathode.

Remaining ALUMINUM_INDUSTRY Submodule Subroutines

For the remaining subroutines that make up the ALUMINUM_INDUSTRY submodule, similar computations on capacity and allocation by technology diffusion are completed in subroutines AL_ANODE_PRD (i.e., anode production), AL_PRIM_ALUMINA (i.e., alumina production), AL_ALLOC (i.e., alumina allocations), AL_SEC_PRD (i.e., secondary production), and AL_SEC_ALLOC (i.e., secondary technology allocation). Outputs from these routines – e.g., respective projected production levels by technology – are linked with the technology-specific energy demands from the CIMS database to allow computation and reporting of energy consumption in the aluminum industry.

CALBYPROD

The Industrial Demand Module is run assuming that all byproduct fuels are consumed prior to the purchasing of any fuels. The CALBYPROD subroutine calculates the energy savings or the location on the technology possibility curve (TPC) based on the current year's industry production and the previous year's industry production for each process step, fuel, and vintage resulting from byproduct fuel consumption. The TPC for biomass byproducts is assumed to be a positive function of energy prices. Other byproducts, such as blast furnace gas, are unrelated to energy prices, and therefore there is no change in the UEC for other byproducts. Currently, only the paper and allied products industry has a TPC for biomass byproducts. For all other industries the UEC remains unchanged. For years after 2006, the ratio of the current year's average industrial energy price to the average price in 2006 is computed. TPCPrat is the greater of this ratio and 1.0. TPC is an increasing function of TPCPrat:

$$X = TPCPrat^{TPCBeta}$$

$$TPCPriceFactor = \frac{X}{(1+X)} \quad (138)$$

$$TPCRate_v = 2 * TPCPriceFactor * BYPCSC_{v.f.s}$$

where

$TPCPrat$ = Maximum (1.0, Ratio of current year average industrial energy price to 2006 price),

$TPCBeta$ = Parameter of logistic function, currently specified as 4,

$TPCPriceFactor$ = TPC price factor, ranging from 0 (no price effect) to 2 for byproducts,

$TPCRate_v$ = TPC multiplier on TPC rate due to energy price increases for vintage v , and

$BYP CSC_{v,f,s}$ = Initial TPC for vintage v , fuel f , and step s .

CALBYPROD calculates the rate of byproduct energy produced for each process step, fuel, and vintage as shown in the following equation. This value is based on the previous year's rate of production and the current energy savings for each vintage.

$$BYPINT_{v,f,s} = (BYPINTLag_{v,f,s})^{TPCRate_v} \quad (139)$$

where

$BYPINT_{v,f,s}$ = Rate of byproduct energy production (or UEC) for byproduct fuel f at process step s for vintage v ,

$BYPINTLag_{v,f,s}$ = Lagged rate of byproduct energy production for byproduct fuel f at process step s for vintage v , and

$TPCRate_v$ = TPC multiplier on TPC rate due to energy price increases for vintage v .

The UEC for middle vintage is a weighted average (by production) of the prior year's energy savings for new vintage and the previous year's energy savings for middle vintage.

$$BYPINT_{mid,f,s} = \left[\frac{(PRODLag_{mid,f,s} * BYPINTLag_{mid,f,s})}{(PRODLag_{mid,s} + PRODLag_{new,s})} + \frac{(PRODLag_{new,s} * BYPINTLag_{new,f,s})}{(PRODLag_{mid,s} + PRODLag_{new,s})} \right]^{TPCRate_{mid}} \quad (140)$$

where

$PRODLag_{new,s}$ = Prior year's production from new vintage capacity at process step s ,

$BYPINTLag_{new,f,s}$ = Lagged rate of byproduct energy production for byproduct fuel f at process step s for new vintage,

$PRODLag_{mid,s}$ = Prior year's production from middle vintage capacity at process step s ,

$BYPINTLag_{mid,f,s}$ = Lagged rate of byproduct energy production for byproduct fuel f at process step s for middle vintage, and

$TPCRate_{mid}$ = TPC multiplier on TPC rate due to energy price increases for middle vintage.

The rate of byproduct fuel production is used to calculate the quantity of byproduct energy produced by multiplying total production at the process step by the production rate.

$$BYPQTY_{v,f,s} = PRODCUR_{v,s} * BYPINT_{v,f,s} \quad (141)$$

where

$BYPQTY_{v,f,s}$ = Byproduct energy production for byproduct fuel f at process step s for vintage v ,

$PRODCUR_{v,s}$ = Production at process step s for vintage v , and

$BYPINT_{v,f,s}$ = Rate of byproduct energy production for byproduct fuel f at process step s for vintage v .

Note that $PRODCUR_{v,s}$ is production by a vintage at a step and is not fuel-specific. The rate of byproduct fuel production is then converted from millions of Btu to trillions of Btu. Byproduct fuel production is subdivided into three categories: main fuels, intermediate fuels, and renewable fuels.

Byproduct production for each group of fuels is determined by summing byproduct production over the individual process steps for each fuel and vintage as shown below for main byproduct fuels. The equations for intermediate and renewable fuels are similar.

$$ENBYM_f = \sum_{x=1}^{MPASTP} BYPQTY_{v,f,s} \quad (142)$$

where

$ENBYPM_{f,v}$ = Byproduct energy production for main byproduct fuel f for vintage v ,

$MPASTP$ = Number of process steps, and

$BYPQTY_{v,f,s}$ = Byproduct energy production for byproduct fuel f at process step s for vintage v .

CALPATOT

CALPATOT calculates the total energy consumption from the process and assembly (PA) component. Energy consumption at each process step is determined by multiplying the current production at that particular process step by the unit energy consumption (UEC) for that process step. Energy consumption is calculated for each fuel, vintage, and step using the following equation.

$$ENPQTY_{v,f,s} = PRODCUR_{v,s} * ENPINT_{v,f,s} \quad (143)$$

where

$ENPQTY_{v,f,s}$ = Consumption of fuel f at process step s for vintage v ,

$PRODCUR_{v,s}$ = Production at process step s , for vintage v , and

$ENPINT_{v,f,s}$ = Unit energy consumption of fuel f at process step s for vintage v .

Consumption of each fuel is converted to trillions of Btu. Energy consumption is subdivided into main fuels, intermediate fuels, and renewable fuels. The main fuel group includes:⁴⁷

- Electricity
- Core and non-core natural gas
- Natural gas feedstocks
- Steam coal
- Coking coal (including net coke imports)
- Residual oil
- Distillate oil
- Liquefied petroleum gas for heat and power
- Liquefied petroleum gas for feedstocks
- Motor gasoline
- Still gas
- Petroleum coke
- Asphalt and road oil
- Petrochemical feedstocks
- Other petroleum feedstocks
- Other petroleum

The intermediate fuel group includes:

- Steam
- Coke oven gas
- Blast furnace gas
- Other byproduct gas
- Waste heat
- Coke

The renewable fuels group represented in the model includes:

- Hydropower
- Biomass--wood
- Biomass--pulping liquor
- Municipal solid waste

⁴⁷Still gas and petroleum coke are consumed primarily in the refining industry, which is modeled in the Liquid Fuels Market Module of NEMS.

Geothermal, solar, and wind are currently not represented in the model because of their low industrial penetration.

Energy consumption for the three fuel groups is determined for each fuel by summing over the process steps and the three vintage categories, as shown below for main fuels. The equations for intermediate and renewable fuels are similar.

$$ENPMQTY_f = \sum_{x=1}^{MPASTP} \sum_{v=1}^3 ENPQTY_{v,f,s} \quad (144)$$

where

$ENPMQTY_f$ = Consumption of main fuel f in the process/assembly component,

$MPASTP$ = Number of process step s , and

$ENPQTY_{v,f,s}$ = Consumption of fuel f at process step s for all vintages.

The impact of increased corn-based ethanol production on energy used in agriculture and in producing nitrogenous fertilizer is projected as follows:

$$CORNFUEL_f = \sum_{f=1}^6 CORNFAC_f * CORNINCR \quad (145)$$

where

$CORNFUEL_f$ = Consumption of fuel f in agricultural production for ethanol feedstocks,

$CORNFAC_f$ = Thousand Btu of fuel f to produce 1 bushel of corn, and

$CORNINCR$ = Incremental corn production.

The fuels, f , are electricity, natural gas, distillate, LPG, motor gasoline, and natural gas used for additional fertilizer production.

The increased fuel requirements are then added to the energy projections for the agricultural crops industry (NAICS 111), and, for fertilizer, to the agricultural chemicals industry (NAICS 3253). The values for $CORNFAC_f$ are given in Table B.27.

Energy consumption for coke imports is calculated as the difference between coke consumption and coke production. In the current Industrial Demand Module, coke is consumed only in the BF/BOF process step in the iron and steel industry. Coke is produced only in the coke oven process step in the iron and steel industry. The equation for net coke imports is shown below.

$$ENPMQTY_{coke} = ENPIQTY_{coke} - \left(PRODCUR_{total,co} * \frac{24.8}{10^6} \right) \quad (146)$$

where

$ENPMQTY_{coke}$ = Quantity of coke imports in the PA component,

$ENPIQTY_{coke}$ = Consumption of coke in the PA component,

$PRODCUR_{total,co}$ = Current production at the coke oven process step for all vintages,
and

$24.8/10^6$ = Conversion factor, where there are 24.8 million Btu per short ton of coke,
converted to trillion Btu.

MOTORS

Subroutine MOTORS calculates machine drive energy consumption for these end-use manufacturing industries: food, bulk chemicals, metal-based durables, and the balance of manufacturing. The Energy Independence and Security Act of 2007 increased motor efficiency standards effective no later than 2011. The motor model has been revised to reflect this and the fact that the EPACT92 standards no longer apply. The motor model is a stock model which tracks the number of motors in each of these four industries for seven size groups: 1-5 horsepower (hp), 6-20 hp, 21-50 hp, 51-100 hp, 101-200 hp, 201-500 hp, >500 hp. The first step is to initialize the following variables for their base year (2002) values:

$MotorStock_{s,2002}$ = Motor stock for motor size group s in the base year (2002), number of motors,

$MotAvgEnergy_{s,2002}$ = Average energy consumption per motor for motor size group s in the base year (2002), kWh per motor per year,

$MotAvgEff_{s,2002}$ = Average motor energy efficiency rating for motor size group s in the base year (2002),

$FailurePct_s$ = Percentage of motors which fail each year for motor size group s ,

$MotorRetPct_s$ = Percentage of motors retired upon failure for motor size group s ,

$MotorRewDrop_s$ = Drop in efficiency for rewound motors in motor size group s ,

$MotorSysLife_s$ = Motor system efficiency program life in motor size group s ,

$PumpAppPct_s$ = Motor system efficiency applicability, percentage of pump systems in motor size group s ,

$FanAppPct_s$ = Motor system efficiency applicability, percentage of fan systems in motor size group s ,

$CompAppPct_s$ = Motor system efficiency applicability, percentage of compressor systems in motor size group s ,

$PumpSavPct_s$ = Motor system efficiency savings fraction for pump systems in motor size group s ,

$FanSavPct_s$ = Motor system efficiency savings fraction for fan systems in motor size group s ,
and

$CompSavPct_s$ = Motor system efficiency savings fraction for compressor systems in motor
size group s .

Once these variables have been initialized, the base year energy consumption is calculated:

$$TotalMotorEnergy_s = MotorStock_s * \left(MotorAvgEnergy_{s,2006} * \frac{3412}{10^{12}} \right) \quad (147)$$

where

$TotalMotorEnergy_s$ = Motor energy consumption in trillion Btu for motor size group s in the
base year (2006),

$MotorStock_s$ and $MotorAvgEnergy_s$ are defined above.

Projections of the motor stock, and the associated energy consumption, are grounded in these initial base year values. The growth in the value of shipments for each industry provided by the Macroeconomic Activity Module is the driving force determining the overall stock of motors. New motors are purchased to accommodate the projected industrial growth, as well as to replace retired motors. The number of motors retired upon failure is evaluated using a cost and performance algorithm. The initial cost differential for replacing the failed motor is weighed against the energy expenditure savings to determine the payback period in years. A payback acceptance curve provides the split between replaced and repaired motors. The first calculation is the price differential for the new motor:

$$ReplacePrPrem_s = PEListPrice_s * (1 - DealerDisc) - RewindCost_s \quad (148)$$

where

$ReplacePrPrem_s$ = Premium for replacing a failed motor for motor size group s ,

$PEListPrice_s$ = The manufacturers' list price for an EISA efficiency motor in motor size
group s ,

$DealerDisc$ = The average dealer discount offered on purchases of EISA efficiency motors, and

$RewindCost_s$ = The cost to rewind a failed motor for motor size group s .

The energy expenditure savings are calculated, with prices in 2002 dollars for convenience, as follows:

$$ReplaceAnnSav_s = MotorHP_s * HPtoKW * MotorOpHr_s * IndElecPrice * \left[\left(\frac{1}{RewoundEff_s} \right) - \left(\frac{1}{PEPctEff_s} \right) \right] \quad (149)$$

where

$ReplaceAnnSav_s$ = The expected annual savings from the replacing a failed motor with a minimum efficiency motor for motor size group s , in 2002 dollars,

$MotorHP_s$ = The rated motor horsepower for motor size group s ,

$HPtoKW_s$ = The conversion factor from horsepower to kilowatts,

$MotorOpHr_s$ = The annual operating hours for motors in motor size group s ,

$IndElecPrice$ = The industrial electricity price in 2002 dollars per kWh,

$RewoundEff_s$ = The efficiency rating for a rewind motor for motor size group s , and

$PEPctEff_s$ = The efficiency rating for an EISA minimum efficiency motor for motor size group s ,

The simple payback period in years is estimated as:

$$ReplacePayback_s = \frac{ReplacePrPrem_s}{ReplaceAnnSav_s / (1 + disrate)^{year}} \quad (150)$$

where

$disrate$ = Real discount rate, which is the 10-year Treasury bill rate adjusted for risk, and

$ReplacePayback_s$ = Payback period, rounded to nearest year, for replacing a failed motor with a minimum efficiency motor purchased for motor size group s .

$ReplacePrPrem_s$ and $ReplaceAnnSav_s$ are defined above.

Given the payback calculated for each industry and motor size group, the model estimates the number of failed motors that are replaced with EISA minimum efficiency motors and the number of failed motors that are repaired. This calculation uses an assumed distribution of required investment payback periods referred to as the payback acceptance curve. Rather than using an actual curve, a table of assumed acceptance rates is used for each integer payback period from 0 to 4 years. To obtain an acceptance fraction, or economic fraction, from a non-integer value for payback, a linear interpolation is done. The economic fraction is determined from a lookup table and interpolation function called *Acceptance*, given the table of acceptance fractions, the five acceptance rates, and the payback period for the motor size group:

$$ReplaceAccept_s = Acceptance(PremAccept, 5, ReplacePayback_s) \quad (151)$$

where

$ReplaceAccept_s$ = Fraction of premium efficiency motors purchased in motor size group s based on payback period acceptance assumptions, and

$PremAccept$ = Array of payback acceptance rates corresponding to integer payback periods ranging from 0 to 4 (a total of 5 rates).

$ReplacePayback_s$ is defined above.

The number of failed motors is given by:

$$FailedMotors_{i,s,r,y} = MotorStock_{i,s,r,y-1} * FailurePct_{i,s} \quad (152)$$

Finally, the number of motors purchased to replace failed motors is given by:

$$RepMotorFlow_s = FailedMotors_s * ReplaceAccept_s \quad (153)$$

where

$RepMotorFlow_s$ = Number of new motors purchased to replace failed motors in motor size group s based on payback period acceptance assumptions.

$FailedMotors_s$ and $ReplaceAccept_s$ are defined above.

Motor stock changes are then summarized as:

$$TotalMotorFlow_s = MotorStock_{s,y-1} * IndShipGr + RepMotorFlow_s \quad (154)$$

where

$TotalMotorFlow_s$ = New motors purchased for motor size group s , and

$IndShipGr$ = Growth from previous year in industrial value of shipments.

$MotorStock_{s,y-1}$ and $RepMotorFlow_s$ are defined above.

The new motor stock is then:

$$\begin{aligned} MotorStock_s &= MotorStock_{s,y-1} - FailedMotors_s \\ &+ RewoundMotors_s + TotalMotorFlow_s \end{aligned} \quad (155)$$

In order to track the various vintages with their differing efficiencies, one additional calculation is required:

$$RewoundMotors_s = FailedMotors_s * RepMotFlow_s \quad (156)$$

where

$RewoundMotors_s$ = Number of motors rewound for motor size group s .

$FailedMotors_{s,y-1}$ and $RepMotorFlow_s$ are defined above.

When motors are rewound, there is generally a drop in efficiency. The magnitude of the efficiency decline can be specified by the user. The equation to calculate the efficiency of rewound motors is:

$$RewoundEff_s = MotAvgEff_{s,y-1} - MotRewDrop_s \quad (157)$$

where

$RewoundEff_s$ = The efficiency of rewind motors for motor size group s , and

$MotRewDrop_s$ = The user-specified drop in efficiency for rewind motors in motor size group s .

$MotAvgEff_s$ is defined above.

The average efficiency of new motors is calculated as a weighted average efficiency of the motors purchased:

$$NewMotorEff_s = (PEPctEff_s * PremMotorFlow_s) / RepMotFlow_s \quad (158)$$

where

$NewMotorEff_s$ = The average efficiency of new motors for motor size group s ,

$PEPctEff_s$, $PremMotorFlow_s$, and $RepMotFlow_s$ are defined above.

The average amount of energy consumed by the new motors purchased is given by

$$NewMotorEnergy_s = MotAdjEnergy_{s,y-1} * \left(1 - \frac{(NewMotorEff_s - MotAvgEff_{s,y-1})}{NewMotorEff_s} \right) \quad (159)$$

where

$NewMotorEnergy_s$ = The average energy consumed by new motors for motor size group s in kWh per motor per year, and

$MotAdjEnergy_{s,y-1}$ = The adjusted average energy consumed by motors for motor size group s and year $y - 1$ in kWh per motor per year (the process used to adjust the average energy is described below).

$NewMotorEff_s$ and $MotAvgEff_{s,y-1}$ are defined above.

The average amount of energy consumed by the rewind motors is given by:

$$RewMotorEnergy_s = MotAdjEnergy_{s,y-1} * \left(1 - \frac{RewoundEff_s - MotAvgEff_{s,y-1}}{RewoundEff_s} \right) \quad (160)$$

where

$RewMotorEnergy_s$ = The average energy consumed by rewind motors for motor size group s in kWh per motor per year, and

$MotAdjEnergy_{s,y-1}$ = The adjusted average energy consumed by motors for motor size group s and year $y - 1$ in kWh per motor per year (the process used to adjust the average energy is described below).

$RewoundEff_s$ and $MotAvgEff_{s,y-1}$ are defined above.

The average amount of energy consumed by all motors in the stock is given by:

$$MotAvgEnergy_s = \frac{\left(\begin{array}{l} MotAdjEnergy_{s,y-1} * \\ (MotorStock_{s,y-1} - FailedMotors_s) \\ + (TotalMotorFlow_s * NewMotorEnergy_s) \\ + (RewoundMotors_s * RewMotorEnergy_s) \end{array} \right)}{MotorStock_s} \quad (161)$$

where

$MotAvgEnergy_s$ = The average energy consumed by all motors for motor size group s in kWh per motor per year, and

$MotAdjEnergy_{s,y-1}$ = The adjusted average energy consumed by motors for motor size group s and year $y - 1$ in kWh per motor per year (the process used to adjust the average energy is described below).

$MotorStock_{s,y-1}$, $FailedMotors_s$, $TotalMotorFlow_s$, $NewMotorEnergy_s$, $RewoundMotors_s$, $RewMotorEnergy_s$, and $MotAdjEnergy_{s,y-1}$ are defined above.

The average energy efficiency of the stock of motors is given by:

$$RewoundEff_s = MotAvgEff_{s,y-1} - MotRewDrop_s \quad (162)$$

where

$MotAvgEff_s$ = The average energy efficiency of motors for motor size group s

$RewoundEff_s$ and $MotRewDrop_s$ are defined above.

The energy efficiency of motor systems is affected not only by the efficiency of the motors themselves, but also by the efficiency of the systems in which the motors are used. The three largest categories of motor systems are pump systems, fan systems, and compressor systems. The following equation calculates the overall motor system energy consumption savings rate:

$$SystemSavingsR_s = \frac{\left(\begin{array}{l} (PumpAppPct_s * PumpSavPct_s) \\ + (FanAppPct_s * FanSavPct_s) \\ + (CompAppPct_s * CompSavPct_s) \end{array} \right)}{MotSysLife_s} \quad (163)$$

where

$SystemSavingsR_s$ = The overall savings rate from pump, fan, and compressor system efficiency improvements for motor size group s ,

$PumpAppPct_s$ = Motor system efficiency applicability, percentage of pump systems in motor size group s ,

$PumpSavPct_s$ = Motor system efficiency savings fraction for pump systems in motor size group s ,

$FanAppPct_s$ = Motor system efficiency applicability, percentage of fan systems in motor size group s ,

$FanSavPct_s$ = Motor system efficiency savings fraction for fan systems in motor size group s ,

$CompAppPct_s$ = Motor system efficiency applicability, percentage of compressor systems in motor size group s ,

$CompSavPct_s$ = Motor system efficiency savings fraction for compressor systems in motor size group s ,

$MotorSysLife_s$ = Motor system efficiency improvement life in years for motors in motor size group s .

Applying the overall motor system energy savings percentage to the total energy consumption for the motor stock results in the total energy consumption by motor systems:

$$MotAdjEnergy_s = MotAvgEnergy_s * (1 - SystemSavingsR_s) \quad (164)$$

where

$MotAdjEnergy_s$ = The adjusted average energy consumption of the motor stock for motor size group s in kWh per motor per year.

$MotAvgEnergy_{s,y-1}$ and $SystemSavingsR_s$ are defined above.

The total amount of energy is calculated for the stock and converted from GWh to trillion Btu:

$$TotalMotorEnergy_s = (MotorStock_s * MotorAvgEnergy_s) * \frac{3412}{10^{12}} \quad (165)$$

where

$TotalMotorEnergy_s$ = The total motor energy consumption of the motor stock for motor size group s in trillion Btu per year.

$MotorStock_s$ and $MotorAvgEnergy_s$ are defined above.

Finally, the adjusted total amount of energy is calculated for the stock and converted from GWh to trillion Btu.

$$TotalAdjMotorEnergy_s = (MotorStock_s * MotorAdjEnergy_s) * \frac{3412}{10^{12}} \quad (166)$$

where

$TotalAdjMotorEnergy_s$ = The total adjusted motor energy consumption of the motor stock for motor size group s in trillion Btu per year.

$MotorStock_s$ and $MotorAdjEnergy_s$ are defined above.

CALBTOT

CALBTOT calculates the total energy consumption for the buildings portion of the IDM. Building energy consumption is calculated for three building uses: lighting; heating, ventilation, and air conditioning (HVAC); and onsite transportation. Total energy consumption is determined as a weighted average of the industry employment UEC and the industry output UEC.

$$ENBQTY_{e,f} = \left(\begin{array}{l} EWeight * [EMPLX * ENBINT_{e,f}] \\ + PWeight * [ProdVX * ONBINT_{e,f}] \end{array} \right) * BldPFac \quad (167)$$

where

$ENBQTY_{e,f}$ = Consumption of fuel f for building end use e ,

$EMPLX$ = Employment,

$ProdVX$ = Output,

$ENBINT_{e,f}$ = Employment unit energy consumption (Btu per employee) of fuel f for building end use e ,

$ONBINT_{e,f}$ = Output unit energy consumption of fuel f for building end use e ,

$EWeight$ = Weight for employment unit energy consumption (0.7),

$PWeight$ = Weight for output unit energy consumption (0.3), and

$BldPFac$ = Effect of energy price increases on buildings energy consumption.

The *BldPFac* variable adjusts buildings energy consumption if the average industrial energy price increases above a threshold. Below the threshold, *BldPFac* is equal to 1. Above the threshold, the value of *BldPFac* is calculated as follows:

$$BldPFac = BldPRat^{BldElas} \quad (168)$$

where

BldPRat = Ratio of current year's average industrial energy price to 2006 price, and

BldElas = Assumed elasticity, currently -0.5.

CALGEN

Subroutine CALGEN accounts for electricity generation from cogeneration. It combines estimated existing and planned cogeneration with new projected cogeneration based on an endogenous economic and engineering evaluation. The subroutine estimates market penetration of new (not currently planned) cogeneration capacity as a function of steam load, steam already met through cogeneration, and cost and performance factors affecting cogeneration economics. CALGEN calls subroutine COGENT to read in the cogeneration assumptions and calls subroutine EvalCogen to evaluate the economics of prototypical cogeneration systems sized to match steam loads in four size ranges. A function, *SteamSeg*, is also called to access a size distribution of steam loads for each industry. Generation for own use and electricity sales to the grid are calculated based on total generation and the shares of sales to the grid reported on Form EIA-860B data.⁴⁸

CALGEN begins by computing total steam demand as the sum of steam use in buildings (HVAC being the only system using steam) and steam use from the process and assembly component.⁴⁹

$$STEMCUR = ENBQTY_{hvac,steam} + ENPIQTY_{steam} \quad (169)$$

where

STEMCUR = Total steam demand,

ENBQTY_{hvac,steam} = Consumption of steam for HVAC, and

ENPIQTY_{steam} = Consumption of steam in the process/assembly component.

Next, the portion of steam requirements that could be met by new cogeneration plants, up to the current model year, is determined as follows:

$$NonCogSteam = STEMCUR - CogSteam \quad (170)$$

⁴⁸Several subroutines not shown here perform the calculations required to initialize, aggregate, and summarize the cogeneration data derived from the EIA-860B and EIA-906 surveys and to incorporate changes from model additions. These subroutines include IRCOGEN, COGINIT, MECSLESS860B, and ADDUPCOGS.

⁴⁹This subroutine also calculates the amount of steam produced by byproduct fuels, which reduces the amount of steam required to be produced by purchased fuels.

where

$NonCogSteam$ = Non-cogenerated steam based on existing cogeneration capacity,

$STEMCUR$ = Total steam demand, and

$CogSteam$ = Steam met by existing cogeneration units as of the last data year.

Non-cogeneration steam uses are disaggregated into eight size ranges, or segments, based on an exogenous data set providing the boiler size distribution for each industry. These data are accessed through the function $SteamSeg_{loadsegment}$. It is assumed for this purpose that steam load segments are distributed in the same proportions as boiler capacity:

$$AggSteamLoad_{loadsegment} = NonCogSteam * SteamSeg_{loadsegment} \quad (171)$$

where

$AggSteamLoad_{loadsegment}$ = Steam demand for a given load segment,

$NonCogSteam$ = Non-cogenerated steam based on existing cogeneration capacity, and

$SteamSeg_{loadsegment}$ = The fraction of total steam in each of eight boiler firing ranges, in million Btu/hour, ranges are 1.5-3, 3-6.5, 6.5-10, 10-50, 50-100, 100-250, 250-500, and >500.

The average hourly steam load, $AvgHourlyLoad_{loadsegment}$ in each segment is calculated from the aggregate steam load, $AggSteamLoad_{loadsegment}$, based on 8,760 operating hours per year and converting from trillions to millions of Btu per hour:

$$AveHourlyLoad_{loadsegment} = \frac{AggSteamLoad_{loadsegment}}{0.008760} \quad (172)$$

The maximum technical potential for cogeneration is calculated assuming all non-cogeneration steam demand for each load segment is converted to cogeneration. This assumes that the technical potential is based on sizing systems, on average, to meet the average hourly steam load in each load segment. Using the power-steam ratio of the prototype cogeneration system selected for each load segment (from subroutine EvalCogen) this calculation is:

$$TechPot_{loadsegment} = AveHourlyLoad_{loadsegment} * PowerSteam_{isys} \quad (173)$$

where

$TechPot_{loadsegment}$ = Technical potential for cogeneration, in megawatts, for a load segment, irrespective of the economics,

$AveHourlyLoad_{loadsegment}$ = Average hourly steam load in each load segment, and

$PowerSteam_{isys}$ = Power-Steam ratio of the cogeneration system (equivalent to the ratio of electrical efficiency to thermal efficiency), $isys$.

The economic potential for cogeneration is estimated from the technical potential by applying the estimated fraction of that potential that will be realized over an extended time period, based on market acceptance criteria (as applied in subroutine EvalCogen):

$$EconPot_{loadsegment} = TechPot_{loadsegment} * EconFrac_{loadsegment} \quad (174)$$

where

$EconPot_{loadsegment}$ = Economic potential for cogeneration in megawatts,

$TechPot_{loadsegment}$ = Technical potential for cogeneration, in megawatts, for a load segment if all cogeneration was adopted, irrespective of the economics, and

$EconFrac_{loadsegment}$ = Economic fraction based on the payback period and the assumed payback acceptance curve.

Given the total economic potential for cogeneration, the amount of capacity that would be added in the current model year is given by:

$$CapAddMW_{loadsegment} = EconPot_{loadsegment} * PenetrationRate \quad (175)$$

where

$CapAddMW_{loadsegment}$ = Cogeneration capacity added, in megawatts, for a load segment,

$EconPot_{loadsegment}$ = Economic potential for cogeneration in megawatts,

$PenetrationRate$ = Constant annual rate of penetration, assumed to be five percent based on the economic potential being adopted over a 20-year time period; also includes “collaboration coefficients” provided by the American Council for an Energy Efficient Economy (ACEEE)⁵⁰ that show the relative likelihood of CHP adoption among U.S. regions.

Based on the results of a study performed for EIA,⁵¹ which includes cogeneration system cost and performance characteristics, capacity additions are assumed to be natural-gas-fired except in certain industries that are known to use biomass for existing CHP, notably pulp and paper products. The corresponding generation and fuel use from these aggregated capacity additions are calculated from the

⁵⁰ American Council for an Energy-Efficient Economy, “Challenges Facing Combined Heat and Power Today: A State-by-State Assessment,” September 2011, <http://aceee.org/research-report/ie111>, and U.S. Energy Information Administration, Office of Energy Analysis.

⁵¹ SENTECH Inc., *Commercial and Industrial CHP Technology Cost and Performance Data for EIA*, report prepared for the Office of Integrated Analysis and Forecasting, Energy Information Administration, Washington, DC, June 2010.

assumed capacity factors and heat rates of the prototypical systems. The energy characteristics of the additions are used to increment the model's cogeneration data arrays: capacity (COGCAP), generation (COGGEN), thermal output (COGTHR) and electricity-related-fuel use (COGELF). These arrays are all indexed by Census Division, year, industry, and fuel. Since the model runs at the Census Region level, results are shared equally among the Census Divisions using a factor, *DSHR*, where *DSHR* is either one half or one third. The assignment statements to increment the arrays are as follows:

$$COGGEN_{d,ngas} = COGGEN_{d,ngas} + CAPADDGWH * DSHR \quad (176)$$

$$COGCAP_{d,ngas} = COGCAP_{d,ngas} + CAPADDGWH * DSHR \quad (177)$$

$$COGTHR_{d,ngas} = COGTHR_{d,ngas} + STMADDTRIL * DSHR \quad (178)$$

$$COGELF_{d,ngas} = COGELF_{d,ngas} \left(\left(\frac{CAPADDGWH * AVEHTRT}{10^6} \right) - \left(\frac{STMADDTRIL}{0.8} \right) \right) * DSHR \quad (179)$$

where

CAPADDGWH = Generation from new capacity in gigawatthours,

STMADDTRIL = Thermal (steam) output of new capacity in trillion Btu,

STMADDTRIL/0.8 = Fuel input assumed to be associated with thermal output based on 80 percent boiler efficiency, and

AVEHTRT = Heat rate, or total fuel use per unit of generation in Btu/kWh.

Cogeneration from biomass (*BIO*) for the pulp and paper industry is also directly related to the amount of biomass available for that industry (calculated in subroutine CALBYPROD), which is calculated as follows:

$$BIO = MAX \left(0, \frac{BioAvail - BioAvail_{y-1}}{HeatRate} \right) \quad (180)$$

where

BioAvail = Biomass available for generation,

BioAvail_{y-1} = Biomass available in the previous model year *y* - 1, and

HeatRate = Converts Btu to kWh (assumed to be 25,000 through 2003 and decline linearly to 17,000 by 2020).

The available biomass generation is then added to the current year's cogeneration arrays by the following calculation (incremental assignment shown):

$$COGGEN_{d,biomass} = COGGEN_{d,biomass} + BIO * DSHR \quad (181)$$

where

$COGGEN_{d,biomass}$ = Total biomass cogeneration by Census Division d ,

$DSHR$ = Factor to share Census Region addition to Census Divisions such that each division gets an equal share.

The biomass capacity, thermal output, and electricity-related fuel use associated with the generation (BIO), are used to increment the corresponding cogeneration data arrays, $COGCAP$, $COGTHR$, and $COGELF$.

Once the energy input and output characteristics of the cogeneration capacity additions have been combined with those of the existing capacity, the effect of cogeneration on purchased electricity demand and conventional fuel use can be determined.

The cogeneration capacity values ($COGCAP$) are used only for reporting purposes and not used within the IDM. The thermal output and fuel use from cogeneration, derived from arrays $COGTHR$ and $COGELF$, are used in subroutine CALSTOT (see below) to determine the balance of the industry's steam demand that must be met by conventional boilers, and then combined with boiler fuel use to estimate total BSC component energy requirements.

The amount of cogenerated electricity used on site ("own-use") is estimated, with the balance of total electricity needs met from purchased electricity. The shares of electricity generation for grid sales and own-use are derived from the EIA-860B survey data and assumed to remain constant for existing capacity. The grid share for each Census Division, industry, and fuel, by year, is maintained in array $COGGRD_{d,f}$. In most industries, capacity additions are assumed to have the same grid/own-use shares as that of the average (across regions) of the existing capacity in the last complete data year (2008). For the three industries in which cogeneration has already penetrated extensively (Food, Paper, and Bulk Chemicals), a higher grid-sales share of 60 percent is assumed. As capacity is added, the average grid-sales share for each region and industry ($COGGRD$) is recomputed as follows:

$$NEWGEN_{d,f} = CapAddGWH_f * DSHR \quad (182)$$

$$OLDGRD_{d,f} = COGGEN_{d,f} + COGGRD_{d,f} \quad (183)$$

$$NEWGRD_{d,f} = NEWGEN_{d,f} * COGGRDNEW_i \quad (184)$$

$$COGGRD_{d,f} = \frac{(OLDGRD_{d,f} + NEWGRD_{d,f})}{(COGGEN_{d,f} + NEWGEN_{d,f})} \quad (185)$$

Electricity generation for own use is then calculated as follows:

$$ELOWN = \sum_d \sum_f (COGGEN_{d,f} + COGGRD_{d,f}) \quad (186)$$

where

$ELOWN$ = Electricity generation for own use,

$COGGEN_{d,f}$ and $COGGRD_{d,f}$ are defined above.

Electricity generation for sales to the grid is calculated similarly.

EvalCogen

Subroutine EvalCogen is called by subroutine CALGEN to evaluate a set of prototype cogeneration systems sized to match steam loads in eight size ranges, or load segments. The thermal capacities of the systems are assigned to approximately match the average boiler size in each industry for each of the following ranges (in million Btu per hour): 1.5-3, 3-6.5, 6.5-10, 10-50, 50-100, 100-250, 250-500, and >500. The corresponding steam output, or steam load, is determined from the average boiler capacity as follows:

$$SteamLoad_{loadsegment} = AveBoilSize_{loadsegment} * EboilEff_{loadsegment} \quad (187)$$

where

$SteamLoad_{loadsegment}$ = Steam output of average boiler in the load segment, in million Btu per hour,

$AveBoilSize_{loadsegment}$ = Firing capacity of average boiler in the load segment, and

$EboilEff_{loadsegment}$ = Assumed boiler efficiency.

For each load segment, the model preselects a candidate cogeneration system with thermal output that roughly matches the steam output of the average-sized boiler in the load segment. The number of system/segment options is $nsys$, currently 8, with each system indicated by the subscript $isys$. The model relies on the following user-supplied set of characteristics for each cogeneration system:

$CogSizeKW_{isys}$ = Net electric generation capacity in kilowatts,

$CogCapCostKW_{isys}$ = Total installed cost, in 2005 dollars per kilowatthour,

$CapFac_{isys}$ = System capacity factor,

$CHeatRate_{isys}$ = Total fuel use per kilowatthour generated (Btu/kWh), and

$OverAlLEff_{isys}$ = Fraction of input energy converted to useful heat and power.

From the above user-supplied characteristics, the following additional parameters for each system are derived:

$ElecGenEff_{isys}$ = Fraction of input energy converted to electric energy, or electric energy efficiency,

$$\approx 3412 / CHeatRate_{isys}$$

$$\begin{aligned} ElecSizeMWh_{isys} &= \text{Electric generation from the cogeneration plant in megawatthours,} \\ &\approx CogSizeKW_{isys} * 8.76 * CapFac_{isys} \end{aligned}$$

$$\begin{aligned} FuelUse_{isys} &= \text{Cogeneration system fuel use per year in billion Btu,} \\ &\approx ElecSizeMWh_{isys} * CHeatRate_{isys} / 10^6 \end{aligned}$$

$$\begin{aligned} PowerSteam_{isys} &= \text{Ratio of electric power output to thermal output, and} \\ &\approx ElecGenEff_{isys} / (OverAllEff_{isys} - ElecGenEff_{isys}) \end{aligned}$$

$$\begin{aligned} SteamOutput_{isys} &= \text{Thermal output of the cogeneration system in MMBtu/hr.} \\ &\approx CogSizeKW_{isys} * 0.003412 / PowerSteam_{isys} \end{aligned}$$

disrate = Real discount rate, which is the 10-year Treasury bill rate adjusted for risk.

For consistency the system number for each steam load segment is the same as the subscript *isys*:

$$CogSys_{loadsegment} = isys$$

and the following relation holds (with one exception: the largest system, in terms of electrical capacity, is a combined cycle with lower thermal output than the next largest system):

$$SteamOutput_{isys} \leq SteamLoad_{loadsegment} < SteamOutput_{isys+1} \quad (188)$$

where

*SteamOutput*_{*isys*} = Steam output of the pre-selected cogeneration system, and

*SteamLoad*_{*loadsegment*} = Matching thermal output in the load segment.

Next, the model estimates investment payback period (*Cpayback*_{*loadsegment*}) required to recover the aggregate cogeneration investment for each load segment. This is determined by estimating the annual cash flow from the investment, defined as the value of the cogenerated electricity, less the cost of the incremental fuel required for generation. For this purpose, the annual cost of fuel (natural gas) and the value of the electricity are based on the prices averaged over the first 10 years of operating the cogeneration system. The electricity is valued at the average industrial electricity price in the region, net of standby charges that would be incurred after installing cogeneration (*CogElecPrice*). The standby charges are assumed to be the user-specified fraction of the industrial electricity rate (10 percent). For natural gas (*CogFuelPrice*), the price of firm-contract natural gas was assumed to apply. The steps performed in each annual model loop are as follows:

Determine annual fuel cost of the aggregated cogeneration systems in each load segment:

$$FuelCost_{loadsegment} = FuelUse_{isys} * CogFuelPrice \quad (189)$$

Determine the annual fuel use and cost of operating the existing system (conventional boiler):

$$ExistFuelUse_{loadsegment} = \frac{SteamOutput_{isys} * 8.76 * CapFac_{isys}}{EboilEff_{loadsegment}} \quad (190)$$

$$ExistFuelCost_{loadsegment} = ExistFuelUse_{loadsegment} * CogFuelPrice \quad (191)$$

Determine incremental fuel cost and the value of cogenerated electricity:

$$IncrFuelCost_{loadsegment} = FuelCost_{loadsegment} - ExistFuelCost_{loadsegment} \quad (192)$$

$$ElecValue_{loadsegment} = ElecSizeMWh_{isys} * CogElecPrice * 0.003412 \quad (193)$$

Determine the cash flow, or operating profit, of the investment:

$$OperProfit_{loadsegment} = ElecValue_{loadsegment} - IncrFuelCost_{loadsegment} \quad (194)$$

Determine the investment capital cost and the investment payback period:

$$Investment_{loadsegment} = CogSizeKW_{isys} * CogCapCostKW_{isys} \quad (195)$$

$$CPayBack_{loadsegment} = \frac{Investment_{loadsegment}}{OperProfit_{loadsegment} / (1 + disrate)^{year}} \quad (196)$$

Given the payback for the aggregated system evaluated for each load segment, the model estimates the fraction of total technical potential considered economical. This calculation uses an assumed distribution of required investment payback periods, referred to as the payback acceptance curve. A table of assumptions is used containing acceptance rates for each integer payback period from 0 to 12 years. To obtain an acceptance fraction, or economic fraction, from a non-integer value for payback, a linear interpolation is done. The economic fraction is determined from a table lookup and interpolation function called *Acceptance*.

Given the table of acceptance fractions, the number of rows in the table (13), and the payback period for the load segment, the calculation is:

$$EconFrac_{loadsegment} = Acceptance (AcceptFrac, 13, CPayBack_{loadsegment}) \quad (197)$$

where

EconFrac_{loadsegment} = Fraction of cogeneration investments adopted based on payback period of acceptance assumptions,

AcceptFrac = Array of payback acceptance rates corresponding to integer payback periods ranging from 0 to 12 (13 rates altogether), and

CPayBack_{loadsegment} = Cogeneration investment payback period.

CALSTOT

CALSTOT calculates total fuel consumption in the BSC component based on total steam demand within an industry (*STEMCUR*). Steam demand and fuel consumption (in BTU) are allocated between

cogeneration and conventional boilers. Fuel use and steam demand from cogeneration, calculated in subroutine CALGEN, are treated as inputs to this subroutine.

Steam from cogeneration (*COGSTEAM*) is obtained by summing the cogeneration thermal output (in array *COGTHR*) across fuels and Census Divisions. Steam demand to be met by conventional boilers (*NonCOGSTEAM*) is equal to total steam demand (*STEMCUR*) minus cogeneration steam (*COGSTEAM*) production.

The estimated consumption of fuel for cogeneration is stored in two variables: fuel used to generate electricity (*COGELF*) and fuel associated with the thermal output (*COGTHR*). The fuel associated with the thermal output assumes a hypothetical 80-percent efficiency, so it is computed as *COGTHR* divided by 0.8. Thus, total cogeneration system fuel use, *FuelSys_f*, is given by:

$$FuelSys_f = \sum_d COGELF_{d,f} + (COGTHR_{d,f}/0.8) \quad (198)$$

Conventional boiler fuel use is split between biomass-derived fuels and fossil fuels. The total available biomass is calculated as byproduct fuels (*BYPBSCR_{biofuel}*). Some of it is used in cogeneration; the remainder of the available biomass (*AvailBiomass*) is assumed to be used as boiler fuel. The amount of steam from this biomass (*BIOSTEAM*) is estimated based on an assumed biomass boiler efficiency (0.69).

The steam demand that must be met through fossil-fired boilers is the total non-cogenerated steam (*NonCogSteam*) less the biofueled steam (*BIOSTEAM* or *NonCogFosSteam*). A trial estimate for total fossil fuel for boilers is derived from *NonCogFosSteam* assuming average boiler efficiency across fuels.

Allocating this total to specific fuels in a manner consistent with MECS data is difficult. The MECS data indicate only the total amounts of indirect fuels associated with boilers and cogeneration, so fuel-specific boiler use cannot be computed from MECS alone. Because fuel use and thermal output data is taken from EIA Form 860B, deriving an estimated conventional boiler fuel requirement consistent with MECS requires a calibration step. The model calibrates the fuel volumes to ensure that the sum of the cogeneration fuel and conventional boiler fuel (from Form 860B) equals the MECS indirect fuel estimate in the base year.

The derivation of the boiler fuel calibration factor is based on the results of subroutine *MecsLess860b*, which, as its name implies, calculates the difference between total MECS indirect fuels (*BSCbsyr*) and the cogeneration (or CHP) fuel use from form 860B (*CHPbsyr*), and stores it in array *BOILBSYR*. A separate calibration is performed for biomass- and fossil-fueled boilers. The calibration factor for fossil fuels is computed as follows in model year 2006:

$$Estimated = NonCogFosSteam / 0.8$$

$$Implied = \sum_f BOILBSYR_f$$

$$CALIB2002_FOS = Implied / Estimated$$

where

Estimated = Preliminary estimate of fossil fuel use from conventional boilers,

Implied = Conventional boiler fuel use,

$BOILBSYR_f$ = Ratio of MECS and form 860b for each boiler fuel f , and

$CALIBBSYR_FOS$ = Calibration factor for conventional boiler fuel use.

In the projection, the calibration factors for the base year adjust the preliminary estimates to yield the estimated non-cogeneration fossil fuel:

$$NonCogFosFuel = NonCogFosSteam * BSSHR_f \quad (199)$$

where

$NonCogFosFuel$ = Non-cogeneration (conventional) fossil fuel use in boilers, calibrated to match MECS when combined with 860B cogeneration data; and

$BSSHR_f$ = Boiler fuel shares estimated in subroutine CALBSC.

$NonCogFosSteam$ is defined above.

Conventional boiler fuel use ($FuelFosSteam_f$) is allocated to fuels based on fuel shares adjusted for price changes since 2006 and fuel-specific efficiencies:

$$FuelFosSteam_f = (NonCogFosFuel \div beff_f) * CALIBBSYR_FOS \quad (200)$$

where

$beff_f$ = Boiler efficiency by fuel given in Table 10.

$CALIBBSYR_FOS$ is defined above.

Table 29. Boiler efficiency by fuel

Fuel	Efficiency (%)
Natural Gas	78
Coal	83
Residual Oil	84
Distillate	80
LPG	76
Pet. Coke	80
Other	80
Biomass	69

The fossil fuels consumption for non-cogeneration boilers is added to cogeneration fuel consumption to yield total fuel consumption in the BSC component:

$$ENSQTY_f = CogBoilFuel_f + FosFuelSteam_f \quad (201)$$

where

$CogBoilFuel_f$ = Fossil fuel consumption for cogeneration by fuel f , and

$FosFuelSteam_f$ = Fossil fuel consumption for conventional boilers by fuel f .

INDTOTAL

The consumption estimates derived in the PA, BSC, and BLD components are combined in INDTOTAL to estimate overall energy consumption for each industry. The consumption estimates include byproduct consumption for each of the main, intermediate, and renewable fuels. Only electricity, natural gas, and steam are included in building consumption. For all fuels except electricity, the following equation is used:

$$QTYMAIN_{r,f} = ENPMQTY_f + ENBQTY_{total,f} + ENSQTY_f + BYPBSCM_f \quad (202)$$

where

$QTYMAIN_{r,f}$ = Consumption of fuel f ,

$ENPMQTY_f$ = Consumption of fuel f in the PA component,

$ENBQTY_{total,f}$ = Consumption of fuel f for all building end uses,

$ENSQTY_f$ = Consumption of fuel f to generate steam, and

$BYPBSCM_f$ = Byproduct consumption of fuel f to generate electricity from the BSC component.

For modeling purposes, consumption of electricity is defined as purchased electricity only; therefore, electricity generation for own use is removed from the consumption estimate as follows:

$$QTYMAIN_{r,elec} = ENPMQTY_{elec} + ENBQTY_{total,elec} - ELOWN \quad (203)$$

where

$QTYMAIN_{r,elec}$ = Consumption of purchased electricity in Census Region r ,

$ENPMQTY_{elec}$ = Consumption of electricity in the PA component,

$ENBQTY_{total,elec}$ = Consumption of electricity for all building end uses, and

ELOWN = Electricity generated for own use, from subroutine CALGEN.

NATTOTAL

After calculating all four Census Regions for an industry, NATTOTAL computes a national industry estimate of energy consumption. This subroutine also computes the consumption total over all fuel categories (main, intermediate, and renewable). Total consumption for the entire industrial sector for each main, intermediate, and renewable fuel is computed by accumulating across all industries:

$$TQMAIN_f = \sum_{i=1}^{INDMAX} QTYMAIN_{r,f} \quad (204)$$

where

$TQMAIN_f$ = Total consumption for fuel f ,

$INDMAX$ = Number of industries, and

$QTYMAIN_{r,f}$ = Consumption of fuel f within the current industry calculation loop.

CONTAB

CONTAB reports consumption values for individual industries. National consumption values are reported for each of the fuels used in each particular industry. The equation below illustrates the procedure for main fuels in the food products industry.⁵² Similar equations are used for the other industries.

$$FOODCON_f = \sum_{r=1}^4 QTYMAIN_{r,f} \quad (205)$$

where

$FOODCON_f$ = Total national consumption of fuel $f \in \{1,2, \dots, NUM_f\}$ in the food products industry,

NUM_f = Number of fuels in fuel category, and

$QTYMAIN_{r,f}$ = Consumption of fuel f for Census Region r in the food products industry.

WRBIN

WRBIN writes data for each industry to a binary file. Two different binary files are created. The first contains variables and coefficients that do not change over time but vary over industry or process. The second binary file contains data that change from year to year.

INDCGN

Subroutine INDCGN calculates aggregate industrial sector cogeneration capacity, generation, and fuel use by summing the results of subroutine CALGEN over the 21 industries. Subroutine INDCGN shares these cogeneration results into two parts: that associated with generation for own use and that used

⁵²Another subroutine, INDFILLCON, is called from CONTAB to actually fill the FOODCON consumption array.

for sales to the grid. The results are copied to the corresponding NEMS global data variables for industrial cogeneration capacity ($CGINDCAP$), generation ($CGINDGEN$), and fuel use ($CGINDQ$).

$$\begin{aligned}
 CGINDCAP_{d,f,grid} &= \sum_i^{ind\ max} (COGCAP_{d,i,f} * COGGRD_{d,i,f}) \\
 CGINDCAP_{d,f,ownuse} &= \sum_i^{ind\ max} (COGCAP_{d,i,f} * (1 - COGGRD_{d,i,f})) \\
 CGINDGEN_{d,f,grid} &= \sum_i^{ind\ max} (COGGEN_{d,i,f} * COGGRD_{d,i,f}) \quad (206) \\
 CGINDGEN_{d,f,ownuse} &= \sum_i^{ind\ max} (COGGEN_{d,i,f} * (1 - COGGRD_{d,i,f})) \\
 CGINDQ_{d,f,grid} &= \sum_i^{ind\ max} (COGELF_{d,i,f} * COGGRD_{d,i,f}) \\
 CGINDQ_{d,f,ownuse} &= \sum_i^{ind\ max} (COGELF_{d,i,f} * (1 - COGGRD_{d,i,f}))
 \end{aligned}$$

where

$CGINDCAP_{d,f,u}$ = Cogeneration capacity by Census Division d , fuel f , and use $u \in [grid, ownuse]$,

$CGINDGEN_{d,f,u}$ = Cogeneration generation by Census Division d , fuel f , and use u ,

$CGINDQ_{d,f,u}$ = Cogeneration fuel use, electricity portion, by Census Division d , fuel f , and use u ,

$COGGRD_{d,i,f}$ = Share of cogeneration sold to the grid by Census Division d , industry i , and fuel f ,

$COGCAP_{d,i,f}$ = Cogeneration capacity by Census Division d , industry i , and fuel f ,

$COGGEN_{d,i,f}$ = Cogeneration generation by Census Division d , industry i , and fuel f , and

$COGELF_{d,i,f}$ = Cogeneration fuel use, electricity portion, by Census Division d , industry i , and fuel f .

WEXOG

WEXOG writes calculated industrial quantities to the NEMS exogenous variable array. Prior to assigning values to the NEMS variables, the model computes total industrial fuel consumption quantities. These values are then calibrated or benchmarked to the *State Energy Data System* (SEDS) estimates for each data (history) year, and thereafter are calibrated to the *Short Term Energy Outlook* (STEO) projection estimates. The calibration factors are multiplicative for all fuels that have consumption values greater than zero and are additive otherwise.

The equation for total industrial electricity consumption is below. Similar equations are used for all other fuels. Where appropriate, the summands include refinery consumption and oil and gas consumption, included only where appropriate.⁵³

$$BMAIN_f = TQMAIN_f + QELRF \quad (207)$$

where

$BMAIN_f$ = Total (industrial and refinery) consumption of fuel f (electricity),

$TQMAIN_f$ = IDM consumption of fuel f (electricity), and

$QELRF$ = Refinery consumption of fuel f (electricity).

The equation for total industrial natural gas consumption is:

$$BMAIN_f = TQMAIN_f + QNGRF + CGOGQ_s + CGOGQ_o \quad (208)$$

where

$BMAIN_f$ = Consumption of fuel f (natural gas),

$TQMAIN_f$ = Consumption of fuel f (natural gas),

$QNGRF$ = Consumption of natural gas from Refining,

$CGOGQ_s$ = Consumption of natural gas from cogeneration of electricity for sales to the grid in enhanced oil recovery s , input from Oil and Gas Supply Module, and

$CGOGQ_o$ = Consumption of natural gas from cogeneration of electricity for own use in enhanced oil recovery o , input from Oil and Gas Supply Module.

Total industrial consumption for other fuels is calculated similarly.

SEDS benchmark factors are calculated as follows:

$$SEDSBF_f = \frac{SEDS4_{f,d}}{BMAIN_f} \quad (209)$$

where

$SEDSBF_f$ = Current SEDS data year benchmark factors by fuel f and,

$SEDS4_{f,d}$ = Current SEDS data year consumption aggregated from the Census Division level d to the Census Region level by fuel f , and

⁵³ Consumption of electricity and fuels for the production of ethanol is calculated in the Liquid Fuels Market Module and consumption of electricity for the processing of oil shale is calculated in the Oil and Gas Supply Module.

$BMAIN_f$ = Total industrial consumption of fuel f .

SEDS benchmark factors are then multiplied by the total industrial consumption value as follows:

$$BENCH_f = SEDSBF_f * BMAIN_f \quad (210)$$

where

$BENCH_f$ = Benchmarked total industrial consumption of fuel f ,

$SEDSBF_f$ and $BMAIN_f$ are defined above.

STEO benchmark factors are calculated as follows:

$$STEOBF_f = \frac{STEO_f}{\sum_f \sum_r BENCH_f} \quad (211)$$

where:

$STEOBF_f$ = STEO benchmark factor, which equals each fuel's share of the total SEDS benchmarked industrial consumption, by fuel f (note that these factors are applied post SEDS data years),

$STEO_f$ = STEO projected industrial consumption by fuel f for each STEO projection year, and

$BENCH_f$ = Benchmarked total industrial consumption by fuel f .

The STEO factors are applied to the SEDS industrial benchmarked consumption values as follows:

$$FinalBENCH_f = STEOBF_f * BENCH_f \quad (212)$$

To avoid a break in the series after the last STEO projection year, the STEO benchmark factors are incrementally decreased to one (zero impact) beginning in the first year after the STEO projection year through 2015.

Because most renewable fuel consumption occurs in the paper and lumber industries, the consumption shares for renewable fuels depend on the paper and lumber industries:

$$DSRENEW_{f,d} = \frac{OUTIND_{13,d} + OUTIND_{11,d}}{\sum_{d=1}^{NUMr} (OUTIND_{13,d} + OUTIND_{11,d})} \quad (213)$$

where

$DSRENEW_{f,d}$ = Share of output for renewable fuel f in Census Division d ,

$OUTIND_{13,d}$ = Gross value of output for the paper and allied products industry ($i = 13$) in Census Division d ,

$OUTIND_{11,d}$ = Gross value of output for the lumber and wood products industry ($i = 11$) in Census Division d ,

NUM_r = Number of Census Divisions in Census Region r .

The benchmark factor for biomass is computed as follows:

$$BENCHFAC_{bm,d} = \frac{BIOFUELS_d}{\sum_{f=2}^3 DQRENW_{f,d}} \quad (214)$$

where

$BENCHFAC_{bm,d}$ = Benchmark factor for biomass bm in Census Division d ,

$BIOFUELS_d$ = Consumption of biofuels in Census Division d , and

$DQRENW_{f,d}$ = Consumption of renewable fuel f in Census Division d .

The renewable fuel consumption estimated above is calculated as:

$$DQRENW_{f,d} = TQRENW_{f,r} * DSRENW_{f,d} \quad (215)$$

where

$TQRENW_{f,r}$ = Industrial total consumption of renewable fuel f in Census Region r , and

$DSRENW_{f,d}$ = Share of output for renewable fuel f in Census Division d within region r .

Benchmarked consumption values are then passed into the appropriate variables for reporting to NEMS. The following equation calculates consumption of electricity. Equations for other fuels are similar.

$$QELIN_d = BENCH_{elec} * SEDSHR_{elec,d} \quad (216)$$

where

$QELIN_d$ = Industrial consumption of electricity in Census Division d ,

$BENCH_{elec}$ = Consumption of electricity, and

$SEDSHR_{elec,d}$ = SEDS share of electricity in Census Division d .

The following two equations represent the consumption of core and non-core natural gas.

$$QGFIN_d = BENCH_{ngas} * SEDSHR_{ngas,d} * \left[\frac{TQMAIN_{cng} + TQMAIN_{fds}}{BMAIN_{ngas}} \right] \quad (217)$$

where

- $QGFIN_d$ = Industrial consumption of core natural gas in Census Division d ,
- $BENCH_{ngas}$ = Benchmarked consumption of total natural gas,
- $SEDSHR_{ngas,d}$ = SEDS share of natural gas in Census Division d ,
- $TQMAIN_{cng}$ = Consumption of core natural gas, from Subroutine NATTOTAL,
- $TQMAIN_{fds}$ = Consumption of feedstock natural gas, from Subroutine NATTOTAL, and
- $BMAIN_{ngas}$ = Total un-benchmarked (calculated) consumption of natural gas.

$$QGIIN_d = QNGIN_{ngas,d} - QGFIN_d \quad (218)$$

where

- $QGIIN_d$ = Industrial consumption of non-core natural gas in Census Division d ,
- $QNGIN_{ngas,d}$ = Consumption of natural gas in Census Division d , and
- $QGFIN_d$ = Industrial consumption of core natural gas in Census Division d .

Industrial consumption of biomass is calculated as follows:

$$QBMIN_d = \left[\sum_{f=2}^3 DQRENW_{f,d} \right] + \left[\sum_{u=1}^2 CGOGO_{d,bm,u} \right] + QBMRF_d \quad (219)$$

where

- $QBMIN_d$ = Industrial consumption of biomass in Census Division d ,
- $DQRENW_{f,d}$ = Consumption of renewable fuel f in Census Division d ,
- $CGOGO_{d,bm,u}$ = Consumption of biomass from cogeneration of electricity for use in enhanced oil recovery u in Census Division d , and
- $QBMRF_d$ = Biomass consumed by petroleum refining industry in Census Division d .

Consumption of total renewable fuels is calculated by summing the consumption totals for the individual renewable fuel sources.

$$\begin{aligned}
 QTRIN_d &= QHOIN_d + QBMIN_d + QGEIN_d + QSTIN_d \\
 &+ QPVIN_d + QWIIN_d + QMSIN_d
 \end{aligned}
 \tag{220}$$

where

$QTRIN_d$ = Total industrial consumption of renewable fuels in Census Division d ,

$QHOIN_d$ = Industrial consumption of hydropower in Census Division d ,

$QBMIN_d$ = Industrial consumption of biomass in Census Division d ,

$QGEIN_d$ = Industrial consumption of geothermal in Census Division d ,

$QSTIN_d$ = Industrial consumption of solar thermal in Census Division d ,

$QPVIN_d$ = Industrial consumption of photovoltaic in Census Division d ,

$QWIIN_d$ = Industrial consumption of wind in Census Division d ,

$QMSIN_d$ = Industrial consumption of municipal solid waste in Census Division d .

RDBIN

RDBIN is called by the main industrial subroutine ISEAM on model runs after the first model year. This subroutine reads the previous year's data from the binary files. The previous year's values are assigned to lagged variables for price, value of output, and employment. The previous year's UECs, TPC coefficients, price elasticities, and intercepts are read into the variables for initial UEC, TPC, price elasticity, and intercept. Process specific data is read into either a lagged variable or an initial estimate variable. Three cumulative variables are calculated in this subroutine for future use. A cumulative output variable, a cumulative UEC, and a cumulative production variable are computed for each fuel and process step.

MODCAL

MODCAL performs like the main industrial subroutine ISEAM in all years after the first model year. In subsequent years, no data need to be read from the input files; however, UECs and TPC coefficients must be adjusted to reflect the new model year, whereas the first model year uses only initial estimates of these values. MODCAL calls the following subroutines: CALPROD, CALCSC, CALPRC, CALPATOT, CALBYPROD, CEMENT_INDUSTRY, LIME_INDUSTRY, CALBTOT, CALGEN, CALBSC, CALSTOT, INDTOTAL, NATTOTAL, and CONTAB. Similar to the functioning of ISEAM, the subroutines NATTOTAL and CONTAB are called only after the last region for an industry has been processed.

CALPROD

CALPROD determines the throughput for production flows for the process and assembly component. Existing old and middle vintage production is reduced by applying a retirement rate of capital (Table B.14). The retirement rate is posited to be a positive function of energy prices. For years after 2006, *RetirePrat* is calculated as the greater of 1 and the ratio of the current year's average industrial energy price to the average price in 2006.

$$X = \text{RetirePrat}^{\text{RetireBeta}}$$

$$\text{RetirePriceFactor} = \frac{X}{(1+X)} \quad (221)$$

$$\text{RetireRate}_s = 2 * \text{RetirePriceFactor} * \text{ProdRetr}_s$$

where

RetirePrat = Maximum (1, Ratio of current year average industrial energy price to 2006 price),

RetireBeta = Parameter of logistic function, currently specified as 2 for retirements,

RetirePriceFactor = TPC price factor, ranging from 0 (no price effect) to 2 for retirements,

RetireRate_s = Retirement rate, after accounting for energy price increases, for step *s*; and

ProdRetr_s = Default retirement rate for step *s*.

$$\text{PRODCUR}_{old,s} = (\text{PRODCUR}_{old,s} + \text{IDLCAP}_{old,s}) * (1 - \text{RetireRate}_s) \quad (222)$$

where

PRODCUR_{old,s} = Existing production for process step *s* for old vintage,

IDLCAP_{old,s} = Idle production at process step *s* for old vintage, and

RetireRate_s = Retirement rate, after accounting for energy price increases, for process step *s*.

$$\text{PRODCUR}_{mid,s} = \text{PRODCUR}_{mid,s} + \text{PRODCUR}_{new,s} \quad (223)$$

where

PRODCUR_{mid,s} = Existing production for process step *s* for mid vintage,

PRODCUR_{new,s} = Production at process step *s* for new vintage, and

RetireRate_s = Retirement rate, after accounting for energy price increases, for process step *s*.

Total production throughput for the industry is calculated. If the initial UEC is in physical units, the value of output for the current year is multiplied by the fixed ratio of physical units to value of output calculated in the first model year.

$$\text{PRODX} = \text{PHDRAT} * \text{PRODVX} \quad (224)$$

where

PRODX = Value of output in physical units,

PHDRAT = Ratio of physical units to value of output (by industry but not region), and

PRODVX = Output in dollars.

If the initial UEC is in dollar units, then the current year's value of output is used to determine total production throughput. Total production throughput is calculated by determining new capacity requirements at each process step so as to meet final demand changes and replace retired capacity. This is complicated because retirement rates of some steps differ, as do the process flow rates of old and new capacity. In addition, several process steps may jointly provide output for one or more "downsteps." The solution to the problem is simplified by formulating the process flow relationships as input-output coefficients as described in the Leontief Input-Output Model (as described in Chiang, *Fundamental Methods of Mathematical Economics*, pp. 123-131). In this model, the output of a process step can either be a final demand or used as input to another process step. The objective is to determine the mix of old and new productive capacity at each process step such that all final demands are met. In this case, the final demand is the industry output.

The following definitions are provided to illustrate the problem:

A = Input/Output coefficient matrix with final demand as the first column and the production steps as the other columns. The coefficients are the values in the *PRODFLOW* array, placed in the array according to the *IPASTP* step definitions,

I = Identity array,

D = Final demand vector, but only the first element is nonzero (D_1 is equivalent to *PRODX*), and

X = Vector of productive capacity needed to meet the final demand, based on **A** and **D** (**X** is equivalent to *PRODCUR*).

The input-output model is written as:

$$(I - A) * X = D \quad (225)$$

X is obtained by pre-multiplying both sides by the inverse of **(I-A)**:

$$\mathbf{X} = (\mathbf{I} - \mathbf{A})^{-1} * \mathbf{D} \quad (226)$$

Since the **A** coefficients for old and new capacity differ, there are two such arrays: **A_{old}** and **A_{new}**. The corresponding "technology" matrices **(I-A_{old})** and **(I-A_{new})** will be referred to as **IA_{old}** and **IA_{new}**.

Likewise, **X_{old}** and **X_{new}** are distinguished to account for old and new productive capacity. However, to incorporate the retirement calculation, the base year productive capacity will be referred to as **X_{old}** and

the portion of that capacity that survives to a given year is called X_{surv} . The portion that is retired is called X_{ret} . Therefore, total productive capacity (X_{tot}) is given by:

$$X_{\text{tot}} = X_{\text{surv}} + X_{\text{new}} \quad (227)$$

Or

$$X_{\text{tot}} = X_{\text{old}} - X_{\text{ret}} + X_{\text{new}}$$

X_{old} is defined in the base year as follows:

$$IA_{\text{old}} * X_{\text{old}} \equiv D_{2006}$$

$$\text{Or} \quad (228)$$

$$X_{\text{old}} \equiv IA_{\text{old}}^{-1} * D_{2006}$$

X_{new} is defined as the cumulative capacity additions since the base year.

A set of retirement rates, R , is defined for each producing step. The final demand step need not have a designated retirement rate. Retired capacity is given by:

$$X_{\text{ret}} = X_{\text{old}} * (1 - R)^{(\text{Year} - 2006)} \quad (229)$$

$$X_{\text{surv}} = X_{\text{old}} - X_{\text{ret}} \quad (230)$$

The final demand that can be met by the surviving capacity is given by:

$$D_{\text{old}} = IA_{\text{old}} * X_{\text{surv}} \quad (231)$$

The remaining demand must be met by new capacity, such that the following condition holds:

$$IA_{\text{old}} * X_{\text{surv,year}} + IA_{\text{new}} * X_{\text{new,year}} = D_{\text{year}} \quad (232)$$

where, $X_{\text{new,year}}$ is the cumulative additions to productive capacity since the base year. $X_{\text{new,year}}$ can be determined by solving the following system:

$$IA_{\text{new}} * X_{\text{new,year}} = D_{\text{year}} - IA_{\text{old}} * X_{\text{surv,year}} \quad (233)$$

Therefore,

$$X_{\text{new,year}} = IA_{\text{new}}^{-1} * (D_{\text{year}} - IA_{\text{old}} * X_{\text{surv,year}}) \quad (234)$$

The last equation is used to implement the approach in the model. The solution is found by calling a matrix inversion routine to determine IA_{new}^{-1} , followed by calls to intrinsic matrix multiplication functions to solve for X_{new} . As a result, the amount of actual code to implement this approach is minimal.

CALCSC

CALCSC computes Unit Energy Consumption (UEC) for all industries. The current UECs for the old and new vintages are calculated as the product of the previous year's UEC and a factor that reflects the assumed rate of intensity decline over time and the impact of energy price changes on the assumed decline rate.

$$ENPINT_{v,f,s} = ENPINTLAG_{v,f,s} * (1 + TPCRate_v) \quad (235)$$

where

$ENPINT_{v,f,s}$ = UEC of process step s for fuel f and vintage v ,

$ENPINTLAG_{v,f,s}$ = Lagged UEC of process step s for fuel f and vintage v , and

$TPCRate_v$ = Energy intensity decline rate for vintage v after accounting for the impact of increased energy prices.

$TPCRate_v$ is calculated using the following relationships when $TPCPrat$ is greater than 1.0. Otherwise, the default value for the intensity decline rate is used, $BCSC_{v,f,s}$.

$$X = TPCPrat^{TPCBeta}$$

$$TPCPriceFactor = \frac{X}{(1+X)} \quad (236)$$

$$TPCRate_v = 2 * TPCPriceFactor * BCSC_{v,f,s}$$

where

$TPCPrat$ = Ratio of current year average industrial energy price to 2006 price,

$TPCBeta$ = Parameter of logistic function, currently specified as 4,

$TPCPriceFactor$ = TPC price factor, ranging from 0 (no price effect) to 2 for $ENPINT$, and

$BCSC_{v,f,s}$ = Default intensity rate for old and new vintage v for fuel f and step s .

$TPCRate_v$ is defined above.

The UEC for middle vintage is calculated as the ratio of cumulative UEC to cumulative production for all process steps and industries, i.e., the weighted average UEC, as follows:

$$ENPINT_{mid,f,s} = \frac{SUMPINT_{f,s}}{CUMPROD_{new,s}} \quad (237)$$

where

$ENPINT_{mid,f,s}$ = UEC of process step s for fuel f at middle vintage,

$SUMPINT_{f,s}$ = Cumulative UEC of process step s for fuel f , and

$CUMPROD_{new,s}$ = Cumulative production at process step s for new vintage.

CALBSC

The boiler fuel shares are revised each year based on changes in fuel prices since the base year. The fuel sharing is calculated using a logit formulation. The fuel shares apply only to conventional boiler fuel use. Cogeneration fuel shares are assumed to be constant and are based on data from EIA Form 860B. Base year boiler fuel use is obtained by subtracting cogeneration fuel use from total MECS indirect fuels (this calculation is done in subroutine MecsLess860b). Waste and byproduct fuels are excluded from the logit calculation because they are assumed to be consumed first. The boiler fuel sharing equation for each manufacturing industry is as follows:

$$ShareFuel_f = \frac{(P_f^{\alpha_f} \beta_f)}{\sum_{f=1}^3 P_f^{\alpha_f} \beta_f} \quad (238)$$

where

$ShareFuel_f$ = Boiler fuel share for fuel f

P_f = Fuel price relative to the 2006 price for fuel f with fuel premium index applied (Table 11)⁵⁴,

α_f = Sensitivity parameter for fuel f , default value is -2.0

$BCSC_{v,f,s}$ = Fuel shares calibrated to 2006 using relative prices that prevailed in that year

Table 30. Index price premiums for boiler fuel share selection

	Coal	Oil	Natural Gas
Cost premium (index)	1.25	1.10	1.00

The fuels (f) are limited to coal, petroleum, and natural gas because these are the only fuels used in substantial quantities in industrial boilers. Base year boiler shares for individual petroleum products are calculated explicitly to obtain exact estimates of these fuel shares from the aggregate petroleum fuel share calculation. The byproduct fuels are consumed before the quantity of purchased fuels is estimated using this equation.

⁵⁴ NESCAUM, Applicability and feasibility of NO_x, SO₂, and PM Emissions Control Technologies for Industrial, Commercial, and Institutional (ICI) Boilers, January 2009.

Appendix A. Model Abstract

Model name:

Industrial Demand Module

Model acronym:

IDM

Description:

The Industrial Demand Module is based upon economic and engineering relationships that model industrial sector energy consumption at the Census Division level of detail. The seven most energy-intensive industries are modeled at the detailed process step level and eight other industries are modeled at a less-detailed level. The IDM incorporates three components: buildings; process and assembly; and boiler, steam, and cogeneration.

Purpose of the model:

As a component of the National Energy Modeling System integrated modeling tool, the IDM generates long-term projections of industrial sector energy consumption. The IDM facilitates policy analysis of energy markets, technological development, environmental issues, and regulatory development as they impact industrial sector energy consumption.

Most recent model update:

October 2012.

Part of another Model:

National Energy Modeling System (NEMS)

Model interfaces:

The Industrial Demand Module receives inputs from the Electricity Market Module, Natural Gas Transmission and Distribution Module, Oil and Gas Market Module, Renewable Fuels Module, Macroeconomic Activity Module (MAM), Transportation Sector Module (TSM), Commercial Demand Module (CDM), and Liquid Fuels Market Module (LFMM).

Official model representatives:

Kelly Perl (202)586-1743
EIA-OECEAIndustrialTeam@eia.gov
Office of Energy Analysis,
Office of Energy Consumption and Efficiency Analysis
EI-32
1000 Independence Avenue, SW
Washington, DC 20585

Documentation:

Model Documentation Report: Industrial Demand Module of the National Energy Modeling System, August 2013.

Archive media and installation manual(s):

The model is archived as part of the National Energy Modeling System production runs used to generate *AEO2013*.

Energy system described:

Domestic industrial sector energy consumption.

Coverage:

Geographic: Nine Census divisions: New England, Middle Atlantic, East North Central, West North Central, South Atlantic, East South Central, West South Central, Mountain, and Pacific.

Time Unit/Frequency: Annual, 2006 through 2040.

Modeling features:

Structure: 15 manufacturing and 6 non-manufacturing industries. The manufacturing industries are further classified as energy-intensive or non-energy-intensive industries.

Each industry is modeled as three separate but interrelated components consisting of the process/assembly component (PA), the buildings component (BLD), and the boiler/steam/cogeneration component (BSC).

Modeling Technique: The energy-intensive industries are modeled either through the use of a detailed process flow with technology diffusion or end-use accounting procedure. The remaining industries use the same general procedure but do not include a detailed process flow.

Non-DOE input sources:

Historical Dollar Value of Shipments in the Industrial Sector

Energy Expenditures in the Agriculture and Construction sectors

Energy Consumption in the Mining sector

DOE input sources:

Form EI-906 and predecessor forms: Annual Electric Generator Report – Nonutility

Electricity generation, total and by prime mover

Electricity generation for own use and sales

Capacity utilization

Manufacturing Energy Consumption Survey 2006, June 2009

State Energy Data System 2009, June 2011

Annual Energy Review 2010, October 2011

Computing environment:

Hardware Used: Intel Xeon CPU

Operating System: Microsoft Windows XP

Language/Software Used: Intel Visual FORTRAN 11.1

Estimated Run Time: 53 seconds for a 2006-2040 run in non-iterating, stand-alone mode.

Special Features: None

Appendix B. Data Inputs

Table B.1. Building component energy consumption, part 1

trillion Btu

Organic Chemicals	Region	Lighting	Heating, Ventilation, and Air Conditioning		
		Electricity	Electricity	Natural Gas	Steam
Food	NE	1.496	1.654	1.744	1.201
	MW	8.269	9.140	14.949	5.293
	SO	6.458	7.138	8.702	5.996
	WE	3.544	3.917	6.980	4.809
Paper	NE	1.577	1.774	2.599	0.000
	MW	3.655	4.112	2.878	0.000
	SO	8.671	9.755	9.500	0.000
	WE	3.870	4.354	2.924	0.000
Bulk Chemical	NE	0.999	1.307	1.621	0.000
	MW	2.919	3.820	4.201	0.000
	SO	11.074	14.487	11.470	0.000
	WE	1.123	1.469	1.694	0.000
Glass	NE	0.366	0.312	3.415	0.000
	MW	1.207	1.028	5.837	0.000
	SO	1.099	0.936	6.071	0.000
	WE	0.320	0.273	3.140	0.000
Cement	NE	0.243	0.364	0.748	0.000
	MW	0.534	0.801	0.707	0.000
	SO	0.728	10.92	0.823	0.000
	WE	0.486	0.728	0.635	0.000
Steel	NE	1.049	0.750	2.605	0.000
	MW	2.825	2.018	8.763	0.000
	SO	2.744	1.960	3.568	0.000
	WE	0.444	0.317	1.273	0.000
Aluminum	NE	0.354	0.236	0.585	0.000
	MW	0.492	0.328	1.076	0.000
	SO	1.870	1.247	2.776	0.000
	WE	0.276	0.184	0.410	0.000
Fab. Metal	NE	1.780	1.780	4.388	3.971
	MW	5.934	5.934	18.723	15.859
	SO	4.747	4.747	11.861	10.046
	WE	1.780	1.780	2.535	2.147

Table B.1. Building component energy consumption, part 1 (cont.)

trillion Btu

Organic Chemicals	Region	Lighting	Heating, Ventilation, and Air Conditioning		
		Electricity	Electricity	Natural Gas	Steam
Machinery	NE	2.516	3.931	5.113	3.010
	MW	9.472	14.801	18.976	11.169
	SO	3.700	5.781	9.058	5.331
	WE	0.740	1.156	0.957	0.563
Computer	NE	2.030	4.798	4.418	3.855
	MW	1.672	3.951	4.581	3.997
	SO	3.105	7.338	4.178	3.646
	WE	4.299	10.160	7.402	6.459
Trans. Equip.	NE	3.458	4.531	11.564	0.863
	MW	15.185	19.898	56.199	4.193
	SO	7.968	10.441	14.106	1.052
	WE	2.706	3.546	5.977	0.446
Electrical	NE	0.575	0.690	0.657	0.509
	MW	1.725	2.070	2.413	1.870
	SO	2.530	3.036	4.754	3.684
	WE	0.230	0.276	0.462	0.358
Wood Prod.	NE	0.480	0.343	0.480	0.935
	MW	2.079	1.485	2.972	5.790
	SO	3.278	2.342	1.885	3.672
	WE	1.439	1.028	1.694	3.300
Plastic	NE	2.029	2.536	4.346	0.000
	MW	6.968	8.710	9.645	0.000
	SO	5.909	7.387	11.210	0.000
	WE	1.147	1.433	0.806	0.000
BOM/Other	NE	5.715	8.822	14.900	0.000
	MW	16.729	25.821	23.108	0.000
	SO	21.370	32.985	43.672	0.000
	WE	3.984	6.149	11.065	0.000

Source: SAIC, *IDM Base Year Update with MECS 2006 Data*, unpublished data prepared for the Office of Integrated Analysis and Forecasting, Energy Information Administration, Washington, DC, August 2010.

Table B.2. Building component energy consumption, part 2

(trillion Btu)

	Region	Facility Support				On-site Transportation			
		Electricity	Nat. Gas	Distillate	LPG	Electricity	Nat. Gas	Distillate	LPG
Food	NE	0.473	0.475	0.046	0.021	0.079	0.013	0.381	0.086
	MW	2.611	4.276	0.030	0.086	0.435	0.114	0.254	0.360
	SO	2.039	2.447	0.061	0.086	0.340	0.065	0.508	0.360
	WE	1.119	1.944	0.107	0.086	0.187	0.052	0.888	0.360
Paper	NE	0.394	0.148	0.021	0.115	0.099	0.035	0.266	1.440
	MW	0.914	0.173	0.021	0.058	0.228	0.041	0.266	0.720
	SO	2.168	0.569	0.170	0.115	0.542	0.136	2.130	1.440
	WE	0.967	0.191	0.064	0.058	0.242	0.046	0.799	0.720
Bulk Chem.	NE	0.544	0.067	0.278	0.237	0.171	0.009	0.666	1.026
	MW	1.588	0.490	0.397	0.607	0.499	0.065	0.952	2.632
	SO	6.024	3.050	1.183	0.383	1.893	0.402	2.840	1.658
	WE	0.611	0.103	0.278	0.260	0.192	0.014	0.666	1.128
Glass	NE	0.109	0.130	0.480	1.440	0.109	0.000	0.960	1.440
	MW	0.358	0.439	0.480	1.440	0.358	0.000	0.960	1.440
	SO	0.326	0.469	0.480	1.440	0.326	0.000	0.960	1.440
	WE	0.095	0.095	0.480	1.440	0.095	0.000	0.960	1.440
Cement	NE	0.121	0.003	0.026	0.480	0.029	0.000	0.213	0.480
	MW	0.267	0.120	0.107	0.480	0.064	0.000	0.889	0.480
	SO	0.364	0.072	0.213	0.480	0.087	0.000	1.778	0.480
	WE	0.243	0.048	0.107	0.480	0.058	0.000	0.889	0.480
Steel	NE	0.150	0.150	0.000	0.480	0.036	0.000	0.160	0.480
	MW	0.404	0.580	0.000	0.480	0.097	0.000	1.333	0.480
	SO	0.392	0.215	0.000	0.480	0.094	0.000	0.667	0.480
	WE	0.063	0.055	0.000	0.480	0.015	0.000	0.160	0.480
Aluminum	NE	0.118	0.114	0.058	0.071	0.028	0.027	0.058	0.071
	MW	0.164	0.237	0.058	0.071	0.039	0.057	0.058	0.071
	SO	0.623	0.605	0.058	0.298	0.150	0.145	0.058	0.298
	WE	0.092	0.070	0.058	0.071	0.022	0.017	0.058	0.071
Fab. Metal	NE	0.381	0.249	0.032	0.015	0.031	0.030	0.134	0.191
	MW	1.272	10.38	0.032	0.127	0.102	0.125	0.134	1.590
	SO	1.017	0.626	0.134	0.127	0.081	0.075	0.560	1.590
	WE	0.381	0.137	0.070	0.015	0.031	0.016	0.291	0.191
Machinery	NE	0.472	0.158	0.029	0.021	0.157	0.038	0.029	0.086
	MW	1.776	0.585	0.120	0.086	0.592	0.140	0.120	0.360
	SO	0.694	0.256	0.029	0.131	0.231	0.061	0.029	0.547
	WE	0.139	0.024	0.029	0.021	0.046	0.006	0.029	0.086

Table B.2. Building component energy consumption, part 2 (cont.)
(trillion Btu)

	Region	Facility Support				On-site Transportation			
		Electricity	Nat. Gas	Distillate	LPG	Electricity	Nat. Gas	Distillate	LPG
Computers	NE	1.107	0.051	0.071	0.480	0.044	0.000	0.071	0.480
	MW	0.912	0.057	0.071	0.480	0.036	0.000	0.071	0.480
	SO	1.693	0.051	0.071	0.480	0.068	0.000	0.071	0.480
	WE	2.345	0.097	0.071	0.480	0.094	0.000	0.071	0.480
Elec. Equip.	NE	0.835	0.392	0.021	0.015	0.119	0.031	0.086	0.127
	MW	3.665	1.971	0.086	0.127	0.524	0.158	0.360	1.060
	SO	1.923	0.477	0.086	0.064	0.275	0.038	0.360	0.530
	WE	0.653	0.208	0.066	0.015	0.093	0.017	0.274	0.127
Transp. Equip.	NE	0.230	0.018	0.000	0.000	0.028	0.018	0.000	0.298
	MW	0.690	0.070	0.000	0.000	0.083	0.070	0.000	0.298
	SO	1.012	0.140	0.000	0.000	0.121	0.140	0.000	0.298
	WE	0.092	0.012	0.000	0.000	0.011	0.012	0.000	0.298
Wood Products	NE	0.069	0.017	0.016	0.014	0.016	0.017	0.677	0.173
	MW	0.297	0.111	0.065	0.101	0.071	0.111	2.709	1.267
	SO	0.468	0.066	0.081	0.115	0.112	0.066	3.387	1.440
	WE	0.206	0.051	0.081	0.058	0.049	0.051	3.387	0.720
Plastic & Rubber Products	NE	0.634	0.344	0.111	0.125	0.127	0.041	0.111	1.040
	MW	2.177	0.802	0.021	0.050	0.435	0.096	0.021	0.419
	SO	1.847	0.851	0.107	0.050	0.369	0.102	0.107	0.419
	WE	0.358	0.065	0.021	0.026	0.072	0.008	0.021	0.218
BOM	NE	1.768	0.575	0.000	0.000	0.000	0.000	1.857	0.000
	MW	5.176	0.892	0.000	0.000	0.000	0.000	1.289	0.000
	SO	6.611	1.686	0.000	0.000	0.000	0.000	2.089	0.000
	WE	1.232	0.427	0.000	0.000	0.000	0.000	0.861	0.000

Source: SAIC, *IDM Base Year Update with MECS 2006 Data*, unpublished data prepared for the Office of Integrated Analysis and Forecasting, Energy Information Administration, Washington, DC, August 2010.

Table B.3. Food industry national UECs, 2006

thousand Btu/2005\$ of shipments, unless otherwise indicated

End Use	Shipments		Natural					
	(Billion 2005\$)	Electricity	Gas	Residual	Distillate	LPG	Coal	Steam
Direct Heat	541.2	0.031	0.392	0.000	0.004	0.001	0.021	0.877
Refrigeration	541.2	0.133	0.006	0.000	0.000	0.000	0.000	0.000
Machine Drive	541.2	0.247	0.021	0.000	0.006	0.001	0.000	0.000
Other	541.2	0.004	0.019	0.000	0.002	0.000	0.000	0.000

Source: SAIC, *IDM Base Year Update with MECS 2006 Data*, unpublished data prepared for the Office of Integrated Analysis and Forecasting, Energy Information Administration, Washington, DC, August 2010.

Table B.4. Pulp and paper industry national UECs. 2006

million Btu/ton of flow, unless otherwise indicated

End Use	Flow (MMtons)	Electricity	Natural						Byproduct Produced
			Gas	Residual	Distillate	LPG	Coal	Steam	
Wood									
Preparation	102.0	0.249	0.000	0.000	0.000	0.000	0.000	0.000	3.266
Pulping									
Waste	47.2	1.246	0.000	0.000	0.000	0.000	0.000	1.138	0.000
Mech.	4.8	4.965	0.000	0.000	0.000	0.000	0.000	0.407	0.000
Semi-chem.	3.8	1.338	0.000	0.000	0.000	0.000	0.000	4.377	0.000
Kraft	51.2	1.338	1.374	0.252	0.039	0.015	0.080	9.401	16.466
Bleaching	52.4	0.277	0.000	0.000	0.000	0.000	0.000	4.617	0.000
Paper Making	96.6	1.532	0.830	0.144	0.021	0.010	0.050	5.515	0.000

Source: SAIC, *IDM Base Year Update with MECS 2006 Data*, unpublished data prepared for the Office of Integrated Analysis and Forecasting, Energy Information Administration, Washington, DC, August 2010.

Table B.5. Bulk chemical industry total and sub-total national UECs, 2006

thousand Btu/2005\$ of shipments, unless otherwise indicated

Bulk Chemicals Total	Shipments (Billion 2005\$)	Natural						Petro-chemical	
		Electricity	Gas	Residual	Distillate	LPG	Coal	Steam	Feedstocks
End Use									
Direct Heat									
Refrigeration	320.7	0.576	2.112	0.042	0.012	0.169	0.021	4.272	0.000
Machine	320.7	0.002	0.003	0.000	0.000	0.000	0.000	0.000	0.000
Drive									
Electrolytic	320.7	1.152	0.034	0.000	0.003	0.001	0.000	0.000	0.000
Other	320.7	0.162	0.000	0.000	0.000	0.000	0.000	0.000	0.000
Feedstocks	320.7	0.000	0.000	0.000	0.000	0.000	0.000	0.000	0.000
Inorganic	320.7	0.000	1.731	0.000	0.000	6.075	0.000	0.000	4.426
End Use									
Direct Heat									
Refrigeration	37.3	0.097	1.695	0.045	0.093	0.002	0.088	1.826	0.000
Machine	37.3	0.000	0.000	0.000	0.000	6.075	0.000	0.000	0.000
Drive									
Electrolytic	37.3	6.553	0.000	0.000	0.013	0.002	0.000	0.000	0.000
Other	37.3	1.397	0.000	0.000	0.000	0.000	0.000	0.000	0.000
Feedstocks	37.3	0.000	0.000	0.000	0.000	0.000	0.000	0.000	0.000
Organic	37.3	0.000	8.561	0.000	0.000	0.000	0.000	0.000	0.000
End Use									
Direct Heat									
Refrigeration	154.6	1.010	3.151	0.070	0.001	0.351	0.011	6.320	0.000
Machine	154.6	0.004	0.006	0.000	0.000	0.000	0.000	0.000	0.000
Drive									
Electrolytic	154.6	0.140	0.009	0.000	0.000	0.000	0.000	0.000	0.000
Other	154.6	0.000	0.000	0.000	0.000	0.000	0.000	0.000	0.000
Feedstocks	154.6	0.000	0.000	0.000	0.000	0.000	0.000	0.000	0.000
	154.6	0.000	0.000	0.000	0.000	12.602	0.000	0.000	9.181

Table B.5. Bulk chemical industry total and sub-total national UECs, 2006 (cont.)

thousand Btu/2005\$ of shipments, unless otherwise indicated

	Shipments		Natural					Petro-chemical	
	(Billion 2005\$)	Electricity	Gas	Residual	Distillate	LPG	Coal	Steam	Feedstocks
Resins									
End Use									
Direct Heat	102.3	0.056	0.432	0.004	0.001	0.000	0.009	1.058	0.000
Refrigeration	102.3	0.000	0.000	0.000	0.000	0.000	0.000	0.000	0.000
Machine Drive	102.3	0.823	0.023	0.001	0.001	0.001	0.000	0.000	0.000
Electrolytic	102.3	0.000	0.000	0.000	0.000	0.000	0.000	0.000	0.000
Other	102.3	0.000	0.000	0.000	0.000	0.000	0.000	0.000	0.000
Feedstocks	102.3	0.000	0.000	0.000	0.000	0.000	0.000	0.000	0.000
Agricultural Chemicals									
End Use									
Direct Heat	26.5	0.730	3.125	0.023	0.003	0.000	0.023	8.172	0.000
Refrigeration	26.5	0.000	0.000	0.000	0.000	0.000	0.000	0.000	0.000
Machine Drive	26.5	0.730	0.273	0.000	0.008	0.000	0.000	0.000	0.000
Electrolytic	26.5	0.000	0.000	0.000	0.000	0.000	0.000	0.000	0.000
Other	26.5	0.000	0.000	0.000	0.000	0.000	0.000	0.000	0.000
Feedstocks	26.5	0.000	8.095	0.000	0.000	0.000	0.000	0.000	0.000

Table B.6. Glass products industry national UECs, 2006

million Btu/ton of flow, unless otherwise indicated

Process Step	Flow	Electricity	Natural		LPG	Coal	Steam
	(MMtons)		Gas	Distillate			
Virgin							
Batch Prep	16.3	0.240	0.000	0.000	0.000	0.000	0.000
Melting/Refining	16.3	0.567	5.309	0.032	0.398	0.460	0.643
Scrap							
Batch Prep	2.3	0.207	0.000	0.000	0.000	0.000	0.000
Melting/Refining	2.3	0.458	4.248	0.026	0.319	0.368	0.611
Forming	19.0	1.058	1.636	0.010	0.123	0.142	0.193
Post-Forming	19.0	0.458	1.924	0.012	0.144	0.167	0.225

Source: SAIC, *IDM Base Year Update with MECS 2006 Data*, unpublished data prepared for the Office of Integrated Analysis and Forecasting, Energy Information Administration, Washington, DC, August 2010.

Table B.7. Cement industry national UECs, 2006

million Btu/ton of flow, unless otherwise indicated

Process Step	Flow	Electricity	Natural			LPG	Coal	Coke	Steam
	(MMtons)		Gas	Residual	Distillate				
Dry Process	70.0	0.216	0.195	0.009	0.029	0.000	2.349	0.051	0.000
Wet Process	20.3	0.197	0.237	0.030	0.036	0.000	3.263	0.065	0.290
Finish Grinding	99.3	0.207	0.000	0.000	0.000	0.000	0.000	0.000	0.000

Source: SAIC, *IDM Base Year Update with MECS 2006 Data*, unpublished data prepared for the Office of Integrated Analysis and Forecasting, Energy Information Administration, Washington, DC, August 2010.

Table B.8. Iron and steel industry national UECs, 2006

million Btu/ton of flow, unless otherwise indicated

Process Step	Flow	Electricity	Natural			Coal	Coke	Steam	Byproduct
	(MMtons)		Gas	Residual	Distillate				Consumed
Coke Ovens	17.5	0.104	0.010	0.000	0.000	38.700	0.000	0.570	2.083
Iron & Steel making									
BOF	52.2	0.217	1.650	0.035	0.000	0.690	8.710	0.835	1.360
EAF	52.8	1.565	0.591	0.000	0.000	0.000	0.000	0.000	0.000
Casting									
Ingot	2.9	0.320	1.436	0.000	0.000	0.000	0.090	0.024	0.000
Continuous	102.3	0.094	0.253	0.000	0.000	0.000	0.000	0.008	0.000
Hot Rolling	110.1	0.377	1.300	0.000	0.000	0.000	0.000	0.016	0.040
Cold Rolling	41.0	0.849	1.436	0.000	0.004	0.000	0.000	1.051	0.000

Source: SAIC, *IDM Base Year Update with MECS 2006 Data*, unpublished data prepared for the Office of Integrated Analysis and Forecasting, Energy Information Administration, Washington, DC, August 2010.

Table B.9. Aluminum industry national UECs, 2006

million Btu/ton of flow, unless otherwise indicated

Process Step	Flow	Electricity	Natural				Coal	Steam
	(MMtons)		Gas	Distillate	LPG			
Alumina Refining	3.6	0.352	1.674	0.005	0.056	3.729	0.000	
Primary Smelting	2.3	47.030	3.774	0.049	0.163	0.315	13.702	
Secondary/Scrap	2.3	0.792	7.228	0.077	0.253	0.000	0.000	
Semi-Fabrication								
Sheet, Plate, Foil	3.7	2.818	9.877	0.076	0.332	0.000	0.000	
Other	1.7	2.994	5.367	0.054	0.188	0.000	0.000	

Source: SAIC, *IDM Base Year Update with MECS 2006 Data*, unpublished data prepared for the Office of Integrated Analysis and Forecasting, Energy Information Administration, Washington, DC, August 2010.

Table B.10. Metal-based durables pa component national UECs, 2006

thousand Btu/2005\$ of shipments, unless otherwise indicated

	Shipments		Natural				Petro-chemical		
	(Billion 2005\$)	Electricity	Gas	Residual	Distillate	LPG	Coal	Steam	Feedstocks
Fabricated Metals									
Heating	304.9	0.093	0.521	0.000	0.000	0.004	0.017	0.000	0.000
Refrigeration	304.9	0.017	0.003	0.000	0.000	0.000	0.000	0.000	0.000
Machine Drive	304.9	0.251	0.003	0.000	0.001	0.000	0.000	0.000	0.000
Electrochemical	304.9	0.010	0.000	0.000	0.000	0.000	0.000	0.000	0.000
Other	304.9	0.013	0.003	0.000	0.001	0.000	0.000	0.000	0.000
Machinery									
Heating	317.2	0.026	0.081	0.000	0.001	0.001	0.000	0.000	0.000
Refrigeration	317.2	0.010	0.001	0.000	0.000	0.000	0.000	0.000	0.000
Machine Drive	317.2	0.135	0.001	0.000	0.001	0.001	0.000	0.000	0.000
Electrochemical	317.2	0.001	0.000	0.000	0.000	0.000	0.000	0.000	0.000
Other	317.2	0.006	0.013	0.000	0.001	0.000	0.000	0.000	0.000
Computers and Electronics									
Heating	461.3	0.093	0.028	0.000	0.002	0.017	0.000	0.000	0.000
Refrigeration	461.3	0.093	0.005	0.000	0.000	0.000	0.000	0.000	0.000
Machine Drive	461.3	0.068	0.002	0.000	0.002	0.017	0.000	0.000	0.000
Electrochemical	461.3	0.009	0.000	0.000	0.000	0.000	0.000	0.000	0.000
Other	461.3	0.065	0.009	0.000	0.002	0.000	0.000	0.000	0.000
Electrical Equipment									
Heating	115.6	0.020	0.042	0.000	0.000	0.001	0.000	0.000	0.000
Refrigeration	115.6	0.004	0.002	0.000	0.000	0.000	0.000	0.000	0.000
Machine Drive	115.6	0.157	0.000	0.000	0.000	0.001	0.000	0.000	0.000
Electrochemical	115.6	0.002	0.000	0.000	0.000	0.000	0.000	0.000	0.000
Other	115.6	0.002	0.002	0.000	0.000	0.000	0.000	0.030	0.000
Transportation Equipment									
Heating	688.4	0.040	0.111	0.000	0.000	0.000	0.000	0.000	0.071
Refrigeration	688.4	0.018	0.004	0.000	0.000	0.000	0.000	0.000	0.000
Machine Drive	688.4	0.112	0.004	0.000	0.002	0.000	0.000	0.000	0.000
Electrochemical	688.4	0.003	0.000	0.000	0.000	0.000	0.000	0.000	0.000
Other	688.4	0.007	0.050	0.000	0.000	0.000	0.000	0.000	0.000

Source: SAIC, *IDM Base Year Update with MECS 2006 Data*, unpublished data prepared for the Office of Integrated Analysis and Forecasting, Energy Information Administration, Washington, DC, August 2010.

Table B.11. Other manufacturing sectors pa component national UECs, 2006

thousand Btu/2005\$ of shipments, unless otherwise indicated

	Shipments								
	(Billion 2005\$)	Electricity	Natural Gas	Residual	Distillate	LPG	Coal	Petroleum Coke	Steam
Wood Products									
Heating	114.1	0.064	0.422	0.003	0.002	0.010	0.133	0.000	1.652
Refrigeration	114.1	0.009	0.004	0.000	0.000	0.000	0.000	0.000	0.000
Machine Drive	114.1	0.499	0.018	0.003	0.018	0.002	0.000	0.000	0.000
Electrochemical	114.1	0.009	0.000	0.000	0.000	0.000	0.000	0.000	0.000
Other	114.1	0.002	0.027	0.003	0.002	0.000	0.000	0.000	0.000
Plastic Products									
Heating	196.4	0.143	0.163	0.010	0.001	0.011	0.000	0.000	0.320
Refrigeration	196.4	0.082	0.001	0.000	0.000	0.000	0.000	0.000	0.000
Machine Drive	196.4	0.501	0.016	0.000	0.001	0.001	0.000	0.000	0.000
Electrochemical	196.4	0.001	0.000	0.000	0.000	0.000	0.000	0.000	0.000
Other	196.4	0.015	0.016	0.000	0.000	0.000	0.000	0.000	0.000
Balance of Manufacturing									
Heating	1056.2	0.064	0.367	0.009	0.004	0.000	0.057	0.000	1.000
Refrigeration	1056.2	0.033	0.000	0.000	0.000	0.000	0.000	0.000	0.000
Machine Drive	1056.2	0.287	0.000	0.000	0.005	0.000	0.000	0.000	0.000
Electrochemical	1056.2	0.011	0.000	0.000	0.000	0.000	0.000	0.000	0.000
Other	1056.2	0.006	0.015	0.001	0.001	0.000	0.010	0.000	0.000

Source: SAIC, *IDM Base Year Update with MECS 2006 Data*, unpublished data prepared for the Office of Integrated Analysis and Forecasting, Energy Information Administration, Washington, DC, August 2010.

Table B.12. Non-manufacturing sector pa component national UECs, 2006

thousand Btu/2005\$ of shipments, unless otherwise indicated

	Shipments							
	(Billion 2005\$)	Electricity	Natural Gas	Distillate	LPG	Motor Gasoline	Coal	Asphalt
Agriculture - Crops								
Buildings	112.6	0.363	0.479	0.296	0.298	0.000	0.000	0.000
Vehicles	112.6	0.000	0.086	1.165	0.034	0.000	0.000	0.000
Irrigation &								
Other	112.6	0.165	0.297	0.092	0.004	0.000	0.000	0.000
Agriculture - Other								
Buildings	182.6	0.329	0.163	0.127	0.184	0.000	0.000	0.000
Vehicles	182.6	0.000	0.031	0.501	0.021	0.745	0.000	0.000
Irrigation &								
Other	182.6	0.113	0.118	0.041	0.003	0.002	0.000	0.000
Coal Mining	26.8	1.154	0.226	1.280	0.000	0.189	0.131	0.000
Oil & Gas	464.7	0.147	0.000	0.085	0.000	0.057	0.000	0.000
Other Mining	37.8	2.512	4.220	1.072	0.000	0.265	0.177	0.000
Construction	1339.5	0.114	0.375	0.476	0.000	0.088	0.000	0.932

Notes: Natural gas exclude lease and plant fuel.

Sources: Calculated from data provided in U.S. Census Bureau.

Table B.13. Regional technology shares

percent

Industry	Technology	Census Region			
		Northeast	Midwest	South	West
Pulp and Paper	Kraft (incl. Sulfite)	9	7	72	12
	Semi-Chemical	2	40	52	6
	Mechanical	16	18	46	20
	Waste Fiber	18	28	39	15
	Bleaching	13	18	56	13
	Paper making	13	18	56	13
Cement	Wet Process	23	29	40	8
	Dry Process	8	28	36	28
	Clinker	11	28	37	24
Iron and Steel	Electric Arc Furnace	12	34	46	8
	Basic Oxygen Furnace	5	80	15	0
	Coke Oven	32	46	22	0
Aluminum	Alumina Refining	0	0	100	0
	Primary Smelting	6	20	39	35
	Secondary/Scrap	10	41	31	18
	Semi-Fab: Sheet	19	22	55	4
	Semi-Fab: Other	15	33	38	14

Source: SAIC, *IDM Base Year Update with MECS 2006 Data*, unpublished data prepared for the Office of Integrated Analysis and Forecasting, Energy Information Administration, Washington, DC, August 2010.

Table B. 14. Coefficients for technology possibility curves and retirement rates, Reference case

Industry/Process Unit	Existing Facilities			New Facilities	
	REI 2040	TPC (%)	REI to Existing	REI 2040	TPC(%)
Food Products					
Process Heating	0.865	-0.426	0.900	0.765	-0.477
Process Heating-Steam	0.747	-0.853	0.900	0.650	-0.953
Process Cooling - Electricity	0.832	-0.540	0.850	0.715	-0.506
Process Cooling – Natural Gas	0.865	-0.426	0.900	0.765	-0.477
Other – Electricity	0.883	-0.364	0.915	0.773	-0.493
Other – Natural Gas	0.865	-0.426	0.900	0.765	-0.477
Paper and Allied Products					
Wood Preparation	0.760	-0.802	0.882	0.674	-0.790
Waste Pulping - Electricity	0.925	-0.228	0.936	0.936	0.000
Waste Pulping – Steam	0.856	-0.456	0.936	0.936	0.000
Mechanical Pulping - Electricity	0.770	-0.767	0.931	0.580	-1.380
Mechanical Pulping - Steam	0.591	-1.533	0.931	0.359	-2.760
Semi-Chemical - Electricity	0.943	-0.173	0.971	0.923	-0.149
Semi - Chemical - Steam	0.889	-0.346	0.971	0.877	-0.297
Kraft, Sulfite, Misc. Chemicals	0.838	-0.519	0.914	0.793	-0.415
Kraft, Sulfite, Misc. Chemicals - Steam	0.701	-1.037	0.914	0.688	-0.830
Bleaching – Electricity	0.747	-0.853	0.878	0.651	-0.878
Bleaching – Steam	0.557	-1.706	0.878	0.481	-1.756
Paper Making	0.848	-0.485	0.885	0.846	-0.132
Paper Making - Steam	0.944	-0.969	0.885	0.809	-0.264
Glass and Glass Products					
Batch Preparation - Electricity	0.931	-0.209	0.882	0.882	0.000
Melting/Refining	0.923	-0.235	0.900	0.863	-0.125
Melting/Refining - Steam	0.852	-0.470	0.900	0.827	-0.250
Forming	0.981	-0.056	0.982	0.966	-0.048
Forming – Steam	0.963	-0.111	0.982	0.950	-0.096
Post-Foaming	0.974	-0.078	0.968	0.953	-0.045
Iron and Steel					
Coke Oven	0.924	-0.233	0.902	0.863	-0.128
Coke Oven – Steam	0.853	-0.467	0.902	0.826	-0.257
BF/BOF	0.992	-0.022	0.987	0.987	0.000
BF/BOF – Steam	0.985	-0.045	0.987	0.987	0.000
EAF	0.901	-0.308	0.990	0.805	-0.606
Ingot Casting/Primary Rolling	1.000	0.000	NA	NA	NA

Table B.14. Coefficients for technology possibility curves and retirement rates, Reference case (cont.)

Industry/Process Unit	Existing Facilities		REI to Existing	New Facilities	
	REI 2040	TPC (%)		REI 2040	TPC(%)
Iron and Steel (cont'd)					
Continuous Casting	1.000	0.000	1.000	1.000	0.000
Hot Rolling	0.788	-0.699	0.800	0.608	-0.804
Hot Rolling – Steam	0.620	-1.397	0.800	0.461	-1.608
Cold Rolling	0.677	-1.141	0.924	0.380	-2.580
Cold Rolling – Steam	0.456	-2.281	0.924	0.153	-5.160
Metal-Based Durables					
Fabricated Metals					
Process Heating	0.613	-1.427	0.675	0.366	-1.784
Process Cooling – Electricity	0.680	-1.127	0.638	0.332	-1.903
Process Cooling – Natural Gas	0.680	-1.127	0.675	0.380	-1.679
Other	0.680	-1.127	0.675	0.380	-1.679
Other – Electricity	0.680	-1.127	0.686	0.366	-1.834
Machinery					
Process Heating	0.613	-1.427	0.675	0.366	-1.784
Process Cooling – Electricity	0.680	-1.127	0.638	0.332	-1.903
Process Cooling – Natural Gas	0.680	-1.127	0.675	0.380	-1.679
Other	0.680	-1.127	0.675	0.380	-1.679
Other – Electricity	0.680	-1.127	0.686	0.366	-1.834
Computers and Electronics					
Process Heating	0.722	-0.952	0.720	0.531	-0.892
Process Cooling – Electricity	0.774	-0.751	0.680	0.491	-0.952
Process Cooling – Natural Gas	0.774	-0.751	0.720	0.541	-0.840
Other	0.774	-0.751	0.720	0.541	-0.840
Other – Electricity	0.774	-0.751	0.732	0.535	-0.917

Table B.14. Coefficients for technology possibility curves and retirement rates, Reference case (cont.)

Industry/Process Unit	Existing Facilities		New Facilities		
	REI 2040	TPC (%)	REI to Existing	REI 2040	TPC(%)
Electrical Equipment					
Process Heating	0.722	-0.952	0.720	0.531	-0.892
Process Heating – Steam	NA	-1.502	NA	NA	-1.679
Process Cooling – Electricity	0.774	-0.751	0.680	0.491	-0.952
Process Cooling – Natural Gas	0.774	-0.751	0.720	0.541	-0.840
Other	0.774	-0.751	0.720	0.541	-0.840
Other – Electricity	0.774	-0.751	0.732	0.535	-0.917
Transportation Equipment					
Process Heating	0.797	-0.666	0.765	0.600	-0.714
Process Heating - Steam	0.698	-1.052	0.765	0.483	-1.343
Process Cooling – Electricity	0.836	-0.526	0.723	0.557	-0.761
Process Cooling – Natural Gas	0.836	-0.526	0.765	0.608	-0.672
Other	0.836	-0.526	0.765	0.608	-0.672
Other – Electricity	0.836	-0.526	0.778	0.606	-0.734
Other Non-Intensive Manufacturing					
Wood Products					
Process Heating	0.613	-1.427	0.630	0.342	-1.784
Process Heating - Steam	0.720	-2.253	0.630	0.386	-3.358
Process Cooling – Electricity	0.680	-1.127	0.595	0.310	-1.903
Process Cooling – Natural Gas	0.680	-1.127	0.630	0.354	-1.679
Other	0.680	-1.127	0.630	0.354	-1.679
Other – Electricity	0.683	-1.115	0.641	0.340	-1.845
Plastic Products					
Process Heating	0.722	-0.952	0.675	0.498	-0.892
Process Heating - Steam	0.598	-1.502	0.675	0.380	-1.679
Process Cooling – Electricity	0.774	-0.751	0.638	0.461	-0.952
Process Cooling – Natural Gas	0.774	-0.751	0.675	0.507	-0.840
Other	0.774	-0.751	0.675	0.507	-0.840
Other – Electricity	0.776	-0.743	0.686	0.501	-0.922
Balance of Manufacturing					
Process Heating	0.784	-0.714	0.675	0.529	-0.714
Process Heating - Steam	0.903	-0.600	0.900	0.762	-0.980
Process Cooling – Electricity	0.825	-0.563	0.638	0.492	-0.761
Process Cooling – Natural Gas	NA	-0.563	NA	NA	-0.672
Other – Natural Gas	0.825	-0.563	0.675	0.537	-0.672

Source: SAIC, *IDM Base Year Update with MECS 2006 Data*, unpublished data prepared for the Office of Integrated Analysis and Forecasting, Energy Information Administration, Washington, DC, August 2010.

Table B.15. National cement industry inputs and UECs for technology choice, 2008, Reference case

Process Node	Flow (MMtons)	Electricity	Natural Gas	Petroleum	Coal	Coke	Steam	Equipment Lifespan (Years)	
								Existing	New
Raw Grinding	106.8	0.238	0.074	0.000	0.000	0.000	0.000	20	35
Kilns	70.4	0.146	0.125	0.092	2.726	1.026	0.000	20	35
Finish Grinding	74.1	0.200	0.000	0.000	0.000	0.000	0.000	20	25

Source: SAIC, *Model Documentation Report The U.S. Cement Industry*, unpublished data prepared for the Office of Energy Analysis, U.S. Energy Information Administration, Washington, DC, August 2012.

Table B.16. National aluminum industry inputs and UECs for technology choice, 2008, Reference case

Process Node	Flow (MMtons)	Electricity	Natural			Coal	Coke	Steam	Equipment Lifespan (Years)	
			Gas	Petroleum	Existing				New	
Alumina Refining	2.8	8.8	1.7	0.0	0.0	0.0	0.0	20	30	
Primary Smelting	1.8	96.8	4.0	0.0	30.0	0.0	0.0	20	30	
Secondary/Scrap	2.3	0.0	24.7	0.0	0.0	0.0	0.0	20	30	
Semi-Fab: Sheet	3.2	5.4	13.8	0.0	0.0	0.0	0.0	20	30	
Semi-Fab: Other	1.7	8.8	22.4	0.0	0.0	0.0	0.0	20	30	

Source: SAIC, *Model Documentation Report The U.S. Aluminum Industry*, unpublished data prepared for the Office of Energy Analysis, U.S. Energy Information Administration, Washington, DC, June 2013.

Table B.17. Coefficients for technology possibility curves, high technology case

Industry/Process Unit	Existing Facilities		New Facilities	
	REI 2040	TPC (%)	REI 2040	TPC(%)
Food Products				
Process Heating	0.985	-0.045	0.872	-0.094
Process Heating-Steam	0.940	-0.182	0.792	-0.375
Process Cooling - Electricity	0.981	-0.057	0.822	-0.100
Process Cooling – Natural Gas	0.985	-0.045	0.872	-0.094
Other – Electricity	0.987	-0.039	0.885	-0.097
Other – Natural Gas	0.985	-0.045	0.872	-0.094
Paper and Allied Products				
Wood Preparation	0.989	-0.033	1.006	0.386
Waste Pulping - Electricity	0.947	-0.161	0.866	-0.228
Waste Pulping – Steam	0.896	-0.322	0.801	-0.456
Mechanical Pulping - Electricity	1.007	0.021	1.259	0.893
Mechanical Pulping - Steam	1.015	0.043	1.699	1.787
Semi-Chemical - Electricity	0.991	-0.025	0.954	-0.052
Semi - Chemical - Steam	0.983	-0.051	0.937	-0.105
Kraft, Sulfite, Misc. Chemicals	0.919	-0.249	0.770	-0.502
Kraft, Sulfite, Misc. Chemicals - Steam	0.844	-0.498	0.648	-1.004
Bleaching – Electricity	0.918	-0.252	0.918	0.129
Bleaching – Steam	0.842	-0.504	0.959	0.259
Paper Making	0.809	-0.621	0.553	-1.376
Paper Making - Steam	0.809	-0.621	0.553	-1.376
Glass and Glass Products				
Batch Preparation - Electricity	1.000	0.000	0.882	0.000
Melting/Refining	0.822	-0.576	0.561	-1.381
Melting/Refining - Steam	0.675	-1.151	0.347	-2.761
Forming	0.971	-0.085	0.925	-0.175
Forming – Steam	0.944	-0.170	0.871	-0.350
Post-Foaming	0.989	-0.034	0.945	-0.069
Iron and Steel				
Coke Oven	0.864	-0.429	0.624	-1.076
Coke Oven – Steam	0.746	-0.858	0.431	-2.152
BF/BOF	0.943	-0.172	0.869	-0.375
BF/BOF – Steam	0.889	-0.345	0.764	-0.751
EAF	0.889	-0.346	0.750	-0.813
Ingot Casting/Primary Rolling	1.000	0.000	NA	NA

Table B.17. Coefficients for technology possibility curves, high technology case (cont)

Industry/Process Unit	Existing Facilities		New Facilities	
	REI 2040	TPC (%)	REI 2040	TPC(%)
Iron and Steel (cont'd)				
Continuous Casting	1.000	0.000	1.000	0.000
Hot Rolling	0.890	-0.344	0.573	-0.978
Hot Rolling – Steam	0.791	-0.687	0.409	-1.956
Cold Rolling	0.940	-0.183	0.842	-0.273
Cold Rolling – Steam	0.883	-0.365	0.767	-0.546
Metal-Based Durables				
Fabricated Metals				
Process Heating	0.605	-1.468	0.299	-2.370
Process Cooling – Electricity	0.536	-1.820	0.270	-2.493
Process Cooling – Natural Gas	0.605	-1.468	0.299	-2.370
Other	0.605	-1.468	0.299	-2.370
Other – Electricity	0.647	-1.274	0.296	-2.439
Machinery				
Process Heating	0.605	-1.468	0.299	-2.370
Process Cooling – Electricity	0.536	-1.820	0.270	-2.493
Process Cooling – Natural Gas	0.605	-1.468	0.299	-2.370
Other	0.605	-1.468	0.299	-2.370
Other – Electricity	0.647	-1.274	0.296	-2.439
Computers and Electronics				
Process Heating	0.716	-0.979	0.480	-1.185
Process Cooling – Electricity	0.660	-1.213	0.444	-1.247
Process Cooling – Natural Gas	0.716	-0.979	0.480	-1.185
Other	0.716	-0.979	0.480	-1.185
Other – Electricity	0.748	-0.850	0.482	-1.219
Electrical Equipment				
Process Heating	0.716	-0.979	0.480	-1.185
Process Heating – Steam	NA	-3.914	NA	-4.740
Process Cooling – Electricity	0.660	-1.213	0.444	-1.247
Process Cooling – Natural Gas	0.716	-0.979	0.480	-1.185
Other	0.716	-0.979	0.480	-1.185
Other – Electricity	0.748	-0.850	0.482	-1.219

Table B.17. Coefficients for technology possibility curves, high technology case (cont)

Industry/Process Unit	Existing Facilities		New Facilities	
	REI 2040	TPC (%)	REI 2040	TPC(%)
Transportation Equipment				
Process Heating	0.792	-0.685	0.553	-0.948
Process Heating - Steam	0.389	-2.740	0.389	-3.792
Process Cooling – Electricity	0.748	-0.849	0.514	-0.997
Process Cooling – Natural Gas	0.792	-0.685	0.553	-0.948
Other	0.792	-0.685	0.553	-0.948
Other – Electricity	0.816	-0.595	0.557	-0.975
Other Non-Intensive Manufacturing				
Wood Products				
Process Heating	0.608	-1.452	0.342	-2.358
Process Heating - Steam	0.386	-5.807	0.386	-9.432
Process Cooling – Electricity	0.539	-1.804	0.310	-2.481
Process Cooling – Natural Gas	0.608	-1.452	0.354	-2.358
Other	0.647	-1.272	0.354	-2.209
Other – Electricity	0.860	-0.443	0.340	-2.388
Plastic Products				
Process Heating	0.718	-0.968	0.451	-1.179
Process Heating - Steam	0.380	-3.871	0.380	-4.716
Process Cooling – Electricity	0.663	-1.203	0.417	-1.241
Process Cooling – Natural Gas	0.718	-0.968	0.451	-1.179
Other	0.749	-0.848	0.463	-1.104
Other – Electricity	0.904	-0.295	0.456	-1.194
Balance of Manufacturing				
Process Heating	0.781	-0.726	0.489	-0.943
Process Heating - Steam	0.589	-1.546	0.348	-2.753
Process Cooling – Electricity	0.735	-0.902	0.454	-0.992
Process Cooling – Natural Gas	NA	-0.726	NA	-0.943
Other – Natural Gas	0.805	-0.636	0.499	-0.883

Source: SAIC, *IDM Base Year Update with MECS 2006 Data*, unpublished data prepared for the Office of Integrated Analysis and Forecasting, Energy Information Administration, Washington, DC, August 2010.

Table B.18. National cement industry inputs and UECs for technology choice, 2008, high technology case

Process Node	Flow (MMtons)	Electricity	Natural				Equipment Lifespan (Years)		
			Gas	Petroleum	Coal	Coke	Steam	Existing	New
Raw Grinding	106.8	0.238	0.074	0.000	0.000	0.000	0.000	20	35
Kilns	70.4	0.146	0.125	0.092	2.726	1.026	0.000	20 for Dry 10 for Wet	35
Finish Grinding	74.1	0.200	0.000	0.000	0.000	0.000	0.000	20	25

Source: SAIC, *Model Documentation Report The U.S. Cement Industry*, unpublished data prepared for the Office of Energy Analysis, U.S. Energy Information Administration, Washington, DC, August 2012.

Table B.19. Advanced and state of the art technologies

Sector	Major Process Step	Technology	Improvement in Sub-Process	Alternative Process	EERE
Pulp/Paper (S-O-A)		Wood Preparation			
		Bar-type chip screens	1		
		Belt conveyor	1		
		Chip conditioners	1		
		Chip Screening Equipment*	1		
		Cradle de-barker			1
		Enzyme-assisted de-barker			1
		Fine slotted wedge wire baskets		1	
		Improved screening processes		1	
		Ring Style de-barker			1
		Whole Tree Debarking/Chipping*			1
		Chemical Pulping Technologies (Kraft, Sulfite)			
		Advanced Black Liquor Evaporator		1	
		Alkaline Sulfite Anthraquinone (ASOQ) & Neutral Sulfite Anthraquinone (NSAQ) Pulping			1
		Anthraquinone Pulping			1
		Batch Digesters		1	
		Continuous Digesters		1	
		EKONO's White Liquor Impregnation			1
		Falling Film black liquor evaporation		1	

Table B.19. Advanced and state of the art technologies (cont.)

Major Process		Improvement	Alternative		
Sector	Step	Technology	in Sub-Process	Process	EERE
		Lime kiln modifications	1		
		Process Controls System	1		
		Radar Displacement Heating	1		
		Sunds Defibrator Cold Blow and Extended Delignification		1	
		Tampella Recovery System	1		
		Mechanical and Semi-Mechanical Technologies			
		Biopulping		1	
		Chemi-mechanical Pulping	1		
		Chemi-Thermo-mechanical Pulping (CTMP)	1		
		Cyclotherm System for Heat Recovery*	1		
		Heat Recovery in TMP*	1		
		Improvements in Chemi-thermo-mechanical pulping	1		
		LCR (low consistency refining)	1		
		PGW-Plus		1	
		Pressurized Ground Wood (PGW)		1	
		Process Control System	1		
		Refiner Improvements	1		
		RTS (short Residence time, elevated Temperature, high speed)			
		Super Pressurized ground wood pulping		1	
		Thermo-pulping		1	
		Thermo-Refiner Mechanical Pulping	1		
		Chemical Pulping Technologies (Kraft, Sulfit)			
	Semi-Chemical	See Chemical and Mechanical S-O-A technologies above			
		Waste Paper Pulping Technologies			
		Advanced Deinking	1		
		Improvements in steam use, computer control, etc.	1		

Table B.19. Advanced and state of the art technologies (cont.)

Sector	Major Process Step	Technology	Improvement in Sub-Process	Alternative Process	EERE
	Bleaching Oxygen Pre-delignification Technologies				
		Oxygen Bleaching		1	
		Displacement Bleaching	1		
		Bio-bleaching		1	
		Extended cooking (delignification)		1	
		Oxygen pre-delignification		1	
		Ozone Bleaching		1	
		Oxidative Extraction		1	
		Improved brownstock washing		1	
		Washing presses (post delignification)		1	
	Papermaking Technologies				
		Condebelt drying	1		
		Direct drying cylinder firing	1		
		Dry sheet forming		1	
		Extended Nip Press*	1		
		Gap Forming	1		
		High consistency forming	1		
		Hot Pressing	1		
		Infrared profiling	1		
		IR Moisture Profiling*	1		
		Process Control System*	1		
		Reduced Air Equipment	1		
		Waste Heat Recovery*	1		
Pulp/Paper (Advanced)	Wood Preparation				
		Improvements in S-O-A technologies shown above			
	Chemical (Kraft/Sulfite) Technologies				

Table B.19. Advanced and state of the art technologies (cont.)

Sector	Major Process Step	Technology	Improvement in Sub-Process	Alternative Process	EERE
		Advanced Alcohol Pulping		1	
		Alcohol based solvent pulping		1	
		Biological Pulping		1	
		Black liquor Concentration*	1		
		Black liquor gasified and gas turbines	1	1	
		Black Liaur Heat Recovery*	1		
		Black Liquor Steam Reforming/Pulsed Combustion	1		1
		Combined Cycle Biomass Gasification	1	1	1
		Direct alkali recovery system	1		
		High Sensitivity Oxygen Delignification	1		1
		Improved composit tubes for Kraft Recover Boilers*	1		1
		Increasing Yield and Quality of Low-Temperature, Low-Alkali Kraft Cooks with Microwave Penetration	1		1
		Non-Sulfur Chemi-mechanical (NSCM) Pulping		1	
		Ontario Paper Co. (OPCO) Process		1	
		Pretreatment of incoming pulp into drying section		1	
		Steam Reforming Black Liquor Gasification*	1		1
		Use of Borate Autocausticizing to Supplement Lime Kiln and Causticizing Capacities	1		1
		Mechanical Technologies			
		Advanced Chemical/Thermal Treatment	1		
		Non-Sulfur Chemi-mechanical (NSCM) OPCO Process.		1	
		Semi-Chemical Technologies			
		NSCM Process	1		
		OPCO Process		1	

Table B.19. Advanced and state of the art technologies (cont.)

Sector	Major Process Step	Technology	Improvement in Sub-Process	Alternative Process	EERE
		Waste Pulping			
		Mechanical alternatives to chemicals in recycle mills		1	1
		Replacing Chemicals in Recycle Mills with Mechanical Alternatives	1	1	1
		Removal of Light and Sticky Contaminants from Waste Paper	1		
		Bleaching Technologies			
		Biobleaching		1	
		NO ₂ /O ₂ Bleaching		1	
		Ozone Bleaching		1	
		Papermaking Technologies			
		Acoustic Humidity Sensor*	1		1
		Acoustic Separation Technology*	1		1
		Advances in Wet Pressing*	1		
		Air Impringement drying	1		
		Air Radio-Frequency-Assisted (ARFA) Drying*	1		
		Airless Drying	1		
		High-Consistency Forming*	1		
		Impulse Drying of Paper	1		1
		Impulse Drying*	1		
		Infrared Drying	1		
		Linear Corrugating		1	1
		Molten-Film High-Intensity Paper Dryer*		1	1
		Online Fluidics Controlled Headbox*	1		1
		Online Paper Sensors*	1		1
		Press Drying*	1		
		Steam impingement drying	1		
		Sludge Combustion			
		Methane De-Nox Reburn Process*	1		1

Table B.19. Advanced and state of the art technologies (cont.)

Sector	Major Process Step	Technology	Improvement in Sub-Process	Alternative Process	EERE
Glass (S-O-A)					
	Batch Preparation Technologies				
		Computerized Weighing, Mixing, and Charging	1		
	Melting/Refining Technologies				
		Automatic Tap Charging Transformers for Electric Melters	1		
		Chemical Boosting	1		
		Chimney Block Regenerator Refractories	1		
		Dual-Depth Melter	1		
		Oxygen Enriched Combustion Air*	1		
		Recuperative Burners*	1		
		Reduction of Regenerator Air Leakage*	1		
		Sealed-in Burner Systems*	1		
Forming/Post-Forming Technologies					
		Emhart Type 540 Forehearth	1		
		EH-F 400 Series Forehearth	1		
		Forehearth High-Pressure Gas Firing System	1		
		Lightweighted	1		
Glass (Advanced)					
	Batch Preparation Technologies				
		Integrated Batch and Cullet Preheat for Glass Furnaces*	1		1
		Electrostatic Batch Preheater System*			1
		SingleChip Color Sensor*	1		1
	Melting/Refining Technologies				
		Coal-Fired Hot Gas Generation*	1		
		Director Coal Firing	1		
		Energy Efficiency, Electric Rotary Furnace for Glass Molding of Precision Optical Blanks	1		1
		Excess Heat Extraction from Regenerators	1		

Table B.19. Advanced and state of the art technologies (cont.)

Sector	Major Process Step	Technology	Improvement in Sub-Process	Alternative Process	EERE
		Furnace Insulation Materials*	1		
		High Luminosity, Low-NOx Burner	1		1
		High Intensity Plasma Glass Melter		1	1
		Hollow Fiber Membrane Air Separation Process*		1	
		Measurement and Control of Glass Feedstocks	1		1
		Molybdenum-Lined Electric Melter		1	
		Oxy-Gas submerged combustion (Energy-Efficient Glass Melting)	1	1	1
		Oxygen Enriched Combustion System Performance Study	1		1
		Phase/Doppler Laser Light-Scattering System*	1		1
		Pressure Swing Adsorption Oxygen Generator*	1		
		Rotary Burner Technology Demonstration (Phase 1)	1		1
		Sol-Gel Process		1	
		Thermo-chemical Recuperator	1		
		Ultrasonic Bath Agitation/Refining*	1		
		Forming/Post-Forming Technologies			
		Advanced Low-E Coatings	1		1
		Automatic Gob Control	1		1
		Improved Glass Strengthening Techniques*	1		
		Improved Protective Coatings*	1		
		Mold Cooling Systems	1		
		Mold Design*	1		
Cement (S-O-A)		Process Technologies			
		Addition of pre-calciner to pre-heater kiln	1		
		Controlled Particle Size Distribution Cement	1		

Table B.19. Advanced and state of the art technologies (cont.)

Sector	Major Process		Improvement	Alternative	EERE
	Step	Technology	in Sub-Process	Process	
		Conversion to modern grate cooler	1		
		Dry-Preheater/Pre-calciner Kilns	1		
		Finish Mill Internals, Configuration, and Operation	1		
		Grinding Aids*	1		
		Heat Recovery for Power Generation	1		
		Kiln combustion system improvements	1		
		Kiln Feed Slurry Dewatering*	1		
		Kiln Internal Efficiency Enhancement*	1		
		Kiln Radiation and Infiltration Losses*	1		
		Kiln shell heat loss reduction	1		
		Long dry kiln conversion to multi-stage pre-heater, pre-calciner kiln		1	
		Low Pressure drop cyclones for suspension pre-heaters	1		
		Optimize grate coolers	1		
		Use of waste fuels	1		
		Waste Heat Drying*	1		
		Finish Grinding Technologies	1		
		Controlled Particle Size Distribution Cement*	1		
		Finish Mill Internals, Configuration, and Operation	1		
		Grinding Media and Mill Linings*			
		High-Efficiency Classifiers*	1		
		High Pressure Roller Press	1		
		Improve mill internals	1		
		Improved grinding media (ball mills)	1		
		Roller Mills*	1		
		Utilization of Ground Granulated Blast Furnace Slag (GGBS)	1		

Table B.19. Advanced and state of the art technologies (cont.)

Sector	Major Process Step	Technology	Improvement in Sub-Process	Alternative Process	EERE
Cement (Advanced)					
Process Technologies					
Advanced (Non-Mechanical)					
		Comminution	1		
		Advanced Kiln Control*	1		
		Advanced Waste Combustion	1		
		Alkali Specification Modification*	1		
		All-Electric Kilns		1	
		Autogenous Mills	1		
		Blended Cements*	1		
		Catalyzed, Low-Temperature Calcination		1	
		Cone Crushers*	1		
		Differential Grinding	1		
		Fluidized-Bed Drying	1		
		Grinding Mill Optimization Software*	1		1
		Modifying Fineness Specifications*	1		
		Sensors and Controls*	1		
		Sensors for On-Line Analysis*	1		
		Stationary Clinkering Systems	1		
Finish Grinding					
Advanced (Non-Mechanical)					
		Comminution		1	
		Blended Cements*	1		
		Cone Crushers*	1		
		Grinding Mill Optimization Software	1		1
		Modifying Fineness Specifications*	1		
		Sensors and Controls*	1		
Iron & Steel (S-O-A)					
Coke Making Technologies					
		Carbonization Control	1		
		Coal Moisture Control			

Table B.19. Advanced and state of the art technologies (cont.)

Sector	Major Process Step	Technology	Improvement in Sub-Process	Alternative Process	EERE
		Coke Dry Quenching (CDQ)*	1		
		Continuous Coke Making		1	
		Non-Recovery Coke Ovens		1	
		Programmed Heating	1		
		Sensible Heat Recovery of Off-Gases*	1		
		Iron Making Technologies			
		Coal Injection*	1		
		COREX		1	
		Direct Reduced Iron (DRI) use	1		
		External Desulfurization-inject calcium carbide or mag-coke as a desulfurizing reagent*	1		
		Hot Stove Waste Heat Recovery*	1		
		Induction Heated Hot Metal Mixer	1		
		Insulation of Cold Blast Main*	1		
		Midrex/HBI		1	
		Movable Throat Armor*	1		
		Optimization by enhanced control systems*	1		
		Optimize Preheated Blast Air	1		1
		Other fuel injection* (e.g., natural gas, oil, coke oven gas)	1		
		Oxygen injection	1		
		Paul Wurth Top*	1		
		Recovery of BF Gas Released During Charging	1		
		Slag Waste Heat Recovery*	1		
		Stave-cooling & steam recovery	1		
		Stove Operation Optimization	1		
		Submerged Arc Furnace (SAF) to produce iron from reduced pellets		1	
		Top Gas Pressure Recovery*	1		

Table B.19. Advanced and state of the art technologies (cont.)

Sector	Major Process Step	Technology	Improvement in Sub-Process	Alternative Process	EERE
		Waste energy fuel injection* (e.g., plastics)	1		
		Steel Making Technologies (BOF)			
		Combined Top and Bottom Oxygen Blowing*	1		
		Gas Recovery in Combination with Sensible Heat Recovery*	1		
		In-Process Control (Dynamic) of Temp and Carbon Content*	1		
		Post Combustion*	1		
		Two working vessels concept*	1		
		Steel Making Technologies			
		Bottom Tap Vessels*	1		
		Computerization*	1		
		DC Arc Furnaces*	1		
		Direct reduced Iron (DRI)			
		Energy Optimizing Furnaces*		1	
		Foamy Slag Practice (with Long Arc)	1		
		Gas stirring including Argon stirring	1		
		Hot Briquetted Iron (HBI)	1		
		Hot Charging DRI	1		
		Induction Furnaces*		1	
		Induction Stirring	1		
		Long Arc Foamy Slag Practice*	1		
		Material Handling Practices*	1		
		Oxy-Fuel Burners*	1		
		Post Combustion*	1		
		Process Control by Laser Based Gas Sensor*	1		1
		Scrap-Preheating*	1		
		Ultra-High Power (UHP)*	1		

Table B.19. Advanced and state of the art technologies (cont.)

Sector	Major Process Step	Technology	Improvement in Sub-Process	Alternative Process	EERE
		Water-Cooled Electrode Sections*	1		
		Water-Cooled Furnace Panels and Top*	1		
		Other Technologies			
		Injection Steelmaking (ladle metallurgy)	1		
		Ladle Drying and Preheating*	1		
		Specialty Steelmaking Technologies			
		Argon-Oxygen Decarburization (AOD)*		1	
		Electron Beam Melting (EBM)*		1	
		Electroslag Remelting (ESR)*		1	
		Vacuum Arc Decarburization*			
		Vacuum Arc Remelting (VAR)*		1	
		Vacuum Induction Melting (VIM)*		1	
		Steel casting Technologies			
		Clean Cast Steel			1
		Continuous-Conti-Casting	1		
		Modern Casters (near net shape)*		1	
		Plasma heated Tundish for temperature control	1		
		Slab Heat Recovery*	1		
		Soaking Pit Utilization and Pit Vacant Time*	1		
		Thin Slab Casting		1	
		Thin Strip Caster*		1	
		Steel forming (Rolling) Technologies			
		Air Preheating*	1		
		Combustion Control*	1		
		Continuous Cold Rolling		1	
		Covered Delay Table*	1		
		Direct Rolling (Hot Direct Rolling, Hot Charge Rolling)	1		
		Evaporative Cooling of Furnace Skids	1		

Table B.19. Advanced and state of the art technologies (cont.)

Sector	Major Process Step	Technology	Improvement in Sub-Process	Alternative Process	EERE
		Fuel Gas Preheating	1		
		Improved Insulation*	1		
		Increased Length of the Preheating Furnace	1		
		PC Controlled Hot Rolling	1		1
		Preheating Furnaces			
		Ultra-thin steel		1	
		Waste Heat Boilers on Furnaces	1		
		Waste Heat Recovery and Air Preheating*	1		
		Waste Heat Recovery and Fuel Gas Preheating*	1		
		Steel Finishing			
		Continuous Annealing		1	
		Pickling – Insulated Floats*	1		
Iron & Steel (Advanced)		Scrap Preparation			
		Electrochemical Dezincing of Steel Scrap		1	1
		Iron Making Technologies			
		Advanced Sensors	1		1
		AISI direct smelting		1	
		CCF direct smelting		1	
		Cicored		1	
		Cyclone Converter Furnace		1	
		DIOS direct smelting		1	
		FASTMELT		1	
		HiSmelt		1	
		Hot Oxygen Injection into the Blast Furnace*	1		1
		Intelligent Control of the Cupola Furnace			
		Iron Carbide Process		1	
		Plasmared		1	

Table B.19. Advanced and state of the art technologies (cont.)

Sector	Major Process Step	Technology	Improvement in Sub-Process	Alternative Process	EERE
		Pulverized Coal Injection (PCI) at High Rates	1		1
		REDSMELT		1	
		Rotary Hearth Iron Ore Reduction		1	
		Submerged Arc Furnace (SAF)		1	
		Waste Heat Recovery and Air Preheating*	1		
Steel Making Technologies					
		BOF Scrap Preheating*	1		
		Capture heat from off-gases by constructing twin shells		1	
		Capture heat from off-gases by mounting shafts on the furnace roof		1	
		Capture heat from off-gases by pulling gases through a side door into scrap-filled tunnel		1	
		AISI direct smelting		1	
		CCF direct smelting		1	
		Continuous charging of scrap to EAF		1	
		Direct Steel making (AISI)		1	
		Energy Optimizing Furnace (EOF)		1	
		Fast electrode changing		1	
		Flue Dust Recycling		1	
		Full Post Combustion in BOF	1		1
		Full Post Combustion in EAF	1		
		Increase gas, oxygen, and carbon use in EAF		1	
		Increased Scrap Use in BOF			
		Injection of Carbonaceous Fuels			
		Injection Steel making	1		
		Inred		1	
		Ladle Drying and Preheating*	1		

Table B.19. Advanced and state of the art technologies (cont.)

Sector	Major Process Step	Technology	Improvement in Sub-Process	Alternative Process	EERE
		Modern Electric Arc Furnace with Continuous Charging/Scrap Preheating	1		
		Optical Sensor for Post-Combustion Control in EAF Steelmaking	1		1
		Optimization of Post Combustion (in BOF and EAF)	1		1
		Plasmamelt		1	
		Processing Electric Arc Furnace Dust into Salable Products	1		1
		Use multiple burner/lances for carbon, oxygen, and oxy-fuel in EAF		1	
		Use waste gas to preheat scrap		1	
		Steel casting Technologies			
		Advanced Sensors	1	1	
		Clean Cast Steel	1		1
		Direct Strip Casting*		1	
		Horizontal Continuous Caster*		1	
		Magnetic Gate System for Molten Metal Flow Control	1		1
		Near Net Shapecasting*		1	
		Spray Casting		1	1
		Three-Dimensional Objects by Photosolidification*	1		1
		Ultra Thin Strip Casting*		1	
		Use surface inspection devices to measure surface quality		1	
		Hot Rolling.Cold Rolling/Finishing			
		Advanced Coating	1		
		Advanced High Intensity Infra-Red Preheating of Steel Strip	1		1
		Automated surface inspection	1		1
		Continuous Cold Rolling and Finishing	1		

Table B.19. Advanced and state of the art technologies (cont.)

Sector	Major Process Step	Technology	Improvement in Sub-Process	Alternative Process	EERE
		Controlled Thermo-Mechanical Processing (CTMP) of Tubes and Pipes for Enhanced Manufacturing and Performance	1		1
		Direct Flame Impingement Reheat Furnace (Development and Demonstration of a High-Efficiency, Rapid-Heating, Low-NOx alternative to Conventional Heating of Steel Shapes)	1		1
		Efficient reheat furnaces with elements such as recuperators, low-Nox burners, and computer controls		1	
		Improved Surface Quality of Exposed Automotive Sheet Steels	1		1
		Intelligent Systems for Induction Hardening	1		1
		Laser Ultrasonics to Measure Grain Size	1		1
		Laser Ultrasonics to Measure Tube Wall Thickness	1		1
		Nickel Aluminide Radiant Heater	1		1
		Non-Chromium Passivation Techniques for Electrolytic Tin Plate		1	1
		On-Line Non-Destructive Mechanical Properties Measurement	1		1
		Phase Measurement of Galvanneal	1		1
		Ultra-thin strip caster to strip ready for galvanizing		1	
Aluminum (S-O-A)		Alumina Refining Technologies			
		Advanced Digesters	1		
		Heat Recovery*	1		
		Primary Aluminum Technologies			
		Advanced Cells	1		

Table B.19. Advanced and state of the art technologies (cont.)

Sector	Major Process Step	Technology	Improvement in Sub-Process	Alternative Process	EERE
		Advanced Process Controls*	1		1
		Pre-baked Anodes	1		
		Semi-Fabrication Technologies			
		Continuous-Strip Casting		1	
		Advanced Burners for Melting Furnaces			
		Electromagnetic Casting	1		
		Induction Heating	1		
		Secondary Aluminum Technologies			
		Advanced Burners	1		
		Advanced Melting		1	
		Induction Melting		1	
Aluminum (Advanced)		Alumina Refining Technologies			
		Advanced Digesters	1		
		Primary Aluminum Technologies			
		Aluminum Carbo-thermic Technology			
		Advanced Reactor Process		1	1
		Bipolar Cell Technology		1	
		Converting Spent Pot Liners (SPL) to Products*		1	1
		Inert Anodes*	1		1
		Low-Temperature Reduction of Alumina		1	1
		Microwave-Assisted Electrolytic Cell	1		1
		Reduction of Oxidative Melt Loss	1		1
		Wettable Cathodes*	1		
		Semi-Fabrication Technologies			
		Improved Grain-Refinement Process*	1		1
		Induction Heaters		1	
		Novel Techniques for Increasing Corrosion Resistance of Aluminum and Al Alloys	1		1
		Spray Casting	1		1

Table B.19. Advanced and state of the art technologies (cont.)

Major Process		Technology	Improvement in	Alternative	EERE
Sector	Step		Sub-Process	Process	
		Spray Rolling Aluminum	1		1
		Secondary Aluminum Technologies			
		Aluminum Salt Cake: Electro-dialysis Processing of Brine*		1	1
		Heat Recovery Technology	1		
		Immersion Heating (Advanced Clean Aluminum Melting Systems)		1	1
		New Melting Technology (submerged radiant burners)	1		
		Oxidative Melt Loss Reduction*	1		1
		Plasma Furnaces for dross treatment	1	1	
		Preheaters for scrap*	1		
		Vertical Flotation Melter		1	1
Chemical and Generic Technologies (Advanced)					
		Synthesis			
		Advanced Catalytic Hydrogenation Retrofit Reactor*	1		1
		Biofine Technology	1		1
		Novel Membrane-based Process for Producing Lactate Esters		1	1
		Alloys for Ethylene Production*	1		1
		Separation			
		Advanced Sorbents for Gas Separation*		1	1
		Advanced Inorganic Membranes (Impact Chemical and Petrochemical Industries)	1	1	1
		Membrane Systems for Energy Efficient Separation of Light Gases		1	1
		Electrochemistry			
		Advanced Electro-deionization Technology*	1		1
		Advanced Chlor-Alkali Technology		1	1
		Product Recovery			

Table B.19. Advanced and state of the art technologies (cont.)

Sector	Major Process Step	Technology	Improvement in Sub-Process	Alternative Process	EERE
		Chloro-silane Recovery from Silicone Production	1		1
		Olefin Recovery from Chemical Waste Streams*	1		1
		Pressure Swing Adsorption for Product Recovery*	1		1
		Separation and Recovery of Thermo Plastics for Reuse via Froth Flotation* Heating	1		1
		Development of a Highly Preheated Combustion Air System with/without Oxygen Enrichment	1		1
		Low-Nox High Luminosity Burner	1		1
		Nox Emission Reduction by Oscillating Combustion	1		1
		Ultra-Low Nox Burners with Flue Gas Recirculation and Partial Reformer Boilers	1		1
		Forced Internal Recirculation Burner	1		1
		Super Boiler - including recovery of latent heat in flue gases		1	1
		Metals-based Durables			
		Lost Form Casting Technology		1	1

Source: FOCIS Associates, Inc., *Industrial Technology and Data Analysis Supporting the NEMS Industrial Model*, unpublished report prepared for the Office of Integrated Analysis and Forecasting, Energy Information Administration, Washington, DC, October 2005.

Table B.20. Industrial motor characteristics

Industrial Sector	2002 Stock	2002 Average Energy Use (kWh/motor)	2002 Average Efficiency	Average Part Load	Average Operating Hours
Food					
1 – 5 hp	676117	5568	0.8130	0.61	3829
6 – 20 hp	232005	24840	0.8713	0.61	3949
21 – 50 hp	63280	96574	0.9013	0.61	4927
51 – 100 hp	24649	212729	0.9272	0.61	5524
101 – 200 hp	18733	323470	0.9348	0.61	5055
201 – 500 hp	8784	605525	0.9375	0.61	3711
>500 hp	4487	153901	0.9303	0.61	5362
Bulk Chemicals					
1 – 5 hp	329907	5326	0.8197	0.65	4082
6 – 20 hp	233030	29476	0.8739	0.65	4910
21 – 50 hp	112516	86578	0.9044	0.65	4873
51 – 100 hp	45837	216594	0.9241	0.65	5853
101 – 200 hp	31509	484522	0.9348	0.65	5868
201 – 500 hp	17108	1132905	0.9333	0.65	6474
>500 hp	7833	5631554	0.9324	0.65	7566
Metal-Based Durables ^a					
1 – 5 hp	5409080	4121	0.8189	0.62	2804
6 – 20 hp	1463782	19178	0.8704	0.62	3480
21 – 50 hp	371691	55031	0.8992	0.62	3736
51 – 100 hp	57708	120722	0.9198	0.62	3478
101 – 200 hp	38699	329256	0.9348	0.62	5370
201 – 500 hp	4411	717862	0.9367	0.62	2824
>500 hp	1652	602126	0.9303	0.62	1633

Table B.20. Industrial motor characteristics (cont.)

Industrial Sector	2002 Stock	2002 Average Energy Use (kWh/motor)	2002 Average Efficiency	Average Part Load	Average Operating Hours
Balance of Manufacturing ^b					
1 – 5 hp	1749537	4108	0.8293	0.62	2881
6 – 20 hp	975489	19069	0.8828	0.62	3359
21 – 50 hp	324188	64797	0.9032	0.62	3844
51 – 100 hp	112315	186951	0.9267	0.62	4906
101 – 200 hp	71728	352241	0.9426	0.62	4801
201 – 500 hp	20041	796960	0.9423	0.62	5131
>500 hp	6143	2446170	0.9291	0.62	4803

a The metal-based durables group includes five sectors that are modeled separately: Fabricated Metals; Machinery; Computers and Electronics; Electrical Equipment; and Transportation Equipment.

b The balance of manufacturing group includes three sectors that are modeled separately: Wood Products; Plastic and Rubber Products; and All Other Manufacturing.

Source: U.S. Department of Energy, *United States Industrial Electric Motor Systems Market Opportunities Assessment* (Burlington, MA, December 1988); USDOE, MotorMaster+ 4.0 software database, 2007; Energy Information Administration, *Manufacturing Consumption of Energy 2006*.

Table B.21. Cost and performance parameters for industrial motor choice model

Industrial Sector Horsepower				
Range	2002 Stock Efficiency (%)	Premium Efficiency (%)	Premium Cost (2002\$)	
Food				
1 – 5 hp	81.3	89.2	601	
6 – 20 hp	87.1	92.5	1,338	
21 – 50 hp	90.1	93.8	2,585	
51 – 100 hp	92.7	95.3	6,290	
101 – 200 hp	93.5	95.2	11,430	
201 – 500 hp	93.8	95.4	29,991	
>500 hp	93.0	96.2	36,176	
Bulk Chemicals				
1 – 5 hp	82.0	89.4	601	
6 – 20 hp	87.4	92.6	1,338	
21 – 50 hp	90.4	93.9	2,585	
51 – 100 hp	92.4	95.4	6,290	
101 – 200 hp	93.5	95.3	11,430	
201 – 500 hp	93.3	95.5	29,991	
>500 hp	93.2	96.2	36,176	
Metal-Based Durables^a				
1 – 5 hp	81.9	89.2	601	
6 – 20 hp	87.0	92.5	1,338	
21 – 50 hp	89.9	93.9	2,585	
51 – 100 hp	92.0	95.3	6,290	
101 – 200 hp	93.5	95.2	11,430	
201 – 500 hp	93.7	95.4	29,991	
>500 hp	93.0	96.2	36,176	
Balance of Manufacturing^b				
1 – 5 hp	83.0	89.2	601	
6 – 20 hp	88.3	92.5	1,338	
21 – 50 hp	90.3	93.9	2,585	
51 – 100 hp	92.7	95.3	6,290	
101 – 200 hp	94.3	95.2	11,430	

Table B.21. Cost and performance parameters for industrial motor choice model (cont.)

Industrial Sector	2002 Stock Efficiency	Premium Efficiency	Premium Cost
Horsepower Range	(%)	(%)	(2002\$)
Balance of Manufacturing ^b			
201 – 500 hp	94.2	95.4	29,991
>500 hp	92.9	96.2	36,176

^aThe metal-based durables group includes five sectors that are modeled separately: Fabricated Metals; Machinery; Computers and Electronics; Electrical Equipment; and Transportation Equipment.

^bThe balance of manufacturing group includes three sectors that are modeled separately: Wood Products; Plastic and Rubber Products; and All Other Manufacturing.

Sources: U.S. Department of Energy, *United States Industrial Electric Motor Systems Market Opportunities Assessment* (Burlington, MA, December 1998), and U.S. Department of Energy, *MotorMaster+ 4.0* software database (2007).

Note: The efficiencies listed in this table are operating efficiencies based on average part-loads. Because the average part-load is not the same for all industries, the listed efficiencies for the different motor sizes vary across industries.

Table B.22. Payback acceptance assumptions for motor decisions

Payback Period in Years	Acceptance Rate
1	100%
2	80%
3	35%
4	0%

Source: Energy Information Administration, Office of Energy Analysis.

Table B.23. Energy consumption in boilers

Industry	Region	Alpha	Natural Gas	Coal	Oil	Renewables
Food Products	Northeast	-2.0	19	0	4	1
	Midwest	-2.0	168	109	12	22
	South	-2.0	96	11	12	52
	West	-2.0	76	14	4	4
Paper & Allied Products	Northeast	-2.0	41	40	16	80
	Midwest	-2.0	48	60	12	90
	South	-2.0	159	91	64	998
	West	-2.0	53	13	4	97
Bulk Chemicals	Northeast	-2.0	13	0	56	0
	Midwest	-2.0	97	37	18	0
	South	-2.0	605	31	384	0
	West	-2.0	20	21	6	0
Glass & Glass Products	Northeast	-2.0	2	0	3	10
	Midwest	-2.0	6	0	3	1
	South	-2.0	6	0	3	2
	West	-2.0	1	0	3	1
Cement	Northeast	-2.0	0	0	1	1
	Midwest	-2.0	1	0	1	5
	South	-2.0	0	0	1	3
	West	-2.0	0	0	1	3
Iron & Steel	Northeast	-2.0	4	6	20	0
	Midwest	-2.0	16	1	66	0
	South	-2.0	6	0	7	0
	West	-2.0	1	0	1	0
Aluminum	Northeast	-2.0	2	0	0	0
	Midwest	-2.0	4	0	0	0
	South	-2.0	11	0	0	0
	West	-2.0	1	0	0	0
Metal-Based Durables						
Fabricated Metal Products	Northeast	-2.0	5	0	0	0
	Midwest	-2.0	19	0	0	2
	South	-2.0	12	0	1	0
	West	-2.0	3	0	0	0

Table B.23. Energy consumption in boilers (cont.)

Industry	Region	Alpha	Natural Gas	Coal	Oil	Renewables
Machinery	Northeast	-2.0	3	0	1	0
	Midwest	-2.0	12	1	0	1
	South	-2.0	5	0	0	0
	West	-2.0	1	0	0	0
Computers & Electronic Products	Northeast	-2.0	4	0	1	1
	Midwest	-2.0	5	0		0
	South	-2.0	4	0	1	0
	West	-2.0	8	0	1	0
Electrical Equipment	Northeast	-2.0	5	8		7
	Midwest	-2.0	27	1	1	5
	South	-2.0	7	1	3	4
	West	-2.0	3	0	0	0
Transportation Equipment	Northeast	-2.0	1	0	0	0
	Midwest	-2.0	0	0	0	0
	South	-2.0	4	0	0	0
	West	-2.0	0	0	0	0
Other Non-Intensive Manufacturing						
Wood Products	Northeast	-2.0	2	0	0	11
	Midwest	-2.0	12	1	1	40
	South	-2.0	7	0	1	123
	West	-2.0	5	0	2	48
Plastic Products	Northeast	-2.0	10	0	2	0
	Midwest	-2.0	23	9	0	0
	South	-2.0	25	10	6	0
	West	-2.0	2	0	0	0
Balance of Manufacturing	Northeast	-2.0	41	11	18	1
	Midwest	-2.0	64	51	28	2
	South	-2.0	121	58	31	22
	West	-2.0	31	8	15	0

Note: Alpha is the parameter of the logistic switching function.

Source: Energy Information Administration, Office of Integrated Analysis and Forecasting estimates based on Manufacturing Consumption of Energy 2006.

Table B.24. Boiler population characteristics used for cogeneration system sizing and steam load segmentation

Industry	Firing Capacity (million Btu/hour)					
	1.5-10	10-50	50-100	100-250	250-500	> 500
Food	14.8%	31.0%	18.1%	22.9%	5.4%	7.8%
Paper	1.1%	6.5%	9.7%	21.7%	25.0%	36.0%
Chemicals	6.9%	19.8%	15.7%	21.0%	15.0%	21.6%
Primary Metals	6.7%	17.2%	20.1%	15.8%	16.5%	23.8%
Other Manufacturing	10.5%	28.4%	22.1%	22.2%	6.9%	10.0%

Source: Energy and Environmental Analysis, Inc, Characterization of the U.S. Industrial Commercial Boiler Population (submitted to Oak Ridge National Laboratory), May 2005.

Table B. 25. Characteristics of candidate combine heat and power systems, Reference case

System	Size (kilowatts)	Total Installed Cost per Kilowatt		Total Heat Rate (Btu per kWh)		Overall Efficiency	
		2010	2035	2010	2035	2010	2035
1 Engine	1,000	1,440	576	9,097	9,097	0.806	0.893
2 Engine	2,000	1,260	396	9,394	9,394	0.832	0.918
3 Gas Turbine	3,510	1,719	1,496	13,893	13,893	0.760	0.780
4 Gas Turbine	5,670	1,152	1,023	12,254	12,254	0.772	0.785
5 Gas Turbine	14,990	982	869	10,945	10,945	0.769	0.777
6 Gas Turbine	25,000	987	860	9,945	9,948	0.707	0.729
7 Gas Turbine	40,000	875	830	9,220	9,222	0.721	0.741
8 Combined Cycle	100,000	723	684	6,736	6,337	0.704	0.730

Note: Cost given in constant 2005 dollars.

Source: SENTECH Inc., Commercial and Industrial CHP Technology Cost and Performance Data for EIA, report prepared for the Office of Integrated Analysis and Forecasting, Energy Information Administration, Washington, DC, June 2010.

Table B. 26. Characteristics of candidate combined heat and power systems, high technology case

System	Size (kilowatts)	Total Installed Cost per Kilowatt		Total Heat Rate (Btu per kWh)		Overall Efficiency	
		2010	2035	2010	2035	2010	2035
1 Engine	1,000	1,398	535	8,586	9,097	0.844	0.931
2 Engine	2,000	1,218	354	9,145	9,394	0.843	0.930
3 Gas Turbine	3,510	1,673	1,450	13,751	13,893	0.761	0.781
4 Gas Turbine	5,670	1,135	1,006	11,996	12,254	0.774	0.787
5 Gas Turbine	14,990	982	869	10,833	10,945	0.772	0.780
6 Gas Turbine	25,000	987	860	9,842	9,948	0.709	0.731
7 Gas Turbine	40,000	875	830	9,125	9,222	0.727	0.747
8 Combined Cycle	100,000	716	668	6,667	6,143	0.709	0.744

Note: Cost given in constant 2005 dollars.

Source: SENTECH Inc., Commercial and Industrial CHP Technology Cost and Performance Data for EIA, report prepared for the Office of Integrated Analysis and Forecasting, Energy Information Administration, Washington, DC, June 2010.

Table B.27. Payback acceptance rate assumptions for cogeneration market penetration

Payback Period in Years	Acceptance Rate
0	100.00%
1	89.00%
2	69.75%
3	54.00%
4	42.25%
5	30.38%
6	19.25%
7	13.00%
8	8.00%
9	4.25%
10	1.63%
11	0.25%
12	0.00%

Source: Energy Information Administration, Office of Energy Analysis; Johnson Controls Inc., 2010 Energy Efficiency Indicator IFMA Summary Report (2010) and Converting Distributed Energy Prospects Into Customers, EPRI Number 1010294 (2003).

Table B.28. Fuel factors for incremental corn-based ethanol production

Fuel	Thousand Btu per bushel
Electricity	1.10
Natural Gas	3.05
Distillate	6.65
LPG	3.32
Motor Gasoline	1.64
Natural Gas for Fertilizer	23.4

Source: Energy Information Administration, Office of Integrated Analysis and Forecasting estimates based on U.S. Department of Agriculture, Economic Research Service, Commodity Costs and Returns, Energy Use on Major Field Crops in Surveyed States 2001.

Appendix C. Descriptions of Major Industrial Groups and Selected Industries

This appendix contains descriptions of industrial groups and selected industries taken from the North American Industry Classification System (NAICS). This appendix includes general descriptions of the 15 manufacturing and 6 nonmanufacturing groups that comprise the industries modeled in the Industrial Demand Module. NAICS is the standard used by Federal statistical agencies in classifying business establishments for the purpose of collecting, analyzing, and publishing statistical data related to the U.S. business economy.

NAICS 11 - The **Agriculture, Forestry, Fishing and Hunting** sector comprises establishments primarily engaged in growing crops, raising animals, harvesting timber, and harvesting fish and other animals from a farm, ranch, or their natural habitats.

The establishments in this sector are often described as farms, ranches, dairies, greenhouses, nurseries, orchards, or hatcheries. A farm may consist of a single tract of land or a number of separate tracts which may be held under different tenures. For example, one tract may be owned by the farm operator and another rented. It may be operated by the operator alone or with the assistance of members of the household or hired employees, or it may be operated by a partnership, corporation, or other type of organization. When a landowner has one or more tenants, renters, croppers, or managers, the land operated by each is considered a farm.

The sector distinguishes two basic activities: agricultural production and agricultural support activities. Agricultural production includes establishments performing the complete farm or ranch operation, such as farm owner-operators, tenant farm operators, and sharecroppers. Agricultural support activities include establishments that perform one or more activities associated with farm operation, such as soil preparation, planting, harvesting, and management, on a contract or fee basis.

NAICS 21 - The **Mining, Quarrying, and Oil and Gas Extraction** sector comprises establishments that extract naturally occurring mineral solids, such as coal and ores; liquid minerals, such as crude petroleum; and gases, such as natural gas. The term mining is used in the broad sense to include quarrying, well operations, beneficiating (e.g., crushing, screening, washing, and flotation), and other preparation customarily performed at the mine site, or as a part of mining activity.

The Mining, Quarrying, and Oil and Gas Extraction sector distinguishes two basic activities: mine operation and mining support activities. Mine operation includes establishments operating mines, quarries, or oil and gas wells on their own account or for others on a contract or fee basis. Mining support activities include establishments that perform exploration (except geophysical surveying) and/or other mining services on a contract or fee basis (except mine site preparation and construction of oil/gas pipelines).

Establishments in the Mining, Quarrying, and Oil and Gas Extraction sector are grouped and classified according to the natural resource mined or to be mined. Industries include establishments that develop the mine site, extract the natural resources, and/or those that beneficiate (i.e., prepare) the mineral mined. Beneficiation is the process whereby the extracted material is reduced to particles that can be separated into mineral and waste, the former suitable for further processing or direct use. The operations that take place in beneficiation are primarily mechanical, such as grinding, washing, magnetic separation, and centrifugal separation. In contrast, manufacturing operations primarily use chemical and electrochemical processes, such as electrolysis and distillation. However, some treatments, such as heat treatments, take place in both the beneficiation and the manufacturing (i.e., smelting/refining) stages. The range of preparation activities varies by mineral and the purity of any given ore deposit. While some minerals, such as petroleum and natural gas, require little or no preparation, others are washed and screened, while yet others, such as gold and silver, can be transformed into bullion before leaving the mine site.

NAICS 23 - The **Construction** sector comprises establishments primarily engaged in the construction of buildings or engineering projects (e.g., highways and utility systems). Establishments primarily engaged in the preparation of sites for new construction and establishments primarily engaged in subdividing land for sale as building sites also are included in this sector.

Construction work done may include new work, additions, alterations, or maintenance and repairs. Activities of these establishments generally are managed at a fixed place of business, but they usually perform construction activities at multiple project sites. Production responsibilities for establishments in this sector are usually specified in (1) contracts with the owners of construction projects (prime contracts) or (2) contracts with other construction establishments (subcontracts).

NAICS 311 - Industries in the **Food Manufacturing** subsector transform livestock and agricultural products into products for intermediate or final consumption. The industry groups are distinguished by the raw materials (generally of animal or vegetable origin) processed into food products.

The food products manufactured in these establishments are typically sold to wholesalers or retailers for distribution to consumers, but establishments primarily engaged in retailing bakery and candy products made on the premises not for immediate consumption are included.

NAICS 312 - Industries in the **Beverage and Tobacco Product Manufacturing** subsector manufacture beverages and tobacco products. The industry group, Beverage Manufacturing, includes three types of establishments: (1) those that manufacture nonalcoholic beverages; (2) those that manufacture alcoholic beverages through the fermentation process; and (3) those that produce distilled alcoholic beverages. Ice manufacturing, while not a beverage, is included with nonalcoholic beverage manufacturing because it uses the same production process as water purification.

In the case of activities related to the manufacture of beverages, the structure follows the defined production processes. Brandy, a distilled beverage, was not placed under distillery product manufacturing, but rather under the NAICS class for winery product manufacturing since the production process used in the manufacturing of alcoholic grape-based beverages produces both wines (fermented beverage) and brandies (distilled beverage).

The industry group, Tobacco Manufacturing, includes two types of establishments: (1) those engaged in redrying and stemming tobacco and, (2) those that manufacture tobacco products, such as cigarettes and cigars.

NAICS 313 - Industries in the **Textile Mills** subsector group establishments that transform a basic fiber (natural or synthetic) into a product, such as yarn or fabric that is further manufactured into usable items, such as apparel, sheets, towels, and textile bags for individual or industrial consumption. The further manufacturing may be performed in the same establishment and classified in this subsector, or it may be performed at a separate establishment and be classified elsewhere in manufacturing.

The main processes in this subsector include preparation and spinning of fiber, knitting or weaving of fabric, and the finishing of the textile. The NAICS structure follows and captures this process flow. Major industries in this flow, such as preparation of fibers, weaving of fabric, knitting of fabric, and fiber and fabric finishing, are uniquely identified. Texturizing, throwing, twisting, and winding of yarn contain aspects of both fiber preparation and fiber finishing and is classified with preparation of fibers rather than with finishing of fiber.

NAICS 314 - Industries in the **Textile Product Mills** subsector group establishments that make textile products (except apparel). With a few exceptions, processes used in these industries are generally cut and sew (i.e., purchasing fabric and cutting and sewing to make nonapparel textile products, such as sheets and towels).

NAICS 315 - Industries in the **Apparel Manufacturing** subsector group establishments with two distinct manufacturing processes: (1) cut and sew (i.e., purchasing fabric and cutting and sewing to make a garment), and (2) the manufacture of garments in establishments that first knit fabric and then cut and sew the fabric into a garment. The Apparel Manufacturing subsector includes a diverse range of establishments manufacturing full lines of ready-to-wear apparel and custom apparel: apparel contractors, performing cutting or sewing operations on materials owned by others; jobbers performing entrepreneurial functions involved in apparel manufacture; and tailors, manufacturing custom garments for individual clients are all included. Knitting, when done alone, is classified in the Textile Mills subsector, but when knitting is combined with the production of complete garments, the activity is classified in Apparel Manufacturing.

NAICS 316 - Establishments in the **Leather and Allied Product Manufacturing** subsector transform hides into leather by tanning or curing and fabricating the leather into products for final consumption. It also includes the manufacture of similar products from other materials, including products (except apparel) made from "leather substitutes," such as rubber, plastics, or textiles. Rubber footwear, textile luggage, and plastic purses or wallets are examples of "leather substitute" products included in this group. The products made from leather substitutes are included in this subsector because they are made in similar ways leather products are made (e.g., luggage). They are made in the same establishments, so it is not practical to separate them.

The inclusion of leather making in this subsector is partly because leather tanning is a relatively small industry that has few close neighbors as a production process, partly because leather is an input to some of the other products classified in this subsector and partly for historical reasons.

NAICS 321 - Industries in the **Wood Product Manufacturing** subsector manufacture wood products, such as lumber, plywood, veneers, wood containers, wood flooring, wood trusses, manufactured homes (i.e., mobile homes), and prefabricated wood buildings. The production processes of the Wood Product Manufacturing subsector include sawing, planing, shaping, laminating, and assembling of wood products starting from logs that are cut into bolts, or lumber that then may be further cut, or shaped by lathes or other shaping tools. The lumber or other transformed wood shapes may also be subsequently planed or smoothed, and assembled into finished products, such as wood containers. The Wood Product Manufacturing subsector includes establishments that make wood products from logs and bolts that are sawed and shaped, and establishments that purchase sawed lumber and make wood products. With the exception of sawmills and wood preservation establishments, the establishments are grouped into industries mainly based on the specific products manufactured.

NAICS 322 - Industries in the **Paper Manufacturing** subsector make pulp, paper, or converted paper products. The manufacturing of these products is grouped together because they constitute a series of vertically connected processes. More than one is often carried out in a single establishment. There are essentially three activities. The manufacturing of pulp involves separating the cellulose fibers from other impurities in wood or used paper. The manufacturing of paper involves matting these fibers into a sheet. Converted paper products are made from paper and other materials by various cutting and shaping techniques and include coating and laminating activities.

The Paper Manufacturing subsector is subdivided into two industry groups, the first for the manufacturing of pulp and paper and the second for the manufacturing of converted paper products. Paper making is treated as the core activity of the subsector. Therefore, any establishment that makes paper (including paperboard), either alone or in combination with pulp manufacturing or paper converting, is classified as a paper or paperboard mill. Establishments that make pulp without making paper are classified as pulp mills. Pulp mills, paper mills and paperboard mills comprise the first industry group.

Establishments that make products from purchased paper and other materials make up the second industry group, Converted Paper Product Manufacturing. This general activity is then subdivided based, for the most part, on process distinctions. Paperboard container manufacturing uses corrugating, cutting, and shaping machinery to form paperboard into containers. Paper bag and coated and treated paper manufacturing establishments cut and coat paper and foil. Stationery product manufacturing establishments make a variety of paper products used for writing, filing, and similar applications. Other converted paper product manufacturing includes, in particular, the conversion of sanitary paper stock into such things as tissue paper and disposable diapers.

NAICS 323 - Industries in the **Printing and Related Support Activities** subsector print products, such as newspapers, books, labels, business cards, stationery, business forms, and other materials, and perform support activities, such as data imaging, platemaking services, and bookbinding. The support activities included here are an integral part of the printing industry, and a product (a printing plate, a bound book, or a computer disk or file) that is an integral part of the printing industry is almost always provided by these operations.

Processes used in printing include a variety of methods used to transfer an image from a plate, screen, film, or computer file to some medium, such as paper, plastics, metal, textile articles, or wood. The most prominent of these methods is to transfer the image from a plate or screen to the medium (lithographic, gravure, screen, and flexographic printing). A rapidly growing new technology uses a computer file to directly "drive" the printing mechanism to create the image and new electrostatic and other types of equipment (digital or nonimpact printing).

NAICS 324 - The **Petroleum and Coal Products Manufacturing** subsector is based on the transformation of crude petroleum and coal into usable products. The dominant process is petroleum refining that involves the separation of crude petroleum into component products through such techniques as cracking and distillation.

NAICS 325 - The **Chemical Manufacturing** subsector is based on the transformation of organic and inorganic raw materials by a chemical process and the formulation of products. This subsector distinguishes the production of basic chemicals that comprise the first industry group from the production of intermediate and end products produced by further processing of basic chemicals that make up the remaining industry groups.

NAICS 326 - Industries in the **Plastics and Rubber Products Manufacturing** subsector make goods by processing plastics materials and raw rubber. The core technology employed by establishments in this subsector is that of plastics or rubber product production. Plastics and rubber are combined in the same subsector because plastics are increasingly being used as a substitute for rubber; however the subsector is generally restricted to the production of products made of just one material, either solely plastics or rubber.

Many manufacturing activities use plastics or rubber, for example the manufacture of footwear or furniture. Typically, the production process of these products involves more than one material. In these cases, technologies that allow disparate materials to be formed and combined are of central importance in describing the manufacturing activity. In NAICS, such activities (the footwear and furniture manufacturing) are not classified in the Plastics and Rubber Products Manufacturing subsector because the core technologies for these activities are diverse and involve multiple materials.

NAICS 327 - The **Nonmetallic Mineral Product Manufacturing** subsector transforms mined or quarried nonmetallic minerals, such as sand, gravel, stone, clay, and refractory materials, into products for intermediate or final consumption. Processes used include grinding, mixing, cutting, shaping, and honing. Heat often is used in the process and chemicals are frequently mixed to change the composition, purity, and chemical properties for the intended product. For example, glass is produced by heating silica sand to the melting point (sometimes combined with cullet or recycled glass) and then drawn, floated, or blow molded to the desired shape or thickness. Refractory materials are heated and then formed into bricks or other shapes for use in industrial applications.

The Nonmetallic Mineral Product Manufacturing subsector includes establishments that manufacture products, such as bricks, refractories, ceramic products, and glass and glass products, such as plate glass and containers. Also included are cement and concrete products, lime, gypsum and other nonmetallic mineral products including abrasive products, ceramic plumbing fixtures, statuary, cut stone products, and mineral wool. The products are used in a wide range of activities from construction and heavy and light manufacturing to articles for personal use.

NAICS 327310 - Cement Manufacturing

The **Cement Manufacturing** industry comprises establishments primarily engaged in manufacturing portland, natural, masonry, pozzolanic, and other hydraulic cements. Cement manufacturing establishments may calcine earths or mine, quarry, manufacture, or purchase lime.

NAICS 327410 - Lime Manufacturing

The **Lime Manufacturing** industry comprises establishments primarily engaged in manufacturing lime from calcitic limestone, dolomitic limestone, or other calcareous materials, such as coral, chalk, and shells. Lime manufacturing establishments may mine, quarry, collect, or purchase the sources of calcium carbonate.

NAICS 331 - Industries in the **Primary Metal Manufacturing** subsector smelt and/or refine ferrous and nonferrous metals from ore, pig or scrap, using electrometallurgical and other process metallurgical techniques. Establishments in this subsector also manufacture metal alloys and superalloys by introducing other chemical elements to pure metals. The output of smelting and refining, usually in ingot form, is used in rolling, drawing, and extruding operations to make sheet, strip, bar, rod, or wire, and in molten form to make castings and other basic metal products.

Primary manufacturing of ferrous and nonferrous metals begins with ore or concentrate as the primary input. Establishments manufacturing primary metals from ore and/or concentrate remain classified in the primary smelting, primary refining, or iron and steel mill industries regardless of the form of their output. Establishments primarily engaged in secondary smelting and/or secondary refining recover ferrous and nonferrous metals from scrap and/or dross. The output of the secondary smelting and/or secondary refining industries is limited to shapes, such as ingot or billet, that will be further processed. Recovery of metals from scrap often occurs in establishments that are primarily engaged in activities such as rolling, drawing, extruding, or similar processes.

NAICS 332 - Industries in the **Fabricated Metal Product Manufacturing** subsector transform metal into intermediate or end products, other than machinery, computers and electronics, and metal furniture, or treat metals and metal formed products fabricated elsewhere. Important fabricated metal processes are forging, stamping, bending, forming, and machining, used to shape individual pieces of metal; and other processes, such as welding and assembling, used to join separate parts together. Establishments in this subsector may use one or a combination of these processes.

NAICS 333 - Industries in the **Machinery Manufacturing** subsector create end products that apply mechanical force, for example, the application of gears and levers, to perform work. Some important processes for the manufacture of machinery are forging, stamping, bending, forming, and machining that are used to shape individual pieces of metal. Processes, such as welding and assembling are used to join separate parts together. Although these processes are similar to those used in metal fabricating establishments, machinery manufacturing is different because it typically employs multiple metal-forming processes in manufacturing the various parts of the machine. Moreover, complex assembly operations are an inherent part of the production process.

NAICS 334 - Industries in the **Computer and Electronic Product Manufacturing** subsector group establishments that manufacture computers, computer peripherals, communications equipment, and similar electronic products, and establishments that manufacture components for such products. The Computer and Electronic Product Manufacturing industries have been combined in the hierarchy of NAICS because of the economic significance they have attained. Their rapid growth suggests that they will become even more important to the economies of all three North American countries in the future, and in addition their manufacturing processes are fundamentally different from the manufacturing processes of other machinery and equipment. The design and use of integrated circuits and the application of highly specialized miniaturization technologies are common elements in the production technologies of the computer and electronic subsector. Convergence of technology motivates this NAICS subsector. Digitalization of sound recording, for example, causes both the medium (the compact disc) and the equipment to resemble the technologies for recording, storing, transmitting, and manipulating data. Communications technology and equipment have been converging with computer technology. When technologically-related components are in the same sector, it makes it easier to adjust the classification for future changes, without needing to redefine its basic structure. The creation of the Computer and Electronic Product Manufacturing subsector assists in delineating new and emerging industries because the activities that will serve as the probable sources of new industries, such as computer manufacturing and communications equipment manufacturing, or computers and audio equipment, are brought together. As new activities emerge, therefore, they are less likely to cross the subsector boundaries of the classification.

NAICS 335 - Industries in the **Electrical Equipment, Appliance, and Component Manufacturing** subsector manufacture products that generate, distribute and use electrical power. Electric Lighting Equipment Manufacturing establishments produce electric lamp bulbs, lighting fixtures, and parts. Household Appliance Manufacturing establishments make both small and major electrical appliances and parts. Electrical Equipment Manufacturing establishments make goods, such as electric motors, generators, transformers, and switchgear apparatus. Other Electrical Equipment and Component Manufacturing establishments make devices for storing electrical power (e.g., batteries), for transmitting electricity (e.g., insulated wire), and wiring devices (e.g., electrical outlets, fuse boxes, and light switches).

NAICS 336 - Industries in the **Transportation Equipment Manufacturing** subsector produce equipment for transporting people and goods. Transportation equipment is a type of machinery. An entire subsector is devoted to this activity because of the significance of its economic size in all three North American countries.

Establishments in this subsector utilize production processes similar to those of other machinery manufacturing establishments—bending, forming, welding, machining, and assembling metal or plastic parts into components and finished products. However, the assembly of components and subassemblies

and their further assembly into finished vehicles tends to be a more common production process in this subsector than in the Machinery Manufacturing subsector.

NAICS 337 - Industries in the **Furniture and Related Product Manufacturing** subsector make furniture and related articles, such as mattresses, window blinds, cabinets, and fixtures. The processes used in the manufacture of furniture include the cutting, bending, molding, laminating, and assembly of such materials as wood, metal, glass, plastics, and rattan. However, the production process for furniture is not solely bending metal, cutting and shaping wood, or extruding and molding plastics. Design and fashion trends play an important part in the production of furniture. The integrated design of the article for both esthetic and functional qualities is also a major part of the process of manufacturing furniture. Design services may be performed by the furniture establishments' work force or may be purchased from industrial designers.

NAICS 339 - Industries in the **Miscellaneous Manufacturing** subsector make a wide range of products that cannot readily be classified in specific NAICS subsectors in manufacturing. Processes used by these establishments vary significantly, both among and within industries. For example, a variety of manufacturing processes are used in manufacturing sporting and athletic goods that include products such as tennis racquets and golf balls. The processes for these products differ from each other, and the processes differ significantly from the fabrication processes used in making dolls or toys, the melting and shaping of precious metals to make jewelry, and the bending, forming, and assembly used in making medical products.

Appendix D. Bibliography

American Council for an Energy-Efficient Economy, *Energy-Efficient Motor Systems: A Handbook on Technology, Program, and Policy Opportunities*, Second Edition, Washington, DC, 2002.

American Council for an Energy-Efficient Economy, “Challenges Facing Combined Heat and Power Today: A State-by-State Assessment,” Washington, DC, September 2011, <http://aceee.org/research-report/ie111>.

Centre for the Analysis and Dissemination of Demonstrated Energy Technologies, *Learning from experiences with Gas-Turbine-Based CHP in Industry*, CADDET IEA/OECD, The Netherlands, April 1993.

Centre for the Analysis and Dissemination of Demonstrated Energy Technologies, *Learning from experiences with Small-Scale Cogeneration*, CADDET IEA/OECD, The Netherlands, November 1995.

Dahl, Carol, *A Survey of Energy Demand Elasticities in Support of the Development of the NEMS*, prepared for the Energy Information Administration, Washington, DC, October 1993.

Energy and Environmental Analysis, Inc, *Characterization of the U.S. Industrial Commercial Boiler Population*, submitted to Oak Ridge National Laboratory, Arlington, VA, May 2005.

Energy and Environmental Analysis, Inc, *NEM Industrial Prototype Model Documentation (Draft)*, submitted to Energy Information Administration, Arlington, VA, August 2008.

Executive Office of the President, Office of Management and Budget, *North American Industry Classification System*, United States. Washington, DC, 2007.

FOCIS Associates, Inc., *Industrial Technology and Data Analysis Supporting the NEMS Industrial Model*, unpublished report prepared for the Office of Integrated Analysis and Forecasting, Energy Information Administration, Washington, DC, October 2005.

Johnson Controls Inc., *2009 Energy Efficiency Indicator IFMA Summary Report*, International Facility Management Association, www.ifma.org, 2009.

NESCAUM, *Applicability and Feasibility of NO_x, SO₂, and PM Emissions Control Technologies for Industrial, Commercial, and Institutional (ICI) Boilers*, January 2009.

Portland Cement Association, “U.S. Detail Cement Plant Information.”

Roop, Joseph M. and Chris Bataille, “Modeling Climate Change Policies in the US and Canada: A Progress Report,” p. 7. Presentation to 26th USAEE/IAEE North American Conference, September 27, 2006,

SRA International, “Report on the Analysis and Modeling Approach to Characterize and Estimate Fuel Use by End-Use Applications in the Agriculture and Construction Industries,” unpublished report prepared for the U.S Energy Information Administration, March 2011.

SAIC, “Model Documentation Report the U.S. Cement Industry,” unpublished data report prepared for the Office of Energy Analysis, U.S. Energy Information Administration, Washington, DC, August 2012.

SAIC, "Model Documentation Report the U.S. Lime Industry," unpublished data report prepared for the Office of Energy Analysis, U.S. Energy Information Administration, Washington, DC, August 2012.

SAIC, "Model Documentation Report the U.S. Aluminum Industry," unpublished data report prepared for the Office of Energy Analysis, U.S. Energy Information Administration, Washington, DC, June 2013.

SENTECH Inc., Commercial and Industrial CHP Technology Cost and Performance Data for EIA, report prepared for the Office of Integrated Analysis and Forecasting, Energy Information Administration, Washington, DC, June 2010.

U.S. Department of Agriculture, National Agricultural Statistical Service, 2007 Census of Agriculture, Washington, DC, February 2009.

U.S. Department of Agriculture, Economic Research Service, Commodity Costs and Returns, Energy Use on Major Field Crops in Surveyed States 2001, Washington, DC, 2002.

U.S. Department of Commerce, Census Bureau, Annual Survey of Manufactures, Fuels and Electric Energy Consumed, Washington, DC, Various Years.

U.S. Department of Commerce, Census Bureau, Economic Census 2007: Construction Industry Series; Manufacturing Industry Series; Mining Industry Series, available at <http://www.census.gov/econ/census07/>.

U.S. Department of Energy, MotorMaster+ 4.0 software database, 2007, available at <http://www1.eere.energy.gov/industry/bestpractices/pdfs/mmplus.pdf..>

U.S. Department of Energy, United States Industrial Electric Motor Systems Market Opportunities Assessment, Burlington, MA, December 1998.

U.S. Department of the Interior, United States Geological Survey, Minerals Yearbook 2006 available at <http://minerals.usgs.gov/minerals/pubs/commodity/cement/myb1-2006-cemen.pdf>.

U.S. Department of the Interior, United States Geological Survey, Minerals Yearbook 2010 (Advance Release) available at <http://minerals.usgs.gov/minerals/pubs/commodity/cement/myb1-2010-cemen.pdf>

U.S. Department of the Interior, United States Geological Survey, Minerals Yearbook 2011 available at <http://minerals.usgs.gov/minerals/pubs/commodity/aluminum/myb1-2011-alumi.pdf>.

U.S. Energy Information Administration (EIA), 2006 Manufacturing Energy Consumption Survey, <http://www.eia.gov/consumption/manufacturing/>, Washington, DC, June 2009.

U.S. Energy Information Administration, Annual Energy Outlook 2011. DOE/EIA-0383(2011), Washington, DC, May 2011.

U.S. Energy Information Administration, Annual Energy Review 2010, DOE/EIA-0384 (2010), Washington, DC, August 2011.

U.S. Energy Information Administration, Documentation of the Commercial Sector Demand Module (CSDM), DOE/EIA-M066(2011), Washington, DC, July 2011.

U.S. Energy Information Administration, Documentation of the Oil and Gas Supply Module (OGSM), DOE/EIA-M063(2011), Washington, DC, July 2011.

U.S. Energy Information Administration, Documentation of the Transportation Sector Demand Module (TSDM), DOE/EIA-M071(2011), Washington, DC, July 2011.

U.S. Energy Information Administration, Petroleum Market Model of the National Energy Modeling System, DOE/EIA-M059(2011), Parts 1 and 2, Washington, DC, October 2011.

U.S. Energy Information Administration, State Energy Data Report, Consumption Estimates 1960-2009, June 2011, <http://www.eia.gov/state/seds/>.