



NOAA Technical Memorandum NMFS-AFSC-197

Results of the 2008 Eastern Bering Sea Upper Continental Slope Survey of Groundfish and Invertebrate Resources

by
G. R. Hoff and L. L. Britt

U.S. DEPARTMENT OF COMMERCE
National Oceanic and Atmospheric Administration
National Marine Fisheries Service
Alaska Fisheries Science Center

August 2009

NOAA Technical Memorandum NMFS

The National Marine Fisheries Service's Alaska Fisheries Science Center uses the NOAA Technical Memorandum series to issue informal scientific and technical publications when complete formal review and editorial processing are not appropriate or feasible. Documents within this series reflect sound professional work and may be referenced in the formal scientific and technical literature.

The NMFS-AFSC Technical Memorandum series of the Alaska Fisheries Science Center continues the NMFS-F/NWC series established in 1970 by the Northwest Fisheries Center. The NMFS-NWFSC series is currently used by the Northwest Fisheries Science Center.

This document should be cited as follows:

Hoff, G. R., and L. L. Britt. 2009. Results of the 2008 eastern Bering Sea upper continental slope survey of groundfish and invertebrate resources. U.S. Dep. Commer., NOAA Tech. Memo. NMFS-AFSC-197, 294 p.

Reference in this document to trade names does not imply endorsement by the National Marine Fisheries Service, NOAA.



NOAA Technical Memorandum NMFS-AFSC-197

Results of the 2008 Eastern Bering Sea Upper Continental Slope Survey of Groundfish and Invertebrate Resources

by
G. R. Hoff and L. L. Britt

Alaska Fisheries Science Center
7600 Sand Point Way N.E.
Seattle, WA 98115
www.afsc.noaa.gov

U.S. DEPARTMENT OF COMMERCE
Gary F. Locke, Secretary
National Oceanic and Atmospheric Administration
Jane Lubchenco, Under Secretary and Administrator
National Marine Fisheries Service
James W. Balsiger, Acting Assistant Administrator for Fisheries

August 2009

This document is available to the public through:

National Technical Information Service
U.S. Department of Commerce
5285 Port Royal Road
Springfield, VA 22161

www.ntis.gov

ABSTRACT

The results of the 2008 Alaska Fisheries Science Center's (AFSC) bottom trawl survey of the groundfish and invertebrate resources of the eastern Bering Sea upper continental slope (EBSS) is presented. The 2008 EBSS survey is the third standardized biennial groundfish bottom trawl survey.

Two hundred successful survey bottom trawls were conducted from 200 to 1,200 m on the eastern Bering Sea slope. The survey area stretched from Unalaska and Akutan Island in Alaska (54° N) to the U.S-Russian border at 61° N lat. Sampling was stratified by six subareas running south to north and by five depth stratum within each subarea. Stations were chosen randomly and target sampling density was proportional to the area (km²) in each subarea and depth stratum. Mean sampling density was approximately one tow per 163 km².

This report provides estimates of biomass in metric tons (t), population number, and catch per unit effort (CPUE; no/ha and kg/ha) for all species identified on the survey. Size frequencies (42 species) and CPUE distribution plots (41 species) are presented for the most abundant species or species of commercial and ecological interest. The largest survey total catch weights of fish and invertebrate species were giant grenadier (*Albatrossia pectoralis*), Pacific ocean perch (*Sebastes alutus*), arrowtooth flounder (*Atheresthes stomias*), popeye grenadier (*Coryphaenoides cinereus*), walleye pollock (*Theragra chalcogramma*), cloud sponge (*Rhabdocalyptus* species), deep sea papillate sea cucumber (*Pannychia moseleyi*), and triangle Tanner crab (*Chionoecetes angulatus*).

CONTENTS

ABSTRACT.....	iii
CONTENTS.....	v
LIST OF FIGURES	vi
LIST OF TABLES.....	xii
INTRODUCTION	1
METHODS	2
RESULTS	19
CITATIONS	261
ACKNOWLEDGMENTS	263
APPENDICES: HAUL LOG.....	265

LIST OF FIGURES

Figure 1 Map showing subareas used for the 2008 Eastern Bering Sea slope survey.....	9
Figure 2. Diagram of the Poly Nor’eastern high opening bottom trawl net and bottom contact sensor.....	10-15
Figure 3. Relationship between temperature, latitude and bottom depth collected from trawl stations during the 2008 EBSS survey	16
Figure 4. Distribution and relative abundance of Pacific sleeper shark (<i>Somniosus pacificus</i>) from the 2008 EBSS survey	90-91
Figure 5. Size composition of the estimated Pacific sleeper shark (<i>Somniosus pacificus</i>) population from the 2008 EBSS survey for all subareas by depth	92
Figure 6. Distribution and relative abundance of Alaska skate (<i>Bathyraja parmifera</i>) from the 2008 EBSS survey.....	94-95
Figure 7. Size composition of the estimated Alaska skate (<i>Bathyraja parmifera</i>) population from the 2008 EBSS survey for all subareas by depth	96
Figure 8. Distribution and relative abundance of Aleutian skate (<i>Bathyraja aleutica</i>) from the 2008 EBSS survey.....	98-99
Figure 9. Size composition of the estimated Aleutian skate (<i>Bathyraja aleutica</i>) population from the 2008 EBSS survey for all subareas by depth	100
Figure 10. Distribution and relative abundance of sandpaper skate (<i>Bathyraja interrupta</i>) from the 2008 EBSS survey.....	102-103
Figure 11. Size composition of the estimated sandpaper skate (<i>Bathyraja interrupta</i>) population from the 2008 EBSS survey for all subareas by depth	104
Figure 12. Distribution and relative abundance of Commander skate (<i>Baythraja lindbergi</i>) from the 2008 EBSS survey	106-107
Figure 13. Size composition of the estimated Commander skate (<i>Baythraja lindbergi</i>) population from the 2008 EBSS survey for all subareas by depth	108
Figure 14. Distribution and relative abundance of whiteblotched skate (<i>Bathyraja maculata</i>) from the 2008 EBSS survey	110-111

Figure 15. Size composition of the estimated whiteblotched skate (<i>Bathyraja maculata</i>) population from the 2008 EBSS survey for all subareas by depth	112
Figure 16. Distribution and relative abundance of whitebrow skate (<i>Bathyraja minispinosa</i>) from the 2008 EBSS survey.....	114-115
Figure 17. Size composition of the estimated whitebrow skate (<i>Bathyraja minispinosa</i>) population from the 2008 EBSS survey for all subareas by depth	116
Figure 18. Distribution and relative abundance of rougtail skate (<i>Bathyraja trachura</i>) from the 2008 EBSS survey	118-119
Figure 19. Size composition of the estimated rougtail skate (<i>Bathyraja trachura</i>) population from the 2008 EBSS survey for all subareas by depth..	120
Figure 20. Distribution and relative abundance of mud skate (<i>Bathyraja taranetzi</i>) from the 2008 EBSS survey.....	122-123
Figure 21. Size composition of the estimated mud skate (<i>Bathyraja taranetzi</i>) population from the 2008 EBSS survey for all subareas by depth	124
Figure 22. Distribution and relative abundance of giant grenadier (<i>Albatrossia pectoralis</i>) from the 2008 EBSS survey.....	126-127
Figure 23. Size composition of the estimated giant grenadier (<i>Albatrossia pectoralis</i>) population from the 2008 EBSS survey for all subareas by depth	128
Figure 24. Distribution and relative abundance of Pacific grenadier (<i>Coryphaenoides acrolepis</i>) from the 2008 EBSS survey.....	130-131
Figure 25. Size composition of the estimated Pacific grenadier (<i>Coryphaenoides acrolepis</i>) population from the 2008 EBSS survey for all subareas by depth	132
Figure 26. Distribution and relative abundance of popeye grenadier (<i>Coryphaenoides cinereus</i>) from the 2008 EBSS survey	134-135
Figure 27. Size composition of the estimated popeye grenadier (<i>Coryphaenoides cinereus</i>) population from the 2008 EBSS survey for all subareas by depth	136
Figure 28. Distribution and relative abundance of walleye pollock (<i>Theragra chalcogramma</i>) from the 2008 EBSS survey.....	138-139
Figure 29. Size composition of the estimated walleye pollock (<i>Theragra chalcogramma</i>) population from the 2008 EBSS survey for all subareas by depth	140

Figure 30. Distribution and relative abundance of Pacific cod (<i>Gadus macrocephalus</i>) from the 2008 EBSS survey	142-143
Figure 31. Size composition of the estimated Pacific cod (<i>Gadus macrocephalus</i>) population from the 2008 EBSS survey for all subareas by depth	144
Figure 32. Distribution and relative abundance of shortspine thornyhead (<i>Sebastolobus alascanus</i>) from the 2008 EBSS survey	146-147
Figure 33. Size composition of the estimated shortspine thornyhead (<i>Sebastolobus alascanus</i>) population from the 2008 EBSS survey for all subareas by depth	148
Figure 34. Distribution and relative abundance of Pacific ocean perch (<i>Sebastes alutus</i>) from the 2008 EBSS survey	150-151
Figure 35. Size composition of the estimated Pacific ocean perch (<i>Sebastes alutus</i>) population from the 2008 EBSS survey for all subareas by depth	152
Figure 36. Distribution and relative abundance of rougheyeye rockfish (<i>Sebastes aleutianus</i>) from the 2008 EBSS survey	154-155
Figure 37. Size composition of the estimated rougheyeye rockfish (<i>Sebastes aleutianus</i>) population from the 2008 EBSS survey for all subareas by depth	156
Figure 38. Distribution and relative abundance of black spotted rockfish (<i>Sebastes melanostictus</i>) from the 2008 EBSS survey	158-159
Figure 39. Size composition of the estimated black spotted rockfish (<i>Sebastes melanostictus</i>) population from the 2008 EBSS survey for all subareas by depth	160
Figure 40. Distribution and relative abundance of shorttraker rockfish (<i>Sebastes borealis</i>) from the 2008 EBSS survey	162-163
Figure 41. Size composition of the estimated shorttraker rockfish (<i>Sebastes borealis</i>) population from the 2008 EBSS survey for all subareas by depth	164
Figure 42. Distribution and relative abundance of sablefish (<i>Anoplopoma fimbria</i>) from the 2008 EBSS survey	166-167
Figure 43. Size composition of the estimated sablefish (<i>Anoplopoma fimbria</i>) population from the 2008 EBSS survey for all subareas by depth	168
Figure 44. Distribution and relative abundance of bigmouth sculpin (<i>Hemitripterus bolini</i>) from the 2008 EBSS survey	170-171

Figure 45. Size composition of the estimated bigmouth sculpin (<i>Hemitripterus bolini</i>) population from the 2008 EBSS survey for all subareas by depth	172
Figure 46. Distribution and relative abundance of spinyhead sculpin (<i>Dasycottus setiger</i>) from the 2008 EBSS survey	174-175
Figure 47. Size composition of the estimated spinyhead sculpin (<i>Dasycottus setiger</i>) population from the 2008 EBSS survey for all subareas by depth	176
Figure 48. Distribution and relative abundance of darkfin sculpin (<i>Malacocottus zonurus</i>) from the 2008 EBSS survey.....	178-179
Figure 49. Size composition of the estimated darkfin sculpin (<i>Malacocottus zonurus</i>) population from the 2008 EBSS survey for all subareas by depth	180
Figure 50. Distribution and relative abundance of blob sculpin (<i>Psychrolutes phrictus</i>) from the 2008 EBSS survey	182-183
Figure 51. Size composition of the estimated blob sculpin (<i>Psychrolutes phrictus</i>) population from the 2008 EBSS survey for all subareas by depth	184
Figure 52. Distribution and relative abundance of blacktail snailfish (<i>Careproctus melanurus</i>) from the 2008 EBSS survey	186-187
Figure 53. Size composition of the estimated blacktail snailfish (<i>Careproctus melanurus</i>) population from the 2008 EBSS survey for all subareas by depth	188
Figure 54. Distribution and relative abundance of Bering eelpout (<i>Lycodes beringi</i>) from the 2008 EBSS survey	190-191
Figure 55. Size composition of the estimated Bering eelpout (<i>Lycodes beringi</i>) population from the 2008 EBSS survey for all subareas by depth	192
Figure 56. Distribution and relative abundance of ebony eelpout (<i>Lycodes concolor</i>) from the 2008 EBSS survey.....	194-195
Figure 57. Size composition of the estimated ebony eelpout (<i>Lycodes concolor</i>) population from the 2008 EBSS survey for all subareas by depth	196
Figure 58. Distribution and relative abundance of twoline eelpout (<i>Bothrocara brunneum</i>) from the 2008 EBSS survey	198-199
Figure 59. Size composition of the estimated twoline eelpout (<i>Bothrocara brunneum</i>) population from the 2008 EBSS survey for all subareas by depth	200

Figure 60. Distribution and relative abundance of western eelpout (<i>Bothrocara zestum</i>) from the 2008 EBSS survey.....	202-203
Figure 61. Size composition of the estimated western eelpout (<i>Bothrocara zestum</i>) population from the 2008 EBSS survey for all subareas by depth.	204
Figure 62. Distribution and relative abundance of Pacific halibut (<i>Hippoglossus stenolepis</i>) from the 2008 EBSS survey	206-207
Figure 63. Size composition of the estimated Pacific halibut (<i>Hippoglossus stenolepis</i>) population from the 2008 EBSS survey for all subareas by depth	208
Figure 64. Distribution and relative abundance of flathead sole (<i>Hippoglossoides elassodon</i>) from the 2008 EBSS survey	210-211
Figure 65. Size composition of the estimated flathead sole (<i>Hippoglossoides elassodon</i>) population from the 2008 EBSS survey for all subareas by depth	212
Figure 66. Distribution and relative abundance of Greenland turbot (<i>Reinhardtius hippoglossoides</i>) from the 2008 EBSS survey	214-215
Figure 67. Size composition of the estimated Greenland turbot (<i>Reinhardtius hippoglossoides</i>) population from the 2008 EBSS survey for all subareas by depth	216
Figure 68. Distribution and relative abundance of arrowtooth flounder (<i>Atheresthes stomias</i>) from the 2008 EBSS survey	218-219
Figure 69. Size composition of the estimated arrowtooth flounder (<i>Atheresthes stomias</i>) population from the 2008 EBSS survey for all subareas by depth	220
Figure 70. Distribution and relative abundance of Kamchatka flounder (<i>Atheresthes evermanni</i>) from the 2008 EBSS survey	222-223
Figure 71. Size composition of the estimated Kamchatka flounder (<i>Atheresthes evermanni</i>) population from the 2008 EBSS survey for all subareas by depth	224
Figure 72. Distribution and relative abundance of rex sole (<i>Glyptocephalus zachirus</i>) from the 2008 EBSS survey.....	226-227
Figure 73. Size composition of the estimated rex sole (<i>Glyptocephalus zachirus</i>) population from the 2008 EBSS survey for all subareas by depth	228
Figure 74. Distribution and relative abundance of triangle Tanner crab (<i>Chionoecetes angulatus</i>) from the 2008 EBSS survey.....	230-231

Figure 75. Size composition of the estimated triangle Tanner crab (<i>Chionoecetes angulatus</i>) population from the 2008 EBSS survey for all subareas by depth	232
Figure 76. Distribution and relative abundance of Tanner crab (<i>Chionoecetes bairdi</i>) from the 2008 EBSS survey.....	234-235
Figure 77. Size composition of the estimated Tanner crab (<i>Chionoecetes bairdi</i>) population from the 2008 EBSS survey for all subareas by depth	236
Figure 78. Distribution and relative abundance of snow crab (<i>Chionoecetes opilio</i>) from the 2008 EBSS survey.....	238-239
Figure 79. Size composition of the estimated snow crab (<i>Chionoecetes opilio</i>) population from the 2008 EBSS survey for all subareas by depth	240
Figure 80. Distribution and relative abundance of grooved Tanner crab (<i>Chionoecetes tanneri</i>) from the 2008 EBSS survey.....	242-243
Figure 81. Size composition of the estimated grooved Tanner crab (<i>Chionoecetes tanneri</i>) population from the 2008 EBSS survey for all subareas by depth	244
Figure 82. Distribution and relative abundance of golden king crab (<i>Lithodes aequispinus</i>) from the 2008 EBSS survey	246-247
Figure 83. Size composition of the estimated golden king crab (<i>Lithodes aequispinus</i>) population from the 2008 EBSS survey for all subareas by depth	248
Figure 84. Distribution and relative abundance of scarlet king crab (<i>Lithodes couesi</i>) from the 2008 EBSS survey.....	250-251
Figure 85. Size composition of the estimated scarlet king crab (<i>Lithodes couesi</i>) population from the 2008 EBSS survey for all subareas by depth	252
Figure 86. Distribution and relative abundance of magistrate armhook squid (<i>Berryteuthis magister</i>) from the 2008 EBSS survey	254-255
Figure 87. Size composition of the estimated magistrate armhook squid (<i>Berryteuthis magister</i>) population from the 2008 EBSS survey for all subareas by depth	256
Figure 88. Distribution and relative abundance of Alaskan pink shrimp (<i>Pandalus eous</i>) from the 2008 EBSS survey.....	258-259

LIST OF TABLES

Table 1. Sampling effort and density for each subarea and depth stratum completed during the 2008 EBSS survey	17
Table 2. Survey leg calendar, research staff and their affiliation during the 2008 EBSS survey	18
Table 3. Details of sampling and data recording gear used during the 2008 EBSS survey	21
Table 4. Collection requests completed or attempted during the 2008 EBSS survey	22-23
Table 5. List of all species of fish and invertebrates encountered on the 2008 EBSS survey.	24-39
Table 6. All species encountered in the 2008 EBSS survey with depth range and frequency of occurrence. Species are listed in descending order by total catch weight.	40-47
Table 7. Summary of biological data (lengths, otoliths, individual weights, and stomach samples) collected during the 2008 EBSS survey	48-49
Table 8. Summary of voucher specimens collected during the 2008 EBSS survey	50
Table 9. Abundance and density estimates for all fish and invertebrates encountered by depth range during the 2008 EBSS survey.	51-87
Table 10. Abundance estimates by subarea and depth stratum for Pacific sleeper shark (<i>Somniosus pacificus</i>) from the 2008 EBSS survey	89
Table 11. Abundance estimates by subarea and depth stratum for Alaska skate (<i>Bathyraja parmifera</i>) from the 2008 EBSS survey	93
Table 12. Abundance estimates by subarea and depth stratum for Aleutian skate (<i>Bathyraja aleutica</i>) from the 2008 EBSS survey	97
Table 13. Abundance estimates by subarea and depth stratum for Bering skate (<i>Bathyraja interrupta</i>) from the 2008 EBSS survey	101
Table 14. Abundance estimates by subarea and depth stratum for Commander skate (<i>Bathyraja lindbergi</i>) from the 2008 EBSS survey	105

Table 15. Abundance estimates by subarea and depth stratum for whiteblotched skate (<i>Bathyraja maculata</i>) from the 2008 EBSS survey	109
Table 16. Abundance estimates by subarea and depth stratum for whitebrow skate (<i>Bathyraja minispinosa</i>) from the 2008 EBSS survey.....	113
Table 17. Abundance estimates by subarea and depth stratum for rougetail skate (<i>Bathyraja trachura</i>) from the 2008 EBSS survey	117
Table 18. Abundance estimates by subarea and depth stratum for mud skate (<i>Bathyraja taranetzi</i>) from the 2008 EBSS survey.....	121
Table 19. Abundance estimates by subarea and depth stratum for giant grenadier (<i>Albatrossia pectoralis</i>) from the 2008 EBSS survey.....	125
Table 20. Abundance estimates by subarea and depth stratum for Pacific grenadier (<i>Coryphaenoides acrolepis</i>) from the 2008 EBSS survey.....	129
Table 21. Abundance estimates by subarea and depth stratum for popeye grenadier (<i>Coryphaenoides cinereus</i>) from the 2008 EBSS survey	133
Table 22. Abundance estimates by subarea and depth stratum for walleye pollock (<i>Theragra chalcogramma</i>) from the 2008 EBSS survey.....	137
Table 23. Abundance estimates by subarea and depth stratum for Pacific cod (<i>Gadus macrocephalus</i>) from the 2008 EBSS survey	141
Table 24. Abundance estimates by subarea and depth stratum for shortspine thornyhead (<i>Sebastolobus alascanus</i>) from the 2008 EBSS survey.....	145
Table 25. Abundance estimates by subarea and depth stratum for Pacific ocean perch (<i>Sebastes alutus</i>) from the 2008 EBSS survey	149
Table 26. Abundance estimates by subarea and depth stratum for roughey rockfish (<i>Sebastes aleutianus</i>) from the 2008 EBSS survey.....	153
Table 27. Abundance estimates by subarea and depth stratum for black spotted rockfish (<i>Sebastes melanostictus</i>) from the 2008 EBSS survey	157
Table 28. Abundance estimates by subarea and depth stratum for shorttraker rockfish (<i>Sebastes borealis</i>) from the 2008 EBSS survey	161
Table 29. Abundance estimates by subarea and depth stratum for sablefish (<i>Anoplopoma fimbria</i>) from the 2008 EBSS survey.....	165

Table 30. Abundance estimates by subarea and depth stratum for bigmouth sculpin (<i>Hemitripterus bolini</i>) from the 2008 EBSS survey	169
Table 31. Abundance estimates by subarea and depth stratum for spinyhead sculpin (<i>Dasycottus setiger</i>) from the 2008 EBSS survey	173
Table 32. Abundance estimates by subarea and depth stratum for darkfin sculpin (<i>Malacocottus zonurus</i>) from the 2008 EBSS survey.....	177
Table 33. Abundance estimates by subarea and depth stratum for blob sculpin (<i>Psychrolutes phrictus</i>) from the 2008 EBSS survey	181
Table 34. Abundance estimates by subarea and depth stratum for blacktail snailfish (<i>Careproctus melanurus</i>) from the 2008 EBSS survey	185
Table 35. Abundance estimates by subarea and depth stratum for Bering eelpout (<i>Lycodes beringi</i>) from the 2008 EBSS survey	189
Table 36. Abundance estimates by subarea and depth stratum for ebony eelpout (<i>Lycodes concolor</i>) from the 2008 EBSS survey.....	193
Table 37. Abundance estimates by subarea and depth stratum for twoline eelpout (<i>Bothrocara brunneum</i>) from the 2008 EBSS survey	197
Table 38. Abundance estimates by subarea and depth stratum for western eelpout (<i>Bothrocara zestum</i>) from the 2008 EBSS survey.....	201
Table 39. Abundance estimates by subarea and depth stratum for Pacific halibut (<i>Hippoglossus stenolepis</i>) from the 2008 EBSS survey	205
Table 40. Abundance estimates by subarea and depth stratum for flathead sole (<i>Hippoglossoides elassodon</i>) from the 2008 EBSS survey	209
Table 41. Abundance estimates by subarea and depth stratum for Greenland turbot (<i>Reinhardtius hippoglossoides</i>) from the 2008 EBSS survey	213
Table 42. Abundance estimates by subarea and depth stratum for arrowtooth flounder (<i>Atheresthes stomias</i>) from the 2008 EBSS survey	217
Table 43. Abundance estimates by subarea and depth stratum for Kamchatka flounder (<i>Atheresthes evermanni</i>) from the 2008 EBSS survey	221
Table 44. Abundance estimates by subarea and depth stratum for rex sole (<i>Glyptocephalus zachirus</i>) from the 2008 EBSS survey	225

Table 45. Abundance estimates by subarea and depth stratum for triangle Tanner crab (<i>Chionoecetes angulatus</i>) from the 2008 EBSS survey.....	229
Table 46. Abundance estimates by subarea and depth stratum for Tanner crab (<i>Chionoecetes bairdi</i>) from the 2008 EBSS survey.....	233
Table 47. Abundance estimates by subarea and depth stratum for snow crab (<i>Chionoecetes opilio</i>) from the 2008 EBSS survey	237
Table 48. Abundance estimates by subarea and depth stratum for grooved Tanner crab (<i>Chionoecetes tanneri</i>) from the 2008 EBSS survey.....	241
Table 49. Abundance estimates by subarea and depth stratum for golden king crab (<i>Lithodes aequispinus</i>) from the 2008 EBSS survey	245
Table 50. Abundance estimates by subarea and depth stratum for scarlet king crab (<i>Lithodes couesi</i>) from the 2008 EBSS survey	249
Table 51. Abundance estimates by subarea and depth stratum for magistrate armhook squid (<i>Berryteuthis magister</i>) from the 2008 EBSS survey.....	253
Table 52. Abundance estimates by subarea and depth stratum for Alaskan pink shrimp (<i>Pandalus eous</i>) from the 2008 EBSS survey.....	257
Appendix Table 1. Scope ratio table used during the 2008 EBSS survey.....	267
Appendix Table 2. Performance codes of trawl hauls conducted on the 2008 EBSS survey	268
Appendix Table 3. Haul log for all trawls completed during the 2008 EBSS survey	269

INTRODUCTION

The Alaska Fisheries Science Center's (AFSC) Resource Assessment and Conservation Engineering Division (RACE) conducted a bottom trawl survey in 2008 to assess the groundfish and invertebrate resources on the eastern Bering Sea upper continental slope (EBSS). The survey area extended from Unalaska and Akutan Islands to the U.S.-Russian border near the International Date Line (166° E to 180° W) at depths from 200 to 1,200 m.

Triennial surveys were conducted from 1979 to 1991 on the EBSS using a variety of nets, methods, vessels, and sampling locations. The results from these surveys have been summarized in numerous data reports (Bakkala et al. 1985a, Bakkala et al. 1985b, Sample et al. 1985, Walters et al. 1988, Bakkala et al. 1992, Goddard and Zimmermann 1993).

Prior to the current standardized EBSS biennial surveys (2002, 2004, 2008) a pilot survey was conducted in 2000 which tested two versions of the Poly Nor' eastern bottom trawl gear (mud-sweep and rockhopper footropes). The pilot study showed that the Poly Nor' eastern net with mud sweep gear was more efficient and robust for sampling the EBSS survey area bottom than the rockhopper gear (Mark Wilkins, AFSC pers. commun.). Eastern Bering Sea Slope surveys were conducted in 2002 and 2004 and results are detailed in NOAA Technical Memoranda (Hoff and Britt (2003), and Hoff and Britt (2005)). The slope survey was not conducted in 2006 due to budget limitations. The 2008 EBSS trawl survey is the third in this biennial groundfish survey that incorporate the AFSC's latest sampling technologies and

protocols for survey design, catch data gathering, species identification, and net mensuration monitoring.

Comparisons between the post-2000 surveys and those conducted from 1979 to 1991 remains confounded due to the differences in sampling gear, survey design, sampling methodology, and species identification.

This report summarizes the survey design, sampling gear, and survey logistics used as well as the personnel that participated on this survey. Estimates of abundance, distribution, and size frequency are presented for commercially and ecologically important species. The purpose of this report is to provide information on the biological resources encountered to the scientific community, the fishing industry, and the general public. The results presented herein represent the exclusive report prepared from the EBSS survey conducted in 2008. For additional information from this survey please contact the authors at the Alaska Fisheries Science Center, Seattle Washington (G.R. Hoff email: jerry.hoff@noaa.gov or L.L. Britt email: lyle.britt@noaa.gov).

METHODS

Survey Area and Sampling Design

The EBSS survey area was divided into six geographic subareas (1-6) running south to north along the slope (Fig.1) to assist in the distribution of trawl effort in relation to estimated habitat area. The subareas were based on distinct bathymetric types and underwater features: broad low slope areas, canyon areas, and steep slope inter-canyon faces. Subareas 1 and 6 consist

of broad low slope areas with wide bathymetric contours in the 200-600 m depth range followed by a gradual slope to 1,200 m. Subareas 2 and 4 consist of Pribilof and Zhemchug canyons, respectively, which are characterized by semi-enclosed basins with steep walls and narrow bathymetric contours below 600 m. Subareas 3 and 5 are steep slope inter-canyon “faces” with narrow bathymetric contours throughout most of their depths.

Geographic subareas were stratified by depth every 200 m from 200 to 1,200 m resulting in five depth strata for each geographic subarea (200-400 m; 400-600 m; 600-800 m; 800-1,000 m; 1,000-1,200 m). Substratum areas (km^2) were calculated using known bathymetry contour lines (Table 1) and used to determine sampling density. Two-hundred survey stations were selected using a stratified random sampling design from a pool of 140 successful stations completed during 2002 and 240 stations during 2004 as well as additional stations added randomly in most strata. Stratum sampling densities ranged from one haul per 104.62 km^2 to one haul per 337.76 km^2 with a mean sampling density of one haul per 162 km^2 . Sampling densities varied due to difficulties in successfully completing all planned stations in some deep strata due to areas with untrawlable bottom.

Survey Agenda and Personnel

The EBSS survey began on 29 May 2008 near Unimak Pass and concluded on 11 August 2008 in the south-western eastern Bering Sea. Mobilization and demobilization of the survey took place in Dutch Harbor, Alaska. There were two mid-survey exchanges of scientific crews in Dutch Harbor (legs 1-2, legs 2-3). Research personnel for the survey comprised primarily of AFSC staff and one Hollings Scholarship summer intern (Table 2).

Vessel, Scientific Gear, and Procedures

The F/V *Vesteraalen*, a 38 m long commercial stern trawler powered by twin engines with 1,725 continuous horsepower, was chartered for the survey. Electronic navigation and fishing equipment on the vessel included global positioning system (GPS) receivers, video position plotters, radar, single sideband and VHF transmitter-receivers, an EC-150 color video depth sounder, and auto-pilots. The vessel was operated by Captain Tim Cosgrove during the first leg and by Captain Kenneth Sjong during the second and third legs of the survey. A four-member crew aided in the operation of the vessel and in the use of the fishing gear.

The standard RACE Division fishing gear comprised trawls, bridles, and trawl doors. A Poly Nor' eastern high-opening bottom trawl equipped with mud-sweep roller gear was used to sample all stations (Fig. 2). This sampling trawl had a 27.2 m headrope with twenty-one 30 cm floats and a 24.3 m long-link chain fishing line attached to a 24.9 m footrope. The body of the net was constructed of 127 mm stretched-mesh polyethylene netting, with 89 mm stretched-mesh polyethylene netting in the codend, and a 32 mm stretched-mesh nylon codend liner. The mud-sweep roller gear was constructed of 203 mm solid rubber disks strung over 16 mm high-tensile chain. The net was fished with 1.83 H 2.75 m (6 H 9 ft; 1,000 kg) steel V-doors rigged with four-point bridles to enhance their stability at slow towing speeds and 55 m bridles between the doors and wingtips. This trawl is a modified version of the standard trawl used for the RACE Division's West Coast Upper Continental Slope survey (Lauth 2000). During fishing the net height and width of the trawl were measured using a Scanmar (Scanmar, Asgardstrand, Norway) net measurement system. The GPS system recorded vessel location recording tow duration, distance fished, and precise location. A tilt sensor (bottom contact sensor) attached to the

footrope recorded bottom contact of the footrope indicating the precise beginning and ending of the tow. Bottom depth and water temperature profiles were recorded using a Sea-Bird SBE-39 microbathythermograph (Sea-Bird Electronics Inc., Bellevue, Washington). All net configuration measurements were recorded electronically as well as on paper. The Haul Log (Appendix) details net performance for each tow.

Each station was surveyed with echosounding over a 1.5-2.0 nautical mile (nmi) horizontal distance. A site was considered towable when the depth changed less than 50 m over the 2 nmi transect and it could be determined there was nothing to impede the completion of the tow or the performance of the gear. Trawl operations followed Stauffer (2004) Standard tow speed was 2.5 knots and standard tow duration was 30 minutes at all depths. For each tow date, time, latitude, longitude, gear depth, surface temperature, bottom temperature, water column temperature profile, net spread, net height, and bottom contact of the footrope were recorded. At the end of a tow these haul characteristics were plotted and examined for appropriate distance, bottom contact, and depth range. Upon viewing net performance from a tow, the tow was scored on a graded scale: successful tows were given a positive score, whereas unsuccessful tows received a negative score. In general, a positive tow was considered valid and used for survey abundance estimates, while a negative tow was not used in the analysis. Table 3 lists the specific models, versions, and serial numbers, and RACE numbers for all significant sampling tools used for this survey.

Catch Processing and Collection of Biological Data

Catches were sorted, weighed, and enumerated for all species of fish and invertebrates.

The catch was processed in one of two ways: either by sorting the entire catch and weighing each species in aggregate or by weighing the net codend and discarding the predominant species (except for a weighed and sexed random length frequency sample) and the rest of the catch sorted and weighed in species aggregates. Random samples of all species that were designated for biological data collection were set aside after the baskets were weighed. Total weight and numbers for each species were recorded onto an on-deck catch form. In cases where individuals were not reasonably enumerated (i.e., corals, sponges, bryozoans, ascidians, fish eggs) only total weight was recorded. For large numbers of an individual species in a single haul, the total number was extrapolated from subsample weight and count of 50-200 individuals. In most cases fish length frequency subsamples were used for extrapolation of the total haul count for individual species.

A random subsample of 100-150 fish, depending on the size range for the species, were selected for length frequency measurements. The sex of fish was determined by internal examination of the gonads or by external characters (e.g., claspers for elasmobranchs), and fish were sorted into baskets of males, females, and undetermined sex. Fork length (FL) was measured for most fish, except elasmobranchs which were measured to total length (TL) and macrourids to preanal-fin length (PAFL). Fish and cephalopod species were measured to the nearest centimeter on a bar-coded length board using a Juniper LS 600 Polycorder which uses a bar-code reader wand and species-specific numerical codes. Data from polycorders were downloaded into a database, examined for accuracy, and paper copies printed. All crab species were measured to the nearest 1.0 mm using vernier calipers and recorded on paper form on deck.

Otoliths (age structures) were randomly selected from commercially and ecologically important fish species utilizing a stratified sampling regime based geographic subarea, depth stratum, and length. Two otolith pairs per cm/sex/depth stratum/subarea were collected for each species sampled except for Greenland turbot (*Reinhardtius hippoglossoides*), for which three otolith pairs were collected per strata. An attempt was made to collect otoliths from all fish encountered for shortraker rockfish (*Sebastes borealis*), rougheye rockfish (*S. aleutianus*), blackspotted rockfish (*S. melanostictus*), bigmouth sculpin (*Hemitripterus bolini*), and blacktail snailfish (*Careproctus melanurus*). At the time of otolith collection, the sex, fork length (cm) or pre-anal fin length (PAFL), and weight (kg) of each fish were recorded on paper forms on deck.

Stomach samples were collected from selected fish species for the AFSC's Resource Ecology and Ecosystem Modeling Program. Many commercial and ecologically important species were targeted for food habits including the walleye pollock (*Theragra chalcogramma*), arrowtooth flounder (*Atheresthes stomias*), Pacific ocean perch (*Sebastes alutus*), and Pacific cod (*Gadus macrocephalus*). Specimens were chosen at random and only intact stomachs (non-regurgitated) were chosen for collection. Stomachs were excised and preserved in 10% buffered formalin at sea for later examination. Specimen, haul, and stomach content was recorded on specimen forms at the time of collection.

Voucher specimens were collected from species that were rare, of taxonomic interest, or unidentifiable at the time of encounter. Collections were labeled with a cruise number, vessel number, haul number, species, voucher number, preservative, and collector's name or initials. Voucher specimens were preserved in 10% buffered formalin (most fishes and non-calcareous invertebrates) or 95% ethanol for calcareous invertebrates. A few specimens were stored frozen

and returned to Seattle, Washington. Additional biological samples were collected for study per investigators' requests. Table 4 details the investigators, samples collected, and study purposes.

Abundance Estimates

Catch per unit effort (CPUE) was calculated by dividing catch weight or number for each species by the estimated area swept of the trawl net. Units for CPUE were in kilograms per hectare (kg/ha) and number of fish per hectare (no./ha). Population and biomass (metric tons) estimates were calculated using mean CPUE and extrapolated into the area for each stratum and subsequently all stratum summed. Population size composition for species in which lengths were taken estimated the proportion of fish at each length interval weighted by the CPUE (number of fish/ha) and then expanded to the depth strata population. For details on these methods see Wakabayashi (et al. 1985) and Alverson and Pereyra (1969).

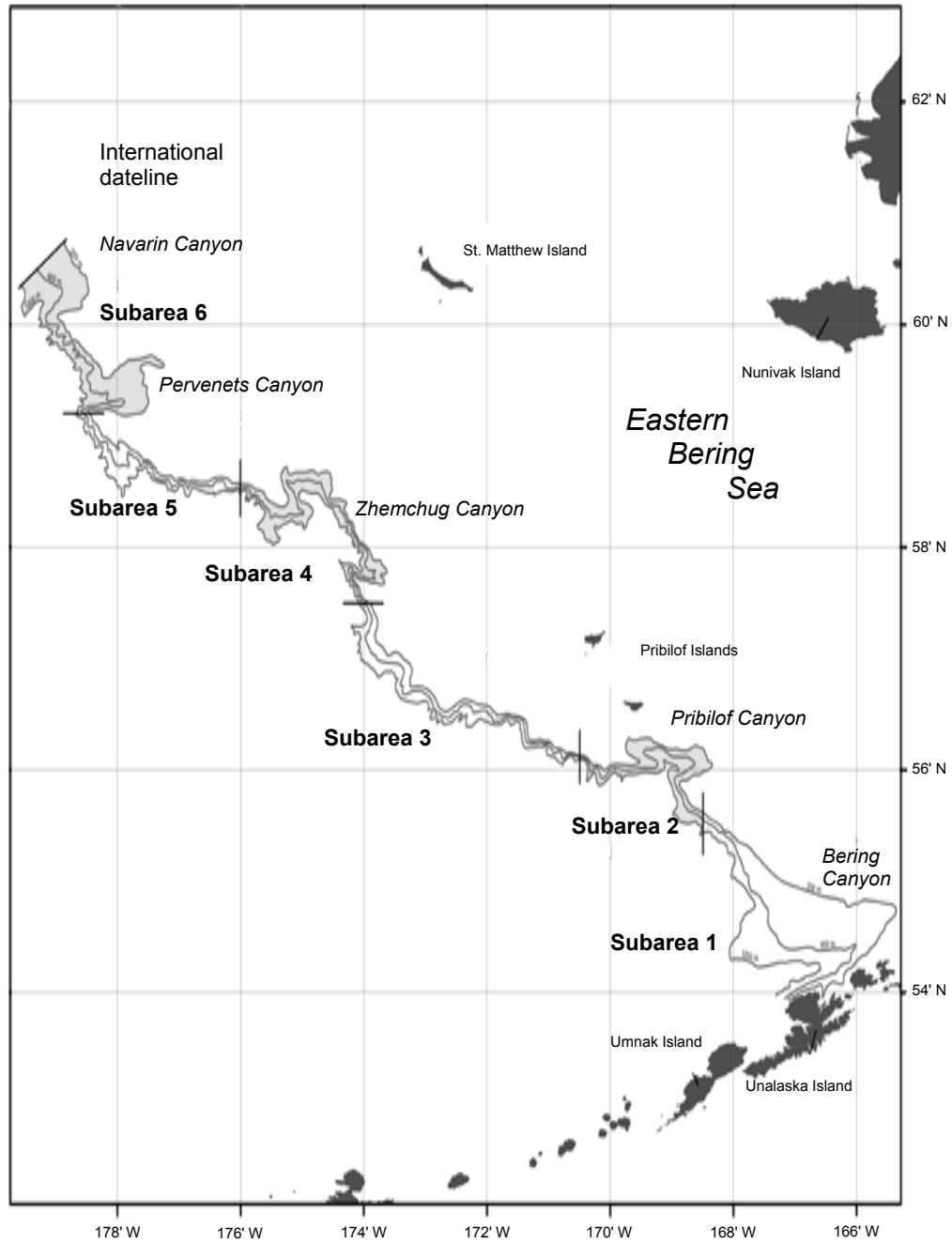

Figure 1. - - Map showing subareas used for the 2008 Eastern Bering Sea slope survey.

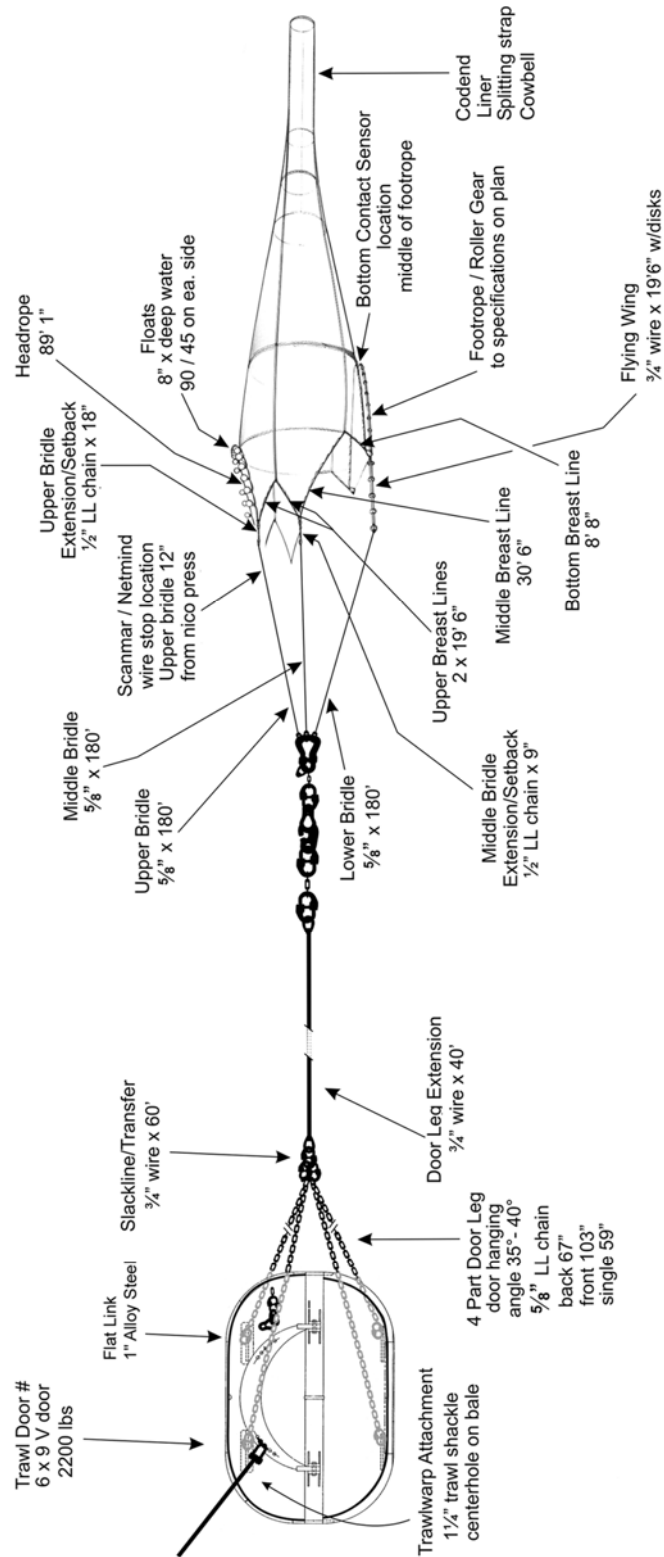
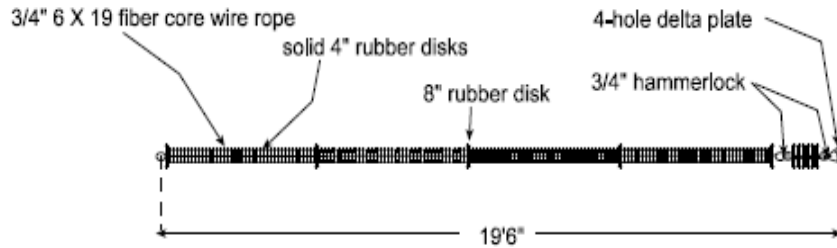
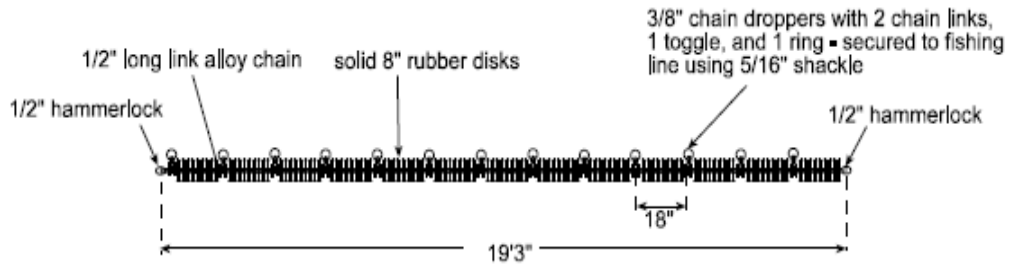

Figure 2A. - - Diagram of the Poly Nor'eastern high-rise opening bottom trawl net used during the 2008 EBSS survey. Diagram includes a general schematic of the trawl doors, rigging and trawl configuration.

Outboard section



Middle section



Inboard section

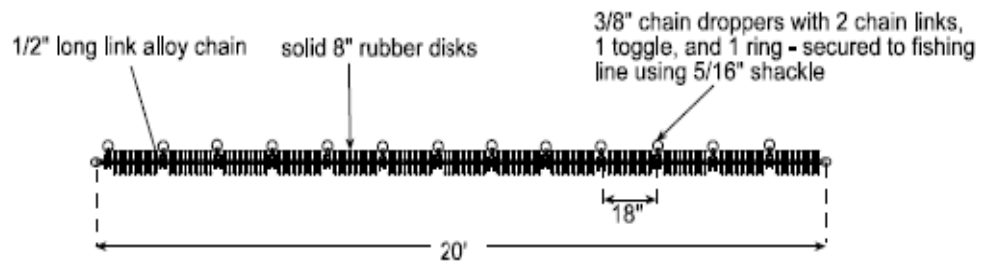

Figure 2B. - - Detailed diagram of the ground sections of the Poly Nor² eastern net used during the 2008 EBSS survey.

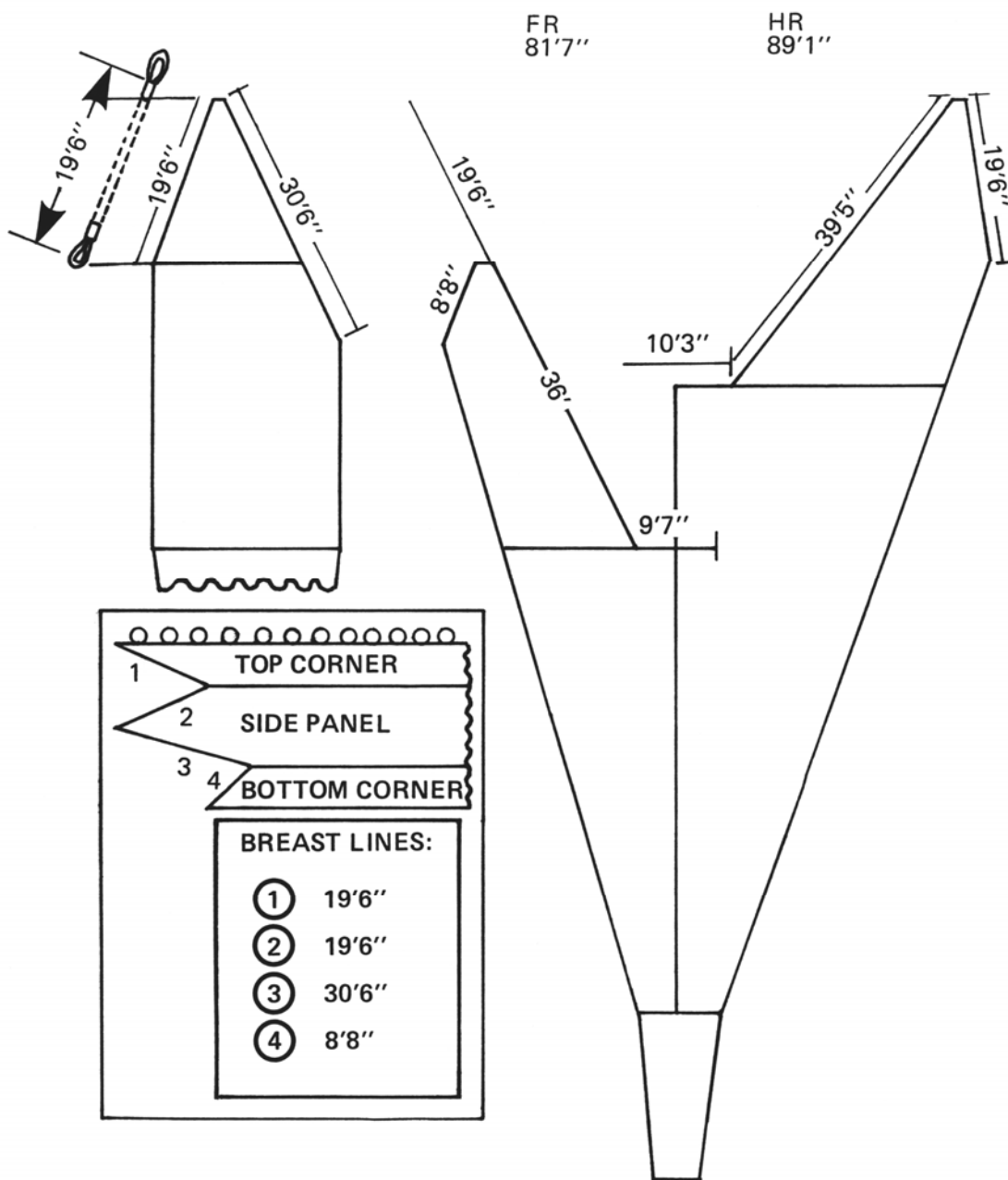

Figure 2C. - - Detailed diagram and dimensions of the Poly Nor'easter net used during the 2008 EBSS survey.

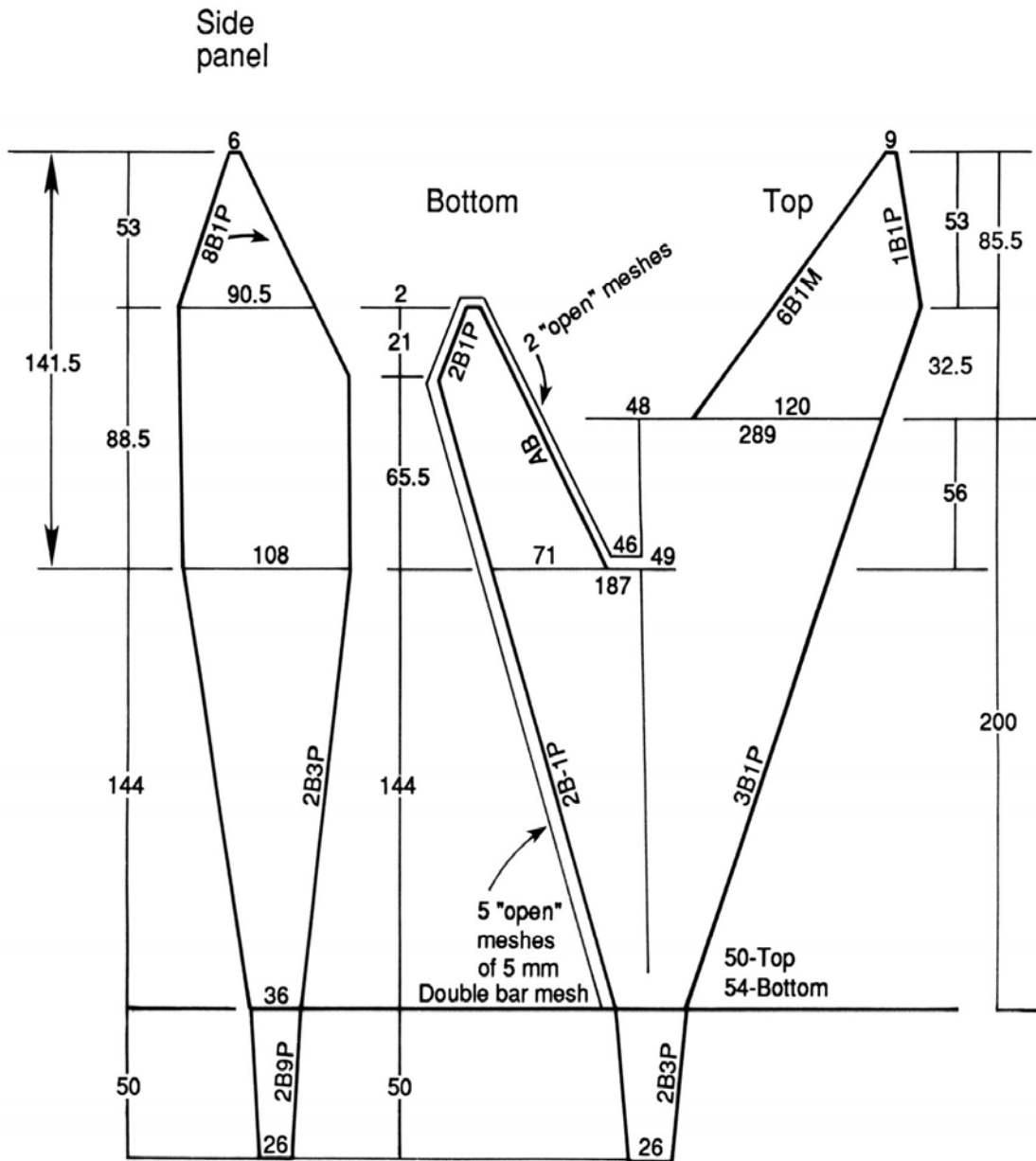

Figure 2D. - - Detailed diagram and dimensions of the Poly Nor' eastern net used during the 2008 EBSS survey.

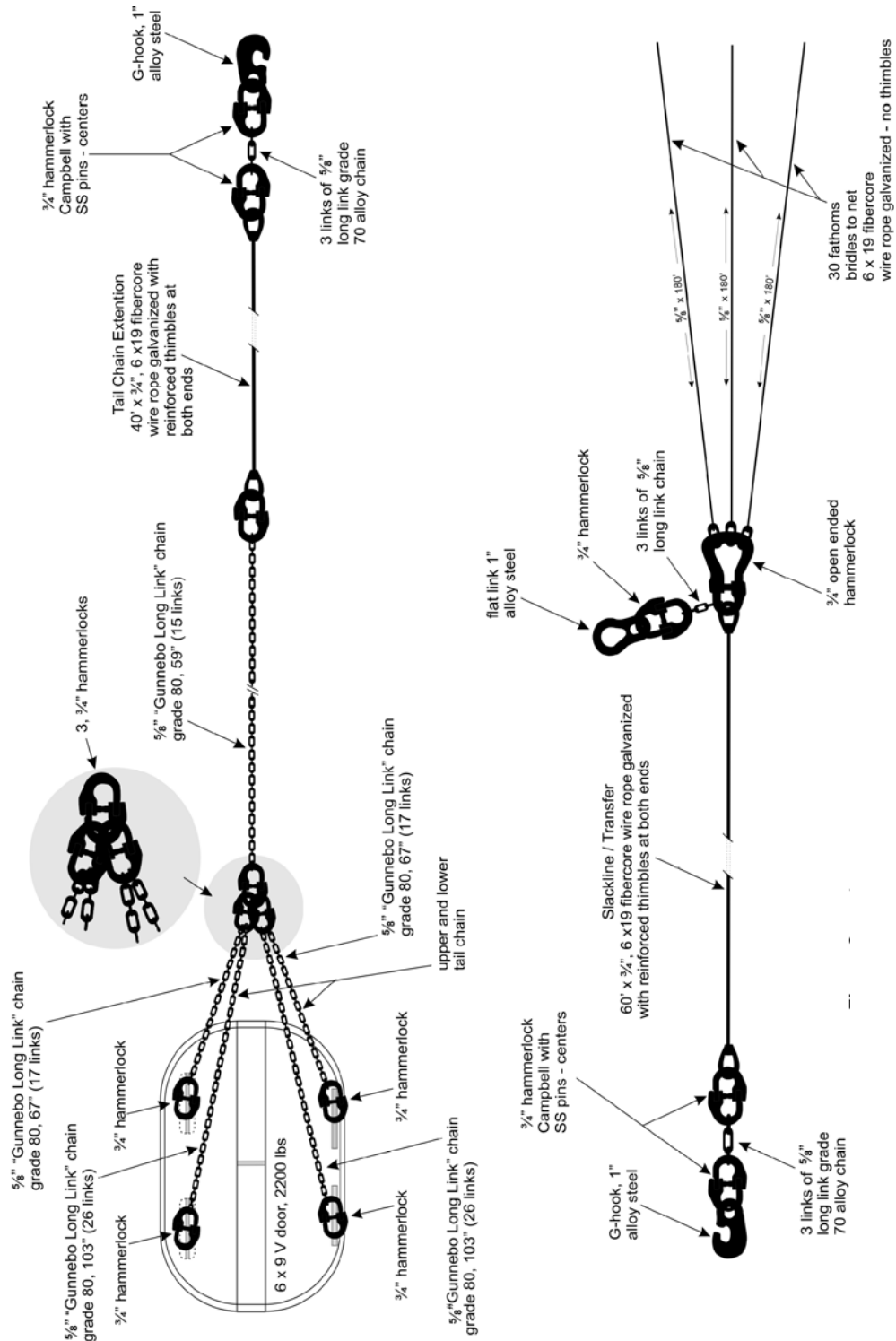

Figure 2E. - - Detailed diagram of the door rigging tail chain, slackline and bridle configuration of the Poly Nor'easter net used during the 2008 EBSS survey.



Figure 2F. - - Photo of the bottom contact sensor and its attachment configuration to the ground gear used during the 2008 EBSS survey.

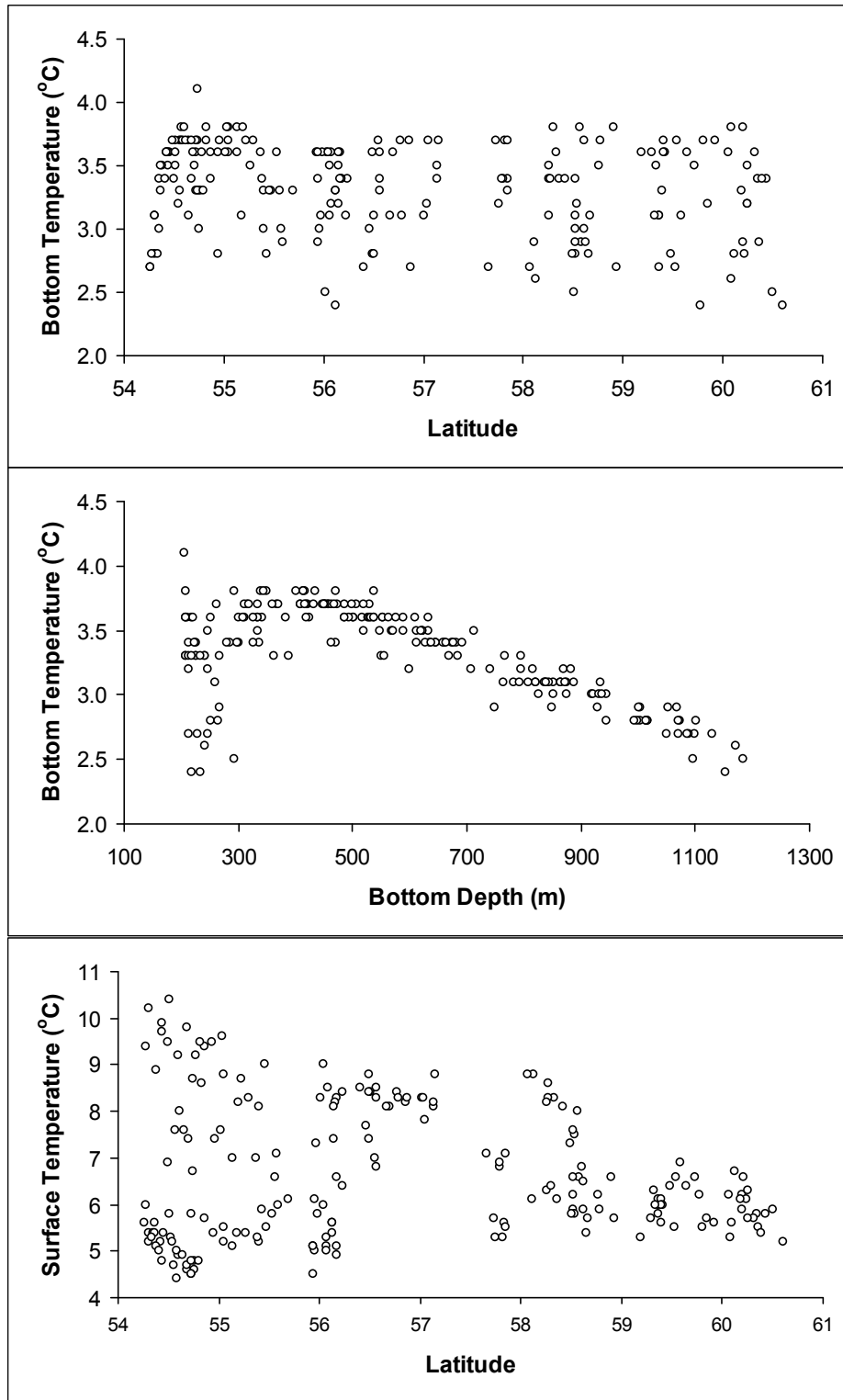

Figure 3. - - Relationship between temperatures, latitude, and bottom depth collected from trawl stations during the 2008 EBSS survey.

Table 1. - - Sampling effort and density for each subarea and depth stratum completed during the 2008 EBSS survey.

Subarea	Depth Stratum (m)	Area Estimate (km²)	Effort Target (%)	Hauls Completed (n)	Effort Achieved (%)	Sampling Density (km²/haul)
1	200-400	4012.41	12.26	25	12.50	160.50
	400-600	4062.77	12.42	25	12.50	162.51
	600-800	1741.66	5.32	11	5.50	158.33
	800-1000	1354.74	4.14	8	4.00	169.34
	1000-1200	1106.89	3.38	7	3.50	158.13
2	200-400	1157.64	3.54	7	3.50	165.38
	400-600	705.08	2.15	4	2.00	176.27
	600-800	591.27	1.81	4	2.00	147.82
	800-1000	552.73	1.69	4	2.00	138.18
	1000-1200	535.67	1.64	3	1.50	178.56
3	200-400	903.78	2.76	6	3.00	150.63
	400-600	886.11	2.71	6	3.00	147.68
	600-800	910.26	2.78	6	3.00	151.71
	800-1000	732.35	2.24	7	3.50	104.62
	1000-1200	675.52	2.06	2	1.00	337.76
4	200-400	1236.27	3.78	7	3.50	176.61
	400-600	730.35	2.23	5	2.50	146.07
	600-800	693.95	2.12	4	2.00	173.49
	800-1000	707.59	2.16	4	2.00	176.90
	1000-1200	662.42	2.02	4	2.00	165.60
5	200-400	423.71	1.29	2	1.00	211.86
	400-600	425.73	1.30	3	1.50	141.91
	600-800	431.83	1.32	2	1.00	215.91
	800-1000	551.99	1.69	3	1.50	184.00
	1000-1200	570.14	1.74	3	1.50	190.05
6	200-400	2595.79	7.93	16	8.00	162.24
	400-600	1705.76	5.21	10	5.00	170.58
	600-800	917.49	2.80	5	2.50	183.50
	800-1000	645.17	1.97	4	2.00	161.29
	1000-1200	496.42	1.52	3	1.50	165.47
Totals	200-1200	32723.49	100	200	100.00	mean 171.10

Table 2. - - Survey schedule, research staff and their affiliation during the 2008 EBSS survey of fish and invertebrate resources.

Name	Title	Affiliation
<u>Leg 1: May 29–June 19</u>		
Gerald R. Hoff	Chief Scientist	AFSC, Seattle
Chris Rooper	Fishery Biologist	AFSC, Seattle
Lyle Britt	Fishery Biologist	AFSC, Seattle
Ned Laman	Fishery Biologist	AFSC, Seattle
John Brogan	Fishery Biologist	AFSC, Seattle
Alison Deary	Fishery Biologist	NOAA Intern
<u>Leg 2: June 19–July 18</u>		
Gerald R. Hoff	Chief Scientist	AFSC, Seattle
James W. Orr	Fishery Biologist	AFSC, Seattle
David Somerton	Fishery Biologist	AFSC, Seattle
Elaina Jorgensen	Fishery Biologist	AFSC, Seattle
Richard Hibpshman	Feeding Ecologist	AFSC, Seattle
Delsa Anderl	Fishery Biologist	AFSC, Seattle
<u>Leg 3: July 18–August 11</u>		
Stan Kotwicki	Chief Scientist	AFSC, Seattle
Duane Stevenson	Fishery Biologist	AFSC, Seattle
Alison Vijgen	Fishery Biologist	AFSC, Seattle
Beth Matta	Fishery Biologist	AFSC, Seattle
Richard Hibpshman	Feeding Ecologist	AFSC, Seattle
Amelia Whitcomb	Fishery Biologist	NOAA Intern

For further information, contact: Russ Nelson, Director, Resource Assessment and Conservation Engineering Division, Alaska Fisheries Science Center, 7600 Sand Point Way NE, Bldg. 4, Seattle, WA, 98115

RESULTS

Haul, Catch, and Biological Data

During the 2008 EBSS survey, 200 tows were completed successfully and were used for abundance estimates (Fig. 1). Seven tows were considered unsatisfactory in meeting survey standards and were recorded but in most cases the location was resampled to obtain a successful tow at that station (see Appendix 1).

The EBSS survey sampling was designed to distribute trawling effort in proportion to the total area (km²) of each stratum. A comparison of the planned total effort distribution by stratum to that actually achieved shown in Table 1. In general, sampling effort in the deepest strata (1,000-1,200 m) were under-represented due to the difficulty in finding trawlable grounds. Shallow strata more commonly received the prescribed sampling density, where on average each a tow represented 162 km² of area. The Haul Log (Appendix A) details date, exact location, depth of all hauls attempted, net parameters during the tow, environmental conditions, and individual species or species group total haul weights for all hauls attempted.

Bottom temperatures recorded during the survey ranged from 2.4 °C to 4.1 °C and were correlated with depth below approximately 400 m. Between 200 and 400 m, bottom temperature was highly variable and showed no direct relationship with depth (Fig. 3). Surface temperatures ranged from 4.4 °C to 10.4 °C and both surface and bottom temperatures showed no relationship with latitude.

Approximately 137 fish species and 251 invertebrate species were identified during the 2008 EBSS survey. The actual number of species encountered may be slightly higher or lower given inadequate field identification characteristics for some species. Tables 5A and 5B list all

species of fishes and invertebrates encountered and identified on the 2008 EBSS survey alphabetized by common name or scientific name, respectively.

Overall giant grenadier (*Albatrossia pectoralis*) represented the largest estimated biomass on the 2008 EBSS survey followed by Pacific ocean perch, and arrowtooth flounder (*Atheresthes stomias*). Numerically the most abundant fish species was the popeye grenadier (*Coryphaenoides cinereus*). The cloud sponge (*Rhabdocalyptus* species) had the largest estimated biomass for invertebrates and the notched brittle star (*Ophiura sarsi*) was the most numerous. Table 6 lists all the species encountered during the survey in descending order of total weight, with additional details on the depth distribution and the frequency of occurrence for each species. Table 7 (lengths, weights, otoliths, stomachs) and Table 8 (voucher specimens) detail the species and numbers of biological data collected for each species.

Population, biomass, and CPUE estimates and variance of the estimates were calculated for every species encountered on the 2008 EBSS survey. Table 9 lists the abundance estimates (population and biomass) for every species encountered. The estimates are reported by: shallow strata (200-600 m), deep strata (600-1,200 m), and all strata combined.

Distributions, length frequencies, and abundance estimates

Abundance estimates, population size estimates, CPUE distribution plots, and estimates of population length frequencies are presented in Tables 10-52 and Figures 5-89 for the 43 most abundant and commercially important fish and invertebrates species. Abundance estimates were calculated for each subarea and each 200 m strata within each subarea, and all subareas and strata combined. CPUE distribution plots represent the abundance of the species for each haul. Fishes are presented in phylogenetic order (Nelson 1994).

Table 3. - - Details of sampling and data recording gear used during the 2008 EBSS survey.

NET & MENSURATION GEAR	DATA TYPE/FUNCTION	MODEL/VERSION/SERIAL #
Poly Nor'Eastern trawl	research sampling tool	Net #4 Hauls 1-47; Net #24 Hauls 48-53, 70-71, 74-103; Net#15 Hauls 54-69, 72-73, 148-176, 179-207; Net #16 Hauls 104-147, 177-178
Doors	spread the net	Doors # 885 Hauls 1-207
Vessel skipper and trawl master	conduct trawling operations	Tim Cosgrove-hauls 1-59; Kenneth Sjong-hauls 60-207
Scanmar height sensor	measure net height	Model HC4-HT60 Serial #'s T254C5, T1340C5
Scanmar slave spread sensor	measure net spread	Model MTR serial # 2851, 110, 4190
Scanmar master spread sensor	measure net spread	Model HC4 serial # 2495, A2621, A3654
Scanmar receiver cabinets	receive spread and height signal	Model 4002 C2 RSST946
Scanmar hydrophone	receive spread and height signal	Serial #'s 140, 166, 207
Scanmar program	records data input from net mensuration gear	AFSC (menu) version 5.71 Bxcrpro-3.51, Convert-4.0, Haulpos-8.0, Haultime-6.82, Scangraf-3.54, Scanplot-11.74, SBELob-1.8, Setclock-3.22, Speedplot-2.41
Vessel depth sounder	record depth soundings	Simrad ES60 software 1.5.2.77 1998
Furuno GPS	determine latitude and longitude	
SeaBird SBE-39 V1.8	depth and water temperature	Serial # 258, 854
ONSET computers optic shuttles	download bottom contact sensor	Serial #'s DTA-128B 26518
ONSET computers optic base stations	download bottom contact sensor	Serial #'s DSA-69617, DSA-714277
Bottom contact sensor (tilt sensors)	record footrope bottom contact	Serial # 320625, 224608
Olympic wire counter	measure trawl cable	Olympic wire counter 750-N cable meter #500
CATCH PROCESSING	DATA TYPE/FUNCTION	MODEL/VERSION/SERIAL #
Marel basket scale	weigh baskets of catch	Model 1100 Type U-2
Marel specimen scale	weigh individual specimens	Model 2000 Type M60
Measurement Systems International (MSI) load cell	weigh cod end with catch	Model 4300
Catch data entry program	onboard catch database	Written in Access 2003 AFSC version no. 20070522
Juniper systems LS 600 Polycorder	record fish length data	Serial #'s 3258, P60-5473, P60-5396, 637-5904
Dell computer	data recording	Optiplex 745 Windows v 5.1
Laser printers	produce hard copy of data	HP Laserjet 1012
Digital camera	photograph specimens	Pentax 4.3v 7.1 megapixel OPTIO W30
Federal Scientific Research Permit	allows research sampling	SRP # 2008-12
State of Alaska Research Permit	allows research sampling	CF-08-014
SPECIES IDENTIFICATION GUIDES		
Clark, R.N. 2006. <i>Field Guide to the Benthic Marine Invertebrates of Alaska's Shelf and Upper Slope</i> unpublished manuscript.		
Kessler, D. 2002. <i>A Working Field Guide to Trawl Caught Animals</i> unpublished manuscript.		
Mecklenburg, C.W., T. A. Mecklenburg, & L. K. Thorsteinson 2002. <i>Fishes of Alaska</i> American Fisheries Society. 1037 pp.		
Orr, J.W., M.A. Brown & D. Baker 2000. <i>Guide to Rockfishes (Scorpaenidae) of the Genera Sebastes, Sebastolobus, and Adelosebastes of the Northeast Pacific Ocean</i> , 2nd Edition NOAA Tech. Memo. NMFS-AFSC-117 47 pp.		
Stevenson, D.E., J. W. Orr, G. R. Hoff & J. D. McEachran 2007. <i>Field Guide to Sharks, Skates, and Ratfish of Alaska</i> Alaska Sea Grant College Program. University of Alaska Fairbanks. 77 pp.		

Table 4. - - Projects and collections completed or attempted during the 2008 EBSS survey.

Project Title	Project Description	Investigator (s) and Affiliation	Data/Samples Collected
Age structures for mission critical species	Collection of otoliths from selected fish species for current stock assessment models	Anne Hollowed (AFSC)	see Table 7 for details on otolith collection numbers
Age structures for giant grenadier	Collection of otoliths from giant grenadiers for future stock assessment models	Dave Clausen (AFSC)	see Table 7 for details on otolith collection numbers
Age structures for non-commercial species	Collection of otoliths from a selected group of fishes for future stock assessment models	Gerald Hoff (AFSC)	see Table 7 for details on otolith collection numbers
Biological data on crab	Collection of carapace size, weight, and shell condition on selected crab species	Robert Foy (AFSC-Kodiak), Jan Haaga (AFSC-Kodiak)	see Table 7 for details on species, length and weight collection numbers. Shell conditions were also recorded
Giant grenadier C-14	Collection of otoliths from largest giant grenadiers for C-14 age validation study	Charles Hutchinson, Delsa Anderl, Dan Kimura (AFSC)	39 otolith pairs collected from female giant grenadiers >44 cm PAFL
Light profiles	Collection of light profiles with light meter on the bottom trawl to determine influence of light on pollock distribution	Stan Kotwicki (AFSC)	Light, depth, temperature, salinity profiles were collected for the complete water column for 207 bottom trawls
Shortraker rockfish tissues	Collection of tissue samples of shortraker rockfish in conjunction with otolith collections for population genetic study	Tony Gharret (UAF), Paul Spencer (AFSC)	400 tissue samples collected from throughout the EBS slope region
Habitat production for POP	Collection of juvenile Pacific ocean perch from two habitats in the Island of Four Mts. in late May and early August	Chris Rooper (AFSC)	Successful trawls were completed in late May and early August and approximately 256 juvenile POP were collected frozen during each sampling period and 7 successful camera transects were completed
Rockfish habitat-Zhemchug	Collection of ES60-hydroacoustic data and video on two unique rocky ridges in the southern arm of Zhemchug Canyon	Gerald Hoff, Chris Rooper (AFSC)	ES60 data were collected from transects conducted during daylight and dark periods and 15 video transects were conducted collecting habitat association data
Shark life history	Collect life history information on sleeper and salmon sharks including gonad, stomachs, lengths and tagging, eye tissue, vertebrate	Robert Foy (AFSC-Kodiak), Gerald Hoff (AFSC)	Spaghetti tags ($n=31$) were deployed and tissue samples ($n=26$) collected from sleeper sharks
Alaska skate tagging	Spaghetti tagging and release of all Alaska skates. Record sex, length, weight and tag number	Olav Ormseth, Gerald Hoff (AFSC)	131 Alaska skates were tagged and released across the survey area

Table 4. - - Continued.

		Investigator (s) and Affiliation	
Project Title	Project Description	Investigator (s)	Data/Samples Collected
Skate eggs & juvenile data	Retain and preserve all specified skate egg cases encountered. Measure all juvenile skates (<300 mm TL) disc width, total length and filament length	Gerald Hoff (AFSC)	173 juvenile skates were measured and egg cases were collected identified to <i>B. trachura</i> (n = 116), <i>B. minispinosa</i> (n = 23), <i>B. lindbergi/maculata</i> (n = 16), <i>B. taranetzi</i> (n = 14), <i>B. abyssicola</i> (n = 7), and <i>Bathyraja</i> species (n = 4)
Octopus data collection	Collection of mantle lengths and sex on all octopus species	Liz Conners (AFSC)	Mantle lengths and sex were taken on approximately 214 octopus. The dominant species were <i>Benthoctopus leioderma</i> (n = 78), <i>B. salebrosus</i> (n = 63), <i>Octopus dofleini</i> (n = 57)
Squid data collection	Collection of mantle lengths on all squid species	Olav Ormseth (AFSC)	Mantle lengths were collected on approximately 1260 squid with the dominant species being <i>Beryteuthis magister</i> (n = 1092) and <i>Gonatopsis borealis</i> (n = 122)
Snailfish taxonomy & food habits	Collection of tissue samples, specimens, and stomachs of selected snailfish species	Jay Orr (AFSC)	>100 specimens of 26 species of snailfish were collected
Outreach/fishermans festival	Collection of selected fish and invertebrate specimens used for public outreach and teaching and display at Fishermans festival	Jason Connor (AFSC)	2 specimens each of a variety of commercial and unusual fish and invertebrate species were frozen
Ocular muscle of deep-sea fishes	Collection of intact eyes of selected deepsea fishes for a study on the development and neurophysiology of the optic nerve	Christina Wahl (Wells College), Lyle Britt (AFSC)	5 specimens each were collected and preserved in 10% formalin of <i>Bathylagus milleri</i> , <i>B. pacificus</i> , <i>B. ochotensis</i> , and <i>Leuroglossus schmidti</i>
DNA barcoding of Alaska fishes	Collection of selected fish species from Alaska for genetic barcoding project	Mike Canino (AFSC), Linda Parks (NWFSC)	5 specimens each were collected (frozen) of <i>Coryphaenoides acrolepis</i> , <i>Sebastes borealis</i> , <i>Sebastes aleutianus</i> , <i>Sebastes melanostictus</i>
Sightings of short-tail Albatross	Report sightings of endangered short-tail Albatross including time, location and maturity	Shannon Fitzgerald (AFSC), Greg Balogh (USFWS)	7 sightings of short-tail albatross were reported
Trophic interactions & feeding ecology	Collections of stomach contents of selected fish species and preserved at sea for later analysis	Kerim Aydin, Troy Buckley (AFSC)	see Table 7 for numbers by species of stomach samples that were collected during the survey
Gadoid liver seasonal energy reserves	Collections of selected gadoid fishes to be frozen for later liver energy reserve analysis	Troy Buckley, Olav Ormseth (AFSC)	<i>Albatrossia pectoralis</i> (n = 59, 28 female, 31 male) <i>Gadus macrocephalus</i> (n = 29, 12 female, 17 male) <i>Theragra chalcogramma</i> (n = 41, 21 female, 20 male) <i>Leuroglossus schmidti</i> (n = 190), <i>Stenobrachius leucopsarus</i>
Energy content & diet of EBS slope forage fishes	Collections of selected forage fish for later examination of energy content and diet analysis	Kerim Aydin, Troy Buckley, Anne Hollowed, Ron Heintz (AFSC)	(n = 170), <i>Stenobrachius</i> sp. (n = 46), <i>Thaleichthys pacificus</i> (n = 52), <i>Diaphus theta</i> (n = 2), <i>Bathylagus</i> sp. (n = 87), Myctophidae (n = 40), <i>Lampanyctus jordani</i> (n = 1), <i>Nanobrachius regale</i> (n = 4), <i>Stenobrachius nanochir</i> (n = 7)

Table 5A. - - Alphabetical list by common name of all fish and invertebrates encountered on the 2008 EBSS survey.

Common Name	Species/Taxon
Alaska eelpout	<i>Bothrocara pusillum</i>
Alaska skate	<i>Bathyraja parmifera</i>
Alaska skate egg case	<i>Bathyraja parmifera</i> egg case
Alaska snailfish	<i>Careproctus colletti</i>
Alaska volute	<i>Arctomelon stearnsii</i>
Alaskan hermit	<i>Pagurus ochotensis</i>
Alaskan pink shrimp	<i>Pandalus eous</i>
Aleutian alligatorfish	<i>Aspidophoroides bartoni</i>
Aleutian skate	<i>Bathyraja aleutica</i>
Aleutian skate egg case	<i>Bathyraja aleutica</i> egg case
Arctic argid	<i>Argis dentata</i>
argid shrimp species	<i>Argis</i> species
arrowtooth flounder	<i>Atheresthes stomias</i>
articulated bamboo coral	<i>Isidella</i> species
Atka mackerel	<i>Pleurogrammus monopterygius</i>
bamboo coral species	Isididae unid.
barracudina species	Paralepididae
barrel sponge	<i>Halichondria panicea</i>
barreleye	<i>Macropinna microstoma</i>
basketstar	<i>Gorgonocephalus eucnemis</i>
Bering eelpout	<i>Lycodes beringi</i>
Bering skate	<i>Bathyraja interrupta</i>
Bering skate egg case	<i>Bathyraja interrupta</i> egg case
Berry armhook squid	<i>Gonatus berryi</i>
bigeye smooth head	<i>Bajacalifornia megalops</i>
bigmouth sculpin	<i>Hemitripterus bolini</i>
blackfin poacher	<i>Bathyagonus nigripinnis</i>
blackfin snailfish	<i>Careproctus cypselurus</i>
blackline snipe eel	<i>Avocettina infans</i>
blacklip snailfish	<i>Elassodiscus tremebundus</i>
blacknose sculpin	<i>Icelus canaliculatus</i>
blacksmelt species	<i>Bathylagus</i> species
blackspined sea star	<i>Lethasterias nanimensis</i>
blackspotted rockfish	<i>Sebastes melanostictus</i>
blacktail snailfish	<i>Careproctus melanurus</i>
blob sculpin	<i>Psychrolutes phrictus</i>
blotched snailfish	<i>Crystallichthys cyclospilus</i>
boreal astarte	<i>Astarte borealis</i>
boreopacific armhook squid	<i>Gonatopsis borealis</i>
Bowers Bank snailfish	<i>Careproctus bowersianus</i>
brisingid sea star	Brisingidae
bristlemouth species	Gonostomatidae
brittle star species	<i>Astrochele laevis</i>
brittle star species	<i>Stegophiura ponderosa</i>
brittle star species	<i>Ophiacantha normani</i>
brittle star species	<i>Ophiacantha</i> species
brittle star species	<i>Ophiopholis</i> species

Table 5A. -- Continued.

Common Name	Species/Taxon
broadfin snailfish	<i>Paraliparis pectoralis</i>
broadfin thornyhead	<i>Sebastolobus macrochir</i>
brokenline lampfish	<i>Lampanyctus jordani</i>
California headlightfish	<i>Diaphus theta</i>
California lamp shell	<i>Laqueus californianus</i>
cannonball sun star	<i>Heterozonias alternatus</i>
caridid shrimp unid.	Caridea unid.
chestnut whelk	<i>Buccinum castaneum</i>
chevron-tentacled anemone	<i>Cribrinopsis fernaldi</i>
chrysaora jellyfish	<i>Chrysaora melanaster</i>
chum salmon	<i>Oncorhynchus keta</i>
clam species	<i>Yoldia</i> species
clam species	<i>Clinocardium</i> species
clawed armhook squid	<i>Gonatus onyx</i>
clay pipe sponge	<i>Aphrocallistes vastus</i>
cloud sponge	<i>Rhabdocalyptus</i> species
comb jelly species	<i>Beroe</i> species
comic snailfish	<i>Careproctus comus</i>
Commander skate	<i>Bathyraja lindbergi</i>
Commander skate egg case	<i>Bathyraja lindbergi</i> egg case
common mud star	<i>Ctenodiscus crispatus</i>
common northern feather star	<i>Florometra asperrima</i>
coral species	<i>Lillipathes</i> species B (Clark, 2006)
coral species	<i>Swiftia beringi</i>
coral species	<i>Amphilaphis</i> species
costate whelk	<i>Buccinum costatum</i>
cowardly anemone	<i>Stomphia didemon</i>
crangonid shrimp species	<i>Crangon</i> species
crested bigscale	<i>Poromitra curilensis</i>
crested sea star	<i>Lophaster furcilliger</i>
crested star	<i>Lophaster vexator</i>
crimson pasiphaeid	<i>Pasiphaea tarda</i>
crusty tube sponge	<i>Heterochone tenerum</i>
darkfin sculpin	<i>Malacocottus zonurus</i>
deep sea papillate cucumber	<i>Pannychia moseleyi</i>
deepsea eualid	<i>Eualus biunguis</i>
deepsea skate	<i>Bathyraja abyssicola</i>
deepsea skate egg case	<i>Bathyraja abyssicola</i> egg case
deepsea sole	<i>Embassichthys bathybius</i>
deepwater bigeye	<i>Pandalopsis ampla</i>
Dover sole	<i>Microstomus pacificus</i>
dreamer species	<i>Oneirodes</i> species
Alaska dreamer	<i>Oneirodes thompsoni</i>
dusky rockfish	<i>Sebastes variabilis</i>
eastern Pacific bobtail	<i>Rossia pacifica</i>
ebony eelpout	<i>Lycodes concolor</i>
echiuroid worm species	Echiura
eelpout species	<i>Lycenchelys</i> species
eelpout species	<i>Lycodes</i> species
eelpout species	<i>Bothrocara</i> species
eelpout species	<i>Lycodapus</i> species
egg yolk jelly	<i>Phacellophora camtschatica</i>
emarginate snailfish	<i>Careproctus furcellus</i>

Table 5A. -- Continued.

Common Name	Species/Taxon
empty bivalve shells	Bivalvia
empty gastropod shells	Gastropoda
encrusting coral	<i>Clavularia incrustans</i>
eulachon	<i>Thaleichthys pacificus</i>
eualid shrimp species	<i>Eualus</i> species
euphausiid species	Euphausiacea
fat whelk	<i>Neptunea ventricosa</i>
fiery armhook squid	<i>Gonatus pyros</i>
firm finger sponge	<i>Plicatellopsis amphispicula</i>
fish eggs species	Osteichthyes eggs
Fisher sun star	<i>Solaster</i> species F (Clark)
flabby sculpin	<i>Zesticelus profundorum</i>
flapjack devilfish	<i>Opisthoteuthis californiana</i>
flathead sole	<i>Hippoglossoides elassodon</i>
fuzzy hermit crab	<i>Pagurus trigonocheirus</i>
garnet lampfish	<i>Stenobranchius nannochir</i>
giant barnacle	<i>Balanus evermanni</i>
giant grenadier	<i>Albatrossia pectoralis</i>
giant octopus	<i>Octopus dofleini</i>
giant orange tochi	<i>Tochuina tetraquetra</i>
giant red mysid	<i>Neognathophausia gigas</i>
gigantic anemone	<i>Metridium farcimen</i>
golden king crab	<i>Lithodes aequispinus</i>
graceful decorator crab	<i>Oregonia gracilis</i>
grand snailfish	<i>Paraliparis grandis</i>
grape anemone	<i>Oractis diomedea</i>
great sculpin	<i>Myoxocephalus polyacanthocephalus</i>
green papillate sponge	<i>Latrunclia</i> species A (Clark, 2006)
green sea urchin	<i>Strongylocentrotus droebachiensis</i>
Greenland turbot	<i>Reinhardtius hippoglossoides</i>
grenadier species	<i>Coryphaenoides</i> species
grooved sea star	<i>Crossaster borealis</i>
grooved Tanner crab	<i>Chionoecetes tanneri</i>
hairy-lure dreamer	<i>Oneirodes bulbosus</i>
hat sponge	<i>Phakellia beringensis</i>
heart urchin	<i>Brisaster latifrons</i>
hermit crab species	<i>Pagurus</i> species
hermit crab species	<i>Pagurus cornutus</i>
highsnout bigscale	<i>Melamphaes lugubris</i>
horsehair crab	<i>Erimacrus isenbeckii</i>
humpback snailfish	<i>Elassodiscus caudatus</i>
hybrid Tanner crab	<i>Chionoecetes</i> hybrid
hydroid species	Hydrozoa
jellyfish species	Scyphozoa
jellyfish species	<i>Periphylla periphylla</i>
jellyfish species	<i>Aequorea</i> species
jellyfish species	<i>Atolla</i> species
Kamchatka coral	<i>Paragorgia arborea</i>
Kamchatka eelpout	<i>Lycenchelys camchatica</i>
Kamchatka flounder	<i>Atheresthes evermanni</i>
keeled aforia	<i>Aforia circinata</i>
king crab species	<i>Paralomis verrilli</i>
king crab species	<i>Paralomis</i> species A (Clark, 2006)

Table 5A. -- Continued.

Common Name	Species/Taxon
king crab species	<i>Paralomis multispina</i>
knobbyhand hermit	<i>Pagurus confragosus</i>
kuro argid	<i>Argis lar</i>
ladder whelk	<i>Buccinum scalariforme</i>
lamellarid	Lamellaridae
lampfish species	<i>Stenobranchius</i> species
lampfish species	<i>Lampanyctus</i> species
lanternfish species	Myctophidae
lebbeid shrimp species	<i>Lebbeus</i> species
lion's mane	<i>Cyanea capillata</i>
longfin dragonfish	<i>Tactostoma macropus</i>
longhorned decorator crab	<i>Chorilia longipes</i>
longnose lancetfish	<i>Alepisaurus ferox</i>
longnose skate	<i>Raja rhina</i>
longsnout prickleback	<i>Lumpenella longirostris</i>
lyre whelk	<i>Neptunea lyrata</i>
magistrate armhook squid	<i>Berryteuthis magister</i>
mollusc species	<i>Neomenia</i> species
mud skate	<i>Bathyraja taranetzi</i>
mud skate egg case	<i>Bathyraja taranetzi</i> egg case
Murray sea pen	<i>Anthoptilum murrayi</i>
mysid shrimp species	<i>Neognathophausia</i> species
mysid species	Mysidacea
northern horsemussel	<i>Modiolus modiolus</i>
northern lampfish	<i>Stenobranchius leucopsarus</i>
northern pearleye	<i>Benthalbella dentata</i>
northern rock sole	<i>Lepidopsetta polyxystra</i>
northern rockfish	<i>Sebastes polyspinis</i>
northern sea star	<i>Dipsacaster borealis</i>
northern smoothtongue	<i>Leuroglossus schmidtii</i>
northern sun sea star	<i>Solaster endeca</i>
notched brittlestar	<i>Ophiura sarsi</i>
nudibranch species	Nudibranchia
nudibranch species	<i>Tritonia</i> species
ocean shrimp	<i>Pandalus jordani</i>
octopus species	<i>Octopus</i> species
octopus species	<i>Japatella diaphana</i>
octopus species	<i>Graneledone</i> species cf. <i>boreopacifica</i> (Nesis)
octopus species	<i>Benthoctopus</i> species
octopus species	<i>Benthoctopus salebrosus</i>
octopus species	<i>Benthoctopus oregonensis</i>
orange actinistolid	<i>Sycionis</i> species A (Clark, 2006)
orange-pink sea urchin	<i>Allocentrotus fragilis</i>
Oregon triton	<i>Fusitriton oregonensis</i>
Oregon triton eggs	<i>Fusitriton oregonensis</i> eggs
Pacific ambereye	<i>Hymenodora frontalis</i>
Pacific blacksmelt	<i>Bathylagus pacificus</i>
Pacific cod	<i>Gadus macrocephalus</i>
Pacific colga	<i>Colga pacifica</i>
Pacific flatnose	<i>Antimora microlepis</i>
Pacific glass shrimp	<i>Pasiphaea pacifica</i>
Pacific grenadier	<i>Coryphaenoides acrolepis</i>
Pacific halibut	<i>Hippoglossus stenolepis</i>

Table 5A. -- Continued.

Common Name	Species/Taxon
Pacific herring	<i>Clupea pallasii</i>
Pacific lamprey	<i>Lampetra tridentata</i>
Pacific lyre crab	<i>Hyas lyratus</i>
Pacific ocean perch	<i>Sebastes alutus</i>
Pacific sergestid	<i>Sergestes similis</i>
Pacific sleeper shark	<i>Somniosus pacificus</i>
Pacific viperfish	<i>Chauliodus macouni</i>
pale moonsnail	<i>Euspira pallidus</i>
pasiphaeid shrimp species	Pasiphaeidae
pinchbug	<i>Munida quadrispina</i>
pincushion sea star	<i>Diplopteraster multipes</i>
pink rose star	<i>Crossaster</i> species B (Clark)
pink salmon	<i>Oncorhynchus gorbuscha</i>
pinpoint lampfish	<i>Nannobranchium regale</i>
polychaete worm species	Polychaeta
popeye blacksmelt	<i>Bathylagus ochotensis</i>
popeye grenadier	<i>Coryphaenoides cinereus</i>
Pribilof whelk	<i>Neptunea pribiloffensis</i>
prickleback species	<i>Bryozoichthys</i> species
proboscis snailfish	<i>Careproctus simus</i>
prowfish	<i>Zaprora silenus</i>
purple hermit	<i>Elassochirus cavimanus</i>
purple striated sea anemone	Actiniaria
pygmy snailfish	<i>Lipariscus nanus</i>
ragfish	<i>Icosteus aenigmaticus</i>
red snailfish	<i>Paraliparis dactylosus</i>
red striated sea anemone	Actiniaria
red tree coral	<i>Primnoa willeyi</i>
redbanded rockfish	<i>Sebastes babcocki</i>
reticulate anemone	<i>Actinauge verrillii</i>
rex sole	<i>Glyptocephalus zachirus</i>
ribbed bryozoan	<i>Rhamphostomella costata</i>
robust blacksmelt	<i>Bathylagus milleri</i>
Roger's buccinid	<i>Bathybuccinum clarki</i>
rose sea star	<i>Crossaster papposus</i>
rosy tritonia	<i>Tritonia diomedea</i>
rough China hat sponge	<i>Neoesperiopsis infundibula</i>
rough purple sea anemone	<i>Paractinostola faeculenta</i>
rougeye rockfish	<i>Sebastes aleutianus</i>
rougetail skate	<i>Bathyraja trachura</i>
rougetail skate egg case	<i>Bathyraja trachura</i> egg case
rusty snailfish	<i>Paraliparis</i> species cf. <i>pectoralis</i>
sablefish	<i>Anoplopoma fimbria</i>
salmon snailfish	<i>Careproctus rastrinus</i>
salp species	Thaliacea
sandy sea cucumber	<i>Pseudostichopus mollis</i>
sawback poacher	<i>Leptagonus frenatus</i>
scallop species	<i>Chlamys</i> species
scarlet king crab	<i>Lithodes couesi</i>
scarlet sea star	<i>Pseudarchaster parelii</i>
sea anemone species	Actiniaria
sea anemone species	Actinostolidae
sea anemone species	<i>Actinoscyphia</i> species

Table 5A. -- Continued.

Common Name	Species/Taxon
sea anemone species	<i>Corallimorphus</i> species
sea anemone species	<i>Stomphia</i> species
sea anemone species	<i>Actinistola</i> species A (Clark, 2006)
sea cucumber species	Holothuroidea
sea cucumber species	Cucumaria
sea cucumber species	<i>Bathyplores</i> species
sea cucumber species	<i>Synallactes</i> species A (Clark, 2006)
sea cucumber species	<i>Synallactes</i> species
sea mouse species	<i>Aphrodita</i> species
sea spider species	Pycnogonida
sea star species	<i>Stephanasterias albula</i>
sea star species	<i>Henricia</i> species
sea star species	<i>Henricia asthenactis</i>
sea star species	<i>Hippasteria</i> species
sea star species	<i>Hippasteria californica</i>
sea star species	<i>Cryptopeltaster lepidonotus</i>
sea star species	<i>Mediaster tenellus</i>
sea star species	<i>Ceramaster</i> species
sea star species	<i>Solaster</i> species
sea star species	<i>Solaster</i> species A (Clark, 1997)
sea star species	<i>Crossaster</i> species
sea star species	<i>Pteraster</i> species
sea star species	<i>Pteraster</i> species A (Clark, 1999)
sea star species	<i>Pteraster tessellatus</i>
sea star species	<i>Pteraster jordani</i>
sea star species	<i>Leptychaster pacificus</i>
sea star species	<i>Nearchaster variabilis</i>
sea star species	<i>Nearchaster</i> species
sea star species	<i>Zoraster evermanni</i>
sea star species	<i>Myxoderma sacculatum</i>
sea urchin species	<i>Strongylocentrotus</i> species
sea whip species	Virgularidae
sea whip species	<i>Halipteris willemoesi</i>
searcher	<i>Bathymaster signatus</i>
serpent sea star	<i>Asteronyx loveni</i>
shadow eelpout	<i>Bothrocara nyx</i>
shining tubeshoulder	<i>Sagamichthys abei</i>
shortraker rockfish	<i>Sebastes borealis</i>
shortspine thornyhead	<i>Sebastolobus alascanus</i>
shrimp species	Shrimp species
shrimp species	<i>Anuropus bathypelagica</i>
shrimp species	<i>Pandalopsis longirostris</i>
shrimp species	<i>Notostomus</i> species
shrimp species	<i>Bentheogennema borealis</i>
sidestripe shrimp	<i>Pandalopsis dispar</i>
sinuous whelk	<i>Buccinum plectrum</i>
skate egg case species	<i>Bathyraja</i> species egg case
slender codling	<i>Halargyreus johnsonii</i>
slender fangjaw	<i>Sigmops gracilis</i>
slim snailfish	<i>Rhinoliparis attenuatus</i>
smalldisk snailfish	<i>Careproctus gilberti</i>
smooth lumpsucker	<i>Aptocyclus ventricosus</i>
smoothskin octopus	<i>Benthoctopus leioderma</i>

Table 5A. -- Continued.

Common Name	Species/Taxon
smoothstem seawhip	<i>Virgularia</i> species
snail egg species	gastropod eggs
snail egg species	<i>Buccinum</i> species eggs
snail egg species	<i>Neptunea</i> species eggs
snail eggs species	<i>Pyrulofusus</i> species eggs
snail species	<i>Neptunea</i> species
snail species	<i>Colus martensi</i>
snail species	<i>Colus jordani</i>
snail species	<i>Pyrulofusus</i> species
snail species	<i>Pyrulofusus melonis</i>
snail species	<i>Beringius frielei</i>
snail species	<i>Plicifusus kroyeri</i>
snail species	<i>Otukaia kiheiziebisu</i>
snail species	<i>Buccinum</i> species
snailfish species	Liparidinae
snailfish species	<i>Elassodiscus</i> species
snailfish species	<i>Careproctus</i> species
snailfish species	<i>Paraliparis ulochir</i>
snailfish species	<i>Careproctus</i> species G
snailfish species	<i>Paraliparis</i> species
snailfish species	<i>Paraliparis</i> species cf. <i>dactylosus</i>
snailfish species	<i>Paraliparis</i> species cf. <i>dipterus</i>
snakehead eelpout	<i>Lycenchelys crotalinus</i>
snow crab	<i>Chionoecetes opilio</i>
snubnosed spiny eel	<i>Notacanthus chemnitzii</i>
soft coral species	<i>Anthomastus</i> species
soft finger sponge	<i>Neoesperiopsis rigida</i>
spatulate sculpin	<i>Icelus spatula</i>
spectacled sculpin	<i>Triglops szepticus</i>
spider crab species	Majidae
spiny dogfish	<i>Squalus acanthias</i>
spiny lebbeid	<i>Lebbeus groenlandicus</i>
spiny red sea star	<i>Hippasteria spinosa</i>
spiny snailfish	<i>Acantholiparis opercularis</i>
spinyhead sculpin	<i>Dasycottus setiger</i>
spinyridge shrimp	<i>Notostomus japonicus</i>
splendid hermit	<i>Labidochirus splendescens</i>
sponge hermit	<i>Pagurus brandti</i>
sponge species	Porifera
sponge species	<i>Polymastia</i> species
sponge species	Yellow papillate sponge
squid species	Teuthoidea
squid species	<i>Gonatus</i> species
squid species	Gonatidae
squid species	<i>Eogonatus tinro</i>
squid species	<i>Galiteuthis phyllura</i>
squid species	<i>Chiroteuthis calyx</i>
squid species	<i>Taonius pavo</i>
stone crab species	Lithodidae
striped sea leech	<i>Notostombodella cyclostomum</i>
sweet sea potato	<i>Molpadia intermedia</i>
swellhead snailfish	<i>Paraliparis cephalus</i>
Swift's sea star	<i>Gephyreaster swifti</i>

Table 5A. -- Continued.

Common Name	Species/Taxon
swimming anemone	<i>Stomphia coccinea</i>
swollen whelk	<i>Buccinum oedematum</i>
tabled whelk	<i>Neptunea tabulata</i>
Tanner crab	<i>Chionoecetes bairdi</i>
tentacle-shedding anemone	<i>Liponema brevicornis</i>
thorny sculpin	<i>Icelus spiniger</i>
three-ribbed whelk	<i>Ancistrolepis eucosmius</i>
Townsend hermit crab	<i>Pagurus townsendi</i>
tree sponge	<i>Mycale loveni</i>
tree sponge species	<i>Mycale</i> species
triangle Tanner crab	<i>Chionoecetes angulatus</i>
tunicate species	Ascidian
twoline eelpout	<i>Bothrocara brunneum</i>
twospine crangon	<i>Crangon communis</i>
ubiquitous brittle star	<i>Ophiopholis aculeata</i>
Vancouver scallop	<i>Delectopecten vancouverensis</i>
vase sponge	<i>Aulosaccus schulzei</i>
vermilion sea star	<i>Mediaster aequalis</i>
walleye pollock	<i>Theragra chalcogramma</i>
warped whelk	<i>Pyrulofusus deformis</i>
western eelpout	<i>Bothrocara zestum</i>
white neptune	<i>Neptunea amianta</i>
white sea urchin	<i>Strongylocentrotus pallidus</i>
whiteblotched skate	<i>Bathyraja maculata</i>
whiteblotched skate egg case	<i>Bathyraja maculata</i> egg case
whitebrow skate	<i>Bathyraja minispinosa</i>
whitebrow skate egg case	<i>Bathyraja minispinosa</i> egg case
whitescaled sea cucumber	<i>Psolus squamatus</i>
wide-eye sculpin	<i>Icelus euryops</i>
worm species	<i>Serpula</i> species
wrinkled star	<i>Pteraster militaris</i>
yellow Irish lord	<i>Hemilepidotus jordani</i>
yellow leafy sponge	<i>Leucosolenia blanca</i>
yellowleg pandalid	<i>Pandalus tridens</i>

Table 5B. - - Alphabetical list by scientific name of all fish and invertebrates encountered on the 2008 EBSS survey.

Species/Taxon	Common Name
<i>Acantholiparis opercularis</i>	spiny snailfish
<i>Actinauge verrillii</i>	reticulate anemone
Actiniaria	purple striated sea anemone
Actiniaria	red striated sea anemone
Actiniaria	sea anemone species
<i>Actinistola</i> species A (Clark, 2006)	sea anemone species
<i>Actinoscyphia</i> species	sea anemone species
Actinostolidae	sea anemone species
<i>Aequorea</i> species	jellyfish species
<i>Aforia circinata</i>	keeled aforia
<i>Albatrossia pectoralis</i>	giant grenadier
<i>Alepisaurus ferox</i>	longnose lancetfish
<i>Allocentrotus fragilis</i>	orange-pink sea urchin
<i>Amphilaphis</i> species	coral species
<i>Ancistrolepis eucosmius</i>	three-ribbed whelk
<i>Anoplopoma fimbria</i>	sablefish
<i>Anthomastus</i> species	soft coral species
<i>Anthoptilum murrayi</i>	Murray sea pen
<i>Antimora microlepis</i>	Pacific flatnose
<i>Anuropus bathypelagica</i>	shrimp species
<i>Aphrocallistes vastus</i>	clay pipe sponge
<i>Aphrodita</i> species	sea mouse species
<i>Aptocyclus ventricosus</i>	smooth lumpsucker
<i>Arctomelon stearnsii</i>	Alaska volute
<i>Argis dentata</i>	Arctic argid
<i>Argis lar</i>	kuro argid
<i>Argis</i> species	argid shrimp species
Ascidian	tunicate species
<i>Aspidophoroides bartoni</i>	Aleutian alligatorfish
<i>Astarte borealis</i>	boreal astarte
<i>Asteronyx loveni</i>	serpent sea star
<i>Astrochele laevis</i>	brittle star species
<i>Atheresthes evermanni</i>	Kamchatka flounder
<i>Atheresthes stomias</i>	arrowtooth flounder
<i>Atolla</i> species	jellyfish species
<i>Aulosaccus schulzei</i>	vase sponge
<i>Avocettina infans</i>	blackline snipe eel
<i>Bajacalifornia megalops</i>	bigeye smooth head
<i>Balanus evermanni</i>	giant barnacle
<i>Bathyagonus nigripinnis</i>	blackfin poacher
<i>Bathybuccinum clarki</i>	Roger's buccinid
<i>Bathylagus milleri</i>	robust blacksmelt
<i>Bathylagus ochotensis</i>	popeye blacksmelt
<i>Bathylagus pacificus</i>	Pacific blacksmelt
<i>Bathylagus</i> species	blacksmelt species
<i>Bathymaster signatus</i>	searcher
<i>Bathyploetes</i> species	sea cucumber species
<i>Bathyraja abyssicola</i>	deepsea skate

Table 5B. - - Continued.

Species/Taxon	Common Name
<i>Bathyraja abyssicola</i> egg case	deepsea skate egg case
<i>Bathyraja aleutica</i>	Aleutian skate
<i>Bathyraja aleutica</i> egg case	Aleutian skate egg case
<i>Bathyraja interrupta</i>	Bering skate
<i>Bathyraja interrupta</i> egg case	Bering skate egg case
<i>Bathyraja lindbergi</i>	Commander skate
<i>Bathyraja lindbergi</i> egg case	Commander skate egg case
<i>Bathyraja maculata</i>	whiteblotched skate
<i>Bathyraja maculata</i> egg case	whiteblotched skate egg case
<i>Bathyraja minispinosa</i>	whitebrow skate
<i>Bathyraja minispinosa</i> egg case	whitebrow skate egg case
<i>Bathyraja parmifera</i>	Alaska skate
<i>Bathyraja parmifera</i> egg case	Alaska skate egg case
<i>Bathyraja</i> species egg case	skate egg case species
<i>Bathyraja taranetzi</i>	mud skate
<i>Bathyraja taranetzi</i> egg case	mud skate egg case
<i>Bathyraja trachura</i>	rougtail skate
<i>Bathyraja trachura</i> egg case	rougtail skate egg case
<i>Benthalbella dentata</i>	northern pearleye
<i>Bentheogennema borealis</i>	shrimp species
<i>Benthoctopus leioderma</i>	smoothskin octopus
<i>Benthoctopus oregonensis</i>	octopus species
<i>Benthoctopus salebrosus</i>	octopus species
<i>Benthoctopus</i> species	octopus species
<i>Beringius frielei</i>	snail species
<i>Beroe</i> species	comb jelly species
<i>Berryteuthis magister</i>	magistrate armhook squid
Bivalvia	empty bivalve shells
<i>Bothrocara brunneum</i>	twoline eelpout
<i>Bothrocara nyx</i>	shadow eelpout
<i>Bothrocara pusillum</i>	Alaska eelpout
<i>Bothrocara</i> species	eelpout species
<i>Bothrocara zestum</i>	western eelpout
<i>Brisaster latifrons</i>	heart urchin
Brisingidae	brisingid sea star
<i>Bryozoichthys</i> species	prickleback species
<i>Buccinum castaneum</i>	chestnut whelk
<i>Buccinum costatum</i>	costate whelk
<i>Buccinum oedematum</i>	swollen whelk
<i>Buccinum plectrum</i>	sinuous whelk
<i>Buccinum scalariforme</i>	ladder whelk
<i>Buccinum</i> species	snail species
<i>Buccinum</i> species eggs	snail egg species
<i>Careproctus bowersianus</i>	Bowers Bank snailfish
<i>Careproctus colletti</i>	Alaska snailfish
<i>Careproctus comus</i>	comic snailfish
<i>Careproctus cypselurus</i>	blackfin snailfish
<i>Careproctus furcellus</i>	emarginate snailfish
<i>Careproctus gilberti</i>	smalldisk snailfish
<i>Careproctus melanurus</i>	blacktail snailfish
<i>Careproctus rastrinus</i>	salmon snailfish
<i>Careproctus simus</i>	proboscis snailfish
<i>Careproctus</i> species	snailfish species

Table 5B. - - Continued.

Species/Taxon	Common Name
<i>Careproctus</i> species G	snailfish species
Caridea unid.	caridid shrimp unid.
<i>Ceramaster</i> species	sea star species
<i>Chauliodus macouni</i>	Pacific viperfish
<i>Chionoecetes angulatus</i>	triangle Tanner crab
<i>Chionoecetes bairdi</i>	Tanner crab
<i>Chionoecetes</i> hybrid	hybrid Tanner crab
<i>Chionoecetes opilio</i>	snow crab
<i>Chionoecetes tanneri</i>	grooved Tanner crab
<i>Chiroteuthis calyx</i>	squid species
<i>Chlamys</i> species	scallop species
<i>Chorilia longipes</i>	longhorned decorator crab
<i>Chrysaora melanaster</i>	chrysaora jellyfish
<i>Clavularia incrustans</i>	encrusting coral
<i>Clinocardium</i> species	clam species
<i>Clupea pallasii</i>	Pacific herring
<i>Colga pacifica</i>	Pacific colga
<i>Colus jordani</i>	snail species
<i>Colus martensi</i>	snail species
<i>Corallimorphus</i> species	sea anemone species
<i>Coryphaenoides acrolepis</i>	Pacific grenadier
<i>Coryphaenoides cinereus</i>	popeye grenadier
<i>Coryphaenoides</i> species	grenadier species
<i>Crangon communis</i>	twospine crangon
<i>Crangon</i> species	crangonid shrimp species
<i>Cribrinopsis fernaldi</i>	chevron-tentacled anemone
<i>Crossaster borealis</i>	grooved sea star
<i>Crossaster papposus</i>	rose sea star
<i>Crossaster</i> species	sea star species
<i>Crossaster</i> species B (Clark)	pink rose star
<i>Cryptopeltaster lepidonotus</i>	sea star species
<i>Crystallichthys cyclospilus</i>	blotched snailfish
<i>Ctenodiscus crispatus</i>	common mud star
Cucumaria	sea cucumber species
<i>Cyanea capillata</i>	lion's mane
<i>Dasycottus setiger</i>	spinyhead sculpin
<i>Delectopecten vancouverensis</i>	Vancouver scallop
<i>Diaphus theta</i>	California headlightfish
<i>Diplopteraster multipes</i>	pincushion sea star
<i>Dipsacaster borealis</i>	northern sea star
Echiura	echiuroid worm species
<i>Elassochirus cavimanus</i>	purple hermit
<i>Elassodiscus caudatus</i>	humpback snailfish
<i>Elassodiscus</i> species	snailfish species
<i>Elassodiscus tremebundus</i>	blacklip snailfish
<i>Embassichthys bathybius</i>	deepsea sole
<i>Eogonatus tinro</i>	squid species
<i>Erimacrus isenbeckii</i>	horsehair crab
<i>Eualus biunguis</i>	deepsea eualid
<i>Eualus</i> species	eualid shrimp species
Euphausiacea	euphausiid species
<i>Euspira pallidus</i>	pale moonsnail
<i>Florometra asperrima</i>	common northern feather star

Table 5B. - - Continued.

Species/Taxon	Common Name
<i>Fusitriton oregonensis</i>	Oregon triton
<i>Fusitriton oregonensis</i> eggs	Oregon triton eggs
<i>Gadus macrocephalus</i>	Pacific cod
<i>Galiteuthis phyllura</i>	squid species
gastropod eggs	snail egg species
Gastropoda	empty gastropod shells
<i>Gephyreaster swifti</i>	Swift's sea star
<i>Glyptocephalus zachirus</i>	rex sole
Gonatidae	squid species
<i>Gonatopsis borealis</i>	boreopacific armhook squid
<i>Gonatus berryi</i>	Berry armhook squid
<i>Gonatus onyx</i>	clawed armhook squid
<i>Gonatus pyros</i>	fiery armhook squid
<i>Gonatus</i> species	squid species
Gonostomatidae	bristlemouth species
<i>Gorgonocephalus eucnemis</i>	basketstar
<i>Graneledone</i> species cf. <i>boreopacifica</i>	octopus species
<i>Halargyreus johnsonii</i>	slender codling
<i>Halichondria panicea</i>	barrel sponge
<i>Halipteris willemoesi</i>	sea whip species
<i>Hemilepidotus jordani</i>	yellow Irish lord
<i>Hemitripterus bolini</i>	bigmouth sculpin
<i>Henricia asthenactis</i>	sea star species
<i>Henricia</i> species	sea star species
<i>Heterochone tenerum</i>	crusty tube sponge
<i>Heterozonias alternatus</i>	cannonball sun star
<i>Hippasteria californica</i>	sea star species
<i>Hippasteria</i> species	sea star species
<i>Hippasteria spinosa</i>	spiny red sea star
<i>Hippoglossoides elassodon</i>	flathead sole
<i>Hippoglossus stenolepis</i>	Pacific halibut
Holothuroidea	sea cucumber species
<i>Hyas lyratus</i>	Pacific lyre crab
Hydrozoa	hydroid species
<i>Hymenodora frontalis</i>	Pacific ambereye
<i>Icelus canaliculatus</i>	blacknose sculpin
<i>Icelus euryops</i>	wide-eye sculpin
<i>Icelus spatula</i>	spatulate sculpin
<i>Icelus spiniger</i>	thorny sculpin
<i>Icosteus aenigmaticus</i>	ragfish
<i>Isidella</i> species	articulated bamboo coral
Isididae unid.	bamboo coral species
<i>Japatella diaphana</i>	octopus species
<i>Labidochirus splendescens</i>	splendid hermit
Lamellaridae	lamellarid
<i>Lampanyctus jordani</i>	brokenline lampfish
<i>Lampanyctus</i> species	lampfish species
<i>Lampetra tridentata</i>	Pacific lamprey
<i>Laqueus californianus</i>	California lamp shell
<i>Latrunculia</i> species A (Clark, 2006)	green papillate sponge
<i>Lebbeus groenlandicus</i>	spiny lebbeid
<i>Lebbeus</i> species	lebbeid shrimp species
<i>Lepidopsetta polyxystra</i>	northern rock sole

Table 5B. - - Continued.

Species/Taxon	Common Name
<i>Leptagonus frenatus</i>	sawback poacher
<i>Leptychaster pacificus</i>	sea star species
<i>Lethasterias nanimensis</i>	blackspined sea star
<i>Leucosolenia blanca</i>	yellow leafy sponge
<i>Leuroglossus schmidti</i>	northern smoothtongue
<i>Lillipathes</i> species B (Clark, 2006)	coral species
Liparidinae	snailfish species
<i>Lipariscus nanus</i>	pygmy snailfish
<i>Liponema brevicornis</i>	tentacle-shedding anemone
<i>Lithodes aequispinus</i>	golden king crab
<i>Lithodes couesi</i>	scarlet king crab
Lithodidae	stone crab species
<i>Lophaster furcilliger</i>	crested sea star
<i>Lophaster vexator</i>	crested star
<i>Lumpenella longirostris</i>	longsnout prickleback
<i>Lycenchelys camchatica</i>	Kamchatka eelpout
<i>Lycenchelys crotalinus</i>	snakehead eelpout
<i>Lycenchelys</i> species	eelpout species
<i>Lycodapus</i> species	eelpout species
<i>Lycodes beringi</i>	Bering eelpout
<i>Lycodes concolor</i>	ebony eelpout
<i>Lycodes</i> species	eelpout species
<i>Macropinna microstoma</i>	barreleye
Majidae	spider crab species
<i>Malacocottus zonurus</i>	darkfin sculpin
<i>Mediaster aequalis</i>	vermilion sea star
<i>Mediaster tenellus</i>	sea star species
<i>Melamphaes lugubris</i>	highsnout bigscale
<i>Metridium farcimen</i>	gigantic anemone
<i>Microstomus pacificus</i>	Dover sole
<i>Modiolus modiolus</i>	northern horsemussel
<i>Molpadia intermedia</i>	sweet sea potato
<i>Munida quadrispina</i>	pinchbug
<i>Mycale loveni</i>	tree sponge
<i>Mycale</i> species	tree sponge species
Myctophidae	lanternfish species
<i>Myoxocephalus polyacanthocephalus</i>	great sculpin
Mysidacea	mysid species
<i>Myxoderma sacculatum</i>	sea star species
<i>Nannobrachium regale</i>	pinpoint lampfish
<i>Nearchaster</i> species	sea star species
<i>Nearchaster variabilis</i>	sea star species
<i>Neoesperiopsis infundibula</i>	rough China hat sponge
<i>Neoesperiopsis rigida</i>	soft finger sponge
<i>Neognathophausia gigas</i>	giant red mysid
<i>Neognathophausia</i> species	mysid shrimp species
<i>Neomenia</i> species	mollusc species
<i>Neptunea amianta</i>	white neptune
<i>Neptunea lyrata</i>	lyre whelk
<i>Neptunea pribiloffensis</i>	Pribilof whelk
<i>Neptunea</i> species	snail species
<i>Neptunea</i> species eggs	snail egg species
<i>Neptunea tabulata</i>	tabled whelk

Table 5B. - - Continued.

Species/Taxon	Common Name
<i>Neptunea ventricosa</i>	fat whelk
<i>Notacanthus chemnitzii</i>	snubnosed spiny eel
<i>Notostombodella cyclostomum</i>	striped sea leech
<i>Notostomus japonicus</i>	spinyridge shrimp
<i>Notostomus</i> species	shrimp species
Nudibranchia	nudibranch species
<i>Octopus dofleini</i>	giant octopus
<i>Octopus</i> species	octopus species
<i>Oncorhynchus gorbuscha</i>	pink salmon
<i>Oncorhynchus keta</i>	chum salmon
<i>Oneirodes bulbosus</i>	hairy-lure dreamer
<i>Oneirodes</i> species	dreamer species
<i>Oneirodes thompsoni</i>	Alaska dreamer
<i>Ophiacantha normani</i>	brittle star species
<i>Ophiacantha</i> species	brittle star species
<i>Ophiopholis aculeata</i>	ubiquitous brittle star
<i>Ophiopholis</i> species	brittle star species
<i>Ophiura sarsi</i>	notched brittlestar
<i>Opisthoteuthis californiana</i>	flapjack devilfish
<i>Oractis diomedea</i>	grape anemone
<i>Oregonia gracilis</i>	graceful decorator crab
Osteichthyes eggs	fish eggs species
<i>Otukaia kiheiziebisu</i>	snail species
<i>Pagurus brandti</i>	sponge hermit
<i>Pagurus confragosus</i>	knobbyhand hermit
<i>Pagurus cornutus</i>	hermit crab species
<i>Pagurus ochotensis</i>	Alaskan hermit
<i>Pagurus</i> species	hermit crab species
<i>Pagurus trigonocheirus</i>	fuzzy hermit crab
<i>Pagurus townsendi</i>	Townsend hermit crab
<i>Pandalopsis ampla</i>	deepwater bigeye
<i>Pandalopsis dispar</i>	sidestripe shrimp
<i>Pandalopsis longirostris</i>	shrimp species
<i>Pandalus eous</i>	Alaskan pink shrimp
<i>Pandalus jordani</i>	ocean shrimp
<i>Pandalus tridens</i>	yellowleg pandalid
<i>Pannychia moseleyi</i>	deep sea papillate cucumber
<i>Paractinostola faeulentata</i>	rough purple sea anemone
<i>Paragorgia arborea</i>	Kamchatka coral
Paralepididae	barracudina species
<i>Paraliparis cephalus</i>	swellhead snailfish
<i>Paraliparis dactylosus</i>	red snailfish
<i>Paraliparis grandis</i>	grand snailfish
<i>Paraliparis pectoralis</i>	broadfin snailfish
<i>Paraliparis</i> species	snailfish species
<i>Paraliparis</i> species cf. <i>dactylosus</i>	snailfish species
<i>Paraliparis</i> species cf. <i>dipterus</i>	snailfish species
<i>Paraliparis</i> species cf. <i>pectoralis</i>	rusty snailfish
<i>Paraliparis ulochir</i>	snailfish species
<i>Paralomis multispina</i>	king crab species
<i>Paralomis</i> species A (Clark, 2006)	king crab species
<i>Paralomis verrilli</i>	king crab species
<i>Pasiphaea pacifica</i>	Pacific glass shrimp

Table 5B. - - Continued.

Species/Taxon	Common Name
<i>Pasiphaea tarda</i>	crimson pasiphaeid
Pasiphaeidae	pasiphaeid shrimp species
<i>Periphylla periphylla</i>	jellyfish species
<i>Phacellophora camtschatica</i>	egg yolk jelly
<i>Phakellia beringensis</i>	hat sponge
<i>Pleurogrammus monopterygius</i>	Atka mackerel
<i>Plicatellopsis amphispicula</i>	firm finger sponge
<i>Plicifusus kroyeri</i>	snail species
Polychaeta	polychaete worm species
<i>Polymastia</i> species	sponge species
Porifera	sponge species
<i>Poromitra curilensis</i>	crested bigscale
<i>Primnoa willeyi</i>	red tree coral
<i>Pseudarchaster parelii</i>	scarlet sea star
<i>Pseudostichopus mollis</i>	sandy sea cucumber
<i>Psolus squamatus</i>	whitescaled sea cucumber
<i>Psychrolutes phrictus</i>	blob sculpin
<i>Pteraster jordani</i>	sea star species
<i>Pteraster militaris</i>	wrinkled star
<i>Pteraster</i> species	sea star species
<i>Pteraster</i> species A (Clark, 1999)	sea star species
<i>Pteraster tessellatus</i>	sea star species
Pycnogonida	sea spider species
<i>Pyrulofusus deformis</i>	warped whelk
<i>Pyrulofusus melonis</i>	snail species
<i>Pyrulofusus</i> species	snail species
<i>Pyrulofusus</i> species eggs	snail species eggs
<i>Raja rhina</i>	longnose skate
<i>Reinhardtius hippoglossoides</i>	Greenland turbot
<i>Rhabdocalyptus</i> species	cloud sponge
<i>Rhizophostomella costata</i>	ribbed bryozoan
<i>Rhinoliparis attenuatus</i>	slim snailfish
<i>Rossia pacifica</i>	eastern Pacific bobtail
<i>Sagamichthys abei</i>	shining tubeshoulder
Scyphozoa	jellyfish species
<i>Sebastes aleutianus</i>	rougeye rockfish
<i>Sebastes alutus</i>	Pacific ocean perch
<i>Sebastes babcocki</i>	redbanded rockfish
<i>Sebastes borealis</i>	shortraker rockfish
<i>Sebastes melanostictus</i>	blackspotted rockfish
<i>Sebastes polyspinis</i>	northern rockfish
<i>Sebastes variabilis</i>	dusky rockfish
<i>Sebastolobus alascanus</i>	shortspine thornyhead
<i>Sebastolobus macrochir</i>	broadfin thornyhead
<i>Sergestes similis</i>	Pacific sergestid
<i>Serpula</i> species	worm species
shrimp species	shrimp species
<i>Sigmops gracilis</i>	slender fangjaw
<i>Solaster endeca</i>	northern sun sea star
<i>Solaster</i> species	sea star species
<i>Solaster</i> species A (Clark, 1997)	sea star species
<i>Solaster</i> species F (Clark)	Fisher sun star
<i>Somniosus pacificus</i>	Pacific sleeper shark

Table 5B. - - Continued.

Species/Taxon	Common Name
<i>Squalus acanthias</i>	spiny dogfish
<i>Stegophiura ponderosa</i>	brittle star species
<i>Stenobranchius leucopsarus</i>	northern lampfish
<i>Stenobranchius nannochir</i>	garnet lampfish
<i>Stenobranchius</i> species	lampfish species
<i>Stephanasterias albula</i>	sea star species
<i>Stomphia coccinea</i>	swimming anemone
<i>Stomphia didemon</i>	cowardly anemone
<i>Stomphia</i> species	sea anemone species
<i>Strongylocentrotus droebachiensis</i>	green sea urchin
<i>Strongylocentrotus pallidus</i>	white sea urchin
<i>Strongylocentrotus</i> species	sea urchin species
<i>Swiftia beringi</i>	coral species
<i>Sycionis</i> species A (Clark, 2006)	orange actinistolid
<i>Synallactes</i> species	sea cucumber species
<i>Synallactes</i> species A (Clark, 2006)	sea cucumber species
<i>Tactostoma macropus</i>	longfin dragonfish
<i>Taonius pavo</i>	squid species
Teuthoidea	squid species
<i>Thaleichthys pacificus</i>	eulachon
Thaliacea	salp species
<i>Theragra chalcogramma</i>	walleye pollock
<i>Tochuina tetraquetra</i>	giant orange tochui
<i>Triglops szepticus</i>	spectacled sculpin
<i>Tritonia diomedea</i>	rosy tritonia
<i>Tritonia</i> species	nudibranch species
<i>Virgularia</i> species	smoothstem seawhip
Virgularidae	sea whip species
Yellow papillate sponge	sponge species
<i>Yoldia</i> species	clam species
<i>Zaprora silenus</i>	prowfish
<i>Zesticelus profundorum</i>	flabby sculpin
<i>Zoraster evermanni</i>	sea star species

Table 6. - - All species encountered on the 2008 EBSS survey with depth range and frequency of occurrence. Species are listed in descending order by total catch weight.

Species name	Total Weight (kg)	Total Number	Min-Max Depth Encountered (m)	Mean Depth Encountered (m)	Frequency of Occurrence (hauls)
<i>Albatrossia pectoralis</i>	109,440.19	30,946	222-1178	691	139
<i>Sebastes alutus</i>	20,889.31	24,130	201-525	322	73
<i>Atheresthes stomias</i>	16,685.69	16,760	201-804	386	121
<i>Coryphaenoides cinereus</i>	11,868.87	71,877	415-1178	774	104
<i>Theragra chalcogramma</i>	6,411.55	6,087	201-676	332	77
<i>Sebastolobus alascanus</i>	6,362.69	8,646	201-1122	609	123
<i>Atheresthes evermanni</i>	6,059.34	5,222	201-1093	508	167
<i>Hippoglossoides elassodon</i>	4,467.69	10,949	201-605	337	95
<i>Reinhardtius hippoglossoides</i>	4,321.24	1,300	207-1148	578	133
<i>Bathyraja aleutica</i>	4,079.19	1,449	201-1165	559	158
<i>Anoplopoma fimbria</i>	3,073.02	1,017	293-1148	660	114
<i>Bothrocara zestum</i>	2,865.46	4,625	218-1148	646	72
<i>Glyptocephalus zachirus</i>	2,751.32	4,394	201-847	350	95
<i>Hippoglossus stenolepis</i>	1,935.75	256	201-676	362	69
<i>Sebastes borealis</i>	1,700.54	431	300-776	451	28
<i>Rhabdocalyptus</i> species	1,218.07		204-1065	621	28
<i>Pannychia moseleyi</i>	1,144.65	9,912	201-1165	627	58
<i>Bathyraja parmifera</i>	1,075.42	182	201-444	269	35
<i>Bathyraja maculata</i>	1,071.35	373	204-1090	441	62
<i>Chionoecetes angulatus</i>	1,052.41	7,543	206-1178	714	96
<i>Coryphaenoides acrolepis</i>	971.92	3,511	679-1178	981	38
<i>Bathyraja lindbergi</i>	822.23	446	207-1090	675	70
<i>Gadus macrocephalus</i>	798.37	264	201-355	250	43
<i>Liponema brevicornis</i>	767.62	6,436	201-1165	453	123
<i>Hemitripteris bolini</i>	698.46	177	202-632	370	68
<i>Paractinostola faeculenta</i>	674.22	2,100	235-1178	621	46
Porifera	661.14		201-1090	451	63
<i>Bathyraja interrupta</i>	623.02	545	201-1081	397	95
<i>Lycodes concolor</i>	579.67	620	329-1148	604	51
<i>Ceramaster</i> species	556.99	6,066	201-1093	533	132
<i>Bathyraja trachura</i>	509.21	281	274-1178	870	53
<i>Bathyraja minispinosa</i>	463.74	357	207-1178	620	111
<i>Somniosus pacificus</i>	460.87	30	207-1043	492	28
<i>Brisaster latifrons</i>	456.78	22,952	255-1165	512	15
<i>Chionoecetes tanneri</i>	443.61	1,478	212-1148	679	97
<i>Berryteuthis magister</i>	414.46	1,091	201-1165	510	128
<i>Florometra asperrima</i>	403.05	28,468	586-1178	948	6
<i>Crossaster borealis</i>	320.26	2,861	201-1178	558	155
<i>Lithodes aequispinus</i>	308.57	398	207-1090	441	60
<i>Aphrocallistes vastus</i>	291.48		202-1148	580	70
<i>Psychrolutes phrictus</i>	281.90	96	685-1178	972	31
<i>Bothrocara brunneum</i>	250.18	216	319-1093	753	59
<i>Malacocottus zonurus</i>	242.11	1,746	201-819	366	89
<i>Bathyraja taranetzi</i>	227.52	264	204-819	381	41
<i>Ophiura sarsi</i>	194.69	233,448	494-1007	620	13
<i>Dipsacaster borealis</i>	165.16	919	201-1097	431	64
<i>Neptunea pribiloffensis</i>	159.13	1,667	201-1148	541	89

Table 6. - - Continued.

Species name	Total Weight (kg)	Total Number	Min-Max Depth Caught (m)	Mean Bottom Depth (m)	Frequency of Occurrence (hauls)
<i>Pandalus eous</i>	146.94	22,192	201-616	278	58
<i>Balanus evermanni</i>	141.50	1	206-355	296	3
<i>Nearchaster variabilis</i>	129.63	3,454	201-1178	688	93
<i>Heterochone tenerum</i>	126.73		321-999	745	6
<i>Lithodes couesi</i>	120.09	199	513-1148	823	29
<i>Embassichthys bathybius</i>	116.99	99	561-993	763	28
<i>Sebastes melanostictus</i>	115.84	137	201-525	332	31
<i>Chionoecetes bairdi</i>	110.55	999	201-466	275	42
<i>Dasycottus setiger</i>	96.74	765	201-846	348	59
<i>Synallactes</i> species A (Clark, 2006)	87.04	2,333	212-1178	642	15
<i>Otopus dofleini</i>	84.01	57	202-565	332	26
<i>Tritonia</i> species	83.04	485	206-1072	505	13
<i>Sebastes aleutianus</i>	80.10	76	201-819	322	22
<i>Microstomus pacificus</i>	77.62	82	202-582	381	29
<i>Paralomis multispina</i>	75.97	143	381-1178	933	25
<i>Aptocyclus ventricosus</i>	70.16	85	222-1165	706	56
<i>Actinauge verrillii</i>	67.20	7,010	233-1165	536	36
<i>Zaprora silenus</i>	61.64	18	212-245	224	5
<i>Antimora microlepis</i>	61.21	247	557-1178	912	45
<i>Gorgonocephalus eucnemis</i>	56.01	223	201-845	415	21
<i>Asteronyx loveni</i>	54.80	1,415	201-1081	438	21
<i>Zoraster evermanni</i>	52.81	498	300-1122	752	31
<i>Careproctus melanurus</i>	52.44	127	303-1064	699	42
<i>Synallactes</i> species	50.44	1,306	418-1072	829	6
<i>Lycodes beringi</i>	49.73	925	206-1093	527	95
<i>Leptagonus frenatus</i>	49.63	975	204-1082	306	44
<i>Myxoderma sacculatum</i>	47.12	503	212-1178	667	29
<i>Aphrodita</i> species	44.97	2,740	201-1165	471	105
<i>Fusitriton oregonensis</i>	44.07	615	201-1097	343	57
<i>Pagurus cornutus</i>	44.03	995	212-925	416	50
<i>Careproctus furcellus</i>	41.25	91	218-1081	493	38
<i>Opisthoteuthis californiana</i>	40.96	39	361-641	516	19
<i>Chrysaora melanaster</i>	40.58	78	220-1178	688	32
<i>Buccinum oedematum</i>	40.52	1,125	286-1097	686	87
<i>Benthoctopus leioderma</i>	39.56	89	201-1093	638	36
<i>Icosteus aenigmaticus</i>	36.86	2	620-620	620	1
<i>Paragorgia arborea</i>	34.79		300-1082	773	7
<i>Bathyraja abyssicola</i>	33.59	2	1081-1148	1115	2
Actinostolidae	32.24	2,472	206-999	461	13
<i>Paralomis verrilli</i>	31.72	121	1148-1148	1148	1
<i>Pyrulofusus melonis</i>	31.60	261	206-613	418	35
<i>Pandalopsis dispar</i>	30.16	2,199	207-916	414	49
<i>Careproctus colletti</i>	30.00	113	412-1178	718	36
<i>Hippasteria spinosa</i>	29.64	66	220-1178	504	22
<i>Diplopteraster multipes</i>	28.47	110	206-1090	429	35
<i>Lophaster furcilliger</i>	27.95	803	201-1178	652	50
<i>Solaster</i> species F (Clark)	26.90	147	201-1090	498	39
<i>Allocentrotus fragilis</i>	25.15	161	202-604	338	25
<i>Neptunea amianta</i>	24.02	437	427-1165	803	31
<i>Bathylagus pacificus</i>	22.39	753	445-1178	876	48
<i>Elassodiscus caudatus</i>	20.97	319	285-1093	779	56
<i>Graneledone</i> species cf. <i>boreopacifica</i>	20.04	41	860-1178	1030	9

Table 6. - - Continued.

Species name	Total Weight (kg)	Total Number	Min-Max Depth Caught (m)	Mean Bottom Depth (m)	Frequency of Occurrence (hauls)
<i>Lampetra tridentata</i>	18.07	56	201-1081	562	46
<i>Careproctus rastrinus</i>	18.04	94	201-624	265	24
<i>Ophiopholis aculeata</i>	16.34	5,710	204-1082	476	22
<i>Lepidopsetta polyxystra</i>	13.98	23	204-303	238	9
<i>Pandalopsis ampla</i>	13.83	750	331-1165	818	36
<i>Gonatopsis borealis</i>	13.74	149	218-1148	584	33
Isididae species	13.43		845-845	845	1
<i>BathYGONUS nigripinnis</i>	13.43	1,007	218-1093	602	90
<i>Leuroglossus schmidti</i>	13.10	1,495	218-1165	657	115
<i>Elassodiscus tremebundus</i>	12.85	117	593-1148	889	31
<i>Beringius frielei</i>	12.81	124	201-1093	437	45
<i>Bathylagus</i> species	12.66	415	561-1148	880	23
<i>Anthoptilum murrayi</i>	12.10	1,112	229-1178	658	4
<i>Strongylocentrotus droebachiensis</i>	11.61	143	206-565	322	23
<i>Chionoecetes opilio</i>	10.77	78	201-463	310	18
<i>Pagurus townsendi</i>	10.75	342	201-1093	666	66
Gastropoda	10.52		201-1097	446	43
Actiniaria	10.52	1,927	845-1165	1049	4
<i>Icelus canaliculatus</i>	10.09	503	377-819	534	23
<i>Pteraster</i> species	9.86	148	204-1178	665	30
<i>Cribrinopsis fernaldi</i>	9.26	89	202-525	293	15
<i>Stomphia</i> species	9.06	116	201-582	282	13
<i>Bathyploetes</i> species	8.92	254	207-1165	552	23
<i>Pleurogrammus monopterygius</i>	8.86	6	212-394	283	5
<i>Thaleichthys pacificus</i>	8.78	155	201-415	298	13
<i>Pasiphaea pacifica</i>	8.68	3,334	361-1093	519	32
Scyphozoa	8.35	15	212-1122	702	20
<i>Stenobrachius leucopsarus</i>	8.28	1,237	204-1178	677	109
<i>Careproctus cypselurus</i>	7.97	113	303-1093	895	28
<i>Eualus biunguis</i>	7.95	3,574	407-1093	773	49
<i>Rossia pacifica</i>	7.53	81	201-333	239	24
<i>Psolus squamatus</i>	7.09	347	845-1122	980	9
Nudibranchia	6.49	722	206-1178	450	36
<i>Alepisaurus ferox</i>	6.22	1	444-444	444	1
<i>Triglops scepticus</i>	6.16	125	201-444	253	19
<i>Bathyrāja parmifera</i> egg case	5.94	262	201-926	351	35
<i>Bathyrāja aleutica</i> egg case	5.87	106	201-1043	412	25
<i>Benthocopus salebrosus</i>	5.85	73	207-1148	502	43
gastropod eggs	5.56		201-1072	500	40
<i>Neomenia</i> species	5.54	86	310-1165	931	7
<i>Pyrulofusus deformis</i>	5.54	30	206-448	289	13
<i>Benthocopus oregonensis</i>	5.41	7	627-1178	916	7
<i>Phacellophora camtschatica</i>	5.23	18	206-1097	549	17
<i>Bathyrāja interrupta</i> egg case	4.72	249	201-1093	369	38
<i>Pagurus trigonocheirus</i>	4.55	167	204-442	250	9
<i>Amphilaphis</i> species	4.48		213-736	449	6
<i>Stomphia coccinea</i>	4.47	77	201-442	272	9
<i>Isidella</i> species	4.38		206-1046	717	7
<i>Coryphaenoides</i> species	4.19	1	938-938	938	1
Actiniaria	4.01	138	201-1122	467	35
Bivalvia	4.01		201-1097	340	12
<i>Oneirodes thompsoni</i>	3.57	23	830-1097	958	14

Table 6. - - Continued.

Species name	Total Weight (kg)	Total Number	Min-Max Depth Caught (m)	Mean Bottom Depth (m)	Frequency of Occurrence (hauls)
Polychaete tubes	3.54		310-1165	703	8
<i>Mycale loveni</i>	3.42		204-303	238	5
<i>Oncorhynchus keta</i>	3.42	3	201-994	598	2
<i>Pteraster tessellatus</i>	3.35	11	207-212	210	2
<i>Chionoecetes</i> hybrid	3.11	58	241-500	354	5
<i>Henricia</i> species	3.10	164	201-1148	431	66
<i>Raja rhina</i>	3.00	1	327-327	327	1
<i>Bathymaster signatus</i>	2.89	15	201-245	218	6
<i>Lampanyctus jordani</i>	2.86	92	294-1072	618	21
<i>Heterozonias alternatus</i>	2.80	24	333-876	628	10
<i>Pseudarchaster parelii</i>	2.74	71	245-1148	624	45
<i>Halargyreus johnsonii</i>	2.68	13	1007-1178	1060	5
<i>Bathylagus milleri</i>	2.59	69	457-1178	924	21
<i>Chauliodus macouni</i>	2.56	56	204-1178	806	30
<i>Myoxocephalus polyacanthocephalus</i>	2.55	1	229-229	229	1
<i>Sebastolobus macrochir</i>	2.35	4	457-845	683	4
<i>Atolla</i> species	2.34	106	402-1165	880	40
<i>Pagurus confragosus</i>	2.30	43	201-311	234	14
<i>Sebastes variabilis</i>	2.27	2	207-207	207	1
<i>Squalus acanthias</i>	2.22	1	220-220	220	1
<i>Japatella diaphana</i>	2.19	16	229-1165	887	15
<i>Pteraster militaris</i>	2.19	50	206-1072	396	16
<i>Stomphia didemon</i>	2.15	138	212-662	418	10
<i>Mediaster tenellus</i>	2.11	87	240-994	689	16
<i>Arctomelon stearnsii</i>	2.11	37	202-676	478	18
<i>Chiroteuthis calyx</i>	2.08	6	207-999	582	6
<i>Stenobrachius nannochir</i>	1.88	272	407-1165	843	21
<i>Stenobrachius</i> species	1.87	292	362-1148	810	27
<i>Tritonia diomedea</i>	1.83	16	229-1178	794	4
<i>Lophaster vexator</i>	1.67	63	464-1082	843	10
<i>Crossaster</i> species B (Clark)	1.66	195	525-819	693	3
<i>Bathyraja trachura</i> egg case	1.57	116	261-1165	761	30
shrimp species	1.52	1,139	586-586	586	1
<i>Lycenchelys camchatica</i>	1.51	16	616-1165	864	5
<i>Hemilepidotus jordani</i>	1.50	2	207-235	221	2
<i>Sebastes babcocki</i>	1.50	2	220-412	316	2
<i>Icelus spiniger</i>	1.45	37	204-286	233	18
<i>Oneirodes</i> species	1.41	13	604-1097	918	10
<i>Ophiacantha</i> species	1.35	2,159	999-999	999	1
<i>Solaster</i> species	1.32	8	207-550	403	3
<i>Solaster endeca</i>	1.19	11	241-641	426	5
<i>Elassochirus cavimanus</i>	1.07	26	204-327	265	9
Osteichthyes eggs	1.04		204-860	450	6
<i>Lumpenella longirostris</i>	1.04	21	402-582	483	3
Thaliacea	1.03	14	206-1081	590	32
Brisingidae	1.00	12	442-1046	639	9
<i>Halichondria panicea</i>	1.00		212-532	372	2
<i>Oncorhynchus gorbuscha</i>	0.96	1	418-418	418	1
<i>Icelus euryops</i>	0.95	88	293-542	409	8
<i>Ctenodiscus crispatus</i>	0.91	91	222-466	347	7
<i>Buccinum costatum</i>	0.86	24	206-1148	847	10
Gonatidae	0.83	20	413-1011	611	8

Table 6. - - Continued.

Species name	Total Weight (kg)	Total Number	Min-Max Depth Caught (m)	Mean Bottom Depth (m)	Frequency of Occurrence (hauls)
<i>Neptunea lyrata</i>	0.83	10	211-545	347	5
<i>Sebastes polyspinis</i>	0.82	1	241-241	241	1
<i>Hippasteria californica</i>	0.82	5	381-1082	714	4
<i>Periphylla periphylla</i>	0.80	58	233-1178	787	36
<i>Gonatus berryi</i>	0.73	5	557-1148	855	4
<i>Halipterus willemoesi</i>	0.72	64	201-545	353	6
<i>Aulosaccus schulzei</i>	0.71		303-303	303	1
<i>Pteraster</i> species A (Clark, 1999)	0.70	11	916-1097	1004	5
<i>Ophiopholis</i> species	0.70	253	327-327	327	1
<i>Buccinum castaneum</i>	0.69	22	526-1072	887	3
<i>Neoesperiopsis infundibula</i>	0.68		212-532	391	3
Teuthoidea	0.65	17	211-605	360	8
<i>Buccinum</i> species	0.64	18	759-1165	961	7
<i>Careproctus gilberti</i>	0.63	83	286-997	512	7
<i>Erimacrus isenbeckii</i>	0.62	1	201-201	201	1
<i>Primnoa willeyi</i>	0.62		876-876	876	1
<i>Delectopecten vancouverensis</i>	0.62	223	355-1007	823	5
<i>Mycale</i> species	0.60		207-207	207	1
<i>Aequorea</i> species	0.57	17	361-1178	837	9
<i>Solaster</i> species A (Clark, 1997)	0.56	16	241-641	469	3
<i>Crossaster</i> species	0.55	24	402-1090	746	2
<i>Galiteuthis phyllura</i>	0.54	3	708-1178	934	3
<i>Latrunculia</i> species A (Clark, 2006)	0.51		220-220	220	1
<i>Henricia asthenactis</i>	0.50	4	207-876	448	4
<i>Buccinum</i> species eggs	0.47		222-1046	587	7
<i>Laqueus californianus</i>	0.45	59	213-1082	530	9
<i>Hippasteria</i> species	0.44	5	550-845	738	3
<i>Pteraster jordani</i>	0.44	10	362-883	569	5
<i>Gonatus</i> species	0.43	3	496-807	652	2
<i>Sycionis</i> species A (Clark, 2006)	0.42	15	377-377	377	1
<i>Crossaster papposus</i>	0.42	29	293-876	557	8
<i>Bajacalifornia megalops</i>	0.42	1	815-815	815	1
<i>Neoesperiopsis rigida</i>	0.41		248-248	248	1
<i>Hyas lyratus</i>	0.41	30	201-381	253	21
Liparidinae	0.39	12	213-1065	749	6
<i>Lillipathes</i> species B (Clark, 2006)	0.39		1046-1046	1046	1
<i>Bathyraja minispinosa</i> egg case	0.36	23	381-997	619	10
<i>Bothrocara nyx</i>	0.35	27	931-1093	1035	7
<i>Ophiacantha normani</i>	0.34	152	500-1178	786	8
Actiniaria	0.34	24	201-412	266	11
<i>Paraliparis</i> species	0.32	24	286-1093	866	10
<i>Lycenchelys crotalinus</i>	0.31	5	617-832	692	3
<i>Lethasterias nanimensis</i>	0.31	4	207-213	210	2
<i>Strongylocentrotus</i> species	0.30	10	212-412	312	2
yellow papillate sponge	0.30		215-274	245	2
<i>Lycodapus</i> species	0.28	55	402-1148	679	25
<i>Paralomis</i> species A (Clark, 2006)	0.27	1	1082-1082	1082	1
<i>Buccinum plectrum</i>	0.27	10	311-444	378	2
<i>Oneirodes bulbosus</i>	0.27	2	1011-1046	1029	2
<i>Poromitra curilensis</i>	0.26	10	402-1081	813	10
<i>Swiftia beringi</i>	0.26		530-819	682	4
<i>Careproctus simus</i>	0.25	13	327-736	506	7

Table 6. - - Continued.

Species name	Total Weight (kg)	Total Number	Min-Max Depth Caught (m)	Mean Bottom Depth (m)	Frequency of Occurrence (hauls)
<i>Bothrocara</i> species	0.24	48	679-1148	995	4
<i>Lampanyctus</i> species	0.23	7	207-1072	757	5
<i>Notacanthus chemnitzii</i>	0.23	1	1082-1082	1082	1
<i>Molpadia intermedia</i>	0.23	10	466-632	526	3
<i>Plicatellopsis amphispicula</i>	0.23		294-632	485	3
<i>Paraliparis pectoralis</i>	0.22	11	997-1093	1046	4
<i>Paraliparis grandis</i>	0.22	4	830-1046	938	2
<i>Leucosolenia blanca</i>	0.22		248-248	248	1
<i>Bathylagus ochotensis</i>	0.22	8	496-1165	824	8
<i>Buccinum scalariforme</i>	0.22	4	207-253	230	3
<i>Careproctus</i> species	0.20	14	286-1090	818	8
<i>Melamphaes lugubris</i>	0.20	9	394-1081	674	8
<i>Bathyraja abyssicola</i> egg case	0.19	7	381-1010	715	6
<i>Gephyreaster swifti</i>	0.19	1	381-381	381	1
<i>Diaphus theta</i>	0.19	14	211-1011	436	9
<i>Pasiphaea tarda</i>	0.19	7	1007-1082	1027	4
<i>Rhinoliparis attenuatus</i>	0.19	24	455-1093	886	12
Paralepididae	0.18	2	788-788	788	1
<i>Neptunea</i> species eggs	0.18		212-997	423	4
Pasiphaeidae	0.18	9	676-883	789	3
<i>Bathyraja lindbergi</i> egg case	0.17	6	333-466	393	3
<i>Tochuina tetraquetra</i>	0.17	4	241-418	330	2
<i>Paraliparis</i> species cf. <i>dactylosus</i>	0.17	11	617-869	747	7
<i>Bathyraja taranetzi</i> egg case	0.16	14	213-804	493	8
<i>Neptunea</i> species	0.16	2	204-846	525	2
<i>Taonius pavo</i>	0.15	2	916-916	916	1
<i>Bathyraja maculata</i> egg case	0.15	10	480-1008	759	4
<i>Macropinna microstoma</i>	0.15	4	542-1081	882	4
<i>Pandalopsis longirostris</i>	0.14	34	327-593	472	4
<i>Cyanea capillata</i>	0.14	1	846-846	846	1
<i>Metridium farcimen</i>	0.14	2	202-319	261	2
Hydrozoa	0.14		218-736	427	3
<i>Euspira pallidus</i>	0.13	3	222-241	233	3
<i>Nannobrachium regale</i>	0.13	3	1046-1178	1112	2
<i>Paraliparis ulochir</i>	0.13	22	617-1093	786	12
<i>Lycodes</i> species	0.12	4	206-604	445	3
<i>Tactostoma macropus</i>	0.12	2	460-911	686	2
<i>Argis</i> lar	0.11	28	202-466	301	12
<i>Careproctus</i> species G	0.11	3	819-1090	973	3
<i>Sagamichthys abei</i>	0.11	2	561-931	746	2
<i>Chorilia longipes</i>	0.11	17	327-526	393	5
<i>Paraliparis</i> species cf. <i>pectoralis</i>	0.11	6	938-1165	1043	6
<i>Lebbeus groenlandicus</i>	0.11	15	593-629	611	2
<i>Pandalus jordani</i>	0.10	17	202-407	286	3
<i>Clavularia incrustans</i>	0.09		355-355	355	1
<i>Modiolus modiolus</i>	0.09	3	292-676	484	2
Ascidian	0.09	2	207-1082	650	3
Virgularidae	0.09	1	201-201	201	1
Pycnogonida	0.09	13	279-1007	598	6
<i>Cryptopeltaster lepidonotus</i>	0.09	1	876-876	876	1
<i>Argis dentata</i>	0.08	24	218-455	334	9
<i>Plicifusus kroyeri</i>	0.08	2	212-235	224	2

Table 6. - - Continued.

Species name	Total Weight (kg)	Total Number	Min-Max Depth Caught (m)	Mean Bottom Depth (m)	Frequency of Occurrence (hauls)
<i>Benthoctopus</i> species	0.08	1	685-685	685	1
<i>Icelus spatula</i>	0.07	4	201-526	364	2
Myctophidae	0.07	8	327-1007	667	2
<i>Pagurus</i> species	0.07	1	253-253	253	1
<i>Bathyraja</i> species egg case	0.07	4	679-916	798	2
Polychaeta	0.07	12	327-530	423	3
<i>Virgularia</i> species	0.07	10	362-546	453	3
<i>Pagurus ochotensis</i>	0.07	1	394-394	394	1
<i>Fusitriton oregonensis</i> eggs	0.07		212-253	229	3
<i>Eogonatus tinro</i>	0.06	3	413-466	440	2
<i>Bentheogennema borealis</i>	0.06	26	655-1178	963	8
<i>Mediaster aequalis</i>	0.06	3	845-845	845	1
<i>Otukaia kiheiziebisu</i>	0.06	5	916-916	916	1
<i>Careproctus bowersianus</i>	0.05	4	418-845	631	3
<i>Crangon communis</i>	0.05	29	206-525	358	9
<i>Eualus</i> species	0.05	32	327-1148	839	6
<i>Argis</i> species	0.05	13	201-402	306	6
<i>Strongylocentrotus pallidus</i>	0.05	3	220-220	220	1
<i>Pseudostichopus mollis</i>	0.05	1	617-617	617	1
<i>Colga pacifica</i>	0.05	4	532-550	541	2
<i>Zesticelus profundorum</i>	0.04	17	526-1081	938	10
Gonostomatidae	0.04	4	605-1010	887	4
<i>Corallimorphus</i> species	0.04	1	381-381	381	1
<i>Elassodiscus</i> species	0.04	7	418-883	691	4
<i>Anuropus bathypelagica</i>	0.04	3	201-883	521	3
<i>Stephanasterias albulata</i>	0.04	4	241-869	477	3
<i>Lebbeus</i> species	0.03	4	550-736	643	2
<i>Colus martensi</i>	0.03	2	286-329	308	2
<i>Hymenodora frontalis</i>	0.03	20	788-1093	974	5
<i>Benthalbella dentata</i>	0.03	1	632-632	632	1
<i>Oractis diomedea</i>	0.03	4	233-241	237	2
Caridea species	0.03	10	833-1165	999	2
<i>Notostomus japonicus</i>	0.03	1	632-632	632	1
Majidae	0.03	2	327-845	586	2
<i>Colus jordani</i>	0.03	4	259-333	284	3
<i>Paraliparis dactylosus</i>	0.03	2	605-860	733	2
<i>Actinistola</i> species A (Clark, 2006)	0.03	4	429-429	429	1
<i>Rhamphostomella costata</i>	0.03		876-876	876	1
<i>Neognathophausia</i> species	0.02	9	745-1097	957	5
<i>Leptychaster pacificus</i>	0.02	1	248-248	248	1
<i>Nearchaster</i> species	0.02	1	207-207	207	1
<i>Pyrulofusus</i> species eggs	0.02		333-333	333	1
<i>Aspidophoroides bartoni</i>	0.02	2	229-229	229	1
<i>Anthomastus</i> species	0.02		845-845	845	1
<i>Actinoscyphia</i> species	0.02	3	1097-1097	1097	1
<i>Notostombodella cyclostomum</i>	0.02	6	211-911	412	4
<i>Pandalus tridens</i>	0.02	5	355-412	384	2
<i>Stegophiura ponderosa</i>	0.02	1	327-327	327	1
<i>Sigmops gracilis</i>	0.01	1	582-582	582	1
<i>Notostomus</i> species	0.01	1	911-911	911	1
Lithodidae	0.01	2	300-496	398	2
<i>Gonatus onyx</i>	0.01	1	279-279	279	1

Table 6. - - Continued.

Species name	Total Weight (kg)	Total Number	Min-Max Depth Caught (m)	Mean Bottom Depth (m)	Frequency of Occurrence (hauls)
<i>Careproctus comus</i>	0.01	1	331-331	331	1
<i>Labidochirus splendescens</i>	0.01	1	259-259	259	1
<i>Pyrulofusus</i> species	0.01	2	448-448	448	1
<i>Chlamys</i> species	0.01	1	213-213	213	1
<i>Clinocardium</i> species	0.01	3	938-938	938	1
<i>Avocettina infans</i>	0.01	2	815-1082	949	2
<i>Serpula</i> species	0.01	1	233-233	233	1
<i>Pagurus brandti</i>	0.01	1	212-212	212	1
<i>Astrochele laevis</i>	0.01	1	444-444	444	1
<i>Paraliparis cephalus</i>	0.01	3	479-997	779	3
<i>Acantholiparis opercularis</i>	0.01	1	997-997	997	1
<i>Paraliparis</i> species cf. <i>dipterus</i>	0.01	3	997-997	997	1
<i>Bothrocara pusillum</i>	0.01	1	286-286	286	1
<i>Neognathophausia gigas</i>	0.01	4	1007-1093	1046	4
<i>Sergestes similis</i>	0.01	3	255-1093	785	3
<i>Neptunea tabulata</i>	0.01	1	201-201	201	1
Cucumaria	0.01	1	241-241	241	1
<i>Bryozoichthys</i> species	0.01	1	327-327	327	1
<i>Lycenchelys</i> species	0.01	1	1081-1081	1081	1
Lamellaridae	0.01	1	496-496	496	1
<i>Aforia circinata</i>	0.01	1	202-202	202	1
<i>Bathybuccinum clarki</i>	0.01	1	494-494	494	1
<i>Ancistrolepis eucosmius</i>	0.01	2	218-218	218	1
<i>Gonatus pyros</i>	0.01	1	412-412	412	1
Holothuroidea	0.01	2	1046-1046	1046	1
<i>Lipariscus nanus</i>	>0.01	1	525-525	525	1
Euphausiacea	>0.01	4	1081-1081	1081	1
<i>Oregonia gracilis</i>	>0.01	1	220-220	220	1
<i>Munida quadrispina</i>	>0.01	1	321-321	321	1
Echiura	>0.01	1	338-338	338	1
<i>Beroe</i> species	>0.01	1	1082-1082	1082	1
Mysidacea	>0.01	1	550-550	550	1
<i>Crangon</i> species	>0.01	1	255-255	255	1
<i>Yoldia</i> species	>0.01	1	1178-1178	1178	1
<i>Astarte borealis</i>	>0.01	1	207-207	207	1
<i>Octopus</i> species	>0.01	1	286-286	286	1

Table 7. - - Summary of biological data collected during the 2008 EBSS survey.

Scientific name	Individuals Measured	Otoliths Collected	Individual Weights	Stomachs Collected
<i>Albatrossia pectoralis</i>	11,035	2040	634	
<i>Coryphaenoides cinereus</i>	8,890			
<i>Atheresthes stomias</i>	7,528			288
<i>Hippoglossoides elassodon</i>	6,907			
<i>Sebastolobus alascanus</i>	5,482			342
<i>Atheresthes evermanni</i>	3,926			249
<i>Glyptocephalus zachirus</i>	3,419			
<i>Chionoecetes angulatus</i>	3,127			
<i>Sebastes alutus</i>	2,818	413	413	202
<i>Coryphaenoides acrolepis</i>	2,811			
<i>Theragra chalcogramma</i>	2,805			337
<i>Bothrocara zestum</i>	2,731	203	560	238
<i>Chionoecetes tanneri</i>	1,510			
<i>Bathyraja aleutica</i>	1,455			21
<i>Reinhardtius hippoglossoides</i>	1,307	504	498	158
<i>Malacocottus zonurus</i>	1,239	191	191	
<i>Berryteuthis magister</i>	1,092			
<i>Chionoecetes bairdi</i>	1,049			
<i>Anoplopoma fimbria</i>	1,017			
<i>Lycodes beringi</i>	839		51	145
<i>Dasycottus setiger</i>	764			
<i>Sebastes borealis</i>	566	540	540	56
<i>Lycodes concolor</i>	547			147
<i>Bathyraja interrupta</i>	543			
<i>Bathyraja lindbergi</i>	446			26
<i>Lithodes aequispinus</i>	415			
<i>Bathyraja maculata</i>	373			
<i>Bathyraja minispinosa</i>	353		38	13
<i>Bathyraja trachura</i>	281		58	18
<i>Bathyraja taranetzi</i>	266			
<i>Gadus macrocephalus</i>	264			125
<i>Hippoglossus stenolepis</i>	257			66
<i>Antimora microlepis</i>	253		97	
<i>Bothrocara brunneum</i>	213	132	139	123
<i>Lithodes couesi</i>	193			
<i>Bathyraja parmifera</i>	184		130	28
<i>Hemitripterus bolini</i>	180	140	140	
<i>Sebastes melanostictus</i>	137	132	132	15
<i>Careproctus melanurus</i>	127	112	112	
<i>Gonatopsis borealis</i>	122			
<i>Embassichthys bathybius</i>	99		9	
<i>Psychrolutes phrictus</i>	96		21	

Table 7. - - Continued.

Scientific name	Individuals Measured	Otoliths Collected	Individual Weights	Stomachs Collected
<i>Chionoecetes opilio</i>	82			
<i>Microstomus pacificus</i>	82			
<i>Aptocyclus ventricosus</i>	80		2	
<i>Benthoctopus leioderma</i>	78		78	
<i>Sebastes aleutianus</i>	76	74	74	29
<i>Lepidopsetta polyxystra</i>	75			
<i>Benthoctopus salebrosus</i>	63		63	
<i>Chionoecetes hybrid</i>	58			
<i>Paralomis multispina</i>	58			
<i>Octopus dofleini</i>	57		57	
<i>Paralomis verilli</i>	57			
<i>Somniosus pacificus</i>	31	26	31	
<i>Rossia pacifica</i>	25		25	
<i>Zaprora silenus</i>	18			
<i>Opisthoteuthis californiana</i>	16		16	
Teuthoidea	10		10	
<i>Pleurogrammus monopterygius</i>	6			
<i>Japatella diaphana</i>	4		4	
<i>Bathyraja abyssicola</i>	3			2
<i>Benthoctopus oregonensis</i>	3		3	
<i>Gonatus berryi</i>	3			
<i>Gonatus species</i>	2		2	
<i>Oncorhynchus keta</i>	2			
<i>Lycenchelys crotalinus</i>	2			
<i>Sebastolobus macrochir</i>	2			
<i>Sebastes variabilis</i>	2			
<i>Sebastes babcocki</i>	2			
Gonatidae	2		2	
<i>Chiroteuthis calyx</i>	2			
<i>Squalus acanthias</i>	1			
<i>Raja rhina</i>	1			
<i>Oncorhynchus gorbuscha</i>	1			
<i>Sebastes polyspinis</i>	1			
<i>Gonatus onyx</i>	1		1	
<i>Gonatus pyros</i>	1			
Totals	78,573	4,507	4,131	2,628

Table 8. - - Summary of voucher specimens collected during the 2008 EBSS survey.
(One lot consists of an individual or group of individuals of a single species).

Species name	Lots	Species name	Lots	Species name	Lots
<i>Lycodapus</i> species	18	<i>Heterozonias alternatus</i>	2	<i>Sagamichthys abei</i>	1
<i>Careproctus colletti</i>	17	<i>Aptocyclus ventricosus</i>	2	<i>Bryozoichthys</i> species	1
<i>Elassodiscus caudatus</i>	14	<i>Careproctus bowersianus</i>	2	<i>Bothrocara pusillum</i>	1
<i>Bathyraja trachura</i> egg case	13	<i>Paraliparis dactylosus</i>	2	<i>Bothrocara zestum</i>	1
<i>Careproctus rastrinus</i>	13	<i>Paraliparis cephalus</i>	2	<i>Lycenchelys crotalinus</i>	1
<i>Careproctus cypselurus</i>	12	<i>Paraliparis grandis</i>	2	<i>Lycenchelys</i> species	1
<i>Paraliparis</i> species	11	<i>Lycodes concolor</i>	2	<i>Sebastolobus macrochir</i>	1
<i>Careproctus furcellus</i>	10	<i>Lycodes beringi</i>	2	<i>Sebastes melanostictus</i>	1
<i>Elassodiscus tremebundus</i>	9	Pasiphaeidae	2	<i>Lillipathes</i> species B	1
<i>Paraliparis ulochir</i>	9	<i>Buccinum</i> species	2	<i>Corallimorphus</i> species	1
<i>Rhinoliparis attenuatus</i>	9	<i>Bathyraja abyssicola</i>	1	<i>Isidella</i> species	1
<i>Careproctus</i> species	8	<i>Raja rhina</i>	1	<i>Anuropus bathypelagica</i>	1
<i>Careproctus simus</i>	7	<i>Bathyraja trachura</i>	1	<i>Pandalus jordani</i>	1
<i>Paraliparis</i> sp. cf. <i>dactylosus</i>	7	<i>Bathyraja lindbergi</i>	1	<i>Argis dentata</i>	1
<i>Careproctus gilberti</i>	6	<i>Lebbeus</i> species	1	<i>Notostomus</i> species	1
<i>Oneirodes</i> species	6	Pycnogonida	1	<i>Paralomis verrilli</i>	1
<i>Graneledone</i> sp. cf. <i>boreopacifica</i>	6	Teuthoidea	1	<i>Paralomis</i> species A	1
Liparidinae	5	Holothuroidea	1	<i>Tochuina tetraquetra</i>	1
<i>Paraliparis</i> sp. cf. <i>pectoralis</i>	5	<i>Aspidophoroides bartoni</i>	1	Lamellaridae	1
<i>Bothrocara nyx</i>	5	<i>Bajacalifornia megalops</i>	1	<i>Otukaia kiheiziebisu</i>	1
Osteichthyes eggs	4	<i>Bathylagus pacificus</i>	1	<i>Buccinum costatum</i>	1
<i>Bathyraja minispinosa</i> egg case	4	<i>Bathylagus milleri</i>	1	<i>Arctomelon stearnsii</i>	1
<i>Halargyreus johnsonii</i>	4	<i>Coryphaenoides</i> species	1	<i>Delectopecten vancouverensis</i>	1
<i>Elassodiscus</i> species	4	<i>Coryphaenoides acrolepis</i>	1	<i>Japatella diaphana</i>	1
<i>Paraliparis pectoralis</i>	4	<i>Zesticelus profundorum</i>	1	<i>Taonius pavo</i>	1
<i>Oneirodes thompsoni</i>	4	<i>Psychrolutes phrictus</i>	1	<i>Crossaster</i> species	1
<i>Bothrocara</i> species	4	<i>Icelus canaliculatus</i>	1	<i>Crossaster borealis</i>	1
<i>Bathyraja abyssicola</i> egg case	3	<i>Sigmops gracilis</i>	1	<i>Lophaster vexator</i>	1
Actiniaria	3	<i>Careproctus comus</i>	1	<i>Pteraster</i> species A	1
<i>Bathylagus ochotensis</i>	3	<i>Lipariscus nanus</i>	1		
<i>Careproctus</i> species G	3	<i>Acantholiparis operculari</i>	1		
<i>Lycodes</i> species	3	<i>Paraliparis</i> sp. cf. <i>dipterus</i>	1		
Nudibranchia	3	<i>Poromitra crassiceps</i>	1		
<i>Bathyraja interrupta</i> egg case	2	<i>Melamphaes lugubris</i>	1		
<i>Bathyraja parmifera</i> egg case	2	<i>Tactostoma macropus</i>	1		
<i>Bathyraja maculata</i> egg case	2	<i>Lampanyctus</i> species	1		
<i>Bathyraja minispinosa</i>	2	<i>Lampanyctus jordani</i>	1		
Gonostomatidae	2	<i>Avocettina infans</i>	1		
Myctophidae	2	<i>Notacanthus chemnitzii</i>	1		
Majidae	2	Paralepididae	1		

Table 9. -- Biomass, population and CPUE estimates of all fishes and invertebrates encountered during the 2008 EBSS survey.

Species	Stratum (depth in meters)			Biomass			Population			CPUE		
		(t)	Variance	Number	Variance	kg/ha	Variance	no./ha	Variance			
Osteichthyes eggs	200-600	5.07E+00	1.70E+01	0.00E+00	0.00E+00	0.00E+00	0.00E+00	0.00E+00	0.00E+00	0.00E+00	0.00E+00	
	600-1200	4.52E-02	1.38E-03	0.00E+00	0.00E+00	0.00E+00	0.00E+00	0.00E+00	0.00E+00	0.00E+00	0.00E+00	
	All Depths	5.11E+00	1.70E+01	0.00E+00	0.00E+00	0.00E+00	0.00E+00	0.00E+00	0.00E+00	0.00E+00	0.00E+00	
<i>Lampetra tridentata</i>	200-600	4.89E+01	8.36E+01	1.48E+05	8.46E+08	2.61E-02	2.82E-03	7.87E-02	2.82E-02	7.87E-02	2.82E-02	
	600-1200	2.69E+01	3.98E+01	8.71E+04	3.84E+08	2.02E-02	1.83E-03	6.42E-02	1.83E-02	6.42E-02	1.83E-02	
	All Depths	7.58E+01	1.23E+02	2.35E+05	1.23E+09	2.36E-02	2.40E-03	7.26E-02	2.40E-02	7.26E-02	2.34E-02	
<i>Squalus acanthias</i>	200-600	1.31E+01	1.72E+02	5.90E+03	3.49E+07	6.83E-03	5.42E-03	3.08E-03	5.42E-03	3.08E-03	1.10E-03	
	600-1200	0.00E+00	0.00E+00	0.00E+00	0.00E+00	0.00E+00	0.00E+00	0.00E+00	0.00E+00	0.00E+00	0.00E+00	
	All Depths	1.31E+01	1.72E+02	5.90E+03	3.49E+07	3.96E-03	3.14E-03	1.79E-03	3.14E-03	1.79E-03	6.37E-04	
<i>Somniosus pacificus</i>	200-600	1.54E+03	2.10E+05	8.57E+04	3.02E+08	8.03E-01	6.34E+00	4.53E-02	6.34E+00	4.53E-02	1.02E-02	
	600-1200	4.30E+02	6.23E+04	3.59E+04	2.03E+08	2.28E-01	9.33E-01	2.28E-02	9.33E-01	2.28E-02	6.58E-03	
	All Depths	1.97E+03	2.72E+05	1.22E+05	5.04E+08	5.62E-01	4.14E+00	3.58E-02	4.14E+00	3.58E-02	8.74E-03	
<i>Bathyrāja species egg case</i>	200-600	0.00E+00	0.00E+00	0.00E+00	0.00E+00	0.00E+00	0.00E+00	0.00E+00	0.00E+00	0.00E+00	0.00E+00	
	600-1200	2.42E-01	5.08E-02	1.41E+04	1.16E+08	1.80E-04	2.41E-06	1.02E-02	2.41E-06	1.02E-02	5.25E-03	
	All Depths	2.42E-01	5.08E-02	1.41E+04	1.16E+08	7.56E-05	1.01E-06	4.27E-03	1.01E-06	4.27E-03	2.22E-03	
<i>Bathyrāja abyssicola</i>	200-600	0.00E+00	0.00E+00	0.00E+00	0.00E+00	0.00E+00	0.00E+00	0.00E+00	0.00E+00	0.00E+00	0.00E+00	
	600-1200	1.60E+02	9.90E+03	1.04E+04	3.74E+07	1.27E-01	4.80E-01	8.51E-03	4.80E-01	8.51E-03	1.99E-03	
	All Depths	1.60E+02	9.90E+03	1.04E+04	3.74E+07	5.31E-02	2.04E-01	3.57E-03	2.04E-01	3.57E-03	8.46E-04	
<i>Bathyrāja abyssicola egg case</i>	200-600	4.29E-01	1.30E-01	1.15E+04	7.36E+07	2.28E-04	4.21E-06	6.13E-03	4.21E-06	6.13E-03	2.39E-03	
	600-1200	2.98E-01	2.29E-02	1.57E+04	6.36E+07	2.07E-04	8.91E-07	1.08E-02	8.91E-07	1.08E-02	2.36E-03	
	All Depths	7.28E-01	1.52E-01	2.72E+04	1.37E+08	2.19E-04	2.81E-06	8.07E-03	2.81E-06	8.07E-03	2.37E-03	
<i>Bathyrāja interrupta</i>	200-600	2.28E+03	1.40E+05	2.03E+06	9.57E+10	1.23E+00	5.14E+00	1.09E+00	5.14E+00	1.09E+00	3.42E+00	
	600-1200	1.65E+02	4.18E+03	1.01E+05	1.10E+09	1.28E-01	2.22E-01	7.72E-02	2.22E-01	7.72E-02	5.79E-02	
	All Depths	2.44E+03	1.45E+05	2.13E+06	9.68E+10	7.66E-01	3.36E+00	6.65E-01	3.36E+00	6.65E-01	2.25E+00	
<i>Bathyrāja interrupta egg case</i>	200-600	1.82E+01	6.53E+01	9.48E+05	1.73E+11	9.52E-03	2.08E-03	4.96E-01	2.08E-03	4.96E-01	5.57E+00	
	600-1200	4.12E-01	5.20E-02	4.69E+04	6.70E+08	3.00E-04	2.33E-06	3.40E-02	2.33E-06	3.40E-02	2.96E-02	
	All Depths	1.86E+01	6.53E+01	9.95E+05	1.74E+11	5.64E-03	1.22E-03	3.02E-01	1.22E-03	3.02E-01	3.28E+00	
<i>Raja rhina</i>	200-600	1.20E+01	1.45E+02	4.01E+03	1.61E+07	6.27E-03	4.56E-03	2.09E-03	4.56E-03	2.09E-03	5.07E-04	
	600-1200	0.00E+00	0.00E+00	0.00E+00	0.00E+00	0.00E+00	0.00E+00	0.00E+00	0.00E+00	0.00E+00	0.00E+00	
	All Depths	1.20E+01	1.45E+02	4.01E+03	1.61E+07	3.64E-03	2.65E-03	1.21E-03	2.65E-03	1.21E-03	2.94E-04	

Table 9. - - Continued.

Species	Stratum (depth in meters)			Biomass		Population			CPUE			CPUE		
		(t)	Variance	Number	Variance	kg/ha	Variance	no./ha	Variance	no./ha	Variance			
<i>Bathyraja taranetzi</i>	200-600	9.43E+02	4.64E+04	1.02E+06	5.31E+10	5.01E-01	1.83E+00	5.41E-01	1.83E+00	5.41E-01	1.97E+00			
	600-1200	3.54E+01	2.29E+02	8.48E+04	1.47E+09	2.64E-02	1.20E-02	6.48E-02	1.20E-02	6.48E-02	8.24E-02			
	All Depths	9.78E+02	4.66E+04	1.11E+06	5.45E+10	3.02E-01	1.12E+00	3.41E-01	1.12E+00	3.41E-01	1.23E+00			
<i>Bathyraja taranetzi</i> egg case	200-600	4.24E-01	7.15E-02	4.06E+04	4.53E+08	2.29E-04	2.33E-06	2.18E-02	2.33E-06	2.18E-02	1.45E-02			
	600-1200	2.92E-01	4.68E-02	2.05E+04	1.71E+08	2.37E-04	2.78E-06	1.64E-02	2.78E-06	1.64E-02	9.75E-03			
	All Depths	7.15E-01	1.18E-01	6.11E+04	6.24E+08	2.32E-04	2.51E-06	1.95E-02	2.51E-06	1.95E-02	1.24E-02			
<i>Bathyraja trachura</i>	200-600	5.94E+00	1.85E+01	2.57E+04	1.43E+08	3.19E-03	6.13E-04	1.44E-02	6.13E-04	1.44E-02	5.14E-03			
	600-1200	2.13E+03	8.27E+04	1.12E+06	3.93E+10	1.51E+00	4.27E+00	8.00E-01	4.27E+00	8.00E-01	1.89E+00			
	All Depths	2.13E+03	8.27E+04	1.14E+06	3.94E+10	6.37E-01	2.34E+00	3.44E-01	2.34E+00	3.44E-01	9.42E-01			
<i>Bathyraja trachura</i> egg case	200-600	3.15E-01	2.06E-02	3.29E+04	2.13E+08	1.69E-04	7.24E-07	1.74E-02	7.24E-07	1.74E-02	7.35E-03			
	600-1200	5.75E+00	2.84E+00	4.19E+05	1.18E+10	4.05E-03	1.12E-04	2.96E-01	1.12E-04	2.96E-01	4.68E-01			
	All Depths	6.06E+00	2.86E+00	4.52E+05	1.20E+10	1.80E-03	5.09E-05	1.35E-01	5.09E-05	1.35E-01	2.19E-01			
<i>Bathyraja parmifera</i>	200-600	4.32E+03	1.91E+06	7.30E+05	5.37E+10	2.26E+00	7.23E+01	3.82E-01	7.23E+01	3.82E-01	2.03E+00			
	600-1200	0.00E+00	0.00E+00	0.00E+00	0.00E+00	0.00E+00	0.00E+00	0.00E+00	0.00E+00	0.00E+00	0.00E+00			
	All Depths	4.32E+03	1.91E+06	7.30E+05	5.37E+10	1.31E+00	4.30E+01	2.22E-01	4.30E+01	2.22E-01	1.21E+00			
<i>Bathyraja aleutica</i>	200-600	1.39E+04	5.92E+06	3.15E+06	2.23E+11	7.41E+00	2.03E+02	1.68E+00	2.03E+02	1.68E+00	8.45E+00			
	600-1200	2.81E+03	7.45E+04	2.82E+06	9.60E+10	2.17E+00	6.82E+00	2.11E+00	6.82E+00	2.11E+00	5.45E+00			
	All Depths	1.67E+04	5.99E+06	5.97E+06	3.19E+11	5.21E+00	1.27E+02	1.86E+00	1.27E+02	1.86E+00	7.20E+00			
<i>Bathyraja aleutica</i> egg case	200-600	2.18E+01	5.58E+01	3.85E+05	1.85E+10	1.17E-02	2.01E-03	2.06E-01	2.01E-03	2.06E-01	6.64E-01			
	600-1200	1.86E+00	1.47E+00	4.75E+04	9.27E+08	1.35E-03	6.92E-05	3.24E-02	6.92E-05	3.24E-02	4.05E-02			
	All Depths	2.37E+01	5.73E+01	4.32E+05	1.94E+10	7.34E-03	1.21E-03	1.33E-01	1.21E-03	1.33E-01	4.08E-01			
<i>Bathyraja parmifera</i> egg case	200-600	2.27E+01	1.20E+02	9.94E+05	2.74E+11	1.19E-02	4.02E-03	5.22E-01	4.02E-03	5.22E-01	9.24E+00			
	600-1200	2.74E+00	4.01E+00	1.41E+05	9.28E+09	2.04E-03	1.88E-04	1.05E-01	1.88E-04	1.05E-01	4.30E-01			
	All Depths	2.54E+01	1.24E+02	1.14E+06	2.83E+11	7.77E-03	2.43E-03	3.47E-01	2.43E-03	3.47E-01	5.56E+00			
<i>Bathyraja lindbergi</i>	200-600	1.08E+03	8.82E+04	3.30E+05	7.12E+09	5.71E-01	2.75E+00	1.74E-01	2.75E+00	1.74E-01	2.28E-01			
	600-1200	2.26E+03	1.74E+05	1.46E+06	5.87E+10	1.68E+00	1.12E+01	1.08E+00	1.12E+01	1.08E+00	3.95E+00			
	All Depths	3.34E+03	2.62E+05	1.79E+06	6.58E+10	1.04E+00	6.57E+00	5.54E-01	6.57E+00	5.54E-01	1.98E+00			
<i>Bathyraja lindbergi</i> egg case	200-600	6.96E-01	2.36E-01	2.43E+04	2.12E+08	3.68E-04	8.02E-06	1.28E-02	8.02E-06	1.28E-02	7.21E-03			
	600-1200	0.00E+00	0.00E+00	0.00E+00	0.00E+00	0.00E+00	0.00E+00	0.00E+00	0.00E+00	0.00E+00	0.00E+00			
	All Depths	6.96E-01	2.36E-01	2.43E+04	2.12E+08	2.14E-04	4.67E-06	7.42E-03	4.67E-06	7.42E-03	4.21E-03			

Table 9. - - Continued.

Species	Stratum (depth in meters)			Biomass		Population			CPUE			CPUE		
		(t)	Variance	Number	Variance	kg/ha	Variance	no./ha	Variance	no./ha	Variance			
<i>Bathyraja maculata</i>	200-600	3.79E+03	5.27E+05	1.24E+06	8.87E+10	1.95E+00	1.84E+01	6.39E-01	1.84E+01	3.27E+00				
	600-1200	6.49E+02	5.54E+04	2.67E+05	7.00E+09	5.09E-01	5.13E+00	2.09E-01	5.13E+00	5.93E-01				
	All Depths	4.44E+03	5.82E+05	1.51E+06	9.57E+10	1.34E+00	1.33E+01	4.58E-01	1.33E+01	2.18E+00				
<i>Bathyraja maculata</i> egg case	200-600	1.14E-01	1.31E-02	4.09E+03	1.67E+07	6.07E-05	4.28E-07	2.17E-03	4.28E-07	5.46E-04				
	600-1200	5.51E-01	1.56E-01	4.25E+04	9.17E+08	4.09E-04	7.27E-06	3.15E-02	7.27E-06	4.26E-02				
	All Depths	6.66E-01	1.70E-01	4.65E+04	9.34E+08	2.07E-04	3.31E-06	1.45E-02	3.31E-06	1.83E-02				
<i>Bathyraja minispinosa</i>	200-600	1.46E+03	9.81E+04	6.75E+05	1.64E+10	7.79E-01	3.25E+00	3.60E-01	3.25E+00	5.77E-01				
	600-1200	4.11E+02	2.96E+03	7.49E+05	1.13E+10	3.18E-01	1.80E-01	5.50E-01	1.80E-01	5.72E-01				
	All Depths	1.87E+03	1.01E+05	1.42E+06	2.77E+10	5.86E-01	2.01E+00	4.40E-01	2.01E+00	5.81E-01				
<i>Bathyraja minispinosa</i> egg case	200-600	8.70E-01	2.03E-01	5.68E+04	8.52E+08	4.56E-04	6.43E-06	2.97E-02	6.43E-06	2.73E-02				
	600-1200	4.93E-01	7.30E-02	3.18E+04	2.38E+08	3.73E-04	3.33E-06	2.42E-02	3.33E-06	1.15E-02				
	All Depths	1.36E+00	2.76E-01	8.86E+04	1.09E+09	4.21E-04	5.11E-06	2.74E-02	5.11E-06	2.06E-02				
<i>Atheresthes stomias</i>	200-600	6.81E+04	7.77E+07	6.85E+07	9.53E+13	3.59E+01	2.90E+03	3.61E+01	2.90E+03	3.59E+03				
	600-1200	1.84E+02	7.89E+03	1.12E+05	2.03E+09	1.38E-01	4.18E-01	8.21E-02	4.18E-01	1.07E-01				
	All Depths	6.83E+04	7.77E+07	6.86E+07	9.53E+13	2.09E+01	1.99E+03	2.09E+01	1.99E+03	2.39E+03				
<i>Atheresthes evermanni</i>	200-600	1.99E+04	2.05E+07	1.90E+07	2.30E+13	1.05E+01	6.91E+02	1.00E+01	6.91E+02	7.62E+02				
	600-1200	4.87E+03	6.93E+05	2.32E+06	1.41E+11	3.66E+00	4.23E+01	1.74E+00	4.23E+01	8.82E+00				
	All Depths	2.48E+04	2.12E+07	2.13E+07	2.31E+13	7.63E+00	4.29E+02	6.55E+00	4.29E+02	4.61E+02				
<i>Reinhardtius hippoglossoides</i>	200-600	1.10E+04	2.99E+06	3.65E+06	5.37E+11	5.81E+00	1.15E+02	1.93E+00	1.15E+02	2.01E+01				
	600-1200	6.46E+03	2.10E+06	1.60E+06	2.31E+11	4.87E+00	1.16E+02	1.21E+00	1.16E+02	1.33E+01				
	All Depths	1.74E+04	5.09E+06	5.25E+06	7.68E+11	5.42E+00	1.15E+02	1.63E+00	1.15E+02	1.73E+01				
<i>Hippoglossus stenolepis</i>	200-600	7.61E+03	1.41E+06	1.06E+06	3.23E+10	3.96E+00	4.62E+01	5.53E-01	4.62E+01	1.02E+00				
	600-1200	3.77E+02	4.19E+04	1.79E+04	8.15E+07	2.90E-01	2.20E+00	1.36E-02	2.20E+00	4.42E-03				
	All Depths	7.99E+03	1.45E+06	1.08E+06	3.24E+10	2.42E+00	3.09E+01	3.26E-01	3.09E+01	6.60E-01				
<i>Hippoglossoides elassodon</i>	200-600	1.86E+04	4.96E+06	4.51E+07	2.89E+13	1.00E+01	1.72E+02	2.39E+01	1.72E+02	9.51E+02				
	600-1200	1.82E+00	3.33E+00	3.42E+03	1.17E+07	1.37E-03	1.58E-04	2.57E-03	1.58E-04	5.54E-04				
	All Depths	1.86E+04	4.96E+06	4.51E+07	2.89E+13	5.80E+00	1.24E+02	1.39E+01	1.24E+02	6.89E+02				
<i>Microstomus pacificus</i>	200-600	3.30E+02	6.61E+03	3.41E+05	6.55E+09	1.75E-01	2.35E-01	1.81E-01	2.35E-01	2.27E-01				
	600-1200	0.00E+00	0.00E+00	0.00E+00	0.00E+00	0.00E+00	0.00E+00	0.00E+00	0.00E+00	0.00E+00				
	All Depths	3.30E+02	6.61E+03	3.41E+05	6.55E+09	1.01E-01	1.43E-01	1.05E-01	1.43E-01	1.39E-01				

Table 9. - - Continued.

Species	Stratum (depth in meters)	Biomass		Population		CPUE		CPUE	
		(t)	Variance	Number	Variance	kg/ha	Variance	no./ha	Variance
<i>Embassichthys bathybius</i>	200-600	6.72E+01	2.57E+03	3.59E+04	6.98E+08	3.67E-02	8.47E-02	1.96E-02	2.31E-02
	600-1200	4.19E+02	1.68E+04	3.75E+05	1.21E+10	3.36E-01	9.09E-01	2.96E-01	6.30E-01
	All Depths	4.86E+02	1.94E+04	4.11E+05	1.28E+10	1.62E-01	4.50E-01	1.36E-01	2.95E-01
<i>Glyptocephalus zachirus</i>	200-600	1.15E+04	2.37E+06	1.82E+07	6.17E+12	6.16E+00	9.68E+01	9.70E+00	2.36E+02
	600-1200	2.56E+01	2.57E+02	5.33E+04	8.95E+08	2.26E-02	1.60E-02	4.55E-02	5.14E-02
	All Depths	1.16E+04	2.37E+06	1.82E+07	6.17E+12	3.58E+00	6.52E+01	5.65E+00	1.59E+02
<i>Lepidopsetta polyxystra</i>	200-600	1.81E+02	1.62E+04	3.25E+05	5.62E+10	9.65E-02	5.42E-01	1.74E-01	1.88E+00
	600-1200	0.00E+00	0.00E+00	0.00E+00	0.00E+00	0.00E+00	0.00E+00	0.00E+00	0.00E+00
	All Depths	1.81E+02	1.62E+04	3.25E+05	5.62E+10	5.60E-02	3.16E-01	1.01E-01	1.09E+00
<i>Leptagonus frenatus</i>	200-600	2.02E+02	4.41E+03	3.95E+06	1.79E+12	1.06E-01	1.56E-01	2.08E+00	6.33E+01
	600-1200	1.17E+00	6.86E-01	2.64E+04	3.49E+08	8.01E-04	2.66E-05	1.81E-02	1.35E-02
	All Depths	2.03E+02	4.41E+03	3.98E+06	1.79E+12	6.20E-02	9.28E-02	1.21E+00	3.76E+01
<i>BathYGONUS nigripinnis</i>	200-600	3.05E+01	5.29E+01	1.99E+06	1.71E+11	1.66E-02	2.05E-03	1.08E+00	7.04E+00
	600-1200	2.18E+01	1.32E+01	1.94E+06	9.57E+10	1.62E-02	7.91E-04	1.44E+00	5.67E+00
	All Depths	5.24E+01	6.60E+01	3.93E+06	2.67E+11	1.64E-02	1.52E-03	1.23E+00	6.46E+00
<i>Aspidophoroides bartoni</i>	200-600	6.47E-02	4.19E-03	7.19E+03	5.17E+07	3.44E-05	1.37E-07	3.82E-03	1.69E-03
	600-1200	0.00E+00	0.00E+00	0.00E+00	0.00E+00	0.00E+00	0.00E+00	0.00E+00	0.00E+00
	All Depths	6.47E-02	4.19E-03	7.19E+03	5.17E+07	1.99E-05	7.95E-08	2.22E-03	9.82E-04
<i>Bajacalifornia megalops</i>	200-600	0.00E+00	0.00E+00	0.00E+00	0.00E+00	0.00E+00	0.00E+00	0.00E+00	0.00E+00
	600-1200	1.82E+00	3.33E+00	4.39E+03	1.92E+07	1.28E-03	1.38E-04	3.08E-03	7.99E-04
	All Depths	1.82E+00	3.33E+00	4.39E+03	1.92E+07	5.39E-04	5.81E-05	1.30E-03	3.36E-04
<i>Anoplopoma fimbria</i>	200-600	4.35E+03	6.32E+05	1.67E+06	7.36E+10	2.31E+00	2.99E+01	8.86E-01	3.94E+00
	600-1200	8.02E+03	1.32E+06	2.40E+06	9.88E+10	6.04E+00	8.29E+01	1.81E+00	6.78E+00
	All Depths	1.24E+04	1.95E+06	4.07E+06	1.72E+11	3.87E+00	5.53E+01	1.27E+00	5.31E+00
<i>Bathylagus pacificus</i>	200-600	6.05E-01	2.04E-01	2.41E+04	1.90E+08	3.19E-04	6.71E-06	1.26E-02	6.02E-03
	600-1200	9.65E+01	5.52E+02	3.27E+06	3.98E+11	7.03E-02	3.07E-02	2.38E+00	2.30E+01
	All Depths	9.71E+01	5.52E+02	3.29E+06	3.98E+11	2.97E-02	1.40E-02	1.01E+00	1.10E+01
<i>Bathylagus species</i>	200-600	2.96E-01	8.73E-02	1.44E+04	2.08E+08	1.57E-04	2.85E-06	7.65E-03	6.78E-03
	600-1200	4.44E+01	1.47E+02	1.49E+06	1.61E+11	3.22E-02	8.51E-03	1.08E+00	8.82E+00
	All Depths	4.47E+01	1.47E+02	1.51E+06	1.61E+11	1.36E-02	3.80E-03	4.57E-01	3.96E+00

Table 9. - - Continued.

Species	Stratum (depth in meters)			Biomass		Population			CPUE			CPUE		
		(t)	Variance	Number	Variance	kg/ha	Variance	no./ha	Variance	no./ha	Variance			
<i>Bathylagus milleri</i>	200-600	3.83E-01	1.47E-01	1.28E+04	1.63E+08	1.94E-04	4.35E-06	6.45E-03	4.83E-03					
	600-1200	1.15E+01	9.18E+00	2.97E+05	4.12E+09	7.92E-03	4.53E-04	2.06E-01	2.77E-01					
	All Depths	1.19E+01	9.33E+00	3.09E+05	4.28E+09	3.44E-03	2.06E-04	9.03E-02	1.28E-01					
<i>Leuroglossus schmidti</i>	200-600	3.49E+01	6.33E+01	4.21E+06	9.66E+11	1.85E-02	2.69E-03	2.23E+00	4.01E+01					
	600-1200	2.00E+01	1.75E+01	2.06E+06	2.08E+11	1.51E-02	9.18E-04	1.55E+00	1.05E+01					
	All Depths	5.49E+01	8.07E+01	6.28E+06	1.17E+12	1.71E-02	1.94E-03	1.95E+00	2.77E+01					
<i>Bathylagus ochotensis</i>	200-600	9.64E-02	4.65E-03	7.46E+03	2.79E+07	5.41E-05	1.02E-07	4.16E-03	9.97E-04					
	600-1200	8.20E-01	2.44E-01	2.57E+04	1.01E+08	5.78E-04	1.02E-05	1.80E-02	4.26E-03					
	All Depths	9.16E-01	2.49E-01	3.32E+04	1.28E+08	2.74E-04	4.41E-06	9.96E-03	2.40E-03					
<i>Bathymaster signatus</i>	200-600	1.66E+01	7.15E+01	8.32E+04	1.56E+09	8.61E-03	2.08E-03	4.35E-02	4.68E-02					
	600-1200	0.00E+00	0.00E+00	0.00E+00	0.00E+00	0.00E+00	0.00E+00	0.00E+00	0.00E+00					
	All Depths	1.66E+01	7.15E+01	8.32E+04	1.56E+09	4.99E-03	1.22E-03	2.52E-02	2.75E-02					
<i>Clupea pallasii</i>	200-600	2.76E+01	7.64E+02	6.34E+04	4.02E+09	1.48E-02	2.56E-02	3.41E-02	1.35E-01					
	600-1200	0.00E+00	0.00E+00	0.00E+00	0.00E+00	0.00E+00	0.00E+00	0.00E+00	0.00E+00					
	All Depths	2.76E+01	7.64E+02	6.34E+04	4.02E+09	8.61E-03	1.48E-02	1.98E-02	7.81E-02					
<i>Coryphaenoides species</i>	200-600	0.00E+00	0.00E+00	0.00E+00	0.00E+00	0.00E+00	0.00E+00	0.00E+00	0.00E+00					
	600-1200	3.25E+01	1.06E+03	7.76E+03	6.02E+07	2.19E-02	4.02E-02	5.22E-03	2.29E-03					
	All Depths	3.25E+01	1.06E+03	7.76E+03	6.02E+07	9.19E-03	1.69E-02	2.19E-03	9.62E-04					
<i>Coryphaenoides acrolepis</i>	200-600	0.00E+00	0.00E+00	0.00E+00	0.00E+00	0.00E+00	0.00E+00	0.00E+00	0.00E+00					
	600-1200	4.07E+03	9.06E+05	1.47E+07	3.73E+12	2.76E+00	5.38E+01	1.02E+01	2.93E+02					
	All Depths	4.07E+03	9.06E+05	1.47E+07	3.73E+12	1.16E+00	2.43E+01	4.27E+00	1.47E+02					
<i>Albatrossia pectoralis</i>	200-600	1.21E+05	2.49E+08	2.78E+07	1.20E+13	6.60E+01	1.66E+04	1.52E+01	8.74E+02					
	600-1200	3.28E+05	2.03E+09	9.83E+07	1.58E+14	2.37E+02	8.23E+04	7.11E+01	6.19E+03					
	All Depths	4.50E+05	2.28E+09	1.26E+08	1.70E+14	1.38E+02	5.11E+04	3.87E+01	3.85E+03					
<i>Coryphaenoides cinereus</i>	200-600	1.77E+03	4.29E+05	8.45E+06	1.15E+13	9.91E-01	1.75E+01	4.71E+00	4.44E+02					
	600-1200	4.73E+04	1.32E+07	2.91E+08	8.58E+14	3.40E+01	8.04E+02	2.07E+02	4.08E+04					
	All Depths	4.91E+04	1.37E+07	2.99E+08	8.70E+14	1.49E+01	6.13E+02	8.98E+01	2.73E+04					
<i>Zesticelus profundorum</i>	200-600	1.53E-02	2.33E-04	3.82E+03	1.46E+07	8.10E-06	7.61E-09	2.03E-03	4.76E-04					
	600-1200	1.61E-01	3.13E-03	6.44E+04	4.58E+08	1.14E-04	1.48E-07	4.55E-02	2.14E-02					
	All Depths	1.76E-01	3.37E-03	6.82E+04	4.72E+08	5.27E-05	6.88E-08	2.03E-02	9.65E-03					

Table 9. - - Continued.

Species	Stratum (depth in meters)	Biomass		Population		CPUE		CPUE	
		(t)	Variance	Number	Variance	kg/ha	Variance	no./ha	Variance
<i>Malacocottus zonurus</i>	200-600	1.03E+03	1.27E+05	7.24E+06	3.46E+12	5.43E-01	4.19E+00	3.82E+00	1.14E+02
	600-1200	4.26E+01	1.42E+03	2.56E+05	3.58E+10	3.40E-02	7.70E-02	2.01E-01	1.92E+00
	All Depths	1.07E+03	1.28E+05	7.50E+06	3.49E+12	3.29E-01	2.52E+00	2.30E+00	6.97E+01
<i>Hemilepidotus jordani</i>	200-600	6.44E+00	2.25E+01	8.47E+03	3.60E+07	3.38E-03	7.11E-04	4.46E-03	1.14E-03
	600-1200	0.00E+00	0.00E+00	0.00E+00	0.00E+00	0.00E+00	0.00E+00	0.00E+00	0.00E+00
	All Depths	6.44E+00	2.25E+01	8.47E+03	3.60E+07	1.96E-03	4.14E-04	2.59E-03	6.66E-04
<i>Triglops szepticus</i>	200-600	2.98E+01	1.36E+02	7.28E+05	1.29E+11	1.54E-02	4.53E-03	3.69E-01	3.71E+00
	600-1200	0.00E+00	0.00E+00	0.00E+00	0.00E+00	0.00E+00	0.00E+00	0.00E+00	0.00E+00
	All Depths	2.98E+01	1.36E+02	7.28E+05	1.29E+11	8.94E-03	2.68E-03	2.14E-01	2.18E+00
<i>Myoxocephalus polyacanthocephalus</i>	200-600	9.17E+00	8.42E+01	3.59E+03	1.29E+07	4.87E-03	2.76E-03	1.91E-03	4.23E-04
	600-1200	0.00E+00	0.00E+00	0.00E+00	0.00E+00	0.00E+00	0.00E+00	0.00E+00	0.00E+00
	All Depths	9.17E+00	8.42E+01	3.59E+03	1.29E+07	2.83E-03	1.60E-03	1.11E-03	2.46E-04
<i>Dasycoctus setiger</i>	200-600	3.71E+02	3.44E+03	2.92E+06	2.26E+11	1.98E-01	1.76E-01	1.56E+00	9.58E+00
	600-1200	2.77E+00	3.90E+00	4.39E+04	8.54E+08	2.06E-03	1.86E-04	3.28E-02	4.32E-02
	All Depths	3.74E+02	3.44E+03	2.97E+06	2.27E+11	1.16E-01	1.11E-01	9.17E-01	6.12E+00
<i>Hemiritripteris bolini</i>	200-600	3.03E+03	2.24E+05	7.38E+05	9.37E+09	1.59E+00	9.30E+00	3.88E-01	4.24E-01
	600-1200	2.62E+01	2.09E+02	2.40E+04	1.23E+08	2.06E-02	1.12E-02	1.86E-02	6.61E-03
	All Depths	3.05E+03	2.24E+05	7.62E+05	9.49E+09	9.29E-01	5.98E+00	2.33E-01	2.81E-01
<i>Icelus spiniger</i>	200-600	5.83E+00	7.63E+00	1.53E+05	1.69E+09	3.09E-03	2.63E-04	7.92E-02	6.14E-02
	600-1200	0.00E+00	0.00E+00	0.00E+00	0.00E+00	0.00E+00	0.00E+00	0.00E+00	0.00E+00
	All Depths	5.83E+00	7.63E+00	1.53E+05	1.69E+09	1.79E-03	1.54E-04	4.60E-02	3.70E-02
<i>Icelus canaliculatus</i>	200-600	1.35E+01	5.17E+01	6.65E+05	1.23E+11	6.82E-03	1.63E-03	3.35E-01	3.94E+00
	600-1200	2.58E+01	2.68E+02	1.30E+06	6.84E+11	2.01E-02	1.62E-02	1.00E+00	4.01E+01
	All Depths	3.93E+01	3.20E+02	1.96E+06	8.07E+11	1.24E-02	7.75E-03	6.14E-01	1.91E+01
<i>Icelus euryops</i>	200-600	4.00E+00	5.70E+00	3.64E+05	5.25E+10	2.05E-03	1.68E-04	1.87E-01	1.54E+00
	600-1200	0.00E+00	0.00E+00	0.00E+00	0.00E+00	0.00E+00	0.00E+00	0.00E+00	0.00E+00
	All Depths	4.00E+00	5.70E+00	3.64E+05	5.25E+10	1.19E-03	9.79E-05	1.08E-01	9.00E-01
<i>Icelus spatula</i>	200-600	2.74E-01	3.81E-02	1.51E+04	1.44E+08	1.47E-04	1.25E-06	8.02E-03	4.70E-03
	600-1200	0.00E+00	0.00E+00	0.00E+00	0.00E+00	0.00E+00	0.00E+00	0.00E+00	0.00E+00
	All Depths	2.74E-01	3.81E-02	1.51E+04	1.44E+08	8.50E-05	7.29E-07	4.65E-03	2.73E-03

Table 9. - - Continued.

Species	Stratum (depth in meters)			Biomass		Population			CPUE			CPUE		
		(t)	Variance	Number	Variance	kg/ha	Variance	no./ha	Variance	no./ha	Variance			
<i>Gadus macrocephalus</i>	200-600	3.53E+03	2.07E+05	1.16E+06	2.42E+10	1.84E+00	1.21E+01	6.07E-01	1.29E+00	1.29E+00				
	600-1200	0.00E+00	0.00E+00	0.00E+00	0.00E+00	0.00E+00	0.00E+00	0.00E+00	0.00E+00	0.00E+00				
	All Depths	3.53E+03	2.07E+05	1.16E+06	2.42E+10	1.07E+00	7.85E+00	3.52E-01	8.34E-01	8.34E-01				
<i>Halargyreus johnsonii</i>	200-600	0.00E+00	0.00E+00	0.00E+00	0.00E+00	0.00E+00	0.00E+00	0.00E+00	0.00E+00	0.00E+00				
	600-1200	8.44E+00	1.43E+01	4.06E+04	2.65E+08	6.21E-03	9.05E-04	3.00E-02	1.87E-02	1.87E-02				
	All Depths	8.44E+00	1.43E+01	4.06E+04	2.65E+08	2.61E-03	3.87E-04	1.26E-02	8.02E-03	8.02E-03				
<i>Antimora microlepis</i>	200-600	4.55E+00	1.40E+01	7.97E+03	3.19E+07	2.37E-03	4.20E-04	4.31E-03	1.07E-03	1.07E-03				
	600-1200	2.74E+02	1.78E+03	1.06E+06	2.51E+10	1.80E-01	8.61E-02	7.22E-01	1.33E+00	1.33E+00				
	All Depths	2.78E+02	1.80E+03	1.06E+06	2.51E+10	7.71E-02	4.39E-02	3.06E-01	6.81E-01	6.81E-01				
<i>Theragra chalcogramma</i>	200-600	2.63E+04	3.26E+07	2.50E+07	2.79E+13	1.36E+01	1.41E+03	1.29E+01	1.19E+03	1.19E+03				
	600-1200	4.68E+01	1.60E+03	4.96E+04	1.77E+09	3.76E-02	9.22E-02	3.98E-02	1.01E-01	1.01E-01				
	All Depths	2.63E+04	3.26E+07	2.51E+07	2.79E+13	7.88E+00	8.58E+02	7.50E+00	7.31E+02	7.31E+02				
Gonostomatidae	200-600	0.00E+00	0.00E+00	0.00E+00	0.00E+00	0.00E+00	0.00E+00	0.00E+00	0.00E+00	0.00E+00				
	600-1200	1.49E-01	6.12E-03	1.85E+04	1.13E+08	1.11E-04	2.98E-07	1.35E-02	4.87E-03	4.87E-03				
	All Depths	1.49E-01	6.12E-03	1.85E+04	1.13E+08	4.66E-05	1.27E-07	5.66E-03	2.08E-03	2.08E-03				
<i>Sigmops gracilis</i>	200-600	6.15E-02	3.79E-03	4.39E+03	1.93E+07	3.26E-05	1.24E-07	2.33E-03	6.30E-04	6.30E-04				
	600-1200	0.00E+00	0.00E+00	0.00E+00	0.00E+00	0.00E+00	0.00E+00	0.00E+00	0.00E+00	0.00E+00				
	All Depths	6.15E-02	3.79E-03	4.39E+03	1.93E+07	1.89E-05	7.17E-08	1.35E-03	3.66E-04	3.66E-04				
<i>Icosteus aenigmaticus</i>	200-600	0.00E+00	0.00E+00	0.00E+00	0.00E+00	0.00E+00	0.00E+00	0.00E+00	0.00E+00	0.00E+00				
	600-1200	1.50E+02	2.24E+04	8.12E+03	6.59E+07	1.13E-01	1.06E+00	6.11E-03	3.13E-03	3.13E-03				
	All Depths	1.50E+02	2.24E+04	8.12E+03	6.59E+07	4.73E-02	4.47E-01	2.56E-03	1.32E-03	1.32E-03				
<i>Aptocyclus ventricosus</i>	200-600	6.08E+01	3.56E+02	8.62E+04	3.96E+08	3.28E-02	1.19E-02	4.65E-02	1.41E-02	1.41E-02				
	600-1200	2.22E+02	1.70E+03	2.71E+05	1.59E+09	1.60E-01	7.15E-02	1.86E-01	6.22E-02	6.22E-02				
	All Depths	2.82E+02	2.06E+03	3.57E+05	1.98E+09	8.61E-02	4.07E-02	1.05E-01	3.89E-02	3.89E-02				
Liparidinae	200-600	4.16E-02	1.73E-03	8.32E+03	6.93E+07	2.17E-05	5.46E-08	4.34E-03	2.18E-03	2.18E-03				
	600-1200	1.51E+00	1.08E+00	4.07E+04	3.97E+08	1.18E-03	5.50E-05	3.01E-02	1.82E-02	1.82E-02				
	All Depths	1.56E+00	1.08E+00	4.90E+04	4.67E+08	5.09E-04	2.33E-05	1.51E-02	9.02E-03	9.02E-03				
<i>Crystallichthys cyclospilus</i>	200-600	1.84E+00	3.38E+00	4.53E+03	2.05E+07	9.88E-04	1.13E-04	2.43E-03	6.87E-04	6.87E-04				
	600-1200	0.00E+00	0.00E+00	0.00E+00	0.00E+00	0.00E+00	0.00E+00	0.00E+00	0.00E+00	0.00E+00				
	All Depths	1.84E+00	3.38E+00	4.53E+03	2.05E+07	5.73E-04	6.57E-05	1.41E-03	3.98E-04	3.98E-04				

Table 9. - - Continued.

Species	Stratum (depth in meters)			Biomass		Population		CPUE			CPUE		
		(t)	Variance	Number	Variance	kg/ha	Variance	no./ha	Variance	no./ha	Variance		
<i>Elassodiscus</i> species	200-600	1.54E-02	2.36E-04	3.84E+03	1.48E+07	7.51E-06	6.55E-09	1.88E-03	4.09E-04				
	600-1200	1.52E-01	1.13E-02	2.67E+04	3.85E+08	1.21E-04	6.44E-07	2.15E-02	2.30E-02				
	All Depths	1.67E-01	1.15E-02	3.06E+04	4.00E+08	5.52E-05	2.76E-07	1.01E-02	9.94E-03				
<i>Elassodiscus caudatus</i>	200-600	2.84E+00	1.03E+00	8.59E+04	1.72E+09	1.57E-03	3.61E-05	4.89E-02	6.73E-02				
	600-1200	8.54E+01	6.01E+02	1.25E+06	6.28E+10	6.14E-02	2.58E-02	9.08E-01	2.74E+00				
	All Depths	8.82E+01	6.02E+02	1.34E+06	6.45E+10	2.67E-02	1.17E-02	4.10E-01	1.36E+00				
<i>Elassodiscus tremebundus</i>	200-600	0.00E+00	0.00E+00	0.00E+00	0.00E+00	0.00E+00	0.00E+00	0.00E+00	0.00E+00				
	600-1200	4.85E+01	1.12E+02	4.62E+05	9.65E+09	3.59E-02	6.00E-03	3.39E-01	6.57E-01				
	All Depths	4.85E+01	1.12E+02	4.62E+05	9.65E+09	1.51E-02	2.82E-03	1.42E-01	3.02E-01				
<i>Careproctus</i> species	200-600	8.66E-02	6.31E-03	7.36E+03	2.71E+07	4.57E-05	2.06E-07	3.75E-03	8.09E-04				
	600-1200	8.08E-01	2.18E-01	5.17E+04	9.53E+08	6.01E-04	9.31E-06	4.10E-02	5.44E-02				
	All Depths	8.95E-01	2.24E-01	5.91E+04	9.80E+08	2.79E-04	4.08E-06	1.94E-02	2.35E-02				
<i>Careproctus melanurus</i>	200-600	7.80E+01	8.60E+02	8.09E+04	9.03E+08	4.21E-02	2.80E-02	4.41E-02	3.07E-02				
	600-1200	1.45E+02	1.56E+03	4.59E+05	1.41E+10	1.05E-01	6.74E-02	3.34E-01	6.26E-01				
	All Depths	2.23E+02	2.42E+03	5.40E+05	1.50E+10	6.85E-02	4.53E-02	1.66E-01	2.99E-01				
<i>Careproctus bowerianus</i>	200-600	8.45E-02	7.14E-03	3.84E+03	1.48E+07	4.13E-05	1.98E-07	1.88E-03	4.09E-04				
	600-1200	1.48E-01	1.09E-02	1.39E+04	1.09E+08	1.14E-04	5.53E-07	1.12E-02	6.26E-03				
	All Depths	2.32E-01	1.80E-02	1.78E+04	1.24E+08	7.21E-05	3.47E-07	5.79E-03	2.87E-03				
<i>Careproctus simus</i>	200-600	4.57E-01	5.35E-02	3.14E+04	1.43E+08	2.28E-04	1.57E-06	1.56E-02	4.87E-03				
	600-1200	6.70E-01	4.49E-01	3.21E+04	1.03E+09	5.40E-04	2.45E-05	2.59E-02	5.62E-02				
	All Depths	1.13E+00	5.02E-01	6.35E+04	1.17E+09	3.59E-04	1.11E-05	1.99E-02	2.63E-02				
<i>Careproctus furcellus</i>	200-600	1.54E+02	1.96E+03	2.56E+05	7.06E+09	8.10E-02	6.40E-02	1.34E-01	2.33E-01				
	600-1200	9.90E+00	8.48E+00	1.19E+05	1.41E+09	7.74E-03	4.08E-04	9.33E-02	7.65E-02				
	All Depths	1.64E+02	1.96E+03	3.75E+05	8.47E+09	5.02E-02	3.85E-02	1.17E-01	1.67E-01				
<i>Paraliparis ulochir</i>	200-600	0.00E+00	0.00E+00	0.00E+00	0.00E+00	0.00E+00	0.00E+00	0.00E+00	0.00E+00				
	600-1200	5.36E-01	3.41E-02	9.28E+04	1.24E+09	3.84E-04	1.47E-06	6.76E-02	5.54E-02				
	All Depths	5.36E-01	3.41E-02	9.28E+04	1.24E+09	1.61E-04	6.50E-07	2.84E-02	2.42E-02				
<i>Careproctus gilberti</i>	200-600	3.37E+00	9.66E+00	4.43E+05	1.63E+11	1.66E-03	2.68E-04	2.19E-01	4.52E+00				
	600-1200	2.69E-02	7.24E-04	4.48E+03	2.01E+07	1.93E-05	3.14E-08	3.22E-03	8.73E-04				
	All Depths	3.39E+00	9.66E+00	4.48E+05	1.63E+11	9.73E-04	1.55E-04	1.29E-01	2.63E+00				

Table 9. - - Continued.

Species	Stratum (depth in meters)			Biomass		Population			CPUE			CPUE		
		(t)	Variance	Number	Variance	kg/ha	Variance	no./ha	Variance	no./ha	Variance			
<i>Careproctus colletti</i>	200-600	8.06E+01	1.55E+03	2.36E+05	1.77E+10	4.22E-02	5.28E-02	1.23E-01	5.74E-01					
	600-1200	4.99E+01	1.94E+02	2.41E+05	4.51E+09	3.37E-02	6.61E-03	1.63E-01	1.75E-01					
	All Depths	1.31E+02	1.74E+03	4.76E+05	2.22E+10	3.86E-02	3.33E-02	1.40E-01	4.05E-01					
<i>Careproctus rastrinus</i>	200-600	6.92E+01	7.12E+02	3.74E+05	1.88E+10	3.70E-02	2.53E-02	1.98E-01	6.79E-01					
	600-1200	1.03E-01	1.06E-02	8.58E+03	7.36E+07	8.29E-05	5.77E-07	6.91E-03	4.01E-03					
	All Depths	6.93E+01	7.12E+02	3.83E+05	1.89E+10	2.15E-02	1.50E-02	1.18E-01	4.03E-01					
<i>Paraliparis dactylosus</i>	200-600	0.00E+00	0.00E+00	0.00E+00	0.00E+00	0.00E+00	0.00E+00	0.00E+00	0.00E+00					
	600-1200	9.14E-02	4.22E-03	7.02E+03	2.46E+07	6.80E-05	1.94E-07	5.23E-03	1.13E-03					
	All Depths	9.14E-02	4.22E-03	7.02E+03	2.46E+07	2.86E-05	8.20E-08	2.20E-03	4.80E-04					
<i>Paraliparis cephalus</i>	200-600	7.46E-03	5.56E-05	3.73E+03	1.39E+07	4.40E-06	2.25E-09	2.20E-03	5.62E-04					
	600-1200	3.86E-02	9.61E-04	1.19E+04	7.52E+07	2.64E-05	3.67E-08	8.22E-03	2.93E-03					
	All Depths	4.61E-02	1.02E-03	1.56E+04	8.91E+07	1.36E-05	1.67E-08	4.73E-03	1.56E-03					
<i>Careproctus species G (Orr)</i>	200-600	0.00E+00	0.00E+00	0.00E+00	0.00E+00	0.00E+00	0.00E+00	0.00E+00	0.00E+00					
	600-1200	4.47E-01	1.39E-01	1.05E+04	3.84E+07	3.10E-04	5.23E-06	7.86E-03	1.71E-03					
	All Depths	4.47E-01	1.39E-01	1.05E+04	3.84E+07	1.30E-04	2.20E-06	3.30E-03	7.29E-04					
<i>Careproctus comus</i>	200-600	7.44E-02	5.54E-03	6.20E+03	3.85E+07	3.63E-05	1.53E-07	3.03E-03	1.06E-03					
	600-1200	0.00E+00	0.00E+00	0.00E+00	0.00E+00	0.00E+00	0.00E+00	0.00E+00	0.00E+00					
	All Depths	7.44E-02	5.54E-03	6.20E+03	3.85E+07	2.11E-05	8.88E-08	1.76E-03	6.17E-04					
<i>Paraliparis pectoralis</i>	200-600	0.00E+00	0.00E+00	0.00E+00	0.00E+00	0.00E+00	0.00E+00	0.00E+00	0.00E+00					
	600-1200	8.09E-01	1.67E-01	3.91E+04	4.57E+08	5.97E-04	8.20E-06	2.90E-02	2.28E-02					
	All Depths	8.09E-01	1.67E-01	3.91E+04	4.57E+08	2.51E-04	3.51E-06	1.22E-02	9.73E-03					
<i>Paraliparis species</i>	200-600	6.47E-02	4.19E-03	7.19E+03	5.17E+07	3.44E-05	1.37E-07	3.82E-03	1.69E-03					
	600-1200	1.37E+00	3.67E-01	9.16E+04	8.65E+08	9.28E-04	9.61E-06	6.95E-02	4.42E-02					
	All Depths	1.43E+00	3.72E-01	9.88E+04	9.16E+08	4.10E-04	4.28E-06	3.14E-02	2.05E-02					
<i>Rhinoliparis attenuatus</i>	200-600	3.97E-02	1.58E-03	4.97E+03	2.47E+07	2.32E-05	6.24E-08	2.90E-03	9.76E-04					
	600-1200	6.16E-01	7.89E-02	8.07E+04	7.73E+08	4.56E-04	4.12E-06	5.98E-02	4.33E-02					
	All Depths	6.56E-01	8.05E-02	8.57E+04	7.98E+08	2.05E-04	1.80E-06	2.68E-02	1.94E-02					
<i>Acantholiparis opercularis</i>	200-600	0.00E+00	0.00E+00	0.00E+00	0.00E+00	0.00E+00	0.00E+00	0.00E+00	0.00E+00					
	600-1200	3.59E-02	1.29E-03	4.48E+03	2.01E+07	2.58E-05	5.59E-08	3.22E-03	8.73E-04					
	All Depths	3.59E-02	1.29E-03	4.48E+03	2.01E+07	1.08E-05	2.35E-08	1.35E-03	3.67E-04					

Table 9. - - Continued.

Species	Stratum (depth in meters)			Biomass		Population			CPUE			CPUE		
		(t)	Variance	Number	Variance	kg/ha	Variance	no./ha	Variance	no./ha	Variance			
<i>Paraliparis</i> species cf. <i>dactylosus</i>	200-600	0.00E+00	0.00E+00	0.00E+00	0.00E+00	0.00E+00	0.00E+00	0.00E+00	0.00E+00	0.00E+00	0.00E+00	0.00E+00	0.00E+00	
	600-1200	7.03E-01	1.03E-01	4.38E+04	2.90E+08	4.83E-04	4.07E-06	3.07E-02	4.07E-06	3.07E-02	1.16E-02	1.16E-02	1.16E-02	
	All Depths	7.03E-01	1.03E-01	4.38E+04	2.90E+08	2.03E-04	1.75E-06	1.29E-02	1.75E-06	1.29E-02	5.08E-03	5.08E-03	5.08E-03	
<i>Paraliparis grandis</i>	200-600	0.00E+00	0.00E+00	0.00E+00	0.00E+00	0.00E+00	0.00E+00	0.00E+00	0.00E+00	0.00E+00	0.00E+00	0.00E+00	0.00E+00	
	600-1200	9.10E-01	4.18E-01	1.64E+04	1.66E+08	6.25E-04	1.65E-05	1.09E-02	1.65E-05	1.09E-02	5.94E-03	5.94E-03	5.94E-03	
	All Depths	9.10E-01	4.18E-01	1.64E+04	1.66E+08	2.62E-04	6.99E-06	4.58E-03	6.99E-06	4.58E-03	2.51E-03	2.51E-03	2.51E-03	
<i>Paraliparis</i> species cf. <i>pectoralis</i>	200-600	0.00E+00	0.00E+00	0.00E+00	0.00E+00	0.00E+00	0.00E+00	0.00E+00	0.00E+00	0.00E+00	0.00E+00	0.00E+00	0.00E+00	
	600-1200	6.74E-01	1.46E-01	3.05E+04	1.87E+08	3.61E-04	2.68E-06	1.84E-02	2.68E-06	1.84E-02	5.03E-03	5.03E-03	5.03E-03	
	All Depths	6.74E-01	1.46E-01	3.05E+04	1.87E+08	1.52E-04	1.15E-06	7.74E-03	1.15E-06	7.74E-03	2.18E-03	2.18E-03	2.18E-03	
<i>Paraliparis</i> species cf. <i>dipterus</i>	200-600	0.00E+00	0.00E+00	0.00E+00	0.00E+00	0.00E+00	0.00E+00	0.00E+00	0.00E+00	0.00E+00	0.00E+00	0.00E+00	0.00E+00	
	600-1200	3.59E-02	1.29E-03	1.35E+04	1.81E+08	2.58E-05	5.59E-08	9.67E-03	5.59E-08	9.67E-03	7.86E-03	7.86E-03	7.86E-03	
	All Depths	3.59E-02	1.29E-03	1.35E+04	1.81E+08	1.08E-05	2.35E-08	4.06E-03	2.35E-08	4.06E-03	3.30E-03	3.30E-03	3.30E-03	
<i>Poromitra curilensis</i>	200-600	2.10E-01	1.42E-02	1.08E+04	3.55E+07	1.11E-04	4.94E-07	5.71E-03	4.94E-07	5.71E-03	1.24E-03	1.24E-03	1.24E-03	
	600-1200	7.26E-01	5.66E-02	2.56E+04	6.82E+07	5.36E-04	3.55E-06	1.88E-02	3.55E-06	1.88E-02	4.07E-03	4.07E-03	4.07E-03	
	All Depths	9.36E-01	7.08E-02	3.63E+04	1.04E+08	2.90E-04	1.81E-06	1.12E-02	1.81E-06	1.12E-02	2.46E-03	2.46E-03	2.46E-03	
<i>Melamphaes lugubris</i>	200-600	3.48E-01	3.06E-02	1.50E+04	5.34E+07	1.91E-04	1.11E-06	8.20E-03	1.11E-06	8.20E-03	1.92E-03	1.92E-03	1.92E-03	
	600-1200	4.19E-01	4.96E-02	1.89E+04	9.61E+07	3.13E-04	2.46E-06	1.41E-02	2.46E-06	1.41E-02	4.73E-03	4.73E-03	4.73E-03	
	All Depths	7.67E-01	8.02E-02	3.40E+04	1.50E+08	2.42E-04	1.67E-06	1.07E-02	1.67E-06	1.07E-02	3.09E-03	3.09E-03	3.09E-03	
<i>Tactostoma macropus</i>	200-600	7.47E-02	5.58E-03	4.15E+03	1.72E+07	4.36E-05	2.21E-07	2.42E-03	2.21E-07	2.42E-03	6.81E-04	6.81E-04	6.81E-04	
	600-1200	3.67E-01	1.35E-01	3.67E+03	1.35E+07	2.58E-04	5.61E-06	2.58E-03	5.61E-06	2.58E-03	5.61E-04	5.61E-04	5.61E-04	
	All Depths	4.42E-01	1.41E-01	7.83E+03	3.07E+07	1.34E-04	2.48E-06	2.49E-03	2.48E-06	2.49E-03	6.27E-04	6.27E-04	6.27E-04	
Myctophidae	200-600	8.02E-03	6.44E-05	4.01E+03	1.61E+07	4.18E-06	2.03E-09	2.09E-03	2.03E-09	2.09E-03	5.07E-04	5.07E-04	5.07E-04	
	600-1200	1.86E-01	3.47E-02	1.81E+04	3.28E+08	1.40E-04	1.65E-06	1.36E-02	1.65E-06	1.36E-02	1.56E-02	1.56E-02	1.56E-02	
	All Depths	1.94E-01	3.48E-02	2.21E+04	3.44E+08	6.13E-05	6.95E-07	6.94E-03	6.95E-07	6.94E-03	6.84E-03	6.84E-03	6.84E-03	
<i>Stenobrachius</i> species	200-600	5.55E-01	8.25E-02	8.99E+04	1.85E+09	3.17E-04	2.96E-06	5.18E-02	2.96E-06	5.18E-02	7.00E-02	7.00E-02	7.00E-02	
	600-1200	6.94E+00	5.00E+00	1.09E+06	9.78E+10	5.15E-03	2.63E-04	7.97E-01	2.63E-04	7.97E-01	4.90E+00	4.90E+00	4.90E+00	
	All Depths	7.49E+00	5.09E+00	1.18E+06	9.97E+10	2.35E-03	1.17E-04	3.65E-01	1.17E-04	3.65E-01	2.22E+00	2.22E+00	2.22E+00	
<i>Stenobrachius nannochir</i>	200-600	9.70E-02	5.21E-03	7.49E+03	2.69E+07	5.15E-05	1.74E-07	3.97E-03	1.74E-07	3.97E-03	9.08E-04	9.08E-04	9.08E-04	
	600-1200	7.95E+00	7.19E+00	1.19E+06	2.02E+11	5.84E-03	3.20E-04	8.72E-01	3.20E-04	8.72E-01	8.83E+00	8.83E+00	8.83E+00	
	All Depths	8.05E+00	7.19E+00	1.20E+06	2.02E+11	2.48E-03	1.42E-04	3.68E-01	1.42E-04	3.68E-01	3.87E+00	3.87E+00	3.87E+00	

Table 9. - - Continued.

Species	Stratum (depth in meters)			Biomass		Population			CPUE			CPUE		
		(t)	Variance	Number	Variance	kg/ha	Variance	no./ha	Variance	no./ha	Variance			
<i>Daphus theta</i>	200-600	7.29E-01	6.49E-02	5.36E+04	3.52E+08	3.89E-04	2.29E-06	2.86E-02	1.24E-02					
	600-1200	3.04E-02	9.23E-04	3.04E+03	9.23E+06	2.29E-05	4.40E-08	2.29E-03	4.40E-04					
	All Depths	7.59E-01	6.58E-02	5.66E+04	3.62E+08	2.35E-04	1.37E-06	1.76E-02	7.52E-03					
<i>Lampanyctus</i> species	200-600	2.65E-02	7.03E-04	4.42E+03	1.95E+07	1.38E-05	2.22E-08	2.30E-03	6.16E-04					
	600-1200	7.94E-01	1.72E-01	2.18E+04	1.44E+08	5.74E-04	7.75E-06	1.57E-02	6.44E-03					
	All Depths	8.21E-01	1.72E-01	2.62E+04	1.64E+08	2.49E-04	3.32E-06	7.93E-03	3.09E-03					
<i>Nannobranchium regale</i>	200-600	0.00E+00	0.00E+00	0.00E+00	0.00E+00	0.00E+00	0.00E+00	0.00E+00	0.00E+00					
	600-1200	5.88E-01	2.14E-01	1.37E+04	1.08E+08	3.82E-04	7.22E-06	8.97E-03	3.70E-03					
	All Depths	5.88E-01	2.14E-01	1.37E+04	1.08E+08	1.61E-04	3.05E-06	3.77E-03	1.56E-03					
<i>Lampanyctus jordani</i>	200-600	1.07E+01	3.88E+01	3.34E+05	3.83E+10	5.66E-03	1.34E-03	1.77E-01	1.32E+00					
	600-1200	1.48E+00	3.16E-01	5.71E+04	4.58E+08	1.09E-03	1.53E-05	4.17E-02	2.17E-02					
	All Depths	1.22E+01	3.91E+01	3.91E+05	3.88E+10	3.74E-03	7.86E-04	1.20E-01	7.77E-01					
<i>Avocettina infans</i>	200-600	0.00E+00	0.00E+00	0.00E+00	0.00E+00	0.00E+00	0.00E+00	0.00E+00	0.00E+00					
	600-1200	4.37E-02	9.87E-04	8.76E+03	3.84E+07	3.11E-05	4.18E-08	6.23E-03	1.61E-03					
	All Depths	4.37E-02	9.87E-04	8.76E+03	3.84E+07	1.31E-05	1.77E-08	2.62E-03	6.81E-04					
<i>Notacanthus chemnitzii</i>	200-600	0.00E+00	0.00E+00	0.00E+00	0.00E+00	0.00E+00	0.00E+00	0.00E+00	0.00E+00					
	600-1200	9.77E-01	9.54E-01	4.32E+03	1.87E+07	7.03E-04	4.15E-05	3.11E-03	8.12E-04					
	All Depths	9.77E-01	9.54E-01	4.32E+03	1.87E+07	2.95E-04	1.74E-05	1.31E-03	3.41E-04					
<i>Oneirodes</i> species	200-600	0.00E+00	0.00E+00	0.00E+00	0.00E+00	0.00E+00	0.00E+00	0.00E+00	0.00E+00					
	600-1200	5.16E+00	2.83E+00	4.67E+04	1.75E+08	3.82E-03	1.61E-04	3.45E-02	9.87E-03					
	All Depths	5.16E+00	2.83E+00	4.67E+04	1.75E+08	1.60E-03	7.06E-05	1.45E-02	4.41E-03					
<i>Oneirodes bulbosus</i>	200-600	0.00E+00	0.00E+00	0.00E+00	0.00E+00	0.00E+00	0.00E+00	0.00E+00	0.00E+00					
	600-1200	1.05E+00	7.86E-01	7.24E+03	2.69E+07	7.65E-04	3.41E-05	5.31E-03	1.19E-03					
	All Depths	1.05E+00	7.86E-01	7.24E+03	2.69E+07	3.21E-04	1.44E-05	2.23E-03	5.05E-04					
<i>Oneirodes thompsoni</i>	200-600	0.00E+00	0.00E+00	0.00E+00	0.00E+00	0.00E+00	0.00E+00	0.00E+00	0.00E+00					
	600-1200	1.58E+01	1.96E+01	9.95E+04	6.33E+08	1.06E-02	8.59E-04	6.85E-02	3.08E-02					
	All Depths	1.58E+01	1.96E+01	9.95E+04	6.33E+08	4.47E-03	3.86E-04	2.88E-02	1.40E-02					
Paralepididae	200-600	0.00E+00	0.00E+00	0.00E+00	0.00E+00	0.00E+00	0.00E+00	0.00E+00	0.00E+00					
	600-1200	5.94E-01	3.53E-01	6.61E+03	4.36E+07	4.47E-04	1.68E-05	4.97E-03	2.07E-03					
	All Depths	5.94E-01	3.53E-01	6.61E+03	4.36E+07	1.88E-04	7.05E-06	2.09E-03	8.70E-04					

Table 9. - - Continued.

Species	Stratum (depth in meters)			Biomass		Population			CPUE			CPUE		
		(t)	Variance	Number	Variance	kg/ha	Variance	no./ha	Variance	no./ha	Variance			
<i>Oncorhynchus gorbuscha</i>	200-600	3.69E+00	1.36E+01	3.84E+03	1.48E+07	1.80E-03	3.77E-04	1.88E-03	3.77E-04	4.09E-04				
	600-1200	0.00E+00	0.00E+00	0.00E+00	0.00E+00	0.00E+00	0.00E+00	0.00E+00	0.00E+00	0.00E+00				
	All Depths	3.69E+00	1.36E+01	3.84E+03	1.48E+07	1.05E-03	2.19E-04	1.09E-03	2.19E-04	2.37E-04				
<i>Oncorhynchus keta</i>	200-600	9.64E+00	9.30E+01	7.65E+03	5.86E+07	5.18E-03	3.11E-03	4.11E-03	3.11E-03	1.96E-03				
	600-1200	4.77E+00	2.28E+01	5.33E+03	2.84E+07	2.99E-03	7.51E-04	3.34E-03	7.51E-04	9.35E-04				
	All Depths	1.44E+01	1.16E+02	1.30E+04	8.70E+07	4.26E-03	2.11E-03	3.79E-03	2.11E-03	1.52E-03				
<i>Benthalbella dentata</i>	200-600	0.00E+00	0.00E+00	0.00E+00	0.00E+00	0.00E+00	0.00E+00	0.00E+00	0.00E+00	0.00E+00				
	600-1200	1.14E-01	1.30E-02	3.80E+03	1.44E+07	8.57E-05	6.17E-07	2.86E-03	6.17E-07	6.86E-04				
	All Depths	1.14E-01	1.30E-02	3.80E+03	1.44E+07	3.60E-05	2.59E-07	1.20E-03	2.59E-07	2.88E-04				
<i>Alepisaurus ferox</i>	200-600	2.71E+01	7.37E+02	4.36E+03	1.90E+07	1.44E-02	2.40E-02	2.31E-03	2.40E-02	6.22E-04				
	600-1200	0.00E+00	0.00E+00	0.00E+00	0.00E+00	0.00E+00	0.00E+00	0.00E+00	0.00E+00	0.00E+00				
	All Depths	2.71E+01	7.37E+02	4.36E+03	1.90E+07	8.35E-03	1.39E-02	1.34E-03	1.39E-02	3.61E-04				
<i>Sagamichthys abei</i>	200-600	1.51E-01	2.29E-02	3.60E+03	1.30E+07	8.03E-05	7.48E-07	1.91E-03	7.48E-07	4.24E-04				
	600-1200	3.16E-01	9.97E-02	4.78E+03	2.29E+07	2.22E-04	4.14E-06	3.36E-03	4.14E-06	9.50E-04				
	All Depths	4.67E-01	1.23E-01	8.39E+03	3.59E+07	1.40E-04	2.16E-06	2.52E-03	2.16E-06	6.42E-04				
<i>Lumpenella longirostris</i>	200-600	4.32E+00	1.25E+01	8.82E+04	6.50E+09	2.20E-03	3.70E-04	4.48E-02	3.70E-04	1.92E-01				
	600-1200	0.00E+00	0.00E+00	0.00E+00	0.00E+00	0.00E+00	0.00E+00	0.00E+00	0.00E+00	0.00E+00				
	All Depths	4.32E+00	1.25E+01	8.82E+04	6.50E+09	1.28E-03	2.15E-04	2.60E-02	2.15E-04	1.12E-01				
<i>Bryzoichthys species</i>	200-600	2.41E-02	5.79E-04	4.01E+03	1.61E+07	1.25E-05	1.83E-08	2.09E-03	1.83E-08	5.07E-04				
	600-1200	0.00E+00	0.00E+00	0.00E+00	0.00E+00	0.00E+00	0.00E+00	0.00E+00	0.00E+00	0.00E+00				
	All Depths	2.41E-02	5.79E-04	4.01E+03	1.61E+07	7.28E-06	1.06E-08	1.21E-03	1.06E-08	2.94E-04				
<i>Macropinna microstoma</i>	200-600	2.77E-01	7.66E-02	3.95E+03	1.56E+07	1.47E-04	2.50E-06	2.10E-03	2.50E-06	5.10E-04				
	600-1200	3.94E-01	4.58E-02	1.56E+04	6.44E+07	3.09E-04	2.27E-06	1.18E-02	2.27E-06	2.87E-03				
	All Depths	6.71E-01	1.22E-01	1.95E+04	8.00E+07	2.15E-04	2.40E-06	6.19E-03	2.40E-06	1.51E-03				
<i>Zaprora silenus</i>	200-600	3.63E+02	9.87E+04	1.06E+05	6.18E+09	1.89E-01	3.10E+00	5.52E-02	3.10E+00	1.93E-01				
	600-1200	0.00E+00	0.00E+00	0.00E+00	0.00E+00	0.00E+00	0.00E+00	0.00E+00	0.00E+00	0.00E+00				
	All Depths	3.63E+02	9.87E+04	1.06E+05	6.18E+09	1.10E-01	1.80E+00	3.20E-02	1.80E+00	1.12E-01				
<i>Bothrocara brunneum</i>	200-600	1.51E+02	1.90E+03	7.49E+04	3.81E+08	8.49E-02	9.80E-02	4.22E-02	9.80E-02	2.12E-02				
	600-1200	8.22E+02	2.32E+04	7.87E+05	1.74E+10	5.75E-01	1.23E+00	5.52E-01	1.23E+00	1.01E+00				
	All Depths	9.73E+02	2.51E+04	8.62E+05	1.78E+10	2.89E-01	6.26E-01	2.55E-01	6.26E-01	4.94E-01				

Table 9. - - Continued.

Species	Stratum (depth in meters)			Biomass		Population			CPUE			CPUE		
		(t)	Variance	Number	Variance	kg/ha	Variance	no./ha	Variance	no./ha	Variance			
<i>Bothrocara pusillum</i>	200-600	2.88E-02	8.27E-04	3.59E+03	1.29E+07	1.53E-05	2.71E-08	1.91E-03	4.23E-04					
	600-1200	0.00E+00	0.00E+00	0.00E+00	0.00E+00	0.00E+00	0.00E+00	0.00E+00	0.00E+00					
	All Depths	2.88E-02	8.27E-04	3.59E+03	1.29E+07	8.86E-06	1.57E-08	1.11E-03	2.46E-04					
<i>Bothrocara nyx</i>	200-600	0.00E+00	0.00E+00	0.00E+00	0.00E+00	0.00E+00	0.00E+00	0.00E+00	0.00E+00					
	600-1200	1.47E+00	5.66E-01	1.17E+05	4.74E+09	1.05E-03	2.43E-05	8.25E-02	1.85E-01					
	All Depths	1.47E+00	5.66E-01	1.17E+05	4.74E+09	4.42E-04	1.04E-05	3.46E-02	7.89E-02					
<i>Bothrocara species</i>	200-600	0.00E+00	0.00E+00	0.00E+00	0.00E+00	0.00E+00	0.00E+00	0.00E+00	0.00E+00					
	600-1200	9.58E-01	3.63E-01	1.91E+05	1.56E+10	7.15E-04	1.94E-05	1.42E-01	8.12E-01					
	All Depths	9.58E-01	3.63E-01	1.91E+05	1.56E+10	3.00E-04	8.23E-06	5.97E-02	3.44E-01					
<i>Lycenchelys croatalinus</i>	200-600	0.00E+00	0.00E+00	0.00E+00	0.00E+00	0.00E+00	0.00E+00	0.00E+00	0.00E+00					
	600-1200	1.29E+00	7.93E-01	2.21E+04	1.81E+08	8.39E-04	2.80E-05	1.44E-02	5.93E-03					
	All Depths	1.29E+00	7.93E-01	2.21E+04	1.81E+08	3.53E-04	1.19E-05	6.05E-03	2.53E-03					
<i>Lycenchelys species</i>	200-600	0.00E+00	0.00E+00	0.00E+00	0.00E+00	0.00E+00	0.00E+00	0.00E+00	0.00E+00					
	600-1200	2.39E-02	5.69E-04	3.98E+03	1.58E+07	1.80E-05	2.71E-08	2.99E-03	7.53E-04					
	All Depths	2.39E-02	5.69E-04	3.98E+03	1.58E+07	7.54E-06	1.14E-08	1.26E-03	3.16E-04					
<i>Lycenchelys camchatica</i>	200-600	0.00E+00	0.00E+00	0.00E+00	0.00E+00	0.00E+00	0.00E+00	0.00E+00	0.00E+00					
	600-1200	6.41E+00	2.03E+01	6.56E+04	1.88E+09	4.31E-03	7.23E-04	4.46E-02	6.76E-02					
	All Depths	6.41E+00	2.03E+01	6.56E+04	1.88E+09	1.81E-03	3.06E-04	1.87E-02	2.87E-02					
<i>Lycodes species</i>	200-600	4.05E-01	1.52E-01	7.50E+03	2.81E+07	2.11E-04	4.80E-06	3.94E-03	8.95E-04					
	600-1200	3.88E-02	1.50E-03	7.75E+03	6.01E+07	2.91E-05	7.14E-08	5.83E-03	2.85E-03					
	All Depths	4.44E-01	1.54E-01	1.53E+04	8.82E+07	1.35E-04	2.81E-06	4.74E-03	1.71E-03					
<i>Lycodes concolor</i>	200-600	1.86E+03	3.55E+05	1.74E+06	2.85E+11	9.75E-01	1.27E+01	9.11E-01	1.02E+01					
	600-1200	5.70E+02	2.30E+04	8.71E+05	5.22E+10	4.03E-01	1.41E+00	6.10E-01	3.40E+00					
	All Depths	2.43E+03	3.78E+05	2.61E+06	3.38E+11	7.35E-01	8.03E+00	7.85E-01	7.33E+00					
<i>Lycodes beringi</i>	200-600	1.46E+02	5.27E+02	2.35E+06	1.42E+11	7.62E-02	2.02E-02	1.23E+00	5.64E+00					
	600-1200	5.61E+01	2.01E+02	1.36E+06	1.34E+11	4.20E-02	1.05E-02	1.02E+00	6.85E+00					
	All Depths	2.02E+02	7.28E+02	3.70E+06	2.76E+11	6.19E-02	1.63E-02	1.14E+00	6.13E+00					
<i>Lycodapus species</i>	200-600	7.39E-01	7.76E-02	1.45E+05	2.85E+09	3.86E-04	2.64E-06	7.58E-02	9.60E-02					
	600-1200	4.15E-01	1.99E-02	7.46E+04	4.94E+08	2.92E-04	7.43E-07	5.39E-02	2.00E-02					
	All Depths	1.15E+00	9.75E-02	2.20E+05	3.34E+09	3.47E-04	1.84E-06	6.66E-02	6.40E-02					

Table 9. - - Continued.

Species	Stratum (depth in meters)			Biomass		Population			CPUE			CPUE		
		(t)	Variance	Number	Variance	kg/ha	Variance	no./ha	Variance	no./ha	Variance			
<i>Sebastolobus alascanus</i>	200-600	1.75E+04	7.02E+06	2.76E+07	1.34E+13	9.22E+00	3.90E+02	1.47E+01	3.90E+02	1.47E+01	7.20E+02			
	600-1200	8.53E+03	3.50E+06	6.89E+06	2.39E+12	6.42E+00	1.96E+02	5.21E+00	1.96E+02	5.21E+00	1.38E+02			
	All Depths	2.61E+04	1.05E+07	3.44E+07	1.58E+13	8.05E+00	3.09E+02	1.07E+01	3.09E+02	1.07E+01	4.96E+02			
<i>Sebastolobus macrochir</i>	200-600	2.04E+00	4.17E+00	4.26E+03	1.81E+07	1.03E-03	1.24E-04	2.15E-03	1.24E-04	2.15E-03	5.37E-04			
	600-1200	8.47E+00	2.44E+01	1.36E+04	6.19E+07	6.13E-03	1.03E-03	1.01E-02	1.03E-03	1.01E-02	2.84E-03			
	All Depths	1.05E+01	2.86E+01	1.79E+04	8.00E+07	3.17E-03	5.07E-04	5.48E-03	5.07E-04	5.48E-03	1.51E-03			
<i>Sebastes melanostictus</i>	200-600	5.13E+02	2.67E+04	6.56E+05	1.08E+11	2.75E-01	9.77E-01	3.47E-01	9.77E-01	3.47E-01	3.73E+00			
	600-1200	0.00E+00	0.00E+00	0.00E+00	0.00E+00	0.00E+00	0.00E+00	0.00E+00	0.00E+00	0.00E+00	0.00E+00			
	All Depths	5.13E+02	2.67E+04	6.56E+05	1.08E+11	1.59E-01	5.83E-01	2.01E-01	5.83E-01	2.01E-01	2.18E+00			
<i>Sebastes alutus</i>	200-600	1.08E+05	1.91E+09	1.30E+08	3.02E+15	5.80E+01	7.38E+04	6.93E+01	7.38E+04	6.93E+01	1.09E+05			
	600-1200	0.00E+00	0.00E+00	0.00E+00	0.00E+00	0.00E+00	0.00E+00	0.00E+00	0.00E+00	0.00E+00	0.00E+00			
	All Depths	1.08E+05	1.91E+09	1.30E+08	3.02E+15	3.36E+01	4.35E+04	4.02E+01	4.35E+04	4.02E+01	6.41E+04			
<i>Sebastes variabilis</i>	200-600	1.00E+01	1.01E+02	8.84E+03	7.82E+07	5.23E-03	3.17E-03	4.61E-03	3.17E-03	4.61E-03	2.46E-03			
	600-1200	0.00E+00	0.00E+00	0.00E+00	0.00E+00	0.00E+00	0.00E+00	0.00E+00	0.00E+00	0.00E+00	0.00E+00			
	All Depths	1.00E+01	1.01E+02	8.84E+03	7.82E+07	3.03E-03	1.84E-03	2.67E-03	1.84E-03	2.67E-03	1.43E-03			
<i>Sebastes polyispinis</i>	200-600	3.15E+00	9.91E+00	3.83E+03	1.47E+07	1.64E-03	3.12E-04	2.00E-03	3.12E-04	2.00E-03	4.62E-04			
	600-1200	0.00E+00	0.00E+00	0.00E+00	0.00E+00	0.00E+00	0.00E+00	0.00E+00	0.00E+00	0.00E+00	0.00E+00			
	All Depths	3.15E+00	9.91E+00	3.83E+03	1.47E+07	9.52E-04	1.81E-04	1.16E-03	1.81E-04	1.16E-03	2.68E-04			
<i>Sebastes babcocki</i>	200-600	6.88E+00	2.37E+01	9.62E+03	4.87E+07	3.82E-03	8.41E-04	5.27E-03	8.41E-04	5.27E-03	1.64E-03			
	600-1200	0.00E+00	0.00E+00	0.00E+00	0.00E+00	0.00E+00	0.00E+00	0.00E+00	0.00E+00	0.00E+00	0.00E+00			
	All Depths	6.88E+00	2.37E+01	9.62E+03	4.87E+07	2.22E-03	4.90E-04	3.06E-03	4.90E-04	3.06E-03	9.57E-04			
<i>Sebastes borealis</i>	200-600	7.20E+03	5.28E+06	1.83E+06	3.18E+11	3.76E+00	1.91E+02	9.38E-01	1.91E+02	9.38E-01	1.14E+01			
	600-1200	1.04E+02	2.67E+03	3.45E+04	2.20E+08	8.27E-02	1.79E-01	2.75E-02	1.79E-01	2.75E-02	1.70E-02			
	All Depths	7.31E+03	5.29E+06	1.86E+06	3.18E+11	2.21E+00	1.14E+02	5.56E-01	1.14E+02	5.56E-01	6.81E+00			
Hydroid	200-600	4.75E-01	1.72E-01	0.00E+00	0.00E+00	0.00E+00	0.00E+00	0.00E+00	0.00E+00	0.00E+00	0.00E+00			
	600-1200	7.34E-02	5.39E-03	0.00E+00	0.00E+00	0.00E+00	0.00E+00	0.00E+00	0.00E+00	0.00E+00	0.00E+00			
	All Depths	5.49E-01	1.77E-01	0.00E+00	0.00E+00	0.00E+00	0.00E+00	0.00E+00	0.00E+00	0.00E+00	0.00E+00			
Scyphozoa	200-600	1.83E+01	6.25E+01	2.79E+04	1.08E+08	8.88E-03	2.12E-03	1.54E-02	2.12E-03	1.54E-02	3.66E-03			
	600-1200	1.53E+01	4.76E+01	3.80E+04	1.67E+08	4.48E-03	2.70E-04	2.62E-02	2.70E-04	2.62E-02	6.38E-03			
	All Depths	3.36E+01	1.10E+02	6.59E+04	2.76E+08	7.06E-03	1.35E-03	1.98E-02	1.35E-03	1.98E-02	4.78E-03			

Table 9. - - Continued.

Species	Stratum (depth in meters)		Biomass		Population		CPUE		CPUE	
		(t)	Variance	Number	Variance	kg/ha	Variance	no./ha	Variance	
<i>Clavularia incrustans</i>	200-600	3.91E-01	1.53E-01	0.00E+00	0.00E+00	0.00E+00	0.00E+00	0.00E+00	0.00E+00	
	600-1200	0.00E+00	0.00E+00	0.00E+00	0.00E+00	0.00E+00	0.00E+00	0.00E+00	0.00E+00	
	All Depths	3.91E-01	1.53E-01	0.00E+00	0.00E+00	0.00E+00	0.00E+00	0.00E+00	0.00E+00	
<i>Virgularia</i> species	200-600	2.54E-01	3.27E-02	3.64E+04	4.43E+08	1.35E-04	1.08E-06	1.94E-02	1.47E-02	
	600-1200	0.00E+00	0.00E+00	0.00E+00	0.00E+00	0.00E+00	0.00E+00	0.00E+00	0.00E+00	
	All Depths	2.54E-01	3.27E-02	3.64E+04	4.43E+08	7.82E-05	6.27E-07	1.13E-02	8.59E-03	
Virgularidae	200-600	3.37E-01	1.13E-01	3.83E+03	1.46E+07	1.81E-04	3.80E-06	2.06E-03	4.90E-04	
	600-1200	0.00E+00	0.00E+00	0.00E+00	0.00E+00	0.00E+00	0.00E+00	0.00E+00	0.00E+00	
	All Depths	3.37E-01	1.13E-01	3.83E+03	1.46E+07	1.05E-04	2.20E-06	1.19E-03	2.84E-04	
<i>Halopteris willemoesi</i>	200-600	2.84E+00	1.69E+00	2.55E+05	3.74E+10	1.49E-03	5.42E-05	1.34E-01	1.22E+00	
	600-1200	0.00E+00	0.00E+00	0.00E+00	0.00E+00	0.00E+00	0.00E+00	0.00E+00	0.00E+00	
	All Depths	2.84E+00	1.69E+00	2.55E+05	3.74E+10	8.64E-04	3.19E-05	7.79E-02	7.07E-01	
Actiniaria	200-600	1.29E+01	1.75E+01	3.92E+05	1.38E+10	6.99E-03	6.59E-04	2.09E-01	4.82E-01	
	600-1200	3.67E+00	3.86E+00	1.85E+05	1.11E+10	2.67E-03	1.70E-04	1.31E-01	4.69E-01	
	All Depths	1.66E+01	2.13E+01	5.77E+05	2.49E+10	5.17E-03	4.56E-04	1.76E-01	4.76E-01	
<i>Actinauge verrillii</i>	200-600	4.83E+01	3.01E+02	6.15E+05	4.70E+10	2.62E-02	1.09E-02	3.32E-01	1.65E+00	
	600-1200	2.05E+02	1.89E+04	2.56E+07	3.34E+14	1.41E-01	7.31E-01	1.76E+01	1.29E+04	
	All Depths	2.53E+02	1.92E+04	2.62E+07	3.34E+14	7.46E-02	3.16E-01	7.61E+00	5.47E+03	
<i>Paractinostola faeulentata</i>	200-600	2.46E+03	1.69E+06	7.46E+06	2.52E+13	1.29E+00	5.36E+01	3.84E+00	7.67E+02	
	600-1200	3.21E+02	3.17E+04	1.42E+06	4.85E+11	2.24E-01	1.48E+00	9.87E-01	2.15E+01	
	All Depths	2.79E+03	1.72E+06	8.89E+06	2.57E+13	8.40E-01	3.19E+01	2.64E+00	4.54E+02	
<i>Actinoscyphia</i> species	200-600	0.00E+00	0.00E+00	0.00E+00	0.00E+00	0.00E+00	0.00E+00	0.00E+00	0.00E+00	
	600-1200	8.00E-02	6.39E-03	1.33E+04	1.78E+08	5.75E-05	2.78E-07	9.59E-03	7.72E-03	
	All Depths	8.00E-02	6.39E-03	1.33E+04	1.78E+08	2.42E-05	1.17E-07	4.03E-03	3.24E-03	
purple striated sea anemone	200-600	0.00E+00	0.00E+00	0.00E+00	0.00E+00	0.00E+00	0.00E+00	0.00E+00	0.00E+00	
	600-1200	4.21E+01	1.29E+03	7.72E+06	4.64E+13	3.04E-02	6.01E-02	5.57E+00	2.13E+03	
	All Depths	4.21E+01	1.29E+03	7.72E+06	4.64E+13	1.28E-02	2.53E-02	2.34E+00	8.96E+02	
red striated sea anemone	200-600	1.26E+00	1.93E-01	8.88E+04	8.66E+08	6.75E-04	7.75E-06	4.75E-02	3.54E-02	
	600-1200	0.00E+00	0.00E+00	0.00E+00	0.00E+00	0.00E+00	0.00E+00	0.00E+00	0.00E+00	
	All Depths	1.26E+00	1.93E-01	8.88E+04	8.66E+08	3.91E-04	4.59E-06	2.76E-02	2.10E-02	

Table 9. - - Continued.

Species	Stratum (depth in meters)			Biomass		Population			CPUE			CPUE		
		(t)	Variance	Number	Variance	kg/ha	Variance	no./ha	Variance	no./ha	Variance			
<i>Corallimorphus</i> species	200-600	1.72E-01	2.96E-02	3.91E+03	1.53E+07	9.15E-05	9.70E-07	2.08E-03	5.01E-04					
	600-1200	0.00E+00	0.00E+00	0.00E+00	0.00E+00	0.00E+00	0.00E+00	0.00E+00	0.00E+00					
	All Depths	1.72E-01	2.96E-02	3.91E+03	1.53E+07	5.30E-05	5.63E-07	1.21E-03	2.91E-04					
<i>Metridium farcimen</i>	200-600	6.04E-01	3.25E-01	7.81E+03	3.10E+07	2.96E-04	8.99E-06	3.98E-03	9.17E-04					
	600-1200	0.00E+00	0.00E+00	0.00E+00	0.00E+00	0.00E+00	0.00E+00	0.00E+00	0.00E+00					
	All Depths	6.04E-01	3.25E-01	7.81E+03	3.10E+07	1.72E-04	5.22E-06	2.31E-03	5.34E-04					
<i>Stomphia didemon</i>	200-600	4.75E+00	6.18E+00	2.05E+05	1.16E+10	2.47E-03	2.03E-04	1.05E-01	3.80E-01					
	600-1200	4.54E+00	1.27E+01	4.21E+05	1.15E+11	2.95E-03	5.01E-04	2.73E-01	4.49E+00					
	All Depths	9.29E+00	1.88E+01	6.26E+05	1.27E+11	2.67E-03	3.26E-04	1.76E-01	2.10E+00					
<i>Stomphia</i> species	200-600	3.78E+01	1.04E+03	4.79E+05	1.23E+11	2.03E-02	3.50E-02	2.57E-01	4.17E+00					
	600-1200	0.00E+00	0.00E+00	0.00E+00	0.00E+00	0.00E+00	0.00E+00	0.00E+00	0.00E+00					
	All Depths	3.78E+01	1.04E+03	4.79E+05	1.23E+11	1.18E-02	2.03E-02	1.49E-01	2.43E+00					
<i>Stomphia coccinea</i>	200-600	1.67E+01	7.22E+01	2.87E+05	1.95E+10	8.98E-03	2.61E-03	1.54E-01	7.03E-01					
	600-1200	0.00E+00	0.00E+00	0.00E+00	0.00E+00	0.00E+00	0.00E+00	0.00E+00	0.00E+00					
	All Depths	1.67E+01	7.22E+01	2.87E+05	1.95E+10	5.21E-03	1.53E-03	8.92E-02	4.12E-01					
<i>Cribrinopsis fernaldi</i>	200-600	4.31E+01	3.26E+02	3.87E+05	2.03E+10	2.20E-02	1.02E-02	1.98E-01	6.50E-01					
	600-1200	0.00E+00	0.00E+00	0.00E+00	0.00E+00	0.00E+00	0.00E+00	0.00E+00	0.00E+00					
	All Depths	4.31E+01	3.26E+02	3.87E+05	2.03E+10	1.28E-02	6.01E-03	1.15E-01	3.85E-01					
<i>Liponema brevicornis</i>	200-600	3.05E+03	2.22E+05	2.52E+07	1.35E+13	1.61E+00	7.83E+00	1.33E+01	4.73E+02					
	600-1200	4.32E+01	4.07E+02	4.94E+05	2.56E+10	3.25E-02	2.14E-02	3.53E-01	1.14E+00					
	All Depths	3.09E+03	2.22E+05	2.57E+07	1.35E+13	9.46E-01	5.14E+00	7.89E+00	3.15E+02					
Actinostolidae	200-600	6.06E+01	1.20E+03	3.73E+06	5.13E+12	3.17E-02	4.01E-02	1.95E+00	1.71E+02					
	600-1200	7.39E+01	4.54E+03	6.78E+06	3.94E+13	4.66E-02	1.50E-01	4.27E+00	1.30E+03					
	All Depths	1.35E+02	5.74E+03	1.05E+07	4.45E+13	3.79E-02	8.56E-02	2.93E+00	6.41E+02					
<i>Actinistola</i> species A (Clark, 2006)	200-600	1.04E-01	1.09E-02	1.61E+04	2.58E+08	5.54E-05	3.56E-07	8.52E-03	8.43E-03					
	600-1200	0.00E+00	0.00E+00	0.00E+00	0.00E+00	0.00E+00	0.00E+00	0.00E+00	0.00E+00					
	All Depths	1.04E-01	1.09E-02	1.61E+04	2.58E+08	3.21E-05	2.07E-07	4.94E-03	4.89E-03					
<i>Sycionis</i> species A (Clark, 2006)	200-600	1.46E+00	2.14E+00	5.18E+04	2.68E+09	7.78E-04	7.02E-05	2.75E-02	8.78E-02					
	600-1200	0.00E+00	0.00E+00	0.00E+00	0.00E+00	0.00E+00	0.00E+00	0.00E+00	0.00E+00					
	All Depths	1.46E+00	2.14E+00	5.18E+04	2.68E+09	4.51E-04	4.07E-05	1.60E-02	5.09E-02					

Table 9. - - Continued.

Species	Stratum (depth in meters)			Biomass		Population			CPUE			CPUE		
		(t)	Variance	Number	Variance	kg/ha	Variance	no./ha	Variance	no./ha	Variance			
Isididae	200-600	0.00E+00	0.00E+00	0.00E+00	0.00E+00	0.00E+00	0.00E+00	0.00E+00	0.00E+00	0.00E+00	0.00E+00	0.00E+00	0.00E+00	
	600-1200	6.31E+01	3.98E+03	0.00E+00	0.00E+00	0.00E+00	0.00E+00	0.00E+00	0.00E+00	0.00E+00	0.00E+00	0.00E+00	0.00E+00	
	All Depths	6.31E+01	3.98E+03	0.00E+00	0.00E+00	0.00E+00	0.00E+00	0.00E+00	0.00E+00	0.00E+00	0.00E+00	0.00E+00	0.00E+00	
<i>Isidella</i> species	200-600	1.76E-01	1.56E-02	0.00E+00	0.00E+00	0.00E+00	0.00E+00	0.00E+00	0.00E+00	0.00E+00	0.00E+00	0.00E+00	0.00E+00	
	600-1200	1.38E+01	7.19E+01	0.00E+00	0.00E+00	0.00E+00	0.00E+00	0.00E+00	0.00E+00	0.00E+00	0.00E+00	0.00E+00	0.00E+00	
	All Depths	1.40E+01	7.19E+01	0.00E+00	0.00E+00	0.00E+00	0.00E+00	0.00E+00	0.00E+00	0.00E+00	0.00E+00	0.00E+00	0.00E+00	
<i>Amphilaphis</i> species	200-600	1.44E+01	1.21E+02	0.00E+00	0.00E+00	0.00E+00	0.00E+00	0.00E+00	0.00E+00	0.00E+00	0.00E+00	0.00E+00	0.00E+00	
	600-1200	6.75E+00	2.34E+01	0.00E+00	0.00E+00	0.00E+00	0.00E+00	0.00E+00	0.00E+00	0.00E+00	0.00E+00	0.00E+00	0.00E+00	
	All Depths	2.11E+01	1.44E+02	0.00E+00	0.00E+00	0.00E+00	0.00E+00	0.00E+00	0.00E+00	0.00E+00	0.00E+00	0.00E+00	0.00E+00	
<i>Beroe</i> species	200-600	0.00E+00	0.00E+00	0.00E+00	0.00E+00	0.00E+00	0.00E+00	0.00E+00	0.00E+00	0.00E+00	0.00E+00	0.00E+00	0.00E+00	
	600-1200	8.64E-03	7.47E-05	4.32E+03	1.87E+07	6.22E-06	3.25E-09	3.11E-03	8.12E-04	8.12E-04	3.11E-03	8.12E-04	8.12E-04	
	All Depths	8.64E-03	7.47E-05	4.32E+03	1.87E+07	2.61E-06	1.36E-09	1.31E-03	3.41E-04	3.41E-04	1.31E-03	3.41E-04	3.41E-04	
Polychaeta	200-600	3.21E-01	5.27E-02	5.37E+04	1.77E+09	1.70E-04	1.74E-06	2.84E-02	5.80E-02	5.80E-02	2.84E-02	5.80E-02	5.80E-02	
	600-1200	0.00E+00	0.00E+00	0.00E+00	0.00E+00	0.00E+00	0.00E+00	0.00E+00	0.00E+00	0.00E+00	0.00E+00	0.00E+00	0.00E+00	
	All Depths	3.21E-01	5.27E-02	5.37E+04	1.77E+09	9.86E-05	1.01E-06	1.65E-02	3.37E-02	3.37E-02	1.65E-02	3.37E-02	3.37E-02	
<i>Aphrodita</i> species	200-600	1.62E+02	1.46E+03	1.03E+07	8.71E+12	8.61E-02	4.97E-02	5.48E+00	2.79E+02	2.79E+02	5.48E+00	2.79E+02	2.79E+02	
	600-1200	1.28E+01	1.51E+01	6.79E+05	3.87E+10	8.87E-03	6.50E-04	4.80E-01	1.82E+00	1.82E+00	4.80E-01	1.82E+00	1.82E+00	
	All Depths	1.75E+02	1.48E+03	1.09E+07	8.75E+12	5.35E-02	3.03E-02	3.37E+00	1.68E+02	1.68E+02	5.35E-02	3.03E-02	1.68E+02	
<i>Notostombodella cyclostomum</i>	200-600	7.55E-02	1.94E-03	2.54E+04	2.29E+08	3.80E-05	6.12E-08	1.26E-02	7.32E-03	7.32E-03	3.80E-05	6.12E-08	7.32E-03	
	600-1200	7.35E-03	5.40E-05	3.67E+03	1.35E+07	5.17E-06	2.24E-09	2.58E-03	5.61E-04	5.61E-04	5.17E-06	2.24E-09	5.61E-04	
	All Depths	8.29E-02	2.00E-03	2.91E+04	2.43E+08	2.42E-05	3.66E-08	8.39E-03	4.49E-03	4.49E-03	2.42E-05	3.66E-08	4.49E-03	
<i>Anuropus bathypelagica</i>	200-600	5.99E-02	2.78E-03	7.56E+03	2.86E+07	3.49E-05	1.12E-07	4.26E-03	1.04E-03	1.04E-03	3.49E-05	1.12E-07	1.04E-03	
	600-1200	9.89E-02	7.19E-03	6.05E+03	1.87E+07	7.62E-05	3.13E-07	5.38E-03	1.21E-03	1.21E-03	7.62E-05	3.13E-07	1.21E-03	
	All Depths	1.59E-01	9.98E-03	1.36E+04	4.73E+07	5.23E-05	1.95E-07	4.73E-03	1.11E-03	1.11E-03	5.23E-05	1.95E-07	1.11E-03	
Euphausiacea	200-600	0.00E+00	0.00E+00	0.00E+00	0.00E+00	0.00E+00	0.00E+00	0.00E+00	0.00E+00	0.00E+00	0.00E+00	0.00E+00	0.00E+00	
	600-1200	1.59E-02	2.53E-04	1.59E+04	2.53E+08	1.20E-05	1.20E-08	1.20E-02	1.20E-02	1.20E-02	1.20E-05	1.20E-08	1.20E-02	
	All Depths	1.59E-02	2.53E-04	1.59E+04	2.53E+08	5.03E-06	5.06E-09	5.03E-03	5.06E-03	5.06E-03	5.03E-06	5.06E-09	5.06E-03	
Mysidacea	200-600	1.12E-02	1.26E-04	5.60E+03	3.14E+07	5.48E-06	3.48E-09	2.74E-03	8.71E-04	8.71E-04	5.48E-06	3.48E-09	8.71E-04	
	600-1200	0.00E+00	0.00E+00	0.00E+00	0.00E+00	0.00E+00	0.00E+00	0.00E+00	0.00E+00	0.00E+00	0.00E+00	0.00E+00	0.00E+00	
	All Depths	1.12E-02	1.26E-04	5.60E+03	3.14E+07	3.18E-06	2.02E-09	1.59E-03	5.05E-04	5.05E-04	3.18E-06	2.02E-09	5.05E-04	

Table 9. - - Continued.

Species	Stratum (depth in meters)			Biomass			Population			CPUE			CPUE		
		(t)	Variance	Number	Variance	kg/ha	Variance	no./ha	Variance						
<i>Neognathophausia</i> species	200-600	0.00E+00	0.00E+00	0.00E+00	0.00E+00	0.00E+00	0.00E+00	0.00E+00	0.00E+00	0.00E+00	0.00E+00	0.00E+00	0.00E+00	0.00E+00	0.00E+00
	600-1200	1.05E-01	1.71E-03	3.95E+04	2.58E+08	7.36E-05	1.20E-07	2.73E-02	1.46E-02	1.15E-02	6.27E-03				
	All Depths	1.05E-01	1.71E-03	3.95E+04	2.58E+08	3.09E-05	5.15E-08	1.15E-02	6.27E-03						
<i>Neognathophausia</i> gigas	200-600	0.00E+00	0.00E+00	0.00E+00	0.00E+00	0.00E+00	0.00E+00	0.00E+00	0.00E+00	0.00E+00	0.00E+00	0.00E+00	0.00E+00	0.00E+00	0.00E+00
	600-1200	2.68E-02	9.61E-05	1.34E+04	2.40E+07	2.02E-05	8.50E-09	1.01E-02	2.12E-03	4.24E-03	9.11E-04				
	All Depths	2.68E-02	9.61E-05	1.34E+04	2.40E+07	8.47E-06	3.64E-09	4.24E-03	9.11E-04						
<i>Balanus</i> evermanni	200-600	5.66E+02	3.01E+05	4.25E+03	1.81E+07	3.00E-04	1.03E-05	2.11E-03	5.09E-04						
	600-1200	0.00E+00	0.00E+00	0.00E+00	0.00E+00	0.00E+00	0.00E+00	0.00E+00	0.00E+00	0.00E+00	0.00E+00	0.00E+00	0.00E+00	0.00E+00	0.00E+00
	All Depths	5.66E+02	3.01E+05	4.25E+03	1.81E+07	1.73E-04	5.91E-06	1.22E-03	2.93E-04						
shrimp species	200-600	5.28E+00	2.79E+01	3.96E+06	1.57E+13	3.12E-03	1.13E-03	2.34E+00	6.34E+02						
	600-1200	0.00E+00	0.00E+00	0.00E+00	0.00E+00	0.00E+00	0.00E+00	0.00E+00	0.00E+00	0.00E+00	0.00E+00	0.00E+00	0.00E+00	0.00E+00	0.00E+00
	All Depths	5.28E+00	2.79E+01	3.96E+06	1.57E+13	1.81E-03	6.54E-04	1.36E+00	3.68E+02						
<i>Sergestes</i> similis	200-600	1.67E-02	2.79E-04	4.18E+03	1.74E+07	8.97E-06	9.34E-09	2.24E-03	5.84E-04						
	600-1200	1.22E-02	6.36E-05	6.08E+03	1.59E+07	9.16E-06	3.56E-09	4.58E-03	8.91E-04						
	All Depths	2.89E-02	3.43E-04	1.03E+04	3.33E+07	9.05E-06	6.88E-09	3.22E-03	7.10E-04						
<i>Pandalus</i> jordani	200-600	3.83E-01	8.34E-02	6.39E+04	1.89E+09	2.05E-04	2.83E-06	3.43E-02	6.37E-02						
	600-1200	0.00E+00	0.00E+00	0.00E+00	0.00E+00	0.00E+00	0.00E+00	0.00E+00	0.00E+00	0.00E+00	0.00E+00	0.00E+00	0.00E+00	0.00E+00	0.00E+00
	All Depths	3.83E-01	8.34E-02	6.39E+04	1.89E+09	1.19E-04	1.64E-06	1.99E-02	3.71E-02						
<i>Pandalus</i> eous	200-600	6.06E+02	1.83E+04	9.15E+07	3.01E+14	3.15E-01	6.01E-01	4.77E+01	1.06E+04						
	600-1200	1.30E-01	9.29E-03	2.39E+04	3.96E+08	9.32E-05	4.13E-07	1.75E-02	1.85E-02						
	All Depths	6.06E+02	1.83E+04	9.15E+07	3.01E+14	1.83E-01	3.72E-01	2.77E+01	6.70E+03						
<i>Pandalopsis</i> longirostris	200-600	6.94E-01	3.59E-01	1.63E+05	1.82E+10	3.40E-04	1.06E-05	8.00E-02	5.54E-01						
	600-1200	4.72E-02	2.23E-03	1.01E+04	1.02E+08	3.80E-05	1.21E-07	8.14E-03	5.57E-03						
	All Depths	7.41E-01	3.61E-01	1.73E+05	1.83E+10	2.13E-04	6.22E-06	4.98E-02	3.23E-01						
<i>Pandalopsis</i> dispar	200-600	1.21E+02	7.27E+02	8.91E+06	5.40E+12	6.34E-02	2.65E-02	4.66E+00	1.88E+02						
	600-1200	5.85E+00	2.43E+01	2.89E+05	5.99E+10	3.81E-03	9.16E-04	1.88E-01	2.24E+00						
	All Depths	1.26E+02	7.52E+02	9.20E+06	5.46E+12	3.84E-02	1.66E-02	2.78E+00	1.14E+02						
<i>Pandalopsis</i> ampla	200-600	1.12E+00	8.14E-01	9.99E+04	4.88E+09	5.84E-04	2.63E-05	5.17E-02	1.56E-01						
	600-1200	4.88E+01	1.58E+02	2.59E+06	3.55E+11	3.53E-02	7.35E-03	1.88E+00	1.79E+01						
	All Depths	5.00E+01	1.58E+02	2.69E+06	3.60E+11	1.51E-02	3.38E-03	8.21E-01	8.39E+00						

Table 9. - - Continued.

Species	Stratum (depth in meters)			Biomass		Population			CPUE			CPUE		
		(t)	Variance	Number	Variance	kg/ha	Variance	no./ha	Variance	no./ha	Variance			
Caridea	200-600	0.00E+00	0.00E+00	0.00E+00	0.00E+00	0.00E+00	0.00E+00	0.00E+00	0.00E+00	0.00E+00	0.00E+00	0.00E+00	0.00E+00	
	600-1200	1.08E-01	6.22E-03	3.88E+04	7.71E+08	7.47E-05	2.43E-07	2.68E-02	3.04E-02	3.04E-02	3.04E-02	3.04E-02	3.04E-02	
	All Depths	1.08E-01	6.22E-03	3.88E+04	7.71E+08	3.14E-05	1.03E-07	1.13E-02	1.29E-02	1.29E-02	1.29E-02	1.29E-02	1.29E-02	
<i>Eualus</i> species	200-600	1.92E-02	1.90E-04	1.52E+04	1.42E+08	9.66E-06	5.47E-09	7.57E-03	3.97E-03	3.97E-03	3.97E-03	3.97E-03	3.97E-03	
	600-1200	1.32E-01	5.61E-03	8.94E+04	2.35E+09	9.75E-05	2.85E-07	6.57E-02	1.18E-01	1.18E-01	1.18E-01	1.18E-01	1.18E-01	
	All Depths	1.52E-01	5.80E-03	1.05E+05	2.49E+09	4.66E-05	1.24E-07	3.20E-02	5.23E-02	5.23E-02	5.23E-02	5.23E-02	5.23E-02	
<i>Eualus biunguis</i>	200-600	4.39E-01	1.90E-02	1.83E+05	3.48E+09	2.25E-04	6.53E-07	9.34E-02	1.19E-01	1.19E-01	1.19E-01	1.19E-01	1.19E-01	
	600-1200	2.98E+01	4.59E+01	1.33E+07	9.72E+12	2.24E-02	3.54E-03	1.00E+01	7.20E+02	7.20E+02	7.20E+02	7.20E+02	7.20E+02	
	All Depths	3.03E+01	4.60E+01	1.35E+07	9.72E+12	9.55E-03	1.60E-03	4.26E+00	3.25E+02	3.25E+02	3.25E+02	3.25E+02	3.25E+02	
<i>Lebbeus</i> species	200-600	5.60E-02	3.14E-03	5.60E+03	3.14E+07	2.74E-05	8.71E-08	2.74E-03	8.71E-04	8.71E-04	8.71E-04	8.71E-04	8.71E-04	
	600-1200	1.10E-01	1.21E-02	1.38E+04	1.90E+08	8.87E-05	6.61E-07	1.11E-02	1.03E-02	1.03E-02	1.03E-02	1.03E-02	1.03E-02	
	All Depths	1.66E-01	1.53E-02	1.94E+04	2.21E+08	5.31E-05	3.27E-07	6.25E-03	4.83E-03	4.83E-03	4.83E-03	4.83E-03	4.83E-03	
<i>Lebbeus groenlandicus</i>	200-600	0.00E+00	0.00E+00	0.00E+00	0.00E+00	0.00E+00	0.00E+00	0.00E+00	0.00E+00	0.00E+00	0.00E+00	0.00E+00	0.00E+00	
	600-1200	3.78E-01	9.47E-02	5.40E+04	1.82E+09	2.95E-04	5.03E-06	4.19E-02	9.58E-02	9.58E-02	9.58E-02	9.58E-02	9.58E-02	
	All Depths	3.78E-01	9.47E-02	5.40E+04	1.82E+09	1.24E-04	2.12E-06	1.76E-02	4.04E-02	4.04E-02	4.04E-02	4.04E-02	4.04E-02	
<i>Crangon</i> species	200-600	8.35E-03	6.97E-05	4.18E+03	1.74E+07	4.49E-06	2.33E-09	2.24E-03	5.84E-04	5.84E-04	5.84E-04	5.84E-04	5.84E-04	
	600-1200	0.00E+00	0.00E+00	0.00E+00	0.00E+00	0.00E+00	0.00E+00	0.00E+00	0.00E+00	0.00E+00	0.00E+00	0.00E+00	0.00E+00	
	All Depths	8.35E-03	6.97E-05	4.18E+03	1.74E+07	2.60E-06	1.35E-09	1.30E-03	3.38E-04	3.38E-04	3.38E-04	3.38E-04	3.38E-04	
<i>Crangon communis</i>	200-600	2.32E-01	9.32E-03	1.31E+05	3.21E+09	1.16E-04	2.60E-07	6.64E-02	9.49E-02	9.49E-02	9.49E-02	9.49E-02	9.49E-02	
	600-1200	0.00E+00	0.00E+00	0.00E+00	0.00E+00	0.00E+00	0.00E+00	0.00E+00	0.00E+00	0.00E+00	0.00E+00	0.00E+00	0.00E+00	
	All Depths	2.32E-01	9.32E-03	1.31E+05	3.21E+09	6.73E-05	1.53E-07	3.85E-02	5.59E-02	5.59E-02	5.59E-02	5.59E-02	5.59E-02	
<i>Argis</i> species	200-600	1.98E-01	6.65E-03	5.36E+04	4.58E+08	1.06E-04	2.41E-07	2.88E-02	1.68E-02	1.68E-02	1.68E-02	1.68E-02	1.68E-02	
	600-1200	0.00E+00	0.00E+00	0.00E+00	0.00E+00	0.00E+00	0.00E+00	0.00E+00	0.00E+00	0.00E+00	0.00E+00	0.00E+00	0.00E+00	
	All Depths	1.98E-01	6.65E-03	5.36E+04	4.58E+08	6.17E-05	1.42E-07	1.67E-02	9.90E-03	9.90E-03	9.90E-03	9.90E-03	9.90E-03	
<i>Argis lar</i>	200-600	4.34E-01	3.86E-02	1.14E+05	2.06E+09	2.26E-04	1.31E-06	5.84E-02	6.85E-02	6.85E-02	6.85E-02	6.85E-02	6.85E-02	
	600-1200	0.00E+00	0.00E+00	0.00E+00	0.00E+00	0.00E+00	0.00E+00	0.00E+00	0.00E+00	0.00E+00	0.00E+00	0.00E+00	0.00E+00	
	All Depths	4.34E-01	3.86E-02	1.14E+05	2.06E+09	1.31E-04	7.67E-07	3.39E-02	4.04E-02	4.04E-02	4.04E-02	4.04E-02	4.04E-02	
Pasiphaeidae	200-600	0.00E+00	0.00E+00	0.00E+00	0.00E+00	0.00E+00	0.00E+00	0.00E+00	0.00E+00	0.00E+00	0.00E+00	0.00E+00	0.00E+00	
	600-1200	6.11E-01	1.19E-01	3.12E+04	3.12E+08	4.35E-04	5.64E-06	2.23E-02	1.46E-02	1.46E-02	1.46E-02	1.46E-02	1.46E-02	
	All Depths	6.11E-01	1.19E-01	3.12E+04	3.12E+08	1.83E-04	2.40E-06	9.36E-03	6.23E-03	6.23E-03	6.23E-03	6.23E-03	6.23E-03	

Table 9. - - Continued.

Species	Stratum (depth in meters)			Biomass		Population			CPUE			CPUE		
		(t)	Variance	Number	Variance	kg/ha	Variance	no./ha	Variance	no./ha	Variance			
<i>Pasiphaea pacifica</i>	200-600	3.32E+01	1.13E+02	1.25E+07	2.22E+13	1.76E-02	4.66E-03	6.61E+00	8.55E+02					
	600-1200	4.62E-01	6.66E-02	1.68E+05	9.69E+09	3.45E-04	3.47E-06	1.25E-01	4.92E-01					
	All Depths	3.37E+01	1.13E+02	1.26E+07	2.22E+13	1.04E-02	2.77E-03	3.89E+00	5.04E+02					
<i>Pasiphaea tarda</i>	200-600	0.00E+00	0.00E+00	0.00E+00	0.00E+00	0.00E+00	0.00E+00	0.00E+00	0.00E+00					
	600-1200	6.40E-01	8.32E-02	2.46E+04	1.32E+08	4.76E-04	4.79E-06	1.82E-02	7.07E-03					
	All Depths	6.40E-01	8.32E-02	2.46E+04	1.32E+08	2.00E-04	2.05E-06	7.64E-03	3.03E-03					
<i>Notostomus species</i>	200-600	0.00E+00	0.00E+00	0.00E+00	0.00E+00	0.00E+00	0.00E+00	0.00E+00	0.00E+00					
	600-1200	5.14E-02	2.65E-03	3.67E+03	1.35E+07	3.62E-05	1.10E-07	2.58E-03	5.61E-04					
	All Depths	5.14E-02	2.65E-03	3.67E+03	1.35E+07	1.52E-05	4.61E-08	1.08E-03	2.35E-04					
<i>Notostomus japonicus</i>	200-600	0.00E+00	0.00E+00	0.00E+00	0.00E+00	0.00E+00	0.00E+00	0.00E+00	0.00E+00					
	600-1200	1.06E-01	1.13E-02	3.80E+03	1.44E+07	8.00E-05	5.38E-07	2.86E-03	6.86E-04					
	All Depths	1.06E-01	1.13E-02	3.80E+03	1.44E+07	3.36E-05	2.26E-07	1.20E-03	2.88E-04					
<i>Hymenodora frontalis</i>	200-600	0.00E+00	0.00E+00	0.00E+00	0.00E+00	0.00E+00	0.00E+00	0.00E+00	0.00E+00					
	600-1200	1.06E-01	4.67E-03	6.65E+04	1.97E+09	7.95E-05	2.24E-07	4.98E-02	9.41E-02					
	All Depths	1.06E-01	4.67E-03	6.65E+04	1.97E+09	3.34E-05	9.48E-08	2.09E-02	3.99E-02					
<i>Bentheogennema borealis</i>	200-600	0.00E+00	0.00E+00	0.00E+00	0.00E+00	0.00E+00	0.00E+00	0.00E+00	0.00E+00					
	600-1200	2.70E-01	2.28E-02	1.10E+05	2.12E+09	1.81E-04	7.78E-07	7.56E-02	8.22E-02					
	All Depths	2.70E-01	2.28E-02	1.10E+05	2.12E+09	7.60E-05	3.33E-07	3.18E-02	3.57E-02					
Majidae	200-600	5.62E-02	3.15E-03	4.01E+03	1.61E+07	2.93E-05	9.94E-08	2.09E-03	5.07E-04					
	600-1200	6.58E-02	4.33E-03	4.70E+03	2.21E+07	5.67E-05	2.70E-07	4.05E-03	1.38E-03					
	All Depths	1.22E-01	7.48E-03	8.71E+03	3.82E+07	4.08E-05	1.70E-07	2.91E-03	8.68E-04					
<i>Oregonia gracilis</i>	200-600	2.36E-02	5.58E-04	5.90E+03	3.49E+07	1.23E-05	1.76E-08	3.08E-03	1.10E-03					
	600-1200	0.00E+00	0.00E+00	0.00E+00	0.00E+00	0.00E+00	0.00E+00	0.00E+00	0.00E+00					
	All Depths	2.36E-02	5.58E-04	5.90E+03	3.49E+07	7.14E-06	1.02E-08	1.79E-03	6.37E-04					
<i>Chorilita longipes</i>	200-600	4.43E-01	8.99E-02	7.19E+04	2.51E+09	2.30E-04	2.80E-06	3.70E-02	7.79E-02					
	600-1200	0.00E+00	0.00E+00	0.00E+00	0.00E+00	0.00E+00	0.00E+00	0.00E+00	0.00E+00					
	All Depths	4.43E-01	8.99E-02	7.19E+04	2.51E+09	1.33E-04	1.63E-06	2.15E-02	4.54E-02					
<i>Chionoecetes bairdi</i>	200-600	5.09E+02	2.80E+04	4.11E+06	1.00E+12	2.71E-01	1.02E+00	2.17E+00	3.61E+01					
	600-1200	0.00E+00	0.00E+00	0.00E+00	0.00E+00	0.00E+00	0.00E+00	0.00E+00	0.00E+00					
	All Depths	5.09E+02	2.80E+04	4.11E+06	1.00E+12	1.57E-01	6.09E-01	1.26E+00	2.20E+01					

Table 9. - - Continued.

Species	Stratum (depth in meters)			Biomass		Population			CPUE			CPUE		
		(t)	Variance	Number	Variance	kg/ha	Variance	no./ha	Variance	no./ha	Variance			
<i>Chionoectes angulatus</i>	200-600	1.31E+02	1.70E+03	1.02E+06	1.04E+11	6.90E-02	6.42E-02	5.37E-01	3.99E+00					
	600-1200	4.06E+03	6.77E+05	3.01E+07	1.16E+14	2.94E+00	3.63E+01	2.18E+01	5.13E+03					
	All Depths	4.19E+03	6.78E+05	3.11E+07	1.17E+14	1.28E+00	1.72E+01	9.47E+00	2.25E+03					
<i>Hyas lyratus</i>	200-600	1.69E+00	1.95E-01	1.27E+05	6.60E+08	9.06E-04	7.03E-06	6.76E-02	2.46E-02					
	600-1200	0.00E+00	0.00E+00	0.00E+00	0.00E+00	0.00E+00	0.00E+00	0.00E+00	0.00E+00					
	All Depths	1.69E+00	1.95E-01	1.27E+05	6.60E+08	5.26E-04	4.27E-06	3.92E-02	1.53E-02					
<i>Chionoectes opilio</i>	200-600	5.84E+01	5.13E+02	3.74E+05	1.59E+10	2.97E-02	1.63E-02	1.93E-01	4.92E-01					
	600-1200	0.00E+00	0.00E+00	0.00E+00	0.00E+00	0.00E+00	0.00E+00	0.00E+00	0.00E+00					
	All Depths	5.84E+01	5.13E+02	3.74E+05	1.59E+10	1.73E-02	9.65E-03	1.12E-01	2.93E-01					
<i>Chionoectes hybrid</i>	200-600	1.26E+01	1.11E+02	2.35E+05	4.09E+10	6.44E-03	3.30E-03	1.20E-01	1.21E+00					
	600-1200	0.00E+00	0.00E+00	0.00E+00	0.00E+00	0.00E+00	0.00E+00	0.00E+00	0.00E+00					
	All Depths	1.26E+01	1.11E+02	2.35E+05	4.09E+10	3.74E-03	1.91E-03	6.96E-02	7.02E-01					
<i>Labidochirus splendescens</i>	200-600	4.43E-02	1.96E-03	3.69E+03	1.36E+07	2.35E-05	6.43E-08	1.96E-03	4.46E-04					
	600-1200	0.00E+00	0.00E+00	0.00E+00	0.00E+00	0.00E+00	0.00E+00	0.00E+00	0.00E+00					
	All Depths	4.43E-02	1.96E-03	3.69E+03	1.36E+07	1.37E-05	3.73E-08	1.14E-03	2.59E-04					
<i>Pagurus species</i>	200-600	2.85E-01	8.11E-02	3.85E+03	1.48E+07	1.51E-04	2.65E-06	2.04E-03	4.85E-04					
	600-1200	0.00E+00	0.00E+00	0.00E+00	0.00E+00	0.00E+00	0.00E+00	0.00E+00	0.00E+00					
	All Depths	2.85E-01	8.11E-02	3.85E+03	1.48E+07	8.77E-05	1.54E-06	1.19E-03	2.81E-04					
<i>Pagurus brandti</i>	200-600	4.29E-02	1.84E-03	4.29E+03	1.84E+07	2.30E-05	6.15E-08	2.30E-03	6.15E-04					
	600-1200	0.00E+00	0.00E+00	0.00E+00	0.00E+00	0.00E+00	0.00E+00	0.00E+00	0.00E+00					
	All Depths	4.29E-02	1.84E-03	4.29E+03	1.84E+07	1.34E-05	3.57E-08	1.34E-03	3.57E-04					
<i>Pagurus townsendi</i>	200-600	1.71E+01	3.04E+01	4.68E+05	2.58E+10	9.04E-03	1.03E-03	2.48E-01	9.13E-01					
	600-1200	2.67E+01	2.80E+01	9.30E+05	2.81E+10	1.96E-02	1.49E-03	6.81E-01	1.47E+00					
	All Depths	4.37E+01	5.85E+01	1.40E+06	5.39E+10	1.35E-02	1.25E-03	4.30E-01	1.19E+00					
<i>Pagurus confragosus</i>	200-600	9.21E+00	1.00E+01	1.72E+05	2.70E+09	4.93E-03	3.94E-04	9.18E-02	1.10E-01					
	600-1200	0.00E+00	0.00E+00	0.00E+00	0.00E+00	0.00E+00	0.00E+00	0.00E+00	0.00E+00					
	All Depths	9.21E+00	1.00E+01	1.72E+05	2.70E+09	2.86E-03	2.34E-04	5.33E-02	6.59E-02					
<i>Pagurus cornutus</i>	200-600	1.66E+02	1.26E+03	3.74E+06	8.51E+11	8.83E-02	4.22E-02	1.98E+00	2.78E+01					
	600-1200	2.90E+00	7.75E+00	9.79E+04	8.88E+09	1.88E-03	2.74E-04	6.36E-02	3.14E-01					
	All Depths	1.69E+02	1.27E+03	3.84E+06	8.60E+11	5.20E-02	2.63E-02	1.18E+00	1.71E+01					

Table 9. - - Continued.

Species	Stratum (depth in meters)			Biomass			Population			CPUE			CPUE		
		(t)	Variance	Number	Variance	kg/ha	Variance	no./ha	Variance		Variance	no./ha	Variance		
<i>Pagurus ochotensis</i>	200-600	2.47E-01	6.10E-02	3.63E+03	1.32E+07	1.31E-04	1.99E-06	1.93E-03	4.31E-04						
	600-1200	0.00E+00	0.00E+00	0.00E+00	0.00E+00	0.00E+00	0.00E+00	0.00E+00	0.00E+00						
	All Depths	2.47E-01	6.10E-02	3.63E+03	1.32E+07	7.60E-05	1.16E-06	1.12E-03	2.50E-04						
<i>Elassochirus cavimanus</i>	200-600	4.25E+00	2.14E+00	1.09E+05	1.32E+09	2.26E-03	8.53E-05	5.74E-02	4.90E-02						
	600-1200	0.00E+00	0.00E+00	0.00E+00	0.00E+00	0.00E+00	0.00E+00	0.00E+00	0.00E+00						
	All Depths	4.25E+00	2.14E+00	1.09E+05	1.32E+09	1.31E-03	5.06E-05	3.33E-02	2.91E-02						
Lithodidae species	200-600	5.37E-02	1.46E-03	7.71E+03	2.98E+07	2.97E-05	5.20E-08	4.25E-03	1.04E-03						
	600-1200	0.00E+00	0.00E+00	0.00E+00	0.00E+00	0.00E+00	0.00E+00	0.00E+00	0.00E+00						
	All Depths	5.37E-02	1.46E-03	7.71E+03	2.98E+07	1.73E-05	3.03E-08	2.46E-03	6.03E-04						
<i>Lithodes couesi</i>	200-600	1.45E+01	2.11E+02	1.60E+04	2.55E+08	7.10E-03	5.85E-03	7.80E-03	7.06E-03						
	600-1200	5.10E+02	1.23E+04	8.32E+05	3.36E+10	3.67E-01	6.27E-01	6.03E-01	1.72E+00						
	All Depths	5.24E+02	1.25E+04	8.48E+05	3.38E+10	1.58E-01	2.96E-01	2.58E-01	8.08E-01						
<i>Lithodes aequispinus</i>	200-600	1.31E+03	9.84E+04	1.72E+06	1.39E+11	6.65E-01	4.66E+00	8.68E-01	8.91E+00						
	600-1200	1.20E+02	2.78E+03	1.36E+05	2.55E+09	9.21E-02	1.86E-01	1.06E-01	2.26E-01						
	All Depths	1.43E+03	1.01E+05	1.86E+06	1.41E+11	4.25E-01	2.85E+00	5.48E-01	5.38E+00						
<i>Paralomis verrilli</i>	200-600	0.00E+00	0.00E+00	0.00E+00	0.00E+00	0.00E+00	0.00E+00	0.00E+00	0.00E+00						
	600-1200	1.23E+02	1.50E+04	4.68E+05	2.19E+11	8.18E-02	5.62E-01	3.12E-01	8.18E+00						
	All Depths	1.23E+02	1.50E+04	4.68E+05	2.19E+11	3.44E-02	2.36E-01	1.31E-01	3.43E+00						
<i>Paralomis species A (Clark, 2006)</i>	200-600	0.00E+00	0.00E+00	0.00E+00	0.00E+00	0.00E+00	0.00E+00	0.00E+00	0.00E+00						
	600-1200	1.18E+00	1.40E+00	4.32E+03	1.87E+07	8.52E-04	6.09E-05	3.11E-03	8.12E-04						
	All Depths	1.18E+00	1.40E+00	4.32E+03	1.87E+07	3.58E-04	2.56E-05	1.31E-03	3.41E-04						
<i>Paralomis multispina</i>	200-600	1.02E-01	1.03E-02	3.91E+03	1.53E+07	5.40E-05	3.39E-07	2.08E-03	5.01E-04						
	600-1200	3.21E+02	6.43E+03	5.93E+05	2.43E+10	2.38E-01	3.90E-01	4.36E-01	1.29E+00						
	All Depths	3.21E+02	6.43E+03	5.97E+05	2.43E+10	1.00E-01	1.76E-01	1.84E-01	5.83E-01						
<i>Erimacrus isenbeckii</i>	200-600	2.25E+00	5.08E+00	3.62E+03	1.31E+07	1.21E-03	1.70E-04	1.95E-03	4.39E-04						
	600-1200	0.00E+00	0.00E+00	0.00E+00	0.00E+00	0.00E+00	0.00E+00	0.00E+00	0.00E+00						
	All Depths	2.25E+00	5.08E+00	3.62E+03	1.31E+07	7.02E-04	9.86E-05	1.13E-03	2.55E-04						
<i>Munida quadrispina</i>	200-600	1.47E-02	2.17E-04	3.68E+03	1.35E+07	7.82E-06	7.09E-09	1.96E-03	4.43E-04						
	600-1200	0.00E+00	0.00E+00	0.00E+00	0.00E+00	0.00E+00	0.00E+00	0.00E+00	0.00E+00						
	All Depths	1.47E-02	2.17E-04	3.68E+03	1.35E+07	4.54E-06	4.11E-09	1.13E-03	2.57E-04						

Table 9. - - Continued.

Species	Stratum (depth in meters)			Biomass		Population			CPUE			CPUE		
		(t)	Variance	Number	Variance	kg/ha	Variance	no./ha	Variance	no./ha	Variance			
Pycnogonida	200-600	6.16E-02	1.42E-03	3.16E+04	3.53E+08	3.23E-05	4.73E-08	1.64E-02	1.12E-02					
	600-1200	2.64E-01	5.43E-02	1.66E+04	1.26E+08	1.87E-04	2.25E-06	1.23E-02	5.80E-03					
	All Depths	3.25E-01	5.57E-02	4.82E+04	4.78E+08	9.73E-05	9.71E-07	1.47E-02	8.91E-03					
gastropod eggs	200-600	1.92E+01	1.68E+01	0.00E+00	0.00E+00	0.00E+00	0.00E+00	0.00E+00	0.00E+00					
	600-1200	2.67E+00	8.69E-01	0.00E+00	0.00E+00	0.00E+00	0.00E+00	0.00E+00	0.00E+00					
	All Depths	2.19E+01	1.77E+01	0.00E+00	0.00E+00	0.00E+00	0.00E+00	0.00E+00	0.00E+00					
<i>Buccinum</i> species eggs	200-600	1.14E+00	6.85E-01	0.00E+00	0.00E+00	0.00E+00	0.00E+00	0.00E+00	0.00E+00					
	600-1200	6.86E-01	1.95E-01	0.00E+00	0.00E+00	0.00E+00	0.00E+00	0.00E+00	0.00E+00					
	All Depths	1.82E+00	8.80E-01	0.00E+00	0.00E+00	0.00E+00	0.00E+00	0.00E+00	0.00E+00					
<i>Fusitriton oregonensis</i> eggs	200-600	2.52E-01	3.92E-02	0.00E+00	0.00E+00	0.00E+00	0.00E+00	0.00E+00	0.00E+00					
	600-1200	0.00E+00	0.00E+00	0.00E+00	0.00E+00	0.00E+00	0.00E+00	0.00E+00	0.00E+00					
	All Depths	2.52E-01	3.92E-02	0.00E+00	0.00E+00	0.00E+00	0.00E+00	0.00E+00	0.00E+00					
<i>Neptunea</i> species eggs	200-600	5.49E-01	2.59E-01	0.00E+00	0.00E+00	0.00E+00	0.00E+00	0.00E+00	0.00E+00					
	600-1200	1.35E-01	1.81E-02	0.00E+00	0.00E+00	0.00E+00	0.00E+00	0.00E+00	0.00E+00					
	All Depths	6.84E-01	2.77E-01	0.00E+00	0.00E+00	0.00E+00	0.00E+00	0.00E+00	0.00E+00					
Nudibranchia	200-600	1.36E+01	1.59E+01	1.42E+06	1.87E+11	7.46E-03	6.43E-04	7.89E-01	7.74E+00					
	600-1200	1.02E+01	7.79E+01	1.17E+06	1.02E+12	8.44E-03	4.82E-03	9.74E-01	6.33E+01					
	All Depths	2.37E+01	9.38E+01	2.60E+06	1.20E+12	7.87E-03	2.38E-03	8.67E-01	3.09E+01					
<i>Tochuina tetraquetra</i>	200-600	6.67E-01	3.24E-01	1.53E+04	1.47E+08	3.44E-04	1.01E-05	7.87E-03	4.55E-03					
	600-1200	0.00E+00	0.00E+00	0.00E+00	0.00E+00	0.00E+00	0.00E+00	0.00E+00	0.00E+00					
	All Depths	6.67E-01	3.24E-01	1.53E+04	1.47E+08	2.00E-04	5.89E-06	4.56E-03	2.64E-03					
<i>Tritonia</i> species	200-600	3.24E+02	9.57E+04	1.87E+06	3.05E+12	1.71E-01	3.13E+00	9.88E-01	1.00E+02					
	600-1200	1.30E+00	4.62E-01	2.85E+04	2.40E+08	1.02E-03	2.31E-05	2.26E-02	1.23E-02					
	All Depths	3.25E+02	9.57E+04	1.90E+06	3.05E+12	9.95E-02	1.82E+00	5.82E-01	5.80E+01					
<i>Tritonia diomedea</i>	200-600	4.60E-01	2.12E-01	3.59E+03	1.29E+07	2.45E-04	6.94E-06	1.91E-03	4.23E-04					
	600-1200	8.04E+00	5.25E+01	7.01E+04	3.84E+09	5.22E-03	1.74E-03	4.52E-02	1.27E-01					
	All Depths	8.50E+00	5.27E+01	7.37E+04	3.85E+09	2.33E-03	7.36E-04	2.01E-02	5.36E-02					
<i>Colga pacifica</i>	200-600	2.42E-01	4.62E-02	2.05E+04	2.96E+08	1.19E-04	1.28E-06	1.01E-02	8.21E-03					
	600-1200	0.00E+00	0.00E+00	0.00E+00	0.00E+00	0.00E+00	0.00E+00	0.00E+00	0.00E+00					
	All Depths	2.42E-01	4.62E-02	2.05E+04	2.96E+08	6.90E-05	7.43E-07	5.84E-03	4.77E-03					

Table 9. - - Continued.

Species	Stratum (depth in meters)			Biomass		Population			CPUE			CPUE		
		(t)	Variance	Number	Variance	kg/ha	Variance	no./ha	Variance	no./ha	Variance			
<i>Euspira pallidus</i>	200-600	5.10E-01	1.10E-01	1.17E+04	3.95E+07	2.71E-04	3.87E-06	6.21E-03	1.47E-03					
	600-1200	0.00E+00	0.00E+00	0.00E+00	0.00E+00	0.00E+00	0.00E+00	0.00E+00	0.00E+00	0.00E+00	0.00E+00	0.00E+00	0.00E+00	
	All Depths	5.10E-01	1.10E-01	1.17E+04	3.95E+07	1.57E-04	2.25E-06	3.60E-03	8.58E-04					
Lamellaridae species	200-600	2.39E-02	5.70E-04	3.98E+03	1.58E+07	1.27E-05	1.86E-08	2.11E-03	5.17E-04					
	600-1200	0.00E+00	0.00E+00	0.00E+00	0.00E+00	0.00E+00	0.00E+00	0.00E+00	0.00E+00	0.00E+00	0.00E+00	0.00E+00	0.00E+00	
	All Depths	2.39E-02	5.70E-04	3.98E+03	1.58E+07	7.35E-06	1.08E-08	1.22E-03	3.00E-04					
<i>Colus jordani</i>	200-600	1.06E-01	5.80E-03	1.54E+04	8.23E+07	5.63E-05	1.94E-07	8.18E-03	2.80E-03					
	600-1200	0.00E+00	0.00E+00	0.00E+00	0.00E+00	0.00E+00	0.00E+00	0.00E+00	0.00E+00	0.00E+00	0.00E+00	0.00E+00	0.00E+00	
	All Depths	1.06E-01	5.80E-03	1.54E+04	8.23E+07	3.26E-05	1.13E-07	4.74E-03	1.63E-03					
<i>Pyrulofusus</i> species	200-600	4.27E-02	1.83E-03	7.12E+03	5.07E+07	2.16E-05	5.41E-08	3.60E-03	1.50E-03					
	600-1200	0.00E+00	0.00E+00	0.00E+00	0.00E+00	0.00E+00	0.00E+00	0.00E+00	0.00E+00	0.00E+00	0.00E+00	0.00E+00	0.00E+00	
	All Depths	4.27E-02	1.83E-03	7.12E+03	5.07E+07	1.25E-05	3.14E-08	2.09E-03	8.71E-04					
<i>Pyrulofusus</i> species eggs	200-600	8.33E-02	6.93E-03	0.00E+00	0.00E+00	0.00E+00	0.00E+00	0.00E+00	0.00E+00	0.00E+00	0.00E+00	0.00E+00	0.00E+00	
	600-1200	0.00E+00	0.00E+00	0.00E+00	0.00E+00	0.00E+00	0.00E+00	0.00E+00	0.00E+00	0.00E+00	0.00E+00	0.00E+00	0.00E+00	
	All Depths	8.33E-02	6.93E-03	0.00E+00	0.00E+00	0.00E+00	0.00E+00	0.00E+00	0.00E+00	0.00E+00	0.00E+00	0.00E+00	0.00E+00	
<i>Pyrulofusus deformis</i>	200-600	2.63E+01	7.15E+01	1.39E+05	2.24E+09	1.33E-02	2.02E-03	7.00E-02	6.37E-02					
	600-1200	0.00E+00	0.00E+00	0.00E+00	0.00E+00	0.00E+00	0.00E+00	0.00E+00	0.00E+00	0.00E+00	0.00E+00	0.00E+00	0.00E+00	
	All Depths	2.63E+01	7.15E+01	1.39E+05	2.24E+09	7.69E-03	1.21E-03	4.06E-02	3.80E-02					
<i>Pyrulofusus melonis</i>	200-600	1.17E+02	5.21E+02	9.64E+05	3.40E+10	6.19E-02	2.39E-02	5.12E-01	1.70E+00					
	600-1200	4.35E+00	1.30E+01	3.67E+04	8.97E+08	3.27E-03	6.41E-04	2.76E-02	4.43E-02					
	All Depths	1.21E+02	5.34E+02	1.00E+06	3.49E+10	3.73E-02	1.49E-02	3.09E-01	1.06E+00					
<i>Beringius frielei</i>	200-600	4.76E+01	1.11E+02	4.51E+05	1.17E+10	2.54E-02	4.20E-03	2.41E-01	4.31E-01					
	600-1200	2.51E+00	8.60E-01	3.29E+04	1.18E+08	1.90E-03	4.77E-05	2.48E-02	6.42E-03					
	All Depths	5.01E+01	1.12E+02	4.84E+05	1.18E+10	1.55E-02	2.59E-03	1.50E-01	2.63E-01					
<i>Neptunea</i> species	200-600	4.10E-01	1.68E-01	0.00E+00	0.00E+00	0.00E+00	0.00E+00	0.00E+00	0.00E+00	0.00E+00	0.00E+00	0.00E+00	0.00E+00	
	600-1200	1.64E-01	2.69E-02	7.46E+03	5.57E+07	1.15E-04	1.12E-06	5.25E-03	2.31E-03					
	All Depths	5.74E-01	1.95E-01	7.46E+03	5.57E+07	4.87E-05	4.72E-07	2.21E-03	9.75E-04					
<i>Neptunea amianta</i>	200-600	3.42E+01	4.38E+02	4.66E+05	8.89E+10	1.92E-02	1.64E-02	2.65E-01	3.47E+00					
	600-1200	6.45E+01	3.27E+02	1.35E+06	1.29E+11	4.69E-02	1.55E-02	9.76E-01	6.12E+00					
	All Depths	9.88E+01	7.65E+02	1.81E+06	2.18E+11	3.09E-02	1.61E-02	5.63E-01	4.68E+00					

Table 9. - - Continued.

Species	Stratum (depth in meters)			Biomass			Population			CPUE			CPUE		
		(t)	Variance	Number	Variance	kg/ha	Variance	no./ha	Variance		Variance	no./ha	Variance		
<i>Neptunea pribiloffensis</i>	200-600	5.15E+02	2.23E+04	4.37E+06	1.88E+12	2.73E-01	8.12E-01	2.32E+00	6.82E+01						
	600-1200	1.05E+02	5.92E+02	2.04E+06	2.23E+11	7.67E-02	3.14E-02	1.49E+00	1.14E+01						
	All Depths	6.20E+02	2.29E+04	6.41E+06	2.11E+12	1.91E-01	4.92E-01	1.97E+00	4.43E+01						
<i>Neptunea tabulata</i>	200-600	2.90E-02	8.40E-04	3.62E+03	1.31E+07	1.56E-05	2.81E-08	1.95E-03	4.39E-04						
	600-1200	0.00E+00	0.00E+00	0.00E+00	0.00E+00	0.00E+00	0.00E+00	0.00E+00	0.00E+00						
	All Depths	2.90E-02	8.40E-04	3.62E+03	1.31E+07	9.03E-06	1.63E-08	1.13E-03	2.55E-04						
<i>Neptunea lyrata</i>	200-600	3.12E+00	2.92E+00	3.73E+04	3.01E+08	1.66E-03	9.51E-05	1.99E-02	9.91E-03						
	600-1200	0.00E+00	0.00E+00	0.00E+00	0.00E+00	0.00E+00	0.00E+00	0.00E+00	0.00E+00						
	All Depths	3.12E+00	2.92E+00	3.73E+04	3.01E+08	9.62E-04	5.57E-05	1.15E-02	5.82E-03						
<i>Plicifusus kroyeri</i>	200-600	3.09E-01	5.36E-02	7.71E+03	2.79E+07	1.64E-04	1.83E-06	4.10E-03	9.69E-04						
	600-1200	0.00E+00	0.00E+00	0.00E+00	0.00E+00	0.00E+00	0.00E+00	0.00E+00	0.00E+00						
	All Depths	3.09E-01	5.36E-02	7.71E+03	2.79E+07	9.52E-05	1.06E-06	2.38E-03	5.64E-04						
<i>Aforia circinata</i>	200-600	2.38E-02	5.67E-04	3.97E+03	1.57E+07	1.28E-05	1.90E-08	2.13E-03	5.27E-04						
	600-1200	0.00E+00	0.00E+00	0.00E+00	0.00E+00	0.00E+00	0.00E+00	0.00E+00	0.00E+00						
	All Depths	2.38E-02	5.67E-04	3.97E+03	1.57E+07	7.42E-06	1.10E-08	1.24E-03	3.06E-04						
<i>Fusitriton oregonensis</i>	200-600	1.75E+02	1.12E+03	2.55E+06	2.06E+11	9.35E-02	4.59E-02	1.36E+00	8.87E+00						
	600-1200	1.32E+00	3.47E-01	2.05E+04	7.10E+07	1.04E-03	1.99E-05	1.61E-02	4.24E-03						
	All Depths	1.76E+02	1.12E+03	2.57E+06	2.06E+11	5.47E-02	2.86E-02	7.96E-01	5.57E+00						
<i>Onukaia kiheizibisu</i>	200-600	0.00E+00	0.00E+00	0.00E+00	0.00E+00	0.00E+00	0.00E+00	0.00E+00	0.00E+00						
	600-1200	2.44E-01	5.94E-02	2.10E+04	4.42E+08	1.58E-04	2.09E-06	1.36E-02	1.55E-02						
	All Depths	2.44E-01	5.94E-02	2.10E+04	4.42E+08	6.62E-05	8.78E-07	5.71E-03	6.52E-03						
<i>Buccinum species</i>	200-600	0.00E+00	0.00E+00	0.00E+00	0.00E+00	0.00E+00	0.00E+00	0.00E+00	0.00E+00						
	600-1200	3.41E+00	2.69E+00	9.29E+04	1.90E+09	2.44E-03	1.13E-04	6.65E-02	8.34E-02						
	All Depths	3.41E+00	2.69E+00	9.29E+04	1.90E+09	1.02E-03	4.87E-05	2.79E-02	3.59E-02						
<i>Buccinum oedematum</i>	200-600	6.74E+01	4.60E+02	1.98E+06	3.80E+11	3.57E-02	1.71E-02	1.05E+00	1.45E+01						
	600-1200	9.67E+01	4.59E+02	2.57E+06	2.68E+11	6.88E-02	1.88E-02	1.84E+00	1.11E+01						
	All Depths	1.64E+02	9.19E+02	4.56E+06	6.48E+11	4.96E-02	1.80E-02	1.38E+00	1.31E+01						
<i>Buccinum plectrum</i>	200-600	1.23E+00	8.57E-01	5.11E+04	1.07E+09	6.57E-04	2.87E-05	2.73E-02	3.59E-02						
	600-1200	0.00E+00	0.00E+00	0.00E+00	0.00E+00	0.00E+00	0.00E+00	0.00E+00	0.00E+00						
	All Depths	1.23E+00	8.57E-01	5.11E+04	1.07E+09	3.81E-04	1.67E-05	1.59E-02	2.09E-02						

Table 9. - - Continued.

Species	Stratum (depth in meters)			Biomass		Population			CPUE			CPUE		
		(t)	Variance	Number	Variance	kg/ha	Variance	no./ha	Variance	no./ha	Variance			
<i>Buccinum scalariforme</i>	200-600	8.59E-01	2.38E-01	1.57E+04	8.11E+07	4.57E-04	8.68E-06	8.33E-03	2.95E-03					
	600-1200	0.00E+00	0.00E+00	0.00E+00	0.00E+00	0.00E+00	0.00E+00	0.00E+00	0.00E+00					
	All Depths	8.59E-01	2.38E-01	1.57E+04	8.11E+07	2.65E-04	5.07E-06	4.83E-03	1.72E-03					
<i>Buccinum castaneum</i>	200-600	1.76E-01	3.08E-02	7.64E+03	5.83E+07	9.32E-05	1.01E-06	4.05E-03	1.90E-03					
	600-1200	2.58E+00	3.34E+00	7.96E+04	3.24E+09	1.83E-03	1.39E-04	5.59E-02	1.31E-01					
	All Depths	2.76E+00	3.37E+00	8.72E+04	3.30E+09	8.23E-04	5.94E-05	2.58E-02	5.64E-02					
<i>Bathybuccinum clarki</i>	200-600	1.96E-02	3.86E-04	3.27E+03	1.07E+07	1.04E-05	1.26E-08	1.74E-03	3.50E-04					
	600-1200	0.00E+00	0.00E+00	0.00E+00	0.00E+00	0.00E+00	0.00E+00	0.00E+00	0.00E+00					
	All Depths	1.96E-02	3.86E-04	3.27E+03	1.07E+07	6.04E-06	7.30E-09	1.01E-03	2.03E-04					
<i>Ancistrolepis eucoosmius</i>	200-600	2.20E-02	4.86E-04	7.35E+03	5.40E+07	1.18E-05	1.63E-08	3.95E-03	1.81E-03					
	600-1200	0.00E+00	0.00E+00	0.00E+00	0.00E+00	0.00E+00	0.00E+00	0.00E+00	0.00E+00					
	All Depths	2.20E-02	4.86E-04	7.35E+03	5.40E+07	6.87E-06	9.43E-09	2.29E-03	1.05E-03					
<i>Arctomelon stearnsii</i>	200-600	7.14E+00	4.08E+00	1.22E+05	1.27E+09	3.80E-03	1.56E-04	6.48E-02	4.94E-02					
	600-1200	1.23E+00	3.38E-01	2.57E+04	1.52E+08	9.28E-04	2.05E-05	1.93E-02	9.14E-03					
	All Depths	8.38E+00	4.42E+00	1.48E+05	1.42E+09	2.59E-03	1.01E-04	4.57E-02	3.29E-02					
<i>Modiolus modiolus</i>	200-600	1.58E-01	2.50E-02	3.60E+03	1.29E+07	8.50E-05	8.38E-07	1.93E-03	4.33E-04					
	600-1200	1.59E-01	2.54E-02	6.64E+03	4.41E+07	1.20E-04	1.21E-06	4.99E-03	2.09E-03					
	All Depths	3.18E-01	5.04E-02	1.02E+04	5.70E+07	9.96E-05	9.87E-07	3.22E-03	1.13E-03					
<i>Chlamys</i> species	200-600	4.99E-02	2.49E-03	4.16E+03	1.73E+07	2.60E-05	7.86E-08	2.17E-03	5.46E-04					
	600-1200	0.00E+00	0.00E+00	0.00E+00	0.00E+00	0.00E+00	0.00E+00	0.00E+00	0.00E+00					
	All Depths	4.99E-02	2.49E-03	4.16E+03	1.73E+07	1.51E-05	4.56E-08	1.26E-03	3.17E-04					
<i>Delectopecten vancouverensis</i>	200-600	8.51E-03	7.24E-05	4.25E+03	1.81E+07	4.15E-06	2.00E-09	2.08E-03	5.00E-04					
	600-1200	1.61E+00	2.41E+00	5.82E+05	3.16E+11	1.21E-03	1.15E-04	4.38E-01	1.50E+01					
	All Depths	1.62E+00	2.41E+00	5.86E+05	3.16E+11	5.11E-04	4.82E-05	1.85E-01	6.31E+00					
<i>Yoldia</i> species	200-600	0.00E+00	0.00E+00	0.00E+00	0.00E+00	0.00E+00	0.00E+00	0.00E+00	0.00E+00					
	600-1200	9.49E-03	9.01E-05	4.75E+03	2.25E+07	5.95E-06	2.97E-09	2.97E-03	7.42E-04					
	All Depths	9.49E-03	9.01E-05	4.75E+03	2.25E+07	2.50E-06	1.25E-09	1.25E-03	3.12E-04					
<i>Astarte borealis</i>	200-600	8.77E-03	7.70E-05	4.39E+03	1.92E+07	4.66E-06	2.52E-09	2.33E-03	6.30E-04					
	600-1200	0.00E+00	0.00E+00	0.00E+00	0.00E+00	0.00E+00	0.00E+00	0.00E+00	0.00E+00					
	All Depths	8.77E-03	7.70E-05	4.39E+03	1.92E+07	2.70E-06	1.46E-09	1.35E-03	3.66E-04					

Table 9. - - Continued.

Species	Stratum (depth in meters)			Biomass		Population			CPUE			CPUE		
		(t)	Variance	Number	Variance	kg/ha	Variance	no./ha	Variance	no./ha	Variance			
<i>Clinocardium</i> species	200-600	0.00E+00	0.00E+00	0.00E+00	0.00E+00	0.00E+00	0.00E+00	0.00E+00	0.00E+00	0.00E+00	0.00E+00	0.00E+00	0.00E+00	
	600-1200	9.31E-02	8.67E-03	2.33E+04	5.42E+08	6.27E-05	3.30E-07	1.57E-02	3.30E-07	2.06E-02	1.57E-02	2.06E-02	2.06E-02	
	All Depths	9.31E-02	8.67E-03	2.33E+04	5.42E+08	2.63E-05	1.39E-07	6.58E-03	1.39E-07	8.66E-03	6.58E-03	8.66E-03	8.66E-03	
<i>Benthoctopus leioderma</i>	200-600	3.98E+01	1.38E+02	1.10E+05	6.53E+08	2.11E-02	5.22E-03	5.84E-02	5.22E-03	2.69E-02	5.84E-02	2.69E-02	2.69E-02	
	600-1200	1.12E+02	7.37E+02	2.35E+05	3.94E+09	8.65E-02	4.76E-02	1.77E-01	4.76E-02	2.17E-01	1.77E-01	2.17E-01	2.17E-01	
	All Depths	1.51E+02	8.75E+02	3.45E+05	4.59E+09	4.86E-02	2.39E-02	1.08E-01	2.39E-02	1.09E-01	1.08E-01	1.09E-01	1.09E-01	
<i>Octopus</i> species	200-600	7.19E-03	5.17E-05	3.59E+03	1.29E+07	3.82E-06	1.69E-09	1.91E-03	1.69E-09	4.23E-04	1.91E-03	4.23E-04	4.23E-04	
	600-1200	0.00E+00	0.00E+00	0.00E+00	0.00E+00	0.00E+00	0.00E+00	0.00E+00	0.00E+00	0.00E+00	0.00E+00	0.00E+00	0.00E+00	
	All Depths	7.19E-03	5.17E-05	3.59E+03	1.29E+07	2.22E-06	9.82E-10	1.11E-03	9.82E-10	2.46E-04	1.11E-03	2.46E-04	2.46E-04	
<i>Japatella diaphana</i>	200-600	3.38E-01	1.14E-01	3.59E+03	1.29E+07	1.80E-04	3.74E-06	1.91E-03	3.74E-06	4.23E-04	1.91E-03	4.23E-04	4.23E-04	
	600-1200	9.39E+00	8.97E+00	6.63E+04	1.94E+08	6.66E-03	4.01E-04	4.56E-02	4.01E-04	1.21E-02	4.56E-02	1.21E-02	1.21E-02	
	All Depths	9.72E+00	9.09E+00	6.99E+04	2.07E+08	2.90E-03	1.80E-04	2.03E-02	1.80E-04	5.76E-03	2.03E-02	5.76E-03	5.76E-03	
<i>Opisthoteuthis californiana</i>	200-600	1.01E+02	1.19E+03	9.67E+04	9.47E+08	5.48E-02	4.10E-02	5.30E-02	4.10E-02	3.48E-02	5.30E-02	3.48E-02	3.48E-02	
	600-1200	5.13E+01	1.24E+03	4.75E+04	1.03E+09	4.00E-02	6.34E-02	3.70E-02	6.34E-02	5.27E-02	3.70E-02	5.27E-02	5.27E-02	
	All Depths	1.52E+02	2.43E+03	1.44E+05	1.97E+09	4.86E-02	5.02E-02	4.63E-02	5.02E-02	4.22E-02	4.63E-02	4.22E-02	4.22E-02	
<i>Octopus dofleini</i>	200-600	3.36E+02	1.22E+04	2.28E+05	3.82E+09	1.77E-01	3.93E-01	1.21E-01	3.93E-01	1.36E-01	1.21E-01	1.36E-01	1.36E-01	
	600-1200	0.00E+00	0.00E+00	0.00E+00	0.00E+00	0.00E+00	0.00E+00	0.00E+00	0.00E+00	0.00E+00	0.00E+00	0.00E+00	0.00E+00	
	All Depths	3.36E+02	1.22E+04	2.28E+05	3.82E+09	1.03E-01	2.35E-01	7.04E-02	2.35E-01	8.19E-02	7.04E-02	8.19E-02	8.19E-02	
<i>Benthoctopus</i> species	200-600	0.00E+00	0.00E+00	0.00E+00	0.00E+00	0.00E+00	0.00E+00	0.00E+00	0.00E+00	0.00E+00	0.00E+00	0.00E+00	0.00E+00	
	600-1200	4.35E-01	1.89E-01	5.44E+03	2.96E+07	2.40E-04	4.84E-06	3.00E-03	4.84E-06	7.56E-04	3.00E-03	7.56E-04	7.56E-04	
	All Depths	4.35E-01	1.89E-01	5.44E+03	2.96E+07	1.01E-04	2.03E-06	1.26E-03	2.03E-06	3.17E-04	1.26E-03	3.17E-04	3.17E-04	
<i>Benthoctopus salebrosus</i>	200-600	1.91E+01	1.19E+01	2.30E+05	1.39E+09	1.01E-02	5.16E-04	1.21E-01	5.16E-04	6.07E-02	1.21E-01	6.07E-02	6.07E-02	
	600-1200	4.00E+00	2.09E+00	5.87E+04	3.20E+08	3.00E-03	1.04E-04	4.43E-02	1.04E-04	1.85E-02	4.43E-02	1.85E-02	1.85E-02	
	All Depths	2.31E+01	1.40E+01	2.88E+05	1.71E+09	7.09E-03	3.54E-04	8.89E-02	3.54E-04	4.42E-02	8.89E-02	4.42E-02	4.42E-02	
<i>Benthoctopus oregonensis</i>	200-600	0.00E+00	0.00E+00	0.00E+00	0.00E+00	0.00E+00	0.00E+00	0.00E+00	0.00E+00	0.00E+00	0.00E+00	0.00E+00	0.00E+00	
	600-1200	2.72E+01	1.17E+02	3.13E+04	1.28E+08	2.23E-02	8.04E-03	2.24E-02	8.04E-03	4.83E-03	2.24E-02	4.83E-03	4.83E-03	
	All Depths	2.72E+01	1.17E+02	3.13E+04	1.28E+08	9.38E-03	3.48E-03	9.40E-03	3.48E-03	2.14E-03	9.40E-03	2.14E-03	2.14E-03	
Teuthoidea	200-600	7.69E-01	1.19E-01	5.89E+04	5.99E+08	4.10E-04	4.02E-06	3.14E-02	4.02E-06	2.04E-02	3.14E-02	2.04E-02	2.04E-02	
	600-1200	1.51E+00	2.28E+00	3.42E+03	1.17E+07	1.14E-03	1.08E-04	2.57E-03	1.08E-04	5.54E-04	2.57E-03	5.54E-04	5.54E-04	
	All Depths	2.28E+00	2.40E+00	6.23E+04	6.11E+08	7.15E-04	4.76E-05	1.93E-02	4.76E-05	1.22E-02	1.93E-02	1.22E-02	1.22E-02	

Table 9. - - Continued.

Species	Stratum (depth in meters)			Biomass		Population			CPUE			CPUE		
		(t)	Variance	Number	Variance	kg/ha	Variance	no./ha	Variance	no./ha	Variance			
<i>Rossia pacifica</i>	200-600	3.54E+01	1.33E+02	3.93E+05	1.22E+10	1.70E-02	4.02E-03	1.87E-01	4.95E-01	4.95E-01				
	600-1200	0.00E+00	0.00E+00	0.00E+00	0.00E+00	0.00E+00	0.00E+00	0.00E+00	0.00E+00	0.00E+00				
	All Depths	3.54E+01	1.33E+02	3.93E+05	1.22E+10	9.88E-03	2.40E-03	1.09E-01	2.95E-01	2.95E-01				
Gonatidae	200-600	2.38E+00	2.78E+00	7.02E+04	1.27E+09	1.23E-03	8.32E-05	3.67E-02	3.99E-02	3.99E-02				
	600-1200	6.98E-01	3.84E-01	7.69E+03	3.09E+07	5.15E-04	1.81E-05	5.20E-03	1.14E-03	1.14E-03				
	All Depths	3.08E+00	3.16E+00	7.79E+04	1.30E+09	9.27E-04	5.58E-05	2.34E-02	2.38E-02	2.38E-02				
<i>Gonatus</i> species	200-600	7.96E-02	6.33E-03	3.98E+03	1.58E+07	4.22E-05	2.07E-07	2.11E-03	5.17E-04	5.17E-04				
	600-1200	1.45E+00	2.11E+00	7.09E+03	5.03E+07	1.02E-03	8.78E-05	4.99E-03	2.09E-03	2.09E-03				
	All Depths	1.53E+00	2.12E+00	1.11E+04	6.62E+07	4.54E-04	3.70E-05	3.32E-03	1.17E-03	1.17E-03				
<i>Gonatus onyx</i>	200-600	6.44E-02	4.14E-03	4.60E+03	2.11E+07	3.14E-05	1.14E-07	2.24E-03	5.84E-04	5.84E-04				
	600-1200	0.00E+00	0.00E+00	0.00E+00	0.00E+00	0.00E+00	0.00E+00	0.00E+00	0.00E+00	0.00E+00				
	All Depths	6.44E-02	4.14E-03	4.60E+03	2.11E+07	1.82E-05	6.64E-08	1.30E-03	3.39E-04	3.39E-04				
<i>Gonatus berryi</i>	200-600	1.98E-01	3.91E-02	4.30E+03	1.85E+07	9.99E-05	1.16E-06	2.17E-03	5.47E-04	5.47E-04				
	600-1200	2.82E+00	5.00E+00	1.64E+04	1.02E+08	2.21E-03	2.68E-04	1.24E-02	5.07E-03	5.07E-03				
	All Depths	3.02E+00	5.04E+00	2.07E+04	1.20E+08	9.84E-04	1.13E-04	6.48E-03	2.46E-03	2.46E-03				
<i>Gonatus pyros</i>	200-600	2.23E-02	4.98E-04	3.72E+03	1.38E+07	1.32E-05	2.01E-08	2.19E-03	5.59E-04	5.59E-04				
	600-1200	0.00E+00	0.00E+00	0.00E+00	0.00E+00	0.00E+00	0.00E+00	0.00E+00	0.00E+00	0.00E+00				
	All Depths	2.23E-02	4.98E-04	3.72E+03	1.38E+07	7.64E-06	1.17E-08	1.27E-03	3.24E-04	3.24E-04				
<i>Berryteuthis magister</i>	200-600	1.37E+03	2.17E+04	3.74E+06	1.71E+11	7.22E-01	9.27E-01	1.98E+00	6.76E+00	6.76E+00				
	600-1200	3.09E+02	5.12E+03	6.67E+05	1.39E+10	2.30E-01	3.28E-01	4.95E-01	1.06E+00	1.06E+00				
	All Depths	1.67E+03	2.68E+04	4.41E+06	1.85E+11	5.15E-01	7.32E-01	1.36E+00	4.89E+00	4.89E+00				
<i>Gonatopsis borealis</i>	200-600	1.38E+01	1.64E+01	2.04E+05	3.43E+09	7.35E-03	6.21E-04	1.10E-01	1.26E-01	1.26E-01				
	600-1200	3.87E+01	4.51E+02	3.85E+05	3.47E+10	2.89E-02	2.39E-02	2.85E-01	1.85E+00	1.85E+00				
	All Depths	5.25E+01	4.67E+02	5.89E+05	3.81E+10	1.64E-02	1.04E-02	1.84E-01	8.51E-01	8.51E-01				
<i>Galiteuthis phyllura</i>	200-600	0.00E+00	0.00E+00	0.00E+00	0.00E+00	0.00E+00	0.00E+00	0.00E+00	0.00E+00	0.00E+00				
	600-1200	2.40E+00	3.18E+00	1.35E+04	6.13E+07	1.55E-03	1.11E-04	8.67E-03	2.06E-03	2.06E-03				
	All Depths	2.40E+00	3.18E+00	1.35E+04	6.13E+07	6.53E-04	4.70E-05	3.64E-03	8.77E-04	8.77E-04				
<i>Chiroteuthis calyx</i>	200-600	5.55E+00	1.07E+01	1.60E+04	6.18E+07	2.94E-03	3.59E-04	8.51E-03	2.08E-03	2.08E-03				
	600-1200	3.12E+00	8.10E+00	9.09E+03	4.13E+07	2.17E-03	3.35E-04	6.03E-03	1.51E-03	1.51E-03				
	All Depths	8.67E+00	1.88E+01	2.51E+04	1.03E+08	2.62E-03	3.47E-04	7.47E-03	1.83E-03	1.83E-03				

Table 9. - - Continued.

Species	Stratum (depth in meters)			Biomass			Population			CPUE			CPUE		
		(t)	Variance	Number	Variance	kg/ha	Variance	no./ha	Variance						
<i>Taonius pavo</i>	200-600	0.00E+00	0.00E+00	0.00E+00	0.00E+00	0.00E+00	0.00E+00	0.00E+00	0.00E+00	0.00E+00	0.00E+00	0.00E+00	0.00E+00	0.00E+00	0.00E+00
	600-1200	6.30E-01	3.97E-01	8.41E+03	7.07E+07	4.08E-04	4.08E-04	1.40E-05	5.44E-03	2.48E-03	5.44E-03	2.48E-03	2.48E-03	1.04E-03	1.04E-03
	All Depths	6.30E-01	3.97E-01	8.41E+03	7.07E+07	1.71E-04	1.71E-04	5.87E-06	2.28E-03	1.04E-03	2.28E-03	1.04E-03	1.04E-03	4.61E-03	4.61E-03
<i>Lethasterias nanimensis</i>	200-600	1.28E+00	1.33E+00	1.72E+04	1.23E+08	6.67E-04	6.67E-04	4.31E-05	8.95E-03	4.61E-03	8.95E-03	4.61E-03	0.00E+00	0.00E+00	0.00E+00
	600-1200	0.00E+00	0.00E+00	0.00E+00	0.00E+00	0.00E+00	0.00E+00	0.00E+00	0.00E+00	0.00E+00	0.00E+00	0.00E+00	0.00E+00	0.00E+00	0.00E+00
	All Depths	1.28E+00	1.33E+00	1.72E+04	1.23E+08	3.87E-04	3.87E-04	2.50E-05	5.19E-03	2.68E-03	5.19E-03	2.68E-03	2.68E-03	2.68E-03	2.68E-03
<i>Stephanasterias albula</i>	200-600	9.95E-02	6.26E-03	7.55E+03	2.66E+07	5.29E-05	5.29E-05	2.11E-07	4.01E-03	9.26E-04	4.01E-03	9.26E-04	2.86E-03	2.86E-03	2.86E-03
	600-1200	4.07E-02	1.65E-03	6.78E+03	4.59E+07	3.50E-05	3.50E-05	1.03E-07	5.84E-03	2.86E-03	5.84E-03	2.86E-03	1.73E-03	1.73E-03	1.73E-03
	All Depths	1.40E-01	7.91E-03	1.43E+04	7.25E+07	4.54E-05	4.54E-05	1.65E-07	4.78E-03	1.73E-03	4.78E-03	1.73E-03	1.73E-03	1.73E-03	1.73E-03
<i>Henricia species</i>	200-600	1.17E+01	5.03E+00	5.76E+05	5.79E+09	6.22E-03	6.22E-03	1.81E-04	3.04E-01	2.42E-01	3.04E-01	2.42E-01	4.94E-02	4.94E-02	4.94E-02
	600-1200	1.35E+00	2.54E-01	9.38E+04	4.66E+08	1.02E-03	1.02E-03	1.22E-05	7.41E-02	4.94E-02	7.41E-02	4.94E-02	1.74E-01	1.74E-01	1.74E-01
	All Depths	1.30E+01	5.29E+00	6.70E+05	6.26E+09	4.04E-03	4.04E-03	1.16E-04	2.07E-01	1.74E-01	2.07E-01	1.74E-01	1.74E-01	1.74E-01	1.74E-01
<i>Henricia asthenactis</i>	200-600	1.96E+00	1.56E+00	1.40E+04	6.76E+07	1.03E-03	1.03E-03	5.25E-05	7.19E-03	2.05E-03	7.19E-03	2.05E-03	5.87E-04	5.87E-04	5.87E-04
	600-1200	1.65E-01	2.71E-02	3.58E+03	1.28E+07	1.22E-04	1.22E-04	1.24E-06	2.64E-03	5.87E-04	2.64E-03	5.87E-04	1.43E-03	1.43E-03	1.43E-03
	All Depths	2.12E+00	1.59E+00	1.76E+04	8.04E+07	6.47E-04	6.47E-04	3.11E-05	5.28E-03	1.43E-03	5.28E-03	1.43E-03	1.43E-03	1.43E-03	1.43E-03
<i>Gephyreaster swiffi</i>	200-600	7.43E-01	5.52E-01	3.91E+03	1.53E+07	3.95E-04	3.95E-04	1.81E-05	2.08E-03	5.01E-04	2.08E-03	5.01E-04	0.00E+00	0.00E+00	0.00E+00
	600-1200	0.00E+00	0.00E+00	0.00E+00	0.00E+00	0.00E+00	0.00E+00	0.00E+00	0.00E+00	0.00E+00	0.00E+00	0.00E+00	0.00E+00	0.00E+00	0.00E+00
	All Depths	7.43E-01	5.52E-01	3.91E+03	1.53E+07	2.29E-04	2.29E-04	1.05E-05	1.21E-03	2.91E-04	1.21E-03	2.91E-04	2.91E-04	2.91E-04	2.91E-04
<i>Hippasteria species</i>	200-600	7.73E-01	5.98E-01	1.12E+04	1.26E+08	3.78E-04	3.78E-04	1.66E-05	5.48E-03	3.48E-03	5.48E-03	3.48E-03	3.57E-03	3.57E-03	3.57E-03
	600-1200	1.05E+00	4.07E-01	1.07E+04	3.92E+07	9.05E-04	9.05E-04	3.58E-05	9.20E-03	3.57E-03	9.20E-03	3.57E-03	3.50E-03	3.50E-03	3.50E-03
	All Depths	1.82E+00	1.00E+00	2.19E+04	1.65E+08	5.99E-04	5.99E-04	2.46E-05	7.04E-03	3.50E-03	7.04E-03	3.50E-03	3.50E-03	3.50E-03	3.50E-03
<i>Hippasteria spinosa</i>	200-600	9.39E+01	2.01E+03	1.76E+05	3.69E+09	4.90E-02	4.90E-02	6.81E-02	9.12E-02	1.31E-01	9.12E-02	1.31E-01	1.26E-01	1.26E-01	1.26E-01
	600-1200	2.43E+01	1.59E+02	9.73E+04	3.40E+09	1.71E-02	1.71E-02	6.07E-03	6.90E-02	1.26E-01	6.90E-02	1.26E-01	1.28E-01	1.28E-01	1.28E-01
	All Depths	1.18E+02	2.17E+03	2.74E+05	7.09E+09	3.56E-02	3.56E-02	4.21E-02	8.19E-02	1.28E-01	8.19E-02	1.28E-01	1.28E-01	1.28E-01	1.28E-01
<i>Pseudarchaster parelii</i>	200-600	6.26E+00	2.58E+00	1.56E+05	1.26E+09	3.36E-03	3.36E-03	9.10E-05	8.27E-02	4.12E-02	8.27E-02	4.12E-02	6.15E-02	6.15E-02	6.15E-02
	600-1200	5.04E+00	1.83E+00	1.48E+05	1.10E+09	3.85E-03	3.85E-03	9.74E-05	1.13E-01	6.15E-02	1.13E-01	6.15E-02	4.97E-02	4.97E-02	4.97E-02
	All Depths	1.13E+01	4.41E+00	3.03E+05	2.36E+09	3.57E-03	3.57E-03	9.33E-05	9.55E-02	4.97E-02	9.55E-02	4.97E-02	4.97E-02	4.97E-02	4.97E-02
<i>Cryptopeltaster lepidonotus</i>	200-600	0.00E+00	0.00E+00	0.00E+00	0.00E+00	0.00E+00	0.00E+00	0.00E+00	0.00E+00	0.00E+00	0.00E+00	0.00E+00	0.00E+00	0.00E+00	0.00E+00
	600-1200	3.08E-01	9.49E-02	3.58E+03	1.28E+07	2.27E-04	2.27E-04	4.34E-06	2.64E-03	5.87E-04	2.64E-03	5.87E-04	2.46E-04	2.46E-04	2.46E-04
	All Depths	3.08E-01	9.49E-02	3.58E+03	1.28E+07	9.55E-05	9.55E-05	1.82E-06	1.11E-03	2.46E-04	1.11E-03	2.46E-04	2.46E-04	2.46E-04	2.46E-04

Table 9. - - Continued.

Species	Stratum (depth in meters)			Biomass		Population			CPUE			CPUE		
		(t)	Variance	Number	Variance	kg/ha	Variance	no./ha	Variance	no./ha	Variance			
<i>Mediaster tenellus</i>	200-600	1.84E+00	9.76E-01	8.26E+04	2.02E+09	9.53E-04	3.05E-05	4.24E-02	6.33E-02					
	600-1200	6.61E+00	1.15E+01	2.70E+05	2.11E+10	4.97E-03	5.41E-04	2.05E-01	9.67E-01					
	All Depths	8.45E+00	1.25E+01	3.53E+05	2.31E+10	2.64E-03	2.47E-04	1.11E-01	4.46E-01					
<i>Mediaster aequalis</i>	200-600	0.00E+00	0.00E+00	0.00E+00	0.00E+00	0.00E+00	0.00E+00	0.00E+00	0.00E+00					
	600-1200	2.91E-01	8.48E-02	1.41E+04	1.99E+08	2.51E-04	5.29E-06	1.21E-02	1.24E-02					
	All Depths	2.91E-01	8.48E-02	1.41E+04	1.99E+08	1.05E-04	2.22E-06	5.10E-03	5.20E-03					
<i>Ceramaster species</i>	200-600	1.90E+03	6.72E+04	1.97E+07	5.00E+12	1.01E+00	2.97E+00	1.05E+01	3.11E+02					
	600-1200	2.68E+02	3.28E+03	3.75E+06	6.00E+11	2.00E-01	1.64E-01	2.82E+00	3.38E+01					
	All Depths	2.17E+03	7.05E+04	2.34E+07	5.60E+12	6.70E-01	1.94E+00	7.26E+00	2.08E+02					
<i>Solaster species</i>	200-600	4.86E+00	2.00E+01	3.17E+04	5.19E+08	2.57E-03	6.50E-04	1.65E-02	1.66E-02					
	600-1200	0.00E+00	0.00E+00	0.00E+00	0.00E+00	0.00E+00	0.00E+00	0.00E+00	0.00E+00					
	All Depths	4.86E+00	2.00E+01	3.17E+04	5.19E+08	1.49E-03	3.77E-04	9.58E-03	9.68E-03					
<i>Solaster endeca</i>	200-600	4.20E+00	1.12E+01	3.44E+04	3.43E+08	2.16E-03	3.50E-04	1.75E-02	1.16E-02					
	600-1200	4.82E-01	2.33E-01	8.32E+03	6.92E+07	3.88E-04	1.27E-05	6.70E-03	3.77E-03					
	All Depths	4.68E+00	1.14E+01	4.27E+04	4.13E+08	1.41E-03	2.08E-04	1.29E-02	8.32E-03					
<i>Solaster species A (Clark, 1997)</i>	200-600	1.72E+00	2.43E+00	5.34E+04	1.90E+09	8.92E-04	7.69E-05	2.75E-02	5.92E-02					
	600-1200	4.57E-01	2.09E-01	8.32E+03	6.92E+07	3.68E-04	1.14E-05	6.70E-03	3.77E-03					
	All Depths	2.18E+00	2.66E+00	6.17E+04	1.97E+09	6.72E-04	4.92E-05	1.88E-02	3.59E-02					
<i>Solaster species F (Clark)</i>	200-600	6.54E+01	4.25E+02	3.18E+05	1.03E+10	3.44E-02	1.41E-02	1.68E-01	3.42E-01					
	600-1200	4.73E+01	4.75E+02	3.04E+05	1.91E+10	3.79E-02	2.93E-02	2.45E-01	1.26E+00					
	All Depths	1.13E+02	9.00E+02	6.22E+05	2.95E+10	3.59E-02	2.03E-02	2.01E-01	7.26E-01					
<i>Crossaster species</i>	200-600	1.05E+00	1.10E+00	3.41E+03	1.16E+07	5.56E-04	3.59E-05	1.81E-03	3.79E-04					
	600-1200	1.07E+00	1.14E+00	1.03E+05	1.07E+10	7.13E-04	4.27E-05	6.89E-02	3.99E-01					
	All Depths	2.12E+00	2.24E+00	1.07E+05	1.07E+10	6.22E-04	3.86E-05	3.00E-02	1.68E-01					
<i>Crossaster species B (Clark)</i>	200-600	9.02E-02	8.14E-03	3.76E+03	1.41E+07	4.41E-05	2.26E-07	1.84E-03	3.92E-04					
	600-1200	7.39E+00	5.16E+01	8.81E+05	7.45E+11	5.96E-03	2.81E-03	7.10E-01	4.05E+01					
	All Depths	7.48E+00	5.16E+01	8.84E+05	7.45E+11	2.53E-03	1.18E-03	2.99E-01	1.70E+01					
<i>Crossaster papposus</i>	200-600	1.39E+00	1.32E+00	9.19E+04	5.05E+09	7.08E-04	3.93E-05	4.68E-02	1.52E-01					
	600-1200	3.78E-01	4.36E-02	3.04E+04	2.48E+08	2.58E-04	1.84E-06	2.06E-02	1.11E-02					
	All Depths	1.77E+00	1.36E+00	1.22E+05	5.30E+09	5.19E-04	2.35E-05	3.58E-02	9.27E-02					

Table 9. - - Continued.

Species	Stratum (depth in meters)			Biomass		Population			CPUE			CPUE		
		(t)	Variance	Number	Variance	kg/ha	Variance	no./ha	Variance	no./ha	Variance			
<i>Heterozonias alternatus</i>	200-600	1.39E+00	4.65E-01	3.44E+04	4.97E+08	7.22E-04	1.50E-05	1.76E-02	1.53E-02	1.53E-02				
	600-1200	1.18E+01	4.70E+01	7.59E+04	1.00E+09	7.23E-03	1.55E-03	4.65E-02	4.69E-02	4.69E-02				
	All Depths	1.32E+01	4.74E+01	1.10E+05	1.50E+09	3.46E-03	6.64E-04	2.97E-02	2.86E-02	2.86E-02				
<i>Lophaster vexator</i>	200-600	6.05E-01	1.91E-01	1.47E+04	1.02E+08	3.06E-04	6.15E-06	7.45E-03	3.33E-03	3.33E-03				
	600-1200	6.71E+00	7.64E+00	2.60E+05	1.54E+10	4.55E-03	2.81E-04	1.78E-01	6.14E-01	6.14E-01				
	All Depths	7.31E+00	7.84E+00	2.75E+05	1.55E+10	2.09E-03	1.25E-04	7.93E-02	2.65E-01	2.65E-01				
<i>Lophaster furcilliger</i>	200-600	2.69E+01	4.48E+02	4.91E+05	3.35E+10	1.55E-02	1.80E-02	2.68E-01	1.30E+00	1.30E+00				
	600-1200	6.79E+01	5.39E+02	2.28E+06	4.66E+11	5.02E-02	3.67E-02	1.67E+00	3.00E+01	3.00E+01				
	All Depths	9.48E+01	9.87E+02	2.77E+06	5.00E+11	3.01E-02	2.60E-02	8.59E-01	1.38E+01	1.38E+01				
<i>Pteraster species</i>	200-600	2.20E+01	1.61E+02	2.46E+05	1.33E+10	1.21E-02	5.98E-03	1.34E-01	4.82E-01	4.82E-01				
	600-1200	2.44E+01	1.87E+02	4.20E+05	2.39E+10	1.60E-02	6.15E-03	2.81E-01	8.74E-01	8.74E-01				
	All Depths	4.64E+01	3.48E+02	6.66E+05	3.73E+10	1.37E-02	6.03E-03	1.96E-01	6.49E-01	6.49E-01				
<i>Pteraster species A (Clark, 1999)</i>	200-600	0.00E+00	0.00E+00	0.00E+00	0.00E+00	0.00E+00	0.00E+00	0.00E+00	0.00E+00	0.00E+00				
	600-1200	2.95E+00	1.63E+00	4.63E+04	3.37E+08	2.02E-03	7.88E-05	3.21E-02	2.03E-02	2.03E-02				
	All Depths	2.95E+00	1.63E+00	4.63E+04	3.37E+08	8.48E-04	3.39E-05	1.35E-02	8.73E-03	8.73E-03				
<i>Pteraster tessellatus</i>	200-600	1.54E+01	1.64E+02	5.68E+04	1.22E+09	8.18E-03	5.36E-03	3.04E-02	4.02E-02	4.02E-02				
	600-1200	0.00E+00	0.00E+00	0.00E+00	0.00E+00	0.00E+00	0.00E+00	0.00E+00	0.00E+00	0.00E+00				
	All Depths	1.54E+01	1.64E+02	5.68E+04	1.22E+09	4.74E-03	3.11E-03	1.76E-02	2.35E-02	2.35E-02				
<i>Pteraster jordani</i>	200-600	1.18E+00	6.78E-01	2.74E+04	3.11E+08	6.25E-04	2.27E-05	1.46E-02	1.04E-02	1.04E-02				
	600-1200	3.20E-01	1.02E-01	6.95E+03	4.83E+07	2.25E-04	4.24E-06	4.88E-03	2.00E-03	2.00E-03				
	All Depths	1.50E+00	7.80E-01	3.44E+04	3.59E+08	4.57E-04	1.49E-05	1.05E-02	6.86E-03	6.86E-03				
<i>Pteraster militaris</i>	200-600	8.82E+00	1.11E+01	1.99E+05	6.22E+09	4.61E-03	3.66E-04	1.04E-01	2.02E-01	2.02E-01				
	600-1200	4.31E-01	1.40E-01	1.29E+04	9.02E+07	3.18E-04	6.58E-06	9.21E-03	4.01E-03	4.01E-03				
	All Depths	9.25E+00	1.12E+01	2.12E+05	6.31E+09	2.81E-03	2.19E-04	6.41E-02	1.20E-01	1.20E-01				
<i>Diplopteraster multipes</i>	200-600	1.24E+02	8.20E+02	4.47E+05	1.58E+10	6.47E-02	2.76E-02	2.34E-01	4.81E-01	4.81E-01				
	600-1200	1.08E+01	2.39E+01	4.86E+04	5.18E+08	6.79E-03	7.86E-04	3.15E-02	1.87E-02	1.87E-02				
	All Depths	1.35E+02	8.44E+02	4.96E+05	1.63E+10	4.04E-02	1.71E-02	1.49E-01	2.96E-01	2.96E-01				
<i>Leptychaster pacificus</i>	200-600	8.14E-02	6.62E-03	3.70E+03	1.37E+07	4.37E-05	2.22E-07	1.99E-03	4.58E-04	4.58E-04				
	600-1200	0.00E+00	0.00E+00	0.00E+00	0.00E+00	0.00E+00	0.00E+00	0.00E+00	0.00E+00	0.00E+00				
	All Depths	8.14E-02	6.62E-03	3.70E+03	1.37E+07	2.53E-05	1.29E-07	1.15E-03	2.66E-04	2.66E-04				

Table 9. - - Continued.

Species	Stratum			Biomass			Population			CPUE			CPUE		
	(depth in meters)	(t)	Variance	Number	Variance	kg/ha	Variance	no./ha	Variance	no./ha	Variance				
<i>Dipsacaster borealis</i>	200-600	6.58E+02	4.38E+04	3.56E+06	7.78E+11	3.52E-01	1.50E+00	1.90E+00	2.77E+01						
	600-1200	1.30E+01	2.95E+01	1.37E+05	2.58E+09	9.35E-03	1.23E-03	1.02E-01	1.30E-01						
	All Depths	6.70E+02	4.39E+04	3.69E+06	7.81E+11	2.08E-01	8.94E-01	1.15E+00	1.69E+01						
<i>Nearchaster variabilis</i>	200-600	1.14E+02	1.05E+03	2.79E+06	4.84E+11	6.17E-02	3.75E-02	1.52E+00	1.71E+01						
	600-1200	4.23E+02	2.09E+04	1.17E+07	1.20E+13	3.23E-01	1.09E+00	8.69E+00	5.98E+02						
	All Depths	5.37E+02	2.20E+04	1.45E+07	1.25E+13	1.71E-01	4.94E-01	4.53E+00	2.72E+02						
<i>Nearchaster</i> species	200-600	9.73E-02	9.46E-03	4.42E+03	1.95E+07	5.07E-05	2.98E-07	2.30E-03	6.16E-04						
	600-1200	0.00E+00	0.00E+00	0.00E+00	0.00E+00	0.00E+00	0.00E+00	0.00E+00	0.00E+00						
	All Depths	9.73E-02	9.46E-03	4.42E+03	1.95E+07	2.94E-05	1.73E-07	1.34E-03	3.57E-04						
Brisingidae	200-600	2.49E+00	2.20E+00	2.08E+04	1.54E+08	1.31E-03	7.28E-05	1.09E-02	5.09E-03						
	600-1200	1.17E+00	6.75E-01	2.49E+04	1.11E+08	2.73E-04	1.91E-06	1.80E-02	5.63E-03						
	All Depths	3.65E+00	2.87E+00	4.57E+04	2.66E+08	8.76E-04	4.33E-05	1.39E-02	5.30E-03						
<i>Zoraster evermanni</i>	200-600	4.20E+01	7.02E+02	4.01E+05	6.49E+10	2.27E-02	2.39E-02	2.23E-01	2.48E+00						
	600-1200	1.75E+02	6.56E+03	1.65E+06	5.67E+11	1.19E-01	2.60E-01	1.11E+00	2.26E+01						
	All Depths	2.17E+02	7.26E+03	2.05E+06	6.32E+11	6.30E-02	1.24E-01	5.97E-01	1.10E+01						
<i>Myxoderma sacculatum</i>	200-600	4.18E+01	2.42E+02	4.99E+05	4.00E+10	2.30E-02	9.34E-03	2.74E-01	1.46E+00						
	600-1200	1.72E+02	2.32E+03	1.77E+06	3.72E+11	1.07E-01	1.06E-01	1.12E+00	1.40E+01						
	All Depths	2.14E+02	2.56E+03	2.27E+06	4.12E+11	5.84E-02	5.15E-02	6.28E-01	6.87E+00						
<i>Strongylocentrotus droebachiensis</i>	200-600	6.40E+01	6.74E+02	6.77E+05	4.59E+10	3.50E-02	2.46E-02	3.73E-01	1.72E+00						
	600-1200	0.00E+00	0.00E+00	0.00E+00	0.00E+00	0.00E+00	0.00E+00	0.00E+00	0.00E+00						
	All Depths	6.40E+01	6.74E+02	6.77E+05	4.59E+10	2.03E-02	1.45E-02	2.16E-01	1.03E+00						
<i>Strongylocentrotus</i> species	200-600	1.28E+00	1.55E+00	4.23E+04	1.50E+09	6.89E-04	5.17E-05	2.29E-02	5.03E-02						
	600-1200	0.00E+00	0.00E+00	0.00E+00	0.00E+00	0.00E+00	0.00E+00	0.00E+00	0.00E+00						
	All Depths	1.28E+00	1.55E+00	4.23E+04	1.50E+09	4.00E-04	3.00E-05	1.33E-02	2.92E-02						
<i>Strongylocentrotus pallidus</i>	200-600	2.83E-01	8.03E-02	1.77E+04	3.14E+08	1.48E-04	2.53E-06	9.23E-03	9.89E-03						
	600-1200	0.00E+00	0.00E+00	0.00E+00	0.00E+00	0.00E+00	0.00E+00	0.00E+00	0.00E+00						
	All Depths	2.83E-01	8.03E-02	1.77E+04	3.14E+08	8.57E-05	1.47E-06	5.36E-03	5.74E-03						
<i>Alloctrotus fragilis</i>	200-600	9.37E+01	7.01E+02	5.95E+05	2.02E+10	5.00E-02	2.57E-02	3.21E-01	7.68E-01						
	600-1200	6.20E-02	3.85E-03	7.75E+03	6.01E+07	4.66E-05	1.83E-07	5.83E-03	2.85E-03						
	All Depths	9.37E+01	7.01E+02	6.03E+05	2.02E+10	2.90E-02	1.54E-02	1.88E-01	4.69E-01						

Table 9. - - Continued.

Species	Stratum (depth in meters)			Biomass			Population			CPUE			CPUE		
		(t)	Variance	Number	Variance	kg/ha	Variance	no./ha	Variance		Variance	no./ha	Variance		
<i>Florometra asperrima</i>	200-600	1.37E+03	1.88E+06	9.24E+07	8.55E+15	8.09E-01	7.59E+01	5.46E+01	3.45E+05						
	600-1200	3.89E+01	5.89E+02	8.12E+06	2.55E+13	2.62E-02	2.27E-02	5.32E+00	8.86E+02						
	All Depths	1.41E+03	1.88E+06	1.01E+08	8.57E+15	4.80E-01	4.40E+01	3.39E+01	2.00E+05						
<i>Gorgonocephalus eucnemis</i>	200-600	1.98E+02	1.02E+04	7.95E+05	1.50E+11	1.00E-01	3.08E-01	4.01E-01	4.74E+00						
	600-1200	2.07E+01	3.00E+02	8.92E+04	2.79E+09	1.58E-02	1.43E-02	7.02E-02	1.53E-01						
	All Depths	2.19E+02	1.05E+04	8.84E+05	1.53E+11	6.48E-02	1.86E-01	2.62E-01	2.83E+00						
<i>Asteronyx loveni</i>	200-600	2.19E+02	1.64E+04	5.27E+06	9.32E+12	1.12E-01	4.92E-01	2.77E+00	3.14E+02						
	600-1200	3.23E-01	2.46E-02	1.80E+04	7.61E+07	2.43E-04	1.27E-06	1.35E-02	4.07E-03						
	All Depths	2.19E+02	1.64E+04	5.29E+06	9.32E+12	6.51E-02	2.88E-01	1.61E+00	1.83E+02						
<i>Astrochele laevis</i>	200-600	3.71E-02	1.38E-03	3.71E+03	1.38E+07	1.97E-05	4.49E-08	1.97E-03	4.49E-04						
	600-1200	0.00E+00	0.00E+00	0.00E+00	0.00E+00	0.00E+00	0.00E+00	0.00E+00	0.00E+00						
	All Depths	3.71E-02	1.38E-03	3.71E+03	1.38E+07	1.14E-05	2.61E-08	1.14E-03	2.61E-04						
<i>Ophiura sarsi</i>	200-600	6.99E+02	2.72E+05	8.83E+08	3.94E+17	3.72E-01	9.06E+00	4.70E+02	1.32E+07						
	600-1200	1.18E+02	1.32E+04	8.53E+07	7.12E+15	9.45E-02	7.17E-01	6.87E+01	3.88E+05						
	All Depths	8.17E+02	2.85E+05	9.68E+08	4.01E+17	2.56E-01	5.55E+00	3.01E+02	7.83E+06						
<i>Stegophiura ponderosa</i>	200-600	7.22E-02	5.21E-03	4.01E+03	1.61E+07	3.76E-05	1.64E-07	2.09E-03	5.07E-04						
	600-1200	0.00E+00	0.00E+00	0.00E+00	0.00E+00	0.00E+00	0.00E+00	0.00E+00	0.00E+00						
	All Depths	7.22E-02	5.21E-03	4.01E+03	1.61E+07	2.18E-05	9.53E-08	1.21E-03	2.94E-04						
<i>Ophiacantha normani</i>	200-600	8.32E-02	6.93E-03	5.90E+04	3.48E+09	5.06E-05	2.97E-07	3.58E-02	1.49E-01						
	600-1200	1.46E+00	1.42E+00	6.21E+05	2.14E+11	9.31E-04	5.07E-05	3.93E-01	7.64E+00						
	All Depths	1.54E+00	1.43E+00	6.80E+05	2.18E+11	4.20E-04	2.15E-05	1.86E-01	3.30E+00						
<i>Ophiacantha species</i>	200-600	0.00E+00	0.00E+00	0.00E+00	0.00E+00	0.00E+00	0.00E+00	0.00E+00	0.00E+00						
	600-1200	6.26E+00	3.91E+01	1.00E+07	1.01E+14	3.92E-03	1.29E-03	6.29E+00	3.32E+03						
	All Depths	6.26E+00	3.91E+01	1.00E+07	1.01E+14	1.65E-03	5.42E-04	2.64E+00	1.40E+03						
<i>Ophiopholis species</i>	200-600	2.81E+00	7.88E+00	1.01E+06	1.03E+12	1.46E-03	2.48E-04	5.29E-01	3.25E+01						
	600-1200	0.00E+00	0.00E+00	0.00E+00	0.00E+00	0.00E+00	0.00E+00	0.00E+00	0.00E+00						
	All Depths	2.81E+00	7.88E+00	1.01E+06	1.03E+12	8.49E-04	1.44E-04	3.07E-01	1.88E+01						
<i>Ophiopholis aculeata</i>	200-600	7.12E+01	2.73E+03	2.55E+07	4.55E+14	3.77E-02	8.92E-02	1.35E+01	1.49E+04						
	600-1200	1.06E+00	3.60E-01	2.34E+05	1.35E+10	7.94E-04	1.94E-05	1.75E-01	7.31E-01						
	All Depths	7.22E+01	2.73E+03	2.57E+07	4.55E+14	2.22E-02	5.19E-02	7.91E+00	8.63E+03						

This page left intentionally blank

Table 10. - Abundance estimates by subarea and depth stratum for Pacific sleeper shark (*Somniosus pacificus*) from the 2008 EBSS survey.

<i>Somniosus pacificus</i>		Pacific sleeper shark					
Subarea	Depth Stratum (m)	Biomass (t)	Population	Biomass Variance	Population Variance	Average CPUE (kg/ha)	Average CPUE (no./ha)
1	200-400	1.29E+02	1.16E+04	6.08E+03	4.09E+07	3.21E-01	2.88E-02
	400-600	3.67E+02	3.71E+04	1.38E+04	8.72E+07	9.05E-01	9.12E-02
	600-800	1.23E+02	1.56E+04	5.68E+03	7.66E+07	7.06E-01	8.97E-02
	800-1,000	3.66E+01	8.17E+03	6.14E+02	2.89E+07	2.70E-01	6.03E-02
	1,000-1,200	3.67E+01	2.59E+03	1.35E+03	6.70E+06	3.32E-01	2.34E-02
2	200-400	2.64E+02	8.84E+03	6.95E+04	7.82E+07	2.28E+00	7.64E-02
	400-600	0.00E+00	0.00E+00	0.00E+00	0.00E+00	0.00E+00	0.00E+00
	600-800	0.00E+00	0.00E+00	0.00E+00	0.00E+00	0.00E+00	0.00E+00
	800-1,000	0.00E+00	0.00E+00	0.00E+00	0.00E+00	0.00E+00	0.00E+00
	1,000-1,200	0.00E+00	0.00E+00	0.00E+00	0.00E+00	0.00E+00	0.00E+00
3	200-400	0.00E+00	0.00E+00	0.00E+00	0.00E+00	0.00E+00	0.00E+00
	400-600	8.57E+01	3.50E+03	7.34E+03	1.22E+07	9.67E-01	3.95E-02
	600-800	0.00E+00	0.00E+00	0.00E+00	0.00E+00	0.00E+00	0.00E+00
	800-1,000	0.00E+00	0.00E+00	0.00E+00	0.00E+00	0.00E+00	0.00E+00
	1,000-1,200	2.34E+02	9.52E+03	5.46E+04	9.06E+07	3.46E+00	1.41E-01
4	200-400	3.80E+02	8.68E+03	8.89E+04	3.14E+07	3.07E+00	7.02E-02
	400-600	0.00E+00	0.00E+00	0.00E+00	0.00E+00	0.00E+00	0.00E+00
	600-800	0.00E+00	0.00E+00	0.00E+00	0.00E+00	0.00E+00	0.00E+00
	800-1,000	0.00E+00	0.00E+00	0.00E+00	0.00E+00	0.00E+00	0.00E+00
	1,000-1,200	0.00E+00	0.00E+00	0.00E+00	0.00E+00	0.00E+00	0.00E+00
5	200-400	0.00E+00	0.00E+00	0.00E+00	0.00E+00	0.00E+00	0.00E+00
	400-600	0.00E+00	0.00E+00	0.00E+00	0.00E+00	0.00E+00	0.00E+00
	600-800	0.00E+00	0.00E+00	0.00E+00	0.00E+00	0.00E+00	0.00E+00
	800-1,000	0.00E+00	0.00E+00	0.00E+00	0.00E+00	0.00E+00	0.00E+00
	1,000-1,200	0.00E+00	0.00E+00	0.00E+00	0.00E+00	0.00E+00	0.00E+00
6	200-400	3.13E+02	1.60E+04	2.45E+04	5.17E+07	1.21E+00	6.18E-02
	400-600	0.00E+00	0.00E+00	0.00E+00	0.00E+00	0.00E+00	0.00E+00
	600-800	0.00E+00	0.00E+00	0.00E+00	0.00E+00	0.00E+00	0.00E+00
	800-1,000	0.00E+00	0.00E+00	0.00E+00	0.00E+00	0.00E+00	0.00E+00
	1,000-1,200	0.00E+00	0.00E+00	0.00E+00	0.00E+00	0.00E+00	0.00E+00
1-6	200-1,200	1.97E+03	1.22E+05	2.72E+05	5.04E+08	6.34E-01	3.18E-02

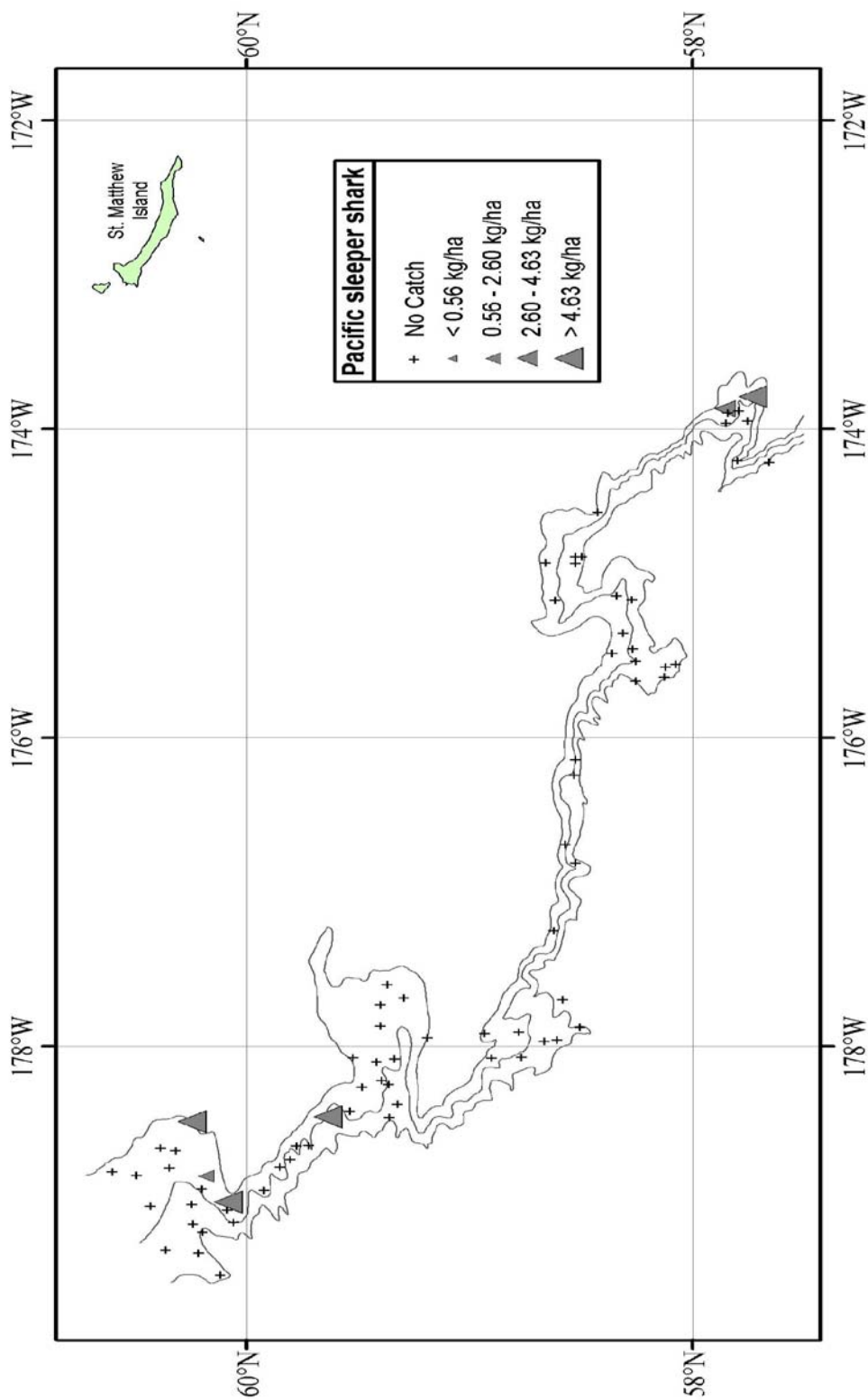

Figure 4. - - Distribution and relative abundance of Pacific sleeper shark from the 2008 EBSS survey. Relative abundance is categorized by no catch, sample CPUE less than the mean CPUE, between the mean CPUE and one standard deviation above the mean, between one and two standard deviations above the mean CPUE, and greater than two standard deviations above the mean CPUE.

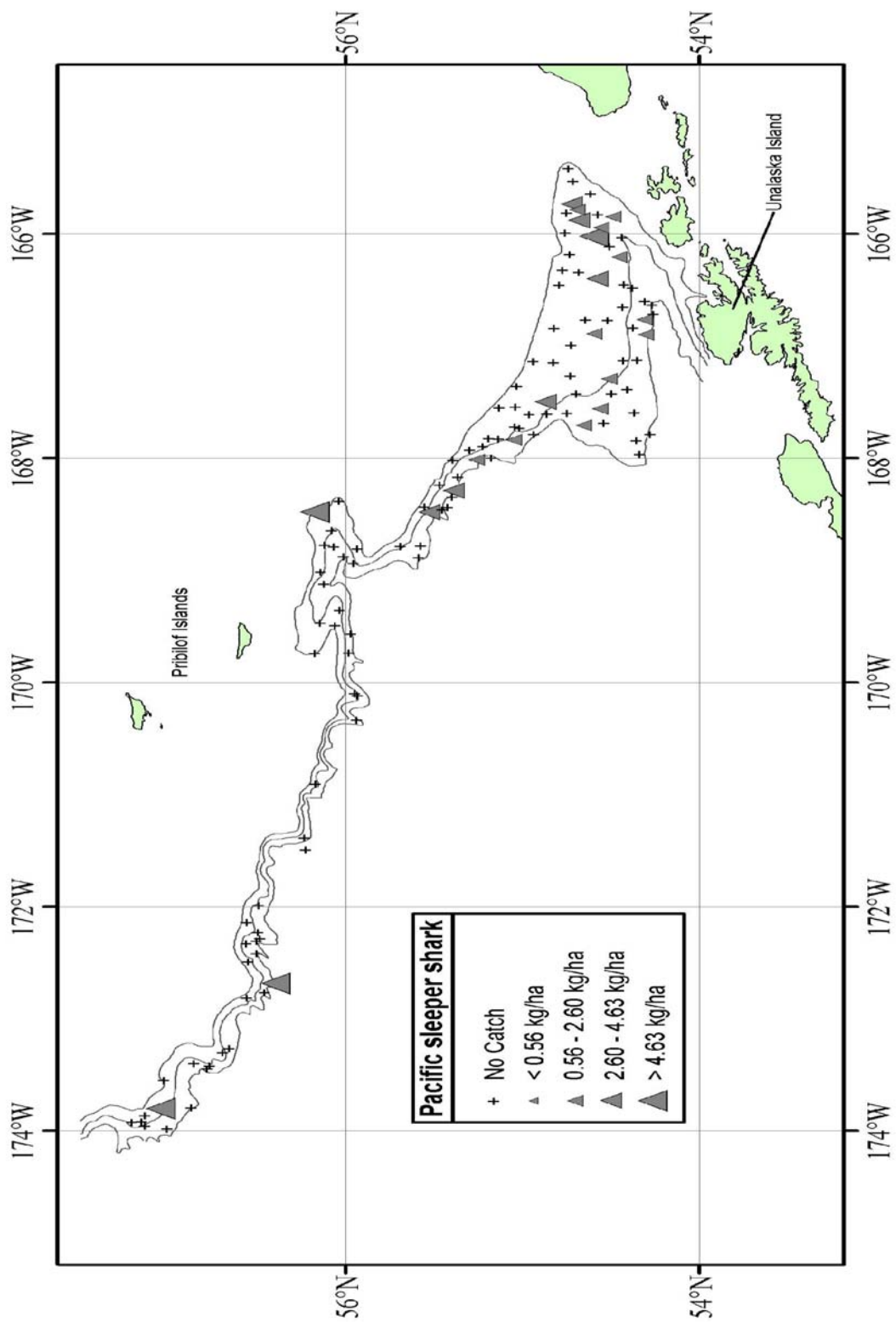

Figure 4. - - Continued.

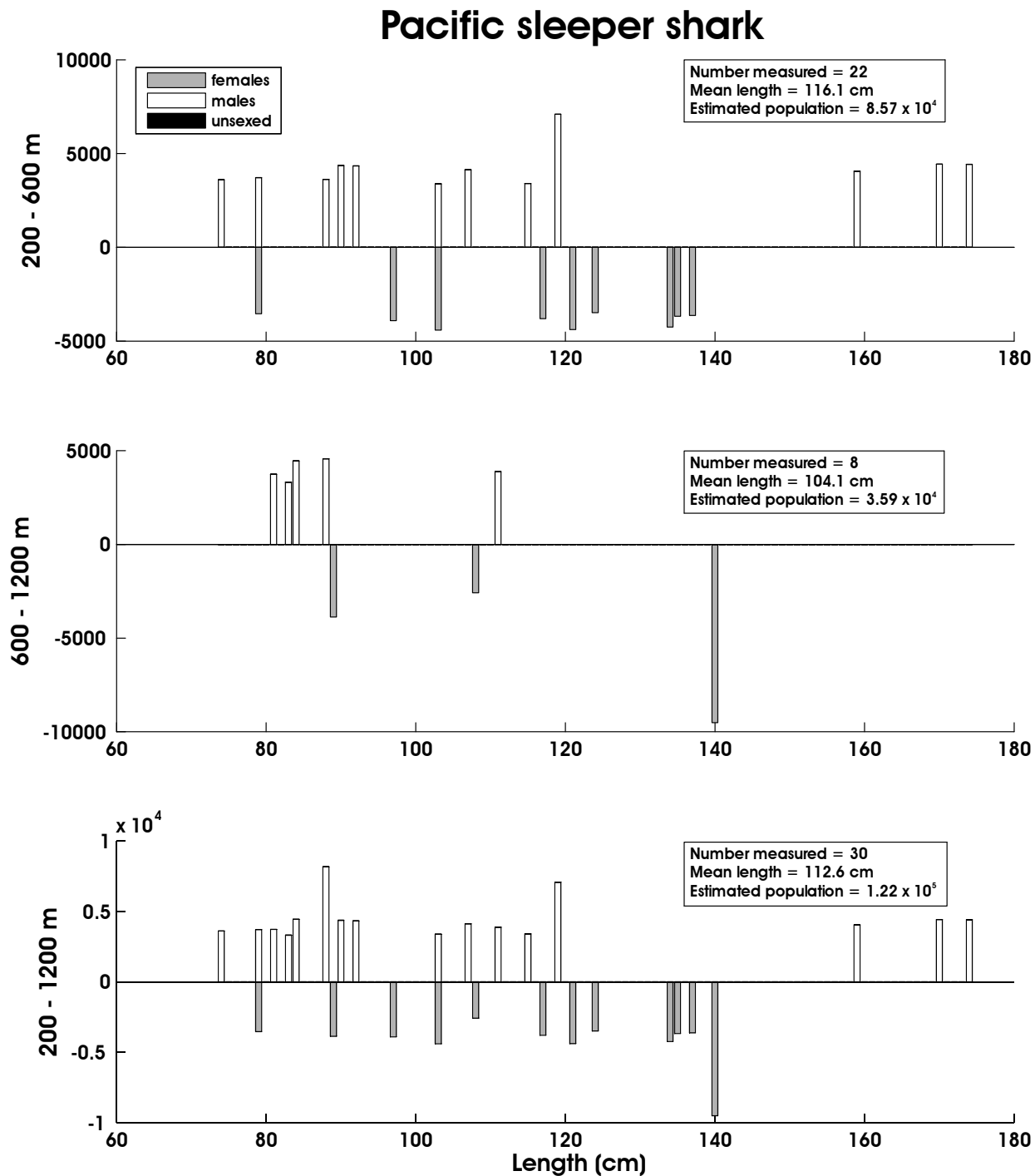

Figure 5. - - Size composition of the estimated Pacific sleeper shark population from the 2008 EBSS survey for all subareas by depth. The abscissa is scaled as total length in centimeters while the ordinate represents the estimated total population.

Table 11. - Abundance estimates by subarea and depth stratum for Alaska skate (*Bathyraja parmifera*) from the 2008 EBSS survey.

<i>Bathyraja parmifera</i>						Alaska skate	
Subarea	Depth Stratum (m)	Biomass (t)	Population	Biomass Variance	Population Variance	Average CPUE (kg/ha)	Average CPUE (no./ha)
1	200-400	3.62E+02	7.96E+04	1.84E+04	1.01E+09	9.03E-01	1.98E-01
	400-600	3.40E-01	4.36E+03	1.16E-01	1.90E+07	8.38E-04	1.07E-02
	600-800	0.00E+00	0.00E+00	0.00E+00	0.00E+00	0.00E+00	0.00E+00
	800-1,000	0.00E+00	0.00E+00	0.00E+00	0.00E+00	0.00E+00	0.00E+00
	1,000-1,200	0.00E+00	0.00E+00	0.00E+00	0.00E+00	0.00E+00	0.00E+00
2	200-400	3.29E+02	4.72E+04	7.37E+04	1.14E+09	2.84E+00	4.08E-01
	400-600	0.00E+00	0.00E+00	0.00E+00	0.00E+00	0.00E+00	0.00E+00
	600-800	0.00E+00	0.00E+00	0.00E+00	0.00E+00	0.00E+00	0.00E+00
	800-1,000	0.00E+00	0.00E+00	0.00E+00	0.00E+00	0.00E+00	0.00E+00
	1,000-1,200	0.00E+00	0.00E+00	0.00E+00	0.00E+00	0.00E+00	0.00E+00
3	200-400	4.05E+01	5.22E+03	1.64E+03	2.72E+07	4.48E-01	5.77E-02
	400-600	0.00E+00	0.00E+00	0.00E+00	0.00E+00	0.00E+00	0.00E+00
	600-800	0.00E+00	0.00E+00	0.00E+00	0.00E+00	0.00E+00	0.00E+00
	800-1,000	0.00E+00	0.00E+00	0.00E+00	0.00E+00	0.00E+00	0.00E+00
	1,000-1,200	0.00E+00	0.00E+00	0.00E+00	0.00E+00	0.00E+00	0.00E+00
4	200-400	2.04E+02	3.92E+04	1.53E+04	3.55E+08	1.65E+00	3.17E-01
	400-600	2.98E+01	3.56E+03	8.90E+02	1.26E+07	4.08E-01	4.87E-02
	600-800	0.00E+00	0.00E+00	0.00E+00	0.00E+00	0.00E+00	0.00E+00
	800-1,000	0.00E+00	0.00E+00	0.00E+00	0.00E+00	0.00E+00	0.00E+00
	1,000-1,200	0.00E+00	0.00E+00	0.00E+00	0.00E+00	0.00E+00	0.00E+00
5	200-400	2.12E+02	2.65E+04	1.29E+04	2.40E+08	5.01E+00	6.25E-01
	400-600	0.00E+00	0.00E+00	0.00E+00	0.00E+00	0.00E+00	0.00E+00
	600-800	0.00E+00	0.00E+00	0.00E+00	0.00E+00	0.00E+00	0.00E+00
	800-1,000	0.00E+00	0.00E+00	0.00E+00	0.00E+00	0.00E+00	0.00E+00
	1,000-1,200	0.00E+00	0.00E+00	0.00E+00	0.00E+00	0.00E+00	0.00E+00
6	200-400	2.92E+03	4.87E+05	1.75E+06	4.99E+10	1.13E+01	1.88E+00
	400-600	2.17E+02	3.69E+04	3.34E+04	1.06E+09	1.27E+00	2.16E-01
	600-800	0.00E+00	0.00E+00	0.00E+00	0.00E+00	0.00E+00	0.00E+00
	800-1,000	0.00E+00	0.00E+00	0.00E+00	0.00E+00	0.00E+00	0.00E+00
	1,000-1,200	0.00E+00	0.00E+00	0.00E+00	0.00E+00	0.00E+00	0.00E+00
1-6	200-1,200	4.32E+03	7.30E+05	1.91E+06	5.37E+10	1.26E+00	2.15E-01

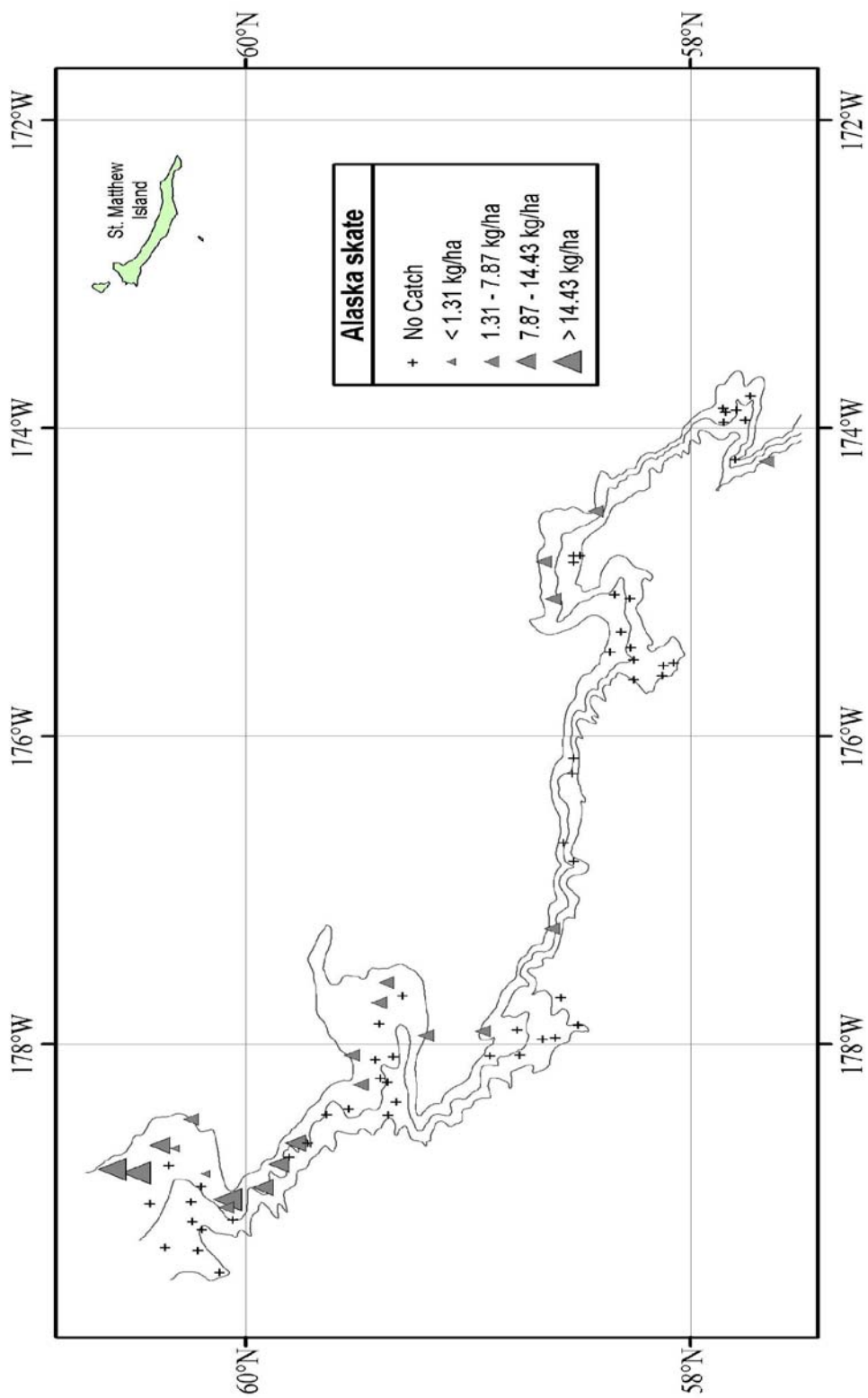

Figure 6. - - Distribution and relative abundance of Alaska skate from the 2008 EBSS survey. Relative abundance is categorized by no catch, sample CPUE less than the mean CPUE, between the mean CPUE and one standard deviation above the mean, between one and two standard deviations above the mean CPUE, and greater than two standard deviations above the mean CPUE.

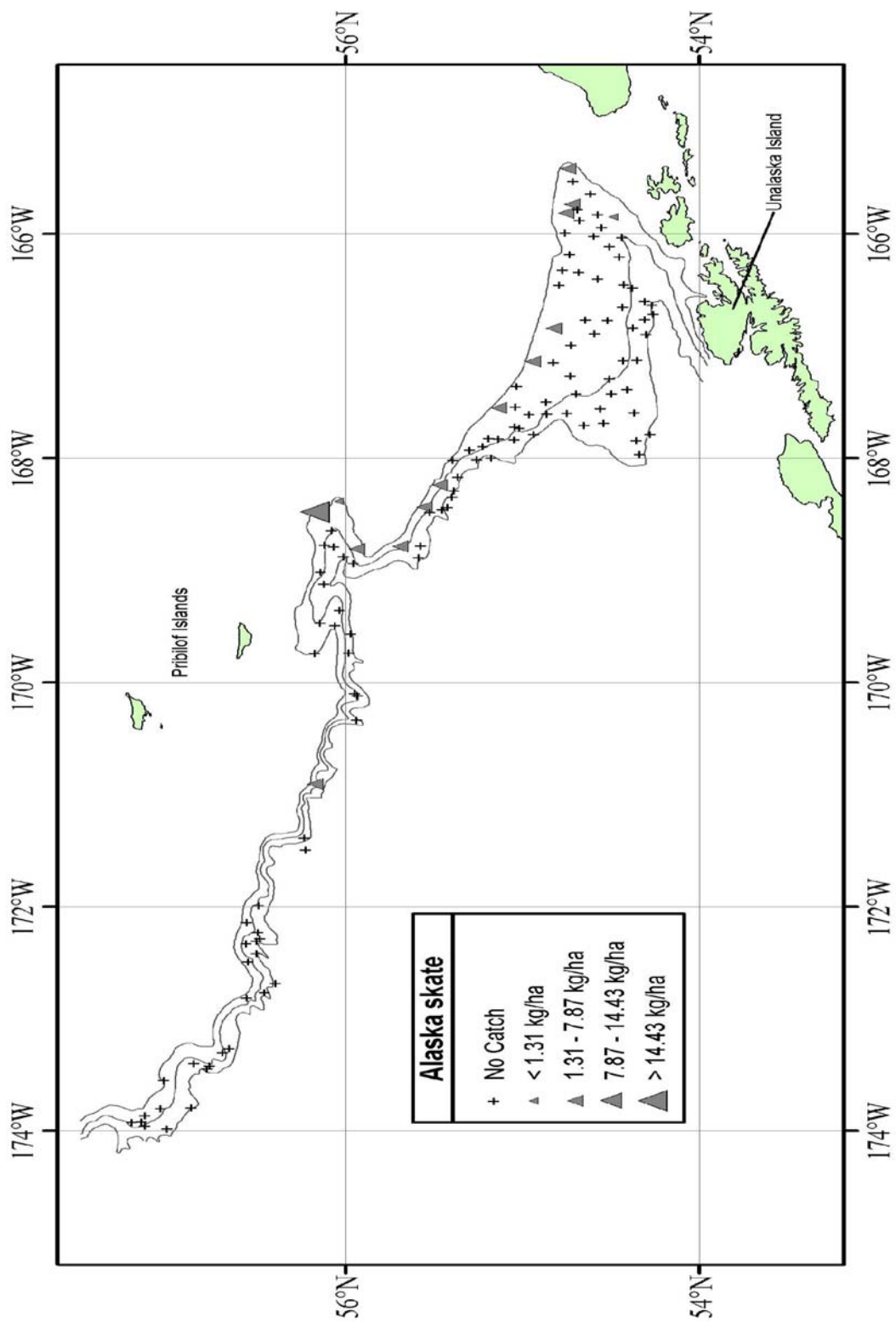

Figure 6. - - Continued.

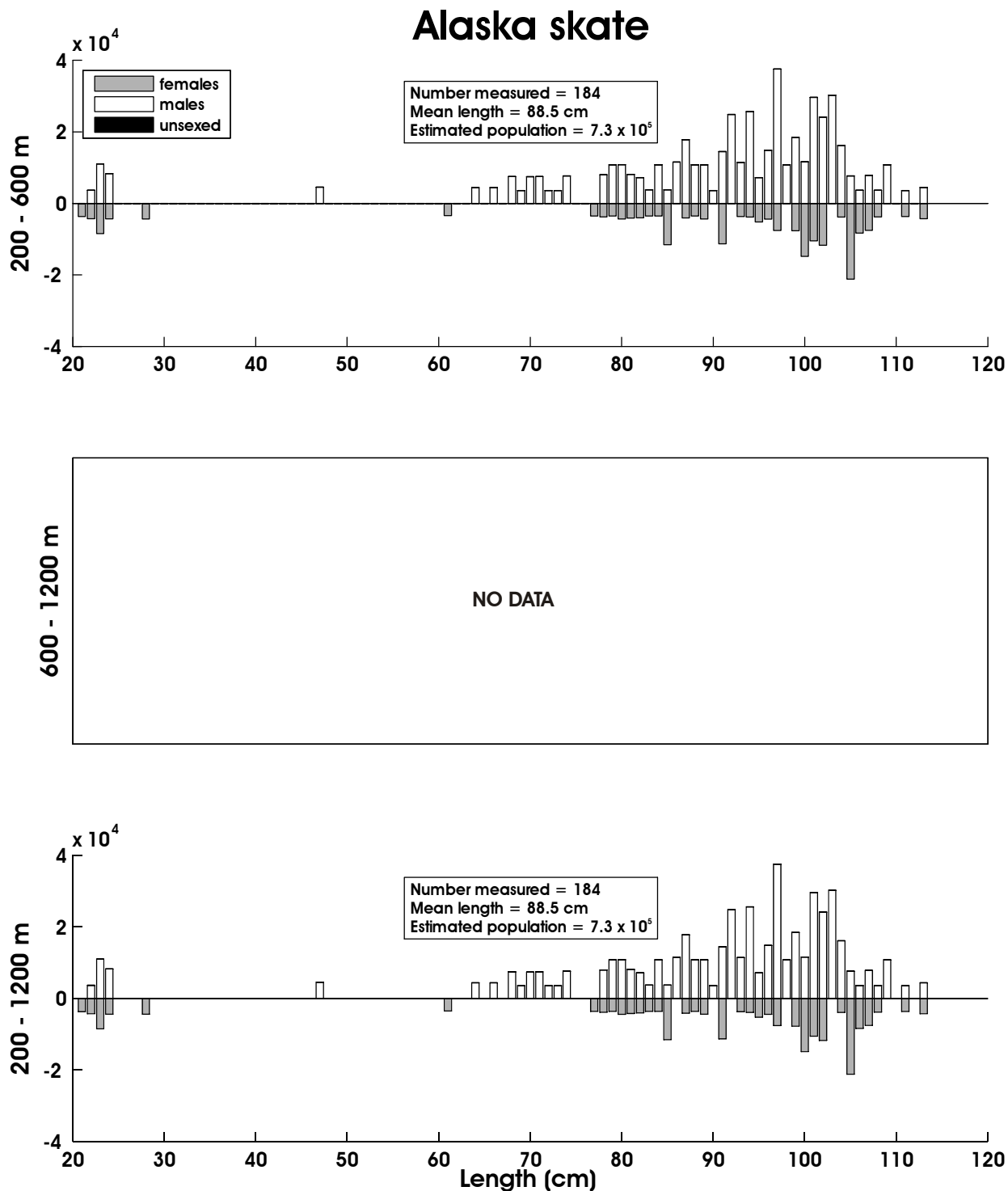

Figure 7. - Size composition of the estimated Alaska skate population from the 2008 EBSS survey for all subareas by depth. The abscissa is scaled as total length in centimeters while the ordinate represents the estimated total population.

Table 12. - Abundance estimates by subarea and depth stratum for Aleutian skate (*Bathyraja aleutica*) from the 2008 EBSS survey.

<i>Bathyraja aleutica</i>					Aleutian skate		
Subarea	Depth Stratum (m)	Biomass (t)	Population	Biomass Variance	Population Variance	Average CPUE (kg/ha)	Average CPUE (no./ha)
1	200-400	3.18E+03	4.21E+05	6.72E+05	9.75E+09	7.92E+00	1.05E+00
	400-600	1.28E+03	3.78E+05	6.87E+04	6.45E+09	3.16E+00	9.31E-01
	600-800	3.96E+02	2.56E+05	8.35E+03	5.05E+09	2.27E+00	1.47E+00
	800-1,000	1.35E+02	2.44E+05	1.78E+03	1.01E+10	9.99E-01	1.80E+00
	1,000-1,200	2.58E+01	1.49E+05	1.80E+02	7.77E+09	2.33E-01	1.34E+00
2	200-400	1.13E+03	2.10E+05	1.78E+05	5.70E+09	9.76E+00	1.82E+00
	400-600	2.11E+02	1.26E+05	1.21E+04	3.33E+09	2.99E+00	1.79E+00
	600-800	4.12E+02	1.76E+05	1.63E+04	4.08E+09	6.98E+00	2.98E+00
	800-1,000	3.83E+02	3.38E+05	7.90E+03	4.67E+09	6.93E+00	6.12E+00
	1,000-1,200	7.62E+01	2.48E+05	7.70E+02	1.09E+10	1.42E+00	4.63E+00
3	200-400	5.15E+02	8.78E+04	9.07E+04	1.96E+09	5.70E+00	9.72E-01
	400-600	5.06E+02	1.74E+05	4.30E+04	3.96E+09	5.71E+00	1.97E+00
	600-800	3.73E+02	2.24E+05	5.80E+03	1.32E+09	4.10E+00	2.46E+00
	800-1,000	1.57E+02	1.18E+05	2.47E+03	1.03E+09	2.15E+00	1.61E+00
	1,000-1,200	4.82E+00	1.56E+04	2.33E+01	2.42E+08	7.14E-02	2.30E-01
4	200-400	8.23E+02	1.44E+05	1.34E+05	5.55E+09	6.66E+00	1.17E+00
	400-600	1.65E+03	4.45E+05	2.28E+06	1.30E+11	2.26E+01	6.09E+00
	600-800	2.75E+02	2.47E+05	2.32E+03	1.60E+08	3.96E+00	3.55E+00
	800-1,000	1.99E+02	2.64E+05	1.82E+04	1.96E+10	2.82E+00	3.73E+00
	1,000-1,200	1.33E+02	2.53E+05	8.96E+03	2.80E+10	2.00E+00	3.82E+00
5	200-400	3.26E+02	2.75E+04	1.06E+05	7.55E+08	7.69E+00	6.49E-01
	400-600	5.22E+01	3.18E+04	6.56E+02	4.22E+08	1.23E+00	7.47E-01
	600-800	8.05E+00	2.18E+04	6.48E+01	4.73E+08	1.86E-01	5.04E-01
	800-1,000	7.29E+00	1.39E+04	5.32E+01	1.93E+08	1.32E-01	2.52E-01
	1,000-1,200	7.62E+00	2.66E+04	5.80E+01	7.09E+08	1.34E-01	4.67E-01
6	200-400	3.05E+03	4.50E+05	2.23E+06	2.63E+10	1.18E+01	1.73E+00
	400-600	1.14E+03	6.50E+05	1.03E+05	2.81E+10	6.71E+00	3.81E+00
	600-800	1.64E+02	1.64E+05	8.32E+02	6.96E+08	1.79E+00	1.79E+00
	800-1,000	4.34E+01	6.14E+04	3.65E+02	9.97E+08	6.73E-01	9.52E-01
	1,000-1,200	4.36E+00	4.20E+03	1.90E+01	1.77E+07	8.77E-02	8.47E-02
1-6	200-1,200	1.67E+04	5.97E+06	5.99E+06	3.19E+11	4.91E+00	1.82E+00

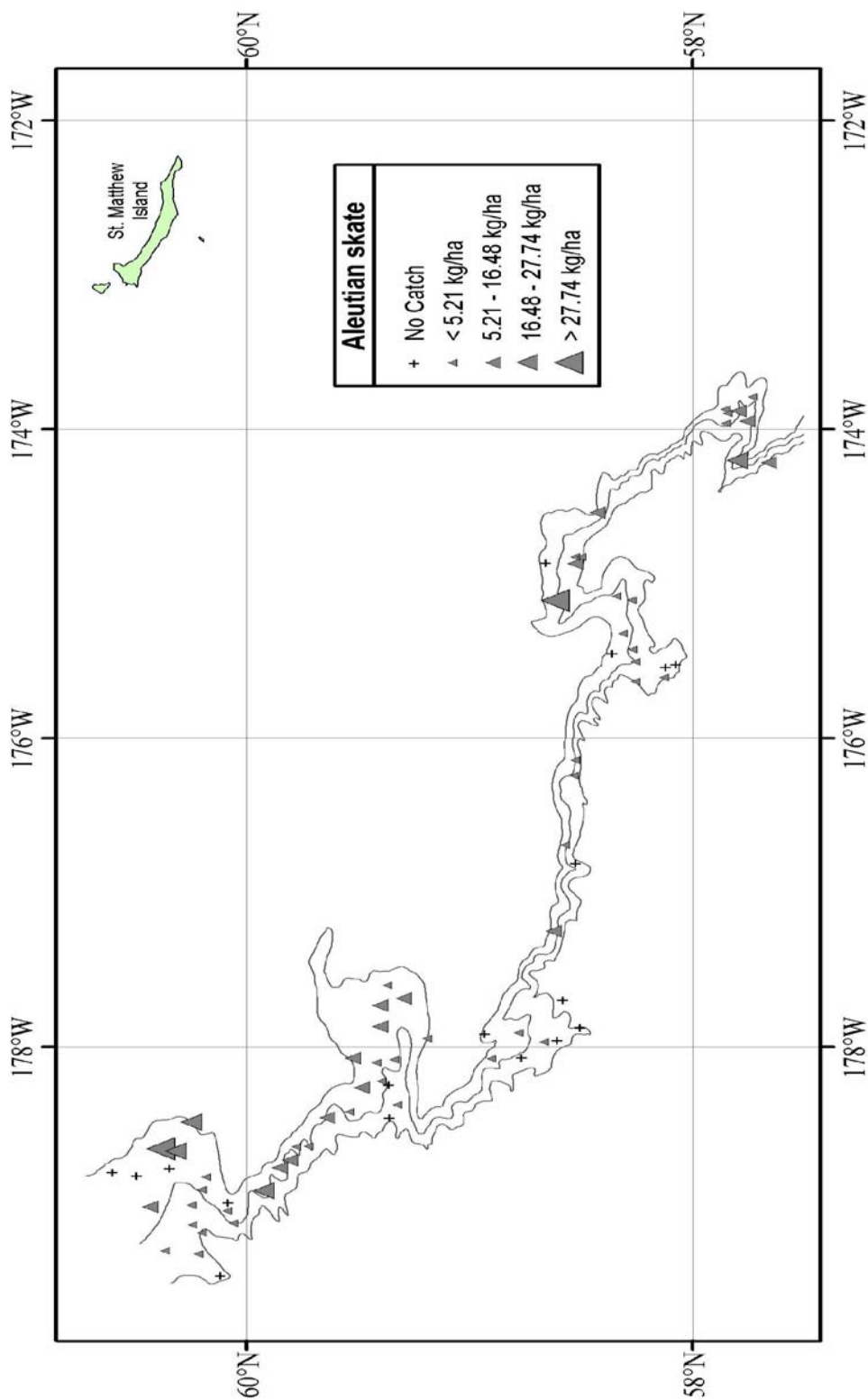

Figure 8. - - Distribution and relative abundance of Aleutian skate from the 2008 EBSS survey. Relative abundance is categorized by no catch, sample CPUE less than the mean CPUE, between the mean CPUE and one standard deviation above the mean, between one and two standard deviations above the mean CPUE, and greater than two standard deviations above the mean CPUE.

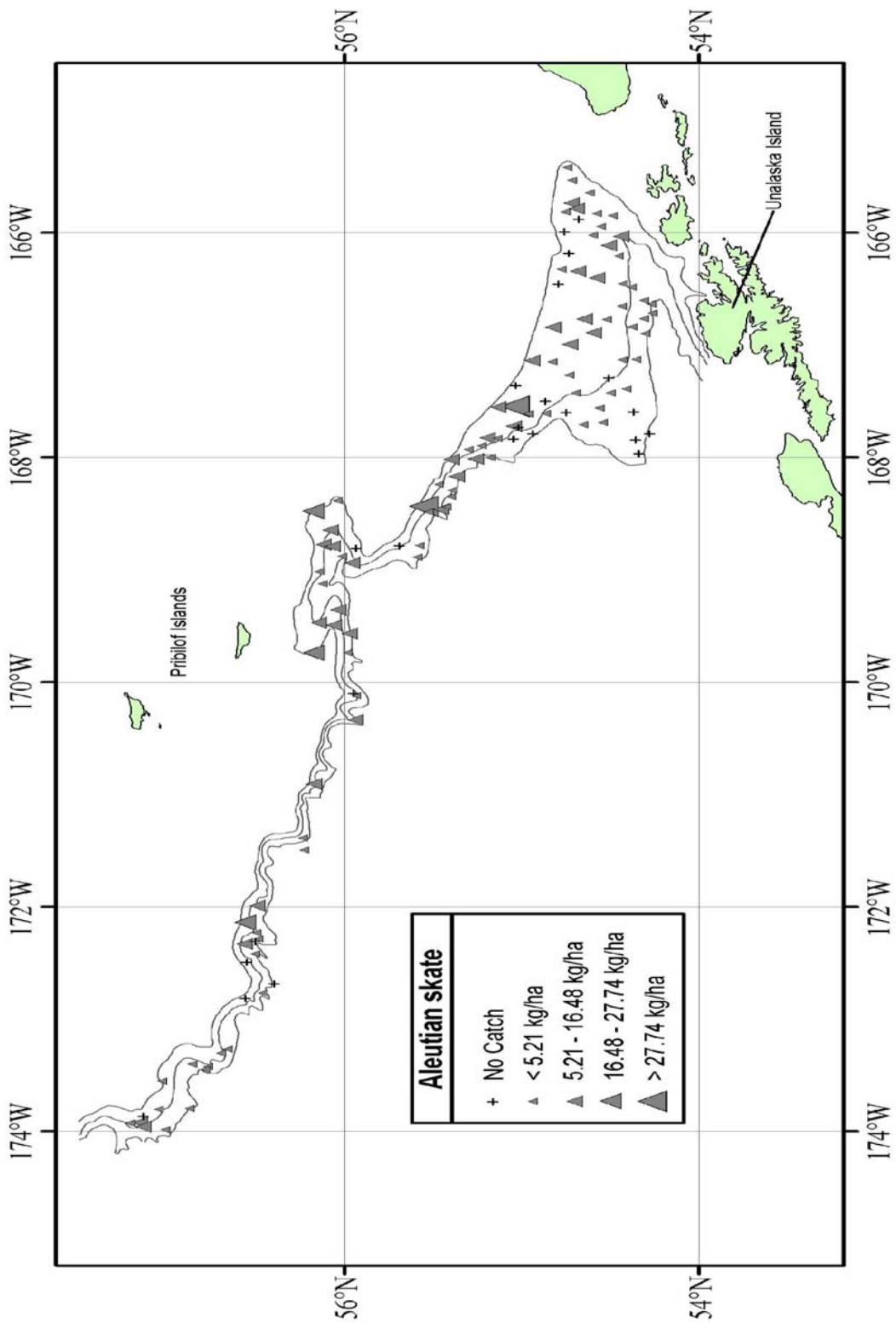

Figure 8. - - Continued.

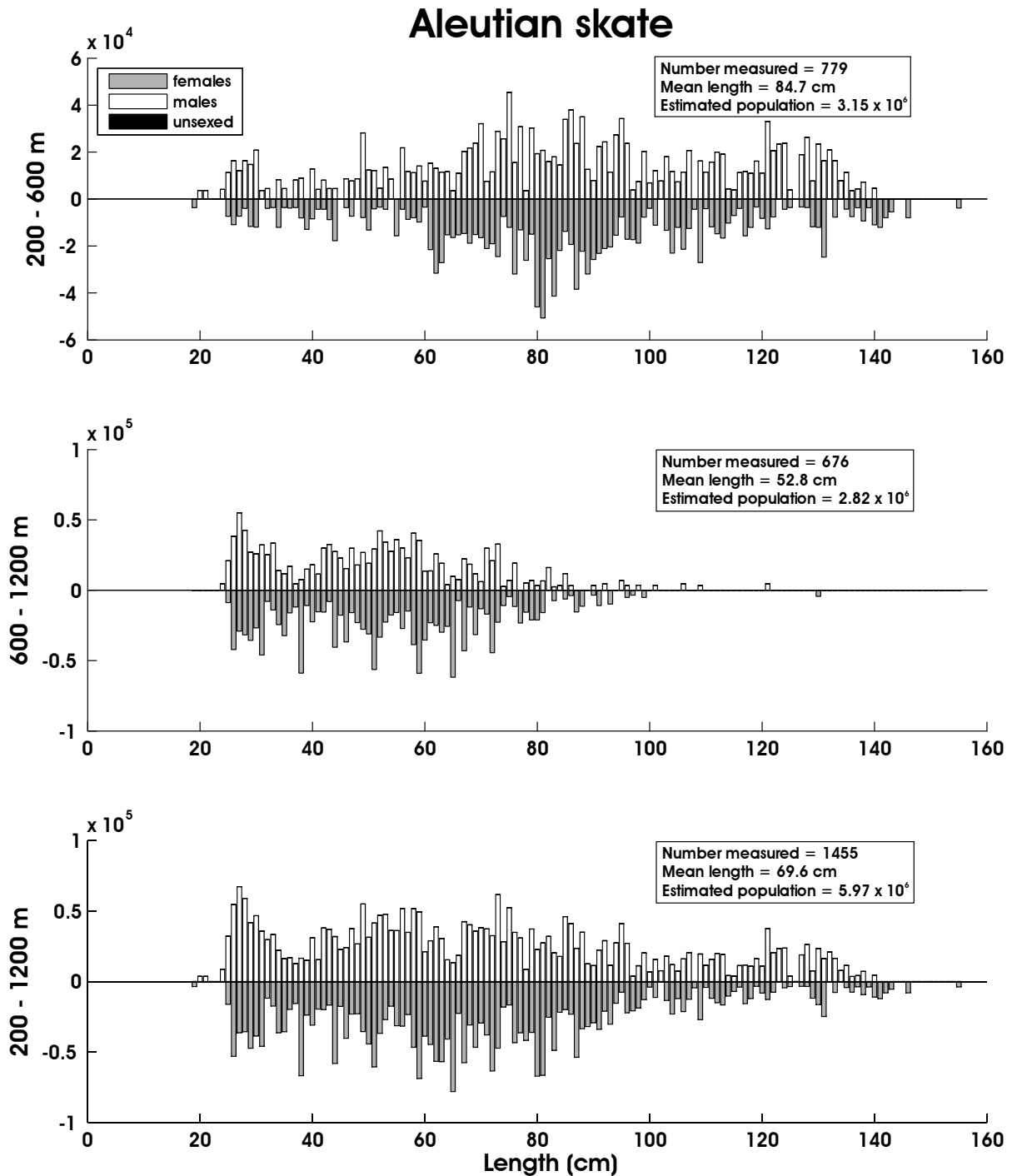

Figure 9. - - Size composition of the estimated Aleutian skate population from the 2008 EBSS survey for all subareas by depth. The abscissa is scaled as total length in centimeters while the ordinate represents the estimated total population.

Table 13. - Abundance estimates by subarea and depth stratum for Bering Skate (*Bathyraja interrupta*) from the 2008 EBSS survey.

<i>Bathyraja interrupta</i>		Bering skate					
Subarea	Depth Stratum (m)	Biomass (t)	Population	Biomass Variance	Population Variance	Average CPUE (kg/ha)	Average CPUE (no./ha)
1	200-400	7.26E+02	6.86E+05	1.19E+04	3.29E+10	1.81E+00	1.71E+00
	400-600	4.96E+02	2.97E+05	1.72E+04	4.82E+09	1.22E+00	7.32E-01
	600-800	9.11E+01	4.25E+04	3.14E+03	7.04E+08	5.23E-01	2.44E-01
	800-1,000	4.15E+01	3.31E+04	6.10E+02	2.87E+08	3.06E-01	2.44E-01
	1,000-1,200	3.32E+00	1.38E+04	7.18E+00	4.32E+07	3.00E-02	1.25E-01
2	200-400	1.40E+02	1.19E+05	8.55E+03	4.89E+09	1.21E+00	1.03E+00
	400-600	0.00E+00	0.00E+00	0.00E+00	0.00E+00	0.00E+00	0.00E+00
	600-800	0.00E+00	0.00E+00	0.00E+00	0.00E+00	0.00E+00	0.00E+00
	800-1,000	1.69E+01	5.68E+03	2.87E+02	3.23E+07	3.06E-01	1.03E-01
	1,000-1,200	0.00E+00	0.00E+00	0.00E+00	0.00E+00	0.00E+00	0.00E+00
3	200-400	6.42E+01	6.66E+04	2.90E+02	6.52E+08	7.10E-01	7.36E-01
	400-600	1.94E+01	2.64E+04	1.88E+02	1.45E+08	2.19E-01	2.97E-01
	600-800	0.00E+00	0.00E+00	0.00E+00	0.00E+00	0.00E+00	0.00E+00
	800-1,000	1.17E+01	5.92E+03	1.36E+02	3.51E+07	1.59E-01	8.09E-02
	1,000-1,200	0.00E+00	0.00E+00	0.00E+00	0.00E+00	0.00E+00	0.00E+00
4	200-400	1.22E+02	1.28E+05	4.52E+03	2.92E+09	9.84E-01	1.03E+00
	400-600	3.14E+02	2.06E+05	9.27E+04	3.90E+10	4.30E+00	2.82E+00
	600-800	0.00E+00	0.00E+00	0.00E+00	0.00E+00	0.00E+00	0.00E+00
	800-1,000	0.00E+00	0.00E+00	0.00E+00	0.00E+00	0.00E+00	0.00E+00
	1,000-1,200	0.00E+00	0.00E+00	0.00E+00	0.00E+00	0.00E+00	0.00E+00
5	200-400	1.06E+01	5.50E+03	1.11E+02	3.02E+07	2.49E-01	1.30E-01
	400-600	1.69E+01	1.50E+04	7.69E+01	6.04E+07	3.97E-01	3.53E-01
	600-800	0.00E+00	0.00E+00	0.00E+00	0.00E+00	0.00E+00	0.00E+00
	800-1,000	0.00E+00	0.00E+00	0.00E+00	0.00E+00	0.00E+00	0.00E+00
	1,000-1,200	0.00E+00	0.00E+00	0.00E+00	0.00E+00	0.00E+00	0.00E+00
6	200-400	2.83E+02	3.76E+05	2.34E+03	8.61E+09	1.09E+00	1.45E+00
	400-600	8.69E+01	1.07E+05	2.39E+03	1.71E+09	5.09E-01	6.25E-01
	600-800	0.00E+00	0.00E+00	0.00E+00	0.00E+00	0.00E+00	0.00E+00
	800-1,000	0.00E+00	0.00E+00	0.00E+00	0.00E+00	0.00E+00	0.00E+00
	1,000-1,200	0.00E+00	0.00E+00	0.00E+00	0.00E+00	0.00E+00	0.00E+00
1-6	200-1,200	2.44E+03	2.13E+06	1.45E+05	9.68E+10	6.81E-01	5.98E-01

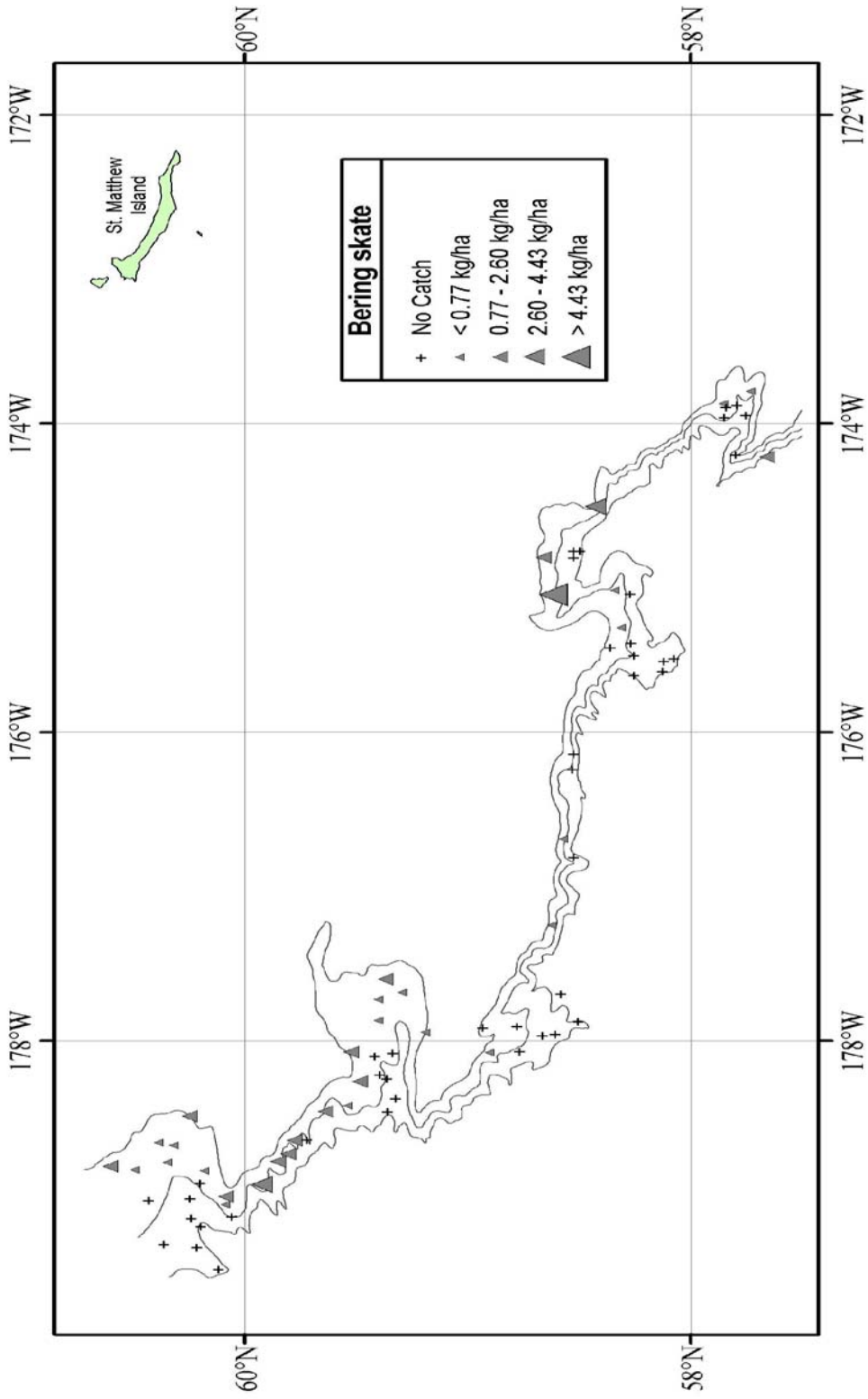

Figure 10. - - Distribution and relative abundance of Bering skate from the 2008 EBSS survey. Relative abundance is categorized by no catch, sample CPUE less than the mean CPUE, between the mean CPUE and one standard deviation above the mean, between one and two standard deviations above the mean CPUE, and greater than two standard deviations above the mean CPUE.

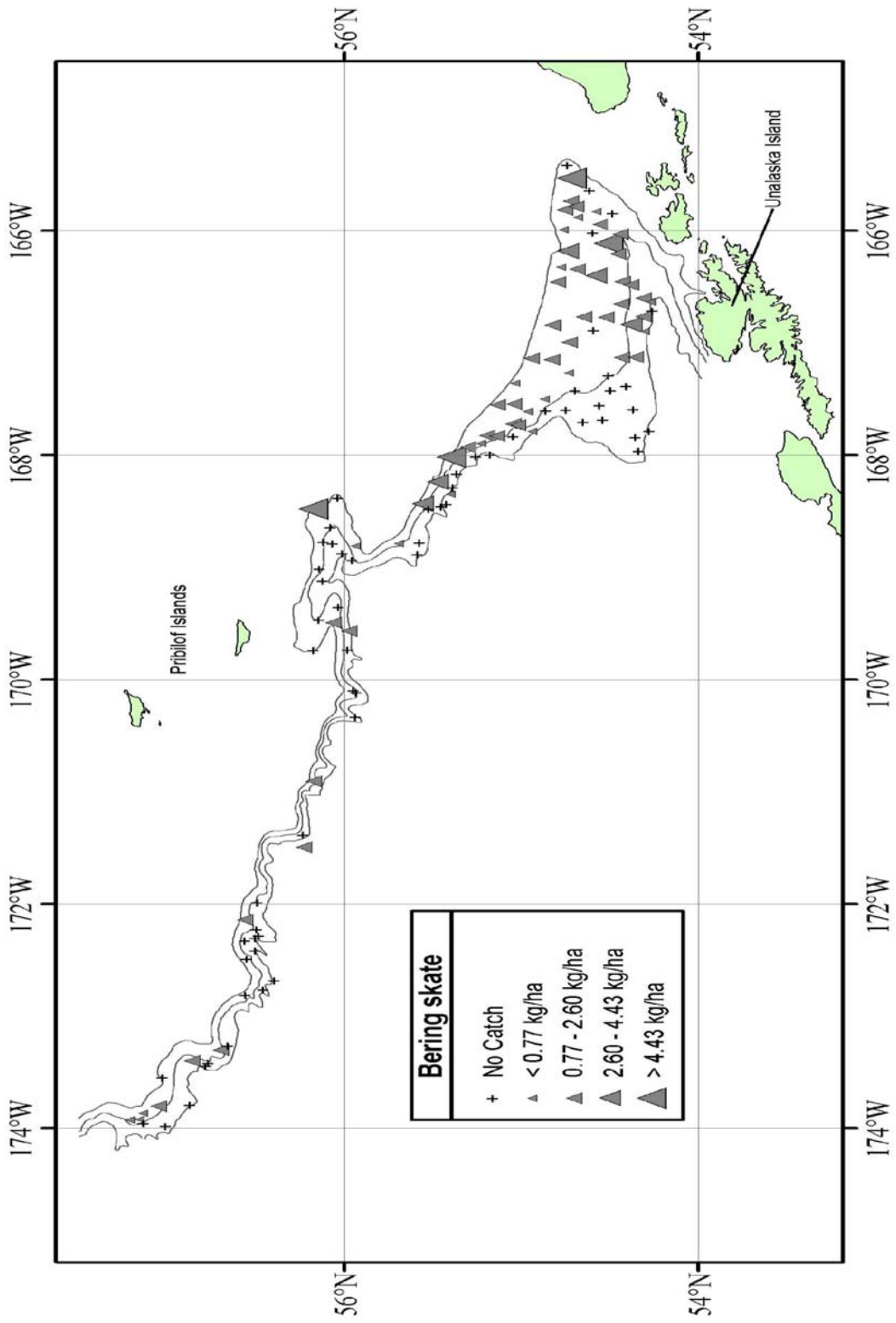

Figure 10. - - Continued.

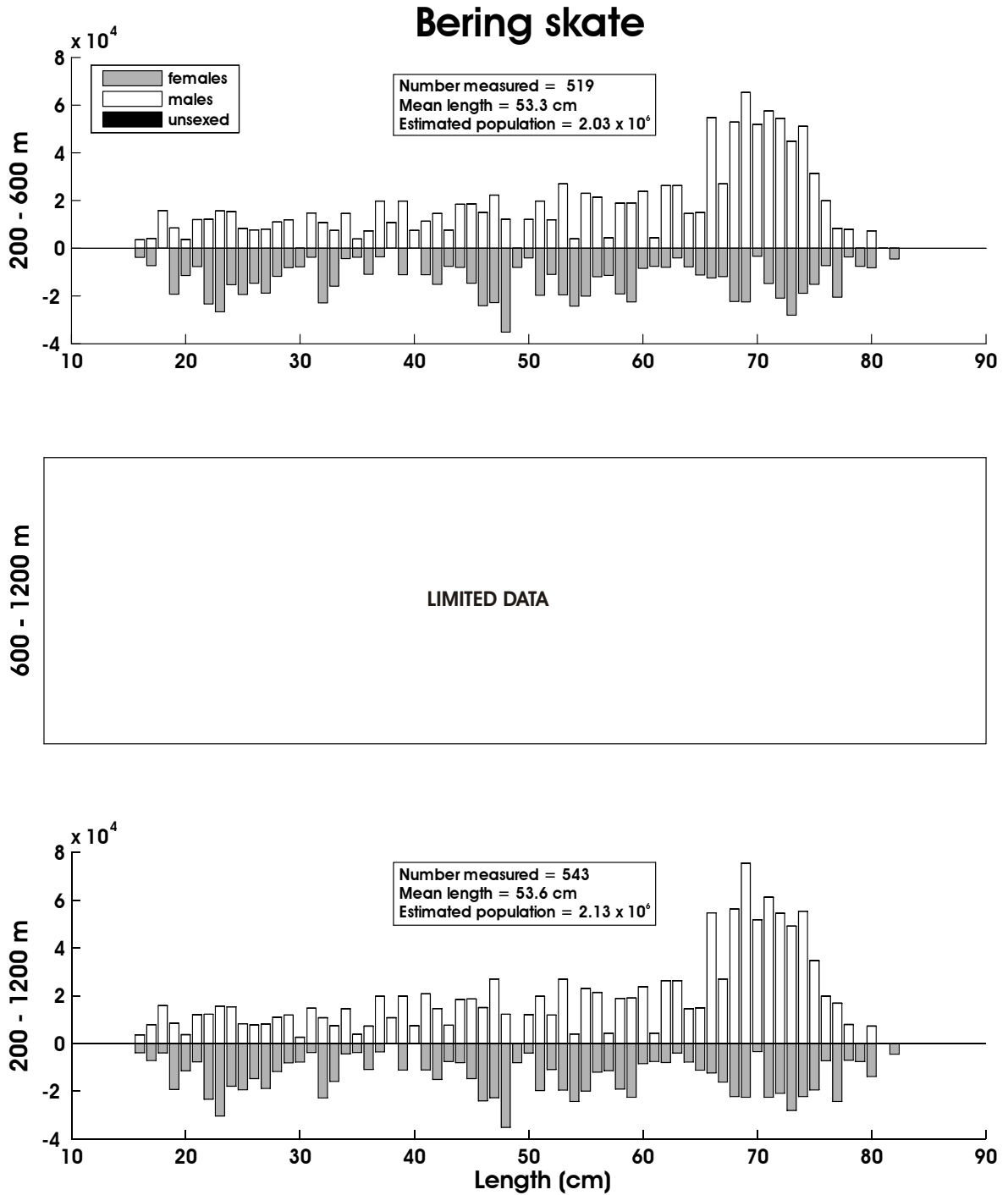

Figure 11. - - Size composition of the estimated Bering skate population from the 2008 EBSS survey for all subareas by depth. The abscissa is scaled as total length in centimeters while the ordinate represents the estimated total population.

Table 14. - - Abundance estimates by subarea and depth stratum for Commander skate
(*Bathyraja lindbergi*) from the 2008 EBSS survey.

<i>Bathyraja lindbergi</i>		Commander skate					
Subarea	Depth Stratum (m)	Biomass (t)	Population	Biomass Variance	Population Variance	Average CPUE (kg/ha)	Average CPUE (no./ha)
1	200-400	0.00E+00	0.00E+00	0.00E+00	0.00E+00	0.00E+00	0.00E+00
	400-600	3.11E+02	8.14E+04	2.36E+04	1.83E+09	7.66E-01	2.00E-01
	600-800	5.76E+00	4.26E+03	3.31E+01	1.82E+07	3.31E-02	2.45E-02
	800-1,000	0.00E+00	0.00E+00	0.00E+00	0.00E+00	0.00E+00	0.00E+00
	1,000-1,200	0.00E+00	0.00E+00	0.00E+00	0.00E+00	0.00E+00	0.00E+00
2	200-400	2.57E+01	8.84E+03	6.62E+02	7.82E+07	2.22E-01	7.64E-02
	400-600	2.39E+02	6.72E+04	5.73E+04	4.52E+09	3.39E+00	9.54E-01
	600-800	4.57E+02	1.83E+05	9.44E+04	2.04E+10	7.72E+00	3.09E+00
	800-1,000	6.46E+01	3.89E+04	4.17E+03	1.51E+09	1.17E+00	7.04E-01
	1,000-1,200	4.32E+01	1.35E+04	1.87E+03	1.82E+08	8.07E-01	2.52E-01
3	200-400	1.68E-01	4.19E+03	2.81E-02	1.75E+07	1.85E-03	4.63E-02
	400-600	6.44E+01	1.99E+04	1.02E+03	9.00E+07	7.27E-01	2.25E-01
	600-800	3.04E+02	1.81E+05	1.40E+04	1.47E+10	3.34E+00	1.99E+00
	800-1,000	1.11E+02	6.77E+04	5.04E+02	3.80E+08	1.52E+00	9.24E-01
	1,000-1,200	1.28E+01	3.89E+04	1.63E+02	1.51E+09	1.89E-01	5.76E-01
4	200-400	1.42E+01	4.38E+03	2.01E+02	1.92E+07	1.15E-01	3.54E-02
	400-600	1.15E+02	3.54E+04	2.30E+03	2.41E+08	1.58E+00	4.85E-01
	600-800	3.79E+02	1.44E+05	5.62E+03	2.24E+08	5.46E+00	2.07E+00
	800-1,000	3.14E+01	1.89E+04	3.20E+02	5.29E+07	4.43E-01	2.68E-01
	1,000-1,200	1.43E+00	1.35E+04	2.03E+00	1.81E+08	2.15E-02	2.03E-01
5	200-400	0.00E+00	0.00E+00	0.00E+00	0.00E+00	0.00E+00	0.00E+00
	400-600	4.88E+01	1.65E+04	6.26E+02	7.27E+07	1.15E+00	3.87E-01
	600-800	3.63E+01	1.59E+04	1.32E+03	2.53E+08	8.42E-01	3.68E-01
	800-1,000	5.73E+01	4.35E+04	4.45E+01	9.35E+07	1.04E+00	7.87E-01
	1,000-1,200	1.70E+01	1.07E+04	2.91E+02	1.14E+08	2.99E-01	1.87E-01
6	200-400	0.00E+00	0.00E+00	0.00E+00	0.00E+00	0.00E+00	0.00E+00
	400-600	2.64E+02	9.22E+04	2.52E+03	2.51E+08	1.55E+00	5.41E-01
	600-800	4.81E+02	2.35E+05	4.72E+04	8.82E+09	5.25E+00	2.56E+00
	800-1,000	1.85E+02	3.12E+05	2.27E+03	3.94E+09	2.87E+00	4.83E+00
	1,000-1,200	7.13E+01	1.45E+05	1.31E+03	6.26E+09	1.44E+00	2.93E+00
1-6	200-1,200	3.34E+03	1.79E+06	2.62E+05	6.58E+10	1.17E+00	7.79E-01

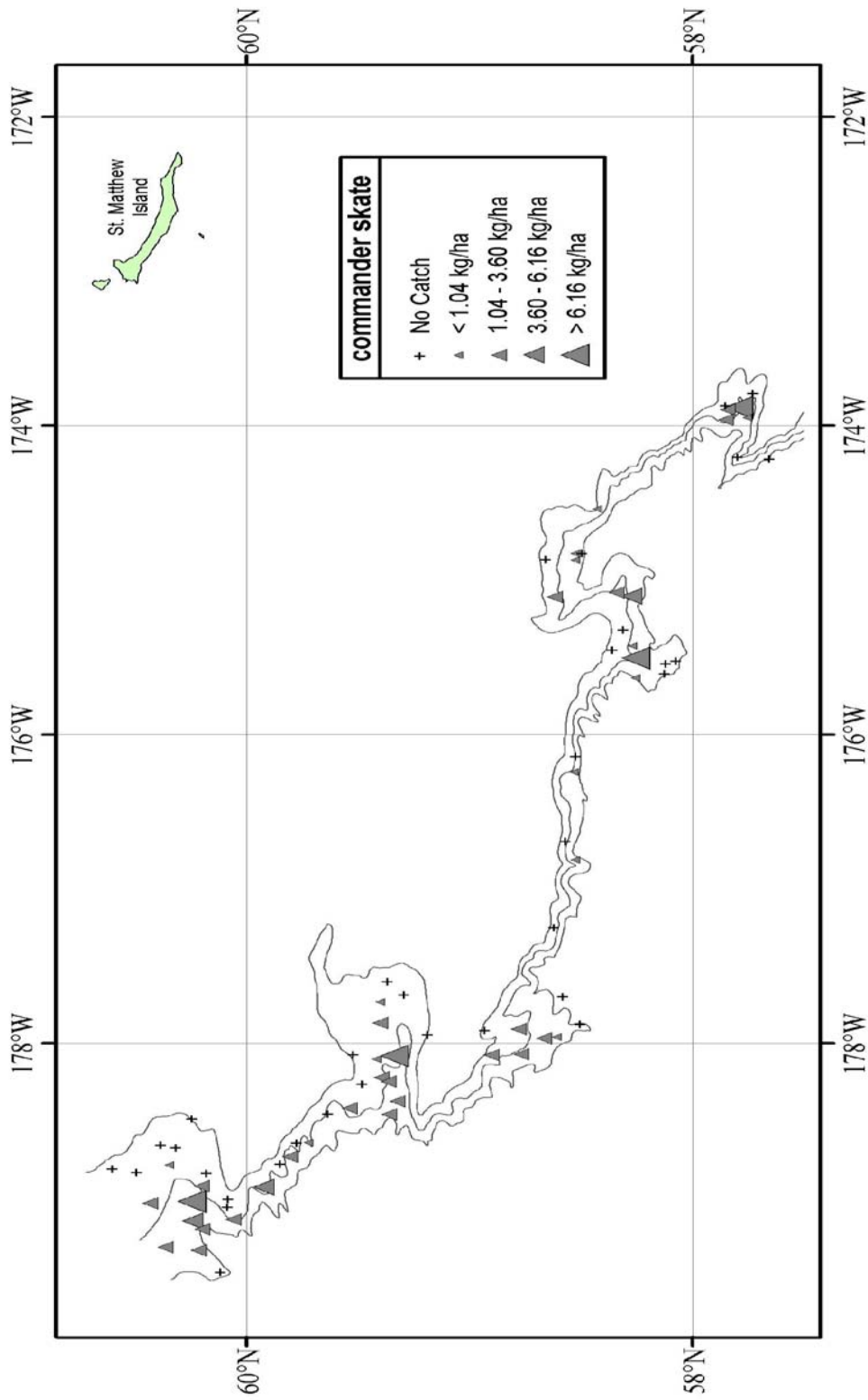

Figure 12. - - Distribution and relative abundance of Commander skate from the 2008 EBSS survey. Relative abundance is categorized by no catch, sample CPUE less than the mean CPUE, between the mean CPUE and one standard deviation above the mean, between one and two standard deviations above the mean CPUE, and greater than two standard deviations above the mean CPUE.

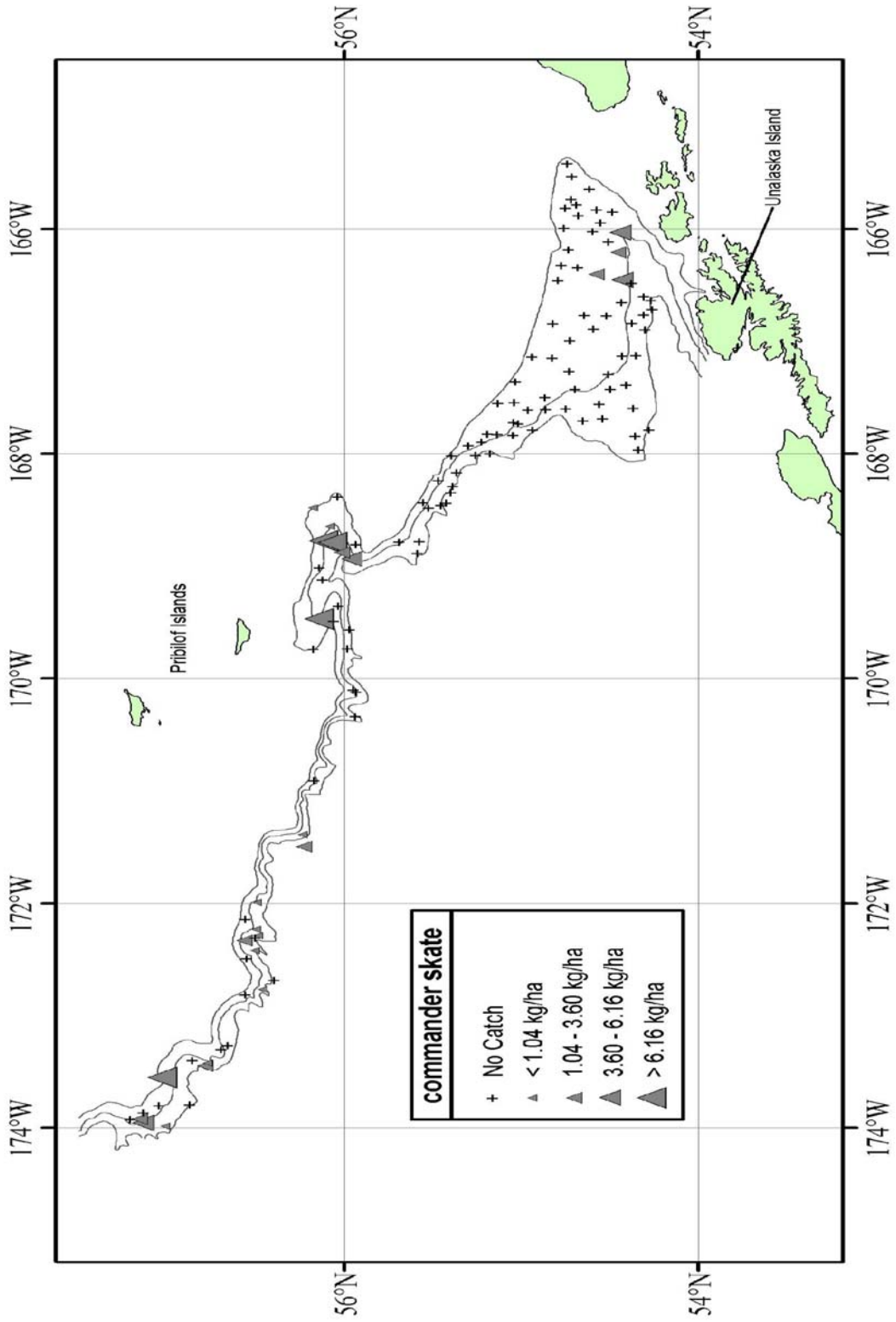

Figure 12. - - Continued.

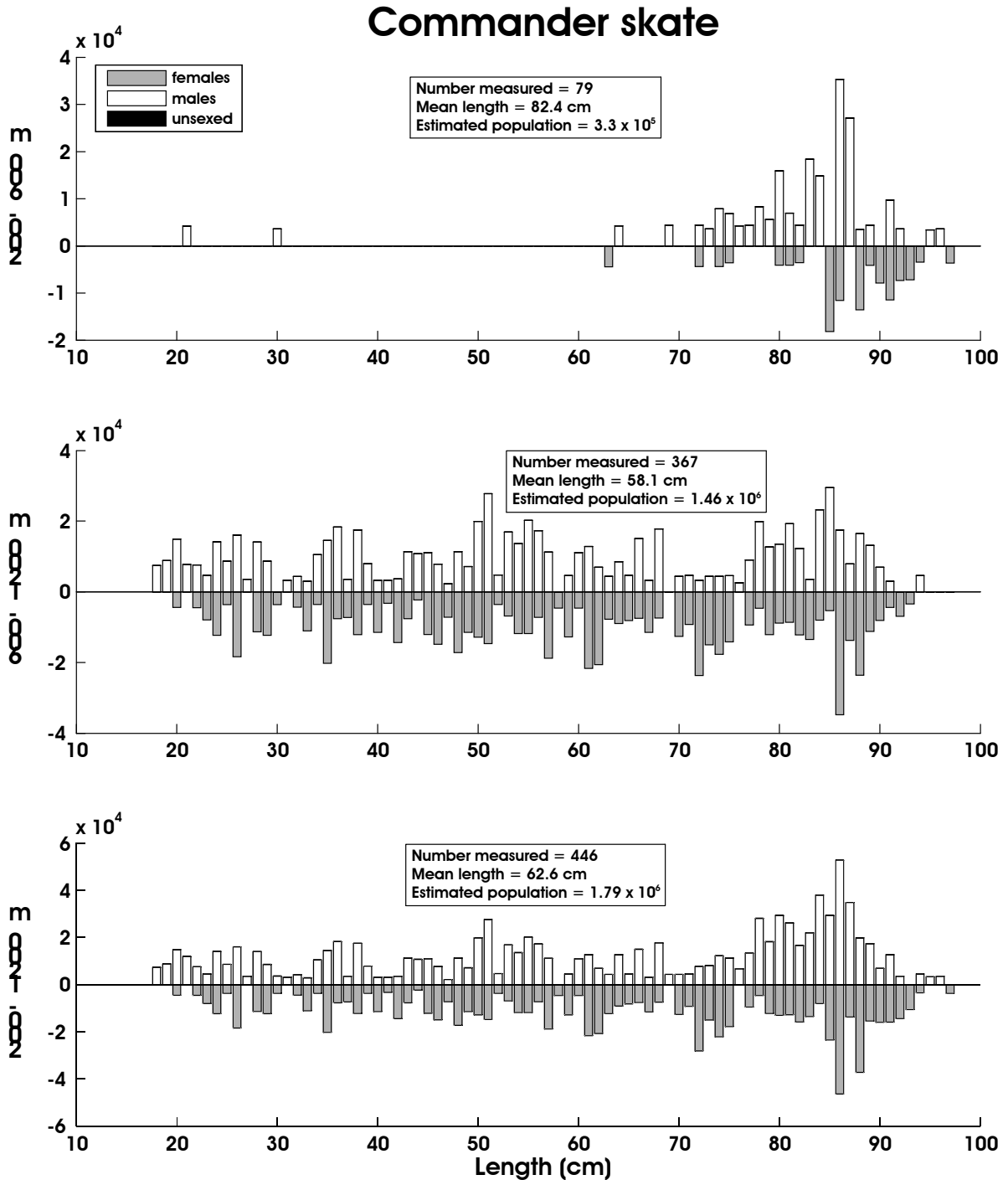

Figure 13. -- Size composition of the estimated Commander skate population from the 2008 EBSS survey for all subareas by depth. The abscissa is scaled as total length in centimeters while the ordinate represents the estimated total population.

Table 15. - Abundance estimates by subarea and depth stratum for whiteblotched skate (*Bathyrāja maculata*) from the 2008 EBSS survey.

<i>Bathyrāja maculata</i>		whiteblotched skate					
Subarea	Depth Stratum (m)	Biomass (t)	Population	Biomass Variance	Population Variance	Average CPUE (kg/ha)	Average CPUE (no./ha)
1	200-400	4.06E+02	7.20E+04	4.85E+04	1.60E+09	1.01E+00	1.79E-01
	400-600	2.95E+02	6.28E+04	1.03E+04	4.01E+08	7.25E-01	1.55E-01
	600-800	0.00E+00	0.00E+00	0.00E+00	0.00E+00	0.00E+00	0.00E+00
	800-1,000	0.00E+00	0.00E+00	0.00E+00	0.00E+00	0.00E+00	0.00E+00
	1,000-1,200	0.00E+00	0.00E+00	0.00E+00	0.00E+00	0.00E+00	0.00E+00
2	200-400	2.06E+02	3.08E+04	9.18E+03	1.40E+08	1.78E+00	2.66E-01
	400-600	4.44E+02	9.03E+04	1.18E+05	5.59E+09	6.29E+00	1.28E+00
	600-800	4.69E+02	1.53E+05	5.03E+04	4.83E+09	7.94E+00	2.58E+00
	800-1,000	1.68E+01	3.29E+04	2.82E+02	1.08E+09	3.04E-01	5.96E-01
	1,000-1,200	3.68E+00	1.35E+04	1.35E+01	1.82E+08	6.86E-02	2.52E-01
3	200-400	0.00E+00	0.00E+00	0.00E+00	0.00E+00	0.00E+00	0.00E+00
	400-600	0.00E+00	0.00E+00	0.00E+00	0.00E+00	0.00E+00	0.00E+00
	600-800	3.36E+01	1.32E+04	6.35E+02	6.98E+07	3.69E-01	1.45E-01
	800-1,000	6.15E+00	2.72E+03	3.78E+01	7.40E+06	8.40E-02	3.72E-02
	1,000-1,200	0.00E+00	0.00E+00	0.00E+00	0.00E+00	0.00E+00	0.00E+00
4	200-400	8.67E+01	3.98E+04	2.21E+03	9.02E+08	7.01E-01	3.22E-01
	400-600	1.33E+01	7.45E+03	1.42E+02	2.08E+07	1.82E-01	1.02E-01
	600-800	9.13E+01	2.62E+04	3.33E+03	1.35E+08	1.32E+00	3.78E-01
	800-1,000	0.00E+00	0.00E+00	0.00E+00	0.00E+00	0.00E+00	0.00E+00
	1,000-1,200	0.00E+00	0.00E+00	0.00E+00	0.00E+00	0.00E+00	0.00E+00
5	200-400	1.86E+02	4.75E+04	1.56E+04	1.33E+09	4.38E+00	1.12E+00
	400-600	3.84E+01	1.33E+04	5.19E+02	4.44E+07	9.01E-01	3.12E-01
	600-800	0.00E+00	0.00E+00	0.00E+00	0.00E+00	0.00E+00	0.00E+00
	800-1,000	0.00E+00	0.00E+00	0.00E+00	0.00E+00	0.00E+00	0.00E+00
	1,000-1,200	0.00E+00	0.00E+00	0.00E+00	0.00E+00	0.00E+00	0.00E+00
6	200-400	1.10E+03	4.15E+05	2.09E+05	5.79E+10	4.22E+00	1.60E+00
	400-600	1.02E+03	4.64E+05	1.13E+05	2.08E+10	6.00E+00	2.72E+00
	600-800	2.81E+01	2.62E+04	7.88E+02	6.88E+08	3.06E-01	2.86E-01
	800-1,000	0.00E+00	0.00E+00	0.00E+00	0.00E+00	0.00E+00	0.00E+00
	1,000-1,200	0.00E+00	0.00E+00	0.00E+00	0.00E+00	0.00E+00	0.00E+00
1-6	200-1,200	4.44E+03	1.51E+06	5.82E+05	9.57E+10	1.07E+00	2.69E-01

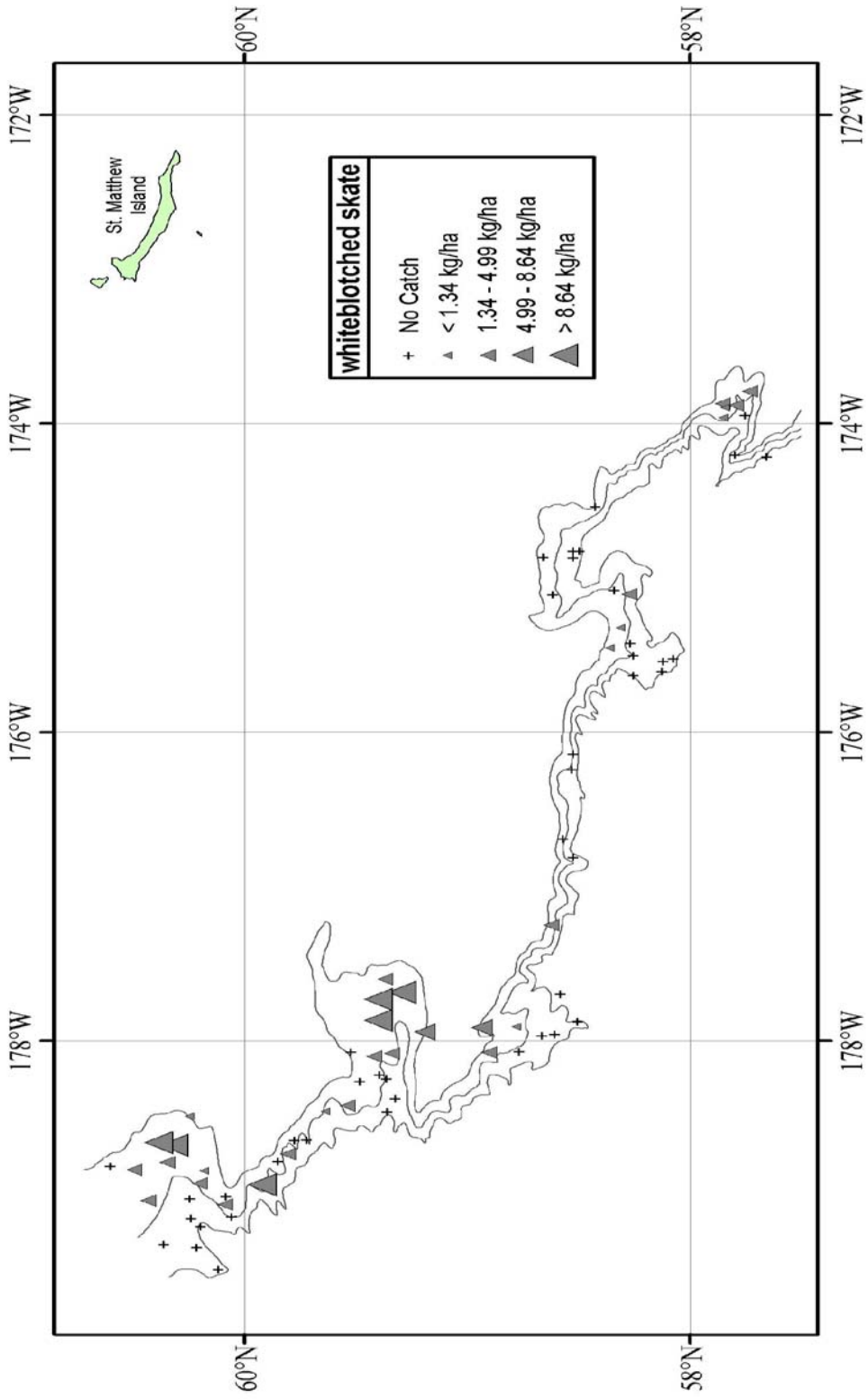

Figure 14. -- Distribution and relative abundance of whiteblotched skate from the 2008 EBSS survey. Relative abundance is categorized by no catch, sample CPUE less than the mean CPUE, between the mean CPUE and one standard deviation above the mean, between one and two standard deviations above the mean CPUE, and greater than two standard deviations above the mean CPUE.

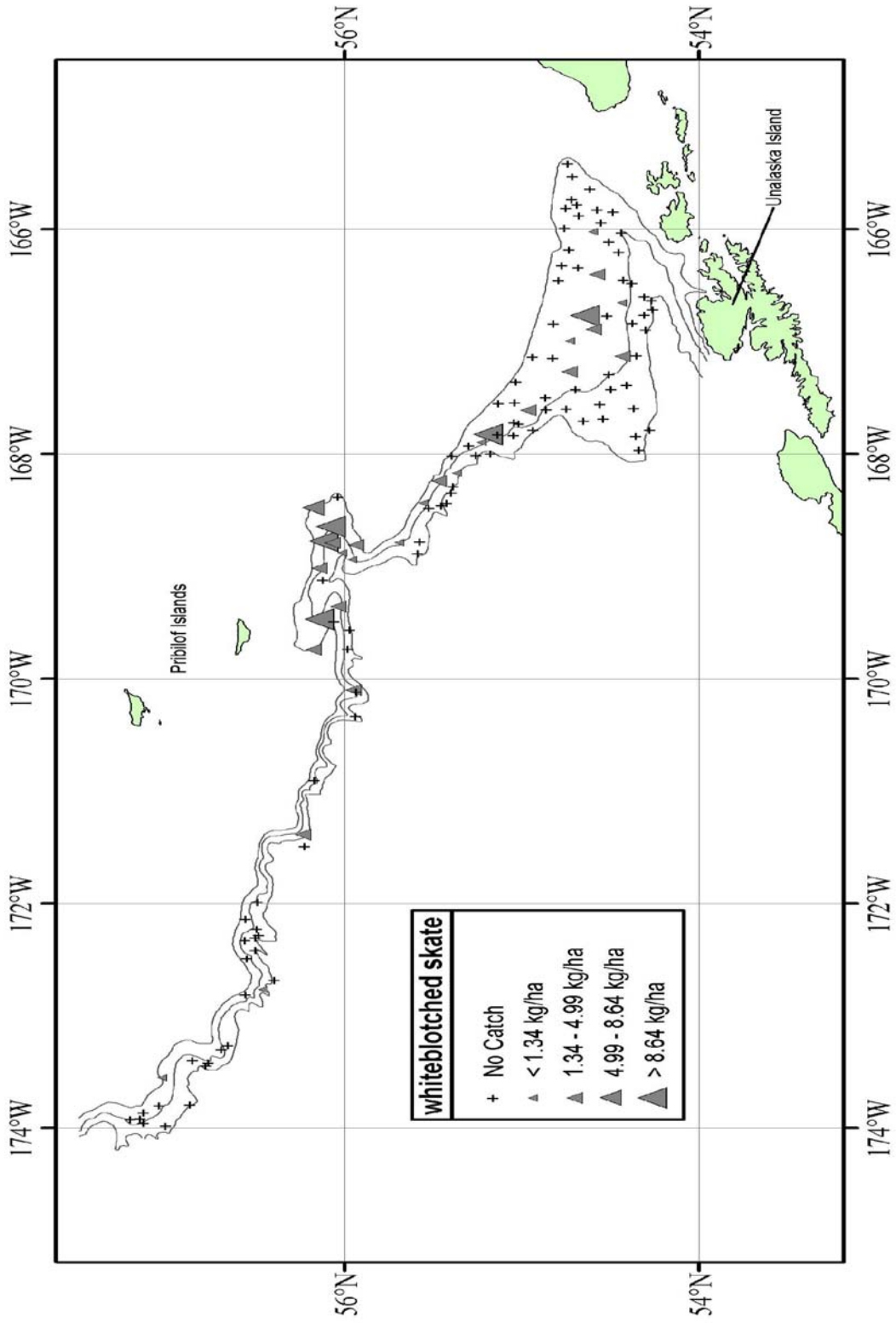

Figure 14. - - Continued.

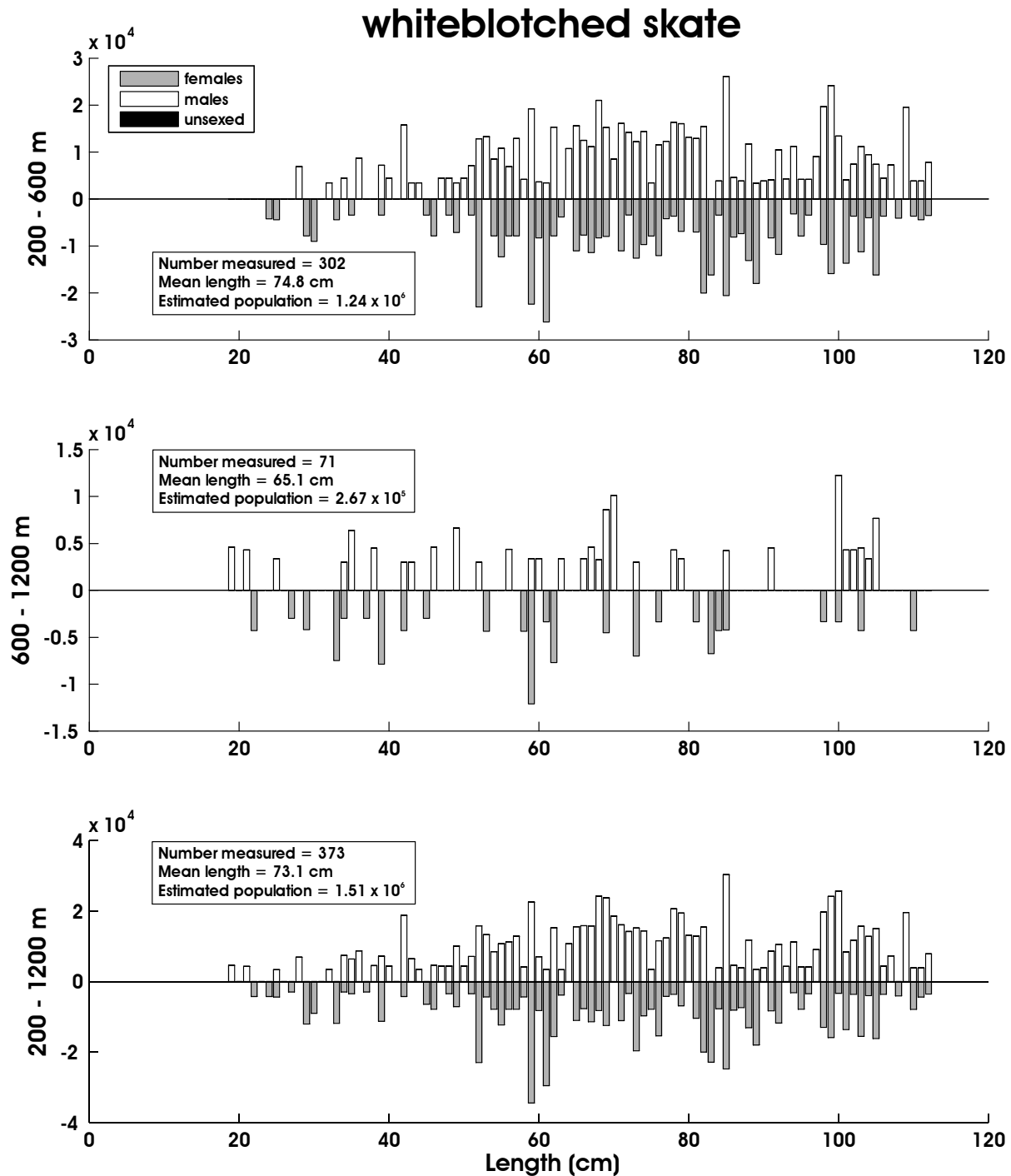

Figure 15. - Size composition of the estimated whiteblotched skate population from the 2008 EBSS survey for all subareas by depth. The abscissa is scaled as total length in centimeters while the ordinate represents the estimated total population.

Table 16. - - Abundance estimates by subarea and depth stratum for whitebrow skate (*Bathyraja minispinosa*) from the 2008 EBSS survey.

<i>Bathyraja minispinosa</i>					whitebrow skate		
Subarea	Depth Stratum (m)	Biomass (t)	Population	Biomass Variance	Population Variance	Average CPUE (kg/ha)	Average CPUE (no./ha)
1	200-400	1.88E+02	6.53E+04	4.47E+03	4.93E+08	4.69E-01	1.63E-01
	400-600	4.15E+02	1.67E+05	5.44E+04	7.54E+09	1.02E+00	4.12E-01
	600-800	5.59E+01	4.97E+04	4.32E+02	1.49E+08	3.21E-01	2.86E-01
	800-1,000	4.87E+01	5.26E+04	4.81E+02	7.27E+08	3.60E-01	3.89E-01
	1,000-1,200	4.19E+01	1.55E+05	4.77E+02	5.08E+09	3.79E-01	1.40E+00
2	200-400	8.17E+00	8.43E+03	6.55E+01	2.97E+07	7.06E-02	7.28E-02
	400-600	5.32E+01	1.36E+04	1.45E+03	6.52E+07	7.54E-01	1.93E-01
	600-800	1.62E+01	7.53E+03	1.10E+02	1.93E+07	2.74E-01	1.27E-01
	800-1,000	4.16E+01	7.72E+04	8.47E+01	5.22E+08	7.53E-01	1.40E+00
	1,000-1,200	9.38E+00	1.67E+04	4.94E+01	2.64E+07	1.75E-01	3.12E-01
3	200-400	7.73E+01	3.06E+04	3.56E+03	4.70E+08	8.55E-01	3.39E-01
	400-600	1.77E+01	1.47E+04	3.13E+02	2.15E+08	2.00E-01	1.66E-01
	600-800	7.26E+01	5.53E+04	5.29E+02	5.29E+08	7.97E-01	6.07E-01
	800-1,000	3.82E+01	4.39E+04	3.35E+02	4.54E+08	5.22E-01	5.99E-01
	1,000-1,200	1.11E+01	4.84E+04	5.78E+01	8.64E+08	1.64E-01	7.17E-01
4	200-400	1.19E+02	5.17E+04	5.45E+03	7.90E+08	9.63E-01	4.18E-01
	400-600	1.74E+02	8.89E+04	1.27E+04	3.00E+09	2.38E+00	1.22E+00
	600-800	2.63E+00	4.38E+03	6.91E+00	1.92E+07	3.79E-02	6.31E-02
	800-1,000	8.84E+00	4.91E+04	2.17E+01	3.49E+08	1.25E-01	6.93E-01
	1,000-1,200	1.00E+01	2.20E+04	3.66E+01	2.90E+08	1.51E-01	3.32E-01
5	200-400	0.00E+00	0.00E+00	0.00E+00	0.00E+00	0.00E+00	0.00E+00
	400-600	9.64E+00	6.94E+03	9.30E+01	4.81E+07	2.26E-01	1.63E-01
	600-800	1.63E-01	5.44E+03	2.66E-02	2.96E+07	3.78E-03	1.26E-01
	800-1,000	3.26E+00	1.33E+04	3.14E+00	6.48E+07	5.91E-02	2.41E-01
	1,000-1,200	1.37E+01	2.61E+04	8.92E+01	3.75E+08	2.40E-01	4.57E-01
6	200-400	1.54E+02	7.56E+04	1.68E+03	3.80E+08	5.92E-01	2.91E-01
	400-600	2.47E+02	1.52E+05	1.40E+04	3.39E+09	1.45E+00	8.94E-01
	600-800	2.37E+01	5.83E+04	1.99E+02	8.55E+08	2.58E-01	6.35E-01
	800-1,000	1.07E+01	4.66E+04	4.91E+01	8.11E+08	1.65E-01	7.23E-01
	1,000-1,200	2.51E+00	1.72E+04	2.57E+00	1.31E+08	5.06E-02	3.46E-01
1-6	200-1,200	1.87E+03	1.42E+06	1.01E+05	2.77E+10	5.54E-01	3.75E-01

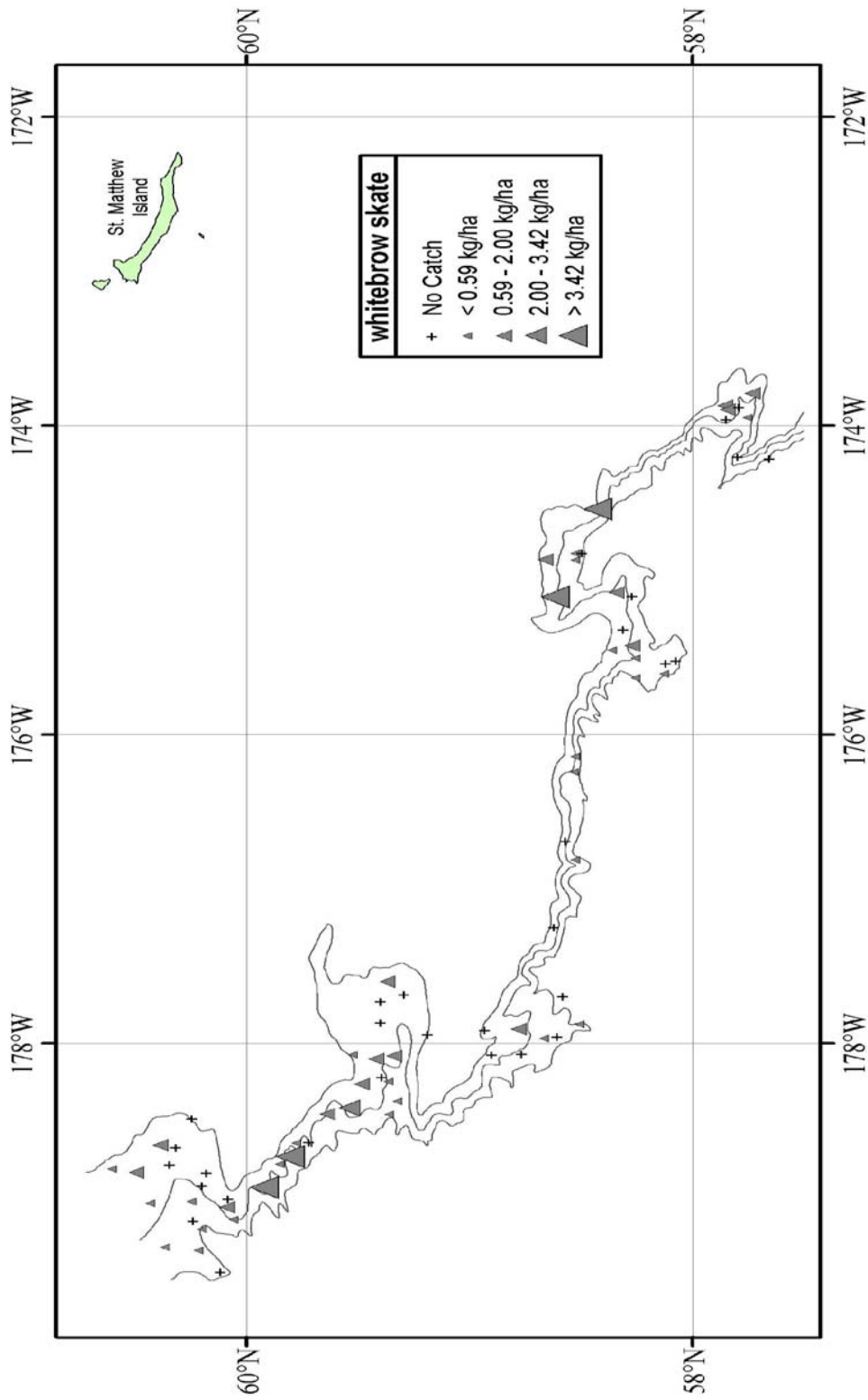

Figure 16. - - Distribution and relative abundance of whitebrow skate from the 2008 EBSS survey. Relative abundance is categorized by no catch, sample CPUE less than the mean CPUE, between the mean CPUE and one standard deviation above the mean, between one and two standard deviations above the mean CPUE, and greater than two standard deviations above the mean CPUE.

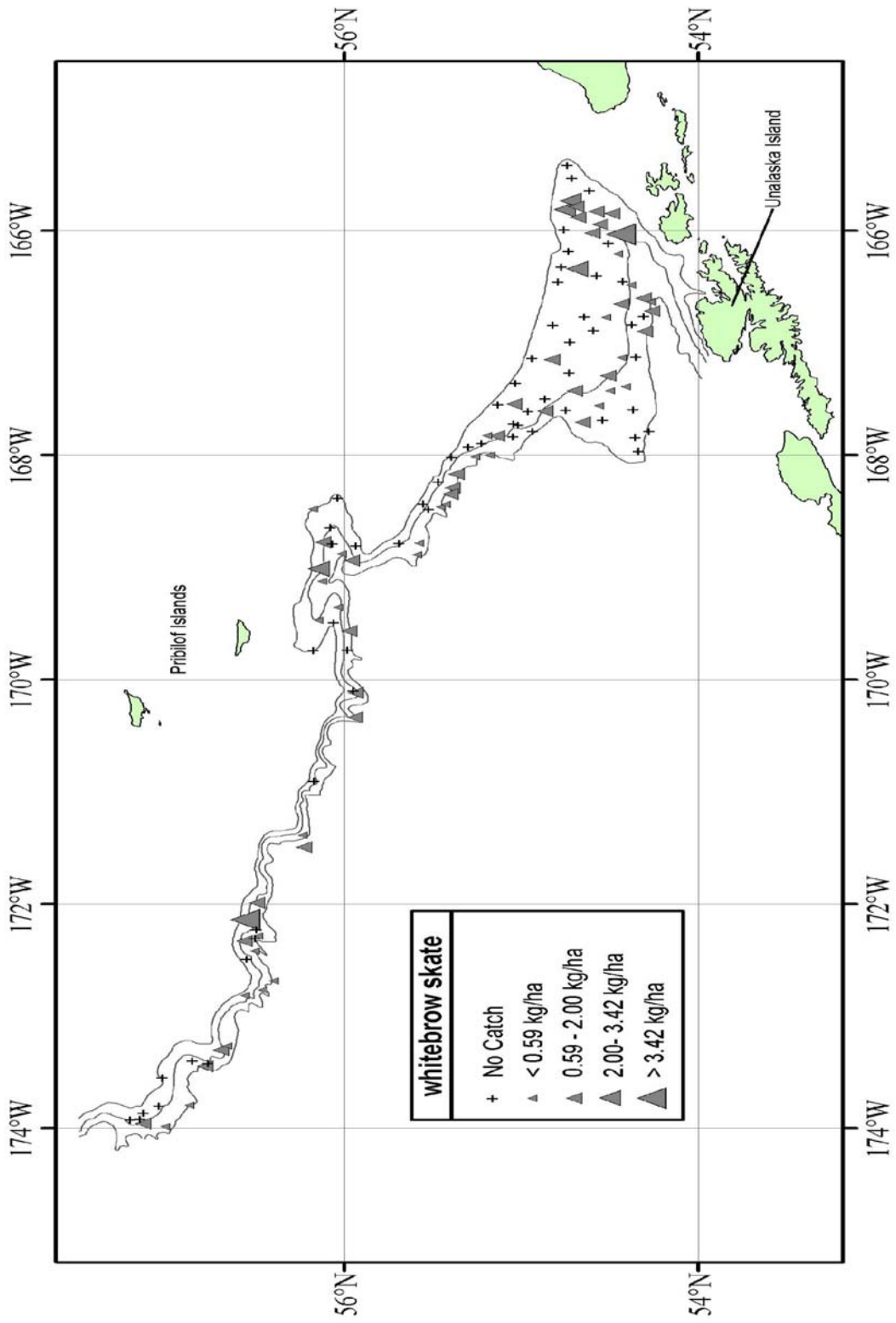

Figure 16. - - Continued.

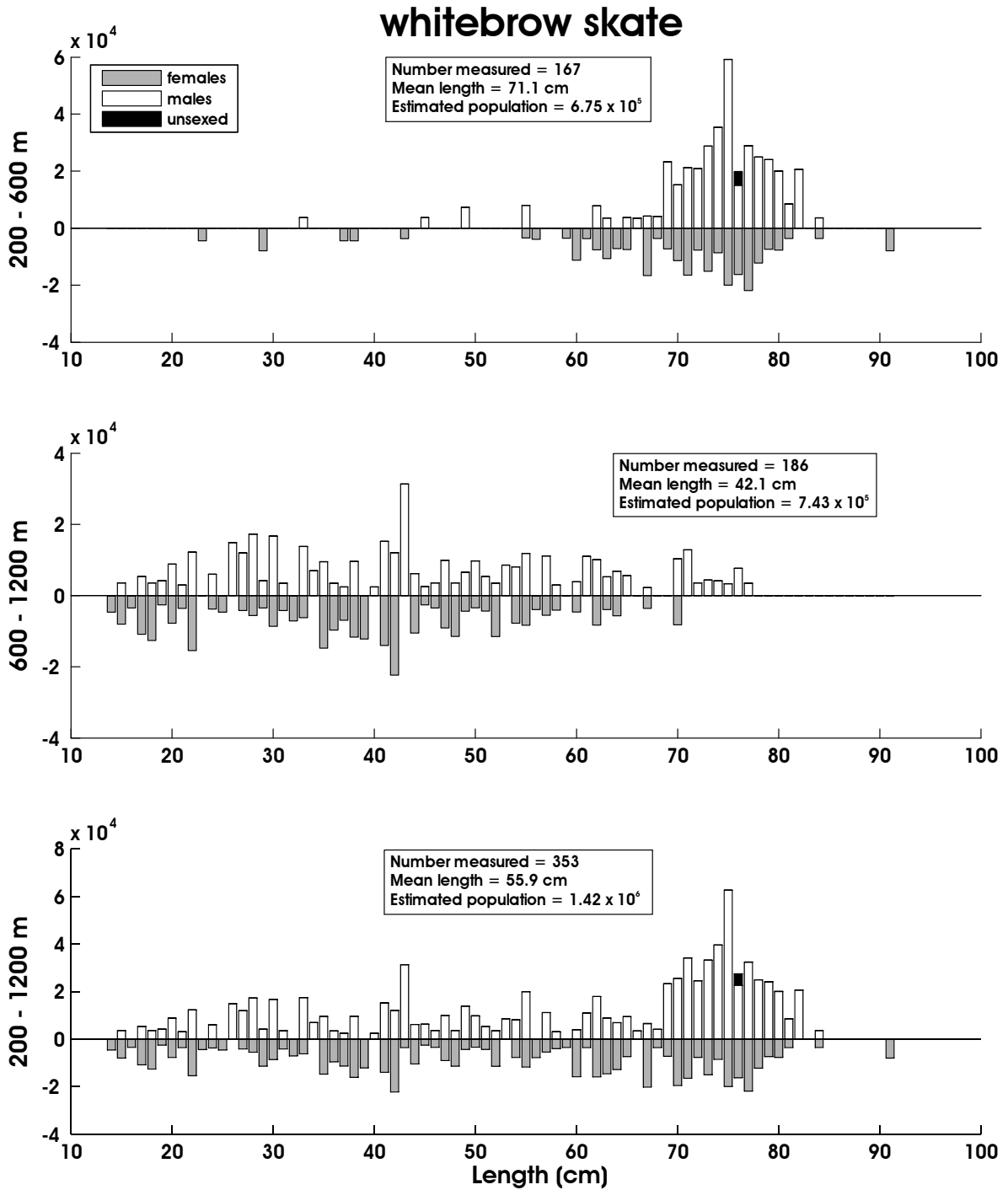

Figure 17. - - Size composition of the estimated whitebrow skate population from the 2008 EBSS survey for all subareas by depth. The abscissa is scaled as total length in centimeters while the ordinate represents the estimated total population.

Table 17. - - Abundance estimates by subarea and depth stratum for roughtail skate (*Bathyraja trachura*) from the 2008 EBSS survey.

<i>Bathyraja trachura</i>						roughtail skate	
Subarea	Depth Stratum (m)	Biomass (t)	Population	Biomass Variance	Population Variance	Average CPUE (kg/ha)	Average CPUE (no./ha)
1	200-400	0.00E+00	0.00E+00	0.00E+00	0.00E+00	0.00E+00	0.00E+00
	400-600	5.09E+00	1.12E+04	1.82E+01	6.43E+07	1.25E-02	2.75E-02
	600-800	5.35E+01	1.45E+04	8.76E+02	6.21E+07	3.07E-01	8.33E-02
	800-1,000	4.80E+02	1.75E+05	1.80E+04	2.92E+09	3.54E+00	1.29E+00
	1,000-1,200	3.47E+02	2.53E+05	1.80E+04	1.44E+10	3.13E+00	2.29E+00
2	200-400	0.00E+00	0.00E+00	0.00E+00	0.00E+00	0.00E+00	0.00E+00
	400-600	0.00E+00	0.00E+00	0.00E+00	0.00E+00	0.00E+00	0.00E+00
	600-800	0.00E+00	0.00E+00	0.00E+00	0.00E+00	0.00E+00	0.00E+00
	800-1,000	9.40E+01	3.30E+04	1.70E+03	2.21E+08	1.70E+00	5.97E-01
	1,000-1,200	1.63E+02	1.31E+05	2.66E+04	1.70E+10	3.04E+00	2.44E+00
3	200-400	2.58E-01	3.79E+03	6.63E-02	1.43E+07	2.85E-03	4.19E-02
	400-600	5.21E-01	3.67E+03	2.71E-01	1.35E+07	5.88E-03	4.14E-02
	600-800	3.25E+01	1.04E+04	1.06E+03	1.08E+08	3.57E-01	1.14E-01
	800-1,000	1.22E+02	8.24E+04	1.52E+03	7.39E+08	1.66E+00	1.13E+00
	1,000-1,200	1.60E+02	9.26E+04	1.23E+03	2.69E+08	2.37E+00	1.37E+00
4	200-400	0.00E+00	0.00E+00	0.00E+00	0.00E+00	0.00E+00	0.00E+00
	400-600	7.11E-02	7.11E+03	5.06E-03	5.06E+07	9.74E-04	9.74E-02
	600-800	1.28E+01	4.38E+03	1.64E+02	1.92E+07	1.84E-01	6.31E-02
	800-1,000	9.51E+01	4.13E+04	4.19E+03	1.04E+09	1.34E+00	5.84E-01
	1,000-1,200	1.13E+02	6.22E+04	1.90E+03	5.87E+08	1.70E+00	9.38E-01
5	200-400	0.00E+00	0.00E+00	0.00E+00	0.00E+00	0.00E+00	0.00E+00
	400-600	0.00E+00	0.00E+00	0.00E+00	0.00E+00	0.00E+00	0.00E+00
	600-800	1.29E+01	5.30E+03	1.67E+02	2.81E+07	2.99E-01	1.23E-01
	800-1,000	1.53E+02	6.68E+04	3.65E+03	1.07E+09	2.78E+00	1.21E+00
	1,000-1,200	5.28E+01	2.01E+04	9.50E+02	1.02E+08	9.25E-01	3.53E-01
6	200-400	0.00E+00	0.00E+00	0.00E+00	0.00E+00	0.00E+00	0.00E+00
	400-600	0.00E+00	0.00E+00	0.00E+00	0.00E+00	0.00E+00	0.00E+00
	600-800	1.26E+01	4.62E+03	1.58E+02	2.14E+07	1.37E-01	5.04E-02
	800-1,000	8.35E+01	4.32E+04	1.84E+03	4.59E+08	1.29E+00	6.69E-01
	1,000-1,200	1.41E+02	7.82E+04	6.43E+02	1.92E+08	2.84E+00	1.57E+00
1-6	200-1,200	2.13E+03	1.14E+06	8.27E+04	3.94E+10	4.57E-01	2.32E-01

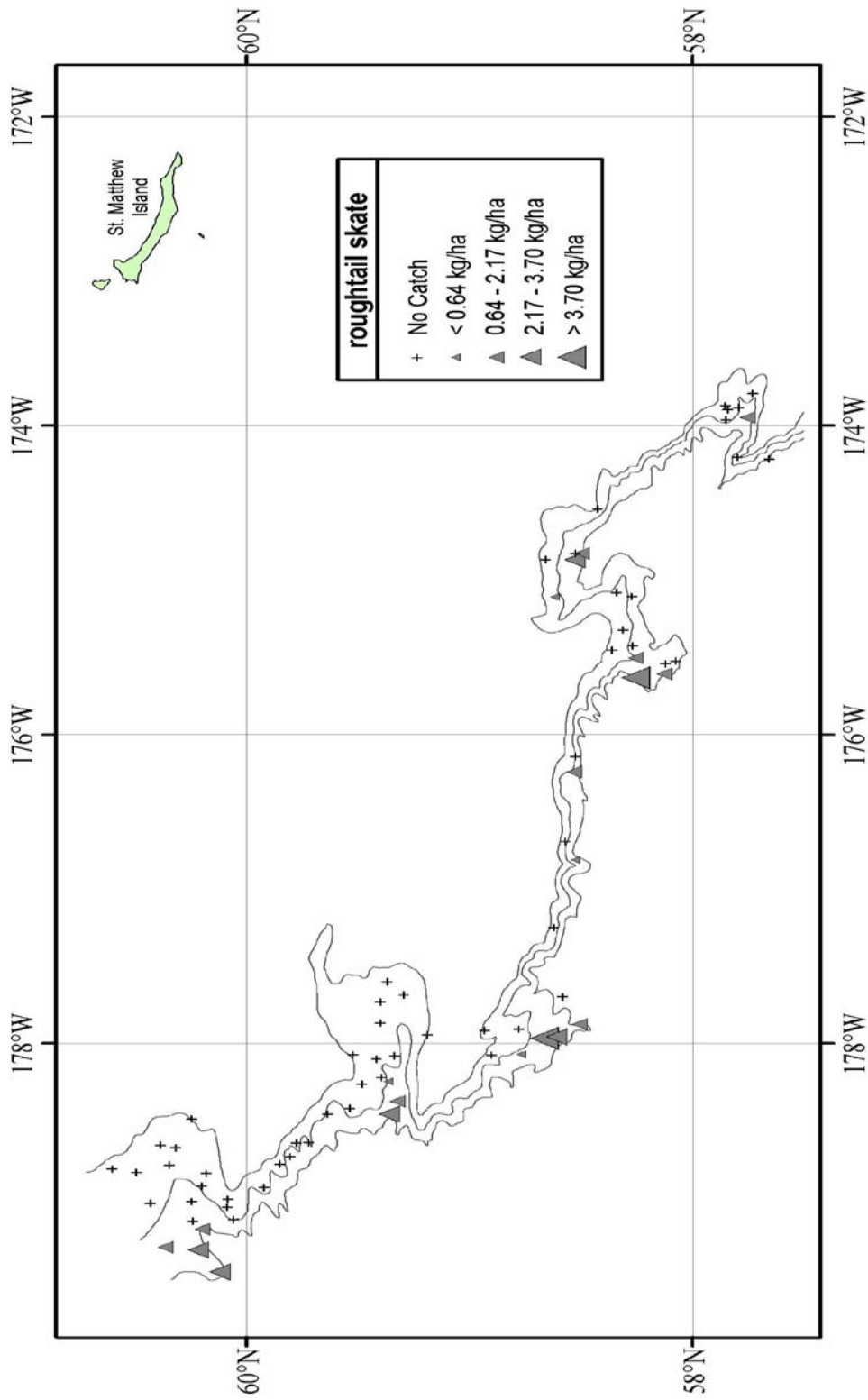

Figure 18. - - Distribution and relative abundance of rough-tail skate from the 2008 EBSS survey. Relative abundance is categorized by no catch, sample CPUE less than the mean CPUE, between the mean CPUE and one standard deviation above the mean, between one and two standard deviations above the mean CPUE, and greater than two standard deviations above the mean CPUE.

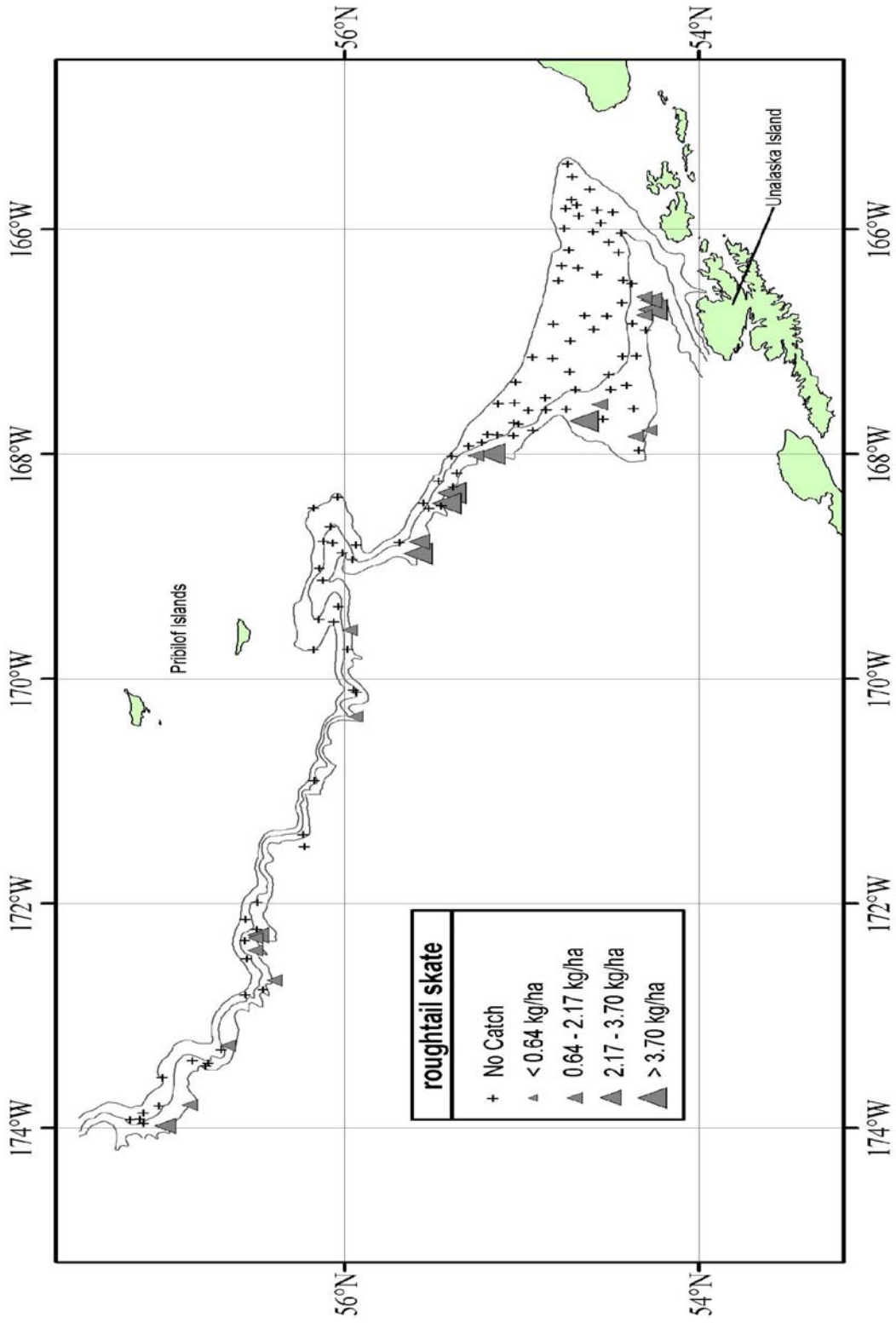

Figure 18. - - Continued.

rougtail skate

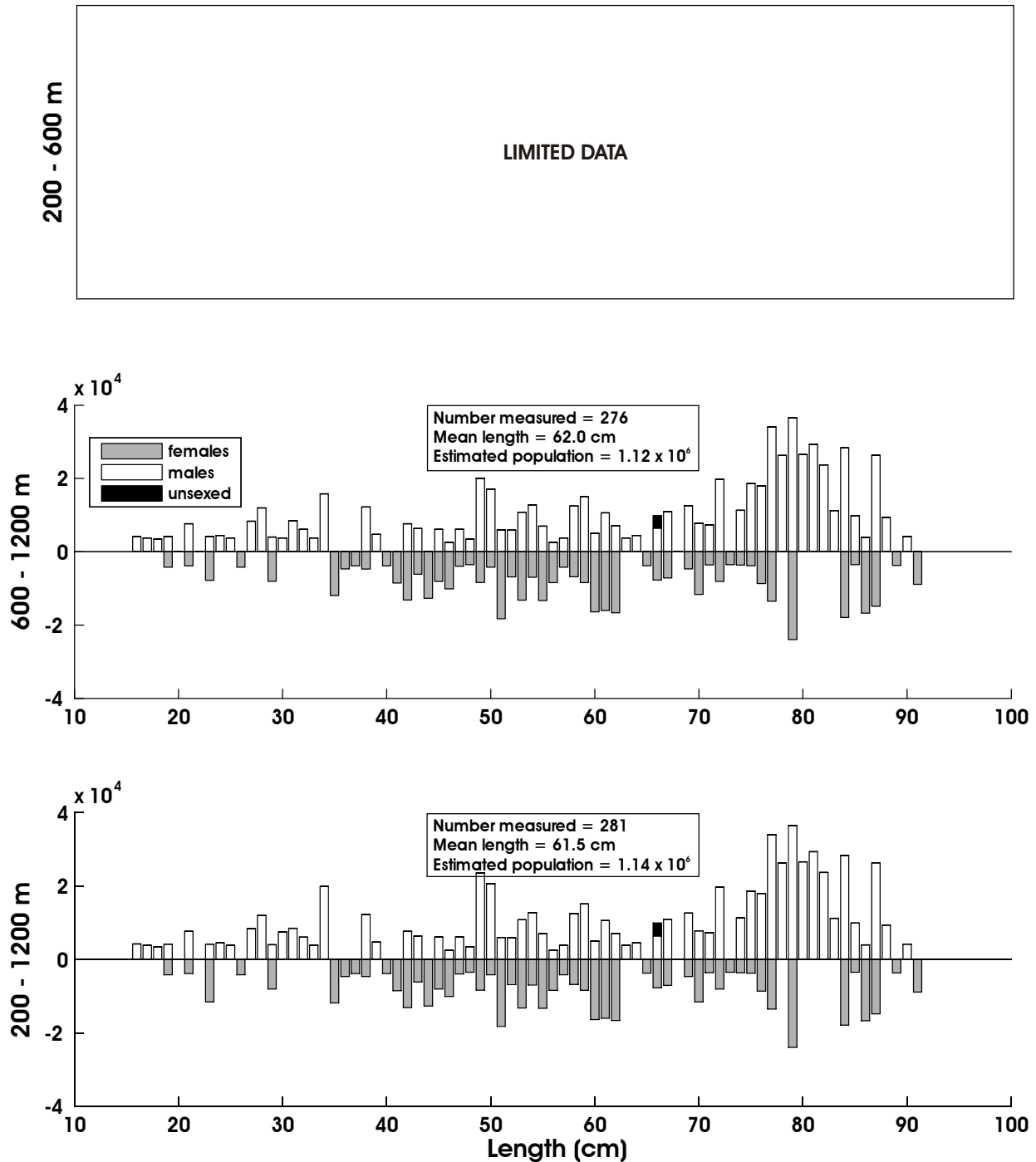

Figure 19. - Size composition of the estimated rougtail skate population from the 2008 EBSS survey for all subareas by depth. The abscissa is scaled as total length in centimeters while the ordinate represents the estimated total population.

Table 18. - - Abundance estimates by subarea and depth stratum for mud skate (*Bathyraja taranetzi*) from the 2008 EBSS survey.

<i>Bathyraja taranetzi</i>		mud skate					
Subarea	Depth Stratum (m)	Biomass (t)	Population	Biomass Variance	Population Variance	Average CPUE (kg/ha)	Average CPUE (no./ha)
1	200-400	1.75E+01	8.75E+03	1.46E+02	3.67E+07	4.35E-02	2.18E-02
	400-600	0.00E+00	0.00E+00	0.00E+00	0.00E+00	0.00E+00	0.00E+00
	600-800	0.00E+00	0.00E+00	0.00E+00	0.00E+00	0.00E+00	0.00E+00
	800-1,000	0.00E+00	0.00E+00	0.00E+00	0.00E+00	0.00E+00	0.00E+00
	1,000-1,200	0.00E+00	0.00E+00	0.00E+00	0.00E+00	0.00E+00	0.00E+00
2	200-400	2.13E+02	2.13E+05	8.09E+03	1.41E+10	1.84E+00	1.84E+00
	400-600	3.35E+01	5.28E+04	5.11E+02	1.83E+09	4.75E-01	7.49E-01
	600-800	8.35E+00	1.84E+04	6.97E+01	3.37E+08	1.41E-01	3.10E-01
	800-1,000	7.48E+00	2.69E+04	5.60E+01	7.26E+08	1.35E-01	4.87E-01
	1,000-1,200	0.00E+00	0.00E+00	0.00E+00	0.00E+00	0.00E+00	0.00E+00
3	200-400	2.27E+02	1.86E+05	2.52E+04	1.78E+10	2.51E+00	2.06E+00
	400-600	1.92E+01	2.00E+04	1.63E+02	1.75E+08	2.16E-01	2.26E-01
	600-800	0.00E+00	0.00E+00	0.00E+00	0.00E+00	0.00E+00	0.00E+00
	800-1,000	0.00E+00	0.00E+00	0.00E+00	0.00E+00	0.00E+00	0.00E+00
	1,000-1,200	0.00E+00	0.00E+00	0.00E+00	0.00E+00	0.00E+00	0.00E+00
4	200-400	1.03E+02	7.70E+04	5.20E+03	2.83E+09	8.31E-01	6.23E-01
	400-600	1.66E+01	1.86E+04	2.75E+02	3.48E+08	2.27E-01	2.55E-01
	600-800	1.45E+01	3.08E+04	7.71E+01	3.36E+08	2.09E-01	4.44E-01
	800-1,000	0.00E+00	0.00E+00	0.00E+00	0.00E+00	0.00E+00	0.00E+00
	1,000-1,200	0.00E+00	0.00E+00	0.00E+00	0.00E+00	0.00E+00	0.00E+00
5	200-400	9.56E+00	5.50E+03	9.15E+01	3.02E+07	2.26E-01	1.30E-01
	400-600	5.12E+00	4.34E+03	2.62E+01	1.88E+07	1.20E-01	1.02E-01
	600-800	0.00E+00	0.00E+00	0.00E+00	0.00E+00	0.00E+00	0.00E+00
	800-1,000	0.00E+00	0.00E+00	0.00E+00	0.00E+00	0.00E+00	0.00E+00
	1,000-1,200	0.00E+00	0.00E+00	0.00E+00	0.00E+00	0.00E+00	0.00E+00
6	200-400	1.98E+02	2.84E+05	3.88E+03	1.12E+10	7.63E-01	1.09E+00
	400-600	1.00E+02	1.52E+05	2.83E+03	4.67E+09	5.88E-01	8.90E-01
	600-800	5.07E+00	8.75E+03	2.57E+01	7.65E+07	5.53E-02	9.53E-02
	800-1,000	0.00E+00	0.00E+00	0.00E+00	0.00E+00	0.00E+00	0.00E+00
	1,000-1,200	0.00E+00	0.00E+00	0.00E+00	0.00E+00	0.00E+00	0.00E+00
1-6	200-1,200	9.78E+02	1.11E+06	4.66E+04	5.45E+10	2.27E-01	2.63E-01

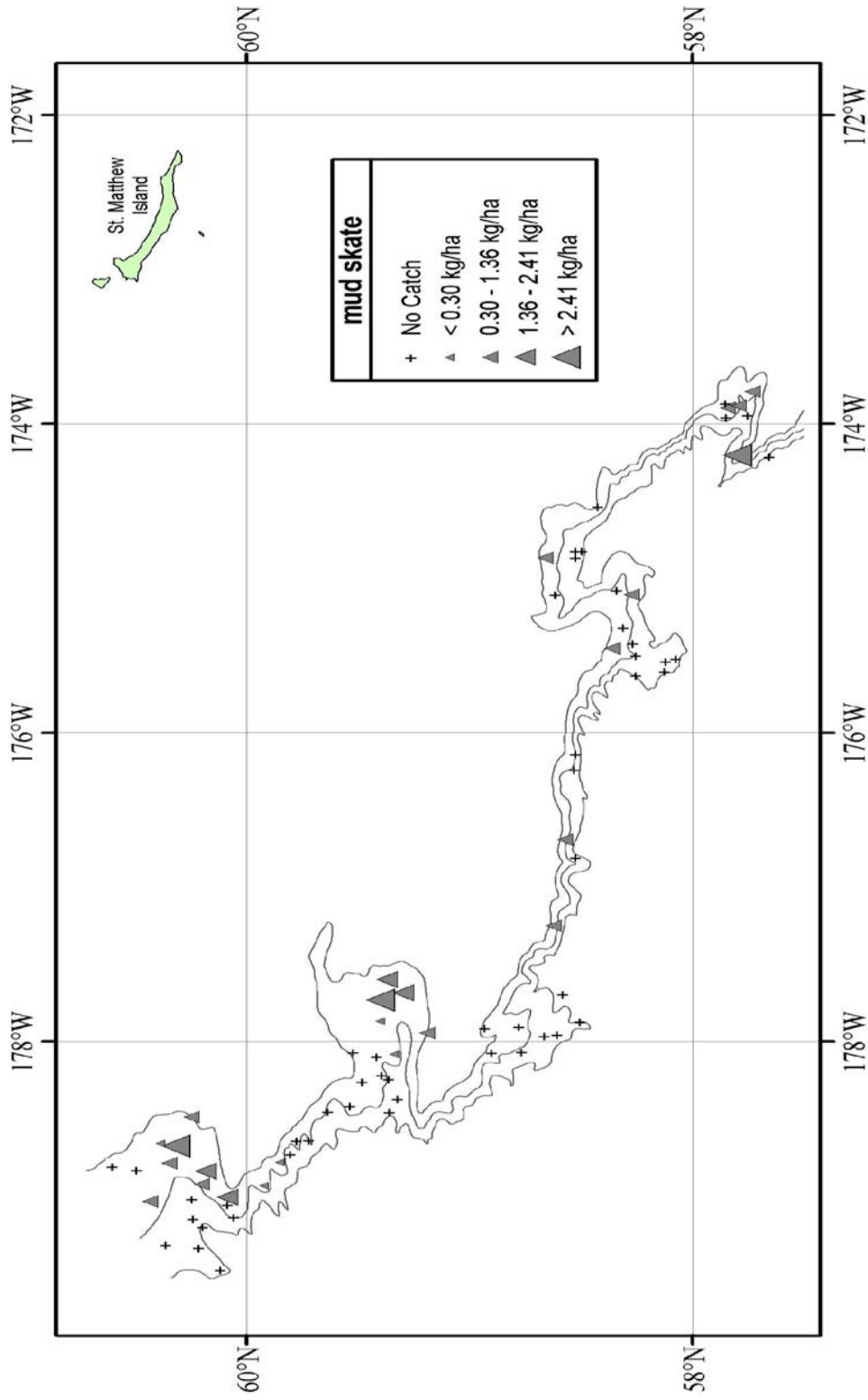

Figure 20. - - Distribution and relative abundance of mud skate from the 2008 EBSS survey. Relative abundance is categorized by no catch, sample CPUE less than the mean CPUE, between the mean CPUE and one standard deviation above the mean, between one and two standard deviations above the mean CPUE, and greater than two standard deviations above the mean CPUE.

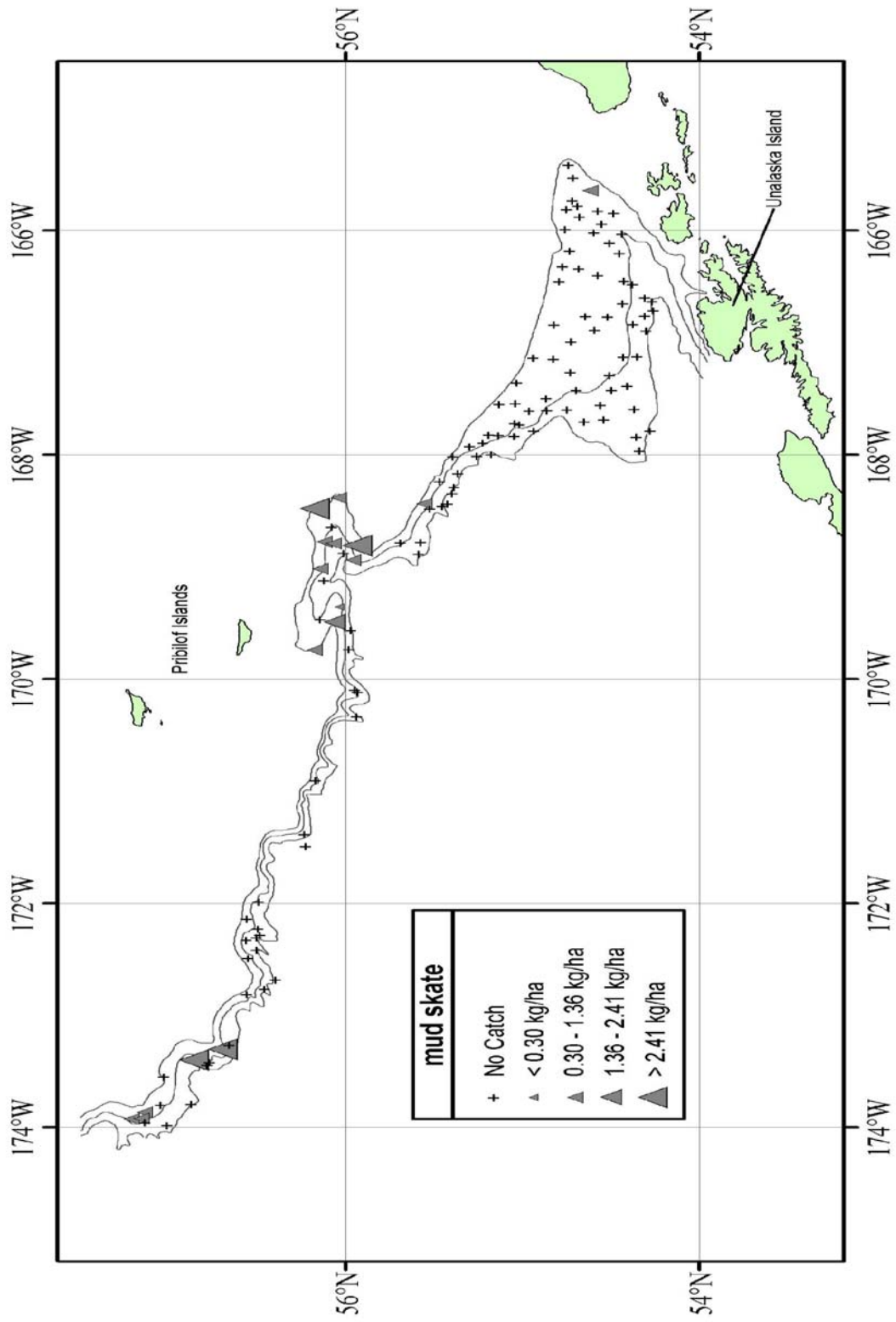

Figure 20. - - Continued.

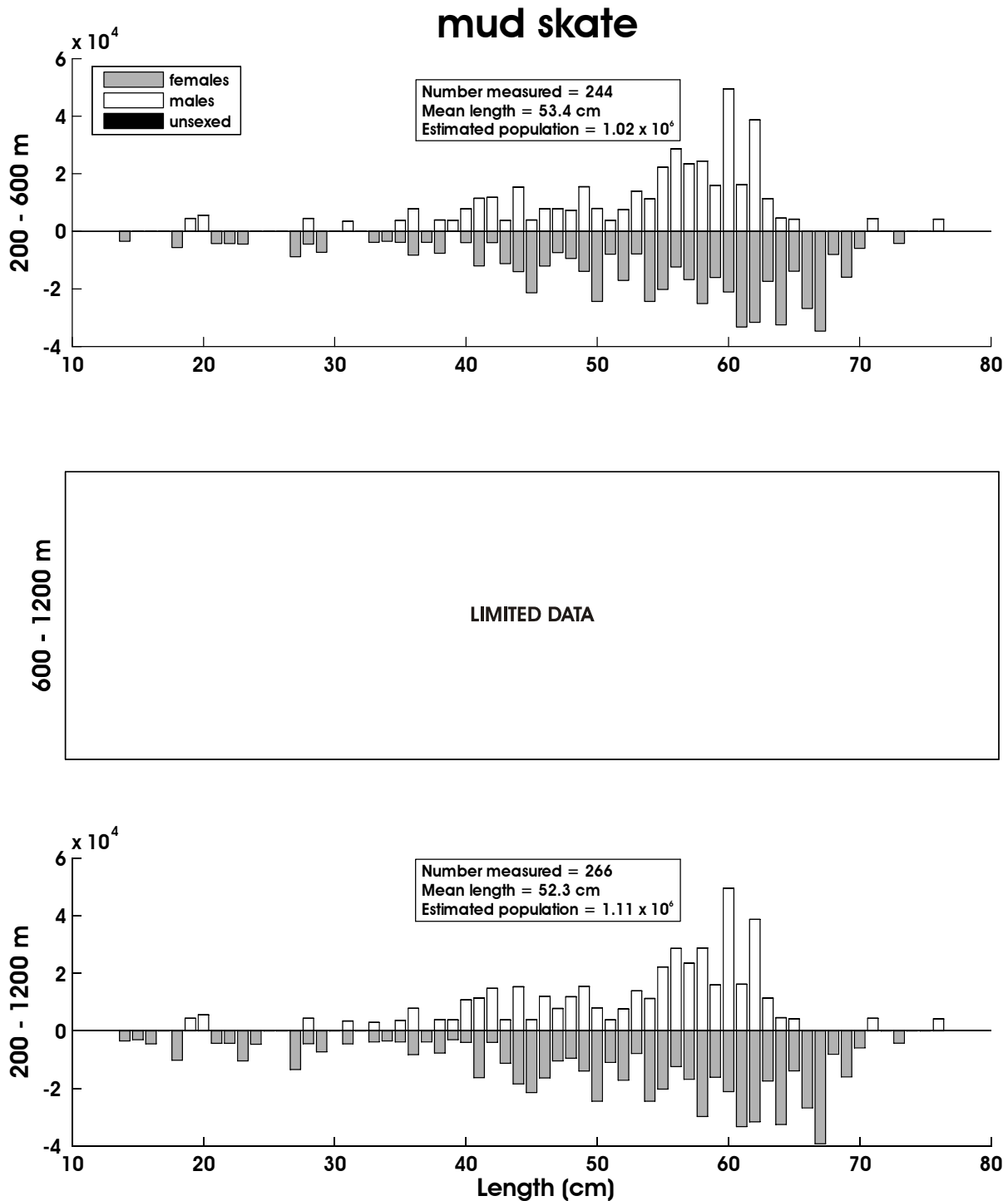

Figure 21. - Size composition of the estimated mud skate population from the 2008 EBSS survey for all subareas by depth. The abscissa is scaled as total length in centimeters while the ordinate represents the estimated total population.

Table 19. - Abundance estimates by subarea and depth stratum for giant grenadier (*Albatrossia pectoralis*) from the 2008 EBSS survey.

<i>Albatrossia pectoralis</i>					giant grenadier		
Subarea	Depth Strata (m)	Biomass (t)	Population	Biomass Variance	Population Variance	Average CPUE (kg/ha)	Average CPUE (no./ha)
1	200-400	1.65E+02	2.94E+04	1.92E+04	5.27E+08	4.11E-01	7.32E-02
	400-600	7.29E+03	2.56E+06	2.51E+06	4.01E+11	1.80E+01	6.31E+00
	600-800	1.17E+04	4.67E+06	9.21E+06	1.64E+12	6.69E+01	2.68E+01
	800-1,000	2.16E+04	9.14E+06	2.91E+07	4.29E+12	1.59E+02	6.75E+01
	1,000-1,200	1.06E+04	4.95E+06	3.26E+06	7.84E+11	9.55E+01	4.47E+01
2	200-400	1.71E+02	2.41E+04	2.93E+04	5.79E+08	1.48E+00	2.08E-01
	400-600	7.59E+03	1.38E+06	2.24E+07	5.94E+11	1.08E+02	1.96E+01
	600-800	2.56E+04	5.10E+06	4.45E+08	1.80E+13	4.33E+02	8.62E+01
	800-1,000	9.45E+03	2.35E+06	8.67E+06	6.44E+10	1.71E+02	4.25E+01
	1,000-1,200	1.23E+04	1.60E+06	8.54E+07	5.84E+11	2.30E+02	2.99E+01
3	200-400	0.00E+00	0.00E+00	0.00E+00	0.00E+00	0.00E+00	0.00E+00
	400-600	2.28E+04	5.83E+06	1.97E+07	1.10E+12	2.57E+02	6.58E+01
	600-800	3.11E+04	1.01E+07	1.79E+07	2.22E+12	3.42E+02	1.11E+02
	800-1,000	2.11E+04	6.07E+06	2.59E+07	2.15E+12	2.88E+02	8.29E+01
	1,000-1,200	1.09E+04	2.98E+06	8.43E+06	7.18E+11	1.61E+02	4.41E+01
4	200-400	1.34E+04	2.09E+06	9.55E+07	2.15E+12	1.08E+02	1.69E+01
	400-600	2.41E+04	5.48E+06	7.56E+05	2.32E+11	3.30E+02	7.50E+01
	600-800	2.92E+04	7.76E+06	1.84E+08	7.58E+12	4.21E+02	1.12E+02
	800-1,000	1.73E+04	5.30E+06	1.68E+07	1.81E+12	2.45E+02	7.48E+01
	1,000-1,200	1.37E+04	3.40E+06	4.34E+06	4.51E+11	2.06E+02	5.14E+01
5	200-400	0.00E+00	0.00E+00	0.00E+00	0.00E+00	0.00E+00	0.00E+00
	400-600	9.80E+03	2.48E+06	2.61E+07	1.81E+12	2.30E+02	5.83E+01
	600-800	1.22E+04	3.14E+06	2.03E+07	2.95E+11	2.82E+02	7.28E+01
	800-1,000	1.84E+04	4.85E+06	9.49E+07	5.93E+12	3.33E+02	8.78E+01
	1,000-1,200	7.95E+03	2.38E+06	5.14E+06	5.18E+11	1.39E+02	4.17E+01
6	200-400	5.29E+02	8.72E+04	1.35E+05	4.00E+09	2.04E+00	3.36E-01
	400-600	3.55E+04	7.85E+06	8.21E+07	5.66E+12	2.08E+02	4.60E+01
	600-800	4.84E+04	1.47E+07	1.05E+09	1.04E+14	5.27E+02	1.61E+02
	800-1,000	1.59E+04	5.22E+06	3.24E+06	1.43E+12	2.46E+02	8.09E+01
	1,000-1,200	1.12E+04	4.61E+06	2.59E+07	5.59E+12	2.25E+02	9.28E+01
1-6	200-1,200	4.50E+05	1.26E+08	2.28E+09	1.70E+14	1.80E+02	4.96E+01

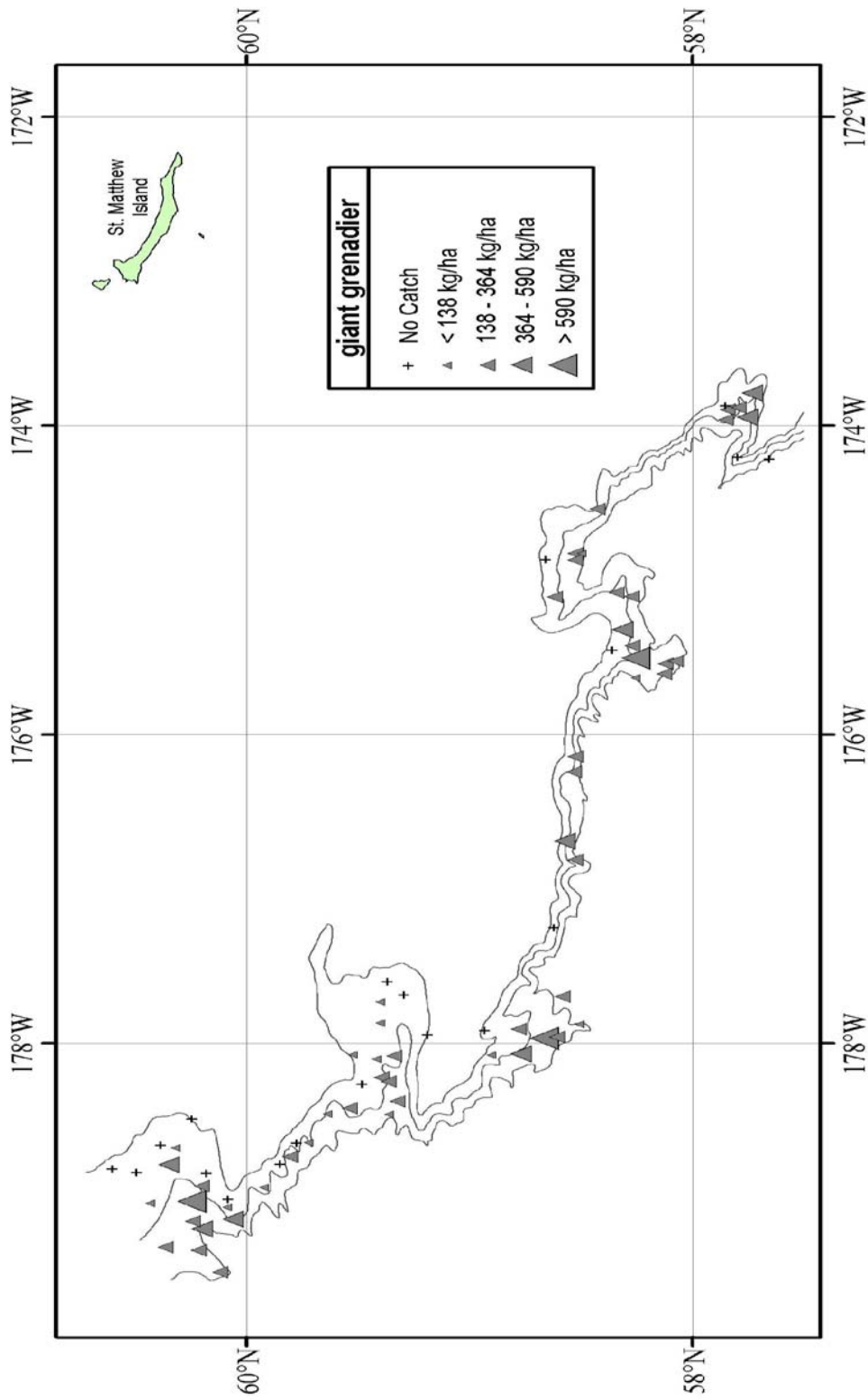

Figure 22. - - Distribution and relative abundance of giant grenadier from the 2008 EBSS survey. Relative abundance is categorized by no catch, sample CPUE less than the mean CPUE, between the mean CPUE and one standard deviation above the mean, between one and two standard deviations above the mean CPUE, and greater than two standard deviations above the mean CPUE.

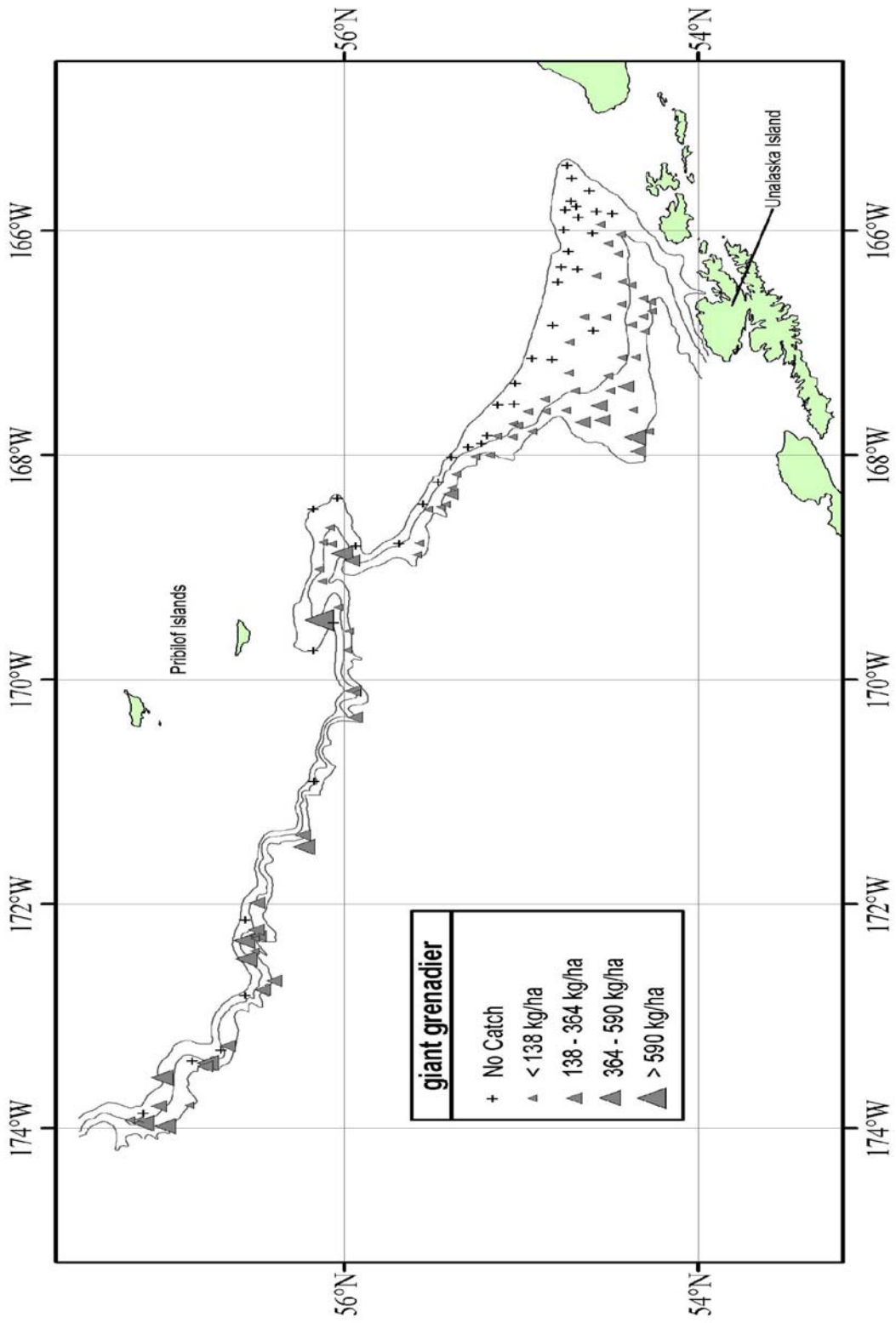

Figure 22. - - Continued.

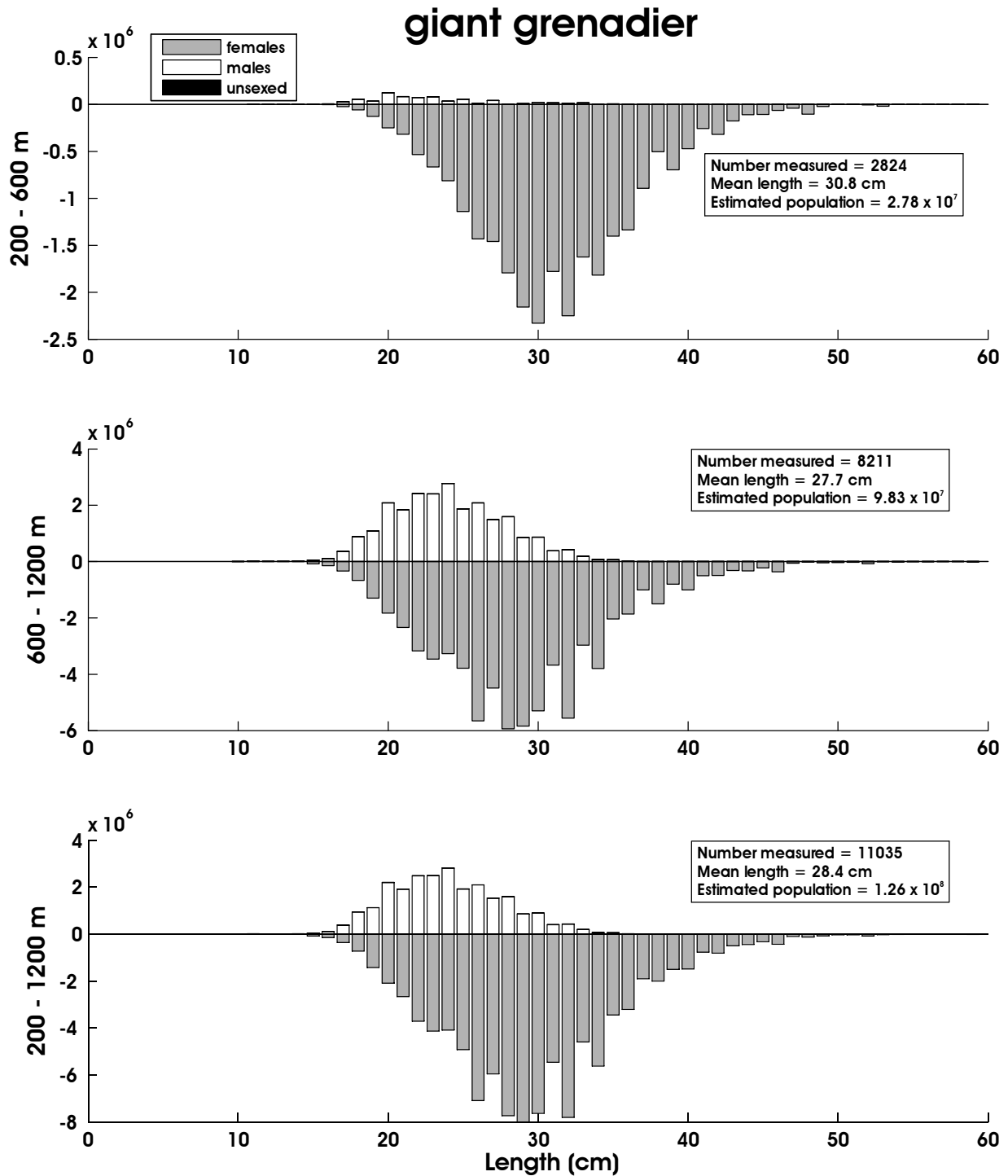

Figure 23. - Size composition of the estimated giant grenadier population from the 2008 EBSS survey for all subareas by depth. The abscissa is scaled as total length in centimeters while the ordinate represents the estimated total population.

Table 20. - Abundance estimates by subarea and depth stratum for Pacific grenadier
(*Coryphaenoides acrolepis*) from the 2008 EBSS survey.

<i>Coryphaenoides acrolepis</i>						Pacific grenadier	
Subarea	Depth Stratum (m)	Biomass (t)	Population	Biomass Variance	Population Variance	Average CPUE (kg/ha)	Average CPUE (no./ha)
1	200-400	0.00E+00	0.00E+00	0.00E+00	0.00E+00	0.00E+00	0.00E+00
	400-600	0.00E+00	0.00E+00	0.00E+00	0.00E+00	0.00E+00	0.00E+00
	600-800	3.97E-01	3.31E+03	1.57E-01	1.09E+07	2.28E-03	1.90E-02
	800-1,000	5.66E+00	3.67E+03	3.20E+01	1.35E+07	4.18E-02	2.71E-02
	1,000-1,200	1.85E+02	5.55E+05	9.02E+03	9.53E+10	1.67E+00	5.02E+00
2	200-400	0.00E+00	0.00E+00	0.00E+00	0.00E+00	0.00E+00	0.00E+00
	400-600	0.00E+00	0.00E+00	0.00E+00	0.00E+00	0.00E+00	0.00E+00
	600-800	0.00E+00	0.00E+00	0.00E+00	0.00E+00	0.00E+00	0.00E+00
	800-1,000	5.64E-02	9.40E+03	3.18E-03	8.83E+07	1.02E-03	1.70E-01
	1,000-1,200	1.42E+03	1.67E+06	7.32E+05	1.51E+12	2.65E+01	3.11E+01
3	200-400	0.00E+00	0.00E+00	0.00E+00	0.00E+00	0.00E+00	0.00E+00
	400-600	0.00E+00	0.00E+00	0.00E+00	0.00E+00	0.00E+00	0.00E+00
	600-800	0.00E+00	0.00E+00	0.00E+00	0.00E+00	0.00E+00	0.00E+00
	800-1,000	3.55E+02	1.67E+06	1.90E+04	2.78E+11	4.85E+00	2.28E+01
	1,000-1,200	5.52E+02	1.94E+06	1.09E+04	8.35E+10	8.17E+00	2.87E+01
4	200-400	0.00E+00	0.00E+00	0.00E+00	0.00E+00	0.00E+00	0.00E+00
	400-600	0.00E+00	0.00E+00	0.00E+00	0.00E+00	0.00E+00	0.00E+00
	600-800	0.00E+00	0.00E+00	0.00E+00	0.00E+00	0.00E+00	0.00E+00
	800-1,000	1.33E+02	1.04E+06	5.86E+03	8.56E+11	1.89E+00	1.48E+01
	1,000-1,200	6.66E+02	2.14E+06	1.21E+05	2.74E+11	1.01E+01	3.24E+01
5	200-400	0.00E+00	0.00E+00	0.00E+00	0.00E+00	0.00E+00	0.00E+00
	400-600	0.00E+00	0.00E+00	0.00E+00	0.00E+00	0.00E+00	0.00E+00
	600-800	0.00E+00	0.00E+00	0.00E+00	0.00E+00	0.00E+00	0.00E+00
	800-1,000	1.97E+02	1.87E+06	1.87E+03	1.48E+11	3.57E+00	3.40E+01
	1,000-1,200	2.87E+02	1.93E+06	5.24E+03	4.53E+11	5.04E+00	3.39E+01
6	200-400	0.00E+00	0.00E+00	0.00E+00	0.00E+00	0.00E+00	0.00E+00
	400-600	0.00E+00	0.00E+00	0.00E+00	0.00E+00	0.00E+00	0.00E+00
	600-800	0.00E+00	0.00E+00	0.00E+00	0.00E+00	0.00E+00	0.00E+00
	800-1,000	3.06E+01	3.83E+05	2.66E+02	3.49E+10	4.74E-01	5.94E+00
	1,000-1,200	2.43E+02	1.51E+06	6.14E+02	1.37E+09	4.89E+00	3.05E+01
1-6	200-1,200	4.07E+03	1.47E+07	9.06E+05	3.73E+12	1.01E+00	3.67E+00

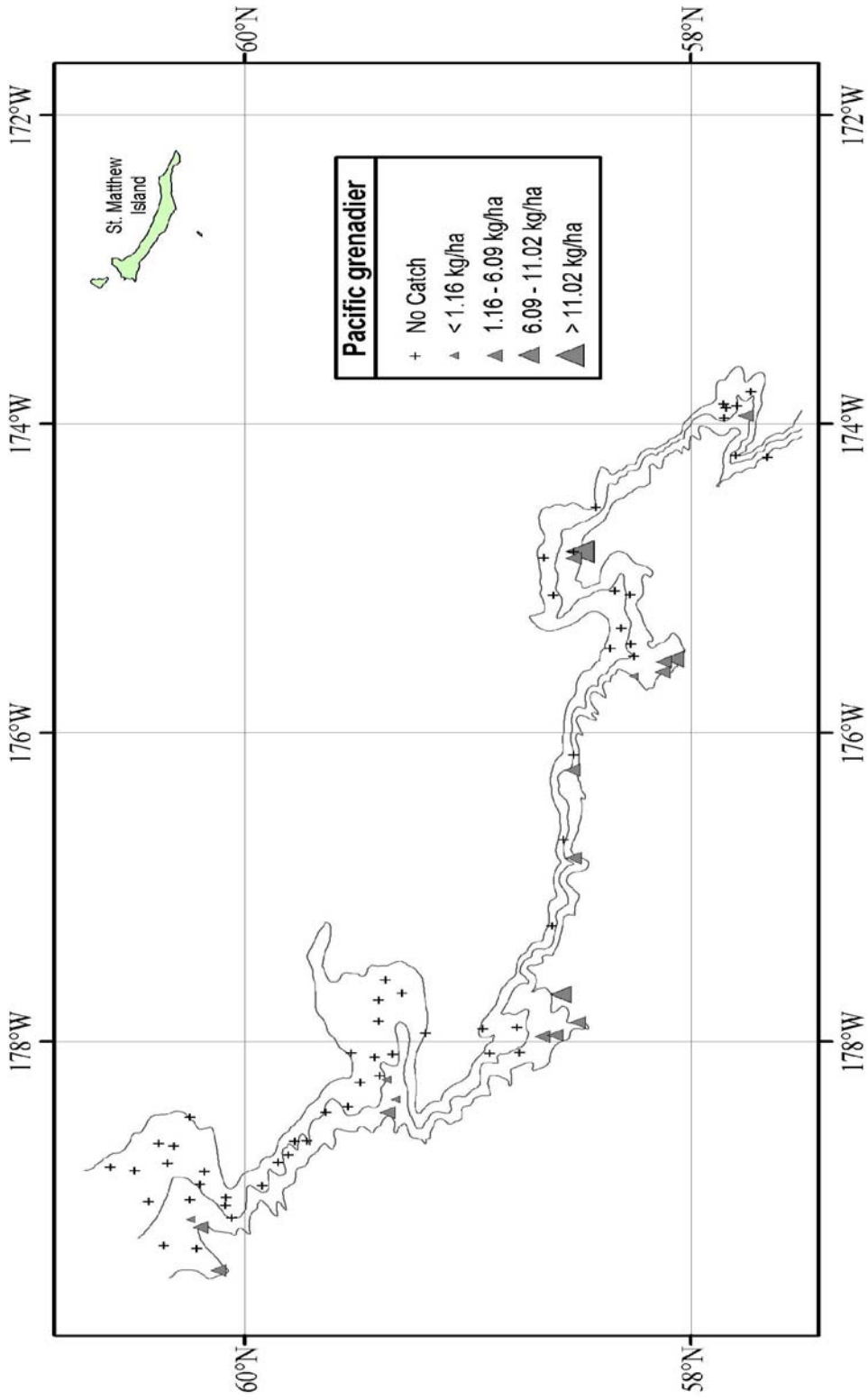

Figure 24. - - Distribution and relative abundance of Pacific grenadier from the 2008 EBSS survey. Relative abundance is categorized by no catch, sample CPUE less than the mean CPUE, between the mean CPUE and one standard deviation above the mean, between one and two standard deviations above the mean CPUE, and greater than two standard deviations above the mean CPUE.

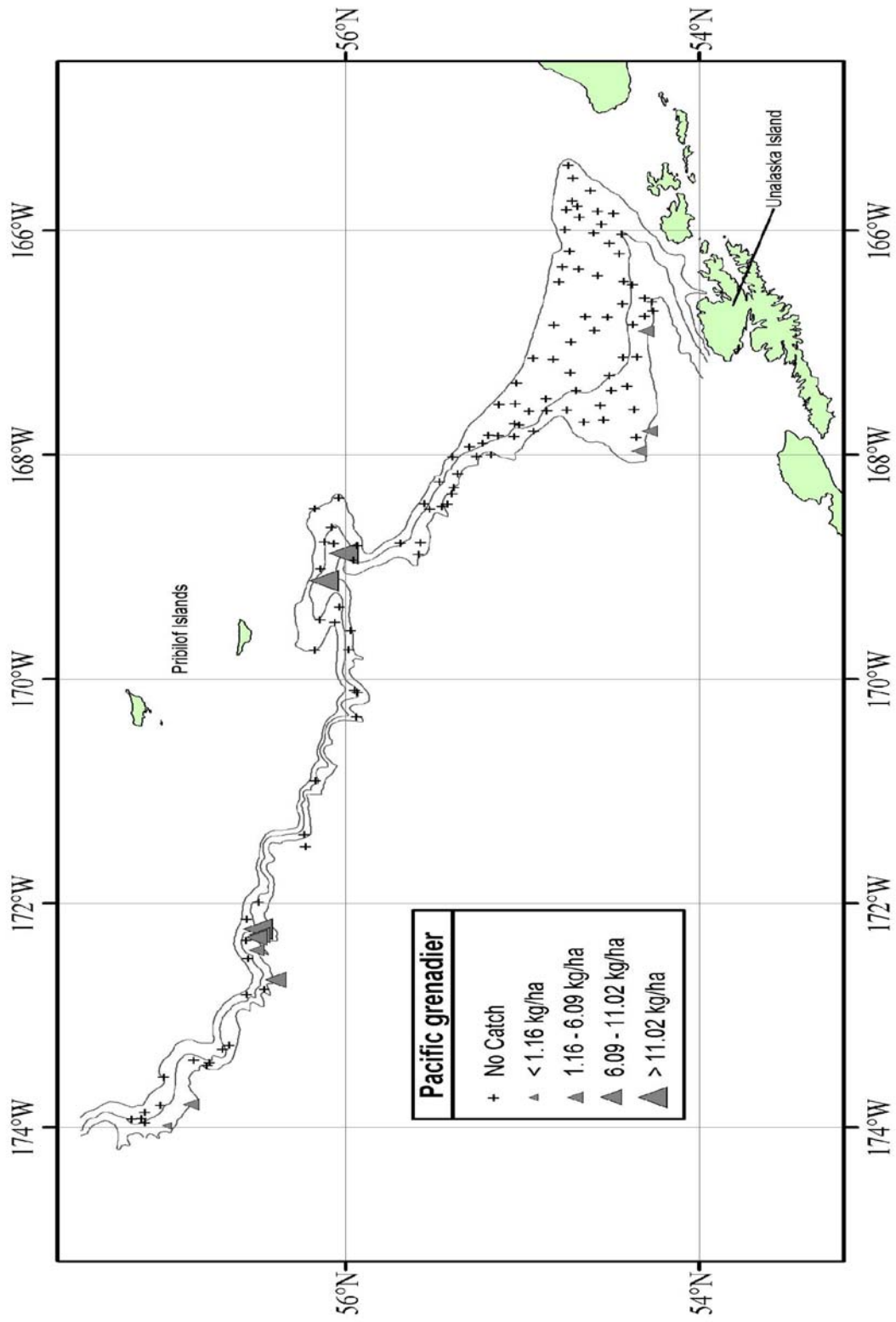

Figure 24. - - Continued.

Pacific grenadier

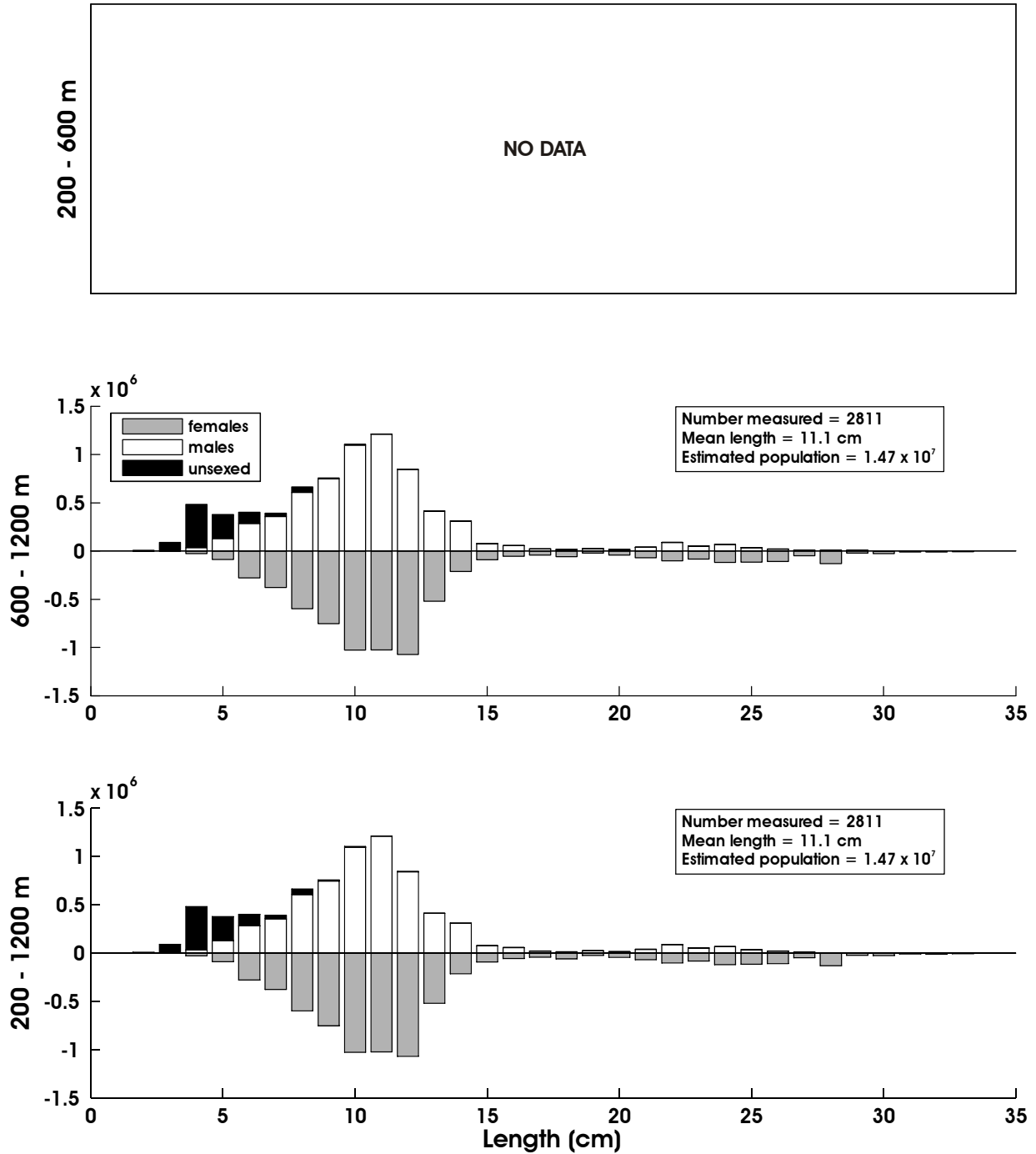

Figure 25. - Size composition of the estimated Pacific grenadier population from the 2008 EBSS survey for all subareas by depth. The abscissa is scaled as total length in centimeters while the ordinate represents the estimated total population.

Table 21. - Abundance estimates by subarea and depth stratum for popeye grenadier (*Coryphaenoides cinereus*) from the 2008 EBSS survey.

<i>Coryphaenoides cinereus</i>						popeye grenadier	
Subarea	Depth Stratum (m)	Biomass (t)	Population	Biomass Variance	Population Variance	Average CPUE (kg/ha)	Average CPUE (no./ha)
1	200-400	0.00E+00	0.00E+00	0.00E+00	0.00E+00	0.00E+00	0.00E+00
	400-600	2.46E+02	8.31E+05	2.30E+04	2.50E+11	6.06E-01	2.04E+00
	600-800	1.54E+03	6.14E+06	2.19E+05	3.86E+12	8.86E+00	3.53E+01
	800-1,000	5.22E+03	2.40E+07	1.31E+06	2.51E+13	3.85E+01	1.77E+02
	1,000-1,200	3.72E+03	1.76E+07	4.03E+05	1.17E+13	3.36E+01	1.59E+02
2	200-400	0.00E+00	0.00E+00	0.00E+00	0.00E+00	0.00E+00	0.00E+00
	400-600	2.74E+01	7.89E+04	5.10E+02	3.54E+09	3.89E-01	1.12E+00
	600-800	8.42E+01	3.24E+05	2.20E+03	3.49E+10	1.42E+00	5.48E+00
	800-1,000	2.82E+03	1.26E+07	9.72E+05	1.35E+13	5.10E+01	2.28E+02
	1,000-1,200	4.89E+03	2.30E+07	7.86E+04	3.10E+12	9.14E+01	4.30E+02
3	200-400	0.00E+00	0.00E+00	0.00E+00	0.00E+00	0.00E+00	0.00E+00
	400-600	4.95E+02	2.24E+06	1.32E+05	2.76E+12	5.59E+00	2.53E+01
	600-800	5.05E+03	3.69E+07	3.17E+06	2.14E+14	5.55E+01	4.05E+02
	800-1,000	3.26E+03	2.03E+07	3.33E+05	1.16E+13	4.45E+01	2.77E+02
	1,000-1,200	2.51E+03	1.50E+07	5.12E+05	1.47E+13	3.72E+01	2.21E+02
4	200-400	0.00E+00	0.00E+00	0.00E+00	0.00E+00	0.00E+00	0.00E+00
	400-600	6.10E+02	2.91E+06	1.41E+05	3.30E+12	8.35E+00	3.99E+01
	600-800	2.18E+03	1.14E+07	7.76E+04	2.83E+12	3.14E+01	1.65E+02
	800-1,000	3.02E+03	2.21E+07	1.71E+06	8.22E+13	4.27E+01	3.12E+02
	1,000-1,200	2.31E+03	1.64E+07	7.20E+05	4.76E+13	3.49E+01	2.48E+02
5	200-400	0.00E+00	0.00E+00	0.00E+00	0.00E+00	0.00E+00	0.00E+00
	400-600	2.27E+00	8.67E+03	5.16E+00	7.52E+07	5.34E-02	2.04E-01
	600-800	2.32E+03	2.45E+07	1.44E+06	2.56E+14	5.37E+01	5.67E+02
	800-1,000	1.34E+03	8.61E+06	6.74E+04	3.50E+12	2.43E+01	1.56E+02
	1,000-1,200	1.83E+03	1.42E+07	4.43E+05	5.14E+13	3.21E+01	2.49E+02
6	200-400	0.00E+00	0.00E+00	0.00E+00	0.00E+00	0.00E+00	0.00E+00
	400-600	3.90E+02	2.38E+06	1.32E+05	5.15E+12	2.29E+00	1.39E+01
	600-800	2.58E+03	1.83E+07	1.22E+06	7.20E+13	2.81E+01	2.00E+02
	800-1,000	2.05E+03	1.55E+07	4.94E+05	4.03E+13	3.18E+01	2.41E+02
	1,000-1,200	5.80E+02	4.04E+06	6.51E+04	4.45E+12	1.17E+01	8.13E+01
1-6	200-1,200	4.91E+04	2.99E+08	1.37E+07	8.70E+14	1.24E+01	7.66E+01

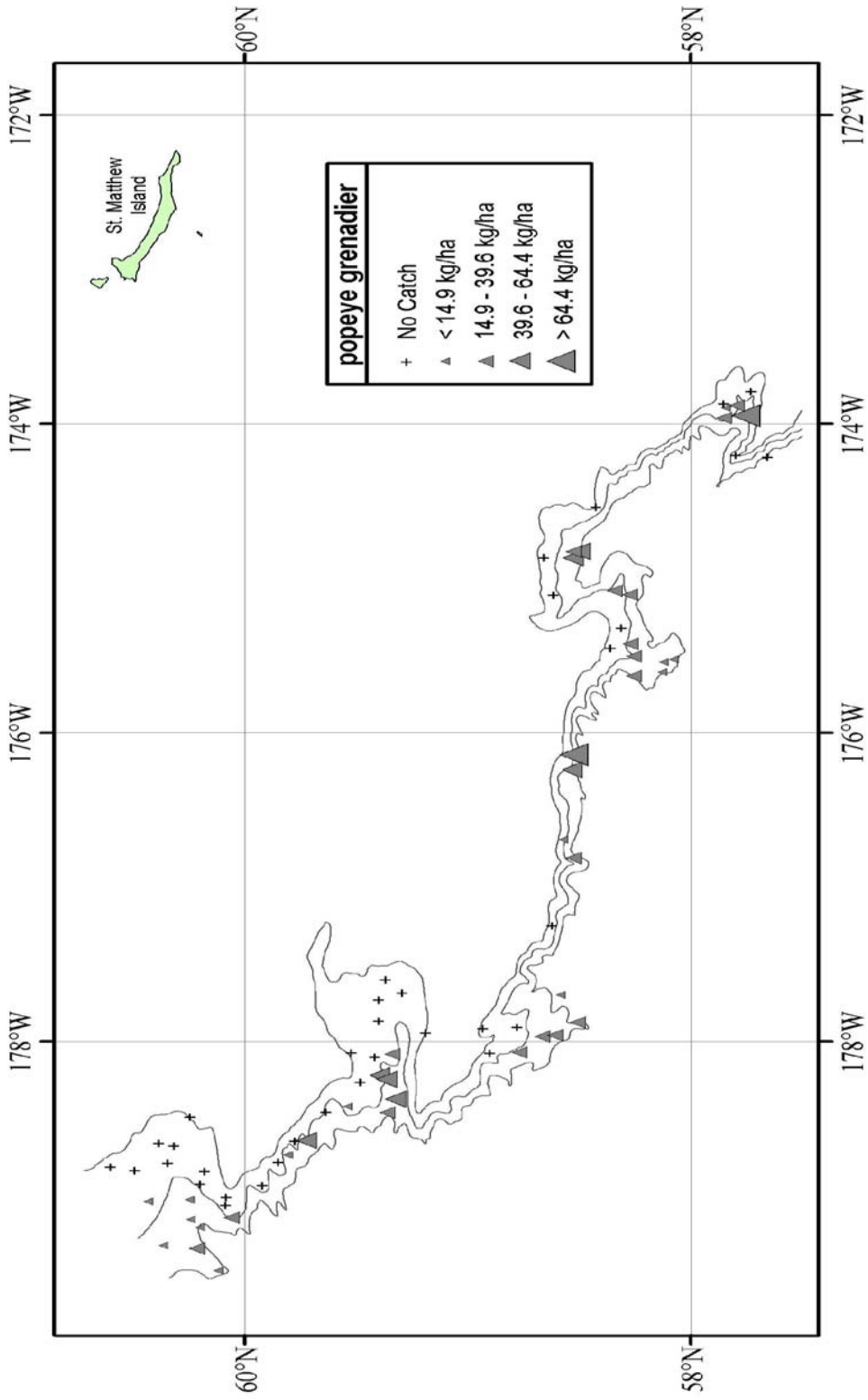

Figure 26. - - Distribution and relative abundance of popeye grenadier from the 2008 EBSS survey. Relative abundance is categorized by no catch, sample CPUE less than the mean CPUE, between the mean CPUE and one standard deviation above the mean, between one and two standard deviations above the mean CPUE, and greater than two standard deviations above the mean CPUE.

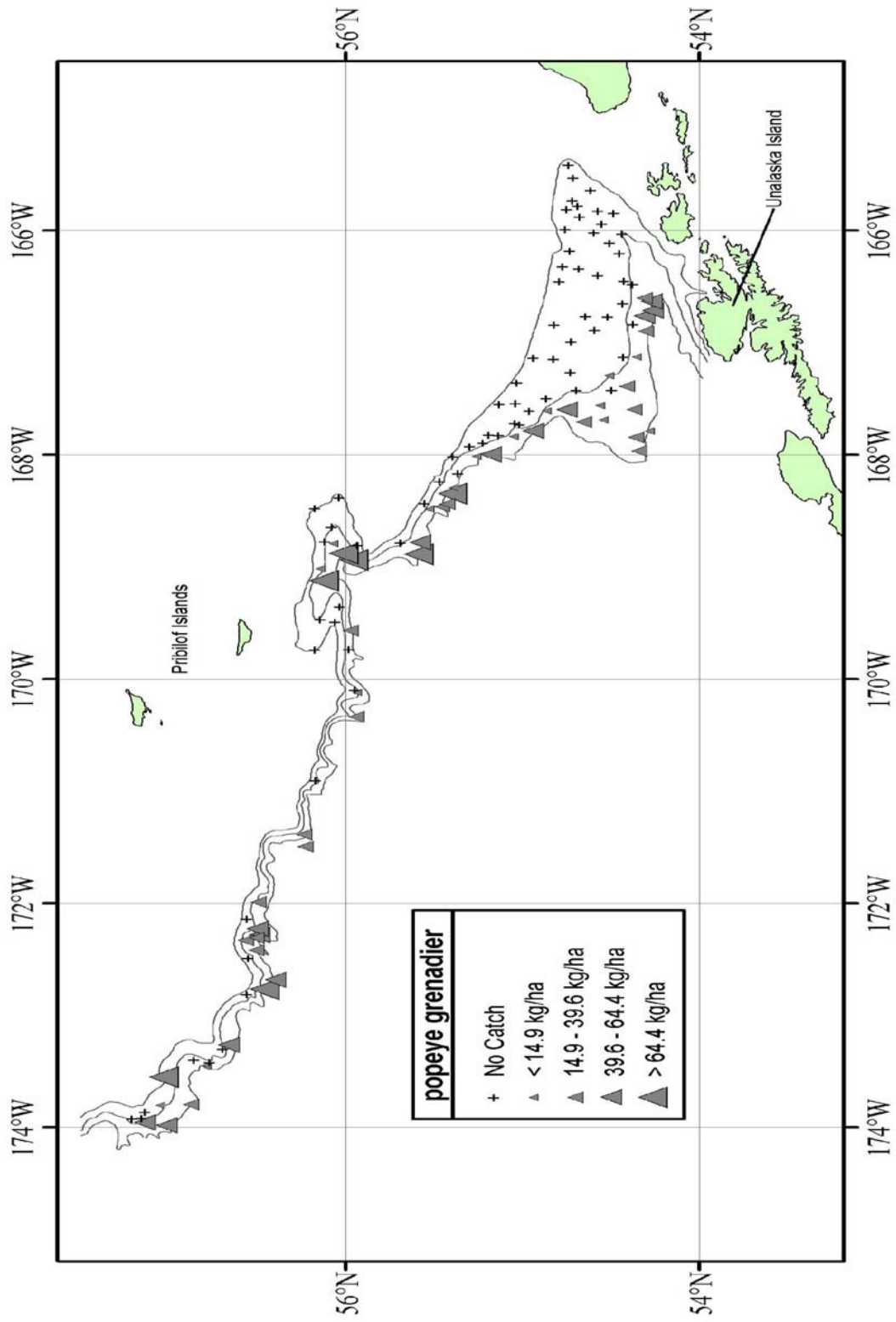

Figure 26. - - Continued.

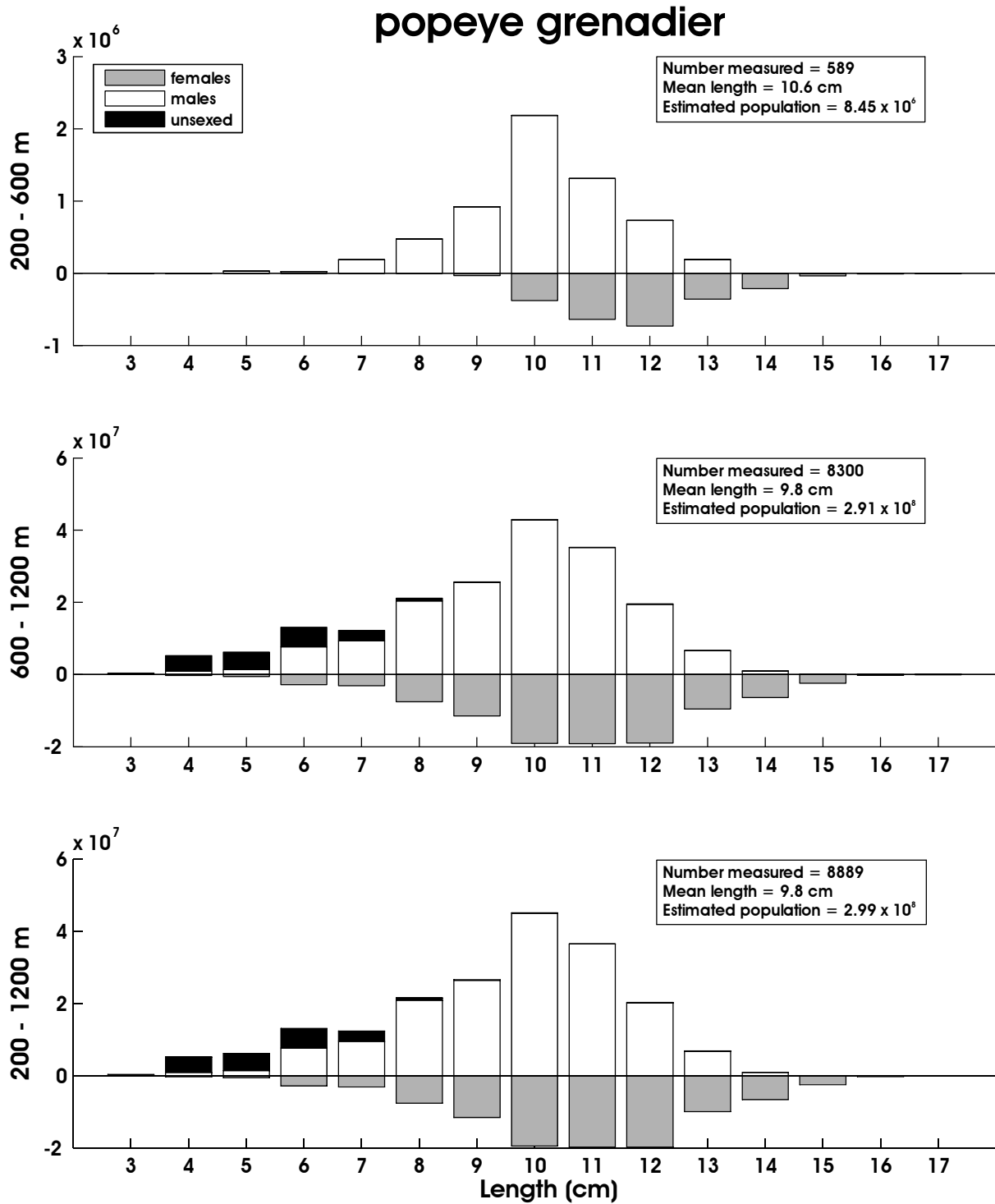

Figure 27. - Size composition of the estimated popeye grenadier population from the 2008 EBSS survey for all subareas by depth. The abscissa is scaled as total length in centimeters while the ordinate represents the estimated total population.

Table 22. - Abundance estimates by subarea and depth stratum for walleye pollock (*Theragra chalcogramma*) from the 2008 EBSS survey.

<i>Theragra chalcogramma</i>						walleye pollock	
Subarea	Depth Stratum (m)	Biomass (t)	Population	Biomass Variance	Population Variance	Average CPUE (kg/ha)	Average CPUE (no./ha)
1	200-400	4.72E+03	4.53E+06	1.71E+06	1.53E+12	1.18E+01	1.13E+01
	400-600	2.48E+03	2.70E+06	9.91E+05	1.24E+12	6.11E+00	6.64E+00
	600-800	2.20E+00	3.32E+03	4.86E+00	1.10E+07	1.27E-02	1.91E-02
	800-1,000	0.00E+00	0.00E+00	0.00E+00	0.00E+00	0.00E+00	0.00E+00
	1,000-1,200	0.00E+00	0.00E+00	0.00E+00	0.00E+00	0.00E+00	0.00E+00
2	200-400	4.07E+02	4.74E+05	6.22E+04	9.52E+10	3.52E+00	4.10E+00
	400-600	1.73E+01	2.36E+04	8.90E+01	1.93E+08	2.45E-01	3.34E-01
	600-800	4.46E+01	4.63E+04	1.60E+03	1.75E+09	7.54E-01	7.82E-01
	800-1,000	0.00E+00	0.00E+00	0.00E+00	0.00E+00	0.00E+00	0.00E+00
	1,000-1,200	0.00E+00	0.00E+00	0.00E+00	0.00E+00	0.00E+00	0.00E+00
3	200-400	2.85E+02	1.92E+05	2.12E+04	7.59E+09	3.15E+00	2.12E+00
	400-600	1.31E+01	8.61E+03	1.71E+02	7.41E+07	1.48E-01	9.72E-02
	600-800	0.00E+00	0.00E+00	0.00E+00	0.00E+00	0.00E+00	0.00E+00
	800-1,000	0.00E+00	0.00E+00	0.00E+00	0.00E+00	0.00E+00	0.00E+00
	1,000-1,200	0.00E+00	0.00E+00	0.00E+00	0.00E+00	0.00E+00	0.00E+00
4	200-400	2.35E+02	2.04E+05	2.29E+04	1.81E+10	1.90E+00	1.65E+00
	400-600	1.21E+01	1.08E+04	7.25E+01	5.12E+07	1.65E-01	1.48E-01
	600-800	0.00E+00	0.00E+00	0.00E+00	0.00E+00	0.00E+00	0.00E+00
	800-1,000	0.00E+00	0.00E+00	0.00E+00	0.00E+00	0.00E+00	0.00E+00
	1,000-1,200	0.00E+00	0.00E+00	0.00E+00	0.00E+00	0.00E+00	0.00E+00
5	200-400	3.43E+03	3.39E+06	8.52E+05	1.46E+12	8.10E+01	7.99E+01
	400-600	0.00E+00	0.00E+00	0.00E+00	0.00E+00	0.00E+00	0.00E+00
	600-800	0.00E+00	0.00E+00	0.00E+00	0.00E+00	0.00E+00	0.00E+00
	800-1,000	0.00E+00	0.00E+00	0.00E+00	0.00E+00	0.00E+00	0.00E+00
	1,000-1,200	0.00E+00	0.00E+00	0.00E+00	0.00E+00	0.00E+00	0.00E+00
6	200-400	1.47E+04	1.35E+07	2.89E+07	2.36E+13	5.65E+01	5.20E+01
	400-600	0.00E+00	0.00E+00	0.00E+00	0.00E+00	0.00E+00	0.00E+00
	600-800	0.00E+00	0.00E+00	0.00E+00	0.00E+00	0.00E+00	0.00E+00
	800-1,000	0.00E+00	0.00E+00	0.00E+00	0.00E+00	0.00E+00	0.00E+00
	1,000-1,200	0.00E+00	0.00E+00	0.00E+00	0.00E+00	0.00E+00	0.00E+00
1-6	200-1,200	2.63E+04	2.51E+07	3.26E+07	2.79E+13	2.00E+01	1.95E+01

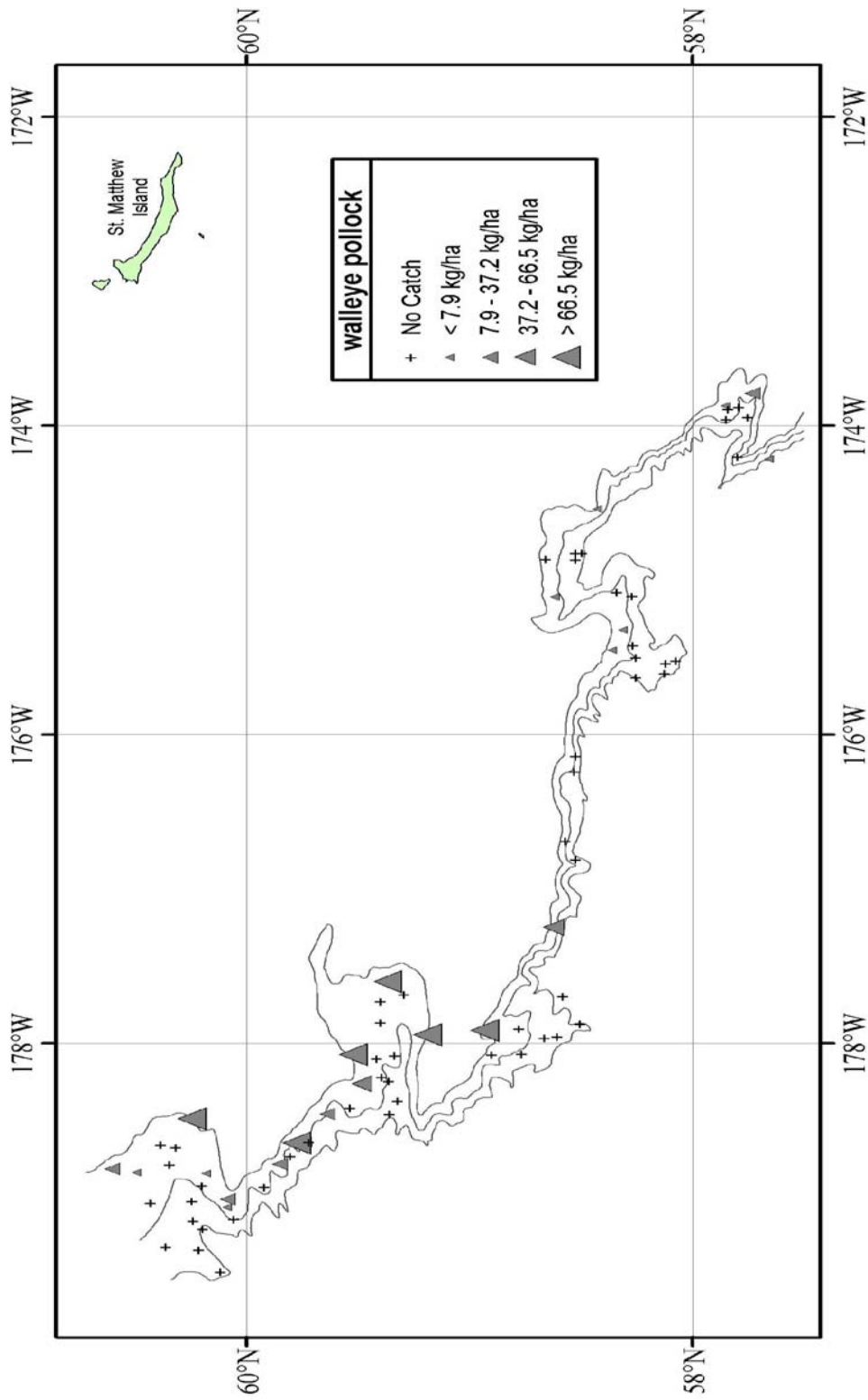

Figure 28. - - Distribution and relative abundance of walleye pollock from the 2008 EBSS survey. Relative abundance is categorized by no catch, sample CPUE less than the mean CPUE, between the mean CPUE and one standard deviation above the mean, between one and two standard deviations above the mean CPUE, and greater than two standard deviations above the mean CPUE.

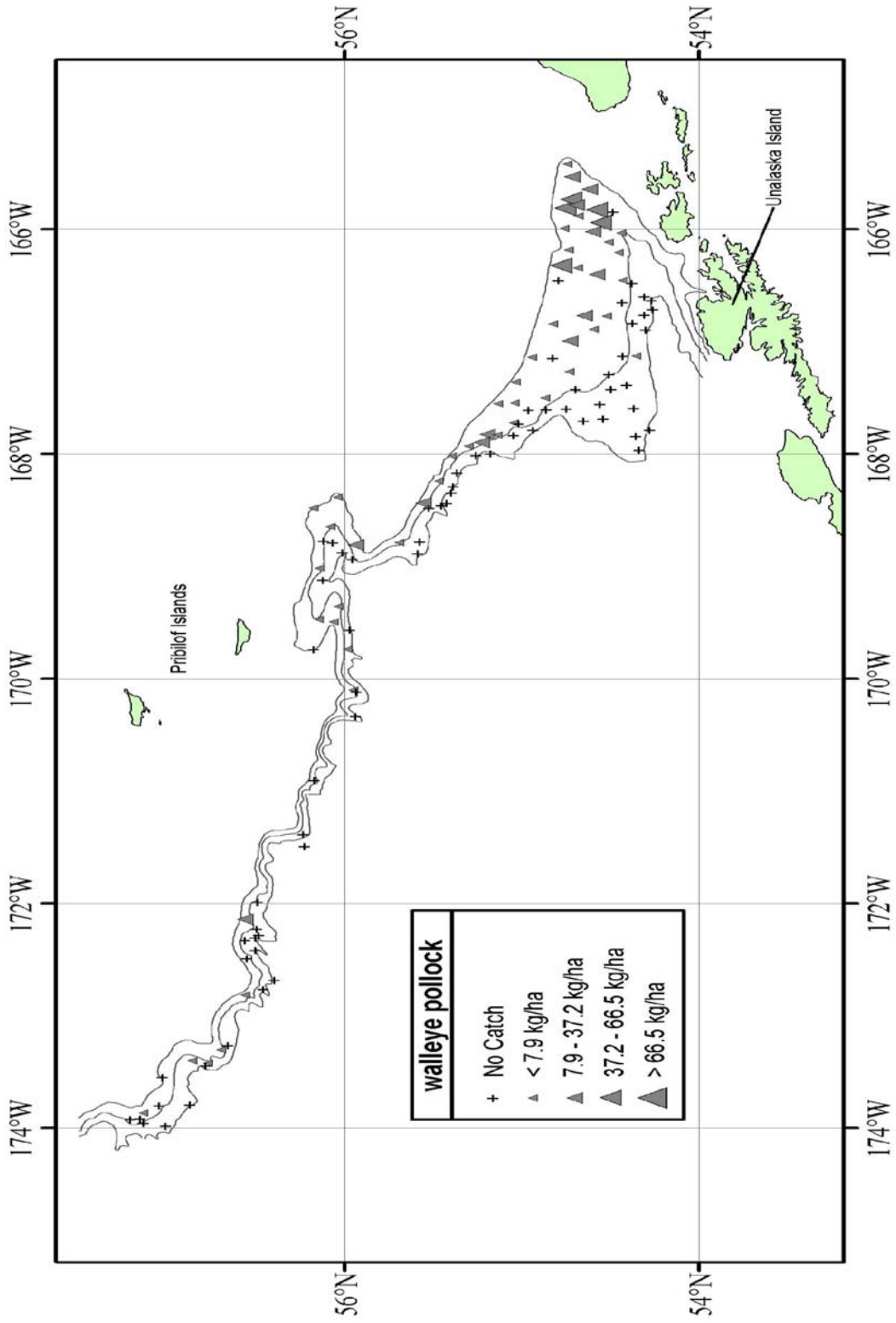

Figure 28. - - Continued.

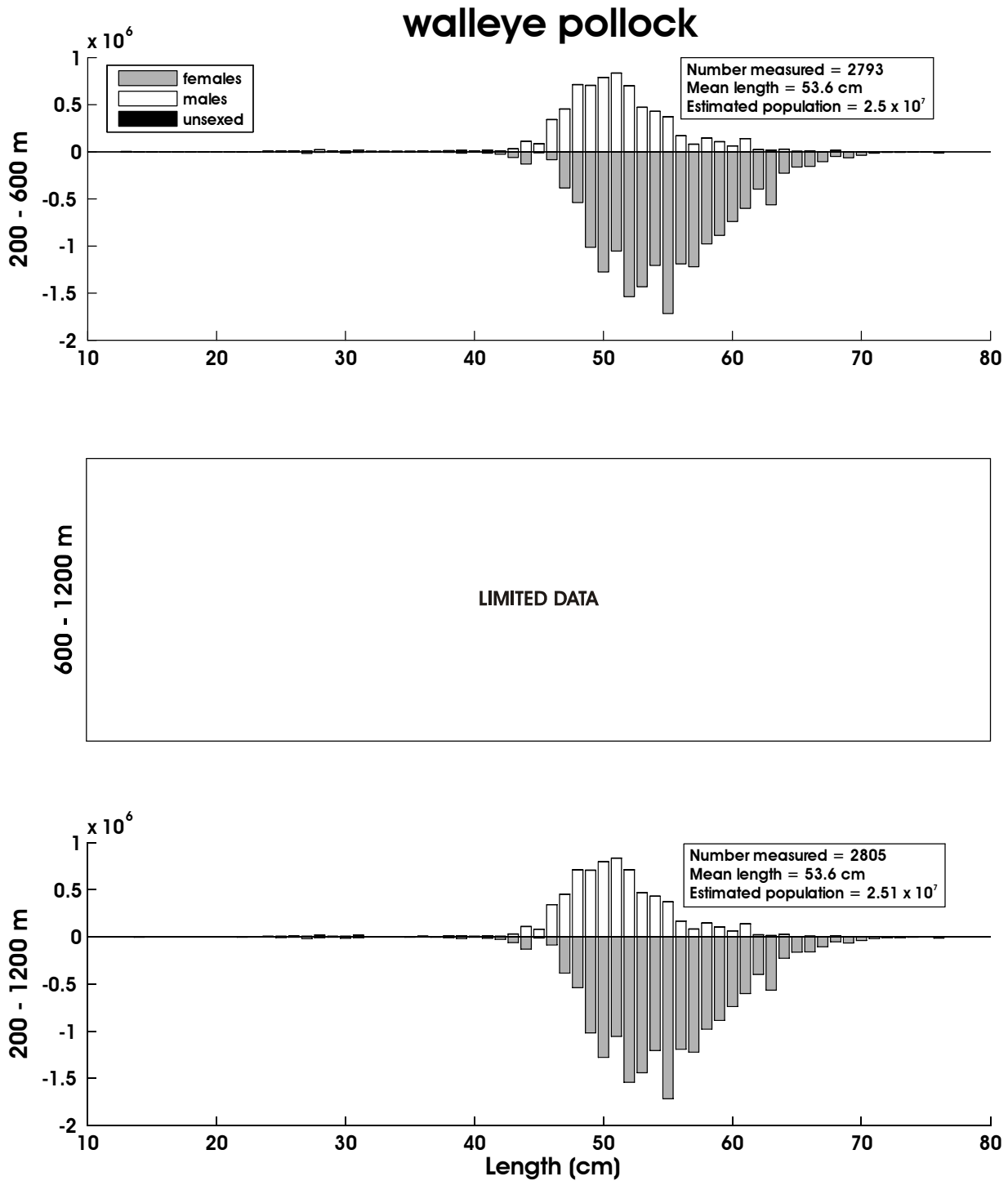

Figure 29. - Size composition of the estimated walleye pollock population from the 2008 EBSS survey for all subareas by depth. The abscissa is scaled as total length in centimeters while the ordinate represents the estimated total population.

Table 23. - Abundance estimates by subarea and depth stratum for Pacific cod (*Gadus macrocephalus*) from the 2008 EBSS survey.

<i>Gadus macrocephalus</i>						Pacific cod	
Subarea	Depth Stratum (m)	Biomass (t)	Population	Biomass Variance	Population Variance	Average CPUE (kg/ha)	Average CPUE (no./ha)
1	200-400	6.38E+02	3.22E+05	2.98E+04	8.38E+09	1.59E+00	8.03E-01
	400-600	0.00E+00	0.00E+00	0.00E+00	0.00E+00	0.00E+00	0.00E+00
	600-800	0.00E+00	0.00E+00	0.00E+00	0.00E+00	0.00E+00	0.00E+00
	800-1,000	0.00E+00	0.00E+00	0.00E+00	0.00E+00	0.00E+00	0.00E+00
	1,000-1,200	0.00E+00	0.00E+00	0.00E+00	0.00E+00	0.00E+00	0.00E+00
2	200-400	1.09E+03	3.22E+05	3.73E+04	1.58E+09	9.43E+00	2.78E+00
	400-600	0.00E+00	0.00E+00	0.00E+00	0.00E+00	0.00E+00	0.00E+00
	600-800	0.00E+00	0.00E+00	0.00E+00	0.00E+00	0.00E+00	0.00E+00
	800-1,000	0.00E+00	0.00E+00	0.00E+00	0.00E+00	0.00E+00	0.00E+00
	1,000-1,200	0.00E+00	0.00E+00	0.00E+00	0.00E+00	0.00E+00	0.00E+00
3	200-400	3.96E+02	1.40E+05	3.20E+04	3.31E+09	4.38E+00	1.55E+00
	400-600	0.00E+00	0.00E+00	0.00E+00	0.00E+00	0.00E+00	0.00E+00
	600-800	0.00E+00	0.00E+00	0.00E+00	0.00E+00	0.00E+00	0.00E+00
	800-1,000	0.00E+00	0.00E+00	0.00E+00	0.00E+00	0.00E+00	0.00E+00
	1,000-1,200	0.00E+00	0.00E+00	0.00E+00	0.00E+00	0.00E+00	0.00E+00
4	200-400	6.91E+02	2.15E+05	6.74E+04	9.06E+09	5.59E+00	1.74E+00
	400-600	0.00E+00	0.00E+00	0.00E+00	0.00E+00	0.00E+00	0.00E+00
	600-800	0.00E+00	0.00E+00	0.00E+00	0.00E+00	0.00E+00	0.00E+00
	800-1,000	0.00E+00	0.00E+00	0.00E+00	0.00E+00	0.00E+00	0.00E+00
	1,000-1,200	0.00E+00	0.00E+00	0.00E+00	0.00E+00	0.00E+00	0.00E+00
5	200-400	1.18E+02	3.75E+04	1.29E+03	2.02E+07	2.79E+00	8.84E-01
	400-600	0.00E+00	0.00E+00	0.00E+00	0.00E+00	0.00E+00	0.00E+00
	600-800	0.00E+00	0.00E+00	0.00E+00	0.00E+00	0.00E+00	0.00E+00
	800-1,000	0.00E+00	0.00E+00	0.00E+00	0.00E+00	0.00E+00	0.00E+00
	1,000-1,200	0.00E+00	0.00E+00	0.00E+00	0.00E+00	0.00E+00	0.00E+00
6	200-400	5.91E+02	1.25E+05	3.88E+04	1.82E+09	2.28E+00	4.80E-01
	400-600	0.00E+00	0.00E+00	0.00E+00	0.00E+00	0.00E+00	0.00E+00
	600-800	0.00E+00	0.00E+00	0.00E+00	0.00E+00	0.00E+00	0.00E+00
	800-1,000	0.00E+00	0.00E+00	0.00E+00	0.00E+00	0.00E+00	0.00E+00
	1,000-1,200	0.00E+00	0.00E+00	0.00E+00	0.00E+00	0.00E+00	0.00E+00
1-6	200-1,200	3.53E+03	1.16E+06	2.07E+05	2.42E+10	1.90E+00	9.82E-01

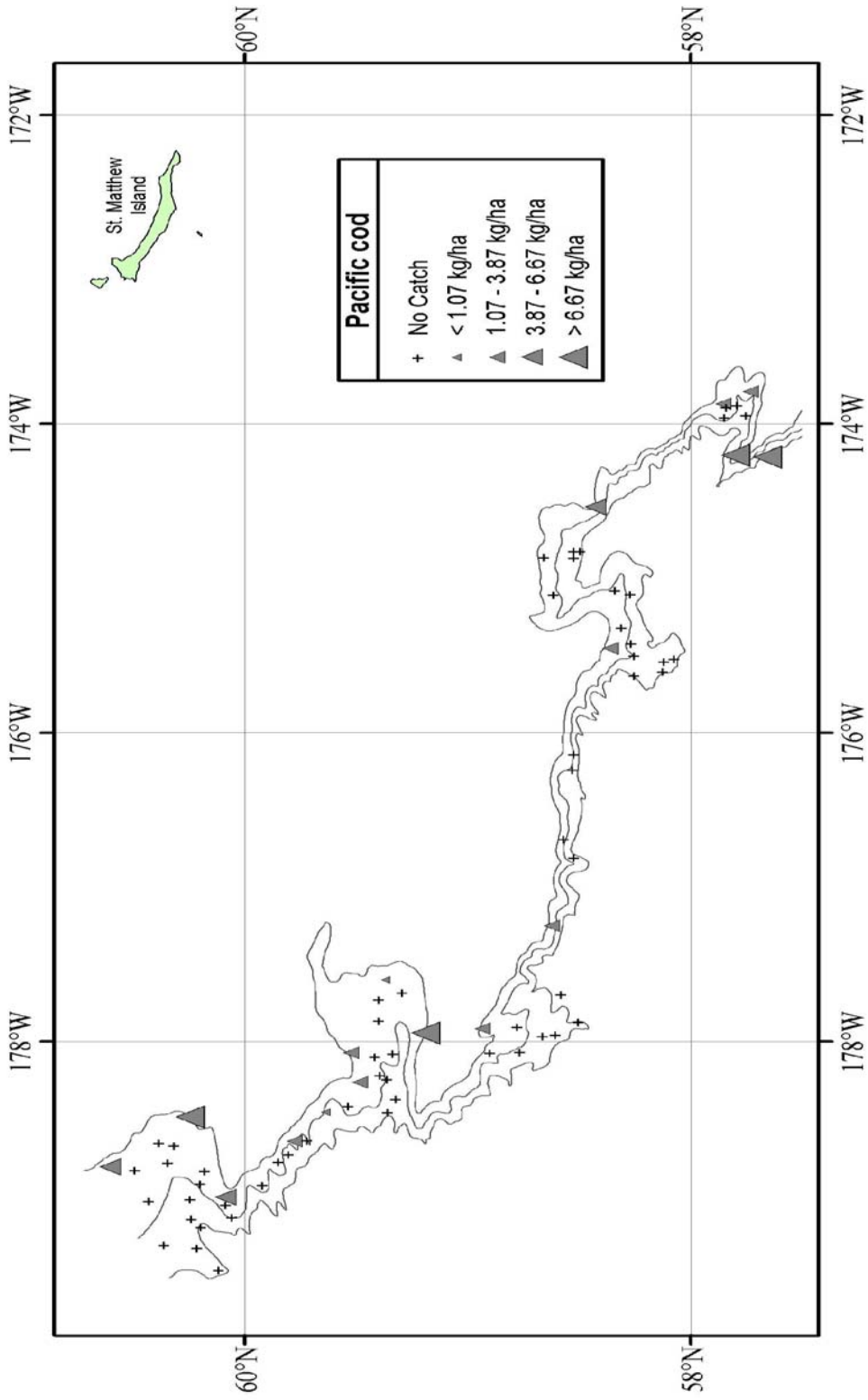

Figure 30. - - Distribution and relative abundance of Pacific cod from the 2880 EBSS survey. Relative abundance is categorized by no catch, sample CPUE less than the mean CPUE, between the mean CPUE and one standard deviation above the mean, between one and two standard deviations above the mean CPUE, and greater than two standard deviations above the mean CPUE.

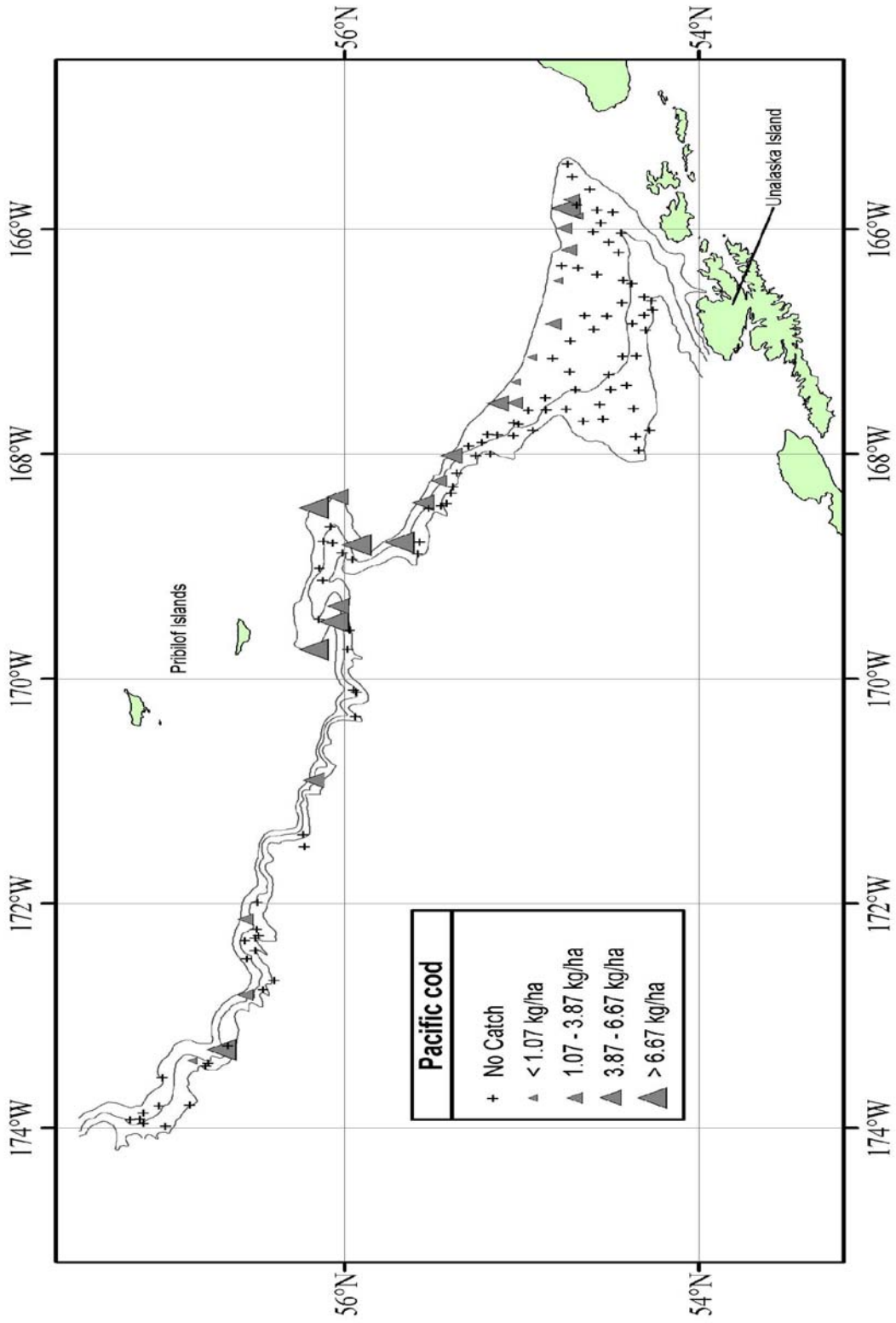

Figure 30. - - Continued.

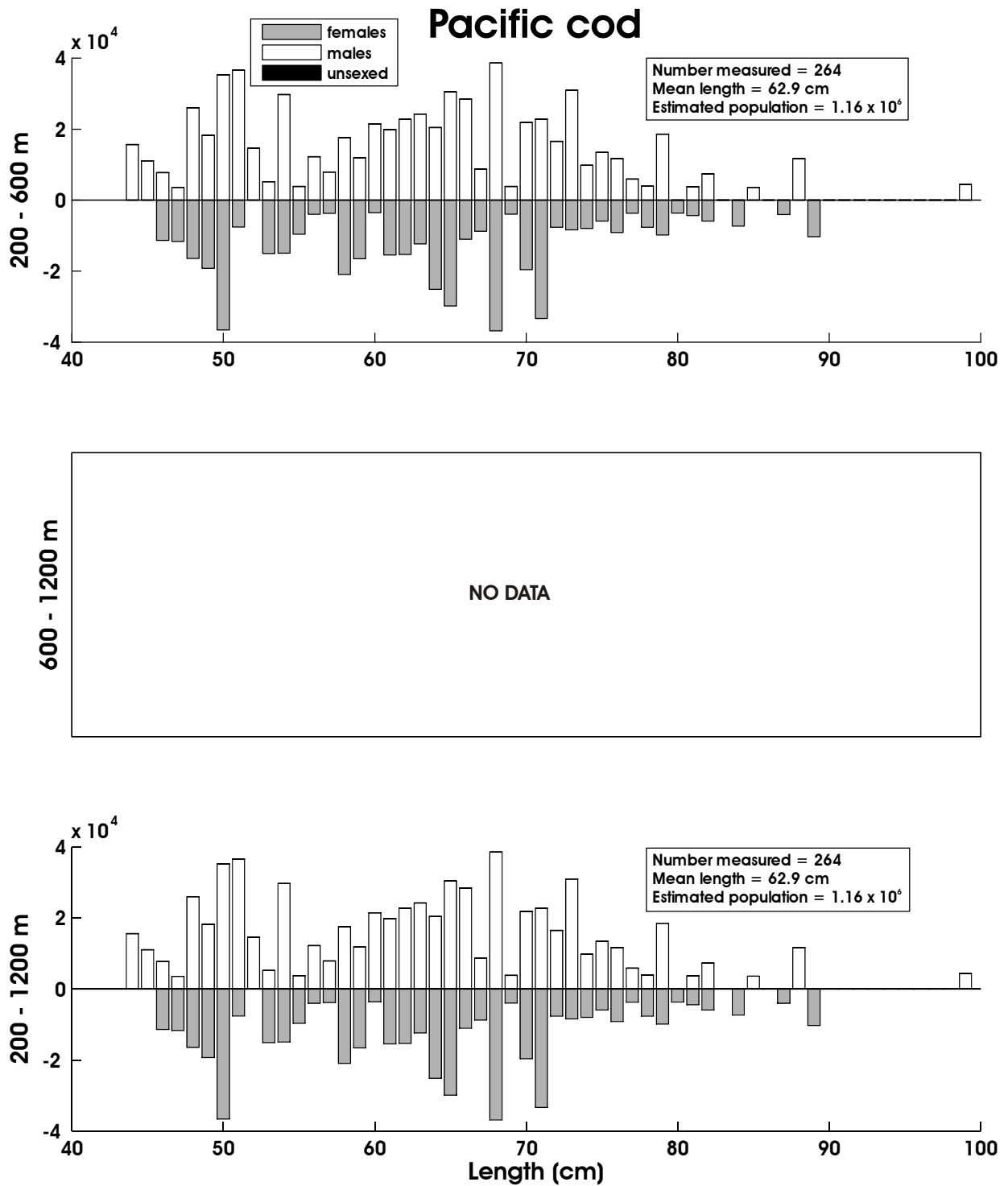

Figure 31. - Size composition of the estimated Pacific cod population from the 2008 EBSS survey for all subareas by depth. The abscissa is scaled as total length in centimeters while the ordinate represents the estimated total population.

Table 24. - - Abundance estimates by subarea and depth stratum for shortspine thornyhead (*Sebastolobus alascanus*) from the 2008 EBSS survey.

<i>Sebastolobus alascanus</i>		shortspine thornyhead					
Subarea	Depth Strata (m)	Biomass (t)	Population	Biomass Variance	Population Variance	Average CPUE (kg/ha)	Average CPUE (no./ha)
1	200-400	7.80E+02	2.46E+06	1.68E+05	1.57E+12	1.94E+00	6.14E+00
	400-600	1.01E+04	1.67E+07	4.54E+06	9.24E+12	2.48E+01	4.12E+01
	600-800	3.36E+03	2.94E+06	2.87E+06	1.86E+12	1.93E+01	1.69E+01
	800-1,000	7.15E+02	5.04E+05	4.47E+04	2.86E+10	5.27E+00	3.72E+00
	1,000-1,200	6.68E+01	5.57E+04	2.74E+03	2.06E+09	6.03E-01	5.03E-01
2	200-400	2.87E+01	3.61E+04	8.25E+02	1.30E+09	2.48E-01	3.12E-01
	400-600	4.34E+03	3.85E+06	2.20E+06	1.76E+12	6.16E+01	5.46E+01
	600-800	6.01E+02	5.69E+05	8.66E+04	1.24E+11	1.02E+01	9.63E+00
	800-1,000	5.99E+02	4.08E+05	6.35E+04	2.79E+10	1.08E+01	7.38E+00
	1,000-1,200	1.09E+02	1.14E+05	6.69E+03	8.50E+09	2.04E+00	2.13E+00
3	200-400	7.28E-03	3.64E+03	5.30E-05	1.32E+07	8.05E-05	4.03E-02
	400-600	8.13E+02	1.40E+06	7.13E+04	3.75E+11	9.17E+00	1.58E+01
	600-800	1.23E+03	1.20E+06	2.86E+05	2.87E+11	1.35E+01	1.32E+01
	800-1,000	1.78E+02	1.31E+05	1.14E+04	7.51E+09	2.43E+00	1.79E+00
	1,000-1,200	0.00E+00	0.00E+00	0.00E+00	0.00E+00	0.00E+00	0.00E+00
4	200-400	1.51E+01	6.20E+03	2.29E+02	3.85E+07	1.22E-01	5.02E-02
	400-600	5.21E+02	1.12E+06	2.55E+04	2.46E+11	7.14E+00	1.54E+01
	600-800	9.28E+02	4.38E+05	1.11E+05	2.62E+10	1.34E+01	6.31E+00
	800-1,000	6.58E+01	2.64E+04	4.33E+03	6.94E+08	9.30E-01	3.72E-01
	1,000-1,200	1.21E+01	3.56E+03	1.46E+02	1.27E+07	1.83E-01	5.37E-02
5	200-400	0.00E+00	0.00E+00	0.00E+00	0.00E+00	0.00E+00	0.00E+00
	400-600	4.96E+02	1.38E+06	8.15E+03	1.36E+11	1.16E+01	3.24E+01
	600-800	2.24E+02	1.99E+05	1.48E+02	3.51E+08	5.19E+00	4.60E+00
	800-1,000	5.53E+01	4.36E+04	1.25E+03	2.52E+08	1.00E+00	7.90E-01
	1,000-1,200	6.22E+01	6.39E+04	3.87E+03	4.09E+09	1.09E+00	1.12E+00
6	200-400	7.75E+00	2.57E+04	4.22E+01	4.90E+08	2.98E-02	9.89E-02
	400-600	4.54E+02	5.22E+05	1.57E+04	2.85E+10	2.66E+00	3.06E+00
	600-800	3.00E+02	1.84E+05	1.14E+04	8.92E+09	3.27E+00	2.01E+00
	800-1,000	2.05E+01	7.20E+03	4.19E+02	5.19E+07	3.17E-01	1.12E-01
	1,000-1,200	0.00E+00	0.00E+00	0.00E+00	0.00E+00	0.00E+00	0.00E+00
1-6	200-1,200	2.61E+04	3.44E+07	1.05E+07	1.58E+13	6.49E+00	1.16E+01

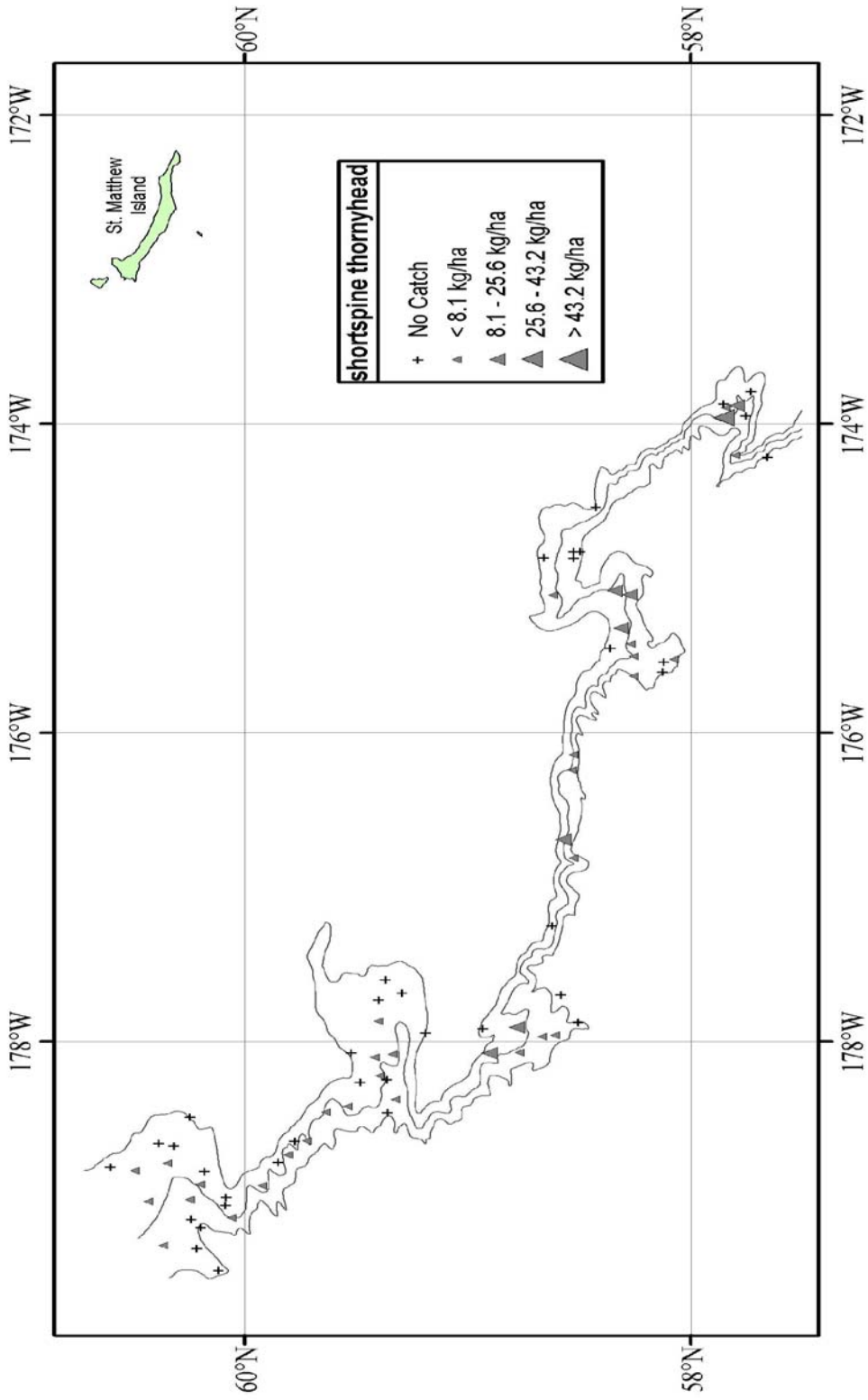

Figure 32. - - Distribution and relative abundance of shortspine thornyhead from the 2008 EBSS survey. Relative abundance is categorized by no catch, sample CPUE less than the mean CPUE, between the mean CPUE and one standard deviation above the mean, between one and two standard deviations above the mean CPUE, and greater than two standard deviations above the mean CPUE.

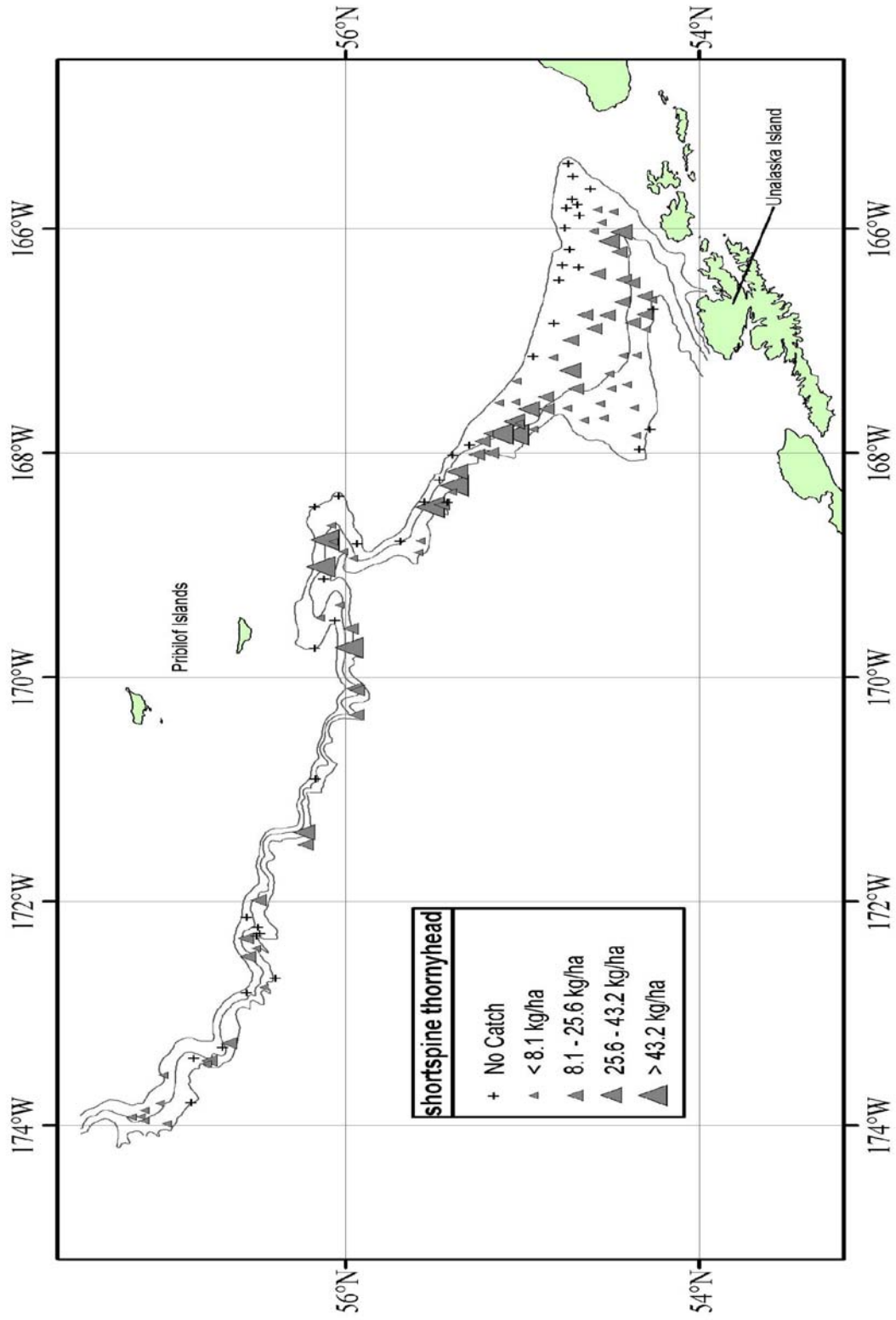

Figure 32. - - Continued.

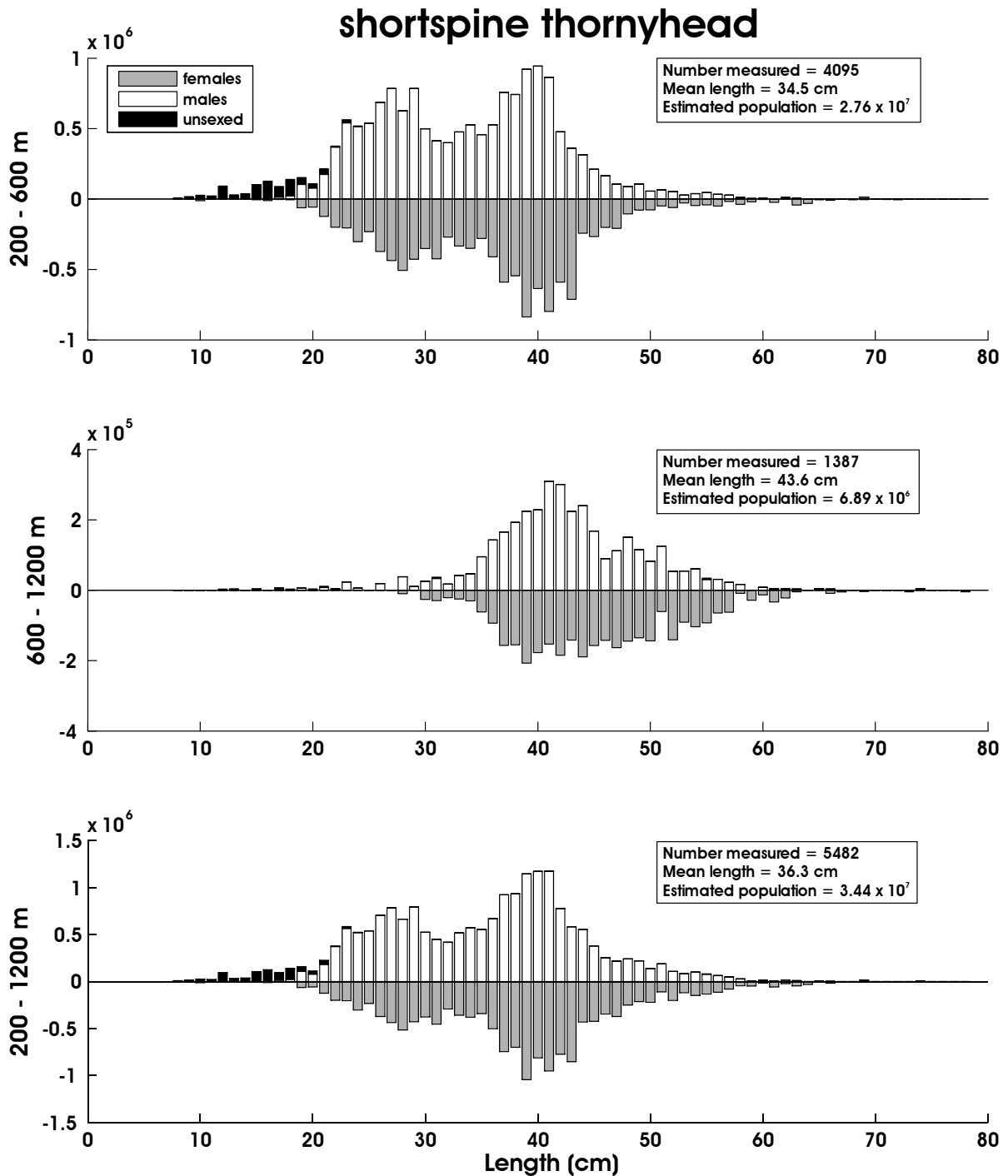

Figure 33. - Size composition of the estimated shortspine thornyhead population from the 2008 EBSS survey for all subareas by depth. The abscissa is scaled as total length in centimeters while the ordinate represents the estimated total population.

Table 25. - Abundance estimates by subarea and depth stratum for Pacific ocean perch
(*Sebastes alutus*) from the 2008 EBSS survey.

<i>Sebastes alutus</i>		Pacific ocean perch					
Subarea	Depth Stratum (m)	Biomass (t)	Population	Biomass Variance	Population Variance	Average CPUE (kg/ha)	Average CPUE (no./ha)
1	200-400	5.10E+03	5.82E+06	1.56E+07	1.93E+13	1.27E+01	1.45E+01
	400-600	3.04E+02	4.01E+05	2.07E+04	3.36E+10	7.49E-01	9.87E-01
	600-800	0.00E+00	0.00E+00	0.00E+00	0.00E+00	0.00E+00	0.00E+00
	800-1,000	0.00E+00	0.00E+00	0.00E+00	0.00E+00	0.00E+00	0.00E+00
	1,000-1,200	0.00E+00	0.00E+00	0.00E+00	0.00E+00	0.00E+00	0.00E+00
2	200-400	1.71E+04	1.74E+07	9.05E+07	7.92E+13	1.48E+02	1.51E+02
	400-600	3.04E+01	3.83E+04	5.04E+02	8.47E+08	4.32E-01	5.43E-01
	600-800	0.00E+00	0.00E+00	0.00E+00	0.00E+00	0.00E+00	0.00E+00
	800-1,000	0.00E+00	0.00E+00	0.00E+00	0.00E+00	0.00E+00	0.00E+00
	1,000-1,200	0.00E+00	0.00E+00	0.00E+00	0.00E+00	0.00E+00	0.00E+00
3	200-400	5.26E+04	5.84E+07	1.01E+09	1.23E+15	5.82E+02	6.47E+02
	400-600	4.19E+01	4.01E+04	1.17E+03	8.87E+08	4.73E-01	4.52E-01
	600-800	0.00E+00	0.00E+00	0.00E+00	0.00E+00	0.00E+00	0.00E+00
	800-1,000	0.00E+00	0.00E+00	0.00E+00	0.00E+00	0.00E+00	0.00E+00
	1,000-1,200	0.00E+00	0.00E+00	0.00E+00	0.00E+00	0.00E+00	0.00E+00
4	200-400	3.14E+04	4.49E+07	7.92E+08	1.69E+15	2.54E+02	3.63E+02
	400-600	2.38E+01	3.22E+04	4.57E+02	7.70E+08	3.27E-01	4.40E-01
	600-800	0.00E+00	0.00E+00	0.00E+00	0.00E+00	0.00E+00	0.00E+00
	800-1,000	0.00E+00	0.00E+00	0.00E+00	0.00E+00	0.00E+00	0.00E+00
	1,000-1,200	0.00E+00	0.00E+00	0.00E+00	0.00E+00	0.00E+00	0.00E+00
5	200-400	1.05E+02	1.37E+05	1.10E+04	1.89E+10	2.47E+00	3.24E+00
	400-600	2.43E+00	4.34E+03	5.90E+00	1.88E+07	5.70E-02	1.02E-01
	600-800	0.00E+00	0.00E+00	0.00E+00	0.00E+00	0.00E+00	0.00E+00
	800-1,000	0.00E+00	0.00E+00	0.00E+00	0.00E+00	0.00E+00	0.00E+00
	1,000-1,200	0.00E+00	0.00E+00	0.00E+00	0.00E+00	0.00E+00	0.00E+00
6	200-400	1.16E+03	2.52E+06	9.74E+05	4.47E+12	4.47E+00	9.70E+00
	400-600	5.41E+00	8.19E+03	2.93E+01	6.71E+07	3.17E-02	4.80E-02
	600-800	0.00E+00	0.00E+00	0.00E+00	0.00E+00	0.00E+00	0.00E+00
	800-1,000	0.00E+00	0.00E+00	0.00E+00	0.00E+00	0.00E+00	0.00E+00
	1,000-1,200	0.00E+00	0.00E+00	0.00E+00	0.00E+00	0.00E+00	0.00E+00
1-6	200-1,200	1.08E+05	1.30E+08	1.91E+09	3.02E+15	3.69E+01	4.23E+01

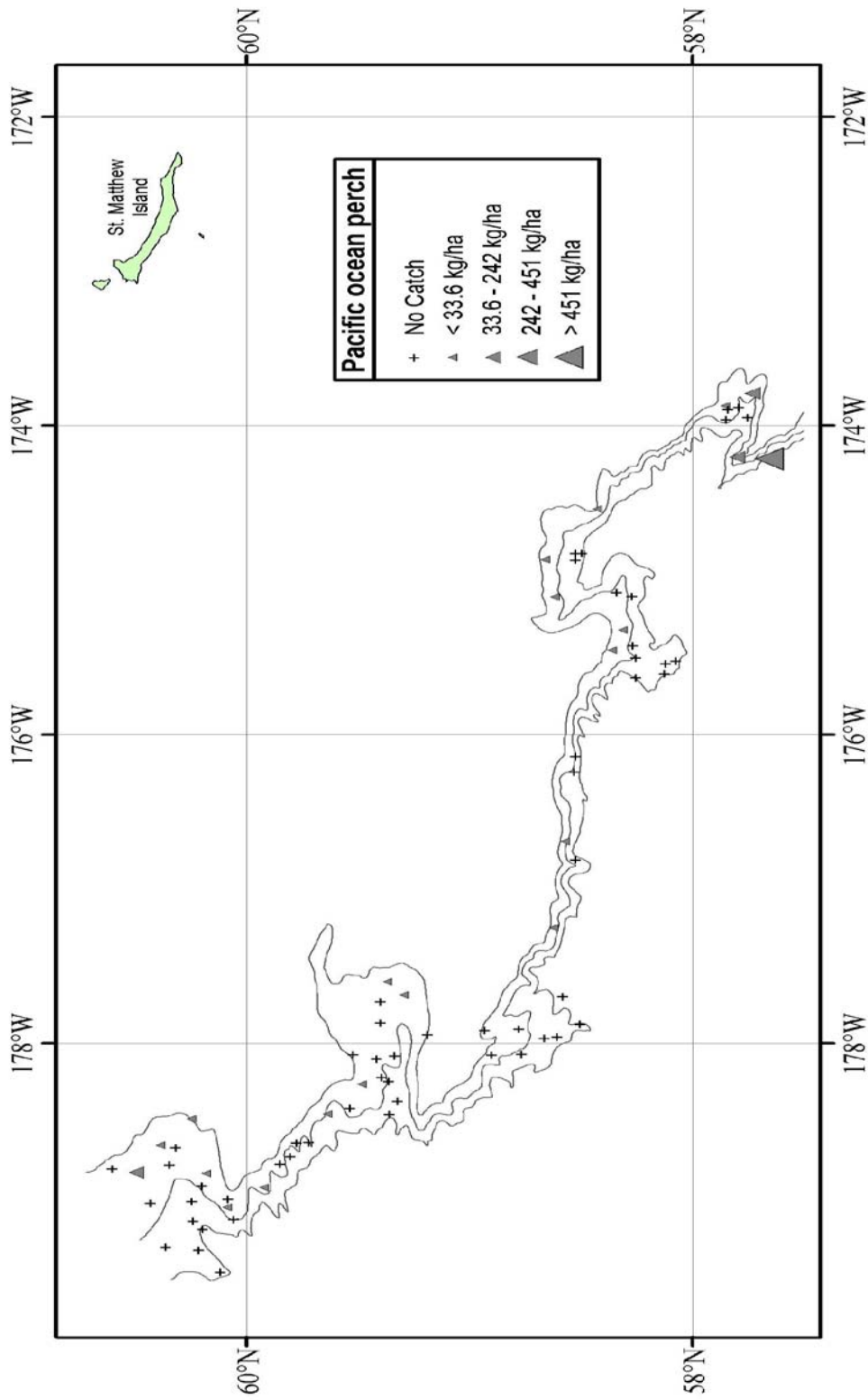

Figure 34. - - Distribution and relative abundance of Pacific ocean perch from the 2008 EBSS survey. Relative abundance is categorized by no catch, sample CPUE less than the mean CPUE, between the mean CPUE and one standard deviation above the mean, between one and two standard deviations above the mean CPUE, and greater than two standard deviations above the mean CPUE.

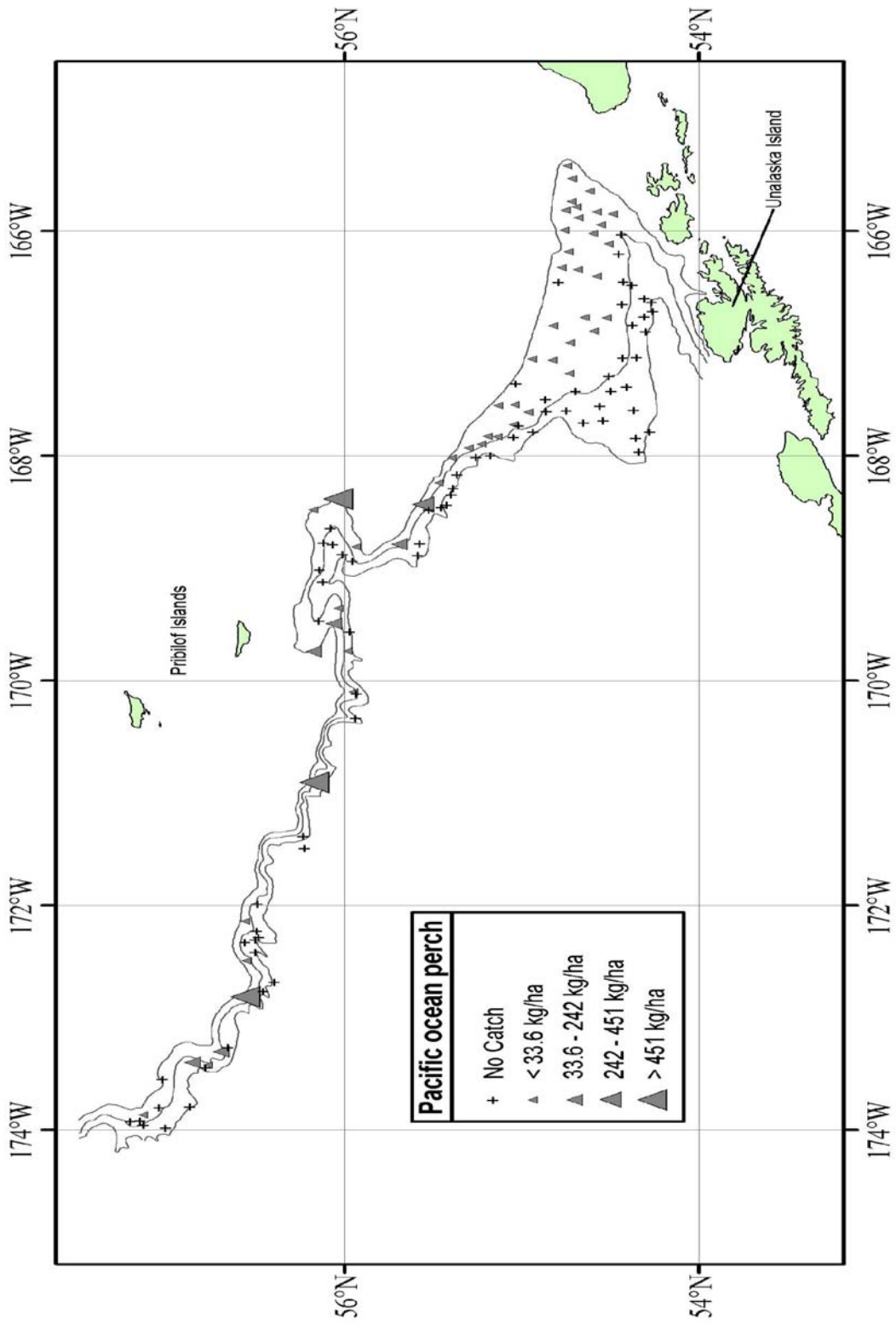

Figure 34. - - Continued.

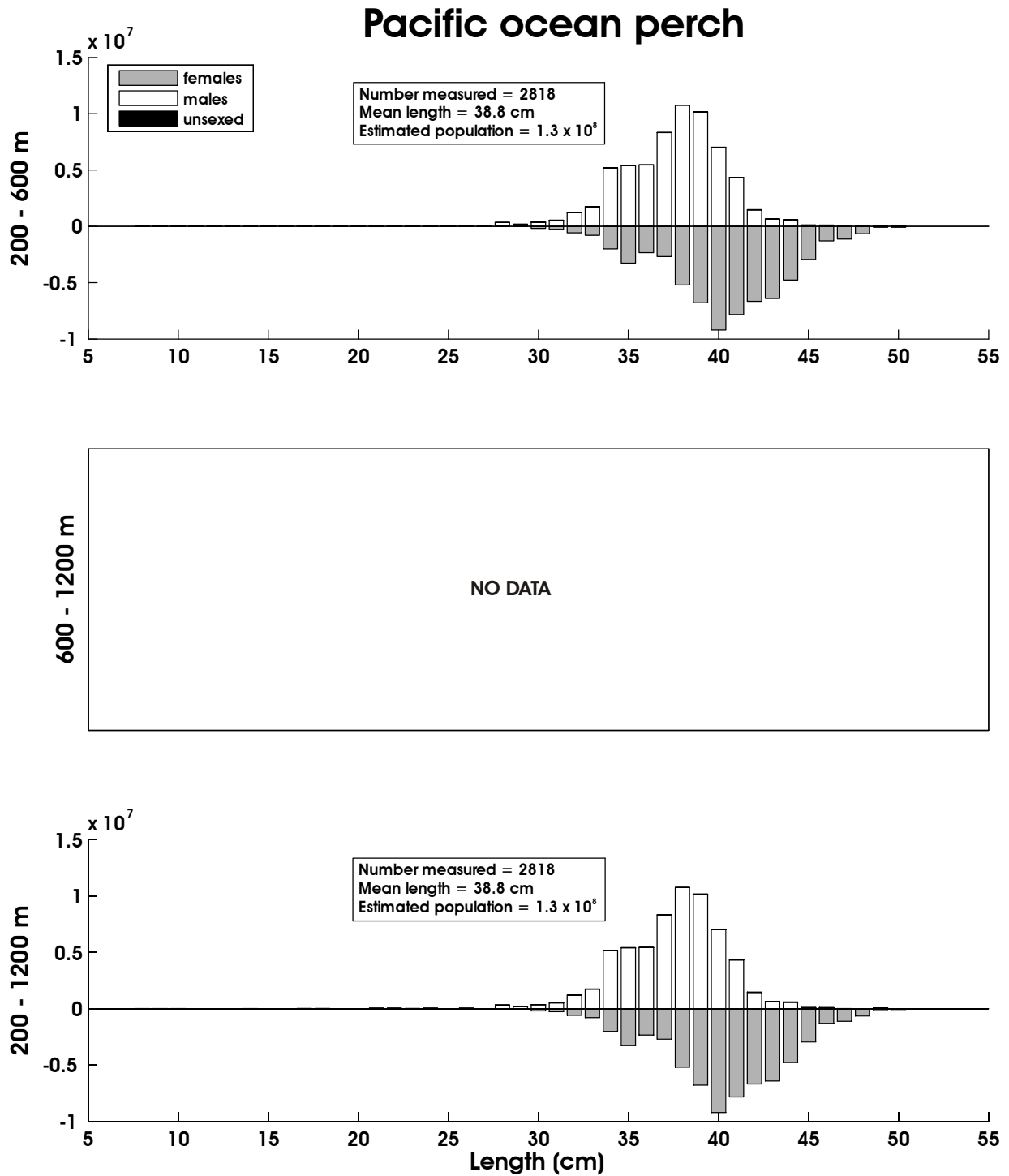

Figure 35. - Size composition of the estimated Pacific ocean perch population from the 2008 EBSS survey for all subareas by depth. The abscissa is scaled as total length in centimeters while the ordinate represents the estimated total population.

Table 26. - Abundance estimates by subarea and depth stratum for roughey rockfish (*Sebastes aleutianus*) from the 2008 EBSS survey.

<i>Sebastes aleutianus</i>		roughey rockfish					
Subarea	Depth Stratum (m)	Biomass (t)	Population	Biomass Variance	Population Variance	Average CPUE (kg/ha)	Average CPUE (no./ha)
1	200-400	1.46E+02	2.01E+05	1.64E+03	3.95E+09	3.65E-01	5.01E-01
	400-600	1.23E+01	1.48E+04	5.04E+01	7.89E+07	3.04E-02	3.63E-02
	600-800	0.00E+00	0.00E+00	0.00E+00	0.00E+00	0.00E+00	0.00E+00
	800-1,000	0.00E+00	0.00E+00	0.00E+00	0.00E+00	0.00E+00	0.00E+00
	1,000-1,200	0.00E+00	0.00E+00	0.00E+00	0.00E+00	0.00E+00	0.00E+00
2	200-400	1.30E+01	1.84E+04	1.70E+02	3.38E+08	1.12E-01	1.59E-01
	400-600	9.60E+00	7.68E+03	9.22E+01	5.90E+07	1.36E-01	1.09E-01
	600-800	0.00E+00	0.00E+00	0.00E+00	0.00E+00	0.00E+00	0.00E+00
	800-1,000	1.19E+01	2.99E+03	1.41E+02	8.96E+06	2.15E-01	5.41E-02
	1,000-1,200	0.00E+00	0.00E+00	0.00E+00	0.00E+00	0.00E+00	0.00E+00
3	200-400	3.32E+00	3.73E+03	1.10E+01	1.39E+07	3.67E-02	4.13E-02
	400-600	0.00E+00	0.00E+00	0.00E+00	0.00E+00	0.00E+00	0.00E+00
	600-800	0.00E+00	0.00E+00	0.00E+00	0.00E+00	0.00E+00	0.00E+00
	800-1,000	0.00E+00	0.00E+00	0.00E+00	0.00E+00	0.00E+00	0.00E+00
	1,000-1,200	0.00E+00	0.00E+00	0.00E+00	0.00E+00	0.00E+00	0.00E+00
4	200-400	1.19E+02	4.42E+04	1.23E+04	1.23E+09	9.66E-01	3.57E-01
	400-600	0.00E+00	0.00E+00	0.00E+00	0.00E+00	0.00E+00	0.00E+00
	600-800	0.00E+00	0.00E+00	0.00E+00	0.00E+00	0.00E+00	0.00E+00
	800-1,000	0.00E+00	0.00E+00	0.00E+00	0.00E+00	0.00E+00	0.00E+00
	1,000-1,200	0.00E+00	0.00E+00	0.00E+00	0.00E+00	0.00E+00	0.00E+00
5	200-400	0.00E+00	0.00E+00	0.00E+00	0.00E+00	0.00E+00	0.00E+00
	400-600	0.00E+00	0.00E+00	0.00E+00	0.00E+00	0.00E+00	0.00E+00
	600-800	0.00E+00	0.00E+00	0.00E+00	0.00E+00	0.00E+00	0.00E+00
	800-1,000	0.00E+00	0.00E+00	0.00E+00	0.00E+00	0.00E+00	0.00E+00
	1,000-1,200	0.00E+00	0.00E+00	0.00E+00	0.00E+00	0.00E+00	0.00E+00
6	200-400	0.00E+00	0.00E+00	0.00E+00	0.00E+00	0.00E+00	0.00E+00
	400-600	0.00E+00	0.00E+00	0.00E+00	0.00E+00	0.00E+00	0.00E+00
	600-800	0.00E+00	0.00E+00	0.00E+00	0.00E+00	0.00E+00	0.00E+00
	800-1,000	0.00E+00	0.00E+00	0.00E+00	0.00E+00	0.00E+00	0.00E+00
	1,000-1,200	0.00E+00	0.00E+00	0.00E+00	0.00E+00	0.00E+00	0.00E+00
1-6	200-1,200	3.16E+02	2.93E+05	1.44E+04	5.68E+09	2.24E-01	2.56E-01

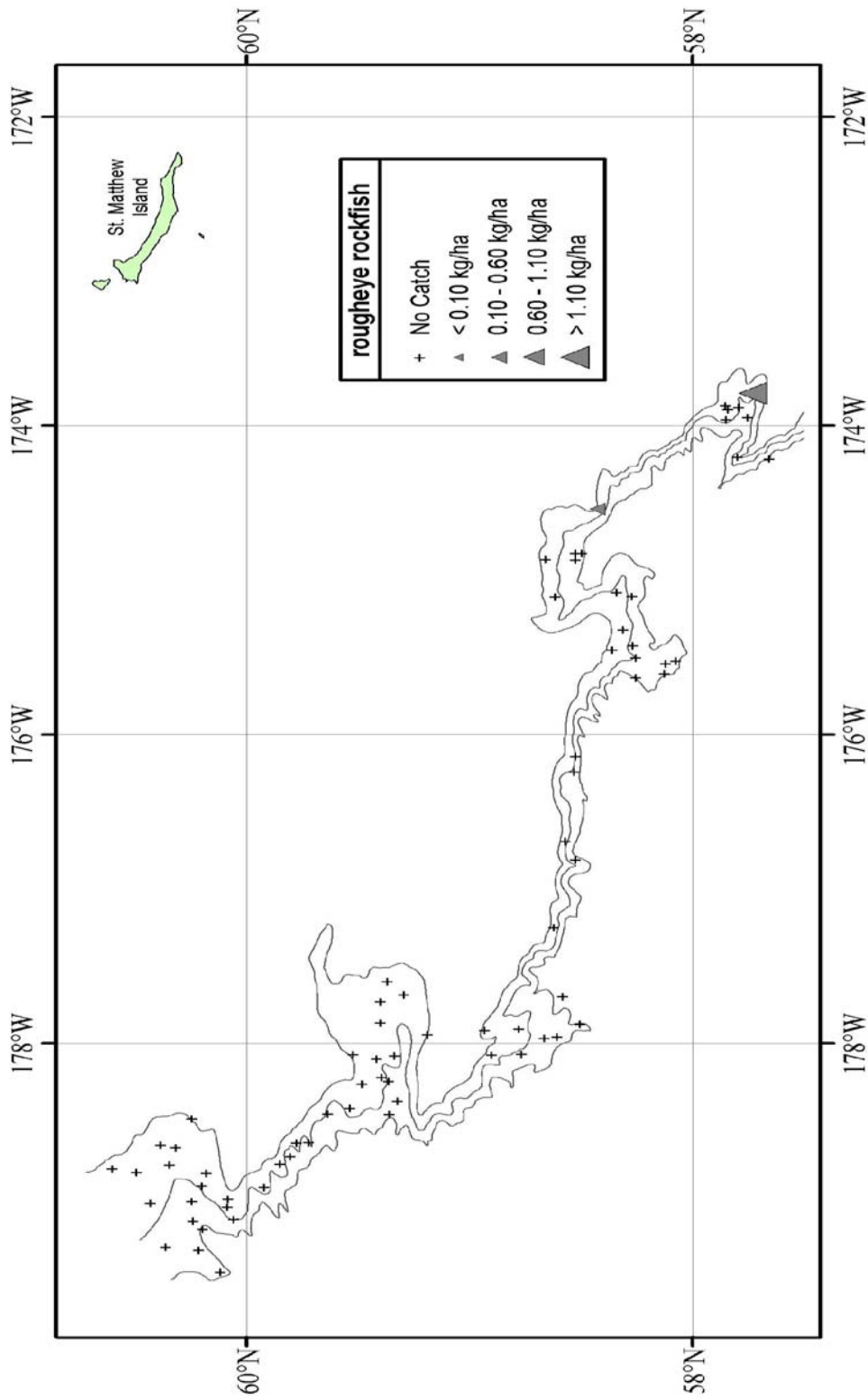

Figure 36. - - Distribution and relative abundance of rougheye rockfish from the 2008 EBSS survey. Relative abundance is categorized by no catch, sample CPUE less than the mean CPUE, between the mean CPUE and one standard deviation above the mean, between one and two standard deviations above the mean CPUE, and greater than two standard deviations above the mean CPUE.

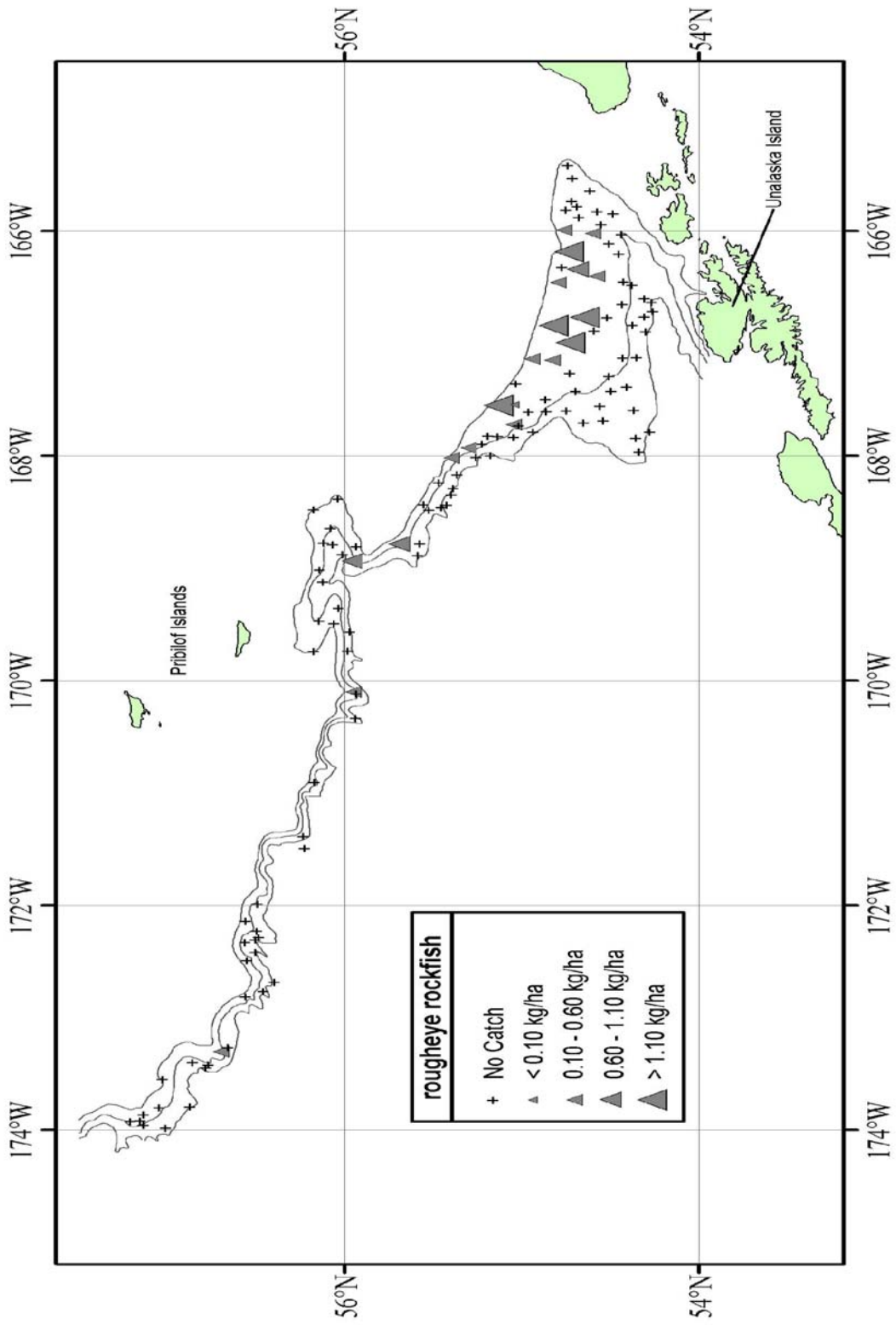

Figure 36.- - Continued.

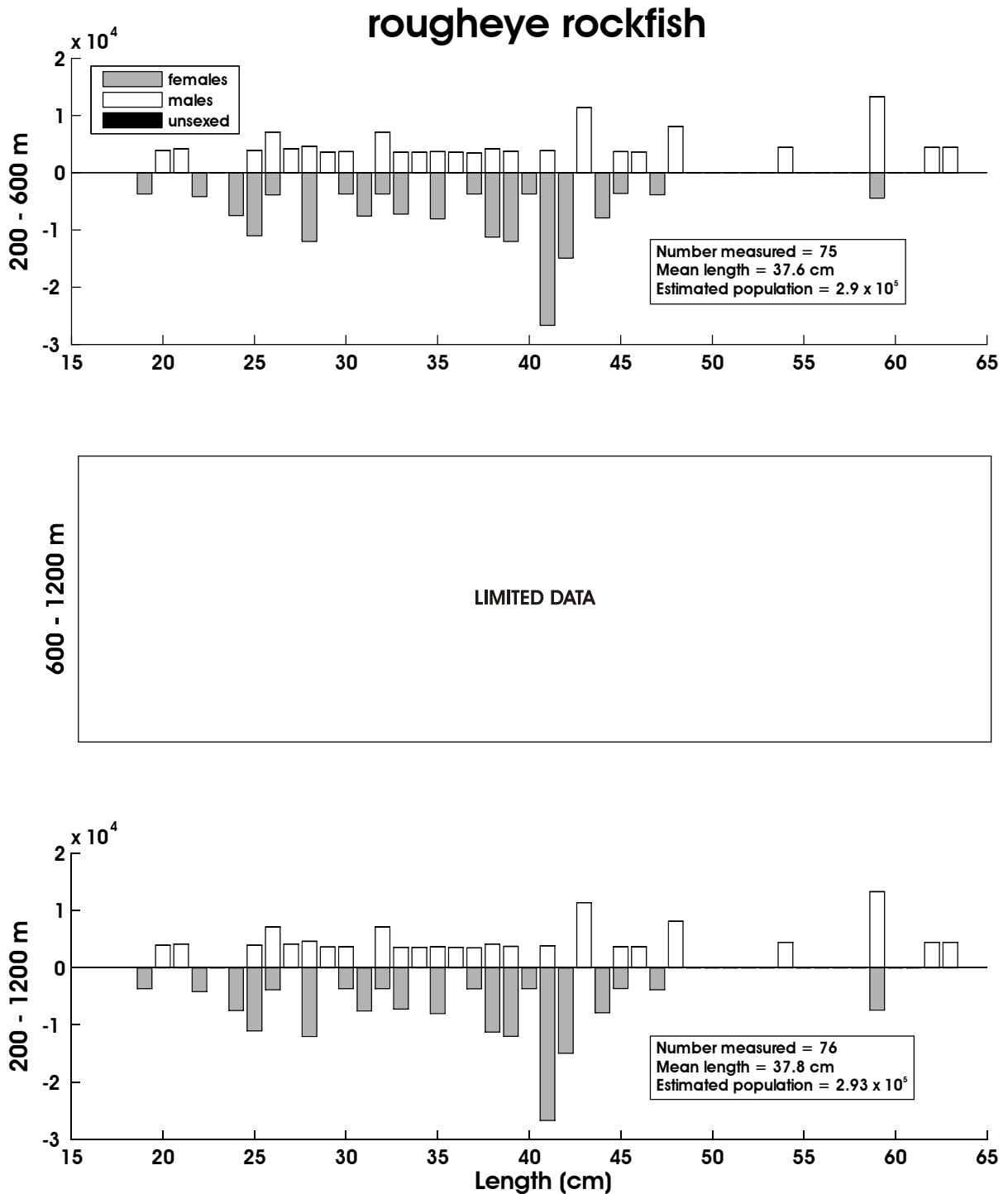

Figure 37. - - Size composition of the estimated roughey rockfish population from the 2008 EBSS survey for all subareas by depth. The abscissa is scaled as total length in centimeters while the ordinate represents the estimated total population.

Table 27. - Abundance estimates by subarea and depth stratum for blackspotted rockfish (*Sebastes melanostictus*) from the 2008 EBSS survey.

<i>Sebastes melanostictus</i>		blackspotted rockfish					
Subarea	Depth Stratum (m)	Biomass (t)	Population	Biomass Variance	Population Variance	Average CPUE (kg/ha)	Average CPUE (no./ha)
1	200-400	7.31E+01	7.88E+04	4.39E+02	4.71E+08	1.82E-01	1.96E-01
	400-600	4.94E+01	3.01E+04	5.17E+02	1.71E+08	1.22E-01	7.40E-02
	600-800	0.00E+00	0.00E+00	0.00E+00	0.00E+00	0.00E+00	0.00E+00
	800-1,000	0.00E+00	0.00E+00	0.00E+00	0.00E+00	0.00E+00	0.00E+00
	1,000-1,200	0.00E+00	0.00E+00	0.00E+00	0.00E+00	0.00E+00	0.00E+00
2	200-400	2.10E+02	4.36E+05	1.95E+04	1.06E+11	1.82E+00	3.76E+00
	400-600	1.38E+01	7.52E+03	1.90E+02	5.66E+07	1.96E-01	1.07E-01
	600-800	0.00E+00	0.00E+00	0.00E+00	0.00E+00	0.00E+00	0.00E+00
	800-1,000	0.00E+00	0.00E+00	0.00E+00	0.00E+00	0.00E+00	0.00E+00
	1,000-1,200	0.00E+00	0.00E+00	0.00E+00	0.00E+00	0.00E+00	0.00E+00
3	200-400	2.55E+00	2.61E+04	6.48E+00	6.80E+08	2.82E-02	2.89E-01
	400-600	1.02E+02	4.42E+04	5.32E+03	8.38E+08	1.16E+00	4.99E-01
	600-800	0.00E+00	0.00E+00	0.00E+00	0.00E+00	0.00E+00	0.00E+00
	800-1,000	0.00E+00	0.00E+00	0.00E+00	0.00E+00	0.00E+00	0.00E+00
	1,000-1,200	0.00E+00	0.00E+00	0.00E+00	0.00E+00	0.00E+00	0.00E+00
4	200-400	4.78E+01	2.36E+04	6.27E+02	1.28E+08	3.87E-01	1.91E-01
	400-600	5.45E+00	3.56E+03	2.98E+01	1.26E+07	7.47E-02	4.87E-02
	600-800	0.00E+00	0.00E+00	0.00E+00	0.00E+00	0.00E+00	0.00E+00
	800-1,000	0.00E+00	0.00E+00	0.00E+00	0.00E+00	0.00E+00	0.00E+00
	1,000-1,200	0.00E+00	0.00E+00	0.00E+00	0.00E+00	0.00E+00	0.00E+00
5	200-400	0.00E+00	0.00E+00	0.00E+00	0.00E+00	0.00E+00	0.00E+00
	400-600	8.25E+00	3.17E+03	6.81E+01	1.01E+07	1.94E-01	7.46E-02
	600-800	0.00E+00	0.00E+00	0.00E+00	0.00E+00	0.00E+00	0.00E+00
	800-1,000	0.00E+00	0.00E+00	0.00E+00	0.00E+00	0.00E+00	0.00E+00
	1,000-1,200	0.00E+00	0.00E+00	0.00E+00	0.00E+00	0.00E+00	0.00E+00
6	200-400	9.52E-02	3.66E+03	9.06E-03	1.34E+07	3.67E-04	1.41E-02
	400-600	0.00E+00	0.00E+00	0.00E+00	0.00E+00	0.00E+00	0.00E+00
	600-800	0.00E+00	0.00E+00	0.00E+00	0.00E+00	0.00E+00	0.00E+00
	800-1,000	0.00E+00	0.00E+00	0.00E+00	0.00E+00	0.00E+00	0.00E+00
	1,000-1,200	0.00E+00	0.00E+00	0.00E+00	0.00E+00	0.00E+00	0.00E+00
1-6	200-1,200	5.13E+02	6.56E+05	2.67E+04	1.08E+11	2.24E-01	2.56E-01

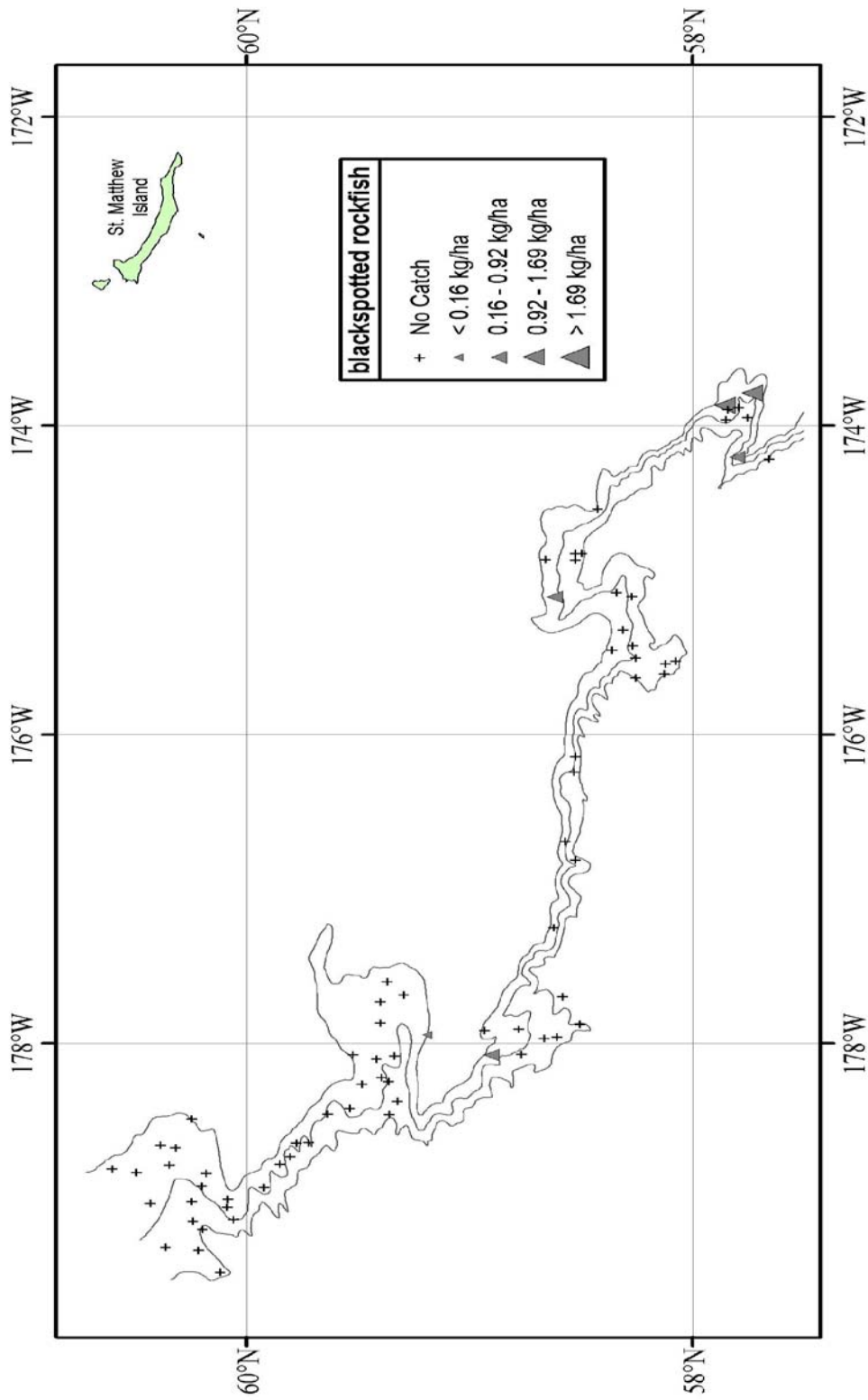

Figure 38. - - Distribution and relative abundance of blackspotted rockfish from the 2008 EBSS survey. Relative abundance is categorized by no catch, sample CPUE less than the mean CPUE, between the mean CPUE and one standard deviation above the mean, between one and two standard deviations above the mean CPUE, and greater than two standard deviations above the mean CPUE.

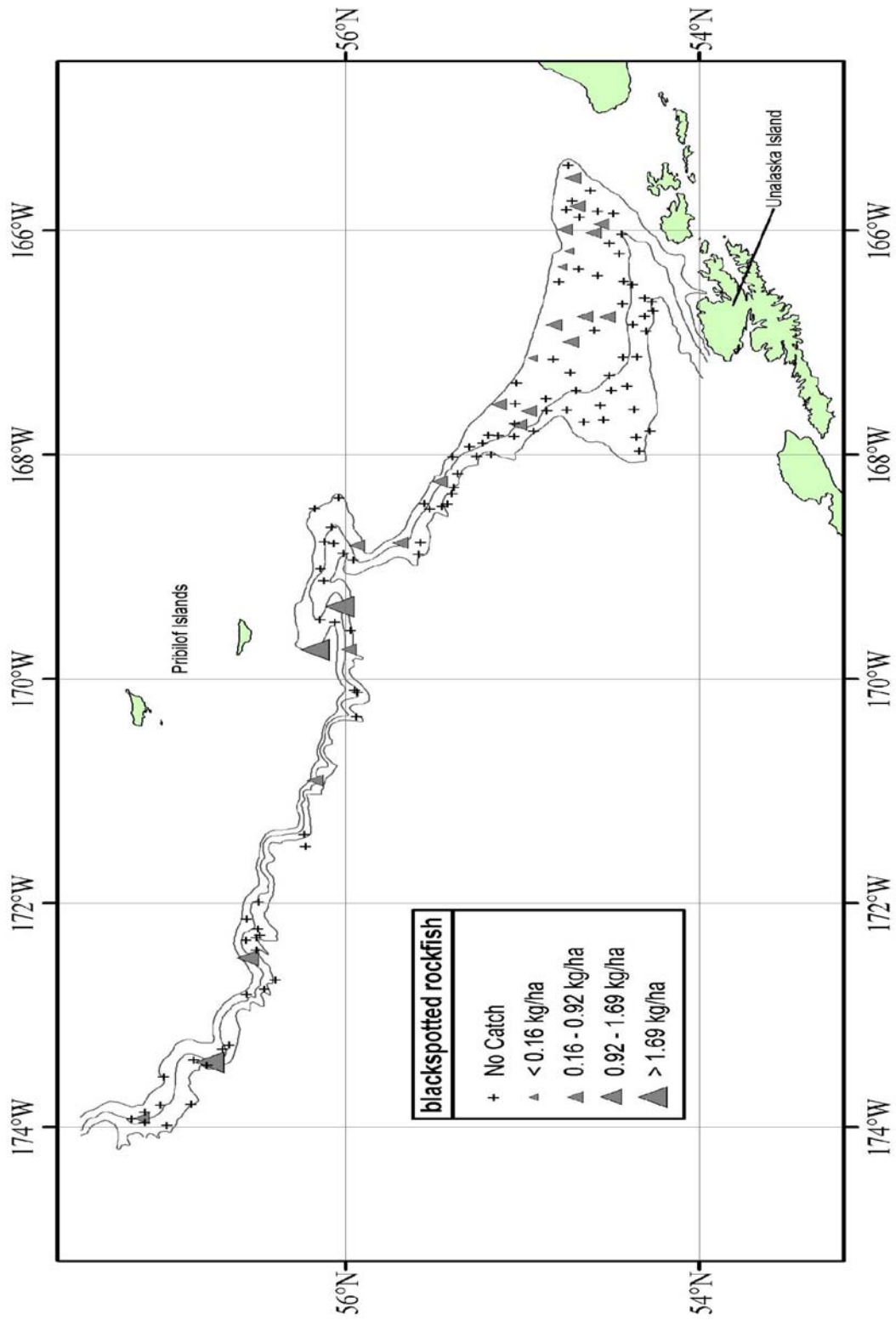

Figure 38. - - Continued.

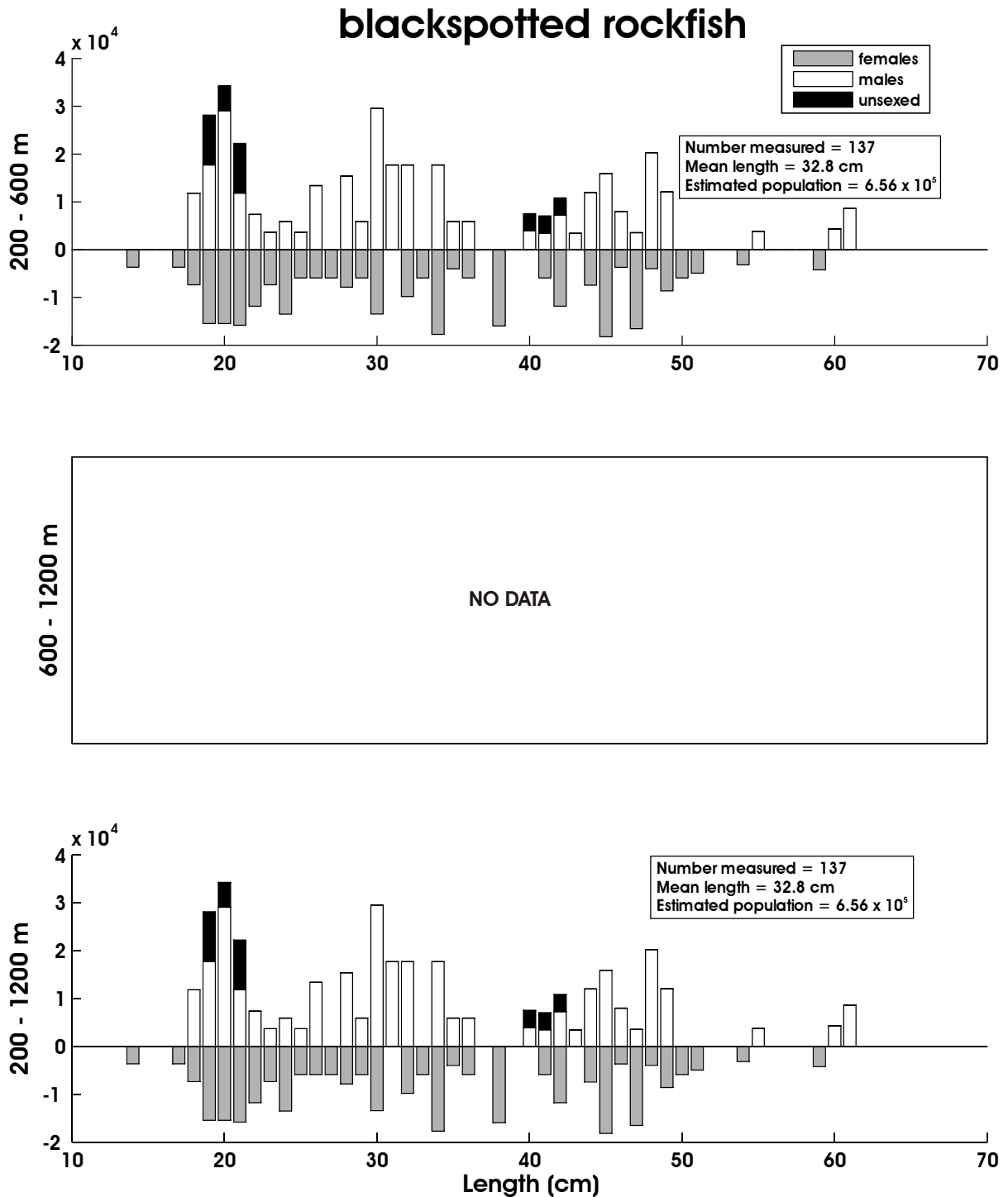

Figure 39. - - Size composition of the estimated blackspotted rockfish population from the 2008 EBSS survey for all subareas by depth. The abscissa is scaled as total length in centimeters while the ordinate represents the estimated total population.

Table 28. - - Abundance estimates by subarea and depth stratum for shorttraker rockfish
(*Sebastes borealis*) from the 2008 EBSS survey.

<i>Sebastes borealis</i>		shorttraker rockfish					
Subarea	Depth Stratum (m)	Biomass (t)	Population	Biomass Variance	Population Variance	Average CPUE (kg/ha)	Average CPUE (no./ha)
1	200-400	1.68E+01	4.01E+03	2.84E+02	1.61E+07	4.20E-02	1.00E-02
	400-600	5.84E+01	2.34E+04	1.66E+03	2.89E+08	1.44E-01	5.77E-02
	600-800	0.00E+00	0.00E+00	0.00E+00	0.00E+00	0.00E+00	0.00E+00
	800-1,000	0.00E+00	0.00E+00	0.00E+00	0.00E+00	0.00E+00	0.00E+00
	1,000-1,200	0.00E+00	0.00E+00	0.00E+00	0.00E+00	0.00E+00	0.00E+00
2	200-400	6.48E+02	1.12E+05	4.20E+05	1.26E+10	5.60E+00	9.70E-01
	400-600	8.22E+02	3.56E+05	5.03E+05	6.08E+10	1.17E+01	5.05E+00
	600-800	6.60E+01	2.27E+04	1.25E+03	8.11E+07	1.12E+00	3.84E-01
	800-1,000	0.00E+00	0.00E+00	0.00E+00	0.00E+00	0.00E+00	0.00E+00
	1,000-1,200	0.00E+00	0.00E+00	0.00E+00	0.00E+00	0.00E+00	0.00E+00
3	200-400	1.76E+03	2.58E+05	1.24E+06	2.65E+10	1.94E+01	2.86E+00
	400-600	5.09E+02	1.30E+05	1.22E+05	7.04E+09	5.75E+00	1.47E+00
	600-800	3.76E+01	1.18E+04	1.41E+03	1.39E+08	4.13E-01	1.29E-01
	800-1,000	0.00E+00	0.00E+00	0.00E+00	0.00E+00	0.00E+00	0.00E+00
	1,000-1,200	0.00E+00	0.00E+00	0.00E+00	0.00E+00	0.00E+00	0.00E+00
4	200-400	3.13E+03	8.72E+05	2.96E+06	2.08E+11	2.53E+01	7.06E+00
	400-600	1.60E+02	4.98E+04	2.56E+04	2.48E+09	2.19E+00	6.82E-01
	600-800	0.00E+00	0.00E+00	0.00E+00	0.00E+00	0.00E+00	0.00E+00
	800-1,000	0.00E+00	0.00E+00	0.00E+00	0.00E+00	0.00E+00	0.00E+00
	1,000-1,200	0.00E+00	0.00E+00	0.00E+00	0.00E+00	0.00E+00	0.00E+00
5	200-400	0.00E+00	0.00E+00	0.00E+00	0.00E+00	0.00E+00	0.00E+00
	400-600	0.00E+00	0.00E+00	0.00E+00	0.00E+00	0.00E+00	0.00E+00
	600-800	0.00E+00	0.00E+00	0.00E+00	0.00E+00	0.00E+00	0.00E+00
	800-1,000	0.00E+00	0.00E+00	0.00E+00	0.00E+00	0.00E+00	0.00E+00
	1,000-1,200	0.00E+00	0.00E+00	0.00E+00	0.00E+00	0.00E+00	0.00E+00
6	200-400	4.84E+01	7.59E+03	1.75E+03	2.69E+07	1.87E-01	2.92E-02
	400-600	5.78E+01	1.54E+04	1.61E+03	6.78E+07	3.39E-01	9.00E-02
	600-800	0.00E+00	0.00E+00	0.00E+00	0.00E+00	0.00E+00	0.00E+00
	800-1,000	0.00E+00	0.00E+00	0.00E+00	0.00E+00	0.00E+00	0.00E+00
	1,000-1,200	0.00E+00	0.00E+00	0.00E+00	0.00E+00	0.00E+00	0.00E+00
1-6	200-1,200	7.31E+03	1.86E+06	5.29E+06	3.18E+11	8.01E-01	3.32E-01

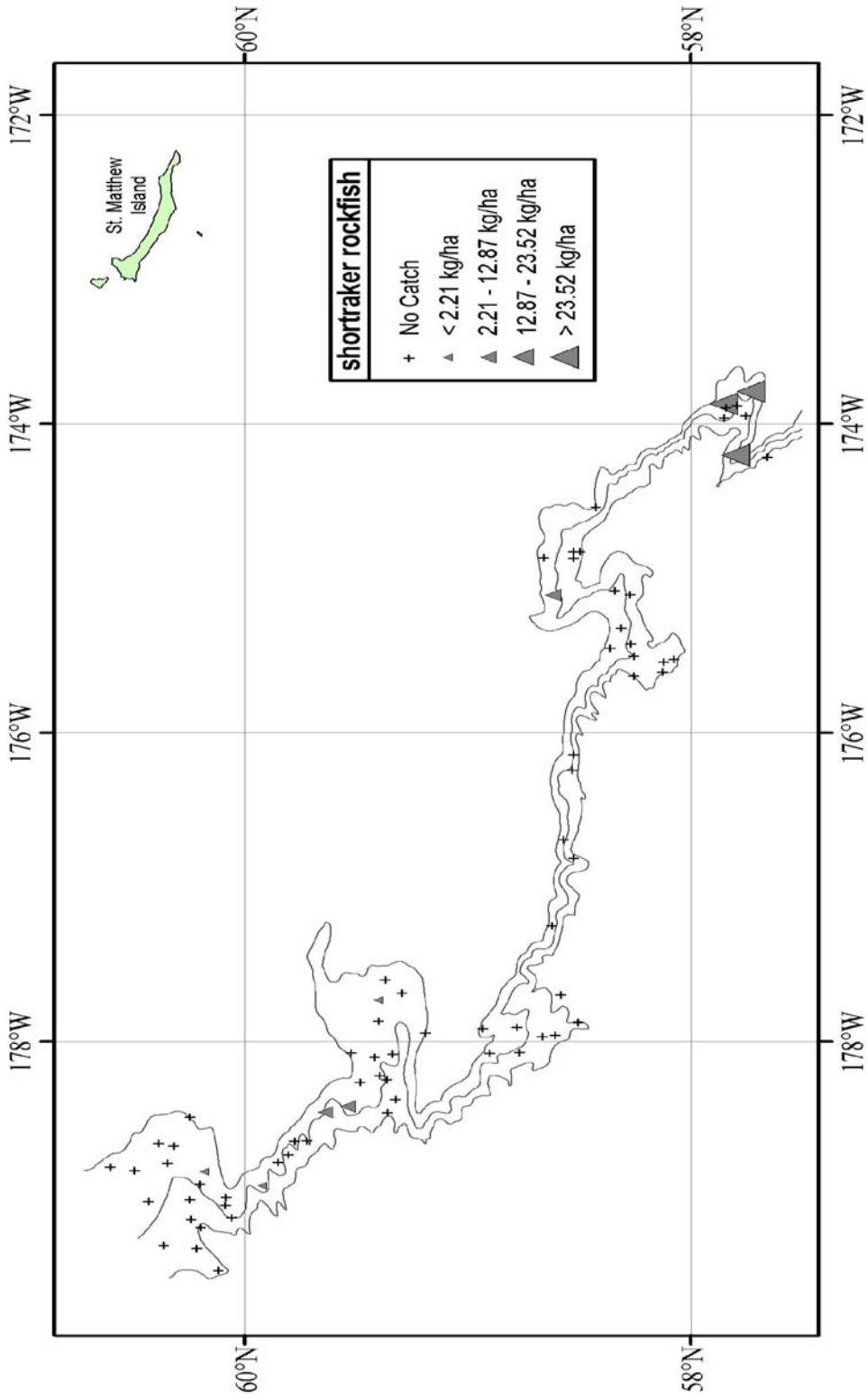

Figure 40. - - Distribution and relative abundance of shorttraker rockfish from the 2008 EBSS survey. Relative abundance is categorized by no catch, sample CPUE less than the mean CPUE, between the mean CPUE and one standard deviation above the mean, between one and two standard deviations above the mean CPUE, and greater than two standard deviations above the mean CPUE.

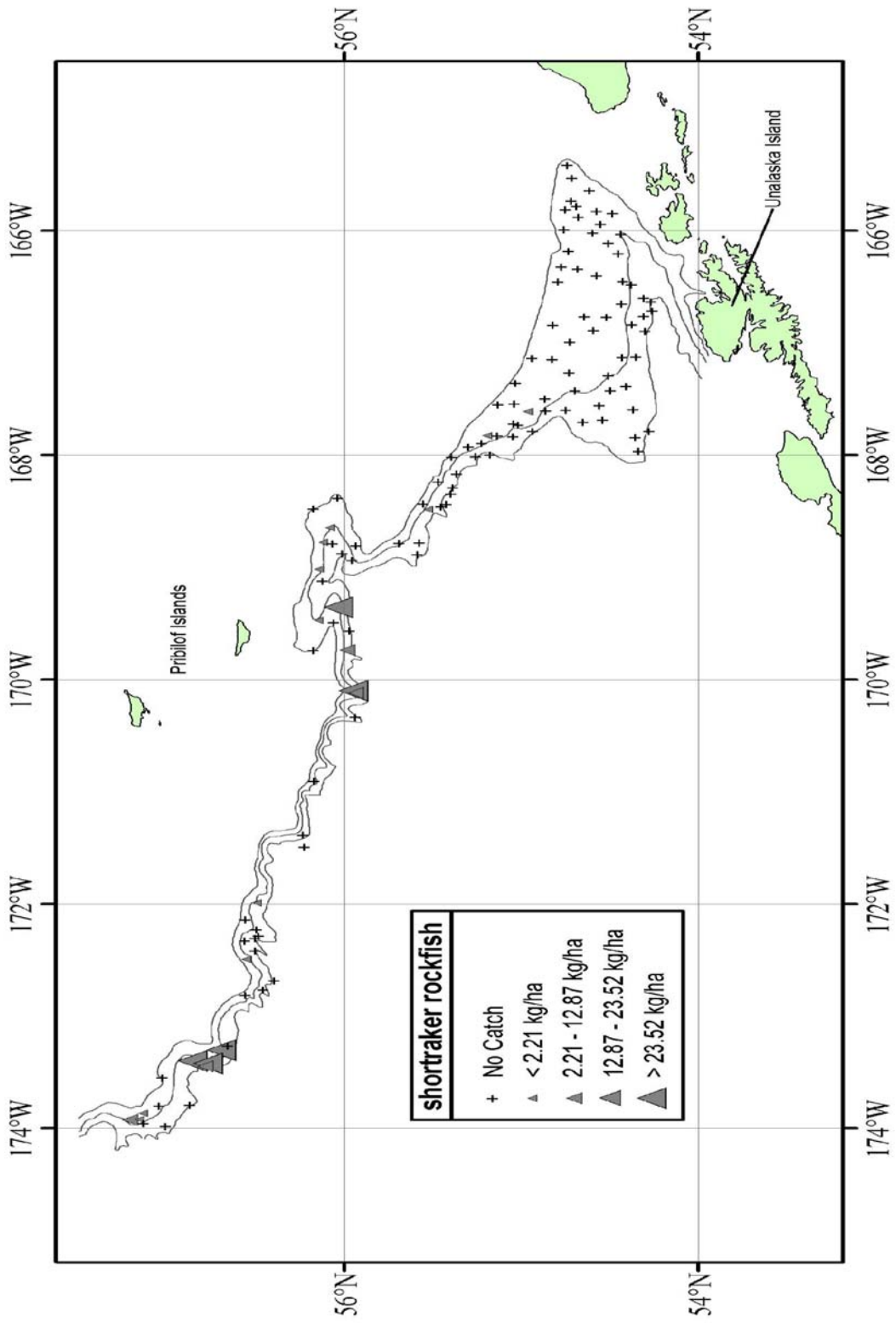

Figure 40. - - Continued.

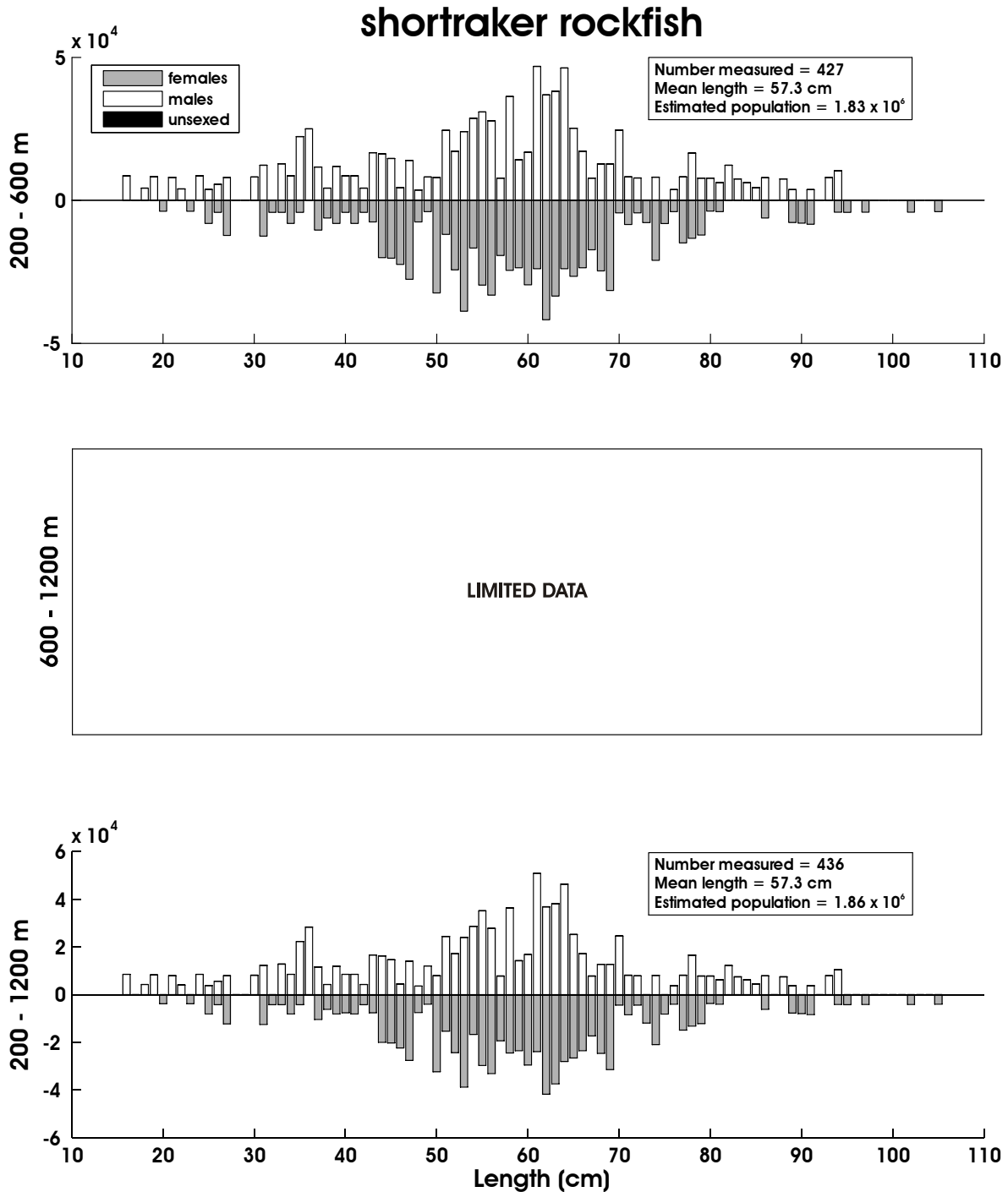

Figure 41. - - Size composition of the estimated shorttraker rockfish population from the 2008 EBSS survey for all subareas by depth. The abscissa is scaled as total length in centimeters while the ordinate represents the estimated total population.

Table 29. - - Abundance estimates by subarea and depth stratum for sablefish (*Anoplopoma fimbria*) from the 2008 EBSS survey.

<i>Anoplopoma fimbria</i>						sablefish	
Subarea	Depth Stratum (m)	Biomass (t)	Population	Biomass Variance	Population Variance	Average CPUE (kg/ha)	Average CPUE (no./ha)
1	200-400	0.00E+00	0.00E+00	0.00E+00	0.00E+00	0.00E+00	0.00E+00
	400-600	3.29E+03	1.32E+06	5.87E+05	6.95E+10	8.09E+00	3.24E+00
	600-800	2.59E+03	8.29E+05	2.32E+05	1.87E+10	1.49E+01	4.76E+00
	800-1,000	5.65E+02	1.70E+05	7.86E+04	6.86E+09	4.17E+00	1.26E+00
	1,000-1,200	3.01E+02	9.10E+04	8.00E+03	7.29E+08	2.72E+00	8.22E-01
2	200-400	0.00E+00	0.00E+00	0.00E+00	0.00E+00	0.00E+00	0.00E+00
	400-600	2.42E+02	8.34E+04	1.26E+04	1.05E+09	3.43E+00	1.18E+00
	600-800	9.72E+02	2.97E+05	2.40E+05	1.88E+10	1.64E+01	5.02E+00
	800-1,000	3.05E+02	9.44E+04	5.63E+03	5.18E+08	5.52E+00	1.71E+00
	1,000-1,200	1.54E+02	4.11E+04	1.66E+03	4.12E+07	2.87E+00	7.67E-01
3	200-400	0.00E+00	0.00E+00	0.00E+00	0.00E+00	0.00E+00	0.00E+00
	400-600	1.92E+02	5.72E+04	1.33E+04	1.07E+09	2.16E+00	6.46E-01
	600-800	1.28E+03	3.49E+05	5.55E+05	3.62E+10	1.41E+01	3.84E+00
	800-1,000	1.82E+02	5.28E+04	3.37E+03	3.25E+08	2.48E+00	7.21E-01
	1,000-1,200	0.00E+00	0.00E+00	0.00E+00	0.00E+00	0.00E+00	0.00E+00
4	200-400	6.87E+01	1.77E+04	4.72E+03	3.14E+08	5.56E-01	1.43E-01
	400-600	7.93E+01	2.83E+04	2.57E+03	2.27E+08	1.09E+00	3.87E-01
	600-800	3.70E+02	1.16E+05	1.35E+04	1.42E+09	5.33E+00	1.68E+00
	800-1,000	4.52E+02	1.34E+05	1.51E+05	1.31E+10	6.39E+00	1.89E+00
	1,000-1,200	6.83E+01	1.79E+04	4.66E+03	3.22E+08	1.03E+00	2.71E-01
5	200-400	0.00E+00	0.00E+00	0.00E+00	0.00E+00	0.00E+00	0.00E+00
	400-600	1.06E+02	3.73E+04	5.69E+03	7.59E+08	2.48E+00	8.76E-01
	600-800	2.13E+02	5.38E+04	2.91E+03	1.31E+08	4.92E+00	1.25E+00
	800-1,000	5.24E+01	1.64E+04	1.00E+03	1.15E+08	9.50E-01	2.97E-01
	1,000-1,200	6.75E+01	1.60E+04	4.56E+03	2.55E+08	1.18E+00	2.80E-01
6	200-400	2.59E+01	1.12E+04	1.95E+02	3.64E+07	1.00E-01	4.32E-02
	400-600	3.49E+02	1.19E+05	5.63E+03	6.29E+08	2.05E+00	6.96E-01
	600-800	2.46E+02	6.87E+04	6.10E+03	4.71E+08	2.68E+00	7.49E-01
	800-1,000	9.53E+01	2.80E+04	6.82E+03	5.48E+08	1.48E+00	4.33E-01
	1,000-1,200	9.62E+01	2.55E+04	2.56E+03	2.12E+08	1.94E+00	5.13E-01
1-6	200-1,200	1.24E+04	4.07E+06	1.95E+06	1.72E+11	3.65E+00	1.34E+00

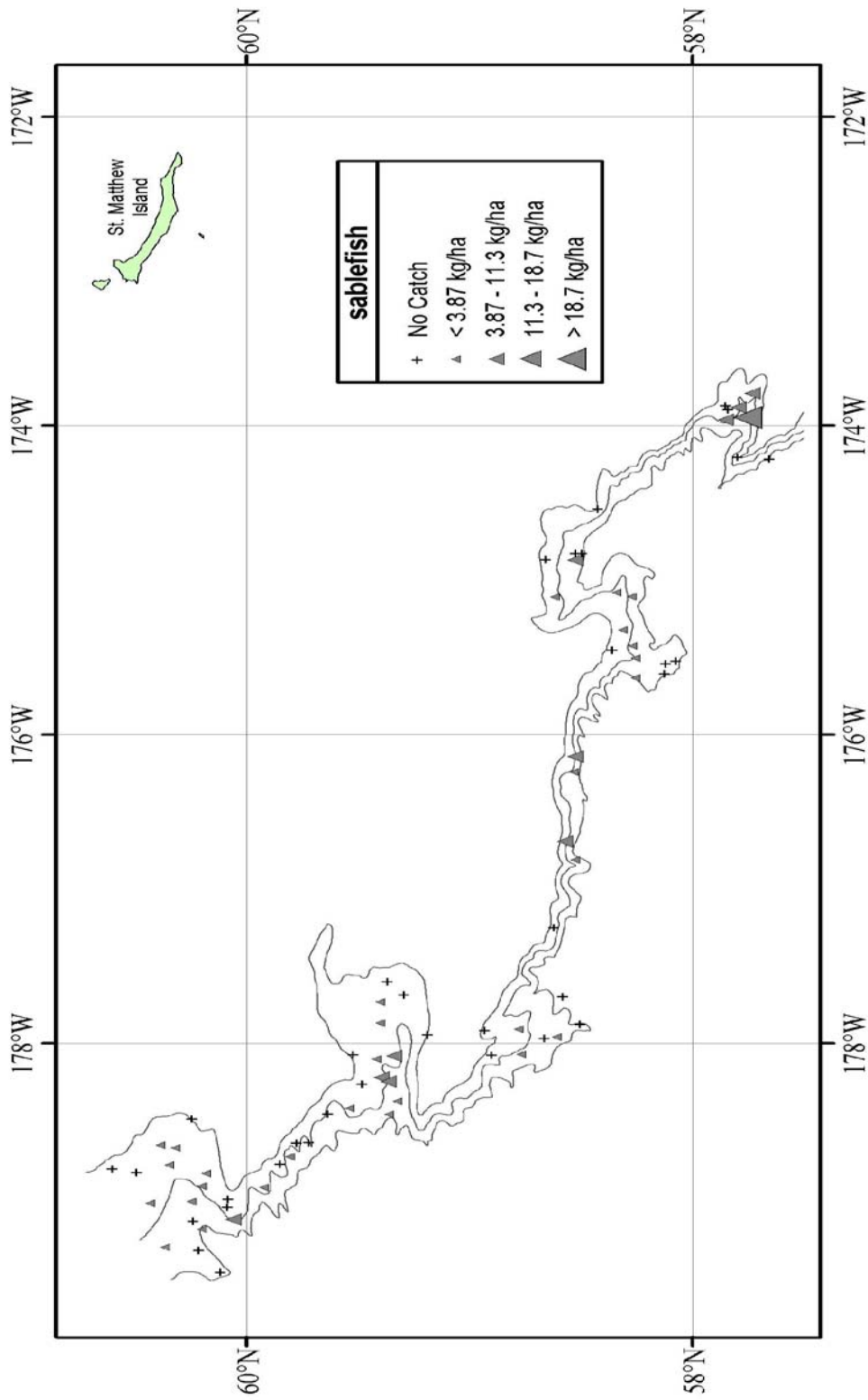

Figure 42. - - Distribution and relative abundance of sablefish from the 2008 EBSS survey. Relative abundance is categorized by no catch, sample CPUE less than the mean CPUE, between the mean CPUE and one standard deviation above the mean, between one and two standard deviations above the mean CPUE, and greater than two standard deviations above the mean CPUE.

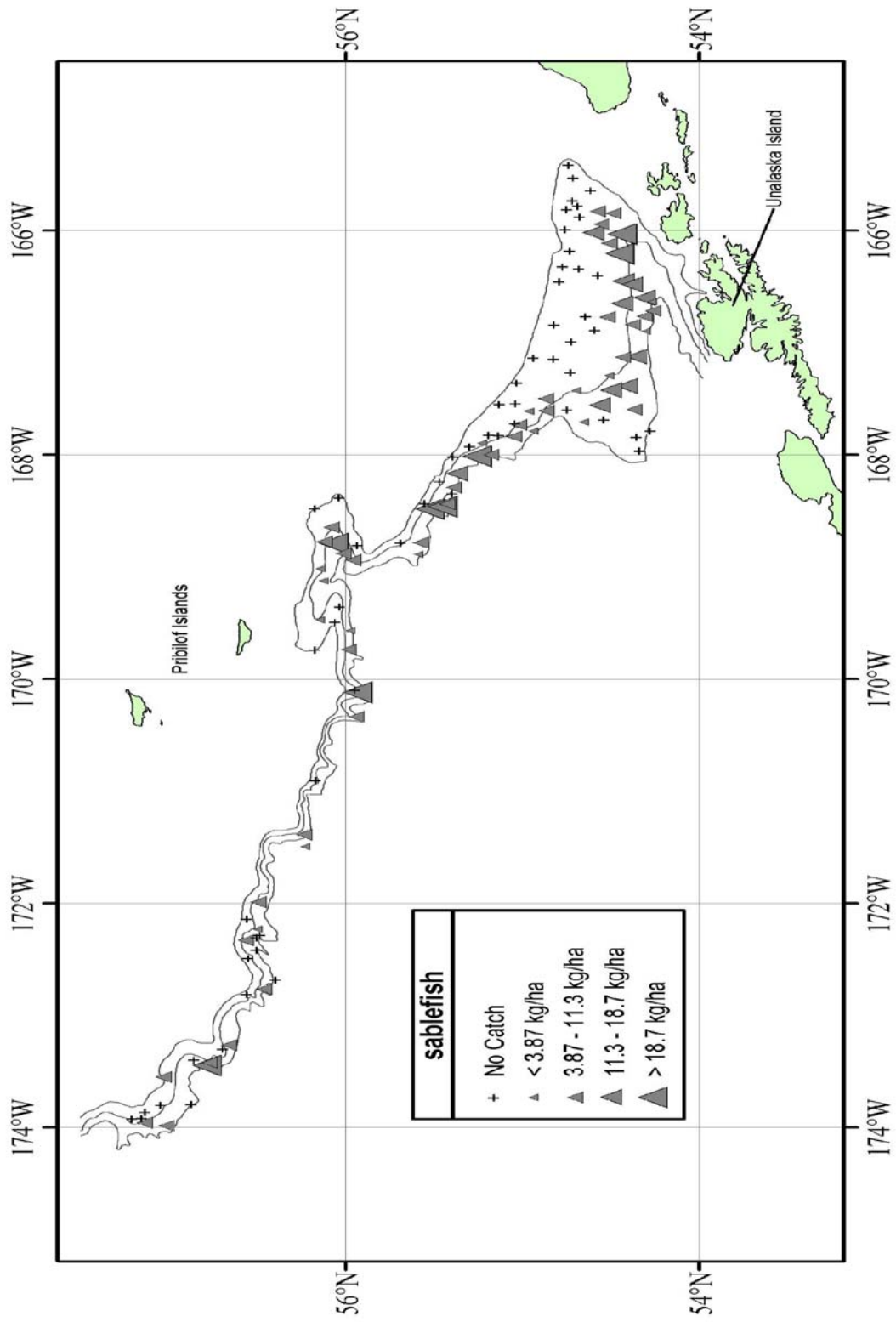

Figure 42. - - Continued.

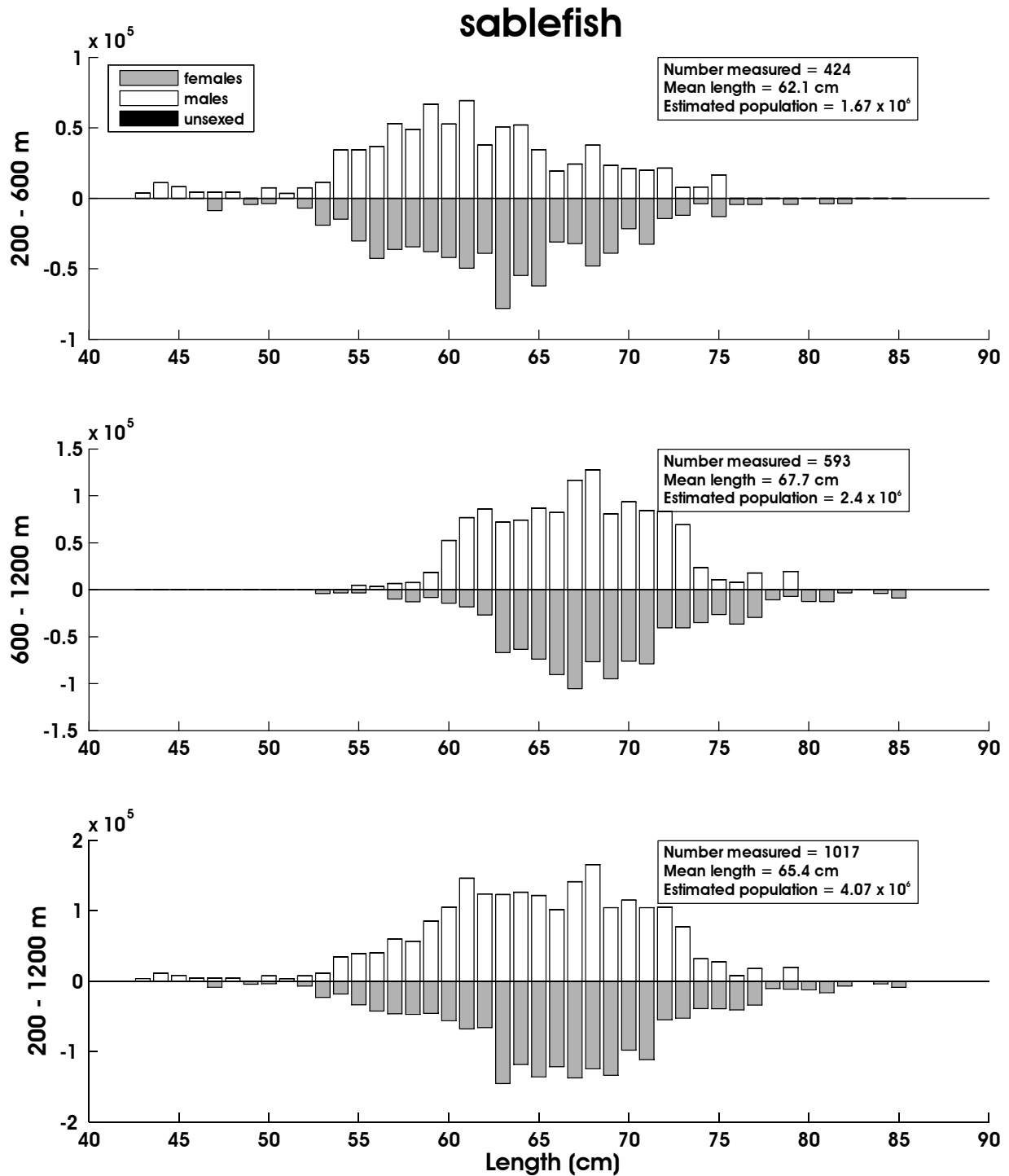

Figure 43. - Size composition of the estimated sablefish population from the 2008 EBSS survey for all subareas by depth. The abscissa is scaled as total length in centimeters while the ordinate represents the estimated total population.

Table 30. - - Abundance estimates by subarea and depth stratum for bigmouth sculpin (*Hemitripterus bolini*) from the 2008 EBSS survey.

<i>Hemitripterus bolini</i>						bigmouth sculpin	
Subarea	Depth Stratum (m)	Biomass (t)	Population	Biomass Variance	Population Variance	Average CPUE (kg/ha)	Average CPUE (no./ha)
1	200-400	2.84E+02	5.60E+04	1.14E+04	3.49E+08	7.07E-01	1.40E-01
	400-600	1.77E+02	8.43E+04	4.38E+03	1.66E+09	4.37E-01	2.08E-01
	600-800	4.60E+00	1.29E+04	1.20E+01	9.07E+07	2.64E-02	7.42E-02
	800-1,000	0.00E+00	0.00E+00	0.00E+00	0.00E+00	0.00E+00	0.00E+00
	1,000-1,200	0.00E+00	0.00E+00	0.00E+00	0.00E+00	0.00E+00	0.00E+00
2	200-400	1.34E+02	2.95E+04	1.55E+03	3.59E+07	1.16E+00	2.55E-01
	400-600	5.64E+02	1.37E+05	8.86E+04	2.15E+09	8.00E+00	1.95E+00
	600-800	9.79E+00	7.66E+03	5.73E+01	2.01E+07	1.66E-01	1.30E-01
	800-1,000	0.00E+00	0.00E+00	0.00E+00	0.00E+00	0.00E+00	0.00E+00
	1,000-1,200	0.00E+00	0.00E+00	0.00E+00	0.00E+00	0.00E+00	0.00E+00
3	200-400	2.38E+02	6.51E+04	3.18E+03	2.36E+08	2.63E+00	7.20E-01
	400-600	3.43E+02	7.73E+04	1.18E+04	3.81E+08	3.87E+00	8.72E-01
	600-800	1.18E+01	3.46E+03	1.40E+02	1.20E+07	1.30E-01	3.80E-02
	800-1,000	0.00E+00	0.00E+00	0.00E+00	0.00E+00	0.00E+00	0.00E+00
	1,000-1,200	0.00E+00	0.00E+00	0.00E+00	0.00E+00	0.00E+00	0.00E+00
4	200-400	7.82E+02	1.52E+05	9.17E+04	3.90E+09	6.33E+00	1.23E+00
	400-600	1.06E+02	2.14E+04	4.60E+03	1.71E+08	1.45E+00	2.93E-01
	600-800	0.00E+00	0.00E+00	0.00E+00	0.00E+00	0.00E+00	0.00E+00
	800-1,000	0.00E+00	0.00E+00	0.00E+00	0.00E+00	0.00E+00	0.00E+00
	1,000-1,200	0.00E+00	0.00E+00	0.00E+00	0.00E+00	0.00E+00	0.00E+00
5	200-400	0.00E+00	0.00E+00	0.00E+00	0.00E+00	0.00E+00	0.00E+00
	400-600	3.12E+01	6.35E+03	9.72E+02	4.03E+07	7.32E-01	1.49E-01
	600-800	0.00E+00	0.00E+00	0.00E+00	0.00E+00	0.00E+00	0.00E+00
	800-1,000	0.00E+00	0.00E+00	0.00E+00	0.00E+00	0.00E+00	0.00E+00
	1,000-1,200	0.00E+00	0.00E+00	0.00E+00	0.00E+00	0.00E+00	0.00E+00
6	200-400	3.49E+02	9.61E+04	5.12E+03	3.55E+08	1.35E+00	3.70E-01
	400-600	1.82E+01	1.27E+04	2.93E+02	8.14E+07	1.06E-01	7.44E-02
	600-800	0.00E+00	0.00E+00	0.00E+00	0.00E+00	0.00E+00	0.00E+00
	800-1,000	0.00E+00	0.00E+00	0.00E+00	0.00E+00	0.00E+00	0.00E+00
	1,000-1,200	0.00E+00	0.00E+00	0.00E+00	0.00E+00	0.00E+00	0.00E+00
1-6	200-1,200	3.05E+03	7.62E+05	2.24E+05	9.49E+09	4.25E-01	1.42E-01

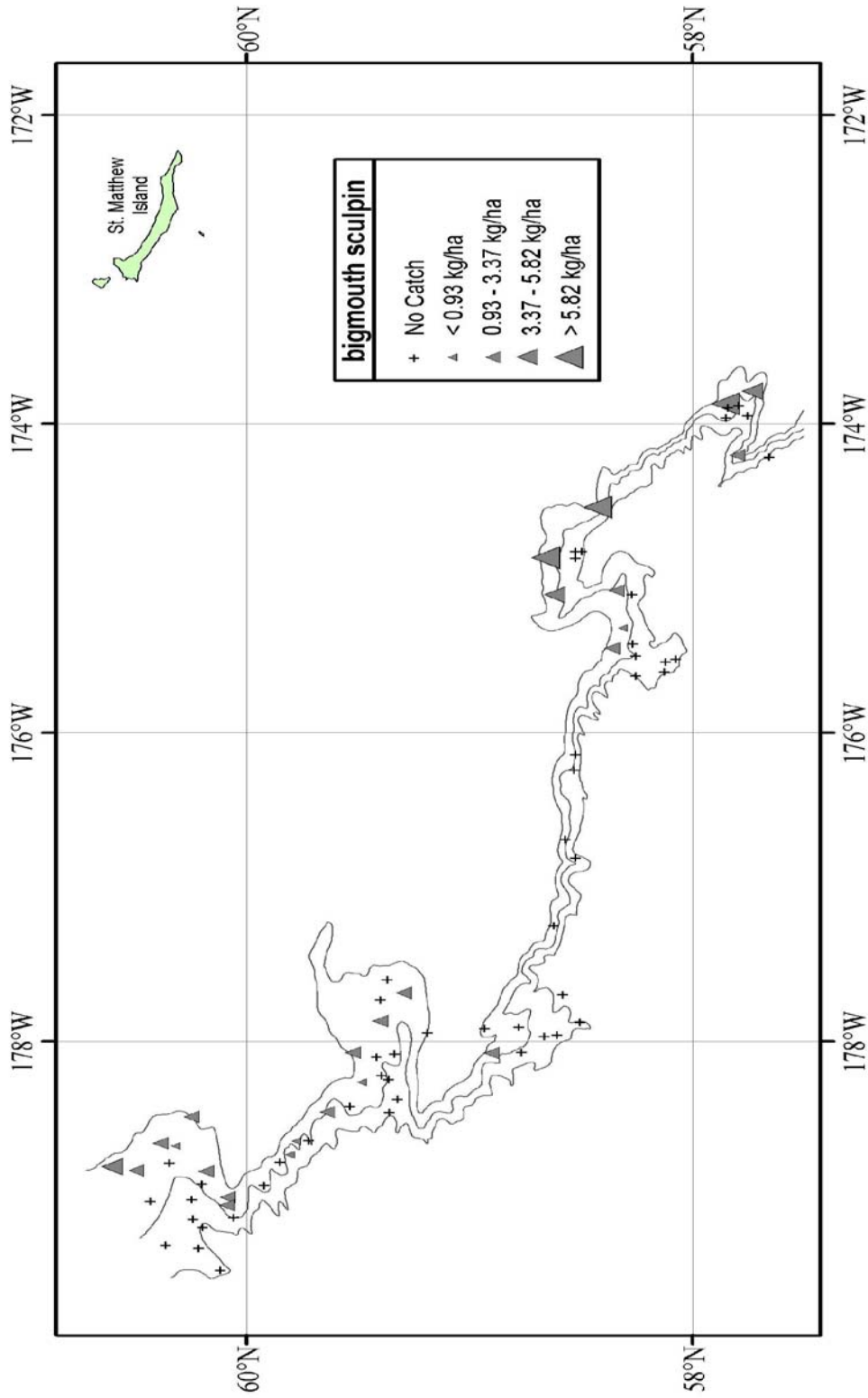

Figure 44. - - Distribution and relative abundance of bigmouth sculpin from the 2008 EBSS survey. Relative abundance is categorized by no catch, sample CPUE less than the mean CPUE, between the mean CPUE and one standard deviation above the mean, between one and two standard deviations above the mean CPUE, and greater than two standard deviations above the mean CPUE.

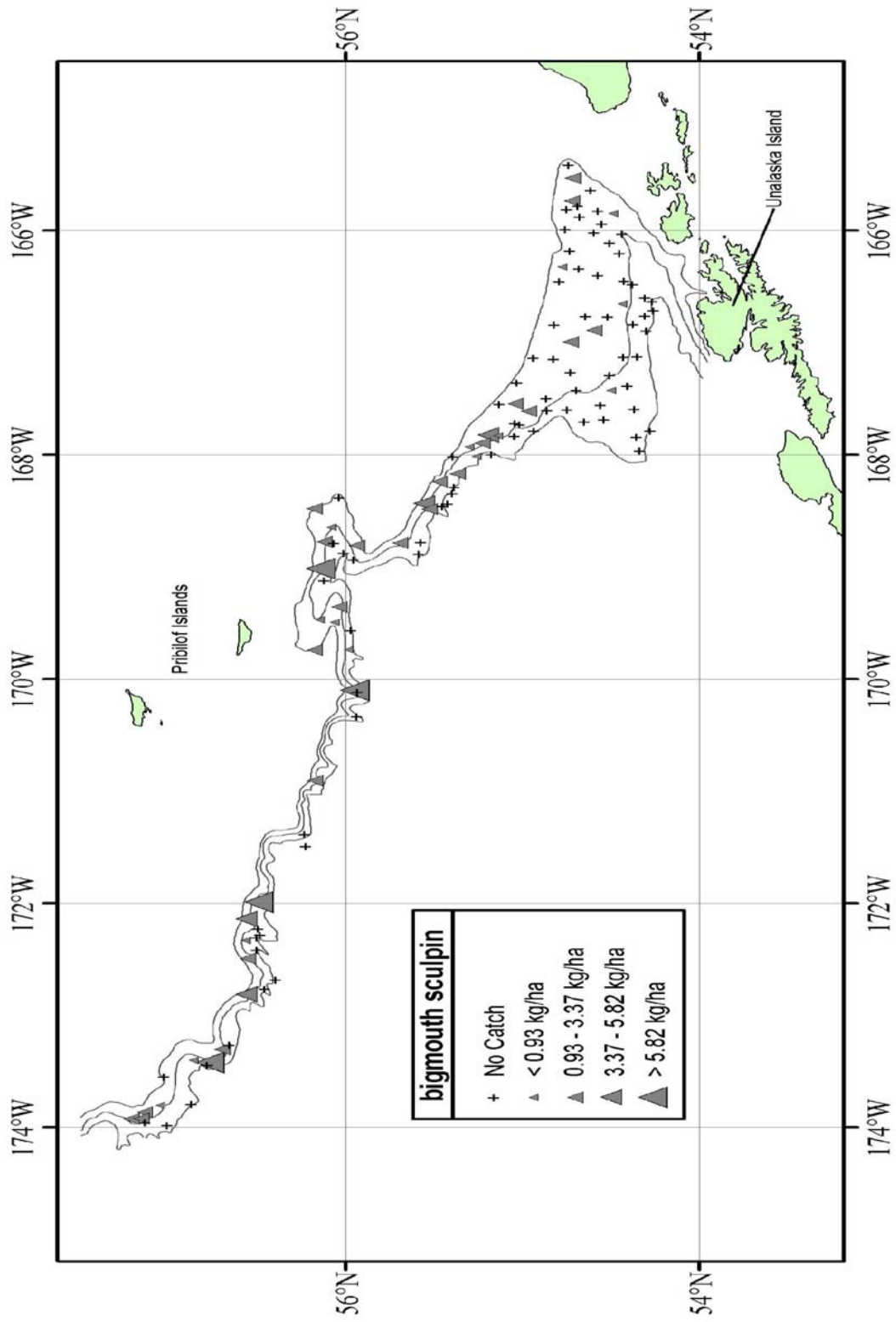

Figure 44. - - Continued.

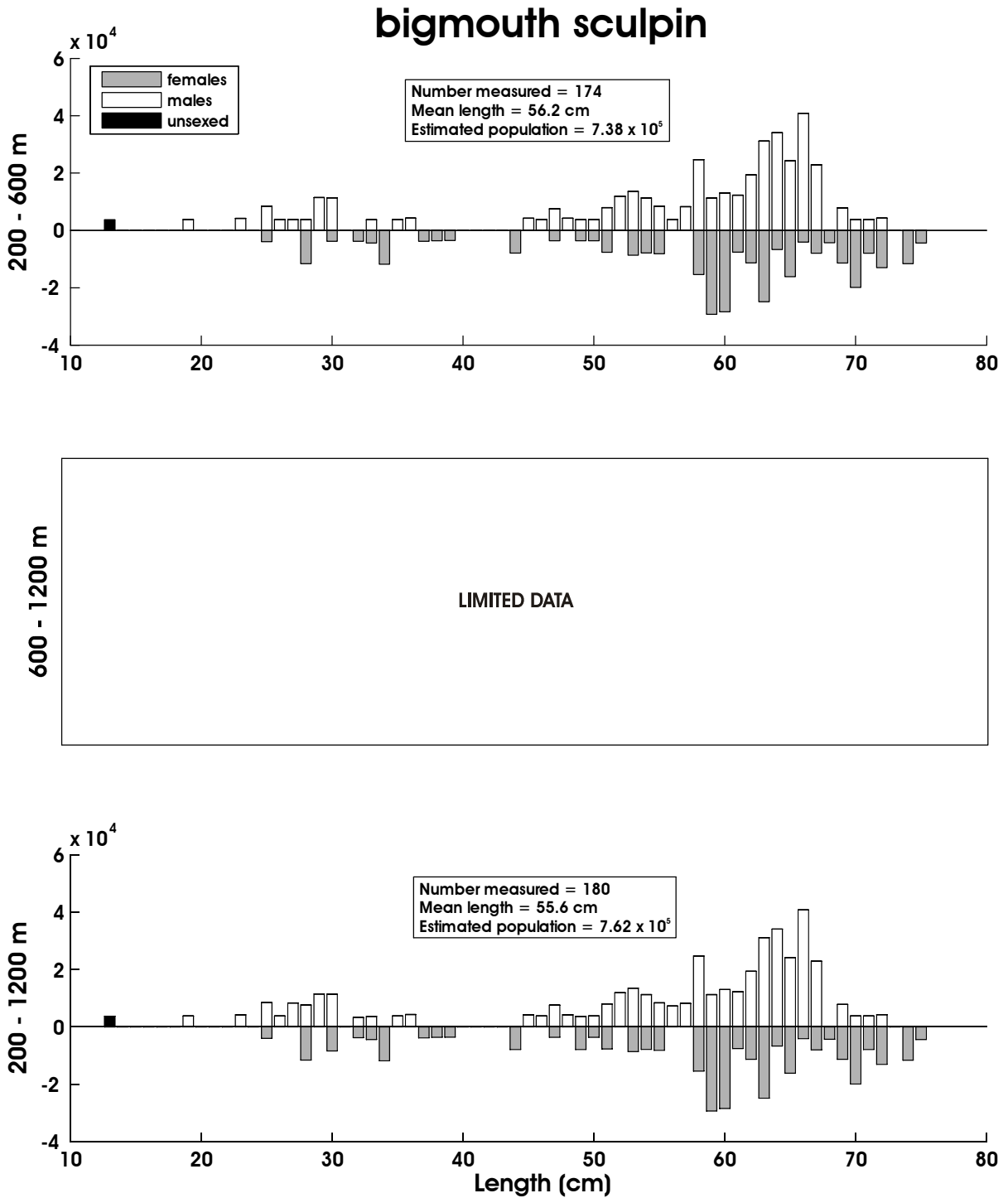

Figure 45. - Size composition of the estimated bigmouth sculpin population from the 2008 EBSS survey for all subareas by depth. The abscissa is scaled as total length in centimeters while the ordinate represents the estimated total population.

Table 31. - - Abundance estimates by subarea and depth stratum for spinyhead sculpin (*Dasycottus setiger*) from the 2008 EBSS survey.

<i>Dasycottus setiger</i>		spinyhead sculpin					
Subarea	Depth Stratum (m)	Biomass (t)	Population	Biomass Variance	Population Variance	Average CPUE (kg/ha)	Average CPUE (no./ha)
1	200-400	2.73E+02	1.78E+06	2.54E+03	1.29E+11	6.80E-01	4.45E+00
	400-600	6.20E+01	4.32E+05	6.38E+02	4.24E+10	1.53E-01	1.06E+00
	600-800	2.18E+00	4.01E+04	3.56E+00	8.40E+08	1.25E-02	2.30E-01
	800-1,000	5.89E-01	3.73E+03	3.47E-01	1.39E+07	4.35E-03	2.75E-02
	1,000-1,200	0.00E+00	0.00E+00	0.00E+00	0.00E+00	0.00E+00	0.00E+00
2	200-400	6.21E-01	1.59E+04	2.49E-01	1.35E+08	5.36E-03	1.37E-01
	400-600	0.00E+00	0.00E+00	0.00E+00	0.00E+00	0.00E+00	0.00E+00
	600-800	0.00E+00	0.00E+00	0.00E+00	0.00E+00	0.00E+00	0.00E+00
	800-1,000	0.00E+00	0.00E+00	0.00E+00	0.00E+00	0.00E+00	0.00E+00
	1,000-1,200	0.00E+00	0.00E+00	0.00E+00	0.00E+00	0.00E+00	0.00E+00
3	200-400	3.30E+00	4.15E+04	4.54E+00	1.08E+09	3.65E-02	4.59E-01
	400-600	7.43E-01	1.23E+04	2.33E-01	6.39E+07	8.38E-03	1.39E-01
	600-800	0.00E+00	0.00E+00	0.00E+00	0.00E+00	0.00E+00	0.00E+00
	800-1,000	0.00E+00	0.00E+00	0.00E+00	0.00E+00	0.00E+00	0.00E+00
	1,000-1,200	0.00E+00	0.00E+00	0.00E+00	0.00E+00	0.00E+00	0.00E+00
4	200-400	1.49E+01	6.57E+04	2.22E+02	4.32E+09	1.20E-01	5.31E-01
	400-600	1.14E-01	7.11E+03	1.29E-02	5.06E+07	1.56E-03	9.74E-02
	600-800	0.00E+00	0.00E+00	0.00E+00	0.00E+00	0.00E+00	0.00E+00
	800-1,000	0.00E+00	0.00E+00	0.00E+00	0.00E+00	0.00E+00	0.00E+00
	1,000-1,200	0.00E+00	0.00E+00	0.00E+00	0.00E+00	0.00E+00	0.00E+00
5	200-400	6.60E-02	5.50E+03	4.35E-03	3.02E+07	1.56E-03	1.30E-01
	400-600	2.40E-01	1.50E+04	1.55E-02	6.04E+07	5.64E-03	3.53E-01
	600-800	0.00E+00	0.00E+00	0.00E+00	0.00E+00	0.00E+00	0.00E+00
	800-1,000	0.00E+00	0.00E+00	0.00E+00	0.00E+00	0.00E+00	0.00E+00
	1,000-1,200	0.00E+00	0.00E+00	0.00E+00	0.00E+00	0.00E+00	0.00E+00
6	200-400	1.01E+01	2.81E+05	2.00E+01	2.13E+10	3.88E-02	1.08E+00
	400-600	6.19E+00	2.64E+05	1.45E+01	2.75E+10	3.63E-02	1.55E+00
	600-800	0.00E+00	0.00E+00	0.00E+00	0.00E+00	0.00E+00	0.00E+00
	800-1,000	0.00E+00	0.00E+00	0.00E+00	0.00E+00	0.00E+00	0.00E+00
	1,000-1,200	0.00E+00	0.00E+00	0.00E+00	0.00E+00	0.00E+00	0.00E+00
1-6	200-1,200	3.74E+02	2.97E+06	3.44E+03	2.27E+11	2.43E-01	2.29E+00

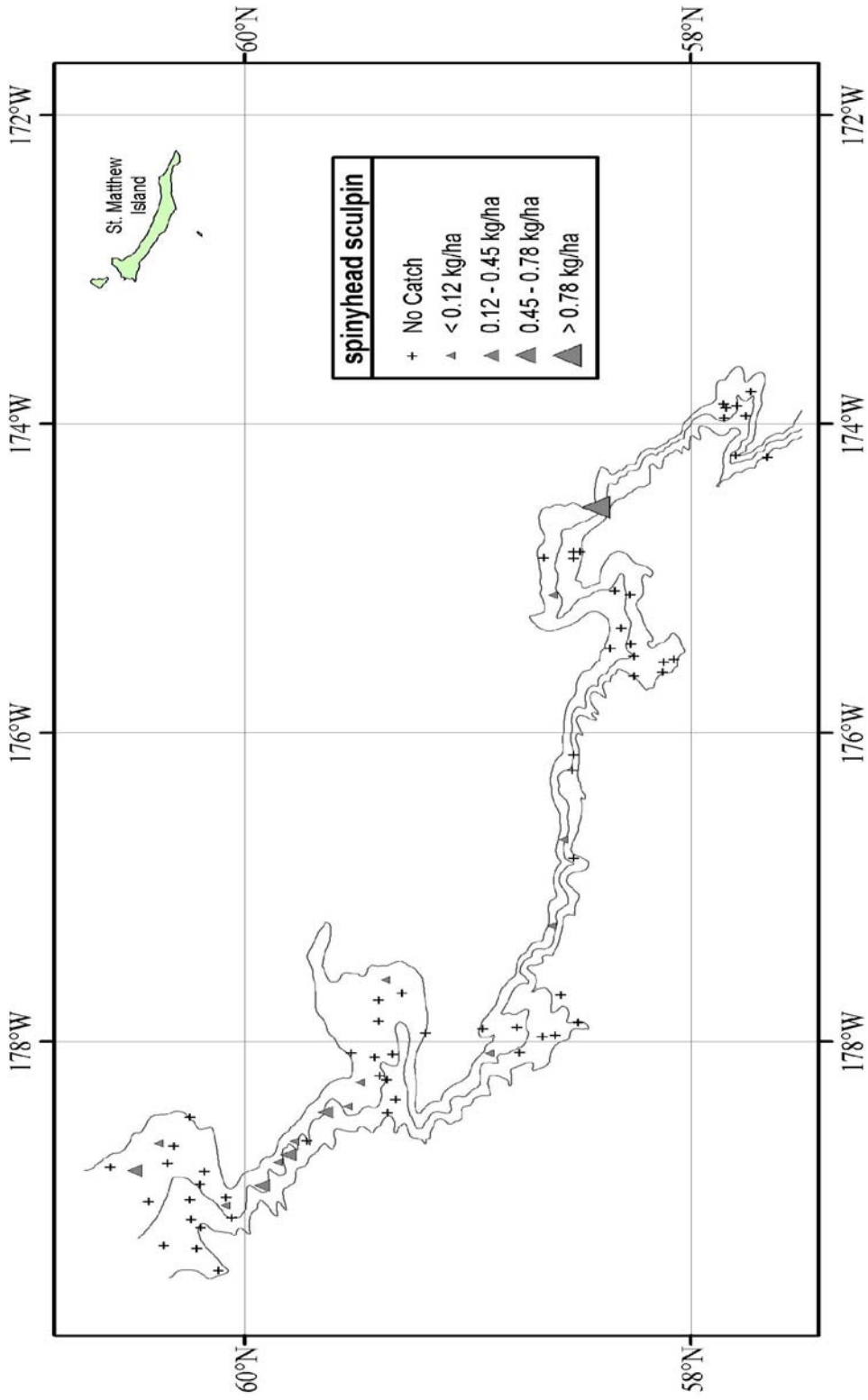

Figure 46. - - Distribution and relative abundance of spinyhead sculpin from the 2008 EBSS survey. Relative abundance is categorized by no catch, sample CPUE less than the mean CPUE, between the mean CPUE and one standard deviation above the mean, between one and two standard deviations above the mean CPUE, and greater than two standard deviations above the mean CPUE.

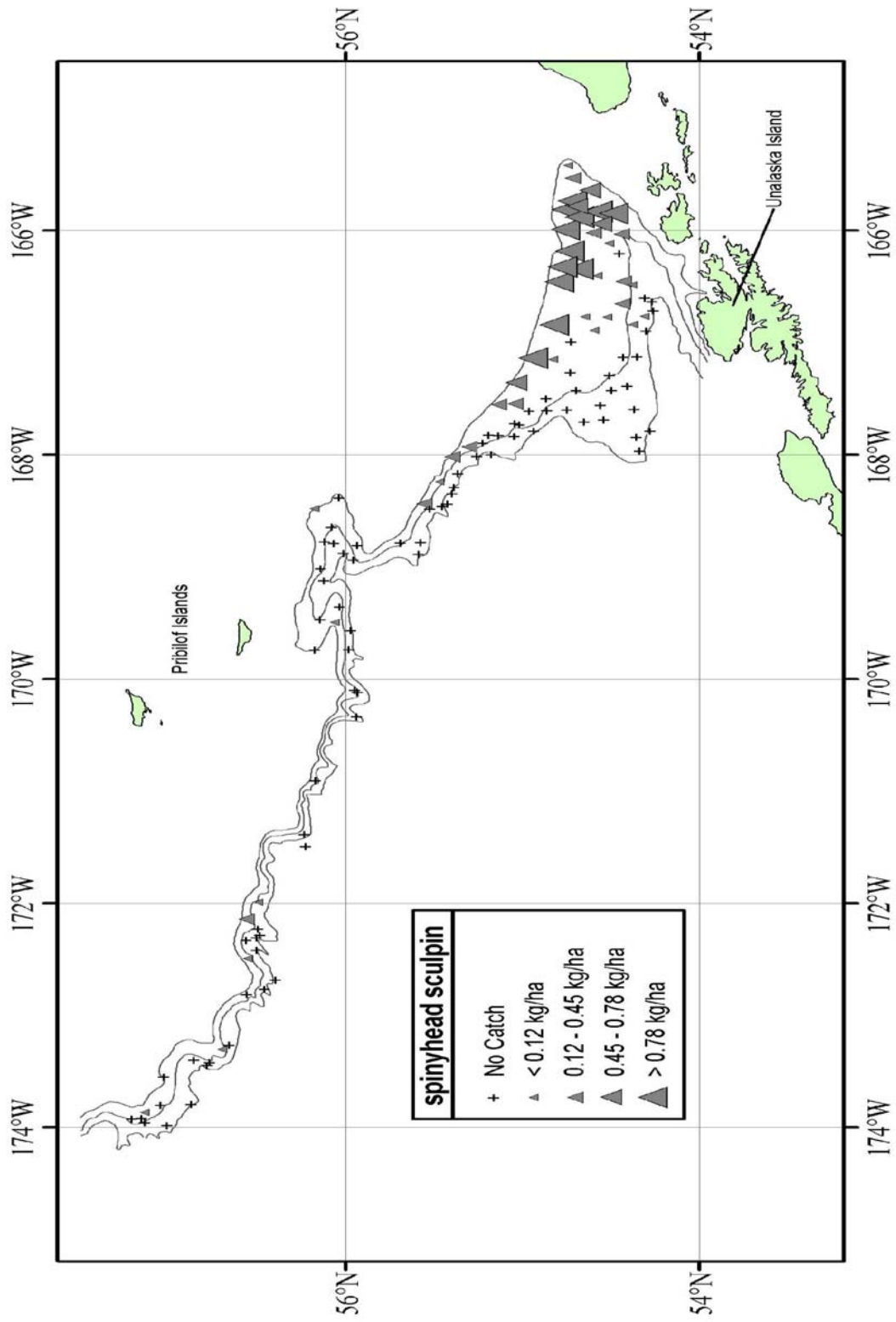

Figure 46. - - Continued.

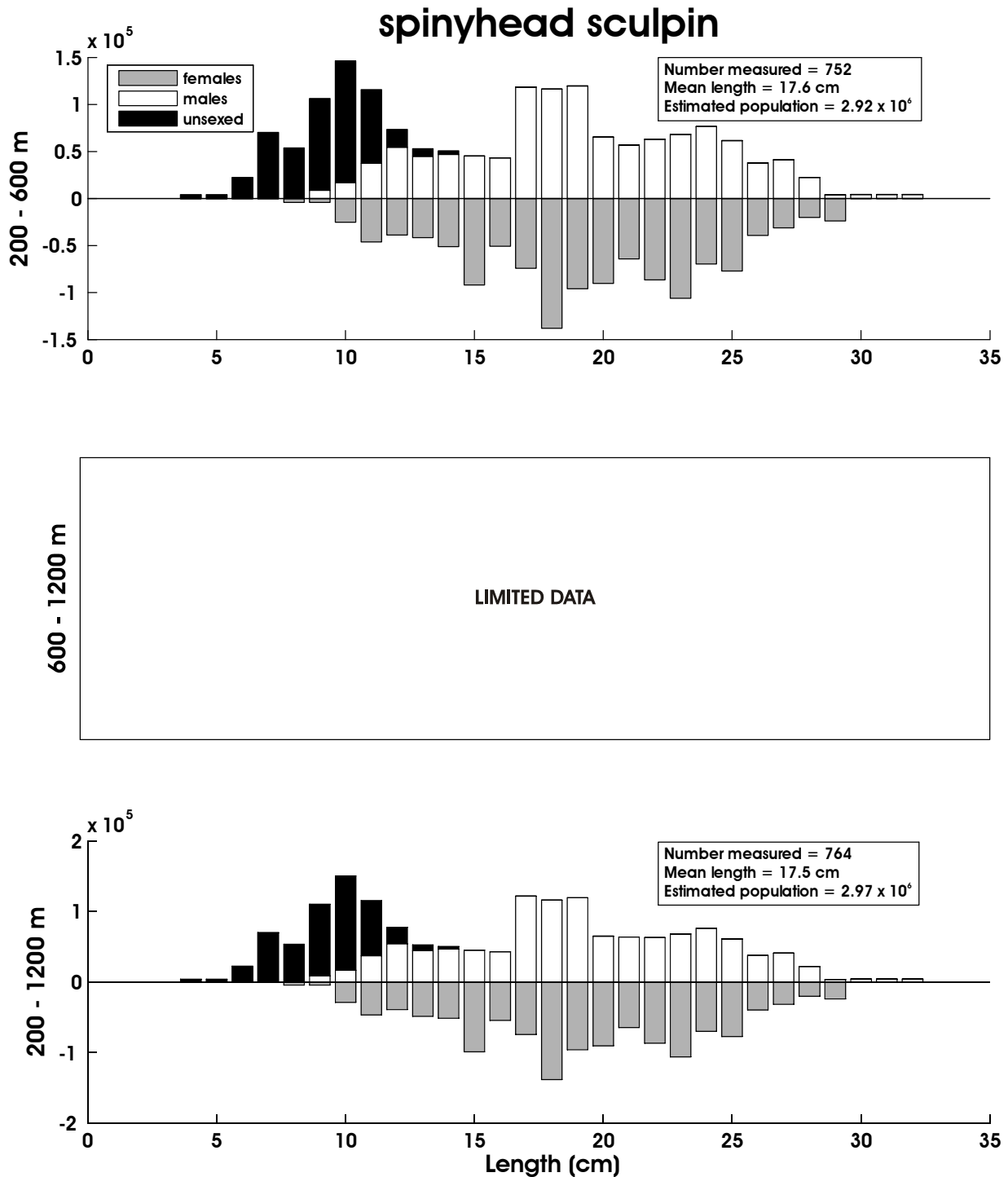

Figure 47. - - Size composition of the estimated spinyhead sculpin population from the 2008 EBSS survey for all subareas by depth. The abscissa is scaled as total length in centimeters while the ordinate represents the estimated total population.

Table 32. - Abundance estimates by subarea and depth stratum for darkfin sculpin
(*Malacocottus zonurus*) from the 2008 EBSS survey.

<i>Malacocottus zonurus</i>						darkfin sculpin	
Subarea	Depth Stratum (m)	Biomass (t)	Population	Biomass Variance	Population Variance	Average CPUE (kg/ha)	Average CPUE (no./ha)
1	200-400	1.55E+02	8.80E+05	2.55E+03	5.25E+10	3.86E-01	2.19E+00
	400-600	7.61E+00	3.02E+05	4.97E+00	7.64E+09	1.87E-02	7.44E-01
	600-800	4.31E+00	4.11E+04	6.96E+00	8.12E+08	2.48E-02	2.36E-01
	800-1,000	0.00E+00	0.00E+00	0.00E+00	0.00E+00	0.00E+00	0.00E+00
	1,000-1,200	0.00E+00	0.00E+00	0.00E+00	0.00E+00	0.00E+00	0.00E+00
2	200-400	4.03E+02	1.81E+06	9.76E+04	1.21E+12	3.48E+00	1.57E+01
	400-600	7.43E+00	1.01E+05	1.59E+01	5.66E+09	1.05E-01	1.44E+00
	600-800	3.76E+01	1.85E+05	1.41E+03	3.44E+10	6.35E-01	3.14E+00
	800-1,000	4.79E-02	5.99E+03	2.29E-03	3.58E+07	8.66E-04	1.08E-01
	1,000-1,200	0.00E+00	0.00E+00	0.00E+00	0.00E+00	0.00E+00	0.00E+00
3	200-400	7.04E+01	8.45E+05	1.94E+03	2.27E+11	7.79E-01	9.35E+00
	400-600	6.96E-02	9.94E+03	4.84E-03	9.87E+07	7.85E-04	1.12E-01
	600-800	0.00E+00	0.00E+00	0.00E+00	0.00E+00	0.00E+00	0.00E+00
	800-1,000	0.00E+00	0.00E+00	0.00E+00	0.00E+00	0.00E+00	0.00E+00
	1,000-1,200	0.00E+00	0.00E+00	0.00E+00	0.00E+00	0.00E+00	0.00E+00
4	200-400	1.78E+01	2.45E+05	2.88E+01	4.75E+09	1.44E-01	1.98E+00
	400-600	2.00E+00	5.29E+04	3.46E+00	1.63E+09	2.73E-02	7.24E-01
	600-800	0.00E+00	0.00E+00	0.00E+00	0.00E+00	0.00E+00	0.00E+00
	800-1,000	0.00E+00	0.00E+00	0.00E+00	0.00E+00	0.00E+00	0.00E+00
	1,000-1,200	0.00E+00	0.00E+00	0.00E+00	0.00E+00	0.00E+00	0.00E+00
5	200-400	1.66E+00	2.20E+04	2.76E+00	4.83E+08	3.92E-02	5.19E-01
	400-600	4.77E-01	3.15E+04	1.30E-01	2.87E+08	1.12E-02	7.40E-01
	600-800	0.00E+00	0.00E+00	0.00E+00	0.00E+00	0.00E+00	0.00E+00
	800-1,000	0.00E+00	0.00E+00	0.00E+00	0.00E+00	0.00E+00	0.00E+00
	1,000-1,200	0.00E+00	0.00E+00	0.00E+00	0.00E+00	0.00E+00	0.00E+00
6	200-400	2.38E+02	1.38E+06	1.33E+04	3.43E+11	9.19E-01	5.32E+00
	400-600	1.27E+02	1.56E+06	1.13E+04	1.61E+12	7.46E-01	9.13E+00
	600-800	7.25E-01	2.38E+04	5.26E-01	5.69E+08	7.90E-03	2.60E-01
	800-1,000	0.00E+00	0.00E+00	0.00E+00	0.00E+00	0.00E+00	0.00E+00
	1,000-1,200	0.00E+00	0.00E+00	0.00E+00	0.00E+00	0.00E+00	0.00E+00
1-6	200-1,200	1.07E+03	7.50E+06	1.28E+05	3.49E+12	2.93E-01	2.48E+00

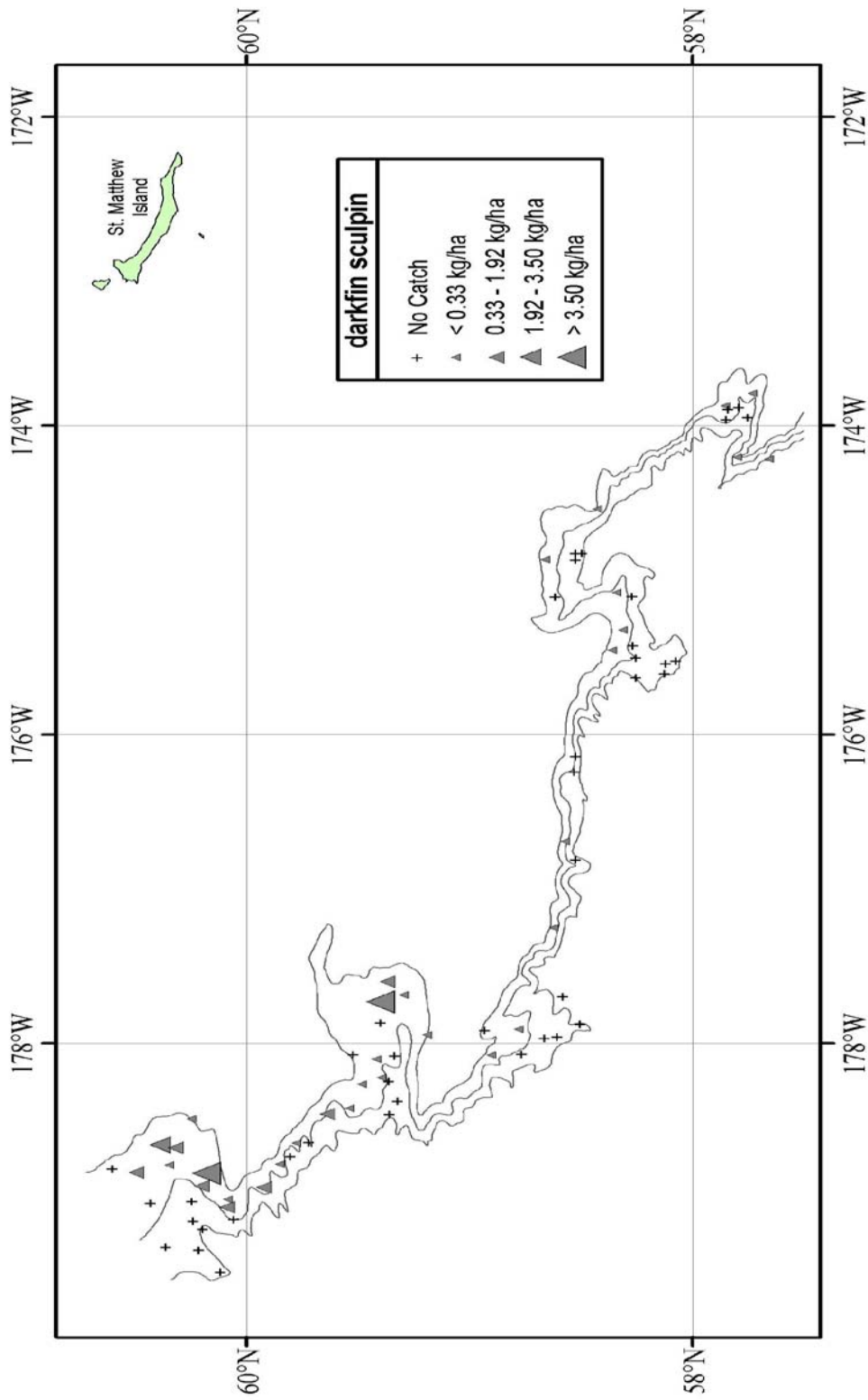

Figure 48. - - Distribution and relative abundance of darkfin sculpin from the 2008 EBSS survey. Relative abundance is categorized by no catch, sample CPUE less than the mean CPUE, between the mean CPUE and one standard deviation above the mean, between one and two standard deviations above the mean CPUE, and greater than two standard deviations above the mean CPUE.

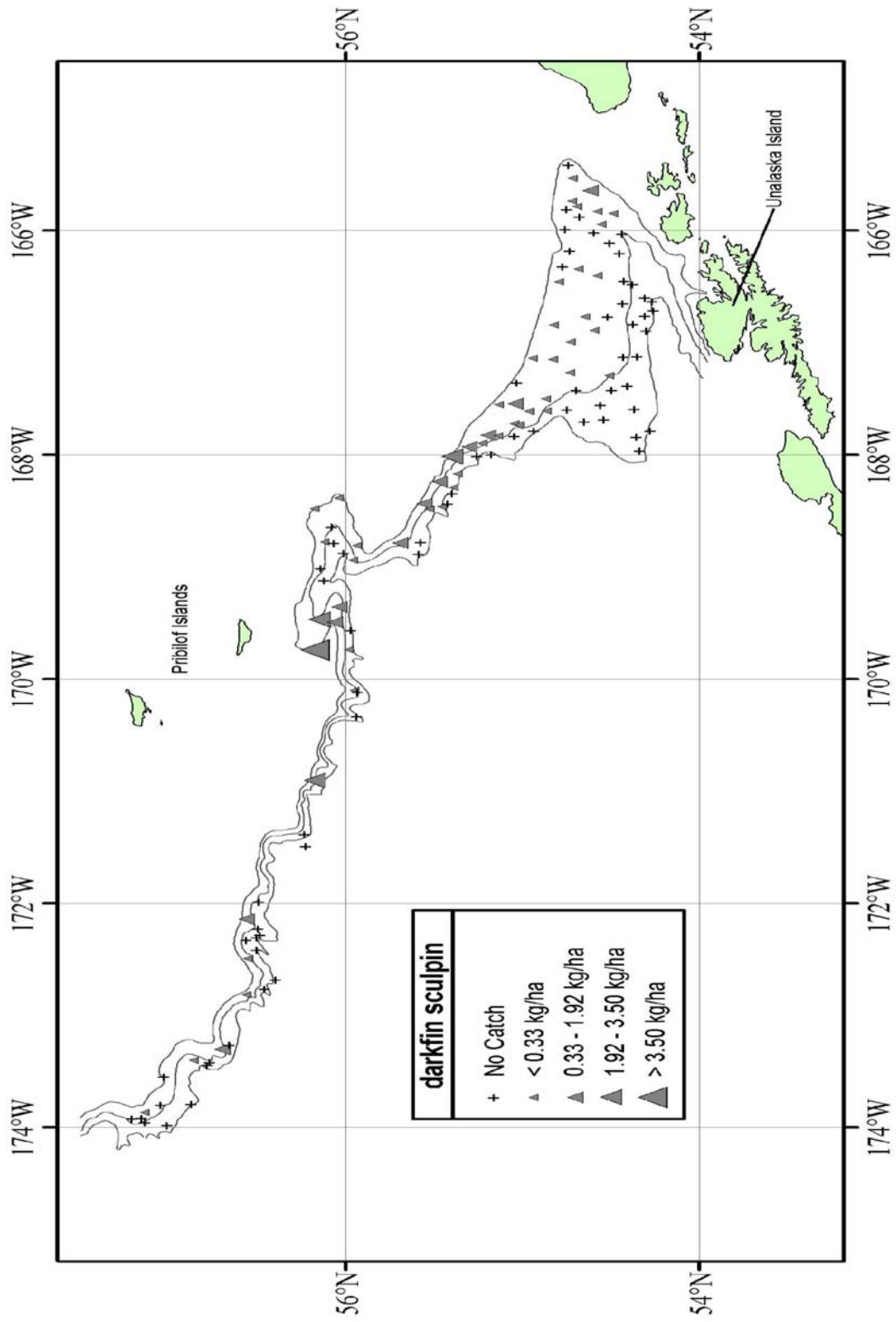

Figure 48. - - Continued.

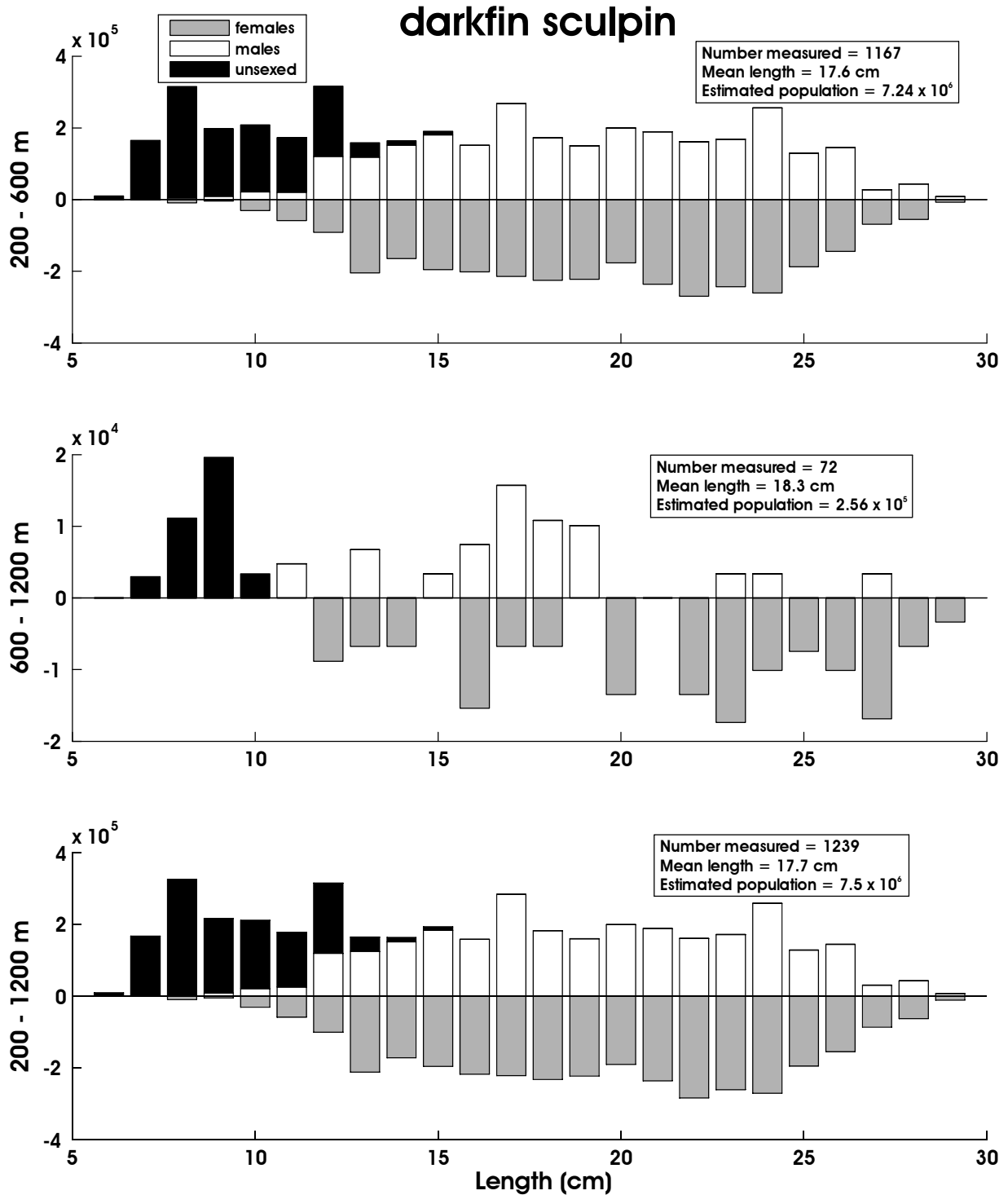

Figure 49. - Size composition of the estimated darkfin sculpin population from the 2008 EBSS survey for all subareas by depth. The abscissa is scaled as total length in centimeters while the ordinate represents the estimated total population.

Table 33. - Abundance estimates by subarea and depth stratum for blob sculpin (*Psychrolutes phrictus*) from the 2008 EBSS survey.

<i>Psychrolutes phrictus</i>						blob sculpin	
Subarea	Depth Stratum (m)	Biomass (t)	Population	Biomass Variance	Population Variance	Average CPUE (kg/ha)	Average CPUE (no./ha)
1	200-400	0.00E+00	0.00E+00	0.00E+00	0.00E+00	0.00E+00	0.00E+00
	400-600	0.00E+00	0.00E+00	0.00E+00	0.00E+00	0.00E+00	0.00E+00
	600-800	0.00E+00	0.00E+00	0.00E+00	0.00E+00	0.00E+00	0.00E+00
	800-1,000	1.34E+02	2.88E+04	5.03E+03	1.01E+08	9.91E-01	2.12E-01
	1,000-1,200	9.52E+01	3.48E+04	3.34E+03	2.34E+08	8.60E-01	3.14E-01
2	200-400	0.00E+00	0.00E+00	0.00E+00	0.00E+00	0.00E+00	0.00E+00
	400-600	0.00E+00	0.00E+00	0.00E+00	0.00E+00	0.00E+00	0.00E+00
	600-800	0.00E+00	0.00E+00	0.00E+00	0.00E+00	0.00E+00	0.00E+00
	800-1,000	2.81E+01	6.78E+03	7.87E+02	4.59E+07	5.07E-01	1.23E-01
	1,000-1,200	5.30E+01	1.54E+04	2.81E+03	2.36E+08	9.90E-01	2.87E-01
3	200-400	0.00E+00	0.00E+00	0.00E+00	0.00E+00	0.00E+00	0.00E+00
	400-600	0.00E+00	0.00E+00	0.00E+00	0.00E+00	0.00E+00	0.00E+00
	600-800	6.66E+01	1.39E+04	4.44E+03	1.93E+08	7.32E-01	1.53E-01
	800-1,000	1.76E+02	4.18E+04	4.83E+03	2.45E+08	2.40E+00	5.71E-01
	1,000-1,200	4.98E+01	1.56E+04	2.48E+03	2.42E+08	7.37E-01	2.30E-01
4	200-400	0.00E+00	0.00E+00	0.00E+00	0.00E+00	0.00E+00	0.00E+00
	400-600	0.00E+00	0.00E+00	0.00E+00	0.00E+00	0.00E+00	0.00E+00
	600-800	0.00E+00	0.00E+00	0.00E+00	0.00E+00	0.00E+00	0.00E+00
	800-1,000	5.12E+01	4.14E+04	3.54E+02	4.93E+08	7.23E-01	5.85E-01
	1,000-1,200	1.65E+02	5.16E+04	3.56E+03	4.37E+08	2.49E+00	7.78E-01
5	200-400	0.00E+00	0.00E+00	0.00E+00	0.00E+00	0.00E+00	0.00E+00
	400-600	0.00E+00	0.00E+00	0.00E+00	0.00E+00	0.00E+00	0.00E+00
	600-800	9.91E+01	2.18E+04	9.81E+03	4.73E+08	2.29E+00	5.04E-01
	800-1,000	6.32E+01	5.46E+04	4.00E+03	2.99E+09	1.15E+00	9.90E-01
	1,000-1,200	1.12E+02	5.53E+04	1.89E+03	5.56E+08	1.96E+00	9.70E-01
6	200-400	0.00E+00	0.00E+00	0.00E+00	0.00E+00	0.00E+00	0.00E+00
	400-600	0.00E+00	0.00E+00	0.00E+00	0.00E+00	0.00E+00	0.00E+00
	600-800	0.00E+00	0.00E+00	0.00E+00	0.00E+00	0.00E+00	0.00E+00
	800-1,000	0.00E+00	0.00E+00	0.00E+00	0.00E+00	0.00E+00	0.00E+00
	1,000-1,200	1.70E+01	8.76E+03	2.87E+02	1.92E+07	3.42E-01	1.77E-01
1-6	200-1,200	1.11E+03	3.90E+05	4.36E+04	6.26E+09	3.72E-01	1.46E-01

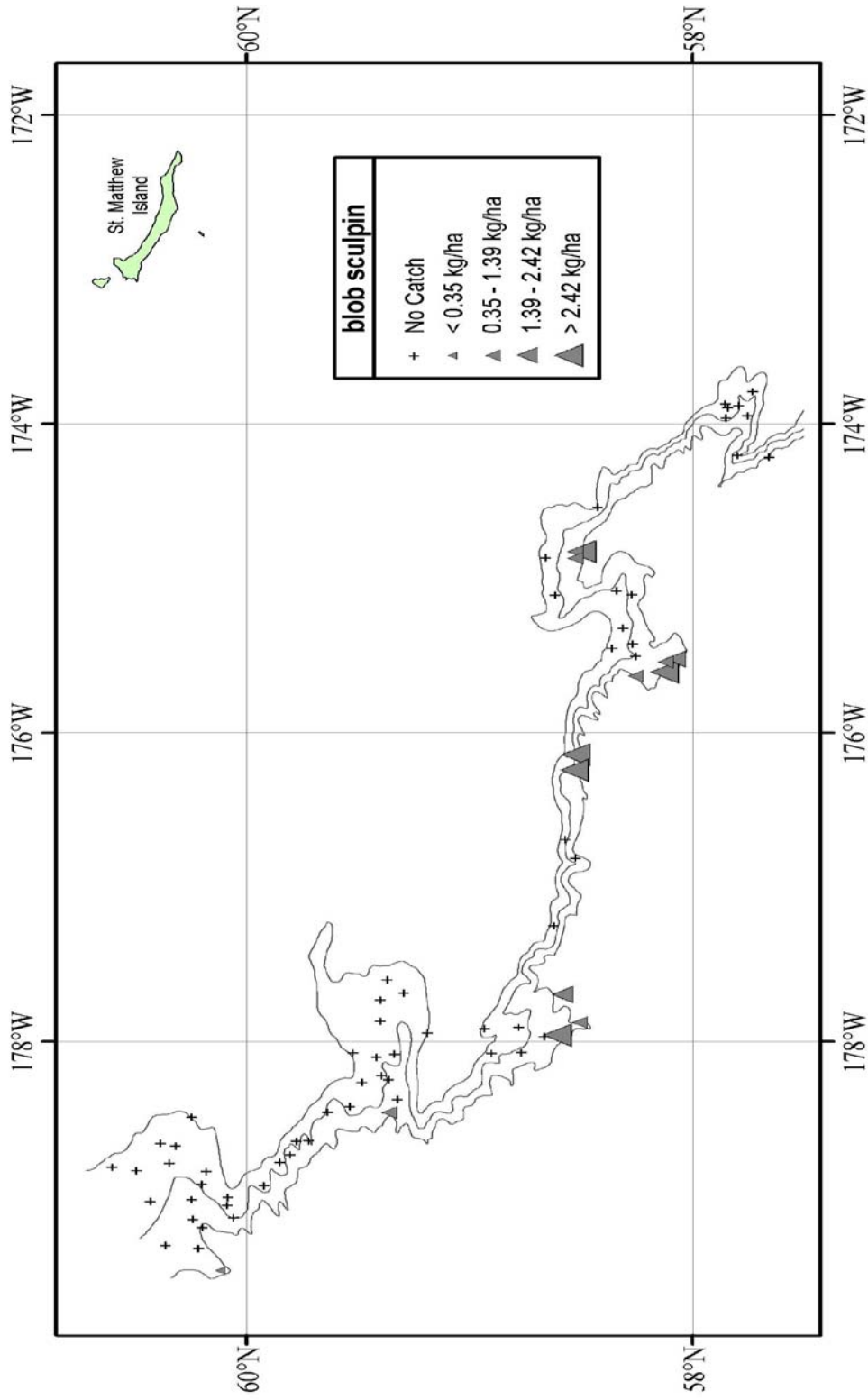

Figure 50. - - Distribution and relative abundance of blob sculpin from the 2008 EBSS survey. Relative abundance is categorized by no catch, sample CPUE less than the mean CPUE, between the mean CPUE and one standard deviation above the mean, between one and two standard deviations above the mean CPUE, and greater than two standard deviations above the mean CPUE.

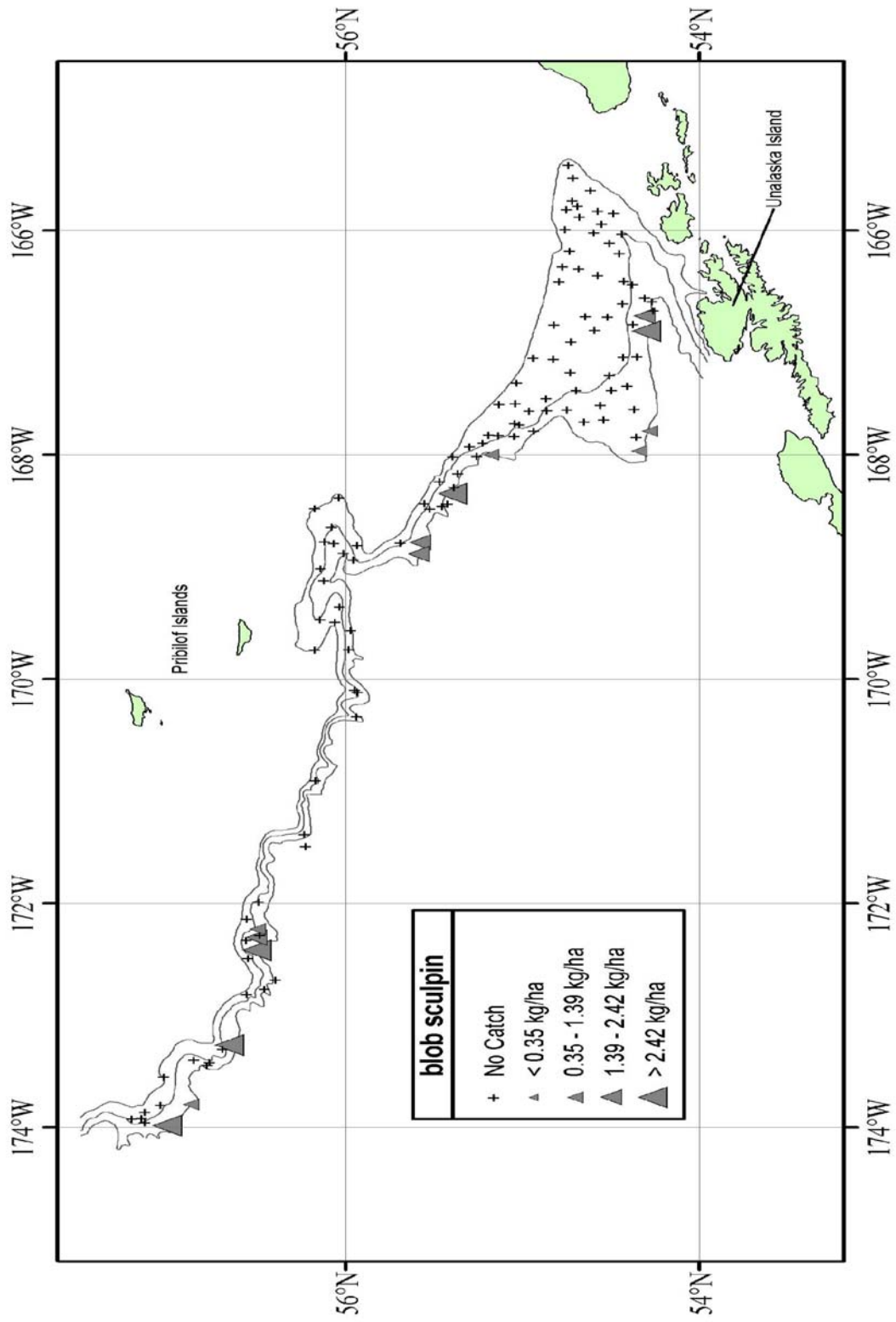

Figure 50. - - Continued.

blob sculpin

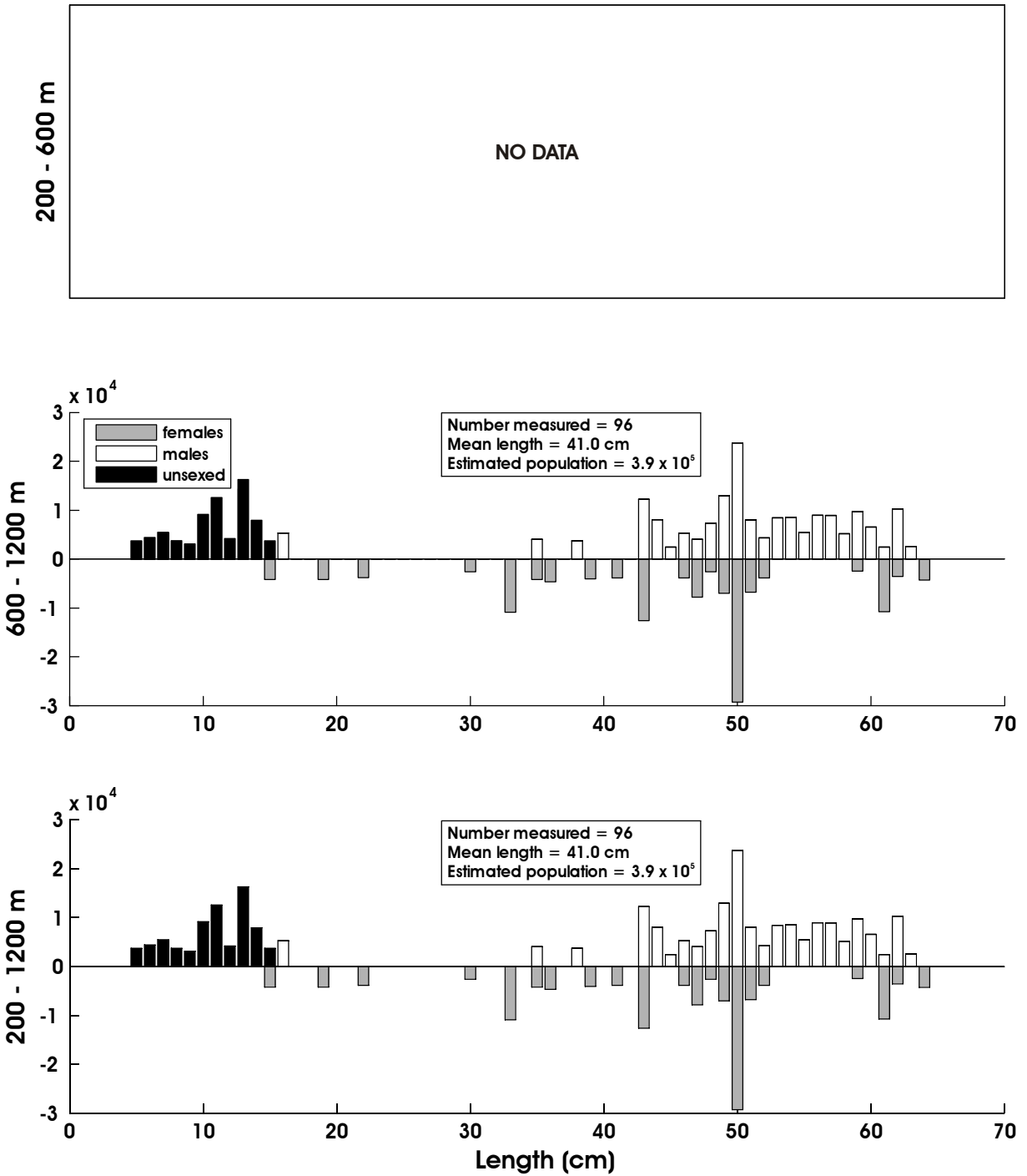

Figure 51. - - Size composition of the estimated blob sculpin population from the 2008 EBSS survey for all subareas by depth. The abscissa is scaled as total length in centimeters while the ordinate represents the estimated total population.

Table 34. - Abundance estimates by subarea and depth stratum for blacktail snailfish (*Careproctus melanurus*) from the 2008 EBSS survey.

<i>Careproctus melanurus</i>					blacktail snailfish		
Subarea	Depth Stratum (m)	Biomass (t)	Population	Biomass Variance	Population Variance	Average CPUE (kg/ha)	Average CPUE (no./ha)
1	200-400	3.98E+00	4.01E+03	1.58E+01	1.61E+07	9.92E-03	1.00E-02
	400-600	2.30E+01	2.29E+04	5.28E+02	5.25E+08	5.66E-02	5.64E-02
	600-800	5.27E+00	9.96E+03	8.09E+00	2.64E+07	3.02E-02	5.72E-02
	800-1,000	1.32E+01	4.15E+04	7.49E+01	6.56E+08	9.72E-02	3.06E-01
	1,000-1,200	4.75E-01	4.65E+03	2.25E-01	2.17E+07	4.29E-03	4.21E-02
2	200-400	6.12E+00	3.98E+03	3.74E+01	1.58E+07	5.29E-02	3.44E-02
	400-600	4.18E+00	3.76E+03	1.75E+01	1.41E+07	5.93E-02	5.33E-02
	600-800	0.00E+00	0.00E+00	0.00E+00	0.00E+00	0.00E+00	0.00E+00
	800-1,000	1.80E+01	6.46E+04	2.33E+02	1.40E+09	3.25E-01	1.17E+00
	1,000-1,200	5.84E-01	7.68E+03	3.41E-01	5.90E+07	1.09E-02	1.43E-01
3	200-400	0.00E+00	0.00E+00	0.00E+00	0.00E+00	0.00E+00	0.00E+00
	400-600	1.14E+01	1.21E+04	4.71E+01	3.10E+07	1.29E-01	1.37E-01
	600-800	3.16E+01	8.48E+04	1.39E+02	2.13E+09	3.47E-01	9.32E-01
	800-1,000	1.74E+00	7.68E+03	7.75E-01	1.31E+07	2.38E-02	1.05E-01
	1,000-1,200	0.00E+00	0.00E+00	0.00E+00	0.00E+00	0.00E+00	0.00E+00
4	200-400	1.32E+01	1.30E+04	1.06E+02	8.24E+07	1.07E-01	1.05E-01
	400-600	5.15E+00	3.61E+03	2.66E+01	1.30E+07	7.06E-02	4.94E-02
	600-800	3.60E+00	1.31E+04	1.30E+01	1.73E+08	5.19E-02	1.89E-01
	800-1,000	2.52E+01	7.05E+04	6.26E+02	4.31E+09	3.56E-01	9.97E-01
	1,000-1,200	3.76E+00	7.71E+03	1.42E+01	5.94E+07	5.68E-02	1.16E-01
5	200-400	0.00E+00	0.00E+00	0.00E+00	0.00E+00	0.00E+00	0.00E+00
	400-600	8.71E+00	1.39E+04	7.58E+01	1.92E+08	2.04E-01	3.26E-01
	600-800	6.71E+00	1.63E+04	4.51E+01	2.66E+08	1.55E-01	3.78E-01
	800-1,000	3.22E+00	1.29E+04	4.29E+00	2.68E+05	5.84E-02	2.34E-01
	1,000-1,200	0.00E+00	0.00E+00	0.00E+00	0.00E+00	0.00E+00	0.00E+00
6	200-400	0.00E+00	0.00E+00	0.00E+00	0.00E+00	0.00E+00	0.00E+00
	400-600	2.27E+00	3.66E+03	5.15E+00	1.34E+07	1.33E-02	2.15E-02
	600-800	2.58E+01	1.00E+05	3.66E+02	4.67E+09	2.81E-01	1.09E+00
	800-1,000	5.50E+00	1.80E+04	3.03E+01	3.24E+08	8.53E-02	2.79E-01
	1,000-1,200	0.00E+00	0.00E+00	0.00E+00	0.00E+00	0.00E+00	0.00E+00
1-6	200-1,200	2.23E+02	5.40E+05	2.42E+03	1.50E+10	1.40E-01	2.29E-01

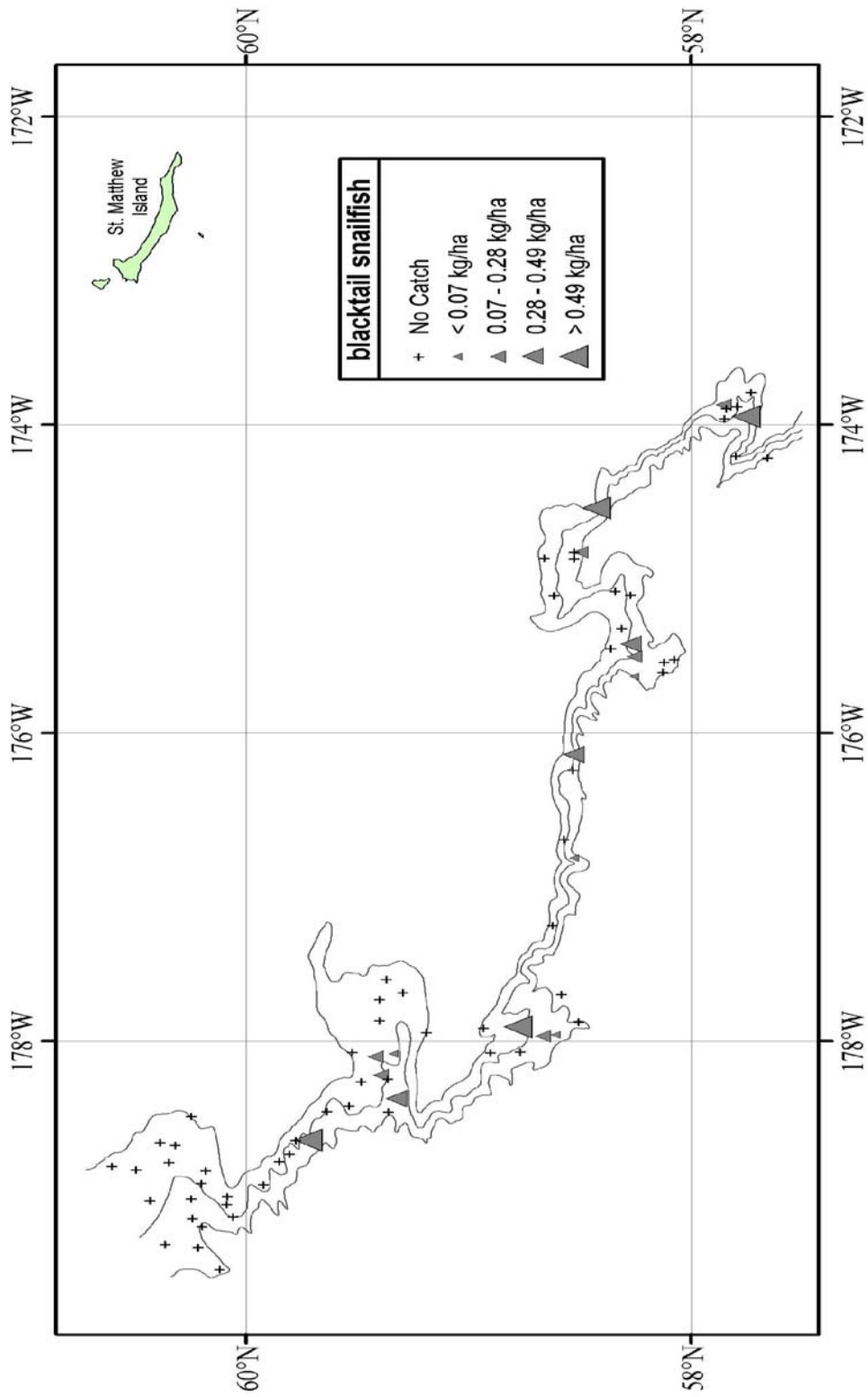

Figure 52. - - Distribution and relative abundance of blacktail snailfish from the 2008 EBSS survey. Relative abundance is categorized by no catch, sample CPUE less than the mean CPUE, between the mean CPUE and one standard deviation above the mean, between one and two standard deviations above the mean CPUE, and greater than two standard deviations above the mean CPUE.

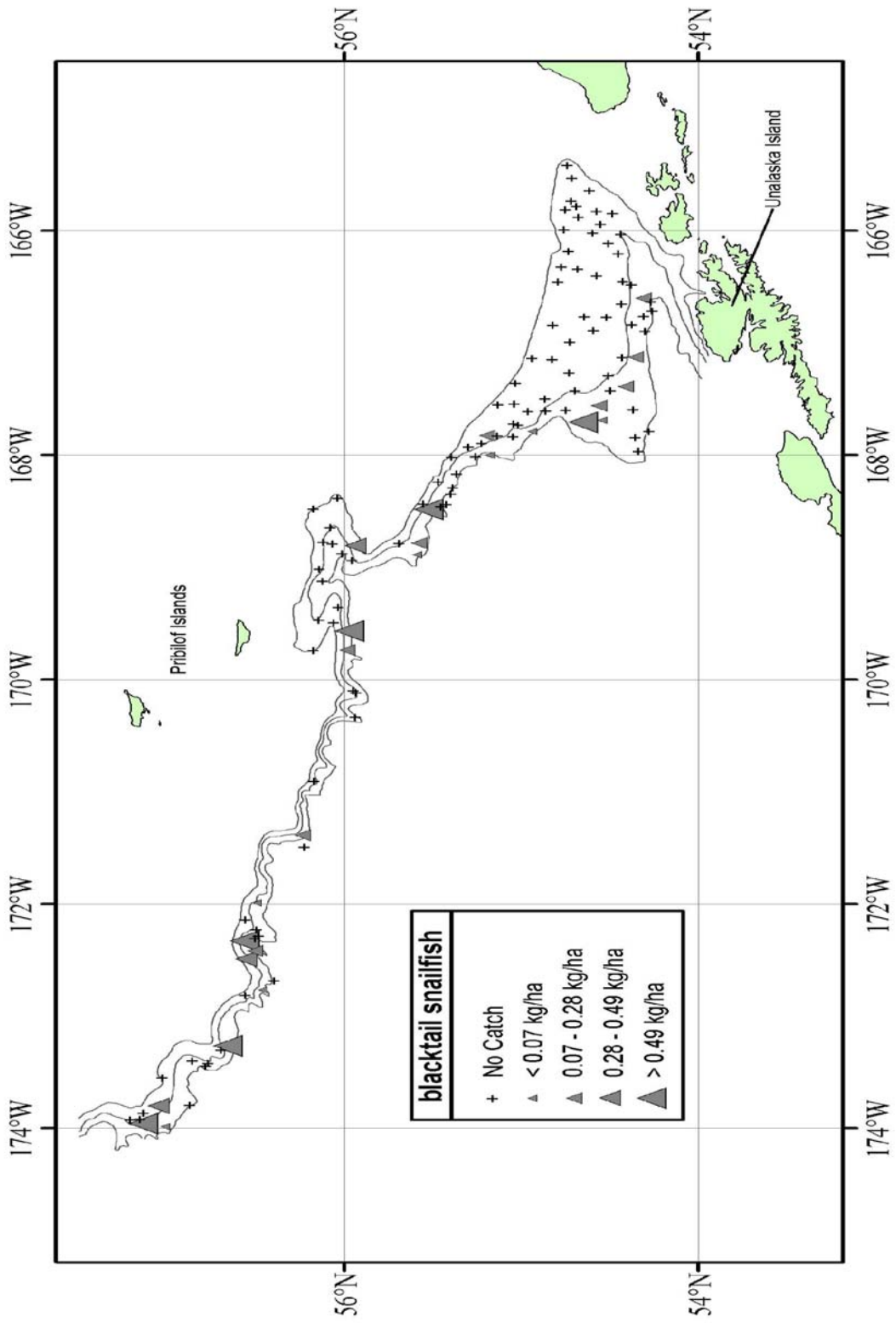

Figure 52. - - Continued.

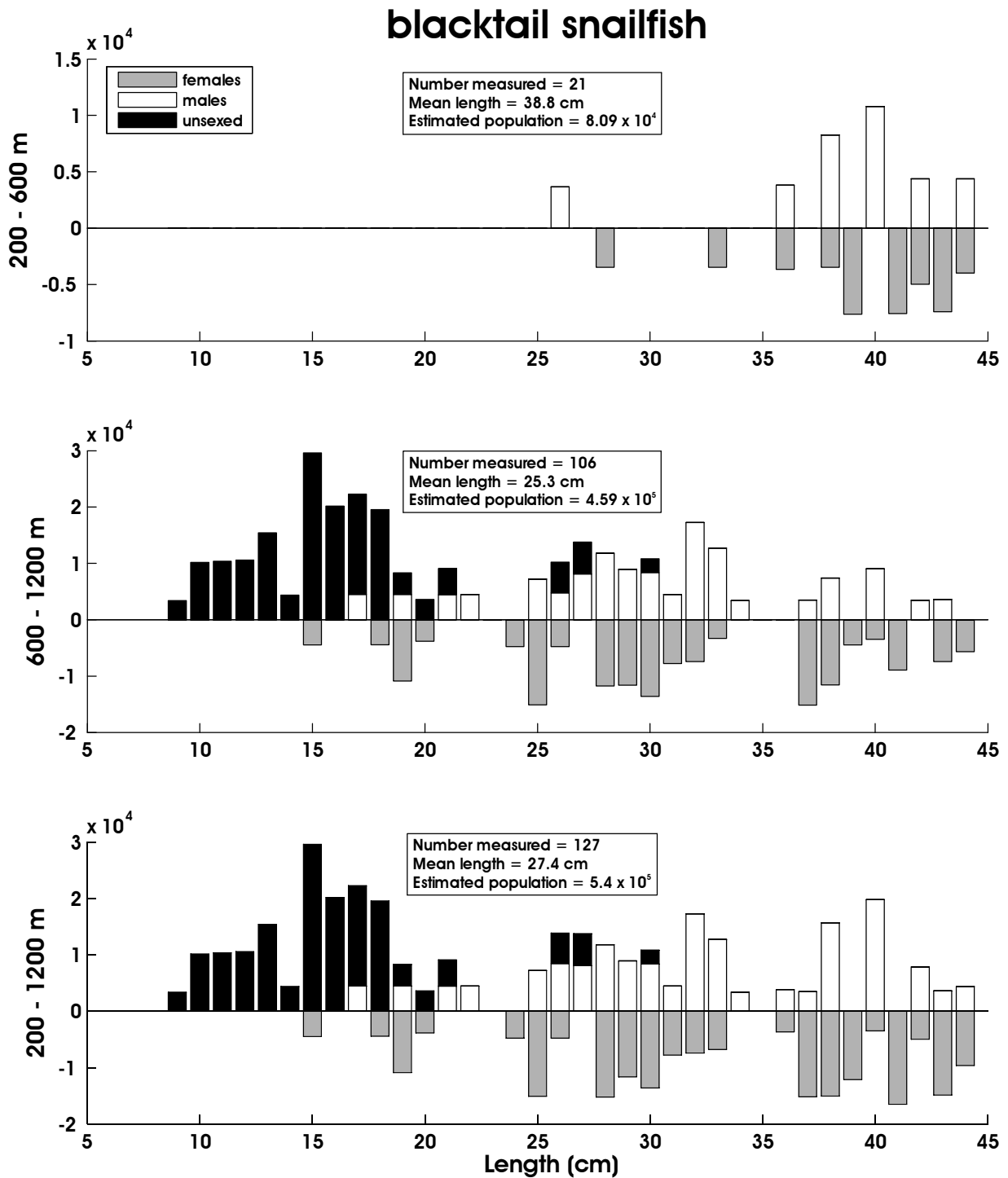

Figure 53. - Size composition of the estimated blacktail snailfish population from the 2008 EBSS survey for all subareas by depth. The abscissa is scaled as total length in centimeters while the ordinate represents the estimated total population.

Table 35. - Abundance estimates by subarea and depth stratum for black eelpout (*Lycodes beringi*) from the 2008 EBSS survey.

<i>Lycodes beringi</i>		Bering eelpout					
Subarea	Depth Stratum (m)	Biomass (t)	Population	Biomass Variance	Population Variance	Average CPUE (kg/ha)	Average CPUE (no./ha)
1	200-400	9.50E+00	1.27E+05	1.02E+01	1.75E+09	2.37E-02	3.18E-01
	400-600	5.94E+01	1.05E+06	3.26E+02	9.20E+10	1.46E-01	2.58E+00
	600-800	7.58E+00	2.07E+05	1.48E+00	7.98E+08	4.35E-02	1.19E+00
	800-1,000	1.93E+01	5.36E+05	1.16E+02	9.03E+10	1.42E-01	3.96E+00
	1,000-1,200	5.87E+00	1.83E+05	2.05E+01	2.04E+10	5.30E-02	1.66E+00
2	200-400	2.70E+00	3.57E+04	3.85E+00	5.44E+08	2.33E-02	3.09E-01
	400-600	1.49E+01	2.87E+05	9.90E+00	5.18E+09	2.12E-01	4.07E+00
	600-800	5.51E-01	1.17E+04	1.01E-01	6.18E+07	9.32E-03	1.98E-01
	800-1,000	9.60E+00	1.99E+05	3.40E+01	1.53E+10	1.74E-01	3.61E+00
	1,000-1,200	0.00E+00	0.00E+00	0.00E+00	0.00E+00	0.00E+00	0.00E+00
3	200-400	2.41E+00	3.09E+04	2.08E+00	2.70E+08	2.67E-02	3.42E-01
	400-600	6.89E+00	9.71E+04	3.04E+00	7.09E+08	7.78E-02	1.10E+00
	600-800	5.01E+00	8.16E+04	5.96E+00	1.06E+09	5.51E-02	8.96E-01
	800-1,000	7.78E-01	1.90E+04	6.06E-01	3.63E+08	1.06E-02	2.60E-01
	1,000-1,200	0.00E+00	0.00E+00	0.00E+00	0.00E+00	0.00E+00	0.00E+00
4	200-400	0.00E+00	0.00E+00	0.00E+00	0.00E+00	0.00E+00	0.00E+00
	400-600	1.60E+00	2.17E+04	9.95E-01	2.05E+08	2.18E-02	2.97E-01
	600-800	0.00E+00	0.00E+00	0.00E+00	0.00E+00	0.00E+00	0.00E+00
	800-1,000	0.00E+00	0.00E+00	0.00E+00	0.00E+00	0.00E+00	0.00E+00
	1,000-1,200	0.00E+00	0.00E+00	0.00E+00	0.00E+00	0.00E+00	0.00E+00
5	200-400	2.58E+00	3.15E+04	6.66E+00	9.91E+08	6.09E-02	7.43E-01
	400-600	8.53E-01	1.39E+04	7.28E-01	1.92E+08	2.00E-02	3.26E-01
	600-800	0.00E+00	0.00E+00	0.00E+00	0.00E+00	0.00E+00	0.00E+00
	800-1,000	0.00E+00	0.00E+00	0.00E+00	0.00E+00	0.00E+00	0.00E+00
	1,000-1,200	0.00E+00	0.00E+00	0.00E+00	0.00E+00	0.00E+00	0.00E+00
6	200-400	1.20E+01	1.63E+05	2.32E+01	4.55E+09	4.63E-02	6.26E-01
	400-600	3.29E+01	4.89E+05	1.40E+02	3.61E+10	1.93E-01	2.87E+00
	600-800	7.42E+00	1.21E+05	2.21E+01	5.78E+09	8.09E-02	1.32E+00
	800-1,000	0.00E+00	0.00E+00	0.00E+00	0.00E+00	0.00E+00	0.00E+00
	1,000-1,200	0.00E+00	0.00E+00	0.00E+00	0.00E+00	0.00E+00	0.00E+00
1-6	200-1,200	2.02E+02	3.70E+06	7.28E+02	2.76E+11	1.07E-01	1.96E+00

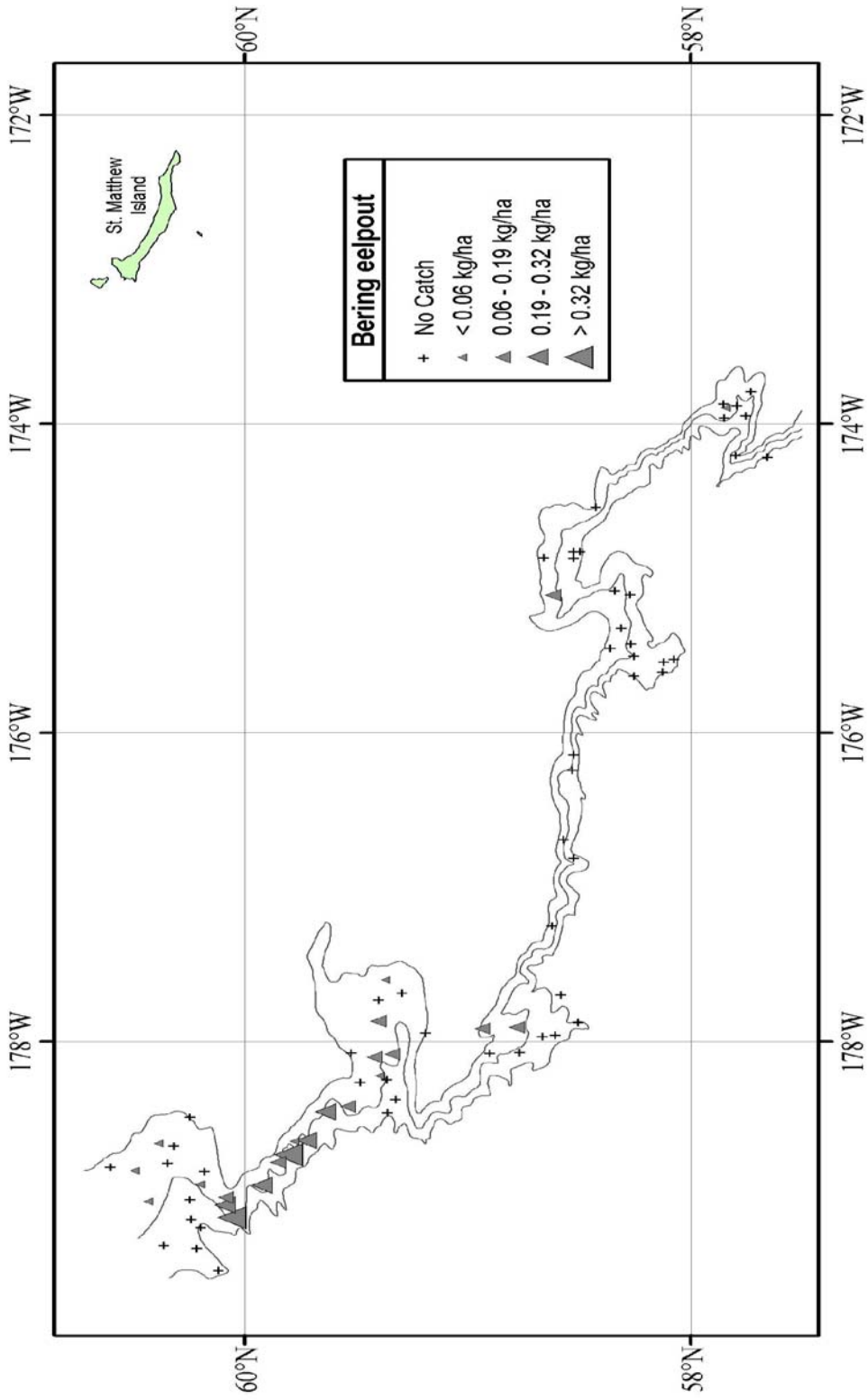

Figure 54. - - Distribution and relative abundance of Bering eelpout from the 2008 EBSS survey. Relative abundance is categorized by no catch, sample CPUE less than the mean CPUE, between the mean CPUE and one standard deviation above the mean, between one and two standard deviations above the mean CPUE, and greater than two standard deviations above the mean CPUE.

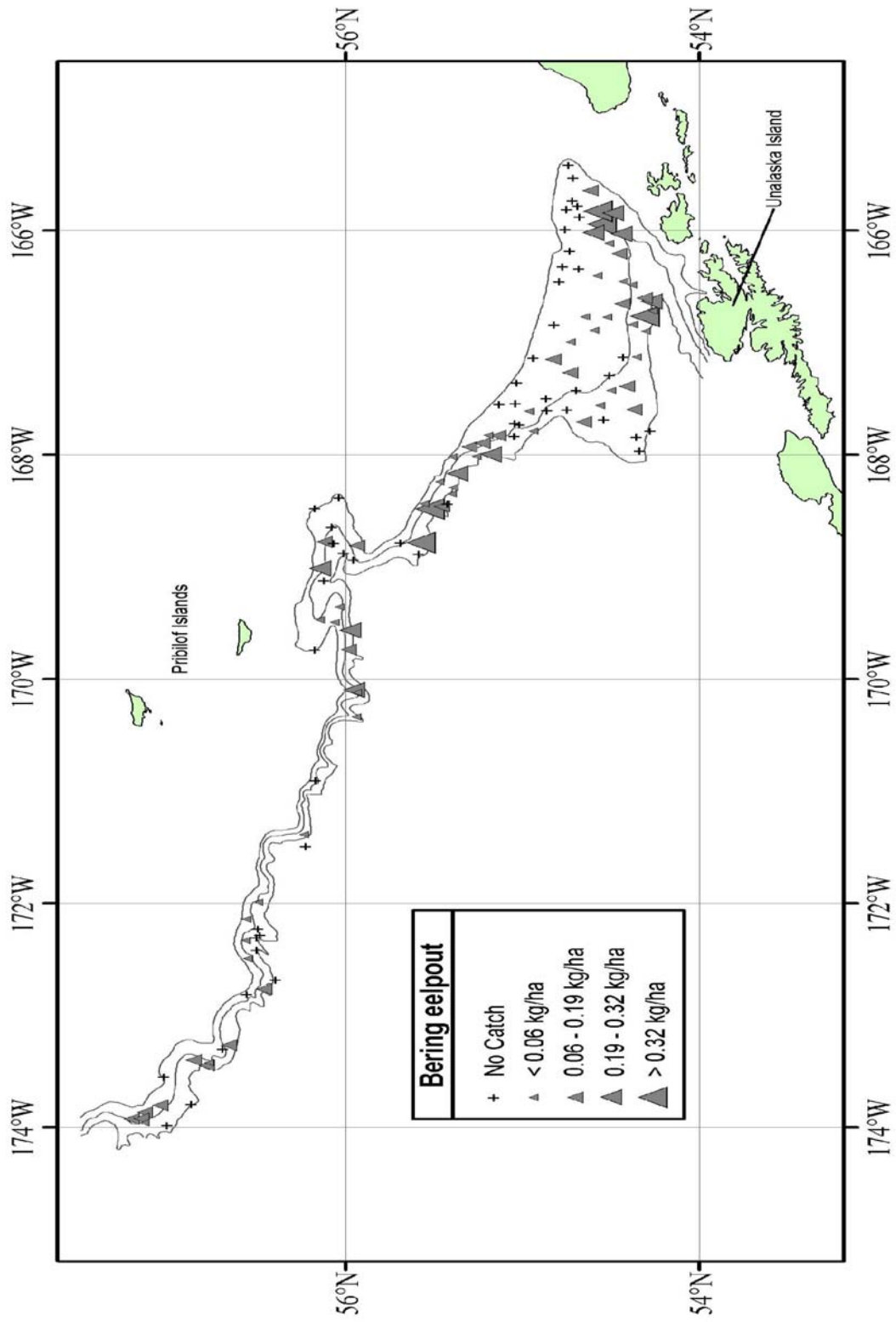

Figure 54. - - Continued.

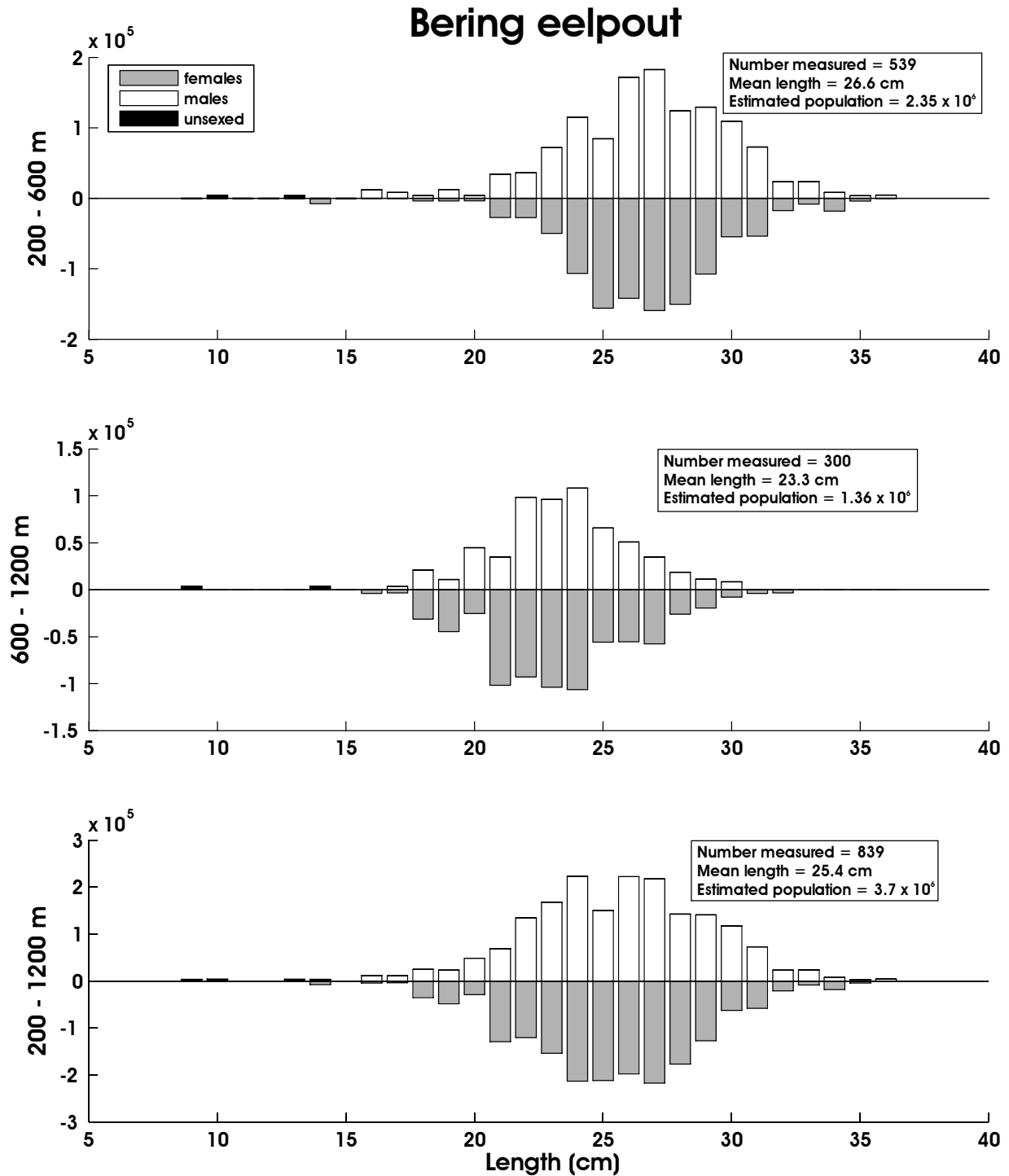

Figure 55. - Size composition of the estimated Bering eelpout population from the 2008 EBSS survey for all subareas by depth. The abscissa is scaled as total length in centimeters while the ordinate represents the estimated total population.

Table 36. - Abundance estimates by subarea and depth stratum for ebony eelpout (*Lycodes concolor*) from the 2008 EBSS survey.

<i>Lycodes concolor</i>					ebony eelpout		
Subarea	Depth Stratum (m)	Biomass (t)	Population	Biomass Variance	Population Variance	Average CPUE (kg/ha)	Average CPUE (no./ha)
1	200-400	0.00E+00	0.00E+00	0.00E+00	0.00E+00	0.00E+00	0.00E+00
	400-600	1.22E+03	1.01E+06	3.17E+05	2.29E+11	3.01E+00	2.49E+00
	600-800	7.67E+01	9.24E+04	2.60E+03	3.33E+09	4.40E-01	5.31E-01
	800-1,000	0.00E+00	0.00E+00	0.00E+00	0.00E+00	0.00E+00	0.00E+00
	1,000-1,200	2.70E-01	3.98E+03	7.31E-02	1.58E+07	2.44E-03	3.59E-02
2	200-400	0.00E+00	0.00E+00	0.00E+00	0.00E+00	0.00E+00	0.00E+00
	400-600	7.99E+01	9.02E+04	3.94E+03	5.60E+09	1.13E+00	1.28E+00
	600-800	5.22E+01	5.67E+04	1.63E+03	1.64E+09	8.83E-01	9.58E-01
	800-1,000	1.10E+00	8.98E+03	1.20E+00	8.06E+07	1.98E-02	1.62E-01
	1,000-1,200	1.25E+02	3.44E+05	6.45E+03	3.36E+10	2.34E+00	6.42E+00
3	200-400	0.00E+00	0.00E+00	0.00E+00	0.00E+00	0.00E+00	0.00E+00
	400-600	5.63E+00	1.49E+04	1.02E+01	5.20E+07	6.36E-02	1.68E-01
	600-800	4.45E+01	5.83E+04	7.69E+02	1.47E+09	4.89E-01	6.40E-01
	800-1,000	0.00E+00	0.00E+00	0.00E+00	0.00E+00	0.00E+00	0.00E+00
	1,000-1,200	0.00E+00	0.00E+00	0.00E+00	0.00E+00	0.00E+00	0.00E+00
4	200-400	0.00E+00	0.00E+00	0.00E+00	0.00E+00	0.00E+00	0.00E+00
	400-600	4.17E+01	3.90E+04	7.08E+02	6.74E+08	5.71E-01	5.34E-01
	600-800	2.37E+02	2.60E+05	1.10E+04	1.14E+10	3.42E+00	3.74E+00
	800-1,000	0.00E+00	0.00E+00	0.00E+00	0.00E+00	0.00E+00	0.00E+00
	1,000-1,200	0.00E+00	0.00E+00	0.00E+00	0.00E+00	0.00E+00	0.00E+00
5	200-400	0.00E+00	0.00E+00	0.00E+00	0.00E+00	0.00E+00	0.00E+00
	400-600	3.11E+00	3.47E+03	9.66E+00	1.20E+07	7.30E-02	8.15E-02
	600-800	0.00E+00	0.00E+00	0.00E+00	0.00E+00	0.00E+00	0.00E+00
	800-1,000	0.00E+00	0.00E+00	0.00E+00	0.00E+00	0.00E+00	0.00E+00
	1,000-1,200	0.00E+00	0.00E+00	0.00E+00	0.00E+00	0.00E+00	0.00E+00
6	200-400	4.49E+01	4.53E+04	1.58E+03	1.71E+09	1.73E-01	1.74E-01
	400-600	4.61E+02	5.38E+05	3.22E+04	4.81E+10	2.70E+00	3.15E+00
	600-800	3.09E+01	3.52E+04	5.66E+02	6.51E+08	3.37E-01	3.84E-01
	800-1,000	1.38E+00	7.18E+03	8.51E-01	1.72E+07	2.15E-02	1.11E-01
	1,000-1,200	6.22E-01	4.32E+03	3.87E-01	1.87E+07	1.25E-02	8.70E-02
1-6	200-1,200	2.43E+03	2.61E+06	3.78E+05	3.38E+11	6.21E-01	7.55E-01

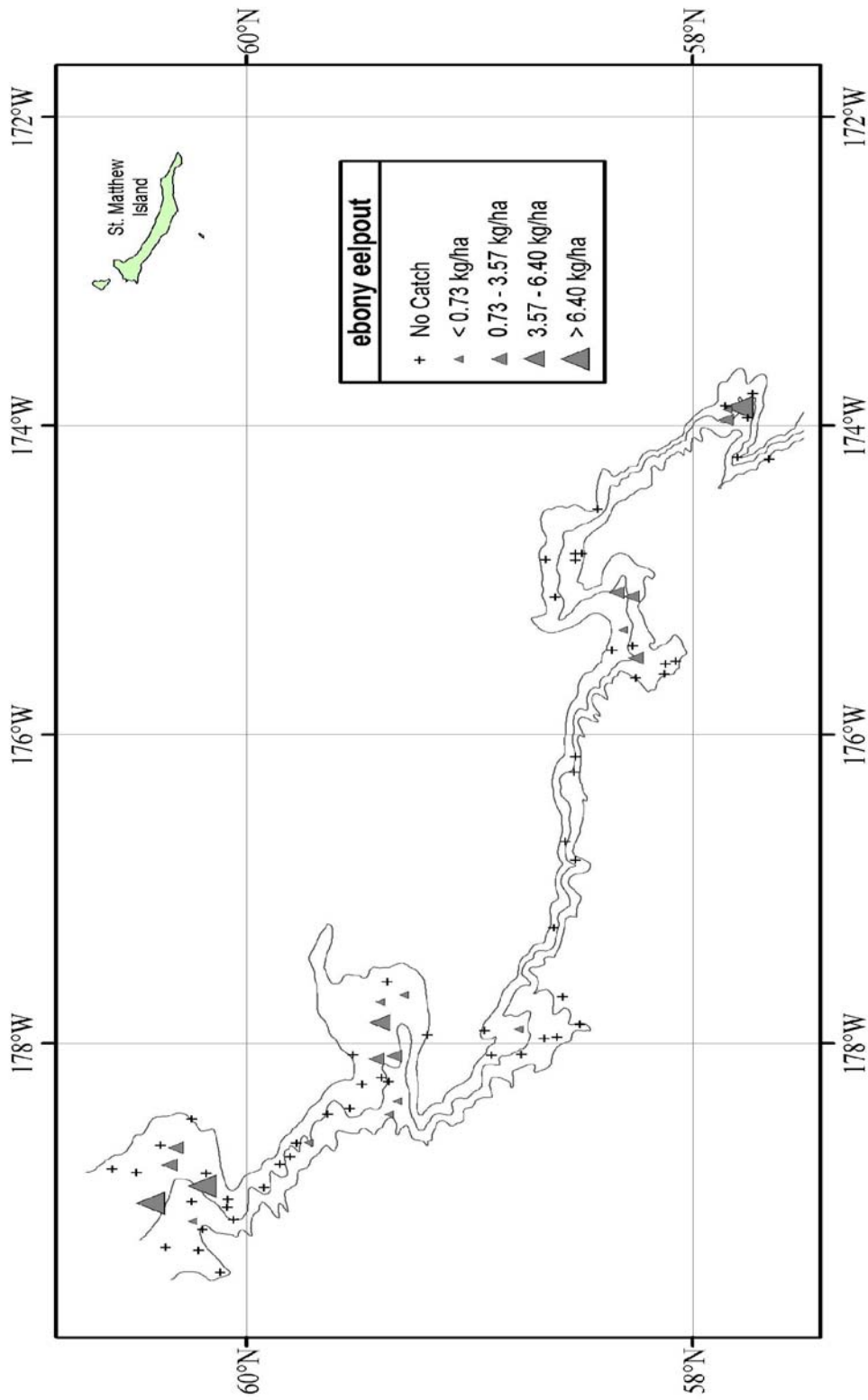

Figure 56. - - Distribution and relative abundance of ebony eelpout from the 2008 EBSS survey. Relative abundance is categorized by no catch, sample CPUE less than the mean CPUE, between the mean CPUE and one standard deviation above the mean, between one and two standard deviations above the mean CPUE, and greater than two standard deviations above the mean CPUE.

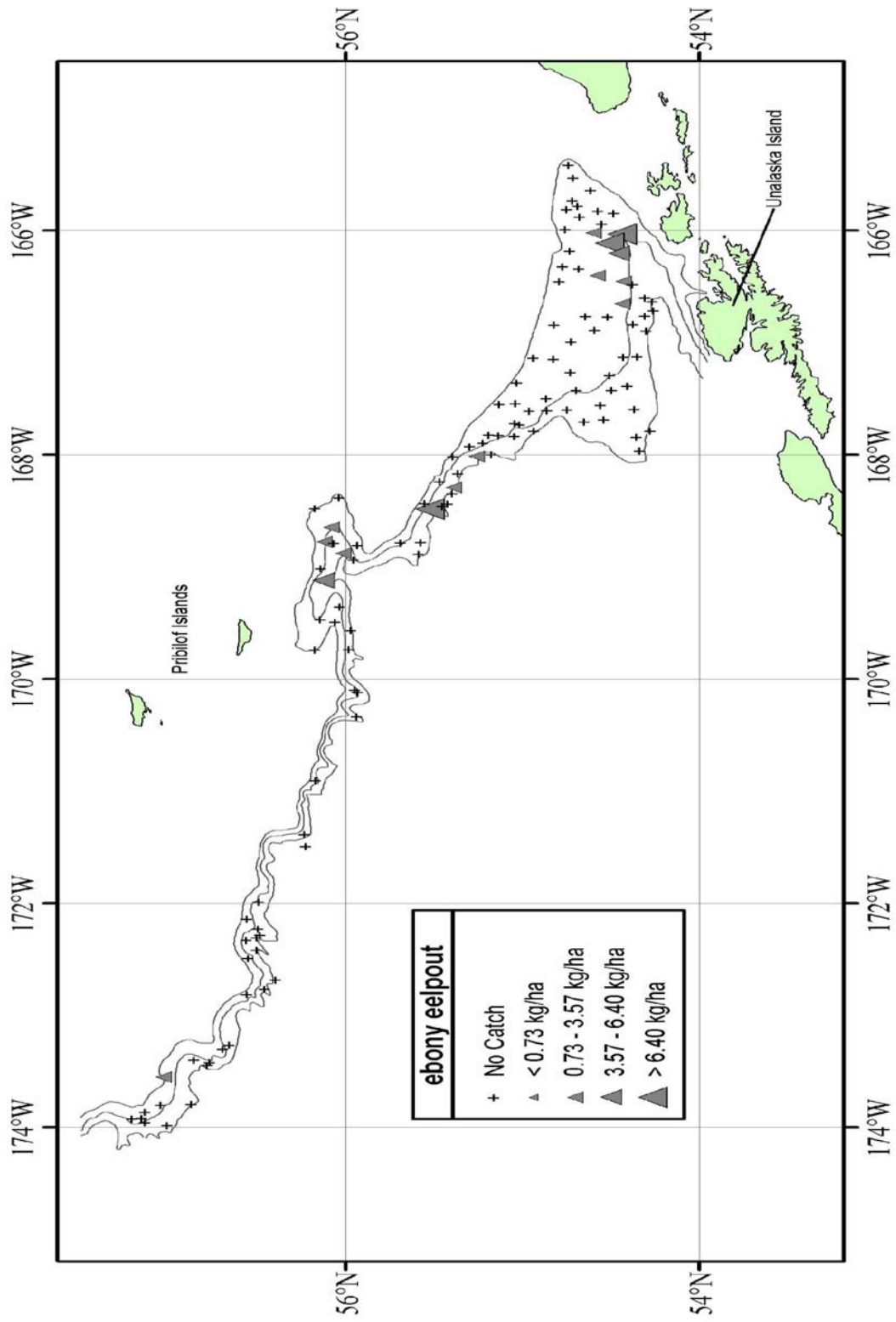

Figure 56. - - Continued.

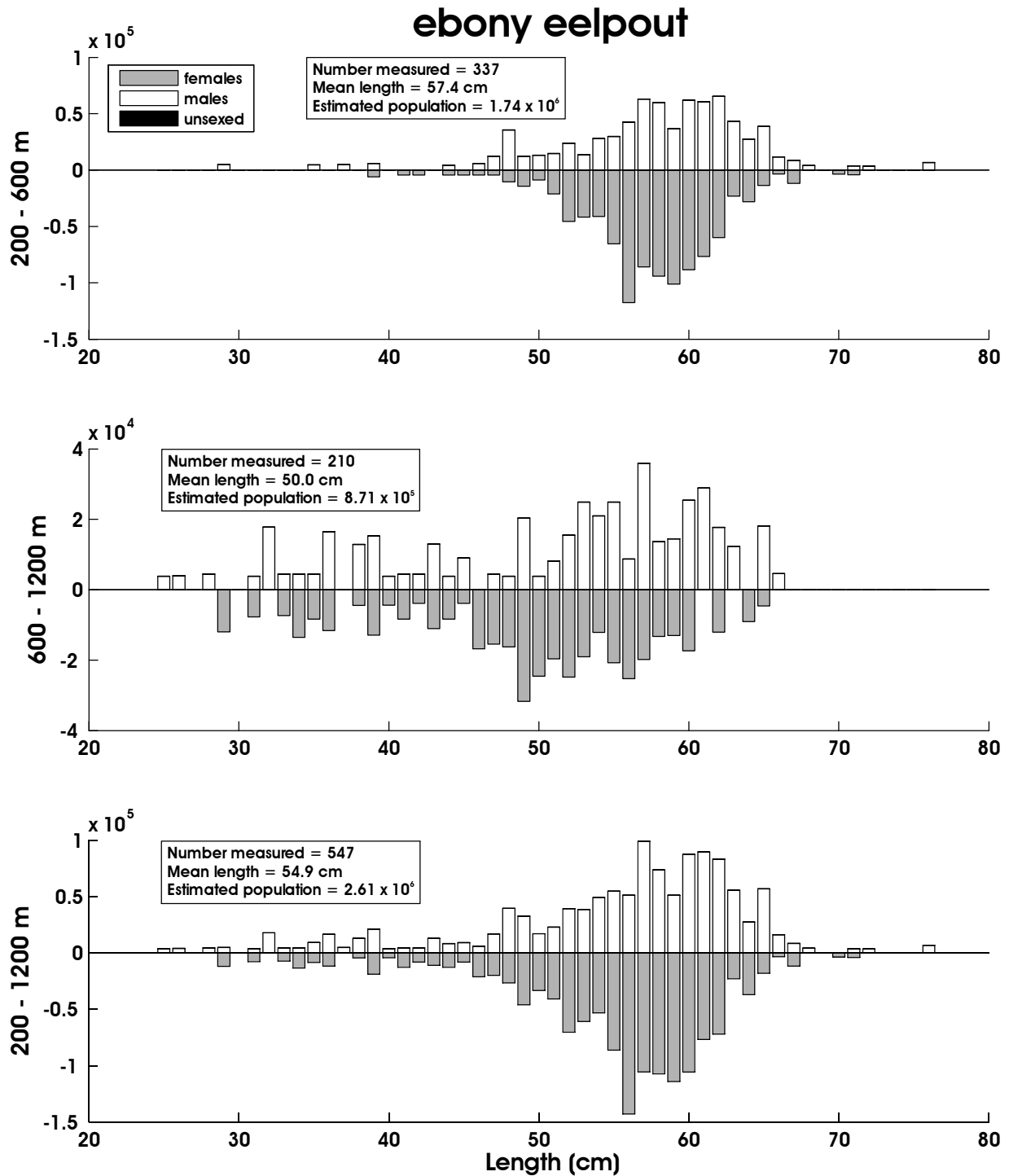

Figure 57. - - Size composition of the estimated ebony eelpout population from the 2008 EBSS survey for all subareas by depth. The abscissa is scaled as total length in centimeters while the ordinate represents the estimated total population.

Table 37. - Abundance estimates by subarea and depth stratum for twoline eelpout (*Bothorcara brunneum*) from the 2008 EBSS survey.

<i>Bothorcara brunneum</i>					twoline eelpout		
Subarea	Depth Stratum (m)	Biomass (t)	Population	Biomass Variance	Population Variance	Average CPUE (kg/ha)	Average CPUE (no./ha)
1	200-400	0.00E+00	0.00E+00	0.00E+00	0.00E+00	0.00E+00	0.00E+00
	400-600	0.00E+00	0.00E+00	0.00E+00	0.00E+00	0.00E+00	0.00E+00
	600-800	4.74E+01	2.38E+04	3.67E+02	8.09E+07	2.72E-01	1.36E-01
	800-1,000	1.88E+02	1.57E+05	5.62E+03	4.59E+09	1.39E+00	1.16E+00
	1,000-1,200	1.03E+02	1.82E+05	2.85E+03	5.51E+09	9.29E-01	1.26E+00
2	200-400	0.00E+00	0.00E+00	0.00E+00	0.00E+00	0.00E+00	0.00E+00
	400-600	0.00E+00	0.00E+00	0.00E+00	0.00E+00	0.00E+00	0.00E+00
	600-800	3.49E+01	5.26E+04	1.50E+02	1.69E+09	5.91E-01	8.89E-01
	800-1,000	3.22E+01	3.03E+04	4.93E+01	1.61E+08	5.83E-01	5.48E-01
	1,000-1,200	7.72E+00	1.15E+04	5.96E+01	1.33E+08	1.44E-01	2.15E-01
3	200-400	0.00E+00	0.00E+00	0.00E+00	0.00E+00	0.00E+00	0.00E+00
	400-600	1.81E+01	1.13E+04	8.35E+01	2.59E+07	2.04E-01	1.28E-01
	600-800	2.00E+02	1.17E+05	8.14E+03	2.73E+09	2.20E+00	1.29E+00
	800-1,000	1.05E+01	1.07E+04	1.08E+02	6.61E+07	1.43E-01	1.46E-01
	1,000-1,200	1.34E+01	7.78E+03	1.78E+02	6.06E+07	1.98E-01	1.15E-01
4	200-400	1.18E+01	4.38E+03	1.40E+02	1.92E+07	9.57E-02	3.54E-02
	400-600	6.70E+01	3.19E+04	9.85E+02	2.00E+08	9.17E-01	4.36E-01
	600-800	5.16E+01	2.61E+04	3.71E+02	1.22E+08	7.44E-01	3.76E-01
	800-1,000	5.61E+00	7.46E+03	3.14E+01	5.56E+07	7.92E-02	1.05E-01
	1,000-1,200	1.92E+00	3.85E+03	3.69E+00	1.49E+07	2.90E-02	5.82E-02
5	200-400	0.00E+00	0.00E+00	0.00E+00	0.00E+00	0.00E+00	0.00E+00
	400-600	1.81E+01	8.67E+03	3.28E+02	7.52E+07	4.26E-01	2.04E-01
	600-800	9.57E+01	1.19E+05	5.13E+03	1.98E+09	2.22E+00	2.75E+00
	800-1,000	9.31E+00	4.63E+03	8.68E+01	2.15E+07	1.69E-01	8.40E-02
	1,000-1,200	0.00E+00	0.00E+00	0.00E+00	0.00E+00	0.00E+00	0.00E+00
6	200-400	0.00E+00	0.00E+00	0.00E+00	0.00E+00	0.00E+00	0.00E+00
	400-600	3.58E+01	1.87E+04	3.61E+02	6.02E+07	2.10E-01	1.09E-01
	600-800	2.02E+01	1.81E+04	8.76E+01	7.09E+07	2.20E-01	1.97E-01
	800-1,000	1.32E+00	7.06E+03	1.62E+00	1.66E+07	2.04E-02	1.09E-01
	1,000-1,200	7.78E-02	8.64E+03	6.05E-03	7.47E+07	1.57E-03	1.74E-01
1-6	200-1,200	9.73E+02	8.62E+05	2.51E+04	1.78E+10	2.25E+00	2.97E+00

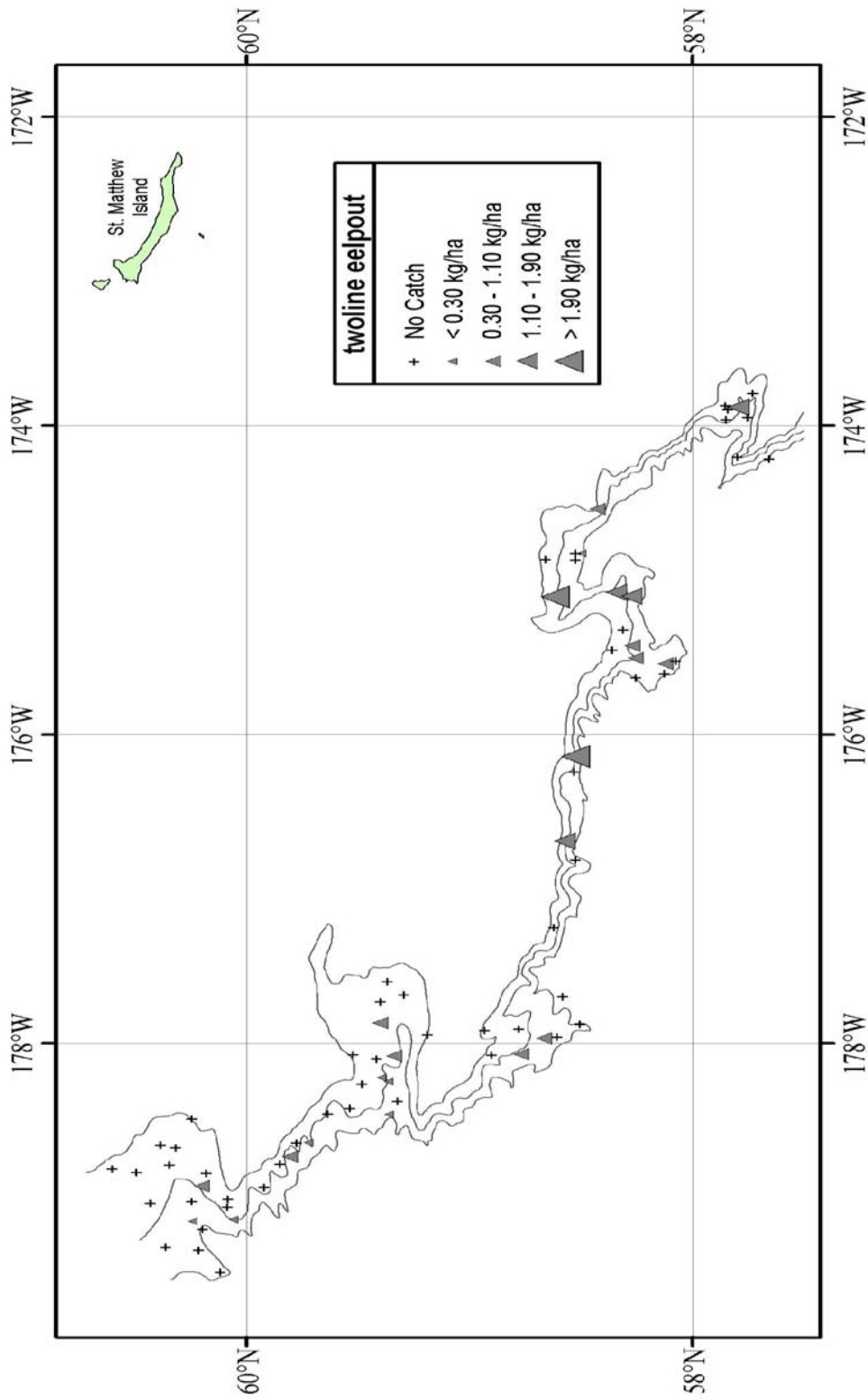

Figure 58. - - Distribution and relative abundance of twoline eelpout from the 2008 EBSS survey. Relative abundance is categorized by no catch, sample CPUE less than the mean CPUE, between the mean CPUE and one standard deviation above the mean, between one and two standard deviations above the mean CPUE, and greater than two standard deviations above the mean CPUE.

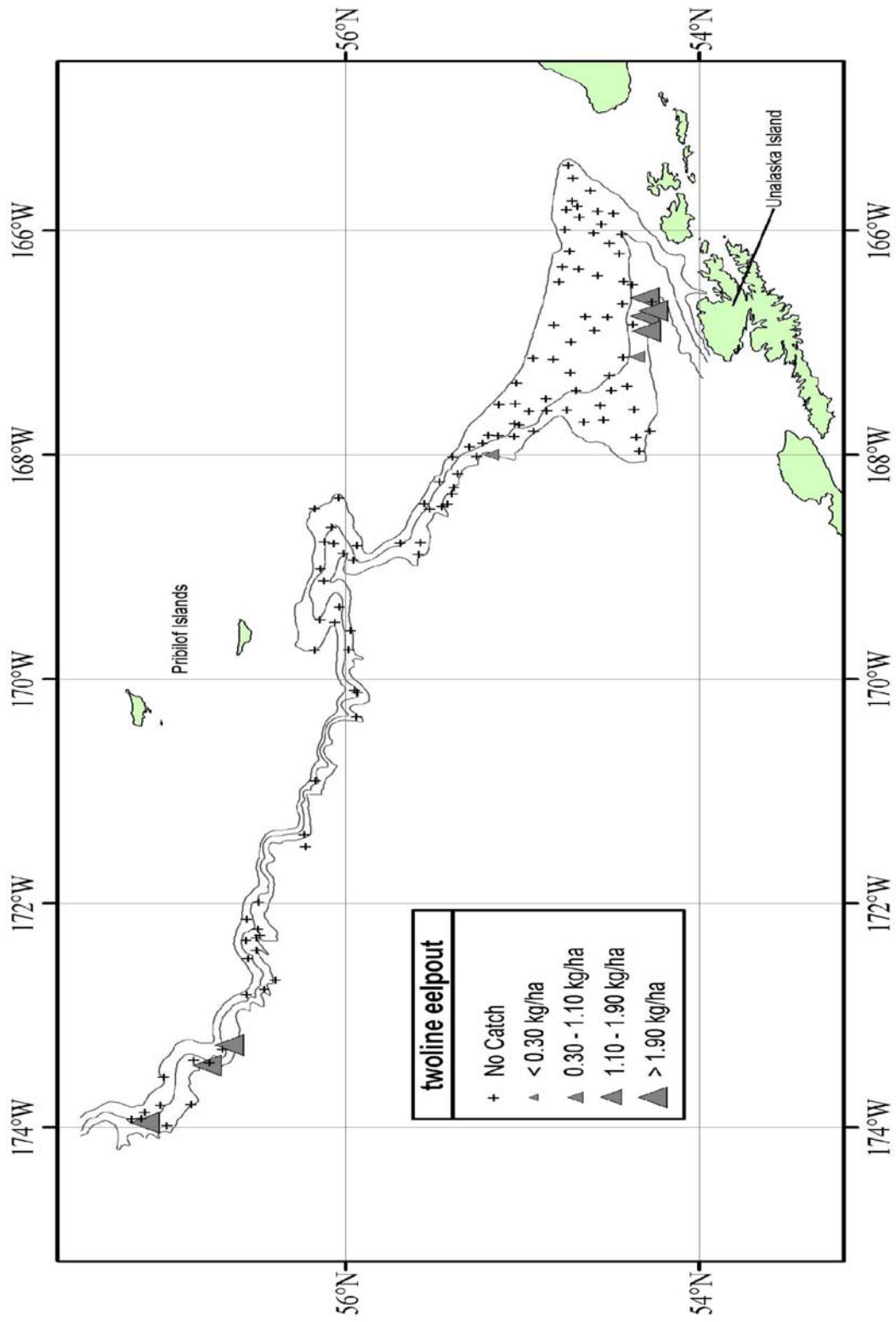

Figure 58. - - Continued.

twoline eelpout

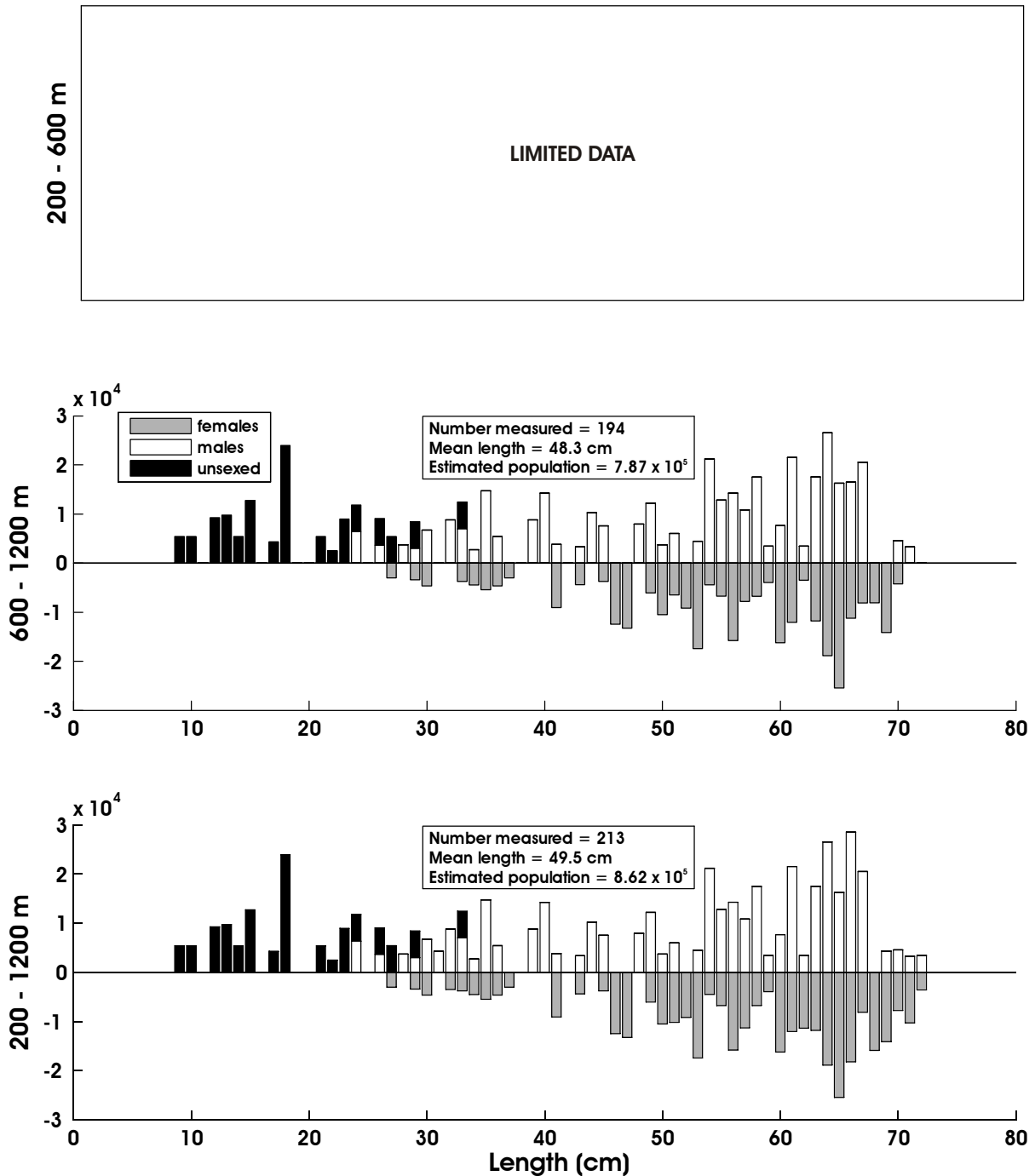

Figure 59. - Size composition of the estimated twoline eelpout population from the 2008 EBSS survey for all subareas by depth. The abscissa is scaled as total length in centimeters while the ordinate represents the estimated total population.

Table 38. - - Abundance estimates by subarea and depth stratum for western eelpout (*Bothrocara zestum*) from the 2008 EBSS survey.

<i>Bothrocara zestum</i>						western eelpout	
Subarea	Depth Stratum (m)	Biomass (t)	Population	Biomass Variance	Population Variance	Average CPUE (kg/ha)	Average CPUE (no./ha)
1	200-400	2.31E+01	2.20E+04	5.12E+02	3.42E+08	5.77E-02	5.47E-02
	400-600	7.86E+03	9.67E+06	2.98E+06	5.62E+12	1.93E+01	2.38E+01
	600-800	2.53E+03	5.98E+06	6.06E+05	6.53E+12	1.46E+01	3.43E+01
	800-1,000	5.19E+02	1.40E+06	1.78E+05	1.28E+12	3.83E+00	1.04E+01
	1,000-1,200	6.59E+01	3.93E+05	1.10E+03	3.40E+10	5.96E-01	3.55E+00
2	200-400	0.00E+00	0.00E+00	0.00E+00	0.00E+00	0.00E+00	0.00E+00
	400-600	1.55E+01	1.97E+04	1.96E+02	2.29E+08	2.20E-01	2.80E-01
	600-800	2.22E+01	1.93E+05	4.28E+02	3.51E+10	3.75E-01	3.26E+00
	800-1,000	6.66E+01	2.23E+05	2.09E+03	2.73E+10	1.20E+00	4.04E+00
	1,000-1,200	3.19E+01	5.26E+05	6.16E+02	2.19E+11	5.95E-01	9.82E+00
3	200-400	0.00E+00	0.00E+00	0.00E+00	0.00E+00	0.00E+00	0.00E+00
	400-600	4.70E+00	3.67E+03	2.20E+01	1.35E+07	5.30E-02	4.14E-02
	600-800	1.59E+01	2.84E+04	1.72E+02	4.26E+08	1.74E-01	3.12E-01
	800-1,000	0.00E+00	0.00E+00	0.00E+00	0.00E+00	0.00E+00	0.00E+00
	1,000-1,200	0.00E+00	0.00E+00	0.00E+00	0.00E+00	0.00E+00	0.00E+00
4	200-400	0.00E+00	0.00E+00	0.00E+00	0.00E+00	0.00E+00	0.00E+00
	400-600	2.78E+01	1.75E+04	4.34E+02	1.81E+08	3.81E-01	2.40E-01
	600-800	4.90E+00	4.22E+03	2.40E+01	1.78E+07	7.06E-02	6.08E-02
	800-1,000	0.00E+00	0.00E+00	0.00E+00	0.00E+00	0.00E+00	0.00E+00
	1,000-1,200	0.00E+00	0.00E+00	0.00E+00	0.00E+00	0.00E+00	0.00E+00
5	200-400	0.00E+00	0.00E+00	0.00E+00	0.00E+00	0.00E+00	0.00E+00
	400-600	0.00E+00	0.00E+00	0.00E+00	0.00E+00	0.00E+00	0.00E+00
	600-800	7.18E+00	1.09E+04	5.16E+01	1.18E+08	1.66E-01	2.52E-01
	800-1,000	0.00E+00	0.00E+00	0.00E+00	0.00E+00	0.00E+00	0.00E+00
	1,000-1,200	0.00E+00	0.00E+00	0.00E+00	0.00E+00	0.00E+00	0.00E+00
6	200-400	0.00E+00	0.00E+00	0.00E+00	0.00E+00	0.00E+00	0.00E+00
	400-600	2.11E+02	1.92E+05	1.27E+04	1.06E+10	1.24E+00	1.13E+00
	600-800	4.77E+01	6.73E+04	2.28E+03	4.53E+09	5.20E-01	7.33E-01
	800-1,000	0.00E+00	0.00E+00	0.00E+00	0.00E+00	0.00E+00	0.00E+00
	1,000-1,200	0.00E+00	0.00E+00	0.00E+00	0.00E+00	0.00E+00	0.00E+00
1-6	200-1,200	1.15E+04	1.88E+07	3.78E+06	1.38E+13	2.25E+00	2.97E+00

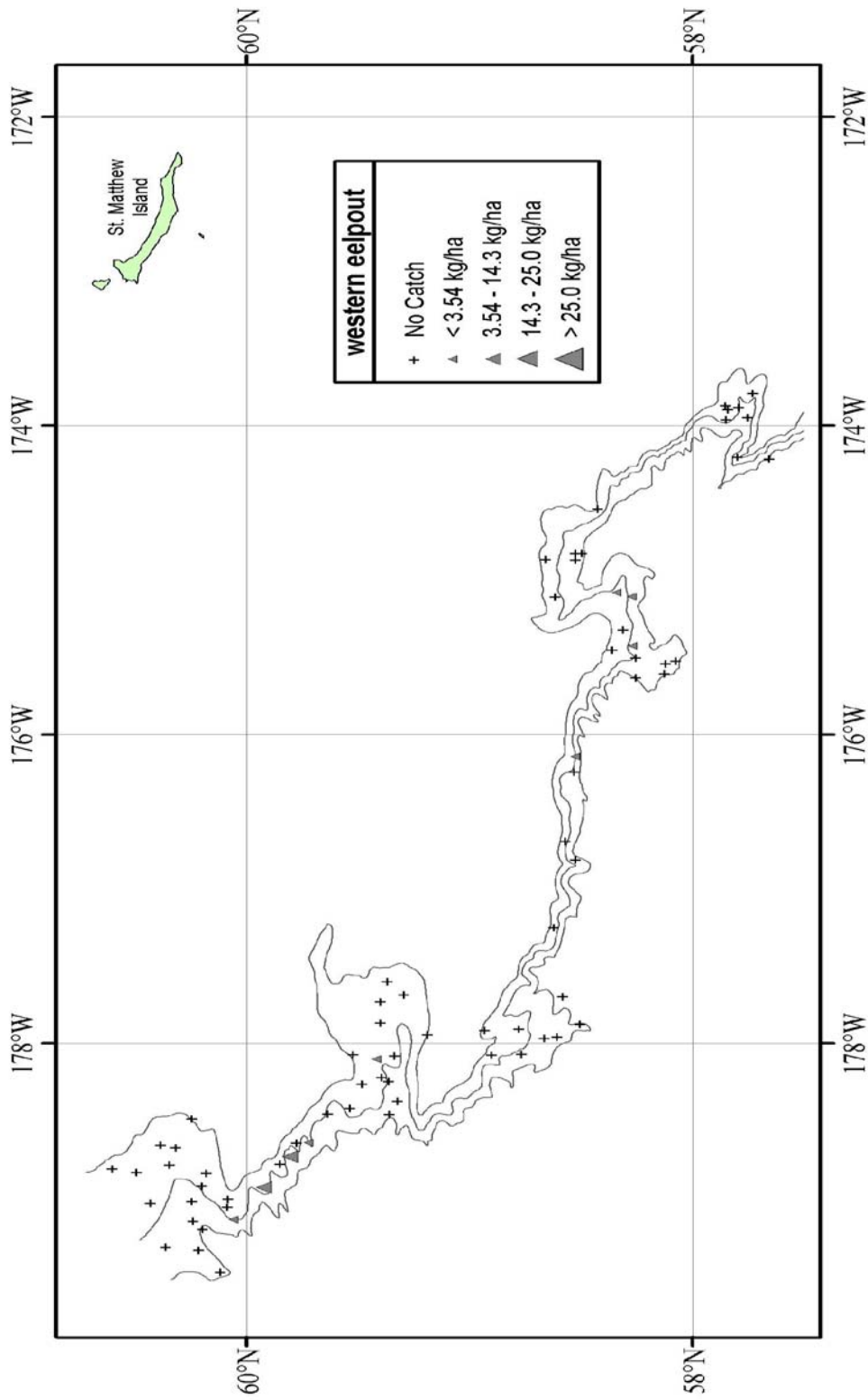

Figure 60. - - Distribution and relative abundance of western eelpout from the 2008 EBSS survey. Relative abundance is categorized by no catch, sample CPUE less than the mean CPUE, between the mean CPUE and one standard deviation above the mean, between one and two standard deviations above the mean CPUE, and greater than two standard deviations above the mean CPUE.

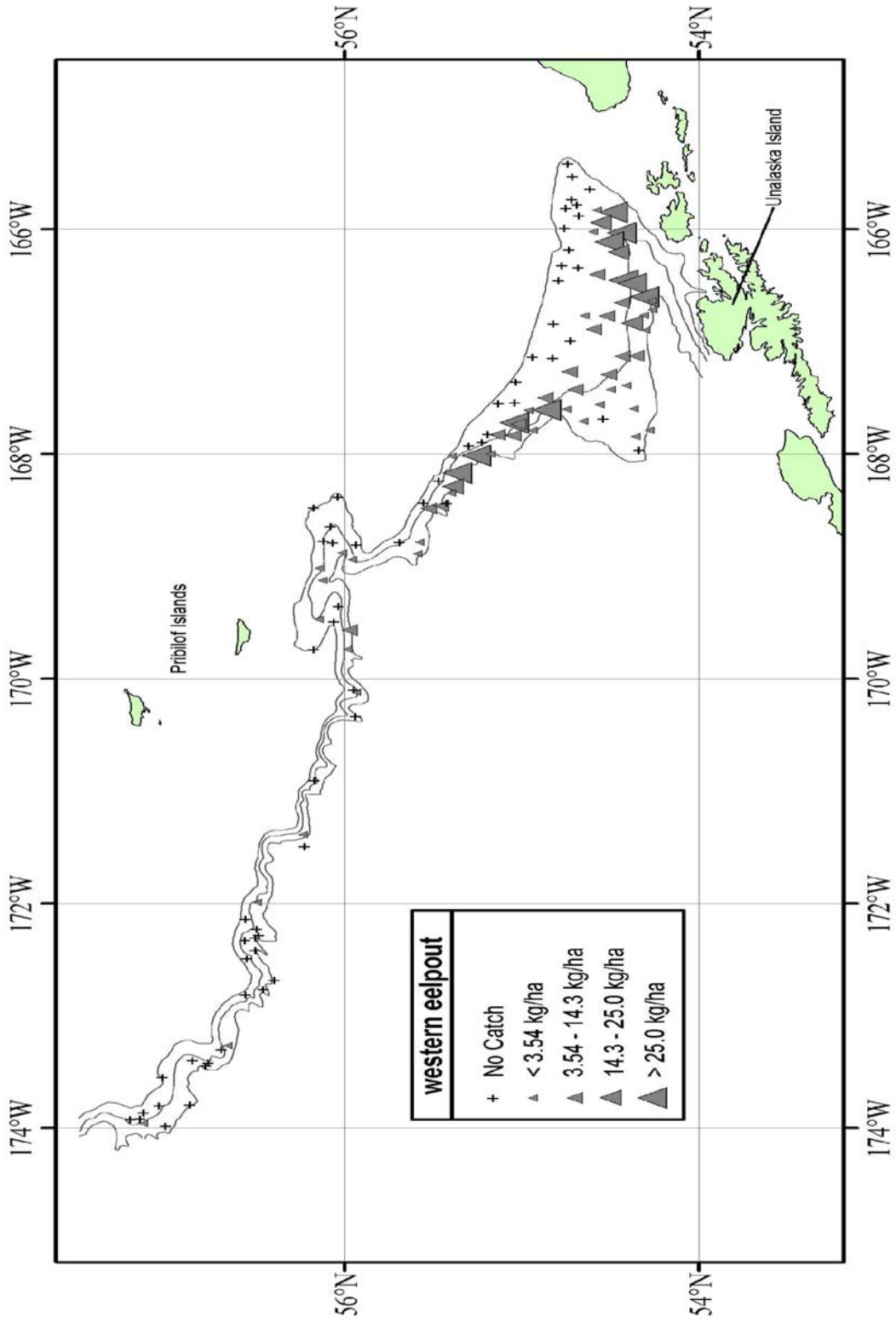

Figure 60. - - Continued.

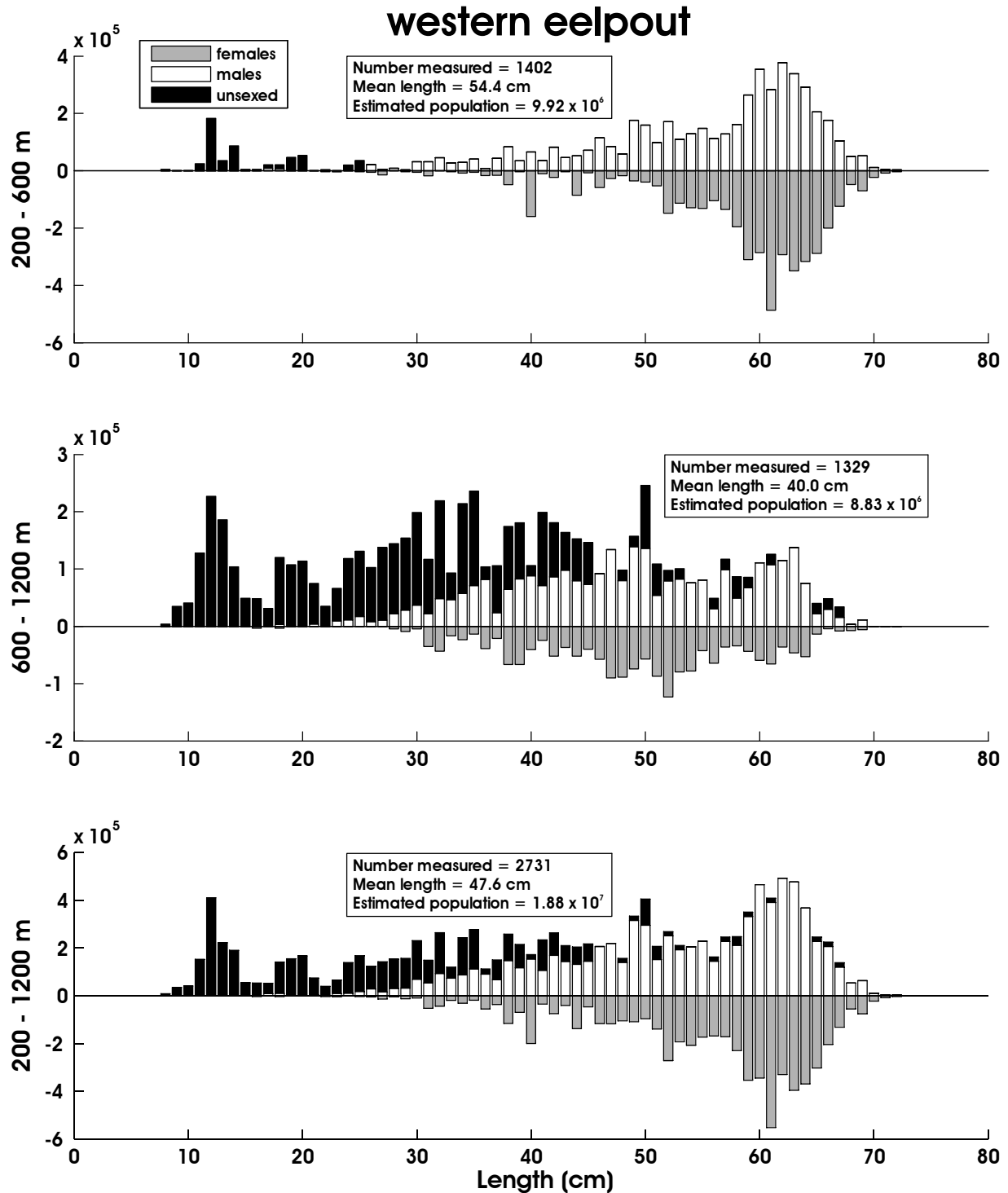

Figure 61. - - Size composition of the estimated western eelpout population from the 2008 EBSS survey for all subareas by depth. The abscissa is scaled as total length in centimeters while the ordinate represents the estimated total population.

Table 39. - Abundance estimates by subarea and depth stratum for Pacific halibut
(*Hippoglossus stenolepis*) from the 2008 EBSS survey.

<i>Hippoglossus stenolepis</i>						Pacific halibut	
Subarea	Depth Stratum (m)	Biomass (t)	Population	Biomass Variance	Population Variance	Average CPUE (kg/ha)	Average CPUE (no./ha)
1	200-400	1.52E+03	2.29E+05	1.94E+05	3.89E+09	3.78E+00	5.72E-01
	400-600	2.50E+03	2.40E+05	7.46E+05	4.02E+09	6.16E+00	5.90E-01
	600-800	2.56E+02	1.45E+04	2.71E+04	7.01E+07	1.47E+00	8.32E-02
	800-1,000	0.00E+00	0.00E+00	0.00E+00	0.00E+00	0.00E+00	0.00E+00
	1,000-1,200	0.00E+00	0.00E+00	0.00E+00	0.00E+00	0.00E+00	0.00E+00
2	200-400	5.81E+02	8.55E+04	7.42E+04	1.85E+09	5.02E+00	7.39E-01
	400-600	2.00E+02	2.09E+04	1.01E+04	9.24E+07	2.84E+00	2.96E-01
	600-800	1.22E+02	3.37E+03	1.48E+04	1.14E+07	2.06E+00	5.70E-02
	800-1,000	0.00E+00	0.00E+00	0.00E+00	0.00E+00	0.00E+00	0.00E+00
	1,000-1,200	0.00E+00	0.00E+00	0.00E+00	0.00E+00	0.00E+00	0.00E+00
3	200-400	9.38E+01	7.46E+03	8.79E+03	5.57E+07	1.04E+00	8.25E-02
	400-600	0.00E+00	0.00E+00	0.00E+00	0.00E+00	0.00E+00	0.00E+00
	600-800	0.00E+00	0.00E+00	0.00E+00	0.00E+00	0.00E+00	0.00E+00
	800-1,000	0.00E+00	0.00E+00	0.00E+00	0.00E+00	0.00E+00	0.00E+00
	1,000-1,200	0.00E+00	0.00E+00	0.00E+00	0.00E+00	0.00E+00	0.00E+00
4	200-400	9.87E+02	1.39E+05	6.69E+04	3.23E+09	7.99E+00	1.12E+00
	400-600	4.99E+02	6.13E+04	5.39E+04	1.56E+09	6.83E+00	8.39E-01
	600-800	0.00E+00	0.00E+00	0.00E+00	0.00E+00	0.00E+00	0.00E+00
	800-1,000	0.00E+00	0.00E+00	0.00E+00	0.00E+00	0.00E+00	0.00E+00
	1,000-1,200	0.00E+00	0.00E+00	0.00E+00	0.00E+00	0.00E+00	0.00E+00
5	200-400	5.04E+02	6.85E+04	1.88E+05	3.30E+09	1.19E+01	1.62E+00
	400-600	3.59E+01	3.17E+03	1.29E+03	1.01E+07	8.44E-01	7.46E-02
	600-800	0.00E+00	0.00E+00	0.00E+00	0.00E+00	0.00E+00	0.00E+00
	800-1,000	0.00E+00	0.00E+00	0.00E+00	0.00E+00	0.00E+00	0.00E+00
	1,000-1,200	0.00E+00	0.00E+00	0.00E+00	0.00E+00	0.00E+00	0.00E+00
6	200-400	5.77E+02	1.91E+05	6.40E+04	1.42E+10	2.22E+00	7.34E-01
	400-600	1.08E+02	1.62E+04	3.78E+03	8.35E+07	6.31E-01	9.47E-02
	600-800	0.00E+00	0.00E+00	0.00E+00	0.00E+00	0.00E+00	0.00E+00
	800-1,000	0.00E+00	0.00E+00	0.00E+00	0.00E+00	0.00E+00	0.00E+00
	1,000-1,200	0.00E+00	0.00E+00	0.00E+00	0.00E+00	0.00E+00	0.00E+00
1-6	200-1,200	7.99E+03	1.08E+06	1.45E+06	3.24E+10	1.53E+00	1.41E-01

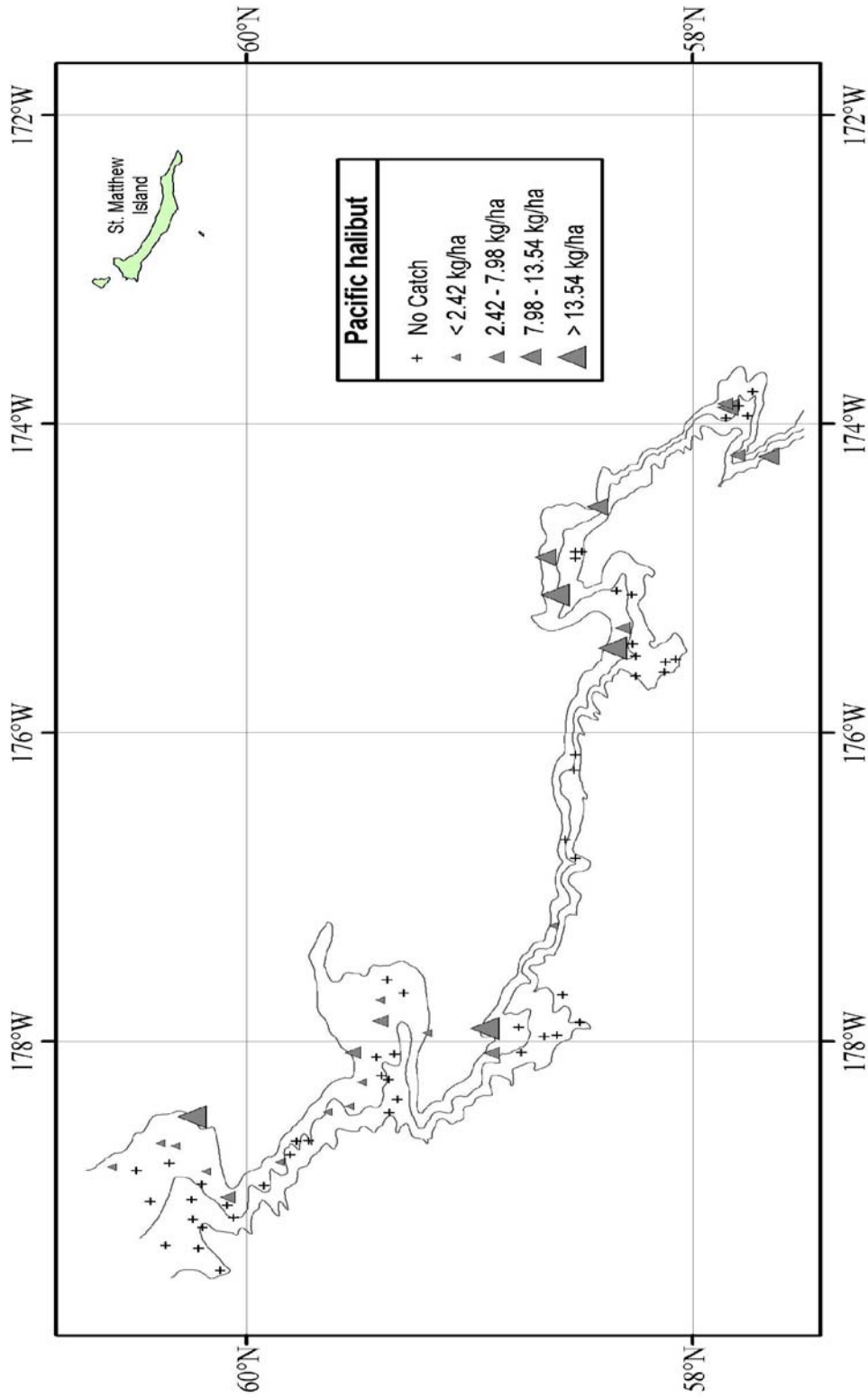

Figure 62. - - Distribution and relative abundance of Pacific halibut from the 2008 EBSS survey. Relative abundance is categorized by no catch, sample CPUE less than the mean CPUE, between the mean CPUE and one standard deviation above the mean, between one and two standard deviations above the mean CPUE, and greater than two standard deviations above the mean CPUE.

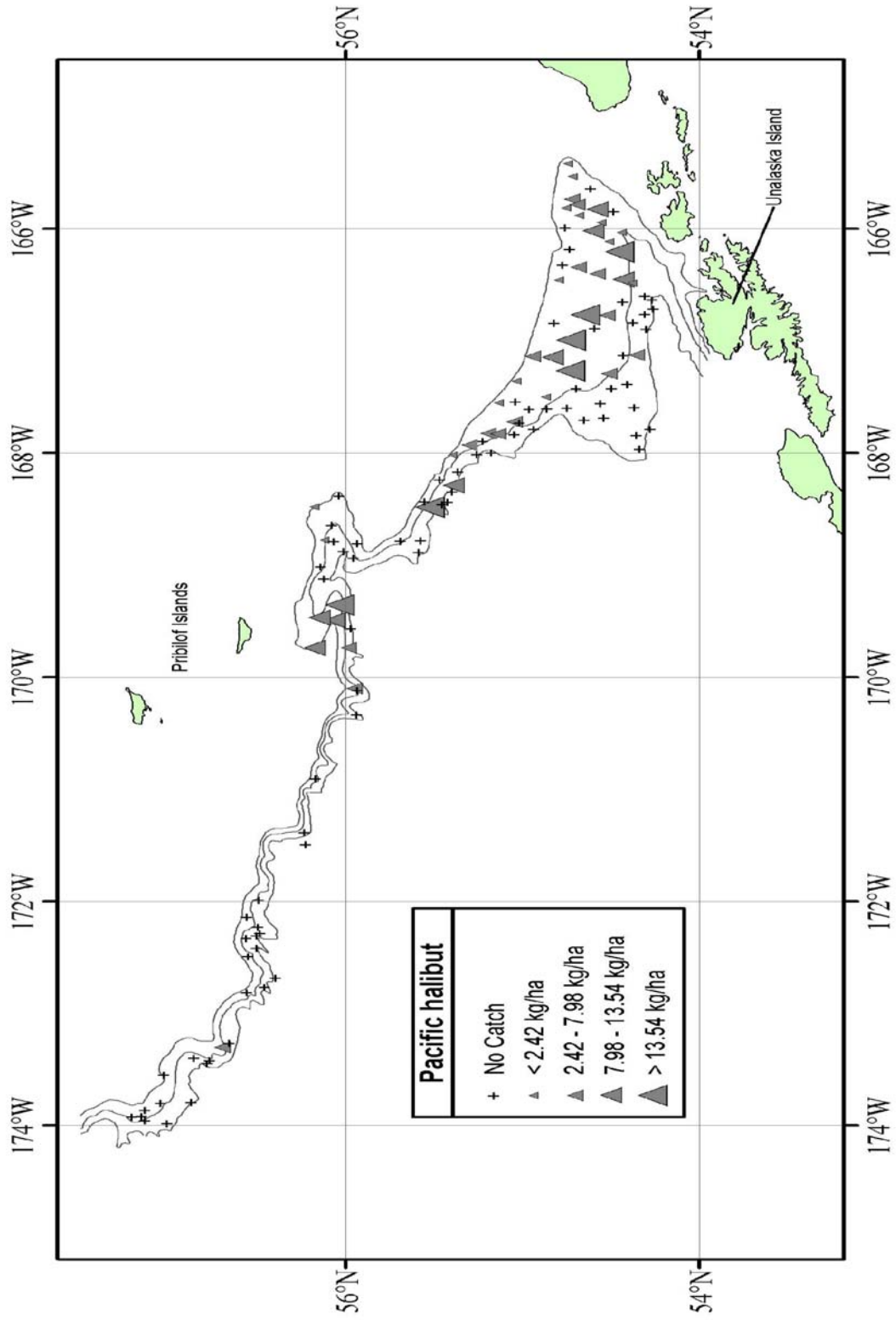

Figure 62. - - Continued.

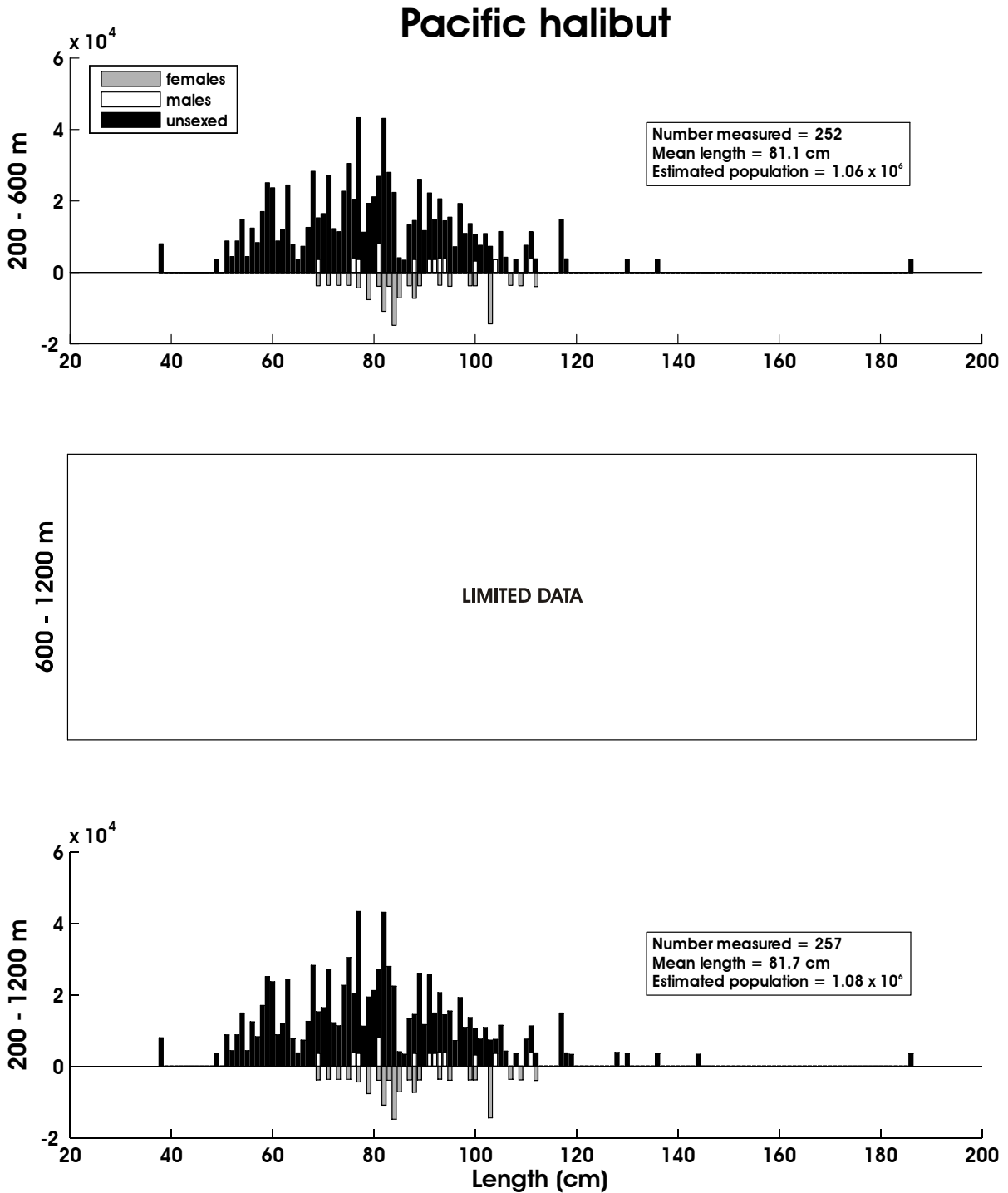

Figure 63. - - Size composition of the estimated Pacific halibut population from the 2008 EBSS survey for all subareas by depth. The abscissa is scaled as total length in centimeters while the ordinate represents the estimated total population.

Table 40. - - Abundance estimates by subarea and depth stratum for flathead sole
(*Hippoglossoides elassodon*) from the 2008 EBSS survey.

<i>Hippoglossoides elassodon</i>						flathead sole	
Subarea	Depth Stratum (m)	Biomass (t)	Population	Biomass Variance	Population Variance	Average CPUE (kg/ha)	Average CPUE (no./ha)
1	200-400	3.41E+03	1.05E+07	3.44E+05	3.42E+12	8.49E+00	2.62E+01
	400-600	3.01E+03	4.36E+06	8.28E+05	1.60E+12	7.42E+00	1.07E+01
	600-800	1.82E+00	3.42E+03	3.33E+00	1.17E+07	1.05E-02	1.96E-02
	800-1,000	0.00E+00	0.00E+00	0.00E+00	0.00E+00	0.00E+00	0.00E+00
	1,000-1,200	0.00E+00	0.00E+00	0.00E+00	0.00E+00	0.00E+00	0.00E+00
2	200-400	5.60E+02	1.28E+06	1.04E+05	5.06E+11	4.84E+00	1.11E+01
	400-600	2.34E+01	2.68E+04	2.13E+02	3.17E+08	3.33E-01	3.80E-01
	600-800	0.00E+00	0.00E+00	0.00E+00	0.00E+00	0.00E+00	0.00E+00
	800-1,000	0.00E+00	0.00E+00	0.00E+00	0.00E+00	0.00E+00	0.00E+00
	1,000-1,200	0.00E+00	0.00E+00	0.00E+00	0.00E+00	0.00E+00	0.00E+00
3	200-400	1.48E+03	3.44E+06	9.30E+04	4.18E+11	1.64E+01	3.80E+01
	400-600	2.23E+03	3.29E+06	5.85E+05	1.31E+12	2.52E+01	3.72E+01
	600-800	0.00E+00	0.00E+00	0.00E+00	0.00E+00	0.00E+00	0.00E+00
	800-1,000	0.00E+00	0.00E+00	0.00E+00	0.00E+00	0.00E+00	0.00E+00
	1,000-1,200	0.00E+00	0.00E+00	0.00E+00	0.00E+00	0.00E+00	0.00E+00
4	200-400	1.81E+03	4.80E+06	4.98E+05	4.09E+12	1.46E+01	3.88E+01
	400-600	9.10E+02	1.53E+06	2.03E+05	6.85E+11	1.25E+01	2.09E+01
	600-800	0.00E+00	0.00E+00	0.00E+00	0.00E+00	0.00E+00	0.00E+00
	800-1,000	0.00E+00	0.00E+00	0.00E+00	0.00E+00	0.00E+00	0.00E+00
	1,000-1,200	0.00E+00	0.00E+00	0.00E+00	0.00E+00	0.00E+00	0.00E+00
5	200-400	8.01E+02	2.91E+06	4.40E+05	5.77E+12	1.89E+01	6.86E+01
	400-600	6.07E+02	1.19E+06	1.19E+05	4.77E+11	1.43E+01	2.80E+01
	600-800	0.00E+00	0.00E+00	0.00E+00	0.00E+00	0.00E+00	0.00E+00
	800-1,000	0.00E+00	0.00E+00	0.00E+00	0.00E+00	0.00E+00	0.00E+00
	1,000-1,200	0.00E+00	0.00E+00	0.00E+00	0.00E+00	0.00E+00	0.00E+00
6	200-400	3.28E+03	1.06E+07	1.63E+06	9.97E+12	1.26E+01	4.07E+01
	400-600	5.09E+02	1.18E+06	1.14E+05	6.89E+11	2.98E+00	6.90E+00
	600-800	0.00E+00	0.00E+00	0.00E+00	0.00E+00	0.00E+00	0.00E+00
	800-1,000	0.00E+00	0.00E+00	0.00E+00	0.00E+00	0.00E+00	0.00E+00
	1,000-1,200	0.00E+00	0.00E+00	0.00E+00	0.00E+00	0.00E+00	0.00E+00
1-6	200-1,200	1.86E+04	4.51E+07	4.96E+06	2.89E+13	7.55E+00	1.73E+01

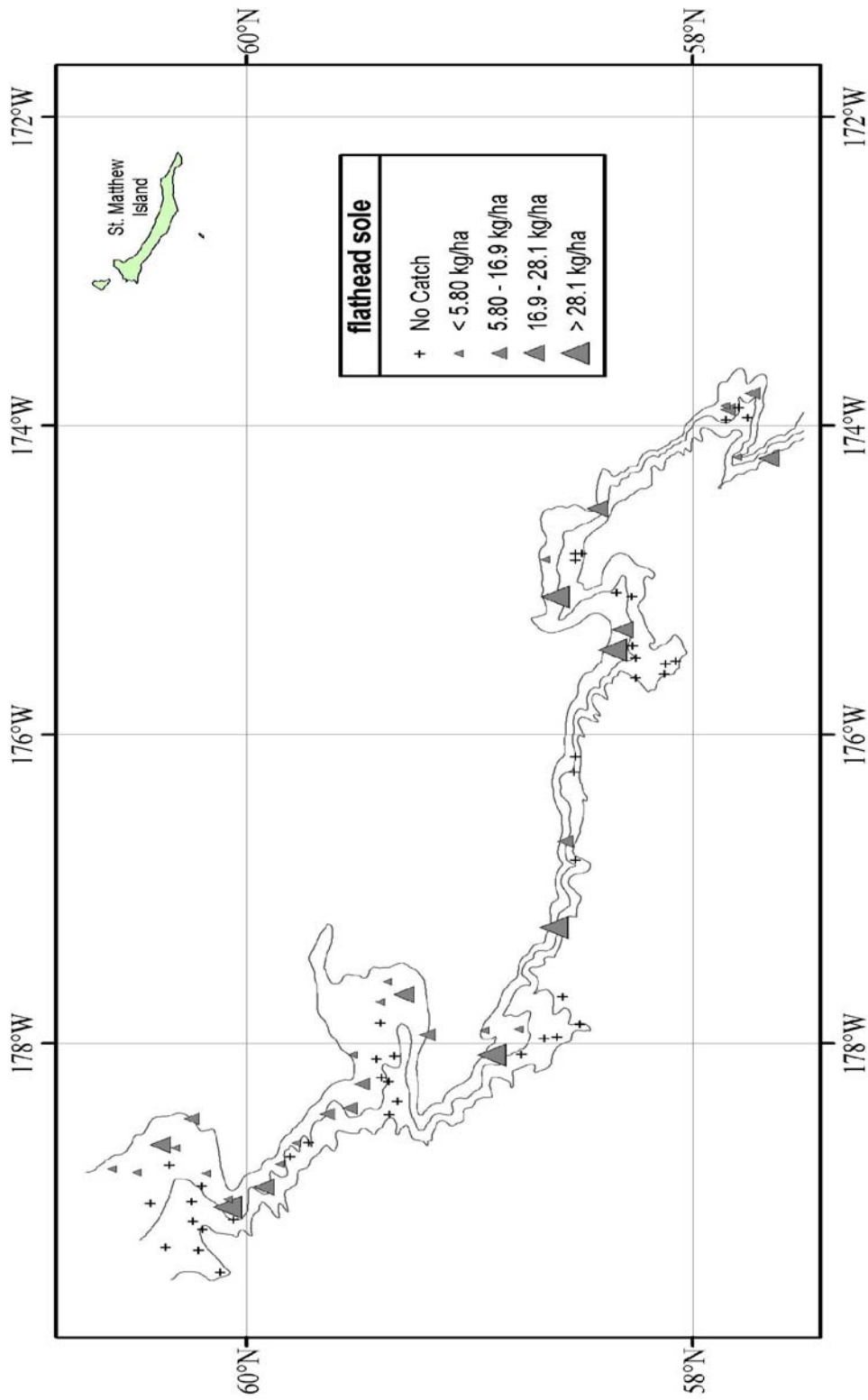

Figure 64. - - Distribution and relative abundance of flathead sole from the 2008 EBSS survey. Relative abundance is categorized by no catch, sample CPUE less than the mean CPUE, between the mean CPUE and one standard deviation above the mean, between one and two standard deviations above the mean CPUE, and greater than two standard deviations above the mean CPUE.

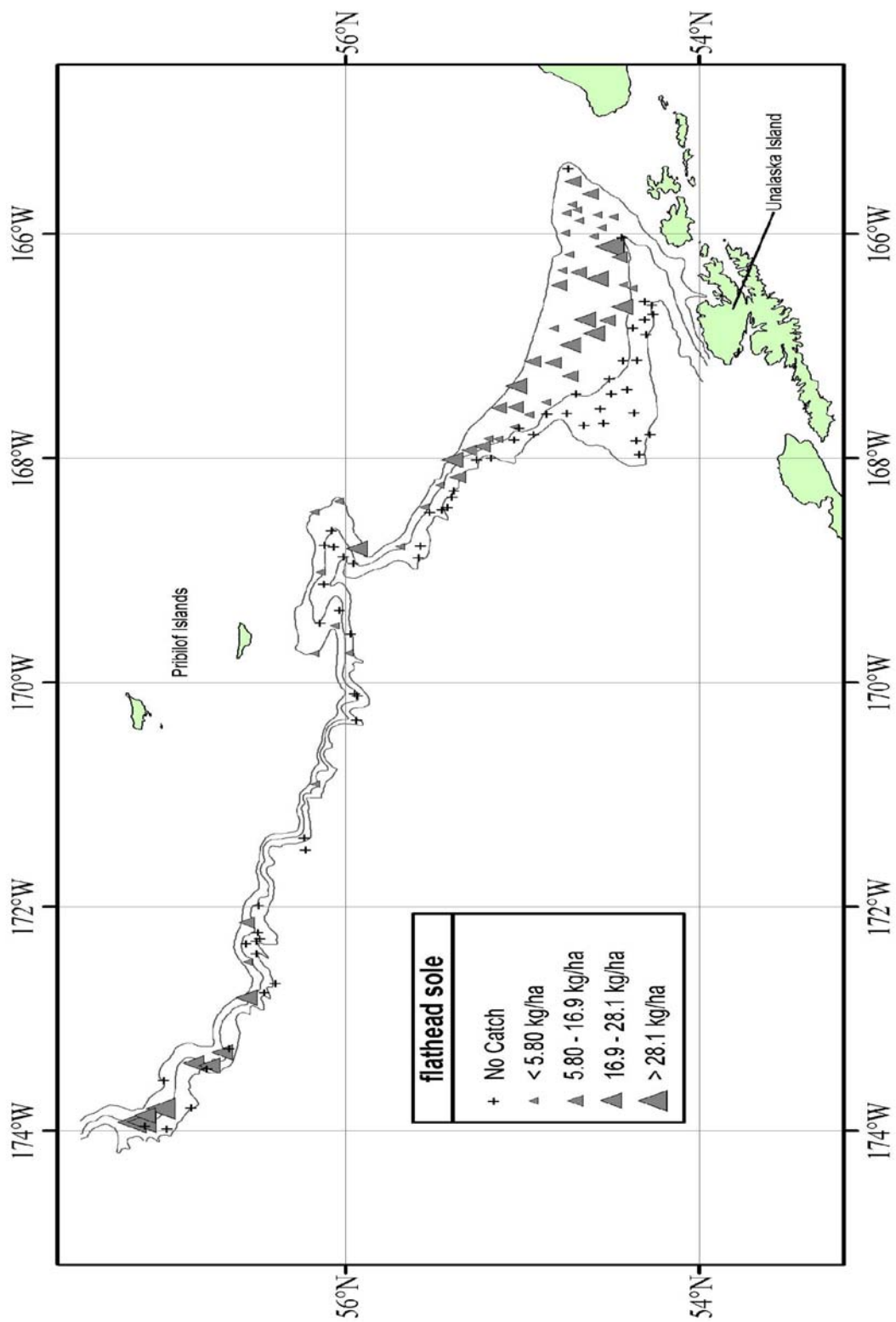

Figure 64. - - Continued.

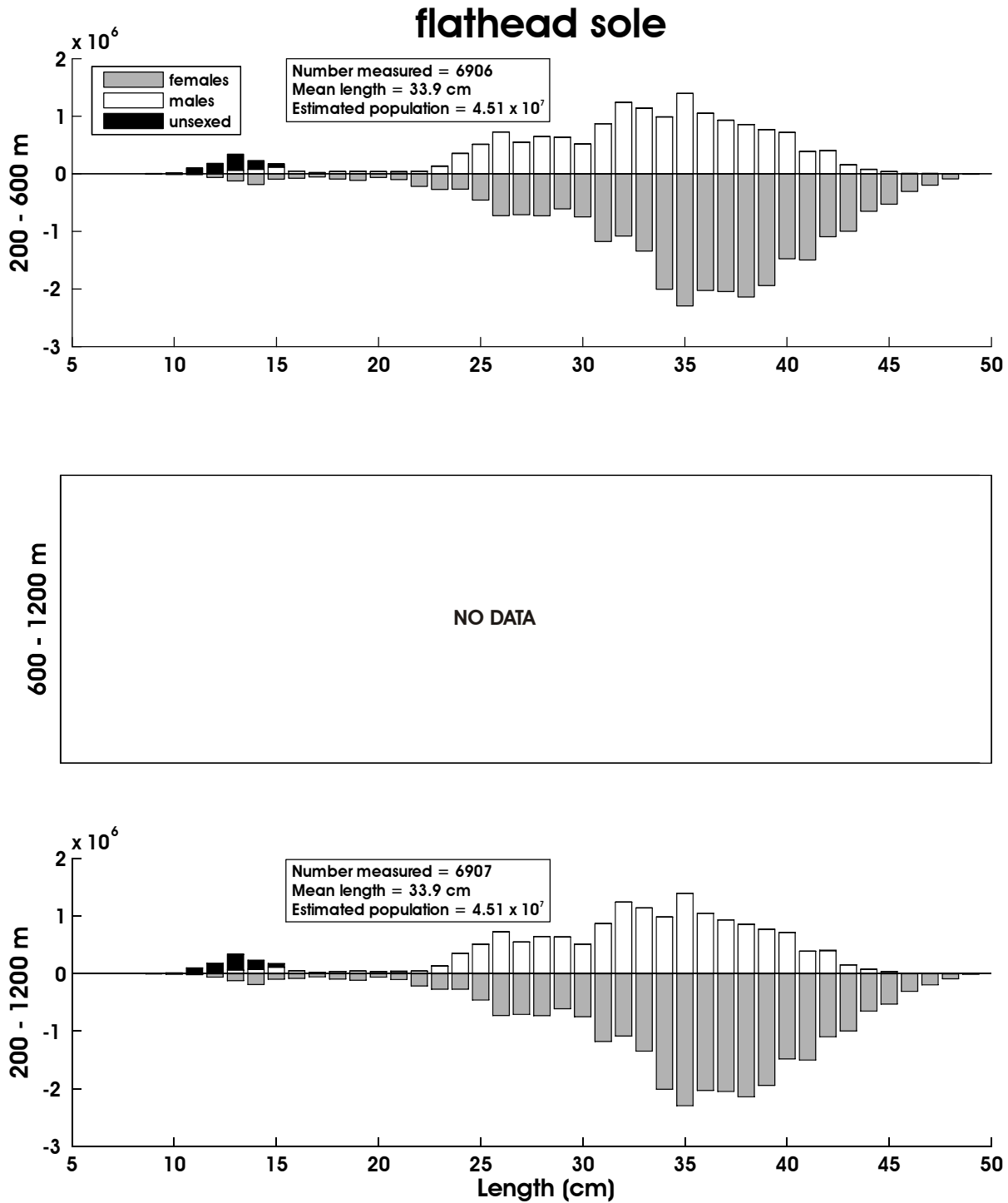

Figure 65. - Size composition of the estimated flathead sole population from the 2008 EBSS survey for all subareas by depth. The abscissa is scaled as total length in centimeters while the ordinate represents the estimated total population.

Table 41. - Abundance estimates by subarea and depth stratum for Greenland turbot (*Reinhardtius hippoglossoides*) from the 2008 EBSS survey.

<i>Reinhardtius hippoglossoides</i>						Greenland turbot	
Subarea	Depth Stratum (m)	Biomass (t)	Population	Biomass Variance	Population Variance	Average CPUE (kg/ha)	Average CPUE (no./ha)
1	200-400	5.19E+02	1.49E+05	6.88E+04	6.50E+09	1.29E+00	3.71E-01
	400-600	2.75E+03	6.38E+05	3.92E+05	1.81E+10	6.76E+00	1.57E+00
	600-800	1.46E+03	3.69E+05	1.36E+05	1.08E+10	8.39E+00	2.12E+00
	800-1,000	9.56E+02	1.78E+05	1.90E+05	5.91E+09	7.06E+00	1.32E+00
	1,000-1,200	5.70E+02	9.76E+04	2.75E+04	8.42E+08	5.15E+00	8.82E-01
2	200-400	1.58E+02	5.97E+04	2.51E+04	3.56E+09	1.37E+00	5.15E-01
	400-600	2.49E+02	7.46E+04	5.45E+03	1.06E+09	3.52E+00	1.06E+00
	600-800	1.53E+03	5.50E+05	1.66E+06	2.09E+11	2.59E+01	9.29E+00
	800-1,000	1.55E+02	3.02E+04	5.61E+03	2.33E+08	2.81E+00	5.46E-01
	1,000-1,200	1.48E+02	2.44E+04	3.03E+02	1.65E+06	2.77E+00	4.56E-01
3	200-400	0.00E+00	0.00E+00	0.00E+00	0.00E+00	0.00E+00	0.00E+00
	400-600	2.72E+02	6.70E+04	1.80E+04	6.00E+08	3.07E+00	7.57E-01
	600-800	5.20E+02	1.07E+05	2.74E+04	1.48E+09	5.71E+00	1.17E+00
	800-1,000	1.04E+02	1.69E+04	4.22E+03	6.60E+07	1.42E+00	2.31E-01
	1,000-1,200	0.00E+00	0.00E+00	0.00E+00	0.00E+00	0.00E+00	0.00E+00
4	200-400	2.80E+02	9.13E+04	9.86E+03	1.25E+09	2.26E+00	7.38E-01
	400-600	6.12E+02	1.20E+05	2.65E+04	1.01E+09	8.38E+00	1.64E+00
	600-800	3.50E+02	6.48E+04	9.24E+03	6.76E+08	5.04E+00	9.33E-01
	800-1,000	8.50E+01	2.23E+04	7.22E+03	4.95E+08	1.20E+00	3.15E-01
	1,000-1,200	3.64E+01	4.48E+03	1.33E+03	2.01E+07	5.50E-01	6.77E-02
5	200-400	0.00E+00	0.00E+00	0.00E+00	0.00E+00	0.00E+00	0.00E+00
	400-600	3.10E+02	1.21E+05	3.03E+04	4.44E+09	7.29E+00	2.84E+00
	600-800	6.02E+01	1.09E+04	3.62E+03	1.18E+08	1.39E+00	2.52E-01
	800-1,000	3.34E+01	4.20E+03	1.11E+03	1.77E+07	6.05E-01	7.61E-02
	1,000-1,200	0.00E+00	0.00E+00	0.00E+00	0.00E+00	0.00E+00	0.00E+00
6	200-400	3.47E+03	1.44E+06	2.04E+06	4.07E+11	1.33E+01	5.55E+00
	400-600	2.35E+03	8.93E+05	3.70E+05	9.30E+10	1.38E+01	5.23E+00
	600-800	3.36E+02	9.55E+04	1.97E+04	1.10E+09	3.66E+00	1.04E+00
	800-1,000	1.19E+02	2.12E+04	3.37E+03	8.11E+07	1.84E+00	3.29E-01
	1,000-1,200	0.00E+00	0.00E+00	0.00E+00	0.00E+00	0.00E+00	0.00E+00
1-6	200-1,200	1.74E+04	5.25E+06	5.09E+06	7.68E+11	1.26E+01	2.47E+00

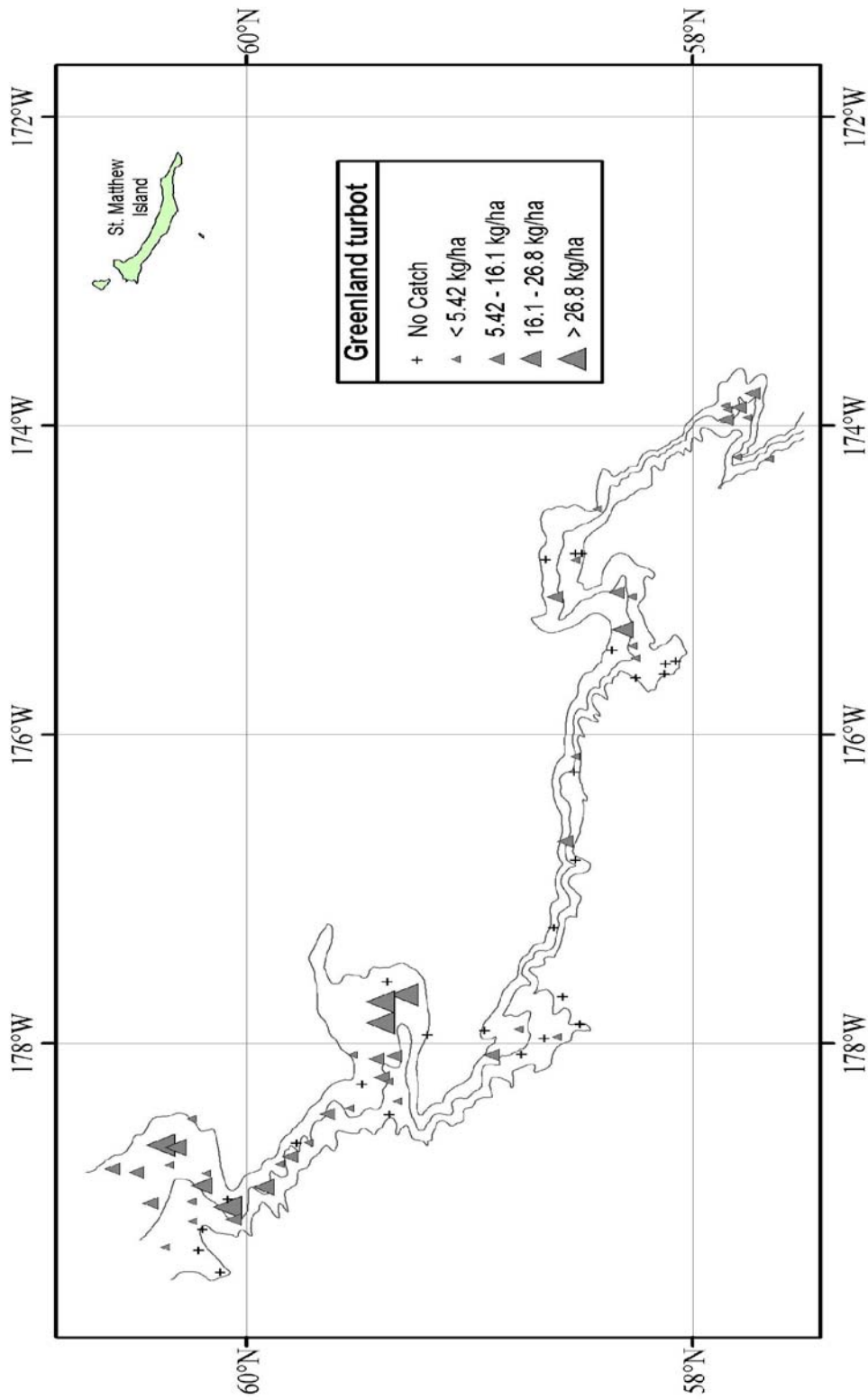

Figure 66. - - Distribution and relative abundance of Greenland turbot from the 2008 EBSS survey. Relative abundance is categorized by no catch, sample CPUE less than the mean CPUE, between the mean CPUE and one standard deviation above the mean, between one and two standard deviations above the mean CPUE, and greater than two standard deviations above the mean CPUE.

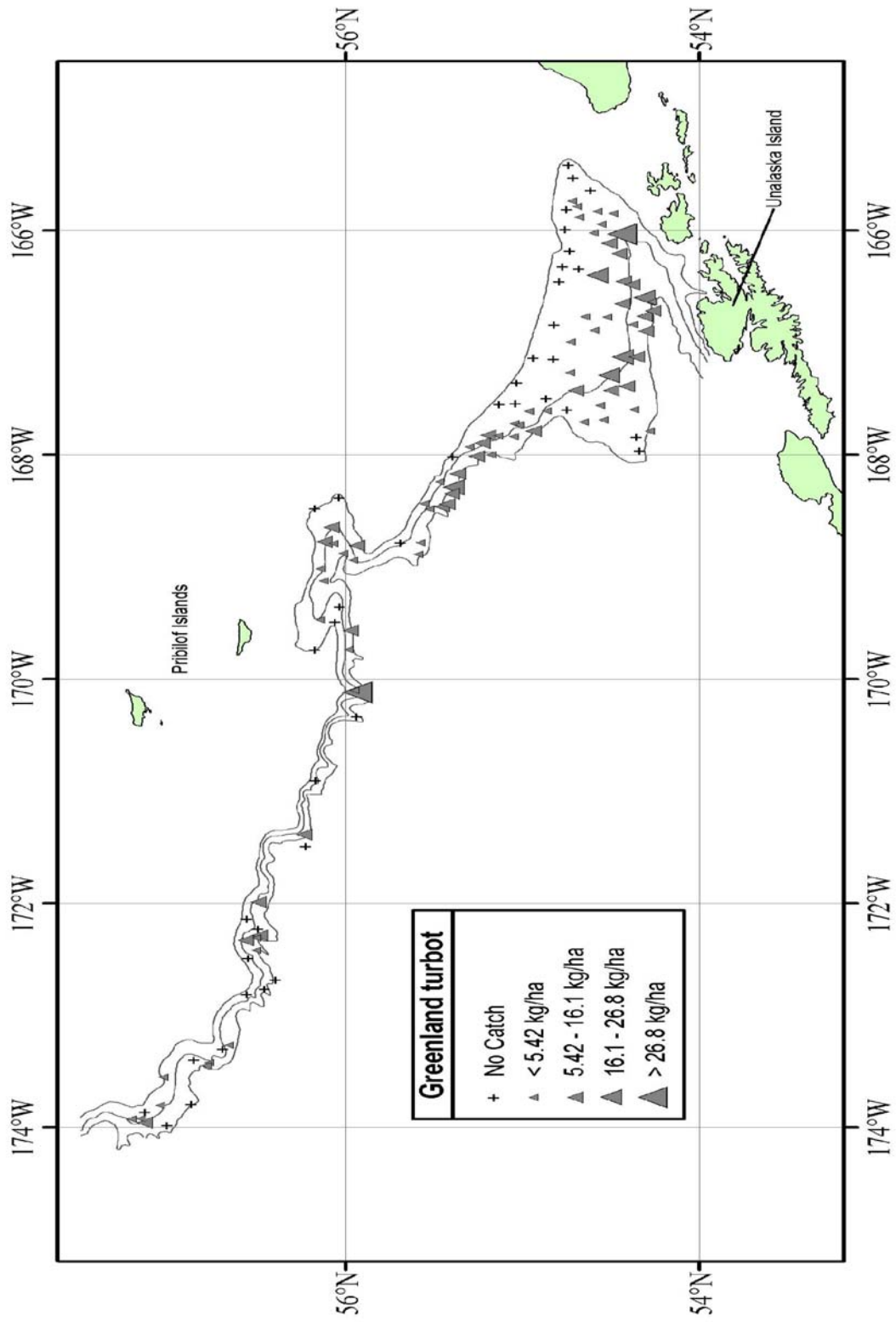

Figure 66. - - Continued.

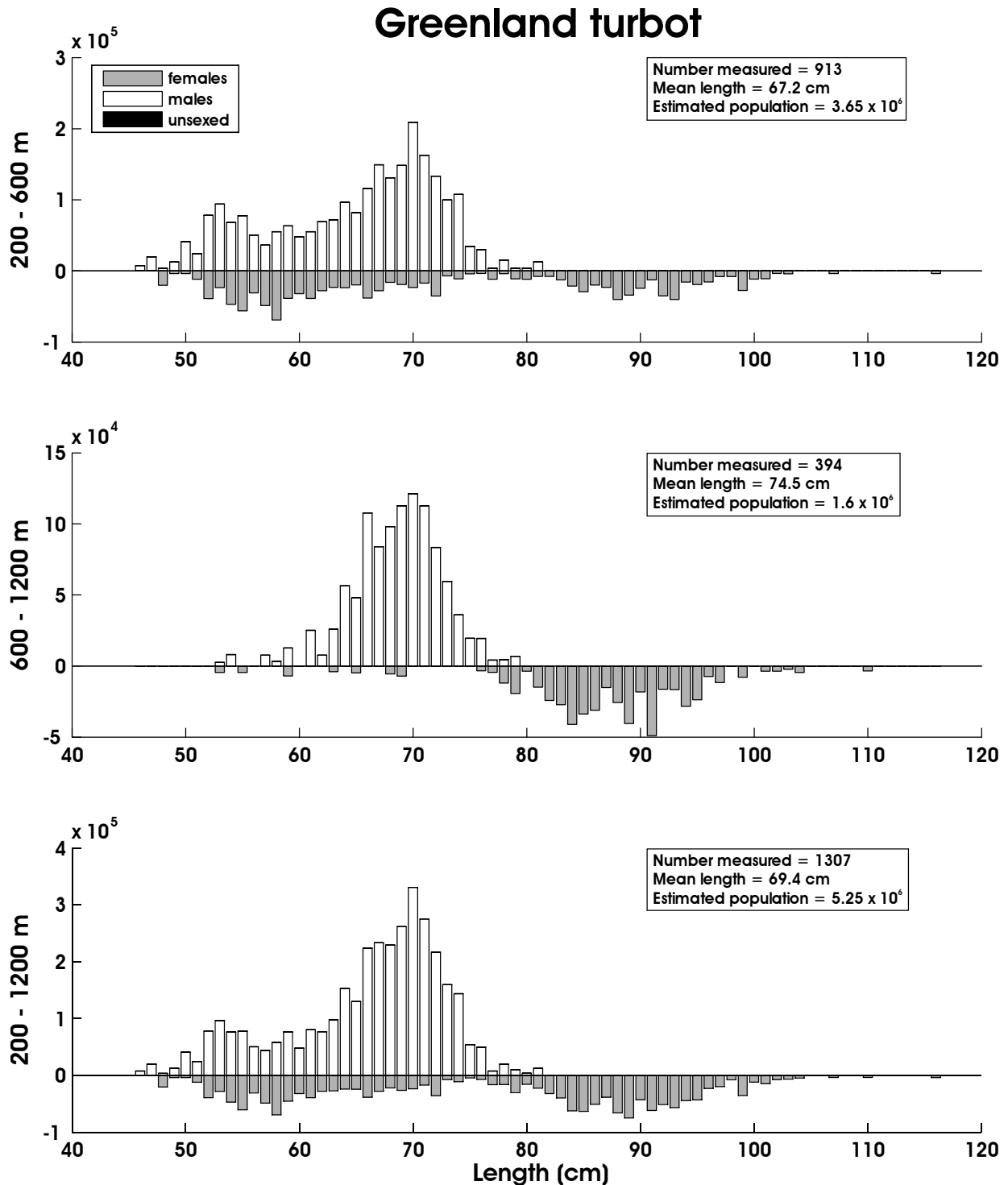

Figure 67. - - Size composition of the estimated Greenland turbot population from the 2008 EBSS survey for all subareas by depth. The abscissa is scaled as total length in centimeters while the ordinate represents the estimated total population.

Table 42. - Abundance estimates by subarea and depth stratum for arrowtooth flounder (*Atheresthes stomias*) from the 2008 EBSS survey.

<i>Atheresthes stomias</i>		arrowtooth flounder					
Subarea	Depth Stratum (m)	Biomass (t)	Population	Biomass Variance	Population Variance	Average CPUE (kg/ha)	Average CPUE (no./ha)
1	200-400	2.10E+04	2.38E+07	2.11E+07	2.77E+13	5.25E+01	5.93E+01
	400-600	5.17E+03	4.05E+06	2.70E+06	2.47E+12	1.27E+01	9.97E+00
	600-800	4.56E+00	4.56E+03	2.08E+01	2.08E+07	2.62E-02	2.62E-02
	800-1,000	0.00E+00	0.00E+00	0.00E+00	0.00E+00	0.00E+00	0.00E+00
	1,000-1,200	0.00E+00	0.00E+00	0.00E+00	0.00E+00	0.00E+00	0.00E+00
2	200-400	7.17E+03	8.72E+06	9.79E+06	2.74E+13	6.19E+01	7.53E+01
	400-600	7.55E+02	3.74E+05	4.45E+04	9.04E+09	1.07E+01	5.30E+00
	600-800	7.45E+00	3.37E+03	5.55E+01	1.14E+07	1.26E-01	5.70E-02
	800-1,000	1.45E+01	5.68E+03	2.11E+02	3.23E+07	2.63E-01	1.03E-01
	1,000-1,200	0.00E+00	0.00E+00	0.00E+00	0.00E+00	0.00E+00	0.00E+00
3	200-400	1.19E+03	6.88E+05	9.64E+04	2.19E+10	1.32E+01	7.61E+00
	400-600	6.80E+02	3.08E+05	8.28E+04	1.16E+10	7.68E+00	3.48E+00
	600-800	9.95E+01	4.92E+04	6.78E+03	1.33E+09	1.09E+00	5.40E-01
	800-1,000	0.00E+00	0.00E+00	0.00E+00	0.00E+00	0.00E+00	0.00E+00
	1,000-1,200	0.00E+00	0.00E+00	0.00E+00	0.00E+00	0.00E+00	0.00E+00
4	200-400	6.72E+03	8.37E+06	4.21E+06	6.61E+12	5.44E+01	6.77E+01
	400-600	1.47E+03	1.01E+06	7.51E+05	3.78E+11	2.01E+01	1.39E+01
	600-800	3.31E+01	3.43E+04	6.45E+02	5.67E+08	4.78E-01	4.94E-01
	800-1,000	0.00E+00	0.00E+00	0.00E+00	0.00E+00	0.00E+00	0.00E+00
	1,000-1,200	0.00E+00	0.00E+00	0.00E+00	0.00E+00	0.00E+00	0.00E+00
5	200-400	6.55E+02	4.67E+05	3.99E+04	2.55E+08	1.55E+01	1.10E+01
	400-600	6.01E+02	3.86E+05	1.56E+05	4.24E+10	1.41E+01	9.08E+00
	600-800	5.38E+00	5.44E+03	2.90E+01	2.96E+07	1.25E-01	1.26E-01
	800-1,000	0.00E+00	0.00E+00	0.00E+00	0.00E+00	0.00E+00	0.00E+00
	1,000-1,200	0.00E+00	0.00E+00	0.00E+00	0.00E+00	0.00E+00	0.00E+00
6	200-400	1.84E+04	1.71E+07	3.47E+07	2.85E+13	7.08E+01	6.58E+01
	400-600	4.31E+03	3.22E+06	4.03E+06	2.25E+12	2.52E+01	1.89E+01
	600-800	1.96E+01	9.14E+03	1.46E+02	3.14E+07	2.14E-01	9.96E-02
	800-1,000	0.00E+00	0.00E+00	0.00E+00	0.00E+00	0.00E+00	0.00E+00
	1,000-1,200	0.00E+00	0.00E+00	0.00E+00	0.00E+00	0.00E+00	0.00E+00
1-6	200-1,200	6.83E+04	6.86E+07	7.77E+07	9.53E+13	1.75E+01	1.74E+01

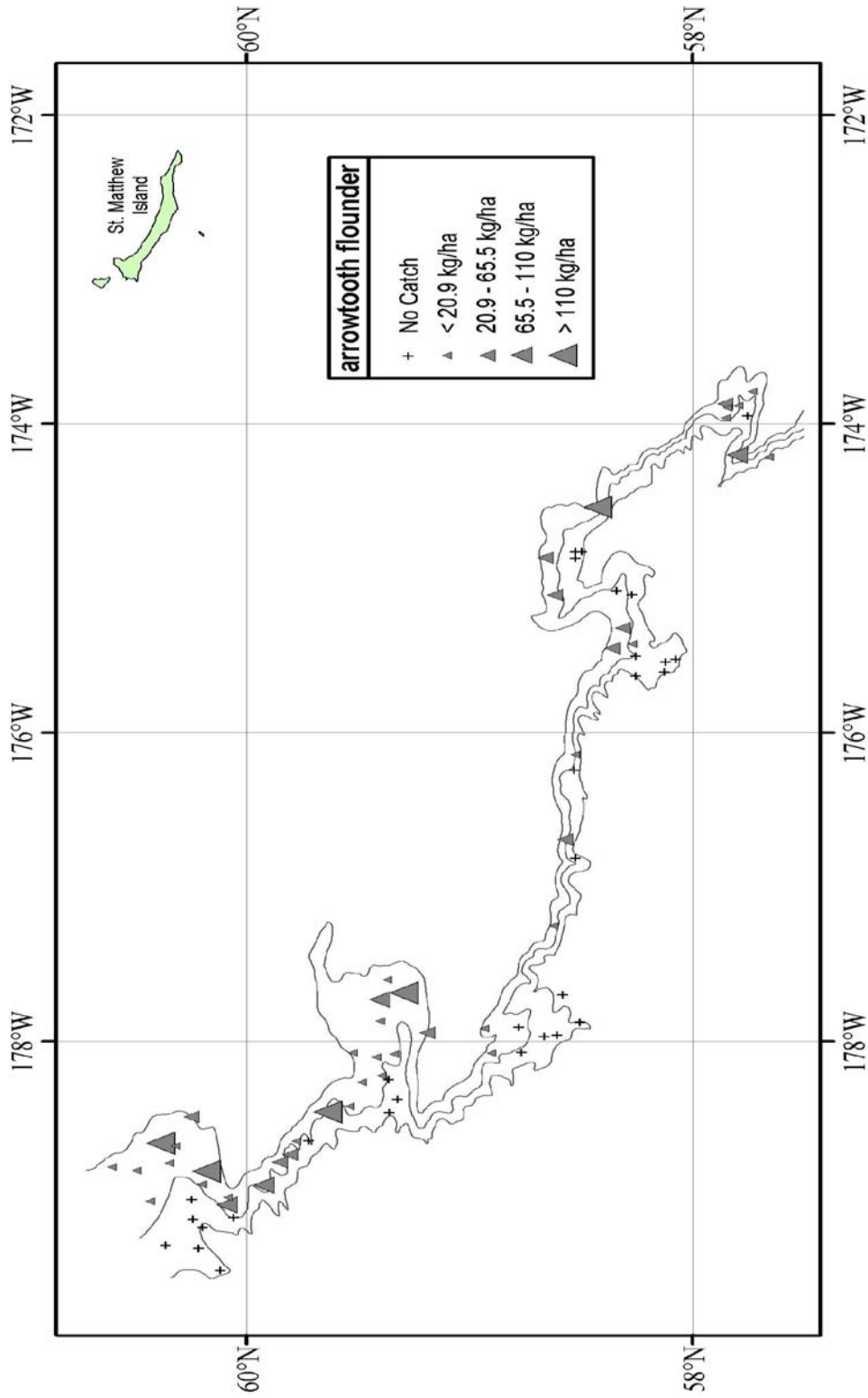

Figure 68. - - Distribution and relative abundance of arrowtooth flounder from the 2008 EBSS survey. Relative abundance is categorized by no catch, sample CPUE less than the mean CPUE, between the mean CPUE and one standard deviation above the mean, between one and two standard deviations above the mean CPUE, and greater than two standard deviations above the mean CPUE.

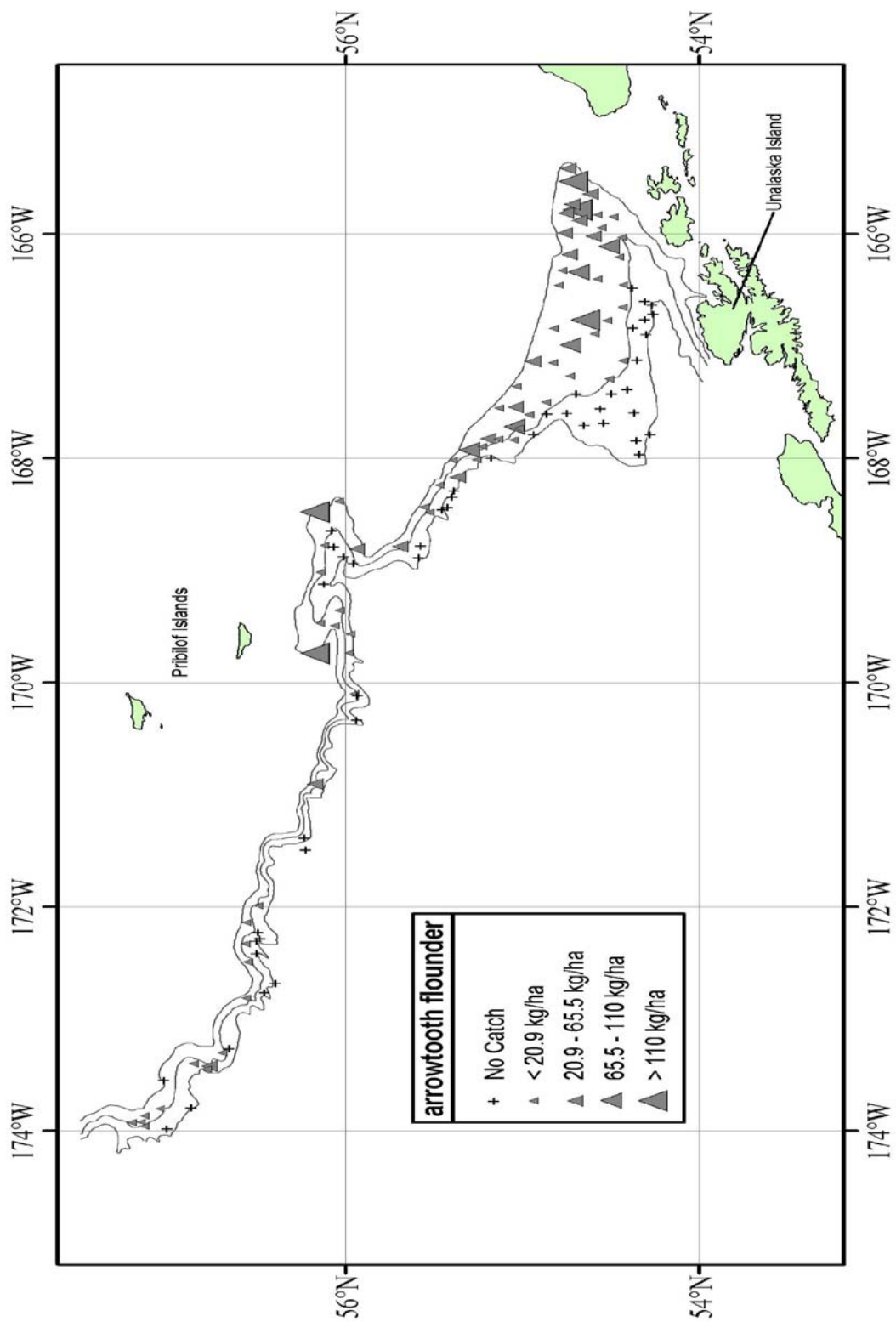

Figure 68. - - Continued.

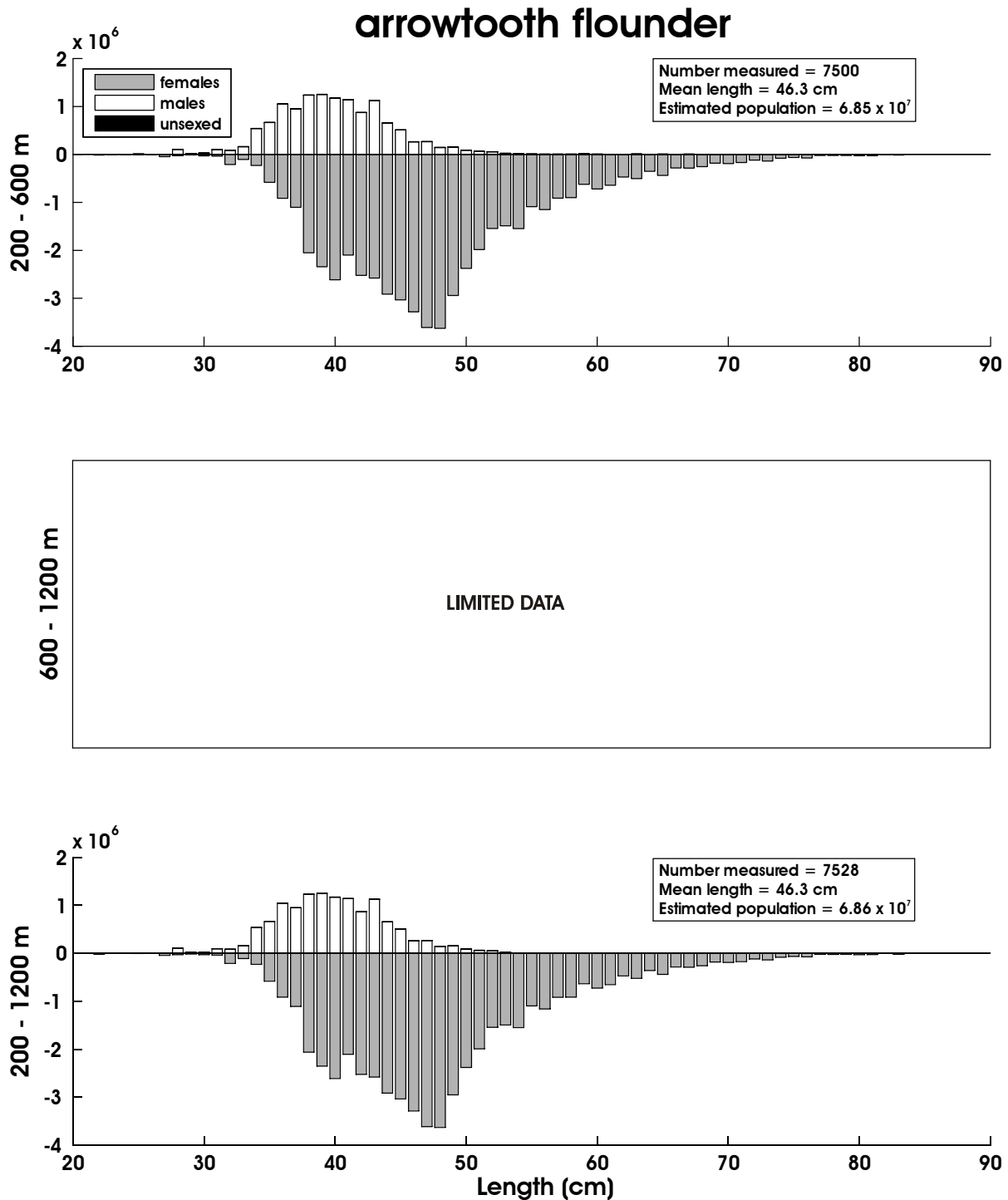

Figure 69. - - Size composition of the estimated arrowtooth flounder population from the 2008 EBSS survey for all subareas by depth. The abscissa is scaled as total length in centimeters while the ordinate represents the estimated total population.

Table 43. - Abundance estimates by subarea and depth stratum for Kamchatka flounder (*Atheresthes evermanni*) from the 2008 EBSS survey.

<i>Atheresthes evermanni</i>		Kamchatka flounder					
Subarea	Depth Stratum (m)	Biomass (t)	Population	Biomass Variance	Population Variance	Average CPUE (kg/ha)	Average CPUE (no./ha)
1	200-400	1.21E+03	1.66E+06	4.77E+04	1.12E+11	3.02E+00	4.14E+00
	400-600	8.35E+03	7.51E+06	1.50E+07	1.89E+13	2.05E+01	1.85E+01
	600-800	1.56E+03	6.23E+05	5.13E+05	6.72E+10	8.97E+00	3.58E+00
	800-1,000	5.54E+02	2.35E+05	3.01E+04	5.20E+09	4.09E+00	1.74E+00
	1,000-1,200	1.36E+02	6.22E+04	3.17E+03	5.40E+08	1.23E+00	5.62E-01
2	200-400	1.12E+03	1.51E+06	2.75E+05	4.48E+11	9.67E+00	1.30E+01
	400-600	2.85E+03	1.29E+06	3.09E+06	3.50E+11	4.04E+01	1.83E+01
	600-800	7.15E+02	3.79E+05	4.60E+04	2.46E+10	1.21E+01	6.42E+00
	800-1,000	4.89E+02	2.53E+05	3.44E+04	2.19E+10	8.85E+00	4.57E+00
	1,000-1,200	5.31E+01	2.18E+04	1.25E+03	2.69E+08	9.92E-01	4.07E-01
3	200-400	2.29E+02	2.50E+05	5.98E+03	3.76E+09	2.53E+00	2.77E+00
	400-600	4.92E+02	2.66E+05	2.17E+04	2.86E+09	5.55E+00	3.00E+00
	600-800	4.19E+02	2.31E+05	2.24E+04	4.15E+09	4.60E+00	2.54E+00
	800-1,000	6.56E+01	2.68E+04	7.45E+02	1.03E+08	8.96E-01	3.67E-01
	1,000-1,200	4.22E+01	1.73E+04	3.34E+01	3.02E+06	6.25E-01	2.56E-01
4	200-400	3.91E+02	6.68E+05	1.05E+04	4.28E+10	3.16E+00	5.40E+00
	400-600	6.25E+02	5.70E+05	5.19E+04	5.27E+10	8.55E+00	7.80E+00
	600-800	2.25E+02	1.48E+05	2.50E+03	8.13E+08	3.24E+00	2.13E+00
	800-1,000	1.16E+02	5.20E+04	7.18E+03	1.78E+09	1.63E+00	7.35E-01
	1,000-1,200	0.00E+00	0.00E+00	0.00E+00	0.00E+00	0.00E+00	0.00E+00
5	200-400	9.67E+01	1.24E+05	8.14E+01	3.61E+08	2.28E+00	2.92E+00
	400-600	1.60E+02	1.33E+05	2.11E+03	1.73E+09	3.75E+00	3.12E+00
	600-800	1.57E+02	9.20E+04	9.03E+03	3.63E+09	3.64E+00	2.13E+00
	800-1,000	0.00E+00	0.00E+00	0.00E+00	0.00E+00	0.00E+00	0.00E+00
	1,000-1,200	0.00E+00	0.00E+00	0.00E+00	0.00E+00	0.00E+00	0.00E+00
6	200-400	3.52E+03	4.32E+06	1.87E+06	3.00E+12	1.35E+01	1.66E+01
	400-600	9.12E+02	6.99E+05	9.74E+04	6.49E+10	5.35E+00	4.10E+00
	600-800	3.22E+02	1.76E+05	2.24E+04	1.03E+10	3.51E+00	1.91E+00
	800-1,000	1.75E+01	7.20E+03	3.06E+02	5.19E+07	2.71E-01	1.12E-01
	1,000-1,200	0.00E+00	0.00E+00	0.00E+00	0.00E+00	0.00E+00	0.00E+00
1-6	200-1,200	2.48E+04	2.13E+07	2.12E+07	2.31E+13	4.99E+00	3.43E+00

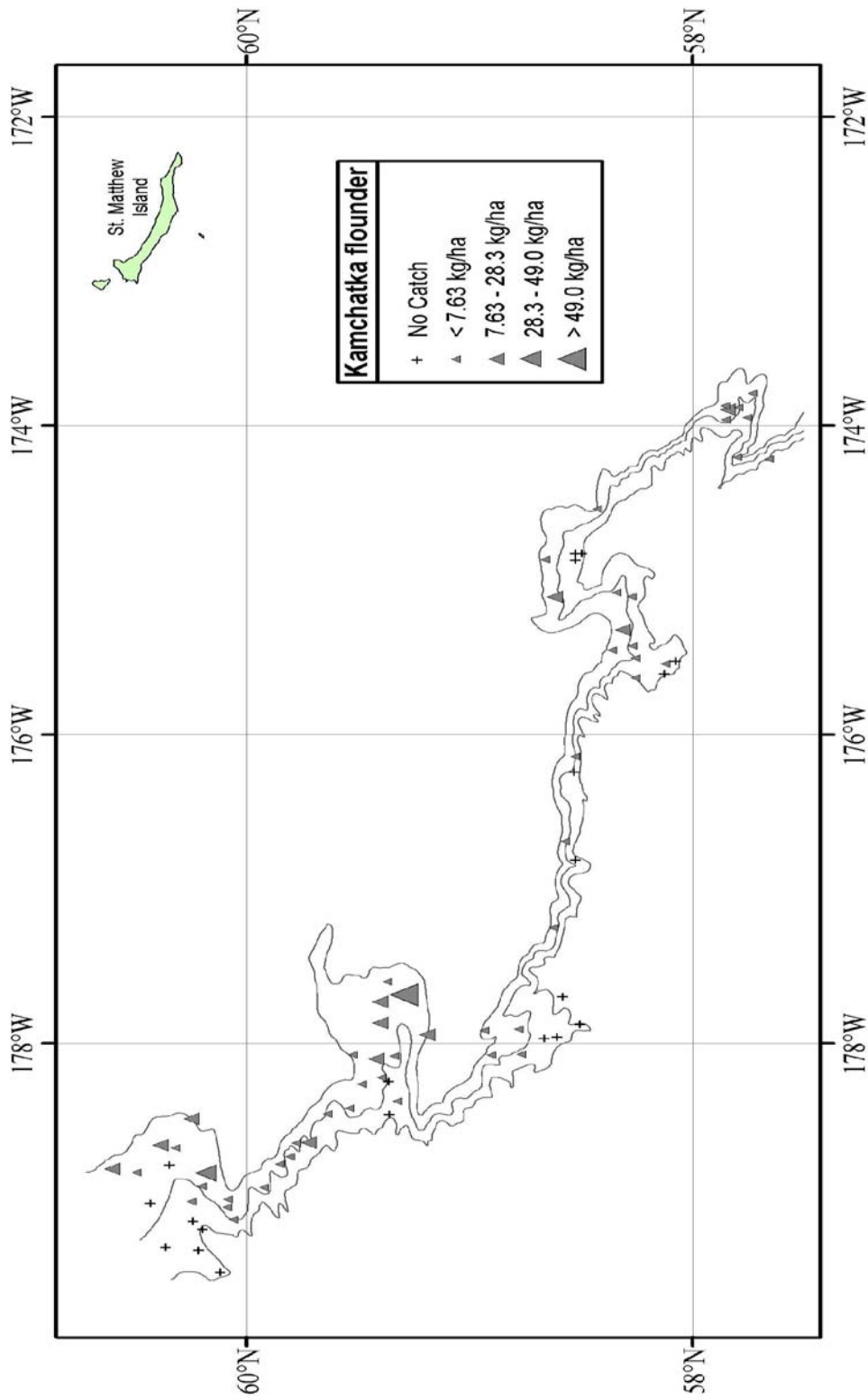

Figure 70. - - Distribution and relative abundance of Kamchatka flounder from the 2008 EBSS survey. Relative abundance is categorized by no catch, sample CPUE less than the mean CPUE, between the mean CPUE and one standard deviation above the mean, between one and two standard deviations above the mean CPUE, and greater than two standard deviations above the mean CPUE.

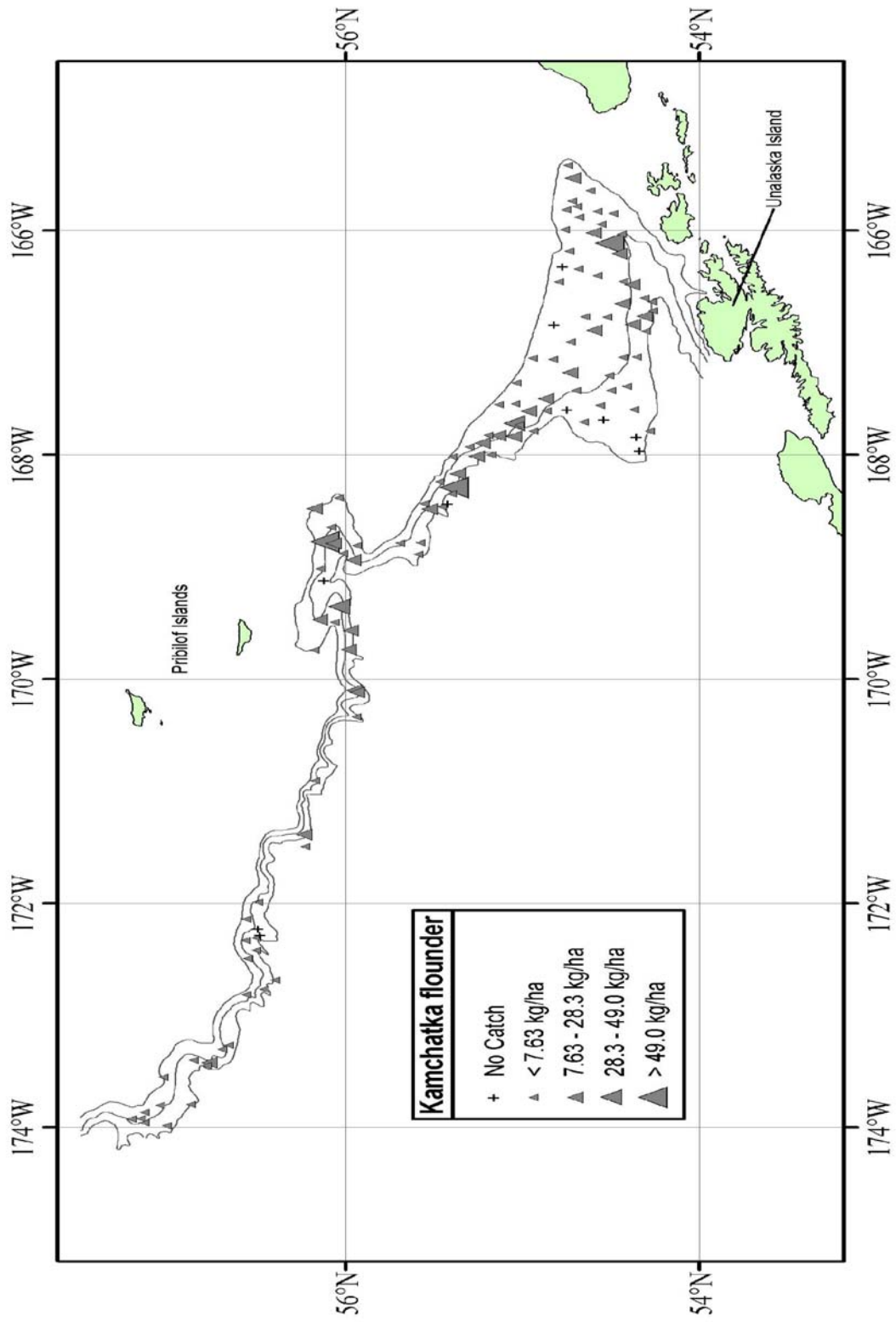

Figure 70. - - Continued.

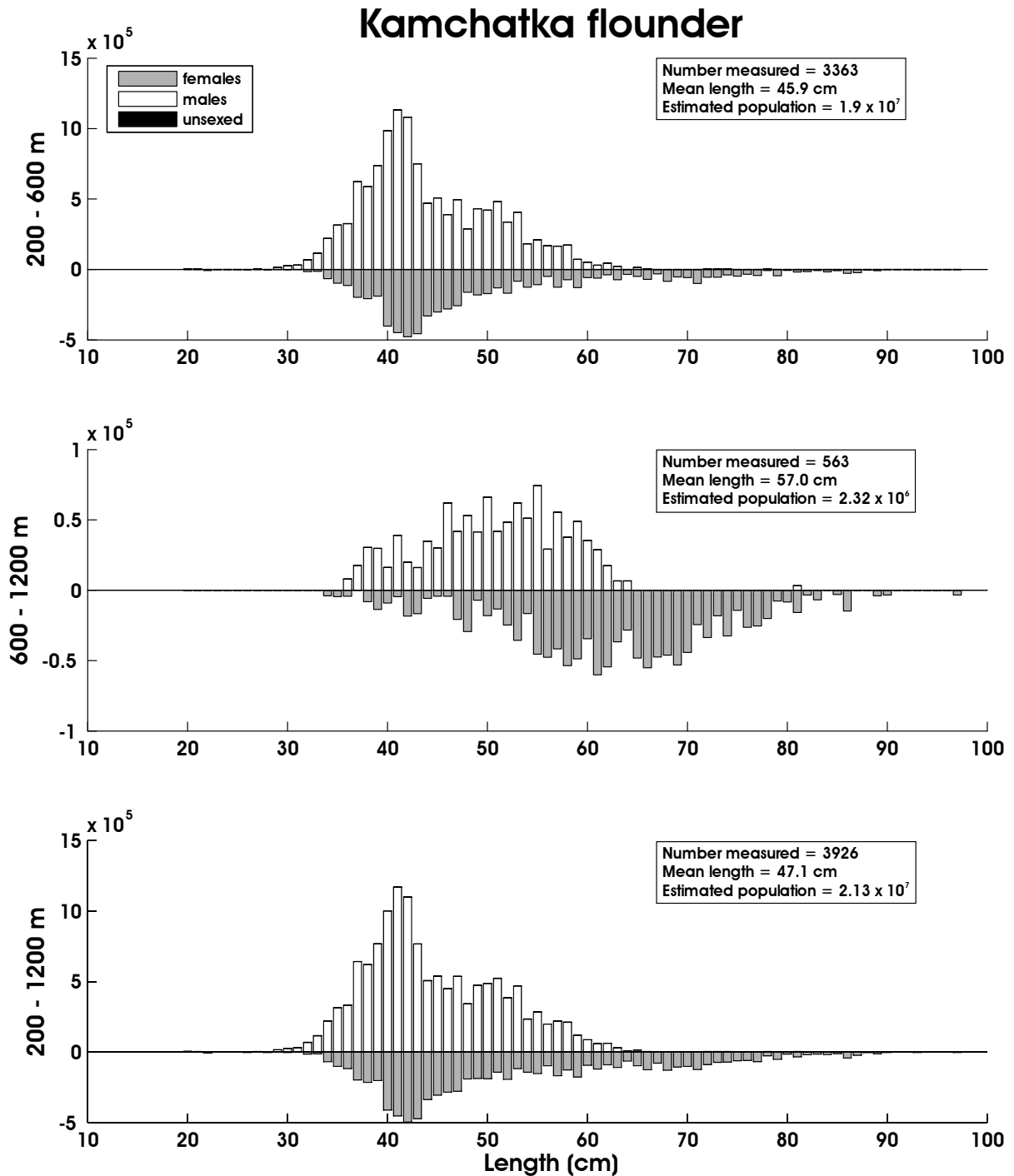

Figure 71. - Size composition of the estimated Kamchatka flounder population from the 2008 EBSS survey for all subareas by depth. The abscissa is scaled as total length in centimeters while the ordinate represents the estimated total population.

Table 44. - Abundance estimates by subarea and depth stratum for rex sole (*Glyptocephalus zachirus*) from the 2008 EBSS survey.

<i>Glyptocephalus zachirus</i>						rex sole	
Subarea	Depth Stratum (m)	Biomass (t)	Population	Biomass Variance	Population Variance	Average CPUE (kg/ha)	Average CPUE (no./ha)
1	200-400	3.01E+03	4.32E+06	6.74E+05	1.04E+12	7.51E+00	1.08E+01
	400-600	8.98E+02	1.24E+06	5.55E+04	9.00E+10	2.21E+00	3.05E+00
	600-800	1.73E+00	1.82E+04	3.00E+00	3.33E+08	9.95E-03	1.05E-01
	800-1,000	0.00E+00	0.00E+00	0.00E+00	0.00E+00	0.00E+00	0.00E+00
	1,000-1,200	0.00E+00	0.00E+00	0.00E+00	0.00E+00	0.00E+00	0.00E+00
2	200-400	1.63E+03	3.00E+06	9.22E+05	3.19E+12	1.41E+01	2.59E+01
	400-600	1.24E+03	1.77E+06	1.63E+05	3.62E+11	1.76E+01	2.50E+01
	600-800	1.42E+01	2.08E+04	2.01E+02	4.32E+08	2.40E-01	3.52E-01
	800-1,000	0.00E+00	0.00E+00	0.00E+00	0.00E+00	0.00E+00	0.00E+00
	1,000-1,200	0.00E+00	0.00E+00	0.00E+00	0.00E+00	0.00E+00	0.00E+00
3	200-400	1.66E+03	2.14E+06	2.49E+05	4.11E+11	1.84E+01	2.37E+01
	400-600	7.59E+02	1.20E+06	7.65E+04	2.13E+11	8.57E+00	1.35E+01
	600-800	3.10E+00	3.34E+03	9.58E+00	1.12E+07	3.40E-02	3.67E-02
	800-1,000	6.58E+00	1.09E+04	4.34E+01	1.18E+08	8.99E-02	1.49E-01
	1,000-1,200	0.00E+00	0.00E+00	0.00E+00	0.00E+00	0.00E+00	0.00E+00
4	200-400	1.22E+03	1.94E+06	1.21E+05	2.74E+11	9.89E+00	1.57E+01
	400-600	2.65E+02	3.59E+05	5.09E+04	1.03E+11	3.62E+00	4.92E+00
	600-800	0.00E+00	0.00E+00	0.00E+00	0.00E+00	0.00E+00	0.00E+00
	800-1,000	0.00E+00	0.00E+00	0.00E+00	0.00E+00	0.00E+00	0.00E+00
	1,000-1,200	0.00E+00	0.00E+00	0.00E+00	0.00E+00	0.00E+00	0.00E+00
5	200-400	5.51E+01	1.65E+05	9.04E+02	1.98E+09	1.30E+00	3.90E+00
	400-600	3.20E+02	7.10E+05	4.70E+04	3.29E+11	7.53E+00	1.67E+01
	600-800	0.00E+00	0.00E+00	0.00E+00	0.00E+00	0.00E+00	0.00E+00
	800-1,000	0.00E+00	0.00E+00	0.00E+00	0.00E+00	0.00E+00	0.00E+00
	1,000-1,200	0.00E+00	0.00E+00	0.00E+00	0.00E+00	0.00E+00	0.00E+00
6	200-400	4.08E+02	1.25E+06	1.14E+04	1.47E+11	1.57E+00	4.82E+00
	400-600	4.99E+01	1.07E+05	2.28E+03	8.77E+09	2.92E-01	6.27E-01
	600-800	0.00E+00	0.00E+00	0.00E+00	0.00E+00	0.00E+00	0.00E+00
	800-1,000	0.00E+00	0.00E+00	0.00E+00	0.00E+00	0.00E+00	0.00E+00
	1,000-1,200	0.00E+00	0.00E+00	0.00E+00	0.00E+00	0.00E+00	0.00E+00
1-6	200-1,200	1.16E+04	1.82E+07	2.37E+06	6.17E+12	4.26E+00	7.45E+00

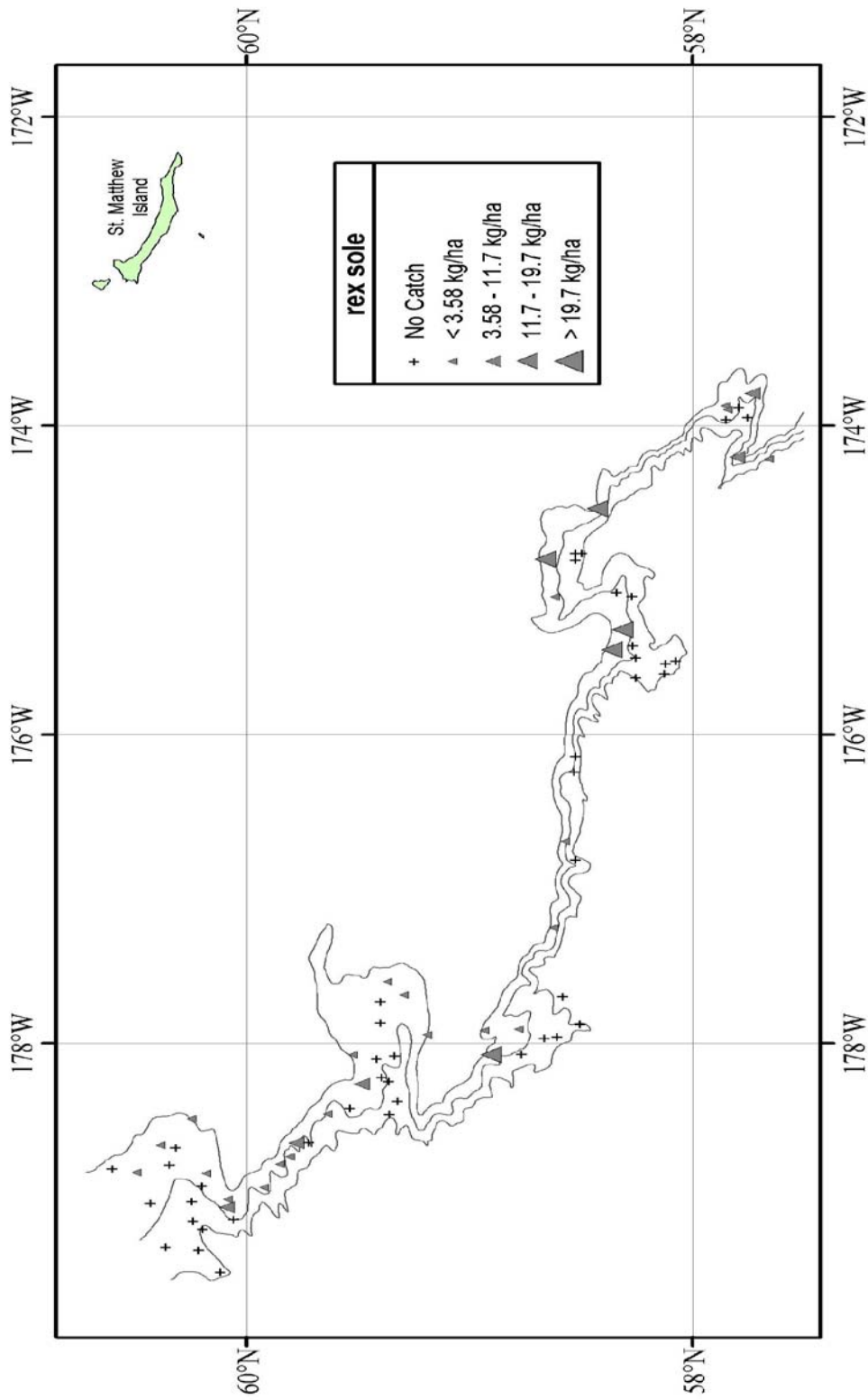

Figure 72. - - Distribution and relative abundance of rex sole from the 2008 EBSS survey. Relative abundance is categorized by no catch, sample CPUE less than the mean CPUE, between the mean CPUE and one standard deviation above the mean, between one and two standard deviations above the mean CPUE, and greater than two standard deviations above the mean CPUE.

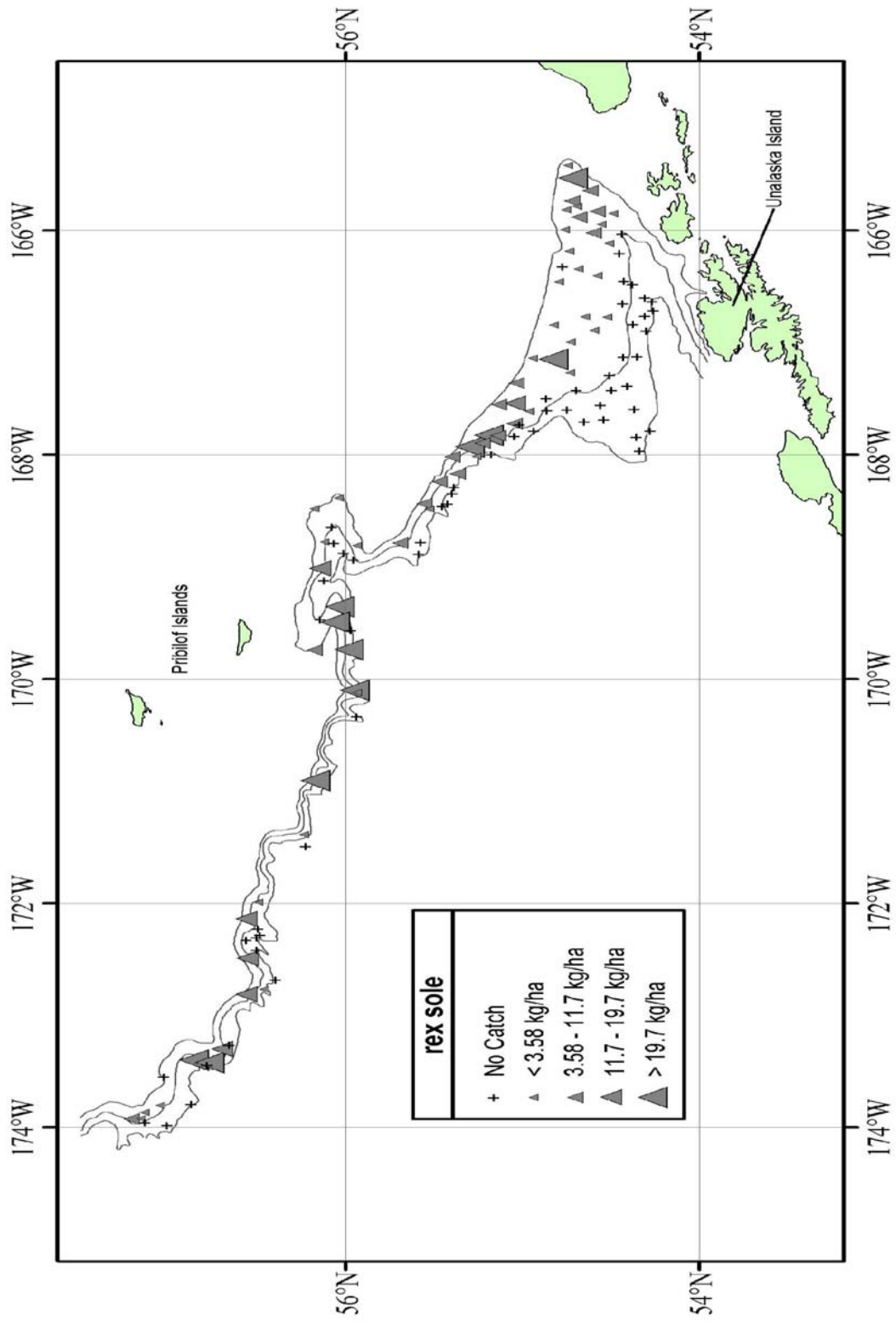

Figure 72. - - Continued.

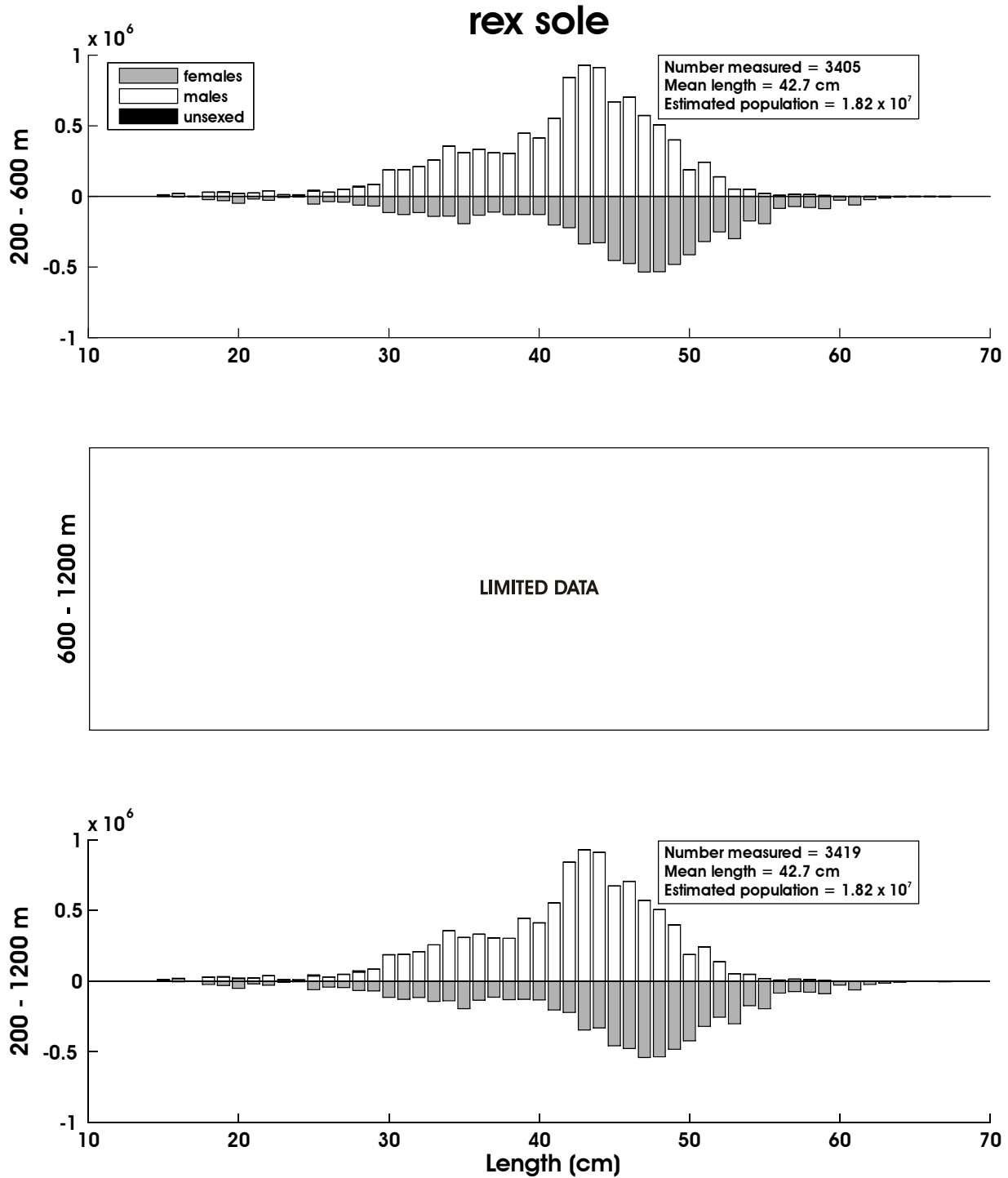

Figure 73. - Size composition of the estimated rex sole population from the 2008 EBSS survey for all subareas by depth. The abscissa is scaled as total length in centimeters while the ordinate represents the estimated total population.

Table 45. - Abundance estimates by subarea and depth stratum for triangle Tanner crab (*Chionoecetes angulatus*) from the 2008 EBSS survey.

<i>Chionoecetes angulatus</i>		triangle Tanner crab					
Subarea	Depth Stratum (m)	Biomass (t)	Population	Biomass Variance	Population Variance	Average CPUE (kg/ha)	Average CPUE (no./ha)
1	200-400	1.37E+00	3.52E+04	9.02E-01	3.19E+08	3.42E-03	8.78E-02
	400-600	1.05E+02	8.60E+05	1.62E+03	1.02E+11	2.59E-01	2.12E+00
	600-800	7.54E+02	3.81E+06	2.31E+05	5.90E+12	4.33E+00	2.19E+01
	800-1,000	1.17E+03	5.58E+06	1.82E+05	4.05E+12	8.65E+00	4.12E+01
	1,000-1,200	9.63E+02	6.24E+06	5.32E+04	3.69E+12	8.70E+00	5.64E+01
2	200-400	0.00E+00	0.00E+00	0.00E+00	0.00E+00	0.00E+00	0.00E+00
	400-600	0.00E+00	0.00E+00	0.00E+00	0.00E+00	0.00E+00	0.00E+00
	600-800	7.34E-01	4.59E+03	5.39E-01	2.11E+07	1.24E-02	7.76E-02
	800-1,000	5.98E+01	3.18E+05	2.83E+03	8.50E+10	1.08E+00	5.76E+00
	1,000-1,200	1.47E+02	1.50E+06	4.01E+03	5.92E+11	2.75E+00	2.80E+01
3	200-400	2.89E+00	8.36E+03	3.36E+00	2.80E+07	3.20E-02	9.25E-02
	400-600	1.38E+00	1.26E+04	7.09E-01	3.31E+07	1.56E-02	1.42E-01
	600-800	6.51E+00	4.52E+04	3.19E+01	1.11E+09	7.16E-02	4.96E-01
	800-1,000	1.03E+01	6.64E+04	8.40E+01	3.37E+09	1.40E-01	9.06E-01
	1,000-1,200	1.20E+01	5.71E+04	1.44E+02	3.26E+09	1.78E-01	8.46E-01
4	200-400	0.00E+00	0.00E+00	0.00E+00	0.00E+00	0.00E+00	0.00E+00
	400-600	0.00E+00	0.00E+00	0.00E+00	0.00E+00	0.00E+00	0.00E+00
	600-800	2.85E+00	4.38E+03	8.11E+00	1.92E+07	4.10E-02	6.31E-02
	800-1,000	4.53E+01	2.03E+05	7.91E+02	3.01E+09	6.40E-01	2.88E+00
	1,000-1,200	4.49E+02	1.01E+07	1.91E+05	1.02E+14	6.78E+00	1.53E+02
5	200-400	2.04E+00	1.05E+04	4.14E+00	1.10E+08	4.80E-02	2.48E-01
	400-600	4.44E-02	3.17E+03	1.97E-03	1.01E+07	1.04E-03	7.46E-02
	600-800	4.62E+00	3.71E+04	2.13E+01	1.38E+09	1.07E-01	8.59E-01
	800-1,000	3.65E+01	2.95E+05	2.87E+02	3.40E+10	6.61E-01	5.34E+00
	1,000-1,200	2.59E+01	1.22E+05	5.07E+01	1.40E+08	4.53E-01	2.15E+00
6	200-400	2.44E-01	3.59E+03	5.98E-02	1.29E+07	9.42E-04	1.38E-02
	400-600	1.76E+01	8.26E+04	6.83E+01	1.55E+09	1.03E-01	4.85E-01
	600-800	1.81E+02	7.60E+05	5.54E+03	6.79E+10	1.97E+00	8.28E+00
	800-1,000	1.22E+02	6.36E+05	4.38E+03	1.42E+11	1.88E+00	9.86E+00
	1,000-1,200	7.07E+01	3.15E+05	1.14E+03	2.42E+10	1.43E+00	6.34E+00
1-6	200-1,200	4.19E+03	3.11E+07	6.78E+05	1.17E+14	1.62E+00	1.96E+01

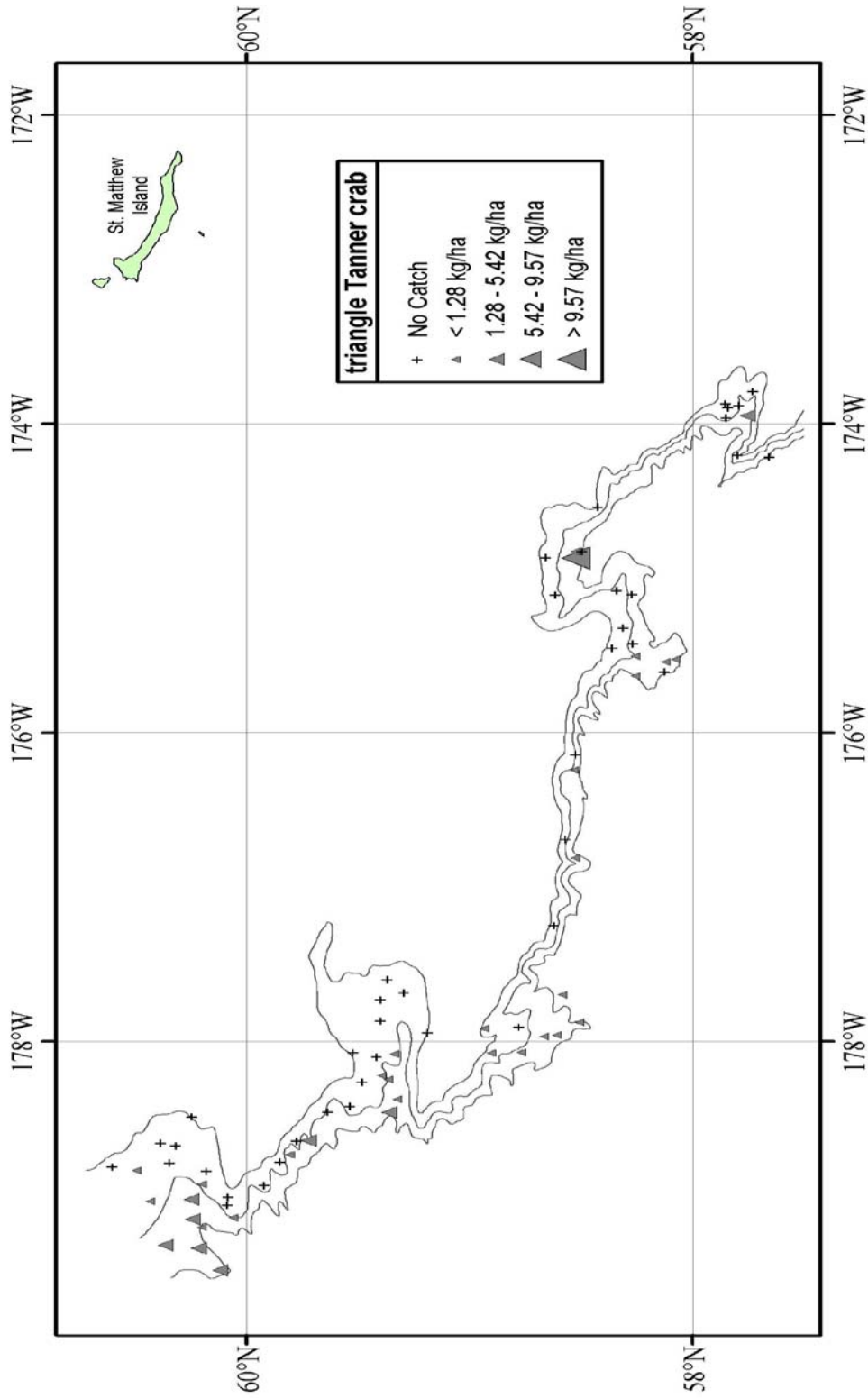

Figure 74. - - Distribution and relative abundance of triangle Tanner crab from the 2008 EBSS survey. Relative abundance is categorized by no catch, sample CPUE less than the mean CPUE, between the mean CPUE and one standard deviation above the mean, between one and two standard deviations above the mean CPUE, and greater than two standard deviations above the mean CPUE.

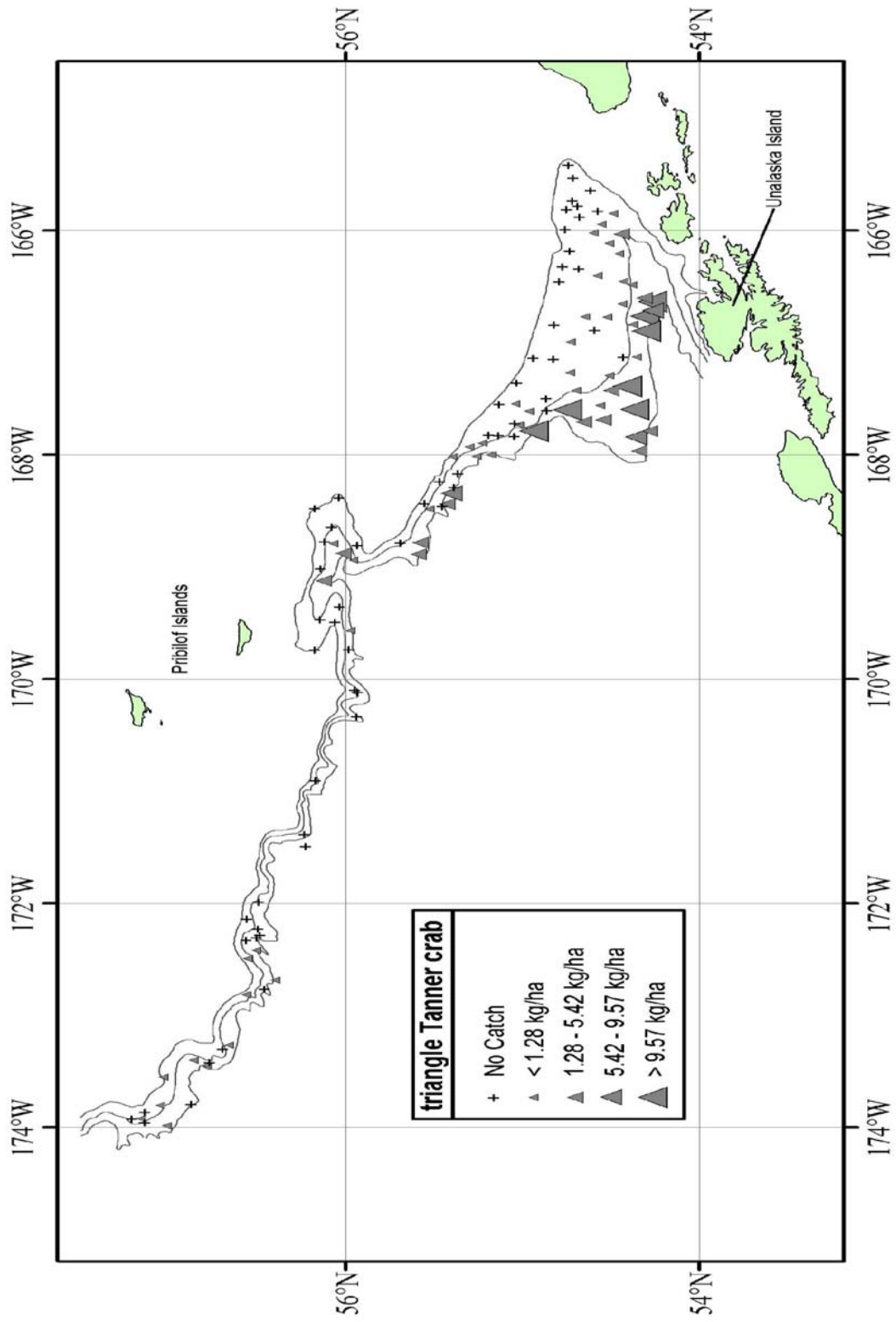

Figure 74. - - Continued.

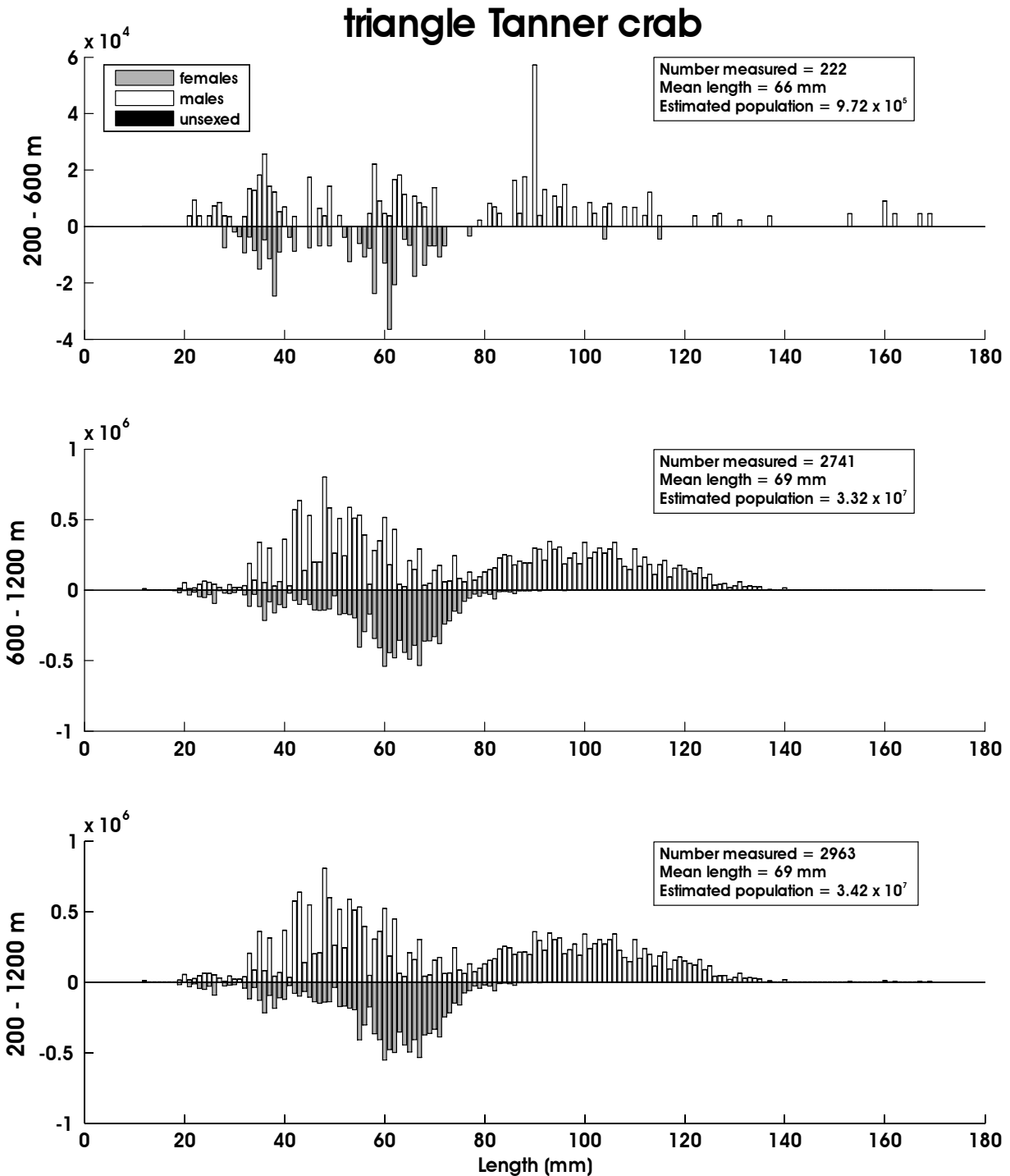

Figure 75. - Size composition of the estimated triangle Tanner crab population from the 2008 EBSS survey for all subareas by depth. The abscissa is scaled as total carapace width in millimeters while the ordinate represents the estimated total population.

Table 46. - Abundance estimates by subarea and depth stratum for Tanner crab (*Chionoecetes bairdi*) from the 2008 EBSS survey.

<i>Chionoecetes bairdi</i>		Tanner crab					
Subarea	Depth Stratum (m)	Biomass (t)	Population	Biomass Variance	Population Variance	Average CPUE (kg/ha)	Average CPUE (no./ha)
1	200-400	3.66E+02	2.52E+06	2.61E+04	5.95E+11	9.13E-01	6.27E+00
	400-600	2.81E+00	2.18E+04	7.90E+00	4.76E+08	6.92E-03	5.37E-02
	600-800	0.00E+00	0.00E+00	0.00E+00	0.00E+00	0.00E+00	0.00E+00
	800-1,000	0.00E+00	0.00E+00	0.00E+00	0.00E+00	0.00E+00	0.00E+00
	1,000-1,200	0.00E+00	0.00E+00	0.00E+00	0.00E+00	0.00E+00	0.00E+00
2	200-400	2.23E+01	1.83E+05	2.77E+02	2.11E+10	1.93E-01	1.59E+00
	400-600	4.23E-01	1.15E+04	1.79E-01	1.33E+08	5.99E-03	1.63E-01
	600-800	0.00E+00	0.00E+00	0.00E+00	0.00E+00	0.00E+00	0.00E+00
	800-1,000	0.00E+00	0.00E+00	0.00E+00	0.00E+00	0.00E+00	0.00E+00
	1,000-1,200	0.00E+00	0.00E+00	0.00E+00	0.00E+00	0.00E+00	0.00E+00
3	200-400	6.14E+00	3.70E+04	2.06E+01	6.86E+08	6.79E-02	4.09E-01
	400-600	0.00E+00	0.00E+00	0.00E+00	0.00E+00	0.00E+00	0.00E+00
	600-800	0.00E+00	0.00E+00	0.00E+00	0.00E+00	0.00E+00	0.00E+00
	800-1,000	0.00E+00	0.00E+00	0.00E+00	0.00E+00	0.00E+00	0.00E+00
	1,000-1,200	0.00E+00	0.00E+00	0.00E+00	0.00E+00	0.00E+00	0.00E+00
4	200-400	1.39E+01	1.87E+05	1.19E+02	2.21E+10	1.12E-01	1.51E+00
	400-600	6.69E-01	3.72E+03	4.48E-01	1.38E+07	9.16E-03	5.09E-02
	600-800	0.00E+00	0.00E+00	0.00E+00	0.00E+00	0.00E+00	0.00E+00
	800-1,000	0.00E+00	0.00E+00	0.00E+00	0.00E+00	0.00E+00	0.00E+00
	1,000-1,200	0.00E+00	0.00E+00	0.00E+00	0.00E+00	0.00E+00	0.00E+00
5	200-400	1.83E+00	1.05E+04	3.33E+00	1.10E+08	4.31E-02	2.48E-01
	400-600	0.00E+00	0.00E+00	0.00E+00	0.00E+00	0.00E+00	0.00E+00
	600-800	0.00E+00	0.00E+00	0.00E+00	0.00E+00	0.00E+00	0.00E+00
	800-1,000	0.00E+00	0.00E+00	0.00E+00	0.00E+00	0.00E+00	0.00E+00
	1,000-1,200	0.00E+00	0.00E+00	0.00E+00	0.00E+00	0.00E+00	0.00E+00
6	200-400	6.51E+01	5.74E+05	6.56E+02	5.66E+10	2.51E-01	2.21E+00
	400-600	2.93E+01	5.61E+05	8.26E+02	3.05E+11	1.71E-01	3.29E+00
	600-800	0.00E+00	0.00E+00	0.00E+00	0.00E+00	0.00E+00	0.00E+00
	800-1,000	0.00E+00	0.00E+00	0.00E+00	0.00E+00	0.00E+00	0.00E+00
	1,000-1,200	0.00E+00	0.00E+00	0.00E+00	0.00E+00	0.00E+00	0.00E+00
1-6	200-1,200	5.09E+02	4.11E+06	2.80E+04	1.00E+12	2.71E-01	3.15E+00

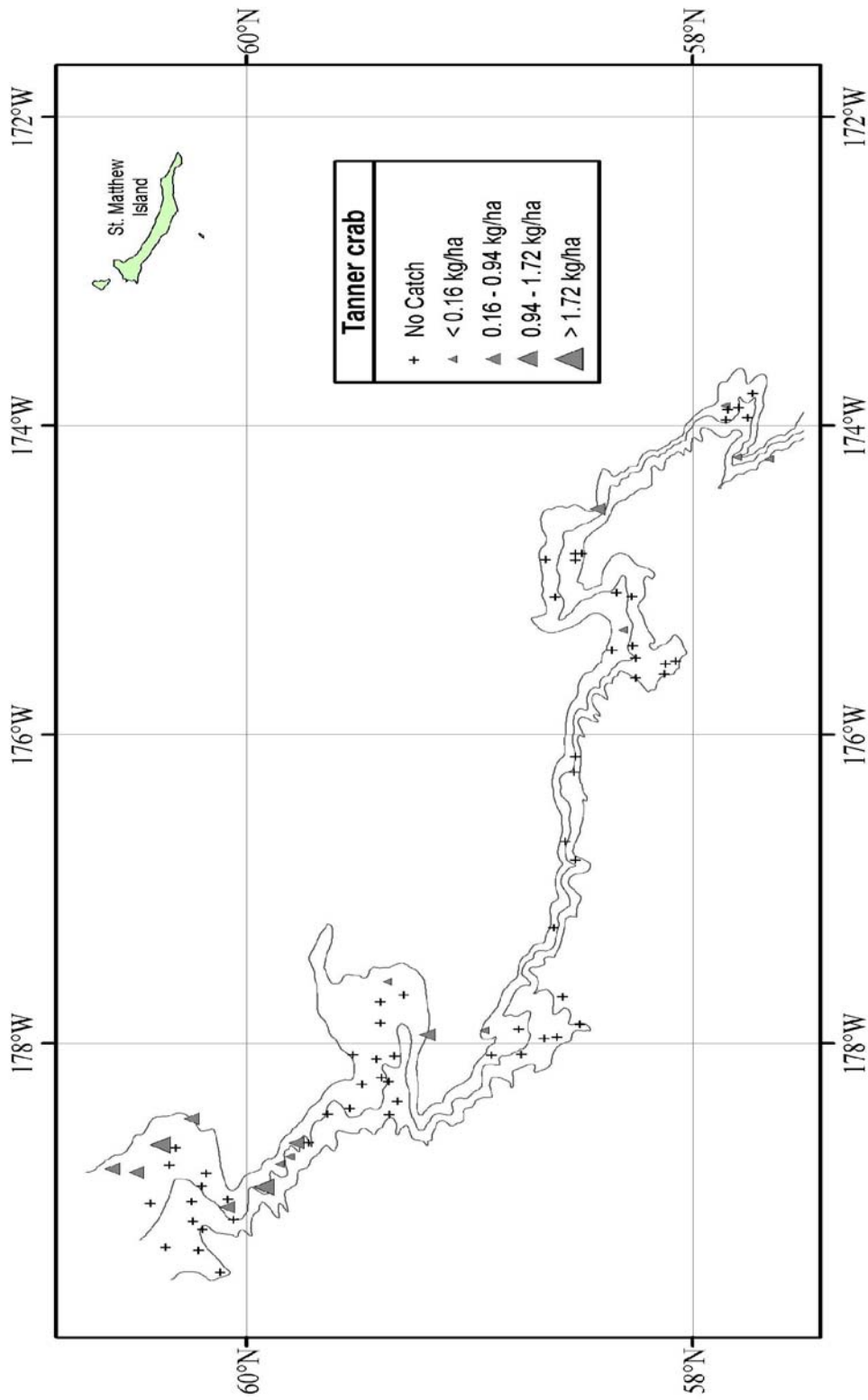

Figure 76. - - Distribution and relative abundance of Tanner crab from the 2008 EBSS survey. Relative abundance is categorized by no catch, sample CPUE less than the mean CPUE, between the mean CPUE and one standard deviation above the mean, between one and two standard deviations above the mean CPUE, and greater than two standard deviations above the mean CPUE.

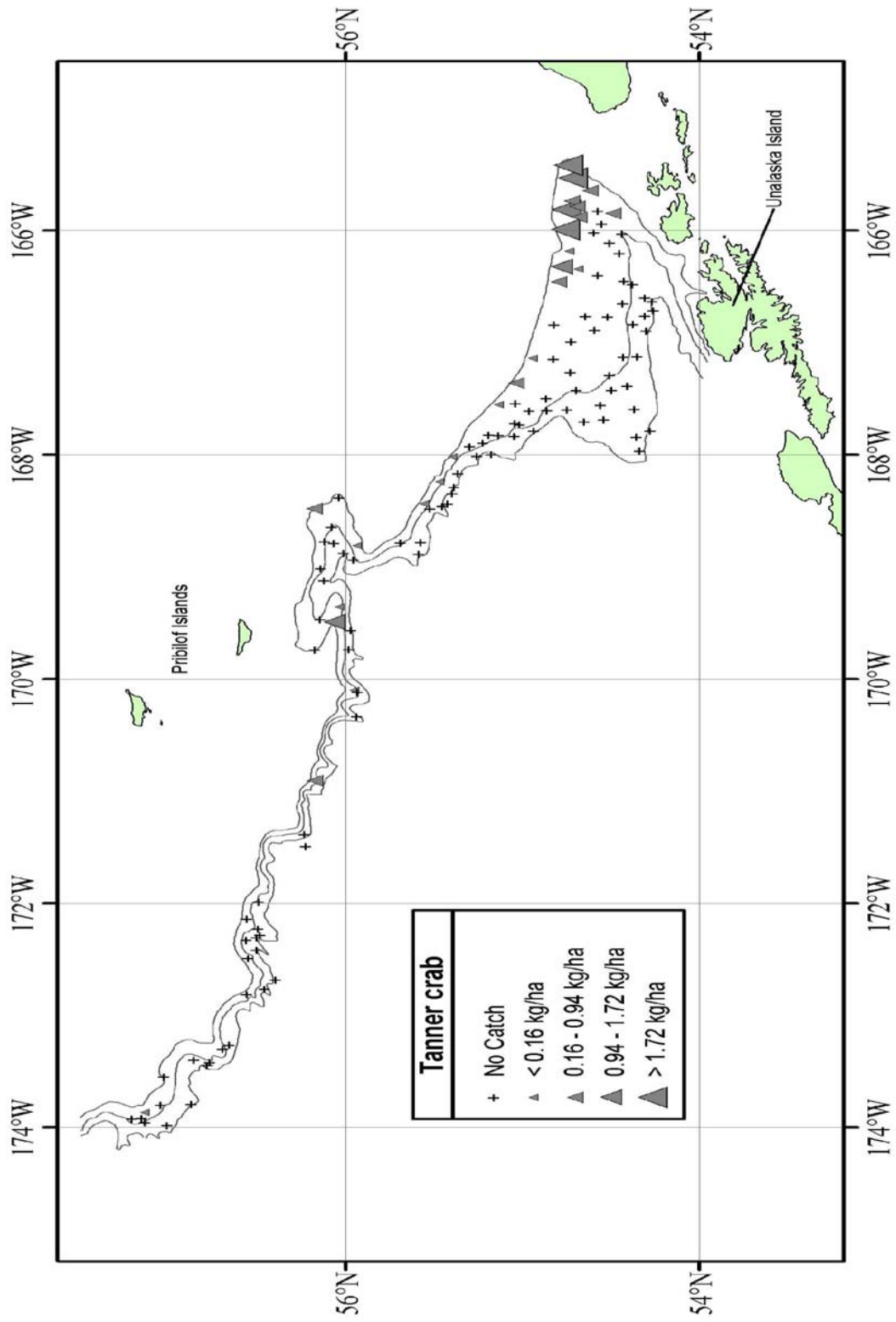

Figure 76. - - Continued.

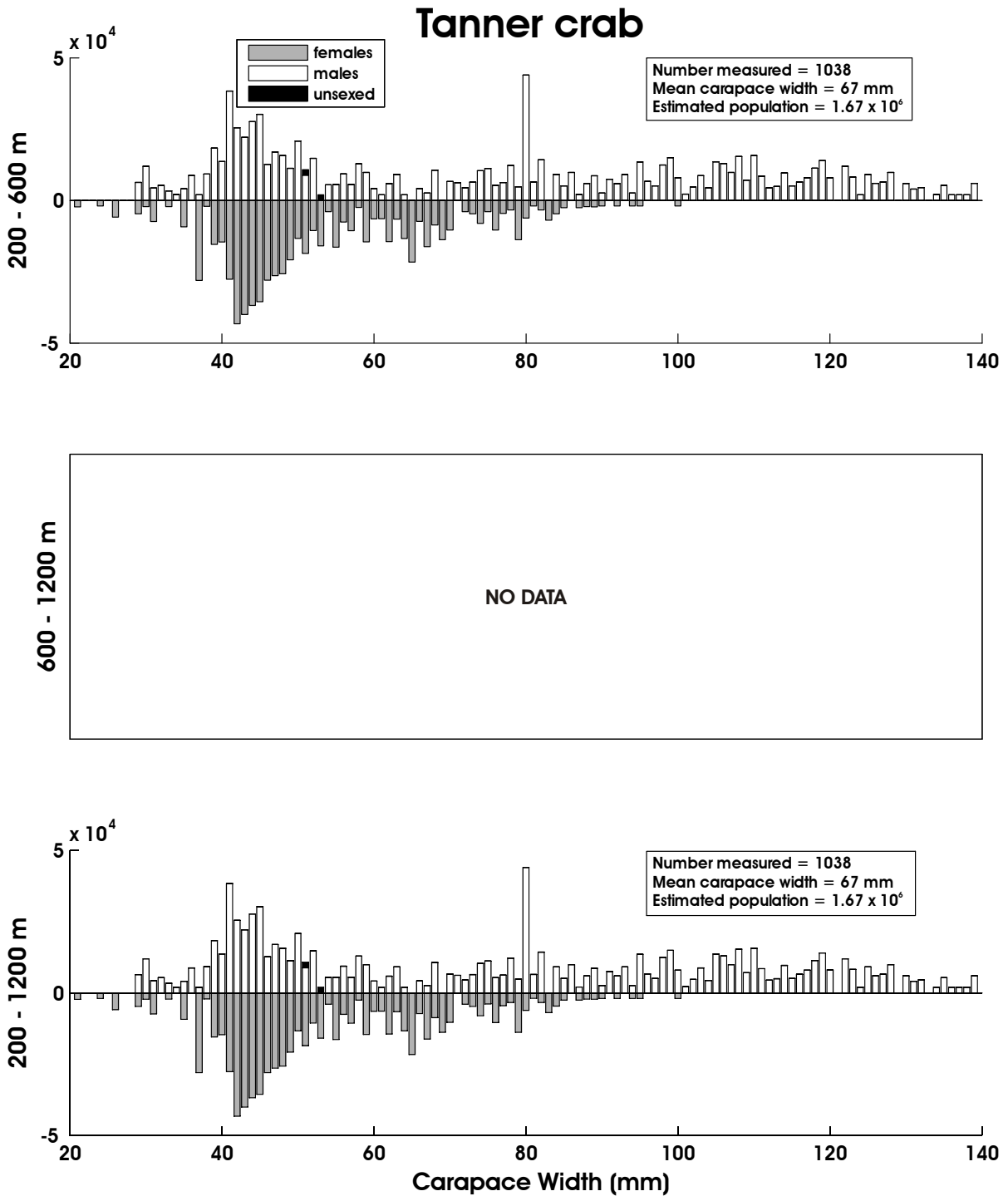

Figure 77. - - Size composition of the estimated Tanner crab population from the 2008 EBSS survey for all subareas by depth. The abscissa is scaled as total carapace width in millimeters while the ordinate represents the estimated total population.

Table 47. - Abundance estimates by subarea and depth stratum for snow crab (*Chionoecetes opilio*) from the 2008 EBSS survey.

<i>Chionoecetes opilio</i>		snow crab					
Subarea	Depth Stratum (m)	Biomass (t)	Population	Biomass Variance	Population Variance	Average CPUE (kg/ha)	Average CPUE (no./ha)
1	200-400	1.58E+01	6.74E+04	7.80E+01	2.09E+09	3.95E-02	1.68E-01
	400-600	2.19E+00	1.93E+04	1.60E+00	1.26E+08	5.39E-03	4.75E-02
	600-800	0.00E+00	0.00E+00	0.00E+00	0.00E+00	0.00E+00	0.00E+00
	800-1,000	0.00E+00	0.00E+00	0.00E+00	0.00E+00	0.00E+00	0.00E+00
	1,000-1,200	0.00E+00	0.00E+00	0.00E+00	0.00E+00	0.00E+00	0.00E+00
2	200-400	0.00E+00	0.00E+00	0.00E+00	0.00E+00	0.00E+00	0.00E+00
	400-600	0.00E+00	0.00E+00	0.00E+00	0.00E+00	0.00E+00	0.00E+00
	600-800	0.00E+00	0.00E+00	0.00E+00	0.00E+00	0.00E+00	0.00E+00
	800-1,000	0.00E+00	0.00E+00	0.00E+00	0.00E+00	0.00E+00	0.00E+00
	1,000-1,200	0.00E+00	0.00E+00	0.00E+00	0.00E+00	0.00E+00	0.00E+00
3	200-400	0.00E+00	0.00E+00	0.00E+00	0.00E+00	0.00E+00	0.00E+00
	400-600	0.00E+00	0.00E+00	0.00E+00	0.00E+00	0.00E+00	0.00E+00
	600-800	0.00E+00	0.00E+00	0.00E+00	0.00E+00	0.00E+00	0.00E+00
	800-1,000	0.00E+00	0.00E+00	0.00E+00	0.00E+00	0.00E+00	0.00E+00
	1,000-1,200	0.00E+00	0.00E+00	0.00E+00	0.00E+00	0.00E+00	0.00E+00
4	200-400	3.04E+01	8.85E+04	4.06E+02	3.64E+09	2.46E-01	7.16E-01
	400-600	0.00E+00	0.00E+00	0.00E+00	0.00E+00	0.00E+00	0.00E+00
	600-800	0.00E+00	0.00E+00	0.00E+00	0.00E+00	0.00E+00	0.00E+00
	800-1,000	0.00E+00	0.00E+00	0.00E+00	0.00E+00	0.00E+00	0.00E+00
	1,000-1,200	0.00E+00	0.00E+00	0.00E+00	0.00E+00	0.00E+00	0.00E+00
5	200-400	4.40E-02	5.50E+03	1.93E-03	3.02E+07	1.04E-03	1.30E-01
	400-600	3.03E-01	4.34E+03	9.21E-02	1.88E+07	7.13E-03	1.02E-01
	600-800	0.00E+00	0.00E+00	0.00E+00	0.00E+00	0.00E+00	0.00E+00
	800-1,000	0.00E+00	0.00E+00	0.00E+00	0.00E+00	0.00E+00	0.00E+00
	1,000-1,200	0.00E+00	0.00E+00	0.00E+00	0.00E+00	0.00E+00	0.00E+00
6	200-400	5.96E+00	1.15E+05	1.42E+01	4.57E+09	2.30E-02	4.44E-01
	400-600	3.69E+00	7.37E+04	1.36E+01	5.44E+09	2.16E-02	4.32E-01
	600-800	0.00E+00	0.00E+00	0.00E+00	0.00E+00	0.00E+00	0.00E+00
	800-1,000	0.00E+00	0.00E+00	0.00E+00	0.00E+00	0.00E+00	0.00E+00
	1,000-1,200	0.00E+00	0.00E+00	0.00E+00	0.00E+00	0.00E+00	0.00E+00
1-6	200-1,200	5.84E+01	3.74E+05	5.13E+02	1.59E+10	1.38E-01	3.33E-01

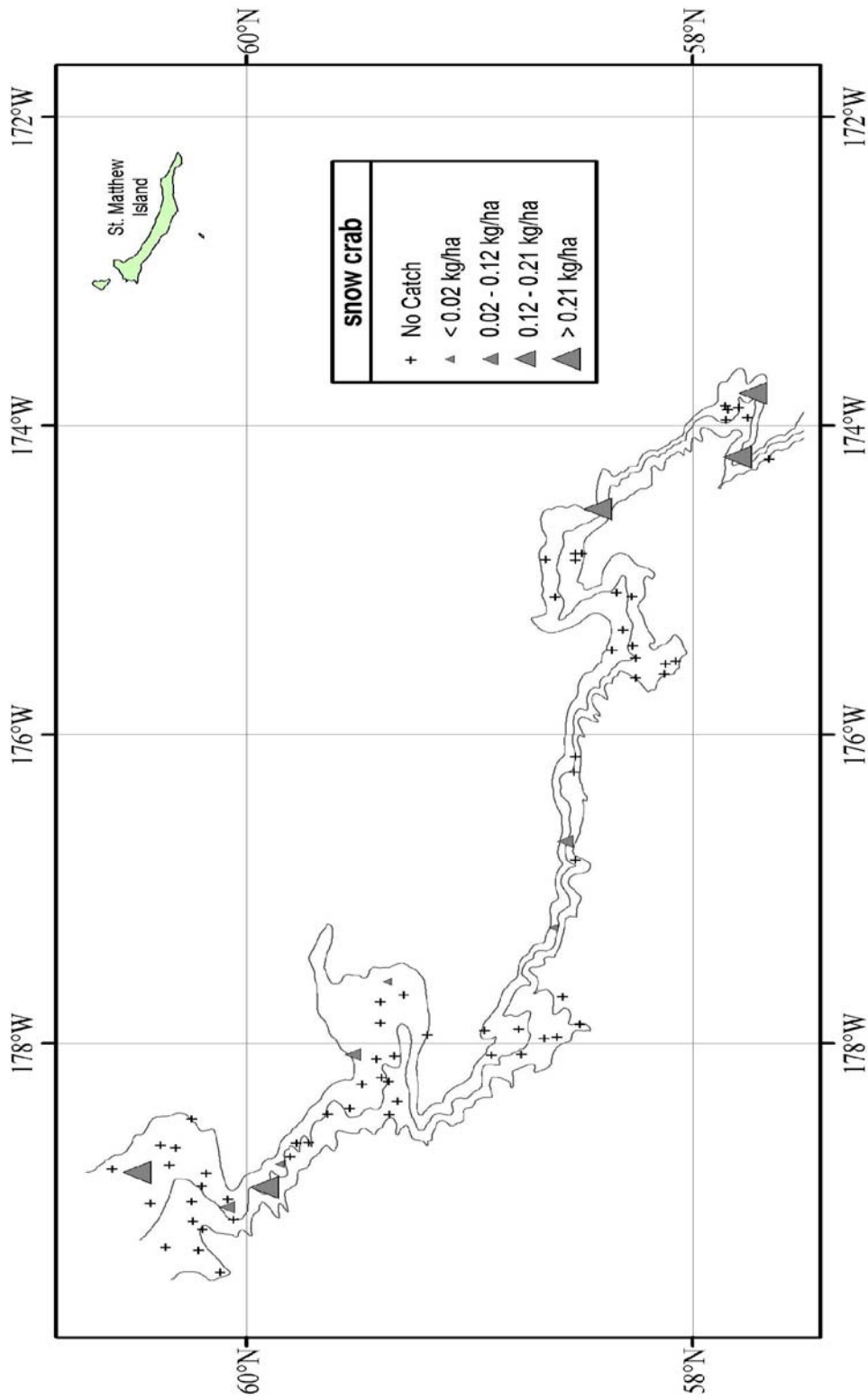

Figure 78. - - Distribution and relative abundance of snow crab from the 2008 EBSS survey. Relative abundance is categorized by no catch, sample CPUE less than the mean CPUE, between the mean CPUE and one standard deviation above the mean, between one and two standard deviations above the mean CPUE, and greater than two standard deviations above the mean CPUE.

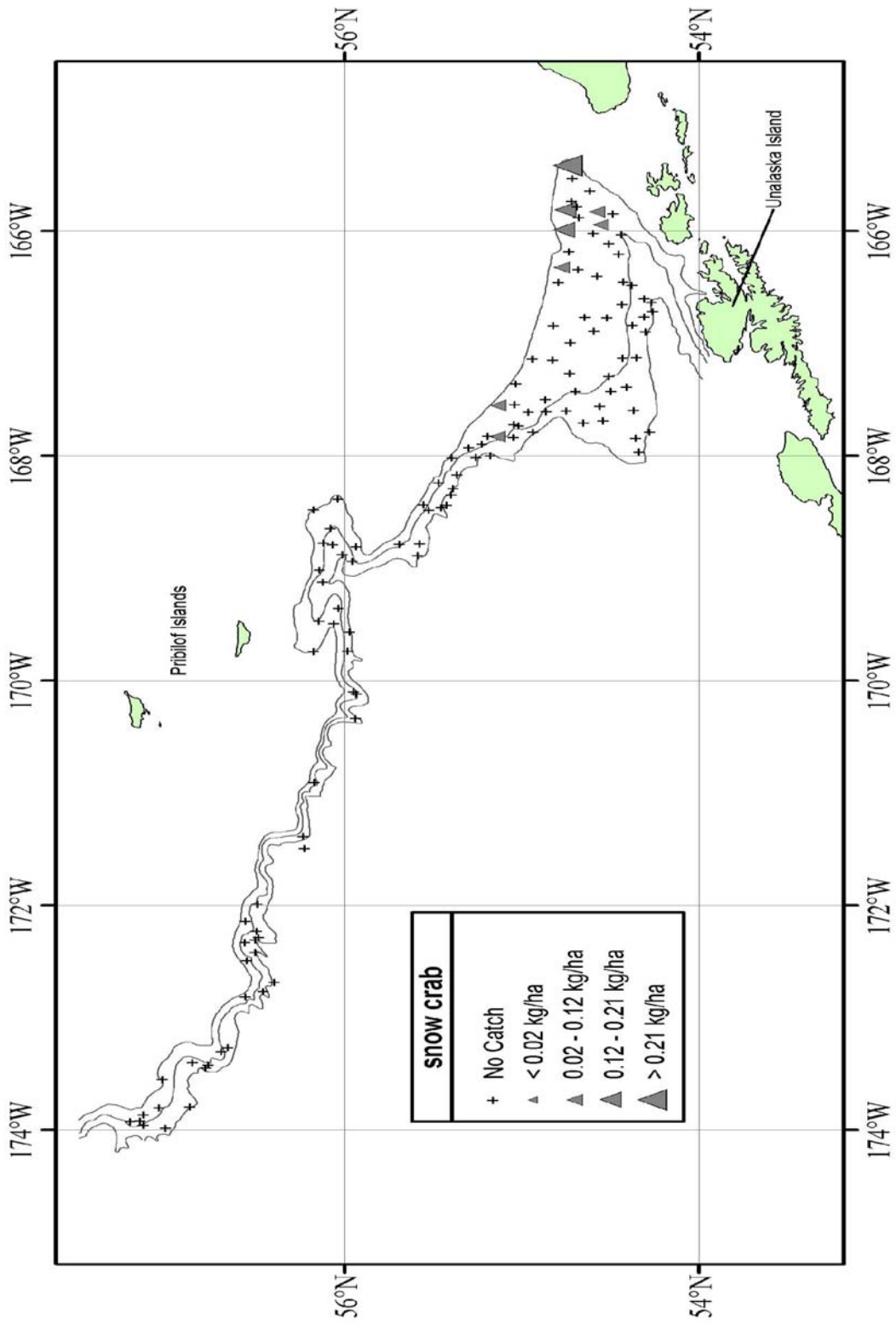

Figure 78. - - Continued.

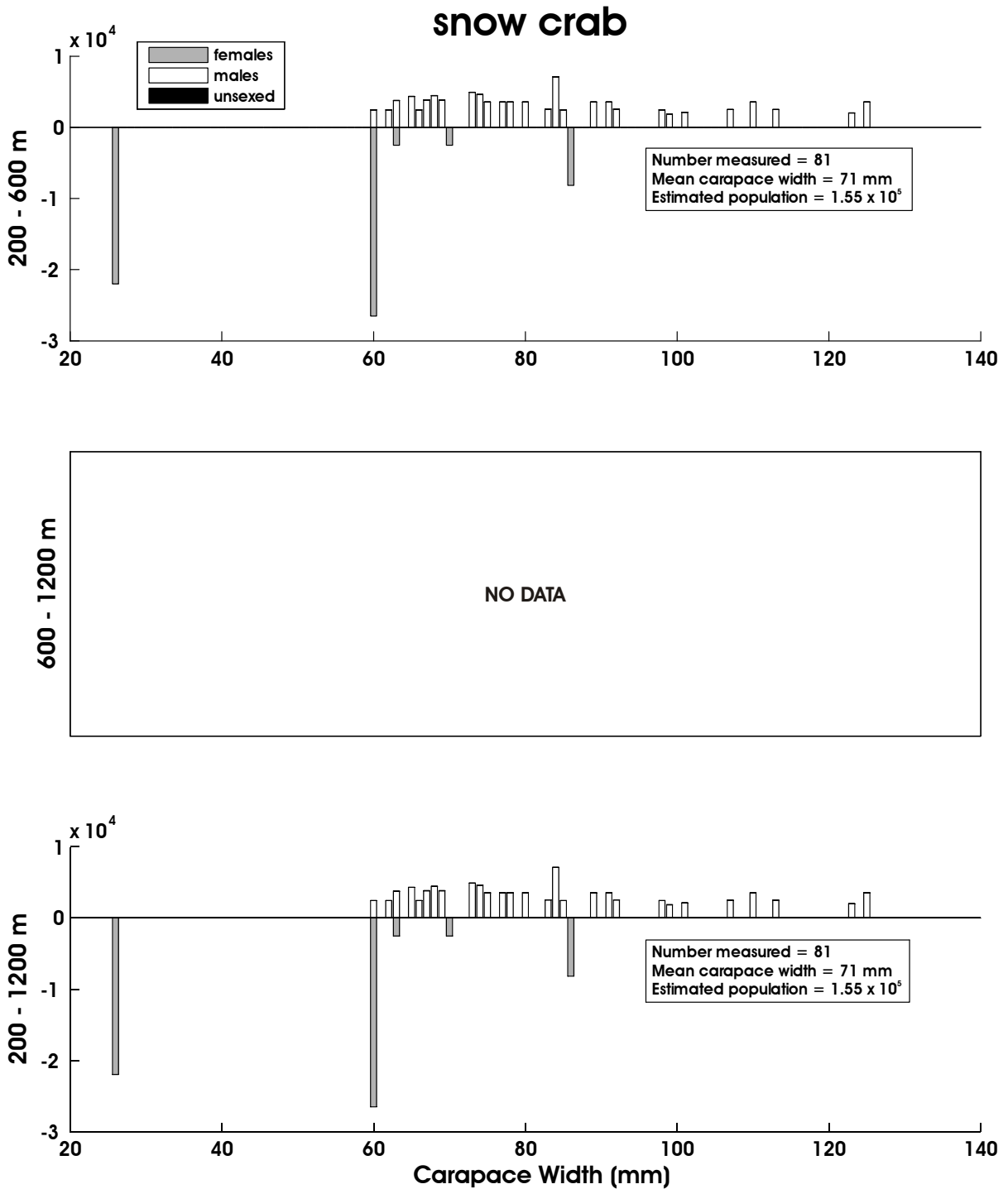

Figure 79. - - Size composition of the estimated snow crab population from the 2008 EBSS survey for all subareas by depth. The abscissa is scaled as total carapace width in millimeters while the ordinate represents the estimated total population.

Table 48. - Abundance estimates by subarea and depth stratum for grooved Tanner crab (*Chionoecetes tanneri*) from the 2008 EBSS survey.

<i>Chionoecetes tanneri</i>		grooved Tanner crab					
Subarea	Depth Stratum (m)	Biomass (t)	Population	Biomass Variance	Population Variance	Average CPUE (kg/ha)	Average CPUE (no./ha)
1	200-400	4.97E+00	1.71E+04	2.47E+01	2.94E+08	1.24E-02	4.27E-02
	400-600	1.35E+02	3.02E+05	3.43E+03	2.10E+10	3.32E-01	7.42E-01
	600-800	4.38E+02	9.08E+05	4.57E+04	1.95E+11	2.51E+00	5.21E+00
	800-1,000	2.16E+02	2.47E+05	2.88E+04	2.92E+10	1.59E+00	1.82E+00
	1,000-1,200	1.60E+01	2.06E+04	1.48E+02	1.46E+08	1.45E-01	1.86E-01
2	200-400	0.00E+00	0.00E+00	0.00E+00	0.00E+00	0.00E+00	0.00E+00
	400-600	1.30E+02	5.03E+05	4.66E+03	7.77E+10	1.84E+00	7.14E+00
	600-800	4.54E+01	9.39E+04	2.49E+02	7.88E+08	7.68E-01	1.59E+00
	800-1,000	3.02E+02	1.27E+06	2.63E+04	3.90E+11	5.46E+00	2.29E+01
	1,000-1,200	1.93E+01	1.66E+05	1.80E+02	2.58E+10	3.61E-01	3.10E+00
3	200-400	6.82E-02	3.79E+03	4.65E-03	1.43E+07	7.54E-04	4.19E-02
	400-600	1.30E+02	5.50E+05	1.29E+04	2.03E+11	1.47E+00	6.21E+00
	600-800	6.38E+01	1.85E+05	6.36E+02	4.39E+09	7.01E-01	2.03E+00
	800-1,000	3.69E+01	1.37E+05	5.45E+02	3.58E+09	5.04E-01	1.87E+00
	1,000-1,200	4.18E+00	1.13E+05	5.79E+00	3.98E+08	6.19E-02	1.68E+00
4	200-400	0.00E+00	0.00E+00	0.00E+00	0.00E+00	0.00E+00	0.00E+00
	400-600	1.12E+01	4.20E+04	1.15E+02	1.41E+09	1.53E-01	5.75E-01
	600-800	6.51E+01	4.18E+05	2.56E+03	1.15E+11	9.38E-01	6.03E+00
	800-1,000	7.87E+01	5.50E+05	4.16E+03	1.98E+11	1.11E+00	7.78E+00
	1,000-1,200	1.15E+00	2.28E+04	7.53E-01	3.38E+08	1.74E-02	3.45E-01
5	200-400	0.00E+00	0.00E+00	0.00E+00	0.00E+00	0.00E+00	0.00E+00
	400-600	1.02E+01	8.35E+04	7.74E+01	4.74E+09	2.39E-01	1.96E+00
	600-800	1.59E+01	3.81E+04	2.53E+02	1.45E+09	3.68E-01	8.82E-01
	800-1,000	8.19E-01	1.25E+04	2.97E-01	5.30E+07	1.48E-02	2.26E-01
	1,000-1,200	6.71E-01	2.13E+04	4.51E-01	4.54E+08	1.18E-02	3.74E-01
6	200-400	1.38E+00	2.18E+04	5.86E-01	1.60E+08	5.31E-03	8.40E-02
	400-600	9.03E+01	3.06E+05	1.61E+03	1.39E+10	5.30E-01	1.80E+00
	600-800	2.19E+01	1.10E+05	2.93E+02	3.28E+09	2.39E-01	1.19E+00
	800-1,000	2.24E+01	2.51E+05	4.36E+02	4.84E+10	3.48E-01	3.89E+00
	1,000-1,200	0.00E+00	0.00E+00	0.00E+00	0.00E+00	0.00E+00	0.00E+00
1-6	200-1,200	1.86E+03	6.39E+06	1.33E+05	1.34E+12	9.23E-01	2.47E+00

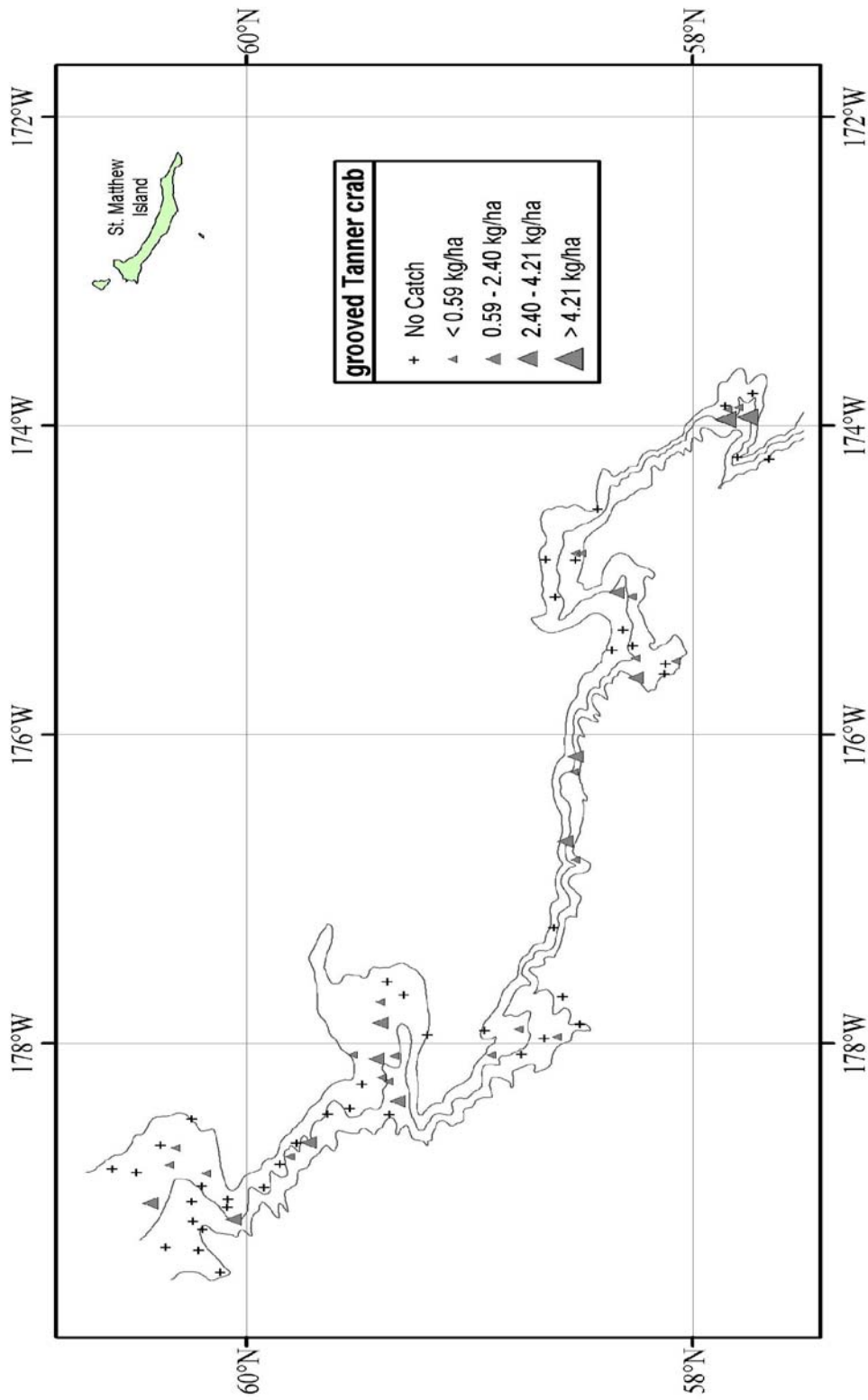

Figure 80. - - Distribution and relative abundance of grooved Tanner crab from the 2008 EBSS survey. Relative abundance is categorized by no catch, sample CPUE less than the mean CPUE, between the mean CPUE and one standard deviation above the mean, between one and two standard deviations above the mean CPUE, and greater than two standard deviations above the mean CPUE.

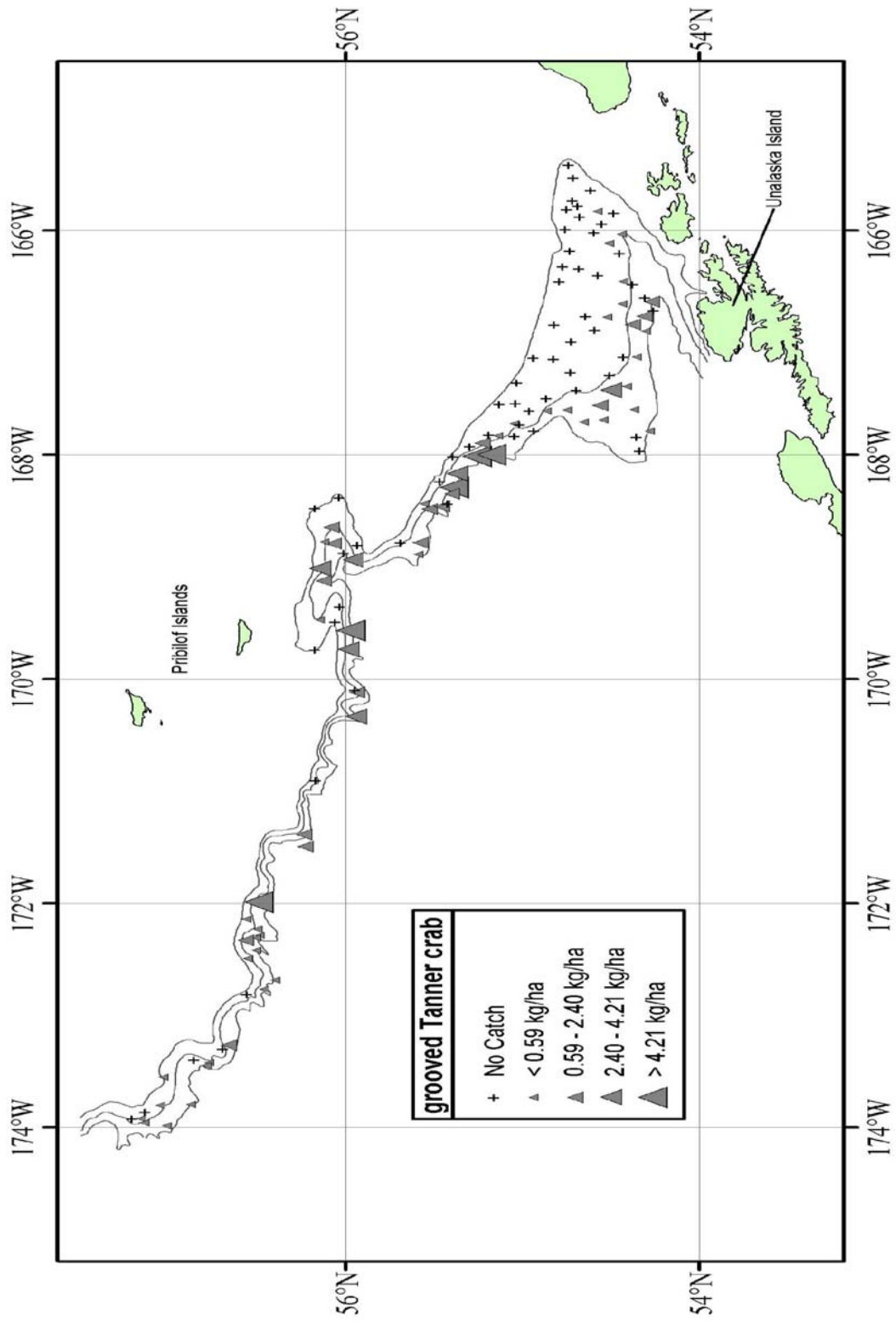

Figure 80. - - Continued.

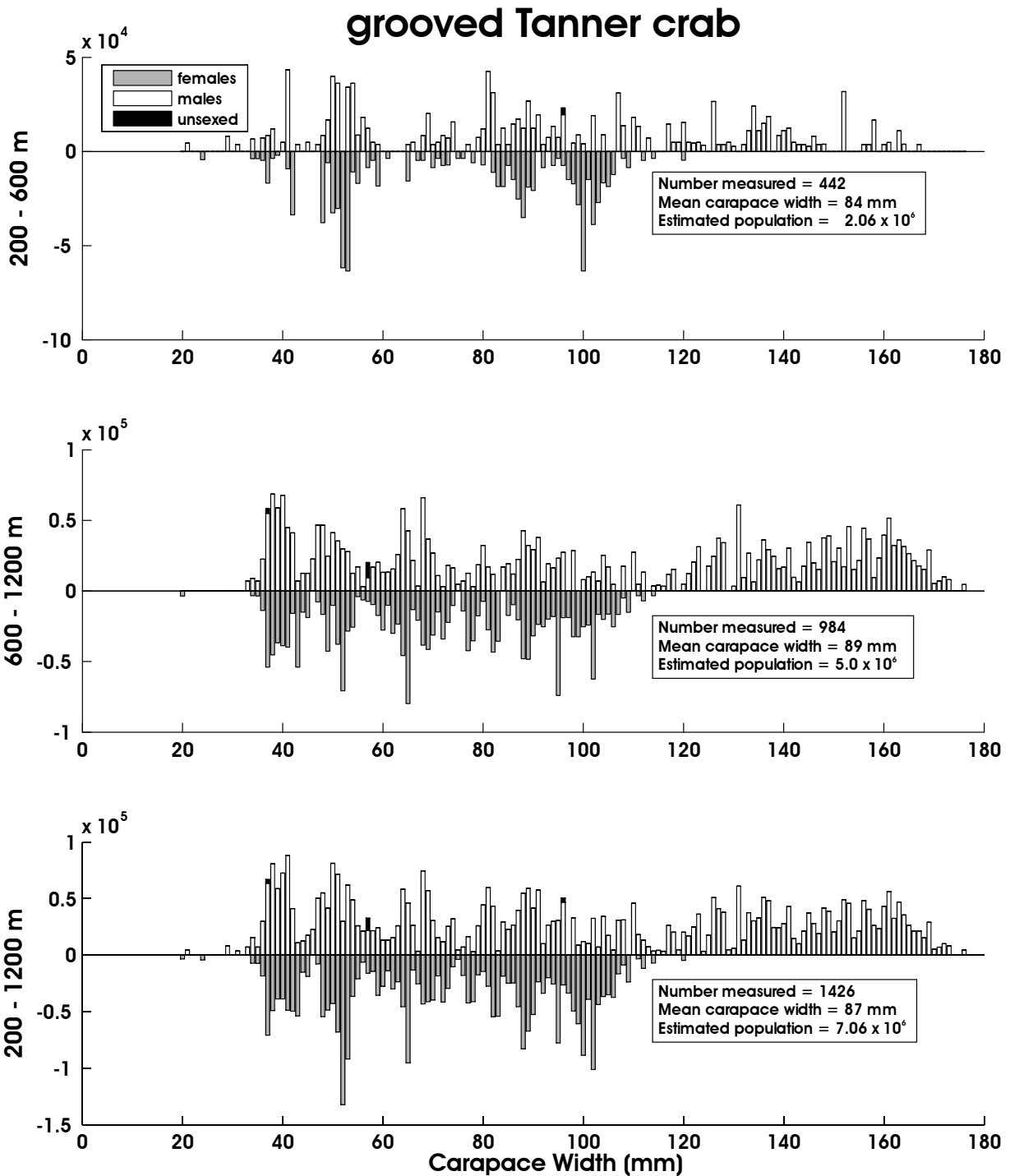

Figure 81. - Size composition of the estimated grooved Tanner crab population from the 2008 EBSS survey for all subareas by depth. The abscissa is scaled as total carapace width in millimeters while the ordinate represents the estimated total population.

Table 49. - Abundance estimates by subarea and depth stratum for golden king crab (*Lithodes aequispinus*) from the 2008 EBSS survey.

<i>Lithodes aequispinus</i>		golden king crab					
Subarea	Depth Stratum (m)	Biomass (t)	Population	Biomass Variance	Population Variance	Average CPUE (kg/ha)	Average CPUE (no./ha)
1	200-400	6.66E+01	7.14E+04	3.04E+03	2.38E+09	1.66E-01	1.78E-01
	400-600	7.77E+01	1.14E+05	3.25E+02	5.66E+08	1.91E-01	2.81E-01
	600-800	2.16E+00	8.62E+03	3.05E+00	3.36E+07	1.24E-02	4.95E-02
	800-1,000	0.00E+00	0.00E+00	0.00E+00	0.00E+00	0.00E+00	0.00E+00
	1,000-1,200	0.00E+00	0.00E+00	0.00E+00	0.00E+00	0.00E+00	0.00E+00
2	200-400	2.58E+02	2.82E+05	1.61E+04	3.94E+10	2.22E+00	2.43E+00
	400-600	5.84E+02	9.20E+05	6.84E+04	8.86E+10	8.28E+00	1.30E+01
	600-800	7.63E+01	9.77E+04	1.71E+03	2.15E+09	1.29E+00	1.65E+00
	800-1,000	0.00E+00	0.00E+00	0.00E+00	0.00E+00	0.00E+00	0.00E+00
	1,000-1,200	1.51E+00	4.49E+03	2.28E+00	2.02E+07	2.82E-02	8.39E-02
3	200-400	6.46E+01	6.65E+04	1.46E+03	1.51E+09	7.14E-01	7.36E-01
	400-600	1.85E+01	1.37E+04	1.37E+02	9.80E+07	2.09E-01	1.55E-01
	600-800	7.59E+00	7.07E+03	2.31E+01	2.00E+07	8.34E-02	7.77E-02
	800-1,000	0.00E+00	0.00E+00	0.00E+00	0.00E+00	0.00E+00	0.00E+00
	1,000-1,200	0.00E+00	0.00E+00	0.00E+00	0.00E+00	0.00E+00	0.00E+00
4	200-400	1.73E+02	1.53E+05	7.90E+03	4.74E+09	1.40E+00	1.24E+00
	400-600	0.00E+00	0.00E+00	0.00E+00	0.00E+00	0.00E+00	0.00E+00
	600-800	3.22E+01	1.81E+04	1.03E+03	3.28E+08	4.63E-01	2.61E-01
	800-1,000	0.00E+00	0.00E+00	0.00E+00	0.00E+00	0.00E+00	0.00E+00
	1,000-1,200	0.00E+00	0.00E+00	0.00E+00	0.00E+00	0.00E+00	0.00E+00
5	200-400	0.00E+00	0.00E+00	0.00E+00	0.00E+00	0.00E+00	0.00E+00
	400-600	2.46E+00	3.47E+03	6.03E+00	1.20E+07	5.77E-02	8.15E-02
	600-800	0.00E+00	0.00E+00	0.00E+00	0.00E+00	0.00E+00	0.00E+00
	800-1,000	0.00E+00	0.00E+00	0.00E+00	0.00E+00	0.00E+00	0.00E+00
	1,000-1,200	0.00E+00	0.00E+00	0.00E+00	0.00E+00	0.00E+00	0.00E+00
6	200-400	3.76E+01	4.63E+04	8.07E+02	7.35E+08	1.45E-01	1.79E-01
	400-600	2.86E+01	5.05E+04	2.87E+02	5.69E+08	1.68E-01	2.96E-01
	600-800	0.00E+00	0.00E+00	0.00E+00	0.00E+00	0.00E+00	0.00E+00
	800-1,000	0.00E+00	0.00E+00	0.00E+00	0.00E+00	0.00E+00	0.00E+00
	1,000-1,200	0.00E+00	0.00E+00	0.00E+00	0.00E+00	0.00E+00	0.00E+00
1-6	200-1,200	1.43E+03	1.86E+06	1.01E+05	1.41E+11	3.81E-01	4.20E-01

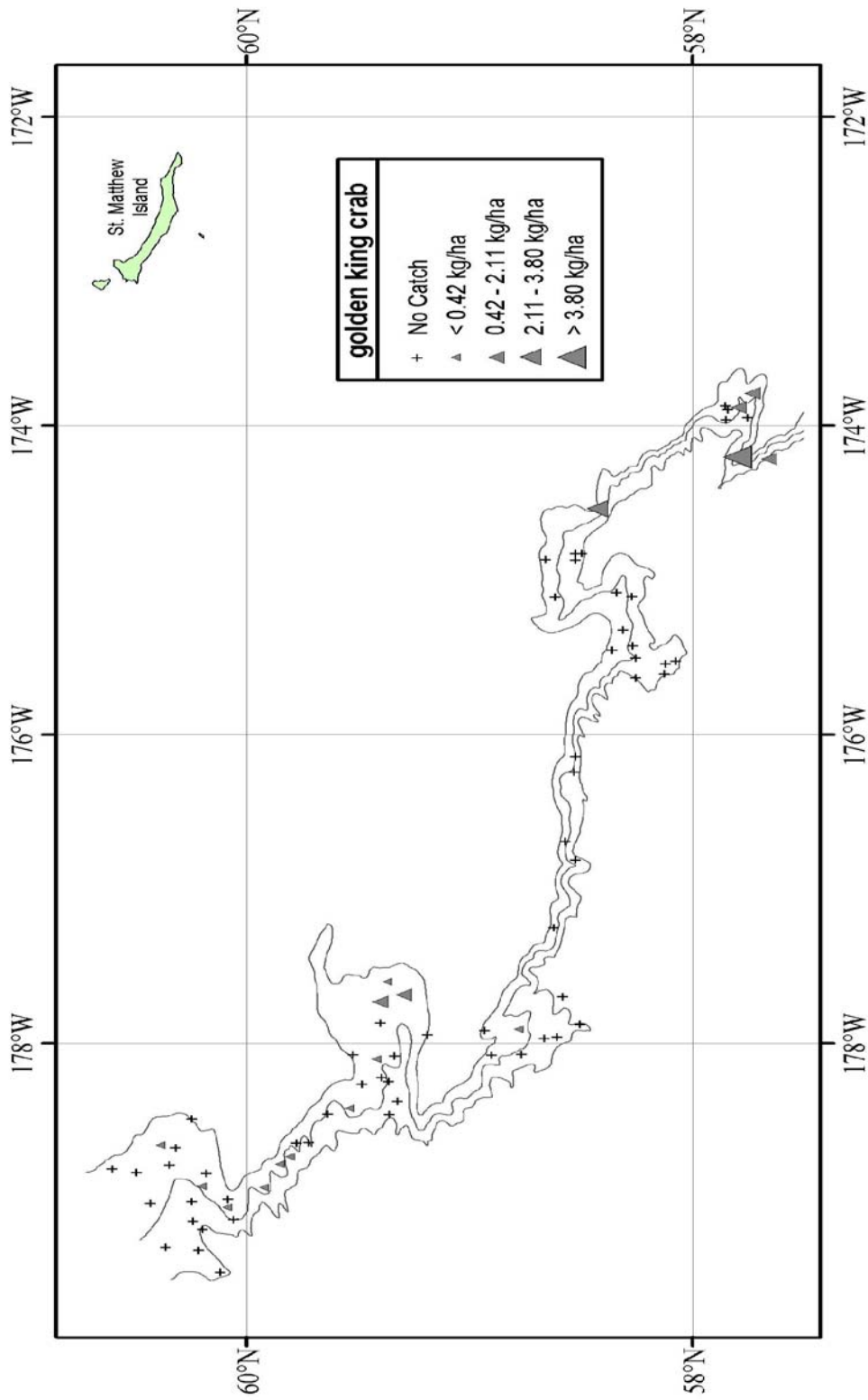

Figure 82. - - Distribution and relative abundance of golden king crab from the 2008 EBSS survey. Relative abundance is categorized by no catch, sample CPUE less than the mean CPUE, between the mean CPUE and one standard deviation above the mean, between one and two standard deviations above the mean CPUE, and greater than two standard deviations above the mean CPUE.

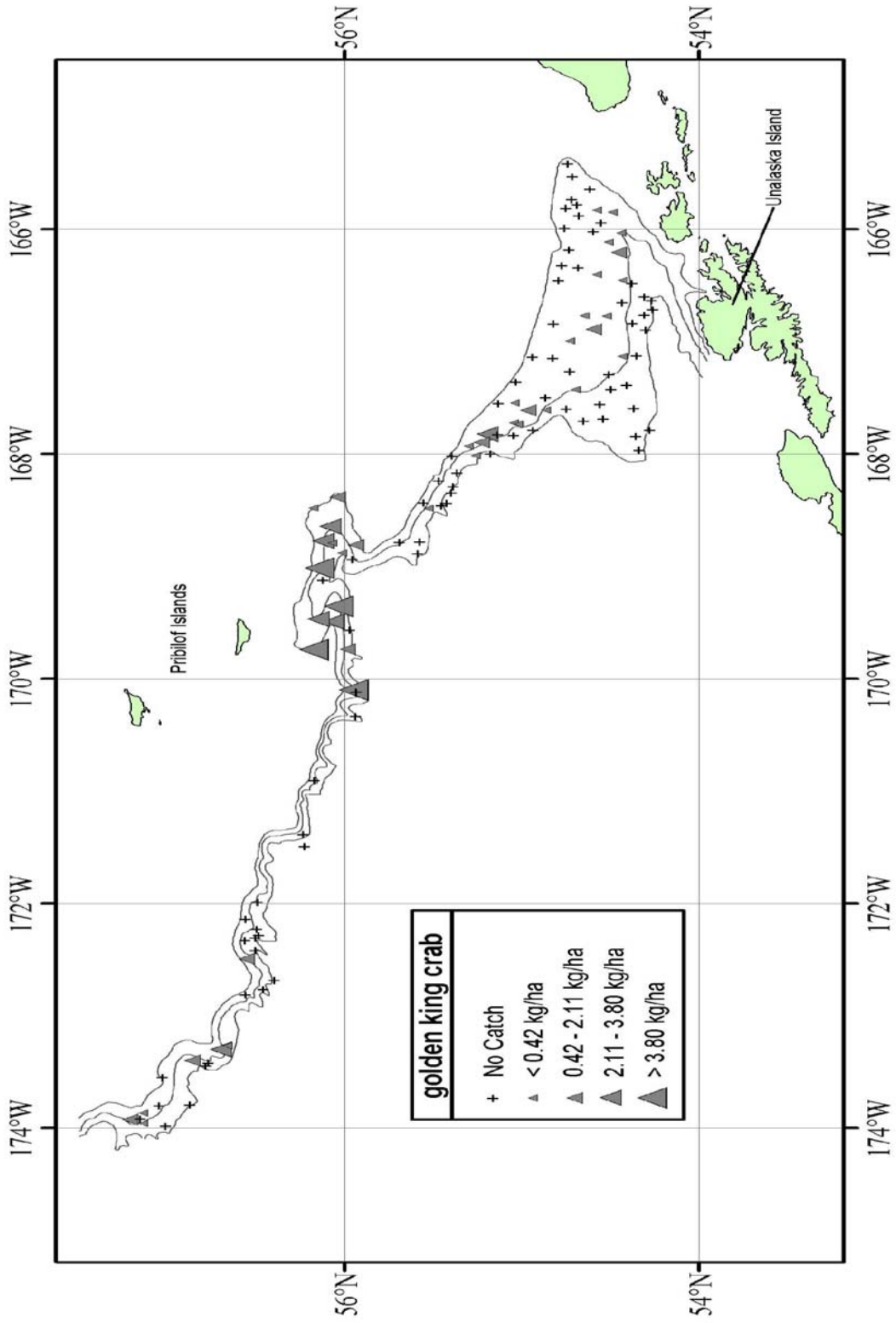

Figure 82. - - Continued.

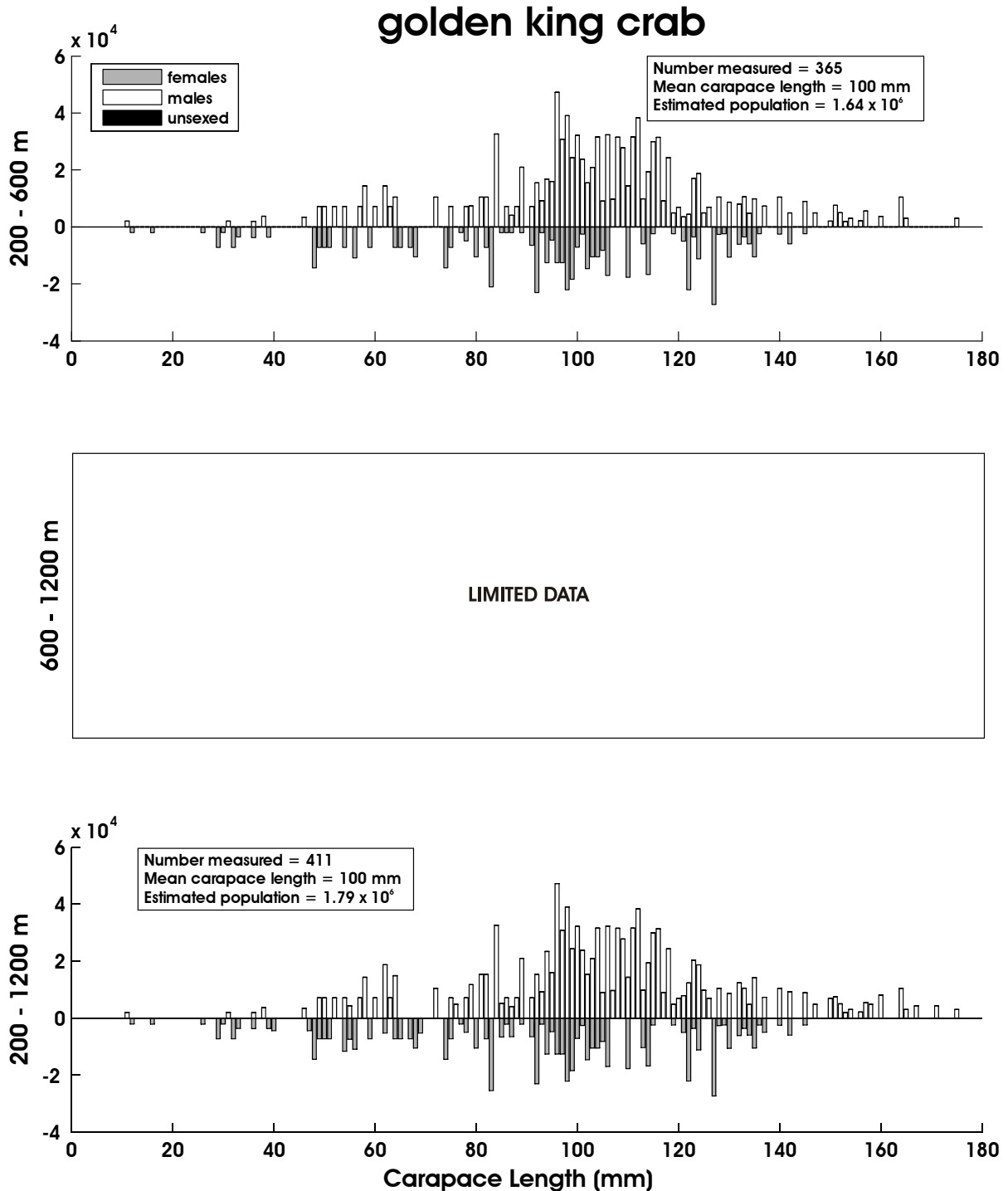

Figure 83. - - Size composition of the estimated golden king crab population from the 2008 EBSS survey for all subareas by depth. The abscissa is scaled as total carapace length from the eye socket in millimeters while the ordinate represents the estimated total population.

Table 50. - Abundance estimates by subarea and depth stratum for scarlet king crab (*Lithodes couesi*) from the 2008 EBSS survey.

<i>Lithodes couesi</i>		scarlet king crab					
Subarea	Depth Stratum (m)	Biomass (t)	Population	Biomass Variance	Population Variance	Average CPUE (kg/ha)	Average CPUE (no./ha)
1	200-400	0.00E+00	0.00E+00	0.00E+00	0.00E+00	0.00E+00	0.00E+00
	400-600	0.00E+00	0.00E+00	0.00E+00	0.00E+00	0.00E+00	0.00E+00
	600-800	0.00E+00	0.00E+00	0.00E+00	0.00E+00	0.00E+00	0.00E+00
	800-1,000	1.07E+01	1.22E+04	7.98E+01	8.03E+07	7.88E-02	9.04E-02
	1,000-1,200	0.00E+00	0.00E+00	0.00E+00	0.00E+00	0.00E+00	0.00E+00
2	200-400	0.00E+00	0.00E+00	0.00E+00	0.00E+00	0.00E+00	0.00E+00
	400-600	1.45E+01	1.60E+04	2.11E+02	2.55E+08	2.06E-01	2.26E-01
	600-800	1.29E+01	1.84E+04	1.66E+02	3.37E+08	2.18E-01	3.10E-01
	800-1,000	3.90E+01	1.06E+05	6.91E+02	4.43E+09	7.06E-01	1.93E+00
	1,000-1,200	2.13E+01	5.59E+04	1.33E+02	1.25E+09	3.98E-01	1.04E+00
3	200-400	0.00E+00	0.00E+00	0.00E+00	0.00E+00	0.00E+00	0.00E+00
	400-600	0.00E+00	0.00E+00	0.00E+00	0.00E+00	0.00E+00	0.00E+00
	600-800	1.64E+01	2.47E+04	1.09E+02	1.81E+08	1.80E-01	2.71E-01
	800-1,000	9.53E+00	1.01E+04	4.37E+01	4.22E+07	1.30E-01	1.37E-01
	1,000-1,200	0.00E+00	0.00E+00	0.00E+00	0.00E+00	0.00E+00	0.00E+00
4	200-400	0.00E+00	0.00E+00	0.00E+00	0.00E+00	0.00E+00	0.00E+00
	400-600	0.00E+00	0.00E+00	0.00E+00	0.00E+00	0.00E+00	0.00E+00
	600-800	4.22E+01	8.22E+04	6.00E+02	2.49E+09	6.08E-01	1.18E+00
	800-1,000	4.55E+01	8.94E+04	1.13E+03	6.30E+09	6.43E-01	1.26E+00
	1,000-1,200	1.31E+01	1.79E+04	1.71E+02	3.22E+08	1.98E-01	2.71E-01
5	200-400	0.00E+00	0.00E+00	0.00E+00	0.00E+00	0.00E+00	0.00E+00
	400-600	0.00E+00	0.00E+00	0.00E+00	0.00E+00	0.00E+00	0.00E+00
	600-800	0.00E+00	0.00E+00	0.00E+00	0.00E+00	0.00E+00	0.00E+00
	800-1,000	1.53E+01	1.39E+04	2.34E+02	1.93E+08	2.77E-01	2.52E-01
	1,000-1,200	7.27E+00	5.33E+03	5.28E+01	2.84E+07	1.27E-01	9.34E-02
6	200-400	0.00E+00	0.00E+00	0.00E+00	0.00E+00	0.00E+00	0.00E+00
	400-600	0.00E+00	0.00E+00	0.00E+00	0.00E+00	0.00E+00	0.00E+00
	600-800	9.03E+01	1.42E+05	3.46E+03	5.37E+09	9.84E-01	1.55E+00
	800-1,000	8.07E+01	1.72E+05	2.14E+03	1.06E+10	1.25E+00	2.67E+00
	1,000-1,200	1.06E+02	8.07E+04	3.23E+03	1.93E+09	2.13E+00	1.63E+00
1-6	200-1,200	5.24E+02	8.48E+05	1.25E+04	3.38E+10	1.38E-01	2.05E-01

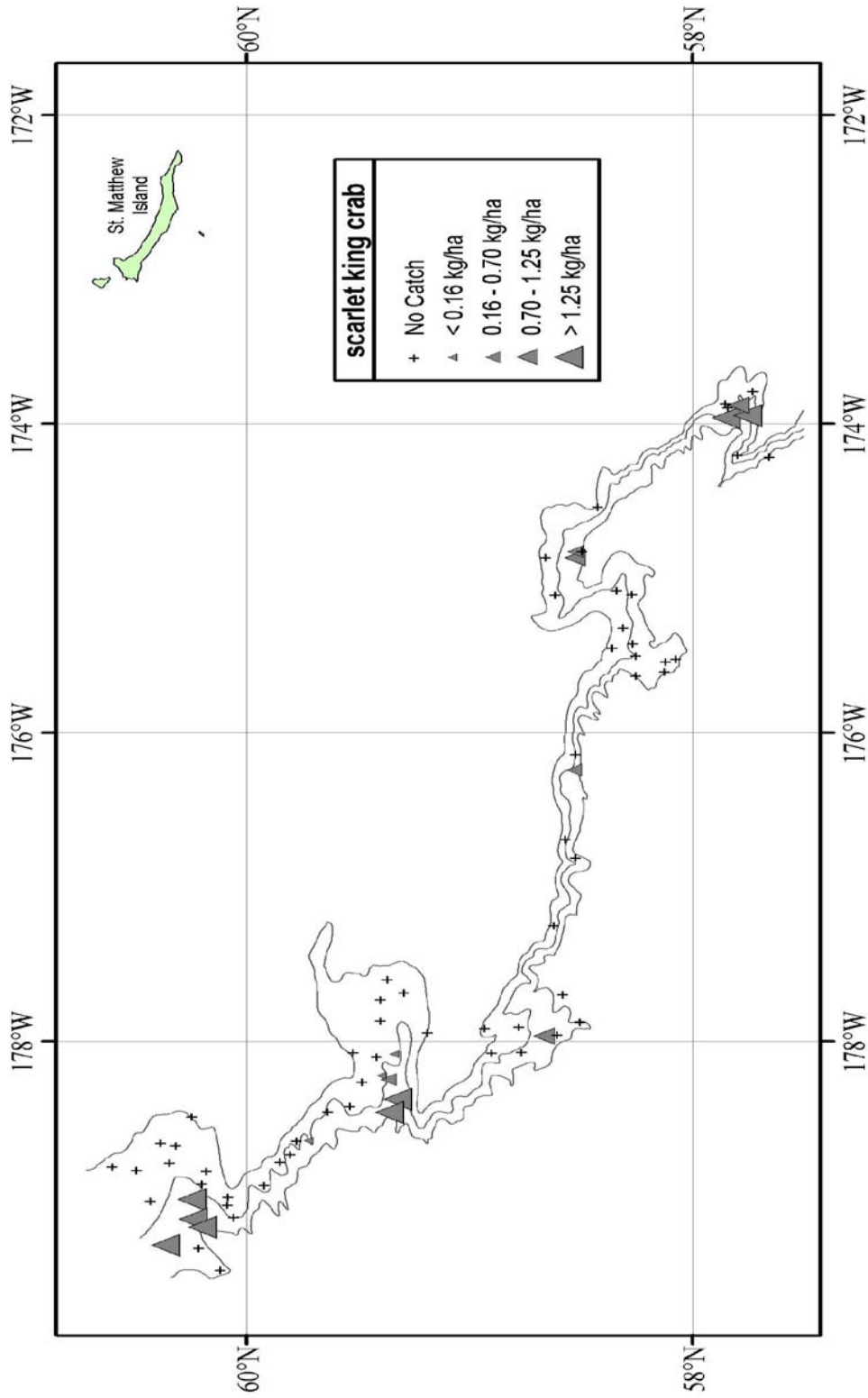

Figure 84. - - Distribution and relative abundance of scarlet king crab from the 2008 EBSS survey. Relative abundance is categorized by no catch, sample CPUE less than the mean CPUE, between the mean CPUE and one standard deviation above the mean, between one and two standard deviations above the mean CPUE, and greater than two standard deviations above the mean CPUE.

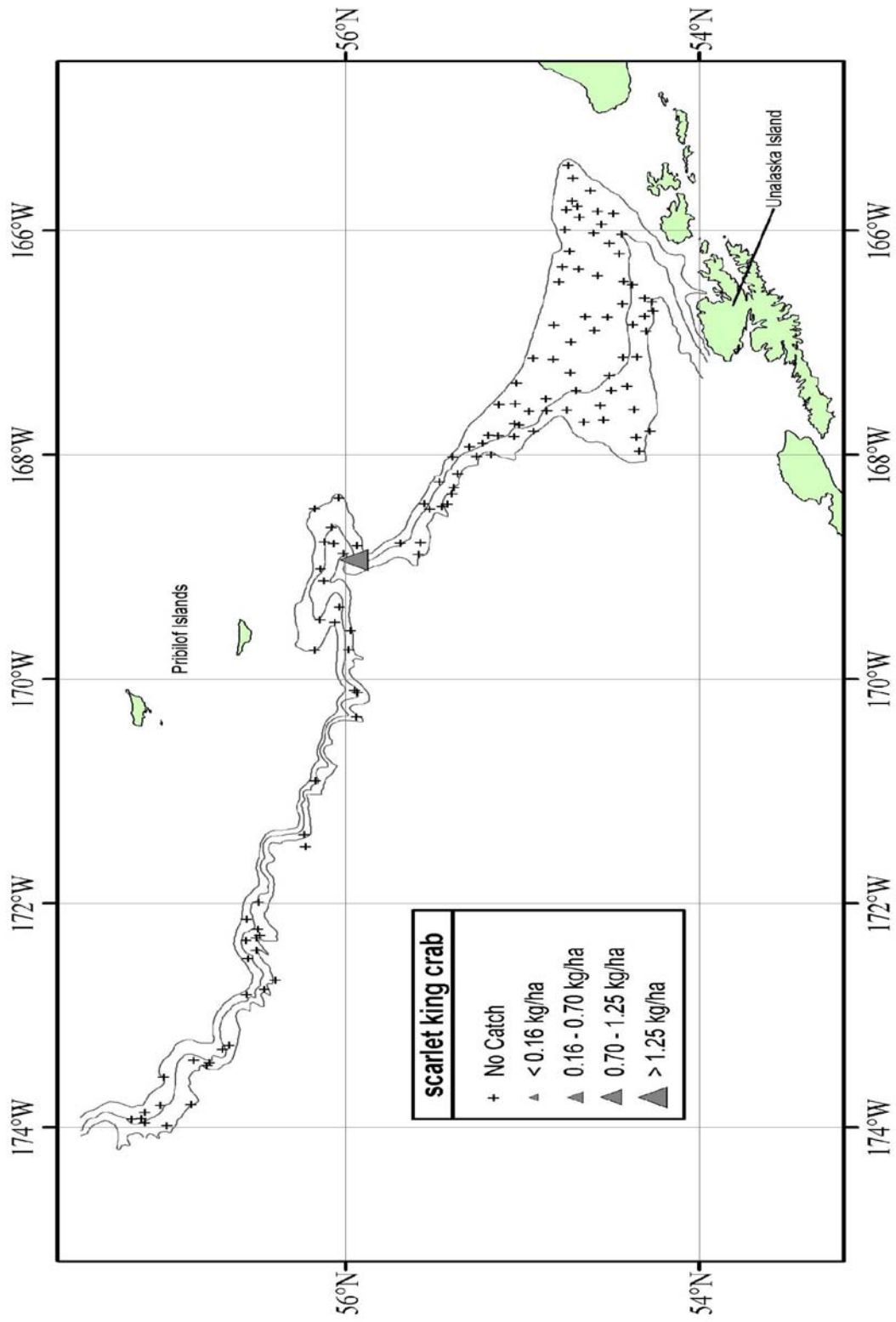

Figure 84. - - Continued.

scarlet king crab

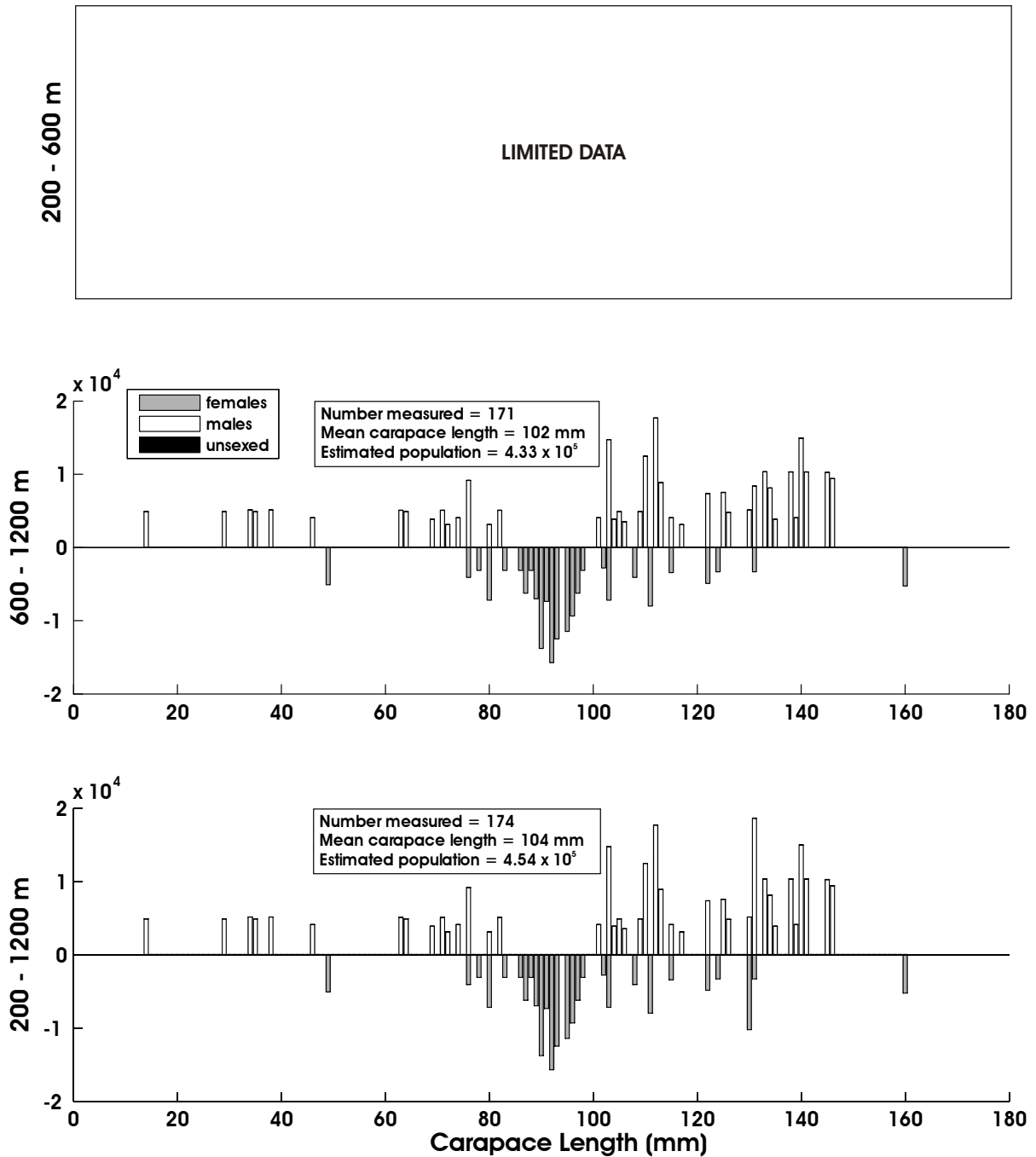

Figure 85. - Size composition of the estimated scarlet king crab population from the 2008 EBSS survey for all subareas by depth. The abscissa is scaled as total carapace length from the eye socket in millimeters while the ordinate represents the estimated total population.

Table 51. - - Abundance estimates by subarea and depth stratum for magistrate armhook squid (*Berryteuthis magister*) from the 2008 EBSS survey.

<i>Berryteuthis magister</i>		magistrate armhook squid					
Subarea	Depth Stratum (m)	Biomass (t)	Population	Biomass Variance	Population Variance	Average CPUE (kg/ha)	Average CPUE (no./ha)
1	200-400	3.61E+02	1.07E+06	9.80E+03	5.14E+10	8.99E-01	2.67E+00
	400-600	5.80E+02	1.24E+06	5.11E+03	2.08E+10	1.43E+00	3.06E+00
	600-800	1.80E+02	3.78E+05	4.67E+03	1.14E+10	1.03E+00	2.17E+00
	800-1,000	3.03E+01	4.90E+04	5.18E+01	9.92E+07	2.23E-01	3.62E-01
	1,000-1,200	2.63E+01	5.67E+04	1.32E+02	9.58E+08	2.38E-01	5.12E-01
2	200-400	1.63E+02	5.93E+05	3.63E+03	6.93E+10	1.41E+00	5.13E+00
	400-600	5.50E+01	1.34E+05	6.14E+02	3.69E+09	7.80E-01	1.90E+00
	600-800	1.58E+01	4.31E+04	4.73E+01	3.14E+08	2.68E-01	7.29E-01
	800-1,000	1.05E+01	2.57E+04	6.92E+01	4.80E+08	1.90E-01	4.65E-01
	1,000-1,200	8.88E+00	2.45E+04	2.01E+01	1.81E+08	1.66E-01	4.57E-01
3	200-400	7.81E+00	2.47E+04	3.93E+01	4.21E+08	8.64E-02	2.73E-01
	400-600	1.57E+01	6.05E+04	7.00E+01	1.20E+09	1.78E-01	6.82E-01
	600-800	1.20E+00	3.34E+03	1.45E+00	1.12E+07	1.32E-02	3.67E-02
	800-1,000	2.95E+00	5.03E+03	3.81E+00	1.06E+07	4.03E-02	6.87E-02
	1,000-1,200	0.00E+00	0.00E+00	0.00E+00	0.00E+00	0.00E+00	0.00E+00
4	200-400	5.02E+01	2.09E+05	1.04E+03	1.08E+10	4.06E-01	1.69E+00
	400-600	2.53E+01	8.92E+04	5.03E+02	6.44E+09	3.46E-01	1.22E+00
	600-800	7.08E+00	2.14E+04	1.15E+01	6.79E+07	1.02E-01	3.08E-01
	800-1,000	5.67E-01	3.73E+03	3.21E-01	1.39E+07	8.01E-03	5.27E-02
	1,000-1,200	1.10E+00	4.04E+03	1.21E+00	1.63E+07	1.66E-02	6.10E-02
5	200-400	5.39E+00	1.60E+04	1.53E+00	2.50E+07	1.27E-01	3.77E-01
	400-600	1.24E+01	2.60E+04	3.60E+01	6.99E+07	2.91E-01	6.11E-01
	600-800	5.78E+00	1.62E+04	3.30E+00	3.12E+07	1.34E-01	3.75E-01
	800-1,000	0.00E+00	0.00E+00	0.00E+00	0.00E+00	0.00E+00	0.00E+00
	1,000-1,200	2.14E+00	5.33E+03	4.59E+00	2.84E+07	3.76E-02	9.34E-02
6	200-400	2.74E+01	9.53E+04	7.83E+01	8.96E+08	1.06E-01	3.67E-01
	400-600	6.25E+01	1.78E+05	7.61E+02	5.83E+09	3.67E-01	1.04E+00
	600-800	1.67E+01	3.13E+04	1.03E+02	2.24E+08	1.82E-01	3.42E-01
	800-1,000	0.00E+00	0.00E+00	0.00E+00	0.00E+00	0.00E+00	0.00E+00
	1,000-1,200	0.00E+00	0.00E+00	0.00E+00	0.00E+00	0.00E+00	0.00E+00
1-6	200-1,200	1.67E+03	4.41E+06	2.68E+04	1.85E+11	3.81E-01	4.20E-01

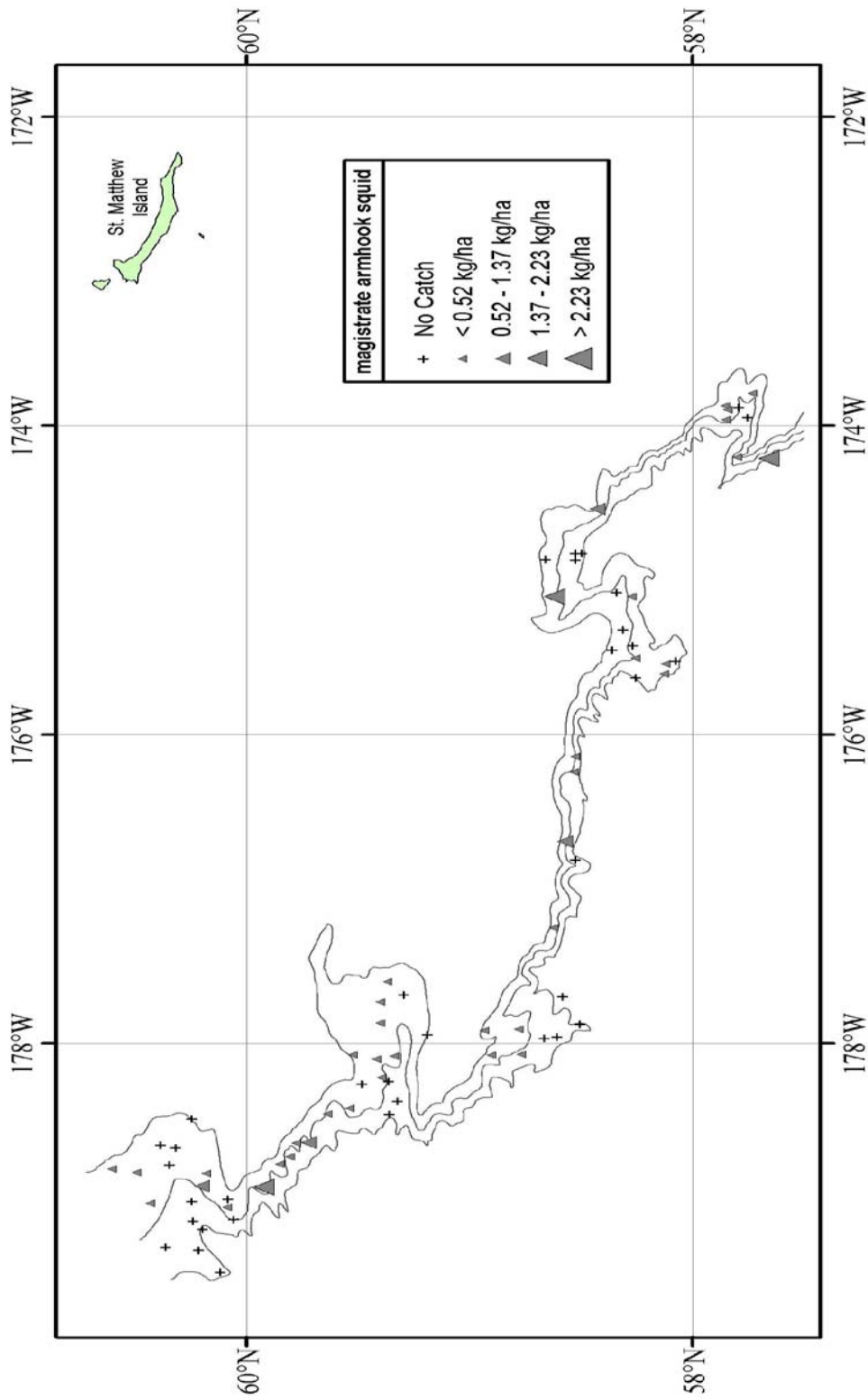

Figure 86. - - Distribution and relative abundance of magistrate armhook squid from the 2008 EBSS survey. Relative abundance is categorized by no catch, sample CPUE less than the mean CPUE, between the mean CPUE and one standard deviation above the mean, between one and two standard deviations above the mean CPUE, and greater than two standard deviations above the mean CPUE.

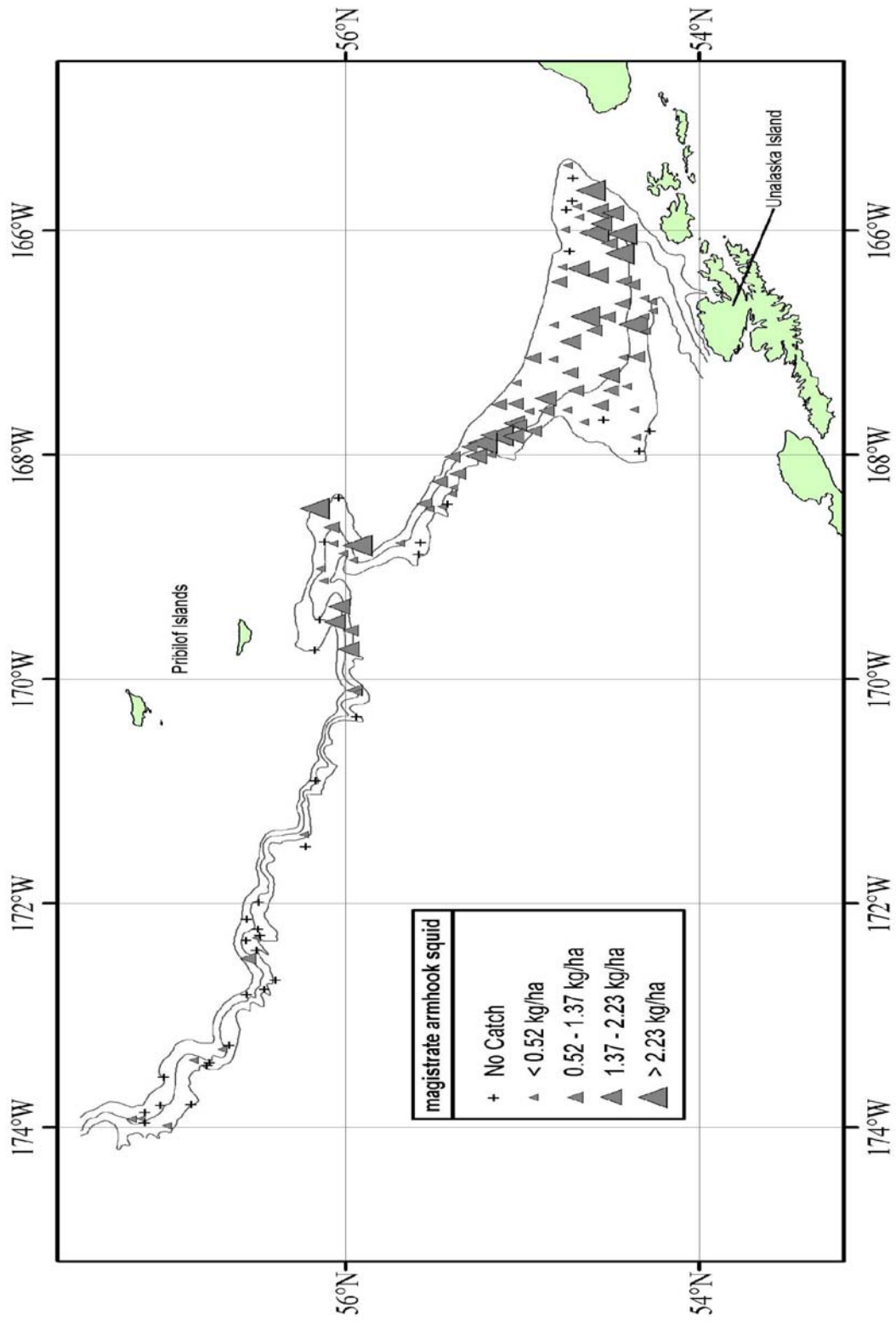

Figure 86. - - Continued.

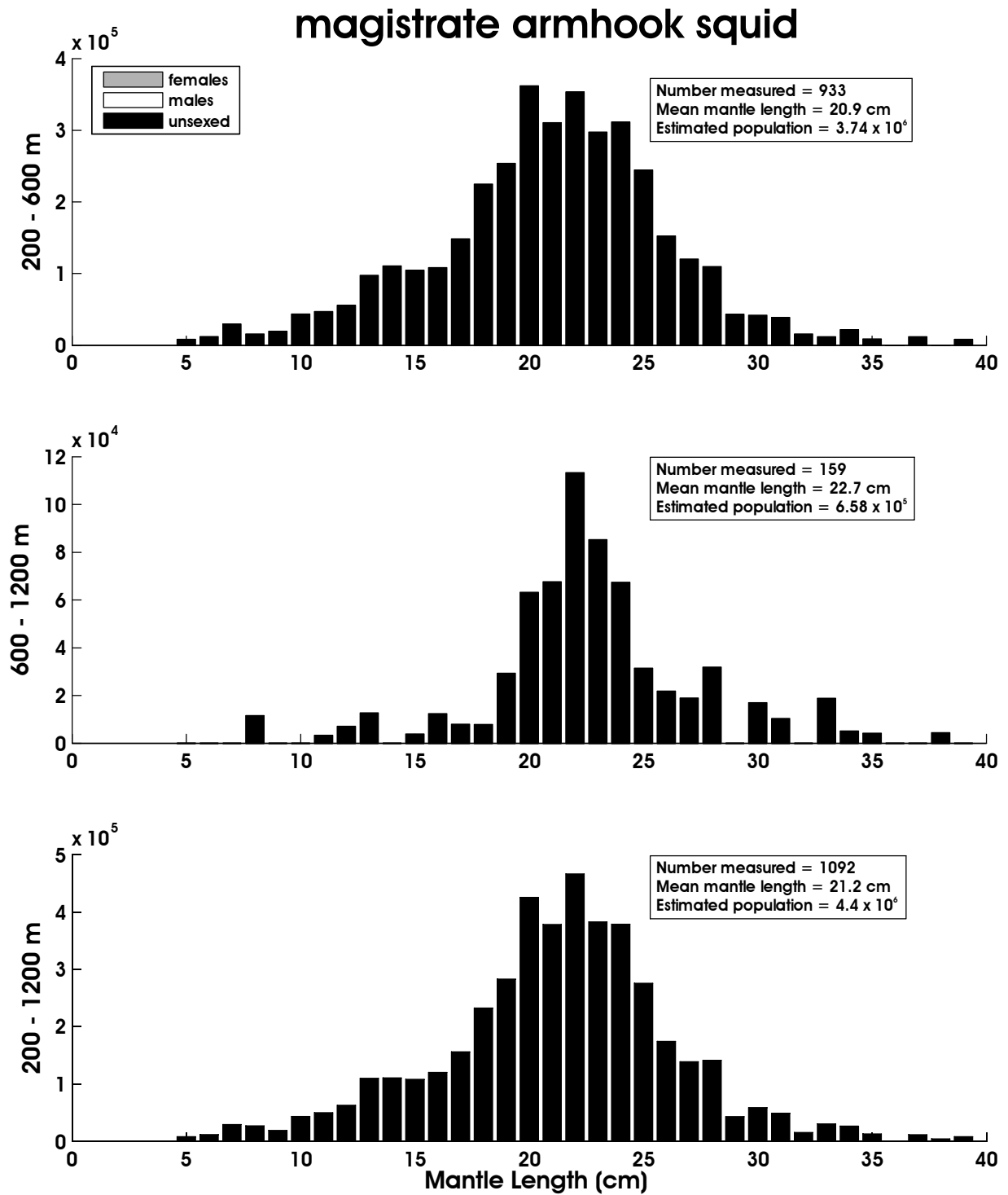

Figure 87. - - Size composition of the estimated magistrate armhook squid population from the 2008 EBSS survey for all subareas by depth. The abscissa is scaled as total mantle length in centimeters while the ordinate represents the estimated total population.

Table 52. - - Abundance estimates by subarea and depth stratum for Alaskan pink shrimp (*Pandalus eous*) from the 2008 EBSS survey.

<i>Pandalus eous</i>		Alaskan pink shrimp					
Subarea	Depth Stratum (m)	Biomass (t)	Population	Biomass Variance	Population Variance	Average CPUE (kg/ha)	Average CPUE (no./ha)
1	200-400	2.12E+02	3.42E+07	2.90E+03	7.97E+13	5.28E-01	8.54E+01
	400-600	1.28E-01	1.51E+04	1.65E-02	2.28E+08	3.16E-04	3.72E-02
	600-800	8.53E-02	1.94E+04	7.27E-03	3.76E+08	4.90E-04	1.11E-01
	800-1,000	0.00E+00	0.00E+00	0.00E+00	0.00E+00	0.00E+00	0.00E+00
	1,000-1,200	0.00E+00	0.00E+00	0.00E+00	0.00E+00	0.00E+00	0.00E+00
2	200-400	1.91E+01	3.23E+06	7.40E+01	2.05E+12	1.65E-01	2.79E+01
	400-600	0.00E+00	0.00E+00	0.00E+00	0.00E+00	0.00E+00	0.00E+00
	600-800	0.00E+00	0.00E+00	0.00E+00	0.00E+00	0.00E+00	0.00E+00
	800-1,000	0.00E+00	0.00E+00	0.00E+00	0.00E+00	0.00E+00	0.00E+00
	1,000-1,200	0.00E+00	0.00E+00	0.00E+00	0.00E+00	0.00E+00	0.00E+00
3	200-400	3.73E+01	6.12E+06	1.22E+02	4.05E+12	4.12E-01	6.77E+01
	400-600	0.00E+00	0.00E+00	0.00E+00	0.00E+00	0.00E+00	0.00E+00
	600-800	0.00E+00	0.00E+00	0.00E+00	0.00E+00	0.00E+00	0.00E+00
	800-1,000	0.00E+00	0.00E+00	0.00E+00	0.00E+00	0.00E+00	0.00E+00
	1,000-1,200	0.00E+00	0.00E+00	0.00E+00	0.00E+00	0.00E+00	0.00E+00
4	200-400	1.67E+02	2.13E+07	1.34E+04	1.69E+14	1.35E+00	1.72E+02
	400-600	0.00E+00	0.00E+00	0.00E+00	0.00E+00	0.00E+00	0.00E+00
	600-800	0.00E+00	0.00E+00	0.00E+00	0.00E+00	0.00E+00	0.00E+00
	800-1,000	0.00E+00	0.00E+00	0.00E+00	0.00E+00	0.00E+00	0.00E+00
	1,000-1,200	0.00E+00	0.00E+00	0.00E+00	0.00E+00	0.00E+00	0.00E+00
5	200-400	1.69E+01	2.75E+06	2.17E+01	4.50E+11	3.99E-01	6.49E+01
	400-600	0.00E+00	0.00E+00	0.00E+00	0.00E+00	0.00E+00	0.00E+00
	600-800	0.00E+00	0.00E+00	0.00E+00	0.00E+00	0.00E+00	0.00E+00
	800-1,000	0.00E+00	0.00E+00	0.00E+00	0.00E+00	0.00E+00	0.00E+00
	1,000-1,200	0.00E+00	0.00E+00	0.00E+00	0.00E+00	0.00E+00	0.00E+00
6	200-400	1.42E+02	2.18E+07	1.61E+03	4.11E+13	5.46E-01	8.39E+01
	400-600	1.15E+01	2.08E+06	1.32E+02	4.33E+12	6.74E-02	1.22E+01
	600-800	4.48E-02	4.48E+03	2.01E-03	2.01E+07	4.89E-04	4.89E-02
	800-1,000	0.00E+00	0.00E+00	0.00E+00	0.00E+00	0.00E+00	0.00E+00
	1,000-1,200	0.00E+00	0.00E+00	0.00E+00	0.00E+00	0.00E+00	0.00E+00
1-6	200-1,200	6.06E+02	9.15E+07	1.83E+04	3.01E+14	1.91E-01	2.88E+01

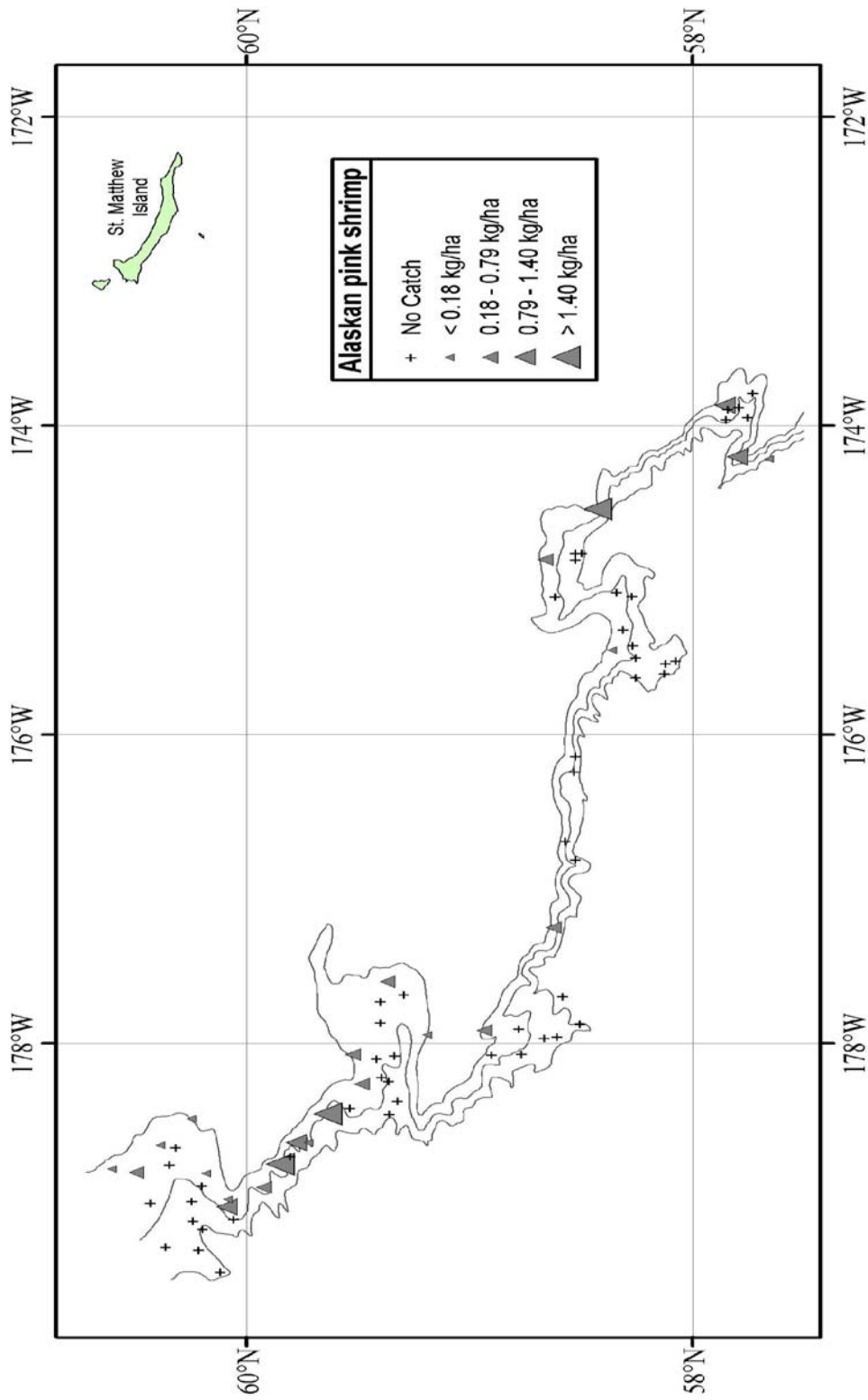

Figure 88. - - Distribution and relative abundance of Alaskan pink shrimp from the 2008 EBSS survey. Relative abundance is categorized by no catch, sample CPUE less than the mean CPUE, between the mean CPUE and one standard deviation above the mean, between one and two standard deviations above the mean CPUE, and greater than two standard deviations above the mean CPUE.

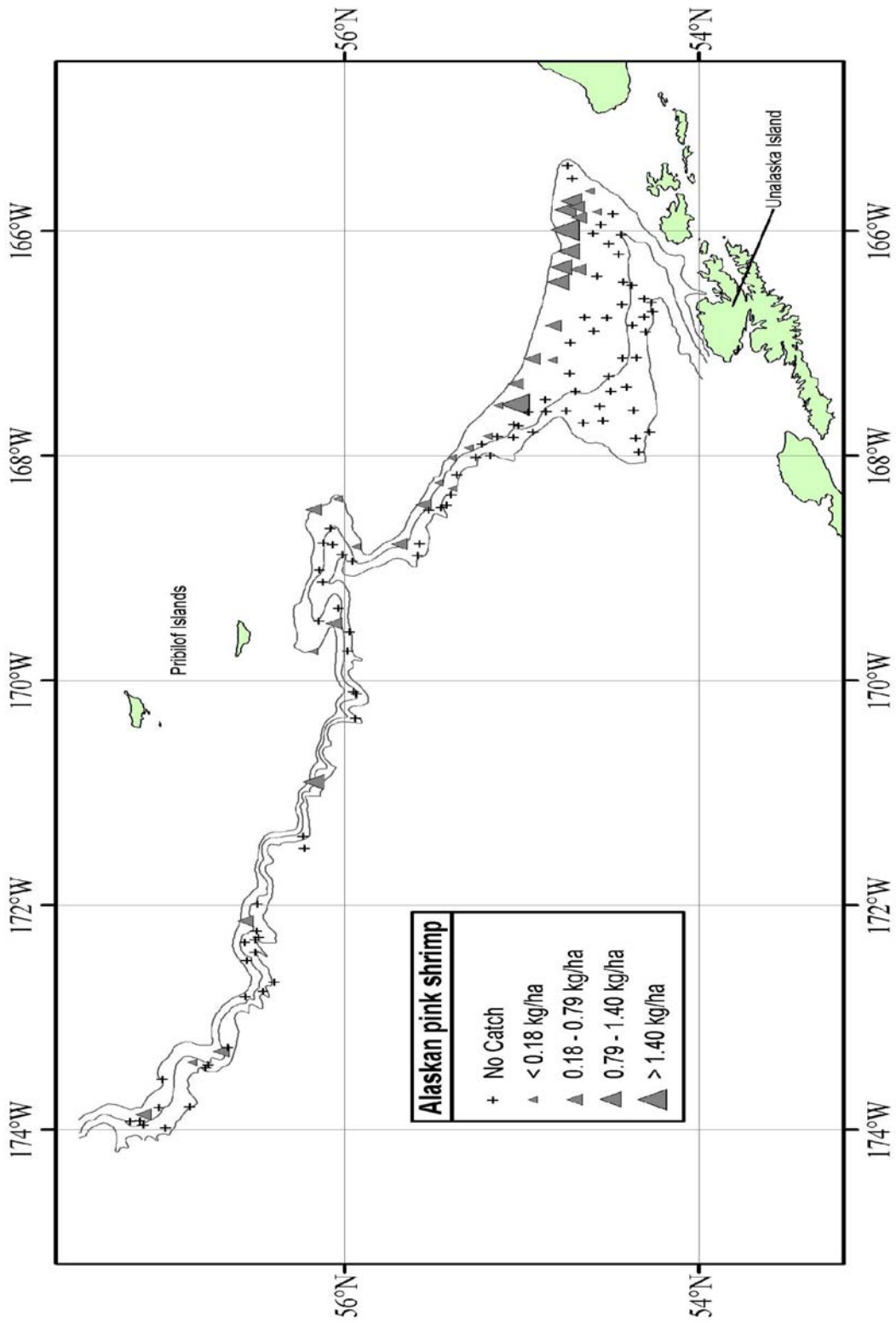

Figure 88. - - Continued.

CITATIONS

- Alverson, D.L., and W.T. Pereyra. 1969. Demersal fish explorations in the northeast Pacific Ocean—An evaluation of exploratory fishing methods and analytical approaches to stock sizes and yield forecasts. *J. Fish. Res. Board Can.* 26:1985-2001.
- Bakkala, R.G., W.A. Karp, G.E. Walters, T. Sasaki, M.T. Wilson, T.M. Sample, A.M. Shimada, D. Adams, and C.E. Armistead. 1992. Distribution, abundance, and biological characteristics of groundfish in the eastern Bering Sea based on results of U.S.-Japan bottom trawl and hydroacoustic surveys during June-September 1988. U.S. Dep. Commer., NOAA Tech. Memo. NMFS F/NWC-213, 372 p.
- Bakkala, R.G., K. Wakabayashi, K. Okada, J.J. Traynor, T.M. Sample, H. Yamaguchi, M.S. Alton, and M.O. Nelson. 1985a. Results of cooperative U.S.-Japan groundfish investigations in the Bering Sea during May-August 1979. *Int. N. Pac. Fish. Comm. Bull.* 44, 252 p.
- Bakkala, R.G., J.J. Traynor, T. Kazuyuki, A.M. Shimada, and H. Yamaguchi 1985b. Results of cooperative U.S.-Japan groundfish investigations in the Eastern Bering Sea during June-November 1982. U.S. Dep. Commer., NOAA Tech. Memo. NMFS F/NWC-87, 448 p.
- Goddard, P., and M. Zimmermann. 1993. Distribution, abundance, and biological characteristics of groundfish in the Eastern Bering Sea based on results of the U.S. bottom trawl survey during June-September 1991. AFSC Processed Rep. 93-15, 338 p. Alaska Fish. Sci. Cent., Natl. Mar. Fish. Serv., NOAA, 7600 Sand Point Way NE Seattle WA 98115.
- Hoff, G.R., and L.L. Britt. 2003. The 2002 eastern Bering Sea upper continental slope survey of groundfish and invertebrate resources. U.S. Dep. Commer., NOAA. Tech. Memo. NMFS-AFSC-141, 261 p.

- Hoff, G.R., and L.L. Britt. 2005. Results of the 2004 eastern Bering Sea upper continental slope survey of groundfish and invertebrate resources. U.S. Dep. Commer., NOAA. Tech. Memo. NMFS-AFSC-156, 276 p.
- Lauth, R.R. 2000. The 1999 Pacific west coast upper continental slope trawl survey of groundfish resources off Washington, Oregon, and California: Estimates of distribution, abundance, and length composition. U.S. Dep. Commer., NOAA Tech. Memo. NMFS-AFSC-115, 287 p.
- Nelson, J.S. 1994. Fishes of the World. 3rd edition. John Wiley & Sons. New York, 600 p.
- Sample, T.M., K. Wakabayashi, R.G. Bakkala, and H. Yamaguchi. 1985. Report of the 1981 cooperative U.S.-Japan bottom trawl survey of the Eastern Bering Sea continental shelf and slope. U.S. Dep. Commer., NOAA Tech. Memo. NMFS F/NWC-88, 338 p.
- Stauffer, G. 2004. NOAA Protocols for groundfish bottom trawl surveys of the Nation's Fishery Resources. U.S. Dep. Commer., NOAA Tech. Memo. NMFS-SPO-65, 205 p.
- Wakabayashi, K., R.G. Bakkala, and M.S. Alton. 1985. Methods of the U.S.-Japan demersal trawl surveys, p. 7-29. *In* R.G. Bakkala and K. Wakabayashi (editors), Results of cooperative U.S.-Japan groundfish investigations in the Bering Sea during May-August 1979. Int. North Pac. Fish. Comm. Bull. 44.
- Walters, G.E., K. Teshima, J.J. Traynor, R.G. Bakkala, J.A. Sassano, K.L. Halliday, W.A. Karp, K. Mito, N.J. Williamson, and D. M. Smith. 1988. Distribution, abundance, and biological characteristics of groundfish in the Eastern Bering Sea based on results of the U.S.-Japan triennial bottom trawl and hydroacoustic surveys during May-September, 1985. U.S. Dep. Commer., NOAA Tech. Memo. NMFS F/NWC-154, 400 p.

ACKNOWLEDGMENTS

We would like to sincerely thank all the scientific survey participants for all their hard work during the 2008 EBSS survey. Thanks also go to the skippers and crew of the F/V *Vesteraalen*. Their cooperation and knowledge was greatly appreciated. A special thanks to Stan Kotwicki for stepping in as Chief Scientist during Leg 3.

APPENDICES

Haul Log

The haul log details the location, depth, time, temperature and net mensuration parameters of each haul conducted during the 2008 EBSS survey as well as each haul's catch by weight (kg) with a breakdown of the species composition and the individual species weight or a grouped weight for less abundant species. Appendix Table 1 describes the trawl warp/bottom depth ratio used for each trawl. Appendix Table 2 lists the number of trawl hauls completed by trawl performance code during the survey. Zero and positive performance codes are considered successful tows and were used for the standard abundance estimates and negative performance tows were not included in the estimates of abundance. Appendix Table 3 is the detailed haul log for every haul completed with data during the survey. For quick reference, the unsuccessful tows not used for abundance estimates are shaded in gray in the haul log.

Appendix Table 1 - - Scope ratio table used during the 2008
EBSS survey.

Bottom Depth		Warp Length	
Minimum (m)	Maximum (m)	Meters	Fathoms
146	176	550	301
177	206	600	328
207	237	650	355
238	267	700	383
269	298	750	410
299	328	800	437
330	358	850	465
360	389	900	492
390	420	950	519
421	450	1000	547
451	481	1050	574
482	511	1100	601
512	542	1150	628
543	572	1200	656
573	603	1250	683
604	633	1300	710
634	664	1350	738
665	694	1400	765
695	725	1450	792
726	755	1500	820
756	786	1550	847
787	816	1600	874
817	847	1650	901
848	877	1700	930
878	908	1750	957
909	938	1800	984
939	969	1850	1012
970	999	1900	1039
1000	1030	1950	1066
1031	1060	2000	1094
1061	1091	2050	1121
1091	1121	2100	1148
1122	1152	2150	1176
1152	1182	2200	1203
1183	1213	2250	1230
1213	1243	2300	1258
1244	1274	2350	1285

Appendix Table 2 - - Performance codes assigned to trawl hauls conducted on the 2008 EBSS survey. Performance codes zero or greater are considered successful hauls, and codes less than zero are unsuccessful hauls.

Performance Code	Description	Number of Hauls
6.24	Satisfactory performance, scope changed during tow	2
6.12	Satisfactory performance, depth range over tow exceeds stratum defined limits	10
6	Satisfactory performance, unspecified problems	6
5.8	Satisfactory performance, light footrope contact	1
5.1	Satisfactory performance, net came off bottom	9
5	Satisfactory performance, unspecified gear performance problem	8
4.2	Satisfactory performance, caught large quantity of mud	1
4.1	Satisfactory performance, caught large rock	3
4	Satisfactory performance, caught unspecified object	2
1.11	Satisfactory performance, completed tow	1
0	Good performance	157
-1.2	unsatisfactory performance, major hang, stopped forward progress of vessel	1
-2.4	unsatisfactory performance, belly damage	3
-4.1	Unsatisfactory performance, caught large rock	3

Appendix Table 3. - - Trawl log for the 2008 EBSS survey.

Haul	1	2	3	4	5	6	7	8
Haul date	6-Jun-2008	6-Jun-2008	6-Jun-2008	6-Jun-2008	7-Jun-2008	7-Jun-2008	7-Jun-2008	7-Jun-2008
Tow start latitude	54.71655	54.75298	54.7219	54.69229	54.44097	54.55558	54.57787	54.59985
Tow start longitude	-165.53059	-165.80949	-165.7323	-165.77901	-166.02991	-165.93829	-165.8248	-166.0172
Tow end latitude	54.72309	54.75428	54.7166	54.68908	54.43126	54.55023	54.58371	54.5979
Tow end longitude	-165.56911	-165.76939	-165.69479	-165.7402	-166.0578	-165.9016	-165.8606	-166.0562
Station ID	11-02	11-06	11-04	11-20	12-44	12-26	12-25	12-22
Bottom depth (m)	253	226	267	301	589	451	414	401
Stratum designation	11	11	11	11	12	12	12	12
Tow duration (fraction of hour)	0.54	0.53	0.52	0.54	0.43	0.52	0.53	0.53
Distance of tow (nm)	2.637	2.618	2.535	2.570	2.147	2.490	2.447	2.567
Average net width (m)	16.46	16.69	16.63	17.27	17.22	17.59	17.57	17.43
Performance code	0	0	0	0	0	0	0	6.12
Surface temperature (°C)	3.9	4.6	4.5	4.6	4.8	4.7	4.4	4.9
Bottom temperature (°C)	3.6	3.3	3.3	3.6	3.5	3.7	3.8	3.8
Pacific sleeper shark			16.41	5.18		4.30		23.76
Bering skate	20.30	5.55	6.78	11.51	7.04	6.44	3.23	
mud skate								
rougtail skate								
Alaska skate		8.46	10.73					
Aleutian skate	15.50	16.75	34.28	62.62	28.30	1.75	14.84	17.58
Commander skate					23.41			
whiteblotched skate								4.61
whitebrow skate		8.75	9.25	6.79	53.82	5.47	2.75	2.75
other elasmobranchs & eggs	1.58	0.82	0.43	0.05	0.07			
arrowtooth flounder	529.16	167.71	232.47	1222.19	12.22	19.88	59.28	115.35
Kamchatka flounder	42.66	10.18	10.35	12.84	21.28	16.01	18.94	38.60
Greenland turbot			2.99	5.42	127.08	10.83	15.90	6.00
Pacific halibut	2.56	4.23	14.35	34.38	5.24	3.91	51.75	49.60
flathead sole	44.85	2.58	6.47	4.25		5.93	13.40	19.97
rex sole	184.44	6.61	16.32	11.55		6.45	29.16	19.19
other flatfish	2.30	0.71	5.26	5.10	3.72	0.88	4.97	11.66
Pacific grenadier								
giant grenadier					20.04	3.31		
poppeye grenadier					0.52			
Pacific cod		34.16	14.73					
walleye pollock	75.48	242.02	167.42	62.70	10.16	181.23	188.75	95.04
other gadoid fishes								
blob sculpin								
bigmouth sculpin	7.74		6.11					
spinyhead sculpin	0.65	8.86	4.42	2.38	0.82	2.43	4.40	0.63
darkfin sculpin	0.80		0.17	0.26		0.05	0.30	
other sculpins		0.13				0.01		
twoline eelpout								
western eelpout					171.16	100.50	2.63	12.08
ebony eelpout					91.12		2.00	4.79
Bering eelpout					0.80	2.85	3.87	1.28
other eelpouts								
sablefish					113.62	24.60	29.50	74.64
blacktail snailfish								
other snailfishes	4.82	1.92	5.73	0.46		1.14	0.41	1.38
poachers	15.43	1.44	8.74	2.50	1.09	0.09		0.04
mesopelagic fishes				0.02	1.44	1.04	1.75	0.40
shortspine thornyhead					112.36	13.30	4.85	13.72
rougheye rockfish								1.41
blackspotted rockfish	1.54			3.58		3.97		3.18
shortraker rockfish								
Pacific ocean perch	18.02	1.34	11.93	8.92		1.57	8.01	38.82
other rockfish								
other fishes			1.39	0.66		1.16		2.24
jellyfishes								
corals, sea whips, anemones	0.45	7.84	4.12	0.01	0.08	55.77	53.36	21.57
Alaskan pink shrimp		4.61	5.19	0.97			0.03	
other shrimps	0.08				0.01	2.48	0.61	0.70
grooved Tanner crab					1.91		0.40	
Tanner crab	7.68	37.71	1.57	1.29				
triangle Tanner crab					7.13	1.80		0.03
scarlet king crab							1.05	
golden king crab					1.52			
hermit crabs	0.12	0.07	0.01	0.01	0.14	1.77	0.21	1.58
other crabs	0.01	0.86	0.01			0.12	0.25	
snails	0.91	2.53	0.34	1.66	4.63	4.67	3.53	9.20
clams								
giant octopus						1.75		
other octopus					1.85	2.29	0.17	0.73
magistrate armhook squid				1.20	9.60	6.05	7.16	14.59
other squid					0.29	0.26	0.26	0.94
sea stars, cucumbers, brittle stars	0.43	0.51	1.58	3.71	213.10	9.94	12.23	7.33
sponges	0.99			0.03	0.40	0.47		0.05
other invertebrates	0.14	0.06	0.69	0.61	0.05	0.18	0.07	0.17
Haul total weight (kg)	978.63	576.41	600.25	1472.86	1046.01	506.67	540.02	615.62

Appendix Table 3. - - Continued.

Haul	9	10	11	12	13	14	15	16
Haul date	8-Jun-2008	8-Jun-2008	8-Jun-2008	8-Jun-2008	8-Jun-2008	8-Jun-2008	9-Jun-2008	9-Jun-2008
Tow start latitude	54.76186	54.73512	54.79546	54.6838	54.57619	54.45625	54.648	54.52289
Tow start longitude	-165.987	-166.17999	-166.4527	-166.33881	-166.3976	-166.2029	-166.76311	-166.76891
Tow end latitude	54.75945	54.73431	54.7988	54.68548	54.57203	54.45646	54.6412	54.52227
Tow end longitude	-166.0287	-166.2197	-166.4915	-166.3768	-166.43671	-166.2411	-166.72639	-166.7319
Station ID	11-14	11-07	11-32	11-31	12-19	12-08	11-24	12-10
Bottom depth (m)	209	241	208	300	409	517	369	458
Stratum designation	11	11	11	11	12	12	11	12
Tow duration (fraction of hour)	0.58	0.55	0.54	0.56	0.55	0.53	0.54	0.54
Distance of tow (nm)	2.739	2.588	2.570	2.537	2.608	2.500	2.549	2.424
Average net width (m)	17.07	17.43	17.24	17.59	18.30	18.33	17.23	18.17
Performance code	6	0	0	4	0	0	0	0
Surface temperature (°C)	4.8	4.5	4.8	4.7	5	5.4	4.9	5.3
Bottom temperature (°C)	3.3	3.3	3.3	3.4	3.7	3.6	3.7	3.7
Pacific sleeper shark					12.70	3.60		
Bering skate	2.68	12.89	5.73	7.80	15.22	10.32	3.59	4.01
mud skate								
rougtail skate								
Alaska skate								
Aleutian skate				33.68	43.53	3.20	67.47	2.75
Commander skate					14.96	16.06		
whiteblotched skate					17.10		42.40	
whitebrow skate				12.28		1.94		1.53
other elasmobranchs & eggs	0.42	0.05	0.10			0.06	0.01	
arrowtooth flounder	218.63	242.49	74.43	410.81	63.43	31.46	486.88	25.08
Kamchatka flounder	1.38	5.11	1.51	7.14	29.28	59.08	26.23	29.84
Greenland turbot					77.16	27.34	3.04	7.86
Pacific halibut			8.95	31.14	30.09	217.88	87.19	28.14
flathead sole	16.67	19.22	74.67	62.99	128.23	60.76	99.27	52.43
rex sole	0.50	0.18	1.14	5.79	14.00		13.28	0.21
other flatfish	1.21				1.28	1.58		
Pacific grenadier					30.40	79.60	7.62	128.78
giant grenadier								
popeye grenadier								
Pacific cod	10.01	11.06	1.20					
walleye pollock	6.24	12.76		21.50	53.28	4.56	118.29	1.54
other gadoid fishes								
blob sculpin								
bigmouth sculpin								
spinyhead sculpin	7.20	6.47	4.28	5.92	0.38		0.22	0.22
darkfin sculpin			0.19	0.47	0.01		1.29	
other sculpins	0.11	0.18	0.06					
twoline eelpout								
western eelpout					28.32	96.88	6.20	57.60
ebony eelpout					7.90	25.44		
Bering eelpout					0.22	0.29	0.22	0.14
other eelpouts					0.02			0.03
sablefish					1.15	163.90		20.58
blacktail snailfish								
other snailfishes	0.35	0.23					0.69	
poachers					0.11	0.10	0.05	0.07
mesopelagic fishes					0.42	0.06	0.15	0.16
shortspine thornyhead					117.47	83.74	70.99	62.27
roughey rockfish	0.76	5.81	1.35	3.80	1.37		5.23	
blackspotted rockfish	2.55	0.65					1.24	1.30
shortraker rockfish								
Pacific ocean perch	4.79	3.53		52.13	2.67		3.88	4.22
other rockfish								
other fishes		0.38	1.68		0.75			
jellyfishes		0.01			0.06		0.88	0.26
corals, sea whips, anemones	35.83	8.03	35.83	8.16	5.02	0.59	4.04	0.10
Alaskan pink shrimp	6.96	4.39	5.33	1.59				
other shrimps	0.01	0.03			0.92		0.07	0.05
grooved Tanner crab								0.19
Tanner crab	11.87	0.23	2.50	0.19				
triangle Tanner crab					0.27	0.14	0.03	0.25
scarlet king crab								
golden king crab					1.03	2.24	0.03	1.22
hermit crabs	0.13			0.41	1.31	1.41	2.60	0.47
other crabs	0.59	0.01	0.62				0.25	
snails	3.33	3.70	1.28		8.95	5.51	3.77	3.22
clams				0.04				
giant octopus	0.90	20.60		3.82				
other octopus			0.77		0.28	0.45	0.90	1.84
magistrate armhook squid	0.93		4.87	8.01	9.31	10.76	15.00	4.10
other squid		0.04					0.04	0.44
sea stars, cucumbers, brittle stars	3.82	0.52	0.06	2.88	26.25	163.05	24.91	51.44
sponges	0.11	0.46	0.03	8.13	0.06	20.44	1.21	0.20
other invertebrates	0.37	0.74	0.12	0.10	0.06	0.25	0.02	0.11
Haul total weight (kg)	338.34	359.77	226.69	692.09	744.97	1092.68	1099.19	492.63

Appendix Table 3. - - Continued.

Haul	17	18	19	20	21	22	23	24
Haul date	9-Jun-2008	9-Jun-2008	9-Jun-2008	10-Jun-2008	10-Jun-2008	11-Jun-2008	11-Jun-2008	11-Jun-2008
Tow start latitude	54.42823	54.38111	54.31118	54.30286	54.26328	54.35565	54.41014	54.36961
Tow start longitude	-166.4494	-166.4803	-166.7599	-166.89549	-166.7135	-167.1227	-167.3842	-167.5928
Tow end latitude	54.42716	54.37745	54.30497	54.31631	54.26405	54.34843	54.40101	54.38891
Tow end longitude	-166.4873	-166.5186	-166.72279	-166.9386	-166.6759	-167.0855	-167.34731	-167.6104
Station ID	12-30	13-02	14-02	15-03	15-02	13-04	13-05	13-14
Bottom depth (m)	553	612	853	1014	1099	683	675	795
Stratum designation	12	13	14	15	15	13	13	13
Tow duration (fraction of hour)	0.56	0.57	0.57	0.75	0.56	0.54	0.55	0.57
Distance of tow (nm)	2.483	2.562	2.570	3.384	2.493	2.598	2.652	2.540
Average net width (m)	17.99	18.09	17.66	18.06	18.14	18.36	17.93	18.87
Performance code	0	0	5	5.1	6	0	0	0
Surface temperature (°C)	5.2	5.1	5.4	5.2	5.6	5.4	5	5.6
Bottom temperature (°C)	3.6	3.5	3.1	2.8	2.7	3.4	3.4	3.3
Pacific sleeper shark			3.78	14.18				
Bering skate	8.44	6.41	4.45	0.19		4.66		
mud skate								
rougtail skate			11.52	6.09	24.76		3.15	
Alaska skate								
Aleutian skate	5.72	9.78	9.35	2.57	1.10	7.40	6.75	
Commander skate	27.60							
whiteblotched skate								
whitebrow skate		1.36		5.63	5.88		0.23	
other elasmobranchs & eggs			0.14	0.12	0.02	0.12	0.05	0.02
arrowtooth flounder	7.85							
Kamchatka flounder	28.58	43.04	41.65	11.42	7.35	21.02	19.63	6.75
Greenland turbot	41.56	29.08	49.98	34.80	56.18	66.83	46.31	8.06
Pacific halibut	42.34	8.46				20.60		
flathead sole	2.86	0.53						
rex sole								
other flatfish						1.94		
Pacific grenadier				14.22	2.07			
giant grenadier	51.86	113.23	160.40	580.67	456.32	131.62	810.22	271.99
popeye grenadier		0.61	243.07	144.61	253.53	18.35	78.91	95.12
Pacific cod								
walleye pollock	3.12					0.66		
other gadoid fishes				1.04	0.10			
blob sculpin			11.78	23.10				
bigmouth sculpin								
spinyhead sculpin	0.65	0.55	0.16					
darkfin sculpin								
other sculpins								
twoline eelpout			21.95	19.67	9.60	4.87	2.16	1.01
western eelpout	143.10	156.34	15.39	2.75	10.01	22.51	3.28	1.36
ebony eelpout	8.25	1.76						
Bering eelpout	0.26	0.18	3.01	0.30	0.03	0.17	0.31	0.33
other eelpouts				0.02				
sablefish	60.74	74.61	49.78	22.24	22.02	72.40	62.54	25.96
blacktail snailfish						0.36	0.53	
other snailfishes	0.41	0.01	0.65	1.80	1.46	0.01	0.44	0.12
poachers	0.16	0.18	0.66	0.10	0.03	0.30	0.63	0.14
mesopelagic fishes	0.10	0.28	1.61	1.70	2.34	0.34	0.52	1.47
shortspine thornyhead	82.22	54.56	37.04	1.95		21.65	37.69	17.97
roughey rockfish								
blackspotted rockfish								
shortraker rockfish								
Pacific ocean perch								
other rockfish								
other fishes	0.40	0.39	1.30		1.13	0.02		
jellyfishes	0.23	0.15	0.32	0.24	0.14	0.01	0.10	0.07
corals, sea whips, anemones	0.01							
Alaskan pink shrimp								
other shrimps	0.03	0.05	0.63	2.20	1.10	0.08	0.07	0.58
grooved Tanner crab	1.74		5.18	1.00		2.30	1.88	1.16
Tanner crab								
triangle Tanner crab	0.04	0.09	49.10	62.13	32.90	4.50	143.03	51.25
scarlet king crab								
golden king crab	0.15							
hermit crabs	0.42		0.62	0.07	0.12	0.01	0.26	0.10
other crabs								
snails	6.12	3.83	2.17	6.07	2.73	1.59	3.99	2.65
clams				0.60		0.05		
giant octopus								
other octopus	1.21	0.99	0.40	3.44	2.78	0.36	1.62	2.27
magistrate armhook squid	3.86	3.36	0.71	1.62	0.91	4.84	1.23	2.21
other squid		5.60	0.30		0.14	0.35	0.21	
sea stars, cucumbers, brittle stars	186.40	117.76	7.16	7.74	5.67	18.24	3.05	1.22
sponges	14.41	2.35	1.34			1.44	0.29	0.18
other invertebrates	1.10	0.81	0.09			0.08		0.04
Haul total weight (kg)	731.93	636.35	735.68	974.29	900.43	429.68	1229.07	492.03

Appendix Table 3. - - Continued.

Haul	25	26	27	28	29	30	31	32
Haul date	11-Jun-2008	12-Jun-2008	12-Jun-2008	12-Jun-2008	12-Jun-2008	12-Jun-2008	13-Jun-2008	13-Jun-2008
Tow start latitude	54.35906	54.33911	54.54326	54.51027	54.73188	54.72726	54.94219	54.86727
Tow start longitude	-167.8396	-167.9619	-167.6841	-167.28889	-167.26379	-166.989	-167.1357	-167.4949
Tow end latitude	54.38106	54.36193	54.5223	54.5277	54.7112	54.73974	54.95257	54.88195
Tow end longitude	-167.8409	-167.9751	-167.668	-167.31149	-167.25459	-167.0183	-167.1673	-167.5273
Station ID	14-04	15-05	14-05	12-31	12-01	11-25	11-30	12-36
Bottom depth (m)	918	1017	815	568	458	370	219	501
Stratum designation	14	15	14	12	12	11	11	12
Tow duration (fraction of hour)	0.51	0.59	0.5	0.53	0.51	0.5	0.52	0.55
Distance of tow (nm)	2.477	2.778	2.616	2.511	2.443	2.392	2.386	2.713
Average net width (m)	18.61	18.19	18.25	17.96	18.44	18.25	17.35	18.30
Performance code	0	0	0	0	0	0	0	0
Surface temperature (°C)	5.4	5.3	5.2	5.8	5.8	4.8	5.4	5.7
Bottom temperature (°C)	3	2.8	3.2	3.5	3.7	3.7	3.6	3.6
Pacific sleeper shark				3.62				14.80
Bering skate					2.12	5.78	8.92	2.64
mud skate								
rougtail skate	11.19	4.36	2.74					
Alaska skate							19.06	
Aleutian skate			0.32		2.71	32.44	67.90	
Commander skate								
whiteblotched skate					19.54	3.04		
whitebrow skate				5.76				
other elasmobranchs & eggs	0.07	0.05		0.01	0.01		0.04	
arrowtooth flounder				0.99	21.50	427.55	115.26	29.99
Kamchatka flounder				17.31	85.88	14.76	1.84	38.53
Greenland turbot			5.44	73.49	4.81	7.75		
Pacific halibut				12.31	91.11	82.33	23.48	6.88
flathead sole					34.34	86.73	34.76	1.17
rex sole					12.86	15.59	3.40	
other flatfish				15.09	0.99	0.57		
Pacific grenadier	1.54	10.78						
giant grenadier	1704.92	903.86	1314.96	288.24	145.76	37.24		159.26
popeye grenadier	132.31	118.37	38.52	7.95				0.79
Pacific cod							3.94	
walleye pollock					2.17	45.82	2.03	0.85
other gadoid fishes		0.79						
blob sculpin	0.02	5.66						
bigmouth sculpin						4.89		
spinyhead sculpin							5.06	
darkfin sculpin				0.44	0.02	0.31	0.32	0.12
other sculpins								
twoline eelpout	1.19	0.23	3.35					
western eelpout	1.95			55.37	17.98			43.48
ebony eelpout								
Bering eelpout					0.28	0.13		
other eelpouts	0.01		0.01					
sablefish			3.90	9.44	3.61			33.01
blacktail snailfish			0.29					
other snailfishes	0.68	1.23	0.31	0.24		0.78		
poachers			0.07		0.09	0.03		0.01
mesopelagic fishes	2.48	1.45	2.68	0.50	0.19	0.09	0.03	0.10
shortspine thornyhead	1.79		5.40	25.47	118.04	87.97		99.59
roughey rockfish						5.94	0.83	
blackspotted rockfish						2.40	0.61	
shortraker rockfish								
Pacific ocean perch					2.97	16.30	6.06	
other rockfish								
other fishes			1.41	0.02		5.25	1.44	0.19
jellyfishes	0.14	0.42	0.10	0.02				
corals, sea whips, anemones			0.06	0.05	1.00	2.28	6.90	0.99
Alaskan pink shrimp							1.79	
other shrimps	0.43	1.40	0.27		0.03	0.07		0.06
grooved Tanner crab			0.29					
Tanner crab							0.39	
triangle Tanner crab	34.08	14.42	23.85	0.27	0.02	0.01		
scarlet king crab								
golden king crab						0.73		
hermit crabs	0.04				3.89	3.09	0.15	0.03
other crabs								
snails	1.00	0.79	0.68	3.22	2.77	3.27	1.46	0.99
clams	0.01							
giant octopus								
other octopus					0.51	0.33		0.15
magistrate armhook squid	1.24			7.39	3.23	6.15	4.51	6.95
other squid			0.41	0.91			0.06	
sea stars, cucumbers, brittle stars	0.86	42.98	1.76	31.93	38.51	25.99	3.00	79.01
sponges		4.01	0.20	2.94	0.27	0.35	0.25	13.42
other invertebrates	0.04	0.01		0.67	0.04	0.05	3.78	0.23
Haul total weight (kg)	1896.00	1110.83	1407.00	563.65	617.24	926.01	317.28	533.22

Appendix Table 3. - - Continued.

Haul	33	34	35	36	37	38	39	40
Haul date	13-Jun-2008	13-Jun-2008	13-Jun-2008	14-Jun-2008	14-Jun-2008	14-Jun-2008	14-Jun-2008	14-Jun-2008
Tow start latitude	55.13428	55.04811	55.04869	55.18046	55.26255	55.39899	55.47115	55.39085
Tow start longitude	-167.5473	-167.7171	-167.8326	-167.994	-168.0107	-168.0161	-168.2348	-168.2883
Tow end latitude	55.11786	55.06511	55.06846	55.19979	55.27641	55.41287	55.45775	55.37963
Tow end longitude	-167.523	-167.7383	-167.84959	-168.01579	-168.02721	-168.04829	-168.1983	-168.2587
Station ID	11-13	12-39	12-17	14-10	13-09	11-10	11-39	13-10
Bottom depth (m)	209	422	552	889	624	226	241	612
Stratum designation	11	12	12	14	13	11	11	13
Tow duration (fraction of hour)	0.54	0.52	0.53	0.58	0.39	0.55	0.55	0.52
Distance of tow (nm)	2.464	2.404	2.529	2.652	1.952	2.623	2.810	2.330
Average net width (m)	16.61	17.50	19.05	18.38	17.79	16.54	16.15	17.53
Performance code	0	0	0	0	0	0	0	6
Surface temperature (°C)	5.1	5.5	5.2	5.4	5.4	5.2	5.5	5.3
Bottom temperature (°C)	3.6	3.7	3.6	3.1	3.5	3.3	3.3	3.4
Pacific sleeper shark			8.86		8.30			18.00
Bering skate	7.99	7.42				23.17	12.33	
mud skate								
rougtail skate				34.27	3.98			
Alaska skate	8.47						7.16	
Aleutian skate	23.01	35.82		7.45	18.71	26.08	2.95	13.40
Commander skate								
whiteblotched skate							17.57	
whitebrow skate				1.19	1.31			5.26
other elasmobranchs & eggs		0.03		0.07	0.01	0.03		
arrowtooth flounder	36.10	355.36	3.75		1.00	51.83	27.60	
Kamchatka flounder	7.31	145.06	111.58	27.86	32.80	20.41	29.04	200.59
Greenland turbot		6.80	16.82	9.41	29.34		15.07	102.89
Pacific halibut	6.13	24.78				3.08		40.82
flathead sole	28.39	4.46				92.27	25.90	
rex sole	27.02	25.72			0.38	35.80	26.02	
other flatfish		0.69						
Pacific grenadier								
giant grenadier		115.07	32.92	436.33	50.06			12.24
popeye grenadier		2.60	8.43	219.27	24.72			27.72
Pacific cod	18.76					26.02	11.87	
walleye pollock	6.78	10.60				10.32	14.56	
other gadoid fishes				1.40				0.16
blob sculpin				7.74				
bigmouth sculpin					0.74		4.96	
spinyhead sculpin	0.82					1.48	0.53	
darkfin sculpin	0.35	0.06				11.01	4.37	0.37
other sculpins				0.01			0.03	
twoline eelpout				5.60				2.60
western eelpout		107.04	46.18	3.00	131.76	0.13		60.20
ebony eelpout					3.84			13.02
Bering eelpout				1.14	0.19	0.14	0.20	0.11
other eelpouts					0.01			0.01
sablefish		4.17	20.21	22.70	82.29			45.00
blacktail snailfish				0.27				
other snailfishes			0.17	0.92	0.02	0.51		
poachers		0.07		0.34	0.10	2.09	0.73	0.25
mesopelagic fishes		0.53	0.14	0.47	0.01	0.01		0.27
shortspine thornyhead	2.66	108.50	542.67	49.82	79.50			469.96
roughey rockfish	4.67	0.66				1.18		
blackspotted rockfish	2.03						1.76	
shortraker rockfish								
Pacific ocean perch	9.70	0.75				21.45	47.09	
other rockfish								
other fishes	0.45	0.03			0.40	0.09		1.22
jellyfishes		0.02		0.07				0.02
corals, sea whips, anemones	5.02	25.38	2.29	0.33		3.04	1.84	0.26
Alaskan pink shrimp	0.56					0.49	0.81	0.02
other shrimps		0.03		1.15		0.01		
grooved Tanner crab		1.21		50.28	14.95			56.94
Tanner crab	0.58					0.06	0.25	
triangle Tanner crab				3.50	0.02	0.05		
scarlet king crab				0.48				
golden king crab		1.04			0.09			
hermit crabs	0.31	0.09	0.01	0.05	0.33	0.12	0.30	0.60
other crabs	0.48					0.02	0.01	
snails	1.46	0.25	1.00	0.05	1.33	4.80	1.49	2.65
clams								
giant octopus						0.68		
other octopus			0.08		0.75			
magistrate armhook squid	2.27	8.78	6.98	1.88	5.14	4.15	5.56	1.72
other squid	0.10		0.12	0.34	3.10	0.55	0.08	
sea stars, cucumbers, brittle stars	2.97	5.59	58.05	22.17	6.98	9.88	15.10	9.25
sponges			0.48			0.45	0.19	
other invertebrates	0.14	0.04	0.03		0.02	0.09	0.10	0.11
Haul total weight (kg)	204.53	998.64	860.76	909.56	502.17	351.49	275.47	1085.67

Appendix Table 3. - - Continued.

Haul	41	42	43	44	45	46	47	48
Haul date	15-Jun-2008	15-Jun-2008	15-Jun-2008	15-Jun-2008	15-Jun-2008	16-Jun-2008	16-Jun-2008	16-Jun-2008
Tow start latitude	55.42625	55.52608	55.59017	55.69244	55.93668	55.95953	56.06768	56.0709
Tow start longitude	-168.4341	-168.4792	-168.88229	-168.7847	-168.80569	-168.9342	-168.78259	-168.7876
Tow end latitude	55.43369	55.5444	55.58129	55.71256	55.92927	55.96556	56.07158	56.07454
Tow end longitude	-168.4679	-168.4982	-168.84579	-168.80881	-168.84219	-168.9725	-168.7388	-168.7601
Station ID	15-09	12-45	25-01	21-01	21-02	24-05	23-02	23-02
Bottom depth (m)	1074	528	1069	214	311	826	764	742
Stratum designation	15	12	25	21	21	24	23	23
Tow duration (fraction of hour)	0.59	0.53	0.66	0.57	0.55	0.58	0.62	0.39
Distance of tow (nm)	2.420	2.482	2.624	2.784	2.495	2.572	2.828	1.795
Average net width (m)	15.61	17.15	17.72	16.15	16.66	17.95	15.62	17.95
Performance code	5.1	5.1	5.1	6.12	0	0	-4.1	0
Surface temperature (°C)	5.9	5.8	6	6.1	5.1	5	5.1	5
Bottom temperature (°C)	2.8	3.6	2.9	3.3	3.6	3	3.1	3.2
Pacific sleeper shark		16.24						
Bering skate				0.63	2.31			
mud skate					19.88	2.50		1.82
rougtail skate	34.78		42.44					
Alaska skate				6.37	6.82			
Aleutian skate	3.27	10.57	2.98			39.24		26.78
Commander skate						21.58		72.84
whiteblotched skate				5.47	5.71	5.61		9.50
whitebrow skate	0.61		2.02			3.36		
other elasmobranchs & eggs		0.09	0.31	0.06	0.04	0.04		
arrowtooth flounder		74.14		95.42	237.64			
Kamchatka flounder		103.92	3.40	11.09	8.99	57.02		26.78
Greenland turbot	22.61	10.39	15.28		39.80	7.45		2.22
Pacific halibut		93.02						
flathead sole				15.38	88.23			
rex sole		5.27		20.22	6.85			
other flatfish					1.16	0.82		
Pacific grenadier	1.62		0.18					
giant grenadier	414.78	120.39	444.57			1081.02		264.34
popeye grenadier	105.34	39.31	379.75			472.67		9.06
Pacific cod				61.78	37.47			
walleye pollock				3.55	66.04			
other gadoid fishes	2.15		2.55					
blob sculpin	0.34		13.81					
bigmouth sculpin		10.50		11.64	4.66			
spinyhead sculpin								
darkfin sculpin		0.11		4.38	0.76	0.02		
other sculpins	0.01	0.04	0.01	0.01		0.25		0.70
twoline eelpout			2.01			1.13		3.04
western eelpout		43.39	0.39			0.43		
ebony eelpout		54.96				0.37		2.10
Bering eelpout		1.42			0.51			
other eelpouts	0.06			0.11				
sablefish	20.27	81.72	9.44			19.15		122.70
blacktail snailfish		6.02	0.15			1.54		
other snailfishes	0.65		2.17	2.90		0.63		0.16
poachers		0.19		1.42	0.11			0.09
mesopelagic fishes	0.97	0.13	0.65		0.19	0.17		0.24
shortspine thornyhead		380.53	5.11			6.13		20.64
roughey rockfish						3.97		
blackspotted rockfish				3.54	3.33			
shortraker rockfish		6.74						
Pacific ocean perch				587.27	14.07			
other rockfish								
other fishes		1.60	0.27	0.67				
jellyfishes	0.56	0.05	0.19	0.05	0.08	0.03		0.16
corals, sea whips, anemones		10.61	0.61	3.24	2.00	0.04		0.64
Alaskan pink shrimp				0.91	0.07			
other shrimps	1.10		0.16		0.12	0.12		0.35
grooved Tanner crab		7.58	1.12			12.06		3.41
Tanner crab					0.02			
triangle Tanner crab	18.01	3.46	23.75			0.47		0.16
scarlet king crab						9.29		2.81
golden king crab		1.30				2.69		0.54
hermit crabs	0.01	0.37	0.17		0.03	0.01		0.17
other crabs	1.54	0.01				7.95		1.59
snails	1.10	0.89	0.77	1.72		2.98		0.08
clams								
giant octopus				16.63				
other octopus	3.92	1.24						0.07
magistrate armhook squid		1.62		2.00	9.74	0.59		0.69
other squid	0.06			0.06	0.07	0.15		
sea stars, cucumbers, brittle stars	2.90	12.61	27.55	7.07	5.90	1.65		2.11
sponges	3.13	0.49			2.08	1.11		12.09
other invertebrates		0.07	0.17	4.10	0.03			0.10
Haul total weight (kg)	639.81	1100.98	981.98	870.26	568.94	1760.00		588.01

Appendix Table 3. - - Continued.

Haul	49	50	51	52	53	54	55	56
Haul date	16-Jun-2008	17-Jun-2008	17-Jun-2008	17-Jun-2008	17-Jun-2008	17-Jun-2008	18-Jun-2008	18-Jun-2008
Tow start latitude	56.17975	56.12736	56.12428	56.12367	56.16743	56.03773	56.06398	55.98671
Tow start longitude	-168.4783	-169.12151	-168.75549	-168.77271	-169.0558	-169.35291	-169.489	-169.7346
Tow end latitude	56.16864	56.12175	56.12417	56.1271	56.15835	56.04155	56.04983	55.98157
Tow end longitude	-168.4463	-169.08521	-168.7599	-168.8008	-169.0136	-169.39079	-169.52071	-169.77499
Station ID	21-10	25-03	22-08	22-08	21-05	21-08	21-07	22-05
Bottom depth (m)	214	1154	551	557	343	335	248	531
Stratum designation	21	25	22	22	21	21	21	22
Tow duration (fraction of hour)	0.55	0.56	0.08	0.42	0.58	0.56	0.55	0.55
Distance of tow (nm)	2.415	2.433	0.288	1.859	2.905	2.452	2.601	2.682
Average net width (m)	15.49	18.98	17.11	16.92	17.12	16.82	16.60	17.48
Performance code	0	0	-4.1	5	-2.4	0	0	0
Surface temperature (°C)	4.9	5.4	5.6	5.6	5.1	6	5.3	5.8
Bottom temperature (°C)	3.4	2.4	3.3	3.3	3.6	3.6	3.5	3.6
Pacific sleeper shark	59.62				11.09			
Bering skate	21.30				2.21		8.94	
mud skate	17.27			4.27		1.01	8.56	
rougtail skate								
Alaska skate	62.90							
Aleutian skate	98.58	11.09		22.44	2.09	44.40	39.33	6.15
Commander skate	5.82			42.71	3.88			
whiteblotched skate	24.16			65.52	14.58	7.80		
whitebrow skate	0.02	0.37		2.29		2.02		
other elasmobranchs & eggs	2.47	13.41				3.00	0.02	
arrowtooth flounder	671.56			6.35	211.93	80.01	28.96	55.96
Kamchatka flounder	86.53			359.60	9.58	125.36	25.82	102.60
Greenland turbot		13.17		17.70	2.00			2.95
Pacific halibut	3.14			5.80	32.96	56.29	35.56	12.96
flathead sole	3.62				0.73		12.04	4.00
rex sole	0.49			5.27	34.63	119.43	251.94	106.66
other flatfish					0.88	2.10	0.74	
Pacific grenadier		254.97						
giant grenadier		103.82		15.56		42.70		487.56
popeye grenadier		428.38		0.51				
Pacific cod	29.90				12.43	20.88	35.90	
walleye pollock	11.36				11.62	1.80	18.93	0.97
other gadoid fishes		0.74						
blob sculpin								
bigmouth sculpin	5.62			4.48	61.05	4.93	0.37	2.78
spinyhead sculpin	0.03				0.02		0.13	
darkfin sculpin	0.81			0.74	1.68	7.08	6.01	0.11
other sculpins	0.95			0.60	0.04		0.07	0.01
twoline eelpout		7.02						0.31
western eelpout		23.70		11.90	0.21			0.94
ebony eelpout				0.44	0.31	0.08	0.09	0.61
Bering eelpout								
other eelpouts		0.04						
sablefish		10.10		21.64				24.73
blacktail snailfish								1.11
other snailfishes		0.02		0.56	0.01	0.02	0.02	0.01
poachers	0.11			0.06	0.06		1.92	0.27
mesopelagic fishes	0.01	0.18		0.10	0.08	0.01	0.03	0.06
shortspine thornyhead				149.94	6.94	7.16		255.33
roughey rockfish					0.30			
blackspotted rockfish					6.28	10.73		3.67
shortraker rockfish				3.30	595.89	161.63		11.50
Pacific ocean perch	20.62				57.91	12.50	292.24	1.77
other rockfish	2.27						0.82	
other fishes					19.16		1.95	0.27
jellyfishes		0.06				0.08	0.67	
corals, sea whips, anemones	5.59				5.63	6.02	0.64	26.23
Alaskan pink shrimp	1.42				0.72		2.08	
other shrimps				0.17	0.96	0.13	0.37	0.02
grooved Tanner crab		3.89		1.03				16.36
Tanner crab	0.92				0.05	0.29	4.45	
triangle Tanner crab		6.65						
scarlet king crab		2.09						
golden king crab	0.61			7.77	52.04	32.96	9.52	6.95
hermit crabs	0.26			0.12		0.24	0.17	0.05
other crabs		33.20				0.09	0.03	
snails	0.23	0.16		0.24	1.98	0.75	2.42	0.05
clams								
giant octopus						0.04		
other octopus	0.14	0.06					0.16	6.50
magistrate armhook squid	14.01	1.24			5.11	7.21	6.81	6.98
other squid		0.14						
sea stars, cucumbers, brittle stars	1.87	0.05		1.24	12.28	11.09	9.09	11.85
sponges	2.18	0.31		22.26	1.65	383.60		0.18
other invertebrates	0.11			0.16	0.05	137.42	0.07	0.11
Haul total weight (kg)	1156.49	914.86		774.77	1181.03	1290.85	806.87	1158.58

Appendix Table 3. - - Continued.

Haul	57	58	59	60	61	62	63	64
Haul date	18-Jun-2008	18-Jun-2008	18-Jun-2008	24-Jun-2008	24-Jun-2008	24-Jun-2008	24-Jun-2008	25-Jun-2008
Tow start latitude	55.93822	55.93959	55.9509	55.13841	55.36995	55.55582	55.57857	56.23589
Tow start longitude	-170.1133	-170.3313	-170.0954	-167.8255	-168.1651	-168.4315	-168.7791	-171.38319
Tow end latitude	55.94242	55.94566	55.94922	55.12192	55.37859	55.56626	55.56675	56.23956
Tow end longitude	-170.0815	-170.30791	-170.13699	-167.80659	-168.1954	-168.4617	-168.7525	-171.42011
Station ID	23-04	24-04	22-06	12-33	12-14	11-34	24-01	33-09
Bottom depth (m)	646	849	424	435	501	218	874	661
Stratum designation	23	24	22	12	12	11	24	33
Tow duration (fraction of hour)	0.44	0.38	0.57	0.5	0.55	0.53	0.49	0.61
Distance of tow (nm)	2.096	1.686	2.674	2.273	2.295	2.297	2.190	2.513
Average net width (m)	16.96	17.45	17.16	17.80	17.79	16.30	18.63	18.06
Performance code	0	4	0	6.24	0	0	0	6.24
Surface temperature (°C)	5.1	4.5	6.1	7	7	6.6	7.1	6.4
Bottom temperature (°C)	3.4	2.9	3.6	3.8	3.6	3.3	3	3.4
Pacific sleeper shark								
Bering skate				6.00		14.24		
mud skate						1.98		
rougtail skate		3.92					14.68	
Alaska skate						25.34		
Aleutian skate	4.90	26.26		15.83	40.82	158.24	8.68	17.28
Commander skate								5.96
whiteblotched skate			8.63		3.34	4.77		7.64
whitebrow skate	2.65	2.34		3.14	3.99		1.38	2.50
other elasmobranchs & eggs		0.01				0.51	0.03	0.02
arrowtooth flounder			71.44	19.58	96.79	29.85		
Kamchatka flounder	73.80	16.68	93.96	57.04	82.00	10.24	4.86	56.10
Greenland turbot	323.26		18.57	5.49	27.74	16.78	13.33	39.26
Pacific halibut			30.98	20.01				
flathead sole				16.70	41.44	14.58		
rex sole	3.41		129.84	37.86	29.46	21.28		0.93
other flatfish	3.66	12.96	5.01					0.88
Pacific grenadier		0.01						
giant grenadier	160.86	839.84	1369.80	68.34	67.14		237.34	713.12
popeye grenadier	9.89	92.66	0.23		1.85		192.51	119.78
Pacific cod						16.10		
walleye pollock			0.68	25.96		30.24		
other gadoid fishes							0.17	
blob sculpin							8.28	
bigmouth sculpin			82.59	3.14	10.16	16.61		
spinyhead sculpin						0.59		
darkfin sculpin			0.75	0.23	0.10	5.62		
other sculpins			0.48			0.04		
twoline eelpout	2.24	1.59					2.93	3.20
western eelpout	0.28			49.48	286.76		4.79	0.57
ebony eelpout					2.25			
Bering eelpout	0.07	0.06	1.28	0.35	1.31	0.13	1.85	0.06
other eelpouts								
sablefish	73.12	13.11		2.10	69.57		39.04	40.64
blacktail snailfish							0.63	0.91
other snailfishes		0.44	0.03			1.33	1.89	0.04
poachers	0.11	0.06	0.16	0.13	0.22	0.49	0.23	0.41
mesopelagic fishes	0.43	0.35	0.05	0.48	1.06		0.40	0.06
shortspine thornyhead	87.32	65.36	105.04	190.82	152.77		25.23	188.58
roughey rockfish			2.50					
blackspotted rockfish								
shortraker rockfish	10.00		191.98					
Pacific ocean perch			6.19	4.73		931.31		
other rockfish		0.48						
other fishes			0.96	0.33	0.01	4.67	2.16	2.46
jellyfishes	0.06	0.33		0.68			0.04	0.44
corals, sea whips, anemones	4.71	14.60	2.82	56.07	4.02	1.63	0.34	0.10
Alaskan pink shrimp						1.21		
other shrimps		0.34	0.05	0.12	0.29		0.61	
grooved Tanner crab	4.41	10.63		1.58	13.18	1.16	5.92	8.50
Tanner crab			0.11			0.08		
triangle Tanner crab							16.18	
scarlet king crab		2.39						3.28
golden king crab			74.62					
hermit crabs	0.24	0.04		0.78	1.09	0.01	0.11	0.02
other crabs		0.01	0.01	0.19	0.01	0.02		
snails	0.51	0.37	0.18	1.12	1.06	3.85	1.30	0.33
clams								
giant octopus						0.51		
other octopus	1.71	0.58	0.17	0.13	1.88		0.08	
magistrate armhook squid	1.05		5.71	13.57	3.12	2.58		0.36
other squid	0.53			0.15	0.04	0.21		
sea stars, cucumbers, brittle stars	53.17	4.80	27.51	16.00	25.44	7.25	84.57	48.58
sponges	0.04	15.84	11.18	0.45				
other invertebrates	0.12			0.01	0.01	0.18		
Haul total weight (kg)	822.53	1126.08	2243.48	618.59	968.92	1323.63	669.55	1262.00

Appendix Table 3. - - Continued.

Haul	65	66	67	68	69	70	71	72
Haul date	26-Jun-2008	26-Jun-2008	26-Jun-2008	26-Jun-2008	26-Jun-2008	27-Jun-2008	27-Jun-2008	27-Jun-2008
Tow start latitude	57.75063	57.72849	57.81569	57.83928	57.84801	58.52569	58.54094	58.52545
Tow start longitude	-173.9391	-173.78101	-173.8598	-173.8876	-173.9538	-174.86591	-174.767	-174.8224
Tow end latitude	57.74831	57.74241	57.8288	57.82385	57.86654	58.50849	58.55083	58.52101
Tow end longitude	-173.9156	-173.80881	-173.822	-173.864	-173.9704	-174.8642	-174.8056	-174.8035
Station ID	44-01	41-03	42-07	42-02	43-06	45-03	43-05	44-02
Bottom depth (m)	869	361	531	486	659	1003	795	944
Stratum designation	44	41	42	42	43	45	43	44
Tow duration (fraction of hour)	0.37	0.54	0.43	0.56	0.59	0.46	0.62	0.27
Distance of tow (nm)	1.471	2.346	2.027	2.299	2.403	1.946	2.610	1.235
Average net width (m)	16.21	17.00	17.09	17.04	17.16	18.98	17.77	18.46
Performance code	5	0	-4.1	0	0	6.12	-2.4	6
Surface temperature (°C)	5.3	5.7	5.3	5.6	5.5	5.9	5.8	6.2
Bottom temperature (°C)	3.2	3.7	3.7	3.7	3.4	2.8	3.2	3
Pacific sleeper shark		68.00						
Bering skate		0.10						
mud skate		1.52		4.45				
rougtail skate	3.58					11.68		
Alaska skate								
Aleutian skate	19.95	8.28		7.71	10.75	22.47		5.10
Commander skate	0.03			4.73	13.37	0.32		1.98
whiteblotched skate		10.38		0.30	0.12			
whitebrow skate	0.24	2.92		2.62		1.36		0.20
other elasmobranchs & eggs						0.01		
arrowtooth flounder		49.24		41.95	6.37			
Kamchatka flounder	12.37	1.84		70.64	7.72			
Greenland turbot	11.45	22.58		19.28	29.60	8.12		
Pacific halibut				37.02				
flathead sole		26.38		38.94				
rex sole		24.28		1.30				
other flatfish								
Pacific grenadier	5.33					15.86		
giant grenadier	886.07	2184.59		1300.73	977.07	946.50		693.46
popeye grenadier	227.37			0.16	93.78	212.13		86.75
Pacific cod		14.56						
walleye pollock		36.00						
other gadoid fishes	1.41				0.14			4.19
blob sculpin						1.88		2.04
bigmouth sculpin		14.38						
spinyhead sculpin								
darkfin sculpin		0.01						
other sculpins								
twoline eelpout								
western eelpout								
ebony eelpout				1.64	4.64			
Bering eelpout				0.18				
other eelpouts	0.01					0.12		
sablefish	54.21	15.51			40.57	15.23		
blacktail snailfish	3.38							
other snailfishes	0.80	0.20		1.44	1.19	0.23		0.08
poachers	0.11	0.02				0.01		
mesopelagic fishes	0.23	0.02		0.04	0.34	0.67		1.06
shortspine thornyhead				8.48	110.79			
roughey rockfish		25.29						
blackspotted rockfish		3.68						
shortraker rockfish		386.49						
Pacific ocean perch		234.30						
other rockfish					0.04	0.50		
other fishes								
jellyfishes				1.14				0.07
corals, sea whips, anemones	0.01	4.30		2.31	0.47	7.49		10.46
Alaskan pink shrimp								
other shrimps	0.08	0.40		0.51		0.02		
grooved Tanner crab	9.10			0.10	12.84			0.07
Tanner crab								
triangle Tanner crab	4.34					98.13		0.20
scarlet king crab	4.80				5.40	2.92		1.27
golden king crab		2.31						
hermit crabs		0.04						
other crabs		0.88						
snails		0.01			0.06	0.36		0.90
clams								0.01
giant octopus								
other octopus								
magistrate armhook squid		0.57		0.63	0.67			
other squid	0.06				0.05			
sea stars, cucumbers, brittle stars	0.22	0.91		1.04	0.98	1.98		0.88
sponges	0.86				8.54			
other invertebrates		0.03		0.11				
Haul total weight (kg)	1246.00	3139.99		1547.45	1325.50	1348.00		808.73

Appendix Table 3. - - Continued.

Haul	73	74	75	76	77	78	79	80
Haul date	27-Jun-2008	27-Jun-2008	28-Jun-2008	28-Jun-2008	28-Jun-2008	28-Jun-2008	29-Jun-2008	29-Jun-2008
Tow start latitude	58.65734	58.61681	58.1184	58.25211	58.30918	58.35976	58.50317	58.66586
Tow start longitude	-174.86169	-175.1058	-175.53799	-175.5025	-175.3179	-175.44991	-177.8813	-177.9734
Tow end latitude	58.65716	58.60653	58.13594	58.26868	58.31097	58.35247	58.51424	58.65535
Tow end longitude	-174.8768	-175.1393	-175.5616	-175.524	-175.35741	-175.4117	-177.84959	-177.9402
Station ID	41-07	42-03	44-03	43-04	42-05	41-15	55-02	54-03
Bottom depth (m)	251	432	930	663	418	286	1184	866
Stratum designation	41	42	44	43	42	41	55	54
Tow duration (fraction of hour)	0.35	0.52	0.54	0.51	0.52	0.58	0.57	0.54
Distance of tow (nm)	1.407	2.325	2.475	2.301	2.370	2.467	2.306	2.332
Average net width (m)	16.24	17.67	19.17	17.21	16.57	15.57	17.37	17.03
Performance code	1.11	0	0	0	0	0	0	5
Surface temperature (°C)	5.4	5.9	6.1	6.3	6.4	6.1	5.8	5.7
Bottom temperature (°C)	2.8	3.7	2.9	3.4	3.8	3.4	2.5	3.1
Pacific sleeper shark								
Bering skate	3.90	86.13			2.02			
mud skate	1.90					1.32		
rougtail skate		0.02		2.92			3.62	16.58
Alaska skate	16.19	8.39						
Aleutian skate		433.00		12.90	2.58			1.57
Commander skate		10.51		24.48				5.08
whiteblotched skate					3.27	3.62		
whitebrow skate	2.20	34.73		0.60		0.01	0.65	0.44
other elasmobranchs & eggs	0.03		0.02	0.07		0.03		0.05
arrowtooth flounder	130.31	261.73			101.79	114.37		
Kamchatka flounder	2.00	52.07	4.05	11.77	31.26	5.60		
Greenland turbot		34.36		13.03	63.79			
Pacific halibut	27.66	69.32			30.74	64.68		
flathead sole	3.46	131.52			79.80	167.44		
rex sole	29.62	7.77			62.44	73.30		
other flatfish				3.96		1.92		
Pacific grenadier			22.76				18.45	12.86
giant grenadier		1361.85	908.54	3987.09	1459.16		247.34	2723.66
popeye grenadier			47.22	105.16			130.60	133.14
Pacific cod						6.42		
walleye pollock		2.45			0.90	1.96		
other gadoid fishes			1.62				2.45	1.32
blob sculpin			6.01				3.04	
bigmouth sculpin	15.82	20.52			2.97	5.10		
spinyhead sculpin		0.03						
darkfin sculpin	0.35				0.03	0.43		
other sculpins		0.06			0.03			
twoline eelpout		9.39	1.50	2.55				2.01
western eelpout								
ebony eelpout				6.00	1.82			
Bering eelpout		0.26						
other eelpouts								
sablefish		1.80		9.52	1.99			
blacktail snailfish				0.82				0.52
other snailfishes			0.44			0.29	1.77	0.64
poachers	1.17	1.15		0.05	0.05	0.13		
mesopelagic fishes			0.65	0.03	0.12	0.01	1.95	0.19
shortspine thornyhead		30.56		19.58	42.77			9.04
roughey rockfish								
blackspotted rockfish		1.53						
shortraker rockfish		45.00						
Pacific ocean perch	3.78	6.13			0.55	8.92		
other rockfish					0.92			
other fishes	4.08			0.56	1.08			0.33
jellyfishes		2.57	0.35				1.23	0.21
corals, sea whips, anemones	2.08	0.79	37.14		1.95	4.48	7.21	
Alaskan pink shrimp	1.25					0.42		
other shrimps	0.15	0.66	2.69		1.65	0.14	0.03	
grooved Tanner crab				1.42				
Tanner crab					0.18			
triangle Tanner crab			1.45	0.65			2.58	4.26
scarlet king crab								3.30
golden king crab								
hermit crabs		3.28	0.03	0.01				
other crabs						0.01	0.93	1.01
snails		5.72	2.15	0.12	0.47	0.13	1.73	0.92
clams								
giant octopus	2.90							
other octopus			8.61	0.51	0.04		3.17	1.60
magistrate armhook squid		6.44	0.15	0.81				
other squid					0.01	0.01	0.01	
sea stars, cucumbers, brittle stars	4.52	19.43	3.21	9.38	3.52	31.20	14.78	6.18
sponges	0.91	1.34	27.11					1.09
other invertebrates		1.48	0.29		0.10	0.03		
Haul total weight (kg)	254.28	2652.00	1076.00	4214.00	1898.00	492.00	441.54	2926.00

Appendix Table 3. - - Continued.

Haul	81	82	83	84	85	86	87	88
Haul date	29-Jun-2008	29-Jun-2008	29-Jun-2008	30-Jun-2008	30-Jun-2008	30-Jun-2008	30-Jun-2008	30-Jun-2008
Tow start latitude	58.76624	58.77858	58.93262	59.36095	59.36428	59.39707	59.41727	59.52314
Tow start longitude	-178.07381	-177.91141	-177.92171	-178.4662	-178.2511	-178.2272	-178.10609	-178.07851
Tow end latitude	58.7496	58.78964	58.93847	59.35193	59.3733	59.39276	59.41792	59.51934
Tow end longitude	-178.05431	-177.9431	-177.9398	-178.43291	-178.2906	-178.1893	-178.1515	-178.1194
Station ID	53-03	52-03	51-05	65-05	64-03	63-02	62-04	61-20
Bottom depth (m)	633	506	213	1089	838	669	538	228
Stratum designation	53	52	51	65	64	63	62	61
Tow duration (fraction of hour)	0.5	0.52	0.3	0.5	0.53	0.51	0.56	0.53
Distance of tow (nm)	2.248	2.292	1.284	2.207	2.540	2.262	2.638	2.424
Average net width (m)	18.13	17.85	15.73	17.35	18.25	17.01	17.66	17.76
Performance code	0	0	6	5	0	0	0	0
Surface temperature (°C)	6.2	5.9	5.7	6.1	6	6.1	6	5.5
Bottom temperature (°C)	3.5	3.7	2.7	2.7	3.1	3.3	3.6	2.7
Pacific sleeper shark								
Bering skate								9.78
mud skate								
rougtail skate	2.44			13.00	2.24			
Alaska skate			15.52					16.53
Aleutian skate		9.94				5.74	21.40	25.96
Commander skate	6.86	6.14		7.46	11.16	6.56	4.34	
whiteblotched skate		3.48	14.80				8.28	
whitebrow skate		2.78		0.42	0.26		5.90	2.41
other elasmobranchs & eggs	0.03	0.03						
arrowtooth flounder			21.68			1.88	13.20	67.78
Kamchatka flounder	5.86	21.94	5.04			11.26	46.84	15.26
Greenland turbot		4.18			7.56	23.72	38.74	1.24
Pacific halibut			44.64					15.46
flathead sole		2.36	6.56					9.92
rex sole		9.70	4.06					13.24
other flatfish	1.42					0.98		0.40
Pacific grenadier				22.14	2.78			
giant grenadier	1573.71	846.39		314.99	766.74	932.14	619.31	3.88
popeye grenadier	105.56			83.47	194.74	229.56		
Pacific cod			3.92					13.46
walleye pollock			207.46					727.13
other gadoid fishes				3.55				
blob sculpin				3.92				
bigmouth sculpin								5.54
spinyhead sculpin								
darkfin sculpin		0.01				0.15	0.01	
other sculpins			0.15			0.06	0.02	0.41
twoline eelpout	2.28			0.02	0.01	1.10		
western eelpout							2.47	
ebony eelpout		0.90		0.14			15.51	
Bering eelpout		0.25	0.25			0.11	0.86	
other eelpouts	0.12				0.19			
sablefish	14.98	6.30		9.06	24.54	18.51	3.04	
blacktail snailfish		2.51				0.94	0.62	
other snailfishes	0.01	0.25	0.06	1.76	0.05	0.54	0.05	0.04
poachers	0.03	0.25	0.65	0.15			0.08	1.09
mesopelagic fishes	0.22	0.08		1.27	0.24	0.12	0.12	
shortspine thornyhead	22.32	37.28				8.04	32.90	
roughey rockfish								
blackspotted rockfish								
shortraker rockfish								
Pacific ocean perch								
other rockfish								
other fishes	0.04	0.51		1.94	0.17			1.16
jellyfishes				0.23				0.05
corals, sea whips, anemones		1.35	1.05	12.93	0.40	1.62	5.70	4.54
Alaskan pink shrimp			0.58					2.38
other shrimps		0.04	0.01	0.06		0.06		
grooved Tanner crab		0.02				0.34	0.55	0.16
Tanner crab			0.17					
triangle Tanner crab	0.87		0.19	7.46	0.98	0.43		
scarlet king crab				15.04	1.15	0.03		
golden king crab		0.71					0.57	
hermit crabs	0.08	0.71				0.08	0.38	0.94
other crabs				11.85		0.12		0.40
snails	0.38		1.44	0.03	0.11	0.18	0.40	1.72
clams								
giant octopus								0.04
other octopus	0.59	0.39		1.17				
magistrate armhook squid	0.37	0.36	0.32			0.37	0.23	1.67
other squid	0.01	0.02	0.22			0.10		0.14
sea stars, cucumbers, brittle stars	19.11	13.27	4.21	11.81	0.34	2.91	36.01	1.67
sponges	0.15	0.28		0.82			0.57	
other invertebrates	0.56	0.30		0.02		0.29	0.18	3.60
Haul total weight (kg)	1758.00	972.71	332.97	524.73	1014.00	1248.17	862.89	948.00

Appendix Table 3. - - Continued.

Haul	89	90	91	92	93	94	95	96
Haul date	1-Jul-2008	1-Jul-2008	1-Jul-2008	1-Jul-2008	1-Jul-2008	2-Jul-2008	2-Jul-2008	2-Jul-2008
Tow start latitude	59.40166	59.19111	59.29689	59.40236	59.37115	60.12072	60.21761	60.36544
Tow start longitude	-177.8734	-177.94859	-177.6897	-177.7352	-177.6049	-179.491	-179.3495	-179.33031
Tow end latitude	59.38729	59.18326	59.31663	59.4225	59.39305	60.10412	60.20301	60.35178
Tow end longitude	-177.8446	-177.90379	-177.6687	-177.7485	-177.60519	-179.4785	-179.3822	-179.30141
Station ID	62-02	61-01	61-17	62-03	61-02	65-03	64-06	63-06
Bottom depth (m)	448	211	335	419	259	1103	944	750
Stratum designation	62	61	61	62	61	65	64	63
Tow duration (fraction of hour)	0.52	0.6	0.53	0.49	0.52	0.42	0.52	0.51
Distance of tow (nm)	2.358	2.774	2.575	2.432	2.462	2.036	2.499	2.274
Average net width (m)	17.12	15.98	16.47	16.93	17.13	18.30	17.80	17.45
Performance code	0	0	0	0	0	0	0	0
Surface temperature (°C)	6	5.3	5.7	5.6	5.8	6.7	6.6	5.5
Bottom temperature (°C)	3.7	3.6	3.6	3.6	3.1	2.8	2.8	2.9
Pacific sleeper shark								
Bering skate	0.62	3.39	2.16	0.03	6.93			
mud skate	0.32	5.02	10.04	13.10	6.42			
rougtail skate						12.29	13.14	2.72
Alaska skate		29.95		8.12	10.29			
Aleutian skate	31.37	20.26	49.90	45.50	13.24		5.78	5.32
Commander skate	5.70			3.42			6.44	11.50
whiteblotched skate	48.86	22.20	53.72	78.36	14.20			
whitebrow skate					6.21		0.54	0.34
other elasmobranchs & eggs	0.02	0.01		1.30	1.59			
arrowtooth flounder	54.03	135.31	1050.36	350.57	42.88			
Kamchatka flounder	51.75	43.78	340.76	67.60	17.67			
Greenland turbot	111.28		314.15	139.14				4.42
Pacific halibut	13.60	5.91		6.45				
flathead sole		62.32	116.36	3.58		6.18		
rex sole		7.16	6.93			1.00		
other flatfish		2.43						
Pacific grenadier						18.00		
giant grenadier	377.68			470.71		630.99	1266.63	642.84
poppeye grenadier						30.73	126.16	7.16
Pacific cod		36.36			2.78			
walleye pollock		1334.05			425.76			
other gadoid fishes						0.23		
blob sculpin								
bigmouth sculpin	4.07		4.60					
spinyhead sculpin					0.12			
darkfin sculpin		0.01	0.78	26.06	1.70			
other sculpins	0.02			2.12	0.18			
twoline eelpout	2.17							
western eelpout								
ebony eelpout	18.80		1.36	0.10				
Bering eelpout	0.49				0.20			
other eelpouts								
sablefish	1.36			7.48				7.80
blacktail snailfish								
other snailfishes	0.12		1.31	0.56	1.25	1.00	1.23	1.04
poachers	0.04	0.26	0.04	0.02	1.29			
mesopelagic fishes	0.08	0.06	0.02	0.12		1.62	0.50	0.25
shortspine thornyhead	4.60							5.11
roughey rockfish								
blackspotted rockfish		0.03						
shortraker rockfish				2.56				
Pacific ocean perch			12.12		1.44			
other rockfish								
other fishes		0.12	1.97	1.37				0.81
jellyfishes						0.92	0.50	0.08
corals, sea whips, anemones	251.85	2.66	10.86	25.88	7.49	4.60	5.61	
Alaskan pink shrimp		0.21			1.39			
other shrimps	0.08	0.01	0.21	0.39		0.02	0.02	0.01
grooved Tanner crab	3.23			0.10				
Tanner crab		1.23			0.22			
triangle Tanner crab						8.38	20.95	12.92
scarlet king crab								6.54
golden king crab			7.48	4.12	1.10			
hermit crabs	0.13	0.18			0.15		0.01	
other crabs		0.03			0.08			
snails	0.02	0.30	0.10		0.62	4.67	0.19	0.02
clams								
giant octopus	0.64	0.28			0.05			
other octopus								
magistrate armhook squid	0.16			0.30	0.27			
other squid	0.06	0.07	0.07	0.07	0.04			
sea stars, cucumbers, brittle stars	1.87	1.14	0.68	4.89	5.80	3.56	2.39	1.01
sponges	0.33	17.24			2.10			
other invertebrates	0.09	0.02			0.11	0.21		
Haul total weight (kg)	985.45	1732.00	1986.00	1264.00	580.74	717.22	1450.09	709.89

Appendix Table 3. - - Continued.

Haul	97	98	99	100	101	102	103	104
Haul date	2-Jul-2008	2-Jul-2008	3-Jul-2008	3-Jul-2008	3-Jul-2008	3-Jul-2008	3-Jul-2008	4-Jul-2008
Tow start latitude	60.43556	60.49807	60.60577	60.34864	60.31988	60.2491	60.38969	60.20054
Tow start longitude	-179.0442	-178.8443	-178.82159	-178.7941	-178.6835	-178.4951	-178.66521	-179.2104
Tow end latitude	60.42536	60.48056	60.58359	60.33224	60.33811	60.22886	60.40868	60.22039
Tow end longitude	-179.0097	-178.8136	-178.8134	-178.77049	-178.71159	-178.5022	-178.6869	-179.2187
Station ID	62-12	61-15	61-16	62-11	61-18	61-13	61-14	65-02
Bottom depth (m)	470	292	235	464	383	214	299	1052
Stratum designation	62	61	61	62	61	61	61	65
Tow duration (fraction of hour)	0.5	0.55	0.52	0.5	0.52	0.5	0.5	0.53
Distance of tow (nm)	2.276	2.662	2.571	2.311	2.621	2.346	2.505	2.324
Average net width (m)	16.93	16.95	17.55	17.35	17.93	15.77	16.87	16.93
Performance code	0	0	0	0	0	0	0	0
Surface temperature (°C)	5.8	5.9	5.2	5.8	5.7	5.7	5.4	6.2
Bottom temperature (°C)	3.4	2.5	2.4	3.4	3.6	3.2	3.4	2.9
Pacific sleeper shark						17.98		
Bering skate		2.90	6.15	1.06	0.80	3.42	2.30	
mud skate	1.80			4.22	12.12	2.14	0.74	
rougtail skate								7.15
Alaska skate		367.76	143.07		1.58	7.40	37.06	
Aleutian skate	23.06				80.95	92.35	398.06	1.04
Commander skate	7.60			1.85				9.30
whiteblotched skate	18.02	7.12		14.12	91.76	1.60	88.98	
whitebrow skate	0.52	4.36	1.39				6.68	0.16
other elasmobranchs & eggs		0.41	0.05				0.09	
arrowtooth flounder	1.74	85.50	77.95	2.50	40.20	204.60	574.71	
Kamchatka flounder		12.12	43.17		4.20	81.14	83.14	
Greenland turbot	21.18	28.86	31.32	3.66	123.82	1.86	229.69	
Pacific halibut			5.62		11.16	59.50	9.20	
flathead sole		11.52	20.81		2.70	34.20	103.46	
rex sole		0.03				1.35	1.16	
other flatfish			2.50			0.55		
Pacific grenadier								15.96
giant grenadier	109.06			1736.23	41.05			1667.43
popeye grenadier	0.56							19.75
Pacific cod			29.88			31.56		
walleye pollock		30.22	55.33			411.63		
other gadoid fishes								1.33
blob sculpin								
bigmouth sculpin		9.24	16.07		3.96	11.64	5.68	
spinyhead sculpin		0.74					0.07	
darkfin sculpin		1.50		0.02	8.64	0.54	12.41	
other sculpins		0.17	2.56	0.02	0.03	0.04	0.04	
twoline eelpout								
western eelpout								
ebony eelpout	34.44			11.52	11.50			
Bering eelpout	0.23	0.11					0.08	
other eelpouts		0.01						
sablefish	7.18			13.05	2.62		2.10	13.58
blacktail snailfish								
other snailfishes		1.02	0.84	9.45			2.82	0.43
poachers		0.10	0.02			0.58	0.01	
mesopelagic fishes	0.35			0.23				0.88
shortspine thornyhead	0.27	0.36		19.90				
roughey rockfish								
blackspotted rockfish								
shortraker rockfish								
Pacific ocean perch		276.87				0.03	15.86	
other rockfish				0.48				
other fishes		0.82					1.61	1.43
jellyfishes				0.10				0.18
corals, sea whips, anemones	1.24	67.90	21.12	0.03	0.55	7.10	10.59	0.88
Alaskan pink shrimp		3.47	0.73			0.05	0.65	
other shrimps		0.23				0.01	0.51	
grooved Tanner crab	8.35			0.13	0.11			
Tanner crab		2.34	2.87			2.47	6.08	
triangle Tanner crab	0.32	0.07						0.31
scarlet king crab								9.66
golden king crab							0.28	
hermit crabs		0.08	0.35			0.08	0.37	
other crabs		0.99				0.04		1.36
snails		0.30	0.97		0.20	0.31	81.63	0.15
clams								
giant octopus								
other octopus		0.18	0.09			0.07	0.14	
magistrate armhook squid	1.32	0.35	0.30					
other squid		0.71	0.18		0.13	0.10	0.13	
sea stars, cucumbers, brittle stars	1.13	23.69	22.63	0.34	0.15	3.73	15.65	2.70
sponges		1.03	10.42		0.60	4.11		0.32
other invertebrates		5.08	1.74	0.09			1.02	
Haul total weight (kg)	238.36	948.16	498.11	1819.00	438.84	982.18	1693.00	1754.00

Appendix Table 3. - - Continued.

Haul	105	106	107	108	109	110	111	112
Haul date	4-Jul-2008	4-Jul-2008	5-Jul-2008	5-Jul-2008	5-Jul-2008	5-Jul-2008	5-Jul-2008	6-Jul-2008
Tow start latitude	60.24265	60.24936	60.20296	60.18257	60.08575	60.09017	60.05998	59.92422
Tow start longitude	-179.15919	-179.0327	-178.9314	-178.8486	-179.0174	-179.0703	-179.1488	-178.94051
Tow end latitude	60.26362	60.26855	60.21351	60.17149	60.06447	60.06924	60.0398	59.90702
Tow end longitude	-179.16859	-179.0233	-178.911	-178.8878	-179.0163	-179.07249	-179.14461	-178.9171
Station ID	64-04	63-05	62-10	61-12	61-11	61-21	62-09	62-08
Bottom depth (m)	882	714	538	388	242	340	563	419
Stratum designation	64	63	62	61	61	61	62	62
Tow duration (fraction of hour)	0.5	0.48	0.34	0.51	0.51	0.53	0.47	0.49
Distance of tow (nm)	2.450	2.271	1.684	2.569	2.396	2.371	2.291	2.389
Average net width (m)	18.38	17.60	17.19	16.14	16.71	16.44	17.32	17.43
Performance code	0	0	0	0	0	6	0	0
Surface temperature (°C)	6.1	6.3	5.9	6.1	5.3	5.6	6.2	5.6
Bottom temperature (°C)	3.2	3.5	3.8	3.3	2.6	3.8	3.6	3.7
Pacific sleeper shark				7.33	30.80			
Bering skate				0.02	9.88	2.16		11.34
mud skate			2.43	8.91	6.02			1.09
rougtail skate								
Alaska skate				0.07	64.14	13.56		44.77
Aleutian skate	4.58	9.30	10.48	4.00		7.50	3.64	80.94
Commander skate	22.22	30.02	3.36				5.80	15.88
whiteblotched skate			7.54	5.26		7.88		50.36
whitebrow skate		1.66				3.71	0.10	24.16
other elasmobranchs & eggs		0.05	0.01	0.42		0.30		0.01
arrowtooth flounder			18.87	1271.54	39.58	357.38		415.00
Kamchatka flounder		2.83	8.80	183.26	7.12	18.82	3.92	22.85
Greenland turbot	19.42	2.86	65.52	15.73		105.24	34.06	73.47
Pacific halibut				2.11	15.37			
flathead sole				4.61	7.35	308.89		74.12
rex sole				1.81	9.08	16.00		11.70
other flatfish	0.83	1.35			2.89			0.67
Pacific grenadier	0.75							
giant grenadier	1271.48	7722.73	957.36			84.46	2111.83	256.78
popeye grenadier	13.66	1.85					85.09	
Pacific cod					16.02			
walleye pollock				1.07	38.57	17.34		
other gadoid fishes	0.29						0.84	
blob sculpin								
bigmouth sculpin				7.41	6.23	10.78		
spinyhead sculpin						0.32		0.79
darkfin sculpin			1.55	28.40	1.02	4.80		2.25
other sculpins		0.73	0.15	0.18	2.38	0.07		0.11
twoline eelpout	0.36		2.85				0.12	
western eelpout							7.54	17.12
ebony eelpout	0.27		20.80					
Bering eelpout			0.06		0.30	0.78	2.67	1.29
other eelpouts								
sablefish		9.86	10.12	2.26			18.36	2.40
blacktail snailfish								
other snailfishes	3.14	5.93	1.38			3.39	1.02	10.32
poachers					0.81	0.11	0.05	0.05
mesopelagic fishes	0.26	0.05	0.04			0.02	0.18	0.30
shortspine thornyhead		4.00	14.26				7.50	12.93
roughey rockfish								
blackspotted rockfish								
shortraker rockfish				1.71				1.71
Pacific ocean perch				3.24		6.18		1.32
other rockfish								
other fishes	2.78	0.04	0.72	0.11		0.19	0.99	0.30
jellyfishes	0.09				0.07	0.14		
corals, sea whips, anemones	18.38	0.14	0.68	15.39	23.76	200.79	1.32	61.07
Alaskan pink shrimp				0.43	0.67	4.15		2.81
other shrimps		0.02	0.04	0.34		0.31	0.04	3.11
grooved Tanner crab				0.10			4.36	
Tanner crab						0.66		7.03
triangle Tanner crab	9.32	8.00	1.01				1.45	
scarlet king crab	7.42	12.86						
golden king crab			0.14			0.39		0.49
hermit crabs					0.06		0.26	2.88
other crabs				0.06		0.18		3.46
snails	0.03	0.15			0.25	1.49	1.13	2.26
clams								
giant octopus				6.86		6.86		1.60
other octopus	0.80	0.44						0.08
magistrate armhook squid			3.52	1.59		1.04		5.79
other squid		0.36			0.31	0.38	0.05	0.39
sea stars, cucumbers, brittle stars	1.11	2.78	0.62	8.02	1.20	16.70	6.27	64.32
sponges	1.80			958.84	1.17	0.13		
other invertebrates	0.03			0.05	0.20	0.18	0.39	1.07
Haul total weight (kg)	1379.00	7818.00	1132.33	2541.10	285.25	1203.28	2299.00	1290.38

Appendix Table 3. - - Continued.

Haul	113	114	115	116	117	118	119	120
Haul date	6-Jul-2008	6-Jul-2008	6-Jul-2008	6-Jul-2008	7-Jul-2008	7-Jul-2008	7-Jul-2008	7-Jul-2008
Tow start latitude	59.85213	59.8078	59.77732	59.72477	59.57978	59.63857	59.53937	59.48424
Tow start longitude	-178.79041	-178.7408	-178.6521	-178.649	-178.5107	-178.4622	-178.4272	-178.2701
Tow end latitude	59.86816	59.82377	59.79617	59.70966	59.58353	59.65658	59.56229	59.50076
Tow end longitude	-178.81799	-178.7661	-178.67889	-178.6223	-178.5088	-178.48599	-178.4248	-178.29649
Station ID	61-09	62-07	61-08	63-04	64-07	61-07	62-05	61-06
Bottom depth (m)	248	473	219	622	875	327	454	265
Stratum designation	61	62	61	63	64	61	62	61
Tow duration (fraction of hour)	0.51	0.5	0.55	0.49	0.41	0.54	0.55	0.52
Distance of tow (nm)	2.442	2.351	2.663	2.317	1.065	2.491	2.612	2.451
Average net width (m)	17.16	17.14	16.64	17.66	18.53	17.70	18.34	17.93
Performance code	0	0	5	6.12	-1.2	0	5	0
Surface temperature (°C)	5.7	5.5	6.2	6.6	6.9	6.4	6.6	6.4
Bottom temperature (°C)	3.2	3.7	2.4	3.5	3.1	3.6	3.7	2.8
Pacific sleeper shark						21.90		
Bering skate	6.71	6.12	4.32			9.37	2.04	3.96
mud skate	0.85							
rougtail skate								
Alaska skate	35.43		49.77					15.85
Aleutian skate	27.78	46.34	16.90	11.14		28.10	10.68	29.26
Commander skate		8.11		2.62			6.92	
whiteblotched skate		11.33				2.52	6.48	
whitebrow skate	1.12	19.20	2.12			7.76	12.02	4.96
other elasmobranchs & eggs	0.08	0.01	0.04			0.24		
arrowtooth flounder	107.97	150.15	79.30			543.62	31.48	74.22
Kamchatka flounder	12.32	12.31	9.28	37.09		29.40	7.80	6.74
Greenland turbot	6.01	48.98		7.94		54.86	3.90	
Pacific halibut	4.80					7.42	6.58	7.08
flathead sole	11.08		17.86			73.88	53.40	43.47
rex sole	8.00	0.47	19.32			1.62		19.76
other flatfish								
Pacific grenadier								
giant grenadier		729.31		266.64		5.80	825.54	
popeye grenadier		5.14		201.62			0.09	
Pacific cod			10.72			3.08		9.60
walleye pollock	123.12		368.28			47.96		287.66
other gadoid fishes				0.29				
blob sculpin								
bigmouth sculpin		0.23	2.78			5.06		1.44
spinyhead sculpin	0.34	0.58	0.02			1.02	0.13	0.06
darkfin sculpin	0.52		0.11			1.55	0.23	0.10
other sculpins	0.25		1.94					0.03
twoline eelpout		2.20		1.10				
western eelpout		23.41		10.64				
ebony eelpout				1.42				
Bering eelpout	0.51	1.75	0.11	1.11		1.01	0.59	
other eelpouts		0.04		0.96				
sablefish		7.05					10.06	
blacktail snailfish				4.48				
other snailfishes	2.80	2.91	0.02	0.16		2.19	0.35	
poachers	0.90	0.34	1.55	0.34		0.82	0.06	0.09
mesopelagic fishes		1.08		0.32				
shortspine thornyhead		6.62		28.40		1.75	8.68	
roughey rockfish								
blackspotted rockfish								
shortraker rockfish						11.34		
Pacific ocean perch						2.50		0.86
other rockfish				0.74			11.30	
other fishes				0.12			0.66	
jellyfishes	0.47		0.23			0.02	0.24	0.11
corals, sea whips, anemones	2.95	0.49	3.10	0.17		16.71	1.45	8.39
Alaskan pink shrimp	8.06		4.33	0.01		7.78		3.12
other shrimps	0.02	1.90		0.19		3.03	0.90	
grooved Tanner crab		0.27		4.00				
Tanner crab	0.20	0.11	0.90					
triangle Tanner crab		0.96		17.28				
scarlet king crab				0.07				
golden king crab	0.53	1.49					0.09	
hermit crabs	0.92	4.19	1.50	1.05		3.76	1.18	1.75
other crabs	0.21							
snails	0.83	4.64	0.63	5.85		6.70	1.60	6.08
clams								
giant octopus		5.56				6.90		0.02
other octopus		0.12		0.04		0.07		
magistrate armhook squid	0.62	0.99	0.38	2.43		0.93	1.48	
other squid	0.44	0.05	0.23					0.46
sea stars, cucumbers, brittle stars	1.00	329.74	1.89	26.70		35.74	40.77	22.79
sponges			0.82	0.18		0.21	0.01	0.81
other invertebrates	2.01	6.82	2.78	0.13		2.41	1.80	2.77
Haul total weight (kg)	368.83	1441.00	601.23	635.23		949.02	1048.50	551.44

Appendix Table 3. - - Continued.

Haul	121	122	123	124	125	126	127	128
Haul date	8-Jul-2008	8-Jul-2008	8-Jul-2008	8-Jul-2008	9-Jul-2008	9-Jul-2008	9-Jul-2008	10-Jul-2008
Tow start latitude	59.3247	59.33917	58.90047	58.6071	58.58193	58.62089	58.52421	57.65426
Tow start longitude	-178.3819	-178.0869	-178.07961	-177.96271	-177.70039	-177.25301	-176.8127	-174.20641
Tow end latitude	59.33392	59.33576	58.9159	58.60564	58.58603	58.62959	58.52934	57.64643
Tow end longitude	-178.3445	-178.1273	-178.10851	-177.92059	-177.7377	-177.28951	-176.8521	-174.19949
Station ID	64-05	63-01	52-04	54-04	55-01	51-06	54-02	41-12
Bottom depth (m)	866	624	415	922	1005	268	836	246
Stratum designation	64	63	52	54	55	51	54	41
Tow duration (fraction of hour)	0.53	0.53	0.51	0.55	0.5	0.51	0.51	0.21
Distance of tow (nm)	2.427	2.386	2.469	2.508	2.267	2.388	2.436	0.997
Average net width (m)	18.45	17.59	18.11	17.46	18.03	16.14	18.61	16.69
Performance code	5	0	0	0	6.12	5.1	5.1	0
Surface temperature (°C)	6.3	6	6.6	6.8	6.6	6.5	6.6	7.1
Bottom temperature (°C)	3.1	3.5	3.8	3	2.9	2.9	3.1	2.7
Pacific sleeper shark								
Bering skate			2.24			1.92		1.94
mud skate		1.16				1.74		
rougtail skate	7.80			15.50			2.81	
Alaska skate						8.98		4.90
Aleutian skate	1.68	4.46	2.80			59.32		15.84
Commander skate	11.98	56.56	8.68	4.10			4.08	
whiteblotched skate		6.42	8.28			5.50		
whitebrow skate	2.16	3.32					0.30	
other elasmobranchs & eggs		0.01			0.01	0.01	0.11	0.03
arrowtooth flounder		2.44	48.22			77.74		29.42
Kamchatka flounder	4.86	20.32	18.69			7.98		8.68
Greenland turbot	6.34	35.18	26.23	7.94				2.90
Pacific halibut			11.32			6.41		13.41
flathead sole			128.12			133.26		35.60
rex sole			79.20			2.28		0.39
other flatfish	1.72			1.72			6.11	
Pacific grenadier	5.06			22.14	30.34		10.91	
giant grenadier	1127.29	980.84	157.44	622.46	666.13		779.54	
popeye grenadier	240.62	122.24		92.96	47.32		82.19	
Pacific cod						14.02		27.40
walleye pollock						228.12		2.48
other gadoid fishes	1.72			2.24	3.14		1.55	0.00
blob sculpin				15.04	7.18			
bigmouth sculpin			9.82					
spinyhead sculpin			0.03			0.01		
darkfin sculpin			0.02			0.30		0.03
other sculpins		0.12				0.06		0.60
twoline eelpout		2.28						
western eelpout								
ebony eelpout	0.11	5.62						
Bering eelpout		0.44						
other eelpouts	0.32							
sablefish	2.76	17.50		3.80			8.98	
blacktail snailfish	1.53	0.27		0.16			0.03	
other snailfishes	0.95	0.24		0.15	0.52		0.16	
poachers	0.05		0.11			0.70	0.03	0.10
mesopelagic fishes	0.59	0.31	0.05	0.68	0.41		0.42	
shortspine thornyhead	5.68	21.12	44.54	2.02			1.22	
roughey rockfish								
blackspotted rockfish			2.60					
shortraker rockfish								
Pacific ocean perch						19.04		2692.31
other rockfish								
other fishes	3.25	2.72	0.21	2.04	1.25		0.02	
jellyfishes				0.35	0.00		0.32	
corals, sea whips, anemones	0.65	1.33	50.67	0.74	14.93	5.68	0.91	0.25
Alaskan pink shrimp						1.96		0.15
other shrimps	0.88		1.17	1.21	0.26		0.09	
grooved Tanner crab	5.90	0.31	0.27	0.05			0.15	
Tanner crab								0.01
triangle Tanner crab	2.44	1.03	0.01	3.72	0.89		0.28	
scarlet king crab	13.92	0.13						
golden king crab								2.85
hermit crabs		0.02	0.57					
other crabs					1.39	0.01	1.08	
snails	0.11		0.65	0.31	0.09	0.01	1.21	0.41
clams								
giant octopus								
other octopus		0.20	3.59	0.34	1.03			
magistrate armhook squid		0.93	0.99			0.38		3.18
other squid			0.07	0.31	0.08	2.34		
sea stars, cucumbers, brittle stars	4.68	1.43	41.75	2.31	20.36	1.89	18.44	2.27
sponges	2.92	0.75		0.46	98.73			
other invertebrates	0.02	0.05		0.03	0.05		0.06	
Haul total weight (kg)	1458.00	1289.74	648.35	802.80	894.12	579.67	921.00	2845.14

Appendix Table 3. - - Continued.

Haul	129	130	131	132	133	134	135	136
Haul date	10-Jul-2008	10-Jul-2008	10-Jul-2008	19-Jul-2008	19-Jul-2008	19-Jul-2008	19-Jul-2008	20-Jul-2008
Tow start latitude	57.7963	57.84971	57.79047	54.28151	54.56321	54.65522	55.0198	55.97305
Tow start longitude	-174.1976	-173.8629	-173.87379	-167.7847	-167.5547	-167.70309	-167.7287	-169.5634
Tow end latitude	57.80324	57.86181	57.77394	54.27754	54.58372	54.6385	55.03547	55.97667
Tow end longitude	-174.2217	-173.89639	-173.8942	-167.7442	-167.5703	-167.7153	-167.75681	-169.54559
Station ID	41-01	41-04	43-01	15-10	13-12	14-06	12-46	24-02
Bottom depth (m)	338	362	635	1017	685	821	485	809
Stratum designation	41	41	43	15	13	14	12	24
Tow duration (fraction of hour)	0.35	0.52	0.51	0.6	0.55	0.44	0.54	0.3
Distance of tow (nm)	1.673	2.495	2.284	2.728	2.583	2.087	2.586	1.218
Average net width (m)	17.02	16.64	16.77	19.08	18.54	18.29	17.76	19.97
Performance code	0	4.1	4.1	0	0	0	0	6.12
Surface temperature (°C)	6.8	7.1	6.9	6	7.6	7.6	7.6	7.3
Bottom temperature (°C)	3.4	3.3	3.4	2.8	3.3	3.1	3.6	3.1
Pacific sleeper shark		18.48			4.62	5.07		
Bering skate		0.53					6.64	2.98
mud skate	12.14		1.96					
rougtail skate				9.09	7.51	20.83	1.19	4.55
Alaska skate								
Aleutian skate	54.57	4.87	22.25		2.52	4.62		19.85
Commander skate			31.16					
whiteblotched skate		5.67	13.38					
whitebrow skate		2.53			0.71	3.45		2.80
other elasmobranchs & eggs					0.07	0.04	0.13	0.08
arrowtooth flounder	239.95	177.05	1.40				13.48	2.56
Kamchatka flounder	10.66	18.93	20.20	3.03	9.56	26.94	29.38	39.39
Greenland turbot	6.08	7.61	29.14	10.26	7.30	16.56	17.08	15.43
Pacific halibut	17.87	14.38						
flathead sole	14.75	14.48						
rex sole	23.72	13.92						
other flatfish						1.18		
Pacific grenadier				32.94	0.12			
giant grenadier			814.20	359.17	797.58	644.37	313.64	257.58
popeye grenadier			143.24	73.00	32.33	104.79	1.10	55.96
Pacific cod	24.58	11.98						
walleye pollock		0.97						
other gadoid fishes				1.16				
blob sculpin				5.36				
bigmouth sculpin	9.00	77.07						
spinyhead sculpin								
darkfin sculpin	0.82	0.64					0.15	
other sculpins		0.05	0.13					
twoline eelpout			4.26	0.05	3.20	3.46		2.01
western eelpout				1.31	6.60	0.03	46.69	8.64
ebony eelpout			29.58					
Bering eelpout					0.11	0.31		0.53
other eelpouts					0.01		0.01	
sablefish			22.46		88.03	6.26	19.42	9.45
blacktail snailfish		0.66			0.70	2.02		2.79
other snailfishes	0.01	0.03	0.94	1.95	1.98	0.34		0.15
poachers		0.11			0.19	0.05		0.12
mesopelagic fishes		0.01	0.09	1.72	0.49	2.02	0.25	0.15
shortspine thornyhead	2.44		50.32		32.20	7.98	30.82	33.21
roughey rockfish								
blackspotted rockfish	1.39	5.38					1.16	
shortraker rockfish	105.60	179.04						
Pacific ocean perch	244.95	31.10						
other rockfish						0.65		
other fishes	0.02	0.43					0.04	0.84
jellyfishes				0.08	0.15	0.32		0.96
corals, sea whips, anemones	0.20	9.09	0.01				5.79	0.24
Alaskan pink shrimp	2.60	3.82						
other shrimps	0.95	2.73	0.02	0.74	0.04	0.23	0.51	0.04
grooved Tanner crab			0.01	0.30	4.23	1.36		34.46
Tanner crab	0.21	0.29						
triangle Tanner crab				20.42	5.38	12.24	0.75	0.64
scarlet king crab			4.30					
golden king crab	14.68		7.10				0.27	
hermit crabs	0.08		0.05	0.05	0.14	0.04	0.08	0.03
other crabs	3.36							
snails	0.07			0.67	1.18	0.59	4.71	0.20
clams		0.00						
giant octopus								
other octopus				0.08	0.02	0.62	0.07	0.37
magistrate armhook squid	0.36	0.49			2.80	1.82	4.48	1.54
other squid				0.20		0.64	0.18	
sea stars, cucumbers, brittle stars	0.60	6.65	1.21	3.56	2.04	2.25	31.64	10.61
sponges	33.40	0.36	0.44		0.04	0.33	2.27	0.14
other invertebrates		0.19			0.06	0.02	0.81	
Haul total weight (kg)	825.05	609.55	1197.86	525.14	1011.92	871.43	532.73	508.30

Appendix Table 3. - - Continued.

Haul	137	138	139	140	141	142	143	144
Haul date	20-Jul-2008	20-Jul-2008	21-Jul-2008	21-Jul-2008	21-Jul-2008	21-Jul-2008	22-Jul-2008	22-Jul-2008
Tow start latitude	56.14858	56.17787	56.56688	56.48874	56.55445	56.46399	57.01237	57.05104
Tow start longitude	-169.4695	-169.7365	-172.32829	-172.2812	-172.4879	-172.7616	-173.98039	-173.7971
Tow end latitude	56.13419	56.19212	56.56736	56.49601	56.54127	56.45807	56.99603	57.06789
Tow end longitude	-169.43781	-169.7442	-172.3662	-172.32111	-172.49969	-172.72771	-173.95731	-173.82159
Station ID	23-03	21-06	33-03	34-02	32-02	34-09	34-01	32-05
Bottom depth (m)	600	226	611	999	462	852	844.00	521
Stratum designation	23	21	33	34	32	34	34	32
Tow duration (fraction of hour)	0.56	0.39	0.53	0.61	0.37	0.49	0.51	0.51
Distance of tow (nm)	2.606	1.721	2.378	2.663	1.693	2.252	2.367	2.463
Average net width (m)	16.83	16.28	18.45	17.40	17.56	17.07	18.027	17.15
Performance code	6.12	0	0	6.12	0	4.1	0	0
Surface temperature (°C)	7.4	6.6	6.8	7.4	7	7.7	8.3	7.8
Bottom temperature (°C)	3.2	3.4	3.6	2.8	3.7	3	3.1	3.7
Pacific sleeper shark								24.50
Bering skate								3.98
mud skate		2.23						
rougtail skate				15.52			15.64	
Alaska skate								
Aleutian skate	51.44	49.37	25.83	1.98		13.24	20.04	21.76
Commander skate	30.94		8.89	8.92		6.20	6.56	
whiteblotched skate	59.72	4.30				2.26		
whitebrow skate	1.54		3.36	1.72		1.76	2.50	
other elasmobranchs & eggs	0.15	2.28				0.01		
arrowtooth flounder	2.21	407.10	24.50		28.82			5.74
Kamchatka flounder	65.60	1.24	18.80		20.56	9.55	2.44	11.18
Greenland turbot	6.97		57.80	28.74				12.70
Pacific halibut	36.12	34.74						
flathead sole		12.13			7.56			211.95
rex sole		10.85			42.50	2.42		10.08
other flatfish				1.21		1.85		
Pacific grenadier				38.10			6.16	
giant grenadier	6589.84		2062.58	1431.64	1087.44	1042.95	2405.58	919.94
popeye grenadier	0.46		156.78	196.34	2.58	315.63	200.38	31.26
Pacific cod		47.36						
walleye pollock	1.06							
other gadoid fishes				0.47			1.77	
blob sculpin				4.02			25.70	
bigmouth sculpin	0.54	4.48	3.42		6.44			2.30
spinyhead sculpin					0.09			
darkfin sculpin	11.14	54.92			0.01			
other sculpins	4.99	0.03			0.03			
twoline eelpout	3.46					3.82		1.53
western eelpout	6.24							
ebony eelpout			1.18					0.27
Bering eelpout	0.08		0.24		0.15	0.29		0.55
other eelpouts								
sablefish	7.98		18.54	3.48		23.04	17.56	3.34
blacktail snailfish			2.76		1.30	0.14	0.23	1.23
other snailfishes	0.91		0.01	0.77	0.59	0.70	0.21	0.17
poachers	0.05	0.04	0.07				0.02	
mesopelagic fishes			0.02	0.38	0.13		0.36	0.12
shortspine thornyhead	34.96		57.60		44.98	19.18	5.82	14.10
roughey rockfish								
blackspotted rockfish		24.49			3.94			
shortraker rockfish	3.86				2.10			
Pacific ocean perch		607.24			1.40			
other rockfish		0.59						
other fishes		53.44	2.80				1.31	
jellyfishes	1.59	0.43	7.34	1.17	0.48			
corals, sea whips, anemones	0.31	2.29	1.24		3.10	1.87	0.22	1.12
Alaskan pink shrimp		0.18						
other shrimps	0.73	0.49			0.66		0.03	
grooved Tanner crab	0.13		3.81	0.22	0.61	0.17	1.81	1.79
Tanner crab								
triangle Tanner crab					0.17		3.78	0.11
scarlet king crab							1.30	
golden king crab	11.57	10.98			1.84			
hermit crabs			0.66		0.10		0.01	
other crabs	0.00	0.01		16.32				
snails	0.41	1.79	0.63		0.20		0.07	
clams								
giant octopus		2.68						
other octopus	0.16		9.91	1.27			2.30	
magistrate armhook squid					1.71		0.49	
other squid		0.36						
sea stars, cucumbers, brittle stars	1.34	1.64	22.80	5.08	4.04	2.21	3.69	2.54
sponges	0.90	84.50	0.24	0.65		6.07		
other invertebrates		0.38	0.20		0.03			
Haul total weight (kg)	6937.40	1422.56	2492.00	1758.00	1263.58	1453.34	2726.00	1282.26

Appendix Table 3. - - Continued.

Haul	145	146	147	148	149	150	151	152
Haul date	22-Jul-2008	22-Jul-2008	22-Jul-2008	23-Jul-2008	23-Jul-2008	23-Jul-2008	23-Jul-2008	24-Jul-2008
Tow start latitude	57.1398	57.14098	57.21413	58.42464	58.49706	58.33851	58.27023	58.56941
Tow start longitude	-173.8597	-173.9539	-173.9209	-174.53259	-174.82291	-175.075	-175.1006	-176.69341
Tow end latitude	57.15962	57.12203	57.19267	58.40911	58.48014	58.35704	58.28991	58.56503
Tow end longitude	-173.8754	-173.9379	-173.92329	-174.5072	-174.80251	-175.06979	-175.09039	-176.66229
Station ID	31-08	33-08	32-06	41-05	45-02	42-04	43-03	52-02
Bottom depth (m)	334	645	413	326	1070	589	676	470
Stratum designation	31	33	32	41	45	42	43	52
Tow duration (fraction of hour)	0.52	0.51	0.54	0.52	0.56	0.46	0.49	0.41
Distance of tow (nm)	2.482	2.389	2.433	2.364	2.336	2.156	2.336	1.920
Average net width (m)	16.68	17.64	16.03	17.056	18.39	19.48	17.59	17.05
Performance code	0	0	0	0	0	0	0	0
Surface temperature (°C)	8.1	8.2	486.1	8.1	7.3	8.3	8.6	8
Bottom temperature (°C)	3.5	3.4	232	3.4	2.8	3.6	3.4	3.8
Pacific sleeper shark								
Bering skate	1.15		0.12	15.56		0.03		2.26
mud skate	3.57		1.85				1.33	1.18
rougtail skate					8.92			
Alaska skate				6.14				
Aleutian skate		28.88	15.34	59.11	8.04	12.14	17.08	2.04
Commander skate		18.12		3.24		15.02	17.56	
whiteblotched skate							7.15	
whitebrow skate		6.29		17.87		5.04		
other elasmobranchs & eggs				0.19		0.01	0.02	0.01
arrowtooth flounder	13.82	1.30	22.54	551.79				103.34
Kamchatka flounder	4.90	18.95	12.50	23.40		13.71	11.75	5.56
Greenland turbot		22.87	13.28	18.00		37.74	8.52	49.00
Pacific halibut				36.94				
flathead sole	92.95		168.27	83.15				44.26
rex sole	9.08		37.94	77.29				8.16
other flatfish						3.37	21.46	
Pacific grenadier					109.36			
giant grenadier		1567.80	486.10	853.46	497.70	1290.03	939.19	1468.93
popeye grenadier		270.60			243.36	79.21	160.58	0.52
Pacific cod				23.56				
walleye pollock	8.98			8.22				
other gadoid fishes		1.42			0.49			
blob sculpin					14.44			
bigmouth sculpin	7.46		12.06	43.23		6.23		
spinyhead sculpin	0.01			3.40				0.03
darkfin sculpin	0.03			1.16		0.54		0.09
other sculpins			0.03					
twoline eelpout		9.44		2.70	0.50	5.35	5.01	4.18
western eelpout		3.74				6.18	1.16	
ebony eelpout			0.88			8.29	13.56	
Bering eelpout	0.37	0.08	0.48					
other eelpouts					0.03		0.14	
sablefish		27.54				16.09	13.26	19.36
blacktail snailfish		2.41		2.37	0.98			
other snailfishes		0.21			1.27	0.36	0.51	0.05
poachers	0.01	0.14	0.02	0.27		0.67	0.04	0.01
mesopelagic fishes	0.01	0.07	0.07		0.59	0.02	0.58	0.07
shortspine thornyhead		22.64	3.71			54.21	35.12	51.90
roughey rockfish				1.70				
blackspotted rockfish								
shortraker rockfish	0.85		24.96					
Pacific ocean perch	95.66			10.76				0.56
other rockfish								
other fishes			0.52		0.26			1.50
jellyfishes	1.30				4.19			0.29
corals, sea whips, anemones	6.56	0.07	7.40	0.95	43.36	2.32		5.19
Alaskan pink shrimp	2.48			27.84				
other shrimps	0.78			4.28		1.52		0.45
grooved Tanner crab		2.21			0.24	3.11	1.14	2.13
Tanner crab	0.43			2.57				
triangle Tanner crab								
scarlet king crab								
golden king crab	0.80	1.05	2.48	9.57				
hermit crabs		0.67		0.14				0.04
other crabs				1.31	2.82			0.07
snails	0.01	0.50		0.46	0.11	0.12	0.05	0.52
clams								
giant octopus								1.28
other octopus				0.08	0.67			
magistrate armhook squid			1.16	2.19			0.16	1.84
other squid			0.01					
sea stars, cucumbers, brittle stars	5.00	4.85	3.64	7.94	2.00	460.59	3.51	3.03
sponges				3.09				0.04
other invertebrates		0.16	0.03	0.07	0.12	0.09	0.03	0.10
Haul total weight (kg)	256.21	2012.00	815.40	1904.00	939.45	2022.00	1258.90	1778.00

Appendix Table 3. - - Continued.

Haul	153	154	155	156	157	158	159	160
Haul date	24-Jul-2008	24-Jul-2008	25-Jul-2008	25-Jul-2008	25-Jul-2008	25-Jul-2008	26-Jul-2008	26-Jul-2008
Tow start latitude	58.53053	58.52462	58.26605	58.25309	58.12443	58.07339	57.15653	57.03325
Tow start longitude	-176.2421	-176.14169	-175.4209	-175.62939	-175.60451	-175.5226	-173.91769	-173.54649
Tow end latitude	58.52831	58.52352	58.27102	58.23176	58.14266	58.06618	57.13953	57.01444
Tow end longitude	-176.2112	-176.1049	-175.4597	-175.62939	-175.60761	-175.4805	-173.9035	-173.5226
Station ID	55-06	53-01	42-01	44-04	45-08	45-01	32-07	33-01
Bottom depth (m)	1001	691	572	840	1171	1129	467	709
Stratum designation	55	53	42	44	45	45	32	33
Tow duration (fraction of hour)	0.45	0.47	0.53	0.6	0.47	0.59	0.45	0.59
Distance of tow (nm)	1.868	2.174	2.410	2.621	2.106	2.689	2.145	2.643
Average net width (m)	19.10	18.26	16.79	17.93	19.46	17.30	16.59	17.60
Performance code	5.8	0	0	0	0	0	0	0
Surface temperature (°C)	7.5	7.6	8.3	8.2	8.8	8.8	8.8	8.3
Bottom temperature (°C)	2.9	3.4	3.5	3.1	2.6	2.7	3.7	3.2
Pacific sleeper shark								
Bering skate							1.22	
mud skate							2.93	
rougtail skate	6.68			18.21	6.41			
Alaska skate								
Aleutian skate	1.43	1.48	9.06	3.14	0.20		33.31	17.76
Commander skate	3.20		2.23	4.20			7.63	43.68
whiteblotched skate								2.46
whitebrow skate	1.99	0.03	6.45	1.46	0.96			
other elasmobranchs & eggs					0.02	0.01	0.01	0.03
arrowtooth flounder		0.99	1.54				20.21	
Kamchatka flounder		23.18	3.39	2.34			6.17	16.22
Greenland turbot		11.06	13.64				3.46	11.38
Pacific halibut								
flathead sole							127.04	
rex sole							8.56	
other flatfish								
Pacific grenadier	11.03			2.40	10.53	36.74		
giant grenadier	689.56	704.59	1237.50	525.22	867.22	1119.22	451.70	2031.46
popeye grenadier	185.50	323.29	92.52	129.40	48.44	63.10		675.80
Pacific cod								
walleye pollock								
other gadoid fishes	0.34	1.22		0.27	1.63	1.53		1.57
blob sculpin	12.05	18.21		3.44	18.58	7.28		
bigmouth sculpin							9.30	
spinyhead sculpin								
darkfin sculpin								
other sculpins							0.07	0.07
twoline eelpout		15.38	4.16					
western eelpout		1.32	1.75					
ebony eelpout							0.32	8.74
Bering eelpout							0.37	
other eelpouts	0.01				0.09			
sablefish	12.68	24.50	2.65	13.23				25.94
blacktail snailfish		1.23	1.43	0.03				
other snailfishes	0.08	0.17	0.04	0.10	0.18	0.62	0.30	0.59
poachers		0.03	0.01	0.03				
mesopelagic fishes	0.45	0.14	0.08	1.56	1.17	1.34	0.19	
shortspine thornyhead	11.68	19.50	9.27	17.49		3.40	11.52	11.28
roughey rockfish								
blackspotted rockfish							1.70	
shortraker rockfish							2.66	
Pacific ocean perch								
other rockfish								
other fishes	2.74	3.88	0.02	1.42	0.59		0.34	2.55
jellyfishes	5.58	3.04	1.00		0.03	1.84	2.18	
corals, sea whips, anemones	2.52	0.38		1.33	11.67	13.07	3.97	
Alaskan pink shrimp								
other shrimps	0.01			0.10	1.12	1.11	0.15	
grooved Tanner crab	0.13	2.92		2.82		0.07	0.82	0.40
Tanner crab								
triangle Tanner crab	1.78			1.62		2.51	0.03	0.16
scarlet king crab	1.36							
golden king crab								
hermit crabs	0.07	0.10						
other crabs	1.40	0.97			0.04			0.87
snails	0.31	0.56	0.08	2.43	3.50	1.55		
clams								
giant octopus			0.66					
other octopus		0.08			4.66	1.78	1.65	
magistrate armhook squid	0.40	0.70			0.27		0.68	
other squid							0.04	
sea stars, cucumbers, brittle stars	4.11	6.97	14.28	9.29	6.41	21.50	7.79	0.83
sponges				0.15				0.18
other invertebrates	0.02	0.06	0.85	0.02	0.09	0.02		
Haul total weight (kg)	957.11	1166.00	1402.61	741.71	983.79	1276.69	708.50	2851.99

Appendix Table 3. - - Continued.

Haul	161	162	163	164	165	166	167	168
Haul date	26-Jul-2008	26-Jul-2008	26-Jul-2008	27-Jul-2008	27-Jul-2008	27-Jul-2008	27-Jul-2008	28-Jul-2008
Tow start latitude	56.86146	56.77416	56.78812	56.87757	56.70048	56.66365	56.56379	56.40093
Tow start longitude	-173.3952	-173.4158	-173.4446	-173.7925	-173.29781	-173.26199	-172.8102	-172.683
Tow end latitude	56.84421	56.7577	56.76771	56.85879	56.71365	56.65373	56.55225	56.39091
Tow end longitude	-173.40981	-173.4034	-173.4503	-173.7724	-173.3297	-173.2262	-172.77969	-172.66119
Station ID	31-05	32-03	33-06	35-03	31-09	33-05	31-04	35-04
Bottom depth (m)	317	500	782	1071	308	793	234	1050
Stratum designation	31	32	33	35	31	33	31	35
Tow duration (fraction of hour)	0.45	0.43	0.52	0.56	0.52	0.57	0.48	0.51
Distance of tow (nm)	2.235	2.063	2.362	2.509	2.518	2.525	2.333	1.892
Average net width (m)	16.09	16.63	16.36	17.30	16.04	17.31	15.47	18.75
Performance code	0	0	4.2	0	0	5.1	0	0
Surface temperature (°C)	8.2	8.4	8.3	8.3	8.1	8.1	8.5	8.5
Bottom temperature (°C)	3.7	3.7	3.1	2.7	3.6	3.1	3.3	2.7
Pacific sleeper shark								24.55
Bering skate	3.11				4.28			
mud skate	39.16				13.44			
rougtail skate				8.02		9.36		10.24
Alaska skate								
Aleutian skate	8.34	2.18	4.10	0.62	6.68	13.94		
Commander skate	0.04	3.90	8.02	1.64		4.20		
whiteblotched skate								
whitebrow skate			6.04	1.20	2.58	1.80	1.37	0.18
other elasmobranchs & eggs					0.04			0.02
arrowtooth flounder	42.47	77.25	2.56		67.80		23.84	
Kamchatka flounder	1.08	43.89	5.90	2.34	6.51	6.32	8.95	2.52
Greenland turbot		3.06	11.24			7.30		
Pacific halibut					25.14			
flathead sole	80.78	67.16			82.76		70.26	
rex sole	82.47	70.09			53.67		50.90	
other flatfish		1.41	3.40			2.76		
Pacific grenadier				28.77				34.48
giant grenadier		1436.45	1313.68	513.42		1205.10		724.62
popeye grenadier			38.36	115.28		225.47		169.39
Pacific cod	3.63				54.66		11.74	
walleye pollock	9.53	3.04			11.50		1.49	
other gadoid fishes			1.90	1.86		7.73		3.90
blob sculpin				6.40		19.20		
bigmouth sculpin	2.21	30.32			8.10		16.27	
spinyhead sculpin					0.35			
darkfin sculpin	0.66				2.60		0.44	
other sculpins								
twoline eelpout			21.86	1.72		19.98		
western eelpout						0.15		
ebony eelpout			3.04					
Bering eelpout	0.22	0.16	0.26			0.78		
other eelpouts								
sablefish		15.91	212.16			19.70		
blacktail snailfish						2.98		
other snailfishes			0.38	0.38	0.86	0.22		0.72
poachers	0.15	0.01	0.03		0.51	0.08		
mesopelagic fishes	0.08	0.36		0.20	0.05	0.08		0.37
shortspine thornyhead		58.79	22.88			56.22		
roughey rockfish					0.89			
blackspotted rockfish		17.61						
shortraker rockfish	230.05	85.36	9.58		211.39			
Pacific ocean perch	505.41	8.12			812.58		7961.33	
other rockfish								
other fishes			3.86	0.03			1.51	
jellyfishes		0.61		0.11		0.34		1.35
corals, sea whips, anemones	0.18	3.33	0.14	0.38	4.51	0.04		0.04
Alaskan pink shrimp	0.46				2.20			
other shrimps	0.58	0.04			0.73	0.01		
grooved Tanner crab		0.33	0.05	0.11		3.67		0.35
Tanner crab								
triangle Tanner crab	0.36		0.05			1.66	0.33	1.26
scarlet king crab			0.83			0.63		
golden king crab	7.01				8.66	1.10		
hermit crabs		0.16		0.02		0.29		
other crabs	0.01			2.13	0.01			6.38
snails	0.30	0.08			0.16	0.12		0.03
clams								
giant octopus								
other octopus				0.02				0.12
magistrate armhook squid	1.53				0.38			
other squid					0.06			
sea stars, cucumbers, brittle stars	1.40	0.28	0.44	0.07	2.39	0.26	0.47	1.63
sponges	0.71		76.28	3.53	42.51	15.50		
other invertebrates								
Haul total weight (kg)	1021.90	1929.90	1747.05	688.26	1428.00	1627.00	8148.90	982.13

Appendix Table 3. - - Continued.

Haul	169	170	171	172	173	174	175	176
Haul date	28-Jul-2008	28-Jul-2008	28-Jul-2008	29-Jul-2008	29-Jul-2008	29-Jul-2008	29-Jul-2008	30-Jul-2008
Tow start latitude	56.50861	56.56302	56.50846	56.49828	56.49623	56.22839	56.17294	56.15197
Tow start longitude	-172.4144	-172.138	-172.3028	-172.2273	-171.98779	-171.49001	-170.90311	-169.03461
Tow end latitude	56.51368	56.55792	56.50483	56.49329	56.48767	56.2322	56.18234	56.14157
Tow end longitude	-172.38029	-172.1017	-172.26961	-172.1886	-171.9545	-171.50369	-170.924	-169.002
Station ID	34-03	31-03	34-04	34-10	32-01	34-05	31-10	22-07
Bottom depth (m)	934	281	964	993	576	872	223	494
Stratum designation	34	31	34	34	32	34	31	22
Tow duration (fraction of hour)	0.49	0.48	0.49	0.57	0.5	0.21	0.38	0.55
Distance of tow (nm)	2.233	2.348	2.134	2.507	2.321	0.968	1.733	2.415
Average net width (m)	18.70	16.94	19.00	18.27	17.35	18.25	16.66	16.01
Performance code	0	0	0	6.12	0	5.1	0	-2.4
Surface temperature (°C)	8.4	8.3		8.4	8.8	8.4	8.3	8.2
Bottom temperature (°C)	3.1	3.4		2.8	3.6	3.1	3.4	3.6
Pacific sleeper shark								
Bering skate		4.52				1.97	2.66	
mud skate								
rougtail skate	8.14	0.07	5.68	3.40	0.14	0.96		
Alaska skate							7.76	
Aleutian skate	12.48	82.42		2.80	61.00	5.07	27.48	
Commander skate	7.12			5.42	4.34	4.71		
whiteblotched skate								
whitebrow skate	1.25	16.35			4.82	3.42		
other elasmobranchs & eggs			10.74					
arrowtooth flounder		53.37			4.12		78.80	
Kamchatka flounder	2.90	24.70	1.86		24.12	3.65	9.86	
Greenland turbot	4.02		11.37		40.82			
Pacific halibut								
flathead sole		48.66					4.08	
rex sole		60.40			8.72		122.54	
other flatfish	2.66			3.46	1.80	7.68	7.56	
Pacific grenadier	14.82		29.09	61.37		0.28		
giant grenadier	430.02		502.70	668.66	1167.50	882.41		
popeye grenadier	80.26		118.00	266.82	101.63	59.24		
Pacific cod		12.96					15.08	
walleye pollock		43.12						
other gadoid fishes	0.59		1.62	0.61	0.25	0.31		
blob sculpin	23.28		11.02	7.35				
bigmouth sculpin		17.34			24.02		7.24	
spinyhead sculpin		0.52			0.08			
darkfin sculpin		2.23					9.12	
other sculpins							0.36	
twoline eelpout	0.04				1.00			
western eelpout					1.28			
ebony eelpout								
Bering eelpout		0.04			0.05			
other eelpouts				0.03				
sablefish	3.74		3.78	4.71	30.36	6.47		
blacktail snailfish	0.32				0.17			
other snailfishes	0.54		1.41	0.36	2.66	0.26		
poachers		2.45			0.04	0.01	0.11	
mesopelagic fishes	0.49		0.44	0.17	0.04	0.32		
shortspine thornyhead	1.98				61.34	18.02		
rougheye rockfish								
blackspotted rockfish							0.49	
shortraker rockfish					7.02			
Pacific ocean perch		67.24					2619.41	
other rockfish								
other fishes			0.57				3.66	
jellyfishes	1.22		1.15	0.02	0.10	0.57		
corals, sea whips, anemones		0.92	0.21	0.03	0.29		0.96	
Alaskan pink shrimp		1.62					2.29	
other shrimps	0.02	0.56	0.01		0.04			
grooved Tanner crab	1.02	0.02	1.39	0.20	31.72	4.21		
Tanner crab							0.88	
triangle Tanner crab	0.39							
scarlet king crab			2.46					
golden king crab								
hermit crabs	0.02	0.28			0.32			
other crabs	2.30		6.30	9.52		0.70	0.03	
snails	0.17	0.14	0.07		1.05	0.03	0.65	
clams								
giant octopus							0.11	
other octopus			2.64	0.06	4.90	0.85		
magistrate armhook squid			0.68					
other squid		0.32					0.38	
sea stars, cucumbers, brittle stars	0.16	8.45	15.24	6.82	4.27	1.19	4.74	
sponges	6.46	0.02		15.91		1.44	75.93	
other invertebrates		0.06	0.02					
Haul total weight (kg)	606.41	448.79	728.46	1057.73	1590.00	1003.78	3002.16	

Appendix Table 3. - - Continued.

Haul	177	178	179	180	181	182	183	184
Haul date	30-Jul-2008	30-Jul-2008	30-Jul-2008	30-Jul-2008	31-Jul-2008	31-Jul-2008	31-Jul-2008	31-Jul-2008
Tow start latitude	56.14512	56.01527	56.0828	56.04226	55.45857	55.40062	55.30184	55.22701
Tow start longitude	-169.01401	-168.87711	-168.64461	-168.37959	-168.457	-168.34351	-167.9248	-167.8936
Tow end latitude	56.14033	56.01621	56.08872	56.06327	55.45218	55.39411	55.28773	55.21068
Tow end longitude	-168.99631	-168.9133	-168.67751	-168.36659	-168.43021	-168.33369	-167.89751	-167.87691
Station ID	22-07	25-02	23-08	21-03	13-15	14-09	11-29	12-16
Bottom depth (m)	520	1096	632	221	766	932	310	409
Stratum designation	22	25	23	21	13	14	11	12
Tow duration (fraction of hour)	0.28	0.58	0.47	0.5	0.41	0.22	0.49	0.47
Distance of tow (nm)	1.256	2.309	2.201	2.552	1.882	0.989	2.401	2.186
Average net width (m)	17.59	17.20	15.66	15.57	17.07	18.25	16.77	16.88
Performance code	0	5.1	0	0	0	0	0	0
Surface temperature (°C)	8.1	8.3	8.5	9	9	8.1	8.3	8.7
Bottom temperature (°C)	3.5	2.5	3.6	3.6	3.3	3	3.7	3.7
Pacific sleeper shark								
Bering skate						0.36	6.32	1.96
mud skate	1.20			1.76				
rougtail skate						13.42		
Alaska skate				0.07				
Aleutian skate	7.81	4.86	22.34	17.78	17.07	3.71	11.28	9.64
Commander skate		9.62	4.22					
whiteblotched skate	5.42	0.82	52.34					3.40
whitebrow skate	5.06	0.04			1.72	2.02		
other elasmobranchs & eggs				0.45	0.40	0.08	1.18	0.81
arrowtooth flounder	29.41			15.47			287.38	48.61
Kamchatka flounder	10.94	8.92	14.94	12.25	20.08	8.53	4.06	64.41
Greenland turbot	8.39	8.62	35.14		39.03	20.98	4.82	43.78
Pacific halibut							17.58	
flathead sole	1.05			4.52			26.74	26.86
rex sole	39.47			5.38			97.20	25.64
other flatfish	4.58			0.74	10.82			1.30
Pacific grenadier		96.06						
giant grenadier	51.58	2274.75	355.56		240.07	293.91		
popeye grenadier	2.97	395.74			89.07	150.38		
Pacific cod				19.76				
walleye pollock	1.38		9.56	0.36			1.18	58.56
other gadoid fishes		2.18						
blob sculpin						6.74		
bigmouth sculpin	26.47		1.86				2.84	4.88
spinyhead sculpin							0.80	
darkfin sculpin				1.03	0.10		5.46	0.28
other sculpins				0.04				
twoline eelpout								
western eelpout	1.80	0.72			39.26	0.36		
ebony eelpout	1.22	7.46	9.92		0.12			
Bering eelpout	0.66				0.26	0.07	0.37	0.32
other eelpouts	0.01	0.12						
sablefish	3.49	17.42	18.10		116.34			8.46
blacktail snailfish								
other snailfishes	0.02	0.10	1.22	0.08	0.44	0.26	0.27	1.19
poachers	0.09			0.14	0.01	0.01		
mesopelagic fishes	0.22	0.06	0.16		0.30	0.94		
shortspine thornyhead	268.01	19.98	6.00		44.20	8.19		50.06
roughey rockfish							1.44	
blackspotted rockfish								
shortraker rockfish	2.90		2.66					
Pacific ocean perch				2409.37			21.54	1.18
other rockfish								
other fishes		0.36		0.21				0.18
jellyfishes	1.56	0.63						0.01
corals, sea whips, anemones	18.13	0.22		0.07			1.74	17.79
Alaskan pink shrimp				0.04			0.44	
other shrimps						0.02	0.14	0.01
grooved Tanner crab	7.80		2.56		5.90	1.18		2.96
Tanner crab								
triangle Tanner crab		6.75				16.55	0.24	0.31
scarlet king crab	1.82	2.94						
golden king crab	28.54	0.34	8.12	2.56			1.20	2.78
hermit crabs					0.22	0.26	0.54	0.16
other crabs		2.08		0.00		0.39	0.01	
snails	0.04	0.07		1.30	0.58	0.64	1.89	0.78
clams				0.01				
giant octopus								
other octopus		0.16						
magistrate armhook squid	0.85	0.91	1.94		0.29	0.31	2.86	9.36
other squid			0.06		0.07			0.09
sea stars, cucumbers, brittle stars	1.42	0.83	0.30	4.30	3.53	2.35	5.73	8.93
sponges		0.60	0.81	2.28	0.02			0.16
other invertebrates				0.03	0.04		0.26	0.05
Haul total weight (kg)	534.31	2863.35	547.81	2500.00	629.92	531.65	505.51	394.92

Appendix Table 3. - - Continued.

Haul	185	186	187	188	189	190	191	192
Haul date	31-Jul-2008	1-Aug-2008	1-Aug-2008	1-Aug-2008	1-Aug-2008	2-Aug-2008	2-Aug-2008	2-Aug-2008
Tow start latitude	55.19332	54.94057	54.96426	55.04296	55.0349	54.86567	54.75002	54.70024
Tow start longitude	-167.82021	-167.7845	-167.6084	-167.5392	-167.35651	-167.6023	-167.5965	-167.4213
Tow end latitude	55.17683	54.92683	54.94856	55.02962	55.04866	54.84664	54.76665	54.7206
Tow end longitude	-167.7997	-167.771	-167.58501	-167.5135	-167.3846	-167.59219	-167.591	-167.4285
Station ID	12-28	15-08	12-40	11-37	11-12	13-07	14-07	12-42
Bottom depth (m)	349	1015	452	292	208	627	937	548
Stratum designation	11	15	12	11	11	13	14	12
Tow duration (fraction of hour)	0.53	0.39	0.52	0.48	0.48	0.49	0.43	0.48
Distance of tow (nm)	2.360	1.815	2.377	2.275	2.421	2.283	1.940	2.371
Average net width (m)	16.95	18.72	16.77	15.34	17.32	17.08	18.25	17.34
Performance code	0	0	0	0	0	0	0	0
Surface temperature (°C)	8.2	9.5	7.4	8.8	9.6	9.4	8.7	7.4
Bottom temperature (°C)	3.8	2.8	3.7	3.8	3.8	3.4	3	3.5
Pacific sleeper shark								
Bering skate	9.54	0.59	2.36	7.45	2.58			
mud skate								
rougtail skate		1.16	0.22					
Alaska skate								
Aleutian skate	20.88		12.87	109.20		6.14		9.52
Commander skate								
whiteblotched skate	39.20		11.03					
whitebrow skate	1.64			5.44		2.71		4.83
other elasmobranchs & eggs	0.61	0.25	0.18	0.10	0.10	0.11		
arrowtooth flounder	166.21		2.31	148.76	65.48			
Kamchatka flounder	28.84	2.50	34.50	22.04	7.36	12.40		24.86
Greenland turbot	63.28	21.62	7.90			6.00		32.02
Pacific halibut	31.70				3.76			
flathead sole	15.72		10.36	42.44	97.30			
rex sole	80.38		12.39	64.30	16.78			
other flatfish				1.00		3.34		
Pacific grenadier								
giant grenadier		147.98	32.96			345.96	325.25	203.11
popoye grenadier		150.72	3.11			30.55	163.67	
Pacific cod				5.60	3.34			
walleye pollock	136.62			5.92	2.30			
other gadoid fishes		0.43						
blob sculpin							0.01	
bigmouth sculpin	18.38		5.56	8.43				
spinyhead sculpin				1.03	2.11			
darkfin sculpin	3.92		0.03	1.44		0.59		
other sculpins		0.01						0.01
twoline eelpout		0.50					3.04	
western eelpout		3.44	4.70			138.97	1.91	40.66
ebony eelpout								
Bering eelpout	0.22	0.07	0.04					
other eelpouts						0.00	0.01	
sablefish		7.88	5.48			17.35		10.17
blacktail snailfish	0.99	0.10						
other snailfishes	0.26	1.82	0.10	0.05	0.11	0.27	0.35	
poachers				0.03			0.23	0.13
mesopelagic fishes		2.76	0.41			0.27	1.65	0.24
shortspine thornyhead	15.86	11.57	108.90	5.22	0.82	31.76	12.12	67.29
roughey rockfish				0.32				
blackspotted rockfish			3.50					
shortraker rockfish	4.20		8.01					
Pacific ocean perch	8.54		2.26	4.31				
other rockfish								
other fishes		2.42	0.02		2.59	39.29		0.31
jellyfishes		0.16	0.01	0.19		0.02	0.03	0.02
corals, sea whips, anemones	3.85	0.45	14.77	3.03	5.58	0.07		0.13
Alaskan pink shrimp	0.04			9.87	0.76			
other shrimps	0.15	0.24	0.34		0.01		0.98	0.02
grooved Tanner crab						1.38	0.82	
Tanner crab					2.61			
triangle Tanner crab		52.76	4.88	0.03			103.16	1.51
scarlet king crab								
golden king crab	13.76		2.62	0.82		0.43		0.55
hermit crabs	0.53	0.03	0.04	0.90	0.83			
other crabs					0.03			
snails	1.63	0.14	0.67	2.92	5.22	0.78	0.28	8.78
clams								
giant octopus								0.39
other octopus			1.64		0.36		2.67	0.83
magistrate armhook squid	3.86	2.35	1.82	3.49	1.41	2.22	0.64	2.24
other squid								
sea stars, cucumbers, brittle stars	8.73	2.09	2.17	8.43	1.42	39.17	4.97	21.19
sponges			0.04	0.16	0.02	3.76		6.40
other invertebrates	0.20	0.01		0.32	0.48	0.16		1.67
Haul total weight (kg)	679.74	414.04	298.22	463.24	223.35	683.70	621.80	436.88

Appendix Table 3. - - Continued.

Haul	193	194	195	196	197	198	199	200
Haul date	2-Aug-2008	3-Aug-2008	3-Aug-2008	3-Aug-2008	3-Aug-2008	4-Aug-2008	4-Aug-2008	4-Aug-2008
Tow start latitude	54.82282	54.82299	54.59449	54.43758	54.7749	54.74332	54.6178	54.6787
Tow start longitude	-167.14391	-166.8373	-166.8869	-166.6479	-166.32069	-165.41341	-165.6418	-165.8783
Tow end latitude	54.81394	54.81527	54.57467	54.43732	54.77355	54.72395	54.63821	54.67834
Tow end longitude	-167.1201	-166.80409	-166.88699	-166.617	-166.2831	-165.40199	-165.6409	-165.91389
Station ID	11-26	11-36	12-15	12-05	11-23	11-03	11-15	11-21
Bottom depth (m)	345	262	418	532	209	205	334	318
Stratum designation	11	11	12	12	11	11	11	11
Tow duration (fraction of hour)	0.49	0.52	0.48	0.45	0.5	0.51	0.48	0.5
Distance of tow (nm)	2.321	2.366	2.224	2.023	2.446	2.363	2.291	2.319
Average net width (m)	17.75	16.25	16.85	17.29	16.54	14.99	15.69	16.76
Performance code	0	0	0	0	0	6.12	0	0
Surface temperature (°C)	8.6	9.5	9.2	9.9	9.2	6.7	8	9.8
Bottom temperature (°C)	3.8	3.7	3.7	3.6	3.6	4.1	3.7	3.7
Pacific sleeper shark			5.20					11.48
Bering skate	9.04	3.65		6.38	2.16			0.54
mud skate							2.01	
rougtail skate								
Alaska skate		6.73				4.72		
Aleutian skate	18.94	60.92	23.56	8.24	18.60	5.30	4.58	
Commander skate								
whiteblotched skate			9.14	2.86				
whitebrow skate	2.44			5.53				2.64
other elasmobranchs & eggs		0.07		0.02			0.08	0.26
arrowtooth flounder	29.76	55.88	27.72	12.10	57.31	119.66	184.65	184.79
Kamchatka flounder	30.82		34.79	45.53		2.06	9.87	8.44
Greenland turbot			2.62	24.86				12.26
Pacific halibut	36.84					7.24		8.23
flathead sole	27.20	8.58	74.41	89.24	22.29		37.83	2.54
rex sole	88.76	1.12	6.72			4.52	14.50	31.62
other flatfish			2.40			27.84		0.49
Pacific grenadier								
giant grenadier				40.70				
popeye grenadier								
Pacific cod		6.65						3.91
walleye pollock		2.06	9.02		197.26	23.32	42.80	2.48
other gadoid fishes								
blob sculpin								
bigmouth sculpin			7.44	0.27	0.28			
spinyhead sculpin	0.05	5.08	0.32	0.80	6.09	0.25	2.08	5.44
darkfin sculpin	1.17	0.06	0.01				2.28	
other sculpins		0.63			0.06	0.10		
twoline eelpout								
western eelpout			21.58	43.06				
ebony eelpout			1.60	8.95				
Bering eelpout	0.47		0.16	0.40			0.51	
other eelpouts				0.02				
sablefish				45.19				
blacktail snailfish								
other snailfishes		0.17	1.78		0.13	0.53		
poachers	1.01	0.05	0.11	0.21		0.96	0.11	0.19
mesopelagic fishes			0.11	0.09		6.10	0.03	0.03
shortspine thornyhead	24.62		74.30	42.60				
roughey rockfish	2.28	5.17						
blackspotted rockfish		2.88			0.36			
shortraker rockfish								
Pacific ocean perch	12.04	4.64	9.44		3.08	9.80	16.10	7.33
other rockfish								
other fishes		0.49	3.29					1.88
jellyfishes		0.34						
corals, sea whips, anemones	10.79	8.88	0.73		8.53	0.39		3.80
Alaskan pink shrimp	0.02	2.11			4.82		0.60	1.71
other shrimps	0.01	0.01	0.57	0.54	0.02		0.01	0.01
grooved Tanner crab				1.86				
Tanner crab					6.24	19.59	1.33	0.69
triangle Tanner crab				0.24				
scarlet king crab								
golden king crab			1.86					
hermit crabs	1.23		0.65	0.52		0.01		0.12
other crabs	0.01	0.14			0.16	1.82		
snails	6.71	4.06	9.17	6.96	3.42	0.90	0.11	5.74
clams								
giant octopus			0.96					
other octopus	0.86		0.48	0.14				0.08
magistrate armhook squid	1.80	0.72	2.43	2.71	1.02	0.47	20.10	0.61
other squid					0.14			
sea stars, cucumbers, brittle stars	49.98	2.93	94.49	49.51	9.22	4.15	1.92	0.39
sponges	0.08	0.79	4.02	34.35	1.40			
other invertebrates	0.51	0.53	1.03	0.49	0.30			0.15
Haul total weight (kg)	357.44	185.35	432.09	474.38	342.89	239.74	341.49	297.85

Appendix Table 3. - - Continued.

Haul	201	202	203	204	205	206	207
Haul date	4-Aug-2008	4-Aug-2008	5-Aug-2008	5-Aug-2008	5-Aug-2008	6-Aug-2008	6-Aug-2008
Tow start latitude	54.48926	54.50997	54.27108	54.30919	54.37547	54.43306	54.49734
Tow start longitude	-165.8416	-166.1111	-166.62981	-166.5966	-166.8331	-167.1257	-167.4231
Tow end latitude	54.46986	54.50583	54.26463	54.31273	54.37312	54.43077	54.51672
Tow end longitude	-165.84599	-166.1452	-166.6627	-166.5654	-166.8	-167.0903	-167.4344
Station ID	12-09	12-20	15-01	14-01	13-03	12-03	13-11
Bottom depth (m)	451	486	1087	822	619	537	638
Stratum designation	12	12	15	14	13	12	13
Tow duration (fraction of hour)	0.49	0.49	0.53	0.44	0.48	0.51	0.5
Distance of tow (nm)	2.219	2.299	2.327	2.097	2.200	2.346	2.347
Average net width (m)	16.78	17.29	17.09	18.41	16.88	15.09	17.75
Performance code	0	0	0	0	0	0	0
Surface temperature (°C)	9.5	10.4	9.4	10.2	8.9	9.7	6.9
Bottom temperature (°C)	3.7	3.6	2.7	3.1	3.5	3.6	3.4
Pacific sleeper shark	7.62						
Bering skate		30.44	0.03	4.90	12.61	6.49	
mud skate							
rougtail skate			13.06	11.10			
Alaska skate	0.08						
Aleutian skate	0.10	31.50	0.41	4.12	6.32	5.33	8.87
Commander skate					1.35		
whiteblotched skate						5.02	
whitebrow skate	5.36		1.06	2.36		1.62	0.60
other elasmobranchs & eggs	0.04	0.23	20.18	0.19	0.03		0.03
arrowtooth flounder	21.76	261.66				4.87	
Kamchatka flounder	11.00	978.70	15.12	23.42	29.76	7.10	5.84
Greenland turbot	15.28	22.22	14.44	101.94	15.36	63.60	31.45
Pacific halibut		7.50					
flathead sole	1.28	179.12					
rex sole	1.20	3.01					
other flatfish		8.42					
Pacific grenadier			0.02				
giant grenadier		8.46	282.52	311.54	97.52	49.89	346.92
popeye grenadier			180.98	61.34			3.60
Pacific cod							
walleye pollock		9.26					
other gadoid fishes			0.74	0.26			
blob sculpin							
bigmouth sculpin	1.50						0.32
spinyhead sculpin	4.37	0.46			0.07		
darkfin sculpin	0.07						
other sculpins	0.10						
twoline eelpout			3.80	9.25			
western eelpout	226.02	292.63	0.96	98.32	62.82	43.82	7.56
ebony eelpout		93.93	0.07		0.49		
Bering eelpout	1.16	0.14	1.17	0.48	0.20		0.13
other eelpouts		0.05	0.20				
sablefish	18.02	17.33	11.38	59.02	22.34	14.88	58.78
blacktail snailfish				0.51			
other snailfishes	0.93		0.75	0.01			
poachers				0.11	0.18	0.11	0.04
mesopelagic fishes	7.57	0.56	5.84	2.60	0.07	0.23	0.47
shortspine thornyhead	1.40	153.20	1.98	47.25	51.42	25.22	16.04
rougheye rockfish							
blackspotted rockfish							
shortraker rockfish							
Pacific ocean perch	2.06	1.34					
other rockfish							
other fishes	0.27	0.59	2.63	0.47	4.29	0.86	
jellyfishes		1.39	0.36	0.02			0.57
corals, sea whips, anemones	28.07	14.22				0.06	
Alaskan pink shrimp							
other shrimps	1.17		1.73	0.09	0.09		0.04
grooved Tanner crab		0.89	3.14		4.41		16.78
Tanner crab	0.64						
triangle Tanner crab	4.32	0.17	65.17	14.45	0.69		19.10
scarlet king crab				2.06			
golden king crab	0.34	0.96				0.45	
hermit crabs	0.75	2.82		0.04	0.03		0.09
other crabs							
snails	4.87	42.57	1.56	2.41	4.48	4.83	3.47
clams							
giant octopus						1.30	
other octopus	1.18	2.66	3.28	3.62	1.18	0.51	0.66
magistrate armhook squid	6.55	3.67	2.02	0.56	17.74	0.97	4.07
other squid	0.11					0.51	
sea stars, cucumbers, brittle stars	4.34	29.85	2.85	1.74	98.96	238.24	34.01
sponges	0.08			0.23	8.41	189.24	6.83
other invertebrates	0.29	0.05	0.03		0.28	2.14	0.35
Haul total weight (kg)	379.90	2200.00	637.46	764.40	441.09	667.86	566.06

RECENT TECHNICAL MEMORANDUMS

Copies of this and other NOAA Technical Memorandums are available from the National Technical Information Service, 5285 Port Royal Road, Springfield, VA 22167 (web site: www.ntis.gov). Paper and microfiche copies vary in price.

AFSC-

- 196 BUCKLEY, T. W., A. GREIG, and J. L. BOLDT. 2009. Describing summer pelagic habitat over the continental shelf in the eastern Bering Sea, 1982-2006, 49 p. NTIS number pending.
- 195 LAUTH, R. R., and E. ACUNA. 2009. Results of the 2008 Eastern Bering Sea continental shelf bottom trawl survey of groundfish and invertebrate resources, 219 p. NTIS number pending.
- 194 HONKALEHTO, T., D. JONES, A. MCCARTHY, D. MCKELVEY, M. GUTTORMSEN, K. WILLIAMS, and N. WILLIAMSON. 2009. Results of the echo integration-trawl survey of walleye pollock (*Theragra chalcogramma*) on the U.S. and Russian Bering Sea shelf in June and July 2008, 56 p. NTIS number pending.
- 193 ANGLISS, R. P., and B. M. ALLEN. 2009. Alaska marine mammal stock assessments, 2008, 258 p. NTIS No. PB2009-109548.
- 192 FOWLER, C. W., T. E. JEWELL and M. V. LEE. 2009. Harvesting young-of-the-year from large mammal populations: An application of systemic management, 65 p. NTIS No. PB2009105146.
- 191 BOVENG, P. L., J. L. BENGTSON, T. W. BUCKLEY, M. F. CAMERON, S. P. DAHLE, A. MEGREY, J. E. OVERLAND, and N. J. WILLIAMSON. 2008. Status review of the ribbon seal (*Histiophoca fasciata*), 115 p. NTIS No. PB2006-104582.
- 190 HONKALEHTO, T., N. WILLIAMSON, D. JONES, A. MCCARTHY, and D. MCKELVEY. 2008. Results of the echo integration-trawl survey of walleye pollock (*Theragra chalcogramma*) on the U.S. and Russian Bering Sea shelf in June and July 2007, 53 p. NTIS No. PB2009-104581.
- 189 VON SZALAY, P. G., M. E. WILKINS, and M. M. MARTIN. 2008. Data Report: Gulf of Alaska bottom trawl survey, 247 p. NTIS No. PB2009-103242.
- 188 TESTA, J. W. (editor). 2008. Fur seal investigations, 2006-2007, 76 p. NTIS No. PB2009-103613.
- 187 CHILTON, E. A., C. E. ARMISTEAD, and R. J. FOY. 2008. The 2008 Eastern Bering Sea continental shelf bottom trawl survey: Results for commercial crab species, 88 p. NTIS No. PB2009-102142.
- 186 CHILTON, E. A., L. RUGOLO, C. E. ARMISTEAD, and R. J. FOY. 2008. The 2007 Eastern Bering Sea continental shelf bottom trawl survey: Results for commercial crab species, 85 p. NTIS No. PB2009-102141.
- 185 ROOPER, C. N., and M. E. WILKINS. 2008. Data Report: 2004 Aleutian Islands bottom trawl survey. 207 p. NTIS No. PB2009-100658.
- 184 KNOTH, B. A., and R. J. FOY. 2008. Temporal variability in the food habits of arrowtooth flounder (*Atheresthes stomias*) in the Western Gulf of Alaska, 30 p. NTIS No. PB2008-110137.
- 183 FRITZ, L., M. LYNN, E. KUNISCH, and K. SWEENEY. 2008. Aerial, ship, and land-based surveys of Steller sea lions (*Eumetopias jubatus*) in Alaska, June and July 2005-2007, 70 p. NTIS No. PB2008-111424.
- 182 HARRIS, P. M., A. D. NEFF, S. W. JOHNSON, and J. F. THEDINGA. 2008. Eelgrass habitat and faunal assemblages in the City and Borough of Juneau, Alaska, 46 p. NTIS No. PB2008-110149.
- 181 ACUNA, E., and R. R. LAUTH. 2008. Results of the 2007 Eastern Bering Sea continental shelf bottom trawl survey of groundfish and invertebrate resources, 195 p. NTIS No. PB2008-109338.