

NOAA GOES-N,O,P — The Next Generation

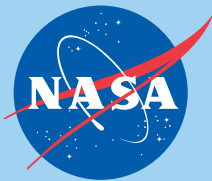

National Aeronautics and
Space Administration

Goddard Space Flight Center
Greenbelt, Maryland

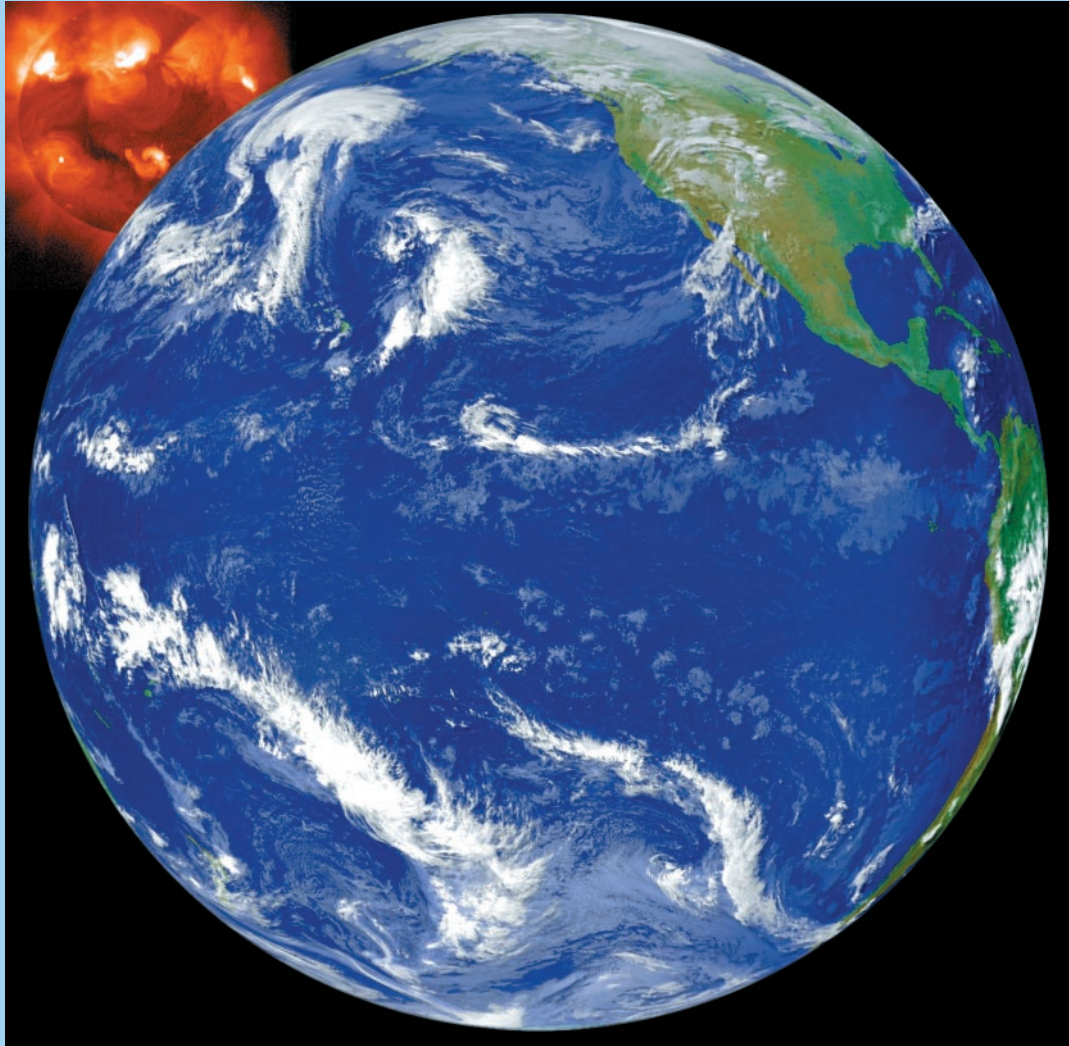

U.S. Department of Commerce

National Oceanic and
Atmospheric Administration
National Environmental Satellite,
Data, and Information Service
Suitland, Maryland

Table of Contents

The Mission	1
Mission History	4
The GOES-N,O,P Spacecraft	7
The GOES-N,O,P Instruments	9
Imager	10
Sounder	11
Space Environment Monitor	12
Solar X-Ray Imager	15
The GOES-N,O,P Satellite System	18
Satellite Operations Control Center	19
Command and Data Acquisition Stations	19
GOES Variable Format Data Distribution	20
NOAA Space Environment Center	20
Low Rate Information Transmission	20
Emergency Managers Weather Information Network	20
Data Collection System	21
Search and Rescue System	22
Launch and Orbit Raising	24
Coverage Area	26
Image Navigation and Registration	27
Data Products and Services	28
NASA and NOAA Roles and Support Systems	31
GOES History	32
GOES Spacecraft Contractors	35
Acronyms and Abbreviations	36

The Mission

The impressive imagery of cloud cover produced by the Geostationary Operational Environmental Satellite (GOES) series, as viewed from orbit high above the Earth, has become a highlight and staple of television weather forecasts. Forecasting the approach of severe storms for more than 25 years, GOES has remained an essential cornerstone of weather observations and forecasting.

The GOES system of weather satellites provides timely environmental information to meteorologists and their audiences alike—graphically displaying the intensity, path, and size of storms. With El Niño and La Niña affecting people worldwide, GOES images have been featured on the covers of the international press, appearing in *National Geographic*, *Der Spiegel*, and *Life* magazines. GOES images have become so common that many people think of hurricanes in terms of the popularized images of Hurricanes Hugo, Andrew, Floyd, Frances and Jeanne.



The GOES program, begun in 1974, is a program of the National Oceanic and Atmospheric Administration of the U.S. Department of Commerce. NOAA funds and manages the program and determines the need for satellite replacement. NASA provides launch support and helps design, engineer, and procure the satellites and some ground system elements. After a satellite is launched and checked out by NASA, it is turned over to NOAA for its operation.

GOES spacecraft operate as a two-satellite constellation in geosynchronous orbit above the equator and observe 60 percent of the Earth. They measure the Earth's atmosphere, its surface, cloud cover, and the solar and geosynchronous space environment and provide a platform for the Imager, Sounder, Solar X-Ray Imager (SXI), and space environment monitoring instruments. The system also supports land and ocean-based Data Collection Platforms (DCPs), transmits Imager and Sounder data, relays Low Rate Information Transmission (LRIT) data (replacement for WEFAX), relays GOES Variable (GVAR) reformatted Imager and Sounder data, relays Emergency Managers Weather Information Network (EMWIN) broadcasts, and participates in the international Cospas-Search and Rescue Satellite-Aided Tracking (SARSAT) system.

NOAA and NASA have developed a new generation of geosynchronous meteorological/environmental satellites, designated GOES-N,O,P, that will continue and enhance the previous generation of GOES satellites. The next generation of satellites will provide a continuation of meteorological/envi-

Cospas is an acronym for the Russian words *Cosmicheskaya Sistyema Poiska Avariynich Sudov*, which mean "Space System for the Search of Vessels in Distress."

ronmental data products and services to the GOES data user community. Indicated below is a summary of the enhancements that have been made from the previous generation of GOES satellites.

GOES N,O,P Enhancement Summary

- GOES N,O,P will have an improved Image Navigation and Registration (INR) system that will use star trackers to provide precision image navigation and registration information for use with the Imaging and Sounding data products. This will improve knowledge of exactly where severe weather events are located.
- A stable optical bench has been provided to isolate the thermal deformations of the spacecraft from the Imager and Sounder instruments.
- A data product improvement has been provided with the development of the digital Low Rate Information Transmission (LRIT) system for distribution of data products that were distributed in an analog WEFAX format in the previous generation of GOES satellites. The LRIT system will permit the transmission of many data products consistent with the World Meteorological Organization (WMO) and will permit the distribution of more National Weather Service (NWS) information at a higher data rate to the NOAA data user community.
- The Data Collection System (DCS) has been enhanced with the addition of 300 and 1200 bps Data Collection Platforms (DCPs) that will use 8-PSK modulation and a higher power satellite transponder so that more DCPs can use the link at the same time.
- The power subsystem has been improved with the use of a single panel solar array that contains high-efficiency dual-junction gallium-arsenide solar cells. A nickel-hydrogen battery is provided to permit the satellites to operate during the eclipse periods.
- A new Solar X-Ray Imager (SXI) has been developed by the Lockheed Martin Advanced Technology Center to permit the observation and collection of solar data products.
- A dedicated transponder is being provided to support the Emergency Manager's Weather Information Network (EMWIN) data product service.
- The Satellite design life time has been improved from 7 to 10 years, and the expected propellant lifetime has been increased to 13.5 years.
- The GOES-N,O,P command data rate has been increased to 2,000 bps, as compared to a data rate of 250 bps for the previous generation of GOES satellites.
- The GOES-N,O,P telemetry data rate has been improved to provide data at either 4,000 or 1,000 bps, as compared to the 2,000 bps data rate on the previous generation of GOES satellites.
- An optional operational "yaw flip" capability and procedure has been developed on the GOES-N,O,P Program to permit optimum performance of the Imager and Sounder radiation coolers. The procedure will permit operation of the Imager and Sounder detectors at a lower temperature and will result in lower noise performance of the instruments because of a lower detector temperature.

- The Space Environment Monitoring (SEM) subsystem has been enhanced by the addition of the Extreme Ultraviolet (EUV) sensor, Energetic Proton, Electron, and Alpha particle Detector (EPEAD), the Magnetospheric Electron Detector (MAGED), the Magnetospheric Proton Detector (MAGPD) and dual magnetometers on a 27.9 foot (8.5 meter) long boom. The EPS sensors have been expanded on GOES-N,O,P to provide coverage over an extended energy range and with improved directional accuracy.
- Provision was made to allow addition of a Lightning Mapper instrument or another instrument of opportunity. No such instrument has been provided at this time and GOES-N and GOES-O have completed their pre-launch qualification testing.
- The communications services have been tailored to comply with modern national and international requirements.
- Potential reduction in striping in the image will be achieved due to increasing the Imager's scan-mirror dwell time during the blackbody calibration process from 0.2 seconds to 2 seconds.
- Outages due to solar intrusion Keep Out Zones (KOZ) will be minimized because thermal shields have been added to the secondary mirror structure elements for the Imager and Sounder instruments.
- There will be no "boom snap" problems on the GOES-N,O,P satellites since the effect is due to the shadow of the magnetometer boom crossing the solar sail boom and the solar sail boom is not used with the GOES-N,O,P satellite design.

Mission History

The launch of the prototype Synchronous Meteorological Satellite, *SMS-A*, in May 1974 inaugurated the series of geosynchronous satellites that has provided systematic, continuous observations of weather patterns. A second prototype, *SMS-B*, followed in February 1975. The GOES program formally began with the launch of the first operational spacecraft, *GOES-A*, in 1975, which was renamed *GOES-1* when it reached orbit. *GOES-2* and *GOES-3* followed in 1977 and 1978, respectively. These spacecraft obtained both day and night data on the Earth's weather from the Visible/Infrared Spin Scan Radiometer (VISSR), a scanning instrument that formed images of the Earth's surface and cloud cover for transmission to regional data-user stations for use in weather prediction and forecasting and also for monitoring the space environment.

Geosynchronous satellites orbit the Earth from west to east at an altitude of approximately 22,240 miles or 35,790 km and at a speed of approximately 6,800 miles per hour that keeps them fixed over the Earth's equator, making one rotation in 24 hours.

A radiometer is an instrument that measures electromagnetic radiation or energy.

GOES 4-7 were similarly configured. *GOES-4*, launched in 1980, introduced an improved VISSR, the VISSR Atmospheric Sounder (VAS), which gathered the standard VISSR image data and also sounded the clear atmosphere, enabling meteorologists to acquire temperature and moisture data profiles. From these profiles, scientists could determine the altitudes and temperatures of clouds and draw a three-dimensional picture of their distribution in the atmosphere, leading to more accurate weather predictions. Using *GOES* imagery, meteorologists also measured the movement of clouds at different altitudes and determined their wind direction and speed to better understand atmospheric circulation patterns. A limitation of the VAS was that it could not gather imaging and sounding data simultaneously, but had to alternate between the two functions.

GOES-7, launched in 1987, was the last spinner-type geosynchronous spacecraft. It inaugurated the use of geosynchronous satellites for international search and rescue efforts. The spacecraft could receive signals from emergency transmitters on ships and planes in distress and send them to ground stations that coordinated search and rescue efforts.

"Real-time" is a common term which means that data is collected and relayed to the ground as soon as it occurs.

GOES 8-12 were three-axis-stabilized satellites that provided significant improvements. *GOES-8*, launched in 1994, carried separate and independently operating Imager and Sounder instruments. Now researchers could gather both imaging and sounding data continuously without having to alternate between the two operating modes. Image resolution also improved significantly, the *GOES* search and rescue system became operational, and the Sounder improved with 18 infrared channels and one visible channel for cloud detection.

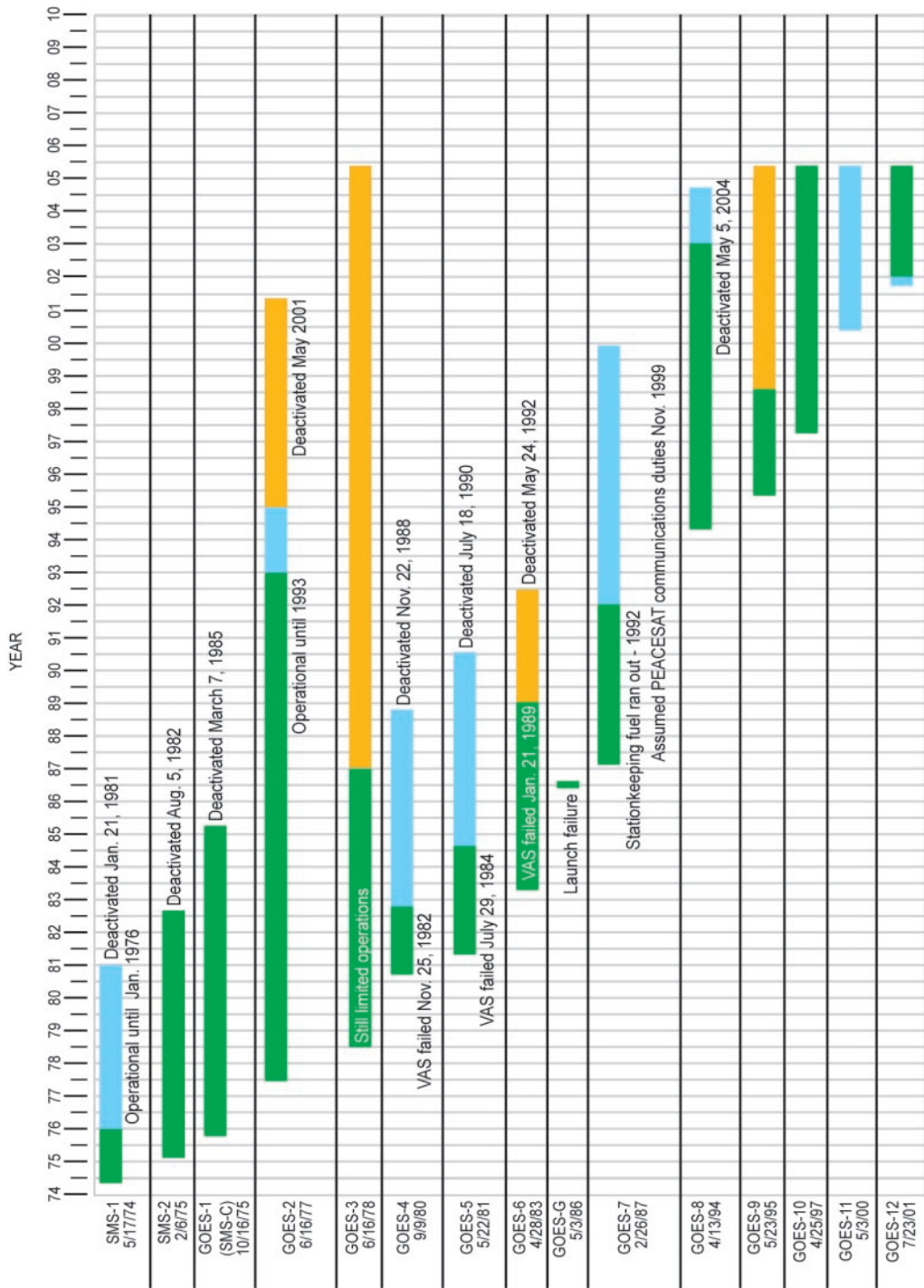

Legend:
 NSF - National Science Foundation
 SMS - Synchronous Meteorological Satellite
 VAS - VISSR Atmospheric Sounder
 VISSR - Visible/Infrared Spin Scan Radiometer
 WEFAX - Weather Facsimile

■ Launch / Active Period
■ Standby / Inactive
■ Diminished capability / Other function assumed

Mission History Summary

The GOES system has continued to improve with new technological innovations and sensors. The present-day GOES spacecraft help meteorologists observe and predict local weather events, including thunderstorms, tornadoes, fog, flash floods, and even snow squalls. GOES observations have proven helpful in monitoring dust storms, volcanic eruptions, and forest fires. As of January 2005, the system consists of GOES-12, operating as GOES-East in the eastern part of the constellation at 75° west longitude, and GOES-10, operating as GOES-West at 135° west longitude. GOES-11 is in an on-orbit storage mode nominally located at 105° W longitude and is serving as a spare that backs up both satellites. See “GOES History” beginning on page 32 for more detailed information about each spacecraft.

Overall, the GOES program continues to provide environmental data for routine meteorological analyses and forecasts, serve user agencies, and provide environmental data that helps expand knowledge of storm development and forecast severe weather events. It supports the Cospas-Sarsat system, contributes to the development of worldwide environmental warning services and enhancements of basic environmental services, improves the capability for forecasting and providing real-time warning of solar disturbances, and provides data that may be used to extend knowledge and understanding of the oceans and the atmosphere and their processes.

GOES-N,O,P Spacecraft

The GOES-N,O,P spacecraft, built by Boeing Satellite Systems, Inc. (formerly Hughes Space and Communications), are based on the Boeing 601 spacecraft and are the latest in the series of three-axis body stabilized geosynchronous weather/environmental satellites. The new satellites will more accurately locate severe storms and other weather phenomena, resulting in precise warnings to the public. The spacecraft enable the primary Imager and Sounder sensors to constantly face the Earth and thus frequently image clouds, monitor the Earth's surface and ocean surface temperatures, and sound the Earth's atmosphere for its vertical temperature and water vapor distribution. Atmospheric phenomena can be tracked, ensuring real-time coverage of events such as severe local storms, tropical hurricanes, and cyclones—meteorological events that directly affect public safety, property, and ultimately, economic health and development.



The spacecraft subsystems, such as telemetry and command, communications, mechanical, electrical, power, propulsion, attitude control, and image navigation and registration, have been designed to support the requirements of the on-board instruments and the data products and services that are described in this brochure. The illustration on page 8 shows the GOES spacecraft in its on-orbit configuration and a summary of the spacecraft description.

Spacecraft Description Summary

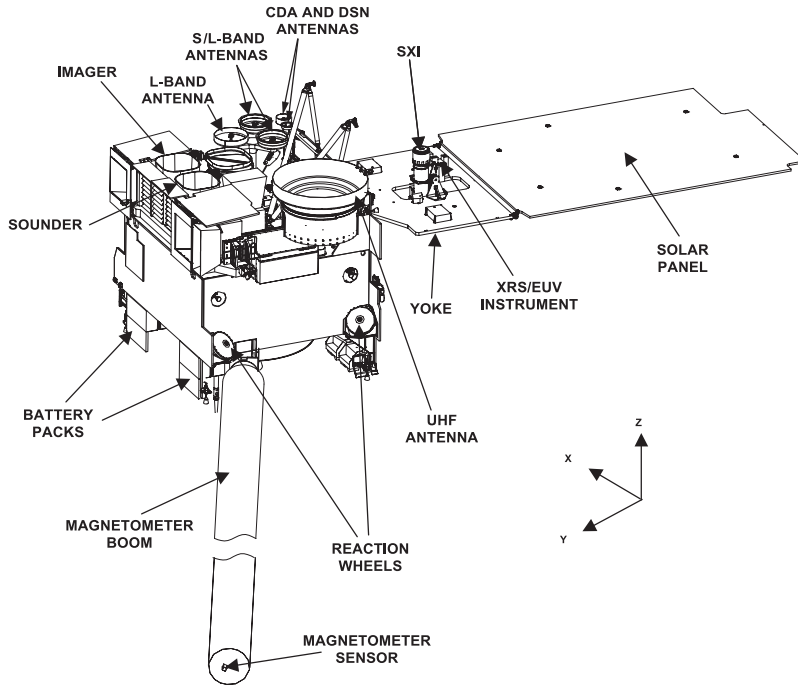

On-Orbit Configuration	Length (solar array to spacecraft body):	331 in. (8.4 m)	
	Height (Imager port to magnetometer boom):	358 in. (9.1 m)	
	Depth:	113 in. (2.9 m)	
	Solar array:	28 ft. 8 in. (8.2 m)	
	Yoke panel:	7 ft. 9 in. x 6 ft. 0.1 in. (2.3 m x 1.8 m)	
General Spacecraft data	Configuration	body stabilized	
	Design Life	10 years	
	Launch Vehicle	Delta IV	
	Maneuver lifetime	13.5 years	
Spacecraft Mass	Deployment mass	3209.5 kg (7076 lb)	
	Dry mass	1543 kg (3402 lb)	
	Propellant and pressurant	1666.5 kg (3674 lb)	
Propulsion Subsystem	Propellant	bi-propellant	
	Fuel	monomethylhydrazine (MMH)	
	Oxidizer	nitrogen tetroxide (N ₂ O ₄)	
	Pressurant	helium	
Power Subsystem		Total Solar Array	
		Output (watts)	
	BOL (2 yrs.**)	summer solstice	2171
	BOL (2 yrs.**)	autumnal equinox	2384
	EOL (10 yrs.)	summer solstice	2077
	EOL	autumnal equinox	2258
	**After two years of storage		
	Battery	1 Nickel-Hydrogen	
	Capacity	123 A-hr	

GOES-N,O,P Instruments

The GOES-N,O,P spacecraft carry an Imager, a Sounder, and a collection of other space environment monitoring instruments. Both the Imager and the Sounder have a flexible scan control mechanism that allows the instruments to scan small areas as well as all of North and South America and global scenes (called full-disk images). Small area scan selection permits rapid and continuous viewing of local areas for monitoring of regional phenomena and accurate wind determination. The scan control mechanism also allows continuous observations of severe storms and changing, short-lived weather phenomena. Commands from the NOAA Satellite Operations Control Center select the position and size of the area for observation.

The resolution, or clarity, of each image depends on the size of the picture elements (pixels) in the image that is being acquired. The size of each pixel, in turn, depends on which band is being used. Different bands take images with different-size pixels (see “Imager Scanning” table below). An image with pixels that are 4 km (2.5 miles) on each side provides twice the resolution of an image whose pixels are 8 km (5 miles) on each side. All Sounder channels generate data that have circular pixels with 10-km (6.2-mile) diameters.

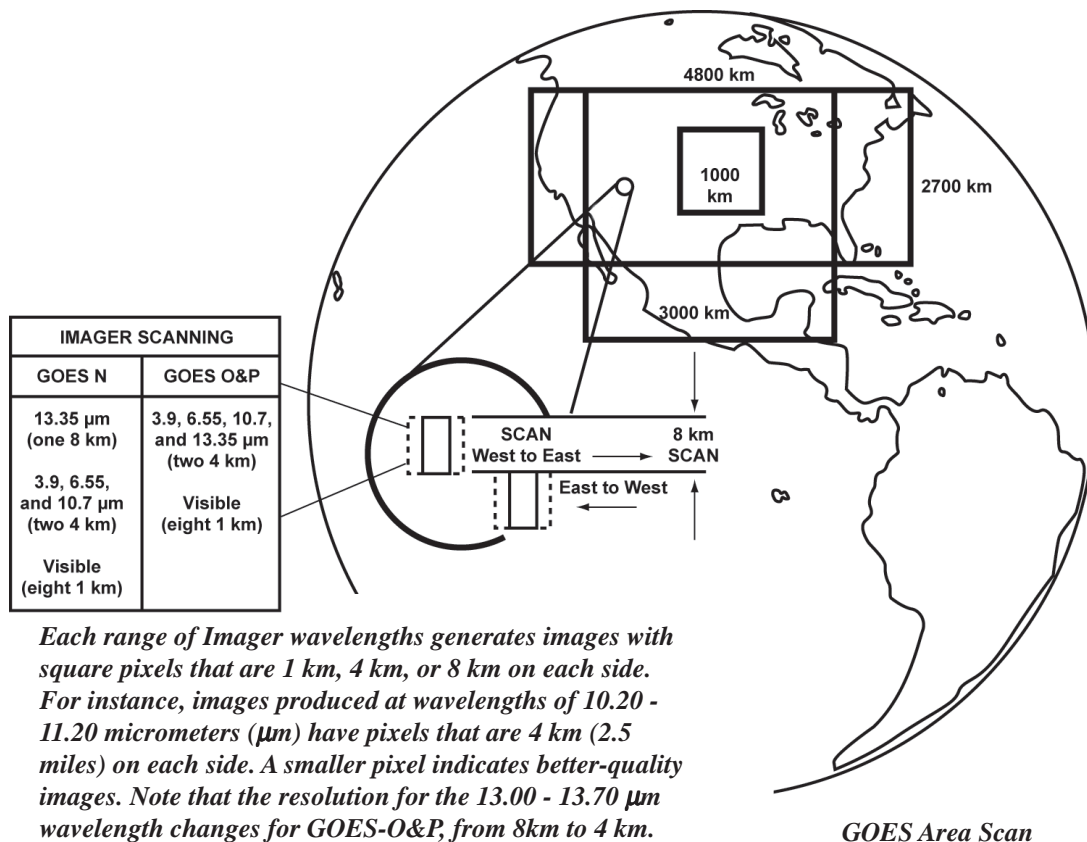

Imager

The Imager, developed by ITT SSD (ITT Space System Division), in Fort Wayne, Indiana, is an imaging radiometer that uses data obtained from its five channels to continuously produce images of the Earth's surface, oceans, severe storm development, cloud cover, cloud temperature and height, surface temperature, and water vapor. It allows users to identify fog at night, distinguish between water and ice clouds during daytime hours, detect hot spots (such as volcanoes and forest fires), locate a hurricane eye, and acquire measurements of ground and sea surface temperatures.

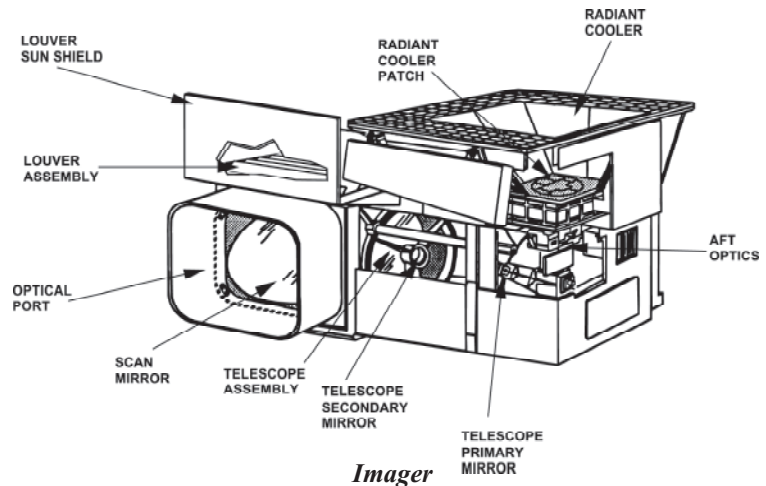

The Imager simultaneously senses emitted thermal and reflected solar energy from selected areas of the Earth. It uses a scan mirror system to alternately sweep east to west and west to east perpendicular to a north-to-south path. The rate of scanning allows the instrument to gather data in its five spectral channels while stepping north-to-south from a 1,864 x 1,864-mile area (3,000 x 3,000 km) in three minutes and from an area of 621 x 621 miles (1,000 x 1,000 km) in just 41 seconds.

Imager Data Products

Wavelength (μm)	Products	Pixel size (km)
visible - 0.52 - 0.71	Daytime cloud cover	1
3.73 - 4.07	Nighttime cloud cover	4
5.80 - 7.30	Water vapor	4
10.20 - 11.20	Earth and cloud images; sea surface temperature and water vapor	4
13.00 - 13.70	Cloud cover and cloud height	8 on GOES-N; 4 on GOES-O&P

Sounder

The Sounder, also built by ITT Space Systems Division (SSD), provides meteorologists with a detailed description of conditions in the atmosphere at any time. It gathers data over an approximately circular area extending from 60° north to 60° south latitude, allowing meteorologists to deduce atmospheric temperature and moisture profiles, surface and cloud-top temperatures, and ozone distributions by mathematical analysis and by adding to data from the Imager. Sounder data is also used in computer models that produce mid-and long-range weather forecasts.

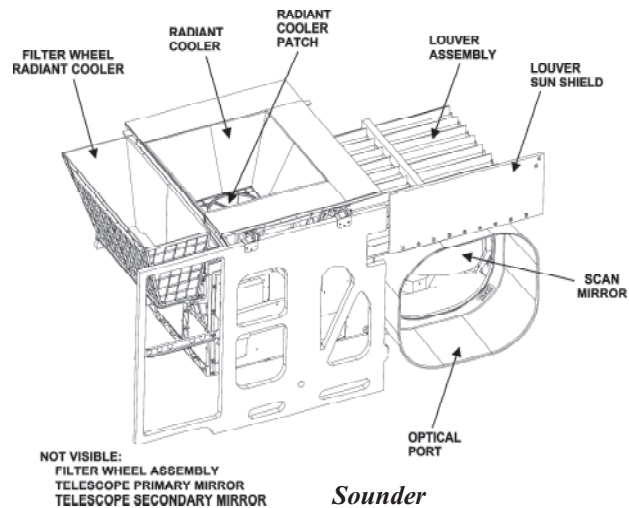

Detecting hot and humid conditions that may lead to severe storms is one major function of the Sounder. Data collected by the instrument is processed on the ground so that it generates a numerical designation called a “lifted index,” which is an indicator of atmospheric stability and

Sounder Channel Allocation and Purpose

Detector	Channel Number	Central Wavelength (μm)	Purpose
Longwave	1	14.71	Temperature sounding
	2	14.37	Temperature sounding
	3	14.06	Temperature sounding
	4	13.64	Temperature sounding
	5	13.37	Temperature sounding
	6	12.66	Temperature sounding
	7	12.02	Surface temperature
Midwave	8	11.03	Surface temperature
	9	9.71	Total ozone
Shortwave	10	7.43	Water vapor
	11	7.02	Water vapor
	12	6.51	Water vapor
	13	4.57	Temperature sounding
	14	4.52	Temperature sounding
	15	4.45	Temperature sounding
	16	4.13	Temperature sounding
	17	3.98	Surface temperature
	18	3.74	Surface temperature
Visible	19	0.70	Cloud detection

of how much air near the surface would keep rising were it lifted to the middle of the atmosphere. The less stable the atmosphere, the greater the likelihood of severe storms.

The Sounder probes the atmosphere measuring emitted radiation in one visible band and 18 thermal bands that are sensitive to temperature, moisture, and ozone as well as to reflected solar radiation. It measures radiated energy at different depths (altitudes) and also records surface and

The visible channel is used to detect the presence of clouds since the Sounder infrared channels cannot penetrate to sound through the clouds. Cloud contaminated soundings are operationally flagged and are not used.

cloud-top temperatures and ozone distribution. It looks at conditions in “columns” of the atmosphere—cylindrical sections that extend from the Earth’s surface to the upper reaches of the atmosphere.

The Sounder operates by means of a scan mirror that steps across the disk of the Earth in a west-to-east and east-to-west direction along a north-to-south path as the filter wheel rotates.

The filter wheel has 18 filters, each of which corresponds to a particular band or wavelength in the electromagnetic spectrum. Each filter allows only energy with a particular wavelength to reach the detectors. All 18 filters and the visible band are sampled during each rotation, which occurs 10 times per second.

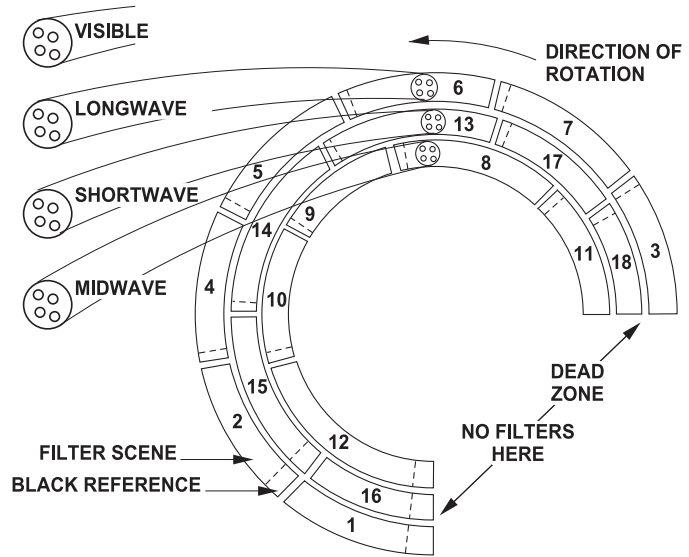

Sounder Filter Wheel Assembly

One-fourth of the wheel has no filters, which allows time for the scanner to move, or “step,” to a new scan position during the period of rotation. For the visible band, the reflected solar energy bypasses the filter wheel completely and goes directly to the 19th channel visible detector. The Sounder’s detector array assemblies sample four separate, but coregistered fields or atmospheric columns simultaneously.

The Sounder operates independently of and simultaneously with the Imager, using a similar type of flexible scan mechanism system. The Sounder scans the full Earth and can be commanded to scan and provide soundings of local regions of interest. It can provide imagery over the entire area that is visible to the Sounder, sector imagery, and scans of local regions. Sounder data from the chosen scan area is fed into powerful computer programs that develop advanced numerical weather prediction models for use by the NOAA national weather service and weather forecasters.

Space Environment Monitor

The Space Environment Monitor (SEM) consists of three instrument groups: 1) an energetic particle sensor (EPS) package, 2) two magnetometer sensors, and 3) a solar x-ray sensor (XRS).

Energetic Particle Sensor

The EPS, developed by Assurance Technology Corporation (ATC), (Formerly GE Panametrics Corp.) in Carlisle, Massachusetts measures the energetic particles at geosynchronous orbit, including protons, electrons, and alpha particles. The radiation in the environment consists of particles trapped within the Earth's magnetosphere as well as particles arriving directly from the sun and cosmic rays that have been accelerated deep in space.

The sensors accurately measure the number of particles over a broad energy range and are the basis for operational alerts and warnings of hazardous conditions. Energetic particles pose a risk to satellites and to astronauts, and they can disrupt navigation and communications systems used on the ground and in aircraft.

The Magnetospheric Electron Detector (MAGED) and Energetic Proton, Electron, and Alpha Detector (EPEAD), two elements of the EPS, detect electrons over the energy range of 30,000 electron volts (30 keV) to greater than 4 million electron volts (4 MeV), in eight channels. The Magnetosphere Proton Detector (MAGPD), EPEAD, and High Energy Proton and Alpha Detector (HEPAD), which are additional EPS elements, detect protons over the energy range of 80 keV to greater than 700 MeV, in 16 channels. The EPEAD and HEPAD detect alpha particles over the energy range 3.8 MeV to greater than 3,400 MeV, in eight channels.

The continuous long-term monitoring of the environment provided by these sensors forms the basis for engineering guidelines for satellite design, for analyzing satellite failure and anomalous behavior, for assessing the risk of human exposure to radiation, and for research leading to improved models of the radiation environment. The sensors on the EPS have been expanded on GOES-N,O,P to provide coverage over an extended energy range and with improved directional accuracy.

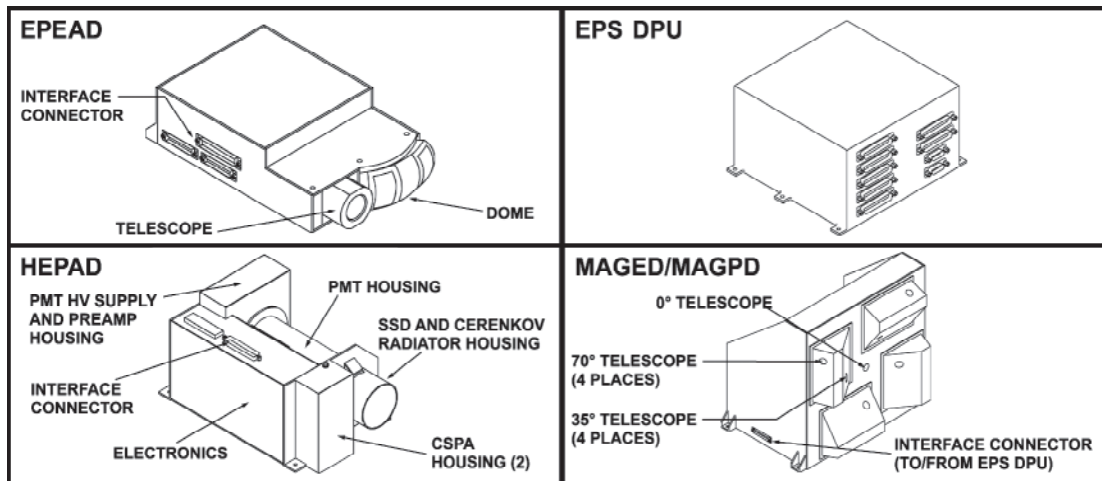

Elements of the EPS: the EPEAD, EPS DPU, HEPAD and MAGED/MAGPD

Magnetometers

Each of the GOES-N,O,P satellites have two identical magnetometers, provided by Science Applications International Corporation (SAIC), Inc. in Columbia, Maryland. They can operate independently and simultaneously to measure the magnitude and direction of the Earth's geomagnetic field, detect variations in the magnetic field near the spacecraft, provide alerts of solar wind shocks or sudden impulses that impact the magnetosphere, and assess the level of geomagnetic activity. Magnetometer data is archived for the scientific community and other interested users. One magnetometer sensor is mounted on the end of the boom 27.9 feet (8.5 m) from the spacecraft. The other is positioned on the same boom 2.6 feet (0.8 m) closer to the spacecraft. The second magnetometer sensor serves as a backup in case the first magnetometer sensor fails and provides for better calibration of the magnetometer data channel.

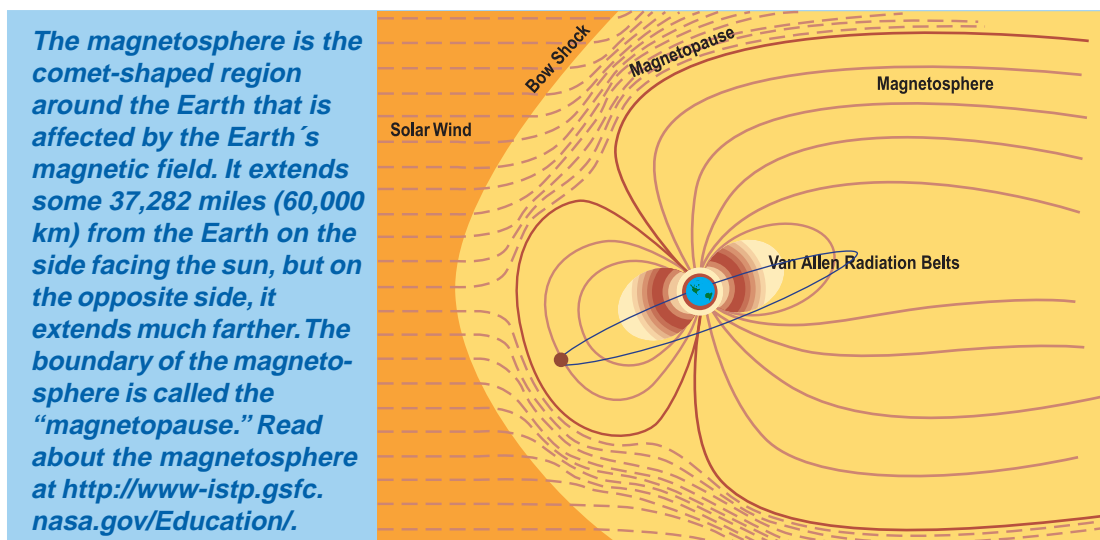

X-Ray Sensor and Extreme Ultraviolet Sensor

The XRS is an x-ray telescope that observes and measures solar x-ray emissions in two ranges—one from 0.05 to 0.3 nanometers (nm) and the second from 0.1 to 0.8 nm. In real-time, it measures the intensity and duration of solar flares in order to provide alerts and warnings of potential geophysical responses, such as changes in ionospheric conditions, that can disrupt radio communications and Global Positioning System (GPS) signals. XRS data is also used to estimate solar flare parameters such as rise-time (how quickly a flare grows) and the length and temperature of a flare for use in energetic proton predictions.

The five-channel EUV telescope is new on the GOES-N,O,P satellites. It measures solar extreme ultraviolet energy in five wavelength bands from 10 nm to 126 nm. The EUV sensor provides a direct measure of the solar energy that heats the upper atmosphere and creates the ionosphere. Changes in solar EUV output can change the density of the upper atmosphere by a

factor of 10, which will cause increased drag for satellites in low-Earth-orbit. Similarly, these changes in EUV level can increase the density of the ionosphere by a factor of 10, which will affect radio communications and satellite navigation.

Both the XRS and EUV are provided by Assurance Technology Corporation, and are part of the sun-observing package mounted on the solar panel yoke assembly. The entire package (including the SXI) continually points at the sun by using a Precision Sun Sensor (PSS) to control the solar panels to track the sun in azimuth and the x-ray positioner (XRP) to track the sun in elevation.

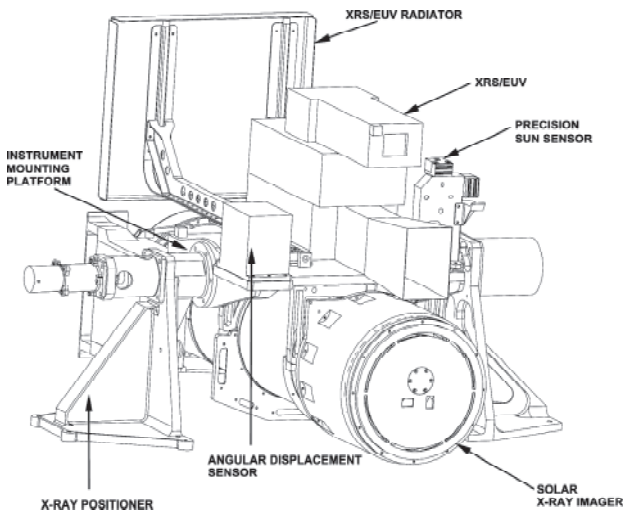

GOES Sun-Observing Package

Solar X-Ray Imager

The SXI, developed by Lockheed Martin Advanced Technology Center (LMATC) in Palo Alto, California, uses a telescope assembly to observe the sun's x-ray emissions and provide early detection and location of flares. These observations allow space weather forecasters to monitor solar features and activities such as solar flares, loops, coronal holes, and coronal mass ejections—clouds of charged particles shooting toward Earth—from the sun. Knowledge of the location and size of these phenomena greatly improves the solar forecaster's ability to predict which solar phenomena may affect the Earth and its atmosphere and to determine when forecasts and alerts of space weather conditions that may interfere with ground and space systems should be issued. Space weather can have quite far-reaching effects. NOAA categorizes these as radio blackouts, radiation storms, and geomagnetic storms. Radio blackouts interfere with military and commercial communications and navigation systems. Radiation storms can damage operating spacecraft and expose humans to excessive radiation during high-altitude missions.

Space Environment Monitoring Terminology

Cosmic rays - A rain of fast ions that constantly bombards the Earth, coming from distant space and much more energetic than any found in the magnetosphere.

Ionosphere - A region of the upper atmosphere that extends from about 30 miles (50 km) to 250 miles (400 km) above the Earth's surface. It is characterized by the presence of ions and electrons that affect radio communications and satellite navigation.

Magnetometer - An instrument that measures the magnitude and direction of the Earth's magnetic field.

Geomagnetic storms can damage power utility systems and disrupt communications and navigation systems.

NOAA and U.S. Air Force forecasters will use data and images from the SXI to monitor solar conditions that affect space weather conditions, including the dynamic environment of energetic particles, solar wind streams, and coronal mass ejections emanating from the sun.

The SXI captures full-disk images of the sun in the x-ray spectral band from 0.6 to 6.0 nm. It is commanded from the ground and can capture at least one image per minute. Ground command can reconfigure the SXI to take image sequences with varying exposure times in different parts of the x-ray spectral band, depending on the level of solar activity. If enabled by ground command, the instrument can also automatically change its imaging sequences during very high solar activity.

The telescope consists of entrance filters that block radiation outside the 0.6-to-6.0-nm range and also protect the Charge Coupled Device (CCD) from undesired radiation. The SXI's x-ray mirror focuses the image on the camera, while the High Accuracy Sun Sensor (HASS) keeps the instrument focused on the sun in the east-west direction.

Images are captured in digital form on the CCD. From there, they are transmitted directly to NOAA's SEC, which processes the data in real time for its own use and use by others in predicting space weather. In processing the data, the SEC corrects known image defects

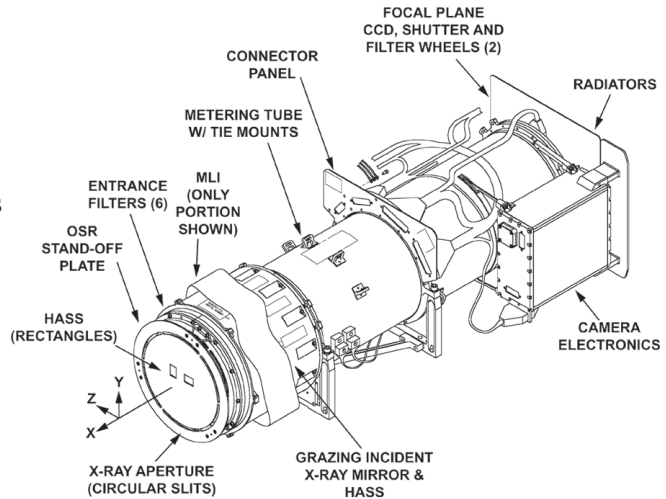

SXI Telescope Assembly

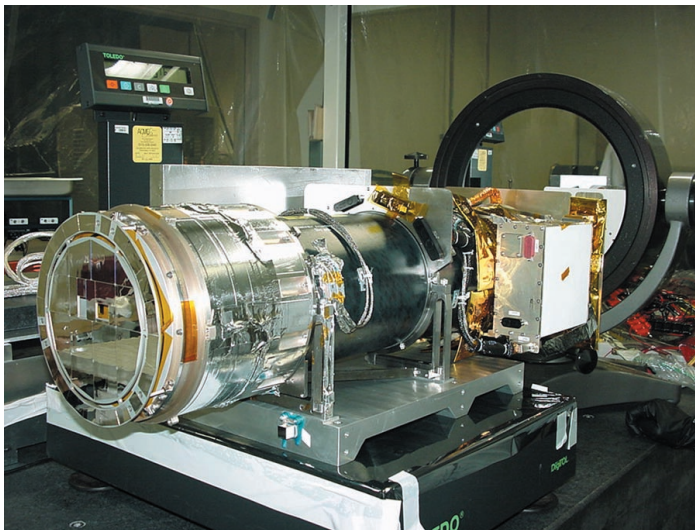

Solar X-Ray Imager

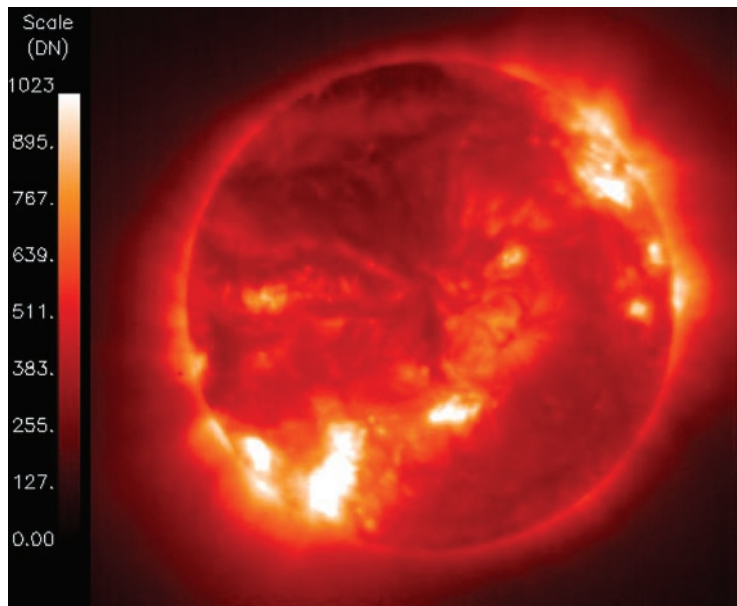

The SXI provides real-time transmissions of x-ray images of the sun through its unprecedented monitoring of solar changes. In this image, the brightest spots indicate solar flares—explosive releases of plasma from the sun’s surface into its atmosphere. Coronal holes appear as dark regions. They are associated with weak magnetic field lines and indicate sources of geomagnetic storms. This image was produced on September 7, 2001, by the first SXI, flown on GOES-12. It was built by NASA’s Marshall Space Flight Center.

and calibrates and stores each image. The calibrated images are used to automatically locate solar flares, produce movie sequences, calculate coronal hole indices, display on real-time monitors, and produce products for the general public. The user will be able to view PNG and MPEG files* and order high-fidelity images for research. Data will be archived at the NOAA National Geophysical Data Center (NGDC) at <http://www.ngdc.noaa.gov>.

*PNG and MPEG are file formats for viewing graphics and motion pictures.

The GOES-N,O,P Satellite System

The GOES-N,O,P satellite system that will be used operationally includes the GOES-East and GOES-West satellites, and a commercially leased transponder on the GE Americom satellite for the distribution of Data Collection Platform (DCP) information. The GOES ground system consists of the ground stations that provide the command, control and communications RF interface with the satellites. A major portion of the ground system includes the Product Generation and Distribution (PG&D) system that is located at the NOAA Science Building in Camp Springs, MD, the Central Environmental Meteorological Satellite Computer System (CEMSCS) in Suitland, MD, the Command and Data Acquisition (CDA) station at Wallops, VA, and other various locations.

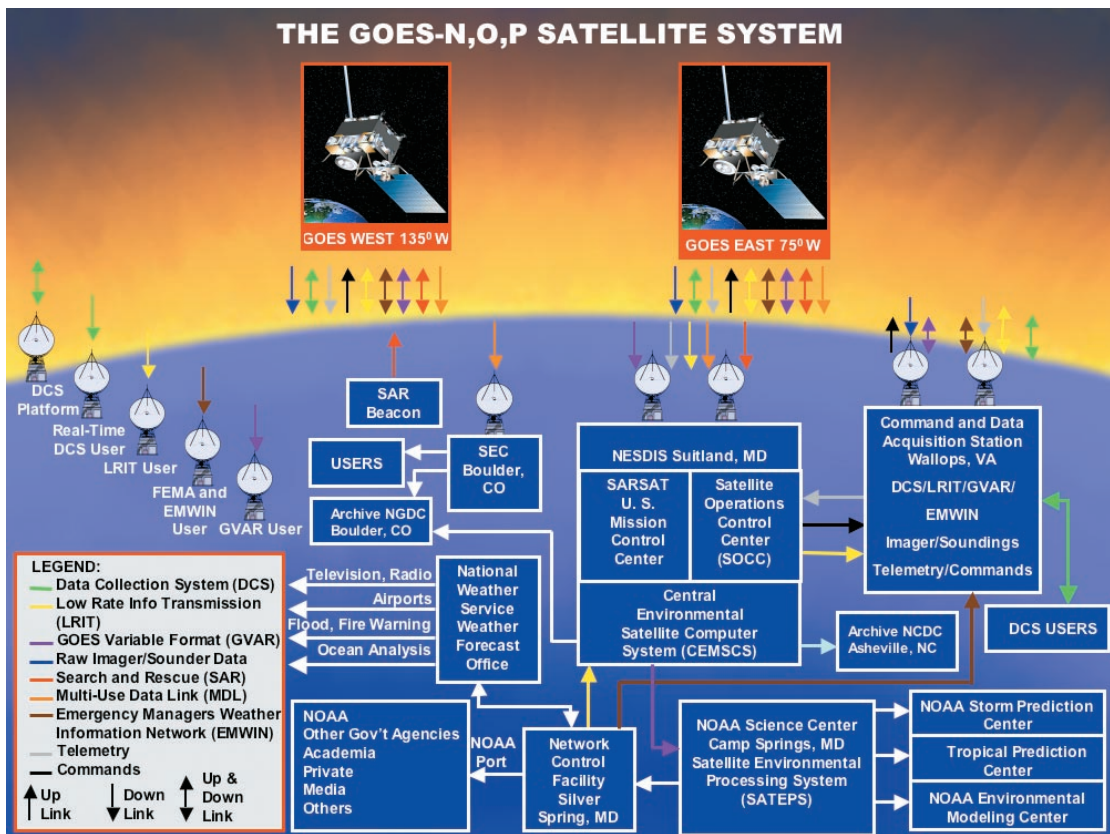

NOAA NESDIS Operations

The NESDIS facilities are headquartered in the Washington, DC metropolitan area (Silver Spring, MD) with data processing services in the Suitland, MD Federal Center and the NOAA Science Center in Camp Springs, MD.

Satellite Operations Control Center

The Satellite Operations Control Center (SOCC) in Suitland, MD conducts continuous 24 hours per day, seven days per week operations and is responsible for the management of the GOES on-orbit satellites. There are normally two fully operational satellites (GOES-East and GOES-West), one or two on-orbit spare satellites, and old satellites that have not yet been de-orbited. The SOCC facility also provides support for each new satellite during the pre-launch and post-launch activities that consist of orbit raising, and post-launch performance verification activities. In summary, SOCC personnel perform the functions that are described below.

- Monitor the health and safety of the GOES satellites and instruments
- Monitor the orbit and attitude of each spacecraft
- Plan and perform the necessary spacecraft maneuvers to maintain spacecraft orbit and attitude
- Monitor onboard schedule execution

Command and Data Acquisition Stations

The Command and Data Acquisition Station (CDAS) located at Wallops, VA is the primary ground station interface with the GOES satellites. The ground station provides the command uplink to the satellites, receives spacecraft telemetry, and provides the operational uplinks and downlinks for the various communication data product services. The CDAS transmits commands to the operational satellites and acquires and records instrument and engineering data received from the satellites. Raw Imager and Sounder data is processed at the CDAS, and then transmitted to the satellite via the GOES Variable (GVAR) data link for re-broadcast to the data user community.

Backup CDASs are located at Goddard Space Flight Center (GSFC) and Fairbanks, Alaska. If the primary station at Wallops is threatened or hit by a hurricane or otherwise unavailable, the backup stations will become operational and take over their command and data acquisition functions ensuring that data from GOES-East and GOES-West will continue to flow. Each backup station can support a single GOES satellite. Some of the GOES functionality is lost during the period of time while it is controlled from the backup CDASs, but the primary mission of providing weather data to NWS and other users is maintained. Fairbanks will become a GOES backup CDA station as soon as it completes its present task of controlling the GOES-9 spacecraft that NOAA has loaned to the Japan Meteorological Agency.



16.4-Meter Backup Antenna at Goddard Space Flight Center

GOES Variable Format Data Distribution

The primary payloads on the GOES-East and GOES-West satellites are the Imager and Sounder instruments that provide raw data to the Command and Data Acquisition Station (CDAS) at Wallops, VA. Following ground system processing by the Operational Ground Equipment (OGE), highly accurate, earth located, calibrated imaging and sounding data is provided in a GVAR data format in near real-time for retransmission via GOES spacecraft to primary end users, typically the NWS Field Service Station end users throughout the United States. The GOES data are then distributed from the satellite field service stations to forecast offices of the World Weather Service (WWS) and other users such as military, private industry, and educational institutions.

NOAA Space Environment Center

The Space Environment Monitor (SEM) instruments on the GOES satellites are used to provide data to the NOAA Space Environment Center (SEC) at Boulder, CO. The SEC, as the nation's "space weather" service, receives, monitors, and interprets a wide variety of solar-terrestrial data, and issues reports, alerts and forecasts for special events such as solar flares or geomagnetic storms. This information is important to the operation of military and civilian radio and satellite communication and navigation systems, as well as electric power networks, and to the mission of geophysical explorers, Shuttle and Space Station astronauts, high-altitude aviators, and scientific researchers.

Low Rate Information Transmission

The digital low Rate Information Transmission (LRIT) data originates from the National Weather Service (NWS) and from NOAA image-processing facilities. The LRIT digital WEFAX products will be similar to the current WEFAX data products. The LRIT is an international standard for data transmission that is supported by all operational geostationary meteorological satellites flown by the United States, European Space Agency, Japan, China, and Russia. The LRIT system will contain significantly more meteorological data, imagery, charts, and other environmental information than the analog WEFAX system from the previous generation of GOES satellites.

Emergency Managers Weather Information Network

The Emergency Managers Weather Information Network (EMWIN) is a direct service that provides users with weather forecasts, warnings, and other information directly from the National Weather Service (NWS) in almost real time, to more than 10,000 users in 35 countries. The EMWIN is a fully operational service supported by the NWS in partnership with the

Federal Emergency Management Agency (FEMA) and other public and private organizations. Additionally, everyone with an appropriate receiving system and a personal computer can be an EMWIN user.

Data Collection System

The Data Collection System (DCS) is a communications relay system that handles information gathered from more than 19,000 data collection platforms located in remote areas. The platforms consist of buoys, free-floating balloons, and weather stations. Sensors on the platforms measure environmental factors such as atmospheric temperature and pressure and the velocity and direction of the ocean and wind currents. The DCS transponder on the spacecraft collects these measurements and provides near real-time relay of environmental data for centralized archiving and distribution. The digital data is used to develop analyses of environmental events such as tsunamis, tropical cyclones, and floods and to map river stages, soil condition, and snow depth. Other sensors on remote platforms collect data on seismic measurements, ocean current monitoring, forest fire danger, river flow rate, and water levels above dams. When the remotely located Data Collection Platforms and Tsunamis detection platforms are located within view of the GOES satellites, the information that is collected by the platforms is transmitted to the GOES satellites and then relayed to the appropriate data user communities.

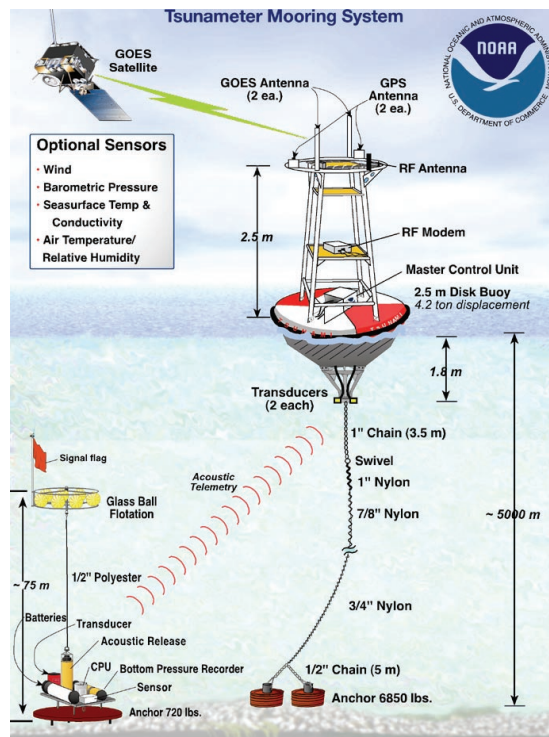

Data Collection System Application

Search and Rescue System

The GOES satellites have a search and rescue transponder that detects signals transmitted by 406 MHz emergency beacons carried by aircraft (Emergency Locator Transmitters—ELTs), maritime vessels (Emergency Position Indicating Radio Beacons—EPIRBs) and individuals (Personal Locator Beacons—PLBs). Optional GPS equipped beacons will allow GOES spacecraft to precisely locate distress signals and significantly improve the response time for providing rescue assistance. When the transponder on a GOES satellite detects an alert, it transmits the alert from the spacecraft to a geosynchronous Local User Terminal (LUT) located at the U.S. Mission Control Center (USMCC) in Suitland, Maryland. The signals sent by the GOES spacecraft can be used in conjunction with the signals sent by the polar-orbiting satellites in low-Earth-orbit to determine the location of the distress call. Satellites in low-Earth-orbit transmit alerts they receive to a LUT located within the field of view of the satellite. U.S. LUTs for satellites in low-Earth-orbit are located at Fairbanks, Alaska; Vandenberg Air Force Base, California; Wahiawa, Hawaii; Miami, Florida; NOAA facility in Suitland, Maryland and Anderson Air Force Base, Guam.

When the location of the distress call is determined, the Mission Control Center (MCC) identifies the appropriate Rescue Coordination Center (RCC) and forwards the distress data after removing redundant information. Additional LUTs and MCCs are located in Canada, France, Russia, and 23 other cooperating countries. All MCCs cooperate in forwarding data to provide rapid global delivery of distress locations received through the satellites. The U.S. portion of the Cospas-Sarsat system is operated by the NOAA Sarsat Office in Suitland, Maryland. Additional information about the system, including the latest U.S. and worldwide lives saved, can be obtained at <http://www.sarsat.noaa.gov>. As of December 2004, more than 18,000 persons have been rescued worldwide since 1982.

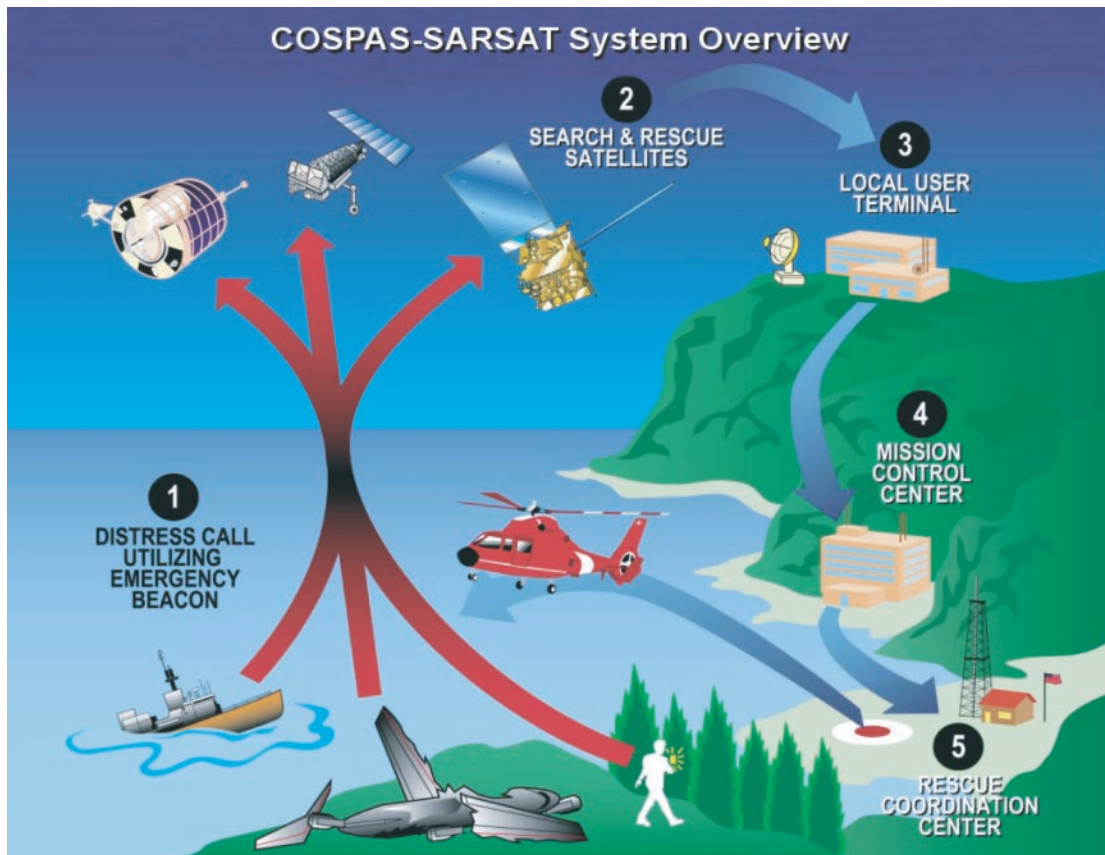

Cospas-Sarsat System

1. Emergency beacons are activated in situations of "grave and imminent danger" when lives are at risk.
2. Emergency alerts received by the satellites are retransmitted to one or more of 58 automatic (unstaffed) ground stations worldwide. These stations are called Local User Terminals (LUTs).
3. Messages are routed to a Mission Control Center (MCC) in the country that operates the LUT. Routed messages include beacon location computed at the LUT if the message was received by one of the system's low-Earth-orbiting satellites. Messages received by system satellites in geosynchronous orbit provide instantaneous alerting and can include location information if the beacon is a self-locating type.
4. After validation processing, alerts are relayed depending on beacon location or country of registration (406-MHz beacons only) to either another MCC or to the appropriate Rescue Coordination Center (RCC).
5. The U.S. Coast Guard and Air Force operate U.S. RCCs. The Air Force Rescue Coordination Center at Langley AFB, Virginia, coordinates all inland search and rescue activities in the lower 48 states. Usually, the actual search and rescue is carried out by the Civil Air Patrol or local rescue services. The Coast Guard coordinates and conducts most maritime search and rescue missions from RCCs located in nine Districts around the United States and two Rescue Sub-Centers (RSCs) in San Juan, Puerto Rico, and Guam. The Coast Guard also coordinates rescue missions in Hawaii.

In Alaska, the Air Force operates an Alaskan Rescue Coordination Center in Anchorage at Ft. Richardson. Air National Guard units, the Alaska State Police, and local authorities carry out Alaskan search and rescue.

Launch and Orbit Raising



Delta IV Launch Vehicle

separation from the launch vehicle. The Delta IV launch vehicle will inject the spacecraft into an orbit to begin the transfer orbit phase.

The GOES launch and orbit insertion sequence starts before lift-off with a buildup of thrust following Stage I engine ignition. Then hold-down bolts are fired and the launch vehicle lifts off. After clearing the launch pad, the launch vehicle climbs to its desired flight altitude and begins to pitch over in the trajectory phase that is described in the illustration below.

The GOES-N,O,P satellites are launched from the Cape Canaveral Air Force Station Launch Complex 37B by a Boeing Delta IV Medium Plus (4,2) Launch vehicle. The first digit in the parenthesis refers to the diameter of the second stage in meters, and the second digit refers to the number of strap-on solid rocket motors (SRMs). The spacecraft telemetry data is provided through the launch vehicle telemetry until

Delta IV Medium+ (4,2) Launch Vehicle

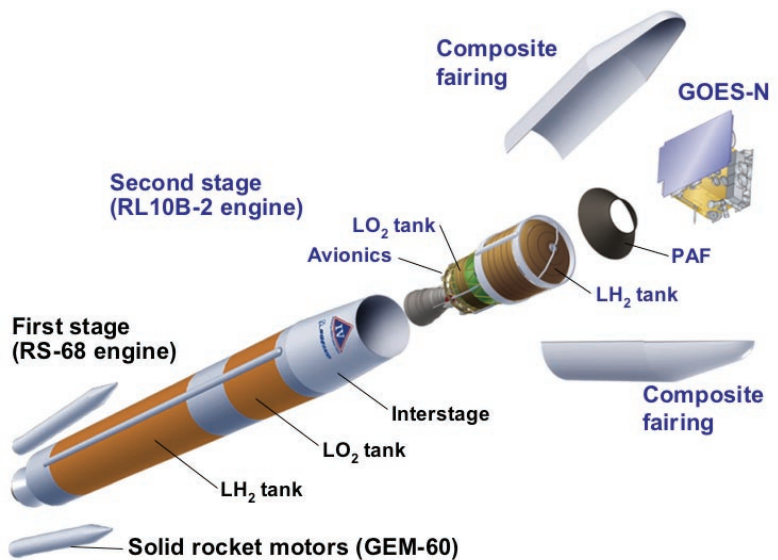

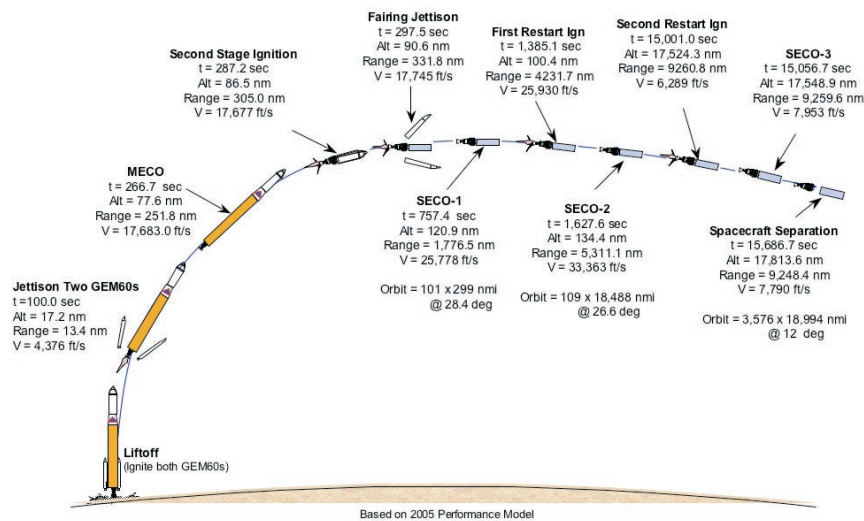

Typical Delta IV Geosynchronous Transfer Orbit Sequence (Times are approximate)

The GOES-N launch will be commercially licensed through the Federal Aviation Agency (FAA). The NASA Integrated Services Network (NISN) will provide the voice and data communications services to support pre-launch, launch, and post-launch activity.

The Deep Space Network (DSN), which is maintained and operated by the Jet Propulsion Laboratory (JPL), provides the primary support for the launch of the GOES-N,O,P satellites. The DSN 26-meter tracking stations are located at Madrid, Spain, Canberra, Australia and Goldstone, California. Additional launch support facilities include the NASA facility at Wallops, Virginia, The University of Chile facility at Santiago, and the Universal Space Network (USN) facilities at Dongara, Australia, and South Point, Hawaii.

ORBIT TERMINOLOGY

Apogee – The part of an orbit where the spacecraft or launch vehicle is the farthest from the Earth.

Geostationary orbit – An orbit in which the satellite is always in the same position in relation to the Earth. It is approximately 22,240 miles (35,790 km) above the Earth's equator.

Liquid apogee motor – A motor that fires at apogee and at perigee to circularize the orbit. This motor uses liquid fuel.

Orbit raising – The sequence of events that maneuvers the spacecraft into its final orbit.

Perigee – The part of an orbit where the spacecraft or launch vehicle is closest to the Earth.

Supersynchronous transfer orbit – A temporary orbit whose apogee is farther away from the Earth than the final orbit.

Trajectory phase – The events that take place when the spacecraft is moving into its correct orbit.

Transfer orbit – A temporary orbit that the spacecraft moves in before moving to its final position.

Transfer orbit phase – The part of the orbit lasting from the time when the spacecraft separates from the launch vehicle to the last perigee motor firing (the motor firing that occurs when the spacecraft is at its perigee, i.e., closest to the Earth).

Coverage Area

Normally, two GOES spacecraft operate concurrently. *GOES-East* is stationed at 75° west longitude, and *GOES-West* is located at 135° west longitude, both over the equator. *GOES-East* observes North and South America and the Atlantic Ocean. *GOES-West* observes North America and the Pacific Ocean to the west of Hawaii. Together, these satellites provide coverage for the central and eastern Pacific Ocean; North, Central, and South America; and the central and western Atlantic Ocean. The images that are produced from this hemispheric coverage and which are familiar to many television viewers are called “full-disk images,” such as the image on the cover of this brochure.

The Imaging and Sounding data product coverage and the coverage of the satellite communication links are described in the illustration below for the satellites that are located at 75 and 135 degrees west longitude. The contour of points with a 6 degree elevation angle to the satellite reflects the limits of useful measurements for the Imager on that particular GOES satellite, and a contour of points with a 27.5 degree elevation angle describes the limit of useful Sounder measurements. The contours with a zero degree antenna elevation angle reflects the very absolute outer limits of possible communications to and from the GOES satellites; but made

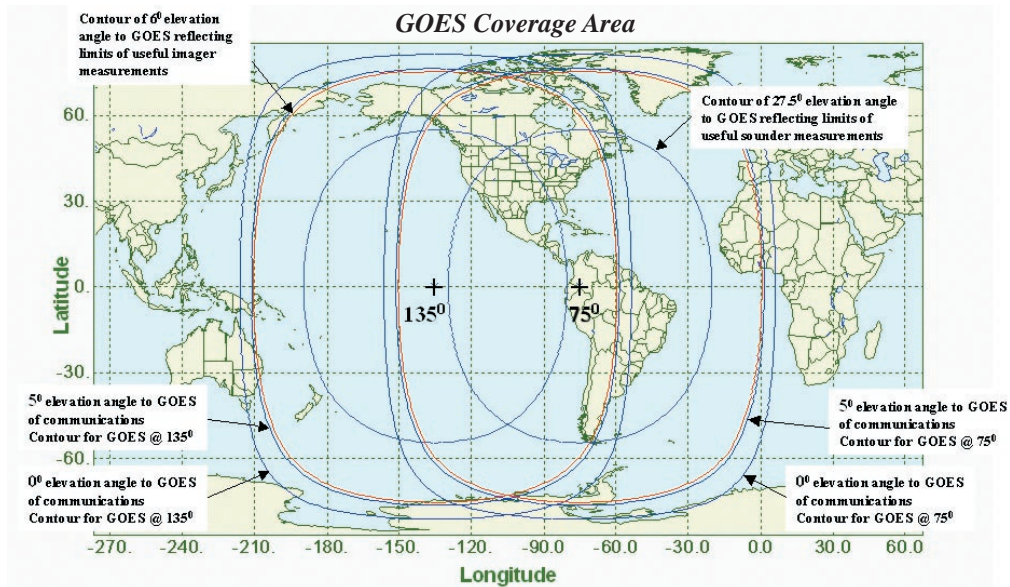

possible only under certain conditions such as ground antennas located multi-thousand feet above sea level and larger antennas.

At least one GOES spacecraft is always within view of Earth-based terminals and ground stations within the western hemisphere. The command and data acquisition station (CDAS) can see both spacecraft so that it can transmit commands to and receive data from each satellite

simultaneously. Data collection platforms (DCPs) within the coverage area of each spacecraft can transmit their sensed surface-based data to the CDAS by means of the onboard data collection system (DCS). Ground terminals can also receive processed environmental data and EMWIN and LRIT/WEFAX transmissions.

Raw Imager and Sounder data received at the NOAA CDAS is processed in the spacecraft support ground system with other data to provide accurate, Earth-located, calibrated imagery and sounding data in near real time for uplink to the satellite and retransmission from the GOES spacecraft to primary end users throughout the United States.

Image Navigation and Registration

The GOES Image Navigation and Registration (INR) system ensures that Imager and Sounder data is consistent during the day by maintaining the pointing accuracy of the instruments. *Image navigation* is the process of determining the coordinates (Earth latitude and longitude) of each pixel within an image or sounding. *Image registration* is the process of maintaining the coordinates of each pixel within an image or sounding at the same Earth latitude and longitude independent of time.

While in orbit, the spacecraft and consequently the instruments move slightly, which can cause the instruments to look at and scan slightly different areas of the Earth. Other conditions, such as vibrations, heat-related distortions, and erroneous signals to the instrument mirrors, can also lead to pointing inaccuracies that can produce inconsistent data. The INR system continuously adjusts the aim of the instruments' scan mirrors to compensate for the motion of the spacecraft and other disturbances. The system uses image landmarks, star views, and satellite range data collected throughout the day to make the adjustments.

INR Line Of Sight (LOS) Performance Requirements Summary			
IMAGER		Microradians (μrad)	Kilometers at Nadir (km)
0	Imager navigation accuracy	65	2.3
0	Registration within an image	54	2.3
0	Registration between repeated images		
	15 minutes	36	1.3
	90 minutes	49	1.7
	24 hours	114	4.0
0	Visible Channel-to-IR channel coregistration	19.3	0.7
SOUNDER			
0	Earth location accuracy	280	10
0	Registration within 120-minute sounding	84	3
0	Registration between repeated soundings		
	90 minutes	84	3
	24 hours	224	8

Data Products and Services

GOES instruments generate many data products and provide several services to the science community, meteorologists, and the public. These include the commonly seen images produced by the Imager and Sounder; data from the SEM that is transmitted to and processed by the SEC in Boulder, Colorado; information gathered by data collection platforms; text, images, and graphics transmitted by EMWIN; data transmitted through the LRIT/WEFAX system; and search and rescue services. A sample of images generated by the Imager and Sounder and from SEM data appears below and on the pages that follow.

This image shows the Jarrell, Texas, tornado event on May 27, 1997. The red areas are clouds with severe storm activity. The image does not distinguish between tornado activity and other severe storms. Radar and other ground data are needed to provide that additional information.

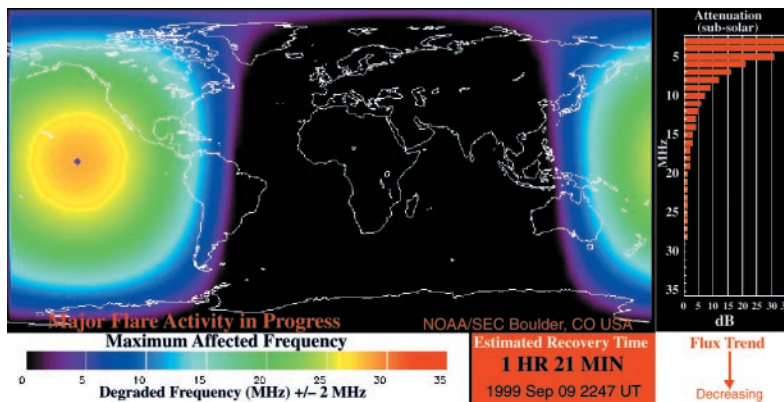
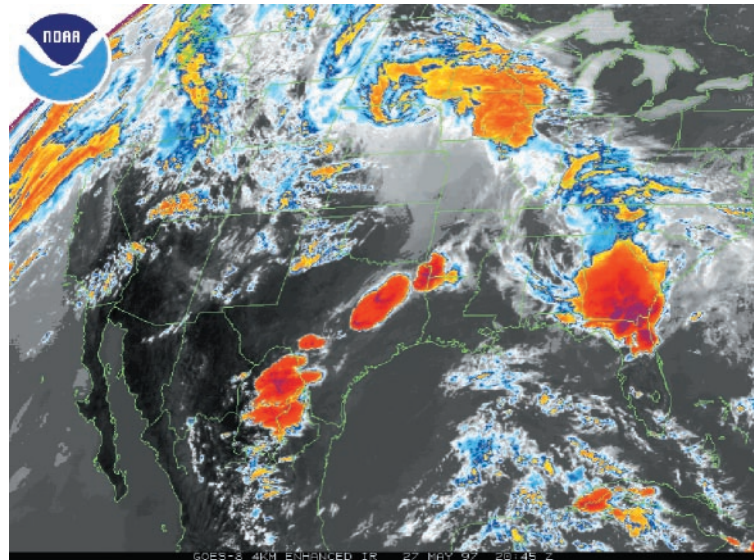

Absorption of high-frequency radio waves in the D-Region of the ionosphere (the lowest layer of the ionosphere) is directly affected by the level of solar x-ray flux. The D-Region absorption product was developed to assist high-frequency radio operators and is based entirely on real-time data from the x-ray sensor.

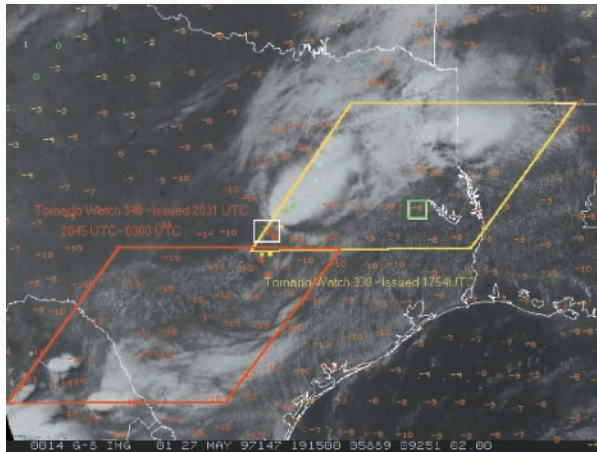

This Sounder-derived image shows the tornado event that occurred near Jarrell, Texas, on May 27, 1997. The numbers, called a lifted index, represent atmospheric stability. The more negative numbers indicate a more unstable atmosphere. A -10 or lower is considered very unstable—a breeding ground for tornadoes and other severe storms. On this map, the most unstable area is bordered in red, where lifted index numbers fall as low as -16 and where the tornado later broke out.

This image, also derived from Sounder data, shows the degree of stability in the atmosphere as expressed in a lifted index scale that is color-coded at the bottom of the image. The red areas of the map in southern Texas and north-eastern Mexico correspond to quite negative lifted index values. They are the most unstable, with serious potential for tornadoes or other severe storm activity. The beige areas of the map show positive lifted index values. They indicate stable conditions over the southwestern states.

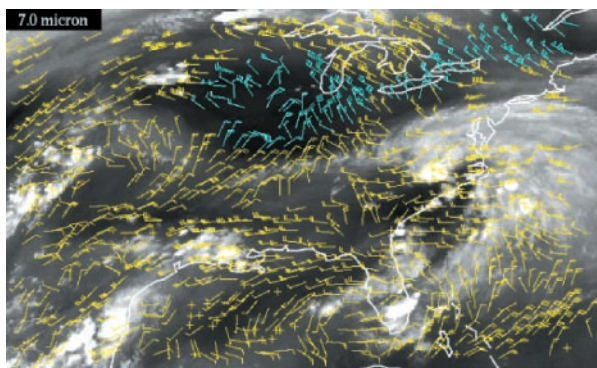
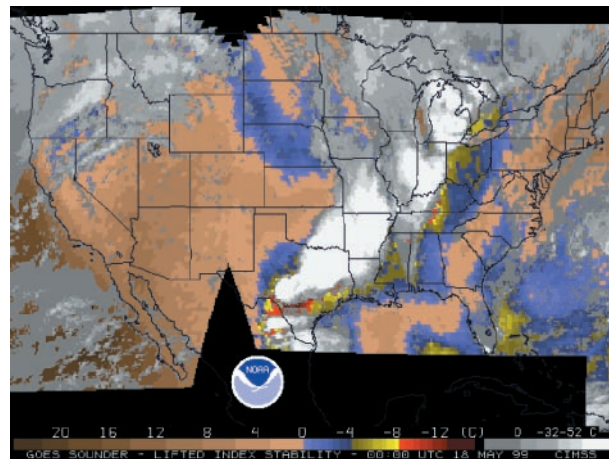

Wind data is derived from the GOES Sounder's water vapor channels in the mid-troposphere, the level of the atmosphere where the jet stream develops and carries weather systems. The straight end of a wind barb points in the direction that the wind is blowing. The density of a barb's tail shows the intensity of the wind. The color of a barb shows its altitude.

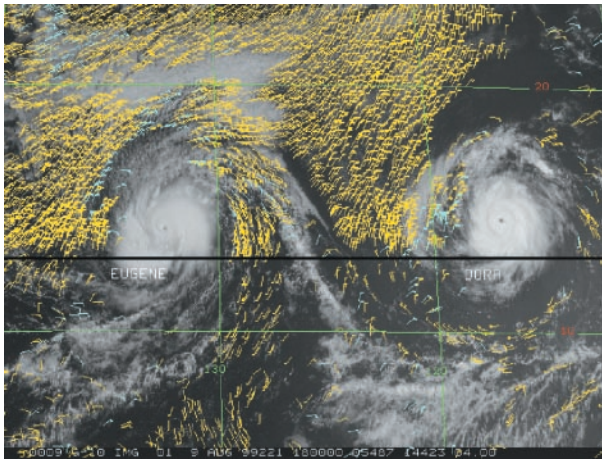

This image shows low-level visible cloud-drift winds around hurricanes Eugene and Dora. Three 15-minute sectors (above the horizontal black line) and three 30-minute sectors (below the black line) were used to derive the visible winds from Imager data. Note the significant improvement in detail of the wind field from data that was obtained in 15-minute intervals in the top half of the image. The straight end of each wind barb points in the direction that the wind is blowing.

This image of Hurricane Floyd was taken on September 15, 1999, from a color combination of GOES visible channel 1 and infrared channels 2 and 4. This color combination presents high clouds as white, low clouds as yellow (such as in the eye of the hurricane), and the ocean as dark blue.

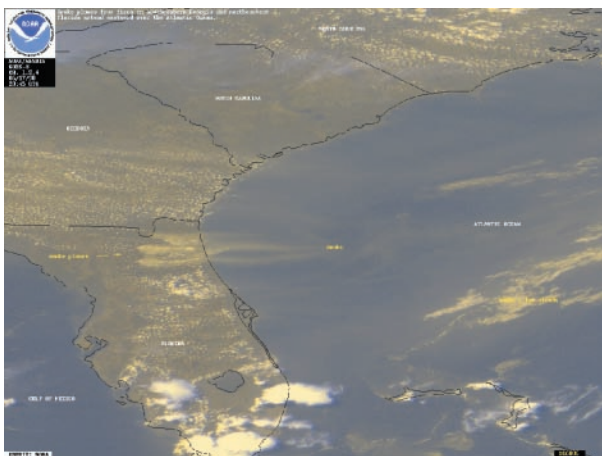
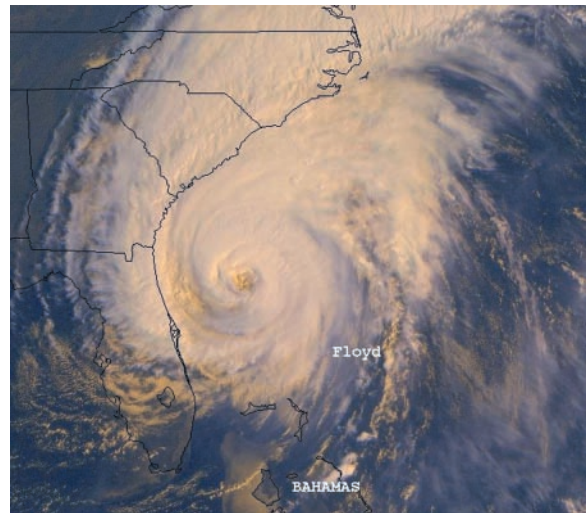

Several fires in northeastern Florida are seen in this image, a color combination of GOES visible channel 1 and infrared channels 2 and 4. Smoke from the fires appears as low (yellow) haze that stretches eastward from northern Florida out over the Atlantic Ocean.

NASA and NOAA Roles and Support Systems

NOAA and NASA are actively engaged in a cooperative program to continue the GOES system with the launch of the GOES-N,O,P satellites. Since 1974, the two partners have worked together to develop, perfect, and operate the GOES program. The current GOES spacecraft are a key element in NOAA's National Weather Service modernization program.

NASA's GSFC procures, develops, and tests the spacecraft, instruments, and unique ground equipment.

NOAA is responsible for program funding and the on-orbit operation of the system. NOAA manages and also determines the need for satellite replacement. The National Environmental Satellite, Data and Information Service (NESDIS) is the arm of NOAA that operates the GOES system. It is responsible for implementing, operating, and maintaining the SOCC facility at Suitland, Maryland; the CDAS at Wallops, Virginia; the command and data acquisition backup station at GSFC in Greenbelt, Maryland, and a station in Fairbanks, Alaska that is primarily used for POES data receipt and receipt of data from the GOES-9 which is on loan to Japan.

NOAA is also responsible for processing, analyzing, disseminating, and archiving all operational data, which is available to government researchers and others for research and environmental applications.

Boeing Satellite Systems, NOAA and NASA jointly design, develop, install, and integrate the ground system needed to acquire, process, and disseminate the data from the satellite sensors. Integral Systems, Inc. in Lanham, MD provided most of the GOES-N,O,P satellite support ground system.

GOES History

SMS-1 (SMS-A) was launched on May 17, 1974, from the Eastern Test Range (ETR) at Cape Canaveral, Florida. It was the first geostationary meteorological satellite. Launched from a Delta 2914 launch vehicle, its objectives were to evaluate a prototype operational meteorological satellite for NOAA's National Weather Service and provide regular daytime and nighttime meteorological observations in support of the national operational meteorological satellite system. The principal instrument on board was the Visible/Infrared Spin Scan Radiometer (VISSR), which provided day and night imagery of cloud conditions. The satellite was also equipped with a SEM and a DCS. The satellite also had the capability to perform facsimile transmissions of processed images and weather maps to WEFAX field stations. The satellite was positioned in a geostationary orbit directly over the equator at 45° W (over the central Atlantic), which provided continuous coverage of the central and eastern United States and the Atlantic Ocean. It was operational until January 1976 and was deactivated and boosted out of orbit on January 21, 1981.

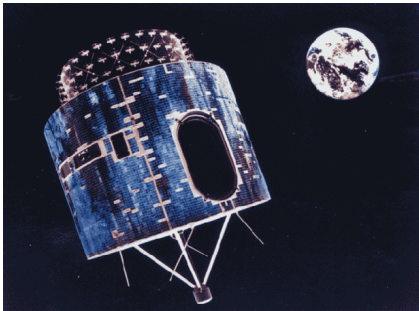

Composite Photo Showing the On-Station Position of SMS-1 in 1974

SMS-2 (SMS-B) was launched February 6, 1975, from a Delta 2914 launch vehicle. It was equipped with a VISRR, SEM, and DCS and had WEFAX capability. It was placed in a geostationary orbit directly over the equator at 135° W (over the east-central Pacific Ocean). The satellite was deactivated August 5, 1982. SMS-1 and SMS-2 proved the viability of geosynchronous meteorological satellites.

GOES-1 (GOES-A) was the first in the series of Geostationary Operational Environmental Satellites. It was launched from a Delta 2914 launch vehicle on October 16, 1975. Its instrument complement was identical to SMS-1 and SMS-2. GOES-1 was placed over the Indian Ocean west of SMS-2 so that the combined coverage of the three satellites would include nearly 60 percent of the Earth's surface. It operated successfully in this orbit until June 1978 when it was relocated to replace SMS-2 and GOES-3 replaced GOES-1. It was deactivated on March 7, 1985.

GOES-2 (GOES-B) was launched on June 16, 1977, from a Delta 2914 launch vehicle. Its instrument complement was identical to the SMS and GOES-1 satellites. GOES-2 was placed in orbit directly over

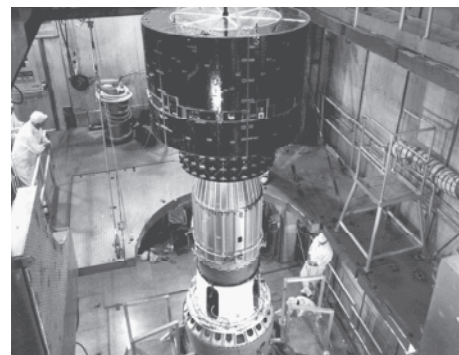

SMS-B Erected Atop Its Delta Booster, 1975



GOES-1 Image, October 25, 1975

the equator at 60° W to replace SMS-1. It was operational until 1993. The satellite was reactivated in 1995 to broadcast National Science Foundation (NSF) transmissions from the South Pole to public broadcasting facilities in the United States. The WEFAX system on GOES-2 continued to operate, although cloud images were no longer being received from the system. The satellite was deorbited at the beginning of May 2001.

GOES-3 (GOES-C) was launched June 16, 1978, from a Delta 2914 launch vehicle. The satellite was used to replace GOES-1 and to support the Global Atmospheric Research Program (GARP) over the Indian Ocean. It had the same instruments and capabilities as the earlier GOES spacecraft.

GOES-4 (GOES-D) was launched September 9, 1980, from a Delta 3914 launch vehicle. It was the first geostationary satellite to provide continuous vertical profiles of atmospheric temperature and moisture, which its primary instrument, the VISSR Atmospheric Sounder (VAS), provided. The VAS also provided both day and nighttime imagery of cloud conditions. Instrument limitations did not permit both types of operations simultaneously. The satellite also used new despun S-band and UHF antennas to relay meteorological data from more than 10,000 surface locations into a central processing center for incorporation into numerical weather prediction models and to transmit processed images and weather maps to WEFAX field stations. It was also equipped with a SEM and DCS similar to those on previous GOES. GOES-4 was placed in orbit at 135° W to replace the failing GOES-3. GOES-4's most serious anomaly occurred on November 25, 1982, when the VAS's scan mirror stopped during retrace after exhibiting excessively high torque. Efforts to restore either the visible or infrared capability were unsuccessful. It was deactivated November 22, 1988.

GOES-5 (GOES-E) was launched May 22, 1981, from a Delta 3914 launch vehicle. Its instrument complement was identical to GOES-4. It was placed in orbit at 75° W longitude. The satellite failed on July 29, 1984, when a VAS encoder lamp filament burned out that was needed to read the angle of the scan mirror used to obtain images. It was deactivated on July 18, 1990.

When satellites are launched, they have a letter designation. After they reach orbit, they are assigned a number. This prevents a missing number if a spacecraft does not reach orbit successfully.

GOES-6 (GOES-F) was launched April 28, 1983, from a Delta 3914 launch vehicle. It was designed to replace GOES-4 and was originally placed in orbit at 136° W. After GOES-5 failed, it was moved to a central location at 98° W. When GOES-7 was placed in service, it was returned to its original location. The VAS imager on GOES-6 failed on January 21, 1989, so

direct readout images and soundings were no longer available. WEFAX data continued to be transmitted to the data user community until the spacecraft was deactivated on May 24, 1992.

GOES-G was launched May 3, 1986, from a Delta 3914 launch vehicle. The spacecraft did not reach operational orbit because of a failure in the launch vehicle.

GOES-7 (GOES-H) was launched February 26, 1987, from a Delta 3924 launch vehicle and placed in orbit at 75° W. The spacecraft was moved to 98° W in July 1989 following the January 1989 failure of GOES-6. In 1992, GOES-7 ran out of stationkeeping fuel, as expected. GOES-7 went to standby in January 1996 and was parked at 95° W in June 1996. Consequently, the VAS instrument and the associated data, along with WEFAX, DCS, and search and rescue services through GOES-7, were deactivated. In mid-November 1999, GOES-7 was moved to 175° W to take over the communications-relay duties of PEACESAT. The high orbital inclination made it possible to relay data from near the poles, particularly to support the National Science Foundation science group at the South Pole. In addition to the same instrument complement as the earlier GOES, GOES-7 carried experimental search and rescue equipment that allowed near-instantaneous detection of emergency distress signals on the ground transmitting at 406 MHz.

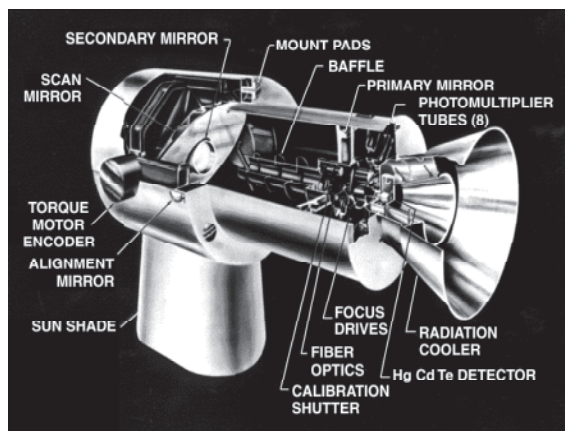

VAS was used on GOES-4 through GOES-7

GOES-8 (GOES-I) was launched April 13, 1994, from an Atlas-I/Centaur launch vehicle. It operated as GOES-East at 75° W for 8 years, from spring of 1995 to spring of 2003. It was the first in a new series of three-axis stabilized GOES that provided significant improvements over the previous GOES spin-stabilized spacecraft in weather imagery and atmospheric sounding information. The satellite was equipped with a separate Imager and Sounder, which allows simultaneous and independent imaging and sounding. Previously, both functions were performed alternately by a single instrument. GOES-8 features a flexible scan mechanism that offers small-scale area imaging, resulting in improved short-term forecasts over local areas. It was also equipped with a SEM and DCS, had WEFAX capabilities, and performed near-instantaneous relay functions for the Sarsat system with its dedicated search and rescue transponder. The GOES-8 satellite reached the end of its useful life and was de-orbited on May 5, 2004.

GOES-9 (GOES-J) was launched May 23, 1995, from an Atlas-I/Centaur launch vehicle into a geostationary orbit at 135° W. The GOES-9 satellite is presently providing support to the Japanese Meteorological Agency (JMA), with ground station support from the NOAA facility at Fairbanks, Alaska.

GOES-10 (GOES-K) was launched April 25, 1997, from an Atlas I/Centaur launch vehicle and was placed in orbit at 105° W. It has the same instrument complement as GOES-8 and GOES-9. In the spring of 1998, GOES-10 was shut down and designated an “on-orbit spare” until the failure of GOES-8 or GOES-9. A month after launch, the GOES-10 solar array ceased rotating, but, due to the ingenuity of the GOES government-industry team, it was possible to invert the satellite, modify software, and operate the solar array in the reverse direction. Shortly thereafter, GOES-9 began experiencing problems with its momentum wheels, and GOES-10 was placed in active service as *GOES-West*, positioned at 135° W.

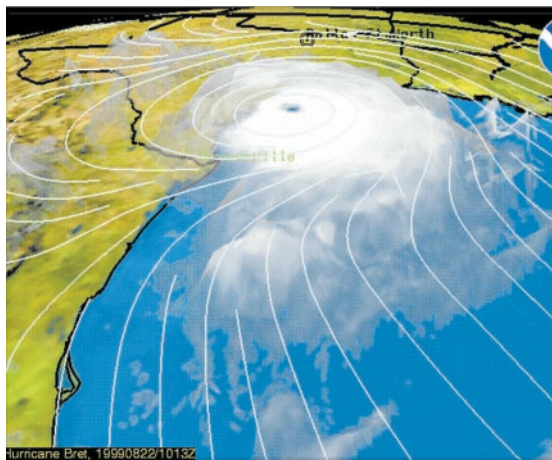

Hurricane Bret, 1999

GOES-11 (GOES-L) was launched May 3, 2000, from an Atlas Centaur IIA launch vehicle and placed in storage mode at 105° W in August 2000. It has the same instrument complement as GOES-8, 9, and 10.

GOES-12 (GOES-M) was launched July 23, 2001, from an Atlas Centaur IIA launch vehicle. It is the first GOES to fly an SXI-type instrument. The GOES-12 satellite has been operating as GOES -East at 75° W longitude since the spring of 2003. It is expected to provide many more years of operational data products for the GOES user community.

GOES Spacecraft Contractors

The SMS and GOES 1-3 spacecraft were built by Ford Aerospace and Communications Corporation (now Space Systems/Loral). The GOES 4-7 series was built by Hughes Space and Communications (now Boeing Satellite Systems). The GOES 8-12 series was built by Space Systems/Loral. GOES-N,O,P are being built and launched by Boeing Satellite Systems (BSS).

As well as the web sites mentioned elsewhere in this brochure, see <http://www.oso.noaa.gov>, <http://scijinks.nasa.gov>, <http://goespoes.gsfc.nasa.gov>, and <http://goes.gsfc.nasa.gov> for additional information on the GOES program and GOES science. For additional copies of this brochure, please write to: GOES Program Manager, NASA Goddard Space Flight Center, Mail Code 416, Greenbelt, MD 20771.

Acronyms and Abbreviations

μm	micrometer (one millionth of a meter)	LO2	Liquid Oxygen
μrad	microradian	LOS	Line Of Sight
ADS	Angular Displacement Sensor	LMATC	Lockheed Martin Advanced Technology Center
AFB	Air Force Base		
AGS	Americom Government Services	LRIT	Low Rate Information Transmission
Alt	altitude	LUT	Local User Terminal
A-hr	Ampere hour	m	meter
ATC	Assurance Technology Corporation	MAGED	Magnetosphere Electron Detector
BOL	Beginning of Life	MAGPD	Magnetosphere Proton Detector
BSS	Boeing Satellite Systems	MCC	Mission Control Center
BUCDAS	Backup CDA Station	MDL	Multi-use Data Link
CCD	Charge Coupled Device	MECO	Main engine cutoff
CDAS	Command and Data Acquisition Station	MeV	Million electron volts
CDDF	Central Data and Distribution Facility	MHz	Megahertz
CEMSCS	Central Environmental Meteorological Satellite Computer System	MLI	Multilayer insulation
		mps	meters per second
COSPAS	<i>Cosmicheskaya Sistyema Poiska Avariynich Sudov</i> (Space System for the Search of Vessels in Distress)	NASA	National Aeronautics and Space Administration
		NASCOM	NASA Communications (Network)
CSPA	Charge Sensitive Preamplifier	NCDC	National Climatic Data Center
DCP	Data collection platform	NGDC	National Geophysical Data Center
DCS	Data collection system	NiH ₂	Nickel hydrogen
DPU	Data processing unit	NISN	NASA Integrated Services Network
DSN	Deep Space Network	NM	Newton Meter
ELT	Emergency Locator Transmitter	nm	nanometer (one-billionth of a meter)
EMWIN	Emergency Managers Weather Information Network	nmi	nautical mile
		NSF	National Science Foundation
EOL	End of Life	NESDIS	National Environmental Satellite, Data, and Information Service
EPEAD	Energetic Proton, Electron, and Alpha Detector		
		NOAA	National Oceanic and Atmospheric Administration
EPIRB	Emergency Position Indicating Radio Beacon	OSR	Optical solar reflector
EPS	Energetic Particle Sensor	PAF	Payload Attach Fitting
ER	Eastern Range	pixel	Picture element
ETR	Eastern Test Range	PLB	Personal Locator Beacon
EUV	Extreme ultraviolet	PMT	Photo Multiplier Tube
FEMA	Federal Emergency Management Agency	POES	Polar Operational Environmental Satellite
eV	Electron volt	PSK	Phase Shift Keying
FOV	Field of view	PSS	Precision Sun Sensor
fps	feet per second	RCC	Rescue Coordination Center
ft	feet, foot	RSC	Rescue Sub-Center
GARP	Global Atmospheric Research Program	RF	Radio frequency
GEM	Graphite epoxy motor	SAIC	Science Applications International Corporation
GINI	GOES I NOAA Interface port		
GOES	Geostationary Operational Environmental Satellite	SARSAT	Search and Rescue Satellite-Aided Tracking
		SATEPS	Satellite Environmental Processing System
GPS	Global Positioning System	SEC	Space Environment Center
GSFC	Goddard Space Flight Center	sec	second
GVAR	GOES variable data format	SECO	Second Engine Cutoff
HASS	High Accuracy Sun Sensor	SEM	Space Environment Monitor
HEPAD	High Energy Proton and Alpha Detector	SLV	Space Launch Vehicle
HV	High voltage	SMS	Synchronous Meteorological Satellite
Hz	hertz	SOCC	Satellite Operations Control Center
in	inch	SSD	Solid State Detector
INR	Image Navigation and Registration	SXI	Solar X-Ray Imager
ITT SSD	ITT Industries-Space Systems Division	UHF	Ultra high frequency
JPL	Jet Propulsion Laboratory	USMCC	U.S. Mission Control Center
keV	kilo (thousand) electron volts	USN	Universal Space Network
kg	kilogram	VAS	VISSR/Atmospheric Sounder
kHz	kilohertz	Vel	velocity
km	kilometer	VISSR	Visible Infrared Spin Scan Radiometer
kW	kilowatt	WEFAX	Weather Facsimile
LAM	Liquid apogee motor	WMO	World Meteorological Organization
lb	pound	XRP	X-ray positioner
lbf	pound-foot	XRS	X-ray sensor
LH2	Liquid Hydrogen		

NASA • NOAA

**GEOSTATIONARY
OPERATIONAL
ENVIRONMENTAL
SATELLITE**

N-SERIES

