

THE 2012 FEASIBILITY STUDY FOR CANAVERAL  
HARBOR, BREVARD COUNTY, FLORIDA

---

COMMUNICATION

FROM

THE ASSISTANT SECRETARY OF THE ARMY,  
CIVIL WORKS, THE DEPARTMENT OF DE-  
FENSE

TRANSMITTING

THE 2012 FINAL INTEGRATED SECTION 203 NAVIGATION STUDY  
REPORT AND ENVIRONMENTAL ASSESSMENT FOR THE CANA-  
VERAL HARBOR, BREVARD COUNTY, FLORIDA

PART 2 OF 2



JULY 26, 2013.—Referred to the Committee on Transportation and  
Infrastructure and ordered to be printed

---

U.S. GOVERNMENT PRINTING OFFICE





**CANAVERAL HARBOR, FLORIDA**  
**Integrated Section 203 Navigation Study Report**  
**&**  
**Final Environmental Assessment**

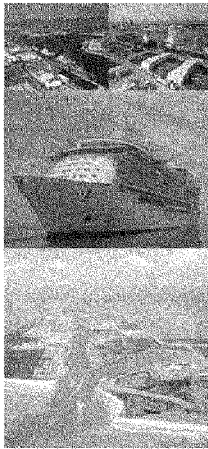

**Volume 2: Engineering Appendix**

**December 2012**  
(last revised October 2012)



**US Army Corps  
of Engineers®**



**FORT  
CANAVERAL**

# Table of Contents

<b>1.0</b>	<b>Engineering Design</b>	<b>6</b>
1.1	Basis of Design	6
1.2	Design Ship Selection	6
1.2.1	Cruise Vessels	7
1.2.2	Displacement Cargo Vessels	11
1.3	Site Environmental Conditions	14
1.3.1	Water Levels	14
1.3.2	Tidal Currents	14
1.3.3	Wind and Wave Climate	16
1.4	Canaveral Harbor Existing Project Features	31
1.5	Navigation Simulation Studies	33
1.6	Project Width Alternatives	38
1.6.1	STAR Center Simulations for Voyager Class and Pilots Dredging	39
1.6.2	STAR Center Simulation Findings and Recommendations for Cruise Ship Freedom and Tanker Jupiter	43
1.6.3	Canaveral Pilot Experience with Freedom Class and Disney Dream Navigation	43
1.6.4	Project Width Analysis Based on Design Guidance	45
1.6.5	West and Middle Basin Turning Area Alternatives	48
1.6.6	Project Widener Alternative Dimensions	49
1.7	Project Depth Analysis	51
1.7.1	Analysis Assumptions and Considerations	51
1.7.2	Project Depth Analysis Results	52
1.8	Canaveral Harbor Recommended Plan Project Features	53
1.8.1	Table Summary of Recommended Plan Project Features	53
1.8.2	Recommended Project Features Narrative Description	55
1.9	Canaveral Harbor Vessel-Induced Surge Modeling	57
1.9.1	Background	57
1.9.2	Surge Effects and Modeling	58
1.9.3	Hydrodynamic Surge Modeling Presentation and Results	59
1.10	Aids to Navigation	61
<b>2.0</b>	<b>Hydrology and Hydraulics</b>	<b>61</b>
<b>3.0</b>	<b>Coastal Studies</b>	<b>61</b>
3.1	Entrance Jetty and South Jetty Sediment Trap Impacts	62
3.2	Sea Level Change Projections	62
3.2.1	Impacts	63
<b>4.0</b>	<b>Surveying and Mapping</b>	<b>66</b>
<b>5.0</b>	<b>Geotechnical Evaluations</b>	<b>67</b>
<b>6.0</b>	<b>Civil/Structural Design</b>	<b>67</b>
6.1	Impacts to Traffic and Projections	67
6.2	Impacts to Water Quality	69
6.3	Impacts to Existing Utilities	70
6.4	Impacts on Embankments and Pier and Bulkhead Structures	72
6.4.1	North Dike Relocation	72
6.4.2	Jetty Park Embankment	72

---

6.4.3	FPL Barge Berth Embankment .....	73
6.4.4	Wharves and Piers .....	73
6.4.5	Bulkhead Walls .....	73
6.4.6	West Basin Corner Cut-Off .....	75
6.5	Project Construction and Sequence of Work .....	75
6.6	Dredged & Upland Excavated Material Disposal and Reuse .....	76
6.6.1	ODMDS (Ocean Dredged Material Disposal Site) .....	77
6.6.2	Disposal and Reuse of Upland Excavated Material .....	79
<b>7.0</b>	<b>Hazardous and Toxic Materials .....</b>	<b>79</b>
<b>8.0</b>	<b>Operations and Maintenance .....</b>	<b>80</b>
8.1	Federal Maintenance Dredging History .....	81
8.2	Areas of Maintenance Dredging .....	82
8.3	Hydraulic Model Results .....	82
8.4	Future Maintenance Dredging Volume Increase .....	82
8.5	Estimated Cost of Maintenance Dredging .....	83
<b>9.0</b>	<b>Project Security .....</b>	<b>84</b>
<b>10.0</b>	<b>Cost Estimates .....</b>	<b>84</b>
10.1	Basic Cost Elements .....	84
10.2	Unit Cost Derivation .....	85
10.3	Cost Estimates .....	85
<b>11.0</b>	<b>Schedule for Design and Construction .....</b>	<b>86</b>
<b>12.0</b>	<b>Special Studies .....</b>	<b>86</b>
<b>13.0</b>	<b>Figures, Tables, Drawings and Attachments .....</b>	<b>86</b>
<b>14.0</b>	<b>Use of Metric System Measurements .....</b>	<b>87</b>

# List of Figures

Figure 1. Cruise Ship Gross Tonnage Trends ..... 8

Figure 2. Cruise Ship Dimension Trends ..... 9

Figure 3. Data Collection Locations ..... 16

Figure 4. Wind Roses for Station 41009 Data -- Summer Season ..... 18

Figure 5. Wind Roses for Station 41009 Data -- Winter Season ..... 19

Figure 6. Wind Roses for NASA Shuttle Facility -- Summer Season ..... 19

Figure 7. Wind Roses for NASA Shuttle Facility -- Winter Season ..... 20

Figure 8. Plan A and Plan B comparison (1 of 3). ..... 34

Figure 9. Plan A and Plan B comparison (2 of 3) ..... 35

Figure 10. Plan A and Plan B comparison (3 of 3) ..... 36

Figure 11. Areas Dredged for Canaveral Pilots, Sht 1 of 2 ..... 41

Figure 12. Areas Dredged for Canaveral Pilots, Sht 2 of 2 ..... 42

Figure 13. USACE Channel Width Design Guidance ..... 45

Figure 14. Design Cruise Vessel Position Relative to Channel Width Plan ..... 47

Figure 15. Regional Sea-Level Change Estimates ..... 64

Figure 16. Seaward End of Canaveral Harbor Approach Channel ..... 66

Figure 17. Vicinity Map (Source: Brevard Co. Precinct Map w/ CPA Boundary) ..... 68

## List of Tables

Table 1.	Present and Future Large Cruise Ships and Classes.....	10
Table 2.	Large Cruise Ship Propulsion .....	11
Table 3.	Present Displacement Vessel Traffic at Port Canaveral .....	12
Table 4.	Displacement Cargo Vessel Statistics.....	13
Table 5.	Water Levels (ft, MLLW) – Trident Pier, Trident Basin .....	14
Table 6.	Wind speed Frequency of Occurrence – Summer – Station 41009.....	21
Table 7.	Wind speed frequency of occurrence – Winter – Station 41009 .....	22
Table 8.	Wind speed percent frequency of occurrence – Summer – Station 41009 .....	23
Table 9.	Wind speed percent frequency of occurrence – Winter – Station 41009 .....	24
Table 10.	Wind speed frequency of occurrence – Summer – NASA Shuttle Facility.....	25
Table 11.	Wind speed frequency of occurrence – Winter – NASA Shuttle Facility .....	26
Table 12.	Wind speed percent frequency of occurrence – Summer – NASA Shuttle Facility .....	27
Table 13.	Wind speed percent frequency of occurrence – Winter – NASA Shuttle Facility .....	28
Table 14.	Wind speed cumulative frequency of exceedance – Station 41009.....	29
Table 15.	Wind speed cumulative frequency of exceedance – NASA Shuttle Facility .....	30
Table 16.	Wave Predictions – Entrance to Canaveral Harbor .....	31
Table 17.	Port Canaveral Existing Project Features .....	32
Table 18.	Simulations Plan Width Geometry.....	33
Table 19.	STAR Center Ship Response Model Characteristics.....	38
Table 20.	USACE Guidance on Interior Channel Width.....	46
Table 21.	Cruise Vessel Clearance to Edge of Channel for Various Channel Widths.....	47
Table 22.	Vessel Wave Motion Response .....	52
Table 23.	Project Depths – Displacement Vessel.....	53
Table 24.	Port Canaveral Recommended Plan Project Features (Plan A).....	54
Table 25.	Sea-Level Trends for Gauges along the Atlantic Coast of Florida.....	63
Table 26.	Projected Regional Sea-Level Change from 2014 through 2064.....	64
Table 27.	Summary of Traffic Accidents, January 2000 – October 2005.....	69
Table 28.	Bulkhead Wall Analysis Summary.....	74
Table 29.	Canaveral ODMS Disposal History (1974-2006) .....	78
Table 30.	Recent Historical Dredge Costs for CPA Projects .....	83

---

## List of Attachments

- A June 2008 Letter from the Canaveral Pilots Assoc.  
Port Canaveral 2003 STAR Center Report  
Port Canaveral 2007 STAR Center Report  
Port Canaveral 2009 STAR Center Report
- B NOT USED
- C Drawings: Existing Conditions and Authorized Channel Depths
- D Project Depth Calculations
- E Drawings: Recommended Plan
- F Hydraulic Modeling Report  
Canaveral Harbor Vessel-Induced Surge Modeling
- G Jetty Impacts Report
- H Drawings: Surveys and Mapping
- I Geotechnical Report
- J Civil Design Impacts: Traffic Report, Utilities Drawings, Disposal Site Drawings
- K Hazardous, Toxic, and Radioactive Waste (HTRW) Assessment Report and Source Removal Report, Beyel Bros. Lease
- L MCACES Format Total Cost Estimate, Basis of Cost Estimates Narrative, Dredging Cost Estimate Detailed Spreadsheet, CPA Bid Tabulations for CCO Work Completed
- M Cost and Schedule Risk Analysis Report
- N USCG Coordination on Navigation Aids (Range Markers)
- O Project Schedule
- P Canaveral Ocean Dredged Material Disposal Site (ODMDS) Site Management and Monitoring Plan (SMMP)

# 1.0 Engineering Design

## 1.1 Basis of Design

Two primary USACE publications were consulted in the preparation of the engineering studies and supporting documentation for the Section 203 feasibility study for navigation improvements at Canaveral Harbor.

- ER 1110-2-1404      Hydraulic Design of Deep-Draft Navigation Projects  
 EM 1110-2-1613      Hydraulic Design Guidance for Deep-Draft Navigation Projects

The following publications and references were also consulted with regard to assessing vessel squat, project width considerations, and passing ship and wind effects on moored ships along the channel:

- TR-60560OCN      NFESC, "Mooring Loads Due to Parallel Passing Ships",  
 30 September 2005  
 UFC 4-159-03      DoD, Design: Moorings, 3 October 2005

1. Barass, Dr. C. B., "Squat Formula for Ships in Rivers," The Naval Architect, November 2004, pp. 24 and 25.
2. Barass, Dr. C. B., "Letter to the Editor on Empirical Equation for Determination of Coefficient K for Prediction of Ship Squat," The Naval Architect, September 2005.
3. USACE ERDC/CHL CHETN-IX-14, "Charleston Harbor Ship Motion Data Collection and Squat Analysis," March 2004.

The following publications are referred to herein, but not contained in the attachments to the engineering appendix:

1. McArthur, Christopher J. and Parsons, Mel, "Ocean Current and Wave Measurements at the Canaveral Harbor Ocean Dredged Material Disposal Site, January 2003 through February 2004," USEPA Region 4, EPA-904-R-05-001, January 2005.

## 1.2 Design Ship Selection

Primary ship types using the commercial Port now and in the future include dry, liquid and break bulk carriers, dry bulk cargo ships, refrigerated cargo ships, passenger (cruise) ships, and product tankers. Ship types including container vessels, LNG, vehicle carriers and RoRo cargo ships are only anticipated to use existing or future berths within Port Canaveral on a very limited basis and of a size that would not be anticipated to drive the design and selection of navigation features. Therefore, these ship types were not considered in design vessel identification and selection.

Port Canaveral is also the base of operations for various government and military missions that occur on the Cape Canaveral Air Force Station (CCAFS) property on the north side of the channel. The Canaveral Port Authority shares Canaveral Harbor with its Mission Partners, the United States Air Force 45<sup>th</sup> Space Wing (USAF 45 SW) and the Naval Ordnance Test Unit (NOTU) and the Military Sealift Command (MSC), both tenants on the

CCAFS. NOTU currently receives various U.S. and U.K. Navy submarines at the Trident and Poseidon Wharves, within the Trident and Middle Basins. NOTU and MSC also accommodate various military surface ships at the Trident and Poseidon wharves. The USAF 45 SW maintains use of the AF wharf and the Delta Mariner pier located at the north end of Middle Basin. The Delta Mariner pier and mission vessel support the Delta IV rocket launch program at CCAFS. The AF wharf is used for a variety of small scale ship and barge operations. There are no known navigation access issues for the non-commercial vessel traffic using Canaveral Harbor.

### 1.2.1 Cruise Vessels

A graphical summary of the size and capacity trends in cruise ship builds since 1997 and for those ships under construction or contract through 2012, are presented in Figures 1 and 2. The trend data is based on dimensions and Gross Registered Tonnage (GRT) for 116 ships. The data comes from various sources including Lloyd's Register of Ships, the cruise lines, and cruise industry publications.

Figure 1 shows the distribution of cruise ship GRT with the year that the ship entered or is scheduled to enter service as in the case of new builds under construction or contract. Vessels with a GRT of at least 122,000 gross tons are identified by name or class and represent the largest ships in the market. This group of vessels comprises roughly 17 percent of the ships reviewed for this period.

Figure 2 shows the cruise ship length, beam, and draft dimensions versus gross tonnage. A distinct increase in beam from panamax to post-panamax occurs for GRT greater than 100,000 tons. To date, 24 cruise ships in service or under construction are greater than 305 m (1000 ft) in length. The major lines have each built one or more ship classes with panamax beams and lengths on the order of 290 to 294 m (950 to 965 ft). The Queen Mary 2 with a maximum draft of 10.3m remains the deepest draft cruise ship so far.



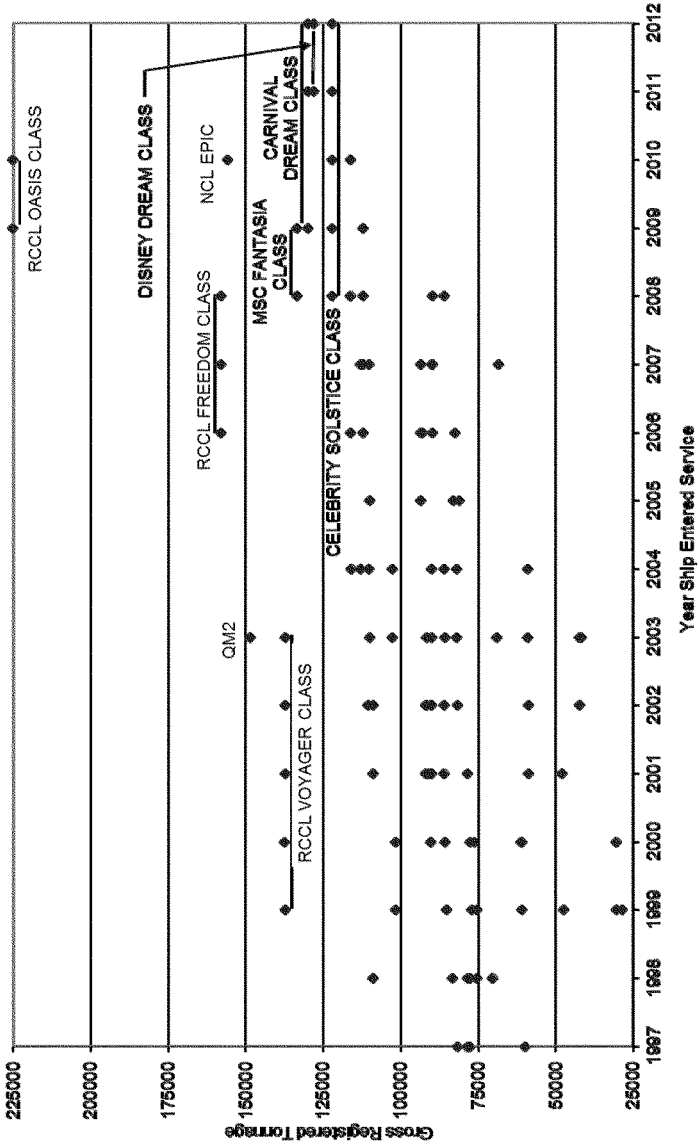

Figure 1. Cruise Ship Gross Tonnage Trends

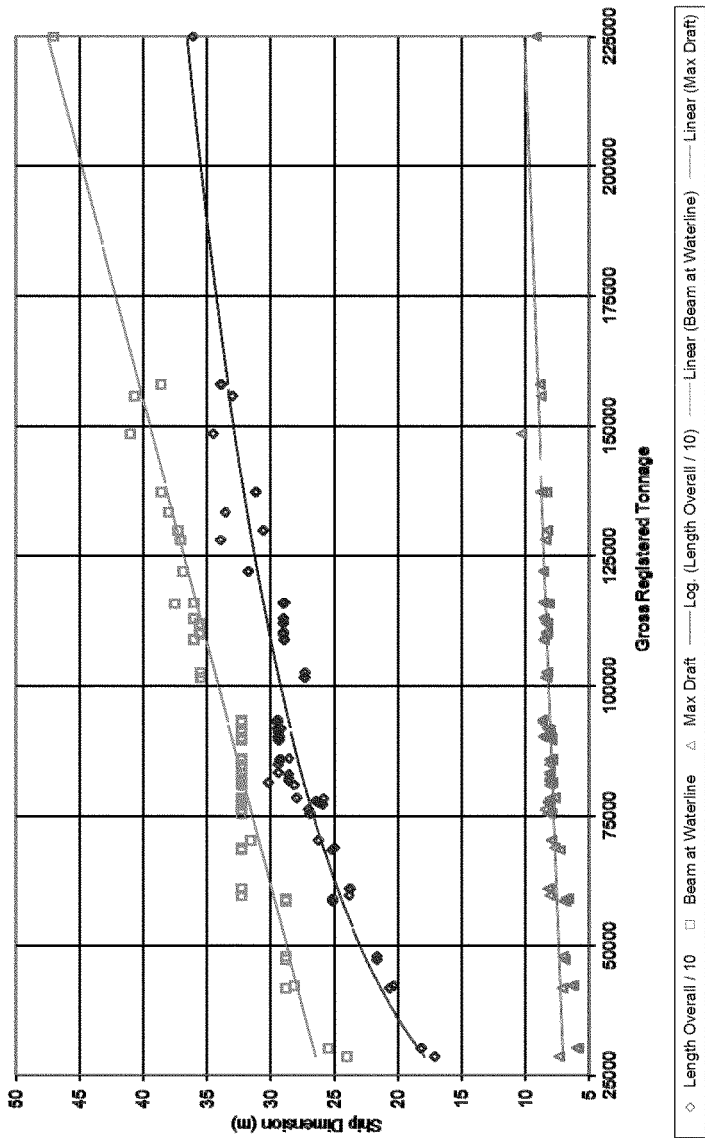

Figure 2. Cruise Ship Dimension Trends

Vessels from Royal Caribbean's Freedom Class, Disney's Dream Class and Carnival's Dream Class, among the largest ships in service, currently operate from Port Canaveral's West Basin on a homeport basis. Royal Caribbean and Carnival have home ported the Freedom of the Seas and the Carnival Dream at Cruise Terminal 10 (CT10) since 2009. Disney began service in late 2010 with the Disney Dream at Port Canaveral's Cruise Terminal 8 (CT8) with the second ship beginning service in 2012. The following list of vessels, in Table 1, describes the present and potential future cruise fleet forecast for Port Canaveral. Tables 1 and 2 summarize key dimensions and propulsion characteristics for the largest current and future vessels with homeport commitments or potential port-of-call and storm refuge considerations at Port Canaveral. Port Everglades has been the home for the initial deployment of Royal Caribbean's Oasis Class (formerly known as Genesis Class) vessels since entering service in 2009 and 2010. Port Canaveral has been identified as a potential port of refuge on an emergency, as needed, space available, basis for these vessels. Recent discussions between the Canaveral Port Authority and Royal Caribbean Cruise Lines indicate no present or future plans to homeport an Oasis Class vessel at Port Canaveral.

**Table 1. Present and Future Large Cruise Ships and Classes**

CRUISE SHIP OR CLASS	Design Draft (ft)	Length Overall (ft)	Beam at Waterline (ft)	Disp. at Design Draft (m. tons)	Side Wind Sail Area (ft <sup>2</sup> )	GRT
Disney Dream/Fantasy Homeport 2011/12	27	1113	121	62,414	132,181	128,000
CCL Dream/ Magic Dream-Homeport 2009-	27	1003	122	62,789	131,191	130,000
RCCL Voyager Class Mariner of the Seas- Homeport 2003-2009	28	1,021	127	62,716	119,523	138,000
NCL Epic Potential Port Call	29	1,081	133	74,800	144,959	150,000
CUNARD Queen Mary 2 Potential Port Call	33	1,131	135	79,827	139,716	150,000
RCCL Freedom Class Freedom of the Seas- Homeport 2009-	28	1,112	127	71,019	140,092	158,000
RCCL Oasis Class Potential Port Call	30	1,187	154	106,000	168,664	225,000

Dimensions rounded up or down to the nearest foot.

**Table 2. Large Cruise Ship Propulsion**

CRUISE SHIP OR CLASS	Voyager	Freedom	Genesis	Carnival Dream	Disney Dream
Propulsion Type	Diesel Electric	Diesel Electric	Diesel Electric	Diesel Electric	Diesel Electric
Propeller Type	FPP (inward)	FPP (inward)	FPP (inward)	FPP (inward)	FPP (inward)
Pods or Propeller Shafts	2 Azipods 1 Fixipod	2 Azipods 1 Fixipod	3 Azipods	2 shafts	2 shafts
Pod or Shaft Power (each)	19,713 hp (14 MW)	19,713 hp (14 MW)	26,820 hp (20 MW)	29,500 hp (22 MW)	27,900 hp (20.37MW)
Thrusters	4 Bow	4 Bow	4 Bow	3 Bow 2 Stern	3 Bow 2 Stern
Thruster Power (each)	4,023 hp (3 MW)	4,425 hp (3.3 MW)	7,376 hp (5.5 MW)	2,950 hp (2.2 MW)	4,080 hp (3 MW)

FPP=Fixed Pitch Propeller

The above data and figures as well as the long history of good service to the cruise lines, provides a solid indication of future cruise ship trends at Port Canaveral in light of continued programs among the cruise lines for new build vessels. Several West Basin berth improvement projects and berth and navigation access dredging projects discussed in the 203 study have been completed over the years since 2003 to be ready for and to better accommodate a representative segment of the largest cruise vessels every built.

The Canaveral Pilots Association offered additional comments regarding the navigation improvements investigated in the Section 203 Feasibility Study for Port Canaveral in light of the present homeport commitments for Freedom of the Seas and the new Disney ships starting. Their letter is contained in Attachment A. The local pilots consider the present accommodation of the Freedom of the Seas, the Carnival Dream, and the Disney ships, as provisional navigation scenarios until such time as the channel widening, the West Basin entrance widening, and entrance turn expansion outside the jetties are accomplished. Based on the size of many of these vessels and homeport commitments at Port Canaveral, channel modifications have been evaluated for the Freedom Class vessel.

### 1.2.2 Displacement Cargo Vessels

Ship parameters for some of the largest dry and liquid bulk carriers calling at Port Canaveral are shown in Table 3.

**Table 3. Present Displacement Vessel Traffic at Port Canaveral**

SHIP	Maximum Draft (ft)	Length Overall (ft)	Beam at Waterline (ft)	Deadweight Tonnage (m. tons)
Gdynia (Dry Bulk-Aggregate)	42.4	738	105.6	65,738
Bernardo Quintana A (Dry Bulk-Limestone)	43.3	753	105.6	67,044
Bregen (Liquid Bulk-Gasoline)	44.7	797	105.6	68,159

Present channel and berth depths limit the ability for these vessels to come in at the full draft-displacement load condition. Presently and subject to harbor pilot discretion, the vessels must arrive at some intermediate load condition and/or wait at the sea buoy until tides are favorable for transiting the channel and unloading at the designated cargo berth. Existing and without-project, future maximum bulk carrier and tanker traffic at Port Canaveral are limited to an operating draft of 36 ft and 39.5 ft without and with the use of tidal advantage, respectively.

Seaport Canaveral, one of the liquid bulk operators, has requested an operational water depth of 42 ft at berth. ASI, a dry bulk operator, has indicated the arrival draft of their current traffic at 39.5 ft, with future vessels of 70,000 to 76,000 Dead Weight Tonnage (DWT) arriving the Port at a draft of 41 to 43 ft, respectively.

In support of defining the design displacement cargo vessel dimensions for Port Canaveral, the Lloyd's Register of Ships Online (SEA WEB) was consulted. Ship particulars were compiled for bulk and oil products carriers in the range of 60,000 to 70,000 DWT, 70,001 to 80,000 DWT, and 80,001 to 100,000 DWT. A statistical analysis of vessel parameters for these categories is summarized below.

**Table 4. Displacement Cargo Vessel Statistics**

CATEGORY	Statistic Dimension	Maximum Draft (ft)	Length Overall (ft)	Beam at Waterline (ft)
60,000 to 70,000 DWT BULK CARRIER (464 vessels)	Maximum	45.8	834	125
	Minimum	32.7	679	104
	Average	42.7	742	106
	90 <sup>th</sup> Percentile	43.7	751	106
70,001 to 80,000 DWT BULK CARRIER (925 vessels)	Maximum	48.8	837	121
	Minimum	37.2	713	105
	Average	45.5	742	106
	90 <sup>th</sup> Percentile	46.8	750	106
80,001 to 100,000 DWT BULK CARRIER (213 vessels)	Maximum	49.3	850	141
	Minimum	37.7	689	106
	Average	45.1	761	118
	90 <sup>th</sup> Percentile	47.3	798	141
60,000 to 70,000 DWT OIL PRODUCTS CARRIER (175 vessels)	Maximum	46.2	800	131
	Minimum	36.5	600	105
	Average	42.7	739	108
	90 <sup>th</sup> Percentile	44.7	791	118
70,001 to 80,000 DWT OIL PRODUCTS CARRIER (244 vessels)	Maximum	49.3	810	138
	Minimum	37.6	700	105
	Average	45.0	749	107
	90 <sup>th</sup> Percentile	47.6	750	106
80,001 to 100,000 DWT OIL PRODUCTS CARRIER (293 vessels)	Maximum	52.8	894	158
	Minimum	38	691	106
	Average	45	792	134.5
	90 <sup>th</sup> Percentile	48.8	814	141

The statistical dimensions for 60,000 to 100,000 DWT bulk carriers and oil products tankers in Table 4 led to selection of a design vessel with length of 800 ft and beam of 138 ft. This size vessel tested in the simulator will adequately demonstrate the safety of navigation through Canaveral Harbor to a new tanker berth at NCP 1 in the Middle Basin.

The statistics in Table 4 show that most of the vessels in this DWT range have drafts exceeding the present vessel draft limits for the harbor. At a minimum, the future channel with-project condition should accommodate a vessel having a draft of 39.5 ft without the use of tidal advantage.

In support of the 203 study, full mission bridge simulations were executed on two occasions at the RTM STAR Center, testing the tanker vessel, Jupiter and the Genesis or Freedom Class cruise vessels. Refer to the STAR Center's Port Canaveral 2009 and 2007 modeling and simulation reports (Attachment A), for evaluation of proposed channel improvements for Canaveral Harbor.

## 1.3 Site Environmental Conditions

### 1.3.1 Water Levels

Water levels at Canaveral Harbor are mainly the result of semi-diurnal tidal fluctuations in the Atlantic Ocean. Elevations of tidal datum's for Canaveral Harbor are shown in Table 5 based on a tide station located at the Trident Pier in Trident Basin. This tide station, established by the National Oceanic and Atmospheric Administration (NOAA), continuously records water levels and has been in operation since 1994. All datum elevations are in feet and referenced to Mean Lower Low Water (MLLW). The lowest and highest observed water levels have been included to provide an indication of the historical extreme water levels.

**Table 5. Water Levels (ft, MLLW) – Trident Pier, Trident Basin**

Station 8721604 (Tidal Epoch: 1983-2001)

Highest Observed Water Level (09/26/2004)	7.93
Mean Higher High Water (MHHW)	3.91
Mean High Water (MHW)	3.56
North American Vertical Datum-1988	2.86
Mean Sea Level (MSL)	1.88
Mean Tide Level (MTL)	1.87
Mean Low Water (MLW)	0.17
Mean Lower Low Water (MLLW)	0.00
Lowest Observed Water Level (01/12/2009)	-1.86

### 1.3.2 Tidal Currents

In support of the Section 203 feasibility study, a current measurement program inside the jetties was accomplished. The Canaveral Locks connecting the Banana River with Canaveral Harbor largely limit tidal current effects within the harbor. Current meter readings taken inside the jetties during August and September of 2005 and calibration of a hydrodynamic model of existing conditions suggest maximum 90%-tile and maximum average current speeds at the west end of the middle reach (Trident Basin entrance) of 0.34 and 0.16 knots, respectively. Current

speeds further decrease moving west to the West Basin with predicted maximum 90%-tile and average current speeds of 0.08 and 0.02 knots, respectively. Considering the negligible current speeds measured inside the jetties along with the results of the hydrodynamic modeling, no currents were considered inside the jetties in the STAR Center simulations. Channel cross current or yawing forces associated with currents are absent within the harbor.

In response to discussions at the July 2009 project meeting between the CPA and HQ USACE, a search ensued for available ocean current speed and direction data at a location outside the jetties. The only source of current data found comes from that collected by the US EPA Region 4, in support of the management and monitoring of the Canaveral's offshore dredge spoil disposal site, Canaveral ODMDS. The EPA collected data at a location approximately 0.5 nautical miles west of the Canaveral ODMDS. This location is southwest of the seaward end of the approach channel. See Figure 3 for location. Data was collected in four deployment periods between January 2003 and February 2004. Major findings include:

- Although a tidal component exists, the currents measured here are not dominated by tides.
- Depth-averaged currents predominantly flow in northerly and southerly directions and rarely exceed 0.5 knots. Seasonal differences do not appear to be significant. The first quarter, February through April 2003, recorded the highest depth-averaged currents. The second quarter was absent a strong southerly component and marked the highest percentage of northerly currents. In all quarters, northerly currents occurred twice as frequently as southerly currents and accounted for approximately 50 percent of the measurements. The highest percentage of measurements for each quarter were 0.1 knots or less. For all quarters, 75 percent of the measurements were 0.2 knots or less. For all quarters, northerly currents occurred about twice as frequently as southerly currents. Depth-averaged currents in the vicinity of the Canaveral ODMDS tend to have a net direction of transport to the north northeast, paralleling the coast.
- Near surface currents characterized by the upper 12 feet of the water column are also predominantly northerly and southerly flowing with predominant direction to the north. Surface currents had more frequent easterly currents than westerly. The maximum surface currents exceeded 0.78 knots. Surface currents tend to have a net direction of transport to the northeast.

During execution of the 2007 STAR Center simulations, the participating pilots validated the use of 0.3-knot northerly and southerly setting currents with similar wind directions for the test vessels. Pursuant to the June 2009 simulations, a pre-simulation meeting was held on March 3 at the CPA and attended by CPA consultants and the USACE navigation experts representing the Corps simulation facility in Vicksburg and the Jacksonville District. During this meeting, one of the pilot co-chairman attended and described northerly setting and to a lesser extent, southerly setting, wind-driven currents outside the jetties with estimates of speeds of up to 0.5 knots southerly and 1.0 knots northerly. Therefore, as agreed by all participants at the 2009 simulations, outside the jetties, southerly current speed of 0.5 knots was modeled for both cruise and tanker vessel runs with winds from northerly directions and northerly speeds of 1.0 and 0.75 knots were modeled for cruise and tanker vessel runs, respectively, for winds from southerly directions.



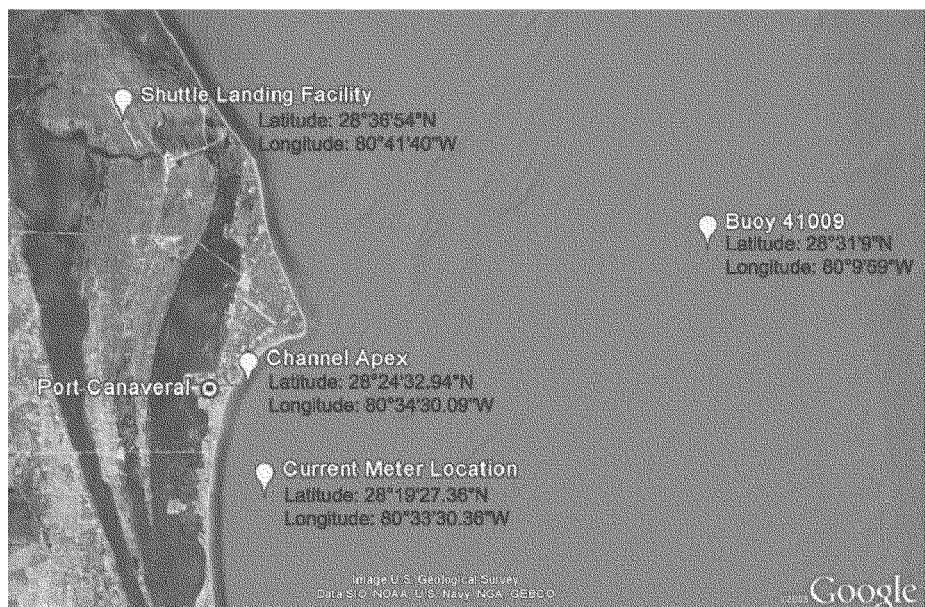

**Figure 3. Data Collection Locations**

### 1.3.3 Wind and Wave Climate

The wind and wave climate at Canaveral Harbor influence the transit conditions for vessel traffic at Port Canaveral. The wind particularly influences cruise ship transits owing to the very large vessel sail areas. Several of the larger cruise ships have air drafts exceeding 200 ft. Swell and wind waves from southerly to southeasterly directions affect the navigation of inbound displacement vessel traffic outside of the jetties. Outbound transits are not normally affected by waves beyond the jetties as vessel speed can be increased as needed.

#### 1.3.3.1 Wind Data and Analysis

Analysis of site specific wind data can be used to establish the probability of occurrence of various wind speeds. Historical wind data was available from a number of sources. Two sources were considered in this analysis. Data from NOAA Buoy 41009, located 20 nautical miles east of Cape Canaveral, were available for the period August 1988 through December 2008. These data are collected at a measurement height of 5 meters every half hour. This offshore buoy is owned and maintained by the National Data Buoy Center (NDBC).

In addition, a meteorological station at the NASA space shuttle facility, located approximately 13 miles north of Port Canaveral, has collected hourly wind data from 1979 to the present. Preliminary review of data from the two stations showed that the NASA wind station, located roughly 7 miles inshore, has similar directional characteristics, but consistently recorded lower wind speeds than the offshore buoy. Data from the two stations are considered to be suitable to provide the range of conditions that would bound the actual conditions inside and approaching Port Canaveral.

Figures 4 and 5 present wind roses for data from buoy 41009 for “summer” and “winter” periods with the summer period defined as May 1 through October 31 and the winter period from November 1 through April 30. Inbound and outbound transits of homeport cruise ships typically occur daily from 4:00 am to 8:00 am and from 3:00 pm to 7:00 pm, respectively. As such, each figure contains two wind roses, one representing data collected between 4:00 and 8:00 am and the other for data collected between 3:00 and 7:00 pm. Similar wind roses are included in Figures 6 and 7 based on data from the NASA space shuttle facility.

Tables 6 and 7 present frequency of occurrence tables for the data from NOAA buoy 41009 for the summer and winter periods, respectively. Tables 8 and 9 present the same data in terms of percent frequency of occurrence. Tables 10 through 13 provide similar tables for the NASA space shuttle facility wind data.

The tables present results for morning and evening periods separately with each 4 hour period treated as a single event. For example, entries in the speed columns (max, min, and avg) represent maximum, minimum, and average speeds for a given 4 hour period. Because the ships will be affected more by winds to their beams, abeam-component (Abeam-comp) columns were included to account for the reduced affect that winds will have if it approaches from an angle other than directly abeam. The abeam-component is the vector component of the wind velocity in the north- or south- direction when the ship is in the east-west oriented portion of the channel. A pilot taking wind readings will take direction into account when assessing the potential effects on his/her ship. Using the abeam-component is felt to be a reasonable approach to quantifying the reduced affect that would be estimated by a knowledgeable pilot for winds at angles other than 90 degrees to port or starboard. These columns are similar to those for the speed, but frequency of occurrence is tallied for the magnitude of the north-components of the speeds rather than the full magnitude of the speed. For example, a 30 knot wind blowing from directly abeam of the ship would affect the ship more than a 30 knot wind blowing from its stern or than a quartering wind. A 30 knot wind blowing from a bearing of 45 degrees (from the northeast) would have an abeam component of approximately 21 knots. The abeam component columns reduce winds in this manner in order to better estimate the potential for impact on the ship movements.

The last three columns, under the heading “window”, look at the “best” 1-, 2-, or 3-hour weather window that would allow the ship to transit into or out of the port within the given 4-hour period. Speeds used to define the windows are also based on the magnitude of the north-component (abeam-component) of the wind speed. Each window is evaluated by looking at a window of the given duration that “slides” within the 4-hour event period. The speed associated with a window is the maximum speed that is contained within the window (i.e. all other measurements within the window are less than or equal to the associated wind speed) at a given location within the 4-hour event period. The “best” window is the window at the location within the 4-hour period that results in the lowest maximum wind speed.

All data used to generate Tables 6 through 13 were first corrected to an observation height of 50 meters, corresponding with the approximate elevation of anemometers used on cruise ships. The conversion from wind speed at 10 meters to wind speed at a different height is a function the vertical wind speed profile, which in turn is a function of wind speed and air-sea temperature difference. Based on plots presented in the Coastal Engineering Manual (CEM)<sup>1</sup>, a conversion

---

<sup>1</sup> Coastal Engineering Manual, Chapter 2 Meteorology and Wave Climate. USACE EM 1110-2-1100 (Part II) (Change 2) 30 April 2005.

factor of 1.2 was conservatively estimated for calculating wind speed at 50 meters based on a 10 meter wind speed.

The wind roses show distinct differences in seasonal as well as daily wind characteristics. Comparison of the morning and afternoon roses for the summer season shows morning winds predominantly from the south and southwest and afternoon winds largely from the east to southeast. Winter season roses show greater wind speeds and show afternoon winds with a greater north/south orientation compared with the summer wind data. The latest navigation simulations at the STAR Center considered maximum winds from the north and south directions. Wind speeds were varied from 30 to 35 knots for most full harbor transits and 35 to 40 knots for ocean turn widener evaluation transits by the cruise ships.

Table 14 presents cumulative frequency of exceedance for the buoy data based on the data in Tables 8 and 9. Similarly, Table 15 was generated for the NASA Space Shuttle Facility data based on Tables 12 and 13. Exceedance probabilities are presented for wind speeds between 15 and 40 knots for maximum and average abeam-component wind speeds and for the best 1-hour, 2-hour, and 3-hour weather windows within the periods during which cruise ships will be entering or leaving port. As indicated above, the weather windows are defined by the maximum wind speed abeam-component over the span of the window. The “best” weather window is the window with the lowest maximum wind speed over the given 4 hour period.

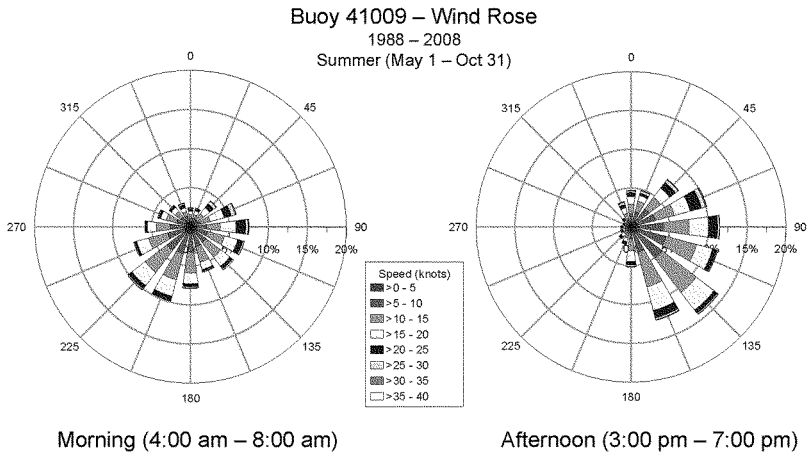

**Figure 4. Wind Roses for Station 41009 Data -- Summer Season**

**Buoy 41009 – Wind Rose**  
 1988 – 2008  
 Winter (Nov 1 - April 30)

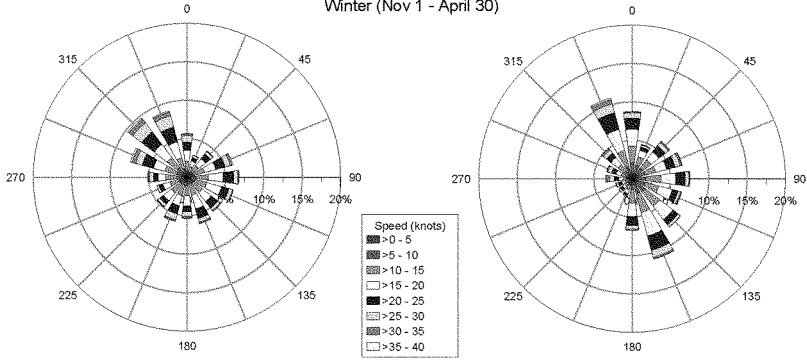

Morning (4:00 am – 8:00 am)

Afternoon (3:00 pm – 7:00 pm)

**Figure 5. Wind Roses for Station 41009 Data -- Winter Season**

**NASA Shuttle Facility - Wind Rose**  
 1978 - 2009  
 Summer (May 1 - Oct 31)

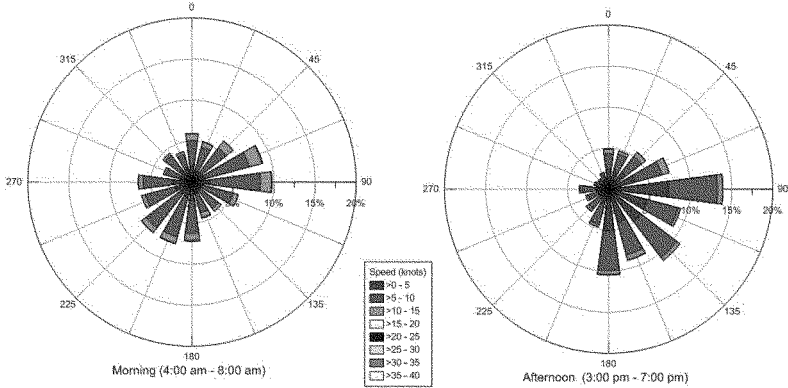

Morning (4:00 am - 8:00 am)

Afternoon (3:00 pm - 7:00 pm)

**Figure 6. Wind Roses for NASA Shuttle Facility -- Summer Season**

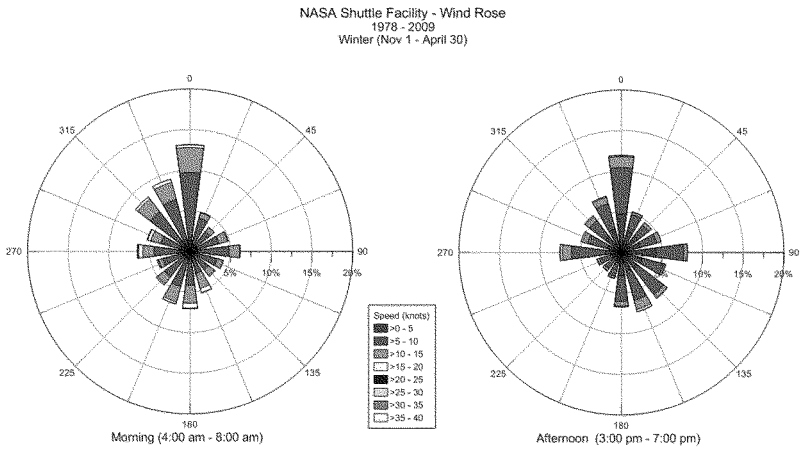

**Figure 7. Wind Roses for NASA Shuttle Facility -- Winter Season**

**Table 6. Wind speed Frequency of Occurrence – Summer – Station 41009**

Speed Range (knots)		Speed frequency			Abeam-comp frequency			"best window"		
from	to	max	min	avg	max	min	avg	1-hr	2-hr	3-hr
Morning period (4:00 am – 8:00 am)										
> 60		2	2	2	1	0	1	1	1	1
55	60	2	0	0	1	0	0	0	1	1
50	55	5	1	2	2	1	1	1	0	1
45	50	12	2	5	5	1	0	0	2	4
40	45	27	3	10	7	1	5	5	6	6
35	40	60	17	32	22	3	7	9	15	12
30	35	161	46	76	49	10	23	20	26	36
25	30	382	108	195	111	27	35	36	66	100
20	25	748	286	489	324	54	124	115	178	242
15	20	970	588	845	687	187	366	319	441	565
10	15	783	862	974	1004	401	741	676	811	942
5	10	335	856	705	1009	775	1170	1034	1137	1091
0	5	47	761	199	312	2072	1061	1318	850	533
Afternoon period (3:00 pm – 7:00 pm)										
> 60		3	0	2	1	0	0	0	0	1
55	60	6	1	1	0	0	0	0	1	0
50	55	5	0	3	3	0	1	1	3	3
45	50	12	4	2	3	0	1	2	1	1
40	45	48	1	9	17	1	4	2	5	14
35	40	113	15	34	35	3	12	12	14	25
30	35	241	41	70	87	13	23	27	48	63
25	30	455	119	217	174	30	68	53	94	137
20	25	752	233	479	410	78	163	159	240	326
15	20	959	521	903	711	182	410	370	506	628
10	15	735	819	1104	920	438	784	692	819	915
5	10	188	993	627	892	767	1123	1006	1052	942
0	5	7	777	73	271	2012	935	1200	741	469

**Table 7. Wind speed frequency of occurrence – Winter – Station 41009**

Speed Range (knots)		Speed frequency			Abeam-comp frequency			"best window"		
from	to	max	min	avg	max	min	avg	1-hr	2-hr	3-hr
Morning period (4:00 am – 8:00 am)										
> 60		1	0	0	0	0	0	0	0	0
55	60	4	0	1	2	0	0	0	1	2
50	55	13	0	3	0	0	0	2	1	0
45	50	49	2	13	13	0	1	1	4	8
40	45	106	30	51	32	1	9	8	20	29
35	40	239	72	138	93	10	38	38	53	65
30	35	489	182	307	211	49	103	95	137	192
25	30	633	377	530	347	131	227	213	269	302
20	25	724	542	669	514	252	372	334	407	475
15	20	689	702	770	722	389	544	524	596	660
10	15	383	709	613	707	540	689	651	699	722
5	10	118	516	306	639	667	825	757	775	684
0	5	10	326	57	178	1419	650	835	496	319
Afternoon period (3:00 pm – 7:00 pm)										
> 60		2	1	1	0	0	0	0	0	0
55	60	4	0	0	1	0	0	0	0	1
50	55	14	0	3	1	0	0	0	1	0
45	50	23	5	16	6	0	2	2	2	5
40	45	96	16	36	23	1	8	7	15	21
35	40	203	58	88	85	20	29	31	43	59
30	35	402	119	240	179	30	78	68	121	155
25	30	598	305	437	360	127	210	202	254	297
20	25	754	475	676	538	231	387	357	435	497
15	20	689	658	739	674	395	550	521	564	629
10	15	495	680	681	745	536	704	632	735	760
5	10	178	611	464	619	661	828	751	741	693
0	5	9	539	86	236	1466	671	896	556	350

**Table 8. Wind speed percent frequency of occurrence – Summer – Station 41009**

Speed Range (knots)		Speed frequency			Abeam-comp frequency			"best window"		
from	to	max	min	avg	max	min	avg	1-hr	2-hr	3-hr
Morning period (4:00 am – 8:00 am)										
> 60		0.1%	0.1%	0.1%	0.0%	0.0%	0.0%	0.0%	0.0%	0.0%
55	60	0.1%	0.0%	0.0%	0.0%	0.0%	0.0%	0.0%	0.0%	0.0%
50	55	0.1%	0.0%	0.1%	0.1%	0.0%	0.0%	0.0%	0.0%	0.0%
45	50	0.3%	0.1%	0.1%	0.1%	0.0%	0.0%	0.0%	0.1%	0.1%
40	45	0.8%	0.1%	0.3%	0.2%	0.0%	0.1%	0.1%	0.2%	0.2%
35	40	1.7%	0.5%	0.9%	0.6%	0.1%	0.2%	0.3%	0.4%	0.3%
30	35	4.6%	1.3%	2.2%	1.4%	0.3%	0.7%	0.6%	0.7%	1.0%
25	30	10.8%	3.1%	5.5%	3.1%	0.8%	1.0%	1.0%	1.9%	2.8%
20	25	21.2%	8.1%	13.8%	9.2%	1.5%	3.5%	3.3%	5.0%	6.8%
15	20	27.4%	16.6%	23.9%	19.4%	5.3%	10.4%	9.0%	12.5%	16.0%
10	15	22.2%	24.4%	27.6%	28.4%	11.3%	21.0%	19.1%	22.9%	26.7%
5	10	9.5%	24.2%	19.9%	28.6%	21.9%	33.1%	29.3%	32.2%	30.9%
0	5	1.3%	21.5%	5.6%	8.8%	58.6%	30.0%	37.3%	24.1%	15.1%
Afternoon period (3:00 pm – 7:00 pm)										
> 60		0.1%	0.0%	0.1%	0.0%	0.0%	0.0%	0.0%	0.0%	0.0%
55	60	0.2%	0.0%	0.0%	0.0%	0.0%	0.0%	0.0%	0.0%	0.0%
50	55	0.1%	0.0%	0.1%	0.1%	0.0%	0.0%	0.0%	0.1%	0.1%
45	50	0.3%	0.1%	0.1%	0.1%	0.0%	0.0%	0.1%	0.0%	0.0%
40	45	1.4%	0.0%	0.3%	0.5%	0.0%	0.1%	0.1%	0.1%	0.4%
35	40	3.2%	0.4%	1.0%	1.0%	0.1%	0.3%	0.3%	0.4%	0.7%
30	35	6.8%	1.2%	2.0%	2.5%	0.4%	0.7%	0.8%	1.4%	1.8%
25	30	12.9%	3.4%	6.2%	4.9%	0.9%	1.9%	1.5%	2.7%	3.9%
20	25	21.3%	6.6%	13.6%	11.6%	2.2%	4.6%	4.5%	6.8%	9.3%
15	20	27.2%	14.8%	25.6%	20.2%	5.2%	11.6%	10.5%	14.4%	17.8%
10	15	20.9%	23.2%	31.3%	26.1%	12.4%	22.2%	19.6%	23.2%	26.0%
5	10	5.3%	28.2%	17.8%	25.3%	21.8%	31.9%	28.5%	29.9%	26.7%
0	5	0.2%	22.0%	2.1%	7.7%	57.1%	26.5%	34.1%	21.0%	13.3%



**Table 9 Wind speed percent frequency of occurrence – Winter – Station 41009**

Speed Range (knots)		Speed frequency			Abeam-comp frequency			"best window"		
from	to	max	min	avg	max	min	avg	1-hr	2-hr	3-hr
<b>Morning period (4:00 am – 8:00 am)</b>										
> 60		0.0%	0.0%	0.0%	0.0%	0.0%	0.0%	0.0%	0.0%	0.0%
55	60	0.1%	0.0%	0.0%	0.1%	0.0%	0.0%	0.0%	0.0%	0.1%
50	55	0.4%	0.0%	0.1%	0.0%	0.0%	0.0%	0.1%	0.0%	0.0%
45	50	1.4%	0.1%	0.4%	0.4%	0.0%	0.0%	0.0%	0.1%	0.2%
40	45	3.1%	0.9%	1.5%	0.9%	0.0%	0.3%	0.2%	0.6%	0.8%
35	40	6.9%	2.1%	4.0%	2.7%	0.3%	1.1%	1.1%	1.5%	1.9%
30	35	14.1%	5.3%	8.9%	6.1%	1.4%	3.0%	2.7%	4.0%	5.6%
25	30	18.3%	10.9%	15.3%	10.0%	3.8%	6.6%	6.2%	7.8%	8.7%
20	25	20.9%	15.7%	19.3%	14.9%	7.3%	10.8%	9.7%	11.8%	13.7%
15	20	19.9%	20.3%	22.3%	20.9%	11.2%	15.7%	15.2%	17.2%	19.1%
10	15	11.1%	20.5%	17.7%	20.4%	15.6%	19.9%	18.8%	20.2%	20.9%
5	10	3.4%	14.9%	8.8%	18.5%	19.3%	23.9%	21.9%	22.4%	19.8%
0	5	0.3%	9.4%	1.6%	5.1%	41.0%	18.8%	24.1%	14.3%	9.2%
<b>Afternoon period (3:00 pm – 7:00 pm)</b>										
> 60		0.1%	0.0%	0.0%	0.0%	0.0%	0.0%	0.0%	0.0%	0.0%
55	60	0.1%	0.0%	0.0%	0.0%	0.0%	0.0%	0.0%	0.0%	0.0%
50	55	0.4%	0.0%	0.1%	0.0%	0.0%	0.0%	0.0%	0.0%	0.0%
45	50	0.7%	0.1%	0.5%	0.2%	0.0%	0.1%	0.1%	0.1%	0.1%
40	45	2.8%	0.5%	1.0%	0.7%	0.0%	0.2%	0.2%	0.4%	0.6%
35	40	5.9%	1.7%	2.5%	2.5%	0.6%	0.8%	0.9%	1.2%	1.7%
30	35	11.6%	3.4%	6.9%	5.2%	0.9%	2.2%	2.0%	3.5%	4.5%
25	30	17.2%	8.8%	12.6%	10.4%	3.7%	6.1%	5.8%	7.3%	8.6%
20	25	21.7%	13.7%	19.5%	15.5%	6.7%	11.2%	10.3%	12.5%	14.3%
15	20	19.9%	19.0%	21.3%	19.4%	11.4%	15.9%	15.0%	16.3%	18.1%
10	15	14.3%	19.6%	19.6%	21.5%	15.5%	20.3%	18.2%	21.2%	21.9%
5	10	5.1%	17.6%	13.4%	17.9%	19.1%	23.9%	21.7%	21.4%	20.0%
0	5	0.3%	15.5%	2.5%	6.8%	42.3%	19.4%	25.8%	16.0%	10.1%

**Table 10. Wind speed frequency of occurrence – Summer – NASA Shuttle Facility**

Speed Range (knots)		Speed frequency			Abeam-comp frequency			"best window"		
from	to	max	min	avg	max	min	avg	1-hr	2-hr	3-hr
Morning period (4:00 am – 8:00 am)										
> 60		0	0	0	0	0	0	0	0	0
55	60	0	0	0	0	0	0	0	0	0
50	55	0	0	0	0	0	0	0	0	0
45	50	0	0	0	0	0	0	0	0	0
40	45	0	0	0	0	0	0	0	0	0
35	40	1	0	0	0	0	0	0	0	0
30	35	8	0	0	3	0	0	0	0	3
25	30	53	1	5	21	0	0	0	8	14
20	25	271	12	61	122	2	11	13	47	78
15	20	1266	165	557	671	38	187	193	392	552
10	15	2103	947	1731	1476	352	962	784	1078	1316
5	10	1631	2511	2472	2279	1456	2124	1930	2160	2244
0	5	239	1936	746	1000	3724	2288	2652	1887	1365
Afternoon period (3:00 pm – 7:00 pm)										
> 60		0	0	0	0	0	0	0	0	0
55	60	0	0	0	0	0	0	0	0	0
50	55	0	0	0	0	0	0	0	0	0
45	50	0	0	0	0	0	0	0	0	0
40	45	0	0	0	0	0	0	0	0	0
35	40	0	0	0	0	0	0	0	0	0
30	35	5	0	0	1	0	0	0	0	1
25	30	19	0	2	6	0	0	0	1	5
20	25	92	6	24	34	0	4	4	12	21
15	20	535	65	189	237	23	55	61	116	173
10	15	1248	364	804	710	134	352	288	414	551
5	10	2949	1943	2437	2266	812	1455	1308	1714	2042
0	5	754	3224	2146	2348	4633	3736	3961	3345	2809

**Table 11. Wind speed frequency of occurrence – Winter – NASA Shuttle Facility**

Speed Range (knots)		Speed frequency			Abeam-comp frequency			"best window"		
from	to	max	min	avg	max	min	avg	1-hr	2-hr	3-hr
Morning period (4:00 am – 8:00 am)										
> 60		0	0	0	0	0	0	0	0	0
55	60	0	0	0	0	0	0	0	0	0
50	55	0	0	0	0	0	0	0	0	0
45	50	0	0	0	0	0	0	0	0	0
40	45	1	0	0	0	0	0	0	0	0
35	40	1	0	0	0	0	0	0	0	0
30	35	4	1	1	1	0	0	0	1	1
25	30	11	0	2	7	0	1	0	1	4
20	25	74	2	9	29	1	4	3	12	17
15	20	563	32	132	187	7	34	42	84	137
10	15	1991	396	1043	802	94	285	259	435	641
5	10	2704	2341	3186	2952	776	1777	1572	2214	2583
0	5	422	2999	1398	1793	4893	3670	3895	3024	2388
Afternoon period (3:00 pm – 7:00 pm)										
> 60		0	0	0	0	0	0	0	0	0
55	60	0	0	0	0	0	0	0	0	0
50	55	1	0	0	0	0	0	0	0	0
45	50	0	0	0	0	0	0	0	0	0
40	45	0	0	0	0	0	0	0	0	0
35	40	2	0	0	1	0	0	0	0	0
30	35	4	0	1	1	0	0	0	0	1
25	30	13	1	0	1	0	0	0	0	0
20	25	65	1	13	27	0	3	2	9	16
15	20	341	22	58	141	6	17	14	54	93
10	15	1255	168	525	578	44	168	128	274	408
5	10	3365	1668	2737	2470	521	1317	1073	1648	2124
0	5	729	3915	2441	2556	5204	4270	4558	3790	3133

**Table 12. Wind speed percent frequency of occurrence – Summer –  
NASA Shuttle Facility**

Speed Range (knots)		Speed frequency			Abeam-comp frequency			"best window"		
from	to	max	min	avg	max	min	avg	1-hr	2-hr	3-hr
Morning period (4:00 am – 8:00 am)										
> 60		0.0%	0.0%	0.0%	0.0%	0.0%	0.0%	0.0%	0.0%	0.0%
55	60	0.0%	0.0%	0.0%	0.0%	0.0%	0.0%	0.0%	0.0%	0.0%
50	55	0.0%	0.0%	0.0%	0.0%	0.0%	0.0%	0.0%	0.0%	0.0%
45	50	0.0%	0.0%	0.0%	0.0%	0.0%	0.0%	0.0%	0.0%	0.0%
40	45	0.0%	0.0%	0.0%	0.0%	0.0%	0.0%	0.0%	0.0%	0.0%
35	40	0.0%	0.0%	0.0%	0.0%	0.0%	0.0%	0.0%	0.0%	0.0%
30	35	0.1%	0.0%	0.0%	0.1%	0.0%	0.0%	0.0%	0.0%	0.1%
25	30	1.0%	0.0%	0.1%	0.4%	0.0%	0.0%	0.0%	0.1%	0.3%
20	25	4.9%	0.2%	1.1%	2.2%	0.0%	0.2%	0.2%	0.8%	1.4%
15	20	22.7%	3.0%	10.0%	12.0%	0.7%	3.4%	3.5%	7.0%	9.9%
10	15	37.7%	17.0%	31.1%	26.5%	6.3%	17.3%	14.1%	19.3%	23.6%
5	10	29.3%	45.1%	44.4%	40.9%	26.1%	38.1%	34.6%	38.8%	40.3%
0	5	4.3%	34.7%	13.4%	17.9%	66.8%	41.1%	47.6%	33.9%	24.5%
Afternoon period (3:00 pm – 7:00 pm)										
> 60		0.0%	0.0%	0.0%	0.0%	0.0%	0.0%	0.0%	0.0%	0.0%
55	60	0.0%	0.0%	0.0%	0.0%	0.0%	0.0%	0.0%	0.0%	0.0%
50	55	0.0%	0.0%	0.0%	0.0%	0.0%	0.0%	0.0%	0.0%	0.0%
45	50	0.0%	0.0%	0.0%	0.0%	0.0%	0.0%	0.0%	0.0%	0.0%
40	45	0.0%	0.0%	0.0%	0.0%	0.0%	0.0%	0.0%	0.0%	0.0%
35	40	0.0%	0.0%	0.0%	0.0%	0.0%	0.0%	0.0%	0.0%	0.0%
30	35	0.1%	0.0%	0.0%	0.0%	0.0%	0.0%	0.0%	0.0%	0.0%
25	30	0.0%	0.0%	0.1%	0.0%	0.0%	0.0%	0.0%	0.1%	0.0%
20	25	0.1%	0.4%	0.6%	0.0%	0.1%	0.1%	0.2%	0.4%	0.1%
15	20	1.2%	3.4%	4.2%	0.4%	1.0%	1.1%	2.1%	3.1%	1.2%
10	15	6.5%	14.4%	12.7%	2.4%	6.3%	4.8%	7.4%	9.8%	6.5%
5	10	34.7%	43.5%	40.4%	14.5%	26.0%	23.3%	30.6%	36.5%	34.7%
0	5	57.6%	38.3%	41.9%	82.7%	66.7%	70.7%	59.7%	50.1%	57.6%

**Table 13. Wind speed percent frequency of occurrence – Winter –  
NASA Shuttle Facility**

Speed Range (knots)		Speed frequency			Abeam-comp frequency			"best window"		
from	to	max	min	avg	max	min	avg	1-hr	2-hr	3-hr
Morning period (4:00 am – 8:00 am)										
> 60		0.0%	0.0%	0.0%	0.0%	0.0%	0.0%	0.0%	0.0%	0.0%
55	60	0.0%	0.0%	0.0%	0.0%	0.0%	0.0%	0.0%	0.0%	0.0%
50	55	0.0%	0.0%	0.0%	0.0%	0.0%	0.0%	0.0%	0.0%	0.0%
45	50	0.0%	0.0%	0.0%	0.0%	0.0%	0.0%	0.0%	0.0%	0.0%
40	45	0.0%	0.0%	0.0%	0.0%	0.0%	0.0%	0.0%	0.0%	0.0%
35	40	0.0%	0.0%	0.0%	0.0%	0.0%	0.0%	0.0%	0.0%	0.0%
30	35	0.1%	0.0%	0.0%	0.0%	0.0%	0.0%	0.0%	0.0%	0.0%
25	30	0.2%	0.0%	0.0%	0.1%	0.0%	0.0%	0.0%	0.0%	0.1%
20	25	1.3%	0.0%	0.2%	0.5%	0.0%	0.1%	0.1%	0.2%	0.3%
15	20	9.8%	0.6%	2.3%	3.2%	0.1%	0.6%	0.7%	1.5%	2.4%
10	15	34.5%	6.9%	18.1%	13.9%	1.6%	4.9%	4.5%	7.5%	11.1%
5	10	46.9%	40.6%	55.2%	51.2%	13.4%	30.8%	27.2%	38.4%	44.8%
0	5	7.3%	52.0%	24.2%	31.1%	84.8%	63.6%	67.5%	52.4%	41.4%
Afternoon period (3:00 pm – 7:00 pm)										
> 60		0.0%	0.0%	0.0%	0.0%	0.0%	0.0%	0.0%	0.0%	0.0%
55	60	0.0%	0.0%	0.0%	0.0%	0.0%	0.0%	0.0%	0.0%	0.0%
50	55	0.0%	0.0%	0.0%	0.0%	0.0%	0.0%	0.0%	0.0%	0.0%
45	50	0.0%	0.0%	0.0%	0.0%	0.0%	0.0%	0.0%	0.0%	0.0%
40	45	0.0%	0.0%	0.0%	0.0%	0.0%	0.0%	0.0%	0.0%	0.0%
35	40	0.0%	0.0%	0.0%	0.0%	0.0%	0.0%	0.0%	0.0%	0.0%
30	35	0.1%	0.0%	0.0%	0.0%	0.0%	0.0%	0.0%	0.0%	0.0%
25	30	0.2%	0.0%	0.0%	0.0%	0.0%	0.0%	0.0%	0.0%	0.0%
20	25	1.1%	0.0%	0.2%	0.5%	0.0%	0.1%	0.0%	0.2%	0.3%
15	20	5.9%	0.4%	1.0%	2.4%	0.1%	0.3%	0.2%	0.9%	1.6%
10	15	21.7%	2.9%	9.1%	10.0%	0.8%	2.9%	2.2%	4.7%	7.1%
5	10	58.3%	28.9%	47.4%	42.8%	9.0%	22.8%	18.6%	28.5%	36.8%
0	5	12.6%	67.8%	42.3%	44.3%	90.1%	73.9%	78.9%	65.6%	54.3%

**Table 14. Wind speed cumulative frequency of exceedance – Station 41009**

Speed (knots)	Frequency of Exceedance (%)			
	Summer <sup>1</sup>		Winter <sup>2</sup>	
	AM <sup>3</sup>	PM <sup>4</sup>	AM <sup>3</sup>	PM <sup>4</sup>
Maximum abeam-component				
15	34.1	40.9	56.0	53.9
20	14.7	20.7	35.1	34.5
25	5.5	9.1	20.2	19
30	2.4	4.2	10.2	8.6
35	1.0	1.7	4.1	3.4
40	0.4	0.7	1.4	0.9
Average abeam-component				
15	15.9	19.2	37.5	36.5
20	5.5	7.6	21.8	20.6
25	2.0	3.0	11	9.4
30	1.0	1.1	4.4	3.3
35	0.3	0.4	1.4	1.1
40	0.1	0.1	0.3	0.3
Best 1-hour weather window				
15	14.3	17.8	35.2	34.3
20	5.3	7.3	20.0	19.3
25	2.0	2.8	10.3	9.0
30	1.0	1.3	4.1	3.2
35	0.4	0.5	1.4	1.2
40	0.1	0.2	0.3	0.3
Best 2-hour weather window				
15	20.8	25.9	43.0	41.3
20	8.3	11.5	25.8	25.0
25	3.3	4.7	14.0	12.5
30	1.4	2.0	6.2	5.2
35	0.7	0.6	2.2	1.7
40	0.3	0.2	0.7	0.5
Best 3-hour weather window				
15	27.2	34.0	50.1	47.9
20	11.2	16.2	31.0	29.8
25	4.4	6.9	17.3	15.5
30	1.6	3.0	8.6	6.9
35	0.6	1.2	3.0	2.4
40	0.3	0.5	1.1	0.7
<sup>1</sup> Summer period defined as May 1 through October 31 <sup>2</sup> Winter period defined as November 1 through April 31 <sup>3</sup> AM period is between 4:00 and 8:00 am <sup>4</sup> PM period is between 3:00 and 7:00 pm				

**Table 15. Wind speed cumulative frequency of exceedance – NASA Shuttle Facility**

Speed (knots)	Frequency of Exceedance (%)			
	Summer <sup>1</sup>		Winter <sup>2</sup>	
	AM <sup>3</sup>	PM <sup>4</sup>	AM <sup>3</sup>	PM <sup>4</sup>
Maximum abeam-component				
15	3.9%	3.0%	14.7%	5.0%
20	0.6%	0.5%	2.6%	0.7%
25	0.1%	0.1%	0.4%	0.1%
30	0.0%	0.0%	0.1%	0.0%
35	0.0%	0.0%	0.0%	0.0%
40	0.0%	0.0%	0.0%	0.0%
Average abeam-component				
15	0.7%	0.3%	3.6%	1.1%
20	0.1%	0.1%	0.2%	0.1%
25	0.0%	0.0%	0.0%	0.0%
30	0.0%	0.0%	0.0%	0.0%
35	0.0%	0.0%	0.0%	0.0%
40	0.0%	0.0%	0.0%	0.0%
Best 1-hour weather window				
15	0.8%	0.3%	3.8%	1.2%
20	0.1%	0.0%	0.2%	0.1%
25	0.0%	0.0%	0.0%	0.0%
30	0.0%	0.0%	0.0%	0.0%
35	0.0%	0.0%	0.0%	0.0%
40	0.0%	0.0%	0.0%	0.0%
Best 2-hour weather window				
15	1.7%	1.1%	8.1%	2.3%
20	0.2%	0.2%	1.0%	0.2%
25	0.0%	0.0%	0.1%	0.0%
30	0.0%	0.0%	0.0%	0.0%
35	0.0%	0.0%	0.0%	0.0%
40	0.0%	0.0%	0.0%	0.0%
Best 3-hour weather window				
15	2.8%	1.9%	11.6%	3.6%
20	0.4%	0.3%	1.7%	0.5%
25	0.1%	0.0%	0.3%	0.1%
30	0.0%	0.0%	0.1%	0.0%
35	0.0%	0.0%	0.0%	0.0%
40	0.0%	0.0%	0.0%	0.0%

<sup>1</sup> Summer period defined as May 1 through October 31  
<sup>2</sup> Winter period defined as November 1 through April 31  
<sup>3</sup> AM period is between 4:00 and 8:00 am  
<sup>4</sup> PM period is between 3:00 and 7:00 pm

Based on these two datasets, it appears that generally the likelihood for delays increases in the winter with average abeam-component winds speeds over the periods the ships will enter or leave port exceeding 15 knots between about 2 to 37% of the time compared with 0.5 to 17% of the time for the summer season. The lower numbers in these ranges are daily averages based on the NASA space shuttle facility data where the upper limits are daily averages based on the buoy data. Similarly maximum abeam-component wind speeds exceed 15 knots between about 10 to 55% of the time during the winter compared to between about 3.5 to 37.5% of the time in the summer.

The best weather windows are a measure of the best conditions over a given period and are meant as a measure of the ability of ships to enter or leave the port during a given 4-hour period. Ships arriving at the port during the morning or evening period, but outside of the given "best" weather window may encounter greater wind speeds and potential for delays may be under-represented by the percentages given for the 1- and 2-hour weather windows in Tables 14 and 15.

### 1.3.3.2 Wave Climate and Design Vessel Motions

The entrance from Port Canaveral sees some protection from wind waves from deep water from the north through east directions due to the Cape Canaveral land mass to the north and the Southeast Shoal approximately 8 to 10 nautical miles east of the harbor.

Wave climate for the entrance channel was forecast for wind speeds ranging from 15 to 20 knots for tanker and bulk carrier traffic and 25 to 30 knots for cruise traffic. The wave conditions at the entrance to the harbor are duration-limited, so the wave growth in terms of height will be limited by the length of time the wind blows. Table 16 summarizes the wave parameter predictions for the Canaveral Harbor entrance. Parameters estimated include spectral wave height (Hmo), peak spectral period (Tp), and wave length (L) for durations of 1, 2, and 3 hours and for wind speeds of 15, 20, 25, and 30 knots based on linear wave theory for an average water depth of 45 ft.

**Table 16. Wave Predictions – Entrance to Canaveral Harbor**

Duration of Wind (hrs)	Duration-Limited Wind Speed (knots)											
	15			20			25			30		
	Hmo (ft)	Tp (sec)	L (ft)	Hmo (ft)	Tp (sec)	L (ft)	Hmo (ft)	Tp (sec)	L (ft)	Hmo (ft)	Tp (sec)	L (ft)
3	1.8	3.0	46	2.8	3.7	70	4.1	4.3	94	5.5	5.0	125
2	1.4	2.5	32	2.1	3.1	49	3.0	3.7	70	4.1	4.2	90
1	0.8	1.9	19	1.3	2.3	27	1.9	2.8	40	2.5	3.2	52

## 1.4 Canaveral Harbor Existing Project Features

The existing Federal project was authorized by the Rivers and Harbors Acts of 2 March 1945 and 23 October 1962, as well as Sections 101, 114, and 117 of the Water Resources Development Act of 1992. The following table summarizes the Federal authorized dimensions of the existing Port Canaveral project features. In addition, a paid overdepth allowance of 2 ft below the project depths shown is authorized.



**Table 17. Port Canaveral Existing Project Features**

Project Feature	Cut and Centerline Station Start / End (ft)	Existing Federal Dimensions Depth X Width X Length (ft)
Outer Reach	Cut 1A, 0+00 to 110+00	44 X 400 X 29,000 (USN)
	Cut 1B 0+00 to 55+00	41 X 400 X 29,000 (CW)
	Cut 1, 0+00 to 125+00	
44-ft Turn Widener		44 X Irregular Shape (USN)
41-ft Turn Widener		41 X Irregular Shape (CW)
Middle Reach	Cut 2, 125+00 to 181+70	44 X 400 X 5,670 (USN)
		41 X 400 X 5,670 (CW)
Trident Access Channel	T.A.C., 5+00 to 32+33.60	44 X Width Varies X 2,733.6 (USN)
Trident Turning Basin	T.T.B., 0+00 to 15+00	41 X 1,200 X 1,500 (USN)
Inner Reach	Cut2, 181+70 to 207+00	40 X 400 X 3,330
	Cut 3, 207+00 to 215+00	
Middle Turning Basin	M.T.B., 215+00 to 241+70	39 X 2,670 X Irregular Shape w/ 1200-ft DIA
West Access Channel (East of Sta 260+00)	W.A.C., 241+60 to 260+00 Cut A, 0+00 to 18+40	39 X 400 X 1,840
West Access Channel, (West of Sta 260+00)	W.A.C., 260+00 to 277+30 Cut A, 18+40 to 36+70	31 X 400 X 1,730 CPA to 35'
West Turning Basin		31 X Irregular Shape w/ 1400-ft DIA, CPA to 35'
Canaveral Barge Canal	Cut 1 to Canaveral Lock, 141+60 to 227+70	12 X 125 X 8,610
Pilot's Draft Limits/Restrictions		36 ft w/o tidal advantage, 39.5 ft w/ maximum tidal advantage and good conditions

USN – US Navy Project

CW – Civil Works Project

Attachment C presents drawings depicting Canaveral Harbor existing conditions and authorized channel depths.

## 1.5 Navigation Simulation Studies

Two separate simulation studies have been executed in 2007 and 2009 in direct support of this navigation improvements feasibility study. Both studies took place at the RTM STAR Center, Dania Beach, Florida. The 2007 simulations considered the test vessels, tanker Jupiter and Genesis Class cruise ship. In the 2009 simulations, a test matrix, coordinated with representatives from the USACE navigation community (Vicksburg, MS and Jacksonville District), was developed for additional tests of the tanker Jupiter and the presently home ported Freedom Class vessel. Both studies were conducted in the STAR Center's 360-degree field-of-view, ship handling simulator with the participation of CPA's consultants and the Canaveral Pilots in both cases and the USACE navigation representatives in the 2009 simulations.

Alternative Plans A and B, also referred to as Plans 2 and 1 in the Main Report, respectively, were investigated in the 2009 simulations. Only alternative Plan A was evaluated in the 2007 simulations. Table 18 summarizes the width geometry for each major navigation feature identified for improvement.

**Table 18. Simulations Plan Width Geometry**

Project Width Navigation Feature	Plan A (Main Report Plan 2)	Plan B (Main Report Plan 1)
Ocean Turn Widener	22.24 acres	11.14 acres
North Side Channel Widener (Inner Reach to North Jetty)	100 ft for 500-ft Channel	50 ft for 450-ft Channel
Channel Widener (West Access Channel, Both Cuts)	87.5 ft, South Side 12.5 ft, North Side	87.5 ft, South Side 12.5 ft, North Side
West Basin Turn Area	1725-ft Diameter	1675-ft Diameter

Figures 8 through 10 detail the differences between Plan A and Plan B in the areas mentioned in Table 18.

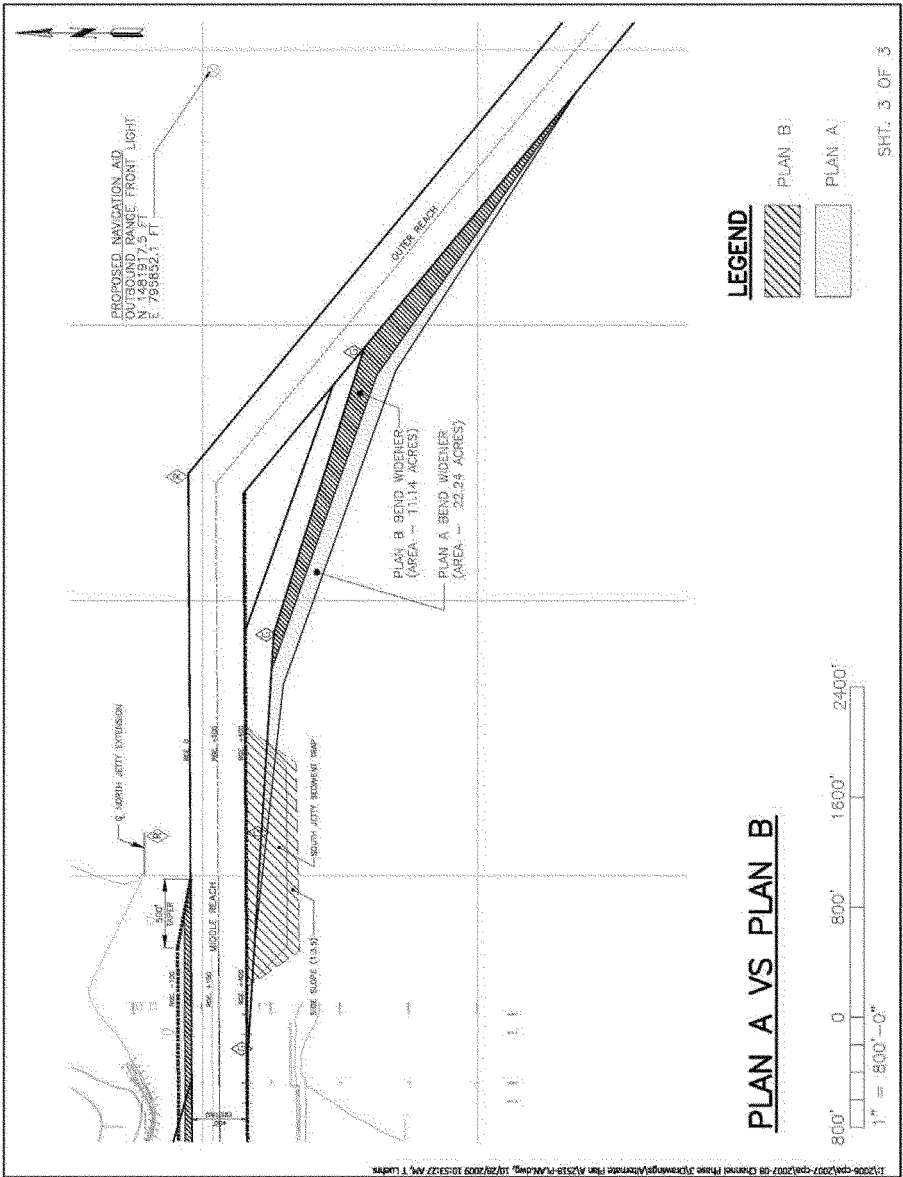

Figure 8. Plan A and Plan B comparison (1 of 3).

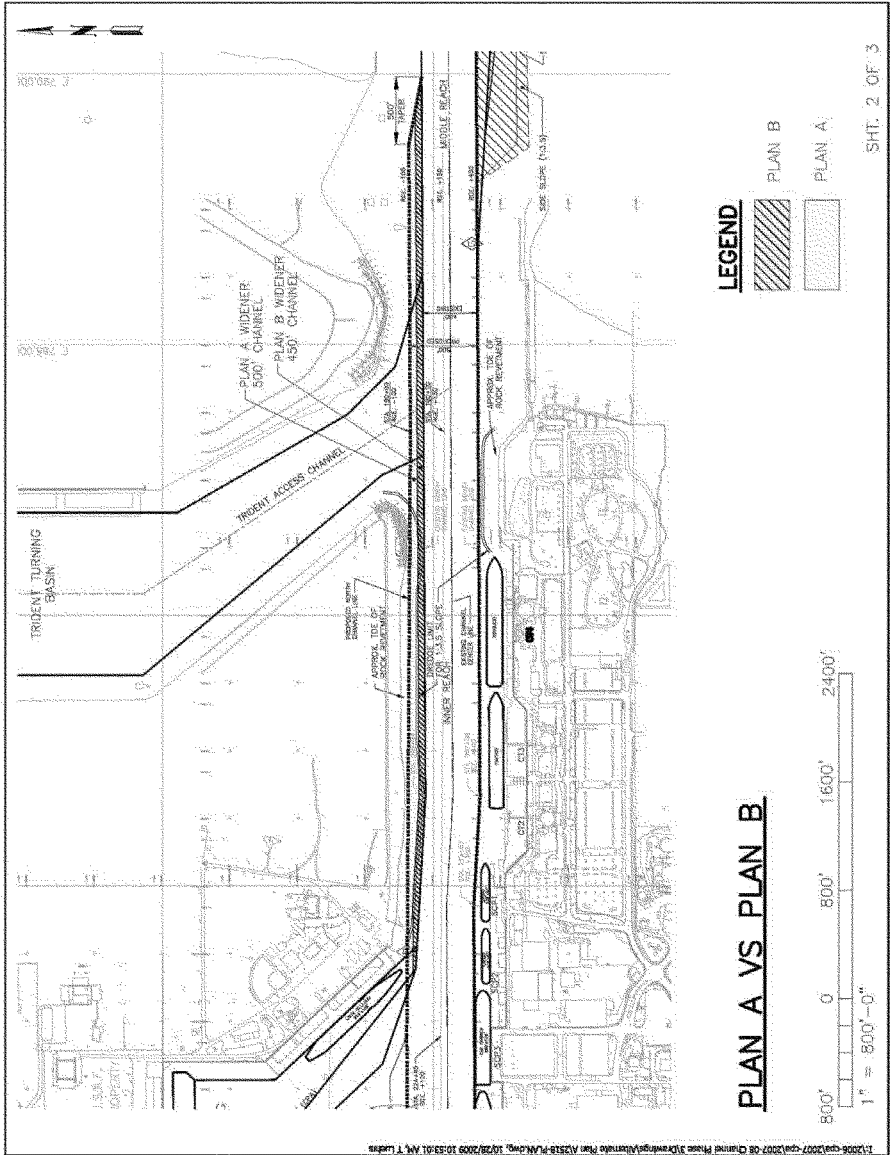

Figure 9. Plan A and Plan B comparison (2 of 3)

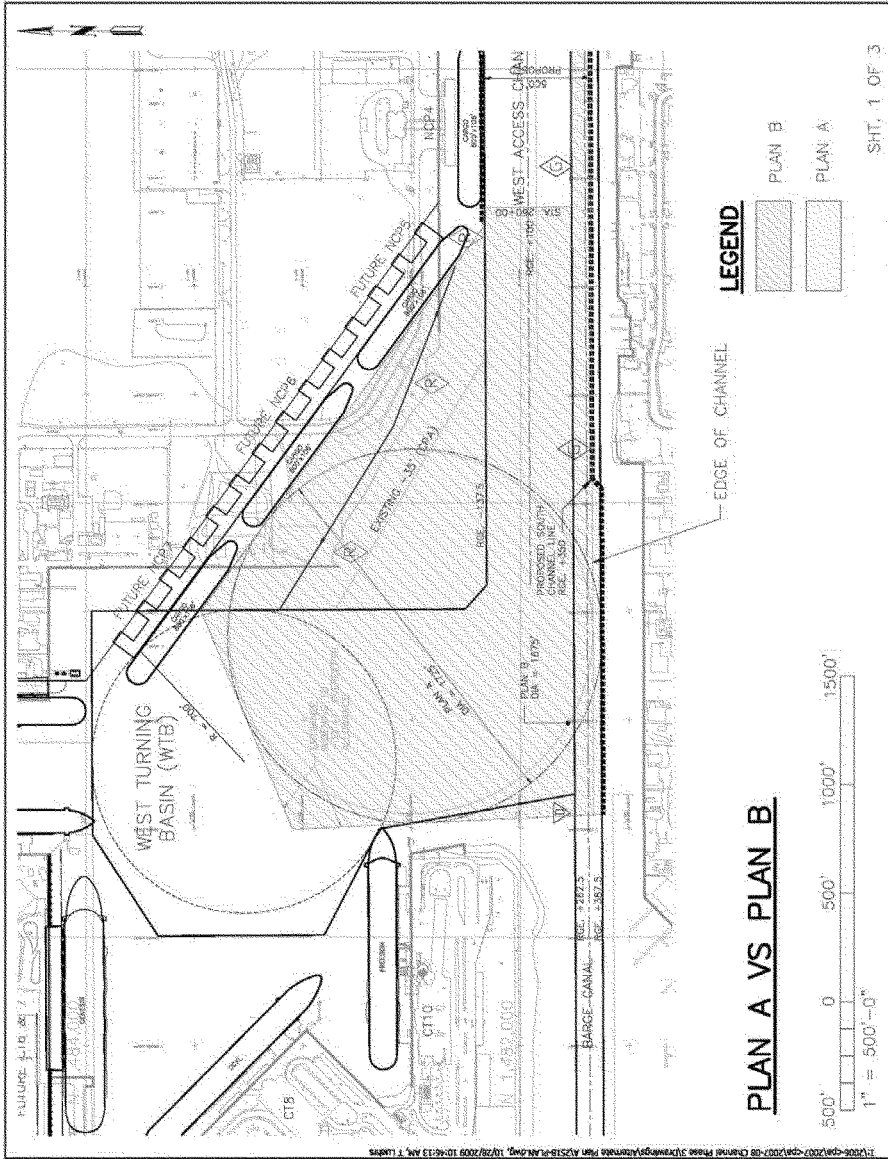

Figure 10. Plan A and Plan B comparison (3 of 3)

The STAR Center utilized three hydrodynamic vessel response models in the simulations: two very large passenger cruise ships, the Genesis and Freedom Class vessels, and the Jupiter, a medium-sized (AFRAMAX) tanker. The Genesis and Freedom models were evaluated for one load condition in all runs. The Jupiter was modeled in a partially loaded condition for inbound runs and a ballasted condition for outbound runs. Table 19 contains the particulars for the ships.

Different model wind and current conditions were used in the 2007 and 2009 simulations. The 2007 simulations evaluated all exercises for wind speeds from 15 to 25 knots with current outside the jetties at 0.3 knots setting northerly or southerly, sometimes opposing the wind, other times in the same direction as the wind. In the 2009 simulations and with USACE navigation team input, higher wind speeds of 30 to 40 knots were used for the cruise ship exercises and 25 to 30 knots for the tanker exercises with northerly setting currents of 0.75 and 1.0 knots and southerly setting currents of 0.5 knots. The 2009 simulations also considered wind and current applied in the same direction. In both simulation studies, three tugs were secured to the tanker and available for use by the pilots as needed. Two 3,000-hp conventional tugs were made fast on the port and starboard bow and one 4,000-hp tractor tug assist was available at the stern. Attachment A contains the complete STAR Center Simulation Reports and each matrix of runs. Subsequent paragraphs of this Engineering Appendix discuss the simulations findings with regard to the project features investigated.

**Table 19. STAR Center Ship Response Model Characteristics**

SHIP MODEL	Freedom Class (Cruise)	Genesis Class (Cruise)	Jupiter (Tanker)
Length Overall	1111.6 ft (338.9m)	1185.7 ft (361.5m)	800.3 ft (244.0m)
Beam at the waterline	126.6 ft (38.6m)	154.2 ft (47.0m)	137.8 ft (42.0m)
Displacement (m. tons)	72,330	103,252	97,200 Partially Laden 54,260 Ballasted <u>Partially Laden (Inbound)</u> Fwd 39.4 ft (12.0m) Aft 39.4 ft (12.0m)
Modeled Draft, forward and aft	Fwd 27.9 ft (8.5m) Aft 27.9 ft (8.5m)	Fwd 30.2 ft (9.2m) Aft 30.2 ft (9.2m)	<u>Ballasted (Outbound)</u> Fwd 18.7 ft (5.7m) Aft 27.2 ft (8.3m)
Propulsion Type	Diesel Electric	Diesel Electric	Diesel
Propeller Type	Fixed Pitch (inward)	Fixed Pitch (inward)	Fixed Pitch CW
Number of Propulsion Pods or Propeller Shafts	2 Azipods (Port/Stbd) 1 Fixipod (Centerline)	3 Azipods	1 Shaft
Shaft Horsepower (each shaft or pod)	18,774 hp	26,820 hp	19,713 hp
Number of Thrusters	4 (Bow)	4 (Bow)	None
Thruster Horsepower	4,425 hp	7,376 hp	--

## 1.6 Project Width Alternatives

The very large cruise ship length and beam dimensions drive the navigation project width requirements as affected by environmental conditions during transit and proximity to moored vessels along Canaveral Harbor's main channel. Cruise ship speed and turn widener geometry can ensure the safety of navigation outside the harbor and jetties. Safe navigation inside the harbor, with minimal surge effects to moored vessels, requires a balance between vessel speed and good ship handling capability to manage the yaw of the vessel or "crab angle" or "leeway" as it moves through the waterway under the influence of moderate to high wind conditions.

Crab angle or leeway carried by a cruise ship is a measure of the effective width of a ship and the space it consumes within a channel. Cruise ship "effective beam" was discussed in a letter from the Canaveral Pilot's Association to CPA in December 2002. This letter was written in anticipation of the arrival of Mariner of the Seas in 2003 and the need for dredging of certain locations within the harbor, but outside and adjacent to the existing 400 ft channel boundaries. The pilots requested these key areas of dredging to improve the safety of navigation for this new large cruise ship. The pilot's define the ship effective beam (SEB) as follows:

$$\text{SEB (ft)} = \text{LOA (ft)} \times (1.75 / 100) \times \text{Crab Angle (deg)} + \text{Beam} \quad (1)$$

Crab angle or leeway refers to the difference between the ship's heading and the course made good. The crab angle carried by a ship increases as wind speed increases and vessel speed decreases. This parameter is most important for the cruise ship traffic having large wind sail areas and post-panamax beams.

Cruise ships now transit Port Canaveral channels twice daily – inbound from early to mid-a.m. hours and outbound approximately late afternoon to mid-p.m. hours. The largest cruise ships home-ported at Port Canaveral, as well as various regularly scheduled Port of Call vessels, sail to and from the West Basin in winds of up to 35 knots unassisted. These large vessels with significant sail area generally travel at speeds on the order of 6 to 7 knots to minimize surge at critical locations in the West Access and Inner Reach channels but are greatly affected by channel cross-winds on occasions where sustained wind speeds exceed 20 knots. In the absence of the project and until such time as the navigation improvements are constructed, the pilots will recommend and/or require tug-assisted cruise ship maneuvering and transit and tug support to berthed tanker and cargo vessels at north and south cargo piers or berthed surface ships and submarines at military berths as wind conditions dictate. Roughly 15 occurrences of tug assistance for inbound or outbound cruise vessels and berthed vessels during 2011 resulted from wind conditions of 25 knots and above from primarily the North and East directions. The tug assist on berthed vessels ensures their safety by minimizing surge effects at commercial or military berths. On four occasions in 2011, the Carnival Dream has required tug assist to maneuver away from the Cruise Terminal 10 berth in winds of 20 to 25 knots. This is an example of the very large cruise vessel with some degree of lesser power and handling capability than say, the Freedom of the Seas. However, during the weekend of October 8, 2011, sustained high winds of 25 knots and greater, not associated with a tropical storm system, necessitated the use of one or two tugs for all cruise ship transits.

In the 2009 simulations, two project channel width alternatives of 500 ft (Plan A) and 450 feet (Plan B) have been considered for a portion of the middle reach, the inner reach, and a very short section of the Middle Basin Channel, east end. In the West Access Channel, the project formalizes the inclusion of an 87.5 ft width along the south side of the existing channel in the barge canal. Approximately 70 percent of this area was previously dredged to the 35 ft project depth in 2003 in preparation to receive the Voyager Class vessel home ported in West Basin from 2003-2009 as discussed below. CPA has historically held a regulatory permit authorizing maintenance dredging of this area along the southern boundary of the West Access Channel to support the safe navigation of the existing cruise vessel traffic. In following sections, the results of the various simulations are discussed with respect to the project width alternatives beginning first with the 2003 simulations as the outcome resulted in dredging the barge canal along the southern boundary of the existing 400 ft West Access Channel and Cut A for a width of 87.5 ft by approximately 2,550 ft long in 2003 to receive the Voyager Class homeport ship.

### 1.6.1 STAR Center Simulations for Voyager Class and Pilots Dredging

A Port Canaveral Berth Access Simulation Study was conducted in May 2003 to evaluate Mariner of the Seas navigation through Port Canaveral in various configurations including: 1) the existing channel; 2) the existing channel along with areas requested to be dredged by the pilots adjacent to but outside the channel; and 3) a 500 ft channel width. The Canaveral Pilots and RCCL ship captains participated in the simulations at the STAR Center.



Through the existing channel, Voyager Class vessel speeds were on the order of 6 to 10 knots between the Port entrance and the Navy's Poseidon Wharf in the MTB. Between the Poseidon Wharf and the entrance to the WTB, ship speeds were generally 6 knots or less. The study reported that for Voyager Class vessel speed of 6 knots, crab angles of 2.5 to 3 degrees were observed for 15-knot cross winds. The crab angle increased to approximately 4.5 degrees for 25-knot cross winds. Also noted were minimal clearances to berthed vessels that likely would have resulted in undesirable surge effects on those moored ships and associated operations. For the configuration that included the pilot dredge areas and for 30-knot cross winds, crab angles of 7 to 8 degrees were observed for transit speeds of 6 knots or less. For 30-knot winds, a more comfortable vessel speed of 6.2 knots limited the crab angle to about 6 degrees.

The STAR Center characterized the test wind conditions of 15- and 25-knot winds at Port Canaveral as average to moderately high. The 2003 report details five simulation exercises, runs 19-23, with the Voyager Class vessel in a 500 ft channel, the widening of the entrance to the West Basin, and the outbound range. Inbound and outbound runs were conducted with 20- and 25-knot winds from the south with one inbound run using 15 knot winds from the north. The pilots considered the southerly wind of most importance, as the cruise vessel tracked along the south side of the channel allowing for leeway, positioning the passing vessel in close proximity to the south side cruise and cargo berths along the Inner Reach. In the presence of high southerly crosswinds, the pilots preferred track is to favor the windward (south) side of the channel such that the stern tracks on or near the channel centerline. This is a key point for navigating these large vessels as the distance to the moored vessels is reduced in the case of southerly winds. Similarly, favoring the windward (north) side of the channel in northerly winds results in a reduced distance to the bank along the inner reach.

A key result of the 2003 navigation simulations for Voyager in the 500 ft channel was that the uniform width of 500 feet allows greater clearance to moored vessels, having a significant reduction of surge effects associated with these transits in the existing 400 ft channel. The additional width would allow the Voyager Class vessel to carry a higher crab angle while maintaining transit speeds of 6 knots or less, optimizing safety and control of the vessel under the widest range of environmental conditions.

Prior to the arrival of the Voyager Class vessel, Mariner of the Seas, in 2003, and at the request of the Canaveral Harbor Pilots (also with confirmation by simulations at the STAR Center), CPA executed dredging at five locations adjacent to but outside the channel that were considered to be key navigation areas and/or restricted channel areas critical to the safe navigation of this cruise vessel (see Figures 11 and 12). Those dredge areas effectively provided 50 ft of additional room north of the channel at either end of the Inner Reach and 87.5 ft of additional room south of the channel along the West Access Channel. Since 2003, the areas dredged have been permitted and authorized for maintenance dredging by the CPA to effectively provide 450 and 487 feet of navigable channel width at key areas where surge effects are of prime concern. This suggests that the pilots are most comfortable navigating the Voyager Class vessel where the channel is 450 ft wide having ideal bank clearances of at least 100 ft.

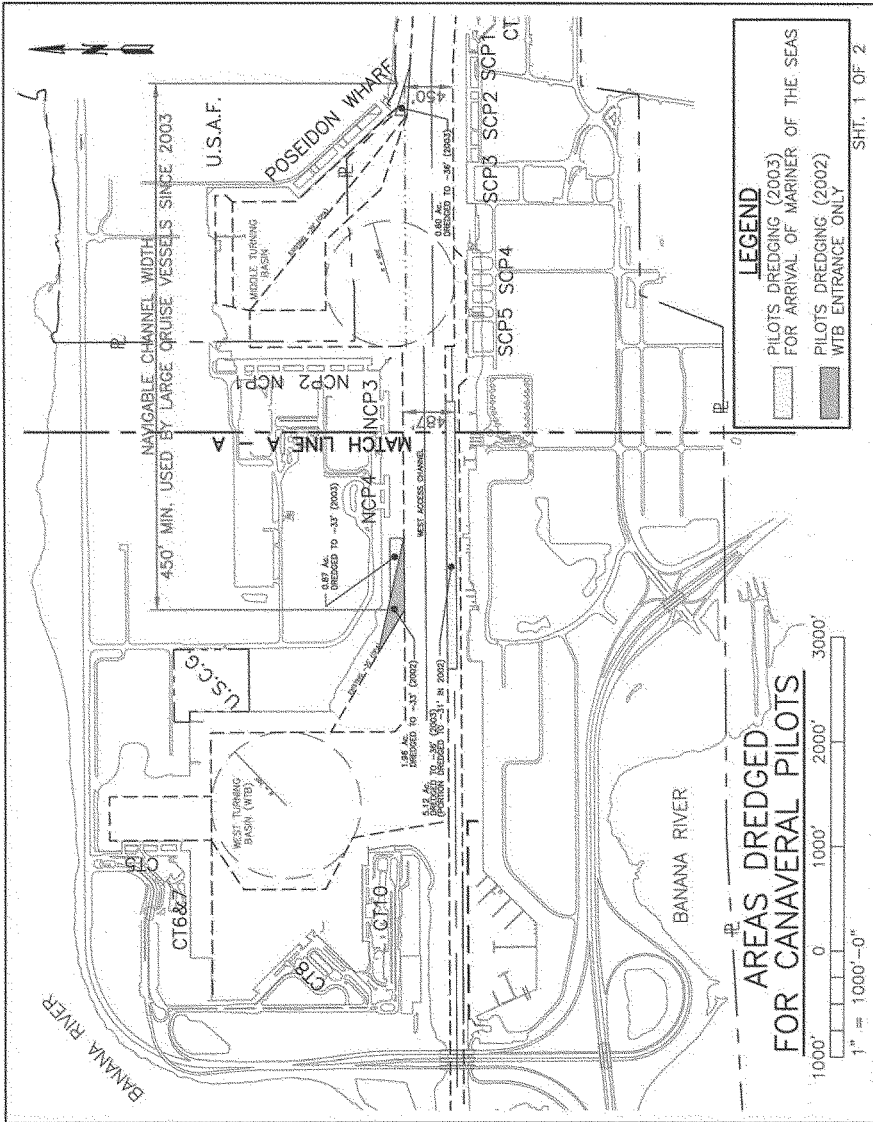

Figure 11. Areas Dredged for Canaveral Pilots, Sht 1 of 2



## 1.6.2 STAR Center Simulation Findings and Recommendations for Cruise Ship Freedom and Tanker Jupiter

The following findings are noted for the Freedom and 30- to 35-knot winds relative to the project channel width alternatives from the 2009 simulations.

- Inside the jetties, the pilots consistently transited the middle and inner reaches at lower speeds in Plan A (4-8.8 knots) than Plan B (5.8-10.1 knots);
- Assessment of leeway for the middle and inner reaches, based on course and heading empirical data that was available for some of the exercises, indicates a mean of 3.7 degrees with a maximum of 13 degrees for Plan A and a mean of 5.1 degrees with a maximum of 12 degrees for Plan B; and
- Assessment of leeway for the west access channel indicates a mean of 3.4 degrees with a maximum of 9 degrees.

Pilot evaluations reflect a strong preference for the Plan A channel width of 500 ft. At the time of the simulations, the pilots expressed that the new Carnival and Disney cruise ships would not have podded propulsion as the Freedom does, and therefore, were expected to have a somewhat lesser degree of controllability and handling responsiveness in the channel.

The following findings are noted for the tanker Jupiter relative to the project channel width alternatives for the inner reach from the 2009 simulations.

- Transit speed inside the jetties, through the middle and inner reaches was noted as similar for both plans in three run sets and the same conditions; inbound speeds were 4.5 to 4.7 knots and outbound speeds were 6.7 to 8.6 knots;
- No significant difference between the plans with regard to the potential for surging cruise ships along the inner reach and clearance to the north channel boundary was demonstrated on the simulator; however,
- The wider inner reach of Plan A does provide increased tug maneuvering room.

The pilots rated the Plan A channel width as providing a better margin of safety than Plan B for partially laden and ballasted ship models.

STAR Center recommends that the 2009 simulations for the Freedom Class and tanker Jupiter vessels support improving the middle and inner reaches inside the jetties per Plan A (500 ft), and improving the west access channel per Plan B (450 ft). Note: the west access channel agreed to modeling should have only considered Plan A widening based on the accomplishment of the 2003 dredge project and subsequent use of the Plan A widener in this area by the cruise ships since that time.

## 1.6.3 Canaveral Pilot Experience with Freedom Class and Disney Dream Navigation

Over the few years that Freedom of the Seas and now the Disney Dream have been home-ported at Port Canaveral, the local pilots have gained much experience and knowledge in the vessel control and handling in a wide range of conditions. The pilots collectively offered their real world experience in handling these vessels with regard to the leeway or yaw angle necessary to maintain the desired course in the channel for beam or beam quartering winds.

Transiting the Middle Reach between the approach turn and the jetties, vessels are affected by surface current as well as wind. At times the forces are opposing rather than from the same direction. The surface current often crosses the jetties which has an effect on the leeway needed. Applied leeway for vessel speeds of 8 to 12 knots outside the jetties and through the turn area, slowing on inbound transit and accelerating on outbound transit, is given as:

<u>Wind Conditions (knots)</u>	<u>Freedom Class Applied Leeway (deg)</u>	<u>Disney Dream Applied Leeway (deg)</u>
15-20	1-4	2-5
20-25	3-5	4-6
25-30	4-6	5-8
30-35	4-7	6-9

Additional leeway may be necessary when surface current and wind come from similar directions. Based on this data, 6 degrees was selected to represent the applied leeway or crab angle carried in this part of the channel for wind speeds of 25 knots and higher for the purpose of project width investigation.

The remainder of the Middle Reach, the Inner Reach, and the West Access Channel, all inside the jetties, are considered together because the transit speed through these channel areas, in most cases, is about 6 knots. In the Middle Reach between the jetties and Trident Basin cruise vessels are slowing or accelerating between 6 and 8 knots. The pilots make every effort to be slowed to approximately 6 knots when passing any vessel at the south side cruise terminals along the Inner Reach. For these areas, the applied leeway commonly occurs within the following ranges:

<u>Wind Conditions (knots)</u>	<u>Freedom Class Applied Leeway (deg)</u>	<u>Disney Dream Applied Leeway (deg)</u>
15-20	2-5	3-6
20-25	3-6	4-7
25-30	4-8	5-9
30-35	5-9	6-10

General Note: Under the without-project conditions and at the location in the Inner Reach adjacent to the eastern end of the South Cargo Piers, transiting vessels make an adjustment of an additional 2 to 4 degrees between the centerline of the channel for Middle and Inner Reaches to or from the centerline of the West Access Channel. This course change adjustment may add to the leeway needed for wind such that on an inbound transit, the pilot might steer 10 to 12 degrees from the base course when passing buoy 14A, just east of Poseidon Wharf.

If required in wind conditions of 20 knots and higher, the pilot may order between 6 and 7.5 knots while transiting these areas in order to keep leeway within the above ranges. In light to moderate winds, 20 knots or less, the vessels may be slowed to between 5 and 5.5 knots in the West Access Channel when approaching the entrance to West Basin on inbound transit.

The pilots conclude by saying that the ranges for applied leeway occur depending on the angle of the wind relative to the beam and whether the ship can be positioned aggressively on the windward side of the channel or whether the situation dictates that the ship be steered near the channel centerline. The pilots generally prefer to work well to windward, within reason, to avoid hydrodynamic effects of being too close to the bank. However, sudden wind shifts associated with frontal passages or summer thunderstorms would not permit this technique. So, the upper end of the applied leeway ranges are more uncommon than the lower to mid-range angles and it may only be necessary to apply the higher leeway for a short period of time, but those are in fact, the very times when a widened channel is imperative.

#### 1.6.4 Project Width Analysis Based on Design Guidance

USACE navigation guidance has been considered in assessing project width alternative requirements. It is understood that the results of real-time navigation simulations for the design vessels are the basis for the recommended plan project navigation features. Primary factors influencing channel width analysis at Port Canaveral include the design cruise and displacement vessel dimensions, one-way vessel traffic, local pilot practices for ship handling at Port Canaveral, the channel cross-section geometry, currents, wind, and wave effects outside and inside the harbor, visibility, and potential for surge effects within the basins and along the channel during consecutive outbound cruise vessel movements. Outside of the jetties, vessels can transit at higher speeds to offset the effects of quartering currents and winds and waves on horizontal ship motions. Channel cross-sections outside the jetties are either shallow water or trench type while inside the jetties, the cross-sections are considered to be asymmetric about the centerline and generally trench type. Some of the interior channel cuts are bounded by commercial vessel operations on one side with sloped banks or shallow-draft recreational concerns along the other side. Figure 13 provides beam multipliers for the desktop assessment of one-way traffic channel width for the type of channel cross-section, current conditions assumed to be aligned with the channel, and for the variation in the cross-section geometry over the length of the channel.

EM 1110-2-1613  
31 May 06

Table 8-2 One-Way Ship Traffic Channel Width Design Criteria			
Channel Cross Section	Design Ship Beam Multipliers for Maximum Current, Knots		
	0.0 to 0.5	0.5 to 1.5	1.5 to 3.0
<b>Constant Cross Section, Best Aids to Navigation</b>			
Shallow	3.0	4.0	5.0
Canal	2.5	3.0	3.5
Trench	2.75	3.25	4.0
<b>Variable Cross Section, Average Aids to Navigation</b>			
Shallow	3.5	4.5	5.5
Canal	3.0	3.5	4.0
Trench	3.5	4.0	5.0

Figure 13. USACE Channel Width Design Guidance

USACE navigation guidance suggests that interior channel widths range from 3.0 to 3.5 times beam width for canal, trench, or shallow type channel cross sections with average to the best aids to navigation and no more than 0.5 knots of current, assumed to be aligned with the channel. Sections in the outer reach are closest to the shallow type, largely unrestricted. Sections near the jetties in the middle reach are either canal or trench type. The inner reach has primarily canal type sections, and the west access channel is a combination with canal type on the north bank and trench type on the south bank owing to the presence of the barge canal. In the case of cruise ships passing occupied berths and carrying a crab angle, the maximum beam of the vessel is of importance to ensure reasonable clearance. Using this simplified empirical approach, recommended project widths of 450 and 500 ft were considered in the simulations and modeling.

**Table 20. USACE Guidance on Interior Channel Width**

Channel Width	Freedom Class	Tug-Assisted Displacement Vessel
Vessel Beam at waterline (ft)	127	138
Vessel Beam, maximum (ft)	156	NA
All Reaches at 3.0 X Beam (ft)	381 to 468	414
All Reaches at 3.5 X Beam (ft)	445 to 546	483

First, to roughly compare the adequacy of alternate channel widths ranging from the existing 400 ft to 500 ft, cruise ship effective widths were assessed for the home ported Freedom Class and Disney Dream for the maximum credible cross-wind conditions of 35 knots. Then, clearances to the edges of the channel were computed assuming transit with the conning point offset from the channel centerline to account for the windward bias applied by the pilots for interior channel cross winds. Pilot experience aboard the Freedom of the Seas and the Disney Dream for the channel reaches inside the jetties suggest crab angles of 5-10 degrees occur for this range of wind conditions. The simulations for Freedom showed maximum crab angles of 9 to 12 degrees carried inside the jetties for the same wind conditions. Table 21 and Figure 14 summarize and illustrate the ship crab angle and bank clearance geometry for either 6 or 8 degrees of leeway and 75 to 100 ft of windward bias about the channel centerline as representative of the range of the majority of the worst transit conditions experienced.

**Table 21. Cruise Vessel Clearance to Edge of Channel for Various Channel Widths**

Cruise Vessel Class	Length Overall (ft)	Beam at Waterline (ft)	Ship Crab Angle (degrees)	Minimum Bank Clearance (ft)		
				400-ft Channel	450-ft Channel	500-ft Channel
Freedom	1,112	127	6°	63	88	113
Disney Dream	1,113	121	8°	32	57	82

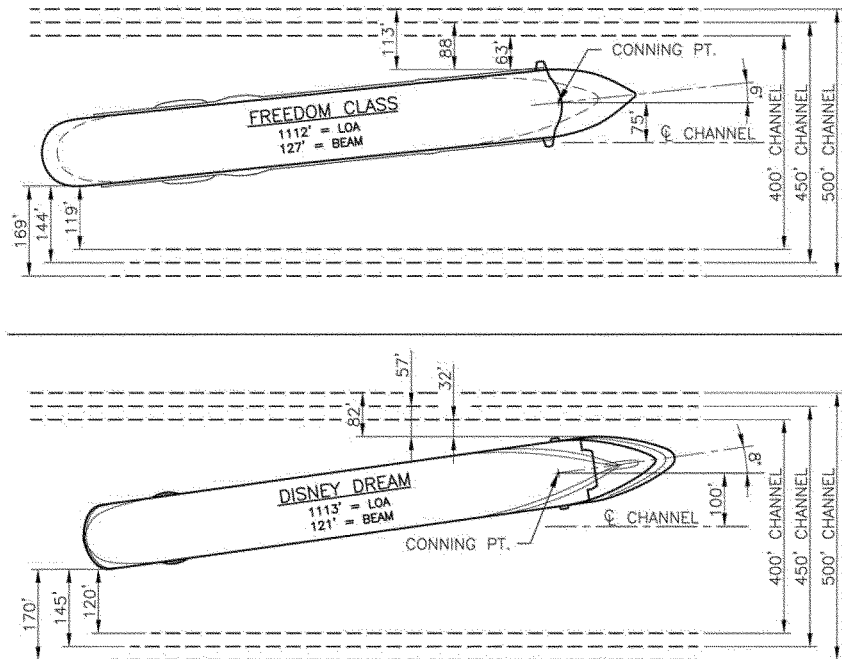

**Figure 14. Design Cruise Vessel Position Relative to Channel Width Plan**

The above minimum clearances to channel edge and the navigation simulations demonstrate that only the Plan A (500 ft) channel will offer a consistent margin of safety and operational capability for these very large cruise vessels. The presence of several of the largest cruise vessels operating from Port Canaveral increases the level of difficulty in safely executing consecutively scheduled ship transits on specific days of every week.

The desktop review suggests that the Freedom Class vessel requires more channel width than afforded by the present channel, at least 450 ft inside the jetties in the middle and inner reaches



and the full width of 500 ft through the West Access Channel. At the approach turn and in adverse winds, the rate of turn for Freedom will be higher than desired to remain in navigable waters. In addition to berth improvements, at the entrance to the West Basin, the Plan A corner cut-off has been completed and allows good access for the largest cruise vessels arriving and departing the West Basin.

The 500 ft channel modeled in the recent simulations with the Freedom Class vessel confirms that a 500 ft wide channel promotes safe navigation within the Harbor and a level of comfort among the pilots for this size vessel. It is also apparent from discussions with the pilots and in the simulations that the cruise vessels tend to track on the windward side of the channel centerline to maintain good position in the channel. This serves to reduce bank clearance on the favored side of the channel, making the 500 ft wide channel significant for the safety of navigation for the very large cruise vessels that will frequent the port on the same days and with consecutively scheduled arrivals and departures. The 500 ft wide channel further assists the pilots in minimizing bank effects in the Inner Reach and West Access Channel and surge effects within Trident Basin, at south side cruise and cargo piers along the Inner Reach, particularly opposite the U.S. Navy Poseidon Wharf, and at north side cargo piers along the West Access Channel. The widening on the north side of the middle and inner reaches and south side of the west access channel in accordance with Plan A provides a straighter channel alignment than the present 400 ft or alternative 450 ft channel (Plan B) allows.

Historically, no problems with the width of the outer reach of the entrance channel have been identified. The pilots have indicated that the existing 400 ft width of the Outer Reach will be suitable for the design vessel traffic.

In recent simulations, the cruise and cargo vessels began inbound transits from the center of the outer reach in the vicinity of Buoys 7 and 8, just seaward of the start of the proposed turn widener where the existing channel is 400 ft wide. The results of the simulations do not suggest any further widening of the outer reach is required.

The project design ship drafts for navigation without tidal advantage result in new project recommended depths assuming economic viability. Therefore, the existing outer reach will support vessel transit speeds that allow good control of vessels within the bounds of the 400 ft wide channel in the design environmental conditions.

The existing approach channel width of 400 ft will be adequate for navigation considering that vessel speeds can be increased as needed on approach to or departure from the jetties. Design vessel transit speeds in each part of the channel are discussed in subsequent sections regarding project depth alternatives.

### **1.6.5 West and Middle Basin Turning Area Alternatives**

A new turning area is proposed at the location of the corner cut-off at the entrance to the West Basin to accommodate the design cruise vessel traffic utilizing the West Basin. The existing federal 1400 ft diameter circle leaves no margin of safety in turning the Freedom Class and Disney Dream vessels in moderate to high wind conditions. The existing turning area is not considered adequate for routine use by the new larger vessels now calling Port Canaveral home.

The pilots requested a turning circle of 1,725 ft minimum diameter (Plan A) or 1.55 times the length of the Freedom and the new larger Disney ships. USACE guidelines suggest turning circle diameters of 1.2 to 1.5 times ship length depending on the use of tugs and environmental wind and current conditions. While some of the cruise ships are well powered and highly

maneuverable for their size, the wind sail area on a large cruise ship is still significant and results in large applied forces in moderate to high winds often experienced at Port Canaveral. The location of the proposed turning circle is economically driven by the fact that the corner cut-off is the only unimproved shoreline to accommodate the basin expansion without expensive removal and replacement of the cruise terminal piers. The 2009 simulations considered an alternate turning area of 1,675 ft in diameter (Plan B). Both circles were located tangentially to the future berth line of the new cargo piers along the corner cut-off. As a result, the Plan B turn area would result in a slightly smaller dredge quantity. The size and location of the two circles considered and clearance to surrounding existing and future bulkheads is further justified in the interest of minimizing surge effects at NCPs 3 & 4, at future cargo berths along the corner cut-off, and at the small marina docks located along the shallow draft bulkhead wall on the south side of the channel. The 1,725 ft diameter turning area affords the greatest level of safety for the surrounding berthed vessels while providing adequate maneuvering area for the large cruise vessels frequently moving to and from the West Basin. The STAR Center observed no significant difference between maneuvering of the Freedom Class vessel in the Plan A or Plan B turn areas and as such, recommended that Plan B was acceptable. However, the project team with strong endorsement by the pilots has adopted the slightly larger 1,725-ft basin as necessary to provide a comfortable margin of safety for frequent maneuvering by very large cruise vessels in close proximity of berthed bulk and cargo vessels conducting operations along the corner cutoff and adjacent small craft marinas at this very busy vessel movement location within Canaveral Harbor.

Historically, no navigation issues have been reported with the existing turning area provided within the Middle Turning Basin. The existing turning circle diameter provided by the federal 39 ft project depth boundary is 1,200 ft. Including the CPA central portion of the basin, also currently maintained to -39 ft, an expanded turning circle of approximately 1,422 ft in diameter can be accommodated. The assumption of maintenance of the central portion of the basin currently maintained by CPA to -39 ft is recommended as the present cargo traffic fully utilizes this area in accessing NCP 1 and particularly when there is traffic at NCP2. The simulations show that the Jupiter had no difficulty turning within the turning area provided in Middle Basin. The near term tanker traffic that begins arriving at the Middle Basin berths in early 2010 will utilize the portion of the basin now maintained by CPA; thus, it is imperative that this area be authorized under the federal project as there is no means of maneuvering these AFRAMAX tankers to and from NCP1 without passing through this area.

### 1.6.6 Project Widener Alternative Dimensions

The USACE has constructed two wideners at the interior of the entrance channel turn. The triangular-shaped Navy widener at 44 ft project depth was constructed adjacent to the existing inside southerly channel boundaries at the intersection of the outer and middle reaches to accommodate USN Trident submarine traffic to and from Trident Basin. The civil works widener at 41 ft project depth was constructed to further expand or widen the turn to the south, largely for cruise ship traffic that began to dramatically increase in size in the late 1980's.

In previous interviews and prior to the recent simulations, the pilots provided the following rationale in support of the approach turn widening:

- For large cruise liners departing the port in moderate to severe winds from southerly through westerly directions, it is difficult to execute the turn without using a high rate of turn through the existing widener. The increased speed necessary to make the turn results in the ship

experiencing up to a 20 degree/minute rate of turn and listing of the vessel with a directly negative effect on the comfort of passengers and crew carrying out shipboard functions. Some of this negative effect has been lessened as the pilots have allowed the stern of these vessels to swing outside the channel limit, where sufficient under keel clearance exists, and enables a slower speed and thus lower rate of turn. This occurs sometimes in the Outer Reach from Buoys 7/8 to the turn, where the pilots currently use, as environmental conditions dictate, the sufficiently deep water to the north side of the existing 400 ft channel width to navigate the 950 ft to 1,113 ft long cruise vessels using the Port today. This is not considered to be good practice and the current widener geometry currently does not suitably meet the needs of navigation for the long term.

- Similarly, with the inbound larger cruise vessels, it has been necessary to set-up and be strategically positioned relative to the navigational buoys to allow a reduced rate of turn while transiting through the existing turn.
- An expanded widener as the pilots envision (Plan A) will allow the future vessel traffic to be operated completely within the project limits with consistently reduced rates of turn estimated at 10 to 15 degrees per minute, even in adverse conditions, having a positive effect on vessel stability and passenger and crew comfort and safety.

Considering the Freedom Class and Disney Dream vessels, a segmented circle turn, providing symmetrical geometry on the inside of the 40-degree turn deflection angle, is recommended to eliminate the need for the unofficial use of area outside of the present 400 ft channel as described. This turn area also eliminates the need for channel widening on the north side of the middle reach and east of USACE North Jetty Sta 11+00 (roughly the west end of the new north jetty extension).

It has been determined that any channel widening/deepening to the north side of the existing channel from USACE North Jetty Sta 11+00 eastward will endanger the stability of the recently constructed north jetty extension. The proposed project does not encroach upon this envelope. Subsequent sections discuss the consideration of the north and south jetties, and the south jetty sediment trap, and their stability in relation to the proposed project. A Jetty Impacts Report was performed by hydrodynamic experts at Olsen & Associates, Jacksonville, Florida, and is included as Attachment G.

In accordance with USACE design guidance, Table 8-4, for channel deflection angles of 35 to 50 degrees, the turn radius ranges from 7 to 10 times ship length. For the Port Canaveral turn deflection angle of 40 degrees, a radius of 9 times design cruise ship length ( $R = 10,638$  ft) has been determined to encompass the pilot requested widener area in the vicinity of the outer and middle reaches (Plan A). The Plan A widener covers roughly 22 acres. This will enable the pilots to begin the turn sooner while maintaining a safe rate of turn for inbound and outbound transits. The Plan B widener is a narrower widener that still maintains the symmetry of the westerly and southeasterly dog legs of the Plan A widener and encompasses roughly 11 acres.

The design guidance indicates that the design of tankers and bulk carriers may degrade their turn ability. Displacement vessels at Port Canaveral are tug-assisted, so their maneuvering is largely dependent on the tugs and the environmental conditions encountered. Port Canaveral's approach turn is subject to cross currents, winds and waves and has a large deflection angle of 40 degrees. The width of the proposed widener area as measured at the apex of the turn from the centerline of the channel to the inside edge of the Plan A improved turn geometry is 1,008 ft or 1.33 times the waterline length of the vessel. Consideration of a stepped depth widener as exists now, has

been dismissed at the request of the pilots and their desire to maximize the safety of displacement vessel maneuvering in this area.

The STAR Center 2009 simulations report concludes that both Freedom Class and Jupiter simulations support expanding the ocean turn widener per Plan A. The cruise ship simulations for Freedom suggested inbound and outbound rates of turn and use of the Plan A and B wideners varied with the direction of applied wind and with transit speed. Transit speed generally decreased through the turn on inbound runs and increased on outbound runs. Runs with southerly winds utilized the ocean turn wideners. On Freedom inbound runs to west basin, observed rates of turn were 10 to 13 degrees per minute for Plan A and as much as 16 degrees per minute for Plan B. On outbound runs from west basin in southerly winds, observed rates of turn were roughly 12 to 15 degrees per minute with use of portions of both widener plans. In the inbound runs with southerly winds that were designed to primarily evaluate the ocean turn widener, observed rates of turn for Plan A and B were similar at 10 to 12 degrees per minute. However, the transits in the Plan A widener showed a more consistently gradual swept path of the vessel as noted by the STAR Center. The tanker Jupiter track plots also show a more controlled and slower transit through 203 civil turn widener (Plan A). Pilot comments and safety ratings during the simulations were highly favorable regarding the geometry and increased safety of the Plan A 203 civil turn widener.

## 1.7 Project Depth Analysis

The deep-draft displacement vessels (non-cruise) drive the project depth requirements. Present maximum panamax tanker and bulk carrier traffic visiting Port Canaveral is limited to a draft of 39.5 ft and existing federal project depths require the pilots to rely on tidal advantage when drafts exceed 36 ft.

Future displacement vessel traffic will be of similar to slightly larger size, having increased draft as channels, turning basins, and berths will permit. The new project features should permit all vessels with draft of up to 39.5 ft to transit without tidal restriction. Maintenance of cruise ship schedules to and from multiple berths along the channel and within the West Basin on twice daily channel transits severely restricts the opportunities for non-cruise displacement vessel traffic to use tide advantage without incurring significant delay upon arrival and departure.

### 1.7.1 Analysis Assumptions and Considerations

- Uniform density across the Port equal to that of seawater and therefore, no depth correction for salinity effects is used. This is considered reasonable as the Canaveral Lock design and operation essentially prevents flow between the river and the WTB, so salinity differences in the Port may only randomly occur and would likely be the result of stormwater runoff and circulation patterns in the Port.
- To avoid any limitations on navigation for the deep-draft displacement vessels, all ships should be able to transit the channel at Mean Lower Low Water (MLLW) datum. This will always be the case for cruise ships with static drafts of no more than about 30 ft. However, transiting on rising or high tide may still allow displacement vessels with draft of more than 39.5 ft to access the port where berth water depth permits.
- Vessel loading effects are negligible and vessels transit with even trim and without list.
- Wave effects inside the Port are negligible.

- Vessel vertical motion response due to heave and pitch due to wind-driven waves outside of the jetties has been conservatively estimated at 0.5 times the 3-hr duration wave height. The vessel lengths are an order of magnitude larger than the wave length for each wind condition and the wave periods are quite short, so the vertical response estimated is reasonably conservative. No consideration is given to roll as the planned turn widener permits a low rate of turn for the displacement vessels such that roll effects on vertical motion are anticipated to be insignificant.

**Table 22. Vessel Wave Motion Response**

Design Displacement Vessel	Design Cruise Vessel
20-knot Wind-driven Wave	30-knot Wind-driven Wave
Vertical Wave Response = 1.4'	Vertical Wave Response = 2.75'

- General parameters for design vessel squat have been estimated based on existing channel cross-sections and vessel transit speed through each portion of the channel as defined by pilots and/or documented in STAR Center simulations. Speeds are necessarily faster in the outer reach and slowest at either Middle or West Basin. These vessel sinkage depths are based on Barass Squat empirical formulas for unconfined and confined channels as applicable to the various portions of Canaveral Harbor channel reaches and compare reasonably well with STAR Center estimates of squat for the simulation test vessel, Jupiter.

Briefly, from the outer reach to the inner reach (inbound), design displacement vessel transit speeds decrease from 10 to 5 knots with corresponding squat ranging from 2.7 to 1.3 ft. Similarly, design cruise vessel transit speeds decrease from 12.5 to 5 knots with predicted squat ranging from 3.1 to 0.9 ft.

- The channel bottom inside the port generally consists of softer silt and clay soils. No unusual hard material or rock was encountered in subsurface investigations, so no additional depth allowance for soils is required as may be required in ports with hard, rock or calcified bottoms.
- For more than ten years, the Canaveral Pilots have conducted vessel movements observing the established minimum under keel clearance requirement of 2.5 ft for all ships underway, in all channel reaches and basins, and for all stages of the tide (MLLW to MHHW). This is similar to the USACE design guidance that suggests a safety clearance of at least 2 ft between the bottom of the ship and the design channel bottom. The pilots require at least 6 inches of clearance under the keel at berth for all tides and stages of unloading or loading operations.

### 1.7.2 Project Depth Analysis Results

The following table presents the required project depths for the design displacement vessel considering only deepening of the existing channel cross sections. Attachment D contains project depth calculations for the design displacement vessel providing the total required water depth by channel reach or cut as summarized below. The project depth calculations consider design vessel draft, wave motion, squat, and safety clearance. Proposed project depths for the displacement vessel are more than adequate for the design cruise vessel. The depth calculations for the design displacement vessel inbound at 39.5 ft draft and without the use of tidal advantage,

indicate deepening is required from the outer reach through the West Access Channel to NCPs 3 and 4. The STAR Center report confirms these findings, but does not address wave motions outside the jetties.

**Table 23. Project Depths—Displacement Vessel**

Parameter	WAC	MTB	INNER CHANNEL		ENTRANCE CHANNEL		APPROACH CHANNEL		
	NCP 4 Sta 255+00	NOTU/SCP2 Sta 215+00	INNER REACH		MIDDLE REACH		OUTER REACH		
			Cut 2 (CT3) Sta 200+00	Cut 2 (TTB) Sta 185+00	Cut 2 (S. Jetty) Sta 165+00	Cut 2 (N. Jetty) Sta 150+00	Cut 1 Sta 85+00	Cut 1 (B7/8) Sta 55+00	Cut 1A/1B
Vessel Speed (knots)	4.5	5	6	7	7	8	8.5	9	10
Draft (ft)	39.5	39.5	39.5	39.5	39.5	39.5	39.5	39.5	39.5
Salinity & Temp Corr (ft)	--	--	--	--	--	--	--	--	--
Wave Motions (ft)	--	--	--	--	1.4	1.4	1.4	1.4	1.4
Squat (ft)	0.9	1.1	1.6	2.0	1.8	2.3	2.0	2.2	2.8
Safety Clearance (ft)	2.5	2.5	2.5	2.5	2.5	2.5	2.5	2.5	2.5
Total Required Water Depth (ft)	42.9	43.1	43.6	44.0	45.2	45.7	45.4	45.6	46.2
Existing Authorized Depth (ft)	39	39	40	40	44	44	44	44	44
Proposed Project Depth (ft, MLLW)	43	43	44	44	46	46	46	46	46

## 1.8 Canaveral Harbor Recommended Plan Project Features

### 1.8.1 Table Summary of Recommended Plan Project Features

The following table summarizes the Canaveral Harbor proposed federal authorized dimensions of the recommended plan with widening per the cruise design vessel requirements and deepening to maximum required project depths based on the design displacement ship selection. The recommended plan considers an overdepth allowance of 1 ft below the project depths for the inner reach and westward navigation areas inside the harbor and 2 ft below the project depths for the middle and outer reaches and turn widener areas.

**Table 24. Port Canaveral Recommended Plan Project Features (Plan A)**

Project Feature	Cut and Centerline Station Start / End (ft)	Proposed Federal Dimensions Depth X Width X Length (ft)
Outer Reach	Cut 1A, 0+00 to 110+00 Cut 1B 0+00 to 55+00 Cut 1, 0+00 to 125+00	46 X 400 X 29,000 (CW) 44 X 400 X 29,000 (USN)
44-ft Turn Widener		46 X 400 X 29,000 (CW) 44 X Irregular Shape (USN)
41-ft Turn Widener		46 X Irregular Shape (CW)
203 Turn Widener		46 X Irregular Shape (CW)
Middle Reach	Cut 2, 125+00 to 181+70	46 X 400 X 5,670 (CW) 44 X 400 X 5,670 (USN)
Trident Access Channel	T.A.C., 5+00 to 32+33.60	44 X Width Varies X 2,733.6 (USN)
Trident Turning Basin	T.T.B., 0+00 to 15+00	41 X 1,200 X 1,500 (USN)
Inner Reach	Cut2, 181+70 to 207+00 Cut 3, 207+00 to 215+00	44 X 400 X 3,330
Middle Turning Basin	M.T.B., 215+00 to 241+70	43 X 2,670 X Irregular Shape w/ 1,422-ft DIA
West Access Channel (East of Sta 260+00)	W.A.C., 241+60 to 260+00 Cut A, 0+00 to 18+40	43 X 400 X 1,840
West Access Channel (West of Sta 260+00)	W.A.C., 260+00 to 277+30 Cut A, 18+40 to 36+70	31 X 400 X 1,730, CPA to 35'
West Turning Basin		31 X Irregular Shape w/ 1,725-ft DIA, CPA to 35'
Canaveral Barge Canal	Cut 1 to Canaveral Lock 241+60 to 260+00 260+00 to 272+43 272+43 to 300+25 300+25 to 327+70	43/12 X 87.5/37.5 X 1,840 35/12 X 87.5/37.5 X 1,243 35 X 125 X 2,782 12 X 125 X 2,745

## 1.8.2 Recommended Project Features Narrative Description

The recommended plan changes the Canaveral Harbor existing federal project features through widening, deepening, realignment of the centerline of the interior channels and Middle Reach, relocation of the inbound range structures, and construction of new outbound range structures. The outer reach portion of the entrance channel is oriented on a roughly northwest-southeast alignment. Except for the Trident Access Channel, all other harbor channels are oriented on a generally east-west alignment.

The following narrative describes the Canaveral Harbor recommended plan project features (Plan A) relative to existing conditions and progressing from the Atlantic Ocean entrance channel to the West Basin. Attachment E contains a set of drawings and color pictorial that describes the Recommended Plan project. The drawings identify the project features and show dimensions, stationing, typical feature sections, dredge areas, and dredge volumes.

- Outer Reach, Cut 1A: Existing civil works dimensions are 41 ft project depth by 400 ft wide by 11,000 ft long. New dimensions would increase the project depth to 46 ft. Recent USACE quarterly condition surveys indicate that the existing water depth at the seaward end of the project and up to 200 ft beyond the end of the project is at least 47 ft.
- Outer Reach, Cut 1B: Existing civil works dimensions are 41 ft project depth by 400 ft wide by 5,500 ft long. New dimensions would increase the project depth to 46 ft.
- Outer Reach, Cut 1: Existing civil works dimensions are 41 ft project depth by 400 ft wide by 12,500 ft long. New dimensions would increase the project depth to 46 ft.
- US NAVY Turn Widener: Existing civil works dimensions are 41 ft project depth by 7.7 acres (triangular shaped area) bounded by outer and middle reaches to the north and northeast and the civil turn widener to the southwest. New dimensions would increase the project depth to 46 ft.
- Civil Turn Widener: Existing dimensions are 41 ft project depth by 15.6 acres (irregular shaped area) bounded to the north and northeast by the middle reach and the US Navy turn widener. New dimensions would increase the project depth to 46 ft.
- 203 Civil Turn Widener: New dimensions are 46 ft project depth by 22.2 acres (irregular shaped area) bounded to the north and northeast by the existing civil turn widener and Cut 1 of the outer reach.

The proposed interior channel widening at key locations has been defined relative to a new channel centerline. The new channel centerline consists of three segments and two alignments as defined for the Middle Reach, Inner Reach, Middle Turning Basin, West Access Channel, and Cut A. The new alignment through the middle and inner reaches into the middle basin removes the navigation awkwardness of the short alignment transition of the inner reach, Cut 2. The new alignment also provides direct transit between Middle Basin and the West Access Channel, eliminating the discontinuous centerline transition that now exists at the beginning of the West Access Channel. The first alignment has two segments and extends from Middle Reach, Cut 2, Station 124+77 / Range +215 to Station 180+00 / Range +150 to Middle Turning Basin, Station 224+65 / Range +100 (azimuth 89° 39' 46.5224"). The second alignment with one segment extends from Middle Turning Basin, Station 224+65 / Range +100 to West Access Channel, Cut A, Station 266+96 / Range +100 (azimuth 90° 18' 16.9613").



The widening along the north side of the channel in the area from Middle Basin eastward to Trident Basin and along the south side of the West Access Channel and Cut A varies slightly in width between key stations. The southern channel boundary of the Middle Reach, the Inner Reach, and the Middle Turning Basin and the northern boundary of the Middle Reach outside the jetties remains unchanged from the existing authorized project.

- **Middle Reach:** The middle reach extends from the apex of the channel turn westward to the western boundary of the Trident access channel. Existing civil works dimensions are 41 ft project depth by 400 ft wide by 5,670 ft long. New dimensions would increase the project depth to 46 ft and the project width from 400 ft to 500 ft, providing a 100 ft widener of 2,123 ft in length, parallel to and along the north side of the existing channel for the portion of the middle reach that is inside of the north jetty to Station 180+00. The eastern terminus of the 100 ft widener transitions from the existing to the new northern channel boundary over a plan distance of 500 ft. This portion of the project requires that the western “Surge Warning” notification sign structure be relocated 100 ft north of its present location. For the remainder of the Middle Reach, west of Station 180+00, the new northern channel boundary is parallel to the new channel centerline and the width of widening is 100 ft.
- **Trident Access Channel and Trident Basin:** With exclusive use by US Navy, the Trident Access Channel connects the middle reach to the trident basin. Existing dimensions are 44 and 41 ft project depth for the access channel and the basin, respectively. The new 100 ft north side channel widening at 46-ft project depth incorporates a portion of the entrance to the Trident Access Channel.
- **Inner Reach, Cut 2 and Cut 3:** Existing dimensions are 40 ft project depth by 400 ft wide by 3,330 ft long. New dimensions increase the project depth to 44 ft and the project width from 400 to 500 to 525 ft. The width of the north side widening ranges from 100 ft to 125 ft to 87 ft at the east and west ends of Cut 2 and the west end of Cut 3, respectively. The new northern channel boundary provides a constant 250 ft width north of the new Inner Reach channel centerline. The rip-rap protected shoreline and berm between the Middle and Trident Basins will be relocated northward to accommodate the widening.
- **Middle Turning Basin:** The Middle Turning Basin has shared use by commercial and military activities. The federal project area encompasses 92.4 acres with project depths of 35 ft in the north and east portions of the basin used exclusively by the military and 39 ft in the remainder of the basin supporting commercial vessel traffic. Because of the somewhat limited room afforded by the present 39 ft federal project boundaries toward the northwest portion of the basin, CPA maintains an irregular shaped central portion of the basin to 39 ft. This provides additional area for maneuvering cargo vessels to and from the North Cargo Pier 1 and ro-ro ramp and enlarges the available area for turning displacement vessels on arrival or departure. The existing 39 ft federal project provides a turning circle diameter of 1,200 ft. The new project dimensions for commercial purposes encompass 68.9 acres with a project depth of 43 ft yielding a turning circle diameter of 1,422 ft. Approximately 1.9 acres of the new 43 ft project area completes the western end of the north side channel widening in the area between the inner reach and the US Navy’s Poseidon Wharf. The north side widening through this area ranges from 64 ft to 87 ft. As in the inner reach, the rip-rap protected north side shoreline will be relocated northward to accommodate the north side channel widening. The US Navy’s mooring dolphin, located east of Poseidon Wharf, sits within 25 ft of the new channel boundary and will be removed to eliminate a potential hazard to navigation and a new monopile mooring dolphin will be constructed adjacent to the

existing boat ramp. The widening also impacts the AF property such that a new bulkhead retaining wall is required to provide the minimum 86 foot shoreline setback required by USAF regulations to the existing Bldg 1064. This bulkhead wall will also be configured to stabilize the existing boat ramp used by military security patrol boats. The USN submarine sail on display will also be relocated north. Work performed near under-channel communications lines, and related communications manholes will require careful coordination with the 45th Space Wing and AT&T to avoid service interruptions. This channel widening project will bear the cost to mitigate, replace, or relocate any impacted federal structure, utilities, or communications infrastructure.

- West Access Channel (east of Station 260+00): Existing dimensions are 39 ft project depth by 400 ft wide by 1,840 ft long. New dimensions would increase the project depth to 43 ft and increase the project width from 400 to 500 ft, providing 100 ft of widening along the entire length of the channel by redefining the northern channel boundary 12.5 ft north of the existing northern boundary, and widening the channel by 87.5 ft along the south side, incorporating a portion of the barge canal.
- West Turning Basin and West Access Channel, Cut A (west of Station 260+00): The West Turning Basin has exclusive use by commercial activities and the Coast Guard. The existing federal basin and Cut A of the West Access Channel make up 78.6 acres with a project depth of 31 ft as federally maintained and 35 ft as maintained by the CPA.

The existing federal project basin provides a turning circle diameter of 1,400 ft. The recommended plan, comprising 103 acres, expands the federal project limits to support cruise ship access to existing terminals and enlarges the entrance to the west basin providing a new turning circle diameter of 1,725 ft. The turning circle and entrance widening will be created by dredging beyond the present federal and CPA project boundaries to the northeast and to the south for the full width of the barge canal. Approximately 18.5 acres of existing bank, shoreline, and uplands adjacent to the CPA 35 ft project boundary, known as the corner cutoff, has been dredged to 35 ft as of September 2011. Roughly 6.9 acres within the existing barge canal will be dredged to the new project depth of 35 ft.

## 1.9 Canaveral Harbor Vessel-Induced Surge Modeling

### 1.9.1 Background

An analysis of vessel-induced surge was commissioned in 2011 in support of the Port Canaveral Harbor, Florida Integrated Section 203 Report sponsored by the Canaveral Port Authority (CPA). The Naval Ordnance Test Unit (NOTU), a United States Air Force 45<sup>th</sup> Space Wing (USAF 45 SW) tenant on the Cape Canaveral Air Force Station (CCAFS) and the USAF 45 SW requested the study to demonstrate that the recommended project and the present and foreseeable future ship traffic will not adversely impact current or future NOTU and CCAFS port operations within the Trident and Middle Basins. NOTU accommodates various classes of US and UK Navy submarines at Trident wharf located on the eastern side of the Trident Basin. NOTU and the Military Sealift Command (MSC) accommodate various military ships at Poseidon wharf located on the southeastern side of Middle Basin. The Mariner pier and the AF wharf are located at the north end of Middle Basin. The Mariner Pier supports the United Launch Alliance Evolved Expendable Launch Vehicle (EELV) Atlas and Delta launch programs at CCAFS and the occasional accommodation of MSC vessels and Kennedy Space Center program support vessels. The AF wharf is used for a variety of small scale ship and barge operations.

NOTU has experienced surge effects on vessels moored at both the Poseidon and Trident wharves when outbound cruise ships, departing from West Basin, are required to increase transit speed under the occasional occurrence of high quartering or cross-wind conditions. Under the existing navigation project conditions, operational mitigation measures have been employed for several years to manage the surge effects. Those measures include increased coordination and notification of conditions between the Canaveral Harbor Pilots and NOTU Port Operations, diligent tending of moored vessel lines in preparation for transit, and use of tugs to restrain vessel movements at the wharves. USAF 45 SW and NOTU expressed the need for a surge study to demonstrate that the recommended navigation channel widening and deepening plan will result in no additional impact on current and future port operations. This request was documented in a 4-13-11 email by Executive Officer CDR Michael LaPrade and a 4-14-11 email by USAF 45 SW Plans and Program Director Patrick Blucker, following a 4-13-11 briefing at Canaveral Port Authority. This request was reiterated at the 4-15-11 Alternate Formulations Briefing (AFB) at Canaveral Port Authority by both organizations, as well as the United States Coast Guard. Associated with the channel widening and deepening project, the CCAFS and NOTU have collectively identified the following facilities and operations of concern with regard to adverse impacts:

- Trident Basin, Trident Wharf
- Middle Basin, Poseidon Wharf
- Middle Basin, Delta Mariner Berth
- Middle Basin, AF Wharf
- Adjacent to Inner Reach, Poseidon Wharf Mooring Dolphin
- Adjacent to Inner Reach, Boat Ramp
- Adjacent to Inner Reach, Submarine Sail Monument
- Adjacent to Inner Reach, Bldg. 1064

### 1.9.2 Surge Effects and Modeling

Large cruise ships transiting the Canaveral Harbor main channel cause motions and forces on moored vessels at berths along the main channel or at berths within the east and middle basins. Transiting vessels pass moored vessels in the main channel in a parallel configuration and in the basins in perpendicular or oblique orientation. These motions and forces are typically referred to as surge or passing effects. Over the last decade and on a very limited number of occasions, passing effects have caused mooring lines to part or failed facility fixtures, damaged shoreside connections and personnel gangways, and injured shipboard personnel.

Passing effects are more problematic in complex or confined waterway configurations such as Canaveral Harbor and its east-west main channel, which is constrained by the Canaveral Locks system and three dead-end basins oriented in the north-south direction and positioned north of the main channel. Recent modeling and research suggests that in addition to the passing ship-moored ship interaction due to the flow effects surrounding a transiting vessel, the free surface effects associated with long period (low-frequency) waves that may be generated even by slow moving ships in channels and harbors with restricted water depths, sloping banks, and bulkheads, can significantly contribute to moored vessel motions and forces.

Physical and numerical modeling on this subject for both open water and more confined boundary conditions has been advanced in this decade. In 2005 and 2007, the Ocean Engineering Program within the U.S. Naval Academy and under the direction of David Kreibel has accomplished a series of parallel and perpendicular passing model test cases in open water

conditions, where the free surface effects would not be present. Since 2004, J. A. Pinkster of the Department of Marine and Transport Technology, Delft University of Technology in the Netherlands has developed and enhanced numerical modeling of both the primary flow potential method for ships moored in open water conditions and most recently a model based on potential flow but to also include the free surface effects where harbor boundary conditions create discontinuities in the flow field. Most recently, Coast & Harbor Engineering developed numerical modeling tools for vessel hydrodynamics and loading on berthed vessels that address the complete range of vessel-generated hydrodynamic (surge) effects. These proprietary numerical models with various levels of validation represent the state of the art for passing ship-moored ship analysis. The Navy's model test data and empirical force formulations that are in the public domain provide a means of estimating the passing ship effects on moored ships as limited to open water conditions, which does not represent the situation at Port Canaveral.

The free surface effects, which are long period water level fluctuations, arise from the excitation and interaction of the water motions associated with the flow field moving with the passing ship by the surrounding harbor geometry. Port Canaveral's constrained geometry, the size of the largest cruise ships operating within Port Canaveral's constrained geometry, and the speed cruise ships need to maintain during channel transits all work to increase the magnitude and severity of dynamic motions and forces that may be experienced by moored ships in basins adjacent to channels.

With the start of Seaport Canaveral's tanker operations in Port Canaveral's Middle Basin at north cargo piers 1 & 2, there is a growing awareness of and intolerance to injury, disruption of operations, and environmental impacts that accidental disconnections could generate as a result of certain passing ship conditions. It is anticipated that the increase in large cruise ship passing traffic events will increase the incidence of passing effects on moored tankers with potentially detrimental consequences. In fact, a moored vessel at NCP 2 recently experienced surge effects that parted lines as a result of consecutive outbound cruise ship traffic. The surge effects were experienced some 13 minutes following the passing departure of the Freedom of the Seas.

Coast & Harbor Engineering performed the numerical modeling using their proprietary Vessel Hydrodynamics Longwave Unsteady (VH-LU) tool in accordance with a rigorous modeling plan coordinated and endorsed by the Mission Partners to evaluate passing ship effects for several combinations of berthed vessel scenarios at commercial and military berths. Modeling of the passing ship effects was conducted for port existing conditions and for the recommended plan navigation improvement features that include channel widening and deepening. The berthed vessels included detailed three-dimensional hull definitions for commercial and military surface ships and submarines. The passing vessel scenarios included the consecutive outbound transit of the Carnival Fantasy, the Freedom of the Seas, and the Disney Dream in a timed sequence, from the West Basin, a typical Saturday late afternoon departure scenario. The passing vessel conditions considered prescribed track, speed, and leeway carried relative to the existing conditions and recommended plan channel centerlines as fully coordinated with the Canaveral Pilots.

### 1.9.3 Hydrodynamic Surge Modeling Presentation and Results

The dynamic surge effects within the harbor, at key locations and berths, and passing ship forces for select berthed vessel scenarios were demonstrated in a presentation at the CPA on September 20, 2011, and delivered to the CPA, the Mission Partners, the Canaveral Pilots, the U.S. Coast

Guard, and the Canaveral Harbor Section 203 Project Team. The presentation compared the modeled impacts under “without-project” and “with-project” channel dimensions.

Key findings shared during the presentation include:

- The numerical modeling reproduced the primary surge effects as observed by the Canaveral Pilots and associated with the present channel (existing conditions) as follows:
  - Significant and consistent surge effects at SCP4 due to the limited separation between the passing and berthed vessel (parallel passing case);
  - Surge effects at Trident Wharf for passing speeds of 7.5 knots or greater—very large distance between the passing and berthed vessel (perpendicular passing case);
  - Delayed surge effects at NCP2 occurring some 10 to 15 minutes following the departure of one or more cruise ships; and
  - Water level retreat and wave breaking at the north jetty area just east of the Trident Access Channel.
- General effects of harbor widening and deepening as compared to the existing conditions show:
  - an overall reduction in peak water surface elevations throughout the harbor;
  - an overall improvement in moored vessel conditions throughout the harbor;
  - the passing vessel loading on berthed vessels at most terminals are reduced anywhere from a negligible amount to roughly 35 percent;
  - the passing vessel loading on berthed vessels at some terminals do not change significantly owing to the passing vessel route through the harbor as defined relative to the existing or recommended project channel centerlines;
  - except for the large, deep-draft USS America and the USNS Bob Hope, the peak passing surge and sway loads on the surface ships and submarines at Mission Partner berths are 20,000 lbf or less;
  - reductions in the peak passing vessel loads are generally predicted for ships at commercial berths; however, the predicted loads in some cases will contribute substantially to overall mooring loads and should be considered for the present and future operations at those terminals
  - reduction in maximum peak to trough surge height; and
  - a slight modification in the timing of surge waves and forces; and
  - a general reduction in the forces and moments on the berthed vessels ranging from slight to fairly significant.

Attachment F contains the vessel-induced surge modeling report.

## 1.10 Aids to Navigation

Port Canaveral currently has U.S. Coast Guard navigational range structures for inbound traffic centered on the present 400 ft wide entrance channel middle and inner reaches. Of the two structures, the entrance channel range front light is located in the water just east of the SR401 bridge and the entrance channel range rear light is positioned in the uplands on USACE property west of the bridge. For approximately 10 years the Canaveral Pilots Association has requested that the Coast Guard provide an outbound range for the existing channel.

The local pilots consider the inbound and outbound range structures as key navigation aids. The inbound aids will be relocated or replaced north and east of their existing locations to align with the new middle and inner reach centerline. Similarly, with expansion of the channel and handling of the largest cruise vessels afloat—the pilots and the STAR Center strongly urge that outbound range structures be installed to align with the new channel centerline in the Atlantic Ocean waters east of the turn widener area. The pilots conducted the recent simulations with inbound and outbound range structures featured in the visual geographical database. The outbound range structures were found to be extremely useful and enhanced safety as confirmed by the 2007 and 2009 simulations.

The authorization, funding, design and construction of aids to navigation such as the channel ranges and buoys are under the jurisdiction of the US Coast Guard. This navigation improvement project has been identified to the US Coast Guard, 7<sup>th</sup> District Aids to Navigation Office in Miami, Florida, to prepare a formal cost estimate of construction for new outbound ranges and relocation of the existing inbound ranges as dictated by the channel realignment due to widening. Documentation of coordination of the range navigation aids between the USCG and the Canaveral Port Authority and its consultants is included as Attachment N. The Canaveral Pilots confirm that the Recommended Plan project may be appropriately marked by relocating the existing floating aids to navigation such that no new floating aids will be required.

## 2.0 Hydrology and Hydraulics

Canaveral Harbor hydraulic modeling calibration data were collected based on two tide gages and a current meter deployed from August to September 2005 at strategic locations within the port. The data collection program, numerical modeling methods, discussion and results of the calibration and verification of the hydrodynamic model for the existing conditions, and discussion and results of the recommended plan hydrodynamic modeling are presented in Attachment F.

## 3.0 Coastal Studies

Coastal studies have been limited to analysis of entrance jetty and south jetty sediment trap impacts. As this project is simply an expansion of existing channels and turn areas and as evidenced in the hydraulic modeling of the recommended plan as compared with the existing conditions, no discernible impact is anticipated to adjacent shorelines to the north and south of the inlet.

### 3.1 Entrance Jetty and South Jetty Sediment Trap Impacts

Proposed channel widening and turn expansion were investigated for impacts to the north and south jetties and the South Jetty Sediment Trap. A Jetty Impacts Report was performed by hydrodynamic experts at Olsen & Associates, Jacksonville, Florida, and is included as Attachment G.

The proposed South Channel Widener does not pose significant risk for increasing adverse impacts to the south jetty structure. This topic was re-visited by the hydrodynamics consultant for CPA in December 2007. The proposed widener and existing sediment trap were altered in area (the sediment trap proposed wider as well) to effect a greater buffer. The reduction in capacity due to the South Channel Widener to the South Jetty Sediment Trap can be recaptured by deepening and expanding the trap as advised by the consultant in their report.

The proposed North Channel Widener does not pose significant potential for adverse impacts to the north jetty following channel and side-bank equilibration. The eastern limit of the improvement was set at USACE North Jetty Station 11+00 to establish a minimal seabed buffer between the channel and the north jetty. Any widener that extends further east of this limit has some likelihood of undermining the north jetty.

Two surge warning signs for local mariners and fishermen are presently located just west of the north jetty. The eastern sign is not affected by the north side channel widening and will remain at its present location. The western sign will be removed and a new sign constructed 100 ft north of the existing western sign position as part of this project.

### 3.2 Sea Level Change Projections

The USACE requires that potential relative sea-level change be considered in every USACE coastal activity as far inland as the extent of estimated tidal influence. Guidance for incorporating the direct and indirect physical effects of projected future sea-level change in USACE projects is provided in the Engineering Circular EC 1165-2-211 titled *Water Resource Policies and Authorities Incorporating Sea-Level Change Considerations in Civil Works Programs* (USACE 2009). EC 1165-2-211 has an expiration date of July 1, 2011 and is slated to be updated and replaced by a new guidance document, EC 1165-2-212. However, at this point, EC 1165-2-212 has not been formally issued and is still under review. Therefore, EC 1165-2-211 is considered to be the current guidance document for the Port Canaveral widening and deepening project.

The Corps guidance states that consideration should be given to how sensitive and adaptable proposed alternatives are to climate change and other related global changes. Because of the variability and uncertainty in projected future sea-levels, alternatives should be evaluated using low, intermediate, and high rates of future sea-level change for both “with” and “without” project conditions in order to bound the likely future conditions.

The estimated potential sea-level change at Port Canaveral over the period 2014 to 2064 based on guidelines presented in EC 1165-2-211 is presented below.

Low estimates of rate of sea-level change are based on extrapolation of historic rates of sea-level change. Intermediate and high rates include potential future acceleration of sea-level rise based on scenarios represented by modified NRC Curves I and III, respectively, from updates to NRC (1987).

Mean sea-level trends are available for a number of tidal stations along the Florida Atlantic coast from NOAA. The standard error for the calculated trends is related to the period of record for the individual stations. The uncertainty can become large compared to the calculated trend values for smaller periods of record and, therefore, EC 1165-2-211 indicates that the stations used for calculating sea-level trends should have a minimum duration of 40 years of data.

Table 25 presents sea-level trends for the three stations along the Florida Atlantic coast both north and south of Port Canaveral obtained from the NOAA website (<http://tidesandcurrents.noaa.gov/sltrends/>).

The nearest station, Daytona Beach Shores, contains a record that spans 48 years, but with significant gaps (on the order of 20 years of missing data) and therefore, has more uncertainty than the other two stations. For comparison, the next closest station, Mayport, located approximately 145 miles north of the Port has a continuous 78 year record. Miami Beach, located approximately 185 miles south of the Port has a 50 year record with a single gap in the record of about 5 years. EC 1165-2-211 directs to consider the next closest gauge if the period of record of the closest gauge is not greater than 40 years. The sea-level trend of +2.4 mm/year calculated for the Mayport station was used for this analysis to represent the regional sea-level change due to the period of record of the station and apparent relative uniformity of the trends between the three stations.

**Table 25. Sea-Level Trends for Gauges along the Atlantic Coast of Florida**

Station	Distance from Port	Period of Record	Trend	95% Confidence Limit
Mayport, FL	145 mi north	1928 to 2006	2.40 mm/yr	+/- 0.31 mm/yr
Daytona Beach Shores, FL	60 mi north	1925 to 1983	2.32 mm/yr	+/- 0.63 mm/yr
Miami Beach, FL	185 mi south	1931 to 1981	2.39 mm/yr	+/-0.43 mm/yr

Figure 15 shows results of low, intermediate, and high relative sea-level projections based on methods from EC 1165-2-211. Table 26 presents the results of calculations from the project completion in 2014 through 2064 in five year increments. These show sea-level change estimates over a 50-year life of the project ranging from 0.120 meters (0.39 ft) for the low rate of change scenario, to 0.245 m (0.80 ft) for the intermediate rate scenario, and 0.653 m (2.14 ft) for the high rate scenario.

### 3.2.1 Impacts

Sea-level rise at the rates presented in Table 26 below will have little or no impacts related to the proposed navigation improvements.

With respect to the channel deepening, an increase in sea-level can result in greater water depths within the Port. However the channel depth is set relative to Mean Lower Low Water (MLLW), so as sea-level rises and the MLLW datum is adjusted upward in response, the dredged water depth relative to the new datum will not change.



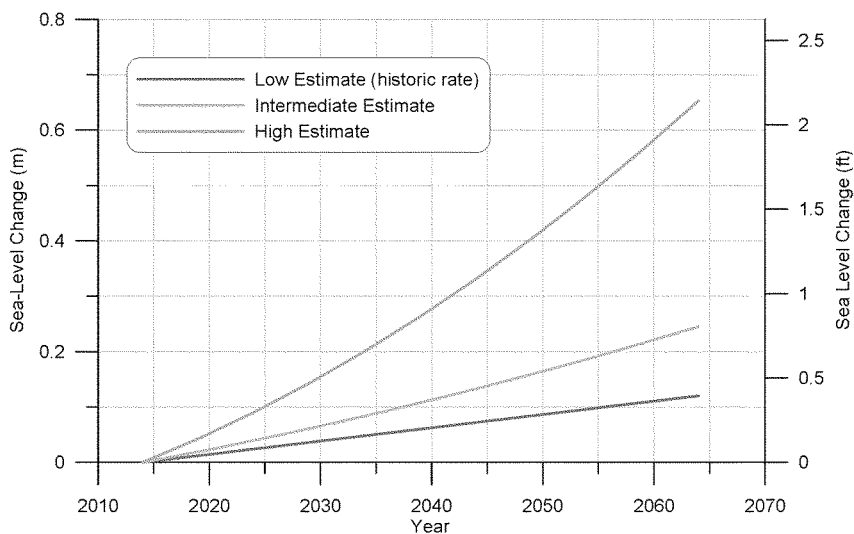

**Figure 15. Regional Sea-Level Change Estimates**

**Table 26. Projected Regional Sea-Level Change from 2014 through 2064.**

Year	Projected Sea-Level Change (m)		
	Low (Historic rate)	Intermediate (NRC Curve I)	High (Curve III)
2014	0	0	0
2019	0.012	0.019	0.043
2024	0.024	0.040	0.090
2029	0.036	0.061	0.143
2034	0.048	0.084	0.201
2039	0.060	0.108	0.264
2044	0.072	0.133	0.331
2049	0.084	0.159	0.404
2054	0.096	0.187	0.482
2059	0.108	0.215	0.565
2064	0.120	0.245	0.653

The same can be said about the navigation improvements outside the mouth of the Port. As part of the recommended plan, the new turn widener will be constructed, and cut through the footprint of the existing sediment trap. To maintain the sediment trap's design capacity, it is proposed that the trap be deepened, consistent with the new channel depth, and slightly expanded to the south as described in Attachment J of the Engineering Appendix. Sea level rise should have no impact related to these improvements. Depths of the sediment trap and the widener are both set relative to MLLW and though sea level may rise, maintenance dredging of these features will maintain similar depths relative to the future sea level. The duration between maintenance dredging cycles would be extended reducing long-term O&M costs.

Inside the Port, the project also includes a corner cut-off (CCO) at the entrance to the West Turning Basin (WTB). A portion of the cut bank will be protected by a bulkhead with concrete rubble extending from the top of the bulkhead at 0 ft Mean Low Water (MLW) to +8 feet MLW. These shore protection measures are temporary until the construction of deep sheetpile wall berths along the CCO. The new berths are not part of this project and the temporary measures will be replaced long before sea level rise is projected to become significant.

# 4.0 Surveying and Mapping

Existing USACE Jacksonville District hydrographic condition survey data along with other project area specific surveys commissioned by CPA or performed by Morgan & Eklund were compiled to create a three-dimensional model of Canaveral Harbor and the navigation areas outside of the jetties. Attachment H presents the project survey with sources of data, cross-sections, and volume cut/fill quantities for incremental depths that were used in the economic analysis and construction cost estimate for project feasibility.

At the seaward end of the outer reach, marking the seaward end of the project, USACE Quarterly Condition Survey 07-050 and most recent survey 11-088, Sheet 02, for Canaveral Harbor indicates bottom depths to be at least -47 ft MLLW. Therefore, present water depths, as shown in Figure 16 suggest that no extension of the length of the outer reach is required to achieve the project depth of 46 feet at this location.

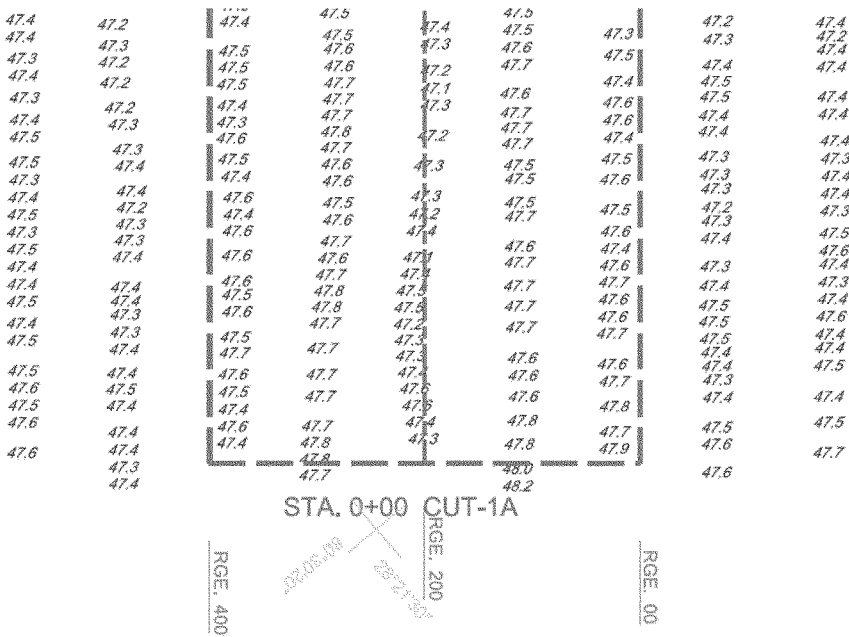

Figure 16. Seaward End of Canaveral Harbor Approach Channel

## 5.0 Geotechnical Evaluations

Geotechnical information has been collected, reviewed, and summarized from previous studies within the vicinity of the project area. A land side and marine side field exploration program has been conducted at eight locations where available geotechnical information was limited. The following geotechnical engineering tasks have been performed in support of the Section 203 feasibility study including characterization of site geology within the project area, soil classification and laboratory testing of samples from new borings, selection of design soil parameters, and limited engineering analyses to evaluate the stability of submerged slopes, the relocated north side berm along the inner reach, the West Basin corner cut-off, and existing structural bulkheads within the harbor. Existing submerged slopes vary slightly, but are approximately 1V:3H. Therefore, any proposed project slopes are at maximum steepness of 1V:3H.

Previous dredging projects in Port Canaveral have not had been documented to cause groundwater impacts. The Florida aquifer in this area is mineralized and it is subject to artesian pressure (vertical flow upward). In addition, the confining unit at Port Canaveral is approximately 40 feet thick and is located between elevation -85 feet (MSL) and -125 feet (MSL), well below the project dredging depths.

Attachment I contains the full geotechnical evaluation and analyses. Further structural assessment of existing bulkheads considering various project depth increments is found in the following section.

## 6.0 Civil/Structural Design

The engineering requirements relative to civil design of the navigation project include:

- impacts to vehicle traffic within the port;
- water quality in terms of storm water runoff and retention;
- impacts of the project with regard to existing utilities crossing the channel and those uplands utilities, roads, and structural features, and shoreline protection; and
- excavation and stabilization of uplands in expanding the entrance to the West Basin and construction of channel widening along the north side of the channel from middle basin to the north jetty at the harbor inlet.

### 6.1 Impacts to Traffic and Projections

Port Canaveral's predominant mainland access is State Road (SR) 528, the "Beachline Expressway". SR 528 is a limited access expressway extending from an interchange with Interstate 4 in Central Florida through interchanges with the Florida Turnpike and Interstate 95 to the Port. Currently, the Florida Department of Transportation (FDOT) is completing a Project Development and Environmental (PD&E) Study to evaluate alternative ways to widen SR 528 from four to six lanes from State Road 520 to the Port and to provide other improvements needed to serve the ever-increasing traffic demand. According to Brevard County, the average daily traffic along the road near the Port last year was 39,820 vehicles.

Access to the north side of the Port is provided by the SR528 interchange with SR401, a four-lane arterial. SR401 ends shortly after the Port's property line at the Cape Canaveral Air Force Station. The highway's current capacity is expected to meet both the needs of the AF and CPA through 2025. The roadway crosses over the Barge Canal from the Port Channel to the Banana River via a drawbridge.

Access to the Southside of the Port is primarily provided by the SR528 interchange with George King Boulevard (GKB). The interchange constructed in 2002 provides two lanes on the off-ramps from eastbound SR528 traffic to accommodate future growth within the Port. Additional access to the south side of the Port is provided by North Atlantic Avenue, a two lane local street within the City of Cape Canaveral that has access from A1A, a state road which turns into SR528. Due to residential growth within the City, improvements to the roadway are likely warranted.

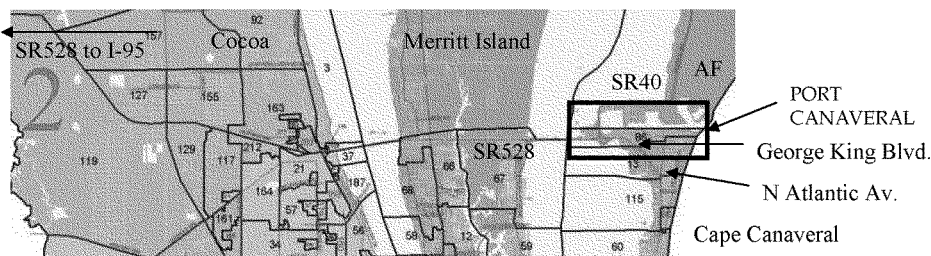

**Figure 17. Vicinity Map (Source: Brevard Co. Precinct Map w/ CPA Boundary)**

In May 2006, Ghyabi & Associates completed the "North side and Southside Traffic Study, Port Canaveral" which was commissioned by the Port Authority. The traffic Study is included in Attachment J. The internal roadway system of the Port is evaluated in the report. The existing traffic conditions were evaluated using the 24-hour volume counts, 72 hour classification counts and the turning moving counts at various roadway segments. The operating conditions at eleven critical intersections were analyzed. The level of service (LOS) for each of these intersections was an A or B, except for the GKB/Dave Nesbit Drive intersection which operates at a LOS of C during the Mid-day and PM peak hours. A weave analysis of the GKB segment between the A1A eastbound off-ramp to Dave Nesbit Drive determined an operational LOS of B during AM and Mid-day peak hours and a LOS of A during PM peak. In summary, the current operating conditions at these roadways are highly adequate for the existing roadway capacity.

Future traffic conditions were determined from trip generations for future development described by the Port Authority and a 3% annual growth rate for traffic not associated with the Port's development. Southside expansion projects include the aggregate conveyor/yard by, fully occupied Premier Office Building, Milrose Hotel, and a Hotel and Conference Center on the Banana River site. North side expansion projects include the Cruise Terminals 6 and 7 by 2008, Cargo Piers 5 and 6 supported by 18.5 acres of uplands by 2010 and then another 35 acres by 2015, and a 30-acre fuel tank farm by 2010. Future traffic analysis was performed for years 2010 and 2025. Further details of the developments can be read in the Ghyabi report.

Traffic volume forecasts were determined, a LOS analysis of the intersections was performed, and mitigation possibilities were investigated. By 2010, the proposed developments will

generate approximately 15,330 new daily trips. By 2025, the proposed developments will generate approximately an additional 1,630 new daily trips. Other than the new roadways required by the developments, modifications to three existing critical intersections were recommended.

The GKB/Nesbit intersection would unsuccessfully operate at a LOS of F by 2010. A traffic signal would allow the intersection to improve to a LOS of C. By 2025, another left-turn lane would need to be added to GKB at this intersection to allow an operating LOS of D. Other improvements required by 2025 include lengthened signal cycles at the SR401/Charles Rowland Drive intersection to the Cruise Terminals and the SR401/Grouper Road intersection to the north side Cargo Area.

The proposed upland developments as outlined in the Ghyabi report align with the developments associated with the proposed channel improvements. Overall, the existing roadway system with a few modifications can accommodate the traffic growth associated with Port's expansion plans.

Additional supporting traffic information is provided in Attachment J including details from the "Brevard County Accident Analysis" from January 2000 through October 2005 for the following intersections: GKB/A1A, GKB/SR528, GKB/N Atlantic Av., and SR401/Grouper Rd. The following Table 27 summarizes the reported accidents. Attachment J also provides traffic counts from the County's database for roadway segments of SR528, George King Blvd. and N. Atlantic Avenue.

**Table 27. Summary of Traffic Accidents, January 2000 – October 2005**

Year	GKB/A1A	GKB/SR528	GKB/N Atlantic	SR401/Grouper
2000	0	0	4	1
2001	0	1	3	2
2002	3	0	4	2
2003	1	1	3	3
2004	0	2	1	0
2005	0	1	2	0
<b>6-YR TOTAL</b>	<b>4</b>	<b>5</b>	<b>17</b>	<b>8</b>

## 6.2 Impacts to Water Quality

Monthly water quality sampling has been performed continuously by the Canaveral Port Authority since September 1992. Based on the *Port Canaveral Harbor Water Quality Monitoring 2004 Annual Report* by Safety & Environmental Assessment Services, Inc., the Canaveral Harbor generally met requirements of its designation as a Class III predominantly marine water body per 62-302 Florida Administrative Code (FAC).

Seven sampling stations were utilized until 2004. One station was located in each of the three turning basins and the other four stations were along the access and barge channels. Field measurements were profiled at one foot below the water surface, mid-depth, and one foot above

the mudline. Field measurements included temperature, pH, conductivity, dissolved oxygen and salinity. General chemistry samples such as turbidity, biochemical oxygen demand, total suspended solids, and total organic carbon content were collected at mid-depth. Chlorophyll samples were collected at mid-Secchi depth. Total coliform, fecal coliform, and oil and grease samples were taken at the surface.

This proactive water quality monitoring program assists the CPA in addressing concerns by the public as to the quality of the Port's water and identifies any potential issues that exist. Another program that the Port engages in to address water quality concerns is the monitoring of freshwater runoffs under the NPDES. CPA monitors discharge from nine of the 42 freshwater outfalls into the Harbor.

No adverse impacts to water quality are anticipated as a result of the construction or maintenance of the navigation project. Dredging would result in a temporary and localized water column impact from turbidity, but all dredging would be conducted in accordance with State Water Quality Standards dictated in the state (FDEP) environmental permit standard conditions. Turbidity monitoring would be required to insure that turbidity levels would not exceed 29 NTUs above background at the edge of the 150-meter mixing zone. If turbidity levels exceed 29 NTUs over baseline at any time, construction activities would cease immediately and not resume until modifications or corrective measures were taken and turbidity has returned to acceptable levels.

Excavation to the -13 MLLW elevation in the two upland removal areas for the project will require turbidity control on the uplands and in the adjacent waters. State/FDEP Best Management Practices shall be employed throughout the upland excavation and dredging portions of the project. For upland removal work, the form of turbidity control would be to completely surround the adjacent slope work area with double floating turbidity. If the upland site is left unattended or a significant rain event is anticipated where excavation work cannot proceed, then staked hay bales and/or silt curtains shall be employed at the top of the bank to guard against sediment runoff. Turbidity control for dredging operations may include installing temporary sheet pile walls or double turbidity barriers.

### 6.3 Impacts to Existing Utilities

There are no overhead utility crossings within the project study area. The Middle Basin and West Access channels have communications, gas, electrical, and the CPA CCTV utility crossings as described below and presented on each of four drawings contained in Attachment J.

Military Communications Duct:

Location: Station 214+72.5 on a north-south alignment.

- Owner: USAF
- Year Installed: 1993
- Approximate depth at center of existing channel: -83 feet (MLW)
- Remarks: The duct consists of a cluster of seven, 4-inch HDPE conduits encased in 24" of concrete. This duct was installed by horizontal directional drilling and replaced the original USAF communications duct as part of the previous channel widening project. The present duct is well clear of all proposed channel alternative plans, both at the bottom and at the side slopes. No remedial action is necessary.

**Natural Gas Pipe Line:**

Location: Center at approximately Station 214+72 on an east of north-south alignment.

- Owner: NUI/City Gas
- Year Installed: 1999
- Approximate depth at center of existing channel: -70 feet (MLW)
- Remarks: The pipe line consists of a single pipe installed by horizontal directional drilling. The present pipe line is well clear of all proposed channel alternative plans, both at the bottom and at the side slopes. No remedial action is necessary.

**FPL Electrical Power Feeder Duct:**

Location: Center at approximately Station 260+45 on a north-south alignment.

- Owner: Florida Power & Light
- Year Installed: 1999
- Approximate depth at center of existing channel: -67 feet (MLW)
- Remarks: The feeder duct consists of a single, 6-inch PVC conduit installed by horizontal directional drilling. The present feeder duct is well clear of all proposed channel alternative plans at the bottom. A future sheet pile wall along the corner cut off will cross the duct. The elevation of the duct at this point is -44 feet (MLW). The future wall will be engineered at that location with shorter sheets and king piles as necessary to avoid impacting the duct.

**CPA CCTV Duct:**

Location: Centered at approximately Station 285+45 on a west of north-south alignment.

- Owner: Canaveral Port Authority
- Year Installed: 2006
- Approximate depth at center of the existing Barge Canal channel: -26 feet (MLW)
- Remarks: The CCTV duct consists of three, 4-inch HDPE conduits installed by horizontal directional drilling. The present duct is west of the western limits of all alternative plans. No remedial action is necessary.

**Grouper Road Utilities:**

Location: West Turning Basin (WTB) Corner Cut Off (CCO)

The WTB CCO and Grouper Road relocation have been constructed in advance by the Canaveral Port Authority. This work preceded the Section 203 project out of necessity to accommodate the feasibility study design cruise vessels which are now homeported at Port Canaveral. Grouper Road in the vicinity of the relocation is a two-lane access accommodating large shipping trucks hauling/loading cargo into and out of North Cargo Piers 3 and 4. The relocation entailed approximately 1,600 LF of roadway, drainage swales, water main, wastewater force main, and communications lines.



## 6.4 Impacts on Embankments and Pier and Bulkhead Structures

The inner channel and turning basins are bounded by various bulkheads, wharfs, dikes, and embankments. The impact of the alternative plans was evaluated for typical sections from each structure.

### 6.4.1 North Dike Relocation

Dredge spoil containment dikes are located on the north side of the Inner Reach and the Middle Reach. The east-west dike adjacent to the harbor channel will be shifted 100 feet north to accommodate the channel widening. Stability analyses were conducted on a typical design cross section for the existing and proposed replication of the dike on the north side of the channel. The computer model SLOPE/W was used to analyze the various stability considerations.

SLOPE/W, developed by Geo-Slope International Ltd. of Calgary, Alberta, Canada, is a fully integrated slope stability analysis program. The computer program determines the critical failure surface for each failure mode by converging on the failure surface through an iterative procedure. Final stability analyses on the most critical failure surfaces identified in the search routine were completed using Spencer's method, which satisfies total force and moment equilibrium. The stability analyses were performed using an estimated pore pressure distribution assuming ponding of water to elevation 20 feet (MLLW) behind the dike.

The computed factor of safety for the slope stability analyses of the existing dike geometry is approximately 1.57 for failure in the foundation soils, 1.69 for the lower slope by the shoreline and 2.29 on the dike slopes, all of which exceed the minimum recommended safety factor of 1.5. Since the geometry of the relocated dike is proposed to be identical to the existing geometry, and the soil profile is generally similar to the profile of the existing dike, the factor of safety obtained from the slope stability analyses would also be similar to the factor of safety of the relocated dike.

The above analysis was a preliminary assessment utilizing SPT data and soil index testing. A detailed laboratory testing program and design analysis on undisturbed clay samples will be needed to further optimize the slope stability solution. During the detailed design process, all scenarios should be analyzed using Slope/W including circular and wedge failure.

Dike relocation will involve the movement of approximately 100,000 cubic yards of material. The existing rock rip-rap will be recovered for reuse on the new shoreline. The existing unimproved (earthen) perimeter road, security fence, and signage will be re-established at the new location and will be consistent with existing conditions. The abandoned boresight tower guy foundation (concrete pile tripod) and an existing mooring dolphin east of the U.S. Navy Poseidon Wharf will be removed and replaced with a monopile dolphin positioned near the new shoreline.

### 6.4.2 Jetty Park Embankment

The Jetty Park embankment is located at the south side of the Inner Reach. The stability of the existing embankment was analyzed for a worst case project depth of -46 ft. Using the computer model Geoslope, Version 4, it was determined that the embankment would have a factor of safety of 2.57. Therefore, the deepening options will have no impact on the existing embankment.

### 6.4.3 FPL Barge Berth Embankment

The FPL Barge Berth embankment is located on the south side of the West Access Channel. The computer model SLOPE/W was used to analyze the stability of the embankment for the worst case channel depth of -44 ft. The safety factor was found to be 1.91. Therefore, the deepening options will have no impact on the existing embankment.

### 6.4.4 Wharves and Piers

The open pile pier structures were not significantly affected by the various channel depth options. Increasing the berth depth, to take advantage of the deeper channel, did reduce the pile load capacities. Most pier piles in Port Canaveral are 18-inch and 24-inch square prestressed concrete piles with tip elevations ranging from -75 to -110 feet (MLW). The piles are designed as friction and bearing piles, using factors of safety of 2 and 3, respectively. The worst case reduction in pile capacity occurs at NCP 3 and 4, where the berth depth would be increased from -35 feet to -44 feet (MLW). This resulted in a pile capacity reduction of about 6% for the pile row near the berth face. This reduction decreased as the pile rows progressed towards the bulkhead. The new capacities were then compared to actual loads and it was determined that the reduced allowable loads were acceptable and that additional remedial action would not be necessary.

SCP3, however, is a deep wall wharf with a pile supported relieving platform that replaced an anchored SSP bulkhead wall in 1980. The wall was analyzed for a berth depth of -41 feet with a channel depth of -44 feet using USACE program CWALSHT. The wall safety factor was found to be 0.86 for the Free Earth Method. Previous studies of this wall have also resulted in safety factors less than one, in spite of the fact that the wall has shown no distress. This may be due to somewhat stronger soil conditions than those selected for the analyses, or it may be due to the relieving platform piles penetrating the wall's active wedge and reducing the soil pressure on the wall. In any case, it is recommended that the berth depth be limited to the present -41 feet regardless of the final depth of the channel, and that the port continue to monitor the wall. As far as this feasibility study is concerned, no remedial action is necessary.

### 6.4.5 Bulkhead Walls

Existing bulkhead walls were analyzed for various alternative plan channel and berth depths using USACE program CWALSHT. It was found that the older walls, which have been in service for 30 plus years, had safety factors well below 1.0 for almost all of the channel depth options. Because these walls were already programmed for replacement during the next ten years, the recommendation will be to advance the replacement to coincide with the channel project. The replacement walls would then be designed for the needed depths and slopes for the selected plan.

The newer walls generally had safety factors that were acceptable and the future wall along the corner cut off at the entrance to West Basin would be designed for the recommended plan project depth for West Basin and West Access Channel, Cut A. Table 28 summarizes the results of the bulkhead wall analysis.

**Table 28. Bulkhead Wall Analysis Summary**

Bulkhead Wall Location	Adjacent Channel or Reach	Safety Factor Based on Channel Depth			Elevation of Wall Toe (ft)	Wall Section	Wall Surcharge (psf)	Recommended Action
		40 or 41 ft	43 ft	46 ft				
Cove		2.94	2.8	2.68	-37	AZ13	200	None
Wall "L" (west of cove)	West Access Channel	0.51	0.51	0.51	-15	MP115	200	Replace wall
Scallop Road Wall, "O"	West Access Channel, Cut A	1.44	1.44	1.44	-20	MP116	200	None
George King Outfall	West Basin	1.64	1.45	1.29	-30.5	AZ13	600	None
NCP3&4 (Exist. Berth -35)	West Access Channel	0.86	0.86	0.86	-30.5	FROD3N	600	Replace wall
NCP3&4 (match channel depth)	West Access Channel	0.84	0.81	0.7	-30.5	FROD3N	600	Replace wall
CT2&3	Inner Reach	1.33	1.33	1.33	-19	Concrete	200	None
CT14 (Exist. Berth -35)	Inner Reach	N/A	1.38	1.38	-19	BZ7	200	Add fill to -5 ft
SCP1&2 -41' Berth	Inner Reach & Middle Basin Channel	1.43	1.43	1.43	-36	AZ26	600	None
SCP3 front face	Middle Basin Channel	0.86 (41')	~	~	-59	PZ32	500	Continue to monitor
SCP3 E/W face	Middle Basin Channel	1.42 (41')	1.42	1.42	-70	AZ49w/36" pipe	500	None
TB1&2 Cantilever (between SCP	Middle Basin Channel	4.12 (41')	4.03	3.86	-85	CA218	200	None
TB1&2 Anchored	Middle Basin Channel	1.62 (41')	1.59	1.31	-71.5	BZ42	200	None
USN Bulkhead	Middle Basin	2.51	2.51	2.51	-18.4	Concrete	300	None
SCP1 at former ATA crossing	Inner Reach							Fill in gap in wall
West of George King Outfall	West Basin							Fill in gap in wall

### 6.4.6 West Basin Corner Cut-Off

Expanding the entrance to the West Basin to enable navigation access by the design cruise vessel and to accommodate a new turning basin requires the excavation of submerged lands and uplands along the southeast corner of the present entrance to the West Basin. This project feature is referred to as the Corner Cut-Off (CCO). The excavation area measures 18.5 acres at an estimated 861,575 cy. Excavated material above -13 feet MLW has been identified as material for reuse within the Port or for other beneficial uses as identified elsewhere in this feasibility study. Excavated material below -13 feet MLW will be tested, and assuming approval, permitted for disposal at the Canaveral ODMDS. Work at the corner cut off also requires removal of 822 linear feet of shallow bulkhead wall within the project feature areas and along the eastern boundary of the basin. A water line, sewer force main, and Grouper Road, all within the project area, will require relocation and realignment. The geometry of the constructed corner cut off bank slope is proposed to be 1V:3H, similar to or flatter than the existing profile. With similar soil profiles and slope conditions, the CCO is anticipated to be at least as stable as existing conditions.

It should be noted that the CCO dredging has been executed and completed by the Canaveral Port Authority as of September 2011. This work included 354,322 CY of upland excavated material (above -13 MLW), 507,253 CY of dredged material (below -13 MLW) with removal of 879 linear feet of shallow bulkhead wall and the Grouper Road and associated utilities relocation. This portion of the Section 203 project was completed in advance out of necessity to accommodate homeport ships, Freedom of the Seas and Carnival Dream which began in 2009. The costs of this work are included in the Section 203 Feasibility Study, and the Port Authority plans to obtain cost-shared funds through legislation.

## 6.5 Project Construction and Sequence of Work

The major cost magnitude and time duration element of the project is the harbor and channel dredging. The dredging accounts for approximately 68 percent of the total project cost. The dredging duration is estimated at 272 days or nine months. The total project duration including dredging and non-dredging elements is estimated to be 430 days. It is anticipated that some of the non-dredging project elements will be performed while dredging in other areas is taking place. Some necessary sequencing of work will be required in the area of the northside widening. Excavation and dredging work in that area must be performed well enough in advance to accommodate the berm and rock revetment replacements that must follow.

Construction methods shall conform to federal, state and local environmental permitting regulations. State standards for maintaining water quality, manatee protection and sea turtle protection would be adhered to throughout the project. Hopper dredging would not be employed and has been discouraged in past state and federal permits. Hydraulic and clamshell dredging are the methods of choice for economic and environmental concerns and are not known to "take" manatees or sea turtles when the state standards for operations and observance are employed. More detailed environmental project information can be found in the Environmental Appendix (a separate document from the Engineering Appendix).

Construction of the project involves both marine and uplands work and equipment. The following sequence of work is provided to generally describe the progression of the project:

- Remove all physical obstructions within the submerged project area and remove or relocate all physical obstructions within the uplands portions of the project area.
- Install temporary project security measures for protection of the uplands property and work.
- Perform the uplands earth work along the north side of the channel from the Middle Basin to the start of the north jetty. Install the SSP wall and monopile features adjacent to the Poseidon pier prior to dredging to allow continued use of the facilities. For the north dike relocation project feature, remove and stockpile rip-rap for reuse.
- At the same time, dredging of the project features would begin starting in the Outer Reach and working toward the Harbor and to the West Basin.
- Replacement of the rock revetment at the northside widener, installation of the security fencing for the USACE dredged material containment site, relocation/addition of the aids to navigation (range structures) and replacement of the west "Surge Warning" sign at the North Jetty complete the project.

The dredging operation will consist of clamshell bucket dredge(s) and bottom dumping scows used for transportation and disposal at the Canaveral Offshore Dredged Material Disposal Site (ODMDS). This method is preferred due to the 10 mile distance from the mouth of the harbor to the ODMDS. Piping of hydraulically dredged material would not prove to be logistically (from a navigation standpoint) or economically feasible. Dredged material suitable for nearshore disposal or other beneficial reuse would be disposed of in the USACE upland containment site on Air Force property. Work would be closely coordinated with local pilots to ensure the safety of navigation while working around ship transits with the least disruption to the dredge operations. The dredge contractor may take advantage of working inside the harbor when conditions do not allow work outside the jetties.

## 6.6 Dredged & Upland Excavated Material Disposal and Reuse

In Attachment J, drawings C1 and C2 show the uplands and offshore disposal sites that would receive the dredged or excavated material from the recommended plan. The upland site consists of one existing containment area utilized by the USACE on Air Force property between the Middle and Trident Basins. The offshore sites, Canaveral Ocean Dredged Material Disposal Site (ODMDS) and the Nearshore Disposal Area are located approximately 10 miles from the entrance jetties via the outer reach.

The recommended plan requires dredging of approximately 3.6 million CY and excavation of approximately 808,391 CY of sand, silts and clays. The completed CCO dredging has resulted in placement of 507,253 CY in the ODMDS leaving approximately 3.1 million CY for future ODMDS placement. The CCO excavation of 354,322 CY was placed in uplands on CPA property. An estimated 454,069 CY of excavation would occur at the northside widener. 100,000 CY of this volume is estimated as dike relocation of the existing upland containment area on Air Force property and the remaining 354,069 CY from existing grade

down to elevation -13 MLLW is designated for disposal in the containment area after the dike relocation and improvements are completed. The geotechnical investigations show that sands suitable for reuse are generally located at and above elevation -13 feet (MLLW). Although these sands do not appear to be suitable for direct placement on the beach, they can be stockpiled on land for beneficial reuse as construction fill material. Excavated material below -13 feet MLLW is generally not suitable for reuse and would be disposed in the offshore disposal site. In the event that suitable material is found below -13 feet MLLW, it could be placed in the Nearshore Disposal Area.

### **6.6.1 ODMDS (Ocean Dredged Material Disposal Site)**

The Canaveral ODMDS is located approximately 10 miles south of Canaveral Harbor and has historically been used for placement of dredged materials from new work and maintenance events that are predominately silts and clays and have been tested to meet Ocean Dumping Criteria of the Marine Protection Research and Sanctuaries Act (MPRSA). Dredge material below -13 feet (MLLW) generally consists of the silts and clays typically evaluated for ODMDS placement (see Attachment I) and are included as part of the Recommended Plan. CPA upland disposal sites are currently at capacity will material removed from above -13 feet MLLW which is considered preferred material for future reuse.

The most recent management plan for the ODMDS is the Site Management and Monitoring Plan (SMMP) dated February 2012, which replaced the previous SMMP that expired October 2011. The SMMP is a ten-year plan, jointly implemented by the Corps' Jacksonville District and USEPA's Region 4. The new February 2012 SMMP does not identify an annual placement volume limit. Additionally, overall planning for the revised SMMP accounts for construction and maintenance dredging volumes associated with this project. The SMMP identifies a ten-year cap of 9.2 million cubic yards, which may be increased if an increase is supported by future modeling.

The following table (Table 29) provides the history of disposal within the Canaveral ODMDS. In addition, EPA coordination of the 10-year update to the SMMP is considering allowing project specific volumes greater than the current 3 million annual limit.

Table 29. Canaveral ODMDS Disposal History (1974-2011)

YEAR	TYPE OF ACTION	SOURCE	VOLUME (CY)	SPONSOR	COMPOSITION
1974	NW	Entrance Channel & Trident Basin	645,198	Navy	Sandy Silt
1974	MD	Entrance Channel & Trident Basin	223,986	Navy	Sandy Silt
1975	NW	Entrance Channel & Trident Basin	2,196,470	Navy	Sandy Silt
1975	MD	Entrance Channel & Trident Basin	187,212	Navy	Silty Sand
1975	MD	Trident Basin	63,077	Navy	Sandy Silt
1976	NW	Entrance Channel	1,343,121	Civil Works	Sandy Silt
1976	MD	Entrance Channel	341,888	Civil Works	Sandy Silt
1977	MD	Entrance Channel	48,017	Civil Works	Sandy Silt
1978	MD	Entrance Channel	282,517	Civil Works	Sandy Silt
1980	MD	Entrance Channel	1,402,547	Civil Works	Sandy Silt
1981	MD	Entrance Channel	257,326	Civil Works	Sandy Silt
1983	MD	Entrance Channel	929,555	Civil Works	Sandy Silt
1985	MD	Entrance Channel	2,958,827	Civil Works	Silty Sand
1986	NW	Entrance Channel	63,370	Civil Works	Silty Sand
1986	MD	Entrance Channel	351,535	Civil Works	Silty Sand
1988	MD	Entrance Channel	442,750	Civil Works	Silty Sand
1988	MD	Entrance Channel	1,200,188	Civil Works	Silt
1988	MD	General berth Areas	15,600	CPA	Silts & Clays
1989	MD	Entrance Channel	203,000	Civil Works	Silt
1990	MD	Entrance Channel	173,772	Civil Works	Silt
1991	MD	Middle Turning Basin	497,380	Civil Works	Silt
1991	MD	General berth Areas	178,800	CPA	Silts & Clays
1992	MD	Entrance Channel	342,000	Civil Works	Silt
1992	MD	Middle Turning Basin	208,000	Civil Works	Silt
1993	MD	Entrance Channel	1,878,460	Civil Works	Silt
1993	MD	Trident Access Channel	108,410	Navy	Silty Sand
1993	NW	WTB SE Corner	400,000	CPA	Clay
1994	NW	Entrance Channel	454,000	Civil Works	Silty Sand
1994	NW	Middle Turning Basin	1,039,000	Civil Works	Silty Sand
1994	MD	Entrance Channel	98,820	Civil Works	Silt
1994	MD	Trident Access Channel	17,510	Navy	Sandy Silt
1994	MD	WTB CT5	24,000	CPA	Sandy Clay
1994	NW	WTB CT10	86,000	CPA	Silty Sand
1995	MD	Entrance Channel	243,180	Civil Works	Silt
1995	MD	Trident Access Channel & Turning Basin	12,090	Navy	Silt
1996	MD	Entrance Channel	245,274	Civil Works	Sandy Silt
1996	MD	General berth Areas	33,000	CPA	Silts & Clays
1996	NW	WTB CT8	212,000	CPA	Silty Sand
1997	MD	Entrance Channel	773,999	Civil Works	Sandy Silt
1997	MD	Trident Turning Basin	36,965	Navy	Silts & Clays
1998	MD	Entrance Channel	688,839	Civil Works	Sandy Silt
1998	MD	Entrance Channel, TTB & Poseidon Wharf	160,044	Navy	Sandy Silt
1998	MD	WTB CT5	5,600	CPA	Sandy Clay
1999	MD	Entrance Channel	1,312,703	Navy	Sandy Silt
2000	MD	Entrance Channel	300,320	Civil Works	Silt
2002	MD	Entrance Channel	410,000	Civil Works	Silts & Clays
2002	MD	CT5, NCP4, SCP1-3, TB 1&2	41,000	CPA	Silts & Clays
2002	NW	WTB Entrance	89,000	CPA	Silts & Clays
2003	NW	Inner Reach & West Access Channel	132,000	CPA	Silts & Clays
2003	MD	Entrance Channel & Trident Entrance Channel	512,482	Navy	Silts & Clays
2004	MD	Entrance Channel	202,624	Civil Works	Silts & Clays *
2004	MD	Trident Access Channel & Turing Basin	28,195	Navy	Silts & Clays *
2004	MD	CT8, NCP3 & 4	11,000	CPA	Silts & Clays
2005	MD	Entrance Channel	417,997	Civil Works	Silts & Clays *
2006	MD	WTB Entrance, Federal WTB, CT5, 8, 10, NCP 1&2	104,500	CPA	Silts & Clays
2006	MD	Entrance Channel & Middle Turning Basin	952,705	Civil Works	Silts & Clays *
2007	NW	S. Jetty Sand Trap	368,160	CPA	Silty Sand
2007	MD	CT6/7,CT10,NCP3/4	124,756	CPA	Silts & Clays
2008	MD	EC,TAC,TTB,MTB	436,627	CW/Navy	Silts & Clays
2008	MD	Cuts 1b&1&2,TAC,TTB,Poseidon Wharf	286,230	CW/Navy	Silts & Clays
2009	MD	WTB	92,160	CPA	Silts & Clays
2009	NW	ICCO	239,714	CPA	Silty Sand
2010	MD	Cuts 1,&2,TAC,TTB	1,170,762	CW/Navy	Silts & Clays
2011	MD	S. Jetty Sand Trap	172,130	CPA	Silty Sand
2011	NW	ICCO	267,539	CPA	Silty Sand

\* Includes sands that were placed on the Near Shore Berm (estimated to be a small percentage of the total)

The suitability of the dredged material for ocean disposal will be verified as part of the permit process. Based on the past history of testing and evaluation of dredged material in Port Canaveral and the current Section 103 EPA authorizations, it is anticipated that all of the material proposed for ocean disposal will be approved.

### **6.6.2 Disposal and Reuse of Upland Excavated Material**

The maximum amount of excavated material for reuse and/or upland disposal is estimated to be 354,069 cubic yards and will be disposed at the existing USACE upland containment site on the USAF property. Reuse of upland excavated material is considered to consist of the sands that are generally found at and above elevation -13 feet MLLW. The dredge material is expected to be of a quality suitable for construction fill material and would be stockpiled at an agreeable location on the containment site for later reuse pending formal Air Force approval for use of that area for material placement.

Air Force approval for use of the existing USACE upland containment site for material placement would be based on an evaluation of competing interests and on test results of the composition of the spoils to be placed. The Sponsor is well aware that Brevard County has a beach restoration project that intends to use the USAF disposal area to stockpile beach quality sand. The beach quality sand will be hydraulically dredged from just offshore of the USAF coastline and will require a competent dike system to contain the fluid spoil. The existing USAF containment dike, however, is in poor condition and will need to be restored, possibly raised in elevation, and a new intermediate dike constructed to subdivide the containment area. Based on the previous channel widening and the Sponsor's experience with recent dredging, the material above elevation -13 feet will be construction grade fill material recovered using excavation methods. This material will be suitable for the dike modifications and the new intermediate dike needed for the Brevard County project. CPA is currently coordinating with USAF and Brevard County to insure that the one-time placement of the recovered spoil will complement the Brevard County project. Use of the recovered stockpiled material to reconstruct and improve the containment dike system would not reduce the area available for spoil.

In the unlikely event that the USAF should not approve placing the excavated upland material on their existing spoil disposal site, other options for reuse of the upland excavated material can be further developed, including off-site placement or existing disposal area dike upgrades requiring suitable fill. If the USAF wishes to retain ownership of their material (since the upland material is being excavated from their property), then the Sponsor could truck the material to a different site on CCAFS as designated by the USAF. These alternatives would be slightly more expensive than the recommended upland disposal plan due to additional haul distances, but would be expected to remain within the contingency allowance for upland material disposal costs estimated in this report.

## **7.0 Hazardous and Toxic Materials**

The Section 203 Feasibility Study, Hazardous, Toxic, and Radioactive Waste (HTRW) Assessment - Preliminary Assessment Report is comprised of the following five components: 1) Records and Database Review, 2) Historical Aerial Photography and Topographic Map



Study, 3) Site Reconnaissance, 4) Interviews, 5) Report. The goal of the site investigation was to identify Recognized Environmental Conditions (RECs) and indicate the presence or likely presence of hazardous substances or petroleum products in and around the target property areas. To the extent supported by the investigative approach typically used for this type of project, the assessment attempts to reveal conditions that indicate an existing release, a past release, or a material threat of a release of hazardous substances or petroleum products on the properties or into the ground, groundwater, or surface water of the properties. This report substantially satisfies the requirements of ER-1165-2-132 and ASTM Practice E 1527. Refer to Attachment K for the HTRW report.

As recommended in the HTRW report, a further detailed study was performed for the property formerly leased by Beyel Brothers, Inc. that is located within the West Basin entrance corner cutoff project area. The site, vacated in 2006, is the former location of Beyel Brothers, a crane and rigging company. On the site, a portable skid above-ground storage tank (AST) was maintained for fueling equipment with diesel fuel. A limited scope soil and groundwater assessment was completed in October 2006. The assessment identified the presence of petroleum impacted soil and groundwater and a discharge report form was submitted to Brevard County Natural Resources Management Office in December 2006. An environmental services company was then contracted to complete the source removal and assessment activity. In August 2007, approximately 779 tons of petroleum contaminated soil was excavated from the source area at the site and transported from the site for disposal at the Omni Waste Landfill in St. Cloud, Florida. Laboratory analysis of 24 confirmatory soil samples indicated the presence of petroleum fuel constituents, but at levels well below the most restrictive Residential Soil Cleanup Target Levels. Laboratory analysis of groundwater samples collected from seven monitor wells installed at the excavation sites did not indicate the presence of petroleum impacts to the groundwater in excess of the most restrictive Residential Groundwater Cleanup Target Levels.

The site now meets the FDEP criteria for a “No Further Action with Conditions” status. Attachment K includes the assessment and source removal report. No further review of activities associated with Coastal Fuels or Mid-Florida Freezer were performed as their lease properties are well outside the limits of the project area and will not impact or to be impacted by this navigation project.

## 8.0 Operations and Maintenance

Historical data available for federal and non-federal (Canaveral Port Authority) maintenance dredging disposal at offshore and nearshore locations provides a trend indicating where shoaling, and therefore, maintenance dredging is typically required along with volumes dredged. The greatest concentration of maintenance dredge material, roughly 200,000 cy or one-third of dredge/disposal quantity removed per dredge event, has occurred in the vicinity of the Canaveral Harbor inlet and attributable to littoral shoaling. The remaining roughly 400,000 cy or two-thirds of dredge/disposal quantity removed from the Federal Project originates as non-littoral background deposition. Waters outside the jetties and inside the harbor are relatively quiet and without tidal flow or sufficient bottom current that would otherwise tend to sweep away the finer silts and clays from the deep approach channel and turn wideners cut through overbanks on either side. The interior of the harbor is mostly lined with bulkheads, with some natural shorelines. Interior maintenance dredging consists of

more fine, silty material with the source being slough from the natural shorelines or underwater grade transitions caused by ship thrusters and wakes.

The implementation of the Port Canaveral Inlet Management Plan, ca. 1995-1998 and on-going, has resulted in a decrease in maintenance dredging and offshore disposal at Canaveral Harbor particularly over the last decade. The transport of sand into the inlet channel from the adjacent shoals has been minimized to nearly negligible levels through the combined actions of (a) sand-tightening and extending the inlet jetties, completed in 2005; (b) dredging and bypassing of sand from the updrift beach immediately north of the inlet to the shoreline south of the inlet, performed four times from 1995 and most recently in 2010, and perpetual 6-year cycles thereafter; and (c) construction of the advance-maintenance south jetty sediment trap in 2007. Additionally, in recent years, the frequency of dredging has been potentially decreased from annual to bi-annual events. Before the plan and implementation of the improvements, the need for annual dredging was largely dictated by critical shoaling at the inlet jetties. Maintenance dredging of the south jetty sand trap may be performed without impeding navigation and as convenient with regard to budget and schedule.

The first regular placement of maintenance dredged material into the nearshore disposal area offshore of Cocoa Beach began in 1992. This allows dredged littoral material containing less than 20 percent fine sediment to be returned to and retained within the littoral system instead of being disposed of offshore at Canaveral ODMDS. Most of the sand placed nearshore in the last decade was due to severe shoaling of the channel in 2004 as a result of the passing of multiple hurricanes.

Maintenance dredging is performed using a clamshell bucket rig on a barge. Loaded scows transport dredged material to a state and federal permitted offshore disposal site. This is simply due to the fact that upland dredged material disposal is limited at Port Canaveral and it is not economical to hydraulically dredge and pump to the offshore disposal site approximately ten miles from the mouth of the harbor. The average yearly federal maintenance dredge volume, before Section 203 project construction, ranges from approximately 400,000 to 575,000 cubic yards. As detailed below, the increase in federal maintenance dredging is estimated to be 67,400 cubic yards at a cost of approximately \$544,592 per year, in 2007 U.S. dollars. An escalation factor of 11% based on September 2010 CWCCIS cost index tables for ports and harbors increases the estimated federal maintenance dredging cost to \$604,578 in 2011 U.S. dollars.

## 8.1 Federal Maintenance Dredging History

Based on the Canaveral Ocean Dredged Material Disposal System history, average annual federal project maintenance dredging volumes can be tabulated. From 1974 to 2000, a 27-year period, the Navy and Civil maintenance dredging projects averaged 585,266 cubic yards of dredging per year. Similarly, over the last 12-year period, 1998-2011, the average annual Navy and Civil dredge volume is approximately 565,000 cy, showing good agreement with the longer range historical average. This maintenance work has primarily been referenced to the entrance channel outer and middle reaches and navy and civil wideners. Review of federal maintenance dredging west of Trident Basin indicates that work has been negligible compared to the mass of longshore sandy material that deposits near the port inlet.

## 8.2 Areas of Maintenance Dredging

Port Canaveral's submerged federal areas subject to maintenance dredging, including basins, inner channels and the ocean access channel, is 674.6 acres. The proposed widening of the Section 203 includes areas such as West Turning Basin CCO, the channel widening to the south into the existing barge canal, the north channel widening from middle basin eastward to the north jetty area, and the 203 widener enlarging the turn area between the middle and outer reaches.

Based on the nature of sedimentation at the port, recent hydraulic modeling of the recommended plan as compared to the existing conditions, and the federal maintenance dredge history, it is anticipated that only the middle reach portion of the north side channel widening and the 203 widener at the entrance channel turn will appreciably contribute to future annual maintenance dredge volumes post-construction.

## 8.3 Hydraulic Model Results

Comparison of hydraulic models for the existing conditions and the recommended plan shows that the general pattern of currents throughout the port does not appreciably change and the magnitude of currents remains relatively low. The velocities ranged from a low of 0.048 ft/sec in the West Basin to a maximum predicted velocity of 0.576 ft/sec found at the inlet. No significant increase in scour potential or rate of sedimentation is indicated or predictable from the hydraulic model of the preferred alternative and recommended plan.

## 8.4 Future Maintenance Dredging Volume Increase

Discussion with the USACE site manager for federal dredging projects at Port Canaveral reveals that the material removed west of the Trident Basin is softer material, silt and may contain muck and is more likely the result of sloughing of perimeter bank slopes than transport from the inlet. The perimeter of the harbor and basins is not significantly increased by the widening areas, but is simply shifted due to the constructed Section 203 project, and any increase in maintenance dredging would therefore take place near the inlet as historically observed. The accumulation of material west of Trident Basin is negligible compared to areas just inside and mostly outside of the inlet as evidenced by the infrequency of federal maintenance dredging required west of the Trident Basin. The sedimentation in the middle and outer reaches near the inlet is sandy in nature.

In order to project the annual incremental maintenance dredge volume associated with the construction of the project, it is necessary to determine an average annual depth of maintenance material removed from the primary dredge areas just inside and mostly outside of the inlet. The annual federal dredge volume considered for these areas was 575,000 cy (15,525,000 cf). For the previous two multi-year maintenance dredging contracts, significant portions of the reaches and cuts are dredged every year, but not 100% of the area. So to account for that, it is reasonable and representative to assume that on average, dredging occurs on an annual basis in the following areas:

50% of the outer reach Cut 1A (11,000' x 400')	2,200,000 sf
100% of the outer reach Cut 1B (5,500' x 400')	2,200,000 sf

50% of the outer reach Cut 1	(12,500' x 400')
	2,500,000 sf
100% of the navy and civil wideners	1,013,500 sf
100% of the middle reach (5,658' x 400')	<u>2,263,200 sf</u>
<b>TOTAL AREA</b>	<b>10,176,700 sf</b>

The total annual dredge volume divided by the total representative area dredged yields the average dredge depth for the middle and outer reaches and navy and civil wideners.

$$15,525,000 \text{ cf} / 10,176,700 \text{ sf} = 1.52 \text{ ft average dredge depth}$$

Therefore, the estimated incremental maintenance volume for the 203 widener and the eastern portion of the north side channel widener adjacent to the middle reach is:

203 Widener (22.24 Acres):

$$968,774 \text{ sf} \times 1.52 \text{ ft} / (27 \text{ cf/cy}) = 54,538 \text{ cy}$$

North side Channel Widener Adjacent to Middle Reach (2282' x 100'):

$$228,200 \text{ sf} \times 1.52 \text{ ft} / (27 \text{ cf/cy}) = 12,847 \text{ cy}$$

Total incremental annual federal maintenance dredge volume = 54,538 cy + 12,847 cy = 67,385 cy, say 67,400 cy.

Projected sea level change discussed in Section 3.2 would increase the mean water levels by 0.8 feet over the next fifty years. Based on the estimated volume calculation above, this would potentially reduce the annual maintenance volume by approximately half.

## 8.5 Estimated Cost of Maintenance Dredging

The cost estimate for the new work dredging portion of the Section 203 construction project is \$5.42/CY, excluding mobilization and demobilization of equipment. The CPA has bid recent non-federal maintenance dredging projects in 2006 and 2007 with the following most favorable bid sheet results for each contract for selected line items that may be considered for upward bounding the potential cost associated with federal O&M dredging. These values are significantly higher due to the scattered dredge locations, minimal depths of dredging and difficulty in scheduling work around cruise and cargo ship berthing.

Annual O&M dredging averaging 575,000 cy pre-Section 203 project construction and 642,400 cy post-Section 203 project construction still represent significant volumes of material that would be expected to command very competitive bid costs, particularly in the areas just inside and outside the inlet.

Table 30. Recent Historical Dredge Costs for CPA Projects

Year	Project Area	Estimated Dredge Volume	Low Bid Cost / cy	2 <sup>nd</sup> Low Bid Cost / cy
2006	South Jetty Sediment Trap	365,000 cy	\$5.27 * Weight 75%	\$8.80 Weight 75%

Construction				
2006	Federal West Basin Maintenance	65,400 cy	\$7.30 Weight 15%	\$7.70 Weight 15%
2007	Federal West Basin Entrance Maintenance	33,247 cy	\$16.50 Weight 10%	\$17.04 Weight 10%
Unit Cost (Weighted Average)			\$6.70	\$9.46

\* Unit cost reflects that this contractor was already mobilized on-site in support of Canaveral Harbor federal maintenance multi-year dredge contract.

The South Jetty Sediment Trap construction costs come closest to representing the volume and potential costs for dredging for the incremental volume due to the project. The west basin maintenance dredge costs take into consideration the interruptions to operations with ship movements to and from west basin and a fairly small quantity of material. Owing to the 2006 and 2007 dredge locations and bid volumes, the sediment trap costs were assigned a weight of 75% and the west basin maintenance costs were assigned weights of 15% and 10%. This distribution of historical costs provides a weighted dredge cost ranging from \$6.70 to \$9.46 per cy. Using an average cost of \$8.08 per cy, the incremental increase in maintenance dredging cost following construction of the Section 203 project is estimated at 67,400 cy X \$8.08/cy, or approximately \$544,592 per year, in 2007 dollars. Using the September 2010 CWCCIS cost indexing tables for ports and harbors provides an 11% escalation factor applied to the average unit rate. The revised cost for 2011 is \$604,578 at \$8.97 per cy.

## 9.0 Project Security

Multiple agencies have jurisdiction at Port Canaveral including Brevard County Sheriff, Florida Marine Patrol, Florida fish and Wildlife Conservation Commission, Florida Department of Law Enforcement, U.S. Homeland Security, U.S. Fish & Wildlife Service and Canaveral Port Authority Police Department and Security.

Areas of landside project work are located within the secure areas of the Cape Canaveral Air Force Station (CCAFS) and CPA that will require personnel to obtain port security badges and/or a Transportation Worker Identification Card (TWIC). Marine side project work will be executed under the security requirements of CPA.

## 10.0 Cost Estimates

### 10.1 Basic Cost Elements

The channel and harbor were analyzed for different dredge volumes in one-foot deep area increments beginning at existing or maintained elevations. Incremental volumes and the cost to dredge to those increments were compared with benefits at each increment by the project economist to determine the Preferred Alternative, or Section 203 Project. The Preferred

Alternative is graphically described in Attachment E of the Section 203 Feasibility Study Engineering Appendix.

The basic project cost elements consist of dredging the channels and basins, removing upland soil material in two locations, and costs of certain non-dredging items. Project costs, for the purposes of this discussion, do not include operating and maintenance cost (O&M), which is discussed in detail elsewhere in the Section 203 Feasibility Study. Upland port and tenant facility improvements are also not included in the direct harbor improvement costs, but are considered elsewhere in the Section 203 Feasibility Study.

A specific list of project elements includes:

- Dredging (material below -13 MLLW)
- Upland Excavation (WTB CCO and Northside Widener, material above -13 MLLW)
- Stockpiling and Replacing Existing Rock Revetment (associated with northside channel widening)
- Security Fence Around USACE Disposal Area (associated with northside channel widening)
- Mooring Dolphin Demolition and Replacement (associated with northside channel widening)
- Boresight Tower Guy Foundation Demolition (associated with northside channel widening, tower previously removed)
- New Bulkhead Wall Near USAF Building 1064 and Boat Ramp (associated with northside channel widening)
- Aids to Navigation (New outbound pair and relocate existing inbound pair)
- West Surge Warning Sign Replacement

## 10.2 Unit Cost Derivation

Dredging unit costs were prepared using CHECKRATE to calculate dredging equipment and production rates for the Recommended Plan volume. Other project element unit costs are based on industry standards of construction and demolition cost estimate data bases and supplemented when necessary with costs derived from bids for work completed in the port. All cost information has been assembled and reported in Micro-Computer Aided Cost Estimating System (MCACES) format provided in Attachment L. Also included is the Total Project Cost Summary Sheet for work completed and work remaining in the Recommended Plan.

## 10.3 Cost Estimates

The fully funded project cost estimate is \$56,726,000.00 including Sponsor spent costs. A discussion regarding the disposition of Sponsor completed work and work remaining is provided in the Main Report. The costs presented in the Final Draft Section 203 Port Canaveral Navigation Feasibility Study are less than the costs presented in the Total Project

Cost Summary, which was certified by the Cost Center of Expertise at the Walla-Walla District in February, 2012. The total project cost has been reduced based on comments received from HQ Office of Water Policy Review and the South Atlantic Division. The reviewers required that the land value included in WBS Account 01 Lands and Damages be removed from the Total Project Cost Summary because the land is currently owned by the federal government and, therefore; there would be no cost to the project based on the value of the land. The administrative costs associated with the land in question remain as a project cost and is included in WBS Account 30. The difference between the Total Project Costs as certified in February, 2012 (\$43,340,000) and the costs used in the final report (\$41,349,000) is \$1,990,600, which is the appraised value of the land in question (plus contingency).

In addition, the reviewers have determined that the costs included in WBS Account 02 Relocations (\$2,429,000) were inappropriately labeled as relocations and should be switched to WBS Account 12 Navigation Ports and Harbors. This change has been made in the main report and does not affect the total cost of the project.

The fully funded estimate includes a contingency factor of 20.97% and escalation to the estimated project midpoint of February 2014. Escalation is based on the current Civil Works Construction Cost Index System (CWCCIS) as provided in EM 1110-2-1304. The contingency was determined using the USACE prescribed procedures in USACE Documents: ETL 1110-2-573, ER 1110-2-1302 and ECB 2007-17. The latter document requires use of the "Crystal Ball" program and preparation of a risk register by the Project Delivery Team (PDT), culminating in a Cost and Schedule Risk Analysis Report. The Cost and Schedule Risk Analysis Report is included as Attachment M. The MCACES format cost estimate in Attachment L provides a complete accounting of all the project cost elements.

## **11.0 Schedule for Design and Construction**

The total project time from the date of approval of the Section 203 Feasibility Study to the end of construction is estimated to be from July 2013 to October 2014. This total project time includes authorization by Congress, negotiating and signing a project cooperation agreement, engineering design, environmental permitting, and acquisition of easements, bidding and construction. The construction phase is estimated at 430 days, or 14.15 months. A project schedule is included as Attachment O.

## **12.0 Special Studies**

No special studies have been identified as being required for the PED phase.

## **13.0 Figures, Tables, Drawings and Attachments**

Figures, tables, drawings and attachments are used throughout this Engineering Appendix and are referenced where applicable.

## 14.0 Use of Metric System Measurements

In keeping with historical navigation project records for Port Canaveral, this feasibility study has been prepared using the traditional British system of units rather than metric system measurements.



# **Port Canaveral Section 203 Feasibility Study**

## **Engineering Appendix**

Attachment A

June 2008 Letter from the Canaveral Pilots Assoc.  
Port Canaveral 2003 STAR Center Report  
Port Canaveral 2007 STAR Center Report  
Port Canaveral 2009 STAR Center Report

Rev Date: 10/30/2009



*First in Safety*

## CANAVERAL PILOTS ASSOCIATION

P.O. Box 816 • Cape Canaveral • FL 32920  
Tel: (321) 783-4645 • Fax (321) 783-6268

Capt. B. Borgie  
Capt. D. Brown

Capt. D. Callan  
Capt. S. Gasecki

Capt. R. Grimison  
Capt. B. McMillin

Capt. L. Mello  
Capt. D. Richard



R. Lacko, Business Mgr.

Mr. Jon Brazee  
Director of Engineering  
Canaveral Port Authority  
Cape Canaveral, FL 32920

June 4, 2008

Dear Mr. Brazee:

Subject: Section 203 Feasibility Study

The Canaveral Pilots Association is pleased to take this opportunity to provide additional comments regarding the navigation improvements outlined in the Section 203 Feasibility Study for Port Canaveral. As you are aware, four members of the Canaveral Pilots Association participated in a simulation for this Feasibility Study in March and April of 2007 at the RTM Star Center and they provided evaluation forms concerning the results of the simulation project.

The purpose of this letter is to provide additional comments to those evaluations, especially in consideration of the fact that the simulation used a Genesis class cruise ship model and as of this date, there are no plans to permanently home port a Genesis class ship at Port Canaveral. However, it is the opinion of the Canaveral Pilots that based on contracts that have been signed between various cruise ship companies and the Canaveral Port Authority, as well as the ongoing construction of a new tank farm and tanker terminal on the north side of the port, the navigation improvements as simulated and detailed in the Feasibility Study are necessary for Port Canaveral regardless of whether or not a Genesis class vessel is home ported here in the short term, and are needed for the immediate future of safe navigation at Port Canaveral.

The Canaveral Port Authority has signed a contract with Royal Caribbean to bring a Freedom class cruise ship vessel to Port Canaveral in 2009. The Freedom class vessels are 339 meters (1112 ft.) in length and 38.6 meters (127 ft.) in beam at the waterline. By comparison, the Genesis class is 361.5 meters (1186 ft.) in length and 47 meters (154 ft.) in beam. The differences between the two classes are 22.5 meters (74 ft.) in length and 8.4 meters (28 ft.) in beam. The Canaveral Pilots do not believe that these differences warrant any decreases in the dimensions of the navigation improvements described in the Feasibility Study for the following reasons.

Since November, 2003 we have had home based at Port Canaveral a Voyager class vessel which is 312 meters (1021 ft.) in length and 38.6 meters (127 ft.) in beam. Our experience in handling this vessel for over four years has given us a good understanding

Email: [thecanaveralpilots@msn.com](mailto:thecanaveralpilots@msn.com)

Mr. Jon Brazee  
June 4, 2008  
Section 203 Feasibility Study  
Page 2

of channel dimension requirements for vessels over 1000 feet in length and has confirmed the channel widening improvements that we recommended and were completed for that class of vessel. Those 2003 channel improvements located on each side of the Trident Turning Basin entrance, at the east, north side corner of the Middle Turning Basin, at the south side of the West Access Channel, and on the north side of the West Access Channel to the west of North Cargo Pier 4, effectively give us a current channel width in those areas of 450 feet or more. We have found that in wind conditions from 15 to 35 knots we are using this increased channel width and based on that experience we believe that the 500 foot channel widening is necessary for the Freedom class, which is 91 feet longer than the Voyager class.

Furthermore, the increased size of the vessels and increased utilization of cruise terminal berths in the West Turning Basin coming online between 2009 and 2012 based on signed contracts with cruise ship companies, as well as the increased utilization of North Cargo Piers 1 and 2 due to the new tanker facility currently under construction will result in changes in the use of other berths at Port Canaveral that will have an impact on the effective channel width in the existing channel configuration. For example, the increased berth utilization in the West Turning Basin will result in the Port Authority berthing port-of-call cruise ships at the South Cruise Terminals located parallel to the Inner Reach. Larger ships berthed at these facilities will result in smaller passing distances between large ships transiting the Inner Reach and vessels at the berths causing an increased possibility of surge. These larger ships berthed on the south side of Inner Reach will also cause a decrease in the available maneuvering room located to the south of the federal project limit off of the South Cruise Terminal berths because these berths are not normally used for large cruise ships. The proposed navigation improvements described in the Feasibility Study are needed to alleviate these problems.

Similarly, the new tanker terminal on the north side will result in increased utilization of South Cargo Pier 1 and North Cargo Piers 3 and 4 for large cargo vessels. This increased use of South Cargo Pier 1 affects vessels transiting the Inner Reach and is especially of concern due to the location of South Cargo Pier 1 at a critical maneuvering area where under the existing channel configuration transiting vessels have to make an adjustment from the centerline of the Inner Reach to the centerline of the West Access Channel. When this adjustment is made in moderate to high wind conditions from 15 to 35 knots, the extra leeway needed to account for set is often substantial and is further justification for a 500 foot channel for a vessel the length of the Freedom class. Every one degree of leeway applied to account for the wind force effectively increases the beam of ships the sizes of the Voyager, Freedom, and Genesis classes by between 18 to 20 feet per degree. It is not uncommon to use up to 10 degrees of leeway and even more when entering the Middle Turning Basin. The increased utilization of North Cargo Piers 3 and 4 located parallel to the West Access Channel in an area that has historically proven to be the most

Mr. Jon Brazee  
June 4, 2008  
Section 203 Feasibility Study  
Page 3

susceptible to surge between moored vessels and large transiting cruise ships, impacts the channel width requirements as well as the need for the West Turning Basin Corner Cut-off.

The experience of the Canaveral Pilots in handling the Voyager class vessel for over four years also confirms our belief that the recommended Feasibility Study navigation improvements at the West Turning Basin Corner Cut-off, the West Turning Basin Widener in to the barge canal, the 1725 foot Turning Circle in the West Turning Basin, the Middle Reach Widener and the Section 203 Widener between Outer Reach and Middle Reach are needed for the Freedom Class vessel. The comments provided by the four pilots on the simulation evaluation forms are relevant to the Freedom class even with the difference in dimensions to the Genesis class. The need for adequate room to apply substantial leeway in high wind conditions, to provide for adequate passing distances between transiting vessels and moored vessels, to allow for appropriate rates of turn, and to provide adequate turning circles for maneuvering off the berths all confirm the need for the proposed navigation improvements.

A more detailed analysis of the differences between the Voyager, Freedom and Genesis classes provides additional insight as to why the Canaveral Pilots believe that these proposed navigation improvements are applicable to both the Freedom class as well as the larger Genesis class. The design displacement tonnages of the three classes are 62,716, 71,019, and 106,000 metric tons, respectively. The propulsion horsepower for both Voyager class and Freedom class is 19,713 per pod for a total of 59,139. The Genesis class has horsepower of 26,820 per pod for a total of 80,460. Bow thruster horsepower for each class totals 16,029, 17,700, and 29,504 respectively. Side wind sail area for each class in square feet is 119, 523, 140,923, and 168,664 respectively.

The Freedom class is essentially a longer version of the Voyager with approximately the same propulsion horsepower and thruster power as Voyager but with more displacement tonnage, greater sail area, and greater length overall. The Genesis displacement tonnage, sail area, and length overall are even more than the Freedom, however the increase in propulsion horsepower and thruster horsepower are significant enough that the vessel can be handled adequately under the improved channel configuration in the expected wind conditions. The increase in bow thruster horsepower of Genesis is approximately 1.8 times that of Voyager while the increase in propulsion horsepower is approximately 1.4 times that of Voyager. This compares with an increase in displacement tonnage between the two classes of approximately 1.7, an increase in side wind sail area of 1.4, and an increase in LOA of about 1.2. An additional design feature of the Genesis class is that the vessel has three azipods as opposed to the Voyager and Freedom which have two azipods and one fixipod. This means that the third pod cannot be directed in any direction except ahead and astern on Voyager and Freedom. The third pod on Genesis

Mr. Jon Brazee  
June 4, 2008  
Section 203 Feasibility Study  
Page 4

can be directed in any direction thus providing the ability to provide greater thrust in a desired direction during maneuvering.

For these reasons we believe that the improvements needed to handle the Freedom class are also adequate for the larger Genesis class. In summary, the Freedom class is a longer version of the Voyager class with the same propulsion horsepower but with a significant increase in length, displacement, and sail area. The navigation improvements recommended by the Feasibility Study provide the increased dimensions needed to handle the Freedom class. The Genesis class is even larger than Freedom but has significant increases in propulsion horsepower, thruster power, and an improved pod arrangement. We believe the recommended improvements would also allow for the Genesis class to be handled safely at Port Canaveral and our participation in simulating the Genesis class confirmed this opinion.

In regards to the dredging improvements we are in agreement that the requested increases to the project depths in the channels and turning basins are necessary and should not be reduced. The 1422 foot turning circle in the Middle Turning Basin is needed for the maneuvering of tankers in and out of the berths at North 1 and 2. The increases in project depths for the channels and the Middle Turning Basin are needed to support the tanker terminal project as well as to minimize surge to moored vessels by transiting vessels. Our pilot guidelines require a minimum of 2' 06" under the keel when a vessel is underway in the channels and basins. These increases in project depths will provide the ability for deep draft vessels to transit the harbor without tide restrictions that currently exist. This is especially important as the port generates increased cruise ship and tanker traffic that is already under contract. This is even more important to provide for the delivery of critical fuel supplies in the event of hurricanes or other national emergencies, especially in light of the fact that one of the reasons the new terminal is being constructed is as a result of a direct call by government officials for additional fuel facilities in Florida to be available in case of emergencies.

Finally, we would like to give our support once again to the installation of ranges for vessels navigating outbound Port Canaveral through the West Access Channel, Inner Reach, and Middle Reach. We have been recommending and requesting the installation of these ranges since 1996 and feel very strongly that outbound ranges would provide a needed increased safety margin especially as the size and number of vessels transiting the harbor increases.

The Canaveral Pilots Association strongly recommends that the navigation improvements proposed in this Feasibility Study be funded and implemented in their entirety. Port Canaveral will soon be home to a Freedom class cruise ship, a class that is currently the

Mr. Jon Brazee  
June 4, 2008  
Section 203 Feasibility Study  
Page 5

largest in the world. Over the next four years the port will see an increase in the number of cruise ships home ported here that are similar in size to the Freedom class. Additionally, the port will see a significant increase in large, deep draft tanker traffic as the new tanker facility comes on line in the near future. We are keenly aware that these navigation improvements must compete for budgetary approval in an increasingly competitive environment. Accordingly, we have very carefully considered our recommendations so as not to include frivolous or unnecessary improvements. The comments we provide in this letter as well as those provided on the simulation evaluation forms are what we consider necessary to provide for safe navigation at Port Canaveral for ships that have already been firmly contracted by the Port Authority. In short, these are not visionary improvements looking toward some abstract point in the future with the hope that ships will come, but rather are improvements necessary to support ships that are already coming in the very near future.

Sincerely,



Captain Richard Grimison  
Co-Chairman  
Canaveral Pilots Association

Cc: J. Stan Payne, CEO, CPA  
Capt. Steve Gasecki, Co-Chairman  
All pilots  
File

---

---

# Port Canaveral Berth Access Project



---

---

## FINAL REPORT

Prepared For:  
Gee & Jenson / CH2M Hill  
730 Mullet Road, Unit A  
Cape Canaveral, Florida 32920

Prepared By:  
RTMSTAR Center  
2 West Dixie Highway  
Dania Beach, Florida 33004



Ft. Lauderdale, FL  
Toledo, OH

RTM CENTER for ADVANCED  
MARITIME OFFICERS TRAINING



# STAR Center



SIMULATION, TRAINING, ASSESSMENT & RESEARCH

7 May 2003

Mr. Gary Ledford  
Vice President, Regional Manager  
Gee & Jenson / CH2M Hill  
730 Mullet Road Unit A  
Cape Canaveral, Florida 32920

Dear Mr. Ledford,

Enclosed is a copy of the Port Canaveral Berth Access Study dated 5 May 2003. Please note, the back cover contains a CD ROM that contains an electronic copy of the Summary Report narrative in .PDF format, and Excel files containing all recorded parameter log numerical data collected by Run number. It has been a pleasure working with you, and especially Ms. Sandra Rice, and of course, the Port Canaveral Harbor Pilots, on this project. I hope our combined efforts yielded all the data necessary for your project, and hope that RTM STAR Center can provide our services in any future projects.

Professionally yours,

Howard Straub  
Research Coordinator



The STAR Center and CAMOT admits students of any race, color, national and ethnic origin or sex.  
2 West Dixie Highway \* Dania Beach, Florida 33004

TEL (954) 921-7254 \* (800) 445-4522 \* FAX (954) 920-4268 \*(800) 431-8815

Website: [www.star-center.com](http://www.star-center.com) \* email: [email@star-center.com](mailto:email@star-center.com)





5 May 2003

## **Summary Report**

### **Port Canaveral Berth Access Simulation Study**

#### **INTRODUCTION**

This report describes a shiphandling simulator study that evaluated the operation of the “VOYAGER OF THE SEAS” class passenger vessel (“VOYAGER Class”) arriving and departing at Port Canaveral. The tests were conducted at the RTM STAR Center in Dania Beach, Florida using a state of the art Full Mission Bridge simulator with a 360° horizontal field-of-view. The objectives of the test were threefold:

- 1) Evaluate the operability of the “VOYAGER Class” passenger vessel under existing channel configuration and moderate to high wind conditions.
- 2) Evaluate the operability of the “VOYAGER Class” passenger vessel under the same wind conditions, with waterway improvements that include dredging shoal areas outside the channel boundary at up to six different locations along the Inner Reach and West Access Channel of Port Canaveral.
- 3) Evaluate the operability of the “VOYAGER Class” passenger vessel with the improvements mentioned in number (2) above. In addition, with widening of the navigational channel along the inner harbor channel to 500 feet from Inner Reach to West Basin. Also, increasing the width of the channel accessing West Turning Basin by removing the landmass in the southeast corner of the West Turning Basin and construction of an outbound channel range.

#### **OVERVIEW OF THE SIMULATION PROGRAM**

The on-line simulation consisted of a series of inbound and outbound transits in Port Canaveral where participants, conned (directed) the simulated ship from the wheelhouse. The participants included Port Canaveral Pilots and a shipmaster from Royal Caribbean Cruise International (RCI) with expertise in the operation of the “VOYAGER OF THE SEAS” class vessel. The simulator provided a realistic computer generated image (CGI) out-the-window view of Port Canaveral. Each simulated transit was evaluated by the participating mariners and RTM STAR Center’s staff. It required three (3) days to complete the on-line testing which was conducted in February 2003.

### ***Participants***

The subjects included four (4) Port Canaveral Pilots and a vessel Master from Royal Caribbean International (RCI). The Pilots participated in the majority of the simulation runs with the RCI Master performing a very limited number of runs for demonstration purposes. The shipmaster served primarily as an advisor to discuss the use of the azipod-fixipod propulsion system and to demonstrate its use where necessary.

Representatives of the engineering firm of Gee & Jenson observed most of the simulation exercises and represented the Canaveral Port Authority during this study. Gee & Jenson's representative provided valuable insight into the project details and design rationale.

Members of the STAR Center's Research staff observed all simulated transits, noted results and conducted debriefings after each exercise. STAR Center provided an experienced helmsman to execute the orders to the helm.

### ***Simulator Bridge***

The wheelhouse of the full-mission shiphandling simulator represents the bridge of a large passenger cruise vessel. The STAR Center's simulator bridge is equipped with the Litton-Sperry Marine Vision Technology Integrated Bridge System (IBS), which is the identical equipment on the bridge of all the "VOYAGER Class" passenger vessels. The equipment suite on the bridge is representative of that found on today's cruise ships, and includes the controls and indicators suitable to the type of main propulsion, e.g. conventional propeller-rudder systems or multiple azipod systems with or without fixipods. The use of the "VOYAGER Class" ship response model required that indicators and controls for two (2) outboard azipods and a centerline fixed pod ("fixipod") be configured on the simulator bridge.

Two (2) control consoles are provided in the wheelhouse:

- One for operations in the at-sea mode; the podded propulsion units are operated using RPM control throttles but rely on a helmsman to control the direction of the azipod units in tandem in the conventional steering mode.
- A second bridge wing console for low speed maneuvering and berthing; the controls permit the Master or Pilot to take direct control of both steering and speed by providing directional and RPM control of each azipod in a single unit, with the fixipod controlled by a separate RPM throttle. Bow thruster controls are included on this console. Other modes of operation from this console provide for a computer-controlled integration of all directional and speed controls, or combinations of directional units into a single mini-wheel.

The control instrumentation is augmented by various displays and indicators showing wind velocity, Doppler speed display of ground and water track, depth under keel display, heading, time, azipod angle and power usage, among other information. The integrated bridge console includes standard ship's Radar and ARPA units, and a CRT-based display unit repeating many of the indicator outputs, centrally located for viewing by the person at the conn. An electronic charting system (ECDIS) is included in the IBS console showing the Master or Pilot a real-time display of the vessel's position, course, and heading plotted on a chart of the waterway.

The Pilots maneuvered the “VOYAGER Class” vessel utilizing the centerline perspective view for most of the simulation runs. When maneuvering in and around the cruise terminal berth the Pilot would normally take up a position on the bridge wing in order to see clearances between the ship’s side and the pier or mooring dolphin. The simulator operator can quickly alter the observer’s eye-point in the visual scene, providing a perspective from either bridge wing, on demand. This gives the Pilot the ability to maneuver the ship with a realistic visual point-of-view without the need to duplicate the distances and structures of bridge wings. The bridge wing perspective is viewed from the center of the simulator wheelhouse.

### ***Ship Response Mathematical Model***

The “VOYAGER Class” ship response model was utilized for all on-line runs. The vessel’s dimensions and other particulars are presented in Table 1 below.

**TABLE 1 – Particulars of the “VOYAGER Class” Vessel**

Ship Name	<b>Voyager of the Seas</b>
Tonnage	137,276 GRT
Length Overall (LOA)	311.0 m (1,020.1 ft)
Beam	38.6 m (126.6 ft)
Modeled Draft	8.6 m (28.2 ft)
Propulsion Type	Diesel Electric
Propeller Type / Number	Azipods / 2 outboard, Fixed Pod / 1 centerline
Speed, Dead Slow	2.0 knots
Speed, Maximum	23.0 knots
Shaft Horsepower (each pod)	19,713 hp
Bow Thrusters	4 x 4,023 hp
Stern Thrusters	none (2 Azipods)

The “VOYAGER Class” vessel has a pod propulsion arrangement consisting of two rotatable, azimuthing pods (“azipods”) outboard at the stern, and a centerline mounted fixed pod unit (“fixipod”) between the azipods. Pods are shrouded propeller housings. The “VOYAGER Class” vessel is equipped with four (4) bow thrusters. There are no rudders or stern thrusters. The ability to set the movable azipods at the stern into various configurations precludes the need for stern thrusters in this vessel.

The “VOYAGER Class” vessel was selected from RTM STAR Center’s library of ship response mathematical models to represent an entirely new vessel of the same class, the “MARINER OF THE SEAS”, that is expected to begin operations into Port Canaveral late in 2003.

### ***Simulator Geographic Model of Port Canaveral***

A geographic database of Port Canaveral with passenger terminal CT-10 and the proposed channel improvements was prepared based on design drawings and information provided by the port and engineering consultants Gee & Jenson. The cruise ship terminal berth, landmass, cultural features and navigational aids in Port Canaveral and the immediate area were depicted in the model by means of visual, radar, map, and bathymetric databases. These features provide the required navigational and visual references to the shiphandler during the simulation runs.

Important hydrographic features that interact with the ship were modeled in the simulator. These features include waterway depths, channel banks, and current. A current model was used for a small number of runs, representing the maximum northerly setting current during high wind conditions. The maximum value used for this wind-driven current was 0.75 knots coupled with wind from the south at 25 knots or higher. However, because the current, which runs parallel to the coastal shoreline is shielded from the Inner Reach by the jetty, current was not determined to be a significant factor in this study. The water current flow inside the harbor is negligible.

The most significant effects in the simulated runs were wind and the extent of shoal areas along the port's channel boundary as represented in each of the three (3) configurations that were examined in this study (see description below). The wind directions and speeds that would have the largest impact on the transit of large cruise vessels, due to their high wind profile, are beam winds from the north and the south directions.

An accurate representation of environmental and bathymetric conditions is essential for any operational evaluation to be valid. The environmental conditions were selected to replicate the maximum credible, adverse wind conditions that the vessels could experience in this port under normal operations. Wind conditions that provided a marginal degree of maneuvering safety were looked at in order to develop recommendations for transit restrictions when severe winds are present or forecast.

### ***Harbor Channel Configurations***

The channel configurations that were examined in this study included a range of channel widths, dredging of shoal areas at or just outside the channel boundaries, changes to aids to navigation, and a major reconfiguration of the Western Turning Basin.

#### Existing Channel Configuration

The initial runs were conducted with the existing, unimproved channel database. This provided the test subjects with familiarization with the geographic database and visual scene as depicted on the simulator, and with the study vessel itself, with which only one of the subjects (an RCI shipmaster) had previous experience. Simulated exercises in the existing channel were conducted with the moderate and high wind conditions in order to provide a baseline for the subsequent runs in the improved channel configurations. Since the evaluation is concerned primarily with channel improvements to the port's inner harbor, runs that were inbound to the port commenced somewhat before the turn in the Entrance channel in order that the vessel's speed on entering the harbor entrance (at the jetty) would be realistic. The speed of the vessel at the entrance is directly related to the residual speed coming out of the turn and given the limited distance for the Pilot to reduce speed for entering the harbor.

### Configuration A – Near-Term Channel Improvements

The second condition examined is the channel configuration following a proposed dredging project that would remove shoal areas at or in the vicinity of the navigable channel boundary at six (6) locations within Port Canaveral from the Inner Reach to West Basin. These improvements were recommended by the Canaveral Pilot Association with the objective of enabling a transiting cruise vessel to pass vessels along the waterway and adjacent to the channel at a greater distance, and reducing the effects of surging on those vessels. The surge effects are a result of the movement of large cruise vessels into the port at transit speeds that may be necessary for steering control under the various environmental conditions that are encountered.

**Figure 1 – Near-Term Dredging Projects in Port Canaveral**

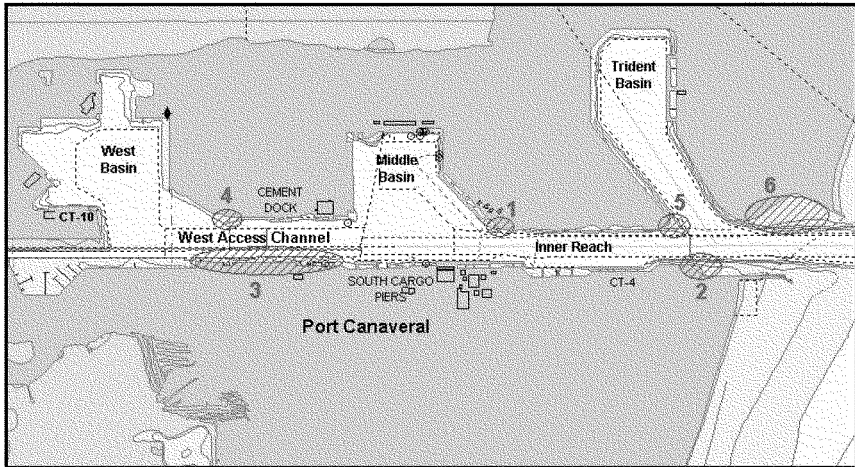

Dredging at locations (2), (5) and (6) will provide an additional safety margin for large cruise ships entering the port and carrying a “crab angle”<sup>1</sup> to compensate for any crosswind condition, and particularly with a northerly beam wind. The removal of shoal areas near the channel boundary will permit the vessel to keep to the north side of the Inner Reach, and to reduce speed on approaching the Trident Basin, which in turn will help to reduce surge effects. The resulting increase in the volume of the channel due to dredging these areas may be expected to have a further damping effect on surge because the water “slug” pushed ahead of the vessel and following the vessel as it transits the waterway will have a greater area in which to flow.

Dredging at the southeast corner of Middle Basin at area (1) will permit the inbound transiting ship to turn up early into the opening at Middle Basin, providing additional clearance to the vessels berthed at the south cargo piers. The vessel would be able to carry a substantial “crab angle” at this point, which represents the most constricted part of the channel. The larger “crab

<sup>1</sup> Crab angle or drift angle. Difference between the course steered and course made good usually caused by current or wind.

angle” for leeway is the tradeoff for transiting at a reduced speed with high crosswinds for these vessels with large sail areas.

Dredging in the harbor at locations on the north and south boundaries near West Basin (areas (3) and (4) in Figure 1), has the additional goal of making the turn into West Basin (where the destination berth, CT-10 is located) easier for ships the length of the “VOYAGER Class”: 311.0 m (1,020.1 ft).

The dredging at locations (3) and (4) respectively, would facilitate egress and ingress to West Turning Basin by:

- enabling the cruise ship to carry a larger “crab angle” for leeway in high wind conditions; it permits the stern of the cruise vessel to pass closer to the southern boundary of the channel with a greater margin of safety when transiting inbound, and
- enabling the ship to “flatten” its turn slightly into, or out of, the West Basin by passing closer to the corner on the north side of the West Access Channel, west of the cement dock.

This project will require the removal and/or relocation of navigation aids on both sides of the channel where the dredging is performed. The bathymetric database used to test this configuration represents the underwater conditions that would result from the proposed dredging of shoal areas. The resulting impact on the hydrodynamic response of the simulated ship model would be apparent to the shiphandler in the reduction of bank effects due to increased clearance between the ship and the shoal areas at the channel boundaries. There were no apparent differences in the visual database between this configuration and the existing port condition, except for the relocation or removal of aids to navigation.

#### Configuration B – Proposed Long-Term Channel Improvements

The final channel configuration that was examined included long-term proposals for improvement of the waterway in Port Canaveral (Figure 2). The changes include:

- dredging and realignment of the shoreline along the north side of the Inner Reach, resulting in the widening of the harbor channel to 500 feet along its entire length to West Basin (area A),
- the widening of West Basin entrance to the eastward by cutting away of the southeast corner and further dredging, providing a broader and flatter entry into the turning basin (area B),
- dredging along the south boundary of the Inner Reach near the port entrance, and of the West Access Channel (West Portion) opposite the West Basin to reduce the shoal area (area C),
- simulation of an outbound channel range to be used for departures, consisting of two (2) range light structures located offshore outside the harbor entrance and aligned with the Inner Reach.

**Figure 2 – Proposed Long-Term Waterway Improvements**

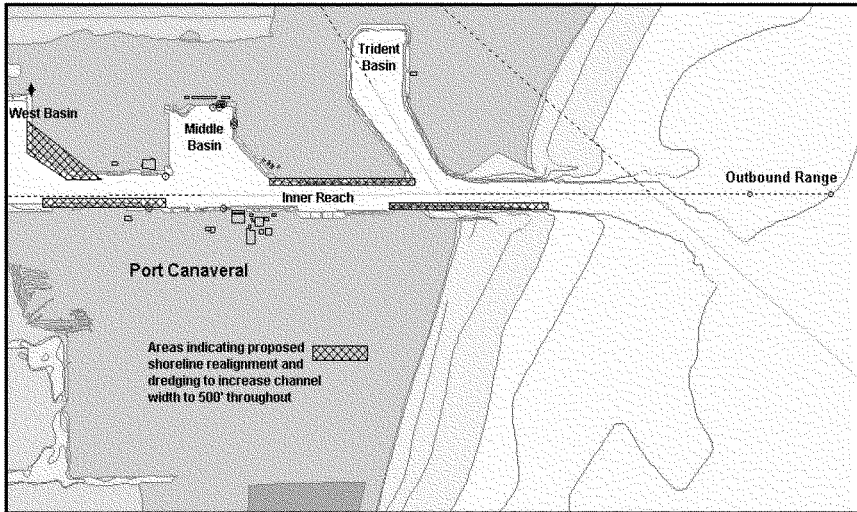

This project requires the removal and/or relocation of navigation aids on both sides of the channel to mark the new boundaries of the navigable channel. The bathymetric database used to test this configuration represents the underwater conditions that would result from the proposed dredging of shoal areas and widening of the navigation channel. These changes would be apparent to the shiphandler in the reduction of bank effects due to increased clearance between the ship and the shoal areas at the channel boundaries. The visual database was modified to show the surface realignment of the bounding landmass and the widening of the West Basin opening.

### ***Wind Modeling***

Wind forces were incorporated into the scenarios to demonstrate a realistic effect on the “VOYAGER Class” ship response model during the simulated maneuvers. Wind forces are calculated based on the instantaneous wind velocity relative to the ship’s speed and heading, using the aerodynamic coefficients that represent the model’s wind profile. The conditions that were tested in this study included moderate wind (15 knots) and high wind conditions (25 knots and higher) from either of two directions, north and south. The channel inside Port Canaveral runs due east and west, therefore these represented both the average and the worst credible cases of actual wind conditions acting on the beam that might impact on transits of large cruise ships in the port, based on the participating Pilots’ experiences. It was determined from discussions with the Pilots that winds from other directions would not have a significant impact on harbor transits.

The wind forces during the study were observed by the Pilots to be realistic. The Pilots stated that the wind direction having the most effect on vessel maneuvers in the harbor would be a southerly wind, due to the necessity of tracking along the south side of the channel to allow for leeway. The south side is where most of the vessel berths are located along the channel bringing the transiting ship in close proximity with the moored vessels.

The following crosswind conditions were simulated for inbound and outbound transits of the “VOYAGER Class” vessel:

<u>from the North</u>	<u>from the South</u>
15 knots	15 knots
25 knots	25 knots
40 knots	30 knots
- -	35 knots

The 25-knot wind condition was the most frequently used, representing usual conditions that might be expected during the passage of squalls. Winds of 30 and 35 knots were examined to try to identify the upper limits at which the transit of the harbor would be marginally safe under existing and improved channel configurations. The 40-knot wind condition was only used to determine whether the “VOYAGER Class” vessel could be safely moved off the berth and whether there was reserve power under those conditions.

### ***Testing Procedures***

The general test program was based on requirements put forward by Gee & Jenson / CH2M Hill, representing the Port Authority of Port Canaveral. After STAR Center reviewed the test program requirements, scenarios were generated to replicate moderate and credible worst case scenarios, concentrating primarily on wind conditions as the major factor. Bathymetric data / design criteria for the dredging projects and other channel improvements were provided by Gee & Jenson. This information was used to develop the geographic, hydrographic, and visual databases used during the simulation program representing test conditions other than the existing channel condition (for which the databases were already available).

The on-line runs evaluated inbound and outbound operation of the “VOYAGER Class” vessel under the command of a Port Canaveral Pilot. Most inbound runs that examined the transit of the Inner Reach began seaward of buoy “7”, or in the turn of the entrance channel, approaching buoy “9”. While several of these runs ended alongside the berth at cruise terminal CT-10 in the West Basin, most were stopped short of the berth or just before completing the turnaround of the ship off the berth to save time.

Several runs were begun in the West Access Channel approaching the cement dock, in order to permit the subject to turn the vessel around and back into the berth. Since the docking and turning of the ship in West Basin was not a primary objective of this study, the number of runs that proceeded all the way to the berth was reduced.

The outbound runs began alongside the dock at CT-10, and continued until the ship was abreast of the entrance jetty or in the entrance channel. Table 2 is a list of exercises, conducted during the test program. This table shows the key variables that define each scenario, Run Number, Transit Direction, Start Position, Test Subject ID, Current Condition, Wind Condition, and Comments.



**Table 2 – Project Run Matrix**

Run No.	Transit Direction	Start Position	Test Subj	Current	Wind	Comments
<b>Day 1 (2/12/03) – Existing conditions database –</b>						
1	I/B	Buoys 7&8	P2	0	0	Database validation and familiarization with visuals, ship response model and Pod propulsion controls
2	I/B	Buoys 7&8	P5	0	N 15	
3	I/B	Inner Reach	P4	0	N 25	
4	I/B	Buoys 7&8	P3	N 0.75	S 25	
5	I/B	Buoys 9&10	P1	N 0.75	S 35	
6	O/B	CT-10 Berth	P2	0	N 25	
<b>Day 2 (2/13/03) – Modification A database – Pilot Recommended Improvements</b>						
7	I/B	Buoys 9&10	P5	0	N 15	
8	I/B	Buoys 9&10	P3	0	N 25	
9	I/B	Buoys 9&10	P1	0	S 15	
10	I/B	Buoys 9&10	P2	N 0.5	S 25	
11	I/B	Buoy 13	P2	0	S 25	OBJECTIVE: Tests of azipod positions for high wind trackkeeping in channel
12	I/B	Buoy 13	P2	0	S 25	
13	I/B	Buoys 9&10	P5	0	S 15	OBJECTIVE: maintain 5 kn. speed during harbor transit
14	O/B	CT-10 Berth	P3	0	S 25	
15	O/B	CT-10 Berth	P1	0	N 25	
16	I/B	Inner Reach	P2	0	S 25	
17	I/B	Inner Reach	P5	0	N 25	
18	O/B	CT-10 Berth	P4/P2	0	N 40	OBJECTIVE: lift vessel off berth in 40 kn wind; Master turns over to Pilot after leaving the berth
<b>Day 3 (2/14/03) – Modification B database – Future Port Enhancements</b>						
19	I/B	Buoys 9&10	P3	0	S 25	
20	O/B	CT-10 Berth	P1	0	S 25	
21	I/B	Buoys 9&10	P2	0	S 30	
22	O/B	CT-10 Berth	P3	0	S 30	
23	I/B	Buoys 9&10	P1	0	N 15	
<b>Day 3 (2/14/03) – Reload Existing Conditions Database</b>						
24	I/B	Buoys 9&10	P2	0	N 25	
25	I/B	Buoys 9&10	P3	0	S 15	
26	O/B	CT-10 Berth	P1	0	S 25	
27	O/B	CT-10 Berth	P2	0	N 15	

A total of 27 simulated transits were conducted at the STAR Center in Dania Beach, Florida over a three-day period. The Full Mission Bridge Simulator, which provides a 360° degree field-of-view from the wheelhouse, was used for the Port Canaveral simulation study. Four (4) Pilots, each with many years of experience handling vessels in Port Canaveral, were participants in the study. In addition, an RCI Master who has significant expertise aboard the “VOYAGER Class” cruise vessel, participated to the extent that he coached the Pilots in the use of the azipod-fixipod propulsion system, and demonstrated on several runs various configurations of the azipods for the most effective maneuvers.

As the Run Matrix in Table 2 shows, the exercises are grouped into four sessions over the three days where the geographic database was the constant in the session. In each session, both inbound and outbound transits were made, while varying the wind condition between runs. The simulation exercises were monitored by a representative from the engineering firm of Gee & Jenson on behalf of the Port Canaveral Authority, and also by STAR Center personnel who made direct observations from the simulator wheelhouse.

For each simulator run the ship response model was initialized at its starting location with a channel position, speed, and heading that was appropriate to the simulated wind and current conditions, as well as the Pilot’s preferences based on procedures used for maneuvering large passenger ships at the port. There were three locations for initializing inbound transits depending on the objective of the particular run:

- approaching the turn in the entrance channel from one to several ship-lengths seaward of buoy “9”,
- after the turn approaching the jetty entrance (abeam buoy “12”),
- approaching the West Basin (abeam the cement dock).

Outbound runs were made from the passenger ship berth, CT-10 in the West Basin. A total of eight (8) outbound runs were made and the vessel was situated starboard side to alongside the berth (bow out) for all but one (1) of those runs. The single port side undocking was conducted in order to evaluate backing out of the berth and turning the vessel around in the basin on departure, although normal procedures would never leave the ship in this position except in an emergency or unusual circumstances according to the participants.

An individual Pilot conned the vessel with one of the other participants performing duties of the ship’s Watch Officer, such as control of the throttles or providing information from the radar display on demand. A competent Helmsman was provided to steer the vessel. The vessel was operated in two modes during the simulation exercises:

- 1) Harbor Transit: While inbound or outbound in the harbor channel, the Pilot issued verbal helm and throttle (or specific ship speed) orders which were executed by a Helmsman and a Watch Officer, respectively. In this mode the azipods operated in tandem for directional control and the vessel was steered by the Helmsman from a steering stand in the same manner as a conventional ship with rudders. Throttles for the azipods and the single fixipod could be operated individually or joined together, at the option of the Pilot. The Pilot either operated the throttles himself, or issued verbal

commands to the Watch Officer to control the throttles separately as would be done on a conventional twin-screw vessel.

- 2) Low Speed Maneuvers: When the ship entered the West Basin (inbound), or until the ship turned into the channel from the basin (outbound), the Pilot assumed direct control of both steering and propulsion (taking over steering from the Helmsman). In this direct mode each azipod unit could be individually controlled in both azimuth and RPM, and the fixipod could be controlled in RPM by its own dedicated throttle control. This control mode is manifested in a special bridge wing console from which the Pilot or shipmaster would have direct control of the ship during low speed maneuvers and docking/undocking. The Pilot might control the bow thrusters, or might issue commands to the Watch Officer to do so.

Each run was terminated when the objectives were met, and the ship was in a stable position.

### ***Data Collection***

The procedures that were followed for the on-line simulation section of this evaluation remained consistent throughout the study. These procedures include a briefing of the participants before each exercise commences regarding environmental conditions, the ship's status and location, the channel configuration being examined, and the run's objectives or destination. Extensive data collection takes place throughout the on-line simulator sessions (as described below), and a final debriefing is held at the conclusion of the program. These procedures insure the complete gathering of real-time man-in-the-loop simulation data required for later analysis.

The simulator automatically records information during each simulation run, such as the vessel's trajectory, speed, heading, information relating to control settings, and forces acting on the vessel. This data is used to generate a track plot for each of the runs which shows the vessel's (Ownship's) position with respect to the navigation channel, landmass, and other vessels throughout the exercise.

The Pilot or Master who has the conn of the simulated vessel during a run is asked to complete a post-run evaluation form immediately following the exercise. This form asks the participant to provide his/her evaluation of the just-completed run, using a 5 point scoring system to record performance items such as:

- adherence to the intended track line,
- vessel controllability,
- assessment of overall safety of the task,
- task difficulty, and
- level of stress generated by the exercise.

The responses from these forms are considered in the final analysis of the simulated transits.

The participating mariners are asked to summarize their opinions and comments in a "Final Evaluation Form" after all simulator testing had been completed. The comments extracted from these forms are used in the formulation of the conclusions and recommendations appearing in this report.

The RTM STAR Center's project team observes the runs and keeps observational notes regarding the action of the Pilot or Master who has the conn during each exercise, and records any comments that may provide insight into the participants' strategies or performance. These notes often provide useful information that may influence the interpretation of results. The combination of the track plots, recorded numerical data, questionnaires, and observer notes enable a comprehensive analysis of the simulator exercises to be performed.

## **SIMULATION RESULTS**

For ease of discussion, the results are presented in the following logical segments:

- Existing Channel Configuration
- Configuration A – Near-Term Channel Improvements
- Configuration B – Proposed Long-Term Channel Improvements (Assumes near-term channel improvements are accomplished)

Before discussing the results, a few statements about Pilot intentions, normal procedures and strategies should be discussed. The worst wind conditions were examined: crosswinds from either the north or south direction.

The consensus among the participants was that a southerly wind is worse than a northerly wind at the same speed. This is due to the fact that most of the vessels at berths along the channel in Port Canaveral would be moored on the south side, and the entering or departing ship would hug the south boundary of the channel to the extent possible, to allow for being set across the channel by the wind. In addition, this tactic is to insure that the stern of the vessel tracks in safe water, and the Pilot tries to keep the vessel's stern tracking along the channel centerline. As a result, when high crosswinds are present, due to the large wind profile of these cruise ships, the preferred track is on the windward side of the channel. With a southerly wind, this places the transiting ship very close to the moored ships along the south side of the channel between the jetty entrance and the West Basin. The "crab angle" that is carried due to the wind has the net effect of greatly increasing the ship's beam, and the fact that the Pilot's viewing point is so far forward (nearly over the bow) on a vessel that exceeds 1000 feet in length, means that it is very difficult to judge where the stern is at all times.

The problem of surging is a significant safety issue at Port Canaveral. Surging of the moored vessels along the channel results from the large underwater profile of the cruise ship and the water it displaces in a narrow channel. The approach of the vessel pushes ahead of it a pressure wave of water. A second flow of water follows behind the ship as it passes along the channel. Pressure differences created by venturi effects between the transiting ship and the moored ship may cause the vessel in the berth to be pulled off the dock and then pushed back, while pressure waves preceding the transiting ship may move the berthed vessel longitudinally along the dock. If these effects are not minimized and/or the moored ships' lines are not properly tended, the mooring lines may part and the ship may move into the channel. All of these effects are exacerbated by the speed of the transiting ships and the distance off the moored ship when passing alongside.

Considering the “crab angle” (which is the difference between the ship’s heading and the course made good) and its impact on the effective breadth of the transiting ship as it moves down a narrow channel, the amount of the “crab angle” is directly related to the wind velocity and inversely related to the ship’s speed through the water. The Pilot must balance the need to keep the forward speed of the ship low to reduce the surge effect, but must retain good steering control. The “crab angle” in a high wind will increase as the vessel’s speed is reduced, with the result of reducing the clearance at which the transiting ship may pass ships at berth and shoal areas along the channel boundary.

### ***Tactics***

Position in the channel: In the effort to keep the vessels’ stern in the middle of the channel (to protect the propellers), the Pilot directed the ship along the windward side of the channel in a strong crosswind during these exercises. In doing so, the ship’s bow will track along the channel boundary while the stern tracks along or near the channel centerline.

When the wind is from the north, and in order to obtain more clearance from vessels berthed on the south side of the channel at the South Cargo Piers, the Pilot will often direct the transiting ship up into the opening of the Middle Basin, essentially tracking along the north boundary of the channel until past Middle Basin because there is no shoal water to be concerned with in the opening on that side. It was observed that this tactic was also employed occasionally when the wind was 25 knots or greater from the south, though once past Middle Basin the Pilot quickly moved the vessel to the south, or windward side of the channel again. The narrower opening of the Trident Basin was used in the same manner with northerly winds of 25 knots, though not as often. The primary reason for this tactic when abreast of Middle Basin is because the Inner Reach becomes narrower at the South Cargo Piers as the southern channel boundary shifts somewhat to the north. This is the most constricted part of the channel.

Speed during transit: It was observed that on inbound transits, the speed of the “VOYAGER Class” vessel could be reduced rapidly from about 9 knots at the harbor entrance abeam the jetty, down to 7 knots or less when passing the cruise ship berthed at CT-4. The target speed (based on Pilots’ statements) of 6 knots is to be achieved by the time the ship is abeam Middle Basin and the South Cargo Piers, however the speed was usually at 6 knots or below upon passing the Navy pier. With the exception of the first day’s runs (see explanation next section) the Pilots had little difficulty keeping the transit speed at 6 knots or below during most of the inner harbor transit.

When outbound in the channel from the berth, the vessel was capable of quickly increasing speed to a safe transit speed of about 6 knots. This speed, or a little less depending on the wind condition, was maintained until abeam of the Navy pier, outbound, at which time the Pilot began increasing speed. By the time the vessel was out of the harbor and in the entrance channel the ship was making 10 knots or better.

### ***Existing Channel Configuration***

Transits into and out of Port Canaveral were conducted in the existing channel database on the first and last days of this program. No groundings, collisions, allisions, or other mishaps were observed during these exercises.

The initial runs that were conducted on the first day in the existing channel were not typical of a transit of a very large passenger vessel. The first few runs were used as familiarization for the participants with the visual database, and the simulated ship's response to wind, current, and control forces. Subsequent runs on the first day exhibited the Pilots' unfamiliarity with the azipod-fixipod configurations that are available with the "VOYAGER Class" vessel, and these runs represented a true learning experience. It should be noted that most of the cruise ships entering port are operated under the control of the ship's Master who has the most expertise with the peculiarities of the ship and its propulsion and steering. Due to the Pilots' unfamiliarity with this class of ship, the simulated transits, though conducted without incident, were made at a somewhat higher speed over the ground than would be considered safe, particularly in view of the number of moored vessels that occupied the berths alongside the inner channel of the port.

The stated optimum speed for transit of the harbor with the number of moored ships that were simulated in these exercises is about 6 knots (maximum), in order to minimize the surge effects that can pull a ship off a dock and part its mooring lines. By their own admission in the final evaluation comments, the Pilots failed to maintain a safe speed on a number of these initial runs. The reason for this was the unfamiliarity with the best configuration of the propulsion units necessary to stabilize the vessel under the simulated high wind conditions. As a result, higher than normal speeds were used at a number of locations in the channel to control the ship's head and to minimize the "crab angle" that would be carried to compensate for leeway under the crosswind conditions that were experienced.

On the third day of the on-line simulation sessions the existing channel configuration was revisited. As a result of their acquired experience with the vessel's handling characteristics and control equipment at this time, the Pilots were able maintain transit speeds that were within the desired criteria for a safe transit with minimum damage potential. When the "VOYAGER Class" passenger vessel maintained a 6-knot speed in the channel, "crab angles" of 2.5° to 3° were observed with 15 knots of wind, and 4.5° with wind at 25 knots. Minimal clearances to some of the berthed vessels would likely have resulted in undesirable surging effects.

Runs conducted into the turning basin (West Basin) and requiring the vessel to turn around and back into the berth at CT-10 were for the most part uneventful under all wind conditions (north 15 and 25 knots; south 15, 25 and 35 knots). During the single inbound run on Day 1 using a 35-knot wind condition, the Pilot experienced difficulty using the azipod controls and as a result the transit speed for this run was unrealistically high.

Outbound runs from the berth were problematic at the point of turning from the West Basin into the West Access Channel. When the wind was northerly there was a tendency to cut the southeast corner of the basin rather closely in an effort to track down the windward or north boundary of the channel. This was particularly the case with winds of 25 knots out of the north. The dredging proposed at the southeast corner under Configuration A condition would facilitate cutting this corner under these conditions.

Little difficulty was observed with southerly winds when leaving the West Basin. The vessel was eased over to the south (windward) side of the channel, and maintained position along the

southern half of the channel throughout, though this brought the ship in close proximity with the moored vessels along the southern edge. The transit speed was kept to 6 knots or less outbound until the ship passed the Navy pier, after which the Pilot began to increase speed.

A single undocking and departure was attempted with winds of 40 knots from the north. The objective was to see if the “VOYAGER Class” passenger vessel had the power to lift off the berth in such winds. The RCI Master handled the undocking, turning over the conn to one of the Pilots once the vessel was clear of the berth. The undocking operation was marginal as the ship was slowly lifted clear of the berth, but bow thrusters had to be used at maximum power for the operation with no reserve. The outbound transit under the 40-knot north wind condition was made at excessive speeds, nearly 9 knots throughout the channel, and with large “crab angles” of 4° to 5°. The Pilot stated that such a transit could only be done safely at high speeds with no moored ships along the channel.

### *Configuration A – Near-Term Channel Improvements (Dredging Projects)*

The Pilots made full use of nearly all the areas that were dredged, defining this channel configuration, refer to Figure 1. They were pleased with the results and with their performance. In using all of the areas they were able to maintain good clearances to berthed ships, and to the shoal areas outside of the channel when the environmental conditions required operation of the ship along the edge of the channel. The dredged areas permitted the following modifications to the normal transit, which had been exhibited under existing conditions of the channel:

- Carrying a larger “crab angle” in some locations along the channel and maintaining a slightly lower transit speed under high wind conditions.
- Maintaining a greater distance to some of the moored vessels by enabling the transiting vessel to track further along the opposite channel boundary because shoal areas were removed in locations (1), (5) and (6).
- Turning sooner into the West Basin because of dredging applied to the east corner at location (4). This allowed the vessel to be held further on the north side under north wind conditions, enabled the Pilot to make a “flatter” or more gradual turn into the West Basin, and also meant that the stern had greater clearance when turning into the basin due to dredging at location (3).

The dredging projects simulated under this configuration permitted the ship to remain on the north side of the channel longer, making good use of the basin entrance at the West Basin and to a lesser extent, the narrower Trident Basin, where removal of shoal areas at the entrance was performed. This permitted greater clearances to be maintained toward the vessels at the South Cargo Piers.

In 30-knot wind conditions, “crab angles” of 7° to 8° were observed while maintaining a transit speed of 6 knots or less in the Inner Reach. Under these wind speeds, a “comfortable” transit speed for the vessel was achieved at about 6.2 knots, with a corresponding “crab angle” of 6°. Adequate clearance to moored vessels was achieved by utilizing the extra channel width that was afforded due to the dredging outside the channel boundary; the stern was kept in good water even though it was tracking along the channel edge rather than the centerline.

One run was conducted with the objective of trying to maintain an inner harbor transit speed of 5 knots or less. This was accomplished successfully, however the trade-off was a “crab angle” of 4.5° in order to maintain the speed at a maximum of 5 knots in the channel with a south wind of only 15 knots. The Pilot made good use of the dredged areas to keep the stern in safe water and to maintain good clearances between shoals and berthed vessels. Distance to moored vessels was somewhat close in some instances, but was compensated by a reduced transit speed, so that the surge effect should have been no greater than usual.

Similar tactics and performance were noted for both inbound and outbound transits. No groundings, collisions, allisions, or other mishaps were observed during these exercises under this channel configuration. Pilot comments during these runs indicated that the proposed dredging was having the desired effect on their performance with the “VOYAGER Class” passenger vessel, and that it enhanced the safety of navigation, particularly with wind speeds of 25 knots and higher acting across the channel.

### ***Configuration B – Long-Term Proposed Channel Improvements***

The waterway improvements that were simulated in this configuration condition provided a further margin of safety for the transit of large passenger ships such as the “VOYAGER Class” response model that was used in this program. Further widening of the navigation channel to a uniform width of 500 feet provides for greater clearances to moored vessels and can be expected to have a significant impact on the reduction of surging effects caused by large ships in transit. The additional width along the channel would permit the Pilot to maintain higher “crab angles” and thus keep the transit speed to the 6 knots and below considered optimum for both safety and controllability under a wide range of environmental conditions.

Channel Widening along Inner Reach: Although the navigation channel still shifts 50 feet northward under this configuration, the cutting away and realignment of the shoreline between the Trident Basin and Middle Basin, allowing a full 500 feet of channel width, eliminates the constriction that currently governs the tactics employed in transiting the Inner Reach. This part of the future enhancement will improve trackkeeping under conditions of northerly cross-channel winds, where the Pilot utilizes the northern edge of the channel during transits, to allow for leeway.

Channel Widening in the West Access Channel: The dredging along the south side of the West Access Channel provides a greater margin of safety for turning a large passenger vessel into and out of the basin. The proposed 500 foot wide channel, through the West access channel area, will formally adopt the Southern dredge boundary as the new channel’s Southern boundary, and relocate the Northern boundary approximately 12.5 feet North of the existing channel’s Northern boundary. The increased width at the south side of this section of the channel, may allow the stern to swing along the channel’s southern boundary with more confidence while turning the ship into the West Basin, because of the greater clearance to shallow water, and to moored vessels as well. It will likely have less impact on departures from West Basin because it was observed that the Pilot will generally hold the track closer to the north side (current location of buoy “18”) on exiting. The “crab angle” necessary in high crosswinds is minimized on departures because the ship is increasing speed, which results in improved steering control.



Cutoff of the Eastern Corner of West Basin: It was observed that the removal of land and the widening of the West Basin entrance west of the cement dock had little impact on the tactics employed to enter the turning basin and turn the ship around for berthing. The dredging that was performed under the previous configuration (Configuration A) had provided some relief from the sharp turn required into West Basin. The track plots from runs conducted with Configuration B, where the West Basin opening is significantly widened, show no difference from the previous day's runs with regard to how the ship entered the basin during inbound transits. However, on departures where the wind was from the north, the Pilot often utilized the additional maneuvering room afforded by this modification to "flatten" the turn out of West Basin and to align the ship on the northern side of the channel for the outbound run.

Outbound Range Lights: The Pilots expressed a need for the establishment of a steering range on the Inner Reach for outbound transits. This enhancement to the waterway was examined as part of the long-term future improvements condition. The range was embraced by the Pilots as essential for track keeping, especially for night departures, based on comments from the Final Evaluation questionnaire.

## **SUMMARY OF MAIN CONCLUSIONS AND RECOMMENDATIONS**

This section will summarize the observations and recorded performance under each channel configuration examined during the study. In addition, it includes the comments and recommendations attributed to the Pilots who participated in the study.

### ***Existing Channel Conditions***

There is a general consensus that the "VOYAGER Class" passenger vessel can transit the waterway safely under the existing channel configuration, so long as winds are moderate, or if somewhat higher winds are present, then the winds at least are not blowing across the channel. High crosswinds will have a significant impact on the passage of a large passenger ship (in excess of 1000 feet LOA), due to the combined requirement to maintain a safe speed while minimizing the amount of channel width taken up by the vessel during its passage. High crosswind conditions can be tolerated by the "VOYAGER Class" passenger vessel, however the tradeoff between the "crab angle" carried, transit speed, and the problem of minimizing surge effects on moored vessels in the harbor is such that only a wider channel will alleviate the problem.

The responses of the participants to the Final Evaluation questionnaire can be summarized by the statement that under existing channel conditions, transits by the "VOYAGER Class" passenger vessel are deemed only marginally safe where crosswinds are somewhat greater than 15 knots. This is influenced by the presence of ships moored at berths along the waterway. The margin of safety can only be improved by transiting at a higher speed, with increased incidence of surge effects as the result. Limiting wind conditions for safe harbor transits with the "VOYAGER Class" passenger vessel (for initial planned operations), are in the range of 20 to 25 knots of wind from the north or south direction, for both inbound and outbound transits. These restrictions are expressed in the Final Evaluation made by the participants at the conclusion of the program.

The West Basin as currently configured, is adequate for maneuvering a vessel of the “VOYAGER Class” into and out of the proposed berth at CT-10 during light to moderate wind conditions. The ship itself has exceptional power in the azimuthing propulsion system and bow thrusters. As a consequence, docking and undocking, even under the extreme conditions examined in this study (up to 35 knots of wind), did not pose any significant problems.

### ***Near-Term Channel Improvements – Dredging of Specific Locations***

The Pilots were unanimous in their approval of the conditions simulated in this channel configuration. These improvements consisted of specific dredging projects eliminating shoals outside of the channel boundaries at six (6) locations along the waterway (Figure 1). There is no surprise in the general approval, as these enhancements were recommended by the Canaveral Pilot Association.

Performance under higher wind conditions was improved because the effective widening of the navigation channel, resulting from shoal removal at these locations, facilitated the use of the entire channel and larger “crab angles” are permitted when necessary. As a result, lower transit speeds could be maintained within the limits desired to reduce surging effects on vessels at berths along the waterway. The safety of the vessel entering and leaving the West Basin is considered much improved by the dredging at the southeast corner of the basin’s entrance (west of the cement dock) and along the south boundary of the West Access Channel. In the former case, the vessel’s bow can be positioned higher in the channel and the turn started earlier, while in the latter case, the vessel’s stern is kept in clear water while turning into the basin because the distance to the shoal area has been increased.

The results of the channel dredging examined in this configuration mean that the effective widening of the channel where dredging is contemplated will contribute to the reduction of surge effects.

- Removal of the shoals at the dredging locations, makes transit speed reductions with increased “crab angles” possible. –and-
- The shoal removal results in an increase in channel volume through which the pressure wave caused by the water flow ahead of and following the transiting vessel can move at a reduced velocity, and consequently a reduction of surge effects is possible.

The participants’ recommendations on transit-limiting wind conditions with these channel improvements in place are in the range of 30 to 35 knots from the north or south direction.

### ***Long-Term Channel Improvements – Dredging, Shoreline Removal, and an Outbound Channel Range***

Channel Widening Project: The shoreline realignments combined with the increase in width of the navigation channel to 500 feet over the entire length from the port entrance to West Basin, further enhances the benefits that were achieved by the dredging projects alone, as observed under the Configuration A condition. Tracking of the ship along the north side of the channel

with northerly crosswind conditions will be enhanced, and this in turn provides an additional safe distance when passing abreast of ships moored on the south side of the channel. Under similar high south wind conditions, the vessel may be directed by the Pilot further toward the centerline when passing vessels in berths along the waterway than is currently done because the increased room available at the north boundary of the channel provides an additional margin of safety for the stern when the ship is carrying a significant “crab angle” due to the wind forces acting on it.

These improvements will mitigate, to a large extent, the channel constriction upon approaching the South Cargo Piers, where delicate maneuvering is necessary in order to maintain a safe distance, as well as a safe speed and good channel position to prevent damage to moored vessels. Wind limits for the “VOYAGER Class” passenger vessel operating in Port Canaveral were recommended to be the same as for the channel with the near-term improvements. Winds acting on the beam of these high-profile vessels have a large impact on the ability to control the vessel’s heading in a narrow channel where the transit speed must be restricted for the safety of other vessels. The proposed 500-foot channel will provide greater safety and convenience in an environment of ever larger mega-vessels.

Recommended Operational Restrictions Due to Wind Velocity: While the “VOYAGER Class” passenger vessel is well-equipped and powered to make a safe transit in winds somewhat higher than 35 knots on the beam, it would require traveling at a higher speed than would be acceptable because of the available channel width (even at 500 feet) and the presence of moored vessels along the harbor channel. Therefore, the channel enhancements cannot realistically be expected to produce recommendations for a higher operational wind limit with Configuration B than with Configuration A. Winds of 30 to 35 knots acting on the ship’s beam have been found to be about the upper practical operational limit for these ships in a number of similar studies, because of the relationship between “crab angle” and transit speed which is a common factor in nearly all narrow channel transits. Pilot comments indicate that the ship may make an uneventful transit at a safe and reasonable speed with wind as high as 40 knots, so long as it is acting on the bow or stern where a minimal profile is presented (i.e., west or east wind direction). However, 40 knots of wind would be problematic during docking and undocking maneuvers.

It should be noted that these recommendations on operational limits based on wind velocity should be considered as guidelines for initial operations, subject to further refinement as experience is gained by the Pilots with the actual vessel in the port.

Steering Range for the Outbound Transits of the Inner Reach: The participants were in unanimous agreement on the need for range structures to be positioned outside the port to assist with trackkeeping along the Inner Reach on departure. This enhancement was deemed as essential for night operations. The channel range will be particularly useful for passenger vessels whose conning position is located very near the bow of the vessel. The extreme length of vessels such as the “VOYAGER Class” passenger vessel tested in the study (over 1000 feet LOA), and the large “crab angles” that can be carried in crosswinds above 15 knots, makes for difficult determination of the ship’s actual position in the channel and the amount of clearance of the stern to other vessels, buoys, and shoal areas, particularly at night.

Enlargement of the West Basin Entrance: The expansion of the opening into West Basin that would be accomplished by cutting off the southeast corner and dredging the area does not seem to provide a significant benefit to the maneuvers of the “VOYAGER Class” passenger vessel to the cruise ship pier, CT-10. The participants indicated that the West Basin’s dimensions are currently sufficient for turning and berthing maneuvers. The benefit gained by dredging the corner west of the cement dock (location 4 in Configuration A) does, however, increase the margin of safety into and out of West Basin for all vessels.

Exercise: Ex\_1-0302124057

Real time: 5:36:50 AM

Vertical Points: Real data: 2/18/2003

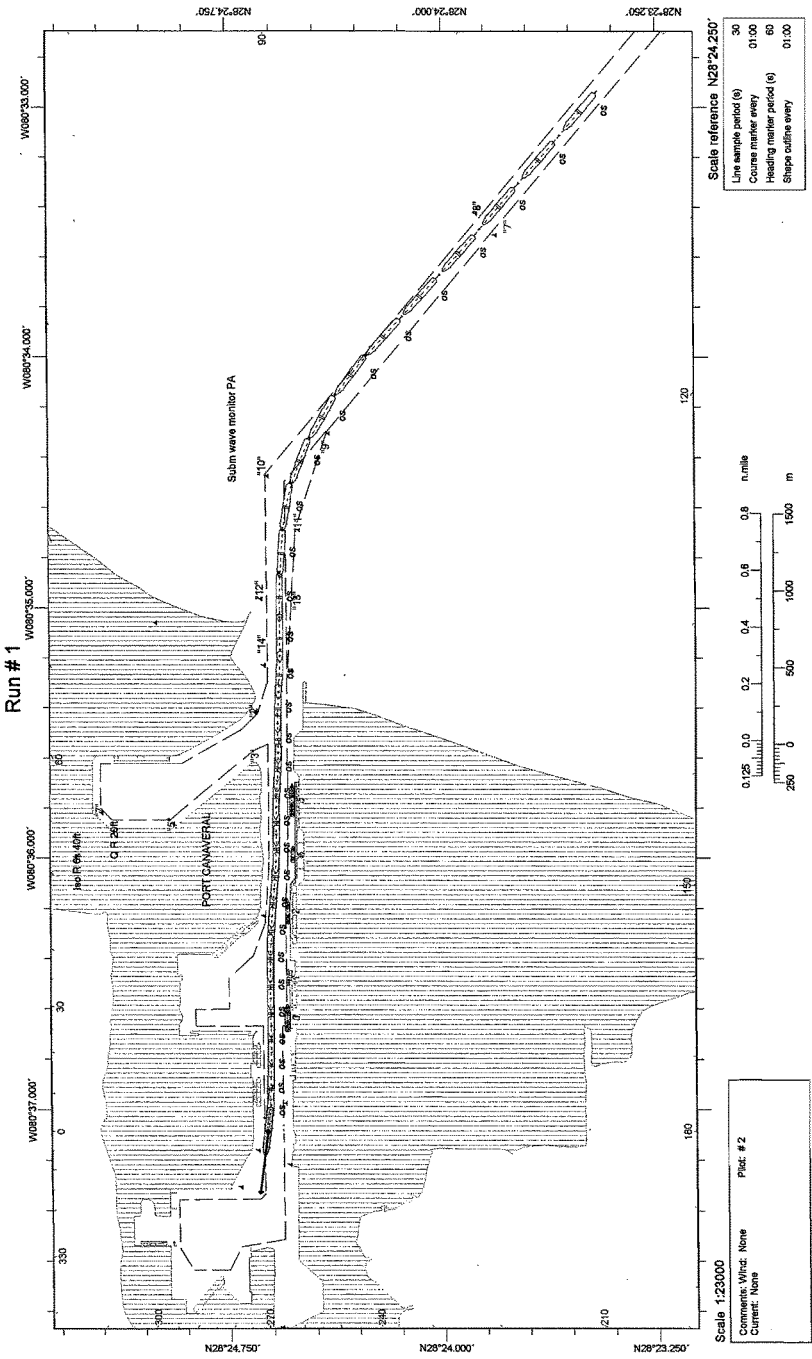

Run # 2

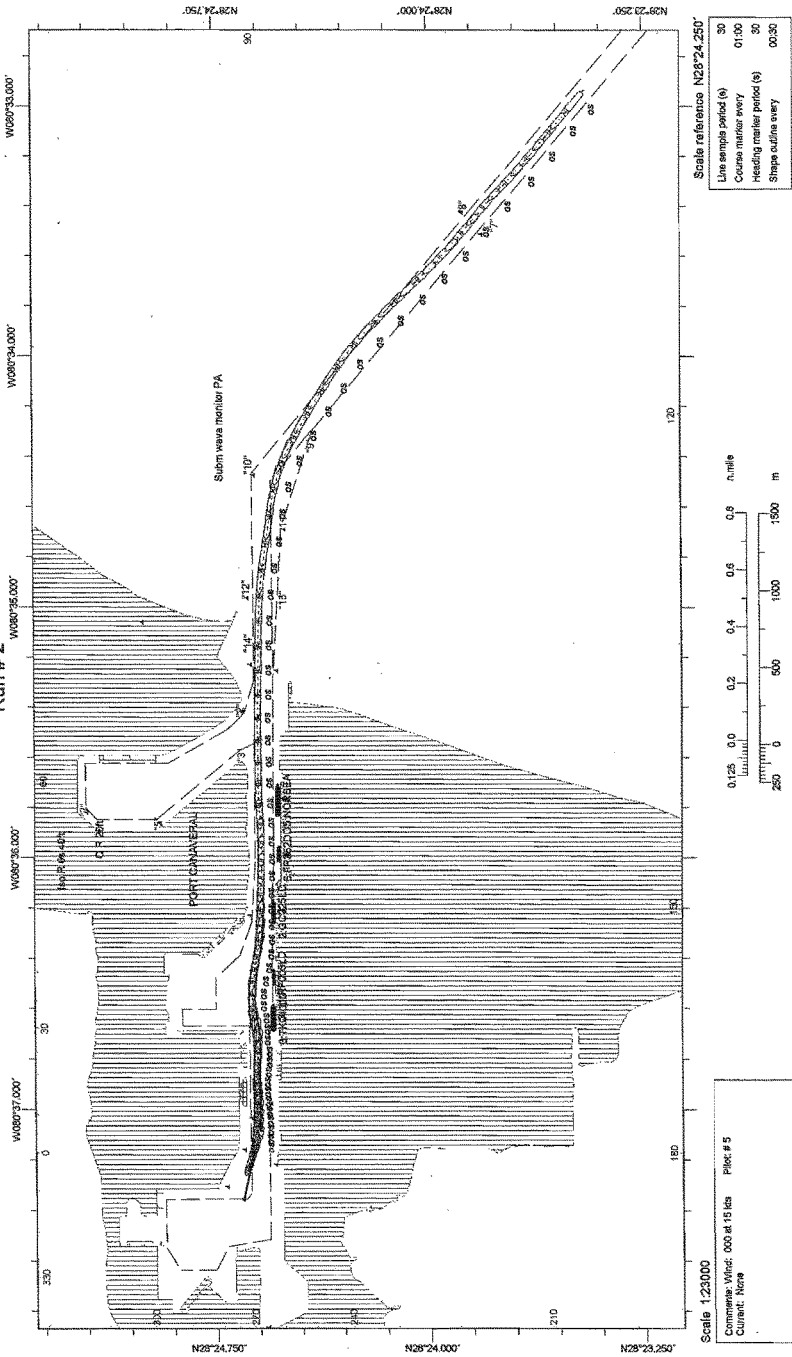

Exercise: E1-0-030212-115

Real time: 9:55:59 AM

Newcorral Pointa, Real date: 2/18/2003

### Run # 3

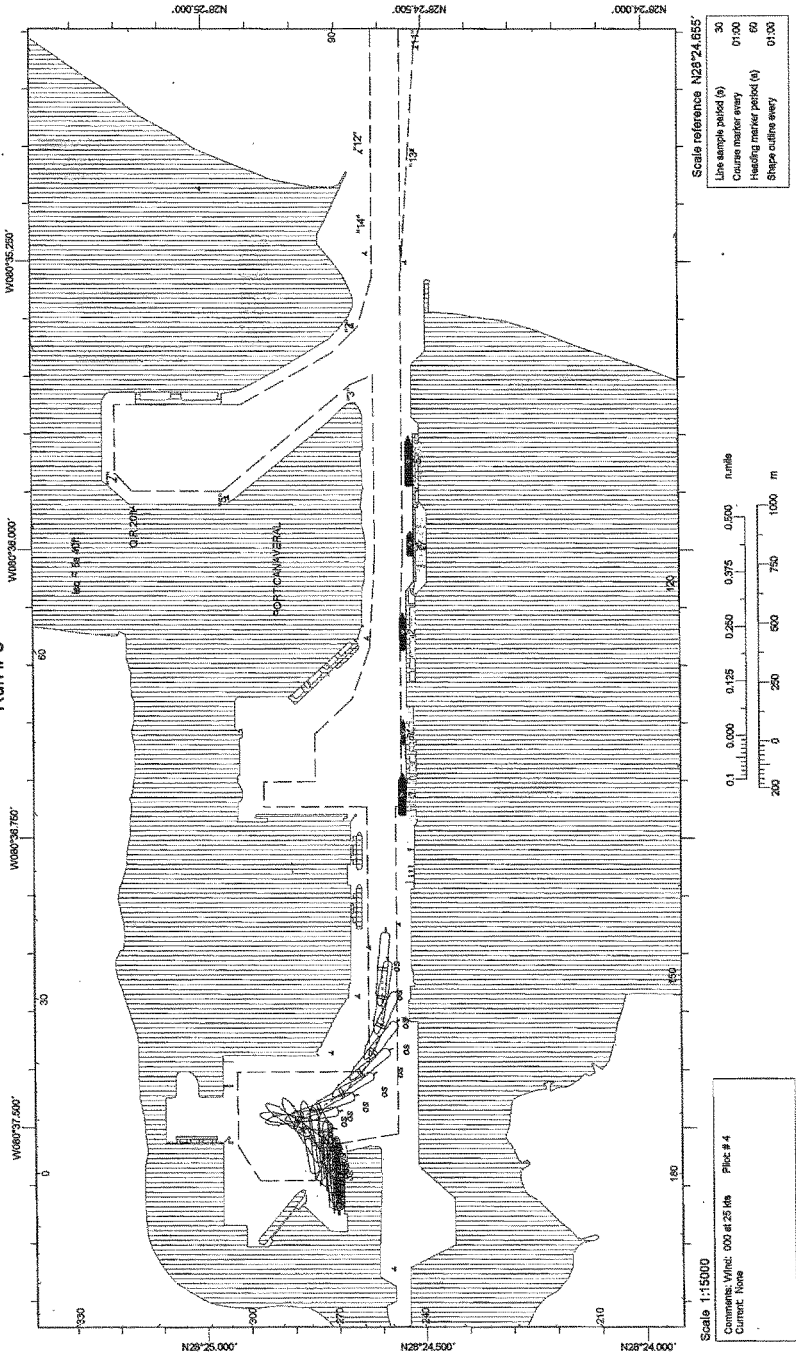

Electrol: Ex-030212-010

Real time: 10:39:23 AM

No control points, Real date: 2/18/2003

### Run # 4



Scale 1:23000  
 Comments: Wind: 180 at 25 kts Plot: # 3  
 Current: Northerly

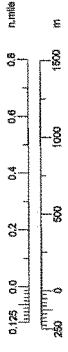



Exercise: 53.5-0602/2-1465

Res time: 10:07:09 AM

Nocontrol Point, Real date: 2/18/2003

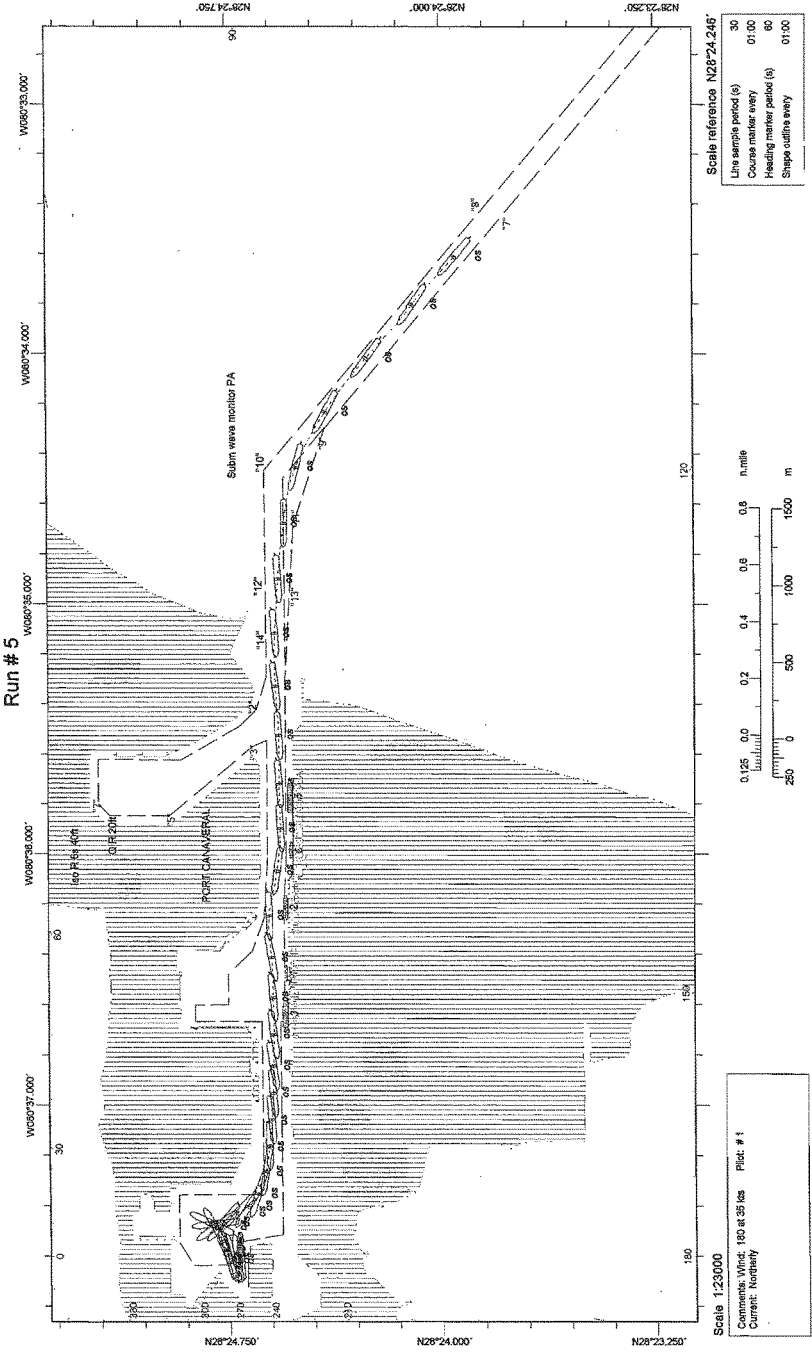

Real time: 3:22:59 PM

# Run # 6

Noncontrol Points, Real date: 2/12/2003



Exc time (elapsed): 5:00:00 AM (12:23:55 AM)

Exc date: 2/3/2003

Real time: 10:13:47 AM

### Run #7

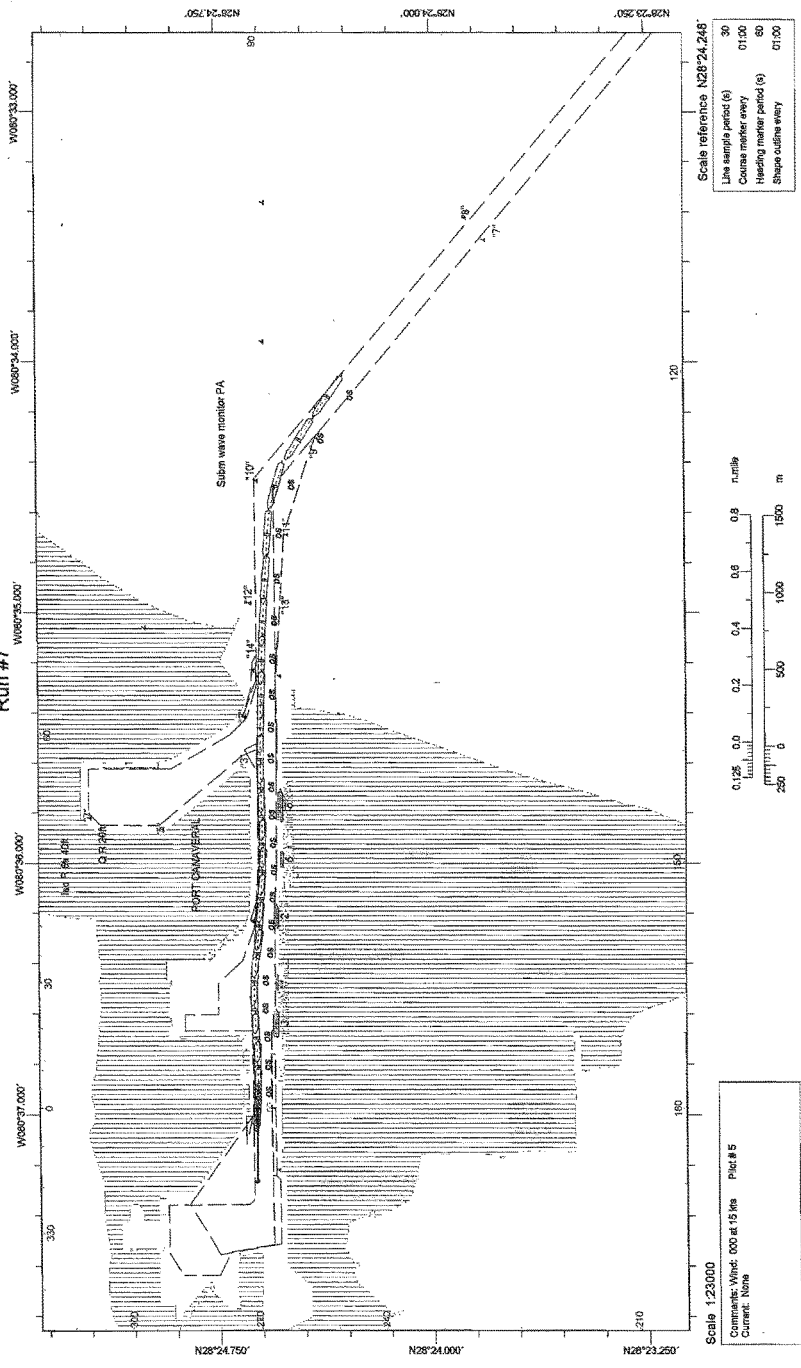

Real time: 9:43:55 AM

Norcontrol Polaris, Road label: 2/13/2003

Run #8

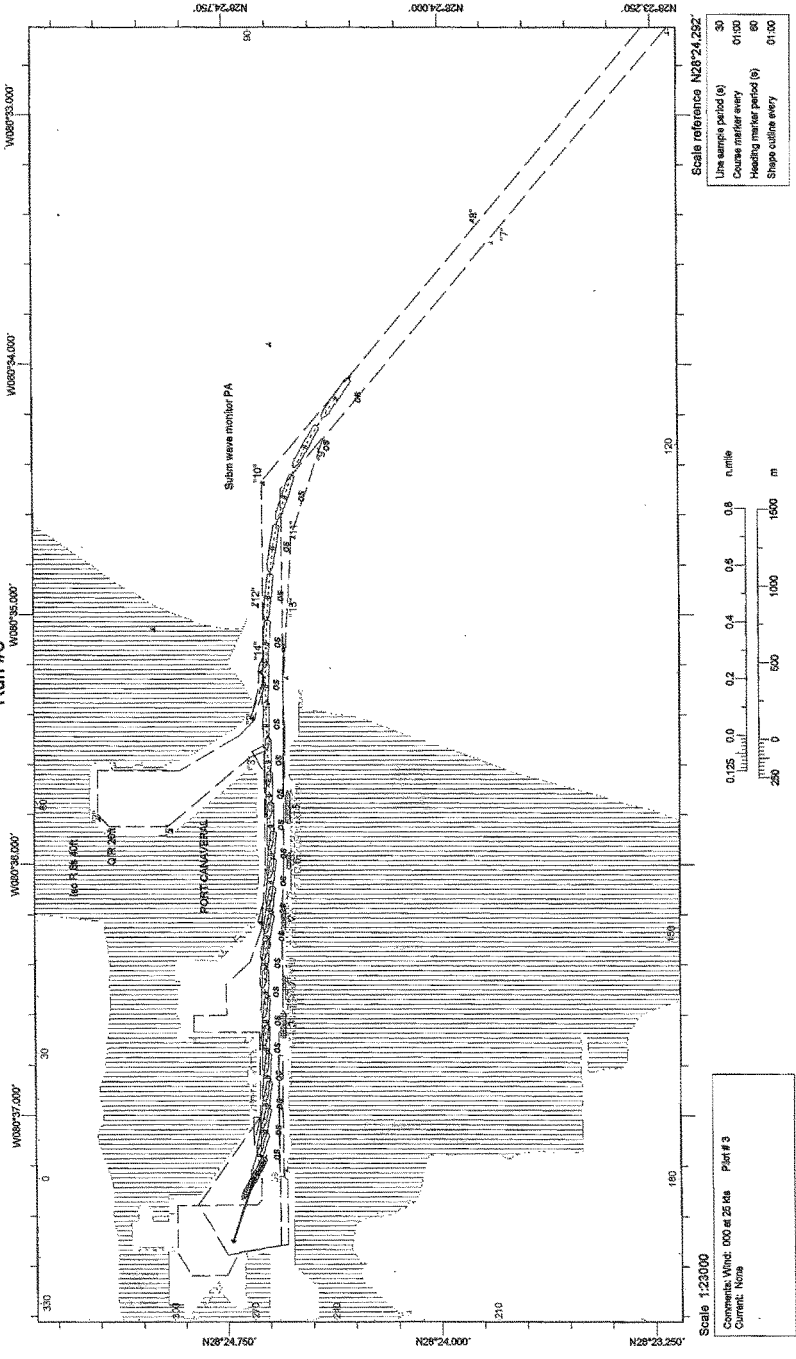

Exc time (slippage): 3:00:00 AM (12:22:59 AM)

Real time: 10:06:16 AM

Neoncotil Islands, Real data: 2/13/2003

### Run #9

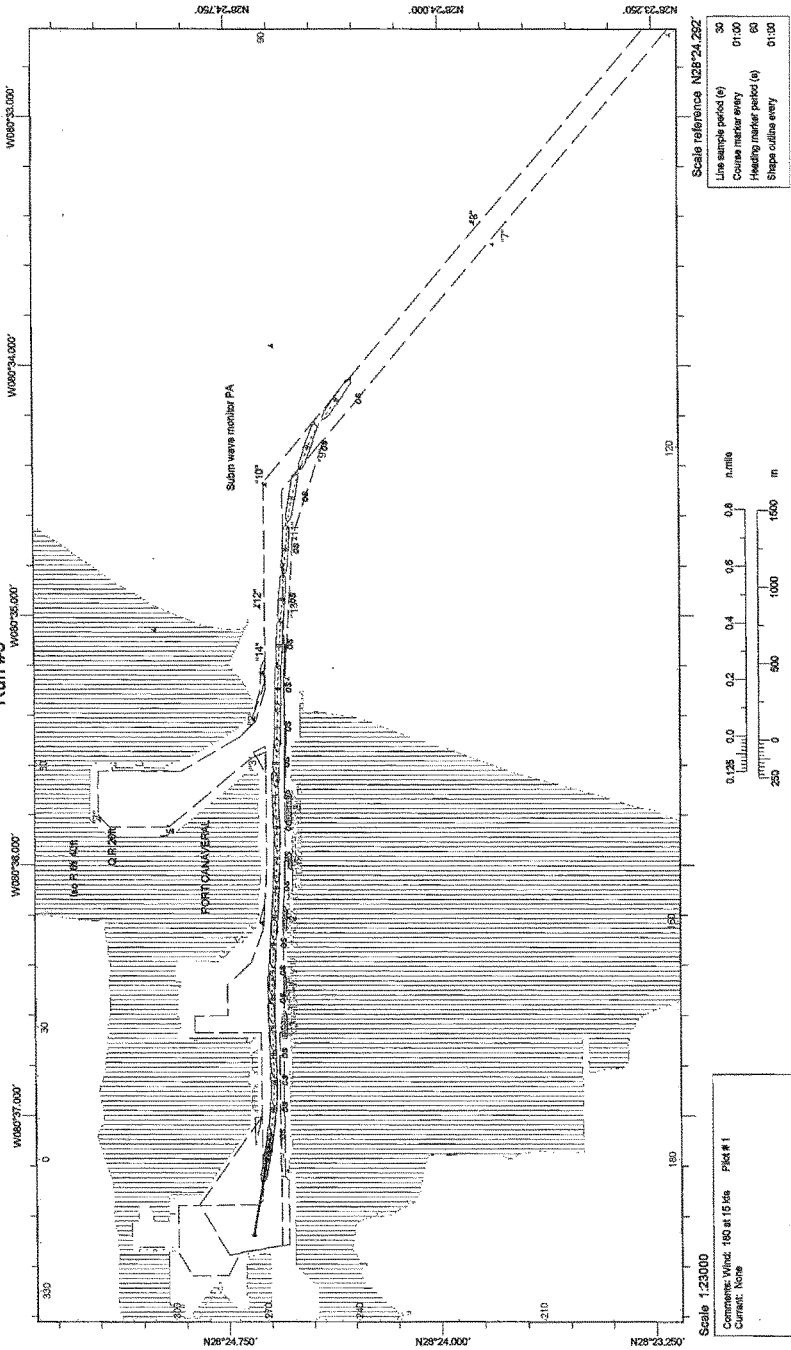

Exc time (elapsed): 8:00:00 AM (12:21:56 AM)

Exc date: 2/3/2003

Run #10

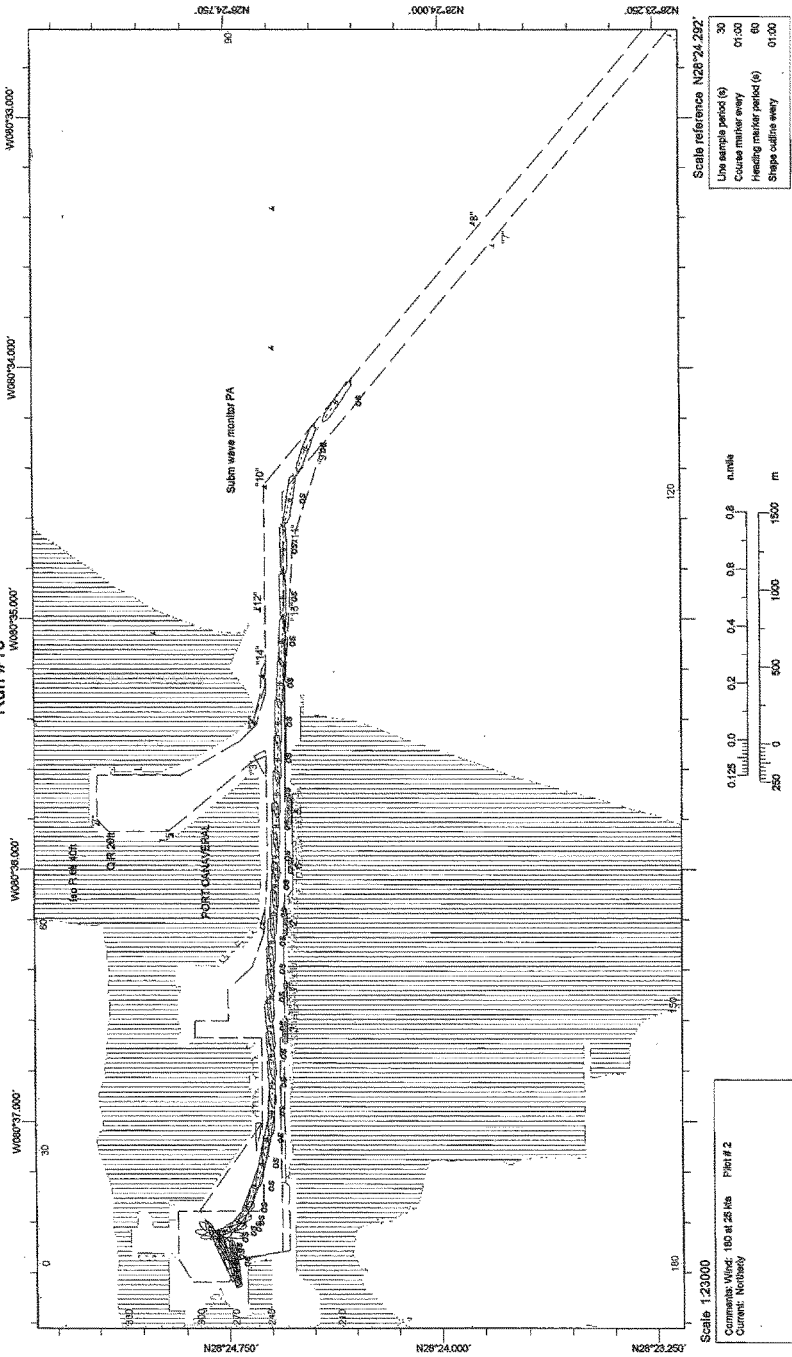

# Run #11

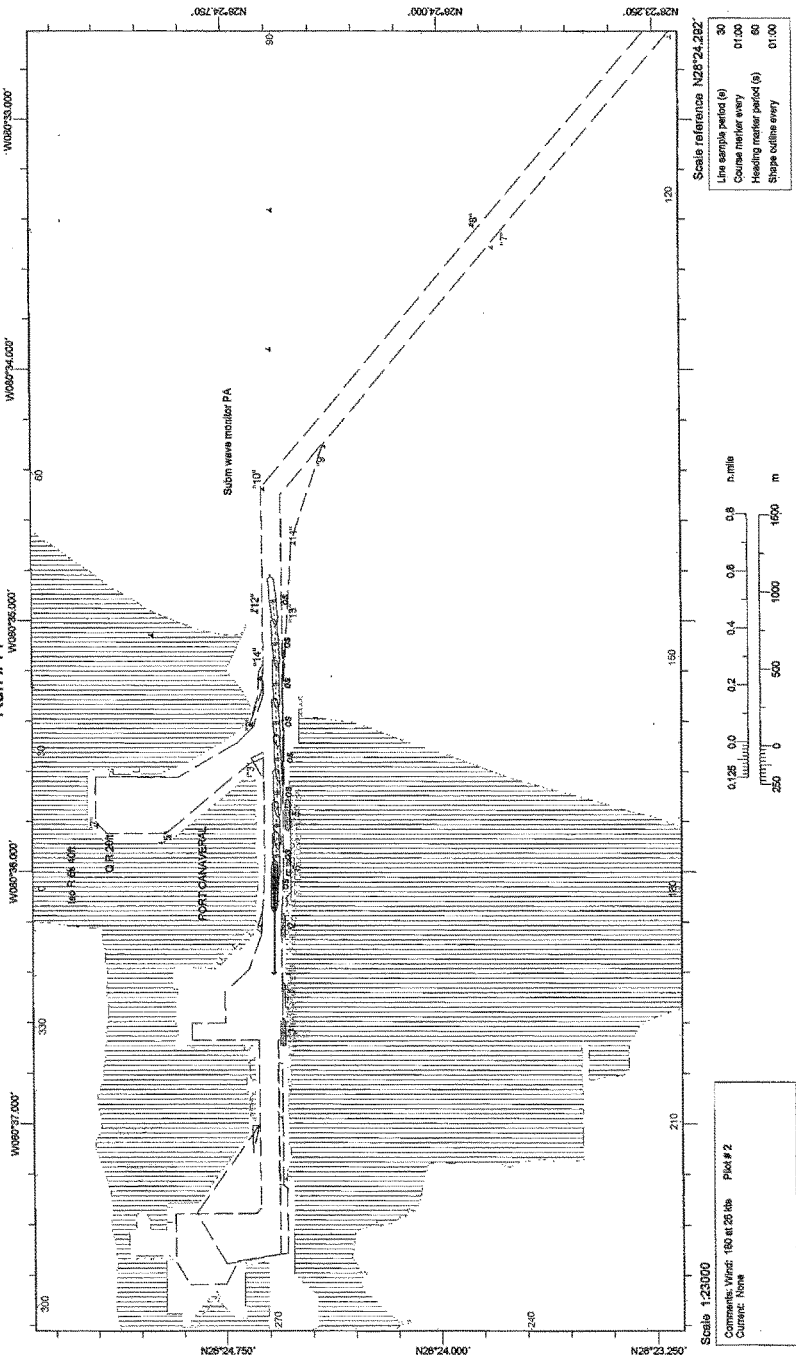

Run time: 11:46:52 AM

### Run #12

Noncompliant Points, Read date: 2/13/2003

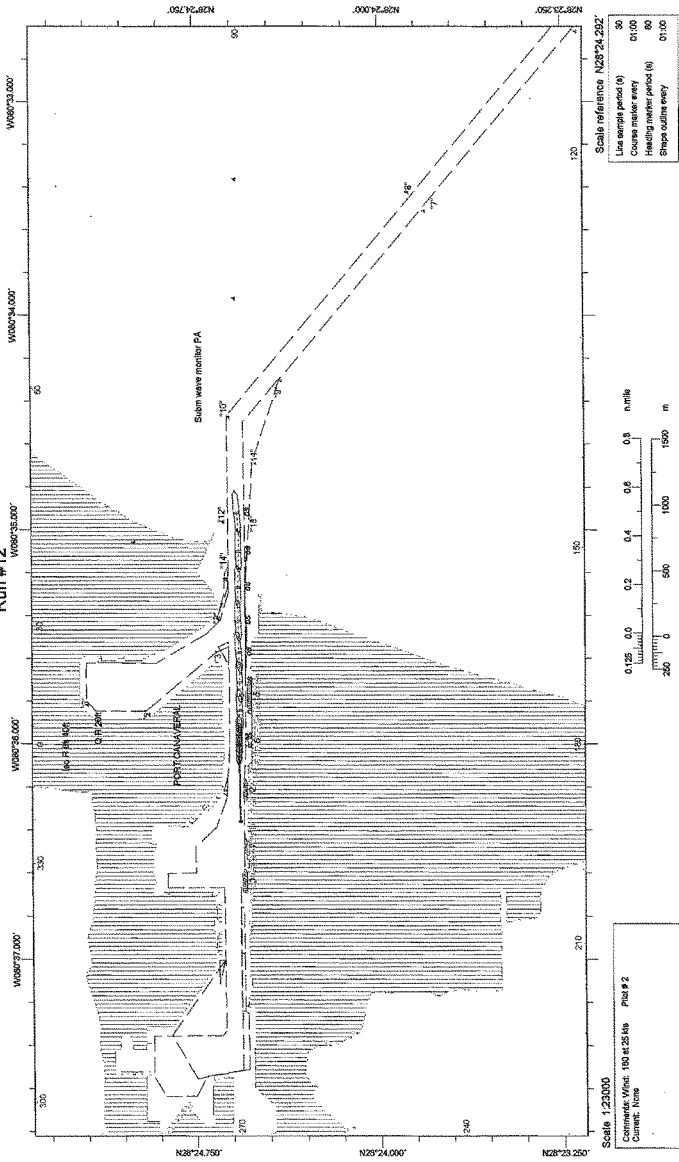

End time (elapsed): 6:00:00 AM (12:07:18 AM)

Exc date: 2/2/2003



### Run #13

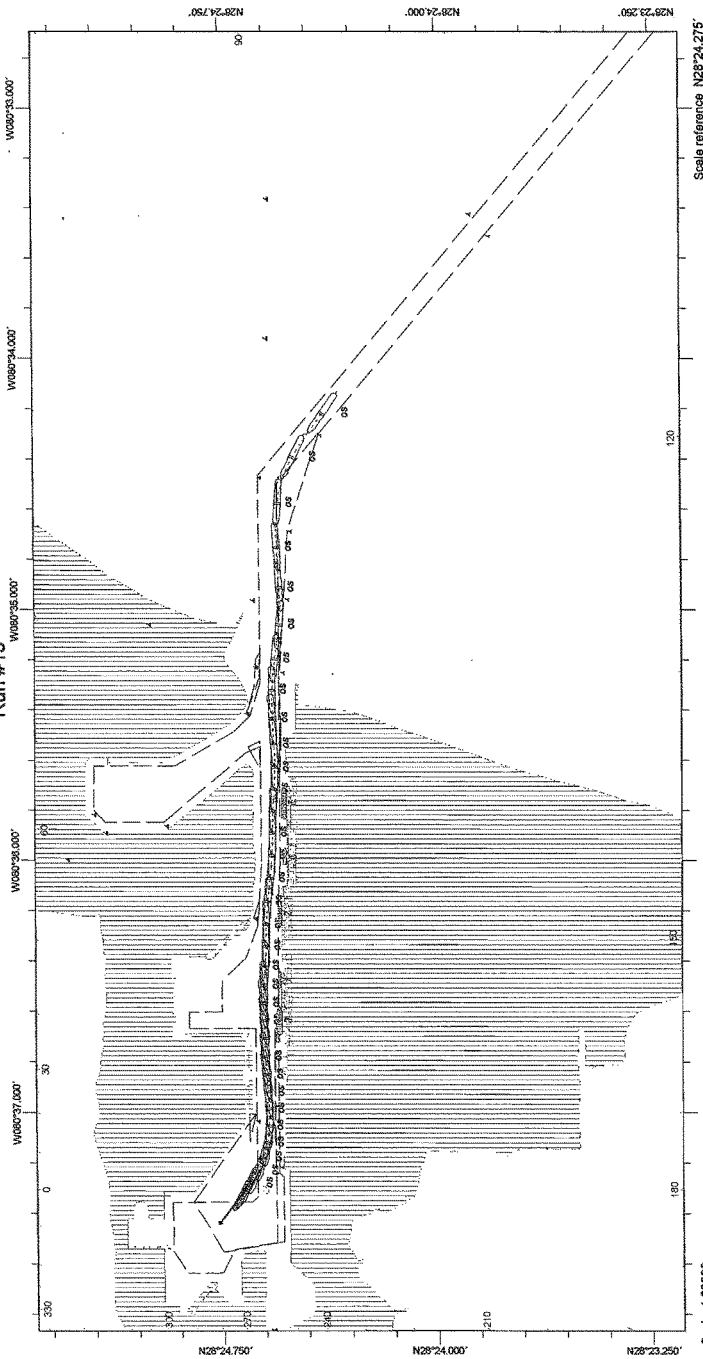

Scale: 1:23000  
 Comments: Wind: 190 at 18kts Plot: #5  
 Current: None

Scale reference: N28°24.275'  
 Line sample period (s) 30  
 Course marker every 01:00  
 Heading marker period (s) 80  
 Shape outline every 01:00

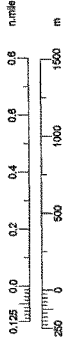

### Run #14

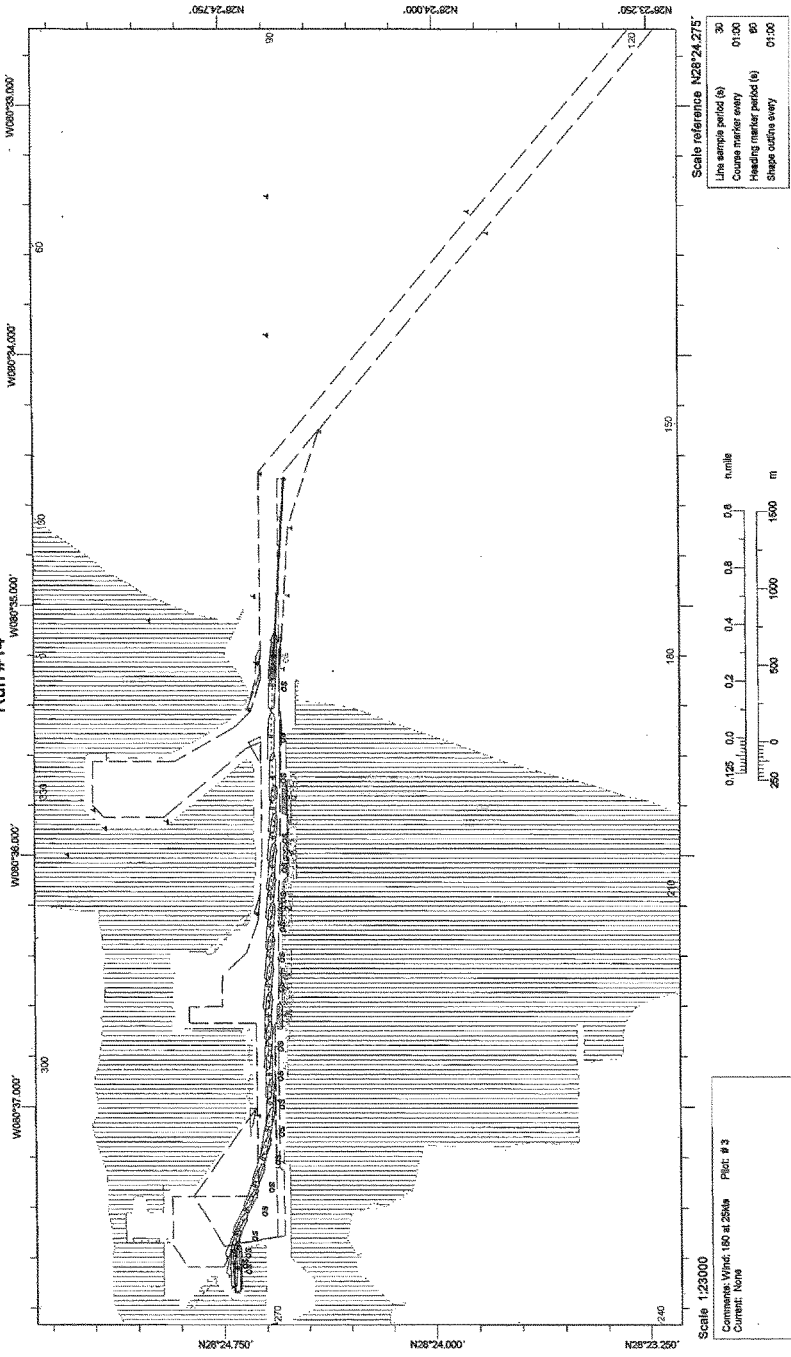

# Run #15

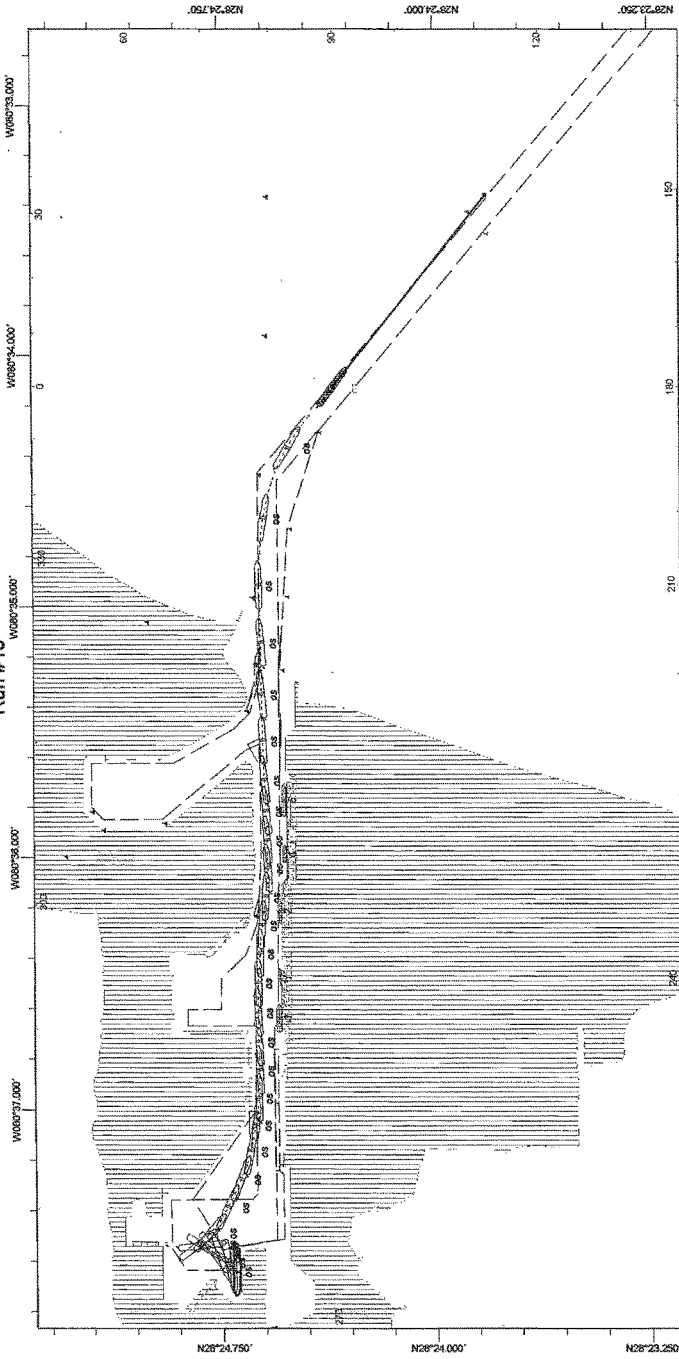

Scale reference: N28°24.275'

Line sample period (s)	30
Course marker every	01:00
Heading marker period (s)	60
Shape outline every	01:30

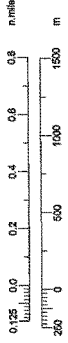

Scale: 1:23000  
 Comments: Wind: 000 at 25kts Plot: # 1  
 Current: None

# Run #16

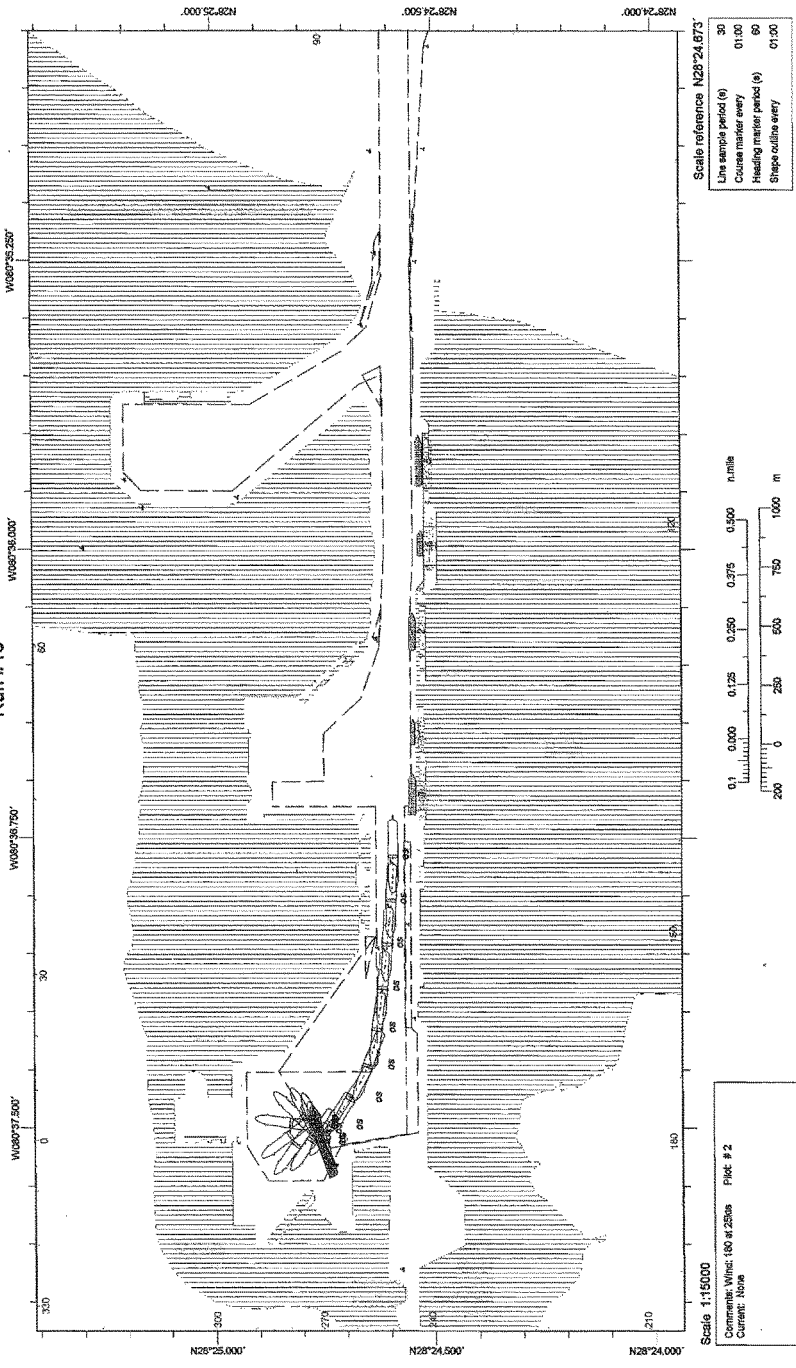

### Run #17

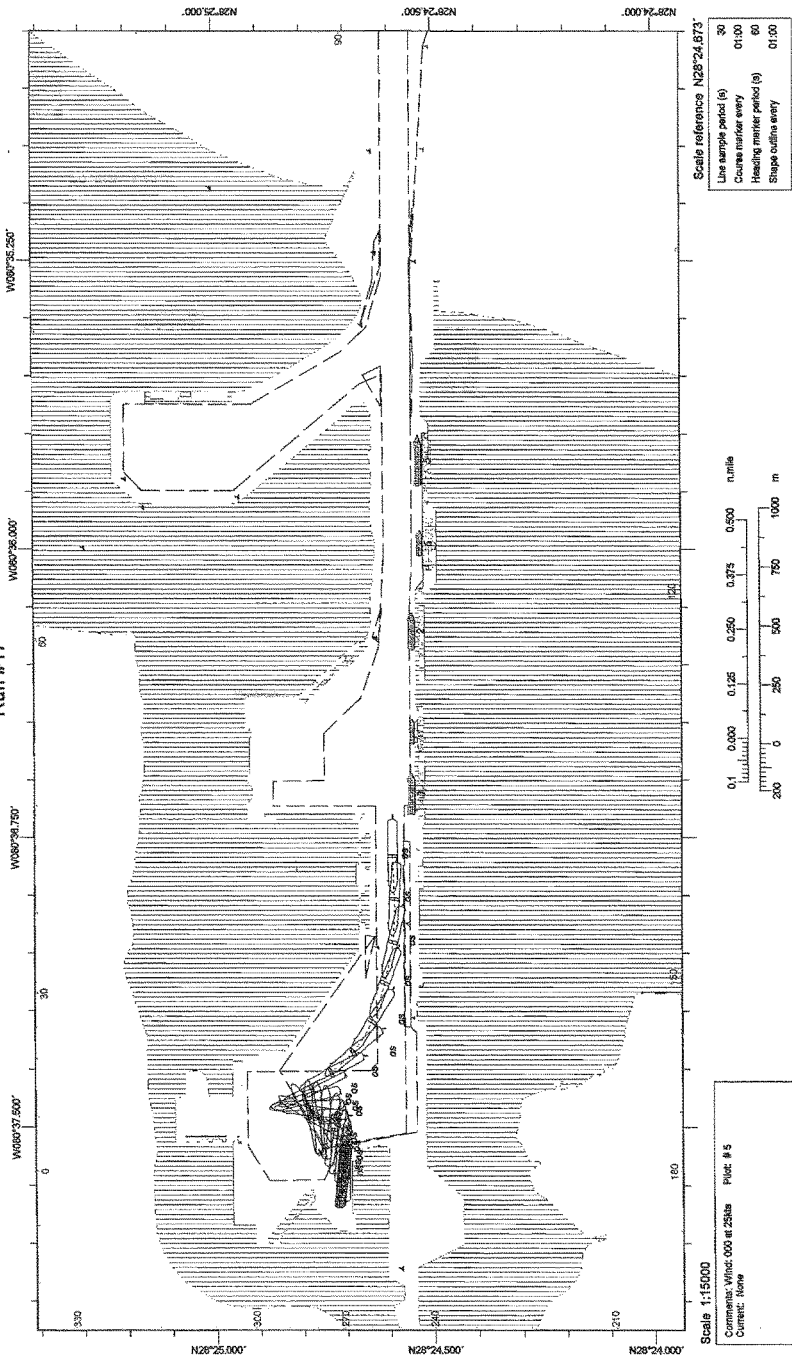

Exercise: Ex 1 Plans

Real time: 3:55:48 PM

Noncontrol Point, Real date: 2/13/2003

# Run #18

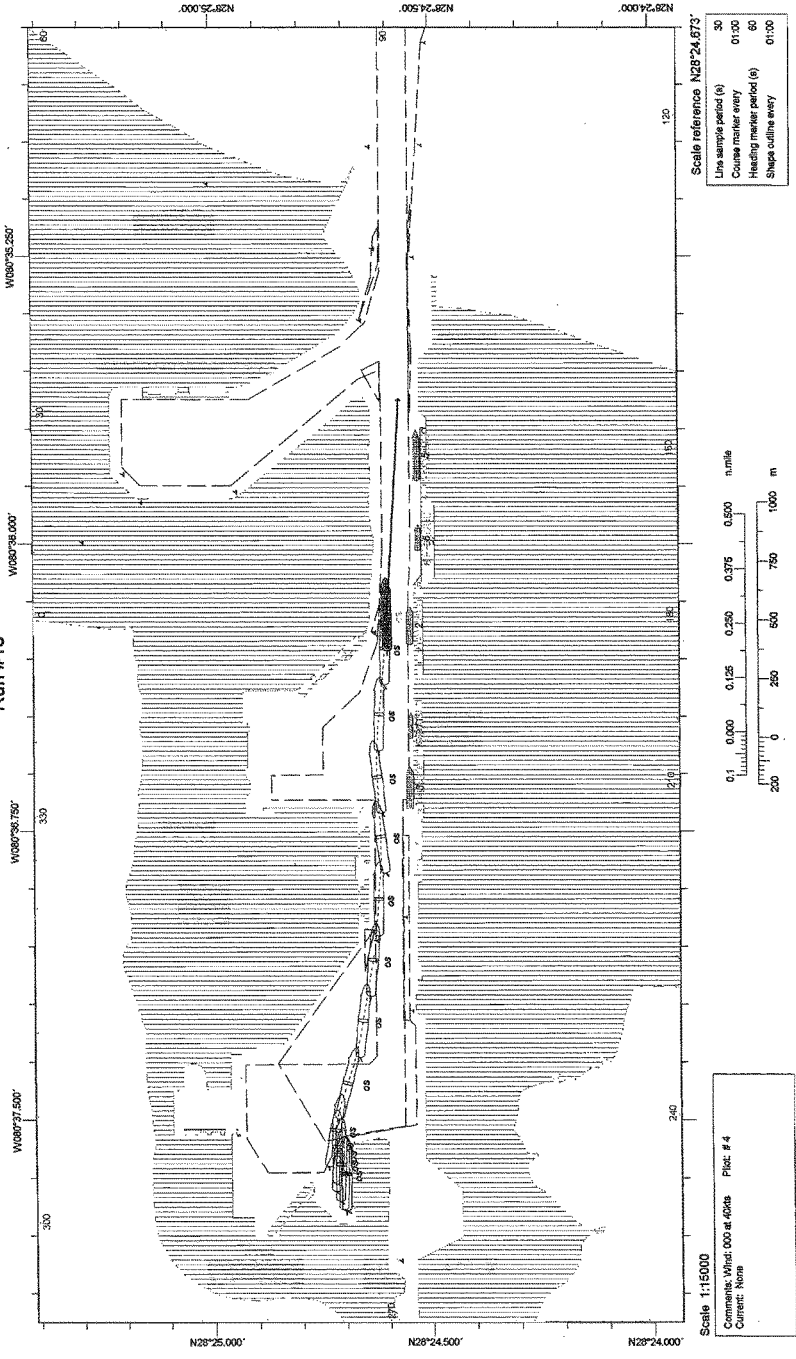

Exc time (elapsed): 8:00:00 AM (12:16:29 AM)

Exc date: 2/13/2003

Page 1

# Run # 19

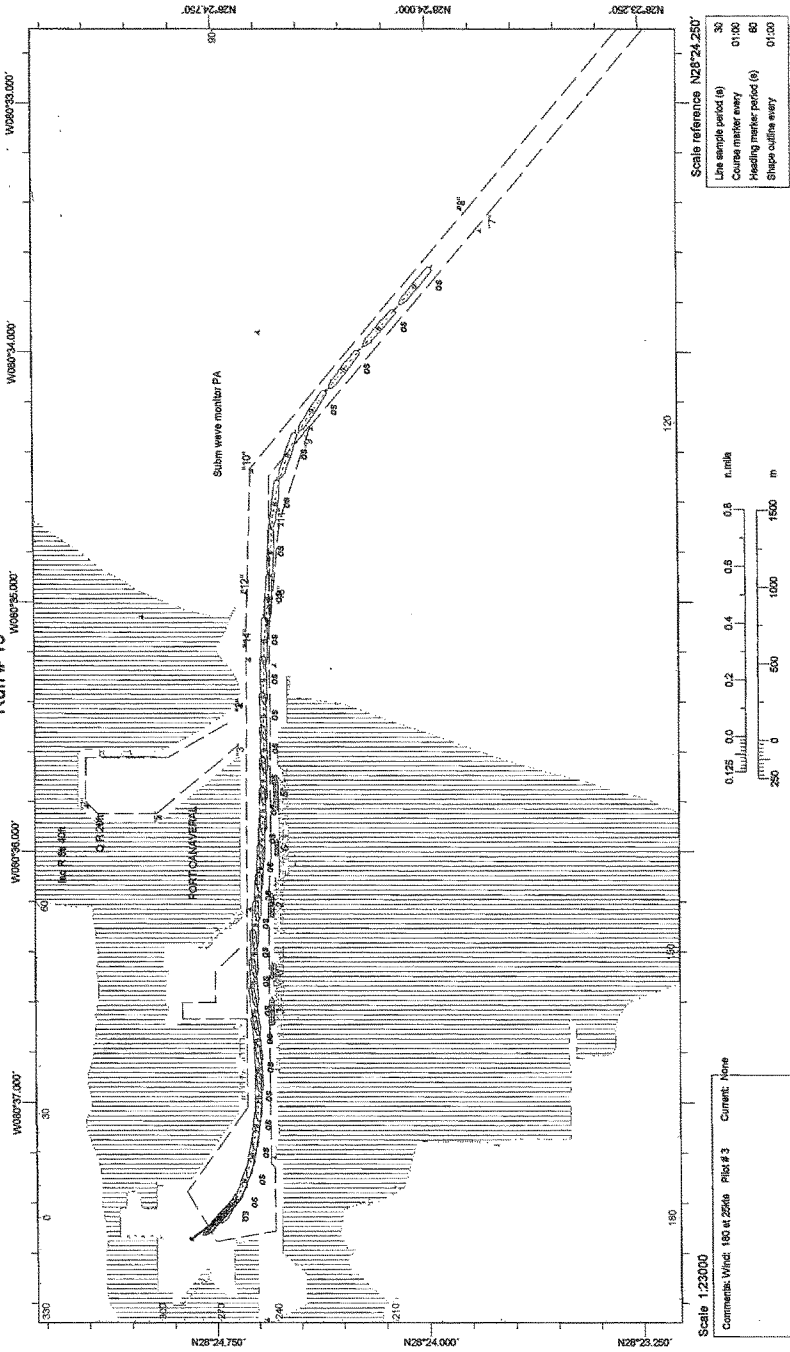

Run # 20

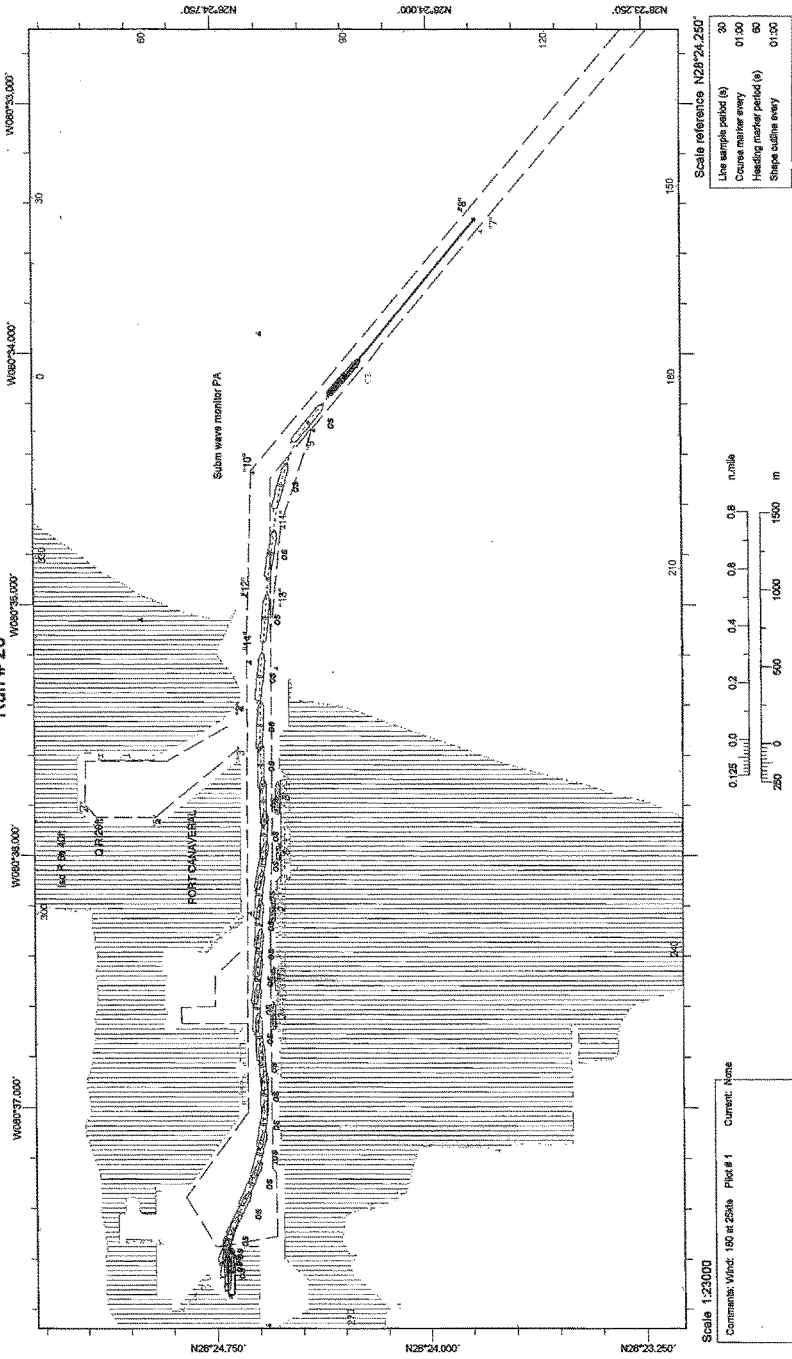



Run # 21

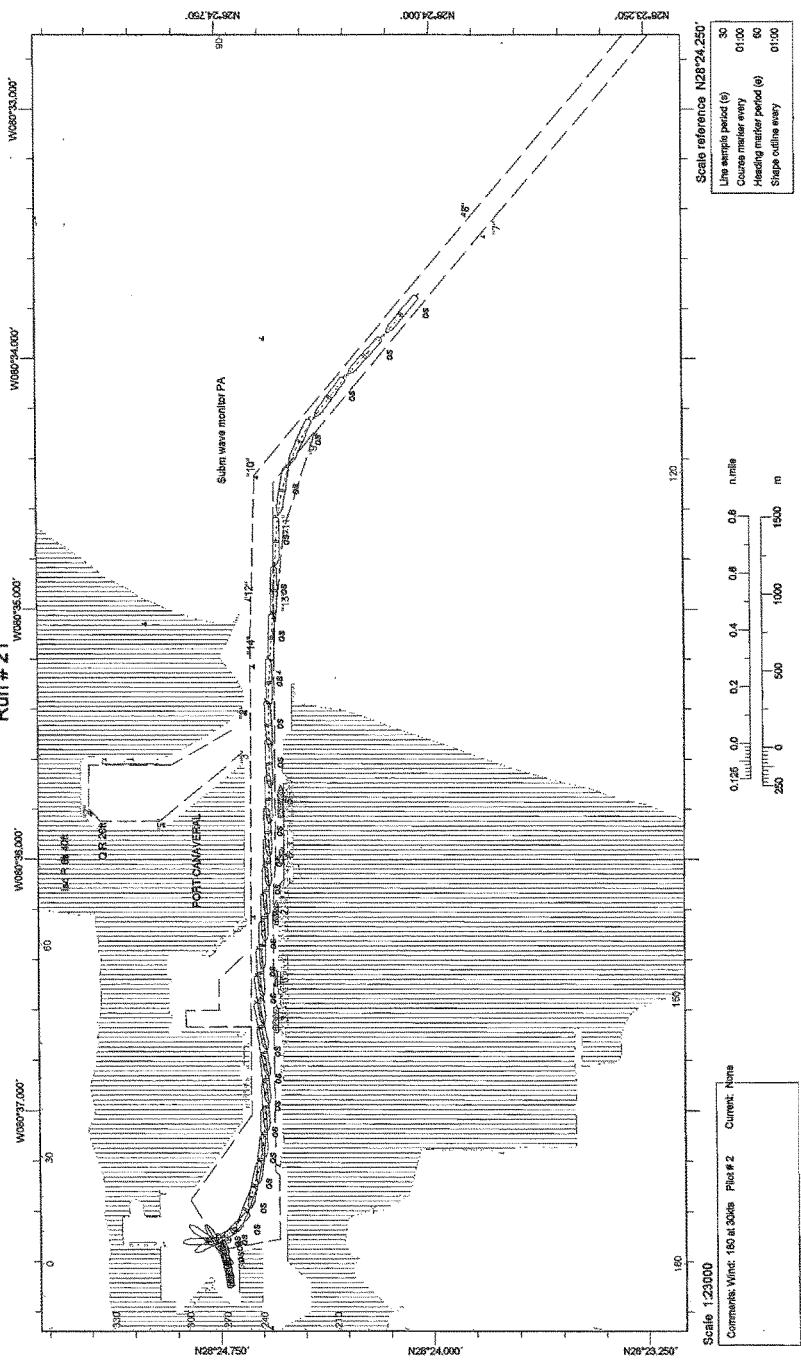

Exercise: Ex1\_Future

Real time: 11:25:12 AM

Noncontrol Polaris, Real date: 2/14/2003

Run # 22



Exc time (elapsed): 6:00:00 AM (12:22:32 AM)

Exc date: 2/13/2003

Elevation: Ex 1 Future

Run time: 12:00:49 PM

### Run # 23

Noncontrol Polaris, Real (date: 2/14/2003)

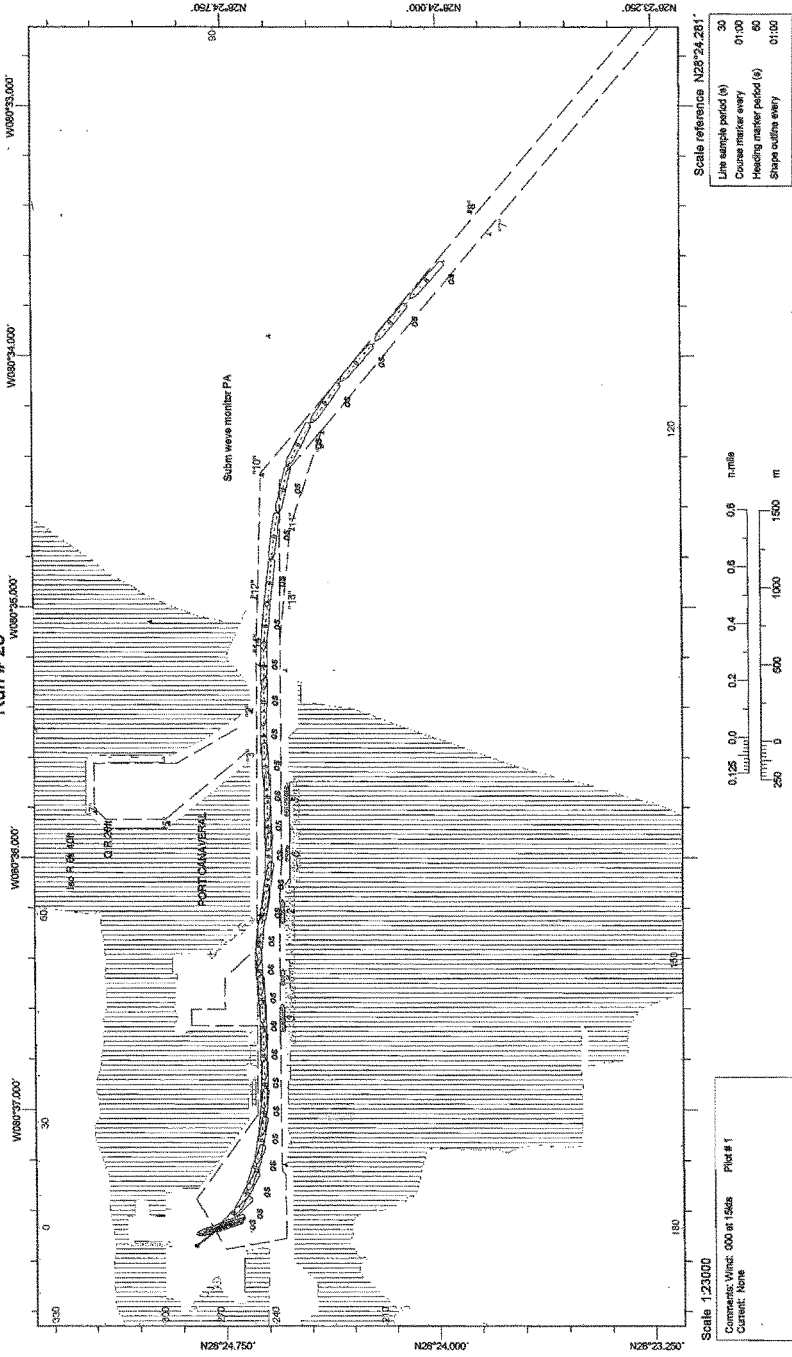

Real time: 1:43:25 PM

### Run # 24

Noncontrol Points, Real User: 2/14/2003

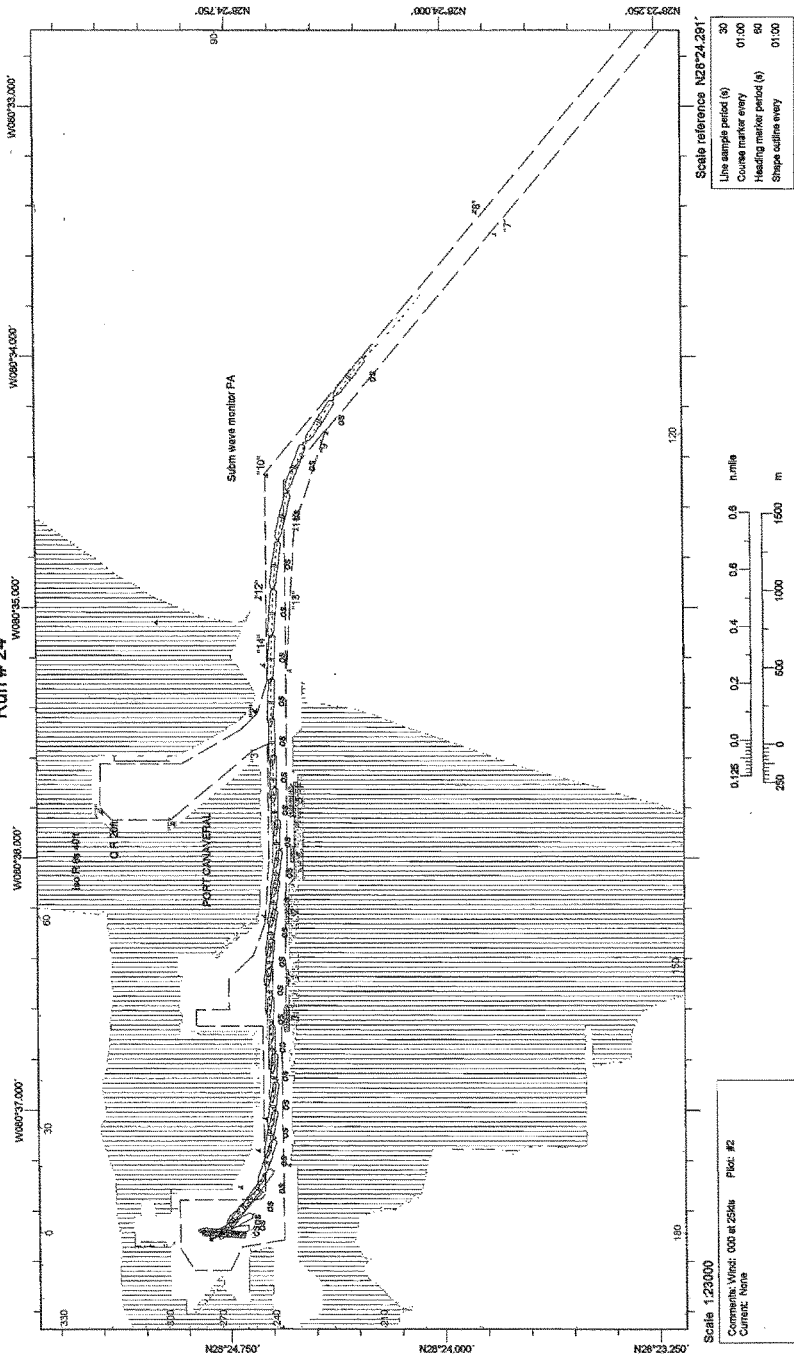

Exc time (elapsed): 5:00:10 AM (12:29:40 AM)



Read time: 2:48:21 PM

### Run # 26

Neocortical Plains, Road data, 2/14/2003

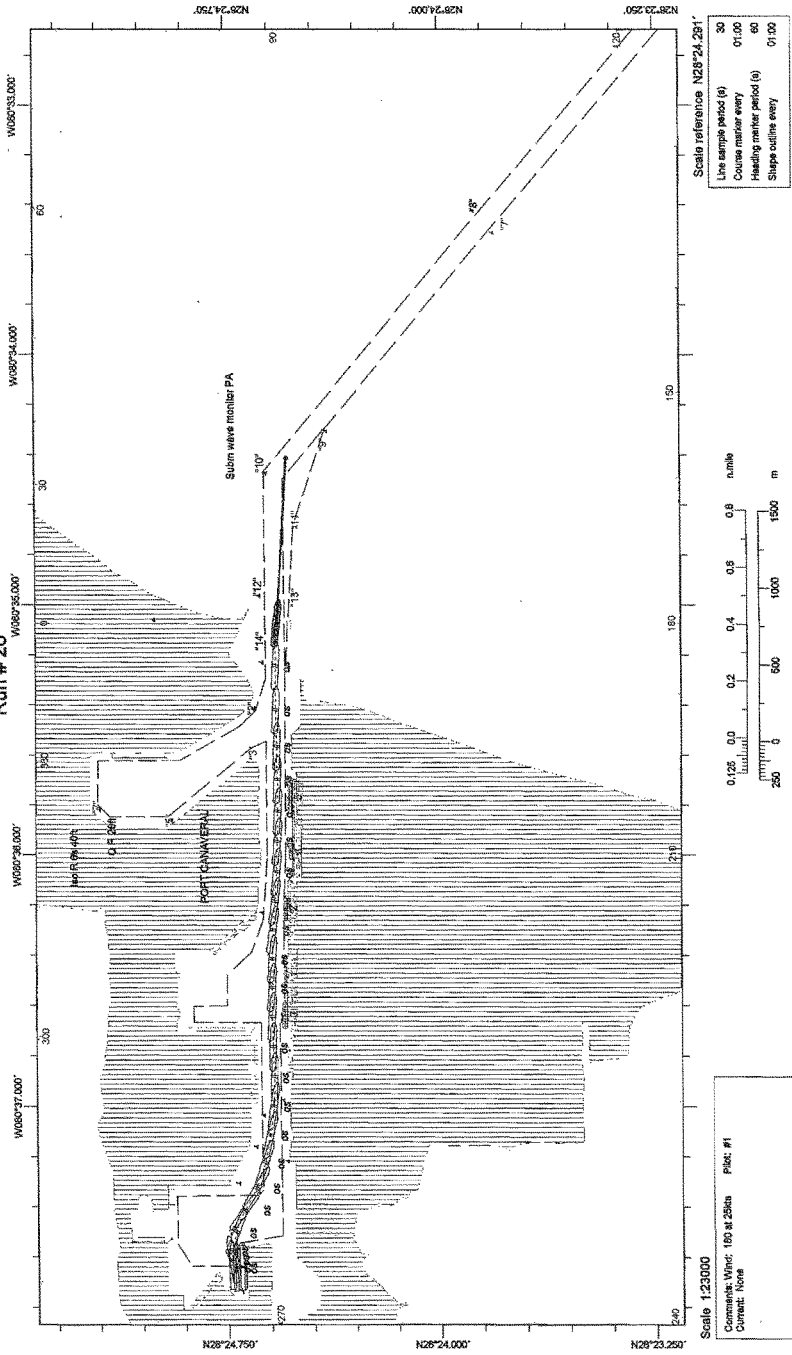

Exp time (elapsed): 5:00:00 AM (12:25:49 AM)

Real time: 3:21:10 PM

Norcross Poland, Real date: 2/14/2003

# Run # 27

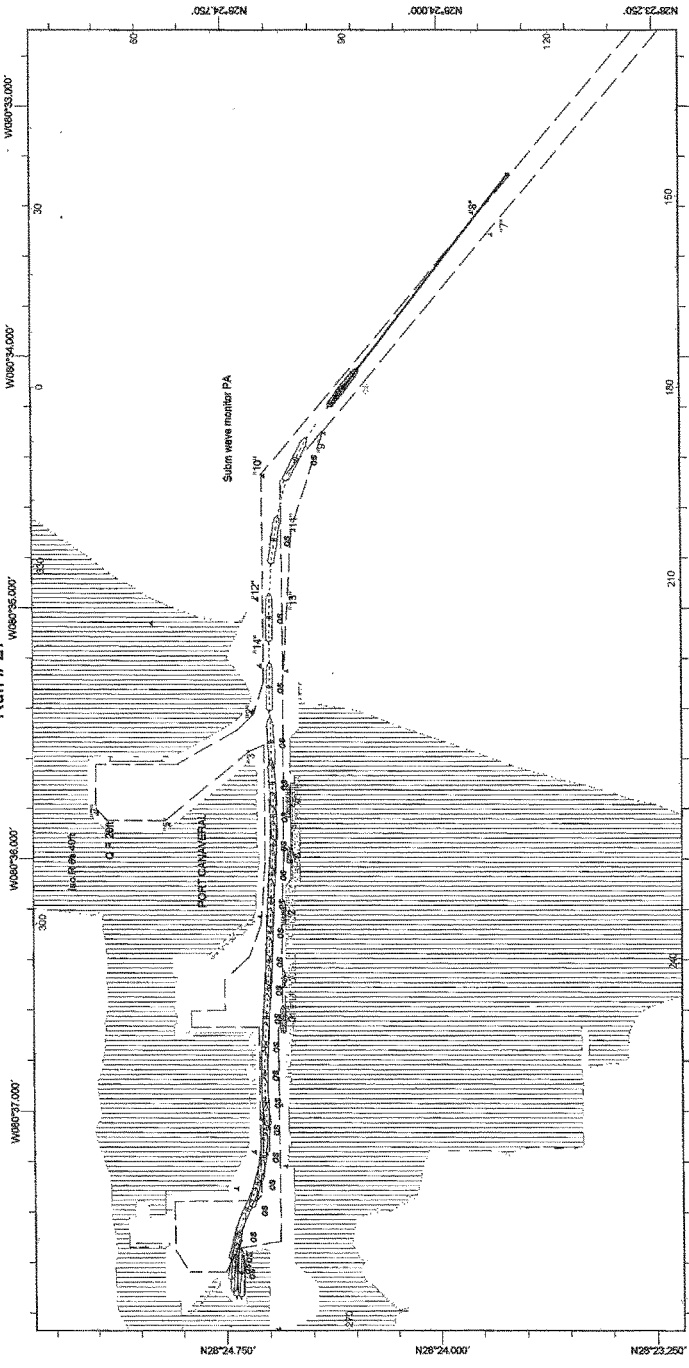

Scale Reference: N28°24.291'

Line sample period (s)	30
Course marker every	01:00
Heading marker period (s)	60
Shape outline every	01:00

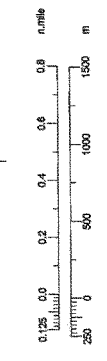

Scale 1:23000  
 Comments: Vlncl: 000 of 1500 Pht: 162  
 Curvel: None

Exc time (elapsed): 5:00:00 AM (12:28:59 AM)

## Port Canaveral Berth Access Run Evaluation Form

Pilot # 2

Date: 12 FEB 2003

Run #: 1

Circle the number that best describes the run just completed:

	5	4	3	2	1	
	Extremely Satisfactory				Not at all Satisfactory	
<b><u>Vessel Trackline</u></b>						
- Vessel position with regard to centerline	5	(4)	3	2	1	
- CPA to channel boundaries and/or buoys at the entrance	5	(4)	3	2	1	
- Vessel position with regard to ships at the berth	5	(4)	3	2	1	
- Maneuvering room at turning basin	5	4	3	2	1	DNA
<b><u>Vessel Controllability</u></b>						
- Engine reserve	5	4	3	2	1	DNA
- Rudder reserve	5	(4)	3	2	1	
- Course Control	5	(4)	3	2	1	
- Speed Control	5	(4)	3	2	1	
- Use of Tugs	5	4	3	2	1	DNA
- Thruster reserve	5	4	3	2	1	DNA

	5	4	3	2	1	
	Absolutely Safe				Not at all safe	
<b><u>Overall Safety</u></b>	5	4	(3)	2	1	

Comments: CONCERN FOR SURGE AT BERTH -  
OK FOR CALM WINDS - TOO FAST IN LEAVING CANAL

(over)



	Extremely Difficult				Not at all Difficult
<b>Task Difficulty</b>	5	4	3	2	1

Comments:

---



---



---



---

Difficult

**Stress Level**

Comments:

NONE

	Extremely High				Not at all
10 230	100 120 150 570	4	3	2	1

---



---



---

Additional Comments:

THANK YOU!

150  
130  
230  
570

---



---



---



---

## Port Canaveral Berth Access Run Evaluation Form

Pilot # 5

Date: 12 FEB 2003

Run #: 2

Circle the number that best describes the run just completed:

	Extremely Satisfactory				Not at all Satisfactory
<b><u>Vessel Trackline</u></b>					
- Vessel position with regard to centerline	5	4	3	2	1
- CPA to channel boundaries and/or buoys at the entrance	5	4	3	2	1
- Vessel position with regard to ships at the berth	5	4	3	2	1
- Maneuvering room at turning basin	5	4	3	2	1
<b><u>Vessel Controllability</u></b>					
- Engine reserve	5	4	3	2	1
- Rudder reserve	5	4	3	2	1
- Course Control	5	4	3	2	1
- Speed Control	5	4	3	2	1
- Use of Tugs	5	4	3	2	1
- Thruster reserve	5	4	3	2	1

	Absolutely Safe				Not at all safe
<b><u>Overall Safety</u></b>	5	4	3	2	1

Comments: WITH TRAINING & EXPERIENCE  
ON THIS CLASS VSL SAFETY  
FACTOR WILL RISE.

(over)

			Extremely Difficult			Not at all Difficult
<b><u>Task Difficulty</u></b>	5	4	3	2	1	

Comments:

---



---



---



---

				Extremely High		Not at all
<b><u>Stress Level</u></b>	5	4	3	2	1	

Comments:

---



---



---



---

Additional Comments:

DID NOT TRY TO SLOW FOR BERTHED  
 VSLs. TRIED TO EVALUATE  
 "WEATHER VANING" OF VSL. /  
 NOT WHAT I ANTICIPATED.  
 THEREFORE, SPD, EXCESSIVE  
 INSIDE HRR.

## Port Canaveral Berth Access Run Evaluation Form

Pilot # 4

Date: 12 FEB 2003

Run #: 3

Circle the number that best describes the run just completed:

	5	4	3	2	1
	Extremely Satisfactory				Not at all Satisfactory
<b><u>Vessel Trackline</u></b>					
- Vessel position with regard to centerline	5	4	3	2	1
- CPA to channel boundaries and/or buoys at the entrance	5	4	3	2	1
- Vessel position with regard to ships at the berth	5	4	3	2	1
- Maneuvering room at turning basin	5	4	3	2	1
<b><u>Vessel Controllability</u></b>					
- Engine reserve	5	4	3	2	1
- Rudder reserve	5	4	3	2	1
- Course Control	5	4	3	2	1
- Speed Control	5	4	3	2	1
- Use of Tugs	5	4	3	2	1
- Thruster reserve	5	4	3	2	1

	5	4	3	2	1
	Absolutely Safe				Not at all safe
<b><u>Overall Safety</u></b>	5	4	3	2	1

Comments: \_\_\_\_\_

---



---



---

(over)

	Extremely Difficult				Not at all Difficult
<b><u>Task Difficulty</u></b>	5	4	3	2	1

**Comments:**

---

---

---

---

	Extremely High				Not at all
<b><u>Stress Level</u></b>	5	4	3	2	1

**Comments:**

---

---

---

---

**Additional Comments:**

---

---

---

---

---

---

## Port Canaveral Berth Access Run Evaluation Form

Pilot # 3

Date: 12 FEB 2003

Run #: 4

Circle the number that best describes the run just completed:

	5	4	3	2	1
	Extremely Satisfactory			Not at all Satisfactory	
<b><u>Vessel Trackline</u></b>					
- Vessel position with regard to centerline	5	4	3	2	1
- CPA to channel boundaries and/or buoys at the entrance	5	4	3	2	1
- Vessel position with regard to ships at the berth	5	4	3	2	1
- Maneuvering room at turning basin	5	4	3	2	1
<b><u>Vessel Controllability</u></b>					
- Engine reserve	5	4	3	2	1
- Rudder reserve	5	4	3	2	1
- Course Control	5	4	3	2	1
- Speed Control	5	4	3	2	1
- Use of Tugs	5	4	3	2	1
- Thruster reserve	5	4	3	2	1

	5	4	3	2	1
	Absolutely Safe			Not at all safe	
<b><u>Overall Safety</u></b>	5	4	3	2	1

Comments: Ship speed excessive to retain control - need better control (should not be a problem) try to (8Kts @ CT-3) reduce to (6.5Kts) (over)

	Extremely Difficult				Not at all Difficult
<b><u>Task Difficulty</u></b>	5	4	3	2	1

Comments:

---

---

---

---

		Extremely High			Not at all
Difficult					
<b><u>Stress Level</u></b>	5	4	3	2	1

Comments:

---

---

---

---

Additional Comments:

---

---

---

---

---

## Port Canaveral Berth Access Run Evaluation Form

Pilot # 1

Date: 12 FEB 2003

Run #: 5

Circle the number that best describes the run just completed:

	Extremely Satisfactory				Not at all Satisfactory
<b><u>Vessel Trackline</u></b>					
- Vessel position with regard to centerline	5	(4)	3	2	1
- CPA to channel boundaries and/or buoys at the entrance	5	(4)	3	2	1
- Vessel position with regard to ships at the berth	5	(4)	3	2	1
- Maneuvering room at turning basin	5	4	3	(2)	1
<b><u>Vessel Controllability</u></b>					
- Engine reserve	5	(4)	3	2	1
- Rudder reserve	5	4	(3)	2	1
- Course Control	5	(4)	3	2	1
- Speed Control	5	(4)	3	2	1
- Use of Tugs <del>NA</del>	5	4	3	2	1
- Thruster reserve	5	(4)	3	2	1

	Absolutely Safe				Not at all safe
<b><u>Overall Safety</u></b>	5	4	(3)	2	1

Comments: Winds 35 knots - South; current North @ 3/21 knot. Had to keep speed 12 kts. up to #9, then 13 kts to 270', then 11 through jetties. past E. Basin. This speed was needed to control ship, but would cause excessive damage due to surging (over) other ships.



	Extremely Difficult			Not at all Difficult
<b>Task Difficulty</b>	5	4	3	2 1

Comments:

Very difficult "if" speed was down to 6 knots as not to surge ships.

	Extremely High			Not at all
<b>Stress Level</b>	5	4	3	2 1

Comments:

Had to use bow thruster transiting channel (twice).

Additional Comments:

Did well (w/ too much speed) controlling vessel in channel. I did not do well in West basin due to inexperience at Azipod control.

### Port Canaveral Berth Access Run Evaluation Form

Pilot # 082

Date: 12 FEB 2003

Run #: 6

Circle the number that best describes the run just completed:

**Vessel Trackline**

	Extremely Satisfactory				Not at all Satisfactory
- Vessel position with regard to centerline	5	(4)	3	2	1
- CPA to channel boundaries and/or buoys at the entrance	5	(4)	3	2	1
- Vessel position with regard to ships at the berth	5	4	3	(2)	1
- Maneuvering room at turning basin	5	(4)	3	2	1

**Vessel Controllability**

- Engine reserve	5	4	(3)	2	1
- Rudder reserve	5	(4)	3	2	1
- Course Control	5	(4)	3	2	1
- Speed Control	5	4	3	(2)	1
- Use of Tugs	5	4	3	2	1
- Thruster reserve	5	(4)	3	2	1

**Overall Safety**

	Absolutely Safe			Not at all safe
	5	4	3	(2)

Comments:

EXCEEDED SPEED - SINCE TUGS HAD TO GO TOO FAR IN EXISTING CHANNEL TO NOT GO AHEAD

(over)

	Extremely Difficult				Not at all Difficult
<b><u>Task Difficulty</u></b>	5	4	3	2	1

**Comments:**

---

---

---

---

	Extremely High				Not at all
<b><u>Stress Level</u></b>	5	4	3	2	1

**Comments:**

---

---

---

---

**Additional Comments:**

---

---

---

---

---

---

### Port Canaveral Berth Access Run Evaluation Form

Pilot # 5

Date: 13 FEB 2003

Run #: 7

Circle the number that best describes the run just completed:

	Extremely Satisfactory				Not at all Satisfactory
<b><u>Vessel Trackline</u></b>					
- Vessel position with regard to centerline	(5)	4	3	2	1
- CPA to channel boundaries and/or buoys at the entrance	(5)	4	3	2	1
- Vessel position with regard to ships at the berth	5	(4)	3	2	1
- Maneuvering room at turning basin	<del>5</del>	<del>4</del>	<del>3</del>	<del>2</del>	<del>1</del>
<b><u>Vessel Controllability</u></b>					
- Engine reserve	(5)	4	3	2	1
- Rudder reserve	(5)	4	3	2	1
- Course Control	(5)	4	3	2	1
- Speed Control	(5)	4	3	2	1
- Use of Tugs	<del>5</del>	<del>4</del>	<del>3</del>	<del>2</del>	<del>1</del>
- Thruster reserve	<del>5</del>	<del>4</del>	<del>3</del>	<del>2</del>	<del>1</del>

	Absolutely Safe				Not at all safe
<b><u>Overall Safety</u></b>	(5)	4	3	2	1

Comments: \_\_\_\_\_

\_\_\_\_\_  
\_\_\_\_\_  
\_\_\_\_\_

(over)



## Port Canaveral Berth Access Run Evaluation Form

Pilot # 3

Date: 13 FEB 2003

Run #: 8

Circle the number that best describes the run just completed:

	Extremely Satisfactory					Not at all Satisfactory
<b><u>Vessel Trackline</u></b>						
- Vessel position with regard to centerline	(5)	4	3	2	1	
- CPA to channel boundaries and/or buoys at the entrance	5	(4)	3	2	1	
- Vessel position with regard to ships at the berth	(3)	4	3	2	1	
- Maneuvering room at turning basin	(5)	4	3	2	1	
<b><u>Vessel Controllability</u></b>						
- Engine reserve	(5)	4	3	2	1	
- Rudder reserve	5	4	3	(2)	1	
- Course Control	5	(4)	3	2	1	
- Speed Control	(5)	4	3	2	1	
- Use of Tugs	5	4	3	2	1	
- Thruster reserve	(5)	4	3	2	1	

	Absolutely Safe					Not at all safe
<b><u>Overall Safety</u></b>	5	(4)	3	2	1	

Comments: Weather Vane seemingly excessive - No Stbd rudder used on 270° courses - lots of hand port with "offset engine"

(over)

	Extremely Difficult				Not at all Difficult
<b><u>Task Difficulty</u></b>	5	4	3	2	1

**Comments:**

---

---

---

---

	Extremely High				Not at all
<b><u>Stress Level</u></b>	5	4	3	2	1

**Comments:**

---

---

---

---

**Additional Comments:**

---

---

---

---

---

---

## Port Canaveral Berth Access Run Evaluation Form

Pilot # 1

Date: 13 FEB 2003

Run #: 9

Circle the number that best describes the run just completed:

	Extremely Satisfactory				Not at all Satisfactory	
<b><u>Vessel Trackline</u></b>						
- Vessel position with regard to centerline	5	(4)	3	2	1	
- CPA to channel boundaries and/or buoys at the entrance	5	(4)	3	2	1	
- Vessel position with regard to ships at the berth	5	(4)	3	2	1	
- Maneuvering room at turning basin	5	4	3	2	1	NA
<b><u>Vessel Controllability</u></b>						
- Engine reserve	(5)	4	3	2	1	
- Rudder reserve	5	(4)	3	2	1	
- Course Control	5	(4)	3	2	1	
- Speed Control	5	(4)	3	2	1	
- Use of Tugs	5	4	3	2	1	NA
- Thruster reserve	(5)	4	3	2	1	

	Absolutely Safe				Not at all safe
<b><u>Overall Safety</u></b>	(5)	4	3	2	1

Comments: Safe w/ safe speeds in Port.

(over)



	Extremely Difficult				Not at all Difficult
<b><u>Task Difficulty</u></b>	5	4	3	2	1

Comments:

---



---



---



---

	Extremely High				Not at all
<b><u>Stress Level</u></b>	5	4	3	2	1

Comments:

---



---



---



---

Additional Comments:

Kept vessel to windward  
using newly dredged area @ Jetty park  
+ along south side of channel  
ⓐ buoys 15 + 19.

## Port Canaveral Berth Access Run Evaluation Form

Pilot # 2

Date: 13 FEB 2003

Run #: 10

Circle the number that best describes the run just completed:

	Extremely Satisfactory				Not at all Satisfactory
<b><u>Vessel Trackline</u></b>					
- Vessel position with regard to centerline	5	(4)	3	2	1
- CPA to channel boundaries and/or buoys at the entrance	5	(4)	3	2	1
- Vessel position with regard to ships at the berth	5	4	(3)	2	1
- Maneuvering room at turning basin	5	(4)	3	2	1
<b><u>Vessel Controllability</u></b>					
- Engine reserve	5	(4)	3	2	1
- Rudder reserve	5	4	(3)	2	1
- Course Control	5	(4)	3	2	1
- Speed Control	5	4	3	2	1
- Use of Tugs	5	4	3	2	1
- Thruster reserve	5	(4)	3	2	1

DNA

	Absolutely Safe				Not at all safe
<b><u>Overall Safety</u></b>	5	(4)	3	2	1

Comments: \* GOOD WITH IMPROVEMENTS!

(over)

	Extremely Difficult				Not at all Difficult
<b>Task Difficulty</b>	5	4	3	2	1

Comments:

---

---

---

---

	Extremely High				Not at all
<b>Stress Level</b>	5	4	3	2	1

Comments:

EXPERIENCE!

---

---

---

---

Additional Comments:

CHANNEL IMPROVEMENTS ENSURE  
SAFETY -

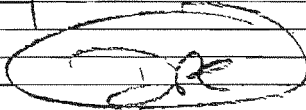

## Port Canaveral Berth Access Run Evaluation Form

Pilot # 5

Date: 13 FEB 2003

Run #: 13

Circle the number that best describes the run just completed:

	Extremely Satisfactory			Not at all Satisfactory	
<b><u>Vessel Trackline</u></b>					
- Vessel position with regard to centerline	5	4	(3)	2	1
- CPA to channel boundaries and/or buoys at the entrance	5	4	(3)	2	1
- Vessel position with regard to ships at the berth	5	4	(3)	2	1
- Maneuvering room at turning basin	(5)	4	3	2	1
<b><u>Vessel Controllability</u></b>					
- Engine reserve	(5)	4	3	2	1
- Rudder reserve	5	(4)	3	2	1
- Course Control	5	(4)	3	2	1
- Speed Control	(5)	4	3	2	1
- Use of Tugs	5	4	3	2	1
- Thruster reserve	(5)	4	3	2	1

	Absolutely Safe			Not at all safe	
<b><u>Overall Safety</u></b>	(5)	4	3	2	1

Comments: EXPERIMENTING WITH SLOW SPD. ABSOLUTELY SAFE AT 5.0 KTS IN S WIND 15 KTS PROVIDED IMPROVEMENTS RECOMMENDED BY PILOTS ARE IN PLACE. (over)

	Extremely Difficult				Not at all Difficult
<u>Task Difficulty</u>	5	4	3	2	1

Comments:

---



---



---



---

	Extremely High				Not at all
<u>Stress Level</u>	5	4	3	2	1

Comments:

---



---



---



---

Additional Comments:

IN ORDER TO ACHIEVE 5.0 KT  
 INBND W/ 15 KT S WIND VESSEL  
 SHOULD BE DOWN TO 10 KTS  
 AT BUOY 9.  
 TO BE AT 5.0 TO W/BASIN THE  
 IMPROVEMENTS RECOMMENDED  
 BY PILOTS ARE NECESSARY

## Port Canaveral Berth Access Run Evaluation Form

Pilot # 3Date: 13 FEB 2003Run #: 14

Circle the number that best describes the run just completed:

	Extremely Satisfactory				Not at all Satisfactory
<b><u>Vessel Trackline</u></b>					
- Vessel position with regard to centerline	(5)	4	3	2	1
- CPA to channel boundaries and/or buoys at the entrance	5	(4)	3	2	1
- Vessel position with regard to ships at the berth	5	4	3	(2)	1
- Maneuvering room at turning basin	(5)	4	3	2	1
<b><u>Vessel Controllability</u></b>					
- Engine reserve	5	(4)	3	2	1
- Rudder reserve	5	4	3	(2)	1
- Course Control	5	(4)	3	2	1
- Speed Control	(5)	4	3	2	1
- Use of Tugs	5	4	3	2	1
- Thruster reserve	(5)	4	3	2	1

	Absolutely Safe				Not at all safe
<b><u>Overall Safety</u></b>	5	(4)	3	2	1

Comments: Good use on using newly dredged area on southside in vicinity of #15 & #19 - However needed full port Azipod to make turn

(over)

	Extremely Difficult				Not at all Difficult
<b><u>Task Difficulty</u></b>	5	4	3	2	1

Comments:

---

---

---

---

	Extremely High				Not at all
Difficult					
<b><u>Stress Level</u></b>	5	4	3	2	1

Comments:

---

---

---

---

Additional Comments:

---

---

---

---

---

## Port Canaveral Berth Access Run Evaluation Form

Pilot # 1  
Run #: 15

Date: 13 FEB 2003

Circle the number that best describes the run just completed:

	Extremely Satisfactory			Not at all Satisfactory	
<b><u>Vessel Trackline</u></b>					
- Vessel position with regard to centerline	5	4	3	2	1
- CPA to channel boundaries and/or buoys at the entrance	5	4	3	2	1
- Vessel position with regard to ships at the berth	5	4	3	2	1
- Maneuvering room at turning basin	5	4	3	2	1
<b><u>Vessel Controllability</u></b>					
- Engine reserve	5	4	3	2	1
- Rudder reserve	5	4	3	2	1
- Course Control	5	4	3	2	1
- Speed Control	5	4	3	2	1
- Use of Tugs	5	4	3	2	1
- Thruster reserve	5	4	3	2	1

	Absolutely Safe			Not at all safe	
<b><u>Overall Safety</u></b>	5	4	3	2	1

Comments: \_\_\_\_\_  
\_\_\_\_\_  
\_\_\_\_\_

(over)



	Extremely Difficult				Not at all Difficult
<b><u>Task Difficulty</u></b>	5	4	3	2	1

Comments:

---



---



---



---

	Extremely High				Not at all
<b><u>Stress Level</u></b>	5	4	3	2	1

Comments:

---



---



---



---

Additional Comments:

Sail from CT-10 - Port side to berth.  
 Turn & head to sea. Wind N. @ 25, then 50 @  
 Jetty. Kept ship on N edge of channel.  
 Maintained 6.0 Kts in harbor by using dredged  
 areas, especially @ E. Basin entrance.  
 Handled 50 knots wind w/ increased  
 RPM.

## Port Canaveral Berth Access Run Evaluation Form

Pilot # 2

Date: 13 FEB 2003

Run #: 16

Circle the number that best describes the run just completed:

		Extremely Satisfactory			Not at all Satisfactory
<b><u>Vessel Trackline</u></b>					
- Vessel position with regard to centerline	5	(4)	3	2	1
- CPA to channel boundaries and/or buoys at the entrance	5	(4)	3	2	1
- Vessel position with regard to ships at the berth	5	(4)	3	2	1
- Maneuvering room at turning basin	5	(4)	3	2	1
<b><u>Vessel Controllability</u></b>					
- Engine reserve	(5)	4	3	2	1
- Rudder reserve	5	(4)	3	2	1
- Course Control	5	(4)	3	2	1
- Speed Control	5	(4)	3	2	1
- Use of Tugs	5	4	3	2	1
- Thruster reserve	(5)	4	3	2	1

		Absolutely Safe			Not at all safe
<b><u>Overall Safety</u></b>	5	(4)	3	2	1

Comments: 25 KTS - SOUTH WIND - VERY UNFAVORABLE.

(over)



## Port Canaveral Berth Access Run Evaluation Form

Pilot # 5

Date: 13 FEB 2003

Run #: 17

Circle the number that best describes the run just completed:

	Extremely Satisfactory				Not at all Satisfactory
<b>Vessel Trackline</b>					
- Vessel position with regard to centerline	5	4	3	2	1
- CPA to channel boundaries and/or buoys at the entrance	5	(4)	3	2	1
- Vessel position with regard to ships at the berth	5	(4)	3	2	1
- Maneuvering room at turning basin	(5)	4	3	2	1
<b>Vessel Controllability</b>					
- Engine reserve	(5)	4	3	2	1
- Rudder reserve	(5)	4	3	2	1
- Course Control	(5)	4	3	2	1
- Speed Control	(5)	4	3	2	1
- Use of Tugs	(5)	4	3	2	1
- Thruster reserve	(5)	4	3	2	1

	Absolutely Safe				Not at all safe
<b>Overall Safety</b>	(5)	4	3	2	1

Comments:

SAFE HOWEVER I  
WOULD LIKE MORE EXPERIENCE  
ON THIS CLASS B/H DOCKING  
S/S TO CT-10 W/ 25<sup>TH</sup> KT'S N

(over)

	Extremely Difficult				Not at all Difficult
<b><u>Task Difficulty</u></b>	5	4	3	2	1

Comments:

---



---



---



---

	Extremely High				Not at all
<b><u>Stress Level</u></b>	5	4	3	2	1

Comments:

---



---



---



---

Additional Comments:

STARTED EXERCISE IN POOR  
 POSITION FOR N WIND.  
 RECOMMENDED DREDGING  
 NECESSARY. VSL DID NOT  
 REACT AS EXPECTED TURNING  
 INTO W/SEASIN

PILOT/MASTER KHANGENEY

RTM STAR Center

Port Canaveral Berth Access

### Port Canaveral Berth Access Run Evaluation Form

Pilot # 4

Date: 13 FEB 2003

Run #: 18

Circle the number that best describes the run just completed:

	Extremely Satisfactory				Not at all Satisfactory
<b><u>Vessel Trackline</u></b>					
- Vessel position with regard to centerline	5	4	3	2	1
- CPA to channel boundaries and/or buoys at the entrance	5	4	3	2	1
- Vessel position with regard to ships at the berth	5	4	3	2	1
- Maneuvering room at turning basin	5	4	3	2	1
<b><u>Vessel Controllability</u></b>					
- Engine reserve	5	4	3	2	1
- Rudder reserve	5	4	3	2	1
- Course Control	5	4	3	2	1
- Speed Control	5	4	3	2	1
- Use of Tugs	5	4	3	2	1
- Thruster reserve	5	4	3	2	1

	Absolutely Safe				Not at all safe
<b><u>Overall Safety</u></b>	5	4	3	2	1

Comments:

40' N WINDS MAKE FOR DIFFICULT CONDITION FOR MANOUVERING.

(over)

	Extremely Difficult				Not at all Difficult
<b><u>Task Difficulty</u></b>	5	4	3	2	1

Comments:

---

---

---

---

	Extremely High				Not at all
<b><u>Stress Level</u></b>	5	4	3	2	1

Comments:

---

---

---

---

Additional Comments:

---

---

---

---

---

---

## Port Canaveral Berth Access Run Evaluation Form

Pilot # 3

Date: 14 FEB 2003

Run #: 19

Circle the number that best describes the run just completed:

**Vessel Trackline**

	Extremely Satisfactory				Not at all Satisfactory
- Vessel position with regard to centerline	5	(4)	3	2	1
- CPA to channel boundaries and/or buoys at the entrance	(5)	4	3	2	1
- Vessel position with regard to ships at the berth	(5)	4	3	2	1
- Maneuvering room at turning basin	(5)	4	3	2	1

**Vessel Controllability**

- Engine reserve	5	(4)	3	2	1
- Rudder reserve	5	4	3	(2)	1
- Course Control	5	(4)	3	2	1
- Speed Control	(5)	4	3	2	1
- Use of Tugs	5	4	3	2	1
- Thruster reserve	(5)	4	3	2	1

**Overall Safety**

	Absolutely Safe				Not at all safe
<b>Overall Safety</b>	(5)	4	3	2	1

Comments:

Able to control ship in safe position @ all times @ a safe speed - wider channel allows keeping more distance from moored vessels to alleviate surge

(over)





## Port Canaveral Berth Access Run Evaluation Form

Pilot # 1

Date: 14 FEB 2003

Run #: 20

Circle the number that best describes the run just completed:

	5	4	3	2	1
	Extremely Satisfactory				Not at all Satisfactory
<b><u>Vessel Trackline</u></b>					
- Vessel position with regard to centerline	5	4	(3)	2	1
- CPA to channel boundaries and/or buoys at the entrance	5	4	(3)	(2)	1
- Vessel position with regard to ships at the berth	5	4	(3)	2	1
- Maneuvering room at turning basin	5	(4)	3	2	1
<b><u>Vessel Controllability</u></b>					
- Engine reserve	5	(4)	3	2	1
- Rudder reserve	5	4	3	(2)	1
- Course Control	5	4	(3)	2	1
- Speed Control	5	(4)	3	2	1
- Use of Tugs	5	4	3	2	1
- Thruster reserve	5	(4)	3	2	1

NA

	5	4	3	2	1
	Absolutely Safe				Not at all safe
<b><u>Overall Safety</u></b>	5	(4)	3	2	1

Comments: Wind S. @ 25. Weather vane effect very strong while transiting harbor @ 6.0 knots, had to keep 15° of rudder to hold steady course, therefore leaving little reserve rudder if ship weather vane's (over) too much.

**Task Difficulty**

	Extremely Difficult			Not at all Difficult
	5	4	3	2
			1	

Comments:

---



---



---



---

**Stress Level**

Difficult		Extremely High		Not at all
	5	4	3	2
			1	

Comments:

*Must not break concentration at all, due to weather vane effect.*

---



---



---

Additional Comments:

*Due to additional dredging ship could be navigated away from other ships moored at V. berths, there by lessening surging effects.*

---



---



---

## Port Canaveral Berth Access Run Evaluation Form

Pilot # 2

Date: 14 FEB 2003

Run #: 21

Circle the number that best describes the run just completed:

	Extremely Satisfactory		3	2	Not at all Satisfactory
<b><u>Vessel Trackline</u></b>					
- Vessel position with regard to centerline	5	(4)			
- CPA to channel boundaries and/or buoys at the entrance	5	* (4)			
- Vessel position with regard to ships at the berth	5	(4)			
- Maneuvering room at turning basin	(5)	(4)			
<b><u>Vessel Controllability</u></b>					
- Engine reserve	(5)	4	3	2	1
- Rudder reserve	5	4	* (3)	2	1
- Course Control	5	(4)	3	2	1
- Speed Control	(5)	(4)	3	2	1
- Use of Tugs	5	4	3	2	1
- Thruster reserve	(5)	(4)	3	2	1

	Absolutely Safe		3	2	Not at all safe
<b><u>Overall Safety</u></b>	5	(4)			

Comments: \* - I BELIEVE IN REAL TIME - THIS

WOULD BE 4/5

ALSO - \*\* - DUE TO ADDITIONAL ROOM ALOFT SOUTH SIDE IN WEST CUT, THIS MANEUVER IS A 4/5 FOR SAFETY - THIS IS TRUE IN DAY 2 SCENARIO.

(over)

	Extremely Difficult		Not at all Difficult
<b>Task Difficulty</b>	5	(4) (3)	2 1

Comments: <sup>30</sup>5-25 KTS is VERY EXTREME & UNSAFE.

	Extremely High		Not at all
<b>Stress Level</b>	5	4	(3) 2 1

Comments:

Additional Comments: CHANNEL IMPROVEMENT MAKE 2-3 SAFE 30 KTS SWAY.

(JAR)

### Port Canaveral Berth Access Run Evaluation Form

Pilot # 3  
Run #: 22

Date: 2/14 2003

Circle the number that best describes the run just completed:

	Extremely Satisfactory				Not at all Satisfactory
<b><u>Vessel Trackline</u></b>					
- Vessel position with regard to centerline	5	(4)	3	2	1
- CPA to channel boundaries and/or buoys at the entrance	(5)	4	3	2	1
- Vessel position with regard to ships at the berth	(5)	4	3	2	1
- Maneuvering room at turning basin	(5)	4	3	2	1
<b><u>Vessel Controllability</u></b>					
- Engine reserve	(5)	4	3	2	1
- Rudder reserve	5	4	3	(2)	1
- Course Control	5	4	(3)	2	1
- Speed Control	(5)	4	3	2	1
- Use of Tugs	5	4	3	2	1
- Thruster reserve	(5)	4	3	2	1

*30 kt outbound  
south wind*

**Overall Safety**      *Absolutely Safe*      Not at all safe

5      (4)      3      2      1

Comments: @ 6.0 Kts - Hard "rudder"

barely can control the weather vane.  
1/2 had over 55 RPM - loss of control due to weather vane  
1/2 " " - 70 RPM - control restored

(over)

**Task Difficulty**

Extremely  
Difficult

5 4 3 2 1

Not at all  
Difficult

**Comments:**

---

---

---

---

**Stress Level**

Difficult

Extremely  
High

5 4 3 2 1

Not at all

**Comments:**

---

---

---

---

**Additional Comments:**

---

---

---

---

---

## Port Canaveral Berth Access Run Evaluation Form

Pilot # 1

Date: 14 FEB 2003

Run #: 23

Circle the number that best describes the run just completed:

	5	4	3	2	1
	Extremely Satisfactory				Not at all Satisfactory
<b><u>Vessel Trackline</u></b>					
- Vessel position with regard to centerline	5	(4)	3	2	1
- CPA to channel boundaries and/or buoys at the entrance	5	(4)	3	2	1
- Vessel position with regard to ships at the berth	5	(4)	3	2	1
- Maneuvering room at turning basin	5	(4)	3	2	1
<b><u>Vessel Controllability</u></b>					
- Engine reserve	5	(4)	3	2	1
- Rudder reserve	5	4	(3)	2	1
- Course Control	5	4	(3)	2	1
- Speed Control	5	(4)	3	2	1
- Use of Tugs	5	4	3	2	1 <i>HA</i>
- Thruster reserve	5	(4)	3	2	1

	5	4	3	2	1
	Absolutely Safe				Not at all safe
<b><u>Overall Safety</u></b>	5	(4)	3	2	1

Comments: \_\_\_\_\_

\_\_\_\_\_

\_\_\_\_\_

\_\_\_\_\_

(over)



	Extremely Difficult			Not at all Difficult
<b><u>Task Difficulty</u></b>	5	4	3 2	1

Comments:

---

---

---

---

	Extremely High			Not at all
<b><u>Stress Level</u></b>	5	4	3 2	1

Comments:

---

---

---

---

Additional Comments:

---

---

---

---

---

## Port Canaveral Berth Access Run Evaluation Form

Pilot # 2Date: 14 FEB 2003Run #: 24

Circle the number that best describes the run just completed:

	Extremely Satisfactory				Not at all Satisfactory
<b><u>Vessel Trackline</u></b>					
- Vessel position with regard to centerline	5	(4)	3	2	1
- CPA to channel boundaries and/or buoys at the entrance	5	(4)	3	2	1
- Vessel position with regard to ships at the berth	5	(4)	3	2	1
- Maneuvering room at turning basin	5	(4)	3	2	1
<b><u>Vessel Controllability</u></b>					
- Engine reserve	5	(4)	3	2	1
- Rudder reserve	5	4	3	(2)	1
- Course Control	5	4	(3)	2	1
- Speed Control	5	(4)	3	2	1
- Use of Tugs	5	4	3	2	1
- Thruster reserve	5	(4)	3	2	1

	Absolutely Safe				Not at all safe
<b><u>Overall Safety</u></b>	5	4	(3)	2	1

Comments: WITH NO CHANNEL IMPROVEMENTS -

25KTS IS ACCEPTABLE ON SIMULATOR BUT AT UPPER MARGIN FOR SAFETY - VERY LITTLE RUDDER RESERVE FOR GUSTS.

(over)

	Extremely Difficult				Not at all Difficult
<b>Task Difficulty</b>	5	4	3	2	1

Comments:

FELT COMFORTABLE W/ 25 KTI KNOWING  
HOW TO HANDLE VESSEL MANOEUVRE

Difficult		Extremely High			Not at all
<b>Stress Level</b>	5	4	3	2	1

Comments:

\_\_\_\_\_  
\_\_\_\_\_  
\_\_\_\_\_

Additional Comments:

IMO FOR SAFETY PORT NEEDS  
IMPROVEMENTS

\_\_\_\_\_  
\_\_\_\_\_  
\_\_\_\_\_



	Extremely Difficult					Not at all Difficult
<b><u>Task Difficulty</u></b>	5	4	3	2		1

**Comments:**

---

---

---

---

---

		Extremely High				Not at all
<b><u>Stress Level</u></b>	5	4	3	2		1

**Comments:**

---

---

---

---

---

**Additional Comments:**

---

---

---

---

---

---

## Port Canaveral Berth Access Run Evaluation Form

Pilot # 1

Date: 14 FEB 2003

Run #: 26

Circle the number that best describes the run just completed:

	Extremely Satisfactory			Not at all Satisfactory	
	5	4	3	2	1
<b><u>Vessel Trackline</u></b>					
- Vessel position with regard to centerline	5	4	(3)	2	1
- CPA to channel boundaries and/or buoys at the entrance	5	4	(3)	2	1
- Vessel position with regard to ships at the berth	5	4	(3)	2	1
- Maneuvering room at turning basin	5	4	(3)	2	1
<b><u>Vessel Controllability</u></b>					
- Engine reserve	(5)	4	3	2	1
- Rudder reserve	5	4	3	(2)	1
- Course Control	5	4	3	(2)	1
- Speed Control	5	(4)	3	2	1
- Use of Tugs	5	4	3	2	1 NA
- Thruster reserve	5	(4)	(3)	2	1

	Absolutely Safe			Not at all safe	
	5	4	3	2	1
<b><u>Overall Safety</u></b>	5	4	(3)	2	1

Comments: South wind @ 25.

Kept vessel 5.8 in harbor + 6.2 @ CT-2  
7.5 @ E. Basin. Had to keep 20°  
rudder to maintain heading.

(over)



## Port Canaveral Berth Access Run Evaluation Form

Pilot # 2

Date: 14 FEB 2003

Run #: 27

Circle the number that best describes the run just completed:

	Extremely Satisfactory				Not at all Satisfactory
<b><u>Vessel Trackline</u></b>					
- Vessel position with regard to centerline	5	(4)	3	2	1
- CPA to channel boundaries and/or buoys at the entrance	5	(4)	3	2	1
- Vessel position with regard to ships at the berth	5	(4)	3	2	1
- Maneuvering room at turning basin	5	(4)	3	2	1
<b><u>Vessel Controllability</u></b>					
- Engine reserve	5	(4)	3	2	1
- Rudder reserve	5	(4)	3	2	1
- Course Control	5	(4)	3	2	1
- Speed Control	5	(4)	3	2	1
- Use of Tugs	5	(4)	3	2	1
- Thruster reserve	5	(4)	3	2	1

	Absolutely Safe				Not at all safe
<b><u>Overall Safety</u></b>	5	(4)	3	2	1

Comments: NO PROBLEMS WHATSOEVER AT 15 KNOTS / NORTH WIND

(over)



	Extremely Difficult				Not at all Difficult
<b><u>Task Difficulty</u></b>	5	4	3	2	1

**Comments:**

---

---

---

---

	Extremely High				Not at all
<b><u>Stress Level</u></b>	5	4	3	2	1

**Comments:**

---

---

---

---

**Additional Comments:**

---

---

---

---

---

---

## Port Canaveral Berth Access Final Evaluation Form

Pilot #:   /  Date:   2-14-03  

1) Were there any differences in the response of the simulated ship model(s) when compared to your experience with the actual ship(s)? (Indicate if no relevant experience.) Please indicate how any differences may have affected the results of the simulation study.

No experience w/ actual ship.

2) Were there any differences in the effect on the vessel of the simulated wind and current when compared to your real-world experience, or with your expectations. If so, please indicate how this difference may have affected the results of the simulation study.

Simulated ship weather vaned (turned into the wind) more than expected. Therefore approximate rudder angle of 15° to 20° was needed to compensate for weather vane effect, leaving only 15° rudder for steering.  
Also, ship did not ~~set~~ set sideways as much as expected even w/ 25 knot on beam.

3) Of the conditions tested with the Voyager Class maneuvering model, which do you consider were the most challenging? Please explain.

South winds are more challenging than north winds due to the fact that you have to hold the ship tight along the pier & ship moored on the south side. Surge will be increased the closer to the ships you are. The higher the winds the more difficult, needing more speed to maintain position, therefore surging ships more.  
North winds allow you to cut up into east, & middle basin entrances.

Configuration Specific Comments**CONFIGURATION 1: Existing Port Conditions**

4) In your opinion does the existing Entrance Channel configuration pose any difficulty for maneuvering the Voyager Class vessel for arrivals and departures? Please explain.

Arrival yes - If winds exceed 15 knots, the crab will increase unless we increase speed, there by surging ship.

Departure yes - same as above.

5) Do you feel that the unimproved Inner Reach to the West Basin portion of the transit poses any difficulty in maneuvering the Voyager Class vessel, within prescribed requirements (such as maximum transit speed, clearance to vessels), or with regard to safe distances from shoal areas or aids to navigation? Please explain, including specific conditions of wind, weather or time of day that would impact the transit.

Yes, as stated above, you must stay extremely close to a ship at N-N in bound, while ~~the~~ the port quarter comes close to the shoals on the south side with North wind.  
If south wind it is difficult to turn out of the basin due to the need to hold tight to the south side shoal near buoys 15 + 19, + not set to north.

6) Is the existing, unimproved West Basin adequate in dimension and configuration to maneuver a vessel of the Voyager Class to/from the target berth (CT 10) under the normal range of conditions (wind and weather) experienced at the port? If not, please explain any deficiencies.

yes.

**CONFIGURATION 2: Near-Term Improvements – Dredging (6 locations)**

7) Under the second configuration that included the various near-term dredging projects, do you feel that the improved areas in the Inner Reach to the West Basin portion of the

port pose any difficulty in maneuvering the Voyager Class vessel, within prescribed requirements (such as maximum transit speed, clearance to vessels), or with regard to safe distances from shoal areas or aids to navigation? Please explain, specifying what deficiencies previously noted above would be corrected by these improvements.

These 6 dredged areas greatly improved the safety margins required to transit the port. Speed can be kept down somewhat depending on wind conditions, due to utilizing these dredged areas. As speed is kept down to approx. 5.8 knots, surging should be minimal.

### CONFIGURATION 3: Long-Term Improvements – Outbound Range, Channel Widening, Shoreline Re-alignments

8) Please comment on the usefulness of the Outbound Channel Range, including in what ways it improves the navigation for departure and/or arrival.

It is imperative to have the outbound range due to the sheer size of the ship and trying to keep her in position, in the channel. This can be accomplished w/ the range + the ship can be kept tight on the windward side of the channel with confidence to maintain safety margins.

9) Please explain how the channel widening corrects any previously noted deficiencies or enhances navigability of the Inner Reach with respect to harbor transits of large vessels, and specifically with respect to the Voyager Class vessel.

With winds of 25 knots, the extra room was necessary in order to keep surging to a minimum. This can be accomplished due to 2 reasons. 1. Physically keeping the Voyager away from the ships on the south side.  
2. Larger crab angle can be safely maintained with relatively slower speeds due to the newly dredged areas.

10) In what way do the shoreline realignments along the Inner Reach (between the Trident Basin and the Middle Basin) and within the West Basin (cutoff of corner area) enhance the safety of navigation in general, and specifically as relates to ships of the Voyager Class? Please be as specific as possible.

Inner Reach Shoreline (north side) Same reasons as #9.

Also the area near buoy #14A allows us to cut up into middle basin earlier as this is the tightest area in the port especially w/ ships at SCP-1.

Cutoff at West Basin Same as #10

---



---



---

11) What in your opinion, should be a restricting upper limit wind condition (direction and speed) for operation of the Voyager Class vessel in the port. Be as specific as possible with reference to maintaining safe transit speeds and clearances to moored vessels, for both departure and arrival situations. This is only a recommendation for initial operations bearing in mind that experience gained with the actual vessel may require reevaluation of any limits or restrictions.

	<del>inbound</del> inbound.		outbound.	
Port # 1	N-20	S-15	N-20	S-15
Port # 2	N-30	S-30	N-30	S-30
Port # 3	N-35	S-30	N-35	S-30

Note, East + West winds can be slightly higher.

12) Do you have any suggestions or recommendations not addressed above?

All pilots should have been aboard the Voyager class ship for observation transits several times, before actually piloting. Some transits may be done on the simulator, but at least one aboard the actual ship.

Additional Comments:

---



---



---



---



---

Please use additional sheets if necessary to complete your responses.

**Thank you for your participation in this important project!**

## Port Canaveral Berth Access Final Evaluation Form

Pilot #: 2Date: 14 FEB 2003

1) Were there any differences in the response of the simulated ship model(s) when compared to your experience with the actual ship(s)? (Indicate if no relevant experience.) Please indicate how any differences may have affected the results of the simulation study.

**Unfortunately, until tomorrow I have no experience with the vessel and cannot make an observation at this time.**

2) Were there any differences in the effect on the vessel of the simulated wind and current when compared to your real-world experience, or with your expectations. If so, please indicate how this difference may have affected the results of the simulation study.

**Please see Question #1.**

3) Of the conditions tested with the Voyager Class maneuvering model, which do you consider were the most challenging? Please explain.

**I feel that the most challenging task was with Configuration #1 when the wind was out of the south at 25 knots with a half-knot of current setting to the north. This is due to the fact that with the requirement to slow down to a safe speed in the harbor it is necessary to have a large crab angle which with this length and air draft of vessel makes it extremely difficult to keep the entire ship in the channel. With the port having most of the berths on the south side of the channel ways, having to steer the vessel close to those ships in order to have the stern in good water in this configuration makes the safety factor close to marginal; however, the job can be done with experienced pilots working at the 95% level of acceptable safety.**

### Configuration Specific Comments

#### **CONFIGURATION 1: Existing Port Conditions**

4) In your opinion does the existing Entrance Channel configuration pose any difficulty for maneuvering the Voyager Class vessel for arrivals and departures? Please explain.

Arrival **With winds in excess of approximately 25 knots, it would be very difficult to maintain the highest standards of safety which we and the port should expect for the vessel and ships at the berths.**

Departure **Same answer**

5) Do you feel that the unimproved Inner Reach to the West Basin portion of the transit poses any difficulty in maneuvering the Voyager Class vessel, within prescribed requirements (such as maximum transit speed, clearance to vessels), or with regard to safe distances from shoal areas or aids to navigation? Please explain, including specific conditions of wind, weather or time of day that would impact the transit.

**Certainly, the areas of concern that have been “fixed” in Configuration #2 would pose a difficulty unless they are addressed for those times when weather conditions exceed the 25 knot parameter I described previously. During the periods of the year between October – May when cold fronts are prevalent and during the summer when afternoon thunderstorms are more evident, tension would run high unless we have the improvements. Most significantly, south wind conditions are of greatest concern.**

6) Is the existing, unimproved West Basin adequate in dimension and configuration to maneuver a vessel of the Voyager Class to/from the target berth (CT 10) under the normal range of conditions (wind and weather) experienced at the port? If not, please explain any deficiencies.

**I am afraid the “normal wind and weather” includes that range of winds we encounter after cold fronts and during thunderstorms and I would have to say that I have grave concerns for the safe transit of this vessel during severe weather which is a certainty not just a possibility but a frequent reality. I offer this comment with the benefit of 18 years of piloting experience. The deficiencies are those areas addressed by Configuration #2.**

**CONFIGURATION 2: Near-Term Improvements – Dredging (6 locations)**

7) Under the second configuration that included the various near-term dredging projects, do you feel that the improved areas in the Inner Reach to the West Basin portion of the port pose any difficulty in maneuvering the Voyager Class vessel, within prescribed requirements (such as maximum transit speed, clearance to vessels), or with regard to safe distances from shoal areas or aids to navigation? Please explain, specifying what deficiencies previously noted above would be corrected by these improvements.

**I believe that the near term improvements if completed will take care of any and all concerns for safety that I address in earlier comments. These deficiencies would allow a slower transit speed ensuring safety to port structures, the vessel, and other ships at port berths. In addition, the vessel will have greater clearances on both the bow and stern to shoal water and other berthed vessels that will allow a margin of error in precision positioning that the existing configuration does not have.**

**CONFIGURATION 3: Long-Term Improvements – Outbound Range, Channel Widening, Shoreline Re-alignments**

8) Please comment on the usefulness of the Outbound Channel Range, including in what ways it improves the navigation for departure and/or arrival.

**This is an absolute essential piece of the ultimate navigational plan due to the fact that with a one-thousand foot long ship, when applying leeway (crab angle) to effect course over the ground, one's perspective is skewed due to the fact that the pilot is so near the bow that he must offset his position to windward of the center of the channel so that the stern is in safe water. This is difficult during the day and even more extreme when at night the only reference points available are the lights from buoys which are on the channel limits and not in such a position where they may be used to accurately ascertain one's position in reference to the center of the channel. This has been true since 1996 when we began bringing in large high-windage cruise ships and even more this year as we enter a new era in length and air draft of vessels.**



9) Please explain how the channel widening corrects any previously noted deficiencies or enhances navigability of the Inner Reach with respect to harbor transits of large vessels, and specifically with respect to the Voyager Class vessel.

**Without a doubt, the channel configuration under this section will enhance the safety of transits in conditions when winds exceed 25 knots due to the ability to have a larger crab angle at a slower speed thus ensuring overall safety of the transit.**

10) In what way do the shoreline realignments along the Inner Reach (between the Trident Basin and the Middle Basin) and within the West Basin (cutoff of corner area) enhance the safety of navigation in general, and specifically as relates to ships of the Voyager Class? Please be as specific as possible.

Inner Reach Shoreline (north side) **Coming from sea, the vessel will have to slow down from a speed of approximately 12 knots at buoy #9 to about six knots or less at the entrance to the middle basin. The shoreline realignment will allow the vessel to be brought down in speed much quicker and with more control than under the existing configuration.**

Cutoff at West Basin **The cutoff at the west basin will allow vessels to slow sooner before entering the west turning basin and begin the actual turn in to the basin much sooner than is now possible that will also ensure that vessels along the south side of the port in west cut are not caused to be too close to the stern of the Mariner with the obvious deleterious effects. The stern of the Mariner will be much better protected to possible grounding because at a slower speed it will be able to "climb" to the north.**

11) What in your opinion, should be a restricting upper limit wind condition (direction and speed) for operation of the Voyager Class vessel in the port. Be as specific as possible with reference to maintaining safe transit speeds and clearances to moored vessels, for both departure and arrival situations. This is only a recommendation for initial operations bearing in mind that experience gained with the actual vessel may require reevaluation of any limits or restrictions. **With north and south wind directions, I believe that 25 - 30 knots under the existing conditions without configuration #2 improvements would be**

**appropriate. East or west winds of 40 Knots would be ok due to the channel headings.**

12) Do you have any suggestions or recommendations not addressed above?

**All pilots who are assigned to the vessel as control pilot should be required to see the vessel in transit under the direction of another pilot whether it be in Port Canaveral or at another port before he or she is allowed to handle the vessel solo.**

Additional Comments:

**I want to thank all the personnel who made it possible for my associates and I to attend the simulation and be able to provide comment on the safety aspects of bringing the Mariner in to Port Canaveral. Thank you: Dave, Victor, Howard, and Sandy and all the unnamed people who I have not met but who have worked behind the scenes to make the simulator so "real."**

Please use additional sheets if necessary to complete your responses.

*Thank you for your participation in this important project!*

### Port Canaveral Berth Access Final Evaluation Form

Pilot #: 3

Date: 2-14-03

1) Were there any differences in the response of the simulated ship model(s) when compared to your experience with the actual ship(s)? (Indicate if no relevant experience.) Please indicate how any differences may have affected the results of the simulation study.

N/A  
No Experience

2) Were there any differences in the effect on the vessel of the simulated wind and current when compared to your real-world experience, or with your expectations. If so, please indicate how this difference may have affected the results of the simulation study.

Less Set  
More "weather vane" } than expected

Therefore: Due to difficulty in controlling heading  
in strong crosswinds the actual (or real)  
ship performance may be different (better)

3) Of the conditions tested with the Voyager Class maneuvering model, which do you consider were the most challenging? Please explain.

Strong Cross winds (25Kts plus) and especially  
from the south

**Configuration Specific Comments**

**CONFIGURATION 1: Existing Port Conditions**

4) In your opinion does the existing Entrance Channel configuration pose any difficulty for maneuvering the Voyager Class vessel for arrivals and departures? Please explain.

Arrival Due to the confines of the channel, ship speeds, in strong crosswinds, may need to be higher than 6 Kts - this will possibly cause surging of docked ships.

Departure Same as above

5) Do you feel that the unimproved Inner Reach to the West Basin portion of the transit poses any difficulty in maneuvering the Voyager Class vessel, within prescribed requirements (such as maximum transit speed, clearance to vessels), or with regard to safe distances from shoal areas or aids to navigation? Please explain, including specific conditions of wind, weather or time of day that would impact the transit.

A) Clearance to vessels could be a problem if the ship, at a given speed, creates more "surge effects" than the present cruise ships

- ① North wind in vicinity of Rinker Dock (25 Kts+)
  - ② South wind in vicinity of SCP #1 (20 Kts+)
- ↑  
south cargo pier

6) Is the existing, unimproved West Basin adequate in dimension and configuration to maneuver a vessel of the Voyager Class to/from the target berth (CT 10) under the normal range of conditions (wind and weather) experienced at the port? If not, please explain any deficiencies.

YES (except to say that the proposed widening just west of RINKER<sub>2</sub> will provide a safer entrance/exit from the West Basin)

**CONFIGURATION 2: Near-Term Improvements – Dredging (6 locations)**

7) Under the second configuration that included the various near-term dredging projects, do you feel that the improved areas in the Inner Reach to the West Basin portion of the

port pose any difficulty in maneuvering the Voyager Class vessel, within prescribed requirements (such as maximum transit speed, clearance to vessels), or with regard to safe distances from shoal areas or aids to navigation? Please explain, specifying what deficiencies previously noted above would be corrected by these improvements.

- 1) Area just west of Rinker - Will enhance safe entry/exit to W Basin
- 2) Area on south side of West Basin Access Channel will improve "surge prevention" @ Rinker and allow the larger ship to enter/exit West Basin safer
- 3) Area by Navy Dock will be very important when ships base at South Cargo Piers

### CONFIGURATION 3: Long-Term Improvements – Outbound Range, Channel Widening, Shoreline Re-alignments

8) Please comment on the usefulness of the Outbound Channel Range, including in what ways it improves the navigation for departure and/or arrival.

- 1) Outbound range for outbound traffic (especially night) is essential for these large ships

9) Please explain how the channel widening corrects any previously noted deficiencies or enhances navigability of the Inner Reach with respect to harbor transits of large vessels, and specifically with respect to the Voyager Class vessel.

The area The 500' Channel will provide a first class safe channel, as opposed to the present piece meal attempts to provide for safe transit of ships

This is a farsighted intelligent plan

10) In what way do the shoreline realignments along the Inner Reach (between the Trident Basin and the Middle Basin) and within the West Basin (cutoff of corner area) enhance the safety of navigation in general, and specifically as relates to ships of the Voyager Class? Please be as specific as possible.

Inner Reach Shoreline (north side) This is an important widening to alleviate surge of docked ships & eliminates the narrow area in vicinity of south cargo piers and navy dock which is always a tight area to navigate with even smaller ships

Cutoff at West Basin This will enhance the entry/exit of mega cruise ships into Basin as well as provide more underwater area to distribute the hydraulic effects (which creates surging at RINKER DOCK) that the ship will create. Slower speeds will be more possible.

11) What in your opinion, should be a restricting upper limit wind condition (direction and speed) for operation of the Voyager Class vessel in the port. Be as specific as possible with reference to maintaining safe transit speeds and clearances to moored vessels, for both departure and arrival situations. This is only a recommendation for initial operations bearing in mind that experience gained with the actual vessel may require reevaluation of any limits or restrictions.

NORTH WIND	30
SOUTH WIND	30
EAST WIND	35
WEST WIND	35

Note, I will not participate in specifics since this is a joint pilot/captain decision

12) Do you have any suggestions or recommendations not addressed above?

\* Outside Turn at Buoy #9 should have a widener that reflects the area in the vicinity of buoy #11.

Additional Comments: SURGE

SURGE could not be addressed by the simulator & only experience will be able to evaluate this - improvements proposed however will improve this situation

Please use additional sheets if necessary to complete your responses.

*Thank you for your participation in this important project!*

## Port Canaveral Berth Access Final Evaluation Form

Pilot #:

4

Date:

2-14-03

1) Were there any differences in the response of the simulated ship model(s) when compared to your experience with the actual ship(s)? (Indicate if no relevant experience.) Please indicate how any differences may have affected the results of the simulation study.

THE VISUAL AND ENVIRONMENTAL EXPERIENCES ARE NOT AS YOU WILL SEE ONBOARD.

THIS PROBLEM CAN CAUSE SOME OVERUSE OF POWER AND/OR POD ANGLES.

2) Were there any differences in the effect on the vessel of the simulated wind and current when compared to your real-world experience, or with your expectations. If so, please indicate how this difference may have affected the results of the simulation study.

IT APPEARS THAT THE MODEL SHIP TURNS MORE INTO THE WIND THAN THE REAL SHIP, MAKING IT NECESSARY TO USE MORE "RUDDER" POD ANGLE TO STAY ON COURSE.

3) Of the conditions tested with the Voyager Class maneuvering model, which do you consider were the most challenging? Please explain.

UNDOCKING WITH 40KN NORTH WIND. HAD TO USE ALL AVAILABLE POWER.

**Configuration Specific Comments****CONFIGURATION 1: Existing Port Conditions**

4) In your opinion does the existing Entrance Channel configuration pose any difficulty for maneuvering the Voyager Class vessel for arrivals and departures? Please explain.

Arrival

ENTRY TO AND FROM TURNING BASIN IS  
SOMEWHAT UNSAFE IN 25 KNOT WINDS FROM NORTH-  
OR SOUTH.  
CHANNEL HOBBING ALSO IS MORE DIFFICULT AT 25 KN + WINDS.

Departure

SAME

5) Do you feel that the unimproved Inner Reach to the West Basin portion of the transit poses any difficulty in maneuvering the Voyager Class vessel, within prescribed requirements (such as maximum transit speed, clearance to vessels), or with regard to safe distances from shoal areas or aids to navigation? Please explain, including specific conditions of wind, weather or time of day that would impact the transit.

WINDS FROM NORTH OR SOUTH AT 25 KN.  
COULD ~~POSE~~ POSE DIFFICULT.

6) Is the existing, unimproved West Basin adequate in dimension and configuration to maneuver a vessel of the Voyager Class to/from the target berth (CT 10) under the normal range of conditions (wind and weather) experienced at the port? If not, please explain any deficiencies.

NORMAL WIND CONDITIONS IN THE TURNING  
BASIN IS NOT DIFFICULT. THERE IS  
ENOUGH SPACE TO TURN AROUND AND TO  
MANOUEVER.

THERE IS HOWEVER VERY LIMITED SPACE  
BEHIND THE STERN WHEN DOCKED.

**CONFIGURATION 2: Near-Term Improvements – Dredging (6 locations)**

7) Under the second configuration that included the various near-term dredging projects, do you feel that the improved areas in the Inner Reach to the West Basin portion of the



port pose any difficulty in maneuvering the Voyager Class vessel, within prescribed requirements (such as maximum transit speed, clearance to vessels), or with regard to safe distances from shoal areas or aids to navigation? Please explain, specifying what deficiencies previously noted above would be corrected by these improvements.

MORE CLEARANCE TO OTHER VESSELS IN THE CHANNEL & MORE SPACE ENTERING/LEAVING THE TURNING BASIN.

### CONFIGURATION 3: Long-Term Improvements – Outbound Range, Channel Widening, Shoreline Re-alignments

8) Please comment on the usefulness of the Outbound Channel Range, including in what ways it improves the navigation for departure and/or arrival.

DELAYED SAAILINGS MAKES FOR CHANNEL TRANSIT AT NIGHT WITH FEW MEANS FOR AIDS TO CHANNEL KEEPING. WITH THE RANGE IN PLACE, IT WILL BE SAFER.

9) Please explain how the channel widening corrects any previously noted deficiencies or enhances navigability of the Inner Reach with respect to harbor transits of large vessels, and specifically with respect to the Voyager Class vessel.

MORE ROOM TO MANOUVER / CRAB ANGLE IN THE CHANNEL.

10) In what way do the shoreline realignments along the Inner Reach (between the Trident Basin and the Middle Basin) and within the West Basin (cutoff of corner area) enhance the safety of navigation in general, and specifically as relates to ships of the Voyager Class? Please be as specific as possible.

Inner Reach Shoreline (north side) NO NEED TO BE AS WORRIED FOR SUCKION IF YOU NEED TO HUG THE NORTH SIDE OF THE CHANNEL DUE TO WIND AND/OR VESSEL DOCK ON THE SOUTH SIDE.

Cutoff at West Basin MAJOR BENEFIT AS THIS IS A GREAT HELP FOR ENTRY AND LEAVING THE TUCKING BASIN.

11) What in your opinion, should be a restricting upper limit wind condition (direction and speed) for operation of the Voyager Class vessel in the port. Be as specific as possible with reference to maintaining safe transit speeds and clearances to moored vessels, for both departure and arrival situations. This is only a recommendation for initial operations bearing in mind that experience gained with the actual vessel may require reevaluation of any limits or restrictions.

1/ 30 KN WIND NORTH/SOUTH. DEPENDS ON OTHER SHIPS IN THE PORT.

2/ 30 - 35 SAME

3/ 30 - Gust 40 - Same as above.

12) Do you have any suggestions or recommendations not addressed above?

Additional Comments:

Please use additional sheets if necessary to complete your responses.

*Thank you for your participation in this important project!*

## Port Canaveral Berth Access Final Evaluation Form

Pilot #: 5 EARL McMILLINDate: 17 FEB 2003

1) Were there any differences in the response of the simulated ship model(s) when compared to your experience with the actual ship(s)? (Indicate if no relevant experience.) Please indicate how any differences may have affected the results of the simulation study.

I HAVE NEVER BEEN ABOARD A VOYAGER CLASS VESSEL.

2) Were there any differences in the effect on the vessel of the simulated wind and current when compared to your real-world experience, or with your expectations. If so, please indicate how this difference may have affected the results of the simulation study.

YES. THE SIMULATED SHIP APPEARED TO TURN INTO A BEAM WIND MUCH FASTER AND CORRECTIVE ACTIONS SEEMED MUCH MORE RADICAL THAN ANTICIPATED. ALSO THE SHIP DID NOT TRAVEL BODILY DOWNWIND AS QUICKLY AS ANTICIPATED.

<SEE PAGE I-A>

3) Of the conditions tested with the Voyager Class maneuvering model, which do you consider were the most challenging? Please explain.

THE ONLY EXERCISE I DID PERSONALLY IN MANEUVERING MODE WAS DOGRINE IN A 25KT NORTH WIND. UNFAMILIARITY WITH THE CONTROLS AND EFFORTS TO USE A "LIGHT TOUCH" RESULTED IN A POOR PERFORMANCE.

WATCHING OTHERS ATTEMPT TO TRANSIT

<SEE PAGE I-A>

Configuration Specific Comments

**CONFIGURATION 1: Existing Port Conditions**

4) In your opinion does the existing Entrance Channel configuration pose any difficulty for maneuvering the Voyager Class vessel for arrivals and departures? Please explain.

Arrival YES. WIDENING THE CHANNEL FROM MIDDLE TO WEST BASIN SEEMS TO ME TO BE ESSENTIAL. THIS IS TO BE DONE BY REMOVING MATERIAL ALONG THE SOUTH SIDE TO GIVE AN ADDITIONAL  
Departure 87+ FEET. THIS WILL GREATLY IMPROVE THE SAFETY MARGIN FOR GETTING BY CEMENT SHIPS AT NORTH CARGO 4 INBOUND OR OUTBOUND AND TURNING IN OR OUT OF WEST BASIN.

5) Do you feel that the unimproved Inner Reach to the West Basin portion of the transit poses any difficulty in maneuvering the Voyager Class vessel, within prescribed requirements (such as maximum transit speed, clearance to vessels), or with regard to safe distances from shoal areas or aids to navigation? Please explain, including specific conditions of wind, weather or time of day that would impact the transit.

YES. CEMENT SHIPS AT NORTH CARGO 4 ARE OFTEN VERY DEEPLY LOADED. ALSO, NORTH CARGO 4 IS 400' LONG AND THE CEMENT SHIPS OVERHANG IT BOTH FORE AND AFT. FREQUENTLY THE ACCOMMODATION LADDERS OF CEMENT SHIPS ARE BARELY ABLE TO REACH THE DOCK. FINALLY THE AUGER UNLOADER

<SEE PAGE 2-A>

6) Is the existing, unimproved West Basin adequate in dimension and configuration to maneuver a vessel of the Voyager Class to/from the target berth (CT 10) under the normal range of conditions (wind and weather) experienced at the port? If not, please explain any deficiencies.

YES.  
\_\_\_\_\_  
\_\_\_\_\_  
\_\_\_\_\_  
\_\_\_\_\_  
\_\_\_\_\_

**CONFIGURATION 2: Near-Term Improvements – Dredging (6 locations)**

7) Under the second configuration that included the various near-term dredging projects, do you feel that the improved areas in the Inner Reach to the West Basin portion of the

port pose any difficulty in maneuvering the Voyager Class vessel, within prescribed requirements (such as maximum transit speed, clearance to vessels), or with regard to safe distances from shoal areas or aids to navigation? Please explain, specifying what deficiencies previously noted above would be corrected by these improvements.

AS STATED ABOVE, IN MY VIEW, THE REMOVAL OF MATERIAL TO WIDEN THE CHANNEL 87+ FEET WILL MAKE TURNING INTO AND OUT OF WEST BASIN AND PASSING SHIPS AT NORTH CARGO 4 INBOUND AND OUTBOUND MUCH SAFER.

**CONFIGURATION 3: Long-Term Improvements – Outbound Range, Channel Widening, Shoreline Re-alignments**

8) Please comment on the usefulness of the Outbound Channel Range, including in what ways it improves the navigation for departure and/or arrival.

ALTHOUGH I WAS UNABLE TO REMAIN AT STAR CENTER AFTER DAY TWO AND DID NOT SEE THE LONG TERM IMPROVEMENTS USED IT IS MY OPINION THAT AN OUTBOUND RANGE IS DESIRABLE.

9) Please explain how the channel widening corrects any previously noted deficiencies or enhances navigability of the Inner Reach with respect to harbor transits of large vessels, and specifically with respect to the Voyager Class vessel.

NO COMMENT. UNABLE TO REMAIN AT STAR CENTER AFTER DAY TWO.

10) In what way do the shoreline realignments along the Inner Reach (between the Trident Basin and the Middle Basin) and within the West Basin (cutoff of corner area) enhance the safety of navigation in general, and specifically as relates to ships of the Voyager Class? Please be as specific as possible.

Inner Reach Shoreline (north side)

NO COMMENT. UNABLE TO REMAIN AT STAR CENTER AFTER DAY TWO.

Cutoff at West Basin \_\_\_\_\_  
\_\_\_\_\_  
\_\_\_\_\_  
\_\_\_\_\_

11) What in your opinion, should be a restricting upper limit wind condition (direction and speed) for operation of the Voyager Class vessel in the port. Be as specific as possible with reference to maintaining safe transit speeds and clearances to moored vessels, for both departure and arrival situations. This is only a recommendation for initial operations bearing in mind that experience gained with the actual vessel may require reevaluation of any limits or restrictions.

WITH THE HARBOR "AS IS" I BELIEVE  
20 KTS CROSSWIND — NORTH OR  
SOUTH — IS THE LIMIT. IF THERE  
ARE SHIPS AT

- |     |                 |   |
|-----|-----------------|---|
| (a) | CRUISE TERMINAL | 4 |
| (b) | SOUTH CARGO     | 1 |
| (c) | NORTH CARGO     | 3 |
| (d) | NORTH CARGO     | 4 |

12) Do you have any suggestions or recommendations not addressed above?

IT WOULD BE WELL IF CANAVERAL  
PILOTS COULD TRAIN ON VOYAGER  
CLASS VESSELS AT STAR CENTER  
AFTER THE PORT & VESSEL  
SIMULATIONS ARE FINE TUNED.

Additional Comments:

IT IS MY INTENTION TO RIDE  
NAVIGATOR OF THE SEAS IN AND  
OUT OF MIAMI AT LEAST ONCE.

ADDITIONALLY I MAY ASK RCI IF  
RIDING MARINER OF THE SEAS  
IS POSSIBLE.

Please use additional sheets if necessary to complete your responses.

Thank you for your participation in this important project!

< SEE PAGE  
# - A >

PORT CANAVERAL BERTH ACCESS  
FINAL EVALUATION

PILOT 5 EARL McMILLIN

#2 I DO NOT BELIEVE THE FACT THAT THE SIMULATED SHIP BEHAVED DIFFERENTLY FROM WHAT I EXPECTED AFFECTED THE STUDY RESULTS.

#3 THE HARBOR IN 25 KT CROSSWINDS WHILE KEEPING SHIP'S SPEED WITHIN LIMITS THAT WOULD NOT CAUSE SURGING OF MOORED VESSELS WAS MOST INTERESTING. WHAT SEEMED TO HELP WAS USING MORE POWER ON ONE AZIPOD THAN THE OTHER — RPM SELECT, IN MY VIEW THIS WAS MOST CHALLENGING.

PAGE 1-A

PORT CANAVERAL BERTH ACCESS  
FINAL EVALUATION

PILOT S EARL McMILLIN

#5 AT NORTH CARGO 4 IS OF CONCERN — A SURGING CEMENT SHIP COULD DAMAGE IT.

SOME YEARS AGO I RECEIVED AN URGENT CALL FROM RINKER ADVISING THAT THE UNLOADER WAS STUCK IN A SHIP'S HOLD AND IT WAS IMPERATIVE THAT APPROACHING INBOUND CRUISE SHIPS PASS BY AS SLOWLY AS POSSIBLE.

A NORTH WIND REQUIRES THAT CEMENT SHIPS BE PASSED CLOSELY AND THIS INCREASES THE POSSIBILITY OF SURGING.

PAGE 2-A



PORT CANAVERAL BERTH ACCESS  
FINAL EVALUATION

PILOT 5 EARL McMILLIN

ADDITIONAL COMMENTS.

ACCORDING TO THE INFORMATION PROVIDED BY RCI THE PODS CANNOT — OR SHOULD NOT — BE OPERATED ASTERN. THIS LIMITS MANEUVERABILITY AND MAKES DPS/TS OPERATION IMPOSSIBLE. SINCE THE SHIP CANNOT FUNCTION AS SHE WAS DESIGNED TO FUNCTION HARBOR IMPROVEMENTS TO ACCOMMODATE HER ARE REQUIRED.

**Port Canaveral Section 203 Feasibility Study  
Engineering Appendix**

Attachment A

Port Canaveral 2007 STAR Center Report



Dania Beach, FL  
Toledo, OH

# RTM STAR Center

## SIMULATION, TRAINING, ASSESSMENT & RESEARCH

2 West Dixie Highway • Dania Beach, Florida 33004  
TEL 954-921-7254 • 800-445-4522 • FAX 954-920-4268 • 800-431-8815  
www.star-center.com • email@star-center.com



ISO 9001  
Certificate No. 38806

4 June 2007

## Port Canaveral 2007

### 1 STUDY OVERVIEW

This report describes the methodology and the results obtained from the simulation-based evaluation of the proposed channel improvements at Port Canaveral, Florida. The objective of the study was to examine vessel operations conducted in a widened channel and improved turning basin.

Improvements that were evaluated include:

- Dredging/widening the turn from the “Outer Reach” to “Middle Reach” at the harbor entrance east of the breakwater.
- Increased depth, 44 feet in the entrance channel and 41 feet in the within the harbor..
- Dredging areas to realign and widen the inner harbor channel, providing a 500-foot wide channel for commercial ship traffic.
- Excavating and dredging to expand the entrance to the West Basin to provide additional maneuvering room for very large passenger vessels.

This study was performed at the RTM STAR Center in Dania Beach, Florida in four, two-day sessions during the months of March and April 2007. The study was conducted in the STAR Center’s 360° field-of-view, shiphandling simulator.

STAR Center’s evaluation encompassed observations of passenger ship transits to and from one of the cruise ship piers in the West Basin and tanker vessel transits to and from various berths in the western end of the channel just beyond the Middle Basin. Transits were conducted during moderate to high wind conditions. Comments were solicited from the participants in the study. Their comments, recommendations, and observations made during the simulations, assisted in forming the basis for the conclusions expressed in this report.

Two test vessels were used in this study. The primary test vessel for this study was a vessel of extreme length and breadth that is yet to be launched, but is expected to be in service in the coming years. The *Genesis* class cruise ship has an overall length of nearly 1200 feet and a beam at the waterline of 154 feet. Though *Genesis* will be highly maneuverable, the existing channel width is anticipated to have a negative impact on this vessel’s operational safety due to its extreme length and vulnerability to wind forces. The second test vessel represented a deep-



draft tanker loaded to approximate the limiting draft for Port Canaveral. The response model used in this study, the *Jupiter*, has a draft of 39.4 feet, both forward and aft. It represents a generic tank vessel that was prepared in both partially loaded (deep draft) condition for inbound transits, and ballasted condition for outbound transits.

The simulated environmental parameters reflected normal daytime conditions known to exist at Port Canaveral, FL. The clear visibility and daylight conditions remained constant throughout the simulated runs. The variables included ship type, and load condition in the case of the tank vessel, direction of transit (arrival vs. departure), wind direction, wind speed, current direction (in the approach channel), and berth location. The test conditions were organized into a total of fourteen scenarios. Seven were run with the *Genesis*, and seven with the *Jupiter* ship response model). Each of the scenarios was repeated by a different test subject during one of four simulation sessions.

On each run, the simulated “Ownship” was controlled by the test subject, of which there were four for this study. The subjects were all experienced and currently practicing pilots at Port Canaveral.

The results of the simulation showed that the proposed widening and deepening of the channel, the West Basin, and the turn in the approach channel should provide the margin of safety necessary for the operation of very large passenger ships of 1000-1200 feet in length at Port Canaveral, FL. The results also indicate that other advantages to the operating efficiency of the port may ensue from the implementation of the widening and deepening project. These advantages include the possibility for two-way traffic for smaller vessels, and the ability to move deep-draft vessels through the port at nearly all stages of the tide, resulting in less port congestion, and the elimination or reduction of delays in berthing for deep-draft vessels.

## **2 PREPARATION**

There are a number of steps involved in setting up a simulation study. The first step is to determine the study’s goals and objectives. This is necessary to develop an efficient test plan within the scope of the simulation program. Consulting engineers, CH2M Hill, for Port Canaveral provided the data defining the proposed channel improvements and information on the operational procedures, expected environmental conditions, and the class of vessels to be tested were obtained from the port.

## **3 SIMULATION COMPONENTS**

The next step in the process is to acquire all the data necessary to identify existing available simulation models or to generate new ones as required. The hydrodynamic model(s) representing the test vessel(s) are selected from the STAR Center’s existing library of ship response models, or if the vessel model or a close approximation does not exist, models can be developed to the user’s specifications. Finally, the geographical database that is required for a high-fidelity simulation study is generated. The components of the simulation project are described in the following sections.



### 3.1 Simulator Ship Models

The ship response model is a mathematical representation of the motion of the simulated vessel in response to aerodynamic, hydrodynamic and control forces. The vessel's hydrodynamic and aerodynamic characteristics are a function of hull form, load condition and draft, rudder size, and above-deck structures and appendages such as stacks, masts, cargo gear and deck cargo. External forces such as wind, waves, current, channel bank and bottom interactions, etc., are all considered with respect to the profile above the waterline (for wind) and the underwater hull form. Control forces include rudder, propeller (or azipod), bow and stern thrusters, assisting tugboats, and deployment of anchors or mooring lines. The equations of motion continuously calculate the acceleration of the vessel in three dimensions, which in turn is used to determine instantaneous velocity, position, and attitude. An individual ship model and its maneuvering performance are characterized by assigning a specific numerical value to each of the many coefficients in the equations of motion, and to the other coefficients that define the vessel's propulsion characteristics.

RTM STAR Center has an extensive library of vessel response models, representing a broad spectrum of the global maritime fleet. The library contains a large number of modern passenger vessels. One of the largest of these response models is the *Genesis* class cruise ship selected for the Port Canaveral study, which is yet to be built and launched. This vessel will be nearly 1200 feet in length and its size will provide numerous challenges to shiphanders navigating in many of the harbors at which this ship is intended to call.

The second ship response model was generated by the STAR Center to the dimensions specified by the client for a large tankship in two (2) different draft conditions: partially loaded to an even keel draft of 12 meters (39.4 feet), and a ballasted version drawing 8.3 meters Aft (27.2 feet) and 5.7 meters Forward (18.7 feet). Inbound transits with the tanker would utilize the partially loaded ship response model, while outbound transits would be conducted with the ballasted model.

Response models that represent actual in-service vessels are first constructed using towing tank and other design data, and are later fine-tuned from data generated during sea trials. Final validation of a model is usually performed with a pilot or shipmaster that is familiar with the actual vessel and its handling characteristics. The two ship response models used in this study have not been validated because no sea trial data exists, and since neither vessel is in service there are no experts who can comment on the maneuvering characteristics of the vessels. The tanker model is constructed using validated ship models of similar proportions as a baseline to generate a new model. The *Genesis* cruise ship model is likewise developed from a slightly smaller baseline model that is in service and has been validated. As a result of this procedure, there is a good degree of confidence in these models.

The particulars of the two ship response models used in this study are presented in Table 4.1.

### 3.2 Simulator Geographic Models

RTM STAR Center possessed an accurate computer model of Port Canaveral as it currently exists, which had been created for prior studies. The research staff prepared a modified model of



Port Canaveral using engineering drawings provided by the engineering firm of CH2M Hill for the proposed modifications to the navigation channel and turning basins. The changes included the widening and realignment of the navigation channel, widening and reconfiguration of the turn in the entrance channel, an increase in the channel and basin depths throughout the port, and widening the entrance to the West Basin. Information provided by the engineers was used to create a new model of the harbor that incorporates the vision for an enhanced waterway designed to accommodate the next generation of very large passenger cruise ships, as well as large, deep-draft commercial vessels such as tankers and bulk carriers, to a maximum draft of 39.5 feet.

The geographic model presents a realistic out-the-window visual display using Computer Generated Image (CGI) technology, and a corresponding radar image on the radar displays located on the simulator's navigation bridge. The visual and radar models incorporate landmass, terrain elevations, aids to navigation, piers, jetties, bridges, buildings, towers, and other characteristics of the modeled geographic area, and display other vessels and aircraft. Specific structures, buildings, stacks, key landmarks, and other prominent features that can be used as visual cues by the pilots when handling ships in the port are identified for inclusion in the 3-dimensional visual scene.

The accurate positioning of fixed and floating aids to navigation is an essential part of the visual database. This includes buoys, fixed beacons, lighthouses, and range structures with their correct height, shape, coloration, light characteristics, and dayshapes and color schemes, as may be applicable.

The visual database is generated starting with the latest editions of local navigation charts for the baseline information. Any available autoCAD engineering drawings are used to define proposed changes to the port area that are not featured on the latest navigation charts. Photographs of the harbor and additional information are gathered by the STAR Center staff or are provided by various sources, in order to produce a complete and reasonably accurate visual depiction of the harbor or waterway.

### **3.2.1 Channel Improvements**

The objective of this study was to evaluate the effectiveness of proposed improvements to the Port Canaveral waterway to support the future operations of very large passenger ships and deep-draft cargo vessels. Modifications were made to the existing geographic database of Port Canaveral to represent proposed changes to the channel configurations and project depths. These changes include dredging to both deepen and widen the navigation channel, and excavation of land areas to increase the size of the West Basin.

Dredging and excavation of channel banks was modeled in the area on the north side of the channel from the entrance jetty to the southeast corner of Middle Basin, and on the south side of the West Access Channel from Tanker Berth 1 (TB1) to the western side of the entrance to West Basin. These modifications resulted in realigning the existing channel and creating a uniform, straight channel of 500 feet (152.4 meters) in width.

The inside of the entrance channel turn was dredged to provide a "widener" at the turn that would enable ships to make this turn more gradual, by starting the turn sooner. It has the effect



of increasing the radius of the turn. On the inbound transit the turn begins just past the “7” buoy. The channel range markers for the inbound transit were shifted in this geographic model to align with the new centerline created by widening and straightening the channel. In addition, a new outbound range was created in the model to provide a visual cue for the new channel centerline when transiting the port outbound. The structures for the new outbound range are situated in the waters beyond the entrance jetty and just north of the turn. See Figure 1

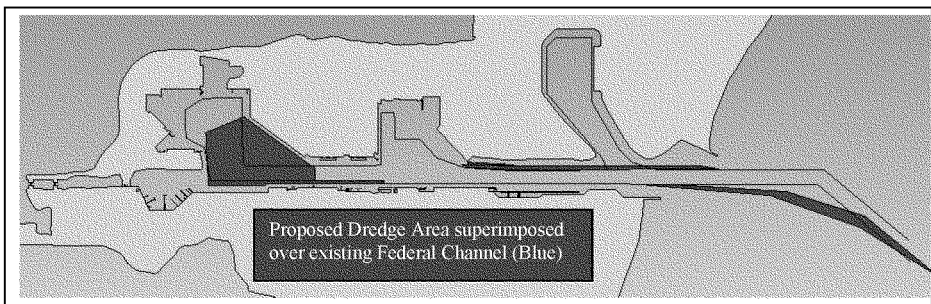

**Figure 1 – Dredge Plan**

### 3.3 Radar Database

The radar databases are developed in conjunction with the visual databases to ensure a realistic radar display that correlates to the visual depiction of the modified waterway. Features that are present in the visual database (landmass, aids to navigation, piers, and breakwaters, etc.) are represented in the radar image.

The RTM STAR Center utilizes authentic shipboard equipment in the full-mission bridge simulator. The simulator’s wheelhouse is equipped with an integrated bridge console hosting two Radar/ARPA units that are identical to units installed aboard modern commercial ships.

### 3.4 Depth Modeling

The depth file used for harbor simulation represents the bathymetric definition of the waterway, including bottom contours and shoals, bottom composition, navigation channels and channel banks, turning basins, and berth dimensions. The bathymetric model includes important features that cause interactions with the ship response model, such as water depth (affecting underkeel clearance, “UKC”), the depth and slope of channel banks, and shoal areas.



Soundings depicted in the depth model for Port Canaveral and the entrance channel were modified from the existing data to produce a “model of the future” representation of the port. The inner harbor depths, including all navigation channels and basins were increased to a uniform project depth of 41 feet (12.5 meters), and the outer approach channel depth was increased to 44 feet (13.4 meters) extending to a point just east of the Trident Basin.

The resulting depths are more than adequate for the *Genesis* test vessel with a draft of 30.2 feet (9.2 m). Planned channel depths after dredging provide a maximum 1.6 feet of under-keel clearance for the tanker *Jupiter* at low water, which has a draft of 39.4 feet (12 m) when partially loaded.

### 3.5 Wind Modeling

Wind forces are automatically calculated on the simulator based upon wind speed and direction relative to the ship’s heading, and the aerodynamic coefficients of the wind profile of each ship response model. The wind effects simulated during these exercises represented average to moderately high wind conditions for the Port Canaveral area.

Wind speeds in the range of 15 knots up to 25 knots were simulated in this study. The large profile presented by today’s large passenger cruise vessels result in a substantial impact on shiphandling due to wind effects. The tanker is less affected by the wind in the partially loaded condition due to its deep draft, broad beam, low freeboard and minimal superstructure in comparison to the passenger ships. In ballast condition, the tanker would experience slightly more of the wind effect.

According to the comments solicited by the subjects during the sessions, the wind forces that were simulated in these scenarios were deemed to produce a very realistic effect on the handling of both of the response models during the harbor transits and slow speed maneuvers off the dock.

### 3.6 Current Modeling

Currents exist offshore in the approaches to Port Canaveral, but are minimal in the harbor itself. The only current simulated in this study was in the approach channel where it runs parallel to the shoreline. The pilots provided information on the expected velocity of currents and the area in which the current is prevalent.

## 4 ON-LINE SIMULATION TESTING PROCEDURES

The tests were conducted at RTM STAR Center in Dania Beach, Florida, using a state-of-the-art full-mission, 360° field-of-view shiphandling simulator. The tests consisted of a series of simulator-based transits where experienced mariners controlled the test vessel from the simulator’s wheelhouse as they would in actual practice. The process of producing a final report of the simulator-based evaluation requires that:

- Each simulated maneuver be observed by RTM STAR Center personnel,
- A self-assessment be performed by each of the participating mariners,
- The mariners themselves comment on the project via a Final Evaluation questionnaire,





- An analysis of both the recorded vessel performance data and the mariner self-appraisals be conducted, and
- The results be condensed and summarized in a final written report that includes the recommendations and comments of the participating mariners.

#### 4.1 Test Conditions

The Port Canaveral Channel Improvement Evaluation study was conducted with the participation of four (4) Port Canaveral pilots. The variables that were examined include environmental conditions (wind and current), ship type, and draft condition, direction of transit, and destination or departure berth. The test conditions are described in detail below.

##### 4.1.1 Environmental Conditions

A variety of wind and current conditions were simulated. During each session, the first simulation run conducted with each of the ship response models exhibited no wind or current. These runs were considered “familiarization” with the vessel, its handling, its controls, and the simulator environment in general. Subsequent runs were made with a combination of wind and current as presented in the project Run Matrix listed in Appendix B.

Wind conditions simulated were calm (no wind), northwesterly winds of 15 knots and 25 knots, and gusting winds of 20-25 knots; southeasterly winds of 15 knots and 25 knots, and gusting winds of 20-25 knots.

Current conditions exist only in the entrance channel, seaward of the jetty, and are minimal. No current was simulated in the inner harbor channel beyond the entrance jetty. The current was simulated at a velocity of 0.3 knots setting to the north on some runs, and to the south on others.

All runs were conducted in daylight, with unrestricted visibility.

##### 4.1.2 Ship Response Models

Two substantially different ship response models were examined in this study: a very large passenger cruise ship, and a medium-sized tank vessel. The latter simulated ship was developed to specific dimensions, representing some of the largest deep-draft bulk cargo vessels expected to enter the port subsequent to the proposed port configuration and channel improvements.

The *Genesis* class passenger cruise ship is 1185.7 feet (361.5 meters) in length. It is a highly maneuverable vessel, equipped with multiple bow thrusters, and azipod main propulsion that enables it to operate within a port routinely without the assistance of tugboats.

The second model employed in the study represents a generic single-screw tanker vessel, the *Jupiter*, which exhibited the draft, length and beam specified for a deep-draft bulk cargo test vessel. Three tugs were available for maneuvering assistance during channel transit, docking and undocking the tanker *Jupiter*. The tank vessel was modeled in two load conditions: partially loaded (deep-draft model), and ballasted. The primary difference between the two versions of the *Jupiter* ship response model is the draft, and the wind profile presented due to the resulting freeboard. Both ships’ particulars can be found in Table 4.1 below.



**Table 4.1 - Ship Response Model Particulars**

Ship Math Model Name	<i>Genesis</i>	<i>Jupiter</i>
Type	Passenger Cruise Ship	Tanker
Displacement	103,252 m tons	97,200 m tons
LOA	1185.7 ft / 361.5 m	800.3 ft / 244.0 m
Beam at the waterline	154.2 ft / 47.0 m	137.8 ft / 42.0 m
Modeled Draft, forward and aft	Fwd 30.2 ft / 9.2 m Aft 30.2 ft / 9.2 m	Partially Laden Condition Fwd 39.4 ft / 12.0 m Aft 39.4 ft / 12.0 m
		Ballasted Condition Fwd 18.7 ft / 5.7 m Aft 27.2 ft / 8.3 m
Propulsion Type	Diesel Electric	Diesel
Propeller Type	Fixed Pitch (inward)	Fixed Pitch CW
Number of Propulsion Pods or propeller shafts	3 Azipods	1 shaft
Shaft hp (each shaft or pod)	26,820 hp	19,713 hp
Bow Thruster hp	4 x 7,376 hp	none

#### 4.1.3 Direction of Transit and Destination

Simulation runs were conducted both inbound and outbound at Port Canaveral. During each session there were five (5) inbound runs and two (2) outbound runs.

The start position for inbound transits was generally at the beginning of the turn, near buoys numbers 7 and 8. The passenger cruise ship made a transit of the entire channel to the West Basin, where the vessel was turned around and backed into Cruise Terminal berths 9 and 10 (CT9/10) on the southwest side of the basin, to lay starboard side to the pier. Tank vessel *Jupiter* transited the channel inbound until it was abeam of the Middle Basin entrance, with three (3) tugboats made up to the ship to assist in slowing the vessel and turning it around. The tanker was turned at the Middle Basin and then backed into either the Tanker Berth 1 (TB1) on the south side of the channel, or North Cargo Pier 4 (NCP4) on the north side.

Outbound transits with the *Genesis* class passenger ship commenced with the vessel departing the West Basin (sailing from CT9/10) and turning into the West Access Channel. Outbound transits of the tank vessel were initiated alongside the pier at North Cargo Pier 3 (NCP3) on the north side of the channel. The tanker was positioned starboard side to the pier, necessitating a turning maneuver to proceed to sea. Depending on the wind direction, the ship was directed either to the Middle Basin or the West Basin in order to turn around, at the pilot's discretion. Refer to the project Run Matrix in Appendix B to this report.



#### **4.2 Conduct of the Simulator-Based Evaluation**

The simulation tests took place over four two-day sessions in 2007: March 3-4, March 10-11, March 31-April 1, and April 21-22. Each session was conducted with the identical simulation scenarios being run by a different pilot. Each day of the two-day session concentrated on a different ship response model. The first run of each day provided the pilot with the opportunity to become familiar with the simulated vessel and with the bridge simulator's equipment for that vessel.

A total of seven (7) runs were completed each day, with five (5) runs being inbound and two (2) runs being outbound transits. A list of all of the conducted simulation exercises and the test conditions applied to each of them can be found in the Run History Listing in Appendix B.

#### **4.3 Participants**

This simulation study was conducted with the active participation of Port Canaveral Pilots Stephen Gasecki, Ben Borgie, David Callan and Richard Grimison.

The simulation exercises were observed by representatives from the engineering firm of CH2M Hill, the Canaveral Port Authority, and Royal Caribbean International. RTM STAR Center staff members were also present as observers and facilitators of this project.

#### **4.4 Simulator Configuration and Procedures**

The simulation runs for the study were conducted on STAR Center's 360° full-mission bridge simulator. STAR Center's simulator bridge is a full-size replica of a commercial vessel's wheelhouse. The equipment on the simulator bridge can be configured to replicate the bridge arrangement of any merchant vessel.

The simulator presents a 360° panoramic out-the-window view from the wheelhouse. Wheelhouse instrumentation may include two ARPA/Radar displays and a CRT presentation referred to as the ship's "conning page" which provides information on rudder position, thruster setting, true and relative wind speed, fore and aft, and lateral speed of the vessel, in a single location. For docking maneuvers and turning around in the turning basin, a "bird's-eye view" display was provided on the console to compensate for the loss of depth perception and the difficulty in estimating distances in the simulator's visual scene. This display is similar in some respects to an ECDIS (Electronic Chart Data Information System), lacking only the detailed chart information.

A full range of communications devices is available in the wheelhouse, including ship-to-ship and ship-to-shore radios, sound-powered phones and intercom systems. Hand-held radios are provided to simulate portable short-range UHF equipment commonly used aboard ships.

The four participating shiphandlers each commanded the simulated vessels on a fixed number of runs into, and out of, Port Canaveral FL. The exercises were each under an hour in duration. Inbound transits began in the entrance channel in the vicinity of buoys 7 & 8, and depending on the ship type, finished in the West Basin at the passenger ship pier CT9/10, or at one of the bulk cargo berths on the south or north side of the channel, west of Middle Basin.



When commanding an azipod-equipped vessel such as a modern passenger ship, the shiphandler will usually take direct control of the combined steering-propulsion controls, so that a separate helmsman is unnecessary. On each run using the *Genesis* ship response model, the test subject controlled (conned) the vessel from a centerline console, where the azipod controls were located, and from which all indicators, radars and navigation equipment could be seen. When the simulator was configured as the tanker *Jupiter*, the test subject controlled the throttle and gave standard helm orders to a qualified helmsman, who steered the vessel from a separate steering stand at the rear of the wheelhouse.

The STAR Center provided support staff during this simulator-based study. The support staff included a technician, and a simulator operator who initializes the systems, ensures the collection and archiving of numerical data, and generates track plots for each exercise. The operator assists in “role playing” support, such as representing crewmembers during docking maneuvers to provide estimates of distances between the ship and pier structures, other vessels, buoys, etc. An observer/data collector is also present to brief/debrief the participants on the details and objectives of each exercise, to note any occurrences that might provide insights into the intentions or actions of the shiphandler, and to record the subject’s verbal comments related to the simulated transits and maneuvers.

#### **4.4.1 Use of Ship Assist Tugs**

The ship response model of the tanker *Jupiter* required the assistance of tugboats to make the transit and for docking and undocking. Three (3) tugs were simulated, representing ship assist tugs that are available for use at Port Canaveral. Two (2) of the tugs were conventional twin-screw tugs of 3000 and 4000 hp. These were positioned on each shoulder of the vessel with lines made fast for the inbound transit. The third tug was a tractor tug of 4000 hp, made up at the tanker’s stern on inbound runs for steering and braking.

The passenger vessel was maneuvered without tugboat assistance.

#### **4.4.2 Special Simulator Procedures**

Close quarters maneuvering such as docking and undocking vessels, turning them around, or navigating narrow channels, often requires the shiphandler to conn (operate) the vessel from the Port or Starboard bridge wing in order to assess the clearance from moored vessels or shoreside structures. The normal position of the eyepoint is in the center of Ownship’s wheelhouse. When the subject needs to observe the Port or Starboard side of the ship, for example during a docking maneuver, he requests the view from the Port (or Starboard) wing, as appropriate. On the simulator the ability to view the operation from the bridge wing is facilitated by moving the eyepoint of the visual scene laterally to the outer edge of Ownship’s side, or in the case of some vessels, to the extended bridge wing beyond the ship’s beam. The simulator operator will immediately alter the eyepoint, which changes the perspective in the visual scene to a position as viewed from the desired bridge wing. This permits the subject to see the entire side of the vessel near the pier, to look around obstructions such as cranes or deck cargo on the foredeck, or to view objects that are astern of the ship.



The shiphandler can request by hand-held radio to the simulator operator to provide clearance distances from the ship's hull to various objects in the visual field. This compensates for the difficulty in estimating distance visually from the level of the wheelhouse. It also simulates the usual shipboard operation where ship's officers are stationed at the bow and stern to estimate distances from a better vantage point.

#### **4.4.3 Data Collection Procedures**

Prior to commencing each exercise, the shiphandler was briefed on the test conditions, including the vessel's position, starting speed, load condition if applicable, and the wind and current conditions to be expected. At the conclusion of each simulator exercise, the subject was asked to complete a quick self-evaluation of the run, the Run Evaluation Form. This form solicited his comments on any occurrences during the exercise, the controllability of the vessel, and a personal assessment of the safety of the maneuver, difficulty, and level of stress experienced. Copies of all of the completed Run Evaluation Forms can be found in Appendix D.

At the completion of all of the simulator runs during a session, each subject was requested to complete a Final Evaluation that solicited detailed comments related to the individual channel improvements and how the handling of the vessels was affected by the channel modifications/improvements that were tested. The pilots provided comprehensive comments about how the various channel improvements would be utilized and under what conditions they would enhance the safety of operations. Comments provided on these forms were used in the formulation of the conclusions appearing in this report. Copies of the completed Final Evaluation Forms can be found in appendix E.

The shiphandlering simulator automatically records numerical data that represent the actual maneuvers made by the simulated vessel under the control of the subject (Ownship) during an exercise, including, but not limited to such elements as: rudder angle, throttle setting, heading, course, speed over ground, thruster power, under-keel clearance, rate-of-turn, etc. The simulator system also provides a graphical output of this data in the form of track plots, showing the relationship of Ownship to the navigation channel, to other vessels, and to piers and other important geographic features. These plots are printed at the conclusion of each run. Multiple plots may be generated if necessary at different chart scales to examine specific components of an exercise, for example, the port approach, channel transit, and final docking maneuver. Track plots depicting each of the test runs appear in Appendix C.

The combination of the track plots, observer notes, post-exercise evaluations, and final program questionnaires permit a thorough professional analysis of the simulation sessions. These procedures ensure the complete gathering of real-time simulation data necessary to describe the results of the study and to draw conclusions.

## **5 FINDINGS**

Several strategies were noted while observing the exercises performed by the participating pilots. Speed control in the channel is important in order to minimize surging impacts on the any ships



that are berthed along the channel. Hydraulic effects caused by the displacement of a large volume of water during the passage of vessels transiting the channel can cause problems in the Trident Basin, home to Navy submarines and other support vessels. On transits involving the Genesis, the shiphandler reduces speed through the turn at the jetty, to make no more than 8 knots when abeam the Trident Basin. For the Jupiter, the speed was generally reduced to a maximum of 7 knots as the vessel approached the Trident Basin.

Speed limitations continue in the channel, so as to pass any passenger vessels moored at the outer cruise terminal docks (CT2 to CT4) at a targeted speed of about 6 knots or less. The shiphandler did not, on every inbound run, always achieve this targeted speed at this location, but it was readily apparent that this was the goal. The maximum speed that the subjects stated was acceptable in the inner channel was 6 to 6.5 knots.

The particular wind condition imposed during a simulation exercise had a significant effect on the strategy employed for navigating the improved waterway. This is more pronounced for the Genesis than for the Jupiter. The direction of the current outside the port had little discernable effect on the outcome of the simulation however, as it produced a minimal influence on the vessels. The current drift was 0.3 knots through most of the exercises and the set varied from North to South for different exercises. The current was sometimes opposed to the wind and sometimes in concert with the wind.

Vessels negotiating the channel in either direction will tend to navigate on the windward side of the channel whenever possible, in anticipation of being set to leeward. This is commonly used strategy was employed and was facilitated by the proposed dredged areas on the north side of the channel (from the jetty to the Middle Basin), and on the south side of the channel (along the West Access Channel) will be most useful. The dredged areas effectively widened the channel on the north side of the Inner Reach, and on the south side approaching the West Basin, allowing more adequate clearance when passing vessels berthed at the outer cruise terminal piers (CT2 to CT4), and at the bulk cargo piers (NCP3 and NCP4). The necessity for maximum passing distances from moored ships in the channel, is to minimize the surge resulting from the expected transit speeds.. Key elements in reducing surge effects as the ship transits the channel are speed reduction, and maximizing passing distances. However, in strong winds blowing across the channel, from the northwest and southeast directions, a reduction in speed means increased a greater “crab angle<sup>1</sup>”, or the angle to the base course necessary to compensate for leeway.

Examination of the track plots recording the ship’s position throughout the exercises may appear to indicate that the shiphandler did not often utilize the widened sections of the channel. It appears that Ownship rarely transits through the dredged areas. But a closer look shows that in most cases the cruise ship is tracking along the original channel boundary or just inside of it, where the dredged widener is present. This indicates that the pilot is utilizing the additional width provided by the dredged sections to minimize bank cushion and suction effects. Bank effects increase proportionately with the vessel’s speed. The additional channel width enables the shiphandler to maintain a good distance from the channel bank, thus minimizing bank effects,

---

<sup>1</sup> Crab angle- or drift angle – difference between course steered and the course made good usually due to the action of current or wind. This effectively increases the footprint of a vessel lessening channel maneuver room.



while keeping the vessel's speed in the 5.5 to 6.5 knot range required both for adequate steering control and reducing the crab angle when making a transit in moderate to high winds.

The Jupiter, on the other hand, uses the middle of the channel and rarely if ever ventures into the area that has been widened by dredging, except perhaps in the entrance channel turn. The deep-draft ship is less affected by the wind, and has excellent directional stability. It can therefore track with a smaller crab angle at slower speeds in the harbor. Because of the deeper draft on the inbound transits, the pilot would want to eliminate the possibility of bank effects by keeping the vessel in the center of the channel.

### 5.1 Passenger Cruise Ship *Genesis*

It was observed that in strong winds, the *Genesis* was difficult to control with less than 6 knots of headway, although the selected propulsion/steering mode by the pilot may have contributed to this difficulty. The shiphandlers usually transited the entire channel from sea, using the *Combi* mode up to the point at which the ship entered the West Basin. *Combi* mode links the rotatable azipods so that they work in tandem to steer the vessel much like a conventional propeller-rudder system. Increased controllability may be achieved by using the bow thrusters to assist in steering and presumably, setting the propulsion system to *Azi* mode. *Azi* mode allows the azipods to be rotated independently, with the possibility of using one azipod for fore and aft propulsion and the other for transverse propulsion similar to a stern thruster.

Most often the shiphandler left the controls in *Combi* mode and did not use the bow thrusters during the transit, changing to *Azi* mode only when the *Genesis* was abeam of NCP3 or as the ship began to enter the West Basin.

The increased channel width substantially improves the margin of safety for a vessel of the *Genesis* class. When any ship is steered in a narrow channel so as to account for leeway due to wind and/or current, the result is an increase in the width of the channel that it occupies which we might call its "footprint". The leeway compensation angle from the base course measured in degrees is termed the "crab angle". The effective beam or width of the vessel is increased significantly by a crab angle of only a few degrees. The extreme length of the *Genesis* class ship, results in an effective beam that is over 60% greater than the ship's actual beam, when carrying a 5° crab angle. During some transits of the *Genesis* with 25-knot winds, crab angles of 10°-12° were noted. The effective beam of the *Genesis* class vessel moving down the channel is more than double its actual beam with a 12° crab angle. Therefore for a vessel whose actual beam is already 38% of the channel's width, minimizing the crab angle in the channel is a priority. Shiphandlers should, even with the widened channel, expect to use bow thrusters extensively through the transit to minimize this crab angle, and footprint.

An increase in speed will help to reduce the crab angle, however as has been discussed, any speed over 6 knots in the channel poses a danger to vessels at berth along the waterway and even in the turning basins due to hydrodynamic forces and the amount of water displaced by the moving vessel. The transit speed of 6 knots, with a maximum of 6.5 knots, has been identified as the balance between good steering control in the channel and the necessary reduction of the impact on other vessels in the waterway. The additional 100 feet of width in the channel permits



the increase in the crab angle, so that an increase in transit speed is not necessary in high wind conditions.

## 5.2 Tanker *Jupiter*

The shiphandlers experienced little difficulty with the transit of the tank vessel *Jupiter* into Port Canaveral in simulation. The 500 foot channel width provided by the improved channel minimizes bank effects because the tanker can navigate further from the channel banks. The increased width also helps to reduce the hydraulic impacts on other vessels in the channel and the turning basins that result from the displacement of water as the ship moves along the channel. The additional width allows more of the displaced water to pass around the sides of the vessel, resulting in less water being pushed ahead of the vessel.

Outbound *Jupiter*, in ballast, will experience greater crab angles than the loaded configuration under high wind conditions, because of their somewhat greater freeboard. As with the cruise ship, the increased channel width enables the vessel to safely carry a larger crab angle and thus travel at a lower speed. Yet the tanker is much shorter in length than the cruise ship *Genesis*, so that the crab angle is not as significant a factor and the “footprint” due to the crab angle is less.

The proposed channel improvement project would provide a depth of 41 feet throughout the inner channel and basins, and 44 feet in the entrance channel that is meant to facilitate deep draft vessels access the port. However, the 41-foot project depth will not be adequate for a ship drawing greater than 39 feet despite the 2 feet of “overdredge<sup>2</sup>” as this additional 2 feet cannot be guaranteed. The pilot association’s criteria of 2.5 feet of water beneath the keel, is not met during low water (charted) conditions. If the goal is to enable deep draft vessels to navigate the port at all stages of the tide, this goal will not be achieved as presently planned.

The test vessel *Jupiter* in this study draws 39.4 feet when partially loaded. Low water was in simulations with a depth of 41 feet in the channel and a 2 foot “overage” totaling 43 feet. “Overage” dredging cannot be relied upon to accommodate vessels, and may disappear in time. The effects of “squat<sup>3</sup>” are very real on a vessel when transiting a narrow channel. Additionally, vessel draft can be increased by “list”. Each of these factors independently, or in combination, could reduce under-keel clearance to an unsafe level. Tidal levels will be a factor for *Jupiter*, when loaded to 39.4 feet, and may preclude transits at specific periods of tide to insure safe passage. **Table 5.2** provides squat information calculated by a commonly used generic formula.

<sup>2</sup> Overdredge or maintenance dredge – normally an extra 2 feet of dredging depth added when possible to the specified depth to combat silting-in etc.

<sup>3</sup> Squat- the increase of a vessel’s draft caused by movement through the water. A vessel’s draft is increased as ship speed through the water is increased.





**Table 5.2 – Squat Table for *Jupiter***

Speed Kts	Open Water Squat m	Confined Squat m
<b>2</b>	0.03	0.07
<b>3</b>	0.08	0.15
<b>4</b>	0.13	0.27
<b>5</b>	0.21	0.42
<b>6</b>	0.30	0.60
<b>7</b>	0.41	0.82
<b>8</b>	0.54	1.08
<b>9</b>	0.68	1.36
<b>10</b>	0.84	1.68
<b>11</b>	1.02	2.03
<b>12</b>	1.21	2.42
<b>13</b>	1.42	2.84

## 6 CONCLUSIONS

### 6.1 Summary Conclusions

The proposed improvements to the Port Canaveral waterway evaluated in this study will enhance safety at the port for a new class of passenger cruise ships and existing large cruise ships. The benefits of dredging the harbor to a deeper project depth will be enjoyed by the deep draft commercial traffic and can reduce port congestion and wait times for ships to proceed to a berth. Widening and straightening the channel will not only enhance the safety of operations for all large vessels, but it may make it possible to open the channel to two-way traffic under certain circumstances.

With regard to the proposed deepening of the navigation channels to a 41 feet project depth, the criteria used by the Port Canaveral Pilots for under-keel clearance (UKC) is 2.5 feet (0.8 m). The tanker *Jupiter*'s loaded draft in the simulation was 39.4 feet (12 m). Thus the *Jupiter* would not meet the criteria for harbor transit at low water with a project depth of 41 feet. Increasing the controlling depth of the navigation channel to greater than the existing 39 feet throughout the inner channel and turning basins would not be a significant benefit to the passenger ships, but a project depth of 41 feet would permit deep-draft vessels such as bulk carriers and tankers to transit the port at other stages of the tide..

For deep-draft vessels, the necessity of minimizing transit speed is a consideration to reduce hydraulic effects that will impact berthed vessels along the waterway, and to reduce the effect known as "squat" that causes the vessel's draft to increase. A balance must be achieved between controllability of the vessel, and permissible maximum speed, hence the necessity to employ tugs to assist in both steering and braking.



### 6.1.1 Widening of the Entrance Channel Turn

The dredged area proposed at the entrance channel turn was used most on outbound transits with southerly winds. Although the vessel may not have entered the dredged area on many of the runs, the additional room permitted the vessel to navigate on the side of the channel toward the inside of the turn, and this was taken advantage of in nearly every exercise. The significant benefit of the widener at the inside of the turn is to create a smoother, more gradual transition by increasing the radius of the turn, allowing a reduction of the rate of turn by half. For the *Genesis* vessel, reducing the rate of turn significantly diminishes the tendency to heel, which is a major safety issue on passenger ships. The simulation exercises showed reduction in turn rates to about 10°/minute, when up to 20°/minute are currently the norm when negotiating the turn as it exists today, according to the pilots participating in this study.

The reduced rate of turn also provides a greater margin of safety in controlling the vessel. Less effort is required to counter the swing rate when steadying up after the turn, and the chances of recovery from a steering or engine casualty are better with lower turn rates.

Dredging the inside of the turn enables the vessel to start the turn sooner, remain closer to the inside through the turn, and consequently keep the stern clear of the channel boundary on the outside of the turn.

### 6.1.2 Harbor Channel Widening

The large passenger cruise ships are expected to transit Port Canaveral at speeds of 6 knots, to a maximum of 6.5 knots, under moderate to high wind conditions in order to reduce crab angle, and to maintain adequate steering control. At speeds approaching and exceeding 6.5 knots, hydraulic forces in the channel cause surging effects that endanger ships moored along the waterway. Increasing the channel width to 500 feet permits the vessel to carry a larger crab angle, which would be the end result of reducing speed during the transit. The increased channel width also permits more water to pass around the moving vessel, and helps to mitigate the hydraulic effects that cause surging. A greater passing distance to moored vessels also reduces the surge effect, and the greater channel width contributes to maintaining a safe distance from other vessels.

The effect of widening the harbor channel in the two locations, north side from the jetty to Middle Basin and the south side from Middle Basin to West Basin, is the elimination of the constriction approaching the south cargo piers inbound. In addition, the navigation channel is realigned and straightened through nearly its entire length. Enhanced safety is a result whenever a navigation channel is straightened and widened.

### 6.1.3 Harbor Channel Deepening

The 41-foot project depth and 2 feet of “overdredge” will not be adequate for a ship drawing 39.5 feet at all stages of the tide. The additional 2 feet cannot be guaranteed and the safety criteria established by the pilot association for 2.5 feet under-keel clearance is not met. Furthermore, ship “squat” has to be considered. At a speed of 4 knots in the harbor, a deep-draft vessel similar to the test vessel *Jupiter* used in this study would experience an increase in draft of 0.9 feet (0.27 m); at 5 knots the increase would be 1.4 feet (0.42 m). Transit speeds of 4 to 5



knots would not be unusual in the channel, and would depend on the vessel's controllability at harbor maneuvering speeds. If the vessel must reduce speed and cannot be adequately controlled, tugs must be used to assist in steering at slow speeds, as they were used in this study.

#### **6.1.4 Reconfiguration of the West Basin**

The cutoff corner on the east side of the West Basin entrance allows for better control of the vessel and a slower speed upon entry. This reduces the hydraulic forces that are generated. This applies mostly to the cruise ships berthing in the West Basin, but also to large bulk carriers and tankers which may, occasionally, utilize this basin to turn around. The widening of the entrance to the West Basin allows a vessel to make a shallower approach from the channel, keeping the stern well away from vessels, marinas and ramps that are situated along the south sea wall opposite the basin, especially in strong northerly winds.

Increasing the width of the basin is necessary to support the maneuvering of very large passenger vessels such as the *Genesis* class that was simulated in this study. During the slow speed maneuver of turning around to back into the berth at CT9/10, the high sides of these large cruise ships are very vulnerable to strong winds when presenting their beam broadside to the wind direction. Adequate turning room must be provided to allow for the sideways set that the vessel may experience.

## **6.2 Comments and Recommendations**

The subjects who participated in this study were very prolific in their comments on the proposed harbor improvement plan. This section comprises a summation of the comments that the pilots provided on their Final Evaluation Questionnaire.

### **6.2.1 Channel Widener in the Entrance Channel Turn**

An increased margin of safety is provided by the reconfiguration of the turn, and is needed by a vessel as large as the *Genesis*. The widener permits an acceptable Rate of Turn (ROT) in comparison to what is currently required (up to 20°/min. ROT with southerly winds). The high Rate of Turn contributes to vessel heel, which is to be avoided on passenger ships. The ability of the pilot to make two gradual turns instead of one sharp turn reduced the ROT to 10°-15°/min.

The extreme dimensions of this vessel produce a much wider swept path when carrying a crab angle to compensate for the wind. The additional width provided by the cutoff turn leading up to the entrance jetty allowed the subject to navigate the channel using the *Combi* mode without requiring the use of the bow thrusters to steer. For the *Genesis* class, the additional width of the widener at the turn is essential when inbound in a strong southeasterly to southwesterly wind, to keep the vessel completely within the channel without swinging the stern outside the north channel limit on the 310° heading. Between buoy "10" and the jetty, the very shallow area outside the channel must be avoided. This widener enables the ship to track toward the inside of the turn, thus keeping the vessel's stern clear of this area.

The improved channel enables the vessel to be at a slower speed upon reaching the jetty when inbound, and therefore headway could be reduced even further by the time the vessel reached the



passenger ship berths (CT4). Passing berthed vessels at CT2 to CT4 was made safer because a speed of 6 knots or less could be easily achieved after coming onto the range.

There was ample width provided at the turn for the tanker *Jupiter* in both partly loaded and ballasted conditions. It is especially useful to have the added width near buoy “9” to enable the inbound loaded tanker to commence the turn earlier. Currently this turn requires that a tug put a line up to assist with the turn and to help in checking the turn in the Approach Channel Reach. Weather conditions often make this difficult if not impossible.

When the tanker was outbound in ballast, the widener enabled the vessel to remain close to the windward side of the channel without the risk of the stern tracking along the outside channel boundary. The widener at the turn will benefit high-windage vessels in southerly winds above 15 knots, both inbound and outbound.

### **6.2.2 Increased Channel Width to 500 Feet from the Jetty to West Basin**

The dredging on the north side to the Middle Basin, and on the south side from Middle Basin to West Basin provides ample width, enabling large ships to be maneuvered at slower, safer speeds.

The increased channel width reduces hydraulic effects generated by deep-draft vessels that result in surging of vessels moored along the waterway. The width also provides for an increase in the safe passing distance from vessels at berth. The 500-foot wide channel enables the transiting vessel to carry a crab angle of up to 5° with strong winds. For the *Genesis* class vessel this effectively increases the ship’s beam to over 250 feet, while providing adequate clearance distance for both the bow and stern.

The dredged area on the north side from the jetty to Middle Basin provides a greater safety margin for vessels that will be able to stay further to the right of the centerline when inbound due to the additional width. This added width enables the pilot to provide the additional clearance needed from the vessels moored on the south side berths at CT2 to CT4 to minimize or eliminate surging effects, and enables the vessel to transit at a reduced speed, enhancing this result.

Dredging the West Access Channel’s south side, from the Tanker Berth to just opposite the entrance to West Basin, provides the additional room needed for the *Genesis* to swing its stern as it enters the basin. This becomes necessary as the vessel tracks to the left of the centerline just before the basin entry point on inbound transits in order to maintain appropriate clearance to vessels berthed at NCP3 or NCP4. On departures from West Basin the widener on the south side of the channel enables cruise ships to maneuver toward the south side of the channel in strong southerly winds, again to pass any ships moored at NCP3/4 at a distance that will minimize surge effects.

### **6.2.3 Increased Depths in the Navigational Channels and Turning Basins**

The 41-foot depth is adequate for most but not all conditions. A deep-draft vessel drawing 39.5 feet (the maximum allowed) cannot be guaranteed passage at all stages of the tide with a controlling depth of 41 feet. These vessels would have to transit on a rising tide only. The Canaveral Pilots Association has established a safety margin of 2.5 feet under the keel, but UKC of only 1.5 feet is available. The further increase in draft due to ship squat must be taken into



account as well. At a speed of 5 knots for a vessel such as the tanker simulated in this study, the squat could reduce the UKC by up to 1.5 feet. Furthermore, the overdredge amount (2 feet) cannot be assured. At low water, and the occasional negative tide, the UKC for a vessel drawing 39.5 feet will be minimal or none at all with squat. One of the pilots' recommendations (see section 6.2.7) is that dredging to 42 feet as the controlling depth, should be considered for the inner channel, and for those basins that support deep-draft vessels.

A controlling depth of 41 feet will require tide restrictions for those ships arriving with draft of 38 feet or more. Under existing conditions, vessels with a draft of 36+ feet are required to take 3 tugs and to time the inbound transit for high water. These restrictions will simply be adjusted upwards for the increased depth in order to maintain the adequate UKC during transit.

#### **6.2.4 Middle Basin**

All respondents were in agreement that the Middle Basin as it exists is adequate for turning around a large bulk carrier or tanker. Vessels berthing at the Tanker Berth on the south side of the channel, or at NCP4 may use the mouth of the Middle Basin to turn around before docking. Vessels berthed "bow in" at NCP3 or NCP4 may opt to turn in the West Basin or in the Middle Basin before proceeding to sea.

#### **6.2.5 West Basin**

Because of the extreme dimensions of the *Genesis* class ship, it is necessary to implement the proposed dredge plan to support the transit of this vessel to and from the West Basin under possible adverse wind conditions. The excavation and dredging of the southeast corner of the West Basin is highly recommended because it enables the pilot to turn sooner into the basin with high winds present. Without this additional maneuvering room, it would be necessary to refrain from turning the vessel too soon because of the effect of the strong north wind when turning into the basin as it now exists. The extra room provided also enables the large vessel to turn around in a strong northerly wind keep its stern well away from vessels, marinas and ramps that are situated along the south sea wall opposite the basin. This additional width provided at the mouth of the basin also provides the needed room to take way off the vessel when combating high winds.

The wider entry to the basin allows the large passenger cruise ship to be positioned further to the south in strong southeasterly winds, and to remain well clear of other vessels in the West Basin while turning around. This is expected to be the choice of many cruise ship captains. A scenario can be envisioned where a *Genesis* class vessel can be turned 180° in the 1750+ feet wide entry to the West Basin in a strong southerly wind in excess of 30 knots, and then be allowed to drift sideways, downwind to the north, to a position from which it can be backed into the berth at CT9/10.

The dredged and excavated area on the southeast corner of the West Basin should also help to alleviate some of the hydraulic effects produced by large vessels in the channel, which have the potential to cause severe surging effects. Vessels berthed in the Rinker Dock (NCP4) are particularly susceptible to these surging effects.



The angled bulkhead on the east side of the basin is expected to provide berths for large vessels in the future. The additional width in the basin that would result from this dredging/excavation plan in the West Basin means that adequate room to turn large vessels of the length of the *Genesis* will also maintain adequate clearance from vessels berthed on the east side when these new berths are created.

### 6.2.6 General Benefits of the Widening and Deepening Plan

All of the subjects were in complete agreement that a significant increase in the margin of safety with respect to the operation of very large passenger cruise ships will result if the improvements to the channel and turning basin that were examined in this study are implemented. Channel widening to 500 feet will be adequate for the *Genesis* class and vessels of similar size (up to 1200 feet LOA).

The new channel width could enable two-traffic to be permitted in some areas of the channel, not with the passage of the largest cruise ships however, but with smaller vessels that operate at Port Canaveral. The additional width provided by reconfiguring and dredging the turn in the entrance channel may provide an “escape plan” for some vessels in the event of an emergency (steering or engine casualty for example). The extra width may allow smaller inbound vessels to be turned around before reaching the inner channel, upon departure.

The depth of water in the channel and basins will be adequate to support operation of these passenger vessels at all stages of the tide when squat is included in the calculation of draft. The increased controlling depth will enable vessels drawing more than 36 feet, such as tankers and bulk carriers, to transit the harbor 24/7 without tide restrictions, thereby improving port efficiency. NOTE: This is an open-ended comment. As discussed in section 6.2.3 above, the maximum draft that could be supported at low tide may be only 38.5 feet with the safety factor of 2.5 feet of UKC included. “Squat” must be considered as well due to the ship’s speed.

Port Canaveral enjoys a high level of passenger ship traffic, and passenger ships are generally given priority over other commercial traffic. There are often periods of two to four days when the high tide coincides with the arrival or departure of cruise ships, and for this reason “tide jobs” which restrict the movement of deep-draft commercial vessels should be eliminated. Deep-draft vessels waiting for the high tide to proceed to berth incur delays at anchor, and further delays occur when passenger ship sailings prevent such movements. In addition to port congestion, this may result in loss of business as ships divert from Port Canaveral to avoid such delays.

### 6.2.7 Recommendations

It is strongly recommended that the channel improvements that were examined by this simulation study be implemented. Besides enhancing the operational safety for the largest of cruise ships, the proposed improvements will help to reduce port congestion by enabling deep-draft vessels to transit at nearly any stage of the tide, and by permitting two-way traffic for medium-sized vessels under certain circumstances.

Other recommendations include:

1. Modified Dredge Plan – Consider dredging to a uniform depth of 43 feet. This would



accommodate the standard UKC of 2.5 feet permitting a vessel at the maximum draft of 39.5 feet to transit at any stage of the tide, except unusually low tides. Should the tanker terminal be developed in the Middle Basin, the issue of vessels transiting the port drawing the maximum permitted draft at all stages of the tide will become a major one.

2. Outbound Centerline Range – In the simulation the STAR Center presented an outbound centerline range for the channel. It is recommended that a channel range be provide for vessels transiting outbound from the port.
3. As in simulation, reposition the existing inbound range to indicate the center of the new 500 foot inner channel.





## SHIP PARTICULARS AZI / AZIMUTHING POD

SHIP NAME **GENESIS**FILE NAME **CR186DE**SHIP TYPE **cruise**LOAD COND **DESIGN**TONNAGE **103,252**DWT  DISPL  GRT Aero: **15290**EYEBOW: **51** | **167** Ft. Height Eye | **36** | **117** Ft. EYESTERN: **310.5** | **018** Ft.Air Draft **57** | **186** Ft.BEAM Bridge Wing **53** | **173.8** Ft.  
(If Wider than Beam)LOA **361.5** | **1,185.7** Ft.

Draft

LBP **330.0** | **1,082.4** Ft.FWD **9.2** | **30.2** Ft.W/L BEAM **47.0** | **154.2** Ft.AFT **9.2** | **30.2** Ft.PROPULSION **DIESEL**AZIPOD NO. **3**SHAFT HP **26,820** EACHPROPELLER DIRECTION **inwar**TYPE **FIXED**  **VARIABLE** BOW THRUSTERS **4** HP **7,376** EACH

## Shaft RPM and Speed

MANEUVERING

MAX\_RPM **136**MIN\_RPM: Max Speed: **24.7**

Lever Position	RPM	Speed Shallow	Speed Deep
8 FULL AHD:	<b>127</b>	<b>21</b>	<b>14</b>
5 HALF AHD:	<b>64</b>	<b>12</b>	<b>13</b>
3 SLOW AHD:	<b>34</b>	<b>6</b>	<b>7</b>
1 DSLOW AHD	<b>18</b>	<b>4</b>	<b>4</b>
8 FULL ASTN	<b>105</b>	<b>13</b>	<b>14</b>
5 HALF ASTN	<b>64</b>	<b>9</b>	<b>9</b>
3 SLOW ASTN	<b>33</b>	<b>5</b>	<b>5</b>
1 DSLOW ASTN	<b>16</b>	<b>3</b>	<b>3</b>

# Conventional Pilot Card

SHIP NAME JUPITERSHIP TYPE tankerFILE NAME TK110PDLOAD COND Partly LoadedTONNAGE 97,200 DWT      DISPL X GRT     EYEBOW: 199 654 Ft. Height Eye 22 72 Ft. EYESTERN: 45 146 Ft.Air Draft 31 100 FtBEAM Bridge Wing 0 0 FtAero: 2389

(If Wider than Beam)

LOA	<u>244.0</u>	<u>800.3</u> Ft.
LBP	<u>229.5</u>	<u>752.8</u> Ft.
BEAM	<u>42.0</u>	<u>137.8</u> Ft.

Draft	
FWD	<u>12</u> <u>39.4</u> Ft.
AFT	<u>12</u> <u>39.4</u> Ft.

PROPULSION DieselPROPELLERS 1TYPE FIXED X VARIABLEPROPELLER DIRECTION CWSHAFT HP 19,713 EACHBOW THRUSTERS     HP      EACHSTERN THRUSTERS     HP      EACHNO RUDDERS 1RUDDER TYPE NormalMAX RUDDER 35

## Shaft RPM and Speed

MANEUVERING

MAX_RPM	105	MIN_RPM:	Max Speed: 15.6	
Lever Position	RPM	Pitch	Speed SH	Speed DP
8 FULL AHD:	87		13.2	
5 HALF AHD:	70		10.6	
3 SLOW AHD:	53		7.9	
1 DSLOW AHD	34		5	
8 FULL ASTN	87			
5 HALF ASTN	70			
3 SLOW ASTN	53			
1 DSLOW ASTN	34			

# Conventional Pilot Card

SHIP NAME JUPITERSHIP TYPE tankerFILE NAME Tk110BDLOAD COND BallastedTONNAGE 54,260 DWT      DISPL X GRT     EYEBOW: 199 653 Ft. Height Eye 22 72 Ft. EYESTERN: 45 148 Ft.Air Draft 31 100 FtBEAM Bridge Wing 0 0 FtAero:      3548

(If Wider than Beam)

LOA	<u>244.0</u>	<u>800.3</u> Ft.
LBP	<u>229.5</u>	<u>752.8</u> Ft.
BEAM	<u>142.0</u>	<u>137.8</u> Ft.

<i>Draft</i>	
FWD	<u>5.7</u> <u>18.7</u> Ft.
AFT	<u>8.3</u> <u>27.2</u> Ft.

PROPULSION DieselPROPELLERS 1 TYPE FIXED X VARIABLEPROPELLER DIRECTION CWSHAFT HP 19,713 EACHBOW THRUSTERS     HP      EACHSTERN THRUSTERS     HP      EACHNO RUDDERS 1RUDDER TYPE NormalMAX RUDDER 35

## Shaft RPM and Speed

MANEUVERING

MAX\_RPM 105 MIN\_RPM:      Max Speed: 17.4

Lever Position	RPM	Pitch	Speed SH	Speed DP
8 FULL AHD:	87			15
5 HALF AHD:	70			12
3 SLOW AHD:	53			9
1 DSLOW AHD	34			5
8 FULL ASTN	87			
5 HALF ASTN	70			
3 SLOW ASTN	53			
1 DSLOW ASTN	34			

## Run Matrix

The contributing factor for the run matrix were one future plan of Port Canaveral to be tested, transit direction, two test vessels are to represent size of vessels in the future , two wind directions are to represent prevailing winter and summer conditions, wind speed to replicate realistic winds velocities, current replicates prevailing and counter current at entrance channel.

<u>Run #</u>	<u>Scenario</u>	<u>Ship</u>	<u>Direction</u>	<u>Wind</u>	<u>Current</u>	<u>Start</u>	<u>End</u>	<u>Remarks</u>
1	Genesis	Genesis	Inbound	0 kts	0 kts	Buoys 7&8	CT 9	Familiarization
2	Genesis	Genesis	Inbound	NW 15kts	N 0.3kts	Buoys 7&8	CT 9	
3	Genesis	Genesis	Inbound	NW 25kts	S 0.3kts	Buoys 7&8	CT 9	
4	Genesis	Genesis	Inbound	SE 15kts	S 0.3kts	Buoys 7&8	CT 9	
5	Genesis	Genesis	Inbound	SE 25kts	N 0.3kts	Buoys 7&8	CT 9	
6	Genesis	Genesis	Outbound	NW 25kts	S 0.3kts	West TB	Buoys 7&8	
7	Genesis	Genesis	Outbound	SE 25kts	N 0.3kts	West TB	Buoys 7&8	

Berth occupancy –  
 Cruise vessel 216.3m x 28.4m at CT4, Cruise vessel 152m x 23.1m, Reefer 106.7m x 16.8m at SCP2  
 Tanker 244m x 42m at Tanker berth 1&2, bulker 234m x 32.2m at NCP3 and NCP4

<u>Run #</u>	<u>Scenario</u>	<u>Ship</u>	<u>Direction</u>	<u>Wind</u>	<u>Current</u>	<u>Start</u>	<u>End</u>	<u>Remarks</u>
8		Tanker / Ld	Inbound	0 kts	0 kts	Buoys 7&8	TB 1	Familiarization
9		Tanker / Ld	Inbound	NW 15kts	N 0.3kts	Buoys 7&8	TB 1	
10		Tanker / Ld	Inbound	NW 20/25kts	S 0.3kts	Buoys 7&8	TB 1	
11		Tanker / Ld	Inbound	SE 15kts	S 0.3kts	Buoys 7&8	NCP 3	
12		Tanker / Ld	Inbound	SE 20/25kts	N 0.3kts	Buoys 7&8	NCP 3	
13		Tanker / Bal	Outbound	NW 20/25kts	S 0.3kts	NCP4	Buoys 7&8	
14		Tanker / Bal	Outbound	SE 20/25kts	N 0.3kts	NCP4	Buoys 7&8	

Berth occupancy -  
 Cruise vessel 216.3m x 28.4m at CT4, Cruise vessel 152m x 23.1m, Reefer 106.7m x 16.8m at SCP2  
 Tanker 244m x 42m at Tanker berth 1&2, bulker 234m x 32.2m at NCP3

**Port Canaveral Channel Improvement Study**  
**Exercise Run History**

<b>RUN #</b>	<b>SCENARIO</b>	<b>SHIP</b>	<b>WIND (kn)</b>	<b>CURRENT (kn)</b>	<b>DIRECTION</b>	<b>START</b>	<b>END</b>	<b>REMARKS</b>
1	1	GENESIS	None	None	Inbound	Buoys 7&8	CT 9/10	Familiarization 03/03/07
2	2	GENESIS	NW 15	N 0.3	Inbound	Buoys 7&8	CT 9/10	
3	3	GENESIS	NW 25	S 0.3	Inbound	Buoys 7&8	CT 9/10	
4	4	GENESIS	SE 15	S 0.3	Inbound	Buoys 7&8	CT 9/10	
5	5	GENESIS	SE 25	N 0.3	Inbound	Buoys 7&8	CT 9/10	
6	6	GENESIS	NW 25	S 0.3	Outbound	CT 9/10	Buoys 7&8	
7	7	GENESIS	SE 25	N 0.3	Outbound	CT 9/10	Buoys 7&8	Bad start - incomplete
8	7	GENESIS	SE 25	N 0.3	Outbound	CT 9/10	Buoys 7&8	Re-start Run 7
9	8	JUPITER	None	None	Inbound	Buoys 7&8	TB 1	Familiarization 03/04/07
10	9	JUPITER/L	NW 15	N 0.3	Inbound	Buoys 7&8	TB 1	grounded at bad depth pt
11	10	JUPITER/L	NW 20/25	S 0.3	Inbound	Buoys 7&8	TB 1	
12	11	JUPITER/L	SE 15	S 0.3	Inbound	Buoys 7&8	NCP 3	
13	12	JUPITER/L	SE 20/25	N 0.3	Inbound	Buoys 7&8	NCP 3	
14	13	JUPITER/B	NW 20/25	S 0.3	Outbound	NCP 4	Buoys 7&8	
15	14	JUPITER/B	SE 20/25	N 0.3	Outbound	NCP 4	Buoys 7&8	
16	1	GENESIS	None	None	Inbound	Buoys 7&8	CT 9/10	Familiarization 03/10/07
17	2	GENESIS	NW 15	N 0.3	Inbound	Buoys 7&8	CT 9/10	
18	3	GENESIS	NW 25	S 0.3	Inbound	Buoys 7&8	CT 9/10	
19	6	GENESIS	NW 25	S 0.3	Outbound	CT 9/10	Buoys 7&8	
20	4	GENESIS	SE 15	S 0.3	Inbound	Buoys 7&8	CT 9/10	
21	5	GENESIS	SE 25	N 0.3	Inbound	Buoys 7&8	CT 9/10	
22	7	GENESIS	SE 25	N 0.3	Outbound	CT 9/10	Buoys 7&8	
23	8	JUPITER/L	None	None	Inbound	Buoys 7&8	TB 1	Familiarization 03/11/07
24	9	JUPITER/L	NW 15	N 0.3	Inbound	Buoys 7&8	TB 1	
25	10	JUPITER/L	NW 20/25	S 0.3	Inbound	Buoys 7&8	TB 1	
26	14	JUPITER/B	SE 20/25	N 0.3	Outbound	NCP 4	Buoys 7&8	
27	11	JUPITER/L	SE 15	S 0.3	Inbound	Buoys 7&8	NCP 3	
28	13	JUPITER/B	NW 20/25	S 0.3	Outbound	NCP 4	Buoys 7&8	

RUN #	SCENARIO	SHIP	WIND (kt)	CURRENT (kt)	DIRECTION	START	END	REMARKS
29	12	JUPITER/L	SE 20/25	N 0.3	Inbound	Buoys 7&8	NCP 3	
30	1	GENESIS	None	None	Inbound	Buoys 7&8	CT 9/10	Familiarization 03/31/07
31	2	GENESIS	NW 15	N 0.3	Inbound	Buoys 7&8	CT 9/10	
32	3	GENESIS	NW 25	S 0.3	Inbound	Buoys 7&8	CT 9/10	
33	7	GENESIS	SE 25	N 0.3	Outbound	CT 9/10	Buoys 7&8	
34	4	GENESIS	SE 15	S 0.3	Inbound	Buoys 7&8	CT 9/10	Speed too fast on entry
35	5	GENESIS	SE 25	N 0.3	Inbound	Buoys 7&8	CT 9/10	
36	6	GENESIS	NW 25	S 0.3	Outbound	CT 9/10	Buoys 7&8	
37	8	JUPITER/L	None	None	Inbound	Buoys 7&8	TB 1	Familiarization 03/11/07
38	9	JUPITER/L	NW 15	N 0.3	Inbound	Buoys 7&8	TB 1	
39	12	JUPITER/L	SE 20/25	N 0.3	Inbound	Buoys 7&8	NCP 3	
40	13	JUPITER/B	NW 20/25	S 0.3	Outbound	NCP 4	Buoys 7&8	
41	10	JUPITER/L	NW 20/25	S 0.3	Inbound	Buoys 7&8	TB 1	
42	11	JUPITER/L	SE 15	S 0.3	Inbound	Buoys 7&8	NCP 3	
43	14	JUPITER/B	SE 20/25	N 0.3	Outbound	NCP 4	Buoys 7&8	
44	1	GENESIS	None	None	Inbound	Buoys 7&8	CT 9/10	Familiarization 04/21/07
45	2	GENESIS	NW 15	N 0.3	Inbound	Buoys 7&8	CT 9/10	
46	3	GENESIS	NW 25	S 0.3	Inbound	Buoys 7&8	CT 9/10	
47	6	GENESIS	NW 25	S 0.3	Outbound	CT 9/10	Buoys 7&8	
48	4	GENESIS	SE 15	S 0.3	Inbound	Buoys 7&8	CT 9/10	
49	7	GENESIS	SE 25	N 0.3	Outbound	CT 9/10	Buoys 7&8	
50	5	GENESIS	SE 25	N 0.3	Inbound	Buoys 7&8	CT 9/10	
51	8	JUPITER/L	None	None	Inbound	Buoys 7&8	TB 1	Familiarization 04/22/07
52	9	JUPITER/L	NW 15	N 0.3	Inbound	Buoys 7&8	TB 1	
53	14	JUPITER/B	SE 20/25	N 0.3	Outbound	NCP 4	Buoys 7&8	
54	10	JUPITER/L	NW 20/25	S 0.3	Inbound	Buoys 7&8	TB 1	
55	11	JUPITER/L	SE 15	S 0.3	Inbound	Buoys 7&8	NCP 3	
56	12	JUPITER/L	SE 20/25	N 0.3	Inbound	Buoys 7&8	NCP 3	
57	13	JUPITER/B	NW 20/25	S 0.3	Outbound	NCP 4	Buoys 7&8	

### Canaveral Research

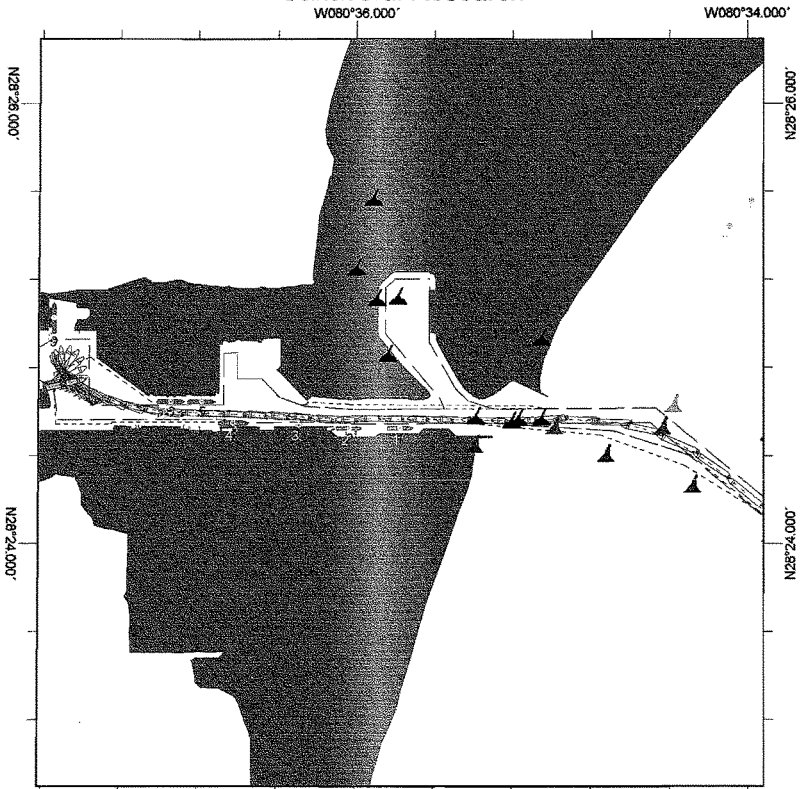

Scale 1:40000

Scale reference N28°24.594'

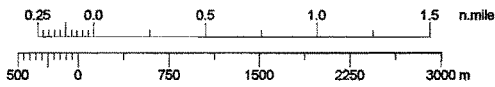

Comments: Wind: 0  
Current: 0

Line sample period (s)	30
Course marker every	N/A
Heading marker period (s)	60
Shape outline every	01:00

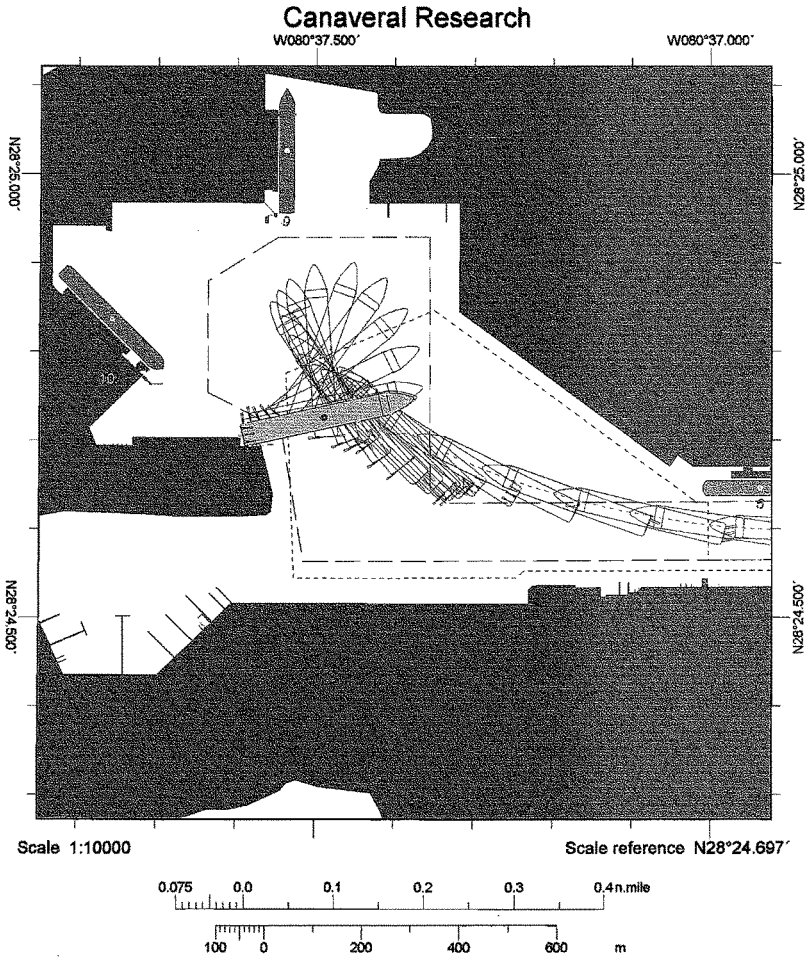

Comments: Wind: 0  
Current: 0

Line sample period (s)	30
Course marker every	N/A
Heading marker period (s)	60
Shape outline every	01:00



### Canaveral Research

W080°36.000'

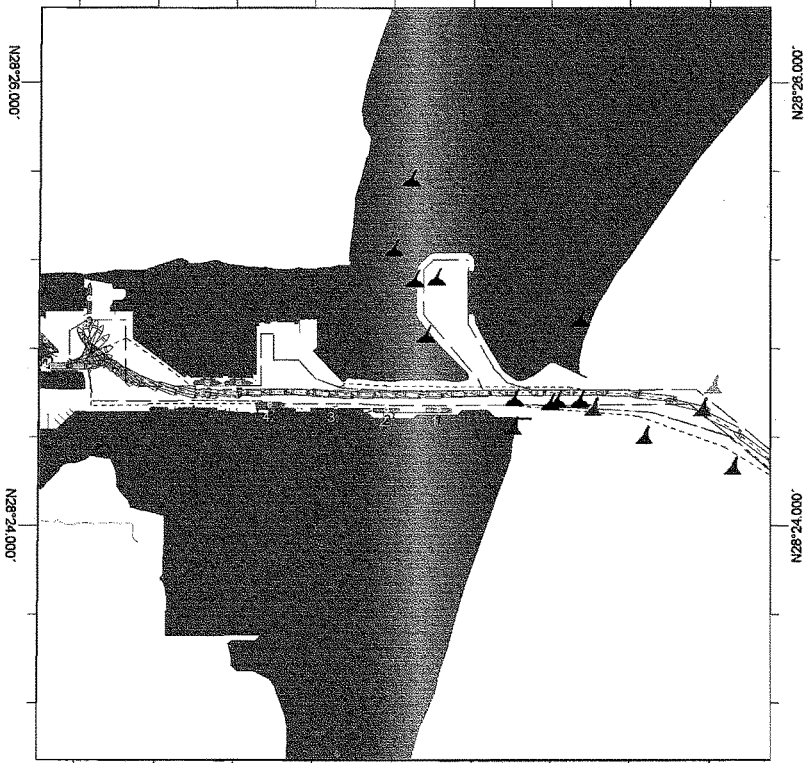

Scale 1:40000

Scale reference N28°24.639'

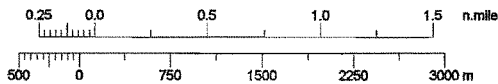

Comments: Wind: NW 15kt  
Current: N0.75

Line sample period (s)	30
Course marker every	N/A
Heading marker period (s)	60
Shape outline every	01:00



### Canaveral Research

W080°36.000'

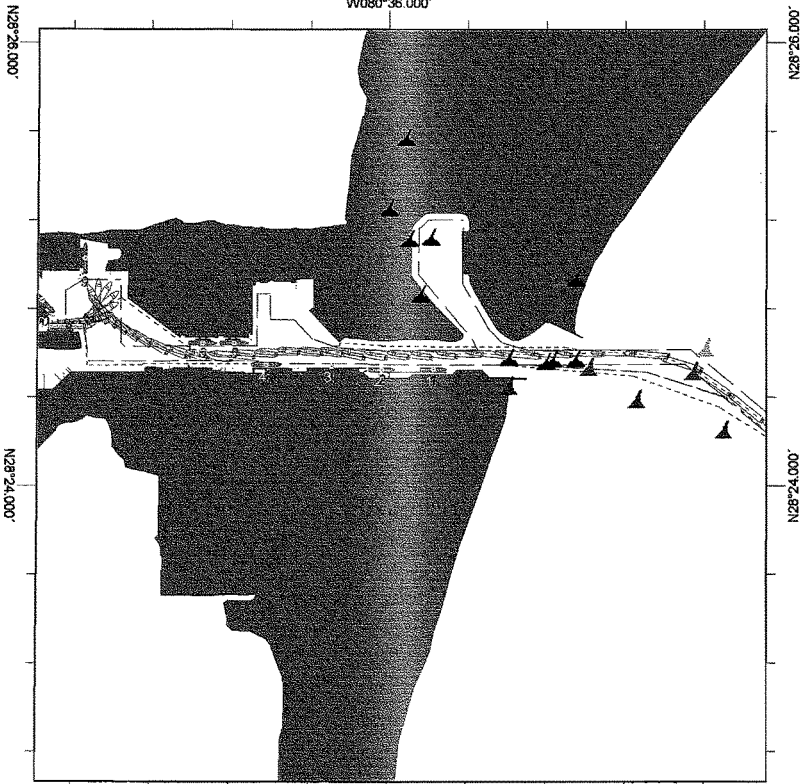

Scale 1:40000

Scale reference N28°24.361'

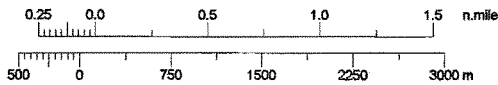

Comments: Wind: NW 25kt  
Current: S 0.75

Line sample period (s)	30
Course marker every	N/A
Heading marker period (s)	60
Shape outline every	01:00

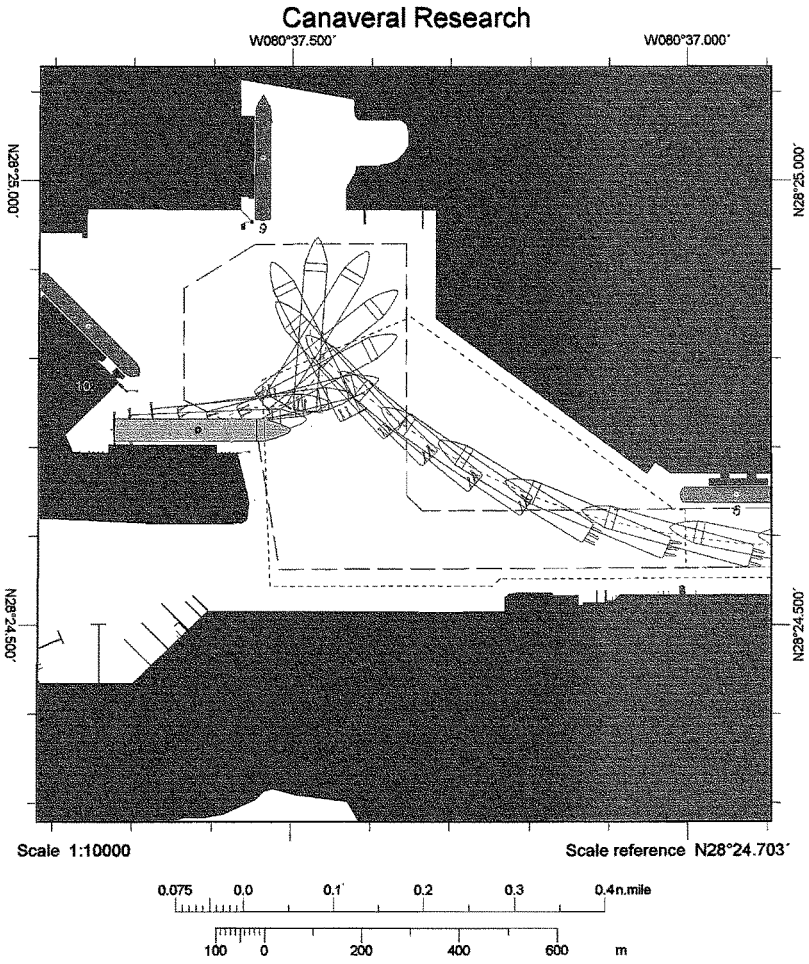

Comments: Wind: NW 25kt  
Current: S 0.75

Line sample period (s)	30
Course marker every	N/A
Heading marker period (s)	60
Shape outline every	01:00

### Canaveral Research

W080°36.000'

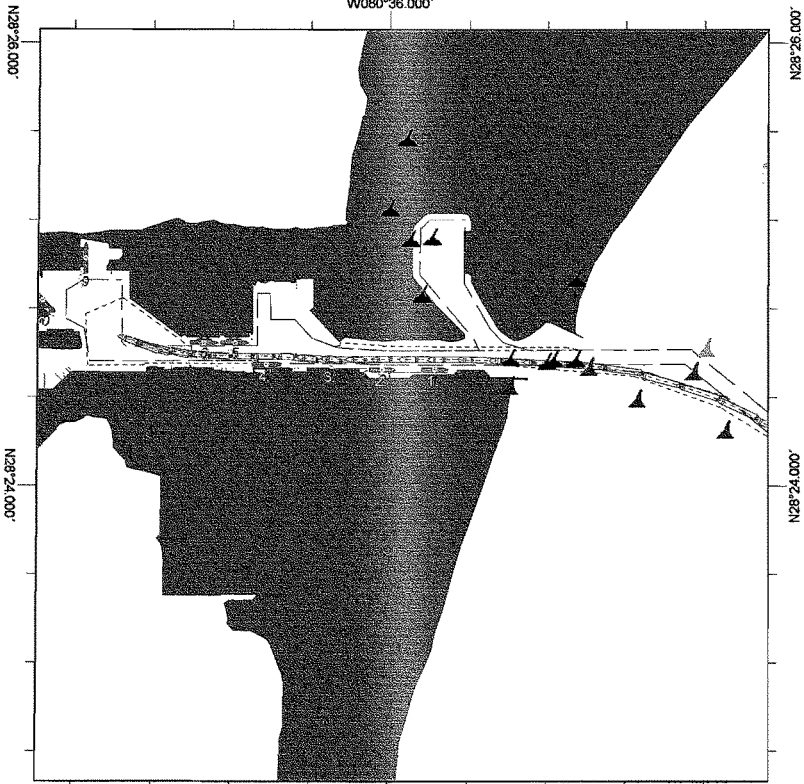

Scale 1:40000

Scale reference N28°24.361'

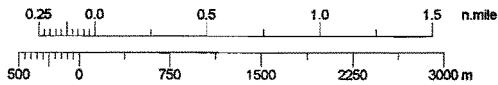

Comments: Wind: SE 15kt  
Current: S 0.75

Line sample period (s)	30
Course marker every	N/A
Heading marker period (s)	60
Shape outline every	01:00

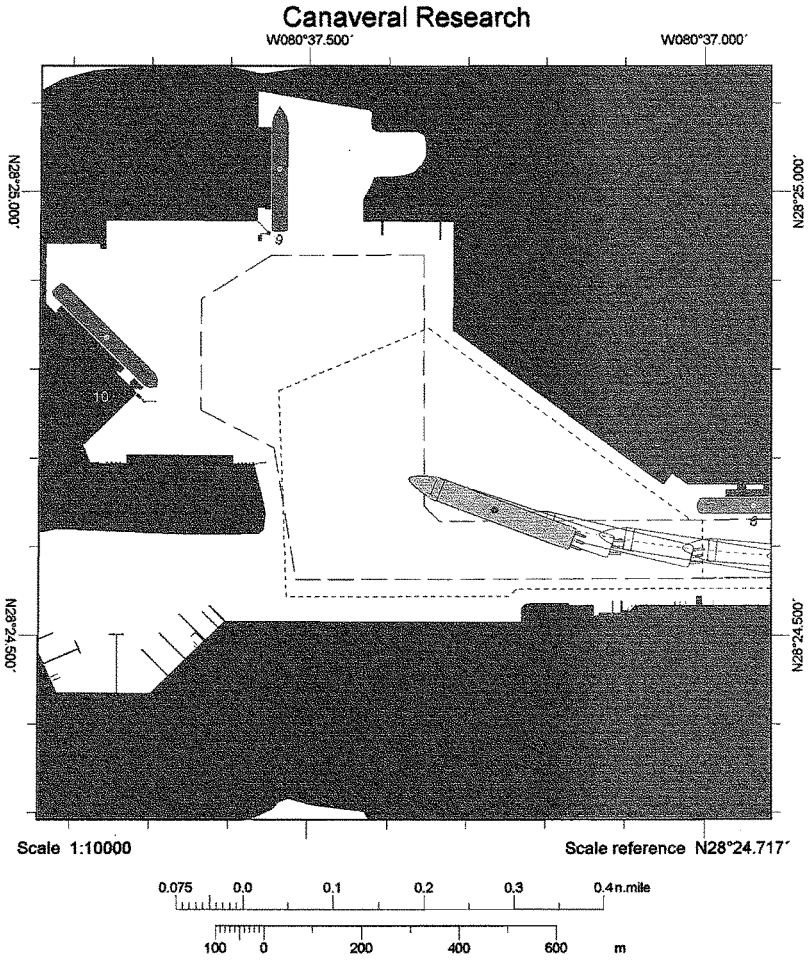

Comments: Wind: SE 15kt  
Current: S 0.75

Line sample period (s)	30
Course marker every	N/A
Heading marker period (s)	60
Shape outline every	01:00

### Canaveral Research

W080°36.000'

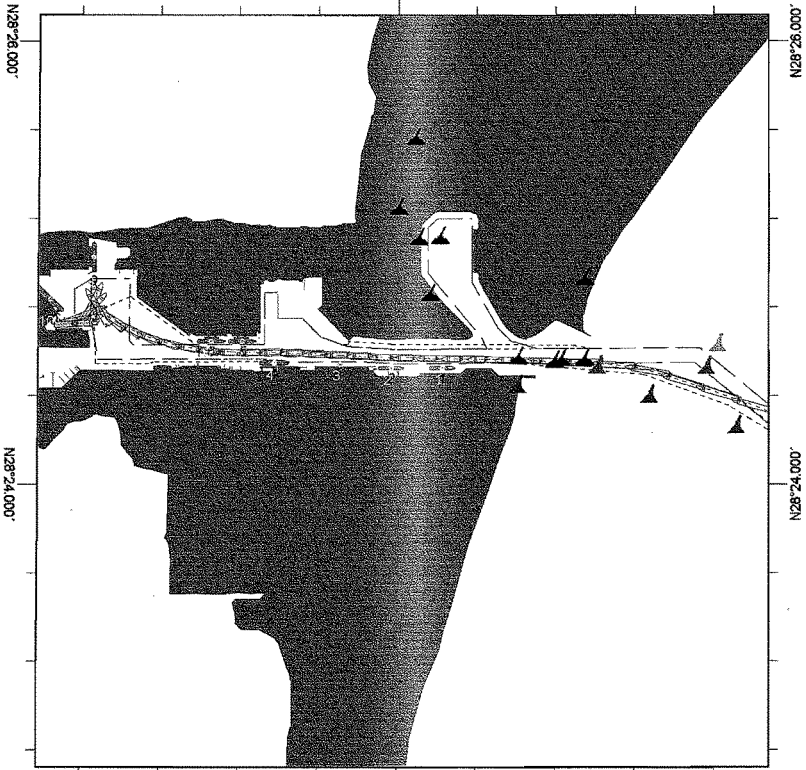

Scale 1:40000

Scale reference N28°24.419'

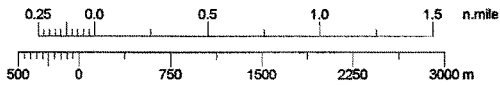

Comments: Wind: SE 25kt  
Current: N 0.75

Line sample period (s)	30
Course marker every	N/A
Heading marker period (s)	60
Shape outline every	01:00

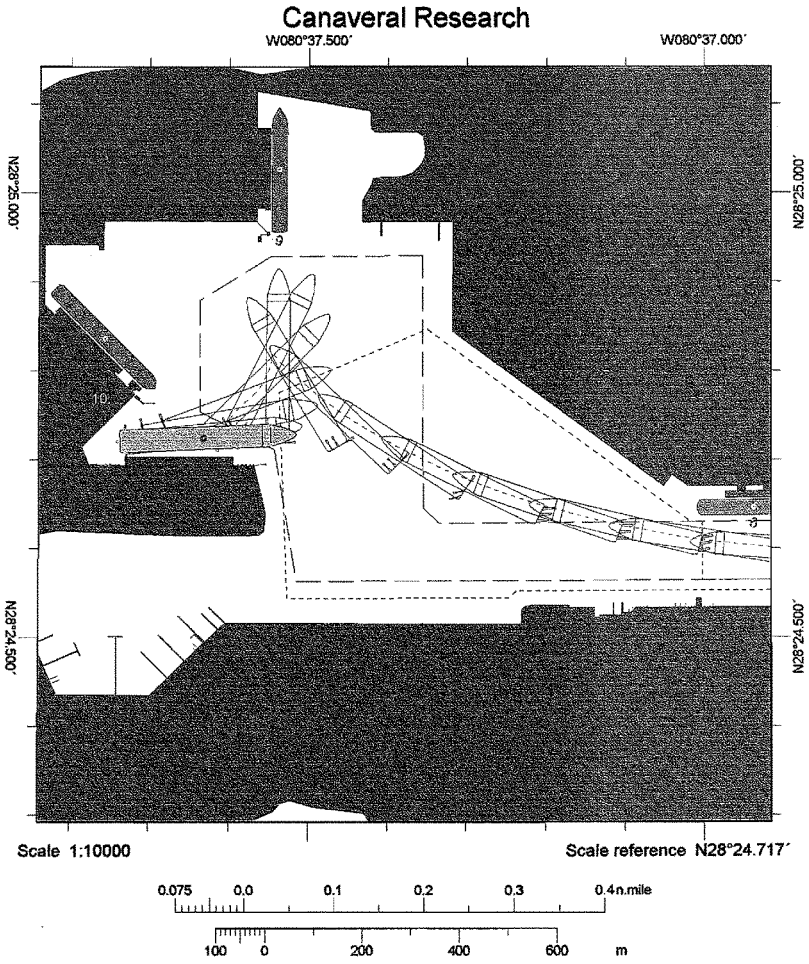

Comments: Wind: SE 25kt  
Current: N 0.75

Line sample period (s)	30
Course marker every	N/A
Heading marker period (s)	60
Shape outline every	01:00



### Canaveral Research

W080°36.000'

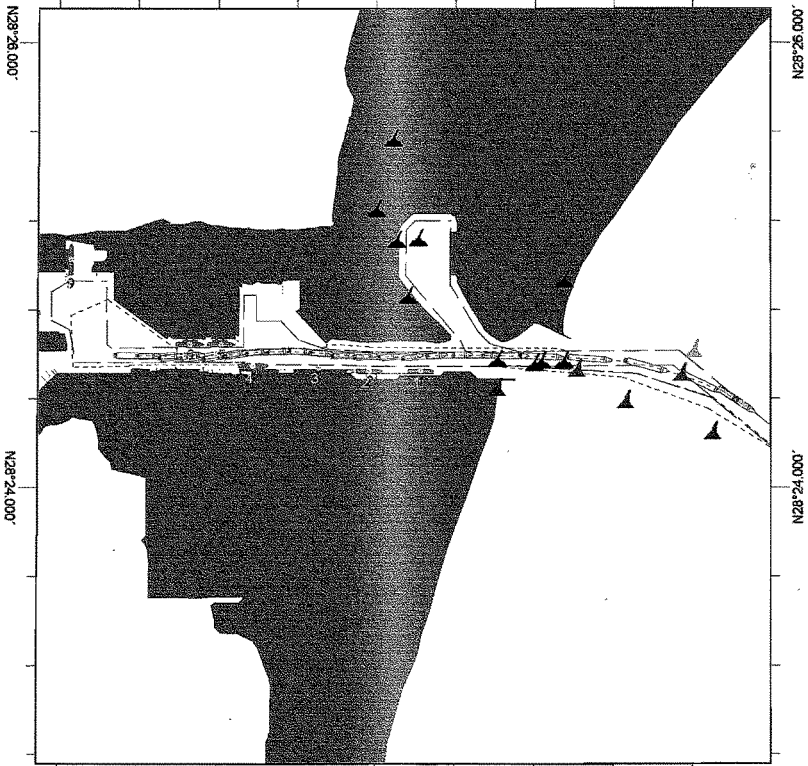

Scale 1:40000

Scale reference N28°24.455'

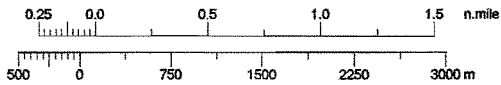

Comments: Wind: NW 25kt  
Current: S 0.75

Line sample period (s)	30
Course marker every	N/A
Heading marker period (s)	60
Shape outline every	01:00

### Canaveral Research

W080°34.500'

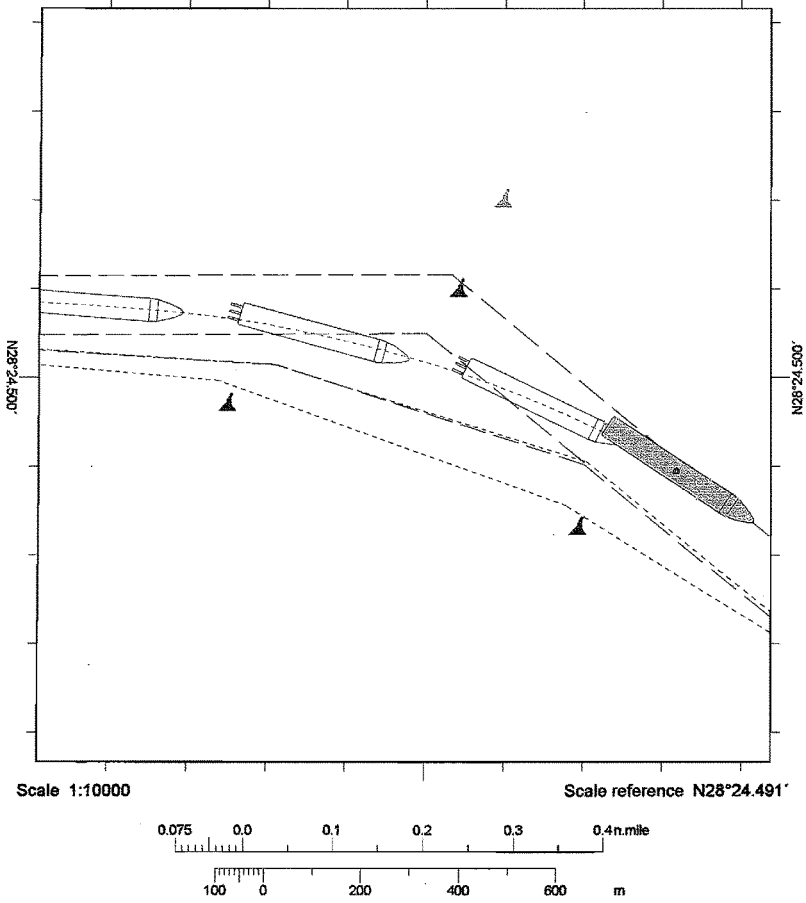

Comments: Wind: NW 25kt  
Current: S 0.75

Line sample period (s)	30
Course marker every	N/A
Heading marker period (s)	60
Shape outline every	01:00

### Canaveral Research

W080°37.000'

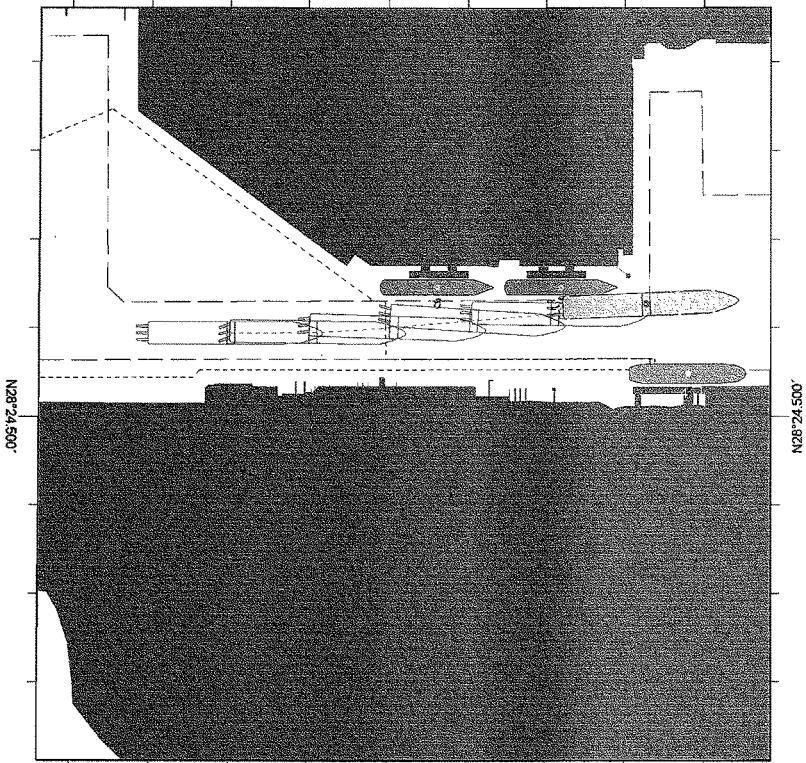

Scale 1:10000

Scale reference N28°24.536'

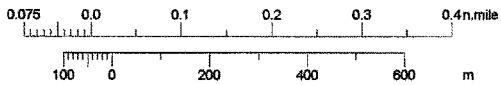

Comments: Wind: SE 25kt  
Current: N 0.75

Line sample period (s)	30
Course marker every	N/A
Heading marker period (s)	60
Shape outline every	01:00

### Canaveral Research

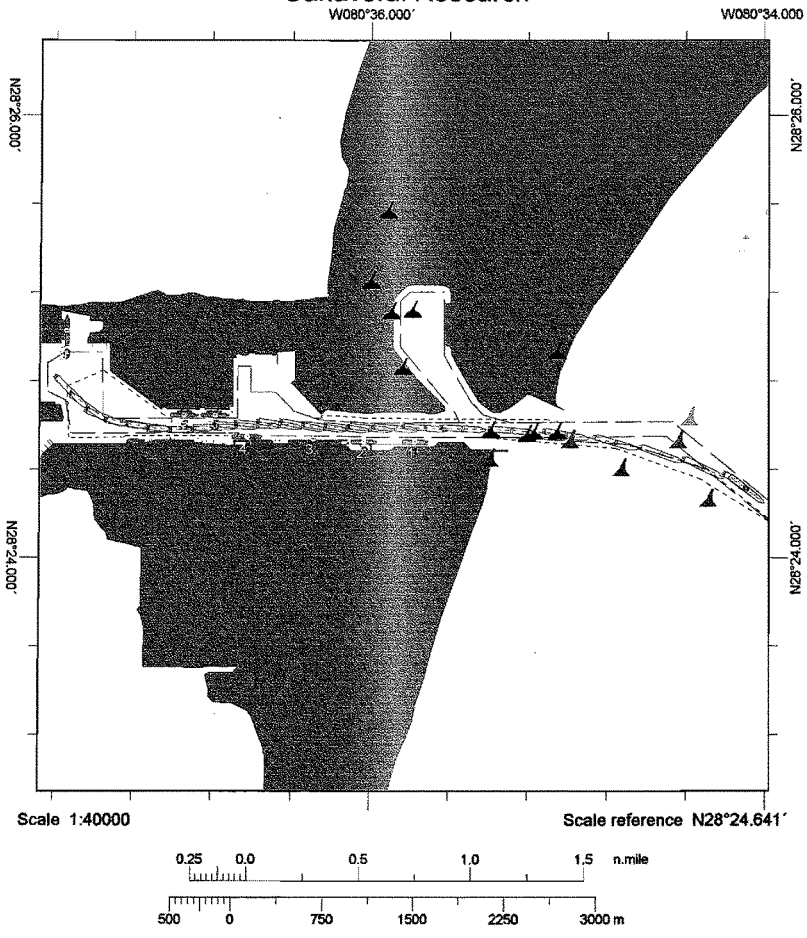

Comments: Wind: SE 25kt  
Current: N 0.75

Line sample period (s)	30
Course marker every	N/A
Heading marker period (s)	60
Shape outline every	01:00

### Canaveral Research

W080°34.500'

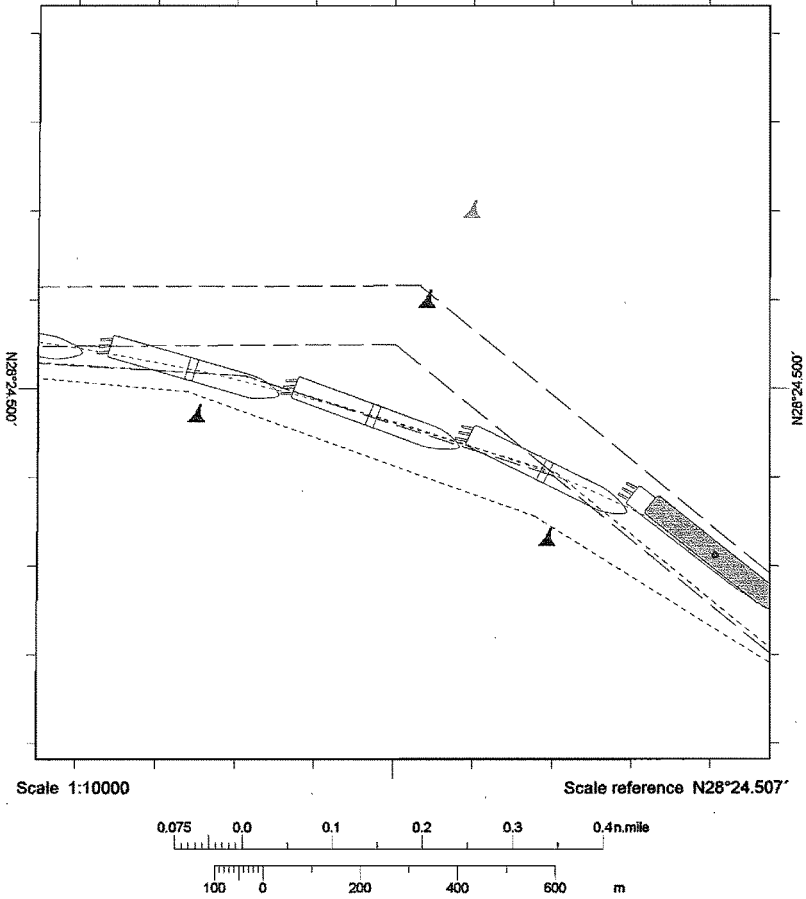

Comments: Wind: SE 25kt  
Current: N 0.75

Line sample period (s)	30
Course marker every	N/A
Heading marker period (s)	60
Shape outline every	01:00

### Canaveral Research

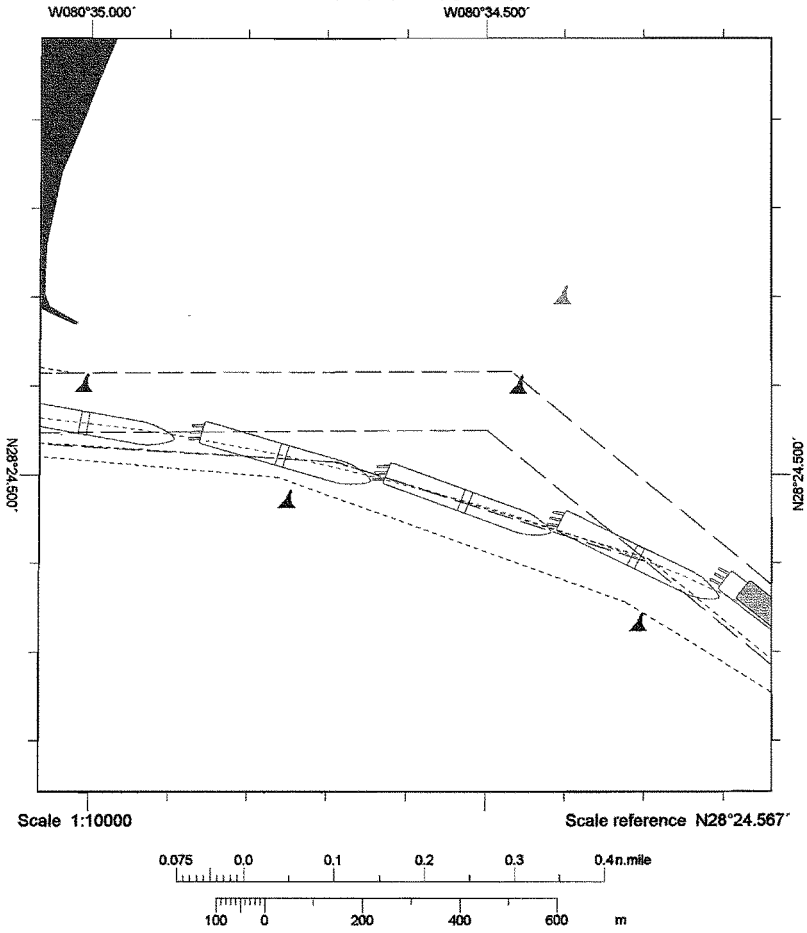

Comments: Wind: SE 25kt  
Current: N 0.75

Line sample period (s)	30
Course marker every	N/A
Heading marker period (s)	60
Shape outline every	01:00

### Canaveral Research

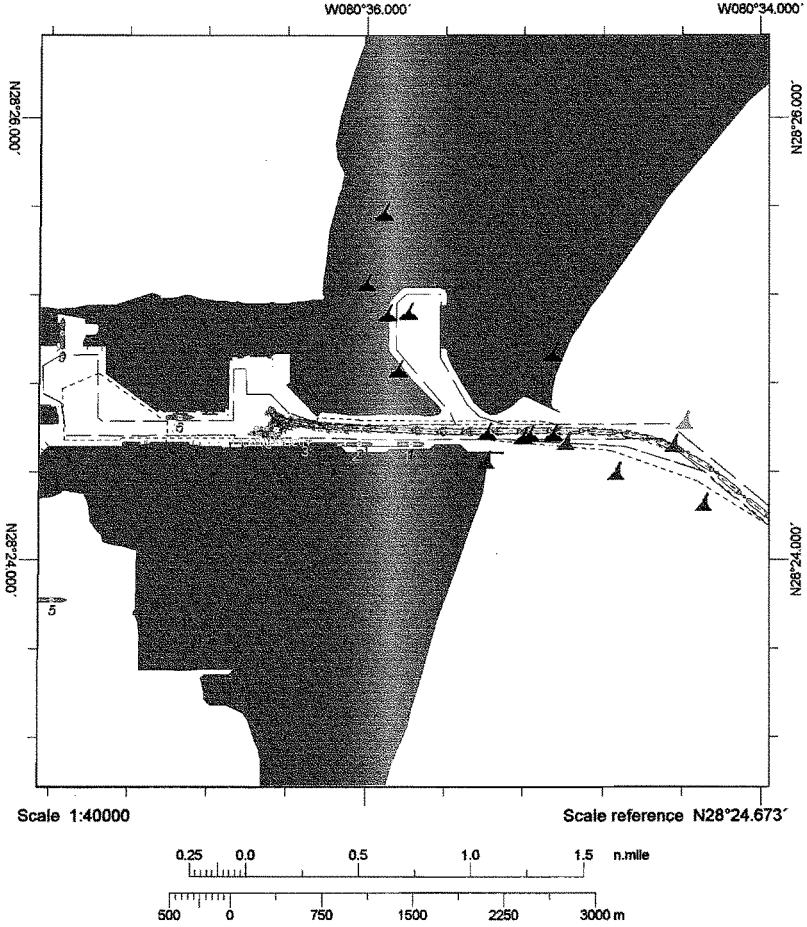

Comments: Wind: 0  
Current: 0

Line sample period (s)	30
Course marker every	N/A
Heading marker period (s)	60
Shape outline every	01:00

### Canaveral Research

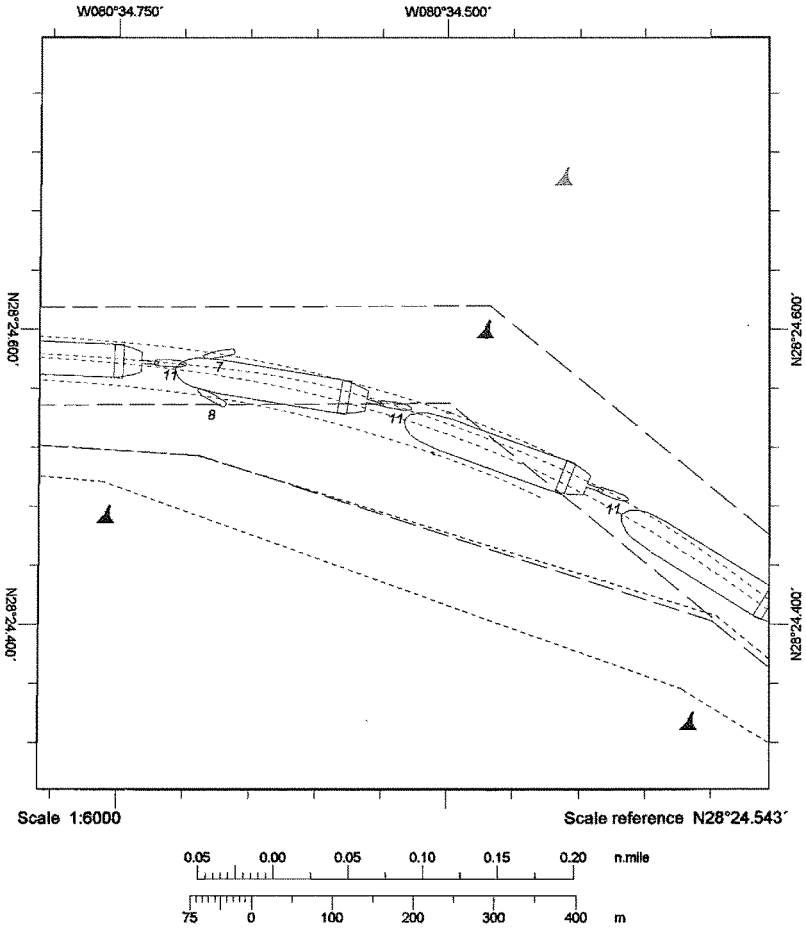

Comments: Wind: 0  
Current: 0

Line sample period (s)	30
Course marker every	N/A
Heading marker period (s)	60
Shape outline every	01:00



### Canaveral Research

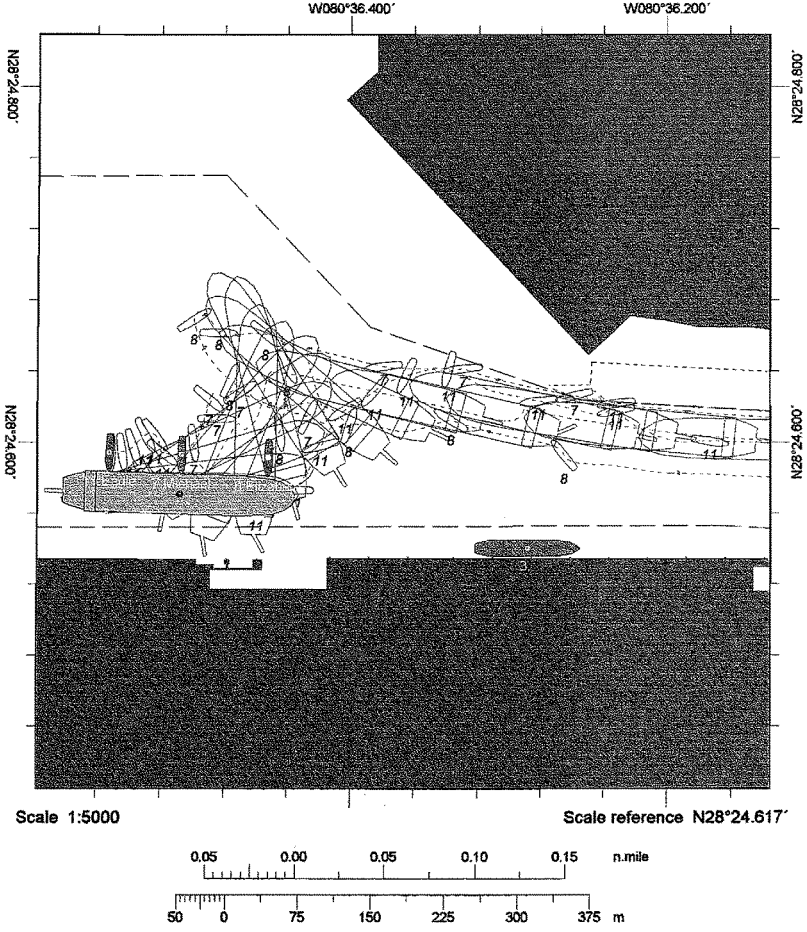

Comments: Wind: 0  
Current: 0

Line sample period (s)	30
Course marker every	N/A
Heading marker period (s)	60
Shape outline every	01:00

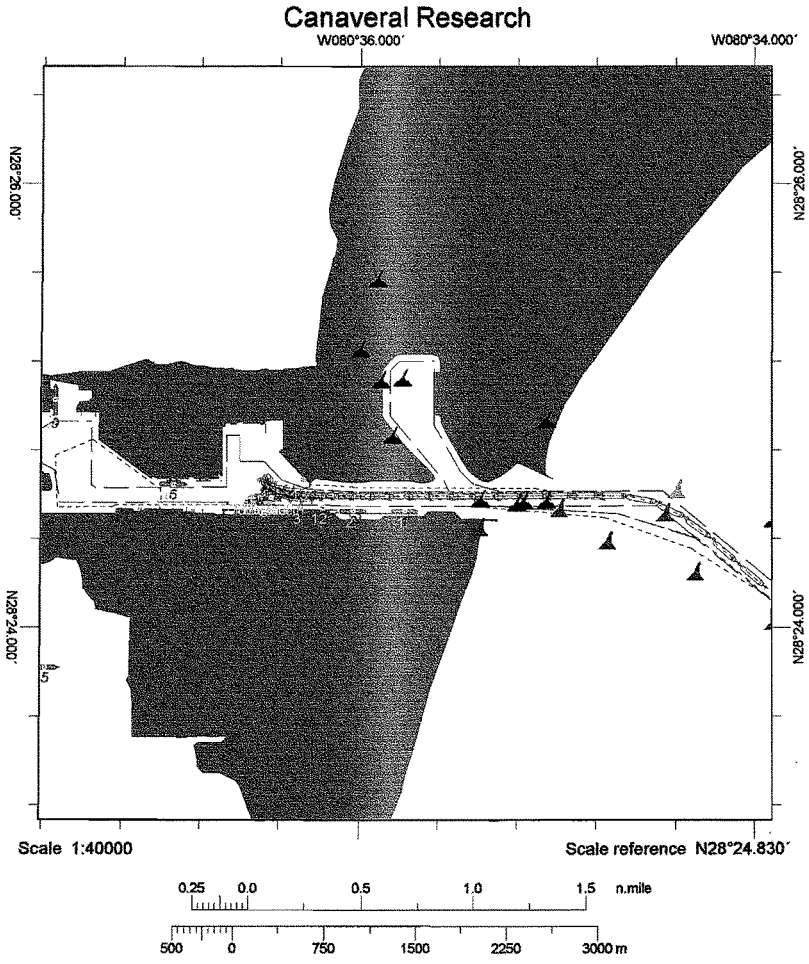

Comments: Wind: NW 15 kts  
Current: N .75

Line sample period (s)	30
Course marker every	N/A
Heading marker period (s)	60
Shape outline every	01:00

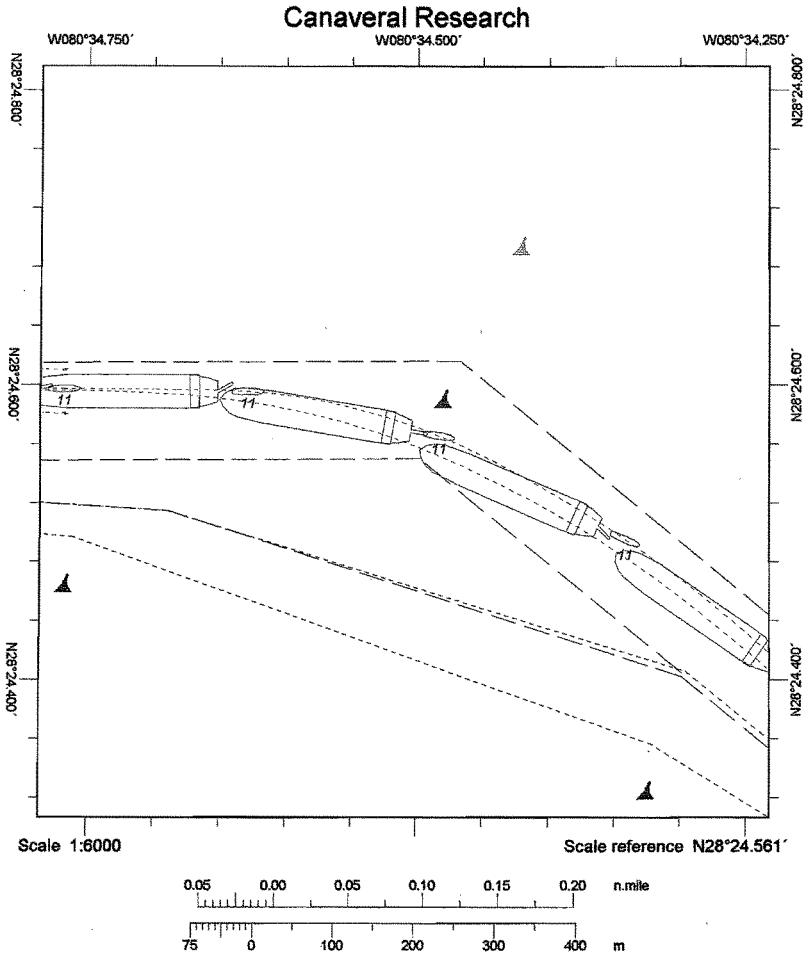

Comments: Wind: NW 15 kts  
 Current: N .75

Line sample period (s)	30
Course marker every	N/A
Heading marker period (s)	60
Shape outline every	01:00

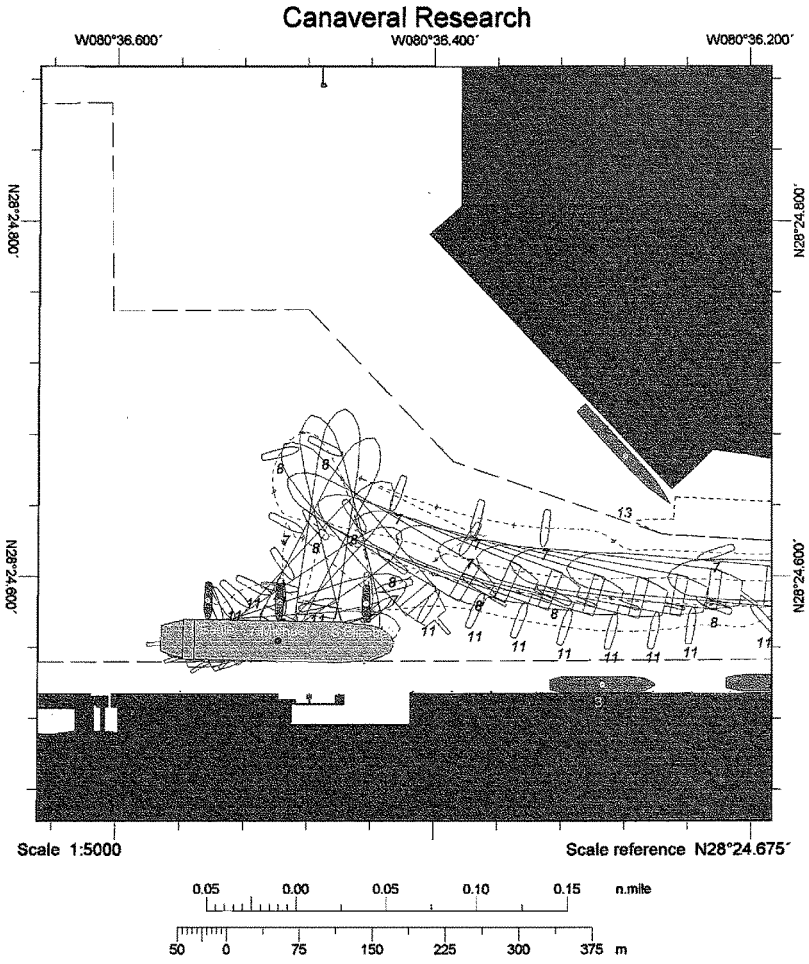

Comments: Wind: NW 15 kts  
 Current: N .75

Line sample period (s)	30
Course marker every	N/A
Heading marker period (s)	60
Shape outline every	01:00

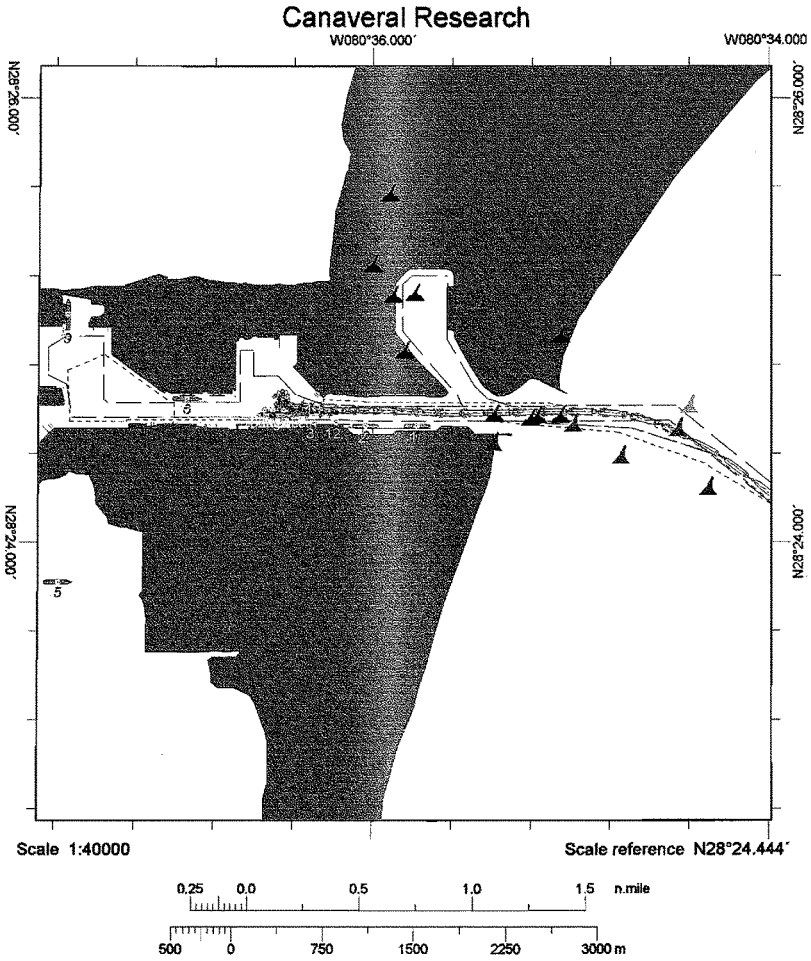

Comments: Wind: NW 20-25 kts  
Current: S .75

Line sample period (s)	30
Course marker every	N/A
Heading marker period (s)	60
Shape outline every	01:00



### Canaveral Research

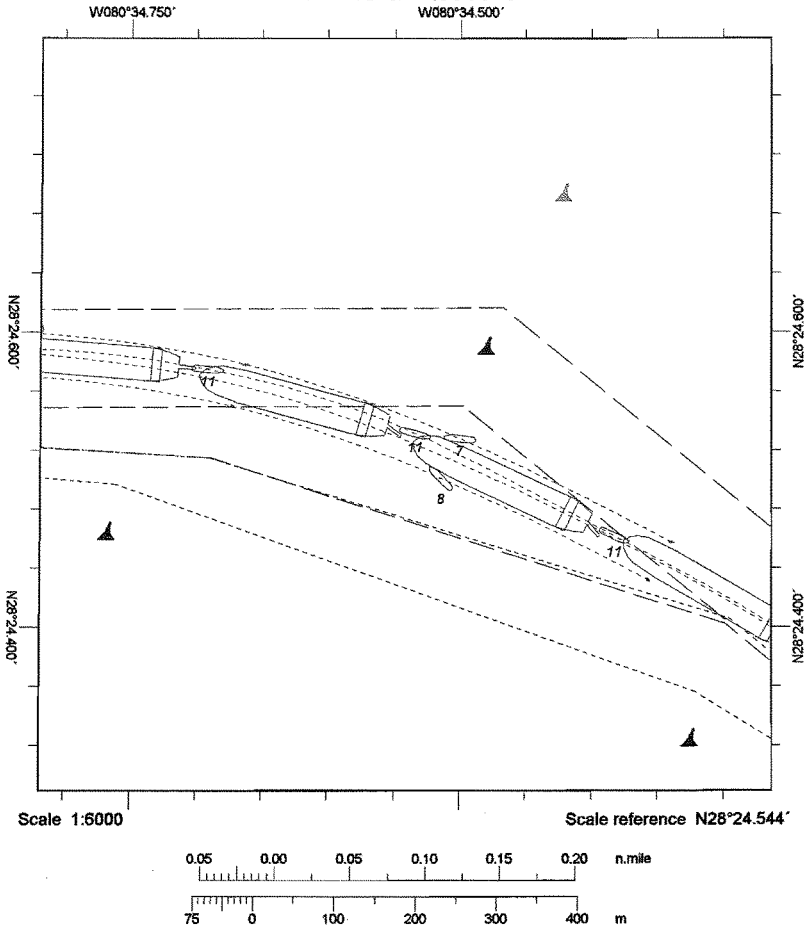

Comments: Wind: NW 20-25 kts  
 Current: S .75

Line sample period (s)	30
Course marker every	N/A
Heading marker period (s)	60
Shape outline every	01:00

### Canaveral Research

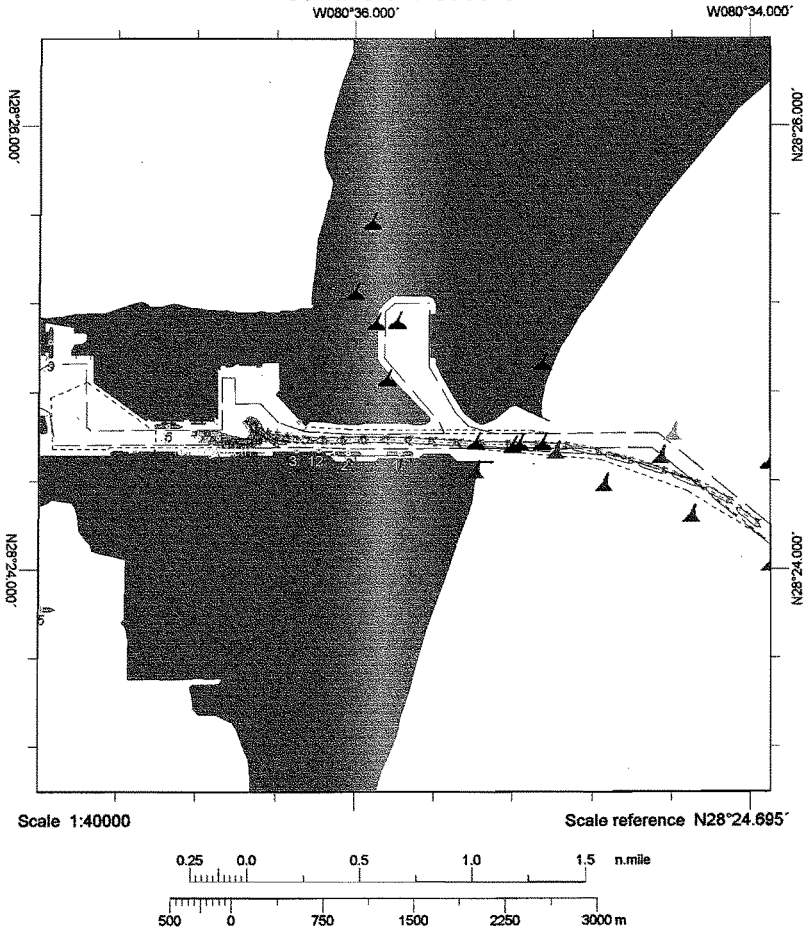

Comments: Wind:SE 15 kts  
Current: S .75

Line sample period (s)	30
Course marker every	N/A
Heading marker period (s)	60
Shape outline every	01:00



### Canaveral Research

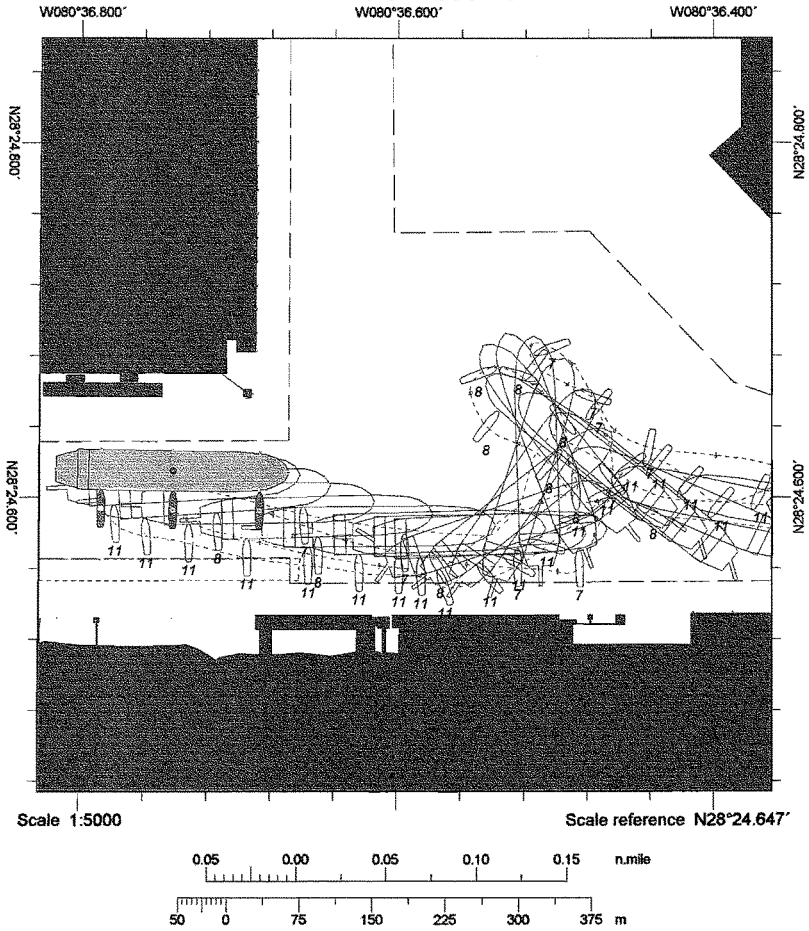

Comments: Wind:SE 15 kts  
Current: S .75

Line sample period (s)	30
Course marker every	N/A
Heading marker period (s)	60
Shape outline every	01:00

### Canaveral Research

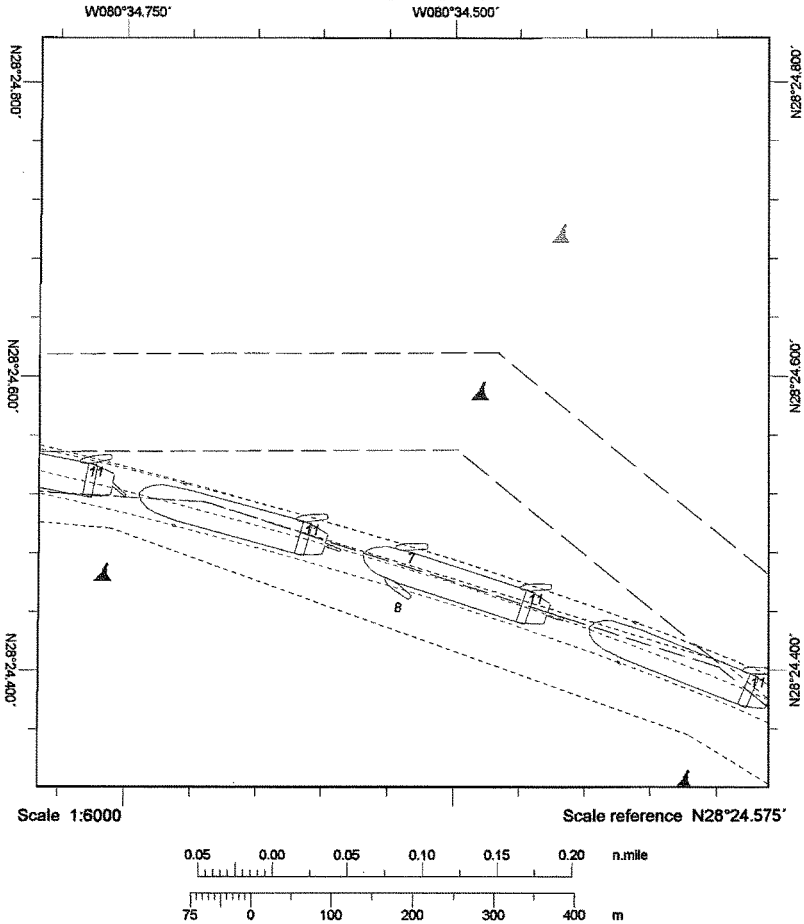

Comments: Wind:SE 15 kts  
Current: S .75

Line sample period (s)	30
Course marker every	N/A
Heading marker period (s)	60
Shape outline every	01:00

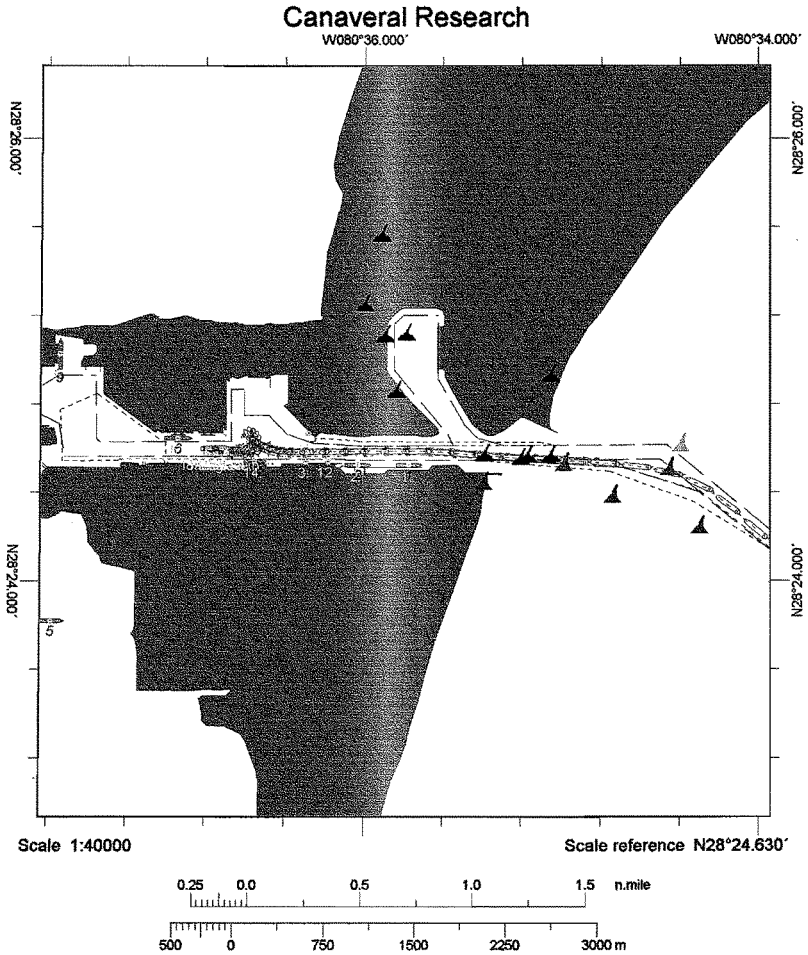

Comments: Wind:SE 20-25 kts  
Current: N .75

Line sample period (s)	30
Course marker every	N/A
Heading marker period (s)	60
Shape outline every	01:00

### Canaveral Research

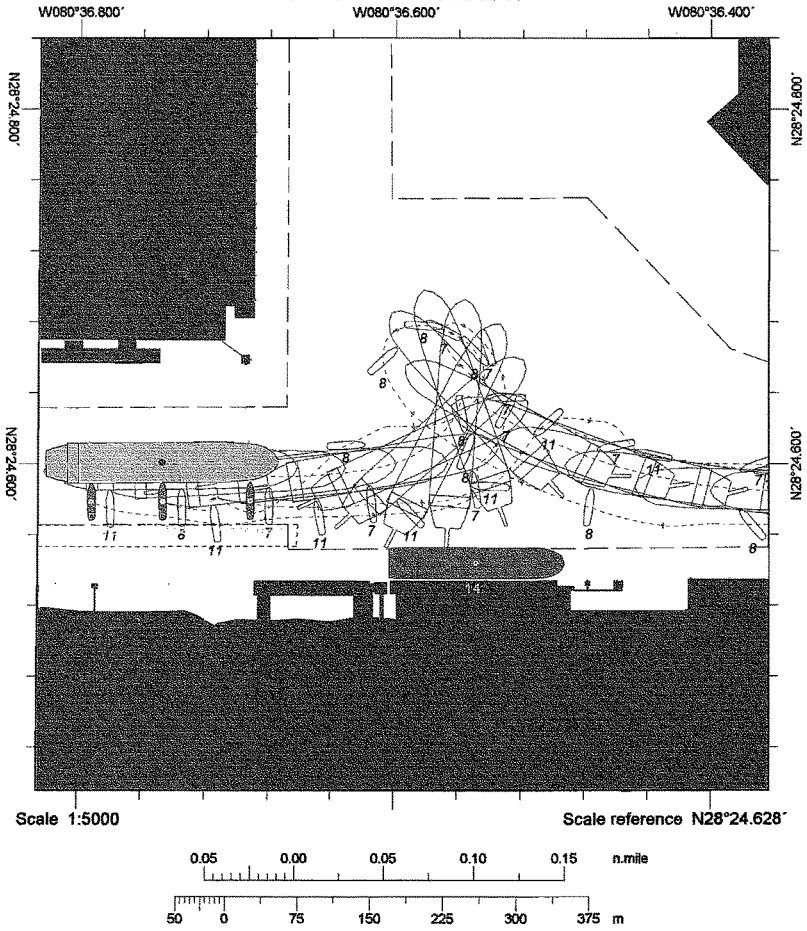

Comments: Wind:SE 20-25 kts  
Current: N .75

Line sample period (s)	30
Course marker every	N/A
Heading marker period (s)	60
Shape outline every	01:00

### Canaveral Research

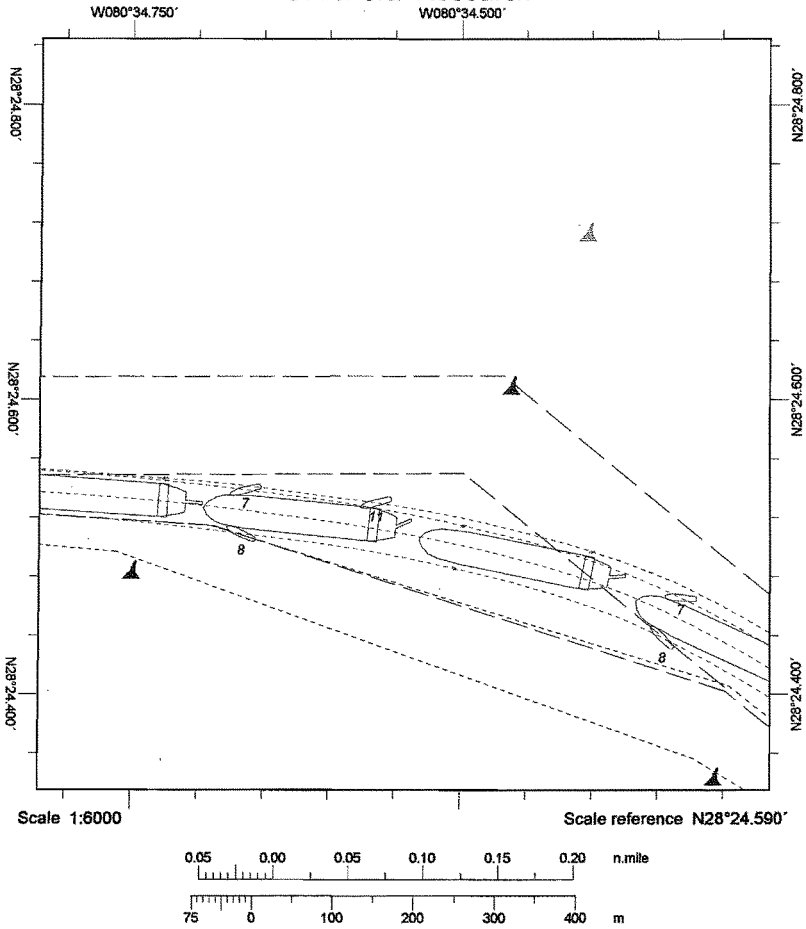

Comments: Wind:SE 20-25 kts  
Current: N .75

Line sample period (s)	30
Course marker every	N/A
Heading marker period (s)	60
Shape outline every	01:00

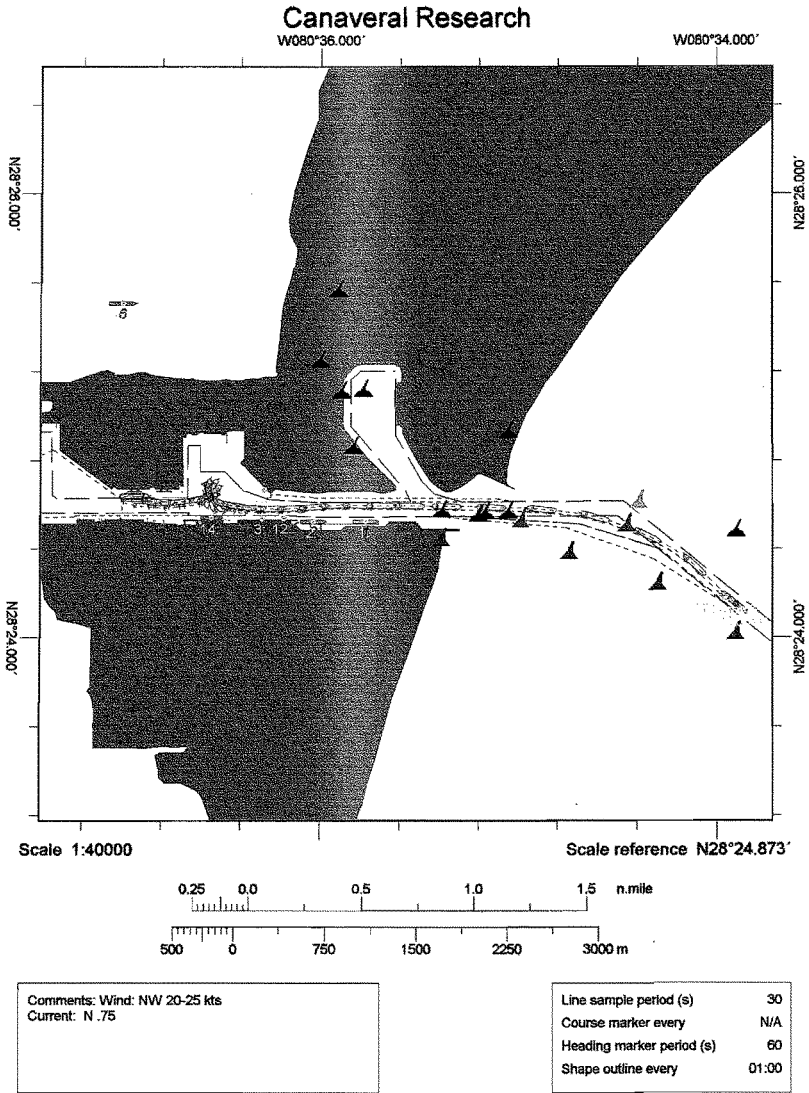

### Canaveral Research

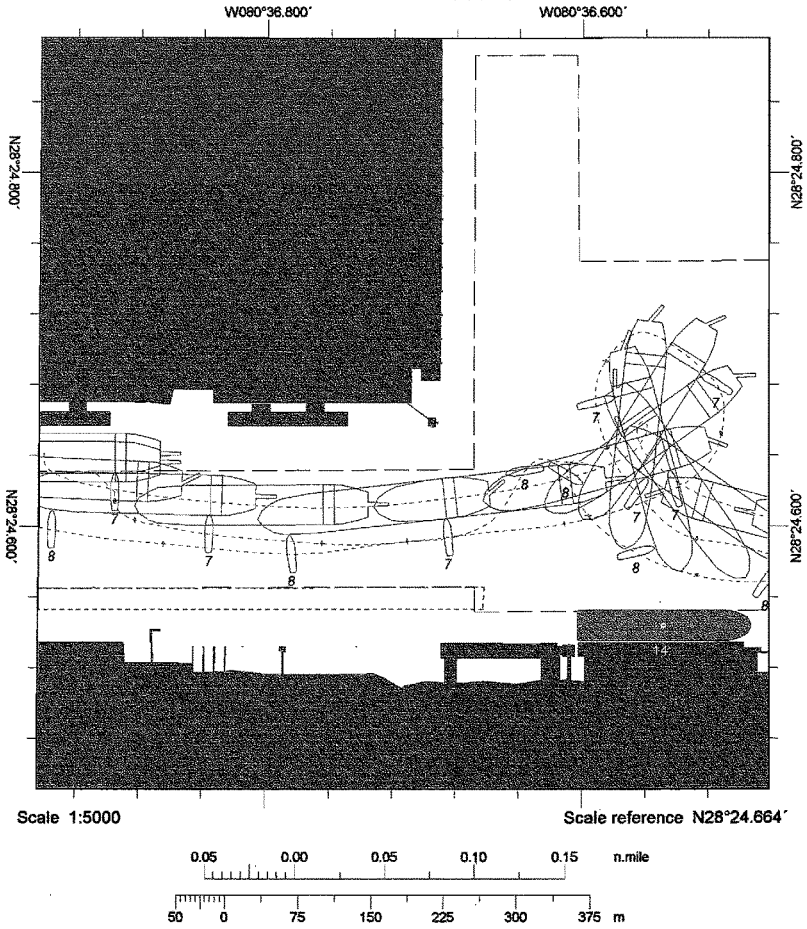

Comments: Wind: NW 20-25 kts  
 Current: N .75

Line sample period (s)	30
Course marker every	N/A
Heading marker period (s)	60
Shape outline every	01:00

### Canaveral Research

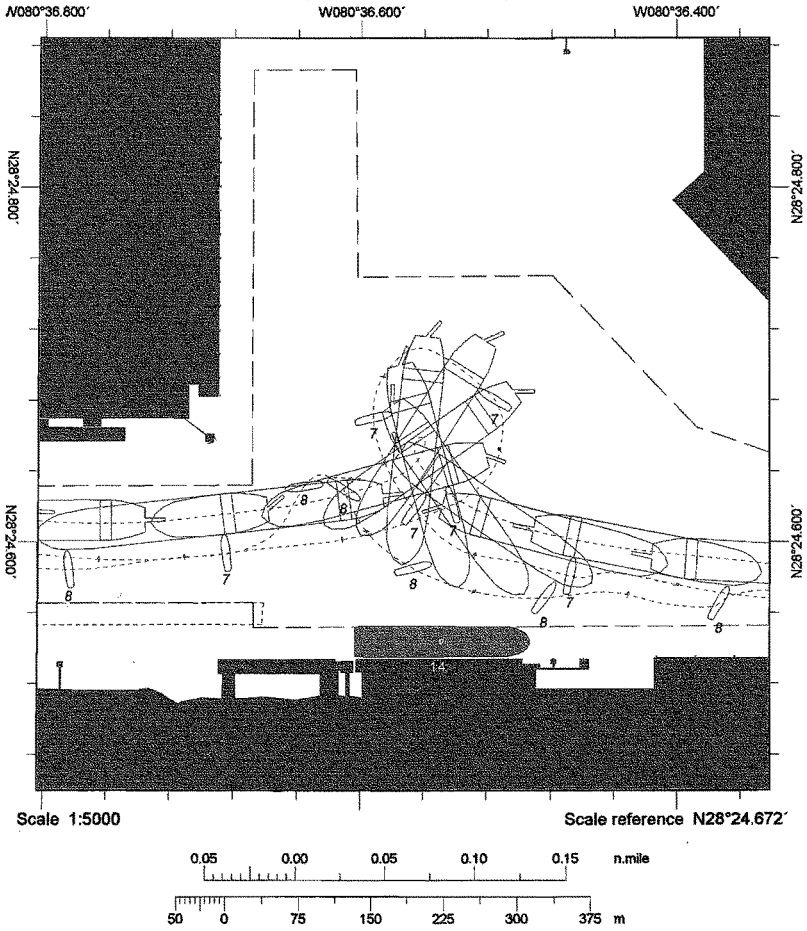

Comments: Wind: NW 20-25 kts  
Current: N .75

Line sample period (s)	30
Course marker every	N/A
Heading marker period (s)	60
Shape outline every	01:00



### Canaveral Research

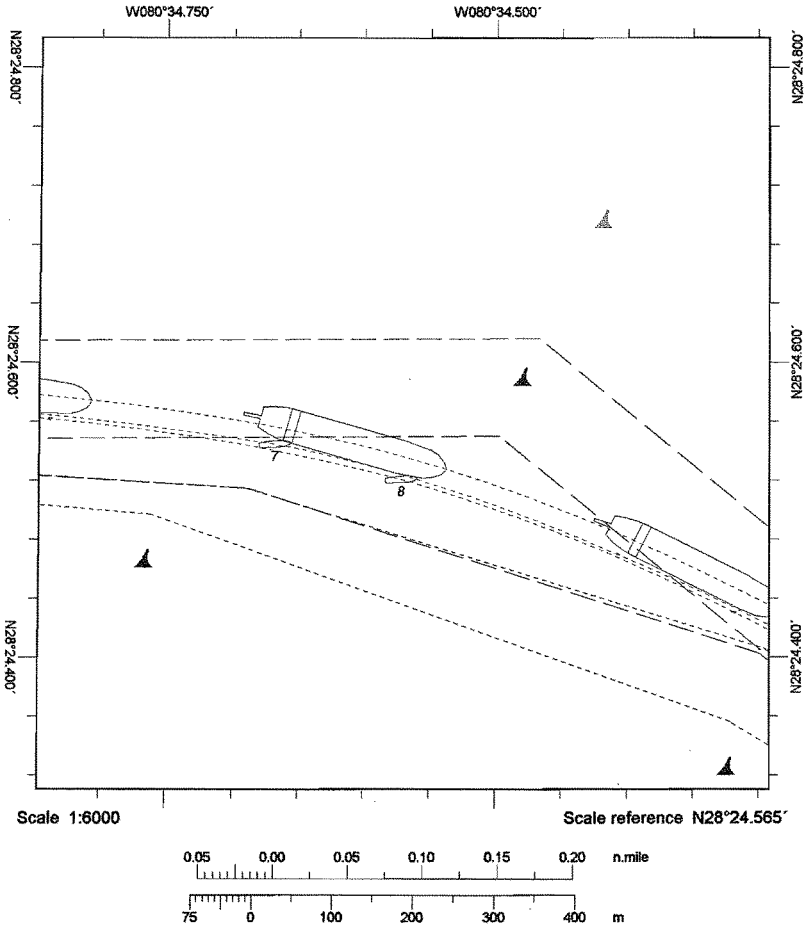

Comments: Wind: NW 20-25 kts  
 Current: N .75

Line sample period (s)	30
Course marker every	N/A
Heading marker period (s)	60
Shape outline every	01:00

### Canaveral Research

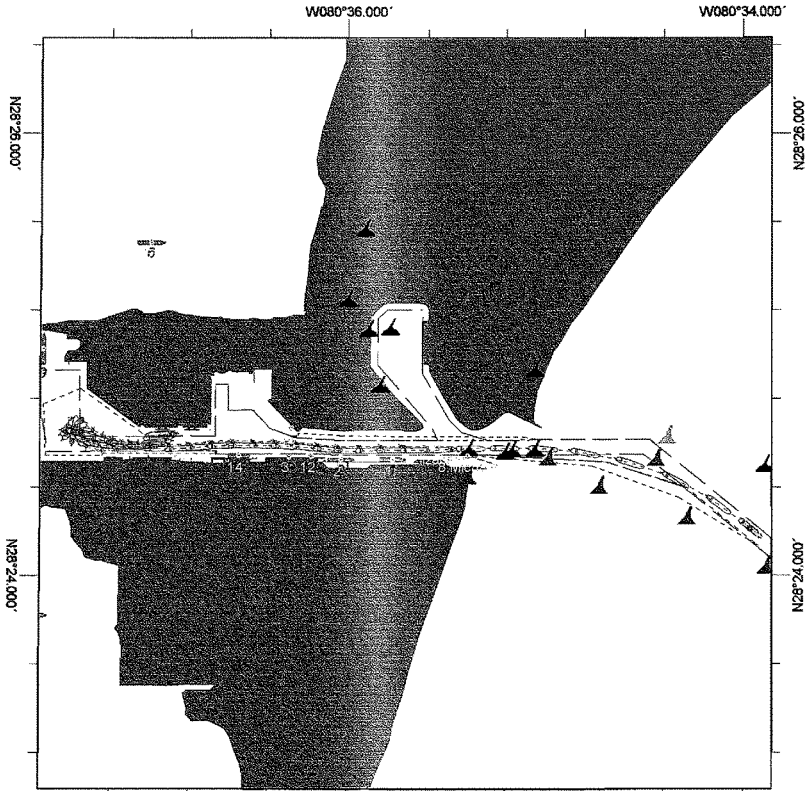

Scale 1:40000

Scale reference N28°24.733'

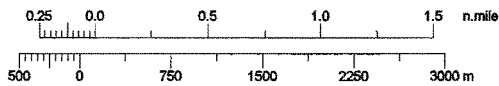

Comments: Wind: SE 20-25 kts  
Current: S .75

Line sample period (s)	30
Course marker every	N/A
Heading marker period (s)	60
Shape outline every	01:00

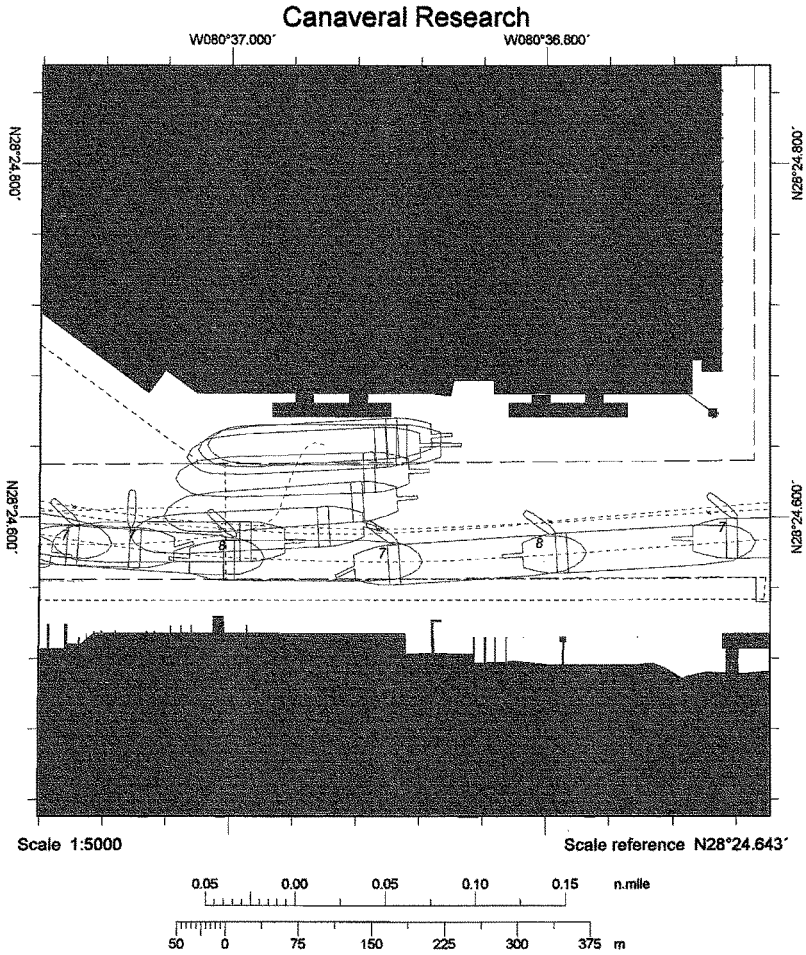

Comments: Wind: SE 20-25 kts  
 Current: S .75

Line sample period (s)	30
Course marker every	N/A
Heading marker period (s)	60
Shape outline every	01:00

### Canaveral Research

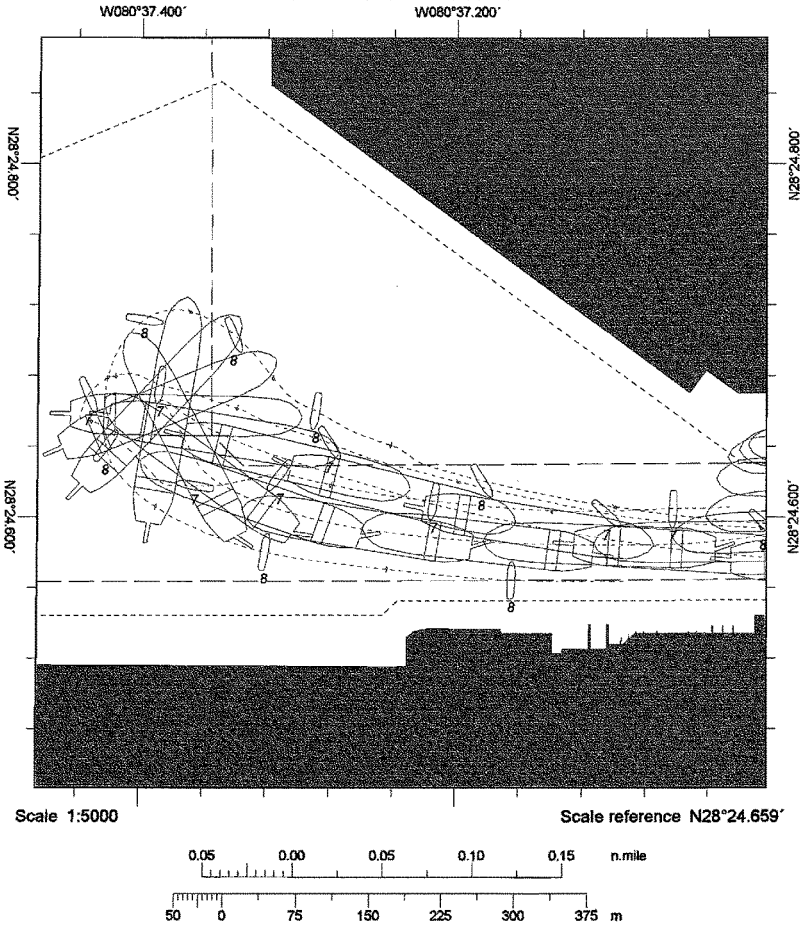

Comments: Wind: SE 20-25 kts  
Current: S .75

Line sample period (s)	30
Course marker every	N/A
Heading marker period (s)	60
Shape outline every	01:00

### Canaveral Research

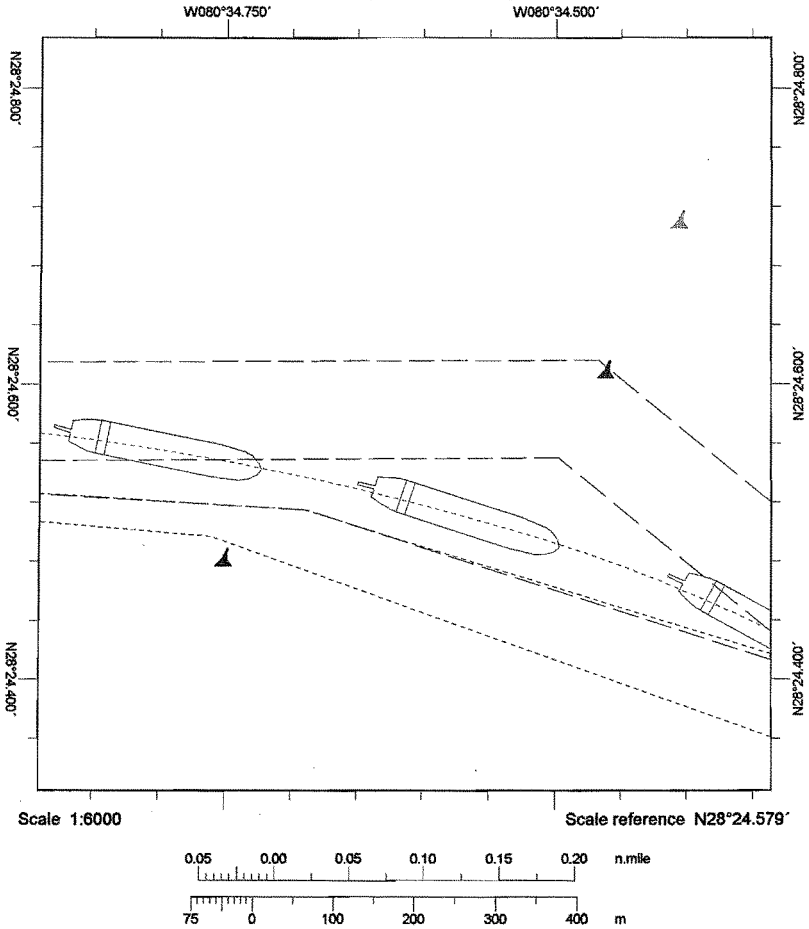

Comments: Wind: SE 20-25 kts  
Current: S .75

Line sample period (s)	30
Course marker every	N/A
Heading marker period (s)	60
Shape outline every	01:00

# Canaveral Research

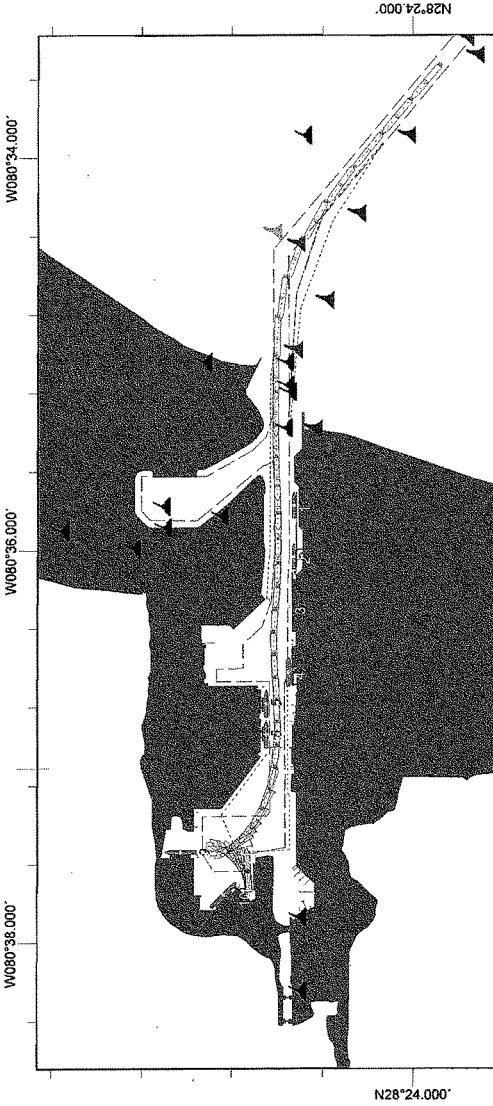

Scale 1:40000

Scale reference N28°24.645'

Comments: Wind: 0  
Current: 0

Line sample period (s)	30
Course marker every	N/A
Heading marker period (s)	60
Shape outline every	01:00

Exercise: Exercise16 Canaveral

Real time: 9:46:22 AM

Norcontrol Polaris, Real date: 3/10/2007

# Canaveral Research

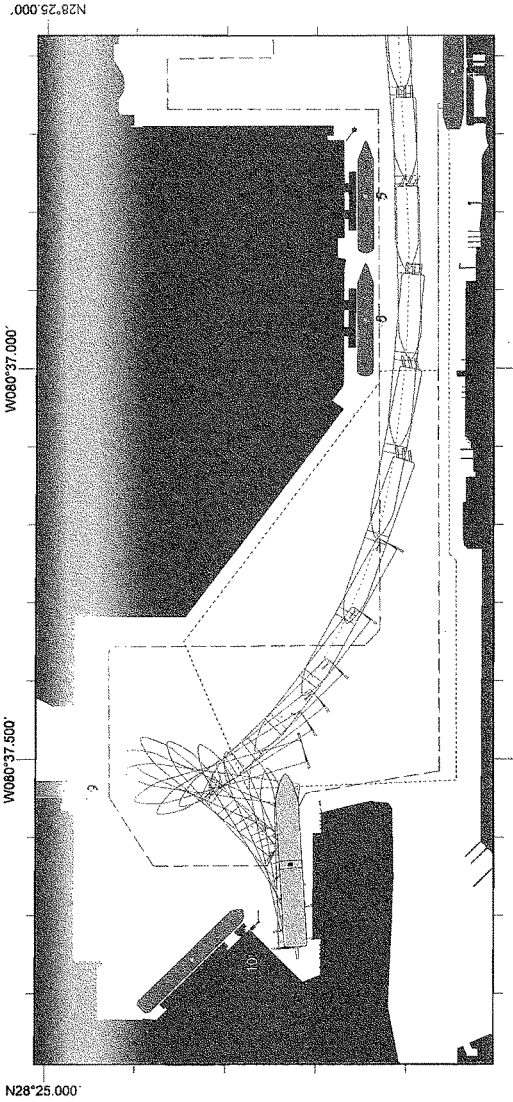

Scale 1:10000

Scale reference N28°24.756'

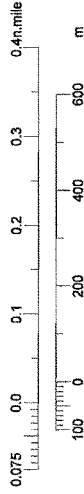

Comments: Wind: 0  
 Current: 0

Line sample period (s)	30
Course marker every	N/A
Heading marker period (s)	60
Shape outline every	01:00

Exc date: 2/25/2007

Exc time (elapsed): 8:39:53 AM (00:39:53)

Page 1

# Canaveral Research

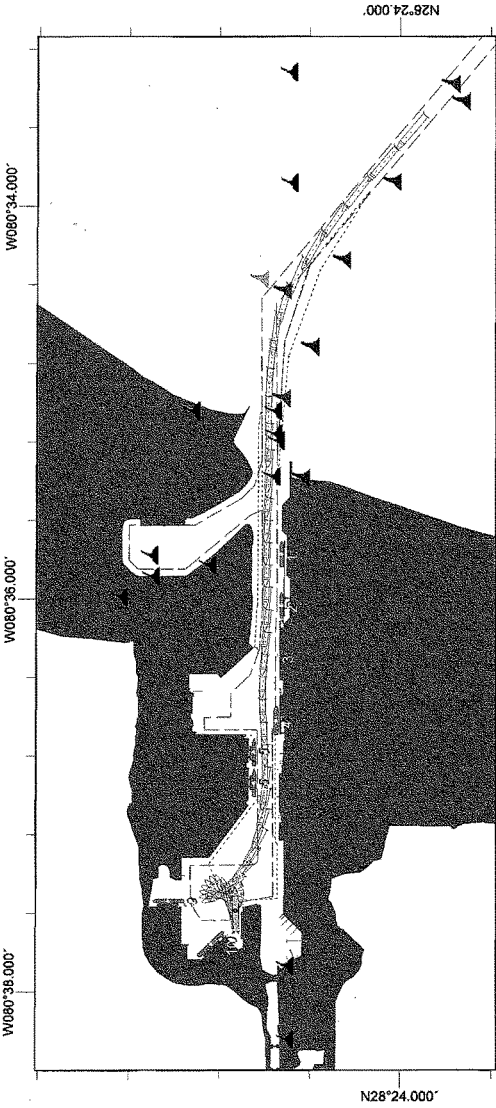

Scale 1:40000

Scale reference N28°24.594°

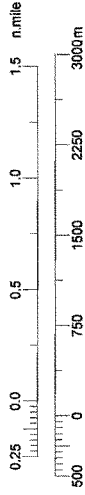

Comments: Wind: NW 15kt  
Current: N0.75

Line sample period (s)	30
Course marker every	N/A
Heading marker period (s)	60
Shape outline every	01:00



# Canaveral Research

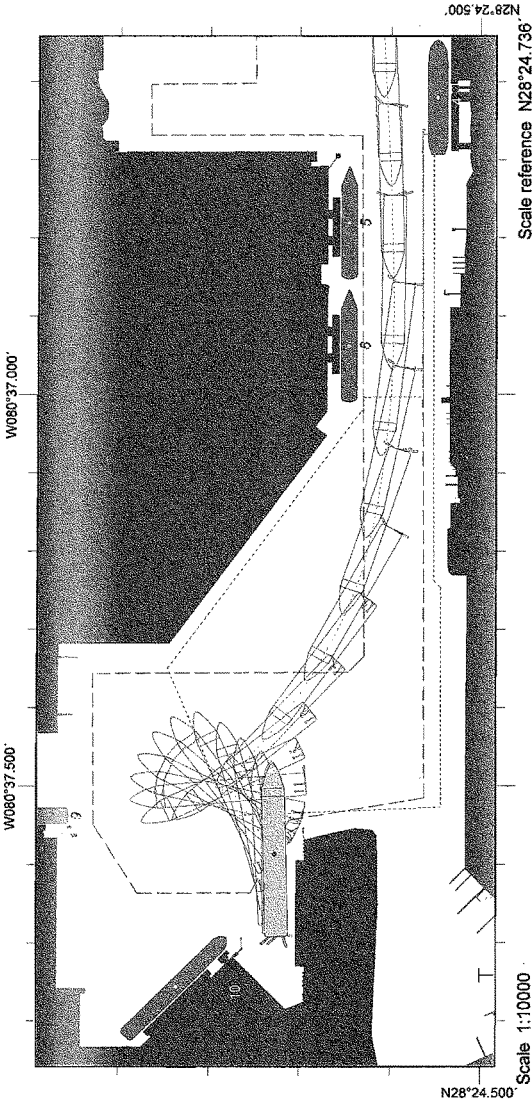

Scale reference N28°24.736'

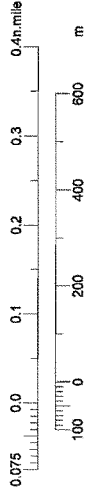

Line sample period (s)	30
Course marker every	N/A
Heading marker period (s)	60
Shape outline every	01:00

Comments: Wind: NW 15kt  
Current: ND.75

# Canaveral Research

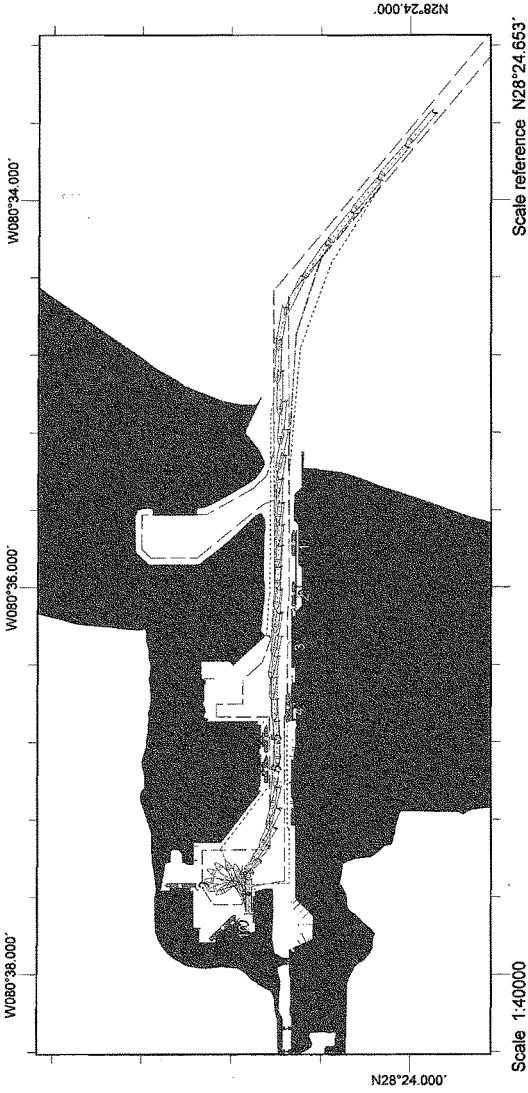

Line sample period (s)	30
Course marker every	N/A
Heading marker period (s)	60
Shape outline every	01:00

Comments: Wind: NW 25kt  
Current: S 0.75

# Canaveral Research

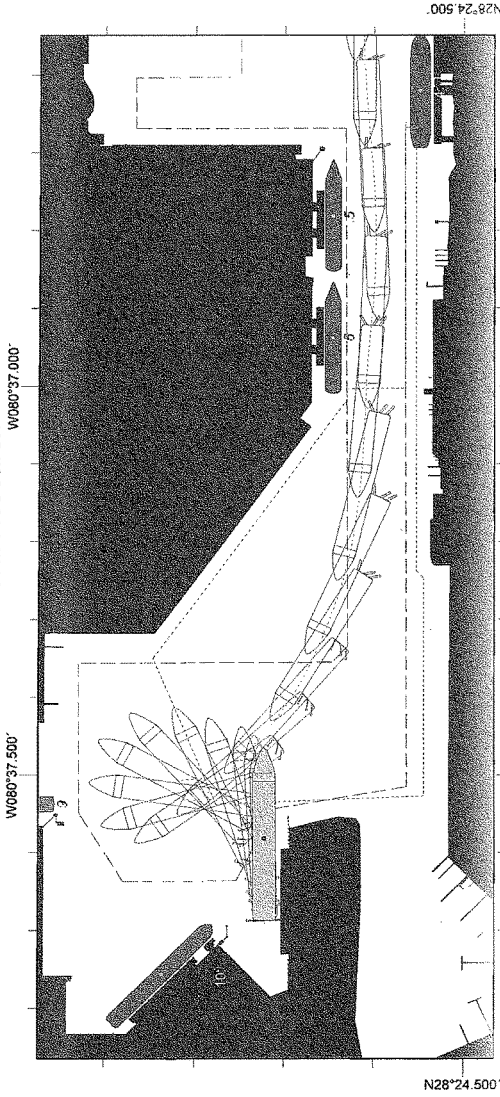

Scale reference N28°24.720'

Scale 1:10000

Line sample period (s)	30
Course marker every	N/A
Heading marker period (s)	60
Shape outline every	01:00

Comments: Wind: NW 25kt  
 Current: S 0.75

# Canaveral Research

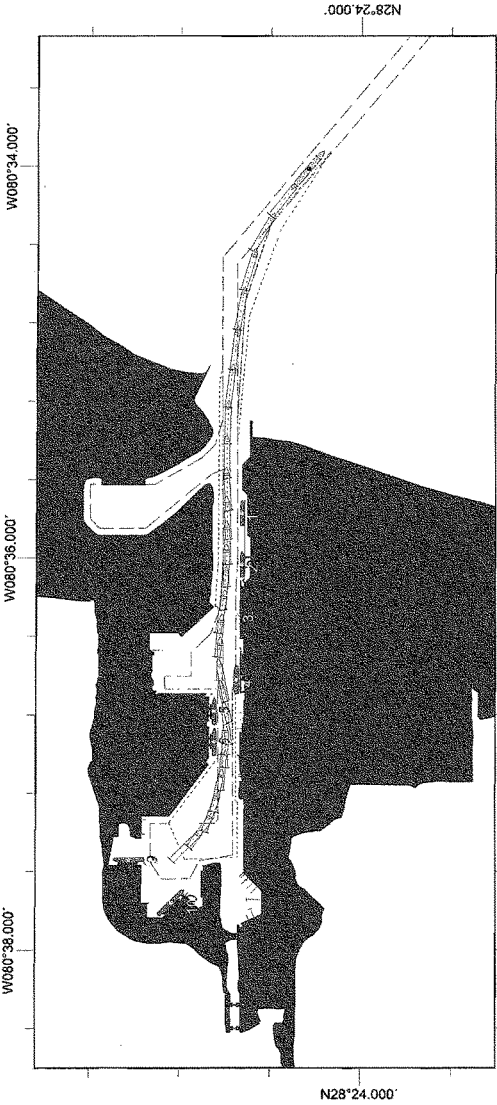

Scale 1:40000

Scale reference N28°24.419'

Comments: Wind: NW 25kt  
Current: S 0.75

Line sample period (s)	30
Course marker every	N/A
Heading marker period (s)	60
Shape outline every	01:00

# Canaveral Research

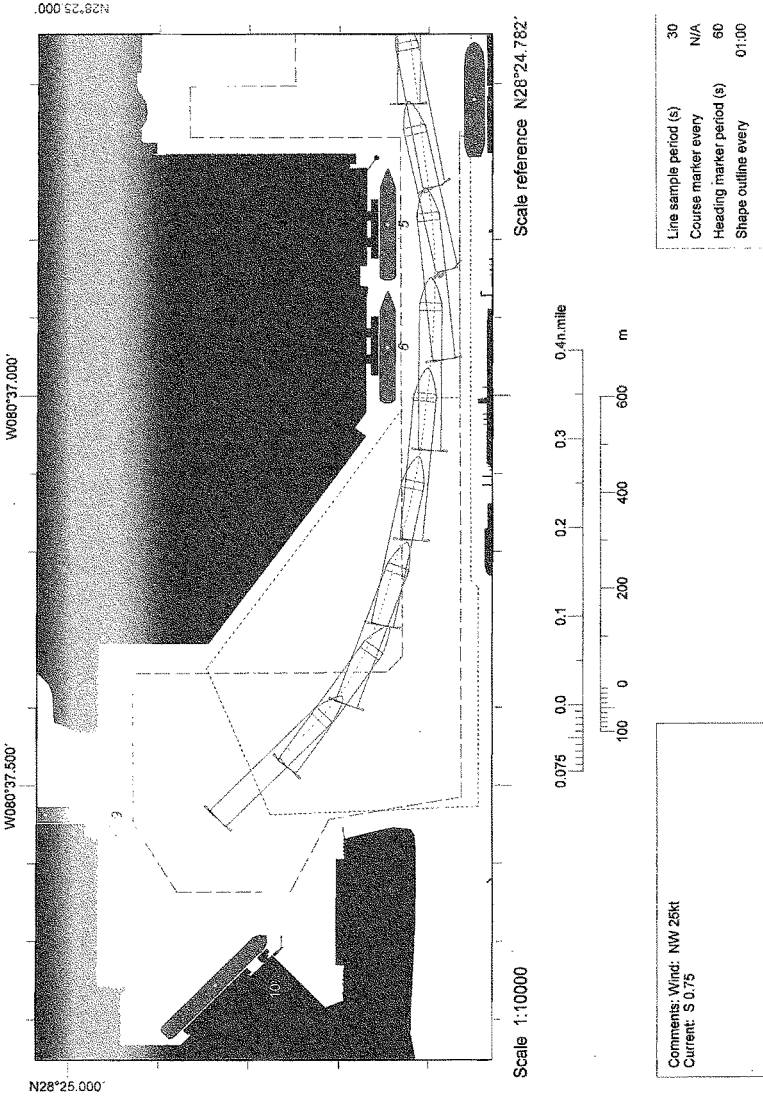

# Canaveral Research

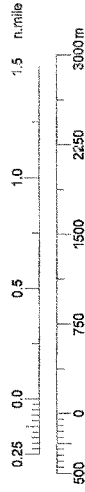
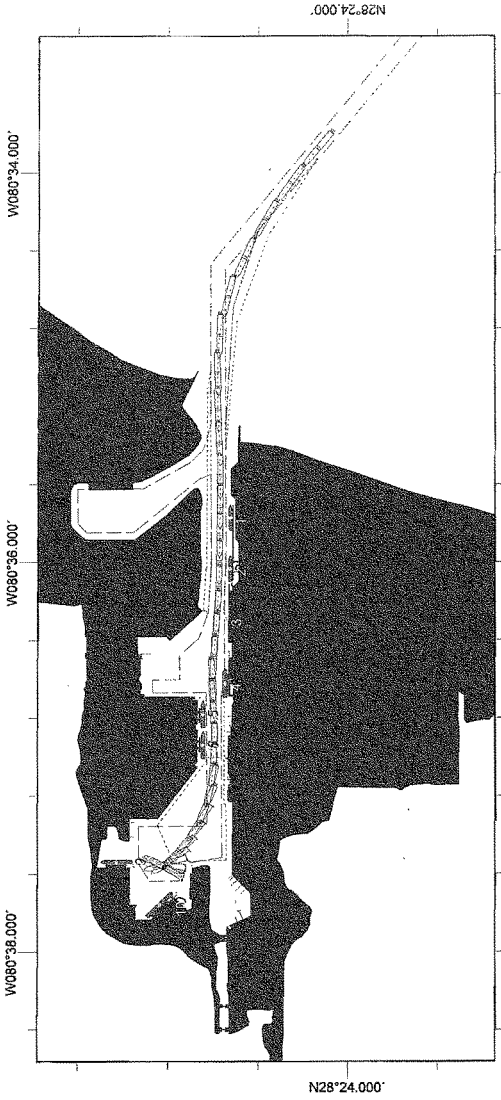

Line sample period (s)	30
Course marker every	N/A
Heading marker period (s)	60
Shape outline every	01:00

Comments: Wind: SE 15kt  
Current: S 0.75

# Canaveral Research

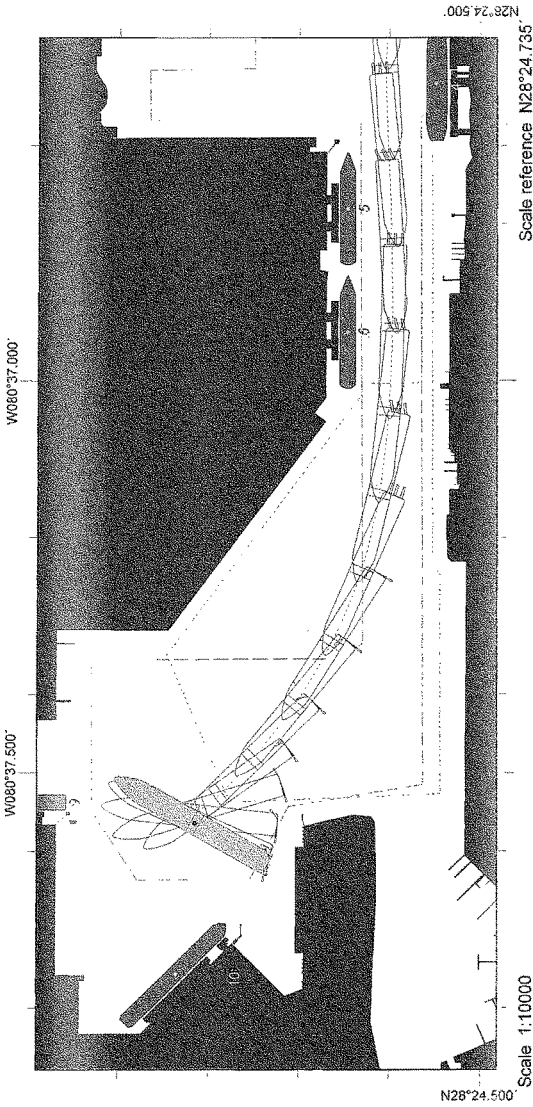

Scale 1:10000

Scale reference: N28°24.735'



Line sample period (s)	30
Course marker every	N/A
Heading marker period (s)	60
Steps outline every	01:00

Comments: Wind: SE 15kt  
Current: S 0.75

# Canaveral Research

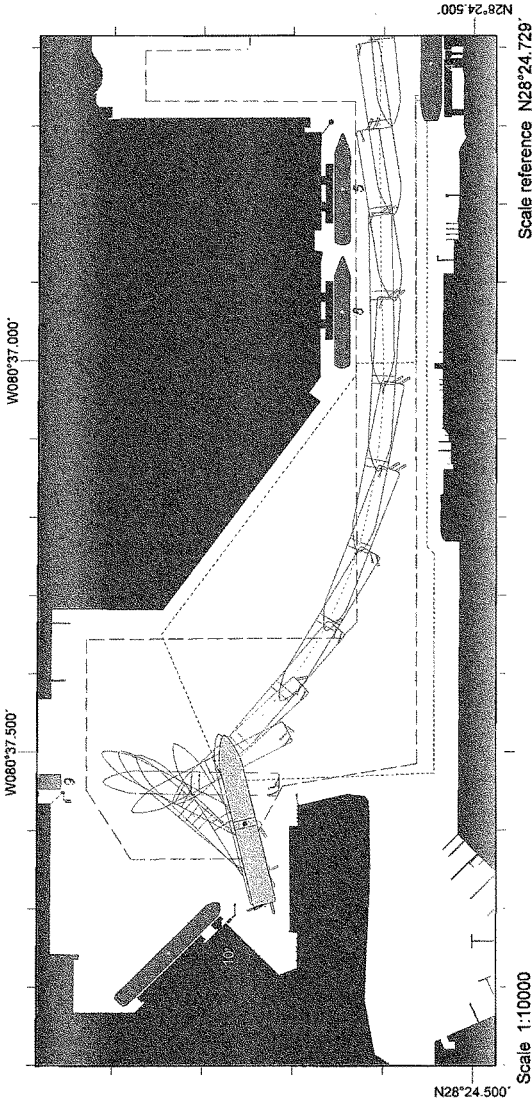

Line sample period (s)	30
Course marker every	N/A
Heading marker period (s)	60
Shape outline every	01:00

Comments: Wind: SE 15kt  
Current: S 0.75



# Canaveal Research

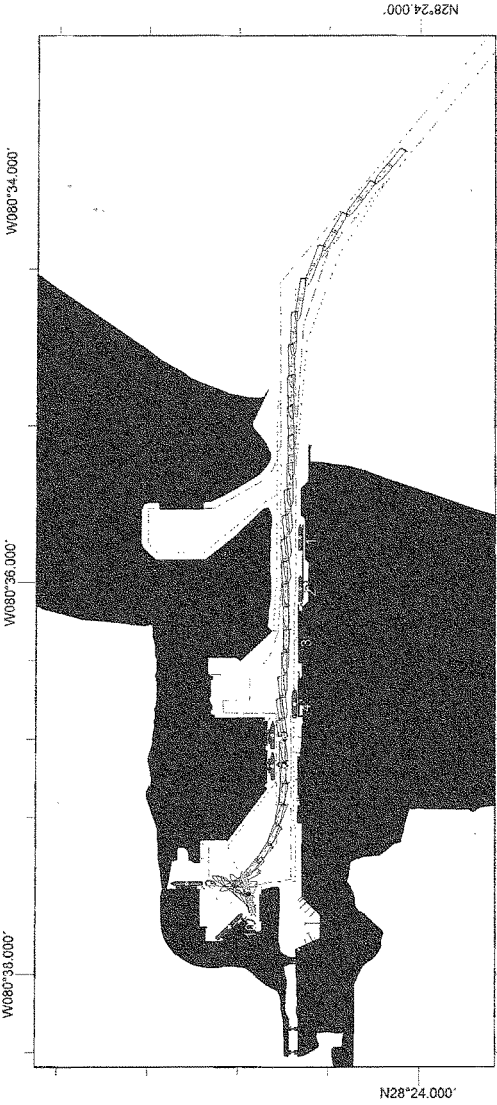

Scale 1:40000

Scale reference N28°24.679'



Comments: Wind: SE 15kt  
Current: S 0.75

Line sample period (s)	30
Course marker every	N/A
Heading marker period (s)	60
Shape outline every	01:00

# Canaveral Research

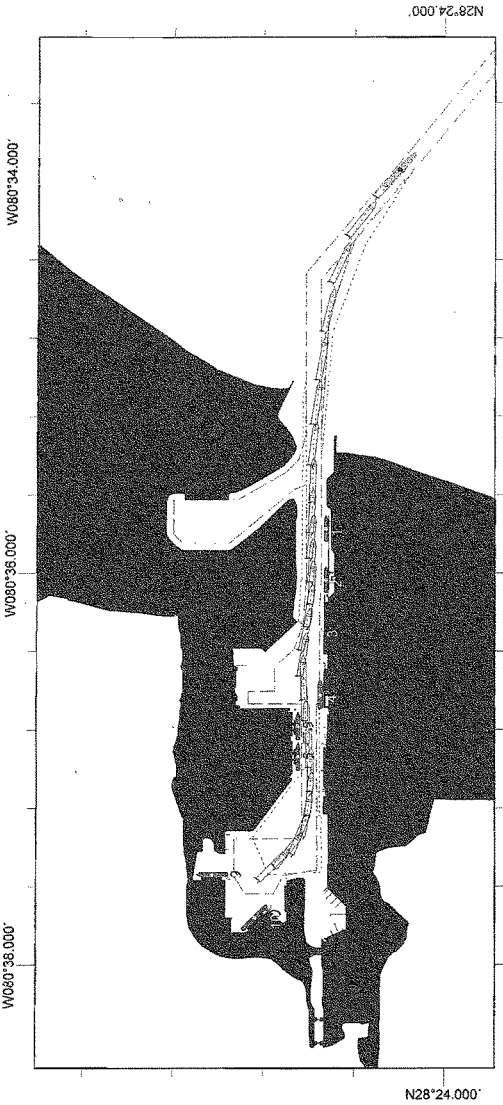

Scale reference N28°24.790'

Scale 1:40000



Line sample period (s)	30
Course marker every	N/A
Heading marker period (s)	60
Shape outline every	01:00

Comments: Wind: SE 25kt  
Current: N 0.75

Exercise: Exercise 22 Canaveral

Real time: 3:40:34 PM

Norcontrol Polaris, Real date: 3/10/2007

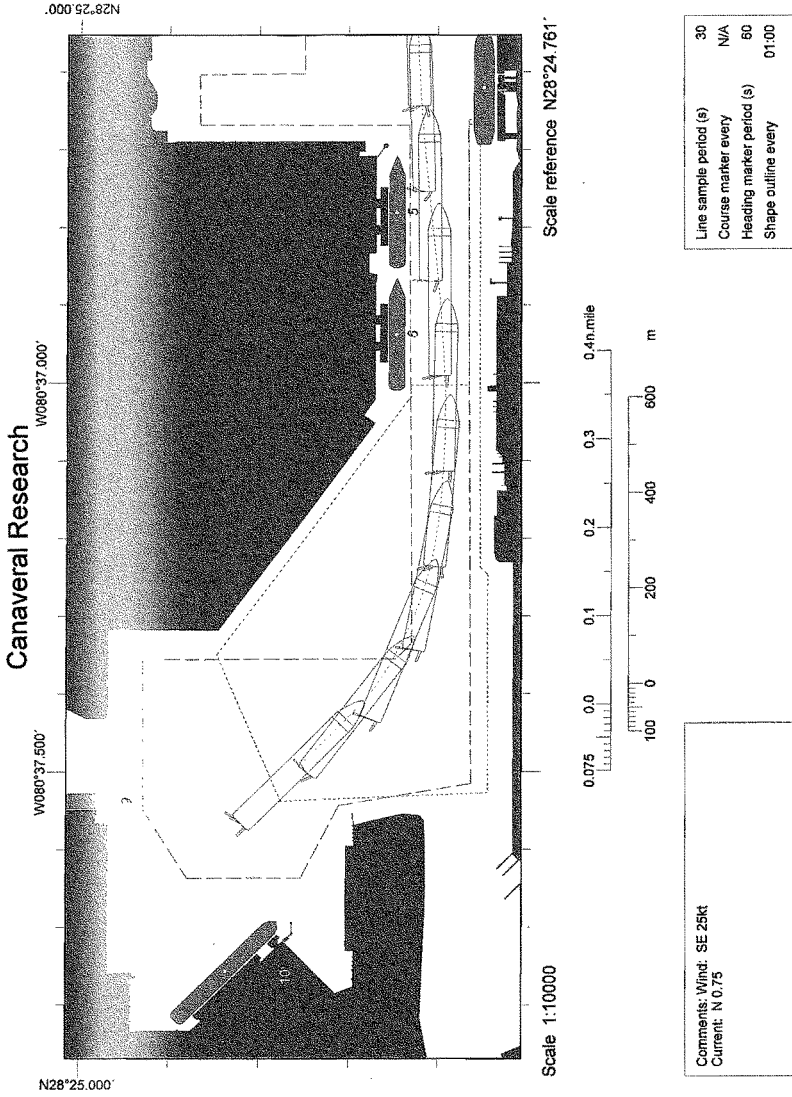

Exc date: 2/25/2007

Exc time (elapsed): 8:24:20 AM (00:24:20)

Page 1

# Canaveral Research

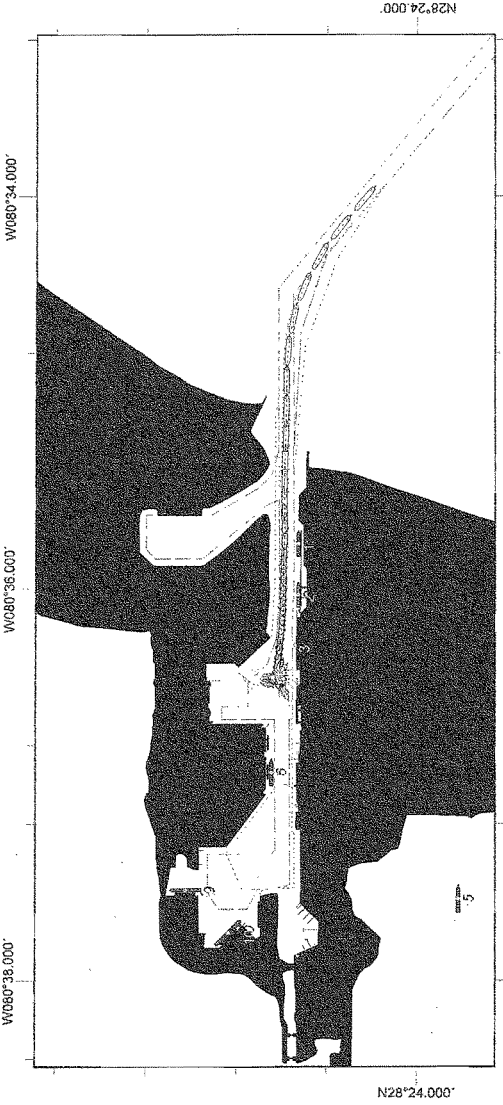

Scale 1:40000

Scale reference N28°24.673'



Comments: Wind: 0  
 Current: 0

Line sample period (s)	30
Course marker every	N/A
Heading marker period (s)	60
Shape outline every	01:00

# Canaveral Research

W080°35.500'

W080°36.000'

W080°36.500'

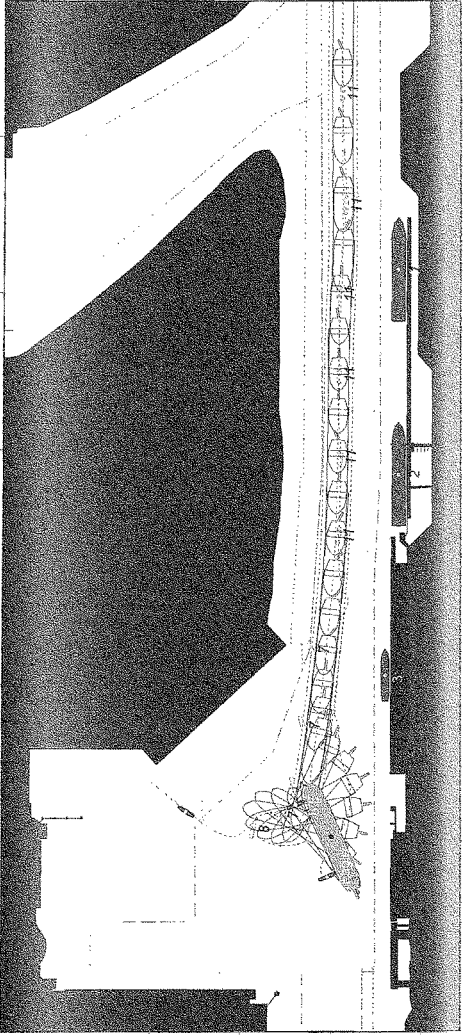

N28°24.500'

N28°24.500'

Scale 1:10000

Scale reference N28°24.710'



Comments: Wind: 0  
Current: 0

Line sample period (s)	30
Course marker every	N/A
Heading marker period (s)	60
Steps outline every	01:00

# Canaveral Research

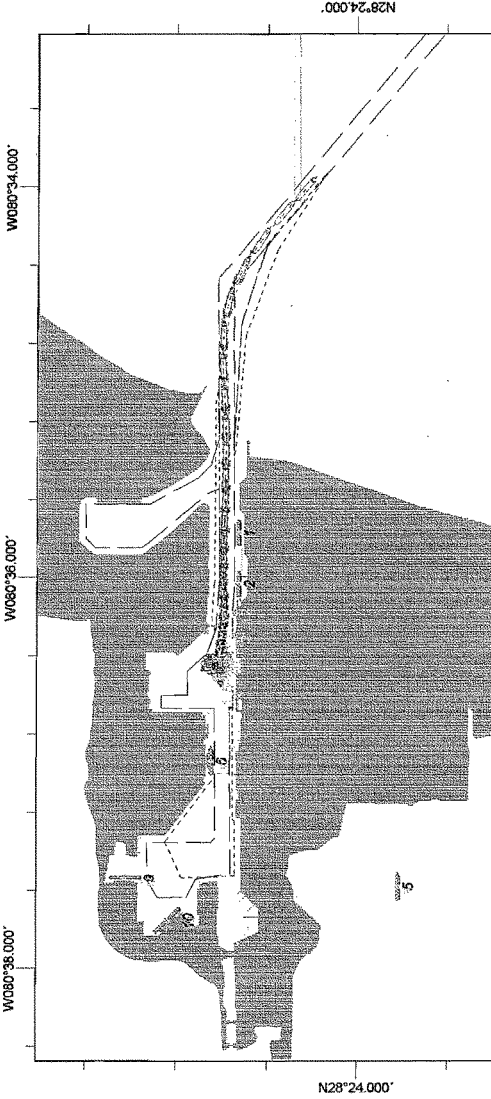

# Canaveral Research

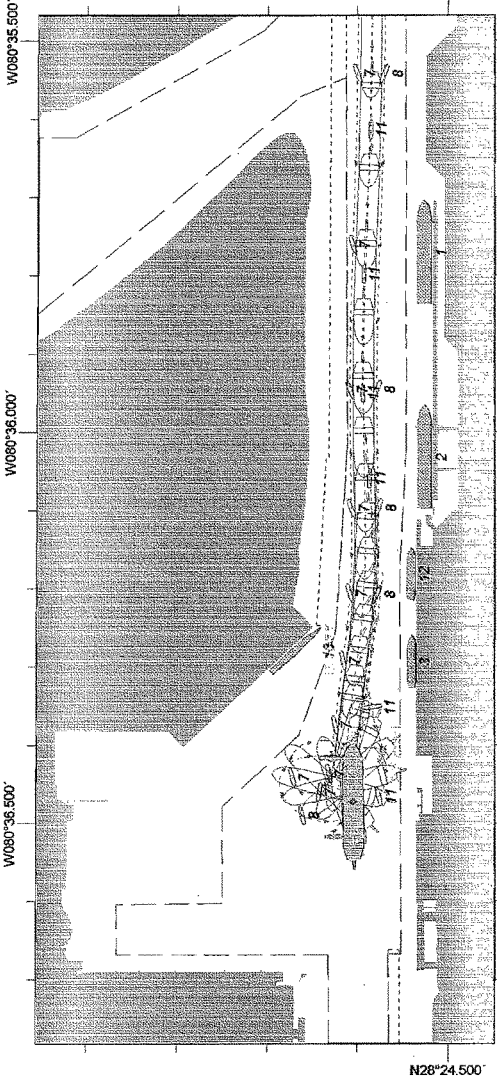

Scale 1:10000

Scale reference N28°24.701'

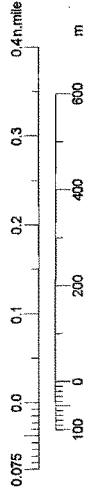

Comments: Wind: NW 15 kts  
 Current: N .75

Line sample period (s)	30
Course marker every	N/A
Heading marker period (s)	60
Shape outline every	01:00

# Canaveral Research

W080°36.500'

W080°36.000'

W080°35.500'

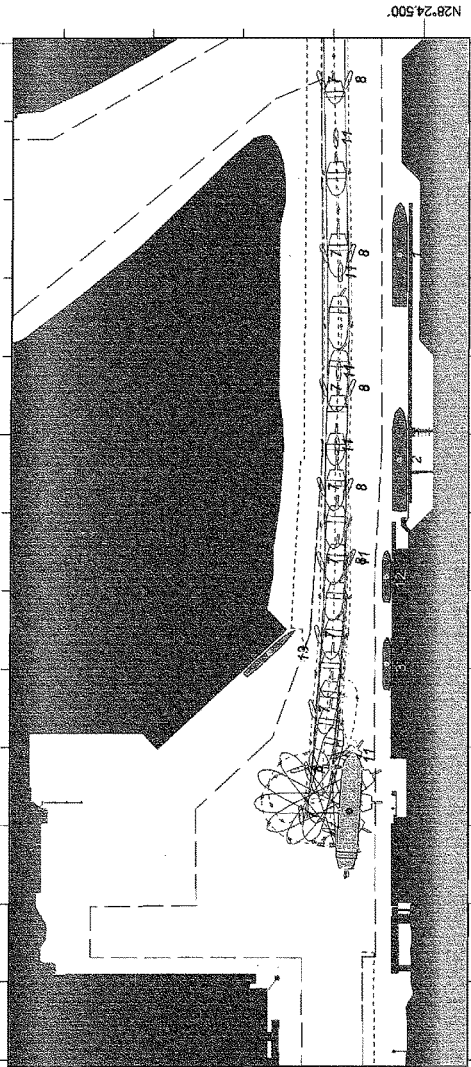

Scale 1:10000

Scale reference N28°24.702'

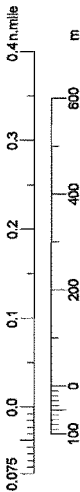

Comments: Wind: NW 15 kts  
 Current: N .75

Line sample period (s)	30
Course marker every	N/A
Heading marker period (s)	60
Shape outline every	01:00



Exercise: Exercise 25 Canaveral

Real time: 10:06:25 AM

Noncontrol Polaris, Real date: 3/11/2007

# Canaveral Research

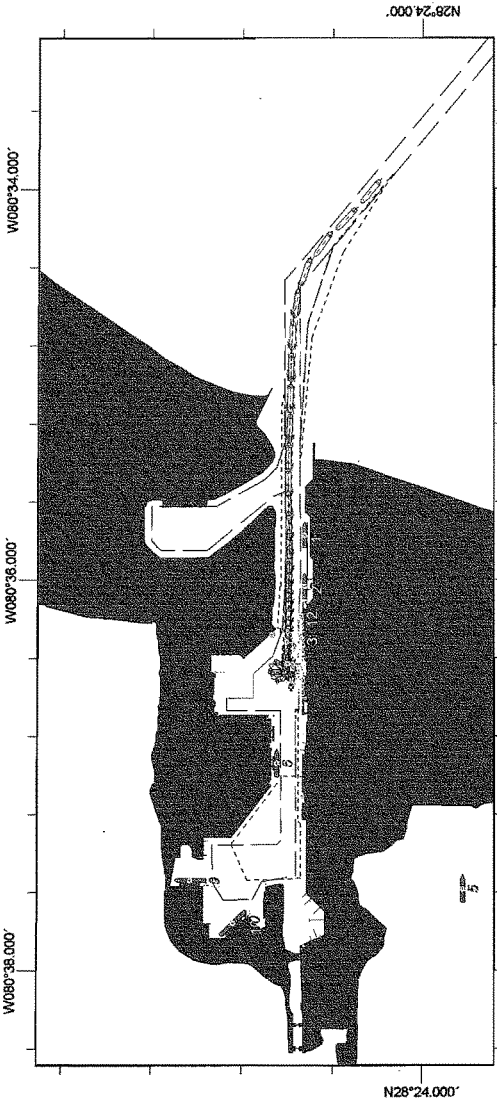

Scale reference N28°24.695'

Scale 1:40000

Line sample period (s)	30
Course marker every	N/A
Heading marker period (s)	60
Shape outline every	01.00

Comments: Wind: NW 15 kts  
Current: N .75

# Canaveral Research

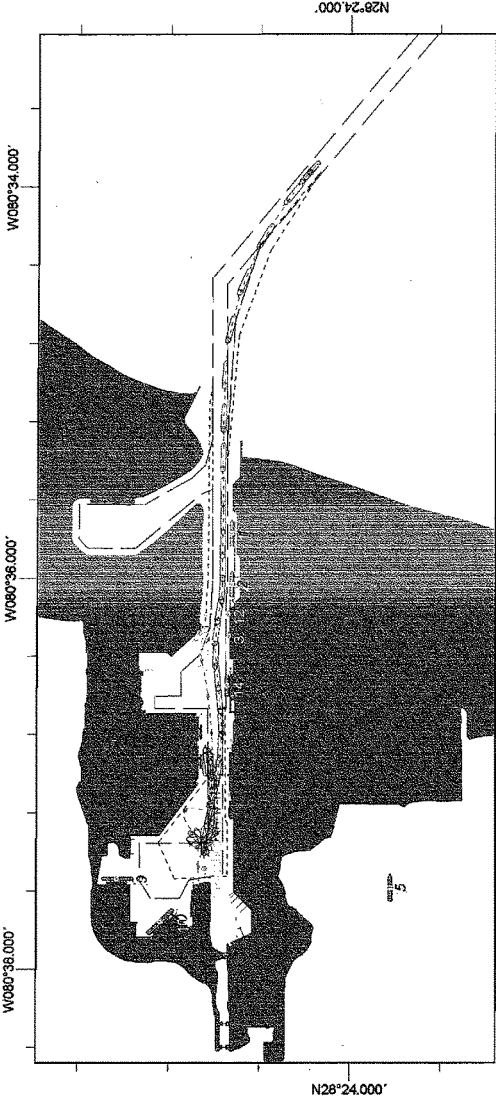

Scale 1:40000

Scale reference N28°24.371'

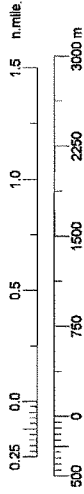

Comments: Wind: SE 20-25 kts  
 Current: N .3 kts

Line sample period (s)	30
Course marker every	N/A
Heading marker period (s)	60
Shape outline every	01:00

# Canaveral Research

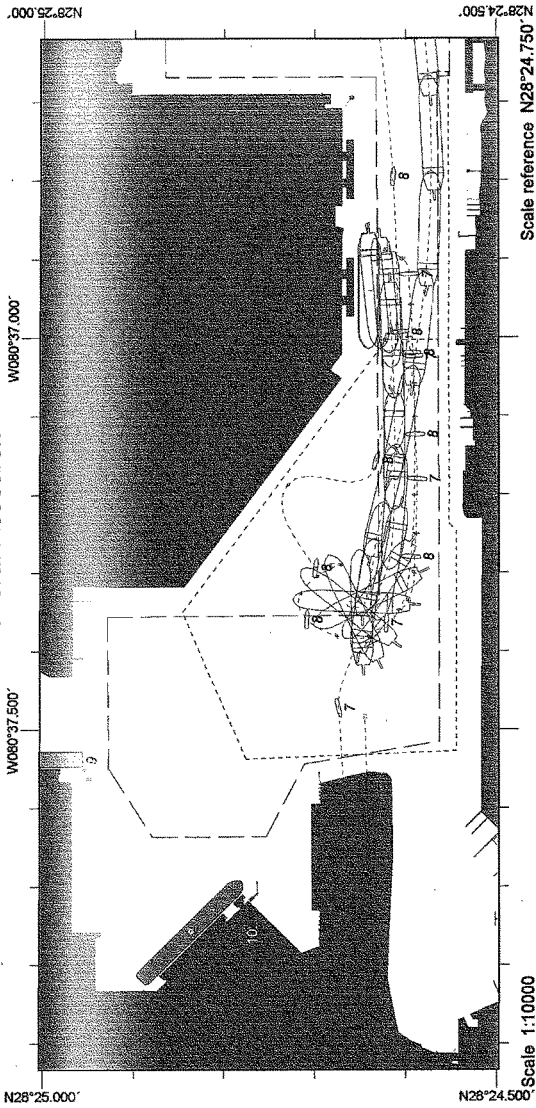

Scale reference N28°24.750'

Scale 1:10000

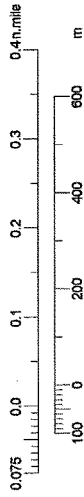

Line sample period (s)	30
Course marker every	N/A
Heading marker period (s)	60
Shape outlines every	01:00

Comments: Wind: SE 20-25 kts  
Current: N .3 kts

# Canaveral Research

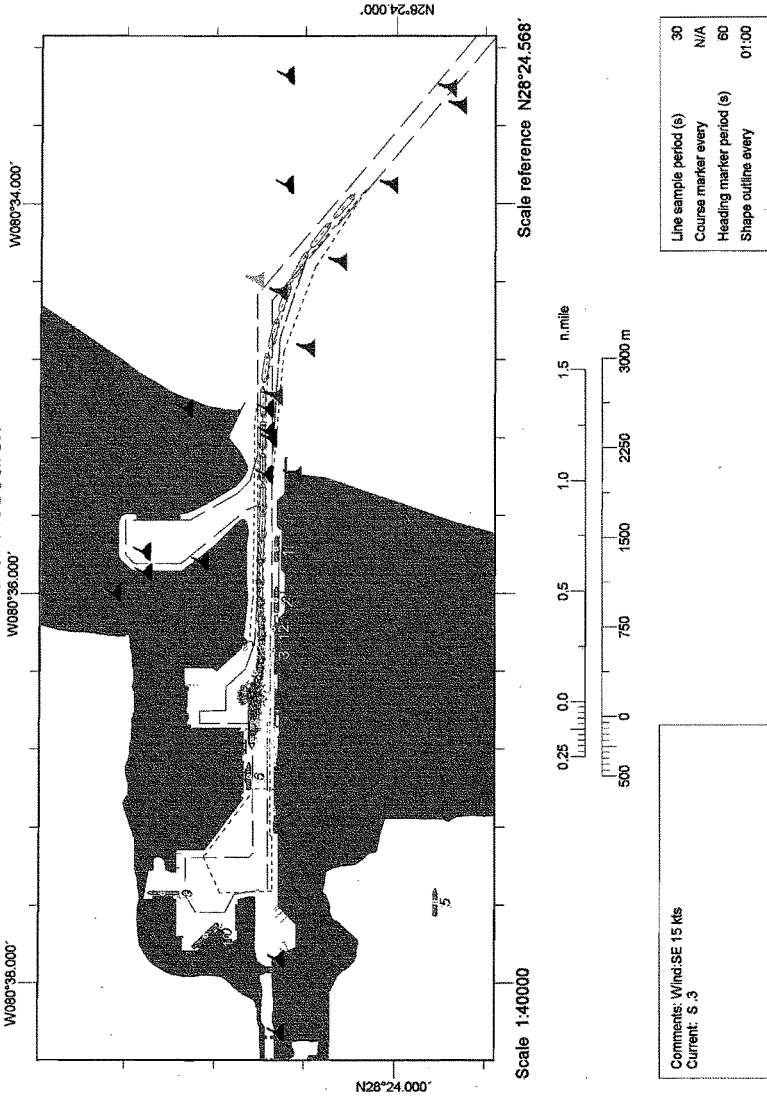

Noncontrol Point, Real date: 3/11/2007

Real time: 12:40:04 PM

Exercise: Exercise 27 Canaveral

# Canaveral Research

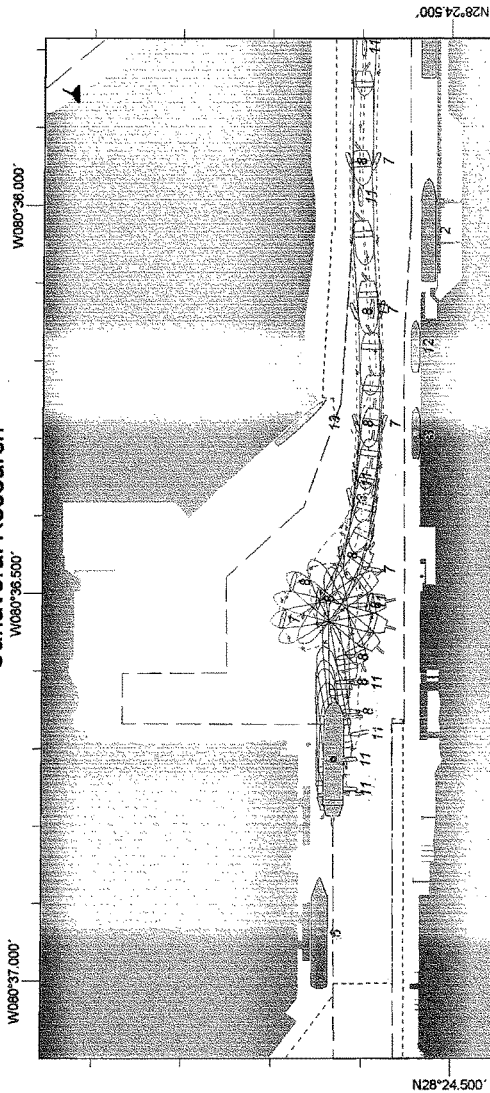

Scale 1:10000

Scale reference N28°24.703'

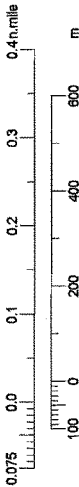

Comments: Wind:SE 15 Kts  
 Current: S .3

Line sample period (s)	30
Course marker every	N/A
Heading marker period (s)	60
Shape outline every	01:00

Exc date: 2/25/2007

Exc time (elapsed): 6:36:47 AM (00:36:47)

Page

Exercise: Exercise 28 Canaveral

Real time: 1:20:31 PM

Norcontrol Points, Real date: 3/11/2007

# Canaveral Research

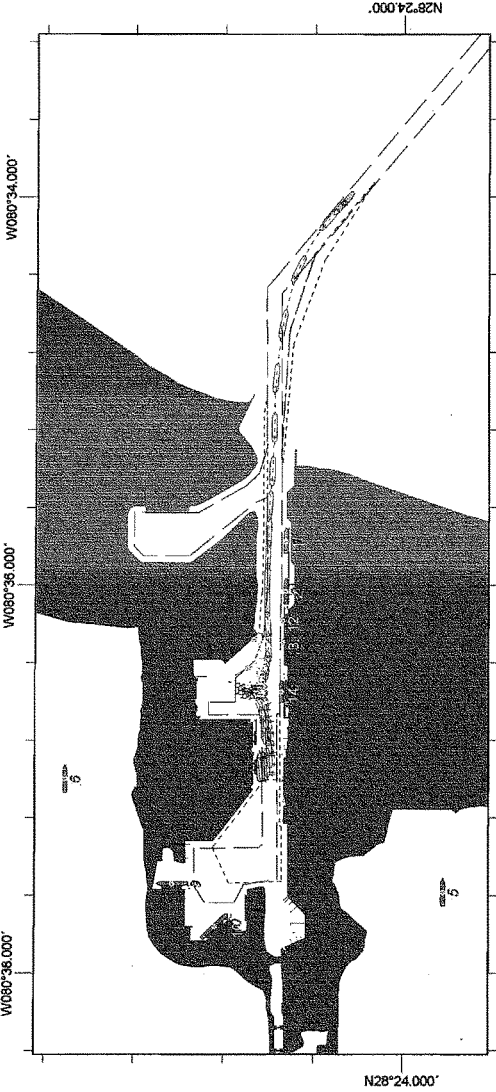

Scale 1:40000

Scale reference N28°24.630'

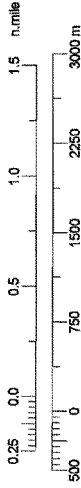

Comments: Wind: NW 20-25 kts  
 Current: N 75

Line sample period (s)	30
Course marker every	N/A
Heading marker period (s)	60
Shape outline every	01:00

Exc date: 2/25/2007

Exc time (elapsed): 8:30:22 AM (00:30:22)

Page 1

# Canaveral Research

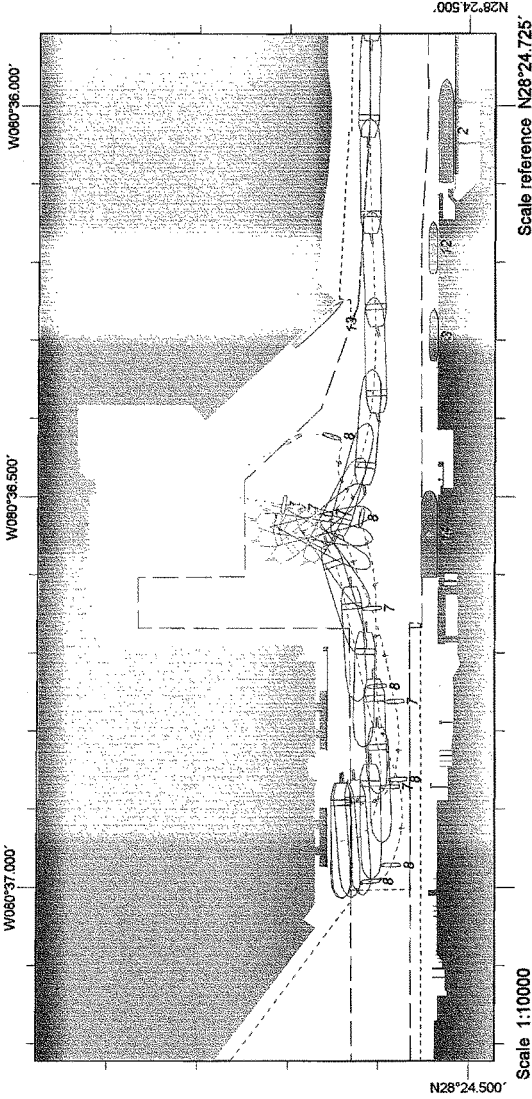

Comments: Wind: NW 20-25 kts  
 Current: N .75

Line sample period (s)	30
Course marker every	N/A
Heading marker period (s)	60
Shape outline every	01:00

# Canaveral Research

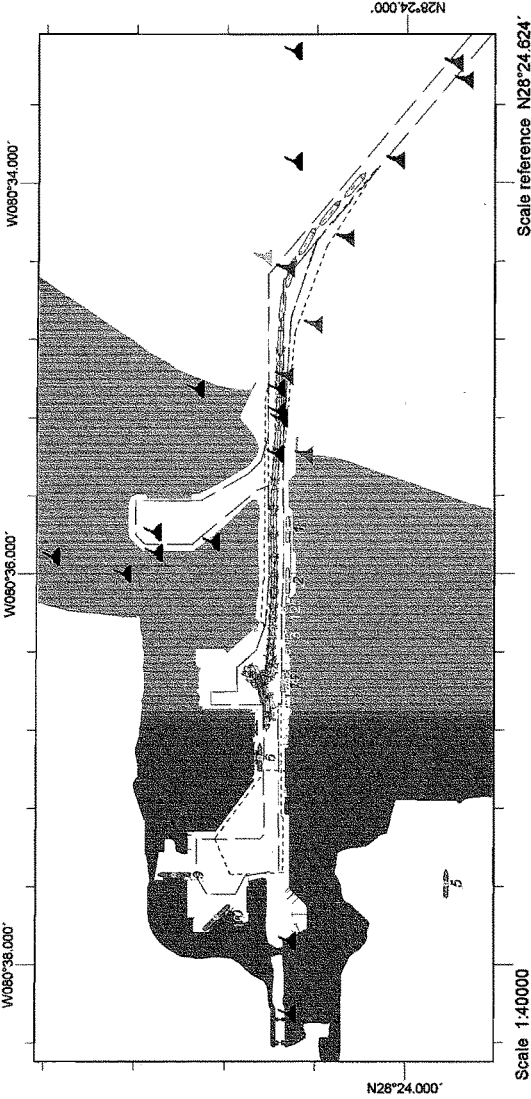

Line sample period (s)	30
Course marker every	N/A
Heading marker period (s)	60
Shape outline every	01:00

Comments: Wind: SE 20-25 kts  
Current: N 75



# Canaveral Research

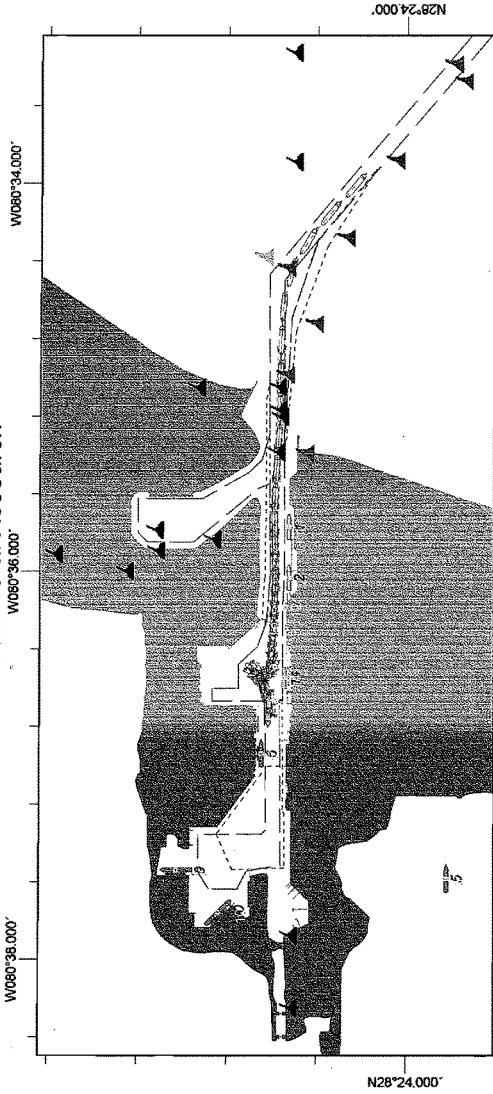

Scale 1:40000

Scale reference N28°24.624'

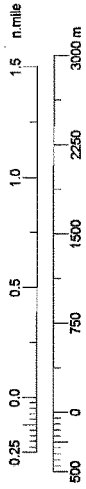

Comments: Wind:SE 20-25 kts  
Current: N, 75

Line sample period (s)	30
Course marker every	N/A
Heading marker period (s)	60
Shape outline every	01:00

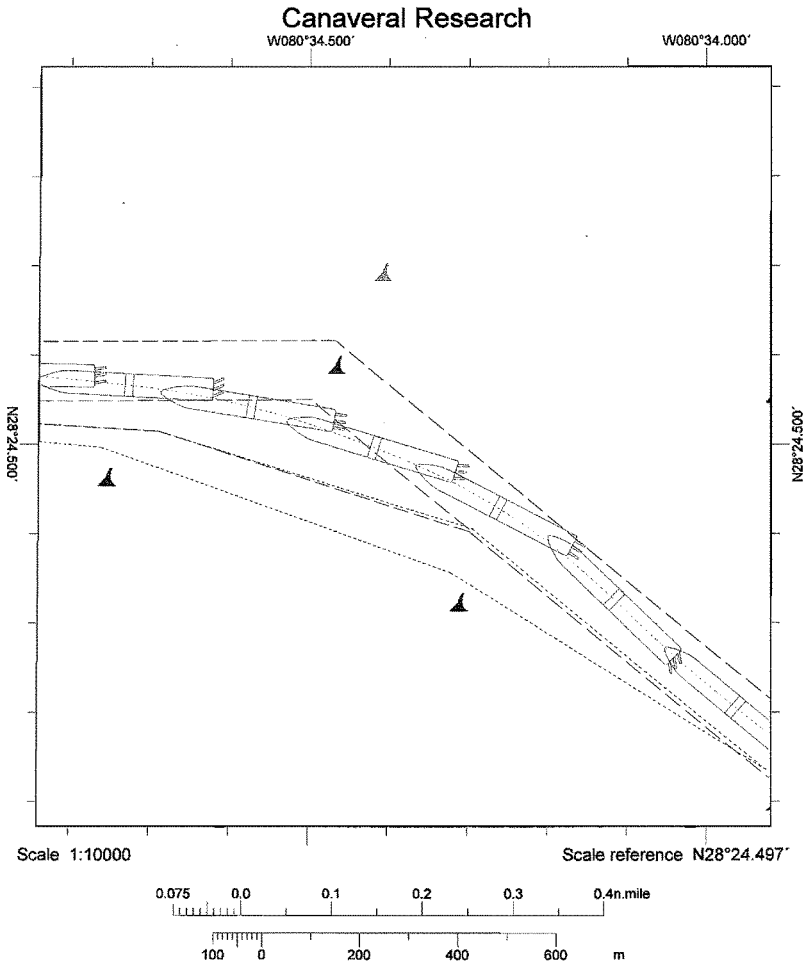

Comments: Wind: 0  
Current: 0

Line sample period (s)	30
Course marker every	N/A
Heading marker period (s)	60
Shape outline every	01:00

### Canaveral Research

W080°36.000'

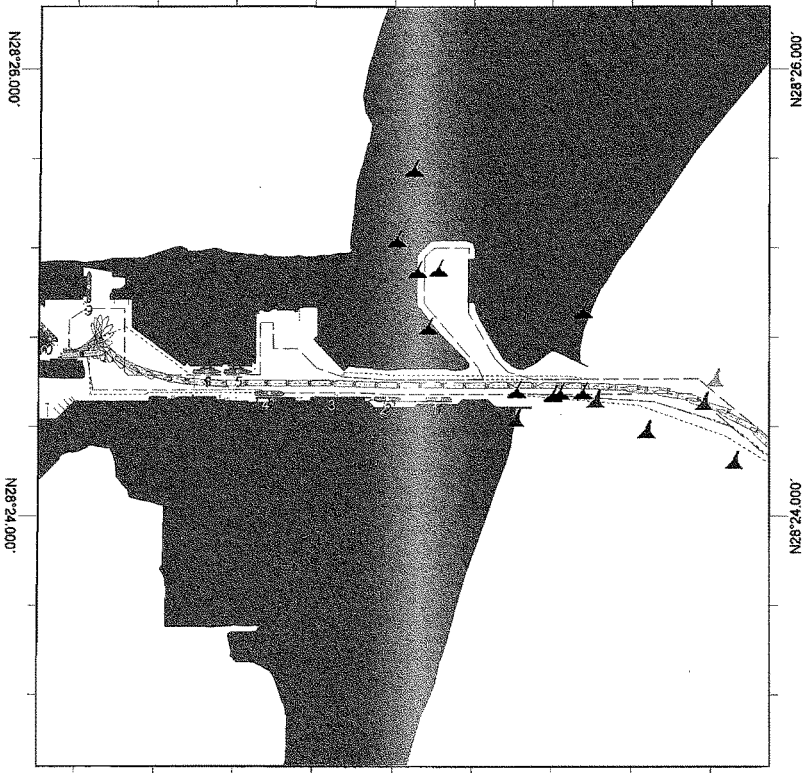

Scale 1:40000

Scale reference N28°24.579'

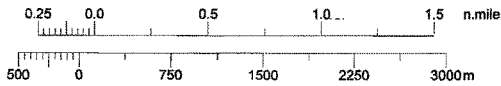

Comments: Wind: 0  
Current: 0

Line sample period (s)	30
Course marker every	N/A
Heading marker period (s)	60
Shape outline every	01:00

### Canaveral Research

W080°34.500'

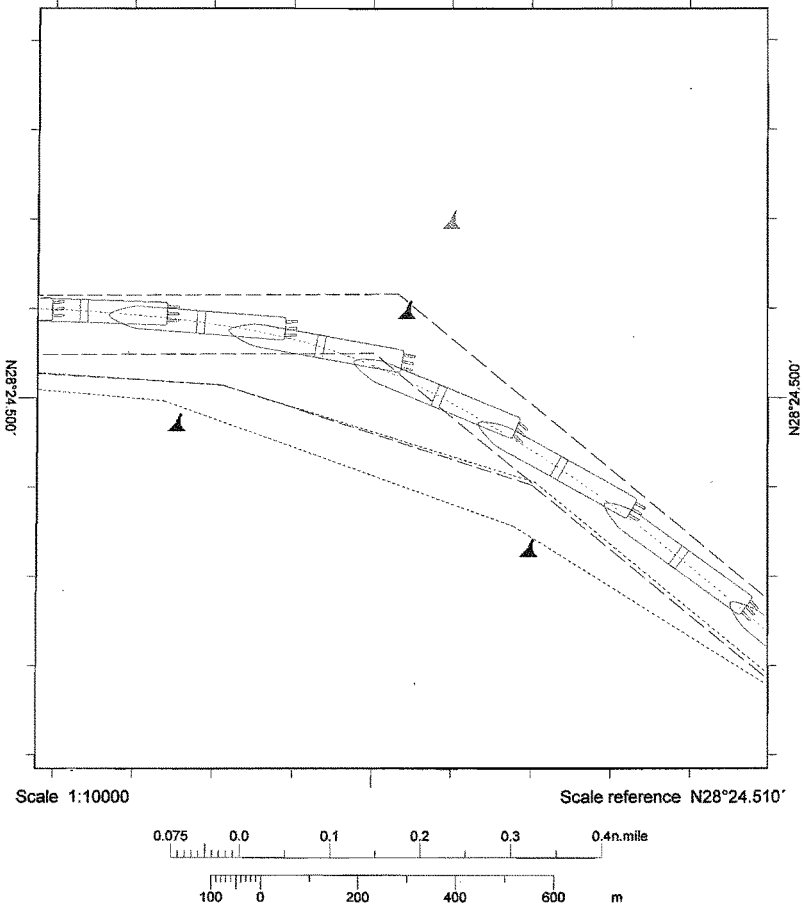

Comments: Wind: NW 15  
Current: N 0.3kts

Line sample period (s)	30
Course marker every	N/A
Heading marker period (s)	60
Shape outline every	01:00

Canaveral Research

W080°36.000'

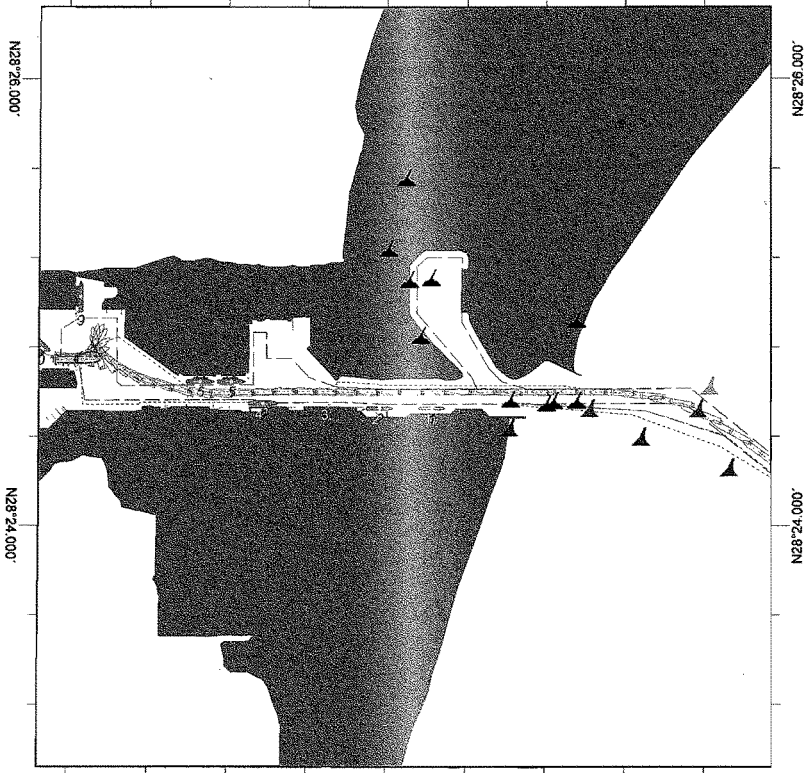

Scale 1:40000

Scale reference N28°24.621'

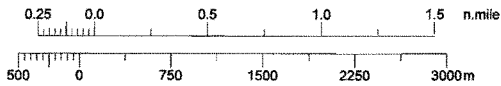

Comments: Wind: NW 15  
Current: N 0.3kts

Line sample period (s)	30
Course marker every	N/A
Heading marker period (s)	60
Shape outline every	01:00

### Canaveral Research

W080°36.000'

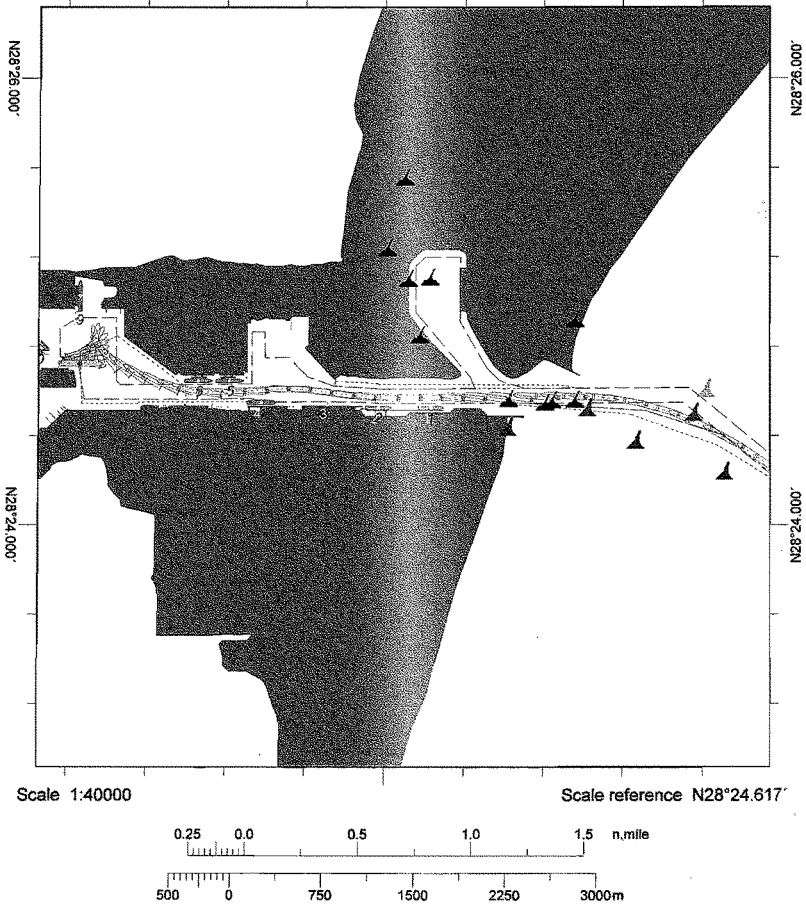

Comments: Wind: NW 25  
Current: S 0.3kts

Line sample period (s)	30
Course marker every	N/A
Heading marker period (s)	60
Shape outline every	01:00

### Canaveral Research

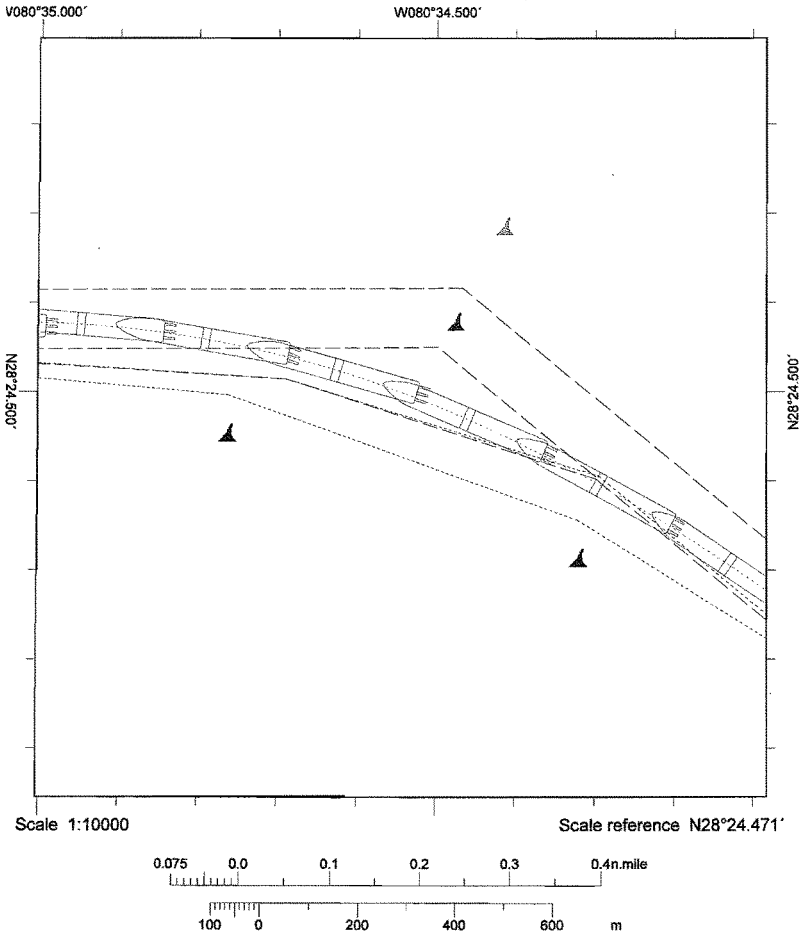

Comments: Wind: NW 25  
 Current: S 0.3kts

Line sample period (s)	30
Course marker every	N/A
Heading marker period (s)	60
Shape outline every	01:00

### Canaveral Research

W080°34.500'

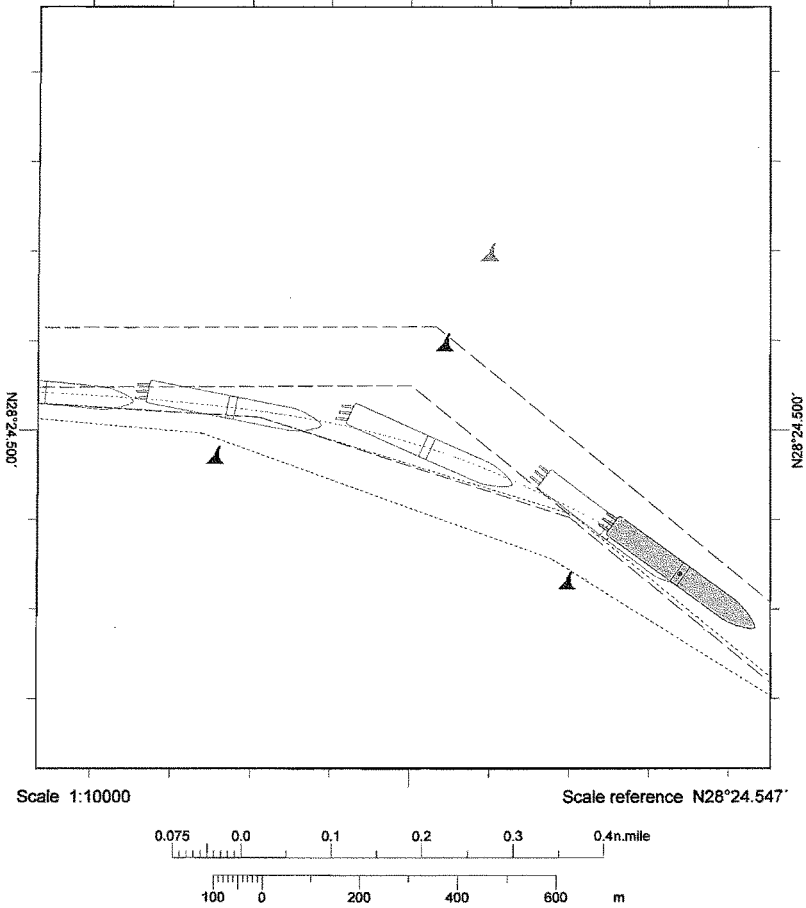

Comments: Wind: SE 25  
Current: N 0.3kts

Line sample period (s)	30
Course marker every	N/A
Heading marker period (s)	60
Shape outline every	01:00



### Canaveral Research

W080°36.000'

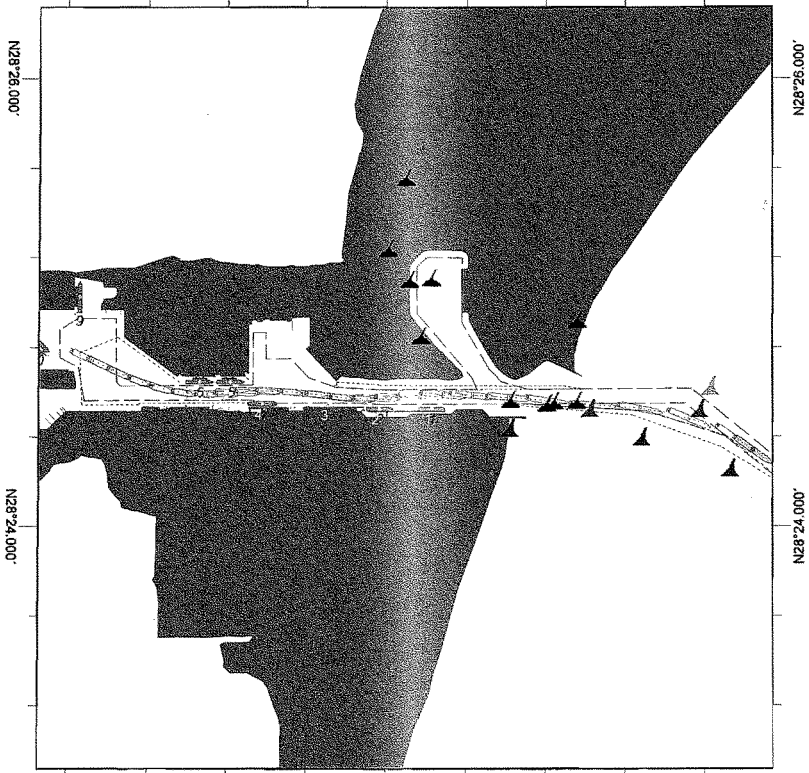

Scale 1:40000

Scale reference N28°24.617'

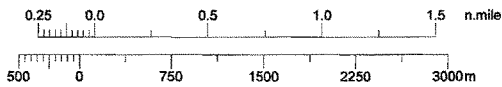

Comments: Wind: SE 25  
Current: N 0.3kts

Line sample period (s)	30
Course marker every	N/A
Heading marker period (s)	60
Shape outline every	01:00

### Canaveral Research

W080°36.000'

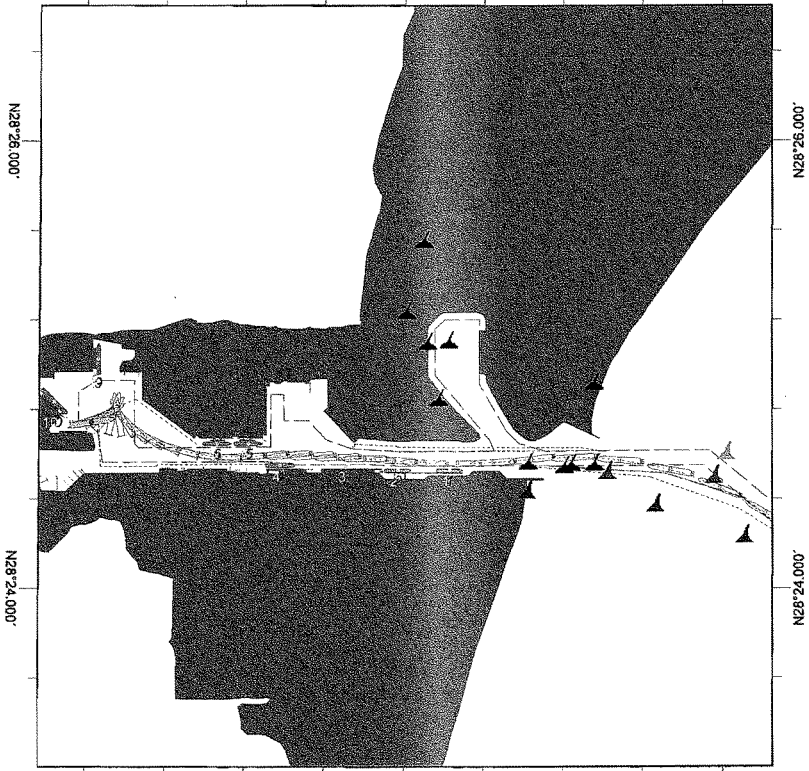

Scale 1:40000

Scale reference N28°24.902'

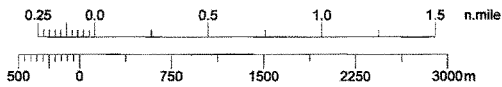

Comments: Wind: SE15  
Current: S 0.3kts

Line sample period (s)	30
Course marker every	N/A
Heading marker period (s)	60
Shape outline every	01:00

### Canaveral Research

W080°34.500'

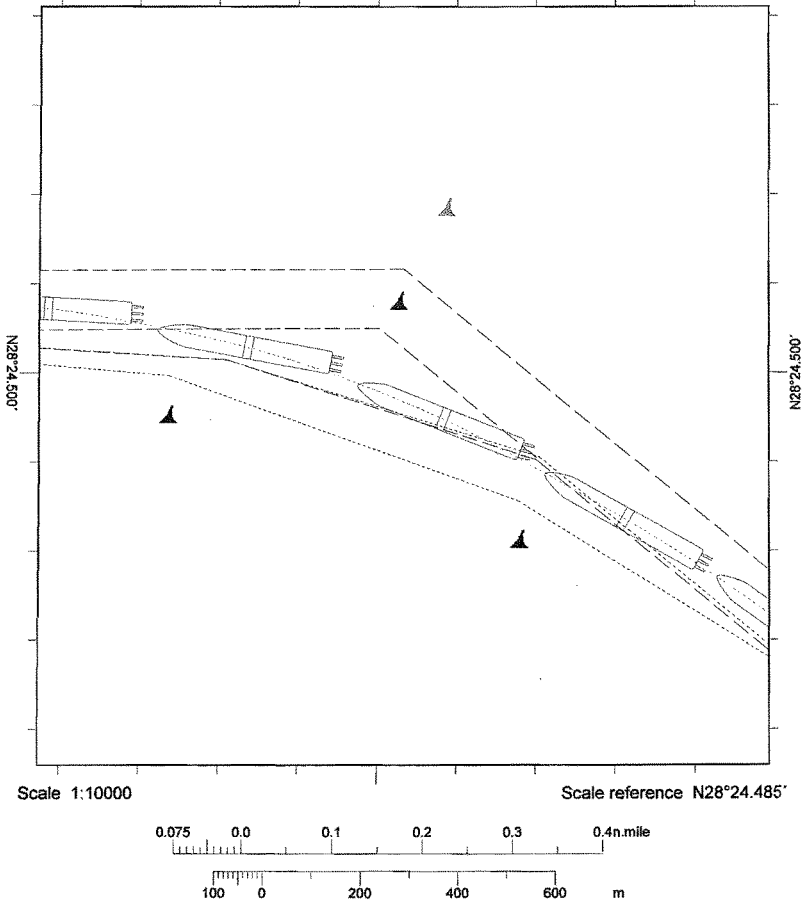

Comments: Wind: SE15  
Current: S 0.3kts

Line sample period (s)	30
Course marker every	N/A
Heading marker period (s)	60
Shape outline every	01:00

### Canaveral Research

W080°36.000'

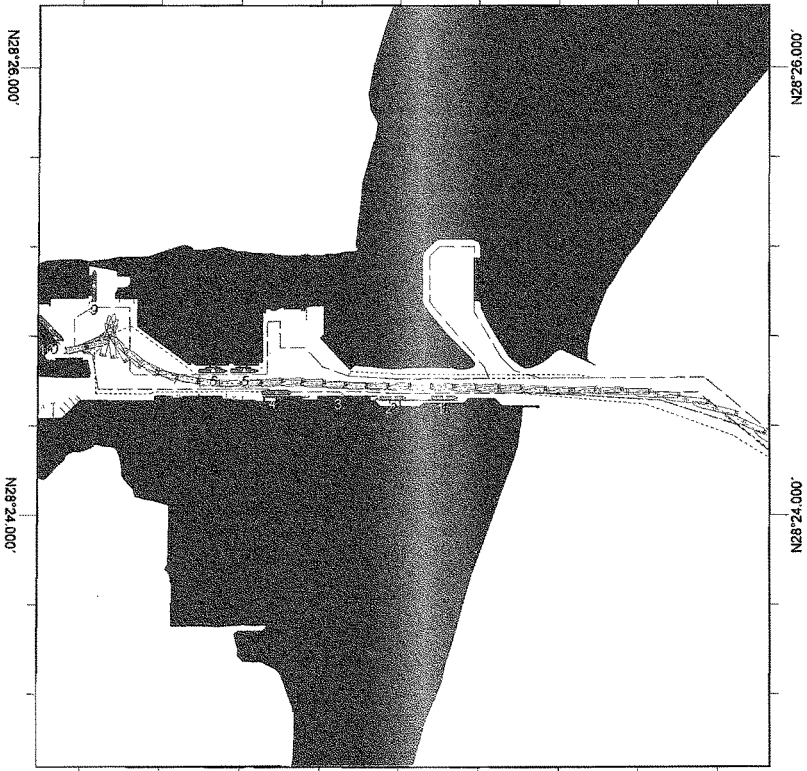

Scale 1:40000

Scale reference N28°24.576'

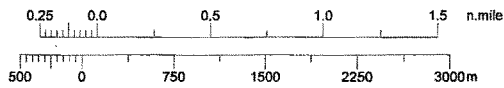

Comments: Wind: SE25  
Current: N 0.3kts

Line sample period (s)	30
Course marker every	N/A
Heading marker period (s)	60
Shape outline every	01:00

### Canaveral Research

W080°34.500'

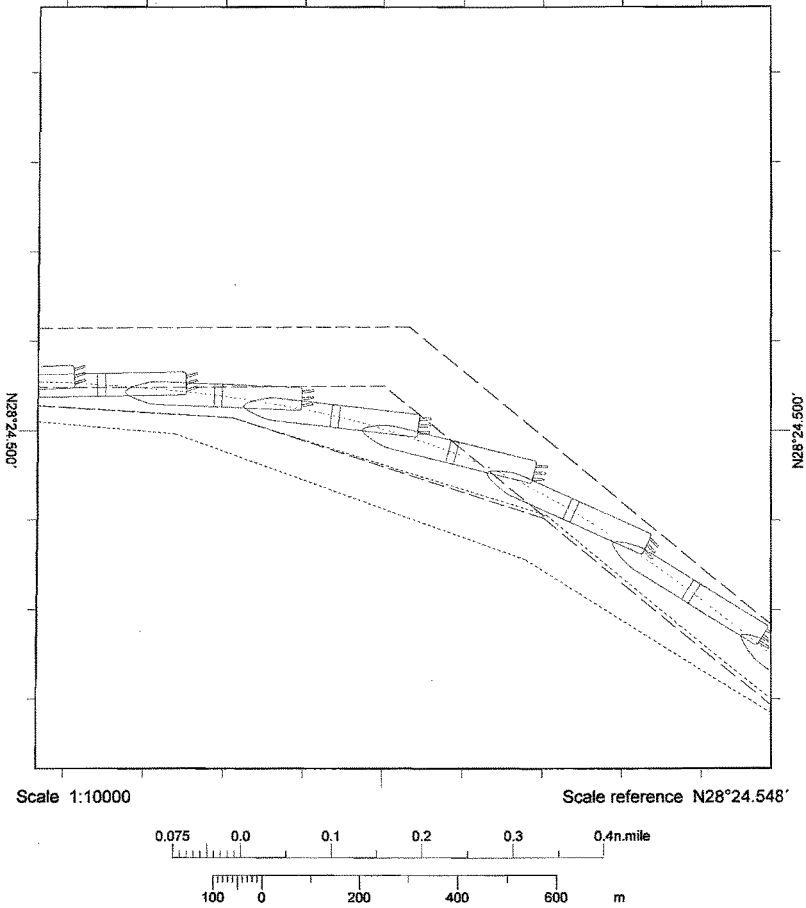

Comments: Wind: SE25  
Current: N 0.3kts

Line sample period (s)	30
Course marker every	N/A
Heading marker period (s)	60
Shape outline every	01:00

### Canaveral Research

W080°36.000'

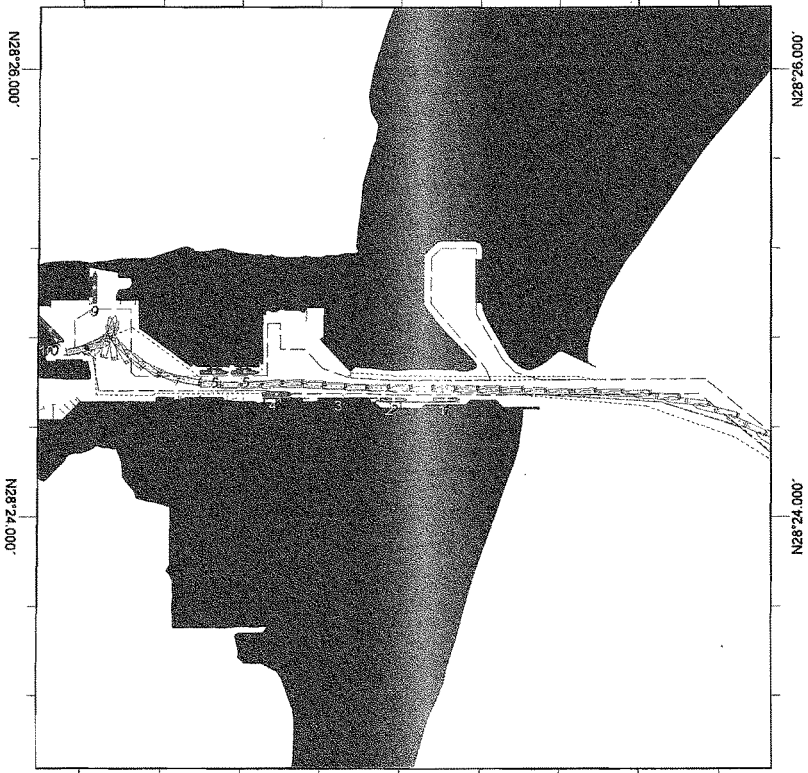

Scale 1:40000

Scale reference N28°24.576'

0.25 0.0 0.5 1.0 1.5 n.mile

500 0 750 1500 2250 3000m

Comments: Wind: SE25  
Current: N 0.3kts

Line sample period (s)	30
Course marker every	N/A
Heading marker period (s)	60
Shape outline every	01:00

### Canaveral Research

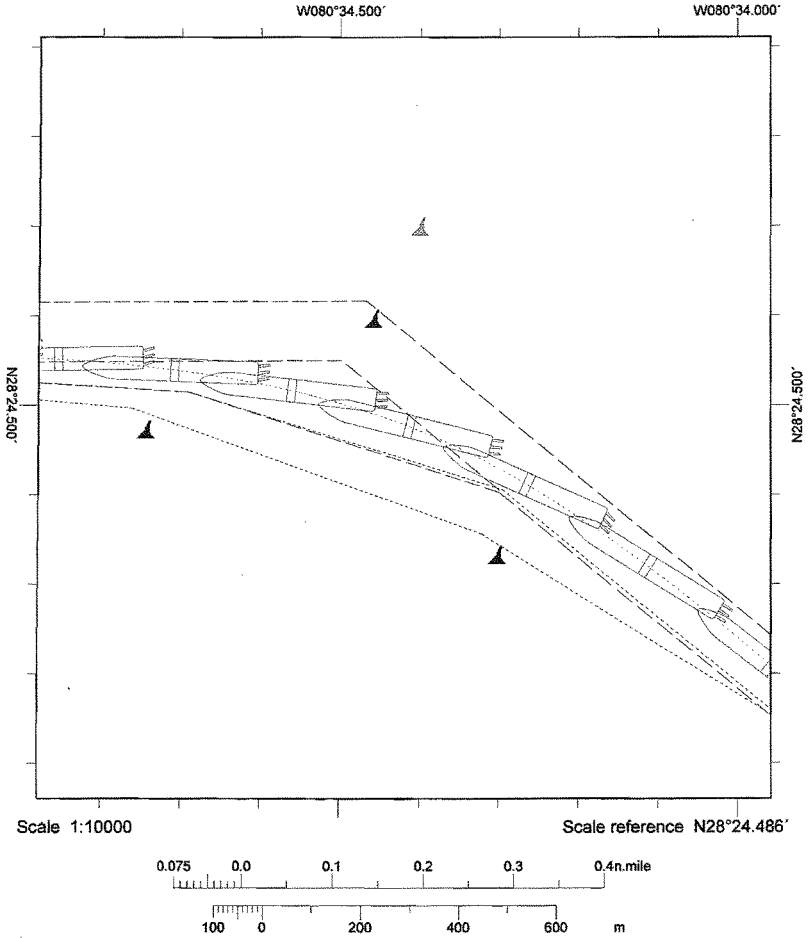

Comments: Wind: SE25  
Current: N 0.3kts

Line sample period (s)	30
Course marker every	N/A
Heading marker period (s)	60
Shape outline every	01:00

### Canaveral Research

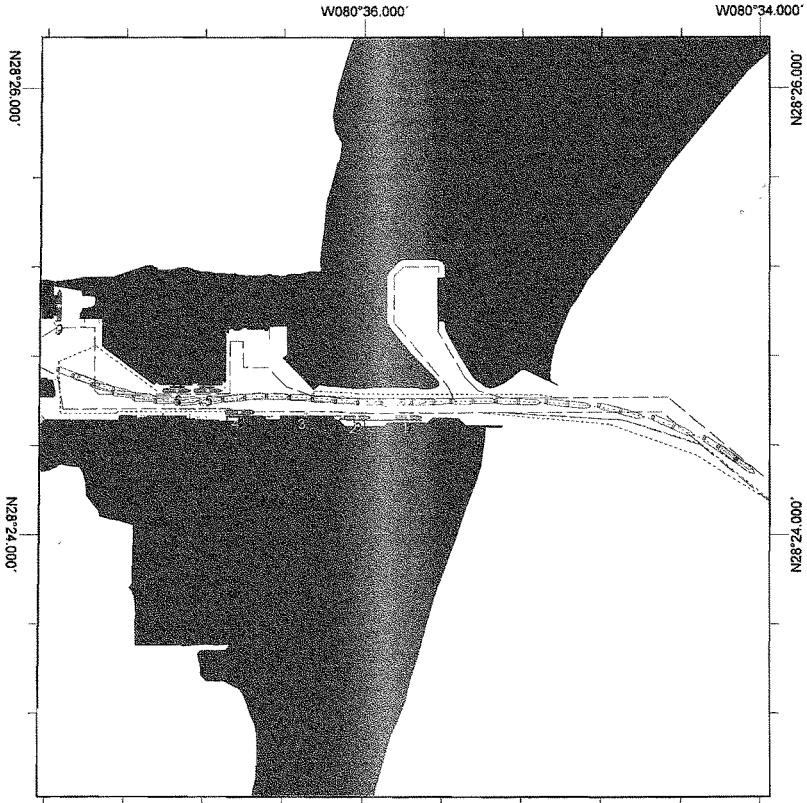

Scale 1:40000

Scale reference N28°24.526'

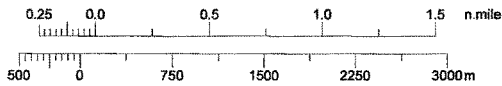

Comments: Wind: NW 25  
Current: S 0.3kts

Line sample period (s)	30
Course marker every	N/A
Heading marker period (s)	60
Shape outline every	01:00



### Canaveral Research

W080°34.500'

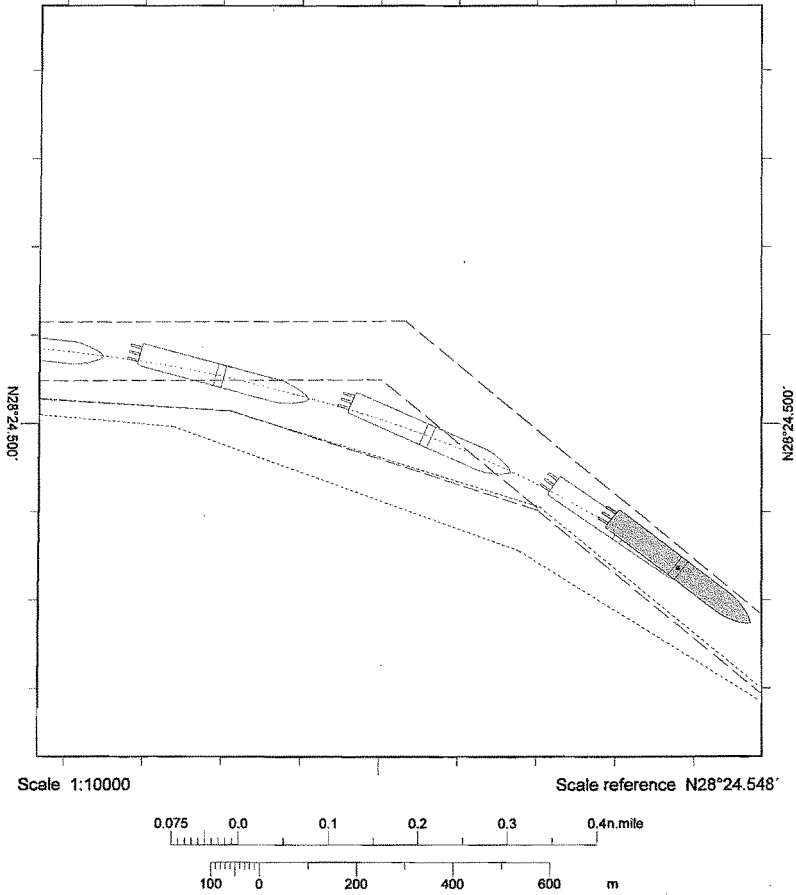

Comments: Wind: NW 25  
Current: S 0.3kts

Line sample period (s)	30
Course marker every	N/A
Heading marker period (s)	60
Shape outline every	01:00

# Canaveral Research

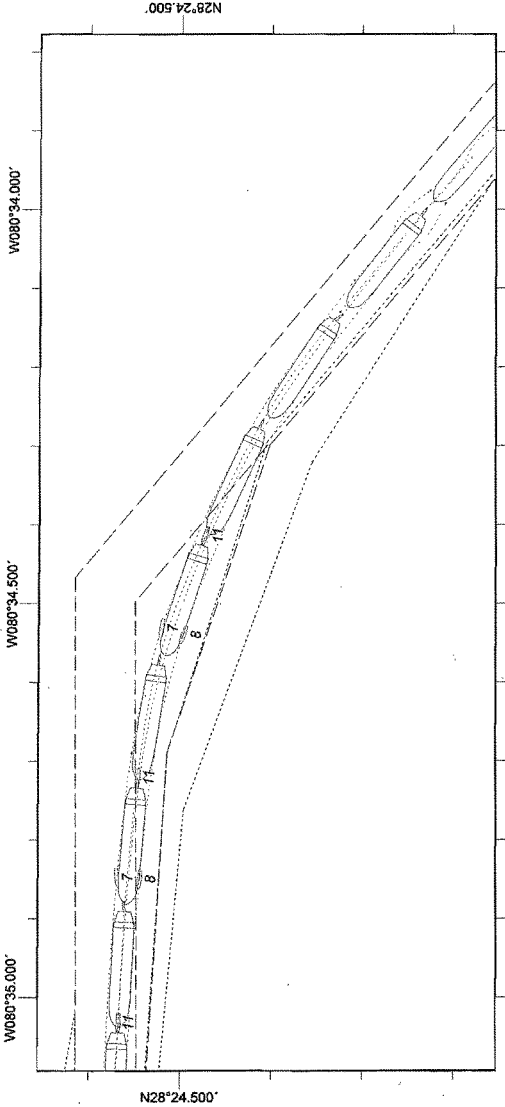

Scale reference N28°24.405'

Scale 1:10000

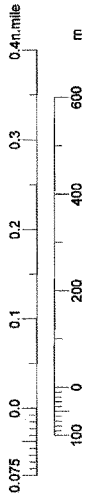

Line sample period (s)	30
Course marker every	N/A
Heading marker period (s)	60
Shape outline every	01:00

Comments: Wind: 0 kts  
Current: 0

# Canaveral Research

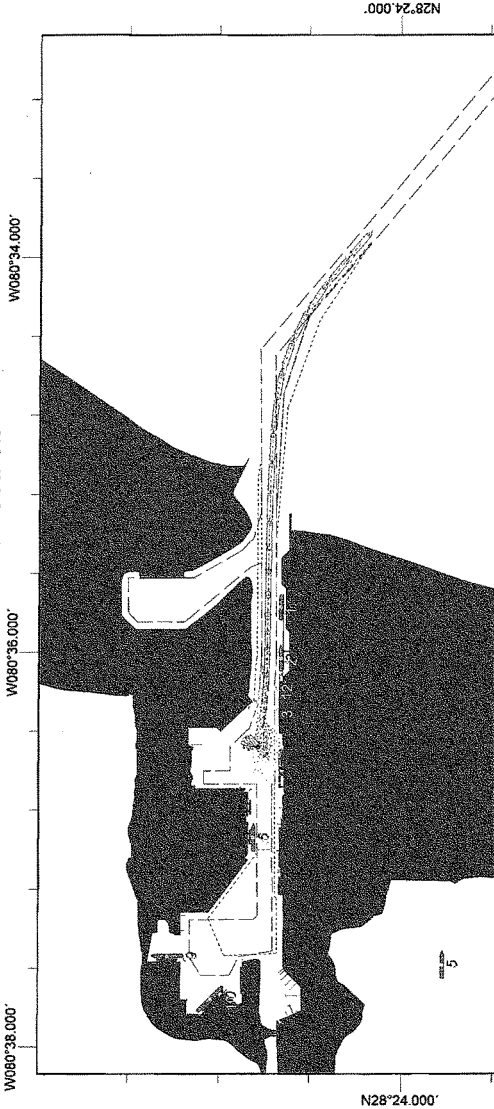

Scale 1:40000

Scale reference N28°24.586'

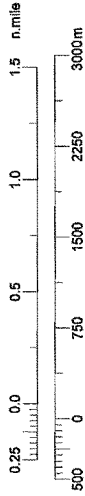

Comments: Wind: 0 kts  
Current: 0

Line sample period (s)	30
Course marker every	N/A
Heading marker period (s)	60
Shape outline every	01:00

# Canaveral Research

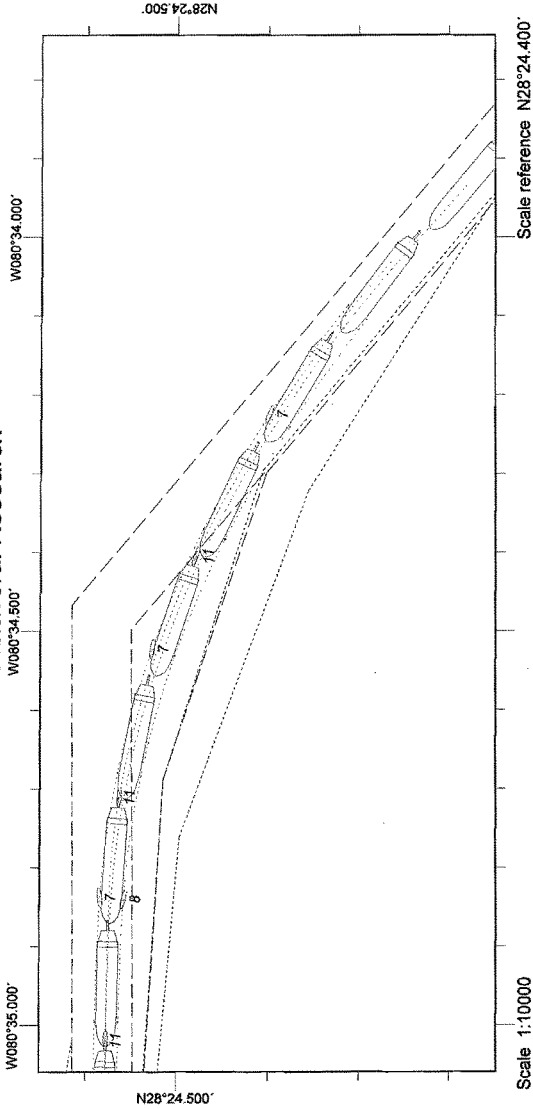

Line sample period (s)	30
Course marker every	N/A
Heading marker period (s)	60
Shape outline every	01:00

Comments: Wind: NW 15 kts  
Current: N 0.3 kts

# Canaveral Research

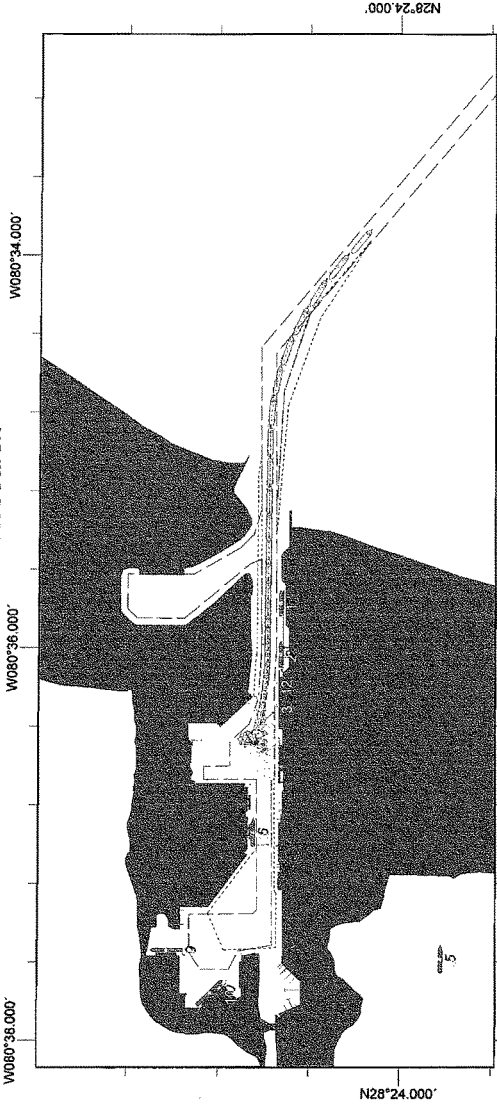

Scale reference N28°24.566'

Scale 1:40000

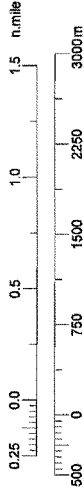

Line sample period (s)	30
Course marker every	N/A
Heading marker period (s)	60
Shape outline every	01:00

Comments: Wind: NW 15 kts  
 Current: N 0.3 kts

# Canaveral Research

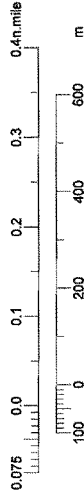
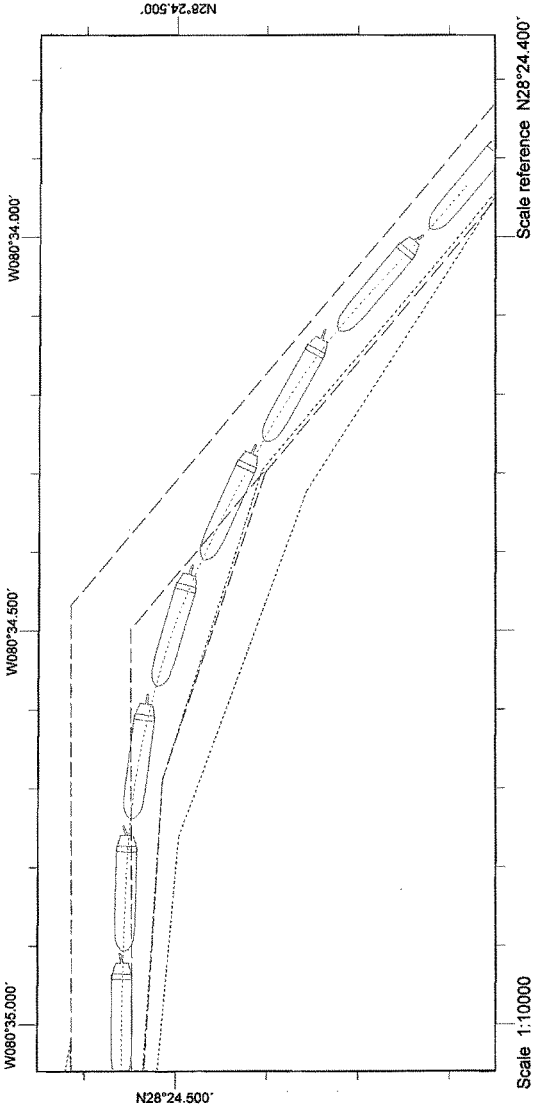

Line sample period (\$)	30
Course marker every	N/A
Heading marker period (\$)	60
Shape outline every	01:00

Comments: Wind: SE 20-25 kts  
Current: N 0.3 kts

# Canaveral Research

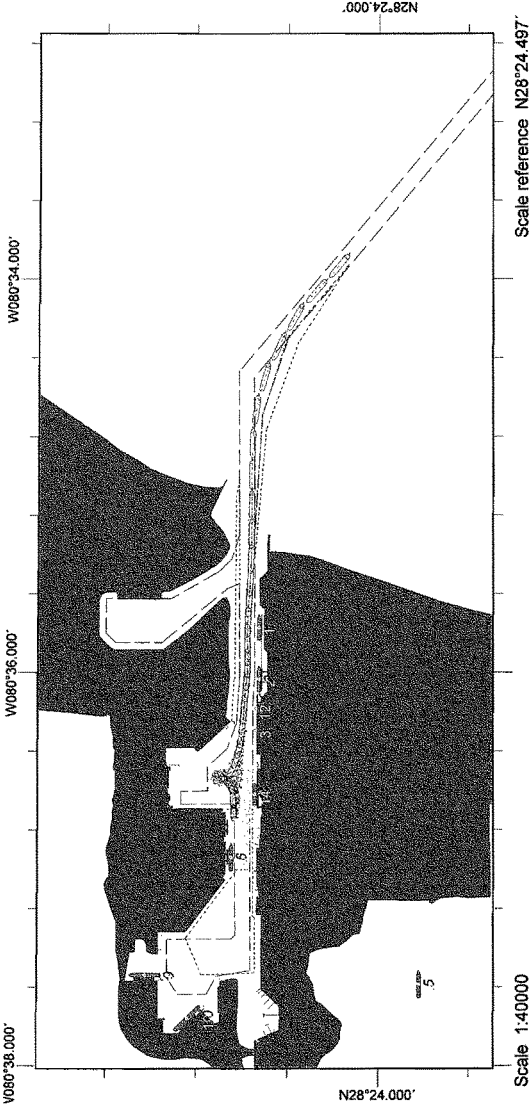

Scale reference N28°24.497'

Scale 1:40000

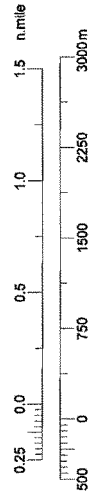

Line sample period (\$)	30
Course marker every	N/A
Heading marker period (\$)	50
Shape outline every	01:00

Comments: Wind: SE 20-25 kts  
 Current: N 0.3 kts

# Canaveral Research

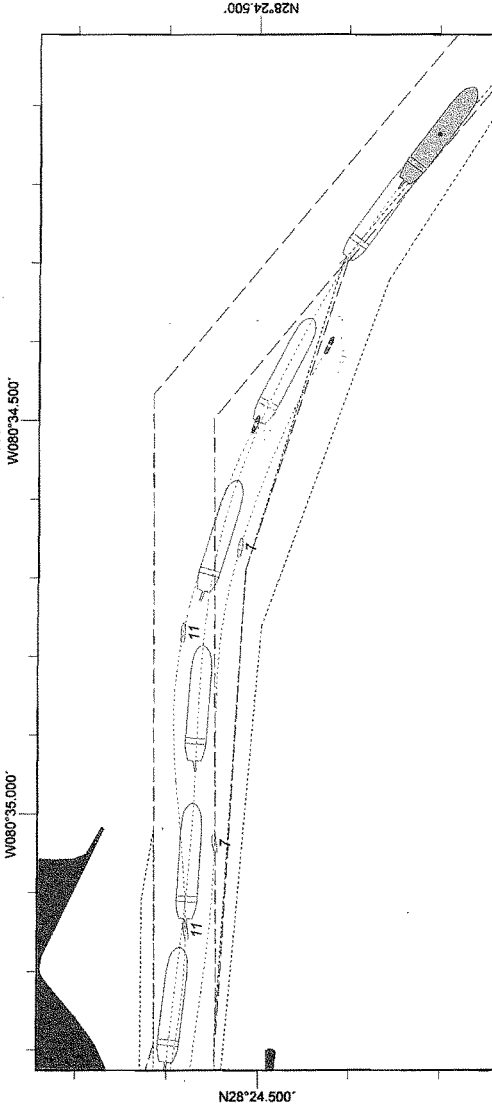

Scale 1:10000

Scale reference N28°24.491'

Comments: Wind: NW 20-25 kts  
 Current: S 0.3 kts

Line sample period (s)	30
Course marker every	N/A
Heading marker period (s)	60
Shape outline every	01:00



# Canaveral Research

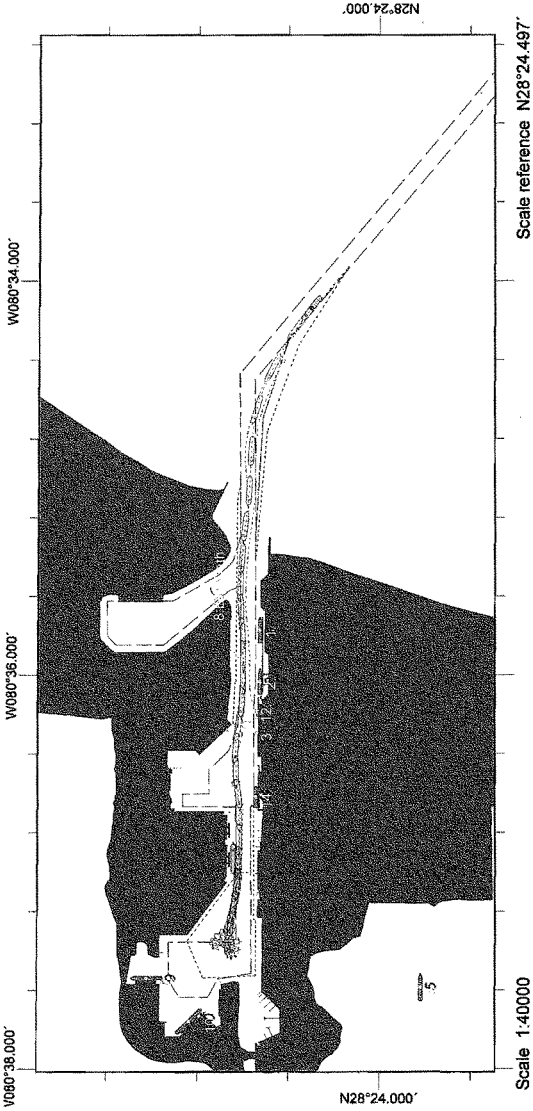

Scale 1:40000

Scale reference N28°24.497'

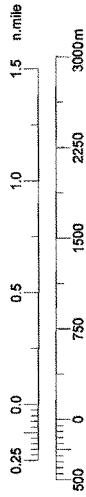

Comments: Wind: NW 20-25 kts  
 Current: S 0.3 kts

Line sample period (\$)	30
Course marker every	N/A
Heading marker period (\$)	60
Shape outline every	01:00

# Canaveral Research

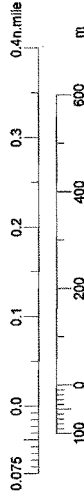
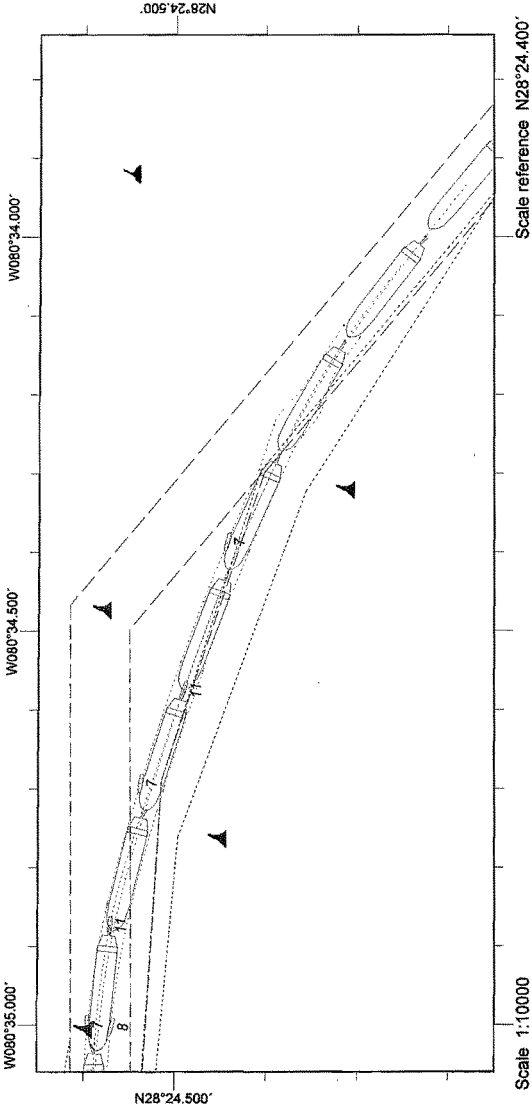

Comments: Wind: NW 20-25 kts  
Current: S 0.3 kts

Line sample period (\$)	30
Course marker every	N/A
Heading marker period (\$)	60
Shape outline every	01:00

# Canaveral Research

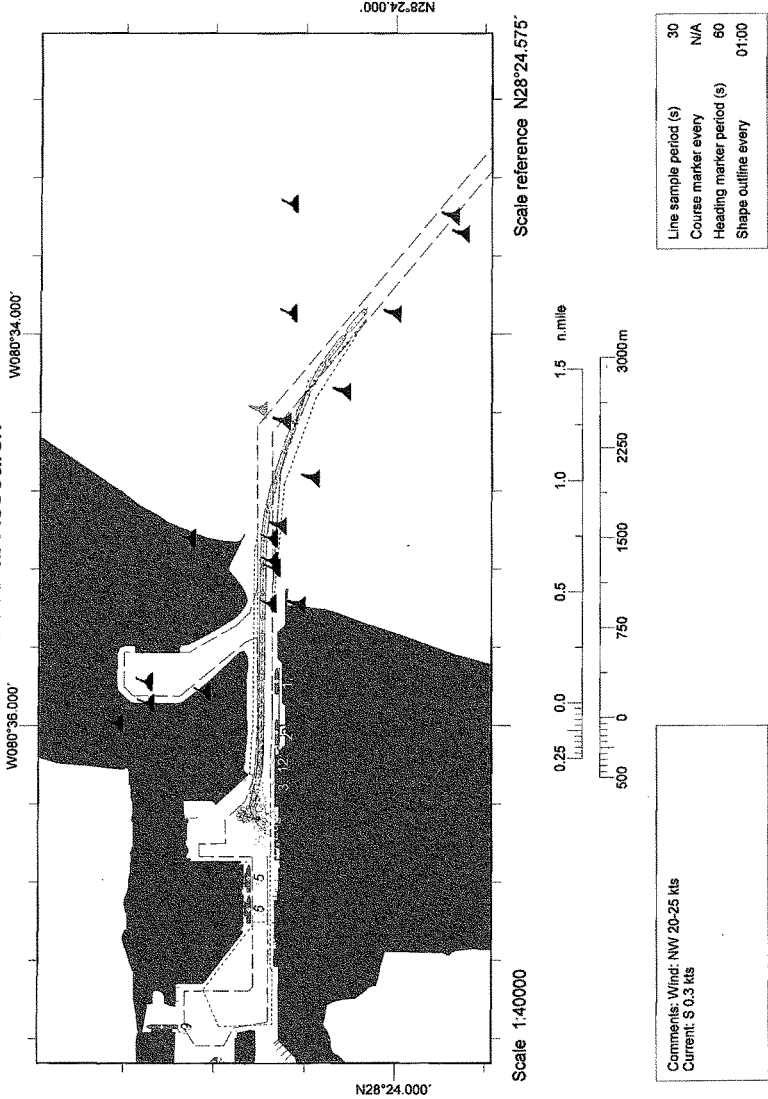

# Canaveral Research

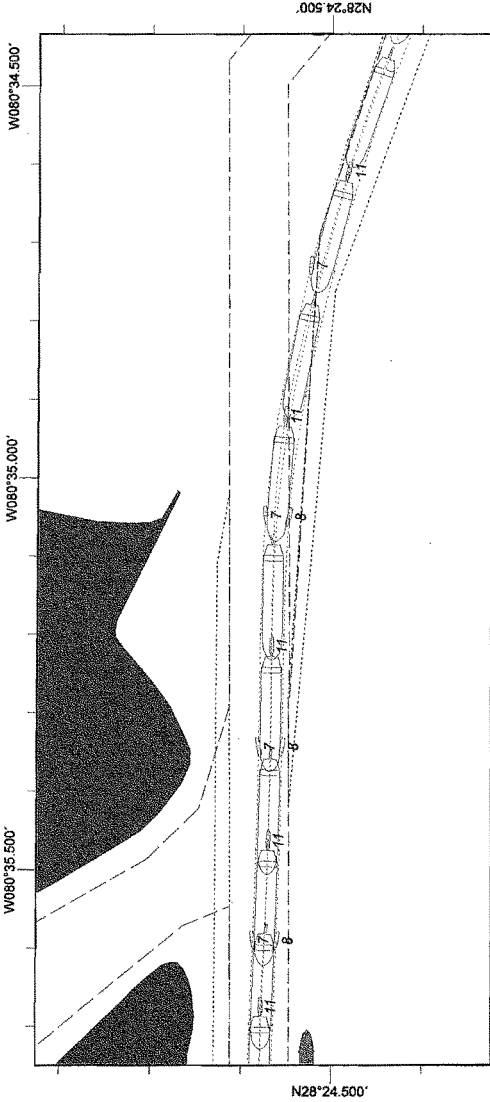

Scale 1:10000

Scale reference N28°24.575'

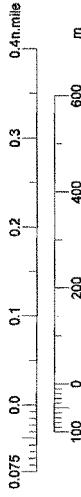

Comments: Wind: SE 15 kts  
 Current: S 0.3 kts

Line sample period (s)	30
Course marker every	N/A
Heading marker period (s)	60
Shape outline every	0'1.00

# Canaveral Research

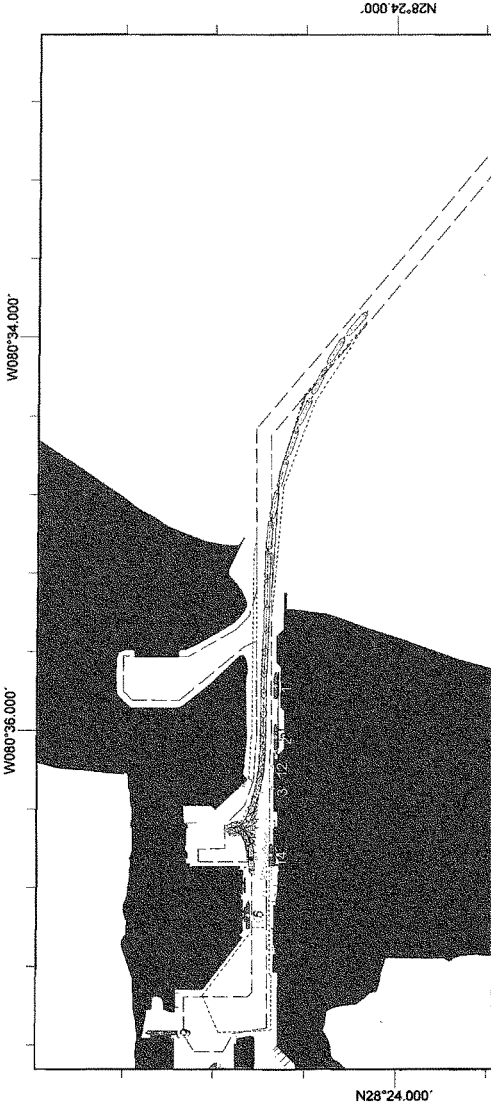

Scale reference N28°24.575'

Scale 1:40000

Line sample period (s)	30
Course marker every	N/A
Heading marker period (s)	60
Shape outline every	01:00

Comments: Wind: SE 15 Kts  
 Current: S 0.3 Kts

# Canaveral Research

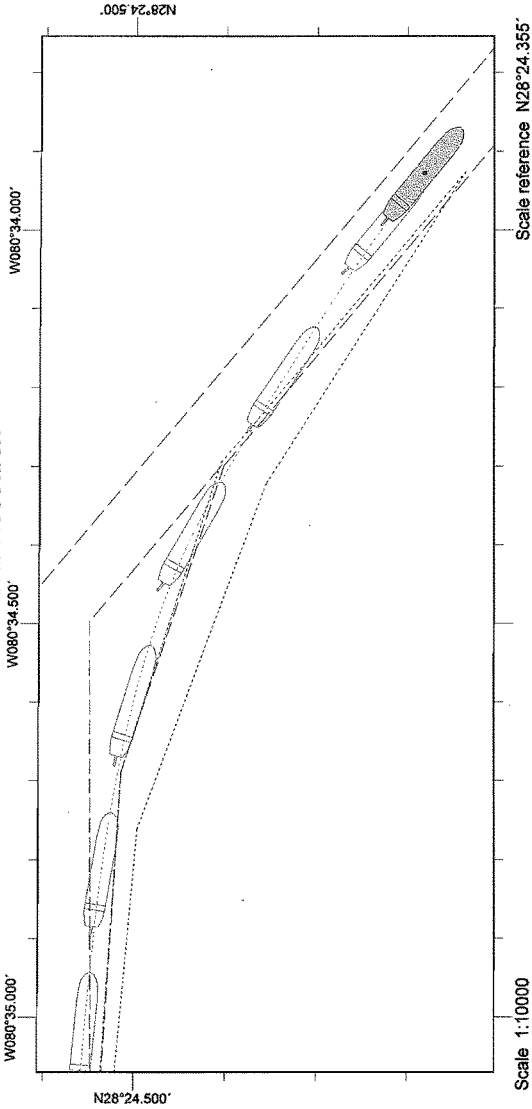

Line sample period (s)	30
Course marker every	N/A
Heading marker period (s)	60
Shape outline every	01:00

Comments: Wind: SE 20-25 kts  
Current: NO.3 kts

# Canaveral Research

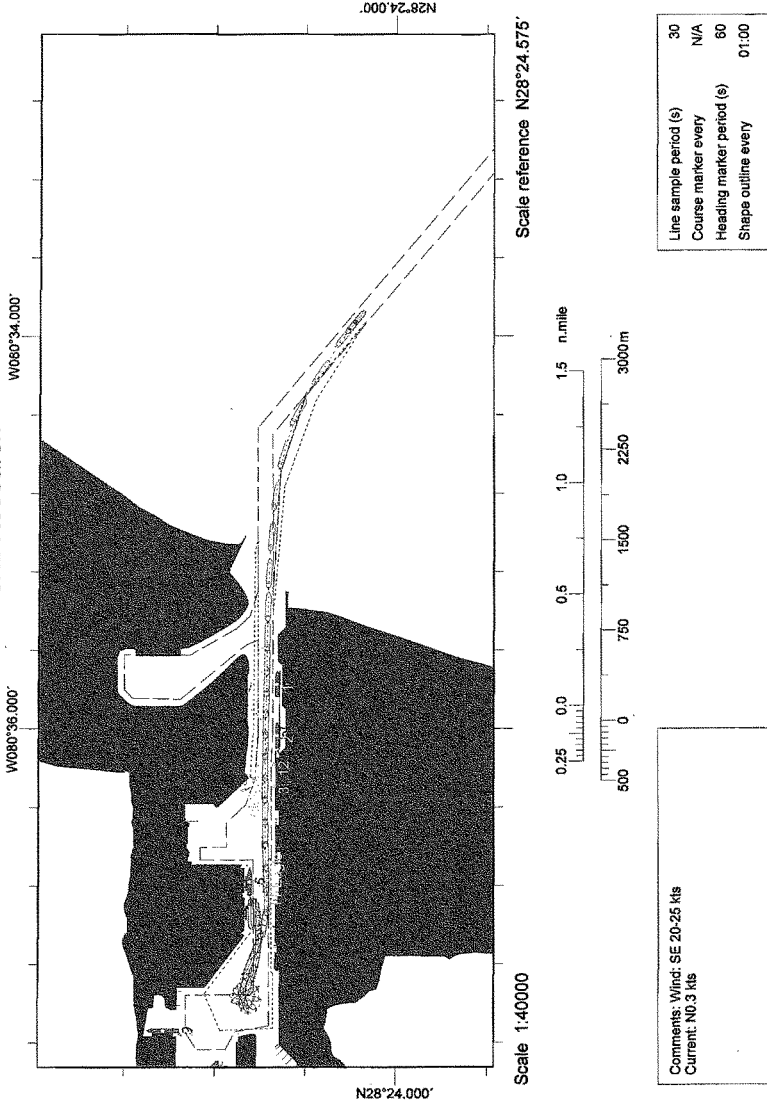

### Canaveral Research

W080°36.000'

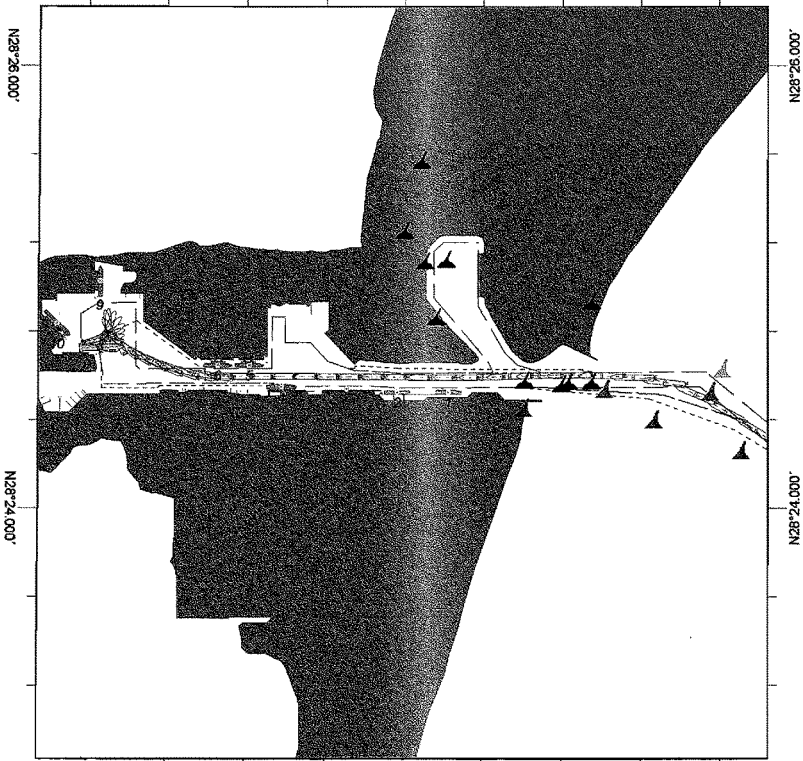

Scale 1:40000

Scale reference N28°24.567'

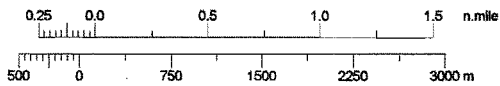

Comments: Wind: 0  
Current: 0 Test

Line sample period (s)	30
Course marker every	N/A
Heading marker period (s)	60
Shape outline every	01:00



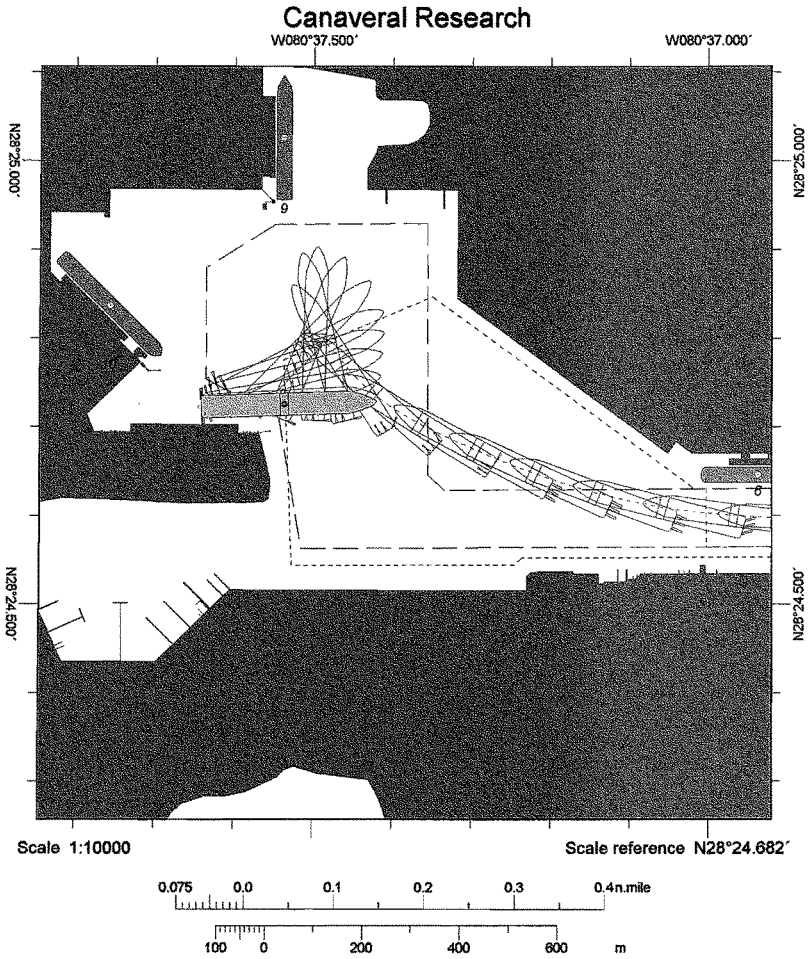

Comments: Wind: 0  
Current: 0 Test

Line sample period (s)	30
Course marker every	N/A
Heading marker period (s)	60
Shape outline every	01:00

### Canaveral Research

W080°36.000°

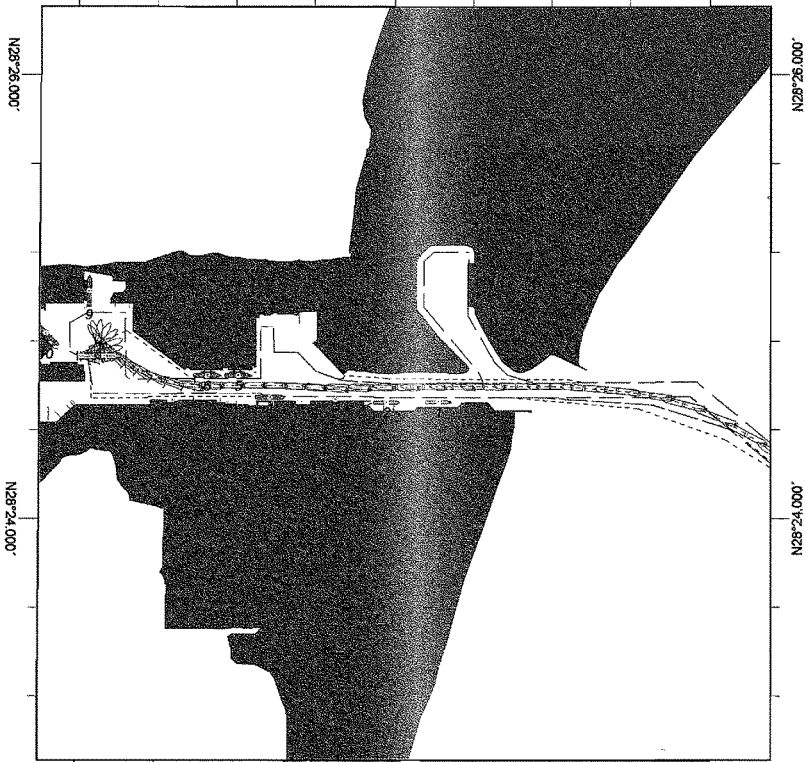

Scale 1:40000

Scale reference N28°24.608'

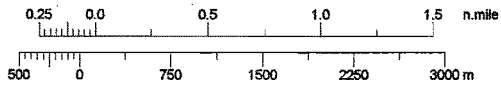

Comments: Wind: NW 15  
Current: N 0.3 k

Line sample period (s)	30
Course marker every	N/A
Heading marker period (s)	60
Shape outline every	01:00

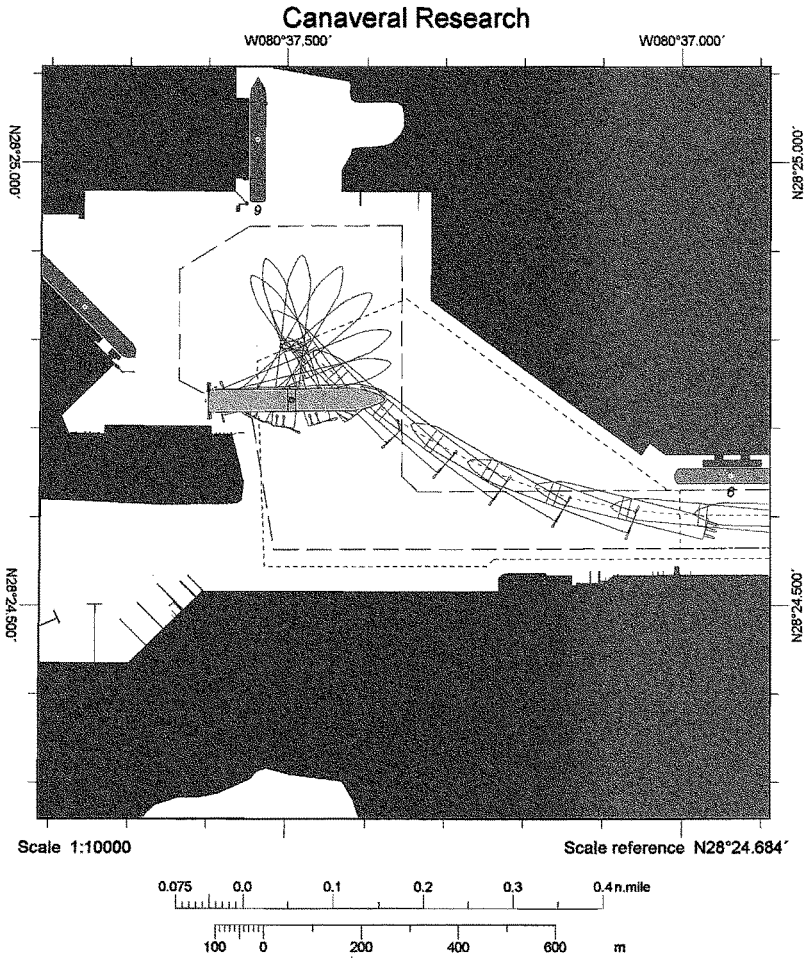

Comments: Wind: NW 15  
Current: N 0.3 k

Line sample period (s)	30
Course marker every	N/A
Heading marker period (s)	60
Shape outline every	01:00

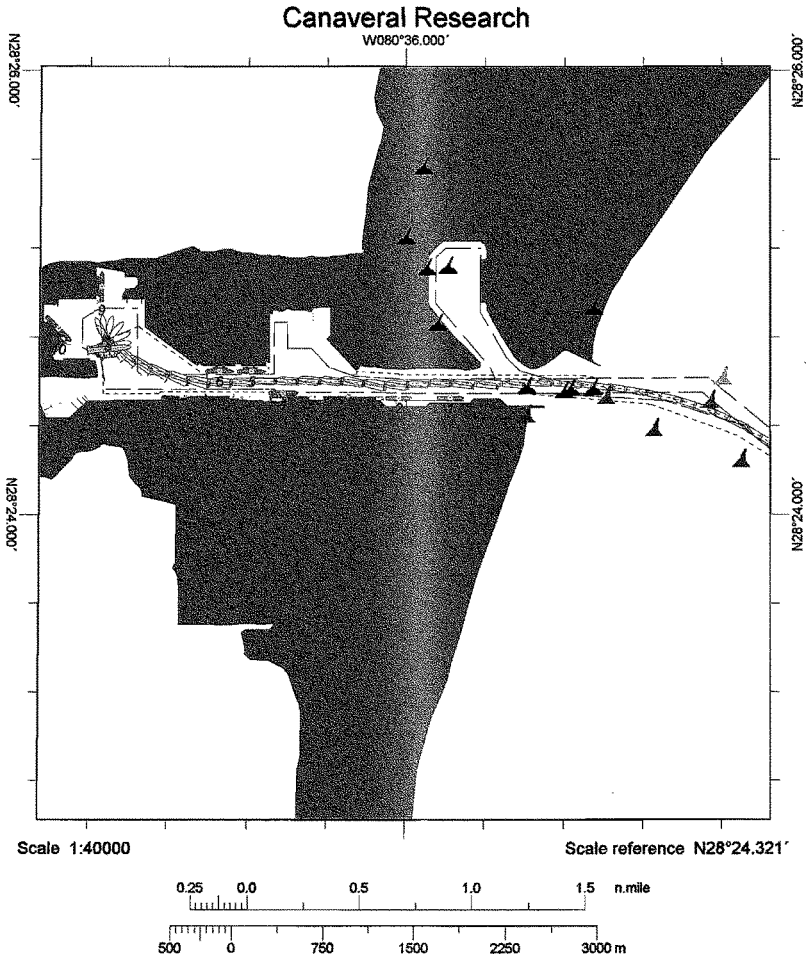

Comments: Wind: NW 25  
Current: S 0.3 k

Line sample period (s)	30
Course marker every	N/A
Heading marker period (s)	60
Shape outline every	01:00

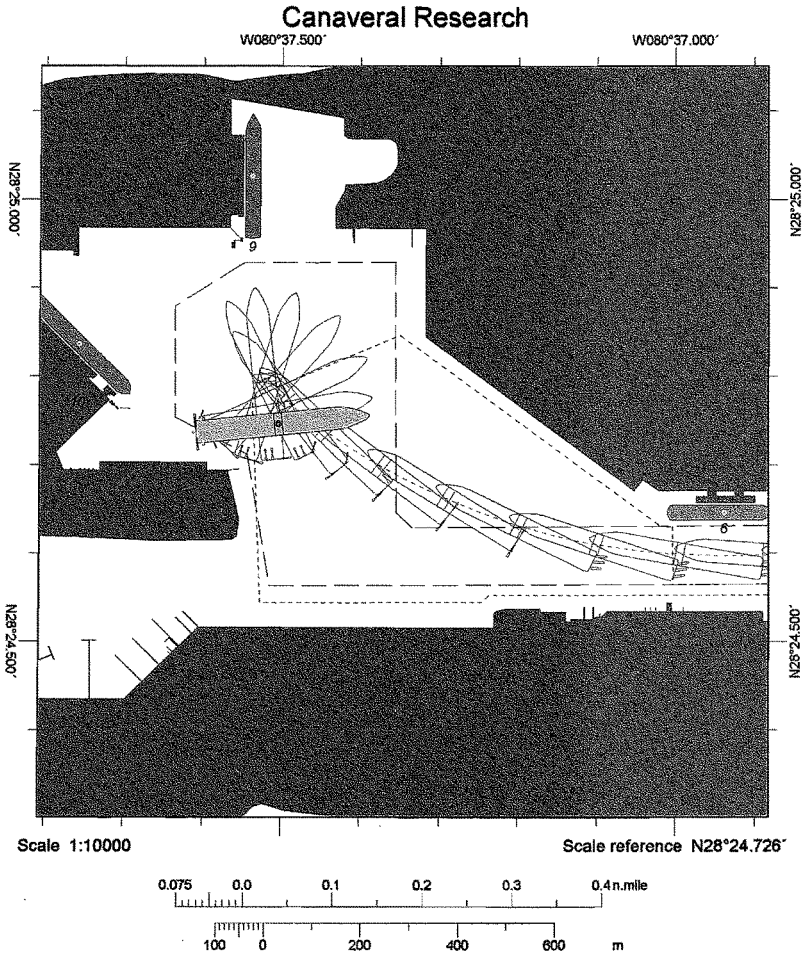

Comments: Wind: NW 25  
 Current: S 0.3 k

Line sample period (s)	30
Course marker every	N/A
Heading marker period (s)	60
Shape outline every	01:00

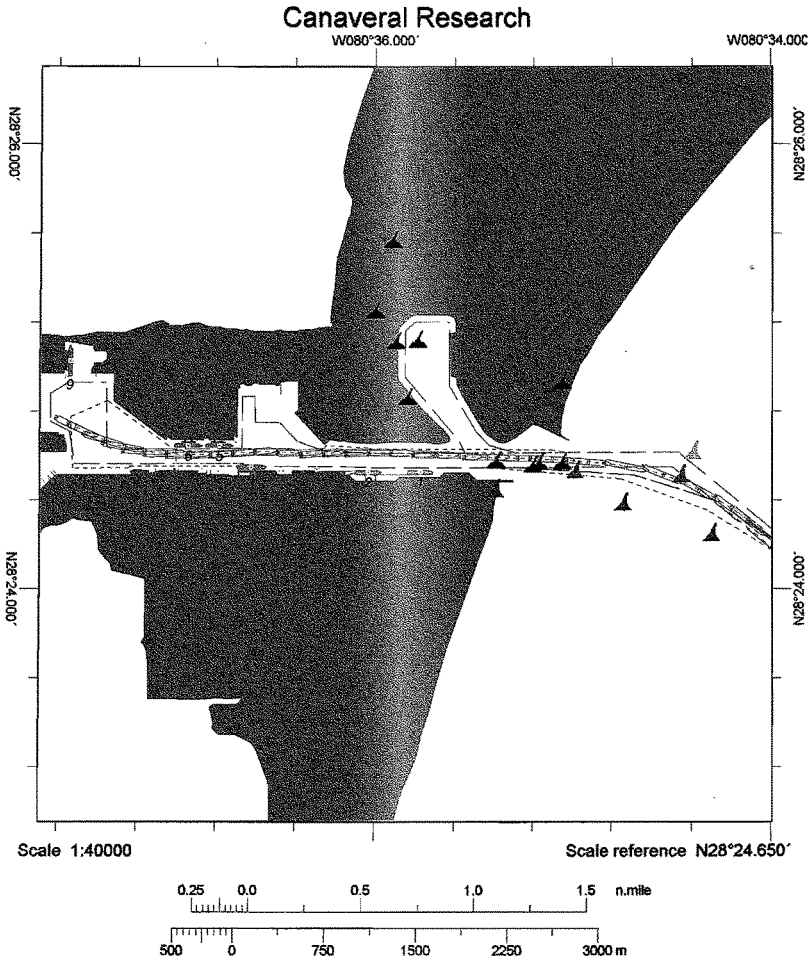

Comments: Wind: NW 25  
Current: S 0.3 k

Line sample period (s)	30
Course marker every	N/A
Heading marker period (s)	60
Shape outline every	01:00

### Canaveral Research

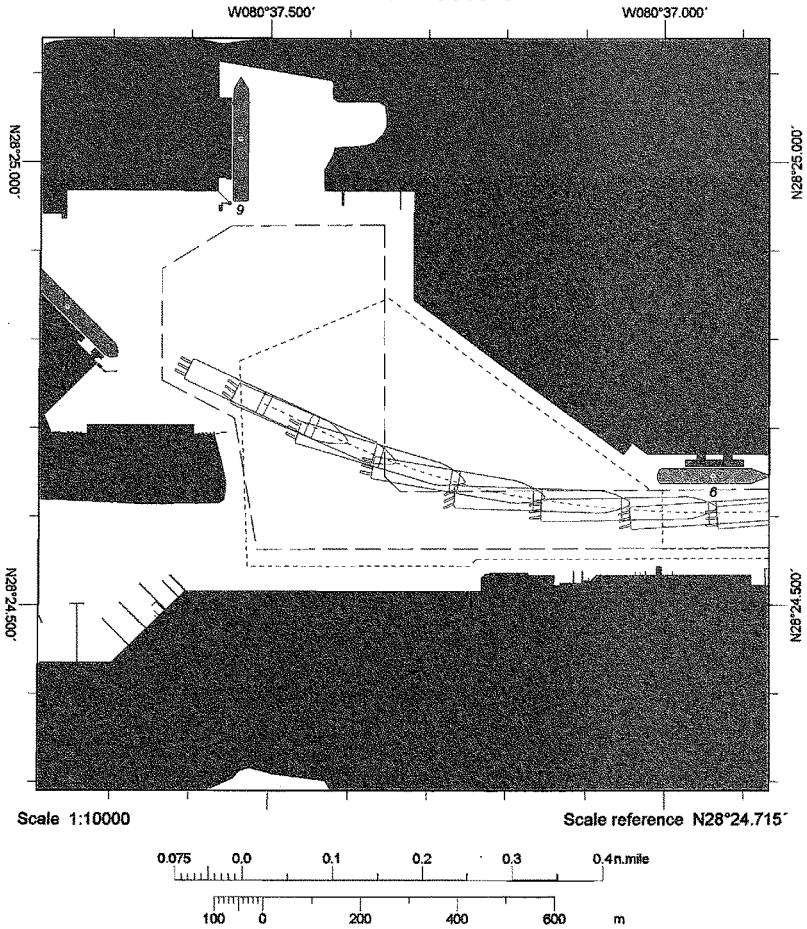

Comments: Wind: NW 25  
Current: S 0.3 k

Line sample period (s)	30
Course marker every	N/A
Heading marker period (s)	60
Shape outline every	01:00

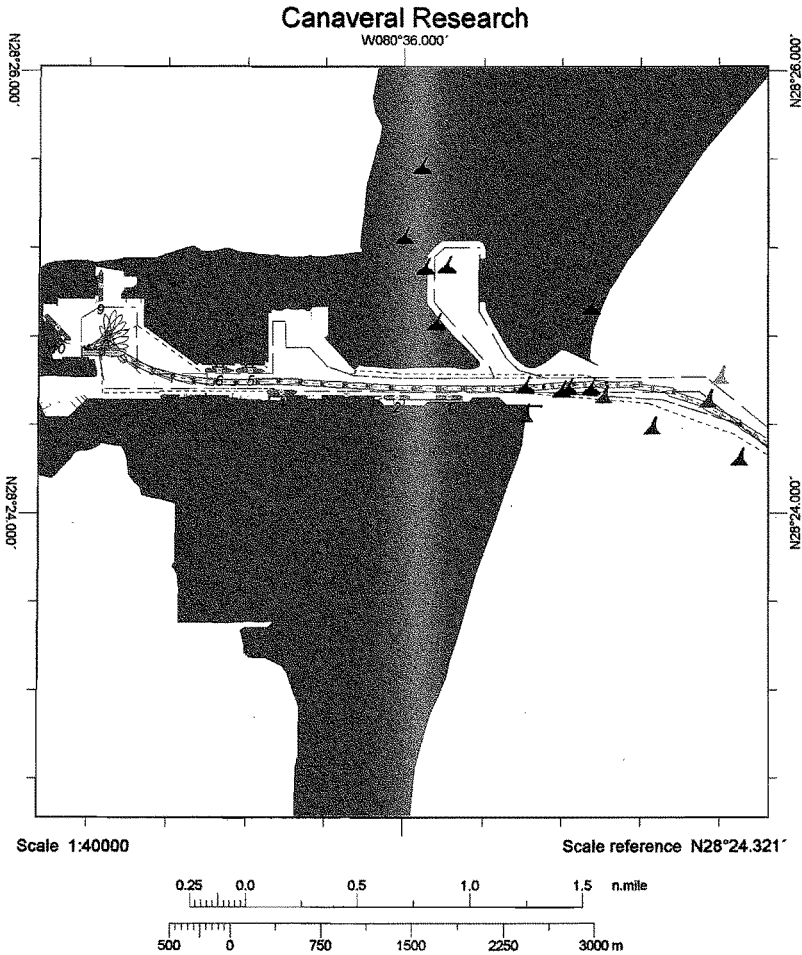

Comments: Wind: SE 15  
Current: S 0.3 k

Line sample period (s)	30
Course marker every	N/A
Heading marker period (s)	60
Shape outline every	01:00



### Canaveral Research

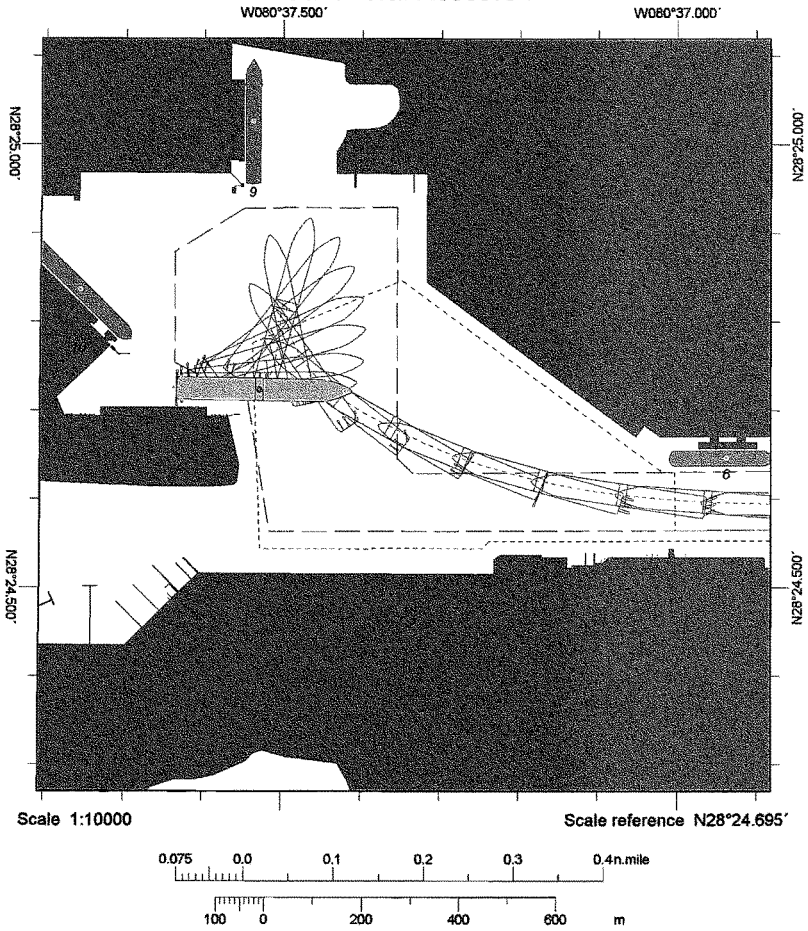

Comments: Wind: SE 15  
 Current: S 0.3 k

Line sample period (s)	30
Course marker every	N/A
Heading marker period (s)	60
Shape outline every	01:00

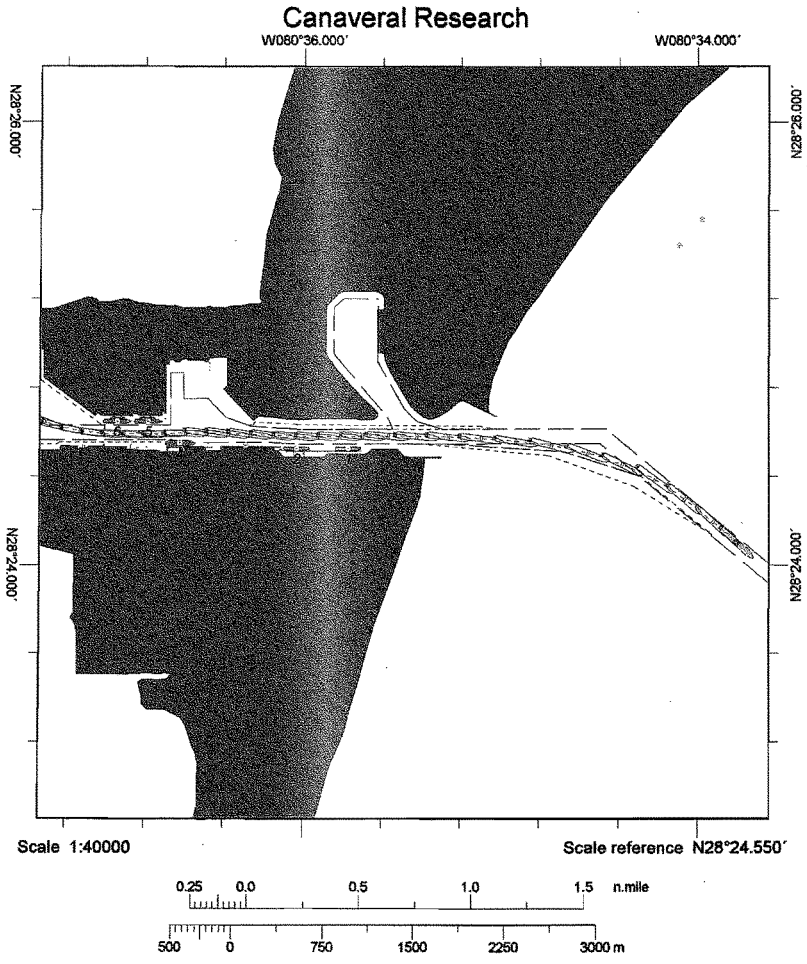

Comments: Wind: SE 25  
Current: N 0.3 k

Line sample period (s)	30
Course marker every	N/A
Heading marker period (s)	60
Shape outline every	01:00

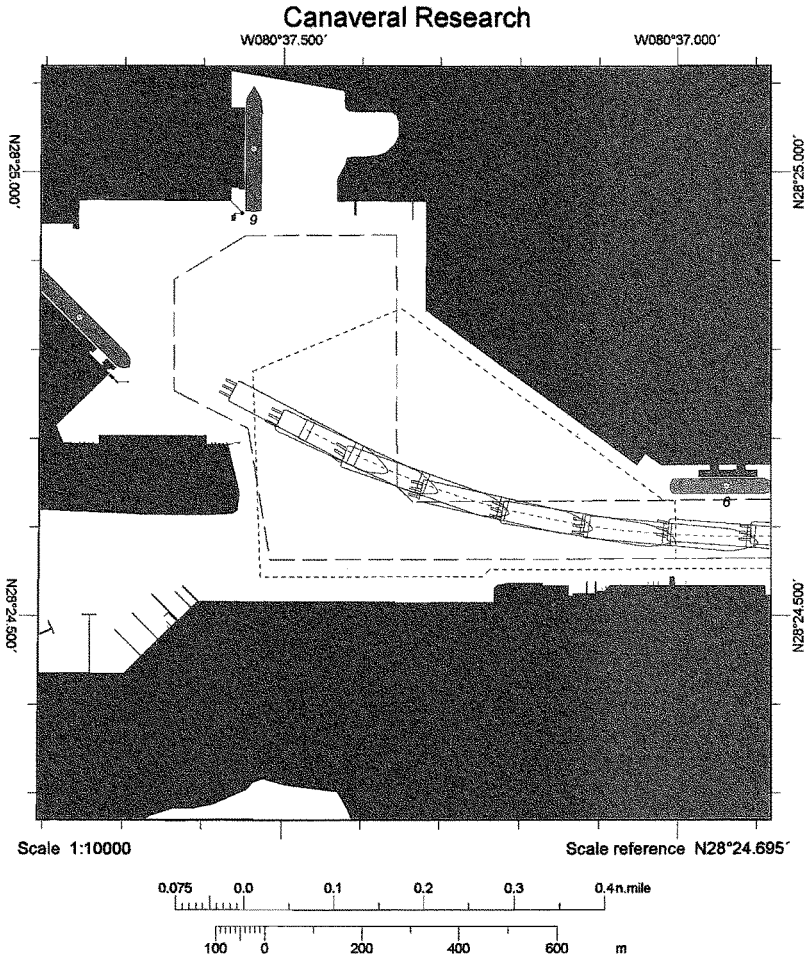

Comments: Wind: SE 25  
 Current: N 0.3 k

Line sample period (s)	30
Course marker every	N/A
Heading marker period (s)	60
Shape outline every	01:00

### Canaveral Research

W080°36.000'

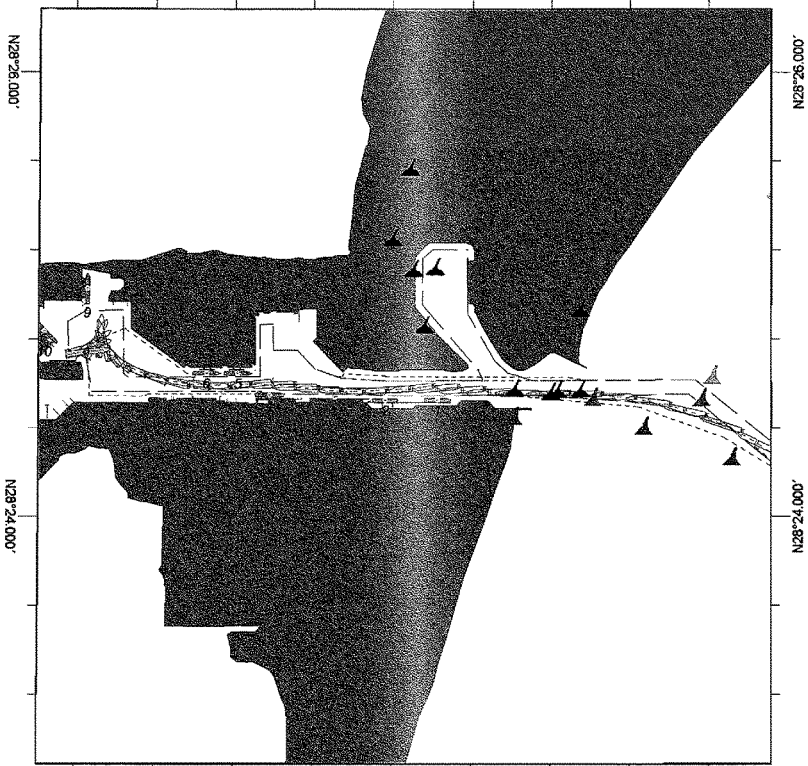

Scale 1:40000

Scale reference N28°24.585'

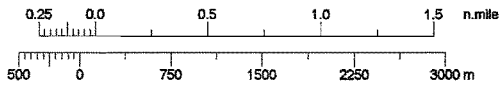

Comments: Wind: SE 25  
Current: N 0.3 k

Line sample period (s)	30
Course marker every	N/A
Heading marker period (s)	60
Shape outline every	01:00

### Canaveral Research

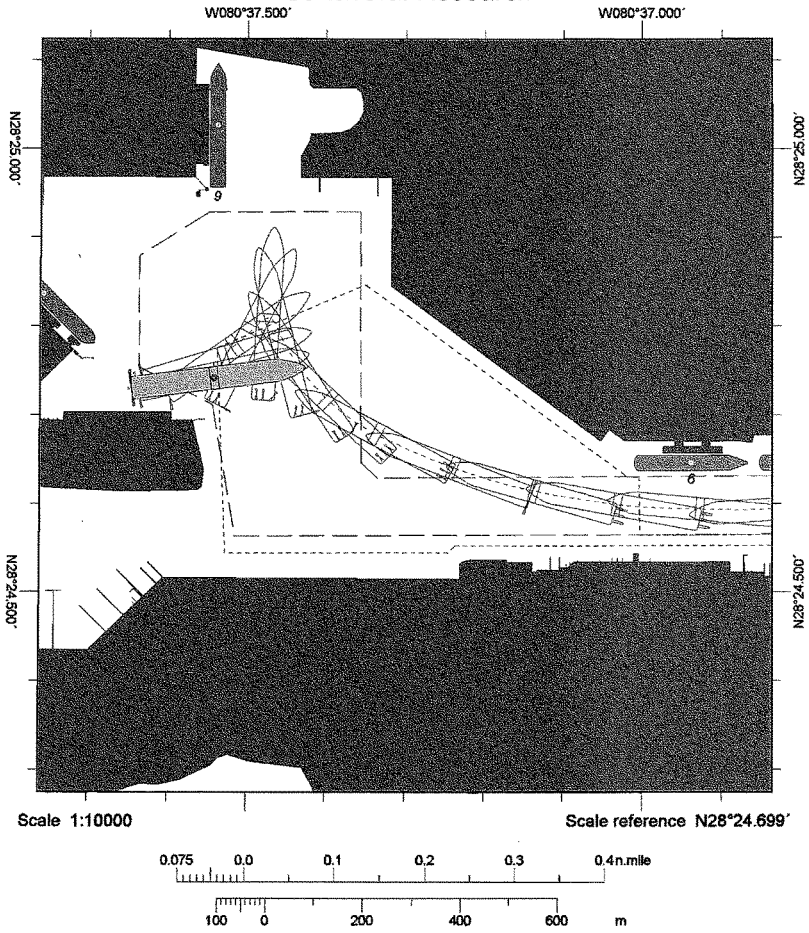

Comments: Wind: SE 25  
Current: N 0.3 k

Line sample period (s) 30  
Course marker every N/A  
Heading marker period (s) 60  
Shape outline every 01:00

### Canaveral Research

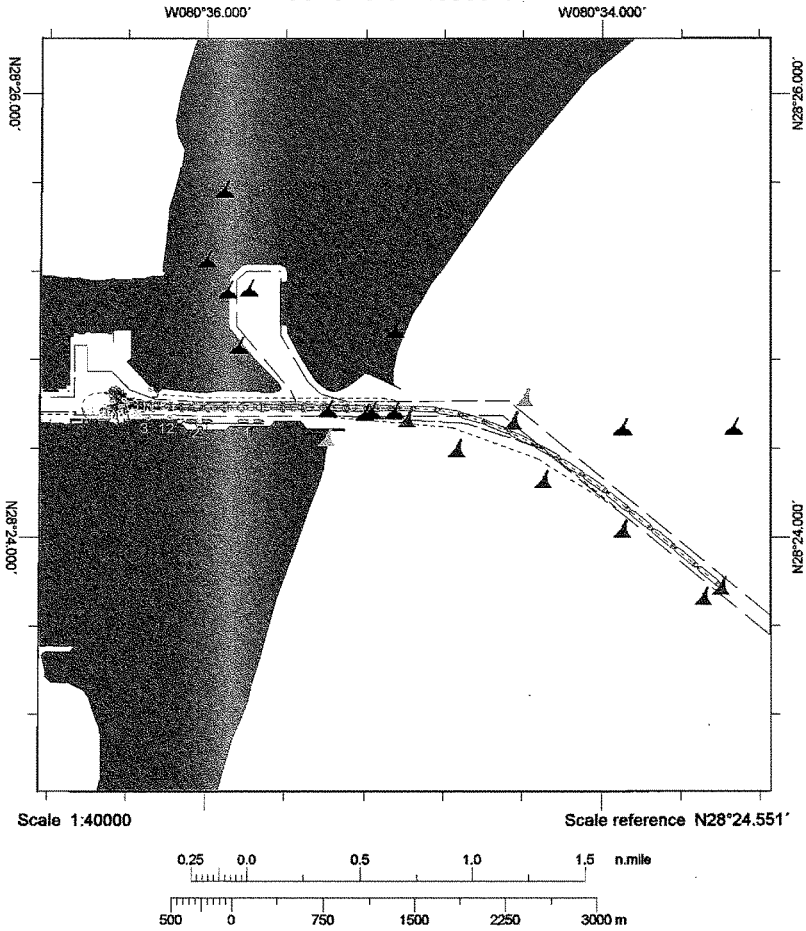

Comments: Wind:   
 Current:

Line sample period (s)	30
Course marker every	N/A
Heading marker period (s)	60
Shape outline every	01:00

### Canaveral Research

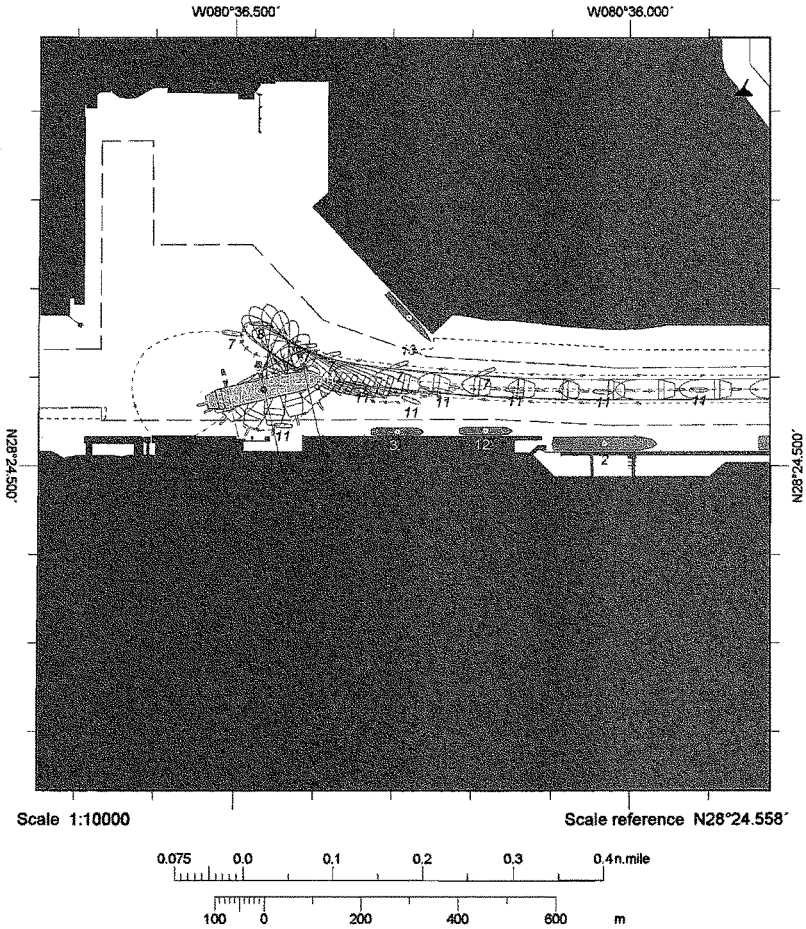

Comments: Wind: 0  
Current: 0

Line sample period (s)	30
Course marker every	N/A
Heading marker period (s)	60
Shape outline every	01:00

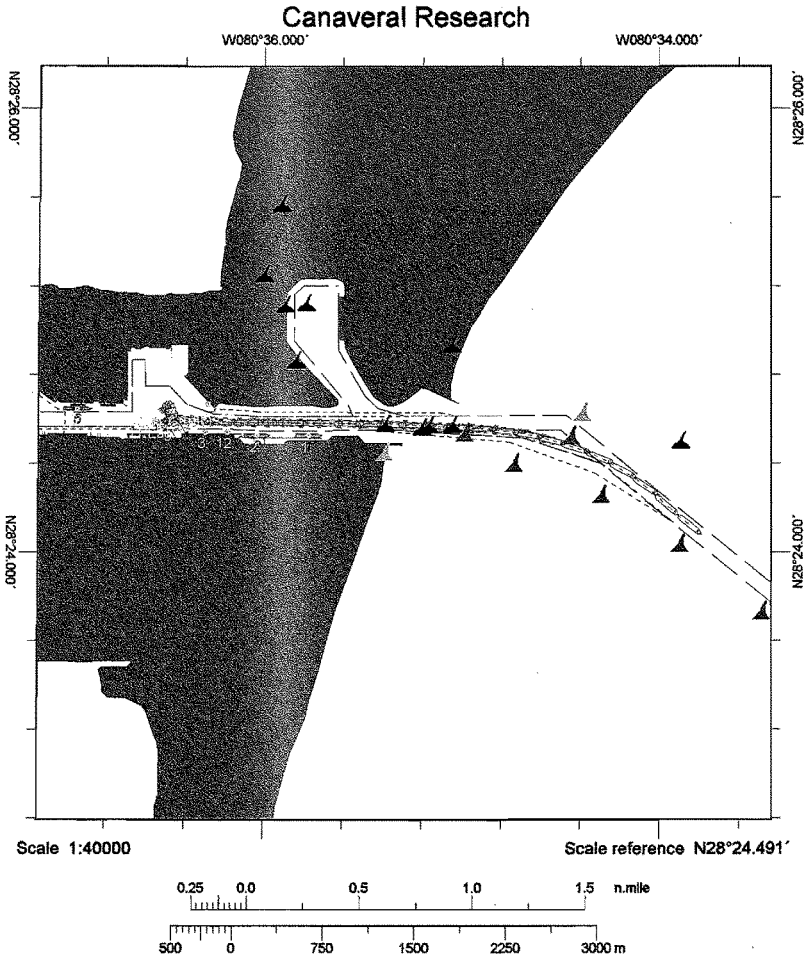

Comments: Wind: NW 15K  
Current: N 0.3 K

Line sample period (s)	30
Course marker every	N/A
Heading marker period (s)	60
Shape outline every	01:00



### Canaveral Research

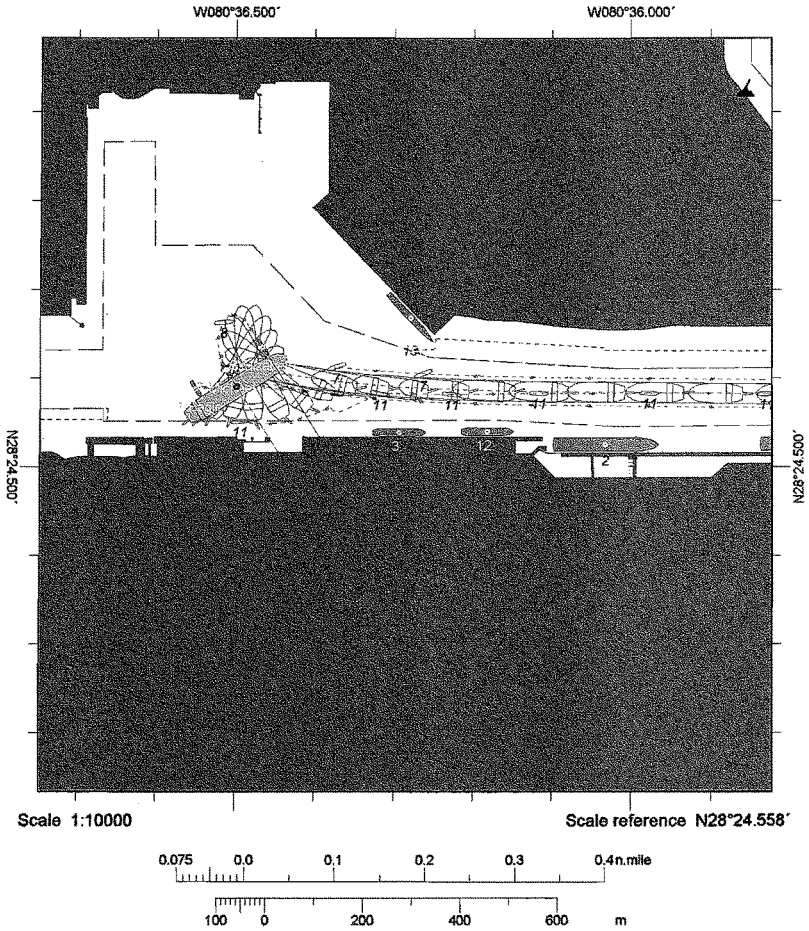

Comments: Wind: NW 15K  
Current: N 0.3 K

Line sample period (s)	30
Course marker every	N/A
Heading marker period (s)	60
Shape outline every	01:00

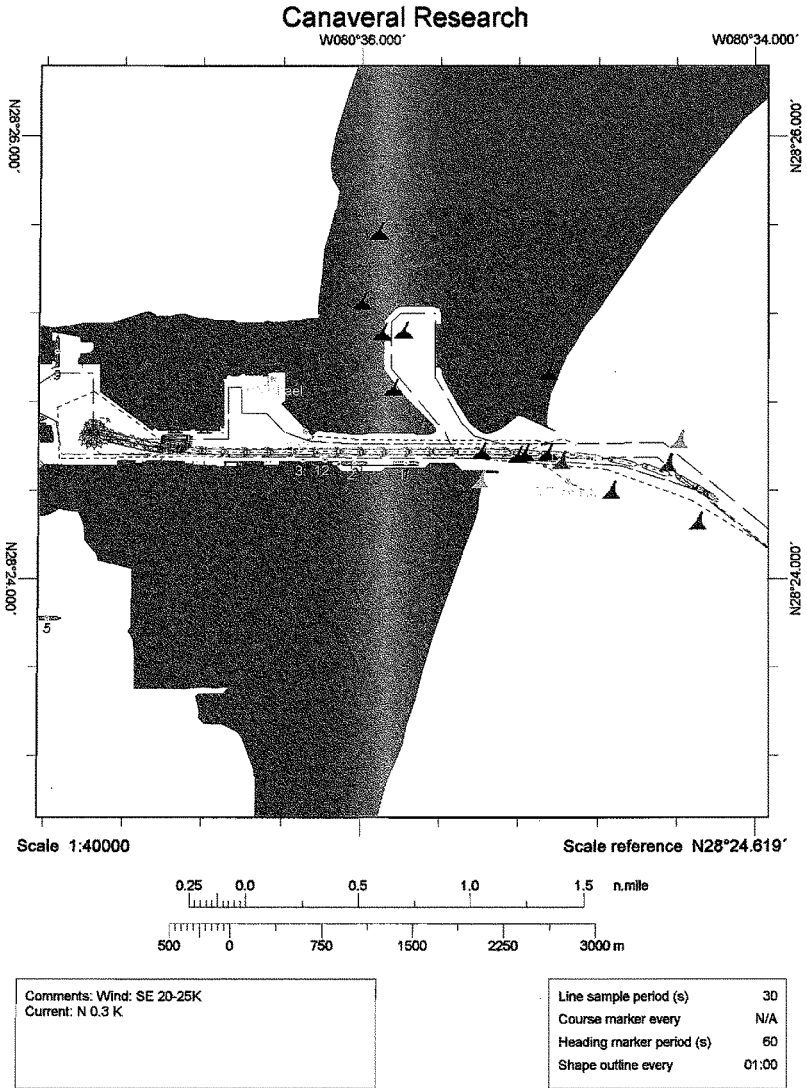

### Canaveral Research

W080°37.000°

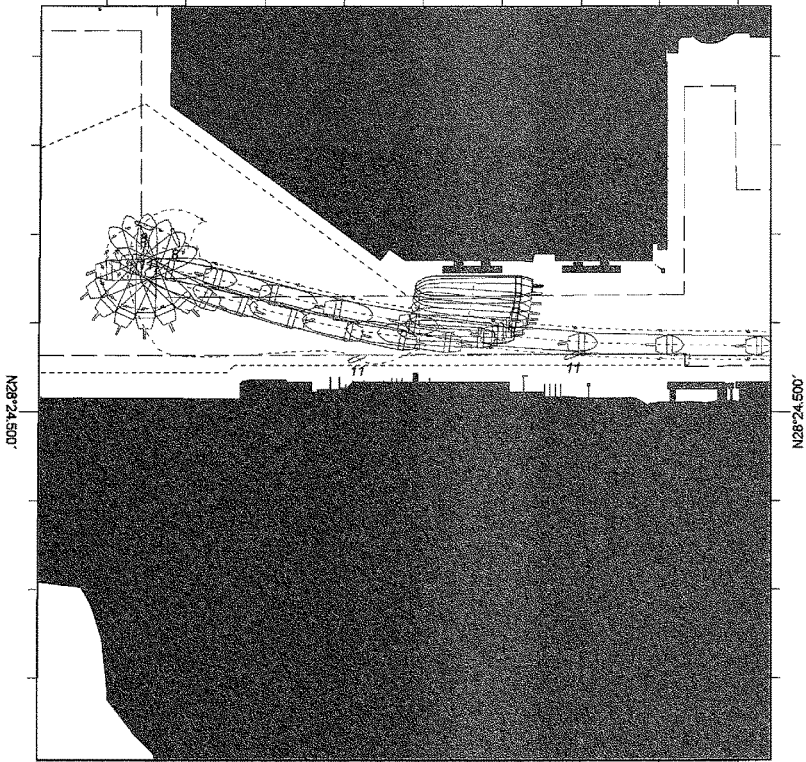

Scale 1:10000

Scale reference N28°24.532'

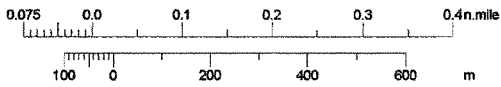

Comments: Wind: SE 20-25K  
Current: N 0.3 K

Line sample period (s)	30
Course marker every	N/A
Heading marker period (s)	60
Shape outline every	01:00

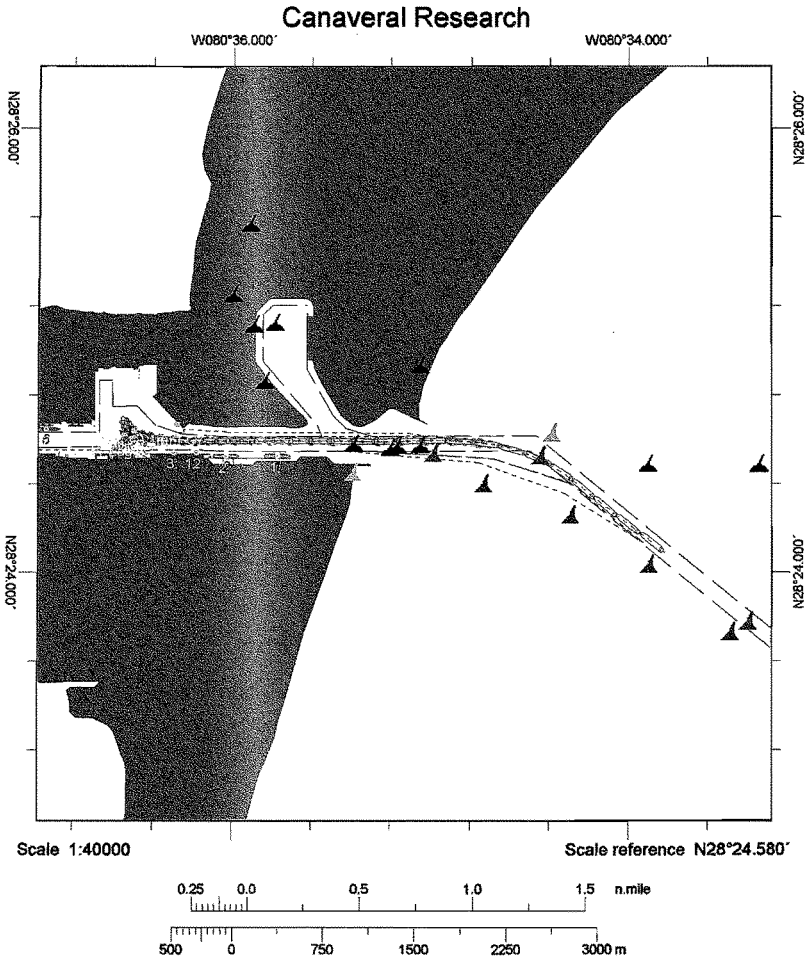

Comments: Wind: NW 20-25K  
Current: S 0.3 K

Line sample period (s)	30
Course marker every	N/A
Heading marker period (s)	60
Shape outline every	01:00

### Canaveral Research

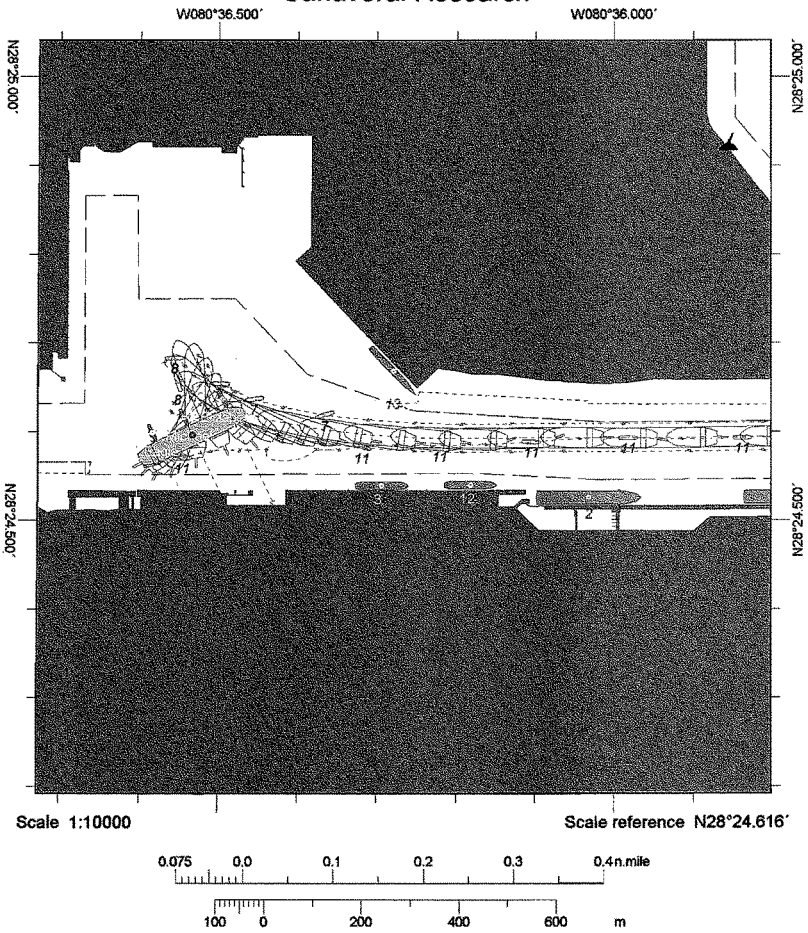

Comments: Wind: NW 20-25K  
Current: S 0.3 K

Line sample period (s)	30
Course marker every	N/A
Heading marker period (s)	60
Shape outline every	01:00

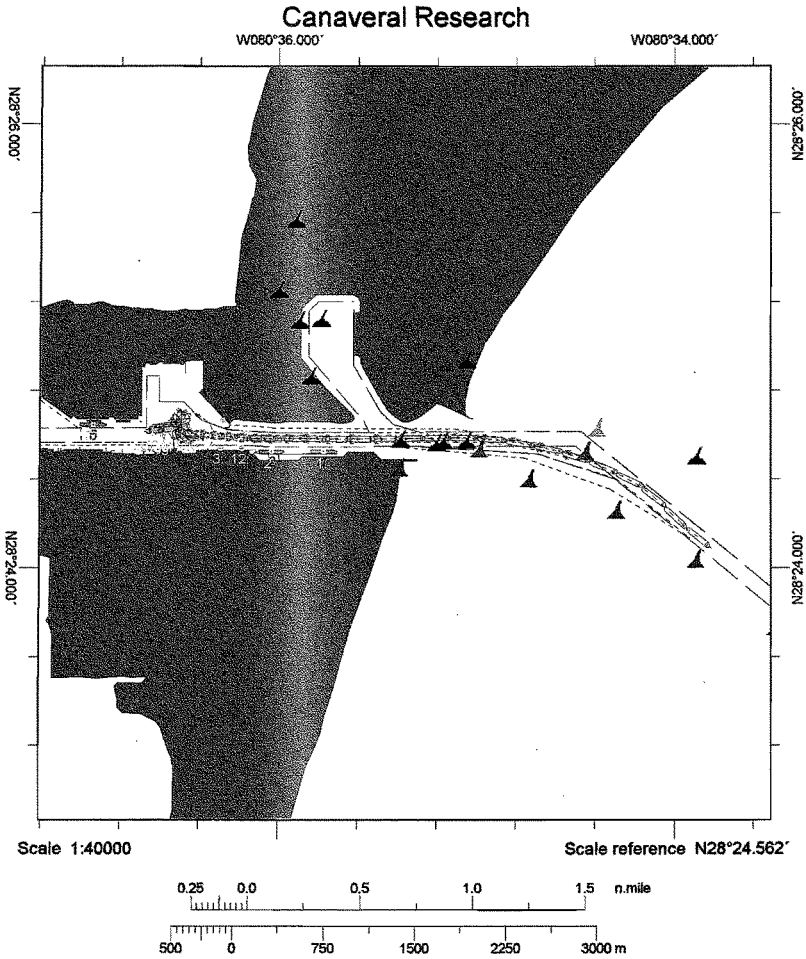

Comments: Wind: SE 20-25K  
Current: N 0.3 K

Line sample period (s)	30
Course marker every	N/A
Heading marker period (s)	60
Shape outline every	01:00

### Canaveral Research

W080°36.500'

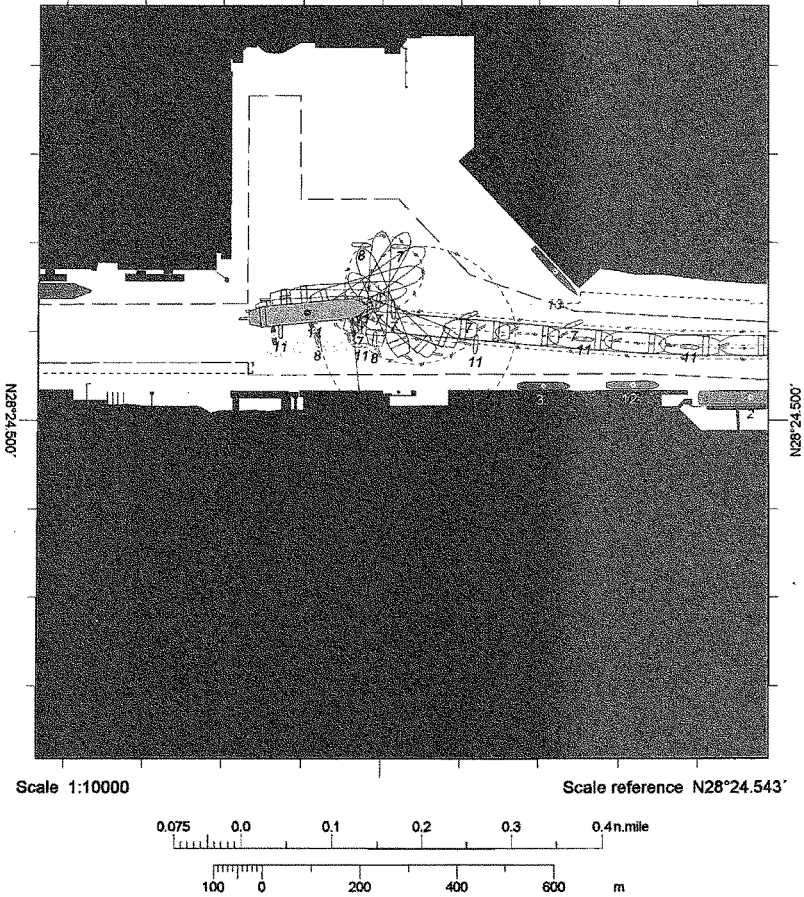

Comments: Wind: SE 20-25K  
Current: N 0.3 K

Line sample period (s)	30
Course marker every	N/A
Heading marker period (s)	60
Shape outline every	01:00

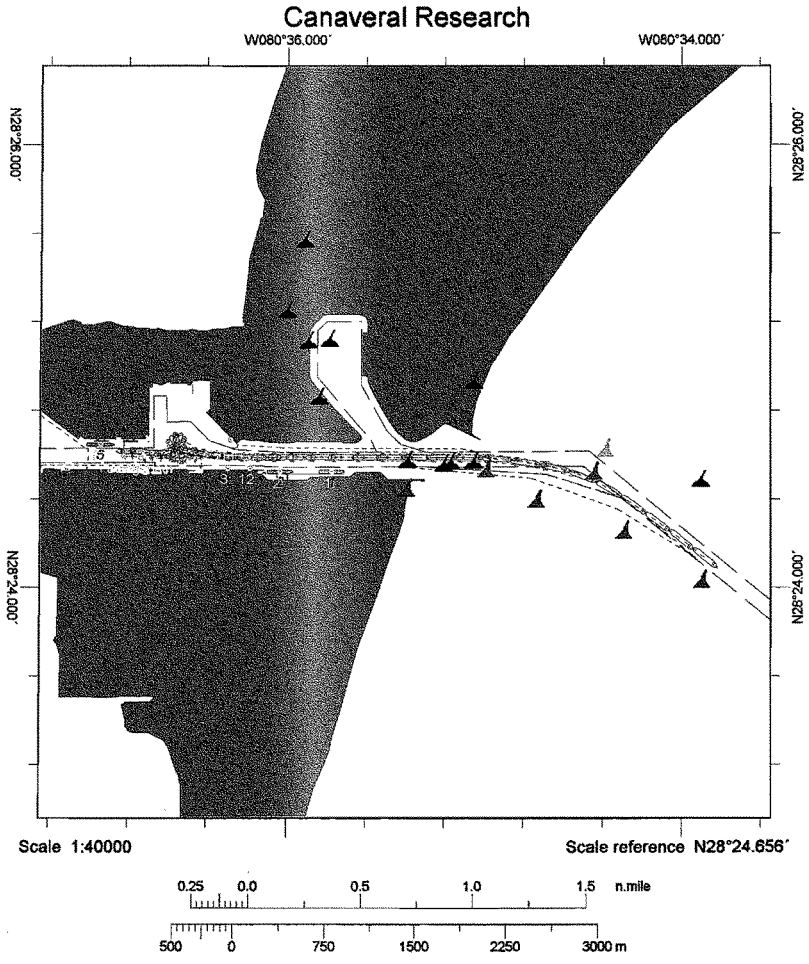

Comments: Wind: NW 20-25K  
 Current: S 0.3 K

Line sample period (s)	30
Course marker every	N/A
Heading marker period (s)	60
Shape outline every	01:00



### Canaveral Research

W080°36.500'

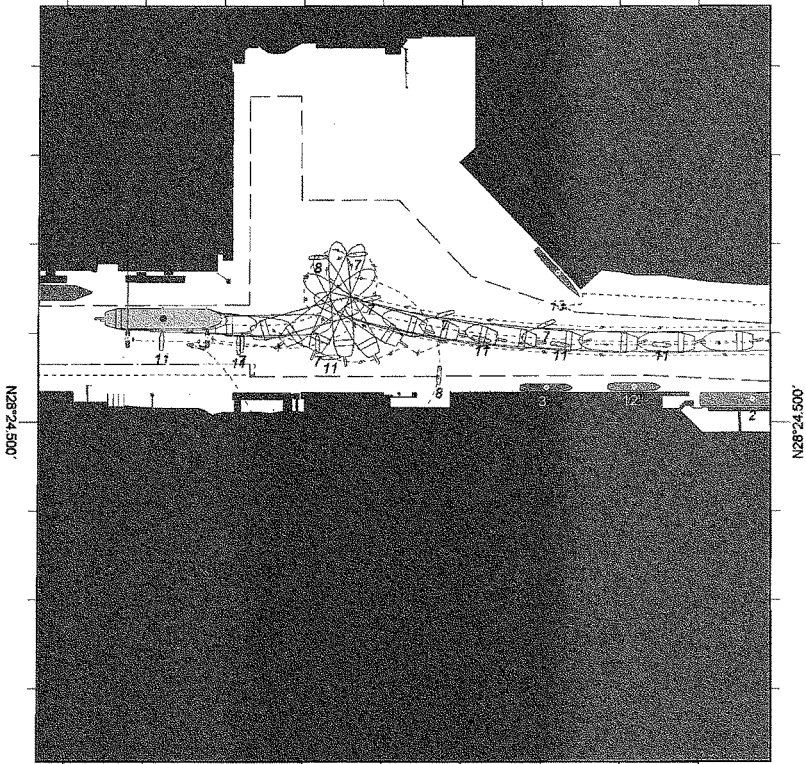

Scale 1:10000

Scale reference N28°24.543'

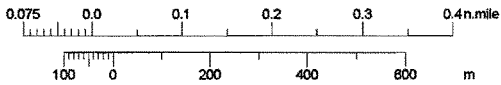

Comments: Wind: NW 20-25K  
Current: S 0.3 K

Line sample period (s)	30
Course marker every	N/A
Heading marker period (s)	60
Shape outline every	01:00

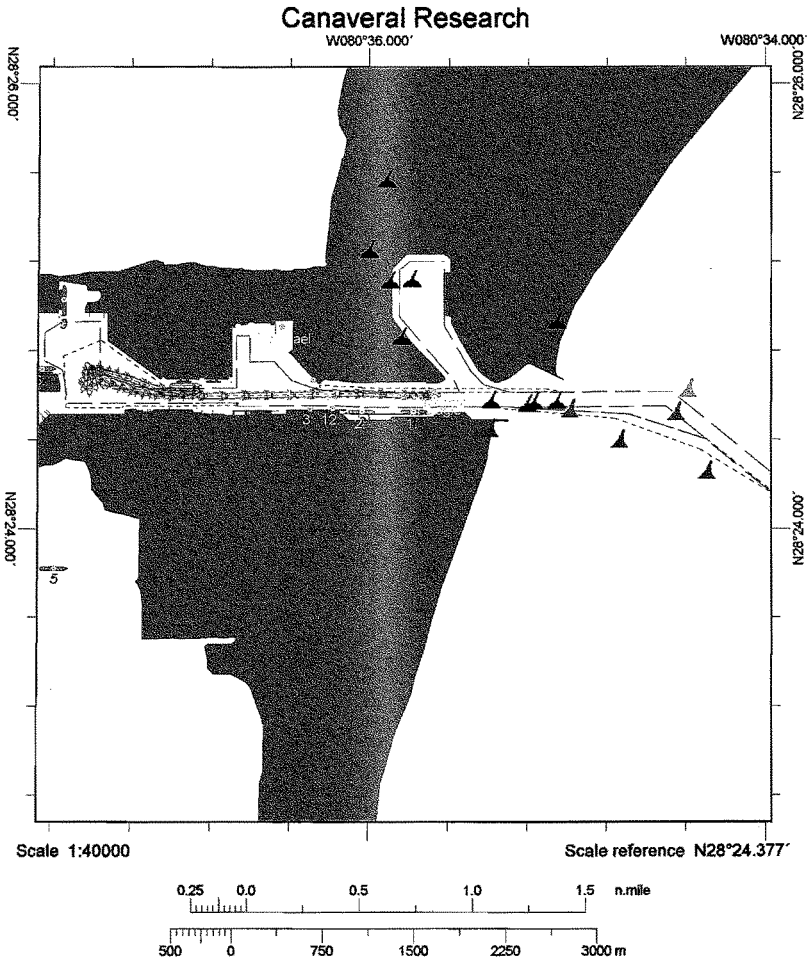

Comments: Wind: NW 20-25K  
 Current: S 0.3 K

Line sample period (s)	30
Course marker every	N/A
Heading marker period (s)	60
Shape outline every	01:00

### Canaveral Research

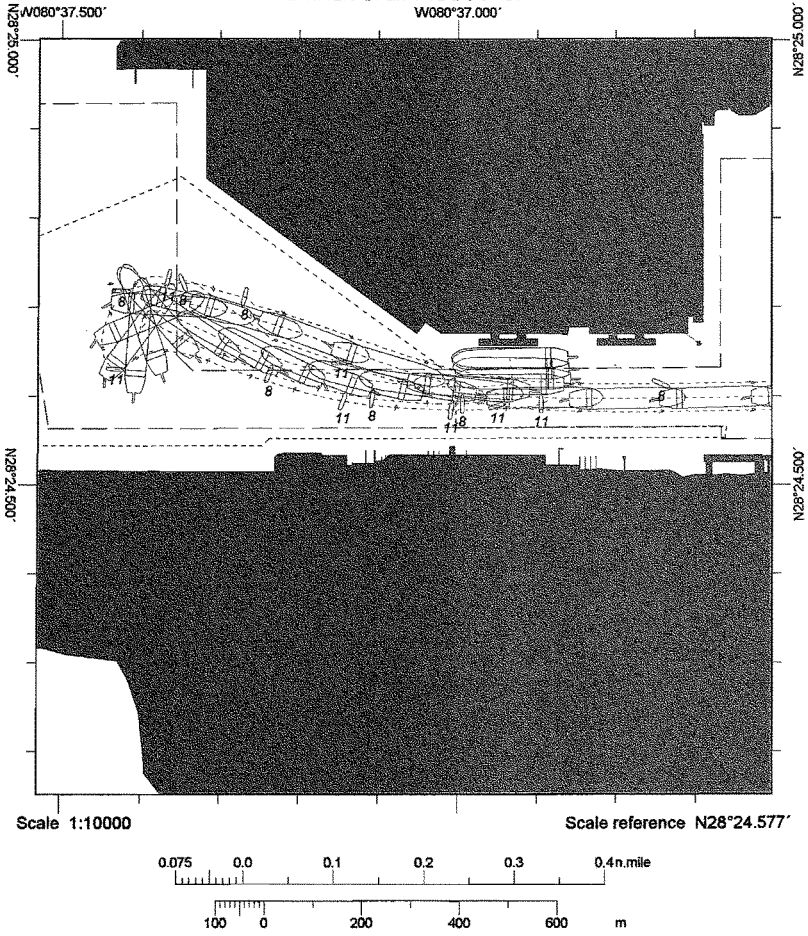

Comments: Wind: NW 20-25K  
Current: S 0.3 K

Line sample period (s)	30
Course marker every	N/A
Heading marker period (s)	60
Shape outline every	01:00

## Port Canaveral 2007 Run Evaluation Form

Pilot # 2Date March 10-11, 2007Run #: 16

Circle the number that best describes the run just completed:

	Extremely Satisfactory	←-----→			Not at all Satisfactory
<b>Vessel Trackline</b>					
- Vessel position with regard to centerline	5	(4)	3	2	1
- CPA to channel boundaries and/or buoys at the entrance	5	4	(3)	2	1
- Vessel position with regard to ships at the berth	5	(4)	3	2	1
- Maneuvering room at turning basin	5	(4)	3	2	1
<b>Vessel Controllability</b>					
- Engine reserve	(5)	4	3	2	1
- Rudder reserve	5	(4)	3	2	1
- Course Control	5	(4)	3	2	1
- Speed Control	5	(4)	3	2	1
- Use of Tugs	5	4	3	2	1
- Thruster reserve	(5)	4	3	2	1

	Absolutely Safe	←-----→			Not at all Safe
<b>Overall Safety</b>	5	(4)	3	2	1

Comments: NO WIND, FIRST RUN, NEEDED

ADDITIONAL WIDENER OUTSIDE TO KEEP  
ARIE OF TUN TO ACCEPTABLE LIMITS.

(over)

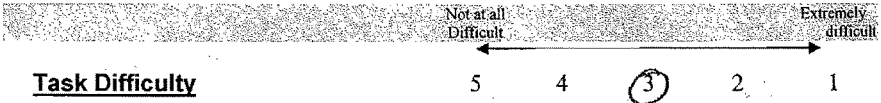

**Task Difficulty**

**Comments:**

FIRST RUN REQUIRED SOME TIME TO GET FAMILIAR WITH EQUIPMENT.

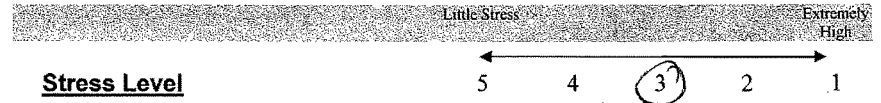

**Stress Level**

**Comments:**

FIRST RUN SITTERS TO GET COMFORTABLE WITH EQUIPMENT.

**Additional Comments:**

## Port Canaveral 2007 Run Evaluation Form

Pilot # 2Date March 10-11, 2007Run #: 17

Circle the number that best describes the run just completed:

	←	Extremely Satisfactory	←	→	Not at all Satisfactory	→
<b>Vessel Trackline</b>						
- Vessel position with regard to centerline	5	4	(3)	2	1	
- CPA to channel boundaries and/or buoys at the entrance	5	(4)	3	2	1	
- Vessel position with regard to ships at the berth	5	4	(3)	2	1	
- Maneuvering room at turning basin	5	(4)	3	2	1	
<b>Vessel Controllability</b>						
- Engine reserve	5	(4)	3	2	1	
- Rudder reserve	5	(4)	3	2	1	
- Course Control	5	4	(3)	2	1	
- Speed Control	5	(4)	3	2	1	
- Use of Tugs	5	4	3	2	1	
- Thruster reserve	5	(4)	3	2	1	

	←	Absolutely Safe	←	→	Not at all Safe	→
<b>Overall Safety</b>	5	4	(3)	2	1	

Comments: EVEN W/ 15 KNOTS WIND, EXTRA CHANNEL WIDTH IN INNER REACH WAS NEEDED FOR SAFETY.

(over)

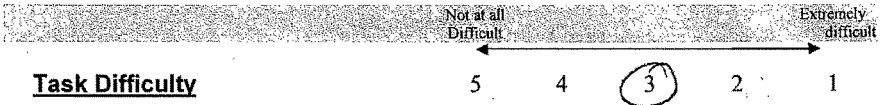

**Task Difficulty**

**Comments:**

MORE FAMILIAR WITH EQUIPMENT  
 NOW JOB WENT SMOOTHER, EVEN IS KNOWS  
 OF WIND MAKES A VESSEL THIS  
 BIG MORE DIFFICULT TO HANDLE.

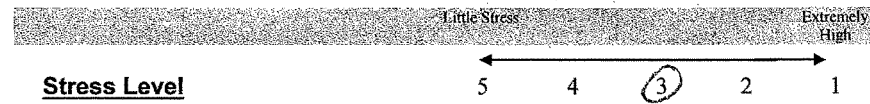

**Stress Level**

**Comments:**

USING THE IMPROVED CHANNEL  
 GAVE THE NEEDED EXTRA MARGIN  
 OF SAFETY, LOWERING STRESS LEVEL  
 ON NOTCH.

**Additional Comments:**

---

---

---

---

---

---

---

---

## Port Canaveral 2007 Run Evaluation Form

Pilot # 2Date March 10-11, 2007Run #: 18

Circle the number that best describes the run just completed:

	← Extremly Satisfactory → Not at all Satisfactory →				
<b>Vessel Trackline</b>					
- Vessel position with regard to centerline	5	4	3	②	1
- CPA to channel boundaries and/or buoys at the entrance	5	4	③	②	1
- Vessel position with regard to ships at the berth	5	4	③	2	1
- Maneuvering room at turning basin	5	④	3	2	1
<b>Vessel Controllability</b>					
- Engine reserve	5	④	3	2	1
- Rudder reserve	5	4	③	2	1
- Course Control	5	4	③	2	1
- Speed Control	5	④	3	2	1
- Use of Tugs	5	4	3	2	1
- Thruster reserve	5	4	③	2	1

	← Absolutely Safe → Not at all Safe →				
<b>Overall Safety</b>	5	4	③	2	1

Comments: ABSOLUTELY NEEDED EXTRA

WIDNER, AND EXTRA CHANNEL WIDTH TO SAFELY MANEUVER THIS VESSEL UNDER THESE CONDITIONS.

(over)



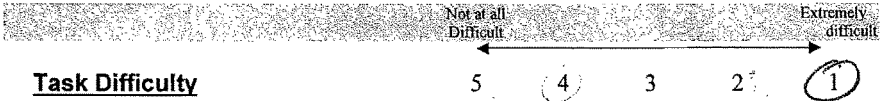

**Task Difficulty**

**Comments:**

NEEDED 4 THRUSTERS TO MAINTAIN SAFE CHANNEL POSITION, AN INTENSE JOB.

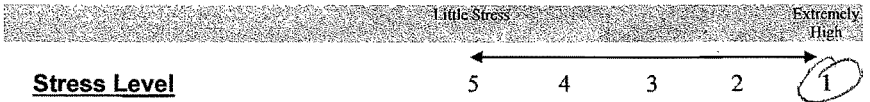

**Stress Level**

**Comments:**

HIGH STRESS. USING TO USE FULL THRUSTER POWER, AND HEAVY MW USAGE

**Additional Comments:**

## Port Canaveral 2007 Run Evaluation Form

Pilot # 2

Date March 10-11, 2007

Run #: 19

Circle the number that best describes the run just completed:

	Extremely Satisfactory ← → Not at all Satisfactory				
<b>Vessel Trackline</b>					
- Vessel position with regard to centerline	5	4	3	2	1
- CPA to channel boundaries and/or buoys at the entrance	5	4	3	2	1
- Vessel position with regard to ships at the berth	5	4	3	2	1
- Maneuvering room at turning basin	5	4	3	2	1
<b>Vessel Controllability</b>					
- Engine reserve	5	4	3	2	1
- Rudder reserve	5	4	3	2	1
- Course Control	5	4	3	2	1
- Speed Control	5	4	3	2	1
- Use of Tugs	5	4	3	2	1
- Thruster reserve	5	4	3	2	1

	Absolutely Safe ← → Not at all Safe				
<b>Overall Safety</b>	5	4	3	2	1

Comments: EXTRA CHANNEL WIDTH SOUTH OF WEST BASIN ENTRANCE (BUOY 19) WAS ABSOLUTELY NECESSARY WITH SHIPS AT NORTH CARGO PIER 3 AND 4 ALSO, NORTH OF SOUTH 2, THAT AREA WAS USED, AS WELL. (over)

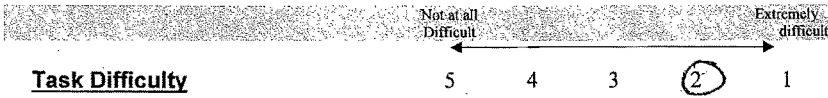

**Task Difficulty**

**Comments:**

HOLDING STERN OFF SOUTH SIDE  
USING MINIMAL POWER TO AVOID  
WASH DAMAGE WAS DIFFICULT.

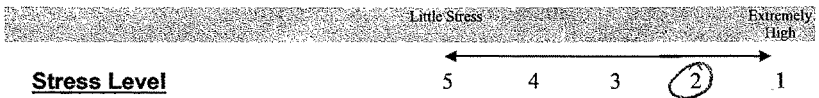

**Stress Level**

**Comments:**

WITHOUT USING "BLUE AREAS" IT WOULD  
HAVE BEEN UNSAFE IN THESE CONDITIONS.

**Additional Comments:**

\_\_\_\_\_  
\_\_\_\_\_  
\_\_\_\_\_  
\_\_\_\_\_  
\_\_\_\_\_

## Port Canaveral 2007 Run Evaluation Form

Pilot # 2Date March 10-11, 2007Run #: 20

Circle the number that best describes the run just completed:

	←	Extremely Satisfactory	←	→	Not at all Satisfactory	→
<b>Vessel Trackline</b>						
- Vessel position with regard to centerline	5	(4)	3	2	1	
- CPA to channel boundaries and/or buoys at the entrance	5	4	(3)	2	1	
- Vessel position with regard to ships at the berth	5	4	(3)	2	1	
- Maneuvering room at turning basin	5	(4)	3	2	1	
<b>Vessel Controllability</b>						
- Engine reserve	5	(4)	3	2	1	
- Rudder reserve	5	(4)	3	2	1	
- Course Control	5	(4)	3	2	1	
- Speed Control	5	(4)	3	2	1	
- Use of Tugs	5	(4)	3	2	1	
- Thruster reserve	5	(4)	3	2	1	

	←	Absolutely Safe	←	→	Not at all Safe	→
<b>Overall Safety</b>	5	4	(3)	2	1	

Comments: EXTRA WIDENER IN OUTSIDE TURN  
ALLOWED FOR A SAFER, SLOWER RATE  
OF TURN INBOUND. EXTRA "IMPROVED" CHANNEL  
BY WEST BASIN ENTRANCE ALLOWED THE  
STERN TO STAY TO WINDWARD A SAFE  
DISTANCE FROM NORTH 4. (over)

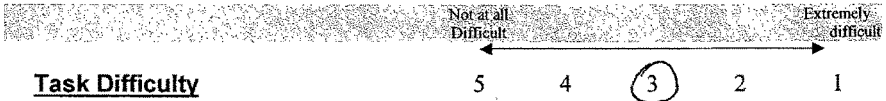

**Task Difficulty**

**Comments:**

MODERATE WIND ALLOWED FOR LIMITED THRUSTER USE.

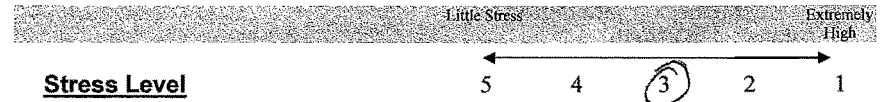

**Stress Level**

**Comments:**

STRESS INCREASED BY HAVING TO KEEP SHIP CLOSE TO SHIPS ON SOUTH SIDE.

**Additional Comments:**

## Port Canaveral 2007 Run Evaluation Form

Pilot # 2Date March 10-11, 2007Run #: 21

Circle the number that best describes the run just completed:

	Extremely Satisfactory	←	→	Not at all Satisfactory	
<b>Vessel Trackline</b>					
- Vessel position with regard to centerline	5	(4)	3	2	1
- CPA to channel boundaries and/or buoys at the entrance	5	(4)	3	2	1
- Vessel position with regard to ships at the berth	5	4	(3)	2	1
- Maneuvering room at turning basin	5	(4)	3	2	1
<b>Vessel Controllability</b>					
- Engine reserve	5	(4)	3	2	1
- Rudder reserve	5	(4)	3	2	1
- Course Control	5	(4)	3	2	1
- Speed Control	5	(4)	3	2	1
- Use of Tugs	5	4	3	2	1
- Thruster reserve	5	(4)	3	2	1

	Absolutely Safe	←	→	Not at all Safe	
<b>Overall Safety</b>	5	(4)	3	2	1

Comments: \* THIS IS ONLY SAFE IF THE

IMPROVED CHANNEL IS USED. WITHOUT THE  
EXTRA MANEUVERING ROOM, THE VESSEL  
WOULD BE DANGEROUSLY CLOSE TO CHANNEL  
EDGES AND OTHER MOORED VESSELS.

(over)

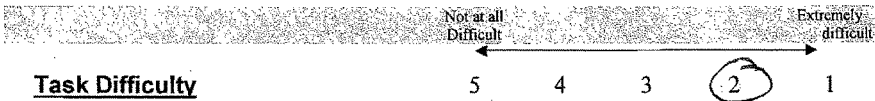
**Comments:**

EXTRA BEAM AND LENGTH OF THIS  
SHIP MADE IT MORE DIFFICULT IN  
WINDS OF 25 KTS

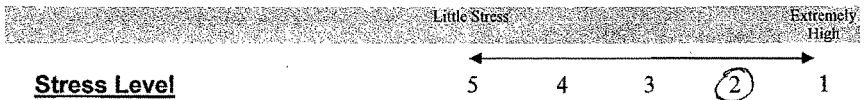
**Comments:**

AGAIN, EXTRA ROOM PROVIDES EXTRA  
MARGIN OF SAFETY WHICH LOWERS STRESS  
LEVEL.

**Additional Comments:**

IN THIS EXERCISE THERE IS NOT A  
VESSEL @ SOUTH CARLO PIER 1. IF  
THERE HAD BEEN, I WOULD HAVE HAD  
TO PUT THE VESSEL FURTHER NORTH  
BY BUOY 14A.

## Port Canaveral 2007 Run Evaluation Form

Pilot # 2Date March 10-11, 2007Run #: 22

Circle the number that best describes the run just completed:

	←	Extremely Satisfactory	←	→	Not at all Satisfactory	→
<b>Vessel Trackline</b>						
- Vessel position with regard to centerline	5	(4)	3	2	1	
- CPA to channel boundaries and/or buoys at the entrance	5	(4)	3	2	1	
- Vessel position with regard to ships at the berth	5	(4)	3	2	1	
- Maneuvering room at turning basin	5	(4)	3	2	1	
<b>Vessel Controllability</b>						
- Engine reserve	5	(4)	3	2	1	
- Rudder reserve	5	(4)	3	2	1	
- Course Control	5	(4)	3	2	1	
- Speed Control	5	(4)	3	2	1	
- Use of Tugs	5	4	3	2	1	
- Thruster reserve	5	(4)	3	2	1	

	←	Absolutely Safe	←	→	Not at all Safe	→
<b>Overall Safety</b>	5	(4)	3	2	1	

Comments: WITH SE WIND AREA SOUTH OF

WEST BASIN ENTRANCE USED, AREA BY

14A, AND ESPECIALLY EXTRA WIDENER

(over)



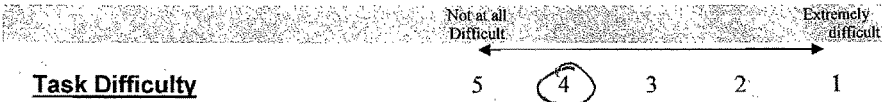

**Task Difficulty**

**Comments:**

SIZE OF VESSEL MAKES FOR MORE DIFFICULTY, BUT POWER AVAILABILITY AND EXTRA ROOM MAKES IT "DOABLE"

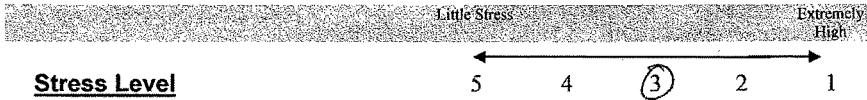

**Stress Level**

**Comments:**

SE WIND MEANS YOU HAVE TO "DRIVE" SOUTH, GETTING CLOSER TO MOORED VESSELS AND MARINAS.

**Additional Comments:**

\_\_\_\_\_

\_\_\_\_\_

\_\_\_\_\_

\_\_\_\_\_

\_\_\_\_\_

\_\_\_\_\_

## Port Canaveral 2007 Run Evaluation Form

Pilot # 2

Date March 10-11, 2007

Run #: 23 SCEN 24

Circle the number that best describes the run just completed:

	←	Extremely Satisfactory	←	→	Not at all Satisfactory	→
<b>Vessel Trackline</b>						
- Vessel position with regard to centerline	5	4	3	2	1	
- CPA to channel boundaries and/or buoys at the entrance	5	4	3	2	1	
- Vessel position with regard to ships at the berth	5	4	3	2	1	
- Maneuvering room at turning basin	5	4	3	2	1	
<b>Vessel Controllability</b>						
- Engine reserve	5	4	3	2	1	
- Rudder reserve	5	4	3	2	1	
- Course Control	5	4	3	2	1	
- Speed Control	5	4	3	2	1	
- Use of Tugs	5	4	3	2	1	
- Thruster reserve	5	4	3	2	1	

	←	Absolutely Safe	←	→	Not at all Safe	→
<b>Overall Safety</b>	5	4	3	2	1	

Comments: EXTRA CHANNEL WIDTH ALLOWED ME TO PASS AT A SLOWER SPEED FURTHER AWAY FROM SHIPS ON SOUTH SIDE

(over)

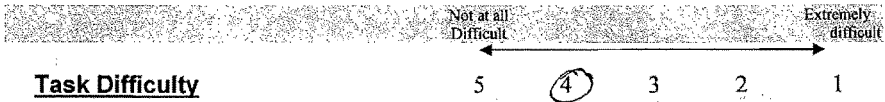

**Task Difficulty**

**Comments:**

SHIP HANDLED WELL, GOOD WK

---

---

---

---

---

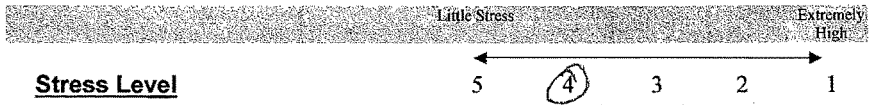

**Stress Level**

**Comments:**

GOOD SHIP, GOOD TUGS, GOOD WK,  
WIDE CHANNEL MADE FOR A SAFER AND  
LESS STRESSFUL TRANSIT.

---

---

---

---

---

**Additional Comments:**

---

---

---

---

---

---

---

---

---

---

## Port Canaveral 2007 Run Evaluation Form

Pilot # 2Date March 10-11, 2007Run #: 24 SCEN 25

Circle the number that best describes the run just completed:

	←	←	←	←	←
	Extremely Satisfactory				Not at all Satisfactory
<b>Vessel Trackline</b>					
- Vessel position with regard to centerline	5	④	3	2	1
- CPA to channel boundaries and/or buoys at the entrance	5	④	3	2	1
- Vessel position with regard to ships at the berth	⑤	4	3	2	1
- Maneuvering room at turning basin	⑤	4	3	2	1
<b>Vessel Controllability</b>					
- Engine reserve	5	④	3	2	1
- Rudder reserve	5	④	3	2	1
- Course Control	5	④	3	2	1
- Speed Control	5	④	3	2	1
- Use of Tugs	5	④	3	2	1
- Thruster reserve	5	4	3	2	1

	←	←	←	←	←
	Absolutely Safe				Not at all Safe
<b>Overall Safety</b>	5	④	3	2	1

Comments: EXTRA WIDENER ALLOWED SLOWER RATE OF TURN INBOUND, WHICH WOULD BE VERY HELPFUL IN ENSURING SAFETY WITH A "CRANKY" SHIP.

(over)

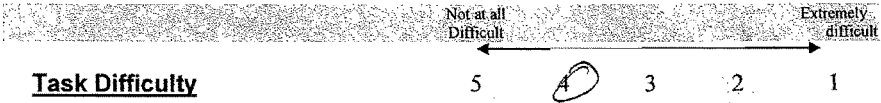

**Task Difficulty**

**Comments:**

EXTRA WIDTH, GOOD WX, GOOD SHIP CONTROL

---

---

---

---

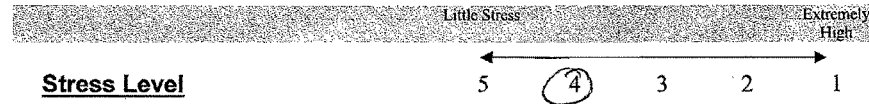

**Stress Level**

**Comments:**

AS ABOVE.

---

---

---

---

**Additional Comments:**

---

---

---

---

---

---

---

---

## Port Canaveral 2007 Run Evaluation Form

Pilot # 2Date March 10-11, 2007Run #: 25 SCEN 26

Circle the number that best describes the run just completed:

	←	Extremely Satisfactory	→	Not at all Satisfactory	→
<b>Vessel Trackline</b>					
- Vessel position with regard to centerline	5	(4)	3	2	1
- CPA to channel boundaries and/or buoys at the entrance	5	(4)	3	2	1
- Vessel position with regard to ships at the berth	5	(4)	3	2	1
- Maneuvering room at turning basin	(5)	4	3	2	1
<b>Vessel Controllability</b>					
- Engine reserve	5	(4)	3	2	1
- Rudder reserve	5	(4)	3	2	1
- Course Control	5	(4)	3	2	1
- Speed Control	5	(4)	3	2	1
- Use of Tugs	5	(4)	3	2	1
- Thruster reserve	5	4	3	2	1

	←	Absolutely Safe	→	Not at all Safe	→
<b>Overall Safety</b>	5	(4)	3	2	1

Comments: EVEN WITH WINDY CONDITIONS, THE

ADDITIONAL DEPTH AND CHANNEL WIDTH  
PROVIDED FOR AN INCREASED MARGIN OF  
SAFETY.

(over)

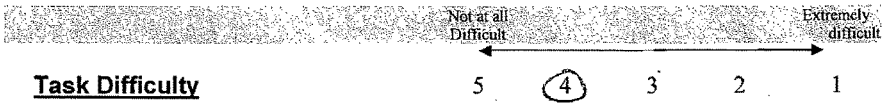

**Task Difficulty**

**Comments:**

GOOD SHIP, AND WIDE CHANNEL PROVIDED FOR LESS DIFFICULTY

---

---

---

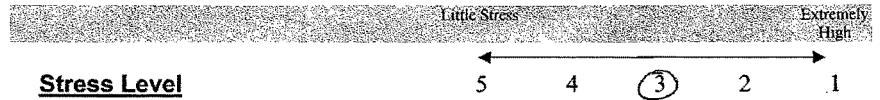

**Stress Level**

**Comments:**

EVEN IN WINDY CONDITIONS, THE COMBINATION OF GOOD SHIP CONTROL AND THE "IMPROVED CHANNEL" REDUCED STRESS LEVEL

---

---

---

**Additional Comments:**

---

---

---

---

---

---

---

## Port Canaveral 2007 Run Evaluation Form

Pilot # 2Date March 10-11, 2007Run #: 26 SCEN 30

Circle the number that best describes the run just completed:

	←—————→				
	Extremely Satisfactory				Not at all Satisfactory
<b>Vessel Trackline</b>					
- Vessel position with regard to centerline	5	4	3	②	1
- CPA to channel boundaries and/or buoys at the entrance	5	4	③	2	1
- Vessel position with regard to ships at the berth	5	4	③	2	1
- Maneuvering room at turning basin	5	④	3	2	1
<b>Vessel Controllability</b>					
- Engine reserve	5	④	3	2	1
- Rudder reserve	5	④	3	2	1
- Course Control	5	④	3	2	1
- Speed Control	5	④	3	2	1
- Use of Tugs	5	④	3	2	1
- Thruster reserve	5	4	3	2	1

	←—————→				
	Absolutely Safe				Not at all Safe
<b>Overall Safety</b>	5	④	3	2	1

Comments: THE IMPROVED CHANNEL SOUTH OF WEST BASIN WAS HELPFUL WITH STRONG SOUTH WIND; AND THE IMPROVED CHANNEL TO THE NORTH IN INNER/MIDDLE REACH ALLOWED ME TO REMAIN FURTHER FROM SHIPS ON SOUTH SIDE.

(over)



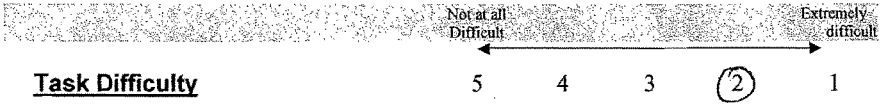

**Task Difficulty**

**Comments:**

EXTRA CHANNEL WIDTH WAS VERY  
NEEDED HERE WITH BALLAST TANKER  
IN HIGH WIND

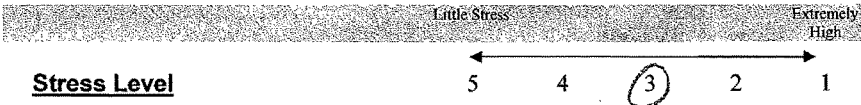

**Stress Level**

**Comments:**

MORE WIND = MORE STRESS

**Additional Comments:**

THIS MANEUVER IS SIMPLY NOT  
POSSIBLE WITHOUT PROPOSED IMPROVED  
CHANNEL. (TURNING 900' SHIP OFF WEST  
BASIN ENTRANCE.)

## Port Canaveral 2007 Run Evaluation Form

Pilot # 2

Date March 10-11, 2007

Run #: 27 SECON 27

Circle the number that best describes the run just completed:

	Extremely Satisfactory	←	→	Not at all Satisfactory		
<b>Vessel Trackline</b>						
- Vessel position with regard to centerline	5	(4)	3	2	1	
- CPA to channel boundaries and/or buoys at the entrance	5	(4)	3	2	1	
- Vessel position with regard to ships at the berth	5	(4)	3	2	1	
- Maneuvering room at turning basin	5	(4)	3	2	1	
<b>Vessel Controllability</b>						
- Engine reserve	5	(4)	3	2	1	
- Rudder reserve	5	(4)	3	2	1	
- Course Control	5	(4)	3	2	1	
- Speed Control	5	(4)	3	2	1	
- Use of Tugs	5	(4)	3	2	1	
- Thruster reserve	5	4	3	2	1	

	Absolutely Safe	←	→	Not at all Safe		
<b>Overall Safety</b>	5	(4)	3	2	1	

Comments: ADDITIONAL DREDGING MADE

FOR PLENTY OF DEEP WATER TO

SAFELY MANEUVER.

(over)

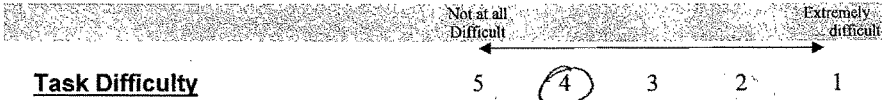

**Task Difficulty**

**Comments:**

GOOD SHIP CONTROL, WIND NOT MUCH OF A FACTOR WITH THIS DRAFT

---

---

---

---

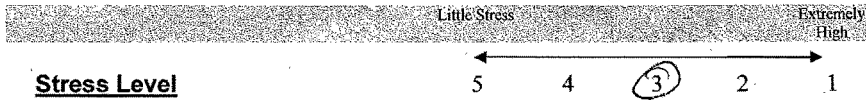

**Stress Level**

**Comments:**

HEAVY SHIP DUE TO DRAFT AND DOING AN "UNUSUAL" MANEUVER.

---

---

---

---

**Additional Comments:**

---

---

---

---

---

---

---

---

## Port Canaveral 2007 Run Evaluation Form

Pilot # 2Date March 10-11, 2007Run #: 28 SCEN 29

Circle the number that best describes the run just completed:

	←	Extremely Satisfactory	←	→	Not at all Satisfactory	→
<b>Vessel Trackline</b>						
- Vessel position with regard to centerline	5	④	3	2	1	
- CPA to channel boundaries and/or buoys at the entrance	5	④	3	2	1	
- Vessel position with regard to ships at the berth	5	④	3	2	1	
- Maneuvering room at turning basin	5	④	3	2	1	
<b>Vessel Controllability</b>						
- Engine reserve	5	④	3	2	1	
- Rudder reserve	5	④	3	2	1	
- Course Control	5	④	3	2	1	
- Speed Control	5	④	3	2	1	
- Use of Tugs	5	④	3	2	1	
- Thruster reserve	5	4	3	2	1	

	←	Absolutely Safe	←	→	Not at all Safe	→
<b>Overall Safety</b>	5	④	3	2	1	

Comments: EXTRA ROOM @ NW CORNER OF

INNER REACH ALLOWED VESSEL TO REMAIN  
A SAFER DISTANCE FROM MOORED VESSELS  
AT SOUTH LARGO PIER.

(over)

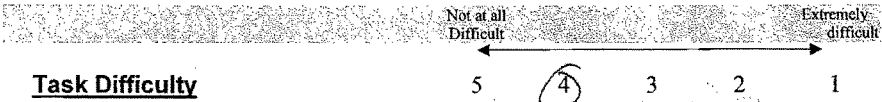

**Task Difficulty**

**Comments:**

GOOD SHIP POWER, EVEN IN HIGH WINDS, LARGE BASINS, MADE JOB SAFER.

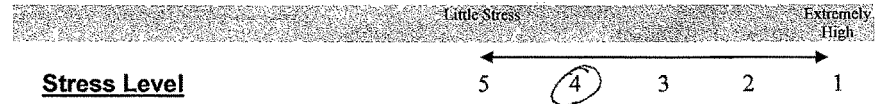

**Stress Level**

**Comments:**

AFTER MANY SIMULATIONS, I FELT COMFORTABLE WITH SHIP CONTROLS.

**Additional Comments:**

## Port Canaveral 2007 Run Evaluation Form

Pilot # 3

Date March 31-1 Apr, 2007

Run #: 30

Circle the number that best describes the run just completed:

	Extremely Satisfactory				Not at all Satisfactory
<b>Vessel Trackline</b>					
- Vessel position with regard to centerline	5	<span style="border: 1px solid black; border-radius: 50%; padding: 2px;">4</span>	3	2	1
- CPA to channel boundaries and/or buoys at the entrance	5	4	<span style="border: 1px solid black; border-radius: 50%; padding: 2px;">3</span>	2	1
- Vessel position with regard to ships at the berth	<span style="border: 1px solid black; border-radius: 50%; padding: 2px;">5</span>	4	3	2	1
- Maneuvering room at turning basin	<span style="border: 1px solid black; border-radius: 50%; padding: 2px;">5</span>	4	3	2	1
<b>Vessel Controllability</b>					
- Engine reserve	<span style="border: 1px solid black; border-radius: 50%; padding: 2px;">5</span>	4	3	2	1
- Rudder reserve	<span style="border: 1px solid black; border-radius: 50%; padding: 2px;">5</span>	4	3	2	1
- Course Control	<span style="border: 1px solid black; border-radius: 50%; padding: 2px;">5</span>	4	3	2	1
- Speed Control	<span style="border: 1px solid black; border-radius: 50%; padding: 2px;">5</span>	4	3	2	1
- Use of Tugs	<del>5</del>	<del>4</del>	3	2	1
- Thruster reserve	<span style="border: 1px solid black; border-radius: 50%; padding: 2px;">5</span>	4	3	2	1

	Absolutely Safe				Not at all Safe
<b>Overall Safety</b>	5	4	<span style="border: 1px solid black; border-radius: 50%; padding: 2px;">3</span>	2	1

Comments: GETTING USED TO POPS & PARADIMONES

---



---



---



---

(over)

## Port Canaveral 2007 Run Evaluation Form

Pilot # 3

Date March 31-1 Apr, 2007

Run #: 31

Circle the number that best describes the run just completed:

	←	Extremely Satisfactory	→	Not at all Satisfactory		
<b>Vessel Trackline</b>						
- Vessel position with regard to centerline	5	(4)	3	2	1	
- CPA to channel boundaries and/or buoys at the entrance	5	(4)	3	2	1	
- Vessel position with regard to ships at the berth	5	(4)	3	2	1	
- Maneuvering room at turning basin	(5)	4	3	2	1	
<b>Vessel Controllability</b>						
- Engine reserve	(5)	4	3	2	1	
- Rudder reserve	(5)	4	3	2	1	
- Course Control	5	(4)	3	2	1	
- Speed Control	(5)	(4)	3	2	1	
- Use of Tugs	5	(4)	3	2	1	
- Thruster reserve	5	(4)	3	2	1	

	←	Absolutely Safe	→	Not at all Satsf.		
<b>Overall Safety</b>	5	(4)	3	2	1	

Comments: \_\_\_\_\_

\_\_\_\_\_

\_\_\_\_\_

\_\_\_\_\_

(over)

## Port Canaveral 2007 Run Evaluation Form

Pilot # 3

Date March 31-1 Apr, 2007

Run #: 32

Circle the number that best describes the run just completed:

	Extremely Satisfactory	←	→		Not at all Satisfactory
<b>Vessel Trackline</b>					
- Vessel position with regard to centerline	5	←	(4)	3	2 1
- CPA to channel boundaries and/or buoys at the entrance	5	←	(4)	3	2 1
- Vessel position with regard to ships at the berth	5	←	(4)	3	2 1
- Maneuvering room at turning basin	(5)		4	3	2 1
<b>Vessel Controllability</b>					
- Engine reserve	(5)		4	3	2 1
- Rudder reserve	(5)		4	3	2 1
- Course Control	(5)		4	3	2 1
- Speed Control	(5)		4	3	2 1
- Use of Tugs	5	←	4	3	2 1
- Thruster reserve	(5)		4	3	2 1

	Absolutely Safe	←	→		Not at all Safe
<b>Overall Safety</b>	(5)		4	3	2 1

Comments: Extra Run to North Wharves here!

---



---



---

(over)



## Port Canaveral 2007 Run Evaluation Form

Pilot # 3

Date March 31-1 Apr, 2007

Run #: 33

Circle the number that best describes the run just completed:

	←	Extremely Satisfactory	←	→	Not at all Satisfactory	→
<b>Vessel Trackline</b>						
- Vessel position with regard to centerline	5	(4)	3	2	1	
- CPA to channel boundaries and/or buoys at the entrance	5	(4)	3	2	1	
- Vessel position with regard to ships at the berth	5	(4)	3	2	1	
- Maneuvering room at turning basin	(5)	4	3	2	1	
<b>Vessel Controllability</b>						
- Engine reserve	(5)	4	3	2	1	
- Rudder reserve	(5)	4	3	2	1	
- Course Control	5	(4)	3	2	1	
- Speed Control	5	(4)	3	2	1	
- Use of Tugs	5	4	3	2	1	
- Thruster reserve	5	(4)	3	2	1	

	←	Absolutely Safe	←	→	Not at all Safe	→
<b>Overall Safety</b>	5	4	3	2	1	

Comments: 1 SS. TIME OUT - KNOW WIDEE BUOY  
ARE NOW

(over)

## Port Canaveral 2007 Run Evaluation Form

Pilot # 3

Date March 31-1 Apr, 2007

Run #: 34

**Circle** the number that best describes the run just completed:

	←	Extremely Satisfactory	→	Not at all Satisfactory	→
<b>Vessel Trackline</b>					
- Vessel position with regard to centerline	5	(4)	3	2	1
- CPA to channel boundaries and/or buoys at the entrance	5	(4)	3	2	1
- Vessel position with regard to ships at the berth	5	(4)	3	2	1
- Maneuvering room at turning basin	(5)	4	3	2	1
<b>Vessel Controllability</b>					
- Engine reserve	(5)	4	3	2	1
- Rudder reserve	(5)	4	3	2	1
- Course Control	(5)	4	3	2	1
- Speed Control	5	4	3	(2)	1
- Use of Tugs	5	4	3	2	1
- Thruster reserve	(5)	4	3	2	1

	←	Absolutely Safe	→	Not at all safe	→
<b>Overall Safety</b>	5	(4)	3	2	1

Comments: SPEED?

---



---



---



---

(over)

## Port Canaveral 2007 Run Evaluation Form

Pilot # 3

Date March 31-1 Apr, 2007

Run #: 35

Circle the number that best describes the run just completed:

	← Extremely Satisfactory				Not at all Satisfactory →
<b>Vessel Trackline</b>					
- Vessel position with regard to centerline	5	(4)	3	2	1
- CPA to channel boundaries and/or buoys at the entrance	5	(4)	3	2	1
- Vessel position with regard to ships at the berth	5	(4)	3	2	1
- Maneuvering room at turning basin	(5)	(4)	3	2	1
<b>Vessel Controllability</b>					
- Engine reserve	(5)	4	3	2	1
- Rudder reserve	(5)	4	3	2	1
- Course Control	(5)	4	3	2	1
- Speed Control	(5)	4	3	2	1
- Use of Tugs	(5)	4	3	2	1
- Thruster reserve	(5)	4	3	2	1

	← Absolutely Safe				Not at all Safe →
<b>Overall Safety</b>	(5)	4	3	2	1

Comments: EXCELLEN!

---



---



---



---

(over)

## Port Canaveral 2007 Run Evaluation Form

Pilot # 3

Date March 31-1 Apr, 2007

Run #: 36

Circle the number that best describes the run just completed:

	←	Extremely Satisfactory			Not at all Satisfactory	→
<b>Vessel Trackline</b>						
- Vessel position with regard to centerline	5	(4)	3	2	1	
- CPA to channel boundaries and/or buoys at the entrance	5	(4)	3	2	1	
- Vessel position with regard to ships at the berth	5	(4)	3	2	1	
- Maneuvering room at turning basin	(5)	4	3	2	1	
<b>Vessel Controllability</b>						
- Engine reserve	(5)	4	3	2	1	
- Rudder reserve	(5)	4	3	2	1	
- Course Control	(5)	4	3	2	1	
- Speed Control	(3)	4	3	2	1	
- Use of Tugs	(5)	4	3	2	1	
- Thruster reserve	(5)	4	3	2	1	

	←	Absolutely Safe			Not at all Safe	→
<b>Overall Safety</b>	(5)	4	3	2	1	

Comments: NO PROBLEMS!

---



---



---



---

(over)

## Port Canaveral 2007 Run Evaluation Form

Pilot # 3

Date March 31-1 Apr, 2007

Run #: 37

Circle the number that best describes the run just completed:

	←	Extremely Satisfactory	→	Not at all Satisfactory	→
<b>Vessel Trackline</b>					
- Vessel position with regard to centerline	5	<span style="border: 1px solid black; border-radius: 50%; padding: 2px;">4</span>	3	2	1
- CPA to channel boundaries and/or buoys at the entrance	5	<span style="border: 1px solid black; border-radius: 50%; padding: 2px;">4</span>	3	2	1
- Vessel position with regard to ships at the berth	5	<span style="border: 1px solid black; border-radius: 50%; padding: 2px;">4</span>	3	2	1
- Maneuvering room at turning basin	<span style="border: 1px solid black; border-radius: 50%; padding: 2px;">5</span>	4	3	2	1
<b>Vessel Controllability</b>					
- Engine reserve	<span style="border: 1px solid black; border-radius: 50%; padding: 2px;">5</span>	4	3	2	1
- Rudder reserve	<span style="border: 1px solid black; border-radius: 50%; padding: 2px;">5</span>	4	3	2	1
- Course Control	<span style="border: 1px solid black; border-radius: 50%; padding: 2px;">5</span>	4	3	2	1
- Speed Control	<span style="border: 1px solid black; border-radius: 50%; padding: 2px;">5</span>	4	3	2	1
- Use of Tugs	<span style="border: 1px solid black; border-radius: 50%; padding: 2px;">5</span>	4	3	2	1
- Thruster reserve	<del>5</del>	<del>4</del>	<del>3</del>	<del>2</del>	1

	←	Absolutely Safe	→	Not at all Safe	→
<b>Overall Safety</b>	<span style="border: 1px solid black; border-radius: 50%; padding: 2px;">5</span>	4	3	2	1

Comments: \_\_\_\_\_

---



---



---



---

(over)

## Port Canaveral 2007 Run Evaluation Form

Pilot # 3

Date March 31-1 Apr, 2007

Run #: 38

Circle the number that best describes the run just completed:

	←	Extremely Satisfactory	←	→	Not at all Satisfactory	→
<b>Vessel Trackline</b>						
- Vessel position with regard to centerline	5	4	3	2	1	
- CPA to channel boundaries and/or buoys at the entrance	5	4	3	2	1	
- Vessel position with regard to ships at the berth	5	4	3	2	1	
- Maneuvering room at turning basin	5	4	3	2	1	
<b>Vessel Controllability</b>						
- Engine reserve	5	4	3	2	1	
- Rudder reserve	5	4	3	2	1	
- Course Control	5	4	3	2	1	
- Speed Control	5	4	3	2	1	
- Use of Tugs	5	4	3	2	1	
- Thruster reserve	5	4	3	2	1	

	←	Absolutely Safe	←	→	Not at all Safe	→
<b>Overall Safety</b>	5	4	3	2	1	

Comments: \_\_\_\_\_

\_\_\_\_\_

\_\_\_\_\_

\_\_\_\_\_

(over)

## Port Canaveral 2007 Run Evaluation Form

Pilot # 3

Date March 31-1 Apr, 2007

Run #: 39

Circle the number that best describes the run just completed:

	← Extremely Satisfactory				Not at all Satisfactory →
<b>Vessel Trackline</b>					
- Vessel position with regard to centerline	5	← 4	3	2	1
- CPA to channel boundaries and/or buoys at the entrance	5	← 4	3	2	1
- Vessel position with regard to ships at the berth	5	← 4	3	2	1
- Maneuvering room at turning basin	5	4	3	2	1
<b>Vessel Controllability</b>					
- Engine reserve	5	4	3	2	1
- Rudder reserve	5	4	3	2	1
- Course Control	5	4	3	2	1
- Speed Control	5	4	3	2	1
- Use of Tugs	5	4	3	2	1
- Thruster reserve	5	4	3	2	1

	← Absolutely Safe				Not at all Safe →
<b>Overall Safety</b>	5	4	3	2	1

Comments: \_\_\_\_\_

\_\_\_\_\_

\_\_\_\_\_

\_\_\_\_\_

(over)

## Port Canaveral 2007 Run Evaluation Form

Pilot # 3

Date March 31-1 Apr, 2007

Run #: 40

Circle the number that best describes the run just completed:

	← Extremely Satisfactory				Not at all Satisfactory →
<b>Vessel Trackline</b>					
- Vessel position with regard to centerline	5	4	3	2	1
- CPA to channel boundaries and/or buoys at the entrance	5	4	3	2	1
- Vessel position with regard to ships at the berth	5	4	3	2	1
- Maneuvering room at turning basin	5	4	3	2	1
<b>Vessel Controllability</b>					
- Engine reserve	5	4	3	2	1
- Rudder reserve	5	4	3	2	1
- Course Control	5	4	3	2	1
- Speed Control	5	4	3	2	1
- Use of Tugs	5	4	3	2	1
- Thruster reserve	<del>5</del>	<del>4</del>	<del>3</del>	2	1

	← Absolutely Safe				Not at all Safe →
<b>Overall Safety</b>	5	4	3	2	1

Comments: \_\_\_\_\_

\_\_\_\_\_

\_\_\_\_\_

\_\_\_\_\_

\_\_\_\_\_

(over)



## Port Canaveral 2007 Run Evaluation Form

Pilot #   3  

Date March 31-1 Apr, 2007

Run #:   41  

Circle the number that best describes the run just completed:

	Extremely Satisfactory				Not at all Satisfactory
<b>Vessel Trackline</b>					
- Vessel position with regard to centerline	5	<span style="border: 1px solid black; border-radius: 50%; padding: 2px;">4</span>	3	2	1
- CPA to channel boundaries and/or buoys at the entrance	5	<span style="border: 1px solid black; border-radius: 50%; padding: 2px;">4</span>	3	2	1
- Vessel position with regard to ships at the berth	5	<span style="border: 1px solid black; border-radius: 50%; padding: 2px;">4</span>	3	2	1
- Maneuvering room at turning basin	<span style="border: 1px solid black; border-radius: 50%; padding: 2px;">5</span>	4	3	2	1
<b>Vessel Controllability</b>					
- Engine reserve	<span style="border: 1px solid black; border-radius: 50%; padding: 2px;">5</span>	4	3	2	1
- Rudder reserve	<span style="border: 1px solid black; border-radius: 50%; padding: 2px;">5</span>	4	3	2	1
- Course Control	<span style="border: 1px solid black; border-radius: 50%; padding: 2px;">5</span>	4	3	2	1
- Speed Control	<span style="border: 1px solid black; border-radius: 50%; padding: 2px;">5</span>	4	3	2	1
- Use of Tugs	<span style="border: 1px solid black; border-radius: 50%; padding: 2px;">5</span>	4	3	2	1
- Thruster reserve	5	4	3	2	1

	Absolutely Safe				Not at all Safe
<b>Overall Safety</b>	<span style="border: 1px solid black; border-radius: 50%; padding: 2px;">5</span>	4	3	2	1

Comments: \_\_\_\_\_

\_\_\_\_\_

\_\_\_\_\_

\_\_\_\_\_

\_\_\_\_\_

(over)

## Port Canaveral 2007 Run Evaluation Form

Pilot # 3

Date March 31-1 Apr, 2007

Run #: 42

Circle the number that best describes the run just completed:

	←	Extremely Satisfactory		→	Not at all Satisfactory	
<b>Vessel Trackline</b>						
- Vessel position with regard to centerline		5	4	3	2	1
- CPA to channel boundaries and/or buoys at the entrance		5	4	3	2	1
- Vessel position with regard to ships at the berth		5	4	3	2	1
- Maneuvering room at turning basin		5	4	3	2	1
<b>Vessel Controllability</b>						
- Engine reserve		5	4	3	2	1
- Rudder reserve		5	4	3	2	1
- Course Control		5	4	3	2	1
- Speed Control		5	4	3	2	1
- Use of Tugs		5	4	3	2	1
- Thruster reserve		5	4	3	2	1

	←	Absolutely Safe		→	Not at all Safe	
<b>Overall Safety</b>		5	4	3	2	1

Comments: \_\_\_\_\_

---



---



---



---

(over)

## Port Canaveral 2007 Run Evaluation Form

Pilot # 3

Date March 31-1 Apr. 2007

Run #: 43

Circle the number that best describes the run just completed:

	Extremely Satisfactory				Not at all Satisfactory
<b>Vessel Trackline</b>					
- Vessel position with regard to centerline	<span style="border: 1px solid black; border-radius: 50%; padding: 2px;">5</span>	4	3	2	1
- CPA to channel boundaries and/or buoys at the entrance	<span style="border: 1px solid black; border-radius: 50%; padding: 2px;">5</span>	<span style="border: 1px solid black; border-radius: 50%; padding: 2px;">4</span>	3	2	1
- Vessel position with regard to ships at the berth	5	<span style="border: 1px solid black; border-radius: 50%; padding: 2px;">4</span>	3	2	1
- Maneuvering room at turning basin	<span style="border: 1px solid black; border-radius: 50%; padding: 2px;">5</span>	4	3	2	1
<b>Vessel Controllability</b>					
- Engine reserve	<span style="border: 1px solid black; border-radius: 50%; padding: 2px;">5</span>	4	3	2	1
- Rudder reserve	<span style="border: 1px solid black; border-radius: 50%; padding: 2px;">5</span>	4	3	2	1
- Course Control	<span style="border: 1px solid black; border-radius: 50%; padding: 2px;">5</span>	4	3	2	1
- Speed Control	<span style="border: 1px solid black; border-radius: 50%; padding: 2px;">5</span>	4	3	2	1
- Use of Tugs	<span style="border: 1px solid black; border-radius: 50%; padding: 2px;">5</span>	4	3	2	1
- Thruster reserve	5	4	3	2	1

	Absolutely Safe				Not at all Safe
<b>Overall Safety</b>	5	4	3	2	1

Comments: \_\_\_\_\_

\_\_\_\_\_

\_\_\_\_\_

\_\_\_\_\_

(over)

## Port Canaveral 2007 Run Evaluation Form

Pilot #   1  

Date   3/3/07   2007

Run #:   1  

**Circle** the number that best describes the run just completed:

	Extremely Satisfactory				Not at all Satisfactory
<b>Vessel Trackline</b>					
- Vessel position with regard to centerline	5	<b>4</b>	3	2	1
- CPA to channel boundaries and/or buoys at the entrance	<b>5</b>	4	3	2	1
- Vessel position with regard to ships at the berth	<b>5</b>	4	3	2	1
- Maneuvering room at turning basin	<b>5</b>	4	3	2	1
<b>Vessel Controllability</b>					
- Engine reserve	5	<b>4</b>	3	2	1
- Rudder reserve	<b>5</b>	4	3	2	1
- Course Control <i>N/A</i>	5	4	3	2	1
- Speed Control	<b>5</b>	4	3	2	1
- Use of Tugs <i>N/A</i>	5	4	3	2	1
- Thruster reserve	5	<b>4</b>	3	2	1

	Absolutely Safe				Not at all Safe
<b>Overall Safety</b>	5	<b>4</b>	3	2	1

Comments:   Familiarization run    
  Instrumentation    
 \_\_\_\_\_  
 \_\_\_\_\_  
 \_\_\_\_\_

(over)

## Port Canaveral 2007 Run Evaluation Form

Pilot # 1

Date 3/3/ 2007

Run #: 2

Circle the number that best describes the run just completed:

	←	Extremely Satisfactory	←	→	Not at all Satisfactory	→
<b>Vessel Trackline</b>						
- Vessel position with regard to centerline		<span style="border: 1px solid black; border-radius: 50%; padding: 2px;">5</span>	4	3	2	1
- CPA to channel boundaries and/or buoys at the entrance		<span style="border: 1px solid black; border-radius: 50%; padding: 2px;">5</span>	4	3	2	1
- Vessel position with regard to ships at the berth		<span style="border: 1px solid black; border-radius: 50%; padding: 2px;">5</span>	4	3	2	1
- Maneuvering room at turning basin		<span style="border: 1px solid black; border-radius: 50%; padding: 2px;">5</span>	4	3	2	1
<b>Vessel Controllability</b>						
- Engine reserve		<span style="border: 1px solid black; border-radius: 50%; padding: 2px;">5</span>	4	3	2	1
- Rudder reserve		<span style="border: 1px solid black; border-radius: 50%; padding: 2px;">5</span>	4	3	2	1
- Course Control <i>N/A</i>		<span style="border: 1px solid black; border-radius: 50%; padding: 2px;">5</span>	<span style="border: 1px solid black; border-radius: 50%; padding: 2px;">4</span>	3	2	1
- Speed Control		<span style="border: 1px solid black; border-radius: 50%; padding: 2px;">5</span>	4	3	2	1
- Use of Tugs <i>N/A</i>		<span style="border: 1px solid black; border-radius: 50%; padding: 2px;">5</span>	4	3	2	1
- Thruster reserve		<span style="border: 1px solid black; border-radius: 50%; padding: 2px;">5</span>	4	3	2	1

	←	Absolutely Safe	←	→	Not at all Safe	→
<b>Overall Safety</b>		<span style="border: 1px solid black; border-radius: 50%; padding: 2px;">5</span>	4	3	2	1

Comments: Having N. Jetty cut 160' N  
increases channel safety by allowing  
vessel to remain + 30m North of Range &  
& reduces bank cushion/suction effect.

(over)

## Port Canaveral 2007 Run Evaluation Form

Pilot # 1Date 3/3 2007Run #: 3

Circle the number that best describes the run just completed:

	← Extremely Satisfactory				Not at all Satisfactory →
<b>Vessel Trackline</b>					
- Vessel position with regard to centerline	5	4	3	2	1
- CPA to channel boundaries and/or buoys at the entrance	5	4	3	2	1
- Vessel position with regard to ships at the berth	5	4	3	2	1
- Maneuvering room at turning basin	5	4	3	2	1
<b>Vessel Controllability</b>					
- Engine reserve	5	4	3	2	1
- Rudder reserve	5	4	3	2	1
- Course Control <i>N/A</i>	5	4	3	2	1
- Speed Control	5	4	3	2	1
- Use of Tugs <i>N/A</i>	5	4	3	2	1
- Thruster reserve	5	4	3	2	1

	← Absolutely Safe				Not at all Safe →
<b>Overall Safety</b>	5	4	3	2	1

Comments:

*25 kts NW wind imperative to have N'ly channel widened 100 ft Jetty to Middle Basin & from Middle Basin to West Basin cut to South. 100 ft enables stern to safely transit harbor speeds 6 kts.*

(over)

## Port Canaveral 2007 Run Evaluation Form

Pilot # 1

Date 3/3 2007

Run #: 4

Circle the number that best describes the run just completed:

	Extremely Satisfactory				Not at all Satisfactory
<b>Vessel Trackline</b>					
- Vessel position with regard to centerline	5	4	3	2	1
- CPA to channel boundaries and/or buoys at the entrance	5	4	3	2	1
- Vessel position with regard to ships at the berth	5	4	3	2	1
- Maneuvering room at turning basin	5	4	3	2	1
<b>Vessel Controllability</b>					
- Engine reserve	5	4	3	2	1
- Rudder reserve	5	4	3	2	1
- Course Control	5	4	3	2	1
- Speed Control	5	4	3	2	1
- Use of Tugs <i>n/a</i>	5	4	3	2	1
- Thruster reserve	5	4	3	2	1

	Absolutely Safe				Not at all Safe
<b>Overall Safety</b>	5	4	3	2	1

Comments: SE 1/4 15 kts can be done adequately with existing channel however widening of south channel dredging must be done in order to safely transit without surge of vessels moored & entering West basin to allow stern port get from channel edge.

(over)

## Port Canaveral 2007 Run Evaluation Form

Pilot # 1

Date 3/3 2007

Run #: 5

Circle the number that best describes the run just completed:

	Extremely Satisfactory				Not at all Satisfactory
<b>Vessel Trackline</b>					
- Vessel position with regard to centerline	<span style="border: 1px solid black; border-radius: 50%; padding: 2px;">5</span>	4	3	2	1
- CPA to channel boundaries and/or buoys at the entrance	<span style="border: 1px solid black; border-radius: 50%; padding: 2px;">5</span>	4	3	2	1
- Vessel position with regard to ships at the berth	<span style="border: 1px solid black; border-radius: 50%; padding: 2px;">5</span>	4	3	2	1
- Maneuvering room at turning basin	<span style="border: 1px solid black; border-radius: 50%; padding: 2px;">5</span>	4	3	2	1
<b>Vessel Controllability</b>					
- Engine reserve	<span style="border: 1px solid black; border-radius: 50%; padding: 2px;">5</span>	4	3	2	1
- Rudder reserve <i>N/A</i>	5	4	3	2	1
- Course Control	5	<span style="border: 1px solid black; border-radius: 50%; padding: 2px;">4</span>	3	2	1
- Speed Control	<span style="border: 1px solid black; border-radius: 50%; padding: 2px;">5</span>	4	3	2	1
- Use of Tugs <i>N/A</i>	5	4	3	2	1
- Thruster reserve	5	<span style="border: 1px solid black; border-radius: 50%; padding: 2px;">4</span>	3	2	1

	Absolutely Safe				Not at all Safe
<b>Overall Safety</b>	5	4	3	<span style="border: 1px solid black; border-radius: 50%; padding: 2px;">2</span>	1

Comments: 25 kt<sup>s</sup> SE wind inbound widened  
utilized dredged area to South made it  
possible to reduce speed of set up properly and range.  
Entering West Basin vessel set/drift into North  
dredged area to facilitate turn into West Basin  
difficult to negotiate turn into West Basin  
without the dredged area (North) of turn vessel  
in basin



## Port Canaveral 2007 Run Evaluation Form

Pilot # 1

Date 3/3 2007

Run #: 6

Circle the number that best describes the run just completed:

	← Extremely Satisfactory				Not at all Satisfactory →
<b>Vessel Trackline</b>					
- Vessel position with regard to centerline	(5)	4	3	2	1
- CPA to channel boundaries and/or buoys at the entrance	5	(4)	3	2	1
- Vessel position with regard to ships at the berth	(5)	4	3	2	1
- Maneuvering room at turning basin <i>N/A</i>	5	4	3	2	1
<b>Vessel Controllability</b>					
- Engine reserve	(5)	4	3	2	1
- Rudder reserve	(5)	4	3	2	1
- Course Control	5	(4)	3	2	1
- Speed Control	5	(4)	3	2	1
- Use of Tugs <i>N/A</i>	5	4	3	2	1
- Thruster reserve	5	(4)	3	2	1

	← Absolutely Safe				Not at all Safe →
<b>Overall Safety</b>	5	(4)	(3)	2	1

Comments: Only 25Kts vessels bow skirted along existing channel limits from Middle to East basin. Widener improvements allowed for reduced rate of turn 16°/or less to negotiate outboard turn 090 → 360

(over)

### Port Canaveral 2007 Run Evaluation Form

Pilot # 1

Date 3/3 2007

Run #: 7 F 8 (RESTART)

Circle the number that best describes the run just completed:

<b>Vessel Trackline</b>	←	Extremely Satisfactory	4	3	2	1	→	Not at all Satisfactory
- Vessel position with regard to centerline		<span style="border: 1px solid black; border-radius: 50%; padding: 2px;">5</span>	4	3	2	1		
- CPA to channel boundaries and/or buoys at the entrance		<span style="border: 1px solid black; border-radius: 50%; padding: 2px;">5</span>	4	3	2	1		
- Vessel position with regard to ships at the berth		<span style="border: 1px solid black; border-radius: 50%; padding: 2px;">5</span>	4	3	2	1		
- Maneuvering room at turning basin		5	<span style="border: 1px solid black; border-radius: 50%; padding: 2px;">4</span>	3	2	1		
<b>Vessel Controllability</b>	←	Extremely Satisfactory	4	3	2	1	→	Not at all Satisfactory
- Engine reserve		<span style="border: 1px solid black; border-radius: 50%; padding: 2px;">5</span>	4	3	2	1		
- Rudder reserve		<span style="border: 1px solid black; border-radius: 50%; padding: 2px;">5</span>	4	3	2	1		
- Course Control		5	<span style="border: 1px solid black; border-radius: 50%; padding: 2px;">4</span>	3	2	1		
- Speed Control		<span style="border: 1px solid black; border-radius: 50%; padding: 2px;">5</span>	4	3	2	1		
- Use of Tugs <i>N/A</i>		5	4	3	2	1		
- Thruster reserve		5	<span style="border: 1px solid black; border-radius: 50%; padding: 2px;">4</span>	3	2	1		

<b>Overall Safety</b>	←	Absolutely Safe	4	3	2	1	→	Not at all Safe
Overall Safety		5	4	3	2	1		

Comments: *SE 1/4 R5K's existing channel can be utilized but without any safety margin. Need for 5'ly dredging West - Middle Basin in order to negotiate safe passage tanker berth. Outboard widene reduces rate of turn necessary 90° - 7.1300 and reduces radius arc of turn.* (over)

## Port Canaveral 2007 Run Evaluation Form

Pilot # 1Date 3/4 2007Run #: 9

Circle the number that best describes the run just completed:

	←	Extremely Satisfactory	←	→	Not at all Satisfactory	→
<b>Vessel Trackline</b>						
- Vessel position with regard to centerline	5	(4)	3	2	1	
- CPA to channel boundaries and/or buoys at the entrance	(5)	4	3	2	1	
- Vessel position with regard to ships at the berth	(5)	4	3	2	1	
- Maneuvering room at turning basin	(5)	4	3	2	1	
<b>Vessel Controllability</b>						
- Engine reserve	(5)	4	3	2	1	
- Rudder reserve	(5)	4	3	2	1	
- Course Control	5	(4)	3	2	1	
- Speed Control	5	(4)	3	2	1	
- Use of Tugs	5	(4)	3	2	1	
- Thruster reserve N/A	5	4	3	2	1	

	←	Absolutely Safe	←	→	Not at all Safe	→
<b>Overall Safety</b>	5	4	3	2	1	

Comments: North dredged area East Basin → Middle Basin - essential to reduce bank cushion/suction effect. Also allows widening channel reduces surge effect on vessels moored along South side of channel. Also, opens constricted area South Cargo Pier 1 and Posiden's berth (over) North.

## Port Canaveral 2007 Run Evaluation Form

Pilot # 1Date 3/4 2007Run #: 10

Circle the number that best describes the run just completed:

	Extremely Satisfactory				Not at all Satisfactory
<b>Vessel Trackline</b>					
- Vessel position with regard to centerline	(5)	4	3	2	1
- CPA to channel boundaries and/or buoys at the entrance	(5)	4	3	2	1
- Vessel position with regard to ships at the berth	(5)	4	3	2	1
- Maneuvering room at turning basin	(5)	4	3	2	1
<b>Vessel Controllability</b>					
- Engine reserve	5	(4)	3	2	1
- Rudder reserve	(5)	4	3	2	1
- Course Control	(5)	4	3	2	1
- Speed Control	5	(4)	3	2	1
- Use of Tugs	(5)	4	3	2	1
- Thruster reserve N/A	5	4	3	2	1

	Absolutely Safe				Not at all Safe
<b>Overall Safety</b>	5	4	3	2	1

Comments: Added vessels Poseidon East Berth - North and South side cargo pier 1 - added degree of difficulty entering Middle Basin, requiring more exactness in vessel positioning in channel & maneuvering in Middle Basin.

(over)

## Port Canaveral 2007 Run Evaluation Form

Pilot # 1

Date 3/4 2007

Run #: 11

Circle the number that best describes the run just completed:

	Extremely Satisfactory				Not at all Satisfactory
<b>Vessel Trackline</b>					
- Vessel position with regard to centerline	<span style="border: 1px solid black; border-radius: 50%; padding: 2px;">5</span>	4	3	2	1
- CPA to channel boundaries and/or buoys at the entrance	<span style="border: 1px solid black; border-radius: 50%; padding: 2px;">5</span>	4	3	2	1
- Vessel position with regard to ships at the berth	<span style="border: 1px solid black; border-radius: 50%; padding: 2px;">5</span>	4	3	2	1
- Maneuvering room at turning basin	5	<span style="border: 1px solid black; border-radius: 50%; padding: 2px;">4</span>	3	2	1
<b>Vessel Controllability</b>					
- Engine reserve	<span style="border: 1px solid black; border-radius: 50%; padding: 2px;">5</span>	4	3	2	1
- Rudder reserve	<span style="border: 1px solid black; border-radius: 50%; padding: 2px;">5</span>	4	3	2	1
- Course Control	5	<span style="border: 1px solid black; border-radius: 50%; padding: 2px;">4</span>	3	2	1
- Speed Control	<span style="border: 1px solid black; border-radius: 50%; padding: 2px;">5</span>	4	3	2	1
- Use of Tugs	<span style="border: 1px solid black; border-radius: 50%; padding: 2px;">5</span>	4	3	2	1
- Thruster reserve N/A	5	4	3	2	1

	Absolutely Safe				Not at all Safe
<b>Overall Safety</b>	5	<span style="border: 1px solid black; border-radius: 50%; padding: 2px;">4</span>	3	2	1

Comments: Dredging project from N. Jetty to Middle Basin allows for vessels hydrodynamic effect to be reduced greatly reducing surge upon moored vessels.

(over)

## Port Canaveral 2007 Run Evaluation Form

Pilot # 1

Date 3/4 2007

Run #: 12

Circle the number that best describes the run just completed:

	←	Extremely Satisfactory				→	Not at all Satisfactory
<b>Vessel Trackline</b>							
- Vessel position with regard to centerline	5	4	3	2	1		
- CPA to channel boundaries and/or buoys at the entrance	5	4	3	2	1		
- Vessel position with regard to ships at the berth	5	4	3	2	1		
- Maneuvering room at turning basin	5	4	3	2	1		
<b>Vessel Controllability</b>							
- Engine reserve	5	4	3	2	1		
- Rudder reserve	5	4	3	2	1		
- Course Control	5	4	3	2	1		
- Speed Control	5	4	3	2	1		
- Use of Tugs	5	4	3	2	1		
- Thruster reserve N/A	5	4	3	2	1		

	←	Absolutely Safe				→	Not at all Safe
<b>Overall Safety</b>	5	4	3	2	1		

Comments: SE'ly winds utilized windward improvement to maintain vessel position in channel.

---



---



---

(over)

## Port Canaveral 2007 Run Evaluation Form

Pilot # 1

Date 3/4 2007

Run #: 13

Circle the number that best describes the run just completed:

	Extremely Satisfactory				Not at all Satisfactory
<b>Vessel Trackline</b>					
- Vessel position with regard to centerline	(5)	4	3	2	1
- CPA to channel boundaries and/or buoys at the entrance	(5)	4	3	2	1
- Vessel position with regard to ships at the berth	(5)	4	3	2	1
- Maneuvering room at turning basin	(3)	4	3	2	1
<b>Vessel Controllability</b>					
- Engine reserve	5	(4)	3	2	1
- Rudder reserve	(5)	4	3	2	1
- Course Control	5	(4)	3	2	1
- Speed Control	5	(4)	3	2	1
- Use of Tugs	(5)	4	3	2	1
- Thruster reserve N/A	5	4	3	2	1

	Absolutely Safe				Not at all Safe
<b>Overall Safety</b>	5	4	3	2	1

Comments: SE'ly winds & skts necessitated utilizing  
Oppside Widener improvements to allow for set/drift  
allowing vessel to remain on range centerline/lineup.

(over)

## Port Canaveral 2007 Run Evaluation Form

Pilot # 1

Date 3/4 2007

Run #: 14

Circle the number that best describes the run just completed:

	← Extremely Satisfactory				→ Not at all Satisfactory
<b>Vessel Trackline</b>					
- Vessel position with regard to centerline	5	4	3	2	1
- CPA to channel boundaries and/or buoys at the entrance	5	4	3	2	1
- Vessel position with regard to ships at the berth	5	4	3	2	1
- Maneuvering room at turning basin	5	4	3	2	1
<b>Vessel Controllability</b>					
- Engine reserve	5	4	3	2	1
- Rudder reserve	5	4	3	2	1
- Course Control	5	4	3	2	1
- Speed Control	5	4	3	2	1
- Use of Tugs	5	4	3	2	1
- Thruster reserve <i>N/A</i>	5	4	3	2	1

	← Absolutely Safe				→ Not at all Safe
<b>Overall Safety</b>	5	4	3	2	1

Comments: \_\_\_\_\_  
 \_\_\_\_\_  
 \_\_\_\_\_  
 \_\_\_\_\_

(over)



## Port Canaveral 2007 Run Evaluation Form

Pilot # 1

Date 3/4 2007

Run #: 15

Circle the number that best describes the run just completed:

	←	Extremely Satisfactory				Not at all Satisfactory	→
<b>Vessel Trackline</b>							
- Vessel position with regard to centerline	5	4	3	2	1		
- CPA to channel boundaries and/or buoys at the entrance	5	4	3	2	1		
- Vessel position with regard to ships at the berth	5	4	3	2	1		
- Maneuvering room at turning basin	5	4	3	2	1		
<b>Vessel Controllability</b>							
- Engine reserve	5	4	3	2	1		
- Rudder reserve	5	4	3	2	1		
- Course Control	5	4	3	2	1		
- Speed Control	5	4	3	2	1		
- Use of Tugs	5	4	3	2	1		
- Thruster reserve <i>r/a</i>	5	4	3	2	1		

	←	Absolutely Safe				Not at all Safe	→
<b>Overall Safety</b>	5	4	3	2	1		

Comments: Turning and 800' vessel off West  
Turning Basin entrance cannot be safely accomplished  
without channel dredging improvements.  
Currently turning 600 ft vessels in the area  
safely

(over)

## Port Canaveral 2007 Run Evaluation Form

Pilot # 4

Date April 21, 2007

Run #: 44

Circle the number that best describes the run just completed:

	← Extremely Satisfactory				Not at all Satisfactory →
<b>Vessel Trackline</b>					
- Vessel position with regard to centerline	5	4	3	2	1
- CPA to channel boundaries and/or buoys at the entrance	5	4	3	2	1
- Vessel position with regard to ships at the berth	5	4	3	2	1
- Maneuvering room at turning basin	5	4	3	2	1
<b>Vessel Controllability</b>					
- Engine reserve	5	4	3	2	1
- Rudder reserve	5	4	3	2	1
- Course Control	5	4	3	2	1
- Speed Control	5	4	3	2	1
- Use of Tugs	5	4	3	2	1
- Thruster reserve	5	4	3	2	1

	← Absolutely Safe				Not at all Safe →
<b>Overall Safety</b>	5	4	3	2	1

Comments: \_\_\_\_\_

---



---



---



---

(over)

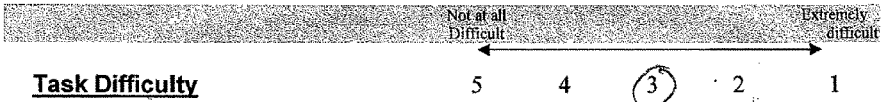

**Task Difficulty**

**Comments:**

---

---

---

---

---

---

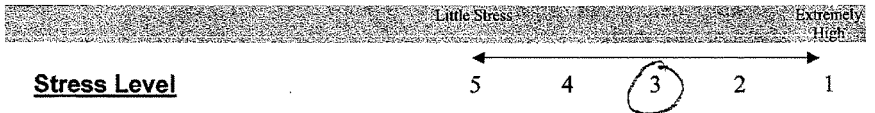

**Stress Level**

**Comments:**

---

---

---

---

---

---

**Additional Comments:**

---

---

---

---

---

---

## Port Canaveral 2007 Run Evaluation Form

Pilot # 4

Date April 21, 22, 2007

Run #: 45

Circle the number that best describes the run just completed:

	←	Extremely Satisfactory				Not at all Satisfactory	→
<b>Vessel Trackline</b>							
- Vessel position with regard to centerline		<span style="border: 1px solid black; border-radius: 50%; padding: 2px;">5</span>	4	3	2	1	
- CPA to channel boundaries and/or buoys at the entrance		<span style="border: 1px solid black; border-radius: 50%; padding: 2px;">5</span>	4	3	2	1	
- Vessel position with regard to ships at the berth		<span style="border: 1px solid black; border-radius: 50%; padding: 2px;">5</span>	4	3	2	1	
- Maneuvering room at turning basin		<span style="border: 1px solid black; border-radius: 50%; padding: 2px;">5</span>	4	3	2	1	
<b>Vessel Controllability</b>							
- Engine reserve		<span style="border: 1px solid black; border-radius: 50%; padding: 2px;">5</span>	4	3	2	1	
- Rudder reserve		5	<span style="border: 1px solid black; border-radius: 50%; padding: 2px;">4</span>	3	2	1	
- Course Control		<span style="border: 1px solid black; border-radius: 50%; padding: 2px;">5</span>	4	3	2	1	
- Speed Control		<span style="border: 1px solid black; border-radius: 50%; padding: 2px;">5</span>	4	3	2	1	
- Use of Tugs		5	4	3	2	1	
- Thruster reserve		<span style="border: 1px solid black; border-radius: 50%; padding: 2px;">5</span>	4	3	2	1	

	←	Absolutely Safe				Not at all Safe	→
<b>Overall Safety</b>		5	4	3	2	1	

Comments: \_\_\_\_\_

---



---



---



---

(over)

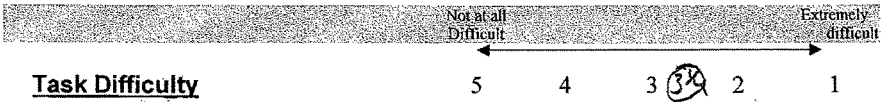

**Task Difficulty**

**Comments:**

---

---

---

---

---

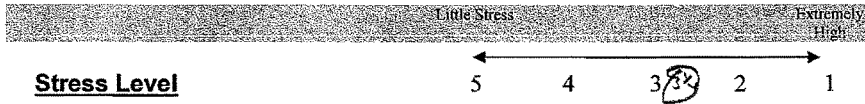

**Stress Level**

**Comments:**

---

---

---

---

---

**Additional Comments:**

---

---

---

---

---

---

---

---

## Port Canaveral 2007 Run Evaluation Form

Pilot # 4Date April 21-22, 2007Run #: 46

Circle the number that best describes the run just completed:

	Extremely Satisfactory				Not at all Satisfactory
<b>Vessel Trackline</b>					
- Vessel position with regard to centerline	5	<span style="border: 1px solid black; border-radius: 50%; padding: 2px;">4</span>	3	2	1
- CPA to channel boundaries and/or buoys at the entrance	<span style="border: 1px solid black; border-radius: 50%; padding: 2px;">5</span>	4	3	2	1
- Vessel position with regard to ships at the berth	5	<span style="border: 1px solid black; border-radius: 50%; padding: 2px;">4</span>	3	2	1
- Maneuvering room at turning basin	<span style="border: 1px solid black; border-radius: 50%; padding: 2px;">5</span>	4	3	2	1
<b>Vessel Controllability</b>					
- Engine reserve	<span style="border: 1px solid black; border-radius: 50%; padding: 2px;">5</span>	4	3	<span style="border: 1px solid black; border-radius: 50%; padding: 2px;">2</span>	1
- Rudder reserve	5	4	3	<span style="border: 1px solid black; border-radius: 50%; padding: 2px;">2</span>	1
- Course Control	<span style="border: 1px solid black; border-radius: 50%; padding: 2px;">5</span>	4	3	2	1
- Speed Control	<span style="border: 1px solid black; border-radius: 50%; padding: 2px;">5</span>	4	3	2	1
- Use of Tugs	5	4	3	2	1
- Thruster reserve	<span style="border: 1px solid black; border-radius: 50%; padding: 2px;">5</span>	4	3	2	1

	Absolutely Safe				Not at all Safe
<b>Overall Safety</b>					
	5	4	3	2	1

Comments: On this run I would have liked

to have had the ship closer to the North side between EAST Basin & Middle Basin. I had the ship too close to the centerline which was not the optimal position. I would have preferred to have been closer to the north using some of the north dredged area.

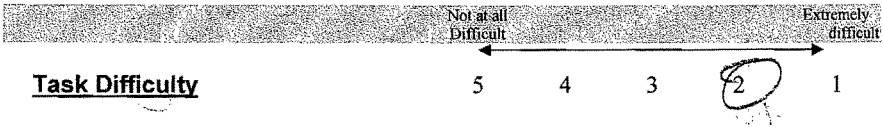

**Task Difficulty**

**Comments:**

---

---

---

---

---

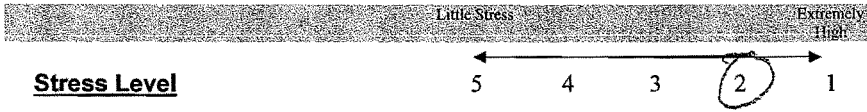

**Stress Level**

**Comments:**

---

---

---

---

---

**Additional Comments:**

I noticed that I had to use a lot of rudder angle on the pods at times full rudder giving no reserve on the rudder at 6 Kts with this wind condition.

## Port Canaveral 2007 Run Evaluation Form

Pilot # 4

Date April 21, 2007

Run #: 47

Circle the number that best describes the run just completed:

	Extremely Satisfactory				Not at all Satisfactory
<b>Vessel Trackline</b>					
- Vessel position with regard to centerline	<u>5</u>	4	3	2	1
- CPA to channel boundaries and/or buoys at the entrance	<u>5</u>	4	3	2	1
- Vessel position with regard to ships at the berth	5	<u>4</u>	3	2	1
- Maneuvering room at turning basin	<u>5</u>	4	3	2	1
<b>Vessel Controllability</b>					
- Engine reserve	<u>5</u>	4	3	2	1
- Rudder reserve	5	4	<u>3</u>	2	1
- Course Control	<u>5</u>	4	3	2	1
- Speed Control	<u>5</u>	4	3	2	1
- Use of Tugs	5	4	3	2	1
- Thruster reserve	<u>5</u>	4	3	2	1

	Absolutely Safe				Not at all Safe
<b>Overall Safety</b>	5	4	3	2	1

Comments: On this outbound run I held the ship tight on the north bank in contrast to the inbound run with NW 25 knots of wind, where I was closer to the centerline. Being tight to the north was better to keep the ship away from ships moored on the south side.

between middle of EAST A-6/1/2



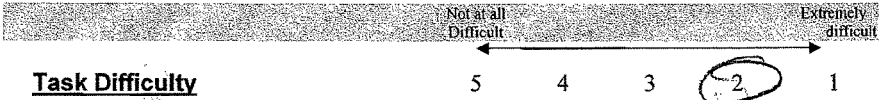

**Task Difficulty**

**Comments:**

---

---

---

---

---

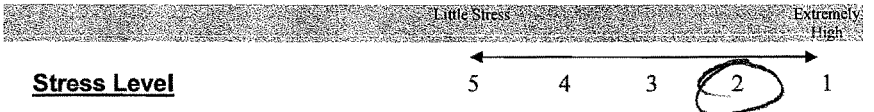

**Stress Level**

**Comments:**

---

---

---

---

---

**Additional Comments:**

---

---

---

---

---

---

---

---

## Port Canaveral 2007 Run Evaluation Form

Pilot # 4

Date April 21/22, 2007

Run #: 48

Circle the number that best describes the run just completed:

	Extremely Satisfactory				Not at all Satisfactory
<b>Vessel Trackline</b>					
- Vessel position with regard to centerline	5	4	3	2	1
- CPA to channel boundaries and/or buoys at the entrance	5	4	3	2	1
- Vessel position with regard to ships at the berth	5	4	3	2	1
- Maneuvering room at turning basin	5	4	3	2	1
<b>Vessel Controllability</b>					
- Engine reserve	5	4	3	2	1
- Rudder reserve	5	4	3	2	1
- Course Control	5	4	3	2	1
- Speed Control	5	4	3	2	1
- Use of Tugs	5	4	3	2	1
- Thruster reserve	5	4	3	2	1

	Absolutely Safe				Not at all Safe
<b>Overall Safety</b>	5	4	3	2	1

Comments: On this run I had the ship to the south of centerline a little more than necessary between EAST Basin + Middle Basin for the wind conditions. The dredged area on the north side allows for giving more room to ships on the south docks.

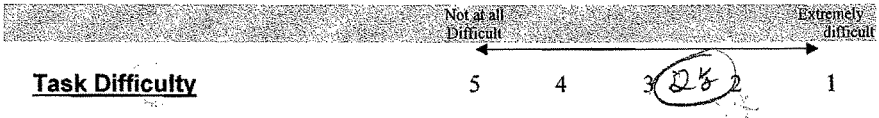

**Task Difficulty**

**Comments:**

---

---

---

---

---

---

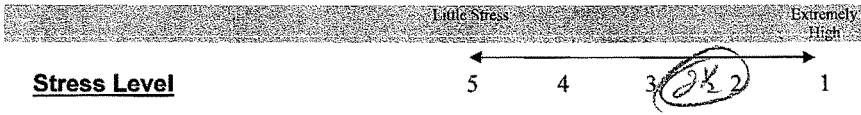

**Stress Level**

**Comments:**

---

---

---

---

---

---

**Additional Comments:**

---

---

---

---

---

---

## Port Canaveral 2007 Run Evaluation Form

Pilot # 4

Date April 21/22, 2007

Run #: 49

Circle the number that best describes the run just completed:

	Extremely Satisfactory					Not at all Satisfactory
<b>Vessel Trackline</b>						
- Vessel position with regard to centerline	5	<b>4</b>	3	2	1	
- CPA to channel boundaries and/or buoys at the entrance	5	4	<b>3</b>	2	1	
- Vessel position with regard to ships at the berth	5	<b>4</b>	3	2	1	
- Maneuvering room at turning basin	<b>5</b>	4	3	2	1	
<b>Vessel Controllability</b>						
- Engine reserve	<b>5</b>	4	3	2	1	
- Rudder reserve	5	4	<b>3</b>	2	1	
- Course Control	<b>5</b>	4	3	2	1	
- Speed Control	<b>5</b>	4	3	2	1	
- Use of Tugs	5	4	3	2	1	
- Thruster reserve	<b>5</b>	4	3	2	1	

	Absolutely Safe				Not at all Safe
<b>Overall Safety</b>	5	<b>4</b>	3	2	1

Comments:

*on the outside turn at the final part, the vessel set to the red) as shaped up on to 130 leg - had I kept the vessel tighter on the green in the new dredged area I could have kept her on the centerline. (over)*

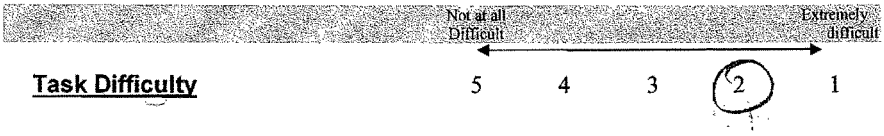

**Task Difficulty**

**Comments:**

---

---

---

---

---

---

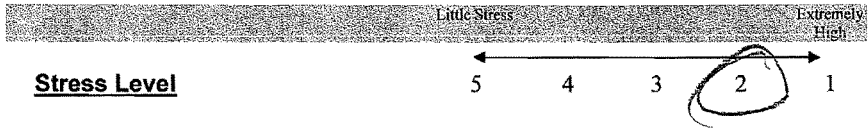

**Stress Level**

**Comments:**

---

---

---

---

---

---

**Additional Comments:**

---

---

---

---

---

---

## Port Canaveral 2007 Run Evaluation Form

Pilot # 4

Date April 21-22, 2007

Run #: 50

Circle the number that best describes the run just completed:

	←	Extremely Satisfactory	←	→	Not at all Satisfactory	→
<b>Vessel Trackline</b>						
- Vessel position with regard to centerline	5	4	3	2	1	
- CPA to channel boundaries and/or buoys at the entrance	5	4	3	2	1	
- Vessel position with regard to ships at the berth	5	4	3 1/2	2	1	
- Maneuvering room at turning basin	5	4	3	2	1	
<b>Vessel Controllability</b>						
- Engine reserve	5	4	3	2	1	
- Rudder reserve	5	4	3	2	1	
- Course Control	5	4	3 1/2	2	1	
- Speed Control	5	4	3	2	1	
- Use of Tugs	5	4	3	2	1	
- Thruster reserve	5	4	3	2	1	

	←	Absolutely Safe	←	→	Not at all Safe	→
<b>Overall Safety</b>	5	3 1/2	2	1		

Comments: Tos tight on channel boundary coming through jetties

---



---



---

(over)

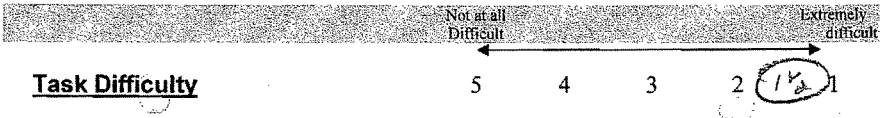

**Task Difficulty**

**Comments:**

---

---

---

---

---

---

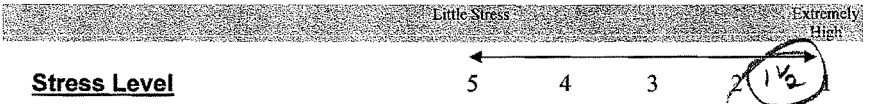

**Stress Level**

**Comments:**

---

---

---

---

---

---

**Additional Comments:**

---

---

---

---

---

---

# Port Canaveral 2007 Run Evaluation Form

Pilot # 4

Date April 21-22, 2007

Run #: 51

Circle the number that best describes the run just completed:

	←	Extremely Satisfactory				Not at all Satisfactory	→
<b>Vessel Trackline</b>							
- Vessel position with regard to centerline	5	4	3	2	1		
- CPA to channel boundaries and/or buoys at the entrance	5	4	3	2	1		
- Vessel position with regard to ships at the berth	5	4	3	2	1		
- Maneuvering room at turning basin	5	4	3	2	1		
<b>Vessel Controllability</b>							
- Engine reserve	5	4	3	2	1		
- Rudder reserve	5	4	3	2	1		
- Course Control	5	4	3	2	1		
- Speed Control	5	4	3	2	1		
- Use of Tugs	5	4	3	2	1		
- Thruster reserve	5	4	3	2	1		

	Absolutely Safe				Not at all Safe
<b>Overall Safety</b>	5	4	3	2	1

Comments: \_\_\_\_\_

---



---



---



---

(over)



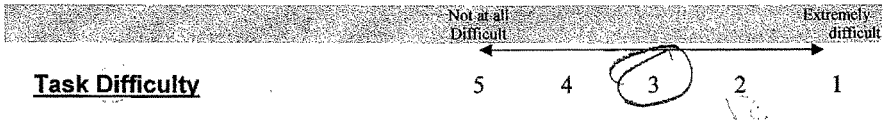

**Task Difficulty**

**Comments:**

---

---

---

---

---

---

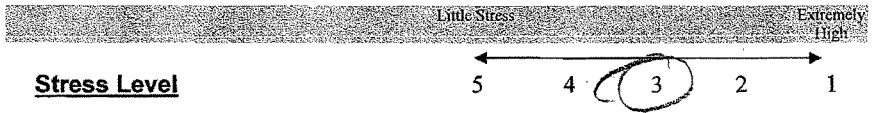

**Stress Level**

**Comments:**

---

---

---

---

---

---

**Additional Comments:**

---

---

---

---

---

---

---

---

## Port Canaveral 2007 Run Evaluation Form

Pilot # 4

Date April 21-22, 2007

Run #: 52

Circle the number that best describes the run just completed:

	Extremely Satisfactory				Not at all Satisfactory
<b>Vessel Trackline</b>					
- Vessel position with regard to centerline	5	<span style="border: 1px solid black; border-radius: 50%; padding: 2px;">4</span>	3	2	1
- CPA to channel boundaries and/or buoys at the entrance	5	<span style="border: 1px solid black; border-radius: 50%; padding: 2px;">4</span>	3	2	1
- Vessel position with regard to ships at the berth	5	<span style="border: 1px solid black; border-radius: 50%; padding: 2px;">4</span>	3	2	1
- Maneuvering room at turning basin	<span style="border: 1px solid black; border-radius: 50%; padding: 2px;">5</span>	4	3	2	1
<b>Vessel Controllability</b>					
- Engine reserve	<span style="border: 1px solid black; border-radius: 50%; padding: 2px;">5</span>	4	3	2	1
- Rudder reserve	5	<span style="border: 1px solid black; border-radius: 50%; padding: 2px;">4</span>	3	2	1
- Course Control	<span style="border: 1px solid black; border-radius: 50%; padding: 2px;">5</span>	4	3	2	1
- Speed Control	<span style="border: 1px solid black; border-radius: 50%; padding: 2px;">5</span>	4	3	2	1
- Use of Tugs	<span style="border: 1px solid black; border-radius: 50%; padding: 2px;">5</span>	4	3	2	1
- Thruster reserve	5	4	3	2	1

	Absolutely Safe				Not at all Safe
<b>Overall Safety</b>	<span style="border: 1px solid black; border-radius: 50%; padding: 2px;">5</span>	<span style="border: 1px solid black; border-radius: 50%; padding: 2px;">4</span>	3	2	1

Comments: I had the ship slightly south of centerline inbound, ideally would have been on centerline.

(over)

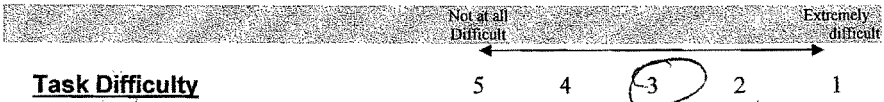

**Task Difficulty**

**Comments:**

---

---

---

---

---

---

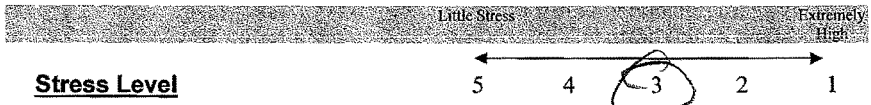

**Stress Level**

**Comments:**

---

---

---

---

---

---

**Additional Comments:**

---

---

---

---

---

---

## Port Canaveral 2007 Run Evaluation Form

Pilot # 4

Date April 21 ~~22~~ 2007

Run #: 53

Circle the number that best describes the run just completed:

	Extremely Satisfactory				Not at all Satisfactory
<b>Vessel Trackline</b>					
- Vessel position with regard to centerline	<span style="border: 1px solid black; border-radius: 50%; padding: 2px;">5</span>	4	3	2	1
- CPA to channel boundaries and/or buoys at the entrance	<span style="border: 1px solid black; border-radius: 50%; padding: 2px;">5</span>	4	3	2	1
- Vessel position with regard to ships at the berth	<span style="border: 1px solid black; border-radius: 50%; padding: 2px;">5</span>	4	3	2	1
- Maneuvering room at turning basin	<span style="border: 1px solid black; border-radius: 50%; padding: 2px;">5</span>	4	3	2	1
<b>Vessel Controllability</b>					
- Engine reserve	<span style="border: 1px solid black; border-radius: 50%; padding: 2px;">5</span>	4	3	2	1
- Rudder reserve	<span style="border: 1px solid black; border-radius: 50%; padding: 2px;">5</span>	4	3	2	1
- Course Control	<span style="border: 1px solid black; border-radius: 50%; padding: 2px;">5</span>	4	3	2	1
- Speed Control	<span style="border: 1px solid black; border-radius: 50%; padding: 2px;">5</span>	4	3	2	1
- Use of Tugs	<span style="border: 1px solid black; border-radius: 50%; padding: 2px;">5</span>	4	3	2	1
- Thruster reserve	5	4	3	2	1

	Absolutely Safe				Not at all Safe
<b>Overall Safety</b>	<span style="border: 1px solid black; border-radius: 50%; padding: 2px;">5</span>	4	3	2	1

Comments: \_\_\_\_\_

---



---



---



---

(over)

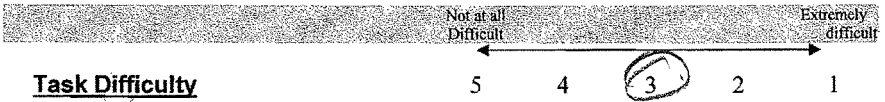

**Task Difficulty**

**Comments:**

---

---

---

---

---

---

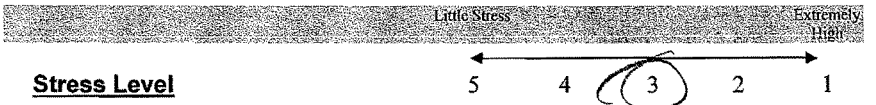

**Stress Level**

**Comments:**

---

---

---

---

---

---

**Additional Comments:**

---

---

---

---

---

---

## Port Canaveral 2007 Run Evaluation Form

Pilot # 4

Date April 21-22 2007

Run #: 54

Circle the number that best describes the run just completed:

	← Extremely Satisfactory				Not at all Satisfactory →
<b>Vessel Trackline</b>					
- Vessel position with regard to centerline	5	4	3	2	1
- CPA to channel boundaries and/or buoys at the entrance	5 <u>4.5</u>	4	3	2	1
- Vessel position with regard to ships at the berth	5	4	3	2	1
- Maneuvering room at turning basin	5	4	3	2	1
<b>Vessel Controllability</b>					
- Engine reserve	5	4	3	2	1
- Rudder reserve	5	4	3	2	1
- Course Control	5	4	3	2	1
- Speed Control	5	4	3	2	1
- Use of Tugs	5	4	3	2	1
- Thruster reserve	5	4	3	2	1

	← Absolutely Safe				Not at all Safe →
<b>Overall Safety</b>	5	4	3	2	1

Comments: \_\_\_\_\_

---



---



---



---

(over)

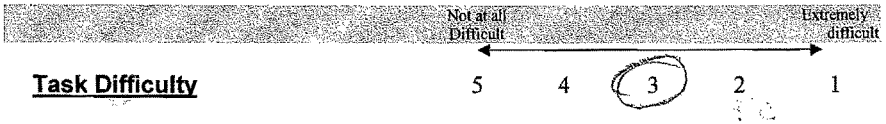

**Task Difficulty**

**Comments:**

---

---

---

---

---

---

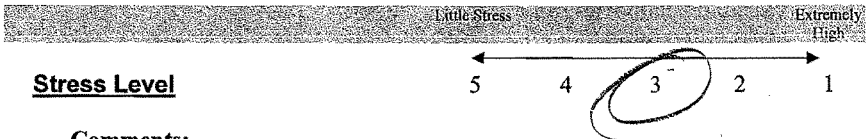

**Stress Level**

**Comments:**

---

---

---

---

---

---

**Additional Comments:**

---

---

---

---

---

---

## Port Canaveral 2007 Run Evaluation Form

Pilot # 4

Date April 21, 22 2007

Run #: 55

Circle the number that best describes the run just completed:

	← Extremely Satisfactory				→ Not at all Satisfactory
<b>Vessel Trackline</b>					
- Vessel position with regard to centerline	5	4	3	2	1
- CPA to channel boundaries and/or buoys at the entrance	5	4	3	2	1
- Vessel position with regard to ships at the berth	5	4	3	2	1
- Maneuvering room at turning basin	5	4	3	2	1
<b>Vessel Controllability</b>					
- Engine reserve	5	4	3	2	1
- Rudder reserve	5	4	3	2	1
- Course Control	5	4	3	2	1
- Speed Control	5	4	3	2	1
- Use of Tugs	5	4	3	2	1
- Thruster reserve	5	4	3	2	1

	← Absolutely Safe				→ Not at all Safe
<b>Overall Safety</b>	5	4	3	2	1

Comments: \_\_\_\_\_

\_\_\_\_\_

\_\_\_\_\_

\_\_\_\_\_

(over)



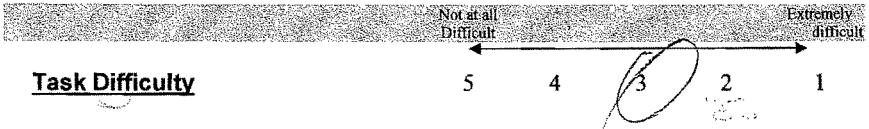

**Task Difficulty**

**Comments:**

---

---

---

---

---

---

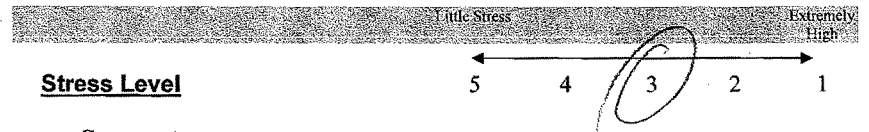

**Stress Level**

**Comments:**

---

---

---

---

---

---

**Additional Comments:**

---

---

---

---

---

---

## Port Canaveral 2007 Run Evaluation Form

Pilot # 4

Date April 21-22 2007

Run #: 56

Circle the number that best describes the run just completed:

	← Extremely Satisfactory				Not at all Satisfactory →
<b>Vessel Trackline</b>					
- Vessel position with regard to centerline	5	4	3	2	1
- CPA to channel boundaries and/or buoys at the entrance	5	4	3	2	1
- Vessel position with regard to ships at the berth	5	4	3	2	1
- Maneuvering room at turning basin	5	4	3	2	1
<b>Vessel Controllability</b>					
- Engine reserve	5	4	3	2	1
- Rudder reserve	5	4	3	2	1
- Course Control	5	4	3	2	1
- Speed Control	5	4	3	2	1
- Use of Tugs	5	4	3	2	1
- Thruster reserve	5	4	3	2	1

	← Absolutely Safe				Not at all Safe →
<b>Overall Safety</b>	5	4	3	2	1

Comments: \_\_\_\_\_

---



---



---



---

(over)

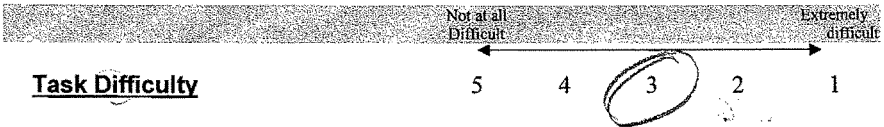

**Task Difficulty**

**Comments:**

---

---

---

---

---

---

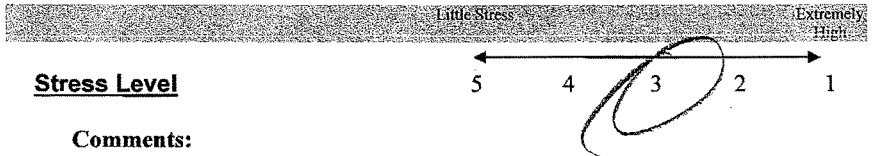

**Stress Level**

**Comments:**

---

---

---

---

---

---

**Additional Comments:**

---

---

---

---

---

---

## Port Canaveral 2007 Run Evaluation Form

Pilot # 4

Date April 21 ~~22~~ 2007

Run #: 57

Circle the number that best describes the run just completed:

	←	Extremely Satisfactory				→	Not at all Satisfactory
<b>Vessel Trackline</b>							
- Vessel position with regard to centerline	5	4	3	2	1		
- CPA to channel boundaries and/or buoys at the entrance	5	4	3	2	1		
- Vessel position with regard to ships at the berth	5	4	3	2	1		
- Maneuvering room at turning basin	5	4	3	2	1		
<b>Vessel Controllability</b>							
- Engine reserve	5	4	3	2	1		
- Rudder reserve	5	4	3	2	1		
- Course Control	5	4	3	2	1		
- Speed Control	5	4	3	2	1		
- Use of Tugs	5	4	3	2	1		
- Thruster reserve	5	4	3	2	1		

	←	Absolutely Safe				→	Not at all Safe
<b>Overall Safety</b>	5	4	3	2	1		

Comments: \_\_\_\_\_

---



---



---



---

(over)

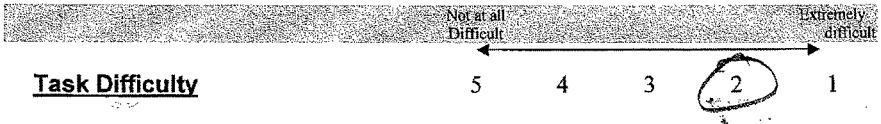

**Task Difficulty**

**Comments:**

---

---

---

---

---

---

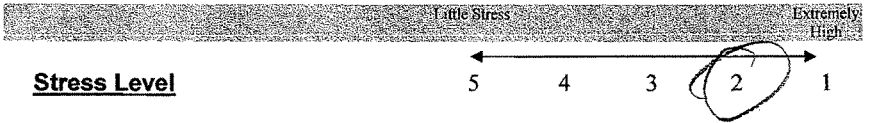

**Stress Level**

**Comments:**

---

---

---

---

---

---

**Additional Comments:**

---

---

---

---

---

---

---

---

---

---

## Port Canaveral 2007 Final Evaluation Form

Name: BENJAMIN BORGIEDate: MARCH 10-11/2007

A geographic database of Port Canaveral was constructed for use in these simulations. This database, a "model of the future", included a dredge plan to modify/widen part of the entrance channel, the channel through the harbor, and the turning basin area at the Western end of the port.

Two vessels were used in the simulations: "Genesis" (LOA 361.5m, Beam 47m, Draft 9.2m) a cruise vessel, and the tanker "Jupiter" (LOA 244m, Beam 42m, Draft 12m) partially loaded, and ballasted (Draft 8.3m).

1) Does this "improved channel" provide ample width for transit of these vessels in the environmental conditions of wind and current as tested? Comments?

"Genesis" YES, THE "IMPROVED CHANNEL" PROVIDED AN INCREASED MARGIN OF SAFETY DURING THE SIMULATED TRANSITS. A VESSEL THIS HUGE NEEDS THE WIDER CHANNEL, AS THE EXTREME DIMENSIONS RESULT IN A MUCH WIDER "SWEEP" PATH, WHEN SUBJECT TO SET/DRIFT.  
 "Jupiter" YES, "IMPROVED CHANNEL" PROVIDED AMPLE WIDTH FROM BEGINNING OF WIDENER TO MIDDLE BASIN. THE IMPROVED CUT AT THE NW CORNER OF INNER REACH IS AN IMPORTANT IMPROVEMENT TO ALLOW VESSEL TO BE BETTER CONTROLLED AND ALLOW SLOWER SPEEDS TO REDUCE DANGEROUS HYDRODYNAMIC FORCES  
 2) Depths in the channel are 44 feet in the entrance channel, and 41 feet in the harbor proper and turning areas. Is this depth adequate for the vessels, especially the "Jupiter" with a draft of 12 meters (approximately 39 feet)? Comments?

THE SIMULATION PROVED TO ME THAT DUE TO THE LENGTH/BEAM/DRAFT, THAT THE 41' DEPTH IS ADEQUATE FOR MOST, BUT NOT ALL CONDITIONS, IN ORDER TO MAINTAIN 2'06" UNDER KEEL DEPTH IS ADEQUATE EXCEPT IN RARE CASE WHERE A 39' DRAFT VESSEL WANTS TO TRANSIT AT EXTREME LOW TIDE.

3) "Jupiter" is expected to utilize the Middle Turning Basin into or out of the berth. Does the Middle turning basin area provide ample maneuver room for this operation in the conditions tested?

YES, ADEQUATE ROOM EXISTS TO SAFELY MANEUVER A VESSEL OF THIS SIZE AND DRAFT.

4) "Genesis" will utilize the West Turning Basin. Does the additional dredging in this area provide ample maneuver room for this operation in conditions tested? Comments?

THE SIMULATION PROVED TO ME THAT DUE TO THE LENGTH OF THE VESSEL AND THE RELATIVELY SHARP TURN, IT IS MANDATORY THE ADDITIONAL DREDGING BE DONE TO ALLOW VESSEL TO MANEUVER SAFELY.

5) Under what conditions will the additional width provided by dredging at the inside of the turn of the entrance channel be most useful?

DURING THE SIMULATION, IT WAS PROVEN TO ME HOW IMPORTANT THE ADDITIONAL WIDTH IS WHEN WIND IS S'LY. THE ADDITIONAL ROOM ALSO ALLOWS FOR A SLOWER AND THEREFORE, SAFER, RATE OF TURN UNDER ALL CONDITIONS.

6) Under what conditions and during what maneuvers will the additional channel width provided by dredging the North side of the channel from the East Turning Basin to the Middle Turning Basin be most useful?

ADDITIONAL CHANNEL WIDTH IN THIS AREA WILL ALLOW TRANSITING VESSELS TO REDUCE DANGEROUS HYDRODYNAMIC FORCES ON MOORED VESSELS, REDUCE CUSHION/SUCKTION, AND ALLOW FOR GREATER LEEWAY UNDER HIGH WIND CONDITIONS.

7) Under what conditions and during what maneuvers will the additional channel width provided by dredging the South side of the channel opposite the West Turning Basin be most useful?

THIS AREA IS ESPECIALLY NEEDED UNDER HIGH WIND CONDITIONS. IT WILL ALLOW TRANSITING VESSELS A SAFE DISTANCE OFF MOORED VESSELS AND PERMITS A MORE CONTROLLED (SAFER) TURN INBOUND AND OUTBOUND OF WEST BASIN.

8) In your opinion, will this dredge plan provide for greater maneuverability and safety when accommodating these vessels? Comments?

YES, ABSOLUTELY! SAFETY IS FIRST AND FOREMOST TO THE PILOTS IN PORT CANAVERAL. THIS DREDGING WILL ALLOW "GENESIS" CLASS VESSELS TO SAFELY TRANSIT AND WILL PROVIDE INCREASED PROTECTION FOR ALL VESSELS, TRANSITING AND MOORED, AS WELL AS THE MARINAS, DOCKS AND STATE PROPERTY.

9) Are there any issues or comments, or suggestions not covered by simulations or as part of this project? Comments?

1.) A WIDER CHANNEL IN THE MIDDLE AND INNER REACH COULD PROVIDE FOR TWO-WAY TRAFFIC FOR SMALLER VESSELS, REDUCING CONGESTION AND VESSEL WAIT TIMES.

2.) OF HUGE IMPORTANCE, IS THAT THE DEEPER CHANNELS WILL ALLOW EVEN DEEP VESSELS TO TRANSIT AT ANY TIME AND NOT BE DELAYED (AT GREAT EXPENSE) FOR THE TIDE TO RISE.

3.) ADDITIONAL ROOM AT THE OUTSIDE TURN AND AT THE ENTRANCE TO WEST BASIN WILL PROVIDE FOR A SMOOTHER, SAFER, SLOWER, MORE CONTROLLED TURN.

4.) THE EXTRA AREA NORTH OF INNER/MIDDLE REACH WILL ALLOW FOR LARGER VESSELS ON THE SOUTH SIDE.

Please use additional sheets if necessary to complete your responses.

Thank you for your participation in this important project!

## Port Canaveral 2007 Final Evaluation Form- Day One - Genesis

Name: Dave Callan

Date: 31 March 2007

A geographic database of Port Canaveral was constructed for use in these simulations. This database, a “model of the future”, included a dredge plan to modify/widen part of the entrance channel, the channel through the harbor, and the turning basin area at the Western end of the port.

Two vessels were used in the simulations: “Genesis” (LOA 361.5m, Beam 47m, Draft 9.2m) a cruise vessel, and the tanker “Jupiter” (LOA 244m, Beam 42m, Draft 12m) partially loaded, and ballasted (Draft 8.3m).

1) Does this “improved channel” provide ample width for transit of these vessels in the environmental conditions of wind and current as tested? Comments?

“Genesis” Based upon my experiences on the simulator today, I would say that with certainty if the channel improvements are implemented, there will be adequate width for transit of the Genesis class as well as other vessels with similar length and beam. Specifically, the new and improved widener as simulated will allow these vessels to make inbound and outbound turns with a low rate of turn (less than 15 degrees and more likely approaching 10 degrees per minute) which is a design element desirable by the cruise liners of this length so that angles of list are not introduced that are unsafe for passengers moving about the decks and for various objects subject to motion onboard that may be subject to breakage or damage to passengers in the form of “missiles.” Inbound, I noticed I had the ability to slow down on the approach to the jetties sooner that allowed me to pass moored vessels berthed at CT# 3 & 4 at six knots or less even with winds in excess of 20 knots. At the same time, I was able in the portion of the channel between the east and middle basins to have no more than five degrees of leeway that effectively increased the beam to over 250 feet yet still gave me adequate room on both the north and south limits of the channel because I now had five hundred feet in which to place the vessel. In strong south winds, this manifested itself by allowing me to keep the stern from impacting the north bank yet keeping the bow clear of ships on the south side. Also, the ability of the bow thrusters to be effective at six knots and higher would have allowed me to maintain less leeway should I had chosen to utilize them more. It was my desire, however, to navigate in the combi mode as much as possible in the channel without using the thrusters any more than I needed to. The wider channel just outside the jetties and between the basins was just the adjustment needed to be able to effect this scenario. The additional width between the middle and west turning basins on the south side also improved the handling of the vessel with vessels at the two berths (North Cargo Piers # 3 & 4) most importantly with strong south winds. By positioning the vessel on the south side of the channel in these circumstances, issues of surge were reduced for vessels on the lee side (north side) and by enlarging the west basin access widener the vessel could be turned sooner and thus eliminating the requirement to “hold off” turning the vessel when strong north winds were prevalent. In summary, in all the simulations tested, the additional width was not only effective and ample for this class vessel but, in the opinion of this experienced pilot, addressed all of the problem areas for vessels in excess of 1000’



up to and including 1200' LOA. In strong N'y winds I was able to use the new width on the north side between the east and middle basins to keep myself well to windward with ample room to vessels moored on the south side and at a speed that would not amplify surge effects.

2) Depths in the channel are 44 feet in the entrance channel, and 41 feet in the harbor proper and turning areas. Is this depth adequate for the vessels, especially the "Jupiter" with a draft of 12 meters (approximately 39 feet)? Comments?

Comments regarding the Jupiter will be forthcoming after I have had the opportunity to complete the simulation runs for her on day two but without a doubt there is adequate and ample depth in the entrance and harbor channels as well as the turning basins for the Genesis class vessel even considering all conditions of squat. Preliminary to my handling the Jupiter, I will point out that the maximum draft in Port Canaveral for existing tanker traffic and future projected traffic for the VITOL project is 39'06." Existing parameters established by the pilots for vessels underway in the channels and basins is for a minimum under keel clearance of 2'06." If we are to position ourselves to eliminate tidal restrictions the harbor and turning basins should be dredged to 42 feet vice 41 feet. I am aware there is 2' over dredging but we do often experience "minus" MLLW tidal conditions that might affect a vessel's ability to transit the channels during any stage of the tide. Due to the large amount of passenger ship traffic – currently given priority over any other vessel excepting emergency movements – it is essential that we eliminate the need for "tide jobs" as there are often two-to-four day stretches where the high tides fall around the time of arrival and departure of cruise ships. This can often result in extensive delays for deeply laden vessels causing them to remain at anchorage for days and sometimes diverting from Port Canaveral altogether.

3) "Jupiter" is expected to utilize the Middle Turning Basin into or out of the berth. Does the Middle turning basin area provide ample maneuver room for this operation in the conditions tested?

4) "Genesis" will utilize the West Turning Basin. Does the additional dredging in this area provide ample maneuver room for this operation in conditions tested? Comments? Most certainly, the additional dredging in the West Turning Basin provides ample room for maneuvering. I was most impressed with this fact when turning the vessel with strong SE'y winds and expect that with any wind direction clockwise from east through south to west the additional widener area is most productive and allows for the Genesis class to be positioned further to the south and well clear of other vessels in the West Turning Basin. Also, the widener allows a vessel in strong N'y winds to turn sooner to the wind and thus developing further distance between the vessel's stern and vessels/marinas/ramps that are situated along the southern seawall in this vicinity. While not tested today, I can envision a scenario that a Genesis class in a strong S'y wind in excess of 30 knots would turn completely in this new 1750'+ widener and drift north when turned 180 degrees and then backed into her berth.

5) Under what conditions will the additional width provided by dredging at the inside of the turn of the entrance channel be most useful?

Speaking about the Genesis class, the additional width will be an absolutely essential improvement and necessity for this class when inbound in strong SE – SW'y winds in order to keep the vessel completely in the channel without swinging the stern outside the north channel limit along the 310 heading of the Approach Channel and from keeping the stern from swinging outside the channel to the extremely shallow area north of the channel between buoy #10 and the north jetty. Given more room to the south as described by the widener improvement will allow inbound vessels to come out of the turn much further to windward and also allow vessels to slow sooner on the approach to berthed vessels reducing the possibility of dynamic surge to the berthed vessels. Outbound, historically we have needed a higher rate of turn than desired because with the vessels accelerating, twenty-degree rate of turns in S'y winds are often required to maintain the ships in the channel accentuating list and the deleterious effects previously described. The new width and extended widener will allow for a more gradual and less rate of turn transit through this section. As noted below, the possibility of two-way traffic for medium sized cargo vessels with resultant improvement in efficiency and reduced delays may be possible with further study by the pilots.

6) Under what conditions and during what maneuvers will the additional channel width provided by dredging the North side of the channel from the East Turning Basin to the Middle Turning Basin be most useful?

Certainly, when vessels are moored on the south side of the channel, a wider channel will allow greater distance to passing ships and slower speeds for these transiting vessels with the reduced possibility of surge effects to the docked vessels. Another hopeful outcome would be the introduction of two-way traffic for smaller cargo vessels thus making the port more efficient and eliminating many delays that the current scheme requires.

7) Under what conditions and during what maneuvers will the additional channel width provided by dredging the South side of the channel opposite the West Turning Basin be most useful?

In strong SE'y through SW'y winds that usually are prevalent before the arrival of a cold front, as described previously, the additional room to the south of the west turning basin will actually increase the room available for turning when inbound and for outbound transits, a vessel will be able to come out of the basin on the extreme south side before turning east to sea and keeping her stern well clear of vessels berthed at North Cargo Pier # 3 & 4 as well as new construction along the NW-SE face of the widener seawall where vessels will be berthed. With vessels berthed along this new section of seawall, added room to the south of the west turning basin will be essential to maintain a safe distance from moored vessels.

8) In your opinion, will this dredge plan provide for greater maneuverability and safety when accommodating these vessels? Comments?

It is my professional opinion based upon twenty-two years as a pilot in Port Canaveral, six years of experience as a ship master prior to that, and as a federal pilot in New York Harbor and the Delaware River before then that this new dredge plan will without a doubt provide for maximum safety for vessels that are turning in the basins and transiting the channels. To date, we have often been on the edge for vessels in the 1000' range due to crab angle in a four hundred foot channel; the new five hundred foot channel and

increased room at the widener will eliminate this dilemma. The existing 1440' turning circle in the West Turning Basin will be enhanced with a new and improved 1750+ foot turning circle that will accommodate a vessel nearly twelve-hundred feet in length. According to documents published by the ACOE, a turning circle should have a diameter that approaches 1.5 times the length of the largest vessel and this parameter would be met by the new dredge plan. I completely support the plan as proposed and would not recommend that it be diminished in any fashion.

9) Are there any issues or comments, or suggestions not covered by simulations or as part of this project? Comments?

To begin with, I would like to thank all those individuals involved in the project. Mr. Howard Straub of the STAR Center, Dave Nieri from New York, Victor the pilot from PR, and Melyne Chiariello from CH2M Hill provided no small amount of support. (Thanks to Jennifer for her assistance in the control room responding to my requests in a timely manner). I might liked to have had an opportunity to make one simulator run not "on the books" at the beginning to get a feel for the controls and to adjust to the simulated environment but the learning curve was ascended rather rapidly and I have to say that having attended several simulators the STAR Center has the best that I have seen. I especially liked the fact that one could go from the center position to port or starboard wing position rapidly. Certainly, the graphics and real time simulation were superb. This enabled me to see that the action I was taking was having the desired effect. As far as the Genesis goes, I believe Port Canaveral will be well positioned to entertain such a vessel calling there should the improvements simulated be implemented. Again, my thanks to all involved.

Please use additional sheets if necessary to complete your responses.

Thank you for your participation in this important project!

## Port Canaveral 2007 Final Evaluation Form

Name: Stephen GaseckiDate: March, 2007

A geographic database of Port Canaveral was constructed for use in these simulations. This database, a "model of the future", included a dredge plan to modify/widen part of the entrance channel, the channel through the harbor, and the turning basin area at the Western end of the port.

Two vessels were used in the simulations: "Genesis" (LOA 361.5m, Beam 47m, Draft 9.2m) a cruise vessel, and the tanker "Jupiter" (LOA 244m, Beam 42m, Draft 12m) partially loaded, and ballasted (Draft 8.3m).

1) Does this "improved channel" provide ample width for transit of these vessels in the environmental conditions of wind and current as tested? Comments?

"Genesis" Yes "improved channel" provided improved safety margin for vessel transit. Allowed proper rate of turn at widening and allowed for set/drift Middle/Tower reaching channel position due to extreme LOA/Beam.

"Jupiter" Yes "improved channel" provided ample width from widening to Middle Basin. Vessel can be maneuvered at slower speeds which reduce hydrodynamic effects - surge induced vessels of bank cushion section.

2) Depths in the channel are 44 feet in the entrance channel, and 41 feet in the harbor proper and turning areas. Is this depth adequate for the vessels, especially the "Jupiter" with a draft of 12 meters (approximately 39 feet)? Comments?

Yes, depths are adequate to maintain a minimum under keel clearance of 2ft. This will allow 24hr unrestricted transits rather than high water tide restrictions.

3) "Jupiter" is expected to utilize the Middle Turning Basin into or out of the berth. Does the Middle turning basin area provide ample maneuver room for this operation in the conditions tested?

Yes, there is adequate area to maneuver in the Middle Basin for a vessel of Jupiter dimensions LOA/Beam/Draft

4) "Genesis" will utilize the West Turning Basin. Does the additional dredging in this area provide ample maneuver room for this operation in conditions tested? Comments?

It is imperative the additional dredging be done in order to safely maneuver "Genesis" class vessels inbound/outbound West Basin, due to the size of the vessel under adverse wind conditions.

5) Under what conditions will the additional width provided by dredging at the inside of the turn of the entrance channel be most useful?

The Widening improvements will greatly improve safe handling of high draft vessels inbound/outbound in S/Ly. Boats, greater shifts, allowing drafts to compensate for set/drift and also allows for a reduced rate of turn radius etc.

6) Under what conditions and during what maneuvers will the additional channel width provided by dredging the North side of the channel from the East Turning Basin to the Middle Turning Basin be most useful?

Additional channel width along Northside East → Middle Basin serves to reduce hydrodynamic effects since moored vessels, bank suction/propulsion, and gives high draft vessels crab angle set/drift transiting inbound/outbound.

7) Under what conditions and during what maneuvers will the additional channel width provided by dredging the South side of the channel opposite the West Turning Basin be most useful?

Channel improvements along the South side West → Middle Basin greatly improve those cruise ships transiting in/out West Basin in N/Ly & S/Ly cross beam winds causing vessels hard to stop, proper positioning entering/exiting West Basin due to the increased LOA & beam of the large ships.

8) In your opinion, will this dredge plan provide for greater maneuverability and safety when accommodating these vessels? Comments?

Absolutely! Safety is primary concern. Without these dredge plan improvements vessels maneuver without any margin of safety, endangering vessels, public, & property all susceptible to damage.

9) Are there any issues or comments, or suggestions not covered by simulations or as part of this project? Comments?

Yes additionally improvements to the channel will also provide for tanker/bulk carriers deeply laden greater than 26ft drafts to transit safely without wide margins allowing more efficient & timely passages. It will also add on a limited basis for two way vessel passage/mooring Middle & Inass Beach. The widening improvements greatly reduce the rate of turn needed to negotiate inbound/outbound turns and offset also weather arc radius of turn.

Please use additional sheets if necessary to complete your responses.

Thank you for your participation in this important project!

## Port Canaveral 2007 Final Evaluation Form

Name: Rich GrimsonDate: April 21-22, 2007

A geographic database of Port Canaveral was constructed for use in these simulations. This database, a "model of the future", included a dredge plan to modify/widen part of the entrance channel, the channel through the harbor, and the turning basin area at the Western end of the port.

Two vessels were used in the simulations: "Genesis" (LOA 361.5m, Beam 47m, Draft 9.2m) a cruise vessel, and the tanker "Jupiter" (LOA 244m, Beam 42m, Draft 12m) partially loaded, and ballasted (Draft 8.3m).

1) Does this "improved channel" provide ample width for transit of these vessels in the environmental conditions of wind and current as tested? Comments?

"Genesis" Yes the improved channel provides ample width for the Genesis class in the conditions tested. The increased channel width is necessary to provide for additional room required for a vessel of this size to use adequate leeway (continued on back)  
 "Jupiter" Yes, the improved channel provides ample width for the Jupiter in all conditions tested. The increased channel width is necessary for deep draft vessels to reduce hydrodynamic affects and provide safe distance for passing moored vessels.

2) Depths in the channel are 44 feet in the entrance channel, and 41 feet in the harbor proper and turning areas. Is this depth adequate for the vessels, especially the "Jupiter" with a draft of 12 meters (approximately 39 feet)? Comments?

This depth is adequate for all vessels however there will have to be tide restrictions for vessels approximately 38' in draft and above to insure adequate underkeel clearance. Under current channel configurations with a project depth of 39' in the middle basin, any vessel over 36' in draft is required (cont. on back)  
 3) "Jupiter" is expected to utilize the Middle Turning Basin into or out of the berth. Does the Middle turning basin area provide ample maneuver room for this operation in the conditions tested?

Yes the Middle Turning Basin provides ample maneuver room.

4) "Genesis" will utilize the West Turning Basin. Does the additional dredging in this area provide ample maneuver room for this operation in conditions tested? Comments?

Yes, the additional dredging in this area provides ample maneuvering room in the conditions tested. The dredged area at the entrance to the West Basin is a critical area due to several factors including the proximity of

1) Genesis (cont.) during moderate to high wind conditions and to provide room for the vessel to maintain a safe distance and passing speed for moored vessels on both sides of the channel.

4) (cont.) south side of the channel as the ships are turned in to the West Basin; and the requirement for ~~additional room for margin of safety as ships begin~~ to slow the vessel for docking, especially in high wind conditions. It should be noted that the cut on the Northeast side of this area will be a berth for large vessels so that the apparent room to the northeast on the simulated exercise will not be available when vessels are moored there. However, I believe there will be ample room even when vessels are moored at the berths. I would also note that some cruise ship captains may prefer to turn their vessels in the newly widened area and then backing in to the existing basin to the berth rather than turning the vessel further to the north as I did in the simulator exercises, especially in southerly wind conditions.

2) (cont.) to take 3 assist tugs and time the inbound transit for high water. With an increase in project depth this requirement could be appropriately adjusted but will not be deep enough to allow all deep draft vessels to transit at any tidal condition.

5) Under what conditions will the additional width provided by dredging at the inside of the turn of the entrance channel be most useful?

*The additional width provided at the entrance channel widener is needed for vessels the size of the Genesis class for all conditions and especially in high wind conditions when the vessel will have higher set and drift maneuvering through the turn.*

6) Under what conditions and during what maneuvers will the additional channel width provided by dredging the North side of the channel from the East Turning Basin to the Middle Turning Basin be most useful?

*The additional channel width on the North side will be most useful in moderate to high wind conditions, allowing for necessary leeway of this size vessel as well as safe distance off and appropriate passing speed for moored vessels. Also the additional channel width provides a greater*

7) Under what conditions and during what maneuvers will the additional channel width provided by dredging the South side of the channel opposite the West Turning Basin be most useful?

*The additional channel width on the south side will be most useful in moderate to high wind conditions for the cruise ships for the reasons given in no. 6 above and especially due to the cruise ship sterns swinging to the south when entering the basin and to provide for holding the cruise*

8) In your opinion, will this dredge plan provide for greater maneuverability and safety when accommodating these vessels? Comments?

*Yes, I believe that this dredge plan provides for greater maneuverability and safety, for all the reasons addressed in previous questions.*

9) Are there any issues or comments, or suggestions not covered by simulations or as part of this project? Comments?

*I'd like to make a few comments regarding the simulation runs I made on the Genesis class vessel. During portions of several of the runs I made I ran the vessel well to windward in some cases in relatively close proximity to moored vessels. This is something I am accustomed to doing with the current channel configurations in high winds. However, I believe with the channel improvements I could have given the moored vessels substantially additional passing distance while maintaining a safe position in the channel. I also noticed during my inbound simulator runs with the Genesis that I often passed the first moored vessel on the South side at a speed slightly higher than what I consider to be the desirable speed of approximately six knots.*

Please use additional sheets if necessary to complete your responses.

Thank you for your participation in this important project!



7. (cont.) ships down to the south when departing the basin outboundly in strong southerly winds.
6. margin of safety for hydrodynamic affects on deep draft vessels.

9. (cont.) I believe this tendency was due to the fact that under existing conditions we rarely have a vessel moored at that berth and I am accustomed to slowing the cruise ships to six knots further to the west. I do not anticipate that there <sup>will be</sup> ~~is~~ any problem in slowing the Genesis class to six knots by the time the vessel passes the first berth to the South in the future.

This simulation provided an outbound range to navigate outbound vessels, something which does not currently exist but which the pilots have been recommending for many years. This simulation convinced me even further that an outbound range should be installed at Port Canaveral.

Additional benefits to the Port will be provided by these channel improvements such as allowing two-way traffic for some vessels, decreasing the amount of deep draft tankers that need to enter the port timed for high water, and providing a potential turn-around area for vessels in the improved widener.

The improved channel newly dredged areas may not necessarily be entered by maneuvering vessels during routine transits, however they are necessary to provide the additional margin of safety required for very large vessels.

## TABLE OF CONTENTS

1	STUDY OVERVIEW.....	1
2	SIMULATOR AND SIMULATION MODELS .....	2
2.1	Ship Response Models.....	2
2.1.1	FREEDOM OF THE SEAS.....	2
2.1.2	Jupiter.....	2
2.1.3	Assist Tug Modeling and Deployment .....	3
2.2	Simulator Geographic Model.....	3
2.2.1	Channel Improvement Modeling.....	4
2.2.2	Other Ship Traffic.....	4
2.2.3	Depth Modeling.....	4
2.2.4	Aids to Navigation.....	5
2.3	Environmental Conditions .....	5
2.3.1	Wind Modeling.....	5
2.3.2	Current Modeling.....	6
3	SIMULATION PROCEDURES.....	7
3.1	Participants.....	7
3.2	Wheelhouse Procedures.....	7
3.3	Data Collection Procedures.....	7
3.4	Special Procedures.....	8
3.4.1	Ship Control Procedures on the FREEDOM .....	8
3.4.2	Bridge Wing View .....	9
3.4.3	"Birds Eye View".....	9
4	RESULTS .....	10
4.1	Criteria for Evaluating Results.....	10
4.1.1	Pilots Overall Safety Rating.....	10
4.1.2	Surge Effects.....	10
4.1.3	Proximity to Channel Boundary .....	11
4.2	<i>Jupiter</i> Exercises.....	11
4.2.1	Results in Entrance Channel Turn Widener.....	12
4.2.2	Results in Middle and Inner Harbor Reaches .....	12
4.3	<i>FREEDOM OF THE SEAS</i> Exercises.....	12
4.3.1	Results in Entrance Channel Turn Widener.....	13
4.3.2	Results in Middle and Inner Harbor Reaches .....	13
4.3.3	Results in West Access Channel.....	13
4.3.4	Results in West Basin Turning Area.....	13
5	CONCLUSIONS AND RECOMMENDATIONS .....	14
5.1	Middle and Inner Harbor Reach Wideners .....	14
5.1.1	Outbound Ranges.....	14
5.2	West Access Channel Widening and West Basin Turn Area.....	15
5.3	Channel Depths.....	15
5.4	Related Observations .....	15

## **LIST OF APPENDICES**

APPENDIX A – Test Ship Principle Particulars

APPENDIX B – Engineering Drawings for Navigation Simulations

APPENDIX C – Ships at Piers and Project Depth for Navigation Simulations

APPENDIX D – Test Plan (as run)

APPENDIX E – Trackplots

APPENDIX F – Pilots' Run Evaluation Forms

APPENDIX G – Pilots' Final Evaluation Forms

## 1 STUDY OVERVIEW

This report describes the methodology and the results obtained from the simulation based evaluation of navigation channel improvement designs at Port Canaveral, Florida. The Port Canaveral Authorities plan to increase channel depth, and in places, expand channel width to provide increased safety and facilitate accessibility by larger and future visiting vessels. The objective of this study was to examine the two expansion dredge plans to determine which of the plans would provide safe passage for these vessels in normal to more extreme environmental conditions of wind and tidal current. The simulations were performed at the STAR Center in Dania Beach, Florida during three days of testing during the period 3-5 June 2009 using STAR Center's 360° field-of-view, shiphandling simulator.

The expansion designs are designated as Plan A and Plan B. Both plans effect the same general locations but the channel expansions in Plan A provide a larger/wider navigable area than the dimensions of Plan B. Both of the plans provide for identical increases in channel depths. In cooperation with the US Army Corps of Engineers, the Port has selected two "design vessels" to be used in simulations. The design vessels selected were a large Azipod propelled Cruise vessel and a product Tanker considered to be representative of larger vessels utilizing the facilities at the port now or in the future. Since the focus of the evaluation was vessel safety in all conditions, maximum credible worse-case environmental conditions of wind and current were simulated during each simulation run. Experienced Port Canaveral Pilots actively participated in the evaluation by controlling the simulated ships from the simulator wheelhouse and providing their professional opinion based on their experience and observations on the simulator.

## 2 SIMULATOR AND SIMULATION MODELS

The simulation runs for the study were conducted on STAR Center's full-mission bridge simulator. STAR Center's simulator bridge is a full-size replica of a commercial vessel's wheelhouse. The simulator presents a 360° panoramic out-the-window view from the wheelhouse. Wheelhouse instrumentation includes two ARPA/Radar displays and a CRT presentation referred to as the ship's "conning page" which provides information on rudder position, thruster setting, true and relative wind speed, transverse, and lateral speed of the vessel, in a single location. The equipment on the simulator bridge can be configured to replicate the bridge arrangement of any merchant vessel.

Taken together, this provided for a highly realistic work environment for the participating Port Canaveral Pilots. Relevant details regarding the configuration of the simulation models are provided in the following sections.

### 2.1 Ship Response Models

Two different ships from STAR Center's library of ship response models were used. They included the *FREEDOM OF THE SEAS*, the first build of a class of large cruise ships that may routinely call at the Port in the future. The second ship was the *Jupiter*, a moderate sized tanker that is representative of the deepest draft vessels that the channel improvements will accommodate.

Ship characteristics relevant to this evaluation are discussed below. Appendix A shows the particulars for each ship as modeled.

#### 2.1.1 *FREEDOM OF THE SEAS*

The *FREEDOM OF THE SEAS* is a large cruise ship with a LOA of 1,111.6 feet, a beam of 126.6 feet and draft of 27.9 feet. Exercises on the *FREEDOM* were completed without use of assist tugs because passenger ships rarely require assist tugs. This is possible because modern passenger ships are equipped with maneuvering aids designed to improve slow speed maneuvering and ship self-sufficiency during port transits, docking and undockings. The *FREEDOM* is equipped with four powerful side thrusters at the bow and azi-pod propulsion at the stern.

With respect to this evaluation, it is the *FREEDOM's* length that will challenge the channel widths in the alternative plans. This is because longer ships require wider channels when they are turning and when they must "crab"<sup>1</sup> to counter the effects of the winds and currents used during channel transits.

#### 2.1.2 *Jupiter*

The *Jupiter* is a relatively large tanker for the Port due to its draft. The ship's LOA is 800 feet and beam is 137.8 feet. A partially loaded version of the vessel was loaded on an even keel draft of 39.4 feet displacing 97,200 tons was used for inbound transits. A ballasted version drawing 27.2 feet aft and 18.7 feet forward and displacing 54,260 tons was used for outbound transits. Note that a fully loaded tanker of similar length and

---

<sup>1</sup> Crab angle- or drift angle – difference between course steered and the course made good usually due to the action of current or wind. This effectively increases the footprint of a vessel lessening channel maneuver room

breath would displace around 120,000 tons and draw 48 feet. All transits on the *Jupiter* were conducted with tug assistance.

The ship's key characteristics with respect to evaluating the channel design were her draft and low engine power relative to displacement during inbound transits on the partially loaded ship. During outbound transits, the ballasted version of the ship was more wind sensitive and this provided an opportunity to look at how the channel designs fared with a low powered, wind sensitive ship in the high wind conditions.

### 2.1.3 Assist Tug Modeling and Deployment

Three harbor assistance tugs were used by the Pilots for simulation runs on the *Jupiter*. The tugs were configured to replicate the power and performance characteristics of three tugs presently serving the port. The bollard pulls (BP) used on the simulator was estimated based on the rated horsepower and mechanical efficiency of the tug type as indicated below.

- Elizabeth - 3000 hp conventional - estimated BP at 100% Power = 40 tons
- Michael - 3000 hp conventional - estimated BP at 100% Power = 40 tons
- Eagle - 4000 hp tractor - estimated BP at 100% Power = 52 tons

The tugs were made fast at the start of every exercise on the *Jupiter*. Per the Pilots direction, the same deployment scheme was used each exercise. The Elizabeth and Michael were made fast on the port and starboard bow respectively and the Eagle at the stern with a line through the centerline chock. The Pilots controlled the tugs by communicating with the tug Captains (simulator operator) using a hand-held radio. The tug was identified by name, the direction of the tug relative to the ship's side was ordered and the engine power setting was ordered, e.g., "Bow Tug" push half ahead at 90 degrees".

The simulator operator activated the tug by assigning a direction of action relative to the ship's centerline and tons of force based on the engine power. The only exception to this procedure occurred when the ship was moving too fast for the tug to deliver full power. In those instances, the simulator operator reduced the tug force as appropriate to the ship speed through the water and the type of tug being simulated (i.e., conventional propulsion vs. azimuth propulsion).

## 2.2 Simulator Geographic Model

The geographic model presents a realistic out-of-window visual display using Computer Generated Image (CGI) technology, and a corresponding radar image on the radar displays located on the simulator's navigation bridge. The visual and radar models incorporate landmass, terrain elevations, aids to navigation, piers, jetties, bridges, buildings, towers, and other characteristics of the modeled geographic area, and displays other vessels and aircraft.

Specific structures, buildings, stacks, key landmarks, and other prominent features that can be used as visual cues by the pilots when handling ships in the port are identified for inclusion in the 3-dimensional visual scene.

### 2.2.1 Channel Improvement Modeling

STAR Center possessed an accurate computer model of Port Canaveral that had been created for a prior evaluation. This geographic database and bathymetric model was modified to reflect dredge plans A and B provided by the Port's consulting firm. The following table quantifies the main differences between Plan A and B. Details of the alternative plans are shown on the engineering drawings in the attached appendices.

HARBOR FEATURE	PLAN A	PLAN B
Entrance Channel turn widener	surface area 22.2 acres	surface area 11.14 acres
Middle and Inner Reaches widening (along north side)	100 feet over 500 ft. length (i.e. 50,000 ft <sup>2</sup> )	50 feet over 450 ft. length i.e. (i.e. 22,500 ft <sup>2</sup> )
West Access Channel widening	100 feet on south side 13 feet on north side	no change from width
West Basin Turning Basin	1725 feet diameter	1675 feet diameter

When reviewing the engineering drawings, note that both plans deepen to the same depths and widen the navigation channels in the same general areas. Both add new berths and both remove land areas to increase the size of the West Basin however, Plan A provides for wider navigational channels and maneuvering areas.

### 2.2.2 Other Ship Traffic

Only one-way traffic was simulated so there was only one ship underway during the simulations however, a ship, appropriate in size and type to each berth, was moored alongside at all of the Port's berths. The specific ship selected for a berth was the one with the widest beam likely to dock at that particular berth. This provided for a worse case analysis of the Plans since the ships at berth reduced the available maneuvering area by their beam widths.

Future passenger and cargo ship berths were also included in the simulator databases of Plans A and B and occupied by a ship as well. These included future berths CT6/7, CT12, NCP5, NCP6 and NCP7. The ships at berth are shown on the attached track plots and a list showing the ship name/type and dimensions at each berth is included in the attached appendices.

### 2.2.3 Depth Modeling

The depth files used for harbor simulation represent the bathymetric definition of the waterway that included bottom contours and shoals and the navigation channels and channel banks, turning basins, and berth dimensions. The bathymetric model provides an extremely important input and is fundamental to providing a high fidelity simulation. Underkeel clearance and proximity to banks and other underwater features have a fundamental and important effect on the maneuvering characteristics of the ship response models.

Project depths are the same for both Plans A and B (except as dictated by the differences in areas effected) and represent an increase over the Port's existing depths. With respect to impact on the simulation analysis, the channel depths of most interest were those in the areas traversed by the *Jupiter* when partially loaded to a draft of 39.4 feet. This included the Outer, Middle and Inner Reaches. Channel depths in the West Access Channel and West Basin (not normally used by tankers) were of less importance to the evaluation

because of the relatively shallow draft of the *FREEDOM*, which at 27.9 feet, is typical for large modern passenger ships.

The following table shows the existing channel depths, and the depths as modeled in the areas traversed during the simulation tests.

HARBOR FEATURE	EXISTING DEPTH	SIMULATED DEPTH (2009 evaluation)
Entrance Channel (Outer Reach)	44 feet	46 feet
Middle Reach	44 feet	46 feet
Inner Reach	40 feet	44 feet
West Access Channel (east of Sta. 260)	39 feet	43 feet
West Access Channel (west of Sta. 260)	31 & 35 feet	35 feet
West Basin Turn Area	31 & 35 feet	35 feet

The water level was held at datum (i.e., the project depths) during the simulation evaluations to provide for a worse-case analysis. A detailed breakdown of the project proposed depths as prepared by the Port's engineering consulting firm is provided in the attached appendices.

#### 2.2.4 Aids to Navigation

Accurate positioning of fixed and floating aids (buoys) to navigation is an essential part of the visual database. The key aids to navigation used in the evaluation included buoys marking the channel limits and range markers marking the centerline of the middle and inner harbor reaches for each alternative channel plan. The Port Canaveral Pilots worked with STAR Center technicians to position buoys at the most appropriate locations to conform to the Plan boundaries.

The existing inbound channel range markers were shifted slightly north in the alternative Plan A and B geographic models to align them with the new channel centerline created by widening and straightening of this channel. In addition, a new outbound range was created in the simulator model to provide a visual cue for the new channel centerlines when transiting the port outbound.

### 2.3 Environmental Conditions

Since the objective of the evaluation was to compare the navigational safety of the alternative plans, maximum credible adverse environmental conditions of both wind and current were used during all simulations. The Port Canaveral Pilots and Port representatives identified the specific conditions that met these criteria.

According to comments made by the participating Pilots, the wind and current effects that were simulated were deemed to produce a very realistic effect on the handling of both ship response models. The specific conditions modeled were as follows.

#### 2.3.1 Wind Modeling

Winds ranging up to a maximum of 40 knots were used. The general approach was to vary the wind within a five-knot range and set the wind direction at right angles to the inner harbor reaches that is from either the north or the south when the scenario included a transit through these reaches. A NE wind was simulated for exercises that looked at the most extreme wind conditions in the entrance channel (i.e., 40 knots).



Wind forces are automatically calculated on the simulator based upon wind speed and direction relative to the ship's heading, and the aerodynamic coefficients of the wind profile of each ship response model. The large profile presented by today's large passenger cruise vessels result in a substantial impact on shiphandling due to wind effects. The tanker is less affected by the wind in the partially loaded condition due to its deep draft, broad beam, low freeboard and minimal superstructure in comparison to the passenger ships. In ballast condition however, the tanker would experience slightly more of the wind effect. The relative force of the wind on each of the test ships can be compared by comparing the beam on surface area of each ship as noted in table of ship's principle particulars in the appendices.

### 2.3.2 *Current Modeling*

The Pilots provided information on the expected direction and velocity of the current based on the wind direction and speed. They noted that wind driven currents exist offshore in the approaches to Port Canaveral, but are minimal in the harbor itself.

The only current simulated was therefore in the approach channel where these currents runs parallel (north and south) to the shoreline. Since currents in this area are wind driven, the effect of the current on the ship's submerged hull was added to that produced by the wind on the ship's exposed hull and house to provide a worse case condition during the testing. A wind from the north therefore generated a current setting the ship south and visa versa for a southerly wind.

Besides setting a ship in the Entrance Channel, the current produces a strong "shear" effect as a ship enters or leaves the breakwater. The shear is more of a safety concern for an inbound ship because the ship handler has the option of increasing engine speed and accelerating the ship when outbound; increasing speed on the inbound vessel is not a desirable option. The shear effect is caused by the bow entering sheltered water while the stern is still out in the current stream which twists the ship into a sudden yaw.

The current speed was set to maximum velocity for a given wind speed and direction, which assumed a prolonged blow from the direction being tested. Current speed for northerly winds was limited to a southerly set of 0.5 knots due to the limited fetch (intervening land mass) lying to the north of the port. This was adjusted downward from the 1.0 and .75 knots that was originally planned. The maximum northerly set tested was 1.0 knot since open water lies to the south of the Port.

### **3 SIMULATION PROCEDURES**

The simulation procedures used during this evaluation are discussed below.

#### **3.1 Participants**

Two of Port Canaveral's Pilots participated in the study by handling the simulated ships and by assisting with fine-tuning of the simulation models and the operational procedures and environmental conditions used during the simulations.

Other persons representing organizations with vested interests in the project were present to observe the simulations. This included representative from Port Canaveral and the engineering consultant firms involved in the development of the designs under evaluation. Also present were representatives from the US Army Corps of Engineers Waterways Experiment Station and the Jacksonville District. These individuals helped shape the direction of the testing program by providing valuable insight into project details such as engineering design criteria and operational priorities.

STAR Center's Senior Researcher and a consultant to STAR Center observed simulated transits, noted results and conducted debriefings after each test run. STAR Center also provided an experienced helmsman to steer the ship under the Pilots' direction and a simulator operator to configure the simulator, monitor proper operation of the simulator, control the assist tugs, capture data, and make track plots for each test run.

#### **3.2 Wheelhouse Procedures**

The simulation exercises consisted of a number of partial inbound and outbound transits and maneuvers with a Port Canaveral Pilot controlling the vessel from the simulator wheelhouse just as he would in actual practice. The Pilots took turns conning the ships so that each Pilot could rest between exercises as well as observe the other Pilot's activities. Prior to commencing each exercise, the Pilot at the con was briefed on the test conditions, including the vessel's position, starting speed, load condition if applicable, and the wind and current conditions to be expected. The Pilots started with a familiarization exercise on each ship prior to starting the formal test exercises that were recorded for analysis.

Real-world navigational procedures were used during the exercises so far as practical including real-world commands and the simulated transits occurred in "real-time". The Pilot conned the ship and controlled the bow thruster and engines using the controls on the main consoles. The qualified helmsman was available to steer the ship under the Pilots direction when he chose to control the ship in this manner. The tugs were controlled via hand-held radio communication with the tug Captains (i.e., the simulator operator). The Pilot monitored the ship position relative to the channel boundaries, aids to navigation and ships at berths using the out the window view, by observing the simulator's birds eye plan view and by asking the simulator operator to feedback distances from obstructions or fixed objects.

#### **3.3 Data Collection Procedures**

The simulator automatically recorded information during each exercise. This includes the vessel's trajectory and heading and information relating to control settings including a

continuous record of each tug's direction and power output. This information was used to generate the attached track plots and to calculate average ships speed and rates of turn. It was also archived so that the test runs can be played back at a later date or if further analysis is needed.

The Pilots filled out a "Run Evaluation Form" after every exercise. This form solicited specific questions about the just completed test run based on: adherence to intended track line, vessel controllability, and adequacy of assist tugs and overall safety and task difficulty. The Pilots also summarized their opinions regarding the overall test program and operation evaluation by completing a "Final Evaluation Form" after all simulator testing was completed. Comments from this form were used in the formulation of the conclusions appearing in this report. STAR Center's project team kept notes regarding each simulator test and noted simulator specific factors that might influence the interpretation of results. Copies of all Exercise and Final Evaluation Forms are included in the attached appendices.

### 3.4 Special Procedures

There will always be differences between the simulated environment and the real world regardless of how sophisticated the simulator. STAR Center has therefore developed a number of special operating procedures to mitigate the effect of these differences on the performance of the shiphandler on the simulator bridge. Some of the principle procedures are discussed below.

#### 3.4.1 Ship Control Procedures on the *FREEDOM*

The normal real-world practice for maneuvering modern cruise ships in confined Port areas is that the ship's Master maintains the con and manipulates the ship's steering and propulsion controls. The Port Pilot acts as an advisor with regard to local knowledge and Port practices and procedures (e.g., speed limits, passing/meeting, dock line placement, etc.). This is the case because specialized knowledge and familiarity with the ship's systems is necessary. For example, the *FREEDOM* is equipped with a sophisticated dynamic positioning system mode that puts many control functions under computer control. However, when maneuvering a modern azipod and bow thruster equipped cruise ship in confined waters, the shiphandler has a number of simpler operational modes that can be used to control the ship.

During simulations, the *FREEDOM* was conned by the Pilots from the centerline console where the azipod controls were located, and from which all indicators, radars and navigation equipment could be seen. The ship's dynamic positioning maneuvering mode was not used. The pilots were however given the opportunity to practice handling the *FREEDOM* using the following simpler control modes.

- Combi Mode – ship steers much like a conventional ship, the azi pods turn under helm control and propeller RPM for each pod changes in unison per a single throttle lever
- AziMan – azi-pods are controlled independently, usually one is used as a stern thruster and the other used to control fore and aft speed

The ship's four powerful bow thrusters and engines were under direct Pilot control in both of the above maneuvering modes. When in the Combi mode, the Pilot could steer

the ship himself using a mini-wheel on the console or he could delegate the steering task to the helmsman. Simply stated, the AziMan mode provides the shiphandler with more positive control at low speeds while the Combi mode is better for higher ship speeds. Making a distinction between the ships control modes is important because the ship handler can drastically reduce a ships crab angle in high wind conditions by switching from Combi to AziMan mode.

The usual progression of control is that an inbound ship would be in the Combi mode in the Entrance Channel and be changed over to the AziMan mode in the more confined inner harbor areas.

#### *3.4.2 Bridge Wing View*

During simulation, the normal position of the eye point represented by the simulators out-the window view is in the center of the simulator wheelhouse. Close quarters maneuvering such as docking and undocking often requires that the shiphandler work from the bridge wing in order to observe the clearance to moored vessels or shore side structures. In the real world, this is accomplished by merely walking out to the ships wing.

On the simulator the ability to view the operation from the bridge wing is facilitated by moving the eye point of the visual scene laterally to the outer edge of the simulated ship's side, or in the case of some vessels, to the extended bridge wing beyond the ship's beam. This permits the shiphandler to see the entire side of the vessel near the pier, to look around obstructions such as cranes or deck cargo on the foredeck, or to view objects that are astern of the ship.

#### *3.4.3 "Birds Eye View"*

For docking maneuvers and turning around in the turning basin, a "bird's-eye view" display was provided on the console. This display provides a plan view of the harbor area and is similar in some respects to an ECDIS (Electronic Chart Data Information System), lacking only the detailed chart information.

## 4 RESULTS

Testing took place during three consecutive days in June 2009. A test plan consisting of 16 scenarios was used as the basis of the program. Additional runs were added as time and conditions allowed so that a total of 20 simulation exercises were completed. In all, 18 exercises were retained for analysis and 2 were discarded because simulation related factors rendered their results unusable.

The test plan provided a head to head comparison of the Plans by simulating identical conditions for Plan A and Plan B. This included wind, current, ship and direction of transit. Exercises were numbered sequentially with Plan A first then Plan B under the identical conditions; an odd number was assigned to an exercise using Plan A and an even number assigned to an exercise in Plan B.

While the exercises have sequential numbers, the exercises were not run in their sequential order on the simulator. That is, the order that the Pilots actually completed the exercises was randomized except that exercise on the first day of testing used the *Jupiter* exclusively and exercises on days 2 and 3 were with the *FREEDOM* exclusively. Alternating between test conditions helped to prevent a learning effect due to the back to back running of the exact same conditions twice in a row. A table listing all completed exercises and associated test conditions is provided in the attached appendices.

### 4.1 Criteria for Evaluating Results

The following are the main factors that were considered during evaluating and interpretation of the results of the simulation tests.

#### 4.1.1 Pilots Overall Safety Rating

Since the simulations considered the maximum credible adverse environmental conditions, a key factor in the comparison of the plans is their relative safety. As noted earlier, the Pilots filled out an “Run Evaluation Form” after every test run which included an Overall Safety rating. The rating assigned by the Pilots was based on a 5 point scale where a rating of 5 = “Absolutely Safe” and a Rating of 1 = “Not at All Safe”. The overall safety rating for each exercise is documented in these Debriefing Forms and is therefore reported in this section.

#### 4.1.2 Surge Effects

Hydraulic effects caused by the displacement of a large volume of water during the passage of vessels transiting the channel can cause problems in the Trident Basin, home to Navy submarines and other support vessels or any passenger vessels moored at the outer cruise terminal docks (CT2 to CT4). Speed control in the Middle and Inner Harbor is an important factor in order to minimize surging impacts on any ships that are berthed along the channel. Another factor to minimize surge effects is lateral distance from the moored vessel. Maintaining the north side of the channel as much as practical depending on environmental conditions, contributes to a lessened effect. The maximum speed that the Pilots stated was acceptable in these reaches was in the 6 to 6.5 knot range.

The extreme wind conditions imposed during a simulation exercise forced the Pilots to go as fast as they dared to help maintain control and to minimize crab angle. Therefore, consistent differences in average speed when transiting the Inner and Middle Reaches would be indicative of a safety advantage of one plan over another. That is, a higher

average speed equates to a lower margin of safety and a higher probability of surge damage to other ships. The ship's average ground speed was therefore calculated for each exercise for that portion of the transit between the east side of the Trident Basin and the east side of the Middle Basin.

Note that maintaining an adequate lateral distance when going past the cruise ships at berths CT3 and CT4 is also important to minimizing surging impacts since hydrodynamic forces are a function of both speed and separation distance. In this regard, Plan A has a built in advantage over Plan B since it provides 50 feet of additional width on the north side of the channel. Conversely, the negative impact of a higher ship speeds is amplified in Plan B.

#### 4.1.3 Proximity to Channel Boundary

The shiphandler strives to maintain adequate clearance between the ship and channel boundaries. First and foremost this is to insure a margin of safety against grounding. In addition, when a ship has significant headway, the closer that a ship is to an underwater bank and the faster it is moving, the larger the hydrodynamic force on the ship's hull due to its interaction with the channel bank walls. The resultant "bank cushion" or "bank suction" can make it more difficult to control a ship's heading, and, under extreme conditions, can overwhelm a ship's rudder and cause a dangerous uncontrolled shear away from the bank.

The track plots, which provide a visual record of the ships clearance to the channel boundary, were therefore examined and are referenced in this section as appropriate. Track plots of all exercises, including expanded scale track showing details in areas of interest, are therefore provided in the attached appendices.

The Pilots also rated their bank clearance in the Entrance Channel and in the West Basin area in the Run Debriefing Forms. The rating assigned by the Pilots was based on a 5 point scale where a rating of 5 = "Extremely Satisfactory" and a Rating of 1 = "Not at All Satisfactory". The ratings, as documented in the Debriefing Forms, are therefore reported in this section when appropriate.

## 4.2 Jupiter Exercises

There were six exercises using the tanker *Jupiter*. All exercises retained for analyses were completed without serious mishaps. The exercise conditions and a summary contrasting the results in each plan is shown in the following table.

Exercise Numbers (A & B)	Wind & Current Conditions	Transit Direction	Pilot's Overall Safety Rating		Turn Widener Clearance Rating		Ave. Speed Middle & Inner Reaches	
			Plan A	Plan B	Plan A	Plan B	Plan A	Plan B
5 & 6	S 25/30 kts, N .75 kts.	inbound	3.5	2	4	2	4.7 kts.	4.5 kts.
7 & 8	N 25/30 kts, S .5 kts.	outbound	4.5	2.5	5	2	8.6	8.5
19 & 20	S 25/30 kts, N 1.0 kts.	outbound	NR	3	4	3	7.1	6.7

Exercises on the *Jupiter* were limited to examining the Entrance Channel turn widener and Middle and Inner Reach wideners since areas west will be too shallow to accommodate vessels drawing as much as the partially loaded *Jupiter*. The area transited therefore ranged from the south of Buoy #9 in the Outer Reach through where the Middle Reach joins the Middle Basin.

The overall safety rating for the six exercises indicates that the Pilots thought that Plan A provided a better margin of safety than did Plan B for both the partially loaded and ballasted version of the ship. Both Pilots also commented that the increased depths in the Entrance Channel and Inner Harbor improved the overall handling of the partially laden *Jupiter*. Observed results in each channel segment are discussed below.

#### 4.2.1 Results in Entrance Channel Turn Widener

Ship clearance to the channel boundaries was consistently rated as satisfactory in Plan A and unsatisfactory in Plan B. A visual inspection of the trackplots shows marginal clearance in exercise #6 only, however, closer inspection of the trackplots suggests a slower and more controlled turn through the bend that provides a smoother transition between the Outer and Middle Reaches facilitated by the larger turning radius allowed by Plan A.

#### 4.2.2 Results in Middle and Inner Harbor Reaches

Average speed through the reaches was essentially the same for both Plans. While Plan A should have allowed the ship to pass further north of the docked ships, this did not consistently happen on the simulator. Differences between the two plans with regard to the potential for damaging the berthed passenger ships and with regard to clearance to the northern channel boundary was therefore not demonstrated on the simulator. The Pilots however, were definitely more comfortable in Plan A as expressed in their Final Debriefing Form comments. This fact is attributed to the fact that the wider channel in Plan A, while not utilized by the ship, did provide increased tug boat maneuver room should it be required.

### 4.3 FREEDOM OF THE SEAS Exercises

There were twelve exercises aboard the *FREEDOM* and 11 of the 12 exercises retained for analyses were completed without serious mishaps. The only problem occurred in exercise #2 when the Pilot grounded the ship on the north side of the Inner Reach widened per Plan B. The grounding was however, a direct result of the Pilot's unfamiliarity with simulator bridge equipment, and not indicative of vessel handling problems. The vessel would have grounded in either Plan A or B, and was discounted as mechanical problems in our analysis.

The exercises conditions and a summary contrasting the results in each plan are shown in the following table.

Exercise Numbers (A & B)	Wind & Current Conditions	Transit Direction	Pilot's Overall Safety Rating		Turn Widener (West Basin) Clearance Rating		Ave. Speed Middle & Inner Reaches	
			Plan A	Plan B	Plan A	Plan B	Plan A	Plan B
1a & 2	N 30/35 kt, S .5 kt.	inbound	5	2	5 (5)	2 (4)	5.8	8.8
3 & 4	S 30/35 kt, N 1.0 kt.	inbound	4	4	5 (5)	5 (5)	4.0	5.8
9 & 10	N 30/35 kt, S .5 kts.	outbound	5	4	4	3	8.8	10.1
11 & 12	S 30/35 kt, N 1.0 kt.	outbound	4	NR	4	4	5.6	7.0
13 & 14	S 35/40 kt, N 1.0 kt	inbound	3	NR	4	4	NA	NA
15 & 16	NE 30/35 kt, S .5 kt.	outbound	2	3.5	4	5	NA	NA

Exercises on the *FREEDOM* included all of the areas under evaluation. Therefore areas transited ranged from south of Buoy #9 in the Outer Reach through to the West Basin Turning Area.

The Pilots' overall safety rating for the exercises suggest that Plan A offers a slight to moderate safety advantage over Plan B. The ratings do not however reflect the strong preference for Plan A voiced by the Pilots in their Final Debriefing Forms. This may be attributable to the fact that the *FREEDOM* is an exceptionally powerful and sure handling ship and the Pilots were able to keep the ship safe and under firm control in both plans, even under the extreme environmental conditions. The opinions expressed in the Final Debriefing Forms take into account that fact that the Pilots are very aware that not all ships as easily controlled as is the *FREEDOM*.

Observed results in each segment of the waterway are discussed below.

#### *4.3.1 Results in Entrance Channel Turn Widener*

Twelve exercises included transits through the Entrance Channel Turn Widener on the *FREEDOM*. The Pilots rating for clearance to the channel boundaries was only marginally better for the Plan A widener however, the Pilots pointed out that the Plan A widener allowed for a smoother, more gradual turn during both inbound and outbound transits that was facilitated by the larger turning radius provided by the increased area in Plan A.

The Pilots observation is confirmed by the ships maximum rate-of-turn as recorded by the simulator and as can be seen by closely examining the trackplots. Analysis of the simulator data showed a consistently lowered maximum rate of turn in the Plan A exercises when transitioning between the Middle and Outer Reaches.

The advantage of the Plan A over the Plan B widener is most observable on the trackplots of the four exercises that used the most extreme environmental conditions (wind 35 to 40 knots) and that only transited the wideners, i.e., exercise #s 13 & 14 and 15 & 16. The trackplots clearly illustrate a slower rate of turn and smother transition between the Outer and Middle reaches in the Plan A exercises.

#### *4.3.2 Results in Middle and Inner Harbor Reaches*

Eight exercises included the transit through the Middle and Inner Harbor Reaches. The results show that, given identical environmental conditions, the Pilots were consistently able to transit the reaches at a lower speed in Plan A (see previous summary table). This performance demonstrates a measurable increased margin of safety over Plan B and it is consistent with the Pilot's extensive description of the navigational issues as documented in their Final Debriefing Forms.

#### *4.3.3 Results in West Access Channel*

Eight exercises examined the transit through the West Access Channel. The trackplots show that, given identical environmental conditions, the Pilots were able to safely transit the area in both Plans A and B. Plan A did provide for a greater clearance to the channel boundaries, however, the reduced clearance was not significant given the powerful maneuvering capability of the *FREEDOM*.

#### *4.3.4 Results in West Basin Turning Area*

The Freedom was turned in the Turning Basin area in four exercises (i.e., 1a&2 and 3&4). The smaller radius West Basin (by 50 feet) provided by Plan B proved adequate and safe for the *FREEDOM* and the Pilots rated the channel boundary clearance as satisfactory for both Plans A and B.



## 5 CONCLUSIONS AND RECOMMENDATIONS

The simulation evaluations demonstrated that both Plans A and B can accommodate the design vessels, even during maximum credible adverse environmental conditions. However, it was also demonstrated using both the *Jupiter* and *FREEDOM OF THE SEAS* design vessels that Plan A provides a significantly wider margin of safety over Plan B in the Inner and Middle Reaches and, to a lesser extent, in the Entrance Channel turn widener. These findings are supported by the observed results of the simulations and by the strong endorsements of the participating Port Canaveral Pilots

The Pilots were also of the opinion that Plan A would provide significant safety advantages over Plan B in the West Access Channel and in the West Basin Turning area. The advantages noted by the Pilots were however not directly observable during the simulated transits on the design vessel, the *FREEDOM OF THE SEAS*.

A more detailed discussion of the conclusions and associated recommendation follows.

### 5.1 Middle and Inner Harbor Reach Wideners

The simulation exercises clearly demonstrated a safety advantage of Plan A over Plan B during transits of the *FREEDOM* as reflected in consistent an significantly lower transit speeds in the reaches with the Plan A widening. The effect on transit speed was not observed on the *Jupiter*, however, a greater clearance to the north channel boundary on the deeper draft *Jupiter* was available in Plan A's wider channel. In addition, the Pilots strongly endorsed Plan A and they provided a comprehensive explanation of its advantages from the ship handler's perspective in their Final Evaluation Forms which are reproduced in the appendices.

Therefore, STAR Center recommends that the Middle and Inner Harbor reaches be improved per the Plan A design.

#### 5.1.1 Outbound Ranges

The Pilots made extensive use of the outbound range during all of the outbound simulations during this evaluation. Both Pilots noted that the range is particularly helpful when handling large cruise ship with the house forward and that the range would enhance the safety of nighttime transits. They also strongly recommend that the centerline range be included in the project in their Final Evaluation comments.

STAR Center concurs that an outbound range marking the centerline of the Middle and Inner Harbor reaches be included in the final project design for either Plan A or Plan B. Entrance Channel Turn Widener

The simulations also clearly demonstrated that the entrance channel widener in Plan A allowed for a smoother transition with a lower rate of turn between the Outer and Middle Harbor reaches. This is especially important to passenger ships which must limit their turn rates to insure that the ship does not develop a list (heel angle) that is avoided on any and all passenger vessels.

The smoother turn was especially beneficial for an inbound ship with a strong southerly wind, which caused a shear current effect at the breakwater. In this case, both the wind and current acted in concert to turn the ship to the left towards the passenger ship at CT4

as the ship was passing through the breakwater. The smoother and more controlled turn in Plan A allowed the Pilot to better position and control of the ship as it entered the Middle Reach and likely contributed to the dramatically improved performance seen in the Middle and Inner Reaches. The two Plan A design elements in effect worked together to improve safety margins for an inbound ship during extreme environmental conditions.

STAR Center concurs that the Plan A Entrance Channel widener be implemented in tandem with the Middle and Inner Reach Plan A widener.

### **5.2 West Access Channel Widening and West Basin Turn Area**

Both Plans were observed to be equally safe and usable by the *FREEDOM*. While Plan A did provide a larger clearance to the channel boundaries, the added space was not needed given the exceptional power and maneuverability of this particular design ship.

Given that the simulation evaluation findings are restricted to the observed results using the two design ships (see discussion below), STAR Center must conclude that both Plans A and B are acceptable from a navigational safety perspective for these waterway segments.

### **5.3 Channel Depths**

While only two exercises were completed on the deeply laden, partially loaded tanker, both Pilots reported that the increased project depths, as modeled in the simulations, provided a more acceptable underkeel clearance for the deep draft vessel. They noted that the added depth improved the ship's maneuverability, shortened its stopping distance and reduced the chances of the ship bottoming out due to ship movement in a seaway or due to squat.

### **5.4 Related Observations**

A simulation evaluation is narrowly focused on a few key operations and/or areas out of economic and technical necessity. Ship's Masters, Pilots, Port Officials, tug Captains and other participants in a simulation evaluation on the other hand, have a much more encompassing and integrated understanding of the environment being simulated. Consequently, these individuals often logically deduce and report other benefits or predict problems not directly addressed by the simulations. It is often the case that this is due to what they have observed on the simulator or is a result of discussions with the other participants.

This evaluation was especially productive in this regard and the reader is referred to the attached Final Debriefing Forms where the Pilots commented extensively on what they believe are advantages of Plan A over Plan B. Their main observations not necessarily addressed in simulations are briefly described below.

- the increased channel depth (in both Plans A and B) would reduce or totally eliminate "tide jobs where the movement of deep draft commercial ships is delayed due to the higher priority given to passenger ships

- the wider Plan A could enable two-way-traffic to be permitted in some areas of the channel, with smaller vessels that operate at Port Canaveral
- additional width of Plan A Entrance Channel widener may provide an “escape plan” for small to moderate size vessels in the event of an emergency (steering or engine casualty for example) while transiting the Outer Reach
- the Plan A West Basin would provide additional room and a wider safety margin when maneuvering ships that require tug assistance
- the larger West Basin and widened West Access depicted by Plan A Channel could accommodate cruise ships larger than the design ship (e.g., *GENESIS* Class)
- the Plan A widening along the south side of the West Access Channel provides for advanced maintenance dredging and thus reduces the chances of a grounding should the area silt in prior to maintenance dredging



Figure 1 - Plans A and B

## SHIP PARTICULARS AZI / AZIMUTHING POD

SHIP NAME **FREEDOM OF THE SEAS**FILE NAME **CR112DE**SHIP TYPE **cruise**LOAD COND **Design**TONNAGE **72,330**DWT DISPL GRT Aero: **13020**EYEBOW: **43.8** **144 Ft.** Height Eye **34** **110 Ft.** EYESTERN: **295.1** **968 Ft.**Air Draft **64** **210 Ft.**BEAM Bridge Wing **47** **154.2 Ft.**

(If Wider than Beam)

LOA **338.9** **1,111.6 Ft.**

Draft

LBP **303.3** **994.8 Ft.**FWD **8.5** **27.9 Ft.**W/L BEAM **38.6** **126.6 Ft.**AFT **8.5** **27.9 Ft.****PROPULSION** **Diesel Azipod**AZIPOD NO. **3**SHAFT HP **18,774 EACH**PROPELLER DIRECTION **Inwar**TYPE **FIXED**  **VARIABLE** BOW THRUSTERS **4** HP **4,425 EACH**

## Shaft RPM and Speed

## MANEUVERING

MAX RPM **143**MIN RPM: Max Speed: **23.3**

Lever Position

RPM

Speed Shallow

Speed Deep

8 FULL AHD:

**134****20****22**

5 HALF AHD:

**67****11****11**

3 SLOW AHD:

**36****6****6**

1 DSLOW AHD

**20****3****3**

8 FULL ASTN

**111****12****13**

5 HALF ASTN

**68****8****8**

3 SLOW ASTN

**35****4****4**

1 DSLOW ASTN

**18****2****2**

APPENDIX B – Engineering Drawings for Navigation Simulations

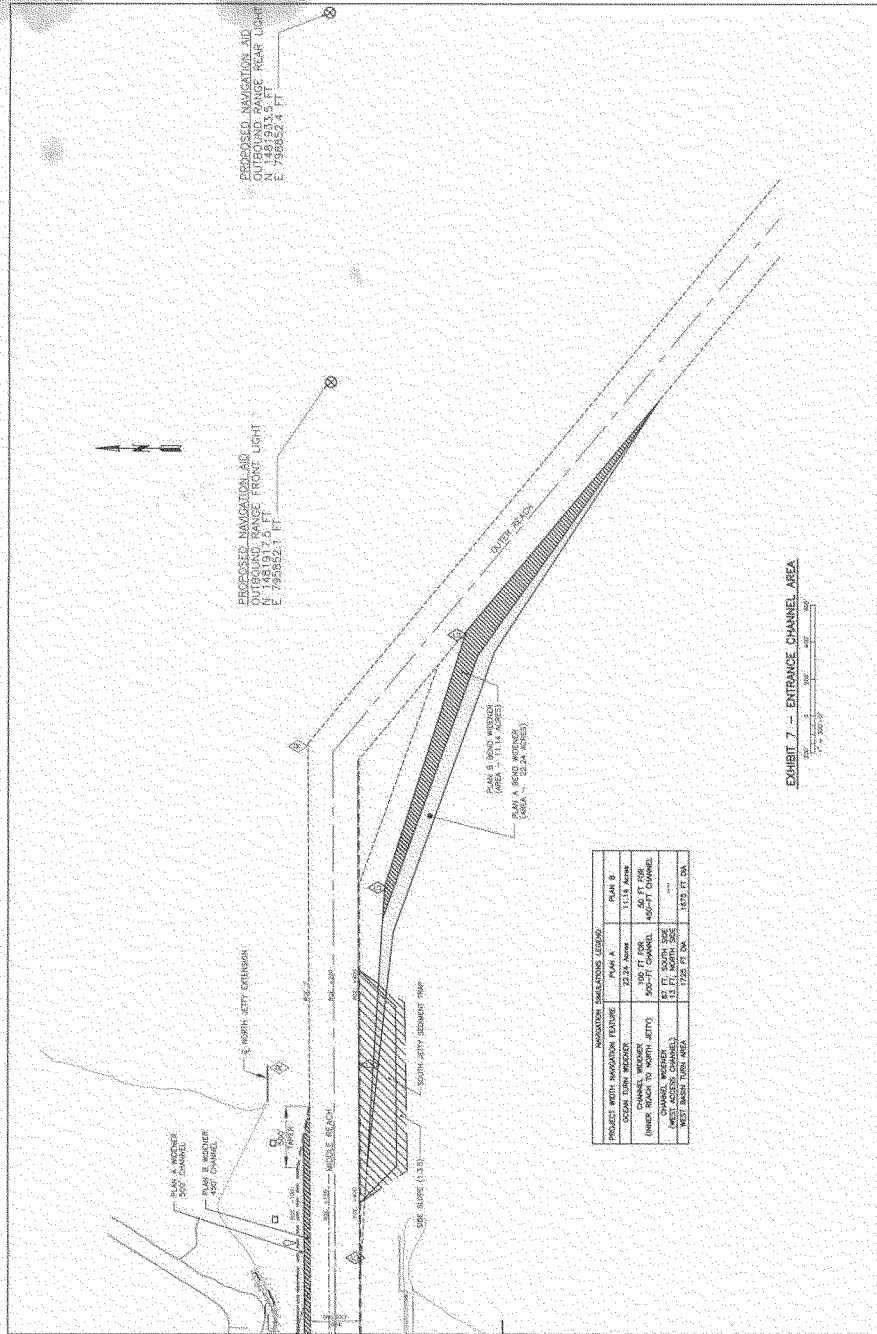

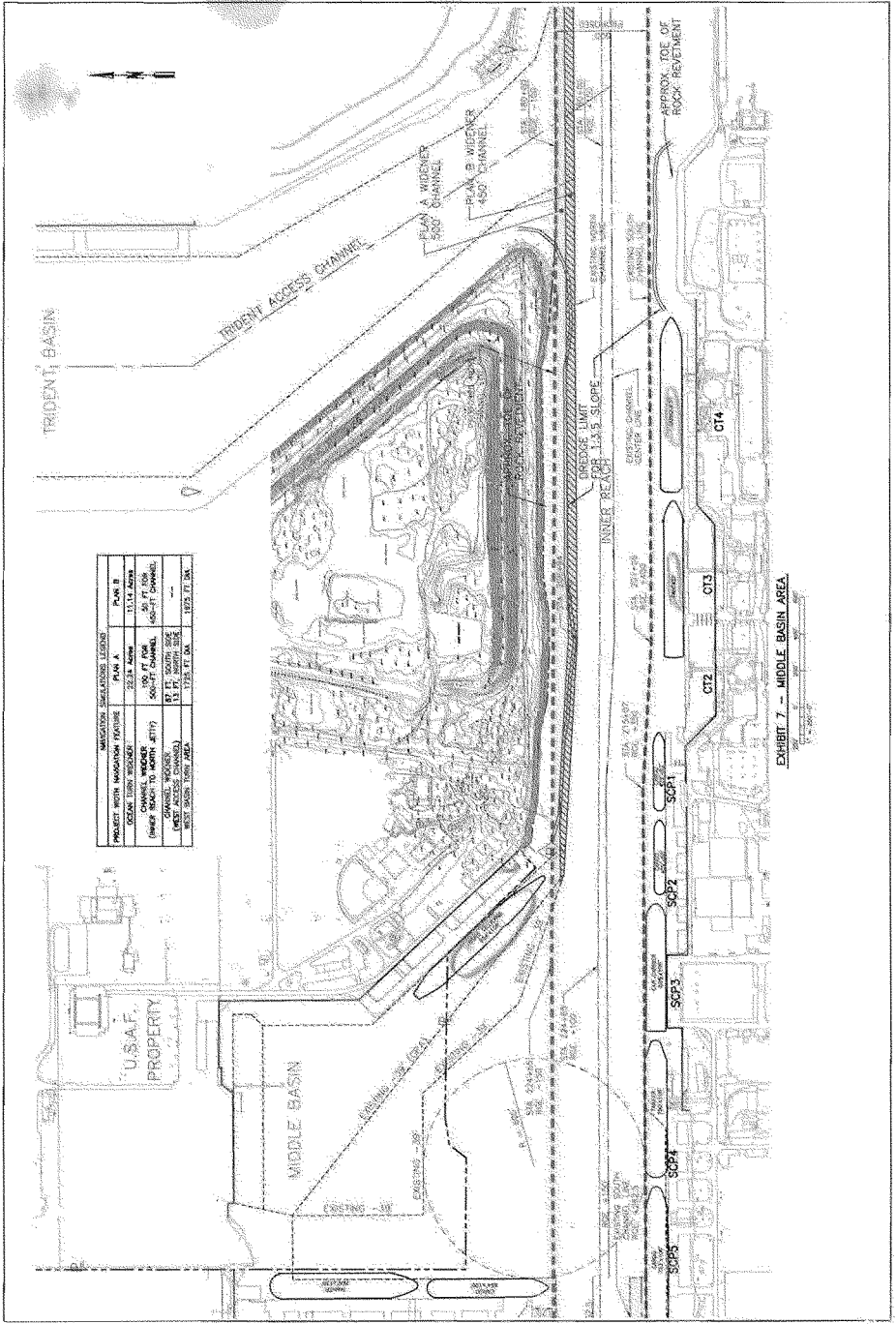





## APPENDIX C

## SHIPS AT PIERS FOR SIMULATIONS

<u>Cruise Pier</u>	<u>Ship Type</u>	<u>GRT</u>	<u>Length (ft)</u>	<u>Beam (ft)</u>	<u>Draft (ft)</u>
CT3	Fantasy Class	70,400	855	103.3	26
CT4	Conquest Class	110,000	952	116.5	27
CT4	Destiny Class	101,400	893	116.5	27
CT5	Spirit Class	84,000	960	105.6	26
Future CT6/7	Genesis Class	220,000	1187	154	30
CT8	DCXL Class	122,000	1115	121	27
CT10	Freedom Class	158,000	1112	127	28
Future CT12	Voyager Class	138,000	1021	127	28

<u>Cargo/Fuel Pier</u>	<u>Ship Type</u>	<u>DWT</u>	<u>Length (ft)</u>	<u>Beam (ft)</u>	<u>Draft (ft)</u>	
SCP1	Sunbelt Spirit-Car Carrier	17,950	696	105.7	32	air draft = 125 ft
SCP2	Bulk-BreakBulk	Green Spring	409	60?	24	
SCP3	Bulk-BreakBulk	Prince of Seas	428	62	25.5	
SCP4/TB1	Tanker	65,000	750	105.6	39.5	max draft = 42.7 ft
SCP5	Bulk-Limestone	67,000	753	105.6	39.5	max draft = 43.3 ft
NCP1	Tanker	110,000	800	138	39.4	max draft = 48.9 ft
NCP2	Bulk-BreakBulk	47,027	653.6	100	38.8	Saga Andorinha
NCP3	Bulk-BreakBulk	43,420	672	105.6	37.4	Cutrale Juice
NCP4	Cargo-Sm Cont	45,000	800	105.6	39.4	
Future NCP5	Cargo-Sm Cont	45,000	800	105.6	32.5	max draft = 39.4 ft
Future NCP6	Cargo-Sm Cont	45,000	800	105.6	32.5	max draft = 39.4 ft
Future NCP7	Cargo-Sm Cont	45,000	800	105.6	32.5	max draft = 39.4 ft
Poseidon Pier	MPS-LMSR Ship	USNS Gilliland	954	105.7	31	Bow at SE end of pier

## PROJECT DEPTHS FOR SIMULATIONS

<u>Canaveral Harbor Feature</u>	<u>Existing Project Depth (ft)</u>	<u>Simulation Project Depth (ft)</u>
Outer Reach	44	46
Navy Widener	44	46
Civil Widener	41	46
Plan A Widener	--	46
Plan B Widener	--	46
Middle Reach	44	46
Trident Access Channel	44	44
Trident Basin	41	41
Inner Reach	40	44
Middle Basin	39 & 35 & 39 (CPA)	43 & 35
West Access Channel (East of Sta 260+00)	39	43
West Access Channel, Cut A (West of Sta 260+00)	31 & 35 (CPA)	35
Plan A or B TB at WB Entrance	31 & 35 (CPA)	35
Remainder of West Basin	31 & 35 (CPA)	35

## APPENDIX D – Test Plan (as run)

Ex. #	Seq.*	Pilot	Project Element(s) Evaluated	Plan	Ship	Dir.	Wind	Current
1	1	1	not included in evaluation					
1a	13	1	Outer, Middle & Inner Reaches, West Access Channel & West Basin	A	Freedom	Inbound	N 30/35	S 0.5
2	2	2	Outer, Middle & Inner Reaches, West Access Channel & West Basin	B	Freedom	Inbound	N 30/35	S 0.5
3	3	2	Outer, Middle & Inner Reaches, West Access Channel & West Basin	A	Freedom	Inbound	S 30/35	N 1.0
4	4	1	Outer, Middle & Inner Reaches, West Access Channel & West Basin	B	Freedom	Inbound	S 30/35	N 1.0
5	14	2	Outer, Middle & Inner Reaches	A	Jupiter	Inbound	S 25/30	N .75
6	15	2	Outer, Middle & Inner Reaches	B	Jupiter	Inbound	S 25/30	N .75
7	16	1	Outer, Middle & Inner Reaches	A	Jupiter	Outbound	N 25/30	S 0.5
8	17	1	Outer, Middle & Inner Reaches	B	Jupiter	Outbound	N 25/30	S 0.5
9	5	1	Outer, Middle & Inner Reaches, West Access Channel	A	Freedom	Outbound	N 30/35	S 0.5
10	6	2	Outer, Middle & Inner Reaches, West Access Channel	B	Freedom	Outbound	N 30/35	S 0.5
11	7	2	Outer, Middle & Inner Reaches, West Access Channel	A	Freedom	Outbound	S 30/35	N 1.0
12	8	1	Outer, Middle & Inner Reaches, West Access Channel	B	Freedom	Outbound	S 30/35	N 1.0
13	9	2	Outer and Middle Reaches	A	Freedom	Inbound	S 35/40	N 1.0
14	10	1	Outer and Middle Reaches	B	Freedom	Inbound	S 35/40	N 1.0
15	11	1	Outer and Middle Reaches	A	Freedom	Outbound	NE 35/40	S 0.5
16	12	1	Outer and Middle Reaches	B	Freedom	Outbound	NE 35/40	S 0.5
19	20	1	Outer, Middle & Inner Reaches	A	Jupiter	Outbound	S 25/30	N 1.0
20	21	2	not included in evaluation					
20a**	22	2	Outer, Middle & Inner Reaches	B	Jupiter	Outbound	S 25/30	N 1.0

\* Sequential order that exercises were completed

\*\* Trackplot for this exercises is designated as Exercise #21, Pilot's Run Evaluation Form is designated as Run #20

### PORT CANAVERAL Run #1

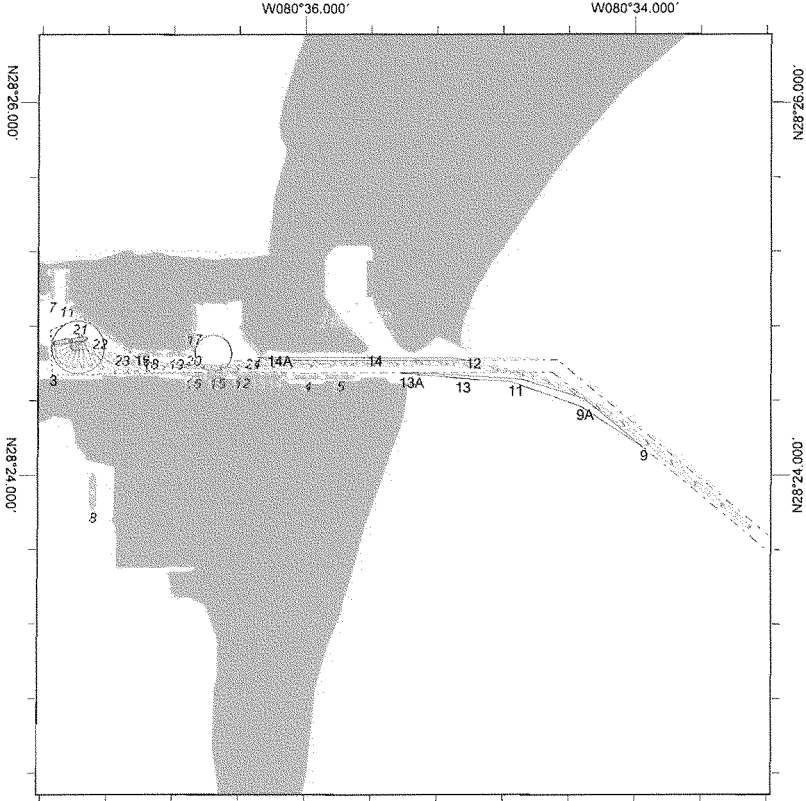

Scale 1:48000

Scale reference N28°24.324'

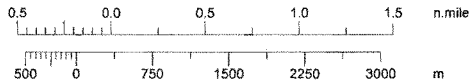

Comments: Wind: N30-35kts / Current: S0.5kts

Line sample period (s)	30
Course marker every	N/A
Heading marker period (s)	30
Shape outline every	01:00

### PORT CANAVERAL Run #1

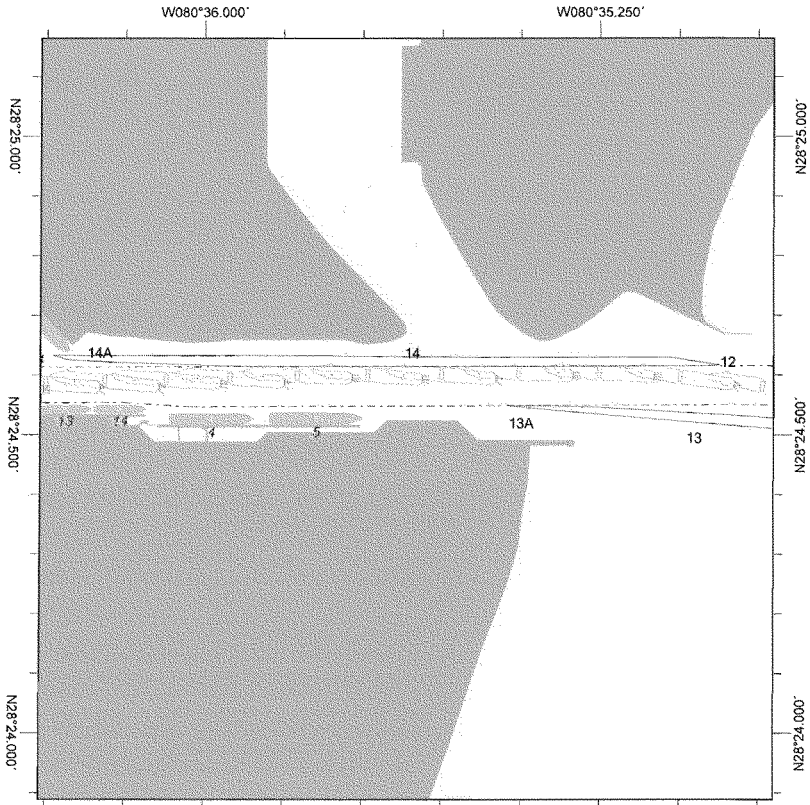

Scale 1:15000

Scale reference N28°24.526'

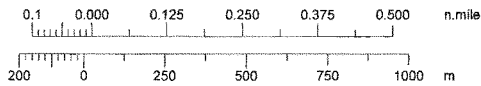

Comments: Wind: N30-35kts / Current: S0.5kts

Line sample period (s)	30
Course marker every	N/A
Heading marker period (s)	30
Shape outline every	01:00

PORT CANAVERAL Run#1A

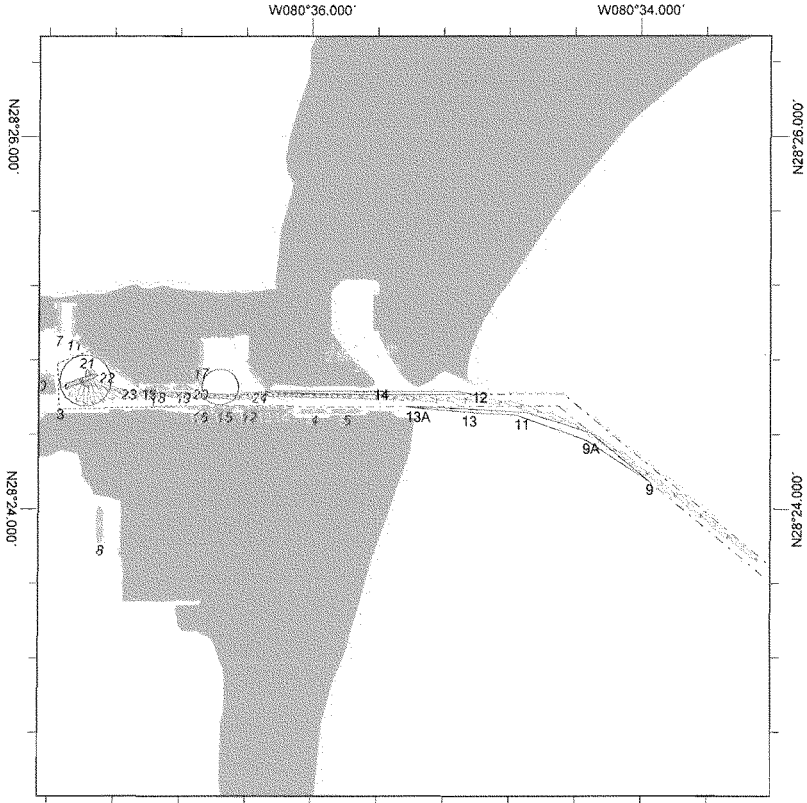

Scale 1:48000

Scale reference N28°24.497'

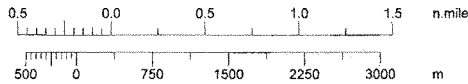

Comments: Wind: N30-35kts / Current: S0.5kts

Line sample period (s)	30
Course marker every	N/A
Heading marker period (s)	30
Shape outline every	01:00

PORT CANAVERAL Run#1A

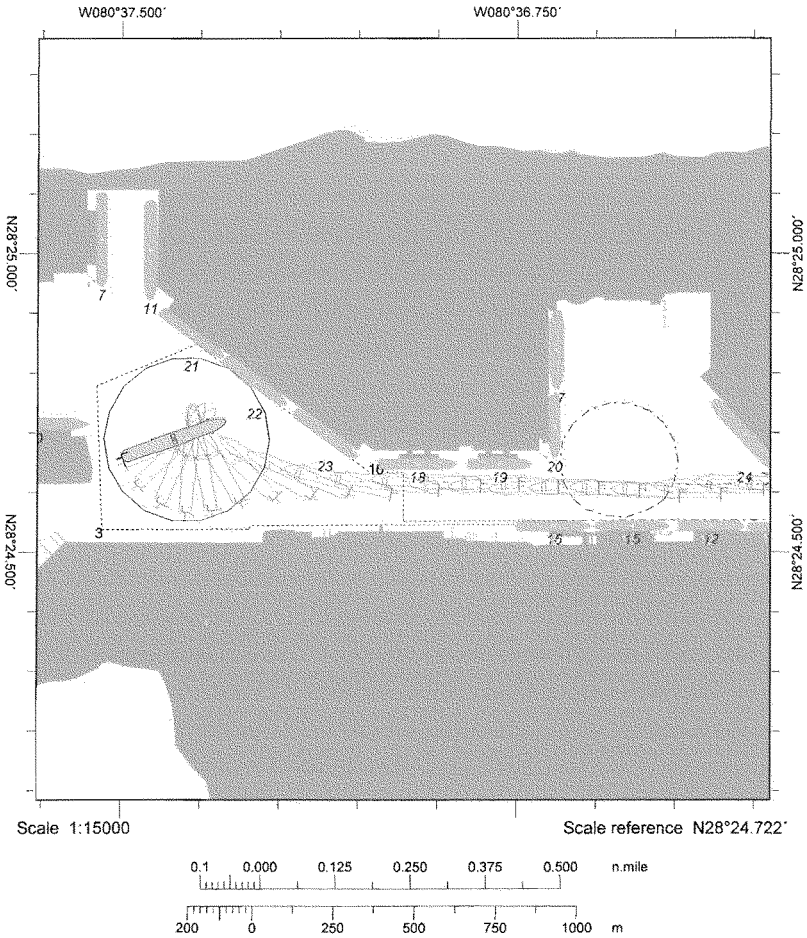

Comments: Wind: N30-35kts / Current: S0.5kts

Line sample period (s)	30
Course marker every	N/A
Heading marker period (s)	30
Shape outline every	01:00

### PORT CANAVERAL Run#2

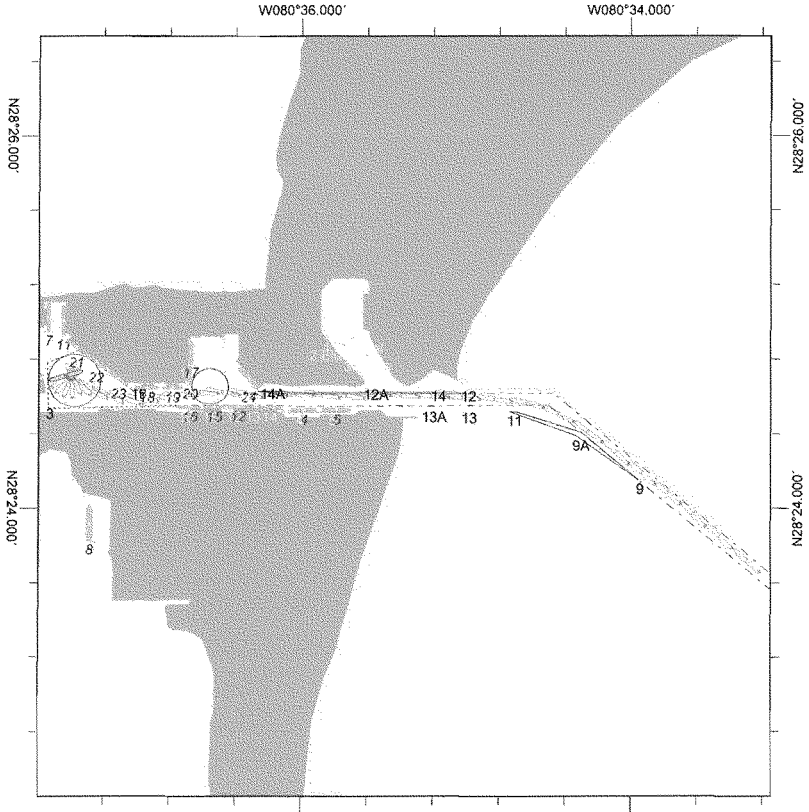

Scale 1:48000

Scale reference N28°24.493'

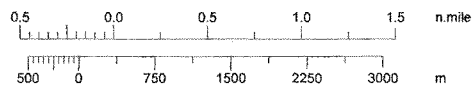

Comments: Wind: N30-35kts / Current: S0.5kts

Line sample period (s)	30
Course marker every	N/A
Heading marker period (s)	30
Shape outline every	01:00

PORT CANAVERAL Run#2

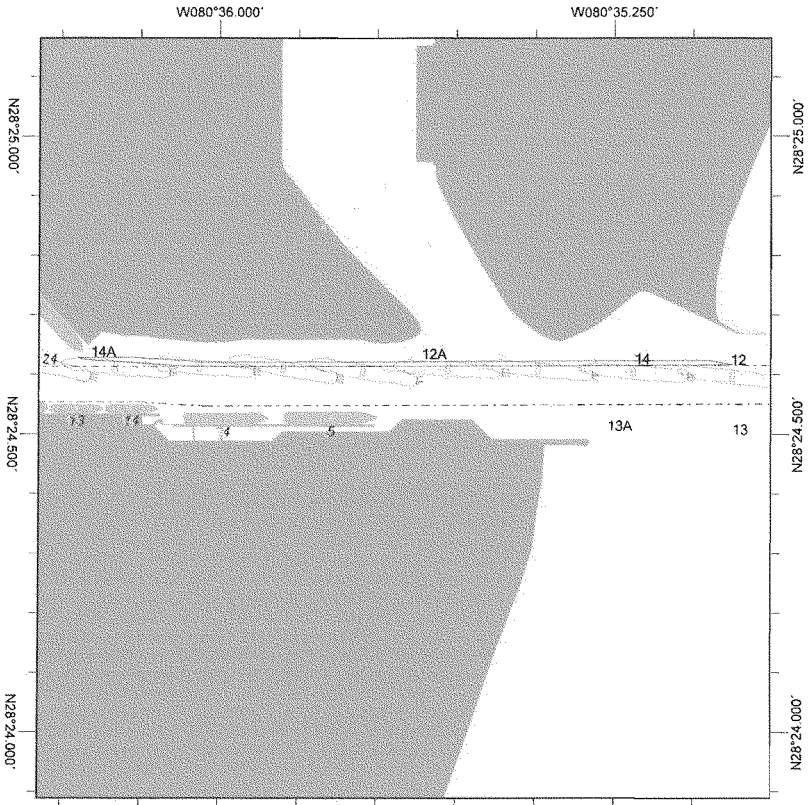

Scale 1:15000

Scale reference N28°24.526'

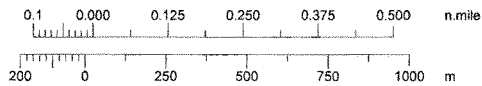

Comments: Wind: N30-35kts / Current: S0.5kts

Line sample period (s)	30
Course marker every	N/A
Heading marker period (s)	30
Shape outline every	01:00



PORT CANAVERAL Run#3

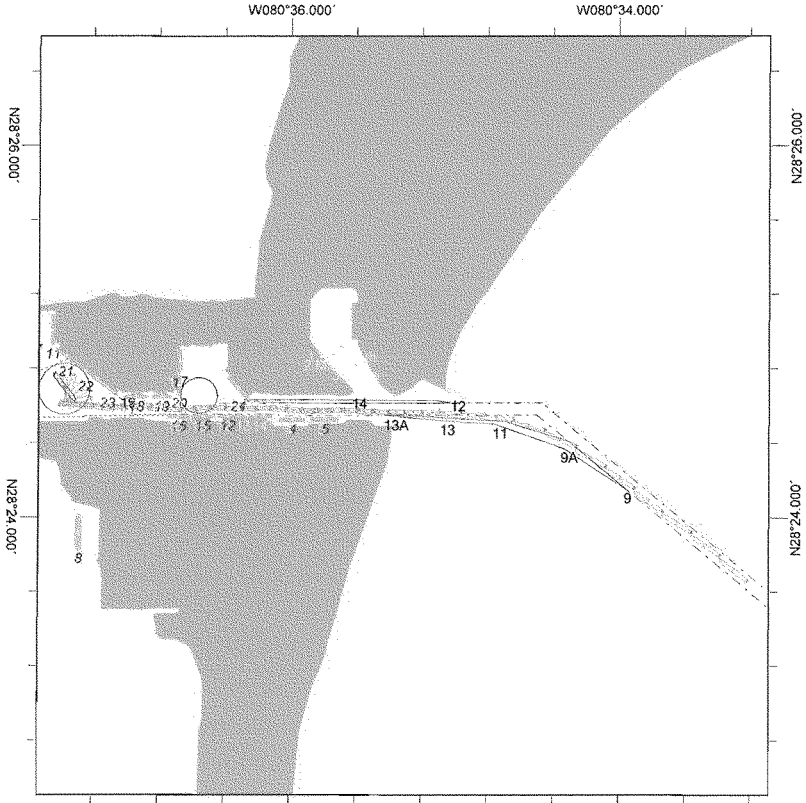

Scale 1:48000

Scale reference N28°24.547'

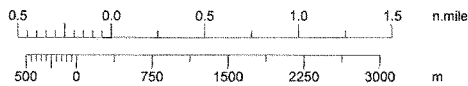

Comments: Wind: S30-35kts / Current: N1.0kts

Line sample period (s)	30
Course marker every	N/A
Heading marker period (s)	30
Shape outline every	01:00

PORT CANAVERAL Run#3

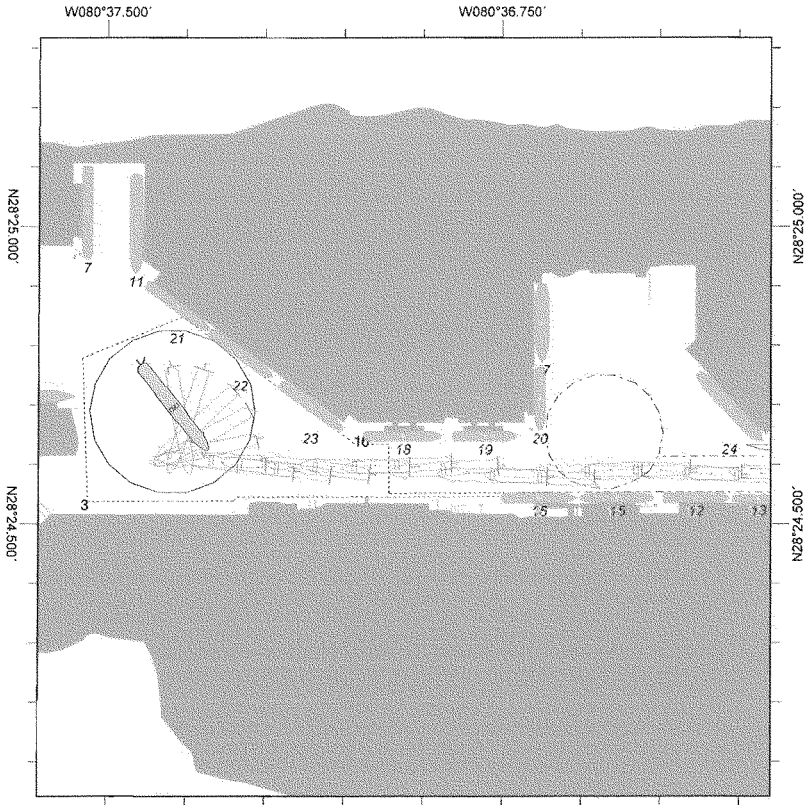

Scale 1:15000

Scale reference N28°24.679'

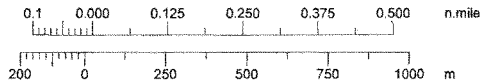

Comments: Wind: S30-35kts / Current: N1.0kts

Line sample period (s)	30
Course marker every	N/A
Heading marker period (s)	30
Shape outline every	01:00

PORT CANAVERAL Run#4

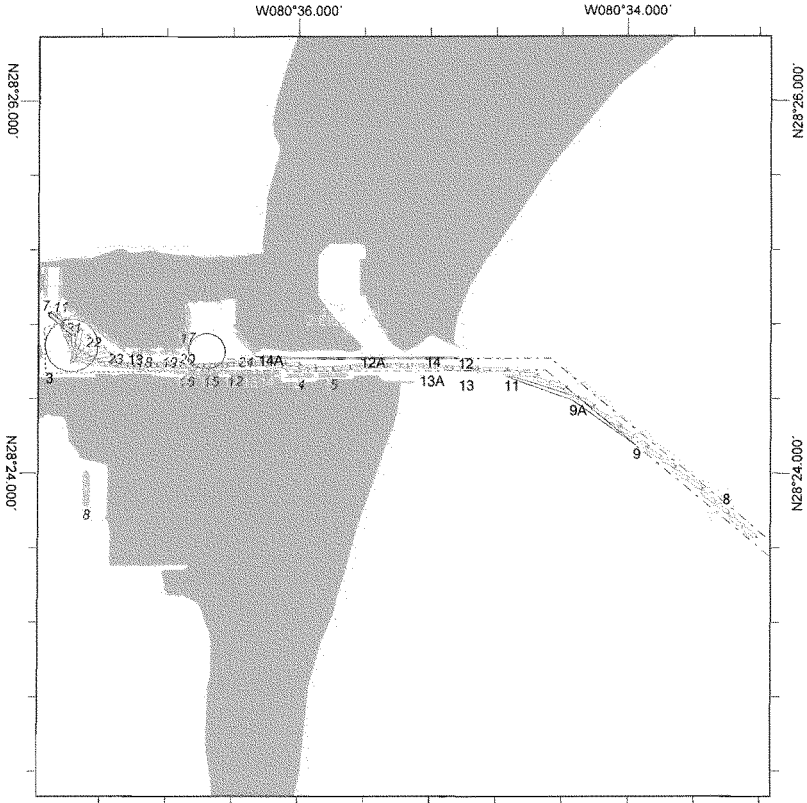

Scale 1:48000

Scale reference N28°24.303'

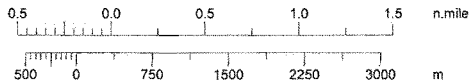

Comments: Wind: S30-35kts / Current: 1.0kt N

Line sample period (s)	30
Course marker every	N/A
Heading marker period (s)	30
Shape outline every	01:00

PORT CANAVERAL Run#4

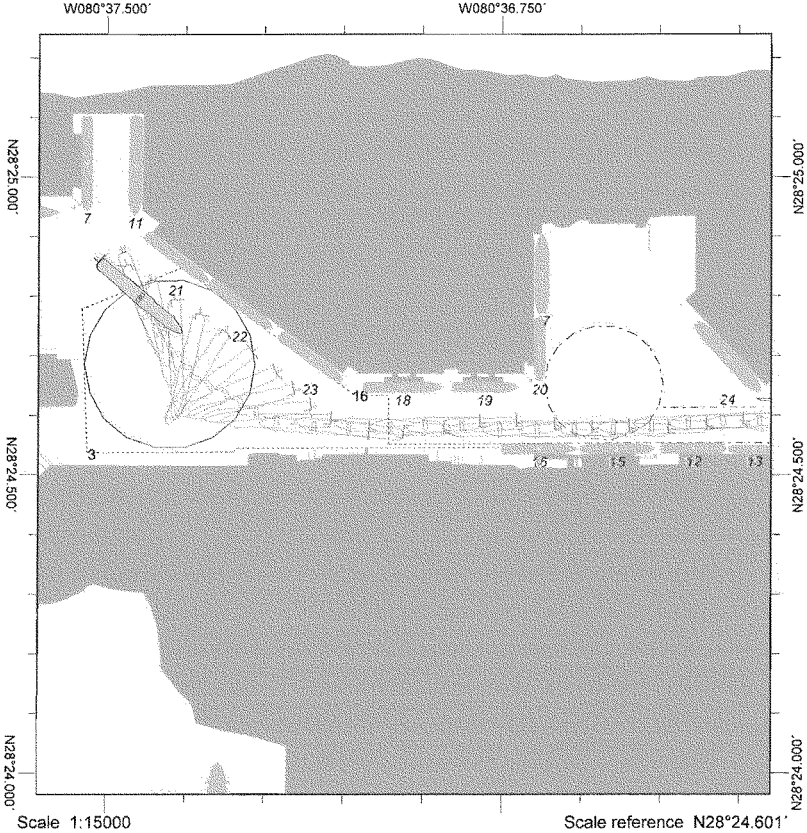

Scale 1:15000

Scale reference N28°24.601'

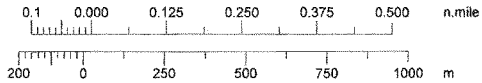

Comments: Wind: S30-35kts / Current: 1.0kt N

Line sample period (s)	30
Course marker every	N/A
Heading marker period (s)	30
Shape outline every	01:00

PORT CANAVERAL Run #5

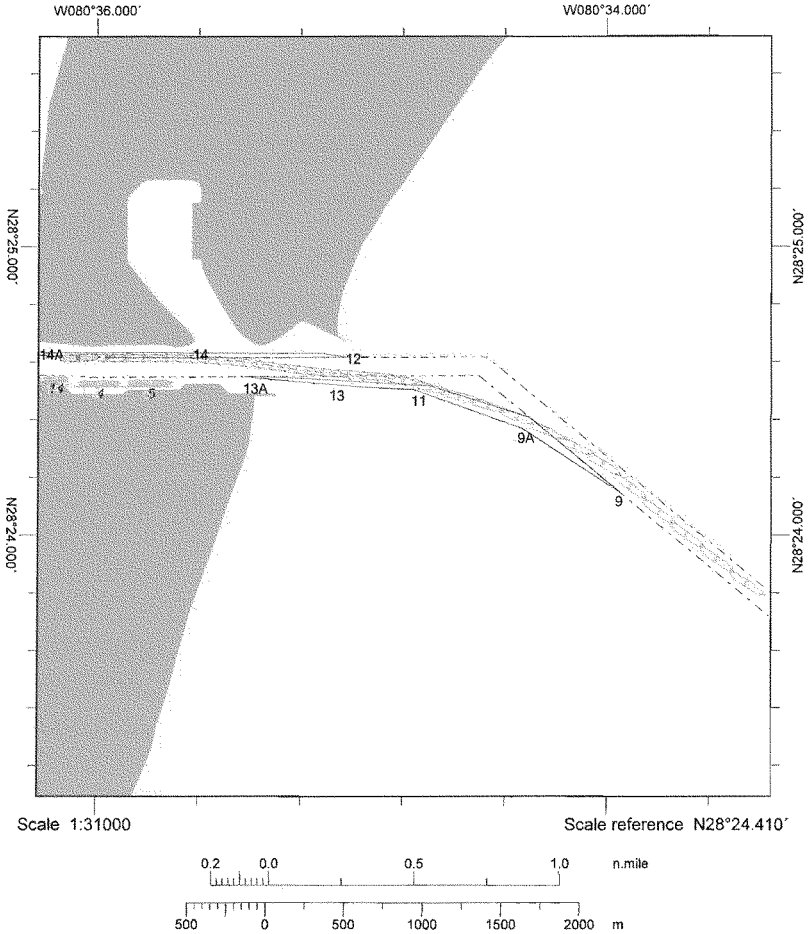

Comments: Wind: 25-30 Current: 0.75kt N

Line sample period (s)	30
Course marker every	N/A
Heading marker period (s)	30
Shape outline every	01:00

PORT CANAVERAL Run #5

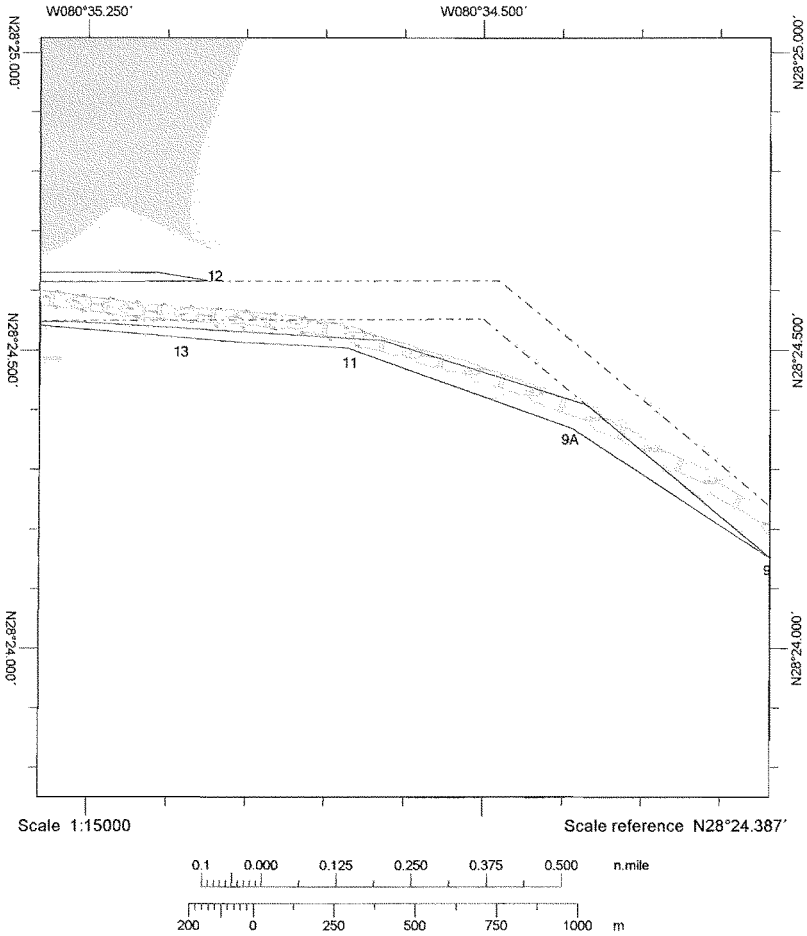

Comments: Wind: 25-30 Current: 0.75kt N

Line sample period (s)	30
Course marker every	N/A
Heading marker period (s)	30
Shape outline every	01:00

PORT CANAVERAL #6

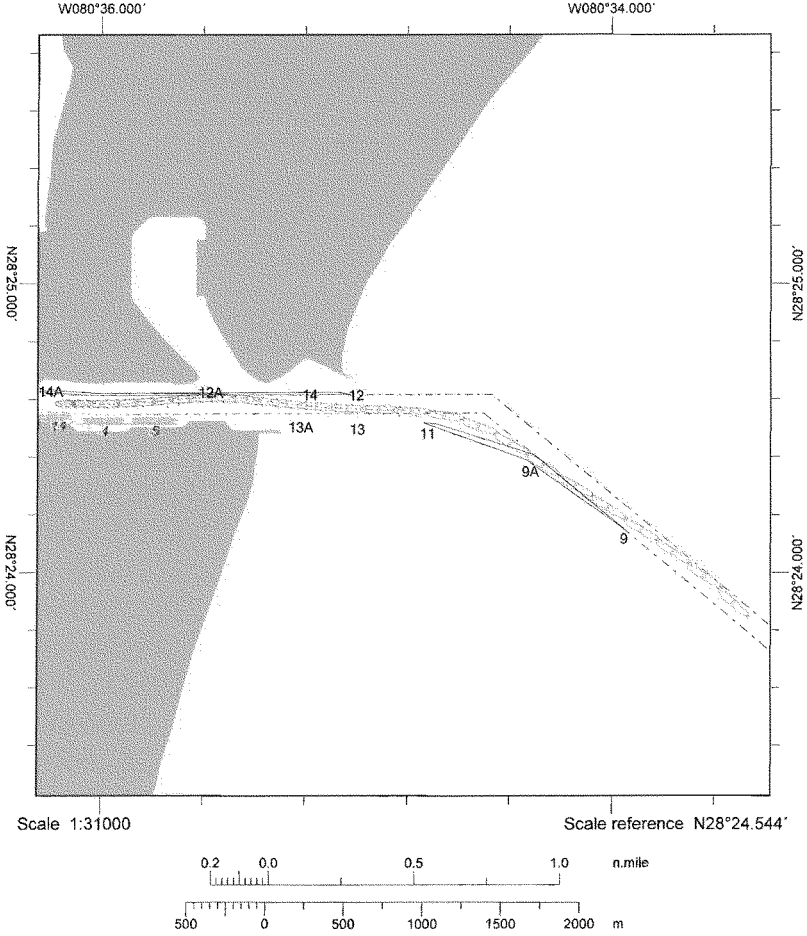

Comments: Wind: S25-30kts / Current: N0.75kts

Line sample period (s)	30
Course marker every	N/A
Heading marker period (s)	30
Shape outline every	01:00

PORT CANAVERAL #6

W080°34.500'

W080°33.750'

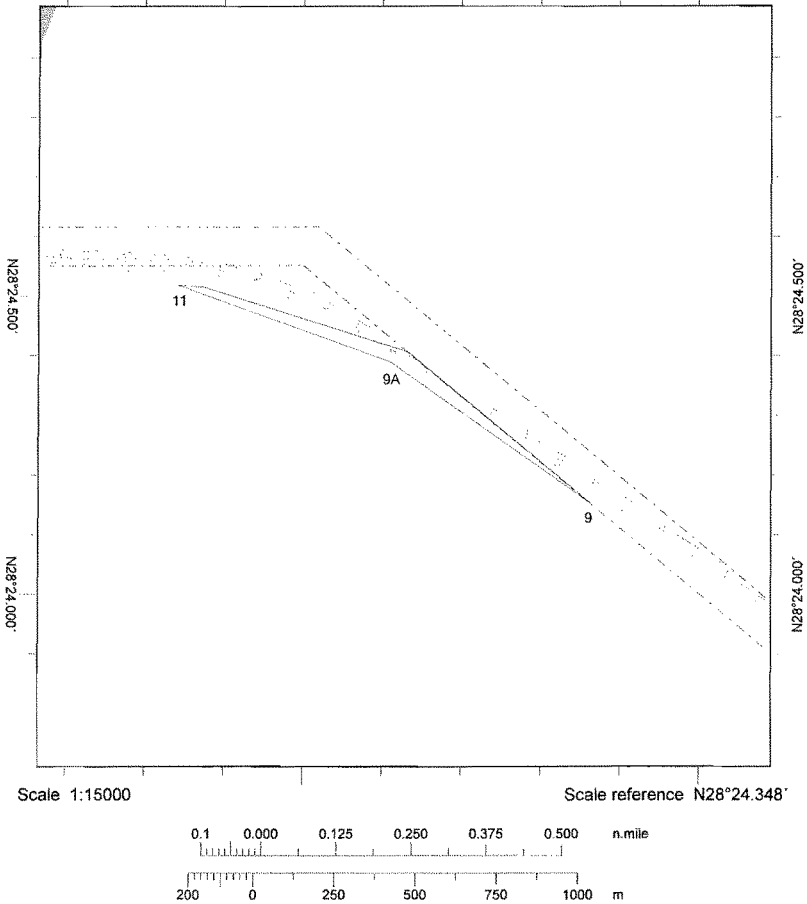

Scale 1:15000

Scale reference N28°24.348'

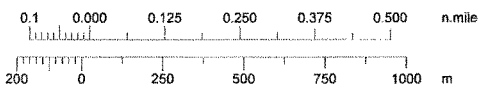

Comments: Wind: S25-30kts / Current: N0.75kts

Line sample period (s)	30
Course marker every	N/A
Heading marker period (s)	30
Shape outline every	01:00



### PORT CANAVERAL Run #7

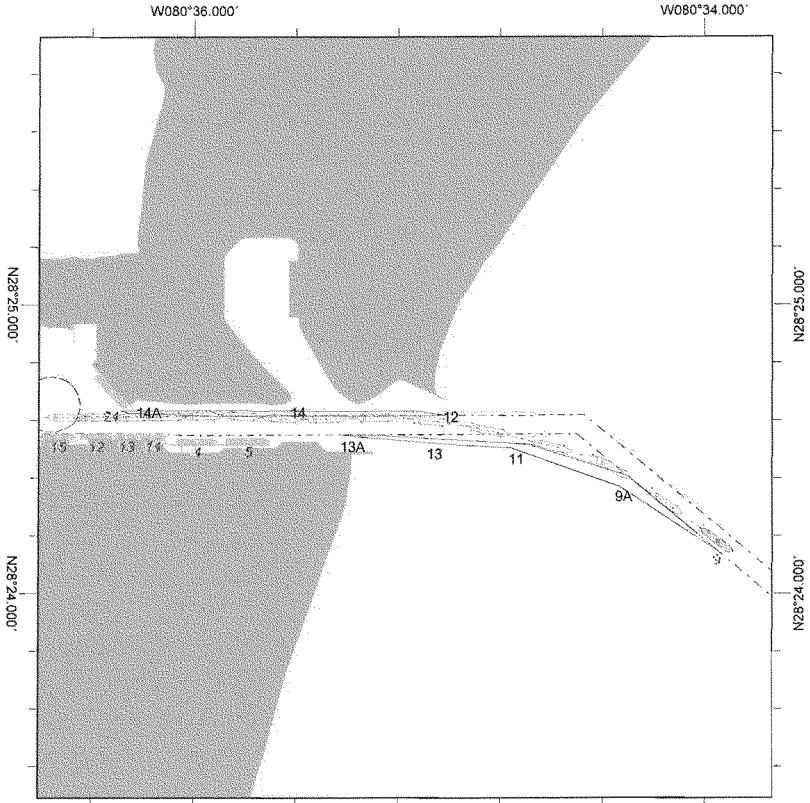

Scale 1:31000

Scale reference N28°24.609'

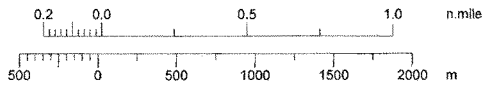

Comments: Wind: N25-30kts / Current: 0.5kt S

Line sample period (s)	30
Course marker every	N/A
Heading marker period (s)	30
Shape outline every	01:00

# PORT CANAVERAL Run #7

W080°34.500'

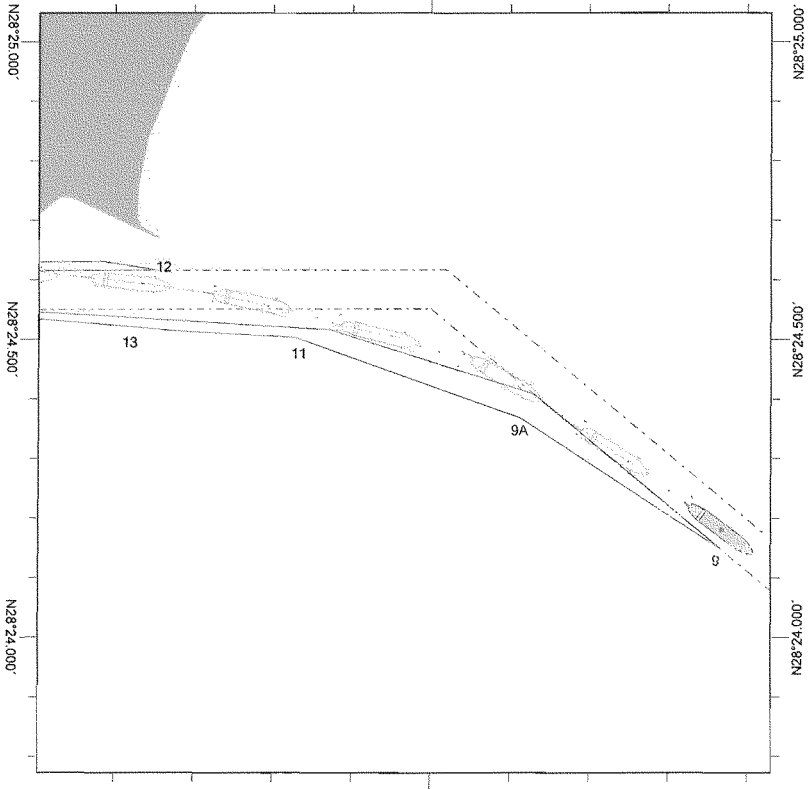

Scale 1:15000

Scale reference N28°24.410'

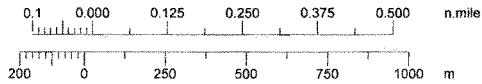

Comments: Wind: N25-30kts / Current: 0.5kt S

Line sample period (s)	30
Course marker every	N/A
Heading marker period (s)	30
Shape outline every	01:00

PORT CANAVERAL Run #8

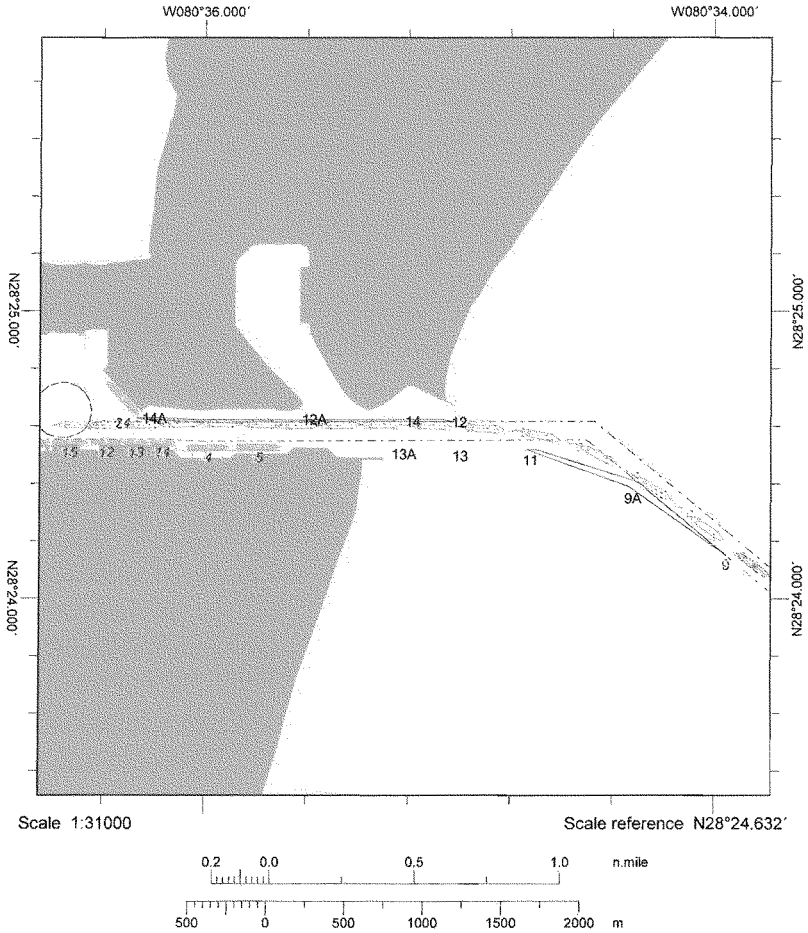

Comments: Wind: 25-30kts N / Current: 0.5kt S

Line sample period (s)	30
Course marker every	N/A
Heading marker period (s)	30
Shape outline every	01:00

PORT CANAVERAL Run #8

W080°34.500'

W080°33.750'

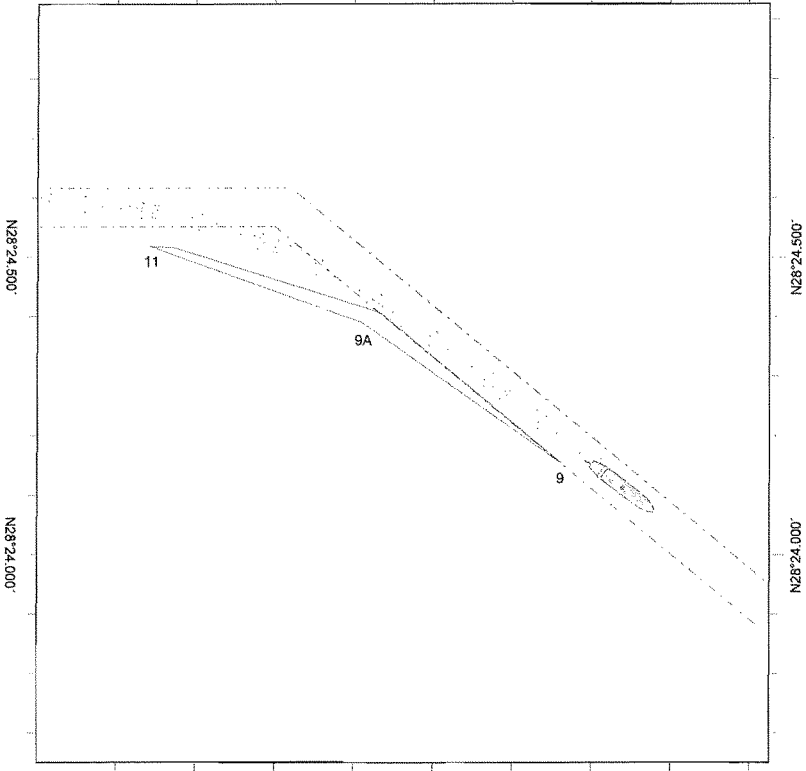

Scale 1:15000

Scale reference N28°24.288'

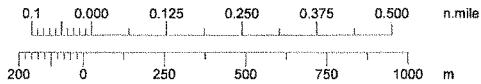

Comments: Wind: 25-30kts N / Current: 0.5kt S

Line sample period (s)	30
Course marker every	N/A
Heading marker period (s)	30
Shape outline every	01:00

PORT CANAVERAL Run #9

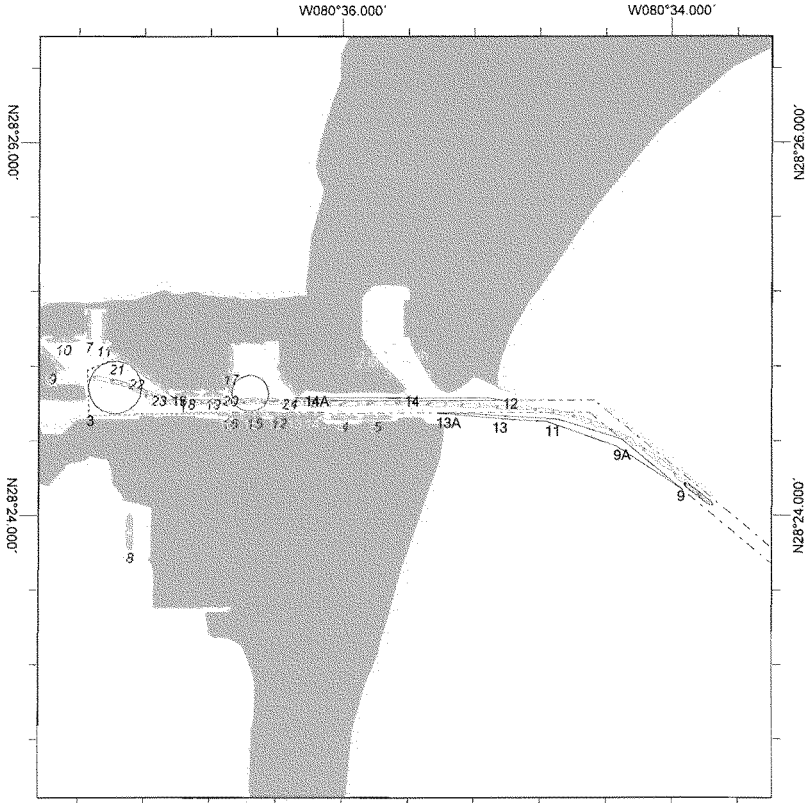

Scale 1:48000

Scale reference N28°24.526'

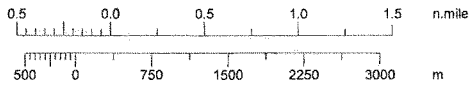

Comments: Wind: N30-35kts / Current: S0.5kts

Line sample period (s)	30
Course marker every	N/A
Heading marker period (s)	30
Shape outline every	01:00

PORT CANAVERAL Run #9

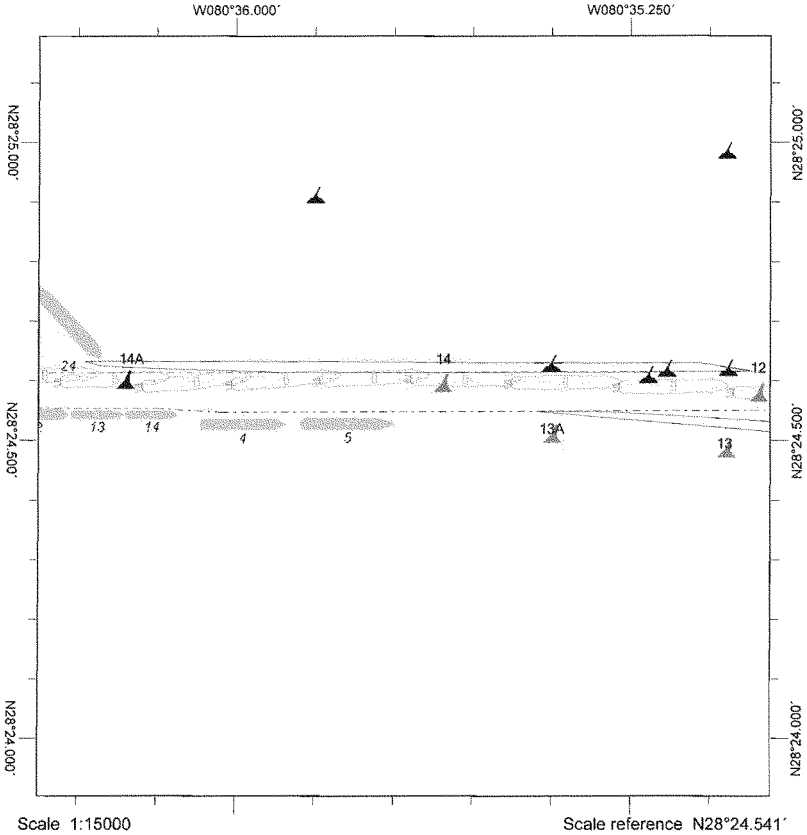

Scale 1:15000

Scale reference N28°24.541'

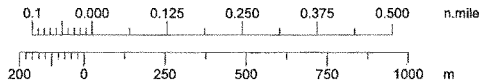

Comments: Wind: N30-35kts / Current: S0.5kts

Line sample period (s)	30
Course marker every	N/A
Heading marker period (s)	30
Shape outline every	01:00

# PORT CANAVERAL Run#10

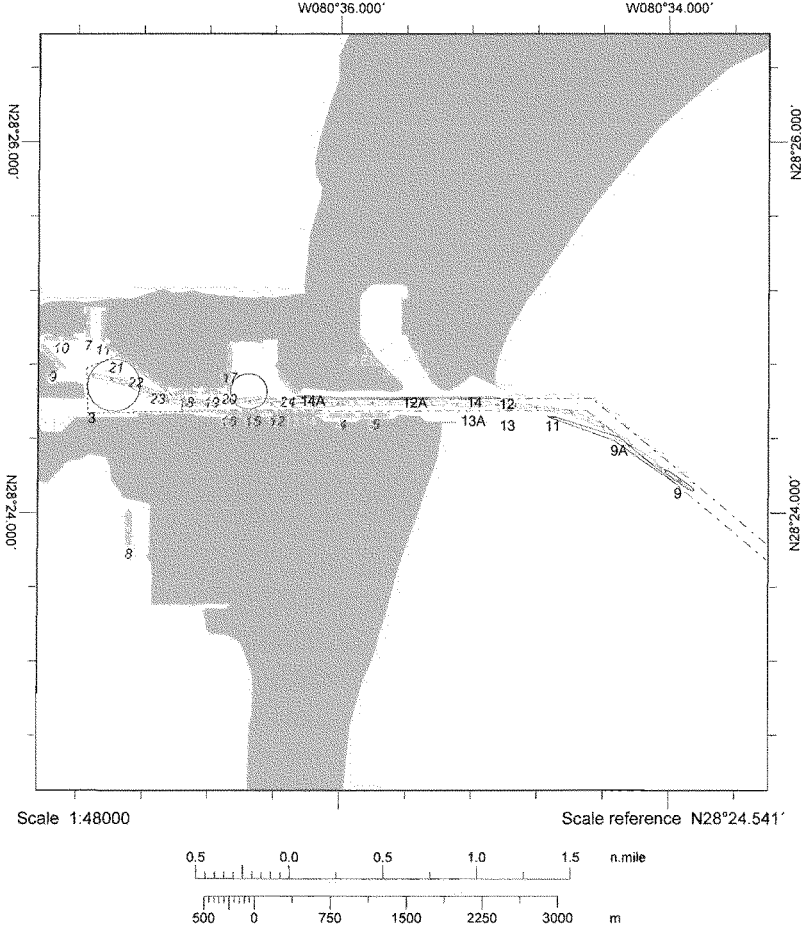

Comments: Wind: N30-35kts / Current: 0.5kts S

Line sample period (s)	30
Course marker every	N/A
Heading marker period (s)	30
Shape outline every	01:00

PORT CANAVERAL Run#10

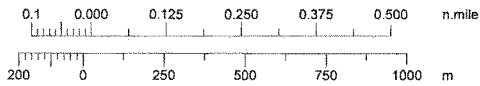
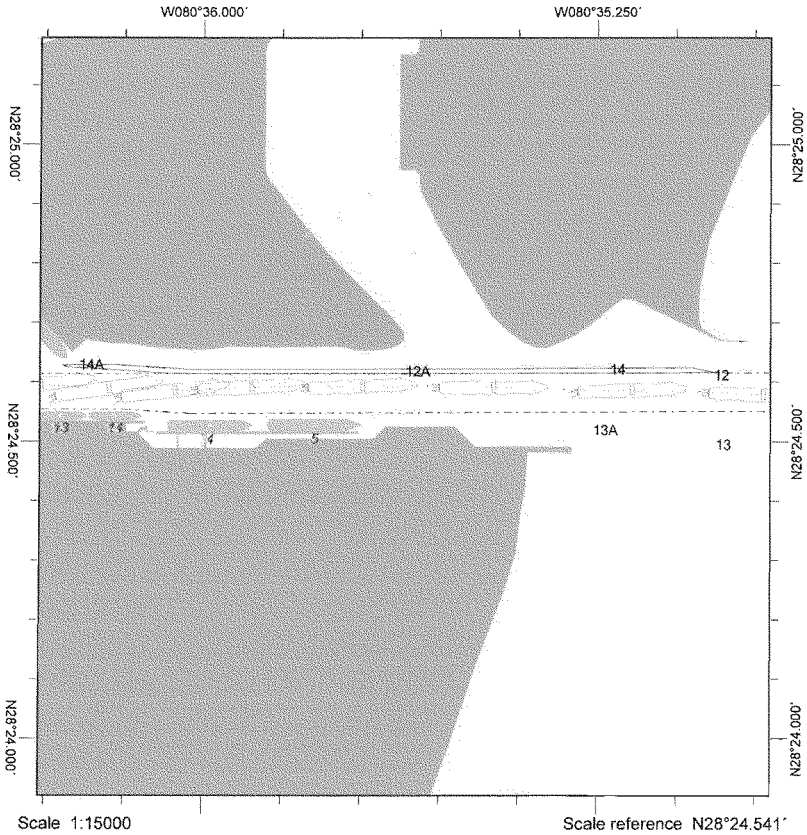

Comments: Wind: N30-35kts / Current: 0.5kts S

Line sample period (s)	30
Course marker every	N/A
Heading marker period (s)	30
Shape outline every	01:00



# PORT CANAVERAL Run#11

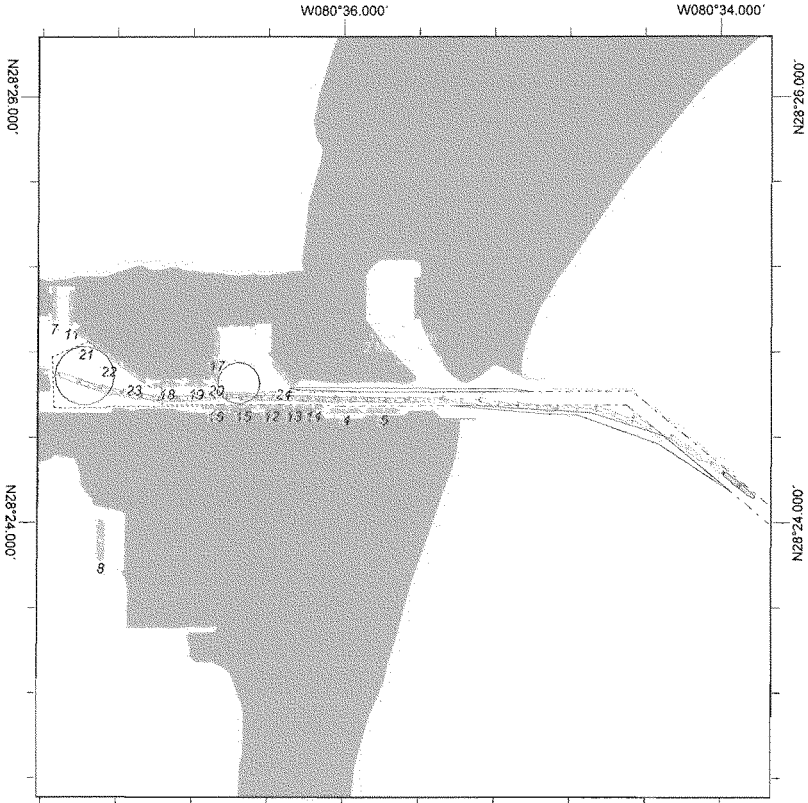

Scale 1:42000

Scale reference N28°24.495'

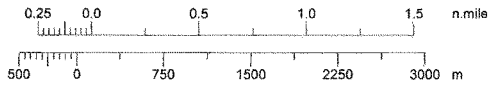

Comments: Wind: S30-35kts / Current: N1.0kts

Line sample period (s)	30
Course marker every	N/A
Heading marker period (s)	30
Shape outline every	01:00

PORT CANAVERAL Run#11

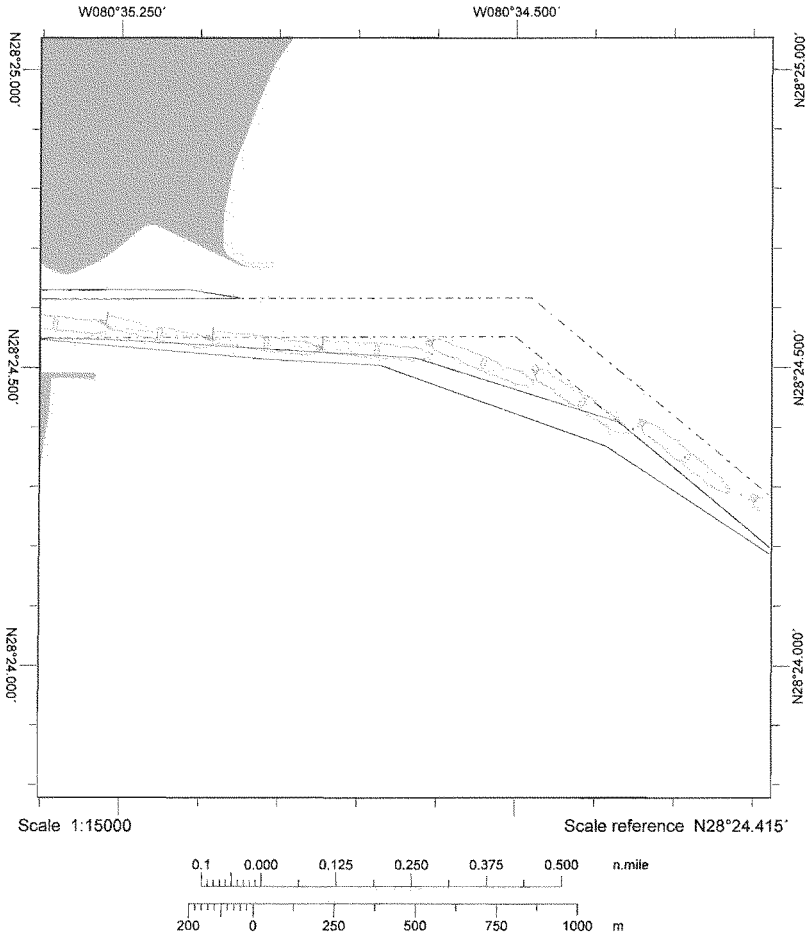

Comments: Wind: S30-35kts / Current: N1.0kts

Line sample period (s)	30
Course marker every	N/A
Heading marker period (s)	30
Shape outline every	01:00

PORT CANAVERAL Run#12

W080°36.000'

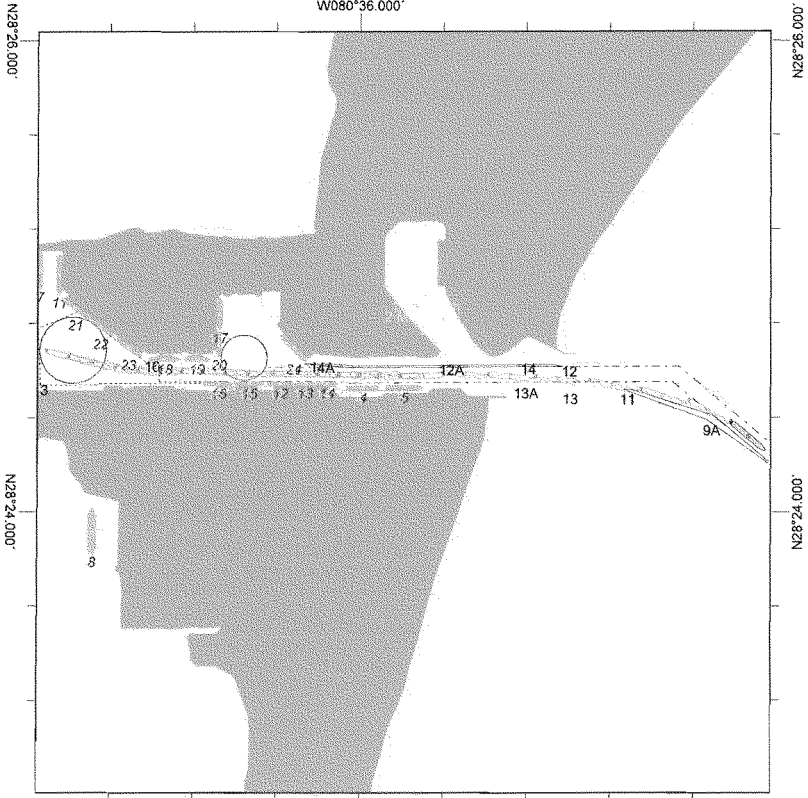

Scale 1:38000

Scale reference N28°24.422'

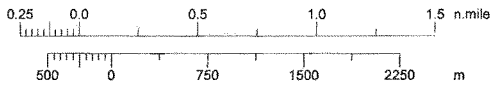

Comments: Wind: S30-35kts / Current: N1.0kt

Line sample period (s)	30
Course marker every	N/A
Heading marker period (s)	30
Shape outline every	01:00

PORT CANAVERAL Run#12

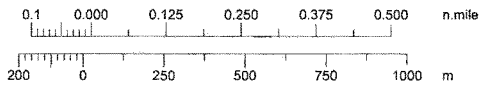
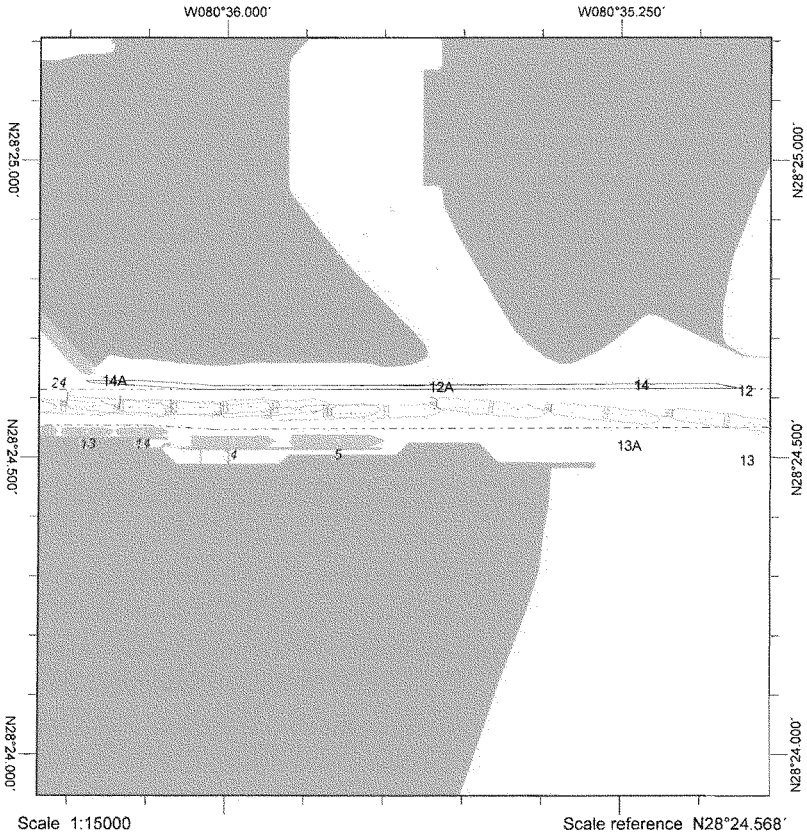

Comments: Wind: S30-35kts / Current: N1.0kt

Line sample period (s)	30
Course marker every	N/A
Heading marker period (s)	30
Shape outline every	01:00

PORT CANAVERAL Run#13

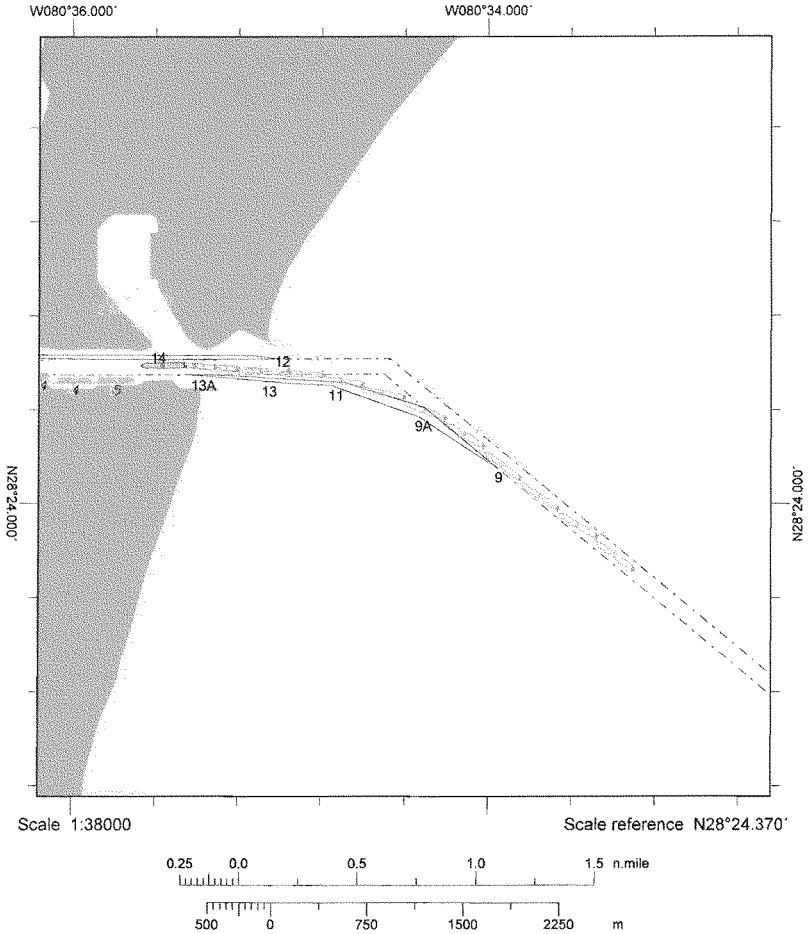

Comments: Wind: S35-40kts / Current: N1.0kt

Line sample period (s)	30
Course marker every	N/A
Heading marker period (s)	30
Shape outline every	01:00

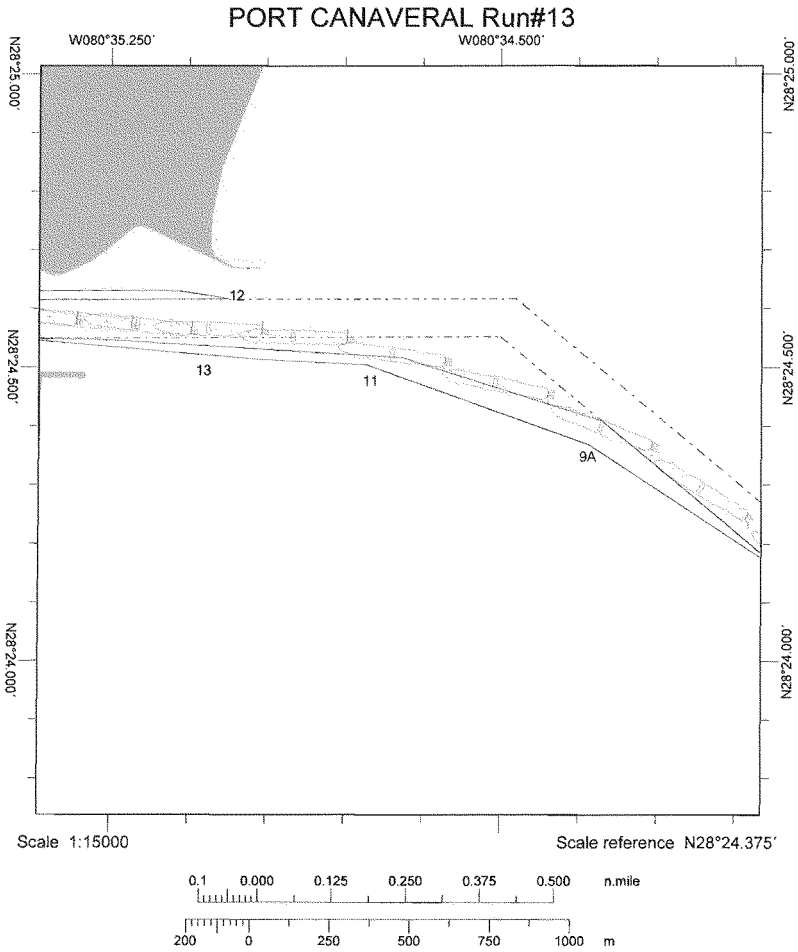

Comments: Wind: S35-40kts / Current: N1.0kt

Line sample period (s)	30
Course marker every	N/A
Heading marker period (s)	30
Shape outline every	01:00

PORT CANAVERAL Run#14

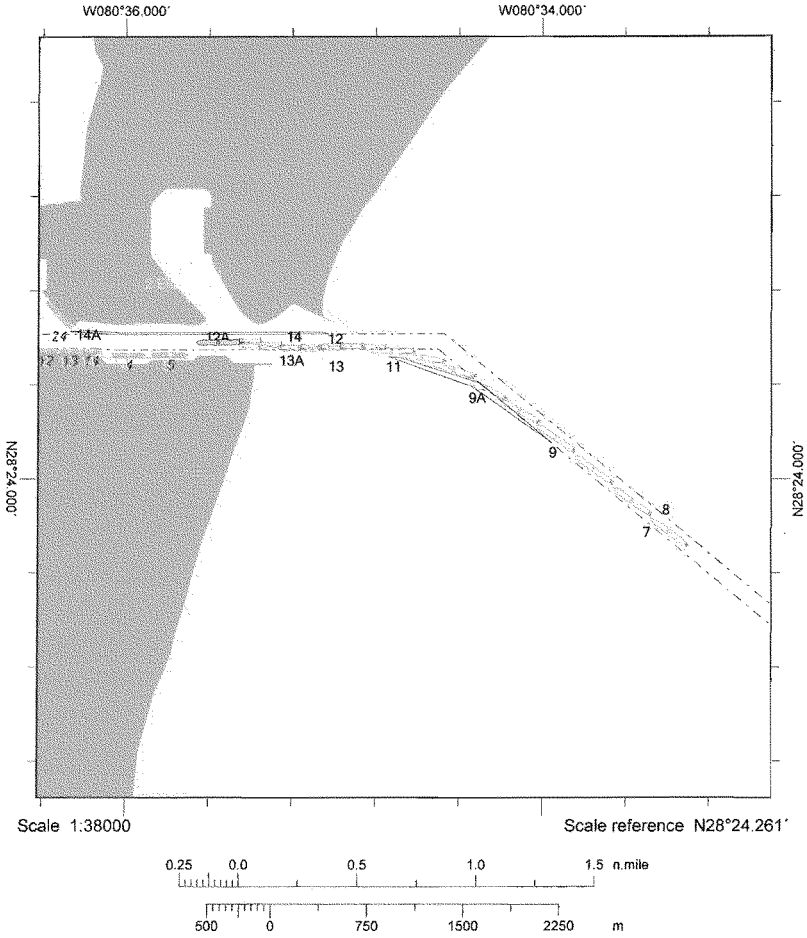

Comments: Wind: S35-40kts / Current: N1.0kt

Line sample period (s)	30
Course marker every	N/A
Heading marker period (s)	30
Shape outline every	01:00

# PORT CANAVERAL Run#14

W080°34.500'

W080°33.750'

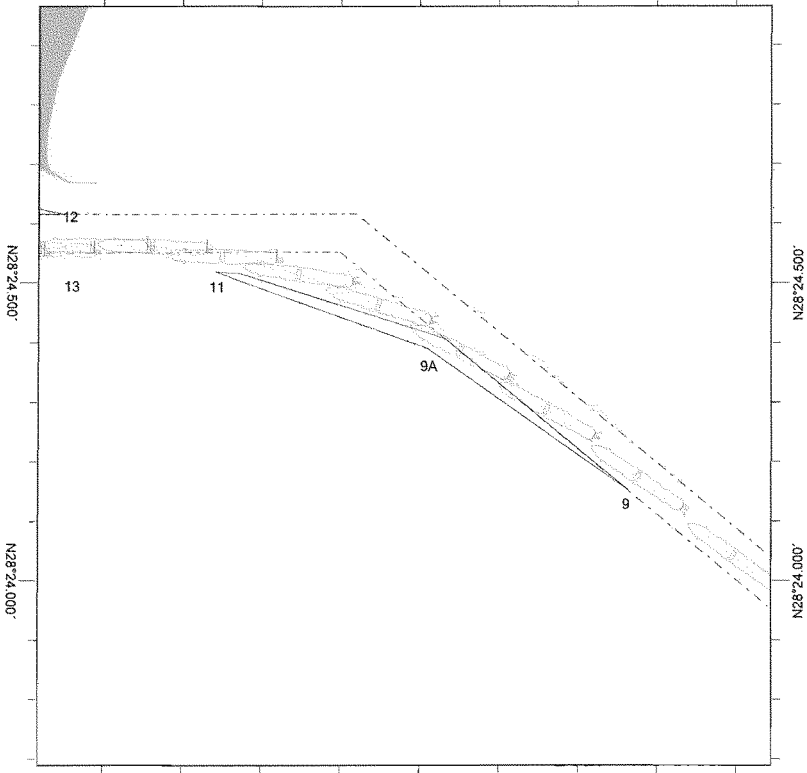

Scale 1:15000

Scale reference N28°24.327'

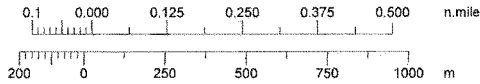

Comments: Wind: S35-40kts / Current: N1.0kt

Line sample period (s)	30
Course marker every	N/A
Heading marker period (s)	30
Shape outline every	01:00



### PORT CANAVERAL Run#15

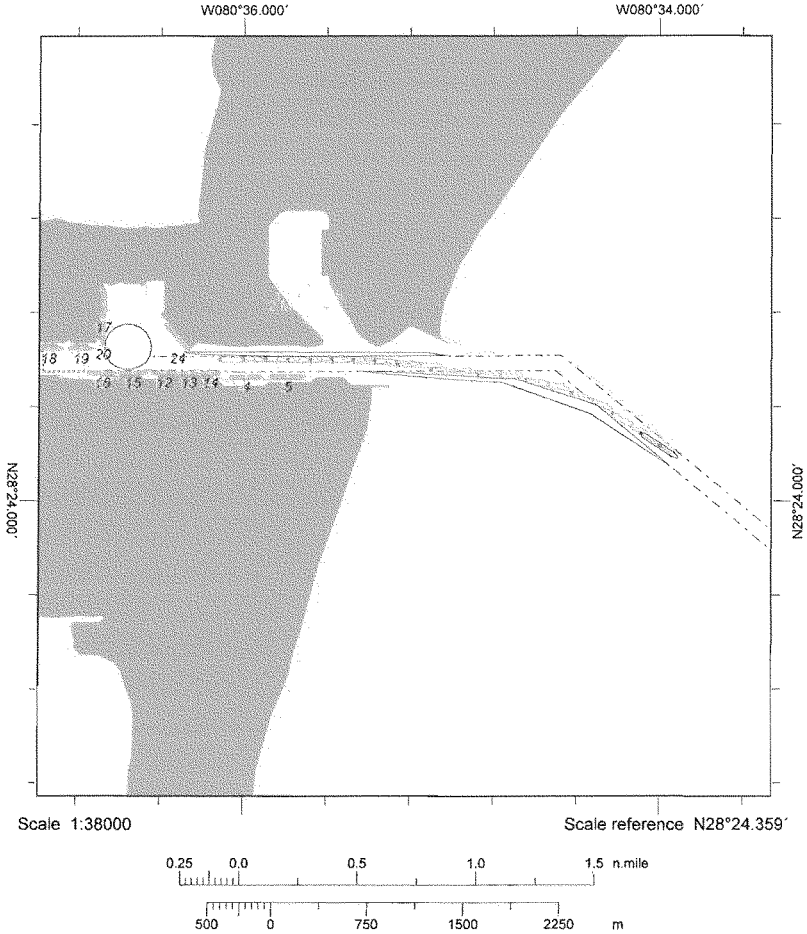

Comments: Wind: NE35-40kts / Current: S0.5kt

Line sample period (s)	30
Course marker every	N/A
Heading marker period (s)	30
Shape outline every	01:00

PORT CANAVERAL Run#15

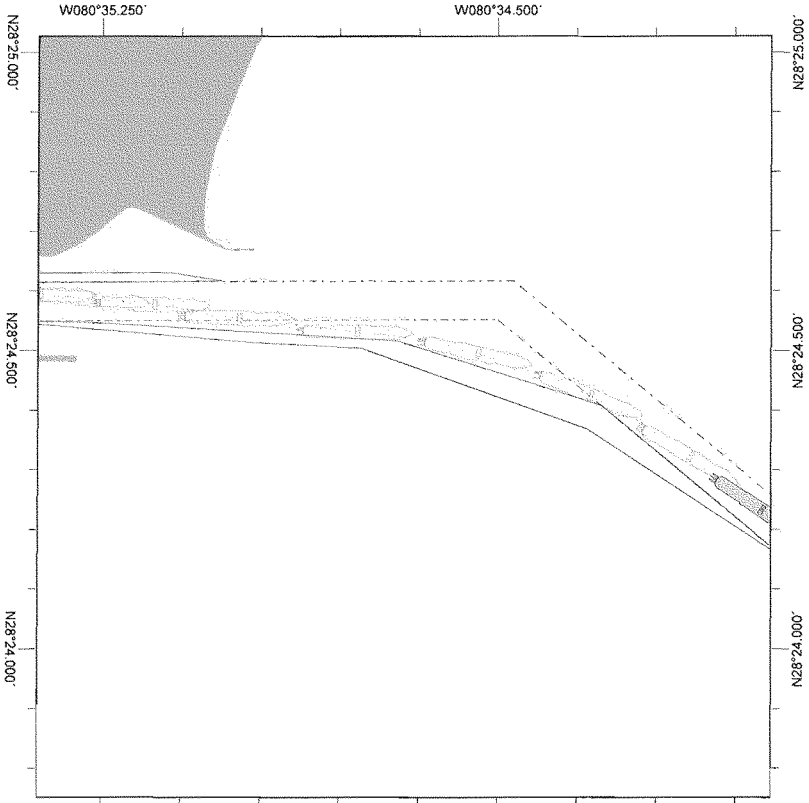

Scale 1:15000

Scale reference N28°24.389'

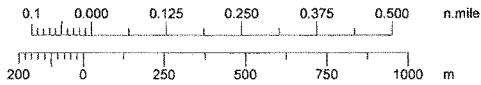

Comments: Wind: NE35-40kts / Current: S0.5kt

Line sample period (s)	30
Course marker every	N/A
Heading marker period (s)	30
Shape outline every	01:00

PORT CANAVERAL Run#16

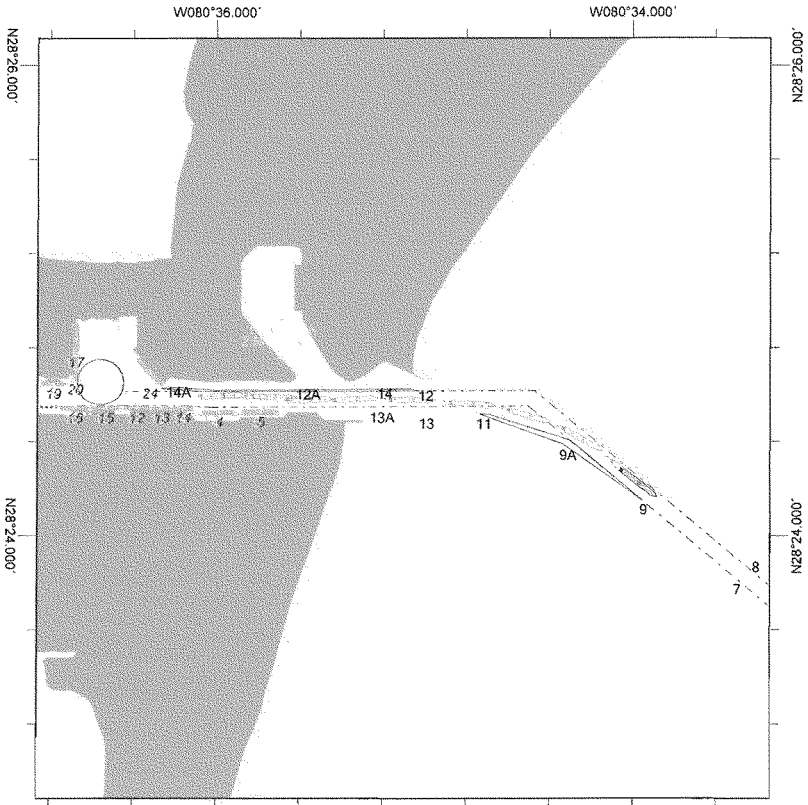

Scale 1:38000

Scale reference N28°24.499'

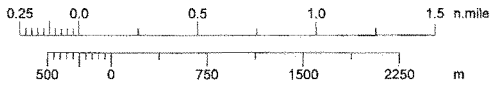

Comments: Wind: NE35-40kts / Current: S0.5kts

Line sample period (s)	30
Course marker every	N/A
Heading marker period (s)	30
Shape outline every	01:00

PORT CANAVERAL Run#16

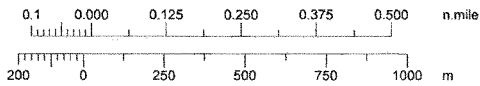
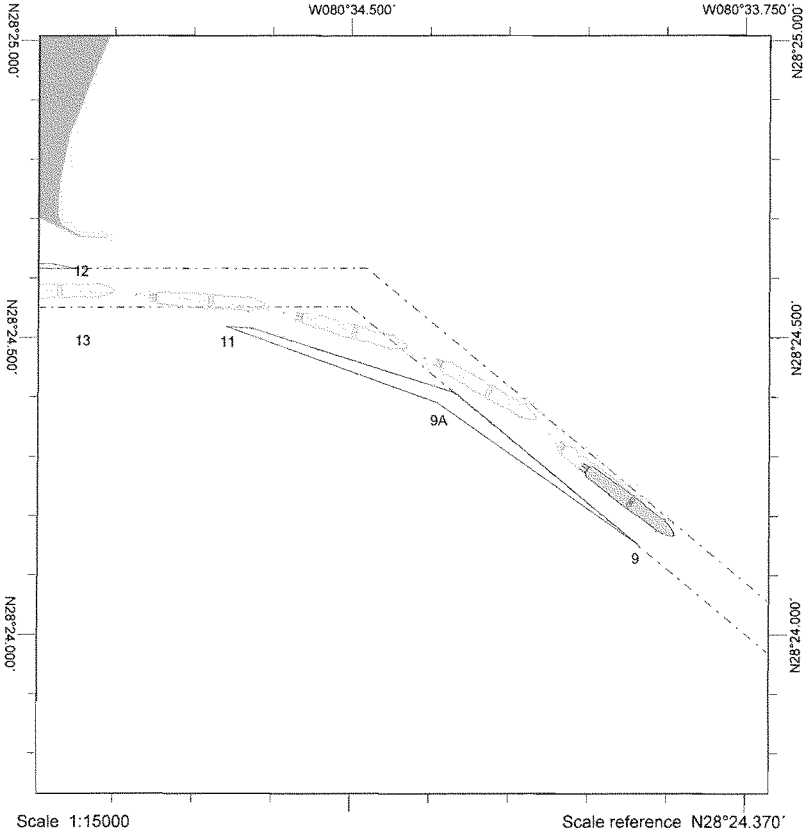

Comments: Wind: NE35-40kts / Current: S0.5kts

Line sample period (s)	30
Course marker every	N/A
Heading marker period (s)	30
Shape outline every	01:00

PORT CANAVERAL Run #19

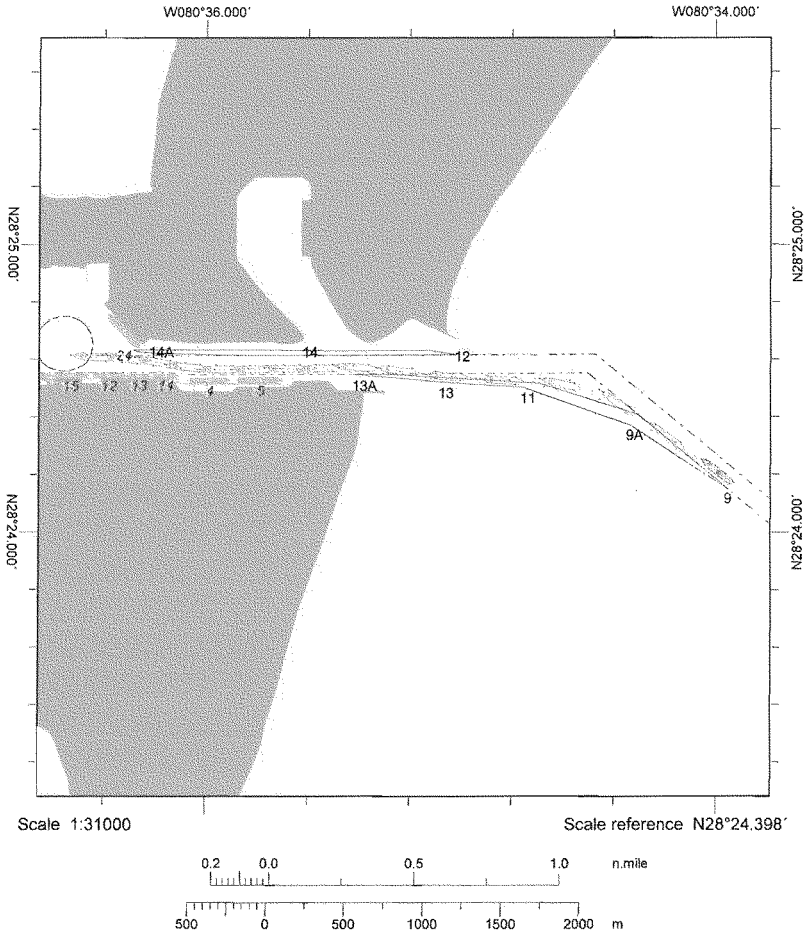

Comments: Wind: S25-30kts / Current: 1.0kt N

Line sample period (s)	30
Course marker every	N/A
Heading marker period (s)	30
Shape outline every	01:00

PORT CANAVERAL Run #19

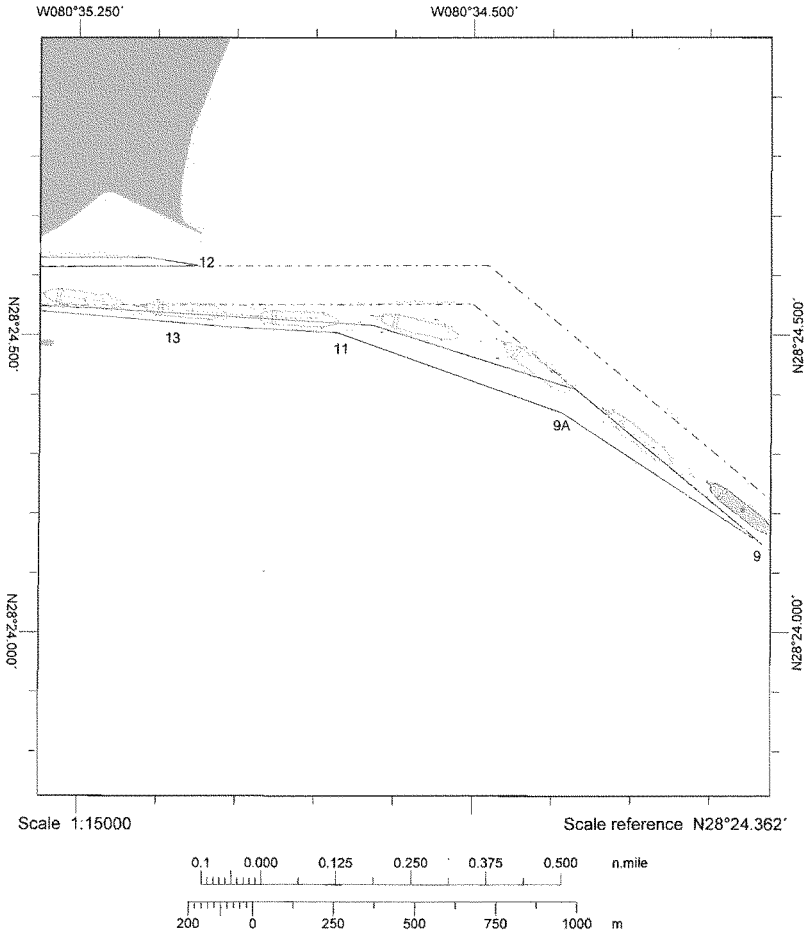

Comments: Wind: S25-30kts / Current: 1.0kt N

Line sample period (s)	30
Course marker every	N/A
Heading marker period (s)	30
Shape outline every	01:00

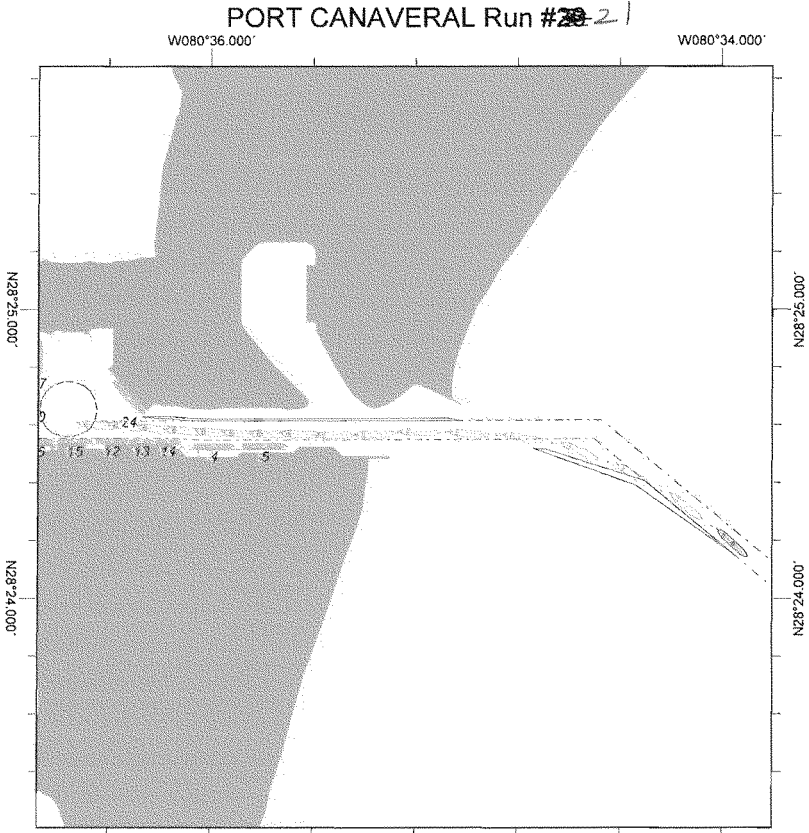

Scale 1:31000

Scale reference N28°24.523'



Comments: Wind: S25-30kts / Current: N1.0kts

Line sample period (s)	30
Course marker every	N/A
Heading marker period (s)	30
Shape outline every	01:00

# PORT CANAVERAL Run #20 2 /

W080°34.500'

W080°33.750'

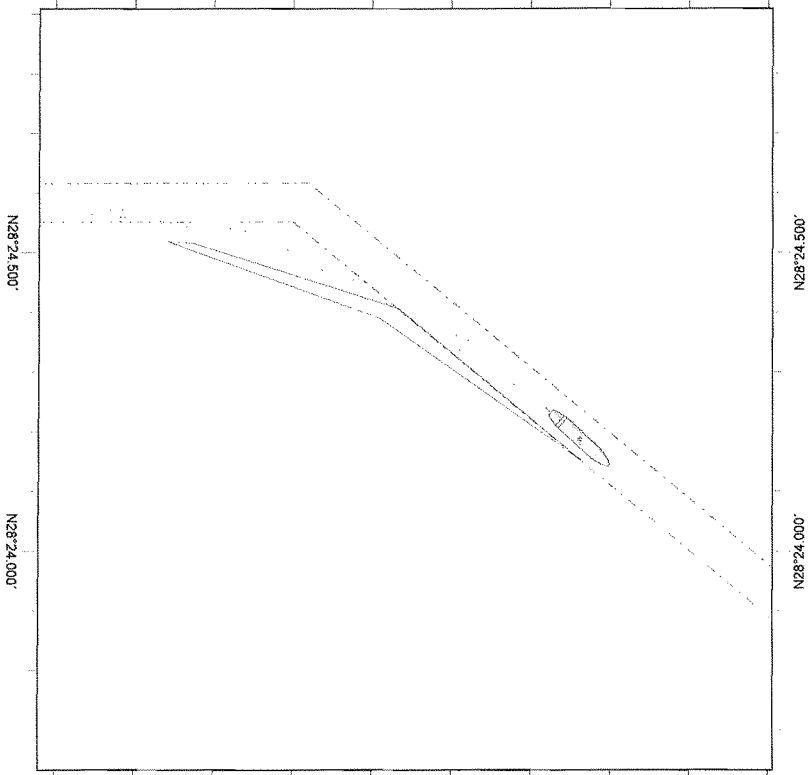

Scale 1:15000

Scale reference N28°24.271'



Comments: Wind: S25-30kts / Current: N1.0kts

Line sample period (s)	30
Course marker every	N/A
Heading marker period (s)	30
Shape outline every	01:00



## Port Canaveral Evaluation 2009 Final Evaluation Form

Name: Captain Ben Borgie

Date: 3-5 June 2009

The existing geographic database for Port Canaveral was modified to reflect two different dredge expansion plans. Both plans "A" and "B" widen the channel at the "dog leg" or junction of the outer reach and middle reach channels, and an area on the north side of middle reach channel. Plan "B" provides the narrower of the two options. Both plans provide for an expanded west turning basin as well except that the plan B basin has a slightly reduced diameter (50 feet). Channel depths were increased slightly and to the same controlling depth in both plans.

Two vessels were used in the simulations as the design vessel for the project: "Freedom of the Seas" (LOA 338.8m, Beam 38.6m, Draft 8.5m), and "Jupiter" (LOA 244m, Beam 42m, Draft 12m and 8.3m).

Northerly and Southerly winds of between 25 to 40 knots were used in simulation, in addition to currents both Northerly and Southerly of up 1 knot in velocity.

1) Does the channel widening provided by Plan A provide ample width for safe transit in the environmental conditions of wind and current as tested for all improved areas? Please comment for both the Jupiter and Freedom of the Seas if differences were noted?

Bend Widener "dog leg" After spending three days in the simulator and comparing and evaluating both Plan A and Plan B, it is my opinion that Plan A provides ample width for the safe transit of both deep-draft vessels and high-windage cruise ships. In consideration of the special handling characteristics of heavy laden, deep-draft ships, (simulated as the Jupiter) the extra room provided by Plan A allows for a greater safety margin. The wider area allows the vessel to transit further from the channel edges, reducing the very dangerous effects of bank cushion and stern suction. Additionally, some of these large tankers arrive with an improper trim (the bow deeper than the stern). This condition makes these vessels very difficult to steer and the extra room provided by the Plan A widener will certainly allow for a greater safety margin when the vessel exhibits this "sloppy" steering. The extra room also gives the escort tugs more time and more room to accomplish their maneuvers in an emergency, thereby avoiding a bad situation!

As of the date of this evaluation, the Freedom is currently one of the largest operating cruise ships in the world. This massive vessel, while possessing adequate power,

clearly needs a lot of room to safely transit her thousands of passengers into and out of Port Canaveral under all expected weather conditions. There are multiple reasons why the additional width provided by Plan A will permit a safer transit of this area. One reason is that it allows the pilot to slow down earlier. The vessel has to be going slow upon entering the port as to not surge and damage moored vessels. By slowing down, the crab angle of the vessel will increase and when dealing with ships the size of the *Freedom* (or larger) the extra room needed to accommodate the new "virtual beam" (actual beam + crab angle) is substantial and sufficient room is provided for this in Plan A. Secondly, Plan A allows the pilot to better position the vessel for the turn by buoy 9. This allows the pilot to plan ahead in anticipation of the increased drift angle. The extra room provided by buoy 11 and 13 would be very useful in a S'yly wind to stay a safe distance off the north jetty. Additionally, the larger area provides for a smaller, more preferable, rate of turn.

Middle/Inner Harbor Reach Vessels the size of the *Freedom* are approaching their safe limits when navigating 400' wide channels. The need for the extra 100' of width provided by Plan A cannot be overstated. The ever-critical crab angle is even more of an issue in the Middle and Inner reach, because outside these channel edges is hard rock to the north and moored vessels to the south. Speeds in the inner reach also need to be kept low to avoid surge, making the crab angle even worse. When operating vessels of this size, the extra room is needed so that in the case of an equipment failure or helmsman error, there is adequate time and maneuvering room to perform emergency maneuvers.

At first, it may seem that the extra room in the middle and inner reach is not applicable when dealing with the heavy, deep draft ships, because these ships usually do not use the edges of the channels like the cruise ships do. But again, we have the issue of dangerous hydraulic effects on the vessel (amplified in the inner reach), which can be reduced or eliminated when the vessel is able to transit further from the edges of the channel. The extra maneuvering room provided by Plan A also allows the escort tugs to do their job in an emergency if called upon to break a sheer or slow the vessel.

Turning Basin The Plan A turning basin as simulated, is sufficient in size to allow vessels the size of the Freedom to turn around safely under all expected weather conditions. Plan A allows the vessel to stay a safe distance off any moored vessels and simultaneously maintain a safe distance off the shore. The placement and size of the turning basin provide adequate room to slow and stop the vessel, while still maintaining control. The extra room to the east of the basin in the west cut, will also make the transit safer in both strong N'ly and strong S'ly wind conditions.

2) Does the channel widening provided by Plan B provide ample width for safe transit in the environmental conditions of wind and current as tested for all improved areas? Please comment for both the Jupiter and Freedom of the Seas if differences were noted?

Bend Widener "dog leg" The simulator provided a very good way to compare the two plans. In the drawings, the difference between Plan A and B may seem small, but from the bridge of a huge cruise ship in strong winds, the difference is VERY noticeable. The simulator runs using plan B forced the pilot much closer to channel edges and much closer to dangerous situations. Both of the vessels simulated need the extra room of Plan A. Plan B simply forces the tanker too close to the shallow edges of the channel. The cruise ship is not as concerned about shallow water effects, but still needs the extra channel width to swing that big stern and keep it in good water. Shoaling in the bend widener also needs to be considered. Shoaling will reduce the usable channel, so Plan B would become even smaller, thereby reducing the safety margin even more! Plan B would simply not provide as large of a safety margin as is needed here.

Middle/Inner Harbor Reach Fifty feet may not seem like much, but as a pilot who handles these ships within very tight operating parameters, the narrower channel provided by Plan B makes a BIG difference. As pilots, we routinely pass buoys only 15' off. This is done on purpose to get the ship in the safest position in the channel. By subtracting another fifty feet from the equation as provided by in Plan B, the safety margin shrinks substantially.

Turning Basin The difference on paper here seems small between A and B, but B still falls a bit short here in providing the necessary room for future growth. While highly

maneuverable ships like the Freedom can have sufficient room with Plan B, future ships expected over the next decade may be less maneuverable and may have insufficient area within the turning basin to safely turn around under Plan B.

3) Both Plans A and B provide slightly increased depth in channels. Are these depths adequate for the vessels, especially the "Jupiter" with a draft of 12 meters (approximately 39 feet)? Comments?

Ships do not like shallow water. In other words, the maneuverability of a ship degrades as the depth under the keel decreases. The extra depth provided in the simulation increased safety for many reasons. One being a vessel is less likely to touch bottom. Another reason is the more water under the keel, the more control I have as a pilot to safely maneuver the vessel. The extra depth would also allow vessels 39 feet deep to transit at any time, because the vessels would not have to wait for high tide. With the new oil terminal coming online next year, the extra depth will have a direct, positive impact on port operations.

4) Only maximum credible adverse environmental conditions were simulated. Would Plan A provide any advantages to the shiphandler over Plan B under less extreme environmental conditions?

Bend Widener "dog leg" Even under "normal" conditions, Plan A provides some advantages over Plan B. Plan A's extra room would allow for a slower rate of turn on cruise ships. These large cruise ships can be 16 decks high and when the ship rolls due to excessive rate of turn, the roll is felt more on the upper decks. Too much roll could result in passenger falls or equipment damage. Secondly, Plan A would allow for two-way traffic, something that would not likely be possible under Plan B.

Middle/Inner Harbor Reach The ability to handle two-way traffic is the differentiator here. Plan A could accommodate it, but Plan B would likely not provide enough room. It also bears repeating that the extra 50' missing under Plan B would be very missed in the case of an emergency!

Turning Basin The Freedom could safely use either turning circle, but the size and maneuverability of all vessels projected to use the basin must be considered. It is very conceivable that vessels in the future may well need the extra room to the south that Plan A provides.

5) Please comment on the effectiveness of the new outbound range. Do you recommend any other fixed (non-buoy) navigational aids to improve the overall project navigability? I was very pleased to see the outbound range simulated. I found it very effective in helping me place the vessel properly in the channel. Being so far forward on a cruise ship, one must remember that almost 90% of the ship is behind you. This requires a lot of expertise to put the stern of the ship (that you cannot see) in the proper place in the channel. The range allows me to do that. Inbound, the range is probably the most important navigational tool, so I dream of the day when we can finally get one for the outbound leg. Also, even though we did not simulate it, ranges are especially effective at night. Many of our large "port of call" ships leave at night and that outbound range would sure increase safety as an additional tool.

6) Please comment on the accuracy of the simulation models. It seems like simulator technology is improving exponentially. I have used many simulators around the country and the one at STAR center is the best. The handling characteristics of both vessels were very realistic and allowed me to really get into the moment and "feel" the ship. The degree of realism had a positive impact on my ability to evaluate the proposed channel improvements.

7) Is there a thought or impression that you would like to express, that is not characterized or encouraged by any of the above impressions.

Safety is always paramount in this business and is more important than all else. However, in order to have a sustainable port providing positive financial impact, both locally and nationally, we need to move ships. The cost benefit of these proposed changes, while of secondary importance to safety, needs to be given strong consideration.

The extra depth will raise current restrictions on draft, which means deep draft ships could come and go at any tide, thereby saving tens of thousands of dollars that otherwise would have been wasted sitting at anchor. Secondly, deeper ships with more cargo could call at the port and more cargo means more revenue. It also allows for increased capacity to bring in emergency supplies after a hurricane. Currently under construction in Port Canaveral is the

largest tank farm on the east coast of Florida. The deeper depth of the channel will allow us to bring in more amount of product to meet the needs of central Florida.

Under Plan A two-way traffic is a possibility. This will reduce congestion delays and allow ships to transit at any time, without incurring expensive delays while dockside or at anchor.

The cruise ships being built now were unimaginable just a decade ago. How big will these ships get? I do not believe we know that answer yet. We need to be looking and planning for 20 to 30 years ahead and not just for the minimum required now. We are simulating ships that are already here! With 4 million Americans riding these cruise ships in and out of Port Canaveral annually, I have a duty as a pilot to not only keep the passengers safe, but to protect the port and Florida's pristine beaches and maritime environment. It is my belief, as an experienced pilot, that the improvements outlined in Plan A will provide a safer and financially beneficial improvement to the current channel and will encourage growth and commerce for decades to come.

## Port Canaveral Evaluation 2009 Final Evaluation Form

Name: Captain David P CallanDate: 3-5 June 2009

The existing geographic database for Port Canaveral was modified to reflect two different dredge expansion plans. Both plans "A" and "B" widen the channel at the "dog leg" or junction of the outer reach and middle reach channels, and an area on the north side of middle reach channel. Plan "B" provides the narrower of the two options. Both plans provide for an expanded west turning basin as well except that the plan B basin has a slightly reduced diameter (50 feet). Channel depths were increased slightly and to the same controlling depth in both plans.

Two vessels were used in the simulations as the design vessel for the project: "Freedom of the Seas" (LOA 361.5m, Beam 47m, Draft 8.5m), and "Jupiter" (LOA 244m, Beam 42m, Draft 12m and 8.3m).

Northerly and Southerly winds of between 25 to 40 knots were used in simulation, in addition to currents both Northerly and Southerly of up 1 knot in velocity.

1) Does the channel widening provided by Plan A provide ample width for safe transit in the environmental conditions of wind and current as tested for all improved areas? Please comment for both the Jupiter and Freedom of the Seas if differences were noted?

Bend Widener "dog leg" **It is my professional opinion, after three full days evaluating the two plans for the "Bend Widener," that Plan A will undoubtedly provide ample width for the safe transit of both deep draft tankers and high freeboard / high windage cruise vessels for the most severe of wind conditions whether they be from the N'yly or S'yly directions. Certainly, there is a difference between the two types of vessels in that tankers have less freeboard affecting the set of the vessel but as has been pointed out by Mr. Jon Brazee of the Canaveral Port Authority: the soon-to-be new partner in the port, Vitol S.A., with its looming, large tank farm to be completed by year end, will be expanding the refined product market within six months to include both longer and deeper drafted vessels that will command the larger bend widener.**

**Simultaneously, at 1111' LOA according to the pilot card, the passenger vessel Freedom (1186' as referred to above) is third among the largest three cruise class vessels in the world. Coming from the 400' wide approach channel into the widener of Plan A will allow the pilot onboard to adequately position the vessel for the approach to buoy 13A near the entrance of the expanded 500' channel that will be provided throughout the middle and inner reaches. At the same time, Plan A will provide the pilot with the ability to slow the vessel much sooner, even with increasing side drift, in order to reduce the surge effect upon vessels inside the port, and still maintain proper channel placement leaving the widener, and ensuring safe speed at all times in accordance with both International and Inland Rules of the Road.**

Middle/Inner Harbor Reach Of equal importance to the new Plan A widener, and certainly just as crucial to the overall enhancement of safe navigation in the port, is the 25% increase in channel width along these reaches to a 500' channel vice the current 400' channel. Not only is it critical to give the vessels a wide berth that rest along the piers at Cruise Terminals 2, 3 & 4 and at South Cargo Piers 1, 2 & 3, to preclude any possible surge to these vessels, it is an area where the pilots must continue to slow the vessels for a safe speed in the middle basin that often result in large crab angles of leeway not necessarily seen by the *Freedom* runs but are very evident for other vessels that are not fixed with azipods but must rely on speed and rudder power to effect a safe crab angle transiting this area.

With respect to the "Jupiter," the additional width will allow the deeply laden tankers to not only maintain a larger, and thus safer distance to the ships on the south side at the various berths, but will minimize the effects of bow cushion and stern suction that we pilots must currently "fight" by strenuously utilizing the various assist tugs while slowing down for entry into the middle basin and docking therein. There can be no doubt that safety will be enhanced in the delivery of petroleum products to the port with the benefit of much safer transits and a reduction in the possibility of marine incidents that may result in oil pollution or allision with other moored vessels. Even in extreme S'ly winds, vessels transiting the area will be able to use the additional 100' channel width on the north side to maintain a greater distance to these vessels berthed on the south side as described above.

Turning Basin Again, there can be no doubt that the Plan A turning Basin near the west basin will be adequate for the safe turning of the *Freedom* class vessel under all extreme weather directions and conditions as tested during the simulation. There is ample room to maintain a safe speed coming out of the middle basin and passing vessels in the West Cut A / West Cut B channel portion on the approach to the turning circle, especially considering the additional and essential widening along the south side in this West Cut section. Sufficient stopping distance will be available upon approach to the turning circle to slow the large passenger vessels and deep draft cargo vessels to a stop and proceed with the turning maneuver.

What is most significant with the new widener when discussing other classes of vessels is to note that while not simulated, all of the vessels that will be berthed at North Cargo Piers 3, 4, 5, 6, & 7 will have adequate room to proceed inbound from sea, turn around under any condition of draft and weather, and dock port side to, headed for sea in the event of an emergency that requires vessels to leave port in haste due to approaching tropical storms or for an emergency in the port as per the port tariff. These vessels will more than likely have to be turned with the assist of tugs and they do not possess the same maneuverability that cruise vessels have so it is essential that the largest possible turning diameter be provided to these sometimes older but always less handy vessels in terms of engine usage and power reserve as well as thruster capacity, if provided at all. It is not as easy to check up headway and sternway as efficiently as cruise vessels due to the type of propulsion available.



2) Does the channel widening provided by Plan B provide ample width for safe transit in the environmental conditions of wind and current as tested for all improved areas? Please comment for both the Jupiter and Freedom of the Seas if differences were noted?

Bend Widener “dog leg” I do not feel that Plan B would provide the same standard of safety that Plan A would for the simple fact that it is imperative in strong S’ly winds to “hug” the south channel limit so as to allow a gradual decrease in speed on the approach to the middle / inner reaches for the reasons of safety provided previously. While it may not seem to the layman that 50’ is a significant and necessary improvement, one must recognize that in our current training program a pilot must develop the skills necessary to oftentimes pass within 10-15’ of a windward buoy so as to allow the vessel to both slow and maintain channel integrity. Regardless of the Plan A improvements that may come to fruition, this skill will still need to be developed due to the fact that most vessels do not have the same tools that the Freedom does.

Further, especially in the case of Plan B, it will be necessary at times to place the ship close to the channel limit well into the left outside quarter inbound in strong S’ly winds. This will not be ideal for either high freeboard vessels such as large cruise liners and certainly deep draft tankers such as the simulated “Jupiter” that would feel the cushion and suction effects to a greater extent.

It should also be remembered that channel degradation occurs first along the outer limits of the channel and historically Port Canaveral has seen most shoaling occur on that Southerly side of the channel. The recently constructed sand trap on the south widener limit has been documented to be almost completely full and there have been channel condition reports that there is further shoaling into the channel along the south limit of the section from buoys 11 through 13A. This is due to the large fetch to the south of the channel that is impacted by strong southerly winds of an extended duration. This is fact and not myth, as ACOE records will show.

Middle/Inner Harbor Reach Quite simply, Plan B does not offer the same degree of safety as does Plan A. I cannot overstate the significance of 50’ when maneuvering vessels at slow speed. One must continue slowing down, maintain adequate clearance to berthed vessels so as to eliminate surge, and still provide for channel integrity, i.e.: keeping the ship in the channel within the channel limits and eliminating bank cushion and stern suction effects. For both the widener and middle / inner reaches, understand that we are talking about almost one entire ship’s beam in plan A but less than half a ship’s beam in Plan B. Again, let me remind you that a 10% increase in channel width is considerable.

Again, it is imperative that along this channel section the pilots are able to utilize the right inside quarter more so than infringing upon the right outside quarter where cushion/suction effects are exacerbated. Plan A offers greater advantages in this respect.

Turning Basin Once more, it must be pointed out that for those vessels at North Cargo Piers 3 - 7, the largest diameter turning basin that is possible should be constructed due to the limitations in maneuverability, the time lag especially in

going from ahead to astern and vice versa, and the need for assist tugs to turn the vessels. The situation, from a pilot's point of view, mandates the largest possible turning circle under Plan A vice Plan B. When using tugs, they will often need to be repositioned during the turning maneuver and will need area adjacent to the vessel turning to relocate themselves but will have to remain inside the turning circle clear of small boat marinas on the south side especially when doing so.

3) Both Plans A and B provide slightly increased depth in channels. Are these depths adequate for the vessels, especially the "Jupiter" with a draft of 12 meters (approximately 39 feet)? Comments?

As witnessed during the simulation, the additional depth will allow for a more acceptable under keel clearance when transiting the channel with deep draft laden tankers. A larger under keel clearance will ensure that the vessels do not come close to "bottoming out" in the channel due to the effects of squat at higher speeds in the approach channel and when maneuvering with strong backing bells in the turning basins. A deeper channel will allow the vessels to have a larger, denser medium of water in which to go astern and result in both shorter stopping distances and decrease in time of overall transit. One cannot overstate the shallow water effect on deep draft tankers/ bulkers / container vessels in our modest turning basins. Current tide restrictions as a result of the existing project depth, as well as delays incurred by the high priority cruise ships calling the port, oftentimes cause delays and/or cancellations of vessels that do not wish to sit and wait for the tides to cycle out of the cruise ship scheduling time frames. The new Project Depth simulated will allow tide restrictions to be lifted and allow twenty-four hour transit availability for commercial traffic.

4) Only maximum credible adverse environmental conditions were simulated. Would Plan A provide any advantages to the shiphandler over Plan B under less extreme environmental conditions?

Bend Widener "dog leg" Plan A would most certainly be effective in providing sufficient width in the widener to allow for two-way traffic for medium size vessels under less extreme environmental conditions thus eliminating the need for strictly one-way traffic in the channel ways. Pilots will be able to time their vessel passages to be conducted either in the widener or, as in the next question, along the improved 500' middle/inner reach. This will most definitely have a favorable economic effect on vessels arriving and departing that would normally have been delayed in the past. Unwarranted charges for berthing and delays at their next port of call would be minimized if not eliminated. Plan B would more than likely not provide this advantage to the degree of Plan A, if at all.

Middle/Inner Harbor Reach For the same reason noted in the previous question, the 500' channel would allow for two way traffic for medium sized vessels and would improve the cost effectiveness of Port Canaveral that now only allows for one-way traffic due to the narrow nature of the reaches and widener. Plan B would remain sufficiently constricted so as to preclude such two-way traffic. The additional fifty feet would enhance safety and provide economic benefits.

Turning Basin The answer to this question is the same as that responded to earlier: with the exception of highly-maneuverable cruise ships, Plan A would afford the

**best possible turning circle diameter for vessels that are less maneuverable and that require tug assistance, or for other cruise vessels that will need to back up an extended distance from the turning circle to their berths on the north side of the West Basin. Plan B will not provide this additional safety enhancement.**

- 5) Please comment on the effectiveness of the new outbound range. Do you recommend any other fixed (non-buoy) navigational aids to improve the overall project navigability?

**The outbound range is an essential part of the equation. When working close to the bow of an 1100' cruise liner, with no view of the stern "dragging" behind you, the range is necessary to determine the position of the vessel in the channel in coordination with the perspective offered by the buoys. I would recommend, as we did during the simulation, that a buoy be placed along the upper channel limit of the middle / inner reach south of the west bank of the entrance to the east basin. This will provide an intermediary buoy between 14A and 12 to give the pilot an additional aid to navigation that will allow him to work as close to the North Channel limit as he needs to in this section. As well, an additional buoy will need to be positioned at the southwest corner of the West Basin turning circle to show the extent of the maneuvering area. (Near the barge canal approach channel)**

- 6) Please comment on the accuracy of the simulation models.

**Having been to several simulations at the STAR Center, I can attest to the constant improvements that I have seen each time I have been there in terms of real time movement, accurate depiction of the surrounding environs, and most importantly the actual handling characteristics of the vessels being simulated. I found this latter fact most striking for the *Freedom* and *Jupiter* and I must commend the designers and staff at the center for their positive reaction to real time feedback from the ships' crews and pilots alike. Having been to many simulation facilities, I find the STAR Center to be the most realistic. I personally feel that the STAR center gives an accurate portrayal of both the port layout and the handling characteristics of the ships simulated.**

- 7) Is there a thought or impression that you would like to express, that is not characterized or encouraged by any of the above impressions.

**While I neither infer nor imply that I am a professional channel designer, my personal reference source is the ASCE Publication "Ship Channel Design and Operation" Publication No. 107. In Section 2.4, it states that, "The designer will use the information on traffic type to select the design ship – usually the largest commodity mover expected to most frequently use the channel improvements." Certainly we have done that during this simulation and as noted in this section's response below we address the anticipated future scope of vessels calling Canaveral that are even larger than that simulated.**

**Quite appropriately, Section 8.7.3, Turn Design, addresses specific turn types. In my opinion, the Circle Turn (Figure 8-6) shown and simulated this past week properly addresses the anticipated deflection angle of these large cruise vessels throughout the turn, provides for the optimal radius of the navigation channel curve from the**

channel center line to the center of curvature, and accurately increases the channel width in the turn.

I think it is very important, and hopefully not seemingly disingenuous, to take into consideration the fact that the responses that I have provided do indeed come from an individual who has a deep pool of experience in piloting vessels in Port Canaveral, New York Harbor, and the Delaware River. None of my comments are frivolous or exaggerated in nature. I have mentioned that a width of 50', while to an untrained eye may seem insignificant, is indeed a factor both my fellow pilots and I use on an almost daily basis while performing our duties. One should consider that 50' represents an increase of 10% in channel width, significant in itself, but more importantly it is almost 40-50% of a ship's beam that we normally handle in the port. This is noteworthy.

Also, while we did not simulate other vessels, it should be clearly understood that Disney Cruise Lines is currently building two 1110+ foot long ships to be home ported out of Canaveral that will not have the benefit of azipods but will have conventional Becker rudders and less horsepower from the bow and stern thrusters that will necessitate larger crab angles than simulated. This factor alone will make it essential to have all four improvements: the larger bend widener, the 500' channel, the additional channel width in West Cut, and the larger turning circle. For these vessels and for cruise vessels berthing at the to-be-built cruise terminals in the northern part of the west basin, it will be essential to have the largest possible turning basin to the south so as to allow for a safe and proper approach to these berths.

The consideration of Plan B does not factor in the very simple detail that while we are planning for the maneuvering of 1100+ feet vessels currently built, there are other vessels such as the *Queen Mary* at 1150' and the *Genesis* class at 1175' that are also scheduled to use Canaveral as a port of call. Should the pilots be presented with a channel and turning basin that is anything less than that established by Plan A, there can be no question that safety would not be enhanced and, quite possibly, may prohibit such vessels from calling. If we are to consider a safety factor of 1.5 times the length of a vessel for the design dimension of a turning circle, the Plan A configuration best suits our needs.

Therefore, if we are to consider that such a large capital outlay should ensure viability for the port well into the next thirty years, it would be imprudent, if not shortsighted, to consider any improvements that do not take into account the future demand for even larger vessels. In the past ten years, yours truly has seen the largest cruise ship in Canaveral go from 880' in length to the now simulated *Freedom* and *Disney* class vessels. The former is already calling Canaveral while the *Disney* vessels will be constructed in late 2010 and early 2011. With the *Queen Mary* and *Genesis* class vessels a reality, one can only anticipate the scope of vessels to appear on the horizon and Port Canaveral needs to be ready to be a proper port of call or homeport for them as the need arises.

As one aside before I end, it is my experience that the people of the state of Florida demand that the most experienced individuals – their harbor pilots – make strong arguments for providing the safest parameters for operating conditions and it is in this spirit that I have made my observations. It is in this spirit that I include one last quote from the ASCE Publication referred to above regarding factors influencing channel design, Chapter 4, “Navigation project planners / designers should develop strong coordination with the local pilot groups throughout the project development.” I hope that the participation of both Captain Ben Borgie and myself during the simulation study this past week has served this interest.

Finally, while I am mere pilot at this point in time, I have over forty years of experience in the maritime industry after having been graduated from the United States Merchant Marine Academy and I have seen a consistent trend towards both the enrichment of safety oversight that Plan A will provide, and for larger and deeper vessels that again will be adequately addressed by the establishment of the Plan A channel and basin improvements. We must be pro-active in providing for the future of Port Canaveral rather than finding ourselves having to act in hindsight and being reactive to the ships that are built with further requests for channel relief. Plan A will provide Port Canaveral with the necessary improvements to enable it to be a first class port in our ever changing and challenging maritime world well into the future without the need to revisit the existing channel and turning basin scenarios.

Thank you for the opportunity to participate,

Captain David P. Callan

Please use additional sheets if necessary to complete your responses.

Thank you for your participation in this important project!

**Port Canaveral Section 203 Feasibility Study  
Engineering Appendix**

Attachment B

KSC NASA Shuttle Facility Wind Data Summaries, 1978 to 2003  
Station TRDF1: Cruise Ship Wind Speeds, Elevation Corrected  
PASS-MOOR Passing Ship Force Results  
Moored Ship Wind Force Results

NOT USED

**Port Canaveral Section 203 Feasibility Study  
Engineering Appendix**

Attachment C

Drawings: Existing Conditions and Authorized Channel Depths

Rev Date: October 2011







**Port Canaveral Section 203 Feasibility Study  
Engineering Appendix**

Attachment D

Project Depth Calculations

Rev Date: October 2011

80K-100K DWT Post-Panamax Tanker or Bulk Carrier SQUAT - Alternative Water Depths - Inbound, Loaded to 39.5'

References:

- 1) Barass. "Squat Formula for Ships in Rivers." The Naval Architect, November 2004.
- 2) Heimore, Phillip. "Determination of Coefficient K for Prediction of Ship Squat." The Naval Architect, 2005.
- 3) USACE ERDC/CHL CHETN-IX-14. "Charleston Harbor Ship Motion Data Collection and Squat Analysis." March 2004.
- 4) PIANC WGA. "Guidelines for the Design and Construction of Flexible Revetments Incorporating Geotextiles for Inland Waterways." Supplement to Bulletin No. 57, 1987.
- 5) PIANC PTC II-30. "Approach Channels: A Guide for Design." Supplement to Bulletin No. 95, June 1997
- 6) EM 1110-2-1613: Hydraulic Design of Deep-Draft Navigation Projects, 31 Aug 1995 (Equation 6-4, Shallow Water Squat).

Design Vessel Dimensions:

Draft, T (m or ft)	12.04	39.5
Beam, B (m or ft)	42	137.8
Length Overall, LOA (m or ft)	244	800.5
Length at waterline, LW (m or ft)	231.6	759.8
Length between Perps, Lpp (m or ft)	231.6	759.8
Displacement (tonnes)	97200	--
Block Coefficient, Cb (calc)	0.81	same
Cb used	0.8	same
Ship X-Area, As=0.98*B*T (m <sup>2</sup> or ft <sup>2</sup> )	495.6	5334
g (m/sec <sup>2</sup> or ft/sec <sup>2</sup> )	9.807	32.2

Unrestricted Shallow Water X-Section = 8'B\*h

Empirical Formulas:

- Depth Froude #,  $F_{rh} = V_s / (g \cdot h)^{0.5}$   
 Schijf Limiting Velocity Froude #,  $SF_{rh} = (8^{1/3} \cdot \text{COS}(\pi / (3 + 1/3 \cdot \text{ACOS}(1 - \text{BR})))^{0.5})^{0.5}$   
 Schijf Limiting Ship Speed,  $S_{rh} = SF_{rh} \cdot (g \cdot h)^{0.5}$ , Maximum Practical = 90% of Value  
 Barass K ( $1.1 < h/T \text{ ratio} < 1.3$ ) =  $6 / ((\text{waterway width} / B) / (h/T) + 0.4)$ , where waterway width = Ach/Ch h  
 Barass II Squat: (ft) =  $K \cdot C_b \cdot V_s^2 / (100 \cdot 3048)$ , where  $V_s$  (knots),  $1.1 < h/T \text{ ratio} < 1.5$   
 EM Shallow Water Squat, Eqn. 6-4,  $Z = 1/4 \cdot 706 \cdot C_b / (Lpp \cdot B)^{-1} \cdot (T/h)^{-0.2}$ , where  $V_s$  is in knots

Width of Influence (ft) 1171 Less than this width of water and ship will be in confined channel conditions  
 Note: Outbound ships will have less draft or be at light condition

OR-Cut 1A, Sta 0+00, Sta 100+00,  
 OR-Cut AB, Sta 50+00

	Barass Squat (ft)	Barass K	Barass II Squat (ft)	90% SVs (knots)	SF <sub>rh</sub>	S <sub>rh</sub> (knots)	< 0.6 F <sub>rh</sub>	V <sub>s</sub> (knots)	h/T ratio	S <sub>2</sub> =As/(Ach-As)	B <sub>R</sub> =As/Ach	Ach (ft <sup>2</sup> )	SB n	Ch w (ft)Ch h (ft)	NB n	EM 6-4 Squat (ft)	
Vs Max Speed,	2.62	1.00	2.61	12.1	0.605	0.449	0.449	10	1.11	0.12	0.11	48504	--	400	44	--	2.77
Unrestricted Channel X-Section = 8*B*h	2.62	1.00	2.57	12.4	0.609	0.444	0.444	10	1.14	0.12	0.11	49606	--	400	45	--	2.71
	2.62	1.00	2.52	12.6	0.613	0.439	0.439	10	1.16	0.12	0.11	50709	--	400	46	--	2.65
	2.62	1.00	2.48	12.8	0.617	0.434	0.434	10	1.19	0.11	0.10	51811	--	400	47	--	2.59
Vs Max Speed, Restricted	2.78	1.06	2.57	12.2	0.609	0.449	0.449	10	1.11	0.12	0.11	48500	--	400	44	--	2.77
Use Sta 55+00 x-sect	2.77	1.05	2.55	12.4	0.610	0.444	0.444	10	1.14	0.12	0.11	49900	--	400	45	--	2.71
	2.74	1.04	2.52	12.7	0.613	0.434	0.434	10	1.16	0.12	0.11	50300	--	400	46	--	2.65
	2.74	1.04	2.52	12.7	0.613	0.434	0.434	10	1.19	0.12	0.11	50700	--	400	47	--	2.59
Vs from Pilot Input, Restricted	2.25	1.06	2.06	12.2	0.609	0.404	0.404	9	1.14	0.12	0.11	49500	--	400	44	--	2.77
Use Sta 55+00 x-sect	2.24	1.05	2.05	12.4	0.610	0.399	0.399	9	1.14	0.12	0.11	49900	--	400	45	--	2.71
	2.23	1.05	2.04	12.5	0.612	0.395	0.395	9	1.16	0.12	0.11	50300	--	400	46	--	2.65
	2.22	1.04	2.03	12.7	0.613	0.391	0.391	9	1.19	0.12	0.11	50700	--	400	47	--	2.59

**OR-Cut 1, -Buoya 7/8, Sta 55+00**

Barass Squat (ft)	Barass K	Barass II Squat (ft)	90% SVs (knots)	SF <sub>Frh</sub>	< 0.6 Frh	< SVs Vs (knots)	h/T ratio	SZ= As/(Ach-As)	BR=As/Ach	Ach (ft/2)	SB n	Ch w (ft)Ch h (ft)	NB n	EM 6-4 Squat (ft)
2.13	1.00	2.10	12.1	0.605	0.404	9	1.11	0.12	0.11	48504	--	400 44	--	2.24
2.13	1.00	2.06	12.4	0.609	0.399	9	1.14	0.12	0.11	49606	--	400 45	--	2.19
2.13	1.00	2.03	12.6	0.613	0.395	9	1.16	0.12	0.11	50709	--	400 46	--	2.14
2.13	1.00	2.00	12.8	0.617	0.391	9	1.19	0.11	0.10	51611	--	400 47	--	2.10
2.25	1.06	2.06	12.2	0.609	0.404	9	1.11	0.12	0.11	49500	--	400 44	--	
2.24	1.05	2.05	12.4	0.610	0.399	9	1.14	0.12	0.11	49900	--	400 45	--	
2.23	1.05	2.04	12.5	0.612	0.395	9	1.16	0.12	0.11	50300	--	400 46	--	
2.22	1.04	2.03	12.7	0.613	0.391	9	1.19	0.12	0.11	50700	--	400 47	--	

Vs Max Speed, Restricted  
Use Sta 55+00 x-sect

Vs from Pilot Input, Restricted  
Use Sta 55+00 x-sect

**OR-Cut 1, Sta 85+00**

Barass Squat (ft)	Barass K	Barass II Squat (ft)	90% SVs (knots)	SF <sub>Frh</sub>	< 0.6 Frh	< SVs Vs (knots)	h/T ratio	SZ= As/(Ach-As)	BR=As/Ach	Ach (ft/2)	SB n	Ch w (ft)Ch h (ft)	NB n
2.05	1.08	1.88	12.1	0.603	0.381	8.5	1.11	0.13	0.11	48000	--	400 44	--
2.04	1.07	1.86	12.3	0.605	0.377	8.5	1.14	0.12	0.11	48400	--	400 45	--
2.03	1.07	1.85	12.4	0.606	0.373	8.5	1.16	0.12	0.11	48800	--	400 46	--
2.02	1.06	1.84	12.6	0.608	0.369	8.5	1.19	0.12	0.11	49200	--	400 47	--
1.02	1.08	0.91	12.1	0.603	0.269	6	1.11	0.13	0.11	48000	--	400 44	--
1.02	1.07	0.90	12.3	0.605	0.266	6	1.14	0.12	0.11	48400	--	400 45	--
1.01	1.07	0.90	12.4	0.606	0.263	6	1.16	0.12	0.11	48800	--	400 46	--
1.01	1.06	0.89	12.6	0.608	0.260	6	1.19	0.12	0.11	49200	--	400 47	--

Vs from Pilot Input, Restricted  
Use Sta 85+00 x-sect

**MR-Cut 2, -B12/13, Sta 150+00  
Jetties**

Barass Squat (ft)	Barass K	Barass II Squat (ft)	90% SVs (knots)	SF <sub>Frh</sub>	< 0.6 Frh	< SVs Vs (knots)	h/T ratio	SZ= As/(Ach-As)	BR=As/Ach	Ach (ft/2)	SB n	Ch w (ft)Ch h (ft)	NB n
2.58	1.54	2.47	9.9	0.493	0.389	8	1.11	0.23	0.19	28732	8	400 44	3.5
2.52	1.50	2.41	10.1	0.500	0.355	8	1.14	0.22	0.18	29644	8	400 45	3.5
2.47	1.47	2.35	10.4	0.507	0.351	8	1.16	0.21	0.17	30567	8	400 46	3.5
2.41	1.44	2.29	10.7	0.514	0.347	8	1.19	0.20	0.17	31502	8	400 47	3.5
1.22	1.54	1.13	9.9	0.493	0.247	5.5	1.11	0.23	0.19	28732	8	400 44	3.5
1.19	1.50	1.10	10.1	0.500	0.244	5.5	1.14	0.22	0.18	29644	8	400 45	3.5
1.17	1.47	1.08	10.4	0.507	0.241	5.5	1.16	0.21	0.17	30567	8	400 46	3.5
1.14	1.44	1.05	10.7	0.514	0.239	5.5	1.19	0.20	0.17	31502	8	400 47	3.5

Vs from Pilot Input, Restricted

**MR-Cut 2, Sta 165+00  
Trident Basin East**

Barass Squat (ft)	Barass K	Barass II Squat (ft)	90% SVs (knots)	SF <sub>Frh</sub>	< 0.6 Frh	< SVs Vs (knots)	h/T ratio	SZ= As/(Ach-As)	BR=As/Ach	Ach (ft/2)	SB n	Ch w (ft)Ch h (ft)	NB n
2.05	1.60	1.95	9.6	0.480	0.314	7	1.11	0.24	0.20	27280	5	400 44	5
2.01	1.56	1.90	9.9	0.488	0.310	7	1.14	0.23	0.19	28125	5	400 45	5
1.96	1.53	1.86	10.1	0.495	0.307	7	1.16	0.23	0.18	28980	5	400 46	5
1.92	1.49	1.81	10.4	0.502	0.304	7	1.19	0.22	0.18	29845	5	400 47	5
1.05	1.60	0.97	9.6	0.480	0.224	5	1.11	0.24	0.20	27280	5	400 44	5
1.02	1.56	0.94	9.9	0.488	0.222	5	1.14	0.23	0.19	28125	5	400 45	5
1.00	1.53	0.92	10.1	0.495	0.219	5	1.16	0.23	0.18	28980	5	400 46	5
0.98	1.49	0.90	10.4	0.502	0.217	5	1.19	0.22	0.18	29845	5	400 47	5

Vs from Pilot Input, Restricted

**IR-Cut 2, Trident Basin West  
Sta 185+00**

Barass Squat (ft)	Barass K	Barass II Squat (ft)	90% SVs (knots)	SFrh	<0.6 Frh	Vs (knots)	< SVs	h/T ratio	S2= As/(Ach-As)	BR=As/Ach	Ach (ft <sup>2</sup> )	SB n	Ch w (ft)Ch h (ft)	NB n
2.20	1.71	2.10	8.9	0.458	0.325	7	7	1.04	0.27	0.21	24973	3.4	400	41
2.14	1.67	2.04	8.9	0.466	0.321	7	7	1.06	0.26	0.21	25796	3.4	400	42
2.09	1.63	1.99	9.4	0.474	0.318	7	7	1.09	0.25	0.20	26630	3.4	400	43
2.04	1.59	1.94	9.7	0.482	0.314	7	7	1.11	0.24	0.19	27474	3.4	400	44
1.12	1.71	1.04	8.9	0.458	0.232	5	5	1.04	0.27	0.21	24973	3.4	400	41
1.09	1.67	1.02	9.1	0.466	0.230	5	5	1.06	0.26	0.21	25796	3.4	400	42
1.07	1.63	0.99	9.4	0.474	0.227	5	5	1.09	0.25	0.20	26630	3.4	400	43
1.04	1.59	0.96	9.7	0.482	0.224	5	5	1.11	0.24	0.19	27474	3.4	400	44

**Vs from Pilot Input, Restricted**

**IR-Cut 2, CT3, Sta 200+00**

Barass Squat (ft)	Barass K	Barass II Squat (ft)	90% SVs (knots)	SFrh	<0.6 Frh	Vs (knots)	< SVs	h/T ratio	S2= As/(Ach-As)	BR=As/Ach	Ach (ft <sup>2</sup> )	SB n	Ch w (ft)Ch h (ft)	NB n
1.86	1.97	1.79	7.9	0.410	0.279	6	6	1.04	0.34	0.26	20813	1.5	400	41
1.82	1.92	1.74	8.2	0.418	0.275	6	6	1.06	0.33	0.25	21431	1.5	400	42
1.78	1.88	1.70	8.4	0.426	0.272	6	6	1.09	0.32	0.24	22054	1.5	400	43
1.74	1.84	1.66	8.7	0.433	0.269	6	6	1.11	0.31	0.24	22682	1.5	400	44
1.05	1.97	0.98	7.9	0.410	0.209	4.5	4.5	1.04	0.34	0.26	20813	1.5	400	41
1.02	1.92	0.96	8.2	0.418	0.207	4.5	4.5	1.06	0.33	0.25	21431	1.5	400	42
1.00	1.88	0.93	8.4	0.426	0.204	4.5	4.5	1.09	0.32	0.24	22054	1.5	400	43
0.98	1.84	0.91	8.7	0.433	0.202	4.5	4.5	1.11	0.31	0.24	22682	1.5	400	44

**Vs from Pilot Input, Restricted**

**MTB, SCPs, Sta 215+00**

Barass Squat (ft)	Barass K	Barass II Squat (ft)	90% SVs (knots)	SFrh	<0.6 Frh	Vs (knots)	< SVs	h/T ratio	S2= As/(Ach-As)	BR=As/Ach	Ach (ft <sup>2</sup> )	SB n	Ch w (ft)Ch h (ft)	NB n
1.37	2.09	1.31	7.5	0.390	0.232	5	5	1.04	0.38	0.28	19342	0	400	41
1.34	2.04	1.27	7.8	0.397	0.230	5	5	1.06	0.37	0.27	19887	0	400	42
1.31	2.00	1.24	8.0	0.405	0.227	5	5	1.09	0.35	0.26	20486	0	400	43
1.28	1.96	1.21	8.3	0.412	0.224	5	5	1.11	0.34	0.25	20988	0	400	44
1.11	2.09	1.05	7.5	0.390	0.209	4.5	4.5	1.04	0.38	0.28	19342	0	400	41
1.09	2.04	1.02	7.8	0.397	0.207	4.5	4.5	1.06	0.37	0.27	19887	0	400	42
1.06	2.00	1.00	8.0	0.405	0.204	4.5	4.5	1.09	0.35	0.26	20486	0	400	43
1.04	1.96	0.97	8.3	0.412	0.202	4.5	4.5	1.11	0.34	0.25	20988	0	400	44

**Vs from Pilot Input, Restricted**

**WAC, NCP3/4 ~Sta 255+00**

Barass Squat (ft)	Barass K	Barass II Squat (ft)	90% SVs (knots)	SFrh	<0.6 Frh	Vs (knots)	< SVs	h/T ratio	S2= As/(Ach-As)	BR=As/Ach	Ach (ft <sup>2</sup> )	SB n	Ch w (ft)Ch h (ft)	NB n
1.04	1.95	0.97	8.0	0.413	0.209	4.5	4.5	1.04	0.34	0.25	21073	5.56	400	41
1.01	1.90	0.95	8.3	0.421	0.207	4.5	4.5	1.06	0.33	0.25	21704	5.56	400	42
0.99	1.86	0.92	8.5	0.429	0.204	4.5	4.5	1.09	0.31	0.24	22340	5.56	400	43
0.97	1.82	0.90	8.8	0.437	0.202	4.5	4.5	1.11	0.30	0.23	22982	5.56	400	44
0.56	1.95	0.51	8.0	0.413	0.153	3.3	3.3	1.04	0.34	0.25	21073	5.56	400	41
0.54	1.90	0.50	8.3	0.421	0.152	3.3	3.3	1.06	0.33	0.25	21704	5.56	400	42
0.53	1.86	0.48	8.5	0.429	0.150	3.3	3.3	1.09	0.31	0.24	22340	5.56	400	43
0.52	1.82	0.47	8.8	0.437	0.148	3.3	3.3	1.11	0.30	0.23	22982	5.56	400	44

**Vs from Pilot Input, Restricted**

## CHANNEL CROSS-SECTIONS

The following select cross-sections of the channel were considered in the analysis of project dimensions. The cross-sections for the Outer Reach, from the seaward end to the apex of the turn at the beginning of the Middle Reach, are considered to be nearly unrestricted. Only very slight banks exist for as much as 400 ft on either side of the channel. No cross-sections are shown for Outer Reach Cuts 1A and 1B. The first cross-section presented, OR, Cut 1, Sta. 55+00, conservatively represents cross-sections along Cut 1A and 1B. For the restricted channel cross-sections in the Middle Reach, Inner Reach, and West Access Channel, minimum bank slope lines are approximated and horizontal slope values ( $n$ ) are stated. The horizontal and vertical geometry for all cross-sections are shown in feet.

OR, CUT 1, STA. 55+00

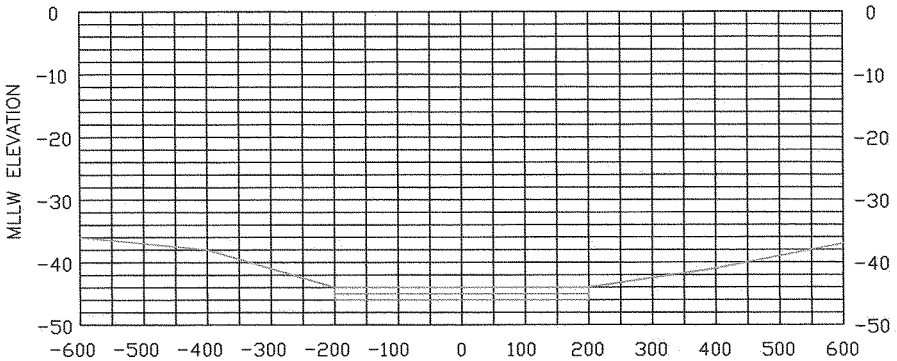

OR, CUT 1, STA. 85+00

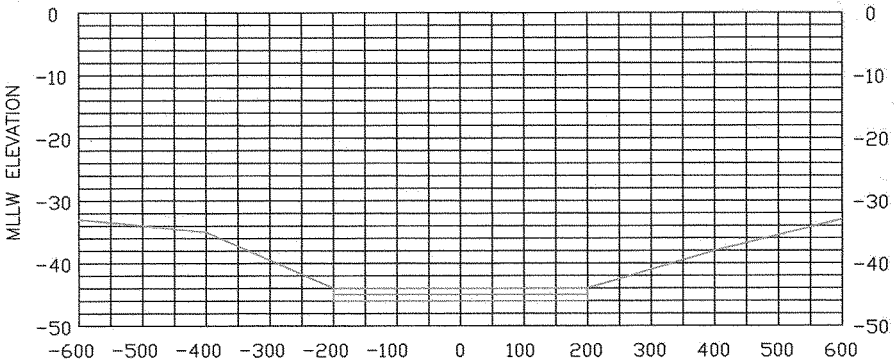

MR, CUT 2, STA. 150+00

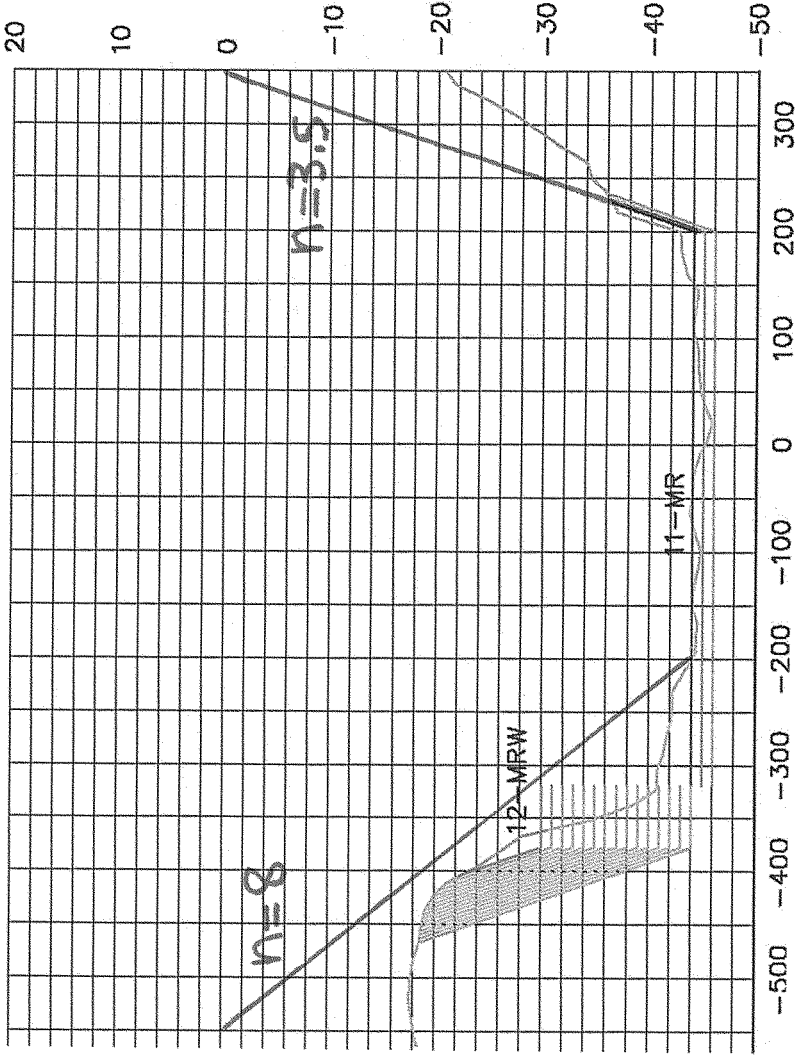

## MR, CUT 2, STA. 165+00

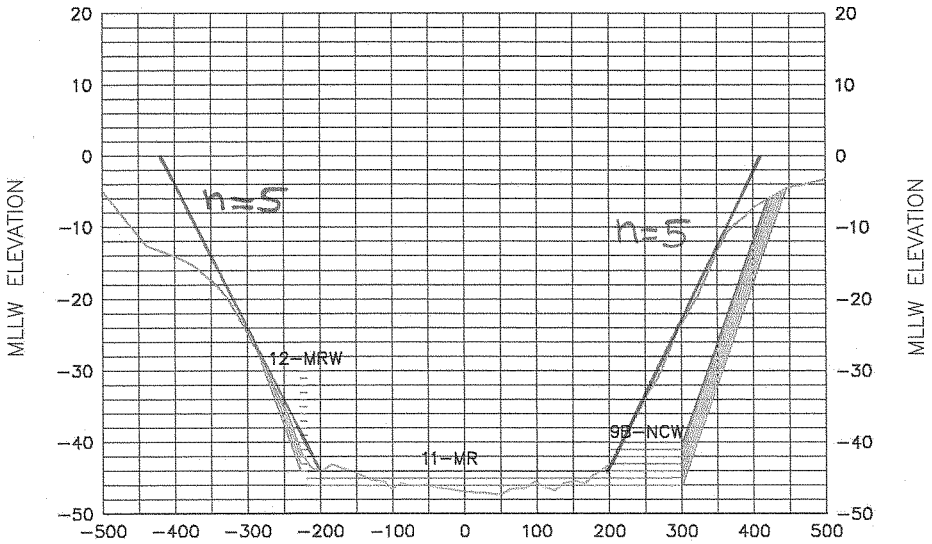

## IR, CUT 2, STA. 185+00

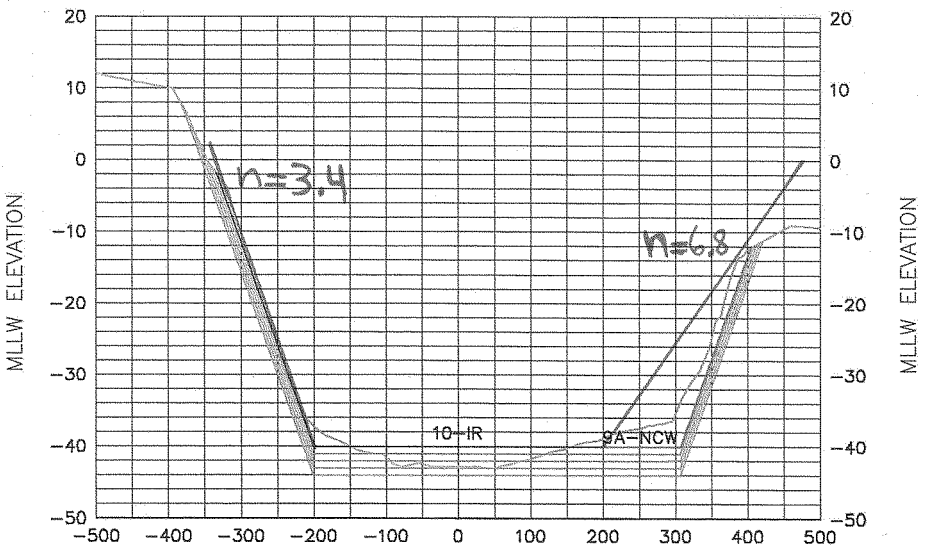



## IR, CUT 2, STA. 200+00

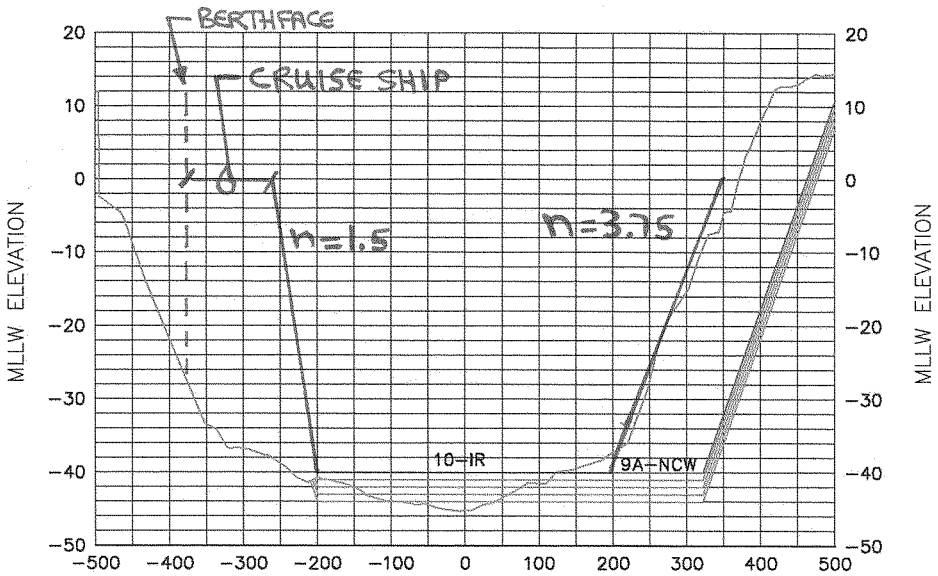

## MTB, STA. 215+00

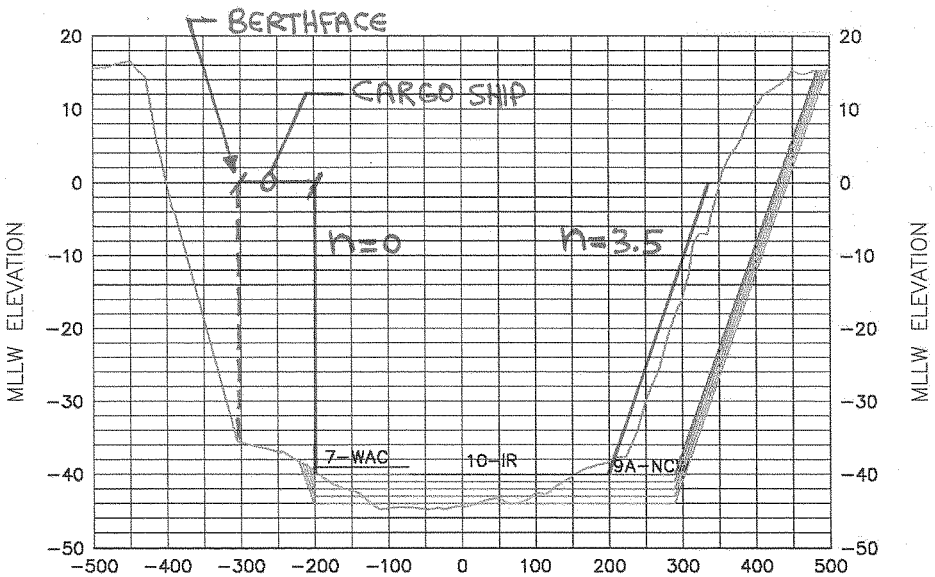

# MR, CUT 2, STA. 150+00

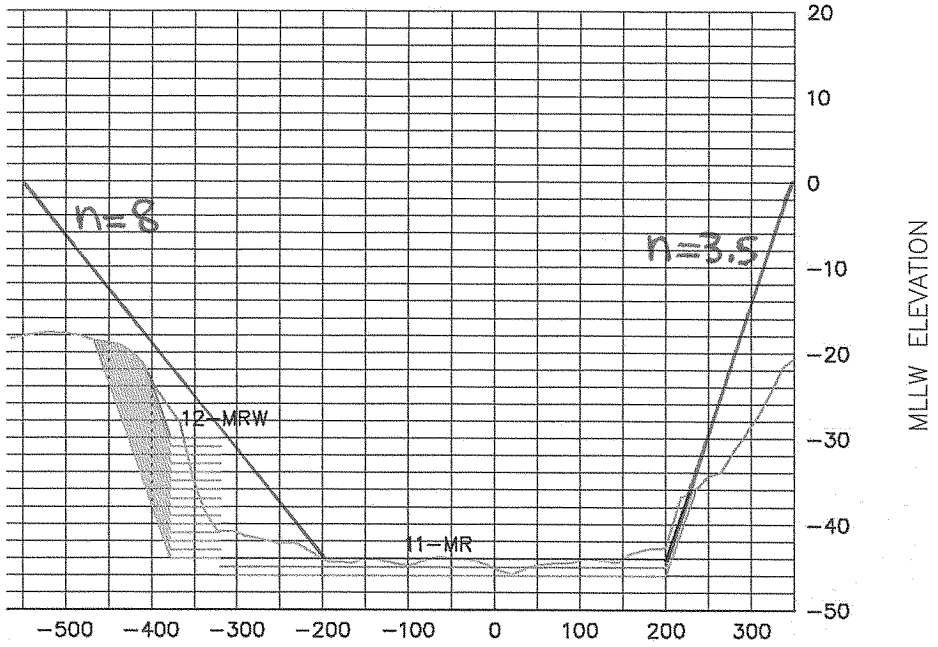

**Port Canaveral Section 203 Feasibility Study  
Engineering Appendix**

Attachment E

Drawings: Recommended Plan

Rev Date: September 2012

**LEGEND**

- NO NEW DREDGING OR WIDENING.
- ▨ WIDENING
- ▩ DEEPENING, FEDERAL PROJECT, DEPTH VARIES AS INDICATED
- ▧ DEEPENING, FEDERAL PROJECT, -43' MLLW

NOTE  
 EACH AREA IDENTIFIER SHOWS PLAN ACREAGE AND PROJECT DEPTH. THE EXCAVATION VOLUME QUANTITY REFLECTS PAID OVERDEPTH OF 1' FOR THE INNER REACH WESTWARD AND 2' FOR THE MIDDLE REACH EASTWARD.

MTB CORNER CUT-OFF OF EXIST. UPLANDS AND NEARSHORE SLOPE. SURVEY AREA (3) (4) (COMPLETED 2011)

MTB SURVEY AREA (8)

1725' Ø TURNING CIRCLE

14221' Ø TURNING CIRCLE

USACE

USACE

USACE

USACE

USACE

USACE

USACE

USACE

USACE

USACE

USACE

USACE

USACE

USACE

USACE

USACE

USACE

USACE

USACE

USACE

Survey Area	Dredging Table Area (ft. MLLW)	Depth (ft. MLLW)	Volume (CY)
3	6.2	-35'+1'	70,717
4	12.3	-35'+1'	436,536
6A	6.9	-35'+1'	121,234
6B	3.7	-43'+1'	33,687
7	46	-43'+1'	107,200
8	40.3	-43'+1'	175,340
9A	9.7	-43'/-44'+1'	491,838
9B	5.9	-46'+2'	229,597
10	30.6	-44'+2'	108,494
11	141.5	-46'+2'	456,574
12	22.2	-46'+2'	713,352
13	200.6	-46'+2'	629,041
S. Jetty Sand Trap			43,800

OUTER REACH TO STA. 53+00  
 OF CUT 1, INCLUDING MIDDLE  
 REACH, NAVY WIDENING, & CIVIL  
 WIDENING. SURVEY AREA (11)

100' MIDDLE REACH WIDENING. SURVEY AREA (9B)

100' INNER REACH WIDENING SURVEY AREA (9A)

203 CIVIL WIDENER SURVEY AREA (12)

SOUTH JETTY SANDTRAP

STA. 124+77  
 R.C.E. +215

N 1481869.08  
 E 795851.81

**RECOMMENDED PLAN -- DREDGING**

(OTHER NON-DREDGING WORK DESCRIBED IN ENGINEERING APPENDIX & ATTACHMENTS)

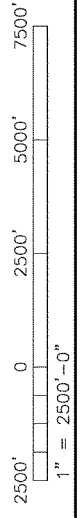

NEW OUTBOUND RANGE STRUCTURES ALIGNED ON  
NEW INNER/MIDDLE REACH CENTERLINE. NEW  
LOCATION TO BE VERIFIED WITH U.S.C.G.  
(SEE SHEET 5)

N 1481851.43  
E 798851.95

N 1481869.08  
E 795851.81

OUTER REACH TO STA. 53+00 OF CUT 1,  
INCLUDING MIDDLE REACH, NAVY  
WIDENER, & CIVIL WIDENER.  
SURVEY AREA (11)

203 CIVIL WIDENER.  
SURVEY AREA (12)

OUTER REACH  
SURVEY AREA (13)  
STA. 0+00 OF CUT 1A TO  
STA. 53+00 OF CUT 1.  
200.6 Ac., -46' MLLW.  
629,041 CY.

BEGINNING OF MARKED  
CHANNEL STA. 0+00 CUT 1A.

STA. 124+77  
RGE. +215





SEE  
SHEET 5

STA. 53+00 CUT 1

STA. 0+00 CUT 1B  
STA. 53+00 CUT 1B

STA. 0+00 CUT 1A  
STA. 110+00 CUT 1A

**LEGEND**

	NO NEW DREDGING OR WIDENING.
	WIDENING
	DEEPENING, FEDERAL PROJECT, DEPTH VARIES AS INDICATED
	DEEPENING, FEDERAL PROJECT, -4.3' MLLW

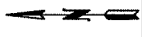

**RECOMMENDED PLAN - DREDGING**

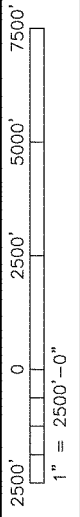

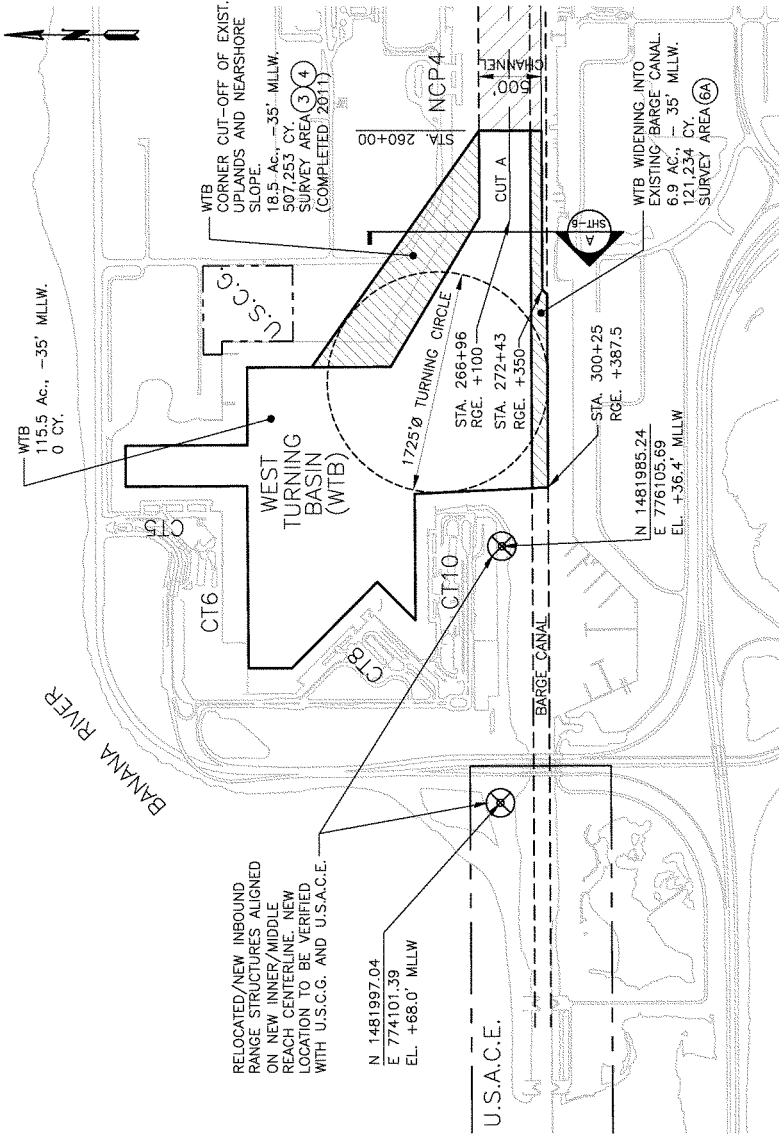

**RECOMMENDED PLAN -- WEST TURNING BASIN  
AND INBOARD NAVIGATION AIDS**

NOTE: SEE LEGEND ON SHT. 1  
FOR AREA DESIGNATIONS.

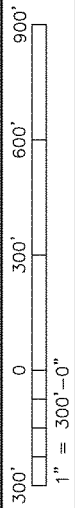



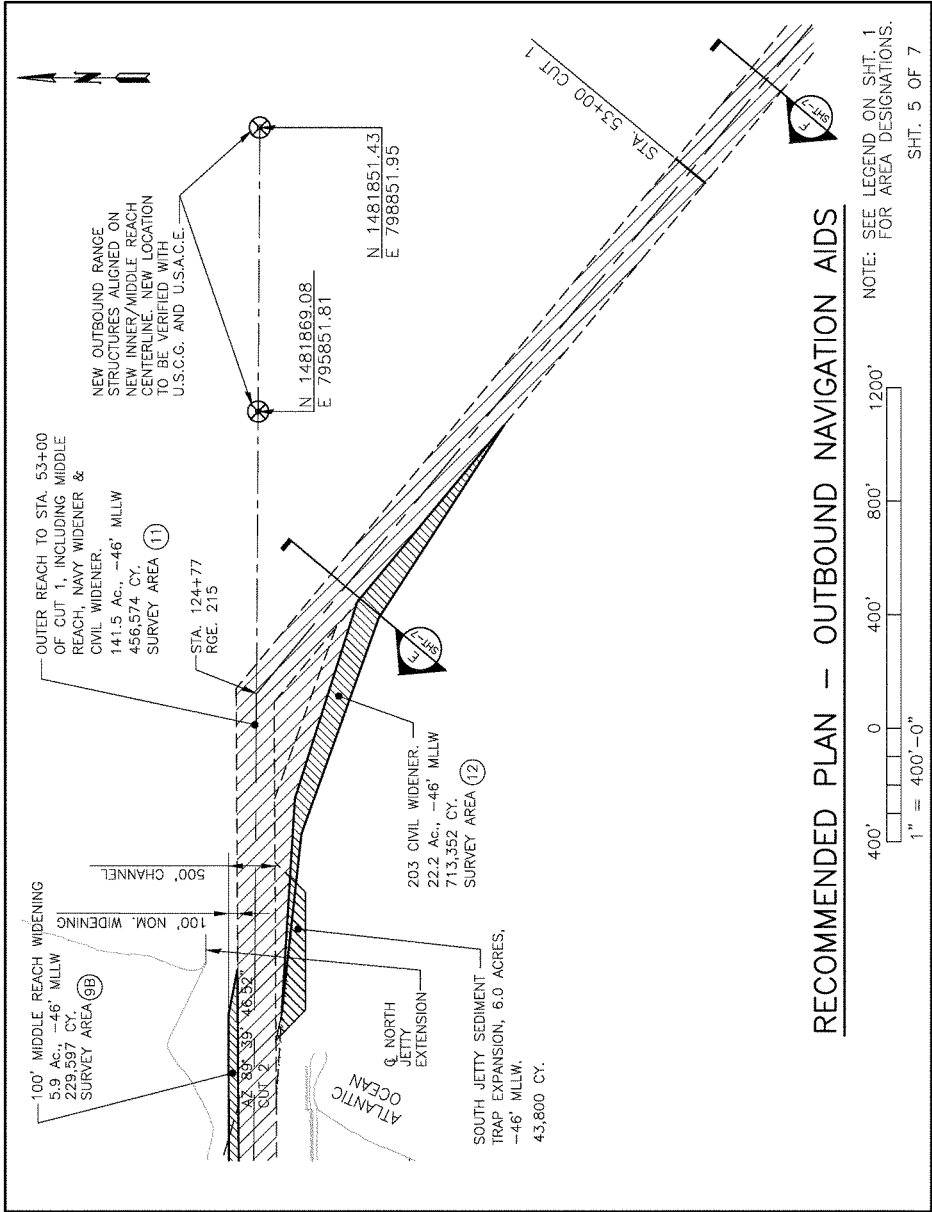

RECOMMENDED PLAN - OUTBOUND NAVIGATION AIDS



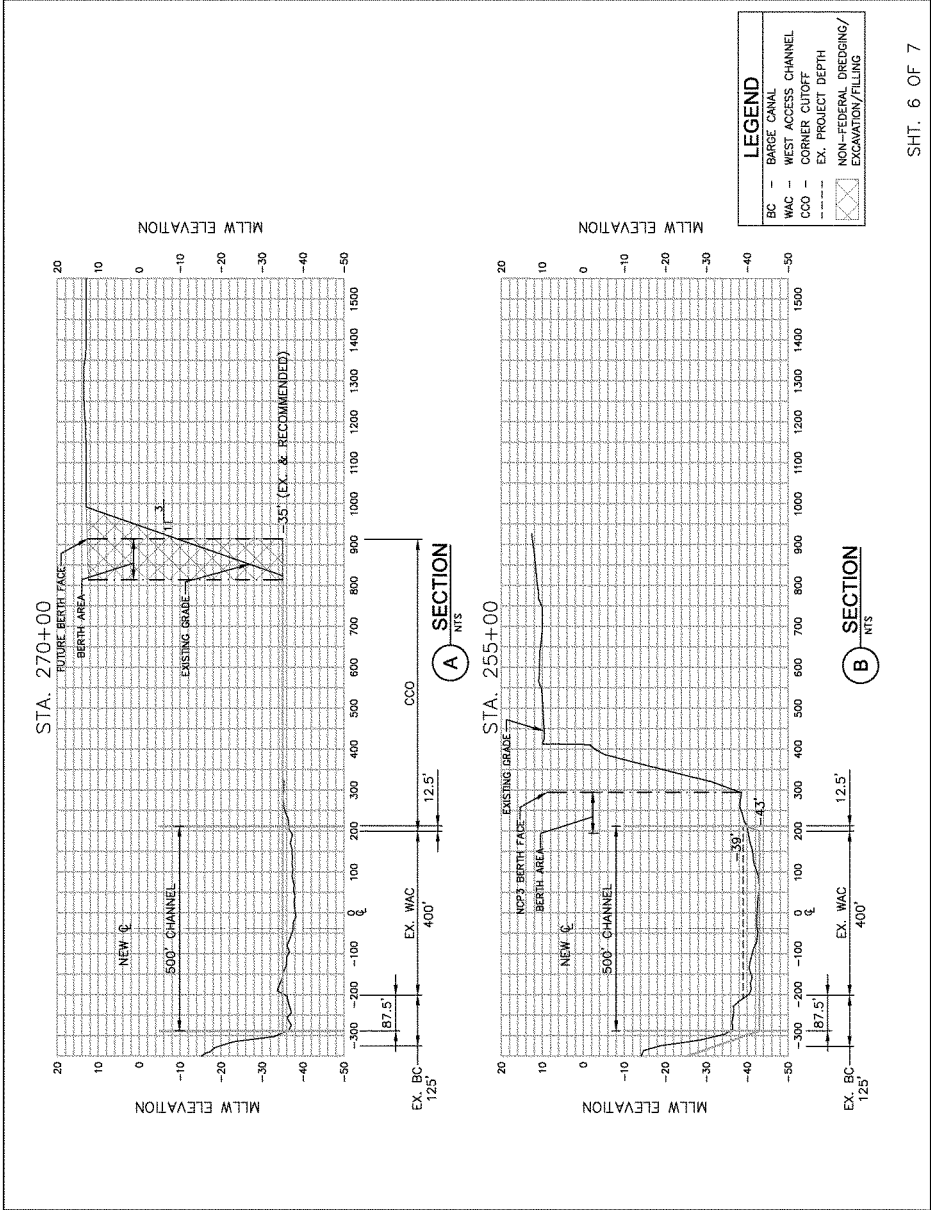





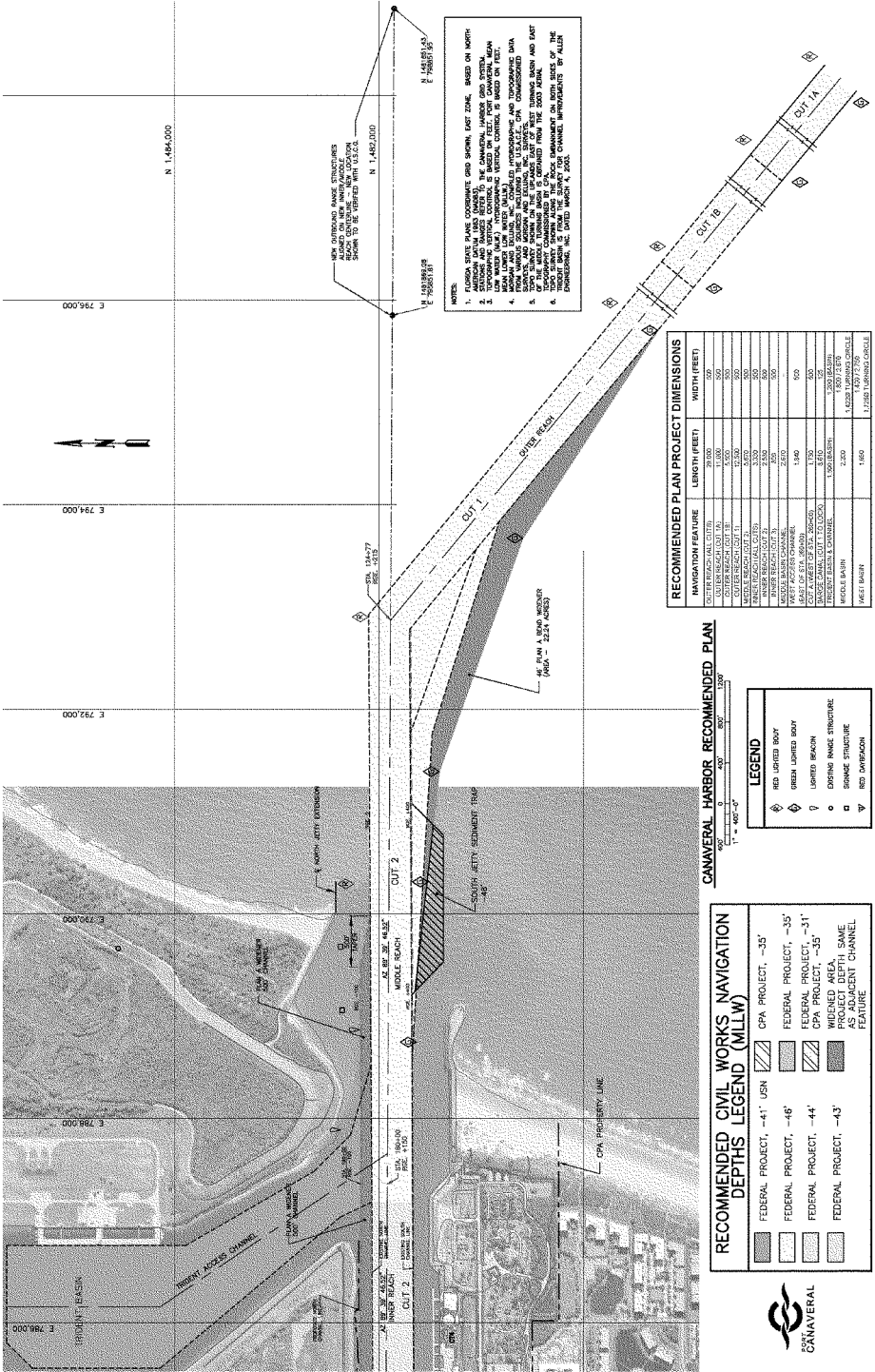

NOTES:

1. FLORIDA STATE PLANE COORDINATE GRID SPINAL EAST ZONE, BASED ON NAD83 (2011) WITH LOCAL ADJUSTMENTS.
2. CANADIAN NATIONAL CONTROL, 2011, BASED ON ITRF97 WITH CANADIAN NAD83 ADJUSTMENTS.
3. NATIONAL TIDE GAUGE DATA, 2011, BASED ON ITRF97 WITH CANADIAN NAD83 ADJUSTMENTS.
4. NOAA LIGHT HOUSE DATA, 2011, BASED ON ITRF97 WITH CANADIAN NAD83 ADJUSTMENTS.
5. NOAA LIGHT HOUSE DATA, 2011, BASED ON ITRF97 WITH CANADIAN NAD83 ADJUSTMENTS.
6. THE ABOVE DATA IS BASED ON THE DATUM OF THE CANADIAN NATIONAL CONTROL GRID, 2011, WHICH IS A LOCAL DATUM.
7. THE ABOVE DATA IS BASED ON THE DATUM OF THE CANADIAN NATIONAL CONTROL GRID, 2011, WHICH IS A LOCAL DATUM.
8. THE ABOVE DATA IS BASED ON THE DATUM OF THE CANADIAN NATIONAL CONTROL GRID, 2011, WHICH IS A LOCAL DATUM.

NAVIGATION FEATURE	LENGTH (FEET)	WIDTH (FEET)
OUTER REACHAL CUTS	28,000	500
CUT 1 (MIDDLE REACH)	1,000	500
CUT 2 (MIDDLE REACH)	1,000	500
CUT 3 (MIDDLE REACH)	1,000	500
CUT 4 (MIDDLE REACH)	1,000	500
CUT 5 (MIDDLE REACH)	1,000	500
CUT 6 (MIDDLE REACH)	1,000	500
CUT 7 (MIDDLE REACH)	1,000	500
CUT 8 (MIDDLE REACH)	1,000	500
CUT 9 (MIDDLE REACH)	1,000	500
CUT 10 (MIDDLE REACH)	1,000	500
CUT 11 (MIDDLE REACH)	1,000	500
CUT 12 (MIDDLE REACH)	1,000	500
CUT 13 (MIDDLE REACH)	1,000	500
CUT 14 (MIDDLE REACH)	1,000	500
CUT 15 (MIDDLE REACH)	1,000	500
CUT 16 (MIDDLE REACH)	1,000	500
CUT 17 (MIDDLE REACH)	1,000	500
CUT 18 (MIDDLE REACH)	1,000	500
CUT 19 (MIDDLE REACH)	1,000	500
CUT 20 (MIDDLE REACH)	1,000	500
CUT 21 (MIDDLE REACH)	1,000	500
CUT 22 (MIDDLE REACH)	1,000	500
CUT 23 (MIDDLE REACH)	1,000	500
CUT 24 (MIDDLE REACH)	1,000	500
CUT 25 (MIDDLE REACH)	1,000	500
CUT 26 (MIDDLE REACH)	1,000	500
CUT 27 (MIDDLE REACH)	1,000	500
CUT 28 (MIDDLE REACH)	1,000	500
CUT 29 (MIDDLE REACH)	1,000	500
CUT 30 (MIDDLE REACH)	1,000	500
CUT 31 (MIDDLE REACH)	1,000	500
CUT 32 (MIDDLE REACH)	1,000	500
CUT 33 (MIDDLE REACH)	1,000	500
CUT 34 (MIDDLE REACH)	1,000	500
CUT 35 (MIDDLE REACH)	1,000	500
CUT 36 (MIDDLE REACH)	1,000	500
CUT 37 (MIDDLE REACH)	1,000	500
CUT 38 (MIDDLE REACH)	1,000	500
CUT 39 (MIDDLE REACH)	1,000	500
CUT 40 (MIDDLE REACH)	1,000	500
CUT 41 (MIDDLE REACH)	1,000	500
CUT 42 (MIDDLE REACH)	1,000	500
CUT 43 (MIDDLE REACH)	1,000	500
CUT 44 (MIDDLE REACH)	1,000	500
CUT 45 (MIDDLE REACH)	1,000	500
CUT 46 (MIDDLE REACH)	1,000	500
CUT 47 (MIDDLE REACH)	1,000	500
CUT 48 (MIDDLE REACH)	1,000	500
CUT 49 (MIDDLE REACH)	1,000	500
CUT 50 (MIDDLE REACH)	1,000	500
CUT 51 (MIDDLE REACH)	1,000	500
CUT 52 (MIDDLE REACH)	1,000	500
CUT 53 (MIDDLE REACH)	1,000	500
CUT 54 (MIDDLE REACH)	1,000	500
CUT 55 (MIDDLE REACH)	1,000	500
CUT 56 (MIDDLE REACH)	1,000	500
CUT 57 (MIDDLE REACH)	1,000	500
CUT 58 (MIDDLE REACH)	1,000	500
CUT 59 (MIDDLE REACH)	1,000	500
CUT 60 (MIDDLE REACH)	1,000	500
CUT 61 (MIDDLE REACH)	1,000	500
CUT 62 (MIDDLE REACH)	1,000	500
CUT 63 (MIDDLE REACH)	1,000	500
CUT 64 (MIDDLE REACH)	1,000	500
CUT 65 (MIDDLE REACH)	1,000	500
CUT 66 (MIDDLE REACH)	1,000	500
CUT 67 (MIDDLE REACH)	1,000	500
CUT 68 (MIDDLE REACH)	1,000	500
CUT 69 (MIDDLE REACH)	1,000	500
CUT 70 (MIDDLE REACH)	1,000	500
CUT 71 (MIDDLE REACH)	1,000	500
CUT 72 (MIDDLE REACH)	1,000	500
CUT 73 (MIDDLE REACH)	1,000	500
CUT 74 (MIDDLE REACH)	1,000	500
CUT 75 (MIDDLE REACH)	1,000	500
CUT 76 (MIDDLE REACH)	1,000	500
CUT 77 (MIDDLE REACH)	1,000	500
CUT 78 (MIDDLE REACH)	1,000	500
CUT 79 (MIDDLE REACH)	1,000	500
CUT 80 (MIDDLE REACH)	1,000	500
CUT 81 (MIDDLE REACH)	1,000	500
CUT 82 (MIDDLE REACH)	1,000	500
CUT 83 (MIDDLE REACH)	1,000	500
CUT 84 (MIDDLE REACH)	1,000	500
CUT 85 (MIDDLE REACH)	1,000	500
CUT 86 (MIDDLE REACH)	1,000	500
CUT 87 (MIDDLE REACH)	1,000	500
CUT 88 (MIDDLE REACH)	1,000	500
CUT 89 (MIDDLE REACH)	1,000	500
CUT 90 (MIDDLE REACH)	1,000	500
CUT 91 (MIDDLE REACH)	1,000	500
CUT 92 (MIDDLE REACH)	1,000	500
CUT 93 (MIDDLE REACH)	1,000	500
CUT 94 (MIDDLE REACH)	1,000	500
CUT 95 (MIDDLE REACH)	1,000	500
CUT 96 (MIDDLE REACH)	1,000	500
CUT 97 (MIDDLE REACH)	1,000	500
CUT 98 (MIDDLE REACH)	1,000	500
CUT 99 (MIDDLE REACH)	1,000	500
CUT 100 (MIDDLE REACH)	1,000	500

**RECOMMENDED CIVIL WORKS NAVIGATION DEPTHS LEGEND (MLLW)**

[Pattern]	FEDERAL PROJECT, -41' USN	[Pattern]	CPA PROJECT, -35'
[Pattern]	FEDERAL PROJECT, -46'	[Pattern]	FEDERAL PROJECT, -35'
[Pattern]	FEDERAL PROJECT, -44'	[Pattern]	FEDERAL PROJECT, -31'
[Pattern]	FEDERAL PROJECT, -43'	[Pattern]	WIDENED AREA
[Pattern]	FEDERAL PROJECT, SAME DEPTH, SAME FEATURE	[Pattern]	WIDENED CHANNEL
[Pattern]	FEDERAL PROJECT, SAME DEPTH, SAME FEATURE	[Pattern]	WIDENED CHANNEL

**LEGEND**

[Symbol]	RED LIGHTED BOAT
[Symbol]	GREEN LIGHTED BOAT
[Symbol]	LIGHTED BREAKER
[Symbol]	DOING BANK STRUCTURE
[Symbol]	SPRANG STRUCTURE
[Symbol]	RED DIVERSION

**CANAVERAL HARBOR - RECOMMENDED PLAN**

1" = 400'-0"

**RECOMMENDED PLAN PROJECT DIMENSIONS**



**Port Canaveral Section 203 Feasibility Study  
Engineering Appendix**

Attachment F

Hydraulic Modeling Report  
Canaveral Harbor Vessel-Induced Surge Modeling (Report Pending)

Rev Date: October 2011

## Port Canaveral Hydrodynamic Model Calibration

PREPARED FOR: Ray Cox/CH2M HILL  
PREPARED BY: Don Kingery/CH2M HILL  
COPIES: file  
DATE: June 3, 2007

### Introduction

The Canaveral Port Authority (CPA) is conducting a feasibility study of potential navigation improvements under the authority granted by Section 203 of WRDA 1986. This technical memorandum documents the setup, calibration, and initial model runs of a hydrodynamic model that will be used to evaluate the potential effects of alternative scenarios considered in the Port Canaveral Feasibility Study.

### Scope

An aerial view showing the overall layout of Port Canaveral is shown in Figure 1. The port's main channel runs east-west with three turning basins, the Trident Turning Basin, the Middle Turning Basin, and the West Turning basin extending off the north side of the main channel as shown in the figure.

The purpose of the model is to demonstrate any potential impacts that the alternative scenarios may have on the hydraulics within the port. The focus of the model is to evaluate magnitudes of currents at different locations inside the port. Boundaries of the model extend out into the open ocean, however, data for calibration of the model along the coastline are not available and no attempt is made to calibrate or verify circulation outside of the port.

Data used to calibrate the model were collected in August and September 2005. These consist of data from two tide gages, one mounted to the South Jetty Fishing Pier at the mouth of the harbor and the second mounted on a mooring dolphin at Cruise Ship Terminal 5 (CT5) in the West Turning Basin, and a Horizontal Acoustic Doppler Current Profiler (HADCP) mounted on a pile at Cruise Ship Terminal 4 (CT4). These data are documented in a separate memorandum (CH2M HILL, 2006)

This technical memorandum describes the model setup and calibration and presents results of initial simulations using the calibrated model that will be used as a baseline "existing conditions" case against which various alternatives will be compared.

## Approach

A 2-dimensional depth-averaged finite element hydrodynamic model, RMA2, was used to model circulation within the port. RMA2 computes water surface elevations and horizontal velocity components for subcritical, free-surface two-dimensional flow fields.

RMA2 computes a finite element solution of the Reynolds form of the Navier-Stokes equations for turbulent flows. Friction is calculated with the Manning's or Chezy equation, and eddy viscosity coefficients are used to define turbulence characteristics. Both steady and unsteady (dynamic) problems can be analyzed.

RMA2 is a general-purpose model designed for far-field problems in which vertical accelerations are negligible and velocity vectors generally point in the same direction over the entire depth of the water column at any instant of time. It expects a vertically homogeneous fluid with a free surface.

The program is widely accepted and has a long history of successful application to a variety of situations. It has been applied to calculate water levels and flow distribution around islands, flow at bridges having one or more relief openings, in contracting and expanding reaches, into and out of off-channel hydropower plants, at river junctions, and into and out of pumping plant channels, circulation and transport in water bodies with wetlands, and general water levels and flow patterns in rivers, reservoirs, and estuaries.

RMA2 is part of the Corps of Engineers' Surface Water Modeling System (SMS). SMS provides a pre- and post-processor and a platform for running RMA2 as well as a number of other models for modeling circulation, water quality, sediment transport, and wave dynamics for inland and coastal water bodies. SMS was used for setting up the model, running RMA2, and extracting data from the model simulations.

Details of the steps taken to setup and run the model are documented below. These include:

- **Model Setup** which describes the model grid and documents the data and procedures used for its setup,
- **Model Calibration** which describes adjustments made during the calibration process and documents results of the final simulation, and
- **Baseline Simulations** which presents results of a baseline simulation for a number of locations within the Port. These will be considered existing conditions for comparison to subsequent simulations run for the developed alternatives.

## Model Setup

Shoreline boundaries of the model were defined based on a plan view drawing and aerial photographs of the port. These images were imported into the SMS pre-processor and geo-referenced by assigning actual coordinates to selected points. An offshore boundary was generated approximately 3 miles out from the harbor mouth. The model is driven by specifying water surface elevations along this boundary. As stated above, modeling the actual circulation of the area between the boundary and mouth of the port is not within the scope of this project. This area is included to act as a buffer between the boundaries and the

mouth of the port so that any boundary effects that are present do not influence predicted circulation inside the port.

Survey data used to define the bathymetry for inside the harbor were provided by Morgan & Eklund based on the most recent historical surveys and additional surveys performed for this project. Bathymetry data for areas along the coast and offshore of the port were taken from the National Geophysical Data Center (NGDC) Coastal Relief Model for the Florida coast. A contour plot of the model bathymetry is shown in Figure 2.

After the boundaries and any interior features were defined and bathymetry data were imported, the finite element mesh for the port model was generated using the SMS mesh generation feature. Once generated, the mesh was refined by hand to ensure better model stability. The final finite-element mesh used for the baseline model is shown in Figure 3. This mesh will be further edited during the alternatives analysis to reflect the different scenarios considered in the feasibility study including changes to model boundaries, changes to interior node locations, and changes to element water depths, as necessary.

Time series measurements of water surface elevation from tide gages were used as boundary conditions for the offshore boundary. These are discussed in more detail below.

## Model Calibration

The following discusses model calibration and includes a brief description of the data used to calibrate the model, a discussion of the approach to model calibration, a summary of results of the model calibration and verification, and a discussion of the calibration results.

### Calibration Data

Field data collected between August 17 and September 19, 2005 are used for calibration and verification of the model. These data were collected using two tide gages, one installed at the South Jetty Fishing Pier and the second installed on a mooring dolphin for Cruise Ship Terminal 5 (CT5) in the West Turning Basin (WTB), and a Horizontal Acoustic Doppler Current Profiler (HADCP) deployed to collect current data along a transect extending into the main channel from Cruise Ship Terminal 4 (CT4). These data are presented and discussed further in a separate Technical Memorandum titled "Port Canaveral Tide and Current Measurements" (CH2M HILL, 2006).

**Water Surface Elevation Data.** Figure 4 presents a plot of the data from the two tide gages over the length of the deployment. The water surface elevation data showed a well defined tidal signal, with higher frequency oscillations with periods on the order of 45 minutes superimposed on the tidal signal. This oscillation occurs over the length of the record but varies in amplitude. It can be clearly seen on and around August 26 which corresponds to the day that Hurricane Katrina made landfall in South Florida.

There was no observable difference in tidal amplitude or tidal phase between water surface elevation data collected at the South Jetty Fishing Pier and the West Turning Basin. Comparison of the higher frequency components of water surface elevation show no phase difference between the two signals, but show an amplification in the magnitude of the oscillations at CT5 compared to that at the Fishing Pier.



Review of the entire record showed two periods (from August 30 through September 4, and from September 15 through the end of the record) in which there were differences in water surface elevations between the two gages at low tide of up to a foot. Data obtained from a tide gage installed on the Trident Pier in the Trident Turning Basin closely matched that collected in the WTB. It was concluded that these portions of the Fishing Pier data were erroneous and these periods were not used in the model calibration and verification.

**Current Velocity Data.** The HADCP was set up to record time series of current speed and direction for 18 6-meter (20-foot) long bins extending across the channel from the edge of CT4. The HDACP was installed at a depth of 21.5 feet below MLLW to collect current measurements at approximately mid-water depth for the main channel.

Data from three bins (Bins 2, 10, and 18) were retrieved from the HADCP and used as the model calibration data. Figure 5 shows velocity data for bin number 10 of the HADCP data at a location approximately 203 feet north of CT4 for the one week period used for calibration and verification of the model. The upper graph shows the east/west component of the current velocity with positive values corresponding to ebb currents and negative values to currents in the flood direction. The lower graph shows the north/south component, with positive values corresponding to a northward flow. As with the water surface elevation data, these data exhibit a tidal component combined with a higher frequency component. For the velocity data, the magnitude of the higher frequency component is generally the same order of magnitude as that for the tidal component.

## Approach

Data from the tide gages were used to drive the water surface elevation at the model's offshore boundary. Model predictions corresponding to locations of bins 2, 10, and 18 of the HADCP profile at distances of approximately 45 feet, 203 feet, and 360 feet, respectively, from the edge of CT4 were compared with the recorded current velocities from these same locations. Adjustments were made to the model, as appropriate, so that the predicted velocities reasonably matched those measured in the field.

The locations of the model observation points corresponding to HDACP bins 2, 10, and 18 are shown in Figure 6. Locations of these bins with respect to the edge of CT4, the south boundary of the dredged main channel, and the centerline of the main channel are listed in Table 1. Bins 10 and 18 are both inside the dredged channel near the south edge and centerline of the channel, respectively. Bin 2 is outside of the main channel within the berthing area of CT4.

Eddy viscosity, bottom roughness, wind speed velocity, and water surface elevation time series applied to the model boundary were all varied during the calibration process to determine the sensitivity of the model to these parameters and to ultimately refine the model so that the model yielded predictions that were comparable to those observed in the field.

TABLE 1  
Locations of HADCP Bins used for Model Calibration

Bin Number	Location
2	45 feet north of CT4
10	23 feet north of south boundary of dredged channel
18	18 feet south of dredged channel centerline

Each calibration run simulated a two day time period beginning 12:00 AM August 20, 2005 and ending 12:00 AM August 22, 2005. Following the final calibration run, a one week run spanning the period from August 20 through August 26 was made to verify that the model would perform satisfactorily under a variety of conditions. This period included the calibration period which appears representative of normal conditions within the harbor during the field studies, as well as the period following passage of Hurricane Katrina which included the largest current velocities during the record.

The ability of the model to represent the actual currents observed during the field studies was determined by visually comparing model predictions of currents versus field data on time series plots for the period of the simulations.

### Calibration Run Results

Water surface elevation data from the South Jetty Fishing Pier were applied to the ocean boundary to drive the final model. Results from the final calibration run are shown in Figure 7. This figure compares model predictions with field data for water surface elevation at CT5 in the WTB (top graph) and east and north components of the current velocity for the location of the HADCP bin number 10. The east component is in the direction of the harbor axis and represents the general ebb and flood direction, with ebb flows to the east being positive. The results show a good correlation with measured data.

### Model Verification

A one week long simulation was made using the Fishing Pier data to drive the model boundary. Results of this run are shown in Figures 8 through 10 for the locations corresponding to HADCP bins 2, 10, and 18, respectively.

The model predictions show a good correlation at all three locations with measured currents for the period of the highest currents around August 26. Overall, predictions correlate best with observed currents at Bin 10 and show good correlation over the week with currents observed at Bin 2.

The model overpredicts currents at the location of Bin 18 between August 22 and 25 compared to observed data. The HADCP data for Bin 18 between August 22 and 25 show a period of significantly smaller currents that are not observed in the other two datasets.

## Discussion

The currents inside the port contain two dominant components: one due to the flooding and ebbing of the tides, and a second higher frequency component that may be due to harbor resonance. The period of these higher frequency oscillations is on the order of about 45 minutes and these components are observed to be as large as or larger than the tidal component during certain periods with the highest currents occurring following the passing of Hurricane Katrina.

Evidence of the higher frequency flows can be seen as perturbations in the water surface elevation data in Figure 4 with larger perturbations in the WTB data collected at the back of the port than in the South Jetty Fishing Pier data at the harbor mouth. Sensitivity runs show the model to be very sensitive to the magnitude of these oscillations.

Current measurements were taken at a water depth that was approximately equal to the mid-depth inside the main channel. Model predictions from the 2-dimensional model represent depth-averaged velocities. A 2-dimensional model with depth-averaged velocities is appropriate for modeling flows in which there is little or no stratification of the water column due to temperature or freshwater inflows and the direction of water movement at any location is generally the same through the water column. This was expected to be the case for Port Canaveral, and based on the good correlation between modeled and observed currents, these assumptions appear to be valid.

The one week scenario used for the model verification run should be sufficient for use as a baseline conditions case for comparison of existing conditions with flows from model runs simulating potential future scenarios. This period contains data that appears representative of “normal” as well as “high-current” conditions. Comparison of results and statistics between scenario runs and the baseline run should give an indication of potential impacts of the given scenario on the hydraulics of the harbor.

Changes in currents in the harbor due to harbor modifications can affect the amplitude of tidal oscillations by changing the tidal prism and the flow area at different locations of the port and can affect the amplitude of components due to harbor resonance by changing the resonant frequencies in the port. The ability of the model to simulate both the tidal and higher frequency components suggests that changes in harbor geometry that will affect these should be reflected in the model results.

The time step necessary to reproduce the higher frequency current velocities observed in the harbor resulted in significant model run times. The two day simulations took on the order of three and a half hours of computer run time on a desktop computer; the week long scenario took on the order of twelve hours. The run time will be a constraint on the number and length of scenarios that can feasibly be run.

## Baseline Simulation

The purpose of the baseline simulation is to provide a set of “existing” conditions against which to compare changes in port hydraulics due to implementation of various alternative harbor modification scenarios. The baseline scenario is based on the one week verification

scenario described above. Additional observation points, shown in Figure 16, were defined and time series of current velocities were extracted from the model for these locations.

In general, three observation points each were defined for transects intersecting the harbor at various locations. These locations include:

- The mouth of the port (Inlet)
- Main channel west of the Trident Turning Basin (Trident TB)
- Main channel east of the Middle Turning Basin (Middle TB – east)
- Main channel west of the Middle Turning Basin (Middle TB – west)
- Entrance to the West Turning Basin (West TB)

The highest velocities predicted at these stations were at the Trident TB transect, located at a point in the main channel west of the Trident Turning Basin where the channel necks down with an average current speed over the transect of 0.28 feet per second and a maximum 90<sup>th</sup> percentile current speed at mid-channel of 0.58 feet per second. A summary of average and maximum 90<sup>th</sup> percentile currents at these locations are presented in Table 2.

TABLE 2  
Current Statistics for Results of Baseline Simulation for Defined Transects

Transect	Maximum 90%-tile Current Speed (fps)	Average Current Speed (fps)
Inlet	0.48	0.21
Trident TB	0.58	0.28
Middle TB – east	0.44	0.21
Middle TB – west	0.34	0.14
West TB	0.14	0.04

## Conclusions

- Largest currents within the harbor will be due to a combination of tidal currents plus higher frequency oscillating currents that are potentially a product of harbor resonance. The passage of Hurricane Katrina provided conditions that may represent the higher end of current magnitudes that are expected in the port.
- Applying South Jetty Fishing Pier water surface elevation data to the offshore boundary of the model resulted in a good correlation between model predictions and observed currents. These data are appropriate for use as boundary conditions during periods in which the discrepancies in the data noted above were absent.

- The one week simulation used for the model verification run should be sufficient for comparisons of future harbor and channel scenarios. This period includes “typical” and “high-velocity” currents and will allow prediction of the expected changes in current speeds during these conditions.
- Longer term (one month) simulations can be made using WTB data filtered to reduce amplitude of higher frequency forcing, however, it is felt that the longer simulations will not provide significantly more useful information for addressing the goals of the modeling to warrant the increase in run time.

## Figures.

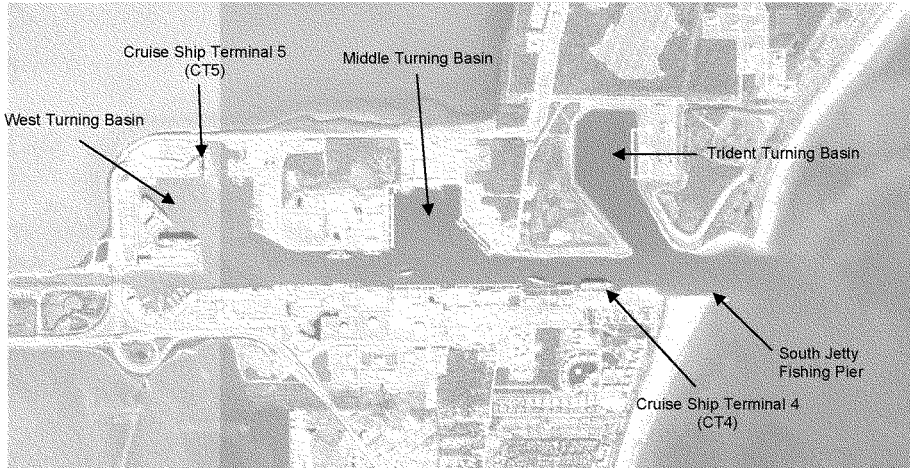

Figure 1. General Layout of Port Canaveral.

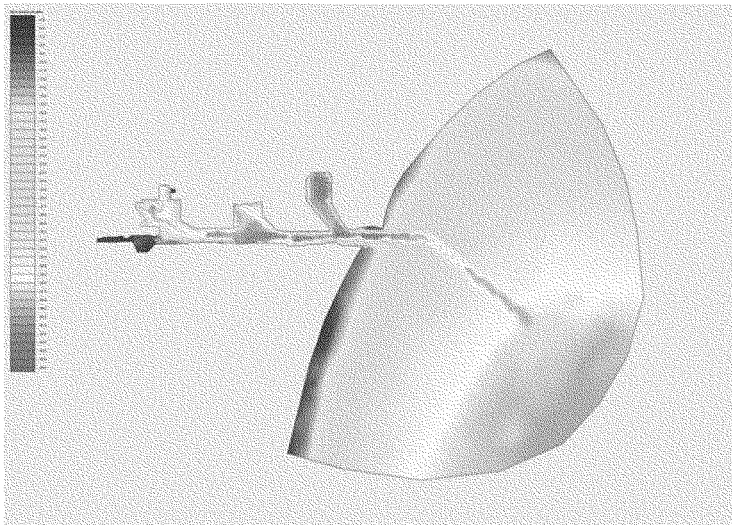

Figure 2. Port Canaveral Model Bathymetry

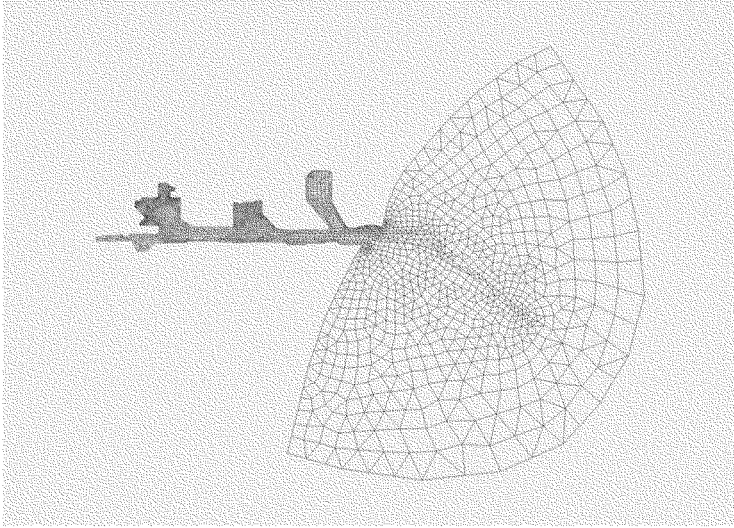

Figure 3. Finite Element Mesh for Port Canaveral Hydrodynamic Model

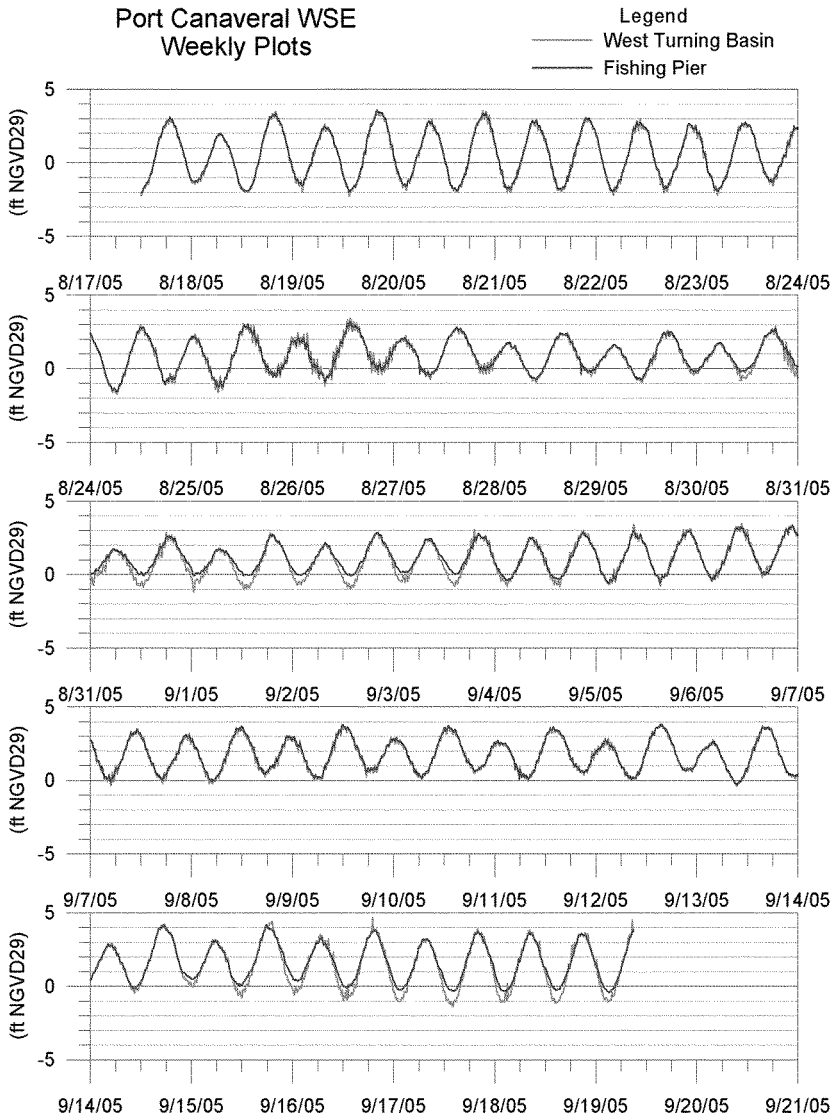

Figure 4. Water Surface Elevation Observations in Port Canaveral, August 17, 2005 through September 19, 2005.



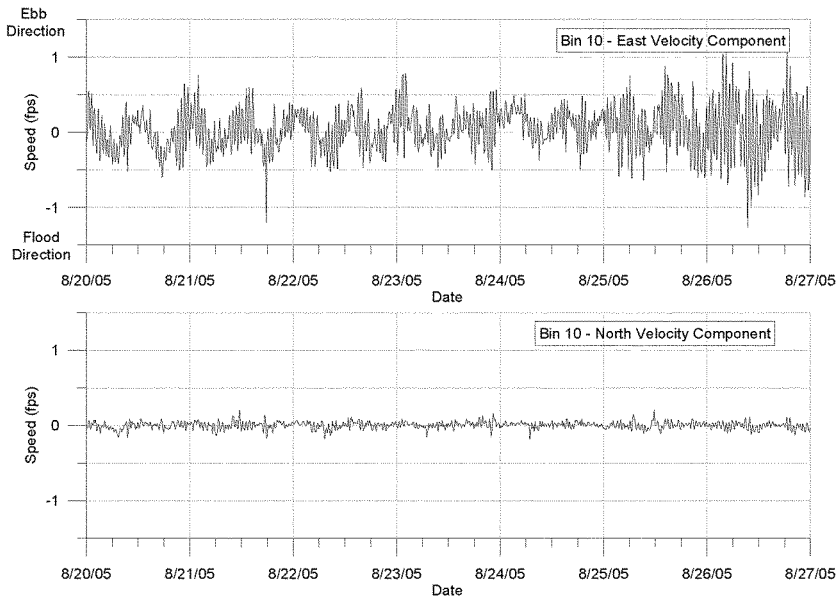

Figure 5. Velocity Data from HADCP Bin 10 Used for Model Calibration.

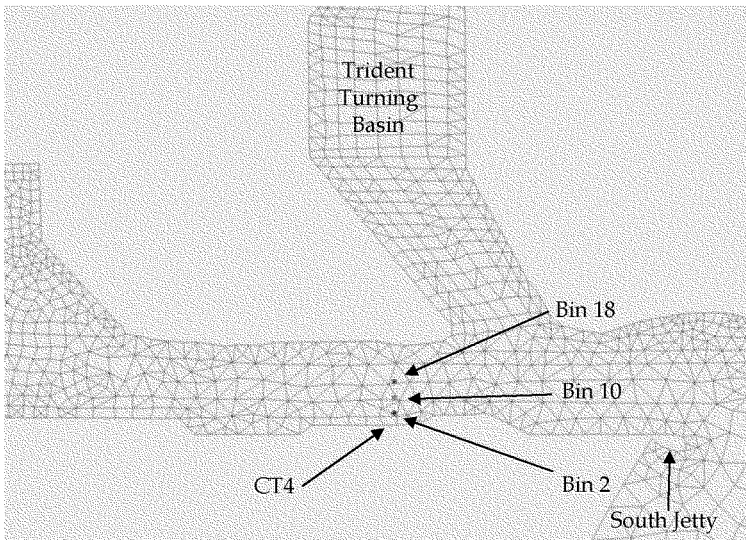

Figure 6. Locations of HADCP Velocity Data Used in Model Calibration.

## Final Model Calibration Results

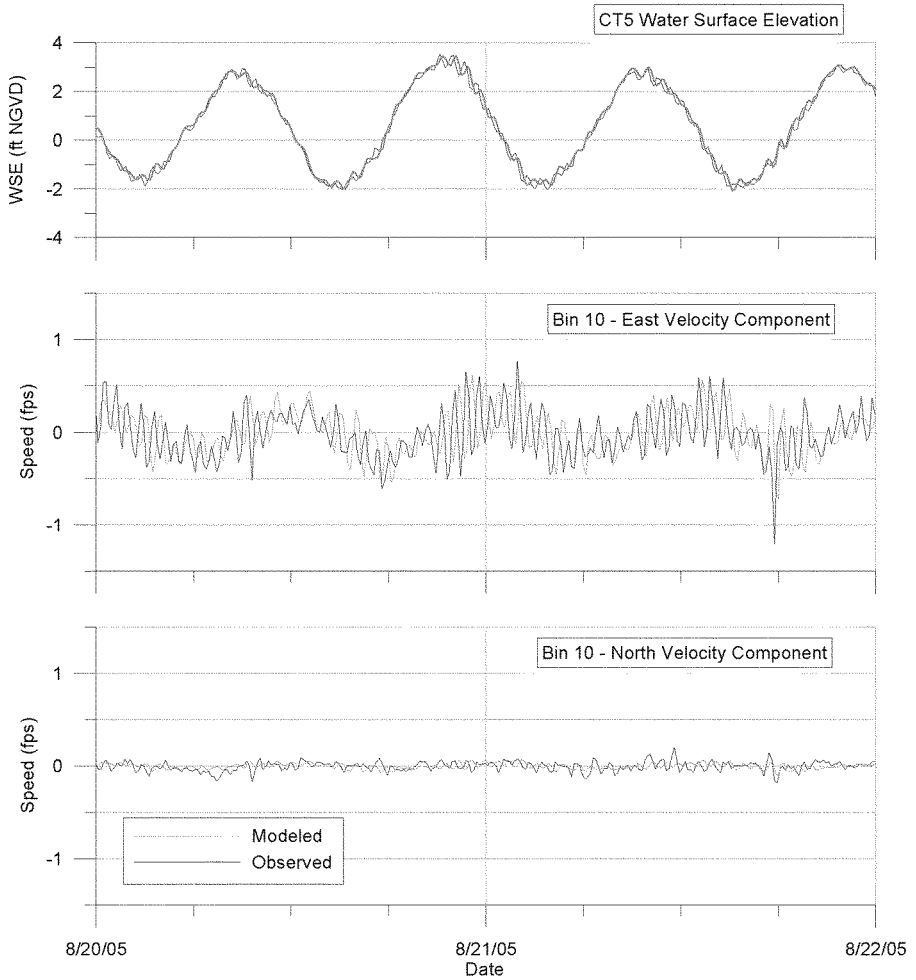

Figure 7. Final Model Calibration Results at Location of HADCP Bin 10

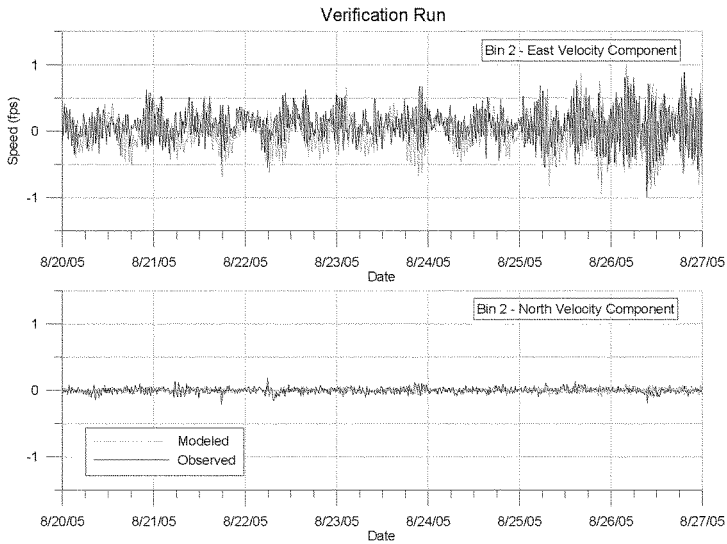

Figure 8. Model Verification Run, Bin 2, August 20 through August 27, 2005.

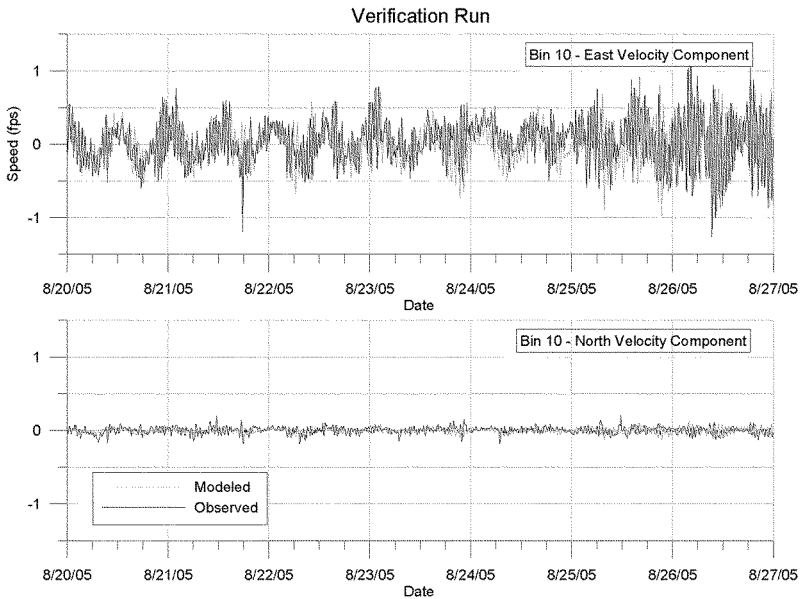

Figure 9. Model Verification Run, Bin 10, August 20 through August 27, 2005.

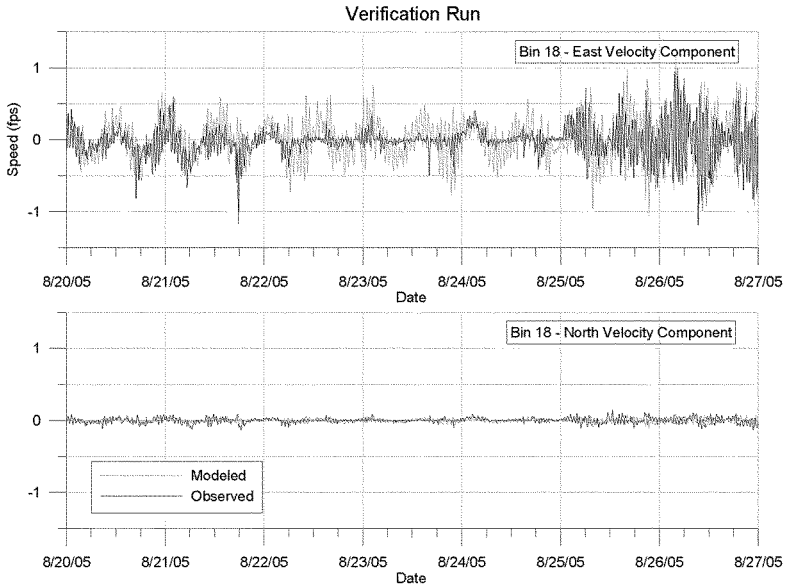

Figure 10. Model Verification Run, Bin 18, August 20 through August 27, 2005.

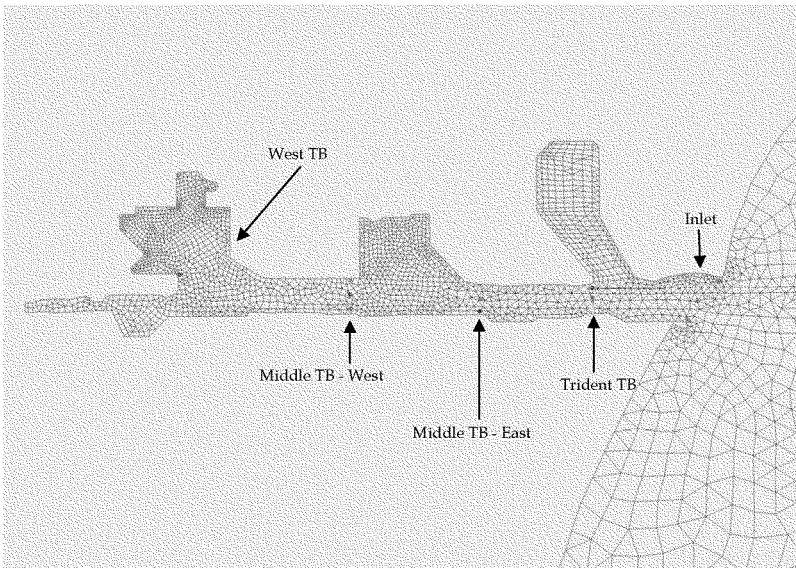

Figure 11. Observation Points Defined for Model Scenario Comparisons

## References

CH2M HILL, 2006. Port Canaveral Tide and Current Measurements. Draft Technical Memorandum. CH2M HILL. January, 25, 2006

## Preferred Alternative Modeling Results

PREPARED FOR: Collins K. McKay, P.E./CH2M HILL/CCG, and  
Canaveral Port Authority

PREPARED BY: Don L. Kingery, ME/CH2M HILL/BAO  
Kyle T. Winslow, PhD/CH2M HILL/SDO

DATE: October 4, 2007

The following is a brief description of changes made to the model for the Preferred Alternative runs and summary of results of model runs.

Modifications were made to the harbor shoreline based on the geometry shown in the sketches in Figures 1 and 2 below and water depths changes shown in Table 1. These required making changes to the model shoreline, regenerating the model grid, and updating the bathymetry. These changes are described briefly below:

### Model Shoreline

The model shoreline was changed for the Preferred Alternative by cutting back the entrance to the West Turning Basin (WTB) in the areas designated as Areas 3 and 4 in Figure 1 to accommodate the larger turning basin.

### Refinements to the Model Mesh

Refinements were made to the model grid by defining feature lines/arcs that corresponded to the dredge boundaries in order to clearly define the channel boundaries. The mesh was regenerated and modified, as necessary, by hand. Meshes for the Existing Conditions and Preferred Alternative models are shown in Figures 3 and 4.

### Bathymetry

Changes to the bathymetry were made by hand to the areas within the dredge boundaries shown on Figures 1 and 2 based on depths shown in Table 1. Changes were made to bring the bathymetry down to the depths shown in the figures. No changes were made for points or elements where the existing elevations were deeper than the proposed dredge depths for the Preferred Alternative.

Comparisons of the resulting model bathymetries are presented graphically in Figures 5 and 6.

**TABLE 1**  
Updates to Model Bathymetry for the Preferred Alternative

Area	Dredged Depth Updates
1	no change
2	no change
3 and 4	from existing (uplands) to -35 ft MLLW
5	no change
6a	from existing to -35 ft MLLW
6b	from existing to -43 ft MLLW
7 and 8	from -39 to -43 ft MLLW
9a	from existing to -44 ft MLLW
9b	from existing to -46 ft MLLW
10	from -40 to -44 ft MLLW
11	from -44 to -46 ft MLLW
12	from existing to -46 ft MLLW
13	from -44 to -48

## Observation Points

Observation points defined during the model calibration procedure were used for comparing velocities at various locations in the harbor. These are shown for each model in Figures 3 and 4. Note that the observation points were defined in each model using identical coordinates. As a result, changes in the shoreline at the WTB cutoff results in the eastern-most observation point for the transect in this area being farther from the shoreline in the Preferred Alternative scenario than in the existing conditions case.

The single observation point shown in the back of the WTB was used in the model calibration procedures to observe water surface elevation predictions only and is not used for comparing model velocities below.

## Results

Table 2 summarizes the results of the model runs for the existing conditions and the Preferred Alternative scenarios. Results are summarized for the three observation points for each transect shown in Figure 3.

**TABLE 2**  
Comparison of Model Results – Preferred Alternative vs Existing Conditions

Location	Average Speed (fps)			90%-tile speed		
	(Existing)	(Preferred)	% change	(Existing)	(Preferred)	% change
<b>Inlet</b>						
North Jetty	0.164	0.185	12.9%	0.326	0.374	14.6%
Inlet (mid)	0.223	0.228	2.3%	0.447	0.462	3.5%
South Jetty	0.185	0.279	51.3%	0.367	0.576	57.2%
<b>Average</b>	<b>0.191</b>	<b>0.231</b>	<b>21.2%</b>	<b>0.380</b>	<b>0.471</b>	<b>23.9%</b>
<b>West of Trident Turning Basin</b>						
North	0.249	0.227	-8.6%	0.503	0.464	-7.8%
Mid	0.262	0.236	-10.1%	0.528	0.490	-7.2%
South	0.261	0.221	-15.4%	0.526	0.456	-13.2%
<b>Average</b>	<b>0.257</b>	<b>0.228</b>	<b>-11.4%</b>	<b>0.519</b>	<b>0.470</b>	<b>-9.4%</b>
<b>East of Middle Turning Basin</b>						
North	0.193	0.180	-6.5%	0.392	0.377	-3.7%
Mid	0.195	0.186	-4.8%	0.395	0.382	-3.2%
South	0.192	0.185	-3.5%	0.391	0.376	-4.0%
<b>Average</b>	<b>0.193</b>	<b>0.184</b>	<b>-4.9%</b>	<b>0.393</b>	<b>0.378</b>	<b>-3.6%</b>
<b>West of Middle Turning Basin</b>						
North	0.108	0.129	20.1%	0.219	0.264	20.2%
Mid	0.128	0.136	6.3%	0.262	0.280	6.9%
South	0.148	0.137	-7.7%	0.303	0.283	-6.6%
<b>Average</b>	<b>0.128</b>	<b>0.134</b>	<b>4.8%</b>	<b>0.261</b>	<b>0.275</b>	<b>5.4%</b>
<b>West Turning Basin</b>						
West	0.022	0.023	8.3%	0.044	0.048	9.8%
Mid	0.040	0.038	-3.3%	0.082	0.080	-2.4%
East	0.060	0.074	23.3%	0.126	0.153	21.1%
<b>Average</b>	<b>0.041</b>	<b>0.045</b>	<b>11.9%</b>	<b>0.084</b>	<b>0.093</b>	<b>11.5%</b>



Review of the results showed no observable changes in overall circulation patterns in the port. The results indicate there is an overall increase in flow into and out of the harbor as a result of opening up the channel and cutting back the entrance to the WTB.

Because the increase in surface area of the Port caused by cutting back the entrance to the WTB will result in an increase in the tidal prism, increased flows through the channel east of the WTB were expected. Whether this increase in flow would result in an overall increase in velocity depends on the magnitude of changes to the flow area at the given transect.

Field data and model predictions both indicate that velocities in the port are due to a superposition of tidal currents with a higher frequency oscillating current that may be a product of harbor resonance. Model results of water surface elevations in the WTB show a greater amplitude high frequency component for the Preferred Alternative than for the existing conditions. This suggests that the modifications (channel widening and deepening) may slightly alter the response of the harbor to the higher frequency forcing resulting in greater flow into and out of the harbor.

Velocity decreases were predicted for the section of the channel between the Trident Turning Basin (TTB) and the MTB. These changes are relatively small, with velocities decreasing on the order of 5 to 10% at the transects observed. These decreases are due to the affects of widening and deepening the channel along this section.

Increased velocities were observed at the other locations due to increases in flow in and out of the harbor.

Velocities predicted by the model, both for the existing conditions and Preferred Alternative, are relatively low. Areas with decreased velocities could see a slight increase in sedimentation as finer sediments are able to settle out. Conversely, areas with higher velocities could see a slight decrease in sedimentation as more of the fine sediments were kept in suspension. However for the purposes of maintenance planning, it is unlikely that the overall sedimentation rate inside the port will change to appreciable degree.

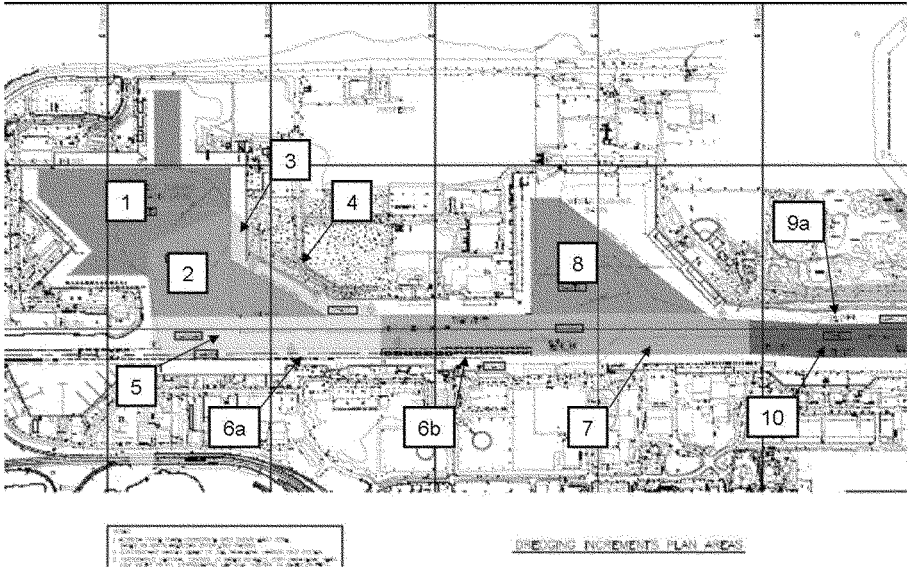

Figure 1. Preferred Alternative Modifications Western Portion of Model

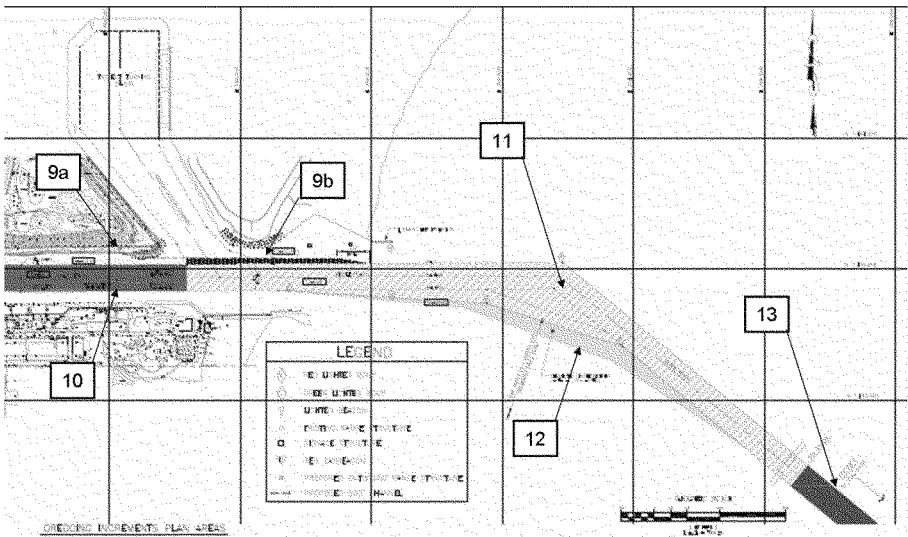

Figure 2. Preferred Alternative Modifications - Eastern Portion of Model

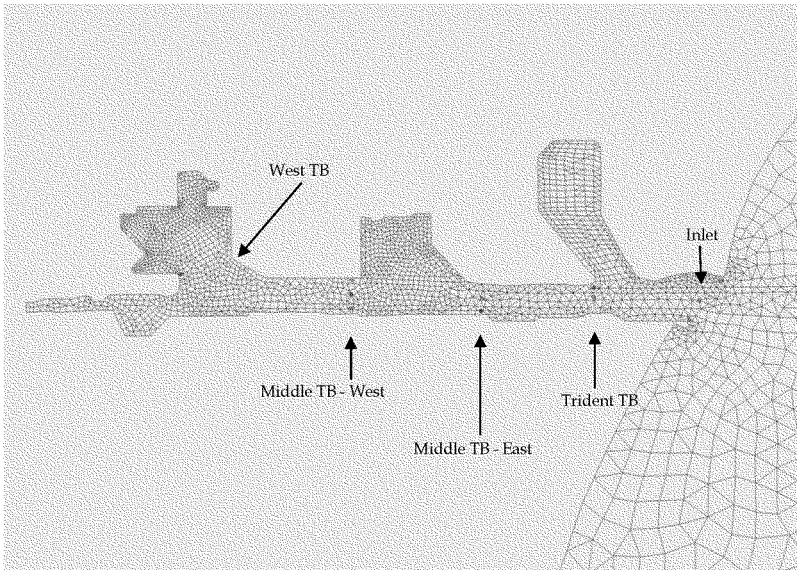

Figure 3. Existing Harbor Model Mesh with Observation Points for Model Scenario Comparisons

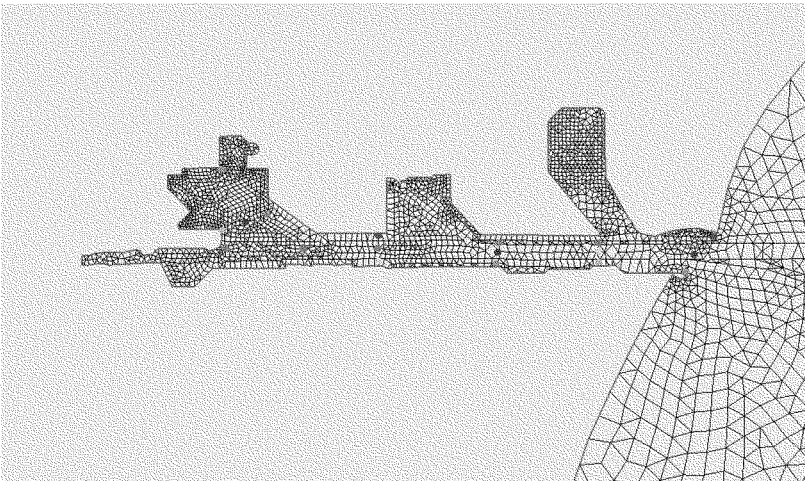

Figure 4. Preferred Alternative Model Mesh with Observation Points for Model Scenario Comparisons

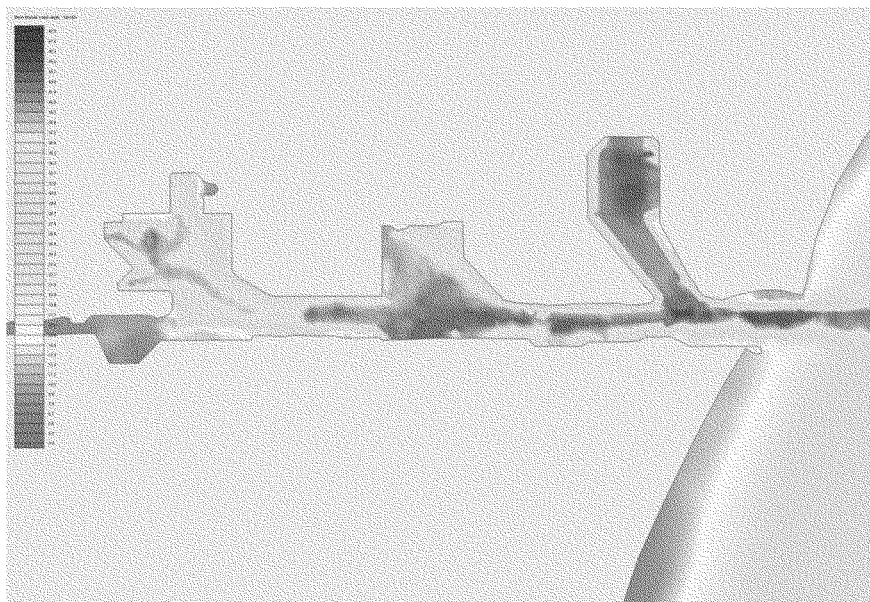

Figure 5. Model Bathymetry for the Existing Harbor Configuration

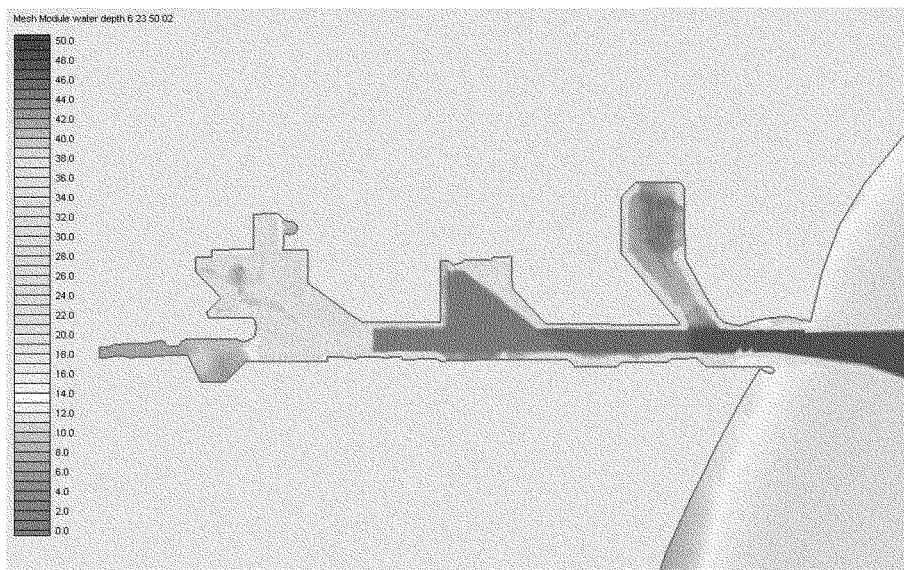

Figure 6. Model Bathymetry for Preferred Alternative Configuration.













**Port Canaveral Section 203 Feasibility Study  
Engineering Appendix**

Attachment G

Jetty Impacts Report



**olsen** associates, inc.  
 4438 Herschel Street  
 Jacksonville, FL. 32210  
 (904) 387-6114  
 (904) 384-7368 fax

## MEMORANDUM

---

To: Collins McKay

From: Bill Hobensack, PE  
 Steve Howard, PE  
 Kevin Bodge, PhD, PE

Re: Canaveral Harbor Navigation Channel Improvements: Potential Impacts to Inlet  
 Jetties and Sediment Trap

Date: December 21, 2007

The following analysis is offered pursuant to your request in regard to potential impacts to the north and south jetties following construction of the proposed channel widening and deepening at the Canaveral Harbor Entrance. This analysis likewise includes consideration of impacts to the existing south jetty sediment trap. Our investigation and findings, below, reflect the “preferred project alternative” as illustrated in **Attachment A** of this memorandum.

### 1.0 SOUTH CHANNEL WIDENER

The configuration of the proposed south-bank widener in the preferred alternative is illustrated in **Figure 1**, relative to existing conditions. In this alternative, the new widener commences within, and continues eastward through and beyond, the existing sediment trap. Our analysis considered that the existing channel and widener would be deepened to -48 ft MLLW elevation and the new widener would be likewise dredged to -48 ft MLLW elevation, representing a project depth of 46’+2’.

**Figure 2** illustrates *existing* conditions at Section Cuts A, B, and C; the locations of which are shown in Figure 1. **Figure 3** illustrates *proposed* conditions at the same three sections, per the preferred alternative. In the section views, the location of the south jetty is developed from planform view. The south jetty structure is comprised of vertical steel sheet pile (not illustrated) with rock armor on either side. In the absence of detailed as-built or existing surveys of the structure, the side-slopes of the rock armor are represented as 1(v):2.5(h). Data describing the actual foundation (toe) depth of the rock, nominally illustrated in the section views, were not available for this analysis; although, as indicated below, this does not appear to affect the conclusions of our analysis.

The existing bank (seabed) slope in the vicinity of each section is illustrated in Figures 2 and 3 by green and red lines. These reflect survey data measured in June-July 2007 and November 2007 (Corps surveys #07-085 and #08-027, respectively).

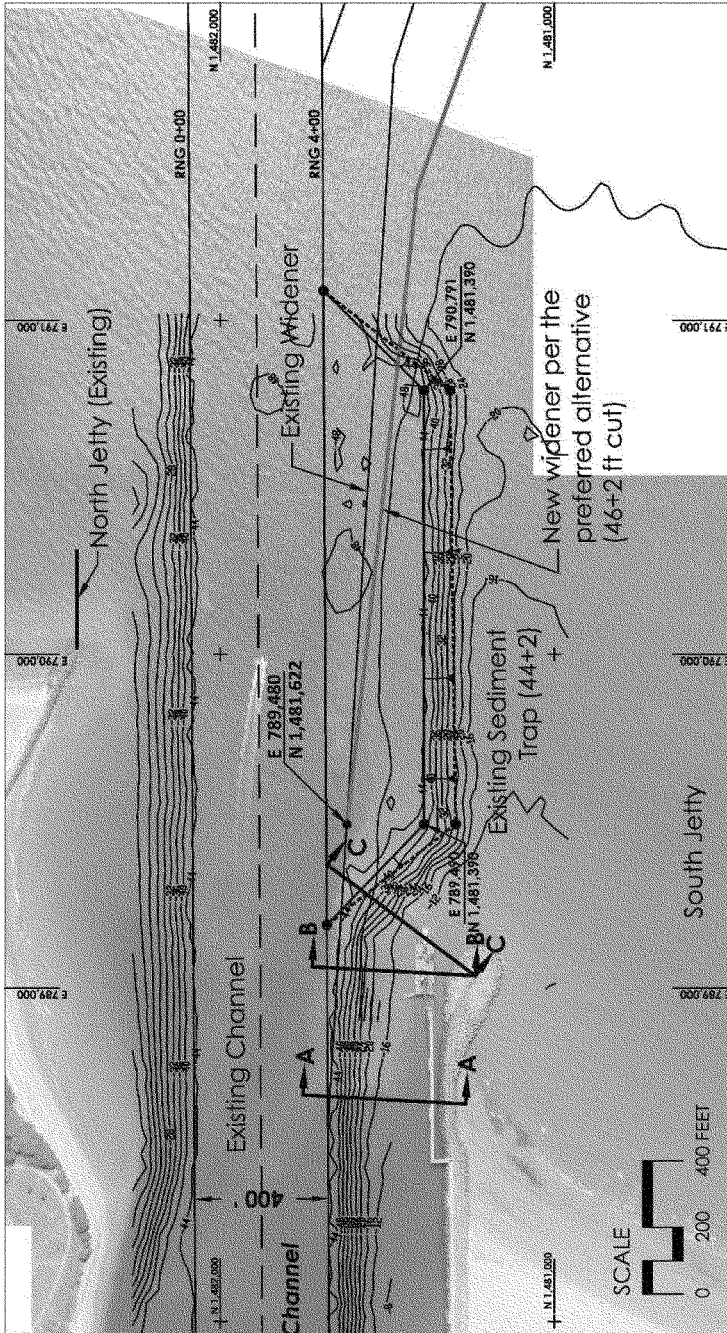

**Figure 1:** Configuration of existing navigation channel, sediment trap, and proposed widener per the preferred alternative, in the vicinity of the Canaveral Harbor Entrance south jetty.

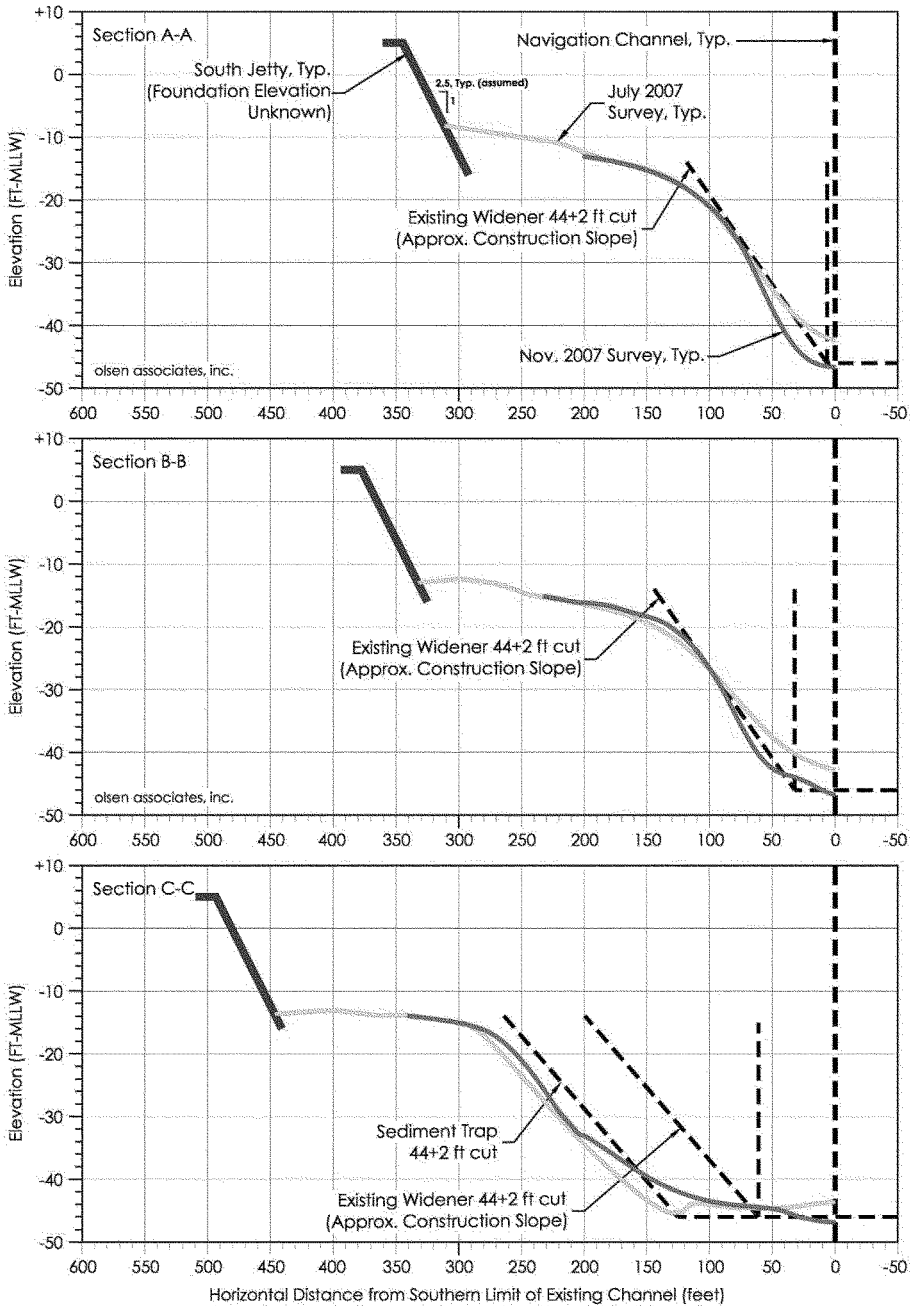

**Figure 2:** Existing conditions at Sections A, B, C, indicated in Figure 1.

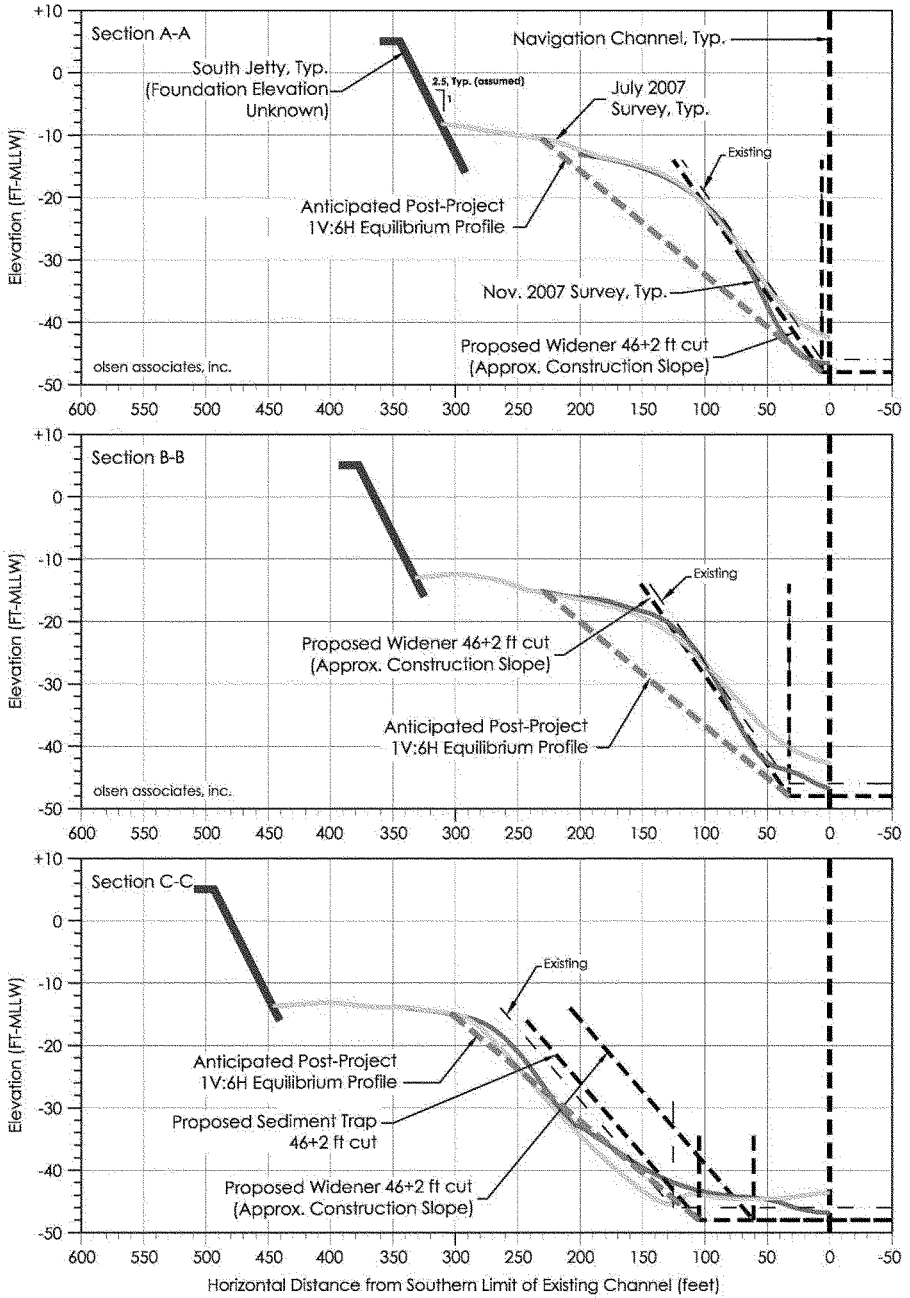

**Figure 3:** Post-project conditions at Sections A, B, C, indicated in Figure 1.

Within the entrance and along the main channel (Sections A and B), the average, existing bank slope is typically on the order of 1:3.5 to 1:5 (vertical : horizontal, typ.), depending upon the vertical span of measurement. At the entrance, between the jetty head and the sediment trap (Section C), the existing bank slope is on the order of 1:5 to 1:5.8. As described in the analysis of the north-channel widener, below, the latter is generally consistent with the observed side-slopes along the north bank of the channel. For the purposes of this analysis, the equilibrated bank slope above the proposed project improvements is presumed to be 1(v):6(h). This represents a reasonable proxy value for the equilibrated channel side-slopes, based upon observed, existing conditions. It is a slightly conservative estimate for the side-slopes within the entrance (Sections A and B), where the observed sideslopes are typically steeper than 1:6.

At its closest proximity, the boundaries of the existing channel/widener and sediment trap are approximately 320 to 340 feet from the MLLW waterline of the south jetty, respectively (see Figures 1 and 2). Likewise, at its closest point, the proposed widener is located over 500 feet from the waterline of the south jetty; or, at least 160 to 180 feet further distant from the jetty than the boundaries of the existing channel/widener and sediment trap. Thus, in the preferred alternative, consideration of the structural stability of the south jetty is dictated by *deepening of the existing channel/widener and sediment trap* – and *not* by the configuration of the new widener. (By this same reasoning, the western boundary of the proposed new widener in the preferred alternative *could* be shifted westward in future refinements of the plan, by as much as 300 feet, more or less, and still remain as far distant from the south jetty as the *existing* channel/widener or sediment trap. To the extent that deepening of the *existing* channel/widener and trap would not adversely impact the south jetty, as described below, such a westward shift of the new widener boundary would likewise not be predicted to adversely impact the south jetty.)

As noted, **Figure 3** illustrates deepening of the existing channel/widener to 46'+2'. (Section C in the figure additionally illustrates deepening of the sediment trap, which is described below.) In the figure, the dashed magenta line illustrates a 1:6 bank slope projected above the base of the deepened cut – which is a generally *conservative* proxy estimate of the anticipated, equilibrium side-slope that might be expected in the long-term after construction. At Sections A and B, along the deepened channel/widener at the entrance, there remains at least an 80- to 100-ft wide “buffer” between the top of the conservative bank adjustment and the south jetty structure, measured at the seabed. At Section C, this buffer distance is greater (about 180-ft, in absence of deepening the sediment trap, described below.) The existing pile-supported fishing pier, not shown in the section views, is located wholly within this buffer; it is at least 50-ft or more from the top of the presumed 1:6 side-slope bank adjustment.

Accordingly, based upon the information described above, this analysis indicates that deepening of the existing channel/widener to 46'+2' is not reasonably anticipated to

adversely impact either the existing south jetty structure or fishing pier. Likewise, the configuration of the proposed new widener, excavated to 46'+2', is not reasonably anticipated to adversely impact either of these structures, particularly because this project feature is located further from the structures than the existing channel/widener which is to be deepened to 46'+2'.

## 2.0 IMPACT TO THE SOUTH JETTY SEDIMENT TRAP

Because the proposed widener in the preferred alternative occupies a portion of the existing south jetty sediment trap, the effective capacity of the trap would be reduced. Deepening that portion of the existing trap outside the limits of the widener, from 44'+2' to 46'+2' (to match the remainder of the project), would reclaim most, but not all of this lost capacity. That is, the capacity of the 46'+2' trap, at its existing boundaries, would be reduced by about 35,600 cubic yards, more or less, from its design capacity; i.e., from 234,000 cubic yards to about 198,400 cubic yards.<sup>1</sup> In order to regain this 35,600 cubic yards, and to maintain the sediment trap's design effective capacity, the southern boundary of the sediment trap must be expanded (shifted southward) by approximately 20 feet. This 20-ft southward expansion of the trap, likewise cut to 46'+2', is therefore recommended.

Along its existing west boundary, deepening of the existing trap from 44'+2' to 46'+2' would slightly increase the potential for adverse impact to the south jetty. At a presumed equilibrium bank slope of 1:6, the 2-ft deepening would theoretically translate the top-of-bank location by a distance of  $2' \times 6 = 12'$  closer to the structure. While the potential for adverse impact to the structure is not necessarily indicated by the analysis illustrated in Figure 3 (Section C), above; it is nonetheless considered prudent to shift the western boundary of the existing sediment trap *seaward* by 12-feet, in order that the presumed top-of-bank of the deepened trap remains at the same location as for the existing trap. This slight "contraction" of the deepened trap's western boundary results in a small net effect to the trap's volumetric capacity; and, it is accounted for in the recommended 20-ft expansion of the trap's southern boundary, in order to retain the trap's original design capacity.

In sum, in order to preserve the trap's effective shoaling capacity and to result in no net increase of potential impacts to the south jetty, it is recommended that (1) the southern boundary of the trap be expanded by 20-ft southward, (2) the western boundary be contracted by 12-ft northeastward, and (3) the entirety of the trap within these adjusted boundaries be deepened to -48 ft MLLW (46'+2'). This recommended configuration is illustrated in **Figure 4**, following page.

---

<sup>1</sup> In this analysis, as in the original design formulation of the existing trap, the effective capacity of the trap is estimated by comparing the November, 2004 (post-hurricane) shoal bathymetry to the geometry of the dredged sediment trap.

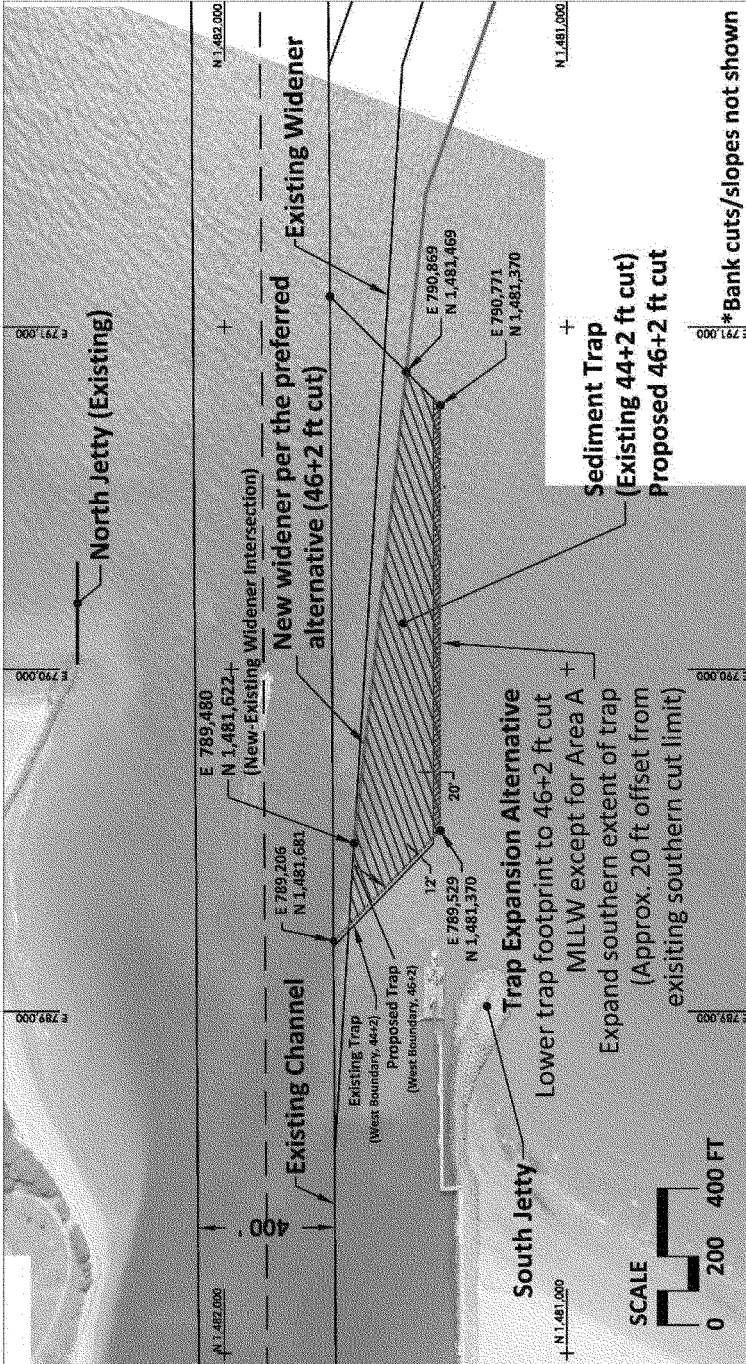

Figure 4: Proposed configuration of sediment trap in conjunction with the preferred alternative.



With respect to these adjusted boundaries, the planform footprint of the trap to be deepened by 2-feet, to 46'+2', outside of the boundaries of the proposed new widener, amounts to approximately 6.0 acres. (This value includes the 0.6 acre southward expansion of the existing trap and excludes the 0.1 acres which is "deleted" from the existing trap footprint along the western boundary.) This acreage estimate reflects the floor limits of the trap, at 46'+2', and does not include side-slopes.

Based upon a November 2007 condition survey (#08-027), the required dredge volume to establish the revised trap boundaries to its existing depth of 44'+2' is approximately 26,300 cubic yards. This is mostly comprised of the 20-ft southward expansion of the trap. The required dredge volume to establish the revised trap boundaries to a depth of 46'+2' is approximately 43,800 cubic yards. These estimates include only the trap area outside (south of) the limits of the proposed new widener.

### 3.0 NORTH CHANNEL WIDENER

In the preferred alternative (**Attachment A**), the proposed 100-ft north bank widener terminates at Easting 789,477 ft (NAD83) and tapers for a distance of 500 ft to the existing channel boundary (Range 0) at Easting 789,977 ft. The latter point corresponds to approximately Station 11+00 along the inlet's north jetty – based upon baseline stationing used for the Corps of Engineers' construction of jetty improvements in 2005. See **Figure 5**. This places the limits of the north bank widener wholly west of the 300-ft extension of the north jetty. This extension, constructed in late 2005, consists of steel sheet pile with rock armor placed on either side. The existing channel and the proposed widener are to be dredged to 46-ft plus 2-ft; or, elevation -48 ft MLLW. Our analysis indicates that the proposed deepening of the channel and location of the north bank widener, per the preferred alternative, does not pose significant potential for adverse impacts to the north jetty following channel side-bank equilibration.

Our analysis was based in part upon: (a) U.S. Army Corps of Engineers (USACE) construction drawings for the north jetty sand-tightening and extension (DACW17-02-B-0004), (b) a 2005 post-construction survey of the north jetty extension (prepared by Morgan & Eklund Surveyors for J. E. McAmis Inc., Commission #5445.00), and (c) the January 2006 condition survey of the Canaveral Harbor navigation channel prepared by the USACE. In order to examine the potential effect of channel modifications upon the north jetty, we considered the probable (equilibrated) slope of the channel's north bank, relative to the apparent location of the north jetty structure, for a 0-ft, 50-ft, and 100-ft widening of the channel. For each, we considered dredge elevations of both -46 ft and -48 ft MLLW (44'+2' and 46'+2', respectively). Examination of various surveys indicated that a 1:6 (vertical:horizontal) slope provided a reasonable approximation of the equilibrated bank slope in the vicinity of the north jetty.

**Figures 6 through 10** depict five (5) section views through the north jetty and navigation channel. The figures depict the proxy estimate of the equilibrated bank slope (1v:6h) along the channel, for 0-, 50-, and 100-ft widening scenarios, relative to the north jetty structure. The location of the jetty was derived from a comparison between the aforementioned construction drawings and the post-construction, as-built jetty survey. The anticipated bank slopes associated with the preferred alternative are indicated by the bold line in each section.

The data and this analysis suggest that any *widening* of the north channel along the newly extended north jetty (east of jetty Sta. 11+00) presents a potential for undermining the rock armor placed along the new jetty sheet pile. At the same time, *deepening* of the existing channel to 46+2 ft along the newly extended north jetty does *not* indicate significant increased potential for undermining the rock armor, relative to existing conditions. (See **Figures 8-10.**) It is for this reason that the north channel widener described in the preferred alternative terminates west of the new jetty extension; viz., at Easting 789,977 ft.

West of the new jetty extension, where the jetty alignment is northwest, tending away from the channel, the analysis indicates that a gradual widening of the north channel – deepened to 46+2 ft – does not indicate significant increased potential for undermining the jetty structure. (See **Figures 6 and 7.**) In sum, the configuration of the north bank widening, along with the channel deepening to 46+2, described in the preferred alternative, does not indicate a significant potential for adverse impacts to the existing north jetty structure.

There are two pile-supported surge warning signs, constructed by the Canaveral Port Authority in 2001, located inside the entrance, north of the proposed widener cut. (The approximate locations of these signs are indicated by two squares shown in Figure 5.) An analysis similar to that conducted above suggests that the easternmost warning sign is not anticipated to be substantially affected by construction of the proposed widener. Construction of the proposed widener near the westernmost sign, however, may result in exposure of up to one-half of the buried pile length – assuming the pile was driven 20-feet below grade, per the Port’s construction drawings. This amount of exposure may destabilize the western sign. Relocation (or, more probably, reconstruction) of this sign at least 100 feet north of its existing location is therefore anticipated to be necessary.

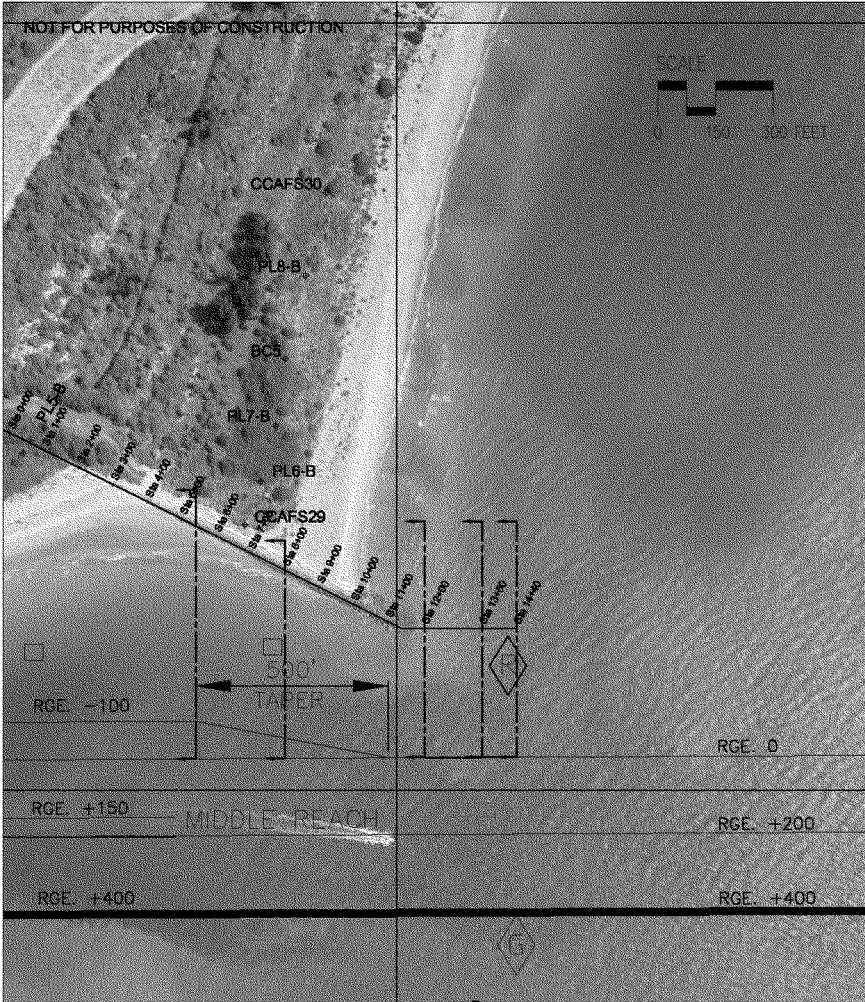

**Figure 5** – Proposed north jetty widener (preferred alternative) and location of sectional views in relation to USACE construction stationing along the north jetty.

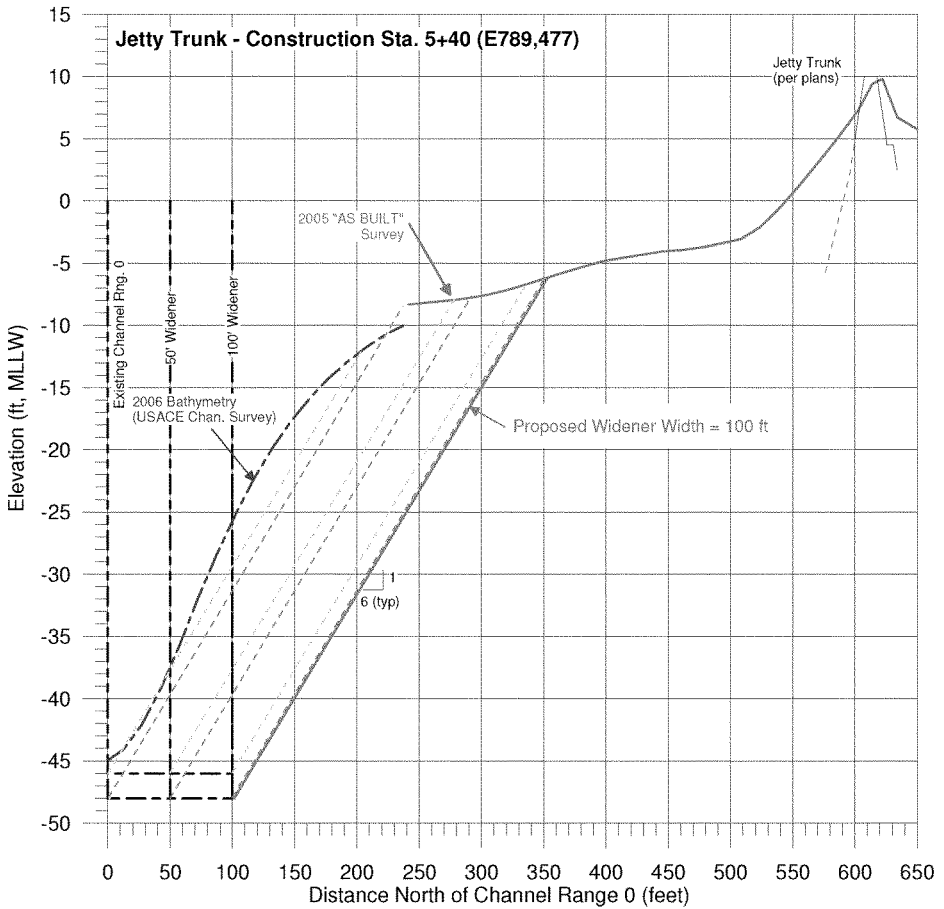

**Figure 6** – Proposed widener at USACE jetty Station 5+40 relative to the north jetty – jetty position is based upon the 2005 as-built survey and construction drawings.

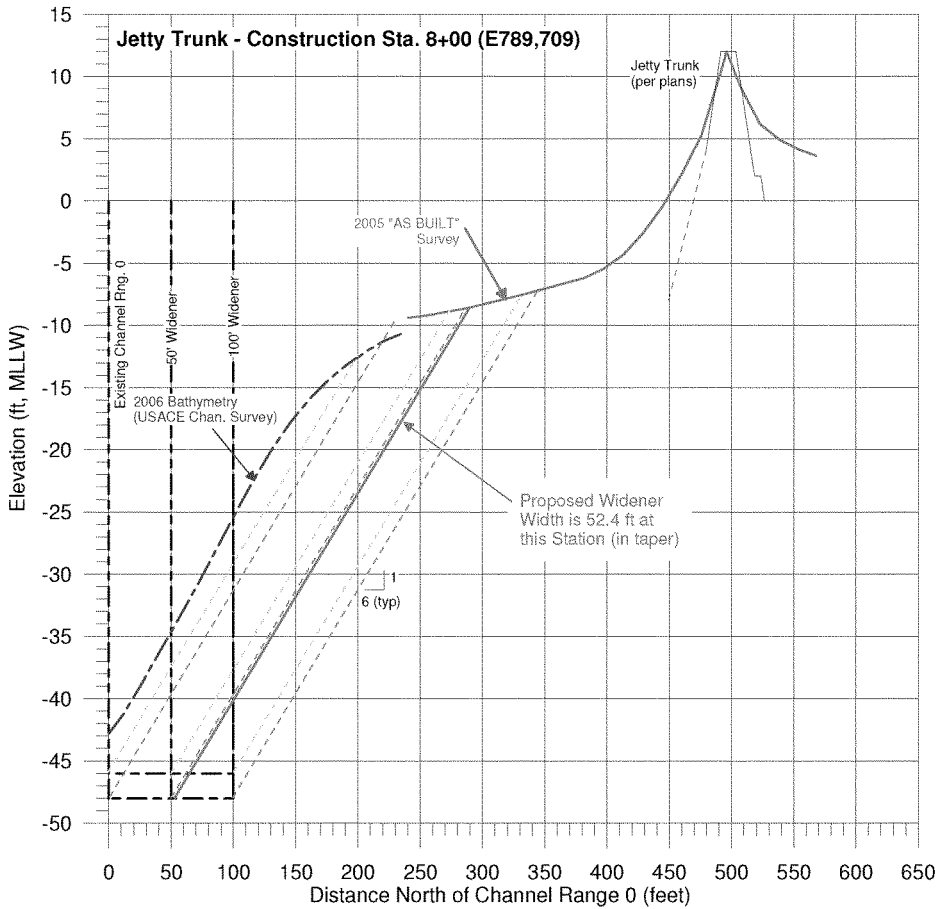

**Figure 7** – Proposed widener at USACE jetty Station 8+00 relative to the north jetty – jetty position is based upon the 2005 as-built survey and construction drawings.

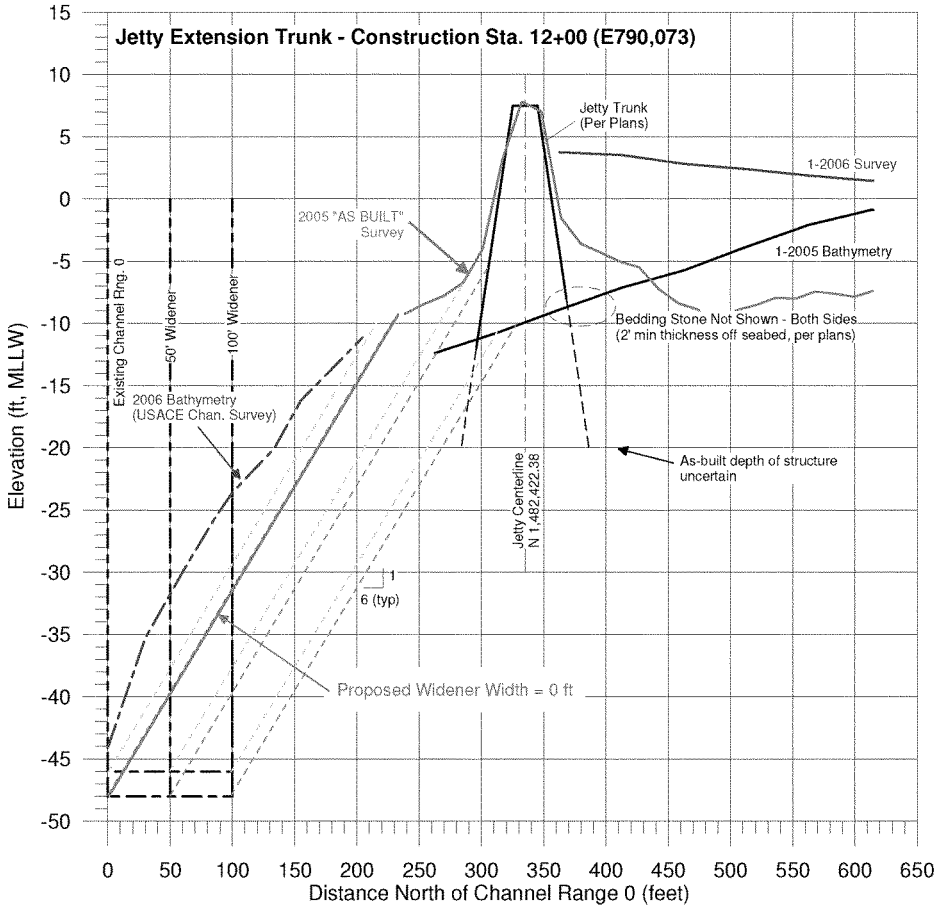

**Figure 8** – Proposed widener at USACE jetty Station 12+00 relative to the north jetty – jetty position is based upon the 2005 as-built survey and construction drawings.

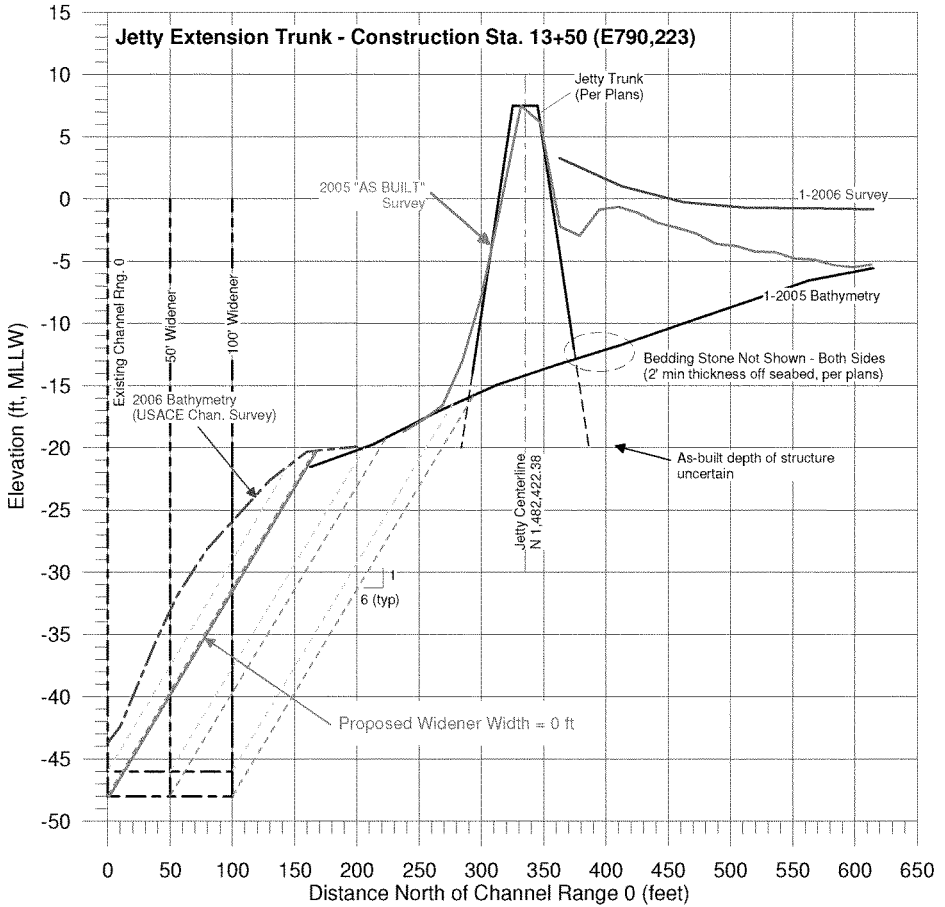

**Figure 9** – Proposed widener at USACE jetty Station 13+50 relative to the north jetty – jetty position is based upon the 2005 as-built survey and construction drawings.

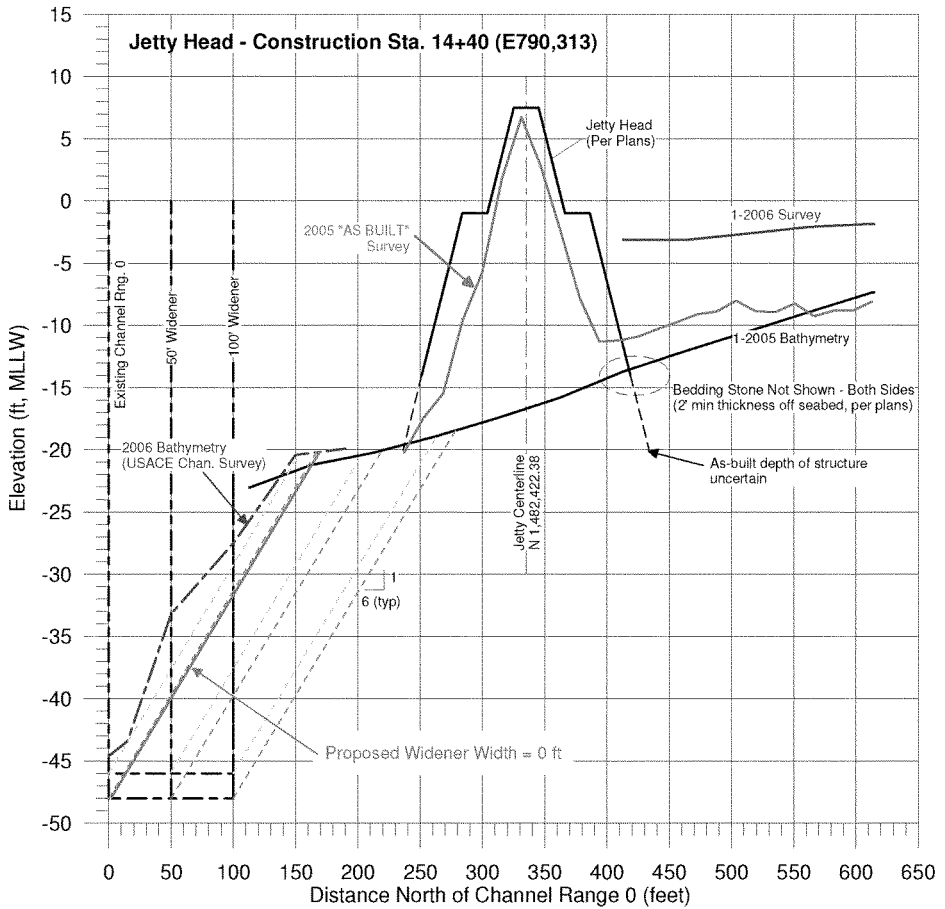

**Figure 10** – Proposed widener at USACE jetty Station 14+40 relative to the north jetty – jetty position is based upon the 2005 as-built survey and construction drawings.





**Port Canaveral Section 203 Feasibility Study  
Engineering Appendix**

Attachment H

Drawings: Surveys and Mapping



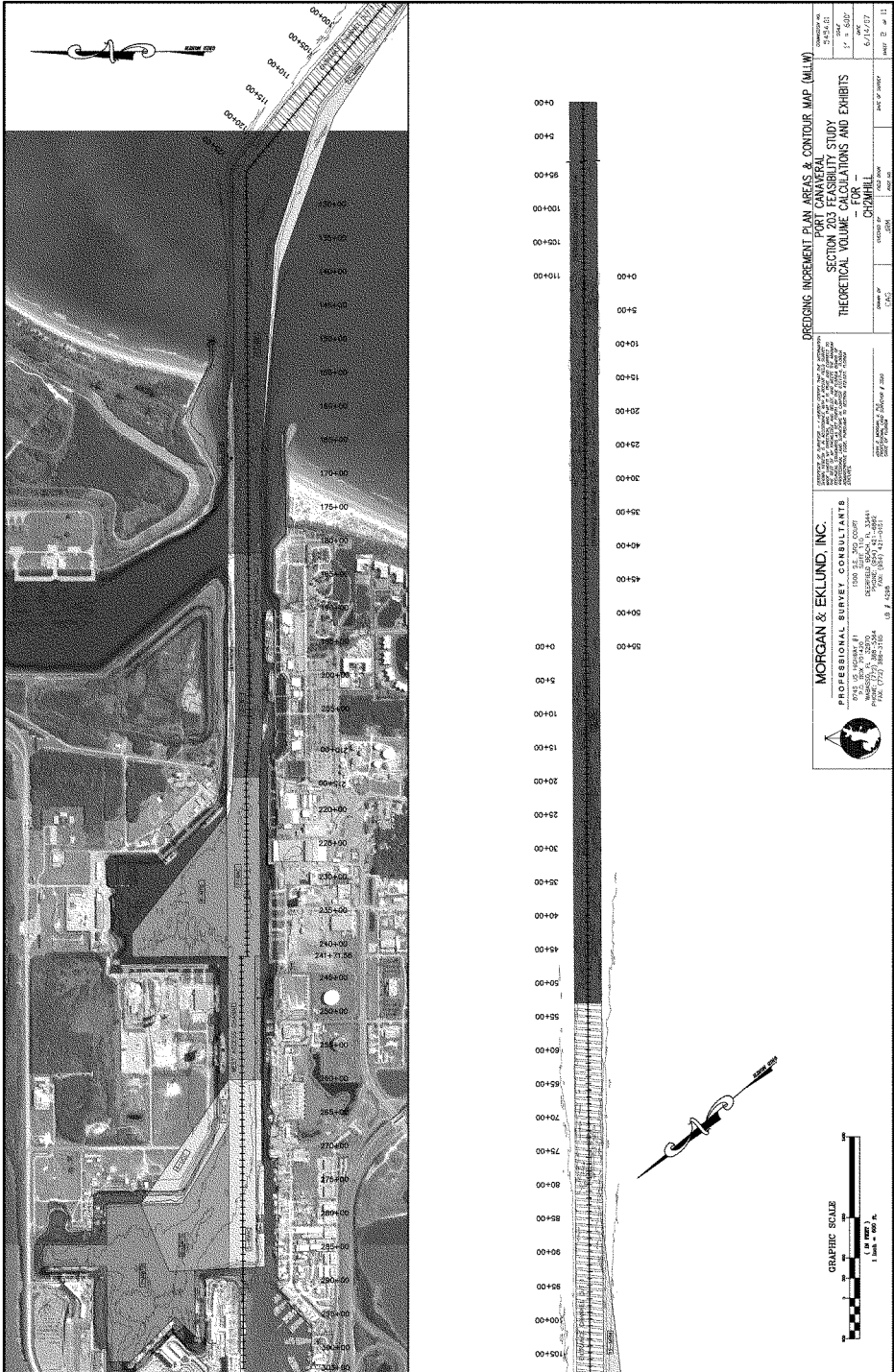

**CREDDING INCREMENT PLAN AREAS & CONTOUR MAP (M.I.M.)**

**SECTION 203 FEASIBILITY STUDY**

**THEORETICAL VOLUME CALCULATIONS AND EXHIBITS**

FOR THE  
CONSTRUCTION OF  
PORT CANAVERAL

DATE: 11/11/03

SCALE: 1" = 80'

SHEET NO. 612 OF 611

---

**MORGAN & EKLAND, INC.**  
PROFESSIONAL SURVEY CONSULTANTS  
1500 SOUTH FLORISSANT  
PORT CANAVERAL, FL 32913  
PHONE: (321) 266-7334  
FAX: (321) 266-7334  
U.S. / CANADA

STATE OF FLORIDA  
SURVEYORS  
MORGAN & EKLAND, INC.  
MEMBER OF THE SURVEYING PROFESSION  
SINCE 1968  
LICENSE NO. 12547  
EXPIRES 12/31/04  
REGISTERED PROFESSIONAL SURVEYORS  
STATE OF FLORIDA



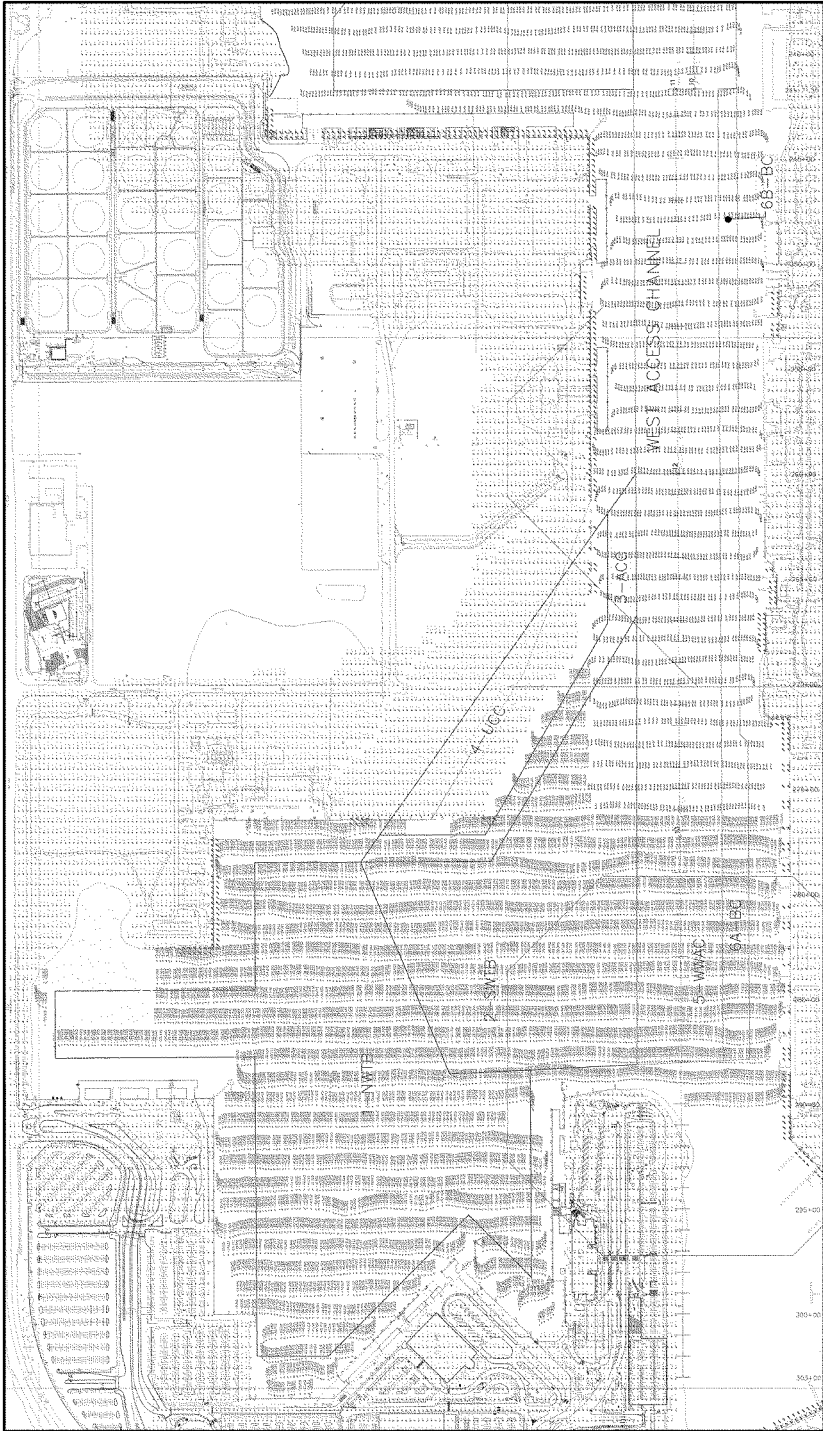

ELEVATION DATA POINT (M.A.S.T.)

PORT CANNON

SECTION 203 FEASIBILITY STUDY

THEORETICAL VOLUME CALCULATIONS AND EXHIBITS

FOR

CITY OF PORT CANNON

DATE: 10/20/11

SCALE: 1" = 200'

SHEET NO. 203-01

---

**MORGAN & EKLAND, INC.**

PROFESSIONAL SURVEY CONSULTANTS

10000 S. STATE ST. SUITE 100  
DENVER, CO 80231  
PHONE: (303) 441-1000  
FAX: (303) 441-1001  
WWW.MORGAN-AND-EKLAND.COM

---

DATE: 10/20/11  
BY: J. H. HARRIS  
CHECKED: J. H. HARRIS  
SCALE: 1" = 200'  
SHEET NO. 203-01

---

EXPANDED DETAILED SURVEY OF PORT CANNON  
BASED ON SURVEY BY MORGAN & EKLAND  
SHT. 3 OF 11 AS PREPARED BY CH2MHILL, OCT 2011



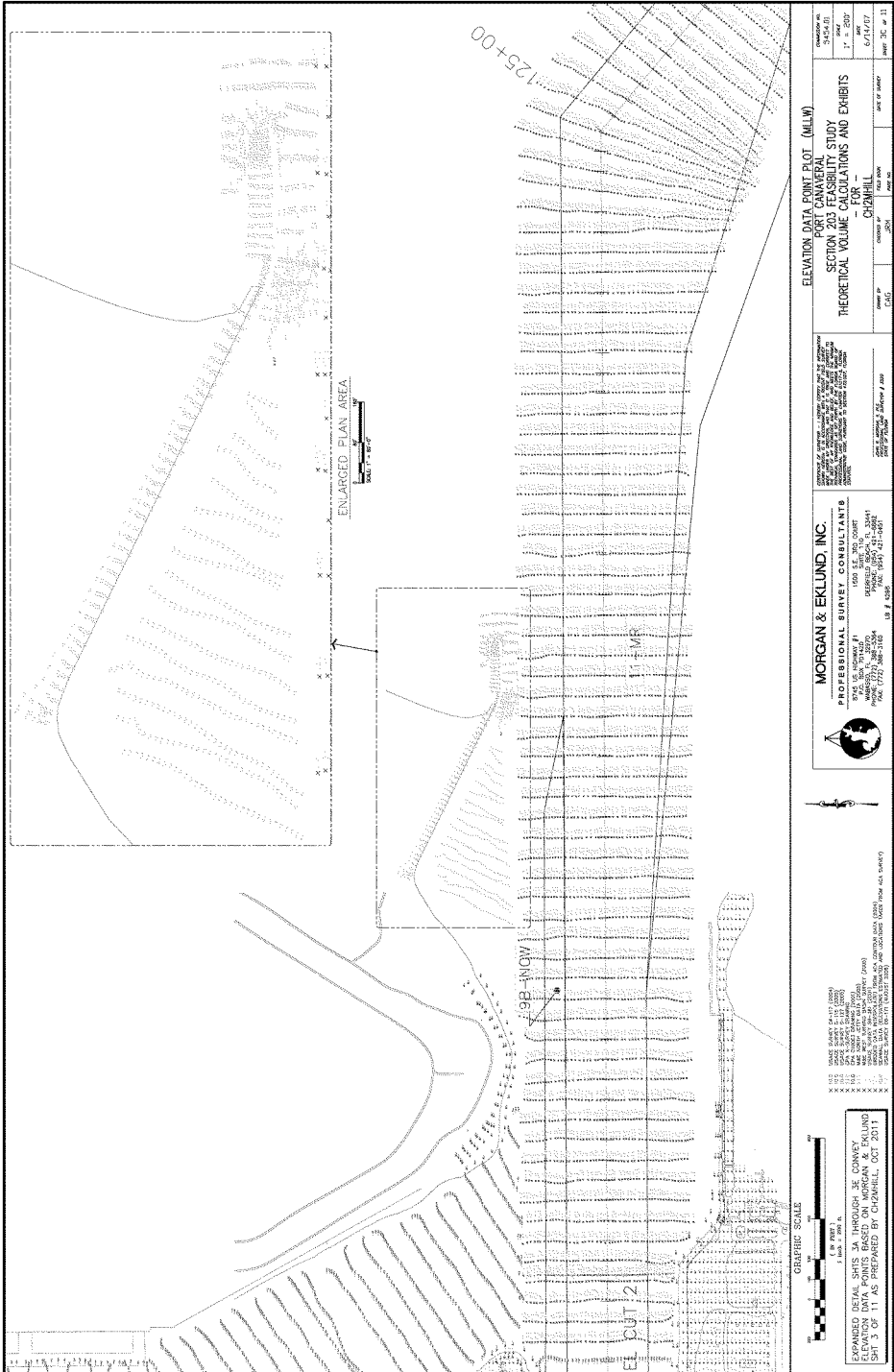

**ELEVATION DATA POINT PLOT (MILLIM)**  
**SECTION 203 FEASIBILITY STUDY**  
**THEORETICAL VOLUME CALCULATIONS AND EXHIBITS**  
**FOR**  
**CHZBELL**

DATE: 10/11/11  
 SHEET NO. 616 OF 616

**MORGAN & EKUND, INC.**  
**PROFESSIONAL SURVEY CONSULTANTS**

1500 S. 10th St., Suite 100  
 Lincoln, NE 68502  
 PHONE: (402) 471-2000  
 FAX: (402) 471-2001  
 US # 2008

DATE: 10/11/11  
 SHEET NO. 616 OF 616

GRAPHIC SCALE  
 1" = 200' FT.

ENLARGED PLAN AREA  
 1" = 200' FT.

DATE: 10/11/11  
 SHEET NO. 616 OF 616



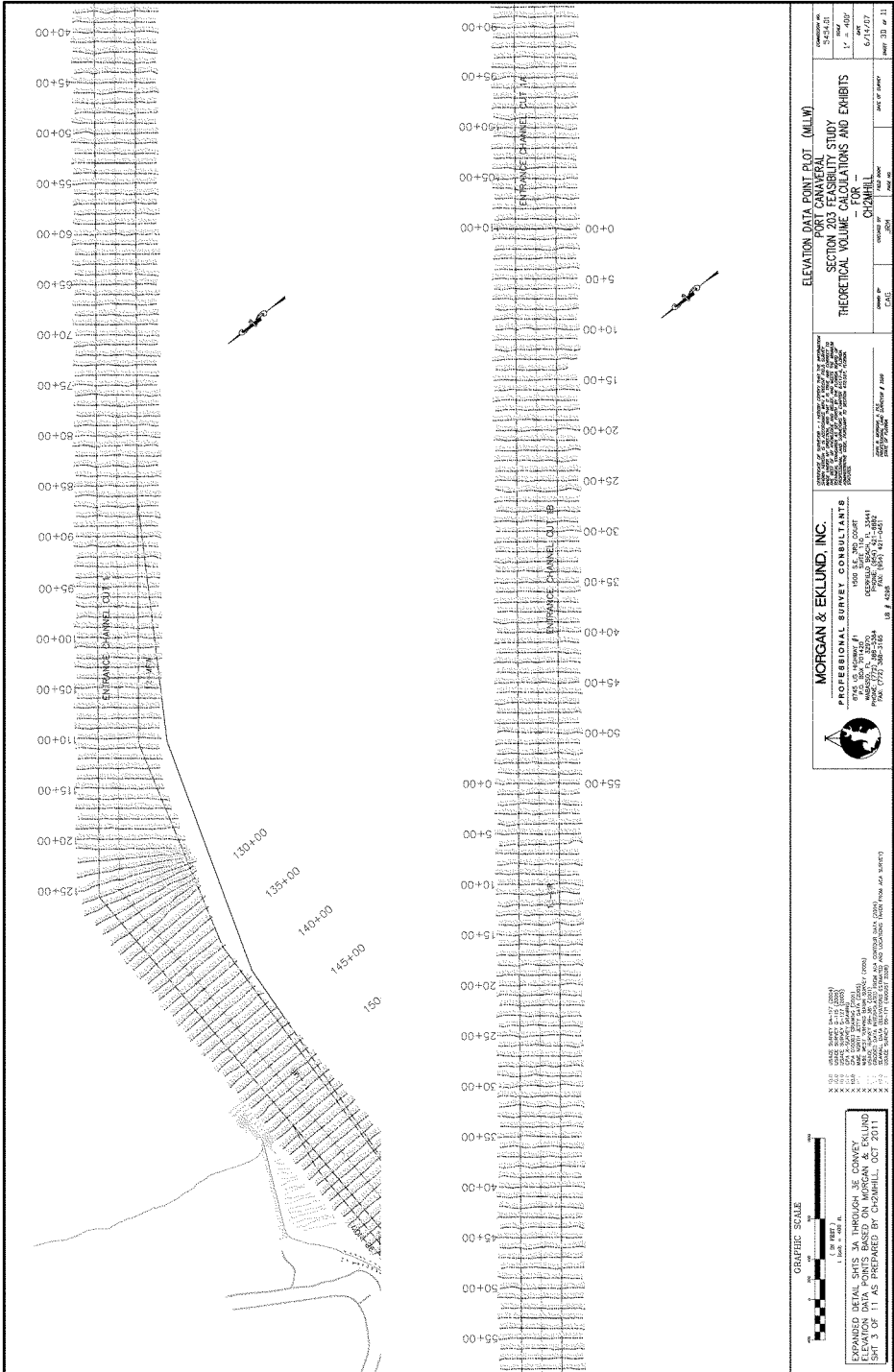

ELEVATION DATA POINT (MILL)

SECTION 203 FEASIBILITY STUDY  
THEORETICAL VOLUME CALCULATIONS AND EXHIBITS

DATE: 10/21/2011  
DRAWN BY: [Name]  
CHECKED BY: [Name]  
SCALE: AS SHOWN

**MORGAN & EKUND, INC.**  
PROFESSIONAL SURVEY CONSULTANTS  
1500 S.W. 15th Street  
Fort Lauderdale, FL 33304  
Phone: (954) 471-8844  
Fax: (954) 471-8844  
www.morganandekund.com



DATE: 10/21/2011  
DRAWN BY: [Name]  
CHECKED BY: [Name]  
SCALE: AS SHOWN

GRAPHIC SCALE  
1" = 100'  
DATE: 10/21/2011  
DRAWN BY: [Name]  
CHECKED BY: [Name]  
SCALE: AS SHOWN



ENTRANCE CHANNEL CUT 1A

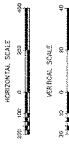
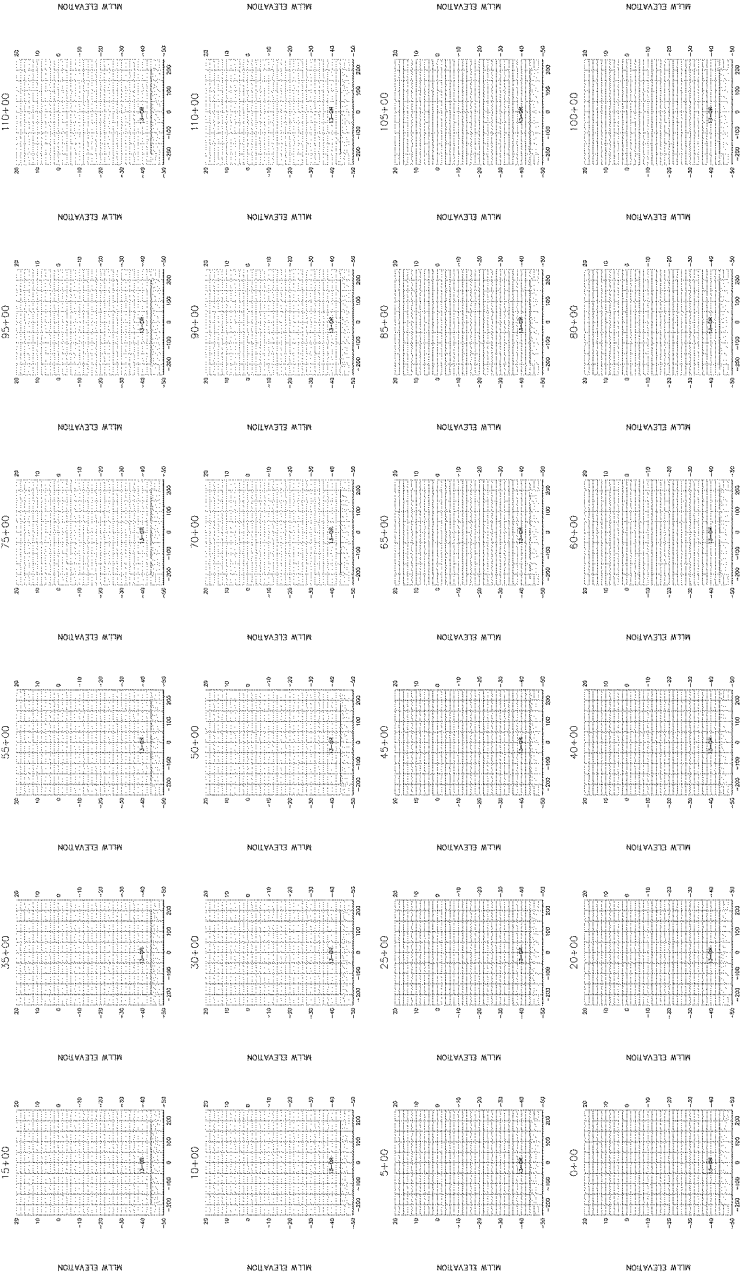

**LEGEND**  
 --- PROPOSED  
 --- EXISTING  
 --- BRIDGE APPROACH  
 --- BRIDGE PAVEMENT  
 --- BRIDGE DECK

**MORGAN & EKLAND, INC.**  
 PROFESSIONAL SURVEY CONSULTANTS  
 1500 S. MAIN ST., SUITE 100  
 DENVER, COLORADO 80202  
 PHONE: (303) 733-7338  
 FAX: (303) 733-7339  
 13' x 19" (305 x 483 mm)

DATE: 10/20/2014  
 DRAWN BY: J. B. BROWN  
 CHECKED BY: J. B. BROWN  
 PROJECT NO.: 14-001  
 SHEET NO.: 619

**CROSS SECTION VIEW (MLW)**  
**SECTION 203 FEASIBILITY STUDY**  
**THEORETICAL VOLUME CALCULATIONS AND EXHIBITS**  
**FOR**  
**CONVERSION OF**  
**AS SHOWN**

DATE: 10/20/2014  
 SHEET NO.: 619

ENTRANCE CHANNEL CUT 1B

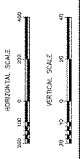
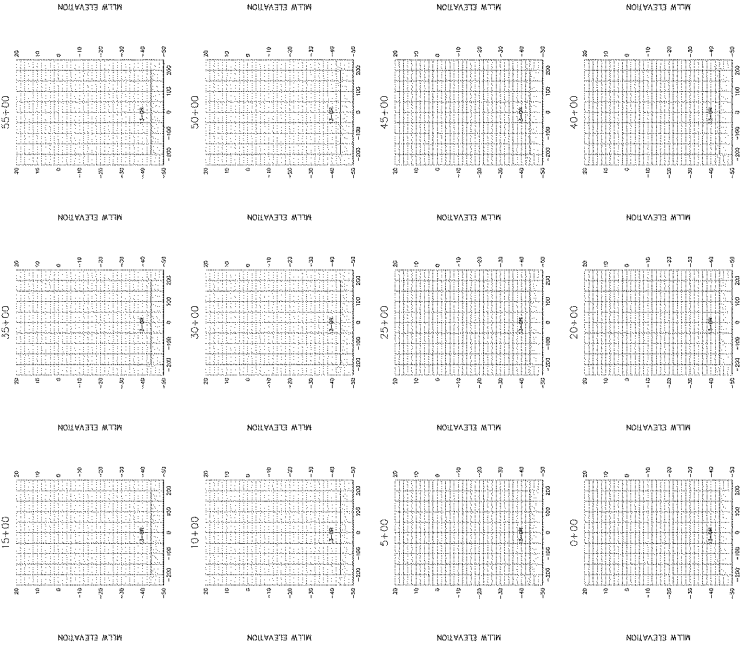

**LEGEND**  
 --- PROPOSED  
 --- EXISTING  
 --- BRIDGE

**MORGAN & EKLUND, INC.**  
 PROFESSIONAL SURVEY CONSULTANTS  
 1500 BULLOCK BLVD., SUITE 100  
 FORT WORTH, TEXAS 76104  
 PHONE (817) 336-7300  
 FAX (817) 336-7308  
 WWW.MORGAN-EKLUND.COM

STATE OF TEXAS  
 COUNTY OF TARRANT  
 ENGINEER'S EXPIRES 12/31/2024  
 LICENSE NO. 12487  
 EXPIRES 12/31/2024

**CROSS SECTION VIEW (MLW)**  
 PORT CANAVAL  
 SECTION 203 FEASIBILITY STUDY  
 THEORETICAL VOLUME CALCULATIONS AND EXHIBITS  
 FOR  
 CHINA  
 DATE: 11/20/2024  
 DRAWN BY: [Name]  
 CHECKED BY: [Name]  
 IN CHARGE: [Name]  
 PROJECT NO.: [Number]  
 SHEET NO. 21 OF 11

ENTRANCE CHANNEL CUT 1

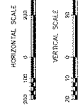
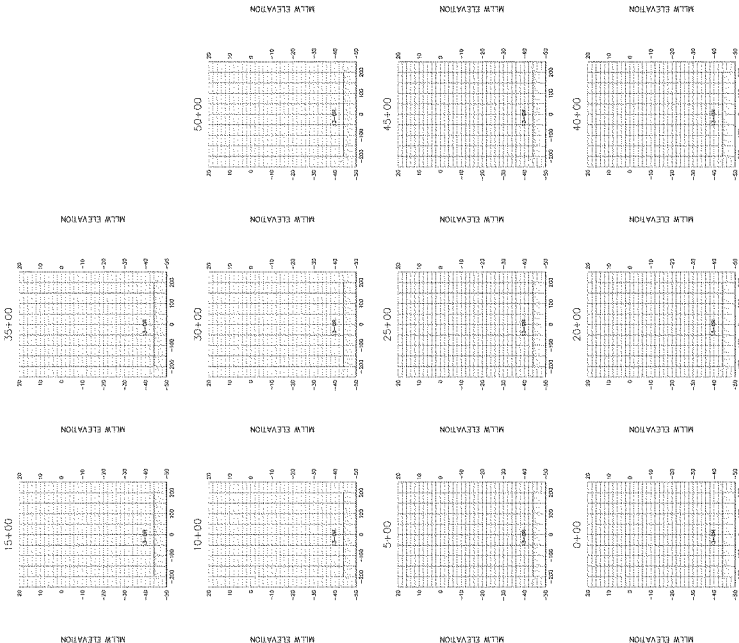

LEGEND  
 --- PROPOSED IMPROVEMENTS  
 --- EXISTING IMPROVEMENTS  
 --- EXISTING CHANNELS

**MORGAN & EKLUND, INC.**  
 PROFESSIONAL SURVEY CONSULTANTS  
 1500 EAST 10<sup>TH</sup> AVENUE  
 DENVER, COLORADO 80202  
 PHONE (303) 733-7338  
 FAX (303) 733-7339  
 WWW.MORGAN-EKLUND.COM

APPROVED FOR CONSTRUCTION BY THE COLORADO DEPARTMENT OF TRANSPORTATION  
 PROJECT NO. 15-000000-01  
 CONTRACT NO. 15-000000-01  
 SHEET NO. 621 OF 621

CROSS SECTION VIEW (MLW)  
 SECTION 203 FEASIBILITY STUDY  
 FOR  
 COLORADO  
 THEORETICAL VOLUME CALCULATIONS AND EXHIBITS

DATE: 11/17/11  
 DRAWN BY: [Name]  
 CHECKED BY: [Name]  
 IN CHARGE: [Name]  
 PROJECT NO.: 15-000000-01  
 SHEET NO.: 621 OF 621

ENTRANCE CHANNEL CUT 1

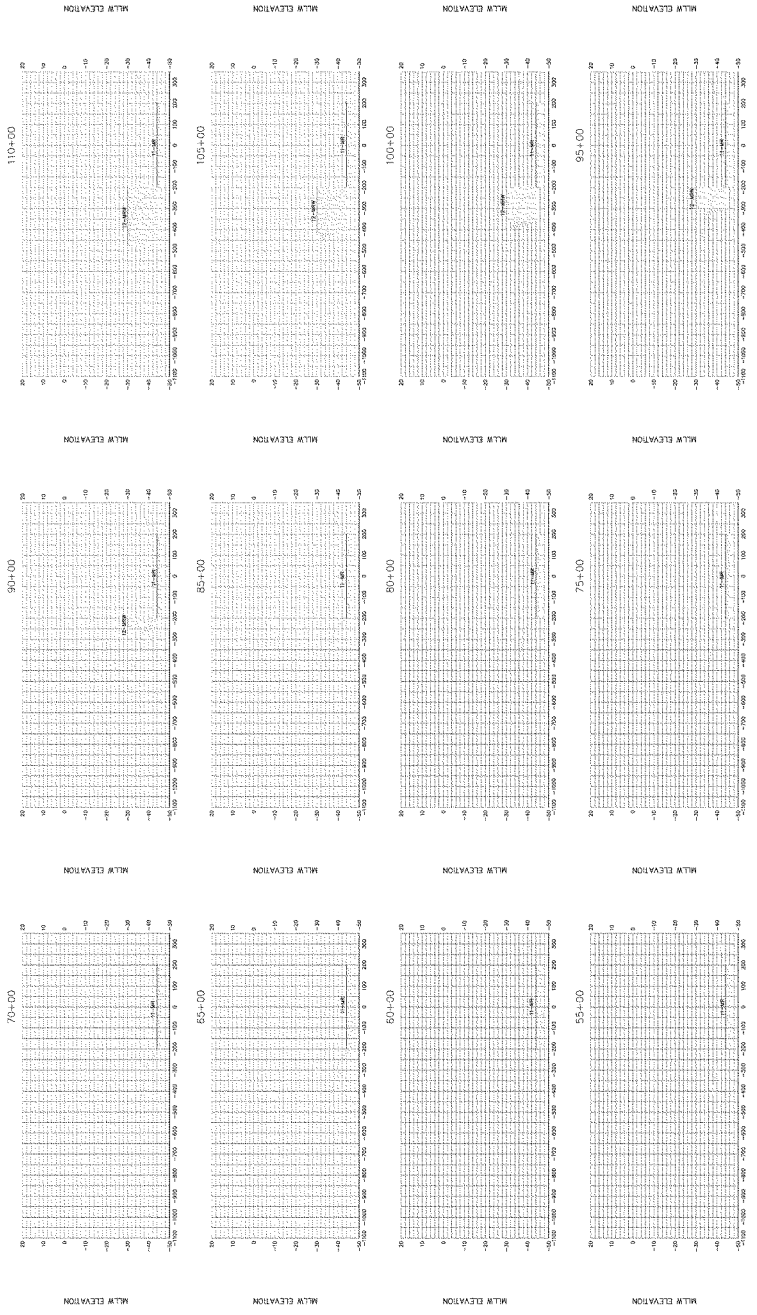

**ORIGIN: SECTION VIEW (MLW)**  
**SECTION: PART CHANNEL**  
**SECTION: 203 FEASIBILITY STUDY**  
**THEORETICAL VOLUME CALCULATIONS AND EXHIBITS**  
**FOR: CHANNEL**  
**DATE: 10/20/2014**  
**SCALE: 1" = 20'**  
**DATE: 7/28/11**

**MORGAN & EKLAND, INC.**  
 PROFESSIONAL SURVEY CONSULTANTS  
 1500 S. 10TH ST., SUITE 100  
 DENVER, CO 80202  
 PHONE: (303) 733-7300  
 FAX: (303) 733-7301  
 137 P. 00206

**LEGEND**  
 --- PROPOSED  
 --- EXISTING  
 --- CHANNEL CENTERLINE  
 --- CHANNEL INTERSECTIONS



**DATE: 10/20/2014**  
**SCALE: 1" = 20'**  
**DATE: 7/28/11**

ENTRANCE CHANNEL CUTS 1 & 2

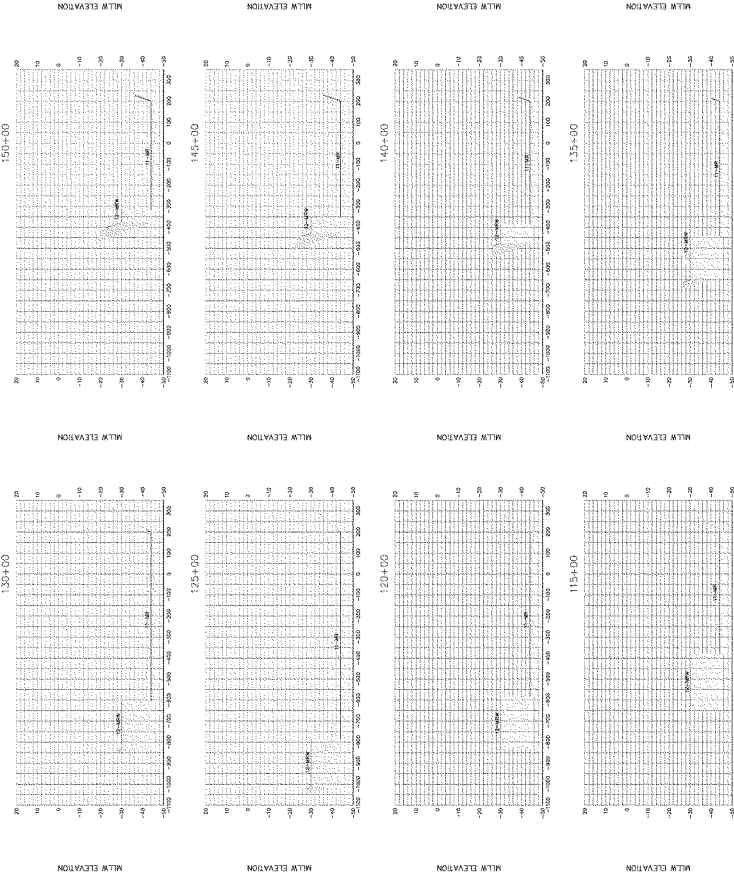

**CROSS SECTION VIEW (MILL)**  
**FORT CANABAL**  
**SECTION 203 FEASIBILITY STUDY**  
**THEORETICAL VOLUME CALCULATIONS AND EXHIBITS**  
**FOR**  
**CONSTRUCTION**

DATE: 01/27/21  
 DRAWN BY: AS SHOWN  
 CHECKED BY: [Signature]  
 SCALE: 1" = 20'

PROFESSIONAL SURVEY CONSULTANTS  
 1500 South 10th Street  
 Phoenix, AZ 85034  
 PHONE: (602) 471-0800  
 FAX: (602) 471-0801  
 www.morgan-eklund.com



SEE SHEET 1 FOR NOTES

**LEGEND**  
 --- PROPOSED  
 --- EXISTING  
 --- GROUND ELEVATIONS







ENTRANCE CHANNEL CUT 2

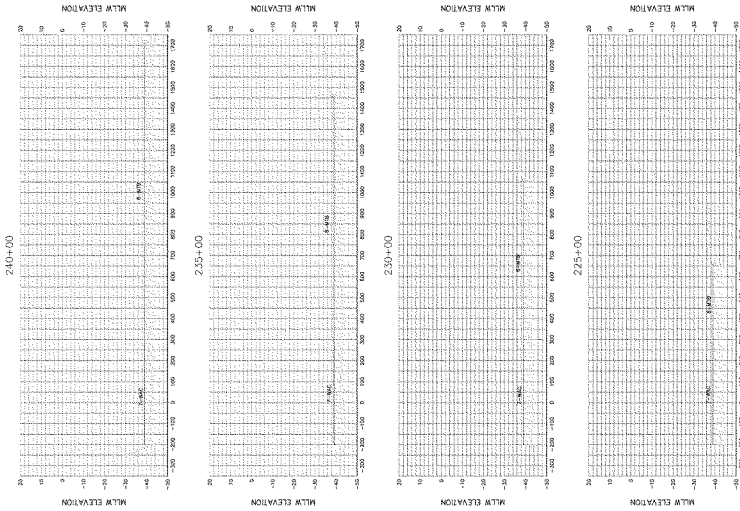

**CROSS SECTION VIEW (MLW)**  
**FORT CANAL**  
**SECTION 203 FEASIBILITY STUDY**  
**THEORETICAL VOLUME CALCULATIONS AND EXHIBITS**  
**FOR**  
**CUTS**

DRAWN BY:                           DATE:                       
 CHECKED BY:                           DATE:                       
 APPROVED BY:                           DATE:                     

**MORGAN & EKLUIND, INC.**  
 PROFESSIONAL SURVEY CONSULTANTS  
 1500 EAST 10TH AVENUE  
 DENVER, COLORADO 80202  
 PHONE: (303) 733-7330  
 FAX: (303) 733-7331  
 WWW.MORGAN-INC.COM

PROJECT NO.                       
 SHEET NO.                      OF                     

SEE SHEET 1 FOR NOTES

WEST ACCESS CHANNEL

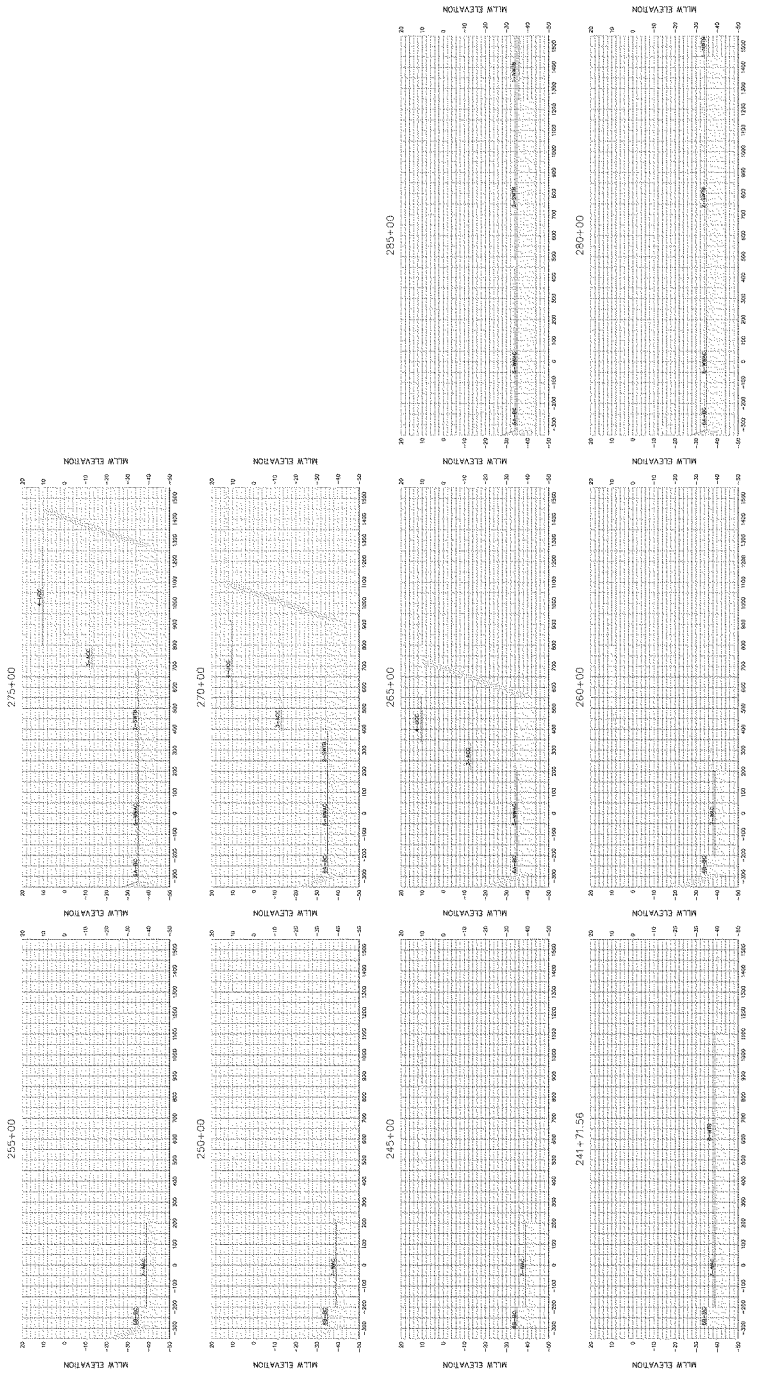

**CROSS SECTION VIEW (MLW)**  
**SECTION 203 FEASIBILITY STUDY**  
**THEORETICAL VOLUME CALCULATIONS AND EXHIBITS**  
**FOR**  
**CONSTRUCTION**

DATE: 11/11/11

**MORGAN & EKLAND, INC.**  
 PROFESSIONAL SURVEY CONSULTANTS  
 1500 S. 10th St., Suite 100  
 Phoenix, AZ 85004  
 Phone: (602) 998-7300  
 Fax: (602) 998-7301  
 Website: www.morgan-ekland.com

**LEGEND**  
 --- CHANNEL CENTERLINE  
 --- CHANNEL BANK  
 --- CHANNEL BED  
 --- CHANNEL SHOULDER

HORIZONTAL SCALE: 1" = 100'  
 VERTICAL SCALE: 1" = 10'

DATE: 11/11/11

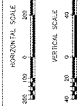
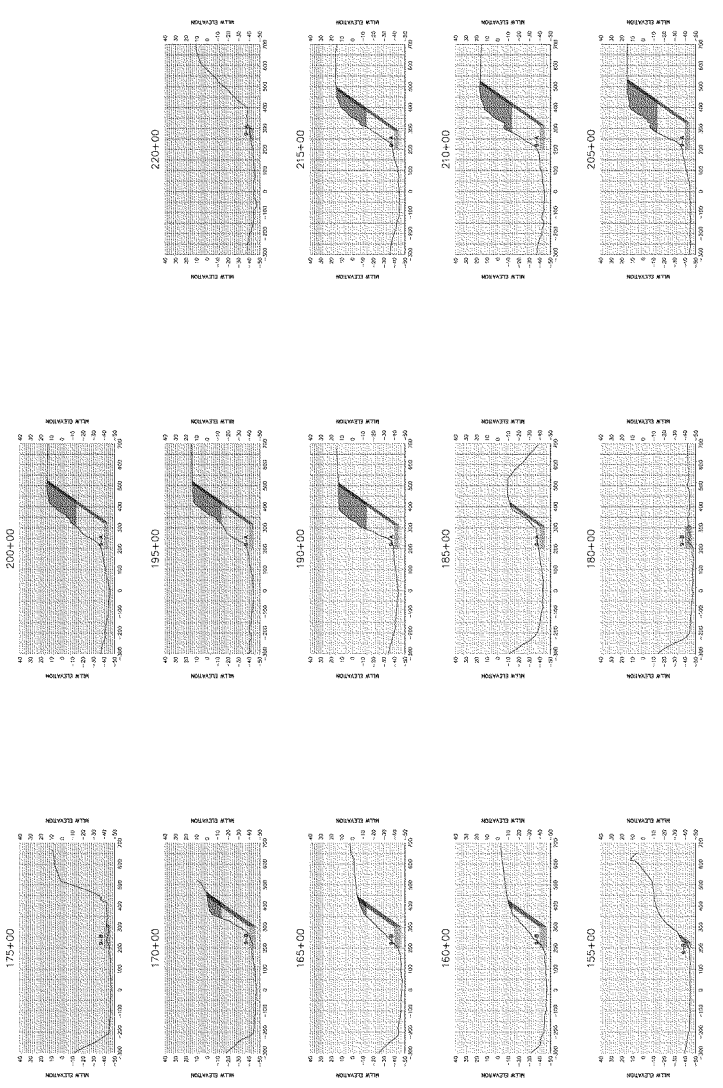

AREA CALCULATED ABOVE ELEVATION -13 MLW

**MORGAN & EKUND, INC.**  
 PROFESSIONAL SURVEY CONSULTANTS  
 15600 S.W. 15th Street  
 Suite 100  
 Miami, FL 33187  
 Phone: (305) 271-2000  
 Fax: (305) 271-2001  
 www.morgan-ekund.com

DATE OF SURVEY: 08/20/2014  
 DATE OF PLOTTING: 08/20/2014  
 DRAWN BY: J. L. BROWN  
 CHECKED BY: J. L. BROWN  
 PROJECT NO.: 14-001

CROSS SECTION, NEW (MLW)  
 CHANNEL CALCULATIONS  
 PORT CANAVERAL ENTRANCE CHANNEL  
 FOR  
 BREVARD COUNTY, FLORIDA

DATE: 08/20/2014  
 SHEET: 2 OF 11  
 DRAWING NO.: 14-001

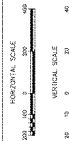
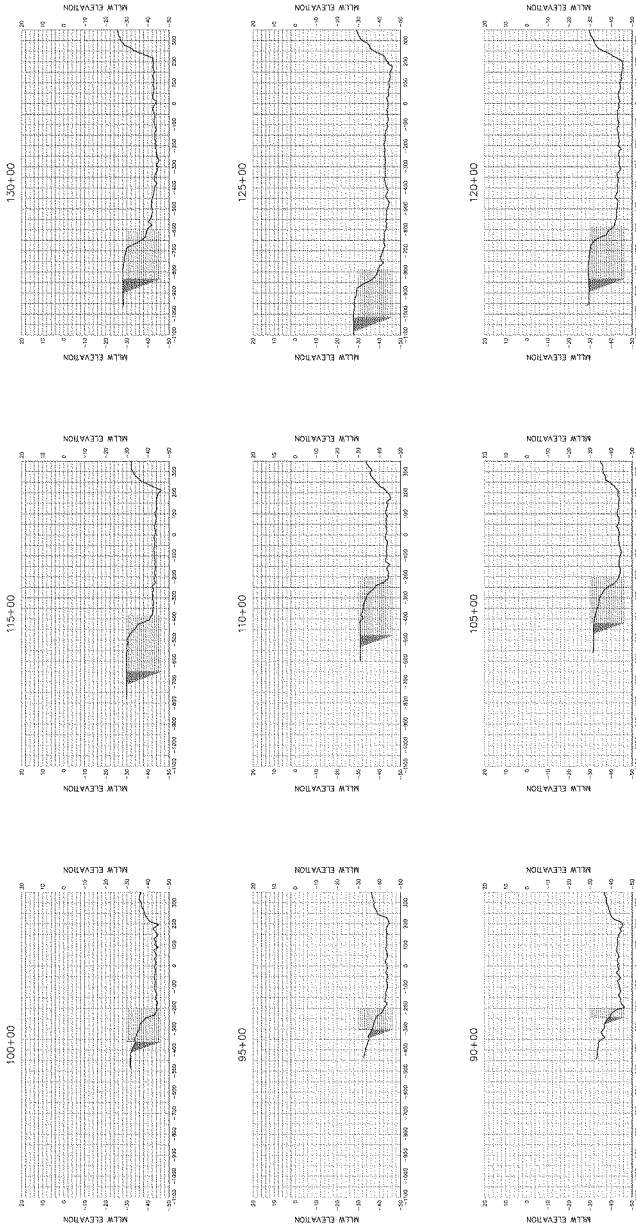

**MORGAN & EKUND, INC.**  
 PROFESSIONAL SURVEY CONSULTANTS  
 15000 S.W. 10th COURT  
 MIAMI, FLORIDA 33187  
 PHONE (305) 261-2334  
 FAX (305) 261-2334  
 WWW.MORGAN-AND-ERUND.COM  
 U.S. # 10258

APPROVED AS SHOWN FOR THE PROJECT BY THE PROFESSIONAL SURVEYOR'S SIGNATURE AND SEAL.  
 I, **DAVID L. BROWN**, PROFESSIONAL SURVEYOR, No. 12345, State of Florida, do hereby certify that the above is a true and correct copy of the original as shown to me by the engineer or other person claiming to be the author of the same.  
 DATE: 05/15/2011

CROSS SECTION, NEW (MLW) FOR THE CALCULATIONS AREA 12-NWP PORT CANAL/ENRANCE CHANNEL, BREVARD COUNTY, FLORIDA FOR CHANNEL CLEARANCE

DATE OF PLOT: 05/15/2011  
 SHEET NO. 628 OF 628

DATE PLOTTED: 05/15/2011  
 SHEET NO. 628 OF 628

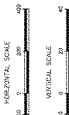
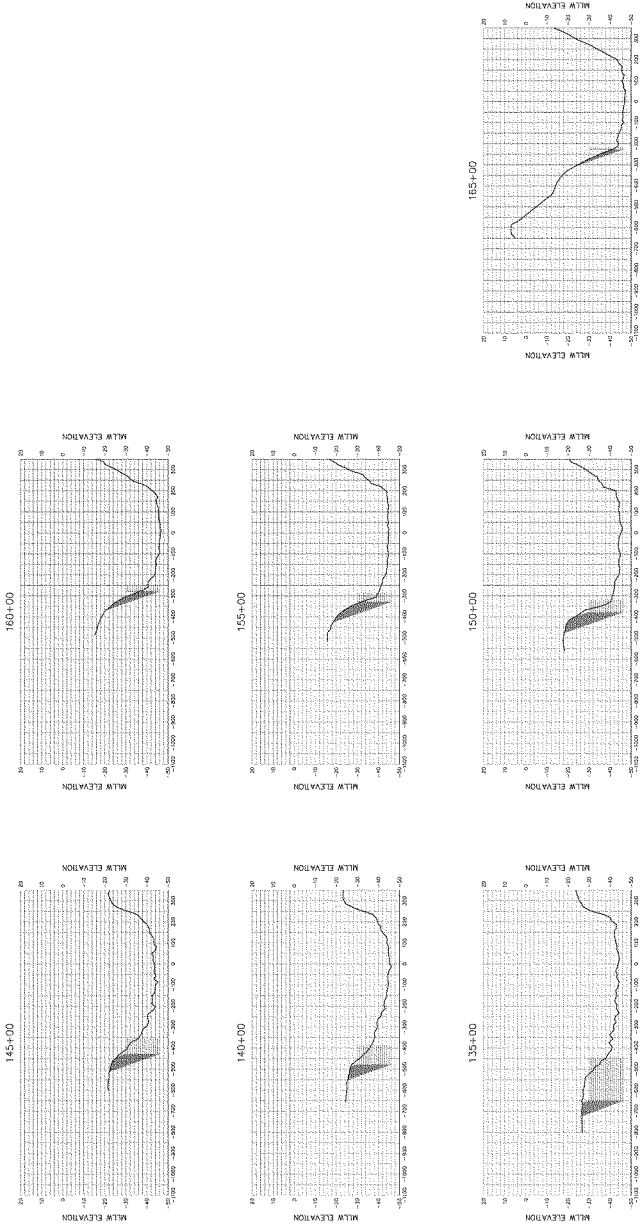

**MORGAN & EKLUK, INC.**  
PROFESSIONAL SURVEY CONSULTANTS  
15000 E. HIGHWAY 111, SUITE 110  
P.O. BOX 11111  
DENVER, CO 80231  
PHONE: (303) 755-7334  
FAX: (303) 755-7334  
13 P. 2025

CONTRACT NO. 12-1000  
DRAWING NO. 12-1000-1  
DATE: 12/15/00  
SCALE: AS SHOWN  
SHEET NO. 2 OF 2

CROSS SECTION VIEW (MLW)  
CHANNEL CALCULATIONS  
AREA 12-NHW PORT CANAL ENRANCE CHANNEL  
FOR -  
COLEMAN  
BREVARD COUNTY, FLORIDA

DATE: 12/15/00  
SHEET NO. 2 OF 2

**Port Canaveral Section 203 Feasibility Study**  
**Engineering Appendix**

Attachment I

Geotechnical Report

Section 203 Study  
Navigation Improvements  
Entrance Channel, Access Channels,  
and West Turning Basin  
Geotechnical Data Report  
Port Canaveral Harbor, Florida

Prepared by

Ardaman & Associates, Inc.

July 3, 2006

## TABLE OF CONTENTS

<u>Section</u>	<u>Title</u>	<u>Page</u>
1	INTRODUCTION AND SCOPE OF WORK	1
	1.1 Introduction	1
	1.2 Scope of Work	1
2	CHARACTER OF MATERIALS	2
	2.1 Regional Geology	2
	2.2 Material Encountered	2
	2.2.1 Channel Cuts 1, 1A and 1B - Outer Reach	3
	2.2.2 Channel Cut 2 and Widener - Middle Reach	3
	2.2.3 Canaveral Pilot Channel Widener	3
	2.2.4 Channel Cut 3 - Middle Turning Basin Channel and West Access Channel	3
	2.2.5 West Turning Basin Channel	3
3	FIELD AND LABORATORY TESTING PROGRAM	4
	3.1 Definitions	4
	3.2 Boring Log Notes	5
	3.3 Summary of Field Investigations	5
	3.4 Summary of Index Testing Data	5
	3.5 Recovered Materials	10
	3.6 Summary of Past Marine Boring Programs	10
	3.7 Summary of Past Landside Boring Programs	41
4	DESIGN SOIL PROFILES	74
	4.1 West Turning Basin Corner Cut-off	74
	4.1.1 Corner Cut-off - Northwest End	74
	4.1.2 Corner Cut-off - Southeast End	74
	4.1.3 Corner Cut-off - Bulkhead Wall Design	75
	4.2 Inner Reach North Side Dike Relocation	75



**TABLE OF CONTENTS (continued)**

<u>Section</u>	<u>Title</u>	<u>Page</u>
5	DIKE RELOCATION STABILITY ANALYSES	75
5.1	Slope Stability Analyses Methodology	75
5.2	Material Properties	76
	5.2.1 Dike Fill	76
	5.2.2 Dredge Material	76
	5.2.3 Dense Sand	76
	5.2.4 Marine Clay	76
	5.2.5 Sandy Clay	77
	5.2.6 Shallow Silty Sand	77
	5.2.7 Sandy Clay	77
	5.2.8 Deep Silty Sand	77
5.3	Existing Dike Slope Stability	78
5.4	Relocated Dike Slope Stability	78
6	BULKHEAD WALL EVALUATION AND RECOMMENDATION	78
6.1	General Soil Profile and Engineering Properties Used in Analyses	78
	6.1.1 West End of South Side of the West Turning Basin Channel	78
	6.1.2 East End of South Side of the West Turning Basin Channel	79
	6.1.3 Corner Cut-off of the West Turning Basin	80
6.2	Anchored Bulkhead Evaluation	81
7	CLOSURE	81
<u>Appendix</u>	<u>Title</u>	
1	Sampling Procedures	
2	Recent Ardaman Test Boring Logs	
3	Historic Test Boring Logs - Non-Ardaman	
4	Historic Test Boring Logs - Ardaman	

### LIST OF TABLES

<u>Table</u>	<u>Title</u>
1	Borings Drilled for this Project
2	Index Testing Conducted for this Project
3	Location, Elevations and Depths of Previous Marine Borings
4	Index Testing Data of Previous Marine Borings
5	Location, Elevations and Depths of Previous Landside Borings
6	Index Testing Data of Previous Landside Borings

### LIST OF FIGURES

<u>Figure</u>	<u>Title</u>
1	Location of Field Investigations
2	Boring Location and Recovered Material Plan - 1
3	Boring Location and Recovered Material Plan - 2
4	Boring Location and Recovered Material Plan - 3
5	Boring Location and Recovered Material Plan - 4
6	Boring Location and Recovered Material Plan - 5
7	Boring Location and Recovered Material Plan - 6
8	Boring Location and Recovered Material Plan - 7
9	Soil Profile of West Turning Basin Corner Cut-Off - North West End
10	Soil Profile of West Turning Basin Corner Cut-Off - South East End
11	Soil Profile of West Turning Basin Corner Cut-Off - Bulkhead Wall
12	Soil Profile of Middle Turning Basin Access Channel Dike Relocation
13	Stability Analyses Results for Existing Inner Reach North Side Dike
14	Typical Cross-Section for West End of South Side of the West Turning Basin Channel
15	Typical Cross-Section for East End of South Side of the West Turning Basin Channel
16	Typical Cross-Section for Corner Cut-Off of the West Turning Basin Channel

## 1 INTRODUCTION AND SCOPE OF WORK

### 1.1 Introduction

The Canaveral Port Authority (CPA) is conducting a feasibility study of potential navigation improvements of the existing Federal Navigation Channel, widening the Seaward Turn, Middle and Inner Reach and the West Turning Basin Channel. The location of the prospective improvements is presented in Figure 1. The potential improvements include:

- Dredging the entrance to the Outer Reach of the Federal Navigation Channel to a depth of 44 feet, with a 2-foot allowable overdepth - Cuts 1, 1A and 1B.
- Dredging the Canaveral Pilots Widener Southwest of the Civil Widener at the Seaward Turn to a depth of 41 feet, with a 2-foot allowable overdepth - Cut CPW.
- Widening the Middle Reach of the Federal Navigation Channel by 100 feet to the north to a total width of 500 feet and dredge to a depth of 44 feet, with a 2-foot allowable overdepth - Cut 2.
- Widening the Inner Reach by up to 100 feet to the north to a total width of up to 500 feet and dredge to a depth of 41 feet, with a 2-foot allowable overdepth - Cut 3.
- Widening the West Access Channel by up to 100 feet to the south to a total width of up to 500 feet and dredge to a depth of 41 feet, with a 2-foot allowable overdepth.
- Widening the turning circle in the West Turning Basin to 1,725 feet, including removal of an approximately 400 foot wide section of the existing corner to the North of the entrance and dredging to a depth of 41 feet, with a 2-foot allowable overdepth - Cut WTB.

The objective of this study is to provide geotechnical data and an engineering assessment to enable the CPA to determine the feasibility of the potential navigation improvements from a geotechnical engineering point of view.

### 1.2 Scope

The scope of this study includes collecting, reviewing and summarizing geotechnical information from previous studies within the vicinity of the subject project, conducting landside and marine side field exploration program in locations with limited available geotechnical information, performing laboratory testing for soil classification and performing limited engineering analyses to evaluate the stability of slopes and existing bulkhead walls.

The information provided in this section encompasses the geotechnical field investigations relevant to this project. The investigations consist of borings with the associated boring logs and laboratory data presented in sections 3.2 and 3.3, respectively. A character of materials paragraph is included to provide a comprehensive description of the materials utilizing both recent and historical

knowledge of the project area. Also included in this section are definitions of terms and boring log notes, which provide additional explanation of the boring logs and drilling techniques.

Items discussed in the character of materials paragraph may not appear explicitly on the test boring logs. Based on historic knowledge of the project area, the character of materials paragraph includes items that supplement the data documented by the test boring logs. When reviewing test boring logs, use all data on the logs, including the materials description, legend, and blow counts. When evaluating the subsurface conditions, use all data, including the character of materials paragraph and test boring logs.

Any questions that pertain to the information provided in this section should be addressed to Mr. Mohamad Al-Hawaree, P.E., Ardaman & Associates, Inc. at (407) 855-3860.

## 2 CHARACTER OF MATERIALS

### 2.1 Regional Geology

Canaveral Harbor is located within the barrier islands between the Atlantic Ocean and the Banana River, in central Brevard County, in the Coastal Lowlands physiographic unit. The regional geology of Brevard County for the Quaternary and upper Tertiary Systems range in age from Recent to Pleistocene to Miocene Age sediments. The Recent to Pleistocene Age sediments are undifferentiated and cover the entire county and consist of unconsolidated quartz sands with beds of sandy coquina. These sediments occur at land surface and range in thickness from 20 feet in the St. Johns River valley to over 100 feet in the coastal ridge area. These deposits lie conformably with the sediments of the Upper Miocene/Pliocene sediments. The Miocene/Pliocene sediments are comprised of unconsolidated beds of quartz sands, shells, clay, and calcareous clay. These sediments vary in thickness (20-90 feet) throughout the county, and have an overall trend to thicken to the southeast.

The Hawthorn Formation of Miocene Age, lies unconformably below the Upper Miocene/Pliocene sediments that underlie all of Brevard County. The sediments of the Hawthorn Formation are composed of greenish gray, calcareous clay; sandy, phosphatic limestone; black and brown phosphorite; and light green to white phosphatic radiolarian clay. Its formational contact may occur at depths of approximately 50 to 100 feet below land surface and may be as thin as 10 feet in the north and thicken to approximately 220 feet in the south.

### 2.2 Materials Encountered

Historically, areas within Port Canaveral have been dredged several times and dredged material was used to form portions of what is today Port Canaveral. Some of the materials shown on the test boring logs may have been removed by previous dredging. New materials deposited at these locations are expected to be similar to the descriptions in the boring logs. Elevations of the newly deposited material are shown on the channel survey.

A cohesionless layer of clay and silt commonly found in this area is held in suspension at the bottom of the channels and basins. This layer varies in thickness and becomes denser with depth. In

addition, debris is commonly found in the channel and along loading docks, i.e., tires, ropes, cables, cement blocks, boulders, pilings, etc.

The location of the materials and areas of cuts are presented in Figures 1 through 8.

#### 2.2.1 Channel Cuts 1, 1A and 1B - Outer Reach

The materials in Channel Cuts 1, 1A and 1B are shoal deposits that have formed since the areas were last dredged. Historically these shoals have consisted primarily of sandy-silt and clay, with occasional thin layers of silty/clayey fine quartz sands and trace of shell. The deposits are semi-cohesive and have a consistency that ranges from soft to firm and generally have high plasticity.

#### 2.2.2 Channel Cut 2 and Widener - Middle Reach

The materials to be excavated in Cut 2 (up to the Trident Access Channel) and the widener are shoal deposits that have formed since the areas were last dredged. Historically, these shoals have consisted of silt, clay, poorly-graded fine quartz sand, and silty-sand with trace amounts of shell. The deposits are semi-cohesive, have a consistency that ranges from soft to firm and have high plasticity.

#### 2.2.3 Canaveral Pilots Channel Widener

The materials to be excavated for the Canaveral Pilots Widener consist of soft to firm silts and clays with occasional fine poorly-graded quartz sand and silty-sand with trace amounts of shell. The deposits are semi-cohesive and have a consistency that ranges from soft to firm and have a high plasticity. Adjacent dredging for the Civil Works Widener may have removed some material shown in the test boring logs.

#### 2.2.4 Channel Cut 3, Middle Turning Basin Channel and West Access Channel

The materials within Cut 3, the Middle Turning Basin Channel and the West Access Channel (WAC) consist primarily of soft to firm silts, clays, and fine to medium poorly-graded silty-quartz sands. The WAC has higher percentages of silt and sand than Cut 3. The sand, randomly dispersed in both channels, can be found in the form of thin layers, or mixed with silt and clays. In the WAC, the floor of the channel is occasionally lined with a sandstone layer. Gravel and cobbles may be found in this area. The dike material on the north side of Cut 3 consists of fine to medium poorly-graded quartz sands. Additional material that forms the foundation of the dike consists of dredged soft to firm silty sands, dense medium poorly-graded quartz sands, soft clay, soft sandy clays and natural firm silty sands, all with trace amounts of shell.

#### 2.2.5 West Turning Basin Channel

The materials within the West Turning Basin Channel consist primarily of soft to firm silts, fine to medium poorly-graded silty quartz sands, occasional soft thin clay layers, and a trace of shell. The bottom of the excavated basin may have minor amounts of gravel-to-cobble sized rock fragments that were left from past dredging events. The materials behind the existing seawall in the southeast

corner of the West Turning Basin that are to be removed consist of soft to firm silty sands, clayey sands, sandy clays, fine poorly-graded quartz sand, soft clay layers and trace amounts of shell.

### 3 FIELD AND LABORATORY TESTING PROGRAM

#### 3.1 Definitions

Terms commonly used in the boring logs shall be defined as:

Banded - Rock from 0.02 to 0.1-foot thick.

Carbonate - Soil component that reacts with HCl of an indeterminate origin (shell, rock, etc.).

Cavity - Voids greater than the diameter of the core.

Decomposed - Applicable to saprolitic rock; rock is essentially reduced to a soil with a relic rock texture; can be molded or crumbled by hand.

Dense - Equivalent to SPT N-value of 30 to 50.

Fill - Material that has been placed by man, described with all soil characteristics.

Firm - Thumb will indent soil about 1/4 inch (6 mm).

Hard - Soil that can be indented with difficulty by thumbnail or rock that is difficult to scratch with knife (cannot be pitted with a geology hammer but can be chipped with moderate blows of the hammer).

Highly Weathered - Entire rock section is discolored; alteration is greater than 50%; some areas of slightly weathered rock are present; some minerals are leached away; retains only a fraction of its original strength (wet strength usually lower than dry strength).

Incompetent - Rock that disintegrates while coring; weak.

Indurated - Rock or soil hardened or consolidated by pressure or cementation. Very difficult to break by hand.

Layer - Rock or soil with thickness of 6 inches or less.

Laminated - Alternating layers of varying material or color with layers less than 6 mm thick.

Lens - A geologic deposit of variable thickness, which disappears laterally in all directions and cannot be correlated to adjacent borings.

Massive Bedded - Rock over 3-foot thick.

Moderately Hard - Rock that can be scratched easily with a knife; cannot be scratched with fingernail (can be pitted with moderate blows of geology hammer).

Moderately Weathered - Discoloration is evident; rock surface is pitted and altered, with alterations penetrating well below rock surfaces; 10% to 50% of the rock is altered; strength is noticeably less than unweathered rock.

Pitted - Rock with voids 0.03 (1 mm) to 0.02-foot (6 mm) diameter.

Poorly-Indurated - See semi-indurated.

Rock - A naturally occurring substance composed of one or more minerals bound together. This geologic term includes a range of engineering properties: strength, hardness, permeability, weathering, and discontinuity. These properties are noted or can be inferred from the boring logs as blow counts, penetration rate, RQD, hardness, etc.

Seam - Rock or soil with average thickness of 2 to 3 inches.

Semi-Indurated - Rock or soil with a lesser degree of hardening or consolidation by pressure or cementation. Crumbles with little effort by hand.

Shell - Material composed of predominantly (>75%) coarse-grained sand to gravel-sized whole or broken shell.

Slightly Weathered - Rock with superficial discoloration, alteration and/or discoloration along discontinuities; less than 10% of the rock volume is altered; strength is essentially unaffected.

Soft - Thumb will penetrate soil about 1 inch (25 mm).

Thick Bedded - Rock from 1 to 3-foot thick.

Thin Bedded - Rock from 0.1 to 0.3-foot thick.

Unweathered - Rock with no evidence of any mechanical or chemical alteration.

Very Hard - Rock that cannot be scratched with a knife (chips can be broken off only with heavy blows of the geology hammer).

Vuggy - Rock with voids 0.02 foot (6 mm) to the diameter of the core.

### 3.2 Boring Log Notes

Borings TH-1 through TH-8 were driven using the Standard Penetration Test (SPT) procedure with a 140 lb. hammer with a 30-inch drop using a 2.0-foot split spoon (1 3/8-inch I.D. and 2-inch O.D.) until refusal was encountered. Refusal is defined as a total of 50 blows of the hammer within any 6-inch increment, a total of 100 blows of the hammer within any 1-foot increment, or no observed advance of the sampler after 10 successive blows of the hammer. When refusal was encountered, the borings were continued with a 4-inch x 5 1/2-inch diameter core barrel until the rate of penetration indicated softer material, at which point the SPT procedure was resumed. The procedures for conducting SPT borings and obtaining samples are presented in Appendix 1.

### 3.3 Summary of Field Investigations

The table below summarizes the field investigation conducted for this project. The individual SPT Boring Logs are presented in Appendix 2. The locations of these borings are presented in Figures 3 and 4.

Table 1. Borings Drilled for this Project

Boring Reference No.	Boring Name	Boring Performed By:	State Plane NAD 83		Surface Elevation (feet, MLLW)	Total Depth (feet)	End of Boring Elevation (feet, MLLW)	Location	Date of Boring
			Easting	Northing					
1524	TH-1	AAI	793859	1480514	-32	21	-53	CPW	Sep-06
1525	TH-2	AAI	791859	1482208	-26	24	-50	CUT 2	Sep-06
1526	TH-3	AAI	788494	1482165	-25.5	25.5	-51	CUT 2	Sep-06
1527	TH-4	AAI	792886	1481002	-31	21	-52	CPW	Sep-06
1528	TH-5	AAI	790820	1482198	-33	18	-51	CUT 2	Sep-06
1529	TH-6	AAI	786895	1482196	-34.2	16.5	-50.7	CUT 3	Sep-06
1530	TH-7	AAI	784870	1482595	20	80	-60	DIKE	Nov-06
1531	TH-8	AAI	786305	1482510	40	100	-60	DIKE	Nov-06

ABBREVIATIONS: AAI Ardaman & Associates, Inc.  
CPW Canaveral Pilots Widener

### 3.4 Summary of Index Testing Data

The table below summarizes the index testing conducted for this project. The laboratory test results are also summarized together with plots of particle size sieve analyses in Appendix 2.

Table 2. Index Testing Conducted for this Project

Boring Reference No.	Boring Name	Stratum Upper Elevation (ft, MLLW)	Stratum Lower Elevation (ft, MLLW)	Soil Description	SPT N-value	Moisture Content (%)	Percent Passing U.S. 200 Sieve (%)	Plasticity Index (%)
1524	TH-1	-32	-41	Clay, fat, medium plasticity, soft, mostly clay, little silt, trace shell, trace fine-gravel sized shell, moist, stratified, gray (CH).	0	68	68	43
		-41	-48	Clay, fat, high plasticity, soft, mostly clay, trace shell, trace fine gravel-sized shell, moist, gray (CH).	2	58	74	21
1525	TH-2	-26	-34.5	Sand, clayey, medium plasticity, very soft, mostly sand, some clay, little silt, homogeneous, organic odor, gray (SC).	0	66	47	30
		-34.5	-38	Sand, silty, mostly fine-grained sand-sized sand, little silt, stratified, organic odor, gray (SM).	0	57	49	-
		-38	-40	Clay, lean, medium plasticity, soft, mostly clay, little silt, thin layers of fine grained SM, gray (CL).	2	74	91	-
		-40	-50	Clay, fat, high plasticity, soft, mostly clay, homogeneous, gray (CH).	4	73	92	-
1526	TH-3	-25.5	-32	Sand, poorly-graded with silt, mostly subrounded fine to medium-grained sand-sized quartz, trace silt, trace fine to medium-grained sand-sized shell, moist, homogeneous, gray (SP-SM).	24	23	7	-
		-32	-39	Sand, poorly-graded with silt, mostly rounded fine-grained sand-sized quartz, trace silt, moist, stratified, organic odor, dark gray (SP-SM).	10	26	8	-



Table 2. Index Testing Conducted for this Project (continued)

Boring Reference No.	Boring Name	Stratum Upper Elevation (ft, MLLW)	Stratum Lower Elevation (ft, MLLW)	Soil Description	SPT N-value	Moisture Content (%)	Percent Passing U.S. 200 Sieve (%)	Plasticity Index (%)
1526	TH-3	-39	-51	Clay, fat, high plasticity, soft, mostly clay, moist, homogeneous, occasional thin layers of medium and coarse grained SP, gray (CH).	4	78	95	-
1527	TH-4	-31	-40	Clay, lean, medium plasticity, very soft, mostly clay, little silt, trace fine-grained sand-sized sand, trace angular fine-grained sand-sized shell, trace fine gravel-sized shell, homogeneous, organic odor, gray (CL).	0	68	64	-
		-40	-52	Clay, fat, high plasticity, very soft, mostly clay, homogeneous, organic odor, gray (CH).	0	104	94	68
1528	TH-5	-33	-41	Sand, silty, mostly fine-grained sand-sized sand, little silt, trace shell, stratified, organic odor, gray (SM).	0	48	21	-
		-41	-44	Clay, fat, high plasticity, very soft, mostly clay, homogeneous, organic odor, gray (CH).	0	100	59	-
		-44	-47	Sand, silty, mostly fine-grained sand-sized quartz, little silt, trace shell, stratified, organic odor, gray (SM).	0	67	53	-
1529	TH-6	-34.2	-40.7	Sand, silty, mostly rounded fine-grained sand-sized quartz, little silt, trace shell, moist, homogeneous, organic odor, gray (SM).	5	32	14	-
		-40.7	-50.7	Clay, fat, high plasticity, soft, mostly clay, homogeneous, occasional thin layers of fine-grained SP, gray (CH).	5	60	90	53

Table 2. Index Testing Conducted for this Project (continued)

Boring Reference No.	Boring Name	Stratum Upper Elevation (ft. MLLW)	Stratum Lower Elevation (ft. MLLW)	Soil Description	SPT N-value	Moisture Content (%)	Percent Passing U.S. 200 Sieve (%)	Plasticity Index (%)
1530	TH-7	20	15	Sand, poorly-graded, mostly rounded fine-grained sand-sized quartz, trace silt, dry, homogeneous, brown (SP).	23	28	-	-
		15	4	Sand, poorly-graded with silt, mostly rounded fine-grained sand-sized quartz, trace silt, wet, homogeneous, gray (SP-SM).	7	33	26	-
		4	3.5	Clay, fat, high plasticity, very soft, mostly clay, moist, homogeneous, gray (CH).	5	41	44	-
		3.5	-2	Sand, poorly-graded with silt, mostly subangular fine to coarse-grained sand-sized quartz, trace silt, trace shell, moist, homogeneous, gray (SP-SM).	12	29	-	-
		-2	-36	Sand, poorly-graded, mostly subangular fine to coarse-grained sand-sized, quartz, little shell, trace silt, trace fine gravel-sized shell, moist, homogeneous, brown (SP).	73	20	-	-
		-36	-54	Clay, fat, high plasticity, soft, mostly clay, moist, homogeneous, gray (CH).	9	68	93	61
		-54	-58	Sand, clayey, low plasticity, soft, mostly rounded fine-grained sand-sized quartz, little clay, moist, homogeneous, gray (SC).	13	30	52	-
		-58	-60	Clay, fat, high plasticity, soft, mostly clay, moist, homogeneous, gray (CH).	13	33	-	67
1531	TH-8	40	26	Sand, poorly-graded, mostly subrounded fine to medium-grained sand-sized quartz, trace silt, dry, homogeneous, brown (SP).	26	9	-	-
		26	22	Sand, poorly-graded, mostly subrounded fine to medium-grained sand-sized quartz, trace silt, moist, homogeneous, brown (SP-SM).	18	19	7	-

Table 2. Index Testing Conducted for this Project (continued)

Boring Reference No.	Boring Name	Stratum Upper Elevation (ft, MLLW)	Stratum Lower Elevation (ft, MLLW)	Soil Description	SPT N-value	Moisture Content (%)	Percent Passing U.S. 200 Sieve (%)	Plasticity Index (%)
1531	TH-8	22	14	Sand, poorly-graded, mostly subrounded fine to medium-grained sand-sized quartz, trace silt, trace shell, trace fine gravel-sized shell, moist, homogeneous, brown (SP).	67	15	8	-
		14	12	Sand, poorly-graded with silt, mostly rounded fine-grained sand-sized quartz, trace silt, trace shell, moist, homogeneous, brown (SP-SM).	97	18	9	-
		12	6	Sand, poorly-graded with silt, mostly subangular fine to coarse-grained sand-sized shell, trace silt, trace gravel-sized shell, moist, homogeneous, brown (SP).	39	17	-	-
		6	-2	Sand, poorly-graded with silt, mostly rounded fine-grained sand-sized quartz, trace silt, moist, homogeneous, gray (SP-SM).	50	24	-	-
		-2	-6	Sand, poorly-graded, mostly subrounded fine to medium-grained sand-sized quartz, trace silt, trace shell, trace phosphate, moist, homogeneous, gray (SP).	78	21	-	-
		-6	-8	Sand, silty, poorly-graded, mostly subrounded fine to medium-grained sand-sized quartz, little silt, trace shell, moist, homogeneous, brown (SM).	-	13	19	-
		-8	-16	Sand, poorly-graded with silt, mostly rounded fine-grained sand-sized quartz, trace silt, trace shell, moist, homogeneous, gray (SP-SM).	91	21	11	-
		-16	-54	Sand, poorly-graded, mostly rounded fine-grained sand-sized quartz, trace shell, trace phosphate, moist, homogeneous, gray (SP).	68	20	-	-
		-54	-60	Sand, silty, mostly rounded fine-grained sand-sized quartz, little silt, trace clay, moist, homogeneous, brown (SM).	29	28	-	-

## 3.5 Recovered Materials

The material recovered from borings TH-1 through TH-8 were transported to the Ardaman & Associates Corporate Laboratory for inspection and additional index testing was carried out.

## 3.6 Summary of Past Marine Boring Programs

A total of 265 marine side borings have been conducted by Ardaman & Associates, Inc., United States Army Corps of Engineers, United States Army Engineering Division, Universal Engineering Testing Company, Pittsburgh Testing Laboratory, Law Engineering Testing Company and Warren George, Inc.. The tables below summarize the past field investigations conducted for similar dredging projects. The individual test boring logs are presented in Appendices 3 and 4. The locations of these boring are presented in Figures 2 through 8.

Table 3. Locations, Elevations and Depths of Previous Marine Borings

Boring Reference No.	Boring Name	Boring Performed By:	State Plane NAD 83		Surface Elevation (feet, MLLW)	Total Depth (feet)	End of Boring Elevation (feet, MLLW)	Date of Boring
			Easting	Northing				
5	CB-NLS-7	USACE	776785	1482195	-2	33	-35	Jan-59
21	CH-8-C	USACE	777721	1481768	0.8	98	-97.2	-
22	CH-7-C	USACE	777722	1481646	0.6	98	-97.4	-
23	CH-10-C	USACE	777951	1481703	0.4	96	-95.6	-
24	CH-1-C	USACE	778187	1481768	0.1	94.7	-94.6	-
25	CH-2-C	USACE	778185	1481654	0.1	89.6	-89.5	-
26	P-1	PTL	778512	1482373	-	101	-	Nov-56
28	P-3	PTL	777516	1482426	-	101	-	Dec-56
30	B-3	LAW	782002	1481578	-	106	-	-
31	B-4	LAW	782305	1481584	-	110	-	-
32	B-5	LAW	782440	1481570	-	110	-	-
33	CN-1	USACE	783652	1482599	12.9	95	-82.1	Apr-56
39	CN-7	USACE	783404	1482191	-26.5	35.5	-62	Apr-56
40	CN-8	USACE	783227	1482328	-27.3	53.3	-80.6	Apr-56
49	H-3	USACE	786757	1481680	-25.8	5	-30.8	Dec-55
50	H-4	USACE	782240	1482313	-24.5	8	-32.5	Dec-55
51	H-5	USACE	781889	1481829	-25.4	7.5	-32.9	Nov-55
52	CH-18	USACE	783953	1481915	12.7	47	-34.3	Mar-51
53	CH-19	USACE	785371	1481783	12	47	-35	Mar-51
54	CH-20	USACE	786983	1481789	12	47	-35	Mar-51
56	CHE-1	USACE	781197	1481787	-36.9	4.5	-41.4	Nov-71
57	CHE-2	USACE	780195	1482131	5	45	-40	Dec-71
58	CHE-3	USACE	779197	1481776	-22.8	18	-40.8	Nov-71
59	CHE-4	USACE	778195	1482071	6.6	46.5	-39.9	Dec-71
60	CHE-5	USACE	777197	1481765	-13.2	27	-40.2	Nov-71
62	CHE-7	USACE	777192	1482665	-18.5	22.5	-41	Nov-71

Table 3. Locations, Elevations and Depths of Previous Marine Borings (continued)

Boring Reference No.	Boring Name	Boring Performed By:	State Plane NAD 83		Surface Elevation (feet, MLLW)	Total Depth (feet)	End of Boring Elevation (feet, MLLW)	Date of Boring
			Eastings	Northing				
64	CHE-9	USACE	776689	1483162	-16	24	-40	Dec-71
72	1-N	UNI	777728	1482498	-	100	-	-
145	TB-7	UNI	784897	1481389	10	130	-120	Aug-76
146	TB-8	UNI	784774	1481392	10	130	-120	Aug-76
147	TB-9	UNI	784578	1481391	10	130	-120	Aug-76
152	CB-W-5	WGI	776734	1482861	-	40	-	Mar-82
157	CB-E-10	WGI	778407	1482372	-	82	-	Mar-82
192	ER-3	USACE	777096	1483107	-25.5	12	-37.5	Apr-82
193	ER-4	USACE	777102	1482507	-18	6	-24	Apr-82
194	ER-5	USACE	778231	1481730	-15	5	-20	Apr-82
195	ER-6	USACE	779348	1481982	-35.5	6	-41.5	Apr-82
203	CHM84-8	USACE	777162	1483334	-22.6	20	-42.6	Apr-84
206	CHM84-11	USACE	776650	1482953	-21.9	20	-41.9	Apr-84
207	CHM84-12	USACE	777180	1482911	-23	20	-43	Apr-84
208	CHM84-13	USACE	776816	1482590	-23.5	20	-43.5	Apr-84
209	CHM84-14	USACE	777321	1482593	-22.4	20	-42.4	Apr-84
210	CHM84-15	USACE	777181	1482274	-13.1	30	-43.1	Apr-84
211	CHM84-16	USACE	777519	1482102	-16	24.2	-40.2	Apr-84
212	CHM84-17	USACE	778062	1481744	-18.3	24	-42.3	Apr-84
213	CHM84-18	USACE	778647	1481744	-20.7	22	-42.7	Apr-84
214	CHM84-19	USACE	779012	1481954	-23.7	20	-43.7	Apr-84
215	CHM84-20	USACE	779337	1481744	-17.8	25	-42.8	Apr-84
216	CHM84-21	USACE	779837	1481744	-27.1	15	-42.1	Apr-84
217	CHM84-22	USACE	780367	1481744	-21.5	20	-41.5	Apr-84
218	CHM84-23	USACE	780867	1481744	-22.8	20	-42.8	Apr-84
219	CHM84-24	USACE	778747	1481949	-16.5	25.5	-42	Mar-84
220	CHM84-25	USACE	778602	1481954	-16	26	-42	Mar-84
221	CHM84-26	USACE	778372	1482074	9.7	48	-38.3	Mar-84
222	CHM84-27	USACE	777992	1481990	5	46.5	-41.5	Apr-84
223	CHM84-28	USACE	777732	1481909	-4.5	37.5	-42	Apr-84
224	CHM84-29	USACE	776997	1482009	-14.1	28.5	-42.6	Apr-84
225	CHM84-30	USACE	776697	1481884	-12.8	30	-42.8	Apr-84
226	CHM84-31	USACE	776667	1482164	-5	37.5	-42.5	Apr-84
230	CHM84-35	USACE	787007	1481754	-31	10	-41	Jul-84
231	CHM84-36	USACE	786347	1481744	-33.5	10	-43.5	Jul-84
232	CHM84-37	USACE	786107	1481764	-31	10	-41	Jul-84
233	CHM84-38	USACE	785602	1481759	-30.8	10	-40.8	Jul-84
234	CHM84-39	USACE	790132	1482024	-38.5	10	-48.5	Jul-84
235	CHM84-40	USACE	789107	1481724	-40	10	-50	Jul-84

Table 3. Locations, Elevations and Depths of Previous Marine Borings (continued)

Boring Reference No.	Boring Name	Boring Performed By:	State Plane NAD 83		Surface Elevation (feet, MLLW)	Total Depth (feet)	End of Boring Elevation (feet, MLLW)	Date of Boring
			Easting	Northing				
236	CB-CH87-1	USACE	777557	1481993	-22.5	15.6	-38.1	Feb-87
237	CB-CH87-2	USACE	777453	1481977	-25.5	13.1	-38.6	Feb-87
238	CB-CH87-3	USACE	777404	1481922	-25.4	13	-38.4	Feb-87
239	CB-CH87-4	USACE	777468	1481898	-26.5	12	-38.5	Feb-87
240	CB-CH88-1	USACE	786799	1482049	-22.3	25	-47.3	Aug-88
241	CB-CH88-2	USACE	786279	1481690	-41.7	7	-48.7	Aug-88
242	CB-CH88-3	USACE	784785	1482029	-35.5	10.8	-46.3	Aug-88
243	CB-CH88-4	USACE	783791	1481768	-40.9	5	-45.9	Aug-88
244	CB-CH88-5	USACE	782944	1481680	-38.1	10	-48.1	Aug-88
245	CB-CH88-6	USACE	781962	1481834	-40.6	6	-46.6	Aug-88
246	CB-CH88-7	USACE	782472	1482392	-38.4	10	-48.4	Sep-88
248	CB-CH88-9	USACE	781479	1482374	-37.1	11	-48.1	Sep-88
249	CB-CH88-10	USACE	780614	1482167	-39.1	6	-45.1	Sep-88
250	CB-CH88-11	USACE	779645	1481779	-35.4	11	-46.4	Sep-88
251	CB-CH88-12	USACE	778652	1482117	-23.4	22	-45.4	Sep-88
252	CB-CH88-13	USACE	777732	1481867	-39.4	6	-45.4	Sep-88
253	CB-CH89-1	USACE	812033	1466107	-45.1	7	-52.1	Feb-89
254	CB-CH89-2	USACE	811778	1467242	-44.3	10	-54.3	Feb-89
255	CB-CH89-3	USACE	810747	1466903	-45.6	10	-55.6	Feb-89
256	CB-CH89-4	USACE	809784	1467374	-43.9	7.5	-51.4	Mar-89
257	CB-CH89-5	USACE	810257	1467969	-43.4	10	-53.4	Mar-89
258	CB-CH89-6	USACE	809264	1468304	-45.4	10	-55.4	Feb-89
259	CB-CH89-7	USACE	808226	1468667	-43.6	10	-53.6	Feb-89
260	CB-CH89-8	USACE	808742	1469247	-42.5	10	-52.5	Feb-89
261	CB-CH89-9	USACE	807675	1469603	-45.3	8	-53.3	Feb-89
262	CB-CH89-10	USACE	806673	1469933	-42.3	10	-52.3	Feb-89
263	CB-CH89-11	USACE	807150	1470554	-41.8	10	-51.8	Feb-89
264	CB-CH89-12	USACE	806164	1470891	-45.7	8	-53.7	Feb-89
265	CB-CH89-13	USACE	805162	1471208	-42.2	10	-52.2	Feb-89
266	CB-CH89-14	USACE	805655	1471808	-42.6	10	-52.6	Feb-89
267	CB-CH89-15	USACE	804655	1472134	-45.2	11	-56.2	Feb-89
268	CB-CH89-16	USACE	804128	1473072	-41.8	11.4	-53.2	Feb-89
269	CB-CH89-17	USACE	803620	1472453	-42	10	-52	Feb-89
270	CB-CH89-18	USACE	803109	1473383	-45.1	7	-52.1	Feb-89
271	CB-CH89-19	USACE	802096	1473711	-40.1	11.6	-51.7	Feb-89
272	CB-CH89-20	USACE	802618	1474573	-46.1	10.5	-56.6	Feb-89
273	CB-CH89-21	USACE	801622	1474632	-48.2	5.2	-53.4	Feb-89
274	CB-CH89-22	USACE	801084	1475585	-39.8	13.4	-53.2	Feb-89
275	CB-CH89-23	USACE	800594	1474947	-40.9	12.4	-53.3	Feb-89
276	CB-CH89-24	USACE	800105	1475934	-47.3	5	-52.3	Feb-89
277	CB-CH89-25	USACE	799115	1476269	-39.5	13	-52.5	Feb-89

Table 3. Locations, Elevations and Depths of Previous Marine Borings (continued)

Boring Reference No.	Boring Name	Boring Performed By:	State Plane NAD 83		Surface Elevation (feet, MLLW)	Total Depth (feet)	End of Boring Elevation (feet, MLLW)	Date of Boring
			Easting	Northing				
278	CB-CH89-26	USACE	799561	1476852	-38.9	13	-51.9	Feb-89
279	CB-CH89-27	USACE	798573	1477174	-46.7	6	-52.7	Feb-89
280	CB-CH89-28	USACE	798065	1478120	-38.8	12.5	-51.3	Feb-89
281	CB-CH89-29	USACE	797558	1477496	-36.5	17	-53.5	Feb-89
282	CB-CH89-30	USACE	797037	1478522	-46.4	9.3	-55.7	Jan-89
283	CB-CH89-31	USACE	796033	1478789	-34.9	19	-53.9	Jan-89
284	CB-CH89-32	USACE	796523	1479349	-38.1	16	-54.1	Jan-89
285	CB-CH89-33	USACE	795520	1479667	-46.4	6.2	-52.6	Feb-89
286	CB-CH89-34	USACE	794542	1480012	-32	19.5	-51.5	Feb-89
287	CB-CH89-35	USACE	795049	1480607	-34.4	19.5	-53.9	Feb-89
288	CB-CH89-36	USACE	794026	1480932	-47.7	10	-57.7	Jan-89
289	CB-CH89-37	USACE	793193	1481563	-47.7	9.6	-57.3	Feb-89
290	CB-CH89-38	USACE	792435	1481919	-47.2	11.5	-58.7	Feb-89
291	CB-CH89-39	USACE	790431	1481908	-46.1	7.8	-53.9	Feb-89
292	CB-CH89-40	USACE	790287	1481889	-46.5	10	-56.5	Feb-89
293	CB-CH89-41	USACE	789316	1481894	-46.6	10.2	-56.8	Feb-89
294	CB-CH89-42	USACE	788344	1481864	-49.5	10.3	-59.8	Feb-89
295	CB-CH89-43	USACE	787306	1481864	-40.6	15	-55.6	Feb-89
296	CB-CH89-44	USACE	786316	1481864	-39.1	8.7	-47.8	Feb-89
297	CB-CH89-45	USACE	785308	1481874	-40.3	6.5	-46.8	Feb-89
298	CB-CH89-46	USACE	784333	1481874	-40.8	4.5	-45.3	Feb-89
299	CB-CH89-47	USACE	783331	1481844	-41.9	5	-46.9	Feb-89
300	CB-CH89-48	USACE	782323	1481789	-39.8	4.7	-44.5	Feb-89
301	CB-CH89-49	USACE	781303	1481844	-37.3	7.3	-44.6	Feb-89
304	CB-CH89-52	USACE	781511	1482456	-35	11	-46	Feb-89
305	CB-CH89-53	USACE	780247	1481964	-35.7	11	-46.7	Feb-89
306	CB-CH89-54	USACE	779245	1481926	-36.2	11.5	-47.7	Feb-89
307	CB-CH89-55	USACE	778252	1481905	-37	10	-47	Feb-89
313	CB-CH91-6	USACE	781493	1481754	-31.4	20	-51.4	May-91
314	CB-CH91-7	USACE	782055	1483250	-31.1	20	-51.1	May-91
315	CB-CH91-8	USACE	783836	1481988	-32.6	20	-52.6	May-91
316	CB-CH91-9	USACE	784454	1481989	-31.6	20	-51.6	May-91
317	CB-CH91-10	USACE	785947	1481727	-35.6	20.4	-56	May-91
318	CB-CH91-11	USACE	787031	1481736	-29	23	-52	May-91
319	CB-CH91-12	USACE	787953	1482339	-34.8	20	-54.8	May-91
321	CB-CH92-1	USACE	786434	1482105	-11	33	-44	Feb-92
322	CB-CH92-1A	USACE	787178	1481587	-15	30	-45	Feb-92
323	CB-CH92-2	USACE	785827	1482021	-34	11	-45	Jan-92
324	CB-CH92-3	USACE	785431	1482136	-13.2	31.5	-44.7	Mar-92
325	CB-CH92-4	USACE	785338	1481726	-43.4	5	-48.4	Jan-92
326	CB-CH92-5	USACE	784855	1481760	-42.4	5	-47.4	Jan-92

Table 3. Locations, Elevations and Depths of Previous Marine Borings (continued)

Boring Reference No.	Boring Name	Boring Performed By:	State Plane NAD 83		Surface Elevation (feet, MLLW)	Total Depth (feet)	End of Boring Elevation (feet, MLLW)	Date of Boring
			Eastings	Northing				
327	CB-CH92-6	USACE	784621	1481968	-22.5	21	-43.5	Feb-92
328	CB-CH92-7	USACE	784370	1481741	-42.6	5	-47.6	Jan-92
329	CB-CH92-8	USACE	783543	1481731	-38.7	10	-48.7	Feb-92
330	CB-CH92-9	USACE	783740	1482147	-15	30	-45	Mar-92
331	CB-CH92-10	USACE	783131	1482321	-35.8	10	-45.8	Feb-92
332	CB-CH92-11	USACE	782728	1482133	-39.9	5	-44.9	Jan-92
333	CB-CH92-12	USACE	781966	1481681	-37.7	10	-47.7	Feb-92
337	CB-CH92-16	USACE	780803	1481557	-13.5	31.5	-45	Mar-92
338	CB-CH92-17	USACE	780813	1481893	-35.7	9	-44.7	Feb-92
339	CB-CH92-18	USACE	780280	1481615	-14.7	30	-44.7	Mar-92
340	CB-CH92-19	USACE	779777	1481616	-12	35	-47	Mar-92
341	CB-CH92-20	USACE	779970	1481943	-37.4	7.5	-44.9	Feb-92
342	CB-CH92-21	USACE	779252	1481620	-13	32	-45	Mar-92
343	CB-CH92-22	USACE	778743	1481614	-14.5	30	-44.5	Mar-92
344	CB-CH92-23	USACE	778760	1481744	-34.4	10	-44.4	Mar-92
345	CB-CH92-24	USACE	778232	1481632	-21	21	-42	Feb-92
346	CB-CH92-25	USACE	777571	1481495	-14.3	31.5	-45.8	Mar-92
347	CB-CH-M2	USACE	792643	1482081	-43	9	-52	Nov-82
348	CB-CH-M3	USACE	791811	1481736	-44	9	-53	Nov-82
349	CB-CH-M4	USACE	791011	1481691	-43	8	-51	Nov-82
350	CB-CH-M5	USACE	790197	1481664	-38	11	-49	Nov-82
351	CB-CH-M9	USACE	789497	1482030	-41.5	10	-51.5	Nov-82
352	CB-CH-M10	USACE	789128	1481875	-41.5	10	-51.5	Nov-82
353	CB-CH-M11	USACE	788875	1481685	-29	20	-49	Nov-82
354	CB-CH-M12	USACE	788840	1482070	-35.5	18	-53.5	Nov-82
355	CB-CH-M13	USACE	788245	1482119	-30.5	20	-50.5	Nov-82
356	CB-CH-M14	USACE	787764	1482295	-40	11	-51	Nov-82
358	CB-CH-FY83-	USACE	790910	1482073	-43	11	-54	Nov-82
359	CB-CH-FY83-	USACE	790454	1482098	-40.5	12	-52.5	Nov-82
360	CB-CH-FY83-	USACE	790047	1482074	-23.5	25	-48.5	Nov-82
361	CB-CH-M1	USACE	792933	1481998	-44	8	-52	Nov-82
366	CB-CH01-01	USAED	785210	1481885	-44.4	8.3	-52.7	Jul-01
367	CB-CH01-02	USAED	786203	1482061	-38.3	3.8	-42.1	Jul-01
368	CB-CH01-03B	USAED	786207	1481887	-42.6	9.9	-52.5	Jul-01
369	CB-CH01-04	USAED	786219	1481675	-43.3	5.4	-48.7	Jul-01
370	CB-CH01-05	USAED	787223	1482086	-42.4	4.3	-46.7	Jul-01
371	CB-CH01-06	USAED	787209	1481879	-47	4.1	-51.1	Jul-01
372	CB-CH01-07	USAED	787223	1481673	-45.8	4.2	-50	Jul-01
373	CB-CH01-08	USAED	788211	1482094	-46.6	8.5	-55.1	Jul-01
374	CB-CH01-09	USAED	788213	1481879	-46.8	6	-52.8	Jul-01
375	CB-CH01-10	USAED	788207	1481680	-45.1	5.7	-50.8	Jul-01



Table 3. Locations, Elevations and Depths of Previous Marine Borings (continued)

Boring Reference No.	Boring Name	Boring Performed By:	State Plane NAD 83		Surface Elevation (feet, MLLW)	Total Depth (feet)	End of Boring Elevation (feet, MLLW)	Date of Boring
			Easting	Northing				
376	CB-CH01-11	USAED	789214	1482079	-49	6.1	-55.1	Jul-01
377	CB-CH01-12	USAED	789212	1481865	-49.5	7.1	-56.6	Jul-01
378	CB-CH01-13	USAED	789229	1481683	-48.7	7.9	-56.6	Jul-01
379	CB-CH01-14	USAED	790206	1482071	-46.3	5.5	-51.8	Jul-01
380	CB-CH01-15	USAED	790214	1481878	-46.7	6.3	-53	Jul-01
381	CB-CH01-16	USAED	790280	1481614	-41.1	7.1	-48.2	Jul-01
382	CB-CH01-17	USAED	791271	1482060	-44.6	5.3	-49.9	Jul-01
383	CB-CH01-18	USAED	791212	1481880	-41.1	11.8	-52.9	Jul-01
384	CB-CH01-19	USAED	791242	1481601	-41.8	9.8	-51.6	Jul-01
385	CB-CH01-20	USAED	792947	1482063	-43.8	12.3	-56.1	Jul-01
386	CB-CH01-21	USAED	792792	1481769	-44.9	11	-55.9	Jul-01
387	CB-CH01-22	USAED	792706	1481537	-43.5	12.7	-56.2	Jul-01
388	CB-CH01-23	USAED	793895	1481245	-43.9	9	-52.9	Jul-01
389	CB-CH01-24A	USAED	793783	1481146	-44.9	9.3	-54.2	Jul-01
390	CB-CH01-25B	USAED	793649	1481015	-43.8	10.4	-54.2	Jul-01
391	CB-CH01-26C	USAED	794643	1480453	-44.1	4.4	-48.5	Jul-01
397	PC-1E	AAI	785522	1481462	10	83	-73	Jul-84
398	TH-1E	AAI	785566	1481422	11	111	-100	Jul-84
399	TH-4A	AAI	785825	1481373	10	90	-80	Jul-84
400	TH-4B	AAI	786322	1481446	8	90	-82	Jul-84
414	TH-20	AAI	778349	1481549	10	80	-70	Jul-84
415	TH-21	AAI	777931	1482291	5	41	-36	Jul-84
416	TH-22	AAI	778381	1482169	8	46	-38	Jul-84
421	TH-30	AAI	776922	1481800	-7	27	-34	Jul-84
448	PC-10	AAI	777699	1482369	9	93	-84	Jul-84
457	PC-19	AAI	778264	1482362	12	86	-74	Jul-84
458	PC-20	AAI	778266	1481943	8	92	-84	Jul-84
639	TH-37	AAI	777328	1482466	-14.9	22	-36.9	Aug-85
640	TH-38	AAI	777464	1482247	-16.8	14	-30.8	Aug-85
641	TH-39	AAI	777295	1482091	-18	20	-38	Aug-85
642	TH-40	AAI	777332	1481756	-13.6	22	-35.6	Aug-85
643	TH-41	AAI	776825	1482073	-24.7	16	-40.7	Aug-85
644	TH-42	AAI	776697	1481752	-12.8	26	-38.8	Aug-85
652	TH-50	AAI	777500	1482967	-23.5	9	-32.5	Aug-85
677	TH-70	AAI	777722	1482598	8.6	91	-82.4	Aug-85
743	THR-1	AAI	786929	1481576	-2.9	34	-36.9	Apr-86
744	THR-2	AAI	787304	1481523	1.4	36.2	-34.8	Apr-86
751	THW-1	AAI	777807	1482389	8.9	96	-87.1	Apr-86
752	THW-2	AAI	778047	1482371	9	76	-67	Apr-86
753	THW-3	AAI	778318	1482370	14.1	96	-81.9	Apr-86
756	THW-6	AAI	777929	1482447	9.8	21	-11.2	Apr-86
757	THW-7	AAI	778146	1482426	10	21	-11	Apr-86
848	TH-1H	AAI	777601	1482747	-18	115	-133	Jul-88

Table 3. Locations, Elevations and Depths of Previous Marine Borings (continued)

Boring Reference No.	Boring Name	Boring Performed By:	State Plane NAD 83		Surface Elevation (feet, MLLW)	Total Depth (feet)	End of Boring Elevation (feet, MLLW)	Date of Boring
			Easting	Northing				
849	TH-2H	AAI	777599	1483247	-19.8	116	-135.8	Jul-88
903	B-1	AAI	780339	1481563	-12	24.5	-36.5	Sep-89
938	TH-1	AAI	781218	1481537	-42.5	61.5	-104	Sep-89
939	TH-2	AAI	781713	1481540	-27.5	88.5	-116	Sep-89
978	TH-13	AAI	781959	1481469	8.7	76	-67.3	May-90
982	TH-3	AAI	783923	1481572	-18	79.9	-97.9	Jul-90
983	TH-4	AAI	784116	1481573	-20.7	75.3	-96	Jul-90
1012	TH-16	AAI	777771	1482768	8	112	-104	Jun-92
1013	THW-8	AAI	777731	1482728	8.1	45	-36.9	Jun-92
1014	THW-9	AAI	777891	1482729	10	45	-35	Jun-92
1015	THW-10	AAI	777732	1482563	7.5	45	-37.5	Jun-92
1016	THW-11	AAI	777892	1482564	10.7	45	-34.3	May-92
1017	THW-12	AAI	778052	1482565	10.1	45	-34.9	May-92
1018	THW-13	AAI	777733	1482398	7.6	45	-37.4	May-92
1019	THW-14	AAI	777893	1482399	8.8	45	-36.2	May-92
1020	THW-15	AAI	778053	1482400	8.8	45	-36.2	May-92
1021	THW-16	AAI	778213	1482401	9.5	45	-35.5	May-92
1022	THW-17	AAI	778373	1482401	13.3	45	-31.7	May-92
1040	TH-N	AAI	777803	1482518	8.5	31	-22.5	Sep-91
1041	TH-O	AAI	778303	1482521	11.2	31	-19.8	Sep-91
1051	ND-1	AAI	783706	1482241	15.8	111	-95.2	Apr-92
1052	CD-1	AAI	783882	1482231	17.2	91	-73.8	Apr-92
1053	BT-1	AAI	784043	1482259	12.4	111	-98.6	Apr-92
1096	TH-4D	AAI	786510	1481501	8.8	51	-42.2	Feb-93
1204	SJW-1	AAI	788609	1481337	-6.14	60	-66.14	Aug-95
1205	SJW-2	AAI	788859	1481333	-7.83	60	-67.83	Aug-95
1206	SJW-3	AAI	789110	1481260	-12.43	70	-82.43	Aug-95
1207	TH-1	AAI	789787	1482164	-36	40	-76	Sep-95
1208	TH-1A	AAI	789787	1482264	-7	40	-47	Aug-95
1209	TH-2	AAI	790237	1482284	-14	40	-54	Aug-95
1210	TH-3	AAI	790637	1482284	-17	40	-57	Aug-95
1211	TH-5	AAI	790917	1482664	-16.5	40	-56.5	Aug-95
1212	TH-6	AAI	790827	1482989	-21.5	40	-61.5	Aug-95
1213	WH2-1	AAI	780730	1483004	10.28	61	-50.72	Nov-95
1319	TH-A	AAI	781848	1481532	0	123	-123	Jul-98
1320	TH-B	AAI	782076	1481571	0	123.5	-123.5	Jul-98
1345	TH-3	AAI	780363	1481516	10.1	51	-40.9	Aug-00

ABBREVIATIONS:		
PTL	Pittsburgh Testing Laboratory	
UNI	Universal Engineering Testing Company	
WGI	Warren George Inc.	
USACE	United States Corps of Engineer	
USAED	United States Army Engineering Division - Wilmington	
LAW	Law Engineering Testing Company	
AAI	Ardaman & Associates, Inc.	

Table 4. Index Testing Data of Previous Marine Borings

Boring Reference No.	Boring Name	Stratum Upper Elevation (ft. MLLW)	Stratum Lower Elevation (ft. MLLW)	Soil Description	SPT N-value	Moisture Content (%)	Percent Passing U.S. 200 Sieve (%)	Plasticity Index (%)
5	CB-NLS-7	-25.3	-35.0	Sand, fine/medium quartz and calcite, shelly, gray.	63	-	-	-
21	CH-8-C	-36.1	-49.0	Fine sand and shell, some clay light gray.	-	-	-	-
22	CH-7-C	-38.4	-52.3	Silty sand.	-	-	-	-
23	CH-10-C	-31.1	-47.9	Sand, shell, some clay, dark gray.	-	-	-	-
24	CH-1-C	-35.8	-61.5	Fine silty sand particles of shell, trace clay.	-	-	-	-
25	CH-2-C	-37.6	-60.5	Fine sand and shell some plastic gray to dark gray.	-	-	-	-
26	P-1	-32.5	-43.0	Soft gray clay.	2	-	-	-
28	P-3	-32.0	-48.5	Soft gray clay.	3	-	-	-
30	B-3	-34.0	-48.0	Firm gray clay with some broken shell.	6	-	-	-
31	B-4	-34.0	-58.0	Soft gray clay with some broken shell.	9	-	-	-
32	B-5	-36.0	-45.0	Very soft gray silt.	4	-	-	-
39	CN-7	-34.5	-52.0	Clay, green (CH).	6	-	-	-
40	CN-8	-33.4	-47.7	Clay, green (CH).	-	-	-	-
49	H-3	-26.6	-30.8	Sand, fine, gray/green (SP).	0	-	-	-
50	H-4	-30.0	-32.5	Sand, fine, gray/green (SP).	0	-	-	-
51	H-5	-25.4	-32.9	Clay, very slightly sandy gray/green (CH).	0	-	-	-
52	CH-18	-30.2	-39.5	Clay, gray.	-	-	-	-
53	CH-19	-32	-34	Clay and shell, gray.	-	-	-	-
54	CH-20	-32.3	-34	Clay, gray with shells.	-	-	-	-
56	CHE-1	-38.4	-41.4	Clay, soft, gray (CL).	0	-	-	-
57	CHE-2	-22	-40	Clay, gray, slightly silty (CH).	5	-	-	-
58	CHE-3	-28.8	-40.8	Clay, soft, gray (CH).	0	-	-	-
59	CHE-4	-33.4	-39.9	Sand, fine to coarse, quartz and shell, light gray, clean, tight, very shelly (SP).	58	-	-	-

Table 4. Index Testing Data of Previous Marine Borings (continued)

Boring Reference No.	Boring Name	Stratum Upper Elevation (ft. MLLW)	Stratum Lower Elevation (ft. MLLW)	Soil Description	SPT N-value	Moisture Content (%)	Percent Passing U.S. 200 Sieve (%)	Plasticity Index (%)
60	CHE-5	-32.7	-40.2	Sand, fine, quartz, slightly silty, very shelly, gray (SP).	58	-	-	-
62	CHE-7	-38	-41	Clay, silty, slightly sandy, green (CL).	9	-	-	-
64	CHE-9	-39	-40	Sand, clayey, gray (SC).	9	-	-	-
72	1-N	-33	-42	Gray clayey silt.	7	-	-	-
145	TB-7	-27	-45	Dark gray silty clay with trace of shell.	4	-	-	-
146	TB-8	-27	-42.5	Dark gray silty clay with trace of shell.	2	-	-	-
147	TB-9	-27	-49	Dark gray silty clay with trace of shell.	4	-	-	-
152	CB-W-5	-28	-42	Gray fine silty sand, and silt, trace shell.	3	-	-	-
		-42	-53	Gray compact fine to medium sand, shell.	33	-	-	-
157	CB-E-10	-39	-50	Gray compact sand, shells, trace silt.	38	-	-	-
192	ER-3	-25.5	-37.5	Silt, drk gray, very sandy, shelly, soft (ML).	-	-	-	-
193	ER-4	-18	-24	Sand, dark gray, very silty, very clayey, slightly, shelly, soft (SC).	-	-	-	-
194	ER-5	-15	-20	Sand, gray, fine to medium quartz, fine to coarse shell, slightly silty (SP).	-	-	-	-
195	ER-6	-35.5	-41.5	Sand, dark gray, fine quartz, slightly shelly, silty (SM).	-	-	-	-
203	CHM84-8	-34.6	-42	Sand, coarse to fine, shelly, silty, green (SM)	8	-	-	-
206	CHM84-11	-31.9	-41.9	Silt, slightly sandy, trace of shells, green (ML).	1	-	-	-
207	CHM84-12	-35	-43	Sand, coarse to fine, quartz, silty, green (SM).	4	-	-	-
208	CHM84-13	-28.5	-43.5	Sand, fine, quart, shelly, slightly silty to silty, gray (SP-SM).	15	-	-	-

Table 4. Index Testing Data of Previous Marine Borings (continued)

Boring Reference No.	Boring Name	Stratum Upper Elevation (ft, MLLW)	Stratum Lower Elevation (ft, MLLW)	Soil Description	SPT N-value	Moisture Content (%)	Percent Passing U.S. 200 Sieve (%)	Plasticity Index (%)
209	CHM84-14	-32.7	-42.4	Sand, coarse to fine quartz, shelly, silty, green (SM)	7	-	-	-
210	CHM84-15	-38.1	-43.1	Silt, sandy, some shell (ML)	2	-	-	-
211	CHM84-16	-39.7	-40.2	Sandstone, medium, hard.	148	-	-	-
212	CHM84-17	-36.3	-42.3	Sand, medium to fine, quartz, gray (SM)	57	-	-	-
213	CHM84-18	-38.7	-42.7	Sand, fine, calcareous, shelly, white (SP)	22	-	-	-
214	CHM84-19	-33.7	-41.7	Clay, silty, traces of sand, shell and organic plant remains (CH)	3	-	-	-
		-41.7	-43	Sand, medium quartz, silty, black (SM)	3	-	-	-
		-43	-43.7	Sandstone.	17	-	-	-
215	CHM84-20	-19.3	-42	Clay, silty, trace of sand and shell (CH)	2	-	-	-
		-42	-42.8	Sandstone, medium hard, calcareous, shell fragments, brown.	80	-	-	-
216	CHM84-21	-27.1	-42.1	Clay, silty, traces of sand, shell and organic plant remains, green (CH)	2	-	-	-
217	CHM84-22	-21.5	-41.5	Clay, silty, trace of sand, trace of shell, trace of organic plant remains, green (CH)	2	-	-	-
218	CHM84-23	-39	-42.8	Clay, silty, gray, trace of sand, and shell, slightly organic (CH)	6	-	-	-
219	CHM84-24	-39.5	-42	Sand, fine, quartz, light gray, clayey (SC)	16	-	-	-
220	CHM84-25	-39	-40	Sand, fine to medium quartz, shelly (45% shell), clayey (SC)	30	-	-	-
		-40	-42	Sand, fine quartz, clayey, trace silt, trace shell, gray (SC)	22	-	-	-

Table 4. Index Testing Data of Previous Marine Borings (continued)

Boring Reference No.	Boring Name	Stratum Upper Elevation (ft. MLLW)	Stratum Lower Elevation (ft. MLLW)	Soil Description	SPT N-value	Moisture Content (%)	Percent Passing U.S. 200 Sieve (%)	Plasticity Index (%)
221	CHM84-26	-34.8	-38.3	Sand fine to coarse, quartz, shelly, tan (SP) isolated limestone lenses, slightly limy, 80% sand size shell fragments from -36.8 to -38.3	50	-	-	-
222	CHM84-27	-38.5	-41.5	Sand, fine to medium quartz, shelly, slightly silty, gray (SP).	40	-	-	-
223	CHM84-28	-37.5	-42	Sand, fine quartz, clayey, slightly shelly, with bed of sandy clay from -38.5 to -39.3, (SC).	21	-	-	-
224	CHM84-29	-39.6	-42.6	Clay, soft, sandy, slightly silty, seams of shelly sand (CH).	6	-	-	-
225	CHM84-30	-39.8	-42.8	Silt, sandy, clayey, slightly shelly, gray, riddled with seams of silty shelly sand (ML).	9	-	-	-
226	CHM84-31	-40	-42.5	Clay, silty, gray, slightly compact, sandy, slightly shelly (CL).	5	-	-	-
230	CHM84-35	-40	-41	Sand, gray, fine quartz, silty (SM).	-	-	-	-
231	CHM84-36	-41.5	-43.5	Clay, gray, sandy (CL).	-	-	-	-
232	CHM84-37	-36	-41	Sand, gra, fine quartz, silty with occasional clay layers below -36, SM.	-	-	-	-
233	CHM84-38	-38.8	-40.8	Clay, gray (CH).	-	-	-	-
234	CHM84-39	-38.5	-45	Sand, gray, fine quartz, silty (SM).	-	-	-	-
235	CHM84-40	-40	-50	Sand, dark gray, fine quartz, silty (SM).	-	-	-	-
236	CB-CH87-1	-36.1	-38.1	Sand, fine quartz, silty, gray (SM).	2	-	-	-

Table 4. Index Testing Data of Previous Marine Borings (continued)

Boring Reference No.	Boring Name	Stratum Upper Elevation (ft, MLLW)	Stratum Lower Elevation (ft, MLLW)	Soil Description	SPT N-value	Moisture Content (%)	Percent Passing U.S. 200 Sieve (%)	Plasticity Index (%)
237	CB-CH87-2	-35.6	-38.6	Sand, fine quartz, little to some silt, shelly, gray (SM).	11	-	-	-
238	CB-CH87-3	-36.9	-38.4	Silt, sandy, little shell, gray, trace clay (ML).	2	-	-	-
239	CB-CH87-4	-35.5	-38.5	Sand, fine quartz, little shell, gray, little silt (SM).	8	-	-	-
240	CB-CH88-1	-32.3	-47.3	Clay, gray, a few brown traces of leaves and stems (CH).	6	-	-	-
241	CB-CH88-2	-41.7	-45.4	Silt with a little very fine quartz sand, gray (ML).	0	-	-	-
242	CB-CH88-3	-38.5	-46.3	Clay, a trace of very fine quartz sand, gray (CH), trace of brown leaves and stems, a very few shells (CH).	1	-	-	-
243	CB-CH88-4	-40.9	-41.9	Silt, a little very fine sand, gray (ML).	0	-	-	-
		-41.9	-45.9	Clay, gray, a few brown traces of leaves and stems (CH).	3	-	-	-
244	CB-CH88-5	-39.4	-48.1	Clay, gray, a few brown traces of leaves and stems (CH).	6	-	-	-
245	CB-CH88-6	-40.6	-43.1	Silt, gray-green (MH).	0	-	-	-
		-43.1	-46.6	Clay, a trace of very fine quartz sand, gray, a few brown traces of leaves and stems (CH).	0	-	-	-
246	CB-CH88-7	-39.9	-48.4	Clay, gray (CH).	6	-	-	-
248	CB-CH88-9	-39.6	-45.1	Clay, gray (CH).	0	-	-	-
249	CB-CH88-10			No boring data.	0	-	-	-
250	CB-CH88-11	-39.8	-46.4	Shell, medium sand size, silty, a trace of very fine quartz sand, white with gray.	11	-	-	-

Table 4. Index Testing Data of Previous Marine Borings (continued)

Boring Reference No.	Boring Name	Stratum Upper Elevation (ft, MLLW)	Stratum Lower Elevation (ft, MLLW)	Soil Description	SPT N-value	Moisture Content (%)	Percent Passing U.S. 200 Sieve (%)	Plasticity Index (%)
251	CB-CH88-12	-36.4	-44.4	Shell, medium sand size, silty, a little very fine quartz sand, a trace of silt, gray.	30	-	-	-
252	CB-CH88-13	-39.4	-42.4	Sand, fine to medium shell, very fine quartz, a little silt to silty layers of silt, gray (SM).	7	-	-	-
		-42.4	-45.4	Silt, very sandy, some shell, green (ML)	10	-	-	-
253	CB-CH89-1	-45.1	-51.1	Sand, very fine, quartz, very silty, little clay, gray, little shell, wet, soupy (SM).	0	-	-	-
254	CB-CH89-2	-44.3	-46.8	Sand, fine, quartz, silty, wet, soupy, gray, little shell (SM).	0	-	-	-
255	CB-CH89-3	-45.6	-48.1	Clay, plastic, gray, wet (CH).	0	-	-	-
256	CB-CH89-4	-43.9	-44.8	Clay, dark gray, wet, soupy, trace shell (CL).	1	-	-	-
257	CB-CH89-5	-43.4	-45.1	clay, slightly plastic, sandy, silty, wet, soupy, dark gray, trace shell (CL).	2	-	-	-
258	CB-CH89-6	-45.4	-46.9	Silt, soft, soupy, sandy, dark gray (ML).	0	-	-	-
259	CB-CH89-7	-43.6	-45.1	Clay, plastic, dark gray, trace sand, wet (CH).	13	-	-	-
260	CB-CH89-8	-42.5	-44	Sand, fine to medium, quartz, clayey, little shell, gray (SC).	11	-	-	-
261	CB-CH89-9	-45.3	-49.3	Clay, wet, soupy, sandy, dark gray, slightly plastic seams, clayey sand (CL).	0	-	-	-



Table 4. Index Testing Data of Previous Marine Borings (continued)

Boring Reference No.	Boring Name	Stratum Upper Elevation (ft, MLLW)	Stratum Lower Elevation (ft, MLLW)	Soil Description	SPT N-value	Moisture Content (%)	Percent Passing U.S. 200 Sieve (%)	Plasticity Index (%)
262	CB-CH89-10	-42.3	-44.5	Clay, plastic, wet, dark gray, trace shell, gray, trace to little sand from -42.3 to -42.8, sandy, silty from -44.0 to -44.5 (CH).	0	-	-	-
263	CB-CH89-11	-41.8	-44.8	Sand, very fine, quartz, very clayey little silt, gray (SC).	3	-	-	-
264	CB-CH89-12	-45.7	-53.7	Clay, plastic, trace to little sand, gray, wet, soupy (CH).	0	-	-	-
265	CB-CH89-13	-42.2	-43	Clay, plastic, dark gray (CH).	0	-	-	-
		-43	-45.9	Sand, very fine quartz, clayey, gray, little shell (SC).	4	-	-	-
266	CB-CH89-14	-42.6	-47.6	Sand, very fine, quartz, very clayey, soft, wet, many thin bed sandy clay, gray, little shell (SC).	3	-	-	-
267	CB-CH89-15	-45.2	-47.7	Clay, plastic, dark gray, wet (CH).	4	-	-	-
268	CB-CH89-16	-41.8	-43.8	Clay, slightly plastic, soupy, wet, little sand, some silt, gray (CL).	0	-	-	-
		-43.8	-53.2	Sand, very fine, quartz, clayey, little silt, gray, trace shell (SC).	0	-	-	-
269	CB-CH89-17	-42	-49	Clay, plastic, sandy, little silt, gray, wet, trace shell (CH).	0	-	-	-
270	CB-CH89-18	-45.1	-50.1	Clay, plastic, gray-black, wet, trace shell (CH).	0	-	-	-
271	CB-CH89-19	-40.1	-51.7	Clay, slightly plastic, sandy, silty, gray, wet, trace shell (CL).	0	-	-	-

Table 4. Index Testing Data of Previous Marine Borings (continued)

Boring Reference No.	Boring Name	Stratum Upper Elevation (ft, MLLW)	Stratum Lower Elevation (ft, MLLW)	Soil Description	SPT N-value	Moisture Content (%)	Percent Passing U.S. 200 Sieve (%)	Plasticity Index (%)
272	CB-CH89-20	-41.6	-49.1	Clay, plastic, trace sand and silt, trace shell, gray (CH).	0	-	-	-
273	CB-CH89-21	-48.2	-51.2	Clay, plastic, gray, wet to damp, trace shell (CH).	0	-	-	-
274	CB-CH89-22	-39.8	-48.2	Clay, sandy, trace shell, gray, many seams clayey sand, slightly plastic (CL).	0	-	-	-
275	CB-CH89-23	-40.9	-53.3	Clay, plastic, trace silt and sand, trace shell, gray, damp; clay, very plastic, fat from -48.3 to -53.3 (CH).	3	-	-	-
276	CB-CH89-24	-47.3	-51.3	Clay, plastic, soupy, wet, gray, seams of clayey sand from -50.3 to -51.3 (CH).	0	-	-	-
277	CB-CH89-25	-39.5	-52.5	Clay, plastic, wet, little sand, with seams clayey sand, gray; very plastic, fat, damp, wood fragments, gray from -43.5 to -52.5 (CH).	0	-	-	-
278	CB-CH89-26	-38.9	-50.9	Clay, plastic, sandy, with seam clayey sand, gray, wet; very plastic, fat, damp, dark gray, organic stain (wood fragments) from -42.9 to -50.9 (CH).	0	-	-	-
279	CB-CH89-27	-46.7	-51.3	Clay, plastic, wet, soupy, disturbed (CH).	0	-	-	-
280	CB-CH89-28	-38.8	-46.3	Clay, slightly plastic, little to some sand with seams of clayey sand, wet, trace shell (CL).	0	-	-	-

Table 4. Index Testing Data of Previous Marine Borings (continued)

Boring Reference No.	Boring Name	Stratum Upper Elevation (ft, MLLW)	Stratum Lower Elevation (ft, MLLW)	Soil Description	SPT N-value	Moisture Content (%)	Percent Passing U.S. 200 Sieve (%)	Plasticity Index (%)
281	CB-CH89-29	-36.5	-53.5	Clay, plastic, little silt and sand, trace shell, damp to wet, gray; fat, plastic, dark gray from -44.0 to -49.0 (CH).	0	-	-	-
282	CB-CH89-30	-46.4	-55.7	Clay, plastic, gray, wet; very plastic, undisturbed gray from -52.7 to -55.7 (CH).	0	-	-	-
283	CB-CH89-31	-36.9	-53.9	Clay, plastic, damp, trace shell, gray, undisturbed, seams of clay with little silt (CH).	0	-	-	-
284	CB-CH89-32	-38.1	-39.8	Silt, plastic, little shell, gray (MH).	0	-	-	-
		-39.8	-51.1	Clay plastic, gray, damp, little shell, trace organic stain below -44.1 (CH).	0	-	-	-
285	CB-CH89-33	-46.4	-47.4	Clay, plastic, gray, damp, trace to little shell, wet, soupy from -46.4 to -47.4 (CH).	0	-	-	-
286	CB-CH89-34	-32.0	-48.5	Clay, plastic, gray, damp, trace to little shell (CH).	0	-	-	-
287	CB-CH89-35	-34.4	-53.9	Clay, plastic, gray, damp, trace shell (CH).	0	-	-	-
288	CB-CH89-36	-47.7	-57.7	Clay, plastic, wet, dark gray (CH).	0	-	-	-
289	CB-CH89-37	-47.7	-56.8	Clay, plastic, damp, trace shell, gray (CH).	0	-	-	-
290	CB-CH89-38	-47.2	-57.2	Clay, black plastic, wet (CH).	0	-	-	-
291	CB-CH89-39	-46.1	-51.2	Clay, plastic, dark gray, trace sand, wet to damp (CH).	0	-	-	-

Table 4. Index Testing Data of Previous Marine Borings (continued)

Boring Reference No.	Boring Name	Stratum Upper Elevation (ft, MLLW)	Stratum Lower Elevation (ft, MLLW)	Soil Description	SPT N-value	Moisture Content (%)	Percent Passing U.S. 200 Sieve (%)	Plasticity Index (%)
292	CB-CH89-40	-46.5	-49.8	Sand, fine, quartz, clayey, little silt, dark gray, wet, soupy (SC).	0	-	-	-
293	CB-CH89-41	-46.6	-48.6	Clay, black, wet, soupy, silty, littly sand (CL).	0	-	-	-
294	CB-CH89-42	-49.5	-50	Sand, fine, quartz, clean, tan (SP).	0	-	-	-
295	CB-CH89-43	-40.6	-47.6	Sand, fine quartz, clean, gray, wet (SP).	7	-	-	-
296	CB-CH89-44	-39.1	-41.1	Clay, plastic, trace to little sand, gray, wet, soupy (CH).	0	-	-	-
		-41.1	-46.1	Sand, fine, quartz, little clay to clayey, gray, loose, wet (SC).	0	-	-	-
297	CB-CH89-45	-40.3	-46.8	Clay, plastic, gray, wet, undisturbed, fat from -44.8 to -46.8 (CH).	0	-	-	-
298	CB-CH89-46	-40.8	-45.3	Clay, plastic, fat, stiff, gray (CH).	0	-	-	-
299	CB-CH89-47	-41.9	-46.9	Clay, plastic, fat, damp, gray, stiff (CH).	0	-	-	-
300	CB-CH89-48	-39.8	-44.5	Clay, plastic, gray, fat (CH).	0	-	-	-
301	CB-CH89-49	-37.3	-41.3	Clay, slightly plastic, black, wet soft (CL).	0	-	-	-
		-41.3	-44.6	Clay, plastic, stiff, fat, gray (CH).	2	-	-	-
304	CB-CH89-52	-35	-46	Clay, plastic, wet, gray (CH).	0	-	-	-
305	CB-CH89-53	-35.7	-42.2	Clay, plastic, fat, damp, undisturbed, gray (CH).	0	-	-	-
		-42.2	-44.7	Silt, sandy, organic stain, dark brown, trace clay, slightly plastic (ML).	3	-	-	-

Table 4. Index Testing Data of Previous Marine Borings (continued)

Boring Reference No.	Boring Name	Stratum Upper Elevation (ft. MLLW)	Stratum Lower Elevation (ft. MLLW)	Soil Description	SPT N-value	Moisture Content (%)	Percent Passing U.S. 200 Sieve (%)	Plasticity Index (%)
306	CB-CH89-54	-36.6	-42.7	Clay, plastic, wet, soupy, disturbed, gray, sandy with clayey sand seams (CH).	0	-	-	-
		-42.7	-47.7	Sand, fine, quartz, clayey, wet, gray; very shelly from -42.7 to -43.7; some shell, gray, wet, fine quartz from -47.7 to -47.7 (SC).	4	-	-	-
307	CB-CH89-55	-37	-40	Silt, sandy, gray, wet, soupy, seams silty sand, little shell (ML).	0	-	-	-
		-42.5	-47	Sand size shell fragments, silty, wet gray.	16	-	-	-
		-42.5	-47	Sand, fine quartz, some clay, little shell, light gray (SC).	0	-	-	-
		-42.5	-47	Silt, undisturbed, trace shell, gray-green, damp (ML)	2	-	-	-
313	CB-CH91-6	-37.9	-41.9	Clay, some sand, trace shell, soft, organic odor, dark gray (CL).	1	-	-	-
		-41.9	-45.4	Clay, trace sand, trace shell, wood fragments, organic odor, stiff, dark gray (CH).	3	-	-	-
314	CB-CH91-7	-38.6	-43.1	Clay, trace sand, trace shell, strong organic odor, wood fibers throughout, stiff, gray (CH).	3	-	-	-
		-43.1	-51.1	Sand, fine grain quartz, silty, shelly, slight organic odor, light gray, (SM).	8	-	-	-

Table 4. Index Testing Data of Previous Marine Borings (continued)

Boring Reference No.	Boring Name	Stratum Upper Elevation (ft, MLLW)	Stratum Lower Elevation (ft, MLLW)	Soil Description	SPT N-value	Moisture Content (%)	Percent Passing U.S. 200 Sieve (%)	Plasticity Index (%)
315	CB-CH91-8	-39.6	-46.7	Clay, trace sand, trace shell, stiff, slight organic, odor, wood fragments, dark gray (CH).	8	-	-	-
316	CB-CH91-9	-31.6	-41.6	Clay, little sand, trace shell, organic, odor, soft, dark gray (CL).	1	-	-	-
		-41.6	-49.6	Clay, trace sand, little shell, organic, odor, firm, dark gray (CH).	6	-	-	-
317	CB-CH91-10	-39.8	-43	Sand, medium to fine grained quartz, some silt, little clay, trace shell, dark gray (SM).	2	-	-	-
		-43	-47.9	Clay, trace sand, trace shell, organic odor, wood fragments, dark gray, stiff (CH).	5	-	-	-
318	CB-CH91-11	-36	-46	Sand, fine to coarse grained quartz, trace shell, trace silt, gray (SP-SM).	30	-	-	-
319	CB-CH91-12A	-38.24	-53.24	Gray silt, trace wood (MH).	4	-	-	-
321	CB-CH92-1	-31.7	-44	Clay, plastic, gray, damp, trace sand; shelly from -39.5 to -40.5; trace shell, dark gray, fat, isolated seams organic material from -40.5 to -42.5, shell bed, little silt from -42.5 to -43.0; fat clay from -43.0 to -44.0 (CH).	4	-	-	-
322	CB-CH92-1A	-37.5	-45	Clay, plastic, little silt, trace shell, damp, isolated seams organic material from -40.5 to -45.0 (CH).	3	-	-	-

Table 4. Index Testing Data of Previous Marine Borings (continued)

Boring Reference No.	Boring Name	Stratum Upper Elevation (ft, MLLW)	Stratum Lower Elevation (ft, MLLW)	Soil Description	SPT N-value	Moisture Content (%)	Percent Passing U.S. 200 Sieve (%)	Plasticity Index (%)
323	CB-CH92-2	-40	-45	Sand, fine to medium, quartz, little silt, some shell, gray (SM).	23	-	-	-
324	CB-CH92-3	-37.2	-44.7	Clay, plastic, trace shell, damp, slightly organic stain from -41.7 to -44.7 (CH).	3	-	-	-
325	CB-CH92-4	-43.4	-48.4	Clay, plastic, gray, little sand with seams of sand from -43.4 to -44.9 (CH).	0	-	-	-
326	CB-CH92-5	-42.4	-47.4	Clay, plastic, gray, trace shell wet from -42.0 to -43.9 (CH).	0	-	-	-
327	CB-CH92-6	-31.5	-43.5	Clay, plastic, gray, trace shell, trace silt, damp, some seams of silt and fine sand (CH).	3	-	-	-
328	CB-CH92-7	-42.8	-47.6	Clay, plastic, gray, trace shell, trace organic material, undisturbed, damp (CH).	2	-	-	-
329	CB-CH92-8	-36.7	-48.7	Clay, plastic, wet, gray, trace shell.	2	-	-	-
330	CB-CH92-9	-31.2	-45	Clay, plastic, trace shell, trace, silt, damp, gray to light gray (CH).	4	-	-	-
331	CB-CH92-10	-39.8	-45.8	Undisturbed damp plastic clay (CH).	0	-	-	-
332	CB-CH92-11	-39.9	-44.9	Clay, plastic, damp, gray (CH).	4	-	-	-
333	CB-CH92-12	-37.7	-46.2	Clay, plastic, wet, disturbed, gray (CH).	0	-	-	-
337	CB-CH92-16	-24.3	-43.7	Clay, plastic, gray, damp, trace shell; isolated seams organic material from -40.5 to -45.0 (CH).	2	-	-	-

Table 4. Index Testing Data of Previous Marine Borings (continued)

Boring Reference No.	Boring Name	Stratum Upper Elevation (ft. MLLW)	Stratum Lower Elevation (ft. MLLW)	Soil Description	SPT N-value	Moisture Content (%)	Percent Passing U.S. 200 Sieve (%)	Plasticity Index (%)
338	CB-CH92-17	-35.7	-43.6	Clay, plastic, very wet, soupy, dark gray, trace sand, little silt; isolated seams of silty sand from -38.7 to -40.2 (CH).	0	-	-	-
		-43.6	-44.7	Sand, fine quartz, clayey, slight organic stain, dark brown (SC).	3	-	-	-
339	CB-CH92-18	-23.3	-43.7	Clay, plastic, damp, little sand, trace shell, gray, trace sand and silt, trace organic material, damp from -24.7 to -43.7 (CH).	0	-	-	-
		-43.7	-44.7	Sand, fine, quartz, clayey, some lenses medium hard, calcareous sandstone, trace shell, green/gray, damp (SC).	14	-	-	-
340	CB-CH92-19	-19	-44	Clay, plastic, sandy, gray, damp, trace sand from -22.0 to -44.0, trace shell (CH).	8	-	-	-
		-44	-45	Slightly plastic clay with thin lenses moderately hard sandstone (CL).	7	-	-	-
341	CB-CH92-20	-37.4	-44.4	Clay, plastic, soupy, wet, little silt, dark gray, damp, trace shell, fat, gray from -38.9 to -44.4 (CH).	0	-	-	-
		-44.4	-44.9	Sand, fine to medium quartz, little silt, some shell, many thin lenses, moderately hard calcareous sandstones (SM).	10	-	-	-



Table 4. Index Testing Data of Previous Marine Borings (continued)

Boring Reference No.	Boring Name	Stratum Upper Elevation (ft, MLLW)	Stratum Lower Elevation (ft, MLLW)	Soil Description	SPT N-value	Moisture Content (%)	Percent Passing U.S. 200 Sieve (%)	Plasticity Index (%)
342	CB-CH92-21	-19.7	-41	Clay, plastic, gray, damp, trace shell, trace sand (CH).	4	-	-	-
		-41	-41.5	Bed shelly sand with little silt (SM).	-	-	-	-
		-41.5	-43.5	Limestone, soft weathered seams calcareous silt, tan, lenses medium hard (LS).	43	-	-	-
		-43.5	-45	Sand, fine quartz, some silt, limy, some shell, light gray, damp (SM).	27	-	-	-
343	CB-CH92-22	-37.5	-44.5	Sand, fine to medium, quartz, little silt, little shell, wet with lenses of moderately hard sandstone, shelly, light gray, some silt -42.0 to -44.5 (SM).	49	-	-	-
344	CB-CH92-23	-36.9	-44.4	Sand, fine to medium quartz, shelly, little to some silt, light gray; shell bed from -39.9 to -40.9; silty, some shell, light gray from -40.0 to -44.4 (SM).	14	-	-	-
345	CB-CH92-24	-37.5	-43	Sand, fine quartz, little to some shell, tan, little silt, dry (SM).	68	-	-	-
		-43	-46	Silt, damp, trace shell, trace sand, slightly plastic, gray (ML).	6	-	-	-
346	CB-CH92-25	-38.7	-40.5	Sand, fine to medium, quartz, little silt, isolated seams of clay, gray, shelly (SM).	19	-	-	-
		-40.5	-45.8	Silt, slightly plastic, gray, trace sand, trace shell (ML).	8	-	-	-

Table 4. Index Testing Data of Previous Marine Borings (continued)

Boring Reference No.	Boring Name	Stratum Upper Elevation (ft, MLLW)	Stratum Lower Elevation (ft, MLLW)	Soil Description	SPT N-value	Moisture Content (%)	Percent Passing U.S. 200 Sieve (%)	Plasticity Index (%)
347	CB-CH-M2	-43	-52	Clay, soft, soupy, slightly plastic, dark gray; slightly compacted, green, silty, plastic from -49.0 to -52.0 (CL).	0	-	-	-
348	CB-CH-M3	-44	-53	Clay, soft, slightly plastic, dark gray, slightly silty (CL).	0	-	-	-
349	CB-CH-M4	-43	-51	Clay, soft, soupy, dark gray to black, silty; -48.0 to -51.0 plastic, slightly sandy, dark gray (CL).	0	-	-	-
350	CB-CH-M5	-38	-49	Clay, very plastic, fat, gray (CH).	4	-	-	-
351	CB-CH-M9	-41.5	-51.5	Sand, dark gray, very silty, fine to medium quart (SM); bed of sand from -42.5 to -43.5 (SP).	4	-	-	-
352	CB-CH-M10	-41.5	-42.5	Sand, dark gray, loose, very silty (SM).	0	-	-	-
		-42.5	-49.5	Sand, fine quartz, gray (SP).	11	-	-	-
353	CB-CH-M11	-29	-41	Sand, fine quartz, slightly silty, gray; -37.0 to -41.0 fine to medium quartz, slightly shelly, slightly silty (SP).	32	-	-	-
		-41	-47	Sand, fine to medium quartz, slightly silty to silty, gray (SM).	107	-	-	-
354	CB-CH-M12	-37.5	-41.5	Sand, fine quartz, silty, slightly clayey, dark gray (SM).	7	-	-	-
		-41.5	-49	Sand, fine quartz, clayey, slightly silty, seams (CL) clay, gray (SP-SC).	7	-	-	-

Table 4. Index Testing Data of Previous Marine Borings (continued)

Boring Reference No.	Boring Name	Stratum Upper Elevation (ft, MLLW)	Stratum Lower Elevation (ft, MLLW)	Soil Description	SPT N-value	Moisture Content (%)	Percent Passing U.S. 200 Sieve (%)	Plasticity Index (%)
355	CB-CH-M13	-33.5	-44.5	Sand, fine to medium quartz, clean, dense, light gray (SP).	27	-	-	-
		-44.5	-47.5	Sand, fine to medium quartz, clayey, slightly silty, slightly shelly, gray (SC).	14	-	-	-
356	CB-CH-M14	-40	-48	Sand, fine to medium quartz, slightly silty to silty, gray (SP-SM).	0	-	-	-
358	CB-CH-FY83-M6	-43	-49	Clay, dark gray, slightly plastic, silty, soft (CL).	0	-	-	-
359	CB-CH-FY83-M7	-40.5	-52.5	Clay, drk gray to black, soupy, silty (CL).	0	-	-	-
360	CB-CH-FY83-M8	-36.5	-45.5	Sand, fine to medium, quartz, gray, slightly silty (SP).	65	-	-	-
361	CB-CH-M1	-44	-52	Clay, soft, soupy, slightly plastic, dark gray; -48.0 to -52.0 silty, plastic, green, lenses of soft weathered limestone (CL).	0	-	-	-
366	CB-CH01-01	-44.4	-45.2	Silt, little fine quartz sand, gray (MH).	-	-	-	-
367	CB-CH01-02	-38.3	-40	Sand, fine quartz, little silt, gray (SM).	-	-	-	-
		-40	-40.7	Sand, fine quartz, some sand size shell fragments, gray (SP).	-	-	-	-
		-40.7	-42.1	Clay, some fine quartz sand, gray (CH).	-	-	-	-
368	CB-CH01-03B	-42.6	-44.9	Silt, little fine quartz sand, gray (MH).	-	-	-	-
369	CB-CH01-04	-43.3	-46.3	Silt, little fine quartz sand, gray (MH).	-	-	-	-

Table 4. Index Testing Data of Previous Marine Borings (continued)

Boring Reference No.	Boring Name	Stratum Upper Elevation (ft, MLLW)	Stratum Lower Elevation (ft, MLLW)	Soil Description	SPT N-value	Moisture Content (%)	Percent Passing U.S. 200 Sieve (%)	Plasticity Index (%)
370	CB-CH01-05	-42.4	-45.2	Silt, some fine quartz sand, gray (MH).	-	-	-	-
371	CB-CH01-06	-47	-48	Silt, trace fine quartz sand, dark gray (MH).	-	-	-	-
372	CB-CH01-07	-45.8	-48.1	Silt, little fine quartz sand, dark gray (MH).	-	-	-	-
373	CB-CH01-08	-46.6	-47.9	Sand, fine quartz, some silt, gray (SM).	-	-	-	-
374	CB-CH01-09	-46.8	-47.8	Silt, some fine quartz sand, dark gray (MH).	-	-	-	-
375	CB-CH01-10	-45.1	-49.3	Silt, some fine quartz sand, dark gray to gray (MH).	-	-	-	-
376	CB-CH01-11	-49	-52	Silt, some fine quartz sand, dark gray (MH).	-	-	-	-
377	CB-CH01-12	-49.5	-51.2	Silt, some fine quartz sand, dark gray (MH).	-	-	-	-
378	CB-CH01-13	-48.7	-49.5	Silt, little fine quartz sand, dark gray (MH).	-	-	-	-
379	CB-CH01-14	-46.3	-50.3	Sand, little quartz, gray (SP).	-	-	-	-
380	CB-CH01-15	-46.7	-53	Sand, fine quartz, trace silt, gray (SP).	-	-	-	-
381	CB-CH01-16	-41.1	-44.4	Clay, little fine quartz sand, gray (CH).	-	-	-	-
		-44.4	-46.1	Sand, fine quartz, little silt, dark gray (SP-SM).	-	-	-	-
382	CB-CH01-17	-44.6	-49.9	Silt, little fine quartz sand, dark gray to gray (MH).	-	-	-	-
383	CB-CH01-18	-41.1	-44.1	Silt, little fine quartz sand, dark gray to gray (MH).	-	-	-	-
		-44.1	-48.6	Clay, little fine quartz sand, gray (CH).	-	-	-	-

Table 4. Index Testing Data of Previous Marine Borings (continued)

Boring Reference No.	Boring Name	Stratum Upper Elevation (ft, MLLW)	Stratum Lower Elevation (ft, MLLW)	Soil Description	SPT N-value	Moisture Content (%)	Percent Passing U.S. 200 Sieve (%)	Plasticity Index (%)
384	CB-CH01-19	-41.8	-43.6	Silt, dark gray (MH).	-	-	-	-
		-43.6	-51.6	Clay, little fine quartz sand, gray (CH).	-	-	-	-
385	CB-CH01-20	-43.8	-47.3	Silt, little fine quartz sand, dark gray (MH).	-	-	-	-
386	CB-CH01-21	-44.9	-47.6	Silt, dark gray (MH).	-	-	-	-
387	CB-CH01-22	-43.5	-45.9	Silt, some fine quartz sand, dark gray (MH).	-	-	-	-
388	CB-CH01-23	-43.9	-46.6	Silt, little fine quartz sand, dark gray to gray (MH).	-	-	-	-
389	CB-CH01-24A	-44.9	-48.7	Silt, little fine quartz sand, dark gray to gray (MH).	-	-	-	-
390	CB-CH01-25B	-43.8	-47.7	Silt, little fine quartz sand, dark gray to gray (MH).	-	-	-	-
391	CB-CH01-26C	-44.1	-47.9	Silt, some fine quartz sand, gray (MH).	-	-	-	-
397	PC-1E	-33	-51	Gray to dark greenish gray sand clay to clay with occasional seams of fine sand, silt and shells.	-	-	-	-
398	TH-1E	-33	-53	Gray to dark greenish gray sand clay to clay with occasional seams of fine sand, silt and shells.	0	52	92	45
399	TH-4A	-33	-51	Gray to dark greenish gray sand clay to clay with occasional seams of fine sand, silt and shells.	4	76	97	47

Table 4. Index Testing Data of Previous Marine Borings (continued)

Boring Reference No.	Boring Name	Stratum Upper Elevation (ft. MLLW)	Stratum Lower Elevation (ft. MLLW)	Soil Description	SPT N-value	Moisture Content (%)	Percent Passing U.S. 200 Sieve (%)	Plasticity Index (%)
400	TH-4B	-30	-53	Gray to dark greenish gray sand clay to clay with occasional seams of fine sand, silt and shells.	4	78	98	55
414	TH-20	-29	-41	Gray to dark greenish gray sandy clay to clay with occasional seams of fine sands, silt and shells.	1	75	74	75
		-41	-48	Gray to dark gray or dark brown slightly silty to silty fine sand with shells, occasionally cemented.	33	-	-	-
415	TH-21	-30	-36	Gray to dark gray or dark brown slightly silty to silty fine sand with shells, occasionally cemented.	43	-	-	-
416	TH-22	-36	-38	Gray to dark greenish gray slightly clay to clayey fine sand with shell fragment and occasional trace of cemented sand.	0	-	-	-
421	TH-30	-33	-36	Gray to dark greenish gray sandy clay to clay with occasional seams of fine sands, silt and shells.	3	-	-	-
448	PC-10	-35	-51	Gray to dark greenish, gray sandy clay to clay with occasional seams of fine sands, silt and shells.	-	-	-	-
457	PC-19	-39	-72	Gray to dark greenish gray very clayey fine sand to very sandy clay with shells.	-	-	-	-

Table 4. Index Testing Data of Previous Marine Borings (continued)

Boring Reference No.	Boring Name	Stratum Upper Elevation (ft, MLLW)	Stratum Lower Elevation (ft, MLLW)	Soil Description	SPT N-value	Moisture Content (%)	Percent Passing U.S. 200 Sieve (%)	Plasticity Index (%)
458	PC-20	-38	-46	Gray to dark greenish gray or brown fine sand with shells, occasionally cemented.	-	-	-	-
459	PC-21	-39	-48	Gray to dark greenish gray or brown fine sand with shells, occasionally cemented.	-	-	-	-
639	TH-37	-32.9	-36.9	Dark gray silty clay with seams of fine sand and shell (CH).	3	-	-	-
640	TH-38	-21.8	-30.8	Dark gray slightly silty fine sand with shell fragments (SP-SM).	4	-	-	-
641	TH-39	-30	-38	Gray silty fine sand with shell (SM).	24	-	-	-
642	TH-40	-33.1	-35.6	Light gray slightly silty fine sand with shell (SP-SM).	14	-	-	-
643	TH-41	-36.7	-40.7	Gray sand clay (CH).	5	-	-	-
644	TH-42	-36.3	-38.8	Dark gray slightly sandy clay (CH).	3	-	-	-
652	TH-50	-30.5	-32.5	Dark greenish gray silty sand with shell fragments (SM).	7	-	-	-
677	TH-70	37	41	Gray fine sand with shells (SP)	45	-	-	-
		41	47.5	Gray sandy clay (CL)	7	-	-	-
743	THR-1	-32.9	-36.9	Dark gray clay with shell (CH).	3	-	-	-
744	THR-2	-32.6	-35.1	Dark gray clay with shell (CH).	14	-	-	-

Table 4. Index Testing Data of Previous Marine Borings (continued)

Boring Reference No.	Boring Name	Stratum Upper Elevation (ft. MLLW)	Stratum Lower Elevation (ft. MLLW)	Soil Description	SPT N-value	Moisture Content (%)	Percent Passing U.S. 200 Sieve (%)	Plasticity Index (%)
751	THW-1	37	42.5	Dark gray slightly silty fine sand with shell (SP-SM).	23	24	-	-
		42.5	46.4	Gray clay and clayey fine sand with shell (CH, SC)	0	-	-	-
752	THW-2	37.5	42.5	Dark grayish brown clayey fine sand (SC).	4	-	-	-
		37.5	47.5	Gray fine sand with shell (SP)	39	-	-	-
753	THW-3	39	48.5	Gray clay with shell (CH)	7	83	99	-
756	THW-6	17.5	21	Gray clayey fine sand (SC)	3	-	-	-
757	THW-7	17.5	21	Gray slightly silty with shell (SP-SM)	7	-	-	-
848	TH-1H	-39.5	-44.5	Gray clayey fine sand (SC)	2	-	-	-
		-44.5	-54.5	Gray sandy clay with shell (CL)	2	-	-	-
849	TH-2H	-40	-45	Gray clay with trace of shell (CH)	3	-	-	-
903	B-1	-27.5	-36.5	Dark gray clay with traces of fine sand and shell fragments (CH).	0	80	-	-
938	TH-1	-42.5	-51	Dark gray silty clay (CH)	0	-	-	-
939	TH-2	-27.5	-45.5	Dark gray silty clay with traces of shells (CH)	0	94	89	-
978	TH-13	-29	-48	Gray clay (CH)	2	76	94	-
982	TH-3	-29.5	-49.6	Gray clay with shell (CH)	2	70	97	-



Table 4. Index Testing Data of Previous Marine Borings (continued)

Boring Reference No.	Boring Name	Stratum Upper Elevation (ft. MLLW)	Stratum Lower Elevation (ft. MLLW)	Soil Description	SPT N-value	Moisture Content (%)	Percent Passing U.S. 200 Sieve (%)	Plasticity Index (%)
983	TH-4	-36.8	-51.8	Gray clay (CH)	0	79	97	-
1012	TH-16	-38	-61	Gray to dark greenish gray sandy clay to clay with occasional seams of fine sands, silt and shells.	6	40	69	-
1013	THW-8	-29.4	-36.9	Gray fine sand (SP).	38	-	-	-
1014	THW-9	-34	-35	Brown fine sand with shell (SP).	10	-	-	-
1015	THW-10	-36	-37.5	Light grayish-white fine sand with shell (SP).	56	-	-	-
1016	THW-11	-34	-34.3	Gray fine sand with shell (SP).	19	-	-	-
1017	THW-12	-31.9	-34.9	Dark greenish brown to gray fine sand (SP).	16	-	-	-
1018	THW-13	-36	-37.4	Gray clayey fine sand with shell (SC).	13	-	-	-
1019	THW-14	-33.2	36.2	Light gry fine sand with shell (SP).	33	-	-	-
1020	THW-15	-33.7	-36.2	Gray fine sand with shell (SP)	22	-	-	-
1021	THW-16	-32.5	-35.5	Dark brown to gray fine sand (SP).	19	-	-	-
1022	THW-17	-25.7	-31.7	Gray clay (CL).	0	-	-	-
1040	TH-N	-19.5	-22.5	Gray slightly silty fine sand (SP-SM).	2	-	-	-
1041	TH-O	-0.8	-19.8	Gray fine sand (SP).	23	-	-	-
1051	ND-1	-27.2	-46.2	Gray soft clay (CL).	0	-	-	-
1052	CD-1	-29.8	-46.8	Gray soft clay (CL).	2	-	-	-

Table 4. Index Testing Data of Previous Marine Borings (continued)

Boring Reference No.	Boring Name	Stratum Upper Elevation (ft, MLLW)	Stratum Lower Elevation (ft, MLLW)	Soil Description	SPT N-value	Moisture Content (%)	Percent Passing U.S. 200 Sieve (%)	Plasticity Index (%)
1053	BT-1	-30.6	-50.1	Gray soft clay (CL).	1	-	-	-
1096	TH-4D	-35.2	-42.2	Gray clay with traces of shell fragments and organics (CH)	3	-	-	-
1204	SJW-1	-32	-63	Greenish gray silty clay (CH).	2	74	99	52
1205	SJW-2	-32	-63	Greenish gray silty clay (CH).	3	73	99	72
1206	SJW-3	-34	-64.5	Greenish gray sandy clay silty clay to silty clay (CL/CH).	3	64	88	39
1207	TH-1	-40	-76	Fat clay (CH)	3	-	-	-
1208	TH-1A	-35	-47	Fat clay (CH)	2	-	-	-
1209	TH-2	-37	-54	Fat clay (CH)	3	-	-	-
1210	TH-3	-34	-57	Fat clay (CH)	4	-	-	-
1211	TH-5	-38.5	-56	Fat clay (CH)	2	-	-	-
1212	TH-6	-38	-61	Fat clay (CH)	3	-	-	-
1319	TH-A	-31.5	-42.5	Dark gray clay (CH)	1	96	98	-
		-42.5	-47	Dark gray sandy clay (CL/CH)	2	-	-	-
1320	TH-B	-40	-43	Gray silty clay with traces of shells (CL/CH)	0	-	-	-
		-43	-47	Gray sandy clay with clayey sand lenses (CL/CH)	3	24	58	-
1345	TH-3	-38.9	-41.9	Shell fragments with gray clayey sand	7	-	-	-

## 3.7 Summary of Past Landside Boring Programs

A total of 70 borings have been conducted by Ardaman & Associates, Inc., Law Engineering Testing Company and Universal Engineering Testing Company. The tables below summarize the past field investigations conducted for previous landside construction projects. The individual test boring logs are presented in Appendices 3 and 4. The locations of these borings are presented in Figures 2 and 3.

Table 5. Location, Elevation and Depths of Previous Landside Borings

Boring Reference No.	Boring Name	Boring Performed By:	State Plane NAD 83		Surface Elevation (feet, MLLW)	Total Depth (feet)	End of Boring Elevation (feet, MLLW)	Date of Boring
			Easting	Northing				
33	CN-1	USACE	783652	1482599	12.9	95	-82.1	Apr-56
67	1S	UNI	777478	1481422	-	30	-	-
75	4-N	UNI	777730	1483122	-	49	-	-
163	R-385	LAW	779001	1482419	10	20.5	-10.5	Jan-75
409	TH-15	AAI	777749	1483666	8	110	-102	Jul-84
410	TH-16	AAI	777753	1482869	7	110	-103	Jul-84
414	TH-20	AAI	778349	1481549	10	80	-70	Jul-84
447	PC-9	AAI	777729	1483064	9	93	-84	Jul-84
459	PC-21	AAI	778271	1481553	11	104	-93	Jul-84
505	TH-A	AAI	778594	1483149	13.1	20	-6.9	Apr-85
506	TH-B	AAI	778561	1482689	9.2	20	-10.8	Apr-85
507	TH-C	AAI	778976	1483087	14.7	20	-5.3	Apr-85
508	TH-D	AAI	778982	1482679	9.8	21	-11.2	Apr-85
510	TH-F	AAI	779381	1482679	8.3	20	-11.7	Apr-85
512	TH-H	AAI	778776	1482886	10.3	50	-39.7	Apr-85
513	TH-I	AAI	779183	1482853	10.3	50	-39.7	Apr-85
578	PF-1	AAI	778817	1479859	7	5.5	1.5	-
678	TH-71	AAI	777720	1482998	7	91	-84	Aug-85
754	THW-4	AAI	778566	1482423	9.8	21	-11.2	Apr-86
755	THW-5	AAI	778871	1482389	9.9	96	-86.1	Apr-86
758	THC-5	AAI	778830	1482600	8.1	91	-82.9	Apr-86
769	THY-1	AAI	778418	1483319	12.8	12	0.8	Sep-86
784	TH-88	AAI	779228	1482396	8.3	66	-57.7	Nov-86
785	TH-69	AAI	779040	1482383	8.4	91	-82.6	Nov-86
904	B-2	AAI	780315	1481353	8.4	15	-6.6	Sep-89
905	B-3	AAI	780531	1481385	9.2	15	-5.8	Sep-89
984	THD-1	AAI	779292	1481543	7.8	71.5	-63.7	Feb-91
985	THD-2	AAI	777369	1481422	7.5	76.5	-69	Feb-91
986	THD-3	AAI	776614	1481422	8	71.5	-63.5	Feb-91
1036	TH-J	AAI	777797	1483518	9.3	31	-21.7	Sep-91
1038	TH-L	AAI	777850	1483019	9.4	31	-21.6	Sep-91
1039	TH-M	AAI	778300	1483021	11.8	31	-19.2	Sep-91
1042	TH-1	AAI	778708	1482573	10.1	31	-20.9	Aug-92
1043	TH-2	AAI	778441	1482761	9.9	10.5	-0.6	Aug-92
1044	TH-3	AAI	778422	1482712	10.1	10.5	-0.4	Sep-92
1045	TH-4	AAI	778487	1482672	9.5	10.5	-1	Sep-92
1046	TH-5	AAI	778552	1482632	9.2	10.5	-1.3	Sep-92
1047	TH-6	AAI	778617	1482593	10	10.5	-0.5	Sep-92
1048	TH-7	AAI	778672	1482563	9.9	10.5	-0.6	Sep-92

Table 5. Location, Elevation and Depths of Previous Landside Borings (continued)

Boring Reference No.	Boring Name	Boring Performed By:	State Plane NAD 83		Surface Elevation (feet, MLLW)	Total Depth (feet)	End of Boring Elevation (feet, MLLW)	Date of Boring
			Eastings	Northing				
1049	TH-8	AAI	778723	1482533	9.9	10.5	-0.6	Sep-92
1050	TH-9	AAI	778773	1482504	10.3	10.5	-0.2	Sep-92
1067	CR-9	AAI	778449	1483172	13.8	15	-1.2	Oct-92
1068	CR-10	AAI	778649	1483173	14	15	-1	Oct-92
1072	CR-14	AAI	778450	1482992	12.3	15	-2.7	Oct-92
1073	CR-15	AAI	778650	1482983	13.8	15	-1.2	Oct-92
1074	CR-16	AAI	778850	1482994	13.8	15	-1.2	Oct-92
1075	CR-17	AAI	779050	1482995	14.3	15	-0.7	Oct-92
1076	CR-18	AAI	779230	1482996	15.6	15	0.6	Oct-92
1167	B-3	AAI	778444	1481352	10.6	11	-0.4	May-93
1168	B-4	AAI	778949	1481365	8.5	11	-2.5	May-93
1169	B-5	AAI	779519	1481368	8.3	11	-2.7	May-93
1173	B-9	AAI	779968	1481445	9.2	11	-1.8	May-93
1346	TH-4	AAI	779536	1481512	9	51	-4.2	Aug-00
1347	TH-5	AAI	779804	1481520	8.2	51	-42.8	Aug-00
1428	GR-1	AAI	778321	1483316	13.5	10	3.5	Jun-01
1464	TH-1	AAI	778759	1481466	8.5	60	-51.5	Dec-02
1465	TH-2	AAI	778830	1481470	8.5	60	-51.5	Dec-02
1471	TH-1	AAI	776579	1481337	10	25	-15	Aug-03
1472	TH-2	AAI	776909	1481354	10	105	-95	Aug-03
1473	TH-3	AAI	777149	1481370	9.5	40	-30.5	Aug-03
1474	TH-4	AAI	777549	1481317	9.6	25	-15.5	Aug-03

ABBREVIATIONS: UNI Universal Engineering Testing Company  
LAW Law Engineering Testing Company  
AAI Ardaman & Associates, Inc.

Table 6. Index Testing Data of Previous Landside Borings

Boring Reference No.	Boring Name	Stratum Upper Elevation (ft, MLLW)	Stratum Lower Elevation (ft, MLLW)	Principal Soil Type	SPT N-value	Moisture Content (%)	Percent Passing U.S. 200 Sieve (%)	Plasticity Index (%)
33	CN-1	12.9	-10.1	SP - Sand, fine/medium, quartz & shell, tan.	43	-	-	-
		-10.1	-13.4	SP-SM- Sand, fine, slightly calcareous, quartz & shell, 5% consolidated.	-	-	-	-
		-13.4	-13.9	Shell, sand.	-	-	-	-

Table 6. Index Testing Data of Previous Landside Borings (continued)

Boring Reference No.	Boring Name	Stratum Upper Elevation (ft, MLLW)	Stratum Lower Elevation (ft, MLLW)	Principal Soil Type	SPT N-value	Moisture Content (%)	Percent Passing U.S. 200 Sieve (%)	Plasticity Index (%)
33	CN-1	-13.9	-15.7	SP - Sand, fine/medium, quartz & shell.	30	-	-	-
		-15.7	-23.4	SP-SM - Sand, fine, silty, calcareous, slightly shelly with thin beds of shell and medium sand.	26	-	-	-
		-23.4	-27.1	SM - Sand, fine, silty, slightly shelly, gray, slightly calcareous.	118	-	-	-
		-27.1	-30.9	ML - Silt, very slightly shelly, gray.	3	-	-	-
		-30.9	-49.8	CL - Clay, silty, very slightly shelly, slightly organic.	2	-	-	-
		-49.8	-51.3	SM - Sand, organic, very fine, silty.	20	-	-	-
		-51.3	-72.1	SM - Sand, very fine, silty. Very silty, very shelly from -57.1 to -62.9.	14	-	-	-
		-72.1	-82.1	ML - Silt, shelly.	5	-	-	-
67	1S	10	4	Grey sand and shell.	11	-	-	-
		4	-0.5	Grey sand and shell with trace of silt.	12	-	-	-
		-0.5	-6.5	Fine grey sand and shell.	12	-	-	-
		-6.5	-14.5	Grey silt with trace of silt and shell.	6	-	-	-
		-14.5	-20	Grey sand with trace of shell.	14	-	-	-
75	4-N	10	3	Grey silty sand & shell	8	-	-	-
		3	-2	Grey silt & shell	2	-	-	-
		-2	-21	Grey sand & shell	7	-	-	-
		-21	-28	Grey silt	4	-	-	-
		-28	-34	Coarse grey sand and shell	14	-	-	-
		-34	-40	Grey clayey silt	8	-	-	-

Table 6. Index Testing Data of Previous Landside Borings (continued)

Boring Reference No.	Boring Name	Stratum Upper Elevation (ft, MLLW)	Stratum Lower Elevation (ft, MLLW)	Principal Soil Type	SPT N-value	Moisture Content (%)	Percent Passing U.S. 200 Sieve (%)	Plasticity Index (%)
163	R-385	10	9	Gray fine to medium sand with shell	-	-	-	-
		9	7	Loose gray fine to medium sand with clayey fine sand lenses and shell	4	-	-	-
		7	4.5	Firm gray fine to medium sand with clayey fine sand lenses and shell	13	-	-	-
		4.5	2	Very loose gray slightly silty fine to medium sand with shell and asphalt concrete fragments	3	-	-	-
		2	-3	Very loose gray slightly silty fine sand with some shell fragments.	2	-	-	-
		-3	-7	Very loose gray silty clayey fine sand with trace of shell fragments.	0	-	-	-
		-7	-10.6	Firm gray fine sand with trace of shell fragments.	18	-	-	-
409	TH-15	8.5	-6	Gray to dark gray or dark brown slightly silty to silty fine sand with shells.	11	-	-	-
		-6	-19	Gray to dark greenish gray or brown fine sand with shells, occasionally cemented.	14	-	-	-
		-19	-40	Gray to dark gray or dark brown slightly silty to silty fine sand with shells.	14	-	-	-

Table 6. Index Testing Data of Previous Landside Borings (continued)

Boring Reference No.	Boring Name	Stratum Upper Elevation (ft, MLLW)	Stratum Lower Elevation (ft, MLLW)	Principal Soil Type	SPT N-value	Moisture Content (%)	Percent Passing U.S. 200 Sieve (%)	Plasticity Index (%)
409	TH-15	-40	-59	Gray to dark greenish gray sandy clay to clay with occasional seams of fine sands, silt and shells.	6	37	44	-
		-59	-64	Gray to dark gray or dark brown slightly silty to silty fine sand with shells.	8	-	-	-
		-64	-79	Gray to dark greenish gray very clayey fine sand to very sandy clay with shells.	9	35	34	-
		-79	-94	Gray to dark gray or dark brown slightly silty to silty fine sand with shells.	17	-	-	-
		-94	-102.5	Gray to dark greenish gray slightly clayey to clayey fine sand with shell fragments and occasional traces of cemented sand	23	-	-	-
410	TH-16	8.5	-4.5	Gray to dark gray or dark brown slightly silty to silty fine sand with shells.	14	-	-	-
		-4.5	-9.5	Gray to dark greenish gray or brown fine sand with shells, occasionally cemented.	7	-	-	-
		-9.5	-15	Gray to dark gray or dark brown slightly silty to silty fine sand with shells.	1	-	-	-
		-15	-20	Gray to dark greenish gray slightly clayey to clayey fine sand with shell fragments and occasional traces of cemented sand	7	-	-	-
		-20	-37	Gray to dark greenish gray or brown fine sand with shells, occasionally cemented.	20	-	-	-

Table 6. Index Testing Data of Previous Landside Borings (continued)

Boring Reference No.	Boring Name	Stratum Upper Elevation (ft, MLLW)	Stratum Lower Elevation (ft, MLLW)	Principal Soil Type	SPT N-value	Moisture Content (%)	Percent Passing U.S. 200 Sieve (%)	Plasticity Index (%)
414	TH-20	-28	-32	Gray to dark gray or dark brown slightly silty to silty fine sand with shells.	0	-	-	-
		-32	-36	Gray to dark greenish gray or brown fine sand with shells, occasionally cemented.	43	-	-	-
447	PC-9	8	-7	Gray to dark gray or dark brown slightly silty to silty fine sand with shells.	-	-	-	-
		-7	-40	Gray to dark greenish gray or brown fine sand with shells, occasionally cemented.	-	-	-	-
		-40	-64	Gray to dark greenish gray sandy clay to clay with occasional seams of fine sands, silt and shells.	-	-	-	-
		-64	-67	Gray to dark gray or dark brown slightly silty to silty fine sand with shells.	-	-	-	-
		-67	-79	Gray to dark greenish gray very clayey fine sand to very sandy clay with shells.	-	-	-	-
		-79	-84	Gray to dark gray or dark brown slightly silty to silty fine sand with shells.	-	-	-	-
459	PC-21	11	-18	Gray to dark greenish gray or brown fine sand with shells, occasionally cemented.	-	-	-	-
		-18	-21	Gray to dark greenish gray slightly clayey to clayey fine sand with shell fragments and occasional traces of fine sand.	-	-	-	-



Table 6. Index Testing Data of Previous Landside Borings (continued)

Boring Reference No.	Boring Name	Stratum Upper Elevation (ft, MLLW)	Stratum Lower Elevation (ft, MLLW)	Principal Soil Type	SPT N-value	Moisture Content (%)	Percent Passing U.S. 200 Sieve (%)	Plasticity Index (%)
459	PC-21	-21	-27	Gray to dark greenish gray or brown slightly silty to silty fine sand with shells.	-	-	-	-
		-27	-39	Gray to dark greenish gray sand clay to clay with occasional seams of fine sand, silt and shells.	-	-	-	-
		-39	-47.5	Gray to dark greenish gray or brown fine sand with shells, occasionally cemented.	-	-	-	-
		-47.5	-94	Gray to dark greenish gray very clayey fine sand to very sand clay with shells.	-	-	-	-
505	TH-A	13	9	Light gray to brown fine sand with shells and traces of clay.	3	-	-	-
		9	7	Light gray sandy clay to clay with seams of clayey fine sand.	2	39	49	-
		7	5.5	Brown to grayish brown fine sand with traces of shells.	7	-	-	-
		5.5	-7	Gray slightly silty to silty fine sand with traces of shells.	1	-	-	-
506	TH-B	9.5	7	Light gray to brown fine sand with shells and traces of clay.	7	-	-	-
		7	4	Gray to grayish brown slightly clayey to clayey fine sand with lenses of clay and shells.	7	38	35	-
		4	1	Brown to grayish brown fine sand with traces of shells.	7	-	-	-
		1	-12	Gray slightly silty to silty fine sand with traces of shells.	6	-	-	-

Table 6. Index Testing Data of Previous Landside Borings (continued)

Boring Reference No.	Boring Name	Stratum Upper Elevation (ft, MLLW)	Stratum Lower Elevation (ft, MLLW)	Principal Soil Type	SPT N-value	Moisture Content (%)	Percent Passing U.S. 200 Sieve (%)	Plasticity Index (%)
410	TH-16	-37	-60	Gray to dark greenish gray sandy clay to clay with occasional seams of fine sands, silt and shells.	5	40	69	-
		-60	-65	Gray to dark greenish gray slightly clayey to clayey fine sand with shell fragments and occasional traces of cemented sand	7	-	-	-
		-65	-75	Gray to dark greenish gray very clayey fine sand to very sandy clay with shells.	6	35	41	-
		-75	-80	Gray to dark greenish gray slightly clayey to clayey fine sand with shell fragments and occasional traces of cemented sand	22	-	-	-
		-80	-95	Gray to dark greenish gray or brown fine sand with shells, occasionally cemented.	31	-	-	-
		-95	-103	Gray to dark greenish gray slightly clayey to clayey fine sand with shell fragments and occasional traces of cemented sand	21	-	-	-
414	TH-20	10	-22	Gray to dark gray or dark brown slightly silty to silty fine sand with shells.	6	-	-	-
		-22	-28	Gray to dark greenish gray sandy clay to clay with occasional seams of fine sand, silt and shells.	5	-	-	-

Table 6. Index Testing Data of Previous Landside Borings (continued)

Boring Reference No.	Boring Name	Stratum Upper Elevation (ft, MLLW)	Stratum Lower Elevation (ft, MLLW)	Principal Soil Type	SPT N-value	Moisture Content (%)	Percent Passing U.S. 200 Sieve (%)	Plasticity Index (%)
507	TH-C	14.5	13	Light gray to brown fine sand with shells and traces of clay.	2	-	-	-
		13	11	Gray to grayish brown slightly clayey to clayey fine sand with lenses of clay and shells.	14	-	-	-
		11	9	Gray to grayish brown sandy clay to clay with traces of shells.	1	32	72	61
		9	7	Grayish to brown slightly clayey to clayey fine sand with shells and occasional seams of clay.	7	-	-	-
		7	5	Gray slightly silty to silty fine sand with traces of shells.	0	-	-	-
		5	4	Grayish brown slightly silty to silty fine sand with shells and occasional pockets of clay.	0	-	-	-
		4	2.5	Gray sandy silt with seams of clay and traces of shells.	0	-	-	-
		2.5	-0.5	Brown to grayish brown fine sand with traces of shells.	11	-	-	-
		-0.5	-3.5	Gray slightly silty to silty fine sand with traces of shells.	3	-	-	-
		-3.5	-5.5	Brown to grayish brown fine sand with traces of shells.	14	-	-	-
508	TH-D	9.5	7	Gray to grayish brown slightly clayey to clayey fine sand with lenses of clay and shells.	8	-	-	-
		7	5.5	Grayish to brown slightly silty clayey to silty fine sand with shells and occasional pockets of clay.	8	-	-	-

Table 6. Index Testing Data of Previous Landside Borings (continued)

Boring Reference No.	Boring Name	Stratum Upper Elevation (ft, MLLW)	Stratum Lower Elevation (ft, MLLW)	Principal Soil Type	SPT N-value	Moisture Content (%)	Percent Passing U.S. 200 Sieve (%)	Plasticity Index (%)
508	TH-D	5.5	-5	Gray slightly silty to silty fine sand with traces of shells.	4	-	-	-
		-5	-8	Gray to grayish brown sandy clay to clay with traces of shells.	6	-	-	-
		-8	-9.5	Gray slightly silty to silty fine sand with traces of shells.	6	-	-	-
		-9.5	-11	Brown to grayish brown fine sand with traces of shells.	18	-	-	-
510	TH-F	8.5	7	Gray to grayish brown slightly clayey to clayey fine sand with lenses of clay and shells.	9	-	-	-
		7	-0.5	Brown to grayish brown fine sand with traces of shells.	9	-	-	-
		-0.5	-3.5	Gray slightly silty to silty fine sand with traces of shells.	7	-	-	-
		-3.5	-5	Brown to grayish brown fine sand with traces of shells.	14	-	-	-
		-5	-10.5	Gray to brown slightly clayey to clayey fine sand with shells and occasional seams of clay.	1	40	22	-
		-10.5	-12	Gray slightly silty to silty fine sand with traces of shells.	3	-	-	-
512	TH-G	29	20	Grayish brown slightly silty to silty fine sand with shells and occasional pockets of clay.	5	-	-	-
		20	18.5	Gray slightly silty to silty fine sand with traces of shells.	3	-	-	-
		18.5	17.5	Gray to grayish brown sandy clay to clay with traces of shells.	3	67	94	-

Table 6. Index Testing Data of Previous Landside Borings (continued)

Boring Reference No.	Boring Name	Stratum Upper Elevation (ft, MLLW)	Stratum Lower Elevation (ft, MLLW)	Principal Soil Type	SPT N-value	Moisture Content (%)	Percent Passing U.S. 200 Sieve (%)	Plasticity Index (%)
512	TH-G	17.5	10.5	Gray slightly silty to silty fine sand with traces of shells.	7	-	-	-
		10.5	9	Gray to grayish brown sandy clay to clay with traces of shells.	2	-	-	-
		9	-15	Gray slightly silty to silty fine sand with traces of shells.	6	-	-	-
		-15	-19	Brown to grayish brown fine sand with traces of shells.	61	-	-	-
		-19	-33	Gray to grayish brown sandy clay to clay with traces of shells.	1	88	96	-
		-33	-39.5	Gray to brown slightly clayey to clayey fine sand with shells and occasional seams of clay.	3	-	-	-
		-39.5	-48.5	Gray to grayish brown very clayey fine sand to very sandy clay with shells.	9	24	21	-
		-48.5	-56	Gray sandy silt with seams of clay and traces of shells.	3	-	-	-
		-56	-68	Gray to grayish brown very clayey fine sand to very sandy clay with shells.	6	32	19	-
		-68	-87	Gray slightly silty to silty fine sand with traces of shells.	32	-	-	-
513	TH-I	10	7	Grayish brown slightly silty to silty fine sand with shells and occasional pockets of clay.	5	-	-	-

Table 6. Index Testing Data of Previous Landside Borings (continued)

Boring Reference No.	Boring Name	Stratum Upper Elevation (ft. MLLW)	Stratum Lower Elevation (ft. MLLW)	Principal Soil Type	SPT N-value	Moisture Content (%)	Percent Passing U.S. 200 Sieve (%)	Plasticity Index (%)
513	TH-1	7	4	Brown to grayish brown fine sand with traces of shells.	4	-	-	-
		4	-7	Gray slightly silty to silty fine sand with traces of shells.	6	-	-	-
		-7	-12	Gray to brown slightly clayey to clayey fine sand with shells and occasional seams of clay.	2	-	-	-
		-12	-18	Gray slightly silty to silty fine sand with traces of shells.	11	-	-	-
		-18	-34	Gray to grayish brown sandy clay to clay with traces of shells.	1	90	99	66
		-34	-39	Gray slightly silty to silty fine sand with	24	-	-	-
578	PF-1	7.5	4.5	Gray or brown fine sand.	-	-	-	-
		4.5	4	Gray or brown slightly silty fine sand.	-	-	-	-
		4	3	Gray or brown fine sand.	-	-	-	-
		3	1.5	Gray or brown clay (CH).	-	-	-	-
678	TH-71	7.9	5.4	Brown fine sand with shells (SP)	32	-	-	-
		5.4	0.4	Gray clayey fine sand (SC)	30	-	-	-
		0.4	-4.6	Gray slightly clayey fine sand with shells (SM-SC)	5	-	-	-
		-4.6	-9.6	Gray fine sand with shells (SP)	5	-	-	-
		-9.6	-14.6	Gray silty fine sand (SM)	6	-	-	-
		-14.6	-19.6	Gray clayey fine sand (SC)	2	-	-	-

Table 6. Index Testing Data of Previous Landside Borings (continued)

Boring Reference No.	Boring Name	Stratum Upper Elevation (ft, MLLW)	Stratum Lower Elevation (ft, MLLW)	Principal Soil Type	SPT N-value	Moisture Content (%)	Percent Passing U.S. 200 Sieve (%)	Plasticity Index (%)
678	TH-71	-19.6	-24.6	Gray silty fine sand (SM)	8	-	-	-
		-24.6	-34.6	Grayish brown fine sand (SP)	42	-	-	-
		-34.6	-52.1	Gray clay with traces of shell (CH)	5	-	-	-
		-52.1	-69.6	Gray sandy clay with shells (CL)	9	-	-	-
		-69.6	-77.1	Gray clayey fine sand with shells (SC)	7	-	-	-
		-77.1	-83.1	Gray sandy clay (CL)	5	-	-	-
754	THW-4	9.6	8.1	Brown fine sand and shell with limestone (SP)	10	-	-	-
		8.1	5.1	Light brown limestone	52	-	-	-
		5.1	3.6	Brown fine sand with shells (SP)	68	-	-	-
		3.6	2.1	Brown slightly silty fine sand with shell (SP-SM)	44	-	-	-
		2.1	-2.9	Gray slightly silty fine sand with shell (SP-SM)	22	-	-	-
		-2.9	-7.9	Gray clayey fine sand with shells (SC)	5	-	-	-
		-7.9	-17.9	Gray fine sand with shell (SP)	36	-	-	-
		-17.9	-22.9	Gray slightly silty fine sand (SP-SM)	9	-	-	-
		-22.9	-32.9	Gray clay with traces of clayey fine sand and shell (CH)	0	77	99	-
		-32.9	-37.9	Gray fine sand with shells (SP)	54	-	-	-
		-37.9	-42.9	Light gray slightly silty fine sand with shell (SP-SM)	37	-	-	-

Table 6. Index Testing Data of Previous Landside Borings (continued)

Boring Reference No.	Boring Name	Stratum Upper Elevation (ft, MLLW)	Stratum Lower Elevation (ft, MLLW)	Principal Soil Type	SPT N-value	Moisture Content (%)	Percent Passing U.S. 200 Sieve (%)	Plasticity Index (%)
754	THW-4	-42.9	-48.9	Gray sandy clay with shells (CL)	3	51	-	-
		-48.9	-52.9	Gray clayey fine sand with shells (SC)	5	-	-	-
		-52.9	-57.9	Gray sandy clay with shells (CL)	8	-	-	-
		-57.9	-66.4	Gray clayey fine sand with shells (SC)	7	-	-	-
755	THW-5	9.9	5.9	Brown fine sand and shell with traces of clayey fine sand (SP)	16	-	-	-
		5.9	2.4	Gray fine sand and shell (SP)	14	-	-	-
		2.4	0.9	Gray silty fine sand and shell (SM)	3	-	-	-
		0.9	-7.6	Gray clayey fine sand with shells (SC)	2	-	-	-
		-7.6	-12.6	Gray fine sand (SP)	17	-	-	-
		-12.6	-17.6	Gray clay and shell (CH)	2	-	-	-
		-17.6	-22.6	Gray sandy clay (CL)	4	-	-	-
		-22.6	-32.6	Gray clay (CH)	1	83	99	-
		-32.6	-42.6	Gray silty fine sand and shell (SM)	29	-	-	-
		-42.6	-48.6	Gray clayey fine sand and shell (SC) with seams of gray clay	0	40	44	-
		-48.6	-82.6	Gray clayey fine sand and shell (SC)	8	-	-	-
-82.6	-91.1	Gray silty fine sand with cemented fine sand and shell (SM)	32	-	-	-		
758	THC-5	8.1	6.6	Very light brown limestone (road base materials)	44	-	-	-
		6.6	3.6	Grayish brown silty fine sand with shell (SP-SM)	20	16	10	-



Table 6. Index Testing Data of Previous Landside Borings (continued)

Boring Reference No.	Boring Name	Stratum Upper Elevation (ft, MLLW)	Stratum Lower Elevation (ft, MLLW)	Principal Soil Type	SPT N-value	Moisture Content (%)	Percent Passing U.S. 200 Sieve (%)	Plasticity Index (%)
758	THC-5	3.6	0.6	Gray slightly silty fine sand with shell (SP-SM)	6	19	7	-
		0.6	-0.9	Gray clayey fine sand with seams of clay (SC-CH)	1	-	-	-
		-0.9	-6.9	Gray fine sand with shells (SP)	10	-	-	-
		-6.9	-8.9	Gray silty fine sand with shell (SM)	12	-	-	-
		-8.9	-17.4	Gray fine sand with shells (SP)	17	17	3	-
		-17.4	-19.4	Gray clay with shell (CH)	9	-	-	-
		-19.4	-24.4	Gray silty fine sand with seams of gray clay (SM-CH)	3	-	-	-
		-24.4	-38.9	Gray clay (CH)	1	-	-	-
		-38.9	-44.4	Gray silty fine sand with shell (SM)	21	-	-	-
		-44.4	-54.4	Gray clayey fine sand with traces of clay (SC-CH)	5	-	-	-
		-54.4	-59.4	Gray slightly silty fine sand with shell (SP-SM)	28	-	-	-
		-59.4	-79.4	Gray clayey fine sand with shells (SC)	14	-	-	-
-79.4	-82.9	Gray silty fine sand with shell (SM)	49	-	-	-		
769	THY-1	12.8	11.8	Brown fine sand and scallop shell (SP)	33	-	-	-
		11.8	11.3	Gray slightly clayey fine sand and scallop shell (SM-SC)	33	-	-	-
		11.3	9.8	Brown fine sand with trace of shell (SP)	32	-	-	-

Table 6. Index Testing Data of Previous Landside Borings (continued)

Boring Reference No.	Boring Name	Stratum Upper Elevation (ft. MLLW)	Stratum Lower Elevation (ft. MLLW)	Principal Soil Type	SPT N-value	Moisture Content (%)	Percent Passing U.S. 200 Sieve (%)	Plasticity Index (%)
769	THY-1	9.8	7.8	Brown slightly silty fine sand with trace of shell and clayey fine sand (SP-SM)	34	-	-	-
		7.8	4.8	Grayish brown fine sand with trace of shell (SP)	25	-	-	-
		4.8	2.3	Gray fine sand and shell (SP)	25	-	-	-
		2.3	0.8	Gray slightly silty fine sand with shell (SP-SM)	20	-	-	-
784	TH-68	8.3	4.8	Grayish brown slightly silty fine sand with shells (SP-SM)	11	-	-	-
		4.8	2.3	Gray slightly silty fine sand with clayey fine sand (SP-SM)	22	-	-	-
		2.3	0.8	Gray fine sand with shells (SP)	6	-	-	-
		0.8	-5.2	Gray silty fine sand with shells (SM)	6	-	-	-
		-5.2	-8.2	Gray clayey fine sand with shells (SC)	0	-	-	-
		-8.2	-14.2	Gray slightly silty fine sand with shell (SP-SM)	23	-	-	-
		-14.2	-17.2	Gray slightly clayey fine sand (SM-SC)	1	-	-	-
		-17.2	-26.2	Gray clay (CH)	1	70	98	57
		-26.2	-34.2	Gray clayey fine sand with shells (SC)	2	-	-	-
		-34.2	-41.2	Gray clay (CH)	0	95	100	-
		-41.2	-44.2	Light gray slightly silty fine sand with shell (SP-SM)	12	-	-	-
		-44.2	-48.9	Gray sandy clay with shells (CL)	0	-	-	-
-48.9	-57.7	Gray clayey fine sand with shells (SC)	8	-	-	-		

Table 6. Index Testing Data of Previous Landside Borings (continued)

Boring Reference No.	Boring Name	Stratum Upper Elevation (ft. MLLW)	Stratum Lower Elevation (ft. MLLW)	Principal Soil Type	SPT N-value	Moisture Content (%)	Percent Passing U.S. 200 Sieve (%)	Plasticity Index (%)
785	TH-69	8.4	4.9	Light brown fine sand with shells (SP)	17	-	-	-
		4.9	2.4	Grayish brown fine sand with shells (SP)	35	-	-	-
		2.4	-4.1	Gray silty fine sand with shells (SM)	4	-	-	-
		-4.1	-9.1	Gray clayey fine sand with shells (SC)	3	-	-	-
		-9.1	-14.1	Gray fine sand (SP)	35	-	-	-
		-14.1	-19.1	Gray clayey fine sand with shells (SC)	3	-	-	-
		-19.1	-34.1	Gray clay (CH)	1	95	99	-
		-34.1	-44.1	Light gray slightly silty fine sand with traces of shells (SP-SM)	22	-	-	-
		-44.1	-49.1	Gray sandy clay with shells (CL)	3	-	-	-
		-49.1	-82.6	Gray clayey fine sand with shells (SC)	7	-	-	-
904	B-2	8.5	4	Gray to brown fine sand with traces of shell (SP).	17	-	-	-
		4	0.5	Gray to grayish-brown silty fine sand with occasional shell (SM).	8	-	-	-
		0.5	-2	Gray to brown fine sand with traces of shell (SP).	12	-	-	-
		-2	-4	Gray to grayish-brown silty fine sand with occasional shell (SM).	3	-	-	-
		-4	-6.5	Gray to brown fine sand with traces of shell (SP).	28	-	-	-
905	B-3	9	7.5	Gray to brown fine sand with traces of shell (SP).	7	-	-	-
		7.5	4.5	Gray to brown fine sand with seams of gray clay (SP-CH).	9	27	23	-

Table 6. Index Testing Data of Previous Landside Borings (continued)

Boring Reference No.	Boring Name	Stratum Upper Elevation (ft. MLLW)	Stratum Lower Elevation (ft. MLLW)	Principal Soil Type	SPT N-value	Moisture Content (%)	Percent Passing U.S. 200 Sieve (%)	Plasticity Index (%)
905	B-3	4.5	3	Gray clay and slightly sand clay (CH).	7	49	55	-
		3	-1.5	Gray to brown fine sand with traces of shell (SP).	12	-	-	-
		-1.5	-3.5	Gray to grayish-brown silty fine sand with occasional shell (SM).	1	-	-	-
		-3.5	-5.5	Gray to brown fine sand with traces of shell (SP).	29	-	-	-
984	THD-1	7.8	2.8	Brown fine sand and shell (SP).	6	-	-	-
		2.8	1.3	Brown slightly silty fine sand with traces of shell (SP-SM).	1	-	-	-
		1.3	-0.7	Grayish brown silty fine sand with traces of shell (SM).	4	-	-	-
		-0.7	-1.7	Gray fine sand with traces of shell (SP).	5	-	-	-
		-1.7	-2.7	Gray clayey fine sand with traces of shell (SC).	5	-	-	-
		-2.7	-18.7	Gray fine sand with traces of shell (SP).	19	-	-	-
		-18.7	-41.2	Gray clay with traces of shell (CH).	1	90	100	-
		-41.2	-44.7	Gray fine sand and shell with traces of gray clay (SP).	10	35	-	-
		-44.7	-63.7	Gray clayey fine sand with shell (SC).	9	-	-	-
985	THD-2	7.5	6	Gray silty fine sand and shell (SM).	16	-	-	-
		6	-2	Gray fine sand and shell (SP).	13	-	-	-
		-2	-3.5	Gray silty fine sand (SM).	2	-	-	-

Table 6. Index Testing Data of Previous Landside Borings (continued)

Boring Reference No.	Boring Name	Stratum Upper Elevation (ft, MLLW)	Stratum Lower Elevation (ft, MLLW)	Principal Soil Type	SPT N-value	Moisture Content (%)	Percent Passing U.S. 200 Sieve (%)	Plasticity Index (%)
985	THD-2	-3.5	-6	Gray fine sand with traces of shell (SP).	6	-	-	-
		-6	-20	Gray clayey fine sand with traces of shell (SC).	3	-	-	-
		-20	-27.5	Gray organic clay (CH).	0	92	-	-
		-27.5	-35.5	Gray fine sand with organic fine sand (SP).	12	-	-	-
		-35.5	-45	Gray clayey fine sand (SC).	2	-	-	-
		-45	-50	Gray slightly sandy clay with shell (CL).	1	-	-	-
		-50	-55	Gray clayey fine sand with shell (SC).	1	-	-	-
		-55	-60	Gray sandy clay with traces of shell (CL).	2	-	-	-
		-60	-69	Gray clayey fine sand with shell (SC).	7	-	-	-
986	THD-3	8	5	Light brown fine sand and shell (SP).	-	-	-	-
		5	1.5	Gray fine sand with traces of shell (SP).	18	-	-	-
		1.5	0	Gray fine sand and shell with traces of clay (SP).	14	-	-	-
		0	-2.5	Gray fine sand with traces of shell (SP).	10	-	-	-
		-2.5	-4.5	Gray clayey fine sand with traces of shell (SC).	0	-	-	-
		-4.5	-9.5	Gray fine sand with traces of shell (SP).	15	-	-	-
		-9.5	-14.5	Gray silty fine sand with traces of shell (SM).	3	-	-	-
		-14.5	-19.5	Gray clay (CH).	0	-	-	-

Table 6. Index Testing Data of Previous Landside Borings (continued)

Boring Reference No.	Boring Name	Stratum Upper Elevation (ft. MLLW)	Stratum Lower Elevation (ft. MLLW)	Principal Soil Type	SPT N-value	Moisture Content (%)	Percent Passing U.S. 200 Sieve (%)	Plasticity Index (%)
986	THD-3	-19.5	-32	Grayish brown fine sand (SP).	18	-	-	-
		-32	-34.5	Gray fine sand and shell (SP).	41	-	-	-
		-34.5	-39.5	Gray fine sand and shell with traces of clay (SP).	11	-	-	-
		-39.5	-44.5	Gray sandy clay and shell (CL).	2	-	-	-
		-44.5	-49.5	Gray sandy clay with traces of shell (CL).	2	-	-	-
		-49.5	-59.5	Gray sandy clay and shell (CL).	3	-	-	-
		-59.5	-63.5	Gray clayey fine sand and shell (SC).	5	-	-	-
1036	TH-J	9.3	4.8	Gray slightly clayey fine sand with traces of shell (SP-SC)	26	-	-	-
		4.8	3.3	Gray fine sand with traces of shell and clay (SP-CH)	28	-	-	-
		3.3	-3.2	Gray fine sand with traces of shell (SP)	12	-	-	-
		-3.2	-4.7	Gray slightly silty fine sand (SP-SM)	14	-	-	-
		-4.7	-7.9	Gray fine sand with traces of shell (SP)	22	-	-	-
		-7.9	-13.6	Gray slightly clayey fine sand with shells (SM-SC)	10	-	-	-
		-13.6	-18.6	Gray clayey fine sand with shells (SC)	6	-	-	-
		-18.6	-21.7	Gray fine sand with shells (SP)	22	-	-	-
1038	TH-L	9.4	7.4	Light brown fine sand with traces of shells (SP)	15	-	-	-
		7.4	4.9	Gray clayey fine sand with traces of shells (SC)	22	-	-	-

Table 6. Index Testing Data of Previous Landside Borings (continued)

Boring Reference No.	Boring Name	Stratum Upper Elevation (ft. MLLW)	Stratum Lower Elevation (ft. MLLW)	Principal Soil Type	SPT N-value	Moisture Content (%)	Percent Passing U.S. 200 Sieve (%)	Plasticity Index (%)
1038	TH-L	4.9	1.4	Gray fine sand with traces of shells (SP)	12	-	-	-
		1.4	-1.1	Gray slightly clayey fine sand with shells (SP-SC)	8	-	-	-
		-1.1	-7.7	Gray fine sand with traces of shell (SP)	18	-	-	-
		-7.7	-18.5	Gray silty fine sand with traces of shell (SM)	2	-	-	-
		-18.5	-21.6	Gray silty fine sand (SM)	3	-	-	-
1039	TH-M	11.8	10.3	Brown fine sand with shells and clay seams (SP-CH)	13	-	-	-
		10.3	6.3	Brown fine sand with shells and traces of clay (SP)	18	-	-	-
		6.3	1.3	Gray fine sand with shells (SP)	6	-	-	-
		1.3	-0.7	Gray silty fine sand with shells (SM)	0	-	-	-
		-0.7	-19.7	Gray fine sand (SP)	19	-	-	-
1042	TH-1	10.1	7.1	Gray fine sand and shell fragments (SP) with traces of clayey silt (ML)	9	-	-	-
		7.1	5.6	Gray fine sand and shell fragments (SP) with clay (CH)	3	-	-	-
		5.6	3.1	Gray sandy clay to clay (CH) with shell fragments	6	79	-	-
		3.1	-0.4	Gray slightly silty fine sand and shell fragments (SP) with very slight traces of clay (CH)	8	-	-	-

Table 6. Index Testing Data of Previous Landside Borings (continued)

Boring Reference No.	Boring Name	Stratum Upper Elevation (ft, MLLW)	Stratum Lower Elevation (ft, MLLW)	Principal Soil Type	SPT N-value	Moisture Content (%)	Percent Passing U.S. 200 Sieve (%)	Plasticity Index (%)
1043	TH-2	9.9	5.4	Light gray fine sand with shell fragments (SP)	11	-	-	-
		5.4	3.4	Gray fine sand with shell fragments (SP)	5	-	-	-
		3.4	2.4	Gray fine sand and shell fragments (SP) with traces of gray clay (CH)	3	-	-	-
		2.4	-0.6	Gray fine sand with shell fragments (SP)	4	-	-	-
1044	TH-3	10.1	4.1	Gray fine sand with shell fragments (SP)	22	-	-	-
		4.1	3.1	Dark gray fine sand with shell fragments (SP)	13	-	-	-
		3.1	2.1	Dark gray fine sand and shell fragments (SP) with slight traces of gray clay (CH)	14	-	-	-
		2.1	-0.4	Dark gray fine sand with shell fragments (SP)	15	-	-	-
1045	TH-4	9.5	6.5	Light gray fine sand with shell fragments (SP)	16	-	-	-
		6.5	4.5	Dark gray slightly silty fine sand (SP-SM)	14	-	-	-
		4.5	3.5	Dark gray silty fine sand (SP-SM)	3	-	-	-
		3.5	2	Gray sandy clay with shell fragments (CL)	4	-	-	-
		2	-1	Gray fine sand and shell fragments (SP) with traces of gray clay (CH)	10	-	-	-
1046	TH-5	9.2	7.7	Light gray fine sand with shell fragments (SP)	4	-	-	-



Table 6. Index Testing Data of Previous Landside Borings (continued)

Boring Reference No.	Boring Name	Stratum Upper Elevation (ft, MLLW)	Stratum Lower Elevation (ft, MLLW)	Principal Soil Type	SPT N-value	Moisture Content (%)	Percent Passing U.S. 200 Sieve (%)	Plasticity Index (%)
1046	TH-5	7.7	4.7	Gray fine sand and shell fragments (SP) with layers of gray clay (CH) (50% sand, 50% clay)	6	-	-	-
		4.7	-1.3	Gray fine sand with shell fragments (SP)	8	-	-	-
1047	TH-6	10	8.5	Light gray fine sand with shell fragments (SP)	6	-	-	-
		8.5	7	Light grayish brown fine sand and shell fragments (SP) with traces of clay (CH)	10	-	-	-
		7	5.5	Gray fine sand with shell fragments (SP)	5	-	-	-
		5.5	3.5	Gray clay with shell fragments (CH)	5	-	-	-
		3.5	-0.5	Gray fine sand with shell fragments (SP)	11	-	-	-
1048	TH-7	9.9	8.4	Light gray fine sand with shell fragments (SP)	9	-	-	-
		8.4	6.4	Light gray fine sand with shell fragments (SP) with gray clay (CH) (50% sand, 50% clay)	10	-	-	-
		6.4	5.4	Light gray fine sand with shell fragments (SP)	11	-	-	-
		5.4	3.9	Dark gray fine sand and shell fragments (SP) with slight traces of gray clay (CH)	5	-	-	-
		3.9	2.9	Gray clay with shell fragments (CH)	6	-	-	-
		2.9	-0.6	Gray fine sand and shell fragments (SP) with traces of gray clay (CH)	12	-	-	-

Table 6. Index Testing Data of Previous Landside Borings (continued)

Boring Reference No.	Boring Name	Stratum Upper Elevation (ft. MLLW)	Stratum Lower Elevation (ft. MLLW)	Principal Soil Type	SPT N-value	Moisture Content (%)	Percent Passing U.S. 200 Sieve (%)	Plasticity Index (%)
1049	TH-8	9.9	7.9	Light gray fine sand with shell fragments (SP)	10	-	-	-
		7.9	6.9	Light gray fine sand and shell fragments (SP) with gray clay (CH) (50% sand, 50% clay)	4	-	-	-
		6.9	5.4	Gray fine sand with shell fragments (SP)	11	-	-	-
		5.4	3.9	Gray slightly silty fine sand with shell fragments (SP-SM)	7	-	-	-
		3.9	2.4	Gray silty fine sand with shell fragments (SM)	12	-	-	-
		2.4	-0.6	Gray fine sand with shell fragments (SP)	16	-	-	-
1050	TH-9	10.3	6.8	Light gray fine sand with shell fragments (SP)	17	-	-	-
		6.8	5.3	Dark gray slightly silty fine sand (SP-SM) with traces of clay (CH)	10	-	-	-
		5.3	-0.2	Dark gray fine sand and shell fragments (SP) with slight traces of gray clay (CH) (50% sand, 50% clay)	7	-	-	-
1067	CR-9	13.8	9.3	Gray fine sand with shell fragments (SP)	6	2	-	-
		9.3	6.3	Gray slightly sandy clay (CL)	3	-	-	-
		6.3	4.3	Gray silty fine sand with shell fragments (SP-SM)	6	6	-	-
		4.3	1.8	Gray fine sand with traces of shell fragments (SP)	9	-	-	-
		1.8	-1.2	Gray medium to fine sand with shell fragments (SP, SP-SM)	18	5	-	-

Table 6. Index Testing Data of Previous Landside Borings (continued)

Boring Reference No.	Boring Name	Stratum Upper Elevation (ft. MLLW)	Stratum Lower Elevation (ft. MLLW)	Principal Soil Type	SPT N-value	Moisture Content (%)	Percent Passing U.S. 200 Sieve (%)	Plasticity Index (%)
1068	CR-10	14	9	Gray fine sand with shell fragments (SP, SP-SM)	8	5	-	-
		9	7.5	Gray silty, clayey fine sand (SM-SC)	4	24	-	-
		7.5	6	Gray sandy clay (CL)	7	-	-	-
		6	5	Gray silty fine sand with traces of shell fragments (SP-SM)	10	-	-	-
		5	2	Gray fine sand with traces of shell fragments (SP)	13	-	-	-
		2	-1	Gray medium to fine sand with shell fragments (SP)	18	-	-	-
1072	CR-14		-11.1	Grayish brown fine sand with shell fragments (SP)	11	-	-	-
			6.1	Grayish-brown fine sand with traces of shell fragments (SP, SM)	17	8	-	-
			3.6	Gray fine sand with traces of shell fragments (SP)	8	-	-	-
			0.6	Gray fine sand with shell and traces of gray clay (SP, SP-SM)	15	8	-	-
			-1.4	Gray fine sand with traces of shell (SP)	18	-	-	-
			-2.4	Brown sandy, organic clay with shell fragments (CL)	12	-	-	-
1073	CR-15	12.3	9.3	Grayish-brown fine sand with traces of shell fragments (SP, SP-SM)	4	4	-	-
		9.3	7.3	Gray fine sand with clay (SP-SC)	2	51	-	-
		7.3	6.3	Gray fine sand with traces of shell fragments (SP)	3	-	-	-

Table 6. Index Testing Data of Previous Landside Borings (continued)

Boring Reference No.	Boring Name	Stratum Upper Elevation (ft, MLLW)	Stratum Lower Elevation (ft, MLLW)	Principal Soil Type	SPT N-value	Moisture Content (%)	Percent Passing U.S. 200 Sieve (%)	Plasticity Index (%)
1073	CR-15	6.3	3.3	Gray sandy clay (CL)	4	-	-	-
		3.3	0.3	Gray silty fine sand with traces of shell fragments (SP-SM)	8	-	-	-
		0.3	-1.2	Gray sandy clay (CL)	7	-	-	-
		-1.2	-2.7	Brown sandy clay with shell fragments (CL)	13	-	-	-
1074	CR-16	13.8	11.8	Brown fine sand with shell fragments (SP)	6	3	-	-
		11.8	9.3	Gray clay (CH)	4	-	-	-
		9.3	8.3	Gray clay with seams of gray fine sand with shell fragments (CL)	6	-	-	-
		8.3	7.3	Gray sandy clay with shell fragments (CL)	5	-	-	-
		7.3	6.3	Gray clayey fine sand with shell fragments (SC)	3	-	-	-
		6.3	4.3	Gray sandy clay (CL)	4	-	-	-
		4.3	3.3	Gray silty fine sand with traces of shell fragments (SM)	5	-	-	-
		3.3	1.3	Gray sandy clay (CL)	8	-	-	-
1075	CR-17	1.3	-1.2	Gray silty fine sand with traces of shell fragments (SM)	8	-	-	-
		14.3	11.8	Brown fine sand with shell fragments (SP, SP-SM)	4	6	-	-
		11.8	8.3	Gray clay (CH)	3	-	-	-
		8.3	6.3	Gray sandy clay with shell fragments (CL)	1	-	-	-
		6.3	3.3	Gray silty fine sand with traces of shell (SM)	4	-	-	-
3.3	1.8	Gray silty fine sand with traces of shell and gray clay (SM)	3	-	-	-		

Table 6. Index Testing Data of Previous Landside Borings (continued)

Boring Reference No.	Boring Name	Stratum Upper Elevation (ft, MLLW)	Stratum Lower Elevation (ft, MLLW)	Principal Soil Type	SPT N-value	Moisture Content (%)	Percent Passing U.S. 200 Sieve (%)	Plasticity Index (%)
1075	CR-17	1.8	0.8	Gray sandy clay with traces of shell fragments (CL)	5	-	-	-
		0.8	-0.7	Gray clayey fine sand with shell fragments (SC)	10	-	-	-
1076	CR-18	15.6	10.6	Grayish-brown fine sand with shell fragments (SP)	9	2	-	-
		10.6	9.1	Gray fine sand with shell fragments and gray clay (SP, SC)	4	33	-	-
		9.1	6.6	Gray sandy clay (CL)	5	-	-	-
		6.6	5.1	Dark gray sandy clay (CL)	2	-	-	-
		5.1	2.1	Gray silty fine sand (SM)	6	-	-	-
		2.1	0.6	Gray silty, sandy clay (CL)	4	-	-	-
1167	B-3	-10.57	9.07	Light brown to gray fine sand with shell fragments (SP)	24	-	-	-
		9.07	5.57	Light brown to gray fine sand with traces of shell fragments (SP)	29	-	-	-
		5.57	4.57	Light brown to gray, slightly silty fine sand with shell fragments (SP-SM)	22	-	-	-
		4.57	2.57	Brownish gray medium to fine sand with shell fragments (SP)	-	18	2	-
		2.57	1.07	Gray slightly silty fine sand with shell fragments (SP-SM)	8	-	-	-
		1.07	0.07	Gray fine sand with shell fragments (SP)	8	-	-	-

Table 6. Index Testing Data of Previous Landside Borings (continued)

Boring Reference No.	Boring Name	Stratum Upper Elevation (ft, MLLW)	Stratum Lower Elevation (ft, MLLW)	Principal Soil Type	SPT N-value	Moisture Content (%)	Percent Passing U.S. 200 Sieve (%)	Plasticity Index (%)
1168	B-4	8.48	-4.48	Light brown fine sand with shell fragments (SP).	15	-	-	-
		4.48	-3.98	Gray silty fine sand (SM).	17	-	-	-
		3.98	-1.02	Gray fine sand with shell fragments (SP).	22	22	2	-
		-1.02	-2.52	Gray fine sand (SP).	9	-	-	-
1169	B-5	8.32	-5.82	Light brown to gray clayey fine sand with traces of shell fragments and roots (SC).	8	-	-	-
		5.82	-4.82	Gray silty fine sand with traces of shell fragments (SM).	7	-	-	-
		4.82	-2.32	Gray clayey fine sand with traces of shell fragments (SC).	6	-	-	-
		2.32	0.32	Gray sandy clay (CL).	-	32	58	-
		0.32	-1.18	Gray fine sand (SP).	4	-	-	-
		-1.18	-2.68	Gray medium to fine sand with shell fragments (SP).	6	-	-	-
1173	B-9	9.24	-5.74	Gray to light brown fine sand with shell fragments (SP).	21	-	-	-
		5.74	-4.24	Gray medium to fine sand with clay pockets and shell fragments (SP, CH).	9	-	-	-
		4.24	-1.24	Gray clay (CH).	4	-	-	-
		1.24	-1.76	Gray medium to fine sand with shell fragments (SP).	12	-	-	-
1346	TH-4	9	7.5	Brown silty fine sand with shells.	12	-	-	-
		7.5	6	Light brown silty fine sand with shell.	8	-	-	-

Table 6. Index Testing Data of Previous Landside Borings (continued)

Boring Reference No.	Boring Name	Stratum Upper Elevation (ft, MLLW)	Stratum Lower Elevation (ft, MLLW)	Principal Soil Type	SPT N-value	Moisture Content (%)	Percent Passing U.S. 200 Sieve (%)	Plasticity Index (%)
1346	TH-4	6	4.5	Brown slightly silty fine sand with clay lenses and shell.	13	-	-	-
		4.5	3	Gray fine and medium sand with trace shell.	10	-	-	-
		3	-3	Gray silty fine sand with shell.	10	-	-	-
		-3	-4.5	Gray fine sand with shell and trace clay.	3	-	-	-
		-4.5	-8	Gray sandy clay with shell.	2	-	-	-
		-8	-10	Gray silty fine sand with trace shell.	4	-	-	-
		-10	-17	Gray fine sand with shell.	20	-	-	-
		-17	-18	Gray slightly clayey fine sand with shell.	8	-	-	-
		-18	-19.5	Gray sandy clay with traces shell.	2	-	-	-
		-19.5	-21	Gray sandy clay to clayey sand.	2	-	-	-
		-21	-22.5	Gray clay with trace shell.	2	-	-	-
		-22.5	-27	Gray slightly sandy clay with trace shell.	2	-	-	-
		-27	-28.5	Gray clay with trace organics and trace shell.	2	-	-	-
		-28.5	-30	Gray clay	1	-	-	-
		-30	-31.5	Gray clay with trace shell.	2	-	-	-
		-31.5	-37.5	Gray clay.	2	-	-	-
		-37.5	-39	Gray clay with trace organics and trace shell.	3	-	-	-
-39	-40.5	Gray clay with trace shell.	2	-	-	-		
-40.5	-42	Light gray sandy clay with trace shell and trace cemented sand.	8	-	-	-		

Table 6. Index Testing Data of Previous Landside Borings (continued)

Boring Reference No.	Boring Name	Stratum Upper Elevation (ft, MLLW)	Stratum Lower Elevation (ft, MLLW)	Principal Soil Type	SPT N-value	Moisture Content (%)	Percent Passing U.S. 200 Sieve (%)	Plasticity Index (%)
1347	TH-5	8.2	6.7	Light brown fine sand with shell.	-	-	-	-
		6.7	5.2	Brown sandy clay with shell.	-	-	-	-
		5.2	3.7	Light brown fine sand with shell and trace clay.	-	-	-	-
		3.7	2.2	Gray fine sand with shell and trace clay.	9	-	-	-
		2.2	0.7	Gray fine to medium sand with shell.	16	-	-	-
		0.7	-0.8	Gray fine sand.	8	-	-	-
		-0.8	-3.8	Gray fine sand with trace shell.	3	-	-	-
		-3.8	-5.3	Gray fine sand with shell.	16	-	-	-
		-5.3	-6.8	Gray slightly silty fine sand.	12	-	-	-
		-6.8	-8.3	Gray fine sand with shell.	17	-	-	-
		-8.3	-9.8	Dark gray clayey fine sand to sandy clay with trace shell.	6	-	-	-
		-9.8	-11.3	Gray silty fine sand with trace clay and shell.	3	-	-	-
		-11.3	-12.8	Gray clayey fine sand with shell.	14	-	-	-
		-12.8	-15.8	Gray fine sand with shell.	33	-	-	-
		-15.8	-18.8	Gray fine sand.	24	-	-	-
		-18.8	-20.3	Gray clayey silty fine sand with trace shell.	5	-	-	-
		-20.3	-21.8	Gray slightly sandy clay with trace shell.	4	-	-	-
-21.8	-38.3	Gray clay with trace shell.	2	-	-	-		



Table 6. Index Testing Data of Previous Landside Borings (continued)

Boring Reference No.	Boring Name	Stratum Upper Elevation (ft, MLLW)	Stratum Lower Elevation (ft, MLLW)	Principal Soil Type	SPT N-value	Moisture Content (%)	Percent Passing U.S. 200 Sieve (%)	Plasticity Index (%)
1347	TH-5	-38.3	-39.8	Gray clay with trace shell and trace organics.	2	-	-	-
		-39.8	-41.3	Light gray sandy clay with trace shell and trace cemented sand.	2	-	-	-
		-41.3	-42.8	Light greenish-gray silty fine sand with shell.	13	-	-	-
1428	GR-1	13.5	13	Light gray limerock base material with traces of shell fragments.	-	14	8	-
		13	11	Gray silty fine sand with traces of shell fragments.	-	-	-	-
		11	7	Light gray slightly silty fine sand with traces of shell fragments.	-	-	-	-
		7	3.5	Gray fine sand with shell fragments.	-	-	-	-
1464	TH-1	-8.5	-9.5	Gray fine sand with trace shell.	23	-	-	-
		-9.5	-14.5	Gray sand and shell.	22	-	-	-
		-14.5	-18.5	Gray clayey fine sand with trace shell.	7	-	-	-
		-18.5	-23.5	Gray fine sand with trace shell.	7	-	-	-
		-23.5	-35	Gray clay with trace shell.	4	-	-	-
		-35	-43.5	Gray sand and shell.	30	-	-	-
		-43.5	-51.5	Gray fine sand with trace shell.	15	-	-	-

Table 6. Index Testing Data of Previous Landside Borings (continued)

Boring Reference No.	Boring Name	Stratum Upper Elevation (ft. MLLW)	Stratum Lower Elevation (ft. MLLW)	Principal Soil Type	SPT N-value	Moisture Content (%)	Percent Passing U.S. 200 Sieve (%)	Plasticity Index (%)
1465	TH-2	8.5	-4.5	Gray fine sand with trace shell.	11	-	-	-
		-4.5	-13.5	Gray sand and shell.	25	-	-	-
		-13.5	-19	Gray fine sand with trace shell and clay.	16	-	-	-
		-19	-34.5	Gray clay.	5	-	-	-
		-34.5	-51.5	Light gray sand and shell.	27	-	-	-
1471	TH-1	10	8.5	Light brown fine sand with trace shell fragments and clay.	14	-	-	-
		8.5	7	Light brown fine sand few clay and shell.	22	-	-	-
		7	4.5	Gray fine sand with silt trace clay and shell fragments.	20	-	-	-
		4.5	3.5	Gray fine sand with clay and shell.	22	-	-	-
		-3.5	1	Gray fine sand few shell and silt.	22	-	-	-
		1	-9	Gray fine sand with silt few shell.	7	-	-	-
		-9	-15	Gray clayey fine sand few shell fragments.	-	39	48	-
1472	TH-2	10	8.5	Light brown fine sand with trace silt.	-	-	-	-
		8.5	5.5	Gray fine sand with trace silt and shell fragments.	-	-	-	-
		5.5	4	Gray to light brown silty fine sand with trace shell fragments and clay.	24	-	-	-
		4	-2	Light gray fine sand with trace silt and shell fragments.	15	-	-	-

Table 6. Index Testing Data of Previous Landside Borings (continued)

Boring Reference No.	Boring Name	Stratum Upper Elevation (R, MLLW)	Stratum Lower Elevation (R, MLLW)	Principal Soil Type	SPT N-value	Moisture Content (%)	Percent Passing U.S. 200 Sieve (%)	Plasticity Index (%)
1472	TH-2	-2	-8.5	Gray clayey fine sand with shell.	3	-	-	-
		-8.5	-12.5	Gray fine sand few clay and shell.	2	-	-	-
		-12.5	-23	Gray clay with trace shell fragments and fine sand.	2	58	99	-
		-23	-27.5	Gray fine sand and silt with shell fragments.	14	-	-	-
		-27.5	-38	Gray fine sand with shell and trace silt.	23	-	-	-
		-38	-57.5	Bluish-gray sandy clay with trace shell fragments.	4	45	62	-
		-57.5	-67	Greenish-gray sandy clay few shell fragments.	12	30	57	-
		-67	-73.5	Greenish-gray fine sand few silt with trace shell fragments.	10	-	-	-
		-73.5	-95	Light gray calcareous cemented sand with trace silt and fine sand.	54	-	-	-
1473	TH-3	9.5	6.5	Light brown fine sand with shell and trace silt and clay.	-	-	-	-
		6.5	3.5	Gray fine sand few shell fragments with trace silt and clay.	14	-	-	-
		3.5	0.5	Gray fine sand with trace silt and shell fragments.	10	-	-	-
		0.5	-2.5	Light brown fine sand to clayey fine sand with few clay and shell fragments and trace silt.	4	-	-	-
		-2.5	-12.5	Greenish-gray silty fine sand.	7	-	-	-
		-12.5	-22.5	Gray clay with fine sand with trace shell fragments.	3	-	-	-

Table 6. Index Testing Data of Previous Landside Borings (continued)

Boring Reference No.	Boring Name	Stratum Upper Elevation (ft, MLLW)	Stratum Lower Elevation (ft, MLLW)	Principal Soil Type	SPT N-value	Moisture Content (%)	Percent Passing U.S. 200 Sieve (%)	Plasticity Index (%)
1473	TH-3	-22.5	-31.5	Gray fine sand few silt with trace clay and shell fragments.	5	-	-	-
1474	TH-4	9.5	-13	Gray fine sand with trace silt and shell fragments.	13	-	-	-
		-13	-15.5	Gray clayey fine sand with trace shell fragments.	2	37	44	-

#### 4. DESIGN SOIL PROFILES

##### 4.1 West Turning Basin Corner Cut-off

As a result of widening the West Turning Basin approximately 13.5 acres of land located at the south east corner of the West Turning Basin will have to be excavated below water surface to the new desired elevation. Twenty-one borings within the vicinity of the subject area have been drilled for previous field investigations and can be found in Appendices 3 and 4. The field and lab results of these borings indicate that the material to be excavated from the site can be summarized into two general soil profiles. The first general soil profile represents soils at the northwest end, while the second general soil profile represents soils at the southeast end.

##### 4.1.1 Corner Cut-off - Northwest End

The materials to be excavated from the northwest end of the West Turning Basin Corner Cut-off consist of silty sands with occasional lenses of fine poorly-graded quartz sand and clayey sand/sandy clay with trace amounts of shell to elevation -20 feet, MLLW. There is a higher percentage of clayey materials present in the borings furthest from the bulkhead walls. The upper portion of the silty sand to approximate elevation -5 feet, MLLW was firmer than that below. The material between approximate elevations -20 and -37 feet, MLLW, consisted of fine poorly-graded quartz sand with trace amounts of shell and occasional lenses of silty-sand. Below elevation -37 feet, MLLW, the materials to be excavated consisted of soft sandy clays to clayey sands with occasional lenses of soft clay. The general soil profile of the northwest end of the Corner Cut-off is presented in Figure 9.

##### 4.1.2 Corner Cut-off - Southeast End

The materials to be excavated from the southeast end of the West Turning Basin Cut-off consist of fine poorly-graded quartz sand with occasional clayey sand layers and trace amounts of shell from the ground surface to elevation 6 feet, MLLW. Below this clayey fine sands and sandy clays with trace amounts of shell, hard lenses of fine to medium poorly-graded quartz sand with an increasing percentage of sandy

clay and soft clay towards the center of the considered area, and silty sand to the southeast end are typically found down to elevation -8 feet, MLLW. Below this to an elevation -12 feet, MLLW is a layer of fine to medium poorly-graded quartz sand. From elevation -12 feet, MLLW to elevation -20 feet, MLLW is a layer of clayey fine sand to sandy clay with occasional fine poorly-graded quartz sand and soft clay lenses. A layer of very soft clay is found between elevation -20 to -32 feet, MLLW and below this is a silty-sand layer with occasional fine poorly-graded quartz sand. The general soil profile of the southeast end of the Corner Cut-off is presented in Figure 10.

#### 4.1.3 Corner Cut-off - Bulkhead Wall Design

Widening the West Turning Basin and excavation of the Corner Cut-Off will also result in relocation of the existing beach with a bulkhead wall being installed at a later date. The soil profile of the area of the bulkhead wall consists of silty sands with occasional lenses of clayey fine sand, sandy clay and soft clay from the ground surface to elevation -2.5 feet, MLLW. A layer of silty sands and clayey fine sands is found from elevation -2.5 feet, MLLW to elevation -24 feet, MLLW. Soft clays and sandy clays are found from elevation -24 feet, MLLW to elevation -42.5 feet, MLLW with sandy clay below that to elevation -55 feet, MLLW and silty to clayey sands below that. The general soil profile behind a future bulkhead wall in this location is presented in Figure 11.

#### 4.2 Inner Reach North Side Dike Relocation

The materials to be excavated or relocated from the dike at the north side of the Inner Reach between the Middle Turning Basin and the Trident Turning Basin consist of fine to medium poorly-graded quartz sand dike fill, silty sand dredge material, soft clay and sandy clay. Silty sands and soft sandy clay layers below the proposed dredge line were included in the stability analyses, but are not to be excavated. The general soil profile is detailed further in Section 5.2 and presented on Figure 12.

### 5 DIKE RELOCATION STABILITY ANALYSES

#### 5.1 Slope Stability Analyses Methodology

Stability analyses were conducted on a typical design cross section for the existing and proposed relocation dike to the north of the Inner Reach. The stability analyses determined the factors of safety against failure of the foundation soils and circular arc failure through the upstream and downstream slopes.

The computer model SLOPE/W was used to analyze the various stability considerations. SLOPE/W, developed by Geo-Slope International Ltd. of Calgary, Alberta, Canada, is a fully integrated slope stability analysis program. The computer program determines the critical failure surface for each failure mode by converging on the failure surface through an iterative procedure. Final stability analyses on the most critical failure surfaces identified in the search routine were completed using Spencer's method, which satisfies total force and moment equilibrium. The stability analyses were performed using an estimated pore pressure distribution assuming ponding of water to elevation 20 feet, MLLW behind the dike, along with the shear strength parameters and unit weights selected in Section 5.2.

The relevant material properties used in the slope stability and bearing capacity analyses, along with the critical failure surfaces, for the existing and proposed design cross sections are presented on Figure 12.

## 5.2 Material Properties

### 5.2.1 Dike Fill

The dike fill material consists of fine to medium poorly-graded quartz sand. This fill is placed above elevation 14 feet, MLLW. For stability analyses, the following engineering properties were selected for this soil:



### 5.2.2 Dredge Material

The dredge material found in our recent boring TH-7 (1530) is typical of the disposed dredge materials deposited inside the dike footprint. The dredge materials consist mainly of soft silty sands with occasional clay seams. Potential slope failure surfaces of the existing dike location do not pass through this dredged material, however, once the dike is relocated, potential failure surfaces will pass through the dredged material. Directly under the existing dike footprint is a layer of loose fine poorly-graded quartz sand. These soil types are typically found between elevations 1 feet, MLLW and 14 feet, MLLW and based upon our limited field exploration and laboratory testing program, the two soils exhibit nearly identical properties. For stability analyses, the following engineering properties were selected for these soils:



### 5.2.3 Dense Sand

This stratum is a dense layer of fine to medium poorly-graded quartz sand with occasional lenses of firm silty sand. The layer is typically found between elevation 1 feet, MLLW and -24 feet, MLLW. For stability analyses, the following engineering properties were selected for this soil:



### 5.2.4 Marine Clay

Soft marine clay is typically found across Port Canaveral, at this location the stratum ranges from elevation -22 to -50 feet, MLLW within lenses of sandy clay above. In the design cross-section, the marine clay is expected to occur between elevations -24 feet, MLLW and -44 feet, MLLW. For stability analyses, the following engineering properties were selected for this soil:

•	Standard Penetration Test "N" Value	3
•	Saturated Unit Weight, $\gamma_{s\bar{u}}$	105 psf
•	Effective Friction Angle, $\bar{\phi}$	0
•	Undrained Shear Strength, $S_u$	500 psf

#### 5.2.5 Clayey Sand to Sandy Clay

Soft sandy clay to occasionally clayey fine sand underlies the marine clay between elevations -44 feet, MLLW to -60 feet, MLLW. For stability analyses, the following engineering properties were selected for this soil:

•	Standard Penetration Test "N" Value	5
•	Saturated Unit Weight, $\gamma_{s\bar{u}}$	110 psf
•	Effective Friction Angle, $\bar{\phi}$	30°
•	Effective Cohesion, $\bar{c}$	0 psf

#### 5.2.6 Shallow Silty Sand

The shallower layer of silty sand is found between elevations -60 and -65 feet, MLLW, but can be as shallow as -55 feet, MLLW. For stability analyses, the following engineering properties were selected for this soil:

•	Standard Penetration Test "N" Value	20
•	Saturated Unit Weight, $\gamma_{s\bar{u}}$	115 psf
•	Effective Friction Angle, $\bar{\phi}$	33°
•	Effective Cohesion, $\bar{c}$	0 psf

#### 5.2.7 Clayey Sand to Sandy Clay

A layer of soft sandy clay is typically found between the two silty sand layers in the range of elevation -65 to -75 feet, MLLW. For stability analyses, the following engineering properties were selected for this soil:

•	Standard Penetration Test "N" Value	2
•	Saturated Unit Weight, $\gamma_{s\bar{u}}$	105 psf
•	Effective Friction Angle, $\bar{\phi}$	28°
•	Effective Cohesion, $\bar{c}$	0 psf

#### 5.2.8 Deep Silty Sand

The soft sandy clay is underlain by silty sands. For stability analyses, the following engineering properties were selected for this soil:

•	Standard Penetration Test "N" Value	20
•	Saturated Unit Weight, $\gamma_{s\bar{u}}$	115 psf
•	Effective Friction Angle, $\bar{\phi}$	33°
•	Effective Cohesion, $\bar{c}$	0 psf

### 5.3 Existing Dike Slope Stability

The computed factor of safety for the slope stability analyses of the existing dike geometry is approximately 1.57 for failure in the foundation soils, 1.69 for the lower slope by the shoreline and 2.29 on the dike slopes, all of which exceed the minimum recommended safety factor of 1.5. The analyses of the existing dike included the sandier dredge deposits as the dike foundation. The slope stability analyses results are presented in Figure 13.

### 5.4 Relocated Dike Slope Stability

The geometry of the relocated dike is proposed to be identical to the existing geometry. From the results of recent field and laboratory testing program it is not evident that there is any difference between the soil properties of the silty sand in the pond bottom and loose sand found in the foundation of the existing dike. The remainder of the soil profile is generally similar to the profile of the existing dike, and thus the factor of safety obtained from slope stability analyses would also be similar to the factor of safety at the existing slope.

## 6 BULKHEAD WALL EVALUATION AND RECOMMENDATIONS

### 6.1 General Soil Profile and Engineering Properties Used in the Analyses

The results of the past field explorations and laboratory testing programs are graphically summarized on the soil boring profiles presented in Appendices 3 and 4. The stratification of the boring profiles represents our interpretation of the field boring logs and the results of laboratory examinations of the recovered samples. The stratification lines represent the approximate boundary between soil types. The actual transition may be more gradual than implied.

The below soil profiles are outlined in general terms only. Please refer to the individual boring logs for soil profile details at the test boring locations. The selected engineering properties for each layer are based upon our interpretation of the soil type and our experience with similar subsurface conditions in the site vicinity.

#### 6.1.1 West End of the South Side of the West Turning Basin Channel

The following soil properties are recommended for use in the analyses and design of the bulkhead at the west end of the south side of the West Turning Basin Channel for the bulkhead stability analysis shown on Figure 14.

- Loose to medium dense fine sand with shells (ground surface to Elevation -18 feet (MLLW)).

Saturated Unit Weight, $\gamma_s$	120 pcf
Effective Cohesion, $\bar{c}$	0 psf
Effective Friction Angle, $\bar{\phi}$	33°



- Very loose fine sand from Elevation -18 feet (MLLW) to Elevation -20 feet (MLLW).
 

Saturated Unit Weight, $\gamma_s$	115 pcf
Effective Cohesion, $\bar{c}$	0 psf
Effective Friction Angle, $\bar{\phi}$	30°
  
- Soft Clay in the general depth range of -20 feet (MLLW) to -41 feet (MLLW).
 

Saturated Unit Weight, $\gamma_s$	100 pcf
Undrained Shear Strength, $S_u$	800 psf
Effective Friction Angle, $\bar{\phi}$	0°
  
- Loose clayey fine sand below Elevation -41 feet (MLLW).
 

Saturated Unit Weight, $\gamma_s$	115 pcf
Effective Cohesion, $\bar{c}$	0 psf
Effective Friction Angle, $\bar{\phi}$	32°

#### 6.1.2 East End of South Side of the West Turning Basin Channel

The following soil properties are recommended for use in the analyses and design of the bulkhead at the east end of the south side of the West Turning Basin Channel for bulkhead wall stability analyses shown on Figure 15 .

- Medium dense fine sand to silty fine sand with shells (ground surface to Elevation -11 feet (MLLW)).
 

Saturated Unit Weight, $\gamma_s$	115 pcf
Effective Cohesion, $\bar{c}$	0 psf
Effective Friction Angle, $\bar{\phi}$	32°
  
- Clayey sand to sandy clay in the general depth range of -11 feet (MLLW) to -27 feet (MLLW).
 

Saturated Unit Weight, $\gamma_s$	100 pcf
Undrained Shear Strength, $S_u$	800 psf
Effective Friction Angle, $\bar{\phi}$	0°
  
- Medium dense silty to clayey fine sand from Elevation -27 feet (MLLW) to Elevation -39 feet (MLLW).
 

Saturated Unit Weight, $\gamma_s$	115 pcf
Effective Cohesion, $\bar{c}$	0 psf
Effective Friction Angle, $\bar{\phi}$	32°

- Sandy clay below Elevation -39 feet (MLLW).

Saturated Unit Weight, $\gamma_s$	100 pcf
Undrained Shear Strength, $\bar{c}$	1,500 psf
Effective Friction Angle, $\bar{\phi}$	0

### 6.1.3 Corner Cut-off of the West Turning Basin Channel

The following soil properties are recommended for use in the analyses and design of the bulkhead at the corner cut-off of the West Turning Basin Channel. These parameters are also presented in Figure 11 for the bulkhead wall stability analysis shown on Figure 16.

- Medium dense silty fine sand with shells (ground surface to Elevation -2.5 feet (MLLW)).

Saturated Unit Weight, $\gamma_s$	115 pcf
Effective Cohesion, $\bar{c}$	0 psf
Effective Friction Angle, $\bar{\phi}$	31

- Medium dense silty to clayey fine sand from Elevation -2.5 feet (MLLW) to Elevation -24 feet (MLLW).

Saturated Unit Weight, $\gamma_s$	115 pcf
Effective Cohesion, $\bar{c}$	0 psf
Effective Friction Angle, $\bar{\phi}$	31

- Soft clay to sandy clay in the general range from Elevation -24 feet (MLLW) to Elevation -42.5 feet (MLLW).

Saturated Unit Weight, $\gamma_s$	105 pcf
Undrained Shear Strength, $S_u$	800 psf
Effective Friction Angle, $\bar{\phi}$	0

- Clayey fine sand to sandy clay from Elevation -42.5 feet (MLLW) to Elevation -55 feet (MLLW).

Saturated Unit Weight, $\gamma_s$	120 pcf
Undrained Shear Strength, $S_u$	1,500 psf
Effective Friction Angle, $\bar{\phi}$	0

- Loose silty to clayey fine sand below Elevation -55 feet (MLLW).

Saturated Unit Weight, $\gamma_s$	110 pcf
Effective Cohesion, $\bar{c}$	0 psf
Effective Friction Angle, $\bar{\phi}$	30

## 6.2 Anchored Bulkhead Evaluation

A typical bulkhead section was evaluated for stability for three different cross sections, as shown in Figures 14 through 16 using U.S. Army Corps of Engineers program CWALSHT. The anchored bulkhead was checked for structural stability using the fixed earth, free earth and equivalent beam support method.

Some of the criteria and assumptions which were used in the analyses are listed below:

- Final ground surface behind wall will be +10.0 feet (MLLW).
- The water table is at Elevation +6.0 feet (MLLW) behind the wall.
- The water level in the West Turning Basin is at Elevation 0.0 feet (MLLW).
- A factor of safety greater than or equal to 1.5.

Figure 14 shows the original design condition with a depth of -13 feet (MLLW) at the bulkhead and a slope of 2.4 (H) to 1.0 (V) to the dredge line at a depth of -33 feet (MLLW) in the channel. Figure 15 shows a depth of -18 feet (MLLW) at the bulkhead with a slope of 2.4 (H) to 1.0 (V) to the dredge line at a depth of -35 feet (MLLW) in the channel. Figure 16 shows the existing ground surface and shoreline without a bulkhead with a slope of 2.3 (H) to 1.0 (V) to the dredge line at a depth of -34 feet (MLLW). Also shown on Figures 15 through 16 are the projected limits of the proposed dredging to a depth of -40 feet (MLLW) with a slope of 3.0 (H) to 1.0 (V) on the south side of the channel and on the slope for the northeast corner cut-off. These cross-sections were used in the bulkhead stability analyses.

The estimated depths of embedment and anchor loads that resulted from this evaluation were similar, for the two bulkhead cases considered on the south side of the West Turning Basin, to the existing geometry. A new bulkhead wall will be required for the Corner Cut-off of the West Turning Basin and should be investigated and designed at a later date.

## 7 CLOSURE

The analyses and recommendations submitted herein are based upon the data obtained from the soil borings presented in Appendix B. This report does not reflect any variations which may occur adjacent to or between the borings. The nature and extent of the variations between the borings may not become evident until during construction. If variations then appear evident, it will be necessary to re-evaluate the recommendations presented in this report after performing onsite observations during the construction period and noting the characteristics of the variations.

This report has been prepared in accordance with generally accepted soil and foundation engineering practices. In the event any changes occur in the design, nature or location of the proposed facility, we should review the applicability of conclusions and recommendations in this report. We also recommend a general review of final design and specifications by our office to make sure that earthwork and foundation recommendations are properly interpreted and implemented in the design specifications.

Canaveral Port Authority  
File Number 05-100

-82-

We appreciate the opportunity to be of service to you on this phase of the project. If you have any questions or comments regarding this report, or if we may be of further assistance, please feel free to contact us.

Very truly yours,  
ARDAMAN & ASSOCIATES, INC.

Mohamad Al-hawaree, P.E.  
Project Manager

Simon J. Brooks, P.E.  
Project Engineer

John E. Garlanger, Ph.D., P.E.  
Principal Engineer  
Florida Registration No. 19782

MH/SJB/JEG/bh

T:\Projects\2005\05-100\05-100 Section 203 Study.wpd

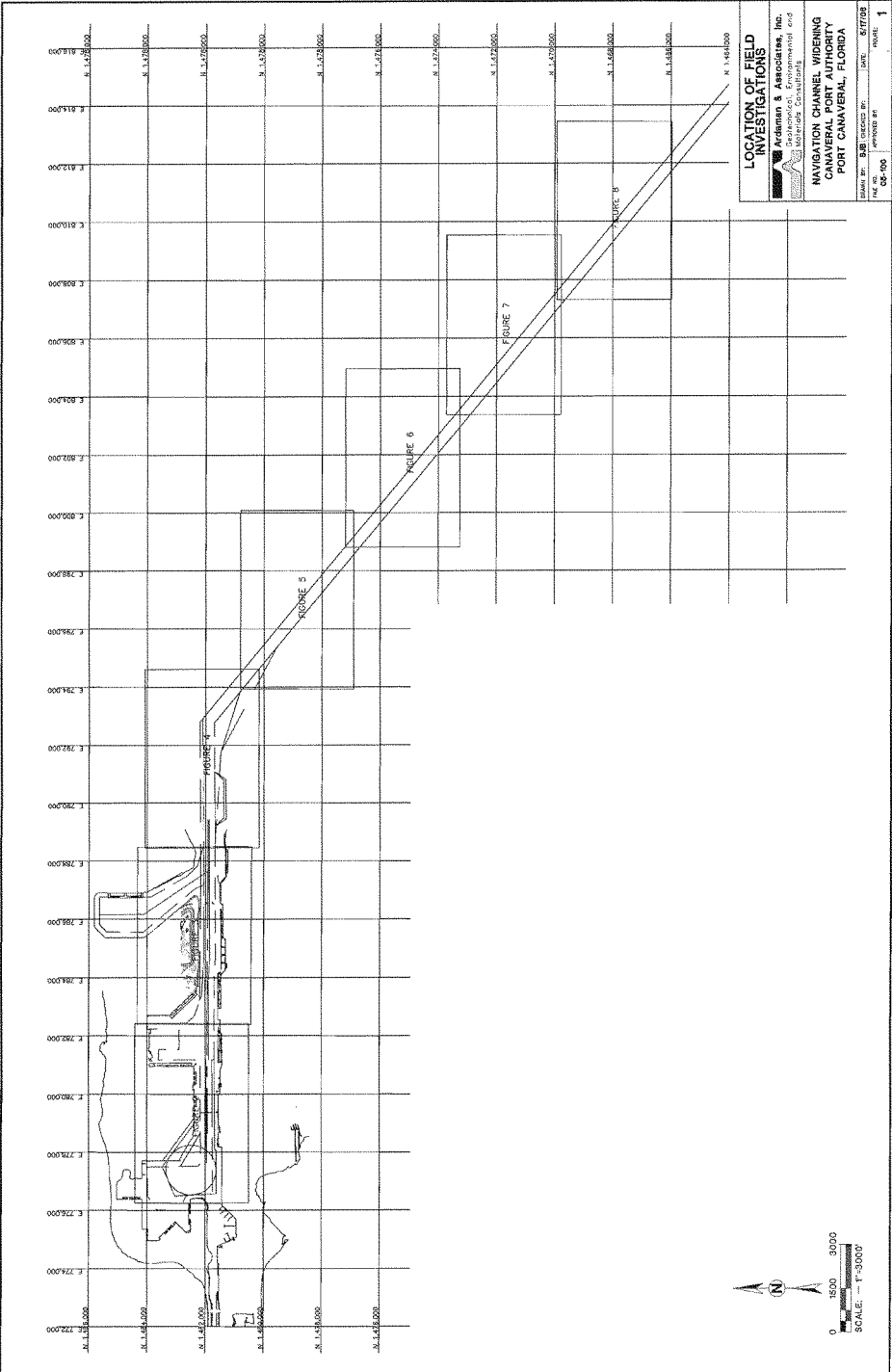

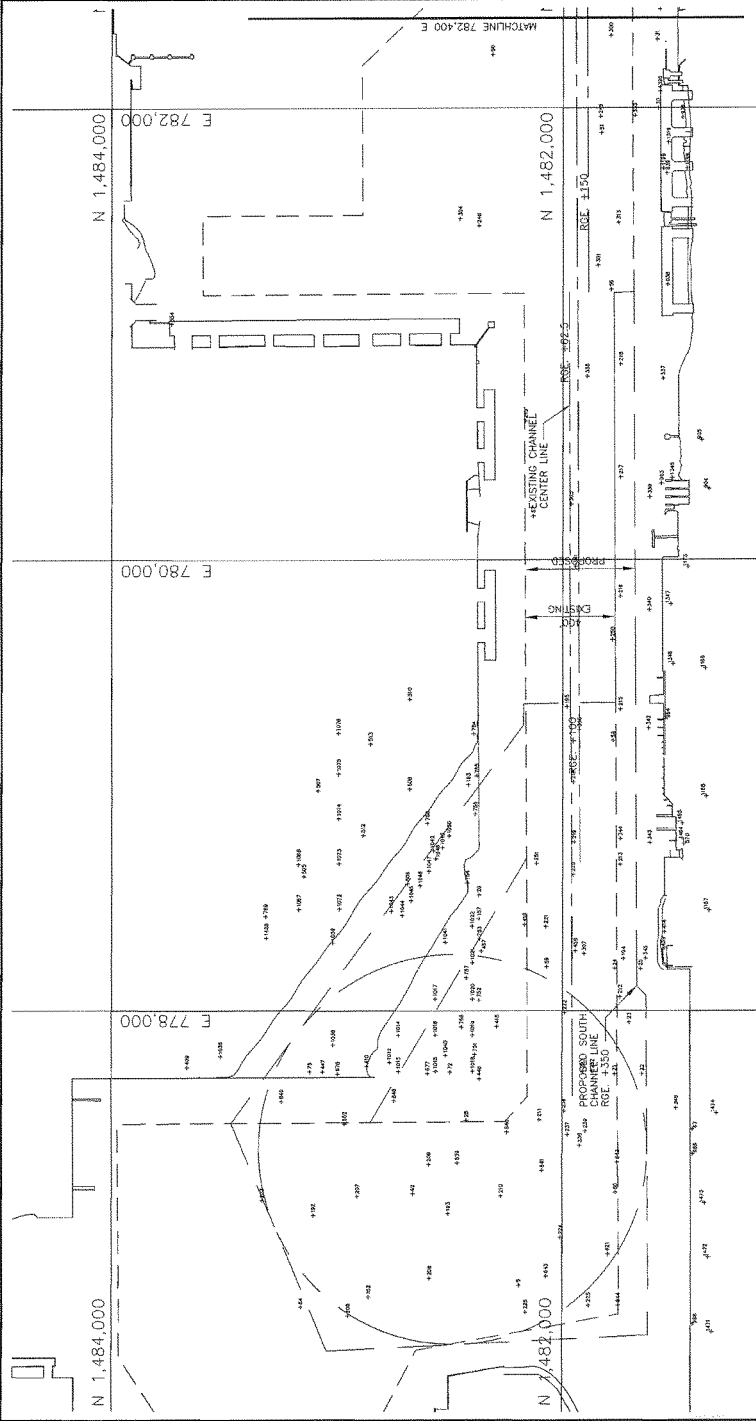

**BORING LOCATION AND RECOVERED MATERIAL PLAN - 1**

**Ardimen & Associates, Inc.**  
 10000 NW 11th Street, Suite 200  
 Miramar, Florida 33187-1101  
 Phone: (305) 231-1100

**NAVIGATION CHANNEL WIDENING  
 CANAVERAL PORT AUTHORITY  
 PORT CANAVERAL, FLORIDA**

DATE: 9/28/09  
 DRAWN BY: JRM  
 CHECKED BY: JRM  
 FILE NO.: 138-000  
 SHEET NO.: 2

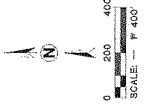

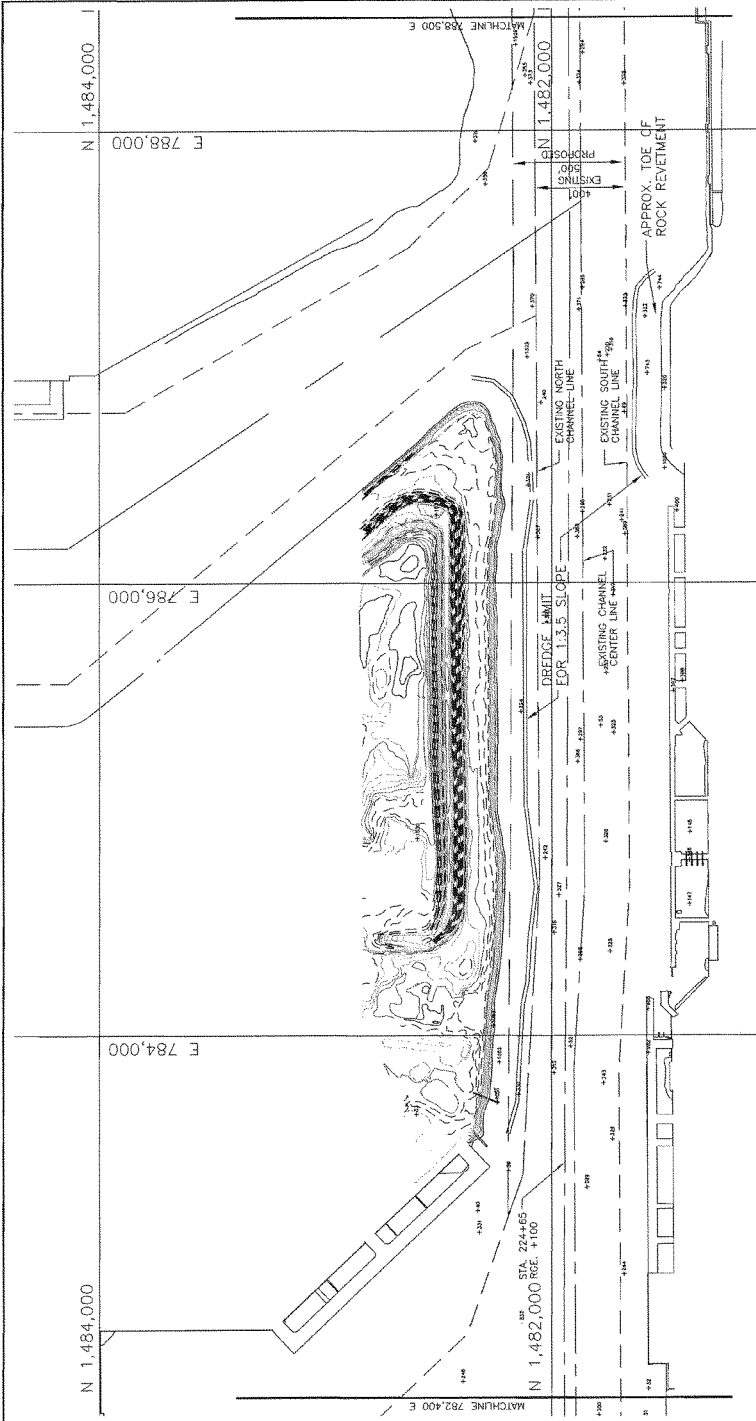

**BORING LOCATION AND RECOVERED MATERIAL PLAN - 2**

Adelman & Associates, Inc.  
 10000 W. US Highway 90  
 Maitland, Florida 32751  
 Telephone: 407/875-1100  
 Fax: 407/875-1101

NAVIGATION CHANNEL WIDENING  
 CANAVERAL PORT AUTHORITY  
 PORT CANAVERAL, FLORIDA

DATE: 05/24/06  
 DRAWN BY: SJB  
 CHECKED BY: JAC  
 PLOTTED BY: JAC  
 SCALE: AS SHOWN  
 SHEET NO. 05-100  
 PROJECT NO. 05-100  
 DATE: 07/09  
 PAGE: 3

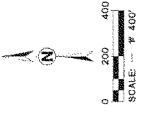

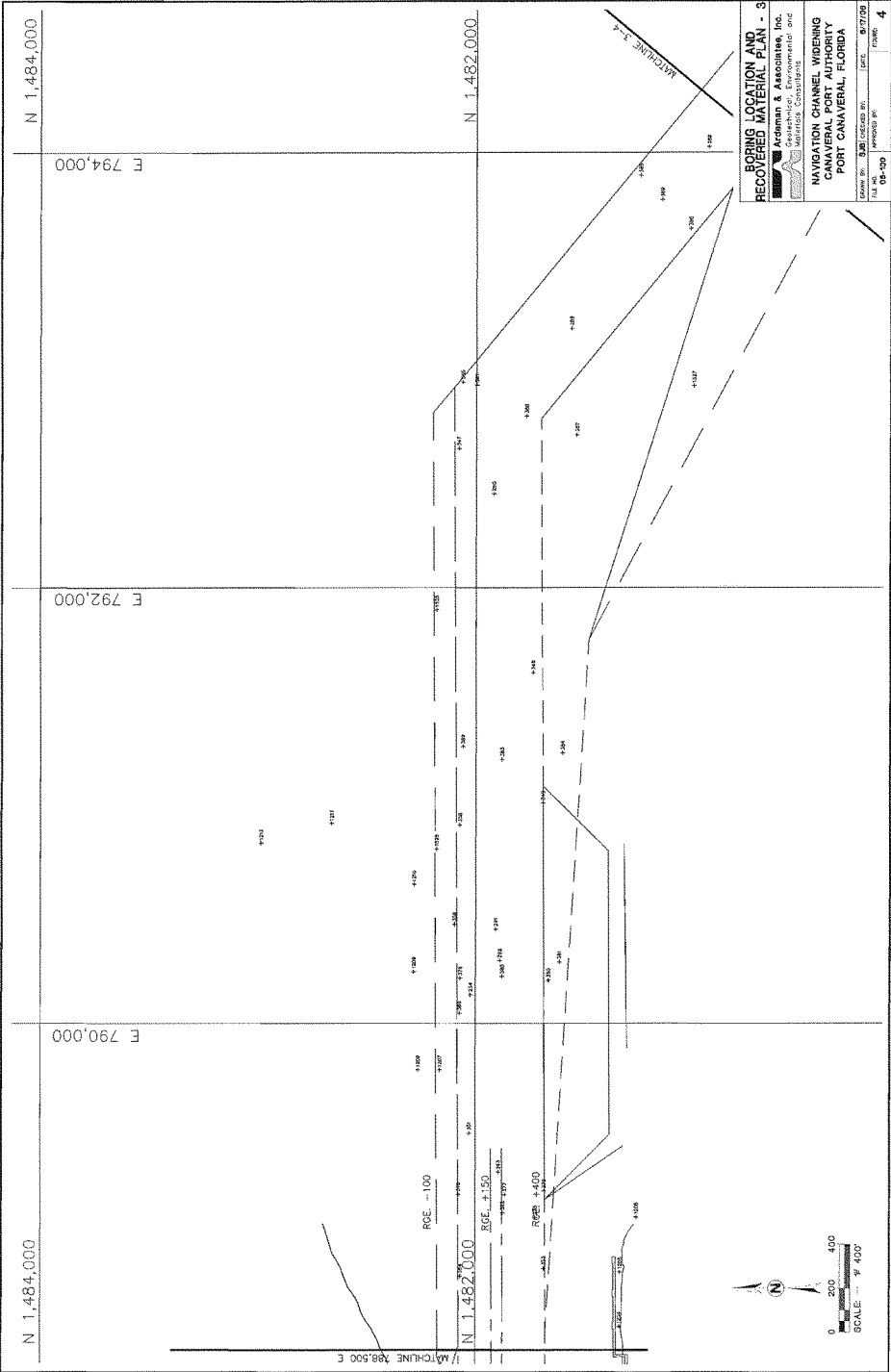



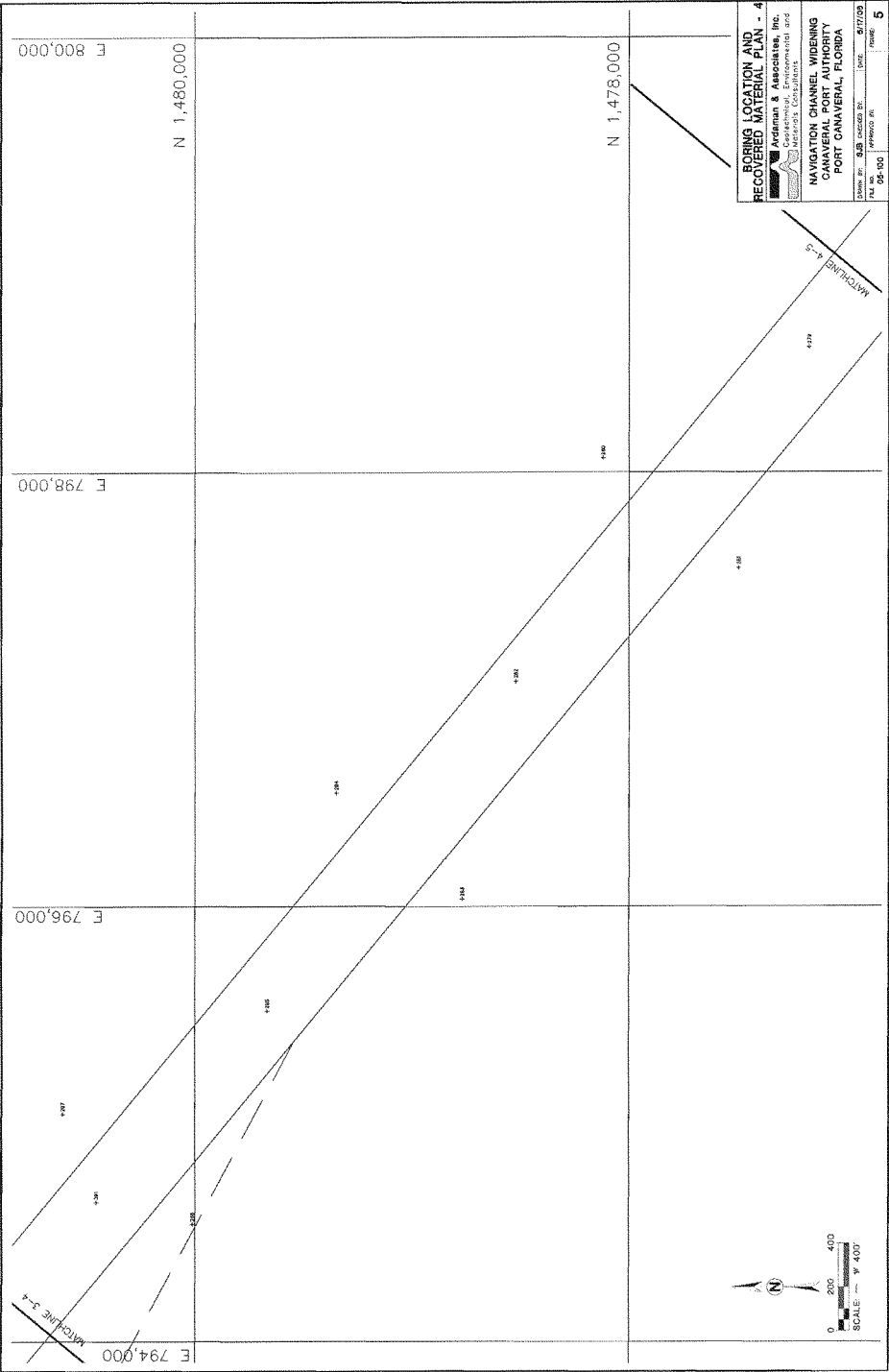

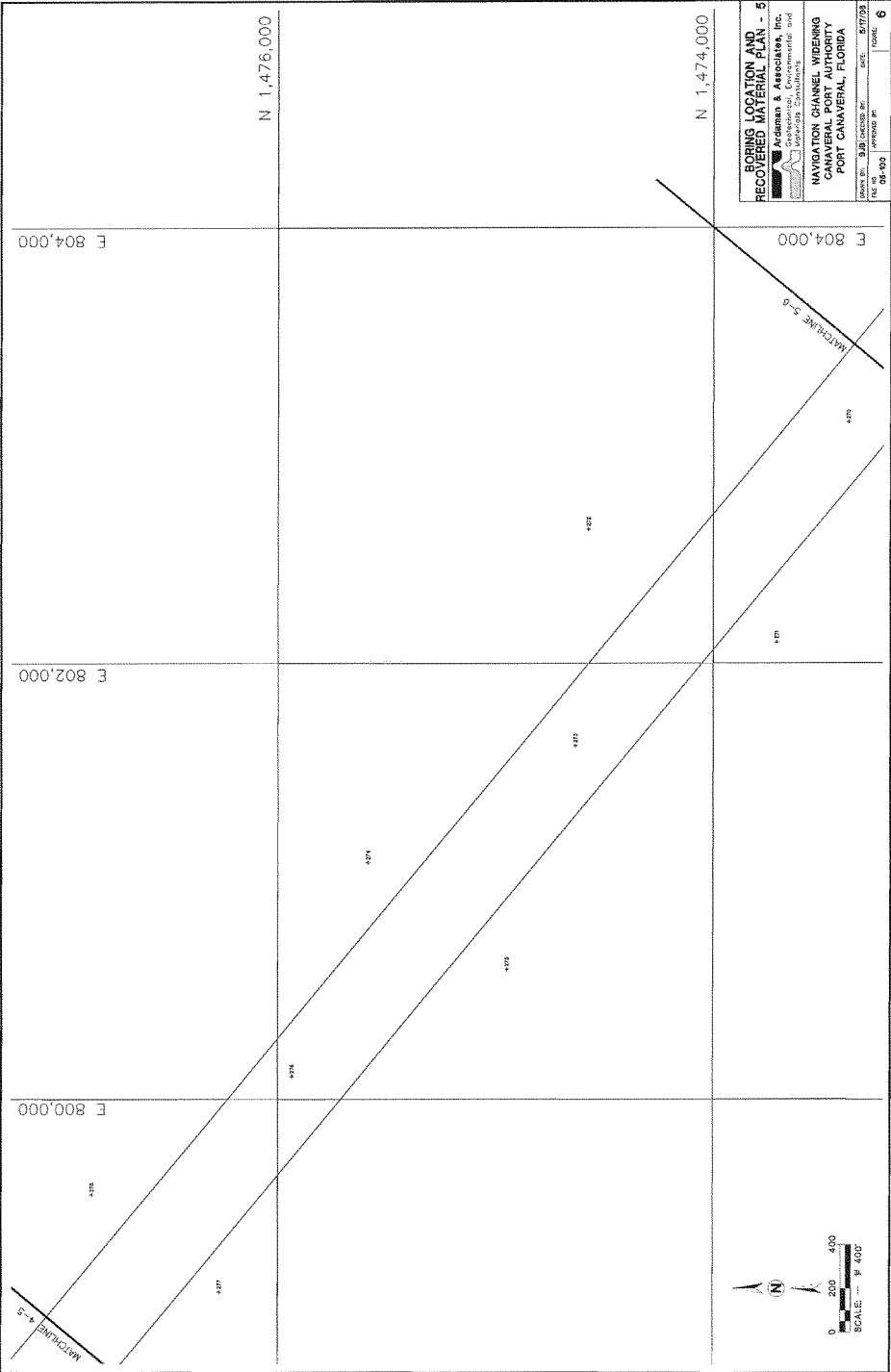

**BORING LOCATION AND RECOVERED MATERIAL PLAN - 5**

Arden & Associates, Inc.  
 10000 International Blvd.  
 Jacksonville, Florida 32217  
 Phone: 904/381-1111  
 Fax: 904/381-1112

NAVIGATION CHANNEL WIDENING  
 CANAVERAL PORT AUTHORITY  
 PORT CANAVERAL, FLORIDA

DATE: 05/17/03  
 DRAWN BY: SJB CHECKED BY: [ ]  
 FILE NO: 05-03 PROJECT NO: 6

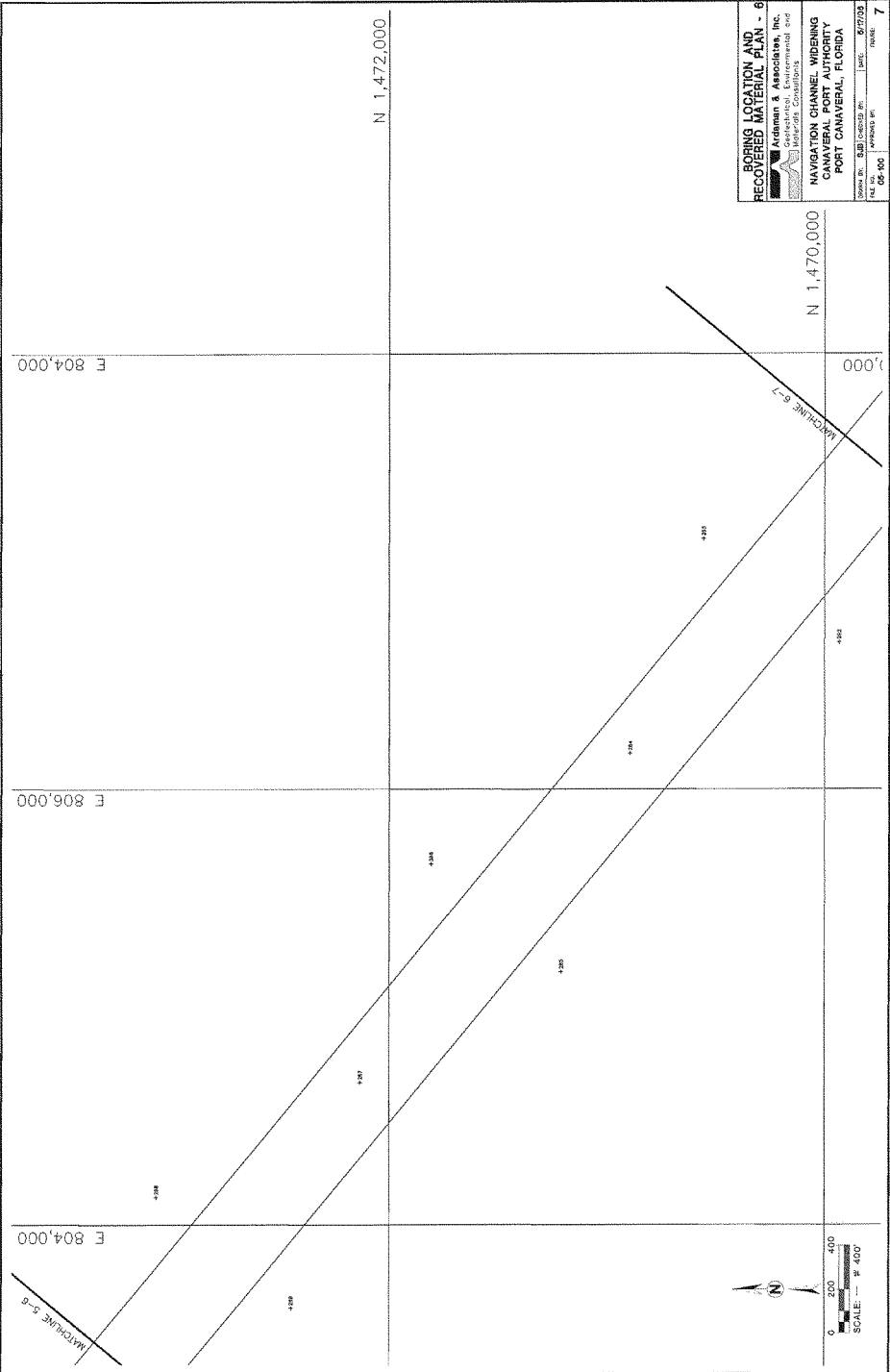

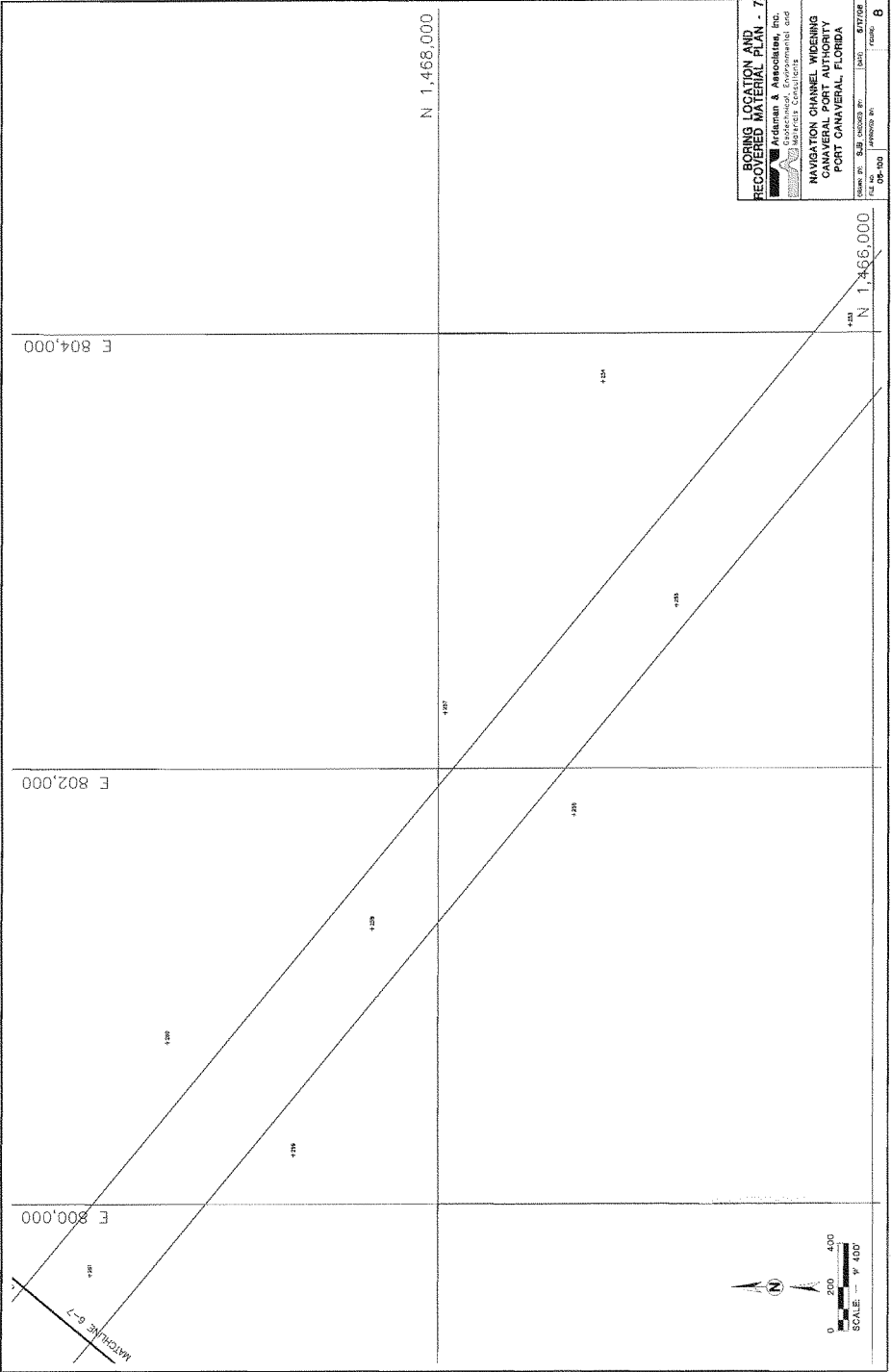

**BORING LOCATION AND RECOVERED MATERIAL PLAN - 7**

**Ardaman & Associates, Inc.**  
 10000 W. US Highway 90  
 Miramar, Florida 33181  
 (305) 666-1100  
 FAX (305) 666-1101

**NAVIGATION CHANNEL WIDENING  
 CANAVERAL PORT AUTHORITY  
 PORT CANAVERAL, FLORIDA**

Drawn by: SJB Checked by: [ ] Date: 8/17/08  
 File No: 03D-100 Approval by: [ ] Permit: 6

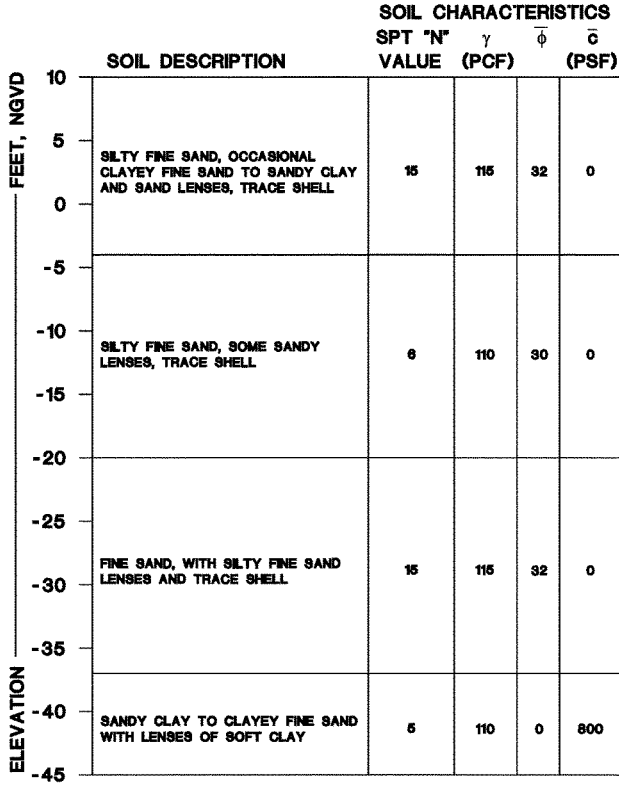

SOIL PROFILE OF WEST TURNING BASIN CORNER CUT-OFF - NORTHWEST END

 **Ardaman & Associates, Inc.**  
Geotechnical, Environmental and  
Materials Consultants

**NAVIGATION CHANNEL WIDENING  
CANAVERAL PORT AUTHORITY  
PORT CANAVERAL, FLORIDA**

DRAWN BY: SJB | CHECKED BY: | DATE: 5/23/06

FILE NO. 05-100 | APPROVED BY: | FIGURE 9

ELEVATION FEET, NGVD	SOIL DESCRIPTION	SOIL CHARACTERISTICS			
		SPT "N" VALUE	$\gamma$ (PCF)	$\phi$ (PSF)	$c$ (PSF)
10	FINE SAND, OCCASIONAL CLAYEY FINE SAND LENSES, TRACE SHELL	12	115	32	0
5	CLAYEY FINE SAND TO SANDY CLAY WITH FINE TO MEDIUM SAND AND SOFT CLAY LENSES	10	115	31	0
0					
-5	FINE SAND WITH TRACE SHELL	20	120	33	0
-10					
-15	CLAYEY FINE SAND TO SANDY CLAY WITH FINE SAND AND SOFT CLAY LENSES	3	105	29	0
-20	SOFT CLAY	1	105	0	800
-25					
-30	SILTY FINE SAND, OCCASIONAL FINE SAND	25	120	34	0
-35					
-40					
-45					

**SOIL PROFILE OF WEST TURNING BASIN CORNER CUT-OFF - SOUTHEAST END**



**Ardaman & Associates, Inc.**  
Geotechnical, Environmental and Materials Consultants

**NAVIGATION CHANNEL WIDENING  
CANAVERAL PORT AUTHORITY  
PORT CANAVERAL, FLORIDA**

DRAWN BY: <b>SJB</b>	CHECKED BY:	DATE: <b>5/23/06</b>
FILE NO. <b>08-100</b>	APPROVED BY:	PAGES <b>10</b>

CADD FILE: SIMON\PROJECTS\DOBBS\2005\05-100 FIGURES\SE PROFILE.DWG DATE: 05/23/06 REVISED BY: SJB

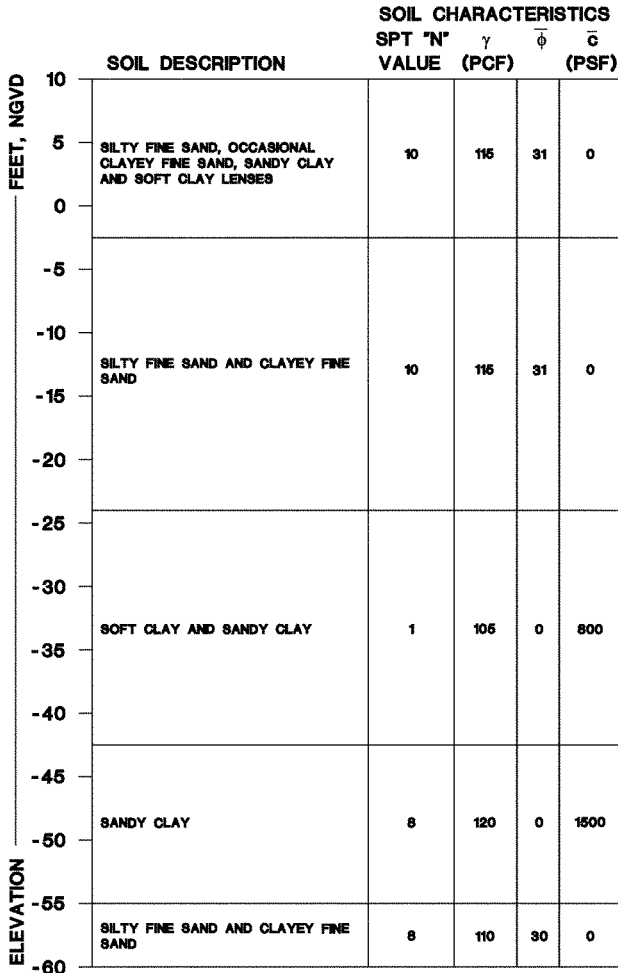

**SOIL PROFILE OF WEST TURNING BASIN CORNER CUT-OFF - BULKHEAD WALL**



**Ardaman & Associates, Inc.**  
Geotechnical, Environmental and Materials Consultants

**NAVIGATION CHANNEL WIDENING  
CANAVERAL PORT AUTHORITY  
PORT CANAVERAL, FLORIDA**

DRAWN BY: SJB	CHECKED BY:	DATE: 5/23/06
FILE NO. 05-100	APPROVED BY:	FIGURE 11

CADD FILE: SIMON\PROJECTS\DOBBS\2005\05-100 FIGURES\BH PROFILE.DWG DATE: 05/23/06 REMISED BY: SJB

CADD FILE: SIMON\PROJECTS\JOBS\2005\05-100 FIGURES\MTBAC PROFILE.DWG DATE: 05/24/06 REVISED BY: SJB

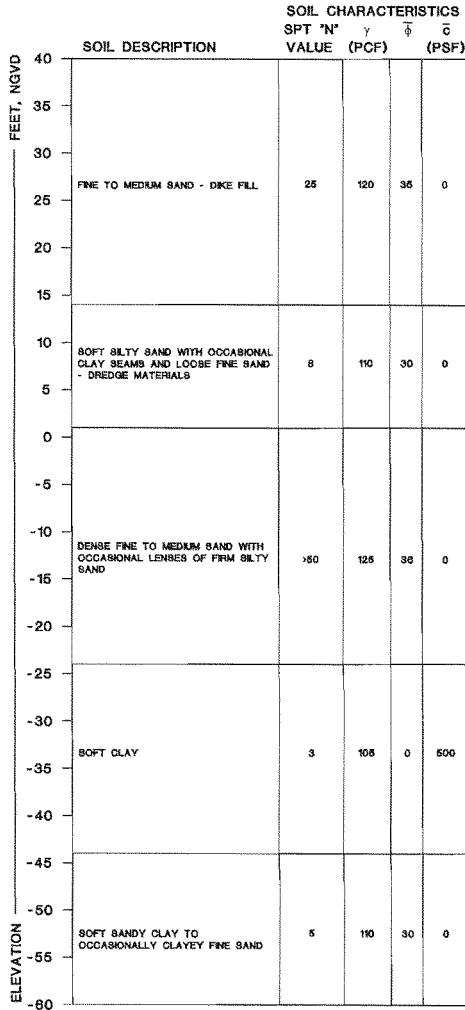

SOIL PROFILE OF MIDDLE TURNING BASIN ACCESS CHANNEL DIKE RELOCATION

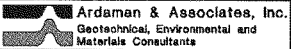

NAVIGATION CHANNEL WIDENING  
CANAVERAL PORT AUTHORITY  
PORT CANAVERAL, FLORIDA

DRAWN BY: SJB	CHECKED BY:	DATE: 5/24/08
FILE NO: 06-100	APPROVED BY:	FIGURE: 12



STABILITY RESULTS FOR  
DIKE RELOCATION

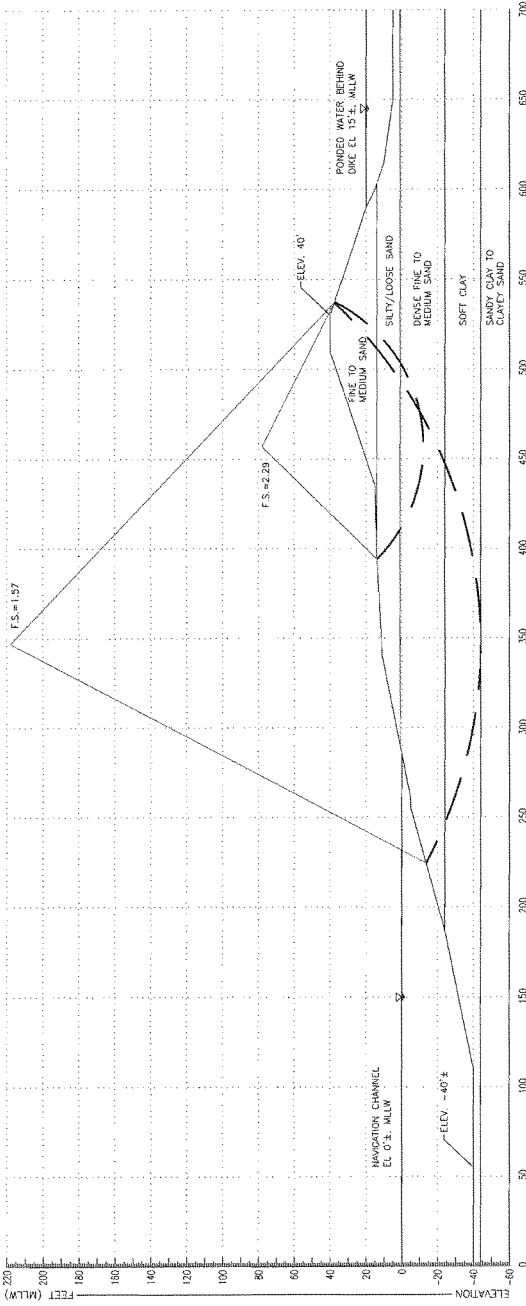

**STABILITY ANALYSES RESULTS FOR  
EXISTING MIDDLE TURNING BASIN  
ACCESS CHANNEL DIKE RELOCATION**

**Wideman & Associates, Inc.**  
Geotechnical, Environmental and  
Waterway Consultants

**NAVIGATION CHANNEL WIDENING  
CANAVERAL PORT AUTHORITY  
PORT CANAVERAL, FLORIDA**

DRAWN BY: BMB	CHECKED BY:	DATE: 8/17/08	FIGURE: <b>13</b>
FILE NO:	APPROVED BY:		

CONCEPTUAL CROSS-SECTION  
FOR BARGE CANAL ENTRANCE

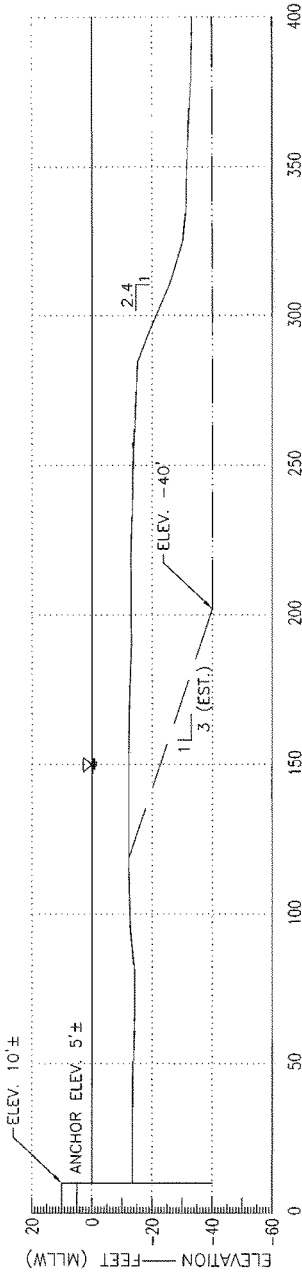

<b>CONCEPTUAL CROSS-SECTION BARGE CANAL ENTRANCE</b>	
	Alderman & Associates, Inc. Geotechnical, Environmental and Inlet/Outlet Consultants
NAVIGATION CHANNEL WIDENING CANAVERAL PORT AUTHORITY PORT CANAVERAL, FLORIDA	
DRAWN BY: BLM	CHECKED BY: [ ] DATE: 8/17/06
FILE NO. 06-100	APPROVED BY: [ ]
	POSS: 14

CONCEPTUAL CROSS-SECTION  
FOR WEST TURNING BASIN ENTRANCE

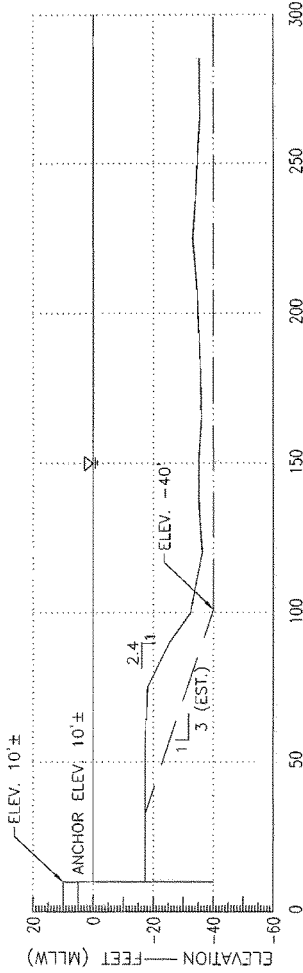

<b>CONCEPTUAL CROSS-SECTION WEST TURNING BASIN ENTRANCE</b>	
	Ardaman & Associates, Inc. Geotechnical, Environmental and Marine Consultants
NAVIGATION CHANNEL WIDENING CANAVERAL PORT AUTHORITY PORT CANAVERAL, FLORIDA	
DRAWN BY: BJB	CHECKED BY:
FILE NO.: 04-100	DATE: 8/17/07
APPROVED BY:	SCALE:
	15

CONCEPTUAL CROSS-SECTION  
WEST TURNING CIRCLE CORNER CUT-OFF

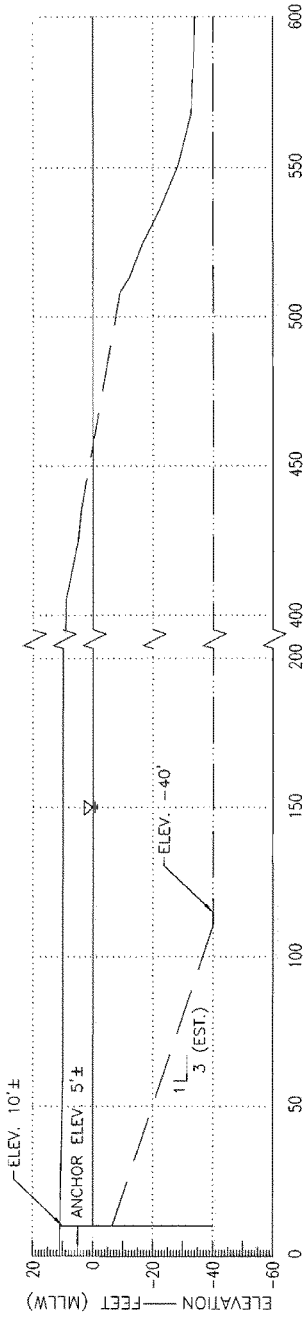

CONCEPTUAL CROSS-SECTION  
WEST TURNING CIRCLE  
CORNER CUT-OFF

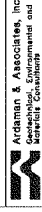

Archiman & Associates, Inc.  
Geotechnical, Environmental and  
Statistical Consultants

NAVIGATION CHANNEL WIDENING  
CANAVERAL PORT AUTHORITY  
PORT CANAVERAL, FLORIDA

DATE: 8/17/08  
DRAWN BY: GMB  
CHECKED BY:  
FILE NO: DP-100  
APPROVED BY:  
PAGE: 18

Appendix 1

**Sampling Procedures**

## STANDARD PENETRATION TEST

The standard penetration test is a widely accepted test method of *in situ* testing of foundation soils (ASTM D 1586). A 2-foot long, 2-inch O.D. split-barrel sampler attached to the end of a string of drilling rods is driven 18 inches into the ground by successive blows of a 140-pound hammer freely dropping 30 inches. The number of blows needed for each 6 inches of penetration is recorded. The sum of the blows required for penetration of the second and third 6-inch increments of penetration constitutes the test result or N-value. After the test, the sampler is extracted from the ground and opened to allow visual examination and classification of the retained soil sample. The N-value has been empirically correlated with various soil properties allowing a conservative estimate of the behavior of soils under load.

The tests are usually performed at 5-foot intervals. However, more frequent or continuous testing is done by our firm through depths where a more accurate definition of the soils is required. The test holes are advanced to the test elevations by rotary drilling with a cutting bit, using circulating fluid to remove the cuttings and hold the fine grains in suspension. The circulating fluid, which is a bentonitic drilling mud, is also used to keep the hole open below the water table by maintaining an excess hydrostatic pressure inside the hole. In some soil deposits, particularly highly pervious ones, NX-size flush-coupled casing must be driven to just above the testing depth to keep the hole open and/or to prevent the loss of circulating fluid.

Representative split-spoon samples from the soils at every 5 feet of drilled depth and from every different stratum are brought to our laboratory in air-tight jars for further evaluation and testing, if necessary. Samples not used in testing are stored for a least six months prior to being discarded. After completion of a test boring, the hole is kept open until a steady state groundwater level is recorded. The hole is then sealed, if necessary, and backfilled.

Appendix 2

**Recent Ardaman Test Boring Logs**

Boring Designation TH-1

<b>DRILLING LOG</b>		DIVISION Corporate Engineering		INSTALLATION		SHEET 1 OF 2 SHEETS	
1. PROJECT PORT CANAVERAL CHANNEL WIDENING				9. SIZE AND TYPE OF BIT 3" Tricone			
2. BORING DESIGNATION TH-1				10. COORDINATE SYSTEM/DATUM State Plane, FLE (U.S. Ft.)		HORIZONTAL VERTICAL	
3. DRILLING AGENCY AMDRILL, Inc.				LOCATION COORDINATES X = 793,859 Y = 1,480,514		11. MANUFACTURER'S DESIGNATION OF DRILL CME-45 (barge-mounted)	
4. NAME OF DRILLER T. Clarkson				CONTRACTOR FILE NO. 05-100		DISTURBED UNDISTURBED (UD)	
5. DIRECTION OF BORING <input checked="" type="checkbox"/> VERTICAL <input type="checkbox"/> INCLINED				DEG. FROM VERTICAL		BEARING	
6. THICKNESS OF OVERBURDEN N/A				13. TOTAL NUMBER CORE BOXES 0			
7. DEPTH DRILLED INTO ROCK N/A				14. ELEVATION GROUND WATER Not Determined			
8. TOTAL DEPTH OF BORING 21.0 Ft.				15. DATE BORING STARTED 09-23-05 COMPLETED 09-23-05			
				16. ELEVATION TOP OF BORING -32.0 Ft.			
				17. TOTAL RECOVERY FOR BORING 62 %			
				18. SIGNATURE AND TITLE OF INSPECTOR R. Burr, Geologist			

ELEV.	DEPTH	LEGEND	CLASSIFICATION OF MATERIALS	SR. REC.	BOX OR SAMPLE NO.	RQD OR UD	REMARKS	BLOCKS/0.5 FT.	N-VALUE
-32.0	0.0		CLAY, fat, medium plasticity, soft, mostly clay, little silt, trace shell, trace fine gravel-sized shell, moist, stratified, gray (CH)				-32.0		
				67	1	SPT Sampler	WR		0
				67	2	SPT Sampler	WR		0
				67	3	SPT Sampler	WR		0
				67	4	SPT Sampler	WR		0
				67	5	SPT Sampler	WR		0
				67	6	SPT Sampler	WR		0
				67	7	SPT Sampler	WR		0
				67	8	SPT Sampler	WR		0
				67	9	SPT Sampler	WR		0
-41.0	9.0		CLAY, fat, high plasticity, soft, mostly clay, trace shell, trace fine gravel-sized shell, moist, gray (CH)				-41.0		
				67	7	SPT Sampler	2 1 3		4
				67	8	SPT Sampler	WH WH WH		0
		67	9	SPT Sampler	WH WH 2		2		
		0	10	SPT Sampler	WR WR WR		0		
							-47.0		



Boring Designation TH-1

DRILLING LOG (Cont. Sheet)			INSTALLATION			SHEET 2 OF 2 SHEETS			
PROJECT			COORDINATE SYSTEM/DATUM		HORIZONTAL	VERTICAL			
PORT CANAVERAL CHANNEL WIDENING			State Plane, FLE (U.S. Ft.)		NAD83	MLLW			
LOCATION COORDINATES			ELEVATION TOP OF BORING						
X = 793,859 Y = 1,480,514			-32.0 Ft.						
ELEV.	DEPTH	LEGEND	CLASSIFICATION OF MATERIALS	% REC.	NO. OF SAMPLES	ROD OR ID	REMARKS	BLOWS/0.5 FT.	N-VALUE
-48.0	16.0			67	11		SPT Sampler	5 4	15
			SAND, clayey, low plasticity, soft, mostly fine-grained sand-sized sand, little silt, trace clay, moist, dark brown (SC)				-48.5	5	9
				67	12		SPT Sampler	1 3	9
							-50.0	6	
-51.0	19.0			67	13		SPT Sampler	4 3	11
			SAND, silty, mostly fine-grained sand-sized sand, little silt, trace clay, dry, green (SM)				-51.5	8	
				67	14		SPT Sampler	2 3	20
-53.0	21.0						-53.0	12	15
NOTES:						140# hammer w/30" drop used with 2.0' split spoon (1-3/8" I.D. x 2" O.D.).			
1. Soils are field visually classified in accordance with the Unified Soils Classification System.									
2. Laboratory Testing Results									
SAMPLE ID			SAMPLE DEPTH			LABORATORY CLASSIFICATION			
1			0.0/1.5			CH			
7			9.0/10.5			CH			
3. Additional Laboratory Testing									
1			Moisture Content						
7			Moisture Content						
12,13			Moisture Content						
14			Moisture Content						

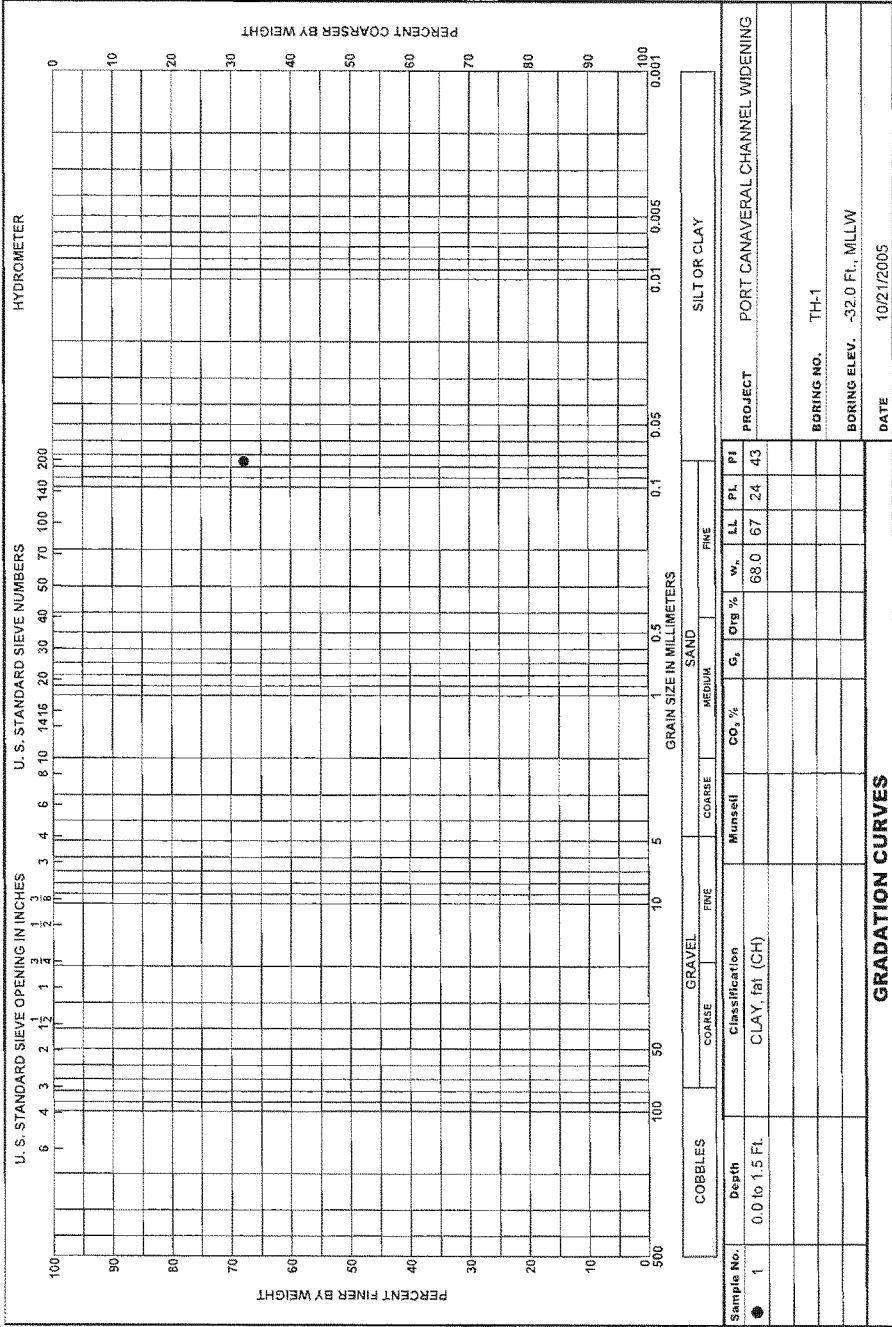



Boring Designation TH-2

<b>DRILLING LOG</b>		DIVISION Corporate Engineering		INSTALLATION		SHEET 1 OF 2 SHEETS	
1. PROJECT PORT CANAVERAL CHANNEL WIDENING				9. SIZE AND TYPE OF BIT 3" Tricone			
2. BORING DESIGNATION TH-2				10. COORDINATE SYSTEM/DATUM State Plane, FLE (U.S. Ft.)		HORIZONTAL NAD83	
3. DRILLING AGENCY AMDRILL, Inc.				LOCATION COORDINATES X = 791,859 Y = 1,482,208		VERTICAL MLLW	
4. NAME OF DRILLER T. Clarkson				11. MANUFACTURER'S DESIGNATION OF DRILL CME-45 (barge-mounted)		<input type="checkbox"/> AUTO HAMMER <input checked="" type="checkbox"/> MANUAL HAMMER	
5. DIRECTION OF BORING <input checked="" type="checkbox"/> VERTICAL <input type="checkbox"/> INCLINED				CONTRACTOR FILE NO. 05-100		12. TOTAL SAMPLES DISTURBED 16 UNDISTURBED (UD) 0	
6. THICKNESS OF OVERBURDEN N/A				13. TOTAL NUMBER CORE BOXES 0			
7. DEPTH DRILLED INTO ROCK N/A				14. ELEVATION GROUND WATER Not Determined			
8. TOTAL DEPTH OF BORING 24.0 Ft.				15. DATE BORING STARTED 09-24-05 COMPLETED 09-24-05			
				16. ELEVATION TOP OF BORING -26.0 Ft.			
				17. TOTAL RECOVERY FOR BORING 71 %			
				18. SIGNATURE AND TITLE OF INSPECTOR R. Burr, Geologist			

ELEV.	DEPTH	LEGEND	CLASSIFICATION OF MATERIALS	% REC.	BOX OR SAMPLE	ROD OR UD	REMARKS	BLOWS/0.5 FT.	N-VALUE		
-26.0	0.0	[Hatched pattern]	SAND, clayey, medium plasticity, very soft, mostly sand, some clay, little silt, homogeneous, organic odor, gray (SC)  At El. -30.0 Ft., thin layer of fine grained SM  At El. -31.5 Ft., 3" layer of fine grained SM	0	1		-26.0		0		
								SPT Sampler	WR		
									WR	0	
						67	2		-27.5		
								SPT Sampler	WR		
									WR	0	
						67	3		-29.0		
								SPT Sampler	WR		
									WR	0	
						67	4		-30.5		
						SPT Sampler	WR				
							WR	0			
				67	5		-32.0				
						SPT Sampler	WR				
							WR	0			
				67	6		-33.5				
						SPT Sampler	WR				
							WR	0			
				67	7		-35.0				
			SAND, silty, mostly fine-grained sand-sized sand, little silt, stratified, organic odor, gray (SM)								
						SPT Sampler	WR				
							WR	0			
				67	8		-36.5				
						SPT Sampler	WR				
							WR	0			
				67	9		-38.0				
			CLAY, lean, medium plasticity, soft, mostly clay, little silt, thin layers of fine grained SM, gray (CL)								
						SPT Sampler	WR	1			
							WR	1	2		
							-39.5				
						SPT Sampler	WR	1			
							WR	1	4		
				67	10		-41.0				
			CLAY, fat, high plasticity, soft, mostly clay, homogeneous, gray (CH)								
						SPT Sampler	WR	1			
							WR	3			

Boring Designation TH-2

DRILLING LOG (Cont. Sheet)			INSTALLATION			SHEET 2 OF 2 SHEETS																		
PROJECT PORT CANAVERAL CHANNEL WIDENING			COORDINATE SYSTEM/DATUM State Plane, FLE (U.S. Ft.)		HORIZONTAL NAD83	VERTICAL MLLW																		
LOCATION COORDINATES X = 791,859 Y = 1,482,208			ELEVATION TOP OF BORING -26.0 Ft.																					
ELEV.	DEPTH	LEGEND	CLASSIFICATION OF MATERIALS	% REC.	BOX OF SAMPLE	RQD COR ID	REMARKS	BLOWS/ 0.5 FT.	N-VALUE															
		At El. -45.0 Ft., trace of wood		67	11		SPT Sampler	1																
								-42.5	1	2														
					67	12		SPT Sampler	2															
								-44.0	3	6														
					100	13		SPT Sampler	2	5														
								-45.5	3															
					100	14		SPT Sampler	1	20														
								-47.0	1	4														
									3															
					100	15		SPT Sampler	2	4														
								-48.5	2															
					100	16		SPT Sampler	1	5														
								-50.0	2															
-50.0	24.0								3															
NOTES:						140# hammer w/30" drop used with 2.0' split spoon (1-3/8" I.D. x 2" O.D.).																		
1. Soils are field visually classified in accordance with the Unified Soils Classification System.																								
2. Laboratory Testing Results																								
<table border="1"> <thead> <tr> <th>SAMPLE ID</th> <th>SAMPLE DEPTH</th> <th>LABORATORY CLASSIFICATION</th> </tr> </thead> <tbody> <tr> <td>2</td> <td>1.5/3.0</td> <td>SC</td> </tr> <tr> <td>7</td> <td>9.0/10.5</td> <td>SM*</td> </tr> <tr> <td>9</td> <td>12.0/13.5</td> <td>CL*</td> </tr> <tr> <td>10</td> <td>13.5/15.0</td> <td>CH*</td> </tr> </tbody> </table>			SAMPLE ID	SAMPLE DEPTH	LABORATORY CLASSIFICATION	2	1.5/3.0	SC	7	9.0/10.5	SM*	9	12.0/13.5	CL*	10	13.5/15.0	CH*							
SAMPLE ID	SAMPLE DEPTH	LABORATORY CLASSIFICATION																						
2	1.5/3.0	SC																						
7	9.0/10.5	SM*																						
9	12.0/13.5	CL*																						
10	13.5/15.0	CH*																						
*Lab visual classification based on gradation curve. No Atterberg limits.																								
3. Additional Laboratory Testing																								
2 Moisture Content																								
7 Moisture Content																								
9 Moisture Content																								
10 Moisture Content																								



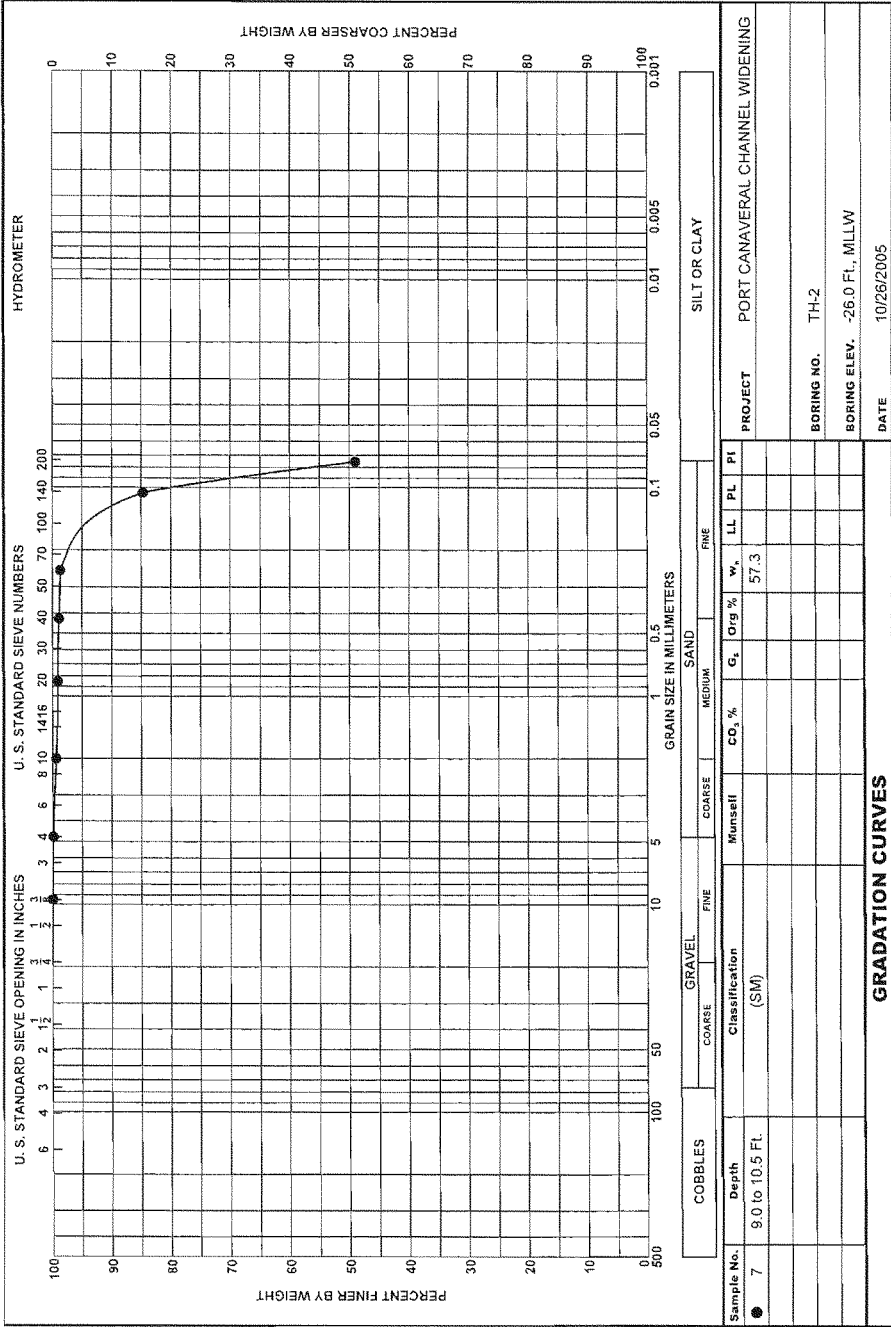





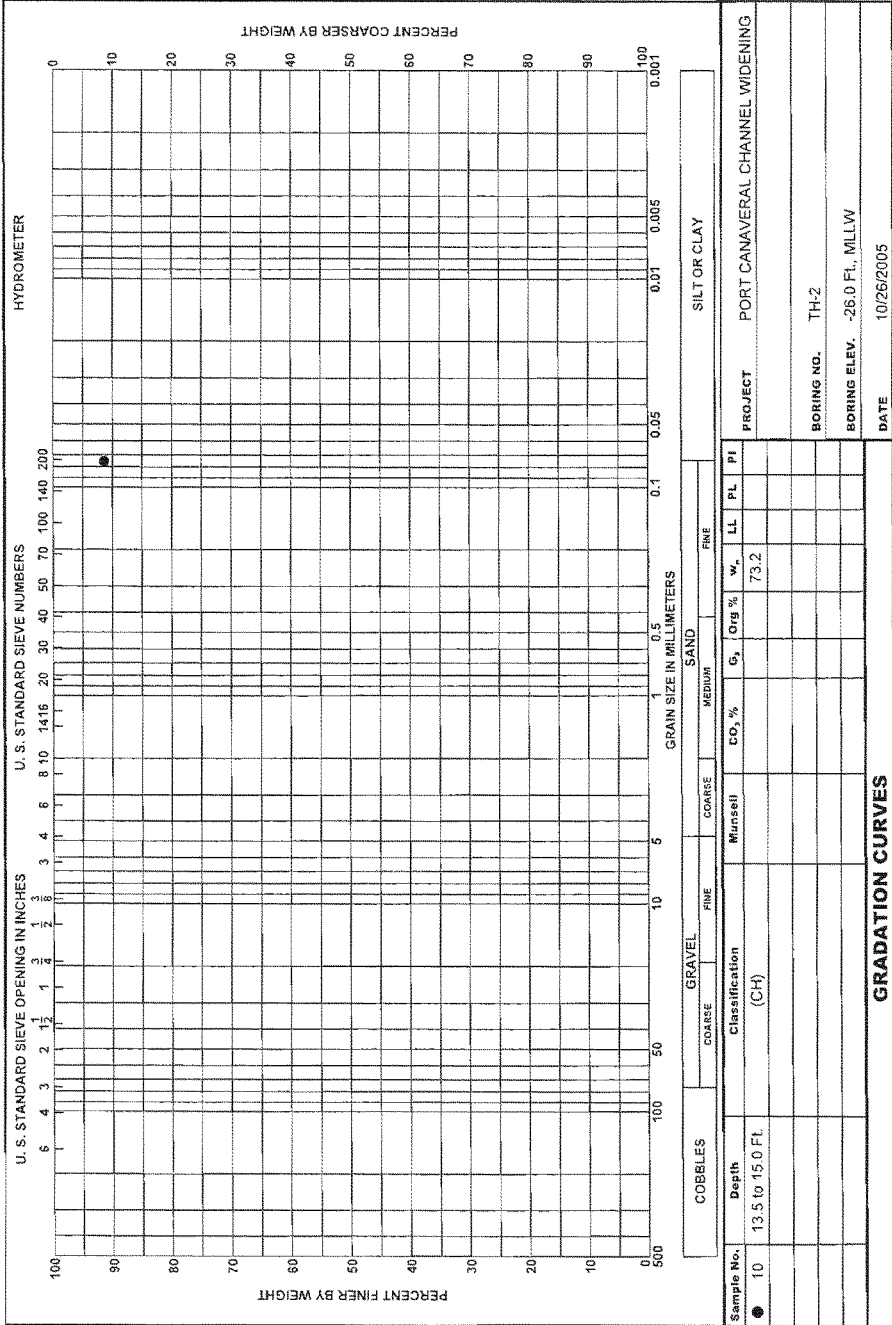

Sample No.	10	Depth	13.5 to 15.0 Ft.	Classification	(Ch)	Minisell	CO <sub>2</sub> %	G <sub>s</sub>	Org %	w <sub>r</sub>	LL	PL	PI
										73.2			
<b>GRADATION CURVES</b>													
PROJECT: PORT CANAVERAL CHANNEL WIDENING													
BORING NO.: TH-2													
BORING ELEV.: -26.0 Ft., MLLW													
DATE: 10/26/2005													



Boring Designation TH-3

DRILLING LOG (Cont. Sheet)			INSTALLATION			SHEET 2 OF 2 SHEETS				
PROJECT PORT CANAVERAL CHANNEL WIDENING			COORDINATE SYSTEM/DATUM State Plane, FLE (U.S. Ft.)		HORIZONTAL NAD83	VERTICAL MLLW				
LOCATION COORDINATES X = 788,494 Y = 1,482,165			ELEVATION TOP OF BORING -25.5 Ft.							
ELEV.	DEPTH	LEGEND	CLASSIFICATION OF MATERIALS	% REC.	NO. OF SAMPLES	ROD OR ID	REMARKS	BLOWS/ 0.5 FT.	N-VALUE	
								3	15	
					100	11		SPT Sampler	2	5
								-42.0	3	
					100	12		SPT Sampler	2	6
								-43.5	3	
					100	13		SPT Sampler	2	4
								-45.0	2	
					100	14		SPT Sampler	2	20
								-46.5	2	
					100	15		SPT Sampler	1	5
								-48.0	2	
					100	16		SPT Sampler	2	5
								-49.5	3	
					100	17		SPT Sampler	2	25
								-51.0	1	
-51.0	25.5								2	
NOTES:			140# hammer w/30" drop used with 2.0' split spoon (1-3/8" I.D. x 2" O.D.).							
1. Soils are field visually classified in accordance with the Unified Soils Classification System.										
2. Laboratory Testing Results										
SAMPLE ID			SAMPLE DEPTH			LABORATORY CLASSIFICATION				
1			0.0/1.5			SP-SM*				
5			6.0/7.5			SP-SM*				
10			13.5/15.0			CH*				
*Lab visual classification based on gradation curve. No Atterberg limits.										
3. Additional Laboratory Testing										
1 Moisture Content										
5 Moisture Content										
10 Moisture Content										



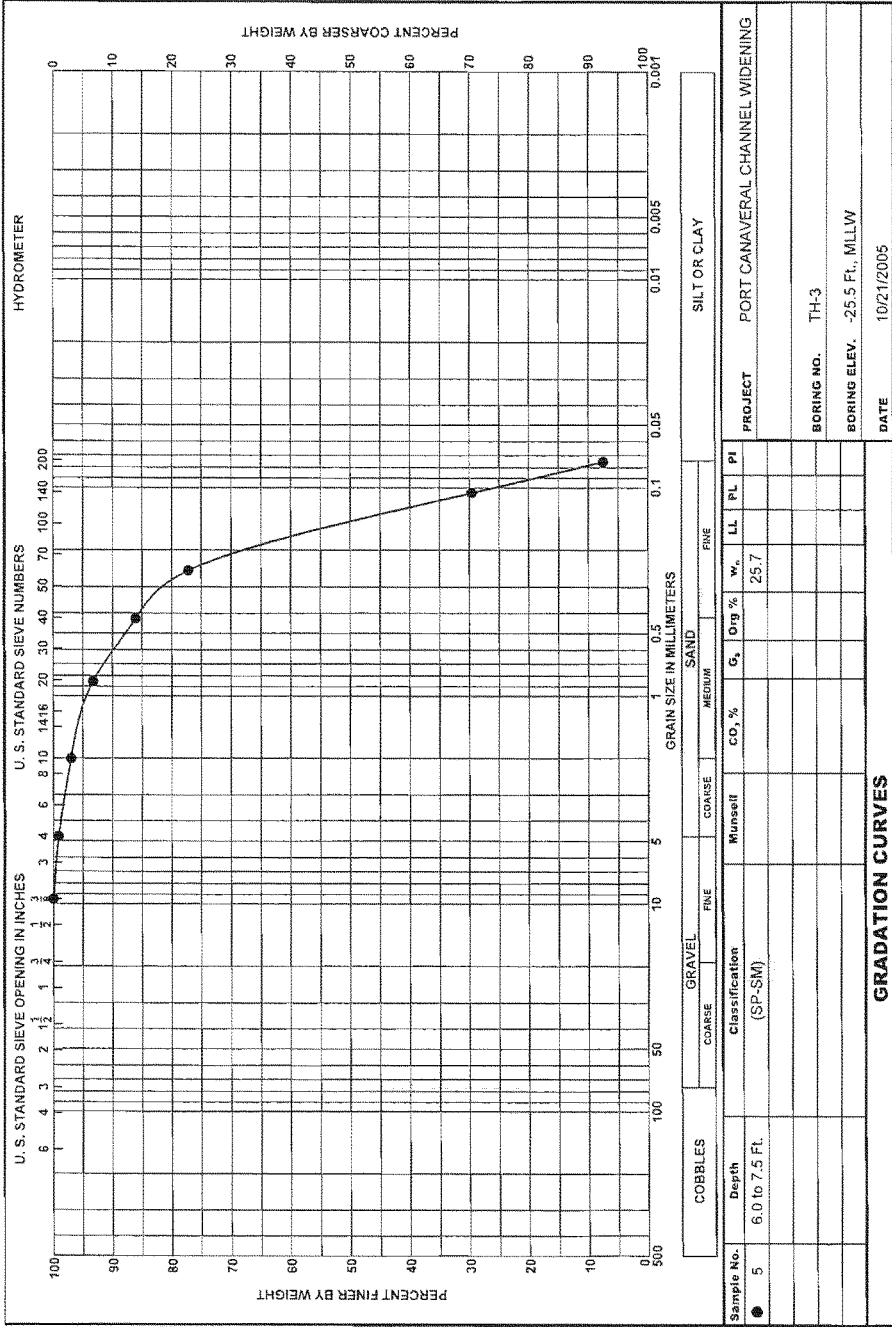

COBBLES		GRAVEL		SAND		FINE SAND		SILT OR CLAY	
Sample No.	5	Classification	(SP-SM)	CO, %		G <sub>s</sub>		w <sub>c</sub> , %	25.7
Depth	6.0 to 7.5 Ft.	Munsell		LL		PL		PI	
<b>GRADATION CURVES</b>									
PROJECT					PORT CANAVERAL CHANNEL WIDENING				
BORING NO.					TH-3				
BORING ELEV.					-25.5 Ft., MLLW				
DATE					10/21/2005				

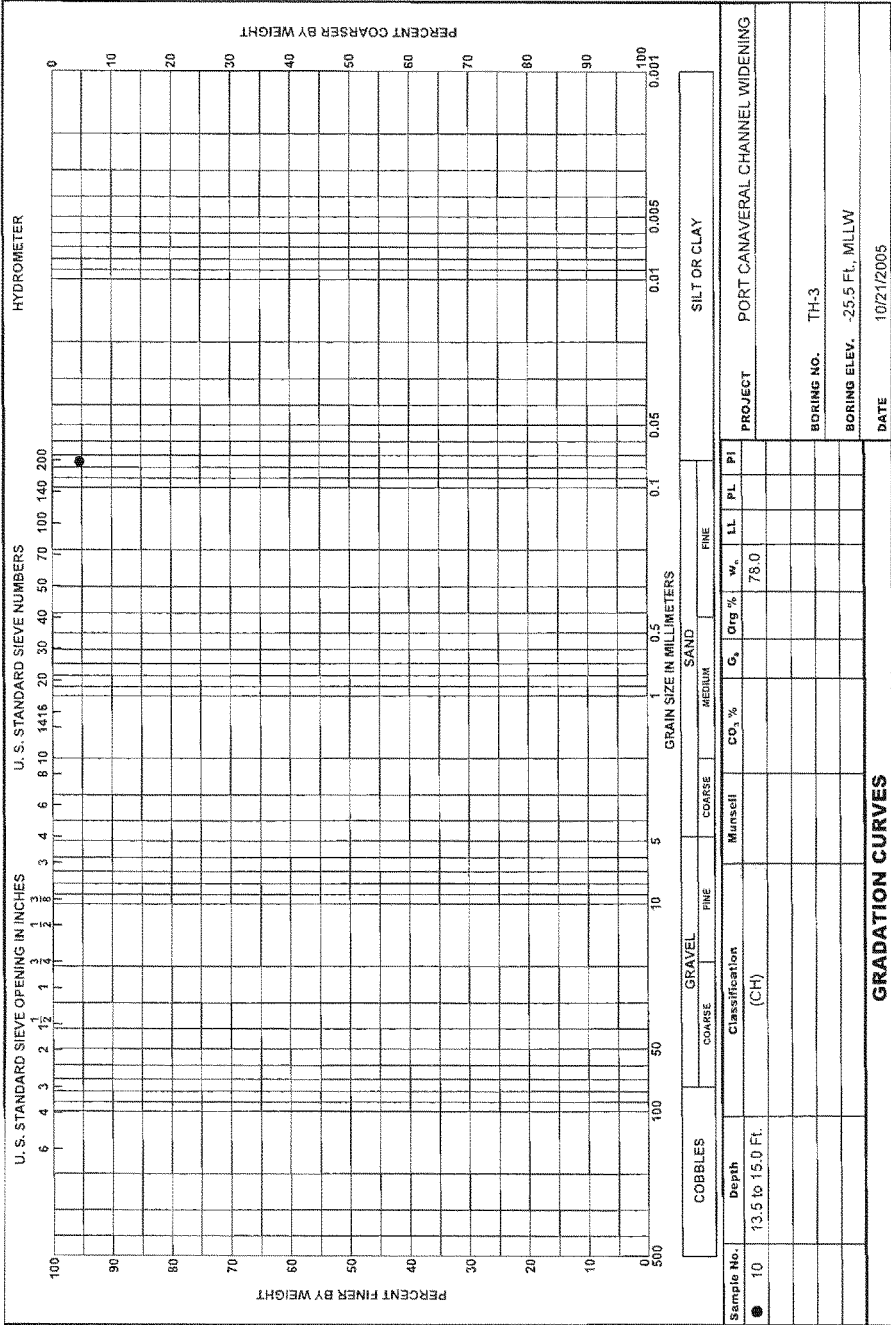



Boring Designation TH-4

DRILLING LOG (Cont. Sheet)			INSTALLATION			SHEET 2 OF 2 SHEETS															
PROJECT PORT CANAVERAL CHANNEL WIDENING			COORDINATE SYSTEM/DATUM State Plane, FLE (U.S. Ft.)		HORIZONTAL NAD83	VERTICAL MLLV															
LOCATION COORDINATES X = 792,886 Y = 1,481,002			ELEVATION TOP OF BORING -31.0 Ft.																		
ELEV.	DEPTH	LEGEND	CLASSIFICATION OF MATERIALS	% REC.	BOX OR SAMPLER ID	RQD OR ID	REMARKS	BLOWS/ 0.25 FT.	N-VALUE												
			At El. -46.5 Ft., trace of wood	100	11		SPT Sampler	WR	15												
									WR	0											
						100	12		SPT Sampler	WR	0										
										WR	0										
						100	13		SPT Sampler	WR	0										
								WR	0												
				100	14		SPT Sampler	WR	20												
-52.0	21.0							WR	0												
			NOTES: 1. Soils are field visually classified in accordance with the Unified Soils Classification System. 2. Laboratory Testing Results <table border="1" style="margin-left: 20px;"> <thead> <tr> <th>SAMPLE ID</th> <th>SAMPLE DEPTH</th> <th>LABORATORY CLASSIFICATION</th> </tr> </thead> <tbody> <tr> <td>1</td> <td>0.0/1.5</td> <td>CL*</td> </tr> <tr> <td>7</td> <td>9.0/10.5</td> <td>CH</td> </tr> </tbody> </table> *Lab visual classification based on gradation curve. No Atterberg limits. 3. Additional Laboratory Testing <table border="1" style="margin-left: 20px;"> <tbody> <tr> <td>1</td> <td>Moisture Content</td> </tr> <tr> <td>7</td> <td>Moisture Content</td> </tr> </tbody> </table>	SAMPLE ID	SAMPLE DEPTH	LABORATORY CLASSIFICATION	1	0.0/1.5	CL*	7	9.0/10.5	CH	1	Moisture Content	7	Moisture Content			140# hammer w/30" drop used with 2.0' split spoon (1-3/8" I.D. x 2" O.D.).		25
SAMPLE ID	SAMPLE DEPTH	LABORATORY CLASSIFICATION																			
1	0.0/1.5	CL*																			
7	9.0/10.5	CH																			
1	Moisture Content																				
7	Moisture Content																				
									30												
									35												





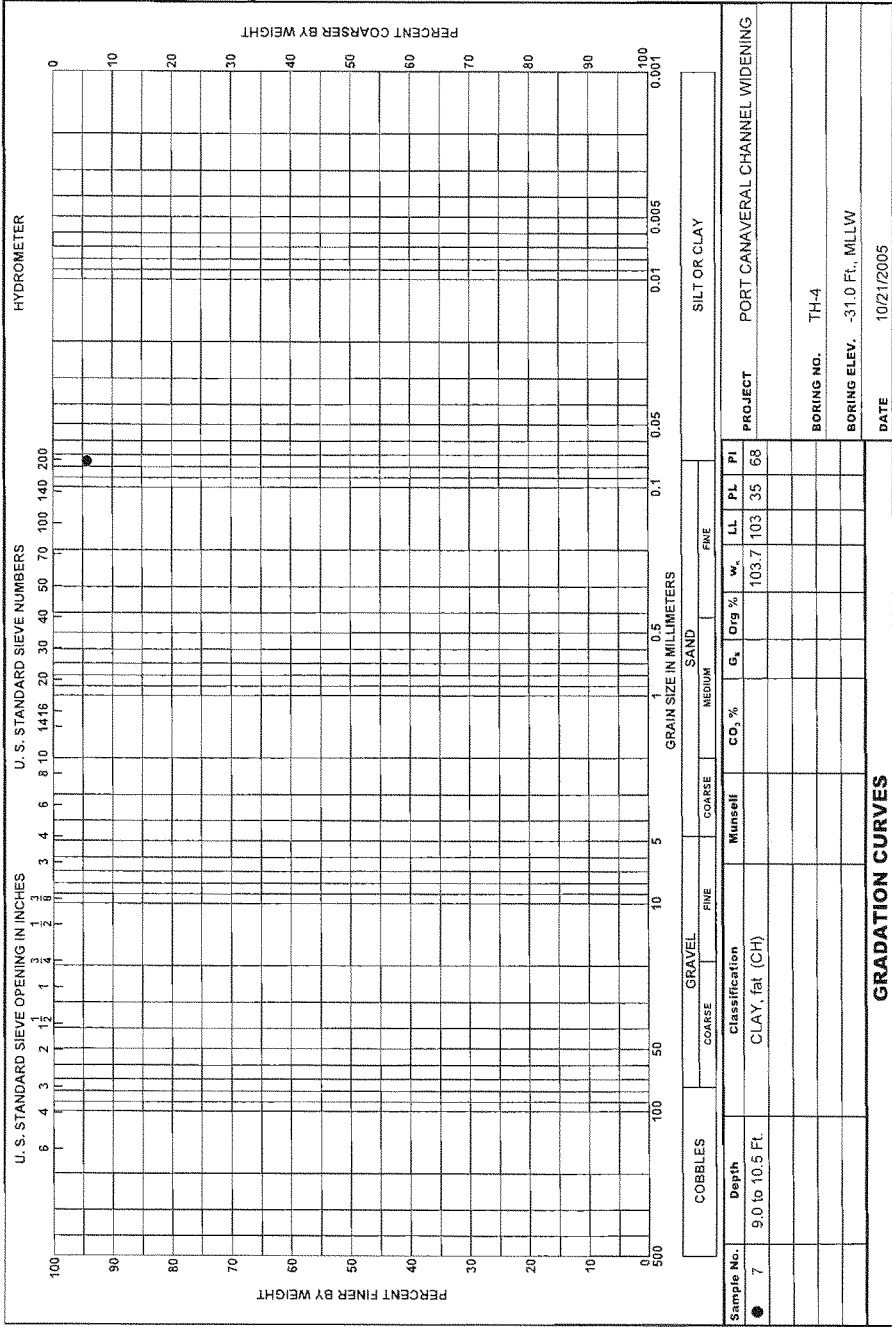

Boring Designation TH-5

<b>DRILLING LOG</b>		DIVISION Corporate Engineering		INSTALLATION		SHEET 1 OF 2 SHEETS	
1. PROJECT PORT CANAVERAL CHANNEL WIDENING				9. SIZE AND TYPE OF BIT 3" Tricone		10. COORDINATE SYSTEM/DATUM HORIZONTAL: STATE PLANE, FLE (U.S. FL.) VERTICAL: MLLW	
2. BORING DESIGNATION TH-5		LOCATION COORDINATES X = 790,820 Y = 1,482,198		11. MANUFACTURER'S DESIGNATION OF DRILL CME-45 (barge-mounted) <input type="checkbox"/> AUTO HAMMER <input checked="" type="checkbox"/> MANUAL HAMMER			
3. DRILLING AGENCY AMDRILL, Inc.		CONTRACTOR FILE NO. 05-100		12. TOTAL SAMPLES 12		DISTURBED 0	
4. NAME OF DRILLER T. Clarkson				13. TOTAL NUMBER CORE BOXES 0			
5. DIRECTION OF BORING <input checked="" type="checkbox"/> VERTICAL <input type="checkbox"/> INCLINED		DEC. FROM VERTICAL		BEARING		14. ELEVATION GROUND WATER Not Determined	
6. THICKNESS OF OVERBURDEN N/A				15. DATE BORING STARTED: 09-24-05 COMPLETED: 09-24-05			
7. DEPTH DRILLED INTO ROCK N/A				16. ELEVATION TOP OF BORING -33.0 Ft.			
8. TOTAL DEPTH OF BORING 18.0 Ft.				17. TOTAL RECOVERY FOR BORING 37 %			
				18. SIGNATURE AND TITLE OF INSPECTOR R. Burr, Geologist			

ELEV.	DEPTH	LEGEND	CLASSIFICATION OF MATERIALS	% REC.	BOX OR SAMPLE	RQD OR UD	REMARKS	BLOWS/0.5 FT.	N-VALUE		
-33.0	0.0		SAND, silty, mostly fine-grained sand-sized quartz, little silt, trace shell, stratified, organic odor, gray (SM)	0	1		-33.0	WR	0		
								SPT Sampler	WR	0	
					13	2		-34.5	WR	0	
									SPT Sampler	WR	0
								-36.0	WR	0	
			CLAY, fat, high plasticity, very soft, mostly clay, homogeneous, organic odor, gray (CH)	13	3		-37.5	WR	0		
									SPT Sampler	WR	0
					13	4		-39.0	WR	0	
									SPT Sampler	WR	0
								-40.5	WR	0	
-41.0	8.0		SAND, silty, mostly fine-grained sand-sized quartz, trace shell, stratified, organic odor, gray (SM)	100	6		-42.0	WR	0		
									SPT Sampler	WR	0
					13	7		-43.5	WR	0	
									SPT Sampler	WR	0
								-45.0	WR	0	
-44.0	11.0		CLAY, fat, high plasticity, very soft, mostly clay, trace shell, homogeneous, organic odor, gray (CH)	67	8		-46.5	WR	0		
									SPT Sampler	WR	0
					67	9		-48.0	WR	0	
									SPT Sampler	WR	0
								-47.0	WR	0	
-47.0	14.0			67	10		-48.0	WR	0		
								SPT Sampler	WR	0	

Boring Designation TH-5

DRILLING LOG (Cont. Sheet)			INSTALLATION			SHEET 2 OF 2 SHEETS																		
PROJECT PORT CANAVERAL CHANNEL WIDENING			COORDINATE SYSTEM/DATUM State Plane, FLE (U.S. Ft.)		HORIZONTAL NAD83	VERTICAL MLLW																		
LOCATION COORDINATES X = 790,820 Y = 1,482,198			ELEVATION TOP OF BORING -33.0 Ft.																					
ELEV.	DEPTH	LEGEND	CLASSIFICATION OF MATERIALS	% REC.	BOX OF SAMPLES	RCD OR ID	REMARKS	BLOWS/0.5 FT.	N-VALUE															
				67	11		SPT Sampler	WR	15															
							-49.5	WR	0															
					67	12		SPT Sampler	WR															
-51.0	18.0						-51.0	1	3															
			NOTES: 1. Soils are field visually classified in accordance with the Unified Soils Classification System. 2. Laboratory Testing Results <table border="1" style="width: 100%; border-collapse: collapse;"> <thead> <tr> <th>SAMPLE ID</th> <th>SAMPLE DEPTH</th> <th>LABORATORY CLASSIFICATION</th> </tr> </thead> <tbody> <tr> <td>2</td> <td>1.5/3.0</td> <td>SM*</td> </tr> <tr> <td>6</td> <td>7.5/9.0</td> <td>CH*</td> </tr> <tr> <td>8</td> <td>10.5/12.0</td> <td>SM*</td> </tr> <tr> <td>10</td> <td>13.5/15.0</td> <td>CH*</td> </tr> </tbody> </table> *Lab visual classification based on gradation curve. No Atterberg limits. 3. Additional Laboratory Testing 2 Moisture Content 6 Moisture Content 8 Moisture Content 10 Moisture Content	SAMPLE ID	SAMPLE DEPTH	LABORATORY CLASSIFICATION	2	1.5/3.0	SM*	6	7.5/9.0	CH*	8	10.5/12.0	SM*	10	13.5/15.0	CH*				140# hammer w/30" drop used with 2.0" split spoon (1-3/8" I.D. x 2" O.D.).		20
SAMPLE ID	SAMPLE DEPTH	LABORATORY CLASSIFICATION																						
2	1.5/3.0	SM*																						
6	7.5/9.0	CH*																						
8	10.5/12.0	SM*																						
10	13.5/15.0	CH*																						
									25															
									30															



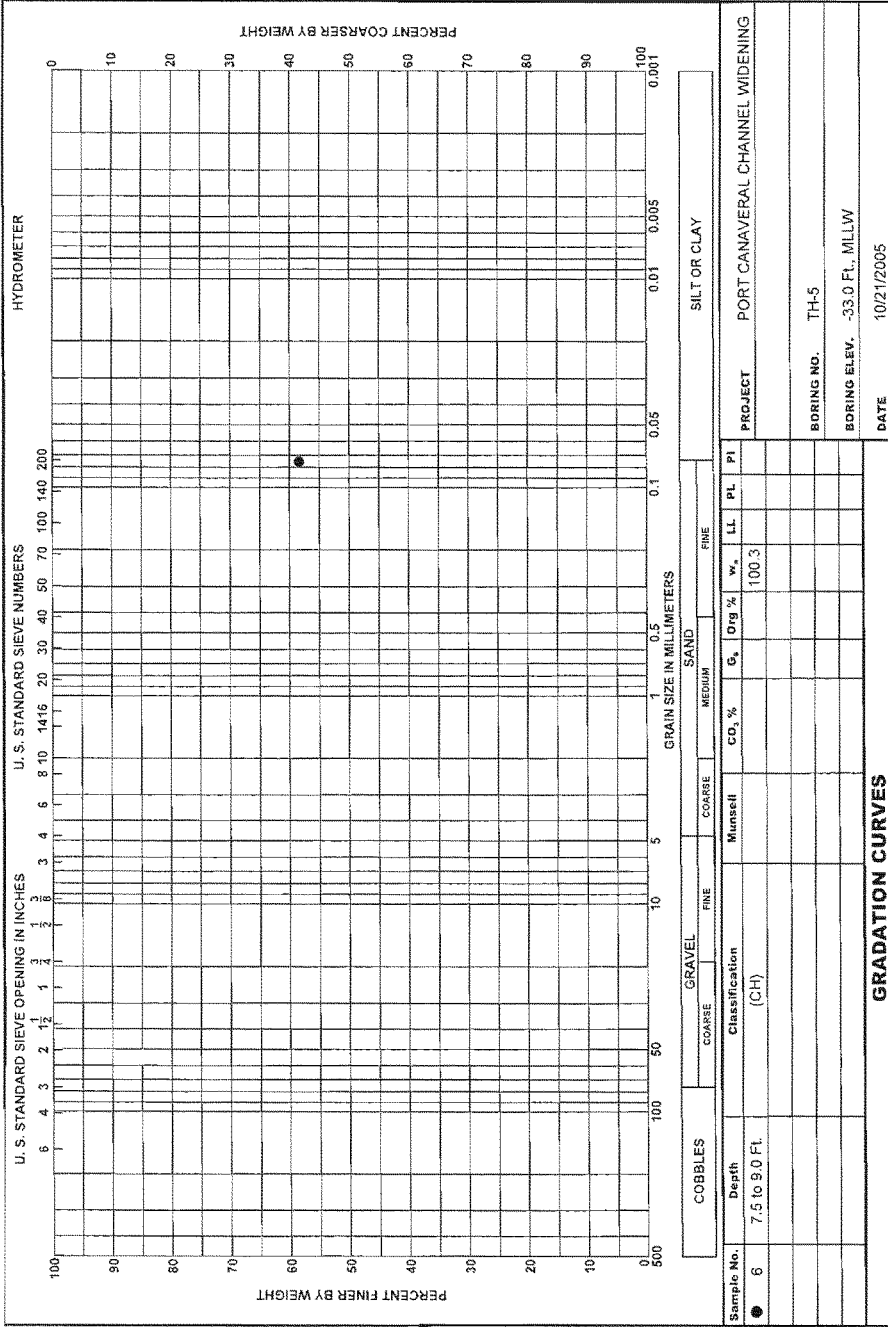

**GRADATION CURVES**

SAJ FORM 2087  
 JUN 02

PROJECT: PORT CANAVERAL CHANNEL WIDENING  
 BORING NO.: TH-5  
 BORING ELEV.: -33.0 Ft., MLLW  
 DATE: 10/21/2005

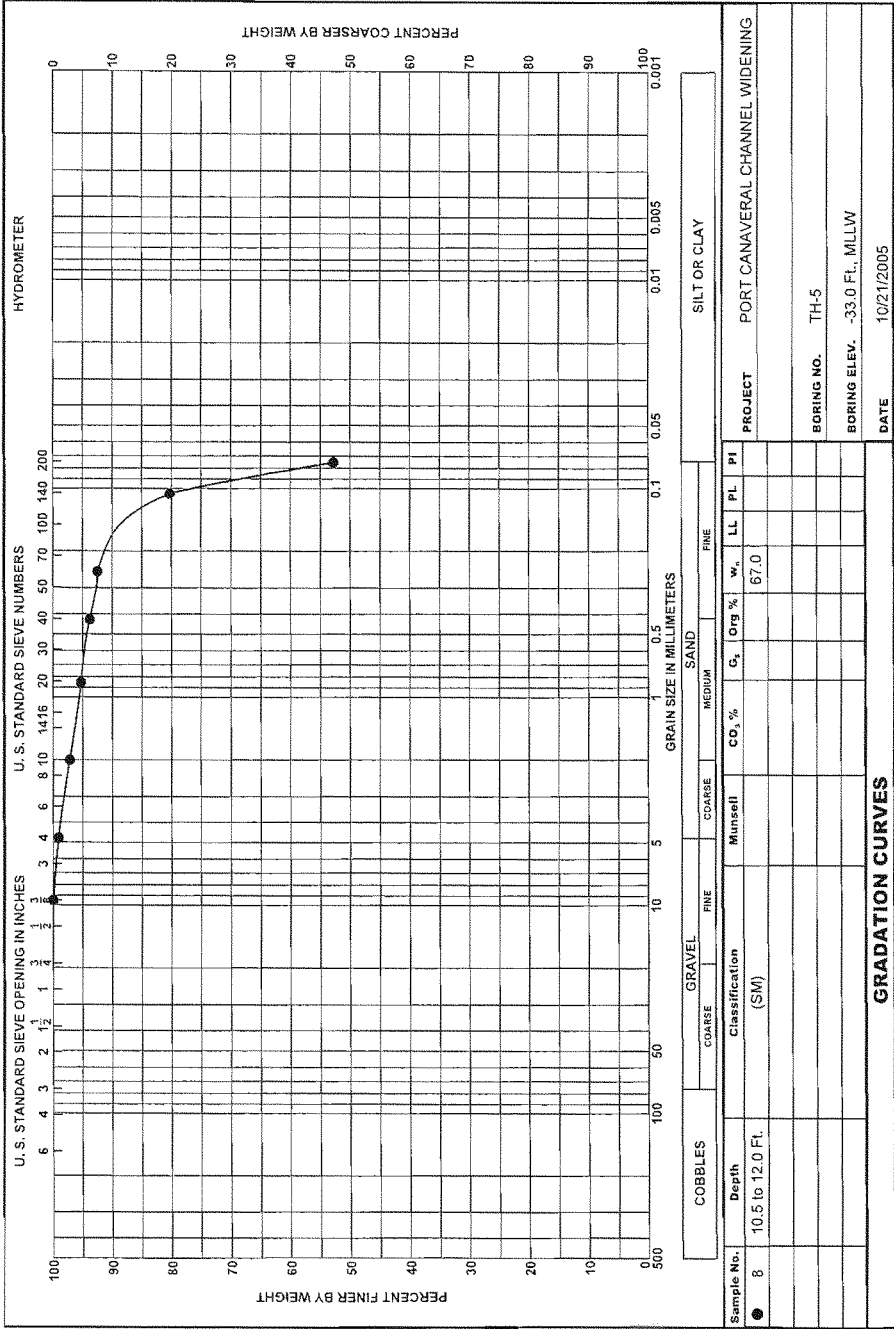





Boring Designation TH-6

DRILLING LOG		DIVISION Corporate Engineering		INSTALLATION		SHEET 1 OF 2 SHEETS			
1. PROJECT PORT CANAVERAL CHANNEL WIDENING				9. SIZE AND TYPE OF BIT 3" Tricone					
2. BORING DESIGNATION TH-6				10. COORDINATE SYSTEM/DATUM State Plane, FLE (U.S. Ft.)		HORIZONTAL NAD83			
3. DRILLING AGENCY AMDRILL, Inc.				LOCATION COORDINATES X = 786,895 Y = 1,482,196		VERTICAL MLLW			
4. NAME OF DRILLER T. Clarkson				11. MANUFACTURER'S DESIGNATION OF DRILL CME-45 (barge-mounted)					
5. DIRECTION OF BORING <input checked="" type="checkbox"/> VERTICAL <input type="checkbox"/> INCLINED				CONTRACTOR FILE NO. 05-100		12. TOTAL SAMPLES 11			
6. THICKNESS OF OVERBURDEN N/A				13. TOTAL NUMBER CORE BOXES 0		DISTURBED 11			
7. DEPTH DRILLED INTO ROCK N/A				14. ELEVATION GROUND WATER Not Determined		UNDISTURBED (UD) 0			
8. TOTAL DEPTH OF BORING 16.5 Ft.				15. DATE BORING 09-21-05		16. ELEVATION TOP OF BORING -34.2 Ft.			
				17. TOTAL RECOVERY FOR BORING 79 %		18. SIGNATURE AND TITLE OF INSPECTOR R. Burr, Geologist			
ELEV.	DEPTH	LEGEND	CLASSIFICATION OF MATERIALS	% REC.	BOX OF SAMPLE	RQD FOR UD	REMARKS	BLOWS/ 0.5 FT.	N-VALUE
-34.2	0.0		SAND, silty, mostly rounded fine-grained sand-sized quartz, little silt, trace shell, moist, homogeneous, organic odor, gray (SM)				-34.2		
				33	1		SPT Sampler	0	
								2	2
				67	2		SPT Sampler	10	
								3	13
				33	3		SPT Sampler	4	
								2	4
				33	4		SPT Sampler	2	
								0	5
								2	2
-40.7	6.5		CLAY, fat, high plasticity, soft, mostly clay, homogeneous, occasional thin layers of finer grained SP, gray (CH)				-40.2		
				100	5		SPT Sampler	1	
								1	2
				100	6		SPT Sampler	2	
								2	4
				100	7		SPT Sampler	1	
								4	5
				100	8		SPT Sampler	3	
								3	8
				100	9		SPT Sampler	2	
							1	4	
			100	10		SPT Sampler	2		
							3	6	
							2		
							4	15	

Boring Designation TH-6

<b>DRILLING LOG (Cont. Sheet)</b>			INSTALLATION			SHEET 2 OF 2 SHEETS			
PROJECT PORT CANAVERAL CHANNEL WIDENING			COORDINATE SYSTEM/DATUM State Plane, FLE (U.S. Fl.)		HORIZONTAL NAD83	VERTICAL MLLW			
LOCATION COORDINATES X = 786,895 Y = 1,482,196			ELEVATION TOP OF BORING -34.2 Ft.						
ELEV.	DEPTH	LEGEND	CLASSIFICATION OF MATERIALS	% REG.	BOX OR SAMPLER	ROD OR ID	REMARKS	BLOWS/ 0.5 FT.	N-VALUE
-50.7	16.5			100	11		SPT Sampler	1 3 5	8
NOTES:			140# hammer w/30" drop used with 2.0' split spoon (1-3/8" I.D. x 2" O.D.).						
1. Soils are field visually classified in accordance with the Unified Soils Classification System.									
2. Laboratory Testing Results									
SAMPLE ID			SAMPLE DEPTH			LABORATORY CLASSIFICATION			
1			0.0/1.5			SM*			
5			6.0/7.5			CH			
*Lab visual classification based on gradation curve. No Atterberg limits.									
3. Additional Laboratory Testing									
1 Moisture Content									
5 Moisture Content									

15  
20  
25  
30  
35



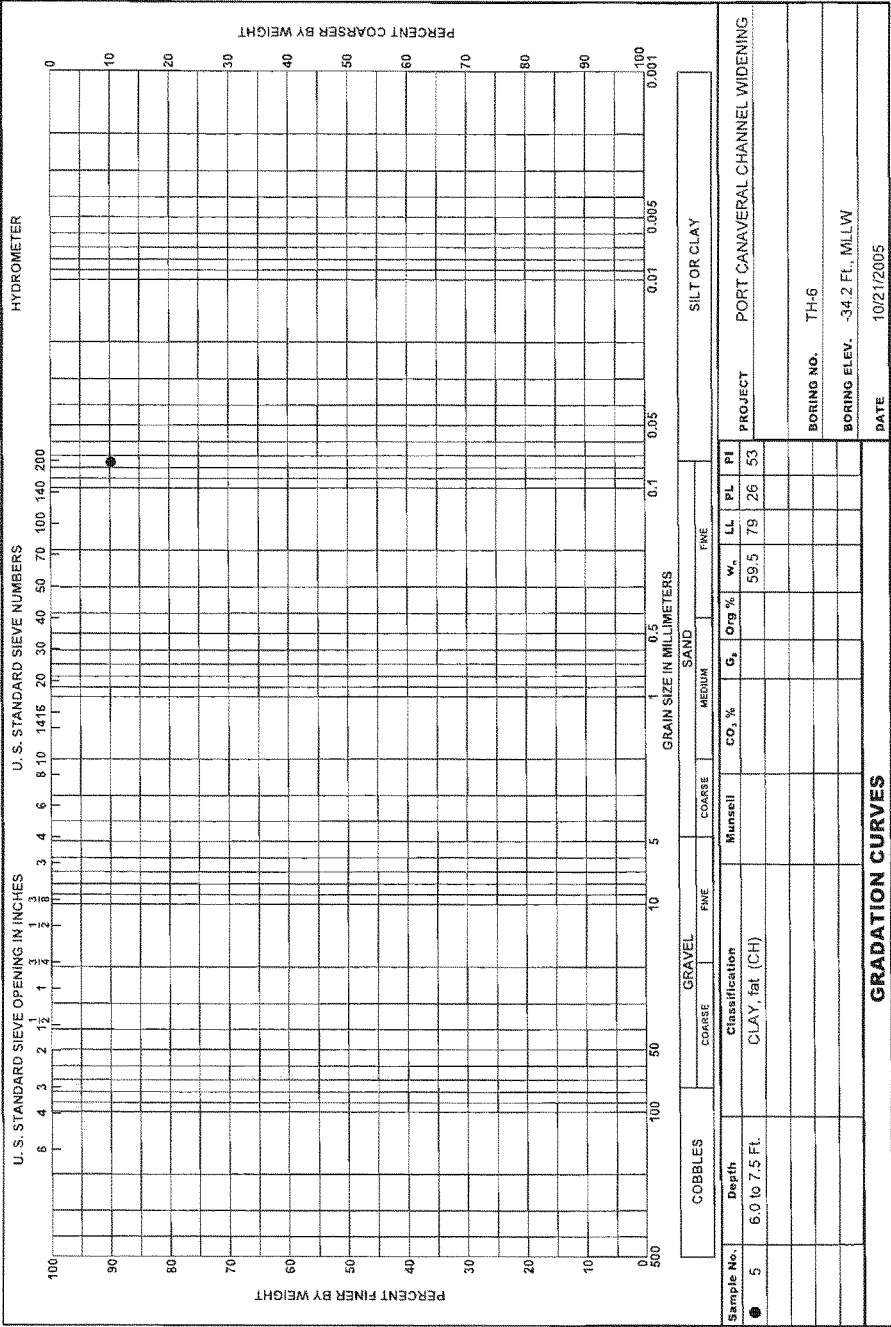

Boring Designation TH-7



<b>DRILLING LOG</b>		DIVISION Corporate Engineering		INSTALLATION		SHEET 1 OF 5 SHEETS	
1. PROJECT PORT CANAVERAL CHANNEL WIDENING				9. SIZE AND TYPE OF BIT 3" Tricone			
2. BORING DESIGNATION TH-7				10. COORDINATE SYSTEM/DATUM State Plane, FLE (U.S. FL)		HORIZONTAL VERTICAL	
3. DRILLING AGENCY ARDAMAN & ASSOCIATES, INC.				LOCATION COORDINATES X = 784,870 Y = 1,482,595		11. MANUFACTURER'S DESIGNATION OF DRILL CME-55 Truck Mount	
4. NAME OF DRILLER				CONTRACTOR FILE NO. 05-100		<input type="checkbox"/> AUTO HAMMER <input checked="" type="checkbox"/> MANUAL HAMMER	
5. DIRECTION OF BORING <input checked="" type="checkbox"/> VERTICAL <input type="checkbox"/> INCLINED				DEC. FROM VERTICAL		BEARING	
6. THICKNESS OF OVERBURDEN N/A				12. TOTAL SAMPLES 40			
7. DEPTH DRILLED INTO ROCK N/A				13. TOTAL NUMBER CORE BOXES 0			
8. TOTAL DEPTH OF BORING 80.0 Ft.				14. ELEVATION GROUND WATER Not Determined			
				15. DATE BORING 11-03-05		STARTED 11-03-05	
				16. ELEVATION TOP OF BORING 20.0 Ft.		COMPLETED 11-03-05	
				17. TOTAL RECOVERY FOR BORING Not Recorded			
				18. SIGNATURE AND TITLE OF INSPECTOR			

ELEV.	DEPTH	LEGEND	CLASSIFICATION OF MATERIALS	% REC.	BOX OR SAMPLE	RQD OR UD	REMARKS	BLOWS/0.5 FT.	N-VALUE
20.0	0.0		SAND, poorly-graded, mostly rounded fine-grained sand-sized quartz, trace silt, dry, homogeneous, brown (SP)	NR	1		20.0	12	0
							SPT Sampler	16	26
								10	
							18.0	11	
								6	
								8	19
								11	
								5	
								3	
15.0	5.0		SAND, poorly-graded with silt, mostly rounded fine-grained sand-sized quartz, trace silt, wet, homogeneous, gray (SP-SM)	NR	3			2	4
								2	5
								4	
								5	
								9	17
								8	
								9	
								4	
								4	7
								3	
								4	10
								4	
								4	7
								3	
								4	4
								3	
								3	4
								1	
								1	
								3	15
								1	

Boring Designation TH-7

DRILLING LOG (Cont. Sheet)			INSTALLATION			SHEET 2 OF 5 SHEETS					
PROJECT PORT CANAVERAL CHANNEL WIDENING			COORDINATE SYSTEM/DATUM State Plane, FLE (U.S. Ft.)		HORIZONTAL NAD83	VERTICAL MLLW					
LOCATION COORDINATES X = 784,870 Y = 1,482,595			ELEVATION TOP OF BORING 20.0 Ft.								
ELEV.	DEPTH	LEGEND	CLASSIFICATION OF MATERIALS	% REC.	BOX OR SAMPLE	RQD OR UD	REMARKS	BLOWS/ 0.5 FT.	N-VALUE		
4.0	16.0		CLAY, fat, high plasticity, very soft, mostly clay, moist, homogeneous, gray (CH) SAND, poorly-graded with silt, mostly subangular fine to coarse-grained sand-sized quartz, trace silt, trace shell, moist, homogeneous, gray (SP-SM)	NR	8		SPT Sampler	1	2		
3.5	16.5								3		
						NR	9		SPT Sampler	2	5
										3	
										6	
						NR	10		SPT Sampler	7	14
										8	
										6	
										5	20
						NR	11		SPT Sampler	7	11
										6	
										5	
-2.0	22.0									11	
					SAND, poorly-graded, mostly subangular fine to coarse-grained sand-sized quartz, little shell, trace silt, trace fine gravel-sized shell, moist, homogeneous, brown (SP)	NR	12		SPT Sampler	17	93
										44	
										49	
										50/0.3	
										34	
				NR	13		SPT Sampler	47	97		
								50			
								50/0.2			
								31			
								40			
				NR	14		SPT Sampler	49	89		
								49			
								31			
								47			
				NR	15		SPT Sampler	45	92		
								48			
								36	30		
								44			
				NR	16		SPT Sampler	44	93		
								49			
								50			
								41			
				NR	17		SPT Sampler	47	95		
								48			
								50/0.3			
								36			
				NR	18		SPT Sampler	43			

DRILLING LOG (Cont. Sheet)			INSTALLATION			SHEET 3 OF 5 SHEETS					
PROJECT PORT CANAVERAL CHANNEL WIDENING			COORDINATE SYSTEM/DATUM State Plane, FLE (U.S. Ft.)		HORIZONTAL NAD83	VERTICAL MLLV					
LOCATION COORDINATES X = 784,870 Y = 1,482,595			ELEVATION TOP OF BORING 20.0 Ft.								
ELEV.	DEPTH	LEGEND	CLASSIFICATION OF MATERIALS	% REC.	BOX OR SAMPLE NO.	RQD OR UD	REMARKS	BLOG(S)/ 0.5 FT.	N-VALUE		
			From El. -16.0 to -24.0 Ft., mostly subangular fine to coarse-grained sand-sized quartz, little shell, trace silt, trace fine gravel-sized shell, trace phosphate, moist, homogeneous, gray	NR	18		SPT Sampler	46	89		
								-16.0	37		
									28		
					NR	19			SPT Sampler	28	54
									19		
									13		
					NR	20			SPT Sampler	18	36
									21		
					NR	21			SPT Sampler	17	40
									17		
					NR	22			SPT Sampler	21	53
											-24.0
								45			
				NR	23			SPT Sampler	33	45	
											-26.0
								29			
				NR	24			SPT Sampler	32	69	
											-28.0
								41			
				NR	25			SPT Sampler	37	56	
											-30.0
								28			
				NR	26			SPT Sampler	28	50	
											-30.9
								50/0.4'			
							-31.0	29			
							Advanced Boring				
			NR	27			SPT Sampler	29	55		
										-32.0	13
							23				
			NR	28			SPT Sampler	28	55		
										-34.0	27
							33				
							SPT Sampler	31			
								36	55		

DRILLING LOG (Cont. Sheet)		INSTALLATION		SHEET 4 OF 5 SHEETS							
PROJECT PORT CANAVERAL CHANNEL WIDENING		COORDINATE SYSTEM/DATUM State Plane, FLE (U.S. Ft.)		HORIZONTAL NAD83	VERTICAL MLLV						
LOCATION COORDINATES X = 784,870 Y = 1,482,595		ELEVATION TOP OF BORING 20.0 Ft.									
ELEV.	DEPTH	LEGEND	CLASSIFICATION OF MATERIALS	% REC.	BOX OF SAMPLE	RQD OR COR. OF	REMARKS	BLOWS/ 0.5 FT.	N-VALUE		
-36.0	56.0			NR	28		SPT Sampler	19 11	55		
			CLAY, fat, high plasticity, soft, mostly clay, moist, homogeneous, gray (CH)	NR	29		SPT Sampler	5 4 3	7		
									4		
						NR	30		SPT Sampler	3 5	8
										4	
						NR	31		SPT Sampler	3 4	7
										9	
										6	
						NR	32		SPT Sampler	3 5	11
										5	
						NR	33		SPT Sampler	4 5 6	11
										5	
						NR	34		SPT Sampler	4 4	8
										4	
				NR	35		SPT Sampler	5 3 4	7		
								4			
				NR	36		SPT Sampler	10 6 5	11		
								6			
				NR	37		SPT Sampler	7 5 5	10		
								6			
-54.0	74.0		SAND, clayey, low plasticity, soft, mostly rounded fine-grained sand-sized quartz, little clay, moist, homogeneous, gray (SC)	NR	38		SPT Sampler	6 7			



Boring Designation TH-7

DRILLING LOG (Cont. Sheet)			INSTALLATION			SHEET 5 OF 5 SHEETS			
PROJECT PORT CANAVERAL CHANNEL WIDENING			COORDINATE SYSTEM/DATUM State Plane, FLE (U.S. Ft.)		HORIZONTAL NAD83	VERTICAL MLLW			
LOCATION COORDINATES X = 784.870 Y = 1,482,595			ELEVATION TOP OF BORING 20.0 FT.						
ELEV.	DEPTH	LEGEND	CLASSIFICATION OF MATERIALS	% REC.	NO. OF SAMPLES	RQD OR ID	REMARKS	BLOWS/ 0.5 FT.	N-VALUE
				NR	38		SPT Sampler	4	75
								5	
-58.0	78.0			NR	39		SPT Sampler	8	15
								6	
								9	
			CLAY, fat, high plasticity, soft, mostly clay, moist, homogeneous, gray (CH)						
				NR	40		SPT Sampler	11	13
								7	
-60.0	80.0						6		
			NOTES:				140# hammer w/30" drop used with 2.0' split spoon (1-3/8" I.D. x 2" O.D.).		
			1. Soils are field visually classified in accordance with the Unified Soils Classification System.				Abbreviations: NR = Not Recorded.		
			2. Borehole grouted at completion of sampling.						
			3. Laboratory Testing Results						
			SAMPLE ID      SAMPLE DEPTH      LABORATORY CLASSIFICATION						
			5      8.0/10.0      SP-SM*						85
			9      16.0/18.0      CH*						
			29      56.0/58.0						
			33      64.0/66.0						
			38      74.0/76.0      SC*						
			*Lab visual classification based on gradation curve. No Atterberg limits.						
			4. Additional Laboratory Testing						
			1-4 Moisture Content						90
			5 Moisture Content						
			9 Moisture Content						
			10-11 Moisture Content						
			12-13 Moisture Content						
			14-18 Moisture Content						
			19-22 Moisture Content						
			23-26 Moisture Content						
			27-28 Moisture Content						
			29 Moisture Content						
			33 Moisture Content						
			38 Moisture Content						
			40 Moisture Content						



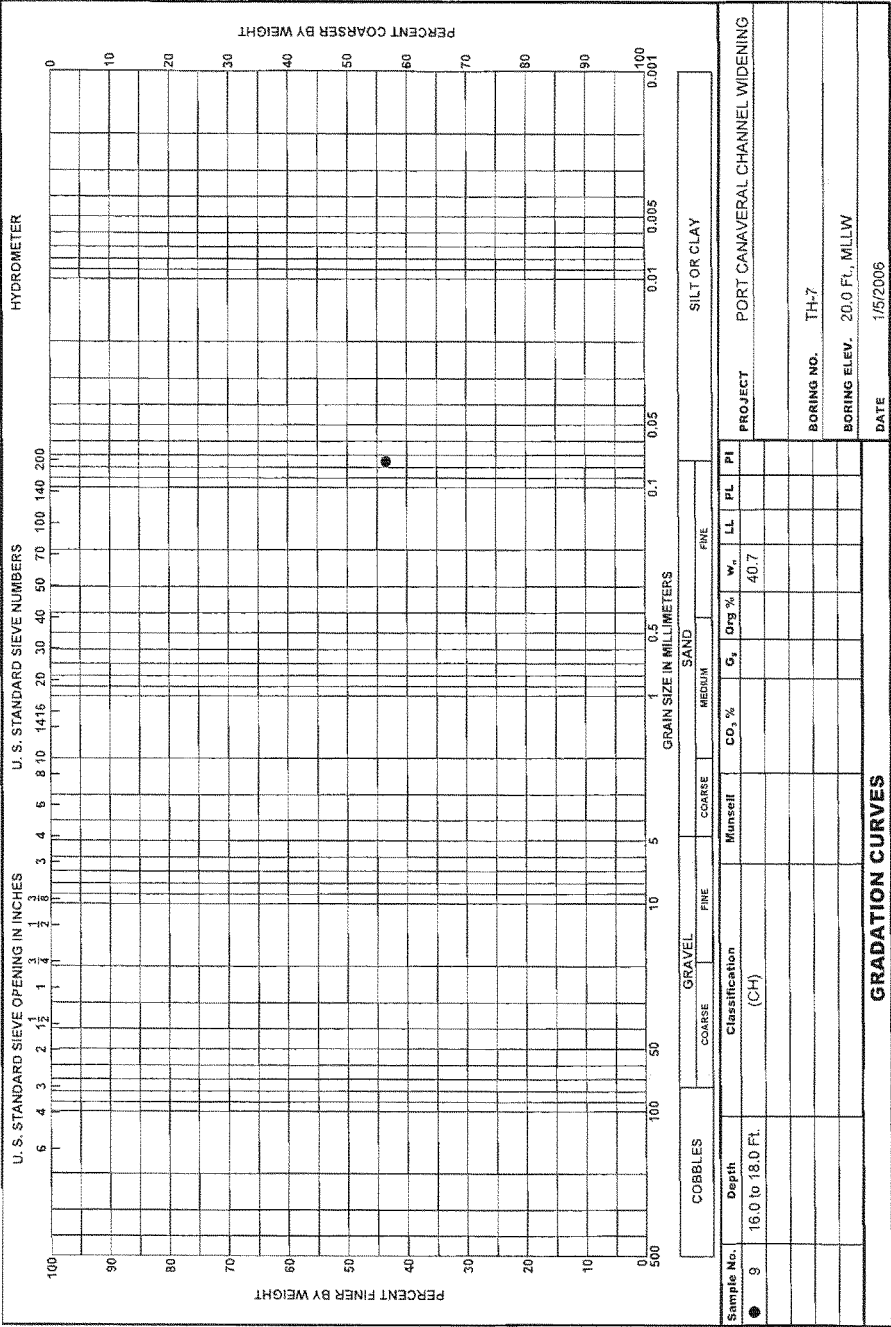

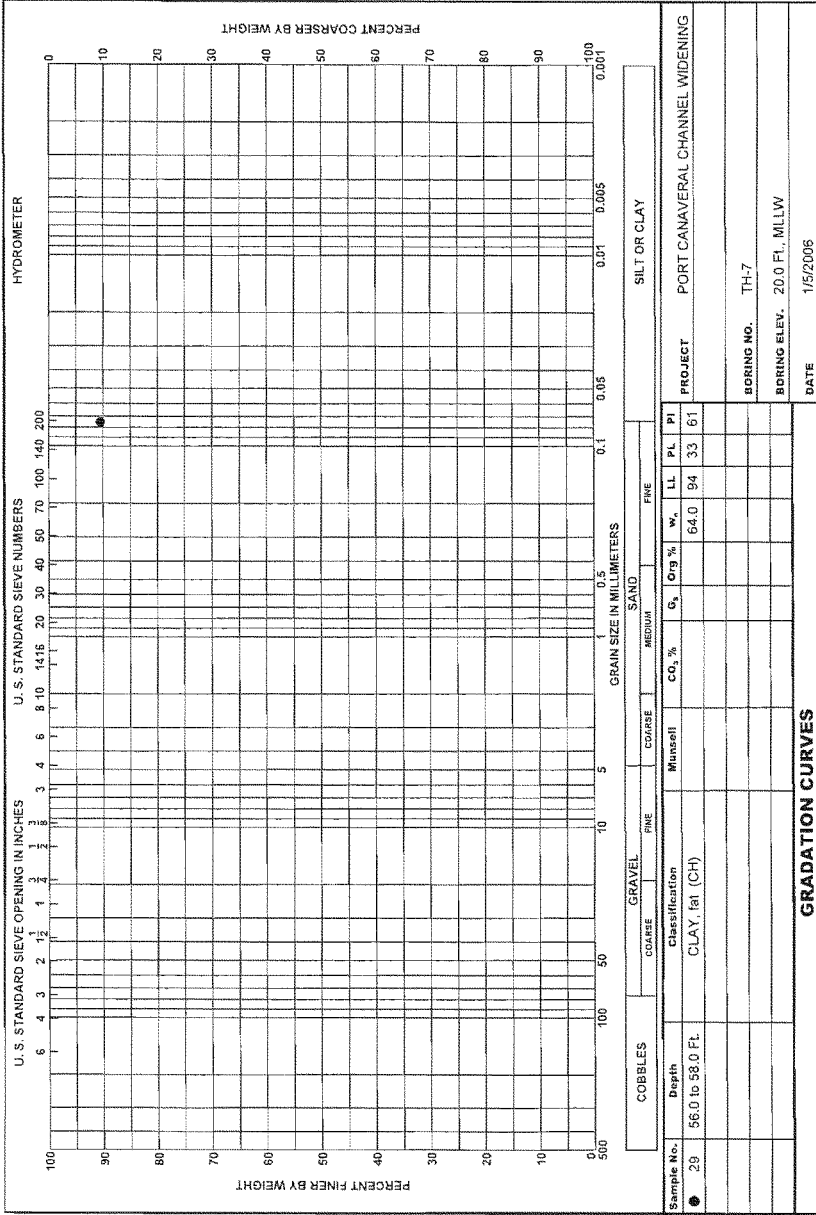

SAJ FORM 2087  
 JUN 02

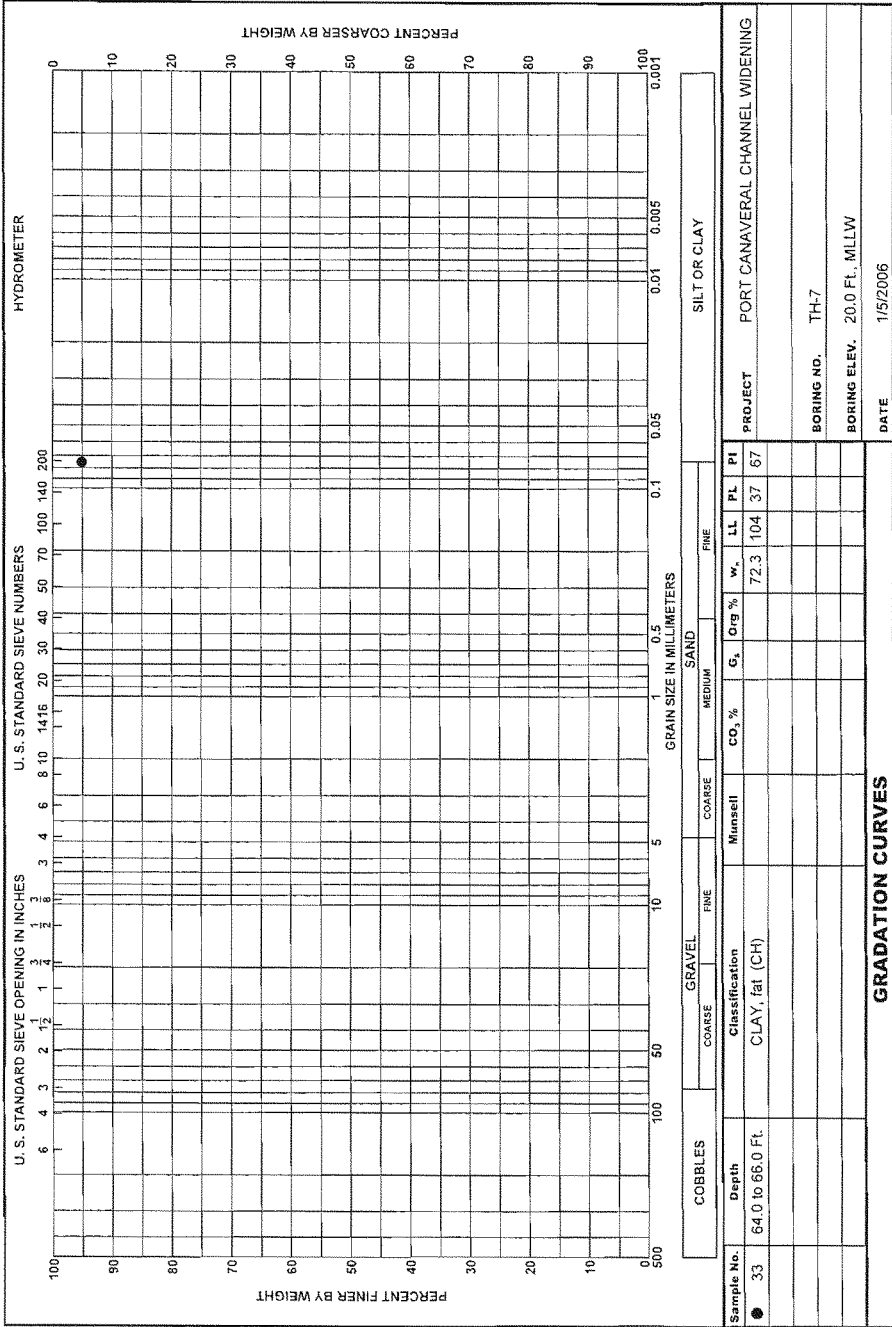

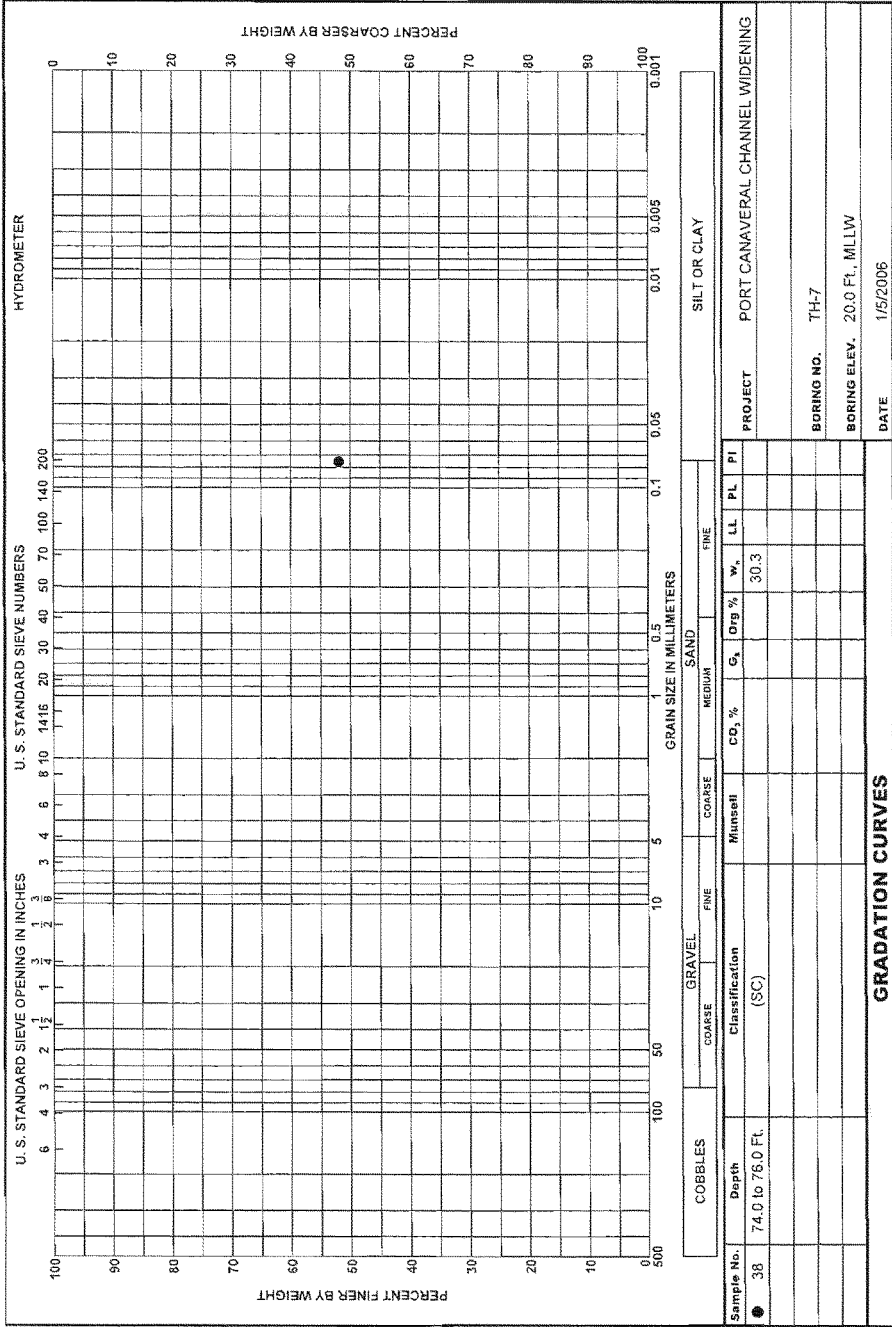

Boring Designation TH-8

<b>DRILLING LOG</b>		DIVISION Corporate Engineering	INSTALLATION	SHEET 1 OF 6 SHEETS
1. PROJECT PORT CANAVERAL CHANNEL WIDENING			9. SIZE AND TYPE OF BIT 3" Tricone	10. COORDINATE SYSTEM/DATUM HORIZONTAL: State Plane, FLE (U.S. FL.) VERTICAL: NAD83 MLLW
2. BORING DESIGNATION TH-8	LOCATION COORDINATES X = 786,305 Y = 1,482,510		11. MANUFACTURER'S DESIGNATION OF DRILL CME-55 Truck Mount	<input type="checkbox"/> AUTO HAMMER <input checked="" type="checkbox"/> MANUAL HAMMER
3. DRILLING AGENCY ARDAMAN & ASSOCIATES, INC.	CONTRACTOR FILE NO. 05-100		12. TOTAL SAMPLES 50	DISTURBED 0
4. NAME OF DRILLER			13. TOTAL NUMBER CORE BOXES 0	
5. DIRECTION OF BORING <input checked="" type="checkbox"/> VERTICAL <input type="checkbox"/> INCLINED		6. DEG. FROM VERTICAL	7. BEARING	14. ELEVATION GROUND WATER Not Determined
8. THICKNESS OF OVERBURDEN N/A			15. DATE BORING STARTED: 11-03-05 COMPLETED: 11-03-05	16. ELEVATION TOP OF BORING 40.0 Ft.
7. DEPTH DRILLED INTO ROCK N/A			17. TOTAL RECOVERY FOR BORING Not Recorded	
8. TOTAL DEPTH OF BORING 100.0 Ft.			18. SIGNATURE AND TITLE OF INSPECTOR	

ELEV.	DEPTH	LEGEND	CLASSIFICATION OF MATERIALS	% REC.	BOX OR SAMPLE	RQD OR UD	REMARKS	BLOWS/0.5 FT.	N-VALUE
40.0	0.0		FILL, mostly subrounded fine to medium-grained sand-sized sand, trace silt, dry, homogeneous, brown				40.0		
				NR	1		SPT Sampler	3 4 6	10
				NR	2		SPT Sampler	4 7 8	16
				NR	3		SPT Sampler	8 3 4	6
				NR	4		SPT Sampler	2 5 7 10	19
				NR	5		SPT Sampler	9 13 11 15	30
				NR	6		SPT Sampler	15 27 11 20	45
				NR	7		SPT Sampler	25 34 20 22	54
				NR	8		SPT Sampler	37 17	
								14	

DRILLING LOG (Cont. Sheet)			INSTALLATION			SHEET 2 OF 6 SHEETS			
PROJECT PORT CANAVERAL CHANNEL WIDENING			COORDINATE SYSTEM/DATUM State Plane, FLE (U.S. Ft.)		HORIZONTAL NAD83	VERTICAL MLLW			
LOCATION COORDINATES X = 786,305 Y = 1,482,510			ELEVATION TOP OF BORING 40.0 Ft.						
ELEV.	DEPTH	LEGEND	CLASSIFICATION OF MATERIALS	% REC.	BOX OR SAMPLE NO.	RQD OR LOG	REMARKS	BLOWS/ 0.5 FT.	N-VALUE
22.0	18.0	[Cross-hatched pattern]		NR	8		SPT Sampler	11	25
							24.0	7	
14.0	26.0	[Dotted pattern]	SAND, poorly-graded, mostly subrounded fine to medium-grained sand-sized quartz, trace silt, trace shell, trace fine gravel-sized shell, moist, homogeneous, brown (SP)	NR	10		SPT Sampler	3	11
							22.0	2	
							16	9	
							20.0	27	
12.0	28.0	[Dotted pattern]	SAND, poorly-graded with silt, mostly rounded fine-grained sand-sized quartz, trace silt, trace shell, moist, homogeneous, brown (SP-SM)	NR	11		SPT Sampler	14	20
							20.0	23	
							24	27	
							28	33	
							18.0	31	
							16.0	41	
6.0	34.0	[Dotted pattern]	SAND, poorly-graded, mostly subangular fine to coarse-grained sand-sized shell, trace silt, trace fine gravel-sized shell, moist, homogeneous, brown (SP)	NR	12		SPT Sampler	24	25
							14.6	28	
							14.5	31	
							14.0	41	
6.0	34.0	[Dotted pattern]	SAND, poorly-graded with silt, mostly rounded fine-grained sand-sized quartz, trace silt, moist, homogeneous, brown	NR	13		SPT Sampler	29	25
							14.0	33	
							12.6	35	
							12.5	40	
6.0	34.0	[Dotted pattern]	SAND, poorly-graded with silt, mostly rounded fine-grained sand-sized quartz, trace silt, moist, homogeneous, brown	NR	14		Advanced Boring	50/0.4'	90+
							14.0	37	
							12.6	47	
							12.5	50/0.4'	
6.0	34.0	[Dotted pattern]	SAND, poorly-graded with silt, mostly rounded fine-grained sand-sized quartz, trace silt, moist, homogeneous, brown	NR	15		Advanced Boring	50/0.4'	97+
							12.1	36	
							12.0	41	
							10.0	20	
6.0	34.0	[Dotted pattern]	SAND, poorly-graded with silt, mostly rounded fine-grained sand-sized quartz, trace silt, moist, homogeneous, brown	NR	16		SPT Sampler	21	30
							8.0	20	
							18	24	
							14	38	
6.0	34.0	[Dotted pattern]	SAND, poorly-graded with silt, mostly rounded fine-grained sand-sized quartz, trace silt, moist, homogeneous, brown	NR	17		SPT Sampler	14	38
							8.0	20	
							19	17	
							22	39	
6.0	34.0	[Dotted pattern]	SAND, poorly-graded with silt, mostly rounded fine-grained sand-sized quartz, trace silt, moist, homogeneous, brown	NR	18		SPT Sampler	12	39
							6.0	7	
							SPT Sampler	8	35



Boring Designation TH-8

DRILLING LOG (Cont. Sheet)			INSTALLATION			SHEET 3 OF 6 SHEETS			
PROJECT PORT CANAVERAL CHANNEL WIDENING			COORDINATE SYSTEM/DATUM State Plane, FLE (U.S. Ft.)		HORIZONTAL NAD83	VERTICAL MLLW			
LOCATION COORDINATES X = 786,305 Y = 1,482,510			ELEVATION TOP OF BORING 40.0 Ft						
ELEV.	DEPTH	LEGEND	CLASSIFICATION OF MATERIALS	% REC.	BOX OR SAMPLE NO.	RQD OR COR.	REMARKS	BLOWS/ 0.5 FT.	N-VALUE
			(SP-SM)						
				NR	18		4.0 SPT Sampler	9 12	17
								13	
				NR	19		2.0 SPT Sampler	10 11	21
								16	
				NR	20		SPT Sampler	26 44	94+
							0.6	50/0.4'	
				NR			0.5 Advanced Boring		
							0.0 SPT Sampler	48	40
								28	
				NR	21		SPT Sampler	29 37	66
-2.0	42.0						-2.0	46	
			SAND, poorly-graded, mostly subrounded fine to medium-grained sand-sized quartz, trace silt, trace shell, trace phosphate, moist, homogeneous, gray (SP)					33	
				NR	22		SPT Sampler	34 44	78
							-3.8	50/0.3'	
							-4.0	Advanced Boring	
				NR	23		SPT Sampler	43	
							-4.9	50/0.4'	
							-5.0	Advanced Boring	45
-6.0	46.0			NR			SPT Sampler	46	
							-5.9	50/0.4'	
							-6.0	Advanced Boring	
			SAND, silty, mostly subrounded fine to medium-grained sand-sized quartz, little silt, trace shell, moist, homogeneous, brown (SM)					49	
				NR	24		SPT Sampler	50/0.4'	
							-6.9	Advanced Boring	
							-7.0	Advanced Boring	
				NR			SPT Sampler	47	
-8.0	48.0						-8.0	46	
			SAND, poorly-graded with silt, mostly rounded fine-grained sand-sized quartz, trace silt, trace shell, moist, homogeneous, brown (SP-SM)					44	
				NR	25		SPT Sampler	45	95+
							-9.4	50/0.4'	
							-9.5	Advanced Boring	
				NR			SPT Sampler	44	50
							-10.0	Advanced Boring	
				NR	26		SPT Sampler	50	
							-10.9	50/0.4'	
							-11.0	Advanced Boring	
							-11.4	SPT Sampler	50/0.4'
							-11.5	Advanced Boring	
							-12.0	SPT Sampler	48
								44	
				NR	27		SPT Sampler	44	94+
							-13.4	50/0.4'	
							-13.5	Advanced Boring	
				NR			SPT Sampler	46	
							-14.0	Advanced Boring	
								46	
				NR	28		SPT Sampler	39	

Boring Designation TH-8

DRILLING LOG (Cont. Sheet)			INSTALLATION			SHEET 4 OF 6 SHEETS				
PROJECT PORT CANAVERAL CHANNEL WIDENING			COORDINATE SYSTEM/DATUM State Plane, FLE (U.S. Ft.)		HORIZONTAL NAD83	VERTICAL MLLV				
LOCATION COORDINATES X = 786,305 Y = 1,482,510			ELEVATION TOP OF BORING 40.0 Ft.							
ELEV.	DEPTH	LEGEND	CLASSIFICATION OF MATERIALS	% REC.	BOX OR SAMPLE	RQD OR UD	REMARKS	BLOWS/ 0.5 FT.	N-VALUE	
-16.0	56.0			NR	28		SPT Sampler	44 46	83	
			SAND, poorly-graded, mostly rounded fine-grained sand-sized quartz, trace silt, trace shell, trace phosphate, moist, homogeneous, gray (SP)	NR	29		SPT Sampler	40 37 39	76	
									29	
				NR	30		SPT Sampler	26 27 21	48	
									23	
				NR	31		SPT Sampler	20 20	40	
									22	
				NR	32		SPT Sampler	23 25 22	47	
									22	
				NR	33		SPT Sampler	28 26 22	48	
									21	
				NR	34		SPT Sampler	24 34 14	48	
									23	
				NR	35		SPT Sampler	27 25 26	51	
								22		
			NR	36		SPT Sampler	24 28	52		
								33		
			NR	37		SPT Sampler	27 29 24	53		
								26		
			NR	38		SPT Sampler	30			
								38		

Boring Designation TH-8

DRILLING LOG (Cont. Sheet)			INSTALLATION			SHEET 5 OF 6 SHEETS					
PROJECT PORT CANAVERAL CHANNEL WIDENING			COORDINATE SYSTEM/DATUM State Plane, FLE (U.S. Ft.)		HORIZONTAL NAD83	VERTICAL MLLV					
LOCATION COORDINATES X = 786,305 Y = 1,482,510			ELEVATION TOP OF BORING 40.0 Ft.								
ELEV.	DEPTH	LEGEND	CLASSIFICATION OF MATERIALS	% REC.	BOX OR SAMPLE NO.	RQD OR UD	REMARKS	BLOWS/ 0.5 FT.	N-VALUE		
			From El. -36.0 to -54.0 Ft., mostly subangular fine to coarse-grained sand-sized quartz, trace silt, trace shell, trace fine gravel-sized shell, trace phosphate, moist, homogeneous, gray	NR	38		SPT Sampler	24	75		
								-36.0	30		
						NR	39		SPT Sampler	41	
										49	99+
								-37.4		50/0.4'	
								-37.5	Advanced Boring		
						NR			SPT Sampler	45	
								-38.0			
						NR	40		SPT Sampler	48	
								-38.8		50/0.3'	
								-39.0	Advanced Boring		
						NR			SPT Sampler	47	
								-40.0		44	80
								41			
				NR	41		SPT Sampler	43	93+		
						-41.4		50/0.4'			
						-41.5	Advanced Boring				
				NR			SPT Sampler	41			
								45			
								45			
				NR	42		SPT Sampler	48	93		
						-44.0		50			
								41			
								34	78		
				NR	43		SPT Sampler	44	85		
						-46.0		46			
								44			
				NR	44		SPT Sampler	47	90		
						-48.0		44			
								44			
				NR	45		SPT Sampler	44			
						-48.8		50/0.3'			
						-49.0	Advanced Boring				
				NR			SPT Sampler	43			
						-50.0		46	90		
								43			
				NR	46		SPT Sampler	44	93		
								49			
						-51.8		50/0.3'			
						-52.0	Advanced Boring				
								40			
								43			
				NR	47		SPT Sampler	37	80		
								38			
-54.0	94.0										
			SAND, silty, mostly rounded fine-grained sand-sized quartz, little silt, trace clay, moist, homogeneous, brown (SM)	NR	48		SPT Sampler	24			
								26	95		

Boring Designation TH-8

DRILLING LOG (Cont. Sheet)			INSTALLATION			SHEET 6 OF 6 SHEETS																					
PROJECT PORT CANAVERAL CHANNEL WIDENING			COORDINATE SYSTEM/DATUM State Plane, FLE (U.S. Ft.)		HORIZONTAL NAD83	VERTICAL MLLW																					
LOCATION COORDINATES X = 786,305 Y = 1,482,510			ELEVATION TOP OF BORING 40.0 Ft.																								
ELEV.	DEPTH	LEGEND	CLASSIFICATION OF MATERIALS	% REC.	BOX OR SAMPLE	RCD OR UD	REMARKS	BLOWS/ 0.5 FT.	N-VALUE																		
-60.0	100.0			NR	48		SPT Sampler	24	50																		
								17																			
				NR	49		SPT Sampler	9	14																		
								5																			
								14																			
				NR	50		SPT Sampler	10	22																		
								11																			
								11																			
								13																			
			NOTES:				140# hammer w/30" drop used with 2.0' split spoon (1-3/8" I.D. x 2" O.D.).																				
			1. Soils are field visually classified in accordance with the Unified Soils Classification System.				Abbreviations: NR = Not Recorded.																				
			2. Borehole grouted at completion of sampling.																								
			3. Laboratory Testing Results																								
			<table border="1"> <thead> <tr> <th>SAMPLE ID</th> <th>SAMPLE DEPTH</th> <th>LABORATORY CLASSIFICATION</th> </tr> </thead> <tbody> <tr> <td>8</td> <td>14.0/16.0</td> <td>SP-SM*</td> </tr> <tr> <td>10</td> <td>18.0/20.0</td> <td>SP-SM*</td> </tr> <tr> <td>14</td> <td>26.0/27.4</td> <td>SP-SM*</td> </tr> <tr> <td>24</td> <td>46.0/46.9</td> <td>SM*</td> </tr> <tr> <td>25</td> <td>48.0/49.4</td> <td>SP-SM*</td> </tr> </tbody> </table>	SAMPLE ID	SAMPLE DEPTH	LABORATORY CLASSIFICATION	8	14.0/16.0	SP-SM*	10	18.0/20.0	SP-SM*	14	26.0/27.4	SP-SM*	24	46.0/46.9	SM*	25	48.0/49.4	SP-SM*						
SAMPLE ID	SAMPLE DEPTH	LABORATORY CLASSIFICATION																									
8	14.0/16.0	SP-SM*																									
10	18.0/20.0	SP-SM*																									
14	26.0/27.4	SP-SM*																									
24	46.0/46.9	SM*																									
25	48.0/49.4	SP-SM*																									
			*Lab visual classification based on gradation curve. No Atterberg limits.																								
			4. Additional Laboratory Testing																								
			1 Moisture Content																								
			2-4 Moisture Content																								
			5 Moisture Content																								
			6 Moisture Content																								
			7 Moisture Content																								
			8 Moisture Content																								
			10 Moisture Content																								
			14 Moisture Content																								
			15-17 Moisture Content																								
			18-21 Moisture Content																								
			22-23 Moisture Content																								
			24 Moisture Content																								
			25 Moisture Content																								
			29-38 Moisture Content																								
			39-47 Moisture Content																								
			48-50 Moisture Content																								

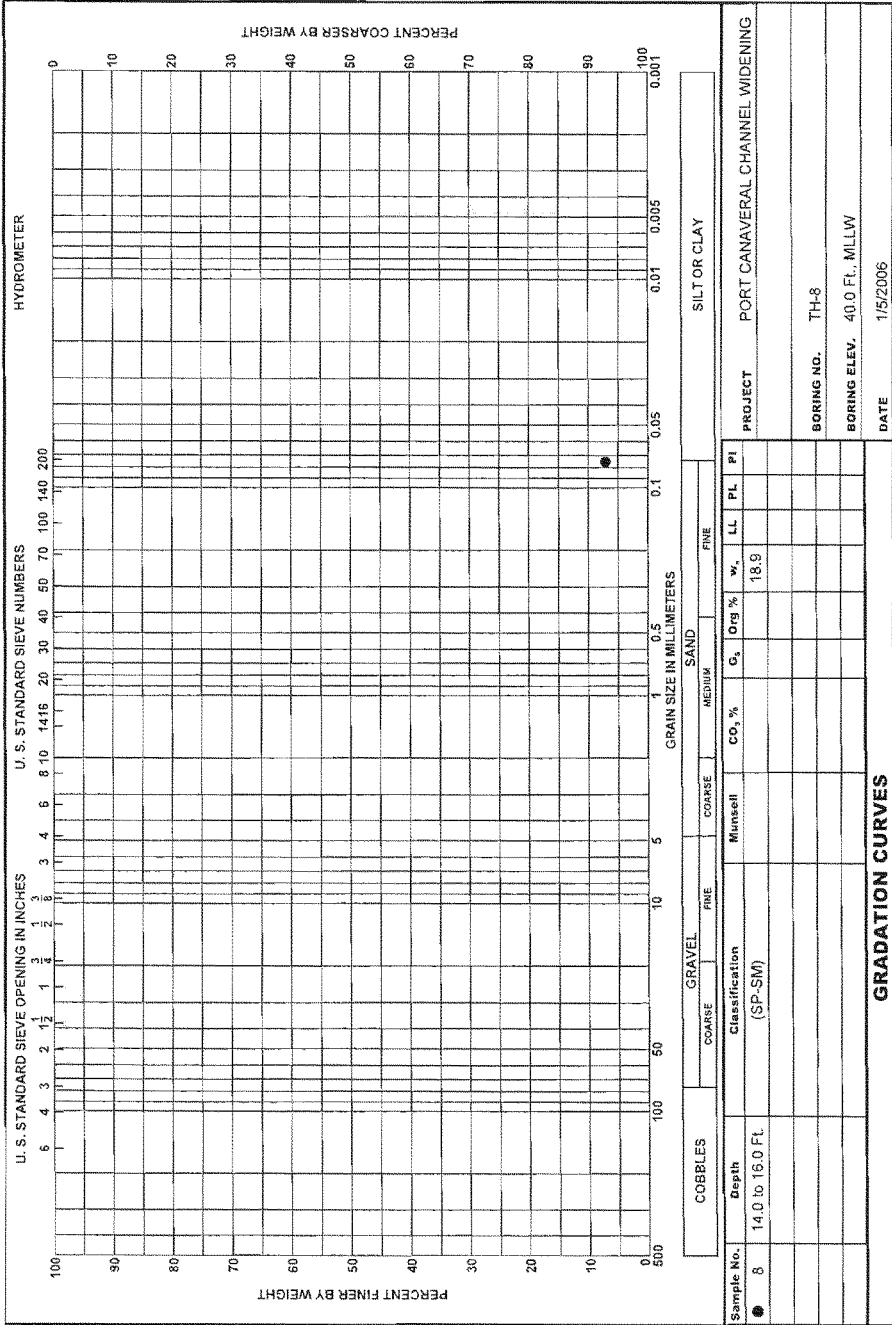









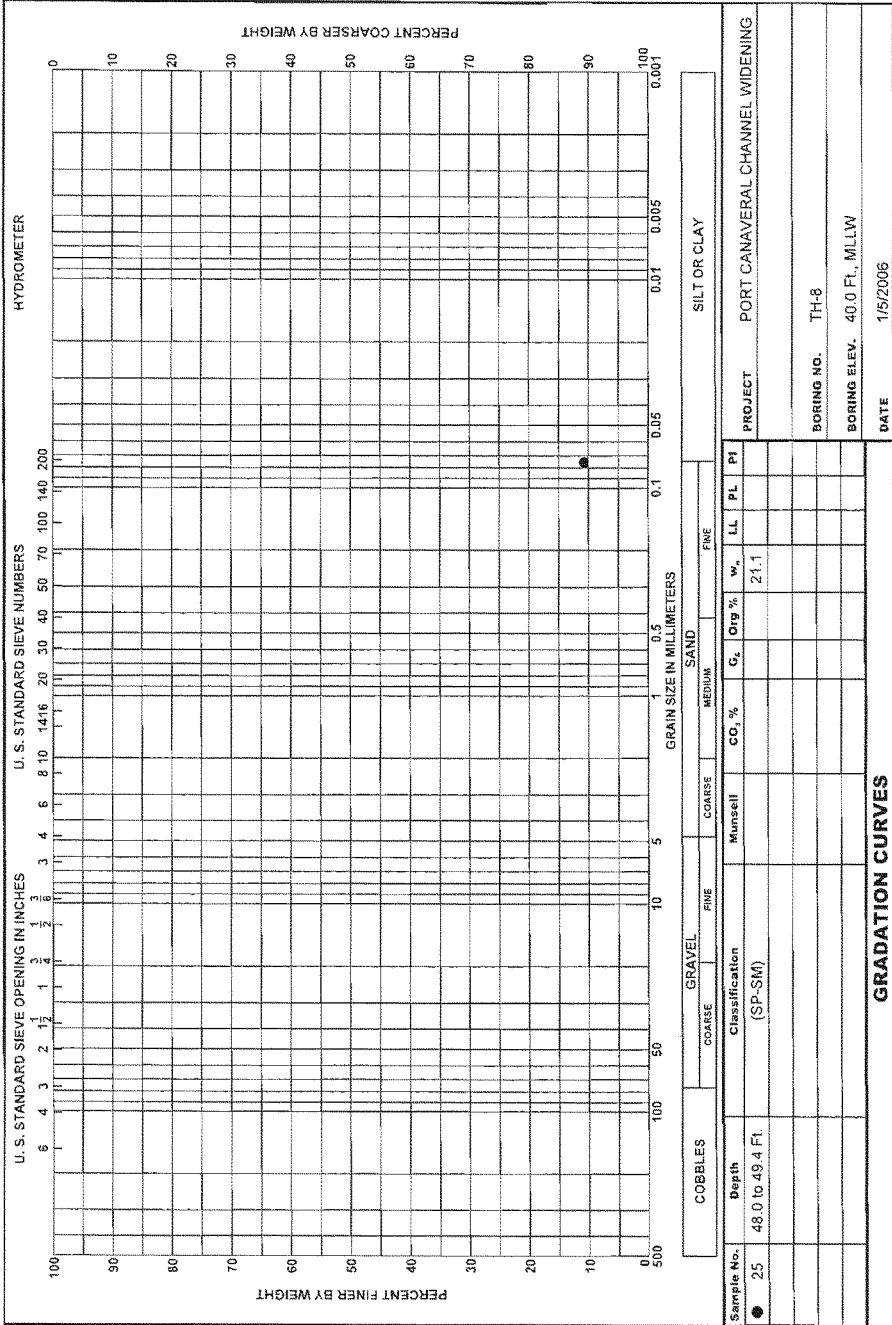

SAJ FORM 2087  
JUN 02

PROJECT: PORT CANAVERAL CHANNEL WIDENING

BORING NO.: TH-8

BORING ELEV.: 40.0 Ft., MLLW

DATE: 1/5/2006

Appendix 3

**Historic Test Boring Logs - Non-Ardaman**

DEPARTMENT OF THE ARMY DIVISION <u>Corps of Engineers</u> INSTALLATION <u>Jacksonville, Florida</u>			MOLE NO. <u>CB-NLS-7</u> PROJECT <u>Canaveral Harbor</u> <u>New Lock Site.</u>		SHEET 1 OF 1
DRILLING LOG			2. LOCATION (Coordinates or Station) <u>REG 1</u> X = Y =		
4. HOLE NO. (As shown on drawing title and file no.)			3. DRILLING AGENCY <u>Law, Barron Ages Laboratories</u>		
6. DIRECTION OF HOLE <input checked="" type="checkbox"/> VERTICAL <input type="checkbox"/> INCLINED    DEGREES WITH VERTICAL			7. THICKNESS OF OVERBURDEN		8. DEPTH DRILLED INTO ROCK
10. SIZE AND TYPE OF BIT <u>2" I. D. Spoon</u>			11. DATUM FOR ELEVATION SHOWN <u>XTXUCXCSXO MIN *</u>		9. TOTAL DEPTH OF HOLE <u>33.0'</u>
13. TOTAL NO. OF OVERBURDEN SAMPLES TAKEN DISTURBED    UNDISTURBED			14. TOTAL NO. CORE BOXES		12. MANUFACTURER'S DESIGNATION OF DRILL 15. ELEV. GROUND, WATER, TIDAL <u>17.2/59</u> 16. DATE HOLE <u>1/23/59</u>
17. ELEV. TOP OF HOLE <u>-2.0</u>			18. TOTAL CORE RECOVERY FOR BORING (%)		19. <del>GEOLOGIST</del> <u>Geologist</u> <u>R. R. Thompson</u>
ELEVATION	DEPTH	LEGEND	CLASSIFICATION OF MATERIALS (prescription)	RECOVERED SAMPLE NO.	REMARKS (drilling time, water loss, depth of weathering, etc., if significant)
-2.0	0.0				Bit & Barrel Bls/Ft
					-2.0
			SAND, fine/medium quartz, silty, very slightly shelly, gray, quite loose in bottom	1	2" I.D. Spoon
					3
					11
					12
					9
					5
					-7.0
					3
					8
					10
					7
					5
					-11.5
			CLAY, slightly shelly, green		Wt of Hammer
					1
					2
					3
			Sandy		2
					4
					5
					6
					-17.0
			SAND, medium/coarse, very clayey, green	5	
					4
					13
					16
					11
					25
					-22.0
			SAND, medium/coarse quartz, brown	6	" "
					52
					10
					17
					32
					51
					-27.0
			SAND, fine/medium quartz & calcite, shelly, gray	7	" "
					60
					14
					19
					-32.0
					28
					-35.0
					180# Hammer w/30" Drop Used on 2" I. D. Spoon
					* Banana River MSL = 0.1' below MSL

- LEGEND
- ① Test pile
  - ② Anchor pile
  - ③ Core borings

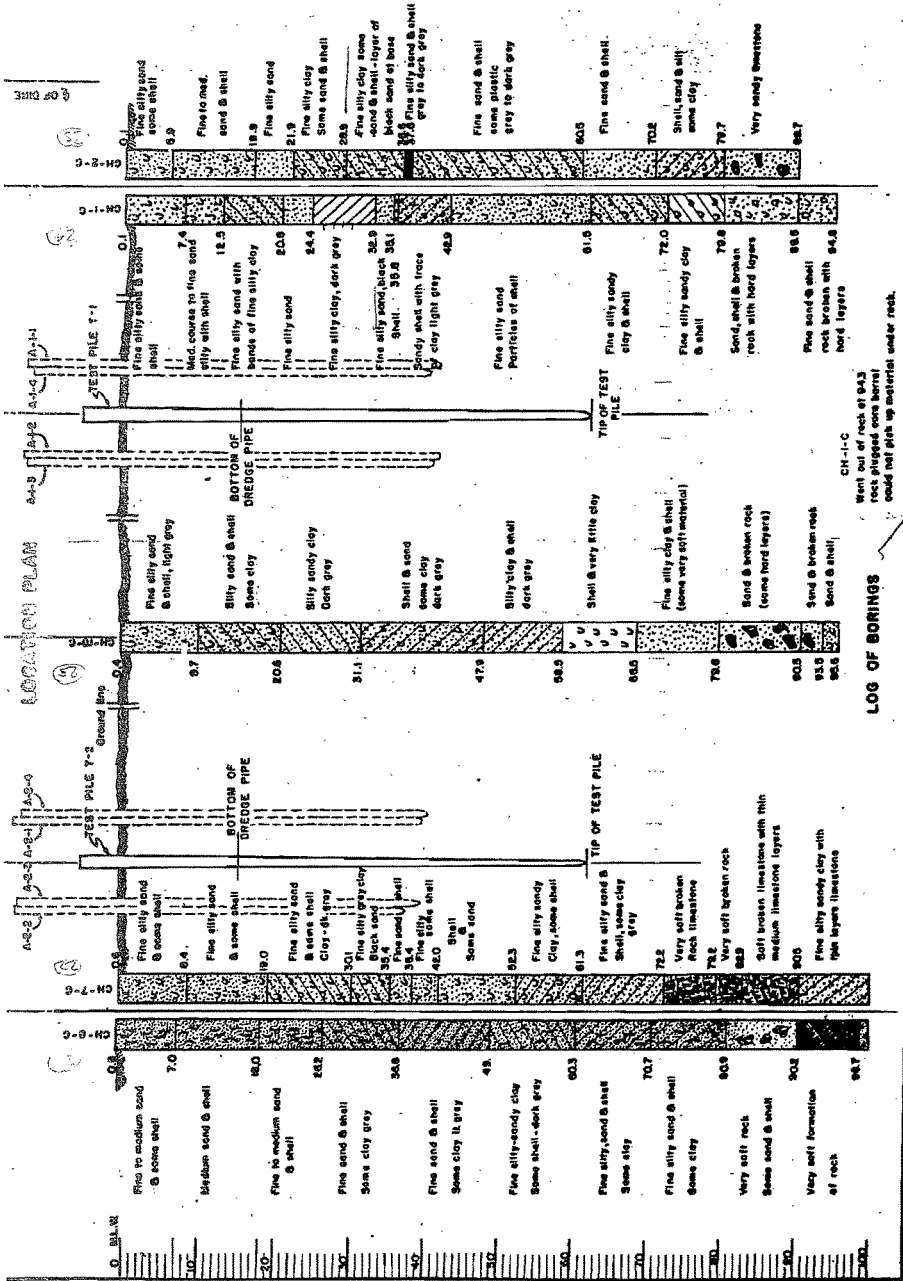

**CANAVERAL**  
**LOCATION OF**  
**AND DONE**  
 JAC. SONNENLICH & CO. INC.  
 1000 S. 10th St.  
 OMAHA, NEB.

NOTE: Material, especially field inspection.



**PITTSBURGH TESTING LABORATORY**  
3281 N.W. 7th STREET MIAMI 35, FLORIDA

AS A MUTUAL PROTECTION TO CLIENTS, THE PUBLIC AND OURSELVES ALL REPORTS ARE SUBMITTED AS THE CONFIDENTIAL PROPERTY OF CLIENTS, AND AUTHORIZATION FOR PUBLICATION OF STATEMENTS, CONCLUSIONS OR EXTRACTS FROM OR REPRODUCING OUR REPORTS IS RESERVED PENDING OUR WRITTEN APPROVAL

**TEST BORING REPORT**

P-1

CLIENT: Canaveral Port Authority, Cocoa, Florida ORDER No. PA-1432  
 PROJECT: Test Borings in easterly part of the Port Authority POST No. 1  
 LOCATION: Shown on location plat drawn by Gee & Property HOLE No. 1 (Sheet 1 of 3)  
Jensen, Consulting Engineers Inc. W. Palm Beach, Fla. DATE STARTED 11-18-56  
 DRILLER: Gaultney & Chapman DRILL No. 10 DATE COMPLETED 11-23-56

GROUND ELEVATION	DESCRIPTION OF MATERIALS	Sample Number	Number Blows on Sampler	Penetration Foot	Velocity of Casing		
Established @ 100.0'	Loose to very loose Grey & Tan medium to fine sand with shell fragments	103	9	1.0			
				2.0			
				3.0			
				4.0			
				5.0			
		106	1	6.0			
				7.0			
				8.0			
				9.0			
				10.0			
7.5' 7.5'	Very Loose Grey silty sand with shell fragments	111	1	11.0			
13.5' 8.0'				12	12	12.0	
						13.0	
						14.0	
						15.0	
		16.0					
29.0' 15.5'		Medium to Loose Grey medium to fine sand	116	21	17.0		
					18.0		
					19.0		
					20.0		
	21.0						
	121		13	13	22.0		
					23.0		
					24.0		
					25.0		
					26.0		
32.5' 3.5'	Grey sandy clay	131	2	27.0			
				28.0			
				29.0			
				30.0			
				31.0			
		32.0	2	2	32.0		
					33.0		
					34.0		
					35.0		
					36.0		

Scale: \_\_\_\_\_  
 Hammer weight: Casing \_\_\_\_\_ lbs. Spoon 140 lbs.  
 Hammer drop: Casing \_\_\_\_\_ ins. Spoon 50 ins.  
 Sampler size: 1 3/8" O.D. 2 "O.D. Std. Pene.  
 Casing size: \_\_\_\_\_ I.D. \_\_\_\_\_ O.D. Type Drilling Mud  
 Water level: 2.5 below surface or 8.00 date 11-19-56

As a mutual protection to the owners and ourselves, the engineer in the owner's behalf shall check this report with the samples submitted prior to the purchase of property or designing of structures.

PITTSBURGH TESTING LABORATORY

BY: [Signature]



# PITTSBURGH TESTING LABORATORY

3281 N.W. 7th STREET MIAMI 35, FLORIDA

AS A MUTUAL PROTECTION TO CLIENTS, THE PUBLIC AND OURSELVES, ALL REPORTS ARE SUBMITTED AS THE CONFIDENTIAL PROPERTY OF CLIENTS AND AUTHORIZATION FOR PUBLICATION OF STATEMENTS, CONCLUSIONS OR EXTRACTS FROM OR REGARDING OUR REPORTS IS RESERVED PENDING OUR WRITTEN APPROVAL.

## TEST BORING REPORT

P-1

CLIENT Canaveral Port Authority, Cocoa, Florida ORDER No. 44-1432  
 PROJECT Test Borings in Westerly Port of the Port Authority HOLE No. 1  
 LOCATION Shown on location plat. drawn by Dee A. Property (Sheet 2 of 3) 1  
Jensen Consulting Engrs. West Palm Beach, Florida DATE STARTED 11-23-56  
 DRILLER Gaultney & Chapman DRILL No. 10 DATE COMPLETED 11-23-56

GROUND ELEVATION Established	DESCRIPTION OF MATERIALS	Sample Number	Hammer Blows on Sampler	Penetration Foot	Hammer Blow on Casing	
45.0' 10.6'	2 Soft Grey Clay (Shelby)	137	Press	36.0		
		135	2	37.0		
				38.0		
				39.0		
				40.0		
			140	2	41.0	
					42.0	
					43.0	
					44.0	
					45.0	
49.0' 6.0'	Medium tan fine sand with shell fragments	146	15	46.0		
				47.0		
				48.0		
				49.0		
				50.0		
		(Medium)	151	14	51.0	
					52.0	
					53.0	
					54.0	
					55.0	
64.5' 15.5'	2 (Shelby)	157	Press	57.0		
	(Loose)	158	8	58.0		
				59.0		
				60.0		
		2 (Shelby)	162	Press	61.0	
	(Medium)	163	11	62.0		
					63.0	
					64.0	
					65.0	
		4 Stiff Grey sandy clay (Shelby)	167	Press	66.0	
		168	9	67.0		
				68.0		
				69.0		
				70.0		
				71.0		
		171	10			

Scale: \_\_\_\_\_ = 1 foot  
 Hammer weight: Casing \_\_\_\_\_ lbs. Spoon 140 lbs.  
 Hammer drop: Casing \_\_\_\_\_ ins. Spoon 31 ins.  
 Sampler size 1 3/8 O.D. 2 " O.D. and None  
 Casing size: \_\_\_\_\_ I.D. \_\_\_\_\_ " O.D. Type Drilling Mud  
 Water level: 2.6 below surface at 8:00 date 11-19-56

As a mutual protection to the owners and ourselves, the engineer in the owner's behalf shall check this report with the samples submitted prior to the purchase of property, or designing of structures.

PITTSBURGH TESTING LABORATORY

BY

*Joe. Harlowe*



**PITTSBURGH TESTING LABORATORY**  
3281 N.W. 7th STREET MIAMI 35, FLORIDA

AS A MUTUAL PROTECTION TO CLIENTS, THE PUBLIC AND OURSELVES, ALL REPORTS  
ARE SUBMITTED AS THE CONFIDENTIAL PROPERTY OF CLIENTS, AND AUTHORIZATION  
FOR PUBLICATION OF STATEMENTS, CONCLUSIONS OR EXTRACTS FROM OR REGARDING  
OUR REPORTS IS RESERVED PENDING OUR WRITTEN APPROVAL

**TEST BORING REPORT**

P-1

CLIENT Canaveral Port Authority, Cocoa, Florida ORDER No. MA-1432  
PROJECT Test borings in Westerly Port of the Port Authority REPORT No. 1  
LOCATION Shown on location plat drawn by Geo. & Property HOLE No. 1 (Sheet 5 of 8)  
Jensen consulting engineers, West Palm Beach, Florida DATE STARTED 11-18-56  
DRILLER Gaultney & Chapman DRILL No. 10 DATE COMPLETED 11-23-56

GROUND ELEVATION	DESCRIPTION OF MATERIALS	Sample Number	HAMMER STROKES OR SAMPLES	Penetration (in)	DEPTH FROM CASING
<u>Established 100.0'</u>					
<u>73.0'</u>	<u>Grey sandy clay</u>				<u>72.0</u>
					<u>73.0</u>
					<u>74.0</u>
	<u>Loose Grey Silty sand</u>				<u>75.0</u>
		<u>176</u>	<u>5</u>		<u>76.0</u>
					<u>77.0</u>
					<u>78.0</u>
					<u>79.0</u>
					<u>80.0</u>
		<u>181</u>	<u>4</u>		<u>81.0</u>
					<u>82.0</u>
					<u>83.0</u>
					<u>84.0</u>
					<u>85.0</u>
		<u>186</u>	<u>4</u>		<u>86.0</u>
					<u>87.0</u>
					<u>88.0</u>
					<u>89.0</u>
					<u>90.0</u>
		<u>191</u>	<u>4</u>		<u>91.0</u>
					<u>92.0</u>
					<u>93.0</u>
					<u>94.0</u>
					<u>95.0</u>
		<u>196</u>	<u>5</u>		<u>96.0</u>
					<u>97.0</u>
					<u>98.0</u>
<u>98.0'</u>	<u>Medium tan silty sand with flintrock fragments</u>				<u>99.0</u>
		<u>191</u>	<u>15</u>		<u>100.0</u>
<u>101.0'</u>	<u>End of boring</u>				<u>101.0</u>

Scale \_\_\_\_\_ 1 foot  
 Hammer weight: Casing \_\_\_\_\_ lbs. Spoon 140 lbs.  
 Hammer drop: Casing \_\_\_\_\_ ins. Spoon 30 ins.  
 Sampler size: 1 3/8 I.D. 2 " O.D. Std. Panc.  
 Casing size: \_\_\_\_\_ I.D. \_\_\_\_\_ O.D. Type Drilling mud  
 Water level: 2.6 ' below surface at 8:00 date 11-18-56

As a mutual protection to the owners and ourselves, the engineer in the owner's behalf shall check this report with the samples submitted prior to the purchase of property, or designing of structures

PITTSBURGH TESTING LABORATORY

BY Jaw Haller



# PITTSBURGH TESTING LABORATORY

3281 N.W. 7th STREET MIAMI 35, FLORIDA

AS A MUTUAL PROTECTION TO CLIENTS, THE PUBLIC AND OURSELVES, ALL REPORTS ARE SUBMITTED AS THE CONFIDENTIAL PROPERTY OF CLIENTS, AND AUTHORIZATION FOR PUBLICATION OF STATEMENTS, CONCLUSIONS OR EXTRACTS THEREFROM OR REPRODUCING OUR REPORTS IS RESERVED PENDING OUR WRITTEN APPROVAL

## TEST BORING REPORT

22

P-3

CLIENT General Port Authority, Cocoa, Florida ORDER No. PA-1432  
 PROJECT Test borings in the westerly part of the Port Authority property  
 LOCATION Shown on Location Plat - drawn by George Jensen HOIF No. 3 (Sheet 1 of 3)  
Consulting Engineers, West Palm Beach, Florida DATE STARTED 11-30-56  
 DRILLER Gauley & Chapman DRILL No. 10 DATE COMPLETED \_\_\_\_\_

GROUND ELEVATION	DESCRIPTION OF MATERIALS	Sample Number	Hammer Blows per Sample	Penetration (ft.)	Number of blows per Footing
99.5'	Loose grey medium sand			1.0 2.0 3.0 4.0 5.0 6.0 7.0	
3.5' 3.5'	Loose grey clayey sand	307 308	4 5	7.0 8.0 9.0	
8.0' 5.5'	Loose grey medium silty sand			10.0 11.0 12.0 13.0 14.0 15.0 16.0 17.0 18.0 19.0 20.0 21.0	
24.0' 15.0'	Soft grey sandy clay	322 323 324 331	res 3 3 1	22.0 23.0 24.0 25.0 26.0 27.0 28.0 29.0 30.0 31.0 32.0 33.0 34.0 35.0	

Scale \_\_\_\_\_ 1 foot  
 Hammer weight: Casing \_\_\_\_\_ lbs. Spoon 140 lbs.  
 Hammer drop: Casing \_\_\_\_\_ ins. Spoon \_\_\_\_\_ ins.  
 Sampler size: 1 3/8 " I.D. 2 " O.D. Standard  
 Casing size: \_\_\_\_\_ " I.D. \_\_\_\_\_ " O.D. Type Walling W  
 Water level: 2.0 below surface of 12.00 date 11-2-56

As a mutual protection to the owners and ourselves the engineer in the owner's behalf shall check this report with the samples submitted prior to the purchase of property, or designing of structures.

PITTSBURGH TESTING LABORATORY

BY

*Geo. Walker*





**PITTSBURGH TESTING LABORATORY**

3281 N.W. 7th STREET MIAMI 35, FLORIDA

AS A MUTUAL PROTECTION TO CLIENTS, THE PUBLIC AND OURSELVES ALL REPORTS ARE SUBMITTED AS THE CONFIDENTIAL PROPERTY OF CLIENTS, AND AUTHORIZATION FOR PUBLICATION OF STATEMENTS, CONCLUSIONS OR EXTRACTS FROM OR REPRODUCING OUR REPORTS IS RESERVED PENDING OUR WRITTEN APPROVAL

**TEST BORING REPORT**

P-3

CLIENT Canaveral Port Authority, Cocoa, Florida ORDER No. A-1432  
 PROJECT Test borings in the westerly part of the Port Authority property  
 LOCATION South on location plot - drawn by use of 1954 HOLE No. 3 (Sheet 2 of 3)  
Consulting Engineers, West Palm Beach, Florida DATE STARTED 11-30-56  
 DRILLER Gaultney & Chapman DRILL No. 10 DATE COMPLETED 12-2-56

GROUND ELEVATION	DESCRIPTION OF MATERIALS	Sample Number	Number of Blows on Sampler	Penetration Feet	Pressure Piles on Logging	
48.5' 16.5'	Soft Grey Clay	346	3	36.0		
				37.0		
				38.0		
				39.0		
			341	3	40.0	
					41.0	
					42.0	
					43.0	
					44.0	
					45.0	
					46.0	
			347	3	47.0	
			341	3	48.0	
					49.0	
					50.0	
	Very loose to medium grey to tan medium to fine sand with some cemented particles	352	3	51.0		
		353	2	52.0		
				53.0		
				54.0		
		356	12	55.0		
				56.0		
				57.0		
				58.0		
				59.0		
				60.0		
		361	5	61.0		
				62.0		
				63.0		
				64.0		
				65.0		
		360	12	66.0		
				67.0		
				68.0		
				69.0		
				70.0		

Scale \_\_\_\_\_ 1 foot  
 Hammer weight Casing = \_\_\_\_\_ lbs. Spoon 140 lbs.  
 Hammer drop Casing = \_\_\_\_\_ ins. Spoon 30 ins.  
 Sampler size 1 3/8 " 2 " O.D. 1 1/2 " O.D.  
 Casing size = \_\_\_\_\_ " I.D. = \_\_\_\_\_ " O.D. Type Drilling - 16  
 Water level: 2.0 ' below surface at 12:00 date 1-3-56

As a mutual protection to the owners and ourselves, the engineer in the owner's behalf shall check this report with the samples submitted prior to the purchase of property or designing of structures

**PITTSBURGH TESTING LABORATORY**

BY J. W. Hinkle



**PITTSBURGH TESTING LABORATORY**  
3281 N.W. 7th STREET MIAMI 35, FLORIDA

AS A MUTUAL PROTECTION TO CLIENTS, THE PUBLIC AND OURSELVES, ALL REPORTS ARE SUBMITTED AS THE CONFIDENTIAL PROPERTY OF CLIENTS AND AUTHORIZATION FOR PUBLICATION OF STATEMENTS, CONCLUSIONS OR EXTRACTS FROM OR REGARDING OUR REPORTS IS RESERVED PENDING OUR WRITTEN APPROVAL.

**TEST BORING REPORT**

P-3

CLIENT: Canaveral Port Authority, Cocoa, Florida ORDER No. 14-1432  
 PROJECT: Test Borings in the Wasterly Part of the Port Authority Property  
 LOCATION: shown on Location Plat - drawn by Geo. Jensen HOLE No. 3 (Sheet 3 of 3)  
Consulting Engineers, West Palm Beach, Florida DATE STARTED 11-30-56  
 DRILLER: Galitney Chapman DRILL No. 10 DATE COMPLETED 12-2-56

GROUND ELEVATION	DESCRIPTION OF MATERIALS	Sample Number	Number Blows or Sampler	Penetration (ft)	Number Blows of Casing
89.5'	Very Loose to medium grey to tan medium to fine sand with some cemented particles	371	14	71.0 72.0 73.0 74.0 75.0	
73.5'	Loose tan fine silty sand	376	4	71.0 72.0 73.0 74.0 75.0	
		381	3	76.0 77.0 78.0 79.0 80.0	
		386	3	81.0 82.0 83.0 84.0 85.0	
89.5'	Medium tan cemented sand	381	10	81.0 82.0 83.0 84.0 85.0	
		386	12	86.0 87.0 88.0 89.0 90.0	
101.0'		3101	14	100.0 101.0	

Scale \_\_\_\_\_ " 1 foot  
 Hammer weight: Casing \_\_\_\_\_ lbs. Spoon 140 lbs.  
 Hammer drop: Casing \_\_\_\_\_ ins. Spoon 30 ins.  
 Sampler size: 1 3/8 " O.D. 2 " O.D. 3/8 " O.D. Type Rolling Mud  
 Water level: 2.0 " below surface of 12:00 date 12-3-56

As a mutual protection to the owners and ourselves, the engineer in the owner's behalf shall check this report with the samples submitted prior to the purchase of property or designing of structures.

**PITTSBURGH TESTING LABORATORY**

BY S. W. [Signature]

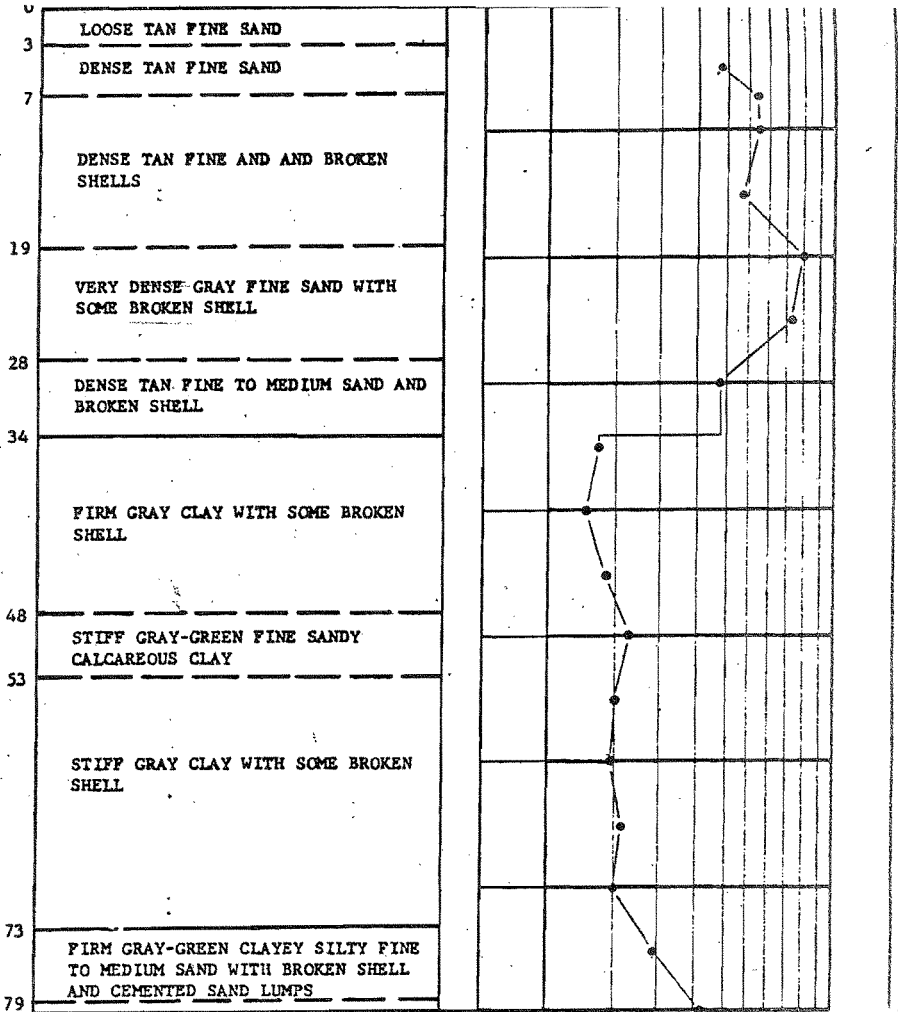

(30)

TEST BORING RECORD

PENETRATION IS THE NUMBER OF BLOWS OF 140 LB. HAMMER FALLING 30 IN. REQUIRED TO DRIVE 1.5 IN. SAMPLER 1 FT.

UNDISTURBED SAMPLE  
 50% ROCK CORE RECOVERY WATER TABLE

BORING NO. B-3 (continued)

JOB NO. T-588

LAW ENGINEERING TESTING CO. 340-



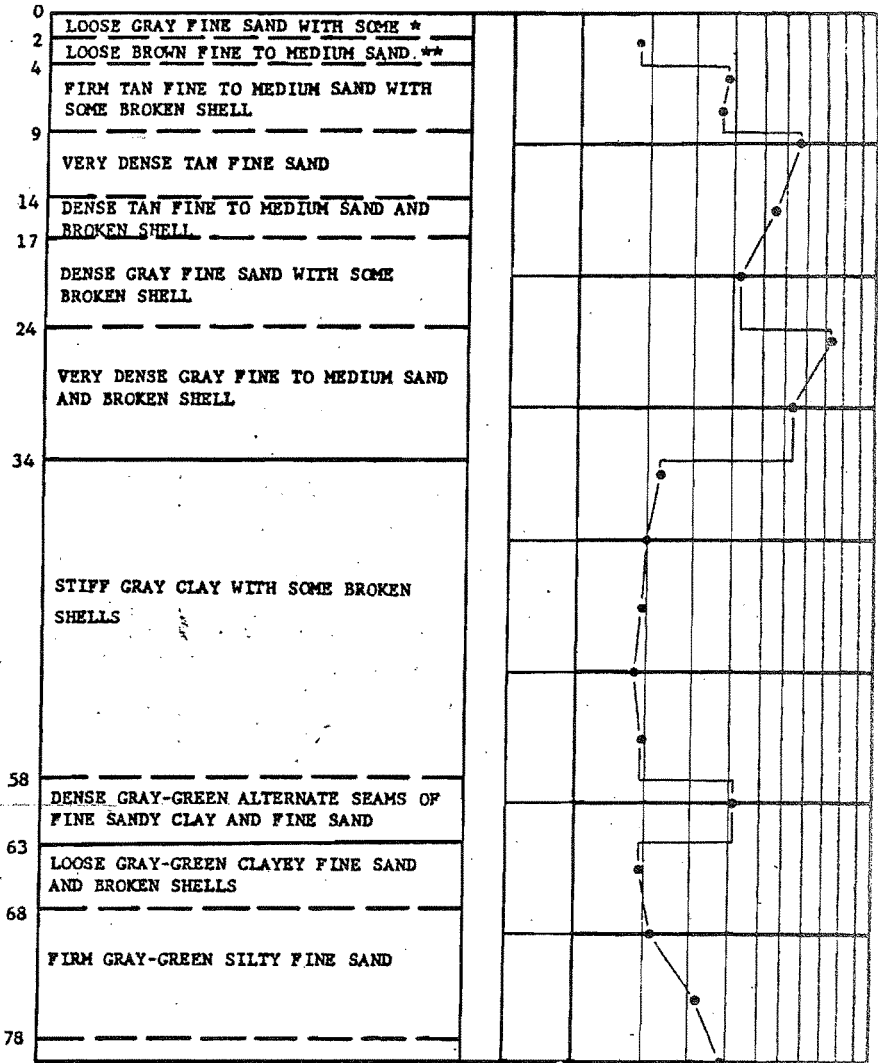

\* BROKEN SHELL

\*\* WITH SOME BROKEN SHELL

(3)

TEST BORING RECORD

PENETRATION IS THE NUMBER OF BLOWS OF 140 LB. HAMMER FALLING 30 IN. REQUIRED TO DRIVE 1.5 IN. SAMPLER 1 FT.

BORING NO B-4 (continued)

JOB NO T-588

UNDISTURBED SAMPLE  WATER TABLE  
 50% ROCK CORE RECOVERY

LAW ENGINEERING TESTING CO.

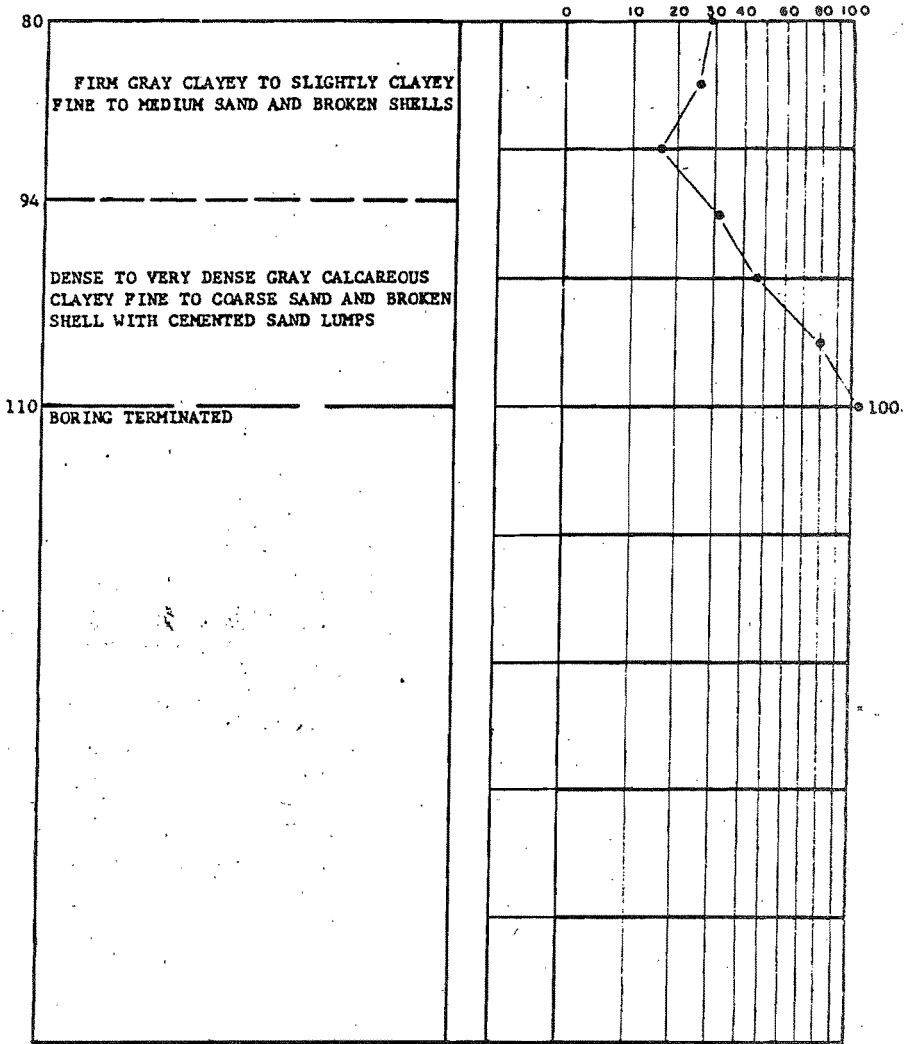

TEST BORING RECORD

PENETRATION IS THE NUMBER OF BLOWS OF 140 LB. HAMMER FALLING 30 IN. REQUIRED TO DRIVE 1.5 IN. SAMPLER 1 FT.

BORING NO. B-4

UNDISTURBED SAMPLE  
 50% ROCK CORE RECOVERY  WATER TABLE

JOB NO. T-588

LAW ENGINEERING TESTING CO

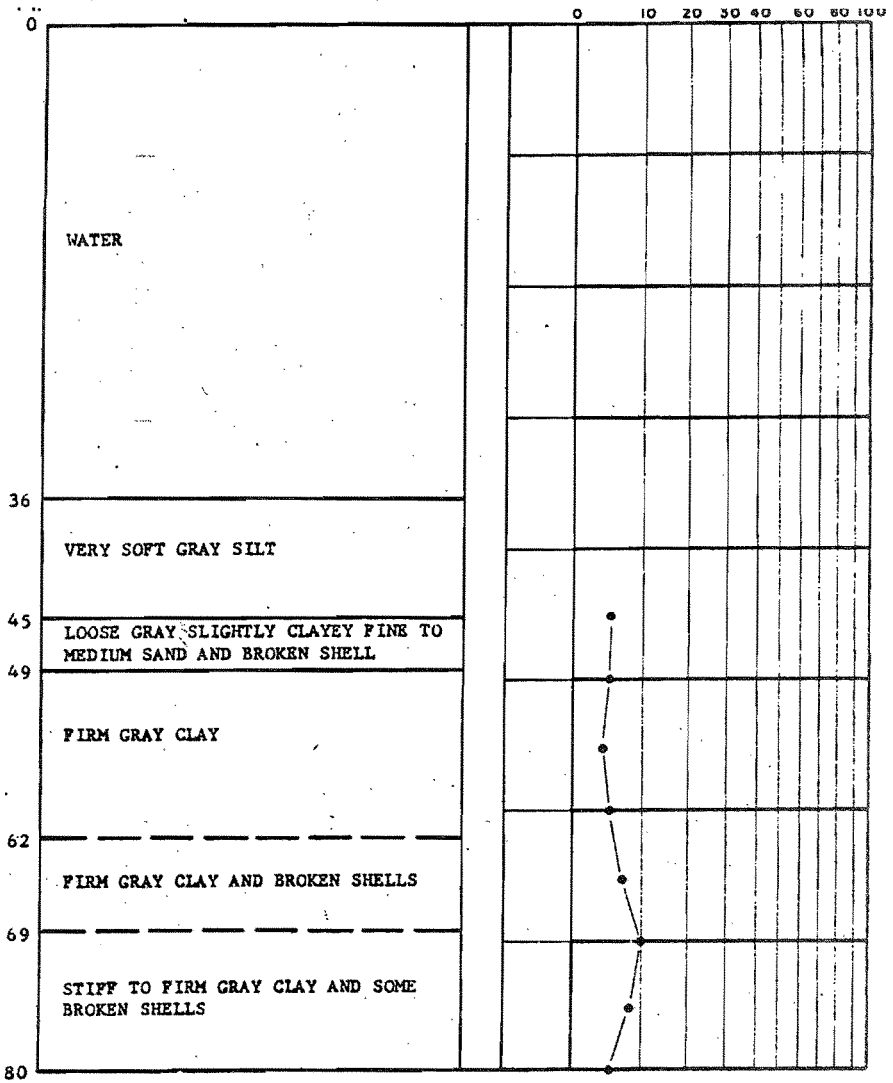

NOTE: WATER DEPTH MEASURED AT 3:00 P.M. 9/29/59.

TEST BORING RECORD

PENETRATION IS THE NUMBER OF BLOWS OF 140 LB. HAMMER FALLING 30 IN. REQUIRED TO DRIVE 1.5 IN. SAMPLER 1 FT.

BORING NO. B-5 (continued)

JOB NO. T-588

UNDISTURBED SAMPLE  
 % ROCK CORE RECOVERY  WATER TABLE

LAW ENGINEERING TESTING CO.

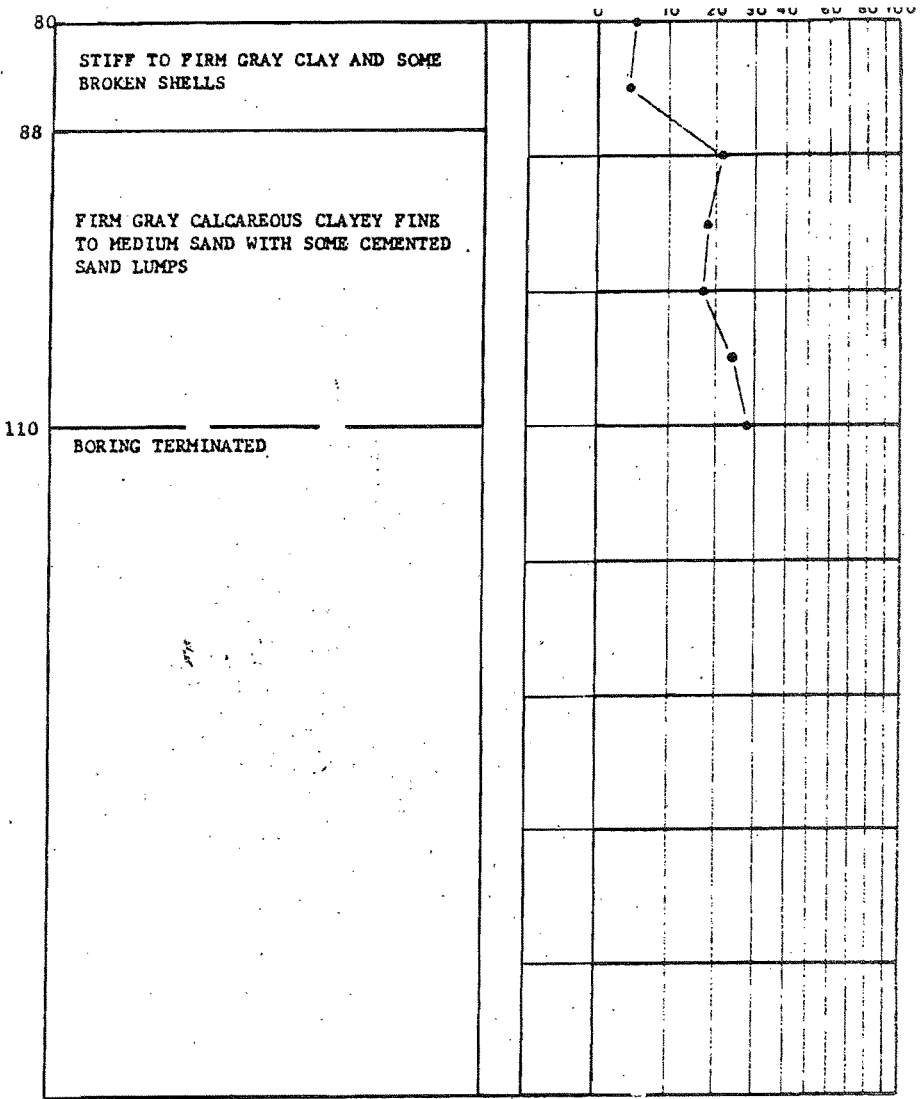

TEST BORING RECORD

PENETRATION IS THE NUMBER OF BLOWS OF 140 LB. HAMMER FALLING 30 IN. REQUIRED TO DRIVE 1.5 IN. SAMPLER 1 FT.

BORING NO B-5

UNDISTURBED SAMPLE  
 30% ROCK CORE RECOVERY      WATER TABLE

JOB NO T-588

LAW ENGINEERING TESTING CO.



DEPARTMENT OF ARMY DIVISION INSTALLATION		CONANVERAL HARBOR Sta: 217+00 Rgs: 460		PROJECT CONANVERAL HARBOR		HOLE NO. CN #1		SHEET 1 OF	
DRILLING LOG				3. DRILLING AGENCY Corps of Engineers		7. THICKNESS OF OVERBURDEN		9. TOTAL DEPTH OF HOLE	
4. HOLE NO. (As shown on drawing title and file No.) Conanveral Harbor CN #1				5. NAME OF DRILLER C. R. Mason		8. DEPTH DRILLED INTO ROCK		9. TOTAL DEPTH OF HOLE	
6. DIRECTION OF NOSE <input checked="" type="checkbox"/> VERTICAL <input type="checkbox"/> INCLINED				DEGREES WITH VERTICAL		7. THICKNESS OF OVERBURDEN		9. TOTAL DEPTH OF HOLE	
10. SIZE AND TYPE OF BIT 500 Remarks		11. DATUM FOR ELEVATION SHOWN (TBM or MSL)		12. MANUFACTURER'S DESIGNATION OF DRILL Spraggs & Hornwood		13. TOTAL NO. OF OVERBOREHOLE SAMPLES TAKEN DISTURBED		14. TOTAL NO. CORE BOXES	
12. ELEV. TOP OF HOLE 12.9		16. TOTAL CORE RECOVERY FOR BORING (%) 73.0%		19. SIGNATURE OF INSPECTING GEOLOGIST Charles Y. Brobston		15. ELEV. GROUND WATER		16. DATE HOLE STOPPED 4/4/56	
17. ELEV. TOP OF HOLE 12.9		18. TOTAL CORE RECOVERY FOR BORING (%) 73.0%		19. SIGNATURE OF INSPECTING GEOLOGIST Charles Y. Brobston		15. ELEV. GROUND WATER		16. DATE HOLE STOPPED 4/4/56	
ELEVATION	DEPTH	LEGEND	CLASSIFICATION OF MATERIALS (see list)	CORE NO.	BOX NO.	REMARKS (drilling time, water loss, depth wash boring, etc., if significant)			
12.9	0.0					Bit & Barrel	Blg/Ft		
			SP-SAND, fn/med, quartz & shell, tan	40	1	2" Spoon	8 15 19 20 23		
			About 1.1-Exposure of soft coquina 100' to the SW & west but did not detect in CB.	64	2	" "	3 15 22 24 30		
				70	3	" "	10 22 50 89 114		
				68	4	" "	Wash 26 42 80 124		
-10.1	23.0		SP-SM-SAND, fine, slightly calc, qtz & shell, 5% consolidated	100	5	" "	19 96 172 314 386		
-13.4	26.5		SHELL, sand	76	6	" "	Wash 21		
-13.9	26.8		SP-SAND, fn/med, qtz & shell	7	7	" "	30 40 48		
-15.7	28.6		SP-SM-SAND, fine, silty (calc) slightly shelly w/thin beds of shell and medium sand	54	8	" "	7 32 60 70 74		
-23.4	36.5			30	9	" "	25 118		
-27.1	40.0		CM-SAND, fine, silty, slightly shelly, gry, slightly calc.			Spoon grouted Lows Casting			

HOLE NO. CN #1

DRILLING LOG (Continuation)		1. PROJECT Canaveral Harbor		SHEET 2 OF 3	
INSTALLATION Corps of Engineers Jacksonville, Florida		2. LOCATION (Coordinates or Station) Sta: 217+00 Rgn: 460		REMARKS (drilling time, water loss, depth of weathering, etc., if significant)	
ELEVATION	DEPTH	LEGEND	CLASSIFICATION OF MATERIALS (Description)	% CORE RECOVERED	BOX OR SAMPLE NO.
-27.1	40.0				3ft & Barrel Hls/Tk
-30.9	43.8		ML-SILT, very slightly shelly, grey	80	10
			CL-CLAY, silty, very slightly shelly, slightly organic		
				100	11
					3 4 6 5 5 1 1/2 3 3 4
					Wt. of hammer
				100	12
					2 3 4 6
					Wt. of hammer
				100	13
					2 3 5 5
					Wt. of hammer
				100	14
					2 5 7 10
-49.9	62.0		SM-SAND, organic, very fine, shelly		
-51.3	64.2		SM-SAND, very fine, silty		
				20	16
					14 10 12 20 22
			very silty, very shelly from -57.1 to -62.9		
				80	17
					2 3 3 3 4
					Wt. of hammer
				40	18
			slightly shelly from -62.9		
					5 15 16 19 37
					Wt. of hammer
				100	19
					10 13 23 32 76
-72.1	95.0				

HOLE NO. CN #1

DRILLING LOG (Continuation)			1. PROJECT		SHEET 3 of 3	
Corps of Engineers			CANAVERAL Harbor		Sta: 217+00	
INSTALLATION Jacksonville, Florida			2. LOCATION (Coordinates or Station)		Elev: 460	
ELEVATION	DEPTH	LEGEND	CLASSIFICATION OF MATERIALS (Description)	% CORE RECOVERY	BOX OR SAMPLE NO.	REMARKS (Drilling time, water loss, depth of weathering, etc., if significant)
-72.1	85.0					1 3/4 Barrel Bls/Ft - 72
-71.2	85.0		CL-SILT, MEDIUM	50	20	2" Spoon
						6 6 7 13
						2 5 7 9 14
-82.1	85.0					130# Hammer w/36" Drop used 0.2/0.0 300# Hammer w/18" Drop used 0.3/0.0 200# Hammer w/21" Drop used 0.5/0.0

DEPARTMENT OF THE ARMY Corps of Engineers Jacksonville, Florida		PROJECT Canaveral Harbor		MOLE NO. <u>CN #7</u>	
INSTALLATION  DRILLING LOG		SHEET <u>19</u> OF <u>19</u>		2. LOCATION (to coordinate or Station) <u>419+50</u> <u>Y - 677139</u> <u>REG: 450</u>	
3. DRILLING AGENCY Corps of Engineers		5. NAME OF DRILLER George Ginsberger		6. DIRECTION OF MOLE <input checked="" type="checkbox"/> VERTICAL <input type="checkbox"/> INCLINED	
8. MOLE NO. (As shown on drawing title and file no.) Canaveral Harbor CN #7		7. THICKNESS OF OVERBURDEN		9. TOTAL DEPTH OF MOLE <u>35.5</u>	
10. SIZE AND TYPE OF BIT See Remarks		11. DATA FOR ELEVATION SHOWN MSL		12. MANUFACTURER'S DESIGNATION OF DRILL Longyear	
13. TOTAL NO. OF OVERBURDEN SAMPLES TAKEN DISTURBED <u>        </u> UNDISTURBED <u>        </u>		14. TOTAL NO. CORE BOXES		15. ELEV. GROUND WATER <u>-1.5</u>	
17. ELEV. TOP OF MOLE <u>-26.5</u>		18. TOTAL CORE RECOVERY FOR BORING (%) <u>61%</u>		16. DATE MOLE STARTED <u>4/1/58</u> COMPLETED <u>4/9/58</u>	
ELEVATION		CLASSIFICATION OF MATERIALS (description)		19. SIGNATURE OF REGISTERED GEOLOGIST John C. Bennett, Jr.	
DEPTH	LEGEND	REMARKS (drilling time, water loss, depth of weathering, etc., if significant)	NO.	REMARKS	NO.
<u>0.0</u>		Bit & Barrel		Bit/Pt	<u>-26</u>
		OL-SILT, organic, blk.	0	2" Spoon	Settled
				Lost sample	<u>-27</u>
				Drove Casing	Wash Boring
<u>34.5</u>		OH-CLAY, grn.	50	1 1A 2" Spoon	Settled
					2
					4
					<u>-29</u>
					Pushed
			100	2 2A " "	2
					Wt. of mass
					2
					<u>-34</u>
					Wash Boring
					Pushed
			100	3 3A 2" Spoon	2
					3
					6
					<u>-30</u>
<u>-52.0</u>		ML-SILT, slightly sandy, slightly shelly	50	4 4A " "	5
		shelly below -53.1			10
					15
					17
					<u>-55</u>
					6
			60	5 5L " "	2
					3
					5
					2
					<u>-60</u>
<u>-62.0</u>		shelly, slightly clayey below -58.1	100	6 6A " "	3
					2
					<u>-60</u>
					250# Hammer w/21" Drop used on Spoon

ELEVATION		DEPTH	LEGEND	CLASSIFICATION OF MATERIALS (Description)	NO. CORE BOX OR RECOVERED SAMPLE NO.	REMARKS (drilling time, water loss, depth of weathering, etc., if significant)
<p>DEPARTMENT OF THE ARMY DIVISION Corps of Engineers INSTALLATION Jacksonville, Florida</p> <p>DRILLING LOG</p> <p>1. PROJECT Canaveral Harbor, CN #8 SHEET 1 OF 2 2. LOCATION (Coordinate or Station) Star 221+27 X = 028,495 Y = 144,321 Rgrt 645 3. DRILLING AGENCY Corps of Engineers 4. HOLE NO. (as shown on Drawing Title and Title No.) Canaveral Harbor - CN #8 5. NAME OF DRILLER George Lineberger 6. DIRECTION OF HOLE <input checked="" type="checkbox"/> VERTICAL <input type="checkbox"/> INCLINED DEGREES WITH VERTICAL 7. THICKNESS OF OVERBURDEN 8. DEPTH DRILLED INTO ROCK 9. TOTAL DEPTH OF HOLE 53.28' 10. SIZE AND TYPE OF BIT 11. DATUM FOR ELEVATION SHOWN (TBM or ISL) = MSL 12. MANUFACTURER'S DESIGNATION OF DRILL Sorax &amp; Benwood 13. TOTAL NO. OF OVERBURDEN SAMPLES TAKEN 14. TOTAL NO. CORE BOXES 15. ELEV. GROUND 16. DATE HOLE STARTED COMPLETED 17. ELEV. TOP OF HOLE -27.30 18. TOTAL CORE RECOVERY FOR BORING (%) 30% 19. SIGNATURE OF INSPECTOR GEOLOGIST John C. Borman, Jr.</p>						
-27.30	0.0			OL-SILT, organic, blk.(?)	0	Bit & Barrel 81s/Ft. -27 Seated casing - could not retain sample. At -33.40 attempted Shelby.
-33.40	6.10			CH-CLAY, grn.	0	Wash boring to -36.00 Dry boring to -37.83
					100	Shelby Tube #1
					0	Wash Boring to -41.00 Dry Boring to -44.03
					100	Shelby Tube #2
-47.73	20.12			SM-SAND, fine, silty, grn.	70	Wt. of hammer 1 4 2 10 20 20
				poss. 20% consolidated below -54.83	0	Wash Boring to -53.83 Dry Boring to -54.83
				no consolidation, smelly, slightly clayey below -56.84	100	Attempted Shelby - would not press - Drove
				some shell, below -62.33	40	Wt. of hammer 3 3 4 4 4 4 3 3
					0	Dry Boring
					100	Attempted shelly - would not press - Drove
					0	Wash Boring
					0	Settled Settled 2" Spoon 6 Lost Sample 15 20
					0	Lost Sample 8
					0	Dry Boring

DRILLING LOG (Continuation)			1. PROJECT Canaveral Harbor - CN #8		SHEET 2 OF 2	
INSTALLATION Corps of Engineers Pensacola, Florida			2. LOCATION (Coordinates or Station) Sta: 221+27 Rrer 645			
ELEVATION	DEPTH	LEGEND	CLASSIFICATION OF MATERIALS (Description)	5. CORE RECOVERY	BOX OR SAMPLE NO.	REMARKS (Drilling time, water loss, depth of weathering, etc., if significant)
-73.57	27.2					Bit & Barrel - 27.57
-74.5			See Drill #1	100	7	Attempted Shelby Drove -75.58
			CL-SILT, slightly clayey, snelly, grn.	60	8	2" Spoon Settled 4 4 5 6 -80.58
-80.58	53.23					Drilled 5" Casing down 250# Hammer w/21" Drop used on Spoon

HOLE NO. H-3

DEPARTMENT OF THE ARMY DIVISION <u>ENGINEER REGIMENT</u> INSTALLATION <u>Canaveral Harbor, Florida</u>		1- PROJECT <u>Canaveral Harbor</u>		SHEET <u>1</u> OF <u>1</u>	
DRILLING LOG		2- LOCATION (coordinates or Station) <u>Sta: 87+50</u> <u>8 -</u>		Hole: <u>50'</u>	
4- HOLE NO. (As shown on drawings 1210 and 116 No.) <u>Canaveral Harbor #3</u>		3- DRILLING AGENCY <u>Corps of Engineers</u>		5- NAME OF DRILLER <u>E. S. Hayes</u>	
6- DIRECTION OF HOLE <input checked="" type="checkbox"/> VERTICAL <input type="checkbox"/> INCLINED <input type="checkbox"/> BEGINS WITH VERTICAL		7- THICKNESS OF OVERBURDEN <u>None</u>		8- DEPTH DRILLED INTO ROCK <u>5'</u>	
10- SIZE AND TYPE OF BIT <u>2" Spoon</u>		11- DATUM FOR ELEVATION SHOWN <u>MLL</u>		12- MANUFACTURER'S DESIGNATION OF DRILL	
13- TOTAL NO. OF OVERBURDEN SAMPLES TAKEN DISTURBED    UNDISTURBED		14- TOTAL NO. CORE BOYS <u>0</u>		15- ELEV. GROUND + H. WATER <u>127.2/55</u>	
17- ELEV. TOP OF HOLE <u>-25.8</u>		18- TOTAL CORE RECOVERY FOR BORING (%) <u>20%</u>		16- DATE HOLE STARTED    COMPLETED <u>12/2/55</u> <u>12/2/55</u>	
19- SIGNATURE OF GEOLOGIST <u>John C. Brown, Jr.</u>		REMARKS (Drilling time, water loss, depth of weathering, etc., if significant)			
ELEVATION	DEPTH	LEGEND	CLASSIFICATION OF MATERIALS (Description)	NO. OF CORE BOXES ON RECOVERY SAMPLE	REMARKS
-25.8	0.0		SP-SAND, grayish, tan, slightly silty		Bit & Barrel
-25.3	0.5		CL-MAY, sandy, gray/red.	1	Soft -
-26.8	1.0		SP-SAND, fine, gray/red	2	Settled w/ weight of rods
				3	
-30.8	5.0				

HOLE NO. H-4

DEPARTMENT OF THE ARMY DIVISION <u>Corps of Engineers</u> INSTALLATION <u>Jacksonville, Florida</u> DRILLING LOG				1. PROJECT <u>Canaveral Harbor</u> SHEET 1 OF 1	
4. HOLE NO. (As shown on drawings 111a and 111b No.) <u>Canaveral Harbor #4</u>				2. LOCATION (Coordinates or Station) X = <u>Sta: 130+00</u> Y = <u>Rce: 650'</u>	
6. DIRECTION OF HOLE <input checked="" type="checkbox"/> VERTICAL <input type="checkbox"/> INCLINED DEGREES WITH VERTICAL				3. DRILLING AGENCY <u>Corps of Engineers</u>	
10. SIZE AND TYPE OF BIT <u>2" Spoon</u>				5. NAME OF DRILLER <u>E. S. Hayes</u>	
11. DATUM FOR ELEVATION SHOWN <u>(TBM or ISL) M.L.W.</u>				7. THICKNESS OF OVERBURDEN	
13. TOTAL NO. OF CYLINDER SAMPLES TAKEN DISTURBED _____ UNDISTURBED _____				8. DEPTH DRILLED INTO ROCK	
14. TOTAL NO. CORE BOXES <u>0</u>				9. TOTAL DEPTH OF HOLE <u>8'</u>	
15. ELEV. GROUND WATER <u>+1.5 M.L.W.</u>				12. MANUFACTURER'S DESIGNATION OF DRILL	
16. DATE HOLE STARTED <u>12/1/55</u>				16. DATE HOLE COMPLETED <u>12/1/55</u>	
17. ELEV. TOP OF HOLE <u>-21.5</u>				18. TOTAL CORE RECOVERY FOR BORING (%) <u>62%</u>	
19. SIGNATURE OF REGISTERED Geologist <u>John U. Bowman, Jr.</u>				4. CORE BOX OR RECOVERY NO.	
ELEVATION	DEPTH	LEGEND	CLASSIFICATION OF MATERIALS (Description)	REMARKS (drilling time, water loss, depth of weathering, etc., if significant)	
-24.5	3.0		CH-CLAY, gry/grn.	Bit & Barrel Bls/Ft -24.5	
-30.0	5.5		SP-SAND, fine, gry/grn.	Soft - Settled w/weight of rods	
-32.5	8.0			2" Spoon	

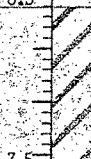

DEPARTMENT OF THE ARMY DIVISION <u>Corps of Engineers</u> INSTALLATION <u>Jacksonville, Florida</u>		PROJECT <u>Canaveral Harbor</u>		HOLE NO. <u>ME-5</u> SHEET <u>1</u> OF <u>1</u>		
DRILLING LOG		2. LOCATION (Continent, State or Station) X - <u>Sta: 136+00</u> Y - <u>Ref: 300'</u>		3. DRILLING AGENCY <u>Corps of Engineers</u>		
4. HOLE NO. (As shown on drawing title and title No.) <u>Canaveral Harbor #5</u>		5. NAME OF DRILLER <u>E. S. Hayes</u>				
6. DIRECTION OF HOLE <input checked="" type="checkbox"/> VERTICAL <input type="checkbox"/> INCLINED    DEGREES WITH VERTICAL		7. THICKNESS OF OVERBURDEN	8. DEPTH DRILLED INTO ROCK	9. TOTAL DEPTH OF HOLE <u>7.5'</u>		
10. SIZE AND TYPE OF BIT <u>2" Spoon</u>		11. DATUM FOR ELEVATION SHOWN <u>MLM</u>		12. MANUFACTURER'S DESIGNATION OF DRILL		
13. TOTAL NO. OF OVERBURDEN SAMPLES TAKEN DISTURBED _____ UNDISTURBED _____		14. TOTAL NO. CORE ROSES <u>0</u>	15. ELEV. GROUND WATER <u>+1.0'</u>	16. DATE HOLE STARTED <u>11/30/55</u>	17. DATE HOLE COMPLETED <u>11/30/55</u>	
17. ELEV. TOP OF HOLE <u>-25.4</u>		18. TOTAL CORE RECOVERY FOR BORING (%) <u>13%</u>		19. SIGNATURE OF INSPECTOR Geologist <u>John G. Bowman, Jr.</u>		
ELEVATION	DEPTH	LEGEND	CLASSIFICATION OF MATERIALS (Describe in full)	% CORE RECOVERY	BOX OR SAMPLE NO.	REMARKS (Drilling time, water loss, depth of penetration, etc., if significant)
-25.4	0.0					Bit & Barrel - Bls/Ft -25
-32.9	7.5		CH-CLAY, very slightly sandy, grn.	13	1	Soft Settled w/weight of rods 2" Spoon
						1 Mason Jar Sample MLM (-25.4/-32.9)

DEPARTMENT OF THE ARMY DIVISION <u>3d of Engineers</u> INSTALLATION <u>Seaside, Florida</u>		1- PROJECT <u>General Harbor</u> <u>Drainage Basin &amp; Channel</u>		SHEET 1 OF 4	
2- LOCATION (Coordinates or Station) <u>SEA: 114+00</u> <u>X = 527,720</u> <u>Y = 114,000</u>		3- DRILLING AGENCY <u>Words of Engineers</u>		HRC: 1501	
DRILLING LOG			5- NAME OF DRILLER <u>W. E. Roper</u>		
4- HOLE NO. (As shown on drawing title and file No.) <u>1</u>			6- DIRECTION OF HOLE <input checked="" type="checkbox"/> VERTICAL <input type="checkbox"/> INCLINED <input type="checkbox"/> DEGREES WITH VERTICAL		
7- THICKNESS OF OVERBURDEN		8- DEPTH DRILLED INTO ROCK		9- TOTAL DEPTH OF HOLE <u>47.0</u>	
10- SIZE AND TYPE OF BIT		11- DATUM FOR ELEVATION SHOWN (Type of MSL)		12- MANUFACTURER'S DESIGNATION OF DRILL LOG/TEST	
13- TOTAL NO. OF WIRE-LOG SAMPLES TAKEN DISTURBED    UNDISTURBED		14- TOTAL NO. CORE BOXES		15- ELEV. GROUND WATER	
17- ELEV. TOP OF HOLE <u>+3.2</u>		18- TOTAL CORE RECOVERY FOR SCRIP (%) <u>80</u>		19- SIGNATURE OF OPERATOR <u>M. E. Green</u>	
16- DATE HOLE STARTED <u>1/15/51</u> COMPLETED <u>1/15/51</u>		REMARKS (Drilling time, water loss, depth of weathering, etc., if significant)			
ELEVATION	DEPTH	LEGEND	CLASSIFICATION OF MATERIALS (Description)	CORE BOX OR RECOVERY SAMPLE NO.	REMARKS
+17.5			Ground Elevation		
+12.1			SAND, fine, brown		1st & barrel Bis/Pt. +12
+11.0			SAND, medium/fine, yellow	100	Recovered w/shovel -11
			SAND, coarse, brown	100	Jar #3 2" Spoon
+ 7.3			SAND, fine, white	70	Box #7 " "
+ 6.7			SAND & SHELL, coarse, yellow	100	Box #4 " "
				100	Box #5 " "
- 1.0			SAND & SHELL, medium/fine	100	Jar #6 " "
				85	Box #11 " "
-12.3			SAND, fine, grey		
-16.5			SAND & SHELL, medium/fine, grey/tan	100	Jar #8 " "
				81	Box #1 " "
-27.0			SAND, medium/fine, grey		
-29.6			SAND, fine, grey, silty		
-32.1			SAND, grey	100	Jar #10 #11 " "

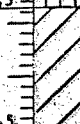

DEPARTMENT OF THE ARMY CORPS OF ENGINEERS INSTALLATION Jacksonville, Florida				PROJECT Canaveral Harbor Main Basin and Channel		SHEET 1	
DRILLING LOG				2. LOCATION (Coordinate or Station) Sta: EL+99.52 Ree: 150'		3. DRILLING AGENCY Corps of Engineers	
4. HOLE NO. (as shown on drawing title and file No.) CH-20				5. NAME OF DRILLER W. D. Roppel		7. THICKNESS OF OVERBURDEN	
DIRECTION OF HOLE <input type="checkbox"/> VERTICAL <input type="checkbox"/> INCLINED				8. DEPTH DRILLED INTO ROCK		9. TOTAL DEPTH OF HOLE	
10. SIZE AND TYPE OF BIT 2" Spoon				11. DATUM FOR ELEVATION SHOWN (FMS or MSL)		12. MANUFACTURER'S DESIGNATION OF DRILL Longyear	
13. TOTAL NO. OF OVERBURDEN SAMPLES TAKEN				14. TOTAL NO. CORE BOXES		15. ELEV. GROUND WATER	
16. UNDISTURBED				17. DATE HOLE STARTED		18. DATE HOLE COMPLETED	
19. ELEV. TOP OF HOLE +12.0				18. TOTAL CORE RECOVERY FOR BORING (%) 86%		19. SIGNATURE OF INSPECTOR/Recorder M. E. Cross	
ELEVATION	DEPTH	LEGEND	CLASSIFICATION OF MATERIALS (per spec)	COMB. BOX OR RECOVER SAMPLE NO.	REMARKS (drilling time, water loss, depth, weathering, etc., if significant)		
-12.0					Bit & Barrel	Dis/Tr #12	
-16.5			SAND, fine, brown	100 Jar #1	Recovered w/shovel	#10	
			SAND & SHELL, medium/fine, yellow	60 Jar #2	2" Spoon		
				60 Box #1			
-0.9			SAND, fine, grey				
-0.0			SAND & SHELL, coarse, grey	60 Jar #4			
-5.0			SAND & SHELL, medium/fine, grey	100 Jar #5			
-9.2			SAND, fine, grey				
				94 Box #1			
				100 Box #1			
				100 Box #1			
				100 Box #1			
-12.3				100 Box #1			
-14.0			CLAY, Grey w/shells	100 Box #1		CH-20	

DRILLING LOG		South Atlantic		Jacksonville District		Sheet 1 of 1 SHEETS	
PROJECT Canaveral Harbor Extension				DATE AND TYPE OF REPORT FOR FEDERAL SERVICE See remarks SHOW 771M (M.S.L.)			
LOCATION (If coordinates are available) Sta. 241+60 Rq. 250				MANUFACTURER'S SIGNATURE OF DRILL MIM Sprague & Henwood 40-C			
DRILLING AGENCY Corps of Engineers				TOTAL NO. OF OVER- BURR H SAMPLES TAKEN		DISTURBED UNDISTURBED	
HOLE NO. (As shown on drawing title and file number) CB-CHE-1				TOTAL NUMBER CORE ROSES 1			
NAME OF DRILLER J. King				ELEVATION GROUND WATER Tidal			
DIRECTION OF HOLE <input checked="" type="checkbox"/> VERTICAL <input type="checkbox"/> INCLINED _____ DEG. FROM VERT.				DATE HOLE STARTED 11-12-71		COMPLETED 11-12-71	
THICKNESS OF OVERRUNDRUN				ELEVATION TOP OF HOLE -36.9			
DEPTH DRILLED INTO ROCK				TOTAL CORE RECOVERY FOR BORING 70 %			
TOTAL DEPTH OF HOLE 4.3'				GEOLOGIST: J. Gentile			
ELEVATION a.	DEPTH b.	LEGEND c.	CLASSIFICATION OF MATERIALS (Description) d.	% CORE RECOVER- ERY e.	SAMPLE NO. f.	REMARKS (Drilling time, water loss, depth of weathering, etc., if significant) g.	
-36.9	0.0					BIT OR BARREL	
-38.4	1.5		SILT, slightly sandy, soft, slightly clayey, gray (ML)	59	1	-36.9 81a/0.5 fc. SPLIT SPOON pushed	
-41.4	4.5		CLAY, fine, soft, gray (CL)	66	2	-38.4 " " pushed	
				86	3	-39.9 " " pushed	
						140# hammer with 30" drop used on 2.0' split spoon. (1-3/8" I.D. X 2" O.D.)	

DRILLING LOG		South S. Gentle		Jacksonville District		SHEET 1 OF 2 SHEETS	
1. PROJECT Canaveral Harbor Extension				10. SIFT AND TYPE OF See remarks			
2. LOCATION (Coordinates as Station) Sta. 251+60 Rge. -100				11. DATUM FOR ELEVATION (AS SHOWN WITHIN THE LOG) MLW			
3. DRILLING AGENCY Corps of Engineers				12. MANUFACTURER'S DESIGNATION OF DRILL Sprague & Henwood 40-C			
4. HOLE NO. (As shown on drawing, title and file number) CB-CHE-2				13. TOTAL NO. OF OVERBURDEN SAMPLES TAKEN UNDISTURBED			
5. NAME OF DRILLER J. King				14. TOTAL NUMBER CORE ROSES: 2			
6. DIRECTION OF HOLE <input checked="" type="checkbox"/> VERTICAL <input type="checkbox"/> INCLINED _____ DEG. FROM VERT.				15. ELEVATION GROUND WATER: Tidal			
7. THICKNESS OF OVERBURDEN				16. DATE HOLE: STARTED 12-7-71 COMPLETED 12-7-71			
8. DEPTH DRILLED INTO ROCK				17. ELEVATION TOP OF HOLE: +5.0			
9. TOTAL DEPTH OF HOLE: 45.0'				18. TOTAL CORE RECOVERY FOR BORING: 51%			
				19. <del>XXXXXXXXXXXXXXXXXXXX</del>			
				GEOLOGIST: J. Gentle			

ELEVATION e	DEPTH b	LEGEND c	CLASSIFICATION OF MATERIALS (Description) d	SCORE RECOVERY e	SAMPLE NO. f	REMARKS (Drilling time, water loss, depth of weathering, etc., if significant) g
+5.0	0.0					BIT OR BARREL
						5.0 Bis/0.5 ft.
			SAND, fine to medium quartz, slightly shelly, clean tan (SP) 0-12% S.H.	26	1	SPLIT SPOON 1
				33	2	" " 6
				40	3	" " 14
						" " 5
+0.5	4.5		SAND, fine, quartz, silty, slightly clayey, gray, slightly shelly, (SM) 12-49% S.H.	40	4	" " 4
				33	5	" " 3
				46	6	" " 2
				20	7	" " 2
-3.5	8.5		bed of slightly silty (SP) sand -3.5 to -5.5	40	8	" " 20
				40	9	" " 5
				46	10	" " 3
				40	11	" " 7
-5.5	10.5		bed of clean, tight, slightly shelly, (SP) sand -13.0 to -16.5	40	12	" " 5
				33	13	" " 12
						" " 3
						" " 7
-13.0	18.0					" " 26
						" " 7
						" " 18
						" " 25

DUPPLICATING LOG (Cont. Sheet)			ON TOP OF HOLE: +5.0	Hole No. CB-CHE-2		
PROJECT: Canaveral Harbor Extension			INSTALLATION: Jacksonville District	SHEET 2 OF 2		
ELEVATION a	DEPTH b	LEGEND c	CLASSIFICATION OF MATERIALS (Description) d	% CORE RECORD- ERY e	SAMPLE NO. f	REMARKS (Drilling time, water loss, depth of weathering, etc., if significant) g
						BIT OR BARREL
						-14.5 Bls/0.5 ft.
				46	14	SPLIT SPOON 10
						26
-16.5	21.5					-16.0 30
				26	15	" " 9
						15
						-17.5 12
				40	16	" " 3
						7
-19.0	24.0					-19.0 8
						3
			SILT, slightly clayey, slightly sandy, gray (ML)	53	17	" " 1
						3
						-20.5 2
				53	18	" " 3
-22.0	27.0					-22.0 7
						1
			CLAY, gray, slightly silty (CH)	66	19	" " 1
						2
				100	20	" " 2
						-23.5 2
						3
				100	21	" " 4
						-25.0 3
						4
				100	21	" " 4
						-26.5 3
				86	22	" " pushed 1
						-28.0 2
						1
				97	23	" " 1
						-29.5 2
						3
				100	24	" " 2
						-31.0 4
						5
				60	25	" " pushed 1
						-32.5 3
						3
				66	26	" " 4
						-34.0 2
						3
				46	27	" " 4
						-35.5 4
						1
				64	28	" " 1
						-37.0 2
						2
				66	29	" " 2
						-38.5 2
						2
				0		" " 2
						-40.0 3
-40.0	45.0					140# hammer with 30" drop used on 2.0' split spoon. (1-3/8" I.D. X 2" O.D.)

DRILLING LOG		DIVISION		INSTALLATION		SHEET	
South Atlantic		Jackknvill District		SHEET 1 OF 1 SHEETS			
PROJECT Canaveral Harbor Extension				10. SIF AND TYPE OF SEC. (MARKS)			
1. LOCATION (Coordinate of Station) Sta. 26160 Rce. 250 CHANNEL				11. DATUM FOR ELEVATION (MOUNTAIN MEAN) M.L.M.			
2. DRILLING AGENCY Corps of Engineers				12. MANUFACTURER'S DESIGNATION OF DRILL Sprague & Henwood 40-C			
3. HOLE NO. (As shown on drawing title and file number) CB-CHE-3				13. TOTAL NO. OF OVERBURDEN SAMPLES TAKEN DISTURBED UNDISTURBED			
4. NAME OF DRILLER J. King				14. TOTAL NUMBER CORE BOXES 1			
5. DIRECTION OF HOLE VERTICAL <input type="checkbox"/> INCLINED <input type="checkbox"/> DES. FROM VERT.				15. ELEVATION GROUND WATER Tidal			
6. THICKNESS OF OVERBURDEN				16. DATE HOLE STARTED COMPLETED 11-16-71 11-16-71			
7. DEPTH DRILLED INTO ROCK				17. ELEVATION TOP OF HOLE -22.8			
8. TOTAL DEPTH OF HOLE 18.0'				18. TOTAL CORE RECOVERY FOR BORING 66%			
				GEOLOGIST: J. Gentile			
ELEVATION	DEPTH	LEGEND	CLASSIFICATION OF MATERIALS (Describe below)	CORE RECOVERY	SAMPLE NO.	REMARKS (Drilling time, meter loss, depth of washing, etc., if significant)	
-22.8	0.0					BIT OR BARREL	
							Blis/0.5 ft.
			SAND, fine, quartz, silty to slightly silty, gray, silty (SM)	40	1	-24.3	SPLIT SPOON pushed
				46	2	-25.8	" " pushed
				40	3	-27.3	" " pushed
				40	4	-28.8	" " pushed
-28.8	6.0						
			CLAY, soft, gray (CH)	46	5	-30.3	" " pushed
				67	6	-31.8	" " pushed
				79	7	-33.3	" " pushed
				93	8	-34.8	" " pushed
				93	9	-36.3	" " pushed
				23	10	-37.8	" " pushed
				86	11	-39.3	" " pushed
-40.8	18.0			86	12	-40.8	" " pushed
						140# hammer with 30" drop used on 2.0" split spoon (1-3/8" I.D. X 2" O.D.)	



DRILLING LOG		South Atlantic		JACKSONVILLE District		SHEET 1 OF 3 SHEETS	
1. PROJECT Canaveral Harbor Extension				10. SIZE AND TYPE OF BIT See remarks			
2. LOCATION (if coordinates or Station) SEA. 271+60 Rge. -50 CHANNEL				11. DATA FOR ELEVATION SHOWN (If in HOLE) MLW			
3. DRILLING AGENCY Corps of Engineers				12. MANUFACTURER'S DESIGNATION OF DRILL Sprague & Henwood 40-C			
4. HOLE NO. (As shown on drawing title and file number) CB-CHE-4				13. TOTAL NO. OF OVERBURDEN SAMPLES TAKEN		DISTURBED _____ UNDISTURBED _____	
5. NAME OF DRILLER J. King				14. TOTAL NUMBER CORE BOXES 2			
6. DIRECTION OF HOLE <input checked="" type="checkbox"/> VERTICAL <input type="checkbox"/> INCLINED _____ DEG. FROM VERT.				15. ELEVATION GROUND WATER Tidal			
7. THICKNESS OF OVERBURDEN				16. DATE HOLE 12-6-71		17. ELEVATION TOP OF HOLE +6.6	
8. DEPTH DRILLED INTO ROCK				18. TOTAL CORE RECOVERY FOR BORING 43%		19. REMARKS (Drilling time, water loss, depth of weathering, etc., if significant)	
9. TOTAL DEPTH OF HOLE 46.5'				GEOLOGIST: J. Gentile			
ELEVATION a	DEPTH b	LEGEND c	CLASSIFICATION OF MATERIALS (Description) d	SCORE RECOVERY e	SAMPLE NO. f	REMARKS	
+6.6	0.0					BIT OR BARREL	
						+6.6	Blg/0.5 ft.
			SAND, fine to medium, quartz shelly, clean, tan, (SP)	20	1	+5.1	SPLIT SPOON
				26	2	+3.6	" "
				26	3	+2.1	" "
+2.1	4.5						
			SAND, fine to medium, quartz silty, gray, slightly clayey, slightly shelly (SM)	20	4	+0.6	" "
				53	5	-0.9	" "
				53	6	-2.4	" "
-2.9	9.5						
				33	7	-3.9	" "
				40	8	-5.4	" "
			SAND, fine to medium, quartz slightly silty, slightly shelly, gray (SR)	26	9	-6.9	" "
				26	10	-8.4	" "
				20	11	-9.9	" "
-11.4	18.0						
				0		-11.4	" "
				40	12	-12.9	" "

DRILLING LOG (Cont Sheet)		ELEVATION		Hole No.		
		+6.6		CB-CHE-4		
PROJECT		INSTALLATION		UNIT		
Canaveral Harbor Extension		Jacksonville District		2 of 3 SHEETS		
ELEVATION	DEPTH	LEGEND	CLASSIFICATION OF MATERIALS (Description)	% CORE RECOVERY	SAMPLE NO.	REMARKS (Drilling time, water loss, depth of weathering, etc., if significant)
a	b	c	d	e	f	g
						BIT OR BARREL
						-12.9 Bls/0.5 ft.
				40	13	SPLIT SPOON 2
						4
						-14.4 15
				66	14	" " 10
						13
						-15.9 15
				66	15	" " 4
						3
						-17.4 4
				33	16	" " 1
						1
						-18.9 3
				53	17	" " 8
						9
						-20.4 13
				33	18	" " 4
						2
-21.9	22.5					-21.9 4
			SAND, fine to medium, quartz (SP)	20	19	" " 12
						19
						-23.4 26
				0		" " 15
			clayey -24.9 to -25.4			21
-24.9	31.5					30
-25.4	32.0					10
			CLAY, gray (CH)	66	20	" " 3
						3
				100	21	" " pushed 3
						3
						-27.9 4
				100	22	" " 4
						6
						-29.4 pushed
				100	23	" " 7
						-30.9 pushed
				100	24	" " 7
						-32.4 pushed
				66	25	" " 8
-33.4	40.0					8
			SAND, fine to coarse, quartz and shell, light gray, clean, tight, very shelly (SP)	26	26	" " 4
						8
						-35.4 19

DRILLING LOG (Cont Sheet)		ELEVATION OF TOP OF HOLE		Hole No.		
PROJECT Canaveral Harbor Extension		+6.6		CR-CHE-4		
INSTALLATION			SHEET			
Jacksonville District			3			
ELEVATION	DEPTH	LOGGING	CLASSIFICATION OF MATERIALS (Description)	% CORE RECOV- ERY	SAMPLE NO.	REMARKS (Drilling time, water loss, depth of weathering, etc., if significant)
a	b	c	d	e	f	g
						BIT OR BARREL
						-35.4 Bls/0.5 ft.
				33	27	SPLIT SPOON
						10
						19
						-36.9
						29
				26	28	" "
						20
						35
						-38.4
						40
				20	29	" "
						20
						43
-39.9	46.5					-39.9
						40
						140# hammer with 30" drop used on 2.0" split spoon. (1-3/8" I.D. X 2" O.D.)

1. DRILLING LOG		DIVISION South Atlantic		INSTALLATION Jacksonville District		SHEET of 2 sheets	
2. PROJECT Canaveral Harbor Extension				10. SIZE AND TYPE OF BIT See Remarks			
3. LOCATION (Continuation of Station) Sta. 281+60 Rte. 250 CHANNEL				11. DATUM FOR ELEVATION MLW			
4. DRILLING AGENCY Corps of Engineers				12. MANUFACTURER'S DESIGNATION OF GRILL Sprague & Henwood 40-C			
6. HOLE NO. (As shown on drawing, title and file number) CB-CHE-5				13. TOTAL NO. OF OVERBURDEN SAMPLES TAKEN DISTURBED _____ UNDISTURBED _____			
5. NAME OF DRILLER J. King				14. TOTAL NUMBER CORE BOXES 1			
8. DIRECTION OF HOLE <input checked="" type="checkbox"/> VERTICAL <input type="checkbox"/> INCLINED _____ DEG. FROM VERT.				15. ELEVATION GROUND WATER Tidal			
7. THICKNESS OF OVERBURDEN				16. DATE HOLE STARTED 11-17-71 COMPLETED 11-17-71			
9. DEPTH DRILLED INTO ROCK				17. ELEVATION TOP OF HOLE -13.2			
8. TOTAL DEPTH OF HOLE 27.0'				18. TOTAL CORE RECOVERY FOR BORING 42 %			
				19. REMARKS GEOLOGIST: J. Gentile			

ELEVATION a	DEPTH b	LEGEND c	CLASSIFICATION OF MATERIALS (Description) d	% CORE RECOVERY e	SAMPLE NO. f	REMARKS (Drilling time, water loss, depth of weathering, etc., if significant) g
-13.2	0.0					BIT OR BARREL
						-13.2 Bls/0.5 ft.
			SAND, fine, quartz, silty, dark gray (SH).	0		SPLIT SPOON pushed
				0		" " pushed
				26	1	" " pushed
-17.7	4.5					-17.7
			CLAY, gray, slightly shelly, soft (CH)	86	2	" " pushed
				80	3	" " pushed
				93	4	" " pushed
-23.7	10.5					-22.2
				93	5	" " pushed
						-23.7
			SAND, fine, quartz, silty, gray (SH)	0		" " pushed
				40	6	" " pushed
						-25.2
						-26.7
				53	7	" " pushed
						-28.2
				47	8	" " pushed
-29.7	16.5					-29.7
						-31.2
			SHELL, slightly sandy, tan	33	9	" " pushed
						-31.2
				25	10	" " pushed
-32.7	19.5					-32.7

DRILLING LOG (Cont Sheet)		ELEVATION OF HOLE		-13.2		Hole No. CB-CHE-5		
PROJECT: Canaveral Harbor Extension			INSTALLATION: Jacksonville District			WELL 2 OF 2 SHEETS		
ELEVATION a	DEPTH b	LEGEND c	CLASSIFICATION OF MATERIALS (Description) d	% CORE RECOVERY e	SAMPLE NO. f	REMARKS (Drilling time, water loss, depth of weathering, etc., if significant) g		
						BIT OR BARREL		
-32.7	19.5					-32.7 Bis/0.5 ft.		
			SAND, fine, quartz, slightly silty, very shelly, gray (SP)	33	11	SPLIT SPOON 15		
							26	
							-34.2 30	
					25	12	" " 16	
							30	
							-35.7 35	
					40	13	" " 15	
						34		
						-37.2 30		
				30	14	" " 11		
						24		
						-38.7 30		
				46	15	" " 10		
						22		
-40.2	27.0					-40.2 31		
						140# hammer with 30" drop used on 2.0' split spoon. (1-3/8" I.D. X 2" O.D.)		

<b>BILLING LOG</b> DIVISION: <b>South Atlantic</b>		INSTALLATION: <b>Jacksonville District</b>		SHEET 1 OF 2 SHEETS						
PROJECT: <b>Canaveral Harbor Extension</b>		10. SIZE AND TYPE OF BIT: <b>SEE REMARKS</b>		11. DAY OF PORT (LOCATION OF BOTTLE IN HOLE)						
LOCATION (Continuation of Section): <b>STA 20110 R.C. - 6.50</b>		12. MANUFACTURER'S DESIGNATION OF DRILL: <b>MLW Sprague &amp; Henwood 40-C</b>		13. TOTAL NO. OF OVERBURDEN SAMPLES TAKEN: <input type="checkbox"/> DISTURBED <input type="checkbox"/> UNDISTURBED						
DRILLING AGENCY: <b>Corps of Engineers</b>		14. TOTAL NUMBER CORE ROCKS: <b>1</b>		15. ELEVATION-GROUND WATER: <b>Tidal</b>						
HOLE NO. (As shown on drawing, title and file number): <b>CB-CHE-7</b>		16. DATE HOLE STARTED: <b>11-23-71</b> COMPLETED: <b>11-23-71</b>		17. ELEVATION-TOP OF HOLE: <b>-18.5</b>						
NAME OF DRILLER: <b>J. King</b>		18. TOTAL CORE RECOVERY FOR BORING: <b>37%</b>		19. <del>REMARKS</del>						
DIRECTION OF HOLE: <input checked="" type="checkbox"/> VERTICAL <input type="checkbox"/> INCLINED _____ DEG. FROM VERT.		GEOLOGIST: <b>J. Gentile</b>								
THICKNESS OF OVERBURDEN:		REMARKS: (Drilling time, water loss, depth of weathering, etc., if significant)								
DEPTH DRILLED INTO ROCK:		BIT OR BARREL								
TOTAL DEPTH OF HOLE: <b>22.5'</b>		ELEVATION      DEPTH      LEGEND      CLASSIFICATION OF MATERIALS (Describe below)      SCORE RECOVERY      SAMPLE NO.      REMARKS								
-18.5	0.0					-18.5	Blk/0.5 Ft.			
			SILT, soft, dark gray, slightly clayey (ML)	0		-20.0				SPLIT SPOON pushed
				0		-21.5				" " pushed
				0		-23.0				" " pushed
				0		-24.5				" " pushed
				20	1	-26.0				" " pushed
				33	2	-27.5				" " pushed
				53	3	-29.0				" " pushed
				60	4	-30.5				" " pushed
				66	5	-32.0				" " pushed
-32.0	13.5		SAND, fine, quartz, slightly silty to silty, slightly shelly, gray (SM)	40	6	-33.5				" " 1
				33	7	-35.0				" " 2 7 12 11

PROJECT		INSTALLATION		Hole No.		
Canaveral Harbor Extension		Jacksonville District		Cl-CHE-7		
ELEVATION	DEPTH	LEGEND	CLASSIFICATION OF MATERIALS (Description)	% CORE RECOVERY	SAMPLE NO.	REMARKS (Drilling time, water loss, depth of weathering, etc., if significant)
a	b	c	d	e	f	g
						BIT OR BARREL
						-35.0 Bls/0.5 ft.
-36.5	18.0		bed of slightly silty, fine to medium, quartz, sand, shelly, from -36.5 to -38.0	40	8	SPLIT SPOON
						8
						9
						12
						7
						8
-38.0	19.5			40	9	" "
						9
						6
						8
						3
						3
						4
-41.0	22.5		CLAY, silty, slightly sandy, green (CL)	86	10	" "
						8
						3
						3
				80	11	" "
						3
						4
						140# hammer with 30" drop used on 2.0' split spoon (1-3/8" I.D. X 2" O.D.)

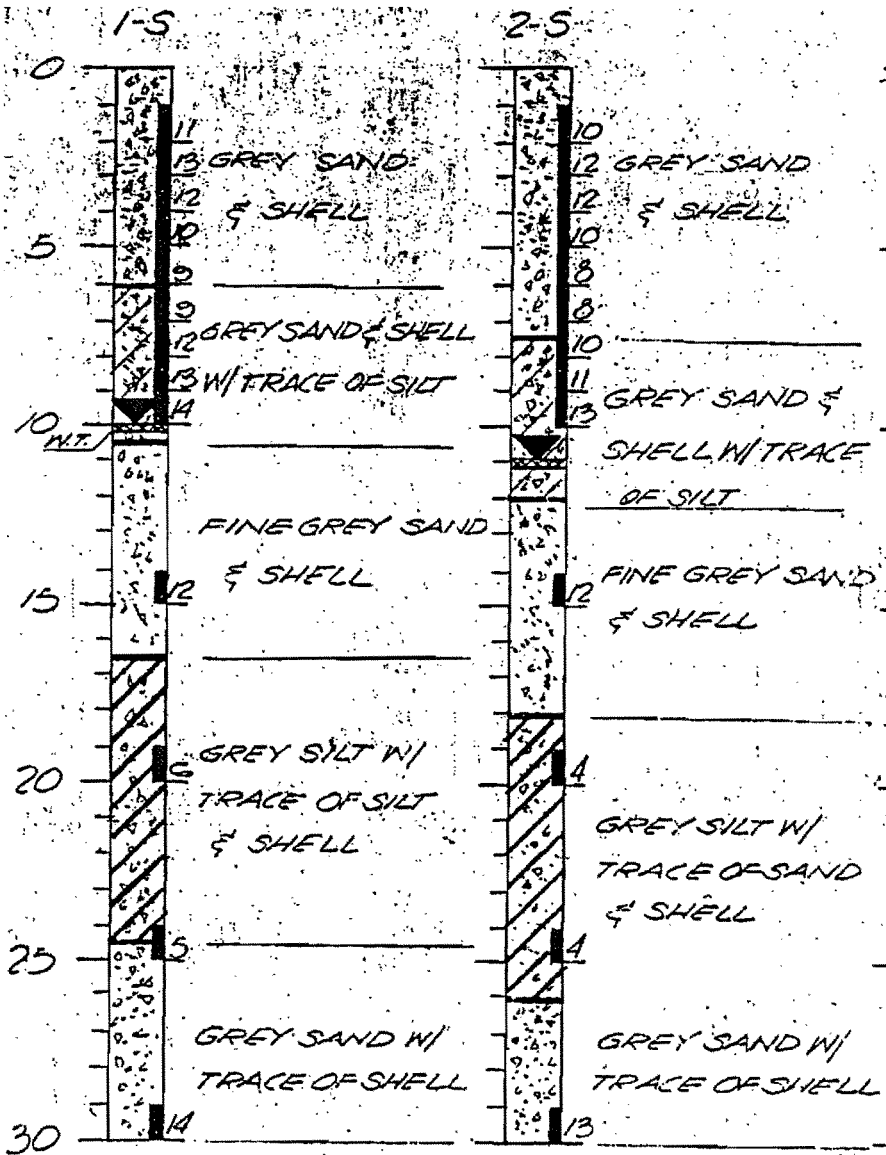



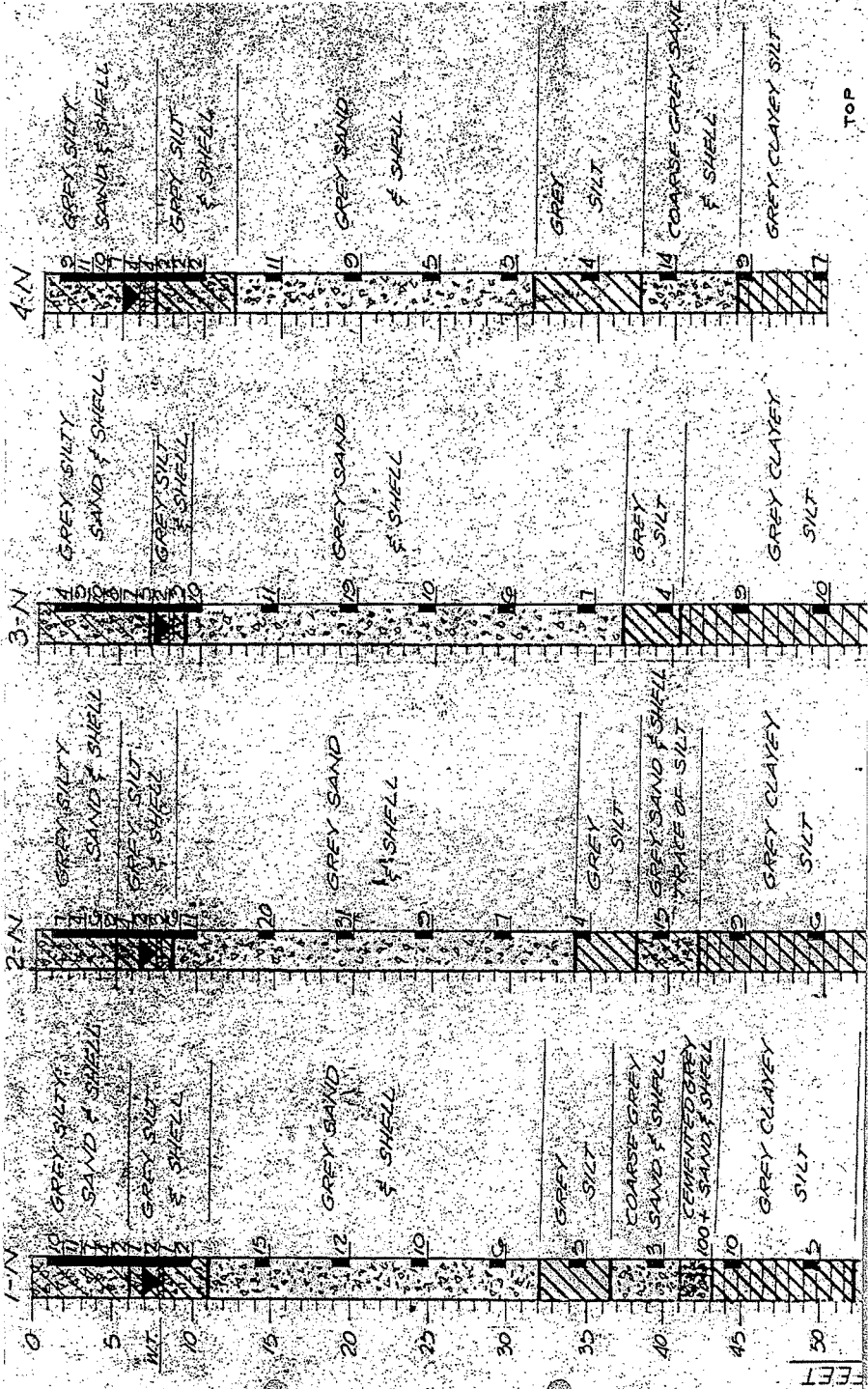



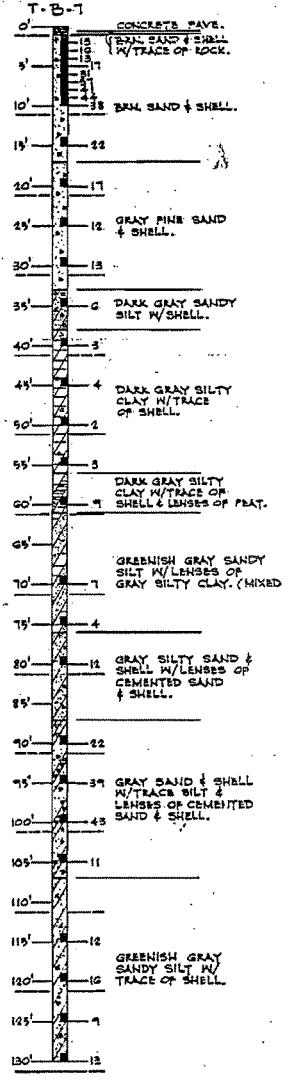
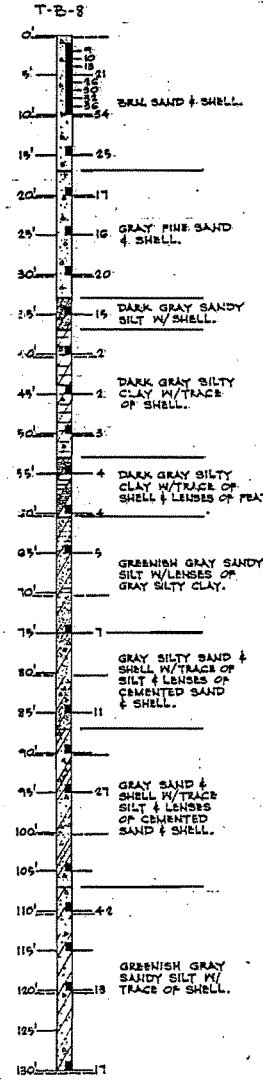
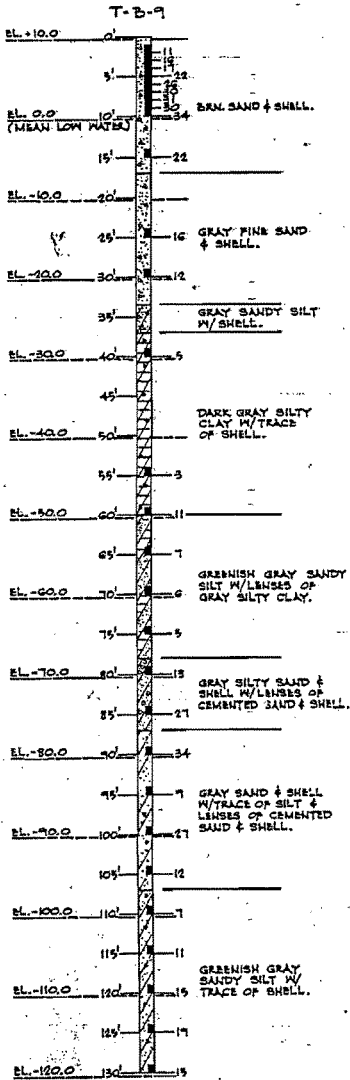

JOB LOCATION: Port Canaveral  Florida	<b>WARREN GEORGE INC.</b> 7641 HOOPER ROAD WEST PALM BEACH, FL. 33411.  FOR: Gee & Jenson, Consulting Engineers	SHEET <u>1</u> OF <u>1</u> LOCATION _____ HOLE NO. C-B-W-5 LINE & STA. _____ OFFSET _____
--	---	---

DEPTH _____ FT.	FT. CASING OUT DATE: _____	DATE, START: <u>3/21/82</u>	GROUND ELEVATION _____
DEPTH _____ FT.	ALL CASING OUT DATE: _____	DATE, FINISH: <u>3/21/82</u>	GROUND WATER ELEVATION _____
CASING O. D. <u>3"</u> I. D. _____	WEIGHT OF HAMMER <u>300-140</u> LBS.	HAMMER FALL _____	
SAMPLER O. D. <u>2"</u> I. D. _____	INSIDE LENGTH OF SAMPLER _____ IN.	CASING <u>24"</u> SAMPLER <u>30"</u>	
DIAMOND BIT SIZE _____			

DEPTH BEL- BY SURFACE	CASING BLOWS PER FOOT	SAMPLE NUMBER	SAMPLE DEPTHS ELEV. / FEET	SAMPLE RECORD	BLOWS PER 6" ON SAMPLER			DENSITY OR CONSIST. MOISTURE	PROFILE CHANGE DEPTH	FIELD IDENTIFICATION OF SOILS REMARKS
					0-6	6-12	12-18			
0			20 Ft. of water							
		1	0'-2'	Weight of Rods						Grey soft organic Silt
		2	5'-7'	Weight of Rods						0'-8'
-10		3	10'-12'	1	1	0	1	1		Grey fine silty Sand, and Silt, trace Shells
		4	15'-17'	1	2	1	1	2		
-20		5	20'-22'	1	2	2	3	5		8'-22'
		6	25'-27'	6	12	14	15	29		Grey compact fine to medium Sand, Shells, trace Shells
-30		7	30'-32'	8	17	17	19	36		22'-33'
		8	35'-37'	2	3	3	6	1		Grey Silt and trace Shells
		9	38'-40'	9	12	15	19	34		33'-38'
-40										38'-40'

Soil's Engineer: _____	Driller: <u>V.J. Peretti</u>
Drilling Inspector: _____	Helper: _____

Hole Complete @ 40 ft

JOB LOCATION: Port Canaveral Florida	<b>WARREN GEORGE INC.</b> 7641 HOOPER ROAD WEST PALM BEACH, FL 33411. FOR: Gee & Jensen, Consulting Engineers	SHEET 1 OF 3 LOCATION: HOLE NO. C-B-E-10 LINE & STA. OFFSET
--	--	---

DEPTH _____ FT.	CASING OUT DATE: _____	DATE, START: 3/24/82	GROUND ELEVATION _____
DEPTH _____ FT.	ALL CASING OUT DATE: _____	DATE, FINISH: 3/25/82	GROUND WATER ELEVATION 8'6"

CASING: O. D. 3" I. D. _____	WEIGHT OF HAMMER 300-140 LBS.	HAMMER FALL _____
SAMPLER: O. D. 2" I. D. _____	INSIDE LENGTH OF SAMPLER: _____ IN.	CASING 24" SAMPLER 30"
DIAMOND BIT SIZE: _____		

DEPTH BELOW SURFACE BY FEET	CASING BLOWS PER FOOT	SAMPLE DEPTHS ELEV. / FEET	SAMPLE NUMBER	BLOWS PER 6" ON SAMPLER			DENSITY OR CONSIST MOISTURE	PROFILE CHANGE DEPTH	FIELD IDENTIFICATION OF SOILS REMARKS
				0-6"	6-12"	12-18"			
				0-6"	6-12"	12-18"			
0									
	1	5'-7'	13	12	12	13	0'-8'6"	Light Brown fine to medium coarse Sand (Fill)	
10	2	10'-12'	4	8	12	10	8'6"-15'	Grey fine to medium coarse Sand, trace Shells & Gravel	
	3	15'-17'	2	1	2	1	15'-21'6"	Grey Silt, some fine Sand, & Shells	
20	4	20'-22'	1	2	2	12			
	5	25'-27'	5	5	7	9			
30	6	30'-32'	6	8	7	7		Grey fine to medium Sand, & Silt	
	7	35'-37'	4	4	4	5	21'6"-38'6"		
40									

Soils Engineer: _____	Driller: V.J. Peretti
Drilling Inspector: _____	Helper: _____

JOB LOCATION: Port Canaveral Florida	<b>WARREN GEORGE INC.</b> 7641 HOOPER ROAD WEST PALM BEACH, FL 33411	SHEET <u>2</u> OF <u>3</u> LOCATION: HOLE NO. C-B-E-10 LINE & STA. OFFSET
FOR: Gee & Jenson, Consulting Engineers		

DEPTH: _____ FT.	DATE, START: <u>3/24/82</u>	GROUND ELEVATION: _____
DEPTH: _____ FT. ALL CASING OUT DATE: _____	DATE, FINISH: <u>3/25/82</u>	GROUND WATER ELEVATION: <u>8'6"</u>
CASING O.D. <u>3"</u> I.D. _____	WEIGHT OF HAMMER: <u>300-140</u> LBS.	HAMMER FALL _____
SAMPLER O.D. <u>2"</u> I.D. _____	INSIDE LENGTH OF SAMPLER _____ IN.	CASING <u>24"</u> SAMPLER <u>30"</u>
DIAMOND BIT SIZE _____		

DEPTH REL TO SURFACE	CASING BLOWS PER FOOT	SAMPLE NUMBER	SAMPLE DEPTH ELEV. / FEET	SAMPLE NUMBER	BLOWS PER 6" ON SAMPLER			DENSITY OR CONSIST MOISTURE	PROFILE CHANGE DEPTH	FIELD IDENTIFICATION OF SOILS REMARKS
					0-6	6-12	12-18			
0										
		8	40'-42'	1	1	1	1			Grey organic silt
									38'6"-46'6"	
		9	45'-47'	1	2	1	12			Grey firm Sand, some Silt
									46'6"-49'	
-10										
		10	50'-52'	20	24	20	32			
		11	55'-57'	8	12	12	12			Grey compact Sand, Shells, trace Silt
									49'-60'	
-20										
		12	60'-62'	3	3	2	3			
		13	65'-67'	3	3	2	4			
-30										
		14	70'-72'	5	6	6	7			
		15	75'-77'	5	5	6	5			
-40										

Soils Engineer: _____	Driller: <u>V.J. Peretti</u>
Drilling Inspector: _____	Helper: _____



<b>DRILLING LOG</b> DIVISION: <b>South Atlantic</b>		INSTALLATION: <b>Jacksonville Dist</b>		SHEET: <b>1</b> OF 2 SHEETS		
PROJECT: <b>Canaveral Harbor Extension</b>		10. SIZING AND TYPE OF HITS: See remarks		11. DAYUM FOR ELEVATION: <b>40m (131m - ML)</b>		
1. LOCATION of Installation or Station: <b>Sta. 286+60 Ege. -1150</b>		12. MANUFACTURER'S DESIGNATION OF DRILL: <b>MLW</b>		13. <b>Sprague &amp; Henwood 40-C</b>		
2. DRILLING AGENCY: <b>Corps of Engineers</b>		14. TOTAL NO. OF OVERBURDEN SAMPLES TAKEN: <b>UNDISTURBED</b>		15. TOTAL NO. OF OVERBURDEN SAMPLES TAKEN: <b>UNDISTURBED</b>		
4. HOLE NO. (As shown on drawing title and file number): <b>CB-CHE-9</b>		16. DATE HOLE: <b>STARTED: 12-2-71 COMPLETED: 12-2-71</b>		17. ELEVATION TOP OF HOLE: <b>-16.0</b>		
5. NAME OF DRILLER: <b>J. King</b>		18. TOTAL CORE RECOVERY FOR BORING: <b>30%</b>		19. <del>XXXXXXXXXXXXXXXXXXXX</del>		
6. DIRECTION OF HOLE: <input type="checkbox"/> VERTICAL <input type="checkbox"/> INCLINED. <b>000. FROM VERT.</b>		GEOLOGIST: <b>J. Gentile</b>				
7. THICKNESS OF OVERBURDEN:		8. TOTAL DEPTH OF HOLE: <b>24.0'</b>				
8. DEPTH DRILLED INTO ROCK:						
ELEVATION	DEPTH	LEGEND	CLASSIFICATION OF MATERIALS (Description)	CORE RECOVERY	SAMPLE NO.	REMARKS (Drilling time, water loss, depth of weathering, etc. if significant)
-16.0	0.0					BIT OR BARREL
			SILT, dark gray, soft (ML)	0		-16.0 Bls/0.5 ft. pushed
				0		-17.5 SPLIT SPOON pushed
				0		-19.0 " " pushed
				0		-20.5 " " pushed
				0		-22.0 " " pushed
				33	1	-23.5 " " pushed
				33	2	-25.0 " " pushed
				52	3	-26.5 " " pushed
				46	4	-28.0 " " pushed
				26	5	-29.5 " " pushed
			SAND, fine to medium, quartz slightly silty, slightly shelly, gray (SP)	53	6	-31.0 " " 1
				66	7	-32.5 " " 13
				40	8	-34.0 " " 14
				33	9	-35.5 " " 2
						4
						8
						12



DRILL LOG (Cont Sheet)		ELEVATION OF MOUTH		-16.0'		Hole No. CB-CHE-9	
PROJECT			INSTALLATION			SHEET	
Canaveral Harbor Extension			Jacksonville District			2 of 2 SHEETS	
ELEVATION	DEPTH	LEGEND	CLASSIFICATION OF MATERIALS (Description)	N. CORE RECOVERY	SAMPLE NO.	REMARKS (Drilling time, water loss, depth of weathering, etc., if applicable)	
a	b	c	d	e	f	g	
						BIT OR BARREL	
						-35.5 Bis/0.5 ft.	
				33	10	SPLIT SPOON	
						-37.0	
				26	11	" "	
						-38.5	
-39.0	23.0					" "	
			SAND, clayey, gray (SC)	46	12	" "	
-40.0	24.0					-40.0	
						140# hammer with 30" drop used on 2.0' split spoon. (1-3/8" I.D. X 2" O.D.)	

DEPTH FT.	DESCRIPTION	ELEV	PENETRATION-BLOWS PER FT.																
			+10	0	10	20	30	40	60	80	100								
0	Gray fine to medium SAND with shell	(1)																	
1.0	LOOSE gray fine to medium SAND with clayey fine sand lenses and shell	(1)																	
3.0	FIRM gray fine to medium SAND with clayey fine sand lenses and shell	(1)	+5																
5.5	VERY LOOSE gray slightly silty fine to medium SAND with shell and asphalt concrete fragments																		
8.0	VERY LOOSE gray slightly silty fine SAND with some shell fragments		0																
12.0	VERY LOOSE gray silty clayey fine SAND with trace of shell fragments		-5																
17.0	FIRM gray fine SAND with trace of shell fragments		-10																
20.5	BORING TERMINATED																		
	(1) fragments																		

TEST BORING RECORD

BORING AND SAMPLING MEETS ASTM D-1586  
 CODE DRILLING MEETS ASTM D-2113  
 PENETRATION IS THE NUMBER OF BLOWS OF 140 LB. HAMMER  
 FALLING 30 IN. REQUIRED TO DRIVE 1.4 IN. I.D. SAMPLE 1 FT.

BORING NO. B-385. Sta 263+46  
 DATE DRILLED 1-10-75  
 JOB NO. 0-718B

UNDISTURBED SAMPLE       WATER TABLE, 24 HR.  
 50% ROCK CORE RECOVERY       WATER TABLE, 1 HR.  
 LOSS OF DRILLING WATER

LAW ENGINEERING TESTING CO.



197  
Hole No. CB-ER-4 ✓

<b>DRILLING LOG</b>		DIVISION South Atlantic	INSTALLATION Jacksonville District	SHEET 1 OF 1 SHEETS
1. PROJECT Cape Fear Harbor Extension		10. SIZE AND TYPE OF BIT MTW		
2. LOCATION (Coordinates or Station) X=620,880 Y=1,482,350		11. DATUM FOR ELEVATION SHOWN (TBM or MSL) Tidal		
3. DRILLING AGENCY Corps of Engineers		12. MANUFACTURER'S DESIGNATION OF DRILL Acker AMC		
4. HOLE NO. (As shown on drawing title and file number) CB-ER-4		13. TOTAL NO. OF OVER-BURDEN SAMPLES TAKEN DISTURBED      UNDISTURBED		
5. NAME OF DRILLER R. Gordon		14. TOTAL NUMBER CORE BOXES --		
6. DIRECTION OF HOLE <input checked="" type="checkbox"/> VERTICAL <input type="checkbox"/> INCLINED      DEG. FROM VERT.		15. ELEVATION GROUND WATER Tidal		
7. THICKNESS OF OVERBURDEN --		16. DATE HOLE STARTED 4/20/82      COMPLETED 4/20/82		
8. DEPTH DRILLED INTO ROCK --		17. ELEVATION TOP OF HOLE -18.0		
9. TOTAL DEPTH OF HOLE 6.0		18. TOTAL CORE RECOVERY FOR BORING 83 %		
		19. SIGNATURE OF INSPECTOR GEOLOGIST: D. Rosen		

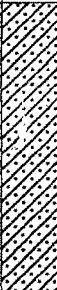
ELEVATION a.	DEPTH b.	LEGEND c.	CLASSIFICATION OF MATERIALS (Description) d.	% CORE RECOVERY e.	BOX OR SAMPLE NO. f.	REMARKS (Drilling time, water loss, depth of weathering, etc., if significant) g.
-18.0	0.0					-18.0
			SAND, dark gray, very silty, very clayey, slightly shelly, soft (SC)	83	1	2" Sampler
-24.0	6.0					-24.0
			NOTE: 1. No sample storage in core boxes. Entire sample used for laboratory analysis. 2. Classification conforms to Lab- oratory analysis.			

Hole No. CB-ER-5 ✓

DRILLING LOG		DIVISION		INSTALLATION		SHEET 1 OF 7 SHEETS	
1. PROJECT Canaveral Harbor Extension		South Atlantic		Jacksonville District			
2. LOCATION (Coordinates or Station) X=622,000 Y=1,481,560				10. SIZE AND TYPE OF BIT			
3. DRILLING AGENCY Corps of Engineers				11. DAYUM FOR ELEVATION SHOWN (TBM or NSL) MLW			
4. HOLE NO. (As shown on drawing title and file number) CB-ER-5				12. MANUFACTURER'S DESIGNATION OF DRILL Acker AMC			
5. NAME OF DRILLER R. Gordon				13. TOTAL NO. OF OVER-BURDEN SAMPLES TAKEN		DISTURBED	UNDISTURBED
6. DIRECTION OF HOLE <input checked="" type="checkbox"/> VERTICAL <input type="checkbox"/> INCLINED _____ DEG. FROM VERT.				14. TOTAL NUMBER CORE BOXES		---	
7. THICKNESS OF OVERBURDEN				15. ELEVATION GROUND WATER		Tidal	
8. DEPTH DRILLED INTO ROCK				16. DATE HOLE		STARTED	COMPLETED
9. TOTAL DEPTH OF HOLE		5.0		17. ELEVATION TOP OF HOLE		-15.0	
				18. TOTAL CORE RECOVERY FOR BORING		100 %	
				19. SIGNATURE AND POSITION GEOLOGIST: D. Rosen			
ELEVATION a	DEPTH b	LEGEND c	CLASSIFICATION OF MATERIALS (Description) d	% CORE RECOVERY e	BOX OR SAMPLE NO. f	REMARKS (Drilling time, water loss, depth of weathering, etc., if significant) g	
-15.0	0.0					-15.0	
		.....	SAND, gray, fine to medium quartz, fine to coarse shell, slightly silty (SP)	100	1	2" Sampler	
-20.0	5.0					-20.00	
			NOTE: 1. No sample storage in core boxes. Entire sample used for laboratory analysis. 2. Classification conforms to Lab- oratory analysis.				

Hole No. CB-ER-6 ✓

<b>DRILLING LOG</b>		DIVISION South Atlantic	INSTALLATION Jacksonville District	SHEET 1 OF 7 SHEETS
1. PROJECT Canaveral Harbor Extension		10. SIZE AND TYPE OF BIT		
2. LOCATION (Coordinates or Station) X=623,120 Y=1,481,800		11. DATUM FOR ELEVATION SHOWN (TBM or MSL) MLW		
3. DRILLING AGENCY Corps of Engineers		12. MANUFACTURER'S DESIGNATION OF DRILL Acker AMC		
4. HOLE NO. (As shown on drawing title and file number) CB-ER-6		13. TOTAL NO. OF OVER-BURDEN SAMPLES TAKEN DISTURBED:      UNDISTURBED:		
5. NAME OF DRILLER R. Gordon		14. TOTAL NUMBER CORE BOXES --		
6. DIRECTION OF HOLE <input checked="" type="checkbox"/> VERTICAL <input type="checkbox"/> INCLINED      DES. FROM VERT.		15. ELEVATION GROUND WATER Tidal		
7. THICKNESS OF OVERBURDEN:		16. DATE HOLE      STARTED      COMPLETED 4/20/82      4/20/82		
8. DEPTH DRILLED INTO ROCK		17. ELEVATION TOP OF HOLE -35.5		
9. TOTAL DEPTH OF HOLE 6.0		18. TOTAL CORE RECOVERY FOR BORING 100 %		
		19. SIGNATURE OF INSPECTOR GEOLOGIST D. Rosen		

ELEVATION a	DEPTH b	LEGEND c	CLASSIFICATION OF MATERIALS (Description) d	% CORE RECOVERY e	BOX OR SAMPLE NO. f	REMARKS (Drilling time, water loss, depth of weathering, etc., if significant) g
-35.5	0.0					-35.5
		.....	SAND, dark gray, fine quartz, slightly shelly, silty (SM)	100	1	2" Sampler
-41.5	6.0					-41.5
			NOTE: 1. No sample storage in core boxes. Entire sample used for laboratory analysis. 2. Classification conforms to Laboratory analysis.			

(202)

Hole No. CB-CHM84-8

<b>DRILLING LOG</b>		DIVISION South Atlantic	INSTALLATION Jacksonville District	SHEET 1		
1. PROJECT Canaveral Harbor Extension		10. SIZE AND TYPE OF BIT SEE REMARKS				
2. LOCATION (Coordinates or Station) X 620 925 Y 1 483,170		11. DATUM FOR ELEVATION SHOWN (TBM or BSL) MLW				
3. DRILLING AGENCY Corps of Engineers		12. MANUFACTURER'S DESIGNATION OF DRILL Failing 1500				
4. HOLE NO. (As shown on drawing title and file number) CB-CHM84-8		13. TOTAL NO. OF OVER-BURDEN SAMPLES TAKEN		DISTURBED UNDISTURBED		
5. NAME OF DRILLER R. Gordon		14. TOTAL NUMBER CORE BOXES 1				
6. DIRECTION OF HOLE <input checked="" type="checkbox"/> VERTICAL <input type="checkbox"/> INCLINED _____ DEG. FROM VERT.		15. ELEVATION GROUND WATER Tidal				
7. THICKNESS OF OVERBURDEN		16. DATE HOLE		STARTED 25 Apr 84		
8. DEPTH DRILLED INTO ROCK		17. ELEVATION TOP OF HOLE		COMPLETED 25 Apr 84		
9. TOTAL DEPTH OF HOLE 20'		18. TOTAL CORE RECOVERY FOR BORING 75 %				
		19. SIGNATURE OF INSPECTOR GEOLOGIST J. Hand				
ELEVATION a	DEPTH b	LEGEND c	CLASSIFICATION OF MATERIALS (Description) d	% CORE RECOVERY e	SAMPLE NO. f	REMARKS (Drilling time, water loss, depth of weathering, etc., if significant) g
-22.6	0.0					Bit or Barrel
			SILT, gray (ML)	50	1	2" Sampler Settled
-34.6	12.0					-32.6 BLS/FT Settled
			SAND, coarse to fine, shelly, quartz, silty, green (SM)	100	2	" Settled
					3	"
					4	"
					5	"
					6	"
					7	"
					8	"
					9	"
					10	"
-42.0	20.0					-42.0
						300# hammer with 18" drop used on 2" Sampler

296

Hole No. CB-CHM84-11

DRILLING LOG		DIVISION South Atlantic	INSTALLATION Jacksonville District		SHEET 1 of 3 SHEETS	
1. PROJECT Canaveral Harbor Extension			10. SIZE AND TYPE OF BIT SEE REMARKS			
2. LOCATION (Coordinates or Station) X=620,413 Y=1,482,789			11. DATE FOR ELEVATION SHOWN (FROM or TO) MLW			
3. DRILLING AGENCY Corps of Engineers			12. MANUFACTURER'S DESIGNATION OF DRILL Failing 1500			
4. HOLE NO. (As shown on drawing title) and file number CB-CHM84-11			13. TOTAL NO. OF OVERBURDEN SAMPLES TAKEN		DISTURBED <input type="checkbox"/> UNDISTURBED <input type="checkbox"/>	
5. NAME OF DRILLER R. Gordon			14. TOTAL NUMBER CORE BOXES 7			
6. DIRECTION OF HOLE <input checked="" type="checkbox"/> VERTICAL <input type="checkbox"/> INCLINED      DEG. FROM VERT.			15. ELEVATION GROUND WATER Tidal			
7. THICKNESS OF OVERBURDEN			16. DATE HOLE STARTED 24 Apr 84 COMPLETED 24 Apr 84			
8. DEPTH DRILLED INTO ROCK			17. ELEVATION TOP OF HOLE -21.9			
9. TOTAL DEPTH OF HOLE 20.0'			18. TOTAL CORE RECOVERY FOR BORING 50 %			
			19. SIGNATURE OF INSPECTOR X GEOLOGIST J. HAND			
ELEVATION a	DEPTH b	LEGEND c	CLASSIFICATION OF MATERIALS (Description) d	% CORE RECOVERY e	SAMPLE NO. f	REMARKS (Drilling time, water logs, depth of weathering, etc., if significant) g
-21.9	0.0					Bit or Barrel
-24.0	3.0		SILT, slightly sandy, gray (ML)	50	1	2" Sampler Settled
-31.9	10.0		SAND, medium to fine, quartz, shelly, silty (SM)		2	
-41.9	20.0		SILT, slightly sandy, trace of shell, green (ML)	50	3	" Settled
						300# hammer with 18" drop used on 2" Sample



(207) Note No. CB-CHM84-12

BOILING LOG	DIVISION South Atlantic	INSTALLATION Jacksonville District	SHEET 1 of 1 sheets
1. PROJECT Canaveral Harbor Extension		10. SIZE AND TYPE OF BIT SEE REMARKS	
2. LOCATION (Coordinates or Station) X=620.943 Y=1.482.747		11. STATUS FOR ELEVATION GROUP (Type of TEST) MLW	
3. DRILLING AGENCY Corps of Engineers		12. MANUFACTURER'S DESIGNATION OF DRILL Falling 1500	
4. HOLE NO. (As given on charting title and file number) CB-CHM84-12		13. TOTAL NO. OF OVERBURDEN SAMPLES TAKEN DISTURBED: _____ UNDISTURBED: _____	
5. NAME OF DRILLER R. Gordon		14. TOTAL NUMBER CORE BONES _____	
6. DIRECTION OF HOLE <input checked="" type="checkbox"/> VERTICAL <input type="checkbox"/> INCLINED _____ DEG. FROM VERT.		15. ELEVATION GROUND WATER Tidal	
7. THICKNESS OF OVERBURDEN		16. DATE HOLE STARTED: 25 Apr 84 COMPLETED: 25 Apr 84	
8. DEPTH DRILLED INTO ROCK		17. ELEVATION TOP OF HOLE -23.0	
9. TOTAL DEPTH OF HOLE 20.0'		18. TOTAL CORE RECOVERY FOR BORING 50 %	
		19. SIGNATURE OF INSPECTOR GEOLOGIST J. Hand	

ELEVATION a	DEPTH b	LEGEND c	CLASSIFICATION OF MATERIALS (Description) d	% CORE RECOVERY e	SAMPLE NO. f	REMARKS (Drilling time, water loss, depth of overburden, etc., if significant) g
-23.0	0.0					Bit or Barrel
			SILT, gray (ML)	33	1	2" Sampler Settled
					2	
-35.0	12.0					
			SAND, coarse to fine, shelly, quartz, silty, green (SM)			
				100	3	
-43.0	20.0					
						300# hammer with 18" drop used on 2" Sampler

(202) Hole No. CB-CHM84-13

DRILLING LOG		DIVISION: South Atlantic		INSTALLATION: Jacksonville District		SHEET: 1 OF 1 SHEETS	
1. PROJECT: Canaveral Harbor Extension				10. SIZE AND TYPE OF BIT: see remarks			
2. LOCATION (Geographic or Station): X=620.579 Y=1.482.426				11. DAY OF YEAR ELEVATION SHOWN (2000 or 1950): M.W.			
3. DRILLING AGENCY: Corps of Engineers				12. MANUFACTURER'S DESIGNATION OF DRILL: Failing 1500			
4. HOLE NO. (As shown on drawing and this end file number): CB-CHM84-13				13. TOTAL NO. OF OVERBURDEN SAMPLES TAKEN:		14. DISTURBED: UNDISTURBED:	
5. NAME OF DRILLER: R. Gordon				16. TOTAL NUMBER CORE BOXES:		17. ELEVATION GROUND WATER: Tida	
6. DIRECTION OF HOLE: <input checked="" type="checkbox"/> VERTICAL <input type="checkbox"/> INCLINED _____ DEG. FROM VERT.				18. DATE HOLE STARTED: 24 Apr 84		19. DATE HOLE COMPLETED: 24 Apr 84	
7. THICKNESS OF OVERBURDEN:				17. ELEVATION TOP OF HOLE: -23.5		18. TOTAL CORE RECOVERY FOR BORING: 85 %	
8. DEPTH DRILLED INTO ROCK:				19. SIGNATURE OF INSPECTOR X: GEOLOGIST J. Hand			
9. TOTAL DEPTH OF HOLE: 20.0'							

ELEVATION a	DEPTH b	LEGEND c	CLASSIFICATION OF MATERIALS (Description) d	% CORE RECOVERY e	SAMPLE NO. f	REMARKS (Drilling time, water loss, depth of coring, etc., if significant) g
-23.5	0.0					Bit or Barrel
-25.0	1.5		SAND, fine, quartz, shelly, silty (SP-SM)	60	1	2" Sampler Settled
-28.5	5.0		CLAY, silty, sandy, green (CH)		2	
			SAND, fine, quartz, slightly silty to silty, gray (SP-SM)	80	3	
				100	4	
				100	5	Settled
-43.5	20.0					300# hammer with 18" drop used on 2" Sampler



210

Mojo No. CB-CHM84-15

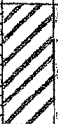
DRILLING LOG		DIVISION South Atlantic	INSTALLATION Jacksonville District		SHEET 1 of 1 SHEETS	
1. PROJECT Canaveral Harbor			10. SIZE AND TYPE OF BIT see remarks			
2. LOCATION (Coordinates or Station) X=620.944 Y=1.482.110			11. DATE(S) FOR ELEVATION SMOOTH (P&M or M&S)			
3. DRILLING AGENCY Corps of Engineers			12. MANUFACTURER'S DESIGNATION OF DRILL Failing 1500			
4. HOLE NO. (for attach on existing title and file number) CB-CHM84-15			13. TOTAL NO. OF OVERBURDEN SAMPLES TAKEN DISTURBED UNDISTURBED			
5. NAME OF DRILLER R. Gordon			14. TOTAL NUMBER CORE BOXES 1			
6. DIRECTION OF HOLE <input checked="" type="checkbox"/> VERTICAL <input type="checkbox"/> INCLINED _____ DEG. FROM VERT.			15. ELEVATION GROUND WATER Tidal			
7. THICKNESS OF OVERBURDEN			16. DATE HOLE STARTED 26 Apr 84 COMPLETED 26 Apr 84			
8. DEPTH DRILLED INTO ROCK			17. ELEVATION TOP OF HOLE -13.1			
9. TOTAL DEPTH OF HOLE 30.0'			18. TOTAL CORE RECOVERY FOR BORING 84 %			
			19. SIGNATURE OF INSPECTOR X GEOLOGIST J. Hand			
ELEVATION e	DEPTH b	LEGEND c	CLASSIFICATION OF MATERIALS (Description) d	1. CORE RECOVERY e	2. SAMPLE NO. f	REMARKS g (Drilling time, water loss, depth of washing, etc., if significant)
-13.1	0.0					Bit or Barrel
-19.1	6.0		SAND, fine, quartz, shelly, slightly silty, gray (SP-SM)	100	1	2" Sampler
-25.1	12.0		CLAY, slightly silty, slightly sandy, green (CH)	100	2	"
-38.1	25.0		SAND, medium to fine, quartz, brown (SP)	30	3	"
				100	4	"
			very shelly from -32.0 to -38.1	100	5	"
-43.1	30.0		SILT, sandy, some shell (ML)	70	6	"
						300# hammer with 18" drop used on 2" Sampler

(21)

Hole No. CB-CHM84-76

DRILLING LOG		DIVISION South Atlantic	INSTALLATION Jacksonville District	SHEET 1 OF 1 SHEETS
PROJECT Canaveral Harbor Extension		10. SIZE AND TYPE OF BIT see remarks MLW		
11. LOCATION (Coordinates or Station) X=621,282 Y=1,481,938		12. MANUFACTURER'S DESIGNATION OF DRILL Failing 1500		
3. DRILLING AGENCY Corps of Engineers		13. TOTAL HD. OF OVERBURDEN SAMPLES TAKEN DISTURBED _____ UNDISTURBED _____		
4. HOLE NO. (As shown on drawing title and file number) CB-CHM84-76		14. TOTAL NUMBER CORE BOXES 1		
5. NAME OF DRILLER R. Gordon		15. ELEVATION GROUND WATER Tidal		
6. DIRECTION OF HOLE <input checked="" type="checkbox"/> VERTICAL <input type="checkbox"/> INCLINED _____ DEG. FROM VERT.		16. DATE HOLE STARTED 26 Apr 84 COMPLETED 26 Apr 84		
7. THICKNESS OF OVERBURDEN		17. ELEVATION TOP OF HOLE -16.0		
8. DEPTH DRILLED INTO ROCK		18. TOTAL CORE RECOVERY FOR BORING 55 %		
9. TOTAL DEPTH OF HOLE 24.2'		19. SIGNATURE OF INSPECTOR GEOLOGIST J. Hand		

ELEVATION a	DEPTH b	LEGEND c	CLASSIFICATION OF MATERIALS (Description) d	% CORE RECOVERY e	SAMPLE NO. f	REMARKS (Drilling time, water loss, depth of overburden, etc., if significant) g
-16.0	0.0					Bit or Barrel
						-16.0 BLS/FT
			SAND, medium, fine, quartz, shelly, slightly silty, green to brown (SP)	40	1	2" Sampler Settled
						-28.7
				80	2	"
						-33.7
				60	3	" Settled
						-38.7
-39.7	23.7				4	"
-40.2	24.2		SANDSTONE, medium, hard	100	5	-40.2
						300# hammer with 18" drop used on 2" Sampler

212

Mole No. CB-CHM84-17

DRILLING LOG		DIVISION South Atlantic	INSTALLATION Jacksonville District		SHEET 1 OF 1 SHEETS	
1. PROJECT Canaveral Harbor			10. SIZE AND TYPE OF BIT SEE REMARKS			
2. LOCATION (Coordinates or Station) X=621,825 Y=1,481,580			11. DATUM FOR ELEVATION BENTON (PND or BSL) MLW			
3. DRILLING AGENCY Corps of Engineers			12. MANUFACTURER'S DESIGNATION OF DRILL Pailing 1500			
4. HOLE NO. (As shown on contract title and file number) CB-CHM84-17			13. TOTAL NO. OF OVERBURDEN SAMPLES TAKEN DISTURBED _____ UNDISTURBED _____			
5. NAME OF DRILLER R. Gordon			14. TOTAL NUMBER CORE BOXES 1			
6. DIRECTION OF HOLE <input checked="" type="checkbox"/> VERTICAL <input type="checkbox"/> INCLINED _____ DEG. FROM VERT.			15. ELEVATION GROUND WATER Tidal			
7. THICKNESS OF OVERBURDEN			16. DATE HOLE STARTED 19 Apr 84 COMPLETED 19 Apr 84			
8. DEPTH DRILLED INTO ROCK			17. ELEVATION TOP OF HOLE -18.3			
9. TOTAL DEPTH OF HOLE 24.0'			18. TOTAL CORE RECOVERY FOR BORING 62 %			
			19. SIGNATURE OF INSPECTOR X GEOLOGIST J. Hand			
ELEVATION a	DEPTH b	LEGEND c	CLASSIFICATION OF MATERIALS (Description) d	% CORE RECOVERY e	UNDESIGNED SAMPLE NO. f	REMARKS (Drilling time, water loss, depth of penetration, etc., if significant) g
						Bit or Barrel
-18.3	0.0					-18.3 BLS/ FT
			SAND, fine to medium, shelly quartz, gray and white (SP)	100	1	2" Sampler
-23.3	5.0					-23.3
			SAND, fine, silty, quartz, green (SM)	40	2	" Settled
-27.3	9.0					
			CLAY, slightly silty, slightly sandy, slightly shelly, slightly organic, green (CH)	30	3	"
						-28.3
						-33.3
-36.3	18.0			100	4	"
			SAND, medium to fine, quartz, gray (SM)		5	
					6	-38.3
				50	7	"
-42.3	24.0					-42.3
						300# hammer with 18" drop used on 2" Sampler

(219) Hole No. CB-CHM84-18

<b>DRILLING LOG</b>		DIVISION South Atlantic	INSTALLATION Jacksonville District	SHEET 1 OF 1 SHEETS
1. PROJECT Canaveral Harbor		10. SIZE AND TYPE OF BIT see remarks		
2. LOCATION (Coordinates as Shown) X=622,410 Y=1,481,580		11. DATE FOR ELEVATION SHOWN (TBM or BSV) MEW		
3. DRILLING AGENCY Comps. of Engineers		12. MANUFACTURER'S DESIGNATION OF GRILL Failing 1500		
4. HOLE NO. (As shown on drawing title and file number) CM-CHM84-18		13. TOTAL NO. OF OVERBURDEN SAMPLES TAKEN DISTURBED UNDISTURBED		
5. NAME OF DRILLER R. Gordon		14. TOTAL NUMBER CORE BOXES 1		
6. DIRECTION OF HOLE <input checked="" type="checkbox"/> VERTICAL <input type="checkbox"/> INCLINED _____ DEG. FROM VERT.		15. ELEVATION GROUND WATER Tidal		
7. THICKNESS OF OVERBURDEN		16. DATE HOLE STARTED COMPLETED 19 Apr 84 19 Apr 84		
8. DEPTH DRILLED INTO ROCK		17. ELEVATION TOP OF HOLE -20.7		
9. TOTAL DEPTH OF HOLE 22.0'		18. TOTAL CORE RECOVERY FOR BORING 90 %		
		19. SIGNATURE OF OPERATOR GEOLOGIST J. Hand		

ELEVATION	DEPTH	LEGEND	CLASSIFICATION OF MATERIALS (Description)	% CORE RECOVERY	NO. OF SAMPLES	REMARKS (Drilling time, water loss, depth of penetration, etc., if significant)
a	b	c	d	e	f	g
-20.7	0.0					Bit or Barrel
			SAND, fine, quartz, silty, trace of shell, green (SM)	100	1	-20.7 BLS/ FT 2" Sampler
-27.0	6.3				2	
			CLAY, silty, slightly sandy, slightly shelly, slightly organic, green (CH)	100	3	"
					4	
				70	4	"
					5	
-38.7	18.0			80	5	-35.7 "
			SAND, fine, calcareous, shelly, white (SP)		6	-40.7
-42.7	22.0			0	-	" -42.7
						300# hammer with 18" drop used on 2" Sampler

(214)

Note No. CB-CHM84-19

DRILLING LOG		DIVISION South Atlantic	INSTALLATION Jacksonville District		SHEET 1 OF 1 SHEETS	
1. PROJECT Canaveral Harbor			10. SIZE AND TYPE OF BIT see remarks			
2. LOCATION (Coordinates or Station) Y=622,775 Y <sub>1</sub> 481,790			11. DATE FOR ELEVATION SHOWN (YEM or HSL) MLM			
3. DRILLING AGENCY Corps of Engineers			12. MANUFACTURER'S DESIGNATION OF DRILL Failing 150D			
4. HOLE NO. (As shown on drawing title) and file number CB-CHM84-19			13. TOTAL NO. OF OVER-BURDEN SAMPLES TAKEN DISTURBED: _____ UNDISTURBED: _____			
5. NAME OF DRILLER R. Gordon			14. TOTAL NUMBER CORE BOXES 1			
6. DIRECTION OF HOLE <input type="checkbox"/> VERTICAL <input type="checkbox"/> INCLINED _____ DEG. FROM VERT.			15. ELEVATION GROUND WATER Tidal			
7. THICKNESS OF OVERBURDEN			16. DATE HOLE STARTED COMPLETED 19 Apr 84 19 Apr 84			
8. DEPTH DRILLED INTO ROCK			17. ELEVATION TOP OF HOLE -23.7			
9. TOTAL DEPTH OF HOLE 20.0'			18. TOTAL CORE RECOVERY FOR BORING 100%			
			19. SIGNATURE OF INSPECTOR X GEOLOGIST J. Hand			
ELEVATION d	DEPTH b	LEGEND c	CLASSIFICATION OF MATERIALS (Description) d	SCORE RECOVERY e	SAMPLE NO. f	REMARKS (Drilling time, water loss, depth of weathering, etc., if significant) g
-23.7	0.0					Bit or Barrel
			SAND, fine, quartz, calcareous, slightly silty to silty, gray (SP-SM)	100	1	-23.7 BLS/ FT 2" Sampler Settled
			medium fine, shell fragments -32.7 to -33.7	100	2	
-33.7	10.0		CLAY, silty, traces of sand, shell and organic plant remains (CH)	100	3	
			SAND, medium quartz, silty, black (SM)	90	4	
-41.7	18.0				5	
-43.0	19.3				6	
-43.7	20.0		SANDSTONE			300# hammer with 18" drop used on 2" Sampler



Hole No. CB-CHM84-20

<b>DRILLING LOG</b>		<b>DIVISION</b> South Atlantic	<b>INSTALLATION</b> Jacksonville District	<b>SHEET</b> 1 OF 1 SHEETS
<b>1. PROJECT</b> Canaveral Harbor		<b>10. SIZE AND TYPE OF BIT</b> see remarks		
<b>2. LOCATION (Coordinates or Station)</b> X = 623,100 Y = 1,481,580		<b>11. DATUM FOR ELEVATION SHOWN (BSM or MSL)</b> MLW		
<b>3. DRILLING AGENCY</b> Corps of Engineers		<b>12. MANUFACTURER'S DESIGNATION OF DRILL</b> Failing 1500		
<b>4. HOLE NO. (As shown on drawing title and file number)</b> CB-CHM84-20		<b>13. TOTAL NO. OF OVERBURDEN SAMPLES TAKEN</b> DISTURBED: _____ UNDISTURBED: _____		
<b>5. NAME OF DRILLER</b> R. GORDON		<b>14. TOTAL NUMBER CORE BOXES</b> 1		
<b>6. DIRECTION OF HOLE</b> <input checked="" type="checkbox"/> VERTICAL <input type="checkbox"/> INCLINED _____ DEG. FROM VERT.		<b>15. ELEVATION GROUND WATER</b> Tidal		
<b>7. THICKNESS OF OVERBURDEN</b>		<b>16. DATE HOLE</b> STARTED: 19 Apr 84 COMPLETED: 19 Apr 84		
<b>8. DEPTH DRILLED INTO ROCK</b>		<b>17. ELEVATION TOP OF HOLE</b> -17.8		
<b>9. TOTAL DEPTH OF HOLE</b> 25.0'		<b>18. TOTAL CORE RECOVERY FOR BORING</b> 100 %		
<b>19. SIGNATURE OF INSPECTOR</b> X GEOLOGIST J. Hand				

ELEVATION	DEPTH	LEGEND	CLASSIFICATION OF MATERIALS (Description)	% CORE RECOVERY	SAMPLE NO.	REMARKS (Drilling logs, water loss, depth of weathering, etc., if significant)
a	b	c	d	e	f	g
-17.8	0.0					Bit or Barrel
-19.3	1.5		SAND, medium to fine, quartz silty, green (SM)		1	2" Sampler
			CLAY, silty, trace of sand and shell (CH)	100	2	
				100	3	
			layers of shell fragments -40.0 to -42.0			
				100	4	
				100	5	
			SANDSTONE, medium hard, calcareous, shell fragments, brown			
				100	6	
						300# hammer with 18" drop used on 2" Sampler

(218)

Holo No. CB-CHM84-21

<b>DRILLING LOG</b>		DIVISION South Atlantic	INSTALLATION Jacksonville District	SHEET 1 of 1 SHEETS
1. PROJECT Canaveral Harbor		10. SIZE AND TYPE OF BIT <i>see remarks</i>		
2. LOCATION (Coordinates or Station) Y=623.600 X=1,481.500		11. DATUM FOR ELEVATION SHOWN (ZEN or MSL) MLW		
3. DRILLING AGENCY Corps of Engineers		12. MANUFACTURER'S DESIGNATION OF DRILL Failing 1500		
4. HOLE NO. (As shown on drawing title and file number) CB-CHM84-21		13. TOTAL NO. OF OVERBURDEN SAMPLES TAKEN DISTURBED:     UNDISTURBED:		
5. NAME OF DRILLER R. Gordon		14. TOTAL NUMBER CORE BOXES 1		
6. DIRECTION OF HOLE <input checked="" type="checkbox"/> VERTICAL <input type="checkbox"/> INCLINED     DEG. FROM VERT.		15. ELEVATION GROUND WATER Tidal		
7. THICKNESS OF OVERBURDEN		16. DATE HOLE STARTED: 18 Apr 84     COMPLETED: 18 Apr 84		
8. DEPTH DRILLED INTO ROCK		17. ELEVATION TOP OF HOLE -27.1		
9. TOTAL DEPTH OF HOLE 15.0'		18. TOTAL CORE RECOVERY FOR BORING 100 %		
19. SIGNATURE OF INSPECTOR X GEOLOGIST J. Hand				

ELEVATION	DEPTH	LEGEND	CLASSIFICATION OF MATERIALS (Description)	CORE RECOVERY	SAMPLE NO.	REMARKS (Drilling time, water loss, depth of weathering, etc., if significant)
a	b	c	d	e	f	g
-27.1	0.0					Bit or Barrel
			CLAY, silty, traces of sand, shell and organic plant remains, green (CH)	100	1	2" Sampler Settled
						32.1
				100	2	"
						-37.1
						"
-42.1	15.0			100	3	300# hammer with 18" drop used on 2" Sampler
						-42.1



Hole No. CB-CHM84-23

<b>DRILLING LOG</b>		DIVISION South Atlantic	INSTALLATION Jacksonville District	SHEET 1 OF 1 SHEETS
1. PROJECT CANAVERAL HARBOR		10. SIZE AND TYPE OF BIT see remarks		
2. LOCATION (Coordinates or Station) Y=624 630 Y=1 081 530		11. DATUM FOR ELEVATION SHOWN (TBM or MSL) MLW		
3. DRILLING AGENCY Corps of Engineers		12. MANUFACTURER'S DESIGNATION OF DRILL Failing 1500		
4. HOLE NO. (As shown on drawing title and file number) CB-CHM84-23		13. TOTAL NO. OF OVER-BURDEN SAMPLES TAKEN UNSTURBED UNSTURBED		
5. NAME OF DRILLER R. Gordon		14. TOTAL NUMBER CORE BOXES 1		
6. DIRECTION OF HOLE <input checked="" type="checkbox"/> VERTICAL <input type="checkbox"/> INCLINED _____ DEG. FROM VERT.		15. ELEVATION GROUND WATER Tidal		
7. THICKNESS OF OVERBURDEN		16. DATE HOLE STARTED 18 Apr 84 COMPLETED 18 Apr 84		
8. DEPTH DRILLED INTO ROCK		17. ELEVATION TOP OF HOLE -22.8		
9. TOTAL DEPTH OF HOLE 20.0'		18. TOTAL CORE RECOVERY FOR BORING 75 %		
		19. SIGNATURE OF INSPECTOR GEOLOGIST J. Hand		

ELEVATION a	DEPTH b	LEGEND c	CLASSIFICATION OF MATERIALS (Description) d	% CORE RECOVERY e	SAMPLER NO. f	REMARKS (Drilling time, water loss, depth of weathering, etc., if significant) g
-22.8	0.0					Bit or Barrel
			SAND, fine, quartz, slightly silty, gray to green (SP)	100	1	2" Sampler Settled
			medium/fine shelly -32.8 to -39.0	80	2	"
				20	3	"
-39.0	16.2		CLAY, silty, gray, trace of sand, and shell, slightly organic (CH)	100	4	"
-42.8	20.0					300# hammer with 18" drop used on 2" Sampler

(71A)

Hole No. CB-CHM84-24

<b>DRILLING LOG</b>		DIVISION South Atlantic	INSTALLATION Jacksonville District	SHEET 1 OF 2 SHEETS
1. PROJECT Canaveral Harbor Extension		10. SIZE AND TYPE OF BIT <i>see remarks</i>		
2. LOCATION (Coordinates or Station) X=622,510 Y=1,481,785		11. DATUM FOR ELEVATION SHOWN (TBM or BLS)		
3. DRILLING AGENCY Corps of Engineers		12. MANUFACTURER'S DESIGNATION OF DRILL S&H		
4. HOLE NO. (As shown on drawing title and file needed) CB-CHM84-24		13. TOTAL NO. OF OVERBURDEN SAMPLES TAKEN		
5. NAME OF DRILLER D. Howser		14. TOTAL NUMBER CORE BOXES 1		
6. DIRECTION OF HOLE <input checked="" type="checkbox"/> VERTICAL <input type="checkbox"/> INCLINED _____ DEG. FROM VERT.		15. ELEVATION GROUND WATER Tidal		
7. THICKNESS OF OVERBURDEN		16. DATE HOLE STARTED 3/27/85 COMPLETED 3/27/85		
8. DEPTH DRILLED INTO ROCK		17. ELEVATION TOP OF HOLE -16.5		
9. TOTAL DEPTH OF HOLE 25.5'		18. TOTAL CORE RECOVERY FOR BORING 76 %		
19. SIGNATURE OF INSPECTOR GEOLOGIST J. Gentile				

ELEVATION e	DEPTH b	LEGEND c	CLASSIFICATION OF MATERIALS (Description) d	% CORE RECOVERY e	DETERMINED SAMPLE NO. f	REMARKS (Drilling time, water loss, depth of weathering, etc., if significant) g
						Bit or Barrel
-16.5	0.0					-16.5 BLS/0.5 FT
			SAND, fine to medium, quartz, slightly shelly, gray, isolated thin seams of clay, slightly silty from -16.5 to -17.0 (SP)	80	1	Split Spoon Settled 12
				73	2	" 7
						5
						6
-20.5	4.0		CLAY, silty, sandy, gray (CH)	66	3	" 7
						12
						21
-22.0	5.5			66	4	" 8
						1
						2
			SAND, fine, quartz, clayey, slightly silty, gray, isolated clay seams (SC)			-22.5 5
				80	5	" 2
-24.0	7.5		CLAY, slightly silty, gray, soft (CH)			-24.0 2
				100	6	" 3
						1
						1
						-25.5 1
				88	7	" 1
						1
						-27.0 1
				100	8	" 1
						1
						-28.5 1
				66	9	" 1
						1
						-30.0 1
				100	10	" 1
						1
						-31.5 1
				73	11	" 3
						3
						-33.0 3
				100	12	" 1
						1
						-34.5 1
				73	13	" 2
-36.0	19.5					2
						2

DRILLING LOG (Cont Sheet)		ELEVATION TOP OF HOLE		Hole No. CB-CWM84-24		
PROJECT			INSTALLATION		SHEET	
CANAVERAL HARBOR EXTENSION			Jacksonville District		2	
ELEVATION	DEPTH	LEGEND	CLASSIFICATION OF MATERIALS (Description)	% CORE RECOVERY	SAMPLE NO.	REMARKS (Drilling time, water loss, depth of weathering, etc., if significant)
a	b	c	d	e	f	g
						Bit or Barrel
-36.0	19.5					-36.0 BLS/0.5 FT
-36.2	19.7		Medium hard limestone, poorly cemented from -36.0 to -36.2	80	14	Split Spoon 10
-37.5	21.0		SAND, fine to medium, quartz, silty, tan, organic stain, slightly shelly (SM)			-37.5 10
			SAND, fine, quartz, shelly, slightly clayey, light gray (SP)	60	15	" 18
-39.5	23.0					-39.0 21
			SAND, fine, quartz, light gray, clayey (SC)	66	16	" 12
						-40.5 7
						7
						4
-42.0	25.5			26	17	" 6
						-42.0 11
						140# hammer with 30" drop used on 2' split spoon (1-3/8" ID x 2" OD)

(220)

Mole No. CB-CHM84-25

DRILLING LOG		DIVISION		INSTALLATION		SHEET		
South Atlantic		Jacksonville District		SHEET 1		OF 2 SHEETS		
1. PROJECT Canaveral Harbor Extension				10. SIZE AND TYPE OF BIT SEE REMARKS				
2. LOCATION (Coordinates or Station) X=622,365 Y=1,481,790				11. DATUM FOR ELEVATION SHOWN (TBM or BSL) MLW				
3. DRILLING AGENCY Corps of Engineers				12. MANUFACTURER'S DESIGNATION OF DRILL SAH Skid Rig				
4. HOLE NO. (As shown on drawing title and file number) CB-CHM84-25				13. TOTAL NO. OF OVER-BURDEN SAMPLES TAKEN		14. TOTAL NUMBER CORE BOXES		
5. NAME OF DRILLER D. HOWSER				15. ELEVATION GROUND WATER Tidal		16. DATE HOLE		
6. DIRECTION OF HOLE <input checked="" type="checkbox"/> VERTICAL <input type="checkbox"/> INCLINED _____ DEG. FROM VERT.				17. ELEVATION TOP OF HOLE -16.0		18. TOTAL CORE RECOVERY FOR BORING 75 %		
7. THICKNESS OF OVERBURDEN				19. SIGNATURE OR IMPRESSION GEOLOGIST J. Gentile				
8. DEPTH DRILLED INTO ROCK								
9. TOTAL DEPTH OF HOLE 26.0'								
ELEVATION a	DEPTH b	LEGEND c	CLASSIFICATION OF MATERIALS (Description) d	% CORE RECOVERY e	DESIGNATION OF SAMPLE NO. f	REMARKS (Drilling time, water loss, depth of weathering, etc., if significant) g		
						Bit or Barrel		
-16.0	0.0					-16.0	BLS/0.5 FT Settled	
		[Pattern: Dotted]	SAND, fine to medium, quartz, slightly silty, loose, gray, slightly shelly (SP)	60	1	Split Spoon		
				33	2	"		
				73	3	"		
-20.5	4.5					-20.5		
		[Pattern: Diagonal lines]	SAND, fine, quartz, clayey, gray, soft (SC)	60	4	"		
				73	5	"		
				60	6	"		
-25.0	9.0					-25.0		
		[Pattern: Horizontal lines]	CLAY, soft, slightly sandy, slightly shelly, gray (CH)	93	7	"		
				80	8	"		
				100	9	"		
				73	10	"		
				93	11	"		
				88	12	"		
				88	13	"		
					slightly compact from -35.0 to -38.0			

DRILLING LOG (Cont Sheet)		ELEVATION TOP OF HOLE -16.0		Hole No. CB-CHM84-25		
PROJECT CANAVERAL HARBOR EXTENSION			INSTALLATION Jacksonville District			
			SHEET 2 OF 2 SHEETS			
ELEVATION a	DEPTH b	LEGEND c	CLASSIFICATION OF MATERIALS (Description) d	% CORE RECOV- ERY e	SAMPLE NO. F	REMARKS (Drilling time, water loss, depth of weathering, etc., if significant) g
						Bit or Barrel
						-35.5 BLS/0.5 FT
				80	14	Split Spoon 2
						2
						-37.0 3
						1
-38.0	22.0		SHELL, fragments, silty with organic stain, brown from -38.0 to -38.5	80	15	" 2
-38.5	22.5					-38.5 13
-39.0	23.0					16
-40.0	24.0		SAND, fine to medium quartz, shelly (45% shell) clayey (SC)	66	16	" 30
						-40.0 24
						6
-42.0	26.0		SAND, fine quartz, clayey, trace silt, trace shell, gray (SC)	80	17	" 8
						10
						-42.0 12
						-140# hammer with 30" drop used on 2' split spoon (1-3/8" ID x 2" OD)



Hole No. CB-CHM84-26

DRILLING LOC South Atlantic		INSTALLATION Jacksonville District		SHEET 1 OF 3 SHEETS	
1. PROJECT Canaveral Harbor Extension			10. SIZE AND TYPE OF BIT see remarks		
2. LOCATION (Coordinates or Station) X=622,135 Y=1,481,910			11. DAY ON FOR ELEVATION SHOWN (FSM or ASL) MLW		
3. DRILLING AGENCY Corps of Engineers			12. MANUFACTURER'S DESIGNATION OF DRILL Falling 1500		
4. HOLE NO. (As shown on drawing title and file number) CB-CHM84-26			13. TOTAL NO. OF OVER-BURDEN SAMPLES TAKEN		DISTURBED UNDISTURBED
5. NAME OF DRILLER D. Housey			14. TOTAL NUMBER CORE BOXES 1		15. ELEVATION GROUND WATER +2.5
6. DIRECTION OF HOLE <input checked="" type="checkbox"/> VERTICAL <input type="checkbox"/> INCLINED _____ DEG. FROM VERT.			16. DATE HOLE 13/12/85		COMPLETED 3/14/85
7. THICKNESS OF OVERBURDEN			17. ELEVATION TOP OF HOLE +9.7		
8. DEPTH DRILLED INTO ROCK			18. TOTAL CORE RECOVERY FOR BORING 76 %		
9. TOTAL DEPTH OF HOLE 48.0'			19. SIGNATURE OF INSPECTOR GEOLOGIST J. Gentile		

ELEVATION a	DEPTH b	LEGEND c	CLASSIFICATION OF MATERIALS (Description) d	% CORE RECOVERY e	SAMPLE NO. f	REMARKS (Drilling time, water loss, depth of weathering, etc. if significant) g
+9.7	0.0					Bit or Barrel
			SAND, fine to coarse, quartz and shell fragments, clean, tan, shelly (SP)	80	1	Split Spoon
						+8.2
				73	2	"
						+6.7
				88	3	"
						+5.2
				80	4	"
						+3.7
				88	5	"
						+2.2
				80	6	"
						+0.7
-0.3	10.0		GRAY (CH) CLAY from -0.3 to	66	7	"
-0.8	10.5					-0.8
			SAND, fine to medium, quartz, silty, slightly clayey, shelly, gray (SM)	73	8	" Pushed
-2.8	12.5					-2.3
			SAND, fine to medium, quartz, slightly clayey, shelly, gray (SP)	66	9	"
-4.8	14.5					-3.8
			SAND, fine to medium, quartz, clayey, silty, shelly, gray, seams of (CH) clay (SC)	73	11	"
						-6.8
-8.3	18.0			73	12	"
			SAND, fine to medium, quartz, slightly shelly, gray (SP)	80	13	"
						-9.8

DRILLING LOG (Cont. Sheet)		ELEVATION TOP OF HOLE +9.7		Hole No. CB-CHMBQ-26		
PROJECT Canaveral Harbor Extension			INSTALLATION Jacksonville District		SHEET 2 of 3 sheets	
ELEVATION a	DEPTH b	LEGEND c	CLASSIFICATION OF MATERIALS (Description) d	% CORE RECOV. ERY e	EXCESSIVE SAMPLE NO. f	REMARKS (Drilling time, water loss, depth of weathering, etc., if significant) g
						Bit or Barrel
						-9.8 BLS/0.5 FT
				88	14	Split Spoon
						-11.3
				73	15	"
						-12.8
				66	16	"
						-14.3
				73	17	"
						-15.8
-15.8	25.5					
			SAND, fine, quartz, silty, gray, (SM), thin seams of (CH) clay	80	18	"
						-17.3
				73	19	"
						-18.8
				66	20	"
						-20.3
				46	21	"
						-21.8
				93	22	"
						-23.3
				66	23	"
			Shelly from -24.8 to -25.3			-24.8
-24.8	34.5					
			CLAY, soft, gray (CH)	100	24	"
						-26.3 Pushed
-25.3	35.0					
				80	25	"
						-27.8
				100	26	"
						-29.3
				80	27	"
						-30.8
				100	28	"
						-32.3
				66	29	"
			SAND, fine to medium quartz,			-33.8
-33.3	43.0					

DRILLING LOG (Cont Sheet)			ELEVATION TOP OF HOLE +9.7		Hole No. CB-CHM84-26	
PROJECT Canaveral Harbor Extension			INSTALLATION Jacksonville District		SHEET 3 OF 3 SHEETS	
ELEVATION a	DEPTH b	LEGEND c	CLASSIFICATION OF MATERIALS (Description) d	% CORE RECOV. ERY e	LABORATORY SAMPLE NO. f	REMARKS (Drilling size, water loss, depth of weathering, etc., if significant) g
						Bit or Barrel
-34.8	44.5		SAND, fine to medium quartz, dark brown, silty, organic stain, trace of shell (SM)	46	30	-33.8 BLS/0.5 FT Split Spoon Washed
-36.8	46.5		SAND, fine to coarse, quartz shelly, tan (SP) isolated limestone lenses, slightly limy, 80% sand size shell fragments from -36.8 to -38.3	73	31	-35.3 " 12 -36.8 23 " 25
-38.3	48.0			66	32	" 18 -38.3 22 " 30
			NOTE: Core Hole backfilled.			140# hammer with 30" drop used on 2' split spoon (1-3/8" ID x 2" OD)

22

Hole No. CB-CHM84-27

<b>DRILLING LOG</b>		DIVISION South Atlantic	INSTALLATION Jacksonville District	SHEET 1 of 2 SHEETS
1. PROJECT Canaveral Harbor Extension		10. SIZE AND TYPE OF BIT 5 1/2" REMARKS		
2. LOCATION (Coordinates or Station) X=621.755 Y=1.481-826		11. DAY ON FOR ELEVATION SHOWN (TBM or HSL) MLW		
3. DRILLING AGENCY Corps of Engineers		12. MANUFACTURER'S DESIGNATION OF DRILL Failing 1500		
4. HOLE NO. (As shown on drawing title and file number) CB-CHM84-27		13. TOTAL NO. OF OVER-BURDEN SAMPLES TAKEN DISTURBED _____ UNDISTURBED _____		
5. NAME OF DRILLER L. C. Gregory		14. TOTAL NUMBER CORE BOXES 1		
6. DIRECTION OF HOLE <input checked="" type="checkbox"/> VERTICAL <input type="checkbox"/> INCLINED _____ DEG. FROM VERT.		15. ELEVATION GROUND WATER +2.0		
7. THICKNESS OF OVERBURDEN		16. DATE HOLE STARTED 4/11/85 COMPLETED 4/12/85		
8. DEPTH DRILLED INTO ROCK		17. ELEVATION TOP OF HOLE +5.0		
9. TOTAL DEPTH OF HOLE 46.5'		18. TOTAL CORE RECOVERY FOR BORING 67 %		
		19. SIGNATURE OF INSPECTOR GEOLOGIST J. Gentile		

ELEVATION a	DEPTH b	LEGEND c	CLASSIFICATION OF MATERIALS (Description) d	% CORE RECOVERY e	DIAGRAM SAMPLE NO. f	REMARKS (Drilling time, water loss, depth of weathering, etc., if significant) g
						Bit or Barrel
+5.0	0.0					+5.0 BLS/0.5 FT
			SAND, fine to medium, quartz, clean, slightly shelly, tan (SP)	73	1	Split Spoon Pushed
						2
						3
						4
						6
						6
+1.5	3.5		Bed of clayey sand (SC) from +1.5 to +0.5	73	3	"
						2
+0.5	4.5		Slightly shelly, slightly clayey from +0.5 to -0.5			+0.5
						4
						5
						6
-0.5	5.5		Bed of clayey sand (SC) from -0.5 to -2.0	66	4	"
						3
						1
-2.0	7.0		Sand (SP), clean, slightly shelly, gray, from -2.0 to -4.5	80	5	"
						2
						8
						5
						11
-4.5	9.5		Bed of (SC) sand from -4.5 to -5.0	53	6	"
						9
-5.0	10.0		CLAY, sandy, gray, soft (CH)	93	7	"
						3
						1
-6.5	11.5			60	8	Pushed
						1
			SAND, fine, quartz, slightly clayey, slightly silty, gray (SP)	66	9	"
						7
						7
						9
						5
						2
						5
						7
						8
						10
						17
						2
						5
-13.0	18.0		Bed of sandy (CL) clay from -13.0 to -13.5	60	12	"
						6
-13.5	18.5					3
						5
-14.5	19.5			66	13	"
						9
						140# hammer with 30" drop used on 2" split spoon (1-3/8" ID x 2" OD)

DRILLING LOG (Cont Sheet)		ELEVATION TOP OF HOLE +5.0		Hole No. CB-CHM84-27		
PROJECT Canaveral Harbor Extension			INSTALLATION Jacksonville District		SHEET 2 OF 2 SHEETS	
ELEVATION a	DEPTH b	LEGEND c	CLASSIFICATION OF MATERIALS (Description) d	% CORE RECOV- ERY e	NO. SAMPLE NO. f	REMARKS (Drilling time, water loss, depth of weathering, etc., if significant) g
						Bit or Barrel
-14.5	19.5					-14.5 BLS/0.5 FT
			CLAY, slightly sandy, slightly shelly, soft, gray (CL)	88	14	Split Spoon
-16.5	21.5					-16.0
			SAND, fine, quartz, clayey, gray, soft (SC)	60	15	"
-17.9	22.9					-17.5
			Bed of (CL) clay, sandy, from -17.9 to -18.5	80	16	"
-18.5	23.5					-19.0
			Bed of (CL) clay, very soft from -20.5 to -21.5	53	17	"
-20.5	25.5					-20.5
				53	18	"
-21.5	26.5					-22.0
				NO REC		"
-23.5	28.5					-23.5
			CLAY, fat, slightly shelly, seams of clayey sand, gray, slightly compact (CH)	80	19	"
						-25.0
				80	20	"
						-26.5
			Bed of (SC) sand from -27.5 to -28.0	93	21	"
-27.5	32.5					-28.0
-28.0	33.0					
				88	22	"
						-29.5
				80	23	"
						-31.0
				80	24	"
			SAND, medium, quartz, silty (SM), dark brown, organic stain from -32.0 to -33.0			-32.5
-32.0	37.0					
				80	25	"
-33.0	38.0					-34.0
-33.8	38.8					
			SAND, fine to medium, quartz, shelly, slightly silty, gray (SP)	66	26	"
						-35.5
				66	27	"
						-37.0
				60	28	"
			slightly shelly, from -38.5 to -41.5			-38.5
-38.5	43.5					
				80	29	"
						-40.0
				60	30	"
						-41.5

213  
Hole No. CB-CHM84-28

DRILLING LOG		DIVISION	INSTALLATION	SHEET		
1. PROJECT Canaveral Harbor Extension		South Atlantic	Jacksonville District	1 of 2 SHEETS		
2. LOCATION (Coordinates or Station) Y=621,495 Y=1,481,745			10. SIZE AND TYPE OF BIT see remarks			
3. DRILLING AGENCY Corps of Engineers			11. DATUM FOR ELEVATION SHOWN (TBM or BSL) MLW			
4. HOLE NO. (As shown on drawing title and file number) CB-CHM84-28			12. MANUFACTURER'S DESIGNATION OF DRILL S&H			
5. NAME OF DRILLER D. Howser			13. TOTAL NO. OF OVERBURDEN SAMPLES TAKEN	1 DISTURBED UNDISTURBED		
6. DIRECTION OF HOLE <input type="checkbox"/> VERTICAL <input type="checkbox"/> INCLINED _____ DEG. FROM VERT.			14. TOTAL NUMBER CORE BOXES 1			
7. THICKNESS OF OVERBURDEN			15. ELEVATION GROUND WATER Tidal			
8. DEPTH DRILLED INTO ROCK			16. DATE HOLE STARTED 4/10/85 COMPLETED 4/10/85			
9. TOTAL DEPTH OF HOLE 37.5'			17. ELEVATION TOP OF HOLE -4.5			
			18. TOTAL CORE RECOVERY FOR BORING 67%			
			19. SIGNATURE OF INSPECTOR GEOLOGIST J. Gentile			
ELEVATION a	DEPTH b	LEGEND c	CLASSIFICATION OF MATERIALS (Description) d	RECOVERY e	SAMPLE NO. f	REMARKS (Drilling time, water loss, depth of washing, etc., if significant) g
-4.5	0.0					Bit or Barrel
						-4.5 BLS/0.5 FT
			SAND, fine, quartz, clayey, slightly silty, gray, isolated thin beds of sandy (Cl) clay (Sc)	80	1	Split Spoon 1
						6.0 2
				66	2	" 1
						-7.5 2
				73	3	" 4
						-9.0 7
				73	4	" 3
						-10.5 4
				88	5	" 1
						-12.0 2
				80	6	" 2
						-13.5 4
				88	7	" 1
						-15.0 1
				60	8	" 2
						-16.5 4
				46	9	" 5
						-18.0 7
				33	10	" 4
						-19.5 4
				60	11	" 5
						-21.0 2
				12	12	" 1
						-22.5 5
				60	13	" 2
						-24.0 1

ENG FORM 1836 MAR 71 PREVIOUS EDITIONS ARE OBSOLETE.

PROJECT CANAVERAL HARBOR EXTENSION HOLE NO. CB-CHM84-28

DRILLING LOG (Cont Sheet)			ELEVATION TOP OF HOLE -4.5	Hole No. CB-CH#84-28		
PROJECT Canaveral Harbor Extension			INSTALLATION Jacksonville District		SHEET 2 OF 2 SHEETS	
ELEVATION a	DEPTH b	LEGEND c	CLASSIFICATION OF MATERIALS (Description) d	% CORE RECOVERY e	EXAMINATION SAMPLE NO. f	REMARKS (Drilling time, water loss, depth of weathering, etc., if significant) g
						Bit or Barrel
						-24.0 BLS/0.5 FT
-25.5	21.0			53	14	Split Spoon 1
						-25.5 2
			CLAY, slightly compact, dark gray, fat (CH)	100	15	" 1
						-27.0 1
				100	16	" 2
						-28.5 1
				100	17	" 1
						-30.0 1
-30.5	26.0			50	18	" 2
			SAND, medium, quartz, silty, brown, organic stain (SM)			-31.5 1
-32.0	27.5			66	19	" 4
-32.5	28.0		SAND, fine to medium, quartz and shell fragments, clean (SP); thin lenses of medium hard Limestone (cemented shell from -32.0 to -32.5	66	20	" 14
						-33.0 24
-34.5	30.0					-34.5 27
			SHELL, sand to gravel size shell fragments, some quartz grains, trace of silt, gray	66	21	" 20
						-36.0 26
				60	22	" 18
						-37.5 18
-37.5	33.0					-37.5 19
-38.5	34.0		SAND, fine, quartz, clayey, slightly shelly (SC)	88	23	" 6
						-39.0 8
-39.3	34.8		Bed of sandy (CL) clay from -38.5 to -39.3	12	24	" 2
			Bed of shelly sand (SP), from -39.3 to -40.5			4
-40.5	36.0					-40.5 20
			very clayey sand (SC), shelly soft, from -40.5 to -42.0	88	25	" 30
						-42.0 1
-42.0	37.5					-42.0 1
						140# hammer with 30" drop used on 2" split spoon (1-3/8" ID x 2" OD)

Hole No. CB-CHM84-29

DRILLING LOG		DIVISION South Atlantic	INSTALLATION Jacksonville District	SHEET OF 2 SHEETS
1. PROJECT Canaveral Harbor Extension		10. SIZE AND TYPE OF BIT see remarks		
2. LOCATION (Coordinates or Station) X=620,760 Y=1,481,845		11. DEPTH FOR ELEVATION SHOWN (TBM or BSL) M.L.W.		
3. DRILLING AGENCY Corps of Engineers		12. MANUFACTURER'S DESIGNATION OF DRILL S&H		
4. HOLE NO. (As shown on drawing title and file number) CB-CHM84-29		13. TOTAL NO. OF OVER-BURDEN SAMPLES TAKEN DISTURBED _____ UNDISTURBED _____		
5. NAME OF DRILLER D. Howser		14. TOTAL NUMBER CORE BOXES 1		
6. DIRECTION OF HOLE <input checked="" type="checkbox"/> VERTICAL <input type="checkbox"/> INCLINED _____ DEG. FROM VERT.		15. ELEVATION GROUND WATER Tidal		
7. THICKNESS OF OVERBURDEN		16. DATE HOLE STARTED 3/29/85 COMPLETED 3/29/85		
8. DEPTH DRILLED INTO ROCK		17. ELEVATION TOP OF HOLE -14.1		
9. TOTAL DEPTH OF HOLE 28.5'		18. TOTAL CORE RECOVERY FOR BORING 56 %		
19. SIGNATURE OF INSPECTOR GEOLOGIST J. Gentile				

ELEVATION a	DEPTH b	LEGEND c	CLASSIFICATION OF MATERIALS (Description) d	% CORE RECOVERY e	SAMPLE NO. f	REMARKS (Drilling time, water loss, depth of weathering, etc., if significant) g
						Bit or Barrel
-14.1	0.0					-14.1 BLS/0.5 FT
			SAND, fine to medium, quartz slightly silty, gray, slightly shelly (SP)	66	1	Split Spoon Settled
				60	2	-15.6
				60	2	
				60	3	
			CLAY, soft, gray, slightly shelly, slightly sandy (CH)	80	3	" Pushed
				80	4	" Pushed
				73	5	" Pushed
-21.6	7.5					-21.6
			SAND, fine to medium, quartz tan, slightly clayey (SP)	26	6	"
				73	7	"
				66	8	"
-26.1	12.0					-26.1
			SHELL, sand to gravel size fragments, trace of silt, sandy,	53	9	"
-27.6	13.5					-27.6
			SAND, fine to medium, quartz, slightly shelly, gray, slightly silty (SP)	NO REC		"
				66	10	"
				46	11	"
				60	12	"
-33.6	19.5					-33.6



DRILLING LOG (Cont) Sheet		ELEVATION TOP OF HOLE		Hole No.		
PROJECT CANAVERAL HARBOR EXTENSION		-14.1		CB-CHM84-29		
		INSTALLATION Jacksonville District		SHEET 2 OF 2 SHEETS		
ELEVATION a	DEPTH b	LEGEND c	CLASSIFICATION OF MATERIALS (Description) d	% CORE RECOVERY e	SAMPLE NO. f	REMARKS (Drilling time, water loss, depth of weathering, etc., if significant) g
						Bit or Barrel
-33.6	19.5					-33.5 BLS/0.5 FT
			SAND, fine quartz, slightly silty, slightly shelly, gray, slightly clayey. (SM)	73	13	Split Spoon
				60	14	"
-36.6	22.5		Sandy, silty clay (CH), from -36.6 to -37.6	66	15	"
-37.6	23.5					
			SAND, fine to medium, quartz, clayey, shelly, gray (SC)	46	16	"
-39.6	25.5					
			CLAY, soft, sandy, slightly silty, seams of shelly sand (CH)	66	17	"
				66	18	"
-42.6	28.5					
						140# hammer with 30" drop used on 2' split spoon (1-3/8" ID x 2" OD)

275

Hole No. CB-CHM84-30

<b>DRILLING LOG</b>		Division South Atlantic	INSTALLATION Jacksonville District	SHEET 1 OF 2 SHEETS
1. PROJECT Canaveral Harbor Extension		10. SIZE AND TYPE OF BIT see remarks		
2. LOCATION (Coordinates or Station) X=620,460 Y=1,481,720		11. DATUM FOR ELEVATION SHOWN (TBM or BSL) MLW		
3. DRILLING AGENCY Corps of Engineers		12. MANUFACTURER'S DESIGNATION OF DRILL S&H		
4. HOLE NO. (As shown on drawing title and file number) CB-CHM84-30		13. TOTAL NO. OF OVER-BURDEN SAMPLES TAKEN DISTURBED _____ UNDISTURBED _____		
5. NAME OF DRILLER D. Howser		14. TOTAL NUMBER CORE BOXES 1		
6. DIRECTION OF HOLE <input checked="" type="checkbox"/> VERTICAL <input type="checkbox"/> INCLINED _____ DEG. FROM VERT.		15. ELEVATION GROUND WATER Tidal		
7. THICKNESS OF OVERBURDEN		16. DATE HOLE STARTED 4/1/85 COMPLETED 4/2/85		
8. DEPTH DRILLED INTO ROCK		17. ELEVATION TOP OF HOLE -12.8		
9. TOTAL DEPTH OF HOLE 30.0'		18. TOTAL CORE RECOVERY FOR BORING 60%		
		19. SIGNATURE OF INSPECTOR GEOLOGIST J. Gentile		

ELEVATION a	DEPTH b	LEGEND c	CLASSIFICATION OF MATERIALS (Description) d	% CORE RECOVERY e	HOLOGRAM SAMPLE NO. f	REMARKS (Ditto, thin, water loss, depth of weathering, etc., if significant) g
						Bit or Barrel
-12.8	0.0					-12.8 BLS/0.5 FT
			SAND, fine to medium, quartz, slightly silty, gray, slightly shelly, (SP)	73	1	Split Spoon
						-14.3
			clayey from -15.8 to -16.8	80	2	"
						-15.8
				73	3	" Pushed
			CLAY, soft, slightly sandy, silty, gray (CH)	66	4	" Pushed
						-17.3
						-18.8
			SAND, medium, quartz, slightly silty, tan (SP)	60	5	"
						-20.3
				33	6	"
						-21.8
				33	7	"
						-23.3
				33	8	"
						-24.8
			slightly clayey, shelly, light gray, from -25.3 to -30.8	60	9	"
						-26.3
				46	10	"
						-27.8
				73	11	"
						-29.3
			slightly shelly, slightly silty, from -30.8 to -34.8	60	12	"
						-30.8
				80	13	" Washed
						-32.3

DRILLING LOG (Cont Sheet)		ELEVATION TOP OF HOLE -12.8		Hole No. CB-CHM64-30		
PROJECT Canaveral Harbor Extension			INSTALLATION Jacksonville District			
ELEVATION a	DEPTH b	LEGEND c	CLASSIFICATION OF MATERIALS (Description) d	% CORE RECOV- ERY e	DIESTER SAMPLE NO. f	REMARKS (Drilling time, water loss, depth of weathering, etc., if significant) g
						Bit or Barrel
						-32.3 BLS/0.5 FT
				73	14	Split Spoon
						7
						15
						23
				66	15	"
						3
						4
-34.8	22.0					-33.8
						1
						2
						5
				60	16	"
						7
						1
						3
						12
				60	17	"
						20
						10
						10
						2
						3
						4
				66	19	"
						3
						4
						3
						4
						7
-42.8	30.0					-41.3
						3
						4
				60	20	"
						4
						7
						-42.8
						140# hammer with 30" drop used on 2' split spoon (1-3/8" ID x 2" OD)





DRILLING LOG (Cont Sheet)			ELEVATION TOP OF HOLE -5.0		Hole No. CB-CHMB4-37	
PROJECT Canaveral Harbor Extension			INSTALLATION Jacksonville District			SHEET 2 OF 2 SHEETS
ELEVATION a	DEPTH b	LEGEND c	CLASSIFICATION OF MATERIALS (Description) d	% CORE RECOV- ERY e	NUMBER FOR SAMPLE NO. f	REMARKS (Drilling time, water loss, depth of weathering, etc., if significant) g
						Bit or Barrel
						-24.5 BLS/0.5 FT
-25.5	20.5		SHELL, sand to gravel (cont'd)	46	14	Split Spoon
						8
						10
			SAND, fine to medium, quartz, clean, shelly, gray (SP)			-26.0
						4
				NO REC		"
						18
						-27.5
						4
				53	15	"
						5
						8
						-29.0
						18
				60	16	"
						10
						14
-30.5	25.5		slightly silty from -30.5 to -32.0			-30.5
						4
-32.0	27.0					"
						4
				66	17	"
						12
						-32.0
						14
-33.5	28.5		SAND, fine, quartz, silty, gray (SM)	46	18	"
						8
						-33.5
						16
						20
				60	19	"
						4
						-35.0
						3
-35.5	30.5		Clayey, with seams of (CH) clay from -33.5 to -35.0			"
						3
						3
				33	20	"
						3
						8
						-36.5
						12
				53	21	"
						2
						-38.0
						3
				33	22	"
						2
						-39.5
						9
-40.0	35.0					4
						4
				88	23	"
						2
						-41.0
						1
						1
-42.5	37.5		CLAY, silty, gray, slightly compact, sandy, slightly shelly (CL)	66	24	"
						1
						2
						4
						-42.5
						4
						140# hammer with 30" drop used on 2" split spoon (1-3/8" ID x 2" OD)

DRILLING LOG		DIVISION		INSTALLATION		Hole No. CB-CHM84-35	
South Atlantic		Jacksonville District		SHEET 1		OF 1 SHEETS	
1. PROJECT Canaveral Harbor Maintenance				10. SIZE AND TYPE OF BIT 2" Sampler			
2. LOCATION (Coordinates or Station) X=630,770 Y=1,481,590				11. DATUM FOR ELEVATION BROWN (FOOT OR METERS) MLW			
3. DRILLING AGENCY Corps of Engineers				12. MANUFACTURER'S DESIGNATION OF DRILL ACKER PORTABLE			
4. HOLE NO. (As shown on drawing title and file number) CB-CHM84-35				13. TOTAL NO. OF OVERBURDEN SAMPLES TAKEN 9		14. TOTAL NUMBER CORE BOXES PARTIAL	
5. NAME OF DRILLER C. Mason				15. ELEVATION GROUND WATER TIDAL			
6. DIRECTION OF HOLE <input checked="" type="checkbox"/> VERTICAL <input type="checkbox"/> INCLINED _____ DEG. FROM VERT.				16. DATE HOLE STARTED 7/16/85		COMPLETED 7/16/85	
7. THICKNESS OF OVERBURDEN				17. ELEVATION TOP OF HOLE -31.0			
8. DEPTH DRILLED INTO ROCK				18. TOTAL CORE RECOVERY FOR BORING 100			
9. TOTAL DEPTH OF HOLE 10.0'				19. SIGNATURE OF INSPECTOR X GEOLOGIST: R. ROSS			
ELEVATION	DEPTH	LEGEND	CLASSIFICATION OF MATERIALS (Description)	% CORE RECOVERY	BOX OR SAMPLE NO.	REMARKS (Drilling time, water loss, depth of weathering, etc., if significant)	
-31.0	0.0						
-31.5	0.5		SAND, gray, fine quartz, silty (SM)	100	1	2" SAMPLER	
			CLAY, gray, medium plasticity, with fine quartz sand (CL)		2		
					3		
-35.0	4.0				4		
			SAND, gray, fine quartz, silty (SM)	100	5	2" SAMPLER	
-37.5	6.5				6		
			SILT, gray, with fine quartz sand (ML)		7		
					8		
-40.0	9.0						
-41.0	10.0		SAND, gray, fine quartz, silty (SM)			-41.0	
			NOTE Sample #9 is a surface grab sample				

(23)

Hole No. CB-CHM84-36

<b>DRILLING LOG</b>		DIVISION South Atlantic	INSTALLATION Jacksonville District	SHEET 1
1. PROJECT Canaveral Harbor Maintenance		10. SIZE AND TYPE OF BIT 2" Sampler		
2. LOCATION (Coordinates or Station) X=630,110 Y=1,481,580		11. DATUM FOR ELEVATION SHOWN (FEET or MSL) MLW		
3. DRILLING AGENCY Corps of Engineers		12. MANUFACTURER'S DESIGNATION OF DRILL ACKER PORTABLE		
4. HOLE NO. (As shown on drawing title and H's number) CB-CHM84-36		13. TOTAL NO. OF OVER-BURDEN SAMPLES TAKEN 4	DISTURBED	UNDISTURBED
5. NAME OF DRILLER C. Mason		14. TOTAL NUMBER CORE BOXES PARTIAL		
6. DIRECTION OF HOLE <input checked="" type="checkbox"/> VERTICAL <input type="checkbox"/> INCLINED _____ DEG. FROM VERT.		15. ELEVATION GROUND WATER TIDAL		
7. THICKNESS OF OVERBURDEN		16. DATE HOLE	STARTED	COMPLETED
8. DEPTH DRILLED INTO ROCK		7/17/85	7/17/85	7/17/85
9. TOTAL DEPTH OF HOLE 10.0		17. ELEVATION TOP OF HOLE -33.5		
		18. TOTAL CORE RECOVERY FOR BORING 50%		
		19. SIGNATURE OF INSPECTOR GEOLOGIST: R. ROSS		

ELEVATION a	DEPTH b	LEGEND c	CLASSIFICATION OF MATERIALS (Description) d	% CORE RECOVERY e	BOX OR SAMPLE NO. f	REMARKS (Drilling time, water loss, depth of weathering, etc., if significant) g
-33.5	0.0					-33.5
-36.5	3.0		CLAY, dark gray, sandy (CL)	50	1	2" Sampler
			SAND, gray, fine quartz, silty (SM)		2	-38.5
-41.5	8.0			50	3	2" Sampler
-43.5	10.0		CLAY, gray, sandy (CL)		4	-43.5

Hole No. CB-CHM84-37

DRILLING LOG		DIVISION	INSTALLATION	SHEET		
		South Atlantic	Jacksonville District	1		
1. PROJECT Canaveral Harbor Maintenance		10. SIZE AND TYPE OF BIT 2" Sampler				
2. LOCATION (Coordinates or Station) X=629,870 Y=1,481,600		11. DATUM FOR ELEVATION (KNOWN OR ASSUMED) MLW				
3. DRILLING AGENCY Corps of Engineers		12. MANUFACTURER'S DESIGNATION OF DRILL ACKER PORTABLE				
4. HOLE NO. (As shown on drawing title and title number) CB-CHM84-37		13. TOTAL NO. OF OVER-BURDEN SAMPLES TAKEN 6	DISTURBED 6	UNDISTURBED		
5. NAME OF DRILLER C. Mason		14. TOTAL NUMBER CORE BOXES PARTIAL				
6. DIRECTION OF HOLE <input checked="" type="checkbox"/> VERTICAL <input type="checkbox"/> INCLINED _____ DEG. FROM VERT.		15. DATE HOLE STARTED 7/17/85	COMPLETED 7/17/85	18. ELEVATION GROUND WATER TIDAL		
7. THICKNESS OF OVERBURDEN		17. ELEVATION TOP OF HOLE -31.0				
8. DEPTH DRILLED INTO ROCK		19. TOTAL CORE RECOVERY FOR BORING 63 %				
9. TOTAL DEPTH OF HOLE 10.0		SIGNATURE OF SUPERVISOR GEOLOGIST: R. ROSS				
ELEVATION	DEPTH	LEGEND	CLASSIFICATION OF MATERIALS (Description)	% CORE RECOVERY	BOX OR SAMPLE NO.	REMARKS (Drilling time, water loss, depth of weathering, etc., if significant)
-31.0	0.0					-31.0
-34.0	3.0		SAND, gray, fine quartz, silty (SM)	75	1	2" Sampler
			Very silty, slightly clayey to -34.0		2	
					3	
-36.0	5.6		Occasional clay layers below -36.0			-36.0
					4	2" Sampler
					5	
-41.0	10.0		Clay below -40.7	50		-41.0
			NOTE: Sample #6 is a surface grab sample.			

ENG FORM 1836 PREVIOUS EDITIONS ARE OBSOLETE.  
MAR 71PROJECT  
Canaveral Harbor Maint.HOLE NO.  
CB-CHM84-37

(TRANSMITTENT)



Hole No. CB-CHM84-38

<b>DRILLING LOG</b>		DIVISION South Atlantic	INSTALLATION Jacksonville District	SHEET 1 OF 1 SHEETS
1. PROJECT Canaveral Harbor Maintenance		10. SIZE AND TYPE OF BIT 2" Sampler		
2. LOCATION (Coordinates of Station) X=629,365 Y=1,481,595		11. DATUM FOR ELEVATION SHOWN (TBM or MSL) MLW		
3. DRILLING AGENCY Corps of Engineers		12. MANUFACTURER'S DESIGNATION OF DRILL ACKER PORTABLE		
4. HOLE NO. (As shown on drawing title and file number) CB-CHM84-38		13. TOTAL NO. OF OVER-BURDEN SAMPLES TAKEN 6	DISTURBED 6	UNDISTURBED
5. NAME OF DRILLER C. Mason		14. TOTAL NUMBER CORE BOXES PARTIAL		
6. DIRECTION OF HOLE <input checked="" type="checkbox"/> VERTICAL <input type="checkbox"/> INCLINED _____ DEG. FROM VERT.		15. ELEVATION GROUND WATER TIDAL		
7. THICKNESS OF OVERBURDEN		16. DATE HOLE STARTED 7/17/85	COMPLETED 7/17/85	
8. DEPTH DRILLED INTO ROCK		17. ELEVATION TOP OF HOLE -30.8		
9. TOTAL DEPTH OF HOLE 10.0		18. TOTAL CORE RECOVERY FOR BORING 63%		
SIGNATURE OF DRILLING SUPERVISOR GEOLOGIST: R. ROSS				

ELEVATION a	DEPTH b	LEGEND c	CLASSIFICATION OF MATERIALS (Description) d	% CORE RECOVERY e	BOX OR SAMPLE NO. f	REMARKS (Drilling time, water loss, depth of weathering, etc., if significant) g
-30.8	0.0					-30.8
-31.8	1.0		SAND, gray, fine quartz, silty, slightly clayey (SM)	50	1	2" Sampler
			Shell layer at -31.8'		2	
-35.8	5.0		Thin clayey layers below -35.8'	75	3	2" Sampler
			35.8 to 38.8, with sand sized shell fragments		4	
-38.8	8.0				5	
-40.8	10.0		CLAY, gray (CH)			-40.8
			NOTE: Sample #6 is a surface grab sample.			

Hole No. CB-CHM84-39

<b>DRILLING LOG</b>	DIVISION South Atlantic	INSTALLATION Jacksonville District	SHEET 1 OF 1 SHEETS
1. PROJECT Canaveral Harbor Maintenance		10. SIZE AND TYPE OF BIT 2" Sampler	
2. LOCATION (Coordinates or Station) X=633,895 Y=1,481,860		11. DATUM FOR ELEVATION SHOWN (TBM or BSL) MLW	
3. DRILLING AGENCY Corps of Engineers		12. MANUFACTURER'S DESIGNATION OF DRILL ACKER PORTABLE	
4. HOLE NO. (As shown on drawing title and file number) CB-CHM84-39		13. TOTAL NO. OF OVERBURDEN SAMPLES TAKEN 6	
5. NAME OF DRILLER C. Mason		14. TOTAL NUMBER CORE BOXES PARTIAL	
6. DIRECTION OF HOLE <input checked="" type="checkbox"/> VERTICAL <input type="checkbox"/> INCLINED _____ DEG. FROM VERT.		15. ELEVATION GROUND WATER TIDAL	
7. THICKNESS OF OVERBURDEN		16. DATE HOLE STARTED 7/16/85 COMPLETED 7/16/85	
8. DEPTH DRILLED INTO ROCK		17. ELEVATION TOP OF HOLE -38.5	
9. TOTAL DEPTH OF HOLE 10.0		18. TOTAL CORE RECOVERY FOR BORING 75 %	
		19. SIGNATURE OF GEOLOGIST GEOLOGIST: R. ROSS	

ELEVATION	DEPTH	LEGEND	CLASSIFICATION OF MATERIALS (Description)	% CORE RECOVERY	BOX OR SAMPLE NO.	REMARKS (Drilling time, water loss, depth of weathering, etc., if significant)
a	b	c	d	e	f	g
-38.5	0.0					-38.5
			SAND, gray, fine quartz, silty (SM)	50	1 2	2" Sampler -43.5
-45.0	6.5				3	2" Sampler
-46.0	7.5				4	
-46.5	8.0			100	5	
-47.5	9.6		CLAY, gray, sandy (CL)		6	
-48.5	10.0		SAND, gray, fine quartz, silty (SP)			-48.5

(235)

Hole No. CB-CHM84-40

<b>DRILLING LOG</b>	DIVISION South Atlantic	INSTALLATION Jacksonville District	SHEET 1 of 1 SHEETS
1. PROJECT Canaveral Harbor Maintenance		10. SIZE AND TYPE OF BIT 2" Sampler	
2. LOCATION (Coordinates or Station) X=632.870 Y=1.461.560		11. DATUM FOR ELEVATION SHOWN (TBM or MSL) MLW	
3. DRILLING AGENCY Corps of Engineers		12. MANUFACTURER'S DESIGNATION OF DRILL ACKER PORTABLE	
4. HOLE NO. (As shown on drawing title and site number) CB-CHM84-40		13. TOTAL NO. OF OVER-BURDEN SAMPLES TAKEN 6	
5. NAME OF DRILLER C. Mason		14. TOTAL NUMBER CORE BOXES PARTIAL	
6. DIRECTION OF HOLE <input checked="" type="checkbox"/> VERTICAL <input type="checkbox"/> INCLINED _____ DEG. FROM VERT.		15. ELEVATION GROUND WATER TIDAL	
7. THICKNESS OF OVERBURDEN		16. DATE HOLE STARTED 7/16/85 COMPLETED 7/16/85	
8. DEPTH DRILLED INTO ROCK		17. ELEVATION TOP OF HOLE -40.0	
9. TOTAL DEPTH OF HOLE 10.0		18. TOTAL CORE RECOVERY FOR BORING 75% 5	
19. SIGNATURE OF INSPECTOR GEOLOGIST: R. ROSS			

ELEVATION a	DEPTH b	LEGEND c	CLASSIFICATION OF MATERIALS (Description) d	% CORE RECOVERY e	BOX OR SAMPLE NO. f	REMARKS (Drilling time, water loss, depth of weathering, etc., if significant) g
-40.0	0.0					-40.0
-43.5	3.5		SAND, dark gray, fine quartz, silty (SM)	50	1	2" Sampler
			-43.5 to -47.5 gray		2	
-47.5	7.5			100	3	2" Sampler
					4	
-50.0	10.0				5	
					6	
						-50.0

225

Hole No. CB-CH87-1

<b>DRILLING LOG</b>		DIVISION South Atlantic	INSTALLATION Jacksonville District	SHEET OF 1 SHEETS
1. PROJECT Canaveral Harbor Investigation		10. SIZE AND TYPE OF BIT see remarks		
2. LOCATION (Coordinates or Station) X=621,320 Y=1,481,829		11. DATUM FOR ELEVATION SHOWN (TBM or MSL) MLW		
3. DRILLING AGENCY Corps of Engineers		12. MANUFACTURER'S DESIGNATION OF DRILL Failing 1500		
4. HOLE NO. (As shown on drawing title and file number) CB-CH87-1		13. TOTAL NO. OF OVER-BURDEN SAMPLES TAKEN DISTURBED UNDISTURBED		
5. NAME OF DRILLER D. Howser		14. TOTAL NUMBER CORE BOXES 1		
6. DIRECTION OF HOLE <input checked="" type="checkbox"/> VERTICAL <input type="checkbox"/> INCLINED _____ DEG. FROM VERT.		15. ELEVATION GROUND WATER Tidal		
7. THICKNESS OF OVERBURDEN		16. DATE HOLE STARTED 2/10/87 COMPLETED 2/10/87		
8. DEPTH DRILLED INTO ROCK		17. ELEVATION TOP OF HOLE -22.5		
9. TOTAL DEPTH OF HOLE 15.6'		18. TOTAL CORE RECOVERY FOR BORING 35 %		
		19. SIGNATURE OF SUPERVISOR JOE GENTILE		

ELEVATION a	DEPTH b	LEGEND c	CLASSIFICATION OF MATERIALS (Description) d	% CORE RECOVERY e	HOW-OR SAMPLE NO. f	REMARKS (Drilling time, water loss, depth of weathering, etc., if significant) g
-22.5	0.0				OR MIN/FT	
						-22.5
			Washed no sample	NO REC		Washed ↓
-29.9	7.4					-29.9
-30.7	8.2		SANDSTONE, hard, fossiliferous, riddled with solution holes filled with loose silty sand, calcareous, dark gray. Soft poorly consolidated egg, sandstone from -30.7 to -31.7	80	7	4x5½ Diamond Start 1453 End 1500
-31.7	9.2			NO REC	19	Start 1548 4x5½ Diamond PSI=700, 0
			SAND, fine to medium quartz, shelly, trace silt, light gray (SP)		1	-33.1 End 1608 1-3/8x2" Spl Spoon Washed with water
-34.6	12.1		fine quartz, gray, little shell, from -34.6 to -36.1	60	1	-34.6
-35.1	13.6			33	2	-36.1
			SAND, fine quartz, silty gray (SM)	0		" Settled
-38.1	15.6					-38.1 140# hammer with 30" drop used on 2.0' split spoon (1-3/8" ID x 2" OD)

Hole No. CB-CH87-2

<b>DRILLING LOG</b>		<b>DIVISION</b> South Atlantic	<b>INSTALLATION</b> Jacksonville District	<b>SHEET</b> 1
1. PROJECT Canaveral Harbor Investigation		10. SIZE AND TYPE OF BIT MLW		
2. LOCATION (Coordinates as Station) X=621,216 Y=1,481,813		11. DATUM FOR ELEVATION SHOWN (TBM or MSL) Falling 1500		
3. DRILLING AGENCY Corps of Engineers		12. MANUFACTURER'S DESIGNATION OF DRILL Falling 1500		
4. HOLE NO. (As shown on drawing title and file number) CB-CH87-2		13. TOTAL NO. OF OVER-BURDEN SAMPLES TAKEN DISTURBED _____ UNDISTURBED _____		
5. NAME OF DRILLER D. HOWSEY		14. TOTAL NUMBER CORE BOXES 1		
6. DIRECTION OF HOLE <input checked="" type="checkbox"/> VERTICAL <input type="checkbox"/> INCLINED _____ DEG. FROM VERT.		15. ELEVATION GROUND WATER Tidal		
7. THICKNESS OF OVERBURDEN		16. DATE HOLE STARTED 2/11/87 COMPLETED 2/11/87		
8. DEPTH DRILLED INTO ROCK		17. ELEVATION TOP OF HOLE -25.5		
9. TOTAL DEPTH OF HOLE 13.1'		18. TOTAL CORE RECOVERY FOR BORING 61%		
19. SIGNATURE OF INSPECTOR GEOLOGIST J. GENTILE				

ELEVATION	DEPTH	LEGEND	CLASSIFICATION OF MATERIALS (Description)	% CORE RECOVERY	NON-SM SAMPLE NO.	REMARKS (Drilling fluid, water loss, depth of weathering, etc., if significant)
a	b	c	d	e	f	g
-25.5	0.0					OR MIN/FT
-27.1	1.6		Washed, no sample			Washed
-28.0	2.5		SANDSTONE, soft, friable, (broken with fingers with some difficulty) dark brown-gray, seams loose sand, very hard sandstone with large voids filled with loose (SP) sand, from -28.0 to -29.7.	95	11	4x5 1/2 Diamond Start 0919
-29.7	4.2		medium hard sandstone from -29.7 to -30.1		15	PSI=weight of rods, End 0945
-30.1	4.6			50	8	4x5 1/2 Diamond Start 1010
			SAND, fine to medium quartz, shelly, light gray (SP)		1	PSI=Weight of Rods End 1019
				66	1	1-3/8"x2 Sp1 Sp. 7
						8
						17
						8
						16
						20
						8
						9
-35.6	10.1					10
			SAND, fine quartz, little to some silt, shelly, gray(SM)	40	4	5
						8
				80	5	3
						1
						3
-38.6	13.1					5
						140# hammer with 30" drop used on 2' split spoon (1-3/8" ID x 2" OD)

278

Hole No. CB-CH87-3

<b>DRILLING LOG</b>		DIVISION South Atlantic	INSTALLATION Jacksonville District	SHEET 1 OF 7 SHEETS
1. PROJECT Canaveral Harbor Investigation			10. SIZE AND TYPE OF BIT MLW	
2. LOCATION (Coordinates or Stationing) X=621,167 Y=1,481,758			11. DATUM FOR ELEVATION SHOWN (TBM or MSL)	
3. DRILLING AGENCY Corps of Engineers			12. MANUFACTURER'S DESIGNATION OF DRILL Failing 1500	
4. HOLE NO. (As shown on drawing title and file number) CB-CH87-3			13. TOTAL NO. OF OVER-BURDEN SAMPLES TAKEN UNDISTURBED: _____ DISTURBED: _____	
5. NAME OF DRILLER D. Howser			14. TOTAL NUMBER CORE BOXES 1	
6. DIRECTION OF HOLE <input checked="" type="checkbox"/> VERTICAL <input type="checkbox"/> INCLINED _____ DEG. FROM VERT.			15. DATE HOLE STARTED: 2/11/87 COMPLETED: 2/11/87	
7. THICKNESS OF OVERBURDEN			17. ELEVATION TOP OF HOLE -25.4	
8. DEPTH DRILLED INTO ROCK			18. TOTAL CORE RECOVERY FOR BORING 66 %	
9. TOTAL DEPTH OF HOLE 13.0'			19. SIGNATURE OF INSPECTOR GEOLOGIST J. Gentle	

ELEVATION a	DEPTH b	LEGEND c	CLASSIFICATION OF MATERIALS (Description) d	% CORE RECOVERY e	BORING SAMPLE NO. f	REMARKS (Drilling time, water loss, depth of monitoring, etc., if significant) g	
-25.4	0.0				OR MIN/FT		
-27.4	2.0		Washed, no sample	NO REC		Washed ↓ -27.4	
-29.4	4.0		SANDSTONE, soft, poorly consolidated, seams loose sand, brown, friable (broken by fingers with difficulty), bed of very hard sandstone with voids of loose sand from -29.4 to -29.8	40	2	4x5' Diamond Start 1250	
-29.8	4.4				3	PSI= Weight of Rods	
					15		
					1		-30.9 End 1311
-35.4	10.0		SAND, fine to medium quartz, trace silt, shelly, gray(SP)	88	1	1-3/8x2" Sp. Sp. 4 Washed with water 3	
						5 4	
				33	2	" 9 -33.9 11	
				66	3	Settled 6 -35.4 8	
-36.9	11.5		SAND, fine, quartz, little silt, gray, little shell(SM)	46	4	" 6 -36.9 8	
						B 1	
-38.4	13.0		SILT, sandy, little shell, gray, trace clay (ML)	93	5	" 1 -38.4 1	
						140# hammer with 30" drop used on 2' spilt spoon (1-3/8" ID x 2" OD)	

2381

Hole No. CR-CH87-4

<b>DRILLING LOG</b>	<b>DIVISION</b> South Atlantic	<b>INSTALLATION</b> Jacksonville District	<b>SHEET</b> 1 of 1 SHEETS
<b>1. PROJECT</b> Converal Harbor Investigation		<b>10. SIZE AND TYPE OF BIT</b> See remarks	
<b>2. LOCATION</b> (According to Station) X=021,231 Y=1,481,734		<b>11. DATUM FOR ELEVATION SHOWN</b> (TBM or BSL) MLW	
<b>3. DRILLING AGENCY</b> Corps of Engineers		<b>12. MANUFACTURER'S DESIGNATION OF DRILL</b> Failing 1500	
<b>4. HOLE NO.</b> (As shown on drawing title and file number) CR-CH87-4		<b>13. TOTAL NO. OF OVERBURDEN SAMPLES TAKEN</b>   <b>DISTURBED</b>   <b>UNDI STURBED</b>	
<b>5. NAME OF DRILLER</b> Howser, Doug		<b>14. TOTAL NUMBER CORE BOXES</b>   <b>1</b>	
<b>6. DIRECTION OF HOLE</b> <input checked="" type="checkbox"/> VERTICAL <input type="checkbox"/> INCLINED _____ DEG. FROM VERT.		<b>15. ELEVATION GROUND WATER</b>   Tidal	
<b>7. THICKNESS OF OVERBURDEN</b>		<b>16. DATE HOLE</b>   <b>STARTED</b> 2/11/87   <b>COMPLETED</b> 2/17/87	
<b>8. DEPTH DRILLED INTO ROCK</b>		<b>17. ELEVATION TOP OF HOLE</b>   -26.5	
<b>9. TOTAL DEPTH OF HOLE</b>   12.0'		<b>18. TOTAL CORE RECOVERY FOR BORING</b>   30 %	
		<b>19. SIGNATURE OF INSPECTION</b> GEOLOGIST J. Gentile	

ELEVATION d	DEPTH b	LEGEND c	CLASSIFICATION OF MATERIALS (Description) e	RECOVERY NO. f	REMARKS (Drilling time, water loss, depth of washing, etc., if significant) g
-26.5	0.0			OR MIN/ FT	
-27.9	1.4		Washed, no sample	NO REC	-26.5 Washed ↓ -27.9
-28.5	2.0		SANDSTONE, soft, poorly consolidated, seams, loose sand, friable (broken between fingers) green, loose sand with thin hard sandstone lenses from -28.5 to -30.0.	4 4	Start 1514 PSI=Weight of Rods 4x5 1/2 Diamond
-30.0	3.5		soft sandstone as above from -30.0 to -31.8	2	
-31.8	5.3		SAND, fine to medium quartz, shelly, trace silt. gray(SP)	0.5	-32.5 End 1522.5 1-3/8" x 2" Sp. Sp Settled Washed w/water
-35.5	9.0			60	5 7 -34.0 5
			SAND, fine quartz, little shell, gray, little silt(SM)	12	3 Settled 4 -37.0 5
-38.5	12.0			NO REC	4 2 -38.5 4
					140# hammer with 30' drop used on 2" split spoon (1-3/8" ID x 2" OD)

Hole No. CB-CH88-1

DRILLING LOG		DIVISION		INSTALLATION		SHEET	
Canaveral Harbor		South Atlantic		Jacksonville District		1 OF 1 SHEETS	
1. PROJECT				10. SIZE AND TYPE OF BIT			
2. LOCATION (Coordinates or Station)				11. DAY ON FOR ELEVATION SHOWN (TBM or MSL)			
3. DRILLING AGENCY				12. MANUFACTURER'S DESIGNATION OF DRILL			
4. HOLE NO. (As shown on drawing title and file number)				13. TOTAL NO. OF OVER-BURDEN SAMPLES TAKEN			
5. NAME OF DRILLER				14. TOTAL NUMBER CORE BOXES			
6. DIRECTION OF HOLE				15. ELEVATION GROUND WATER			
7. THICKNESS OF OVERBURDEN				16. DATE HOLE			
8. DEPTH DRILLED INTO ROCK				17. ELEVATION TOP OF HOLE			
9. TOTAL DEPTH OF HOLE				18. TOTAL CORE RECOVERY FOR BORING			
				19. <del>XXXXXXXXXXXXXXXXXXXX</del>			
				Geologist J. Hand			
ELEVATION	DEPTH	LEGEND	CLASSIFICATION OF MATERIALS (Description)	% CORE RECOVERY	NUMBER SAMPLE NO.	REMARKS (Drilling time, water loss, depth of weathering, etc., if significant)	
-22.3	0.0					Bit or Barrel	
-27.3	5.0		Sand, very fine quartz, a trace of silt, gray (SP)	40	1	-22.3	Blows/Ft settled
-29.9	7.6		Clay, slightly sandy, a trace of shell, gray (CH)	40	2		settled
-32.3	10.0		Sand, very fine to fine quartz, a little shell and a trace of silt, gray (SP)		3		
			Clay, gray, a few brown traces of leaves and stems (CH)	20	4		
				100	5		settled
-47.3	25.0			100	6		
			Soils are field visually classified in accordance with the Unified Soils Classification System.				
			BLS/FT. REFERS TO THE NUMBER OF HAMMER BLOWS REQUIRED TO ADVANCE A 2" SAMPLER (2" I.D. X 2 1/2" O.D.) ONE FOOT. THE SAMPLER IS 5 FT. LONG AND DRIVEN CONTINUOUSLY 5 FT. WHERE POSSIBLE.				
							BLOW COUNTS FOR THE 2" SAMPLER HAVE NOT BEEN CORRELATED WITH STANDARD SPLIT SPOON TESTS AS DESIGNATED IN ASTM D-1586. JUDGEMENT IS NEEDED IN THE USE OF THE BLOW COUNT DATA FOR THE 2" SAMPLER.



2A



Hole No. CB-CH88-2

DRILLING LOG		DIVISION	INSTALLATION	SHEET		
		South Atlantic	Jacksonville District	1		
1. PROJECT		10. SIZE AND TYPE OF BIT see remarks				
Canaveral Harbor		11. DATUM FOR ELEVATION SHOWN (TBM or BSL)				
2. LOCATION (Coordinates or Station)		MLW				
x=630,042 y=1,481,526		12. MANUFACTURER'S DESIGNATION OF DRILL				
3. DRILLING AGENCY		Falling 1500				
Corps of Engineers		13. TOTAL NO. OF OVERBURDEN SAMPLES TAKEN				
4. HOLE NO. (As shown on drawing title and file number)		CB-CH88-2				
5. NAME OF DRILLER		14. TOTAL NUMBER CORE BOXES				
R. Gordon		15. ELEVATION GROUND WATER				
6. DIRECTION OF HOLE		16. DATE HOLE				
<input checked="" type="checkbox"/> VERTICAL <input type="checkbox"/> INCLINED _____ DEG. FROM VERT.		STARTED 30 Aug 88 COMPLETED 30 Aug 88				
7. THICKNESS OF OVERBURDEN		17. ELEVATION TOP OF HOLE				
8. DEPTH DRILLED INTO ROCK		-41.7				
9. TOTAL DEPTH OF HOLE		18. TOTAL CORE RECOVERY FOR BORING				
7.0'		70%				
		19. <del>MARKING</del> <del>XXXXXXXXXXXX</del> GEOLOGIST - J. Hand				
ELEVATION	DEPTH	LEGEND	CLASSIFICATION OF MATERIALS (Description)	% CORE RECOVERY	SAMPLER NO.	REMARKS (Drilling time, water loss, depth of weathering, etc., if significant)
						Bit or Barrel
-41.7	0.0					-41.7 8blows/ft settled
-45.4	3.7		Silt with a little very fine quartz sand, gray (ML)	70	1	2" Sampler
-48.7	7.0		Clay, with a little very fine quartz sand, gray (CH)		2	settled
			Soils are field visually classified in accordance with the Unified Soils Classification System.			
			LABORATORY CLASSIFICATION (based on grain size and visual)			
			Elev. Class -41.7 to -45.7 SM			
			BLS/FT. REFERS TO THE NUMBER OF HAMMER BLOWS REQUIRED TO ADVANCE A 2" SAMPLER (2" I.D. X 2 1/2" O.D.) ONE FOOT. THE SAMPLER IS 5 FT. LONG AND DRIVEN CONTINUOUSLY 5 FT. WHERE POSSIBLE.	BLOW COUNTS FOR THE 2" SAMPLER HAVE NOT BEEN CORRELATED WITH STANDARD SPLIT SPOON TESTS AS DESIGNATED IN ASTM D-1586. JUDGEMENT IS NEEDED IN THE USE OF THE BLOW COUNT DATA FOR THE 2" SAMPLER.		

222

Hole No. CB-CH88-3

DRILLING LOG		DIVISION		INSTALLATION		SHEET	
1. PROJECT Canaveral Harbor		South Atlantic		Jacksonville District		OF 1 SHEETS	
2. LOCATION (Coordinates on Station) x=628,540 y=1,481,865'		3. DRILLING AGENCY Corps of Engineers		10. SIZE AND TYPE OF BIT see remarks		11. DATUM FOR ELEVATION SHOWN (TBM or BLS)	
4. HOLE NO. (As shown on drawing title and file number) CB-CH88-3		5. NAME OF DRILLER R. Gordon		12. MANUFACTURER'S DESIGNATION OF DRILL Falling 1500		13. TOTAL NO. OF OVERBURDEN SAMPLES TAKEN	
6. DIRECTION OF HOLE <input checked="" type="checkbox"/> VERTICAL <input type="checkbox"/> INCLINED _____ DEG. FROM VERT.		7. THICKNESS OF OVERBURDEN		14. TOTAL NUMBER CORE BOXES 1		15. ELEVATION GROUND WATER Tidal	
8. DEPTH DRILLED INTO ROCK		9. TOTAL DEPTH OF HOLE 10.8'		16. DATE HOLE STARTED 31 Aug 88 COMPLETED 31 Aug 88		17. ELEVATION TOP OF HOLE -35.5'	
18. TOTAL CORE RECOVERY FOR BORING 88%		19. SCALE OF OVERBURDEN		GEOLOGIST - J. Hand			
ELEVATION	DEPTH	LEGEND	CLASSIFICATION OF MATERIALS (Description)	CORE RECOVERY	SAMPLE NO.	REMARKS (Drilling time, water loss, depth of weathering, etc., if significant)	
						Bit or Barrel	
-35.5	0.0					-35.5	Blows /ft
-36.5	1.0		Sand, fine quartz, silty, a piece of Visquene, gray (SP)	90	1	2" Sampler	settled
-38.5	3.0		Silt, a trace of very fine sand, gray (MH)		2		
			Clay, a trace of very fine quartz sand, gray (CH)		3		
			From -41.0 to -46.3, clay gray with a few brown traces of leaves and stems, a very few shells (CH)	100	4		settled
-46.3	10.8					-46.3	
			Soils are field visually classified in accordance with the Unified Soils Classification System.			300 # hammer used with 18" drop on 2" Sampler	
			BLS/FT. REFERS TO THE NUMBER OF HAMMER BLOWS REQUIRED TO ADVANCE A 2" SAMPLER (2" I.D. X 2 1/2" O.D.) ONE FOOT. THE SAMPLER IS 6 FT. LONG AND DRIVEN CONTINUOUSLY 5 FT. WHERE POSSIBLE.			BLOW COUNTS FOR THE 2" SAMPLER HAVE NOT BEEN CORRELATED WITH STANDARD SPLIT SPOON TESTS AS DESIGNATED IN ASTM D-1586. JUDGEMENT IS NEEDED IN THE USE OF THE BLOW COUNT DATA FOR THE 2" SAMPLER.	

DRILLING LOG		DIVISION	INSTALLATION	Hole No. <b>CB-CH88-4</b>		SHEET
1. PROJECT <b>Canaveral Harbor</b>		<b>South Atlantic</b>	<b>Jacksonville District</b>	10. SIZE AND TYPE OF BIT <b>see remarks</b>		OF 7 SHEETS
2. LOCATION (Coordinates or Station) <b>X=627,954 y=1,481,604</b>			<b>MLW</b>	11. DATUM FOR ELEVATION SHOWN (Tide or MSL)		
3. DRILLING AGENCY <b>Corps of Engineers</b>			12. MANUFACTURER'S DESIGNATION OF DRILL <b>Failing 1500</b>			
4. HOLE NO. (As shown on drawing title and file number) <b>CB-CH88-4</b>			13. TOTAL NO. OF OVERBURDEN SAMPLES TAKEN		DISTURBED	UNDISTURBED
5. NAME OF DRILLER <b>R. Gordon</b>			14. TOTAL NUMBER CORE BOXES			
6. DIRECTION OF HOLE <input checked="" type="checkbox"/> VERTICAL <input type="checkbox"/> INCLINED _____ DEG. FROM VERT.			15. ELEVATION GROUND WATER <b>Tidal</b>			
7. THICKNESS OF OVERBURDEN			16. DATE HOLE STARTED		COMPLETED	
8. DEPTH DRILLED INTO ROCK			<b>31 Aug 88</b>		<b>31 Aug 88</b>	
9. TOTAL DEPTH OF HOLE <b>5.0'</b>			17. ELEVATION TOP OF HOLE <b>-40.9</b>			
			18. TOTAL CORE RECOVERY FOR BORING <b>80%</b>			
			19. <del>XXXXXXXXXXXXXXXXXXXX</del> <b>GEOLOGIST - J. Hand</b>			
ELEVATION	DEPTH	LEGEND	CLASSIFICATION OF MATERIALS (Description)	CORE RECOVERY	SAMPLE NO.	REMARKS (Drilling time, water loss, depth of wedging, etc., if significant)
						Bit or Barrel
-40.9	0.0					
-41.9	1.0		Silt, a little very fine sand, gray (ML)		1	-40.9 Blows/ft Settled
			Clay, gray, a few brown traces of leaves and stems (CH)	80	2	2" Sampler
-45.9	5.0					-45.9 3
			Soils are field visually classified in accordance with the Unified Soils Classification System.			
			BLS/FT. REFERS TO THE NUMBER OF HAMMER BLOWS REQUIRED TO ADVANCE A 2" SAMPLER (2" I.D. X 2 1/2" O.D.) ONE FOOT. THE SAMPLER IS 5 FT. LONG AND DRIVEN CONTINUOUSLY 5 FT. WHERE POSSIBLE.			
				300# hammer used with 18" drop on 2" Sampler.		
				BLOW COUNTS FOR THE 2" SAMPLER HAVE NOT BEEN CORRELATED WITH STANDARD SPLIT SPOON TESTS AS DESIGNATED IN ASTM D-1586. JUDGEMENT IS NEEDED IN THE USE OF THE BLOW COUNT DATA FOR THE 2" SAMPLER.		

240

Hole No. CB-CH88-5

DRILLING LOG		DIVISION	INSTALLATION		SHEET	
		South Atlantic	Jacksonville District		1 OF 1 SHEETS	
1. PROJECT Canaveral Harbor			10. SIZE AND TYPE OF BIT SEE REMARKS			
2. LOCATION (Groundwater or Sited) x=626,707 y=1,481,516			11. DATUM FOR ELEVATION SHOWN (T.M. or M.S.L.) M.W.			
3. DRILLING AGENCY Corps of Engineers			12. MANUFACTURER'S DESIGNATION OF DRILL Fallings 1500			
4. HOLE NO. (As shown on drawing title and file number) CB-CH88-5			13. TOTAL NO. OF OVERBURDEN SAMPLES TAKEN DISTURBED _____ UNDISTURBED _____			
5. NAME OF DRILLER R. Gordon			14. TOTAL NUMBER CORE BOXES 1			
6. DIRECTION OF HOLE <input checked="" type="checkbox"/> VERTICAL <input type="checkbox"/> INCLINED _____ DEG. FROM VERT.			15. ELEVATION GROUND WATER Tidal			
7. THICKNESS OF OVERBURDEN			16. DATE HOLE STARTED 31 Aug 88 COMPLETED 31 Aug 88			
8. DEPTH DRILLED INTO ROCK			17. ELEVATION TOP OF HOLE -38.1			
9. TOTAL DEPTH OF HOLE 10.0'			18. TOTAL CORE RECOVERY FOR BORING 98% 1			
			19. SIGNATURE OF DRILLER GEOLOGIST - J. Hand			
ELEVATION	DEPTH	LEGEND	CLASSIFICATION OF MATERIALS (Description)	% CORE RECOVERY	SAMPLE NO.	REMARKS (Drilling time, water loss, depth of weathering, etc., if significant)
-38.1	0.0					Bit or Barrel
-39.4	1.3		Silt, a trace of very fine sand, gray (ML) Clay, gray, a few brown traces of leaves and stems (CH)	95	1	2" Sampler
					2	
						Blows/ft settled
						4
						settled
-48.1	10.0			100	3	"
			Soils are field visually classified in accordance with the Unified Soils Classification System.			
			BLS/FT. REFERS TO THE NUMBER OF HAMMER BLOWS REQUIRED TO ADVANCE A 2" SAMPLER (2" I.D. X 2 1/2" O.D.) ONE FOOT. THE SAMPLER IS 5 FT. LONG AND DRIVEN CONTINUOUSLY 5 FT. WHERE POSSIBLE.			300 # hammer used with 18" drop on 2" sampler.
						BLOW COUNTS FOR THE 2" SAMPLER HAVE NOT BEEN CORRELATED WITH STANDARD SPLIT SPOON TESTS AS DESIGNATED IN ASTM D-1586. JUDGEMENT IS NEEDED IN THE USE OF THE BLOW COUNT DATA FOR THE 2" SAMPLER.
						7

249

Hole No. CB-CH88-6

<b>DRILLING LOG</b>		DIVISION South Atlantic	INSTALLATION Jacksonville District	SHEET OF 1 SHEETS
1. PROJECT Canaveral Harbor		10. SIZE AND TYPE OF BIT <i>see remarks</i>		
2. LOCATION (Coordinates or Station) x=625,725 y=1,481,670		11. GATUM FOR ELEVATION SHOWN (FOR OR REF) MLW		
3. DRILLING AGENCY Corps of Engineers		12. MANUFACTURER'S DESIGNATION OF DRILL Failings 1500		
4. HOLE NO. (As shown on drawing title and file number) CB-CH88-6		13. TOTAL NO. OF OVERBURDEN SAMPLES TAKEN DISTURBED _____ UNDISTURBED _____		
5. NAME OF DRILLER R. Gordon		14. TOTAL NUMBER CORE BOXES _____		
6. DIRECTION OF HOLE <input checked="" type="checkbox"/> VERTICAL <input type="checkbox"/> INCLINED _____ DEG. FROM VERT.		15. ELEVATION GROUND WATER Tidal		
7. THICKNESS OF OVERBURDEN _____		16. DATE HOLE STARTED 2 Sept 88 COMPLETED 2 Sept 88		
8. DEPTH DRILLED INTO ROCK _____		17. ELEVATION TOP OF HOLE -40.6		
9. TOTAL DEPTH OF HOLE 6.0 feet		18. TOTAL CORE RECOVERY FOR BORING 85%		
		19. <del>MARKER</del> <del>XXXXXXXXXX</del> GEOLOGIST - J. Hand		

ELEVATION a	DEPTH b	LEGEND c	CLASSIFICATION OF MATERIALS (Description) d	% CORE RECOVERY e	SAMPLER NO. f	REMARKS (Drilling time, water loss, depth of weathering, etc., if significant) g
						Bit or Barrel
-40.6	0.0					
-43.1	2.5		Silt, gray-green (MH)	85	1	-41.6 Blows/Ft settled
-46.6	6.0		Clay, a trace of very fine quartz sand, gray, a few brown traces of leaves and stems (CH)		2	2" Sampler
			Soils are field visually classified in accordance with the Unified Soils Classification System.			300# hammer used with 18" drop on 2" Sampler.
			BLS/FT. REFERS TO THE NUMBER OF HAMMER BLOWS REQUIRED TO ADVANCE A 2" SAMPLER (2" I.D. X 2 1/2" O.D.) ONE FOOT. THE SAMPLER IS 5 FT. LONG AND DRIVEN CONTINUOUSLY 5 FT. WHERE POSSIBLE.			BLOW COUNTS FOR THE 2" SAMPLER HAVE NOT BEEN CORRELATED WITH STANDARD SPLIT SPOON TESTS AS DESIGNATED IN ASTM D-1586. JUDGEMENT IS NEEDED IN THE USE OF THE BLOW COUNT DATA FOR THE 2" SAMPLER.



283

Hole No. CB-CH88-7

DRILLING LOG		DIVISION	INSTALLATION	SHEET		
		South Atlantic	Jacksonville District	1 of 1 SHEETS		
1. PROJECT Canaveral Harbor		10. SIZE AND TYPE OF BIT see remarks				
2. LOCATION (Coordinates of Station) x=625,235 y=1,482,228		11. DATUM FOR ELEVATION SHOWN (TBM or MSL) M.W.				
3. DRILLING AGENCY Corps of Engineers		12. MANUFACTURER'S DESIGNATION OF DRILL Falling 1500				
4. HOLE NO. (As shown on drawing title and file number) CB-CH88-7		13. TOTAL NO. OF OVERBURDEN SAMPLES TAKEN DISTURBED _____ UNDISTURBED _____				
5. NAME OF DRILLER R. Gordon		14. TOTAL NUMBER CORE BOXES 1				
6. DIRECTION OF HOLE <input checked="" type="checkbox"/> VERTICAL <input type="checkbox"/> INCLINED _____ DEG. FROM VERT.		15. ELEVATION GROUND WATER Tidal				
7. THICKNESS OF OVERBURDEN		16. DATE HOLE STARTED 1 Sept 88 COMPLETED 1 Sept 88				
8. DEPTH DRILLED INTO ROCK		17. ELEVATION TOP OF HOLE -38.4				
9. TOTAL DEPTH OF HOLE 10.0'		18. TOTAL CORE RECOVERY FOR BORING 90%				
		19. NAME OF THE DRILLER GEOLOGIST J. Hand				
ELEVATION	DEPTH	LEGEND	CLASSIFICATION OF MATERIALS (Description)	% CORE RECOVERY	BLIND SAMPLE NO.	REMARKS (Drilling time, water loss, depth of weathering, etc., if significant)
						Bit or Barrel
-38.4	0.0					
-39.4	1.0		Silt, gray (ML)	80	1	Blows/Ft settled
-39.9	1.5		Sand, very fine quartz, slightly silty (SM)		2	2" Sampler
			Clay, gray (CH)		3	
						settled
-48.4	10.0			100	4	"
						settled
			Soils are field visually classified in accordance with the Unified Soils Classification System.			300# hammer used with 18" drop on 2" Sampler.
			LABORATORY CLASSIFICATION (based on grain size and visual)			
			Elev. Class -39.9 to -43.4 CH			
			BLS/FT. REFERS TO THE NUMBER OF HAMMER BLOWS REQUIRED TO ADVANCE A 2" SAMPLER (2" I.D. X 2 1/2" O.D.) ONE FOOT. THE SAMPLER IS 5 FT. LONG AND DRIVEN CONTINUOUSLY 5 FT. WHERE POSSIBLE.			BLOW COUNTS FOR THE 2" SAMPLER HAVE NOT BEEN CORRELATED WITH STANDARD SPLIT SPOON TESTS AS DESIGNATED IN ASTM D-1586. JUDGEMENT IS NEEDED IN THE USE OF THE BLOW COUNT DATA FOR THE 2" SAMPLER.

208

Hole No. CB-CH88-9

DRILLING LOG		DIVISION		INSTALLATION		SHEET	
Canaveral Harbor		South Atlantic		Jacksonville District		1 of 1 SHEETS	
1. PROJECT				10. SIZE AND TYPE OF BIT See remarks			
2. LOCATION (Coordinates or Station) X=625,242 Y=1,482,210				11. DATUM FOR ELEVATION SHOWN (TBM or MSL) MLW			
3. DRILLING AGENCY Corps of Engineers				12. MANUFACTURER'S DESIGNATION OF DRILL Failing 1500			
4. HOLE NO. (As shown on drawing title and file number) CB-CH88-9				13. TOTAL NO. OF OVER-BURDEN SAMPLES TAKEN		DISTURBED UNDISTURBED	
5. NAME OF DRILLER R. Gordon				14. TOTAL NUMBER CORE BOXES 1			
6. DIRECTION OF HOLE <input checked="" type="checkbox"/> VERTICAL <input type="checkbox"/> INCLINED _____ DEG. FROM VERT.				15. ELEVATION GROUND WATER Tidal		16. DATE HOLE STARTED 1 Sept 88 COMPLETED 1 Sept 88	
7. THICKNESS OF OVERBURDEN				17. ELEVATION TOP OF HOLE -37.1			
8. DEPTH DRILLED INTO ROCK				18. TOTAL CORE RECOVERY FOR BORING 70%			
9. TOTAL DEPTH OF HOLE 11.0'				19. <del>SPERMATOPHYTES</del> GEOLOGIST - J Hand			
ELEVATION a	DEPTH b	LEGEND c	CLASSIFICATION OF MATERIALS (Description) d	% CORE RECOVERY e	SAMPLER NO. f	REMARKS (Drilling time, water loss, depth of weathering, etc., if significant) g	
							Bit or Barrel
-37.1	0.0						-37.1 Blows/ft settled
-39.6	2.5		Silt, gray-green (MH)	85	1		
			Clay, gray (CH)		2		2" Sampler
							-43.1
-45.1	8.0				3		" settled
-46.1	9.0		Sand, very fine quartz, clayey, gray-brown (Sc)	50	4		5
			Sand, very fine quartz, some shell, very silty, calcareous nodules and layers of moderately hard quartz, sandstone, light green with white (SM)				9
-48.1	11.0						4
Soils are field visually classified in accordance with the Unified Soils Classification System.							
BLS/FT. REFERS TO THE NUMBER OF HAMMER BLOWS REQUIRED TO ADVANCE A 2" SAMPLER (2" I.D. X 2 1/2" O.D.) ONE FOOT. THE SAMPLER IS 5 FT. LONG AND DRIVEN CONTINUOUSLY 5 FT. WHERE POSSIBLE.							
				300 # hammer used with 18" drop on 2" Sampler.			
				BLOW COUNTS FOR THE 2" SAMPLER HAVE NOT BEEN CORRELATED WITH STANDARD SPLIT SPOON TESTS AS DESIGNATED IN ASTM D-1586. JUDGEMENT IS NEEDED IN THE USE OF THE BLOW COUNT DATA FOR THE 2" SAMPLER.			

(250)

Hole No. CB-CH88-11

<b>DRILLING LOG</b>		DIVISION South Atlantic	INSTALLATION Jacksonville District	SHEET OF 7 SHEETS
1. PROJECT Canaveral Harbor		10. SIZE AND TYPE OF BIT SAG remarks		
2. LOCATION (Coordinates of Station) X=623,408 Y=1,481,615		11. DATUM FOR ELEVATION SHOWN (BSM or MSL) MLW		
3. DRILLING AGENCY Corps of Engineers		12. MANUFACTURER'S DESIGNATION OF DRILL Failing 1500		
4. HOLE NO. (As shown on drawing title and file number) CB-CH88-11		13. TOTAL NO. OF OVER-BURDEN SAMPLES TAKEN	DISTURBED	UNDISTURBED
5. NAME OF DRILLER R. Gordon		14. TOTAL NUMBER CORE BOXES 1		
6. DIRECTION OF HOLE <input checked="" type="checkbox"/> VERTICAL <input type="checkbox"/> INCLINED _____ DEG. FROM VERT.		15. ELEVATION GROUND WATER Tidal		
7. THICKNESS OF OVERBURDEN		16. DATE HOLE	STARTED	COMPLETED
8. DEPTH DRILLED INTO ROCK		7 Sept 88	7 Sept 88	
9. TOTAL DEPTH OF HOLE 11.0'		17. ELEVATION TOP OF HOLE -35.4		
		18. TOTAL CORE RECOVERY FOR BORING 77%		
19. <del>XXXXXXXXXXXX</del> GEOLOGIST J. Hand				

ELEVATION a	DEPTH b	LEGEND c	CLASSIFICATION OF MATERIALS (Description) d	% CORE RECOVERY e	NUMBER OF SAMPLES f	REMARKS (Drilling time, water loss, depth of weathering, etc., if significant) g
						Bit or Barrel
-35.4	0.0					-35.4 Blows/ft settled
-38.4	3.0		Silt, Malodorous, gray-green (MH)	80	1	2" Sampler
-39.8	4.4		Clay with a little very fine quartz sand, gray (CH)		2	
		) )	Shell, medium sand size, silty, a trace of very fine quartz sand, white with gray		3	-41.4 settled
		) )				6
		) )				2
-46.4	11.0	) )		50	4	-46.4 7 15
			Soils are field visually classified in accordance with the Unified Soils Classification System.			
			LABORATORY CLASSIFICATION (based on grain size and visual)			
			ELEVATION CLASS -41.4 to -46.4 SP-5M			
			BLS/FT. REFERS TO THE NUMBER OF HAMMER BLOWS REQUIRED TO ADVANCE A 2" SAMPLER (2" I.D. X 2 1/2" O.D.) ONE FOOT. THE SAMPLER IS 5 FT. LONG AND DRIVEN CONTINUOUSLY 5 FT. WHERE POSSIBLE.			
				300 # hammer used with 18" drop on 2" sampler.		
				BLOW COUNTS FOR THE 2" SAMPLER HAVE NOT BEEN CORRELATED WITH STANDARD SPLIT SPOON TESTS AS DESIGNATED IN ASTM D-1586. JUDGEMENT IS NEEDED IN THE USE OF THE BLOW COUNT DATA FOR THE 2" SAMPLER.		



Hole No. CB-CH88-12

<b>DRILLING LOG</b>		DIVISION South Atlantic	INSTALLATION Jacksonville District	SHEET 1 OF 1 SHEETS
1. PROJECT Capeval Harbor		10. SIZE AND TYPE OF BIT <i>see remarks</i>		
2. LOCATION (Coordinates or Station) x=622,415 y=1,481,953		11. DATUM FOR ELEVATION SHOWN (TBM or MSL) MLW		
3. DRILLING AGENCY Corps of Engineers		12. MANUFACTURER'S DESIGNATION OF DRILL Falling 1500		
4. HOLE NO. (As shown on drawing title and title number) CB-CH88-12		13. TOTAL NO. OF OVERBURDEN SAMPLES TAKEN		
5. NAME OF DRILLER R. Gordon		14. TOTAL NUMBER CORE BOXES 1		
6. DIRECTION OF HOLE <input checked="" type="checkbox"/> VERTICAL <input type="checkbox"/> INCLINED _____ DEG. FROM VERT.		15. ELEVATION GROUND WATER Tidal		
7. THICKNESS OF OVERBURDEN		16. DATE HOLE STARTED 2 Aug 88		
8. DEPTH DRILLED INTO ROCK		17. ELEVATION TOP OF HOLE -23.4		
9. TOTAL DEPTH OF HOLE 22.0'		18. TOTAL CORE RECOVERY FOR BORING 61%		
		19. <del>XXXXXXXXXXXXXXXXXXXX</del> GEOLOGIST J. Hand		

ELEVATION a	DEPTH b	LEGEND c	CLASSIFICATION OF MATERIALS (Description) d	% CORE RECOVERY e	NUMBER SAMPLES f	REMARKS (Drilling time, water loss, depth of weathering, etc., if significant) g
						Bit or Barrel
-23.4	0.0					-23.4 Blows/ft settled
-26.4	3.0		Silt, a trace of very fine quartz sand and shell, gray (Mh)		1	
-27.4	4.0		Sand, very fine quartz, a trace of silt and shell, gray (SP)	70	2	2" Sampler
			Clay, gray (CH)		3	
						-30.4 settled
				100	4	
-36.4	13.0					-35.4 2
						3
						10
			Shell, medium sand size, a little very fine quartz sand, a trace of silt, light gray	80	5	-40.4 14
						16
						26
-44.4	21.0			10	6	1
						3
						14
-45.4	22.0		Sand, very fine quartz, slightly silty, light gray (SM)		7	10
						6
			Soils are field visually classified in accordance with Unified Soils Classification System.			300 # hammer used with 18" drop on 2" Sampler.
			LABORATORY CLASSIFICATION (based on grain size and visual)			Blow counts for the 2" sampler have not been correlated with standard split spoon tests as designated in ASTM D-1586. Judgement is needed in the use of the blow count data for the 2" sampler.
			ELEVATION CLASS -26.4 to -27.4 SM			Bls/ft refers to the # of hammer blows required to advance a 2" sampler (2" I.D. x 2 3/4 O.D.) one foot. The sampler is 5 ft. long and driven continuously 5 ft where possible.

250

Hole No. CB-CH-88-13

<b>DRILLING LOG</b>		DIVISION South Atlantic	INSTALLATION Jacksonville District	SHEET 1 OF 1 SHEETS
1. PROJECT Canaveral Harbor		10. SIZE AND TYPE OF BIT see remarks		
2. LOCATION (Coordinates or Station) x=621,495 y=1,481,703		11. DATUM FOR ELEVATION SHOWN (FMS or AFD) MLW		
3. DRILLING AGENCY Corps of Engineers		12. MANUFACTURER'S DESIGNATION OF DRILL Failing 1500		
4. HOLE NO. (As shown on drawing title and file number) CB-CH88-13		13. TOTAL NO. OF OVERBURDEN SAMPLES TAKEN		
5. NAME OF DRILLER R. Gordon		14. TOTAL NUMBER CORE BOXES		
6. DIRECTION OF HOLE <input checked="" type="checkbox"/> VERTICAL <input type="checkbox"/> INCLINED		15. ELEVATION GROUND WATER Tidal		
7. THICKNESS OF OVERBURDEN		16. DATE HOLE STARTED 2 Sept 88 COMPLETED 2 Sept 88		
8. DEPTH DRILLED INTO ROCK		17. ELEVATION TOP OF HOLE -39.4		
9. TOTAL DEPTH OF HOLE 6.0'		18. TOTAL CORE RECOVERY FOR BORING 70%		
19. <del>XXXXXXXXXXXX</del> GEOLOGIST - J. Hand				

ELEVATION a	DEPTH b	LEGEND c	CLASSIFICATION OF MATERIALS (Description) d	% CORE RECOVERY e	NO. OF SAMPLES f	REMARKS (Drilling time, water loss, depth of weathering, etc., if significant) g
						Bit or Barrel
-39.4	0.0					-39.4 Blows/ft settled
-42.4	3.0		Sand, fine to medium shell, very fine quartz, a little silt to silty layers of silt, gray (SM)	70	1	2" Sampler 7
			Silt, very sandy, some shell, green (ML)		2	5
-45.4	6.0				3	-45.4 6
			Soils are field visually classified in accordance with the Unified Soils Classification System.			300 # hammer used with 18" drop on 2" sampler
			LABORATORY CLASSIFICATION (based on grain size and visual)			
			ELEVATION CLASS -39.4 to -41.0 SC			
			BLS/FT. REFERS TO THE NUMBER OF HAMMER BLOWS REQUIRED TO ADVANCE A 2" SAMPLER (2" I.D. X 2 1/2" O.D.) ONE FOOT. THE SAMPLER IS 5 FT. LONG AND DRIVEN CONTINUOUSLY 5 FT. WHERE POSSIBLE.			BLOW COUNTS FOR THE 2" SAMPLER HAVE NOT BEEN CORRELATED WITH STANDARD SPLIT SPOON TESTS AS DESIGNATED IN ASTM D-1586. JUDGEMENT IS NEEDED IN THE USE OF THE BLOW COUNT DATA FOR THE 2" SAMPLER.

259

Hole No. CB-CH89-1

<b>DRILLING LOG</b>	DIVISION SOUTH ATLANTIC	INSTALLATION JACKSONVILLE DISTRICT	SHEET OF 1 SHEETS
1. PROJECT CANAVERAL HARBOR		10. SIZE AND TYPE OF BIT SEE REMARKS	
2. LOCATION (Coordinates or Station) X=555796 Y=1465943		11. DATUM FOR ELEVATION SHOWN (FON or MSL) MLM	
3. DRILLING AGENCY CORPS OF ENGINEERS		12. MANUFACTURER'S DESIGNATION OF DRILL SAH SKID RIG	
4. HOLE NO. (As shown on drawing title and file number) CR-CH89-1		13. TOTAL NO. OF OVER-BURDEN SAMPLES TAKEN DISTURBED: _____ UNDISTURBED: _____	
5. NAME OF DRILLER R. GORDON		14. TOTAL NUMBER CORE BOXES 1	
6. DIRECTION OF HOLE <input checked="" type="checkbox"/> VERTICAL <input type="checkbox"/> INCLINED _____ DEG. FROM VERT.		15. ELEVATION GROUND WATER TIDAL	
7. THICKNESS OF OVERBURDEN		16. DATE HOLE STARTED 2-8-89 COMPLETED 2-8-89	
8. DEPTH DRILLED INTO ROCK		17. ELEVATION TOP OF HOLE -45.1	
9. TOTAL DEPTH OF HOLE 7.0'		18. TOTAL CORE RECOVERY FOR BORING 71	
		19. SIGNATURE OF INVESTIGATOR J. GENTILE GEOLOGIST	

ELEVATION a	DEPTH b	LEGEND c	CLASSIFICATION OF MATERIALS (Description) d	% CORE RECOVERY e	SAMPLER NO. f	REMARKS (Drilling time, water loss, depth of penetration, etc., if significant) g
-45.1	0.0					BIT OR BARNEL
-51.1	6.0		SAND, very fine, quartz, very silty, little clay, gray, little shell, wet, soupy (SM)	71	1	BLS/FT
-52.1	7.0		CLAY, plastic, fat, damp, trace to little shell, gray (CH)		2	SETTLED
			SOILS ARE FIELD VISUALLY CLASSIFIED IN ACCORDANCE WITH THE UNIFIED SOILS CLASSIFICATION SYSTEM			300# hammer with 18" drop used on 2" Sampler.
			SAMPLE LABORATORY ELEVATION CLASSIFICATION			BLOW COUNTS FOR THE 2" SAMPLER HAVE NOT BEEN CORRELATED WITH STANDARD SPLIT-SPOON TESTS AS DESIGNATED IN ASTM D-1586. JUDGEMENT IS NEEDED IN THE USE OF THE BLOW COUNT DATA FOR THE 2" SAMPLER.
			-45.1 to -55.1 (SW-SM)			BLS/FT. REFERS TO THE NUMBER OF HAMMER BLOWS REQUIRED TO ADVANCE A 2" SAMPLER (2" I.D. X 2 3/4" O.D.) ONE FOOT. THE SAMPLER IS 5 FT. LONG AND DRIVEN CONTINUOUSLY 5 FT. WHERE POSSIBLE.
			NOTE: *VISUAL CLASSIFICATION BASED ON GRADATION CURVE No Atterberg Limits.			

201

Hole No. CB-CH89-2

<b>DRILLING LOG</b>	DIVISION SOUTH ATLANTIC	INSTALLATION JACKSONVILLE DISTRICT	SHEET OF 1 SHEETS
1. PROJECT CANAVERAL HARBOR		10. SIZE AND TYPE OF BIT SEE REMARKS	
2. LOCATION (Coordinates or Station) Y=655541 X=1467078		11. DAY/DM FOR ELEVATION SHOWN (75% or NSL) MLW	
3. DRILLING AGENCY CORPS OF ENGINEERS		12. MANUFACTURER'S DESIGNATION OF DRILL S&H SKID RIG	
4. HOLE NO. (As shown on drawing title) and file number CB-CH89-2		13. TOTAL NO. OF OVERBURDEN SAMPLES TAKEN DISTURBED _____ UNDISTURBED _____	
5. NAME OF GRILLER R. GORDON		14. TOTAL NUMBER CORE BOXES 1	
6. DIRECTION OF HOLE <input checked="" type="checkbox"/> VERTICAL <input type="checkbox"/> INCLINED _____ DEG. FROM VERT.		15. ELEVATION GROUND WATER TIDAL	
7. THICKNESS OF OVERBURDEN		16. DATE HOLE STARTED 2-22-89 COMPLETED 2-22-89	
8. DEPTH DRILLED INTO ROCK		17. ELEVATION TOP OF HOLE -44.3	
9. TOTAL DEPTH OF HOLE 10.0'		18. TOTAL CORE RECOVERY FOR BORING 100 %	
		19. SIGNATURE OF <del>XXXXXXXX</del> J. GENTILE GEGOLOGIST	

ELEVATION	DEPTH	LEGEND	CLASSIFICATION OF MATERIALS (Description)	% CORE RECOVERY	SAMPLE NO.	REMARKS (Drilling time, water loss, depth of penetration, etc., if significant)
a	b	c	d	e	f	g
-44.3	0.0					BIT OR BARREL
-46.8	2.5		SAND, fine, quartz, silty, wet, soupy, gray, little shell (SM)	100	1	SETTLED
-49.3	5.0		SAND, fine to medium, quartz, clayey, little shell, gray, damp. (SC)		2	2" SAMPLER
-51.3	2.0		SHELL, clayey, wet, trace sand, gray		3	"
-54.3	10.0		CLAY, plastic, fat, little shell, gray (CH)	100	4	SETTLED
			SOILS ARE FIELD VISUALLY CLASSIFIED IN ACCORDANCE WITH THE UNIFIED SOILS CLASSIFICATION SYSTEM			300# hammer with 18" drop used on 2" Sampler.  BLOW COUNTS FOR THE 2" SAMPLER HAVE NOT BEEN CORRELATED WITH STANDARD SPLIT-SPOON TESTS AS DESIGNATED IN ASTM D-1586. JUDGEMENT IS NEEDED IN THE USE OF THE BLOW COUNT DATA FOR THE 2" SAMPLER.  BLS/FT. REFERS TO THE NUMBER OF HAMMER BLOWS REQUIRED TO ADVANCE A 2" SAMPLER (2" I.D. X 2 1/2" O.D.) ONE FOOT. THE SAMPLER IS 5 FT. LONG AND DRIVEN CONTINUOUSLY 5 FT. WHERE POSSIBLE.

Hole No. CB-CH89-3

DRILLING LOG		DIVISION		INSTALLATION		SHEET	
CANARVAL HARBOUR		SOUTH ATLANTIC		JACKSONVILLE DISTRICT		OF 1 SHEETS	
1. PROJECT				10. SIZE AND TYPE OF BIT			
2. LOCATION (Coordinates or Station)				11. DAY ON FOR ELEVATION SHOWN (TBM or MSL)			
3. DRILLING AGENCY				12. MANUFACTURER'S DESIGNATION OF DRILL			
4. HOLE NO. (As shown on drawing title and file number)				13. TOTAL NO. OF OVER-BURDEN SAMPLES TAKEN			
5. NAME OF DRILLER				14. TOTAL NUMBER CORE BOXES			
6. DIRECTION OF HOLE				15. ELEVATION GROUND WATER			
7. THICKNESS OF OVERBURDEN				16. DATE HOLE			
8. DEPTH DRILLED INTO ROCK				17. ELEVATION TOP OF HOLE			
9. TOTAL DEPTH OF HOLE				18. TOTAL CORE RECOVERY FOR BORING			
				19. SIGNATURE OF GEOLOGIST			
ELEVATION		DEPTH		CLASSIFICATION OF MATERIALS		REMARKS	
a		b		d		e	
						BIT OR BARREL	
-45.6		0.0				-45.6 BLS/FT	
-48.1		2.5		CLAY, plastic, gray wet, (CH)		100 1 SETTLED	
-50.7		5.1		SAND, fine to medium, quartz, some silt, trace clay, some shell, (SH)		2 5 SETTLED	
				CLAY, plastic, little to some shell, gray (CH)		100 3 1 SETTLED	
-55.6		10.0				-55.6	
SOILS ARE FIELD VISUALLY CLASSIFICATION IN ACCORDANCE WITH THE UNIFIED SOILS CLASSIFICATION SYSTEM				300# hammer with 18" DROP USED ON 2" Sampler.			
				BLOW COUNTS FOR THE 2" SAMPLER HAVE NOT BEEN COORELATED WITH STANDARD SPLIT-SPOON TESTS AS DESIGNATED IN ASTM D-1586. JUDGEMENT IS NEEDED IN THE USE OF THE BLOW COUNT DATA FOR THE 2" SAMPLER.			
				BLS/FT. REFERS TO THE NUMBER OF HAMMER BLOWS REQUIRED TO ADVANCE A 2" SAMPLER (2" I.O. X 2 1/2" O.D.) ONE FOOT. THE SAMPLER IS 5 FT. LONG AND DRIVEN CONTINUOUSLY 5 FT. WHERE POSSIBLE.			

25

Hole No. CR-CH89-4

<b>DRILLING LOG</b>	<b>DIVISION</b> SOUTH ATLANTIC	<b>INSTALLATION</b> JACKSONVILLE DISTRICT	<b>SHEET</b> OF 7 SHEETS
1. PROJECT CANAVERAL HARBOR		10. SIZE AND TYPE OF BIT SEE REMARKS	
2. LOCATION (Coordinates or Station) X=653547 Y=1467210		11. DATUM FOR ELEVATION SHOWN (TBM or MSL) MLW	
3. DRILLING AGENCY CORPS OF ENGINEERS		12. MANUFACTURER'S DESIGNATION OF DRILL S&H SKID RIG	
4. HOLE NO. (As shown on drawing title and file number) CB-CH89-4		13. TOTAL NO. OF OVERBURDEN SAMPLES TAKEN	DISTURBED UNDISTURBED
5. NAME OF DRILLER R. GORDON		14. TOTAL NUMBER CORE BOXES	
6. DIRECTION OF HOLE <input checked="" type="checkbox"/> VERTICAL <input type="checkbox"/> INCLINED _____ DEG. FROM VERT.		15. ELEVATION GROUND WATER TIDAL	
7. THICKNESS OF OVERBURDEN		16. DATE HOLE	STARTED 3-1-89 COMPLETED 3-1-89
8. DEPTH DRILLED INTO ROCK		17. ELEVATION TOP OF HOLE	-43.9
9. TOTAL DEPTH OF HOLE 7.5'		18. TOTAL CORE RECOVERY FOR BORING	67 %
		19. SIGNATURE OF INVESTIGATOR GEOLOGIST	J. GENTILE

ELEVATION a	DEPTH b	LEGEND c	CLASSIFICATION OF MATERIALS (Description) d	CORE RECOVERY e	SAMPLE NO. f	REMARKS (Drilling time, water loss, depth of weathering, etc., if significant) g
-43.9	0.0					BIT ON BARREL
-44.8	0.9		CLAY, dark gray, wet, soupy, trace shell, (CL)			-43.9 BLS/FT
-47.4	3.5		SAND, fine to medium, quartz, clayey, wet, little shell, gray, (SC)	67	1 2 3	2" SAMPLER 5 7 SETTLED
-51.4	7.5		CLAY, plastic, dark gray, trace sand, trace shell, damp (CH)			-51.4
			SOILS ARE FIELD VISUALLY CLASSIFIED IN ACCORDANCE WITH THE UNIFIED CLASSIFICATION SYSTEM			
			SAMPLE ELEVATION	LABORATORY CLASSIFICATION		
			-44.8 to -47.4	(SM-SC)		
NOTE: *VISUAL CLASSIFICATION BASED ON GRADATION CURVE ANALYSIS. NO ATTERBERG LIMITS.						
				300# hammer with 18" drop used on 2" Sampler.		
				BLOW COUNTS FOR THE 2" SAMPLER HAVE NOT BEEN COORELATED WITH STANDARD SPLIT-SPOON TESTS AS DESIGNATED IN ASTM D-1586. JUDGEMENT IS NEEDED IN THE USE OF THE BLOW COUNT DATA FOR THE 2" SAMPLER.		
				BLS/FT. REFERS TO THE NUMBER OF HAMMER BLOWS REQUIRED TO ADVANCE A 2" SAMPLER (2" I.D. X 2 1/8" O.D.) ONE FOOT. LONG AND DRIVEN CONTINUOUSLY 5 FT. WHERE POSSIBLE.		

Note No. CR-CH89-5

<b>DRILLING LOG</b>		<b>DIVISION</b> SOUTH ATLANTIC	<b>INSTALLATION</b> JACKSONVILLE DISTRICT		<b>SHEET</b> OF 1 SHEETS
1. PROJECT Canaveral Harbor			10. SIZE AND TYPE OF BIT <b>SEE REMARKS</b>		
2. LOCATION (Coordinates or Station) X=654020 Y=1467805			11. DATUM FOR ELEVATION SHOWN (FORM OR BSL) MLW		
3. DRILLING AGENCY CORPS OF ENGINEERS			12. MANUFACTURER'S DESIGNATION OF DRILL SAH SKID RIG		
4. HOLE NO. (As shown on drawing title and file number) CR-CH89-5			13. TOTAL NO. OF OVERBURDEN SAMPLES TAKEN DISTURBED _____ UNDISTURBED _____		
5. NAME OF DRILLER R. GORDON			14. TOTAL NUMBER CORE BOXES 7		
6. DIRECTION OF HOLE <input checked="" type="checkbox"/> VERTICAL <input type="checkbox"/> INCLINED _____ DEG. FROM VERT.			15. ELEVATION GROUND WATER TIDAL		
7. THICKNESS OF OVERBURDEN			16. DATE HOLE STARTED 3-1-89 COMPLETED 3-1-89		
8. DEPTH DRILLED INTO ROCK			17. ELEVATION TOP OF HOLE -43.4		
9. TOTAL DEPTH OF HOLE 10.0'			18. TOTAL CORE RECOVERY FOR BORING 100		
			19. SIGNATURE OF <del>XXXXXXXX</del> GEOLOGIST J. GENTILE		

ELEVATION a	DEPTH b	LEGEND c	CLASSIFICATION OF MATERIALS (Description) d	% CORE RECOVERY e	SAMPLER NO. f	REMARKS (Drilling time, water loss, depth of weathering, etc., if significant) g										
-43.4	0.0					BIT OR BARREL										
-45.1	1.7		CLAY, slightly plastic, sandy, silty, wet, soupy, dark gray, trace shell (CL)	100	1	-43.4 BLS/FT. SETTLED										
-47.9	4.5		SAND, fine to medium, quartz, clayey, trace shell, wet, gray (SC) Bed of clayey shell, from -47.9 to -48.9		2	2" SAMPLER 6										
-48.9	5.5				3	-48.4 2 SETTLED										
-53.4	10.0		CLAY, plastic, little shell, trace sand, gray, damp, (CH)	100	4	-53.4 7										
			SOILS ARE FIELD VISUALLY CLASSIFIED IN ACCORDANCE WITH THE UNIFIED SOIL CLASSIFICATION SYSTEM													
			<table border="1" style="width:100%; border-collapse: collapse;"> <tr> <th>SAMPLE ELEVATION</th> <th>LABORATORY CLASSIFICATION</th> </tr> <tr> <td>-43.4 to -45.1</td> <td>(SM-H)*</td> </tr> <tr> <td>-45.1 to -47.9</td> <td>(SP-SM)*</td> </tr> <tr> <td>-47.9 to -48.9</td> <td>(SP-SH)*</td> </tr> <tr> <td>-48.9 to -53.4</td> <td>(CH)*</td> </tr> </table>	SAMPLE ELEVATION	LABORATORY CLASSIFICATION	-43.4 to -45.1	(SM-H)*	-45.1 to -47.9	(SP-SM)*	-47.9 to -48.9	(SP-SH)*	-48.9 to -53.4	(CH)*			
SAMPLE ELEVATION	LABORATORY CLASSIFICATION															
-43.4 to -45.1	(SM-H)*															
-45.1 to -47.9	(SP-SM)*															
-47.9 to -48.9	(SP-SH)*															
-48.9 to -53.4	(CH)*															
			NOTE: *VISUAL CLASSIFICATION BASED ON GRADATION CURVE. NO ATTERBERG LIMITS.													
				300# hammer with 18" drop used on 2" Sampler.												
				BLOW COUNTS FOR THE 2" SAMPLER HAVE NOT BEEN CORRELATED WITH STANDARD SPLIT-SPOON TESTS AS DESIGNATED IN ASTM D-1586. JUDGEMENT IS NEEDED IN THE USE OF THE BLOW COUNT DATA FOR THE 2" SAMPLER.												
				BLS/FT. REFERS TO THE NUMBER OF HAMMER BLOWS REQUIRED TO ADVANCE A 2" SAMPLER (2" I.D. X 2 1/2" O.D.) ONE FOOT. THE SAMPLER IS 5 FT. LONG AND DRIVEN CONTINUOUSLY 5 FT. WHERE POSSIBLE.												

(25)

Hole No. CB-CH89-6

<b>DRILLING LOG</b>		DIVISION SOUTH ATLANTIC	INSTALLATION JACKSONVILLE DISTRICT	SHEET OF 1 SHEETS
1. PROJECT CANAVERAL HARBOR		10. SIZE AND TYPE OF BIT <u>SEE REMARKS</u>		
2. LOCATION (Coordinates or Station) X=653027 Y=1468140		11. DATUM FOR ELEVATION SHOWN (TBM or MSL) MLW		
3. DRILLING AGENCY CORPS OF ENGINEERS		12. MANUFACTURER'S DESIGNATION OF DRILL S&H SKID RIG		
4. HOLE NO. (As shown on drawing title and file number) CB-CH89-6		13. TOTAL NO. OF OVER-BURDEN SAMPLES TAKEN <input type="checkbox"/> DISTURBED <input type="checkbox"/> UNDISTURBED		
5. NAME OF DRILLER R. GORDON		14. TOTAL NUMBER CORE BOXES		
6. DIRECTION OF HOLE <input checked="" type="checkbox"/> VERTICAL <input type="checkbox"/> INCLINED _____ DEG. FROM VERT.		15. ELEVATION GROUND WATER TIDAL		
7. THICKNESS OF OVERBURDEN		16. DATE HOLE STARTED 2-3-89 COMPLETED 2-3-89		
8. DEPTH DRILLED INTO ROCK		17. ELEVATION TOP OF HOLE -45.4		
9. TOTAL DEPTH OF HOLE 10.0'		18. TOTAL CORE RECOVERY FOR BORING 80 %		
		19. SIGNATURE OF APPROVING GEOLOGIST J GENTILE		

ELEVATION a	DEPTH b	LEGEND c	CLASSIFICATION OF MATERIALS (Description) d	% CORE RECOVERY e	NO. OF SAMPLES f	REMARKS (Drilling time, water loss, depths of weathering, etc., if significant) g
						BIT OR BARREL
-45.4	0.0					-45.4 BLS/FT. SETTLED
-46.9	1.5		SILT, soft, soupy, sandy, dark gray, (ML)		1	2" SAMPLER
-50.4	5.0		SAND, fine to medium, quartz shelly, silty, gray, wet (SM)	60	2	3
-55.4	10.0		CLAY, plastic, fat, little shell, gray (CH)	100	3	SETTLED
			SOILS ARE FIELD VISUALLY CLASSIFIED IN ACCORDANCE WITH THE UNIFIED SOIL CLASSIFICATION SYSTEM			300# hammer with 18" drop used on 2" sampler. BLOW COUNTS FOR THE 2" SAMPLER HAVE NOT BEEN CORRELATED WITH STANDARD SPLIT-SPOON TESTS AS DESIGNATED IN ASTM D-1586. JUDGEMENT IS NEEDED IN THE USE OF THE BLOW COUNT DATA FOR THE 2" SAMPLER.  BLS/FT. REFERS TO THE NUMBER OF HAMMER BLOWS REQUIRED TO ADVANCE A 2" SAMPLER (2" I.D. X 2 1/2" O.D.) ONE FOOT. THE SAMPLER IS 5 FT. LONG AND DRIVEN CONTINUOUSLY 5 FT. WHERE POSSIBLE.



Note No. CB-CH89-7

<b>DRILLING LOG</b>		DIVISION SOUTH ATLANTIC	INSTALLATION JACKSONVILLE DISTRICT	SHEET OF 1 SHEETS
1. PROJECT CANAVERAL HARBOR		10. SIZE AND TYPE OF BIT SEE REMARKS		
2. LOCATION (Coordinates or Station) X=651989 Y=1468503		11. DATUM FOR ELEVATION SHOWN (FBM or MSL) MLW		
3. DRILLING AGENCY CORPS OF ENGINEERS		12. MANUFACTURER'S DESIGNATION OF DRILL S&H SKID RIG		
4. HOLE NO. (As shown on drawing title and file number) CB-CH89-7		13. TOTAL NO. OF OVER- BURDEN SAMPLES TAKEN		
5. NAME OF DRILLER R GORDON		14. TOTAL NUMBER CORE BOXES		
6. DIRECTION OF HOLE <input checked="" type="checkbox"/> VERTICAL <input type="checkbox"/> INCLINED _____ DEG. FROM VERT.		15. ELEVATION GROUND WATER TIDAL		
7. THICKNESS OF OVERBURDEN		16. DATE HOLE STARTED 2-3-89 COMPLETED 2-3-89		
8. DEPTH DRILLED INTO ROCK		17. ELEVATION TOP OF HOLE -43.6		
9. TOTAL DEPTH OF HOLE 10.0'		18. TOTAL CORE RECOVERY FOR BORING 61		
		19. SIGNATURE OF DRILLER J. GENTILE		

ELEVATION a	DEPTH b	LEGEND c	CLASSIFICATION OF MATERIALS (Description) d	1. CORE RECOVERY e	2. SAMPLE NO. f	REMARKS (Drilling time, water loss, depth of weathering, etc., if significant) g
						BIT OR BARREL
-43.6	0.0					-43.6 BLS/FT.
-45.1	1.5		CLAY, plastic, dark gray trace sand, wet (CH)		1	2" SAMPLER SETTLED
			SAND, fine to medium, quartz little to some silt, gray little shell, (SM)	82	2	
			CLAY, plastic, little sand trace shell, gray (CH)	40	3	
-51.6	8.0				4	
-53.6	10.0					
			SOILS ARE FIELD VISUALLY CLASSIFIED IN ACCORDANCE WITH THE UNIFIED SOIL CLASSIFICATION SYSTEM			
			SAMPLE      LABORATORY ELEVATION    CLASSIFICATION			
			-43.6 to -45.1 (MN)*			
			-45.1 to -51.5 (SP-SM)*			
			NOTE: *VISUAL CLASSIFICATION BASED ON GRADATION CURVE. NO ATTERBERG LIMITS.			
				300# hammer with 18" drop used on 2" Sampler		
				BLOW COUNTS FOR THE 2" SAMPLER HAVE NOT BEEN CORRELATED WITH STANDARD SPLIT-SPOON TESTS AS DESIGNATED IN ASTM D-1586. JUDGEMENT IS NEEDED IN THE USE OF THE BLOW COUNT DATA FOR THE 2" SAMPLER.		
				BLS/FT. REFERS TO THE NUMBER OF HAMMER BLOWS REQUIRED TO ADVANCE A 2" SAMPLER (2" I.D. X 2 1/4" O.D.) ONE FOOT. THE SAMPLER IS 5 FT. LONG AND DRIVER CON- TINUOUSLY 5 FT. WHERE POSSIBLE.		

269

Hole No. CB-CH89-8

<b>DRILLING LOG</b>		DIVISION SOUTH ATLANTIC	INSTALLATION JACKSONVILLE DISTRICT	SHEET of 1 SHEETS
1. PROJECT CANAVERAL HARBOR		10. SIZE AND TYPE OF BIT SEE REMARKS		
2. LOCATION (Coordinate or Station) X=662505 Y=1469083		11. DATUM FOR ELEVATION SHOWN (FDM or MSL) MLW		
3. DRILLING AGENCY CORPS OF ENGINEERS		12. MANUFACTURER'S DESIGNATION OF DRILL S&H SKID RIG		
4. HOLE NO. (As shown on drawing title and file included) CB-CH89-8		13. TOTAL NO. OF OVER-BURDEN SAMPLES TAKEN	DISTURBED	UNDISTURBED
5. NAME OF DRILLER R. GORDON		14. TOTAL NUMBER CORE BOXES		
6. DIRECTION OF HOLE <input checked="" type="checkbox"/> VERTICAL <input type="checkbox"/> INCLINED _____ DEG. FROM VERT.		15. ELEVATION GROUND WATER TIDAL		
7. THICKNESS OF OVERBURDEN		16. DATE HOLE	STARTED	COMPLETED
8. DEPTH DRILLED INTO ROCK		2-6-89	2-6-89	
9. TOTAL DEPTH OF HOLE 10.0'		17. ELEVATION TOP OF HOLE -42.5		
		18. TOTAL CORE RECOVERY FOR BORING 70		
		19. SIGNATURE OF <del>XXXXXXXXXX</del> GEOLOGIST J. GENTILE		

ELEVATION a	DEPTH b	LEGEND c	CLASSIFICATION OF MATERIALS (Description) d	% CORE RECOVERY e	SAMPLE NO. f	REMARKS (Drilling time, water loss, depth of weathering, etc., if significant) g
						BIT OR BARREL
-42.5	0.0					-42.5 BLS/FT.
-44.0	1.5		SAND, fine to medium, quartz, clayey, little shell, gray (SC)	80	1	2" SAMPLER settled
			SAND, fine to medium, quartz, little shell, little to some silt, little clay, (SM)		2	
					9	
					10	
					9	
					7	
-50.5	8.0		CLAY, slightly plastic, sandy, silty, gray, little shell, (CL)	60	3	
					4	
					15	
					16	
					8	
-52.5	10.0					-52.5
			SOILS ARE FIELD VISUALLY CLASSIFIED IN ACCORDANCE WITH THE UNIFIED SOILS CLASSIFICATION SYSTEM			300# hammer with 18" drop used on 2" sampler.
						BLOW COUNTS FOR THE 2" SAMPLER HAVE NOT BEEN CORRELATED WITH STANDARD SPLIT-SPOON TESTS AS DESIGNATED IN ASTM. D-1586. JUDGEMENT IS NEEDED IN THE USE OF THE BLOW COUNT DATA FOR THE 2" SAMPLER.
						BLS/FT. REFERS TO THE NUMBER OF HAMMER BLOWS REQUIRED TO ADVANCE A 2" SAMPLER (2" I.D. X 2 1/2" O.D.) ONE FOOT. THE SAMPLER IS 5 FT. LONG AND DRIVEN CONTINUOUSLY 5 FT. WHERE POSSIBLE.

(261)

Hole No. CB-CH89-9

<b>DRILLING LOG</b>	DIVISION SOUTH ATLANTIC	INSTALLATION JACKSONVILLE DISTRICT	SHEET 1 OF 1 SWEETS
1. PROJECT CANAVERAL HARBOR		10. SIZE AND TYPE OF BIT SEE REMARKS	
2. LOCATION (Coordinates or Station) X=651,438 Y=1,469,439		11. DATE FOR ELEVATION SHOWN (TBM or MSL) MLW	
3. DRILLING AGENCY CORPS OF ENGINEERS		12. MANUFACTURER'S DESIGNATION OF DRILL S&H SKID RIG	
4. HOLE NO. (As shown on drawing title and file number) CB-CH89-9		13. TOTAL NO. OF OVERBURDEN SAMPLES TAKEN DISTURBED: UNDISTURBED:	
5. NAME OF DRILLER R. GORDON		14. TOTAL NUMBER CORE BOXES 7	
6. DIRECTION OF HOLE <input checked="" type="checkbox"/> VERTICAL <input type="checkbox"/> INCLINED _____ DEG. FROM VERT.		15. ELEVATION GROUND WATER TIDAL	
7. THICKNESS OF OVERBURDEN		16. DATE HOLE STARTED: 2-3-89 COMPLETED: 2-3-89	
8. DEPTH DRILLED INTO ROCK		17. ELEVATION TOP OF HOLE -45.3	
9. TOTAL DEPTH OF HOLE 8.0'		18. TOTAL CORE RECOVERY FOR BORING 67%	
		19. SIGNATURE OF DRILLER J. GENTILE	

ELEVATION	DEPTH	LEGEND	CLASSIFICATION OF MATERIALS (Description)	% CORE RECOVERY	LABORATORY SAMPLE NO.	REMARKS (Drilling time, water loss, depths of weathering, etc., if significant)
a	b	c	d	e	f	g
-45.3	0.0					BIT OR BARREL
-49.3	4.0		CLAY, wet, soupy, sandy, dark gray, slightly plastic seams clayey sand, (CL)	80	1	2" SAMPLER SETTLED
-51.3	6.0		SAND, fine to medium, quartz, little clay, some shell, gray (SC)		2	10
-53.3	8.0		CLAY, plastic, fat, little shell, gray, (CH)	43	3	5
			SOILS ARE FIELD VISUALLY CLASSIFIED IN ACCORDANCE WITH THE UNIFIED SOILS CLASSIFICATION SYSTEM			300# hammer with 18" drop used on 2" Sampler.
			SAMPLE ELEVATION			BLOW COUNTS FOR THE 2" SAMPLER HAVE NOT BEEN CORRELATED WITH STANDARD SPLIT-SPOON TESTS AS DESIGNATED IN ASTM D-1586. JUDGEMENT IS NEEDED IN THE USE OF THE BLOW COUNT DATA FOR THE 2" SAMPLER.
			LABORATORY CLASSIFICATION			BLS/FT. REFERS TO THE NUMBER OF HAMMER BLOWS REQUIRED TO ADVANCE A 2" SAMPLER (2" I.D. X 2 1/2" O.D.) ONE FOOT. THE SAMPLER IS 5 FT. LONG AND DRIVEN CONTINUOUSLY 5 FT. WHERE POSSIBLE.
			-43.5 to -49.3 (SM-H)			
			NOTE: *VISUAL CLASSIFICATION BASED ON GRADATION CURVE. NO ATTERBERG LIMITS.			

Hole No. CB-CH89-10



<b>DRILLING LOG</b>		DIVISION SOUTH ATLANTIC	INSTALLATION JACKSONVILLE DISTRICT	SHEET OF 1 SHEETS
1. PROJECT CANAVERAL HARBOR			10. SIZE AND TYPE OF BIT SEE REMARKS	
2. LOCATION (Coordinates of Station) X=650436 Y=1469769			11. DATUM FOR ELEVATION SHOWN (TBM or MSL) MLW	
3. DRILLING AGENCY CORPS OF ENGINEERS			12. MANUFACTURER'S DESIGNATION OF DRILL S&H SKID RIG	
4. HOLE NO. (As shown on drawing title and file number) CB-CH89-10			13. TOTAL NO. OF OVER-BURDEN SAMPLES TAKEN	
5. NAME OF DRILLER R. GORDON			14. TOTAL NUMBER CORE BOXES	
6. DIRECTION OF HOLE <input checked="" type="checkbox"/> VERTICAL <input type="checkbox"/> INCLINED _____ DEG. FROM VERT.			15. ELEVATION GROUND WATER TIDAL	
7. THICKNESS OF OVERBURDEN			16. DATE HOLE STARTED 2-6-89 COMPLETED 2-6-89	
8. DEPTH DRILLED INTO ROCK			17. ELEVATION TOP OF HOLE -42.3	
9. TOTAL DEPTH OF HOLE 10.0'			18. TOTAL CORE RECOVERY FOR BORING 80 %	
			19. SIGNATURE OF DRILLER J. GENTILE GEOLOGIST	

ELEVATION	DEPTH	LEGEND	CLASSIFICATION OF MATERIALS (Description)	NO. CORE RECOVERY	NO. SAMPLE	REMARKS (Drilling time, water loss, depth of weathering, etc., if significant)						
a	b	c	d	e	f	g						
-42.3	0.0					BIT OR BARREL						
-44.5	2.2		CLAY, plastic, wet, dark gray, trace shell (CH) gray, trace to little sand from -42.3 to -42.8; sandy, silty, from -44.0 to -44.5 (CH)	80	1	-42.3 BLS/FT. 2" SAMPLER SETTLED						
			SAND, fine to medium, quartz, little silt, trace clay, little shell, gray (SM)	80	2	9 11 13						
-52.3	10.0				3	2 7 9 21 23						
			SOILS ARE FIELD VISUALLY CLASSIFIED IN ACCORDANCE WITH THE UNIFIED SOILS CLASSIFICATION SYSTEM									
			<table border="1"> <thead> <tr> <th>SAMPLE ELEVATION</th> <th>LABORATORY CLASSIFICATION</th> </tr> </thead> <tbody> <tr> <td>-42.3 to -44.5</td> <td>(SM-R)*</td> </tr> <tr> <td>-44.5 to -52.3</td> <td>(SP-SM)*</td> </tr> </tbody> </table>	SAMPLE ELEVATION	LABORATORY CLASSIFICATION	-42.3 to -44.5	(SM-R)*	-44.5 to -52.3	(SP-SM)*			
SAMPLE ELEVATION	LABORATORY CLASSIFICATION											
-42.3 to -44.5	(SM-R)*											
-44.5 to -52.3	(SP-SM)*											
			NOTE: *VISUAL CLASSIFICATION BASED ON GRADATION CURVE. NO ATTERBERG LIMITS.									
				300# hammer with 18" drop used on 2" Sampler.								
				BLOW COUNTS FOR THE 2" SAMPLER HAVE NOT BEEN CORRELATED WITH STANDARD SPLIT-SPOON TESTS AS DESIGNATED IN ASTM D-1586. JUDGEMENT IS NEEDED IN THE USE OF THE BLOW COUNT DATA FOR THE 2" SAMPLER.								
				BLS/FT. REFERS TO THE NUMBER OF HAMMER BLOWS REQUIRED TO ADVANCE A 2" SAMPLER (2" I.D. X 2 1/2" O.D.) ONE FOOT. THE SAMPLER IS 5 FT. LONG AND DRIVEN CONTINUOUSLY 5 FT. WHERE POSSIBLE.								

249

Hole No. CB-CH89-11

<b>DRILLING LOG</b>		DIVISION SOUTH ATLANTIC	INSTALLATION JACKSONVILLE DISTRICT	SHEET OF 1 SHEETS
1. PROJECT CANAVERAL HARBOR		10. SIZE AND TYPE OF BIT SEE REMARKS		
2. LOCATION (Coordinates or Station) X=650913 Y=1470390		11. DAY/IN FOR ELEVATION SHOWN (75% or MSL) MLW		
3. DRILLING AGENCY CORPS OF ENGINEERS		12. MANUFACTURER'S DESIGNATION OF DRILL S&H SKID RIG		
4. HOLE NO. (As shown on drawing title and file number)		13. TOTAL NO. OF OVER-BURDEN SAMPLES TAKEN	DISTURBED	UNDISTURBED
5. NAME OF DRILLER R. GORDON		14. TOTAL NUMBER CORE BOXES		
6. DIRECTION OF HOLE <input checked="" type="checkbox"/> VERTICAL <input type="checkbox"/> INCLINED _____ DEC. FROM VERT.		15. ELEVATION GROUND WATER TIDAL		
7. THICKNESS OF OVERBURDEN		16. DATE HOLE	STARTED 2-7-89	COMPLETED 2-7-89
8. DEPTH DRILLED INTO ROCK		17. ELEVATION TOP OF HOLE -41.8		
9. TOTAL DEPTH OF HOLE 10.0'		18. TOTAL CORE RECOVERY FOR BORING 65 %		
		19. SIGNATURE OF DRILLER/OPERATOR J. SENTILE		
		20. SIGNATURE OF SUPERVISOR GEOLOGIST		

ELEVATION a	DEPTH b	LEGEND c	CLASSIFICATION OF MATERIALS (Description) d	% CORE RECOVERY e	SAMPLE NO. f	REMARKS (Drilling time, water loss, depth of weathering, etc., if significant) g
						BIT OR BARREL
-41.8	0.0					-41.8 BLS/FT. SETTLED
-44.8	3.0		SAND, very fine, quartz, very clayey little silt, gray (SC)	80	1 2	2" Sampler
			SAND, fine to medium, quartz some silt, little clay, gray, little shell, (SM)			
-51.8	10.0			50	3	-46.8 " 11 6 11 10 15 -51.8 25
			SOILS ARE FIELD VISUALLY CLASSIFIED IN ACCORDANCE WITH THE UNIFIED SOILS CLASSIFICATION SYSTEM			300# hammer with 18" drop used on 2" Sampler.  BLOW COUNTS FOR THE 2" SAMPLER HAVE NOT BEEN CORRELATED WITH STANDARD SPLIT-SPOON TESTS AS DESIGNATED IN ASTM D-1586. JUDGEMENT IS NEEDED IN THE USE OF THE BLOW COUNT DATA FOR THE 2" SAMPLER.  BLS/FT. REFERS TO THE NUMBER OF HAMMER BLOWS REQUIRED TO ADVANCE A 2" SAMPLER (2" I.D. X 2 1/2" O.D.) ONE FOOT. THE SAMPLER IS 5 FT. LONG AND DRIVEN CONTINUOUSLY 5 FT. WHERE POSSIBLE.

267

Hole No. CB-CH89-12

<b>DRILLING LOG</b>		DIVISION SOUTH ATLANTIC	INSTALLATION JACKSONVILLE DISTRICT	SHEET 1 of 1 SHEETS
1. PROJECT CANAVERAL HARBOR		10. SIZE AND TYPE OF BIT SEE REMARKS		
2. LOCATION (Coordinates or Station) X=649927 Y=1470727		11. DATUM FOR ELEVATION SHOWN (TUM or MSL) MLW		
3. DRILLING AGENCY CORPS OF ENGINEERS		12. MANUFACTURER'S DESIGNATION OF DRILL S&H SKID RIG		
4. HOLE NO. (As shown on drawing title and file number) CB-CH89-12		13. TOTAL NO. OF OVERBURDEN SAMPLES TAKEN DISTURBED _____ UNDISTURBED _____		
5. NAME OF DRILLER R. GORDON		14. TOTAL NUMBER CORE BOXES 1		
6. DIRECTION OF HOLE <input checked="" type="checkbox"/> VERTICAL <input type="checkbox"/> INCLINED _____ DEG. FROM VERT.		15. ELEVATION GROUND WATER TIDAL		
7. THICKNESS OF OVERBURDEN		16. DATE HOLE STARTED _____ COMPLETED _____ 2-7-89 2-7-89		
8. DEPTH DRILLED INTO ROCK 8.5'		17. ELEVATION TOP OF HOLE		
		18. TOTAL CORE RECOVERY FOR BORING 12 %		
		19. SIGNATURE OF INSPECTOR G. GENTILE GEOLOGIST		

ELEVATION	DEPTH	LEGEND	CLASSIFICATION OF MATERIALS (Description)	CORE RECOVERY	SAMPLE NO.	REMARKS (Drilling time, water loss, depth of weathering, etc., if significant)
a	b	c	d	e	f	g
-45.7	0.0					BIT OR BARREL -45.7 BLS/FT.
-53.7	8.5		CLAY, plastic, trace to little sand, gray, wet, soupy (CH)	12	1	2" SAMPLER SETTLED -53.7
			SOILS ARE FIELD VISUALLY CLASSIFIED IN ACCORDANCE WITH THE UNIFIED SOILS CLASSIFICATION SYSTEM			300# hammer with 18" drop used on 2" Sampler.  BLOW COUNTS FOR THE 2" SAMPLER HAVE NOT BEEN CORRELATED WITH STANDARD SPLIT-SPOON TESTS AS DESIGNATED IN ASTM D-1586. JUDGEMENT IS NEEDED IN THE USE OF THE BLOW COUNT DATA FOR THE 2" SAMPLER.  BLS/FT. REFERS TO THE NUMBER OF HAMMER BLOWS REQUIRED TO ADVANCE A 2" SAMPLER (2" I.D. X2 1/2" O.D.) ONE FOOT. THE SAMPLER IS 5 FT. LONG AND DRIVEN CONTINUOUSLY 5 FT. WHERE POSSIBLE.

267

Hole No. CB-CH89-13

<b>DRILLING LOG</b>		DIVISION SOUTH ATLANTIC	INSTALLATION JACKSONVILLE DISTRICT	SHEET OF 1 SHEETS
1. PROJECT CANAVERAL HARBOR		10. SIZE AND TYPE OF BIT SEE REMARKS		
2. LOCATION (Coordinates or Station) X=648925 Y=1471044		11. DATUM FOR ELEVATION SHOWN (FSM or MSL) MLW		
3. DRILLING AGENCY CORPS OF ENGINEERS		12. MANUFACTURER'S DESIGNATION OF DRILL SM SKID RIG		
4. HOLE NO. (As shown on drawing title and file number) CB-CH89-13		13. TOTAL NO. OF OVER-BURDEN SAMPLES TAKEN DISTURBED _____ UNDISTURBED _____		
5. NAME OF DRILLER R. GORDON		14. TOTAL NUMBER CORE BOXES 1		
6. DIRECTION OF HOLE <input checked="" type="checkbox"/> VERTICAL <input type="checkbox"/> INCLINED _____ DEG. FROM VERT.		15. ELEVATION GROUND WATER TIDAL		
7. THICKNESS OF OVERBURDEN		16. DATE HOLE STARTED 2-7-89 COMPLETED 2-7-89		
8. DEPTH DRILLED INTO ROCK		17. ELEVATION TOP OF HOLE -42.2		
9. TOTAL DEPTH OF HOLE 10.0		18. TOTAL CORE RECOVERY FOR BORING 6/		
		19. SIGNATURE OF INSPECTOR XXXXXXXXX GEOLOGIST J. GENTILE		

ELEVATION a	DEPTH b	LEGEND c	CLASSIFICATION OF MATERIALS (Description) d	SCORE RECOVERY e	UNDESIGNED SAMPLE NO. f	REMARKS (Drilling time, water loss, depth of weathering, etc., if significant) g
						BIT OR BARREL
-42.2	0.0					-42.2 BLS/FT.
-43.0	0.8		CLAY, plastic dark gray (CH)	84	1	2" SAMPLER SETTLED
-45.9	3.7		SAND, very fine, quartz, clayey, gray, little shell (SC)		2	
					3	
						-47.2 16
						9
						10
						16
-52.2	10.0		SAND, fine to medium, quartz, trace silt, gray, trace shell (SP)	50	4	16
						21
						16
			SOILS ARE FIELD VISUALLY CLASSIFIED IN ACCORDANCE WITH THE UNIFIED SOILS CLASSIFICATION SYSTEM	300# hammer with 18" drop used on 2" Sampler.		
			SAMPLE LABORATORY ELEVATION CLASSIFICATION	BLOW COUNTS FOR THE 2" SAMPLER HAVE NOT BEEN CORRELATED WITH STANDARD SPLIT-SPOON TESTS AS DESIGNATED IN ASTM D-1586. JUDGEMENT IS NEEDED IN THE USE OF THE BLOW COUNT DATA FOR THE 2" SAMPLER.		
			-42.2 to -43.0 (CH)*			
			-43.0 to -45.9 (SM-H)*			
			-45.9 to -52.2 (SP)*			
			Note: * Visual Classification based on gradation curve. No Atterberg Limits.	BLS/FT. REFERS TO THE NUMBER OF HAMMER BLOWS REQUIRED TO ADVANCE A 2" SAMPLER (2" I.D. X2 1/2" O.D.) ONE FOOT. THE SAMPLER IS 5 FT. LONG AND DRIVEN CONTINUOUSLY 5 FT. WHERE POSSIBLE.		

266

Hole No. CB-CH89-14

<b>DRILLING LOG</b>		DIVISION SOUTH ATLANTIC	INSTALLATION JACKSONVILLE DISTRICT	SHEET 1 OF 1 SHEETS
1. PROJECT CANAVERAL HARBOR		10. SIZE AND TYPE OF BIT SEE REMARKS		
2. LOCATION (Coordinates of Station) X=649418 Y=1471544		11. DATUM FOR ELEVATION SHOWN (TBM or MSL) MLW		
3. DRILLING AGENCY CORPS OF ENGINEERS		12. MANUFACTURER'S DESIGNATION OF DRILL S&H SKID RIG		
4. HOLE NO. (As shown on drawing title and file number) CB-CH89-14		13. TOTAL NO. OF OVERBURDEN SAMPLES TAKEN DISTURBED _____ UNDISTURBED _____		
5. NAME OF DRILLER R. GORDON		14. TOTAL NUMBER CORE BOXES 1		
6. DIRECTION OF HOLE <input checked="" type="checkbox"/> VERTICAL <input type="checkbox"/> INCLINED _____ DEG. FROM VERT.		15. ELEVATION GROUND WATER TIDAL		
7. THICKNESS OF OVERBURDEN		16. DATE HOLE STARTED 2-7-89 COMPLETED 2-7-89		
8. DEPTH DRILLED INTO ROCK		17. ELEVATION TOP OF HOLE -42.6		
9. TOTAL DEPTH OF HOLE 10.0'		18. TOTAL CORE RECOVERY FOR BORING 75%		
		19. SIGNATURE OF LOGGING GEOLOGIST J. GENTILE		

ELEVATION a	DEPTH b	LEGEND c	CLASSIFICATION OF MATERIALS (Description) d	% CORE RECOVERY e	SAMPLE NO. f	REMARKS (Drilling time, water loss, depth of weathering, etc., if significant) g
-42.6	0.0					BIT OR BARREL -42.6
-47.6	5.0		SAND, very fine, quartz, very clayey, soft, wet, many thin beds sandy (CH) clay, gray, little shell (SC)	100	1	2" SAMPLER SETTLED -47.6
-50.6	8.0		SAND, fine to medium, quartz trace silt, trace shell, gray (SP)		2	15 29
-52.6	10.0		SAND, fine to medium, quartz little to some silt, gray, wet, trace shell, (SM)	50	3	27 23 20
<p>SOILS ARE FIELD VISUALLY CLASSIFIED IN ACCORDANCE WITH THE UNIFIED SOILS CLASSIFICATION SYSTEM</p> <p>SAMPLE      LABORATORY ELEVATION    CLASSIFICATION</p> <p>-42.6 to -47.6    (SC-H)*</p> <p>NOTE: *VISUAL CLASSIFICATION BASED ON GRADATION CURVE. NO ATTERBERG LIMITS.</p> <p>300# hammer with 18" drop used on 2" Sampler.</p> <p>BLOW COUNTS FOR THE 2" SAMPLER HAVE NOT BEEN CORRELATED WITH STANDARD SPLIT-SPOON TESTS AS DESIGNATED IN ASTM D-1586. JUDGEMENT IS NEEDED IN THE USE OF THE BLOW COUNT DATA FOR THE 2" SAMPLER.</p> <p>BLS/FT. REFERS TO THE NUMBER OF HAMMER BLOWS REQUIRED TO ADVANCE A 2" SAMPLER (2" I.D. X 2 1/2" O.D.) ONE FOOT. THE SAMPLER IS 5 FT. LONG AND DRIVEN CONTINUOUSLY 5 FT. WHERE POSSIBLE.</p>						



(267)

Hole No. CB-CH89-15

<b>DRILLING LOG</b>		DIVISION SOUTH ATLANTIC	INSTALLATION JACKSONVILLE DISTRICT	SHEET OF 1 SHEETS
1. PROJECT CANAVERAL HARBOR			10. SIZE AND TYPE OF BIT SEE REMARKS	
2. LOCATION (Coordinates or Station) X=648418 Y=1471970			11. GAYOR FOR ELEVATION SHOWN (TBM or MSJ) MLW	
3. DRILLING AGENCY CORPS OF ENGINEERS			12. MANUFACTURER'S DESIGNATION OF DRILL S&H SKID RIG	
4. HOLE NO. (As shown on drawing title and file number) CB-CH89-15			13. TOTAL NO. OF OVER-BURDEN SAMPLES TAKEN DISTURBED UNDISTURBED	
5. NAME OF DRILLER R. GORDON			14. TOTAL NUMBER CORE BOXES	
6. DIRECTION OF HOLE <input checked="" type="checkbox"/> VERTICAL <input type="checkbox"/> INCLINED _____ DEG. FROM VERT.			15. ELEVATION GROUND WATER TIDAL	
7. THICKNESS OF OVERBURDEN			16. DATE MOLE STARTED COMPLETED 2-8-89 2-8-89	
8. DEPTH DRILLED INTO ROCK			17. ELEVATION TOP OF HOLE -45.2	
9. TOTAL DEPTH OF HOLE 11.0'			18. TOTAL CORE RECOVERY FOR BORING 100 %	
			19. SIGNATURE OF OPERATOR J GENTILE GEOLOGIST	

ELEVATION a	DEPTH b	LEGEND c	CLASSIFICATION OF MATERIALS (Description) d	% CORE RECOVERY e	SAMPLER NO. f	REMARKS (Drilling time, water loss, depth of washing, etc., if significant) g
-45.2	0.0					BIT OR BARREL -45.2
-47.7	2.5		CLAY, plastic, dark gray, wet (CH)	100	1	2" SAMPLER BLS/FT. SETTLED
-51.2	6.0		SAND, fine to medium, quartz, trace silt, gray, trace shell, (SP)	100	2	18 27 29
-53.2	8.0		SAND, very fine, quartz, clayey, trace shell, gray, (SC)	100	3	SETTLED
-56.2	11.0		CLAY, plastic, fat, stiff, organic stain dark gray, (CH)	100	4	-56.2
<p>SOILS ARE FIELD VISUALLY CLASSIFIED IN ACCORDANCE WITH THE UNIFIED SOILS CLASSIFICATION SYSTEM</p> <p>SAMPLE LABORATORY ELEVATION CLASSIFICATION</p> <p>-45.2 to -47.7 (CH)*                      -47.7 to -51.2 (SP-SM)*                      -51.2 to -53.2 (SC-H)*                      -53.2 to -56.7 (CH)*</p> <p>NOTE:                      *VISUAL CLASSIFICATION BASED ON GRADATION CURVE.                      NO ATTERBERG LIMITS.</p>						
<p>300# hammer with 12" drop used on 2" Sampler.</p> <p>BLOW COUNTS FOR THE 2" SAMPLER HAVE NOT BEEN CORRELATED WITH STANDARD SPLIT-SPOON TESTS AS DESIGNATED IN ASTM D-1586. JUDGEMENT IS NEEDED IN THE USE OF THE BLOW COUNT DATA FOR THE 2" SAMPLER.</p> <p>BLS/FT. REFERS TO THE NUMBER OF HAMMER BLOWS REQUIRED TO ADVANCE A 2" SAMPLER (2" I.D. X 2 1/2" O.D.) ONE FOOT. THE SAMPLER IS 5 FT. LONG AND DRIVEN CONTINUOUSLY 5 FT. WHERE POSSIBLE.</p>						



288

Hole No. CB-CH89-16

DRILLING LOG			DIVISION SOUTH ATLANTIC		INSTALLATION JACKSONVILLE DISTRICT		SHEET 1 OF 1 SHEETS	
1. PROJECT CANAVERAL HARBOR				16. SIZE AND TYPE OF BIT SEE REMARKS				
2. LOCATION (Coordinate or Station) Y=647891 Y=1472908				17. DATUM FOR ELEVATION SHOWN (TON or MSL) MLW				
3. DRILLING AGENCY CORPS OF ENGINEERS				12. MANUFACTURER'S DESIGNATION OF DRILL S&H SKID RIG				
4. HOLE NO. (As shown on drawing title and file number) CB-CH89-16				13. TOTAL NO. OF OVERBURDEN SAMPLES TAKEN		DISTURBED		UNDISTURBED
5. NAME OF DRILLER R. GORDON				14. TOTAL NUMBER CORE BOXES 1				
6. DIRECTION OF HOLE <input checked="" type="checkbox"/> VERTICAL <input type="checkbox"/> INCLINED _____ DEG. FROM VERT.				18. DATE HOLE		STARTED		COMPLETED
7. THICKNESS OF OVERBURDEN				17. ELEVATION TOP OF HOLE		-41.8		2-8-89
8. DEPTH DRILLED INTO ROCK				19. TOTAL CORE RECOVERY FOR BORING 44				
9. TOTAL DEPTH OF HOLE 11.4'				18. SIGNATURE OF INSPECTOR J. GENTILE GEOLOGIST				
ELEVATION	DEPTH	LEGEND	CLASSIFICATION OF MATERIALS (Description)	% CORE RECOVERY	SAMPLE NO.	REMARKS (Drilling time, water loss, depth of overburden, etc., if significant)		
-41.8	0.0					BIT ON BARREL		
-43.8	2.4		CLAY, slightly plastic, soupy, wet, little sand, some silt, gray (CL)		1	-41.8 BLS/FT. SETTLED		
-53.2	11.4		SAND, very fine, quartz, clayey, little silt, gray, trace shell (SC)	44	2	2" SAMPLER		
			SOILS ARE FIELD VISUALLY CLASSIFIED IN ACCORDANCE WITH THE UNIFIED SOILS CLASSIFICATION SYSTEM			300# hammer with 18" drop used on 2" Sampler.		
			SAMPLE ELEVATION -43.8 to -53.2			BLOW COUNTS FOR THE 2" SAMPLER HAVE NOT BEEN CORRELATED WITH STANDARD SPLIT-SPOON TESTS AS DESIGNATED IN ASTM D-1586. JUDGEMENT IS NEEDED IN THE USE OF THE BLOW COUNT DATA FOR THE 2" SAMPLER.		
			LABORATORY CLASSIFICATION (SC-H)*			BLS/FT. REFERS TO THE NUMBER OF HAMMER BLOWS REQUIRED TO ADVANCE A 2" SAMPLER (2" I.D. X 2 1/2" O.D.) ONE FOOT. THE SAMPLER IS 5 FT. LONG AND DRIVEN CONTINUOUSLY 5 FT. WHERE POSSIBLE.		
			NOTE: *VISUAL CLASSIFICATION BASED ON GRADATION CURVE. NO ATTERBERG LIMITS.					

Hole No. CB-CH89-17



<b>DRILLING LOG</b>	<b>DIVISION</b> SOUTH ATLANTIC	<b>INSTALLATION</b> JACKSONVILLE DISTRICT	<b>SHEET</b> 1 OF 1 SHEETS
1. PROJECT CANAVERAL HARBOR		10. SIZE AND TYPE OF BIT SEE REMARKS	
2. LOCATION (Coordinates or Station) X=647383 Y=1472289		11. GATUM FOR ELEVATION SHOWN (FSM or MSL) MLW	
3. DRILLING AGENCY CORPS OF ENGINEERS		12. MANUFACTURER'S DESIGNATION OF DRILL S&H SKID RIG	
4. HOLE NO. (As shown on drawing title and file number) CB-CH89-17		13. TOTAL NO. OF OVER- BURDEN SAMPLES TAKEN	
5. NAME OF DRILLER R. GORDON		14. TOTAL NUMBER CORE BOXES 1	
6. DIRECTION OF HOLE <input checked="" type="checkbox"/> VERTICAL <input type="checkbox"/> INCLINED _____ DEG. FROM VERT.		15. ELEVATION GROUND WATER TIDAL	
7. THICKNESS OF OVERBURDEN		16. DATE HOLE STARTED 2-27-89 COMPLETED 2-27-89	
8. DEPTH DRILLED INTO ROCK		17. ELEVATION TOP OF HOLE -42.0	
9. TOTAL DEPTH OF HOLE 10.0'		18. TOTAL CORE RECOVERY FOR BORING 50 %	
		19. SIGNATURE OF <del>XXXXXXXX</del> GEOLOGIST J. GENTILE	

ELEVATION a	DEPTH b	LEGEND c	CLASSIFICATION OF MATERIALS (Description) d	% CORE REC'Y e	RECOVERY SAMPLE NO. f	REMARKS (Drilling time, water loss, depth of weathering, etc., if significant) g
-42.0	0.0					BIT OR BARREL
-49.0	7.0		CLAY, plastic, sandy, little silt, gray, wet, trace shell (CH)	50	1	2" SAMPLER SETTLED
-52.0	10.0		SAND, fine to medium, quartz, very clayey, gray, trace shell, wet, (SC)		2	
			SOILS ARE FIELD VISUALLY CLASSIFIED IN ACCORDANCE WITH THE UNIFIED SOILS CLASSIFICATION SYSTEM			300# hammer with 18" drop used on 2" sampler.
			SAMPLE ELEVATION      LABORATORY CLASSIFICATION			BLOW COUNTS FOR THE 2" SAMPLER HAVE NOT BEEN CORRELATED WITH STANDARD SPLIT-SPOON TESTS AS DESIGNATED IN ASTM D-1586. JUDGEMENT IS NEEDED IN THE USE OF THE BLOW COUNT DATA FOR THE 2" SAMPLER.
			-42.0 to -49.0      (CH) *			BLS/FT. REFERS TO THE NUMBER OF HAMMER BLOWS REQUIRED TO ADVANCE A 2" SAMPLER (2" I.D. X 2 1/2" O.D.) ONE FOOT. THE SAMPLER IS 5 FT. LONG AND DRIVEN CONTINUOUSLY 5 FT. WHERE POSSIBLE.
			NOTE: * VISUAL CLASSIFICATION BASED ON GRADATION CURVE. NO ATTERBERG LIMITS.			

279

Hole No. CB-CH89-18

<b>DRILLING LOG</b>		DIVISION SOUTH ATLANTIC	INSTALLATION JACKSONVILLE DISTRICT	SHEET of 1 SHEETS
1. PROJECT CANAVERAL HARBOR		10. SIZE AND TYPE OF BIT SEE REMARKS		
2. LOCATION (Coordinates or Station) X=646872 Y=1473219		11. DATUM FOR ELEVATION SHOWN (TBM or MSL) MLW		
3. DRILLING AGENCY CORPS OF ENGINEERS		12. MANUFACTURER'S DESIGNATION OF DRILL S&H SKID RIG		
4. HOLE NO. (As shown on drawing title and file number) CB-CH89-18		13. TOTAL NO. OF OVERBURDEN SAMPLES TAKEN DISTURBED _____ UNDISTURBED _____		
5. NAME OF DRILLER R. GORDON		14. TOTAL NUMBER CORE BOXES 1		
6. DIRECTION OF HOLE <input checked="" type="checkbox"/> VERTICAL <input type="checkbox"/> INCLINED _____ DEG. FROM VERT.		15. ELEVATION GROUND WATER TIDAL		
7. THICKNESS OF OVERBURDEN		16. DATE HOLE STARTED 2-27-89 COMPLETED 2-27-89		
8. DEPTH DRILLED INTO ROCK		17. ELEVATION TOP OF HOLE -45.1'		
9. TOTAL DEPTH OF HOLE 7.0'		18. TOTAL CORE RECOVERY FOR BORING 71 %		
		19. SIGNATURE OF <del>DRILLER</del> GEOLOGIST J. GENTILE		

ELEVATION	DEPTH	LEGEND	CLASSIFICATION OF MATERIALS (Description)	% CORE RECOVERY	SAMPLER NO.	REMARKS (Drilling time, water loss, depth of weathering, etc., if significant)
a	b	c	d	e	f	g
-45.1	0.0					BIT OR BARREL
-50.1	5.0		CLAY, plastic, gray-black, wet, trace shell (CH)	71	1	45.1 BLS/FT.
-52.1	7.0		SAND, very fine, quartz, clayey, gray (SC)		2	2" SAMPLER SETTLED
			SOILS ARE FIELD VISUALLY CLASSIFIED IN ACCORDANCE WITH THE UNIFIED SOILS CLASSIFICATION SYSTEM			300# hammer with 18" drop used on 2" Sampler
						BLOW COUNTS FOR THE 2" SAMPLER HAVE NOT BEEN CORRELATED WITH STANDARD SPLIT-SPOON TESTS AS DESIGNATED IN ASTM D-1586. JUDGEMENT IS NEEDED IN THE USE OF THE BLOW COUNT DATA FOR THE 2" SAMPLER.
						BLS/FT. REFERS TO THE NUMBER OF HAMMER BLOWS REQUIRED TO ADVANCE A 2" SAMPLER (2" I.D. X 2 1/2" O.D.) ONE FOOT. THE SAMPLER IS 5 FT. LONG AND DRIVEN CONTINUOUSLY 5 FT. WHERE POSSIBLE.

(21)

21  
Hole No. CB-CH 89-19

<b>DRILLING LOG</b>		DIVISION SOUTH ATLANTIC	INSTALLATION JACKSONVILLE District	SHEET 1 OF 1 SHEETS
1. PROJECT CANAVERAL HARBOR		10. SIZE AND TYPE OF BIT SEE REMARKS		
2. LOCATION (Coordinates or Station) X=645889 Y=1473547		11. GAYDN FOR ELEVATION SHOWN (729W or MSJ) MLW		
3. DRILLING AGENCY CORPS OF ENGINEERS		12. MANUFACTURER'S DESIGNATION OF DRILL S&H SKID RIG		
4. HOLE NO. (As shown on drawing title and file number) CB-CH89-19		13. TOTAL NO. OF OVERBURDEN SAMPLES TAKEN DISTURBED _____ UNDISTURBED _____		
5. NAME OF DRILLER R. GORDON		14. TOTAL NUMBER CORE BOXES _____		
6. DIRECTION OF HOLE <input checked="" type="checkbox"/> VERTICAL <input type="checkbox"/> INCLINED _____ DEG. FROM VERT.		15. ELEVATION GROUND WATER TIDADL		
7. THICKNESS OF OVERBURDEN _____		16. DATE HOLE STARTED 2-23-89 COMPLETED 2-23-89		
8. DEPTH DRILLED INTO ROCK _____		17. ELEVATION TOP OF HOLE -40.1		
9. TOTAL DEPTH OF HOLE 11.6'		18. TOTAL CORE RECOVERY FOR BORING 43		
		19. SIGNATURE OF SUPERVISOR J. GENTILE GEOLOGIST		

ELEVATION a	DEPTH b	LEGEND c	CLASSIFICATION OF MATERIALS (Describe)	1 CORE RECOVERY %	2 SAMPLE NO.	REMARKS (Drilling time, water loss, depth of weathering, etc., if significant)
-40.1	0.0					BIT OR BARREL
-51.7	11.6		CLAY, slightly plastic, sandy, silty, gray, wet, trace shell (CL)	43	1	2" SAMPLER BLS/FT. SETTLED
			SOILS ARE FIELD VISUALLY CLASSIFIED IN ACCORDANCE WITH THE UNIFIED SOILS CLASSIFICATION SYSTEM  SAMPLE ELEVATION LABORATORY CLASSIFICATION -40.1 to -51.7 (CH)*  NOTE: *VISUAL CLASSIFICATION BASED ON GRADATION CURVE. NO ATTERBERG LIMITS.			300# hammer with 18" drop used on 2" Sampler.  BLOWS COUNTS FOR THE 2" SAMPLER HAVE NOT BEEN GOORELATED WITH STANDARD SPLIT-SPOON TESTS AS DESIGNATED IN ASTM D-1586. JUDGEMENT IS NEEDED IN THE USE OF THE BLOW COUNT DATA FOR THE 2" SAMPLER.  BLS/FT. REFERS TO THE NUMBER OF HAMMER BLOWS REQUIRED TO ADVANCE A 2" SAMPLER (2" I.D. X 2 1/2" O.D.) ONE FOOT. THE SAMPLER IS 5 FT. LONG AND DRIVEN CONTINUOUSLY 5 FT. WHERE POSSIBLE.

272

Hole No. CB-CH89-20

DRILLING LOG		DIVISION SOUTH ATLANTIC		INSTALLATION JACKSONVILLE, DISTRICT		SHEET 1 OF 1 SHEETS	
1. PROJECT CANAVERAL HARBOR				10. SIZE AND TYPE OF BIT SEE REMARKS			
2. LOCATION (Coordinates or Station) X=646,381 Y=1,474,409				11. DATUM FOR ELEVATION SHOWN (TBM or MSL) MLW			
3. DRILLING AGENCY CORPS OF ENGINEERS				12. MANUFACTURER'S DESIGNATION OF DRILL S&H SKID RIG			
4. HOLE NO. (As shown on drawing title and file number) CB-CH89-20				13. TOTAL NO. OF OVER-BURDEN SAMPLES TAKEN		DISTURBED UNDISTURBED	
5. NAME OF DRILLER R. GORDON				14. TOTAL NUMBER CORE BOXES 1			
6. DIRECTION OF HOLE <input checked="" type="checkbox"/> VERTICAL <input type="checkbox"/> INCLINED _____ DEG. FROM VERT.				15. ELEVATION GROUND WATER TIDAL			
7. THICKNESS OF OVERBURDEN				16. DATE HOLE		STARTED 2-28-89	
8. DEPTH DRILLED INTO ROCK				17. ELEVATION TOP OF HOLE		COMPLETED 2-28-89	
9. TOTAL DEPTH OF HOLE 10.5'				18. TOTAL CORE RECOVERY FOR BORING 50			
				19. SIGNATURE OF <del>DRILLER</del> GEOLOGIST J. GENITILE			
ELEVATION	DEPTH	LEGEND	CLASSIFICATION OF MATERIALS (Description)	% CORE RECOVERY	SAMPLE NO.	REMARKS (Drilling time, water loss, depth of penetration, etc., if significant)	
-41.6	0.0					BIT OR BARREL	
-49.1	7.5		CLAY, plastic, trace sand & silt, trace shell, gray (CH)	50	1	-41.6 BLS/FT. 2" SAMPLER SETTLED	
-52.1	10.5		SAND, fine to medium, quartz, clayey, gray, wet, trace shell (SC)		2	-52.1	
			SOILS ARE FIELD VISUALLY CLASSIFIED IN ACCORDANCE WITH THE UNIFIED SOILS CLASSIFICATION SYSTEM				
			SAMPLE LABORATORY ELEVATION CLASSIFICATION				
			-49.1 to -52.1 (SC-H)*				
			NOTE: *VISUAL CLASSIFICATION BASED ON GRADATION CURVE. NO ATTERBERG LIMITS.				
				300# hammer with 18" drop used on 2" sampler.			
				BLS/FT. REFERS TO THE NUMBER OF HAMMER BLS REQUIRED TO ADVANCE A 2" SAMPLER (2" I.D. X 2 1/2" O.D.) ONE FOOT. THE SAMPLER IS 5 FT. LONG AND DRIVEN CONTINUOUSLY 5 FT. WHERE POSSIBLE.			

END PAGE

273

Note No. CB-CH89-21

<b>DRILLING LOG</b>		DIVISION SOUTH ATLANTIC	INSTALLATION JACKSONVILLE DISTRICT	SHEET OF 1 SHEETS
1. PROJECT CANAUVERAL HARBOR		10. SIZE AND TYPE OF BIT SEE REMARKS		
2. LOCATION (Coordinates of Station) X= 645,385 Y= 1,476,468		11. GAYUN FOR ELEVATION SHOWN (TBM or MSL) MLW		
3. DRILLING AGENCY CORPS OF ENGINEERS		12. MANUFACTURER'S DESIGNATION OF DRILL S&H SKID RIG		
4. HOLE NO. (As shown on drawing title and file number) CB-CH89-21		13. TOTAL NO. OF OVER-BURDEN SAMPLES TAKEN DISTURBED _____ UNDISTURBED _____		
5. NAME OF DRILLER R. GORDON		14. TOTAL NUMBER CORE BOXES 1		
6. DIRECTION OF HOLE <input checked="" type="checkbox"/> VERTICAL <input type="checkbox"/> INCLINED _____ DEG. FROM VERT.		15. ELEVATION GROUND WATER TIDAL		
7. THICKNESS OF OVERBURDEN		16. DATE HOLE STARTED 2-28-89 COMPLETED 2-28-89		
8. DEPTH DRILLED INTO ROCK		17. ELEVATION TOP OF HOLE -48.2		
9. TOTAL DEPTH OF HOLE 5.2'		18. TOTAL CORE RECOVERY FOR BORING 80		
		19. SIGNATURE OF <del>XXXXXXXX</del> GEOLOGIST J. GENTILE		

ELEVATION a	DEPTH b	LEGEND c	CLASSIFICATION OF MATERIALS (Description) d	% CORE RECOVERY e	BORING SAMPLE NO. f	REMARKS (Drilling time, water loss, depth of weathering, etc., if significant) g
-48.2	0.0					BIT OR BARREL
-51.2	3.0		CLAY, plastic, gray, wet to damp, trace shell (CH)	80	1	-48.2 BLS/FT. 2" SAMPLER SETTLED
-53.4	5.2		SAND, fine to medium, quartz, very clayey, gray (SC)		2	-53.4
			SOILS ARE FIELD VISUALLY CLASSIFIED IN ACCORDANCE WITH THE UNIFIED SOILS CLASSIFICATION SYSTEM			
			SAMPLE LABORATORY ELEVATION CLASSIFICATION			
			-48.1 to -51.2 (CH)*			
			NOTE: *VISUAL CLASSIFICATION BASED ON GRADATION CURVE. NO ATTERBERG LIMITS.			
				300# hammer with 18" drop used on 2" Sampler		
				BLS/FT. REFERS TO THE NUMBER OF HAMMER BLOWS REQUIRED TO ADVANCE A 2" SAMPLER (2" I.D. X 2 1/2" O.D.) ONE FOOT. THE SAMPLER IS 5 FT. LONG AND DRIVEN CONTINUOUSLY 5 FT. WHERE POSSIBLE.		

274

Hole No. CB-CH89-22

DRILLING LOG		DIVISION	INSTALLATION		SHEET	
		SOUTH ATLANTIC	JACKSONVILLE DISTRICT		OF 1 SHEETS	
1. PROJECT CANAVERAL HARBOR			10. SIZE AND TYPE OF BIT SEE REMARKS			
2. LOCATION (Coordinates or Station) X=644847 Y=1475421			11. DATUM FOR ELEVATION SHOWN (TBM or MSL) MLW			
3. DRILLING AGENCY CORPS OF ENGINEERS			12. MANUFACTURER'S DESIGNATION OF DRILL S&H SKID RIG			
4. HOLE NO. (As shown on drawing title and file number) CB-CH89-22			13. TOTAL NO. OF OVERBURDEN SAMPLES TAKEN DISTURBED _____ UNDISTURBED _____			
5. NAME OF DRILLER R. GORDON			14. TOTAL NUMBER CORE BOXES 1			
6. DIRECTION OF HOLE <input checked="" type="checkbox"/> VERTICAL <input type="checkbox"/> INCLINED _____ DEG. FROM VERT.			15. ELEVATION GROUND WATER TIDAL			
7. THICKNESS OF OVERBURDEN			16. DATE HOLE STARTED 2-23-89 COMPLETED 2-23-89			
8. DEPTH DRILLED INTO ROCK			17. ELEVATION TOP OF HOLE -39.8			
9. TOTAL DEPTH OF HOLE 13.4'			18. TOTAL CORE RECOVERY FOR BORING 80 %			
			19. SIGNATURE OF DRILLER J. GENTILE			
ELEVATION	DEPTH	LEGEND	CLASSIFICATION OF MATERIALS (Description)	CORE RECOVERY	SAMPLE NO.	REMARKS (Drilling time, water loss, depths of penetration, etc., if significant)
-39.8	0.0					BIT OR BARREL
-48.2	8.4		CLAY, sandy, trace shell, gray, many seams clayey sand, slightly plastic (CL)	60	1	2" SAMPLER SETTLED
-53.2	13.4		CLAY, plastic, fat, damp, trace shell, gray (CH)	100	2	SETTLED
			SOILS ARE FIELD VISUALLY CLASSIFIED IN ACCORDANCE WITH THE UNIFIED SOILS CLASSIFICATION SYSTEM.			300# hammer with 18" drop used on 2" Sampler.
			SAMPLE ELEVATION -48.2 to -53.2			BLOWS COUNTS FOR THE 2" SAMPLER HAVE NOT BEEN CORRELATED WITH STANDARD SPLIT-SPOON TESTS AS DESIGNATED IN ASTM D-1586. JUDGEMENT IS NEEDED IN THE USE OF THE BLOW COUNT DATA FOR THE 2" SAMPLER.
			LABORATORY CLASSIFICATION (CH)*			BLS/FT. REFERS TO THE NUMBER OF HAMMER BLOWS REQUIRED TO ADVANCE A 2" SAMPLER (2" I.D. X 2 1/4" O.D.) ONE FOOT. THE SAMPLER IS 5 FT. LONG AND DRIVEN CONTINUOUSLY 5 FT. WHERE POSSIBLE.
			NOTE: *VISUAL CLASSIFICATION BASED ON GRADATION CURVE. NO ATTERBERG LIMITS.			





Hole No. CB-CH89-23

<b>DRILLING LOG</b>		DIVISION SOUTH ATLANTIC	INSTALLATION JACKSONVILLE DISTRICT	SHEET 1 OF 1 SHEETS
1. PROJECT CANAVERAL HARBOR		10. SIZE AND TYPE OF BIT SEE REMARKS		
2. LOCATION (Coordinates or Station) X=644,357 Y= 1,474,783		11. DATUM FOR ELEVATION SHOWN (TBM or MSL) MLW		
3. DRILLING AGENCY CORPS OF ENGINEERS		12. MANUFACTURER'S DESIGNATION OF DRILL S&H SKID RIG		
4. HOLE NO. (As shown on drawing title and file number) CB-CH89-23		13. TOTAL NO. OF OVERBURDEN SAMPLES TAKEN DISTURBED _____ UNDISTURBED _____		
5. NAME OF DRILLER R. GORDON		14. TOTAL NUMBER CORE BOXES 1		
6. DIRECTION OF HOLE <input checked="" type="checkbox"/> VERTICAL <input type="checkbox"/> INCLINED _____ DEG. FROM VEAT.		15. ELEVATION GROUND WATER TIDAL		
7. THICKNESS OF OVERBURDEN		16. DATE HOLE STARTED 2-28-89 COMPLETED 2-28-89		
8. DEPTH DRILLED INTO ROCK		17. ELEVATION TOP OF HOLE -40.9		
9. TOTAL DEPTH OF HOLE 12.4'		18. TOTAL CORE RECOVERY FOR BORING 83 %		
		19. SIGNATURE OF OPERATOR J. GENTILE		

ELEVATION a	DEPTH b	LEGEND c	CLASSIFICATION OF MATERIALS (Description) d	% CORE RECOVERY e	SAMPLER NO. f	REMARKS (Drilling time, water loss, depth of weathering, etc., if significant) g
-40.9	0.0					BIT OR BARREL -40.9 BLS/FT.
			CLAY, plastic, trace silt & sand, trace shell, gray, damp (CH)  (CH) CLAY, very plastic, fat from -48.3 to -53.3	67	1	2" SAMPLER SETTLED -48.3
-53.3	12.4			100	2	" SETTLED -53.3
			SOILS ARE FIELD VISUALLY CLASSIFIED IN ACCORDANCE WITH THE UNIFIED SOILS CLASSIFICATION SYSTEM  SAMPLE                      LABORATORY ELEVATION                      CLASSIFICATION  -40.9 to -48.3      (CH)*  NOTE: *VISUAL CLASSIFICATION BASED ON GRADATION CURVE. NO ATTERBERG LIMITS.			300# hammer with 18" drop used on 2" Sampler.  BLS COUNTS FOR THE 2" SAMPLER HAVE NOT BEEN COORELATED WITH STANDARD SPLIT-SPOON TESTS AS DESIGNATED IN ASTM D-1586. JUDGEMENT IS NEEDED IN THE USE OF THE BLOW COUNT DATA FOR THE 2" SAMPLER.  BLS/FT. REFERS TO THE NUMBER OF HAMMER BLOWS REQUIRED TO ADVANCE A 2" SAMPLER (2" I.D. X 2 1/2" O.D.) ONE FOOT. THE SAMPLER IS 5 FT. LONG AND DRIVEN CONTINUOUSLY 5 FT. WHERE POSSIBLE.

276

Hole No. CB-CH89-24

DRILLING LOG			DIVISION SOUTH ATLANTIC		INSTALLATION JACKSONVILLE DISTRICT		SHEET OF 1 SHEETS	
1. PROJECT CANAVERAL HARBOR			2. LOCATION (Coordinates or Station) X=643868 Y=1475770		10. SIZE AND TYPE OF BIT SEE REMARKS		11. DATUM FOR ELEVATION SHOWN (FROM or MEAN) MLW	
3. DRILLING AGENCY CORPS OF ENGINEERS			4. HOLE NO. (As shown on drawing title and file number) CB-CH89-24		12. MANUFACTURER'S DESIGNATION OF DRILL S&H SKID RIG		13. TOTAL NO. OF OVER-BURDEN SAMPLES TAKEN DISTURBED _____ UNDISTURBED _____	
5. NAME OF DRILLER R. GORDON			6. DIRECTION OF HOLE <input checked="" type="checkbox"/> VERTICAL <input type="checkbox"/> INCLINED _____ DEG. FROM VERT.		14. TOTAL NUMBER CORE BOXES		15. ELEVATION GROUND WATER TIDAL	
7. THICKNESS OF OVERBURDEN			8. DEPTH DRILLED INTO ROCK		16. DATE MOLE STARTED 2-23-89 COMPLETED 2-23-89		17. ELEVATION TOP OF HOLE -47.3	
9. TOTAL DEPTH OF HOLE 5.0'			18. TOTAL CORE RECOVERY FOR BORING 80		19. SIGNATURE OF INSPECTOR J. GENTILE		20. SIGNATURE OF GEOLOGIST	
ELEVATION a	DEPTH b	LEGEND c	CLASSIFICATION OF MATERIALS (Description) d	% CORE RECOVERY e	NO. OF SAMPLES f	REMARKS (Drilling time, water loss, depth of weathering, etc.; if significant)		
-47.3	0.0					BIT OR BARREL		
-51.3	4.0		CLAY, plastic, soupy, wet, gray (CH) Seams of clayey sand from -50.3 to -51.3			-47.3 BLS/FT. 2" SAMPLER SETTLED		
-52.3	5.0		SAND, fine to medium, quartz, clean, gray (SP)			-52.3 22		
			SOILS ARE FIELD VISUALLY CLASSIFIED IN ACCORDANCE WITH THE UNIFIED SOILS CLASSIFICATION SYSTEM	80	1 2	300# hammer with 18" drop used on 2" Sampler. BLS/FT. REFERS TO THE NUMBER OF HAMMER BLOWS REQUIRED TO ADVANCE A 2" SAMPLER (2" I.D. X 2 1/2" O.D.) ONE FOOT. THE SAMPLER IS 5 FT. LONG AND DRIVEN CONTINUOUSLY 5 FT. WHERE POSSIBLE.		
			SAMPLE LABORATORY ELEVATION CLASSIFICATION -47.3 to -51.3 (MH)*			BLS/FT. REFERS TO THE NUMBER OF HAMMER BLOWS REQUIRED TO ADVANCE A 2" SAMPLER (2" I.D. X 2 1/2" O.D.) ONE FOOT. THE SAMPLER IS 5 FT. LONG AND DRIVEN CONTINUOUSLY 5 FT. WHERE POSSIBLE.		
			NOTE: *VISUAL CLASSIFICATION BASED ON GRADATION CURVE. NO ATTERBERG LIMITS.					

Hole No. CB-CH89-25

<b>DRILLING LOG</b>		DIVISION SOUTH ATLANTIC	INSTALLATION JACKSONVILLE DISTRICT	SHEET of 1 SHEETS
1. PROJECT CANAVERAL HARBOR		16. SIZE AND TYPE OF BIT SEE REMARKS		
2. LOCATION (Coordinates of Station) X=642878 Y=1475105		17. DAYUM FOR ELEVATION SHOWN (FROM or TO) MLW		
3. DRILLING AGENCY CORPS OF ENGINEERS		12. MANUFACTURER'S DESIGNATION OF DRILL S&H SKID RIG		
4. HOLE NO. (As shown on drawing title and its number) CB-CH89-25		13. TOTAL NO. OF OVERBURDEN SAMPLES TAKEN DISTURBED UNDISTURBED		
5. NAME OF DRILLER R. GORDON		14. TOTAL NUMBER CORE BOXES 1		
6. DIRECTION OF HOLE <input checked="" type="checkbox"/> VERTICAL <input type="checkbox"/> INCLINED _____ DEG. FROM VERT.		15. ELEVATION GROUND WATER TIDAL		
7. THICKNESS OF OVERBURDEN		16. DATE HOLE STARTED COMPLETED 2-22-89 2-22-89		
8. DEPTH DRILLED INTO ROCK		17. ELEVATION TOP OF HOLE -39.5		
9. TOTAL DEPTH OF HOLE 13.0'		18. TOTAL CORE RECOVERY FOR BORING 81 %		
		19. SIGNATURE OF <del>XXXXXXXX</del> GECOLOGIST J. GENTILE		

ELEVATION a	DEPTH b	LEGEND c	CLASSIFICATION OF MATERIALS (Description) d	% CORE RECOVERY e	SAMPLER NO. f	REMARKS (Drilling time, water, gas, depth of penetration, etc. - If significant) g
-39.5	0.0					BIT OR BARREL
-43.5	4.0		CLAY, plastic, wet, little sand, with seams clayey sand, gray (CH)	63	1	2" SAMPLER SETTLED
			Very plastic, fat, damp, wood fragments, gray (CH) from -43.5 to -52.5		2	
-52.5	13.0			100	3	" SETTLED
			SOILS ARE FIELD VISUALLY CLASSIFIED IN ACCORDANCE WITH THE UNIFIED SOILS CLASSIFICATION SYSTEM			300# hammer with 18" drop used on 2" Sampler.  BLOWS COUNTS FOR THE 2" SAMPLER HAVE NOT BEEN CORRELATED WITH STANDARD SPLIT-SPOON TESTS AS DESIGNATED IN ASTM D-1586. JUDGEMENT IS NEEDED IN THE USE OF THE BLOW COUNT DATA FOR THE 2" SAMPLER.  BLS/FT. REFERS TO THE NUMBER OF HAMMER BLOWS REQUIRED TO ADVANCE A 2" SAMPLER (2" I.D. X 2 1/8" O.D.) ONE FOOT. THE SAMPLER IS 5 FT. LONG AND DRIVEN CONTINUOUSLY 5 FT. WHERE POSSIBLE.

(27)

Hole No. CB-CH89-26

DRILLING LOG		DIVISION SOUTH ATLANTIC		INSTALLATION JACKSONVILLE DISTRICT		SHEET 1 OF 1 SHEETS	
1. PROJECT CANAVERAL HARBOR				10. SIZE AND TYPE OF BIT SEE REMARKS			
2. LOCATION (Coordinates or Station) X=643324 Y=1476688				11. DATUM FOR ELEVATION SHOWN (TBM or MSL) MLW			
3. DRILLING AGENCY CORPS OF ENGINEERS				12. MANUFACTURER'S DESIGNATION OF DRILL S&H SKID RIG			
4. HOLE NO. (As shown on drawing title and file number) CB-CH89-26				13. TOTAL NO. OF OVERBURDEN SAMPLES TAKEN		DISTURBED UNDISTURBED	
5. NAME OF DRILLER R. GORDON				14. TOTAL NUMBER CORE BOXES 1		15. ELEVATION GROUND WATER TIDAL	
6. DIRECTION OF HOLE <input checked="" type="checkbox"/> VERTICAL <input type="checkbox"/> INCLINED _____ DEG. FROM VERT.				16. DATE HOLE STARTED 2-22-89		COMPLETED 2-22-89	
7. THICKNESS OF OVERBURDEN				17. ELEVATION TOP OF HOLE -38.9			
8. DEPTH DRILLED INTO ROCK				18. TOTAL CORE RECOVERY FOR BORING 87 %			
9. TOTAL DEPTH OF HOLE 13.0'				19. SIGNATURE OF <del>XXXXXXXXXX</del> GEOLOGIST J. GENTILE			
ELEVATION a	DEPTH b	LEGEND c	CLASSIFICATION OF MATERIALS (Description) d	% CORE RECOVERY e	SAMPLER NO. f	REMARKS (Drilling time, water loss, depth of weathering, etc., if significant) g	
-38.9	0.0					BIT OR BARREL	
-42.9	4.0		CLAY, plastic, sandy, with seam clayey sand, gray, wet, (CH)	63	1	-38.9 BLS/FT. 2" SAMPLER SETTLED	
			Very plastic, fat, damp, dark gray, organic stain (wood fragments), from -42.9 to -50.9		2	-46.9	
-50.9	12.0		SAND, fine to medium, quartz, some clay, little shell, gray (SC)	100	3	SETTLED	
-51.9	13.6				4	-51.9	
SOILS ARE FIELD VISUALLY CLASSIFIED IN ACCORDANCE WITH THE UNIFIED SOILS CLASSIFICATION SYSTEM							
SAMPLE ELEVATION		LABORATORY CLASSIFICATION					
-38.9 to -42.7		(CH)*					
NOTE: *VISUAL CLASSIFICATION BASED ON GRADATION CURVE. NO ATTERBERG LIMITS.				300# hammer with 18" drop used on 2" Sampler.			
				BLOWS COUNTS FOR THE 2" SAMPLER HAVE NOT BEEN COORELATED WITH STANDARD SPLIT-SPOON TESTS AS DESIGNATED IN ASTM D-1586. JUDGEMENT IS NEEDED IN THE USE OF THE BLOW COUNT DATA FOR THE 2" SAMPLER.			
				BLS/FT. REFERS TO THE NUMBER OF HAMMER BLOWS REQUIRED TO ADVANCE A 2" SAMPLER (2" I.D. X 2 1/2" O.D.) ONE FOOT. THE SAMPLER IS 5 FT. LONG AND DRIVEN CONTINUOUSLY 5 FT. WHERE POSSIBLE.			



Hole No. CB-CH89-27

<b>DRILLING LOG</b>		DIVISION SOUTH ATLANTIC	INSTALLATION JACKSONVILLE DISTRICT	SHEET 1
1. PROJECT CANAVERAL HARBOR		10. SIZE AND TYPE OF BIT SEE REMARKS		
2. LOCATION (Coordinates or Station) X=642336 Y=1477018		11. GATUN FOR ELEVATION SHOWN (TEAM or ASD)		
3. DRILLING AGENCY CORPS OF ENGINEERS		12. MANUFACTURER'S DESIGNATION OF DRILL S&H SKID RIG		
4. HOLE NO. (As shown on drawing title and file number) CB-CH89-27		13. TOTAL NO. OF OVERBURDEN SAMPLES TAKEN		
5. NAME OF DRILLER R. GORDON		14. TOTAL NUMBER CORE BOXES		
6. DIRECTION OF HOLE <input checked="" type="checkbox"/> VERTICAL <input type="checkbox"/> INCLINED _____ DEG. FROM VERT.		15. ELEVATION GROUND WATER TIDAL		
7. THICKNESS OF OVERBURDEN		16. DATE HOLE STARTED 2-22-89 COMPLETED 2-22-89		
8. DEPTH DRILLED INTO ROCK		17. ELEVATION TOP OF HOLE -46.7		
9. TOTAL DEPTH OF HOLE 6.0'		18. TOTAL CORE RECOVERY FOR BORING 67%		
		19. SIGNATURE OF INSPECTOR J. GENTILE GEOLOGIST		

ELEVATION a	DEPTH b	LEGEND c	CLASSIFICATION OF MATERIALS (Description) d	% CORE RECOVERY e	SAMPLER NO. f	REMARKS (Drilling fluid, water level, depth of overburden, etc., if significant) g
-46.7	0.0					BIT OR BARREL -46.7 BLS/FT.
-51.3	4.6		CLAY, plastic, wet, soupy, disturbed, (CH)	67	1	2" SAMPLER SETTLED
-52.7	6.0		SAND, fine to medium, quartz, little to some clay, trace silt, brown-gray (SC)			-52.7 4 10
			SOILS ARE FIELD VISUALLY CLASSIFIED IN ACCORDANCE WITH THE UNIFIED SOILS CLASSIFICATION SYSTEM			300# hammer with 18" drop used on 2" Sampler.  BLOWS COUNTS FOR THE 2" SAMPLER HAVE NOT BEEN CORRELATED WITH STANDARD SPLIT-SPOON TESTS AS DESIGNATED IN ASTM D-1586. JUDGEMENT IS NEEDED IN THE USE OF THE BLOW COUNT DATA FOR THE 2" SAMPLER.  BLS/FT. REFERS TO THE NUMBER OF HAMMER BLOWS REQUIRED TO ADVANCE A 2" SAMPLER (2" I.D. X 2 1/2" O.D.) ONE FOOT. THE SAMPLER IS 5 FT. LONG AND DRIVEN CONTINUOUSLY 5 FT. WHERE POSSIBLE.

280

Hole No. C8-CH89-28

DRILLING LOG			DIVISION SOUTH ATLANTIC	INSTALLATION JACKSONVILLE DISTRICT		SHEET 1 OF 1 SHEETS
1. PROJECT CANAVERAL HARBOR			10. SIZE AND TYPE OF BIT SEE REMARKS			
2. LOCATION (Coordinates or Station) X= 643828 Y=1477956			11. DAY ON FOR ELEVATION SHOWN (TBM or HSL) MLW			
3. DRILLING AGENCY CORPS OF ENGINEERS			12. MANUFACTURER'S DESIGNATION OF DRILL S&H SKID RIG			
4. HOLE NO. (As shown on drawing title and file number) CB-CH89-28			13. TOTAL NO. OF OVERBURDEN SAMPLES TAKEN		DISTURBED UNDISTURBED	
5. NAME OF DRILLER R. GORDON			14. TOTAL NUMBER CORE BOXES 1			
6. DIRECTION OF HOLE <input checked="" type="checkbox"/> VERTICAL <input type="checkbox"/> INCLINED _____ DEG. FROM VERT.			15. ELEVATION GROUND WATER TIDAL			
7. THICKNESS OF OVERBURDEN			16. DATE HOLE		STARTED 2-28-89 COMPLETED 2-28-89	
8. DEPTH DRILLED INTO ROCK			17. ELEVATION TOP OF HOLE -38.8			
9. TOTAL DEPTH OF HOLE 12.5'			18. TOTAL CORE RECOVERY FOR BORING 83			
			19. SIGNATURE OF OPERATOR J. GENTILE GEOLOGIST			
ELEVATION	DEPTH	LEGEND	CLASSIFICATION OF MATERIALS (Description)	CORE RECOVERY	SAMPLE NO.	REMARKS (Drilling time, water loss, depth of weathering, etc., if significant)
-38.8	0.0					BIT OR BARREL
-46.3	7.5		CLAY, slightly plastic, little to some sand with seams of clayey sand, wet, trace shell (CL)	67	1	2" SAMPLER SETTLED
-48.3	9.5		SAND, fine to medium, quartz, trace clay, little shell, lt. gray (SP)		2	" 1 2
-51.3	12.5		CLAY, very plastic, fat, dark gray, damp, little shell (CH)	100	3	" 1 2
			SOILS ARE FIELD VISUALLY CLASSIFIED IN ACCORDANCE WITH THE UNIFIED SOILS CLASSIFICATION SYSTEM			
			300# hammer with 18" drop used on 2" Sampler.			
			BLOW COUNTS FOR THE 2" SAMPLER HAVE NOT BEEN COORELATED WITH STANDARD SPLIT-SPOON TESTS AS DESIGNATED IN ASTM D-1586. JUDGEMENT IS NEEDED IN THE USE OF THE BLOW COUNT DATA FOR THE 2" SAMPLER.			
			BLS/FT. REFERS TO THE NUMBER OF HAMMER BLOWS REQUIRED TO ADVANCE A 2" SAMPLER (2" I.D. X 2 1/4" O.D.) ONE FOOT. THE SAMPLER IS 5 FT. LONG AND DRIVEN CONTINUOUSLY 5 FT. WHERE POSSIBLE.			

Hole No. CB-CH89-29

<b>DRILLING LOG</b>	<b>DIVISION</b> SOUTH ATLANTIC	<b>INSTALLATION</b> JACKSONVILLE DISTRICT	<b>SHEET</b> OF 1 SHEETS
1. PROJECT CANAVERAL HARBOR		10. SIZE AND TYPE OF BIT SEE REMARKS	
2. LOCATION (Coordinates or Station) X=641321 Y=1477332		11. DATUM FOR ELEVATION SHOWN (TBM or MSL) MLW	
3. DRILLING AGENCY CORPS OF ENGINEERS		12. MANUFACTURER'S DESIGNATION OF DRILL S&H SKID RIG	
4. HOLE NO. (As shown on drawing title and file number) CB-CH89-29		13. TOTAL NO. OF OVERBURDEN SAMPLES TAKEN DISTURBED _____ UNDISTURBED _____	
5. NAME OF DRILLER R. GORDON		14. TOTAL NUMBER CORE BOXES 1	
6. DIRECTION OF HOLE <input checked="" type="checkbox"/> VERTICAL <input type="checkbox"/> INCLINED _____ DEG. FROM VERT.		15. ELEVATION GROUND WATER TIDAL	
7. THICKNESS OF OVERBURDEN		16. DATE HOLE STARTED 2-23-89 COMPLETED 2-23-89	
8. DEPTH DRILLED INTO ROCK		17. ELEVATION TOP OF HOLE -36.5	
9. TOTAL DEPTH OF HOLE 17.0'		18. TOTAL CORE RECOVERY FOR BORING 89 %	
		19. SIGNATURE OF LOGGERS J. GENTILE GEOLOGIST	

ELEVATION	DEPTH	LEGEND	CLASSIFICATION OF MATERIALS (Description)	% CORE RECOVERY	SAMPLE NO.	REMARKS (Drilling time, water loss, depth of weathering, etc., if significant)
a	b	c	d	e	f	g
-36.5	0.0					BIT OR BARREL -36.5
-44.0	7.5		CLAY, plastic, little silt & sand, trace shell, damp to wet, gray (CH)	67	1	2" SAMPLER SETTLED -49.0
			Fat, plastic, dark gray from -44.0 to -49.0	100	2	" SETTLED -53.5
-53.5	17.0		Very plastic, fat, gray from -49.0 to -53.5	100	3	" SETTLED -53.5
			SOILS ARE FIELD VISUALLY CLASSIFIED IN ACCORDANCE WITH THE UNIFIED SOILS CLASSIFICATION SYSTEM			300# hammer with 18" drop used on 2" Sampler.  BLOWS COUNTS FOR THE 2" SAMPLER HAVE NOT BEEN CORRELATED WITH STANDARD SPLIT-SPOON TESTS AS DESIGNATED IN ASTM D-1586. JUDGEMENT IS NEEDED IN THE USE OF THE BLOW COUNT DATA FOR THE 2" SAMPLER.  BLS/FT. REFERS TO THE NUMBER OF HAMMER BLOWS REQUIRED TO ADVANCE A 2" SAMPLER (2" I.D. X 2 3/4" O.D.) ONE FOOT. THE SAMPLER IS 5 FT. LONG AND DRIVEN CONTINUOUSLY 5 FT. WHERE POSSIBLE.
			SAMPLE ELEVATION      LABORATORY CLASSIFICATION -36.5 to -44.0      (MR)*			
			NOTE: *VISUAL CLASSIFICATION BASED ON GRADATION CURVE. NO ATTERBERG LIMITS.			

282

Hole No. CB-CH89-30

<b>DRILLING LOG</b>		DIVISION SOUTH ATLANTIC	INSTALLATION JACKSONVILLE DISTRICT	SHEET 1 OF 1 SHEETS
1. PROJECT CANAVERAL HARBOR		10. SIZE AND TYPE OF BIT SEE REMARKS		
2. LOCATION (Coordinates of Boring) X=890,800 Y=1,473,358		11. DATUM FOR ELEVATION SHOWN (TBM or MSL) MLW		
3. DRILLING AGENCY CORPS OF ENGINEERS		12. MANUFACTURER'S DESIGNATION OF DRILL S&H SKID RIG		
4. HOLE NO. (As shown on drawing title and file number) CB-CH89-30		13. TOTAL NO. OF OVER-BURDEN SAMPLES TAKEN	DISTURBED	UNDISTURBED
5. NAME OF DRILLER R. GORDON		14. TOTAL NUMBER CORE BOXES 1		
6. DIRECTION OF HOLE <input checked="" type="checkbox"/> VERTICAL <input type="checkbox"/> INCLINED _____ DEG. FROM VERT.		15. ELEVATION GROUND WATER TIDAL		
7. THICKNESS OF OVERBURDEN		16. DATE HOLE	STARTED 1-31-89	COMPLETED 1-31-89
8. DEPTH DRILLED INTO ROCK		17. ELEVATION TOP OF HOLE -46.4		
9. TOTAL DEPTH OF HOLE 9.3'		18. TOTAL CORE RECOVERY FOR BORING 54 %		
		19. SIGNATURE OF <del>XXXXXXXXXX</del> GEOLOGIST J. GENTILE		

ELEVATION	DEPTH	LEGEND	CLASSIFICATION OF MATERIALS (Description)	% CORE RECOVERY	SAMPLE NO.	REMARKS (Drilling time, water loss, drop of auger, etc., if significant)
a	b	c	d	e	f	g
-46.4	0.0					BIT OR BARREL
-52.7	6.3		CLAY, plastic, gray, wet, (CH)	54	1	SETTLED 2" SAMPLER
-55.7	9.3		Very plastic, undisturbed gray from -52.7 to -55.7			
			Soils are field visually classified in accordance with the Unified Soils Classification System.			300# hammer used with 18" drop on 2" Sampler.
			<p>SAMPLE LABORATORY ELEVATION CLASSIFICATION</p> <p>-46.4 to -55.7 (MH)*</p> <p>NOTE: *VISUAL CLASSIFICATION BASED ON GRADATION CURVE. NO ATTERBERG LIMITS.</p>			<p>BLOW COUNTS FOR THE 2" SAMPLER HAVE NOT BEEN CORRELATED WITH STANDARD SPLIT SPOON TESTS AS DESIGNATED IN ASTM D-1586. JUDGEMENT IS NEEDED IN THE USE OF THE BLOW COUNT DATA FOR THE 2" SAMPLER.</p> <p>BLS/FT. REFERS TO THE NUMBER OF HAMMER BLOWS REQUIRED TO ADVANCE A 2" SAMPLER (2" I.D. X 2 1/2 O.D.) ONE FOOT. THE SAMPLER IS 5 FT. LONG AND DRIVEN CONTINUOUSLY 5 FT. WHERE POSSIBLE.</p>



(283)

Hole No. CB-CH89-31

<b>DRILLING LOG</b>		DIVISION SOUTH ATLANTIC	INSTALLATION JACKSONVILLE DISTRICT	SHEET OF 1 SHEETS
1. PROJECT CANAUVERAL HARBOR		10. SIZE AND TYPE OF BIT SEE REMARKS		
2. LOCATION (Coordinates or Station) X=639,796 Y=1,478,605		11. DATUM FOR ELEVATION SHOWN (FNM or MSL) MLW		
3. DRILLING AGENCY CORPS OF ENGINEERS		12. MANUFACTURER'S DESIGNATION OF DRILL S&H SKID RIG		
4. HOLE NO. (As shown on drawing title and file number) CB-CH89-31		13. TOTAL NO. OF OVER-BURDEN SAMPLES TAKEN DISTURBED _____ UNDISTURBED _____		
5. NAME OF DRILLER E. GORDON		14. TOTAL NUMBER CORE BOXES 1		
6. DIRECTION OF HOLE <input checked="" type="checkbox"/> VERTICAL <input type="checkbox"/> INCLINED _____ DEG. FROM VERT.		15. ELEVATION GROUND WATER TIDAL		
7. THICKNESS OF OVERBURDEN		16. DATE HOLE STARTED 1-31-89 COMPLETED 1-31-89		
8. DEPTH DRILLED INTO ROCK		17. ELEVATION TOP OF HOLE -34.9		
9. TOTAL DEPTH OF HOLE 19.0'		18. TOTAL CORE RECOVERY FOR BORING 69 %		
		19. SIGNATURE OF LOGGERS J. GENTILE GEOLOGIST		

ELEVATION a	DEPTH b	LEGEND c	CLASSIFICATION OF MATERIALS (Description) d	% CORE RECOVERY e	SAMPLER NO. f	REMARKS (Drilling time, water loss, depth of weathering, etc. if significant) g
-34.9	0.0					BIT OR BARREL -34.9 BLS/FT. SETTLED
-36.9	2.0		CLAY, plastic, very wet gray, from -34.9' to -36.9' CLAY, plastic, damp, trace shell, gray (CH) undisturbed from -35.9' to -53.9', seams of clay with little silt from -36.9' to -53.9'	54	1	2" SAMPLER
					2	-43.9 " SETTLED
					3	-48.9 " SETTLED
-53.9	19.0			100	4	-53.9
			Soils are field visually classified in accordance with the Unified Soils Classification System.			
			SAMPLE ELEVATION      LABORATORY CLASSIFICATION			
			-34.9 to -36.9 (MH)*			
			-36.9 to -43.9 (MH)*			
			NOTE: *VISUAL CLASSIFICATION BASED ON GRADATION CURVE. NO ATTERBERG LIMITS.			
				300# hammer used with 18" drop on 2" sampler.  BLOW COUNTS FOR THE 2" SAMPLER HAVE NOT BEEN CORRELATED WITH STANDARD SPLIT SPOON TESTS AS DESIGNATED IN ASTM D-1586. JUDGEMENT IS NEEDED IN THE USE OF THE BLOW COUNT DATA FOR THE 2" SAMPLER.  BLS/FT. REFERS TO THE NUMBER OF HAMMER BLOWS REQUIRED TO ADVANCE A 2" SAMPLER (2" I.D. X 2 1/2 O.D.) ONE FOOT. THE SAMPLER IS 5 FT. LONG AND DRIVEN CONTINUOUSLY 5 FT. WHERE POSSIBLE.		

287

Hole No. CB-CH89-32

<b>DRILLING LOG</b>	DIVISION SOUTH ATLANTIC	INSTALLATION JACKSONVILLE DISTRICT	SHEET 1 OF 1 SHEETS
1. PROJECT CANAVERAL HARBOR		10. SIZE AND TYPE OF BIT SEE REMARKS	
2. LOCATION (Coordinates or Station) X=640286 Y=1,479,185		11. DATUM FOR ELEVATION SHOWN (TBM or MSL) MLW	
3. DRILLING AGENCY CORPS OF ENGINEERS		12. MANUFACTURER'S DESIGNATION OF DRILL SPRAGUE & HENWOOD	
4. HOLE NO. (As shown on drawing title and file number) CB-CH89-32		13. TOTAL NO. OF OVER-BURDEN SAMPLES TAKEN DISTURBED _____ UNDISTURBED _____	
5. NAME OF DRILLER R. GORDON		14. TOTAL NUMBER CORE BOXES 1	
6. DIRECTION OF HOLE <input checked="" type="checkbox"/> VERTICAL <input type="checkbox"/> INCLINED _____ DEG. FROM VERT.		15. ELEVATION GROUND WATER TIDAL	
7. THICKNESS OF OVERBURDEN		16. DATE HOLE STARTED 1/31/83 COMPLETED 1/31/83	
8. DEPTH DRILLED INTO ROCK		17. ELEVATION TOP OF HOLE -38.1	
9. TOTAL DEPTH OF HOLE 16.0 FEET		18. TOTAL CORE RECOVERY FOR BORING 88 %	
		19. SIGNATURE OF INSPECTOR J. GENILE GEOLOGIST	

ELEVATION	DEPTH	LEGEND	CLASSIFICATION OF MATERIALS (Description)	% CORE RECOVERY	SAMPLER NO.	REMARKS (Drilling loss, water loss, depth of weathering, etc. if significant)
a	b	c	d	e	f	g
-38.1	0.0					BIT OR BARREL
-39.8	1.7	2 1/2	SILT, plastic, little shell, gray (MH) SAND (SP) from -38.1 to -38.3		1	2" SAMPLER SETTLED
		2 1/2	CLAY, plastic, gray, damp, little shell, trace organic stain below -44.1' (CH)	83	2	-44.1
		2 1/2			3	" SETTLED
		2 1/2	Bed, silty SAND (SM) with organic stain from -49.6' to -50.1'	100	4	-49.1
-51.1	13.0	2 1/2			5	" 2 4
-54.1	16.0	2 1/2	CLAY, little to some silt, slightly plastic, limey, lt gray to green, damp (CL)	80	5	-54.1 5
			Soils are field visually classified in accordance with the Unified Soils Classification System.			300# hammer used with 18" drop on 2" Sampler.  BLOW COUNTS FOR THE 2" SAMPLER HAVE NOT BEEN CORRELATED WITH STANDARD SPLIT SPOON TESTS AS DESIGNATED IN ASTM D-1586. JUDGEMENT IS NEEDED IN THE USE OF THE BLOW COUNT DATA FOR THE 2" SAMPLER.  BLS/FT. REFERS TO THE NUMBER OF HAMMER BLOWS REQUIRED TO ADVANCE A 2" SAMPLER (2" I.D. X 2 1/2 O.D.) ONE FOOT. THE SAMPLER IS 5 FT. LONG AND DRIVEN CONTINUOUSLY 5 FT. WHERE POSSIBLE.

289

Hole No. CB-CH89-33

<b>DRILLING LOG</b>		DIVISION SOUTH ATLANTIC	INSTALLATION JACKSONVILLE DISTRICT	SHEET 1 OF 1 SHEETS
1. PROJECT CANAVERAL HARBOR			10. SIZE AND TYPE OF BIT SEE REMARKS	
2. LOCATION (Coordinates or Station) X=639,283 Y=1,479,303			11. DATUM FOR ELEVATION SHOWN (FSM or MSL) MLW	
3. DRILLING AGENCY CORPS OF ENGINEERS			12. MANUFACTURER'S DESIGNATION OF DRILL S&H SKID RIC	
4. HOLE NO. (As shown on drawing title and file marked) CB-CH89-33			13. TOTAL NO. OF OVERBURDEN SAMPLES TAKEN DISTURBED _____ UNDISTURBED _____	
5. NAME OF DRILLER R. CORDON			14. TOTAL NUMBER CORE BOXES 1	
6. DIRECTION OF HOLE <input checked="" type="checkbox"/> VERTICAL <input type="checkbox"/> INCLINED _____ DEG. FROM VERT.			15. ELEVATION GROUND WATER TIDAL	
7. THICKNESS OF OVERBURDEN			16. DATE HOLE STARTED 2-1-89 COMPLETED _____	
8. DEPTH DRILLED INTO ROCK			17. ELEVATION TOP OF HOLE -46.4	
9. TOTAL DEPTH OF HOLE 6.2'			18. TOTAL CORE RECOVERY FOR BORING 80 %	
			19. SIGNATURE OF SUPERVISOR J. GENTILE GEOLOGIST	

ELEVATION a	DEPTH b	LEGEND c	CLASSIFICATION OF MATERIALS (Description) d	% CORE RECOVERY e	SAMPLE NO. f	REMARKS (Drilling time, water loss, depth of weather, etc., if significant) g
						BIT OR BARREL
-46.4	0.0					-46.4 BLS/FT.
-47.4	1.0		CLAY, plastic, gray, damp, trace to little shell, wet soupy from -46.4 to -47.4 (CH)	80	1	2" SAMPLER SETTLED
-52.6	6.7		Soils are field visually classified in accordance with the Unified Soils Classification System.  SAMPLE                      LABORATORY ELEVATION                      CLASSIFICATION -46.4 to -52.6 (MH)*  NOTE: *VISUAL CLASSIFICATION BASED ON GRADATION CURVE. NO ATTERBERG LIMITS.			300# hammer used with 18" drop on 2" Sampler.  BLOW COUNTS FOR THE 2" SAMPLER HAVE NOT BEEN CORRELATED WITH STANDARD SPLIT SPOON TESTS AS DESIGNATED IN ASIM D-1586. JUDGEMENT IS NEEDED IN THE USE OF THE BLOW COUNT DATA FOR THE 2" SAMPLER.  BLS/FT. REFERS TO THE NUMBER OF HAMMER BLOWS REQUIRED TO ADVANCE A 2" SAMPLER (2" I.D. X 2 1/2 O.D.) ONE FOOT. THE SAMPLER IS 5 FT. LONG AND DRIVEN CONTINUOUSLY 5 FT. WHERE POSSIBLE.

288

Hole No. CB-CH89-34

<b>DRILLING LOG</b>	<b>DIVISION</b> SOUTH ATLANTIC	<b>INSTALLATION</b> JACKSONVILLE DISTRICT	<b>SHEET 1</b> OF 1 SHEETS
<b>1. PROJECT</b> CANAVERAL HARBOR		<b>10. SIZE AND TYPE OF BIT</b> MLW	
<b>2. LOCATION (Coordinates or Station)</b> X=638,305 Y=1,479,848		<b>11. DATUM FOR ELEVATION SHOWN (TBM or ABL)</b> MLW	
<b>3. DRILLING AGENCY</b> CORPS OF ENGINEERS		<b>12. MANUFACTURER'S DESIGNATION OF DRILL</b> S&R SKID RIG	
<b>4. HOLE NO. (As shown on drawing title and file number)</b> CB-CH89-34		<b>13. TOTAL NO. OF OVERBURDEN SAMPLES TAKEN</b> DISTURBED _____ UNDISTURBED _____	
<b>5. NAME OF DRILLER</b> R. GORDON		<b>14. TOTAL NUMBER CORE BOXES</b> 1	
<b>6. DIRECTION OF HOLE</b> <input checked="" type="checkbox"/> VERTICAL <input type="checkbox"/> INCLINED _____ DEG. FROM VERT.		<b>15. ELEVATION GROUND WATER</b> TIDAL	
<b>7. THICKNESS OF OVERBURDEN</b>		<b>16. DATE HOLE</b> STARTED 2-1-89 COMPLETED 2-1-89	
<b>8. DEPTH DRILLED INTO ROCK</b>		<b>17. ELEVATION TOP OF HOLE</b> -32.0	
<b>9. TOTAL DEPTH OF HOLE</b> 19.5'		<b>18. TOTAL CORE RECOVERY FOR BORING</b> 61 %	
<b>19. SIGNATURE OF INSPECTOR</b> J. GENTILE <b>GEOLOGIST</b>			

ELEVATION	DEPTH	LEGEND	CLASSIFICATION OF MATERIALS (Description)	% CORE RECOVERY	SAMPLE NO.	REMARKS (Drilling time, water loss, depth of weathering, etc., if significant)
a	b	c	d	e	f	g
-32.0	0.0					BIT OR BARREL
			CLAY, plastic, gray, damp, trace to little shell, (CH)	52	1	2" SAMPLER
			Slight organic stain, dark gray from -46.5 to -48.5	60	2	SETTLED
-48.5	16.5		SAND, very fine quartz, clayey, some silt, organic stain, dark gray (SC)	80	3	SETTLED
-49.5	17.5		Gray, limey, isolated limestone lenses from -49.5 to -51.5		4	SETTLED
-51.5	19.5					SETTLED
			Soils are field visually classified in accordance with the Unified Soils Classification System.			300# hammer used with 18" drop on 2" Sampler.
			SAMPLE ELEVATION      LABORATORY CLASSIFICATION			BLOW COUNTS FOR THE 2" SAMPLER HAVE NOT BEEN CORRELATED WITH STANDARD SPLIT SPOON TESTS AS DESIGNATED IN ASTM D-1586. JUDGEMENT IS NEEDED IN THE USE OF THE BLOW COUNT DATA FOR THE 2" SAMPLER.
			-32.0 to -41.5      (MH)*			BLS/FT. REFERS TO THE NUMBER OF HAMMER BLOWS REQUIRED TO ADVANCE A 2" SAMPLER (2" I.D. X 2 1/2 O.D.) ONE FOOT. THE SAMPLER IS 5 FT. LONG AND DRIVEN CONTINUOUSLY 5 FT. WHERE POSSIBLE.
			-41.5 to -48.5      (CH)*			
			-48.5 to -51.5      (SM-H)*			
			NOTE: *VISUAL CLASSIFICATION BASED ON GRADATION CURVE. NO ATTERBERG LIMITS.			

(287)

Hole No. CB-CH89-35

<b>DRILLING LOG</b>		DIVISION SOUTH ATLANTIC	INSTALLATION JACKSONVILLE DISTRICT	SHEET 1 OF 1 SHEETS
1. PROJECT CANAVERAL HARBOR		10. SIZE AND TYPE OF BIT SEE REMARKS		
2. LOCATION (Coordinates or Station) X=638,812 Y=1,480,443		11. DAYUM FOR ELEVATION SHOW (FEET or MET) MLW		
3. DRILLING AGENCY CORPS OF ENGINEERS		12. MANUFACTURER'S DESIGNATION OF DRILL S&K SKID RIG		
4. HOLE NO. (As shown on drawing title and file number) CB-CH89-35		13. TOTAL NO. OF OVERBURDEN SAMPLES TAKEN DISTURBED      UNDISTURBED		
5. NAME OF DRILLER R. GORDON		14. TOTAL NUMBER CORE BOXES 1		
6. DIRECTION OF HOLE <input checked="" type="checkbox"/> VERTICAL <input type="checkbox"/> INCLINED      DEG. FROM VERT.		15. ELEVATION GROUND WATER TIDAL		
7. THICKNESS OF OVERBURDEN		16. DATE HOLE STARTED 2/1/89      COMPLETED 2/7/89		
8. DEPTH DRILLED INTO ROCK		17. ELEVATION TOP OF HOLE -34.4		
9. TOTAL DEPTH OF HOLE 19.5'		18. TOTAL CORE RECOVERY FOR BORING 5'		
		19. SIGNATURE OF INSPECTOR J. GENTILE      GEOLOGIST		

ELEVATION a	DEPTH b	LEGEND c	CLASSIFICATION OF MATERIALS (Description) d	% CORE RECOVERY e	SAMPLE NO. f	REMARKS (Drilling time, water loss, depth of weathering, etc., if significant) g
-34.4	0.0					BIT OR BARREL
			CLAY, plastic, gray, damp, trace shell, (CH)	35	1	-34.4 BLS/FT. SETTLED
			Organic stain, dark gray from -48.9 to -53.9	100	2	-48.9 SETTLED
-53.9	19.5		Soils are field visually classified in accordance with the Unified Soils Classification System.			300# hammer used with 18" drop on 2" Sampler.
			SAMPLE ELEVATION      LABORATORY CLASSIFICATION -48.9 to -53.9      (CH)*			BLOW COUNTS FOR THE 2" SAMPLER HAVE NOT BEEN CORRELATED WITH STANDARD SPLIT SPOON TESTS AS DESIGNATED IN ASTM D-1586. JUDGEMENT IS NEEDED IN THE USE OF THE BLOW COUNT DATA FOR THE 2" SAMPLER.
			NOTE: *VISUAL CLASSIFICATION BASED ON GRADATION CURVE. NO ATTERBERG LIMITS.			BLS/FT. REFERS TO THE NUMBER OF HAMMER BLOWS REQUIRED TO ADVANCE A 2" SAMPLER (2" I.D. X 2 1/2 O.D.) ONE FOOT. THE SAMPLER IS 5 FT. LONG AND DRIVEN CONTINUOUSLY 5 FT. WHERE POSSIBLE.

DRILLING LOG		DIVISION		INSTALLATION		SHEET	
		SOUTH ATLANTIC		JACKSONVILLE DISTRICT		1 OF 1 SHEETS	
1. PROJECT CANAVERAL HARBOR				10. SIZE AND TYPE OF BIT SEE REMARKS			
2. LOCATION (Coordinates or Station) X=637,789 Y=1,480,768				11. DATUM FOR ELEVATION SHOWN (TBM or BSL) MLW			
3. DRILLING AGENCY CORPS OF ENGINEERS				12. MANUFACTURER'S DESIGNATION OF DRILL S&H SKID RIG			
4. HOLE NO. (As shown on drawing title and file number) CB-CH89-36				13. TOTAL NO. OF OVER-BURDEN SAMPLES TAKEN DISTURBED _____ UNDISTURBED _____			
5. NAME OF DRILLER R. GORDON				14. TOTAL NUMBER CORE BOXES 1			
6. DIRECTION OF HOLE <input checked="" type="checkbox"/> VERTICAL <input type="checkbox"/> INCLINED _____ DEG. FROM VERT.				15. ELEVATION GROUND WATER TIDAL			
7. THICKNESS OF OVERBURDEN				16. DATE HOLE STARTED 1-30-89 COMPLETED 1-30-89			
8. DEPTH DRILLED INTO ROCK				17. ELEVATION TOP OF HOLE -47.7			
9. TOTAL DEPTH OF HOLE 10.0'				18. TOTAL CORE RECOVERY FOR BORING 50 %			
				19. SIGNATURE OF SUPERVISOR J. GENTILE			
ELEVATION	DEPTH	LEGEND	CLASSIFICATION OF MATERIALS (Description)	3 CORE RECOVERY	2" SAMPLER NO.	REMARKS (Drilling time, water loss, depth of casing, etc., if significant)	
-47.7	0.0					BIT OR BARREL	
			CLAY, plastic, wet, dark gray, (CH)			-47.7 BLS/FT.	
			Very plastic, thin lenses medium hard limestone, green to gray fat, (CH) from -56.2' to -57.7'	50	1	2" SAMPLER SETTLED	
-57.7	10.0				2	-57.7	
			Soils are field visually classified in accordance with the Unified Soils Classification System.			300# hammer used with 18" drop on 2" Sampler.	
			SAMPLE LABORATORY ELEVATION CLASSIFICATION -47.2 to -56.2 (MR)*			BLOW COUNTS FOR THE 2" SAMPLER HAVE NOT BEEN CORRELATED WITH STANDARD SPLIT SPOON TESTS AS DESIGNATED IN ASTM D-1586. JUDGEMENT IS NEEDED IN THE USE OF THE BLOW COUNT DATA FOR THE 2" SAMPLER.	
			NOTE: *VISUAL CLASSIFICATION BASED ON GRADATION CURVE. NO ATTERBERG LIMITS.			BLS/FT. REFERS TO THE NUMBER OF HAMMER BLOWS REQUIRED TO ADVANCE A 2" SAMPLER (2" I.D. X 2 1/2 O.D.) ONE FOOT. THE SAMPLER IS 5 FT. LONG AND DRIVEN CONTINUOUSLY 5 FT. WHERE POSSIBLE.	

288

Hole No. CB-CH89-37

DRILLING LOG		DIVISION	INSTALLATION	SHEET
1. PROJECT		SOUTH ATLANTIC	JACKSONVILLE DISTRICT	1
CANAVERAL HARBOR		10. SIZE AND TYPE OF BIT		
2. LOCATION (Coordinates of Station) X=636,936 Y=1,481,399		MLW		
3. DRILLING AGENCY		11. DATUM FOR ELEVATION SHOWN (TBM or MSL)		
CORPS OF ENGINEERS		S&H SKID RIG		
4. HOLE NO. (As shown on drawing title and file marking) CB-CH89-37		12. MANUFACTURER'S DESIGNATION OF DRILL		
5. NAME OF DRILLER		13. TOTAL NO. OF OVER-BURDEN SAMPLES TAKEN		
R. GORDON		DISTURBED      UNDISTURBED		
6. DIRECTION OF HOLE		14. TOTAL NUMBER CORE BOXES		
<input checked="" type="checkbox"/> VERTICAL <input type="checkbox"/> INCLINED _____ DEG. FROM VERT.		1		
7. THICKNESS OF OVERBURDEN		15. ELEVATION GROUND WATER		
8. DEPTH DRILLED INTO ROCK		TIDAL		
9. TOTAL DEPTH OF HOLE 9.6'		16. DATE HOLE		
		STARTED      COMPLETED		
		2-1-89      2-1-89		
		17. ELEVATION TOP OF HOLE		
		-47.7		
		18. TOTAL CORE RECOVERY FOR BORING		
		37		
		19. SIGNATURE OF DRILLER		
		J. GENTILE      GEOLOGIST		

ELEVATION	DEPTH	LEGEND	CLASSIFICATION OF MATERIALS (Description)	% CORE RECOVERY	SAMPLE NO.	REMARKS (Drilling time, water loss, depth of weathering, etc., if significant)
a	b	c	d	e	f	g
-47.7	0.0					BIT OR BARREL
			CLAY plastic, damp, trace shell, gray (CH)			-47.7 BLS/FT.
			Limey clay with limestone fragments. from -55.2 to -56.8	37	1	2" SAMPLER SETTLED
-55.2	8.0					
-56.8	9.6					
			Soils are field visually classified in accordance with the Unified Soils Classification System.			300# hammer used with 18" drop on 2" Sampler.
						BLOW COUNTS FOR THE 2" SAMPLER HAVE NOT BEEN CORRELATED WITH STANDARD SPLIT SPOON TESTS AS DESIGNATED IN ASTM D-1586. JUDGEMENT IS NEEDED IN THE USE OF THE BLOW COUNT DATA FOR THE 2" SAMPLER.
						BLS/FT. REFERS TO THE NUMBER OF HAMMER BLOWS REQUIRED TO ADVANCE A 2" SAMPLER (2" I.D. X 2 1/2 O.D.) ONE FOOT. THE SAMPLER IS 5 FT. LONG AND DRIVEN CONTINUOUSLY 5 FT. WHERE POSSIBLE.

790

Hole No. CB-CH89-38

<b>DRILLING LOG</b>		DIVISION SOUTH ATLANTIC	INSTALLATION JACKSONVILLE DISTRICT	SHEET 1 of 1 SHEETS
1. PROJECT Canaveral Harbor		10. SIZE AND TYPE OF BIT SEE REMARKS		
2. LOCATION (Coordinates or Station) X=636,198 Y=1,481,755		11. DATUM FOR ELEVATION SHOWN (FORM OR USE) MLW		
3. DRILLING AGENCY CORPS OF ENGINEERS		12. MANUFACTURER'S DESIGNATION OF DRILL S&H SRID RIG		
4. HOLE NO. (As shown on drawing title and file number) CB-CH89-38		13. TOTAL NO. OF OVER- BURDEN SAMPLES TAKEN		
5. NAME OF DRILLER R. GORDON		14. TOTAL NUMBER CORE BOXES 1		
6. DIRECTION OF HOLE <input checked="" type="checkbox"/> VERTICAL <input type="checkbox"/> INCLINED _____ DEG. FROM VERT.		15. ELEVATION GROUND WATER TIDAL		
7. THICKNESS OF OVERBURDEN		16. DATE HOLE STARTED 2-2-89 COMPLETED 2-2-89		
8. DEPTH DRILLED (INTO ROCK)		17. ELEVATION TOP OF HOLE -47.2		
9. TOTAL DEPTH OF HOLE 11.5'		18. TOTAL CORE RECOVERY FOR BORING 44		
		19. SIGNATURE OF INSPECTOR GEOLOGIST		



ELEVATION a	DEPTH b	LEGEND c	CLASSIFICATION OF MATERIALS (Description) d	RECOVERED CORE e	DEPTH SAMPLE NO. f	REMARKS (Drilling time, water loss, depth of weathering, etc., if significant) g
-47.2	0.0					BIT OR BARREL
-57.2	10.0		CLAY, black plastic, wet (CH)  Gray, plastic, trace shell, (CH) from -49.2 to -57.2	44	1	-47.2 BLS/FT SETTLED  2" SAMPLER
-58.7	11.5		Trace to little sand, with little shell, seams of clayey sand, lt. gray, from -57.2 to -58.7			-58.7
			Soils are field visually classified in accordance with the Unified Soils Classification System.			300# hammer used with 18" drop on 2" Sampler.  BLOW COUNTS FOR THE 2" SAMPLER HAVE NOT BEEN CORRELATED WITH STANDARD SPLIT SPOON TESTS AS DESIGNATED IN ASTM D-1586. JUDGEMENT IS NEEDED IN THE USE OF THE BLOW COUNT DATA FOR THE 2" SAMPLER.  BLS/FT. REFERS TO THE NUMBER OF HAMMER BLOWS REQUIRED TO ADVANCE A 2" SAMPLER (2" I.D. X 2 1/2 O.D.) ONE FOOT. THE SAMPLER IS 5 FT. LONG AND DRIVEN CONTINUOUSLY 5 FT. WHERE POSSIBLE.
			SAMPLE ELEVATION      LABORATORY CLASSIFICATION -47.2 to -58.7      (MR)*			
			NOTE: *VISUAL CLASSIFICATION BASED ON GRADATION CURVE. NO ATTERBERG LIMITS.			



290

Hole No. CB-CH89-39

<b>DRILLING LOG</b>		DIVISION SOUTH ATLANTIC	INSTALLATION JACKSONVILLE DISTRICT	SHEET 1 of 1 SHEETS
1. PROJECT CANAVERAL HARBOR		10. SIZE AND TYPE OF BIT SEE REMARKS		
2. LOCATION (Coordinates or Station) X=634,194 Y=1,481,744		11. DATUM FOR ELEVATION SHOWN (TBM or MSL) MSL		
3. DRILLING AGENCY CORPS OF ENGINEERS		12. MANUFACTURER'S DESIGNATION OF DRILL S&H SKID RIG		
4. HOLE NO. (As shown on drawing title and file number) CB-CH89-39		13. TOTAL NO. OF OVER-BURDEN SAMPLES TAKEN DISTURBED _____ UNDISTURBED _____		
5. NAME OF DRILLER R. GORDON		14. TOTAL NUMBER CORE BOXES 1		
6. DIRECTION OF HOLE <input checked="" type="checkbox"/> VERTICAL <input type="checkbox"/> INCLINED _____ DEG. FROM VERT.		15. ELEVATION GROUND WATER TIDAL		
7. THICKNESS OF OVERBURDEN		16. DATE HOLE STARTED 2-2-89 COMPLETED 2-2-89		
8. DEPTH DRILLED INTO ROCK		17. ELEVATION TOP OF HOLE -46.1		
9. TOTAL DEPTH OF HOLE 7.8'		18. TOTAL CORE RECOVERY FOR BORING 64		
		19. SIGNATURE OF DRILLER J. CENTILE		
		20. SIGNATURE OF GEOLOGIST		

ELEVATION a	DEPTH b	LEGEND c	CLASSIFICATION OF MATERIALS (Description) d	RECOVERY e	SAMPL. NO. f	REMARKS (Drilling time, water loss, depth of weathering, etc., if significant) g
-46.1	0.0					BIT OR BARREL  -46.1 BLS/FT. SETTLED
-51.2	5.1		CLAY, plastic, dk. gray, trace sand, wet to damp, (CH)	64	1	2" SAMPLER
-53.9	7.8		SAND, fine quartz, clayey, dk. gray, (SC)		2	-53.9
			Soils are field visually classified in accordance with the Unified Soils Classification System.  SAMPLE LABORATORY ELEVATION CLASSIFICATION -46.1 to -51.2 (MR)*  NOTE: *VISUAL CLASSIFICATION BASED ON GRADATION CURVE. NO ATTERBERG LIMITS.			100# hammer used with 18" drop on 2" sampler.  BLOW COUNTS FOR THE 2" SAMPLER HAVE NOT BEEN CORRELATED WITH STANDARD SPLIT SPOON TESTS AS DESIGNATED IN ASTM D-1586. JUDGEMENT IS NEEDED IN THE USE OF THE BLOW COUNT DATA FOR THE 2" SAMPLER.  BLS/FT. REFERS TO THE NUMBER OF HAMMER BLOWS REQUIRED TO ADVANCE A 2" SAMPLER (2" I.D. X 2 1/2 O.D.) ONE FOOT. THE SAMPLER IS 5 FT. LONG AND DRIVEN CONTINUOUSLY 5 FT. WHERE POSSIBLE.

299



Hole No. C8-CH89-40

<b>DRILLING LOG</b>	DIVISION SOUTH ATLANTIC	INSTALLATION JACKSONVILLE DISTRICT	SHEET 1 OF 1 SHEETS
1. PROJECT CANAVERAL HARBOR		10. SIZE AND TYPE OF BIT SEE REMARKS	
2. LOCATION (Coordinates or Station) x = 634,050 y = 1,481,725		11. DATUM FOR ELEVATION SHOWN (2884 or MSL) MLW	
3. DRILLING AGENCY CORPUS OF ENGINEERS		12. MANUFACTURER'S DESIGNATION OF DRILL S&H SKID RIG	
4. HOLE NO. (As shown on drawing title and file number) C8-CH89-40		13. TOTAL NO. OF OVERBURDEN SAMPLES TAKEN DISTURBED UNDISTURBED	
5. NAME OF DRILLER R. GORDON		14. TOTAL NUMBER CORE BOXES 1	
6. DIRECTION OF HOLE <input checked="" type="checkbox"/> VERTICAL <input type="checkbox"/> INCLINED _____ DEG. FROM VERT.		15. ELEVATION GROUND WATER TIDAL	
7. THICKNESS OF OVERBURDEN		16. DATE HOLE STARTED COMPLETED 2-13-89 2-13-89	
8. DEPTH DRILLED INTO ROCK		17. ELEVATION TOP OF HOLE -46.5	
9. TOTAL DEPTH OF HOLE 10.0'		18. TOTAL CORE RECOVERY FOR BORING 76 %	
		19. SIGNATURE OF DRILLER J. GENTILE GEOLOGIST	

ELEVATION a	DEPTH b	LEGEND c	CLASSIFICATION OF MATERIALS (Description) d	% CORE RECOVERY e	SAMPLE NO. f	REMARKS (Drilling time, water loss, depth of penetration, etc., if significant) g
-46.5	0.0					BIT OR BARREL -46.5
-49.8	3.3		SAND, fine, quartz, clayey, little silt, dark gray, wet, soupy (SC)	100	1	2" SAMPLER SETTLED
-51.5	5.0		SAND, fine to medium, quartz, gray, trace clay & silt (SP)		2	-51.5 16 21
-53.0	6.5		Fine quartz, with seams of clayey sand, from -51.5 to -53.0		3	" 3 2 1
-56.5	10.0		CLAY, plastic, fat, gray, damp (CH)	52		-56.5 1
			SOILS ARE FIELD VISUALLY CLASSIFIED IN ACCORDANCE WITH THE UNIFIED SOILS CLASSIFICATION SYSTEM			
			SAMPLE ELEVATION -46.5 to -49.8 (SM-H)*			
			LABORATORY CLASSIFICATION (SM-H)*			
			NOTE: *VISUAL CLASSIFICATION BASED ON GRADATION CURVE. NO ATTERBERG LIMITS.			
				BLS/FT. REFERS TO THE NUMBER OF HAMMER BLOWS REQUIRED TO ADVANCE A 2" SAMPLER (2" I.D. X 2 1/4" O.D.) ONE FOOT. THE SAMPLER IS 5 FT. LONG AND DRIVEN CONTINUOUSLY 5 FT. WHERE POSSIBLE.		

Hole No. CB-CH89-41

<b>DRILLING LOG</b>		DIVISION SOUTH ATLANTIC	INSTALLATION JACKSONVILLE DISTRICT	SHEET 1
1. PROJECT CANAVERAL HARBOR		10. SIZE AND TYPE OF BIT SEE REMARKS		
2. LOCATION (Coordinates or Station) X=633079 Y=1481730		11. DATUM FOR ELEVATION SHOWN (TBM or MSL) MLW		
3. DRILLING AGENCY CORPS OF ENGINEERS		12. MANUFACTURER'S DESIGNATION OF DRILL 5BH SKID RIG		
4. HOLE NO. (As shown on drawing title and file number) CB-CH89-41		13. TOTAL NO. OF OVER-BURDEN SAMPLES TAKEN DISTURBED _____ UNDISTURBED _____		
5. NAME OF DRILLER R. GORDON		14. TOTAL NUMBER CORE BOXES 1		
6. DIRECTION OF HOLE <input checked="" type="checkbox"/> VERTICAL <input type="checkbox"/> INCLINED _____ DEG. FROM VERT.		15. ELEVATION GROUND WATER TIDAL		
7. THICKNESS OF OVERBURDEN		16. DATE HOLE STARTED 2-10-89 COMPLETED 2-10-89		
8. DEPTH DRILLED INTO ROCK		17. ELEVATION TOP OF HOLE -46.6		
9. TOTAL DEPTH OF HOLE 10.2'		18. TOTAL CORE RECOVERY FOR BORING 54 %		
		19. SIGNATURE OF <del>XXXXXXXX</del> GEOLOGIST J. GENTILE		

ELEVATION a	DEPTH b	LEGEND c	CLASSIFICATION OF MATERIALS (Description) d	1 CORE RECOVERY e	2 SAMPLE NO. f	REMARKS (Drilling time, water loss, depth of weathering, etc., if significant) g
						BIT OR BARREL
-46.6	0.0					-46.6
-48.6	7.0		CLAY, black, wet, soupy, silty, little sand (CL)			2" SAMPLER SETTLED
-54.6	8.0		SAND, fine, quartz, silty, little clay, dark gray, wet (SM)	54	1 2 3	
-56.8	10.2		SAND, fine to medium, quartz, trace silt, gray (SP)			-56.8
			SOILS ARE FIELD VISUALLY CLASSIFIED IN ACCORDANCE WITH THE UNIFIED SOILS CLASSIFICATION SYSTEM			
			SAMPLE ELEVATION _____ LABORATORY CLASSIFICATION _____			
			-48.6 to -54.6 (SM)*			
			NOTE: *VISUAL CLASSIFICATION BASED ON GRADATION CURVE. NO ATTERBERG LIMITS.			
				300# hammer with 18" drop used on 2" Sampler.		
				BLOWS COUNTS FOR THE 2" SAMPLER HAVE NOT BEEN CORELATED WITH STANDARD SPLIT-SPOON TESTS AS DESIGNATED IN ASTM D-1586. JUDGEMENT IS NEEDED IN THE USE OF THE BLOW COUNT DATA FOR THE 2" SAMPLER.		
				BLS/FT. REFERS TO THE NUMBER OF HAMMER BLOWS REQUIRED TO ADVANCE A 2" SAMPLER (2" I.D. X 2 1/4" O.D.) ONE FOOT. THE SAMPLER IS 5 FT. LONG AND DRIVEN CONTINUOUSLY 5 FT. WHERE POSSIBLE.		

(299)

Hole No. CB- CH89-42

<b>DRILLING LOG</b>	<b>DIVISION</b> SOUTH ATLANTIC	<b>INSTALLATION</b> JACKSONVILLE DISTRICT	<b>SHEET</b> 1 OF 1 SHEETS
1. PROJECT CANAVERAL HARBOR		10. SIZE AND TYPE OF BIT SEE REMARKS	
2. LOCATION (Coordinates or Station) X=632107 Y=1481700		11. DATUM FOR ELEVATION SHOWN (TBM or MSL) MLW	
3. DRILLING AGENCY CORPS OF ENGINEERS		12. MANUFACTURER'S DESIGNATION OF DRILL S&H SKID RIG	
4. HOLE NO. (As shown on drawing title and file number) CB-CH89-42		13. TOTAL NO. OF OVER-BURDEN SAMPLES TAKEN DISTURBED _____ UNDISTURBED _____	
5. NAME OF DRILLER R. GORDON		14. TOTAL NUMBER CORE BOXES 1	
6. DIRECTION OF HOLE <input checked="" type="checkbox"/> VERTICAL <input type="checkbox"/> INCLINED _____ DEG. FROM VERT.		15. ELEVATION GROUND WATER TIDAL	
7. THICKNESS OF OVERBURDEN		16. DATE HOLE STARTED 2-10-89 COMPLETED 2-10-89	
8. DEPTH DRILLED INTO ROCK		17. ELEVATION TOP OF HOLE -49.5	
9. TOTAL DEPTH OF HOLE 10.3'		18. TOTAL CORE RECOVERY FOR BORING 53 %	
		19. SIGNATURE OF OPERATOR J. GENTILE GEOLOGIST	

ELEVATION	DEPTH	LEGEND	CLASSIFICATION OF MATERIALS (Description)	% CORE RECOVERY	SAMPLE NO.	REMARKS (Drilling time, water loss, depth of washings, etc., if significant)
a	b	c	d	e	f	g
-49.5	0.0					BIT OR BARREL
-50.0	0.5		SAND, fine, quartz, clean, tan			-49.5
			CLAY, black, soft, wet, soupy, sandy, slightly plastic, seams silty sand (CL)	53	1	2" SAMPLER SETTLED
			CLAY, plastic, fat, gray (CH)		2	
-56.5	7.0				3	
-59.8	10.3					-59.8
			SOILS ARE FIELD VISUALLY CLASSIFIED IN ACCORDANCE WITH THE UNIFIED SOILS CLASSIFICATION SYSTEM			300# hammer with 18" drop used on 2" Sampler.  BLOWS COUNTS FOR THE 2" SAMPLER HAVE NOT BEEN CORRELATED WITH STANDARD SPLIT-SPOON TESTS AS DESIGNATED IN ASTM D-1586. JUDGEMENT IS NEEDED IN THE USE OF THE BLOW COUNT DATA FOR THE 2" SAMPLER.  BLS/FT. REFERS TO THE NUMBER OF HAMMER BLOWS REQUIRED TO ADVANCE A 2" SAMPLER (2" I.D. X 2 1/2" O.D.) ONE FOOT. THE SAMPLER IS 5 FT. LONG AND DRIVEN CONTINUOUSLY 5 FT. WHERE POSSIBLE.

290

Hole No. CB-CH89-43

<b>DRILLING LOG</b>		DIVISION SOUTH ATLANTIC	INSTALLATION JACKSONVILLE DISTRICT	SHEET 1 of 1 SHEETS
1. PROJECT CANAVERAL HARBOR		10. SIZE AND TYPE OF BIT SEE REMARKS		
2. LOCATION (Coordinates or Station) X=631069 Y=1481700		11. DATE FOR ELEVATION SHOWN (TBM or HSL) MLW		
3. DRILLING AGENCY CORPS OF ENGINEERS		12. MANUFACTURER'S DESIGNATION OF DRILL S&H SKID RIG		
4. HOLE NO. (As shown on drawing title and file number) CB-CH89-43		13. TOTAL NO. OF DUES-BURDEN SAMPLES TAKEN		
5. NAME OF DRILLER R. GORDON		14. TOTAL NUMBER CORE BOXES 1		
6. DIRECTION OF HOLE <input checked="" type="checkbox"/> VERTICAL <input type="checkbox"/> INCLINED _____ DEG. FROM VERT.		15. ELEVATION GROUND WATER TIDAL		
7. THICKNESS OF OVERBURDEN		16. DATE HOLE STARTED 2-14-89 COMPLETED 2-14-89		
8. DEPTH DRILLED INTO ROCK		17. ELEVATION TOP OF HOLE -40.6		
9. TOTAL DEPTH OF HOLE 15.0'		18. TOTAL CORE RECOVERY FOR BORING 47 %		
		19. SIGNATURE OF <del>XXXXXXXX</del> J. GENTILE GEOLOGIST		

ELEVATION a	DEPTH b	LEGEND c	CLASSIFICATION OF MATERIALS (Description) d	SCORE NEEDED e	BOX OR SAMPLE NO. f	REMARKS (Drilling time, water loss, depth of weathering, etc., if significant) g
-40.6	0.0					BIT OR BARREL -40.6 BLS/FT.
-47.6	7.0		SAND, fine quartz, clean, gray, wet (SP)	40	1	2" SAMPLER SETTLED -45.6 4 3
-49.1	8.5		SAND, fine quartz, clayey, dark gray, wet (SC)	40	2	" 4 1
					3	-50.6 6 23
-55.6	15.0		Firm, damp, undisturbed, very fine quartz, gray-green from -49.1 to -55.6	60	4	" 4 12 22 30
			SOILS ARE FIELD VISUALLY CLASSIFIED IN ACCORDANCE WITH THE UNIFIED SOIL CLASSIFICATION SYSTEM			
			SAMPLE ELEVATION      LABORATORY CLASSIFICATION			
			-40.6 to -47.6 (SP-SM)			
			-50.6 to -55.6 (CL)			
				300# hammer with 18" drop used on 2" Sampler.		
				BLOWS COUNTS FOR THE 2" SAMPLER HAVE NOT BEEN CORRELATED WITH STANDARD SPLIT-SPOON TESTS AS DESIGNATED IN ASTM D-1586. JUDGEMENT IS NEEDED IN THE USE OF THE BLOW COUNT DATA FOR THE 2" SAMPLER.		
				BLS/FT. REFERS TO THE NUMBER OF HAMMER BLOWS REQUIRED TO ADVANCE A 2" SAMPLER (2" I.D. X 2 1/2" O.D.) ONE FOOT. THE SAMPLER IS 5-FT. LONG AND DRIVEN CONTINUOUSLY 5 FT. WHERE POSSIBLE.		

296



Hole No. CB-CH89-44

<b>DRILLING LOG</b>	DIVISION SOUTH ATLANTIC	INSTALLATION JACKSONVILLE DISTRICT	SHEET 1 OF 1 SHEETS
1. PROJECT CANAVERAL HARBOR		10. SIZE AND TYPE OF BIT SEE REMARKS	
2. LOCATION (Coordinates of Station) X=630079 Y=1481700		11. DAY ON FOR ELEVATION SHOWN (15M or 65L) MLW	
3. DRILLING AGENCY CORPS OF ENGINEERS		12. MANUFACTURER'S DESIGNATION OF DRILL S&H SKID RIG	
4. HOLE NO. (As shown on drawing title and file number) CB-CH89-44		13. TOTAL NO. OF OVERBURDEN SAMPLES TAKEN DISTURBED _____ UNDISTURBED _____	
5. NAME OF DRILLER R. GORDON		14. TOTAL NUMBER CORE BOXES _____	
6. DIRECTION OF HOLE <input checked="" type="checkbox"/> VERTICAL <input type="checkbox"/> INCLINED _____ DEG. FROM VERT.		15. ELEVATION GROUND WATER TIDAL	
7. THICKNESS OF OVERBURDEN _____		16. DATE HOLE STARTED 2-13-89 COMPLETED 2-13-89	
8. DEPTH DRILLED INTO ROCK _____		17. ELEVATION TOP OF HOLE -39.1	
9. TOTAL DEPTH OF HOLE 8.7'		18. TOTAL CORE RECOVERY FOR BORING 35 %	
		19. SIGNATURE OF <del>XXXXXXXXXX</del> GEOLOGIST J. GENTILE	

ELEVATION a	DEPTH b	LEGEND c	CLASSIFICATION OF MATERIALS (Description) d	% CORE RECOVERY e	SAMPLE NO. f	REMARKS (Drilling time, water loss, depth of weathering, etc., if significant) g								
-39.1	0.0					BIT OR BARREL								
-41.1	2.0		CLAY, plastic, trace to little sand, gray, wet, soupy (CH)		1	2" SAMPLER SETTLED								
-46.1	7.0		SAND, fine, quartz, little clay to clayey, gray, loose, wet (SC)	35	2									
-47.8	8.7		CLAY, plastic, fat, undisturbed, gray, damp (CH)		3									
<p>300# hammer with 18" drop used on 2" Sampler.</p> <p>SOILS HAVE BEEN FIELD VISUALLY CLASSIFIED IN ACCORDANCE WITH THE UNIFIED SOILS CLASSIFICATION SYSTEM</p> <table border="1"> <thead> <tr> <th>SAMPLE ELEVATION</th> <th>LABORATORY CLASSIFICATION</th> </tr> </thead> <tbody> <tr> <td>-39.1 to -41.1</td> <td>(MH)*</td> </tr> <tr> <td>-41.1 to -46.1</td> <td>(SH)*</td> </tr> <tr> <td>-46.1 to -47.8</td> <td>(CH)*</td> </tr> </tbody> </table> <p>NOTE: *VISUAL CLASSIFICATION BASED ON GRADATION CURVE. NO ATTERBERG LIMITS.</p> <p>BLS/FT. REFERS TO THE NUMBER OF HAMMER BLOWS REQUIRED TO ADVANCE A 2" SAMPLER (2" I.D. X 2 1/2" O.D.) ONE FOOT. THE SAMPLER IS 5 FT. LONG AND DRIVEN CONTINUOUSLY 5 FT. WHERE POSSIBLE.</p>							SAMPLE ELEVATION	LABORATORY CLASSIFICATION	-39.1 to -41.1	(MH)*	-41.1 to -46.1	(SH)*	-46.1 to -47.8	(CH)*
SAMPLE ELEVATION	LABORATORY CLASSIFICATION													
-39.1 to -41.1	(MH)*													
-41.1 to -46.1	(SH)*													
-46.1 to -47.8	(CH)*													

Hole No. CB-CH89-45

<b>DRILLING LOG</b>	DIVISION SOUTH ATLANTIC	INSTALLATION JACKSONVILLE DISTRICT	SHEET of 1 SHEETS
1. PROJECT CANAVERAL HARBOR		10. SIZE AND TYPE OF BIT SEE REMARKS	
2. LOCATION (Continent or Station) X=629,071 Y=1,481,710		11. DATUM FOR ELEVATION SHOWN (FDM or ADS) MLN	
3. DRILLING AGENCY CORPS OF ENGINEERS		12. MANUFACTURER'S DESIGNATION OF DRILL S&H SKID RIG	
4. HOLE NO. (As shown on drawing title and file number) CB-CH89-45		13. TOTAL NO. OF OVERBURDEN SAMPLES TAKEN DISTURBED UNDISTURBED	
5. NAME OF DRILLER R. GORDON		14. TOTAL NUMBER CORE BOXES 1	
6. DIRECTION OF HOLE <input checked="" type="checkbox"/> VERTICAL <input type="checkbox"/> INCLINED _____ DEG. FROM VERT.		15. ELEVATION GROUND WATER	
7. THICKNESS OF OVERBURDEN		16. DATE HOLE STARTED 2-13-89 COMPLETED 2-13-89	
8. DEPTH DRILLED INTO ROCK		17. ELEVATION TOP OF HOLE -40.3	
9. TOTAL DEPTH OF HOLE 6.5'		18. TOTAL CORE RECOVERY FOR BORING 77	
		19. SIGNATURE OF <del>XXXXXXXXXX</del> GEOLOGIST J. GENTILE	

ELEVATION a	DEPTH b	LEGEND c	CLASSIFICATION OF MATERIALS (Description) d	% CORE RECOVERY e	OVERBURDEN SAMPLE NO. f	REMARKS (Drilling time, water loss, depth of weathering, etc., if significant) g
-40.3	0.0					BIT OR BARREL -40.3 BLS/FT.
-44.8	4.5		CLAY, plastic, gray, wet from -40.3 to -44.8 (CH)	77	1	2" SAMPLER SETTLED
-46.8	6.5		Undisturbed, fat from -44.8 to -46.8 (CH)			
			SOILS HAVE BEEN FIELD VISUALLY CLASSIFIED IN ACCORDANCE WITH THE UNIFIED SOILS CLASSIFICATION SYSTEM			300# hammer with 18" drop used on 2" Sampler.  BLOWS COUNTS FOR THE 2" SAMPLER HAVE NOT BEEN COORELATED WITH STANDARD SPLIT-SPOON TESTS AS DESIGNATED IN ASTM D-1586. JUDGEMENT IS NEEDED IN THE USE OF THE BLOW COUNT DATA FOR THE 2" SAMPLER.  BLS/FT. REFERS TO THE NUMBER OF HAMMER BLOWS REQUIRED TO ADVANCE A 2" SAMPLER (2" I.D. X 2 1/4" O.D.) ONE FOOT. THE SAMPLER IS 5 FT. LONG AND DRIVEN CONTINUOUSLY 5 FT. WHERE POSSIBLE.

298

Hole No. CB-CH89-46

<b>DRILLING LOG</b>		DIVISION SOUTH ATLANTIC	INSTALLATION JACKSONVILLE DISTRICT	SHEET 1 OF 1 SHEETS
1. PROJECT CANAVERAL HARBOR		10. SIZE AND TYPE OF BIT SEE REMARKS		
2. LOCATION (Coordinates or Station) X=628096 Y=1481710		11. DAYUM FOR ELEVATION SHOWN (FORM or MSL) MLW		
3. DRILLING AGENCY CORPS OF ENGINEERS		12. MANUFACTURER'S DESIGNATION OF DRILL S&H SKID RIG		
4. HOLE NO. (As shown on drawing title and file number) CB-CH89-46		13. TOTAL NO. OF OVERBURDEN SAMPLES TAKEN [DISTURBED] [UNDISTURBED]		
5. NAME OF DRILLER R. GORDON		14. TOTAL NUMBER CORE BOXES 1		
6. DIRECTION OF HOLE <input checked="" type="checkbox"/> VERTICAL <input type="checkbox"/> INCLINED _____ DEG. FROM VERT.		15. ELEVATION GROUND WATER TIDAL		
7. THICKNESS OF OVERBURDEN		16. DATE HOLE STARTED 2-10-89 COMPLETED 2-10-89		
8. DEPTH DRILLED INTO ROCK		17. ELEVATION TOP OF HOLE -40.8		
9. TOTAL DEPTH OF HOLE 4.5'		18. TOTAL CORE RECOVERY FOR BORING 80		
		19. SIGNATURE OF <del>XXXXXXXXXX</del> GEOLOGIST J. GENTILE		

ELEVATION	DEPTH	LEGEND	CLASSIFICATION OF MATERIALS (Description)	% CORE RECOVERY	SAMPL. NO.	REMARKS (Drilling time, water loss, depth of weathering, etc., if significant)
a	b	c	d	e	f	g
-40.8	0.0					BIT OR BARREL -40.8 BLS/FT.
-45.3	4.5		CLAY, plastic, fat, stiff, gray (CH)	80	1	2" SAMPLER SETTLED -45.3
			SOILS HAVE BEEN FIELD VISUALLY CLASSIFIED IN ACCORDANCE WITH THE UNIFIED SOILS CLASSIFICATION SYSTEM			300# hammer with 18" drop used on 2" Sampler.  BLOWS COUNTS FOR THE 2" SAMPLER HAVE NOT BEEN CORRELATED WITH STANDARD SPLIT-SPOON TESTS AS DESIGNATED IN ASTM D-1586. JUDGEMENT IS NEEDED IN THE USE OF THE BLOW COUNT DATA FOR THE 2" SAMPLER.  BLS/FT. REFERS TO THE NUMBER OF HAMMER BLOWS REQUIRED TO ADVANCE A 2" SAMPLER (2" I.D. X 2 1" O.D.) ONE FOOT. THE SAMPLER IS 5 FT. LONG AND DRIVEN CONTINUOUSLY 5 FT. WHERE POSSIBLE.



Hole No. CB-CH89-47

<b>DRILLING LOG</b>	DIVISION SOUTH ATLANTIC	INSTALLATION JACKSONVILLE DISTRICT	SHEET 1 OF 1 SHEETS
1. PROJECT CANAVERAL HARBOR		10. SIZE AND TYPE OF BIT SEE REMARKS	
2. LOCATION (Coordinates or Station) X-627094 Y-1481680		11. DATUM FOR ELEVATION SHOWN (TBM or BSL) MLW	
3. DRILLING AGENCY CORPS OF ENGINEERS		12. MANUFACTURER'S DESIGNATION OF DRILL SAH SKID RIG	
4. HOLE NO. (As shown on drawing title and file number) CB-CH89-47		13. TOTAL NO. OF OVERBURDEN SAMPLES TAKEN DISTURBED _____ UNDISTURBED _____	
5. NAME OF DRILLER R. GORDON		14. TOTAL NUMBER CORE BOXES 1	
6. DIRECTION OF HOLE <input checked="" type="checkbox"/> VERTICAL <input type="checkbox"/> INCLINED _____ DEG. FROM VERT.		15. ELEVATION GROUND WATER TIDAL	
7. THICKNESS OF OVERBURDEN		16. DATE HOLE STARTED 2-10-89 COMPLETED 2-10-89	
8. DEPTH DRILLED INTO ROCK		17. ELEVATION TOP OF HOLE -41.9	
9. TOTAL DEPTH OF HOLE 5.0'		18. TOTAL CORE RECOVERY FOR BORING 83 %	
		19. SIGNATURE OF <del>XXXXXXXXXX</del> GEOLOGIST J. GENTILE	

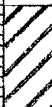
ELEVATION a	DEPTH b	LEGEND c	CLASSIFICATION OF MATERIALS (Description) d	% CORE RECOVERY e	SAMPLER NO. f	REMARKS (Drilling time, water loss, depth, of overburden, etc., if significant) g
-41.9	0.0					BIT OR BARREL
-46.9	5.0		CLAY, plastic, fat, damp, gray, stiff (CH)	83	1	2" SAMPLER SETTLED
			SOILS HAVE BEEN FIELD VISUALLY CLASSIFIED IN ACCORDANCE WITH THE UNIFIED CLASSIFICATION SYSTEM			300# hammer with 18" drop used on 2" Sampler.
			SAMPLE ELEVATION -41.9 to -46.9 (CH)*			BLOWS COUNTS FOR THE 2" SAMPLER HAVE NOT BEEN COORELATED WITH STANDARD SPLIT-SPOON TESTS AS DESIGNATED IN ASTM D-1586. JUDGEMENT IS NEEDED IN THE USE OF THE BLOW COUNT DATA FOR THE 2" SAMPLER.
			NOTE: *VISUAL CLASSIFICATION BASED ON GRADATION CURVE. NO ATTERBERG LIMITS.			BLS/FT. REFERS TO THE NUMBER OF HAMMER BLOWS REQUIRED TO ADVANCE A 2" SAMPLER (2" I.D. X 2 1/2" O.D.) ONE FOOT. THE SAMPLER IS 5 FT. LONG AND DRIVEN CONTINUOUSLY 5 FT. WHERE POSSIBLE.

30

Hole No. CB-CH89-48

<b>DRILLING LOG</b>	DIVISION SOUTH ATLANTIC	INSTALLATION JACKSONVILLE DISTRICT	SHEET OF 1 SHEETS
1. PROJECT CANAVERAL HARBOR		10. SIZE AND TYPE OF BIT SEE REMARKS	
2. LOCATION (Coordinates or Station) X=626086 Y=1 481 625		11. DAY/IN FOR ELEVATION SHOWN (TBM or HSL) MLH	
3. DRILLING AGENCY CORPS OF ENGINEERS		12. MANUFACTURER'S DESIGNATION OF DRILL S&H SKID RIG	
4. HOLE NO. (As shown on drawing title and file number) CB-CH89-48		13. TOTAL NO. OF OVER-BURDEN SAMPLES TAKEN DISTURBED _____ UNDISTURBED _____	
5. NAME OF DRILLER R. GORDON		14. TOTAL NUMBER CORE BOXES 1	
6. DIRECTION OF HOLE <input checked="" type="checkbox"/> VERTICAL <input type="checkbox"/> INCLINED _____ DEG. FROM VERT.		15. ELEVATION GROUND WATER TIDAL	
7. THICKNESS OF OVERBURDEN		16. DATE HOLE STARTED 2-9-89 COMPLETED 2-9-89	
8. DEPTH DRILLED INTO ROCK		17. ELEVATION TOP OF HOLE -39.8	
9. TOTAL DEPTH OF HOLE 4.7'		18. TOTAL CORE RECOVERY FOR BORING 100 %	
		19. SIGNATURE OF <del>XXXXXXXX</del> GEOLOGIST J. GENTILE	

ELEVATION	DEPTH	LEGEND	CLASSIFICATION OF MATERIALS (Description)	% CORE RECOVERY	SAMPLE NO.	REMARKS (Drilling item, water loss, depth of weathering, etc., if significant)				
a	b	c	d	e	f	g				
-39.8	0.0					BIT OR BARREL -39.8 BLS/FT.				
-44.5	4.7		CLAY, plastic, gray, fat, (CH)	100	1	2" SAMPLER SETTLED -44.5				
			SOILS HAVE BEEN FIELD VISUALLY CLASSIFIED IN ACCORDANCE WITH THE UNIFIED SOILS CLASSIFICATION SYSTEM			300# hammer with 18" drop used on 2" sampler.				
			<table border="1"> <thead> <tr> <th>SAMPLE ELEVATION</th> <th>LABORATORY CLASSIFICATION</th> </tr> </thead> <tbody> <tr> <td>-39.8 to -44.5</td> <td>(CH)*</td> </tr> </tbody> </table>	SAMPLE ELEVATION	LABORATORY CLASSIFICATION	-39.8 to -44.5	(CH)*			BLOWS COUNTS FOR THE 2" SAMPLER HAVE NOT BEEN CORRELATED WITH STANDARD SPLIT-SPoon TESTS AS DESIGNATED IN ASTM D-1586. JUDGEMENT IS NEEDED IN THE USE OF THE BLOW COUNT DATA FOR THE 2" SAMPLER.
SAMPLE ELEVATION	LABORATORY CLASSIFICATION									
-39.8 to -44.5	(CH)*									
			NOTE: *VISUAL CLASSIFICATION BASED ON GRADATION CURVE. NO ATTERBERG LIMITS.			BLS/FT. REFERS TO THE NUMBER OF HAMMER BLOWS REQUIRED TO ADVANCE A 2" SAMPLER (2" I.D. X 2 1/2" O.D.) ONE FOOT. THE SAMPLER IS 5 FT. LONG AND DRIVEN CONTINUOUSLY 5 FT. WHERE POSSIBLE.				

Hole No. CB-CH89-49

DRILLING LOG		DIVISION SOUTH ATLANTIC		INSTALLATION JACKSONVILLE DISTRICT		SHEET 1 OF 1 SHEETS	
1. PROJECT CANAVERAL HARBOR				10. SIZE AND TYPE OF BIT SEE REMARKS			
2. LOCATION (Coordinates or Station) Y=620066 X=1481680				11. DATUM FOR ELEVATION SHOWN (TBM or ASL) MLW			
3. DRILLING AGENCY CORPS OF ENGINEERS				12. MANUFACTURER'S DESIGNATION OF DRILL SBH SKID RIG			
4. HOLE NO. (As shown on drawing title and file number) CB-CH89-49				13. TOTAL NO. OF OVERBURDEN SAMPLES TAKEN DISTURBED _____ UNDISTURBED _____			
5. NAME OF DRILLER R. GORDON				14. TOTAL NUMBER CORE BOXES 1			
6. DIRECTION OF HOLE <input checked="" type="checkbox"/> VERTICAL <input type="checkbox"/> INCLINED _____ DEG. FROM VERT.				15. ELEVATION GROUND WATER TIDAL			
7. THICKNESS OF OVERBURDEN				16. DATE HOLE STARTED 2-9-89 COMPLETED 2-9-89			
8. DEPTH DRILLED INTO ROCK				17. ELEVATION TOP OF HOLE -37.3			
9. TOTAL DEPTH OF HOLE 7.3'				18. TOTAL CORE RECOVERY FOR BORING 100 %			
				19. SIGNATURE OF <del>XXXXXXXX</del> J. GENTILE GEOLOGIST			
ELEVATION a	DEPTH b	LEGEND c	CLASSIFICATION OF MATERIALS (Description) d	2 CORE RECOV- ERY e	3 SAMPLE NO. f	REMARKS (Drilling time, water loss, change of weathering, etc., if significant) g	
-37.3	0.0					BIT OR BARREL	
-41.3	4.0		CLAY, slightly plastic, black, wet, soft. (CL)	100	1	-37.3 BLS/FT. 2" SAMPLER SETTLED	
-44.6	7.3		CLAY, plastic, stiff, fat, gray (CH)	100	2	-42.3 2	
					3	-44.6 1 SETTLED	
SOILS HAVE BEEN FIELD VISUALLY CLASSIFIED IN ACCORDANCE WITH THE UNIFIED SOILS CLASSIFICATION SYSTEM							
SAMPLE LABORATORY ELEVATION CLASSIFICATION							
-37.3 to -41.3 (HR)*							
NOTE: *VISUAL CLASSIFICATION BASED ON GRADATION CURVE. NO ATTERBERG LIMITS.							
				300# hammer with 18" drop used on 2" Sampler.			
				BLOWS COUNTS FOR THE 2" SAMPLER HAVE NOT BEEN COORELATED WITH STANDARD SPLIT-SPOON TESTS AS DESIGNATED IN ASTM D-1586. JUDGEMENT IS NEEDED IN THE USE OF THE BLOW COUNT DATA FOR THE 2" SAMPLER.			
				BLS/FT. REFERS TO THE NUMBER OF HAMMER BLOWS REQUIRED TO ADVANCE A 2" SAMPLER (2" I.D. X 2 1/2" O.D.) ONE FOOT. THE SAMPLER IS 5 FT. LONG AND DRIVEN CONTINUOUSLY 5 FT. WHERE POSSIBLE.			

350

File No. CB-CH89-52

<b>DRILLING LOG</b>		DIVISION SOUTH ATLANTIC	INSTALLATION JACKSONVILLE DISTRICT	SHEET 1 OF 1 SHEETS
1. PROJECT CANAVERAL HARBOR		10. SIZE AND TYPE OF BIT SEE REMARKS		
2. LOCATION (Coordinates or Station) X=625274 Y=1482292		11. GAYDS FOR ELEVATION SHOWN (FROM OR TO) MLW		
3. DRILLING AGENCY CORPS OF ENGINEERS		12. MANUFACTURER'S DESIGNATION OF GRILL S&H SKID RIG		
4. HOLE NO. (As shown on drawing title and file number) CB-CH89-52		13. TOTAL NO. OF OVER-BURDEN SAMPLES TAKEN	DISTURBED	UNDISTURBED
5. NAME OF DRILLER R. GORDON		14. TOTAL NUMBER CORE BOXES 1		
6. DIRECTION OF HOLE <input checked="" type="checkbox"/> VERTICAL <input type="checkbox"/> INCLINED DEG. FROM VERT.		15. ELEVATION GROUND WATER TIDAL		
7. THICKNESS OF OVERBURDEN		16. DATE HOLE STARTED	2-14-89	COMPLETED
8. DEPTH DRILLED INTO ROCK		17. ELEVATION TOP OF HOLE -35.0		
9. TOTAL DEPTH OF HOLE 11.0'		18. TOTAL CORE RECOVERY FOR BORING 45		
		19. SIGNATURE OF SUPERVISOR J. GENTILE		

ELEVATION a	DEPTH b	LEGEND c	CLASSIFICATION OF MATERIALS (Description) d	% CORE RECOVERY e	SAMPLE NO. f	REMARKS (Drilling time, water loss, nature of weathering, etc., if significant) g
-35.0	0.0					BIT OR BARREL -35.0 BLS/FT.
-44.0			CLAY, plastic, wet, gray (OH)	1	45	2" SAMPLER SETTLED
-46.0			Undisturbed below -44.0			
			SOILS ARE FIELD VISUALLY CLASSIFIED IN ACCORDANCE WITH THE UNIFIED SOILS CLASSIFICATION SYSTEM			300# hammer with 18" drop used on 2" Sampler.
			SAMPLE LABORATORY ELEVATION CLASSIFICATION -35.0 to -46.0 (OH)*			BLOW COUNTS FOR THE 2" SAMPLER HAVE NOT BEEN CORRELATED WITH STANDARD SPLIT-SPOON TESTS AS DESIGNATED IN ASTM D-1586. JUDGEMENT IS NEEDED IN THE USE OF THE BLOW COUNT DATA FOR THE 2" SAMPLER.
			NOTE: *VISUAL CLASSIFICATION BASED ON GRADATION CURVE. NO ATTERBERG LIMITS.			BLS/FT. REFERS TO THE NUMBER OF HAMMER BLOWS REQUIRED TO ADVANCE A 2" SAMPLER (2" I.D. X 2 1/2" O.D.) ONE FOOT. THE SAMPLER IS 5 FT. LONG AND DRIVEN CONTINUOUSLY 5 FT. WHERE POSSIBLE.

705

Hole No. CB-CH89-53

DRILLING LOG		DIVISION	INSTALLATION		SHEET
1. PROJECT CANAVERAL HARBOR		SOUTH ATLANTIC	JACKSONVILLE DISTRICT		1 OF 1 SHEETS
2. LOCATION (Co-ordinates or Station) X=624010 Y=1481800			10. SIZE AND TYPE OF BIT SEE REMARKS		
3. DRILLING AGENCY CORPS OF ENGINEERS			11. DAYTON FOR ELEVATION SHOWN (FSM or MSL) MLW		
4. HOLE NO. (As shown on drawing title and file number) CB-CH89-53			12. MANUFACTURER'S DESIGNATION OF DRILL SBH SKID RIG		
5. NAME OF DRILLER R. GORDON			13. TOTAL NO. OF OVER- BURDEN SAMPLES TAKEN		DISTURBED UNDISTURBED
6. DIRECTION OF HOLE <input checked="" type="checkbox"/> VERTICAL <input type="checkbox"/> INCLINED _____ DEG. FROM VERT.			14. TOTAL NUMBER CORE BOXES 1		
7. THICKNESS OF OVERBURDEN			15. ELEVATION GROUND WATER TIDAL		
8. DEPTH DRILLED INTO ROCK			16. DATE HOLE		STARTED 2-15-89 COMPLETED 2-15-89
9. TOTAL DEPTH OF HOLE 11.0'			17. ELEVATION TOP OF HOLE -35.7		
			18. TOTAL CORE RECOVERY FOR BORING 91%		
			19. SIGNATURE OF INVESTIGATOR J. GENTILE		
ELEVATION	DEPTH	LEGEND	CLASSIFICATION OF MATERIALS (Descripted)	% CORE RECOVERY	REMARKS (Drilling time, water loss, depth of weathering, etc., if significant)
-35.7	0.0				BIT OR BARREL BLS/FT.
-42.2	6.5		CLAY, plastic, fat, damp, undisturbed, gray (CH)	83	2.0" SAMPLER SETTLED -41.7
-44.7	9.0		SILT, sandy, organic stain, dark brown, trace clay, SL plastic (ML)	100	SETTLED 3
-46.7	11.0		SAND, fine, quartz, clayey, gray-green, little shell wet, limestone lenses from -44.7 to -45.7 (SC)	3	6 12
			SOILS HAVE BEEN FIELD VISUALLY CLASSIFIED IN ACCORDANCE WITH THE UNIFIED SOILS CLASSIFICATION SYSTEM		300# hammer with 18" drop used on 2" Sampler.
			SAMPLE LABORATORY ELEVATION CLASSIFICATION		BLOW COUNTS FOR THE 2" SAMPLER HAVE NOT BEEN CORRELATED WITH STANDARD SPLIT-SPOON TESTS AS DESIGNATED IN ASTM D-1586. JUDGEMENT IS NEEDED IN THE USE OF THE BLOW COUNT DATA FOR THE 2" SAMPLER.
			-35.7 to -42.2 (CH)*		BLS/FT. REFERS TO THE NUMBER OF HAMMER BLOWS REQUIRED TO ADVANCE A 2" SAMPLER (2" I.D. X 2 1/2" O.D.) ONE FOOT. THE SAMPLER IS 5 FT. LONG AND DRIVEN CONTINUOUSLY 5 FT. WHERE POSSIBLE.
			-42.2 to -44.7 (CH)*		
			-44.7 to -46.7 (ML)*		
			NOTE: *VISUAL CLASSIFICATION BASED ON GRADATION CURVE. NO ATTERBERG LIMITS.		

306

Hole No. CB-CH89-54

DRILLING LOG		DIVISION	INSTALLATION		SHEET	
SOUTH ATLANTIC		JACKSONVILLE DISTRICT		1 OF 7 SHEETS		
1. PROJECT CANAVERAL HARBOR			10. SIZE AND TYPE OF BIT SEE REMARKS			
2. LOCATION (Coordinates or Station) N=523000 Y=1481762			11. DAY ON FOR ELEVATION SHOWN (TBM or HSL) MLW			
3. DRILLING AGENCY CORPS OF ENGINEERS			12. MANUFACTURER'S DESIGNATION OF DRILL S&P SKID RIG			
4. HOLE NO. (As shown on drawing title and file number) CB-CH89-54			13. TOTAL NO. OF OVERBURDEN SAMPLES TAKEN DISTURBED _____ UNDISTURBED _____			
5. NAME OF DRILLER R. GORDON			14. TOTAL NUMBER CORE BOXES 1			
6. DIRECTION OF HOLE <input checked="" type="checkbox"/> VERTICAL <input type="checkbox"/> INCLINED _____ DEG. FROM VERT.			15. ELEVATION GROUND WATER TIDAL			
7. THICKNESS OF OVERBURDEN			16. DATE HOLE STARTED 2-15-89 COMPLETED 2-15-89			
8. DEPTH DRILLED INTO ROCK			17. ELEVATION TOP OF HOLE -36.2			
9. TOTAL DEPTH OF HOLE 11.5'			18. TOTAL CORE RECOVERY FOR BORING 73 %			
			19. SIGNATURE OF APPROVING GEOLOGIST J. GENTILE			
ELEVATION	DEPTH	LEGEND	CLASSIFICATION OF MATERIALS (Description)	% CORE RECOVERY	SAMPLE NO.	REMARKS (Drilling time, water loss, depth of recording, etc., if significant)
-36.6	0.0					BIT OR BARREL -36.6 BLS/FT.
-42.7	6.5		CLAY, plastic, wet, soupy, disturbed, gray, sandy, with clayey sand seams, (CH)	45	1	2" SAMPLER SETTLED -42.7
-47.7	11.5		SAND, fine, quartz, clayey, wet, gray (SC) very shelly from -42.7 to -43.7 Some shell, gray, wet, fine quartz, from -43.7 to -47.7	100	2	-47.7
			Soils are field visually classified in accordance with the Unified Soils Classification System.	300# hammer with 18" drop used on 2" Sampler.  BLOW COUNTS FOR THE 2" SAMPLER HAVE NOT BEEN CORRELATED WITH STANDARD SPLIT-SPOON TESTS AS DESIGNATED IN ASTM D-1586. JUDGEMENT IS NEEDED IN THE USE OF THE 2" SAMPLER.  BLS/FT. REFERS TO THE NUMBER OF HAMMER BLOWS REQUIRED TO ADVANCE A 2" SAMPLER (2" I.D. X 2 1/2" O.D.) ONE FOOT. THE SAMPLER IS 5 FT. LONG AND DRIVEN CONTINUOUSLY 5 FT. WHERE POSSIBLE.		

(30)

Hole No. CB-CH89-55

DRILLING LOG		DIVISION	INSTALLATION		SHEET											
SOUTH ATLANTIC		JACKSONVILLE DISTRICT	SEE REMARKS		1 OF 1 SHEETS											
1. PROJECT CANAVEL HARBOR			10. SIZE AND TYPE OF BIT													
2. LOCATION (Coordinates or Station) X-622815 Y-1481741			11. DATUM FOR ELEVATION SHOWN (TBM or MSL) MLW													
3. DRILLING AGENCY CORPS OF ENGINEERS			12. MANUFACTURER'S DESIGNATION OF DRILL S&H SKID RIG													
4. HOLE NO. (As shown on drawing title and file number) CB-CH89-55			13. TOTAL NO. OF OVERBURDEN SAMPLES TAKEN DISTURBED _____ UNDISTURBED _____													
5. NAME OF DRILLER R. GORDON			14. TOTAL NUMBER CORE BOXES 1													
6. DIRECTION OF HOLE <input checked="" type="checkbox"/> VERTICAL <input type="checkbox"/> INCLINED _____ DEG. FROM VERT.			15. ELEVATION GROUND WATER TIDAL													
7. THICKNESS OF OVERBURDEN			16. DATE HOLE STARTED _____ COMPLETED _____ 2-15-89 2-15-89													
8. DEPTH DRILLED INTO ROCK			17. ELEVATION TOP OF HOLE -37.0													
9. TOTAL DEPTH OF HOLE 10.0'			18. TOTAL CORE RECOVERY FOR BORING 100 %													
			19. SIGNATURE OF <del>XXXXXXXX</del> GEOLOGIST J. GENTILE													
ELEVATION	DEPTH	LEGEND	CLASSIFICATION OF MATERIALS (Description)	% CORE RECOVERY	SAMPLER NO.	REMARKS (Drilling time, water loss, depth of weathering, etc., if significant)										
-37.0	0.0					BIT OR BARREL -37.0 BLS/FT.										
-40.0	3.0		SILT, sandy, gray, wet soupy, seams silty sand, (ML) little shell	100	1	2" SAMPLER SETTLED										
-41.0	4.0		SHELL, sand size shell fragments silty, wet gray		2											
-42.5	5.5		SAND, fine, quartz, some clay, little shell, lt gray (SC)		3	6 10										
-47.0	10.0		SILT, undisturbed, trace shell, gray-green, damp, (ML)	100	4	" SETTLED 2										
			SOILS HAVE BEEN FIELD VISUALLY CLASSIFIED IN ACCORDANCE WITH THE UNIFIED SOILS CLASSIFICATION SYSTEM		300# hammer with 18" drop used on 2" Sampler.											
			<table border="1"> <thead> <tr> <th>SAMPLE ELEVATION</th> <th>LABORATORY CLASSIFICATION</th> </tr> </thead> <tbody> <tr> <td>-37.0 to -40.0</td> <td>(SC)*</td> </tr> <tr> <td>-40.0 to -41.0</td> <td>(SP)*</td> </tr> <tr> <td>-41.0 to -42.5</td> <td>(SM)*</td> </tr> <tr> <td>-42.5 to -47.0</td> <td>(CL)*</td> </tr> </tbody> </table>		SAMPLE ELEVATION	LABORATORY CLASSIFICATION	-37.0 to -40.0	(SC)*	-40.0 to -41.0	(SP)*	-41.0 to -42.5	(SM)*	-42.5 to -47.0	(CL)*	BLOW COUNTS FOR THE 2" SAMPLER HAVE NOT BEEN CORRELATED WITH STANDARD SPLIT-SPOON TESTS AS DESIGNATED IN ASTM D-1585. JUDGEMENT IS NEEDED IN THE USE OF THE BLOW COUNT DATA FOR THE 2" SAMPLER.	
SAMPLE ELEVATION	LABORATORY CLASSIFICATION															
-37.0 to -40.0	(SC)*															
-40.0 to -41.0	(SP)*															
-41.0 to -42.5	(SM)*															
-42.5 to -47.0	(CL)*															
			NOTE: *VISUAL CLASSIFICATION BASED ON GRADATION CURVE. NO ATTERBERG LIMITS.		BLS/FT. REFERS TO THE NUMBER OF HAMMER BLOWS REQUIRED TO ADVANCE A 2" SAMPLER (2" I.D. X 2 1/2" O.D.) ONE FOOT. THE SAMPLER IS 5 FT. LONG AND DRIVEN CONTINUOUSLY 5 FT. WHERE POSSIBLE.											

VDW NO. LD-CH91-6

<b>DRILLING LOG</b>		DIVISION South Atlantic	INSTALLATION Jacksonville District	SHEET 1 OF 1 SHEETS
1. PROJECT Canaveral Harbor Maintenance Dredging		10. SIZE AND TYPE OF BIT See remarks		
2. LOCATION (Coordinates or Station) x=625,256 y=1,481,990		11. DATUM FOR ELEVATION SHOWN (TBM or MSL) MLW		
3. DRILLING AGENCY Corps of Engineers		12. MANUFACTURER'S DESIGNATION OF DRILL Failing 1500		
4. HOLE NO. (As shown on drawing title and file number) CB-CH91-6		13. TOTAL NO. OF OVER-BURDEN SAMPLES TAKEN		
5. NAME OF DRILLER LC Gregory		14. TOTAL NUMBER CORE BOXES 1		
6. DIRECTION OF HOLE <input checked="" type="checkbox"/> VERTICAL <input type="checkbox"/> INCLINED _____ DEG. FROM VERT.		15. ELEVATION GROUND WATER Tidal		
7. THICKNESS OF OVERBURDEN		16. DATE HOLE STARTED 5/7/91 COMPLETED 5/7/91		
8. DEPTH DRILLED INTO ROCK		17. ELEVATION TOP OF HOLE -31.4		
9. TOTAL DEPTH OF HOLE 20.0'		18. TOTAL CORE RECOVERY FOR BORING 53 %		
		19. SIGNATURE OF INSPECTOR Geologist, G. Halem		

ELEVATION a	DEPTH b	LEGEND c	CLASSIFICATION OF MATERIALS (Description) d	% CORE RECOVERY e	SAMPLE NO. f	REMARKS (Drilling time, water loss, depth of weathering, etc., if significant) g
-31.4	0.0					Bit or Barrel
						-31.4 Blows/Ft
			CLAY, trace sand, trace silt, strong organic odor, trace shell, soupy, dark gray (CL)	70	1	2" Sampler settled
-36.3	4.9		SAND, fine grained, clayey, trace shell, organic odor, dark gray (SC)		2	2" Sampler settled
-37.9	6.5		CLAY, some sand, trace shell, soft, organic odor, dark gray (CL)	40	3	settled
-41.9	10.5		CLAY, trace sand, trace shell, wood fragments, organic odor, stiff, dark gray (CH)	90	4	2" Sampler settled
-45.4	14.0		shell layer from -44.9 to -45.4		5	
			SAND, silty, fine grained quartz, some shell, limestone fragments and nodules from -45.4 to -45.9, light gray (SM)			2" Sampler
			shelly from -48.4 to -51.4	70	6	
-51.4	20.0					300# hammer with 30" drop used on 2" sampler.
			Soils are field visually classified in accordance with the Unified Soils Classification System.			



DRILLING LOG		DIVISION South Atlantic		INSTALLATION Jacksonville District		SHEET OF 1 SHEETS	
1. PROJECT Canaveral Harbor Maintenance Dredging				10. SIZE AND TYPE OF BIT See remarks			
2. LOCATION (Coordinates or Station) x=625,818 y=1,483,086				11. DATUM FOR ELEVATION SHOWN (FEM or MSL) MLW			
3. DRILLING AGENCY Corps of Engineers				12. MANUFACTURER'S DESIGNATION OF DRILL Failing 1500			
4. HOLE NO. (As shown on drawing title and site number) CB-CH91-7				13. TOTAL NO. OF OVER-BURDEN SAMPLES TAKEN DISTURBED _____ UNDISTURBED _____			
5. NAME OF DRILLER M. Whitson				14. TOTAL NUMBER CORE BOXES }			
6. DIRECTION OF HOLE <input checked="" type="checkbox"/> VERTICAL <input type="checkbox"/> INCLINED _____ DEG. FROM VERT.				15. ELEVATION GROUND WATER Tidal			
7. THICKNESS OF OVERBURDEN				16. DATE HOLE STARTED 5/1/91 COMPLETED 5/1/91			
8. DEPTH DRILLED INTO ROCK				17. ELEVATION TOP OF HOLE -31.1			
9. TOTAL DEPTH OF HOLE 20.0'				18. TOTAL CORE RECOVERY FOR BORING 73 %			
				19. SIGNATURE OF INSPECTOR Geologist, G. Halem			
ELEVATION a	DEPTH b	LEGEND c	CLASSIFICATION OF MATERIALS (Describe in detail) d	% CORE RECOVERY e	SAMPLE NO. f	REMARKS (Drilling time, water loss, depth of weathering, etc., if significant) g	
-31.1	0.0					Bit or Barrel	
						-31.1 Blows/Ft	
			CLAY, trace silt, strong organic odor, trace sand, trace shell, light to dark gray (CL)	30	1	2" Sampler settled	
						↓	
						-36.1	
				80	2	2" Sampler settled	
			CLAY, trace sand, trace shell, strong organic odor, wood fibers throughout, stiff, gray (CH)		3	↓	
						-41.1	
			sandstone fragments and some sand from -42.6 to -43.1		4	2" Sampler	
						↓	
						-46.1	
			SAND, fine grain quartz, silty, shelly, slight organic odor, light gray (SM)	100	5	↓	
						-51.1	
			sandstone fragments and nodules from -47.1 to -51.1	60	6	2" Sampler	
						↓	
						-51.1	
			Soils are field visually classified in accordance with the Unified Soils Classification System.			300# hammer with 30" drop used on 2" sampler.	

Hole No. CB-CH91-8

<b>DRILLING LOG</b>		DIVISION South Atlantic	INSTALLATION Jacksonville District	SHEET OF 1 SHEETS
1. PROJECT Canaveral Harbor Maintenance Dredging			10. SIZE AND TYPE OF BIT See remarks	
2. LOCATION (Coordinates or Station) x=627,599 y=1,481,824			11. DATUM FOR ELEVATION SHOWN (TBM or ASL) MLW	
3. DRILLING AGENCY Corps of Engineers			12. MANUFACTURER'S DESIGNATION OF DRILL Failing 1500	
4. HOLE NO. (As shown on drawing title and file number) CB-CH91-8			13. TOTAL NO. OF OVER-BURDEN SAMPLES TAKEN DISTURBED _____ UNDISTURBED _____	
5. NAME OF DRILLER M. Whitson			14. TOTAL NUMBER CORE BOXES 1	
6. DIRECTION OF HOLE <input checked="" type="checkbox"/> VERTICAL <input type="checkbox"/> INCLINED _____ DEG. FROM VERT.			15. ELEVATION GROUND WATER Tidal	
7. THICKNESS OF OVERBURDEN			16. DATE HOLE STARTED 5/9/91	
8. DEPTH DRILLED INTO ROCK			17. ELEVATION TOP OF HOLE -32.6	
9. TOTAL DEPTH OF HOLE 20.0'			18. TOTAL CORE RECOVERY FOR BORING 59 %	
			19. SIGNATURE OF INSPECTOR Geologist, G. Holm	

ELEVATION a	DEPTH b	LEGEND c	CLASSIFICATION OF MATERIALS (Description) d	% CORE RECOVERY e	SAMPLE NO. f	REMARKS (Drilling time, water loss, depth of weathering, etc., if significant) g
-32.6	0.0					Bit or Barrel
						-32.6 Blows/Ft
			CLAY, trace sand, trace shell, soupy, dark gray (CL)	16		2" Sampler settled
-36.6	4.8					1
			SAND, medium to fine grained quartz, little silt, little shell, dark gray (SM)		1	-37.6
						9
						25
-39.6	7.0				2	2" Sampler
						25
			CLAY, trace sand, trace shell, stiff, slight organic odor, wood fragments, dark gray (CH)	20		
						6
						5
						-42.6
						5
			shell layer from -45.1 to -45.5	100	4	2" Sampler
						1
						3
						2
-46.7	14.1					5
-47.4	14.8		SAND, clayey, little silt, trace shell, brown (SC)		5	-47.6
						3
						3
-49.1	16.5				6	2" Sampler
						10
			SAND, fine to very fine grained, silty, little clay, trace shell, light green (SM)	100	7	
						17
						16
-52.6	20.0					-52.6
						20
			Soils are field visually classified in accordance with the Unified Soils Classification System.			300# hammer with 30" drop used on 2" sampler.

Note No. LD-1131-3



DRELLING LOG		DIVISION	INSTALLATION	SHEET		
		South Atlantic	Jacksonville District	1 OF 1 SHEETS		
1. PROJECT Canaveral Harbor Maintenance Dredging		10. SIZE AND TYPE OF BIT See remarks				
2. LOCATION (Coordinates or Station) x=628,217 y=1,481,825		11. DATUM FOR ELEVATION SHOWN (TBM or MSL) MLW				
3. DRILLING AGENCY Corps of Engineers		12. MANUFACTURER'S DESIGNATION OF DRILL Failing 1500				
4. HOLE NO. (As shown on drawing title and file number) CB-CH91-9		13. TOTAL NO. OF OVER-BURDEN SAMPLES TAKEN				
		14. TOTAL NUMBER CORE BOXES 1				
5. NAME OF DRILLER M. Whitson		15. ELEVATION GROUND WATER Tidal				
6. DIRECTION OF HOLE <input checked="" type="checkbox"/> VERTICAL <input type="checkbox"/> INCLINED _____ DEG. FROM VERT.		16. DATE HOLE STARTED 5/9/91 COMPLETED 5/9/91				
7. THICKNESS OF OVERBURDEN		17. ELEVATION TOP OF HOLE -31.6				
8. DEPTH DRILLED INTO ROCK		18. TOTAL CORE RECOVERY FOR BORING 63 %				
9. TOTAL DEPTH OF HOLE 20.0'		19. SIGNATURE OF INSPECTOR Geologist, G. Halem				
ELEVATION	DEPTH	LEGEND	CLASSIFICATION OF MATERIALS (Description)	% CORE RECOVERY	SAMPLE NO.	REMARKS (Drilling time, water loss, depth of weathering, etc., if significant)
-31.6	0.0					Bit or Barrel
						Blows/Ft
			CLAY, little sand, trace shell, organic odor, soft, dark gray (CL)	40	1	2" Sampler settled
						↓
				16	2	2" Sampler settled
						↓
-41.6	10.0		CLAY, trace sand, little shell, organic odor, firm, dark gray (CH)	94	3	2" Sampler settled
						↓
					4	2" Sampler settled
						↓
-49.6	18.0		SAND, fine to very fine grained, silty, little clay, little shell, limestone fragments, light green (SM)	100	5	2" Sampler settled
						↓
-51.6	20.0					3
						7
						10

Hole No. CB-CH91-10

<b>DRILLING LOG</b>		DIVISION South Atlantic	INSTALLATION Jacksonville District	SHEET 1
1. PROJECT Canaveral Harbor Maintenance Dredging		10. SIZE AND TYPE OF BIT See remarks		
2. LOCATION (Coordinates as Stationed) x=629,710 y=1,481,563		11. DATUM FOR ELEVATION SHOWN (TBM or MSL) MLW		
3. DRILLING AGENCY Corps of Engineers		12. MANUFACTURER'S DESIGNATION OF DRILL Falling 1500		
4. HOLE NO. (As shown on drawing title and IFE number) CB-CH91-10		13. TOTAL NO. OF OVER-BURDEN SAMPLES TAKEN DISTURBED _____ UNDISTURBED _____		
5. NAME OF DRILLER M. Whitson		14. TOTAL NUMBER CORE BOXES 1		
6. DIRECTION OF HOLE <input checked="" type="checkbox"/> VERTICAL <input type="checkbox"/> INCLINED _____ DEG. FROM VERT.		15. ELEVATION GROUND WATER Tidal		
7. THICKNESS OF OVERBURDEN		16. DATE HOLE STARTED 5/9/91 COMPLETED 5/9/91		
8. DEPTH DRILLED INTO ROCK		17. ELEVATION TOP OF HOLE -35.6		
9. TOTAL DEPTH OF HOLE 20.4'		18. TOTAL CORE RECOVERY FOR BORING 52 %		
19. SIGNATURE OF INSPECTOR Geologist, G. Holm				

ELEVATION a	DEPTH b	LEGEND c	CLASSIFICATION OF MATERIALS (Description) d	% CORE RECOVERY e	SAMPLE NO. f	REMARKS (Drilling time, water loss, depth of weathering, etc., if significant) g
-35.6	0.0					Bit or Barrel Blows/Ft
			CLAY, trace sand, trace shell, organic odor, soupy, dark gray (CL)	20	1	2" Sampler settled 1
-39.8	4.2					settled
			SAND, medium to fine grained quartz, some silt, little clay, trace shell, dark gray (SM)	2		↓ 2
-43.0	7.4				3	2" Sampler 1
			CLAY, trace sand, trace shell, organic odor, wood fragments, dark gray, stiff (CH)	60	4	1 2 -45.6 2
			shelly from -48.7 to -49.5	80	5	2" Sampler 2 3 2
-47.9	14.3					3
-50.6	15.0		sand, clayey, little silt, trace shell, brown (SC)	6	6	4
-51.0	15.4					-51.0
Soils are field visually classified in accordance with the Unified Soils Classification System.				300# hammer with 30" drop used on 2" sampler.		

DRILLING LOG		DIVISION South Atlantic		INSTALLATION Jacksonville District		SHEET 1 OF 2 SHEETS	
1. PROJECT Canaveral Harbor Maintenance Dredging				10. SIZE AND TYPE OF BIT See remarks			
2. LOCATION (Coordinates or Station) x=630,794 y=1,481,572				11. DATUM FOR ELEVATION SHOWN (TBM or BSL) MLW			
3. DRILLING AGENCY Corps of Engineers				12. MANUFACTURER'S DESIGNATION OF DRILL Failing 1500			
4. HOLE NO. (As shown on drawing #11a and 11a number) CB-CH91-11				13. TOTAL NO. OF OVER-BURDEN SAMPLES TAKEN		DISTURBED: UNDISTURBED:	
5. NAME OF DRILLER M. Whitson				14. TOTAL NUMBER CORE BOXES 1			
6. DIRECTION OF HOLE <input checked="" type="checkbox"/> VERTICAL <input type="checkbox"/> INCLINED _____ DEG. FROM VERT.				15. ELEVATION GROUND WATER Tidal		16. DATE HOLE STARTED 5/10/91 COMPLETED 5/10/91	
7. THICKNESS OF OVERBURDEN				17. ELEVATION TOP OF HOLE -29.0			
8. DEPTH DRILLED INTO ROCK				18. TOTAL CORE RECOVERY FOR BORING 55 %			
9. TOTAL DEPTH OF HOLE 23.0'				19. SIGNATURE OF INSPECTOR Geologist, G. Holem			
ELEVATION a	DEPTH b	LEGEND c	CLASSIFICATION OF MATERIALS (Description) d	% CORE RECOVERY e	SAMPLE NO. f	REMARKS (Dilling time, water loss, depth of weathering, etc., if significant) g	
-29.0	0.0					Bit or Barrel	
						-29.0 Blows/Ft	
			SAND, fine grained quartz, trace silt, trace shell, tan (SP)	40	1	2" Sampler	
						1	
						4	
						4	
						-34.0	
			SAND, fine grained quartz, little clay, trace silt, trace shell, dark gray (SC)		2	2" Sampler	
						3	
						2	
			SAND, fine to coarse grained quartz, trace shell, trace silt, gray (SP-SM)	30			
					3	5	
						5	
						-39.0	
						14	
						18	
						24	
					40	4	
						28	
						24	
						-44.0	
						15	
						6	
					5	2" Sampler	
						4	
						5	
			CLAY, sandy, trace shell, stiff, slight organic odor, wood fragments, dark gray (CH)	84			
					6	5	
						5	
						-49.0	
						6	

DRILLING LOG (Cont Sheet)		ELEVATION TOP OF HOLE		Hole No. CB-CH91-11		
PROJECT			INSTALLATION		SHEET	
Canaveral Harbor Maint. Dredging			Jacksonville District		2 OF 2 SHEETS	
ELEVATION	DEPTH	LEGEND	CLASSIFICATION OF MATERIALS (Description)	% CORE RECOVERY	SAMPLE NO.	REMARKS (Drilling time, water loss, depth of weathering, etc., if significant)
a	b	c	d	e	f	g
						-49.0
-50.5	21.5			100	7	2" Sampler 5
-51.0	22.0		SAND, clayey, little silt, trace shell, brown (SC)		8	8
-52.0	23.0		SAND, fine to very fine grained, silty, little clay, trace shell, light green (SM)		9	-52.0 19
			Soils are field visually classified in accordance with the Unified Soils Classification System.	300# hammer with 30" drop used on 2" sampler.		

Hole No. CB-CH91-12A

DRILLING LOG		DIVISION SOUTH ATLANTIC		INSTALLATION JACKSONVILLE DISTRICT		SHEET 1 OF 3 SHEETS	
1. PROJECT: CANAVERAL HARBOR PROJECT				10. SIZE AND TYPE BIT 1 3/8" X 1" BTD SPLITSPDR			
2. LOCATION (Coordinates or Station) N= 1481335.65 E= 630624.64				11. DATUM FOR ELEVATION SHOWN (TOP OF HOLE) MEAN SEA LEVEL			
3. DRILLING AGENCY TET, INC.				12. MANUFACTURER'S DESIGNATION OF DRILL SIMCO 2400 SK-1			
4. HOLE NO. (As shown on drawing title and file number) CB-CH91-12				13. TOTAL NO. OF OVERBURDEN SAMPLES TAKEN DISTURBED 44 UNDISTURBED			
5. NAME OF DRILLER CHARLIE WESTON				15. ELEVATION GROUND WATER 3.06			
6. DIRECTION OF HOLE <input checked="" type="checkbox"/> VERTICAL <input type="checkbox"/> INCLINED _____ DEGREES FROM VERTICAL				16. DATE HOLE STARTED 10-20-91 COMPLETED 10-20-91			
7. THICKNESS OF OVERBURDEN 0.0 FEET				17. ELEVATION TOP OF HOLE 8.26			
8. DEPTH DRILLED INTO ROCK 0.0 FEET				18. TOTAL CORE RECOVERY FOR BORING 62.5%			
9. TOTAL DEPTH OF HOLE 66.0 FEET				19. SIGNATURE OF INSPECTOR <i>Charlie Weston</i>			
ELEVATION a	DEPTH b	LOGNO c	CLASSIFICATION OF MATERIALS Description d	% CORE RECOVERY e	BOX OR SAMPLE # f	REMARKS Chilling, Free, Water Loss, Depth of Weathering, Etc., if Significant g	
8.26	0.00					8.26	BLDG'S ELEV
	1.25		Fine Tan SAND, Some Shell Fragments (SP-SM)	70	1	6.76	6
	2.50			60	2	5.26	6
5.26			Fine to Medium Tan SAND, Some Shell Fragments (SP)	60	3	3.76	14
	3.75			60	4	2.26	16
	5.00			60	5	0.76	8
	6.25			70	6	-0.74	10
	7.50			75	7	-2.24	13
	8.75			50	8	-3.74	5
-1.24			Fine to Medium Tan SAND (SP-SM)	50	9	-5.24	8
-1.74	10.00			60	10	-6.74	17
	11.25			60	11	-8.24	10
	12.50		Fine Gray Sand, Some Shell Fragments (SP-SM)	60	12	-9.74	22
-5.24				70	13	-11.24	13
	13.75		Fine Gray SAND (SP-SM)	70	14	-12.74	16
	15.00						8
-7.24							21
	16.25						20
	17.50					14	
	18.75					18	
	20.00					18	
-12.74						5	
						8	
						16	
						12	
						15	
						15	
CORE BORINGS CONTINUED ON PAGE 2.							

DRILLING LOG (Cont. Sheet)			ELEVATION TOP OF HOLE		8.26		Hole No. CB-CH91-12A		
PROJECT CANAVERAL HARBOR PROJECT				INSTALLATION JACKSONVILLE DISTRICT				SHEET 2 OF 3 SHEETS	
ELEVATION	DEPTH	LEGEND	CLASSIFICATION OF MATERIALS (Description)	% CORE RECOVERY	BOX OR SAMPLE #	REMARKS (Coring time, Water Loss, Depth of Weathering, Etc. If Significant)			
a	b	c	d	e	f	g			
			CONTINUED FROM PAGE 1			WDH = WEIGHT OF HAMMER			
	21.25			60	15			10	
	22.50					-14.24		12	
	23.75			80	16			14	
	25.00					-15.74		11	
	26.25			70	17			11	
	27.50					-17.24		7	
	28.75			70	18			8	
	30.00					-18.74		9	
	31.25			70	19			2	
	32.50					-20.24		11	
	33.75			80	20			13	
	35.00					-21.74		10	
	36.25			70	21			12	
	37.50					-23.24		16	
	38.75			60	22			20	
	40.00					-24.74		11	
	41.25			60	23			12	
	-33.74					-26.24		9	
				60	24			10	
						-27.74		12	
				70	25			15	
						-29.24		15	
				70	26			9	
						-30.74		16	
				60	27			12	
						-32.24		13	
				60	28			15	
						-33.74		14	
				60	29			29	
								17	
								18	
								10	
								6	
								4	
								2	
								3	
								2	
								WDH	
								WDH	
								WDH	
			CORE DRINGS CONTINUED ON PAGE 3						





Hole No. CB-CH92-1

<b>DRILLING LOG</b>	DIVISION South Atlantic	INSTALLATION Jacksonville District	SHEET 1 OF 2
1. PROJECT Canaveral Harbor Deepening	2. LOCATION (Coordinates or Station) X=830,197, Y=1,481,941	10. SIZE AND TYPE OF BIT See Remarks	11. DATUM FOR ELEVATION SHOWN (TBM or MSL) MLW (FEET)
3. DRILLING AGENCY Corps of Engineers	4. HOLE NO. (As shown on drawing title and file number) CB-CH92-1	12. MANUFACTURER'S DESIGNATION OF DRILL Falling 1500	13. TOTAL NO. OF OVERBURDEN SAMPLES TAKEN disturbed: 0 undisturbed: 0
5. NAME OF DRILLER L. C. Gregory	6. DIRECTION OF HOLE <input checked="" type="checkbox"/> VERTICAL <input type="checkbox"/> INCLINED	14. TOTAL NUMBER OF CORE BOXES 1	15. ELEVATION GROUND WATER TIDAL
7. THICKNESS OF BURDEN ft.	8. DEPTH DRILLED INTO ROCK 0 ft.	16. DATE HOLE STARTED COMPLETED 2/28/92 2/28/92	17. ELEVATION TOP OF HOLE -11.0
9. TOTAL DEPTH OF HOLE 33 ft.		18. TOTAL CORE RECOVERY FOR BORING 63	19. SIGNATURE OF GEOLOGIST J. GENTILE

ELEV.	DEPTH	LEGEND	CLASSIFICATION OF MATERIALS (Description)	CORE REC %	SAMPLE NUMBER	REMARKS Bit or Barrel	BLOWS/ft
-11.0	0					-11.0	
			SAND, fine to medium quartz, clean, shelly (sand size), Lt. Gray (SP)	80	1	SPLIT SPOON	4
							4
						-12.5	3
-13.0	2.0		Bed silty, shelly sand (SM), from -13.0 to -14.0	80	2	"	5
							2
-14.0	3.0		SAND, (SP), trace silt little shell, gray, from -14.0 to -16.5	80	3	-14.0	1
							2
						-15.5	4
							4
						-16.5	6
							5
-16.5	5.5		SAND, fine to medium quartz, little silt, little shell, gray (SM)	48	5	"	5
						-17.0	2
							8
							2
-18.0	7.0		SAND, fine quartz, trace silt, trace shell, gray (SP)	33	6	-18.5	1
							12
							8
						-20.0	6
							5
							8
							9
-21.5	10.5		SAND, fine quartz, little silt, gray, trace shell, damp (SM)	88	8	-21.5	7
							9
						-23.0	6
							12
							6
-24.5	13.5		SAND, fine to medium quartz, trace silt, trace shell, gray, (SP)	73	10	-24.5	6
							7
							9
-26.0	15.0		SAND, fine quartz, little to some silt, gray, trace shell (SM)	80	11	-26.0	8
							8
							7
						-27.5	11
			SAND, fine quartz, little to some silt, gray, trace shell (SM)	88	12	"	11
			Some shell, little silt, gray, (SM) From - 29.5 to -30.5	88	13	"	11
							10
						-29.0	6
							18

(continued)

ENG FORM 1030 PREVIOUS EDITIONS ARE OBSOLETE MAR 71	PROJECT Canaveral Harbor Deepening	HOLE NUMBER CB-CH92-1
--	---------------------------------------	--------------------------

Hole No. CB-CH92-1

DRILLING LOG (Cont. Sheet)		ELEVATION TOP OF HOLE		-11.0 ft.		SHEET 2 OF 2	
PROJECT			INSTALLATION				
Canaveral Harbor Deepening			Jacksonville District				
ELE V.	DEPTH	LEGEND	CLASSIFICATION OF MATERIALS (Description)	CORE REC %	SAMPLE NUMBER	REMARKS Bit or Barrel	BLOWS/ft
-29	18					-29.0	18
			Trace shell from -30.5 to -31.7	93	14	"	2
							9
						-30.5	8
				100	15	"	11
							2
-31.7	20.7			100	16	"	1
			CLAY, plastic, gray, damp, trace shell (CH)			-32.0	Settled
				100	17	"	↓
						-33.5	Settled
				100	18	"	2
						-35.0	3
				100	19	"	Settled
						-36.5	↓
				100	20	"	2
						-38.0	4
				100	21	"	Settled
						-39.5	↓
-39.5	28.5					-39.5	3
			Shelly from -39.5 to -40.5				Settled
				100	22	"	↓
-40.5	29.5					-41.0	2
			Trace shell, dark gray, fat, isolated seams organic material (CH) from -40.5 to -42.5				Settled
				100	23	"	2
						-42.5	3
-42.5	31.5					-42.5	3
			Shell bed, little silt, from -42.5 to -43.0				2
-43.0	32.0					-44.0	2
			Fat clay (CH) from -43.0 to -44.0	100	24	"	4
							5
-44.0	33.0					-44.0	5
			NOTE: Soils are field visually classified in accordance with the Unified Soils Classification System.			140# HAMMER WITH 30" DROP USED ON 2.0' SPLIT SPOON (1 3/8" I.D. X 2" O.G.)	34
			SAMPLE ELEVATION      LABORATORY CLASSIFICATION				36
			-11.0/-12.5      (SP)*				
			-14.0/-15.5      (SP)*				
			-18.5/-20.5      (SP-SM)*				
			-24.5/-20.5      (SP-SM)*				
			-32.0/-33.5      (MH)*				
			NOTE: *Visual classification based on Gradation Curve. No Atterbert Limits.				38

HOLE NO. CB-CH92-1A

<b>DRILLING LOG</b>	DIVISION South Atlantic	INSTALLATION Jacksonville District	SHEET 1 OF 2
1. PROJECT Canaveral Harbor Deepening		10. SIZE AND TYPE OF BIT See Remarks	
2. LOCATION (Coordinates or Station) X=830,941, Y=1,481,423		11. DATUM FOR ELEVATION SHOWN (T&N or HSL) MLW (FEET)	
3. DRILLING AGENCY Corps of Engineers		12. MANUFACTURER'S DESIGNATION OF DRILL Failing 1500	
4. HOLE NO. (As shown on drawing title and file number) CB-CH92-1A		13. TOTAL NO. OF OVERBURDEN SAMPLES TAKEN disturbed: 0 undisturbed: 0	
5. NAME OF DRILLER L. C. Gregory		14. TOTAL NUMBER OF CORE BOXES 1	
6. DIRECTION OF HOLE <input checked="" type="checkbox"/> VERTICAL <input type="checkbox"/> INCLINED		15. ELEVATION GROUND WATER TIDAL	
7. THICKNESS OF BURDEN ft.		16. DATE HOLE STARTED COMPLETED 2/6/92 2/6/92	
8. DEPTH DRILLED INTO ROCK 0 ft.		17. ELEVATION TOP OF HOLE -15.0	
9. TOTAL DEPTH OF HOLE 30 ft.		18. TOTAL CORE RECOVERY FOR BORING 88	
		19. SIGNATURE OF GEOLOGIST J. GENTILE	

ELEV.	DEPTH	LEGEND	CLASSIFICATION OF MATERIALS (Description)	CORE REC %	W LITH SAMPLE NUMBER	REMARKS Bit or Barrel	FEET/INCHES		
-15.0	0					-15.0	0		
			SAND, fine to medium quartz, clean, trace shell, light Gray (SP)	100	1	SPLIT SPOON	3		
								2	
								3	
						88	2	"	4
								3	
								4	
						88	3	"	5
								4	
						5			
				88	4	"	7		
-21.0	8.0		SAND, fine to medium quartz, little silt, little shell, gray (SM)	73	5	"	8		
								6	
								7	
						88	8	"	7
								8	
						100	7	"	5
						7			
						9			
-25.5	10.5		SAND, fine to medium quartz, clean, gray, trace shell, gray (SP)  Fine quartz from -27.5 to -29.5	88	8	"	8		
								9	
								11	
						88	9	"	8
						22			
						35			
				73	10	"	18		
						32			
-29.5	14.5		SAND, fine quartz, some silt, trace clay, shelly, gray (SM)			"	13		
								4	
				80	11	"	8		
						6			
-31.1	18.1		CLAY, plastic, gray, trace sand and shell, damp (CH)			"	2		
								2	
				100	12	"	1		
						2			
						1			

(continued)

Hole No. CB-CH92-1A

DRILLING LOG (Cont. Sheet)		ELEVATION TOP OF HOLE		SHEET 2 OF 2			
PROJECT Canaveral Harbor Deepening			INSTALLATION Jacksonville District				
ELEV.	DEPTH	LEGEND	CLASSIFICATION OF MATERIALS (Description)	CORE REC %	SAMPLE NUMBER	REMARKS Bit or Barrel	BLOWS/ F <sub>s</sub>
-33.0	18						18
-34.5	19.5			100	13		1
							3
			SILT, plastic, little clay, trace sand, trace shell, gray (MH)	88	14		1
							1
							1
-37.5	22.5			68	15		1
							2
			CLAY, plastic, little silt, trace shell, damp (CH)	100	16		1
							1
			Isolated seams, organic material from -40.5 to -45.0.				2
							2
				100	17		1
							2
				100	18		1
							1
							2
				100	19		1
							1
							2
				100	20		1
							2
-45.0	30.0						2
			NOTE: Soils are field visually classified in accordance with the Unified Soils Classification System.			140# HAMMER WITH 30" DROP USED ON 2.0' SPLIT SPOON (1 3/8" I.O. X 2" O.D.)	
			SAMPLE LABORATORY ELEVATION CLASSIFICATION				
			-15.0/-16.5 (SP)*				
			-21.0/-22.5 (SP-SM)*				
			-24.0/-25.2 (SM)*				
			-31.5/-33.0 (CH)*				
			-34.4/-36.5 (MH)*				
			-37.5/-39.0 (CH)*				
			NOTE: *Visual classification based on Gradation Curve. No Atterbert Limits.				

Hole No. CB-CH92-2

<b>DRILLING LOG</b>	DIVISION South Atlantic	INSTALLATION Jacksonville District	SHEET 1 OF 1
1. PROJECT Canaveral Harbor Deepening		10. SIZE AND TYPE OF BIT See Remarks	
2. LOCATION (Coordinates or Station) X = 629,590, Y = 1,481,657		11. DATUM FOR ELEVATION SHOWN (TBM or MSL) MLW (FEET)	
3. DRILLING AGENCY Corps of Engineers		12. MANUFACTURER'S DESIGNATION OF DRILL Falling 1500	
4. HOLE NO. (As shown on drawing title and file number) CB-CH92-2		13. TOTAL NO. OF OVERBURDEN SAMPLES TAKEN disturbed: 0 undisturbed: 0	
5. NAME OF DRILLER L. Wooters		14. TOTAL NUMBER OF CORE BOXES 1	
6. DIRECTION OF HOLE <input checked="" type="checkbox"/> VERTICAL <input type="checkbox"/> INCLINED		15. ELEVATION GROUND WATER TIDAL	
7. THICKNESS OF BURDEN ft.		16. DATE HOLE STARTED COMPLETED 1/27/92 1/27/92	
8. DEPTH DRILLED INTO ROCK 0 ft.		17. ELEVATION TOP OF HOLE -34.0	
9. TOTAL DEPTH OF HOLE 11 ft.		18. TOTAL CORE RECOVERY FOR BORING 45%	
		19. SIGNATURE OF GEOLOGIST J. GENTILE	

ELE. V.	DEPTH	LEGEND	CLASSIFICATION OF MATERIALS (Description)	CORE REC #	SAMPLE NUMBER	REMARKS Bit or Barrel	BLOWS/ 1'
-34.0	0						0
			CLAY, plastic, dark gray, isolated seams fine sand (CH)	50	1	2" SAMPLER	Settled 2 4 6
-40.0	6.0		SAND, fine to medium, quartz, little silt, some shell, gray (SM)	40	2		5 13 8 12 18 10
-45.0	11.0		NOTE: Soils are field visually classified in accordance with the Unified Soils Classification System.  SAMPLE LABORATORY ELEVATION CLASSIFICATION -34.0/-40.0 (MH)* -40.0/-45.0 (SP-SH)*  NOTE: * Visual classification based on Gradation Curve. No Atterberg Limits			300# HAMMER WITH 18" DROP USED ON 2.0" SAMPLER	12 14 16 18

Hole No. CB-CH92-3

DRILLING LOG		DIVISION South Atlantic	INSTALLATION Jacksonville District		SHEET 1 OF 2			
1. PROJECT Canaveral Harbor Deepening			10. SIZE AND TYPE OF BIT See Remarks					
2. LOCATION (Coordinates of Station) X=629,194, Y=1,481,972			11. DATUM FOR ELEVATION SHOWN (TBM or HSL) MLW (FEET)					
3. DRILLING AGENCY Corps of Engineers			12. MANUFACTURER'S DESIGNATION OF DRILL Felling 1500					
4. HOLE NO. (As shown on drawing title and file number) CB-CH92-3			13. TOTAL NO. OF OVERBURDEN SAMPLES TAKEN disturbed: 0 undisturbed: 0					
5. NAME OF DRILLER L. C. Gregory			14. TOTAL NUMBER OF CORE BOXES 1					
6. DIRECTION OF HOLE <input checked="" type="checkbox"/> VERTICAL <input type="checkbox"/> INCLINED			15. ELEVATION GROUND WATER TIDAL					
7. THICKNESS OF BURDEN ft.			16. DATE HOLE STARTED COMPLETED 3/13/92 3/13/92					
8. DEPTH DRILLED INTO ROCK 0 ft.			17. ELEVATION TOP OF HOLE -13.2					
9. TOTAL DEPTH OF HOLE 31.5 ft.			18. TOTAL CORE RECOVERY FOR BORING 77%					
			19. SIGNATURE OF GEOLOGIST J. GENTILE					
ELE V.	DEPTH	LEGEND	CLASSIFICATION OF MATERIALS (Description)	CORE REC #	SAMPLE NUMBER	REMARKS Bit or Barrel	BLOWS/ft	
-13.2	0.0					-13.2		
			SAND, fine to medium, quartz, shelly, gray, clean (SP)	54	1	SPLIT SPOON	1 3	
			Trace silt, little shell from -14.7' to -17.7'		54	2	"	6 7 5 4
			Clean some shell from -17.7' to -22.2'		54	3	"	7 12 3
					40	4	"	4 3
					60	5	"	2 1
					54	6	"	2 1
			Trace silt, some shell from -22.2' to -23.7', shelly, clean, tan, from -23.7' to -25.7'		80	7	"	1 2
					88	8	"	1 3
					73	9	"	2 8
-26.2	13.0			SAND, fine to medium, quartz, gray, little silt, trace clay, trace shell (SM)	80	10	"	10 5 10
				Little shell, from -28.2' to -29.7', little silt, trace shell from -29.7' to -32.2'	68	11	"	8 8 9
					88	12	"	12 5
				Shelly, some silt, wet from -32.2' to -33.0'	88	13	"	8 6
					88	14	"	7 5
				Little shell, some silt from -33.0' to -35.7'	88	15	"	4 6 4
						-35.7	5	
(continued)								

DRILLING LOG (Cont. Sheet)		ELEVATION TOP OF HOLE		SHEET 2			
PROJECT Canaveral Harbor Deepening		-13.2 ft.		OF 2			
		INSTALLATION Jacksonville District					
ELEV.	DEPTH	LEGEND	CLASSIFICATION OF MATERIALS (Description)	CORE REC X	SAMPLE NUMBER	REMARKS Bit or Barrel	BLOWS/ 5'
-31.2	18						
			Shelly, some silt, wet from -32.2' to -33.0'	88	13	"	6
							5
							3
							7
			Little shell, some silt from -33.0' to -35.7'	88	14	"	5
							4
							9
							4
							5
							6
			Silty, gray, trace shell, fine quartz, from -35.7' to -37.2'	100	18	"	4
							2
-37.2	24.0						
			CLAY, plastic, trace shell, damp (CH)	100	17	"	Settled
							↓
							1
							2
							2
							Settled
							1
							1
							Settled
							↓
							3
							Settled
							2
							3
-44.7	31.5						
			NOTE: Soils are field visually classified in accordance with the Unified Soils Classification System.			140# HAMMER WITH 30" DROP USED ON 2.0' SPLIT SPOON (1 3/8" I.D. X 2" O.D.)	
			SAMPLE ELEVATION				
			LABORATORY CLASSIFICATION				
			-14.7/-18.2 (SP)*				
			-22.2/-23.7 (SP)*				
			-26.7/-28.2 (SM)*				
			-37.2/-38.7 (CH)*				
			NOTE: * Visual classification based on Gradation Curve. No Atterberg Limits				



Hole No. CB-CH92-4

<b>DRILLING LOG</b>		DIVISION South Atlantic	INSTALLATION Jacksonville District	SHEET 1 OF 1
1. PROJECT Canaveral Harbor Deepening		10. SIZE AND TYPE OF BIT See Remarks		
2. LOCATION (Coordinates or Station) X=829,101, Y=1,481,562		11. DATUM FOR ELEVATION SHOWN (TBM or MSL) MLW (FEET)		
3. DRILLING AGENCY Corps of Engineers		12. MANUFACTURER'S DESIGNATION OF DRILL Felling 1600		
4. HOLE NO. (As shown on drawing title and file number) CB-CH92-4		13. TOTAL NO. OF OVERBURDEN SAMPLES TAKEN disturbed: 0 undisturbed: 0		
5. NAME OF DRILLER L. Wooters		14. TOTAL NUMBER OF CORE BOXES 1		
6. DIRECTION OF HOLE <input checked="" type="checkbox"/> VERTICAL <input type="checkbox"/> INCLINED		15. ELEVATION GROUND WATER TIDAL		
7. THICKNESS OF BURDEN ft.		16. DATE HOLE STARTED COMPLETED 1/27/92 1/27/92		
8. DEPTH DRILLED INTO ROCK 0 ft.		17. ELEVATION TOP OF HOLE -43.4		
9. TOTAL DEPTH OF HOLE 5 ft.		18. TOTAL CORE RECOVERY FOR BORING 84%		
		19. SIGNATURE OF GEOLOGIST J. GENTILE		

ELEV.	DEPTH	LEGEND	CLASSIFICATION OF MATERIALS (Description)	CORE REC % C	SAMPLER NUMBER	REMARKS Bit or Barrel	BLOWS/ ft
-43.4	0						0
			CLAY, plastic, gray, (CH) Little sand, with seams fine sand, from -43.4' to -44.9'				Settled
-44.9	1.5		Undisturbed, fat from -44.9' to -48.4'	84	1	2" SAMPLER	2
-48.4	5.0						4
			NOTE: Soils are field visually classified accordance with the Unified Soils Classification System.			300# HAMMER WITH 18" DROP USED ON 2.0" SAMPLER.	6
							8
							10
							12
							14
							16
							18

HOLE NO. CB-CH92-5

<b>DRILLING LOG</b>		DIVISION South Atlantic	INSTALLATION Jacksonville District	SHEET 1 OF 1
1. PROJECT Canaveral Harbor Deepening		10. SIZE AND TYPE OF BIT See Remarks		
2. LOCATION (Coordinates or Station) X=628,618, Y=1,481,586		11. DATUM FOR ELEVATION SHOWN (TBM or NSI) MLW (FEET)		
3. DRILLING AGENCY Corps of Engineers		12. MANUFACTURER'S DESIGNATION OF DRILL Failing 1600		
4. HOLE NO. (As shown on drawing title and file number) CB-CH92-5		13. TOTAL NO. OF OVERBURDEN SAMPLES TAKEN disturbed: 0 undisturbed: 0		
5. NAME OF DRILLER L. Wooters		14. TOTAL NUMBER OF CORE BOXES 1		
6. DIRECTION OF HOLE <input checked="" type="checkbox"/> VERTICAL <input type="checkbox"/> INCLINED		15. ELEVATION GROUND WATER TIDAL		
7. THICKNESS OF BURDEN ft.		16. DATE HOLE STARTED COMPLETED 1/27/92 1/27/92		
8. DEPTH DRILLED INTO ROCK 0 ft.		17. ELEVATION TOP OF HOLE -42.4		
9. TOTAL DEPTH OF HOLE 5 ft.		18. TOTAL CORE RECOVERY FOR BORING 92%		
		19. SIGNATURE OF GEOLOGIST J. GENTILE		

ELEV.	DEPTH	LEGEND	CLASSIFICATION OF MATERIALS (Description)	CORE REC %	SAMPLER NUMBER	REMARKS Bit or Barrel	BLOWS/ ft
-42.4	0					-42.4	0
			CLAY, plastic, gray, trace shell (CH) Wet from -42.0' to -43.9'				Settled
-43.9	1.5			82	1	2" SAMPLER	2
							4
-47.4	5.0					-47.4	5
			NOTE: Soils are field visually classified in accordance with the Unified Soils Classification.			300# HAMMER WITH 18" DROP USED on 2.0" SAMPLER	6
							8
							10
							12
							14
							16
							18

NO. CB-CH92-6

<b>DRILLING LOG</b>	DIVISION South Atlantic	INSTALLATION Jacksonville District	SHEET 1 OF 2
1. PROJECT Canaveral Harbor Deepening	10. SIZE AND TYPE OF BIT See Remarks		
2. LOCATION (Coordinates or Station) X=629,384 Y=1,481,904	11. DATUM FOR ELEVATION SHOWN (TBM or MSL) MLW (FEET)		
3. DRILLING AGENCY Corps of Engineers	12. MANUFACTURER'S DESIGNATION OF DRILL Failing 1500		
4. HOLE NO. (As shown on drawing title and file number) CB-CH92-6	13. TOTAL NO. OF OVERBURDEN SAMPLES TAKEN disturbed: 0 undisturbed: 0		
5. NAME OF DRILLER L. C. Gregory	14. TOTAL NUMBER OF CORE BOXES 1		
6. DIRECTION OF HOLE <input checked="" type="checkbox"/> VERTICAL <input type="checkbox"/> INCLINED	15. ELEVATION GROUND WATER TIDAL		
7. THICKNESS OF BURDEN 1 ft.	16. DATE HOLE STARTED COMPLETED 2/27/92 2/27/92		
8. DEPTH DRILLED INTO ROCK 0 ft.	17. ELEVATION TOP OF HOLE -22.5		
9. TOTAL DEPTH OF HOLE 21 ft.	18. TOTAL CORE RECOVERY FOR BORING 78		
	19. SIGNATURE OF GEOLOGIST J. GENTILE		

ELEV.	DEPTH	LEGEND	CLASSIFICATION OF MATERIALS (Description)	CORE REC %	SAMPLE NUMBER	REMARKS Bit or Barrel	BLOWS/ft.
-22.5	0					-22.5	0
			SAND, fine to medium quartz, shelly, gray, trace silt (SP)	88	1	SPLIT SPOON	2 4
			Little shell, from -24.0 to -25.5	47	2	"	5 10 11
			Shelly, light gray, clean from -25.5 to -28.9	33	3	"	10 5 4
				47	4	"	5 6 8
-28.9	6.4		SAND, fine to medium quartz, little silt, shelly, gray, wet (SH)	60	5	"	3 2 1
				54	6	"	2 1
-30.5	8.0		SILT, plastic, trace shell, gray, little sand, (MH)	54	6	"	1
-31.5	9.0			80	7	"	1
			CLAY, plastic, gray, trace shell, trace silt, damp (CH) some seams of silt and fine sand	80	7	"	Settled ↓ 2
				100	8	"	Settled ↓ 3
				100	9	"	Settled ↓ 2
				100	10	"	Settled ↓ 3
				100	11	"	Settled ↓ 4
				100	12	"	Settled ↓ 3
						(continued)	

Hole No. CB-CH92-6

DRILLING LOG (Cont. Sheet)		ELEVATION TOP OF HOLE		SHEET 2 OF 2		
PROJECT Canaveral Harbor Deepening		INSTALLATION Jacksonville District		-22.5 ft.		
ELEV.	DEPTH	LEGEND	CLASSIFICATION OF MATERIALS (Description)	CORE REC # SAMPLE NUMBER	REMARKS Bit or Barrel	BLOWS/ 1.5'
-40.5	18			100 13	"	Settled ↓ 3
-43.5	21.0			100 14	"	2
			NOTE: Soils are field visually classified in accordance with the Unified Soils Classification System.		140# HAMMER WITH 30" DROP USED ON 2.0' SPLIT SPOON (1 3/8" I.D. X 2" O.D.)	2
			SAMPLE ELEVATION      LABORATORY CLASSIFICATION			
			-22.5/-24.0      (SP)*			
			-31.5/-33.0      (CH)*			
			NOTE: * Visual classification based on Gradation Curve. No Atterbert Limits.			

Hole No. CB-CH92-7

<b>DRILLING LOG</b>	DIVISION South Atlantic	INSTALLATION Jacksonville District	SHEET 1 OF 1
1. PROJECT Canaveral Harbor Deepening	10. SIZE AND TYPE OF BIT See Remarks		
2. LOCATION (Coordinates or Station) X=628,133, Y=1,481,577	11. DATUM FOR ELEVATION SHOWN (TBM or MSL) MLW (FEET)		
3. DRILLING AGENCY Corps of Engineers	12. MANUFACTURER'S DESIGNATION OF DRILL Failing 1500		
4. HOLE NO. (As shown on drawing title and file number) CB-CH92-7	13. TOTAL NO. OF OVERBURDEN SAMPLES TAKEN disturbed: 0 undisturbed: 0		
5. NAME OF DRILLER L. C. Gregory	14. TOTAL NUMBER OF CORE BOXES 1		
6. DIRECTION OF HOLE <input checked="" type="checkbox"/> VERTICAL <input type="checkbox"/> INCLINED	15. ELEVATION GROUND WATER TIDAL		
7. THICKNESS OF BURDEN ft.	16. DATE HOLE STARTED COMPLETED 1/25/92 1/25/92		
8. DEPTH DRILLED INTO ROCK 0 ft.	17. ELEVATION TOP OF HOLE -42.6		
9. TOTAL DEPTH OF HOLE 5 ft.	18. TOTAL CORE RECOVERY FOR BORING 100		
	19. SIGNATURE OF GEOLOGIST J. GENTILE		

ELEV.	DEPTH	LEGEND	CLASSIFICATION OF MATERIALS (Description)	CORE REC. #	SAMPLE NUMBER	REMARKS Bit or Barrel	BLOCKS/ ft.
-42.6	0		CLAY, plastic, gray, trace shell, trace organic material, undisturbed, damp (CH)	100	1	2" SAMPLER	1
-47.6	5.0		NOTE: Soils are field visually classified in accordance with the Unified Soils Classification System.			300# HAMMER WITH 18" DROP USED ON 2.0" SAMPLER	2

Hole No. CB-CH92-8

<b>DRILLING LOG</b>	DIVISION South Atlantic	INSTALLATION Jacksonville District	SHEET 1 OF 1
1. PROJECT Canaveral Harbor Deepening		10. SIZE AND TYPE OF BIT See Remarks	
2. LOCATION (Coordinates or Station) X=627,306, Y=1,481,587		11. DATE FOR ELEVATION SHOWN (TBM or HSL) MLW (FEET)	
3. DRILLING AGENCY Corps of Engineers		12. MANUFACTURER'S DESIGNATION OF DRILL Failing 1600	
4. HOLE NO. (As shown on drawing title and file number) CB-CH92-8		13. TOTAL NO. OF OVERBURDEN SAMPLES TAKEN disturbed: 0 undisturbed: 0	
5. NAME OF DRILLER L. C. Gregory		14. TOTAL NUMBER OF CORE BOXES 1	
6. DIRECTION OF HOLE <input checked="" type="checkbox"/> VERTICAL <input type="checkbox"/> INCLINED		15. ELEVATION GROUND WATER TIDAL	
7. THICKNESS OF BURDEN ft.		16. DATE HOLE STARTED COMPLETED 2/25/92 2/26/92	
8. DEPTH DRILLED INTO ROCK 0 ft.		17. ELEVATION TOP OF HOLE -36.7	
9. TOTAL DEPTH OF HOLE 10 ft.		18. TOTAL CORE RECOVERY FOR BORING 75	
		19. SIGNATURE OF GEOLOGIST J. GENTILE	

ELEV.	DEPTH	LEGEND	CLASSIFICATION OF MATERIALS (Description)	CORE REC *	SAMPLE NUMBER	REMARKS Bit or Barrel	BLOWS/ ft
-36.7	0		CLAY, plastic, wet, gray, trace shell, disturbed to 40.7				0
					50	1	2" SAMPLER
-40.7	4.0		Undisturbed below -40.7				4
							6
				100	2		8
							10
-46.7	10.0		NOTE: Soils are field visually classified in accordance with the Unified Soils Classification System.			300# HAMMER WITH 18" DROP USED IN 2.0" SAMPLER.	12
			SAMPLE LABORATORY ELEVATION CLASSIFICATION				14
			-36.7/-41.7 (MH)* -41.7/-48.2 (CH)*				16
			NOTE: * Visual classification based on Gradation Curve. No Atterbert Limits.				18

<b>DRILLING LOG</b>	DIVISION South Atlantic	INSTALLATION Jacksonville District	SHEET 1 OF 2
1. PROJECT Canaveral Harbor Deepening	10. SIZE AND TYPE OF BIT See Remarks		
2. LOCATION (Coordinates or Station) X=627,503, Y=1,481,983	11. DATUM FOR ELEVATION SHOWN (TBM or MSL) MLW (FEET)		
3. DRILLING AGENCY Corps of Engineers	12. MANUFACTURER'S DESIGNATION OF DRILL Falling 1500		
4. HOLE NO. (As shown on drawing title and file number) CB-CH92-9	13. TOTAL NO. OF OVERBURDEN SAMPLES TAKEN disturbed: 0 undisturbed: 0		
5. NAME OF DRILLER L. C. Gregory	14. TOTAL NUMBER OF CORE BOXES 1		
6. DIRECTION OF HOLE <input checked="" type="checkbox"/> VERTICAL <input type="checkbox"/> INCLINED	15. ELEVATION GROUND WATER TIDAL		
7. THICKNESS OF BURDEN ft.	16. DATE HOLE STARTED COMPLETED 3/3/92 3/3/92		
8. DEPTH DRILLED INTO ROCK 0 ft.	17. ELEVATION TOP OF HOLE -15.0		
9. TOTAL DEPTH OF HOLE 30 ft.	18. TOTAL CORE RECOVERY FOR BORING 81		
		19. SIGNATURE OF GEOLOGIST J. GENTILE	

ELEV.	DEPTH	LEGEND	CLASSIFICATION OF MATERIALS (Description)	CORE REC %	SAMPLE NUMBER	REMARKS Bit or Barrel	BLOCKS/ ft.
-15	0					-15.0	
			SAND, fine to medium quartz, trace silt, shelly (Sand Size), Lt. Gray (SP) Tan	93	1	SPLIT SPOON	Settled 1
						-16.5	1
			Clean, Shelly, from -18.0 to -21.0	40	2	"	4
						-18.0	4
				46	3	"	3
						-19.5	5
							6
							8
							10
							12
-21.0	6.0		SAND, fine to medium quartz, trace shell, clean, Lt. gray (SP)	54	4	"	12
						-21.0	12
				54	5	"	12
						-22.5	17
							21
							15
							22
						-24.0	25
-24.5	9.5				7	"	8
			BED, (CH) Clay, from -24.5 to -25.2	86	7	"	3
-25.2	10.2				8	"	6
			SAND, fine quartz, silty, trace clay, gray (SN) Trace shell			-25.5	6
				40	9	"	3
						-27.0	4
							4
				83	10	"	4
						-28.5	3
							4
				73	11	"	2
							2
-30.0	15.0					-30.0	3
			SILT, little sand, gray, trace shell, trace clay, damp (ML)				1
				100	12	"	1
-31.2	16.2					-31.5	2
			CLAY, plastic, trace shell, trace silt, damp, gray to light gray (CH)				1
				100	13	"	2
						-33.0	2

(continued)

Hole No. CB-CH92-9

DRILLING LOG (Cont. Sheet)		ELEVATION TOP OF HOLE		SHEET 2 OF 2				
PROJECT Canaveral Harbor Deepening			INSTALLATION Jacksonville District					
ELE. V.	DEPTH	LEGEND	CLASSIFICATION OF MATERIALS (Description)	CORE REC %	SAMPLE NUMBER	REMARKS Bit or Barrel	B/CMS/ ft.	
-33	18						18	
					100	14	"	Settled ↓ 2
							-34.5	20
					100	15	"	Settled ↓ 3
							-36.0	22
					100	16	"	Settled ↓ 4
							-37.5	24
					100	17	"	Settled ↓ 1
							-39.0	24
					100	18	"	Settled ↓ 1
						-40.5	28	
				100	19	"	Settled ↓ 2	
						-42.0	28	
				100	20	"	Settled ↓ 2	
						-43.5	30	
				100	21	"	Settled ↓ 2	
						-45.0	30	
-45.0	30.0		<p>NOTE: Soils are field visually classified in accordance with the United Soils Classification System.</p> <p>SAMPLE ELEVATION      LABORATORY CLASSIFICATION</p> <p>-15.0/-18.5      (SP)* -22.5/-24.0      (SP)* -27.0/-29.5      (SM)* -30.0/-31.2      (ML)* -36.0/-37.5      (CH)*</p> <p>NOTE: * Visual classification based on Gradation Curve. No Atterberg Limits.</p>			<p>140# HAMMER WITH 30" DROP USED IN 2.0' SPLIT SPOON (1 3/8" I.D. X 2" O.D.)</p>	30	
							32	
							34	
							36	
							38	
							40	



Hole No. CB-CH92-10

<b>DRILLING LOG</b>	DIVISION South Atlantic	INSTALLATION Jacksonville District	SHEET 1 OF 1
1. PROJECT Canaveral Harbor Deepening	10. SIZE AND TYPE OF BIT See Remarks		
2. LOCATION (Coordinates or Station) X=626,894, Y=1,482,157	11. DATUM FOR ELEVATION SHOWN (TBM or MSL) MLW (FEET)		
3. DRILLING AGENCY Corps of Engineers	12. MANUFACTURER'S DESIGNATION OF DRILL Falling 1500		
4. HOLE NO. (As shown on drawing title and file number) CB-CH92-10	13. TOTAL NO. OF OVERBURDEN SAMPLES TAKEN disturbed: 0 undisturbed: 0		
5. NAME OF DRILLER L. C. Gregory	14. TOTAL NUMBER OF CORE BOXES 1		
6. DIRECTION OF HOLE <input checked="" type="checkbox"/> VERTICAL <input type="checkbox"/> INCLINED	15. ELEVATION GROUND WATER TIDAL		
7. THICKNESS OF BURDEN ft.	16. DATE HOLE STARTED COMPLETED 2/7/92 2/7/92		
8. DEPTH DRILLED INTO ROCK 0 ft.	17. ELEVATION TOP OF HOLE -35.8		
9. TOTAL DEPTH OF HOLE 10 ft.	18. TOTAL CORE RECOVERY FOR BORING 70		
	19. SIGNATURE OF GEOLOGIST J. BENTILE		

ELEV.	DEPTH	LEGEND	CLASSIFICATION OF MATERIALS (Description)	CORE REC %	SAMPLE NUMBER	REMARKS Bit or Barrel	BLOWS/ ft
-35.8	0		CLAY, plastic, wet, disturbed, gray (CH)		1		Settled
-39.3	3.5		BED SILT with Sand Seams from -39.3 to -39.8	60	2	2" SAMPLER	
-39.8	4.0		Undisturbed damp plastic clay (CH) from -39.8 to -45.8		3		
-45.8	10.0			60	4		Settled
			NOTE: Soils are field visually classified in accordance with the Unified Soils Classification System.  SAMPLE LABORATORY ELEVATION CLASSIFICATION -35.8/-39.3 (MH)*  NOTE: * Visual classification based on Gradation Curve. No Atterbert Limits.			300# HAMMER WITH 18" DROP USED IN 2.0" SAMPLER	

Hole No. CB-CH92-II

<b>DRILLING LOG</b>		DIVISION South Atlantic	INSTALLATION Jacksonville District	SHEET 1 OF 1
1. PROJECT Canaveral Harbor Deepening		10. SIZE AND TYPE OF BIT See Remarks		
2. LOCATION (Coordinates or Station) X=626,491, Y=1,481,969		11. DATE FOR ELEVATION SHOWN (TBM or NSL) MLW (FEET)		
3. DRILLING AGENCY Corps of Engineers		12. MANUFACTURER'S DESIGNATION OF DRILL Failing 1500		
4. HOLE NO. (As shown on drawing title and file number) CB-CH92-II		13. TOTAL NO. OF OVERBURDEN SAMPLES TAKEN disturbed: 0 undisturbed: 0		
5. NAME OF DRILLER L. Wooters		14. TOTAL NUMBER OF CORE BOXES 1		
6. DIRECTION OF HOLE <input checked="" type="checkbox"/> VERTICAL <input type="checkbox"/> INCLINED		15. ELEVATION GROUND WATER TIDAL		
7. THICKNESS OF BURDEN ft.		16. DATE HOLE STARTED COMPLETED 1/24/92 1/24/92		
8. DEPTH DRILLED INTO ROCK 0 ft.		17. ELEVATION TOP OF HOLE -39.9		
9. TOTAL DEPTH OF HOLE 5 ft.		18. TOTAL CORE RECOVERY FOR BORING 100%		
		19. SIGNATURE OF GEOLOGIST J. GENTILE		

ELEV.	DEPTH	LEGEND	CLASSIFICATION OF MATERIALS (Description)	CORE REC *	LOG NUMBER	REMARKS Bit or Barrel	BLOCKS /FOOT
-39.9	0		CLAY, plastic, damp, gray, (CH)				
				100	1	2" SAMPLER	Settled 4
-44.9	5.0		NOTE: Soils are field visually classified in accordance with the Unified Soils Classification System.			300# HAMMER WITH 18" DROP USED IN 2.0" SAMPLER	

Hole No. CB-CH92-12

<b>DRILLING LOG</b>		DIVISION South Atlantic	INSTALLATION Jacksonville District	SHEET 1 OF 1
1. PROJECT Canaveral Harbor Deepening		10. SIZE AND TYPE OF BIT See Remarks		
2. LOCATION (Coordinates or Station) X=625,729, Y=1,481,517		11. DATUM FOR ELEVATION SHOWN (TBM or MSL) MLW (FEET)		
3. DRILLING AGENCY Corps of Engineers		12. MANUFACTURER'S DESIGNATION OF DRILL Failing 1500		
4. HOLE NO. (As shown on drawing title and the number) CB-CH92-12		13. TOTAL NO. OF OVERBURDEN SAMPLES TAKEN disturbed: 0 undisturbed: 0		
5. NAME OF DRILLER L. C. Gregory		14. TOTAL NUMBER OF CORE BOXES 1		
6. DIRECTION OF HOLE <input checked="" type="checkbox"/> VERTICAL <input type="checkbox"/> INCLINED		15. ELEVATION GROUND WATER TIDAL		
7. THICKNESS OF BURDEN ft.		16. DATE HOLE STARTED COMPLETED 2/25/92 2/25/92		
8. DEPTH DRILLED INTO ROCK 0 ft.		17. ELEVATION TOP OF HOLE -37.7		
9. TOTAL DEPTH OF HOLE 10 ft.		18. TOTAL CORE RECOVERY FOR BORING 55		
		19. SIGNATURE OF GEOLOGIST J. GENTILE		

ELEV.	DEPTH	LEGEND	CLASSIFICATION OF MATERIALS (Description)	CORE REC #	SAMPLER NUMBER	REMARKS Bit or Barrel	BLOWS/ ↓
-37.7	0		CLAY, plastic, wet, disturbed, gray (CH)	30	1	2" SAMPLER	0 Settled 2 4
-44.7	7.0		Undisturbed, dark gray from -44.7 to -46.2	80	2	"	6 Settled 8
-46.2	8.5		SAND, fine quartz, little to some clay, trace silt, dark gray - green (SC)		3		8 2 7
-47.7	10.0		NOTE: Soils are field visually classified in accordance with Unified Soils Classification System.  SAMPLE ELEVATION      LABORATORY CLASSIFICATION -37.7/-42.7      (MH)*  NOTE: * Visual classification based on Gradation Curve. No Atterberg Limits.			300# HAMMER WITH 30" DROP USED IN 2.0" SAMPLER	10 12 14 16 18

Hole No. CB-CH92-16

<b>DRILLING LOG</b>		DIVISION South Atlantic	INSTALLATION Jacksonville District	SHEET 1 OF 2
1. PROJECT Canaveral Harbor Deepening		10. SIZE AND TYPE OF BIT See Remarks		
2. LOCATION (Coordinates or Station) X=624,506, Y=1,481,393		11. DATUM FOR ELEVATION SHOWN (TBM or MSL) MLW (FEET)		
3. DRILLING AGENCY Corps of Engineers		12. MANUFACTURER'S DESIGNATION OF DRILL Falling 1500		
4. HOLE NO. (As shown on drawing title and file number) CB-CH92-16		13. TOTAL NO. OF OVERBURDEN SAMPLES TAKEN disturbed: 0 undisturbed: 0		
5. NAME OF DRILLER L. C. Gregory		14. TOTAL NUMBER OF CORE BOXES 1		
6. DIRECTION OF HOLE <input checked="" type="checkbox"/> VERTICAL <input type="checkbox"/> INCLINED		15. ELEVATION GROUND WATER TIDAL		
7. THICKNESS OF BURDEN ft.		16. DATE HOLE STARTED COMPLETED 3/12/92 3/12/92		
8. DEPTH DRILLED INTO ROCK 0 ft.		17. ELEVATION TOP OF HOLE -13.5		
9. TOTAL DEPTH OF HOLE 31.5 ft.		18. TOTAL CORE RECOVERY FOR BORING 90		
		19. SIGNATURE OF GEOLOGIST J. GENTILE		

ELEV.	DEPTH	LEGEND	CLASSIFICATION OF MATERIALS (Description)	CORE REC #	SAMPLE NUMBER	REMARKS Bit or Barrel	BLOWS/ ft.
-13.5	0					-13.5	0
			SAND, fine to medium, quartz, little silt, some shell gray (SM)	88	1	SPLIT SPOON	Settled
					2		1
-16.0	2.5		BED SILT (ML) from -16.0 to -16.5	100	3	"	2
-16.5	3.0		Shelly from -17.5 to -19.0			-16.5	1
				88	4	"	Settled
						-18.0	8
							6
-19.0	5.5		Bed silt (ML) from -19.0 to -19.5	33	5	"	8
-19.5	6.0					-19.5	2
			CLAY, plastic, gray, trace sand, damp (CH)	100	6	"	Settled
						-21.0	1
-21.5	8.0		Bed silty sand (SM), from -21.5 to -27.5	73	7	"	Settled
-22.5	9.0				8	"	2
			CLAY, slightly plastic, little silt, gray, trace sand (CL)	88	9	"	Settled
-24.3	10.8					-24.0	10
			CLAY, plastic, gray, damp, trace shell (CH)	100	10	"	Settled
						-25.5	12
				100	11	"	Settled
						-27.0	14
				73	12	"	Settled
						-28.5	16
				93	13	"	Settled
						-30.0	1
				100	14	"	Settled
						-31.5	2
							2

(continued)

Hole No. CB-CH92-16

DRILLING LOG (Cont. Sheet)		ELEVATION TOP OF HOLE		SHEET 2					
PROJECT		INSTALLATION		OF 2					
Canaveral Harbor Deepening		Jacksonville District							
ELEV.	DEPTH	LEGEND	CLASSIFICATION OF MATERIALS (Description)	CORE REC. %	SAMPLE NUMBER	REMARKS Bit or Barrel	BLOWS/ 5'		
-31.5	18		Isolated seams, organic material from -40.5' to -45.0'	100	15	"	Settled 2		
								-33.0 3	
						100	18	"	Settled 1
								-34.5 1	
						100	17	"	Settled ↓ 3
								-36.0 1	
						80	18	"	2
								-37.5 2	
						100	19	"	Settled 1
								-38.0 2	
				100	20	"	Settled ↓ 2		
						-40.5 2			
				100	21	"	Settled ↓ 1		
						-42.0 1			
				80	22	"	Settled ↓ 4		
						-43.5 8			
-43.7	30.2		SAND, fine quartz, silty limy, isolated lenses; medium hard sandstone, tan-gray, some shell (SM)	88	23	"	11		
-45.0	31.5					-45.0			
			NOTE: Soils are field visually classified in accordance with the Unified Soils Classification System.			140# HAMMER WITH 30" DROP USED ON 2.0" SPLIT SPOON (1 3/8" I.D. X 2" O.D.)			
			SAMPLE ELEVATION      LABORATORY CLASSIFICATION						
			-13.5/-15.0      (SM)*						
			-16.5/-18.0      (SM)*						
			-19.5/-21.0      (CH)*						
			-37.5/-39.0      (CH)*						
			NOTE: * Visual Classification based on Gradation Curve. No Atterbert Limits.						



Hole No. CB-CH92-18

<b>DRILLING LOG</b>		DIVISION South Atlantic	INSTALLATION Jacksonville District	SHEET 1 OF 2
1. PROJECT Canaveral Harbor Deepening		10. SIZE AND TYPE OF BIT See Remarks		
2. LOCATION (Coordinates or Station) X=824,043, Y=1,481,451		11. DATUM FOR ELEVATION SHOWN (TBM or MSL) MLW (FEET)		
3. DRILLING AGENCY Corps of Engineers		12. MANUFACTURER'S DESIGNATION OF DRILL Failing 1500		
4. HOLE NO. (As shown on drawing title and file number) CB-CH92-18		13. TOTAL NO. OF OVERBURDEN SAMPLES TAKEN disturbed: 0 undisturbed: 0		
5. NAME OF DRILLER L. C. Gregory		14. TOTAL NUMBER OF CORE BOXES 1		
6. DIRECTION OF HOLE <input checked="" type="checkbox"/> VERTICAL <input type="checkbox"/> INCLINED		15. ELEVATION GROUND WATER TIDAL		
7. THICKNESS OF BURDEN ft.		16. DATE HOLE STARTED COMPLETED 3/2/92 3/2/92		
8. DEPTH DRILLED INTO ROCK 0 ft.		17. ELEVATION TOP OF HOLE -14.7		
9. TOTAL DEPTH OF HOLE 30 ft.		18. TOTAL CORE RECOVERY FOR BORING BS		
		18. SIGNATURE OF GEOLOGIST J. GENTILE		

ELE. V.	DEPTH	LEGEND	CLASSIFICATION OF MATERIALS (Description)	CORE REC %	LEG. ISAMPLER NUMBER	REMARKS Bit or Barrel	BLOCKS/ft.
-14.7	0		SAND, fine to medium quartz, little to some silt, gray, wat, trace shell (SM)	84	1	2" SAMPLER	Settled 5 3 2 4 2
-19.7	5.0		CLAY, plastic, damp, little sand, trace shell, gray (CH)	100	2	"	Settled 6 1 3 2
-22.8	8.1		Bed Silty Sand (SM) from -22.8 to -23.3				8
-23.3	8.6		Trace sand and silt, trace organic material, damp from -24.7 to -43.7	100	3	"	10 12 14 16 18
				88	4	"	18

(continued)





Hole No. CB-CH92-19

<b>DRILLING LOG</b>		DIVISION South Atlantic	INSTALLATION Jacksonville District	SHEET 1 OF 2
1. PROJECT Canaveral Harbor Deepening		10. SIZE AND TYPE OF BIT See Remarks		
2. LOCATION (Coordinates or Station) X=623,540, Y=1,481,452		11. DATUM FOR ELEVATION SHOWN (TBM or MSL) MLW (FEET)		
3. DRILLING AGENCY Corps of Engineers		12. MANUFACTURER'S DESIGNATION OF DRILL Felling 1500		
4. HOLE NO. (As shown on drawing title and file number) CB-CH92-19		13. TOTAL NO. OF OVERBURDEN SAMPLES TAKEN disturbed: 0 undisturbed: 0		
5. NAME OF DRILLER L. C. Gregory		14. TOTAL NUMBER OF CORE BOXES 1		
6. DIRECTION OF HOLE <input checked="" type="checkbox"/> VERTICAL <input type="checkbox"/> INCLINED		15. ELEVATION BROUND WATER TIDAL		
7. THICKNESS OF BURDEN ft.		16. DATE HOLE STARTED COMPLETED 3/2/92 3/2/92		
8. DEPTH DRILLED INTO ROCK 0 ft.		17. ELEVATION TOP OF HOLE -12.0		
9. TOTAL DEPTH OF HOLE 33 ft.		18. TOTAL CORE RECOVERY FOR BORING 83		
		19. SIGNATURE OF GEOLOGIST J. GENTILE		

ELEV.	DEPTH	LEGEND	CLASSIFICATION OF MATERIALS (Description)	CORE REC #	SAMPLE NUMBER	REMARKS Bit or Barrel	BLOWS/ft
-12.0	0					-12.0	0
			SAND, fine to mediu, quartz, little silt, little shell, gray, wet (SM)		1		7
				54		2" SAMPLER	8
-15.0	3.0		SAND, fine to medium, quartz, trace silt, light gray (SP)		2		12
							22
							30
						-17.0	19
					3		30
-18.0	7.0		CLAY, plastic, sandy, gray, damp, trace shell, (CH)		4		18
				50			15
							15
			Trace of sand -22.0' to -44.0'			-22.0	10
							Settled
				100	5		12
							14
						-27.0	18
				100	6		Settled
							18

(continued)

Hole No. CB-CH92-19

DRILLING LOG (Cont. Sheet)		ELEVATION TOP OF HOLE		SHEET 2 OF 2				
PROJECT Canaveral Harbor Deepening			INSTALLATION Jacksonville District					
ELEV.	DEPTH	LEGEND	CLASSIFICATION OF MATERIALS (Description)	CORE REC %	SAMPLE NUMBER	REMARKS BIT or Barrel	BLOWS/ ft	
-30	18			100	6	"	3	
							-32.0	Settled
					100	7	"	2
							-37.0	Settled
					100	8	"	2
							-42.0	Settled
						9	"	2
-44.0	32.0			Slightly plastic clay (CL), with thin lenses moderately hard sandstone from -44.0' to -45.0'	80	10		6
-45.0	33.0			SAND, fine quartz, shelly, some clay, gray-green (SC)				13
						11	"	15
-47.0	35.0						-47.0	
			NOTE: Soils are field visually classified in accordance with the Unified Soils Classification System.  SAMPLE LABORATORY ELEVATION CLASSIFICATION -17.0/-18.0 (SM)* -19.0/-22.0 (MH)* -32.0/-37.0 (CH)*  NOTE: * Visual classification based on Gradation Curve. No Atterbert Limits.			300# HAMMER WITH 16" DROP USED ON 2.0" SAMPLER		

Hole No. CB-CH92-20

<b>DRILLING LOG</b>		DIVISION South Atlantic	INSTALLATION Jacksonville District	SHEET 1 OF 1
1. PROJECT Canaveral Harbor Deepening		10. SIZE AND TYPE OF BIT See Remarks		
2. LOCATION (Coordinates or Station) X=623,733, Y=1,481,779		11. DATUM FOR ELEVATION SHOWN (TBM or MSL) MLW (FEET)		
3. DRILLING AGENCY Corps of Engineers		12. MANUFACTURER'S DESIGNATION OF DRILL Falling 1500		
4. HOLE NO. (As shown on drawing title and file number) CB-CH92-20		13. TOTAL NO. OF OVERBURDEN SAMPLES TAKEN disturbed: 0 undisturbed: 0		
5. NAME OF DRILLER L. C. Gregory		14. TOTAL NUMBER OF CORE BOXES 1		
6. DIRECTION OF HOLE <input checked="" type="checkbox"/> VERTICAL <input type="checkbox"/> INCLINED		15. ELEVATION GROUND WATER TIDAL		
7. THICKNESS OF BURDEN ft.		16. DATE HOLE STARTED COMPLETED 2/28/92 2/28/92		
8. DEPTH DRILLED INTO ROCK 0 ft.		17. ELEVATION TOP OF HOLE -37.4		
9. TOTAL DEPTH OF HOLE 7.5 ft.		18. TOTAL CORE RECOVERY FOR BORING 80		
		19. SIGNATURE OF GEOLOGIST J. GENTILE		

ELEV.	DEPTH	LEGEND	CLASSIFICATION OF MATERIALS (Description)	CORE REC #	SAMPLE NUMBER	REMARKS Bit or Barrel	BLOWS/ 5'	
-37.4	0					-37.4		
			CLAY, plastic, soupy, wet, little silt, dark gray (CH)		1		Settled	
					88	2	SPLIT SPOON	
				Damp, trace shell, fat, gray from -38.9' to -44.4'		3		Settled
					100	4		Settled
					80	5		Settled
					88	6		Settled
-44.4	7.0							
-44.9	7.5		SAND, fine to medium quartz, little silt, some shell, many thin lenses, moderately hard calcareous sandstones (SM)			-44.9	8	
			NOTE: Soils are field visually classified in accordance with the Unified Soils Classification System.			140# HAMMER WITH 30" DROP USED IN 2.0' SPLIT SPOON (1 3/8" I.O. X 2" O.O.)		
			SAMPLE LABORATORY ELEVATION CLASSIFICATION -37.4/-38.9 (MH)*					
			NOTE: * Visual classification based on Gradation Curve. No Atterbert Limits.					

Hole No. CB-CH92-21

<b>DRILLING LOG</b>	DIVISION South Atlantic	INSTALLATION Jacksonville District	SHEET 1 OF 2
1. PROJECT Canaveral Harbor Deepening	10. SIZE AND TYPE OF BIT See Remarks		
2. LOCATION (Coordinates or Station) X=623,015, Y=1,481,456	11. DATUM FOR ELEVATION SHOWN (TBM or MSL) MLW (FEET)		
3. DRILLING AGENCY Corps of Engineers	12. MANUFACTURER'S DESIGNATION OF DRILL Failing 1500		
4. HOLE NO. (As shown on drawing title and file number) CB-CH92-21	13. TOTAL NO. OF OVERBURDEN SAMPLES TAKEN disturbed: 0 undisturbed: 0		
5. NAME OF DRILLER L. C. Gregory	14. TOTAL NUMBER OF CORE BOXES 1		
6. DIRECTION OF HOLE <input checked="" type="checkbox"/> VERTICAL <input type="checkbox"/> INCLINED	15. ELEVATION GROUND WATER TIDAL		
7. THICKNESS OF BURDEN ft.	16. DATE HOLE STARTED COMPLETED 3/4/92 3/4/92		
8. DEPTH DRILLED INTO ROCK 0 ft.	17. ELEVATION TOP OF HOLE -13.0		
9. TOTAL DEPTH OF HOLE 32 ft.	18. TOTAL CORE RECOVERY FOR BORING 76		
		19. SIGNATURE OF GEOLOGIST J. GENTILE	

ELEV.	DEPTH	LEGEND	CLASSIFICATION OF MATERIALS (Description)	CORE REC x	SAMPLER NUMBER	REMARKS Bit or Barrel	BLOWS/ ft.
-13.0	0					-13.0	0
-14.0	1.0		SAND, fine to medium, quartz, little silt, shelly (SM)				8
			SAND, fine to medium, quartz, gray, shelly, trace silt (SP)		1		8
				30		2" SAMPLER	9
					2		24
							48
						-18.0	
					3		12
-19.0	6.0		Bed silty sand (SM) from -18.0' to -19.7'				4
-19.7	6.7		CLAY, plastic, gray, damp, trace shell, trace sand (CH)				3
				30	4		4
							3
						-23.0	
					5		Settled
				100			2
						-28.0	
					6		Settled
				100			2

(continued)

Hole No. CB-CH92-21

DRILLING LOG (Cont. Sheet)		ELEVATION TOP OF HOLE		PROJECT		INSTALLATION		SHEET 2 OF 2			
		-13.0 ft.		Canaveral Harbor Deepening		Jacksonville District					
ELE V.	DEPTH	LEGEND	CLASSIFICATION OF MATERIALS (Description)	CORE REC %	SAMPLE NUMBER	REMARKS Bit or Barrel	BLOWS/ft				
-37	16		Isolated seams silty shell from -38.0' to -41.0'.	100	6		1				
								3			
								-33.0			
						100	7		Settled		
									4		
								-38.0			
							8		3		
									2		
						100			3		
									18		
-41.0	28.0		Bed shelly sand with little silt from -41.0' to -41.5' (SM)				3				
-41.5	28.5						18				
			LIMESTONE, soft weathered seams calcareous silt, tan, lenses medium hard (LS)		9		27				
						-43.0					
-43.5	30.5		SAND, fine quartz, some silt, limy, some shell, light gray, damp (SM)				9				
				100	10		18				
-45.0	32.0					-45.0					
			NOTE: Soils are field visually classified in accordance with the Unified Soils Classification System.					300# HAMMER WITH 18" DROP USED IN 5.0' STANDARD SPLIT SPOON (2" ID X 2 1/2" OD)			
			SAMPLE ELEVATION					LABORATORY CLASSIFICATION			
			-14.0/-18.0					(SP-SM)*			
			-23.0/-28.0					(MH)*			
			NOTE: * Visual classification based on Gradation Curve. No Atterbert Limits.								

Hole No. CB-CH92-22

<b>DRILLING LOG</b>	DIVISION South Atlantic	INSTALLATION Jacksonville District	SHEET 1 OF 2
1. PROJECT Canaveral Harbor Deepening	10. SIZE AND TYPE OF BIT See Remarks		
2. LOCATION (Coordinates or Station) X=622,506, Y=1,481,450	11. DATE FOR ELEVATION SHOWN (F&M or HSL) MLW (FEET)		
3. DRILLING AGENCY Corps of Engineers	12. MANUFACTURER'S DESIGNATION OF DRILL Failing 1500		
4. HOLE NO. (As shown on drawing title and file number) CB-CH92-22	13. TOTAL NO. OF OVERBURDEN SAMPLES TAKEN disturbed: 0 undisturbed: 0		
5. NAME OF DRILLER M. Whitson	14. TOTAL NUMBER OF CORE BOXES 1		
6. DIRECTION OF HOLE <input checked="" type="checkbox"/> VERTICAL <input type="checkbox"/> INCLINED	15. ELEVATION GROUND WATER TIDAL		
7. THICKNESS OF BURDEN ft.	16. DATE HOLE STARTED COMPLETED 3/4/92 3/4/92		
8. DEPTH DRILLED INTO ROCK 0 ft.	17. ELEVATION TOP OF HOLE -14.5		
9. TOTAL DEPTH OF HOLE 30 ft.	18. TOTAL CORE RECOVERY FOR BORING 72		
	19. SIGNATURE OF GEOLOGIST J. GENTILE		

ELEV.	DEPTH	LEGEND	CLASSIFICATION OF MATERIALS (Description)	CORE REC. #	SAMPLE NUMBER	REMARKS Bit or Barrel	BLOWS/ ft.
-14.5	0		SAND, fine to medium, quartz, little shell, gray, little silt (SM)	30	1	2" SAMPLER	5 3 4 8 4
-19.5	5.0		Fine quartz, silty, many seams, sandy silt, from -19.5' to -22.0'.				5 Settled 1 8
-22.0	7.5		CLAY, plastic, damp, trace shell, gray, little silt, seams clay with some shell (CH)	530	2	"	2 3 3 8
			Very plastic, damp, trace shell form -26.0' to -36.3'	100	3	"	3 Settled 12 14
				100	4	"	Settled 16 18





(continued)

Hole No. CB-CH92-22

DRILLING LOG (Cont. Sheet)		ELEVATION TOP OF HOLE		SHEET 2			
PROJECT Canaveral Harbor Deepening		INSTALLATION Jacksonville District		-14.5 ft. OF 2			
ELEV.	DEPTH	LEGEND	CLASSIFICATION OF MATERIALS (Description)	CORE REC #	SAMPLE NUMBER	REMARKS Bit or Barrel	BLOWS/ F
-32.5	18			100	4		18
							20
					5		Settled
-36.3	21.8		Bed clayey sand with organic stain (SC) from -36.3' to -36.9'	100	6		12
-36.9	22.4		Limestone, moderately hard, fossiliferous		7		7
-37.5	23.0		SAND, fine to medium, quartz, little silt, little shell, wet with lenses of moderately hard sandstone, shelly, light gray (SM)	100	8		38
							5
							14
-42.0	27.5		Some silt from -42.0' to -44.5'	50	9		14
							8
-44.5	30.0						30
			NOTE: Soils are field visually classified in accordance with the Unified Soils Classification System.			300# HAMMER WITH 18" DROP USED IN 2.0" SAMPLER	32
							34
							38
							38
							40

Hole No. CB-CH92-23

<b>DRILLING LOG</b>		DIVISION South Atlantic	INSTALLATION Jacksonville District	SHEET 1 OF 1
1. PROJECT Canaveral Harbor Deepening		10. SIZE AND TYPE OF BIT See Remarks		
2. LOCATION (Coordinates or Station) X=622,523, Y=1,481,580		11. DATUM FOR ELEVATION SHOWN (TBM or MSL) MLW (FEET)		
3. DRILLING AGENCY Corps of Engineers		12. MANUFACTURER'S DESIGNATION OF DRILL Falling 1500		
4. HOLE NO. (As shown on drawing title and file number) CB-CH92-23		13. TOTAL NO. OF OVERBURDEN SAMPLES TAKEN disturbed: 0 undisturbed: 0		
5. NAME OF DRILLER M. Whitson		14. TOTAL NUMBER OF CORE BOXES 1		
6. DIRECTION OF HOLE <input checked="" type="checkbox"/> VERTICAL <input type="checkbox"/> INCLINED		15. ELEVATION GROUND WATER TIDAL		
7. THICKNESS OF BURDEN ft.		16. DATE HOLE STARTED COMPLETED 3/6/92 3/6/92		
8. DEPTH DRILLED INTO ROCK 0 ft.		17. ELEVATION TOP OF HOLE -34.4		
9. TOTAL DEPTH OF HOLE 10 ft.		18. TOTAL CORE RECOVERY FOR BORING 45%		
		19. SIGNATURE OF GEOLOGIST J. GENTILE		

ELEV.	DEPTH	LEGEND	CLASSIFICATION OF MATERIALS (Description)	CORE REC #	SAMPLER NUMBER	REMARKS Bit or Barrel	BLOWS/ ft.
-34.4	0		CLAY, plastic, gray, damp (CH)			-34.4	0
					1		Settled ↓
-38.9	2.5		SAND, fine to medium quartz, shelly, little to some silt, light gray (SM)	60	2	2" SAMPLER	2
					2		7
							7
-39.9	5.5		Shell bed from -39.9' to -40.9'			-39.4	10
					3		12
-40.9	6.5		silty, some shell, light gray from -40.0' to -44.4'	40			8
					42		4
							2
-44.4	10.0					-44.4	10
			NOTE: Soils are field visually classified in accordance with the Unified Soils Classification System.			300# HAMMER WITH 18" DROP USED IN 2.0" SAMPLER	12
							14
							16
							18





Hole No. CB-CH92-24

DRILLING LOG (Cont. Sheet)		ELEVATION TOP OF HOLE		SHEET 2 OF 2			
PROJECT			INSTALLATION				
Canaveral Harbor Deepening			Jacksonville District				
ELEV.	DEPTH	LEGEND	CLASSIFICATION OF MATERIALS (Description)	CORE REC %	SAMPLE NUMBER	REMARKS Bit or Barrel	BLOWS/ ft
-39	16			42			43
							52
					8	-41.0	2
							11
-43.0	22.0		SILT, damp, trace shell, trace sand, slightly plastic, gray (ML)	76			6
					9		2
							4
-46.0	25.0					-46.0	
			NOTE: Soils are field visually classified in accordance with the Unified Soils Classification System.			300# HAMMER WITH 18" DRCP USED IN 2.0" SAMPLER	

Hole No. CB-CH92-25

<b>DRILLING LOG</b>	DIVISION South Atlantic	INSTALLATION Jacksonville District	SHEET 1 OF 2
1. PROJECT Canaveral Harbor Deepening	10. SIZE AND TYPE OF BIT See Remarks		
2. LOCATION (Coordinates or Station) <i>See Drawing</i> X=673,334, Y=1,481,485	11. DATUM FOR ELEVATION SHOWN (TBM or MSL) MLW (FEET)		
3. DRILLING AGENCY Corps of Engineers	12. MANUFACTURER'S DESIGNATION OF DRILL Failing 1500		
4. HOLE NO. (As shown on drawing title and the number) CB-CH92-25	13. TOTAL NO. OF OVERBURDEN SAMPLES TAKEN disturbed: 0 undisturbed: 0		
5. NAME OF DRILLER L. C. Gregory	14. TOTAL NUMBER OF CORE BOXES 1		
6. DIRECTION OF HOLE <input checked="" type="checkbox"/> VERTICAL <input type="checkbox"/> INCLINED	15. ELEVATION GROUND WATER TIDAL		
7. THICKNESS OF BURDEN ft.	16. DATE HOLE STARTED COMPLETED 3/10/92 3/10/92		
8. DEPTH DRILLED INTO ROCK 0 ft.	17. ELEVATION TOP OF HOLE -14.3		
9. TOTAL DEPTH OF HOLE 31.5 ft.	18. TOTAL CORE RECOVERY FOR BORING 84%		
	19. SIGNATURE OF GEOLOGIST J. GENTILE		

ELEV.	DEPTH	LEGEND	CLASSIFICATION OF MATERIALS (Description)	CORE REC #	SAMPLE NUMBER	REMARKS Bit or Barrel	BLOWS / SQ FT
-14.3	0		SAND, fine to medium, quartz, shelly, trace silt, gray (SP)	60	1	SPLIT SPOON	2
			Little shell from -15.3' to -17.3'				4
							8
							7
			Trace to little silt, little shell, gray, from -17.3' to -20.3	66	2	"	6
							9
							8
				68	3	"	7
							6
				46	4	"	8
							4
-20.3	6.0		SAND, fine quartz, some silt, trace clay, gray, trace shell (SN)	100	5	"	2
							2
							2
				60	6	"	1
							3
							1
-23.3	9.0		CLAY, plastic, gray, damp, trace sand, trace shell (CH)	100	7	"	1
							Settled
							10
				100	8	"	Settled
							12
				100	9	"	Settled
							14
			Isolated seams sand from -25.3' to -29.3'	100	10	"	Settled
							16
			Trace organic material from -29.3' to -31.3'	100	11	"	Settled
							18
-31.3	17.0		SAND, fine to medium quartz, little silt, organic stain, dark brown (SN)	66	12	"	2
							2

(continued)

ENGINEERING FORM 1830 PREVIOUS EDITIONS ARE OBSOLETE. MAY 71	PROJECT Canaveral Harbor Deepening	HOLE NUMBER CB-CH92-25
---	---------------------------------------	---------------------------

Hole No. CB-CH92-25

DRILLING LOG (Cont. Sheet)		ELEVATION TOP OF HOLE		SHEET 2 OF 2			
PROJECT Canaveral Harbor Deepening			INSTALLATION Jacksonville District				
ELE. V.	DEPTH	LEGEND	CLASSIFICATION OF MATERIALS (Description)	CORE REC %	SAMPLE NUMBER	REMARKS Bit or Barrel	BLOWS/ft.
-32.3	18		Tan seams, moderately hard calcareous sandstone from -33.3' to -34.3'	93	13	-32.3	2
							3
						-33.8	6
							19
							17
						-35.3	23
-36.0	21.7		Bed of sand size shell, little silt, gray from -36.0' to -36.8'	73	15		15
-36.8	22.5				16	-36.8	10
-37.3	23.0				17		3
			CLAY, plastic, gray, trace sand (CH)	58	18		2
						-38.3	2
-38.7	24.4				19		3
			SAND, fine to medium, quartz, little silt, isolated seams of clay, gray, shelly (SM)	100	20		7
						-39.8	12
					21		12
-40.5	28.2			100	22		7
			SILT, slightly plastic, gray, trace sand, trace shell (ML)			-41.3	5
					80		8
							10
						-42.8	4
					100		1
							1
						-44.3	2
							1
					100		1
-45.8	31.5					-45.8	2
			NOTE: Soils are field visually classified in accordance with the Unified Soils Classification System.			140# HAMMER WITH 30" DROP USED IN 2.0' SPLIT SPOON (1 3/8" I.D. X 2" O.D.)	32
							34
							38
							38
							40

Hole No. CB-CH-M2

<b>DRILLING LOG</b>		DIVISION South Atlantic	INSTALLATION Jacksonville District	SHEET 1 of 1 SHEETS
1. PROJECT Canaveral Harbor Maintenance FY 83		10. SIZE AND TYPE OF BIT See remarks		
2. LOCATION (Coordinates or Station) X=636406 Y=1481917 STA:127+09 RGE: 18 Cut 2		11. DAY ON FOR ELEVATION SHOWN (TBM or HGL) MLW		
3. DRILLING AGENCY Corps of Engineers		12. MANUFACTURER'S DESIGNATION OF DRILL Falling 1500		
4. HOLE NO. (As shown on drawing title and file number) CB-CH-M2		13. TOTAL NO. OF OVER-BURDEN SAMPLES TAKEN		
5. NAME OF DRILLER C. Mason		14. TOTAL NUMBER CORE BOXES 1		
6. DIRECTION OF HOLE <input checked="" type="checkbox"/> VERTICAL <input type="checkbox"/> INCLINED _____ DEG. FROM VERT.		15. ELEVATION GROUND WATER Tidal		
7. THICKNESS OF OVERBURDEN		16. DATE HOLE STARTED 23 Nov 82 COMPLETED 23 Nov 82		
8. DEPTH DRILLED INTO ROCK		17. ELEVATION TOP OF HOLE -43.0		
9. TOTAL DEPTH OF HOLE 9.0'		18. TOTAL CORE RECOVERY FOR BORING 56%		
		19. <del>90% RECOVERY FOR BORING</del> GEOLOGIST: J. Gentile		

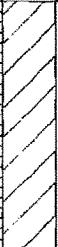
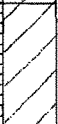
ELEVATION a	DEPTH b	LEGEND c	CLASSIFICATION OF MATERIALS (Description) d	% CORE RECOVERY e	BOX OR SAMPLE NO. f	REMARKS (Drilling time, water logs, depth of weathering, etc., if significant) g
-43.0	0.0					BIT OR BARREL
-49.0	6.0		CLAY, soft, soupy, slightly plastic, dark gray (CL)	56	1	Settled 2-inch Sampler
-52.0	9.0		-49.0 to -52.0 slightly compacted, green, silty, plastic (CL)		2	Pushed
						300 Lb. Hammer with 18" drop used on 2" Sampler

File No. CB-CH-M3

<b>DRILLING LOG</b>		DIVISION South Atlantic	INSTALLATION Jacksonville District	SHEET 1 OF 1 SHEETS
1. PROJECT Canaveral Harbor Maintenance FY 83		10. SIZE AND TYPE OF BIT See remarks		
2. LOCATION (Coordinates or Station) X=635374 Y=1481572 STA: 137+42 RGE: 358 Cut 2		11. DATUM FOR ELEVATION SHOWN (TBM or MSL) MLW		
3. DRILLING AGENCY Corps of Engineers		12. MANUFACTURER'S DESIGNATION OF DRILL Failing 1500		
4. HOLE NO. (As shown on drawing title and file number) CB-CH-M3		13. TOTAL NO. OF OVERBURDEN SAMPLES TAKEN		
5. NAME OF DRILLER C. Mason		14. TOTAL NUMBER CORE BOXES 1		
6. DIRECTION OF HOLE <input checked="" type="checkbox"/> VERTICAL <input type="checkbox"/> INCLINED _____ DEG. FROM VERT.		15. ELEVATION GROUND WATER Tidal		
7. THICKNESS OF OVERBURDEN		16. DATE HOLE STARTED 22 Nov 82		
8. DEPTH DRILLED INTO ROCK		17. DATE HOLE COMPLETED 22 Nov 82		
9. TOTAL DEPTH OF HOLE 9.0'		18. ELEVATION TOP OF HOLE -44.0		
		19. TOTAL CORE RECOVERY FOR BORING 56 %		
		20. WORKING OR WORKING GEOLOGIST: J. Gentile		

ELEVATION a	DEPTH b	LEGEND c	CLASSIFICATION OF MATERIALS (Description) d	CORE RECOVERY e	BOX OR SAMPLE NO. f	REMARKS (Drilling time, water loss, depth of weathering, etc., if significant) g
-44.0	0.0					BIT OR BARREL
-53.0	9.0		CLAY, soft, slightly plastic, dark gray, slightly silty (CL)	56	1	Settled 2-inch Sampler
						300 Lb. Hammer with 18" drop used on 2" Sampler

11019 (ED. CB-CH-M4)

<b>DRILLING LOG</b>		DIVISION South Atlantic	INSTALLATION Jacksonville District	SHEET 1 of 1 SHEETS
1. PROJECT Canaveral Harbor Maintenance FY 83		10. SIZE AND TYPE OF BIT See remarks		
2. LOCATION (Coordinates or Station) X=634774 Y=1481527 STA: 143+43 RGE: 400 Cut 2		11. DATUM FOR ELEVATION SHOWN (ZBM or MSL) MLW		
3. DRILLING AGENCY Corps of Engineers		12. MANUFACTURER'S DESIGNATION OF DRILL Failing 1500		
4. HOLE NO. (As shown on drawing title and file number) CB-CH-M4		13. TOTAL NO. OF OVER-BURDEN SAMPLES TAKEN	DISTURBED	UNDISTURBED
5. NAME OF DRILLER J. Detloff		14. TOTAL NUMBER CORE BOXES 1		
6. DIRECTION OF HOLE <input checked="" type="checkbox"/> VERTICAL <input type="checkbox"/> INCLINED _____ DEG. FROM VERT.		15. ELEVATION GROUND WATER Tidal		
7. THICKNESS OF OVERBURDEN		16. DATE HOLE STARTED 20 Nov 82	COMPLETED 20 Nov 82	
8. DEPTH DRILLED INTO ROCK		17. ELEVATION TOP OF HOLE -43.0		
9. TOTAL DEPTH OF HOLE 8.0'		18. TOTAL CORE RECOVERY FOR BORING 62 %		
19. GEOLOGIST: J. Gentile				

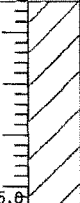
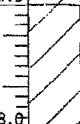
ELEVATION a	DEPTH b	LEGEND c	CLASSIFICATION OF MATERIALS (Description) d	% CORE RECOVERY e	BOX OR SAMPLE NO. f	REMARKS (Drilling logs, water loss, depth of washing, etc., if significant) g
-43.0	0.0					BIT OR BARREL
-48.0	5.0		CLAY, soft, soupy, dark gray to black, silty (CL)	62	1	Settled 2-inch Sampler
-51.0	8.0		-48.0 to -51.0 plastic, slightly sandy, dark gray		2	Pushed
						300 Lb. Hammer with 18" drop used on 2" Sampler

<b>DRILLING LOG</b>		South Atlantic	INSTALLATION Jacksonville District		SHEET 1 OF 1 SHEETS	
1. PROJECT Canaveral Harbor Maintenance FY 83			10. SIZE AND TYPE OF BIT See remarks			
2. LOCATION (Coordinates or Station) X=633960 Y=1481500 STA: 151+57 RGE: 422			11. DATUM FOR ELEVATION SHOWN (TBM or MSL) MLW			
3. DRILLING AGENCY Corps of Engineers			12. MANUFACTURER'S DESIGNATION OF DRILL Fairino 1500			
4. HOLE NO. (As shown on drawing title and file number) CB-CH-M5			13. TOTAL NO. OF OVER-BURDEN SAMPLES TAKEN DISTURBED _____ UNDISTURBED _____			
5. NAME OF DRILLER C. Mason			14. TOTAL NUMBER CORE BOXES 1			
6. DIRECTION OF HOLE <input checked="" type="checkbox"/> VERTICAL <input type="checkbox"/> INCLINED _____ DEG. FROM VERT.			15. ELEVATION GROUND WATER Tidal			
7. THICKNESS OF OVERBURDEN			16. DATE HOLE STARTED 22 Nov 82 COMPLETED 22 Nov 82			
8. DEPTH DRILLED INTO ROCK			17. ELEVATION TOP OF HOLE -38.0			
9. TOTAL DEPTH OF HOLE 11.0'			18. TOTAL CORE RECOVERY FOR BORING 90 %			
			19. NAME OF OPERATOR GEOLOGIST: J. Gentile			
ELEVATION a	DEPTH b	LEGEND c	CLASSIFICATION OF MATERIALS (Description) d	% CORE RECOVERY e	BOX OR SAMPLE NO. f	REMARKS (Drilling time, water loss, depth of weathering, etc., if significant) g
-38.0	0.0					BIT OR BARREL
		/	CLAY, very plastic, fat, gray (CH)	80	1	2-inch Sample Pushed
		/		100	2	" " Pushed
-49.0	11.0					300 Lb. Hammer with 18" drop used on 2" Sampler



<b>DRILLING LOG</b>		South Atlantic		INSTALLATION Jacksonville District		SHEET 1 of 1 SHEETS	
1. PROJECT Canaveral Harbor Maintenance FY 83				10. SIZE AND TYPE OF BIT See remarks			
2. LOCATION (Coordinates or Station) X=633260 Y=1481866 STA: 258+55 RGE: 53				11. DATUM FOR ELEVATION SHOWN (TBM or MSL) MLW			
3. DRILLING AGENCY Corps of Engineers				12. MANUFACTURER'S DESIGNATION OF DRILL Falling 1500			
4. HOLE NO. (As shown on drawing title and file number) CB-CH-M9				13. TOTAL NO. OF OVERBURDEN SAMPLES TAKEN		DISTURBED UNDISTURBED	
5. NAME OF DRILLER J. Detloff				14. TOTAL NUMBER CORE BOXES 1			
6. DIRECTION OF HOLE <input checked="" type="checkbox"/> VERTICAL <input type="checkbox"/> INCLINED _____ DEG. FROM VERT.				15. ELEVATION GROUND WATER Tidal		16. DATE HOLE STARTED 20 Nov 82 COMPLETED 20 Nov 82	
7. THICKNESS OF OVERBURDEN				17. ELEVATION TOP OF HOLE -41.5			
8. DEPTH DRILLED INTO ROCK				18. TOTAL CORE RECOVERY FOR BORING 50 %			
9. TOTAL DEPTH OF HOLE 10.0'				19. <del>XXXXXXXXXXXXXXXXXXXX</del> GEOLOGIST: J. Gentile			
ELEVATION o	DEPTH b	LEGEND c	CLASSIFICATION OF MATERIALS (Description) d	% CORE RECOVERY e	BOX OR SAMPLE NO. f	REMARKS (Drilling time, water loss, depth of weathering, etc., if significant) g	
-41.5	0.0					BIT OR BARREL	
-42.5	1.0		SAND, dark gray, very silty (SM)		1	Settled 2-inch Sample	
-43.5	2.0		Bed of sand (SP) -42.5 to -43.5	50	2 3	4 Settled	
-48.0	6.5				4	V	
-51.5	10.0		SAND, fine to medium quartz, silty, dark gray (SM)			9 8 3 2	
						300 Lb. Hammer with 18" drop used on 2" Sampler	

Hole No. CB-CH-M10

DRILLING LOG		DIVISION South Atlantic	INSTALLATION Jacksonville District:		SHEET 1 of 1 SHEETS	
1. PROJECT Canaveral Harbor Maintenance FY 83			10. SIZE AND TYPE OF BIT See remarks			
2. LOCATION (Coordinates or Station) X=632891 Y=1481711 STA: 162+25 RGE: 205			11. DATUM FOR ELEVATION SHOWN (FBM or MSL) MLW			
3. DRILLING AGENCY Corps of Engineers			12. MANUFACTURER'S DESIGNATION OF DRILL Failing 1500			
4. HOLE NO. (As shown on drawing title) and file number CB-CH-M10			13. TOTAL NO. OF OVER-BURDEN SAMPLES TAKEN DISTURBED      UNDISTURBED			
5. NAME OF DRILLER J. Detloff			14. TOTAL NUMBER CORE BOXES 1			
6. DIRECTION OF HOLE <input checked="" type="checkbox"/> VERTICAL <input type="checkbox"/> INCLINED _____ DEG. FROM VERT.			15. ELEVATION GROUND WATER Tidal			
7. THICKNESS OF OVERBURDEN			16. DATE HOLE STARTED      COMPLETED 20 Nov 82      20 Nov 82			
8. DEPTH DRILLED INTO ROCK			17. ELEVATION TOP OF HOLE -41.5			
9. TOTAL DEPTH OF HOLE 10.0'			18. TOTAL CORE RECOVERY FOR BORING 45 %			
			19. <del>NAME OF OPERATOR</del> GEOLOGIST: J. Gentile			
ELEVATION a	DEPTH b	LEGEND c	CLASSIFICATION OF MATERIALS (Description) d	% CORE RECOVERY e	BOX OR SAMPLE NO. f	REMARKS (Drilling time, water level, depth of washing, etc., if significant) g
-41.5	0.0					BIT OR BARREL
-42.5	1.0		SAND, dark gray, loose, very silty (SM)		1	Settled 2-inch Sampler Pushed
			SAND, fine quartz, gray (SP)	30	2	↓
					2	2
						-46.5
					3	" "
						2
						4
-49.5	8.9		SAND, fine quartz, silty, clayey, seams (CL) clay, dark gray (SM)	60		7
					4	4
-51.5	10.0					11
						300 Lb. Hammer with 18" drop used on 2" Sampler



Hole No. CB-CH-M12

DRILLING LOG		DIVISION South Atlantic		INSTALLATION Jacksonville District		SHEET 1 OF 1 SHEETS	
1. PROJECT Canaveral Harbor Maintenance FY 83				10. SIZE AND TYPE OF BIT See remarks (1. DATUM FOR ELEVATION SHOWN (FOM or MSL))			
2. LOCATION (Coordinates or Station) X=632603 Y=1481906 STA: 165+12 RGE: 9 Cut 2				11. MLW			
3. DRILLING AGENCY Corps of Engineers				12. MANUFACTURER'S DESIGNATION OF DRILL Failing 1500			
4. HOLE NO. (As shown on drawing title and file number) CB-CH-M12				13. TOTAL NO. OF OVER-BURDEN SAMPLES TAKEN		DISTURBED UNDISTURBED	
5. NAME OF DRILLER J. Detloff				14. TOTAL NUMBER CORE BOXES 1			
6. DIRECTION OF HOLE <input checked="" type="checkbox"/> VERTICAL <input type="checkbox"/> INCLINED _____ DEG. FROM VERT.				15. ELEVATION GROUND WATER Tidal			
7. THICKNESS OF OVERBURDEN				16. DATE HOLE		STARTED COMPLETED	
8. DEPTH DRILLED INTO ROCK				20 Nov 82		20 Nov 82	
9. TOTAL DEPTH OF HOLE 18.0'				17. ELEVATION TOP OF HOLE -35.5			
				18. TOTAL CORE RECOVERY FOR BORING 73 %			
				19. <del>XXXXXXXXXXXXXXXXXXXX</del> GEOLOGIST: J. Gentile			
ELEVATION a	DEPTH b	LEGEND c	CLASSIFICATION OF MATERIALS (Description) d	% CORE RECOVERY e	BOX OR SAMPLE NO. f	REMARKS (Drilling time, water loss, depth of weathering, etc., if significant) g	
-35.5	0.0					BIT OR BARREL	
-37.5	2.0		SAND, very silty, dark gray, loose (SM)	80	1	Settled 2-inch Sampler	
-41.5	6.0		SAND, fine quartz, silty, slightly clayey, dark gray (SM)	80	2	2	
						" " 5	
						" " 7	
						" " 10	
						" " 4	
-49.0	13.5		SAND, fine quartz, clayey, slightly silty, seams (CL) clay, gray (SP-SC)	80	3	" " 7	
						" " 7	
						" " 7	
-53.5	18.0		CLAY, plastic, gray, silty (CL)	60	5	" " 7	
						" " 7	
						" " 6	
						300 Lb. Hammer with 18" drop used on 2" Sampler	

Hole No. CB-CH-M13



<b>DRILLING LOG</b>		DIVISION South Atlantic	INSTALLATION Jacksonville District	SHEET <u>1</u> of <u>1</u> SHEETS
1. PROJECT Canaveral Harbor Maintenance FY 83		10. SIZE AND TYPE OF BIT See remarks		
2. LOCATION (Coordinates or Station) ACCESS Channel Y=632008 X=1481955 STA: 3+91 RGT: 398		11. DATUM FOR ELEVATION SHOWN (BSM or MSL) MLM		
3. DRILLING AGENCY Corps of Engineers		12. MANUFACTURER'S DESIGNATION OF DRILL Falling 1500		
4. HOLE NO. (As shown on drawing title and file number) CB-CH-M13		13. TOTAL NO. OF OVER-BURDEN SAMPLES TAKEN	DISTURBED	UNDISTURBED
5. NAME OF DRILLER J. Detloff		14. TOTAL NUMBER CORE BOXES <u>1</u>		
6. DIRECTION OF HOLE <input checked="" type="checkbox"/> VERTICAL <input type="checkbox"/> INCLINED _____ DEG. FROM VERT.		15. ELEVATION GROUND WATER Tidal		
7. THICKNESS OF OVERBURDEN		16. DATE HOLE	STARTED <u>21 Nov 82</u>	COMPLETED <u>21 Nov 82</u>
8. DEPTH DRILLED INTO ROCK		17. ELEVATION TOP OF HOLE <u>-30.5</u>		
9. TOTAL DEPTH OF HOLE <u>20.0'</u>		18. TOTAL CORE RECOVERY FOR BORING <u>67 %</u>		
19. SIGNATURE OF DRILLER GEOLOGIST: Joe Gentile				

ELEVATION a	DEPTH b	LEGEND c	CLASSIFICATION OF MATERIALS (Description) d	% CORE RECOVERY e	BOX OR SAMPLE NO. f	REMARKS (Drilling time, water loss, depth of weathering, etc., if significant) g
						BIT OR BARREL
-30.5	0.0					-30.5
			SAND, fine to medium quartz, slightly silty to silty, gray (SP-3M)	68	1	2-inch Sampler
-33.5	3.0					5
			SAND, fine to medium quartz, clean, dense, light gray (SP)			-35.5
				48	2	4
						" "
						10
						7
						14
						30
						52
						-40.5
						" "
						10
						12
				80	3	24
						26
-44.5	14.0		SAND, fine to medium quartz, clayey, slightly silty, slightly shelly, gray (SC)			-45.5
					4	" "
						9
-47.5	17.0		CLAY, very plastic, fat, gray (CH)	70		5
					5	6
						8
-50.5	20.0					-50.5

Hole No. CB-CH-M14

DRILLING LOG		DIVISION South Atlantic		INSTALLATION Jacksonville District		SHEET 1 of 1 SHEETS	
1. PROJECT Canaveral Harbor Maintenance FY 83				10. SIZE AND TYPE OF BIT See remarks			
2. LOCATION (Coordinates or Station) Access Channel Y=631527 Y=1482131 STA: 8+06 RGE: 699				11. DATUM FOR ELEVATION SHOWN (TBM or MSL) MLW			
3. DRILLING AGENCY Corps of Engineers				12. MANUFACTURER'S DESIGNATION OF DRILL Failing 1500			
4. HOLE NO. (As shown on drawing title and file number) CB-CH-M14				13. TOTAL NO. OF OVER-BURDEN SAMPLES TAKEN		DISTURBED UNDISTURBED	
5. NAME OF DRILLER J. Detloff				14. TOTAL NUMBER CORE BOXES 1			
6. DIRECTION OF HOLE <input checked="" type="checkbox"/> VERTICAL <input type="checkbox"/> INCLINED _____ DEG. FROM VERT.				15. ELEVATION GROUND WATER Tidal		16. DATE HOLE STARTED 21 Nov 82 COMPLETED 21 Nov 82	
7. THICKNESS OF OVERBURDEN				17. ELEVATION TOP OF HOLE -40.0			
8. DEPTH DRILLED INTO ROCK				18. TOTAL CORE RECOVERY FOR BORING 53 %			
9. TOTAL DEPTH OF HOLE 11.0'				19. SPECIAL COMMENTS GEOLOGIST: J. Gentile			
ELEVATION a	DEPTH b	LEGEND c	CLASSIFICATION OF MATERIALS (Description) d	% CORE RECOVERY e	BOX OR SAMPLE NO. f	REMARKS (Drilling time, water loss, depth of weathering, etc., if significant) g	
-40.0	0.0					BIT OR BARREL	
			SAND, fine to medium quartz, slightly silty to silty, gray (SP) to (SM)	30	1	Settled 2-inch Sampler ↓ -45.0	
-48.0	8.0			75	2	Pushed " " ↓	
-51.0	11.0		CLAY, very plastic, fat gray (CH)		3	↓ 4	
						300 Lb. Hammer with 18" drop used on 2" Sampler	

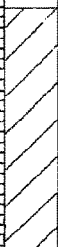
Note No. CB-CR-Fy83-M6

DRILLING LOG			DIVISION South Atlantic	INSTALLATION Jacksonville District	SHEET 1 OF 1 SHEETS	
1. PROJECT Canaveral Hbr Maintenance			10. SIZE AND TYPE OF BIT see remarks			
2. LOCATION (Coordinates or Station) X=634,673 Y=1,481,909 RGE 17 STA 144+41			11. DATUM FOR ELEVATION SHOWN (TBM or MSL) MLW			
3. DRILLING AGENCY Corps of Engineers			12. MANUFACTURER'S DESIGNATION OF DRILL Falling 1500			
4. HOLE NO. (As shown on drawing title and its number) CB-CR-Fy83-M6			13. TOTAL NO. OF CURT- BURDEN SAMPLES TAKEN			
5. NAME OF DRILLER J. Detloff			14. TOTAL NUMBER CORE BOXES 1			
6. DIRECTION OF HOLE <input checked="" type="checkbox"/> VERTICAL <input type="checkbox"/> INCLINED _____ DEG. FROM VERT.			15. ELEVATION GROUND WATER Tidal			
7. THICKNESS OF OVERBURDEN			16. DATE HOLE STARTED 11/19/82 COMPLETED 11/19/82			
8. DEPTH DRILLED INTO ROCK			17. ELEVATION TOP OF HOLE -43.0			
9. TOTAL DEPTH OF HOLE 11.0'			18. TOTAL CORE RECOVERY FOR BORING 49 %			
			19. <del>REMARKS</del> <b>GEOLOGIST I. Gentle</b>			
ELEVATION a	DEPTH b	LEGEND c	CLASSIFICATION OF MATERIALS (Description) d	% CORE RECOV- ERY e	BOX OR SAMPLE NO. f	REMARKS (Drilling time, water loss, depth of weathering, etc., if significant) g
-43.0	0.0					-43.0
-49.0	6.0		CLAY, dark gray, slightly plastic, silty (CL), soft			2" x 5' Sampler Settled
-54.0	11.0		SAND, clayey, silty, soft, dark gray, fine to medium quartz (SC)	49	1 2	Pushed
						300 Lb. Hammer with 18" drop used on 2" Sampler





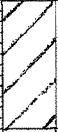

Hole No. CB-CH-FY83-M8

DRILLING LOG		DIVISION	INSTALLATION	SHEET		
		South Atlantic	Jacksonville District	1 of 2 SHEETS		
1. PROJECT		10. SIZE AND TYPE OF BIT See remarks				
Canaveral Hbr Maintenance, FY 83		11. DATE FOR ELEVATION SHOWN (TBM or MSL)				
2. LOCATION (Coordinates or Station)		MLW				
Y=533.810 X=1.481.910 STA 153+04 RGE 12 Cut 2		12. MANUFACTURER'S DESIGNATION OF DRILL				
3. DRILLING AGENCY		Failing 1500				
Corps of Engineers		13. TOTAL NO. OF OVERBURDEN SAMPLES TAKEN				
4. HOLE NO. (As shown on drawing title and file number)		DISTURBED UNDISTURBED				
CR-CH-FY83-M8		14. TOTAL NUMBER CORE BOXES				
5. NAME OF DRILLER		15. ELEVATION GROUND WATER				
J. Detloff		Tidal				
6. DIRECTION OF HOLE		16. DATE HOLE				
<input checked="" type="checkbox"/> VERTICAL <input type="checkbox"/> INCLINED _____ DEG. FROM VERT.		STARTED COMPLETED				
		11/19/82 11/19/82				
7. THICKNESS OF OVERBURDEN		17. ELEVATION TOP OF HOLE				
		-23.5				
8. DEPTH DRILLED INTO ROCK		18. TOTAL CORE RECOVERY FOR BORING				
		70 %				
9. TOTAL DEPTH OF HOLE		19. NAME OF OPERATOR				
25.0'		GEOLOGIST J. Gentile				
ELEVATION	DEPTH	LEGEND	CLASSIFICATION OF MATERIALS (Described)	% CORE RECOVERY	BOX OR SAMPLE NO.	REMARKS (Drilling time, water loss, depth of penetration, etc., if significant)
						Bit or Barrel
-23.5	0.0					-23.5 Settled
			SAND, fine to medium, quartz, gray, slightly silty (SF)	90	1	2" x 5' Sampler
						5
						9
				50	2	13
			Bed plastic silt (MH)			26
			Dark gray from -34.5 to -35.5			44
			Bed silty sand (SM) from -35.5 to -36.5			55
-34.5	11.0			60	3	-33.5
					4	7
-35.5	12.0				5	9
-36.5	13.0					10
						25
						-38.5
						35
						10
				60	6	15
						37
						45
						-43.5
						60

DRILLING LOG (Cont Sheet)		ELEVATION TOP OF HOLE -23.5		Hole No. CB-CH-FY83-M8		
PROJECT Canaveral Hbr Maintenance, FY 83			INSTALLATION Jacksonville District			SHEET 2 OF 9 SHEETS
ELEVATION a	DEPTH b	LEGEND c	CLASSIFICATION OF MATERIALS (Description) d	% CORE RECDY- ERY e	BOX OR SAMPLE NO. f	REMARKS (Drilling time, water loss, depth of weathering, etc., if significant) g
						Bit or Barrel
						-43.5
-45.5	22.0			100	7	2" x 5' Sampler 12
			CLAY, very plastic, gray (CH)		8	18
						35
						55
-48.5	25.0					-48.5 52
						300 Lb. Hammer with 18" drop used on 2" Sampler

Hole No. CB-CH-M1

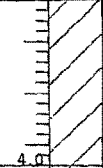
<b>DRILLING LOG</b>		DIVISION South Atlantic	INSTALLATION Jacksonville District	SHEET 1 OF 1 SHEETS
1. PROJECT Canaveral Harbor Maintenance FY 83		10. SIZE AND TYPE OF BIT See remarks		
2. LOCATION (Coordinates or Station) Cut 1 X=636696 Y=1481834 STA: 124+20 RGE: 103		11. DAYUM FOR ELEVATION SHOWN (TBM or BSL) MLW		
3. DRILLING AGENCY Corps of Engineers		12. MANUFACTURER'S DESIGNATION OF DRILL Falling 1500		
4. HOLE NO. (As shown on drawing title and its number) CB-CH-M1		13. TOTAL NO. OF OVER-BURDEN SAMPLES TAKEN DISTURBED _____ UNDISTURBED _____		
5. NAME OF DRILLER C. Mason		14. TOTAL NUMBER CORE BOXES 1		
6. DIRECTION OF HOLE <input checked="" type="checkbox"/> VERTICAL <input type="checkbox"/> INCLINED _____ DEG. FROM VERT.		15. ELEVATION GROUND WATER Tidal		
7. THICKNESS OF OVERBURDEN		16. DATE HOLE STARTED 23 Nov 82 COMPLETED 23 Nov 82		
8. DEPTH DRILLED INTO ROCK		17. ELEVATION TOP OF HOLE -44.0		
9. TOTAL DEPTH OF HOLE 8.0'		18. TOTAL CORE RECOVERY FOR BORING 63 %		
		19. <del>PERMANENT RECORD NUMBER</del> GEOLOGIST: J. Gentile		

ELEVATION a	DEPTH b	LEGEND c	CLASSIFICATION OF MATERIALS (Description) d	% CORE RECOVERY e	BOX OR SAMPLE NO. f	REMARKS (Drilling time, water loss, depth of weathering, etc., if significant) g
-44.0	0.0					BIT OR BARREL
-48.0	4.0		CLAY, soft, soupy, slightly plastic, dark gray (CL)	63	1	Settled 2-inch Sampler
-52.0	8.0		-48.0 to -52.0 silty, plastic, green, lenses of soft weathered limestone (CL)		2	Pushed
						300 Lb. Hammer with 18" drop used on 2" Sampler

Hole No. CB-CH01-1

DRILLING LOG		DIVISION South Atlantic	INSTALLATION Jacksonville District		SHEET OF 1
1. PROJECT Canaveral Harbor		10. SIZE AND TYPE OF BIT 4-inch Vibracore Tube			
2. LOCATION (Coordinates or Station) X=785,210 Y=1481,885		11. DATUM FOR ELEVATION SHOWN (TBM or MSL) NGVD 29; Horizontal Datum: FLE NAD 83			
3. DRILLING AGENCY USAED Villamington		12. MANUFACTURER'S DESIGNATION OF DRILL Vibracore			
4. HOLE NO. (As shown on drawing title and file number) CB-CH01-1		13. TOTAL NO. OF OVERBURDEN SAMPLES TAKEN disturbed: 4 undisturbed: 0			
5. NAME OF DRILLER Snell		14. TOTAL NUMBER OF CORE BOXES 0			
6. DIRECTION OF HOLE <input checked="" type="checkbox"/> VERTICAL <input type="checkbox"/> INCLINED		16. ELEVATION GROUND WATER 0.6			
7. THICKNESS OF BURDEN 0 Ft.		17. DATE HOLE STARTED COMPLETED 7/4/01 7/4/01			
8. DEPTH DRILLED INTO ROCK 0 Ft.		17. ELEVATION TOP OF HOLE -44.4 Ft.			
9. TOTAL DEPTH OF HOLE 8.3 Ft.		18. TOTAL CORE RECOVERY FOR BORING 91 %			
		19. SIGNATURE OF Civil Engineer Trey Broughton (LAW)			

ELEV.	DEPTH	LEGEND	CLASSIFICATION OF MATERIALS (Description)	CORE REC %	SAMPLE NUMBER	REMARKS Vibracore												
-44.4	0					-44.4												
-45.2	0.8		SILT, little fine quartz sand, gray (MH)		1													
			CLAY, little fine quartz sand, gray (CH)		2													
-48.7	4.3		SAND, fine quartz, some clay, gray to blue-gray (SC)	91	3													
-51.9	7.5		SAND, fine quartz, some clay, gray (SC)		4													
-52.7	8.3		SOILS ARE FIELD VISUALLY CLASSIFIED IN ACCORDANCE WITH THE UNIFIED SOILS CLASSIFICATION SYSTEM.  NOTE: Elevation is based on furnished tide and water depth information.  <table style="font-size: small; margin: 5px 0;"> <tr> <td>SAMPLE NO.</td> <td>SAMPLE DEPTH</td> <td>LAB CLASSIF. #</td> </tr> <tr> <td>1</td> <td>0.0 - 0.8</td> <td>MH</td> </tr> <tr> <td>3</td> <td>4.3 - 7.5</td> <td>CH</td> </tr> <tr> <td>4</td> <td>7.5 - 8.3</td> <td>CH</td> </tr> </table> *Lab classification based on gradation curve with no Atterberg Limits.	SAMPLE NO.	SAMPLE DEPTH	LAB CLASSIF. #	1	0.0 - 0.8	MH	3	4.3 - 7.5	CH	4	7.5 - 8.3	CH			-52.7
SAMPLE NO.	SAMPLE DEPTH	LAB CLASSIF. #																
1	0.0 - 0.8	MH																
3	4.3 - 7.5	CH																
4	7.5 - 8.3	CH																
						Vibracore tubes split and logged by Law Engineering and Environmental Services, Inc., Jacksonville, Florida.												

ENG FORM 1836 PREVIOUS EDITIONS ARE OBSOLETE. MAR 71	PROJECT Canaveral Harbor	HOLE NUMBER CB-CH01-1
---	-----------------------------	--------------------------



Hole No. CB-CH01-2

<b>DRILLING LOG</b>		DIVISION South Atlantic	INSTALLATION Jacksonville District	SHEET 1 OF 1
1. PROJECT Canaveral Harbor		10. SIZE AND TYPE OF BIT 4-inch Vibrocure Tube		
2. LOCATION (Coordinates of Station) X=786,203 Y=1482,061		11. DATUM FOR ELEVATION SHOWN (TBM or MSL) NGVD 29; Horizontal Datum: FLE NAD 83		
3. DRILLING AGENCY USAED Wilmington		12. MANUFACTURER'S DESIGNATION OF DRILL Vibrocure		
4. HOLE NO. (As shown on drawing title and file number) CB-CH01-2		13. TOTAL NO. OF OVERBURDEN SAMPLES TAKEN disturbed: 3 undisturbed: 0		
5. NAME OF DRILLER Snell		14. TOTAL NUMBER OF CORE BOXES 1		
6. DIRECTION OF HOLE <input checked="" type="checkbox"/> VERTICAL <input type="checkbox"/> INCLINED		15. ELEVATION GROUND WATER 1.7		
7. THICKNESS OF BURDEN 0 Ft.		16. DATE HOLE STARTED COMPLETED 7/4/01 7/4/01		
8. DEPTH DRILLED INTO ROCK 0 Ft.		17. ELEVATION TOP OF HOLE -38.3 Ft.		
9. TOTAL DEPTH OF HOLE 3.8 Ft.		18. TOTAL CORE RECOVERY FOR BORING 37 %		
		19. SIGNATURE OF Civil Engineer Trey Broughton (LAW)		

ELEV.	DEPTH	LEGEND	CLASSIFICATION OF MATERIALS (Description)	CORE REC %	SAMPLE NUMBER	REMARKS Vibrocure									
-38.3	0					-38.3									
-40.0	1.7		SAND, fine quartz, little silt, gray (SM)		1										
-40.7	2.4		SAND, fine quartz, some sand size shell fragments, gray (SP)	37	2										
-42.1	3.8		CLAY, some fine quartz sand, gray (CH)		3										
			SOILS ARE FIELD VISUALLY CLASSIFIED IN ACCORDANCE WITH THE UNIFIED SOILS CLASSIFICATION SYSTEM.												
			NOTE: Elevation is based on furnished tide and water depth information.												
			<table border="1"> <tr> <th>SAMPLE NO.</th> <th>SAMPLE DEPTH</th> <th>LAB CLASSIF. #</th> </tr> <tr> <td>1</td> <td>0.0 - 1.7</td> <td>SM</td> </tr> <tr> <td>2</td> <td>1.7 - 2.4</td> <td>SP</td> </tr> </table>	SAMPLE NO.	SAMPLE DEPTH	LAB CLASSIF. #	1	0.0 - 1.7	SM	2	1.7 - 2.4	SP			
SAMPLE NO.	SAMPLE DEPTH	LAB CLASSIF. #													
1	0.0 - 1.7	SM													
2	1.7 - 2.4	SP													
			*Lab classification based on gradation curve with no Atterberg Limits.												
			Vibrocure tubes split and logged by Law Engineering and Environmental Services, Inc., Jacksonville, Florida.												



Hole No. CB-CH01-3B

<b>DRILLING LOG</b>		DIVISION South Atlantic	INSTALLATION Jacksonville District	SHEET 1 OF 1
1. PROJECT Canaveral Harbor		10. SIZE AND TYPE OF BIT 4-inch Vibracore Tube		
2. LOCATION (Coordinates of Station) X=786,207 Y=1481,887		11. DATUM FOR ELEVATION SHOWN (TBM or NSL) NGVD 29; Horizontal Datum: FLE NAD 83		
3. DRILLING AGENCY USAED Wilmington		12. MANUFACTURER'S DESIGNATION OF DRILL Vibracore		
4. HOLE NO. (As shown on drawing title and file number) CB-CH01-3B		13. TOTAL NO. OF OVERBURDEN SAMPLES TAKEN disturbed: 3 undisturbed: 0		
5. NAME OF DRILLER Snell		14. TOTAL NUMBER OF CORE BOXES 1		
6. DIRECTION OF HOLE <input checked="" type="checkbox"/> VERTICAL <input type="checkbox"/> INCLINED		15. ELEVATION GROUND WATER 0.4		
7. THICKNESS OF BURDEN 0 Ft.		16. DATE HOLE STARTED COMPLETED 7/4/01 7/4/01		
8. DEPTH DRILLED INTO ROCK 0 Ft.		17. ELEVATION TOP OF HOLE -42.6 Ft.		
9. TOTAL DEPTH OF HOLE 9.9 Ft.		18. TOTAL CORE RECOVERY FOR BORING 75 %		
		19. SIGNATURE OF CIVIL Engineer Trey Broughton (LAW)		

ELEV.	DEPTH	LEGEND	CLASSIFICATION OF MATERIALS (Description)	CORE REC %	SAMPLE NUMBER	REMARKS
-42.6	0		SILT, little fine quartz sand, gray (MH)		1	-42.6
-44.9	2.3		CLAY, little fine quartz, gray (CH)	75	2	
-50.0	7.4		SAND, fine quartz, some clay, gray (SC)		3	
-52.5	9.9		SOILS ARE FIELD VISUALLY CLASSIFIED IN ACCORDANCE WITH THE UNIFIED SOILS CLASSIFICATION SYSTEM.  NOTE: Elevation is based on furnished tide and water depth information.  SAMPLE NO.    SAMPLE DEPTH    LAB CLASSIF. # 1            0.0 - 2.3    MH 3            7.4 - 9.9    CH  *Lab classification based on gradation curve with no Atterberg Limits.			-52.5

Hole No. CB-CH01-4

<b>DRILLING LOG</b>		DIVISION South Atlantic	INSTALLATION Jacksonville District	SHEET 1 OF 1
1. PROJECT Canaveral Harbor		10. SIZE AND TYPE OF BIT 4-inch Vibracore Tube		
2. LOCATION (Coordinates or Station) X=786,219 Y=1481,675		11. DATUM FOR ELEVATION SHOWN (TBM or MSL) NBVD 29; Horizontal Datum: FLE NAD 83		
3. DRILLING AGENCY USAED Wilmington		12. MANUFACTURER'S DESIGNATION OF DRILL Vibracore		
4. HOLE NO. (As shown on drawing title and file number) CB-CH01-4		13. TOTAL NO. OF OVERBURDEN SAMPLES TAKEN disturbed: 2 undisturbed: 0		
5. NAME OF DRILLER Snell		14. TOTAL NUMBER OF CORE BOXES 1		
6. DIRECTION OF HOLE <input checked="" type="checkbox"/> VERTICAL <input type="checkbox"/> INCLINED		15. ELEVATION GROUND WATER 1.8		
7. THICKNESS OF BURDEN 0 Ft.		16. DATE HOLE STARTED COMPLETED 7/4/01 7/4/01		
8. DEPTH DRILLED INTO ROCK 0 Ft.		17. ELEVATION TOP OF HOLE -43.3 Ft.		
9. TOTAL DEPTH OF HOLE 5.4 Ft.		18. TOTAL CORE RECOVERY FOR BORING 54 %		
19. SIGNATURE OF CIVIL ENGINEER Trey Broughton (LAW)				

ELEV.	DEPTH	LEGEND	CLASSIFICATION OF MATERIALS (Description)	CORE REC %	SAMPLE NUMBER	REMARKS
-43.3	.0					-43.3
			SILT, little fine quartz sand, gray, (MH)		1	
-46.3	3.0		CLAY, some fine quartz sand, gray (CH)	54	2	
-48.7	5.4		SOILS ARE FIELD VISUALLY CLASSIFIED IN ACCORDANCE WITH THE UNIFIED SOILS CLASSIFICATION SYSTEM.  NOTE: Elevation is based on furnished tide and water depth information.  SAMPLE NO.    SAMPLE DEPTH    LAB CLASSIF. # 1            0.0 - 3.0        MH 2            3.0 - 5.4        SC  *Lab classification based on gradation curve with no Atterberg Limits.			Vibracore tubes split and logged by Law Engineering and Environmental Services, Inc., Jacksonville, Florida.

Hole No. CB-CH01-5

<b>DRILLING LOG</b>		DIVISION South Atlantic	INSTALLATION Jacksonville District	SHEET 1 OF 1
1. PROJECT Canaveral Harbor		10. SIZE AND TYPE OF BIT 4-inch Vibracore Tube		
2. LOCATION (Coordinates or Station) X=787,223 Y=1482,086		11. DATUM FOR ELEVATION SHOWN (TBM or MSL) NGVD 29; Horizontal Datum: FLE NAD 83		
3. DRILLING AGENCY USAED Wilmington		12. MANUFACTURER'S DESIGNATION OF DRILL Vibracore		
4. HOLE NO. (As shown on drawing title and file number) CB-CH01-5		13. TOTAL NO. OF OVERBURDEN SAMPLES TAKEN disturbed: 2 undisturbed: 0		
5. NAME OF DRILLER Snell		14. TOTAL NUMBER OF CORE BOXES 1		
6. DIRECTION OF HOLE <input checked="" type="checkbox"/> VERTICAL <input type="checkbox"/> INCLINED		15. ELEVATION GROUND WATER 2.6		
7. THICKNESS OF BURDEN 0 Ft.		16. DATE HOLE STARTED COMPLETED 7/4/01 7/4/01		
8. DEPTH DRILLED INTO ROCK 0 Ft.		17. ELEVATION TOP OF HOLE -42.4 Ft.		
9. TOTAL DEPTH OF HOLE 4.3 Ft.		18. TOTAL CORE RECOVERY FOR BORING 41 %		
19. SIGNATURE OF Civil Engineer Trey Broughton (LAW)				

ELEV.	DEPTH	LEGEND	CLASSIFICATION OF MATERIALS (Description)	CORE REC %	SAMPLE NUMBER	REMARKS Vibracore
-42.4	0		SILT, some fine quartz sand, gray (MH)			-42.4
-45.2	2.8		SAND, fine quartz, some silt, gray (SM)	41		
-46.7	4.3		SOILS ARE FIELD VISUALLY CLASSIFIED IN ACCORDANCE WITH THE UNIFIED SOILS CLASSIFICATION SYSTEM.  NOTE: Elevation is based on furnished tide and water depth information.  SAMPLE NO.      SAMPLE DEPTH      LAB CLASSIF. # 1              0.0 - 2.8      MH 2              2.8 - 4.3      MH  *Lab classification based on gradation curve with no Atterberg Limits.		2	Vibracore tubes split and logged by Law Engineering and Environmental Services, Inc., Jacksonville, Florida.





Hole No. CB-CH01-6

<b>DRILLING LOG</b>		DIVISION South Atlantic	INSTALLATION Jacksonville District	SHEET 1 OF 1
1. PROJECT Canaveral Harbor		10. SIZE AND TYPE OF BIT 4-inch Vibracore Tube		
2. LOCATION (Coordinates or Station) X=787,209 Y=1481,879		11. DATUM FOR ELEVATION SHOWN (TBM or NSL) NGVD 29; Horizontal Datum: FLE NAD 83		
3. DRILLING AGENCY USAED Wilmington		12. MANUFACTURER'S DESIGNATION OF DRILL Vibracore		
4. HOLE NO. (As shown on drawing title and file number) CB-CH01-6		13. TOTAL NO. OF OVERBURDEN SAMPLES TAKEN disturbed: 4 undisturbed: 0		
5. NAME OF DRILLER Snell		14. TOTAL NUMBER OF CORE BOXES 1		
6. DIRECTION OF HOLE <input checked="" type="checkbox"/> VERTICAL <input type="checkbox"/> INCLINED		15. ELEVATION GROUND WATER 2.7		
7. THICKNESS OF BURDEN 0 Ft.		16. DATE HOLE STARTED COMPLETED 7/4/01 7/4/01		
8. DEPTH DRILLED INTO ROCK 0 Ft.		17. ELEVATION TOP OF HOLE -47.0 Ft.		
9. TOTAL DEPTH OF HOLE 4.1 Ft.		18. TOTAL CORE RECOVERY FOR BORING 60 %		
		19. SIGNATURE OF CWM Engineer Trey Broughton (LAW)		

ELEV.	DEPTH	LEGEND	CLASSIFICATION OF MATERIALS (Description)	CORE REC %	SAMPLE NUMBER	REMARKS Vibracore												
-47.0	.0					-47.0												
-48.0	1.0		SILT, trace fine quartz sand, dark gray (MH)	60	1	Vibracore tubes split and logged by Law Engineering and Environmental Services, Inc., Jacksonville, Florida.												
			SAND, fine quartz, trace silt, gray (SP)		2													
-49.7	2.7		SAND, fine quartz, little silt, gray (SP-SM)		3													
-50.5	3.5		SAND, fine quartz, little clay, blue-gray (SC)		4													
-51.1	4.1																	
			SOILS ARE FIELD VISUALLY CLASSIFIED IN ACCORDANCE WITH THE UNIFIED SOILS CLASSIFICATION SYSTEM.															
			NOTE: Elevation is based on furnished tide and water depth information.															
			<table border="1"> <tr> <th>SAMPLE NO.</th> <th>SAMPLE DEPTH</th> <th>LAB CLASSIF. #</th> </tr> <tr> <td>2</td> <td>1.0 - 2.7</td> <td>SP-SM</td> </tr> <tr> <td>3</td> <td>2.7 - 3.5</td> <td>MH</td> </tr> <tr> <td>4</td> <td>3.5 - 4.1</td> <td>CH</td> </tr> </table>	SAMPLE NO.	SAMPLE DEPTH	LAB CLASSIF. #	2	1.0 - 2.7	SP-SM	3	2.7 - 3.5	MH	4	3.5 - 4.1	CH			
SAMPLE NO.	SAMPLE DEPTH	LAB CLASSIF. #																
2	1.0 - 2.7	SP-SM																
3	2.7 - 3.5	MH																
4	3.5 - 4.1	CH																
			*Lab classification based on gradation curve with no Atterberg Limits.															

Hole No. CB-CH01-7

<b>DRILLING LOG</b>		DIVISION South Atlantic	INSTALLATION Jacksonville District	SHEET 1 OF 1
1. PROJECT Canaveral Harbor		10. SIZE AND TYPE OF BIT 4-inch Vibracore Tube		
2. LOCATION (Coordinates or Station) X=787,223 Y=1481,673		11. DATUM FOR ELEVATION SHOWN (TBM or HSL) NGVD 29; Horizontal Datum: FLE NAD 83		
3. DRILLING AGENCY USAED Wilmington		12. MANUFACTURER'S DESIGNATION OF DRILL Vibracore		
4. HOLE NO. (As shown on drawing title and file number) CB-CH01-7		13. TOTAL NO. OF OVERBURDEN SAMPLES TAKEN disturbed: 2 undisturbed: 0		
5. NAME OF DRILLER Snell		14. TOTAL NUMBER OF CORE BOXES 1		
6. DIRECTION OF HOLE <input checked="" type="checkbox"/> VERTICAL <input type="checkbox"/> INCLINED		15. ELEVATION GROUND WATER 1.9		
7. THICKNESS OF BURDEN 0 Ft.		16. DATE HOLE STARTED COMPLETED 7/4/01 7/4/01		
8. DEPTH DRILLED INTO ROCK 0 Ft.		17. ELEVATION TOP OF HOLE -45.8 Ft.		
9. TOTAL DEPTH OF HOLE 4.2 Ft.		18. TOTAL CORE RECOVERY FOR BORING 45 %		
19. SIGNATURE OF CIVIL Engineer Trey Broughton (LAW)				

ELEV.	DEPTH	LEGEND	CLASSIFICATION OF MATERIALS (Description)	CORE REC %	SAMPLE NUMBER	REMARKS Vibracore
-45.8	0					-45.8
			SILT, little fine quartz sand, dark gray (MH)		1	
-48.1	2.3		SAND, fine quartz, some clay, blue-gray (SC)	45	2	
-50.0	4.2		SOILS ARE FIELD VISUALLY CLASSIFIED IN ACCORDANCE WITH THE UNIFIED SOILS CLASSIFICATION SYSTEM.  NOTE: Elevation is based on furnished tide and water depth information.  SAMPLE NO. 2      SAMPLE DEPTH 2.3 - 4.2      LAB CLASSIF. # CH  *Lab classification based on gradation curve with no Atterberg Limits.			Vibracore tubes split and logged by Law Engineering and Environmental Services, Inc., Jacksonville, Florida.

Hole No. CB-CHOI-8

<b>DRILLING LOG</b>		DIVISION South Atlantic	INSTALLATION Jacksonville District	SHEET 1 OF 1
1. PROJECT Canaveral Harbor		10. SIZE AND TYPE OF BIT 4-inch Vibracore Tube		
2. LOCATION (Coordinates of Station) X=788,211 Y=1482,094		11. DATUM FOR ELEVATION SHOWN (TBM or MSL) NGVD 29; Horizontal Datum; FLE NAD 83		
3. DRILLING AGENCY USAED Wilmington		12. MANUFACTURER'S DESIGNATION OF DRILL Vibracore		
4. HOLE NO. (As shown on drawing title and file number) CB-CHOI-8		13. TOTAL NO. OF OVERBURDEN SAMPLES TAKEN disturbed: 2 undisturbed: 0		
5. NAME OF DRILLER Snell		14. TOTAL NUMBER OF CORE BOXES 1		
6. DIRECTION OF HOLE <input checked="" type="checkbox"/> VERTICAL <input type="checkbox"/> INCLINED		15. ELEVATION GROUND WATER 3.2		
7. THICKNESS OF BURDEN 0 Ft.		16. DATE HOLE STARTED COMPLETED 7/4/01 7/4/01		
8. DEPTH DRILLED INTO ROCK 0 Ft.		17. ELEVATION TOP OF HOLE -46.6 Ft.		
9. TOTAL DEPTH OF HOLE 8.5 Ft.		18. TOTAL CORE RECOVERY FOR BORING 83 %		
		19. SIGNATURE OF CIVIL Engineer Trey Broughton (LAW)		

ELEV.	DEPTH	LEGEND	CLASSIFICATION OF MATERIALS (Description)	CORE REC %	SAMPLE NUMBER	REMARKS Vibracore
-46.6	0					-46.6
-47.9	1.3		SAND, fine quartz, some silt, gray (SM)		1	
			CLAY, trace fine gravel sized shell fragments, gray (CH)	83	2	
-55.1	8.5		SOILS ARE FIELD VISUALLY CLASSIFIED IN ACCORDANCE WITH THE UNIFIED SOILS CLASSIFICATION SYSTEM.  NOTE: Elevation is based on furnished tide and water depth information.  SAMPLE NO. 1      SAMPLE DEPTH 0.0 - 1.3      LAB CLASSIF. SM  *Lab classification based on gradation curve with no Atterberg Limits.			Vibracore tubes split and logged by Law Engineering and Environmental Services, Inc., Jacksonville, Florida.

DRILLING LOG		DIVISION South Atlantic	INSTALLATION Jacksonville District	SHEET 1 OF 1
1. PROJECT Canaveral Harbor		10. SIZE AND TYPE OF BIT 4-inch Vibracore Tube		
2. LOCATION (Coordinates or Station) X=788,213 Y=1481,879		11. DATUM FOR ELEVATION SHOWN (TBM or NSL) NGVD 28; Horizontal Datum: FLE NAD 83		
3. DRILLING AGENCY USAED Wilmington		12. MANUFACTURER'S DESIGNATION OF DRILL Vibracore		
4. HOLE NO. (As shown on drawing title and file number) CB-CH01-9		13. TOTAL NO. OF OVERBURDEN SAMPLES TAKEN disturbed: 6 undisturbed: 0		
5. NAME OF DRILLER Snell		14. TOTAL NUMBER OF CORE BOXES 1		
6. DIRECTION OF HOLE <input checked="" type="checkbox"/> VERTICAL <input type="checkbox"/> INCLINED		15. ELEVATION GROUND WATER 3.2		
7. THICKNESS OF BURDEN 0 Ft.		16. DATE HOLE STARTED COMPLETED 7/4/01 7/4/01		
8. DEPTH DRILLED INTO ROCK 0 Ft.		17. ELEVATION TOP OF HOLE -48.8 Ft.		
9. TOTAL DEPTH OF HOLE 6.0 Ft.		18. TOTAL CORE RECOVERY FOR BORING 55 %		
		19. SIGNATURE OF Civil Engineer Trey Broughton (LAW)		



ELEV.	DEPTH	LEGEND	CLASSIFICATION OF MATERIALS (Description)	CORE REC %	SAMPLE NUMBER	REMARKS Vibracore												
-48.8	0					-48.8												
-47.8	1.0		SILT, some fine quartz sand, dark gray (MH)		1													
-48.7	1.9		SILT, little fine quartz sand, gray (MH)		2													
-49.3	2.5		SAND, fine quartz, little silt, gray (SM)		3													
-50.2	3.4		SILT, some fine quartz sand, gray (MH)	55	4													
-51.2	4.4		SAND, fine quartz, some silt, gray (SM)		5													
-52.8	6.0		CLAY, little fine quartz sand, gray (CH)		6	-52.8												
			SOILS ARE FIELD VISUALLY CLASSIFIED IN ACCORDANCE WITH THE UNIFIED SOILS CLASSIFICATION SYSTEM.															
			NOTE: Elevation is based on furnished tide and water depth information.															
			<table style="font-size: small; border: none;"> <tr> <td>SAMPLE NO.</td> <td>SAMPLE DEPTH</td> <td>LAB CLASSIF. #</td> </tr> <tr> <td>1</td> <td>0.0 - 1.0</td> <td>SH</td> </tr> <tr> <td>3</td> <td>1.9 - 2.5</td> <td>SR</td> </tr> <tr> <td>5</td> <td>3.4 - 4.4</td> <td>SH</td> </tr> </table>	SAMPLE NO.	SAMPLE DEPTH	LAB CLASSIF. #	1	0.0 - 1.0	SH	3	1.9 - 2.5	SR	5	3.4 - 4.4	SH			
SAMPLE NO.	SAMPLE DEPTH	LAB CLASSIF. #																
1	0.0 - 1.0	SH																
3	1.9 - 2.5	SR																
5	3.4 - 4.4	SH																
			*Lab classification based on gradation curve with no Atterberg Limits.															
						-7.5 -10 -12.5 -15 -17.5 -20 -22.5												

ENG FORM 1930 PREVIOUS EDITIONS ARE OBSOLETE. MAR 71	PROJECT Canaveral Harbor	HOLE NUMBER CB-CH01-9
---	-----------------------------	--------------------------

Hole No. CB-CH01-10

<b>DRILLING LOG</b>		DIVISION South Atlantic	INSTALLATION Jacksonville District	SHEET OF 1
1. PROJECT Canaveral Harbor		10. SIZE AND TYPE OF BIT 4-inch Vibracore Tube		
2. LOCATION (Coordinates or Station) X=788,207 Y=1481,660		11. DATUM FOR ELEVATION SHOWN (TBM or MSL) NGVD 29; Horizontal Datum: FLE NAD 83		
3. DRILLING AGENCY USAED Wilmington		12. MANUFACTURER'S DESIGNATION OF DRILL Vibracore		
4. HOLE NO. (As shown on drawing title and file number) CB-CH01-10		13. TOTAL NO. OF OVERBURDEN SAMPLES TAKEN disturbed: 2 undisturbed: 0		
5. NAME OF DRILLER Sneil		14. TOTAL NUMBER OF CORE BOXES 1		
6. DIRECTION OF HOLE <input checked="" type="checkbox"/> VERTICAL <input type="checkbox"/> INCLINED		15. ELEVATION GROUND WATER 3.1		
7. THICKNESS OF BURDEN 0 Ft.		16. DATE HOLE STARTED COMPLETED 7/4/01 7/4/01		
8. DEPTH DRILLED INTO ROCK 0 Ft.		17. ELEVATION TOP OF HOLE -45.1 Ft.		
9. TOTAL DEPTH OF HOLE 5.7 Ft.		18. TOTAL CORE RECOVERY FOR BORING 51 %		
19. SIGNATURE OF Civil Engineer Trey Broughton (LAW)				

ELEV.	DEPTH	LEGEND	CLASSIFICATION OF MATERIALS (Description)	CORE REC %	SAMPLE NUMBER	REMARKS
-45.1	0					-45.1
			SILT, some fine quartz sand, dark gray to gray (MH)	51	1	
-49.3	4.2		SAND, fine quartz, trace silt, gray (SP)		2	
-50.8	5.7		SOILS ARE FIELD VISUALLY CLASSIFIED IN ACCORDANCE WITH THE UNIFIED SOILS CLASSIFICATION SYSTEM.  NOTE: Elevation is based on furnished tide and water depth information.  SAMPLE NO. 2      SAMPLE DEPTH 4.2 - 5.7      LAB CLASSIF. # SK  *Lab classification based on gradation curve with no Atterberg Limits.			-50.8 Vibracore tubes split and logged by Law Engineering and Environmental Services, Inc., Jacksonville, Florida.

Hole No. CB-CH01-11

<b>DRILLING LOG</b>		DIVISION South Atlantic	INSTALLATION Jacksonville District	SHEET 1 OF 1
1. PROJECT Canaveral Harbor		10. SIZE AND TYPE OF BIT 4-inch Vibracore Tube		
2. LOCATION (Coordinates or Station) X=789,214 Y=1482,079		11. DATUM FOR ELEVATION SHOWN (TEN or HSL) NGVD 29; Horizontal Datum: FLE NAD 83		
3. DRILLING AGENCY USAED Wilmington		12. MANUFACTURER'S DESIGNATION OF DRILL Vibracore		
4. HOLE NO. (As shown on drawing title and file number) CB-CH01-11		13. TOTAL NO. OF OVERBURDEN SAMPLES TAKEN disturbed: 2 undisturbed: 0		
5. NAME OF DRILLER Shell		14. TOTAL NUMBER OF CORE BOXES 1		
6. DIRECTION OF HOLE <input checked="" type="checkbox"/> VERTICAL <input type="checkbox"/> INCLINED		15. ELEVATION GROUND WATER 2.4		
7. THICKNESS OF BURDEN 0 Ft.		16. DATE HOLE STARTED COMPLETED 7/3/01 7/3/01		
8. DEPTH DRILLED INTO ROCK 0 Ft.		17. ELEVATION TOP OF HOLE -49.0 Ft.		
9. TOTAL DEPTH OF HOLE 6.1 Ft.		18. TOTAL CORE RECOVERY FOR BORING 55 %		
		19. SIGNATURE OF Civil Engineer Trey Broughton (LAW)		

ELEV.	DEPTH	LEGEND	CLASSIFICATION OF MATERIALS (Description)	CORE REC %	SAMPLE NUMBER	REMARKS Vibracore
-49.0	0					-49.0
			SILT, some fine quartz sand, dark gray (MH)		1	
-52.0	3.0		CLAY, little fine quartz sand, gray (CH)	55	2	
-55.1	6.1		SOILS ARE FIELD VISUALLY CLASSIFIED IN ACCORDANCE WITH THE UNIFIED SOILS CLASSIFICATION SYSTEM.  NOTE: Elevation is based on furnished tide and water depth information.  SAMPLE    SAMPLE    LAB NO.        DEPTH     CLASSIF. 1         0.0 - 3.0    MH  *Lab classification based on gradation curve with no Atterberg Limits.			Vibracore tubes split and logged by Law Engineering and Environmental Services, Inc., Jacksonville, Florida.

Hole No. CB-CH01-12

<b>DRILLING LOG</b>		DIVISION South Atlantic	INSTALLATION Jacksonville District	SHEET 1 OF 1
1. PROJECT Canaveral Harbor		10. SIZE AND TYPE OF BIT 4-inch Vibracore Tube		
2. LOCATION (Coordinates of Station) X=789,212 Y=1481,866		11. DATUM FOR ELEVATION SHOWN (TBM or NSL) NGVD 29; Horizontal Datum: FLE NAD 83		
3. DRILLING AGENCY USAED Wilmington		12. MANUFACTURER'S DESIGNATION OF DRILL Vibracore		
4. HOLE NO. (As shown on drawing title and file number) CB-CH01-12		13. TOTAL NO. OF OVERBURDEN SAMPLES TAKEN disturbed: 3 undisturbed: 0		
5. NAME OF DRILLER Shell		14. TOTAL NUMBER OF CORE BOXES 1		
6. DIRECTION OF HOLE <input checked="" type="checkbox"/> VERTICAL <input type="checkbox"/> INCLINED		15. ELEVATION GROUND WATER 3.3		
7. THICKNESS OF BURDEN 0 Ft.		16. DATE HOLE STARTED COMPLETED 7/3/01 7/3/01		
8. DEPTH DRILLED INTO ROCK 0 Ft.		17. ELEVATION TOP OF HOLE -49.5 Ft.		
9. TOTAL DEPTH OF HOLE 7.1 Ft.		18. TOTAL CORE RECOVERY FOR BORING 70 %		
		19. SIGNATURE OF Civil Engineer Trey Broughton (LAW)		

ELEV.	DEPTH	LEGEND	CLASSIFICATION OF MATERIALS (Description)	CORE REC %	SAMPLE NUMBER	REMARKS Vibracore
-49.5	0					-49.5
-51.2	1.7		SILT, some fine quartz sand, dark gray (MH)		1	
-53.5	4.0		SAND, fine quartz, gray (SP)	70	2	
-56.6	7.1		CLAY, little fine quartz sand, gray (CH)		3	
			SOILS ARE FIELD VISUALLY CLASSIFIED IN ACCORDANCE WITH THE UNIFIED SOILS CLASSIFICATION SYSTEM.  NOTE: Elevation is based on furnished tide and water depth information.  SAMPLE NO.    SAMPLE DEPTH    LAB CLASSIF. # 1            0.0 - 1.7    MH 2            1.7 - 4.0    SH  *Lab Classification based on gradation curve with no Atterberg Limits.			Vibracore tubes split and logged by Law Engineering and Environmental Services, Inc., Jacksonville, Florida.

DRILLING LOG		DIVISION South Atlantic	INSTALLATION Jacksonville District	SHEET 1 OF 1
1. PROJECT Canaveral Harbor		10. SIZE AND TYPE OF BIT 4-inch Vibracore Tube		
2. LOCATION (Coordinates of Station) X=789,229 Y=1481,683		11. DATUM FOR ELEVATION SHOWN (TBM or HSL) NGVD 29; Horizontal Datum: FLE NAD 83		
3. DRILLING AGENCY USAED Wilmington		12. MANUFACTURER'S DESIGNATION OF DRILL Vibracore		
4. HOLE NO. (As shown on drawing title and file number) CB-CH01-13		13. TOTAL NO. OF OVERBURDEN SAMPLES TAKEN disturbed: 3 undisturbed: 0		
5. NAME OF DRILLER Snell		14. TOTAL NUMBER OF CORE BOXES 1		
6. DIRECTION OF HOLE <input checked="" type="checkbox"/> VERTICAL <input type="checkbox"/> INCLINED		15. ELEVATION GROUND WATER 1.8		
7. THICKNESS OF BURDEN 0 Ft.		16. DATE HOLE STARTED COMPLETED 7/3/01 7/3/01		
8. DEPTH DRILLED INTO ROCK 0 Ft.		17. ELEVATION TOP OF HOLE -48.7 Ft.		
9. TOTAL DEPTH OF HOLE 7.9 Ft.		18. TOTAL CORE RECOVERY FOR BORING 75 %		
		19. SIGNATURE OF Civil Engineer Trey Broughton (LAW)		

ELEV.	DEPTH	LEGEND	CLASSIFICATION OF MATERIALS (Description)	CORE REC X	LI SAMPLE NUMBER	REMARKS Vibracore									
-48.7	0					-48.7									
-49.5	0.8		SILT, little fine quartz sand, dark gray (MH)		1										
		.....	SAND, fine quartz, little silt, gray (SP-SM)		2										
				75											
-53.2	4.5		CLAY, some fine quartz sand, gray (CH)		3										
-56.6	7.9					-56.6									
			SOILS ARE FIELD VISUALLY CLASSIFIED IN ACCORDANCE WITH THE UNIFIED SOILS CLASSIFICATION SYSTEM.												
			NOTE: Elevation is based on furnished tide and water depth information.												
			<table style="font-size: small; border: none;"> <tr> <td>SAMPLE NO.</td> <td>SAMPLE DEPTH</td> <td>LAB CLASSIF. #</td> </tr> <tr> <td>1</td> <td>0.0 - 0.8</td> <td>SH</td> </tr> <tr> <td>2</td> <td>0.8 - 4.5</td> <td>SP-SM</td> </tr> </table>	SAMPLE NO.	SAMPLE DEPTH	LAB CLASSIF. #	1	0.0 - 0.8	SH	2	0.8 - 4.5	SP-SM			
SAMPLE NO.	SAMPLE DEPTH	LAB CLASSIF. #													
1	0.0 - 0.8	SH													
2	0.8 - 4.5	SP-SM													
			*Lab classification based on gradation curve with no Atterberg Limits.												
			Vibracore tubes split and logged by Law Engineering and Environmental Services, Inc., Jacksonville, Florida.												

ENG FORM 1630 PREVIOUS EDITIONS ARE OBSOLETE. MAR 71	PROJECT Canaveral Harbor	HOLE NUMBER CB-CH01-13
---	-----------------------------	---------------------------



Hole No. CB-CH01-14

<b>DRILLING LOG</b>		DIVISION South Atlantic	INSTALLATION Jacksonville District	SHEET 1 OF 1
1. PROJECT Canaveral Harbor		10. SIZE AND TYPE OF BIT 4-inch Vibracore Tube		
2. LOCATION (Coordinates or Station) X=790,206 Y=1482,071		11. DATUM FOR ELEVATION SHOWN (TBM or HSL) NGVD 29; Horizontal Datum: FLE NAD 83		
3. DRILLING AGENCY USAED Wilmington		12. MANUFACTURER'S DESIGNATION OF DRILL Vibracore		
4. HOLE NO. (As shown on drawing title and file number) CB-CH01-14		13. TOTAL NO. OF OVERBURDEN SAMPLES TAKEN disturbed: 2 undisturbed: 0		
5. NAME OF DRILLER Snel		14. TOTAL NUMBER OF CORE BOXES 1		
6. DIRECTION OF HOLE <input checked="" type="checkbox"/> VERTICAL <input type="checkbox"/> INCLINED		15. ELEVATION GROUND WATER 1.4		
7. THICKNESS OF BURDEN 0 Ft.		16. DATE HOLE STARTED COMPLETED 7/3/01 7/3/01		
8. DEPTH DRILLED INTO ROCK 0 Ft.		17. ELEVATION TOP OF HOLE -46.3 Ft.		
9. TOTAL DEPTH OF HOLE 5.5 Ft.		18. TOTAL CORE RECOVERY FOR BORING 45 %		
		19. SIGNATURE OF CIVIL Engineer Trey Broughton (LAW)		



ELEV.	DEPTH	LEGEND	CLASSIFICATION OF MATERIALS (Description)	CORE REC %	SAMPLE NUMBER	REMARKS
-46.3	.0					-46.3
			SAND, fine quartz, gray (SP)	45	1	
-50.3	4.0		CLAY, little fine quartz sand, gray (CH)		2	
-51.8	5.5		SOILS ARE FIELD VISUALLY CLASSIFIED IN ACCORDANCE WITH THE UNIFIED SOILS CLASSIFICATION SYSTEM.  NOTE: Elevation is based on furnished tide and water depth information.  SAMPLE NO. 1 SAMPLE DEPTH 0.0 - 4.0 LAB CLASSIF. # SP-SH  *Lab classification based on gradation curve with no Atterberg Limits.			-51.8 Vibracore tubes split and logged by Law Engineering and Environmental Services, Inc., Jacksonville, Florida.

Hole No. CB-CH01-15

<b>DRILLING LOG</b>		DIVISION South Atlantic	INSTALLATION Jacksonville District	SHEET 1 OF 1
1. PROJECT Canaveral Harbor		10. SIZE AND TYPE OF BIT 4-inch Vibracore Tube		
2. LOCATION (Coordinates or Station) X=790,214 Y=1481,878		11. DATUM FOR ELEVATION SHOWN (TBM or MSL) NGVD 29; Horizontal Datum: FLE NAD 83		
3. DRILLING AGENCY USAED Wilmington		12. MANUFACTURER'S DESIGNATION OF DRILL Vibracore		
4. HOLE NO. (As shown on drawing title and file number) CB-CH01-15		13. TOTAL NO. OF OVERBURDEN SAMPLES TAKEN disturbed: 1 undisturbed: 0		
5. NAME OF DRILLER Snell		14. TOTAL NUMBER OF CORE BOXES 1		
6. DIRECTION OF HOLE <input checked="" type="checkbox"/> VERTICAL <input type="checkbox"/> INCLINED		15. ELEVATION GROUND WATER 1.1		
7. THICKNESS OF BURDEN 0 Ft.		16. DATE HOLE STARTED COMPLETED 7/3/01 7/3/01		
8. DEPTH DRILLED INTO ROCK 0 Ft.		17. ELEVATION TOP OF HOLE -46.7 Ft.		
9. TOTAL DEPTH OF HOLE 8.3 Ft.		18. TOTAL CORE RECOVERY FOR BORING 59 %		
		19. SIGNATURE OF Civil Engineer Trey Broughton (LAW)		

ELEV.	DEPTH	LEGEND	CLASSIFICATION OF MATERIALS (Description)	CORE REC %	LOG SAMPLE NUMBER	REMARKS Vibracore
-46.7	0		SAND, fine quartz, trace silt, gray (SP)			-46.7
				59	1	
-53.0	6.3		SOILS ARE FIELD VISUALLY CLASSIFIED IN ACCORDANCE WITH THE UNIFIED SOILS CLASSIFICATION SYSTEM.  NOTE: Elevation is based on furnished tide and water depth information.  SAMPLE NO. 1      SAMPLE DEPTH 0.0 - 6.3      LAB CLASSIF. # SM			-53.0
			Lab classification based on gradation curve with no Atterberg Limits.			Vibracore tubes split and logged by Law Engineering and Environmental Services, Inc., Jacksonville, Florida.

<b>DRILLING LOG</b>		DIVISION South Atlantic	INSTALLATION Jacksonville District	SHEET 1 OF 1
1. PROJECT Canaveral Harbor		10. SIZE AND TYPE OF BIT 4-inch Vibracore Tube		
2. LOCATION (Coordinates or Station) X=790,280 Y=1481,614		11. DATUM FOR ELEVATION SHOWN (TBM or MSL) NGVD 29; Horizontal Datum: FLE NAD 83		
3. DRILLING AGENCY USAED Wilmington		12. MANUFACTURER'S DESIGNATION OF DRILL Vibracore		
4. HOLE NO. (As shown on drawing title and file number) CB-CH01-16		13. TOTAL NO. OF OVERBURDEN SAMPLES TAKEN disturbed: 3 undisturbed: 0		
5. NAME OF DRILLER Snell		14. TOTAL NUMBER OF CORE BOXES 1		
6. DIRECTION OF HOLE <input checked="" type="checkbox"/> VERTICAL <input type="checkbox"/> INCLINED		15. ELEVATION GROUND WATER 0.9		
7. THICKNESS OF BURDEN 0 Ft.		16. DATE HOLE STARTED COMPLETED 7/3/01 7/3/01		
8. DEPTH DRILLED INTO ROCK 0 Ft.		17. ELEVATION TOP OF HOLE -41.1 Ft.		
9. TOTAL DEPTH OF HOLE 7.1 Ft.		18. TOTAL CORE RECOVERY FOR BORING 67 %		
		19. SIGNATURE OF CWR Engineer Trey Broughton (LAW)		

ELEV.	DEPTH	LEGEND	CLASSIFICATION OF MATERIALS (Description)	CORE REC %	SAMPLE NUMBER	REMARKS Vibracore
-41.1	0					-41.1
			CLAY, little fine quartz sand, gray (CH)		1	
-44.4	3.3		SAND, fine quartz, little silt, dark gray (SP-SM)	67	2	
-46.1	5.0		SILT, trace fine quartz sand, dark gray (MH)		3	
-48.2	7.1		SOILS ARE FIELD VISUALLY CLASSIFIED IN ACCORDANCE WITH THE UNIFIED SOILS CLASSIFICATION SYSTEM.  NOTE: Elevation is based on furnished tide and water depth information.  SAMPLE NO.    SAMPLE DEPTH    LAB CLASSIF. # 1            0.0 - 3.3    CR 2            3.3 - 5.0    SM  *Lab classification based on gradation curve with no Atterberg Limits.			Vibracore tubes split and logged by Law Engineering and Environmental Services, Inc., Jacksonville, Florida.

Hole No. CB-CH01-17

<b>DRILLING LOG</b>		DIVISION South Atlantic	INSTALLATION Jacksonville District	SHEET 1 OF 1
1. PROJECT Canaveral Harbor		10. SIZE AND TYPE OF BIT 4-Inch Vibracore Tube		
2. LOCATION (Coordinates or Station) X=791,271 Y=1482,060		11. DATUM FOR ELEVATION SHOWN (TBM or HSL) NGVD 29; Horizontal Datum: FLE NAD 83		
3. DRILLING AGENCY USAED Wilmington		12. MANUFACTURER'S DESIGNATION OF DRILL Vibracore		
4. HOLE NO. (As shown on drawing title and file number) CB-CH01-17		13. TOTAL NO. OF OVERBURDEN SAMPLES TAKEN disturbed: 1 undisturbed: 0		
5. NAME OF DRILLER Snell		14. TOTAL NUMBER OF CORE BOXES 1		
6. DIRECTION OF HOLE <input checked="" type="checkbox"/> VERTICAL <input type="checkbox"/> INCLINED		15. ELEVATION GROUND WATER 0.6		
7. THICKNESS OF BURDEN 0 Ft.		16. DATE HOLE STARTED COMPLETED 7/3/01 7/3/01		
8. DEPTH DRILLED INTO ROCK 0 Ft.		17. ELEVATION TOP OF HOLE -44.6 Ft.		
9. TOTAL DEPTH OF HOLE 5.3 Ft.		18. TOTAL CORE RECOVERY FOR BORING 27 %		
		19. SIGNATURE OF Civil Engineer Trey Broughton (LAW)		

ELEV.	DEPTH	LEGEND	CLASSIFICATION OF MATERIALS (Description)	CORE REC %	W. SAMPLE NUMBER	REMARKS
-44.6	0		SILT, little fine quartz sand, dark gray to gray (MH)	27	1	Vibracore
-49.9	5.3		SOILS ARE FIELD VISUALLY CLASSIFIED IN ACCORDANCE WITH THE UNIFIED SOILS CLASSIFICATION SYSTEM.  NOTE: Elevation is based on furnished tide and water depth information.  SAMPLE NO. 1 SAMPLE DEPTH 0.0 - 5.3 LAB CLASSIF. # MH  *Lab classification based on gradation curve with no Atterberg Limits.			Vibracore tubes split and logged by Law Engineering and Environmental Services, Inc., Jacksonville, Florida.

Hole No. CB-CHO1-18

<b>DRILLING LOG</b>		DIVISION South Atlantic	INSTALLATION Jacksonville District	SHEET 1 OF 1
1. PROJECT Canaveral Harbor		10. SIZE AND TYPE OF BIT 4-inch Vibracore Tube		
2. LOCATION (Coordinates or Station) X=791,212 Y=1481,880		11. DATUM FOR ELEVATION SHOWN (TBM or MSL) NGVD 29; Horizontal Datum: FLE NAD 83		
3. DRILLING AGENCY USACE Wilmington		12. MANUFACTURER'S DESIGNATION OF GRILL Vibracore		
4. HOLE NO., TAG shown on drawing title and file number CB-CHO1-18		13. TOTAL NO. OF OVERBURDEN SAMPLES TAKEN disturbed: 3 undisturbed: 0		
5. NAME OF DRILLER Snell		14. TOTAL NUMBER OF CORE BOXES 2		
6. DIRECTION OF HOLE <input checked="" type="checkbox"/> VERTICAL <input type="checkbox"/> INCLINED		15. ELEVATION GROUND WATER 0.4		
7. THICKNESS OF BURDEN 0 Ft.		16. DATE HOLE STARTED COMPLETED 7/3/01 7/3/01		
8. DEPTH DRILLED INTO ROCK 0 Ft.		17. ELEVATION TOP OF HOLE -41.1 Ft.		
9. TOTAL DEPTH OF HOLE 11.8 Ft.		18. TOTAL CORE RECOVERY FOR BORING 60 %		
19. SIGNATURE OF Civil Engineer Trey Broughton (LAW)				

ELEV.	DEPTH	LEGEND	CLASSIFICATION OF MATERIALS (Description)	CORE REC %	SAMPLE NUMBER	REMARKS Vibracore
-41.1	0		SILT, little fine quartz sand, dark gray to gray (MH)		1	
-44.1	3.0		CLAY, little fine quartz sand, gray (CH)	60	2	
-48.6	7.5		SAND, fine quartz, some clay, some fine gravel sized shell fragments, gray (SC)		3	
-52.9	11.8		SOILS ARE FIELD VISUALLY CLASSIFIED IN ACCORDANCE WITH THE UNIFIED SOILS CLASSIFICATION SYSTEM.  NOTE: Elevation is based on furnished tide and water depth information.  SAMPLE NO.    SAMPLE DEPTH    LAB CLASSIF. # 1            0.0 - 3.0        MH 3            7.5 - 11.8        CH  *Lab classification based on gradation curve with no Atterberg Limits.			Vibracore tubes split and logged by Law Engineering and Environmental Services, Inc., Jacksonville, Florida.

Hole No. CB-CH01-19

DRILLING LOG		DIVISION	INSTALLATION	SHEET 1 OF 1		
1. PROJECT Canaveral Harbor		South Atlantic	Jacksonville District	10. SIZE AND TYPE OF BIT 4-inch Vibracore Tube		
2. LOCATION (Coordinates or Station) X=791,242 Y=1481,601				11. DATUM FOR ELEVATION SHOWN (TBM or MSL) NGVD 29; Horizontal Datum: FLE NAD 83		
3. DRILLING AGENCY USAED Wilmington				12. MANUFACTURER'S DESIGNATION OF DRILL Vibracore		
4. HOLE NO. (As shown on drawing title and file number) CB-CH01-19				13. TOTAL NO. OF OVERBURDEN SAMPLES TAKEN disturbed: 2 undisturbed: 0		
5. NAME OF DRILLER Shell				14. TOTAL NUMBER OF CORE BOXES 1		
6. DIRECTION OF HOLE <input checked="" type="checkbox"/> VERTICAL <input type="checkbox"/> INCLINED				15. ELEVATION GROUND WATER 0.2		
7. THICKNESS OF BURDEN 0 Ft.				16. DATE HOLE STARTED COMPLETED 7/3/01 7/3/01		
8. DEPTH DRILLED INTO ROCK 0 Ft.				17. ELEVATION TOP OF HOLE -41.8 Ft.		
9. TOTAL DEPTH OF HOLE 9.8 Ft.				18. TOTAL CORE RECOVERY FOR BORING 93 %		
				19. SIGNATURE OF Civil Engineer Trey Broughton (LAW)		
ELEV.	DEPTH	LEGEND	CLASSIFICATION OF MATERIALS (Description)	CORE REC %	SAMPLE NUMBER	REMARKS Vibracore
-41.8	.0		SILT, dark gray (MH)		1	-41.8
-43.6	1.8		CLAY, little fine quartz sand, gray (CH)	93	2	
-51.6	9.8		SOILS ARE FIELD VISUALLY CLASSIFIED IN ACCORDANCE WITH THE UNIFIED SOILS CLASSIFICATION SYSTEM.  NOTE: Elevation is based on furnished tide and water depth information.  SAMPLE    SAMPLE    LAB NO.        DEPTH        CLASSIF. W 1        0.0 - 1.8    MH 2        1.8 - 9.8    CH  *Lab classification based on gradation curve with no Atterberg Limits.			-51.6
						Vibracore tubes split and logged by Law Engineering and Environmental Services, Inc., Jacksonville, Florida.

Hole No. CB-CH01-20

DRILLING LOG		DIVISION South Atlantic	INSTALLATION Jacksonville District	SHEET 1 OF 1		
1. PROJECT Canaveral Harbor		10. SIZE AND TYPE OF BIT 4-inch Vibracore Tube				
2. LOCATION (Coordinates or Station) X=792,847 Y=1482,063		11. DATUM FOR ELEVATION SHOWN (TBM or MSL) NGVD 29; Horizontal Datum: FLE NAD 83				
3. DRILLING AGENCY USAEG Wilmington		12. MANUFACTURER'S DESIGNATION OF DRILL Vibracore				
4. HOLE NO. (As shown on drawing title and file number) CB-CH01-20		13. TOTAL NO. OF OVERBURDEN SAMPLES TAKEN disturbed: 3 undisturbed: 0				
5. NAME OF DRILLER Shell		14. TOTAL NUMBER OF CORE BOXES 2				
6. DIRECTION OF HOLE <input checked="" type="checkbox"/> VERTICAL <input type="checkbox"/> INCLINED		15. ELEVATION GROUND WATER				
7. THICKNESS OF BURDEN 0 Ft.		16. DATE HOLE STARTED COMPLETED 7/3/01 7/3/01				
8. DEPTH DRILLED INTO ROCK 0 Ft.		17. ELEVATION TOP OF HOLE -43.8 Ft.				
9. TOTAL DEPTH OF HOLE 12.3 Ft.		18. TOTAL CORE RECOVERY FOR BORING 61 %				
		19. SIGNATURE OF Civil Engineer Trey Broughton (LAW)				
ELEV.	DEPTH	LEGEND	CLASSIFICATION OF MATERIALS (Description)	CORE REC %	US SAMPLE NUMBER	REMARKS Vibracore
-43.8	0		SILT, little fine quartz sand, dark gray (MH)		1	-43.8
-47.3	3.5		SAND, fine quartz, gray (SP)		2	
-47.9	4.1		SAND, fine quartz, little clay, little fine gravel sized shell fragments, gray (SP-SC)	61	3	
-56.1	12.3		SOILS ARE FIELD VISUALLY CLASSIFIED IN ACCORDANCE WITH THE UNIFIED SOILS CLASSIFICATION SYSTEM.  NOTE: Elevation is based on furnished tide and water depth information.  SAMPLE NO.    SAMPLE DEPTH    LAB CLASSIF. * 2            3.5 - 4.1        NH 3            4.1 - 12.3        CH  *Lab classification based on gradation curve with no Atterberg Limits.			-56.1
						Vibracore tubes split and logged by Law Engineering and Environmental Services, Inc., Jacksonville, Florida.

Hole No. CB-CH01-21

<b>DRILLING LOG</b>		DIVISION South Atlantic	INSTALLATION Jacksonville District	SHEET 7 OF 1
1. PROJECT Canaveral Harbor		10. SIZE AND TYPE OF BIT 4-inch Vibracore Tube		
2. LOCATION (Coordinates or Station) X=792,792 Y=1481,769		11. DATUM FOR ELEVATION SHOWN (TBM or NSL) NGVD 29; Horizontal Datum: FLE NAD 83		
3. DRILLING AGENCY USAED Wilmington		12. MANUFACTURER'S DESIGNATION OF DRILL Vibracore		
4. HOLE NO. (As shown on drawing title and file number) CB-CH01-21		13. TOTAL NO. OF OVERBURDEN SAMPLES TAKEN disturbed: 2 undisturbed: 0		
5. NAME OF DRILLER Snell		14. TOTAL NUMBER OF CORE BOXES 2		
6. DIRECTION OF HOLE <input checked="" type="checkbox"/> VERTICAL <input type="checkbox"/> INCLINED		15. ELEVATION GROUND WATER 0.1		
7. THICKNESS OF BURDEN 0 Ft.		16. DATE HOLE STARTED COMPLETED 7/3/01 7/3/01		
8. DEPTH DRILLED INTO ROCK 0 Ft.		17. ELEVATION TOP OF HOLE -44.9 Ft.		
9. TOTAL DEPTH OF HOLE 11.0 Ft.		18. SIGNATURE OF Civil Engineer Trey Broughton (LAW)		

ELEV.	DEPTH	LEGEND	CLASSIFICATION OF MATERIALS (Description)	CORE REC %	US SAMPLE NUMBER	REMARKS Vibracore
-44.9	0		SILT, dark gray (MH)		1	
-47.6	2.7		SAND, fine quartz, some silt, some fine gravel sized shell fragments, gray (SM)	55	2	
-55.9	11.0		SOILS ARE FIELD VISUALLY CLASSIFIED IN ACCORDANCE WITH THE UNIFIED SOILS CLASSIFICATION SYSTEM.  NOTE: Elevation is based on furnished tide and water depth information.  SAMPLE NO.      SAMPLE DEPTH      LAB CLASSIF. # 1                  0.0 - 2.7      MH 2                  2.7 - 11.0      SM  *Lab classification based on gradation curve with no Atterberg Limits.			Vibracore tubes split and logged by Law Engineering and Environmental Services, Inc., Jacksonville, Florida.



Hole No. CB-CH01-22

ELEV. DEPTH		LEGEND	CLASSIFICATION OF MATERIALS (Description)	CORE REC X	SAMPLE NUMBER	REMARKS									
-43.5	0					-43.5									
-45.9	2.4		SILT, some fine quartz sand, dark gray (MH)		1										
-56.2	12.7		SAND, fine quartz, little clay, little fine gravel sized shell fragments, gray (SC)	63	2										
			SOILS ARE FIELD VISUALLY CLASSIFIED IN ACCORDANCE WITH THE UNIFIED SOILS CLASSIFICATION SYSTEM.			Vibracore tubes split and logged by Law Engineering and Environmental Services, Inc., Jacksonville, Florida.									
			NOTE: Elevation is based on furnished tide and water depth information.												
			<table border="1"> <thead> <tr> <th>SAMPLE NO.</th> <th>SAMPLE DEPTH</th> <th>LAB CLASSIF. *</th> </tr> </thead> <tbody> <tr> <td>1</td> <td>0.0 - 2.4</td> <td>MH</td> </tr> <tr> <td>2</td> <td>2.4 - 12.7</td> <td>CH</td> </tr> </tbody> </table> <p>*Lab classification based on gradation curve with no Atterberg Limits.</p>	SAMPLE NO.	SAMPLE DEPTH	LAB CLASSIF. *	1	0.0 - 2.4	MH	2	2.4 - 12.7	CH			
SAMPLE NO.	SAMPLE DEPTH	LAB CLASSIF. *													
1	0.0 - 2.4	MH													
2	2.4 - 12.7	CH													

<b>DRILLING LOG</b>	DIVISION South Atlantic	INSTALLATION Jacksonville District	SHEET 1 OF 1
1. PROJECT Canaveral Harbor	10. SIZE AND TYPE OF BIT 4-inch Vibracore Tube	11. DATUM FOR ELEVATION SHOWN (TBM or MSL) NGVD 29; Horizontal Datum: FLE NAD 83	12. MANUFACTURER'S DESIGNATION OF DRILL Vibracore
2. LOCATION (Coordinates or Station) X=792,706 Y=1481,537	13. TOTAL NO. OF OVERBURDEN SAMPLES TAKEN disturbed: 2 undisturbed: 0	14. TOTAL NUMBER OF CORE BOXES 2	15. ELEVATION GROUND WATER 0.0
3. DRILLING AGENCY USAED Wilmington	16. DATE HOLE STARTED 7/3/01	17. DATE HOLE COMPLETED 7/3/01	18. ELEVATION TOP OF HOLE -43.5 Ft.
4. HOLE NO. (As shown on drawing title and file number) CB-CH01-22	19. SIGNATURE OF Civil Engineer Trey Broughton (LAW)		
5. NAME OF DRILLER Snell			
6. DIRECTION OF HOLE <input checked="" type="checkbox"/> VERTICAL <input type="checkbox"/> INCLINED			
7. THICKNESS OF BURDEN 0 Ft.			
8. DEPTH DRILLED INTO ROCK 0 Ft.			
9. TOTAL DEPTH OF HOLE 12.7 Ft.			

Hole No. CB-CH01-23

ORILLING LOG		DIVISION South Atlantic	INSTALLATION Jacksonville District	SHEET 1 OF 1		
1. PROJECT Canaveral Harbor		10. SIZE AND TYPE OF BIT 4-inch Vibracore Tube				
2. LOCATION (Coordinates or Station) X=793,895 Y=1481,245		11. DATUM FOR ELEVATION SHOWN (TBM or MSL) NGVD 29; Horizontal Datum: FLE NAD 83				
3. DRILLING AGENCY USAED Wilmington		12. MANUFACTURER'S DESIGNATION OF DRILL Vibracore				
4. HOLE NO. (As shown on drawing title and file number) CB-CH01-23		13. TOTAL NO. OF OVERBURDEN SAMPLES TAKEN disturbed: 2      undisturbed: 0				
5. NAME OF DRILLER Snell		14. TOTAL NUMBER OF CORE BOXES 1				
6. DIRECTION OF HOLE <input checked="" type="checkbox"/> VERTICAL <input type="checkbox"/> INCLINED		15. ELEVATION GROUND WATER 0.1				
7. THICKNESS OF BURDEN 0 Ft.		16. DATE HOLE STARTED    COMPLETED 7/3/01                      7/3/01				
8. DEPTH DRILLED INTO ROCK 0 Ft.		17. ELEVATION TOP OF HOLE -43.9 Ft.				
9. TOTAL DEPTH OF HOLE 9.0 Ft.		18. TOTAL CORE RECOVERY FOR BORING 45 %				
		19. SIGNATURE OF CIVIL Engineer Trey Broughton (LAW)				
ELEV.	DEPTH	LEGEND	CLASSIFICATION OF MATERIALS (Description)	CORE REC %	SAMPLE NUMBER	REMARKS Vibracore
-43.9	0		SILT, little fine quartz sand, dark gray to gray (MH)		1	
-46.6	2.7		SAND, fine quartz, little clay, little fine gravel sized shell fragments, gray (SP-SC)	45	2	
-52.9	9.0		SOILS ARE FIELD VISUALLY CLASSIFIED IN ACCORDANCE WITH THE UNIFIED SOILS CLASSIFICATION SYSTEM.  NOTE: Elevation is based on furnished tide and water depth information.  SAMPLE NO.    SAMPLE DEPTH    LAB CLASSIF. # 1            0.0 - 2.7        MH 2            2.7 - 9.0        CH  *Lab classification based on gradation curve with no Atterberg Limits.			Vibracore tubes split and logged by Law Engineering and Environmental Services, Inc., Jacksonville, Florida.

Hole No. CB-CH01-24A

<b>DRILLING LOG</b>		DIVISION South Atlantic	INSTALLATION Jacksonville District	SHEET 1 OF 1
1. PROJECT Canaveral Harbor		10. SIZE AND TYPE OF BIT 4-inch Vibracore Tube		
2. LOCATION (Coordinates or Station) X=783,783 Y=148,148		11. DATUM FOR ELEVATION SHOWN (VEN or NSL) NGVD 29; Horizontal Datum: FLE NAD 83		
3. DRILLING AGENCY USAED Wilmington		12. MANUFACTURER'S DESIGNATION OF DRILL Vibracore		
4. HOLE NO. (As shown on drawing title and file number) CB-CH01-24A		13. TOTAL NO. OF OVERBURDEN SAMPLES TAKEN disturbed: 4 undisturbed: 0		
5. NAME OF DRILLER Snell		14. TOTAL NUMBER OF CORE BOXES 1		
6. DIRECTION OF HOLE <input checked="" type="checkbox"/> VERTICAL <input type="checkbox"/> INCLINED		15. ELEVATION GROUND WATER 0.1		
7. THICKNESS OF BURDEN 0 Ft.		16. DATE HOLE STARTED COMPLETED 7/3/01 7/3/01		
8. DEPTH DRILLED INTO ROCK 0 Ft.		17. ELEVATION TOP OF HOLE -44.9 Ft.		
9. TOTAL DEPTH OF HOLE 9.3 Ft.		18. TOTAL CORE RECOVERY FOR BORING -46 %		
		19. SIGNATURE OF Civil Engineer Trey Broughton (LAW)		

ELEV.	DEPTH	LEGEND	CLASSIFICATION OF MATERIALS (Description)	CORE REC %	SAMPLE NUMBER	REMARKS Vibracore
-44.9	0		SILT, little fine quartz sand, dark gray to gray (MH)		1	-44.9
-48.7	3.8		SAND, fine quartz, some clay, little coarse sand sized shell fragments, gray (SC)	46	2	
-52.4	7.5		SAND, fine quartz, little clay, some sand sized shell, gray (SC)		3	
-53.2	8.3		SAND, fine quartz, some calcareous silt, weakly cemented, gray (SM)		4	
-54.2	9.3		SOILS ARE FIELD VISUALLY CLASSIFIED IN ACCORDANCE WITH THE UNIFIED SOILS CLASSIFICATION SYSTEM.  NOTE: Elevation is based on furnished tide and water depth information.  SAMPLE NO.    SAMPLE DEPTH    LAB CLASSIF. # 2            3.8 - 7.5        CH 3            7.5 - 8.3        SC 4            8.3 - 9.3        ML  *Lab Classification based on gradation curve with no Atterberg Limits.			-54.2 Vibracore tubes split and logged by Law Engineering and Environmental Services, Inc., Jacksonville, Florida.

Hole No. CB-CH01-25B

DRILLING LOG		DIVISION South Atlantic	INSTALLATION Jacksonville District	SHEET 7 OF 1		
1. PROJECT Canaveral Harbor		10. SIZE AND TYPE OF BIT 4-inch Vibracore Tube				
2. LOCATION (Coordinates or Station) X=793,649 Y=1481,015		11. DATUM FOR ELEVATION SHOWN (TBM or NSL) NGVD 29; Horizontal Datum: FLE NAD 83				
3. DRILLING AGENCY USAED Wilmington		12. MANUFACTURER'S DESIGNATION OF DRILL Vibracore				
4. HOLE NO. (As shown on drawing title and file number) CB-CH01-25B		13. TOTAL NO. OF OVERBURDEN SAMPLES TAKEN disturbed: 3 undisturbed: 0				
5. NAME OF DRILLER Snell		14. TOTAL NUMBER OF CORE BOXES 1				
6. DIRECTION OF HOLE <input checked="" type="checkbox"/> VERTICAL <input type="checkbox"/> INCLINED		15. ELEVATION GROUND WATER 3.2				
7. THICKNESS OF BURDEN 0 Ft.		16. DATE HOLE STARTED COMPLETED 7/5/01 7/5/01				
8. DEPTH DRILLED INTO ROCK 0 Ft.		17. ELEVATION TOP OF HOLE -43.8 Ft.				
9. TOTAL DEPTH OF HOLE 10.4 Ft.		18. TOTAL CORE RECOVERY FOR BORING 55 %				
		19. SIGNATURE OF Civil Engineer Trey Broughton (LAW)				
ELEV.	DEPTH	LEGEND	CLASSIFICATION OF MATERIALS (Description)	CORE REC %	SAMPLE NUMBER	REMARKS Vibracore
-43.8	.0		SILT, little fine quartz sand, dark gray to gray (MH)		1	-43.8
-47.7	3.9		SAND, fine quartz, some silt, little coarse sand sized shell fragments, blue-gray (SM)	55	2	
-50.2	6.4		SAND, fine quartz, little silt, little coarse sand sized shell fragments, blue-gray (SP-SM)		3	
-54.2	10.4		SOILS ARE FIELD VISUALLY CLASSIFIED IN ACCORDANCE WITH THE UNIFIED SOILS CLASSIFICATION SYSTEM.  NOTE: Elevation is based on furnished tide and water depth information.  SAMPLE NO.    SAMPLE DEPTH    LAB CLASSIF. # 2            3.9 - 5.4            MH 3            6.4 - 10.4            MH  *Lab classification based on gradation curve with no Atterberg Limits.			Vibracore tubes split and logged by Law Engineering and Environmental Services, Inc., Jacksonville, Florida.

Hole No. CB-CH01-26C

<b>DRILLING LOG</b>		DIVISION South Atlantic	INSTALLATION Jacksonville District	SHEET 1 OF 1
1. PROJECT Canaveral Harbor		10. SIZE AND TYPE OF BIT 4-inch Vibracore Tube		
2. LOCATION (Coordinates or Station) X=794,643 Y=1480,453		11. DATUM FOR ELEVATION SHOWN (TBM or NSL) NGVD 29; Horizontal Datum: FLE NAD 83		
3. DRILLING AGENCY USAED Wilmington		12. MANUFACTURER'S DESIGNATION OF DRILL Vibracore		
4. HOLE NO. (As shown on drawing title and file number) CB-CH01-26C		13. TOTAL NO. OF OVERBURDEN SAMPLES TAKEN disturbed: 2 undisturbed: 0		
5. NAME OF DRILLER Snell		14. TOTAL NUMBER OF CORE BOXES 1		
6. DIRECTION OF HOLE <input checked="" type="checkbox"/> VERTICAL <input type="checkbox"/> INCLINED		15. ELEVATION GROUND WATER 3.1		
7. THICKNESS OF BURDEN 0 Ft.		16. DATE HOLE STARTED COMPLETED 7/5/01 7/5/01		
8. DEPTH DRILLED INTO ROCK 0 Ft.		17. ELEVATION TOP OF HOLE -44.1 Ft.		
9. TOTAL DEPTH OF HOLE 4.4 Ft.		18. TOTAL CORE RECOVERY FOR BORING 22 %		
		19. SIGNATURE OF CIVIL ENGINEER Steve Kiser (LAW)		

ELEV.	DEPTH	LEGEND	CLASSIFICATION OF MATERIALS (Description)	CORE REC %	SAMPLE NUMBER	REMARKS
-44.1	0					-44.1
			SILT, some fine quartz sand, gray (Mh)	22	1	
-47.9	3.8		SAND, fine quartz, some silt, little sand to gravel sized shell fragments, gray (SM)	2		-48.5
-48.5	4.4		SOILS ARE FIELD VISUALLY CLASSIFIED IN ACCORDANCE WITH THE UNIFIED SOILS CLASSIFICATION SYSTEM.  NOTE: Elevation is based on furnished tide and water depth information.  SAMPLE NO. DEPTH LAB CLASSIF. # 1 0.0 - 3.8 ML 2 3.8 - 4.4 SH  *Lab classification based on gradation curve with no Atterberg Limits.			Vibracore tubes split and logged by Law Engineering and Environmental Services, Inc., Jacksonville, Florida.

Appendix 4

**Historic Test Boring Logs - Ardaman**

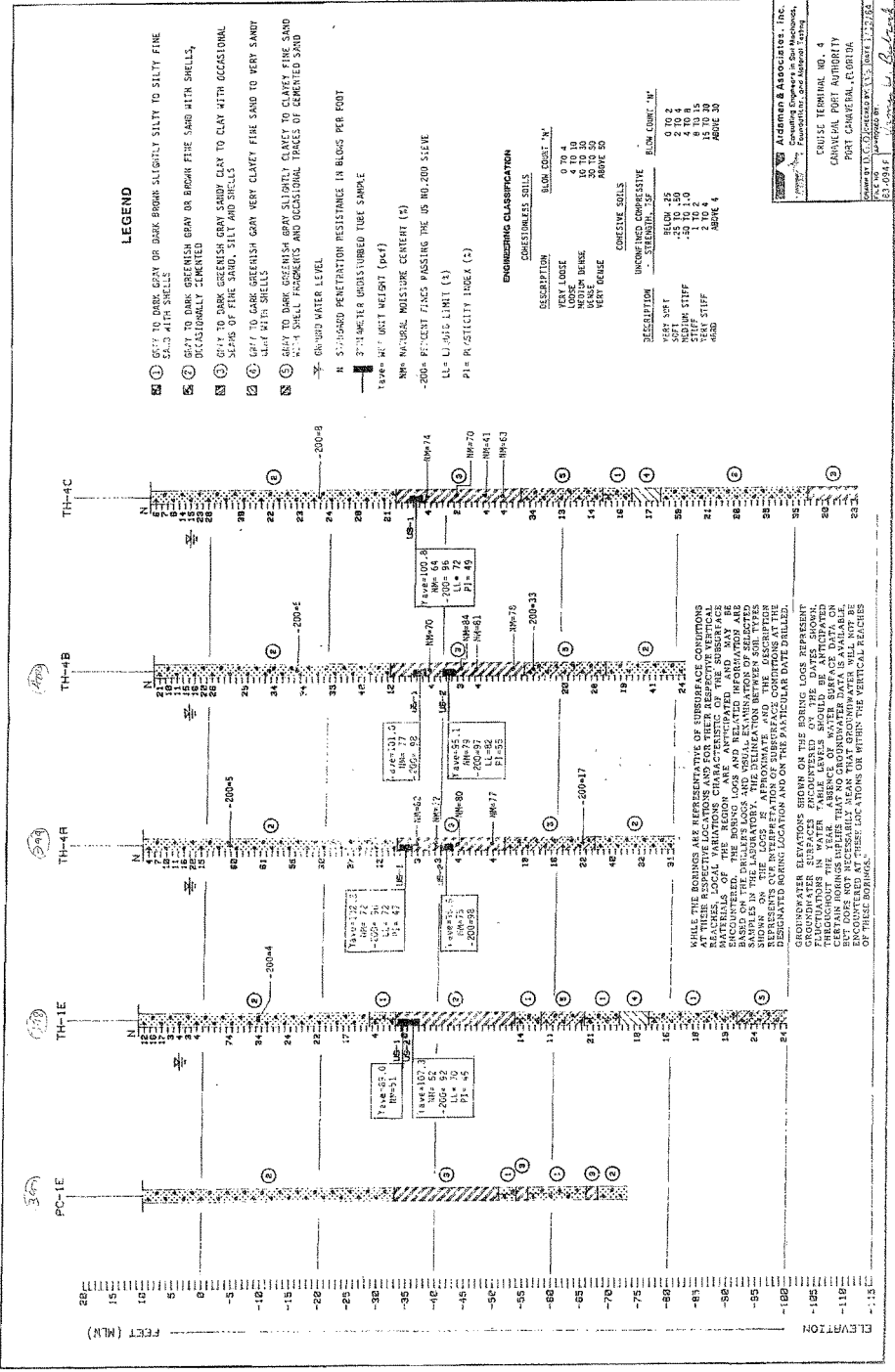







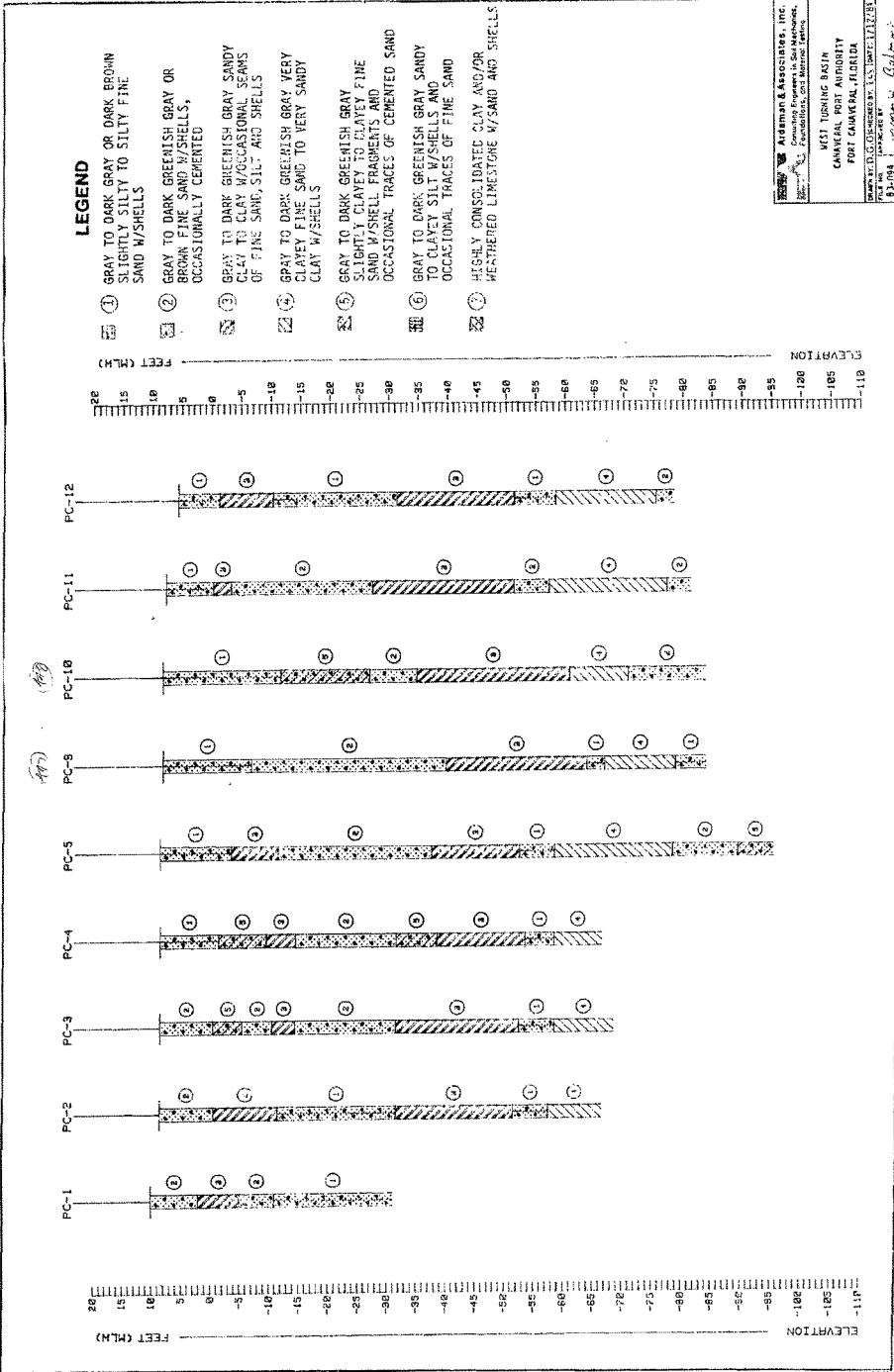

Adelman & Associates, Inc.  
 10000  
 Fort Lauderdale, Florida 33304  
 305-467-1100  
 FTS 10000  
 Fort Lauderdale, Florida 33304  
 305-467-1100  
 10000  
 Fort Lauderdale, Florida 33304  
 305-467-1100

FIGURE 2.6

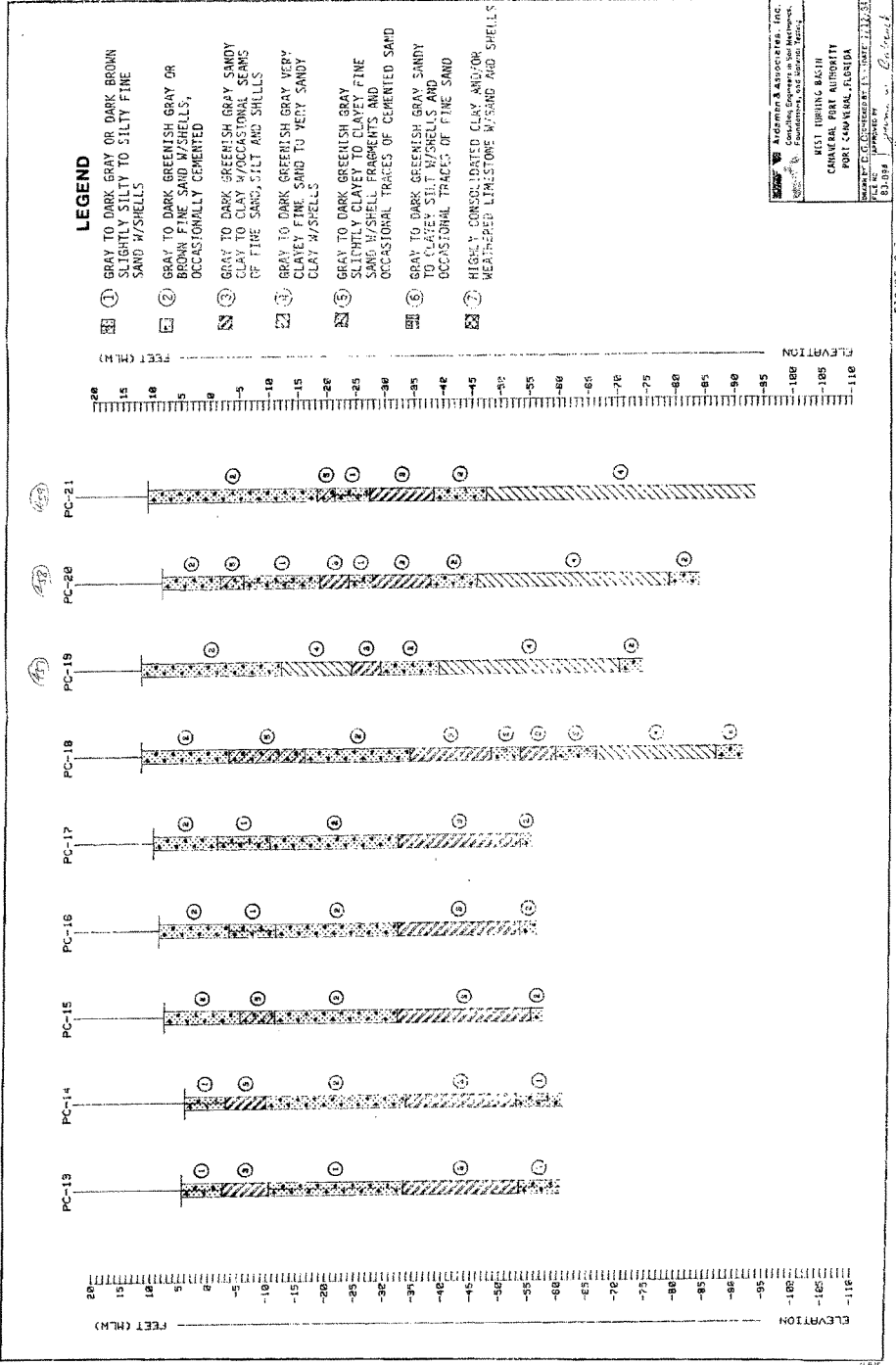

A. J. ... & Associates, Inc.  
 1103 ...  
 CHARLESTON, SOUTH CAROLINA  
 PROJECT NO. ...  
 SHEET NO. ...

FIGURE 2.7



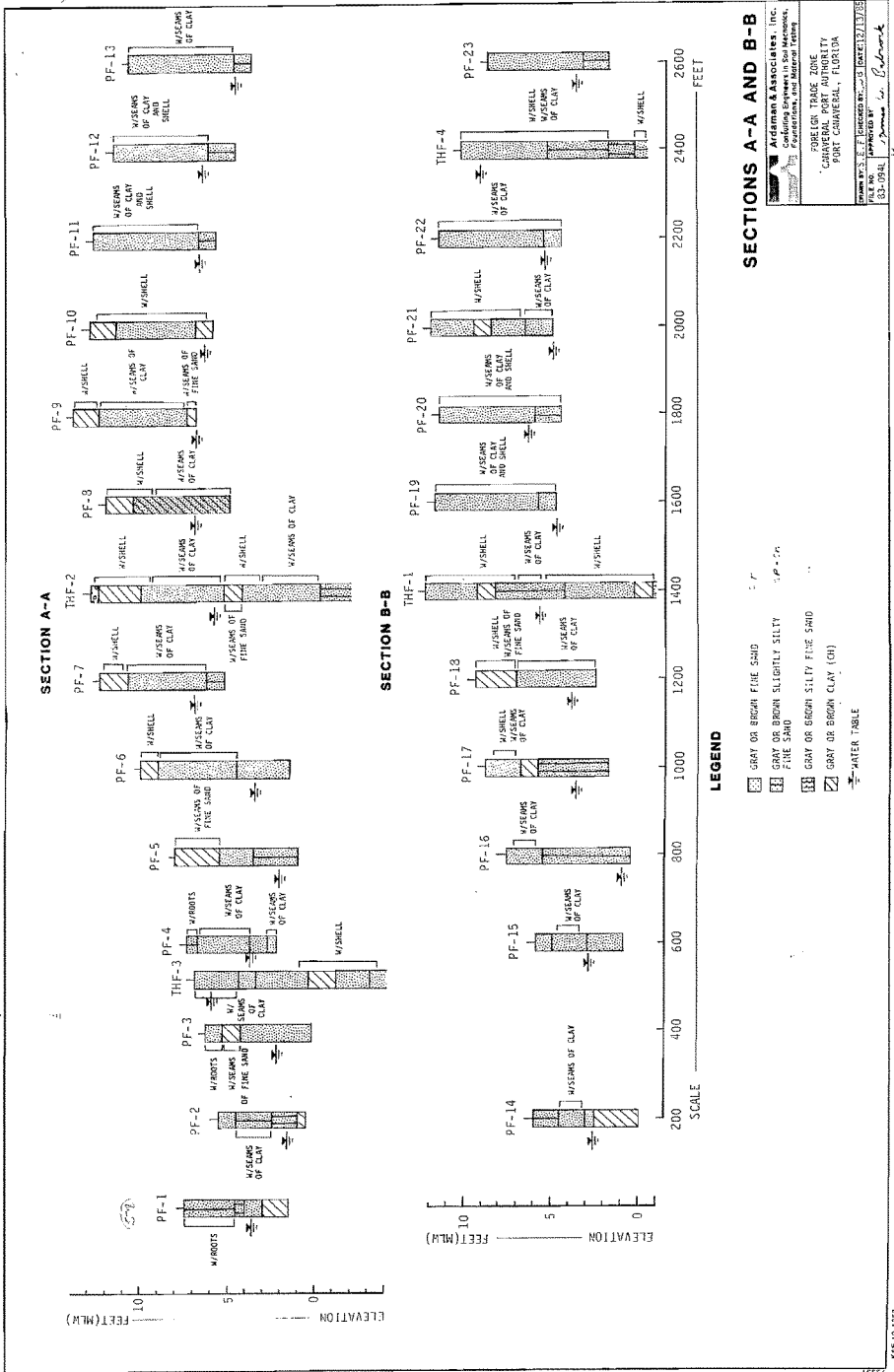

FIGURE 2





<b>BORING LOG</b>		BORING NO. TH-39
<b>ARDAMAN &amp; ASSOCIATES, INC.</b>		TOTAL DEPTH 20.0 ft
		SHEET 1 OF 1
PROJECT <u>West Turning Basin</u>		FILE NO. <u>83-094J</u>
CLIENT <u>Canaveral Port Authority, Cape Canaveral, Florida</u>		
BORING LOCATION <u>Station: 280+60 Range: -75 Port Canaveral Grid System</u>		
COUNTY <u>Brevard</u> STATE <u>Florida</u> ELEVATION <u>-18.0 feet (MLW)</u>		
DATE STARTED <u>8-3-85</u> DATE COMPLETED <u>8-3-85</u> BORING TYPE <u>SPT - 140 lb hammer, 30" drop, 2" OD</u>		
DRILLER/RIG <u>Jones/CME-45</u> LENGTH/TYPE CASING <u>30.0 feet/3" diameter</u>		
WATER TABLE DEPTH: 1st <u>Tidal</u> DATE <u>8-3-85</u> TIME _____		
2nd _____ DATE _____ TIME _____		
REMARKS _____		

Meters	Feet	Standard Penetration Test ASTM D-1586		Lab Data			Soil Description and Remarks (Unified Classification)	Elevation Feet(MLW)
		Blows/6"	N Value	Sample No.	-200 (%)	LL (%)		
1	3-4	8	1				Gray slightly silty fine sand (SP-SM)	-18.0
	4-6							
2	4-5	12	2				Gray clayey fine sand to sandy clay (SC) (CH)	-25.0
	7-8							
3	5-5	10	3				Brown silty fine sand (SM)	-27.0
	5-4							
4	4-4	7	4	29	37	22	Gray silty fine sand with shell (SM)	-30.0
	3-2							
5	1-1	2	5				Boring terminated at -38.0 feet (MLW)	-38.0
	1-2							
6	2-2	7	6				Boring terminated at -38.0 feet (MLW)	-38.0
	5-13							
7	23-22	39	7				Boring terminated at -38.0 feet (MLW)	-38.0
	17-15							
8	6-11	23	8				Boring terminated at -38.0 feet (MLW)	-38.0
	12-6							
9	12-12	23	9				Boring terminated at -38.0 feet (MLW)	-38.0
	11-12							
10	6-5	9	10				Boring terminated at -38.0 feet (MLW)	-38.0
	4-5							
11							Boring terminated at -38.0 feet (MLW)	-38.0
12							Boring terminated at -38.0 feet (MLW)	-38.0





# BORING LOG

**ARDAMAN & ASSOCIATES, INC.**

527

BORING NO. TH-41  
 TOTAL DEPTH 18.0 ft  
 SHEET 1 OF 1

PROJECT West Turning Basin FILE NO. 83-0943  
 CLIENT Canaveral Port Authority, Cape Canaveral, Florida  
 BORING LOCATION Station: 285+30 Range: -60 Port Canaveral Grid System  
 COUNTY Brevard STATE Florida ELEVATION -24.7 feet (MLW)  
 DATE STARTED 8-5-85 DATE COMPLETED 8-5-85 BORING TYPE SPT - 140 lb hammer, 30" drop, 2" OD  
 DRILLER/RIG Jones/CME-45 LENGTH/TYPE CASING 35.0 feet/3" diameter  
 WATER TABLE DEPTH: 1st Tidal DATE 8-5-85 TIME \_\_\_\_\_  
 2nd \_\_\_\_\_ DATE \_\_\_\_\_ TIME \_\_\_\_\_

REMARKS \_\_\_\_\_

Meters	Feet	Standard Penetration Test ASTM D-1586		Lab Data			Soil Description and Remarks (Unified Classification)	Elevation Feet(MLW)
		Blows/ft	N Value	Sample No.	-200 (%)	LL (%)		
		0-0 3-4	3	1			Gray fine sand (SP)	-24.7
1		0-0 0-0	0	2			Gray silty fine sand (SM)	-26.7
	5	0-0 0-0	0	3			Gray clayey fine sand to sandy silt (SC-ML)	-28.7
2		0-1 0-1	1	4			Gray slightly silty fine sand with shell (SP-SM)	-30.7
	10	7-2 4-7	6	5				
		8-9 10-11	19	6				
4		5-4 4-4	8	7			Gray sandy clay (CH)	-36.7
	15	4-0 1-3	1	8				
5							Boring terminated at Elevation 40.7 feet (MLW)	-40.7
6	20							
7								
8	25							
9								
10	30							
11	35							
12	40							

BORING LOG							BORING NO. TH-12	
ARDAMAN & ASSOCIATES, INC.							TOTAL DEPTH 26.0 ft	
							SHEET 1 OF 1	
PROJECT West Turning Basin							FILE NO. 83-094J	
CLIENT Canaveral Port Authority, Cape Canaveral, Florida								
BORING LOCATION Station: 286+60 Range: +260 Port Canaveral Grid System								
COUNTY Brevard Station: 286+60 Range: +260 Port Canaveral Grid System								
DATE STARTED 8-3-95 STATE Florida ELEVATION -12.8 feet (MLW)								
DRILLER/RIG Parker/CME-48 DATE COMPLETED 8-3-95 BORING TYPE SPT - 140 lb hammer, 30" drop, 2" OD								
WATER TABLE DEPTH: 1st Tidal DATE 8-3-95 LENGTH/TYPE CASING 25.0 feet/3" diameter								
REMARKS								
Depth	Standard Penetration Test ASTM D-1586			Lab Data			Soil Description and Remarks (Unified Classification)	Elevation Feet(MLW)
	Meters	feet	Blows/6"	N Value	Sample No.	-200 (%)		
1		0-0					Dark gray slightly silty fine sand (SM)	-12.8
		2-4	2	1				
2		3-0					Dark gray sandy clay (CH)	-17.3
		3-0	3	2				
3		0-0					Brown fine to medium sand (SP)	-20.3
		0-0	0	3				
4		2-3					Dark gray slightly silty fine sand with shell (SP-SM)	-25.3
		4-5	7	6				
5		2-3					Dark gray slightly silty fine sand with shell (SP-SM)	-25.3
		4-3	7	7				
6		5-8					Dark gray slightly silty fine sand with shell (SP-SM)	-25.3
		8-12	16	8				
7		10-10					Dark gray slightly silty fine sand with shell (SP-SM)	-25.3
		13-17	23	9				
8		1-2					Dark gray slightly sandy clay (CH)	-36.3
		2-2	4	10				
9		5-10					Dark gray slightly sandy clay (CH)	-36.3
		7-11	17	11				
10		5-7					Dark gray slightly sandy clay (CH)	-36.3
		8-8	15	12				
11		6-6					Dark gray slightly sandy clay (CH)	-36.3
		5-2	12	13				
12		2-2					Boring terminated at Elevation -38.8 feet (MLW)	-38.8
		1-1	3	14				



# BORING LOG

**ARDAMAN & ASSOCIATES, INC.**

BORING NO. TH-70  
 TOTAL DEPTH 91.0 ft  
 SHEET 1 OF 3

PROJECT Proposed Dry Dock Area - East Wall of West Turning Basin FILE NO. 85-160A  
 CLIENT Canaveral Port Authority  
 BORING LOCATION Station 276+30, Range -580 Port Canaveral Grid System  
 COUNTY Brevard STATE Florida ELEVATION +8.6 feet (MLW)  
 DATE STARTED 12/16/86 DATE COMPLETED 12/16/86 BORING TYPE Rotary/SPT  
 DRILLER/RIG Smith/CMP-55 LENGTH/TYPE CASING Used drilling mud  
 WATER TABLE DEPTH: 1st 7' 2" DATE 12/16/86 TIME \_\_\_\_\_  
 2nd \_\_\_\_\_ DATE \_\_\_\_\_ TIME \_\_\_\_\_

REMARKS

Meters	Feet	Standard Penetration Test ASTM D-1586		Lab Data				Soil Description and Remarks (Unified Classification)	Undisturbed Samples
		Blows/ft	N Value	Sample No.	NM (%)	-200 (%)	LL (%)		
1	5-10-13	23	1					Gray fine sand with shells (SP)	
	15-13-10	23	2					Gray clayey fine sand with shells (SC)	
	16-10-13	23	3						
2	10-10-10	20	4						
	7-5-5	10	5						
3	2-2-3	5	6						
	2-1-1	2	7						
4									
								Gray fine sand with shells (SP)	
5	15								
	3-1-3	4	8						
6									
	3-1-0	1	9					Gray clayey fine sand with shells (SC)	
7									
8	25								
	1-0-1	1	10						
9									
								Gray sandy clay with traces of shell (CL)	
10	30								
	0-0-0	0	11						
11									
								Gray clay (CH)	
12	35								
	0-0-1	1	12					Gray silty fine sand (SM)	
12									
								Gray fine sand with shells (SP)	

<p align="center"><b>BORING LOG</b>  <b>ARDAMAN &amp; ASSOCIATES, INC.</b></p>								BORING NO. TH-70 TOTAL DEPTH 91.0 FT SHEET 2 OF 3		
PROJECT Proposed Dry Dock Area - East Wall of West Turning Basin CLIENT Canaveral Port Authority								FILE NO. 86-160A		
Depth		Standard Penetration Test ASTM D-1586			Lab Data			Soil Description and Remarks (Unified Classification)	Undisturbed Samples	
Meters	Feet	Blows/6"	N Value	Sample No.	NM (%)	-200 (%)	LL (%)			PI (%)
		50-28-17	45	13					Gray fine sand with shells (SP)	
13									Gray sandy clay (CL)	
	45									
14		5-1-6	7	14					Gray clay (CH)	
	50									
15		0-0-2	2	15						
	55									
16		0-0-0	0	16						
	60				30.9				Gray silty clay with shell fragments (CH)	
17										
	65									
18		3-2-3	5	17					Gray clayey fine sand with shells (SC)	
	70									
19										
	75									
20		6-5-5	10	18						
	80									
21										
	85									
22		1-3-4	7	19						
	90									
23		3-6-4	10	20						
	95									
24										
	100									
25		3-6-9	15	21						
	105									
26										
	110									
	115									
	120									
	125									
	130									
	135									
	140									
	145									
	150									
	155									
	160									
	165									
	170									
	175									
	180									
	185									
	190									
	195									
	200									
	205									
	210									
	215									
	220									
	225									
	230									
	235									
	240									
	245									
	250									
	255									
	260									
	265									
	270									
	275									
	280									
	285									
	290									
	295									
	300									
	305									
	310									
	315									
	320									
	325									
	330									
	335									
	340									
	345									
	350									
	355									
	360									
	365									
	370									
	375									
	380									
	385									
	390									
	395									
	400									
	405									
	410									
	415									
	420									
	425									
	430									
	435									
	440									
	445									
	450									
	455									
	460									
	465									
	470									
	475									
	480									
	485									
	490									
	495									
	500									
	505									
	510									
	515									
	520									
	525									
	530									
	535									
	540									
	545									
	550									
	555									
	560									
	565									
	570									
	575									
	580									
	585									
	590									
	595									
	600									
	605									
	610									
	615									
	620									
	625									
	630									
	635									
	640									
	645									
	650									
	655									
	660									
	665									
	670									
	675									
	680									
	685									
	690									
	695									
	700									
	705									
	710									
	715									
	720									
	725									
	730									
	735									
	740									
	745									
	750									
	755									
	760									
	765									
	770									
	775									
	780									
	785									
	790									
	795									
	800									
	805									
	810									
	815									
	820									
	825									
	830									
	835									
	840									
	845									
	850									
	855									
	860									
	865									



# BORING LOG

**ARDAMAN & ASSOCIATES, INC.**

678

BORING NO. TH-71  
 TOTAL DEPTH 91.0 ft  
 SHEET 1 OF 3

PROJECT Proposed Dry Dock Area - East Wall of West Turning Basin FILE NO. 86-160A  
 CLIENT Canaveral Port Authority  
 BORING LOCATION Station 276+30, Range -980 Port Canaveral Grid System  
 COUNTY Brevard STATE Florida ELEVATION +7.9 feet (MLW)  
 DATE STARTED 12/4/86 DATE COMPLETED 12/4/86 BORING TYPE Rotary/SPT  
 DRILLER/RIG Smith/CME-55 LENGTH/TYPE CASING Used drilling mud  
 WATER TABLE DEPTH: 1st 3' 6" DATE 11/5/86 TIME \_\_\_\_\_  
 2nd \_\_\_\_\_ DATE \_\_\_\_\_ TIME \_\_\_\_\_

REMARKS \_\_\_\_\_

Depth		Standard Penetration Test ASTM D-1586		Lab Data				Soil Description and Remarks (Unified Classification)	Undisturbed Samples
Meters	Feet	Blows/6"	N Value	Sample No.	NM (%)	-200 (%)	LL (%)		
1	12-12-16	28	1						Brown fine sand with shells (SP)
	16-23-12	35	2						Gray clay fine sand (SC)
2	8-14-13	27	3						
	12-28-18	46	4						
3	15-10-8	18	5						
	2-4-3	7	6						Gray slightly clayey fine sand with shells (SM-SC)
4	3-1-2	3	7						
5									
	5-3-2	5	8						
6									
									Gray silty fine sand (SM)
7									
	0-2-4	6	9						
8									
	1-0-2	2	10						Gray clayey fine sand (SC)
9									
10									
	1-2-5	8	11						Gray silty fine sand (SM)
11									
	5-7-9	16	12						Grayish brown fine sand (SP)
12									







<b>BORING LOG</b>		BORING NO. THR-1
<b>ARDAMAN &amp; ASSOCIATES, INC.</b>		TOTAL DEPTH 34.0 ft
		SHEET 1 OF 1
PROJECT Port Canaveral Entrance Channel		FILE NO. 83-094R
CLIENT Canaveral Port Authority		
BORING LOCATION Station: 184+28.8		Range: 492 Port Canaveral Grid System
COUNTY Brevard	STATE Florida	ELEVATION -2.9 feet (MLW)
DATE STARTED 4-2-86	DATE COMPLETED 4-2-86	BORING TYPE SPT
DRILLER/RIG MavACME-45, Barge Mounted		LENGTH/TYPE CASING 20 feet/4" diameter
WATER TABLE DEPTH: 1st Tidal	DATE 4-2-86	TIME
2nd	DATE	TIME
REMARKS		

Meters	Foot	Standard Penetration Test ASTM D-1586		Lab Data				Soil Description and Remarks (Unified Classification)	Elevation Feet (MLW)
		Blows/6" N Value	Sample No.	NM (%)	-200 (%)	LL (%)	PI (%)		
1	5	2-3 2-4	5	1				Grayish brown to dark gray fine sand to slightly silty fine sand with shell (SP-SM)	-2.9'
		3-4-3	7						
		2-3-3	6	2		4			
2	5	4-3-3	6	3				Dark gray silty fine sand (SM)	-13.9'
		3-2-3	5	4					
3	10	2-3-4	7					Dark gray slightly silty fine sand with shell (SP-SM)	-19.9'
		3-2-3	5	5					
4	15	2-1-2	3	6				Gray to dark gray silty fine sand with shell (SM)	-23.9'
		1-3 3-6	6	7					
5	20	6-5 6-3	11	8				Dark gray clay with shell (CH)	-32.9'
		5-6 6-4	12	9					
6	25	4-4 6-2	10	10				Boring terminated @ Elevation -36.9 feet (MLW)	-36.9'
		4-3 5-5	8	11					
7	30	6-7 6-5	13	12				Dark gray clay with shell (CH)	-32.9'
		5-5 5-5	10	13					
8	35	6-4 7-5	11					Dark gray clay with shell (CH)	-32.9'
		5-6 6-1	12	14					
9	40	2-1 2-1	3	15				Dark gray clay with shell (CH)	-32.9'
		1-2-1	3	16					
10	40								
11	40								
12	40								

# BORING LOG

**ARDAMAN & ASSOCIATES, INC.**

BORING NO. THR-2  
 TOTAL DEPTH 36.2 ft  
 SHEET 1 OF 1

PROJECT Port Canaveral Entrance Channel FILE NO. 93-094R  
 CLIENT Canaveral Port Authority  
 BORING LOCATION Station: 180+54.1 Range: 547 Port Canaveral Grid System  
 COUNTY Sebastian STATE Florida ELEVATION +1.4 feet (MLW)  
 DATE STARTED 4-15-86 DATE COMPLETED 4-15-86 BORING TYPE SPT  
 DRILLER/RIG Mey/CME-45, Barge Mounted LENGTH/TYPE CASING 10 feet/4" diameter  
 WATER TABLE DEPTH: 1st Tidal DATE 4-15-86 TIME \_\_\_\_\_  
 2nd \_\_\_\_\_ DATE \_\_\_\_\_ TIME \_\_\_\_\_

Depth		Standard Penetration Test ASTM D-1586		Lab Data				Soil Description and Remarks (Unified Classification)	Elevation Feet (MLW)		
Meters	Feet	Blows/5"	N Value	Sample No.	NM (%)	-200 (%)	LL (%)			PI (%)	
1	2-3	5	1						Grayish brown slightly silty fine sand with shell (SP-SM)	+1.4	
	2-4										
2	3-2	4	2								-6.6'
	2-4										
3	4-3	8	3								-8.6'
	5-6										
4	3-4	8	4								-10.6'
	4-6										
5	4-5	10	5								-12.6'
	5-6										
6	5-5	11	6						-14.6'		
	6-7										
7	4-4	8	7						-16.6'		
	4-6										
8	5-6	14	8						-18.6'		
	8-11										
9	6-8	19	9						-20.6'		
	11-16										
10	4-5	8	10						-22.6'		
	3-5										
11	8-16	41	11						-24.6'		
	25-25										
12	6-5	7	12						-26.6'		
	2-2										
13	8-5	7	13						-28.6'		
	2-2										
14	0-0	0	14						-30.6'		
	0-1										
								-32.6'			
								-34.6'			
								-36.6'			
								-38.6'			
								-40.6'			
								-42.6'			
								-44.6'			
								-46.6'			
								-48.6'			
								-50.6'			
								-52.6'			
								-54.6'			
								-56.6'			
								-58.6'			
								-60.6'			
								-62.6'			
								-64.6'			
								-66.6'			
								-68.6'			
								-70.6'			
								-72.6'			
								-74.6'			
								-76.6'			
								-78.6'			
								-80.6'			
								-82.6'			
								-84.6'			
								-86.6'			
								-88.6'			
								-90.6'			
								-92.6'			
								-94.6'			
								-96.6'			
								-98.6'			
								-100.6'			
								-102.6'			
								-104.6'			
								-106.6'			
								-108.6'			
								-110.6'			
								-112.6'			
								-114.6'			
								-116.6'			
								-118.6'			
								-120.6'			
								-122.6'			
								-124.6'			
								-126.6'			
								-128.6'			
								-130.6'			
								-132.6'			
								-134.6'			
								-136.6'			
								-138.6'			
								-140.6'			
								-142.6'			
								-144.6'			
								-146.6'			
								-148.6'			
								-150.6'			
								-152.6'			
								-154.6'			
								-156.6'			
								-158.6'			
								-160.6'			
								-162.6'			
								-164.6'			
								-166.6'			
								-168.6'			
								-170.6'			
								-172.6'			
								-174.6'			
								-176.6'			
								-178.6'			
								-180.6'			
								-182.6'			
								-184.6'			
								-186.6'			
								-188.6'			
								-190.6'			
								-192.6'			
								-194.6'			
								-196.6'			
								-198.6'			
								-200.6'			
								-202.6'			
								-204.6'			
								-206.6'			
								-208.6'			
								-210.6'			
								-212.6'			
								-214.6'			
								-216.6'			
								-218.6'			
								-220.6'			
								-222.6'			
								-224.6'			
								-226.6'			
								-228.6'			
								-230.6'			
								-232.6'			
								-234.6'			
								-236.6'			
								-238.6'			
								-240.6'			
								-242.6'			
								-244.6'			
								-246.6'			
								-248.6'			
								-250.6'			
								-252.6'			
								-254.6'			
								-256.6'			
								-258.6'			
								-260.6'			
								-262.6'			
								-264.6'			
								-266.6'			
								-268.6'			
								-270.6'			
								-272.6'			
								-274.6'			
								-276.6'			
								-278.6'			
								-280.6'			
								-282.6'			
								-284.6'			
								-286.6'			
								-288.6'			
								-290.6'			
								-292.6'			
								-294.6'			
								-296.6'			
								-298.6'			
								-300.6'			
								-302.6'			
								-304.6'			
								-306.6'			
								-308.6'			
								-310.6'			
								-312.6'			
								-314.6'			
								-316.6'			
								-318.6'			
								-320.6'			
								-322.6'			
								-324.6'			
								-326.6'			
								-328.6'			

<b>BORING LOG</b>		BORING NO. THW-1
<b>ARDAMAN &amp; ASSOCIATES, INC.</b>		TOTAL DEPTH 96.0 ft
		SHEET 1 OF 3
PROJECT Port Canaveral Peninsula Bulkhead		FILE NO. 83-094W
CLIENT Canaveral Port Authority		
BORING LOCATION Station: 275+46.5 Range: -370.7 Port Canaveral Grid System		
COUNTY Brevard	STATE Florida	ELEVATION +8.9 feet (MLW)
DATE STARTED 4-22-86	DATE COMPLETED 4-22-86	BORING TYPE SPT
DRILLER/RIG Smith/CMB-55		LENGTH/TYPE CASING Drilling Mud was used
WATER TABLE DEPTH: 1st 3'6"	DATE 4-22-86	TIME
2nd	DATE	TIME
REMARKS		

Depth Meters Feet	Standard Penetration Test ASTM D-1586			Lab Data				Soil Description and Remarks (Unified Classification)	Undisturbed Samples
	Blows/6"	N Value	Sample No.	NM (%)	-200 (%)	LL (%)	PI (%)		
1	4-9-10	19	1					Brown slightly silty fine sand with shell (SP-SM)	
	9-11-9	19	2					Gray clayey fine sand with shell (SC)	
	12-11-9	20	3					Gray silty fine sand with shell (SM)	
2	5-6-7	13	4					Gray silty to clayey fine sand (SM-SC)	
	5-5-4	9	5					Gray silty fine sand with shell (SM)	
3	1-1-0	1	6						
	4-4-6	10	7					Gray slightly silty fine sand with shell (SP-SM)	
5									
	9-8-1	9	8						
6									
	1-1-1	2	9					Gray clayey fine sand (SC)	
8									
	0-1-0	1	10					Gray sandy clay (CL)	
9									
	1-1-1	2	11					Gray silty fine sand (SM)	
11									
	0-0-1	1	12					Gray clay (CH) $q_u = 0.5 \text{ tsf}$	
12					24.1				
								Dark gray slightly silty fine sand with shell (SP-SM) $\gamma_d = 97.4 \text{ pcf}$	

US-1

# BORING LOG

**ARDAMAN & ASSOCIATES, INC.**

BORING NO.	THW-1
TOTAL DEPTH	96.0 ft
SHEET	2 OF 3

PROJECT: Port Canaveral Peninsula Bulkhead  
 CLIENT: Canaveral Port Authority

FILE NO. 83-094W

Depth	Standard Penetration Test ASTM D-1586			Lab Data				Soil Description and Remarks (Unified Classification)	Undisturbed Samples
	Feet	Blows/6"	N Value	Sample No.	NM (%)	-200 (%)	LL (%)		
13	8-12-11	23	13					Dark gray slightly silty fine sand with shell (SP-SM)	
14	1-0-0	0	14					Gray clay and clayey fine sand with shell (CH, SC)	
15				52	80			Gray sandy clay (CH) with seams of clayey fine sand and shell $q_u = 1.25 \text{ tsf}$ $Q_u = 0.73 \text{ tsf}$	US-2
16	6-6-9	14	15						
17	1-0-1	1	16					Gray clayey fine sand with shell (SC)	
19	1-2-1	3	17	39.6	41				
20	3-2-2	4	18	42.1	32				
22	3-3-2	5	19	32.6	38				
23	2-3-2	5	20	33.6	38				
25	4-2-3	5	21						

<b>BORING LOG</b>							BORING NO. THW-1		
ARDAMAN & ASSOCIATES, INC.							TOTAL DEPTH 96.0 ft		
PROJECT Port Canaveral Peninsula Bulkhead							FILE NO. 83-094W		
CLIENT Canaveral Port Authority									
Depth		Standard Penetration Test ASTM D-1586			Lab Data			Soil Description and Remarks (Unified Classification)	Undisturbed Samples
Meters	Feet	Blows/6"	N Value	Sample No.	NM (%)	-200 (%)	LL (%)		
		6-5-8	13	22					Gray clayey fine sand with shell (SC)
27									
	90	10-21-32	53	23					
28									
29	95	6-9-13	22	24					Terminated at 96.0 feet
30									
	100								
31									
	105								
32									
	110								
33									
	115								
34									
	120								
35									
	125								
36									
	130								

# BORING LOG

**ARDAMAN & ASSOCIATES, INC.**

752

BORING NO.	THW-2
TOTAL DEPTH	76.0 ft
SHEET	1 OF 2

PROJECT	Port Canaveral Peninsula Bulkhead			FILE NO.	83-094W
CLIENT	Canaveral Port Authority				
BORING LOCATION	Station: 273+06.6	Range: -351.6	Port Canaveral Grid System		
COUNTY	Brevard	STATE	Florida	ELEVATION	+9.0 feet (MLW)
DATE STARTED	4-16-86	DATE COMPLETED	4-16-86	BORING TYPE	SPT
DRILLER/RIG	Smith/CME-55		LENGTH/TYPE CASING	Drilling Mud was used	
WATER TABLE DEPTH:	1st	3'8"	DATE	4-16-86	TIME
	2nd		DATE		TIME

REMARKS

Meters	Feet	Standard Penetration Test ASTM D-1586		Lab Data				Soil Description and Remarks (Unified Classification)	Undisturbed Samples
		Blows/6"	N Value	Sample No.	NM (%)	-200 (%)	LL (%)		
1		1-2-3	5	1				Grayish brown fine sand with shell and roots (SP)	
		2-3-3	6	2					
		4-2-3	5	3					
2	5	3-3-3	6	4				Gray fine sand with traces of clayey fine sand and gray clay (SP)	
		4-1-1	2	5				Gray slightly silty fine sand with shell (SP-SM)	
3		1-0-1	1	6				Gray silty fine sand with shell (SM)	
	10	8-10-10	20	7				Gray fine sand (SP)	
4									
	15								
5		6-8-6	14	8					
6	20							Gray silty fine sand (SM)	
		0-0-1	1	9					
7									
	25							Gray silty to clayey fine sand (SM-SC)	
8		10-5-4	9	10					
9								Gray fine sand with traces of gray clay (SP)	
	30	5-7-8	15	11					
10									
	35							Gray clay (CH) $q_u = 0.75 \text{ tsf}$	
11		1-0-0	0	12					
12								Dark grayish brown clayey fine sand (SC)	
	40								











# BORING LOG

**ARDAMAN & ASSOCIATES, INC.**

159

BORING NO.	THW-4
TOTAL DEPTH	76.0 ft
SHEET	1 OF 2

PROJECT	Port Canaveral Peninsula Bulkhead	FILE NO.	83-094W
CLIENT	Canaveral Port Authority		
BORING LOCATION	Station: 267+87.5	Range: -400.9	Port Canaveral Grid System
COUNTY	Brevard	STATE	Florida
DATE STARTED	4-22-86	DATE COMPLETED	4-22-86
DRILLER/RIG	Smith/CME-55		
WATER TABLE DEPTH: 1st	6'0"	DATE	4-22-86
2nd		DATE	
REMARKS			

Meters	Feet	Standard Penetration Test ASTM D-1586			Lab Data				Soil Description and Remarks (Unified Classification)	Undisturbed Samples
		Blows/6"	N Value	Sample No.	NM (%)	-200 (%)	LL (%)	PI (%)		
1	3-4-6	10	1					Brown fine sand and shell with limestone (SP)		
	26-24-16	40	2					Light brown limestone		
	32-28-36	64	3							
2	31-36-32	68	4					Brown fine sand with shell (SP)		
	24-25-19	44	5					Brown slightly silty fine sand with shell (SP-SM)		
3	12-13-15	28	6					Gray slightly silty fine sand with shell (SP-SM)		
	8-8-7	15	7							
4										
5										
6										
7										
8										
9										
10										
11										
12										
40					77.4	89		Gray clay with traces of clayey fine sand and shell (CH)  $q_u = 0.5 \text{ tsf}$ $Q_u = 0.65 \text{ tsf}$ $\gamma_d = 54.3 \text{ pcf}$	US-1	

<b>BORING LOG</b>								BORING NO. THW-4	
ARDAMAN & ASSOCIATES, INC.								TOTAL DEPTH 76.0 ft	
								SHEET 2 OF 2	
PROJECT Port Canaveral Peninsula Bulkhead						FILE NO. 83-034W			
CLIENT Canaveral Port Authority									
Meters	Feet	Standard Penetration Test ASTM D-1586			Lab Data			Soil Description and Remarks (Unified Classification)	Undisturbed Samples
		Blows/6"	N Value	Sample No.	NM (%)	-200 (%)	LL (%)		
	13	0-0-0	0	13				Gray clay with traces of clayey fine sand and shell (CH) $q_u = 0.5 \text{ tsf}$	US-2
	45							Gray fine sand with shell (SP)	
	14	20-30-24	54	14					
	15							Light gray slightly silty fine sand with shell (SP-SM)	
	50	16-19-19	37	15					
	16								
	55							Gray sandy clay with shell (CL) $q_u = 0.5 \text{ tsf}$	
	17	2-1-2	3	16					
	18				50.8			$q_u = 0.5 \text{ tsf}$ $f_d = 70.9 \text{ pcf}$	
	60							Gray clayey fine sand with shell (SC)	
	19	3-2-3	5	17					
	65							Gray sandy clay with shell (CL) $q_u = 0.25 \text{ tsf}$	
	20	6-4-4	8	18					
	21							Gray clayey fine sand with shell (SC)	
	70	4-3-2	5	19					
	22								
	75	3-4-4	8	20					
	23								
	80							Terminated at 76.0 feet	
	24								
	25								
	26								

# BORING LOG

**ARDAMAN & ASSOCIATES, INC.**

BORING NO. THW-5  
 TOTAL DEPTH 96.0 ft  
 SHEET 1 OF 3

PROJECT Port Canaveral Peninsula Bulkhead FILE NO. 83-094W  
 CLIENT Canaveral Port Authority  
 BORING LOCATION Station: 284+82.1 Kanga: 365.2 Port Canaveral Grid System  
 COUNTY Brevard STATE Florida ELEVATION +9.9 feet (MLW)  
 DATE STARTED 4-24-86 DATE COMPLETED 4-24-86 BORING TYPE SPT  
 DRILLER/RIG Smith/CME-55 LENGTH/TYPE CASING Drilling Mud was used  
 WATER TABLE DEPTH: 1st 6'9" DATE 4-24-86 TIME \_\_\_\_\_  
 2nd \_\_\_\_\_ DATE \_\_\_\_\_ TIME \_\_\_\_\_

REMARKS \_\_\_\_\_

Depth		Standard Penetration Test ASTM D-1586			Lab Data				Soil Description and Remarks (Unified Classification)	Undisturbed Samples
Meters	Feet	Blows/6"	N Value	Sample No.	NM (%)	-200 (%)	LL (%)	PI (%)		
1	5-8-9	17	1						Brown fine sand and shell with traces of clayey fine sand (SP)	
		5-10-10	20	2						
2	7-7-5	12	3						Gray fine sand and shell (SP)	
		8-7-5	12	4						
		6-9-7	16	5						
3	1-2-1	3	6						Gray silty fine sand and shell (SM)	
		1-1-1	2	7						
4	1-1-1	2	8						Gray clayey fine sand with shell (SC)	
5	1-1-1	2	8						Gray fine sand (SP)	
6	7-7-10	17	9						Gray clay and shell (CH) $q_u = 0.25 \text{ tsf}$	
8	0-1-1	2	10						Gray sandy clay (CL)	
9	5-2-2	4	11						Gray clay (CH) $q_u = 0.5 \text{ tsf}$	
11	0-0-0	0	12						$q_u = 0.75 \text{ tsf}$ $Q_{cl} = 0.45 \text{ tsf}$ $\gamma_d = 48.6 \text{ pcf}$	
12					93.0	99				US-1









# BORING LOG

**ARDAMAN & ASSOCIATES, INC.**

BORING NO. THW-7  
 TOTAL DEPTH 21.0 ft  
 SHEET 1 OF 1

PROJECT Port Canaveral Peninsula Bulkhead FILE NO. 83-094W  
 CLIENT Canaveral Port Authority  
 BORING LOCATION Station: 272+07.3 Range: -405.7 Port Canaveral Grid System  
 COUNTY Brevard STATE Florida ELEVATION +10.0 feet (MLW)  
 DATE STARTED 4-18-86 DATE COMPLETED 4-18-86 BORING TYPE SPT  
 DRILLER/RIG Smith/CME-55 LENGTH/TYPE CASING Drilling Mud was used  
 WATER TABLE DEPTH: 1st 2'8" DATE 4-18-86 TIME \_\_\_\_\_  
 2nd \_\_\_\_\_ DATE \_\_\_\_\_ TIME \_\_\_\_\_

REMARKS \_\_\_\_\_

Meters	Feet	Standard Penetration Test ASTM D-1586		Lab Data				Soil Description and Remarks (Unified Classification)	Undisturbed Samples
		Blows/6"	N Value	Sample No.	NM (%)	-200 (%)	LL (%)		
		3-2-3	5	1				Brown fine sand with clay and roots (SP)	
1		7-7-6	13	2				Brown fine sand with roots (SP)	
	5	5-7-14	21	3				Gray fine sand with shell (SP)	
2		7-7-16	23	4					
		6-4-2	6	5					
		0-0-1	1	6				Grayish brown silty fine sand with shell (SM)	
3	10	0-0-1	1	7					
4									
	15							Gray clayey fine sand with shell (SC)	
5		0-2-4	6	8					
6	20							Gray slightly silty with shell (SP-SM)	
		2-3-4	7	9					
7									
	25								
8									
	30								
9									
	35								
10									
	40								
11									
12									
	40							Terminated at 21.0 feet	

<b>BORING LOG</b>				BORING NO. <u>THC-5</u>
<b>ARDAMAN &amp; ASSOCIATES, INC.</b>				TOTAL DEPTH <u>91.0 ft</u>
				SHEET <u>1</u> OF <u>3</u>
PROJECT <u>Canaveral Cove</u>			FILE NO. <u>83-0940</u>	
CLIENT <u>Canaveral Port Authority, Cape Canaveral, Florida</u>				
BORING LOCATION <u>Station: 576+1</u> Range: <u>265+22.6</u> Port <u>Canaveral Grid System</u>				
COUNTY <u>Brevard</u>		STATE <u>Florida</u>		ELEVATION <u>3.1 feet (MLW)</u>
DATE STARTED <u>4-28-86</u>		DATE COMPLETED <u>4-28-86</u>		BORING TYPE <u>SPT</u>
DRILLER/RIG <u>Smith/CME-55</u>		LENGTH/TYPE CASING <u>Drilling Mud was used</u>		
WATER TABLE DEPTH: 1st <u>3.2 feet</u>		DATE <u>4-28-86</u>		TIME _____
2nd _____		DATE _____		TIME _____
REMARKS _____				

Meters	Feet	Standard Penetration Test ASTM D-1586			Lab Data				Soil Description and Remarks (Unified Classification)	Undisturbed Samples
		Blows/6"	N Value	Sample No.	NM (%)	-200 (%)	LL (%)	PI (%)		
1	23-26-18	44	1						Very light brown limestone (road base material)	
	18-17-14	31	2		16	10			Grayish brown silty fine sand with shell (SP-SM)	
2	7-5-4	9	3							
	3-5-4	9	4						Gray slightly silty fine sand with shell (SP-SM)	
	4-2-1	3	5		19	7				
3	1-1-0	1	6						Gray clayey fine sand with seams of clay (SC-CH)	
	4-4-5	9	7						Gray fine sand with shell (SP)	
4	5-7-8	15	8							
	3-3-6	9	9							
	4-2-6	8	10							
5	2-2-4	6	11						Gray silty fine sand with shell (SM)	
	6-8-10	18	12		17	3				
6	8-10-11	21	13						Gray fine sand with shell (SP)	
	8-8-5	13	14							
8	6-6-3	9	15						Gray clay with shell (CH) $q_u = 0.75$ tsf	
									Gray silty fine sand with seams of gray clay (SM-CH)	
9	1-1-2	3	16							
									Gray clay $q_u = 0.5$ tsf	
11	0-0-1	1	17							

<h2 style="text-align: center;">BORING LOG</h2> <p style="text-align: center;">ARDAMAN &amp; ASSOCIATES, INC.</p>							BORING NO. <u>THC-5</u> TOTAL DEPTH <u>91.0 ft</u> SHEET <u>2</u> OF <u>3</u>		
PROJECT <u>Canaveral Cove</u> CLIENT <u>Canaveral Port Authority</u>							FILE NO. <u>83-0940</u>		
Meters	Feet	Standard Penetration Test ASTM D-1586			Lab Data			Soil Description and Remarks (Unified Classification)	Undisturbed Samples
		Blows/6"	N Value	Sample No.	NM (%)	-200 (%)	LL (%)		
13	45	0-0-0	0	18				Gray clay $q_u = 0.5 \text{ tsf}$	
14		0-1-0	1	19					
15	50	8-10-11	21	20				Gray silty fine sand with shell (SM)	
16									
17	55	2-3-3	6	21				Gray clayey fine sand with traces of clay (SC-CH)	
18									
19	60	1-2-1	3	22					
20	65	17-13-15	28	23				Gray slightly silty fine sand with shell (SP-SM)	
21									
22	70	1-1-1	2	24				Gray clayey fine sand with shell (SC)	
23	75	18-14-13	27	25					
24									
25	80	1-1-4	5	26					
26	85								



# BORING LOG

## ARDAMAN & ASSOCIATES, INC.

760

BORING NO. THY-1  
TOTAL DEPTH 12.0 ft  
SHEET 1 OF 1

PROJECT Scrap Road on North Side of Port Canaveral FILE NO. 83-094 Y  
 CLIENT Canaveral Port Authority  
 BORING LOCATION Station: 269+30 Range: -1297 Florida Port Canaveral Grid System  
 COUNTY Brevard STATE DATE COMPLETED 9-17-86 ELEVATION +12.8 feet (MLW)  
 DATE STARTED 9-17-86 DRILLER/RIG Smith/CME-55 BORING TYPE SPT  
 WATER TABLE DEPTH: 1st 5.5 feet DATE 9-17-86 LENGTH/TYPE CASING Drilling mud was used  
 2nd \_\_\_\_\_ DATE \_\_\_\_\_ TIME \_\_\_\_\_

REMARKS \_\_\_\_\_

Depth Feet	Standard Penetration Test ASTM D-1586		Lab Data			Soil Description and Remarks (Unified Classification)	Undisturbed Samples
	Blows/6" N Value	Sample No.	NM (%)	LL (%)	PI (%)		
1	15-17-16	33				Brown fine sand and scallop shell (SP) Gray slightly clayey fine sand and scallop shell (SM-SC)	
2	15-18-14	32				Brown fine sand with trace of shell (SP)	
3	14-18-19	37				Brown slightly silty fine sand with trace of shell and clayey fine sand (SP-SM)	
4	15-14-17	31				Grayish brown fine sand with trace of shell (SP)	
5	7-8-10	18					
6	13-17-16	33				Gray fine sand and shell (SP)	
7	9-8-9	17					
8	8-9-11	20				Gray slightly silty fine sand with shell (SP-SM)	
9							
10							
11							
12							
13							
14							
15							
16							
17							
18							
19							
20							
21							
22							
23							
24							
25							
26							
27							
28							
29							
30							
31							
32							
33							
34							
35							
36							
37							
38							
39							
40							
41							
42							
43							
44							
45							
46							
47							
48							
49							
50							
51							
52							
53							
54							
55							
56							
57							
58							
59							
60							
61							
62							
63							
64							
65							
66							
67							
68							
69							
70							
71							
72							
73							
74							
75							
76							
77							
78							
79							
80							
81							
82							
83							
84							
85							
86							
87							
88							
89							
90							
91							
92							
93							
94							
95							
96							
97							
98							
99							
100							
101							
102							
103							
104							
105							
106							
107							
108							
109							
110							
111							
112							
113							
114							
115							
116							
117							
118							
119							
120							
121							
122							
123							
124							
125							
126							
127							
128							
129							
130							
131							
132							
133							
134							
135							
136							
137							
138							
139							
140							
141							
142							
143							
144							
145							
146							
147							
148							
149							
150							
151							
152							
153							
154							
155							
156							
157							
158							
159							
160							
161							
162							
163							
164							
165							
166							
167							
168							
169							
170							
171							
172							
173							
174							
175							
176							
177							
178							
179							
180							
181							
182							
183							
184							
185							
186							
187							
188							
189							
190							
191							
192							
193							
194							
195							
196							
197							
198							
199							
200							
201							
202							
203							
204							
205							
206							
207							
208							
209							
210							
211							
212							
213							
214							
215							
216							
217							
218							
219							
220							
221							
222							
223							
224							
225							
226							
227							

<b>BORING LOG</b>		BORING NO. TH-88
ARDAMAN & ASSOCIATES, INC.		TOTAL DEPTH 66.0 ft
		SHEET 1 OF 2
PROJECT Bulkhead West of Pier No. 2		FILE NO. 86-160A
CLIENT Canaveral Port Authority		
BORING LOCATION Station 281+25, Range -370 Port Canaveral Grid System		
COUNTY Brevard STATE Florida ELEVATION +8.3 feet (MLW)		
DATE STARTED 11/6/86 DATE COMPLETED 11/6/86 BORING TYPE Rotary/SPT		
DRILLER/RIG Smith/CME-55 LENGTH/TYPE CASING Used drilling mud		
WATER TABLE DEPTH: 1st 5' 8" DATE 11/6/86 TIME		
2nd DATE TIME		
REMARKS		

Depth Meters Feet	Standard Penetration Test ASTM D-1586			Lab Data				Soil Description and Remarks (Unified Classification)	Undisturbed Samples
	Blows/6"	N Value	Sample No.	NM (%)	-200 (%)	LL (%)	PI (%)		
1	4-5-6	11	1					Grayish brown slightly silty fine sand with shells (SP-SM)	
	5-5-5	10	2						
2	8-11-15	26	3					Gray slightly silty fine sand with clayey fine sand (SP-SM)	
	11-10-8	18	4						
3	4-3-3	6	5					Gray fine sand with shells (SP)	
	1-2-2	4	6					Gray silty fine sand with shells (SM)	
4	2-3-4	7	7						
5								Gray clayey fine sand with shells (SC)	
	0-0-0	0	8						
6								Gray slightly silty fine sand with shells (SP-SM)	
	10-10-13	23	9						
7								Gray slightly clayey fine sand (SM-SC)	
	1-1-0	1	10						
8								Gray clay (CH)	
	1-0-1	1	11						
9									
10				70.2	98	82	57	S <sub>u</sub> = 508 psf T <sub>v</sub> = 260-460 psf	US-1 γ <sub>d</sub> = 58.0 pcf
	0-1-1	2	12					Gray clayey fine sand with shells (SC)	
11									
12									





# BORING LOG

**ARDAMAN & ASSOCIATES, INC.**

BORING NO. TH-69  
 TOTAL DEPTH 91.0 ft  
 SHEET 1 OF 3

PROJECT Bulkhead West of Pier No. 2 FILE NO. 86-150A  
 CLIENT Canaveral Port Authority  
 BORING LOCATION Station 263+25, Range -370 Fort Canaveral Grid System  
 COUNTY Brevard STATE Florida ELEVATION +8.4 feet (MLW)  
 DATE STARTED 11/13/86 DATE COMPLETED 11/13/86 BORING TYPE Rotary/SPT  
 DRILLER/RIG Smith/CME-55 LENGTH/TYPE CASING Used drilling mud  
 WATER TABLE DEPTH: 1st 6' 3" DATE 11/13/86 TIME \_\_\_\_\_  
 2nd \_\_\_\_\_ DATE \_\_\_\_\_ TIME \_\_\_\_\_

REMARKS \_\_\_\_\_

Meters	Feet	Standard Penetration Test ASTM D-1586		Lab Data				Soil Description and Remarks (Unified Classification)	Undisturbed Samples
		Blows/6"	N Value	Sample No.	NM (%)	-200 (%)	LL (%)		
1	4-3-5	8	1					Light brown fine sand with shells (SP)	
	6-12-13	25	2						
2	5	25-25-24	49	3				Grayish brown fine sand with clay and shells (SP)	
	9	12-8	20	4					
3	10	1-2-2	4	5				Gray silty fine sand with shells (SM)	
	10	2-2-2	4	6					
4	15	1-2-1	3	7				Gray clayey fine sand with shells (SC)	
	15	1-2-1	3	8					
5	20							Gray fine sand (SP)	
	20	13-15-20	35	9					
6	25							Gray clayey fine sand with shells (SC)	
	25	1-2-1	3	10					
7	30							Gray clay (CH)	
	30	0-0-0	0	11					
8	35				97.4	99		$S_u = 847$ psf $T_v = 220-340$ psf	US-1 $Y_d = 49.4$ pcf
	35	0-0-1	1	12					
9	40				91.9	98		$S_u = 413$ psf $T_v = 400-660$ psf	US-2 $Y_d = 47.9$ pcf
	40								





# BORING LOG

**ARDAMAN & ASSOCIATES, INC.**

BORING NO. TH-1H  
 TOTAL DEPTH 115.0 ft  
 SHEET 1 OF 3

PROJECT Port Canaveral Navy Pier FILE NO. 88-160H  
 CLIENT Canaveral Port Authority, Port Canaveral, Florida  
 BORING LOCATION Station: 277+50; Range: -730; Port Canaveral Grid System  
 COUNTY Brevard STATE Florida ELEVATION Ground surface approx. El. -18.0 ft (MLW)  
 DATE STARTED 7-19-88 DATE COMPLETED 7-19-88 BORING TYPE SPT-140 lb hammer, 30" drop, 2" OD  
 DRILLER/RIG Jones/CMF 45 Barge Rig LENGTH/TYPE CASING 44 ft/3" diameter  
 WATER TABLE DEPTH: 1st DATE TIME  
 2nd DATE TIME

REMARKS

Depth		Standard Penetration Test ASTM D-1586			Lab Data				Soil Description and Remarks (Unified Classification)	Undisturbed Samples
Meters	Feet	Blows/6"	N Value	Sample No.	NM (%)	-200 (%)	LL (%)	PI (%)		
									Water	EL
1										
	5									
2										
	10									
3										
	15									
4										
	20									
5										
	25									
6										
	30									
7										
	35									
8										
	40									
9										
	45									
10										
	50									
11										
	55									
12										
	60									
	65									
	70									
	75									
	80									
	85									
	90									
	95									
	100									
	105									
	110									
	115									





# BORING LOG

**ARDAMAN & ASSOCIATES, INC.**

BORING NO. TH-2H  
TOTAL DEPTH 116.0 ft  
SHEET 1 OF 3

849

PROJECT Port Canaveral Navy Pier FILE NO. 86-160H  
 CLIENT Canaveral Port Authority, Port Canaveral, Florida  
 BORING LOCATION Station: 277+50; Range: -1239; Port Canaveral Grid System  
 COUNTY Brevard STATE Florida ELEVATION Ground surface approx. El. -19.8 ft (MLW)  
 DATE STARTED 7-13-88 DATE COMPLETED 7-13-88 BORING TYPE SPT-140 lb hammer, 30" drop, 2" OD  
 DRILLER/RIG Jones/CME 45 Barge Rig LENGTH/TYPE CASING 55 ft/3" diameter  
 WATER TABLE DEPTH: 1st \_\_\_\_\_ DATE \_\_\_\_\_ TIME \_\_\_\_\_  
 2nd \_\_\_\_\_ DATE \_\_\_\_\_ TIME \_\_\_\_\_

REMARKS \_\_\_\_\_

Depth		Standard Penetration Test ASTM D-1586		Lab Data				Soil Description and Remarks (Unified Classification)	Undisturbed Samples
		Blows/ft <sup>n</sup>	N Value	Sample No.	NM (%)	-200 (%)	LL (%)		
Meters	Feet								
	1							Water	
	5								
	2								
	3								
	10								
	4								
	15								
	5								
	6								
	20								
	7							GROUND SURFACE	
	25	0-0-0	0					Gray silt (ML)	-20
	8	0-0-0	0	1					
	9	0-0-0	0						
	30	1-2-2	4	2				Gray silty fine sand (SM)	
	10								
	35							Gray silty fine sand with seams of gray clay (SM)	
	11	1-3-1	4	3					
	12							Gray clay fine sand with shell (SC)	-5
	40								



<p align="center"><b>BORING LOG</b> ARDAMAN &amp; ASSOCIATES, INC.</p>							<p>BORING NO. TH-2H TOTAL DEPTH 115.0 ft SHEET 2 OF 3</p>		
<p>PROJECT Port Canaveral Navy Pier CLIENT Canaveral Port Authority, Port Canaveral, Florida</p>							<p>FILE NO. 86-160H</p>		
Depth Meters Feet	Standard Penetration Test ASTM D-1586			Lab Data				Soil Description and Remarks (Unified Classification)	Undisturbed Samples
	Blows/6" N Value	Sample No.		NM (%)	-100 (%)	LL (%)	PI (%)		
13	3-2-1	3	4					Gray clayey fine sand with shell (SC)	[Hatched]
45								Gray clay with trace of shell (CH)	
14	1-1-2	3	5						[Hatched]
15								Light gray to gray clayey fine sand with shell (SC)	
50	3-2-3	5	6						[Hatched]
16									
17	4-6-7	13	7						[Hatched]
18									
60	4-4-3	7	8	42.6	39				[Hatched]
19									
65	2-3-3	6	9						[Hatched]
20									
70	5-2-5	7	10	37.6	39				[Hatched]
21									
75	2-3-2	5	11						[Hatched]
22									
80	4-6-9	15	12						[Hatched]
23									
85								Light gray silty fine sand with shell (SM)	[Hatched]

-45

-67



<b>BORING LOG</b>								BORING NO. <u>B-1</u>	
<b>ARDAMAN &amp; ASSOCIATES, INC.</b>								TOTAL DEPTH <u>24.5 ft.</u>	
								SHEET <u>1</u> OF <u>  </u>	
PROJECT <u>Central Park</u>						FILE NO. <u>89-131</u>			
CLIENT <u>Canaveral Port Authority</u>									
BORING LOCATION <u>Approximate: Sta. 250+20, Range-500</u>						Port Canaveral Grid System			
COUNTY <u>Brevard</u>						STATE <u>Florida</u>			
DATE STARTED <u>9-27-89</u>						DATE COMPLETED <u>9-27-89</u>			
DRILLER/RIG <u>AMDRILL/CME-55, Barge Mounted</u>						BORING TYPE <u>Rotary/SPT</u>			
WATER TABLE DEPTH: 1st <u>Tidal</u>						LENGTH/TYPICAL CASING <u>3 1/4" diameter</u>			
2nd <u>  </u>						TIME <u>  </u>			
REMARKS <u>  </u>									
Depth	Standard Penetration Test ASTM D-1586			Lab Data				Soil Description and Remarks (Unified Classification)	Undisturbed Samples
	Meters	Feet	Blows/6"	N Value	Sample No.	NM (%)	-200 (%)		
1		0-0-0	0	1					Gray fine to medium slightly silty sand with shell fragments (SP-SM)
		11-6-12	18	2					
2	5	6-5-4	9	3					Brownish-gray silty fine sand with shell fragments (SM)
		7-7-8	15	4					
3		9-5-4	9	5					
	10	1-1-2	3	6					
4		1-1-1	2	7					
		0-0-0	0	8					
5		0-0-0	0	9	42.4				Dark gray clay with traces of fine sand and shell fragments (CH)
	15	0-0-0	0	10	37.3				
6		0-0-0	0	11	99.5				Dark gray clay with traces of fine sand and shell fragments (CH)
		0-0-0	0	12	69.4				
7	20	0-0-0	0	13	105.8				
		0-0-0	0	14	104.3				
8		0-0-0	0	15	33.9				
	25	0-0-0	0	16	87.5				
8		Terminated @ 24.5 feet (Elevation - 36.5' (MLW))							
9									
10									
11									
12									

FIGURE 5



# BORING LOG

**ARDAMAN AND ASSOCIATES, INC.**

BORING NO: TH-1  
 TOTAL DEPTH: 61.5ft.  
 SHEET 1 OF 2

PROJECT PORT CANAVERAL CARGO PIER	FILE NO. 89-130
CLIENT CANAVERAL PORT AUTHORITY	ELEVATION -42.5' (MLW)
BORING LOCATION STATION 241+41.0 RANGE 500, PORT CANAVERAL GRID SYSTEM	BORING TYPE SPT
COUNTY BREVARD STATE FLORIDA	CASING TYPE 4" CASING TO 52"
DATE STARTED 9-25-89 COMPLETED 9-25-89	DRILLER/RIG ANDRELL / EMBES, BARGE MOUNTED
WATER TABLE: 1st depth TIDAL DATE	TIME
WATER TABLE: 2nd depth DATE	TIME
REMARKS	

Elevation	Depth (ft)	Standard Pen. Test ASTM D-1586				Lab Data					Soils Description and Remarks	Depth (ft)	Graphic Log	
		Blows/ ft	N Value	Sample Number	NM (%)	-200 (%)	LL (%)	PI (%)	Dry Den (pcf)					
	0-0-0	0		1										
-47.5	5	0-0-0	0	2							Dark gray silty clay (CH)			
-52.5	10	1-3-2	5	3										
-57.5	15	2-1-2	3	4										
-62.5	20	5-5-8	13	5							Gray to greenish gray clayey fine sand with shells (SC)			
-67.5	25	8-5-6	11	6										
-72.5	30	7-3-4	7	7										
-77.5	35	2-2-2	4	8										
-82.5	40	7-10-19	29	9							Light gray to gray slightly silty fine sand with cemented sand and shells (SP-SM)			



# BORING LOG

**ARDAMAN AND ASSOCIATES, INC.**

BORING NO: TH-2  
 TOTAL DEPTH: 88.5ft.  
 SHEET 1 OF 3

PROJECT PORT CANAVERAL CARDO PIER	FILE NO. 89-130
CLIENT CANAVERAL PORT AUTHORITY	ELEVATION -27.5' (MLW)
BORING LOCATION STATION 236+45.0 RANGE 500, PORT CANAVERAL GRID SYSTEM	BORING TYPE Rotary/SPT
COUNTY BREVARD	STATE FLORIDA
DATE STARTED 9-26-89	COMPLETED 9-26-89
WATER TABLE: 1st depth TIDAL	CASING TYPE 4" CASING TO 50'
WATER TABLE: 2nd depth --	DRILLER/RIG AMDRILL / CMESS, BARGE MOUNTED
REMARKS	DATE --
	TIME --

Elevation (ft)	Depth (ft)	Standard Pen. Test ASTM D-1586			Lab Data					Soils Description and Remarks	Depth (ft)	Graphic Log	
		Blows/ 0.1ft	N Value	Sample Number	W ( % )	-200 ( % )	LL ( % )	PI ( % )	Dry Den. (pcf)				
	0-0-0	0	1										
				US-1	79.4	99			52.4	Qu=0.45 tsf			
-32.5	5	2-3-2	5	2									
				US-2	108.2	80			42.9	Qu=0.32 tsf			
-37.5	10	0-0-0	0	3						Dark gray silty clay with traces of shells (CH)			
-42.5	15	0-0-0	0	4									
-47.5	20	0-0-0	0										
-52.5	25	0-0-0	0	5									
-57.5	30	0-0-0	0	6									
-62.5	35	0-4-4	8	7									
-67.5	40	2-3-2	5	8						Gray silty to clayey fine sand with shells (SM-SC)			

**BORING LOG**  
**ARDAMAN AND ASSOCIATES, INC.**

BORING NO: TH-2  
 TOTAL DEPTH: 88.5ft.  
 SHEET 2 OF 3

PROJECT PORT CANAVERAL CARBO PIER FILE NO. 89-130  
 CLIENT CANAVERAL PORT AUTHORITY ELEVATION -27.5' (MLW)  
 BORING LOCATION STATION 236+45.0 RANGE 500, PORT CANAVERAL GRID SYSTEM BORING TYPE Rotary/SPT

Elevation	Depth (ft)	Standard Pen. Test ASTM D-1586			Lab Data					Soils Description and Remarks	Depth (ft) Graphic Log
		Blows/ ft	N Value	Sample Number	NH (%)	-200 (%)	LL (%)	PI (%)	Dry Den. (pcf)		
-72.5	45	0-0-0	0	9						Gray silty to clayey fine sand with shells (SM-SC)	[Hatched Pattern]
-77.5	50	2-1-5	5	10							
-82.5	55	18-29-17	46	11						Light gray to gray silty fine sand with cemented sand and shells (SM)	[Vertical Line Pattern]
-87.5	60	12-15-13	28	12							
-92.5	65	7-10-11	21	13							
-97.5	70	5-9-10	19	14						Light green clayey fine sand with cemented sand and shells (SC)	[Diagonal Line Pattern]
-102.5	75	8-9-13	22	15							
-107.5	80	18-27 50/3*	50/3*	16, 17							[Cross-hatched Pattern]





# BORING LOG

**ARDAMAN & ASSOCIATES, INC.**



BORING NO: TH-13  
 TOTAL DEPTH: 76ft.  
 SHEET 1 OF 3

PROJECT BULKHEAD DESIGN AT TANKER BERTH No. 1 CLIENT Canaveral Port Authority BORING LOCATION Station 233499 ; Range 572 - Port Canaveral Grid System COUNTY Brevard STATE Florida DATE STARTED 5-30-90 COMPLETED 5-30-90 WATER TABLE: 1st depth 5.4' DATE 5-30-90 WATER TABLE: 2nd depth -- DATE --	FILE NO. 90-082 ELEVATION 8.7' (MLW) BORING TYPE Rotary / SPT CASING TYPE None DRILLER/RIG B.S., C.S. / CHE-55 TIME -- TIME --
REMARKS	

Elevation	Depth (ft)	Standard Pen. Test ASTM D-1586				Lab Data				Soils Description and Remarks	Depth (ft)	Graphic Log
		Blows/ 6 in	N	Value	Sample Number	NH (%)	-200 (%)	LL (%)	PI (%)			
3.7	5	5-5-6	11	1						Light brown fine sand with rock fragments (SP)	4-7	
	4-5-4	9	2						Light brown fine sand with traces of shell (SP)			
	3-2-2	4	3									
	3-5-5	10	4									
	4-2-2	4	5									
-1.3	10	1-2-1	3	6						Gray fine sand with shell (SP)	10-15	
	1-5-1	6	7						Gray fine sand and shell (SP)			
	1-3-4	7	8						Gray silty fine sand with shell (SM)			
	1-1-2	3	9						Gray clayey fine sand with shell (SC)			
-6.3	15	1-1-2	3	10							15-20	
	10-11-12	23	11						Gray fine sand (SP)			
-16.3	25										20-25	
	12-18-19	37	12						Gray fine sand and shell (SP)			
-21.3	30									Gray clayey fine sand with traces of shell (SC)	30	

**BORING LOG**  
**ARDAMAN & ASSOCIATES, INC.**

BORING NO: TH-13  
 TOTAL DEPTH: 76ft.  
 SHEET 2 OF 3

PROJECT BULKHEAD DESIGN AT TANKER BERTH No. 1	FILE NO. 90-092
CLIENT Canaveral Port Authority	ELEVATION 8.7' (MLM)
BORING LOCATION Station 233+99; Range 572 - Port Canaveral Grid System	BORING TYPE Rotary / SPT

Elevation	Depth (ft)	Standard Pen. Test ASTM D-1586			Lab Data					Soils Description and Remarks	Depth (ft)	Graphic Log
		BLOWS/ 6 IN	N Value	Sample Number	NH (%)	-200 (%)	LL (%)	PI (%)	Dry Den. (pcf)			
	1-1-2	3	13							Gray clayey fine sand with traces of shell (SC)		
-26.3	35	0-0-0	0	14						Gray clayey fine sand (SC)		
					US#1	78.5	99		54.9	$S_u$ (TORVANE) = 650-700 psf $S_u$ (Pocket Penetrometer) = 410-765 psf $S_u$ (Unconfined Compression) = 512-609 psf		
-31.3	40	0-1-1	2	15								
-36.3	45	0-1-0	1	16								
					US#2	73.2	89		55.7	$S_u$ (TORVANE) = 350-920 psf $S_u$ (Pocket Penetrometer) = 205-1540 psf $S_u$ (Unconfined Compression) = 164-266 psf		
-41.3	50	1-2-1	3	17								
-46.3	55	0-0-3	3	18								
-51.3	60									Light gray slightly clayey fine sand with shell (SC)		





# BORING LOG

## ARDAMAN & ASSOCIATES, INC.

BORING NO: TH-3  
 TOTAL DEPTH: 79.9ft.  
 SHEET 2 OF 3

PROJECT: PILE AND BULKHEAD DESIGN, PROPOSED CRUISE TERMINAL NO. 1  
 CLIENT: CANAVERAL PORT AUTHORITY  
 BORING LOCATION: Station 214+35; Range 490 - Port Canaveral Grid System

FILE NO. 90-082  
 ELEVATION: -18.0' (MLH)  
 BORING TYPE: Rotary / SPT

Elevation	Depth (ft)	Standard Pen. Test ASTM D-1586			Lab Data				Soils Description and Remarks	Depth (ft) Graphic Log
		Blows/ 6 in	N Value	Sample Number	NH (%)	-200 (%)	LL (%)	PI (%)		
									Gray clay with shell (CH)	/
-59	35	5-7-8	15	8	38.3	50			Light gray clayey fine sand with shell (SC)	/
-59	40	0-0-0	0	9					Gray clayey fine sand with shell (SC)	/
-63	45	8-8-15	23	10					Gray silty fine sand with shell (SM)	/
-68	50	8-12-15	27	--						/
-73	55	3-5-7	12	11					Gray clayey fine sand with shell (SC)	/
-78	60	6-4-9	13	12						/































# BORING LOG

*Total*

**ARDAMAN & ASSOCIATES, INC.**

BORING NO: THW-9  
TOTAL DEPTH: 45.0ft.  
SHEET 1 OF 2

PROJECT: PORT CANAVERAL WEST TURNING BASIN CORNER CUT-OFF	FILE NO. 92-091
CLIENT: CANAVERAL PORT AUTHORITY	ELEVATION: 10.0' MLW
BORING LOCATION STATION: 274+60.00 RANGE: -710.0 PORT CANAVERAL GRID SYSTEM	BORING TYPE: SPT
COUNTY: BREVARD STATE: FLORIDA	CASING TYPE: DRILLING "MUD"
DATE STARTED: 06/01/1992 COMPLETED: 06/01/1992	DRILLER/RIG: SMITH / CME-55
WATER TABLE 1st depth: 5.0'	TIME: --
WATER TABLE 2nd depth: --	DATE: --
REMARKS:	TIME: --

Elevation	Depth (ft)	Standard Pen. Test ASTM D-1586		Lab Data					Soils Description and Remarks	Depth (ft)	Graphic Log
		Blows/ ft	N Value	Sample Number	NH (%)	-200 (%)	LL (%)	PI (%)			
	3-5-9	14	1						Brown fine Sand w/ Shell (SP)		
	8-8-13	21	2								
	8-7-7	14	3								
5	7-9-6	15	4						Gray fine Sand w/ Shell fragments (SP)		
	2-2-3	5	5								
0	3-4-4	8	6						Gray sandy Clay to clayey Sand w/ Shell (SC)		
	3-1-1	2	7								
	1-1-0	1	8	36.9	13				Gray silty, clayey fine Sand w/ Shell (SM-SC)		
	0-1-1	2	9								
-5	8-2-5	7	10	27.7	9				Gray slightly silty fine Sand w/ Shell (SP-SM)		
	1-0-1	1	11								
	1-3-10	13	12						Gray fine Sand w/ Shell (SP)		
	2-2-1	3	13	34.9	38						
-10	2-2-1	3	13	34.9	38				Gray silty, clayey fine Sand w/ Shell (SM-SC)		
	3-4-4	8	14	29.8	18						
	4-3-5	8	15						Gray fine Sand w/ Shell (SP)		
	5-4-3	7	16								
-15	1-1-1	2	17	43.1	43				Gray sandy Clay to clayey fine Sand (SC)		
	0-2-4	6	18								
	3-2-1	3	19						Gray silty fine Sand w/ Shell (SM)		
-20	2-3-7	10	20	33.4	23						
	1-5-10	16	21						Gray fine Sand (SP)		
	5-9-7	16	22								
	2-2-1	3	23						Gray silty fine Sand w/ Shell (SM)		
-25	1-2-1	3	24								
	0-0-0	0	25						Gray Clay (CH)		
	0-0-0	0	26								
-30	0-0-0	0	27								



# BORING LOG

ARDAMAN & ASSOCIATES, INC.



BORING NO: THW-10  
TOTAL DEPTH: 45.0ft.  
SHEET 1 OF 2

PROJECT: PORT CANAVERAL WEST TURNING BASIN CORNER CUT-OFF	FILE NO: 92-091
CLIENT: CANAVERAL PORT AUTHORITY	ELEVATION: 7.5' MLW
BORING LOCATION: STATION: 276+20.00 RANGE: -545.0 PORT CANAVERAL GRID SYSTEM	BORING TYPE: SPT
COUNTY: BREVARD STATE: FLORIDA	CASING TYPE: DRILLING "MUD"
DATE STARTED: 06/01/1992 COMPLETED: 06/01/1992	DRILLER/RIG: SMITH / CME-55
WATER TABLE: 1st depth: 4.8'	TIME: --
WATER TABLE: 2nd depth: --	TIME: --
REMARKS:	

Elevation (ft)	Depth (ft)	Standard Pen Test ASTM D-1586		Lab Data					Soils Description and Remarks	Depth (ft)	Graphic Log
		Blows/ 6 in	N Value	Sample Number	NH (%)	-200 (%)	LL (%)	PI (%)			
2.5	4-10-10	20	1						Light brownish-gray fine Sand w/ Shell (SP)	4.8	
	14-12-11	23	2	12.2	20						
	12-13-13	26	3								
-2.5	12-9-8	17	4						Gray silty fine Sand w/ Shell (SM)	12.5	
	3-2-8	11	5	21.1	14						
	5-7-8	15	6								
-7.5	7-6-7	13	7						Gray fine Sand (SP)	17.5	
	4-6-5	11	8	32.5	15						
	4-2-1	3	9								
-12.5	0-3-3	6	10	33.8	14				Gray silty fine Sand (SM)	22.5	
	1-1-2	3	11								
	0-1-3	4	12	35.5	15						
-17.5	2-3-3	6	13						Gray fine Sand (SP)	28.5	
	5-2-1	3	14								
	1-2-1	3	15								
-22.5	1-1-1	2	16						Gray sandy Clay w/ Shell (SC)	34.5	
	0-0-0	0	17								
	2-1-2	3	18	54.8	51						
-27.5	0-0-0	0	19						Gray silty Clay (CL)	40.5	
	0-0-0	0	20								
	1-0-1	1	21	35.5	17						
-32.5	0-0-1	1	22						Gray silty fine Sand (SM)	45.0	
	0-2-5	7	23								
	10-10-11	21	24								
	2-5-6	13	25						Brown silty fine Sand (SM)		
	5-10-13	23	26								
	12-30-35	65	27						Gray fine Sand (SP)		









# BORING LOG

ARDAMAN & ASSOCIATES, INC.

BORING NO: THW-12  
TOTAL DEPTH: 45.0ft.  
SHEET 1 OF 2

PROJECT: PORT CANAVERAL WEST TURNING BASIN CORNER CUT-OFF	FILE NO: 92-091
CLIENT: CANAVERAL PORT AUTHORITY	ELEVATION: 10.1' MLW
BORING LOCATION STATION: 273+00.00 RANGE: -545.0 PORT CANAVERAL GRID SYSTEM	BORING TYPE: SPI
COUNTY: BREVARD STATE: FLORIDA	CASING TYPE: DRILLING "MUD"
DATE STARTED: 05/28/1992 COMPLETED: 05/28/1992	DRILLER/RIG: SMITH / CHE-55
WATER TABLE: 1st depth: 4.6' DATE: 05/28/1992	TIME: --
WATER TABLE: 2nd depth: -- DATE: --	TIME: --
REMARKS:	

Elevation	Depth (ft)	Standard Pen. Test ASTM D-1586				Lab Data					Soils Description and Remarks	Depth (ft)	Graphic Log
		Blows/ ft	N Value	Sample Number		NH (%)	-200 (%)	LL (%)	PI (%)	Dry Den (pcf)			
5.1	5-24-15	39	1								Brown slightly silty fine Sand w/ Shell (SP-SM)	5	
	10-11-9	20	2							Gray fine Sand (SP)			
	6-9-9	18	3										
10	6-10-12	22	4								Gray silty fine Sand w/ Shell (SP-SM)	10	
	7-8-9	17	5							Gray clayey Silt w/ Shell (MH)			
	6-8-8	16	6	20.2	10								
15	5-0-1	1	7	44.6	26						Gray clayey fine Sand (SC)	15	
	1-2-1	3	8							Gray silty fine Sand w/ traces of Shell (SP-SM)			
	2-3-2	5	9										
15	8-5-5	12	10	27.0	10						Gray sandy Silt w/ traces of Shell (MH)	15	
	1-1-1	2	11							Gray fine Sand w/ Shell (SP)			
	1-0-0	0	12	34.9	32								
20	5-6-4	10	13								Gray silty fine Sand (SM)	20	
	2-1-1	2	14							Gray fine Sand w/ traces of Shell (SP)			
	3-4-5	9	15										
25	5-5-5	10	16								Gray sandy Silt w/ Shell (MH)	25	
	2-0-0	0	17							Gray clayey Silt (MH)			
	0-0-0	0	18										
30	1-0-2	2	19								Gray silty fine Sand (SM)	30	
	1-3-3	5	20							Gray slightly silty fine Sand (SP-SM)			
	3-3-1	4	21										
35	2-3-5	8	22								Gray fine Sand (SP)	35	
	2-5-6	12	23							Gray Clay (CH)			
	2-1-1	2	24										
40	0-0-0	0	25								Gray Clay (CH)	40	
	0-0-0	0	26										
	0-0-0	0	27										



# BORING LOG

ARDAMAN & ASSOCIATES, INC.

BORING NO: THW-13  
TOTAL DEPTH: 45.0ft.  
SHEET 1 OF 2

PROJECT PORT CANAVERAL WEST TURNING BASIN CORNER CUT-OFF	FILE NO. 92-091
CLIENT CANAVERAL PORT AUTHORITY	ELEVATION 7.6'MLW
BORING LOCATION STATION: 276+20.00 RANGE: -380.0 PORT CANAVERAL GRID SYSTEM	BORING TYPE SPT
COUNTY BREVARD STATE FLORIDA	CASING TYPE DRILLING "MUD"
DATE STARTED 05/22/1992 COMPLETED 05/22/1992	DRILLER/RIG SMITH / CME-55
WATER TABLE 1st depth 5.4'	TIME
WATER TABLE 2nd depth --	DATE --
REMARKS	TIME --

Elevation	Depth (ft)	Standard Pen. Test ASTM D-1586				Lab Data				Soils Description and Remarks	Depth (ft)	Sonic Log
		Blows/ 6 ft	N Value	Sample Number		NM (%)	-200 (%)	LL (%)	PI (%)			
	5-5-12	17	1							Grayish brown fine Sand w/ Clay & traces of Shell (SP)		
	13-11-12	23	2	18.1	20					Gray fine Sand w/ traces of Shell & Clay (SP)		
2.6	7-10-11	21	3							Gray slightly silty fine Sand w/ traces of Shell (SP-SM)		
	7-7-7	14	4									
	4-6-6	12	5	22.7	15					Gray silty fine Sand w/ traces of Shell (SM)		
-2.4	6-6-5	11	6									
	2-2-2	4	7							Gray fine Sand (SP)		
	10-11-11	22	8	27.1	7							
	5-5-3	8	9							Gray fine Sand w/ Shell (SP)		
-7.4	1-4-6	10	10	29.2	23					Gray clayey fine Sand w/ traces of Shell (SC)		
	4-2-1	3	11							Gray slightly silty fine Sand (SP-SM)		
	1-2-2	4	12	32.1	13							
	2-1-2	3	13									
-12.4	1-1-1	2	14	33.5	29					Gray slightly silty very fine Sand w/ traces of gray Clay (SP-SM)		
	2-4-2	6	15									
	1-3-3	6	16							Gray fine Sand w/ seams of gray Clay (SP/CL)		
-17.4	2-2-1	3	17	39.1	30							
	2-2-2	4	18.19							Gray sandy Clay (CL)		
	0-2-1	3	20									
-22.4	3-1-2	3	21	49.7	48							
	0-0-1	1	22							Gray fine Sand w/ traces of Clay & Shell (SP/CL)		
	1-2-2	4	23									
	0-0-1	1	24							Gray Clay w/ traces of Shell (CH)		
-27.4	2-1-3	4	25									
	2-0-2	2	26							Dark gray very clayey fine Sand (SC)		
	6-14-25	39	27							Gray fine Sand w/ Shell (SP)		
-32.4	4-14-16	30	28									



# BORING LOG

ARDAMAN & ASSOCIATES, INC.

BORING NO: THW-14  
TOTAL DEPTH: 45 FT.  
SHEET 1 OF 2

PROJECT: PORT CANAVERAL WEST TURNING BASIN CORNER CUT-OFF	FILE NO: 92-091
CLIENT: CANAVERAL PORT AUTHORITY	ELEVATION: 8.8' MLH
BORING LOCATION STATION: 274+60.00 RANGE: -380.0 PORT CANAVERAL GRID SYSTEM	BORING TYPE: SPT
COUNTY: BREVARD STATE: FLORIDA	CASING TYPE: DRILLING "MUD"
DATE STARTED: 05/22/1992 COMPLETED: 05/22/1992	DRILLER/RIG: SMITH / CME-55
WATER TABLE 1st depth: 4.3'	TIME: --
WATER TABLE 2nd depth: --	DATE: --
REMARKS:	TIME: --

Elevation	Depth (ft)	Standard Pen. Test ASTM D-1586				Lab Data					Soils Description and Remarks	Depth (ft)	Graphic Log
		Blows/ 6 in	N Value	Sample Number	NH (%)	-200 (%)	LL (%)	PI (%)	Dry Den (pcf)				
	3-15-10	25	1								Brown fine Sand w/ Shell (SP)		
	14-12-10	22	2								Brown fine Sand w/ traces of Shell (SP)		
	6-7-6	13	3								Grayish-brown slightly silty Sand w/ Shell (SP-SM)		
3.8	5	3-9-8	17	4	20.5	15.0							
	4-4-2	6	5										
	5-3-4	7	6								Gray silty fine Sand w/ Shell (SP-SM)		
-1.2	10	1-1-1	2	7	36.5	14.0							
	1-4-10	14	8										
	6-9-8	17	9		27.7	5.0					Gray fine Sand w/ traces of Shell (SP)		
-6.2	15	3-1-1	2	10	33.8	22.0					Gray silty fine Sand w/ Shell (SM)		
	0-5-9	14	11										
	12-10-4	14	12								Gray fine Sand w/ traces of Shell (SP)		
	2-2-2	4	13		24.4	11.0					Gray slightly silty fine Sand w/ Shell (SP-SM)		
-11.2	20	2-2-5	7	14									
	2-2-1	3	15		32.7	13.0					Gray slightly silty fine Sand (SP-SM)		
	0-0-1	1	16								Gray Clay w/ traces of fine Sand & Shell (CL)		
-16.2	25	0-0-0	0	17	45.0	30.0					Gray clayey fine Sand (SC)		
	1-2-4	6	18								Gray silty fine Sand (SP-SM)		
	5-15-15	30	19										
-21.2	30	15-9-10	19	20							Gray fine Sand (SP)		
	2-2-1	3	21								Gray sandy Clay (CL)		
	0-0-0	0	22, 23										
	0-0-0	0	24								Gray slightly silty fine Sand (SP-SM)		
-26.2	35	1-2-1	3	25									
	0-0-0	0	26								Gray Clay (CH)		
	0-2-1	3	27										
-31.2	40	0-0-0	0	28							Dark gray clayey fine Sand (SC)		













# BORING LOG

ARDAMAN & ASSOCIATES, INC.

BORING NO: THW-17  
TOTAL DEPTH 45.0ft.  
SHEET 1 OF 2

PROJECT PORT CANAVERAL WEST TURNING BASIN CORNER CUT-OFF CLIENT CANAVERAL PORT AUTHORITY BORING LOCATION STATION: 269+00.00 RANGE: -380.0 PORT CANAVERAL COUNTY BREVARD STATE FLORIDA DATE STARTED 05/26/1992 COMPLETED 05/26/1992 WATER TABLE 1st depth 8.8' DATE 05/26/1992 WATER TABLE 2nd depth -- DATE -- REMARKS	FILE NO. 92-091 ELEVATION 13.3'MLW BORING TYPE SPT CASING TYPE DRILLING "MUD" DRILLER/RIG SMITH / CME-55 TIME TIME --
---	---

Elevation	Depth (ft)	Standard Pen Test ASTM D-1586				Lab Data					Soils Description and Remarks	Depth (ft)	Graphic Log
		Blows/ 6 ft	N Value	Sample Number	NH (%)	-200 (%)	LL (%)	PI (%)	Dry Den (pcf)				
	5-12-12	24	1								Brown slightly silty fine Sand w/ traces of Shell (SP-SM)		
	12-9-10	19	2	9.6	16.0						Brown slightly silty fine Sand w/ traces of Shell (SP-SM)		
8.3	15-16-18	34	3										
	16-13-18	31	4	4.2	3.0						Brown slightly silty fine Sand w/ traces of Shell (SP-SM)		
	3-14-15	29	5										
	9-8-12	20	6	13.0	12.0						Brown fine Sand w/ Shell & traces of Clay (SP-SM)		
3.3	5-4-2	6	7										
	3-5-7	12	8	18.7	7.0						Gray fine Sand w/ Shell (SP)		
	3-8-3	11	9										
-1.7	1-2-1	3	10								Gray silty fine Sand w/ Shell (SM)		
	1-1-3	4	11	35.2	14.0								
	3-5-7	12	12	30.4	10.0						Gray slightly silty fine Sand (SP-SM)		
	3-2-1	3	13										
-6.7	1-1-1	2	14	32.1	54.0						Gray clayey fine Sand to sandy Clay w/ Shell (SC-CL)		
	4-5-6	11	15										
	14-17-17	34	16	19.8	6.0						Gray fine Sand w/ Shell (SP)		
-11.7	7-7-8	15	17										
	6-4-4	8	18										
	3-2-3	5	19	37.7	28.0						Gray silty fine Sand w/ traces of Shell (SM)		
-16.7	4-6-9	15	20	26.0	8.0								
	6-10-10	20	21								Gray fine Sand (SP)		
	5-3-3	6	22										
	3-5-10	15	23	37.8	27.0						Gray fine Sand w/ traces of gray Clay (SP/CL)		
-21.7	8-4-6	10	24										
	1-4-5	8	25										
	4-4-4	8	25	40.5	33.0						Gray clayey fine Sand (SC)		
-26.7	0-0-0	0	27								Gray Clay (CL)		













# BORING LOG

**ARDAMAN & ASSOCIATES, INC.**

(104)

**BORING NO:** TH-0  
**TOTAL DEPTH:** 31.0ft.  
**SHEET** 1 OF 1

<b>PROJECT</b> Cruise Terminal #8 & #9 - West Turning Basin	<b>FILE NO.</b> 91-116
<b>CLIENT</b> Canaveral Port Authority	<b>ELEVATION</b> 11.2'
<b>BORING LOCATION</b> Station 270+50 ; Range -500 - Port Canaveral Grid System	<b>BORING TYPE</b> SPI
<b>COUNTY</b> Brevard	<b>STATE</b> Florida
<b>DATE STARTED</b> 09/17/1991	<b>COMPLETED</b> 09/17/1991
<b>WATER TABLE: 1st depth</b> 4.4'	<b>DRILLER/RIG</b> B.S. & D.E. / CME-85
<b>WATER TABLE: 2nd depth</b> --	<b>DATE</b> --
<b>REMARKS</b>	<b>TIME</b> --

Elevation	Depth (ft)	Standard Pen. Test ASTM D-1586				Lab Data					Soils Description and Remarks	Depth (ft)	Graphic Log		
		Blows/ 6 in	N Value	Sample Number	NH (%)	-200 (%)	LL (%)	PI (%)	Dry Den (pcf)						
	5	1-2-5	7	1											
		8-6-7	13	2											
6.2		11-10-8	18	3								Grayish-brown fine sand with shells (SP)			
		6-5-5	10	4											
		3-5-4	9	5								Gray fine sand with shells (SP)			
1.2	10	3-2-3	5	6								Gray slightly silty fine sand with shells (SP-SM)			
		2-1-1	2	7											
		2-0-0	0	8								Gray slightly clayey fine sand with shells (SP-SC)			
		5-9-11	20	9											
-3.8	15	6-2-4	6	10											
-8.8	20	12-15-14	29	11								Gray fine sand (SP)			
-13.8	25	8-12-19	31	12											
-18.8	30	10-14-17	31	13											
-23.8	35														
-28.8	40											End of boring at 31.0 feet			





















<b>BORING LOG</b>		BORING NO: ND-1
<b>ARDAMAN &amp; ASSOCIATES, INC.</b>		TOTAL DEPTH: 111.0ft.
		SHEET 1 OF 3
PROJECT Port Canaveral Navy Dolphin Relocation		FILE NO. 92-063
CLIENT Canaveral Port Authority		ELEVATION +15.8' (MLW)
BORING LOCATION Station 216+48.15 ; Range -190.70 -Port Canaveral Grid System		BORING TYPE SPT
COUNTY Brevard	STATE Florida	CASING TYPE Used Drilling Mud
DATE STARTED 04-22-92	COMPLETED 04-22-92	DRILLER/RIG B.S. and G.H.
WATER TABLE: 1st depth +13.6'	DATE 04-22-92	TIME --
WATER TABLE: 2nd depth --'	DATE --	TIME --
REMARKS		

Elevation	Depth (ft.)	Standard Pen. Test ASTM D-1586			Lab Data					Soils Description and Remarks	Depth (ft.)	Graphic Log
		Blows/ 6 in	N Value	Sample Number	NH (%)	-200 (%)	LL (%)	PI (%)	Dry Dens (pcf)			
	1-4-3	7	1							Dark Brown Loose Fine Sand with Shell Fragments (SP)		
	4-4-3	7	2									
10.8	5	3-4-4	8	3								
	3-3-3	6	4									
	4-4-4	8	5									
	4-4-5	13	6									
5.8	10	6-5-8	13	7								
	15	9-13-17	30	8								
-4.2	20	10-22-25	47	9								
-9.2	25	18-30-30	60	10								
-14.2	30	12-14-18	32	11								
-19.2	35	12-20-23	43	12								
-24.2	40											

Gray Clayey Fine Sand with Shell Fragments (SC)



**BORING LOG**  
**ARDAMAN & ASSOCIATES, INC.**

BORING NO: NG-1  
 TOTAL DEPTH: 111.0ft.  
 SHEET 3 OF 3

PROJECT Port Canaveral Navy Dolphin Relocation FILE NO. 92-063  
 CLIENT Canaveral Port Authority ELEVATION +15.8' (MLW)  
 BORING LOCATION Station 216+48.15 ; Range -190.78 -Port Canaveral Grid System BORING TYPE SPT

Elevation	Depth (ft)	Standard Pen. Test ASTM D-1586				Lab Data					Soils Description and Remarks	Depth (ft)	Graphic Log
		Blows/ 0.1ft	R Value	Sample Number	NH (%)	-200 (%)	LL (%)	PI (%)	Dry Den. (pcf)				
	85	3-5-7	12	21							Light Gray Silty Fine Sand with Shell Fragments (SM)		
-69.2													
	90	5-6-7	13	22							Gray Soft Clayey Fine Sand with Shell Fragments (SC)		
-74.2													
	95	1-0-0	0	23									
-79.2													
	100	7-11-10	21	24									
-84.2													
	105	9-10-11	21	25							Light Gray Silty (cemented) Fine Sand with Shell Fragments (SM)		
-89.2													
	110	8-11-9	20	26									
-94.2													
	115	10-6-10	16	27									
-99.2													
104.2	120										End of Boring at 111.0 feet		



BORING LOG										BORING NO: CD-1		
ARDAMAN & ASSOCIATES, INC.										TOTAL DEPTH 91.0ft.		
PROJECT Port Canaveral Communication Duct										FILE NO. 92-064		
CLIENT Canaveral Port Authority										ELEVATION +17.2' (MLM)		
BORING LOCATION Station 214+72.10 ; Range -179.91 -Port Canaveral Grid System										BORING TYPE SPT		
Elevation	Depth (ft)	Standard Pen. Test ASTM D-1586			Lab Data					Soils Description and Remarks	Depth (ft)	Graphic Log
		Blows/ 6 in	N Value	Sample Number	NW (%)	-200 (%)	LL (%)	PI (%)	Dry Den (pcf)			
		13-5-4	9	13, 14								
-27.8	45	2-2-2	4	15						Gray Sandy Clay to Clayey Fine Sand with Shell Fragments (SC)		
		0-0-1	1	16								
-32.8	50											
		0-2-1	3	17						Gray Soft Clay (CL)		
-37.8	55											
		0-0-1	1	18								
-42.8	60											
		2-3-5	8	19								
-47.8	65											
		4-3-2	5	20						Light Gray Sandy Clay to Sandy Silt with Shell Fragments (SM-SC)		
-52.8	70											
		2-1-2	3	21								
-57.8	75											
-62.8	80									Light Gray Silty Fine Sand with Shell Fragments (SM)		























# BORING LOG

**ARDAMAN & ASSOCIATES, INC.**

BORING NO: CR-17  
 TOTAL DEPTH: 15.0ft.  
 SHEET 1 OF 1

PROJECT PORT CANAVERAL SAND SEARCH - SOUTH SIDE OF CARGO ROAD FILE NO. 92-157  
 CLIENT CANAVERAL PORT AUTHORITY ELEVATION 14.3' MLW  
 BORING LOCATION STATION 263+00, RANGE -970 BORING TYPE SPT  
 COUNTY BREVARD STATE FLORIDA CASING TYPE MUD  
 DATE STARTED 10/19/1992 COMPLETED 10/19/1992 DRILLER/RIG B.S. / CME-55  
 WATER TABLE: 1st depth 2.5' DATE 10/19/1992 TIME  
 WATER TABLE: 2nd depth -- DATE -- TIME --  
 REMARKS

Elevation	Depth (ft)	STANDARD PEN. TEST ASTM D-1586				Lab Data				Soils Description and Remarks	Depth (ft)	Graphic Log	
		Blows/6 in	N Value	Sample Number	NM (%)	-200 (#)	LL (%)	PI (%)	Dry Den (pcf)				
	1-2-2	4	1										
	4-2-2	4	2										
	1-2-1	3	3										
9.7	5	1-1-1	2	4									
	1-0-1	1	5										
	1-2-2	4	6										
4.3	10	2-0-4	4	7									
	3-1-2	3	8										
	2-2-3	5	9										
	5-5-5	10	10										
-0.69	15												
-5.7	20												

End of Boring at Elevation -0.7 feet (MLW).



<b>BORING LOG</b>		BORING NO: 7H-40
<b>ARDAMAN &amp; ASSOCIATES, INC.</b>		TOTAL DEPTH: 51.0ft.
PROJECT CRUISE TERMINAL NO. 4 - PIER AND BULKHEAD EXTENSION		FILE NO. 93-012
CLIENT CAHAYERAL PORT AUTHORITY		ELEVATION 6.8' M.W.
BORING LOCATION STATION 188+40. RANGE +565		BORING TYPE SPT
COUNTY BREVARD	STATE FLORIDA	CASING TYPE HUD
DATE STARTED 02/09/1993	COMPLETED 02/09/1993	DRILLER/RIG B.S. / CBE-55
WATER TABLE: 1st depth 4.5'	DATE 02/09/1993	TIME
WATER TABLE: 2nd depth --	DATE --	TIME --
REMARKS		

Elevation	Depth (ft)	Standard Pen. Test ASTM D-1586				Lab Data					Soils Description and Remarks	Depth (ft)	Graphic Log	
		Blows/ 6 in	N Value	Sample Number		NW (%)	-200 (%)	LL (%)	PI (%)	Dry Unit (pcf)				
		1-3-4	7	1								Gray-brown fine Sand w/ Shell fragments (SP)		
		5-6-5	11	2								Tan fine Sand w/ traces of Shell fragments (SP)		
3.9	5	5-5-5	10	3										
		7-7-9	16	4										
		4-9-12	21	5										
		12-13-13	26	6										
-1.2	10	6-14-12	26	7										
		12-18-22	40	8										
		5-10-12	22	9										
-6.2	15	12-15-22	37	10										
		6-12-15	27	11										
		12-12-18	30	12										
		3-6-9	15	13										
-11.2	20	5-12-13	25	14										
		4-7-8	15	15										
		6-8-10	18	16										
-16.2	25	5-7-11	18	17								Gray slightly silty fine Sand w/ traces of Shell fragments (SP/SP-SM)		
		7-12-18	30	18										
		10-12-18	30	19										
-21.2	30	12-19-25	43	20										
		7-11-13	24	21										
		16-20-22	42	22										
		10-10-15	25	23										
-26.2	35	15-20-25	45	24										
		8-6-8	14	25										
		15-20-25	45	26										
-31.2	40	8-8-5	13	27								Gray slightly silty fine Sand w/ traces of Shell fragments and gray Clay (SP/SP-SC)		













BORING LOG										BORING NO: TH-A TOTAL DEPTH: 123.0ft. SHEET 1 OF 4	
ARDAMAN & ASSOCIATES, INC.											
PROJECT South Cargo Pier 4 Extension					FILE NO. 98-148						
CLIENT Canaveral Port Authority					ELEVATION 0.0' (MLW)						
BORING LOCATION Station 235+10; Range +508					BORING TYPE SPT						
COUNTY Brevard					STATE Florida					CASING TYPE Steel casing, 50 feet long	
DATE STARTED 07/14/98					COMPLETED 07/14/98					DRILLER/RIG Amdrill, Inc.	
WATER TABLE 1st depth --					DATE --					TIME --	
WATER TABLE 2nd depth --					DATE --					TIME --	
REMARKS Soil classifications shown on this log are based on visual-manual procedures (ASTM D 2488)											
Elevation	Depth (ft)	Standard Pen. Test ASTM D-1586			Lab. Data				Soils Description and Remarks	Depth (ft)	Graphic Log
		Blows/ 6 in	N Value	Sample Number	NH (%)	-200 (%)	LL (%)	PI (%)			
-5	5										
-10	10								Water		
-15	15										
-20	20										
-25	25	WOR	WOR	N/R					Very dark gray silty to clayey fine sand with shell fragments (SM-SC)		
		WOR	WOR	1							
-30	30	1-0-1	1	2					Dark gray sandy clay to clayey fine sand with traces of shells (SC-CL)		
			US #1	\$4.2	97			67.7			
-35	35	0-0-1-0	1	3					Dark gray clay with traces of fine sand (CH)		
			US #2	95.8	99			47.1			
		WOR	WOR	4					Dark gray clay (CH)		

**BORING LOG**  
**ARDAMAN & ASSOCIATES, INC.**

BORING NO: TH-A  
 TOTAL DEPTH: 123.0ft.  
 SHEET 2 OF 4

PROJECT South Cargo Pier 4 Extension

FILE NO. 98-148

CLIENT Canaveral Port Authority

ELEVATION 9.0' (MLH)

BORING LOCATION Station 235+10; Range +508

BORING TYPE SPT

Elevation (ft)	Depth (ft)	Standard Pen. Test ASTM D-1586			Lab. Data					Soils Description and Remarks	Depth (ft)	Graphic Log
		Blows/ 0.1ft	N Value	Sample Number	NN (%)	-200 (%)	LL (%)	PI (%)	Dry Den. (pcf)			
-40	40	1-0-2	2	5						Dark gray clay (CH)		
-45	45	1-1-1	2	6						Dark gray sandy clay (CL/CH)		
-50	50	3-6-12	18	7						Greenish gray clayey fine sand with shell fragments (SC)		
-55	55	2-1-2	3	8								
-60	60	3-5-10	15	9						Gray silty fine sand with shell fragments (SM)		
-65	65	3-3-3	6	10						Greenish gray clayey fine sand to sandy clay with traces of shells (SC-CL)		
-70	70	4-2-2	4	11						Greenish gray sandy clay with traces of shells (CL/CH)		

US #3  
N/H





BORING LOG										BORING NO: TH-B		
ARDAMAN & ASSOCIATES, INC.										TOTAL DEPTH: 123.5ft.		
(326)										SHEET 1 OF 4		
PROJECT South Cargo Pier 4 Extension					FILE NO. 99-148							
CLIENT Dade County Port Authority					ELEVATION 0.0' (MLW)							
BORING LOCATION Station 232+82; Range +471					BORING TYPE SPT							
COUNTY Brevard					STATE Florida							
DATE STARTED 07/13/98					COMPLETED 07/13/98							
WATER TABLE: 1st depth --					DATE --							
WATER TABLE: 2nd depth --					DATE --							
REMARKS Soil classifications shown on this log are based on visual-manual procedures (ASTM D 2489)												
Elevation	Depth (ft.)	Standard Pen. Test ASTM D-1586			Lab. Data					Soils Description and Remarks	Depth (ft.) Graphic Log	
		Blows/ 6 in	N Value	Sample Number	NH (%)	-200 (%)	LL (%)	PI (%)	Dry Den. (pcf)			
-5	5											
-10	10											
-15	15											
-20	20											
-25	25											
-30	30											
-35	35											

Water



BORING LOG										BORING NO: TH-B	
ARDAMAN & ASSOCIATES, INC.										TOTAL DEPTH: 123.5ft.	
PROJECT: South Cargo Pier 4 Extension										FILE NO: 98-148	
CLIENT: Caguvera Port Authority										ELEVATION: 0.0' (MLW)	
BORING LOCATION: Station 232+82; Range +471										BORING TYPE: SPT	
Elevation	Depth (ft)	Standard Pen. Test ASTM D-1586			Lab. Data				Soils Description and Remarks	Depth (ft)	Graphic Log
		Blows/ 6 in	N Value	Sample Number	NH (%)	-200 (%)	LL (%)	PI (%)			
-75	75	3-2-2	4	9					Gray clayey fine sand with shell fragments (SC)		
-80	80	4-6-5	11	10							
-85	85	6-4-5	9	11					Gray silty fine sand with partially cemented sand lenses and traces of shells (SM)		
-90	90	8-20-12	32	12							
-95	95	6-5-5	10	13	33.8	29			Light brown silty fine sand (SM)		
-100	100	7-7-10	17	14	47.8	59	62	35	Light brown silty to sandy clay (CL/CH)		
-105	105	6-7-10	17	15					Light brown sandy clay (CL/CH)		





# BORING LOG

**ARDAMAN & ASSOCIATES, INC.**

BORING NO: TH-3  
 TOTAL DEPTH: 51.0ft.  
 SHEET 1 OF 2

PROJECT Cove Bulkhead Wall	FILE NO. 00-093
CLIENT Canaveral Port Authority	ELEVATION 10.1' (NLW) approx.
BORING LOCATION Approximate: Station 259+95, Range 516	BORING TYPE SPI
COUNTY Brevard	CASING TYPE No casing - used drilling mud
DATE STARTED 08/15/00	COMPLETED 08/15/00
STATE Florida	DRILLER/RIG Jay Don CHE-55
WATER TABLE: 1st depth 5.1'	TIME --
WATER TABLE: 2nd depth --	DATE --

Elevation	Depth (ft)	Standard Pen. Test ASTM D-1586		Lab. Data					Soils Description and Remarks	Depth (ft) Graphic Log
		Blows/ 6 in	N Value	Sample Number	W (%)	-200 (%)	LL (%)	PI (%)		
5.1	8-13-17	30	1						Light brown silty fine sand with some shell	
	17-24-27	51	2							
	11-19-13	32	3						Light brown slightly silty fine sand with some shell	
	7-9-6	15	4						Gray silty fine sand	
	1-2-1	3	5						Gray slightly sandy clay	
.1	2-11-10	21	6							
	8-8-8	16	7						Gray fine and medium sand with shell	
	5-3-4	7	8						Gray fine sand with trace shell	
-4.9	2-7-8	15	9							
	7-8-12	20	10						Gray fine sand with shell	
	3-2-3	5	11							
-9.89	1-0-1	1	12						Dark gray-green slightly sandy clay with shell	
	1-1-3	4	13						Gray silty fine sand with trace shell and trace clay	
	9-10-14	24	14							
	9-12-18	30	15						Gray fine and medium sand with shell	
-14.9	18-12-16	28	16							
	2-16-18	34	17							
	16-24-17	41	18						Gray fine sand with shell	
-19.9	10-12-13	25	19							
	4-3-3	6	20						Gray clay with trace shell	
	4-3-4	7	21						Gray silty fine sand with trace clay	
	1-2-1	3	22							
-24.9	2-1-1	2	23						Gray clay with trace shell	
	1-1-1	2	24							

# BORING LOG

## ARDAMAN & ASSOCIATES, INC.

BORING NO: TH-3  
 TOTAL DEPTH: 51.0ft.  
 SHEET 2 OF 2

PROJECT Cove Bulkhead Wall FILE NO. 00-093  
 CLIENT Canaveral Port Authority ELEVATION 10.1' (MLW) approx.  
 BORING LOCATION Approximate: Station 259+95, Range 516 BORING TYPE SPT

Elevation (ft)	Depth (ft)	Standard Pen. Test ASTM D-1586			Lab. Data					Soils Description and Remarks	Depth (ft)	Graphic Log
		Blows/ 6 in	N Value	Sample Number	NH (%)	-200 (%)	LL (%)	PI (%)	Dry Den. (pcf)			
-29.9	40	1-1-1	2	24						Gray clay with trace shell	40	[Hatched]
		1-0-1	1	25								
		0-1-1	2	26								
		1-1-1	2	27								
		1-1-2	3	28								
		1-1-1	2	29								
-34.9	45	1-0-1	1	30						45	[Hatched]	
		1-1-1	2	31								
		1-2-1	3	32								
-39.9	50	1-1-4	5	33						50	[Dotted]	
		3-3-4	7	34								Shell fragments with gray clayey sand
-44.9	55									55	[Blank]	
-49.9	60									60	[Blank]	
-54.9	65									65	[Blank]	
-59.9	70									70	[Blank]	
BORING TERMINATED AT 51.0 FEET BELOW LAND SURFACE												























<b>BORING LOG</b>										BORING NO: TH-2	
<b>ARDAMAN &amp; ASSOCIATES, INC.</b>										TOTAL DEPTH: 105.0ft.	
PROJECT Scallop Drive Marina										FILE NO. 03-108	
CLIENT Tom Bennett										ELEVATION 10.0' (MLW) (Approximate)	
BORING LOCATION Approximate Station 284+50; Range 660										BORING TYPE SPT	
COUNTY Brevard										STATE Florida	
DATE STARTED 08/12/03										COMPLETED 08/12/03	
WATER TABLE: 1st depth 2.6'										DRILLER/RIG R.B. / CME 55	
WATER TABLE: 2nd depth --										DATE 08/12/03	
REMARKS										TIME --	
Elevation (ft)	Depth (ft)	Standard Pen. Test ASTM D-1586			Lab. Data				Soils Description and Remarks	Depth (ft)	Graphic Log
		Blows/ 6 in	N Value	Sample Number	NH (%)	-200 (%)	LL (%)	PI (%)			
				1					Light brown fine sand with trace silt		
				2					Gray fine sand with trace silt and shell fragments		
				3							
5	5	14-12-12	24	4					Gray to light brown silty fine sand with trace shell fragments and clay		
		13-11-12	23	5							
		13-11-9	20	6							
0	10	3-1-1	2	7					Light gray fine sand with trace silt and shell fragments		
-5	15	1-1-2	3	8					Gray clayey fine sand with shell		
-10	20	2-0-2	2	9					Gray fine sand few clay and shell		
-15	25	1-1-1	2	10							
-20	30	1-0-1	1	11					Gray clay with trace shell fragments and fine sand		
				US-1	57.6	99.3		65.9			
-25	35	6-7-7	14	12					Gray fine sand and silt with shell fragments		

<p style="text-align: center;"><b>BORING LOG</b> <b>ARDAMAN &amp; ASSOCIATES, INC.</b></p>										<p>BORING NO: TH-2 TOTAL DEPTH: 105.0ft. SHEET 2 OF 3</p>			
<p>PROJECT: Scallop Drive Marina</p>					<p>FILE NO: 03-108</p>								
<p>CLIENT: Tom Bennett</p>					<p>ELEVATION: 10.0' (MLW) (Approximate)</p>								
<p>BORING LOCATION: Approximate Station 284+50; Range 660</p>					<p>BORING TYPE: SPT</p>								
Elevation	Depth (ft)	Standard Pen. Test ASTM D-1586			Lab. Data					Soils Description and Remarks	Depth (ft)	Graphic Log	
		Blows/ 6 in	N Value	Sample Number	NW (%)	-200 (%)	LL (%)	PI (%)	Dry Den. (pcf)				
	-30	8-9-11	20	13							Gray fine sand and silt with shell fragments		
	-35	10-14-12	26	14							Gray fine sand with shell and trace silt		
	-40	1-1-2	3	15									
	-45	2-2-2	4	16							Bluish-gray sandy clay with trace shell fragments		
	-50	1-1-2	3	17	54.1	61.6							
	-55												
	-55	2-2-3	5	18									
	-60	2-2-4	6	19							Greenish-gray sandy clay few shell fragments		

BORING LOG										BORING NO: TH-2		
ARDAMAN & ASSOCIATES, INC.										TOTAL DEPTH: 105.0ft.		
PROJECT: Scallop Drive Marina										FILE NO. 03-108		
CLIENT: Tom Bennett										ELEVATION 10.0' (M.W.) (Approximate)		
BORING LOCATION: Approximate Station 284+50; Range 660										BORING TYPE: SPT		
Elevation	Depth (ft)	Standard Pen. Test ASTM D-1586			Lab. Data					Soils Description and Remarks	Depth (ft)	Graphic Log
		Blows/ 6 in	N Value	Sample Number	NH (%)	-200 (%)	LL (%)	PI (%)	Dry Den. (pcf)			
-65	75	4-7-10	17	20	30.0	57.3				Greenish-gray sandy clay few shell fragments		
-70	80	5-6-4	10	21						Greenish-gray fine sand few silt with trace shell fragments		
-75	85	4-3-4	7	22								
-80	90	3-3-2	5	23								
-85	95	14-26-34	60	24						Light gray calcareous cemented sand with trace silt and fine sand		
-90	100	42-50/5"	50/5"	25								
-95	105	50/2"	50/2"	26						BORING TERMINATED AT 105.0 FEET BELOW GROUND SURFACE		









**Port Canaveral Section 203 Feasibility Study  
Engineering Appendix**

Attachment J

Civil Design Impacts: Traffic Study, Harbor Crossing Utilities Drawings,  
Dredged and Excavated Material Disposal Sites Drawing

Rev Date: September 2012

---

---

# Northside and Southside Traffic Study, Port Canaveral, Florida

Final Report

Prepared for:  
Canaveral Port Authority

Prepared by:  
Ghyabi & Associates

May 2006



*Ghyabi &  
Associates, Inc.*

Engineering & Planning

7575 Dr. Phillips Blvd. Suite 225, Orlando, FL 32819  
Telephone: (407) 351-8733 Fax: (407) 351-8247

**PROFESSIONAL ENGINEERING CERTIFICATION**

I hereby certify that I am a Professional Engineer properly registered in the State of Florida practicing with Ghyabi & Associates, Inc., a corporation authorized to operate as an engineering business, EB 00007311, by the State of Florida Department of Professional Regulation, Board of Professional Engineers, and that I have prepared or approved the evaluations, findings, opinions, conclusions, or technical advice attached hereto for:

**PROJECT:** CPA/North and South Side Traffic Study  
**LOCATION:** Port Canaveral, Florida  
**CLIENT:** Canaveral Port Authority

I hereby acknowledge that the procedures and references used to develop the results contained in these computations are standard to the professional practice of Transportation Engineering as applied through professional judgment and experience.

Ghyabi & Associates, Inc. C.A. #7311  
214 East New York Avenue  
DeLand, FL 32724

---

Mark D. Tobin, P.E. #57304

---

**TABLE OF CONTENTS**

TABLE OF CONTENTS..... I

LIST OF FIGURES ..... II

LIST OF TABLES ..... III

SECTION 1 --- INTRODUCTION ..... 1

    LOCATION..... 1

    STUDY AREA..... 1

    LAND USE ASSUMPTIONS AND ANALYSIS PERIODS ..... 1

    STUDY PROCEDURES..... 3

SECTION 2 --- EXISTING ROADWAY CONDITIONS ..... 6

    INTERSECTION ANALYSIS..... 11

    WEAVE ANALYSIS ..... 16

SECTION 3 --- FUTURE TRAFFIC CONDITIONS ..... 17

    BACKGROUND TRAFFIC GROWTH ..... 17

    TRIP GENERATION ..... 17

    TRIP ASSIGNMENTS..... 19

    FUTURE CONDITIONS ANALYSIS ..... 20

WEAVING ANALYSIS..... 35

SECTION 4 --- CONCLUSION..... 36

Appendix A- Link Volumes

Appendix B - Turning Movement Counts

Appendix C- HCS Worksheets – Existing Conditions

Appendix D - HCS Worksheets- Future Conditions (2010)

Appendix E - HCS Worksheets- Future Conditions (2025)

Appendix F –Central Boulevard Analysis

**LIST OF FIGURES**

---

Figure 1: General Location Map.....	4
Figure 2: Existing Geometry.....	5
Figure 3: Existing (Year 2005) Roadway Volumes.....	8
Figure 4: Opening Year (2010) Roadway Volumes.....	9
Figure 5: Design Year (2025) Roadway Volumes.....	10
Figure 6: Existing Year (2005) AM Peak Hour Turning Movements.....	13
Figure 7: Existing Year (2005) Mid-day Peak Hour Turning Movements.....	14
Figure 8: Existing Year (2005) PM Peak Hour Turning Movements.....	15
Figure 9: Opening Year (2010) AM Peak Hour Turning Movements.....	24
Figure 10: Opening Year (2010) Mid-day Peak Hour Turning Movements.....	25
Figure 11: Opening Year (2010) PM Peak Hour Turning Movements.....	26
Figure 12: Design Year (2025) AM Peak Hour Turning Movements.....	27
Figure 13: Design Year (2025) Mid-day Peak Hour Turning Movements.....	28
Figure 14: Design Year (2025) PM Peak Hour Turning Movements.....	29
Figure 15: Existing Year (2005) Level of Service.....	30
Figure 16: Opening Year (2010) Level of Service.....	31
Figure 17: Design Year (2025) Level of Service.....	32
Figure 18: Opening Year (2010) Geometry.....	33
Figure 19: Design Year (2025) Geometry.....	34



**LIST OF TABLES**

Table 1: Existing AM/Mid-day/PM Peak Hour Level of Service ..... 12

Table 2: Existing Level of Service – Weaving Section ..... 16

Table 3: Future Trip Generation ..... 18

Table 4: Future AM/Mid-day/PM Peak-Hour Level of Service for Intersection ..... 22

Table 5: Future Peak-Hour Level of Service for Weave Analysis ..... 35

## **Section 1 --- Introduction**

Ghyabi & Associates, Inc. (G&A) has been retained by the Canaveral Port Authority (CPA) to provide transportation engineering services for Port Canaveral located in Brevard County, Florida.

### **Location**

The project is located in Port Canaveral, Brevard County, Florida. Figure 1 presents the general location of the project site.

### **Study Area**

For this study, Ghyabi & Associates evaluated conceptual land use/access alternatives and their associated impacts to the operating conditions for the north-side and south-side Port Canaveral internal roadway system. The study limits for the north cargo area extends from the Inlet Bridge to the USAF gate on SR 401. The study area for the south side of Port Canaveral includes the internal roadway system from SR 528 to Jetty Park, notably George King Boulevard, Scallop Drive and Mullet Drive. Port Canaveral area currently includes several land uses including cruise ship terminals, cargo piers, tanker berths, a marina, public boat ramps and various retail and commercial uses.

## **Land Use Assumptions and Analysis Periods**

Future land use for both the North and South sides of the Port was provided to G&A by the CPA. Some of the information provided included estimated opening years. For phasing and build-out information that was not available from the CPA, G&A made assumptions.

South side port expansion projects include the aggregate conveyor and storage area which is expected to open initially in 2006 and have 150 daily truck trips. This site is expected to increase to full operation with 300 daily truck trips by 2009. The Premier Office Building is expected to be fully occupied by 2008. In the Cove area, east of Dave Nesbit Drive, future land uses are evolving. For this study, it is assumed to include a hotel (Milrose), a museum and small amount of retail land use. The Milrose Hotel is assumed to initially open with 115 rooms by 2007 and add 60 rooms by 2010. The museum is assumed to be 15,000 square feet while the retail uses at this location are assumed to be 25,000 square feet. Both were assumed to be open by 2010.

Additionally on the South side, at the west end of George King Boulevard and adjacent to the Banana River is the proposed Ron Jon World project. This project is proposed to include a 400-room hotel, a 25,000 square foot conference center, a 73,000 square foot store, a 10,000 square foot restaurant, approximately 11.5 acre surf/water park and board sports venue and a 1200-vehicle parking garage. Also associated with Ron Jon World is a proposed 5,000 square foot retail site at the current Jetty Park.

Other South side expansion projects include the opening of Cruise Terminals 3 and 4 which are expected to be operating by Fall 2006 and Fall 2008, respectively. Cruise Terminal 3 would serve 2-day cruises while Terminal 4 would serve 3- and 4-day cruises.

North side port expansion includes the opening of Cruise Terminals 6 and 7 by 2008 to accommodate 3 ships per week. Cruise Terminals 11 and 12 are expected to be open by 2012 and accommodate 3 ships

per week as well. Cargo Piers 5 and 6 are expected to be fully operational by 2015. These cargo piers would have an upland container staging area of 18.45 acres (assumed to be operating by 2010) then expand fully to 53.6 acres by 2015. The future land use of the North Side of the Port also includes a 30-acre fuel tank farm expected to be open by 2009 and generate 500 truck trips per day.

Traffic analysis was performed for the following time periods: current year (2005), opening year (2010) and design year (2025).

## Study Procedures

Standard engineering and planning procedures were used to determine the impacts of this project. Reference data was obtained from the Canaveral Port Authority, the Florida Department of Transportation, and the Institute of Transportation Engineers (ITE). Traffic volumes and turning movement counts were collected by G&A in August 2005.

The methodology used in this report includes:

- Determination of the existing Daily traffic volumes and AM peak hour, Mid-day peak hour, and PM peak hour volumes and turning movements for the study areas and the intersections within it, based on collected data.
- Development of opening year (2010) and design year (2025) traffic volume forecasts for the conceptual land use improvements.
- Evaluation of the existing and future traffic conditions.
- Level of Service analysis for the study area intersections for existing and future conditions (opening and design years).
- Recommendations for improvements to accommodate the anticipated travel demand with the study area based on Level of Service analysis.



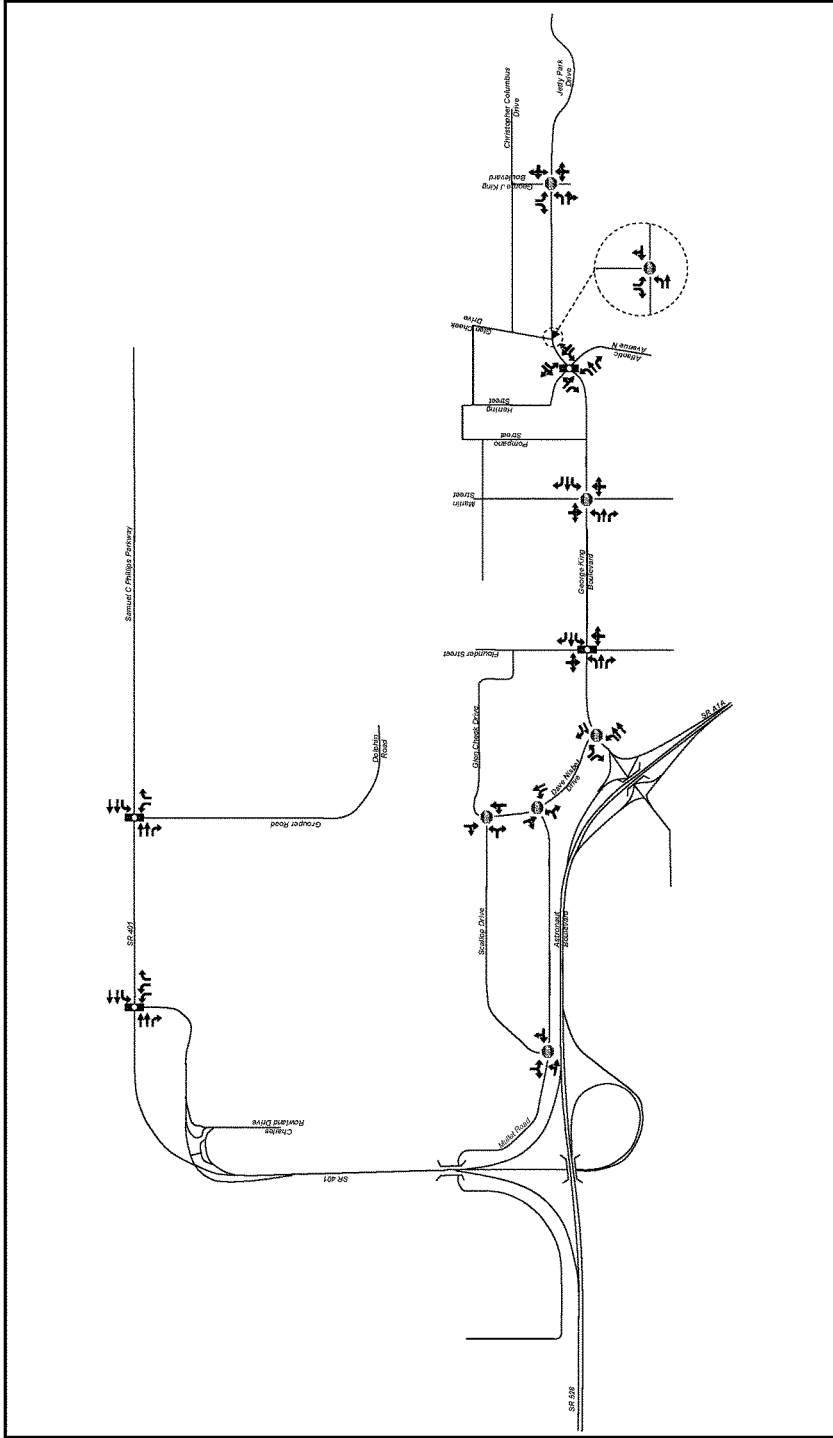

<p><b>Existing Year 2005 - Existing Geometry</b></p>	<p><b>FIGURE: 2</b></p>	
<p>PROJECT NUMBER: 2630.03 &amp; 2630.04</p>		
<p><b>North and South Side Traffic Study for Port Canaveral</b></p>		
<p><b>Ghyabi &amp; Associates, Inc.</b>                  Engineering &amp; Planning                  2745 East Executive Parkway, Suite 204, Ft. St. John, FL 32974                  Telephone: (407) 546-0027 Fax: (407) 546-0071</p>		

## Section 2 --- Existing Roadway Conditions

An analysis of the existing traffic conditions was conducted using the 24 hour volume counts, 72 hour classification counts and the turning movement counts collected by G&A at the segments and intersections, respectively listed below. The turning movement counts were conducted for eight hours. Figure 2 shows the existing intersection geometry. The 2005 AM, Mid-day and PM peak-hour turning movement counts are shown in Figures 6, 7 and 8. The volume count summaries, classification count summaries and turning movement count summaries are attached in Appendix A.

### *North Cargo Area of Port Canaveral:*

- 24-Hour Volume Counts –
  1. SR 401 – NB Off Ramp to Charles Rowland Drive
  2. SR 401 – SB On Ramp from Charles Rowland Drive
  3. SR 401 – West of Charles Rowland Drive
  4. Grouper Road – South of SR 401
- 72-Hour Classification Counts –
  1. SR 401 – East of Charles Rowland Drive
  2. SR 401 – East of Grouper Road
- Turning Movement Counts –
  1. SR 401 @ Charles Rowland Drive
  2. SR 401 @ Grouper Road

### *South Cargo Area of Port Canaveral:*

- 24-Hour Volume Counts –
  1. George King Boulevard – East of Dave Nisbet Drive
  2. George King Boulevard – East of Flounder Street
  3. George King Boulevard – East of Glen Cheek Drive
  4. Jetty Park Drive – East of George King Boulevard
  5. Christopher Columbus Drive – East of Glen Cheek Drive
  6. Atlantic Avenue – South of George King Boulevard
  7. Glen Cheek Drive – East of Dave Nisbet Drive
  8. Dave Nisbet Drive – North of George King Boulevard
  9. Scallop Drive – West of Dave Nisbet Drive
  10. Mullet Road – West of Dave Nisbet Drive

11. Mullet Road – West of Scallop Drive
  12. Mullet Road – West of SR 401 (Bridge)
- 72-Hour Classification Counts –
    1. George King Boulevard – East of Pompano Street
  - Turning Movement Counts –
    1. George King Boulevard @ Dave Nisbet Drive
    2. George King Boulevard @ Flounder Street
    3. George King Boulevard @ Marlin Street
    4. George King Boulevard @ N Atlantic Avenue
    5. George King Boulevard @ Christopher Columbus Road
    6. George King Boulevard @ Jetty Park Drive
    7. Scallop Drive @ Mullet Road
    8. Mullet Road @ Dave Nisbet Drive
    9. Scallop Drive @ Dave Nisbet Drive









## Intersection Analysis

Intersection operational analyses were performed based on the AM, Mid-day and PM peak hours. All intersections were analyzed using the most current adopted procedures as outlined in the Transportation Research Board's Special Report 209 – Highway Capacity Manual (HCM). Roadway levels of service describe the operating condition determined from the number of vehicles passing over a given section of roadway during a specified time period. It is a qualitative measure of several factors which include: speed, travel time, traffic interruptions, freedom to maneuver, driver comfort, convenience, safety and vehicle operating costs. Six levels of service have been established as standards by which to gauge roadway performance, designated by the letters A through F. The level of service categories are defined as follows:

- Level of Service A:* Free flow, individual users virtually unaffected by the presence of others
- Level of Service B:* Stable flow with a high degree of freedom to select operating conditions
- Level of Service C:* Flow remains stable, but with significant interactions with others
- Level of Service D:* High-density stable flow in which the freedom to maneuver is severely restricted
- Level of Service E:* This condition represents the capacity level of the road
- Level of Service F:* Forced flow in which the traffic exceeds the amount that can be served

Intersection levels of service use quantitative measures to describe the operating condition at an intersection. Length of delay due to the traffic signal cycle timings at a signalized intersection or due to traffic conditions at an unsignalized intersection determine intersection level of service. This delay is measured in seconds.

The operating conditions at the intersections were evaluated using the Highway Capacity Software 2000 (HCS). This utilizes the methodology outlined in Chapters 16 and 17 of the *Highway Capacity Manual*. Table 1 shows the existing levels of service for the study intersection for the AM, Mid-day and PM peak-hours. The HCS worksheets for the existing conditions are located in Appendix C.

Table 1 shows the current level of service for the 11 intersections studied as part of this report. All of the intersections operate at level of service A or B, except for George King Blvd and Dave Nisbet Drive which operates at level of service C during the Mid-day and PM peak hours.

**Table 1: Existing AM/Mid-day/PM Peak Hour Level of Service**

Intersection	Am Peak		Mid-day Peak		PM Peak	
	Delay (sec)	LOS	Delay (sec)	LOS	Delay (sec)	LOS
Charles Rowland Drive and SR 401	7.6	A	4.4	A	6.8	A
Grouper Road and SR 401	8.4	A	9.4	A	8.4	A
George King Blvd and Dave Nisbet Drive	14.5	B	17.3	C	17.5	C
George King Blvd and Flounder St	8.8	A	10.6	B	10.6	B
George King Blvd and Marlin Avenue	11.4	B	12.3	A	11.6	B
George King Blvd and N Atlantic Avenue	17.8	B	16.6	B	16.2	B
George King Blvd and Christopher Columbus Road	10.6	B	10.0	A	9.7	A
George King Blvd and Jetty Park Drive	10.2	B	9.1	A	9.5	A
Scallop Drive and Mullet Road	9.0	A	9.1	A	9.2	A
Scallop Drive and Dave Nisbet Drive	8.8	A	9.4	A	10.2	B
Mullet Road and Dave Nisbet Drive	8.9	A	9.7	A	10.8	B

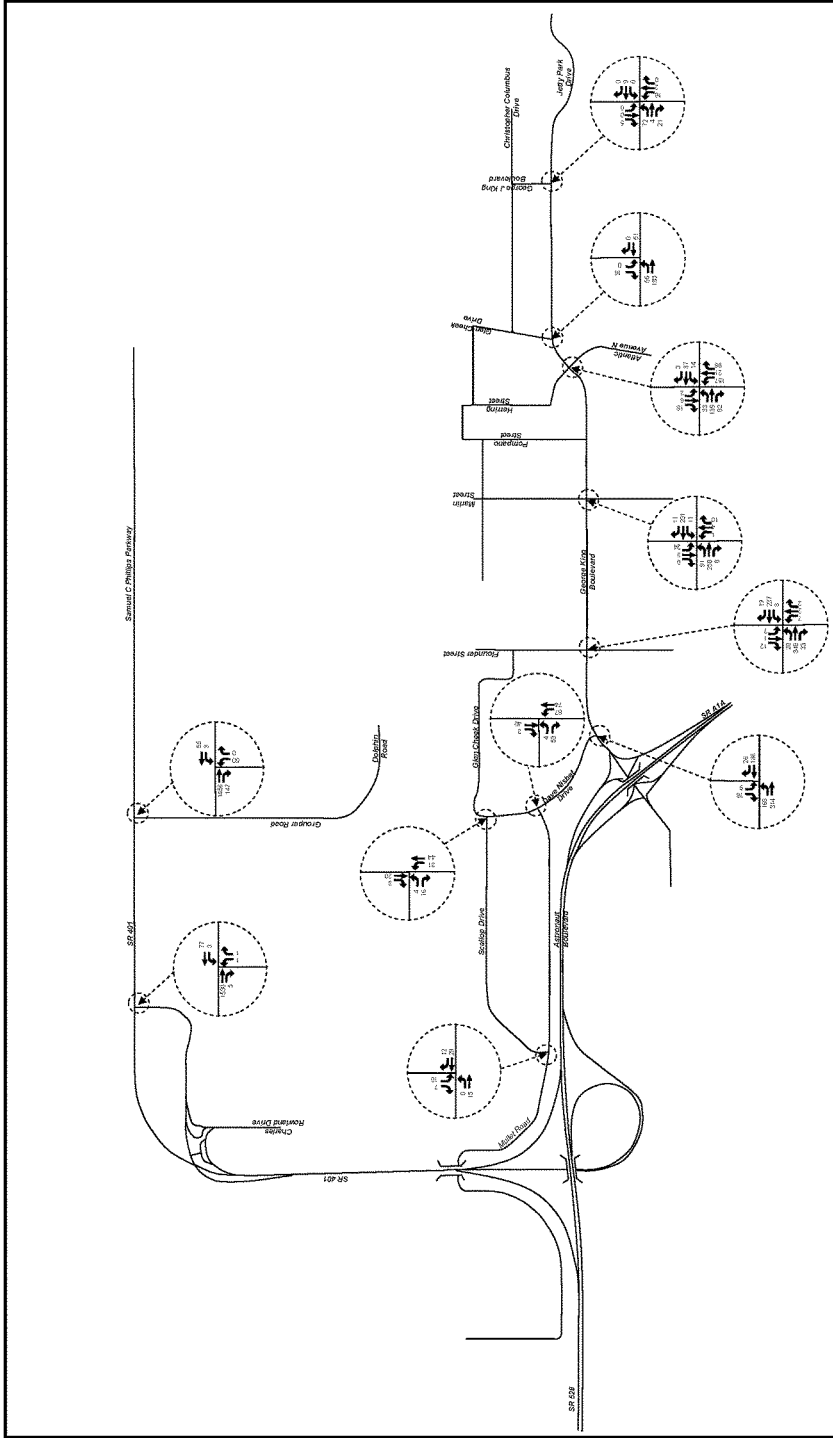

**Ghyabi & Associates, Inc.**  
 Engineering & Planning  
 2115 East New York Avenue, Suite 204, Ft. St. John, FL 32924  
 Telephone: 321-945-0047 Fax: 321-945-0071



Existing Year 2005 - AM Peak Hour  
 Turning Movement Volumes  
 PROJECT NUMBER: 2630.03 & 2630.04  
 FIGURE: 6

North and South Side Traffic Study for Port Canaveral







## Weave Analysis

Weaving occurs when two or more streams of traffic moving in the same general direction merge and then diverge over a short distance, resulting in crossings of portions of the traffic streams. As in this study, weaving is typically found when an on-ramp is followed by an off-ramp. Some portions of the road are usually multilane and much of the traffic is not involved in the weaving movement.

When performing a weave analysis, sufficient length and width of the weaving section need to be provided so that the speed of any non-weaving traffic is not adversely affected. When sufficient space is not available it can be expected that the speed of all traffic passing through the weaving section will be lower than on the open road.

Higher densities are usually obtained for any given LOS obtained on a weaving section. This is due to the fact that drivers expect and accept higher densities along these areas. Factors that affect weaving include the length of the roadway segment, number of lanes, types of weaving configurations, as well as types of terrain or grade conditions.

A weave analysis of the area along George King Boulevard, from the A1A eastbound off-ramp to Dave Nisbet Drive was evaluated using the Highway Capacity Software 2000 (HCS). This utilizes the methodology outlined in Chapter 24 of the *Highway Capacity Manual*. Table 2 shows the existing levels of service for the weaving section for the AM, Mid-day and PM peak-hours. The HCS worksheets for the weave analysis are located in Appendix C.

**Table 2: Existing Level of Service – Weaving Section**

Weaving Section	AM Peak-Hour			Mid-day Peak Hour			PM Peak-Hour		
	Speed (mph)	Density (pc/mi/ln)	LOS	Speed (mph)	Density (pc/mi/ln)	LOS	Speed (mph)	Density (pc/mi/ln)	LOS
GKB from A1A Off-ramp to Dave Nisbet Dr.	31.79	10.68	B	32.08	11.22	B	34.40	6.64	A

## SECTION 3 --- FUTURE TRAFFIC CONDITIONS

### Background Traffic Growth

Traffic on the roadway network within Port Canaveral and along roadways adjacent to or providing access to the Port (i.e., SR 528, SR A1A and North Atlantic Avenue) will continue to grow due to local development approvals. The counts taken by Ghyabi and Associates were used to determine the future growth rate of the background trips. However there was insufficient historical data available to conduct a trend analysis. In order to project future traffic growth associated with a high degree of new development both within the Port's boundaries and in areas in close proximity to the Port, a mixed annual growth rate was used to develop future background traffic. A 4% annual growth rate was used for the first five years (2006-2010) and a 3 % annual growth rate was used for the next 15 years (2011-2025).

### Trip Generation

The trip generation for this development was determined using the trip generation rates published by the Institute of Transportation Engineers (ITE) in their *Trip Generation Manual, 7<sup>th</sup> Edition*. For land uses not found in the *Trip Generation Manual*, data was obtained from the Canaveral Port Authority for estimated number of trips for the aggregate plant/storage site, the fuel tank farm and the cruise ship terminals. In addition, to approximate trip generation rates for the proposed conference center, ITE code 710, General Office Building was used. Similarly, a land use does not exist for museums. The ITE code 590, Library, was used to approximate the trip generation of the maritime museum. These were chosen based on similarities in size and possible traffic generation. The trip generation for the library and the movie theater without a matinee are shown in Table 3.

**Table 3: Future Trip Generation**

Parcel No.	ITE Code	Land Use	Rates					Daily Trips						PM Peak				AM Peak				
			Daily	PM Peak	AM Peak	Units	Size	Total Trips	Dir. Split		Dir. Trips		Total Trips	Dir. Split		Dir. Trips		Total Trips	Dir. Split		Dir. Trips	
									In	Out	In	Out		In	Out	In	Out		In	Out		
1	814	Specialty Retail Center	44.3	5.02	6.84	SF	25,000	1,108	50%	50%	544	544	126	56%	44%	70	55	171	48%	52%	82	89
2	590	Library	54	7.09	1.06	SF	15,000	810	50%	50%	405	405	107	48%	52%	51	56	16	52%	48%	9	7
3	030	Aggregate Plant (1)	300					300	50%	50%	150	150	25	47%	53%	12	13	27	40%	60%	11	16
4	710	Premier Office	11	1.49	1.55	SF	68,480	754	50%	50%	377	377	102	17%	83%	17	85	106	88%	12%	93	13
5	310	Hotel (Milrose)	8.17	0.59	0.56	Room	175	1,430	50%	50%	715	715	103	53%	47%	55	49	98	61%	39%	60	38
6	310	Hotel (Ron Jon)	8.17	0.59	0.56	Room	400	3,268	50%	50%	1634	1634	236	53%	47%	125	111	224	61%	39%	137	87
6		Conference Center (2)	81	11	11.4	SF	25,000	2,025	50%	50%	1,013	1,013	274	53%	47%	145	129	285	61%	39%	174	111
6	814	Retail	44.3	5.02	6.84	SF	20,000	886	50%	50%	443	443	100	56%	44%	56	44	137	48%	52%	66	71
6	932	Restaurant	127.15	11.52	10.92	SF	8,000	1,017	50%	50%	509	509	92	61%	39%	56	36	87	52%	48%	45	42
7	010	Cargo Pier/Container Area (1)	11.9			Acres	18	220	50%	50%	110	110	18	47%	53%	8	9	20	60%	40%	12	8
8	010	Cargo Pier/Container Area (1)	11.9			Acres	54	640	50%	50%	320	320	51	47%	53%	24	27	58	60%	40%	35	23
9	030	Fuel Tank Farm (3)				Acres	30	500	50%	50%	250	250	40	47%	53%	19	21	44	60%	40%	26	18
10		Cruise Terminal 6 & 7 (3)						990	50%	50%	495	495	80	47%	53%	38	42	99	60%	40%	59	40
11		Cruise Terminal 11 & 12 (3)						990	50%	50%	495	495	80	47%	53%	38	42	99	60%	40%	59	40
12		Cruise Terminal 3 (3)						670	50%	50%	335	335	54	47%	53%	25	29	67	60%	40%	40	27
13		Cruise Terminal 4 (3)						1,130	50%	50%	565	565	90	47%	53%	42	48	113	60%	40%	68	45
14	814	Retail (Jetty Park)	44.3	5.02	6.84	SF	5,000	222	50%	50%	111	111	25	56%	44%	14	11	34	48%	52%	16	18
<b>Total</b>								<b>16,960</b>	<b>50%</b>	<b>50%</b>	<b>8,480</b>	<b>8,480</b>	<b>1,603</b>	<b>56%</b>	<b>44%</b>	<b>796</b>	<b>807</b>	<b>1685</b>	<b>56%</b>	<b>44%</b>	<b>99</b>	<b>693</b>

- 1 Used ITE Code 030 Truck Terminal to determine AM and PM trip rates
- 2 Daily and peak hour trips were estimated using data from Prime Osborn Convention Center Traffic Impact Study
- 3 Daily trip volumes provided by Canaveral Port Authority; peak hour trips assumed.

### **Trip Assignments**

The final step in the analysis is to assign the new traffic from future land uses at the Port to the road network. Figures 4 and 5 show the results of the Daily, AM, Mid-day and PM peak-hour assignments to the roadway network for 2010 (opening year) and 2025 (design year).

## Future Conditions Analysis

Eleven critical intersections and the segment of George King Boulevard from SR A1A to the intersection of Dave Nisbet Drive were analyzed based on the existing roadway geometry to determine potential impacts and to investigate mitigation possibilities, if necessary. The total projected traffic volumes, which consist of future background traffic and project trips, were assigned to the road network.

## Intersection Analysis

The operating conditions of the intersections were analyzed using Chapters 16 and 17 of the *Highway Capacity Manual*. The results of the HCS analyses of the intersection for the future conditions for 2010 and 2025 and during the AM, Mid-day and PM peak-hours are presented in Table 4.

The 11 intersections analyzed as part of this study show that all except one, George King Boulevard and Dave Nisbet Drive, will operate at acceptable levels of service with their current lane configurations in 2010. The HCS analysis shows that George King Boulevard and Dave Nisbet Drive will operate at LOS F during the PM peak hour in 2010 if it remains unsignalized. Installing a traffic signal at this intersection will improve the LOS to D during the PM Peak hour at this intersection. During the AM Peak hour this intersection will operate at LOS C.

By 2025, this intersection, George King Boulevard and Dave Nisbet Drive, will need an additional left-turn lane for the eastbound to northbound movement to maintain the LOS at D. A signal at the intersection of George King Boulevard and Marlin Street will be needed to accommodate volumes expected by 2025. In addition, George King Boulevard will need to be widened to provide 2 through-lanes in each direction between Atlantic Avenue North and the interchange with SR A1A. Other improvements required on the south side of the Port by 2025 are additional lanes at Mullett Road and Dave Nesbit Drive. While this intersection can remain unsignalized, a through lane in the southbound direction and the widening of the eastbound approach to provide a left- turn and a right- turn lane will be needed by 2025.

On the Port's north side, the signalized intersections of SR 401 and Charles Rowland Drive, and SR 401 and Grouper Road, will operate at acceptable levels of service provided the signal cycles are lengthened in 2010. An interim year analysis (2015) was performed for these two intersections to determine if improvements would be needed sooner than 2025. By 2015, it is expected that SR 401 will need to be widened to 3 lanes in each direction. By 2025, the intersection of SR 401 and Grouper Road will require a second northbound-left turn lane to maintain an adequate level of service in both the AM and PM peak hours.

Figures 9 through 14 show the future years turning movements for the time periods analyzed (AM peak, mid-day peak and PM peak).

### **Central Boulevard Analysis**

An analysis of the potential impact on Central Boulevard in the City of Cape Canaveral for traffic generated by the proposed Ron Jon World project was performed. Using trip generation data for the proposed land uses at Ron Jon World and the Central Florida Regional Planning Model II to determine trip distribution, it has been estimated that at the full build out of Ron Jon World approximately 60 vehicles would use Central Boulevard between SR A1A and Atlantic Avenue North during the PM peak hour. These 60 vehicles would be nearly evenly split between eastbound and westbound. Worksheets and model output can be found in Appendix F.

**Table 4: Future AM/Mid-day/PM Peak-Hour Level of Service for Intersection**

Future AM/Mid-day/PM Peak Hour Level of Service (2010)						
Intersection	AM Peak		Mid-day Peak		PM Peak	
	Delay (sec)	LOS	Delay (sec)	LOS	Delay (sec)	LOS
Charles Rowland Drive and SR 401	11.0	B	5.3	A	8.7	A
Grouper Road and SR 401	21.4	C	9.7	A	9.8	A
George King Blvd and Dave Nisbet Drive	10.6	B	12.5	B	31.3	C
George King Blvd and Flounder St	10.4	B	11.2	B	12.2	B
George King Blvd and Marlin Avenue	19.3	C	17.4	C	16.7	B
George King Blvd and N Atlantic Avenue	19.9	B	20.7	C	21.1	C
George King Blvd and Christopher Columbus Road	9.0	A	10.8	B	10.5	B
George King Blvd and Jetty Park Drive	11.8	B	10.3	B	10.2	B
Scallop Drive and Mullet Road	9.3	A	9.4	A	9.6	A
Scallop Drive and Dave Nisbet Drive	8.9	A	9.6	A	10.7	B
Mullet Road and Dave Nisbet Drive	9.9	A	11.4	B	13.4	B

Future AM/Mid-day/PM Peak Hour Level of Service (2025)						
Intersection	AM Peak		Mid-day Peak		PM Peak	
	Delay (sec)	LOS	Delay (sec)	LOS	Delay (sec)	LOS
Charles Rowland Drive and SR 401	48.6	D	5.4	A	36.8	D
Grouper Road and SR 401	45.2	D	16.3	B	36.5	D
George King Blvd and Dave Nisbet Drive	19.0	B	29.4	C	35.3	D
George King Blvd and Flounder St	26.2	C	30.0	C	21.8	C
George King Blvd and Marlin Avenue	33.7	C	32.3	C	10.9	B
George King Blvd and N Atlantic Avenue	34.9	C	24.8	C	33.4	C
George King Blvd and Christopher Columbus Road	19.6	C	10.8	B	11.5	B
George King Blvd and Jetty Park Drive	16.6	C	12.6	B	11.2	B
Scallop Drive and Mullet Road	9.8	A	9.5	A	10	B
Scallop Drive and Dave Nisbet Drive	9.4	A	12.1	B	18.3	C

Mullet Road and Dave Nisbet Drive	10.6	B	14.5	B	20.6	C
-----------------------------------	------	---	------	---	------	---







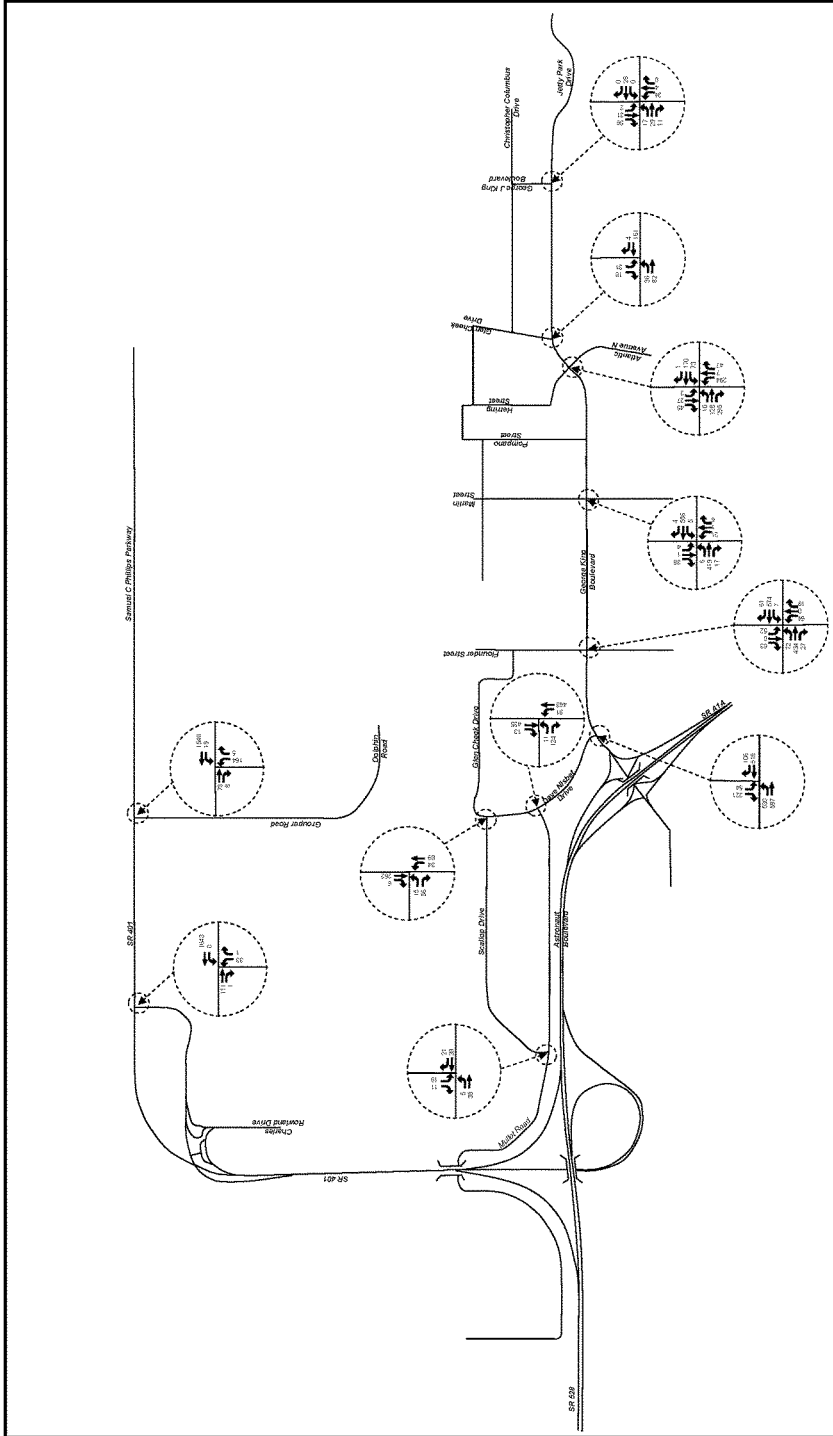

**Ghyabi & Associates, Inc.**  
 Engineering & Planning  
 2714 East Bayshore Avenue, Suite 104, Ft. Lauderdale, FL 33304  
 Telephone: 954-566-0047 Fax: 954-566-0271



Opening Year 2010 - PM Peak Hour  
 Turning Movement Volumes  
 PROJECT NUMBER: 2630.03 & 2630.04  
 FIGURE: 11

North and South Side Traffic Study for Port Canaveral

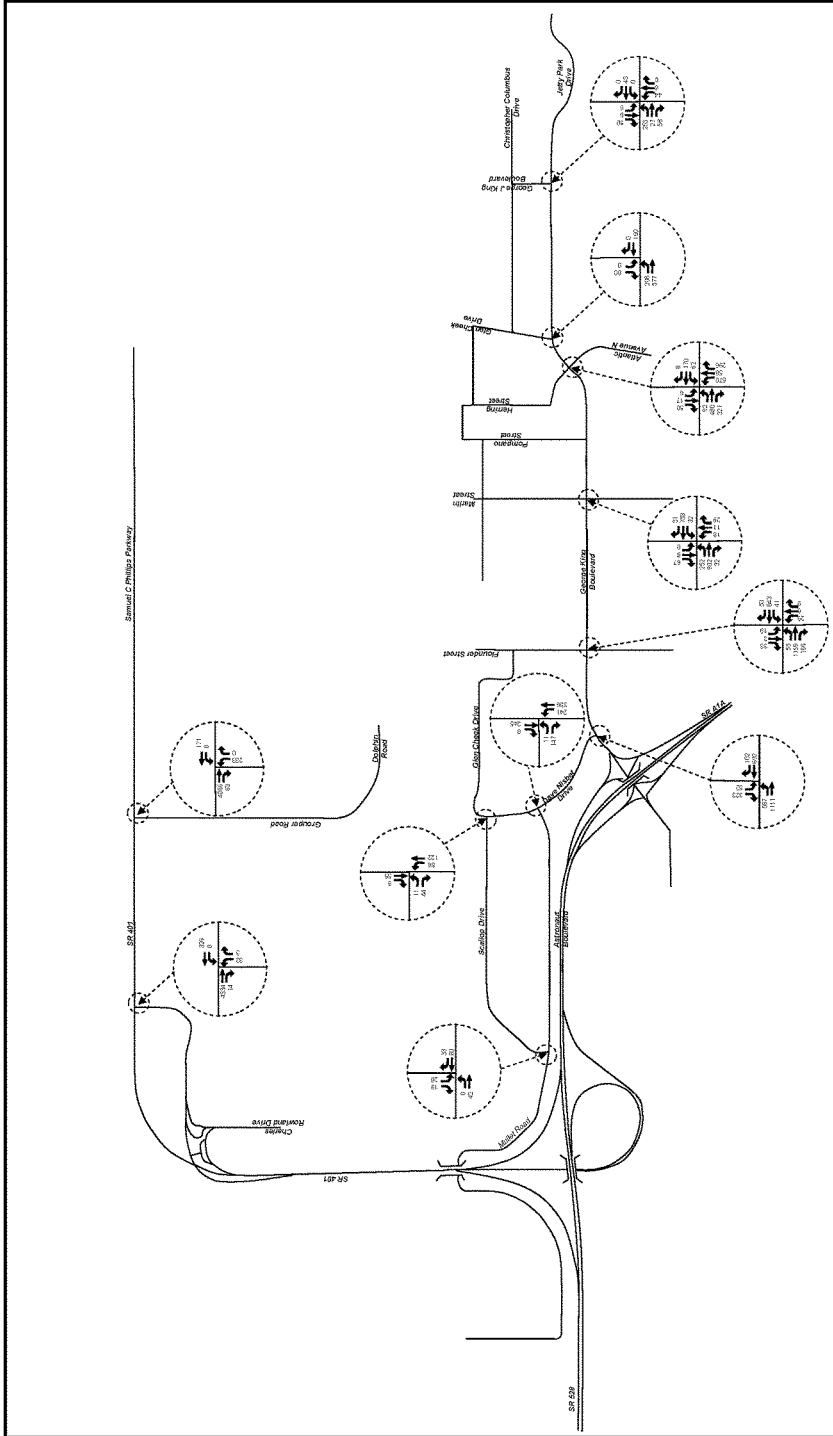

<p><b>North and South Side Traffic Study for Port Canaveral</b></p>	<p>PROJECT NUMBER: 2630.03 &amp; 2630.04</p>	<p>FIGURE: 12</p>
<p>Design Year 2025 – AM Peak Hour Turning Movement Volumes</p>		
<p><b>Ghyabi &amp; Associates, Inc.</b> Engineering &amp; Planning 2114 East Paces Ferry, Atlanta, GA 30329 Telephone: 404-263-0007 Fax: 404-263-0071</p>		

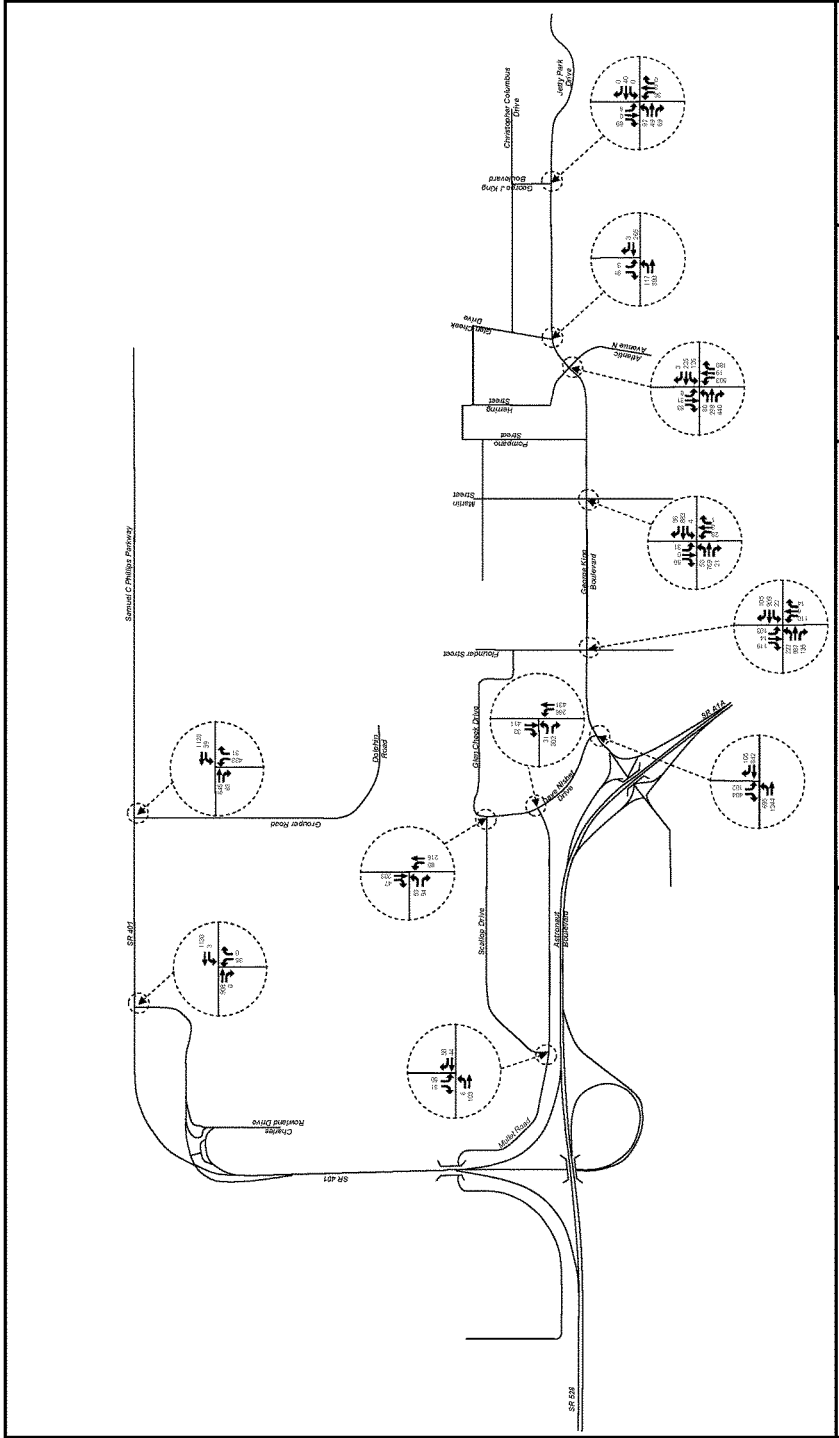

<p><b>Design Year 2025 – Mid-day Peak Hour Turning Movement Volumes</b></p>	<p><b>FIGURE: 13</b></p>	<p><b>PROJECT NUMBER: 2630.03 &amp; 2630.04</b></p>
<p><b>North and South Side Traffic Study for Port Canaveral</b></p>		
<p><b>Ghyabi &amp; Associates, Inc.</b> Engineering &amp; Planning 2715 East New York Avenue, Suite 200, Ft. St. John, FL 32924 Telephone: (407) 946-0047 Fax: (407) 946-0071</p>		



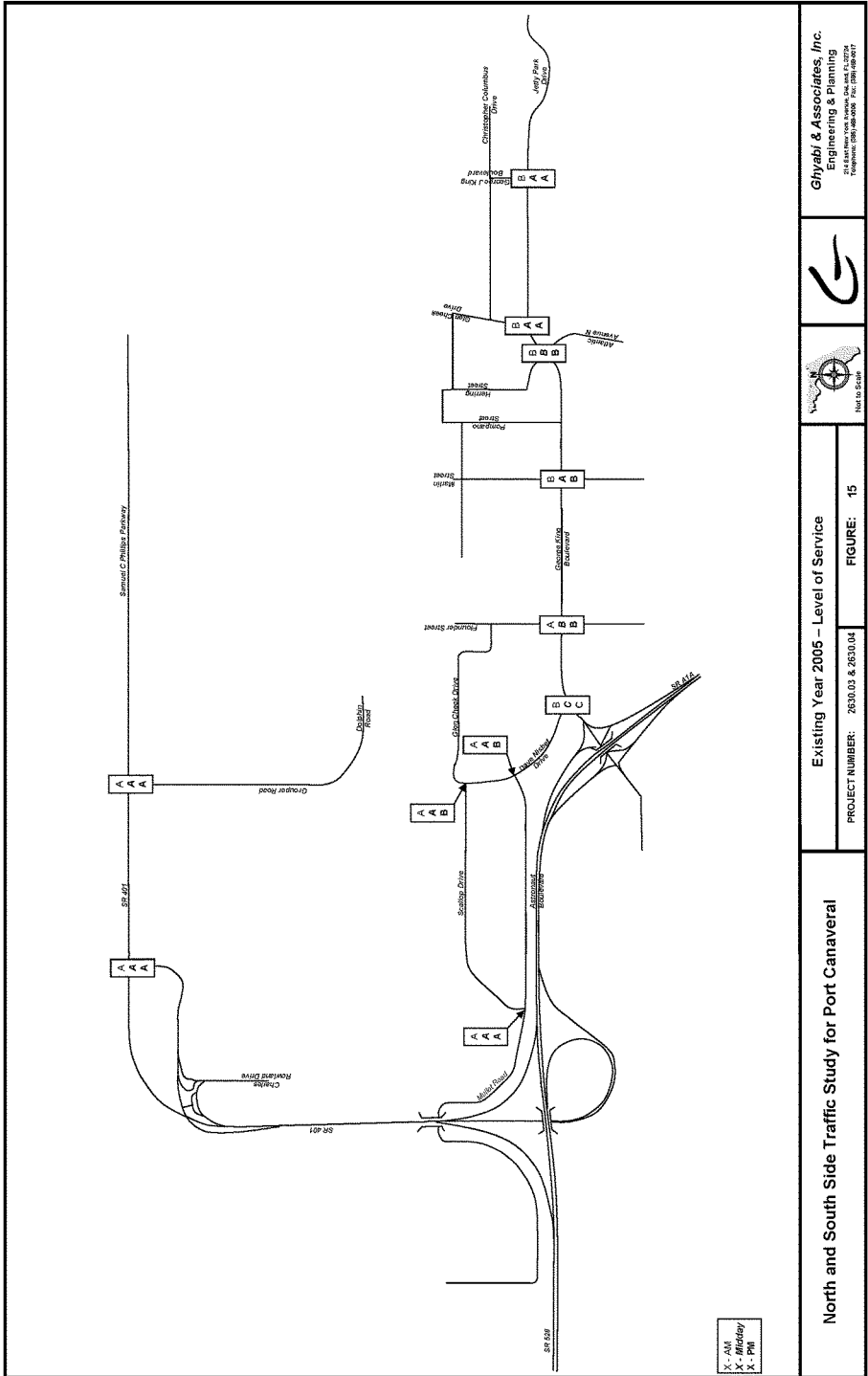

**Ghyabi & Associates, Inc.**  
 Engineering & Planning  
 211 East New York Avenue, Suite 411, Fort Lauderdale, FL 33304  
 Telephone: (954) 546-0047 Fax: (954) 546-0071



**Existing Year 2005 - Level of Service**  
 PROJECT NUMBER: 2630.03 & 2630.04  
 FIGURE: 15

**North and South Side Traffic Study for Port Canaveral**

X - AM  
 X - Midday  
 X - PM

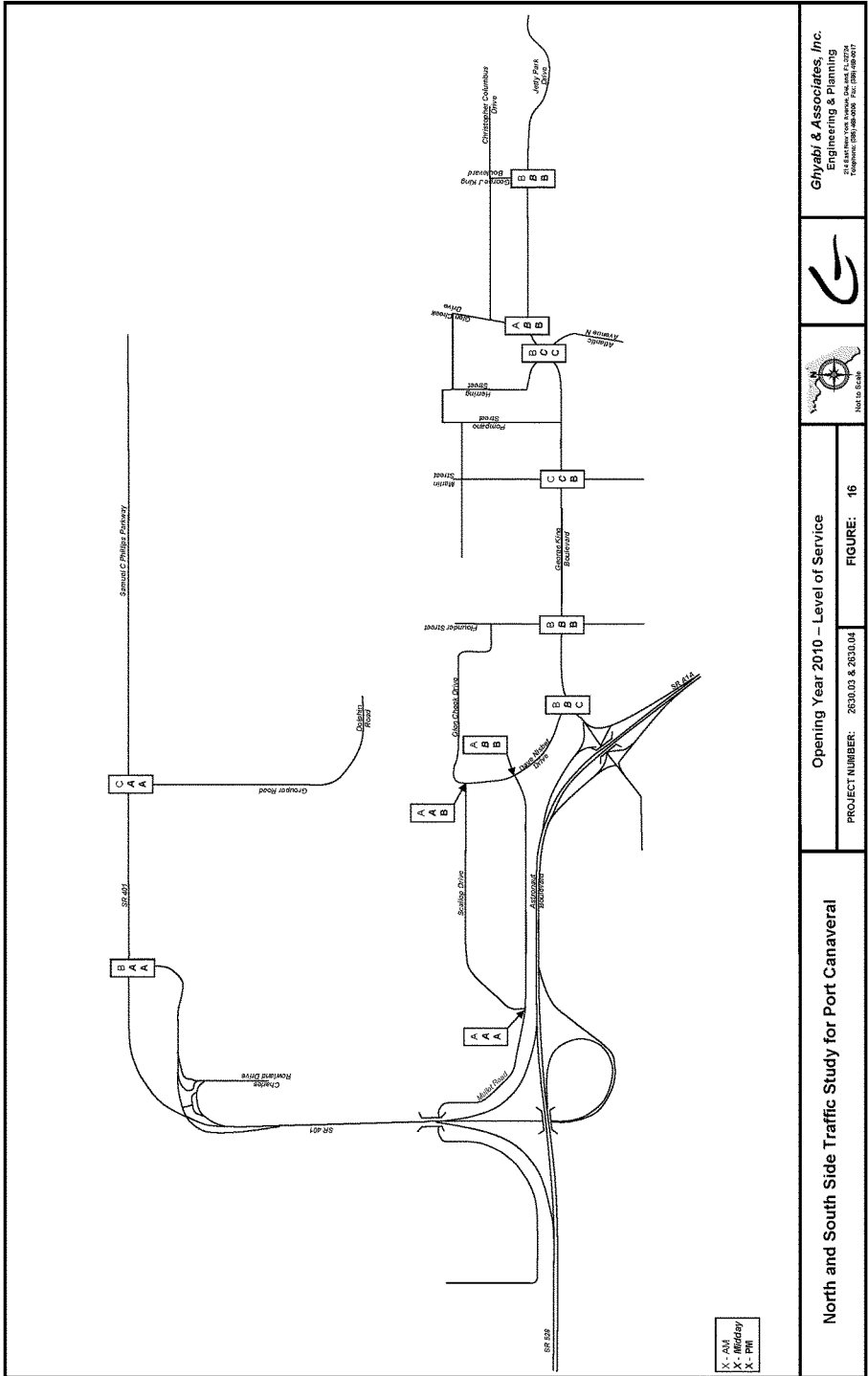

**Ghyabi & Associates, Inc.**  
 Engineering & Planning  
 214 East New York Avenue, Suite 411, Fort Lauderdale, FL 33304  
 Telephone: (954) 562-0027 Fax: (954) 562-0071



**Opening Year 2010 – Level of Service**

**PROJECT NUMBER: 2630.03 & 2630.04**



**FIGURE: 16**

**North and South Side Traffic Study for Port Canaveral**



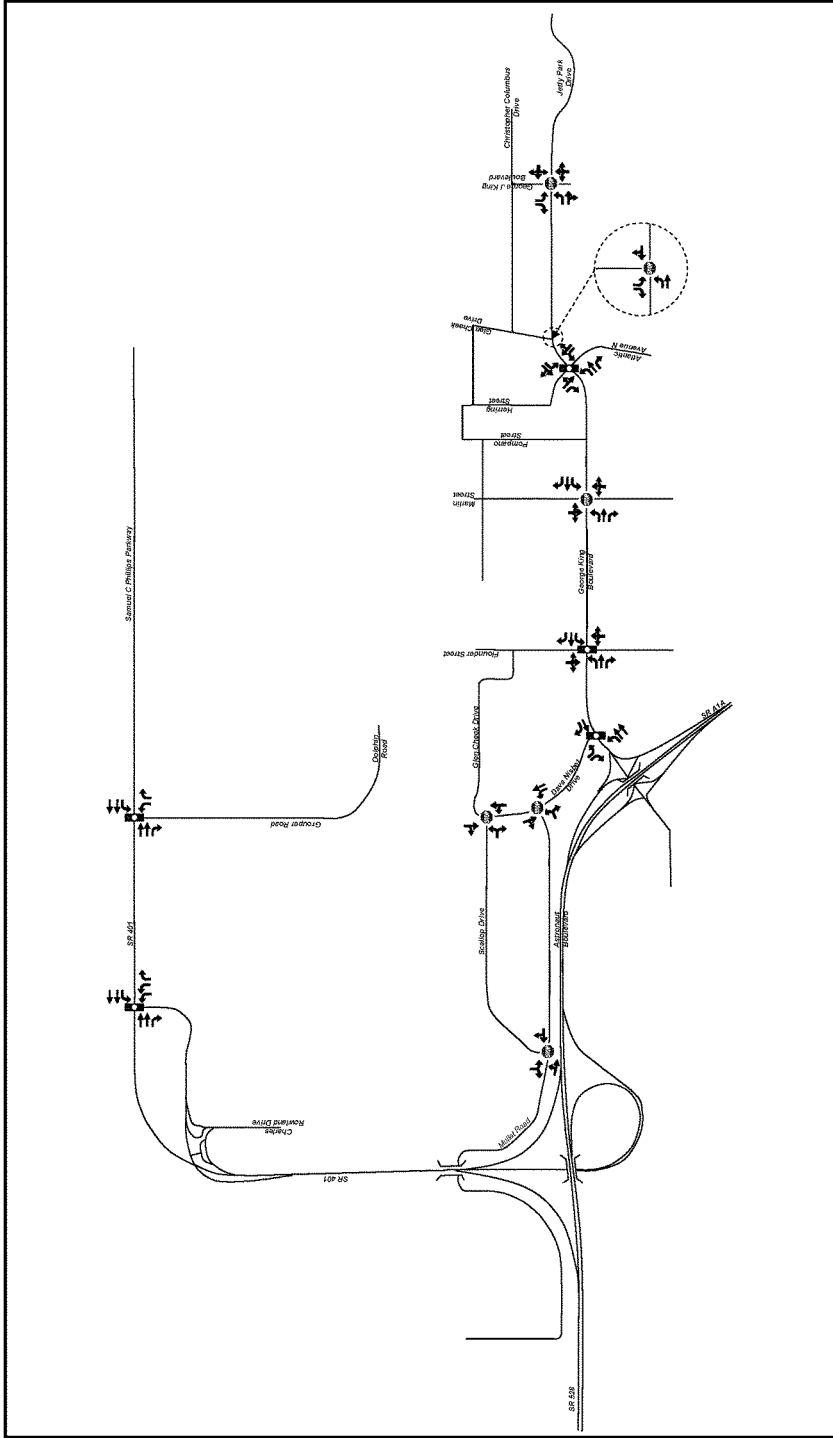



<p><b>North and South Side Traffic Study for Port Canaveral</b></p>	<p>Opening Year 2010 - Future Geometry</p>	<p>FIGURE: 18</p>
<p>PROJECT NUMBER: 2630.03 &amp; 2630.04</p>		
		
		
<p><b>Ghyabi &amp; Associates, Inc.</b>                  Engineering &amp; Planning  <small>214 East New York Avenue, Suite 404, Ft. St. John                  Pompano Beach, Florida 33062-7400 Fax: (305) 962-0111</small></p>		



**Weaving Analysis**

The section of George King Blvd. between the A1A Off-ramp and Dave Nisbet Dr. was analyzed to accommodate the total projected traffic in 2010 and in 2025. The operating conditions of this segment were analyzed according to Chapter 24 of the Highway Capacity Manual. The results of the HCS weaving analyses of the roadway segment are presented in Table 5.

**Table 5: Future Peak-Hour Level of Service for Weave Analysis**

Weaving Section	AM Peak-Hour (2010)			Mid-day Peak-Hour (2010)			PM Peak-Hour (2010)		
	Speed (mph)	Density (pc/mi/ln)	LOS	Speed (mph)	Density (pc/mi/ln)	LOS	Speed (mph)	Density (pc/mi/ln)	LOS
GKB from A1A Off-ramp to Dave Nisbet Dr.	31.6	16	B	32.7	15	B	31.0	18	B
Weaving Section	AM Peak-Hour (2025)			Mid-day Peak-Hour (2025)			PM Peak-Hour (2025)		
	Speed (mph)	Density (pc/mi/ln)	LOS	Speed (mph)	Density (pc/mi/ln)	LOS	Speed (mph)	Density (pc/mi/ln)	LOS
GKB from A1A Off-ramp to Dave Nisbet Dr.	29.9	25	C	28.9	30	D	29.3	30	D

## SECTION 4 --- CONCLUSION

This study was conducted to analyze the effect that future land use changes at both Port Canaveral North side and South side would have on the Port's transportation infrastructure. North side Port expansion includes the opening of Cruise Terminals 6 and 7 by 2008 to accommodate 3 ships per week. Cruise Terminals 11 and 12 are expected to be open by 2012 and accommodate 3 ships per week as well. Cargo Piers 5 and 6 are expected to be fully operational by 2015. These cargo piers would have an upland container staging area of 18.45 acres (assumed to be operating by 2010) then expand fully to 53.6 acres by 2015. The future land use of the North side of the Port also includes a 30-acre fuel tank farm expected to be open by 2009 and generate 500 truck trips per day.

South side Port expansion projects include the aggregate conveyor and storage area which is expected to open in 2006 and have 150 daily truck trips, then increase to full operation with 300 daily truck trips by 2009. The Premier Office Building is expected to be fully occupied by 2008. In the Cove area, east of Dave Nesbit Drive, future land uses are evolving. For this study, the Cove is assumed to include a hotel (Milrose), a museum and small amount of retail land use. The Milrose Hotel is assumed to initially open with 115 rooms by 2007 and add 60 rooms by 2010. The museum is assumed to be 15,000 square feet while the retail uses at this location are assumed to be 25,000 square feet. Both were assumed to be open by 2010.

Also on the South side is a Hotel and Conference Center at the west end of George King Blvd. and adjacent to the Banana River (the proposed Ron-Jon project). This project is proposed to include a 400-room hotel, a 25,000 square foot conference center, a 25,000 square foot store, a 10,000 square foot restaurant and a 1200-vehicle parking garage. Also associated with this Hotel and Conference Center would be a 5,000 square foot retail site at the current Jetty Park.

Other south side expansion projects include the opening of Cruise Terminals 3 and 4 which are expected to be operating by fall 2006 and 2008, respectively. Cruise Terminal 3 would serve 2-day cruises while Terminal 4 would serve 3- and 4-day cruises.

The results of the traffic impacts are summarized below:

- By 2010, the proposed developments at both the North side and South side will generate approximately 15,330 new daily trips with 1472 occurring during the PM peak hour and 1528 occurring during the AM peak hour at build-out. Table 3 illustrates the future project trip generation as it is proposed.
- By 2025, the proposed developments at both the North side and South side will generate approximately an additional 1,630 new daily trips with 131 additional trips occurring during the PM peak hour and 157 additional trips occurring during the AM peak hour at build-out. This will result in a total of 16,960 new daily trips, 1603 new PM peak hour trips and 1685 AM peak hour trips.
- The intersection of George King Boulevard and Dave Nisbet Drive will require a traffic signal at this intersection by 2010.

- George King Boulevard and Dave Nisbet Drive will need an additional left-turn lane for the eastbound to northbound movement by 2025.
- George King Boulevard will need to be widened to provide 2 through-lanes in each direction (eastbound and westbound) between Atlantic Avenue North and the interchange with SR A1A.
- At the intersection of Mullett Drive and Dave Nesbit Drive, a through lane in the southbound direction and the widening of the eastbound approach to provide a left- turn and a right- turn lane will be needed by 2025.
- The signalized intersections of SR 401 and Charles Rowland Drive, and SR 401 and Grouper Road will operate at acceptable levels of service provided the signal cycles are lengthened in 2010.
- By 2015, it is expected that SR 401 will need to be widened to 3 lanes in each direction.
- By 2025, the intersection of SR 401 and Grouper Road will require a second northbound-left turn lane to maintain an adequate level of service in both the AM and PM peak hours.
- The weave analysis conducted for the segment of George King Blvd. between the A1A eastbound off-ramp and Dave Nisbet Drive indicates that this segment of roadway currently operates at a LOS B during the AM and Mid-day Peak hours and a LOS A during the PM Peak hour. In 2010, the analysis indicates that this weave section is expected to operating at a LOS B for all three peak hours (AM, Mid-day and PM). In 2025, this weave section will continue to operate at LOS C during the AM peak hour and will operate at LOS D during the mid-day and PM peak hours.
- At this time the analysis does not indicate a need to modify the segment of George King Boulevard between the A1A off-ramp and Dave Nisbet Drive. This segment appears to adequately accommodate the weaving vehicles and should continue to do so through the design year (2025).
- Using trip generation data for the proposed land uses at Ron Jon World and the Central Florida Regional Planning Model III to determine trip distribution, it has been estimated that at the full build out of Ron Jon World approximately 60 vehicles would use Central Boulevard between SR A1A and Atlantic Avenue North during the PM peak hour. These 60 vehicles would be nearly evenly split between eastbound (28) and westbound (32).

**Port Canaveral Section 203 Feasibility Study**  
**Engineering Appendix**

Attachment K

Hazardous, Toxic, and Radioactive Waste (HTRW) Assessment Report  
and Source Removal Report, Beyel Bros. Lease

**Section 203 Feasibility Study  
Hazardous, Toxic and Radioactive  
Waste (HTRW) Assessment**

**Preliminary Assessment Report**

**Port Canaveral  
Brevard County,  
Florida**

**Performed by  
CH2M HILL, Inc.**

**Performed for  
Canaveral Port Authority**



## TABLE OF CONTENTS

<b>TABLE OF CONTENTS .....</b>	<b>i</b>
<b>1.0 GENERAL.....</b>	<b>1</b>
1.1 Port Canaveral Location and Description .....	1
1.2 Summary .....	1
1.3 Introduction .....	2
1.3.1 Purpose .....	2
1.3.2 Special Terms and Conditions .....	2
1.3.3 Limitations and Exceptions of Assessment .....	3
1.3.4 Limiting Conditions and Methodology Used .....	4
<b>2.0 WEST TURNING BASIN – SITE DESCRIPTION.....</b>	<b>5</b>
2.1 Location and Legal Description .....	5
2.2 Descriptions of Structures, Roads, Other Improvements on the Site (Including Heating/Cooling System, Sewage Disposal, Source of Potable Water) .....	5
2.3 Information (if any) Reported by User Regarding Environmental Liens or Specialized Knowledge or Experience .....	5
2.4 Current Uses of the Property .....	5
2.5 Past Uses of the Property (to the extent identified) .....	6
2.6 Current and Past Uses of Adjoining Properties (to the extent identified).....	6
2.7 Site Rendering, Map, or Site Plan.....	6
2.8 Records Review .....	6
2.8.1 Standard Environmental Records Sources, Federal, State, and/or Local .....	6
2.8.2 Physical Setting Source(s) .....	9
2.8.3 Additional Record Sources.....	9
2.9 Information from Site Reconnaissance and Interviews.....	9
2.9.1 Hazardous Substances in Connection with Identified Uses (Including Storage, Handling, Disposal) .....	9
2.9.2 Hazardous Substance Containers and Unidentified Substance Containers (Including Storage, Handling, Disposal).....	11
2.9.3 Storage Tanks (Including Contents and Assessment of Leakage or Potential for Leakage) .....	11
2.9.4 Indications of PCBs (Including How Contained and Assessment of Leakage or Potential for Leakage) .....	11
2.9.5 Indications of Solid Waste Disposal.....	11
2.9.6 Physical Setting Analysis, If Migrating Hazardous Substances Are an Issue .....	11
2.9.7 Any Other Conditions of Concern.....	12

**3.0 NORTH SIDE OF THE MAIN CHANNEL (INNER AND MIDDLE REACHES) - SITE DESCRIPTION.....13**

3.1 Location and Legal Description .....13

3.2 Descriptions of Structures, Roads, Other Improvements on the Site (Including Heating/Cooling System, Sewage Disposal, Source of Potable Water) .....13

3.3 Information (if any) Reported by Auditor Regarding Environmental Liens or Specialized Knowledge or Experience .....13

3.4 Current Uses of the Property.....13

3.5 Past Uses of the Property (to the extent identified) .....13

3.6 Current and Past Uses of Adjoining Properties (to the extent identified).....14

3.7 Site Rendering, Map, or Site Plan.....14

3.8 Records Review .....14

3.8.1 Standard Environmental Records Sources, Federal, State, and/or Local ..... 14

3.8.2 Physical Setting Source(s) ..... 16

3.8.3 Additional Record Sources..... 16

3.9 Information from Site Reconnaissance and Interviews.....16

3.9.1 Hazardous Substances in Connection with Identified Uses (Including Storage, Handling, Disposal) ..... 17

3.9.2 Hazardous Substance Containers and Unidentified Substance Containers (Including Storage, Handling, Disposal)..... 17

3.9.3 Storage Tanks (Including Contents and Assessment of Leakage or Potential for Leakage) ..... 17

3.9.4 Indications of PCBs (Including How Contained and Assessment of Leakage or Potential for Leakage) ..... 17

3.9.5 Indications of Solid Waste Disposal..... 17

3.9.6 Physical Setting Analysis, If Migrating Hazardous Substances Are an Issue ..... 17

3.9.7 Any Other Conditions of Concern..... 18

**4.0 ENTRANCE CHANNEL TURN – SITE DESCRIPTION.....19**

4.1 Location and Legal Description .....19

4.2 Descriptions of Structures, Roads, Other Improvements on the Site (Including Heating/Cooling System, Sewage Disposal, Source of Potable Water) .....19

4.3 Information (if any) Reported by Auditor Regarding Environmental Liens or Specialized Knowledge or Experience .....19

4.4 Current Uses of the Property.....19

4.5 Past Uses of the Property (to the extent identified) .....19

4.6 Current and Past Uses of Adjoining Properties (to the extent identified).....19

4.7 Site Rendering, Map, or Site Plan.....19

4.8	Records Review .....	20
4.8.1	Standard Environmental Records Sources, Federal, State, and/or Local .....	20
4.8.2	Physical Setting Source(s) .....	21
4.8.3	Additional Record Sources .....	21
4.9	Information from Site Reconnaissance and Interviews .....	21
4.9.1	Hazardous Substances in Connection with Identified Uses (Including Storage, Handling, Disposal) .....	21
4.9.2	Hazardous Substance Containers and Unidentified Substance Containers (Including Storage, Handling, Disposal) .....	22
4.9.3	Storage Tanks (Including Contents and Assessment of Leakage or Potential for Leakage) .....	22
4.9.4	Indications of PCBs (Including How Contained and Assessment of Leakage or Potential for Leakage) .....	22
4.9.5	Indications of Solid Waste Disposal .....	22
4.9.6	Physical Setting Analysis, If Migrating Hazardous Substances Are an Issue .....	22
4.9.7	Any Other Conditions of Concern .....	22
<b>5.0</b>	<b>FINDINGS AND CONCLUSIONS .....</b>	<b>23</b>
5.1	General Comments .....	23
5.2	Regional Overview .....	23
5.3	West Turning Basin .....	23
5.4	North Side of Channel (Inner and Middle Reaches) .....	24
5.5	Entrance Channel Turn .....	24

## **1.0 GENERAL**

### ***1.1 Port Canaveral Location and Description***

Port Canaveral, located just south of the John F. Kennedy Space Center in Brevard County, Florida, has both commercial and military enterprise and use.

Port Canaveral and its waterfront facilities, both commercial and military, have been developed around three deepwater turning basins in addition to areas on either side of the main channel. The West Turning Basin primarily supports the commercial cruise business. Waterfront facilities and uplands on the north side of the West Access Channel support commercial cargo operations.

The Middle Turning Basin has shared use with commercial and military cargo berths. All of the uplands surrounding Canaveral Harbor are owned by CPA except for the land to the north and east sides of the Middle Turning Basin, owned by the Cape Canaveral Air Force Station (CCAFS). In support of the U.S. Navy's Trident Submarine Program, the military dredged the Trident Turning Basin and developed support facilities on the adjacent uplands. The Trident Turning Basin is dedicated to military activity and not for commercial use. The major facilities and operations on the south side of Canaveral Harbor support commercial cruise and cargo activities.

CPA grants long-term leases to tenants whose businesses are related to or dependent on a marine location. The tenants are responsible to develop their own facilities and parking areas while the port provides conventional civil and marine infrastructure as well as fire and police protection. The port, specifically a location within the West Turning Basin, is also home to the U.S. Coast Guard Station Port Canaveral.

Several tenants lease land fronting shallow draft bulkheads for use in their business operations. The long-term shallow draft waterfront leases are held by the fishing industry and various small craft marinas located primarily along the south side of the Barge Canal. Other temporary leases along shallow bulkhead walls on the east side of the West Turning Basin may be terminated to execute future cruise terminal and cargo berth projects.

### ***1.2 Summary***

Three areas within Port Canaveral have been identified for navigation deepening and/or widening improvements that will impact both uplands and submerged lands. The three areas include the entrance to the West Turning Basin; the north side of the channel between the Middle Turning Basin and Trident Turning Basin; and the entrance channel turn area in the Atlantic Ocean at the intersection of the outer and middle channel reaches. In support of the Canaveral Port Authority's Section 203 Feasibility Study for navigation improvements at Port Canaveral, a preliminary Hazardous and Toxic Waste (HTRW) site assessment was conducted along the Canaveral Harbor from the West Turning Basin eastward to the Atlantic Ocean. The hazardous and toxic waste evaluation revealed that the majority of the area is predominantly construction

and activities associated with marine and port facilities, including cruise terminals, marine maintenance, park visitors, marine cargo transfers and a military installation. The potential of finding hazardous and toxic waste is moderate. The areas evaluated are presented separately in this report and discussed in general below.

### ***West Turning Basin***

Within the West Turning Basin Area (WTB), there are several locations and activities which may be HTRW contaminated. These are discussed in detail in Section 2.0.

### ***North Side of the Channel (Inner and Middle Reaches)***

This area includes the uplands and submerged lands on the north side of the Inner and Middle Reaches Within this project area (NC), there are several locations and activities which may be HTRW contaminated. These are discussed in Section 3.0.

### ***Entrance Channel Turn***

This area includes the submerged lands of the Middle Reach, the Outer Reach, and adjacent lands. Within this project area (ECT) the potential for the presence HTRW contamination is low. The area is located approximately one mile offshore in the Atlantic Ocean. No site visit was conducted due to its location in the Atlantic Ocean with water depths of 35 to 41 feet.

## **1.3 Introduction**

### **1.3.1 Purpose**

The goal of this site investigation is to identify Recognized Environmental Conditions (RECs) and indicate the presence or likely presence of hazardous substances or petroleum products in and around the target property areas. To the extent supported by the investigative approach typically used for this type of project, the assessment attempts to reveal conditions that indicate an existing release, a past release, or a material threat of a release of hazardous substances or petroleum products on the properties or into the ground, groundwater, or surface water of the properties. This report substantially satisfies the requirements of ER-1165-2-132 and ASTM Practice E 1527.

### **1.3.2 Special Terms and Conditions**

The RECs that were considered throughout this investigation included hazardous substances or petroleum products even under conditions in compliance with laws. The term, RECs, is not intended to include *de minimis* conditions that generally do not present a material risk of harm to public health or the environment and that generally would not be the subject of an enforcement action if brought to the attention of appropriate governmental agencies.

### 1.3.3 Limitations and Exceptions of Assessment

The conclusions and recommendations contained in this report represent the professional opinions of CH2M HILL. These opinions were arrived at in accordance with the applicable professional standards and practices. However, this report is not a warranty nor does it imply a guarantee of any sort. In addition, the following limitations apply:

- The CH2M HILL staff who performed the site assessment are not attorneys; therefore, this report is not a legal representation or interpretation of environmental laws, rules, regulations, or policies of local, state, or federal governmental agencies.
- This report is based, in part, on unverified preliminary information supplied to CH2M HILL from several sources during this project; therefore, CH2M HILL cannot guarantee the report's completeness or accuracy.
- If hazardous substances or hazardous conditions have not been identified during the performance of the scope of services, such a finding should not be construed as a guarantee or representation, either expressed or implied, that such substances or conditions are absent.
- All opinions or recommendations apply to site conditions existing when services were performed. CH2M HILL cannot report on, or accurately predict, events that may change the site conditions after the described services are performed, whether occurring naturally or caused by external forces.
- No ASTM non-scope considerations were conducted during the performance of the HTRW Assessment.
- This report has been prepared for the exclusive use of the Canaveral Port Authority and their client for specific application to the property described here. There are no beneficiaries of this report other than the Canaveral Port Authority and their client, and no other person or entity is entitled to rely upon this report without the written consent of CH2M HILL.
- CH2M HILL assumes no responsibility for conditions that we were not authorized to investigate, or that were not in our specific scope of work.

This Section 203 Feasibility Study, Hazardous, Toxic, and Radioactive Waste (HTRW) Assessment - Preliminary Assessment Report is comprised of the following five components: 1) Records and Database Review, 2) Historical Aerial Photography and Topographic Map Study, 3) Site Reconnaissance, 4) Interviews, 5) Report. The records review, aerial photography and topographic map study, site reconnaissance, and interviews are intended to be used in concert with each other.

### 1.3.4 Limiting Conditions and Methodology Used

There were limitations imposed by physical obstructions. Approximately 90 percent (%) of the WTB project area is under water at all times (80.4 acres out of a total of 88.6 acres). Only the northern shoreline and banks of the Harbor adjacent to the north side of the channel (NC) could be accessed as the entire project area (23.2 acres) is under water at all times. In addition, there was an adjacent area between the Middle Turning Basin (MTB) and the Trident Turning Basin (TTB) that was inaccessible due to the presence of a 10-foot high, three-stranded barbed wire fence along the entire portion planned for inspection. Furthermore, the eastern one-quarter of this area is located in the Atlantic Ocean. The ECT project area (18.8 acres) is located completely underwater, approximately one-mile from the shoreline in the Atlantic Ocean.

Historic aerial photographs available for review were from the years 1972, 1983, 1993, and 2004. The historic USGS topographic maps available for review were from the years 1951 (revised 1970) and 1976.

One database search was performed by Environmental Data Resources (EDR) using a calculated centroid of all three sites. Upon receipt of the database hand-scribed distances of 0.25 miles, 0.5 miles, and 1.0 mile were placed onto the database Map Findings Summary. From these hand-scribed distances, each database search distance (e.g., RCRIS-SQG = 0.25 miles, ASTs = 0.5 miles, etc.) was reviewed and summarized for the appropriate site. As such three "sub-database" searches were conducted from the large database search performed for the entire area.

Although much of the areas identified for navigation improvements are submerged lands, the Canaveral Port Authority and the U.S. Army Corps of Engineers periodically conduct extensive sediment sampling, testing, and Section 103 evaluation in support of maintenance and new construction dredging of the federal and non-federal portions of Canaveral Harbor and offshore and/or upland disposal of dredged material. Review and discussion of this sampling and testing program is outside the scope of the effort documented herein; however, the environmental studies and Environmental Baseline Report associated with the Section 203 study contains data and information on the submerged lands sediment test analysis results.

## **2.0 WEST TURNING BASIN – SITE DESCRIPTION**

### ***2.1 Location and Legal Description***

The WTB study area is located at the west end of Port Canaveral as shown in Figure 1A.

This portion of the study consists of the area within and north of the Barge Canal and West Access Channel (WAC) at the entrance to the WTB, at the western-most turning basin of the Harbor. The total acreage of this area is 88.6 acres. Of that acreage, 8.2 acres are uplands and the remaining 80.4 acres are underwater.

### ***2.2 Descriptions of Structures, Roads, Other Improvements on the Site (Including Heating/Cooling System, Sewage Disposal, Source of Potable Water)***

The Canaveral Port Authority (CPA) owns the land. There are numerous roads that traverse through the entire uplands area. In addition, most of the uplands area has been subdivided and leased or subleased to individuals or companies generally associated with the marine industry, including marinas, repair and maintenance facilities, cruise line departure areas, restaurants, public parks, and other commercial cargo facilities.

Utilities that are supplied to the upland area consist of potable water by the City of Cocoa, sewer lines by the City of Cocoa Beach, and electrical power by Florida Power and Light.

### ***2.3 Information (if any) Reported by User Regarding Environmental Liens or Specialized Knowledge or Experience***

No specialized knowledge is available for this site.

### ***2.4 Current Uses of the Property***

The upland areas located on the north and south sides of WTB area currently consist of land and buildings that have been developed and redeveloped since approximately 1972. The earthen dike for the WTB peninsula was created from sand as a result of dredging the TTB. The land between the WTB and MTB was created from the dredge spoils from the enlargement of the MTB and creation of the original 300-foot wide channel. The land was built up to create uplands for use by the CPA and to provide an area for the placement of dredge spoils material. Photographs 1-11 taken at several points within the WTB area clearly show the typical terrain.



## **2.5 Past Uses of the Property (to the extent identified)**

Based on the review of historic aerial photography, topographic maps, and interviews with representatives from CPA and the Brevard County Natural Resource Management Office, the project area appears to have a history of significant development, including buildings, marinas, piers to handle imported/exported cargo, public parks, and filling-in of open water to create usable land, as well as dredging other areas to create or deepen the turning basins. A review of the regulatory databases indicates a number of facilities are listed in the vicinity of the project area.

## **2.6 Current and Past Uses of Adjoining Properties (to the extent identified)**

By indications observed throughout the site investigation, the adjoining properties are a mixture of commercial marinas, restaurants, and cruise terminals with associated ancillary buildings, Coast Guard facility, and cargo piers with associated storage and support buildings.

The Port was first opened for commercial fishing operations in November 1953. The import and export of commercial cargo began operations in June 1955. Cruise ship lines began sailing from the port in September 1964. The West Turning Basin area was constructed in 1972. The area owned by the U.S. Air Force (north side of the Harbor from the Trident Basin eastward to the Atlantic Ocean) began construction of their Trident submarine operations in the early 1970s. Since that time, the port has increased the number of operations, especially the cruise line industry.

The location of the WTB and surrounding area is presented on Figure 1A. Photographs 1-11 generally show the conditions and features of the project area and surrounding areas.

## **2.7 Site Rendering, Map, or Site Plan**

See Figure 1A.

## **2.8 Records Review**

### **2.8.1 Standard Environmental Records Sources, Federal, State, and/or Local**

Under subcontract to CH2M HILL, EDR conducted a database search to identify potential or existing environmental liabilities within the target area. Records searched included several databases, such as the Toxic Chemical Release Inventory System (TCRIS), Hazardous Material Information Reporting System (HMIRS), and Leaking Underground Storage Tanks (LUST). The table below lists all of the databases EDR searched, and includes the search distance from the

site. The entries that are bolded are those required by ASTM E 1527-00 and the HTRW guidance document (ER 11695-2-132, 26 June 1992).

Databases Searched

Database	Search Distance (miles)
<b>Federal Environmental Protection Agency (EPA)</b>	
<b>Comprehensive Environmental Response, Compensation, and Liability Information System (CERCLIS)</b>	0.5
<b>Comprehensive Environmental Response, Compensation, and Liability Information System (CERC-NFRAP)</b>	0.25
<b>Emergency Response Notification System (ERNS)</b>	Target Property
Proposed National Priority List (NPL)	1.0
<b>National Priority List (NPL)</b>	1.0
Delisted NPL	1.0
<b>Resource Conservation and Recovery Information System (RCRIS-TSD)</b>	0.5
<b>RCRIS Small Quantity Generator (RCRIS-SQG)</b>	0.25
<b>RCRIS Large Quantity Generator (RCRIS-LQG)</b>	0.25
Superfund (CERCLIS) Consent Decrees (CONSENT)	1.0
<b>Corrective Action Report (CORRACTS)</b>	1.0
Facility Index System (FINDS)	Target Property
Hazardous Materials Information Reporting System (HMIRS)	Target Property
Material Licensing Tracking System (MLTS)	Target Property
Mines Master Index File (MINES)	0.25
Federal Superfund Liens (NPL Liens)	Target Property
PCB Activity Database System (PADS)	Target Property
RCRA Administrative Action Tracking System (RAATS)	Target Property
Record of Decision (ROD)	1.0
Toxic Chemical Release Inventory System (TCRIS)	Target Property
Toxic Substances Control Act (TSCA)	Target Property
FIFRA/TSCA Tracking System – FIFRA (Federal Insecticide, Fungicide, & Rodenticide Act)/TSCA (Toxic Substances Control Act) – (FTTS)	Target Property
<b>State of Florida</b>	
<b>Leaking Underground Storage Tanks (LUST)</b>	0.5
<b>Underground Storage Tanks (UST)</b>	0.25
Aboveground Storage Tanks (AST)	Target Property
<b>State Hazardous Waste Sites (SHWS)</b>	1.0
<b>State Solid Waste Facilities/Landfill Sites (SWF/LF)</b>	0.5
<b>Florida Sites</b>	0.5
Florida Cattle Dip Vats	0.5
Florida Wastewater	Target Property
Florida Dry Cleaners	0.5
Coal Gas	1.0

Based on the review of the Federal and state regulatory databases search, the following table lists the sites within the search distance and the database in which they appear.

Database Review Results						
Name	Address	RCRA-SQG (1/4 mi)	FINDS (TP)	SWF/LF (1/2 mi)	LUST (1/2 mi)	UST (1/4 MI)
Astro Pak Corp.	730 Mullet Rd. Ste B	Yes	No	No	No	No
Beyel Bros. Inc.	9155 Grouper Rd	No	Yes	No	No	No
Canaveral Custom Boats	770 Mullet Rd	Yes	No	No	No	No
Canaveral Scallop Landfill	Grouper Rd/SR 401	No	No	Yes	No	No
Canaveral Seafoods Inc.	520 Glen Cheek Dr.	No	No	No	Yes	Yes
Canaveral Seafoods Inc.	714 Scallop Dr	No	No	No	Yes	Yes
Cape Marina	800 Scallop Dr	Yes	No	No	No	No
Commercial Carrier Corp	9012 Marlin St	No	No	No	Yes	Yes
Disney Cruise Line Terminal	9150 Christopher Columbus Dr	Yes	No	No	No	No
Dutra Construction	707 Mullet Dr	Yes	No	No	No	No
Excel Coatings, Inc.	745 B Scallop Dr	Yes	No	No	No	No
Florida Solar Energy Ctr	700 Snapper Rd	Yes	No	No	No	No
Harbor Fuel & Ice Co.	626 Glen Cheek Dr.	No	No	No	Yes	No
Manutech, Inc.	760 Mullet Dr	Yes	No	No	No	No
Martin Marietta Services	710 Mullet Rd	Yes	No	No	No	No
Port Canaveral Auto Repair	780 Mullet Rd	Yes	No	No	No	No
Port Canaveral Auto Repair	790 Mullet Rd	Yes	No	No	No	No
Port Canaveral Towing	747 Snapper Rd	No	No	No	Yes	No
Sands Salvage & Marine	515 Glen Cheek Dr.	No	No	No	Yes	Yes
Scallop Plant	710 Scallop Rd	No	No	No	Yes	Yes
Sunrise Marina	505 Glen Cheek Dr.	No	No	No	Yes	Yes
USCG Canaveral Light	9235 Grouper Rd	Yes	No	No	No	No
USCG Port Canaveral	Grouper and Snapper Rds.	Yes	No	No	No	No

None of the databases listed any facilities in the WTB project area except for Beyel Brothers, Inc.

This company is listed in the FINDS database, which indicates the facility is under a "Permit Compliance System." No other information was presented in the database document. According to CPA personnel, this leased property was recently inspected (November and December 2005) as part of CPA's annual self-inspection under the requirements of the National Pollutant Discharge Elimination System (NPDES) permit CPA holds. The results of the inspection indicate that RECs are present. This is discussed further in Sections 2.9.1 and 2.9.7, along with

the information provided by CPA for a 17 and 30 November 2005 site inspection performed as part of this effort.

### **2.8.2 Physical Setting Source(s)**

The present configuration of the submerged lands of the WTB and adjacent uplands was created by dredging material from the Canaveral Harbor WTB area and depositing the spoil as fill material, resulting in the surrounding usable uplands. Uplands elevations presented on the historic topographic maps indicate relatively flat terrain, grading from the north to the south on north side of the West Access Channel, and grading south to north on the south side of the West Access Channel and Barge Canal. Photographs 1-11 taken at several locations show that the land is relatively level up to the banks of the Harbor and is or has been used for a variety of port marine activities.

### **2.8.3 Additional Record Sources**

None

## ***2.9 Information from Site Reconnaissance and Interviews***

Ms. A. Tracy Langille, P.G., CH2M HILL, Inc., Jacksonville, Florida office, performed a site inspection on 20 December 2005. Access to the majority of the project area is limited due to fact that nearly all of the project area (90 percent) is under water. There was observed hazardous or toxic waste on the 8.2 acres upland portion of the project area (east upland areas of the WTB). This is described in the following sections. Telephone interviews were conducted with Mr. Dave Maher, P.G. of the Brevard County Natural Resource Management Office and Ms. Jeannie Adame, Director of Environmental Plans & Programs for the CPA regarding information that may be available for the project area and vicinity.

### **2.9.1 Hazardous Substances in Connection with Identified Uses (Including Storage, Handling, Disposal)**

Hazardous substances in connection with identified uses were observed on the property leased by Beyel Brothers, Inc. Per details in the lease, the allowable use of the property is described as follows: "... for the purpose of mooring tugboats and associated crane equipment, the loading of concrete rubble for disposal on reef sites at sea, and the parking of passenger vehicles in connection with the moored vessels and business operations."

Two compliance inspections were performed on 17 November 2005 and 30 November 2005. The earlier inspection was performed as part of the CPA's National Pollutant Discharge and Elimination System (NPDES) annual reporting requirements. The HTRW inspection was

performed for the entire project area on 20 December 2005 by CH2M HILL personnel. The results of the three inspections included, but were not limited to, the following.

- Cylinders with welding gases were tied or chained to the exterior of a small metal building.
- Miscellaneous large vehicle tires, large vehicle and crane engines were stored inside and outside of the property boundary. It is unknown whether all of the engine fluids were drained prior to storage.
- Sand blasting using “Black Beauty” was observed being performed on the hull of a marine vessel. The waste material (Black Beauty and sand blasted material from hull) was allowed to collect on the adjacent bulkhead and surface of the ground. During the 20 December 2005 inspection, employees were observed moving and piling up this waste material using hand shovels and Bobcat.
- Compressor with fluids leaking onto the bare ground was observed.
- Numerous rail cars (with rusted walls and ceilings) were observed containing a number of unlabeled 1- to 55-gallon containers of unknown materials. Given the current operations observed during the 20 December 2005 inspection it is possible that hazardous materials are stored in these containers. The storage method suggests that all of the materials are compatible with each other or that materials are not being properly segregated based on compatibility.
- A few open 5-gallon buckets containing waste oil filters.
- Open and closed unmarked 55-gallon drums outside with no protection from the elements.
- Improper hand washing station is set-up and appears to be in use. Wastewater from station allowed to discharge onto the ground and/or at the bulkhead seawall.
- Numerous waste paint cans, oil cans, primer paint cans, etc. observed in open 5-gallon buckets throughout area.
- Evidence of engine oil spill onto bare ground was observed.

Similar conditions were observed during the 17 and 30 November 2005 inspection by CPA personnel.

Hazardous substances in connection with identified uses were only observed within the uplands portion of the WTB project area as the majority of the area of study is under water.

### **2.9.2 Hazardous Substance Containers and Unidentified Substance Containers (Including Storage, Handling, Disposal)**

Hazardous substance containers and unidentified substance containers were observed and are discussed in the previous section.

### **2.9.3 Storage Tanks (Including Contents and Assessment of Leakage or Potential for Leakage)**

The hazardous and toxic waste database search revealed the presence of several underground storage tanks within the search distance. Additionally, there are two ASTs on the property leased by Beyel Brothers Inc. These ASTs have secondary containment, do not have roofs to keep out stormwater from the containment area, and are not labeled as to contents. ASTs were observed on other nearby properties during the site inspection and discussed in the telephone interviews.

### **2.9.4 Indications of PCBs (Including How Contained and Assessment of Leakage or Potential for Leakage)**

No indications exist that PCB's are present within the WTB area.

### **2.9.5 Indications of Solid Waste Disposal**

No recorded or physical data yielded any indications that the disposal of sanitary solid waste had occurred at any time at the proposed project area. However, inadequate housekeeping was observed throughout the Beyel Brothers, Inc. leased area. This included, but is not limited to, paper, wood, large engine parts, tires, large parts from cranes, etc. Some of this solid waste was observed outside of the Beyel Brothers, Inc. leased boundary.

### **2.9.6 Physical Setting Analysis, If Migrating Hazardous Substances Are an Issue**

Based on the site inspection, results of the database search, and interviews with CPA personnel and Brevard County Natural Resource Management Office many of the operations in the vicinity, both sides of the Barge Canal and West Access Channel, have known or suspected releases. Shallow groundwater flow direction is typically toward the nearest water body, in this area it is the Barge Canal, WTB, and West Access Channel. Therefore, the potential exists for releases to impact the sediment and soils at the WTB entrance which are to be dredged for the deepening/widening to provide navigation improvement. However, the bulkhead seawalls on the south side of the Harbor are anticipated to limit the migration of potential contaminants into the water and sediments in the Harbor.

Additionally, surface water and sediment collection and analyses (as part of the compliance work for the facility's NPDES permit, has been conducted since issuance of the permit. None of the parameters analyzed indicate that reported parameter concentrations are above comparative clean-up criteria for surface water or sediment.

### **2.9.7 Any Other Conditions of Concern**

The level of housekeeping is relatively poor at Beyel Brothers, Inc. Numerous small and very large pieces of scrap material (tires, cranes, paper, wood, engine parts, etc.) were observed throughout the interior and exterior of the Beyel Brothers leased property. Many of these disposal areas were also noted to be tripping hazards.

A telephone interview was conducted on January 12, 2006 with Mr. Dave Maher, P.G. with the Brevard County Natural Resource Management Office. Mr. Maher indicated that Coastal Fuels had a release of petroleum product via a location in their pipeline to the docks. Coastal is located on the south side of the Harbor and upgradient to the NC area. Soil was excavated, during which the laboratory analytical results indicated the presence of chlorinated solvents, which are not typically found in petroleum impacted soils.

Based on the information discussed above, a telephone interview was performed with Ms. Jeannie Adame, Director of Environmental Plans & Programs for the CPA regarding information that may be available for the petroleum releases and discovery of the chlorinated solvents. Ms. Adame provided copies of figures developed by TEA that project the aerial extent of the plume from 1996 to 2012. According to Ms. Adame, this was plume discovered in 1996. The source of the release appears to have been from the property and facilities currently leased by Mid-Florida Freezer. Prior to Mid-Florida Freezer being at this location, Dow Chemical had a facility that used chlorinated solvents in their operations. The extent of impact to groundwater in 1996 appears to be bound by the bulkhead to the north, approximately 225 feet east of Herring Street to the east, approximately 100 feet south of Challenger Road to the south, and approximately 150 west of Pompano Street to the west. The extent of impact in 2004 (last groundwater sampling event) suggests the size of the plume is slightly smaller, although temporal effects in the groundwater concentrations and inferred plume size can occur. Currently, the majority of the plume is being monitored. An air sparging system is being designed for installation along the bulkhead to insure that contaminants are not migrating into the water and sediments in the Harbor. Past sampling and analyses of surface water and sediments in the Harbor indicate that no chlorinated solvents, exceeding comparative clean-up criteria, are present. In addition, a risk assessment is being performed in order to establish alternate groundwater cleanup criteria in the original source area.

### **3.0 NORTH SIDE OF THE MAIN CHANNEL (INNER AND MIDDLE REACHES) - SITE DESCRIPTION**

#### ***3.1 Location and Legal Description***

The NC portion of the study consists of the submerged area and adjacent shoreline and uplands north of the channel from the east side of the MTB eastward to the intersection of the Middle and Outer Reaches and approximately one mile offshore in the Atlantic Ocean. The total acreage of this navigation improvement area is 23.2 acres and is completely underwater. It is anticipated that the adjacent northern shoreline and uplands of CCAFS may be impacted by the width of the northside channel widener, estimated to be as much as 100 ft. The area included in the NC portion of the study is shown in Figures 1A and 1B.

#### ***3.2 Descriptions of Structures, Roads, Other Improvements on the Site (Including Heating/Cooling System, Sewage Disposal, Source of Potable Water)***

The only “structures” on the NBH consist of channel markers, concrete piers, chain-link fence to the waterline, and rip-rap to maintain the side slopes of the Harbor.

#### ***3.3 Information (if any) Reported by Auditor Regarding Environmental Liens or Specialized Knowledge or Experience***

No specialized knowledge is available for this site.

#### ***3.4 Current Uses of the Property***

The submerged lands of the NC project area presently support navigational uses of Port Canaveral. The CCAFS shoreline is protected with rip-rap and the adjacent uplands remain largely undeveloped except for serving as a berm for military construction and dredge spoils containment. Photographs 12-20 taken at several points within the project area clearly show the typical terrain.

#### ***3.5 Past Uses of the Property (to the extent identified)***

Based on historic aerial photography and topographic maps, the project area has been part of the Harbor since at least 1951. A review of the regulatory databases indicates a few facilities that are listed within the search distance of the area.



### **3.6 Current and Past Uses of Adjoining Properties (to the extent identified)**

By indications observed throughout the site investigation, the adjoining properties are a mixture of commercial marinas, restaurants, cruise terminals with associated ancillary buildings, Coast Guard facility, cargo piers with associated storage and support buildings, and the Cape Canaveral Air Force Station (CCAFS) with military tenant operations of the Naval Ordnance Test Unit (NOTU) at the Middle and Trident Turning Basins, the Navy Poseidon and Trident wharves and Trident missile storage facilities.

Excavation of the Canaveral Harbor Project began in 1950 with the dredging of the Barge Canal from the Inland Waterway at the middle of the Indian River to the east across Merritt Island and the Banana River. Much of the dredge spoil was used to construct a causeway across the Indian and Banana Rivers to the south of the Barge Canal which was eventually improved by the State of Florida to become S.R. 528. Finally, the Canaveral Harbor, consisting of one turning basin and a channel to the Atlantic Ocean was dredged. Port Canaveral's channel was opened to the ocean in January 1953.

The Port first opened for commercial fishing operations in November 1953. The import and export of commercial cargo began operations in June 1955. The US Air Force wharf and Navy's Poseidon Pier facilities were constructed in 1957. Cruise ships began sailing intermittently from the port in September 1964. The West Turning Basin area was constructed in 1972. The Trident Turning Basin and pier and uplands facilities were constructed in the early 1970's to support the U.S. Navy and UK Navy Trident Fleet Ballistic Missile (FBM) operations under the sponsorship of NOTU. Cruise ships have been sailing regular schedules from Port Canaveral since approximately 1981. Since that time, Port commerce, operations, and vessel traffic have increased significantly, especially the cruise business portion.

The location of the NC project area and surrounding area is presented on Figures 1A and 1B. Photographs 12-20 generally show the conditions and features of the project area and surrounding areas.

### **3.7 Site Rendering, Map, or Site Plan**

See Figures 1A and 1B.

### **3.8 Records Review**

#### **3.8.1 Standard Environmental Records Sources, Federal, State, and/or Local**

Under subcontract to CH2M HILL, EDR conducted a database search to identify potential or existing environmental liabilities within the target area. Records searched included several

databases, such as the Toxic Chemical Release Inventory System (TCRIS), Hazardous Material Information Reporting System (HMIRS), and Leaking Underground Storage Tanks (LUST). The table below lists all of the databases EDR searched, and includes the search distance from the site. The entries that are bolded are those required of ASTM E 1527-00 and the HTRW guidance document (ER 11695-2-132, 26 June 1992).

## Databases Searched

Database	Search Distance (miles)
<b>Federal Environmental Protection Agency (EPA)</b>	
<b>Comprehensive Environmental Response, Compensation, and Liability Information System (CERCLIS)</b>	<b>0.5</b>
<b>Comprehensive Environmental Response, Compensation, and Liability Information System (CERC-NFRAP)</b>	<b>0.25</b>
<b>Emergency Response Notification System (ERNS)</b>	Target Property
Proposed National Priority List (NPL)	1.0
<b>National Priority List (NPL)</b>	<b>1.0</b>
Delisted NPL	1.0
<b>Resource Conservation and Recovery Information System (RCRIS-TSD)</b>	<b>0.5</b>
<b>RCRIS Small Quantity Generator (RCRIS-SQG)</b>	<b>0.25</b>
<b>RCRIS Large Quantity Generator (RCRIS-LQG)</b>	<b>0.25</b>
Superfund (CERCLIS) Consent Decrees (CONSENT)	1.0
<b>Corrective Action Report (CORRACTS)</b>	<b>1.0</b>
Facility Index System (FINDS)	Target Property
Hazardous Materials Information Reporting System (HMIRS)	Target Property
Material Licensing Tracking System (MLTS)	Target Property
Mines Master Index File (MINES)	0.25
Federal Superfund Liens (NPL Liens)	Target Property
PCB Activity Database System (PADS)	Target Property
RCRA Administrative Action Tracking System (RAATS)	Target Property
Record of Decision (ROD)	1.0
Toxic Chemical Release Inventory System (TCRIS)	Target Property
Toxic Substances Control Act (TSCA)	Target Property
FIFRA/TSCA Tracking System – FIFRA (Federal Insecticide, Fungicide, & Rodenticide Act)/TSCA (Toxic Substances Control Act) – (FTTS)	Target Property
<b>State of Florida</b>	
<b>Leaking Underground Storage Tanks (LUST)</b>	<b>0.5</b>
<b>Underground Storage Tanks (UST)</b>	<b>0.25</b>
Aboveground Storage Tanks (AST)	0.500
<b>State Hazardous Waste Sites (SHWS)</b>	<b>1.0</b>
<b>State Solid Waste Facilities/Landfill Sites (SWF/LF)</b>	<b>0.5</b>
<b>Florida Sites</b>	<b>0.5</b>
Florida Cattle Dip Vats	0.5
Florida Wastewater	Target Property
Florida Dry Cleaners	0.5
Coal Gas	1.0

Based on the review of Federal and state regulatory database search, the following table lists the sites within the search distance and the database in which they appear.

Database Review Results						
Name	Address	RCRA-SQG (1/4 mi)	FINDS (TP)	SWF/LF (1/2 mi)	LUST (1/2 mi)	UST (1/4 MI)
Sterling Shipping	180 Jetty Dr	Yes	No	No	No	No
Canaveral Truck & Bus	9049 Jetty Rd	Yes	Yes	No	No	Yes
Rinker Material - Can. Plant	209 George King Blvd	No	No	No	No	Yes
Commercial Carrier Corp	9012 Marlin St	No	No	No	Yes	Yes

None of the databases listed any facilities in the NC project area.

### 3.8.2 Physical Setting Source(s)

The present configuration of the submerged lands on the north side of the navigation channel of the Inner and Middle Reaches and adjacent uplands was created by dredging material from the Canaveral Harbor area and depositing the spoil as fill material, resulting in the surrounding usable uplands. Uplands elevations presented on the historic topographic maps indicate relatively flat terrain with steep grading on the north bank, forming a berm for military dredge spoil containment. Photographs 12-20 are taken at several locations within the project area.

### 3.8.3 Additional Record Sources

None

## 3.9 Information from Site Reconnaissance and Interviews

Ms. A. Tracy Langille, P.G., CH2M HILL, Inc., Jacksonville, Florida office performed a site inspection on 20 December 2005. Access to the project area was limited to that area that could be observed while walking along the adjacent uplands on CCAFS, as 100 percent of the study area is submerged land. There was no observed hazardous or toxic waste on the upland adjacent to the project area.

Telephone interviews were conducted with Mr. Dave Maher, P.G. of the Brevard County Natural Resource Management Office and Ms. Jeannie Adame, Director of Environmental Plans & Programs for the CPA regarding information that may be available for the project area and vicinity.

### **3.9.1 Hazardous Substances in Connection with Identified Uses (Including Storage, Handling, Disposal)**

Hazardous substances in connection with identified uses were unable to be seen, if present, due to inaccessibility.

### **3.9.2 Hazardous Substance Containers and Unidentified Substance Containers (Including Storage, Handling, Disposal)**

No hazardous substance containers and unidentified substance containers were observed.

### **3.9.3 Storage Tanks (Including Contents and Assessment of Leakage or Potential for Leakage)**

No storage tanks or containers were observed during the site inspection.

### **3.9.4 Indications of PCBs (Including How Contained and Assessment of Leakage or Potential for Leakage)**

No indications exist that PCB's are present within the proposed project area.

### **3.9.5 Indications of Solid Waste Disposal**

No recorded or physical data yielded any indications that the disposal of sanitary solid waste had occurred at any time at the proposed project area.

### **3.9.6 Physical Setting Analysis, If Migrating Hazardous Substances Are an Issue**

Based on the site inspection, results of the database search, and interviews with CPA personnel and Brevard County Natural Resource Management Office some of the operations in the vicinity of the project area, south side of the channel have known or suspected releases. Shallow groundwater flow direction is typically toward the nearest water body, in this area it is the Inner Reach portion of the channel, Therefore, the potential exists for releases to impact the sediment and soils along the north side of the channel in the project area which are to be dredged for the deepening/widening navigation improvement. However, the bulkhead seawalls on the south side of the Harbor are anticipated to limit the migration of potential contaminants into the Harbor water and sediments.

Additionally, surface water and sediment collection and analyses (as part of the compliance work for the facility's NPDES permit, has been conducted since issuance of the permit. None of the

parameters analyzed indicate that reported parameter concentrations are above comparative clean-up criteria for surface water or sediment.

### **3.9.7 Any Other Conditions of Concern**

Other conditions of concern that may be applicable to this project area have been previously discussed in Section 2.9.7.

## **4.0 ENTRANCE CHANNEL TURN – SITE DESCRIPTION**

### ***4.1 Location and Legal Description***

The ECT is an area in the Atlantic Ocean that is to be deepened and widened to accommodate larger vessels maneuvering through the turn between the Middle and Outer Reaches. The total acreage of this area is 18.8 acres. All of that acreage is approximately one-mile off the shoreline in the Atlantic Ocean, completely under water (approximately 41 feet deep). The area included in the ECT portion of the study is shown in Figure 1B.

### ***4.2 Descriptions of Structures, Roads, Other Improvements on the Site (Including Heating/Cooling System, Sewage Disposal, Source of Potable Water)***

There are no reported structures, roads, or other improvements on the site.

### ***4.3 Information (if any) Reported by Auditor Regarding Environmental Liens or Specialized Knowledge or Experience***

No specialized knowledge is available for this site.

### ***4.4 Current Uses of the Property***

The project area is adjacent to and will expand the vessel navigation area at the intersection of the Middle and Outer Reaches.

### ***4.5 Past Uses of the Property (to the extent identified)***

Based on historic aerial photography and topographic maps, the project area appears to have always been underwater.

### ***4.6 Current and Past Uses of Adjoining Properties (to the extent identified)***

By all indications observed throughout the site investigation, the adjoining properties are underwater for approximately one-mile west to the shoreline.

### ***4.7 Site Rendering, Map, or Site Plan***

See Figure 1B.

## 4.8 Records Review

### 4.8.1 Standard Environmental Records Sources, Federal, State, and/or Local

Under subcontract to CH2M HILL, EDR conducted a database search to identify potential or existing environmental liabilities within the target area. Records searched included several databases, such as the Toxic Chemical Release Inventory System (TCRIS), Hazardous Material Information Reporting System (HMIRS), and Leaking Underground Storage Tanks (LUST). The table below lists all of the databases EDR searched, and includes the search distance from the site. The entries that are bolded are those required of ASTM E 1527-00 and the HTRW guidance document (ER 11695-2-132, 26 June 1992).

Databases Searched

Database	Search Distance (miles)
<b>Federal Environmental Protection Agency (EPA)</b>	
<b>Comprehensive Environmental Response, Compensation, and Liability Information System (CERCLIS)</b>	<b>0.5</b>
<b>Comprehensive Environmental Response, Compensation, and Liability Information System (CERC-NFRAP)</b>	<b>0.25</b>
<b>Emergency Response Notification System (ERNS)</b>	<b>Target Property</b>
Proposed National Priority List (NPL)	1.0
<b>National Priority List (NPL)</b>	<b>1.0</b>
Delisted NPL	1.0
<b>Resource Conservation and Recovery Information System (RCRIS-TSD)</b>	<b>0.5</b>
<b>RCRIS Small Quantity Generator (RCRIS-SQG)</b>	<b>0.25</b>
<b>RCRIS Large Quantity Generator (RCRIS-LQG)</b>	<b>0.25</b>
Superfund (CERCLIS) Consent Decrees (CONSENT)	1.0
<b>Corrective Action Report (CORRACTS)</b>	<b>1.0</b>
Facility Index System (FINDS)	Target Property
Hazardous Materials Information Reporting System (HMIRS)	Target Property
Material Licensing Tracking System (MLTS)	Target Property
Mines Master Index File (MINES)	0.25
Federal Superfund Liens (NPL Liens)	Target Property
PCB Activity Database System (PADS)	Target Property
RCRA Administrative Action Tracking System (RAATS)	Target Property
Record of Decision (ROD)	1.0
Toxic Chemical Release Inventory System (TCRIS)	Target Property
Toxic Substances Control Act (TSCA)	Target Property
FIFRA/TSCA Tracking System – FIFRA (Federal Insecticide, Fungicide, & Rodenticide Act)/TSCA (Toxic Substances Control Act) – (FTTS)	Target Property
<b>State of Florida</b>	
<b>Leaking Underground Storage Tanks (LUST)</b>	<b>0.5</b>
<b>Underground Storage Tanks (UST)</b>	<b>0.25</b>
Aboveground Storage Tanks (AST)	0.500
<b>State Hazardous Waste Sites (SHWS)</b>	<b>1.0</b>

## Databases Searched

Database	Search Distance (miles)
<b>Federal Environmental Protection Agency (EPA)</b>	
<b>State Solid Waste Facilities/Landfill Sites (SWF/LF)</b>	0.5
<b>Florida Sites</b>	0.5
Florida Cattle Dip Vats	0.5
Florida Wastewater	Target Property
Florida Dry Cleaners	0.5
Coal Gas	1.0

Based on the review of the Federal and state regulatory database search, no facilities are located within the search distance.

#### 4.8.2 Physical Setting Source(s)

The proposed project area is underwater and subject to variations in tidal action.

#### 4.8.3 Additional Record Sources

None

### 4.9 Information from Site Reconnaissance and Interviews

Ms. A. Tracy Langille, P.G., CH2M HILL, Inc., Jacksonville, Florida office performed a site inspection on 20 December 2005. Access to all of the project area was limited due to fact that it is completely underwater and approximately one-mile offshore in 41 feet of ocean water. Please see Photograph 21.

Telephone interviews were conducted with Mr. Dave Maher, P.G. of the Brevard County Natural Resource Management Office and Ms. Jeannie Adame, Director of Environmental Plans & Programs for the CPA regarding information that may be available for the project area and vicinity.

#### 4.9.1 Hazardous Substances in Connection with Identified Uses (Including Storage, Handling, Disposal)

Hazardous substances in connection with identified uses were unable to be seen, if present, due to inaccessibility.



**4.9.2 Hazardous Substance Containers and Unidentified Substance Containers (Including Storage, Handling, Disposal)**

No hazardous substance containers and unidentified substance containers were observed due to inaccessibility.

**4.9.3 Storage Tanks (Including Contents and Assessment of Leakage or Potential for Leakage)**

No storage tanks or containers were observed due to inaccessibility.

**4.9.4 Indications of PCBs (Including How Contained and Assessment of Leakage or Potential for Leakage)**

Because the entire area is underwater, no indications exist that PCB's are present within the proposed project area.

**4.9.5 Indications of Solid Waste Disposal**

No recorded data yielded any indications that the disposal of sanitary solid waste had occurred at any time at the proposed project area.

**4.9.6 Physical Setting Analysis, If Migrating Hazardous Substances Are an Issue**

Migration of hazardous substances off-site is not a concern because the adjacent property having contamination is located too far to be of concern.

**4.9.7 Any Other Conditions of Concern**

None

## **5.0 FINDINGS AND CONCLUSIONS**

### **5.1 General Comments**

A Section 230 Feasibility Study - HTRW Assessment was conducted in conformance with the scope and limitations of ASTM Practice E 1527 and ER-1165-2-132. The findings and conclusions provided below reflect existing HTRW conditions based on a HTRW database search, aerial photography, reviews of available records, site inspections and interviews. These findings and conclusions are of existing conditions as they were identified at this time.

### **5.2 Regional Overview**

A site inspection was performed on or in the immediate vicinity of the three project areas identified for navigation improvements at Port Canaveral. Two of the three areas (WTB and NC) are located within Canaveral Harbor and the third area (ECT) is located approximately one-mile offshore. The hazardous and toxic waste evaluation revealed that the majority of the area is predominantly developed having construction and activities associated with marine and port facilities, including cruise terminals, marine maintenance, public parks, marine cargo transfers and a military installation. The HTRW database search included the entire area and indicated that overall, that a relatively small portion of the proposed project area may have been impacted, to some extent, with hazardous and toxic waste. Most of these reported properties are located on the uplands portion of the northeast side of the WTB and West Access Channel and on the south side of the Inner Reach portion of the channel, upgradient to two of the three areas (WTB and NC). No properties were reported in the vicinity of the ECT. The most common type of HTRW, hydrocarbons, was reported in the EDR database and located along the southern portion of the Harbor.

The database also revealed several locations of Small Quantity Generators (SQG). Most of these SQG sites are reported to be in compliance with reported requirements. The site inspection revealed the presence of a location in the northeast section of the WTB that appears to be not in compliance with regulatory rules in regards to the operations conducted. There is another site reported by personnel from the Brevard County Natural Resource Management Office (BCNRM) suggests that a release of chlorinated solvents has occurred in the location that is leased to and operated by Mid-Florida Freezer on the south side of the Harbor. Contamination from the sites located on the perimeter of the proposed project may be migrating into the project area.

### **5.3 West Turning Basin**

A site inspection was conducted on 20 December 2005. The HTRW database review of the existing conditions indicated the site to be free of hazardous and toxic materials and waste. However, during the site inspection indicated the presence of hazardous materials and waste in one area: the Beyel Brothers, Inc. property located at the southeastern edge of the WTB uplands.

Most of the items observed were those used in connection with marine vessel repair and painting, and marine scrap (e.g., cranes, shipping containers, etc.). According to the lease agreement with CPA, these activities were not allowed on the property.

Coastal Fuels, located on the south side of the Harbor, had a release of petroleum product via a location in their pipeline to the docks. Soil was excavated, during which the laboratory analytical results indicated the presence of chlorinated solvents, which are not typically found in petroleum impacted soils. The source of the chlorinated solvents is likely from past activities at another facility leased from CPA. The extent of impact in 2004 (last groundwater sampling event) suggests the size of the plume is slightly smaller, although temporal effects in the groundwater concentrations in and inferred plume size can occur. Currently, the majority of the plume is being monitored. An air sparging system is being designed for installation along the bulkhead to insure that contaminants are not migrating into the water and sediments in the Harbor. Past sampling and analyses of surface water and sediments in the Harbor indicate that no chlorinated solvents, exceeding comparative clean-up criteria, are present. In addition, a risk assessment is being performed in order to establish alternate groundwater cleanup criteria in the original source area. A large bulkhead is present at the water's edge that may impede the migration of the chlorinated solvents and petroleum constituents into the Harbor. The potential of HTRW risks at this site is considered moderate.

#### ***5.4 North Side of Channel (Inner and Middle Reaches)***

A site inspection of the land adjacent to NC was performed on 20 December 2005, as the NC area is located completely underwater. The HTRW database review of the existing condition found the site to be free of hazardous and toxic materials and waste. The property surrounding the proposed project is a mix of commercial shipping, marine port activities, and a military installation. Please see the previous section for a discussion of releases on the south side of the Harbor, which is considered to be adjacent property. The potential of HTRW risks at this site is considered low.

#### ***5.5 Entrance Channel Turn***

This area is located approximately one-mile offshore in the Atlantic Ocean. A site visit was not performed as it is in about 41 feet of water. None of the sites listed in the HTRW database review are located within the search distances. The potential of HTRW risk at this area is considered low.

**PRELIMINARY ASSESSMENT SCREENING (PAS) STATEMENT OF FINDINGS**

**REAL PROPERTY TRANSACTION:** This effort was not performed for a "Real Property Transaction", but rather for use in the development of the Feasibility Study. An intrusive soil and groundwater study is recommended for the Beyel Brothers property to evaluate whether the soil and groundwater have been impacted by operations performed there. Upon evaluation and possible remediation of the Beyel Brothers leased property, these sites may be used for the project purposes.

**SUMMARY:**

**COMPREHENSIVE RECORD SEARCH:** Several database searches were performed under subcontract to EDR. The following databases were included in the review: National and State Priority Listed Sites, landfills, Federal and State Conservation Environmental Restoration Comprehensive Liability Act (CERCLA) listed sites, listed violators, underground storage tanks (USTs) and leaking underground storage tanks (LUSTs), Treatment Storage and Disposal facilities (TSDs), listed spills, Small (SQG) and Large Quantity Generators (LQG), Transporters and aboveground storage tanks (ASTs). There are no reported hazardous or toxic waste present on the proposed right of way and source of material site.

**SITE INVESTIGATION:** CH2M HILL, Inc. Staff, Jacksonville Office visited the proposed areas on 20 December 2005.

In conclusion, the Proposed Canaveral Harbor widening may potentially have low to moderate concentration of hazardous and toxic waste. A further detail study is required for the property leased by Beyel Brothers, Inc. associated with the WTB area of the project. Additionally, a file review and summary of activities associated with Coastal Fuels and Mid-Florida Freezer should be performed.

Signed:

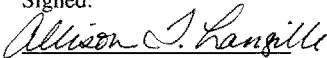

Date:

*May 12, 2006*

Prepared by: A. T. Langille, PG

Senior Hydrogeologist

CH2M HILL, Inc.



THIS DOCUMENT IS THE PROPERTY OF CH2M HILL. IT IS TO BE USED ONLY FOR THE PROJECT AND SITE SPECIFICALLY IDENTIFIED HEREIN. ANY REUSE OR MODIFICATION OF THIS DOCUMENT WITHOUT THE WRITTEN PERMISSION OF CH2M HILL IS STRICTLY PROHIBITED.

PRELIMINARY NOT FOR CONSTRUCTION	U.S. 2007 1 inch = 500 feet	8" x 11"	8" x 11"	8" x 11"	8" x 11"	8" x 11"	8" x 11"
CH2M HILL A DIVISION OF CANTERA GROUP, INC. 15000 W. BUCKLEBOURNE DRIVE SUITE 100 BOCA RATON, FLORIDA 33433							
PORT CANAVERAL							
CANAVERAL PORT AUTHORITY PORT CANAVERAL HTRW SURVEY SECTION 203 FEASIBILITY STUDY FUTURE CONDITIONS							
SHEET DATE: 07/20/08 DRAWN BY: JSS/STP CHECKED BY:							
FIGURE 1A 02228							

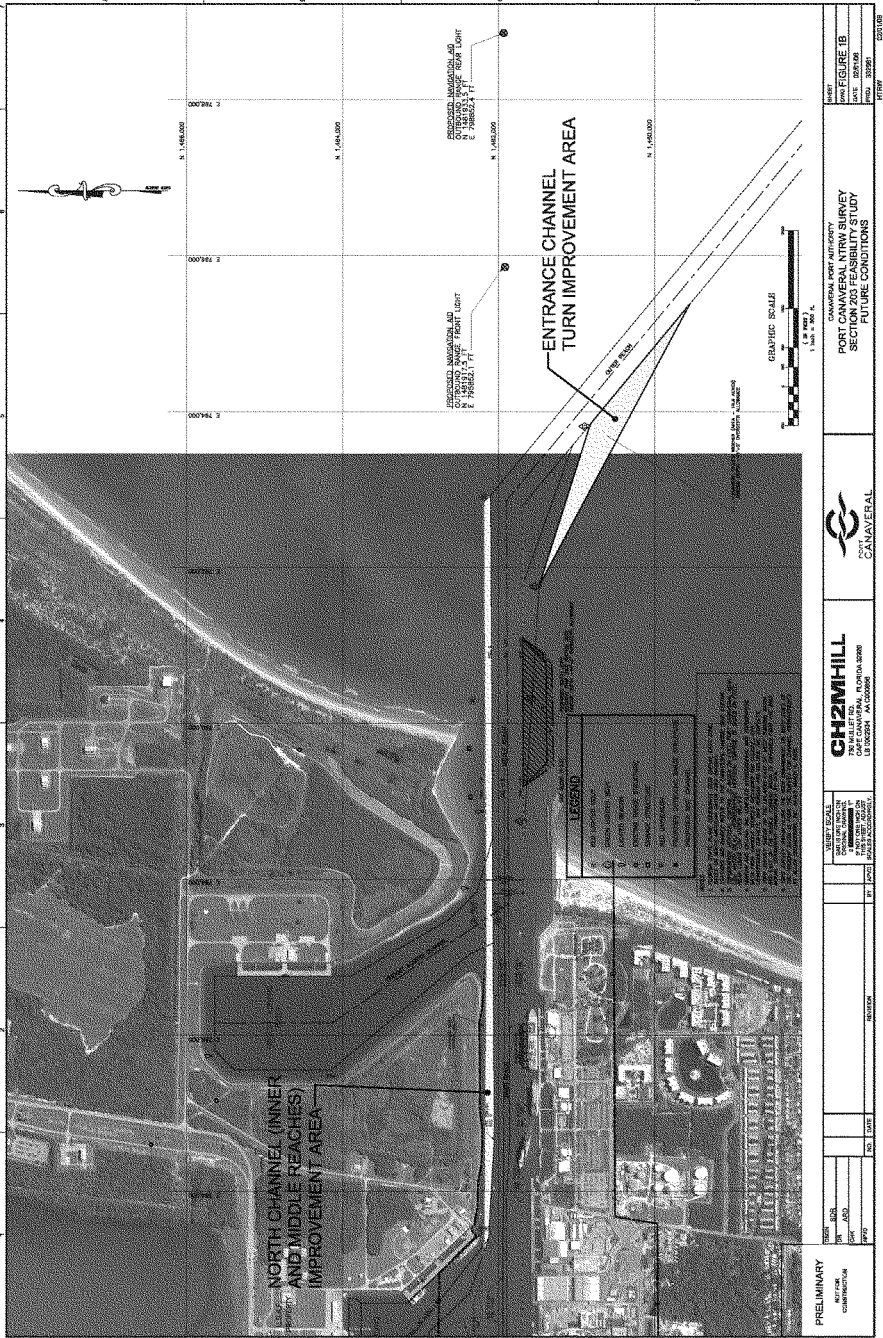

THIS DOCUMENT IS NOT TO BE USED IN WHOLE OR IN PART FOR ANY OTHER PROJECT WITHOUT THE WRITTEN AUTHORIZATION OF CH2M HILL

PRELIMINARY  
 NOT FOR  
 CONSTRUCTION

DATE	ISS	BY	DATE	BY	DATE

**CH2M HILL**  
 200 E. COLLETT AVENUE, SUITE 200  
 AUSTIN, TEXAS 78701-2999  
 TEL: 512.424.2000 FAX: 512.424.2001



CANAVERRAL AREA INCORPORATED  
 PORT CANAVERAL NTRW SURVEY  
 SECTION 703 FEASIBILITY STUDY  
 FUTURE CONDITIONS

SHEET  
 DATE 02/17/06  
 SHEET 020606  
 FIGURE 1B

02/17/06 2:06PM

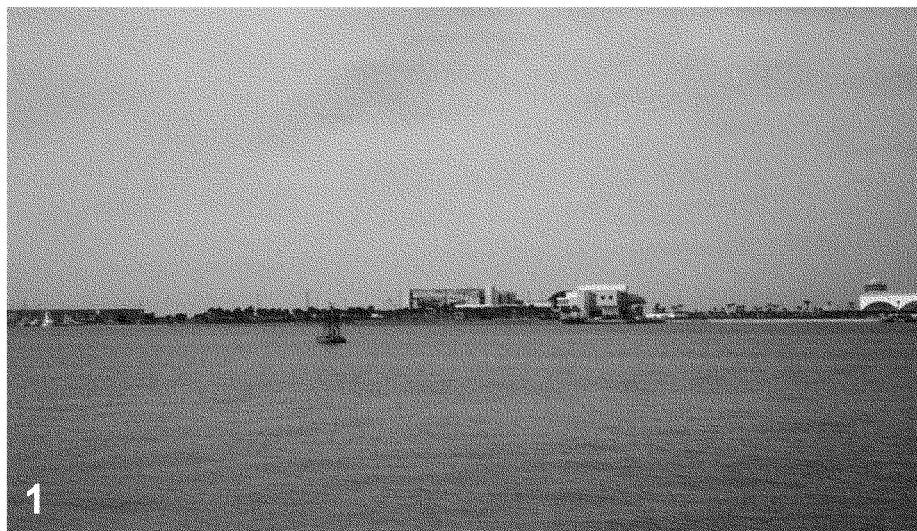

WTB Area



South Side of Channel at WTB Area



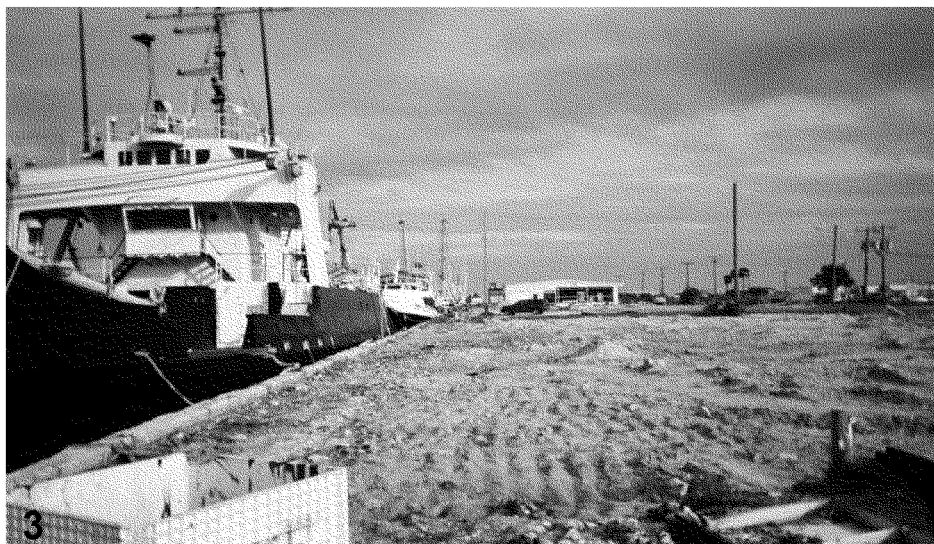

Seawall Along South Side of Channel  
(Adjacent to WTB Area)



Shoreline Along Beyel Brothers, Inc. Lease  
(WTB Area Uplands)





Two-inch Pipe on Shoreline  
(East of WTB)

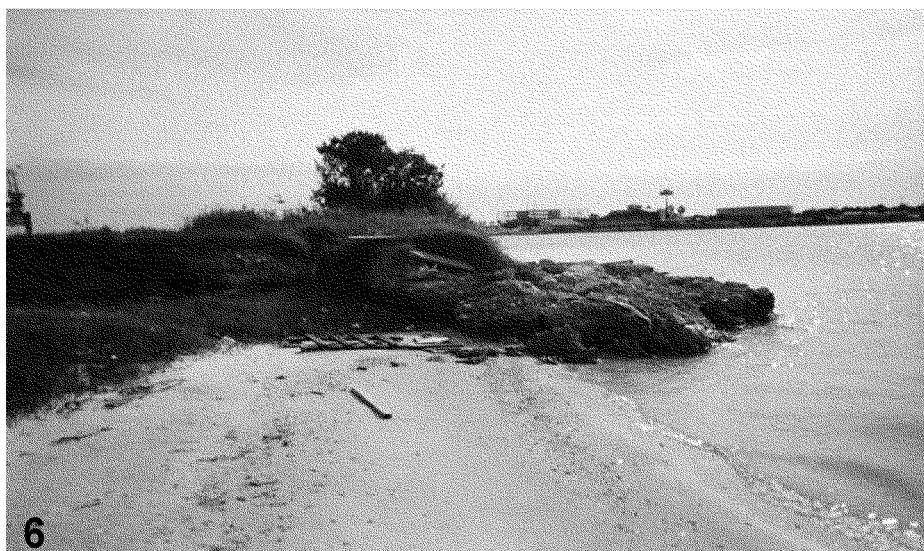

Rip-Rap East of WTB



Uplands East of WTB



36-inch Stormwater Outlet (East of WTB)



Seawall Along East Side of WTB  
(Beyel Brother, Inc. Lease)



Typical Equipment and Materials on Beyel Brother, Inc. Lease  
(WTB Area Uplands)



North Side Shoreline and West Access Channel  
(East of WTB)



Seawall Along South Side of Channel  
(Adjacent to WTB Area)





WTB Entrance Shoreline and Channel  
(West Access Channel)

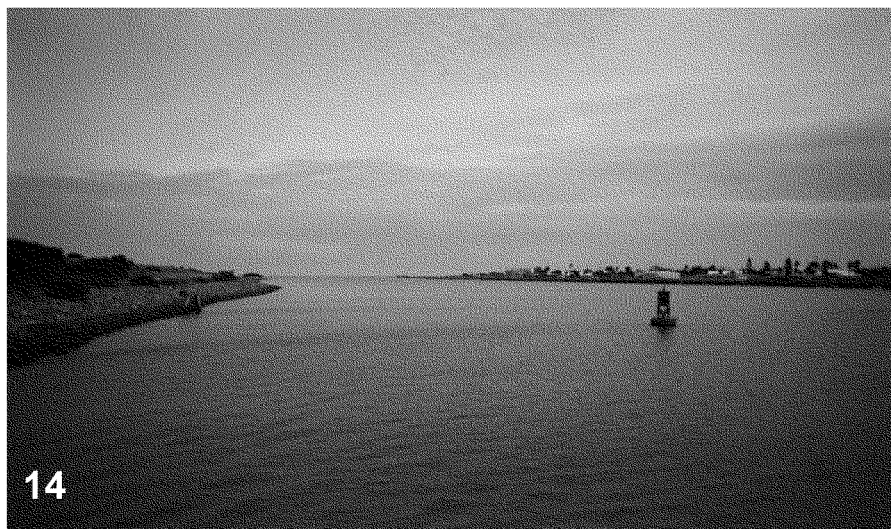

Channel (Inner Reach) East of MTB



CCAFS Shoreline and Uplands East of MTB



CCAFS Shoreline and Uplands East of MTB



Shoreline Along South Side of West Access Channel

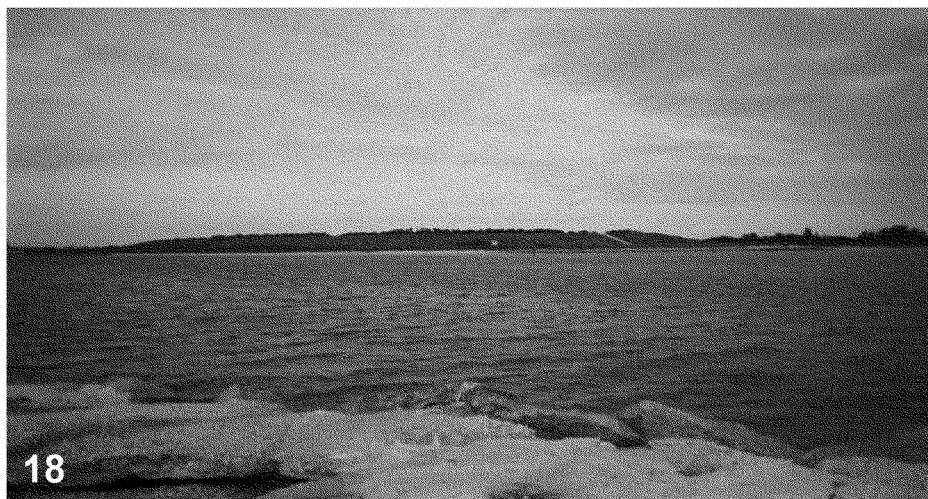

CCAFS Property (TTB on Right)



CCAFS Shoreline (West Side of TTB)



CCAFS Uplands at Port Entrance





Atlantic Ocean at Cocoa Beach  
(ECT Area Approx. One-mile Offshore)



696 Millwheel Drive  
Merritt Island, FL 32952

Phone (321) 454-6899  
Fax (321) 454-4319

November 27, 2007

Brevard County Board of Commissioners  
Natural Resources Management Office  
2725 Judge Fran Jamieson Drive, Bldg. A  
Viera, FL 32940

Attention: Doug Divers

Reference: Source Removal Report  
Beyel Bros. Lease  
Grouper Road  
Port Canaveral, Florida  
FDEP ID# 059809163

Dear Mr. Divers:

On behalf of the property owner, Canaveral Port Authority Daley Environmental Services, Inc. has completed source removal operations at the referenced property.

The report documents the source removal operations completed August 22-23, 2007. Laboratory analyses of soil samples collected after the source removal indicate all petroleum-impacted soil above Residential Soil Cleanup Target Levels has been removed. Laboratory analyses of groundwater samples collected after the source removal did not detect petroleum impacts to the groundwater above allowable Residential Groundwater Cleanup Target Levels.

We are recommending a "No Further Action" status without conditions for the site.

Attached for your use are two copies of the Source Removal Report. If you have any questions or require additional information, please call.

Sincerely,  
**DALEY ENVIRONMENTAL SERVICES, INC.**

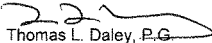
  
Thomas L. Daley, P.G.  
President

Enc.

Dist. Addressee - 2  
Canaveral Port Authority - 2

1275

**SOURCE REMOVAL REPORT  
BEYEL BROS. LEASE  
GROUPEL ROAD  
PORT CANAVERAL, FLORIDA  
FDEP ID# 059809163**

**Prepared For:**

Canaveral Port Authority  
PO Box 267  
Cape Canaveral, FL 32920

**Prepared by:**

Daley Environmental Services, Inc.  
696 Millwheel Drive  
Merritt Island, FL 32952  
(321) 454-6899

DES Project No. 07-105-12  
DES Report No. 7028  
Date: November 27, 2007

---

Thomas L. Daley, P.G.  
President  
FL Registration 1219

**TABLE OF CONTENTS**

<b>1.0 INTRODUCTION</b> .....	<b>1</b>
<b><u>1.1 Purpose</u></b> .....	<b>1</b>
<b><u>1.2 Background</u></b> .....	<b>1</b>
<b>2.0 FIELD OPERATIONS</b> .....	<b>2</b>
<b><u>2.1 Pre-disposal Sampling and Analysis</u></b> .....	<b>2</b>
<b><u>2.2 Soil Screening and Excavation</u></b> .....	<b>2</b>
<b><u>2.3 Soil Transportation and Disposal</u></b> .....	<b>2</b>
<b><u>2.4 Soil Sampling</u></b> .....	<b>3</b>
<b><u>2.5 Groundwater Sampling</u></b> .....	<b>3</b>
<b>3.0 SOIL AND GROUNDWATER QUALITY</b> .....	<b>4</b>
<b><u>3.1 Post Source Removal Soil Quality</u></b> .....	<b>4</b>
<b><u>3.2 Post Source Removal Groundwater Quality</u></b> .....	<b>4</b>
<b>4.0 CONCLUSIONS AND RECOMMENDATIONS</b> .....	<b>5</b>

**TABLES**

<b>TABLE 1</b>	<b>SOIL ANALYTICAL SUMMARY</b>
<b>TABLE 2</b>	<b>GROUNDWATER ANALYTICAL SUMMARY</b>

**FIGURES**

<b>FIGURE 1</b>	<b>SITE LOCATION TOPOGRAPHIC MAP</b>
<b>FIGURE 2</b>	<b>SITE LAYOUT PLAN</b>

**APPENDICES**

<b>APPENDIX A</b>	<b>MANIFESTS / SCALE TICKETS</b>
<b>APPENDIX B</b>	<b>FIELD LOGS</b>
<b>APPENDIX C</b>	<b>LABORATORY REPORTS</b>

## 1.0 INTRODUCTION

### 1.1 Purpose

Daley Environmental Services, Inc. (DES); on behalf the property owner, Canaveral Port Authority; DES has completed source removal operations at a former commercial crane operation on the west side of Grouper Road at Port Canaveral, Florida, Brevard County, Florida. The purpose of the project was to remove and dispose of soils impacted with petroleum products resulting from a discharge from a portable aboveground storage tank formerly located on the property. The location of the site is depicted on Figure 1, Site Location Topographic Map. The site FDEP ID number is 059809163.

The project was completed in accordance with provisions of Florida Administrative Code (FAC) 62-770.300, Source Removal. All field sampling activities were completed in accordance with FDEP Standard Operating Procedures for Field Activities (DEP-SOP-001/01).

### 1.2 Background

The site is the former location of Beyel Bros. a crane and rigging company who used the site as a base of operations. As part of their operations Beyel had a portable skid aboveground storage tank (AST) for fueling equipment with diesel fuel. Beyel Bros. relocated from the site in 2006. DES completed a Limited Scope Soil and Groundwater Assessment documented in a report dated October 17, 2006. The assessment identified the presence of petroleum impacted soil and groundwater. A Discharge Report Form was submitted to Brevard County Natural Resources Management Office on December 14, 2006. The property layout is shown on Figure 2, Site Layout Plan.

DES was later contracted to complete the source removal and assessment activity.

## 2.0 FIELD OPERATIONS

### 2.1 Pre-disposal Sampling and Analysis

DES personnel mobilized to the site on August 3, 2007. We completed a series of nine hand auger borings in the footprint of the known areas of petroleum impacts to the soil. The soil cuttings generated from the auger borings were composited. A representative sample of the composited soil was placed in a soil jar provided by the laboratory. The soil sample, designated, Comp-1, was shipped in an iced cooler with chain-of-custody to US Biosystems Laboratory in Boca Raton, Florida for analysis. Soil sample Comp-1 was analyzed for the pollutant metals, Arsenic, Barium, Cadmium, Chromium, Lead, Selenium and Silver (total and TCLP) as required by Omni Waste for disposal of soils in their Omni Waste Landfill near St. Cloud, Florida.

The results of the laboratory analysis were submitted to Omni Waste and a waste profile was approved allowing for disposal of the soil in their facility. The laboratory report is included in Appendix C.

### 2.2 Soil Screening and Excavation

DES personnel mobilized to the site on August 22-23, 2007. During this time we completed the excavation of all soils with an Organic Vapor levels in excess of one part per million as measured with a Mini Rae 2000 an Organic Vapor Meter with a photo ionization detector (OVM-PID) as the soil as was excavated. Soils exhibiting Volatile Organic Vapors were loaded directly into dump trucks for transportation from the site for disposal.

Representative soil samples were collected as the excavation proceeded. Samples were collected from the excavator bucket, the sidewall and base of the excavations and screened with the OVM. Confirmatory screening of soil samples was completed from samples collected directly from the sidewalls of the west excavation at a depth of approximately two feet which was above the groundwater table at approximately 4 feet bls. Confirmatory screening of soil samples was completed from samples collected directly from the sidewalls of the excavation at a depth of approximately two feet which was above the groundwater table. The field notes for the soil screening including results and locations collected are included in Appendix B.

The screenings indicated high levels of Volatile Organic Vapors from the surface to the groundwater table in all seven identified areas of petroleum-impacted soil. The excavation locations are shown on Figure 2.

### 2.3 Soil Transportation and Disposal

As the excavation proceeded the soil exhibiting Volatile Organic Vapor content greater than one ppm was placed in twenty-five rear dump trucks for transportation from the site. The excavated soil, totaling 778.86, tons was transported from the site for disposal at the Omni Waste Landfill near St. Cloud, Florida by Soil Tech Distributors.

The excavations were backfilled upon completion of the soil removal with clean sandy fill material. The manifest and scale tickets are included in Appendix A.

## **2.4 Soil Sampling**

In an effort to confirm removal of petroleum impacts to the soil, twenty-four soil samples were collected for laboratory analysis. Three or four confirmatory soil samples (depending on size and shape) were collected for laboratory analysis from each of the sidewalls of the excavations. Soil screening from these eight locations indicated Volatile Organic Vapors concentrations below the instrument minimum detection level of one ppm. The soil samples, designated CS-1 through CS-24, were collected at the locations depicted on Figure 2. The samples were placed in containers provided by the laboratory and shipped in an iced cooler with chain-of-custody to US Biosystems in Boca Raton, Florida for analysis.

## **2.5 Monitor Well Installation and Groundwater Sampling**

DES personnel returned to the site on September 6, 2007 with a drill rig and crew. One monitor well was installed at the site at each of the excavation locations. The monitor wells were designated MW-1 through MW-7. The locations of the monitor wells are depicted on Figure 2. The monitor wells were installed by advancing a hollow stem auger to a depth of approximately 13 feet. Into the hollow stem auger was placed a ten-foot section of 2" diameter PVC well screen with 0.006" slot openings. This screen was attached to a section of 2"-diameter PVC riser pipe. A filter pack of 30/40 silica sand was placed around and to one-foot above the well screen. A one-foot seal of 30/65 silica sand was placed above the filter pack and extended to the surface. The wellheads were not completed pending results of the initial sampling. The wells were developed by pumping groundwater from the wells until the discharge was free of sediment. The development water was spread on nearby pavement and allowed to evaporate. The Well Completion and Development Logs are included in Appendix B.

DES personnel returned to the site on October 5, 2007. In an effort to assess potential petroleum impacts to the groundwater, samples were collected for laboratory analysis from monitor wells MW-1 through MW-7. Each monitor well was purged in accordance with FDEP protocol. The groundwater samples were collected using a peristaltic pump. The groundwater samples were placed in containers provided by the laboratory and shipped in an iced cooler with chain-of-custody to USB for analysis.

The results of the first sampling event indicated petroleum impacts to the groundwater exceeded the Groundwater Cleanup Target Level for Benzene at MW-2 only. In order to confirm the results DES personnel returned to the site on October 17, 2007 and re-sampled monitor well MW-2 for BTEX compounds. The field procedures for the re-sampling were identical to that employed during the October 5, 2007 sampling event.

The purge water was spread on a nearby paved surface and allowed to evaporate.

The Groundwater Sampling Logs and Field Instrument Calibration Logs are included in Appendix B.

### 3.0 SOIL AND GROUNDWATER QUALITY

#### 3.1 Post Source Removal Soil Quality

Contaminant impacts to the soil were assessed by laboratory analyses of the twenty-four soil samples collected from the sidewalls and base of the excavations at the locations described above.

The soil samples were analyzed by EPA Methods 8021 and 8310 and Florida Special Method FL-PRO which detect the presence of petroleum fuel constituents.

The laboratory results indicated all contaminants of concern were well below the most restrictive SCTL. The results of the laboratory analysis indicated the presence of Total Recoverable Petroleum Hydrocarbons (TRPH) in all twenty-two of the twenty-four samples, but below the most-restrictive Residential Soil Cleanup Target Level (SCTL) of 340 ppm. Additional petroleum fuel constituents were detected, but at trace levels well below the most restrictive Residential SCTLs. A summary of the detected analytes is presented on Table 1: Soil Analytical Summary.

The laboratory report is included in Appendix C.

#### 3.2 Post Source Removal Groundwater Quality

Contaminant impacts to the groundwater were assessed by laboratory analyses of groundwater samples collected from monitor wells MW-1 and MW-2 by EPA Methods 8021 and 8310 and Florida Special Method FL-PRO which detect the presence of petroleum compounds.

Laboratory analysis of the groundwater samples collected from MW-1 through MW-7 indicated only trace levels of the contaminants of concern well below the state Groundwater Cleanup Target Levels (GCTLs), except at monitor well MW-2 where Benzene was detected at a level of 1.47 ug/l which exceeded the GCTL of 1.0 ug/l.

As discussed above DES re-sampled monitor well MW-2 on October 17, 2007 for analysis by EPA Method 8021B (BTEX). The laboratory results from the October 17, 2007 sampling indicated Benzene was not present at or above the Method Detection Level.

A summary of the detected analytes is presented on Table 2: Groundwater Monitoring Well Analytical Summary.

The laboratory report is included in Appendix C.



#### 4.0 CONCLUSIONS AND RECOMMENDATIONS

On August 22-23, 2007 a total of 778.86 tons of petroleum contaminated soil was excavated from the source area at the site and transported from the site for disposal at the Omni Waste Landfill in St. Cloud, Florida.

Laboratory analysis of twenty-four confirmatory soil samples indicated the presence of petroleum fuel constituents, but at levels well below the most restrictive Residential Soil Cleanup Target Levels.

Laboratory analysis of groundwater samples collected from six of seven monitor wells installed at the excavation sites did not indicate the presence of petroleum impacts to the groundwater in excess of the most restrictive Residential Groundwater Cleanup Target Levels on October 5, 2007. A subsequent re-sampling and laboratory analysis of the one well exceeding the GCTL indicated the seventh monitor well location did not have groundwater impacts in excess of the GCTLs.

The site meets the FDEP criteria for a "No Further Action with Conditions" status.

We recommend a No Further Action status be granted the site in accordance with FAC 62-770.

TABLE 1: SOIL ANALYTICAL SUMMARY

Facility Name: Beyel Bros.

Facility ID#: 059809163

Sample No.	Date Collected	Sample Interval (fibs)	Depth to Water (ft)	OVA		Benzene (ppm)	Toluene (ppm)	Ethylbenzene (ppm)	Total Xylenes (ppm)	MTBE (ppm)	Naphthalene (ppm)	2-Methylnaphth. (ppm)	1-Methylnaphth. (ppm)	TRPHs (ppm)
				Net OVA Reading (ppm)	Reading (ppm)									
CS-1	8/22/2007	2'	4'	0	U.0.0034	U.0.0044	U.0.0056	U.0.0030	U.0.0052	U.0.025	U.0.032	U.0.031	7.261	
CS-2	8/22/2007	2'	4'	0	U.0.0034	U.0.0045	U.0.0056	U.0.0030	U.0.0052	U.0.023	U.0.030	U.0.029	9.241	
CS-3	8/22/2007	2'	4'	0	U.0.0037	U.0.0046	U.0.0057	U.0.0031	U.0.0053	U.0.023	U.0.030	U.0.029	49.5	
CS-4	8/22/2007	2'	4'	0	U.0.0042	U.0.0048	U.0.0061	U.0.0033	U.0.0056	U.0.024	U.0.031	U.0.030	19.0	
CS-5	8/22/2007	2'	4'	0	U.0.0043	U.0.0055	U.0.0069	U.0.0037	U.0.0064	U.0.028	U.0.037	U.0.036	11.21	
CS-6	8/22/2007	2'	4'	0	U.0.0043	U.0.0056	U.0.0071	U.0.0038	U.0.0066	U.0.030	U.0.039	U.0.038	15.81	
CS-7	8/22/2007	2'	4'	0	U.0.0036	U.0.0048	U.0.0060	U.0.0033	U.0.0056	U.0.027	U.0.035	U.0.034	4.981	
CS-8	8/22/2007	2'	4'	0	U.0.0041	U.0.0054	U.0.0068	U.0.0037	U.0.0063	U.0.023	U.0.030	U.0.029	8.411	
CS-9	8/22/2007	2'	4'	0	U.0.0043	U.0.0056	U.0.0071	U.0.0038	U.0.0065	U.0.025	U.0.032	U.0.031	13.61	
CS-10	8/22/2007	2'	4'	0	U.0.0033	U.0.0044	U.0.0055	U.0.0030	U.0.0051	U.0.025	U.0.032	U.0.031	13.21	
CS-11	8/22/2007	2'	4'	0	U.0.0037	U.0.0049	U.0.0062	U.0.0033	U.0.0057	U.0.025	U.0.032	U.0.031	5.971	
CS-12	8/22/2007	2'	4'	0	U.0.0036	U.0.0047	U.0.0060	U.0.0032	U.0.0055	U.0.024	U.0.030	U.0.030	5.201	
CS-13	8/22/2007	2'	4'	0	U.0.0032	U.0.0042	U.0.0052	U.0.0028	U.0.0049	U.0.023	U.0.030	U.0.030	14.41	
CS-14	8/23/2007	2'	4'	0	U.0.0034	U.0.0044	U.0.0056	U.0.0030	U.0.0052	U.0.023	U.0.030	U.0.029	231	
CS-15	8/23/2007	2'	4'	0	U.0.0044	U.0.0057	U.0.0072	U.0.0039	U.0.0067	U.0.028	U.0.036	U.0.035	9.281	
CS-16	8/23/2007	2'	4'	0	U.0.0031	U.0.0041	U.0.0052	U.0.0028	U.0.0048	U.0.024	U.0.030	U.0.030	3.811	
CS-17	8/23/2007	2'	4'	0	U.0.0034	U.0.0045	U.0.0056	U.0.0030	U.0.0052	U.0.026	U.0.033	U.0.033	24.8	
CS-18	8/23/2007	2'	4'	0	U.0.0037	U.0.0049	U.0.0061	U.0.0033	U.0.0057	U.0.024	U.0.031	U.0.031	U.3.3	
CS-19	8/23/2007	2'	4'	0	U.0.0003	U.0.0043	U.0.0054	U.0.029	U.0.0050	U.0.024	U.0.031	U.0.030	U.3.3	
CS-20	8/23/2007	2'	4'	0	U.0.0035	U.0.0045	U.0.0057	U.0.0031	U.0.0053	U.0.025	U.0.032	U.0.032	3.631	
CS-21	8/23/2007	2'	4'	0	U.0.0032	U.0.0043	U.0.0055	U.0.029	U.0.0050	U.0.025	U.0.032	U.0.031	25.5	
CS-22	8/23/2007	2'	4'	0	U.0.0035	U.0.0045	U.0.0057	U.0.0031	U.0.0053	U.0.024	U.0.031	U.0.031	4.471	
CS-23	8/23/2007	2'	4'	0	U.0.0033	U.0.0043	U.0.0052	U.0.0030	U.0.0052	U.0.025	U.0.032	U.0.032	4.581	
CS-24	8/23/2007	2'	4'	0	U.0.0032	U.0.0042	U.0.0053	U.0.0028	U.0.0049	U.0.024	U.0.031	U.0.031	6.381	
SCTL					0.007	0.5	0.6	0.2	0.09	1.2	8.5	3.1	340	

NOTES: U = NOT DETECTED AT OR ABOVE METHOD DETECTION LEVEL.  
 I = DETECTED BETWEEN METHOD DETECTION LEVEL AND PRACTICAL QUANTIFICATION LEVEL

If an analyte is not detected, state the detection limit (i.e. <1)  
 SoilAnalSum T1

**TABLE 2: GROUNDWATER MONITORING WELL ANALYTICAL SUMMARY**

Facility Name: Beyel Bros.

Facility ID#: 059809163

Not Sampled = NS

Analytical Results = ppb

Except TRPH = ppm

Location	Sample Date	Benzene	Toluene	Ethylbenzene	Total Xylenes	Total VOA	MTBE	EDB	Total Lead	TRPHs	Naphthalene	2-Methylnaphth.	1-Methylnaphth.
MW-1	10/5/2007	U 0.21	0.180	U 0.20	U 0.60	0.18	U 0.78	NS	NS	0.170 I	U 0.070	U 0.098	U 0.032
MW-2	10/5/2007	1.47	0.220 I	U 0.20	U 0.60	1.69	5.65	NS	NS	0.787	U 0.070	U 0.098	U 0.032
MW-2	10/17/2007	U 0.21	0.310 I	U 0.20	U 0.60	0.31	U 0.78	NS	NS	NS	NS	NS	NS
MW-3	10/5/2007	U 0.21	0.210	U 0.20	U 0.60	0.21	U 0.78	NS	NS	1.30	U 0.072	U 0.10	0.0593 I
MW-4	10/5/2007	U 0.21	0.190	U 0.20	U 0.60	0.19	U 0.78	NS	NS	0.629 I	U 0.070	U 0.098	U 0.032
MW-5	10/5/2007	U 0.21	0.160	U 0.20	0.0700	0.23	U 0.78	NS	NS	0.333 I	U 0.070	U 0.098	U 0.032
MW-6	10/5/2007	U 0.21	0.210	0.100	U 0.60	0.31	U 0.78	NS	NS	0.634 I	U 0.071	U 0.10	U 0.032
MW-7	10/5/2007	U 0.21	0.170	U 0.20	U 0.60	0.17	0.490	NS	NS	0.509 I	U 0.075	U 0.11	U 0.034
GCTL		1.0	.40	30	20	20	0.02	15	5000	14	28	28	28

NOTES: U = NOT DETECTED AT OR ABOVE METHOD DETECTION LEVEL

I = DETECTED BETWEEN METHOD DETECTION LEVEL AND PRACTICAL QUANTIFICATION LEVEL

If an analyte is not detected, state the detection limit (i.e. <1), not BDL or ND.  
GWAAnalSum T2

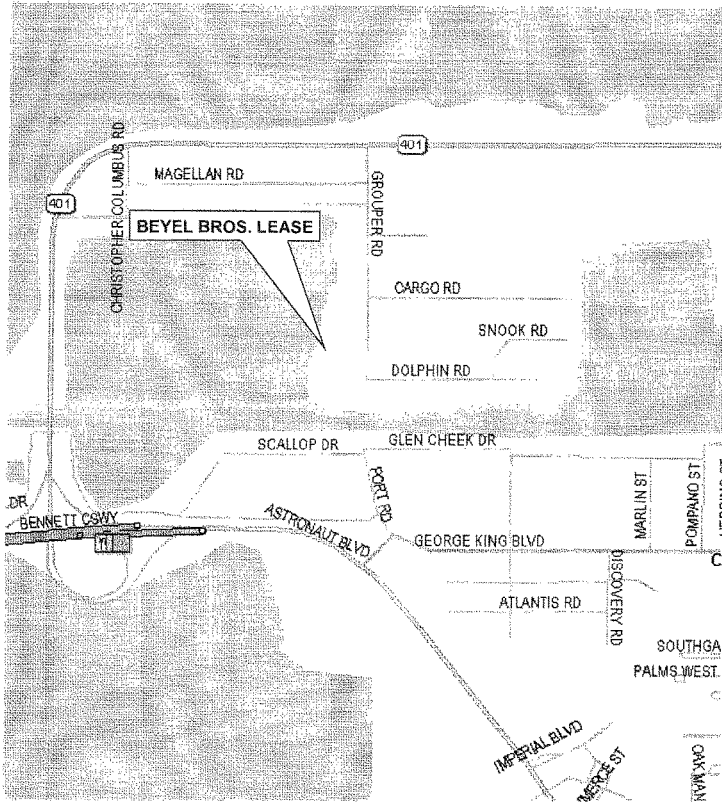

ONE INCH ON ORIGINAL DRAWING



**DES**  
DALEY  
ENVIRONMENTAL  
SERVICES, INC.

**SITE LOCATION MAP**  
**BEYEL BROS. LEASE**  
**GROUPE ROAD**  
**PORT CANAVERAL, FLORIDA**

SCALE: 1" = 1,500'
DATE: 10/31/07
REPORT #: 7028
FIGURE 1

WEST TUR

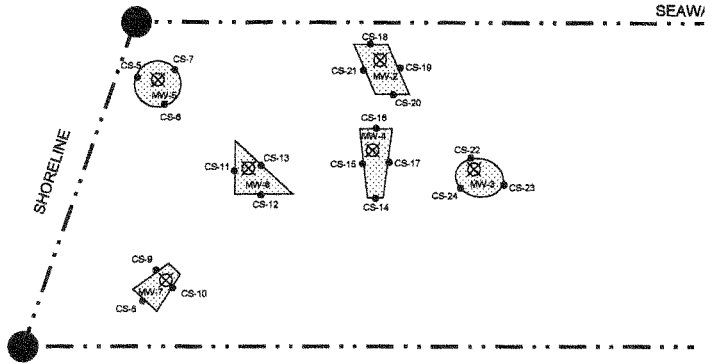

**LEGEND**

-  = AREA OF EXCAVATION
- CS-1 ● = CONFIRMATORY SOIL SAMPLING LOCATION
- MW-1 ☒ = MONITOR WELL

IRNING BASIN

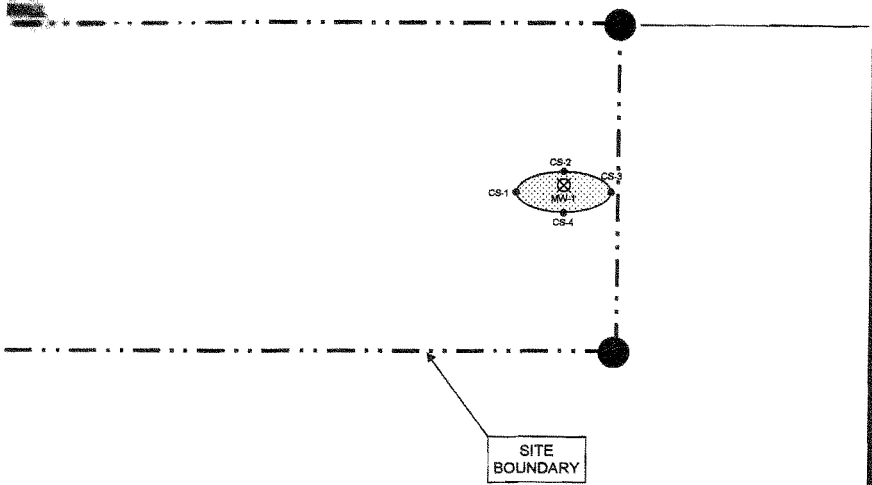

ONE INCH ON ORIGINAL DRAWING



<b>DES</b> DALEY ENVIRONMENTAL SERVICES, INC.	<b>SITE PLAN</b>	SCALE 1" = 50'
	<b>BEYEL BROS. LEASE</b>	DATE 10/31/07
	<b>GROUPEL ROAD</b>	PROJECT # 10228
	<b>PORT CANAVERAL, FLORIDA</b>	FIGURE 2

**Port Canaveral Section 203 Feasibility Study**  
**Engineering Appendix**

Attachment L

Cost Estimates

Rev Date: September 2012

(contains Cost DX Feb 2012 certification/TPCS/MCACES and revised Sept  
2012 TPCS/MCACES per SAD comments)

**WALLA WALLA COST ENGINEERING TECHNICAL  
CENTER OF EXPERTISE**

**COST AGENCY TECHNICAL REVIEW**

**CERTIFICATION STATEMENT**

for  
SAJ – Port Canaveral Section 203

The Port Canaveral Section 203 as presented by the SAJ Sponsor has undergone a successful Cost Agency Technical Review (Cost ATR), performed by the Walla Walla District Cost Engineering Technical Center of Expertise (Cost TCX) team. The Cost ATR included study of the project scope, report, cost estimates, schedules, escalation, and risk-based contingencies. This certification signifies the products meet the quality standards as prescribed in ER 1110-2-1150 Engineering and Design for Civil Works Projects and ER 1110-2-1302 Civil Works Cost Engineering.

As of February 8, 2012, the Cost TCX certifies the estimated total project cost of:

FY 2012 Price Level:	\$43,340,000 (excluding Sponsor spent costs)
Fully Funded Amount:	\$58,741,000 (including Sponsor spent costs)

Note that the certified TPCS is dependent upon sufficient, confident design and resulting Technical ATR. Further, it remains the responsibility of the District to correctly reflect these cost values within the Final Report and to implement effective project management controls and implementation procedures including risk management throughout the life of the project.



**US Army Corps  
of Engineers®**

for   
**Kim C. Callan, PE, CCE, PM1**  
**Chief, Cost Engineering**  
**Walla Walla District**

Date Feb 8 2012





\*\*\*\* TOTAL PROJECT COST SUMMARY \*\*\*\*

\*\*\*\* CONTRACT COST SUMMARY \*\*\*\*

PROJECT: Comprehensive Section 203 Study  
LOCATION: Port Canaveral Study Harbors  
This Estimate reflects the scope and schedule in report.

Estimate Prepared: 12-Dec-11  
Effective Price Level: 12-Dec-11

DISTRICT: SAJ Jacksonville  
POC: CHIEF, COST ENGINEERING, Tracy T. Lesser, P.E.

PREPARED: 2/8/2012

Integrated Section 203 Navigation Study Report

WBS NUMBER	Description	Estimate Prepared: 12-Dec-11		Effective Price Level: 12-Dec-11		RISK BASED		Program Year (Budget EC):		2012		Effective Price Level Date: 1 OCT 11		FULLY FUNDED PROJECT ESTIMATE		
		COST (\$K.)	NTG (%)	COST (\$K.)	NTG (%)	TOTAL (\$K.)	TOTAL (%)	ESC (%)	COST (\$K.)	NTG (%)	TOTAL (\$K.)	TOTAL (%)	ESC (%)	COST (\$K.)	NTG (%)	TOTAL (\$K.)
02	RELOCATIONS	\$2,008	21%	\$421	21%	\$2,429		G	H	I	J	K	L	M	N	O
12	NAVIGATION PORTS & HARBORS	\$27,715	21%	\$5,812	21%	\$33,527										
<b>CONSTRUCTION ESTIMATE TOTALS:</b>		<b>\$29,723</b>	<b>21%</b>	<b>\$6,233</b>	<b>21%</b>	<b>\$35,956</b>										
01	LANDS AND DAMAGES	\$1,645	21%	\$345	21%	\$1,990										
<b>CONSTRUCTION ESTIMATE TOTALS:</b>		<b>\$31,368</b>	<b>21%</b>	<b>\$6,578</b>	<b>21%</b>	<b>\$37,946</b>										
30	PLANNING, ENGINEERING & DESIGN															
7.5%	Project Management															
	Planning & Environmental Compliance															
	Engineering & Design	\$2,229	21%	\$467	21%	\$2,697										
	Engineering Tech Review (TR & VE)															
	Contracting & Reprgraphics															
	Engineering During Construction															
	Planning During Construction															
	Project Operations															
<b>CONSTRUCTION ESTIMATE TOTALS:</b>		<b>\$2,229</b>	<b>21%</b>	<b>\$467</b>	<b>21%</b>	<b>\$2,697</b>										
31	CONSTRUCTION MANAGEMENT															
7.5%	Construction Management															
	Project Operation															
	Project Management															
<b>CONSTRUCTION ESTIMATE TOTALS:</b>		<b>\$35,927</b>	<b>21%</b>	<b>\$7,513</b>	<b>21%</b>	<b>\$43,440</b>										
<b>CONSTRUCTION ESTIMATE TOTALS:</b>		<b>\$30,838</b>	<b>1.2%</b>	<b>\$367</b>	<b>1.2%</b>	<b>\$31,205</b>										
<b>CONSTRUCTION ESTIMATE TOTALS:</b>		<b>\$30,838</b>	<b>1.2%</b>	<b>\$367</b>	<b>1.2%</b>	<b>\$31,205</b>										
<b>CONSTRUCTION ESTIMATE TOTALS:</b>		<b>\$30,838</b>	<b>1.2%</b>	<b>\$367</b>	<b>1.2%</b>	<b>\$31,205</b>										
<b>CONSTRUCTION ESTIMATE TOTALS:</b>		<b>\$30,838</b>	<b>1.2%</b>	<b>\$367</b>	<b>1.2%</b>	<b>\$31,205</b>										
<b>CONSTRUCTION ESTIMATE TOTALS:</b>		<b>\$30,838</b>	<b>1.2%</b>	<b>\$367</b>	<b>1.2%</b>	<b>\$31,205</b>										
<b>CONSTRUCTION ESTIMATE TOTALS:</b>		<b>\$30,838</b>	<b>1.2%</b>	<b>\$367</b>	<b>1.2%</b>	<b>\$31,205</b>										
<b>CONSTRUCTION ESTIMATE TOTALS:</b>		<b>\$30,838</b>	<b>1.2%</b>	<b>\$367</b>	<b>1.2%</b>	<b>\$31,205</b>										
<b>CONSTRUCTION ESTIMATE TOTALS:</b>		<b>\$30,838</b>	<b>1.2%</b>	<b>\$367</b>	<b>1.2%</b>	<b>\$31,205</b>										
<b>CONSTRUCTION ESTIMATE TOTALS:</b>		<b>\$30,838</b>	<b>1.2%</b>	<b>\$367</b>	<b>1.2%</b>	<b>\$31,205</b>										
<b>CONSTRUCTION ESTIMATE TOTALS:</b>		<b>\$30,838</b>	<b>1.2%</b>	<b>\$367</b>	<b>1.2%</b>	<b>\$31,205</b>										
<b>CONSTRUCTION ESTIMATE TOTALS:</b>		<b>\$30,838</b>	<b>1.2%</b>	<b>\$367</b>	<b>1.2%</b>	<b>\$31,205</b>										
<b>CONSTRUCTION ESTIMATE TOTALS:</b>		<b>\$30,838</b>	<b>1.2%</b>	<b>\$367</b>	<b>1.2%</b>	<b>\$31,205</b>										
<b>CONSTRUCTION ESTIMATE TOTALS:</b>		<b>\$30,838</b>	<b>1.2%</b>	<b>\$367</b>	<b>1.2%</b>	<b>\$31,205</b>										
<b>CONSTRUCTION ESTIMATE TOTALS:</b>		<b>\$30,838</b>	<b>1.2%</b>	<b>\$367</b>	<b>1.2%</b>	<b>\$31,205</b>										
<b>CONSTRUCTION ESTIMATE TOTALS:</b>		<b>\$30,838</b>	<b>1.2%</b>	<b>\$367</b>	<b>1.2%</b>	<b>\$31,205</b>										
<b>CONSTRUCTION ESTIMATE TOTALS:</b>		<b>\$30,838</b>	<b>1.2%</b>	<b>\$367</b>	<b>1.2%</b>	<b>\$31,205</b>										
<b>CONSTRUCTION ESTIMATE TOTALS:</b>		<b>\$30,838</b>	<b>1.2%</b>	<b>\$367</b>	<b>1.2%</b>	<b>\$31,205</b>										
<b>CONSTRUCTION ESTIMATE TOTALS:</b>		<b>\$30,838</b>	<b>1.2%</b>	<b>\$367</b>	<b>1.2%</b>	<b>\$31,205</b>										
<b>CONSTRUCTION ESTIMATE TOTALS:</b>		<b>\$30,838</b>	<b>1.2%</b>	<b>\$367</b>	<b>1.2%</b>	<b>\$31,205</b>										
<b>CONSTRUCTION ESTIMATE TOTALS:</b>		<b>\$30,838</b>	<b>1.2%</b>	<b>\$367</b>	<b>1.2%</b>	<b>\$31,205</b>										
<b>CONSTRUCTION ESTIMATE TOTALS:</b>		<b>\$30,838</b>	<b>1.2%</b>	<b>\$367</b>	<b>1.2%</b>	<b>\$31,205</b>										
<b>CONSTRUCTION ESTIMATE TOTALS:</b>		<b>\$30,838</b>	<b>1.2%</b>	<b>\$367</b>	<b>1.2%</b>	<b>\$31,205</b>										
<b>CONSTRUCTION ESTIMATE TOTALS:</b>		<b>\$30,838</b>	<b>1.2%</b>	<b>\$367</b>	<b>1.2%</b>	<b>\$31,205</b>										
<b>CONSTRUCTION ESTIMATE TOTALS:</b>		<b>\$30,838</b>	<b>1.2%</b>	<b>\$367</b>	<b>1.2%</b>	<b>\$31,205</b>										
<b>CONSTRUCTION ESTIMATE TOTALS:</b>		<b>\$30,838</b>	<b>1.2%</b>	<b>\$367</b>	<b>1.2%</b>	<b>\$31,205</b>										
<b>CONSTRUCTION ESTIMATE TOTALS:</b>		<b>\$30,838</b>	<b>1.2%</b>	<b>\$367</b>	<b>1.2%</b>	<b>\$31,205</b>										
<b>CONSTRUCTION ESTIMATE TOTALS:</b>		<b>\$30,838</b>	<b>1.2%</b>	<b>\$367</b>	<b>1.2%</b>	<b>\$31,205</b>										
<b>CONSTRUCTION ESTIMATE TOTALS:</b>		<b>\$30,838</b>	<b>1.2%</b>	<b>\$367</b>	<b>1.2%</b>	<b>\$31,205</b>										
<b>CONSTRUCTION ESTIMATE TOTALS:</b>		<b>\$30,838</b>	<b>1.2%</b>	<b>\$367</b>	<b>1.2%</b>	<b>\$31,205</b>										
<b>CONSTRUCTION ESTIMATE TOTALS:</b>		<b>\$30,838</b>	<b>1.2%</b>	<b>\$367</b>	<b>1.2%</b>	<b>\$31,205</b>										
<b>CONSTRUCTION ESTIMATE TOTALS:</b>		<b>\$30,838</b>	<b>1.2%</b>	<b>\$367</b>	<b>1.2%</b>	<b>\$31,205</b>										
<b>CONSTRUCTION ESTIMATE TOTALS:</b>		<b>\$30,838</b>	<b>1.2%</b>	<b>\$367</b>	<b>1.2%</b>	<b>\$31,205</b>										
<b>CONSTRUCTION ESTIMATE TOTALS:</b>		<b>\$30,838</b>	<b>1.2%</b>	<b>\$367</b>	<b>1.2%</b>	<b>\$31,205</b>										
<b>CONSTRUCTION ESTIMATE TOTALS:</b>		<b>\$30,838</b>	<b>1.2%</b>	<b>\$367</b>	<b>1.2%</b>	<b>\$31,205</b>										
<b>CONSTRUCTION ESTIMATE TOTALS:</b>		<b>\$30,838</b>	<b>1.2%</b>	<b>\$367</b>	<b>1.2%</b>	<b>\$31,205</b>										
<b>CONSTRUCTION ESTIMATE TOTALS:</b>		<b>\$30,838</b>	<b>1.2%</b>	<b>\$367</b>	<b>1.2%</b>	<b>\$31,205</b>										
<b>CONSTRUCTION ESTIMATE TOTALS:</b>		<b>\$30,838</b>	<b>1.2%</b>	<b>\$367</b>	<b>1.2%</b>	<b>\$31,205</b>										
<b>CONSTRUCTION ESTIMATE TOTALS:</b>		<b>\$30,838</b>	<b>1.2%</b>	<b>\$367</b>	<b>1.2%</b>	<b>\$31,205</b>										
<b>CONSTRUCTION ESTIMATE TOTALS:</b>		<b>\$30,838</b>	<b>1.2%</b>	<b>\$367</b>	<b>1.2%</b>	<b>\$31,205</b>										
<b>CONSTRUCTION ESTIMATE TOTALS:</b>		<b>\$30,838</b>	<b>1.2%</b>	<b>\$367</b>	<b>1.2%</b>	<b>\$31,205</b>										
<b>CONSTRUCTION ESTIMATE TOTALS:</b>		<b>\$30,838</b>	<b>1.2%</b>	<b>\$367</b>	<b>1.2%</b>	<b>\$31,205</b>										
<b>CONSTRUCTION ESTIMATE TOTALS:</b>		<b>\$30,838</b>	<b>1.2%</b>	<b>\$367</b>	<b>1.2%</b>	<b>\$31,205</b>										
<b>CONSTRUCTION ESTIMATE TOTALS:</b>		<b>\$30,838</b>	<b>1.2%</b>	<b>\$367</b>	<b>1.2%</b>	<b>\$31,205</b>										
<b>CONSTRUCTION ESTIMATE TOTALS:</b>		<b>\$30,838</b>	<b>1.2%</b>	<b>\$367</b>	<b>1.2%</b>	<b>\$31,205</b>										
<b>CONSTRUCTION ESTIMATE TOTALS:</b>		<b>\$30,838</b>	<b>1.2%</b>	<b>\$367</b>	<b>1.2%</b>	<b>\$31,205</b>										
<b>CONSTRUCTION ESTIMATE TOTALS:</b>		<b>\$30,838</b>	<b>1.2%</b>	<b>\$367</b>	<b>1.2%</b>	<b>\$31,205</b>										
<b>CONSTRUCTION ESTIMATE TOTALS:</b>		<b>\$30,838</b>	<b>1.2%</b>	<b>\$367</b>	<b>1.2%</b>	<b>\$31,205</b>										
<b>CONSTRUCTION ESTIMATE TOTALS:</b>		<b>\$30,838</b>	<b>1.2%</b>	<b>\$367</b>	<b>1.2%</b>	<b>\$31,205</b>										
<b>CONSTRUCTION ESTIMATE TOTALS:</b>		<b>\$30,838</b>	<b>1.2%</b>	<b>\$367</b>	<b>1.2%</b>	<b>\$31,205</b>										
<b>CONSTRUCTION ESTIMATE TOTALS:</b>		<b>\$30,838</b>	<b>1.2%</b>	<b>\$367</b>	<b>1.2%</b>	<b>\$31,205</b>										
<b>CONSTRUCTION ESTIMATE TOTALS:</b>		<b>\$30,838</b>	<b>1.2%</b>	<b>\$367</b>	<b>1.2%</b>	<b>\$31,205</b>										
<b>CONSTRUCTION ESTIMATE TOTALS:</b>		<b>\$30,838</b>	<b>1.2%</b>	<b>\$367</b>	<b>1.2%</b>	<b>\$31,205</b>										
<b>CONSTRUCTION ESTIMATE TOTALS:</b>		<b>\$30,838</b>	<b>1.2%</b>	<b>\$367</b>	<b>1.2%</b>	<b>\$31,205</b>										
<b>CONSTRUCTION ESTIMATE TOTALS:</b>		<b>\$30,838</b>	<b>1.2%</b>	<b>\$367</b>	<b>1.2%</b>	<b>\$31,205</b>										
<b>CONSTRUCTION ESTIMATE TOTALS:</b>		<b>\$30,838</b>	<b>1.2%</b>	<b>\$367</b>	<b>1.2%</b>	<b>\$31,205</b>										
<b>CONSTRUCTION ESTIMATE TOTALS:</b>		<b>\$30,838</b>	<b>1.2%</b>	<b>\$367</b>	<b>1.2%</b>	<b>\$31,205</b>										
<b>CONSTRUCTION ESTIMATE TOTALS:</b>		<b>\$30,838</b>	<b>1.2%</b>	<b>\$367</b>	<b>1.2%</b>	<b>\$31,205</b>										
<b>CONSTRUCTION ESTIMATE TOTALS:</b>		<b>\$30,838</b>	<b>1.2%</b>	<b>\$367</b>	<b>1.2%</b>	<b>\$31,205</b>										
<b>CONSTRUCTION ESTIMATE TOTALS:</b>		<b>\$30,838</b>	<b>1.2%</b>	<b>\$367</b>	<b>1.2%</b>	<b>\$31,205</b>										
<b>CONSTRUCTION ESTIMATE TOTALS:</b>		<b>\$30,838</b>	<b>1.2%</b>	<b>\$367</b>	<b>1.2%</b>	<b>\$31,205</b>										
<b>CONSTRUCTION ESTIMATE TOTALS:</b>		<b>\$30,838</b>	<b>1.2%</b>	<b>\$367</b>	<b>1.2%</b>	<b>\$31,205</b>										
<b>CONSTRUCTION ESTIMATE TOTALS:</b>		<b>\$30,838</b>	<b>1.2%</b>	<b>\$367</b>	<b>1.2%</b>	<b>\$31,205</b>										
<b>CONSTRUCTION ESTIMATE TOTALS:</b>		<b>\$30,838</b>	<b>1.2%</b>	<b>\$367</b>	<b>1.2%</b>	<b>\$31,205</b>										
<b>CONSTRUCTION ESTIMATE TOTALS:</b>		<b>\$30,838</b>														

Port Canaveral Section port work omitted REV 2-8-2012

Estimated by	Jeff McWilliams
Designed by	Jim Moore
Prepared by	Kathleen Roy
Preparation Date	2/8/2012
Effective Date of Pricing	2/8/2012
Estimated Construction Time	400 Days

This report is not copyrighted, but the information contained herein is For Official Use Only.

Print Date Wed 8 February 2012  
Eff. Date 2/8/2012

U.S. Army Corps of Engineers  
Project : Port Canaveral Section port work omitted REV 2-8-2012  
COE Standard Report Selections

Time 14:35:07  
Library Properties Page 1

Designed by  
Jim Moore  
Estimated by  
Jeff McWilliams  
Prepared by  
Kathleen Roy

Design Document  
Document Date 2/8/2012  
District  
Contact Kathleen Roy  
Budget Year 2012  
U/OM System Original

**Direct Costs**

LaborCost  
EQCost  
MatCost  
SubBidCost

**Timeline/Currency**

Preparation Date 2/8/2012  
Escalation Date 2/8/2012  
Eff. Pricing Date 2/8/2012  
Estimated Duration 400 Day(s)

Currency US dollars  
Exchange Rate 1.000000

**Costbook CB10EB: MII English Cost Book 2010**

**Labor NLS2010: National Labor Library - Seattle 2010**

**the website for current Davis Bacon & Service Labor Rates. Fringes paid to the laborers are taxable. In a non-union job the whole fringes are taxable. In a union job, the vacation |**

**Labor Rates**

LaborCost1  
LaborCost2  
LaborCost3  
LaborCost4

**Equipment EP09R03: MII Equipment Region 3 2009**

**03 SOUTHEAST**

Sales Tax 8.50  
Working Hours per Year 1,530  
Labor Adjustment Factor 0.86  
Cost of Money 2.50  
Cost of Money Discount 25.00  
Tire Recap Cost Factor 1.50  
Tire Recap Wear Factor 1.80  
Tire Repair Factor 0.15  
Equipment Cost Factor 1.00  
Standby Depreciation Factor 0.50

**Fuel**

Electricity 0.089  
Gas 2.950  
Diesel Off-Road 3.040  
Diesel On-Road 3.490

**Shipping Rates**

Over 0 CWT 14.96  
Over 240 CWT 13.61  
Over 300 CWT 11.62  
Over 400 CWT 9.72  
Over 500 CWT 5.42  
Over 700 CWT 5.42  
Over 800 CWT 8.01

Labor ID: NLS2010

EQ ID: EP09R03

Currency in US dollars

TRACES MII Version 4.1

Description	Quantity	UOM	Cost	TopPrime	PrimeCMU	ContractCost	Escalation	Contingency	SIOH	ProjectCost
<b>Project Cost Summary Report</b>			<b>49,601,804</b>		<b>0</b>	<b>49,601,804</b>	<b>0</b>	<b>0</b>	<b>0</b>	<b>49,601,804</b>
Completed Work	1.00	EA	13,775,063.00		0	13,775,063.00	0	0	0	13,775,063.00
Port Work	1.00	EA	13,775,063.00		0	13,775,063.00	0	0	0	13,775,063.00
Work Completed By the Port	1.00	EA	13,775,063.00		0	13,775,063.00	0	0	0	13,775,063.00
Remaining Work	1.00	EA	35,826,740.86		0	35,826,740.86	0	0	0	35,826,740.86
01 Lands and Damages	1.00	EA	1,645,245.00		0	1,645,245.00	0	0	0	1,645,245.00
Property Purchase	1.00	EA	1,645,245.00		0	1,645,245.00	0	0	0	1,645,245.00
02 Relocations	1.00	EA	2,008,262.00		0	2,008,262.00	0	0	0	2,008,262.00
0203 Utilities, & Structure	1.00	EA	2,008,262.00		0	2,008,262.00	0	0	0	2,008,262.00
020326 Gvmt Furnished Materials & Equip	1.00	EA	2,008,262.00		0	2,008,262.00	0	0	0	2,008,262.00
Navigation Aids	1.00	EA	2,008,262.00		0	2,008,262.00	0	0	0	2,008,262.00
Inbound/Outbound Navigation Aids	1.00	EA	1,975,000.00		0	1,975,000.00	0	0	0	1,975,000.00
West Surge Warning Sign Replacement	1.00	EA	33,262.00		0	33,262.00	0	0	0	33,262.00
12 Navigation Ports & Harbors	1.00	EA	27,714,778.88		0	27,714,778.88	0	0	0	27,714,778.88
1201 Ports	1.00	EA	27,714,778.88		0	27,714,778.88	0	0	0	27,714,778.88
120115 Mechanical Dredging	1.00	EA	18,637,508.94		0	18,637,508.94	0	0	0	18,637,508.94
12011502 Site Work	1.00	EA	18,637,508.94		0	18,637,508.94	0	0	0	18,637,508.94

Description	Quantity	UOM	Cost	Top	Prime	Prime	Contract	Escalation	Contingency	SIQH	Project
					CMU	Cost	Cost				Cost
120101 Mob, Demob & Preparatory Work	1.00	EA	1,781,000.00		0	1,781,000.00	0	0	0	0	1,781,000.00
12011502 01 Mechanical Dredging	1.00	EA	16,856,508.94		0	16,856,508.94	0	0	0	0	16,856,508.94
120199 Associated General Items	1.00	EA	16,856,509		0	16,856,509	0	0	0	0	16,856,509
090130 Site Work	1.00	EA	9,077,269.94		0	9,077,269.94	0	0	0	0	9,077,269.94
Borsight Tower Guy Foundation Demolition	1.00	EA	9,033,381.19		0	9,033,381.19	0	0	0	0	9,033,381.19
Sign Relocation	1.00	EA	17,267.60		0	17,267.60	0	0	0	0	17,267.60
09019902 02 Dolphins	1.00	EA	57,038.94		0	57,038.94	0	0	0	0	57,038.94
09013002 09 Steel Sheet Piling	1.00	EA	57,039		0	57,039	0	0	0	0	57,039
New SSP Wall At Boat Ramp	1.00	EA	190,000.00		0	190,000.00	0	0	0	0	190,000.00
09013002 06 Riprap	71,100.00	TON	190,000.00		0	190,000.00	0	0	0	0	190,000.00
Revetments	71,100.00	TON	1,189,695.84		0	1,189,695.84	0	0	0	0	1,189,695.84
Mob/Demob	1.00	EA	1,189,696		0	1,189,696	0	0	0	0	1,189,696
Environmental Protection	1.00	EA	1,189,695.84		0	1,189,695.84	0	0	0	0	1,189,695.84
Rock Recovery/Replacement	1.00	EA	46,862.01		0	46,862.01	0	0	0	0	46,862.01
New Filter Stone (Furnish & Install)	1.00	EA	46,862		0	46,862	0	0	0	0	46,862
09013002 03 Upland Excavation	1.00	EA	1,263,433.66		0	1,263,433.66	0	0	0	0	1,263,433.66
	1.00	EA	1,557,274.63		0	1,557,274.63	0	0	0	0	1,557,274.63
	1.00	EA	1,557,275		0	1,557,275	0	0	0	0	1,557,275
	1.00	EA	4,588,251.25		0	4,588,251.25	0	0	0	0	4,588,251.25
	1.00	EA	4,588,251		0	4,588,251	0	0	0	0	4,588,251
			932,972.47			932,972.47					932,972.47

Description	Quantity	UOM	CostToPrime	PrimeCMU	ContractCost	Escalation	Contingency	SIQH	ProjectCost
Existing Rock Retement Removal/Replacement	1.00	EA	932,972	0	932,972	0	0	0	932,972
Northside Channel Widener	1.00	EA	3,655,279	0	3,655,279	0	0	0	3,655,279
Chain Link Fence	1.00	EA	100,758	0	100,758	0	0	0	100,758
Monument Relocation	1.00	EA	43,887	0	43,888	0	0	0	43,888
Submarine Monument	1.00	EA	43,888	0	43,888	0	0	0	43,888
30 Planning, Engineering and Design	1.00	EA	2,229,228	0	2,229,228	0	0	0	2,229,228
3023 Construct Contracts(s) Documents	1.00	EA	2,229,228	0	2,229,228	0	0	0	2,229,228
302301 Plans and Specifications (P&S)	1.00	EA	2,229,228	0	2,229,228	0	0	0	2,229,228
30230102 Plans and Specifications	1.00	EA	2,229,228	0	2,229,228	0	0	0	2,229,228
31 Construction Management	1.00	EA	2,229,228	0	2,229,228	0	0	0	2,229,228
3123 Construction Contracts	1.00	EA	2,229,228	0	2,229,228	0	0	0	2,229,228
312311 Supervision and Administration	1.00	EA	2,229,228	0	2,229,228	0	0	0	2,229,228
31231103 District Office S&A Documents	1.00	EA	2,229,228	0	2,229,228	0	0	0	2,229,228

Description	Quantity	UOM	DirectLabor	DirectEQ	DirectMatl	DirectSubBid	DirectCost
<b>Project Direct Costs Report</b>			<b>3,287,830</b>	<b>3,306,901</b>	<b>3,660,560</b>	<b>39,346,513</b>	<b>49,601,804</b>
Completed Work	1.00	EA	0.00	0	0	13,775,063.00	13,775,063.00
Port Work	1.00	EA	0	0	0	13,775,063.00	13,775,063.00
Work Completed By the Port	1.00	EA	0	0	0	13,775,063.00	13,775,063.00
(Note: The West Turning Basin (WTB) Corner Cut-Off (CCO) and Grouper Road relocation have been constructed in advance by the Canaveral Port Authority. This work precedes the Section 203 project out of necessity to accommodate classes of vessels smaller in size than the Section 203 design vessels, but greater than vessels currently calling on, or home-porting at Port Canaveral. Starting in September 2008, through completion in September 2011, the Canaveral Port Authority competitively bid and awarded contracts for construction of the Grouper Road relocation and CCO.)							
USR, Interim Corner Cut Off	1.00	EA	0.00	0	0	7,028,340.00	7,028,340.00
(Note: Results of Actual Contracts Awarded plus Engineering & Design Cost)							
RSM 023154420330 Corner Cut Off Phase 2	1.00	EA	0.00	0	0	6,292,539.00	6,292,539.00
(Note: Results of Actual Contracts Awarded plus Engineering & Design Cost)							
RSM 023252500510 Grouper Road Relocation	1.00	EA	0.00	0	0	454,184.00	454,184.00
(Note: Results of Actual Contracts Awarded plus Engineering & Design Cost)							
<b>Remaining Work</b>			<b>3,287,829.53</b>	<b>3,306,900.99</b>	<b>3,660,560.00</b>	<b>25,571,450.34</b>	<b>35,826,746.86</b>
01 Lands and Damages	1.00	EA	0.00	0	0	0.00	0.00
Property Purchase	1.00	EA	0	0	0	1,645,245.00	1,645,245.00
USR, AF Property	1.00	EA	0	0	0	1,645,245.00	1,645,245.00
02 Relocations	1.00	EA	0	0	0	2,008,262.00	2,008,262.00
0203 Utilities, & Structure	1.00	EA	0	0	0	2,008,262.00	2,008,262.00
(Note: USCG Aids to Navigation impacted by project construction.)							



Description	Quantity	UOM	DirectLabor	DirectEQ	DirectMatl	DirectSubBid	DirectCost
<b>020326 Gvmt Furnished Materials &amp; Equip</b>							
Navigation Aids	1.00	EA	0.00	0.00	0.00	2,008,262.00	2,008,262.00
Inbound/Outbound Navigation Aids	1.00	EA	0.00	0.00	0.00	2,008,262.00	2,008,262.00
RSM 023252500020 Dredging Aids to Navigation, Inbound, Relocate	1.00	EA	0.00	0.00	0.00	1,975,000.00	1,975,000.00
(Note: Price developed by CH2M HILL per Attachment N (USCG Coordination On Navigation Aids (Range Markers)))	2.00	EA	0.00	0.00	0.00	137,500.00	137,500.00
RSM 023252500020 Dredging Aids to Navigation, Outbound, New	2.00	EA	0.00	0.00	0.00	850,000.00	850,000.00
(Note: Price developed by CH2M HILL per Attachment N (USCG Coordination On Navigation Aids (Range Markers)))	1.00	EA	0.00	0.00	0.00	1,700,000.00	1,700,000.00
<b>West Surge Warning Sign Replacement</b>							
HNC 344313100740 West Surge Warning Sign Replacement	1.00	EA	0.00	0.00	0.00	33,262.00	33,262.00
(Note: In 2001, Olson & Associates, Jacksonville, Florida, prepared a cost estimate for installing the two Surge Warning Signs. The engineer's estimate in 2001 for installing the two signs was \$44,000. Using one-half of this value for one sign, and escalating to 2007 using 3% per year up to 2006 and 4.6 percent for 2007 and 2008, the estimate for installing one new Surge Warning Sign is approximately \$30,000 in 2008 dollars. This value was then escalated by 3.5% to arrive at a cost of \$33,262 in 2012 dollars.)	1.00	EA	0.00	0.00	0.00	33,262.00	33,262.00
<b>12 Navigation Ports &amp; Harbors</b>							
1201 Ports	1.00	EA	3,287,830.00	3,306,900.99	2,015,315.00	19,104,732.00	27,714,778.88
120115 Mechanical Dredging	1.00	EA	3,287,830.00	3,306,900.99	2,015,315.00	19,104,732.00	27,714,778.88
12011502 Site Work	1.00	EA	0.00	0.00	0.00	18,637,508.94	18,637,508.94
12011502 Mob, Demob & Preparatory Work	1.00	EA	0.00	0.00	0.00	18,637,508.94	18,637,508.94
RSM 023252500020 Dredging, mobilization and demobilization	1.00	LS	0.00	0.00	0.00	1,781,000.00	1,781,000.00
(Note: All dredging costs and the cost estimating procedure were performed in accordance with EP-110-1-8, SADDMM 1110-1-1, ER-110-1-1300, ER 1110-2-1302, which provide the guidelines necessary to calculate the dredging costs. Assumptions regarding equipment values are given in the estimate. Ownership and operating costs for all dredging and marine equipment were calculated using the USACE "Checkrate" Excel program, with applicable cost adjustments for FY 2012 and USACE regional factors. Port Canaveral is located within Region III. The total overall cost was divided by the quantity to obtain a dredging cost of \$5.42 per CY in 2012 dollars. The detailed dredging cost estimating spreadsheet performed by Mr. McWilliams is included in this Attachment L.)	1.00	EA	0.00	0.00	0.00	1,781,000.00	1,781,000.00

Description	Quantity	UOM	DirectLabor	DirectEQ	DirectMatl	DirectSubBid	DirectCost
<b>12011502 01 Mechanical Dredging</b>	<b>1.00</b>	<b>EA</b>	<b>0.00</b>	<b>0.00</b>	<b>0.00</b>	<b>16,856,509.94</b>	<b>16,856,509.94</b>
RSM 023252500510 Dredging, dragline or clamshell, harbor channel, middle basin and ocean access channel		BCY	3,110,057.00	0	0	5.42	16,856,509
(Note: All dredging costs and the cost estimating procedure were performed in accordance with EP-1110-1-8, SADDMM 1110-1-1; ER-1110-1-1300; ER 1110-2-1302 which provide the guidelines necessary to calculate the dredging costs. Assumptions regarding equipment values are given in the estimate. Ownership and operating costs for all dredging and marine equipment were calculated using the USACE "Checkrate" Excel program, with applicable cost adjustments for FY 2011 and USACE regional factors. Fort Canaveral is located within Region III. The total overall cost was divided by the quantity to obtain a dredging cost of \$5.42 per CY in 2012 dollars. The detailed dredging cost estimating spreadsheet performed by Mr. McWilliams is included in this Attachment L.)							
<b>120199 Associated General Items</b>	<b>1.00</b>	<b>EA</b>	<b>3,287,830</b>	<b>3,306,900.69</b>	<b>2,015,315.00</b>	<b>467,223.42</b>	<b>9,077,268.94</b>
<b>090130 Site Work</b>	<b>1.00</b>	<b>EA</b>	<b>3,267,074</b>	<b>3,297,751.69</b>	<b>2,004,755.00</b>	<b>463,800.00</b>	<b>9,033,381.19</b>
<b>Boresight Tower Guy Foundation Demolition</b>	<b>1.00</b>	<b>EA</b>	<b>11,230.07</b>	<b>6,037.52</b>	<b>2,004,755</b>	<b>463,800</b>	<b>9,033,381</b>
HTW 024116138011 Structural demolition, concrete pulverizer, 14.5" thick		CF	11,230	6,037	0	0	17,267
<b>Sign Relocation</b>	<b>1.00</b>	<b>EA</b>	<b>45,150.54</b>	<b>6,013.40</b>	<b>5,875.00</b>	<b>0.00</b>	<b>57,038.94</b>
RSM 101453205240 Signs, traffic sign removal and relocation, 41 SF. to 100 SF., including supports		EA	45,151	6,013	5,875	0	57,039
(Note: Several property notification signs with electrical support are located along the shoreline which will require relocation with the shoreline adjustment.)							
<b>09019902 02 Dolphins</b>	<b>1.00</b>	<b>EA</b>	<b>0.00</b>	<b>0.00</b>	<b>0.00</b>	<b>190,000.00</b>	<b>190,000.00</b>
USR Monopile Dolphin With Cap and Bollard		EA	0	0	0	190,000	190,000
(Note: The mooring dolphin to be removed is located along the northside widening just east of the Trident Wharf. It consists of prestressed concrete pilings with a concrete cap and a pile supported walkway to the uplands. It will be replaced in a new location with a large diameter steel monopile with a concrete cap and mooring bollard. This element is estimated using knowledge of many similar small demolition project performed at the port. The demolition and replacement cost estimate is \$190,000/Lump sum.)							
<b>09013002 09 Steel Sheet Piling</b>	<b>1.00</b>	<b>EA</b>	<b>480,060</b>	<b>91,936</b>	<b>366,700</b>	<b>251,000</b>	<b>1,189,696</b>
USR Demolish Existing Open Pile Dolphin		EA	480,060	91,936	366,700	251,000	1,189,696

Description	Quantity	UOM	DirectLabor	DirectEQ	DirectMatl	DirectSubBid	DirectCost
<b>New SSP Wall At Boat Ramp</b>	<b>1.00</b>	<b>EA</b>	<b>480,060</b>	<b>91,936</b>	<b>366,706.00</b>	<b>251,000.00</b>	<b>1,189,696.84</b>
RSM 02325250020 Mobilization and Demobilization, add to below, minimum	1.00	LS	0	0	0	50,000	50,000
RSM 312316141450 Excavating, chain trencher, utility trench, common earth, 6" wide, 36" deep, backfill by hand, add	1,100.00	LF	2,421	159	0	0	2,581
RSM 323213103100 Cast-in place retaining walls, reinforced concrete cantilever, 33 degrees slope embankment, 10' high, includes excavation, backfill & reinforcing	1,100.00	LF	273,924	19,206	97,000	0	363,448
RSM 353116190210 Steel sheet piling seawalls, steel sheeting, 12' high, shore driven	1,100.00	LF	155,091	63,749	92,400	0	311,240
RSM 314116102500 Sheet piling, wales, connections and struts, 2/3 salvage	15,000.00	LB	0	0	30,000	0	30,000
RSM 033105704000 Structural concrete, placing, pile caps, direct chute, over 10 CY, includes strike off & consolidation, includes material	201.00	CY	0	0	0	1,066.00	1,066.00
RSM 032105102820 Screw anchor eye bolts, plain steel, for CIP concrete, 1" x 9" long, includes material only	16.00	EA	3,060.00	550.00	8,450.00	0	12,000.00
RSM 055213500150 Railing, pipe, aluminum, clear finish, 3 rails, 3-6" high, posts @ 5' O.C., 1-1/4" dia, shop fabricated	40.00	LF	48,000	8,800	135,200	0	192,000
<b>09013002 06 Riprap</b>	<b>71,100.00</b>	<b>TON</b>	<b>678,220</b>	<b>647,505</b>	<b>1,541,845</b>	<b>22,800</b>	<b>2,890,370</b>
<b>Revetments</b>	<b>71,100.00</b>	<b>TON</b>	<b>678,220</b>	<b>647,505</b>	<b>1,541,845</b>	<b>22,800</b>	<b>2,890,370</b>
<b>(Note: The existing rock revetment is approximately 3,000 feet in length along the north side of the harbor channel between the Trident Basin and Middle Turning Basin. The estimated tonnage of rock work is 71,100 tons. The area of channel widening is referred to as Areas 9A and 9B in the survey drawings. The structure is an existing granite rock revetment extending up to the natural grade of +10 NGVD +/-)</b>							
<b>Mob/Demob</b>	<b>1.00</b>	<b>EA</b>	<b>0</b>	<b>0</b>	<b>0</b>	<b>22,800.00</b>	<b>22,800</b>

<u>Description</u>	<u>Quantity</u>	<u>UOM</u>	<u>DirectLabor</u>	<u>DirectEQ</u>	<u>DirectMatl</u>	<u>DirectSubBid</u>	<u>DirectCost</u>
RSM 015436300900 Mobilization/Demobilization (Note: Per Revenment Engineer's Estimate)	1.00	EA	0.00	0.00	0.00	22,800.00	22,800.00
<b>Environmental Protection</b>	<b>1.00</b>	<b>EA</b>	<b>28,062.29</b>	<b>759.72</b>	<b>18,040.00</b>	<b>0.00</b>	<b>46,862.01</b>
RSM 334626100170 Geotextile Subsurface Drainage Filtration, fabric ply bonded to 3-dimensional nylon mat, ideal conditions, 0.4" thk	40,000.00	SF	0.33	0.00	0.26	0.00	0.59
RSM 312513101100 Synthetic erosion control, silt fence, polypropylene, adverse conditions, 3' high	15,000.00	LF	0.70	0.00	0.40	0.00	1.10
RSM 312513101200 Synthetic erosion control, place and remove hay bales	10.00	TON	413.14	75.97	164.00	0.00	653.11
<b>Rock Recovery/Replacement</b>	<b>1.00</b>	<b>EA</b>	<b>628,798.61</b>	<b>634,635.05</b>	<b>0.00</b>	<b>0.00</b>	<b>1,263,433.66</b>
HNC 312316440170 Excavate and load, bank measure, blasted rock, 3 -1/2 C.Y. bucket, hydraulic excavator	33,186.00	BCY	1.50	2.39	0.00	0.00	3.89
HNC 312323180470 Hauling, excavated or borrow material, loose cubic yards, 4 mile round trip @ base wide rate, 12 C.Y. truck, highway haulers, excludes loading	33,186.00	LCY	2.02	1.27	0.00	0.00	3.30
RSM 313713100100 Rip-rap and rock lining, random, broken stone, machine placed for slope protection	33,186.00	LCY	14.37	14.87	0.00	0.00	29.24
HNC 312316165000 Excavating, structural, bank measure, 140 H.P., dozer, rough grade, push to stockpile	33,186.00	BCY	476,860	493,355	0	0	970,215
<b>New Filter Stone (Furnish &amp; Install)</b>	<b>1.00</b>	<b>EA</b>	<b>21,359.18</b>	<b>12,110.45</b>	<b>1,523,805.00</b>	<b>0.00</b>	<b>1,557,275</b>
HTW 3123231600041 Backfill with Crushed Stone	17,980.00	CY	1.19	0.67	84.75	0.00	86.61
<b>09013002 03 Upland Excavation</b>	<b>1.00</b>	<b>EA</b>	<b>2,035,626</b>	<b>2,543,291</b>	<b>9,335</b>	<b>0.00</b>	<b>4,588,251</b>
			471,033.86	458,471.11	3,467.50	0.00	932,972.47

Description	Quantity	UOM	DirectLabor	DirectEQ	DirectMatl	DirectSubBid	DirectCost
<b>Existing Rock Revetment Removal/Replacement</b>	<b>1.00</b>	<b>EA</b>	<b>471,034</b>	<b>458,471</b>	<b>3,468</b>	<b>0</b>	<b>932,972</b>
HNC 312316463850 Excavating, bulk, open site, bank measure, loose rock, 140 H.P. dozer, 300' push	100,000.00	BCY	430	339	0.00	0.00	8.29
HNC 312213103020 Rough grading, open site, large area, 300 H.P., dozer	100,000.00	BCY	28,659	52,278	0.00	0.00	80,937
RSM 312216101020 Fine grading, loam or topsoil fine grade for large area, 15,000 S.Y. or more	18,250.00	SY	0.53	0.26	0.00	0.00	0.79
RSM 329219131000 Seeding, mechanical seeding hydro or air seeding for large areas, includes lime, fertilizer and seed	18,250.00	SY	9,738	4,682	0.00	0.00	14,420
<b>Northside Channel Widener</b>	<b>1.00</b>	<b>EA</b>	<b>1,564,591.79</b>	<b>2,084,819.49</b>	<b>5,867.50</b>	<b>0.00</b>	<b>3,655,278.78</b>
RSM 312316480110 Excavation, bulk, dragline, bank measure, heavy clay, 3/4 C.Y. bucket, excavate and load on truck	354,069.00	BCY	3.56	3.61	0.00	0.00	7.18
HNC 312213103020 Rough grading, open site, large area, 300 H.P., dozer	364,069.00	BCY	104,339	190,327	0.00	0.00	294,666
HNC 312323182310 Hauling, excavated or borrow material, loose cubic yards, 1 mile round trip @ 20 MPH (4.2 cycles/hour), 40 C.Y., off highway haulers, excludes loading	364,069.00	LCY	0.53	1.68	0.00	0.00	2.21
RSM 312513101000 Synthetic erosion control, silt fence, polypropylene, ideal conditions, 3' high	6,000.00	LF	2,507	0	2,400	0.00	4,907
RSM 015436500100 Mobilization or demobilization, dozer, loader, backhoe or excavator, above 150 H.P., up to 50 miles	10.00	EA	151.84	151.78	0.00	0.00	303.62
RSM 329219131000 Seeding, mechanical seeding hydro or air seeding for large areas, includes lime, fertilizer and seed	18,250.00	SY	0.15	0.12	0.19	0.00	0.46
<b>Chain Link Fence</b>	<b>1.00</b>	<b>EA</b>	<b>16,788.26</b>	<b>2,970.00</b>	<b>81,000.00</b>	<b>0.00</b>	<b>100,758.26</b>
			<b>16,788</b>	<b>2,970</b>	<b>81,000</b>	<b>0</b>	<b>100,758</b>
			5.60	0.99	27.00	0.00	33.59

<u>Description</u>	<u>Quantity</u>	<u>UOM</u>	<u>DirectLabor</u>	<u>DirectEQ</u>	<u>DirectMatl</u>	<u>DirectSubBid</u>	<u>DirectCost</u>
RSM 323113201200 Fence, chain link industrial, aluminumized steel, add for corner post, 6 ga. wire, 2-1/2" posts @ 10' OC, 8" high, 3" diameter, includes excavation, in concrete, add for corner posts	3,000.00	EA	16,788	2,970	81,000	0	100,758
<b>Monument Relocation</b>							
	1.00	EA	20,755.03	9,149.30	10,560.00	3,423.42	43,887.75
			<b>20,755</b>	<b>9,149</b>	<b>10,560</b>	<b>3,423</b>	<b>43,888</b>
	1.00	EA	20,755.03	9,149.30	10,560.00	3,423.42	43,887.75
			<b>20,755</b>	<b>9,149</b>	<b>10,560</b>	<b>3,423</b>	<b>43,888</b>
<b>Submarine Monument</b>							
HNC 024113332110 Minor site demolition, concrete, unreinforced, 7" to 24" thick, remove with backhoe, excludes hauling	77.00	CY	97.55	11.33	0.00	0.00	108.88
			7,511	872	0	0	8,384
RSM 03303405250 Structural concrete, in place, lift slab (4000 psi) above the foundation, average, includes columns, forms(4 uses), reinforcing steel, concrete, placing and finishing	1,600.00	SF	7.58	0.58	6.60	0.00	14.75
			12,121	925	10,560	0	23,606
RSM 015419500500 Crane crew, daily use for small jobs, 80-ton truck-mounted hydraulic crane, partial to portal (Note: Crane to relocate Submarine Sail)	1.00	DAY	898.41	7,228.37	0.00	0.00	8,126.78
			898	7,228	0	0	8,127
HNC 312323184200 Hauling, rock, 12 C.Y. truck, 5 mile haul, includes loading	77.00	LCY	3.92	1.61	0.00	0.00	4.52
			225	124	0	0	348
HTW 028110301236 Commercial RCRA landfills, solid, non-hazardous, sanitary landfill	77.00	CY	0.00	0.00	0.00	44.46	44.46
			0	0	0	3,423	3,423
<b>30 Planning, Engineering and Design</b>							
	1.00	EA	0.00	0.00	0.00	2,229,227.99	2,229,227.99
			<b>0</b>	<b>0</b>	<b>0</b>	<b>2,229,228</b>	<b>2,229,228</b>
<b>3023 Constructn Contracts(s) Documents</b>							
	1.00	EA	0.00	0.00	0.00	2,229,227.99	2,229,227.99
			<b>0</b>	<b>0</b>	<b>0</b>	<b>2,229,228</b>	<b>2,229,228</b>
<b>302301 Plans and Specifications (P&amp;S)</b>							
	1.00	EA	0.00	0.00	0.00	2,229,227.99	2,229,227.99
			<b>0</b>	<b>0</b>	<b>0</b>	<b>2,229,228</b>	<b>2,229,228</b>
<b>30230102 Plans and Specifications</b>							
	1.00	EA	0.00	0.00	0.00	2,229,227.99	2,229,227.99
			<b>0</b>	<b>0</b>	<b>0</b>	<b>2,229,228</b>	<b>2,229,228</b>
USR 7.5 percent of Construction Cost of Remaining Work (excluding cost for Lands and Damages) (Note: Per Cost Engineering Appendix which indicates a total of 15 percent for PED and S&A.)	1.00	EA	0.00	0.00	0.00	2,229,227.99	2,229,227.99
			0	0	0	2,229,228	2,229,228

<u>Description</u>	<u>Quantity</u>	<u>UOM</u>	<u>DirectLabor</u>	<u>DirectEQ</u>	<u>DirectMatl</u>	<u>DirectSubBid</u>	<u>DirectCost</u>
<b>31 Construction Management</b>							
	1.00	EA	0.00	0.00	0.00	2,229,227.99	2,229,227.99
			0	0	0	<b>2,229,228</b>	<b>2,229,228</b>
<b>3123 Construction Contracts</b>							
	1.00	EA	0.00	0.00	0.00	2,229,227.99	2,229,227.99
			0	0	0	<b>2,229,228</b>	<b>2,229,228</b>
<b>312311 Supervision and Administration</b>							
	1.00	EA	0.00	0.00	0.00	2,229,227.99	2,229,227.99
			0	0	0	<b>2,229,228</b>	<b>2,229,228</b>
<b>31231103 District Office S&amp;A Documents</b>							
	1.00	EA	0.00	0.00	0.00	2,229,227.99	2,229,227.99
			0	0	0	<b>2,229,228</b>	<b>2,229,228</b>

(Note: Technical Management S&A All Other District Office S&A)

USR 7.5 percent of Construction Cost of Remaining Work (excluding cost for Lands and Damages)

(Note: Per Cost Engineering Appendix which indicates a total of 15 percent for PED and S&A.)

PORT CANAVERAL DEEPENING AND WIDENING  
 BUCKET DREDGE PRODUCTION ESTIMATE RECAP - VOLUMES UPDATED 2011  
 CH2M HILL, INC.

Nov. 2011

Estimated By:

J. McWilliams

Dredge Area	Grade + OD MLLW	Available to Grade CY	Available Overdepth CY	Total Available CY	Removed to Grade CY	Removed Overdepth CY	Total Removed CY	Production per Day Paid CY/Day	Duration Weeks	Unit Price/Area \$/CY
13-OR	-46 + 2	0	629,041	629,041	0	629,041	629,041	9,897	9.1	\$ 6.26
11-MR; 12-MRW; 9B-NCW	-46 + 2	796,605	602,918	1,399,523	796,605	602,918	1,399,523	13,408	14.9	\$ 4.62
10-IR; 9A-NCW	-44 + 1	508,689	91,643	600,332	508,689	91,643	600,332	10,730	8.0	\$ 5.77
7-WAC; 8-MTB; 6B-BC	-43 + 1	192,822	123,305	316,127	192,822	123,305	316,127	9,272	4.9	\$ 6.68
6A-BC	-35 + 1	113,501	7,733	121,234	113,501	7,733	121,234	12,975	1.3	\$ 4.77
S. Jetty Sediment Trap	-46 + 2	26,300	17,500	43,800	26,300	17,500	43,800	9,339	0.7	\$ 6.63
<b>Totals</b>		<b>1,637,917</b>	<b>1,472,140</b>	<b>3,110,057</b>	<b>1,637,917</b>	<b>1,472,140</b>	<b>3,110,057</b>		<b>38.9</b>	

Unit Price Calculation, Dredging

Duration, Weeks	38.9
Weekly Cost	\$ 433,596 See "Cost" Tab
Total Cost, Dredging (Weekly Cost X Wks)	\$ 16,849,809
Quantity/Unit Price	3,110,057 \$ 5.418 Per CY

Summary

Description	Quantity	Unit	Unit Price	Total
Mobilization/Demobilization	1	LS		\$ 1,781,000
Dredging and Disposal	3,110,057	CY	\$ 5.42	\$ 16,856,509
<b>TOTAL</b>				<b>\$ 18,637,509</b>



**PORT CANAVERAL DEEPENING AND WIDENING  
 BUCKET DREDGE PRODUCTION ESTIMATE RECAP - VOLUMES UPDATE  
 CH2M HILL, INC.  
 ADJUSTMENTS TO COST ESTIMATE 2011  
 Nov. 2011**

Update	Description
1	Fuel price increased to \$3.05 per gallon, based on prices for 50,000 gallon lots (Marine Diesel), July - September, FOB Port Canaveral, FL.
2	Economic index for equipment costs updated for 2011 based on EP 1110-1-8, Appendix E (value = 8102 for marine equipment), November 2009
3	Labor costs updated based on Davis-Bacon Wages for Heavy Construction/Dredging, Brevard County, FL (latest decision), + benefits and vacation
4	Marine insurance costs (Hull and Machinery, Protection and Indemnity) updated based on quote from Marsh-McLennan, Inc., New Orleans, LA
5	Production rates were adjusted based on updated quantities, slope dredging, and adjusted average bank heights
6	Sales tax rate adjusted for 2011 (6% sales tax)
7	Cost of Money rate adjusted for June - December 2011 (2.5%)

PORT CANAVERAL DEEPENING AND WIDENING  
 BUCKET DREDGE PRODUCTION ESTIMATE  
 CH2M HILL, INC.

Nov. 2011

## Equipment Costs (Calculated using "CkRate")

Equipment	Monthly	Weekly	Daily
Large Clamshell Dredge (24 CY and up)	\$ 294,255	\$ 67,957	\$ 9,708
Dump Scow, 5000 CY	\$ 84,475	\$ 19,509	\$ 2,787
Dump Scow, 5000 CY	\$ 84,475	\$ 19,509	\$ 2,787
Tender Tug, 1500 HP	\$ 164,345	\$ 37,955	\$ 5,422
Survey Vessel, 24 Ft.	\$ 32,506	\$ 7,507	\$ 1,072
Towing Vessel, 3000 HP+ (Charter)	\$ 347,165	\$ 80,177	\$ 11,454
Labor Costs (Dredging)	\$ 355,069	\$ 82,002	\$ 11,715
<b>Totals, Ownership &amp; Operating Costs</b>	<b>\$ 1,362,290</b>	<b>\$ 314,617</b>	<b>\$ 44,945</b>

## Supervision and Survey/Management Costs

Item	Monthly	Weekly	Daily
Project Management	\$ 108,351	\$ 25,023	\$ 3,575
Manatee Observers	\$ 22,733	\$ 5,250	\$ 750
Office Costs	\$ 4,000	\$ 924	\$ 132
Vehicles 6 Each	\$ 5,456	\$ 1,260	\$ 180
Survey Equipment	\$ 5,000	\$ 1,155	\$ 165
Office Equipment	\$ 1,000	\$ 231	\$ 33
Consumables	\$ 1,000	\$ 231	\$ 33
<b>Totals, Management Expenses</b>	<b>\$ 147,539</b>	<b>\$ 34,074</b>	<b>\$ 4,868</b>

Total Job Costs	\$ 1,509,829	\$ 348,690	\$ 49,813
Overhead 16.0%	\$ 241,573	\$ 55,790	\$ 7,970
Profit 8.4%	\$ 126,071	\$ 29,116	\$ 4,159
<b>Subtotal Cost, Dredging Operations</b>	<b>\$ 1,877,472</b>	<b>\$ 433,596</b>	<b>\$ 61,942</b>
<b>Grand Total, Dredging Operations</b>	<b>\$ 1,877,472</b>	<b>\$ 433,596</b>	<b>\$ 61,942</b>

## Mobilization and Demobilization

Item	Distance/Qty.	Number	Unit	Rate	Total Cost
Bonds			1.0	\$ 160,000	\$ 160,000
Project Startup			10.0	\$ 4,868	\$ 48,677
Tow Dredge	1,000	5	8.3	\$ 11,454	\$ 95,448
Dredge Hire Under Tow	1,000	5	8.3	\$ 7,767	\$ 64,721
Tow Scows (Tandem)	1,000	5	8.3	\$ 11,454	\$ 95,448
Lightboat Back	1,000	10	4.2	\$ 11,454	\$ 47,724
Scow Hire Under Tow	1,000	5	8.3	\$ 4,459	\$ 37,160
Mobilize Tender	1,000	10	4.2	\$ 5,422	\$ 22,592
Mobilize Survey Vessel			5.0	\$ 1,000	\$ 5,000
Set up on site			4.0	\$ 49,813	\$ 199,252
Dismantle			4.0	\$ 49,813	\$ 199,252
Tow Dredge	1,000	5	8.3	\$ 11,454	\$ 95,448
Dredge Hire Under Tow	1,000	5	8.3	\$ 7,767	\$ 64,721
Tow Scows (Tandem)	1,000	5	8.3	\$ 11,454	\$ 95,448
Lightboat Up	1,000	10	4.2	\$ 11,454	\$ 47,724
Scow Hire Under Tow	1,000	5	8.3	\$ 4,459	\$ 37,160
Demobilize Tender	1,000	10	4.2	\$ 5,422	\$ 22,592
Demobilize Survey Vessel			5.0	\$ 1,000	\$ 5,000
Project Closure			15.0	\$ 4,868	\$ 73,015

Subtotal, Mob/Demob					\$ 1,416,385
Overhead				16.0%	\$ 226,622
Profit				8.4%	\$ 137,191
<b>Subtotal Cost, Mob/Demob</b>					<b>\$ 1,780,197</b>
<b>Grand Total, Mob/Demob</b>					<b>\$ 1,780,197</b>

## Cost Basis, Equipment Cost (Per USACE Methods)

Item	Basis
Large Clamshell Dredge (24 CY and up)	Plant Value \$5.5M in 1985
Dump Scow, 5000 CY	Plant Value \$7.0M in 2000
Dump Scow, 5000 CY	Plant Value \$7.0M in 2000
Tender Tug, 1500 HP	Plant Value \$1.0M in 1990
Survey Vessel, 24 Ft.	Plant Value \$100K in 2000
Towing Vessel, 3000 HP+ (Charter)	Plant Value \$2.0M in 1990
Labor Costs (Dredging)	Davis Bacon Brevard Co.

## SADDM 1110-1-1 Profit guidelines

Risk	0.07	20%	1.4%
Difficulty	0.10	15%	1.5%
Size	0.03	15%	0.5%
Duration	0.07	15%	1.1%
Investment	0.12	5%	0.8%
Govt. Asst.	0.07	5%	0.4%
Subcontract	0.12	25%	3.0%
Contractor's Profit:			8.4%

PORT CANAVERAL DEEPENING AND WIDENING

Dredge Area 13-OR		
Parameter	Depth	Volume (CY)
Grade MLLW	-46.0	-
Allowable OD	2.0	629,041
Total Volume (CY)		629,041

Dredge Parameters	
Dredge Area (SF)	SF 8,738,000
Length (LF)	LF 21,500
Avg. CY/LF	CY/LF 29.3
Avg. Width (Ft)	Ft 406.4
Cut Width (Ft)	Ft 80.0
Setting Distance (Ft)	Ft 40.0
Avg. Top El	MLLW -46.0
Avg. Dredge El.	MLLW -48.0
Cut	Ft 2.0
Avg. CY/Set	CY 230.4

Bucket Volume	CY 26.0
Bucket Area	SF 260.0
Fill Efficiency	% 0.8
Volume/Set	CY 19.3
No. Buckets/Set	Ea 12.0

Cycle Time	Min 1.2
Dredge time/set	Min 14.6
Set time	Min 5.0
Total Time/Set	Min 19.6
No. Sets	Ea 2,730.6
Total Oper Time	NOH 889.9

Daily Working Time	NOH/Day 14.0
No. Days Required	Days 63.6

Production/Day	CY/Day 9,896.6
Daily Operating Cost	\$ 61,942.34
Cost/CY	\$ 6.26

Category	Weekly Hrs	Pct	Day
Weather	16.0	10%	2.3
Scow Chg	10.5	6%	1.5
Traffic	10.5	6%	1.5
Crew Chg	7.0	4%	1.0
Mechanical	12.0	7%	1.7
Repairs	12.0	7%	1.7
Relocating	2.0	1%	0.3

Delays, Day	10.0
NOH Day	14.0

PORT CANAVERAL DEEPENING AND WIDENING

Dredge Area			11-MR; 12-MRW; 9B-NCW
Parameter	Depth	Volume (CY)	
Grade MLLW	-46.0	796,605	
Allowable OD	2.0	602,918	
Total Volume (CY)		1,399,523	

Dredge Parameters		
Dredge Area (SF)	SF	7,427,000
Length (LF)	LF	12,700
Avg. CY/LF	CY/LF	110.2
Avg. Width (Ft)	Ft	584.8
Cut Width (Ft)	Ft	80.0
Setting Distance (Ft)	Ft	40.0
Avg. Top El	MLLW	-43.1
Avg. Dredge El.	MLLW	-48.0
Bank Height	Ft	4.9
Avg. CY/Set	CY	603.0

Bucket Volume	CY	26.0
Bucket Area	SF	260.0
Fill Efficiency	%	0.8
Avail. Volume/Set	CY	47.1
No. Buckets/Set	Ea	29.0

Cycle Time	Min	1.2
Dredge time/set	Min	35.3
Set time	Min	5.0
Total Time/Set	Min	40.3
No. Sets	Ea	2,321.0
Total Oper Time	NOH	1,558.3

Daily Working Time	NOH/Day	14.9
No. Days Required	Days	104.4

Production/Day	CY/Day	13,407.5
Daily Operating Cost	\$	61,942.34
Cost/CY	\$	4.62

Category	Weekly Hrs	Pct	Day
Weather	12.0	7%	1.7
Scow Chg	10.5	6%	1.5
Traffic	8.0	5%	1.1
Crew Chg	7.0	4%	1.0
Mechanical	12.0	7%	1.7
Repairs	12.0	7%	1.7
Relocating	2.0	1%	0.3

Delays, Day  
NOH Day

9.1  
14.9

PORT CANAVERAL DEEPENING AND WIDENING

Dredge Area 10-IR; 9A-NCW		
Parameter	Depth	Volume (CY)
Grade MLLW	-44.0	508,689
Allowable OD	1.0	91,643
Total Volume (CY)		600,332

Dredge Parameters	
Dredge Area (SF)	SF 1,755,000
Length (LF)	LF 3,300
Avg. CY/LF	CY/LF 181.9
Avg. Width (Ft)	Ft 531.8
Cut Width (Ft)	Ft 80.0
Setting Distance (Ft)	Ft 40.0
Avg. Top El	MLLW -36.2
Avg. Dredge El.	MLLW -45.0
Bank Height	Ft 8.8
Avg. CY/Set	CY 1,094.6

Bucket Volume	CY 18.0
Bucket Area	SF 180.0
Fill Efficiency	% 0.8
Avail. Volume/Set	CY 58.8
No. Buckets/Set	Ea 77.0

Cycle Time	Min 1.2
Dredge time/set	Min 92.4
Set time	Min 5.0
Total Time/Set	Min 97.4
No. Sets	Ea 549.0
Total Oper Time	NOH 891.2

Daily Working Time	NOH/Day 15.9
No. Days Required	Days 56.0

Production/Day	CY/Day 10,729.7
Daily Operating Cost	\$ 61,942.34
Cost/CY	\$ 5.77

Category	Weekly Hrs	Pct	Day
Weather	7.0	4%	1.0
Scow Chg	10.5	6%	1.5
Traffic	6.0	4%	0.9
Crew Chg	7.0	4%	1.0
Mechanical	12.0	7%	1.7
Repairs	12.0	7%	1.7
Relocating	2.0	1%	0.3

Delays, Day	8.1
NOH Day	15.9

PORT CANAVERAL DEEPENING AND WIDENING

Dredge Area 7-WAC; 8-MTB; 6B-BC		
Parameter	Depth	Volume (CY)
Grade MLLW	-43.0	192,822
Allowable OD	1.0	123,305
Total Volume (CY)		316,127

Dredge Parameters

Dredge Area (SF)	SF	3,920,000
Length (LF)	LF	4,200
Avg. CY/LF	CY/LF	75.3
Avg. Width (Ft)	Ft	933.3
Cut Width (Ft)	Ft	80.0
Setting Distance (Ft)	Ft	40.0
Avg. Top El	MLLW	-41.7
Avg. Dredge El.	MLLW	-44.0
Bank Height	Ft	2.3
Avg. CY/Set	CY	258.1

Bucket Volume	CY	18.0
Bucket Area	SF	180.0
Fill Efficiency	%	0.8
Avail. Volume/Set	CY	15.5
No. Buckets/Set	Ea	18.0

Cycle Time	Min	1.2
Dredge time/set	Min	21.6
Set time	Min	5.0
Total Time/Set	Min	26.6
No. Sets	Ea	1,225.0
Total Oper Time	NOH	543.1

Daily Working Time	NOH/Day	15.9
No. Days Required	Days	34.1

Production/Day	CY/Day	9,272.0
Daily Operating Cost	\$	61,942.34
Cost/CY	\$	6.68

Category	Weekly Hrs	Pct	Day
Weather	7.0	4%	1.0
Scow Chg	10.5	6%	1.5
Traffic	6.0	4%	0.9
Crew Chg	7.0	4%	1.0
Mechanical	12.0	7%	1.7
Repairs	12.0	7%	1.7
Relocating	2.0	1%	0.3

Delays, Day  
NOH Day

8.1  
15.9

PORT CANAVERAL DEEPENING AND WIDENING

Dredge Area 6A-BC		
Parameter	Depth	Volume (CY)
Grade MLLW	-35.0	113,501
Allowable OD	1.0	7,733
Total Volume (CY)		121,234

Dredge Parameters	
Dredge Area (SF)	SF 300,000
Length (LF)	LF 2,700
Avg. CY/LF	CY/LF 44.9
Avg. Width (Ft)	Ft 111.1
Cut Width (Ft)	Ft 80.0
Setting Distance (Ft)	Ft 40.0
Avg. Top E1	MLLW -24.8
Avg. Dredge E1	MLLW -36.0
Bank Height	Ft 11.2
Avg. CY/Set	CY 1,293.2

Bucket Volume	CY 18.0
Bucket Area	SF 180.0
Fill Efficiency	% 0.8
Avail. Volume/Set	CY 74.8
No. Buckets/Set	Ea 90.0

Cycle Time	Min 1.0
Dredge time/set	Min 90.0
Set time	Min 5.0
Total Time/Set	Min 95.0
No. Sets	Ea 94.0
Total Oper Time	NOH 148.8

Daily Working Time	NOH/Day 15.9
No. Days Required	Days 9.3

Production/Day	CY/Day 12,974.8
Daily Operating Cost	\$ 61,942.34
Cost/CY	\$ 4.77

Category	Weekly Hrs	Pct	Day
Weather	7.0	4%	1.0
Scow Chg	10.5	6%	1.5
Traffic	6.0	4%	0.9
Crew Chg	7.0	4%	1.0
Mechanical	12.0	7%	1.7
Repairs	12.0	7%	1.7
Relocating	2.0	1%	0.3

Delays, Day  
NOH Day

8.1  
15.9

PORT CANAVERAL DEEPENING AND WIDENING

Dredge Area S Jetty Sediment Trap		
Parameter	Depth	Volume (CY)
Grade MLLW	-46.0	26,300
Allowable OD	2.0	17,500
Total Volume (CY)		43,800

Dredge Parameters	
Dredge Area (SF)	SF 260,000
Length (LF)	LF 1,000
Avg. CY/LF	CY/LF 43.8
Avg. Width (Ft)	Ft 260.0
Cut Width (Ft)	Ft 80.0
Setting Distance (Ft)	Ft 40.0
Avg. Top El	MLLW -43.3
Avg. Dredge El.	MLLW -48.0
Bank Height	Ft 4.7
Avg. CY/Set	CY 539.1

Bucket Volume	CY 18.0
Bucket Area	SF 180.0
Fill Efficiency	% 0.8
Avail. Volume/Set	CY 31.5
No. Buckets/Set	Ea 38.0

Cycle Time	Min 1.2
Dredge time/Set	Min 46.2
Set time	Min 5.0
Total Time/Set	Min 51.2
No. Sets	Ea 82.0
Total Oper Time	NOH 70.0

Daily Working Time	NOH/Day 14.9
No. Days Required	Days 4.7

Production/Day	CY/Day 9,338.5
Daily Operating Cost	\$ 61,942.34
Cost/CY	\$ 6.63

Category	Weekly Hrs	Pct	Day
Weather	12.0	7%	1.7
Scow Chg	10.5	6%	1.5
Traffic	8.0	5%	1.1
Crew Chg	7.0	4%	1.0
Mechanical	12.0	7%	1.7
Repairs	12.0	7%	1.7
Relocating	2.0	1%	0.3

Delays, Day  
NOH Day

9.1  
14.9



PORT CANAVERAL DEEPENING AND WIDENING  
 BUCKET DREDGE PRODUCTION ESTIMATE  
 CH2M HILL, INC.  
 Nov. 2011

No. of Employees	No. of Sub. Employees	Classification	Hours per Week	Weekly/Hourly Rate	Total Weekly	Total Daily	Total Monthly	Fringes Monthly	Vacation Monthly
1	1	Captain	84	\$ 29.00	\$ 2,436.00	\$ 348.00	\$ 10,547.88	\$ 2,364.18	\$ 843.83
3	2	Operator	106	\$ 28.20	\$ 8,967.60	\$ 1,281.09	\$ 38,829.71	\$ 4,728.36	\$ 3,106.38
3	2	Mate	106	\$ 22.58	\$ 7,180.44	\$ 1,025.78	\$ 31,091.31	\$ 4,728.36	\$ 2,487.30
6	4	Deckhand	106	\$ 18.26	\$ 11,613.36	\$ 1,659.05	\$ 50,285.85	\$ 9,456.72	\$ 4,022.87
3	2	Mechanic	106	\$ 24.70	\$ 7,854.60	\$ 1,122.09	\$ 34,010.42	\$ 4,728.36	\$ 2,720.83
6	4	Boatman	106	\$ 24.70	\$ 15,709.20	\$ 2,244.17	\$ 68,020.84	\$ 9,456.72	\$ 5,441.67

15

\$ 53,761.20 \$ 7,680.17 \$ 232,786.00 \$ 35,462.70 \$ 18,622.88

Total Labor \$ 232,786.00  
 Fringes \$ 35,462.70  
 Vacation \$ 18,622.88  
 Per Diem/Travel \$ 150.00 \$ 68,197.50

Total Per Month \$ 355,069.08  
 Total Per Week \$ 82,002.10  
 Total Per Day \$ 11,714.59

**Note: Rates and fringes from Davis-Bacon Wage Rates, Brevard County, FL**

Management Costs	Yearly Salary	Benefits	Monthly
Project Manager	\$ 100,000	\$ 140,000	\$ 11,667
Project Engineer	\$ 80,000	\$ 112,000	\$ 9,333
Engineer	\$ 70,000	\$ 98,000	\$ 8,167
Survey	\$ 60,000	\$ 84,000	\$ 7,000
Survey	\$ 60,000	\$ 84,000	\$ 7,000
QC/Survey	\$ 75,000	\$ 105,000	\$ 8,750
Superintendent	\$ 90,000	\$ 126,000	\$ 10,500
Office Assistant	\$ 30,000	\$ 42,000	\$ 3,500
Travel & Per Diem	7	\$ 200	\$ 42,434
Total, Management			\$ 108,351

\*\*\*\*\* TOTAL PROJECT COST SUMMARY \*\*\*\*\*

PROJECT: Canaveral Harbor, Section 203 Study  
LOCATION: Port Canaveral, Brevard County, Florida

DISTRICT: SAJ-Jacksonville  
CHIEF: COST ENGINEERING, Tracy T. Leesser, P.E.

PREPARED: 9/10/2012

This Estimate reflects the scope and schedule in report: Integrated Section 203 Navigation Study Report

WBS NUMBER	A	B	C	D	E	F	ESTIMATED COST		G	H	I	J	PROJECT FIRST COST		K	L	M	N	O
							COST	NTG					ESC	COST					
		(\$K)		(\$K)		(\$K)		(\$K)		(\$K)		(\$K)		(\$K)		(\$K)		(\$K)	
12	#N/A		\$28,723	\$6,233	21%	\$35,956							\$28,723	\$6,233	\$35,956	\$13,775	\$30,820	\$6,463	\$51,058
<b>CONSTRUCTION ESTIMATE TOTALS:</b>							<b>\$35,956</b>						<b>\$28,723</b>	<b>\$6,233</b>	<b>\$35,956</b>	<b>\$13,775</b>	<b>\$30,820</b>	<b>\$6,463</b>	<b>\$51,058</b>
01	LANDS AND DAMAGES																		
30	PLANNING, ENGINEERING & DESIGN		\$2,229	\$467	21%	\$2,697							\$2,229	\$467	\$2,697				\$2,743
31	CONSTRUCTION MANAGEMENT		\$2,229	\$467	21%	\$2,697							\$2,229	\$467	\$2,697				\$2,904
<b>PROJECT COST TOTALS:</b>							<b>\$34,181</b>	<b>\$7,168</b>	<b>21%</b>	<b>\$41,349</b>			<b>\$34,181</b>	<b>\$7,168</b>	<b>\$41,349</b>	<b>\$13,775</b>	<b>\$35,488</b>	<b>\$7,442</b>	<b>\$56,705</b>
CHIEF, COST ENGINEERING, Tracy T. Leesser, P.E. PROJECT MANAGER, Osvelbo Rodriguez, P.E. CHIEF, REAL ESTATE, Cyris H. Sellers CHIEF, PLANNING, Stuart J. Appelbaum, P.E. CHIEF, ENGINEERING, Luis A. Ruiz, P.E. CHIEF, OPERATIONS, Jim W. Jeffords, P.E. CHIEF, CONSTRUCTION, Jack Riattoui, P.E., PMP CHIEF, CONTRACTING, Cynthia S. Tolle CHIEF, PM-PB, Karen S. Tippett CHIEF, DPM, David S. Hobbie, PMP																			
Percentage basis: Navigation District 20/45 @ 75.24 Navigation Districts 457 & 606/64 50/50 Lands & damages 100% non-federal Aids to Navigation 100% Federal																			
ESTIMATED FEDERAL COST: 65% ESTIMATED NON-FEDERAL COST: 35% ESTIMATED TOTAL PROJECT COST: <b>\$56,705</b>																			
O&M OUTSIDE OF TOTAL PROJECT COST:																			

\*\*\*\* TOTAL PROJECT COST SUMMARY \*\*\*\*  
\*\*\*\* CONTRACT COST SUMMARY \*\*\*\*

PROJECT: Canaveral Harbor, Section 203 Study  
LOCATION: Port Canaveral, Brevard County, Florida  
This Estimate reflects the scope and schedule in report:  
Integrated Section 203 Navigation Study Report

Estimate Prepared: 12-Dec-11  
Effective Price Level: 12-Dec-11

DISTRICT: SAJ Jacksonville  
POC: CHIEF, COST ENGINEERING, Tracy T. Leaser, P.E.  
PREPARED: 9/10/2012

WBS NUMBER	A	B	C	RISK BASED		F	Program Year (Budget EC):		2012		FULLY FUNDED PROJECT ESTIMATE					
				D	E		G	H	I	J	M	N	O			
Feature & Sub-Feature Description	Feature & Sub-Feature Description	Feature & Sub-Feature Description	Feature & Sub-Feature Description	Cost (\$K)	Contingency (\$K)	Total (\$K)	ESC (%)	Cost (\$K)	Contingency (\$K)	Total (\$K)	ESC (%)	Cost (\$K)	Contingency (\$K)	Total (\$K)		
<b>REMAINING CONSTRUCTION BY PORT</b>																
#N/A																
1.2	NAVIGATION PORTS & HARBORS		\$29,723	\$6,233	21%	\$35,956		\$29,723	\$6,233	\$35,956	3.7%	\$30,820	\$5,463	\$37,283		
<b>CONSTRUCTION ESTIMATE TOTALS:</b>																
			\$29,723	\$6,233	21%	\$35,956			\$29,723	\$6,233	\$35,956			\$30,820	\$5,463	\$37,283
01 LANDS AND DAMAGES																
<b>30 PLANNING, ENGINEERING &amp; DESIGN</b>																
Project Management																
Planning & Environmental Compliance																
7.5%			\$2,229	\$467	21%	\$2,697		\$2,229	\$467	\$2,697	1.7%	\$2,267	\$475	\$2,743		
Engineering & Design																
Engineering Tech Review (TR & VE)																
Contracting & Reprographics																
Engineering During Construction																
Planning During Construction																
Project Operations																
<b>31 CONSTRUCTION MANAGEMENT</b>																
7.5%			\$2,229	\$467	21%	\$2,697		\$2,229	\$467	\$2,697	7.7%	\$2,400	\$503	\$2,904		
Construction Management																
Project Operation:																
Project Management																
<b>CONTRACT COST TOTALS:</b>																
			\$34,161	\$7,168		\$41,349			\$34,161	\$7,168	\$41,349			\$35,488	\$7,442	\$42,929

Canaveral Harbor, Florida - Section 203 Study REV 9-11-2012

Estimated by Jeff McWilliams  
Designed by Jim Moore  
Prepared by Kathleen Roy

Preparation Date 9/11/2012  
Effective Date of Pricing 9/11/2012  
Estimated Construction Time 400 Days

This report is not copyrighted, but the information contained herein is For Official Use Only.

Labor ID: NLS2010 EQ.ID: EP09R03

Currency in US dollars

TRACES Mill Version 4.1

Designed by  
Jim Moore  
Estimated by  
Jeff McWilliams  
Prepared by  
Kathleen Roy

Design Document  
Document Date 9/11/2012  
District  
Contact Jim Moore  
Budget Year 2012  
UOM System Original

**Direct Costs**  
LaborCost  
EQCost  
MatlCost  
SubBidCost

**Timeline/Currency**  
Preparation Date 9/11/2012  
Escalation Date 9/11/2012  
Eff. Pricing Date 9/11/2012  
Estimated Duration 400 Day(s)

Currency US dollars  
Exchange Rate 1.000000

**Costbook CB10EB: MII English Cost Book 2010**

**Labor NLS2010: National Labor Library - Seattle 2010**

wdol.gov is the website for current Davis Bacon & Service Labor Rates. Fringes paid to the laborers are taxable. In a non-union job the whole fringes are taxable. In a union job, the vacation pay fringes i

**Labor Rates**  
LaborCost1  
LaborCost2  
LaborCost3  
LaborCost4

**03 SOUTHEAST**

Sales Tax 8.50  
Working Hours per Year 1.530  
Labor Adjustment Factor 0.86  
Cost of Money 2.50  
Cost of Money Discount 25.00  
Tire Recap Cost Factor 1.50  
Tire Recap Wear Factor 1.80  
Tire Repair Factor 0.15  
Equipment Cost Factor 1.00  
Standby Depreciation Factor 0.50

**Equipment EP09R03: MII Equipment Region 3 2009**

**Fuel**  
Electricity 0.089  
Gas 2.950  
Diesel Off-Road 3.040  
Diesel On-Road 3.490

**Shipping Rates**

Over 0 CWT 14.96  
Over 240 CWT 13.61  
Over 300 CWT 11.62  
Over 400 CWT 9.72  
Over 500 CWT 5.42  
Over 700 CWT 5.42  
Over 800 CWT 8.01

Description	Quantity	UOM	CostToPrime	PrimeChIU	ContractCost	Escalation	Contingency	SIQH	ProjectCost
<b>Project Cost Summary Report</b>									
Completed Work	1.0000	EA	47,956,558.86	0.00	47,956,558.86	0.00	0.00	0.00	47,956,558.86
Port Work	1.0000	EA	13,775,063.00	0.00	13,775,063.00	0.00	0.00	0.00	13,775,063.00
Work Completed By the Port	1.0000	EA	13,775,063.00	0.00	13,775,063.00	0.00	0.00	0.00	13,775,063.00
Remaining Work	1.0000	EA	34,181,495.86	0.00	34,181,495.86	0.00	0.00	0.00	34,181,495.86
<b>12 Navigation Ports &amp; Harbors</b>									
1201 Ports	1.0000	EA	29,723,039.88	0.00	29,723,039.88	0.00	0.00	0.00	29,723,039.88
120115 Mechanical Dredging	1.0000	EA	27,714,777.88	0.00	27,714,777.88	0.00	0.00	0.00	27,714,777.88
12011502 Site Work	1.0000	EA	18,637,508.94	0.00	18,637,508.94	0.00	0.00	0.00	18,637,508.94
120101 Mob, Demob & Preparatory Work	1.0000	EA	1,781,000.00	0.00	1,781,000.00	0.00	0.00	0.00	1,781,000.00
12011602 01 Mechanical Dredging	1.0000	EA	16,856,508.94	0.00	16,856,508.94	0.00	0.00	0.00	16,856,508.94
120195 Associated General Items	1.0000	EA	9,077,268.94	0.00	9,077,268.94	0.00	0.00	0.00	9,077,268.94
090130 Site Work	1.0000	EA	9,033,381.19	0.00	9,033,381.19	0.00	0.00	0.00	9,033,381.19
Boresight Tower Guy Foundation Demolition	1.0000	EA	17,266.60	0.00	17,266.60	0.00	0.00	0.00	17,266.60
Sign Relocation	1.0000	EA	57,038.94	0.00	57,038.94	0.00	0.00	0.00	57,038.94
09019902 02 Dolphins	1.0000	EA	190,000.00	0.00	190,000.00	0.00	0.00	0.00	190,000.00
09013002 09 Steel Sheet Piling	1.0000	EA	1,189,695.84	0.00	1,189,695.84	0.00	0.00	0.00	1,189,695.84
New SSP Wall At Boat Ramp	1.0000	EA	1,189,695.84	0.00	1,189,695.84	0.00	0.00	0.00	1,189,695.84
09013002 06 Riprap	71,100.0000	TON	2,890,370.30	0.00	2,890,370.30	0.00	0.00	0.00	2,890,370.30
Revetments	71,100.0000	TON	2,890,370.30	0.00	2,890,370.30	0.00	0.00	0.00	2,890,370.30
Mob/Demob	1.0000	EA	22,800.00	0.00	22,800.00	0.00	0.00	0.00	22,800.00
Environmental Protection	1.0000	EA	46,862.01	0.00	46,862.01	0.00	0.00	0.00	46,862.01
Rock Recovery/Replacement	1.0000	EA	1,263,433.66	0.00	1,263,433.66	0.00	0.00	0.00	1,263,433.66
New Filter Stone (Furnish & Install)	1.0000	EA	1,557,274.63	0.00	1,557,274.63	0.00	0.00	0.00	1,557,274.63
09013002 03 Upland Excavation	1.0000	EA	4,588,251.25	0.00	4,588,251.25	0.00	0.00	0.00	4,588,251.25
Existing Rock Revetment Removal/Replacement	1.0000	EA	932,972.47	0.00	932,972.47	0.00	0.00	0.00	932,972.47
Northside Channel Widener	1.0000	EA	3,655,278.78	0.00	3,655,278.78	0.00	0.00	0.00	3,655,278.78
Chain Link Fence	1.0000	EA	100,758.26	0.00	100,758.26	0.00	0.00	0.00	100,758.26
Monument Relocation	1.0000	EA	43,887.75	0.00	43,887.75	0.00	0.00	0.00	43,887.75
Submarine Monument	1.0000	EA	43,887.75	0.00	43,887.75	0.00	0.00	0.00	43,887.75

Description	Quantity	UOM	CostToPrime	PrimeCMU	ContractCost	Escalation	Contingency	SIQH	ProjectCost
Navigation Aids	1.0000	EA	2,008,262.00	0.00	2,008,262.00	0.00	0.00	0.00	2,008,262.00
Inbound/Outbound Navigation Aids	1.0000	EA	1,975,000.00	0.00	1,975,000.00	0.00	0.00	0.00	1,975,000.00
West Surge Warning Sign Replacement	1.0000	EA	33,262.00	0.00	33,262.00	0.00	0.00	0.00	33,262.00
30 Planning, Engineering and Design	1.0000	EA	2,229,227.99	0.00	2,229,227.99	0.00	0.00	0.00	2,229,227.99
302301 Constructn Contracts(s) Documents	1.0000	EA	2,229,227.99	0.00	2,229,227.99	0.00	0.00	0.00	2,229,227.99
302301 Plans and Specifications (P&S)	1.0000	EA	2,229,227.99	0.00	2,229,227.99	0.00	0.00	0.00	2,229,227.99
30230102 Plans and Specifications	1.0000	EA	2,229,227.99	0.00	2,229,227.99	0.00	0.00	0.00	2,229,227.99
31 Construction Management	1.0000	EA	2,229,227.99	0.00	2,229,227.99	0.00	0.00	0.00	2,229,227.99
3123 Construction Contracts	1.0000	EA	2,229,227.99	0.00	2,229,227.99	0.00	0.00	0.00	2,229,227.99
312311 Supervision and Administration	1.0000	EA	2,229,227.99	0.00	2,229,227.99	0.00	0.00	0.00	2,229,227.99
31231103 District Office S&A Documents	1.0000	EA	2,229,227.99	0.00	2,229,227.99	0.00	0.00	0.00	2,229,227.99

Description	Quantity	UOM	DirectLabor	DirectEQ	DirectMatl	DirectSubBid	DirectCost	CostToPrime	ContractCost
<b>Detail Base Bid</b>			<b>3,287,829.53</b>	<b>3,306,900.99</b>	<b>2,015,315.00</b>	<b>39,346,513.34</b>	<b>47,956,558.86</b>	<b>47,956,558.86</b>	<b>47,956,558.86</b>
Completed Work	1.0	EA	0.00	0.00	0.00	13,775,063.00	13,775,063.00	13,775,063.00	13,775,063.00
Port Work	1.0	EA	0.00	0.00	0.00	13,775,063.00	13,775,063.00	13,775,063.00	13,775,063.00
<b>Work Completed By the Port</b>	<b>1.0</b>	<b>EA</b>	<b>0.00</b>	<b>0.00</b>	<b>0.00</b>	<b>13,775,063.00</b>	<b>13,775,063.00</b>	<b>13,775,063.00</b>	<b>13,775,063.00</b>
(Note: The West Turning Basin (WTB) Corner Cut-Off (CCO) and Grouper Road relocation have been constructed in advance by the Canaveral Port Authority. This work precedes the Section 203 project out of necessity to accommodate classes of vessels smaller in size than the Section 203 design vessels, but greater than vessels currently calling on, or home-porting at Port Canaveral. Starting in September 2008, through completion in September 2011, the Canaveral Port Authority competitively bid and awarded contracts for construction of the Grouper Road relocation and CCO.)									
Interim Corner Cut Off	1.0	EA	0.00	0.00	0.00	7,028,340.00	7,028,340.00	7,028,340.00	7,028,340.00
(Note: Results of Actual Contracts Awarded plus Engineering & Design Cost)									
Corner Cut Off Phase 2	1.0	EA	0.00	0.00	0.00	6,292,539.00	6,292,539.00	6,292,539.00	6,292,539.00
(Note: Results of Actual Contracts Awarded plus Engineering & Design Cost)									
Grouper Road Relocation	1.0	EA	0.00	0.00	0.00	454,184.00	454,184.00	454,184.00	454,184.00
(Note: Results of Actual Contracts Awarded plus Engineering & Design Cost)									
<b>Remaining Work</b>	<b>1.0</b>	<b>EA</b>	<b>3,287,829.53</b>	<b>3,306,900.99</b>	<b>2,015,315.00</b>	<b>25,571,450.34</b>	<b>34,181,495.86</b>	<b>34,181,495.86</b>	<b>34,181,495.86</b>
<b>Navigation Ports &amp; Harbors</b>	<b>1.0</b>	<b>EA</b>	<b>3,287,829.53</b>	<b>3,306,900.99</b>	<b>2,015,315.00</b>	<b>21,112,994.36</b>	<b>29,723,039.88</b>	<b>29,723,039.88</b>	<b>29,723,039.88</b>
<b>Ports</b>	<b>1.0</b>	<b>EA</b>	<b>3,287,829.53</b>	<b>3,306,900.99</b>	<b>2,015,315.00</b>	<b>19,104,732.36</b>	<b>27,714,777.88</b>	<b>27,714,777.88</b>	<b>27,714,777.88</b>
<b>Mechanical Dredging</b>	<b>1.0</b>	<b>EA</b>	<b>0.00</b>	<b>0.00</b>	<b>0.00</b>	<b>18,637,508.94</b>	<b>18,637,508.94</b>	<b>18,637,508.94</b>	<b>18,637,508.94</b>
<b>Site Work</b>	<b>1.0</b>	<b>EA</b>	<b>0.00</b>	<b>0.00</b>	<b>0.00</b>	<b>18,637,508.94</b>	<b>18,637,508.94</b>	<b>18,637,508.94</b>	<b>18,637,508.94</b>
<b>Mob, Demob &amp; Preparatory Work</b>	<b>1.0</b>	<b>EA</b>	<b>0.00</b>	<b>0.00</b>	<b>0.00</b>	<b>1,781,000.00</b>	<b>1,781,000.00</b>	<b>1,781,000.00</b>	<b>1,781,000.00</b>
Dredging, mobilization and demobilization	1.0	LS	0.00	0.00	0.00	1,781,000.00	1,781,000.00	1,781,000.00	1,781,000.00
(Note: All dredging costs and the cost estimating procedure were performed in accordance with EP-1110-1-8; SADDM 1110-1-1; ER-1110-2-1300; ER 1110-2-1302, which provide the guidelines necessary to calculate the dredging costs. Assumptions regarding equipment values are given in the estimate. Ownership and operating costs for all dredging and marine equipment were calculated using the USACE "Checkrate" Excel program, with applicable cost adjustments for FY 2011 and USACE regional factors. Port Canaveral is located within Region III. The total overall cost was divided by the quantity to obtain a dredging cost of \$5.42 per CY in 2012 dollars. The detailed dredging cost estimating spreadsheet performed by Mr. McWilliams is included in this Attachment L.)									
<b>Mechanical Dredging</b>	<b>1.0</b>	<b>EA</b>	<b>0.00</b>	<b>0.00</b>	<b>0.00</b>	<b>16,856,508.94</b>	<b>16,856,508.94</b>	<b>16,856,508.94</b>	<b>16,856,508.94</b>
Dredging, dragline or clamshell, harbor channel, middle basin and ocean access channel	3,110,057.0	BCY	0.00	0.00	0.00	16,856,508.94	16,856,508.94	16,856,508.94	16,856,508.94
(Note: All dredging costs and the cost estimating procedure were performed in accordance with EP-1110-1-8; SADDM 1110-1-1; ER-1110-1-1300; ER 1110-2-1302, which provide the guidelines necessary to calculate the dredging costs. Assumptions regarding equipment values are given in the estimate. Ownership and operating costs for all dredging and marine equipment were calculated using the USACE "Checkrate" Excel program, with applicable cost adjustments for FY 2011 and USACE regional factors. Port Canaveral is located within Region III. The total overall cost was divided by the quantity to obtain a dredging cost of \$5.42 per CY in 2012 dollars. The detailed dredging cost estimating spreadsheet performed by Mr. McWilliams is included in this Attachment L.)									



Description	Quantity	UOM	DirectLabor	DirectEQ	DirectMatl	DirectSubBid	DirectCost	CostToPrime	ContractCost
<b>Associated General Items</b>									
Site Work	1.0	EA	3,287,829.53	3,306,900.99	2,015,315.00	467,223.42	9,077,268.94	9,077,268.94	9,077,268.94
Boresight Tower Guy Foundation Demolition	1.0	EA	3,267,074.50	3,297,751.69	2,004,755.00	463,800.00	9,033,381.19	9,033,381.19	9,033,381.19
Structural demolition, concrete pulverizer, 14.5" thick	1.0	EA	11,230.07	6,036.53	0.00	0.00	17,266.60	17,266.60	17,266.60
Sign Relocation	100.0	CF	11,230.07	6,036.53	0.00	0.00	17,266.60	17,266.60	17,266.60
Signs, traffic sign removal and relocation, 41 S.F. to 100 S.F., including supports	1.0	EA	45,150.54	6,013.40	5,875.00	0.00	57,038.94	57,038.94	57,038.94
(Note: Several property notification signs with electrical support are located along the shoreline which will require relocation with the shoreline adjustment.)									
<b>Dolphins</b>									
Monopile Dolphin With Cap and Bollard	1.0	EA	0.00	0.00	0.00	190,000.00	190,000.00	190,000.00	190,000.00
(Note: The mooring dolphin to be removed is located along the northside widening just east of the Trident Wharf. It consists of prestressed concrete concrete pilings with a concrete cap and a pile supported walkway to the uplands. It will be replaced in a new location with a large diameter steel monopile with a concrete cap and mooring bollard. This element is estimated using knowledge of many similar small demolition project performed at the port. The demolition and replacement cost estimate is \$190,000 Lump sum.)									
Demolish Existing Open Pile Dolphin	1.0	EA	0.00	0.00	0.00	40,000.00	40,000.00	40,000.00	40,000.00
<b>Steel Sheet Piling</b>									
New SSP Wall At Boat Ramp	1.0	EA	480,059.91	91,935.93	366,700.00	251,000.00	1,189,695.84	1,189,695.84	1,189,695.84
Mobilization and Demobilization, add to below, minimum	1.0	EA	480,059.91	91,935.93	366,700.00	251,000.00	1,189,695.84	1,189,695.84	1,189,695.84
Excavating, chain trencher, utility trench, common earth, 6" wide, 36" deep, backfill by hand, add	1.0	LS	0.00	0.00	0.00	50,000.00	50,000.00	50,000.00	50,000.00
Cast-in place retaining walls, reinforced concrete cantilever, 33 degree slope embankment, 10' high, includes excavation, backfill & reinforcing	1,100.0	LF	2,421.32	159.21	0.00	0.00	2,580.53	2,580.53	2,580.53
Steel sheet piling seawalls, steel sheeting, 12' high, shore driven	1,100.0	LF	273,923.68	19,206.14	106,700.00	0.00	399,829.82	399,829.82	399,829.82
Sheet piling, wales, connections and struts, 2/3 salvage	1,100.0	LF	155,091.11	63,748.89	92,400.00	0.00	311,239.99	311,239.99	311,239.99
Structural concrete, placing, pile caps, direct chute, over 10 CY, includes strike off & consolidation, includes material	15,000.0	LB	0.00	0.00	30,000.00	0.00	30,000.00	30,000.00	30,000.00
Screw anchor eye bolts, plain steel, for CIP concrete, 1" x 9' long, includes material only	201.0	CY	0.00	0.00	0.00	201,000.00	201,000.00	201,000.00	201,000.00
	16.0	EA	48,000.00	8,600.00	135,200.00	0.00	192,000.00	192,000.00	192,000.00

Description	Quantity	UOM	DirectLabor	DirectEQ	DirectMatl	DirectSubBid	DirectCost	CostToPrime	ContractCost
Railing, pipe, aluminum, clear finish, 3 rails, 3'-6" high, posts @ 5' O.C., 1-1/4" dia, shop fabricated	40.0	LF	623.79	21.70	2,400.00	0.00	3,045.49	3,045.49	3,045.49
<b>Riprap</b>									
Revetments	71,100.0	TON	678,220.08	647,505.22	1,541,845.00	22,800.00	2,890,370.30	2,890,370.30	2,890,370.30
(Note: The existing rock revetment is approximately 3,000 feet in length along the north side of the harbor channel between the Trident Basin and Middle Turning Basin. The estimated tonnage of rock work is 71,100 tons. The area of channel widening is referred to as Areas 9A and 9B in the survey drawings. The structure is an existing granite rock revetment extending up to the natural grade of +10 NGVD +/-.)									
Mob/Demob	1.0	EA	0.00	0.00	0.00	22,800.00	22,800.00	22,800.00	22,800.00
Mobilization/Demobilization	1.0	EA	0.00	0.00	0.00	22,800.00	22,800.00	22,800.00	22,800.00
(Note: Per Revetment Engineer's Estimate)									
<b>Environmental Protection</b>									
Geotextile Subsurface Drainage Filtration, fabric ply bonded to 3-dimensional nylon mat, ideal conditions, 0.4" thk	1.0	EA	28,062.29	759.72	18,040.00	0.00	46,862.01	46,862.01	46,862.01
Synthetic erosion control, silt fence, polypropylene, adverse conditions, 3 high	40,000.0	SF	13,373.14	0.00	10,400.00	0.00	23,773.14	23,773.14	23,773.14
Synthetic erosion control, place and remove hay bales	15,000.0	LF	10,557.74	0.00	6,000.00	0.00	16,557.74	16,557.74	16,557.74
Synthetic erosion control, place and remove hay bales	10.0	TON	4,131.41	759.72	1,640.00	0.00	6,531.12	6,531.12	6,531.12
<b>Rock Recovery/Replacement</b>									
Excavate and load, bank measure, blasted rock, 3-1/2 C.Y. bucket, hydraulic excavator	1.0	EA	628,798.61	634,635.05	0.00	0.00	1,263,433.66	1,263,433.66	1,263,433.66
Hauling, excavated or borrow material, loose cubic yards, 4 mile round trip @ base wide rate, 12 C.Y. truck, highway haulers, excludes loading	33,186.0	BCY	49,690.80	79,342.08	0.00	0.00	129,032.87	129,032.87	129,032.87
Rip-rap and rock lining, random, broken stone, machine placed for slope protection	33,186.0	LCY	67,184.86	42,163.93	0.00	0.00	109,348.79	109,348.79	109,348.79
Excavating, structural, bank measure, 140 H.P., dozer, rough grade, push to stockpile	33,186.0	LCY	476,860.09	493,355.00	0.00	0.00	970,215.09	970,215.09	970,215.09
<b>New Filter Stone (Furnish &amp; Install)</b>									
Backfill with Crushed Stone	33,186.0	BCY	35,062.86	19,774.04	0.00	0.00	54,836.90	54,836.90	54,836.90
Upland Excavation	17,980.0	CY	21,389.18	12,110.45	1,523,805.00	0.00	1,557,274.63	1,557,274.63	1,557,274.63
Existing Rock Revetment Removal/Replacement	1.0	EA	2,035,625.65	2,543,290.60	9,335.00	0.00	4,588,251.25	4,588,251.25	4,588,251.25
Existing Rock Revetment Removal/Replacement	1.0	EA	471,033.86	458,471.11	3,467.50	0.00	932,972.47	932,972.47	932,972.47

Description	Quantity	UOM	DirectLabor	DirectEQ	DirectMatl	DirectSubBid	DirectCost	CostToPrme	ContractCost
Excavating, bulk, open site, bank measure, loose rock, 140 H.P., dozer, 300' push	100,000.0	BCY	429,886.18	399,379.01	0.00	0.00	829,265.17	829,265.17	829,265.17
Rough grading, open site, large area, 300 H.P., dozer	100,000.0	BCY	28,659.08	52,277.85	0.00	0.00	80,936.93	80,936.93	80,936.93
Fine grading, loam or topsoil fine grade for large area, 15,000 S.Y. or more	18,250.0	SY	9,737.92	4,682.34	0.00	0.00	14,420.27	14,420.27	14,420.27
Seeding, mechanical seeding hydro or air seeding for large areas, includes lime, fertilizer and seed	18,250.0	SY	2,750.70	2,131.91	3,467.50	0.00	8,350.11	8,350.11	8,350.11
<b>Northside Channel Widener</b>	<b>1.0</b>	<b>EA</b>	<b>1,564,591.79</b>	<b>2,084,919.49</b>	<b>5,887.50</b>	<b>0.00</b>	<b>3,655,278.78</b>	<b>3,655,278.78</b>	<b>3,655,278.78</b>
Excavation, bulk, dragline, bank measure, heavy clay, 3/4 C.Y. bucket, excavate and load on truck	354,069.0	BCY	1,261,756.80	1,279,306.40	0.00	0.00	2,541,063.19	2,541,063.19	2,541,063.19
Rough grading, open site, large area, 300 H.P., dozer	364,069.0	BCY	104,338.82	190,327.45	0.00	0.00	294,666.27	294,666.27	294,666.27
Hauling, excavated or borrow material, loose cubic yards, 1 mile round trip @ 20 MPH (4.2 cycles/hour), 40 C.Y., off highway haulers, excludes loading	364,069.0	LCY	191,719.64	611,535.91	0.00	0.00	803,255.55	803,255.55	803,255.55
Synthetic erosion control, silt fence, polypropylene, ideal conditions, 3' high	6,000.0	LF	2,507.46	0.00	2,400.00	0.00	4,907.46	4,907.46	4,907.46
Mobilization or demobilization, dozer, loader, backhoe or excavator, above 150 H.P., up to 50 miles	10.0	EA	1,518.37	1,517.82	0.00	0.00	3,036.19	3,036.19	3,036.19
Seeding, mechanical seeding hydro or air seeding for large areas, includes lime, fertilizer and seed	18,250.0	SY	2,750.70	2,131.91	3,467.50	0.00	8,350.11	8,350.11	8,350.11
<b>Chain Link Fence</b>	<b>1.0</b>	<b>EA</b>	<b>16,788.26</b>	<b>2,970.00</b>	<b>81,000.00</b>	<b>0.00</b>	<b>100,758.26</b>	<b>100,758.26</b>	<b>100,758.26</b>
Fence, chain link industrial, aluminum steel, add for corner post, 6 ga. wire, 2-1/2" posts @ 10' OC, 8' high, 3" diameter, includes excavation, in concrete, add for corner posts	3,000.0	EA	16,788.26	2,970.00	81,000.00	0.00	100,758.26	100,758.26	100,758.26
<b>Monument Relocation</b>	<b>1.0</b>	<b>EA</b>	<b>20,755.03</b>	<b>9,149.30</b>	<b>10,560.00</b>	<b>3,423.42</b>	<b>43,887.75</b>	<b>43,887.75</b>	<b>43,887.75</b>
<b>Submarine Monument</b>	<b>1.0</b>	<b>EA</b>	<b>20,755.03</b>	<b>9,149.30</b>	<b>10,560.00</b>	<b>3,423.42</b>	<b>43,887.75</b>	<b>43,887.75</b>	<b>43,887.75</b>
Minor site demolition, concrete, unreinforced, 7" to 24" thick, remove with backhoes, excludes hauling	77.0	CY	7,511.21	872.40	0.00	0.00	8,383.62	8,383.62	8,383.62

Description	Quantity	UOM	DirectLabor	DirectEQ	DirectMatl	DirectSubBid	DirectCost	CostToPrTime	ContractCost
Structural concrete, in place, lift slab (4000 psi) above the foundation, average, includes columns, forms(4 uses), reinforcing steel, concrete, placing and finishing	1,600.0	SF	12,120.71	924.87	10,560.00	0.00	23,605.58	23,605.58	23,605.58
Crane crew, daily use for small jobs, 80-ton truck-mounted hydraulic crane, portal to portal	1.0	DAY	898.41	7,228.37	0.00	0.00	8,126.78	8,126.78	8,126.78
(Note: Crane to relocate Submarine Sail)									
Hauling, rock, 12 C.Y. truck, 5 mile haul, includes loading	77.0	LCY	224.70	123.66	0.00	0.00	348.36	348.36	348.36
Commercial RCRA landfills, solid, non-hazardous, sanitary landfill	77.0	CY	0.00	0.00	0.00	3,423.42	3,423.42	3,423.42	3,423.42
<b>Navigation Aids</b>									
<b>Inbound/Outbound Navigation Aids</b>									
Dredging Aids to Navigation, Inbound, Relocate (Note: Price developed by CH2M HILL per Attachment N (USCG Coordination On Navigation Aids (Range Markers)))	1.0	EA	0.00	0.00	0.00	2,008,262.00	2,008,262.00	2,008,262.00	2,008,262.00
Dredging Aids to Navigation, Outbound, New (Note: Price developed by CH2M HILL per Attachment N (USCG Coordination On Navigation Aids (Range Markers)))	1.0	EA	0.00	0.00	0.00	1,975,000.00	1,975,000.00	1,975,000.00	1,975,000.00
Dredging Aids to Navigation, Outbound, New (Note: Price developed by CH2M HILL per Attachment N (USCG Coordination On Navigation Aids (Range Markers)))	2.0	EA	0.00	0.00	0.00	275,000.00	275,000.00	275,000.00	275,000.00
Dredging Aids to Navigation, Outbound, New (Note: Price developed by CH2M HILL per Attachment N (USCG Coordination On Navigation Aids (Range Markers)))	2.0	EA	0.00	0.00	0.00	1,700,000.00	1,700,000.00	1,700,000.00	1,700,000.00
<b>West Surge Warning Sign Replacement</b>									
West Surge Warning Sign Replacement	1.0	EA	0.00	0.00	0.00	33,262.00	33,262.00	33,262.00	33,262.00
(Note: In 2001, Olsen & Associates, Jacksonville, Florida, prepared a cost estimate for installing the two Surge Warning Signs. The engineer's estimate in 2001 for installing the two signs was \$44,000. Using one-half of this value for one sign, and escalating to 2007 using 3% per year up to 2006 and 4.6 percent for 2007 and 2008, the estimate for installing one new Surge Warning Sign is approximately \$30,000 in 2008 dollars. This value was then escalated by 3.5% to arrive at a cost of \$33,262 in 2012 dollars.)									
<b>Planning, Engineering and Design</b>									
<b>Construct Contracts(s) Documents</b>									
Plans and Specifications (P&S)	1.0	EA	0.00	0.00	0.00	2,229,227.99	2,229,227.99	2,229,227.99	2,229,227.99
Plans and Specifications	1.0	EA	0.00	0.00	0.00	2,229,227.99	2,229,227.99	2,229,227.99	2,229,227.99
7.5 percent of Construction Cost of Remaining Work (excluding cost for Lands and Damages)	1.0	EA	0.00	0.00	0.00	2,229,227.99	2,229,227.99	2,229,227.99	2,229,227.99
(Note: Per Cost Engineering Appendix which indicates a total of 15 percent for PED and S&A.)									
<b>Construction Management</b>									
Construction Contracts	1.0	EA	0.00	0.00	0.00	2,229,227.99	2,229,227.99	2,229,227.99	2,229,227.99
Supervision and Administration	1.0	EA	0.00	0.00	0.00	2,229,227.99	2,229,227.99	2,229,227.99	2,229,227.99
District Office S&A Documents	1.0	EA	0.00	0.00	0.00	2,229,227.99	2,229,227.99	2,229,227.99	2,229,227.99
(Note: Technical Management S&A All Other District Office S&A)									

Description	Quantity	UOM	DirectLabor	DirectEQ	DirectMatl	DirectSubBid	DirectCost	CostToPrime	ContractCost
-------------	----------	-----	-------------	----------	------------	--------------	------------	-------------	--------------

7.5 percent of Construction Cost of Remaining Work (excluding cost for Lands and Damages)	1.0	EA	0.00	0.00	0.00	2,229,227.99	2,229,227.99	2,229,227.99	2,229,227.99
---	-----	----	------	------	------	--------------	--------------	--------------	--------------

(Note: Per Cost Engineering Appendix which indicates a total of 15 percent for PED and S&A.)

**WALLA WALLA COST ENGINEERING  
MANDATORY CENTER OF EXPERTISE**

**COST AGENCY TECHNICAL REVIEW**

**2013 RE-CERTIFICATION STATEMENT**

for

**SAJ – Port Canaveral Section 203**

The Port Canaveral Section 203 as presented by the SAJ Sponsor has undergone a successful Cost Agency Technical Review (Cost ATR), performed by the Walla Walla District Cost Engineering Mandatory Center of Expertise (Cost MCX) team. The Cost ATR included update study of the project scope, report, cost estimates, schedules, escalation, and risk-based contingencies. This certification signifies the products meet the quality standards as prescribed in ER 1110-2-1150 Engineering and Design for Civil Works Projects and ER 1110-2-1302 Civil Works Cost Engineering.

As of January 22, 2013, the Cost MCX RE-Certifies the estimated total project cost of:

FY 2013 Price Level:	\$40,136,000
Fully Funded Amount:	\$41,003,000

Note that the certified project costs are dependent upon sufficient, confident design and project management. It remains the responsibility of the Proponents to correctly reflect these cost values within the Final Report and to implement effective project and risk management controls throughout the life of the project.

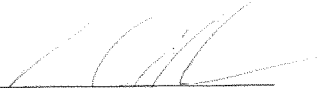

**US Army Corps  
of Engineers®**

  
 \_\_\_\_\_  
**Kim C. Callan, PE, CCE, PM1**  
**Chief, Cost Engineering MCX**  
**Walla Walla District**

Date 1/22/2013

\*\*\*\* TOTAL PROJECT COST SUMMARY \*\*\*\*

PROJECT: Canaveral Harbor, Section 203, Study  
LOCATION: Port Canaveral, Brevard County, Florida  
This Estimate reflects the scope and schedule in report;

DISTRICT: SAJ Jacksonville  
POC: CHIEF, COST ENGINEERING, Tracy T. Leaser, P.E.

PREPARED: 1/15/2013

Integrated Section 203 Navigation Study Report

WBS NUMBER	DESCRIPTION	ESTIMATED COST		ESC (%)	Effective Price Level	PROJECT FIRST COST		Spent Thru: 1.Disc-11	TOTAL PROJECT COST (FULLY FUNDED)					
		CNTG (\$K)	TOTAL (\$K)			COST (\$K)	CNTG (\$K)		ESC (%)	COST (\$K)	CNTG (\$K)	FULL (\$K)	O	
1.2	NAVIGATION PORTS & HARBORS	\$0.281	\$34,006	1.5%	1.5%	\$0.389	\$34,532	\$	\$28,734	\$0.523	\$35,256			
	CONSTRUCTION ESTIMATE TOTALS:	\$6,291	\$34,006	1.5%	1.5%	\$6,389	\$34,532	\$	\$28,734	\$0.523	\$35,256			
01	LANDS AND DAMAGES													
30	PLANNING, ENGINEERING & DESIGN	\$508	\$2,735	2.4%	2.4%	\$2,284	\$2,802		\$2,284	\$518	\$2,802			
31	CONSTRUCTION MANAGEMENT	\$508	\$2,735	2.4%	2.4%	\$2,284	\$2,802		\$2,400	\$545	\$2,945			
	PROJECT COST TOTALS:	\$7,203	\$38,477	1.7%	1.7%	\$7,425	\$40,136	\$	\$33,417	\$7,586	\$41,003			

CHIEF, COST ENGINEERING, Tracy T. Leaser, P.E.  
PROJECT MANAGER, Steve Ross  
CHIEF, REAL ESTATE, Audrey Ormerod  
CHIEF, PLANNING, Eric Bush  
CHIEF, ENGINEERING, Lauren Borchauer, P.E.  
CHIEF, OPERATIONS, Jim W. Jeffords, P.E.  
CHIEF, CONSTRUCTION, Steve Dusa, P.E.  
CHIEF, CONTRACTING, Carlos Clarke  
CHIEF, PIM/PB, Karen S. Tippett  
CHIEF, DPM, David S. Hobbie, PMP

ESTIMATED FEDERAL COST: 71% \$29,112  
ESTIMATED NON-FEDERAL COST: 29% \$11,891  
ESTIMATED TOTAL PROJECT COST: \$41,003

Percentage basis:  
Navigation Digits 20-45 @ 75/25  
Navigation Digits 45 & greater 50/50  
For cost share percentage breakdown see Cost Sharing Section of Main Report

O&M OUTSIDE OF TOTAL PROJECT COST:

\*\*\*\* TOTAL PROJECT COST SUMMARY \*\*\*\*  
\*\*\*\* CONTRACT COST SUMMARY \*\*\*\*

PROJECT: Canaveral Harbor, Section 203 Study  
LOCATION: Port Canaveral, Brevard County, Florida  
This Estimate reflects the scope and schedule in report;  
Integrated Section 203 Navigation Study Report

PROJECT: Canaveral Harbor, Section 203 Study  
LOCATION: Port Canaveral, Brevard County, Florida  
This Estimate reflects the scope and schedule in report;  
Integrated Section 203 Navigation Study Report

DISTRICT: SAU Jacksonville  
POC: CHIEF, COST ENGINEERING, Tracy T. Leaser, P.E.  
PREPARED: 1/15/2013

WBS NUMBER	WBS Description	Estimate Prepared: 12-Dec-11 Effective Price Level: 12-Dec-11		RISK BASED		Program Year (Budget EO): 2013 Effective Price Level Date: 1 OCT 12		FULLY FUNDED PROJECT ESTIMATE					
		COST (\$K)	NTG (%)	CNTG (\$K)	TOTAL (\$K)	ESC (%)	COST (\$K)	Mid Point Date	ESC (%)	COST (\$K)	CNTG (\$K)	ROLL (\$K)	
A	B	C	D	E	F	G	H	I	J	L	M	N	O
<b>REMAINING CONSTRUCTION BY PORT</b>													
1.2	NAVIGATION PORTS & HARBORS #/NA	\$27,715	\$6,291	22.70%	\$34,006	1.5%	\$28,143	\$6,389	\$34,532	2014Q2	\$28,734	\$6,523	\$35,256
<b>CONSTRUCTION ESTIMATE TOTALS:</b>		\$27,715	\$6,291	22.70%	\$34,006		\$28,143	\$6,389	\$34,532		\$28,734	\$6,523	\$35,256
<b>LANDS AND DAMAGES</b>													
01													
<b>PLANNING, ENGINEERING &amp; DESIGN</b>													
3.0	Project Management	incl											
	Planning & Environmental Compliance	incl											
7.5%	Engineering Construction	\$2,729	\$506	22.70%	\$2,735	2.4%	\$2,284	\$518	\$2,802	2013Q1	\$2,284	\$518	\$2,802
	Engineering Construction Review/ ITR & VE	incl											
	Contracting & Procurements	incl											
	Engineering During Construction	incl											
	Planning During Construction	incl											
	Project Operations												
<b>CONSTRUCTION MANAGEMENT</b>													
7.5%	Construction Management	\$2,229	\$506	22.70%	\$2,735	2.4%	\$2,284	\$518	\$2,802	2014Q2	\$2,400	\$545	\$2,945
	Project Operation												
	Project Management												
<b>CONTRACT COST TOTALS:</b>		\$32,173	\$7,303		\$39,477		\$32,711	\$7,425	\$40,136		\$33,417	\$7,586	\$41,003



**Port Canaveral Section 203 Feasibility Study  
Engineering Appendix**

Attachment M

Cost and Schedule Risk Analysis Report

Rev Date: February 2012

**Canaveral Port Authority**

**Section 203 Feasibility Study**  
**for**  
**Widening and Deepening Canaveral Harbor and Channel**  
**Preferred Alternative**

**COST & SCHEDULE RISK ANALYSIS**



Analysis Date: February 2, 2012

Reference Estimate ID: 10222008

Class Estimate: Class 4

Estimate Date: December 8, 2011

Requested By: HQUSACE Review Committee

CSR Analysis By: Robert Wells/PDX/503.872.4622

## Overview

This Analysis was prepared to meet the request of the client and intends to ascertain the probability of cost and schedule overruns, and to assign a studied growth potential as a value applied as a contingency. This analysis included input and guidance from the project delivery team (PDT), and utilized Crystal Ball software to perform the Monte Carlo analysis. It should be noted that this analysis does not intend to recreate the estimate.

## Specific Outcomes

The Cost and Schedule Risk Analysis has the following outcomes:

- (1) Cost and schedule risk register.
- (2) The “most likely” total project cost estimate.
- (3) The “best case” and “worst case” estimates.
- (4) Cost and Schedule Risk assessment models using Crystal Ball

## General Project Description

This project is predominantly a Feature 12 (dredging) project at Port Canaveral, Florida. This Analysis references the related Basis of Estimate for relevant project information, including Project Description, Scope of Work, Markups, Escalation, Market Conditions, Allowances, Major Assumptions, Exclusions and pricing information.

## Cost and Schedule Risk Analysis

The specifics of this analysis were executed with guidance provided by James Neubauer, P.E., C.C.E, PM1, U.S. Army Corps of Engineers, Walla Walla District, National Civil Works Cost Center. Mr. Neubauer provided the procedure for determining the additional cost escalation impact resulting from schedule risk, and for determining the additional escalation cost resulting from Feature 12 projects, where such projects are unduly influenced by volatile fuel escalation.

In order, these steps were followed in order to arrive at a studied contingency amount:

1. The estimate was validated and examined for and removed contingencies at top and lower levels.
2. The analyst, the project manager and the estimator conferred with USACE on specific cost risk analysis methods and issues specific to this study.

3. The analyst, the project manager and the estimator conferred on the PDT membership, the PDT was formed and instructed on the process, and risk concerns and discussion were recorded on the Risk Register.
4. The analyst compiled and organized the Risk Register, determining Risk Levels from reported likelihoods and consequences.
5. The identified High Risk items were selected for market study and inclusion in the Monte Carlo analysis.
6. The preliminary results were communicated and discussed among the analyst, the project manager and the estimator.
7. The draft report was issued, reviewed, and published.

Specifically, the PDT concerns pointed to

- bid market volatility,
- fuel cost uncertainty,
- presence or exposure to rocket fuel,
- and associated delay risks with risk level to warrant inclusion in the study.

All of these are considered risk to cost occurring outside of the base estimate escalation calculation. Therefore the procedure to capture the cost and schedule risk is to assign as contingency the cost risk resulting from uncertain delays or unexpected escalation of key materials, commodities or consumables.

## Findings and Recommendations

The findings of this study include:

- Cost and schedule risk register addressing all project features. This register is appended to this report as Appendix A.
- The cost contingency in percentages, where that percentage is the amount to be added to the base estimate prior to escalation. This is shown in Table: Contingency Analysis, below.
- Cost and schedule risk assessment model using Crystal Ball is appended to this report as Appendix B.

The contingency calculations (as shown in the Table below) are predominantly influenced by the bid market and fuel forecast modeling.

Recommendations relevant to the sensitivity analysis include:

- Bid Market. The model examined the possibility the bid market would influence cost of the project. This is understood as driven by the scarcity or surplus of dredging equipment required for the project. Mitigation or avoidance measures include determining scarcity or surplus by interviewing prospective bidders or through local trade associations, or by requesting proposals with foreknowledge

that bids may not reflect advantageous market conditions, and are rejected and postponed until the market is seeking projects.

- **Material escalation.** The concern is primarily a consumable, diesel fuel, which is of concern, rather than a material placed as a scope deliverable. Diesel fuel, crude oil and related products are known to be volatile and unpredictable. A mitigation method proposed during our PDT discussion is to identify fuel as a separate bid item. This will remove the risk for fuel escalation from the contractor and place it on the project owner. However, the contractor's premium for risk will be avoided. The strategy of bidding fuel separately must be well thought out and utilizing a proved method in order to avoid exposing the owner to more risk.
- **Rocket motor fuel.** As this is an unlikely event outside the control of the project, mitigation in the form of insurance or by means of project or program reserves is recommended.

Table: Contingency Analysis

### Contingency Analysis

Most Likely Cost Estimate	\$35,555,343	
Confidence Level	Value	Contingency
0%	\$29,262,851	-17.70%
5%	\$33,644,299	-5.37%
10%	\$34,723,938	-2.34%
15%	\$35,546,233	-0.03%
20%	\$36,278,428	2.03%
25%	\$36,831,733	3.59%
30%	\$37,322,064	4.97%
35%	\$37,833,692	6.41%
40%	\$38,333,898	7.81%
45%	\$38,933,619	9.50%
50%	\$39,475,431	11.03%
55%	\$39,986,087	12.46%
60%	\$40,481,471	13.85%
65%	\$41,051,987	15.46%
70%	\$41,615,286	17.04%
75%	\$42,296,386	18.96%
80%	\$43,009,622	20.97%
85%	\$43,831,039	23.28%
90%	\$44,974,780	26.49%
95%	\$46,635,066	31.16%
100%	\$54,671,528	53.76%

Further to the above chart, the Total Project Cost chart is displayed graphically below, showing the selection of the 80<sup>th</sup> percentile and the corresponding total project cost values.

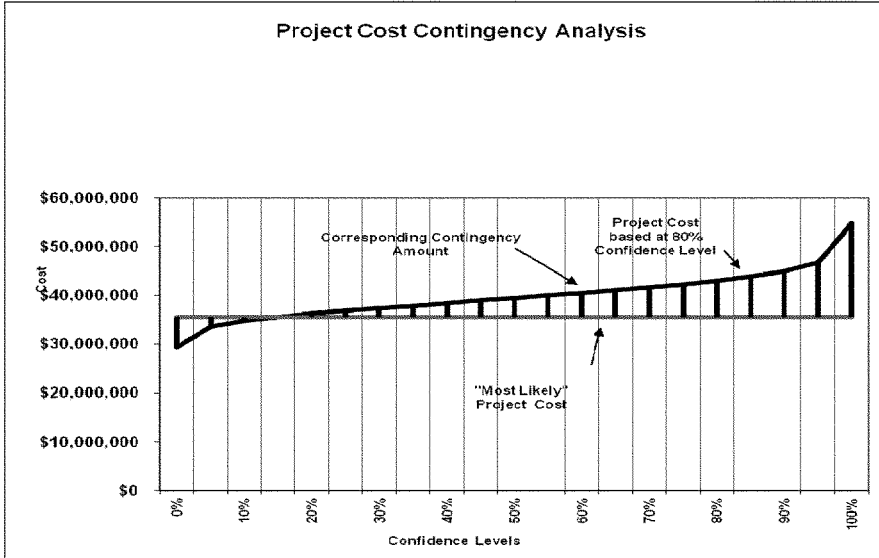

Additionally, the sensitivity analysis (Tornado Chart below) is as is expected with a large proportion of the Feature 12 sensitivity to variance dependent on bid market and fuel cost.

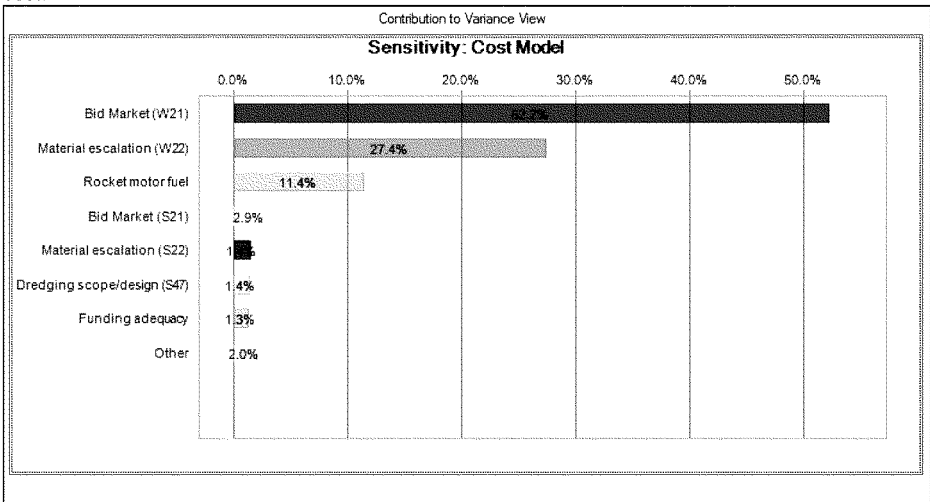

## List of Appendices:

Appendix A: Risk Register.

Appendix B: Cost and Schedule Model.

Appendix C: Market Study and Opinion Basis

## Reference Documents

Excel file with Crystal Ball data:

CSRA\_RiskAnalysis\_CPA\_Section\_203\_Cost 2012-01-27 0730.xlsx

USACE EM 1110-2-1304 - Civil Works Construction Cost Index System

USACE ER 1110-2-1302 – Civil Works Cost Engineering

USACE ECB 2007-17 Cost Risk Analysis Methods for Civil Works Projects

APPENDIX A – RISK REGISTER



Port Canaveral Section 203 - PDT Risk Register (Draft)

**Risk Levels**

Very Low	Low	Medium	High	Critical
Minor	Minor	Minor	Minor	Minor
Minor	Minor	Minor	Minor	Minor
Minor	Minor	Minor	Minor	Minor
Minor	Minor	Minor	Minor	Minor

**Risk Levels**

Very Low	Low	Medium	High	Critical
Minor	Minor	Minor	Minor	Minor
Minor	Minor	Minor	Minor	Minor
Minor	Minor	Minor	Minor	Minor
Minor	Minor	Minor	Minor	Minor

**Thresholds for cost and time**

Cost	Time
+300k*	+1.8MO*
+400k*	+2.4MO*
+500k*	+3.0MO*
+600k*	+3.6MO*
+700k*	+4.2MO*
+800k*	+4.8MO*
+900k*	+5.4MO*
+1M*	+6.0MO*

Risk No.	Risk Opportunity #	Comments	PDT Discussions		Impact Cost		Impact Schedule		Rough Order Impact (\$)	Rough Order Impact (mo)	Risk Level	Impact	Correlation to other risks	Responsible POC	Affected Project Component
			Low/High	Impact (\$)	Risk Level	Impact									
CR1	Non-critical project construction	Eliminate potential schedule pressure	CR1	CR2	CR3	CR4	CR5	CR6	CR7	CR8	CR9	CR10	CR11	CR12	CR13
CR2	Package 20 assigned to USACE	Drive to assigned date final	CR2	CR3	CR4	CR5	CR6	CR7	CR8	CR9	CR10	CR11	CR12	CR13	CR14
CR3	Interchange Slides	PFE time to start activities	CR3	CR4	CR5	CR6	CR7	CR8	CR9	CR10	CR11	CR12	CR13	CR14	CR15
CR4	Market conditions and bidding competition	Project completion to complete phase	CR4	CR5	CR6	CR7	CR8	CR9	CR10	CR11	CR12	CR13	CR14	CR15	CR16
CR5	Interchange excavation on four parallel	Four parallel activities	CR5	CR6	CR7	CR8	CR9	CR10	CR11	CR12	CR13	CR14	CR15	CR16	CR17
CR6	Backlog Strategy	Interchange construction and design	CR6	CR7	CR8	CR9	CR10	CR11	CR12	CR13	CR14	CR15	CR16	CR17	CR18
CR7	Additional Stimulators	Implementation of additional stimulators	CR7	CR8	CR9	CR10	CR11	CR12	CR13	CR14	CR15	CR16	CR17	CR18	CR19
CR8	High Impact Team changing	High impact	CR8	CR9	CR10	CR11	CR12	CR13	CR14	CR15	CR16	CR17	CR18	CR19	CR20
CR9	Inventory on hand from CR9	Inventory on hand from CR9	CR9	CR10	CR11	CR12	CR13	CR14	CR15	CR16	CR17	CR18	CR19	CR20	CR21
CR10	Interchange cost escalation	Interchange cost escalation	CR10	CR11	CR12	CR13	CR14	CR15	CR16	CR17	CR18	CR19	CR20	CR21	CR22
CR11	Survey information	Survey information	CR11	CR12	CR13	CR14	CR15	CR16	CR17	CR18	CR19	CR20	CR21	CR22	CR23
CR12	Project storm during construction	Project storm during construction	CR12	CR13	CR14	CR15	CR16	CR17	CR18	CR19	CR20	CR21	CR22	CR23	CR24





APPENDIX B – COST AND SCHEDULE MODEL

SCHEDULE MODEL RESULTS

**TOTAL SCHED MODEL**

Sum of assumptions	<b>0.0 MO</b>	<b>0.0 MO</b>	<b>0.0 MO</b>	Total Schedule Forecast
			Half of duration assumed elapsed	
Project forecast	<b>0.0 MO</b>	<b>0.0 MO</b>	<b>0.0 MO</b>	

0%	-2.0 MO	0.0 MO	-2.0 MO	0.0 MO
5%	4.6 MO	0.0 MO	4.6 MO	0.0 MO
10%	6.0 MO	0.0 MO	6.0 MO	6.0 MO
15%	6.9 MO	0.8 MO	7.8 MO	7.8 MO
20%	8.2 MO	0.9 MO	9.1 MO	9.1 MO
25%	9.5 MO	1.0 MO	10.5 MO	10.5 MO
30%	10.8 MO	1.1 MO	11.9 MO	11.9 MO
35%	11.8 MO	1.1 MO	12.9 MO	12.9 MO
40%	12.5 MO	1.2 MO	13.7 MO	13.7 MO
45%	13.1 MO	2.4 MO	15.4 MO	15.4 MO
50%	13.6 MO	2.9 MO	16.5 MO	16.5 MO
55%	14.2 MO	3.2 MO	17.4 MO	17.4 MO
60%	15.0 MO	3.5 MO	18.4 MO	18.4 MO
65%	15.8 MO	3.7 MO	19.6 MO	19.6 MO
70%	16.8 MO	4.1 MO	21.0 MO	21.0 MO
75%	17.8 MO	5.0 MO	22.8 MO	22.8 MO
<b>80%</b>	<b>18.9 MO</b>	<b>5.5 MO</b>	<b>24.3 MO</b>	<b>24.3 MO</b>

85%	20.4 MO	5.8 MO	26.2 MO	26.2 MO
90%	23.5 MO	6.9 MO	30.4 MO	30.4 MO
95%	27.6 MO	7.9 MO	35.6 MO	35.6 MO
100%	42.6 MO	11.8 MO	54.3 MO	54.3 MO
Minimum	-2.0 MO	0.0 MO		
Maximum	42.6 MO	11.8 MO		
Trials	10,000	10,000		
Mean	14.2 MO	3.1 MO		

COST MODEL RESULTS

Sum of assumptions	<b>0</b>
Estimated value	<b>35,555,343</b>
Project forecast	<b>35,555,343</b>

0%	-17.51%
5%	-5.89%
10%	-3.03%
15%	-0.95%
20%	0.93%
25%	2.30%
30%	3.48%
35%	4.77%
40%	6.05%
45%	7.48%
50%	8.84%
55%	10.12%
60%	11.34%
65%	12.76%
70%	14.11%
75%	15.72%
<b>80%</b>	<b>17.44%</b>

85%	19.41%
90%	21.88%
95%	25.57%
100%	43.74%
Minimum	29,330,621
Maximum	51,105,944
Trials	10,000
Mean	38,809,047

29,330,621	-17.51%
33,461,682	-5.89%
34,476,691	-3.03%
35,219,219	-0.95%
35,886,832	0.93%
36,371,605	2.30%
36,793,645	3.48%
37,251,430	4.77%
37,707,760	6.05%
38,216,022	7.48%
38,698,334	8.84%
39,153,944	10.12%
39,589,016	11.34%
40,090,933	12.76%
40,570,641	14.11%
41,143,380	15.72%
<b>41,555,842</b>	<b>17.44%</b>
42,454,937	19.41%
43,333,586	21.88%
44,646,573	25.57%
51,105,944	43.74%
29,330,621	
51,105,944	
10,000	
38,809,047	

**ESCALATION COST IMPACT CALCULATIONS**

Escalation Per Month at 1.61%	Project cost less gals fuel 1,288,808	Escalation Cost for Percentile
Per Year (fuel excluded)*	at \$ per gal (in est) \$3.05	
-0.267%	25,399,757	-67,770
0.618%	29,530,818	182,617
0.809%	30,545,827	247,246
1.045%	31,288,354	327,014
1.225%	31,955,967	391,596
1.418%	32,440,741	460,128
1.608%	32,862,781	528,419
1.747%	33,320,565	582,263
1.854%	33,776,896	626,138
2.093%	34,285,158	717,597
2.235%	34,767,469	777,097
2.362%	35,223,079	832,143
2.503%	35,658,152	892,454
2.658%	36,160,069	961,054
2.851%	36,639,777	1,044,645
3.098%	37,212,516	1,153,006
<b>3.315%</b>	<b>37,824,978</b>	<b>1,253,780</b>
3.572%	38,524,073	1,376,102
4.165%	39,402,721	1,641,194
4.884%	40,715,708	1,988,493
7.558%	47,175,080	3,565,583

\*Fuel escalation is considered a separate risk (see: CR-5)  
1.61%/yr escalation based on published table for feature

**TOTAL PROJECT COST CALCULATIONS - ESC**

Percentile	Total Cost including cost risk and cost of schedule risk (no estimate esc)	Derived contingency % on base estimate of
0%	29,262,851	-17.70%
5%	33,644,299	-5.37%
10%	34,723,938	-2.34%
15%	35,546,233	-0.03%
20%	36,278,428	2.03%
25%	36,831,733	3.59%
30%	37,322,064	4.97%
35%	37,833,692	6.41%
40%	38,333,898	7.81%
45%	38,933,619	9.50%
50%	39,475,431	11.03%
55%	39,986,087	12.46%
60%	40,481,471	13.85%
65%	41,051,987	15.46%
70%	41,615,286	17.04%
75%	42,296,386	18.96%
<b>80%</b>	<b>43,009,622</b>	<b>20.97%</b>
85%	43,831,039	23.28%
90%	44,974,780	26.49%
95%	46,635,066	31.16%
100%	54,671,528	53.76%

This table would be used if contingency % is to be  
figured **prior** to the \$347,788 escalation in the  
estimate

**TOTAL PROJECT COST CALCULATIONS + ESC**

Percentile	*Total Cost including cost risk cost of schedule risk and estimate escalation	*Derived contingency % on base estimate (with esc) of
0%	29,610,639	-17.53%
5%	33,992,087	-5.32%
10%	35,071,726	-2.32%
15%	35,894,021	-0.03%
20%	36,626,216	2.01%
25%	37,179,521	3.56%
30%	37,669,852	4.92%
35%	38,181,480	6.35%
40%	38,681,686	7.74%
45%	39,281,407	9.41%
50%	39,823,219	10.92%
55%	40,333,875	12.34%
60%	40,829,259	13.72%
65%	41,399,775	15.31%
70%	41,963,074	16.88%
75%	42,644,174	18.78%
<b>80%</b>	<b>43,357,410</b>	<b>20.76%</b>
85%	44,178,827	23.05%
90%	45,322,568	26.24%
95%	46,982,854	30.86%
100%	55,019,316	53.24%

This table would be used if contingency % is to be  
figured **after** to the \$347,788 escalation in the  
estimate

Risk No.	Risk/Opportunity Event Subsidiary States Regional Risk	MODELING STUDY AND RESEARCH, EXPERT OPINION INFORMATION, AND EVENT CALCULATIONS				COST MODELING				SCHEDULE MODELING				
		Study, Research, Basis of Expert Opinion	Prob of Occur.	Event Impact	Short Name	Range Low	Range High	CB Cost Assumption	Cost Trial Result	Range Low	Range High	CB Sched Assumption	Start Impact Result	Midpoint Impact Result
CR-1	Innovative project construction	Production rates are impacted by LBS/UBS/MSA, P.E., ARS/LS/CS/LI.	0.08	0.08	Innovation	(\$1,054,000)	(\$569,000)	-70000	\$0					
CR-2	Section 203 assignment to USACE	uncertain range of 2% to 4%												
CR-3	Incomplete Studies	Based on \$110 average hourly rate for professional services.												
CR-4	Market conditions and bidding competition	Market needs to be better aligned. Strong info signals in response to equipment supply and market demand.	0.75	0.75	Bid Market	(\$1,000,000)	\$4,000,000	1000000	\$0	-2.0 MO	2.0 MO		0.0 MO	
CR-5	Unexpected escalation on key materials	DOE forecast for crude oil price, natural gas, and coal prices. Review the volatility of cost of fuel. Review the volatility of cost of steel. Review the volatility of cost of cement. Review the volatility of cost of rebar. Review the volatility of cost of concrete. Review the volatility of cost of labor. Review the volatility of cost of equipment. Review the volatility of cost of materials.	0.75	0.75	Material escalation	(\$1,000,000)	\$4,500,000	700000	\$0					
CR-6	Bulkhead Stability													
CR-7	Additional Simulations	12x 600 and 2 month limit of performance based on previous simulation effort by STAG Center.												
CR-8	Jetty impact from dredging	6500 tons of boulders for repair of 11504 plus 24386 installation plus 15% EDSA plus 20% contingency. Estimate prepared by Kevin Boggs, P.E., P.D.												
CR-9	Increase dredging from Jetty shoaling	Based on an estimated unit rate of \$10 per cubic yard of material previously completed in this location previously completed in this location previously completed in this location. Source: Kevin Boggs, P.D., P.E.												
CR-10	Unanticipated soil conditions	Based on previous cost and time estimates for previous projects for this project. Escalation impact to be captured in cost. Capture in historical.	0.75	0.75	Soil Conditions	\$12,000	\$12,000	30000	\$0	1.5 MO	2.5 MO			
CR-11	Survey information	Based on survey cost from previous efforts.	0.75	0.75	Survey information	\$125,000	\$125,000	250000	\$0					0.0 MO







PR-9	Political opposition / threat of lawsuits			
PR-10	Shareholders choose time and / or cost over quality			
PR-11	Acts of God (seismic events, volcanic activity, hurricanes, or severe weather: freezing, flooding or hurricane)			
PR-12	Federal government does not fund Corps to construct sand bypass project in future.	<p>Based on an affidavit filed in 2010 per C.V. non filed by past attorney. Source: Keith Budge, PhD, P. E.</p>		

## APPENDIX C - MARKET RESEARCH

**PORT CANAVERAL DEEPENING/WIDENING  
HOPPER DREDGE CONCEPTUAL ESTIMATE  
SECTIONS 13-OR, 12-MRW, 11-MR, 9-B**

**Back to Register**

Volumes	Grade	OD	Total
13-OR	-	629,041	629,041
12. 11. 9	796,605	602,918	1,399,523
<b>Total</b>	<b>796,605</b>	<b>1,231,959</b>	<b>2,028,564</b>

Removed 796,605 1,231,959 2,028,564 (Assume pay plus unpaid = total available)

Assumptions: Generic Large Hopper Dredge

7,600 CY Hopper Capacity (Water)

Load Ratio (hopper to soft clay): 30%  
 Mud Capacity/Hopper 2,280 CY (Does not assume agitation dredging)  
 Mud Production Rate 4,200 CY/NOH (33" suction diameter)

Production Details:

Loading 33 Minutes  
 Turning 2 each 5 min 10 Minutes  
 Sail Loaded 8 mi 10 mph 48 Minutes  
 Sail Light 8 mi 12 mph 40 Minutes  
 Discharge/Washout 10 Minutes

Total Cycle	141 Minutes
	2.3 Hours

Production (Net) 973 CY/NOH  
 Efficiency (NOH) 90% 22 Hours/Day Net Operating Hours

Total Production/Day (Net)	21,020 CY/Day
----------------------------	---------------

Cost Details:

Daily Cost (Dredge) \$ 78,000 Per Day  
 Supervision/Field OH \$ 3,612 Per Day From Dredge Estimate  
 Survey Vessel \$ 1,072 Per Day From Dredge Estimate  
 Subtotal \$ 82,684 Per Day  
 Markup 24.4% \$ 20,175 Per Day (16.0% OH and 8.4% Profit as per estimate)  
 Total Cost/Day \$ 102,859 Per Day  
 Total Cost/CY \$ 4.89

Mob/Demob 4 Days \$ 102,859 \$ 411,434  
 Dredge Cost 2,028,564 CY \$ 4.89 \$ 9,919,678

**TOTAL COST, HOPPER DREDGE: \$ 10,331,112**

Clamshell Dredge Cost \$ 11,337,360 From Dredge Estimate

<b>Savings by Hopper Dredge:</b>	<b>\$ 1,006,248</b>
<b>Say:</b>	<b>\$ 1,000,000</b>

**Port Canaveral Section 203 Feasibility Study**  
**Engineering Appendix**

Attachment N

USCG Coordination on Navigation Aids (Range Markers)



December 7, 2007

Commander, 7<sup>th</sup> Coast Guard District (DPW)  
Attn: Mr. Joe Embres  
909 SE 1<sup>st</sup> Avenue  
Miami, FL 33131

**RE: Port Canaveral Section 203 Feasibility Study –  
Navigation Improvements & Aids**

A study of potential navigation improvements at Port Canaveral, Florida has been prepared by the Canaveral Port Authority (CPA) under the authority granted by Section 203 of Water Resources Development Act (WRDA) of 1986 (P.L. 99-662). The study evaluated the feasibility of improvements to the existing Federal navigation project at Port Canaveral and identified the solution that best meets the economic, environmental, physical, and social needs of the region and the nation.

Since the last major navigation improvements to the Federal navigation project at Port Canaveral were completed by the Corps of Engineers in 1995, the use of the Port by larger and deeper cruise ships and cargo vessels has resulted in a need to provide deeper and wider channels and expanded turning basins. There are great opportunities for increasing the efficiency of existing operations by providing deeper and wider channels that allow larger cruise ships to use the Port, and larger cargo vessels to carry greater loads. There are vessels presently calling at Port Canaveral that could benefit from deeper, wider channels, as well as new vessels currently on order that would use Port Canaveral if existing channels were improved.

Since construction of the 400-ft wide channel in 1995 and the increase in ever larger cruise ship traffic homeported at Port Canaveral's West Basin, the pilots have made several requests to the U.S. Coast Guard to provide outbound transit navigation aids (range structures) similar to the inbound range structures presently located west of the West Basin and aligned with the 400-ft channel centerline. To date, no federal funds have been available for the range structures and nothing has been constructed.

In addition to deepening all channel reaches, the Section 203 Feasibility Study proposes to widen the federal channel inside the jetties from 400 to 500 ft. A 100-ft widener is to be constructed on the north side of the existing channel between Middle and Trident Basins. Achieving the 100-ft widening for the west access channel, west of the Middle Basin, results from redefining the northern channel boundary 12 ft north of the existing northern boundary and widening the channel by 88 ft along the south side of the channel, deepening a portion of the barge canal.

## CANAVERAL PORT AUTHORITY

Mr. Joe Embres/7<sup>th</sup> Coast Guard District  
December 7, 2007  
Page 2

The enclosures depict and describe all of the features of the preferred alternative for the federal navigation project including the location of the existing inbound and proposed outbound range structures relative to the existing 400-ft and proposed 500-ft channel centerlines. While the proposed project serves to further straighten the main east-west channels within Canaveral Harbor, the 500-ft channel centerlines in the vicinity of the inbound and proposed outbound range structures do not share the same alignment.

Irrespective of whether these aids to navigation are federally or non-federally funded, the federal project costs must include budgetary estimates of the cost to relocate and replace the inbound structures and to construct new outbound structures on the new channel alignment. It is our understanding that significant technology improvements in lights and powering may notably affect the design and therefore the construction cost of these structures as compared to any cost estimates prepared previously.

We respectfully request that an updated design and construction cost estimate be provided in support of this project at the Coast Guard's earliest convenience and no later than December 31, 2007, if at all possible.

The tentative project schedule for milestone completion is as follows:

Construction Authorization – October 2008;  
Engineering Design, Permitting, Construction Bid/Award – January 2010  
Federal Project Construction – April 2011.

Should you have any questions or need additional information, please contact the undersigned at (321) 783-7831, ext 217. We look forward to your response.

Sincerely,

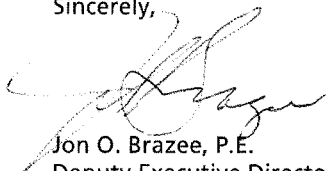

Jon O. Brazee, P.E.  
Deputy Executive Director, Chief Engineer  
Canaveral Port Authority

Encl

cc: Collins K. McKay, P.E.  
CH2M HILL, Cape Canaveral Office  
Consultant to the Canaveral Port Authority

**McKay, Collins/CCG**

---

**From:** Joseph.B.Embres@uscg.mil on behalf of Embres, Joseph [Joseph.B.Embres@uscg.mil]  
**Sent:** Tuesday, June 17, 2008 9:07 AM  
**To:** McKay, Collins/CCG  
**Cc:** Pantelakos, Charlie  
**Subject:** FW: Status of Prot Canaveral navigation aids estimate

Sorry this is the best we can do at this time

-----Original Message-----

**From:** Pantelakos, Charlie  
**Sent:** Tuesday, June 17, 2008 8:19 AM  
**To:** Embres, Joseph  
**Subject:** RE: Status of Prot Canaveral navigation aids estimate

Sir,

I reviewed the aid folders and spoke with the OIC of ANT Ponce. The RFL was rehab by CGC Hammer in 06. The RRL was inspected in 07. Both structures are in very good condition. I estimate the remaining service life of both structures to be 20 yrs. The only upgrade that may be considered is converting the range to a 24 hour configuration. The upgrade would cost less than 10K.

v/r  
 Charlie

-----Original Message-----

**From:** Embres, Joseph  
**Sent:** Monday, June 16, 2008 1:04 PM  
**To:** Pantelakos, Charlie  
**Subject:** FW: Status of Prot Canaveral navigation aids estimate

Can you help me with this??

-----Original Message-----

**From:** Collins.McKay@CH2M.com [mailto:Collins.McKay@CH2M.com]  
**Sent:** Monday, June 16, 2008 12:40 PM  
**To:** Embres, Joseph  
**Cc:** Jdiamantides@dma-us.com  
**Subject:** FW: Status of Prot Canaveral navigation aids estimate

Joe

I know you are short-handed from your last email. However, we are trying to incorporate the "latest and greatest" coordination we can get at this time from USCG since, according to the ASA/HQUSACE review of our draft study, such coordination is a requirement of the Section 203 Feasibility Study program.

Have you been able to confer with your USCG colleagues regarding the two questions below?

Thanks again Joe.

Collins

-----Original Message-----

**From:** McKay, Collins/CCG  
**Sent:** Wednesday, June 11, 2008 3:30 PM  
**To:** Joseph.B.Embres@uscg.mil  
**Subject:** RE: Status of Prot Canaveral navigation aids estimate

Joe

Thank you for your prompt response to my last email. We are preparing to re-submit our



Section 203 Feasibility Study to the ASA/HQUSACE and are updating our project cost estimates. We have two question for you.

1. Your recent estimate included relocation of the existing inbound range. We initially assumed the USCG would take this opportunity to replace them due to age and newer technology available. We are not familiar with the USCG criteria for replacing range markers and wanted to check if you considered this option when making your estimate?
2. Has the one responsible estimator at USCG been able to work on this any further? And, if not, would it be possible over the next week?

As always, thank you for your assistance on our project.

Collins

-----Original Message-----

From: Joseph.B.Embres@uscg.mil [mailto:Joseph.B.Embres@uscg.mil]  
 Sent: Monday, May 05, 2008 9:37 AM  
 To: McKay, Collins/CCG  
 Subject: RE: Status of Prot Canaveral navigation aids estimate

Family emergency is still ongoing, just not as intense for me at this time, thanks for asking.

Getting exact cost for the navigation improvement is extremely difficult. If you would believe the CG has only 1 individual that can supply those numbers and he is responsible for not only the Seventh District but also the Eighth District. That said, we have come up with the following cost estimates (give or take 25%): Establish the outgoing range \$ 1.7 million, relocate the inbound range \$ 275K. We will continue our attempt to obtain more accurate figures.

We have looked at your plan for the reconfiguration of the channel and have some concerns regarding the changing center-line and how it affects CG standard methodology of marking channels. We will need to discuss this with pilots.

Please keep me informed as to the progress.

-----Original Message-----

From: Collins.McKay@ch2m.com [mailto:Collins.McKay@ch2m.com]  
 Sent: Thursday, May 01, 2008 4:11 PM  
 To: Embres, Joseph  
 Subject: RE: Status of Prot Canaveral navigation aids estimate

Joe

The last time we exchanged emails you had a family emergency. I hope that all is well with you and your family now.

If you are back to work, I was wondering if you have had a chance to re-ignite the cost estimating for the navigation aids at Port Canaveral. We have received comments from the Assistant Secretary of the Army on our Section 203 Feasibility Study. They have asked for documentation of our coordination with USCG re navigation improvements. If not, maybe there is a person you could pass it on to.

Again, I sincerely hope that all is well with you and look forward to working with you on this matter.

Collins

-----Original Message-----

From: Joseph.B.Embres@uscg.mil [mailto:Joseph.B.Embres@uscg.mil]

Sent: Wednesday, February 20, 2008 1:33 PM  
To: McKay, Collins/CCG  
Subject: RE: Status of Prot Canaveral navigation aids estimate

Sorry for the delay on this but I have had a major family medical emergency and have been out for several weeks. I should be back, at least for partial days, next week.

-----Original Message-----  
From: Collins.McKay@ch2m.com [mailto:Collins.McKay@ch2m.com]  
Sent: Monday, February 18, 2008 12:08 PM  
To: Embres, Joseph  
Subject: Status of Prot Canaveral navigation aids estimate

Mr. Embres

As consultant to the Canaveral Port Authority (CPA), I send you this email alerting you of a FedEx package coming your way. I want to make sure you understand its context. Back in December, CPA sent you a letter, with attachments, requesting an update of the construction cost estimate for the Port Canaveral navigation aids (inbound and outbound). After receipt of the letter you requested an overlay drawing at 1:10,000 scale to overlay onto the navigation chart for the location. The FedEx package you should receive today is that document.

We also inquire into the status of the estimate. We are a few days away from our response to the USACE comments on our draft Section 203 Feasibility Study and would like to incorporate the figures if you have them. At this time, we have estimated their cost by escalating the estimates from several years ago. This may not be accurate since technology has changed and escalation rates have not been steady with certain market factors such as fuel cost causing major fluctuations.

On behalf of the Canaveral Port Authority,

Thank you.

Collins

Collins K. McKay, P.E.

Picture (Metafile)  
445 Challenger Road - Suite 130  
Cape Canaveral, Florida 32920

Office: 321-799-1236  
Fax: 321-799-1183  
Email: cmckay@ch2m.com <mailto:cmckay@ch2m.com>

**Port Canaveral Section 203 Feasibility Study  
Engineering Appendix**

Attachment O

Project Schedule

Rev Date: October 2012



**Port Canaveral Section 203 Feasibility Study  
Engineering Appendix**

Attachment P

Canaveral Ocean Dredged Material Disposal Site (ODMDS)  
Site Management and Monitoring Plan (SMMP)



**CANAVERAL HARBOR  
OCEAN DREDGED MATERIAL DISPOSAL SITE**



U.S. Army Corps  
of Engineers

**SITE MANAGEMENT  
AND MONITORING PLAN**

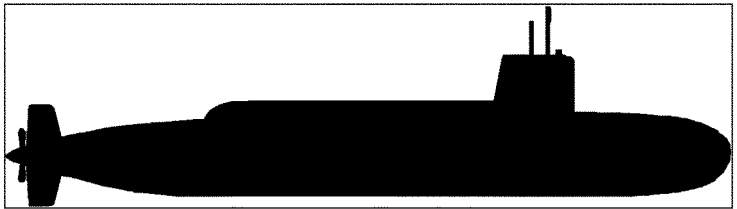
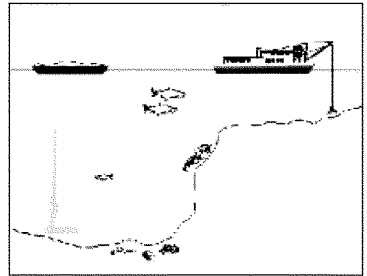
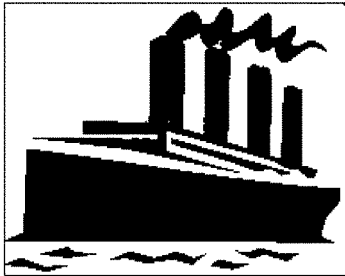
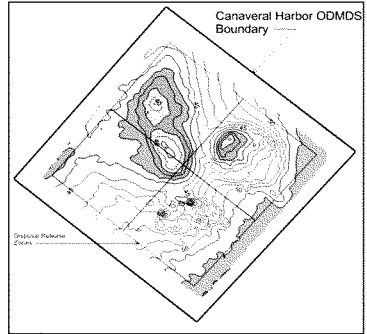
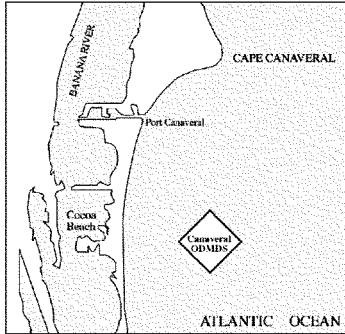

The following Site Management and Monitoring Plan for the Canaveral Harbor ODMDS has been developed and agreed to pursuant to the Water Resources Development Act Amendments of 1992 (WRDA 92) to the Marine Protection, Research, and Sanctuaries Act of 1972 for the management and monitoring of ocean disposal activities, as resources allow, by the U.S. Environmental Protection Agency and the U.S. Army Corps of Engineers.



---

Colonel Alfred A. Pantano  
District Commander  
Jacksonville District  
U.S. Army Corps of Engineers  
Jacksonville, Florida

2/29/12

Date



---

2/21/2012



Gwendolyn Keyes Fleming Date  
Regional Administrator  
U.S. Environmental Protection Agency  
Region 4  
Atlanta, Georgia

This plan is effective from the date of signature for a period not to exceed 10 years. The plan shall be reviewed and revised more frequently if site use and conditions at site indicate a need for revision.

**CANAVERAL HARBOR OCEAN DREDGED MATERIAL DISPOSAL SITE  
SITE MANAGEMENT AND MONITORING PLAN**

TABLE OF CONTENTS

<u>Section</u>	<u>Page</u>
1.0 INTRODUCTION .....	1
1.1 Site Management and Monitoring Plan Team .....	1
2.0 SITE MANAGEMENT.....	2
2.1 Disposal Site Characteristics.....	2
2.2 Management Objectives.....	3
2.3 Disposal History and Dredged Material Volumes .....	4
2.4 Dredged Material Characteristics .....	8
2.4.1 Previously Placed Materials.....	8
2.4.2 Anticipated Materials.....	8
2.4.3 Associated Beach Quality Materials.....	8
2.4.4 Dredge Material Quality Verification .....	9
2.5 Time of Disposal.....	9
2.6 Disposal Technique.....	9
2.7 Disposal Location .....	9
2.8 Permit and Contract Conditions.....	12
2.9 Permit Process.....	13
2.10 Information Management of Dredged Material Placement Activities.....	13
3.0 SITE MONITORING .....	14
3.1 Baseline Monitoring.....	14
3.2 Disposal Monitoring .....	17
3.3 Post Discharge Monitoring.....	18
3.4 Material Tracking and Disposal Effects Monitoring .....	18
3.4.1 Summary of Results of Past Monitoring Surveys.....	19
3.4.2 Future Monitoring Surveys .....	20
3.5 Reporting and Data Formatting .....	24
3.5.1 Project Initiation and Violation Reporting.....	24
3.5.2 Disposal Monitoring Data.....	24
3.5.3 Post Disposal Summary Reports.....	24
3.5.4 Environmental Monitoring.....	24
4.0 MODIFICATION OF THE CANAVERAL HARBOR ODMDS SMMP.....	25
5.0 REFERENCES .....	26



LIST OF FIGURES

<u>Figure No.</u>	<u>Title</u>	<u>Page</u>
Figure 1.	Canaveral Harbor ODMDS Location Map .....	3
Figure 2.	Volume and Sources of Dredged Material Disposed in the Canaveral Harbor ODMDS .....	6
Figure 3.	Canaveral Harbor ODMDS Release Zones .....	12
Figure 4.	Canaveral Harbor ODMDS 2010 Bathymetry.....	17

LIST OF TABLES

<u>Table No.</u>	<u>Title</u>	<u>Page</u>
Table 1.	Dredged Material Disposal Projects 2002-2011 .....	5
Table 2.	Annual Disposal Volumes 2002-2011 .....	6
Table 3.	Projected Volume of Dredged Material Disposed in the Canaveral Harbor ODMDS .....	7
Table 4.	Capacity Estimates Based on Existing Bathymetry and a Minimum Allowable Depth of 40 feet (MLLW).....	8
Table 5.	Canaveral Harbor ODMDS Disposal Release Zones .....	10
Table 6.	Summary of Permit and Contract Conditions.....	13
Table 7.	Surveys Conducted at the Canaveral Harbor ODMDS.....	15-16
Table 8.	Canaveral Harbor ODMDS Monitoring Strategies and Thresholds for Action.....	21-23

APPENDICES

Appendix A: Historic Dredged Material Disposal Volumes

Appendix B: Water Column Evaluations: Numerical Model (STFATE) Input Parameters

Appendix C: Template for MPRSA 103 Standard Permit Conditions

Appendix D: Template for Ocean Disposal Contract Specifications

Appendix E: Surveys and Studies Conducted at the Canaveral Harbor ODMDS (1984-2000)

2012  
Canaveral Harbor ODMDS  
Site Management and Monitoring Plan

## 1.0 INTRODUCTION

It is the responsibility of the U.S. Environmental Protection Agency (EPA) and the U.S. Army Corps of Engineers (USACE) under the Marine Protection, Research, and Sanctuaries Act (MPRSA) of 1972 to manage and monitor each of the Ocean Dredged Material Disposal Sites (ODMDSs) designated by the EPA pursuant to Section 102 of MPRSA. Section 102(c)(3) of the MPRSA requires development of a Site Management and Monitoring Plan (SMMP) for each ODMDS and review and revision of the SMMP not less frequently than every 10 years. The 1996 document, *Guidance Document for Development of Site Management Plans for Ocean Dredged Material Disposal Sites* (EPA/USACE, 1996) and the EPA Region 4 and USACE South Atlantic Division Memorandum of Understanding (EPA/USACE, 2007) have been used as guidance in developing this SMMP.

A SMMP was originally developed as part of the designation process and was published in August 1990 as part of, *Final EIS Canaveral Harbor, Florida Ocean Dredged Material Disposal Site Designation* (EPA, 1990). It was revised in 2001 to incorporate the provisions of the 1992 Water Resources Development Act, which requires the SMMPs to be reviewed and revised not less frequently than every ten years. This revision to the Canaveral Harbor ODMDS SMMP incorporates monitoring results since the 2001 SMMP and updates management strategies for the ODMDS based on those results. The SMMP provisions shall be requirements for all dredged material disposal activities at the site. All Section 103 (MPRSA) ocean disposal permits or contract specifications shall be conditioned as necessary to assure consistency with the SMMP.

1.1 Site Management and Monitoring Plan Team. An interagency SMMP team was established to assist EPA and USACE in developing the 2001 Canaveral Harbor ODMDS SMMP. The team consisted of the following agencies and their respective representatives:

- Jacksonville District U.S. Army Corps of Engineers
- State of Florida (Coastal Zone Management Office)
- EPA Region 4
- U.S. Navy
- Canaveral Port Authority
- National Marine Fisheries Service (NMFS)
- U.S. Coast Guard

These agencies will continue to be consulted in revisions to the Canaveral Harbor ODMDS SMMP. Other agencies such as the Bureau of Ocean Energy Management (BOEM) will be asked to participate where appropriate. The team will assist EPA and USACE on deciding on appropriate disposal practices, appropriate monitoring techniques, the level of monitoring, the significance of results and potential management options.

Specific responsibilities of EPA and the Jacksonville District Corps of Engineers are:

EPA: EPA is responsible for designating/dedesignating MPRSA Section 102 Ocean Dredged Material Disposal Sites, for evaluating environmental effects of disposal dredged material at these sites and for reviewing and concurring on dredged material suitability determinations.

USACE: The USACE is responsible for evaluating dredged material suitability, issuing MPRSA Section 103 permits, regulating site use and developing and implementing disposal monitoring programs.

## 2.0 SITE MANAGEMENT

Section 228.3 of the Ocean Dumping Regulations (40 CFR 220-229) states: "Management of a site consists of regulating times, rates, and methods of disposal and quantities and types of materials disposed of; developing and maintaining effective ambient monitoring programs for the site; conducting disposal site evaluation studies; and recommending modifications in site use and/or designation."

### 2.1 Disposal Site Characteristics

The designation of the Canaveral Harbor ODMDS can be found in 40 CFR 228.15(h)(10). Coordinates in the CFR are provided in NAD 27. They have been converted to NAD83 in this document. The Canaveral Harbor ODMDS is a 2 nautical mile (nmi) by 2 nmi area centered at 28°18.750'N latitude and 80°30.986'W longitude (NAD 83) or state plane coordinates 1,446,630 ft N and 811,757 ft E (NAD83). The site coordinates are as follows:

	Geographic NAD 83		State Plane (Florida East 0901 U.S. Ft) NAD 83	
	North	28 ° 20.267'N	80 ° 31.170'W	1,455,819 N
East	28 ° 18.867'N	80 ° 29.236'W	1,447,378 N	821,139 E
South	28 ° 17.234'N	80 ° 30.870'W	1,437,446 N	812,416 E
West	28 ° 18.617'N	80 ° 32.736'W	1,445,788 N	802,376 E

The site (see Figure 1) lies in the Canaveral Bight on the shallow continental shelf, centered 4.5 nmi offshore Cocoa Beach, Florida, has a depth range of 12 meters (39 feet) to 17 meters (54 feet) and an area of 4 nmi<sup>2</sup>. Physical and biological conditions at the ODMDS are described in,

*Final Environmental Impact Statement Canaveral Harbor, Florida Ocean Dredged Material Disposal Site Designation (EPA, 1990).*

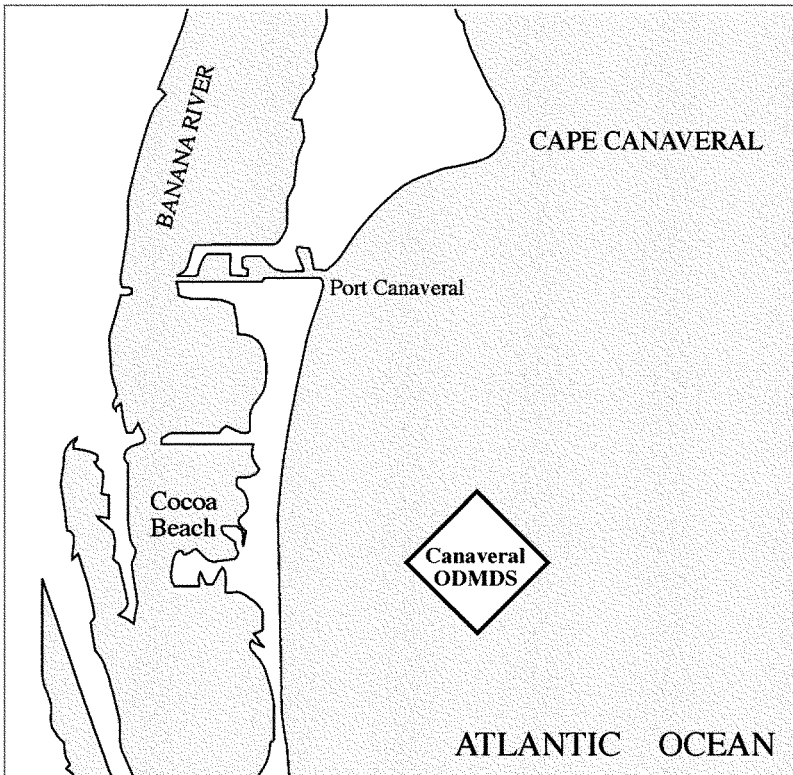

Figure 1: Canaveral Harbor ODMDS Location Map.

**2.2 Management Objectives.** Appropriate management of an ODMDS is aimed at assuring that disposal activities will not unreasonably degrade or endanger human health, welfare, the marine environment or economic potentialities (MPRSA §103(a)). The primary objectives in the management of the Canaveral Harbor ODMDS are:

- Protection of the marine environment;
- Documentation of disposal activities and compliance; and
- Maintenance of a long term disposal alternative for dredged material generated in the

### Canaveral, Florida vicinity

The following sections provide the framework for meeting these objectives to the extent possible.

2.3 Disposal History and Dredged Material Volumes. It is intended that the Canaveral Harbor ODMDS will be used for dredged material from the greater Canaveral, Florida vicinity. The three primary users of the Canaveral Harbor ODMDS are:

- U.S. Army Corps of Engineers for Civil Works (West and Middle Turning Basins, Entrance Channel (Cut 1), Inner Channel (Cuts 2 and 3), and the Barge Canal)
- U.S. Navy (Trident Access Channel and Turning Basin, Cut 1A, Entrance Channel Widener)
- Canaveral Port Authority (West and Middle Turning Basins and Berthing Areas, Sand Trap)

Since 1974, approximately 28 million cubic yards of dredged materials have been disposed in the Canaveral Harbor ODMDS (Tables 1 and 2 and Appendix A). Since 1990 (the date of site designation), approximately 14.6 million cubic yards of dredged materials have been disposed in the Canaveral Harbor ODMDS. Between 1974 and 1990, the average annual volume of dredged material disposed in the ocean was about 943,000 cubic yards and between 1990 and 2000 the average annual disposal volume was about 847,000 cubic yards. Over the last ten years, the annual average has decreased to 550,000 cubic yards per year. The reduction in annual volumes is due to a lack of significant construction dredging projects, beneficial use of material at the nearshore site and sand tightening of the north jetty structure, which has resulted in a reduction in the amount of shoaling. Figure 2 shows the yearly record of ocean dredged material disposal in the Canaveral Harbor ODMDS for the period 1990 through 2011.

Table 1: Dredged Material Disposal Projects 2002-2011

Dates	Dredging Area	Permittee	Permit No.	Characteristics	Maintenance/ New Work	Volume Disposed Per Zone			ODMDS Total
						North	South	East	
8/25/02-9/14/02	CT5, CT10, NCP1-2, NCP4, SCP1-2, WTB	CPA	200005030	silt with sand	Maintenance		91,079		91,079
6/15/02-8/28/02	Cuts 2b, 82c, MTB-4	CW/Navy	199904378		Maintenance		665,396		665,396
6/27/03-7/23/03	WTB, MTB, TAC, CT8	CPA	200005030	silt/clay/sand	Maintenance		133,804		133,804
5/11/03-6/26/03	Cut1, WTB, WAC, Cut 2b	CW/Navy	199904378	silt/clay/sand	Maintenance		526,500		526,500
6/15/04-8/1/04	Cut2, Cut1, TAC, TTB	CW/Navy	199904378	silt/clay	Maintenance		263,643		263,643
12/21/04-12/22/04	NCP3, CT8	CPA	200005030	silt/clay/sand	Maintenance		10,565		10,565
6/15/05-10/29/05	Cut2, Cut1	CW/Navy	199904378	silt/clay	Maintenance		417,995		417,995
6/20/06-11/11/06	Cuts 1b&18&2&3, MTB	CW		silts/clays/sand	Maintenance		378,060		378,060
9/10/06-11/2/06	WTB, CT8, CT10, CT5, NCP1/2	CPA	200005030		Maintenance	104,471			104,471
5/1/07-7/9/07	South Jetty Sediment Trap	CPA	2005-3195		New Work		368,160		368,160
11/5/07-11/26/07	CT6/7, CT10, NCP3/4	CPA	200005030	mud		124,756			124,756
6/30/07-2/6/08	EC, TAC, TTB, MTB	CW/Navy			Maintenance		436,627		436,627
7/17/2008-10/6/08	Cuts 1b&1&2, TAC, TTB, Poseidon Wharf	CW/Navy	20075637	mud, sand, clay, soft clay	Maintenance		286,230		286,230
2/11/09-2/28/09	WTB	CPA	200005030		Maintenance		92,160		92,160
2/28/09-4/4/09	ICCO	CPA	19871217		New Work		239,714		239,714
5/12/10-8/5/10	Cuts 1, &2, TAC, TTB	CW/Navy	20075637	mud, clay, sand, soft-clay	Maintenance		1,170,762		1,170,762
5/14/11-6/14/11	South Jetty Sediment Trap	CPA	2005-3195	Sand, silt, clay	Maintenance	172,130			172,130
5/27/11-9/3/2011	WTB CCO Phase 2	CPA	19871217	Silt, clay, silty sand	New Work		322,580		322,580
<b>Total</b>						<b>401,357</b>	<b>1,165,902</b>	<b>4,237,373</b>	<b>0 5,804,632</b>

Table 2: Annual Disposal Volumes 2002-2011

Year	CPA	CW	Navy	Total
2002	91,079	624,407	40,989	756,475
2003	133,804	526,500	-	660,304
2004	10,565	238,162	25,481	274,208
2005		416,257	1,738	417,995
2006	104,471	378,060	-	482,531
2007	492,916	305,535	131,092	929,543
2008		263,683	22,547	286,230
2009	331,874	-	-	331,874
2010		1,152,022	18,740	1,170,762
2011	494,710	-	-	494,710
Total	1,659,419	3,904,626	240,587	5,804,632
Percent	29%	67%	4%	100%

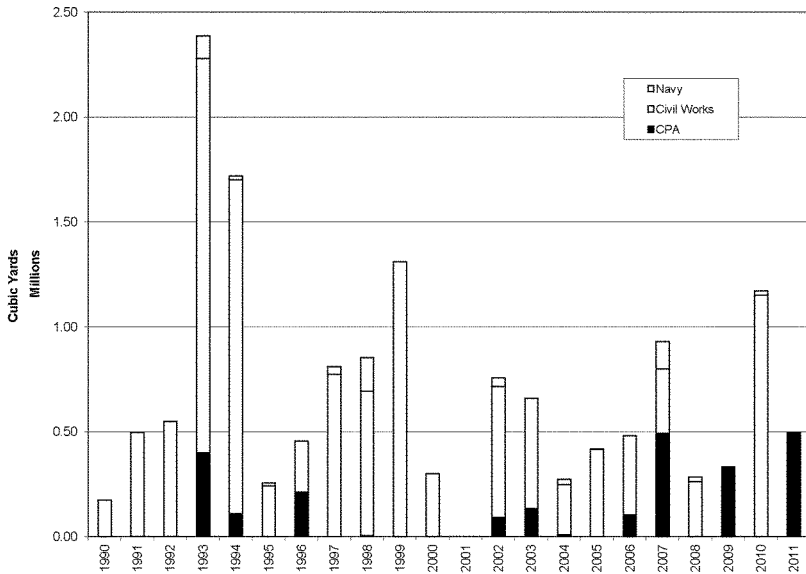

Figure 2: Volume and Sources of Dredged Material Disposed at the Canaveral Harbor ODMDS

Future volumes and rates of disposal, from both Federal and non-federal applicants, are expected to average around 900,000 cubic yards per year. Short term (10 year) projected disposal volumes are shown in Table 3 and total 9.2 million cubic yards over ten years. Civil works projects for Canaveral Harbor are anticipated to account for a majority of the total volume of material to be disposed at the ODMDS.

**Table 3.** Projected Volume of Dredged Material Disposed in the Canaveral Harbor ODMDS (10 year)

Year	Type of Action	Source	Volume <sup>1</sup> (yd <sup>3</sup> )	Sponsor <sup>2</sup>	Composition
2012-2022	MD	Entrance Channel, West and Middle Turning Basins, Inner Channel and Barge Canal	364,000 per year	Civil Works	Silt and Fine Sand
2012-2022	MD	Entrance Channel Widener, Cut 1A & Trident Access Channel and Turning Basin	26,000 per year	Navy	Silt and Fine Sand
2012-2022	MD	Berthing Areas	74,000 per year	CPA	Silt and Fine Sand
2012	NW	CT5&6	178,000	CPA	Silty Sand
2012-2022	NW	Canaveral Shoals 1 offshore borrow area access lane	200,000	CW/KSC/ PAFB/BC	Silty Sand
2012-2022	MD	S. Jetty Sed. Trap	50,000 per year	CPA	Silt and Fine Sand
2012	NW	NCB8	139,000	CPA	Silts and Sands
2012	NW	Permitted CCO Ph 2 Deepening	202,000	CPA	Silt and Fine Sand
2012	NW	NCB 5/6	36,000	CPA	Silts and Fine Sand
2013-2014	NW	NCB 8 Expansion Setback	166,000	CPA	Silt and Fine Sand
2014	NW	Deepening and Widening of the Entrance Channel and Channel to MTB	3,100,000	Civil Works	Unknown

<sup>1</sup>*In situ*

<sup>2</sup>NW: New Work; MD: Maintenance Dredging; CPA: Canaveral Port Authority; KSC: Kennedy Space Center; PAFB: Patrick Air Force Base; BC: Brevard County

The Canaveral Harbor ODMDS has been determined to be a dispersive site (EPA, 1990). However, the dispersiveness of the site and consequently the long-term capacity of the ODMDS has yet to be determined. Site-specific field data has been collected to facilitate modeling the long-term capacity of the ODMDS (see Section 3.4.1). Capacity estimates based on the available fill volume using existing bathymetry and a maximum depth of -40 feet MLLW have been conducted for each release zone (see Table 4). Dispersion and consolidation of the disposed dredged material was not considered, nor was the need for side-slopes of the disposal mound. Therefore, use of these estimates for long range planning purposes should be cautioned. The capacity to a depth of -40 feet MLLW was estimated at 23.9 million cubic yards or 18.4 million



cubic yards *in situ* based on a bulking factor of 1.3 (Hensch, 2011).

**Table 4:** Capacity Estimates Based on Existing Bathymetry and a Minimum Allowable Depth of -40 feet (MLLW).

Release Zone <sup>1</sup>	Capacity (million cubic yards)	<i>In Situ</i> Capacity (million cubic yards)
North	3.6	2.8
East	7.6	5.9
West	4.3	3.3
South	8.2	6.3
<b>Total</b>	<b>23.9</b>	<b>18.4</b>

<sup>1</sup>See Section 2.7

Until the capacity of the ODMDS has been determined utilizing USACE approved models, use of the ODMDS should not exceed half the estimated remaining site capacity (9.2 million cubic yards). This will allow sufficient time for a more detailed assessment of site capacity, implementation of management options, or environmental studies for site expansion to be conducted if necessary without adversely impacting maintenance dredging of the Port. Based on current estimates, exceedence of this volume is not anticipated. Should the approval of any project cause the exceedence of this value, an analysis of the remaining capacity of the ODMDS will have to be conducted by the USACE or permit applicant, as the case may be, prior to approval for ocean disposal of the project. The analysis should demonstrate that more than half the remaining capacity will not be consumed within the next ten years from the date of the analysis.

## 2.4 Dredged Material Characteristics.

2.4.1 Previously Placed Materials. Materials placed in the Canaveral Harbor ODMDS have historically consisted of silty sand, and silts and clay. Since 1992, most dredged material with less than 20 percent silt has been placed in a nearshore area rather than the ODMDS.

2.4.2. Anticipated Materials. Two basic sources of material are expected to be placed at the site; new work dredged material and maintenance material. These materials will consist of mixtures of silt, clay and sand in varying percentages. Dredged material with less than 20 percent silt is anticipated to be placed at the nearshore area rather than the ODMDS.

2.4.3 Associated Beach Quality Materials. USACE Beneficial Use of Dredged Material EM 1110-2-5026 requires dredged material be maximized within the coastal system. Dredged materials that qualify for beach or near-shore placement per the FDEP's 'Sand Rule' shall be beneficially placed in such location, to the maximum extent practicable. It is expected that the State of Florida will exercise its authority and responsibility, regarding beach nourishment, to the full extent during any future permitting activities. Beneficial use of beach compatible dredged material for beach nourishment is strongly encouraged and supported by EPA.

2.4.4 Dredge Material Quality Verification. The suitability of dredged material for ocean disposal must be verified by the USACE and agreed to via written concurrence from EPA prior to disposal. Verification will be valid for three years from the most current verification.

Verification process:

- 1) Case-specific evaluation against the exclusion criteria (40 CFR 227.13(b))
- 2) Determination of testing requirements for non-excluded material based on the potential of sediment contamination since last verification.
- 3) When applicable, execute testing and determination of suitability of non-excluded material for ocean disposal.

Verification documentation for suitability will be completed prior to use of the Canaveral Harbor ODMDS. Documentation will be in the form of a MPRSA Section 103 Evaluation. Potential testing and the Evaluation will follow the procedures outlined in the 1991 EPA/USACE Dredged Material Testing Manual and 2008 Southeast Regional Implementation Manual (SERIM) or the appropriate updated versions. This includes how dredging projects will be subdivided into project segments for sampling and analysis. The MPRSA Section 103 Evaluation will be in the form outlined in Appendix C of the SERIM. Water Quality Compliance determinations will be made using the STFATE (ADDAMS) model and the input parameters provided in Appendix B of this document. Only material determined to be suitable through the verification process by the USACE and EPA, Region 4 will be placed at the Canaveral Harbor ODMDS.

2.5 Time of disposal. At present no restrictions have been determined to be necessary for disposal related to seasonal variations in ocean current or biotic activity. As monitoring results are compiled, should any such restrictions appear necessary, disposal activities will be scheduled so as to avoid adverse impacts. During the winter, precautions necessary to protect whales, as described in Section 2.6, are required. Additionally, if new information indicates that endangered or threatened species are being adversely impacted, restrictions may be incurred.

2.6 Disposal Technique. No specific disposal technique is required for this site. However, in order to protect North Atlantic right whales, disposal vessel (either hopper dredge or tug and scow) speed and operation will be restricted in accordance with the most recent USACE South Atlantic Division Endangered Species Act Section 7 Consultation Regional Biological Opinion for Dredging of Channels and Borrow Areas in the Southeastern United States. In addition, the disposal vessel's captain should be aware of the vessel approach restrictions in 50 CFR §224.103 which at the time of this SMMP prohibits approach within 500 yards of a right whale by vessel, aircraft, or any other means.

2.7 Disposal Location. 40 CFR §227.28 requires that disposal occur no less than 330 feet (100 meters) inside the designated site boundaries. Release zones have been established to satisfy this criterion as well as manage dredged material disposal from multiple site users and multiple

projects. The release zones are described below in Table 5 and shown in Figure 3. Disposal shall be initiated within the applicable release zone boundary and completed (i.e. doors closed) prior to leaving the ODMDS boundaries. Placement methods, which prevent mounding of dredged materials from becoming an unacceptable navigation hazard, will be used. Dredged material shall be disposed so that at no point will depths less than -40 feet Mean Lower Low Water (MLLW) occur (i.e., a clearance of 40 feet above the bottom will be maintained) until further studies have been completed (see Section 2.3).

Table 5: Canaveral Harbor ODMDS Disposal Release Zones

## North Zone

Vertices	Geographic NAD 83		State Plane (Florida East 0901 U.S. Ft) NAD 83	
North	28 ° 19.921'N	80 ° 31.133'W	810,940	1,453,721
East	28 ° 19.380'N	80 ° 30.386'W	814,961	1,450,458
South	28 ° 18.746'N	80 ° 31.003'W	811,666	1,446,607
West	28 ° 19.120'N	80 ° 31.503'W	807,714	1,449,851
The north zone is for disposal of material from the Canaveral Port Authority maintenance projects.				

## South Zone

Vertices	Geographic NAD 83		State Plane (Florida East 0901 U.S. Ft) NAD 83	
North	28 ° 18.746'N	80 ° 31.003'W	811,666	1,446,607
East	28 ° 18.208'N	80 ° 30.269'W	815,618	1,443,364
South	28 ° 17.578'N	80 ° 30.899'W	812,525	1,439,532
West	28 ° 18.113'N	80 ° 31.620'W	808,372	1,442,757
The south zone is for disposal of material from the Canaveral Port Authority construction projects and any civil works construction projects such as the proposed port widening and deepening.				

## East Zone

Vertices	Geographic NAD 83		State Plane (Florida East 0901 U.S. Ft) NAD 83	
	North	28 ° 19.380'N	80 ° 30.386'W	814,961
East	28 ° 18.839'N	80 ° 39.638'W	818,982	1,447,196
South	28 ° 18.208'N	80 ° 30.269'W	815,618	1,443,364
West	28 ° 18.746'N	80 ° 31.003'W	811,666	1,446,607
The east zone is for disposal of material from the U.S. Navy and USACE Civil Works maintenance projects.				

## West Zone

Vertices	Geographic NAD 83		State Plane (Florida East 0901 U.S. Ft) NAD 83	
	North	28 ° 19.284'N	80 ° 31.738'W	807,714
West	28 ° 18.746'N	80 ° 31.003'W	811,666	1,446,607
South	28 ° 18.113'N	80 ° 31.620'W	808,372	1,442,757
East	28 ° 18.648'N	80 ° 32.342'W	804,488	1,445,982
The west zone is for disposal of material from the U.S. Navy and USACE Civil Works maintenance projects.				

While control of placement to minimize mounding is preferred, the physical removal or leveling of material above -30 feet MLLW is a management alternative.

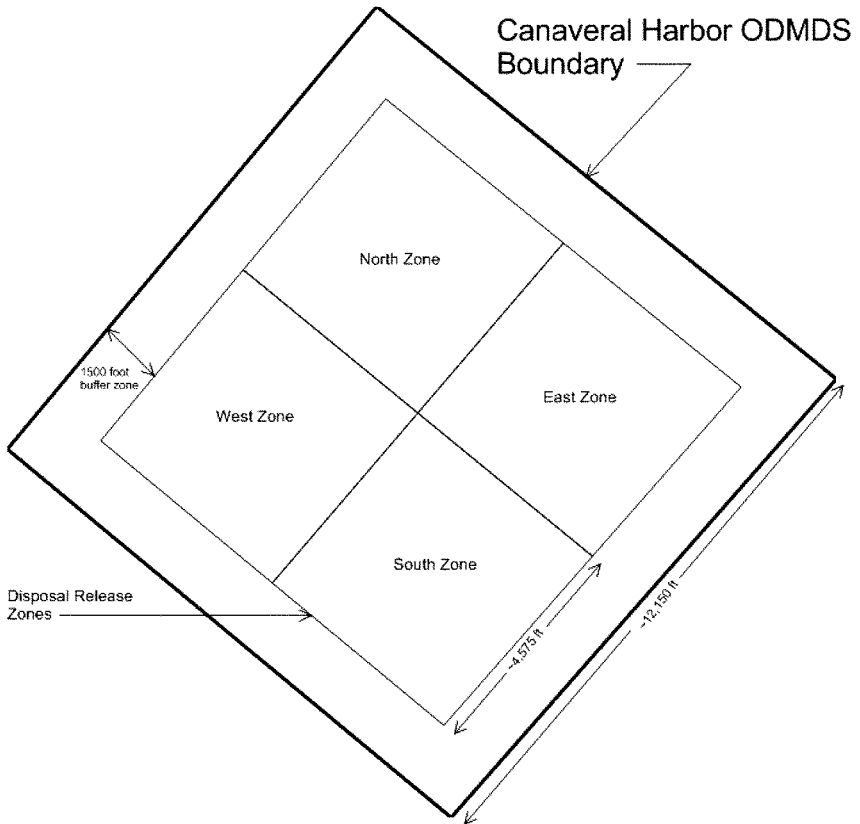

Figure 3: Canaveral Harbor ODMDS Disposal Release Zones

**2.8 Permit and Contract Conditions.** The disposal monitoring and post-disposal monitoring requirements described under Site Monitoring will be included as permit conditions on all MPRSA Section 103 permits and will be incorporated in the contract language for all federal projects. A summary of the management and monitoring requirements to be included are listed in Table 6. Template language that can be used is included in appendices (see Appendix C and D).

**Table 6.** Summary of Permit and Contract Conditions

Condition	Reference
Dredged Material Suitability and Term of Verification	Canaveral Harbor ODMDS SMMP page 9, Southeast Regional Implementation Manual
Disposal within Appropriate Zones	Canaveral Harbor ODMDS SMMP page 9-11
Northern Right Whale Avoidance	Canaveral Harbor ODMDS SMMP page 9
Post Bathymetric Surveys within 30 days of Project Completion	Canaveral Harbor ODMDS SMMP page 18
Biannual Full Site Bathymetry Surveys	Canaveral Harbor ODMDS SMMP page 22
Disposal Monitoring and Recording of Disposal Locations	Canaveral Harbor ODMDS SMMP page 18
Reporting Requirements: Disposal Summary Reports within 90 Days of Project Completion	Canaveral Harbor ODMDS SMMP page 24

2.9 Permit Process. All disposal of dredged material in the ocean, with the exception of Federal Civil Works projects, requires an ocean dumping permit issued by the USACE pursuant to Section 103 of the MPRSA. A summary of the permitting process can be found at: [http://www.epa.gov/region4/water/oceans/Dredged\\_Material\\_Permit\\_Process.htm](http://www.epa.gov/region4/water/oceans/Dredged_Material_Permit_Process.htm).

2.10 Information Management of Dredged Material Placement Activities. As discussed in the following sections, a substantial amount of diverse data regarding use of the Canaveral Harbor ODMDS and effects of disposal is required from many sources. If this information is readily available and in a useable format it can be used to answer many questions typically asked about a disposal site:

- What is being dredged?
- How much is being dredged?
- Where did the dredged material come from?
- Where was the dredged material placed?
- Was dredged material dredged and disposed correctly?
- What will happen to the environment at the disposal site?

In an attempt to streamline data sharing, EPA Region 4 and USACE South Atlantic Division have agreed on an eXtensible Markup Language (XML) standard for sharing of disposal monitoring data (see also Section 3.5). Additional standards will continue to be investigated for sharing of other disposal site related information (e.g. environmental monitoring data, testing data, etc.).

### 3.0 SITE MONITORING

The MPRSA establishes the need for including a monitoring program as part of the Site Management Plan. Site monitoring is conducted to ensure the environmental integrity of a disposal site and the areas surrounding the site and to verify compliance with the site designation criteria, any special management conditions, and with permit requirements. Monitoring programs should be flexible, cost effective, and based on scientifically sound procedures and methods to meet site-specific monitoring needs. The intent of the program is to provide the following:

- (1) Information indicating whether the disposal activities are occurring in compliance with the permit and site restrictions;
- (2) Information indicating the short-term and long-term fate of materials disposed of in the marine environment.
- (3) Information concerning the short-term and long-term environmental impacts of the disposal;

The main purpose of a disposal site monitoring program is to determine whether dredged material site management practices, including disposal operations, at the site need to be changed to avoid significant adverse impacts.

3.1 Baseline Monitoring. Disposal has occurred at the present site since 1974 and predates any data gathering at the site. Therefore, no true baseline information has or can be collected. The results of investigations presented in the designation EIS (See FEIS Appendices A, B, C, D, F, and G) and subsequent surveys listed in Appendix E and Table 7 will serve as the main body of data for the monitoring of the impacts associated with the use of the Canaveral Harbor ODMDS.

**Table 7. Surveys and Studies Conducted at the Canaveral Harbor ODMDS (2001-present)**

Survey/Study Title	Conducted By:	Date	Purpose	Results
Canaveral Harbor ODMDS Dredged Material Erosion Rate Analysis	EPA Region 4 / Sandia National Laboratories	2001	Determine erosive properties of dredged material as a function of density, consolidation and shear stress as input to long term fate models.	<ul style="list-style-type: none"> <li>- Disposed dredged material reaches full consolidation within 2 months.</li> <li>- Disposed dredged material is susceptible to erosion until full consolidation.</li> <li>- Parameters for LTFATE model calculated</li> </ul>
Spatial Analysis of Sediment Grain Size in the Vicinity of the Canaveral Harbor ODMDS	EPA Region 4	2003	Determine extent of physical impact due to dredged material disposal as determined by changes in grain size distribution.	-fine grain material in the vicinity of the Canaveral Harbor ODMDS does not appear to be originating from the ODMDS.
Ocean Current & Wave Measurements at the Canaveral Harbor ODMDS	EPA	2004	Determine site specific wave and current parameters for long and short term dredged material fate models.	<ul style="list-style-type: none"> <li>-Currents are predominately northerly directed &amp; of sufficient magnitude to initiate mound erosion 20% of the time.</li> <li>-Highest waves occur during late hurricane season and winter and are in excess of 3 meters.</li> <li>-Median wave height: 0.75 meters</li> <li>-Median wave period: 8.5 seconds</li> <li>-Wave periods are of sufficient length to influence near bottom currents.</li> </ul>



**Table 7. Surveys and Studies Conducted at the Canaveral Harbor ODMDS (2001-present)**

Survey/Study Title	Conducted By:	Date	Purpose	Results
Trend Assessment Survey at the Canaveral Harbor ODMDS	EPA Region 4	2007	Periodically evaluate the impact of disposal on the marine environment (40CFR 228.9)	-Organic tins elevated in northern disposal zone. -No significant differences identified between biological stations inside and outside the ODMDS. -Lower number of taxa and density of organisms in active disposal zones (north & east zones).
Cape Canaveral Tributary/Tin Study	EPA Region 4	2010	Determine bioavailability of organic tin through measurement of pore water concentrations.	-Organic tins not detected in the pore water. -Organic tins no longer elevated in the sediments in north disposal zone.
Post Disposal Bathymetry Surveys	USACE, Canaveral Port Authority	Annually 2001-2011	- Insure safe navigation depth. - Monitor bathymetric trends. - Determine the aerial extent of the disposal mounds.	- Minimum depth has increased at center of ODMDS from -30.5 feet (2000) to -39.3 feet (2010) - Mounds approaching -40 feet in north and east zones. - see Figure 4.

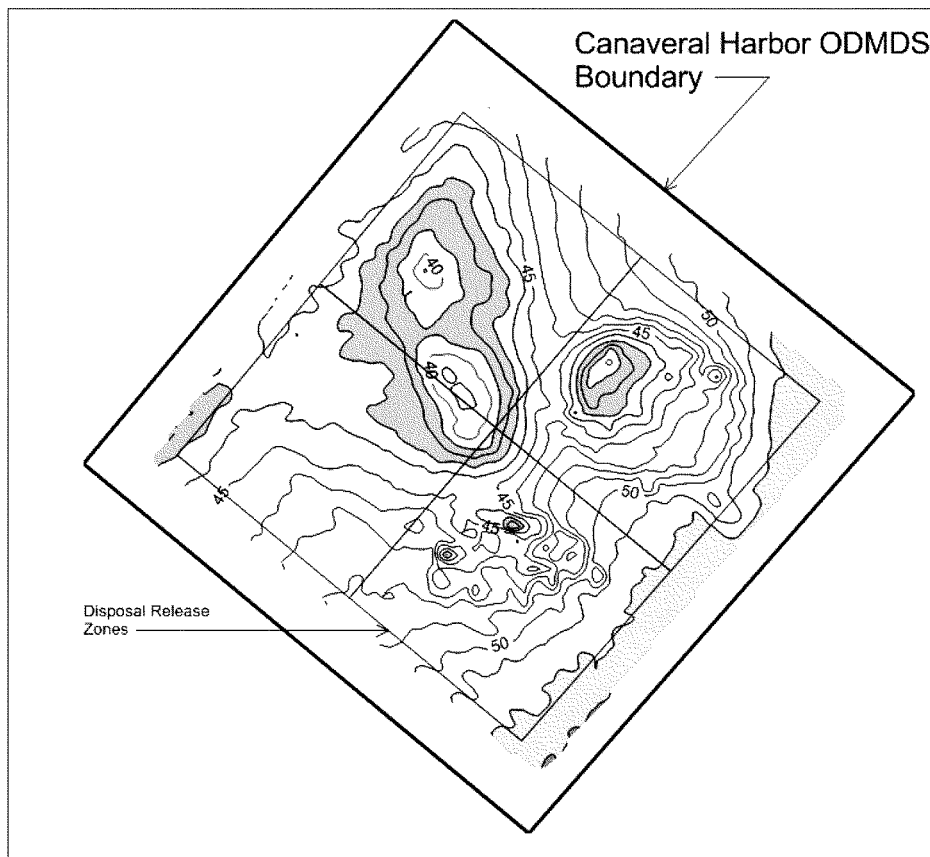

Figure 4: Canaveral Harbor ODMDS October 2010 Bathymetry

**3.2 Disposal Monitoring.** For all disposal activities, an electronic tracking system (ETS) must be utilized. The ETS will provide surveillance of the transportation and disposal of dredged material. The ETS will be maintained and operated to continuously track the horizontal location and draft condition (nearest 0.5 foot) of the disposal vessel (i.e. hopper dredge or disposal scow) from the point of dredging to the disposal site and return to the point of dredging. Data shall be collected at least every 500 feet during travel to and from the ODMDS and every minute or every 200 feet of travel, whichever is smaller, while approaching within 1,000 feet of the ODMDS and within the ODMDS. In addition to the continuous tracking data, the following trip

information shall be electronically recorded for each disposal cycle:

- a. Load Number
- b. Disposal Vessel Name and Type (e.g. scow)
- c. Tow Vessel Name (if applicable)
- d. Captain of Disposal or Tow Vessel
- e. Estimated volume of Load
- f. Description of Material Disposed
- g. Source of Dredged Material
- h. Date, Time and Location at Start at Initiation and Completion of Disposal Event

It is expected that disposal monitoring will be conducted utilizing the Dredge Quality Management (DQM) system for Civil Works projects [see <http://dqm.usace.army.mil/Specifications/Index.aspx>], although other systems are acceptable. Disposal monitoring and ETS data will be reported to EPA Region 4 on a weekly basis utilizing the eXtensible Markup Language (XML) specification and protocol per Section 3.5. EPA Region 4 and the USACE District shall be notified within 24 hours if disposal occurs outside of the ODMDS or specified disposal zone or if excessive leakage occurs.

**3.3 Post Discharge Monitoring.** The USACE or other site user will conduct a bathymetric survey within 30 days after disposal project completion. Surveys will not be required for projects less than 50,000 cubic yards. Bathymetric surveys will be used to monitor the disposal mound to insure a navigation hazard is not produced, to assist in verification of material placement, to monitor bathymetry changes and trends and to insure that the site capacity is not exceeded, i.e., the mound does not exceed the site boundaries. Surveys will conform to the minimum performance standards for Corps of Engineers Hydrographic Surveys for "Other General Surveys & Studies" as described in the USACE Engineering Manual, EM1110-2-1003, *Hydrographic Surveying* dated January 1, 2002 [<http://140.194.76.129/publications/eng-manuals/em1110-2-1003/toc.htm>]. The number and length of transects required will be sufficient to encompass the release zone utilized and a 500 foot wide area around it. The surveys will be taken along lines spaced at 500-foot intervals or less. The minimum performance standards from table 3-1 *Hydrographic Surveying* shall be followed. Horizontal location of the survey lines and depth sounding points will be determined by an automated positioning system utilizing a differential global positioning system. The vertical datum will be referenced to prescribed NOAA Mean Lower Low Water (MLLW) datum. The horizontal datum should be referenced to the local State Plane Coordinate System (SPCS) for that area or in Geographical Coordinates (latitude-longitude). The horizontal reference datum should be the North American Datum of 1983 (NAD 83).

**3.4 Material Tracking and Disposal Effects Monitoring.** Surveys can be used to address possible changes in bathymetric, sedimentological, chemical, and biological aspects of the ODMDS and surrounding area as a result of the disposal of dredged material at the site. The 2001 Canaveral

Harbor ODMDS SMMP included a Long-Term Monitoring Strategy aimed at primarily addressing capacity and the long-term fate of dredged material disposed at the ODMDS. Most of the tasks were completed. However, the modeling to address capacity issues and the long-term fate of the material was not initiated.

#### 3.4.1 Summary of Results of Past Monitoring Surveys

Appendix E and Table 7 lists the past surveys at the Canaveral Harbor ODMDS. In general, the surface of the site is covered by rippled very fine sand below which fine grained mud exists. The surface sands probably represent *in-situ* washing of the sediment with removal of fines from the upper surface. However, it is difficult to determine if the observed sand-over-mud stratigraphy is: 1) uniquely related to surficial washing of muddy dredged materials, 2) a natural phenomenon reflecting existing sedimentation of fines derived from coastal erosion or riverine input, 3) a result of reworking of ancient muddy sediments, or 4) a reflection of all of the above sources.

The surveys/studies listed in appendix E and table 7 have indicated that the ODMDS is a dispersive site for fine grained material and as a result dredged material may extend beyond the designated site boundaries. Indicators of dredged material (from the sediment mapping, REMOTS, sidescan sonar and bathymetric surveys) appear within the ODMDS and to the northwest. Dredged material to the northwest of the site is likely either a result of offsite transport or historic short dumping. Current measurements indicate predominate currents are to the north. Erosion of fine-grained material from the bottom appears to be taking place within the center of the disposal site and is apparently related to the presence of dredged material deposits over consolidated clays. A bathymetric survey conducted in January 2000 indicated significant mounding occurring near the center of the ODMDS. Since 2000, the mound height has decreased by nine feet as disposal has been diverted from this location. However, a mound with a relief of approximately 7 feet has developed in the northwest portion of the east release zone. See figure 4 for the most recent site bathymetry.

Erosion rate analysis has indicated that disposed dredged material is most susceptible to erosion within 60 days following disposal. Currents in the vicinity of the Canaveral Harbor ODMDS tend to the north-northeast paralleling the coast. Maximum surface currents exceeded 40 cm/sec. The median surface current was 10 cm/sec whereas the median bottom current was 6 cm/sec. The depth averaged median current was 7 cm/sec. Currents are not dominated by tides although there exists a tidal component. Velocities on the order of 16 cm/sec are needed to initiate erosion of Canaveral Harbor dredged material. Near bottom currents of this magnitude or greater occur approximately 20 percent of the time. If storms or other high current/wave events occur shortly after disposal, offsite transport of disposed dredged material is likely to occur.

A 2007 Trend Assessment Study of the Canaveral Harbor ODMDS indicated elevated organic tins in the sediments within the north release zone. Concentrations of tributyltin were as high as 57µg/kg compared to background levels of less than 0.7µg/kg. All other analytes were at

background levels. There were no significant differences identified between biological stations inside and outside the ODMDS. However, there were a lower number of taxa and density of organisms observed in the active release zones (North and East).

As a follow-up to the 2007 Trend Assessment Study, a study of the pore water concentration of organic tins was conducted in 2010. Organic tin partitioning is highly complex and the relationship between concentrations and observed effects is much stronger for pore water. Five sediment samples and five pore water samples were collected within the north release zone. Organic tins were not detected in either the pore water or sediment samples indicating that organic tin levels are no longer elevated due to degradation, dispersion or burial.

#### 3.4.2 Future Monitoring Surveys

Based on the type and volume of material disposed and impacts of concern, various monitoring surveys can be used to examine if and the direction the disposed dredged material is moving, and what environmental effect the material is having on the site and adjacent areas.

At the current time, no nearby biological resources have been identified that are of concern for potential impact. The Canaveral Harbor ODMDS is at least one nautical mile from all known fish havens, artificial reefs, and fishing areas. The site has been identified as partially dispersive. This means that it is expected that material will be moved outside the site boundaries. It is also expected that this material will not move in distinct mounds, but instead will blend with the surrounding environment causing a progressive transition to sediments containing a higher percentage of silt and clay. Changes in sediment composition will likely alter the benthic community structure. However, based on previous benthic studies, it is unlikely that permanent or long-term adverse impacts will result due to changes in sediment composition.

Concern has been raised regarding the potential for disposed dredged material impacting offshore sand sources and the magnitude and extent of disposed dredged material dispersal outside of the ODMDS boundaries. Additionally, mounding at the site has raised capacity concerns. Future surveys as outlined in Table 8 will focus on monitoring for adverse environmental effects and determining the rate and direction of disposed dredged material dispersal and the capacity of the ODMDS. Should future disposal at the Canaveral Harbor ODMDS result in unacceptable adverse impacts, further studies may be required to determine the persistence of these impacts, the extent of the impacts within the marine system, and/or possible means of mitigation. In addition, the management plan presented may require revision based on the outcome of any monitoring program.

**Table 8. Canaveral Harbor ODMDS Monitoring Strategies and Thresholds for Action**

Goal	Technique	Sponsor	Rationale	Frequency	Threshold for Action	Management Options	
						Threshold Not Exceeded	Threshold Exceeded
Trend Assessment	Water and Sediment Quality, Benthic Community Analysis (40CFR228.13)	U.S. EPA	Periodically evaluate the impact of disposal on the marine environment (40CFR 228.9)	Approximately every 10 years.	-Absence from the site of pollution sensitive biota -Progressive non-seasonal changes in water or sediment quality	Continue Monitoring	-Conduct Environmental Effects Monitoring or Advanced Environmental Effects Monitoring -Review dredged material evaluation procedures
Environmental Effects Monitoring	Chemical Monitoring	EPA/USACE	Determine if chemical contaminants are significantly elevated <sup>1</sup> within and outside of site boundaries	Implement if disposal footprint extends beyond the site boundaries or if Trend Assessment results warrant.	Contaminants are found to be elevated <sup>1</sup>	Discontinue monitoring.	- Institute Advanced Environmental Effects Monitoring - Implement case specific management options (ie. Remediation, limits on quantities or types of material).
	Benthic Monitoring	EPA/USACE	Determine whether there are adverse changes in the benthic populations outside of the site and evaluate recovery rates	Assessment results warrant.	Adverse changes observed outside of the site that may endanger the marine environment		-Consider isolating dredged material (capping)

<sup>1</sup> Significantly elevated: Concentrations above the range of contaminant levels in dredged sediments that the Regional Administrator and the District Engineer found to be suitable for disposal at the ODMDS.

<sup>2</sup> Examples of sub-lethal effects include without limitation the development of lesions, tumors, development abnormality, and/or decreased fecundity.

**Table 8. Canaveral Harbor ODMDS Monitoring Strategies and Thresholds for Action**

Goal	Technique	Sponsor	Rationale	Frequency	Threshold for Action	Management Options	
						Threshold Not Exceeded	Threshold Exceeded
Advanced Environmental Effects Monitoring	Tissue Chemical Analysis	EPA/ USACE	Determine if the site is a source of adverse bioaccumulation which may endanger the marine environment	Implement if Environmental Effects Monitoring warrants.	Benthic body burdens and risk assessment models indicate potential for food chain impacts.	Discontinue monitoring	-Discontinue site use - Implement case specific management options (i.e. Remediation, limits on quantities or types of material).
	Benthic Monitoring		Determine if the site is a source of adverse sub-lethal <sup>2</sup> changes in benthic organisms which may endanger the marine environment				
Monitor Bathymetric Trends	Bathymetry	USACE	Determine the extent of the disposal mound and major bathymetric changes	Every 2 years	Disposal mound occurs outside ODMDS boundaries	Continue Monitoring	-Modify disposal method/ -Restrict disposal volumes -Enlarge site
Insure Safe Navigation Depth	Bathymetry	Site User	Determine height of mound and any excessive mounding	Post disposal for projects greater than 50,000 cy	Mound height > -40 feet mean lower low water (MLLW)	Continue Monitoring	-Modify disposal method/ -Restrict disposal volumes
					Mound height > -30 feet MLLW	Continue Monitoring	- Physically level material

**Table 8. Canaveral Harbor ODMDS Monitoring Strategies and Thresholds for Action**

Goal	Technique	Sponsor	Rationale	Frequency	Threshold for Action	Management Options	
						Threshold Not Exceeded	Threshold Exceeded
Long-term Fate	LTFATE Modeling	CPA/ USACE	Determine dispersiveness of site and potential aerial extent of impact	-As resources allow	Measurable deposition (>5cm) outside of site boundaries	-Reduce buffer size to increase capacity -Continue site use without restrictions	-Increase buffer as needed. -Restrict disposal volumes. -Create sand berms to retard dredged material transport.
Site Capacity	Regional Grain Size Analysis or SPI	CPA/ USACE	Determine if site use if affecting grain size outside of the ODMDS	10 years	Significant decrease in mean grain size outside of ODMDS	Continue site use without restrictions	
Site Capacity	MDFATE Modeling	CPA/ USACE	Determine capacity of the site	-As resources allow - See section 2.3	Volumes exceed estimated capacity	Continue to use site without restrictions	-Enlarge site or designate new site. -Decrease depth restriction to ~30 feet.
Compliance	Disposal Site Use Records in EPA Region 4's XML format	Site User	-Insure management requirements are being met -To assist in site monitoring	Weekly during the project	Disposal records required by SMMP are not submitted or are incomplete	Continue Monitoring	-Restrict site use until requirements are met



### 3.5 Reporting and Data Formatting.

3.5.1 Project Initiation and Violation Reporting. The USACE or other site user shall notify EPA 15 days prior to the beginning of a dredging cycle or project disposal. The user is also required to notify the USACE and the EPA within 24 hours if a violation of the permit and/or contract conditions related to MPRSA Section 103 or SMMP requirements occur during disposal operations.

3.5.2 Disposal Monitoring Data. Disposal monitoring data shall be provided to EPA Region 4 electronically on a weekly basis. Data shall be provided per the EPA Region 4 XML format and delivered as an attachment to an email to [DisposalData.R4@epa.gov](mailto:DisposalData.R4@epa.gov). The XML format is available from EPA Region 4.

3.5.3 Post Disposal Summary Reports. A Post Disposal Summary Report shall be provided to EPA within 90 days after project completion. These reports should include: dredging project title; permit number and expiration date (if applicable); contract number; name of contractor(s) conducting the work, name and type of vessel(s) disposing material in the ODMDS; disposal timeframes for each vessel; volume disposed at the ODMDS (as paid *in situ* volume, total paid and un paid *in situ* volume, and gross volume reported by dredging contractor), number of loads to ODMDS, type of material disposed at the ODMDS; identification by load number of any misplaced material; dates of pre and post disposal bathymetric surveys of the ODMDS and a narrative discussing any violation(s) of the 103 concurrency and/or permit (if applicable). The narrative should include a description of the violation, indicate the time it occurred and when it was reported to the EPA and USACE, discuss the circumstances surrounding the violation, and identify specific measures taken to prevent reoccurrence. The Post Disposal Summary Report should be accompanied by the bathymetry survey results (plot and X,Y,Z ASCII data file), a summary scatter plot of all disposal start locations, and a summary table of the trip information required by Section 3.2 with the exception of the disposal completion data. If all data is provided in the required XML format, scatter plots and summary tables will not be necessary.

3.5.4 Environmental Monitoring. Material tracking, disposal effects monitoring, and any other data collected shall be coordinated with and be provided to SMMP team members and federal and state agencies as appropriate. Data will be provided to other interested parties requesting such data to the extent possible. Data will be provided for all surveys in a report generated by the action agency.

The report should indicate:

- 1)How the survey relates to the SMMP and previous surveys at the Canaveral Harbor ODMDS
- 2)Provide data interpretations, conclusions, and recommendations
- 3)Project the next phase of the SMMP

Monitoring results will be summarized in subsequent revisions to the SMMP.

#### 4.0 MODIFICATION OF THE CANAVERAL HARBOR ODMDS SMMP

Should the results of the monitoring surveys or reports from other sources indicate that continued use of the ODMDS would lead to unacceptable effects as determined by EPA and USACE; the ODMDS SMMP will be modified to mitigate the adverse impacts. The SMMP will be reviewed and revised at a minimum of every ten years. The SMMP will be reviewed and updated as necessary if site use changes significantly. For example, the SMMP will be reviewed if the quantity or type of dredged material placed at the site changes significantly or if conditions at the site indicate a need for revision.

## 5.0 REFERENCES

Continental Shelf Associates, Inc. 1986. *Final Report for Field Survey of the Canaveral Harbor Candidate Ocean Dredged Material Disposal Site*. A report for U.S. Department of the Army, Corps of Engineers, Jacksonville District.

Fredette, Thomas J., Nelson, David A., Clausner, James E., and Anders, Fred J. 1990. *Guidelines for Physical and Biological Monitoring of Aquatic Dredged Material Disposal Sites*, Technical Report D-90-12, US Army Engineer Waterways Experiment Station, Vicksburg, MS.

Hensch, Michael. 2011. Memorandum. Canaveral Harbor ODMDS Volume Calculations. December 12, 2011.

Pequegnat, Willis E., Gallaway, Benny J., and Wright, Thomas D., 1990. *Revised Procedural Guide for Designation Surveys of Ocean Dredged Material Disposal Sites*, Technical Report D-90-8, US Army Engineer Waterways Experiment Station, Vicksburg, MS.

Sandia National Laboratories. 2001 May. *Canaveral Harbor ODMDS Dredged Material Erosion Rate Analysis*. Carlsbad, NM.

U.S. Army Corps of Engineers (COE). 2002. *Engineering & Design - Hydrographic Surveying*. Engineering Manual 1110-2-1003, Department of the Army, Washington D.C.

U.S. Environmental Protection Agency (EPA). 1990. *Environmental Impact Statement (EIS) for Canaveral Harbor, Florida Ocean Dredged Material Disposal Site Designation A Supplement to the Jacksonville Harbor Dredged Material Disposal Final Environmental Impact Statement*, August 1990.

U.S. Environmental Protection Agency (EPA). 1991. *Canaveral Harbor, Florida, ODMDS Benthic Communities*, May 27, 1991. Prepared by Barry A. Vittor & Associates, Inc. under contract to Battelle Ocean Sciences for U.S. EPA, Office of Marine and Estuarine Protection.

U.S. Environmental Protection Agency (EPA). 1996. *Postdisposal Areal Mapping of Sediment Chemistry at the Canaveral, Florida ODMDS*, April 8, 1996. Prepared by Center for Applied Isotope Studies under contract to Battelle Ocean Sciences for U.S. EPA, Office of Wetlands, Oceans and Watersheds.

U.S. Environmental Protection Agency (EPA). 1989. *Sediment Mapping and Rapid Surveillance of Fernandina and Canaveral, Florida ODMDS, Florida ODMDS*, September 8, 1989. Prepared by Center for Applied Isotope Studies under contract to Battelle Ocean Sciences for U.S. EPA, Office of Wetlands, Oceans and Watersheds.

U.S. Environmental Protection Agency (EPA). 1990. *Canaveral Harbor Dredged Material Disposal Site REMOTS Survey*, August 24, 1990. Prepared by Science Applications International Corporation for U.S. EPA, Office of Research and Development.

U.S. Environmental Protection Agency and U.S. Army Corps of Engineers, 1991. *Evaluation of Dredged Material Proposed for Ocean Disposal (Testing Manual)*, February 1991. Prepared by Environmental Protection Agency Office of Marine and Estuarine Protection and Department of Army United States Army Corps of Engineers under EPA Contract No. 68-C8-0105.

U.S. Environmental Protection Agency and U.S. Army Corps of Engineers, 1996. *Guidance Document for Development of Site Management Plans for Ocean Dredged Material Disposal Sites*, February 1996. Prepared by Environmental Protection Agency Office of Water and Department of Army United States Army Corps of Engineers.

U.S. Environmental Protection Agency Region 4 and U.S. Army Corps of Engineers South Atlantic Division, 2008. *Southeast Regional Implementation Manual Requirements and Procedures for Evaluation of the Ocean Disposal of Dredged Material in Southeastern Atlantic and Gulf Coastal Waters*, August 2008.

Vann, Julie E. *A Study of Dredged Material Dispersion on the Inner Continental Shelf, Cape Canaveral, Florida* [thesis]. Melbourne, FL: Florida Institute of Technology; 1995.

APPENDIX A  
VOLUME OF DREDGED MATERIAL DISPOSED  
IN THE CANAVERAL ODMDS  
(1974-2000)

Volume of Dredged Material Disposed in the Canaveral ODMDS (1974-2000)

Year	Type of Action	Source	Volume (yd <sup>3</sup> )	Sponsor	Composition
1974	NW	Entrance Channel & Trident Basin	645,198	Navy	Sandy Silt
1974	MD	Entrance Channel & Trident Basin	223,986	Navy	Sandy Silt
1975	NW	Entrance Channel & Trident Basin	2,196,470	Navy	Sandy Silt
1975	MD	Entrance Channel & Trident Basin	187,212	Navy	Silty Sand
1975	MD	Trident Basin	63,077	Navy	Sandy Silt
1976	NW	Entrance Channel	1,343,121	Civil Works	Sandy Silt
1976	MD	Entrance Channel	341,888	Civil Works	Sandy Silt
1977	MD	Entrance Channel	48,017	Civil Works	Sandy Silt
1978	MD	Entrance Channel	282,517	Civil Works	Sandy Silt
1980	MD	Entrance Channel	1,402,547	Civil Works	Sandy Silt
1981	MD	Entrance Channel	257,326	Civil Works	Sandy Silt
1983	MD	Entrance Channel	929,555	Civil Works	Sandy Silt
1985	MD	Entrance Channel	2,958,827	Civil Works	Silty Sand
1986	NW	Entrance Channel	63,370	Civil Works	Silty Sand
1986	MD	Entrance Channel	351,535	Civil Works	Silty Sand
1988	MD	Entrance Channel	442,750	Civil Works	Silty Sand
1988	MD	Entrance Channel	1,200,188	Civil Works	Silt
1989	MD	Entrance Channel	203,000	Civil Works	Silt
1990	MD	Entrance Channel	173,772	Civil Works	Silt
1991	MD	Middle Turning Basin	497,380	Civil Works	Silt
1992	MD	Entrance Channel	342,000	Civil Works	Silt
1992	MD	Middle Turning Basin	208,000	Civil Works	Silt
1993	MD	Entrance Channel	1,878,460	Civil Works	Silt
1993	MD	Trident Access Channel	108,410	Navy	Silty Sand
1993	NW	W. Turning Basin SE Corner Cutoff	400,000	CPA	Clay
1994	NW	Entrance Channel	454,000	Civil Works	Silty Sand
1994	NW	Middle Turning Basin	1,039,000	Civil Works	Silty Sand

Year	Type of Action	Source	Volume (yd <sup>3</sup> )	Sponsor	Composition
1994	MD	Entrance Channel	98,820	Civil Works	Silt
1994	MD	Trident Access Channel	17,510	Navy	Sandy Silt
1994	MD	W. Turning Basin CT5	24,000	CPA	Sandy Clay
1994	NW	W. Turning Basin CT10	86,000	CPA	Silty Sand
1995	MD	Entrance Channel	243,180	Civil Works	Silt
1995	MD	Trident Access Channel & Turning Basin	12,090	Navy	Silt
1996	MD	Entrance Channel	245,274	Civil	Sandy Silt
1996	NW	W. Turning Basin CT8	212,000	CPA	Silty Sand
1997	MD	Entrance Channel	773,999	Civil Works	Sandy Silt
1997	MD	Trident Turning Basin	36,965	Navy	Silts & Clays
1998	MD	Entrance Channel	688,839	Civil Works	Sandy Silt
1998	MD	Entrance Channel, TTB, & Poseidon Wharf	160,044	Navy	Sandy Silts & Clays
1998	MD	W. Turning Basin CT5	5,600	CPA	Sandy Clay
1999	MD	Entrance Channel	1,312,703	Navy	Sandy Silt
2000	MD	Entrance Channel	300,320	Civil Works	Silt

NW: New Work MD: Maintenance Dredging CPA: Canaveral Port Authority  
All volumes are *in situ* volumes from surveys conducted at the dredging site.

APPENDIX B

WATER COLUMN EVALUATIONS  
NUMERICAL MODEL (STFATE) INPUT  
PARAMETERS



Water Column Evaluations  
Numerical Model (STFATE) Input Parameters  
Canaveral ODMDS

**SITE DESCRIPTION**

<b>Parameter</b>	<b>Value</b>	<b>Units</b>
Number of Grid Points (left to right)	45	
Number of Grid Points (top to bottom)	45	
Spacing Between Grid Points (left to right)	350	ft
Spacing Between Grid Points (top to bottom)	350	ft
Constant Water Depth	47	ft
Roughness Height at Bottom of Disposal Site	.005 <sup>1</sup>	ft
Slope of Bottom in X-Direction	0	Deg.
Slope of Bottom in Z-Direction	0	Deg.
Number of Points in Ambient Density Profile Point	3	
Ambient Density at Depth = 3 ft	1.0257	g/cc
Ambient Density at Depth = 26 ft	1.0257	g/cc
Ambient Density at Depth = 47 ft	1.0259	g/cc

**AMBIENT VELOCITY DATA**

<b>Parameter</b>	<b>Value</b>	<b>Units</b>
Profile	2-Point at constant depth	
X-Direction Velocity = 8 feet	-0.17	ft/sec
Z-Direction Velocity = 8 feet	0.29	ft/sec
X-Direction Velocity = 38 feet	-0.17	ft/sec
Z-Direction Velocity = 38 feet	0.11	ft/sec

**DISPOSAL OPERATION DATA**

<b>Parameter</b>	<b>Value</b>	<b>Units</b>
Location of Disposal Point from Top of Grid	7,875	ft
Location of Disposal Point from Left Edge of Grid	7,875	ft
Dumping Over Depression	0	

**INPUT, EXECUTION AND OUTPUT**

Parameter	Value	Units
Location of the Upper Left Corner of the Disposal Site - Distance from Top Edge	1,800	ft
Location of the Upper Left Corner of the Disposal Site - Distance from Left Edge	1,800	ft
Location of the Lower Right Corner of the Disposal Site - Distance from Top Edge	13,950	ft
Location of the Lower Right Corner of the Disposal Site - Distance from Left Edge	13,950	ft
Duration of Simulation	14,400	sec
Long Term Time Step	600	sec

**COEFFICIENTS**

Parameter	Keyword	Value
Settling Coefficient	BETA	0.000 <sup>1</sup>
Apparant Mass Coefficient	CM	1.000 <sup>1</sup>
Drag Coefficient	CD	0.500 <sup>1</sup>
Form Drag for Collapsing Cloud	CDRAG	1.000 <sup>1</sup>
Skin Friction for Collapsing Cloud	CFRIC	0.010 <sup>1</sup>
Drag for an Ellipsoidal Wedge	CD3	0.100 <sup>1</sup>
Drag for a Plate	CD4	1.000 <sup>1</sup>
Friction Between Cloud and Bottom	FRICTN	0.010 <sup>1</sup>
4/3 Law Horizontal Diffusion Dissipation Factor	ALAMDA	0.001 <sup>1</sup>
Unstratified Water Vertical Diffusion Coefficient	AKYO	Pritchard Expression
Cloud/Ambient Density Gradient Ratio	GAMA	0.250 <sup>1</sup>
Turbulent Thermal Entrainment	ALPHAO	0.235 <sup>1</sup>
Entrainment in Collapse	ALPHAC	0.100 <sup>1</sup>
Stripping Factor	CSTRIP	0.003 <sup>1</sup>

<sup>1</sup> Model Default Value

Expected dilution at 4 hours = 2,500:1.

Expected dilution at edge of disposal site > 60,000:1

Dilution will be dependent on the characteristics of the dredged material and the size of the disposal vessel. These values are for a very silty material with high water content and a 4,000 cubic yard scow.

# Canaveral ODMDS STFATE Input Parameters

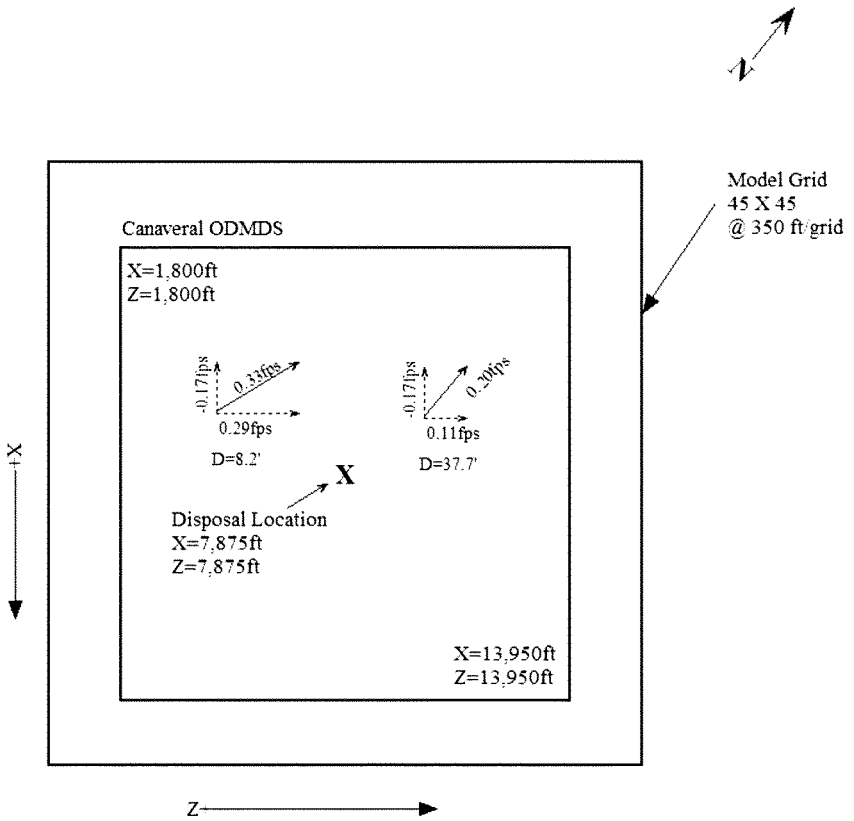

<b>Canaveral Harbor ODMDS Background Water Concentration.</b>	
<b>Chemicals of Concern</b>	<b>Background Concentration Levels (µg/l)</b>
Arsenic	1.36 <sup>1</sup>
Cadmium	0.008 <sup>1</sup>
Chromium (VI)	0.29 <sup>2</sup>
Copper	0.34 <sup>1</sup>
Lead	0.076 <sup>2</sup>
Mercury	0.01 <sup>2,4</sup>
Nickel	0.25 <sup>2</sup>
Selenium	5.0 <sup>1,4</sup>
Silver	0.009 <sup>1</sup>
Zinc	2.33 <sup>1</sup>
Cyanide	0 <sup>5</sup>
Tributyltin (TBT)	0.01 <sup>1,4</sup>
Aldrin	0.005 <sup>1,4</sup>
Chlordane	0.005 <sup>1,4</sup>
DDT	0.012 <sup>1,4</sup>
Dieldrin	0.005 <sup>1,4</sup>
alpha - Endosulfan	0.005 <sup>1,4</sup>
beta - Endosulfan	0.010 <sup>1,4</sup>
Endrin	0.010 <sup>1,4</sup>
gamma-BHC (Lindane)	0.002 <sup>1,4</sup>
Heptachlor	0.004 <sup>1,4</sup>
Heptachlor Epoxide	0.005 <sup>1,4</sup>
Toxaphene	0 <sup>5</sup>
Pentachlorophenol	4.85 <sup>1,4</sup>

<sup>1</sup> 2007 EPA Status and Trends Survey at the Canaveral ODMDS

<sup>2</sup> Site Designation Studies for a New Ocean Dredged Material Disposal Site off Jacksonville, Florida: Spring and Fall 2010 Survey Results

<sup>3</sup> Reference Station Water from the 2006 Mayport Harbor 103 Evaluation

<sup>4</sup> Analyte not detected. Value based on one half the reporting limit.

<sup>5</sup> Analyte detection limits are well above WQC. If analytes are detected in the dredged material elutriate, a concentration of zero will be assumed at the ODMDS.

APPENDIX C  
TEMPLATE  
GENERIC SPECIAL CONDITIONS  
FOR MPRSA SECTION 103 PERMITS  
CANAVERAL HARBOR, FL ODMDS

GENERIC SPECIAL CONDITIONS  
FOR MPRSA SECTION 103 PERMITS

I. DISPOSAL OPERATIONS

A. For this permit, the term disposal operations shall mean: navigation of any vessel used in disposal of operations, transportation of dredged material from the dredging site to the Canaveral Harbor ODMDS, proper disposal of dredged material at the disposal area within the Canaveral Harbor ODMDS, and transportation of the hopper dredge or disposal barge or scow back to the dredging site.

B. The Canaveral Harbor ODMDS is defined as the rectangle with center coordinates of 28°18.750'N latitude and 80°30.986'W longitude (NAD 83) or state plane coordinates 1,446,630 ft N and 811,757 ft E (NAD83). The site coordinates are as follows:

	Geographic NAD 83		State Plane (Florida East 0901 U.S. Ft) NAD 83	
North	28 ° 20.267'N	80 ° 31.170'W	1,455,819 N	810,734 E
East	28 ° 18.867'N	80 ° 29.236'W	1,447,378 N	821,139 E
South	28 ° 17.234'N	80 ° 30.870'W	1,437,446 N	812,416 E
West	28 ° 18.617'N	80 ° 32.736'W	1,445,788 N	802,376 E

C. No more than [NUMBER] cubic yards of dredged material excavated at the location defined in [REFERENCE LOCATION IN PERMIT] are authorized for disposal at the Canaveral Harbor ODMDS.

D. The permittee shall use an electronic positioning system to navigate to and from the Canaveral Harbor ODMDS. For this section of the permit, the electronic positioning system is defined as: a differential global positioning system or a microwave line of site system. Use of LORAN-C alone is not an acceptable electronic positioning system for disposal operations at the Canaveral Harbor ODMDS. If the electronic positioning system fails or navigation problems are detected, all disposal operations shall cease until the failure or navigation problems are corrected.

E. The permittee shall certify the accuracy of the electronic positioning system proposed for use during disposal operations at the Canaveral Harbor ODMDS. The certification shall be accomplished by direct comparison of the electronic positioning system's accuracy with a known fixed point.

F. The permittee shall not allow any water or dredged material placed in a hopper dredge or disposal barge or scow to flow over the sides or leak from such vessels during transportation to the Canaveral Harbor ODMDS.

G. A disposal operations inspector and/or captain of any tug boat, hopper dredge or other vessel used to transport dredged material to the Canaveral Harbor ODMDS shall insure compliance with disposal operation conditions defined in this permit.

1. If the disposal operations inspector or the captain detects a violation, he shall report the violation to the permittee immediately.

2. The permittee shall contact the U.S. Army Corps of Engineers, Jacksonville District's Regulatory Division [TELEPHONE NUMBER] and EPA Region 4 at (404) 562-9391 to report the violation within twenty-four (24) hours after the violation occurs. A complete written explanation of any permit violation shall be included in the disposal summary report.

H. When dredged material is disposed, no portion of the hopper dredge or disposal barge or scow shall be outside of the boundaries of the Canaveral Harbor ODMDS as defined in Special Condition B. Additionally, disposal shall be initiated within the disposal release zone defined by the following coordinates:

[insert coordinates for appropriate release zone]

Vertices	Geographic NAD 83		State Plane (Florida East 0901 U. S. Ft) NAD 83	
Center				
North				
West				
South				
East				

I. [Reserved]

J. The permittee shall use an electronic tracking system (ETS) that will continuously track the horizontal location and draft condition of the disposal vessel (hopper dredge or disposal barge or scow) to and from the Canaveral Harbor ODMDS. Data shall be collected at least every 500 feet during travel to and from the ODMDS and every minute or every 200 feet of travel, whichever is smaller, while approaching within 1,000 feet and within the ODMDS. The permittee shall use Florida State Plane or latitude and longitude coordinates (North American Datum 1983). State Plane coordinates shall be reported to the nearest foot and latitude and longitude coordinates shall be reported as decimal degrees out to 6 decimals. Westerly longitudes are to be reported as negative. Draft readings shall be recorded in feet out to 2 decimals.

K. The permittee shall record electronically for each load the following information:

- a. Load Number
- b. Disposal Vessel or Scow Name
- c. Tow Vessel Name (if scow used)
- d. Captain of Disposal or Tow Vessel

- e. Estimated volume of Load
- f. Description of Material Disposed
- g. Source of Dredged Material
- h. Date, Time and Location at Start at Initiation and Completion of Disposal Event
- i. The ETS data required by Special Condition I.J.

L. The permittee shall conduct a bathymetric survey of the Canaveral Harbor ODMDS within 30 days following project completion.

1. The number and length of the survey transects shall be sufficient to encompass the release zone specified in Special Condition H and a 500 foot wide area around the site. The transects shall be spaced at 500-foot intervals or less.

2. Vertical accuracy of the survey shall be  $\pm 0.5$  feet. Horizontal location of the survey lines and depth sounding points will be determined by an automated positioning system utilizing either microwave line of site system or differential global positioning system. The vertical datum shall be mean lower low water (m.l.l.w) and the horizontal datum shall use Florida State Plane or latitude and longitude coordinates (North American Datum 1983). State Plane coordinates shall be reported to the nearest 0.10 foot and latitude and longitude coordinates shall be reported as decimal degrees to 6 decimal points.

M. Enclosed is the Regional Biological Opinion (RBO) dated [INSERT DATE], for swimming sea turtles, whales, and sturgeon. The RBO contains mandatory terms and conditions to implement the reasonable and prudent measures that are associated with "incidental take" that is also specified in the RBO. Your authorization under the Corps permit is conditional upon your compliance with all of the mandatory terms and conditions associated with the incidental take of the attached RBO, which terms and conditions are incorporated by reference in the permit. Failure to comply with the terms and conditions associated with the incidental take of the RBO, where a take of the listed species occurs, would constitute an unauthorized take, and it would also constitute non-compliance with your Corps permit. However, depending on the affected species NMFS is the appropriate authority to determine compliance with the terms and conditions of its RBO and with the Endangered Species Act (ESA). For further clarification on this point, you should contact the appropriate agency. Should they determine that the conditions of the RBO have been violated; normally they will enforce the violation of the ESA, or refer the matter to the Department of Justice.

## II. REPORTING REQUIREMENTS

A. All reports, documentation and correspondence required by the conditions of this permit shall be submitted to the following addresses: U.S. Army Corps of Engineers (Corps), Regulatory Division, Enforcement Section, P.O. Box 4970, Jacksonville, Florida 32232-0019 and U. S. Environmental Protection Agency (EPA) Region 4's Wetlands, Coastal and Oceans Branch, 61 Forsyth Street, Atlanta, GA 30303. The Permittee shall



reference this permit number, [INSERT PERMIT NUMBER], on all submittals.

B. At least 15 days before initiating any dredging operations authorized by this permit, the Permittee shall provide to the Corps and EPA a written notification of the date of commencement of work authorized by this permit.

C. Electronic data required by Special Conditions I.J and I.K shall be provided to EPA Region 4 on a weekly basis. Data shall be submitted as an eXtensible Markup Language (XML) document via Internet e-mail to [DisposalData.R4@epa.gov](mailto:DisposalData.R4@epa.gov). XML data file format specifications are available from EPA Region 4.

D. The permittee shall send one (1) copy of the disposal summary report to the Jacksonville District's Regulatory Division and one (1) copy of the disposal summary report to EPA Region 4 documenting compliance with all general and special conditions defined in this permit. The disposal summary report shall be sent within 90 days after completion of the disposal operations authorized by this permit. The disposal summary report shall include the following information:

1. The report shall indicate whether all general and special permit conditions were met. Any violations of the permit shall be explained in detail.

2. The disposal summary report shall include the following information: dredging project title; dates of disposal; permit number and expiration date; name of contractor(s) conducting the work, name and type of vessel(s) disposing material in the ODMDS; disposal timeframes for each vessel; volume disposed at the ODMDS (as paid *in situ* volume, total paid and un paid *in situ* volume, and gross volume reported by dredging contractor), number of loads to ODMDS, type of material disposed at the ODMDS; identification of any misplaced material (outside disposal zone or the ODMDS boundaries); dates of pre and post disposal bathymetric surveys of the ODMDS and a narrative discussing any violation(s) of the 103 permit. The disposal summary report should be accompanied by the bathymetry survey results (plot and X,Y,Z ASCII data file).

### III. PERMIT LIABILITY

A. The permittee shall be responsible for ensuring compliance with all conditions of this permit.

B. The permittee and all contractors or other third parties who perform an activity authorized by this permit on behalf of the permittee shall be separately liable for a civil penalty of up to \$50,000 for each violation of any term of this permit they commit alone or in concert with the permittee or other parties. This liability shall be individual, rather than joint and several, and shall not be reduced in any fashion to reflect the liability assigned to and civil penalty assessed against the permittee or any other third party as defined in 33 U.S.C. Section 1415(a).

C. If the permittee or any contractor or other third party knowingly violates any term of this permit (either alone or in concert), the permittee, contractor or other party shall be individually liable for the criminal penalties set forth in 33 U.S.C. Section 1415(b).

APPENDIX D

TYPICAL CONTRACT LANGUAGE  
FOR IMPEMENTING THE  
CANAVERAL HARBOR ODMDS SMMP  
REQUIREMENTS

TYPICAL CONTRACT LANGUAGE FOR IMPEMENTING SMMP  
REQUIREMENTS

3.3 DISPOSAL OF DREDGED MATERIAL

3.3.1 General

All material dredged shall be transported to and deposited in the disposal area(s) designated on the drawings. The approximate maximum and average distance to which the material will have to be transported are as follows:

Disposal Area	Maximum Distance Statute Miles	Average Distance Statute Miles
Canaveral Harbor ODMDS		
[INSERT DISPOSAL AREA 2]	[XX miles]	[XX miles]

[IF MATERIAL FROM DIFFERENT PROJECT AREAS GO TO DIFFERENT  
DISOSAL AREAS, IT COULD BE SPECIFIED HERE]

3.3.2 Ocean Disposal Notification

- a. The Corps or the contractor shall notify EPA Region 4 's Wetlands, Coastal and Oceans Branch (61 Forsyth Street, Atlanta, GA 30303) at least 15 calendar days and the local Coast Guard Captain of the Port at least 5 calendar days prior to the first ocean disposal. The notification will be by certified mail with a copy to the Contracting Officer. The following information shall be included in the notification:
  - (1) Project designation; Corps of Engineers' Contracting Officer's name and contract number; and, the Contractor's name, address, and telephone number.
  - (2) Port of departure.
  - (3) Location of ocean disposal area (and disposal zone if required).
  - (4) Schedule for ocean disposal, giving date and time proposed for first ocean disposal.

3.3.3 Ocean Dredged Material Disposal Sites (ODMDS)

The material excavated shall be transported to and deposited in the Canaveral Harbor ODMDS shown on the drawings. When dredged material is disposed, no portion of the hopper dredge or disposal barge or scow shall be outside of the boundaries of the Canaveral Harbor ODMDS as shown on the drawings. Additionally, disposal shall be initiated within the disposal release zone defined by the following coordinates:  
[insert coordinates for appropriate release zone]

Vertices	Geographic NAD 83		State Plane (Florida East 0901 U.S. Ft) NAD 83	
	Center			
North				
West				
South				
East				

### 3.3.4 Logs

The Contractor shall keep a log for each load placed in the Canaveral Harbor ODMDS.

The log entry for each load shall include:

- a. Load Number
- b. Disposal Vessel or Scow Name
- c. Tow Vessel Name (if scow used)
- d. Captain of Disposal or Tow Vessel
- e. Estimated volume of Load
- f. Description of Material Disposed
- g. Source of Dredged Material
- h. Date, Time and Location (coordinates) at Start of Initiation and Completion of Disposal Event

At the completion of dredging and at any time upon request, the log(s) shall be submitted in paper and electronic formats to the Contracting Officer for forwarding to the appropriate agencies.

### 3.3.5 Overflow, Spills and Leaks

Water and dredged materials shall not be permitted to overflow or spill out of barges, hopper dredges, or dump scows during transport to the disposal site(s). Failure to repair leaks or change the method of operation which is resulting in overflow of spillage will result in suspension of dredging operations and require prompt repair or change of operation to prevent overflow or spillage as a prerequisite to the resumption of dredging.

### 3.3.6 Electronic Tracking System (ETS) for Ocean Disposal Vessels

The Contractor shall furnish an ETS for surveillance of the movement and disposition of dredged material during dredging and ocean disposal. This ETS shall be established, operated and maintained by the Contractor to continuously track in real-time the horizontal location and draft condition of the disposal vessel (hopper dredge or disposal barge or scow) for the entire dredging cycle, including dredging area and disposal area. The ETS shall be capable of displaying and recording in real-time the disposal vessel's draft and location.

-----  
 [USE LANGUAGE BELOW FOR NON DQM PROJECTS]

### 3.3.6.1 ETS Standards

The Contractor shall provide automated (computer) system and components to perform in accordance with COE EM 1110-1-2909. A copy of the EM can be downloaded from the following web site: <http://www.usace.army.mil/inet/usace-docs/eng-manuals/em.htm>. Horizontal location shall have an accuracy equal to or better than a standard DGPS system, equal to or better than plus/minus 10 feet (horizontal repeatability). Vertical (draft) data shall have an accuracy of plus/minus 0.5 foot. Horizontal location and vertical data shall be collected in sets and each data set shall be referenced in real-time to date and local time (to nearest minute), and shall be referenced to the same state plane coordinate system used for the survey(s) shown in the contract plans. The ETS shall be calibrated, as required, in the presence of the Contracting Officer at the work location before disposal operations have started, and at 30-day intervals while work is in progress. The Contracting Officer shall have access to the ETS in order to observe its operation. Disposal operations will not commence until the ETS to be used by the Contractor is certified by the Contracting Officer to be operational and within acceptable accuracy. It is the Contractor's responsibility to select a system that will operate properly at the work location. The complete system shall be subject to the Contracting Officer's approval.

### 3.3.6.2 ETS Data Requirements and Submissions

- a. The ETS for each disposal vessel shall be in operation for all dredging and disposal activities and shall record the full round trip for each loading and disposal cycle. (NOTE: A dredging and disposal cycle constitutes the time from commencement of dredging to complete discharge of the material.) The Contracting Officer shall be notified immediately in the event of ETS failure and all dredging operations for the vessel shall cease until the ETS is fully operational. Any delays resulting from ETS failure shall be at the Contractor's expense.
- b. Data shall be collected, during the dredging and disposal cycle, every 500 feet (at least) during travel to the disposal area, and every minute or every 200 feet, whichever is smaller, while approaching within 1,000 feet and within the disposal area.
- c. Plot Reporting (2 types):
  - a. Tracking Plot - For each disposal event, data collected while the disposal vessel is in the vicinity of the disposal area shall be plotted in chart form, in 200-foot intervals, to show the track and draft of the disposal vessel approaching and traversing the disposal area. The plot shall identify the exact position at which the dump commenced. A sample Track and Draft Plot Diagram is on the web site indicated in paragraph CONSTRUCTION FORMS AND DETAILS below.
  - b. Scatter Plot - Following completion of all disposal events, a single and separate plot will be prepared to show the exact disposal locations of all

dumps. Every plotted location shall coincide with the beginning of the respective dump. Each dump shall be labeled with the corresponding Trip Number and shall be at a small but readable scale. A sample Scatter Plot Diagram is on the web site indicated in paragraph CONSTRUCTION FORMS AND DETAILS below.

- c. Summary Table – A spreadsheet which contains all of the information in the log(s) [Section 3.3.4] above shall be prepared and shall correspond to the exact dump locations represented on the Scatter Plot. A sample Summary Table spreadsheet is on the web site indicated in paragraph CONSTRUCTION FORMS AND DETAILS below.
- d. ETS data and log data required by Section 3.3.4 shall be provided to EPA Region 4 on a weekly or more frequent basis. Data shall be submitted to EPA Region 4 as an eXtensible Markup Language (XML) document via Internet e-mail to [DisposalData.R4@epa.gov](mailto:DisposalData.R4@epa.gov). XML data file format specifications are available from EPA Region 4. All digital ETS data shall be furnished to the Contracting Officer within 24 hours of collection. The digital plot files should be in an easily readable format such as Adobe Acrobat PDF file, Microstation DGN file, JPEG, BMP, TIFF, or similar. The hard copy of the ETS data and tracking plots shall be both maintained onboard the vessel and submitted to the Contracting Officer on a weekly basis.

-----  
[FOR DQM PROJECTS]

See: <http://dqm.usace.army.mil/Specifications/Index.aspx>

For scows, the monitoring profile, TDS profile or Ullage profile shall be used.

---

### 3.3.6.3 Misplaced Materials

Materials deposited outside of the disposal zone specified in 3.3.3 will be classified as misplaced material and will result in a suspension of dredging operations. Redredging of such materials will be required as a prerequisite to the resumption of dredging unless the Contracting Officer, at his discretion, determines that redredging of such material is not practical. If redredging of such material is not required then the quantity of such misplaced material shall be deducted from the Contractor's pay quantity. If the quantity for each misplaced load to be deducted cannot initially be agreed to by both the Contractor and Contracting Officer, then an average hopper/scow load quantity for the entire contract will be used in the determination. Misplaced loads may also be subject to penalty under the Marine, Protection, Research and Sanctuaries Act. Materials deposited above the maximum indicated elevation or outside of the disposal area template shown will require the redredging or removal of such materials at the Contractor's expense. In addition, the Contractor must notify the Contracting Officer and the Environmental Protection Agency Region 4's Wetlands, Coastal and Oceans Branch (61 Forsyth Street, Atlanta, GA 30303) within 24 hours of a misplaced dump or any other violation of the Site Management and Monitoring Plan for the Canaveral Harbor ODMDS. Corrective actions must be implemented by the next dump and the Contracting Officer must be informed of actions taken.

APPENDIX E

SURVEYS AND STUDIES CONDUCTED AT THE  
CANAVERAL HARBOR ODMDS  
1984-2000



## Surveys and Studies Conducted at the Canaveral Harbor ODMDS

Survey/Study Title	Conducted By:	Date	Purpose	Results
Interpretative Analysis of Surficial Sediments as an Aid in Transport Studies of Dredged Materials in Cape Canaveral, FL	U.S. COE Waterways Experiment Station	1984	Determine the direction and amount of sediment transport from a dredged material disposal site.	-No trends in sediment distribution -Sand waves indicate recent current activity capable of transporting sediment. -Detailed site-specific data are necessary in order to make conclusive statements about sediment transport off the disposal site.
Field Survey of the Canaveral Harbor ODMDS	Continental Shelf Associates for COE	1986	Video, Bathymetry, Hydrography, Water Quality, Sediment Benthic Survey, Tissue Analysis	-Baseline Survey -All data collected except could not obtain video due to poor clarity.
Sediment Mapping at Charleston, SC and Canaveral, FL	UGA Center for Applied Isotopes for EPA	1988	Characterization of bottom sediments using gamma spectrometry	-Showed possible presence of dredged material west of the site (low gamma activity). -Showed a mound of dredged material in the center of the site (low gamma activity).
Sidescan Sonar	EPA	July 1988	Clear candidate site with respect to obstructions and outcrops (live bottom)	-Areas of differing sediment character identified coincidental with low gamma activity.

## Surveys and Studies Conducted at the Canaveral Harbor ODMDS

Survey/Study Title	Conducted By:	Date	Purpose	Results
Video & Still Photography	EPA	July 1988	Visually observe the nature of the sediment exhibiting unique gamma isotope signatures as well as differing sonar returns.	<ul style="list-style-type: none"> <li>-Could not obtain video due to poor clarity.</li> <li>-Photo's verified that the areas identified in sediment mapping and sidescan sonar surveys contained dredged material.</li> <li>-The dredged material identified to the west of the site appears to be from direct disposal and not transport.</li> </ul>
Sediment Mapping & Rapid Surveillance of Fernandina Beach & Canaveral, FL ODMDSs	UGA Center for Applied Isotopes for EPA	April 1989	Examine areas identified in previous survey and areas to the northwest of the site boundaries	<ul style="list-style-type: none"> <li>-Area of low gamma activity extends beyond the site boundaries to the northwest</li> </ul>
REMOTS (Remote Ecological Monitoring of the Seafloor)	Science Applications International Corp. for EPA	1990	Delineate the areal extent of dredged material at the Canaveral ODMDS, assess the biological status of the area, & compare the mapped results of the gamma sled with those of REMOTS.	<ul style="list-style-type: none"> <li>-Verified sediment mapping results.</li> <li>-Concluded site is dispersive for fines. Fines are eroded from the surface of the deposited material.</li> <li>-Dredged material may extend well beyond designated site boundaries.</li> <li>-Recommend precision bathymetric and sidescan survey and current meters and wave gauges.</li> </ul>
Canaveral Harbor, FL ODMDS Benthic Communities Study	Battelle Ocean Sciences/Barry Vittor & Associates for	1990	Benthic community characterization	<ul style="list-style-type: none"> <li>-Sampled 15 sites based on REMOTS data.</li> <li>-Species abundance very high and individual abundance moderately high.</li> </ul>

## Surveys and Studies Conducted at the Canaveral Harbor ODMDS

Survey/Study Title	Conducted By:	Date	Purpose	Results
	EPA			
Bathymetric Survey	COE - Jacksonville District	December 1991	Monitor bathymetry changes	-Minimum depth of 39.6 feet northwest of center of ODMDS -Depth at southern corner of ODMDS = 52.4 feet
Bathymetric Survey	COE - Jacksonville District	January 1993	Monitor bathymetry changes	-Minimum depth of 40.2 feet northwest of center of ODMDS -Depth at southern corner of ODMDS = 52.7 feet
Bathymetric Survey	COE - Jacksonville District	March 1994	Monitor bathymetry changes	-Minimum depth of 40.0 feet northwest of center of ODMDS -Depth at southern corner of ODMDS = 51.0 feet
Disposal Monitoring	Lyman Burk	October 1994	-Compliance	-Disposal occurred throughout site. -No disposal occurred outside of site.
Post Disposal Sediment Mapping at the Canaveral, FL ODMDS	UGA Center for Applied Isotopes for EPA	March 1995	Document changes in seafloor environment since 1989.	-Mound in center of site is still present. -Western & northwestern extensions of dredged material still present. -New deposit of dredged material detected just inside the eastern corner of the ODMDS. -Possible presence of dredged material still exists to west of site. This material does not match material in site or surrounding ambient material.

## Surveys and Studies Conducted at the Canaveral Harbor ODMDS

Survey/Study Title	Conducted By:	Date	Purpose	Results
Thesis: A Study of Dredged Material Dispersion on the Inner Continental Shelf, Cape Canaveral, FL	Julie Ellen Vann: Florida Institute of Technology	August 1995	Estimate potential for burial of the inner shelf sediments and benthic communities by disposed dredged material	-Dispersion of plume phase of disposal the significant factor in overall dispersion. -Erosion of bulk or solid phase is less significant. More current data is necessary to assess this phase. -Dredged material has dispersed to cover a 596 km <sup>2</sup> area.
Disposal Monitoring	Gahagan & Bryant Assoc.	August 1995		-Disposal occurred mostly at the center of the site. -No disposal occurred outside of site.
Bathymetric Survey	COE - Jacksonville District	July 1996	Monitor bathymetry changes	-Minimum depth of 42.2 feet north corner of ODMDS -Depth at southern corner of ODMDS = 52.9 feet
Disposal Monitoring	CPA	August 1996	Compliance for CT#8 (permit #199101718)	-Disposal occurred mostly at the center of the site. -No disposal occurred outside of site.
Bathymetric Survey	COE - Jacksonville District	January 2000	Monitor bathymetry changes	-Minimum depth of 33.2 feet northwest of center of ODMDS -Depth at southern corner of ODMDS = 50.5 feet -Significant shoaling occurring
Acoustic Plume	EPA/NOAA	August	Estimate Dispersion	-Results inconclusive. Leakage plumes and

## Surveys and Studies Conducted at the Canaveral Harbor ODMDS

Survey/Study Title	Conducted By:	Date	Purpose	Results
Tracking		2000	Coefficient	barge malfunction interfered with ability to measure plumes.
Erosion Rate Study	EPA / Sandia National Laboratories	October 2000	Determine Erodibility of Dredged Material as function of bulk density and shear stress for use in long term fate models.	<ul style="list-style-type: none"> <li>- Disposed dredged material reaches full consolidation within 2 months.</li> <li>- Disposed dredged material is susceptible to erosion until full consolidation.</li> <li>- Parameters for L/FATE model calculated</li> </ul>
Bathymetric Survey	COE - Jacksonville District	November 2000	Monitor bathymetry changes	<ul style="list-style-type: none"> <li>-Minimum depth of 30.5 feet northwest of center of ODMDS</li> <li>-Depth at southern corner of ODMDS = 52.0 feet</li> <li>-Significant shoaling occurring</li> </ul>

**CANAVERAL HARBOR, FLORIDA**  
**Integrated Section 203 Navigation Study Report**  
**&**  
**Final Environmental Assessment**



**Economics Appendix**  
(sub-part of Volume 3)

**December 2012**  
(last revised February 2012)



**US Army Corps  
of Engineers** ®



**PORT  
CANAVERAL**

**ECONOMICS APPENDIX**

**Canaveral Harbor, Florida  
Integrated Section 203 Navigation Study Report &  
Draft Environmental Assessment**

**February 2012**

## Table of Contents

1	Introduction.....	1
1.1	Project Location.....	1
1.2	Port Description.....	3
2	Existing Conditions.....	6
2.1	Federal Project Dimensions.....	6
2.2	Existing Conditions: Terminal Facilities.....	7
2.2.1	Existing South Side Cargo Terminal Facilities.....	8
2.2.2	Existing North Side Cargo Terminal Facilities.....	9
2.2.3	Cruise Terminal Facilities.....	12
2.3	Socio-Economics.....	13
2.4	Port Hinterland.....	14
2.5	Port Canaveral Historical and Current Cruise Ship Operations.....	14
2.5.1	Florida’s Cruise Ship Industry.....	16
2.5.2	Port Canaveral’s Cruise Ship Industry.....	19
2.5.3	Port Canaveral Cruise Ship Operations.....	23
2.6	Port Canaveral Historical and Current Cargo.....	27
2.6.1	Existing Cargo Traffic Characterization.....	29
2.6.2	Existing Cargo Fleet.....	32
2.6.3	Existing Cargo Fleet Operations and Tidal Advantage.....	36
3	Without-Project Conditions.....	40
3.1	Navigation Features.....	40
3.1.1	Canaveral Ocean Dredged Material Disposal Site (ODMDS).....	40
3.1.2	Channel Conditions.....	41
3.2	Terminal Facilities.....	41
3.2.1	Cargo Terminals.....	41
3.2.2	Cruise Terminals.....	42
3.3	Economic Conditions in the Project Hinterland.....	42
3.4	Port Canaveral Operations.....	44
3.4.1	Commodity Projections.....	44
3.4.2	Cargo Fleet Forecast.....	50
3.4.3	Projected Cruise Ship Operations.....	51



4	Problems Addressed by the Economic Analysis .....	53
4.1	Cruise Ship Size Limitations .....	53
4.1.1	Channel Widths .....	53
4.1.2	Turning Basins .....	54
4.2	Cargo Vessel Size Limitations .....	55
4.3	Surge Effects .....	58
4.4	Future Berth Congestion .....	59
4.5	Limitations on New Cargo and Cruise Terminals .....	59
5	Alternative Plan Evaluation .....	59
5.1	Detailed Alternative Plan Description .....	60
5.1.1	Without-Project Condition Channel Description .....	60
5.1.2	Alternative With-Project Condition Channel Descriptions .....	60
5.1.3	Identification of Alternative Plan Increments .....	60
5.2	Alternative Plan Costs .....	68
5.2.1	Construction and Investment Costs .....	68
5.2.2	Operations and Maintenance Costs .....	72
5.2.3	Total Average Annual Equivalent Costs .....	73
5.3	With-Project Condition Benefits .....	75
5.3.1	Channel Widening Benefits .....	76
5.3.2	Channel Deepening Benefits .....	86
5.4	Net Benefits of Alternative Plans .....	94
5.5	Summary of Accounts .....	96
5.6	Risk and Uncertainty .....	96
5.6.1	Commodity Forecast Uncertainty Ranking .....	97
5.6.2	Reduced Cargo Forecast and Cruise Schedule .....	98
5.6.3	Increased Cargo Forecast .....	98
5.6.4	Increased Seaport Canaveral Forecast .....	99
5.6.5	Alternative Seaport Canaveral Vessel Origins .....	100
5.6.6	Alternative Cement Forecasts .....	102
5.6.7	Alternative Slag Forecasts .....	105
5.6.8	Alternative Aggregate Materials Forecast .....	108

**List of Tables**

Table 2-1 Port Canaveral Channel Dimensions.....	6
Table 2-2 Port Canaveral Cargo Category by Berth.....	8
Table 2-3 Port Canaveral Existing South Side Cargo Terminal Facilities Summary.....	9
Table 2-4 Seaport Canaveral (Vitol, S.A., Inc) Terminal Storage Capability.....	10
Table 2-5 Seaport Canaveral Vessel Type Summary February 2010 through July 2011.....	11
Table 2-6 Port Canaveral Existing North Side Cargo Terminal Facilities Summary.....	11
Table 2-7 Port Canaveral Cruise Terminal Summary.....	13
Table 2-8 Projected Growth for City of Orlando 2004 - 2030.....	14
Table 2-9 RCI Voyager, Freedom, and Oasis Class Vessel Deployment Schedules.....	16
Table 2-10 North American Multi-Day Cruise Passengers by Selected Departure Ports (000's)	17
Table 2-11 North American Cruise Passengers By Destination (000's).....	18
Table 2-12 Port Canaveral Multi-day Cruise Ship Operations FY2011 & FY2012.....	20
Table 2-13 Port Canaveral Revenue Passengers (Fiscal Years).....	21
Table 2-14 Comparative Normal Capacity Utilization (2004 – 2011).....	22
Table 2-15 Port Canaveral Cruise Ship Capacity Utilization (2003 – 2011).....	23
Table 2-16 Port Canaveral Historical Wind-Related Cruise Ship Tug Assist Occurrences.....	26
Table 2-17 Port Canaveral Historical Total Annual Tonnage (short tons).....	28
Table 2-18 Port Canaveral Total Annual Tonnage Long Term Growth Rates.....	29
Table 2-19 Port Canaveral Commodity Tonnage FY 2001 – FY 2011 (Short Tons).....	31
Table 2-20 Cement Imports – 36 Feet or Greater Arrival Draft (Jan 2006 – Sep 2009).....	33
Table 2-21 Aggregate Rock/Granite Imports – 36 Feet or Greater Arrival Draft (Jan 2006 – Sep 2009).....	34
Table 2-22 Limestone Imports – 36 Feet or Greater Arrival Draft (Jan 2006 – Sep 2009).....	35
Table 2-23 Slag Imports – 36 Feet or Greater Arrival Draft (Jan 2006 – Sep 2009).....	36
Table 2-24 Port Canaveral Deep Draft Vessel Arrival Drafts 2002 - 2006.....	37
Table 2-25 Seaport Canaveral Point-to-Point Vessel Sailing Drafts Aug 2010 – July 2011.....	38
Table 3-1 Six-County Regional Population Projections (2010 – 2035).....	43
Table 3-2 Fuel Consumption Projections in Millions of Barrels per Day (2010 – 2035).....	44
Table 3-3 Base Case Commodity Forecast – Selected Years (Tons).....	49
Table 3-4 Without-Project Condition Projected Cargo Vessel Calls.....	50
Table 3-5 Present and Future Large Cruise Ships and Classes.....	52

Table 4-1 Largest Cargo Vessels to Call at Port Canaveral in 2006 .....	56
Table 4-2 Characteristics of Cargo Vessels from the World Fleet Currently Using and Projected to Use Port Canaveral .....	57
Table 5-1 Channel Depth Design Requirements (feet below MLLW).....	64
Table 5-2 Alternative Plan Channel Depths and Widths (feet below MLLW) .....	64
Table 5-3 Construction Costs: Widening Alternatives* .....	69
Table 5-4 Construction Costs: Channel Deepening Alternatives* .....	70
Table 5-5 Construction Costs: Widening Plan 1 (450 feet) and Channel Deepening .....	71
Table 5-6 Construction Costs: Widening Plan 2 (500 feet) and Channel Deepening .....	72
Table 5-7 Average Annual Equivalent (AAEQ) Project Costs: Channel Widening .....	73
Table 5-8 Average Annual Equivalent (AAEQ) Project Costs: Channel Deepening.....	74
Table 5-9 Average Annual Equivalent (AAEQ) Project Costs: Widening Plan 1 (450 feet) and Channel Deepening.....	74
Table 5-10 Average Annual Equivalent (AAEQ) Project Costs: Widening Plan 2 (500 feet) and Channel Deepening.....	75
Table 5-11 Joint Probability of Occurrence (Sustained Winds and Vessel Transits).....	79
Table 5-12 Operations Matrix: Widening Plan 1 (Number of Tugs).....	80
Table 5-13 Operations Matrix: Widening Plan 2 (Number of Tugs).....	81
Table 5-14 Sample Tug Cost Calculation: Freedom of the Seas (160,000 GRT) .....	82
Table 5-15 Weighted Average Tug Assist Costs* .....	82
Table 5-16 Alternative Widening Plan Annual Benefits – Tug Assistance Reductions: 2020 ....	83
Table 5-17 Actual Seaport Canaveral Point-to-Point Distances Feb2010 – July2011* .....	84
Table 5-18 Alternative Channel Widening Transportation Costs – Large Tankers: 2020 .....	85
Table 5-19 Alternative Channel Widening Plan Annual Benefits – Large Tankers: 2020 .....	85
Table 5-20 AAEQ Total Annual Channel Widening Benefits .....	86
Table 5-21 Large Cargo Vessel Characteristics.....	88
Table 5-22 Without and With-project Operating Drafts and Tons per Call .....	90
Table 5-23 Projected Benefiting Cargo Vessel Calls (without widening): 2020.....	91
Table 5-24 Projected Benefiting Cargo Vessels Transportation Costs: 2020.....	92
Table 5-25 Average Annual Equivalent Transportation Cost Savings: Deepening Alternatives .	93
Table 5-26 Total Project AAEQ Benefits: Widening and Deepening Plan Combinations .....	94
Table 5-27 Cost – Benefit Analysis: Channel Widening Only.....	94
Table 5-28 Cost – Benefit Analysis: Channel Deepening Only .....	95

Table 5-29 Cost – Benefit Analysis: Widening Plan 1 (450 feet) and Channel Deepening.....	95
Table 5-30 Cost – Benefit Analysis: Widening Plan 2 (500 feet) and Channel Deepening.....	95
Table 5-31 Port Canaveral Economic Impacts .....	96
Table 5-32 Port Canaveral Commodity Forecast Uncertainty Ranking .....	97
Table 5-33 Cost – Benefit Analysis: Low Forecast Scenario .....	98
Table 5-34 Cost – Benefit Analysis: High Forecast Scenario .....	99
Table 5-35 Cost – Benefit Analysis: Alternative Seaport Canaveral Forecasts .....	99
Table 5-36: Weighted Average Distances (nautical miles) .....	100
Table 5-37: Seaport Canaveral Origins Sensitivity Analyses Average Annual Equivalent Transportation Cost Savings: Channel Deepening Only .....	101
Table 5-38 Port Canaveral Cement Import Projection Sensitivity Analyses (Transportation Cost Savings).....	104
Table 5-39 Sensitivity Analysis: Alternative Slag Import Forecasts.....	105
Table 5-40 Port Canaveral Slag Import Projection Sensitivity Analyses.....	107
Table 5-41 Port Canaveral Aggregate Import Projection Sensitivity Analyses .....	109

### **List of Charts & Figures**

Figure 1-1 Port Canaveral Location Map .....	2
Figure 1-2 Port Canaveral Navigation Features.....	4
Figure 1-3 Port Canaveral Major Facilities .....	5
Figure 2-1 Seaport Canaveral Fuel Terminal.....	12
Chart 2-1 Annual Port Canaveral Total Cargo Tonnage (1966 – 2011).....	27
Chart 2-2 Port Canaveral Deep Draft Vessel Arrival Drafts (2002-2006) .....	37
Chart 2-3 Seaport Canaveral Point-to-Point Vessel Sailing Drafts August 2010 – July 2011 .....	39
Chart 2-4 Seaport Canaveral Point-to-Point Vessel Length Overall August 2010 – July 2011 ...	39
Figure 5-1 Alternative Plans: Sheet 1 .....	65
Figure 5-2 Alternative Plans: Sheet 2 .....	66
Figure 5-3 Alternative Plans: Sheet 3 .....	67

## **1 Introduction**

The Canaveral Port Authority has conducted an economic analysis as a component of the Section 203 study to determine the feasibility of improvements to the Federal navigation project at Port Canaveral. Potential improvements include deepening and widening of navigational channels, expansion of the West Turning Basin, and expanded wideners at the port. The purpose of these potential improvements is to increase the efficiency of cargo vessel operations and to accommodate larger cruise ships, which are already calling at the port, or projected to use the port in the very near future. This economic analysis evaluates alternatives that will:

- 1) reduce congestion at Port Canaveral;
- 2) improve navigation safety at Port Canaveral;
- 3) accommodate recent and anticipated future growth in cargo and cruise vessel traffic;
- 4) improve the efficiency of operations for cargo vessels and cruise ships within the Port complex;
- 5) allow for use of the Port by larger and more efficient cargo vessels and cruise ships;  
and
- 6) allow for development of additional terminals/berths without encroaching on the existing Federal channels and turning basins.

### **1.1 Project Location**

Port Canaveral is located on the east coast of Florida in Brevard County, directly south of the John F. Kennedy Space Center, and five to six miles north of Cocoa Beach. The Port is located about 155 miles south of Jacksonville Harbor, Florida, about 168 miles north-northwest of Miami Harbor, and 50 miles east of Orlando, Florida. The Port occupies both sides of the Canaveral Barge Canal and the Inner Reach of the deepwater entrance channel. A location map is provided on Figure 1-1 and a map showing the major channel and basins is provided on Figure 1-2.

The City of Cape Canaveral, just south of the Port, is located on the north end of the offshore barrier island following the Florida coast line and is connected to the mainland by the Florida State Road (SR) 528 Martin Andersen Beachline Expressway extending across the Banana and Indian Rivers.

**Figure 1-1  
Port Canaveral Location Map**

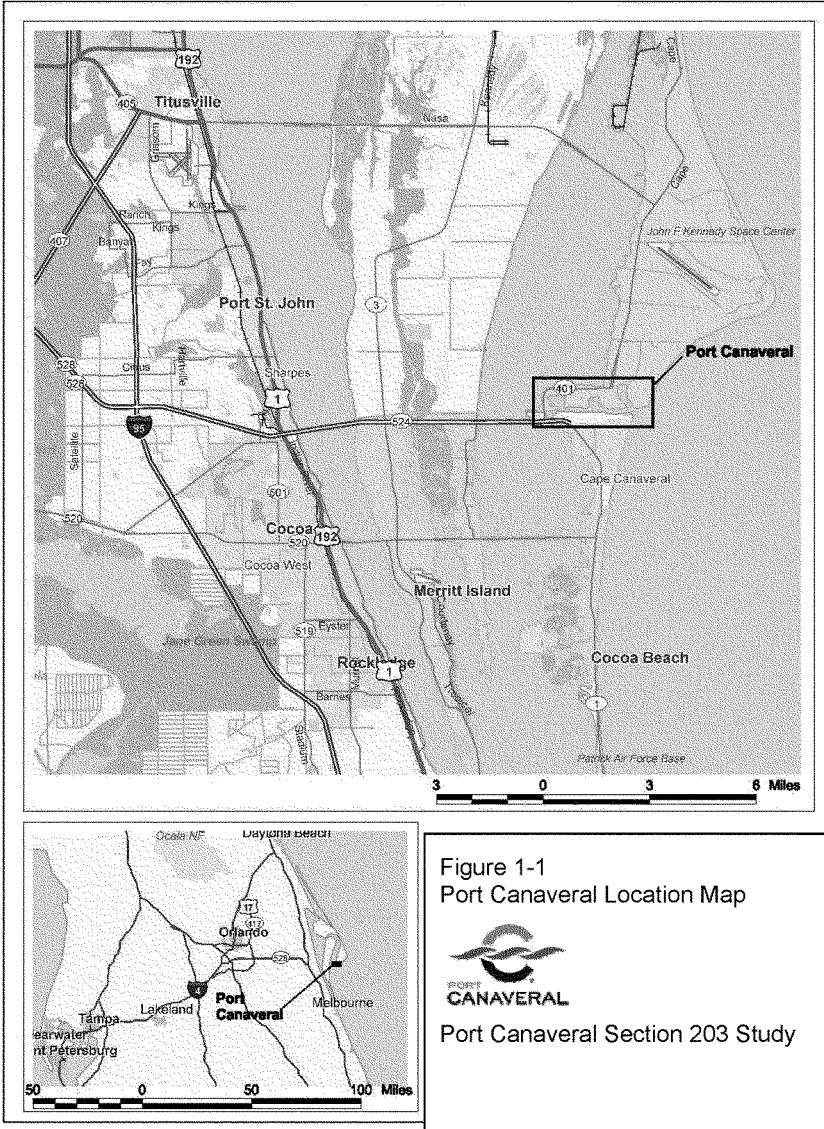

## **1.2 Port Description**

The deepwater entrance to the Port is via a dredged channel approaching from the southeast, then in an east-west direction across the entrance to the east and middle basins on the north side of the channel. The deep draft channel then continues westerly for approximately 3,570 feet terminating at the entrance to west basin to the north side of the channel. The shallow draft Barge Canal runs adjacent to the south side of the deep draft channel, starting at the west side of middle basin in a westerly direction to the Canaveral Locks, operated by the US Army Corps of Engineers. The north side of the Barge Canal and the south side of the existing 400' deep draft channel share a common boundary from middle to west basins. The Canaveral Barge Canal continues through the lock, across the Banana River, and through Merritt Island to connect with the Atlantic Intracoastal Waterway running north-south in the Indian River.

The Port is a multiple-use facility composed of cruise ship berths, cargo berths, U.S. Navy, U.S. Coast Guard, and Military Sealift Command (MSC) berths. Commercial waterfront facilities (described in detail in Section 2) are located along the south side of the main channel, along the north side of the channel west of the middle basin, and along the sides of the middle and west basins. Approaching from the Atlantic Ocean, the eastern basin (also referred to as the Trident Basin) is used by U.S. Navy vessels; the middle basin is jointly used by commercial, U.S. Navy and MSC vessels; and the west basin is used by commercial traffic, cruise ships, and home to the U.S. Coast Guard Station, Port Canaveral, Seventh District, Jacksonville Sector. The berths situated on the Inner Reach of the entrance channel are used primarily by cruise ships, cargo ships and tankers. The primary U.S. Navy facilities at Port Canaveral consist of the Trident Wharf on the east side of the east (Trident) basin, the Poseidon Wharf on the southeast side of the middle basin, and the Military Traffic Management Command (MTMC) Wharf on the north side of the middle basin.

Figure 1-2  
Port Canaveral Navigation Features

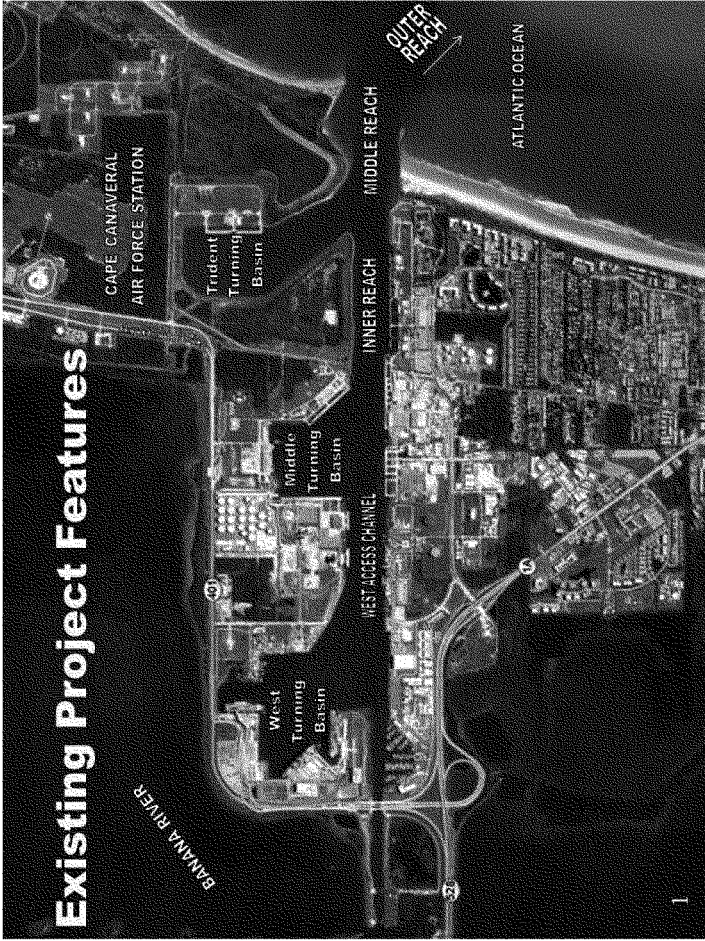
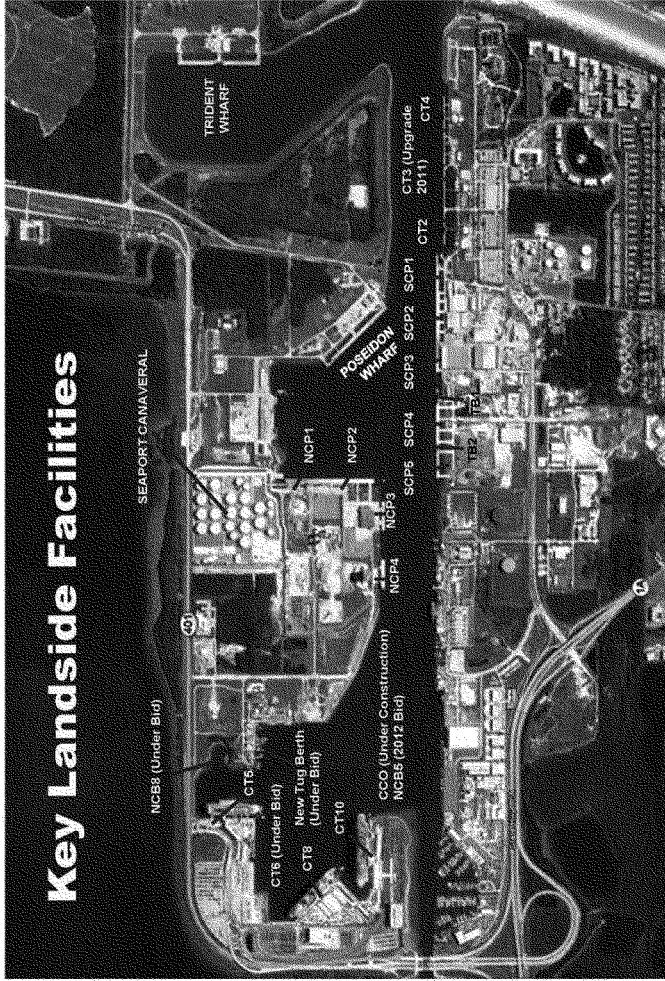



Figure 1-3  
Port Canaveral Major Facilities



## 2 Existing Conditions

### 2.1 Federal Project Dimensions

The existing Federal project at Port Canaveral was authorized by the Rivers and Harbors Acts of 2 March 1945 and 23 October 1962, and Sections 101, 114, and 117 of the Water Resources Development Act (WRDA) of 30 October 1992. The Federal navigation project consists of four channel segments that lead to the three turning basins and terminate at the Barge Canal (see Figure 1-2 and Table 2-1).

**Table 2-1**  
**Port Canaveral Channel Dimensions**

(Project depths in Federally Authorized feet MLLW, lengths and width in linear feet)

Reach	Length	Width <sup>1</sup>	Depth
Outer Reach	29,000	400	-44 <sup>2</sup>
Middle Reach	5,658	400	-44 <sup>2</sup>
Inner Reach	3,344	400	-40
Middle Basin	2,260	NA	-39
West Access Channel (east of Station 260+00)	1,840	400	-39
West Access Channel (west of Station 260+00)	1,730	400	-31 (CPA maintains to -35)
Barge Canal <sup>3</sup>	8,610±	125	-12

Notes: <sup>1</sup>CPA maintains a channel width of approximately 450' in some limited areas  
<sup>2</sup>US Navy Project to 44 feet, Civil Works Project authorized to 41 feet  
<sup>3</sup>Barge Canal length from start of West Access Channel to Canaveral Locks

The three turning basins have the following dimensions:

- Trident Turning Basin: Approximate 1,600 feet wide by 1,800 feet long basin with an access channel that tapers in width from 650 feet at the north end, to 400 feet at the south end, -41 foot depth. The access channel has an authorized depth of -44 feet.
- Middle Turning Basin: Approximate 2,200 feet long basin (including channel), 1,800 feet wide at the north end, 2,600 feet wide at the south end, -35 foot depth east and north portion, -39 feet west and south portion, 1,200 foot diameter turning circle located in the south west corner.
- West Turning Basin: Trapezoidal basin, 2,750 feet wide at the widest point in the north, 1,400 feet wide at the narrowest point near the existing corner cut off, 1,650 feet long between Cruise Terminals 5 and 10, -31 feet Federal Project depth, -35 feet CPA

maintained depth, 1,400 foot diameter turning circle in the NE quadrant. At the north side is the Cruise Terminal 5 Basin, 650 feet wide by 800 feet long, -35 foot depth.

The channel and turning basin dimensions portray a tightly fitted seaport that heavily relies on pilot, multiple tug, and thruster assistance on all vessel maneuvers within the port. The channel is too narrow for turning a vessel, so all cargo, cruise, and naval vessels (with the exception of Trident submarine operations) use either the Middle Turning Basin or the West Turning Basin for maneuvering.

In order to accommodate regular access by Voyager Class vessels some areas have been dredged and maintained by the CPA which extends the channel width beyond the 400-foot authorization. This “Pilots Dredging” as these areas are known, provides a controlling depth of -33 ft to -36 ft to accommodate cruise ship transits. The effective width of the channel from the middle reach to the beginning of the West Access Channel is 450 feet. The effective width of portions of the West Access Channel is 487 feet. This dredging was originally conducted in 2002 and 2003. In 2009 and in preparation to homeport the wave of new larger cruise vessels, CPA executed the Interim Corner Cut Off (ICCO) new work dredging, shifting the -35’ CPA maintained dredge boundary further to the east and north. As of 2009, the CPA maintains a depth of -35’ at 18.5 acres of navigation area that lie beyond the existing federal project limits at the entrance to west basin.

The ICCO is intended to be an interim measure for cruise ship navigation, and is not anticipated to support access in the full range of conditions encountered at Port Canaveral. Vessel use of the ICCO is included as a without-project condition in all alternative plan evaluations, however the Canaveral Pilots have indicated that this single element of the overall project is not sufficient to ensure that large cruise ships would be able to continue calling at Port Canaveral. The construction and maintenance costs of the ICCO are included as project costs, as this project element was completed in advance of project authorization. It is the CPA’s intention to request that this in-kind construction work be credited against the sponsor’s share of total project costs.

## **2.2 Existing Conditions: Terminal Facilities**

Port Canaveral terminal facilities can be generally grouped into four categories: dry bulk cargo, liquid bulk cargo, cruise, and naval. Naval facilities exist along the east side of the Middle Turning Basin and at the Trident Turning Basin, although naval vessels do layover at cargo berths occasionally. Naval use of the port’s facilities have an insignificant impact on overall port operations and therefore are not addressed in detail in this analysis. Similarly, commercial industries that occur along the Port’s waterfront, such as marinas, restaurants, and small commercial fishing enterprises are not addressed in detail.

A Florida Power and Light (FPL) barge berth is located on the south side of the West Access Channel. The barges take fuel from the on-site FPL fuel storage tank (filled by tankers berthed at Tanker Berth 2) through the barge canal to FPL facilities on the Indian River. FPL barge traffic does not have a significant impact on Port Canaveral operations.

The types of cargo that can be handled at each of the Port’s berths are listed in Table 2-2. Containers are typically handled at a temporary 300-foot berth at the north cargo area, but may also be handled at North Cargo Pier (NCP) 2 and South Cargo Piers (SCP) 3 & 5. The listing of south side tanker berths 1 & 2 may be somewhat misleading because the designation “tanker berth” indicates the presence of a fuel manifold for offloading tankers. The tanker berths are not

physically separate berths, but are shared with SCP 4 & 5 on the south side. SCP 3 also has a fuel manifold that is often used to load bunker oil onto barges for delivery to cruise ships in the West Turning Basin. Fuel barges may also be loaded at tanker berths (TB) 1 & 2. The Seaport Canaveral Terminal unloads tankers at NCP 1 & 2. Roll-on/Roll-off capabilities exist at NCP 1 and Cruise Terminal (CT) 2 (formerly used by Premier Cruise Line).

**Table 2-2**  
**Port Canaveral Cargo Category by Berth**

South Side Berths	Berth Depth	Dry Cargo	Liquid Bulk	Cruise
SCP1	-41	Yes	No	No
SCP2	-41	Yes	No	No
SCP3	-39	Yes	Yes	No
SCP4	-41	Yes	No	No
SCP5	-41	Yes	No	No
TB1	-41	N/A	Yes	N/A
TB2	-41	N/A	Yes	N/A
CT2	-35	No	No	Yes
CT3	-35	No	No	Yes
CT4	-35	No	No	Yes
North Side Berths		Dry Cargo	Liquid Bulk	Cruise
NCP1	-41	Yes	Yes	No
NCP2	-41	Yes	Yes	No
NCP3	-41	Yes	No	No
NCP4	-41	Yes	No	No
CT5	-35	No	No	Yes
CT8	-35	No	No	Yes
CT 9/10	-35	No	No	Yes

Note: SCP = South Cargo Pier, TB = Tanker Berth, NCP = North Cargo Pier, CT = Cruise Terminal  
Source: CPA

### 2.2.1 Existing South Side Cargo Terminal Facilities

The south side of the Inner Reach (a.k.a. the East Access Channel), features nearly continuous cruise and cargo wharfs from the entrance to the Trident turning basin to the west side of the Middle Turning Basin. Three cruise terminal berths (CT2, CT3, and CT4) are located at the east end of the southern berths. Five cargo berths (SCP1-5) and two tanker berths (TB1 and TB2) extend westward from the termination of the cruise terminal berths. From the western end of the south cargo berths westward to the SR401 bridge, the bulkhead wall is leased to commercial fishing, restaurant, small vessel and marina operators.

Use of SCP1 is limited by the narrow pier apron along the eastern end of the berth and by the narrowness of the channel at that point. The Canaveral Pilots Association limits the size and placement of vessels at SCP1 because of the potential need to “crab” (i.e., sail at an angle that

increases a vessel's effective beam) cruise ships through this reach under windy conditions. SCP1, SCP2 and SCP3 share a continuous pier that is 1,614 feet long. SCP4 and SCP5 are not continuous. Cement and aggregates are both offloaded at SCP4 due to the location of offloading equipment. An overhead conveyor system is available to transport aggregates from the SCP4, over and across George King Boulevard, to the Ambassador Services, Inc. storage facility. Ambassador Services, Inc. is one of the major shipping agent and stevedore service providers at the port.

TB1 is the primary tanker berth used by Transmontaigne for multiple petroleum products and SCP3 is a secondary berth for tankers. Transmontaigne operates a tank farm off CPA property near the port's south cargo facilities. The tank farm includes 730,000-barrel storage capacity for gasoline, diesel, asphalt, and bunker fuel. TB2 is used by RRI Energy, Inc. and FPL. Historical deliveries to TB2 for FPL have recently been terminated, as the Cape Canaveral Power Plant is currently undergoing modernization as a gas-fired plant. It is important to note that tug/barge combinations are frequently used to deliver petroleum products to Port Canaveral (Transmontaigne and Seaport Canaveral). These tug/barge combinations are often greater than 600 feet long and are no different from tankers in their use of berth facilities, however they typically draft less than 30 feet, and therefore are not projected to benefit from channel improvements. Table 2-3 summarizes Port Canaveral's south side cargo terminal facilities. Additionally, vessels are also offloaded using mobile harbor cranes, ship's gear, and other mobile equipment.

**Table 2-3**  
**Port Canaveral Existing South Side Cargo Terminal Facilities Summary**

Berth	Length (ft)	Unloading Facilities	Storage facilities
SCP1	655	None	Warehouses (dry, cool, and freezer)
SCP2	660	None	Warehouses (dry, cool, and freezer)
SCP3	400	Petroleum Products Manifold	Warehouses (dry, cool, and freezer)
SCP4	560	Mobile conveyor system <sup>1</sup> Mobile cement unloader	Open Storage Cement silos
SCP5	400	None	Open Storage
TB-1	NA	Petroleum Products Manifold	Off-site tank farm
TB-2	NA	Petroleum Products Manifold	On-Site 325,000 barrel & 268,000 barrel storage tanks

Note: <sup>1</sup> Conveyor system transports materials off CPA property to an open storage facility

Source: CPA

## 2.2.2 Existing North Side Cargo Terminal Facilities

Cargo berths on the north side of Port Canaveral are located along the western edge of the Middle Turning Basin and along the adjacent north side of the inner reach. The largest single cargo facility on the north side is the Seaport Canaveral Terminal. Seaport Canaveral is a 2.84 million barrel fuel storage and terminal facility on Port Canaveral's north cargo area (Table 2-4).

**Table 2-4**  
**Seaport Canaveral (Vitol, S.A., Inc) Terminal Storage Capability**

Product	Number of Tanks	Storage Capacity (bbls)
Marine Diesel Oil	3	150,000
#6 Fuel Oil	2	300,000
Ethanol	2	110,000
Diesel	4	600,000
Jet Fuel	2	300,000
Regular Gasoline	5	750,000
Premium Gasoline	3	450,000
Blend Components	3	180,000
<b>Existing Sub-Total</b>	<b>24</b>	<b>2,840,000</b>
Future Tanks	7	950,000
<b>Full Build Out Total</b>	<b>31</b>	<b>3,790,000</b>

Source: CPA

Vitol, S.A., Inc. has a 30-year lease agreement with the CPA for 36 acres of land in the north cargo area. The lease agreement includes two 10-year extension options. Vitol, S.A., Inc. is an international fuel trading company operating fuel terminals in seven countries, with Port Canaveral's terminal (Figure 2-1) making the United States the eighth country in their system. The company is operating at Port Canaveral as Seaport Canaveral LLC. Facility operations began in February 2010. Oil tankers and barges use a new petroleum product hook-up system at berths NCP1/NCP2. A more detailed discussion of future operations at the Seaport Canaveral Fuel Terminal is found in Section 3.0 Future Without-Project Conditions.

Since starting operations through July 2011, Seaport Canaveral has used three types of vessels:

- tug/barge combinations, which may be as long as 600 feet and operate with arrival drafts up to 30 feet;
- multi-point service vessels, which are tankers typically in the 400 to 500-foot range with arrival drafts of 32 feet and less, and
- Point-to-point service vessels which are tankers typically 600 feet long with design drafts averaging 39.2 feet and operate at the port with arrival drafts from 34 to 36 feet.

Only the point-to-point tankers are depth constrained at Seaport Canaveral. Table 2-5 presents the total cargo tonnage and total number of trips for each vessel type during February 2010 through July 2011. Additional Seaport Canaveral information through September 2011 indicates that from February 2010 through September 2011 a total of 3,348,133 tons of petroleum products was handled at Seaport Canaveral, but at the time of this writing, detailed vessel operations information was not available after July 2011.

**Table 2-5**  
**Seaport Canaveral Vessel Type Summary**  
**February 2010 through July 2011**

Vessel / Service Type	Total Tonnage	Total Trips
Tug/Barge Combination	664,293	49
Multi-point Service Tankers	970,473	37
Point-to-point Service Tankers	1,272,625	36
<b>All Vessel Types Totals</b>	<b>2,907,391</b>	<b>122</b>

Source: CPA

Most roll-on/roll-off activity has taken place at NCP1. Vessels berthed at NCP2 often extend beyond the southern limit of the pier, but this practice is limited by the proximity to the channel. NCP4, although not a dedicated berth, is used typically by vessels bringing cement to the adjacent Cemex (formerly Rinker) silos. Salt has always been offloaded at NCP1 and slag has always been offloaded at NCP2 due to the close proximity of the facilities to these berths. A temporary 300-foot berth, which mostly is used for containers, is the only cargo berth currently located in the West Turning Basin. Plans for future additional cargo berths (NCP5, NCP6, and NCP8) are being developed by the CPA. Table 2-6 summarizes the existing condition of Port Canaveral's north side cargo terminal facilities.

**Table 2-6**  
**Port Canaveral Existing North Side Cargo Terminal Facilities Summary**

Berth	Length (ft)	Depth (ft)	Unloading Facilities	Storage facilities
NCP1	645	-41	Mobile Conveyor Mobile Hoppers Petroleum Products Manifold	Paved container yard Open and paved storage On-site 2.84 million barrel storage facility
NCP2	645	-41	Mobile Conveyor Mobile Hoppers Petroleum Products Manifold	Slag silo Open Storage On-site 2.84 million barrel storage facility
NCP3	400	-41	None	Dry storage warehouse Paved open storage
NCP4	400	-41	Rail mounted auger cement unloader	Cement silos

**Figure 2-1 Seaport Canaveral Fuel Terminal**

### 2.2.3 Cruise Terminal Facilities

Port Canaveral's cruise terminals are located at the eastern end of the Port's south side and in the West Turning Basin. Along the port's south side, CT2, 3, and 4 were the first cruise terminals to be developed at Port Canaveral. The newer cruise terminals (CT5, CT8, and CT9/10), which service the large multi-day cruise ships, are located in the West Turning Basin. Currently the *Carnival Sensation* uses CT5 and the *Carnival Dream*, which replaced the *Carnival Glory*, began using CT9/10 in mid-November 2009. The *Disney Magic* and *Disney Dream* share CT8, as will the *Disney Fantasy*, which is scheduled to replace the *Disney Magic* at Port Canaveral when it comes into service in March 2012. CT9/10 is also shared by Royal Caribbean International's (RCI) *Monarch of the Seas* and the *Freedom of the Seas*. The *Norwegian Sun* also berths at CT9/10 during her seasonal homeport use of Port Canaveral. Port-of-call vessels typically use CT5 and small port-of-call vessels may use CT3 or CT4. An additional cruise terminal (CT6/7), to be located at the northwestern end of the West Turning Basin, has been identified in the Port's Master Plan. Recently completed construction activities for Port Canaveral's cruise terminal facilities include an additional mooring dolphin and pier expansion at CT10 to accommodate RCI's Freedom Class vessels. Table 2-7 summarizes Port Canaveral's cruise terminal facilities.



**Table 2-7**  
**Port Canaveral Cruise Terminal Summary**

<b>South Side</b>				
Berth	Length (ft)	Maximum Vessel Length (ft)	Terminal Size (sq ft) Ticketing/Luggage	Passenger Capacity
CT2	468	440	8,000/16,500	1,800
CT3	694	782	8,000/16,500	1,800
CT4	882	782	9,000/20,700	1,800
<b>North Side</b>				
Berth	Length (ft)	Maximum Vessel Length (ft)	Terminal Size (sq ft) Ticketing/Luggage	Passenger Capacity
CT5	565	960	61,000/19,000	3,000
CT8	795	1,115	70,000/14,900	4,000
CT9/10	725	1,100	89,000/17,500	3,500

### 2.3 Socio-Economics

The 2010 population of Brevard County (543,346) indicates 14.1% growth over the 2000 population of 476,230. The annual average population growth rate has been 1.6% since 1990. The median household income in the county in 2009 is \$45,683, which is an average annual increase of 2.0% since 1989. Approximately 12% of the population was living below the poverty level in 2009. More than 76% of households are owner occupied. The labor force was 268,149 in 2010, an increase from 252,338 in 2005. However, the unemployment rate in Brevard County has increased markedly, from 3.7% in 2005 to 11.5% in 2010.

Neighboring Orange County, which includes the City of Orlando, has experienced a population increase of 27.8% (from 896,354 to 1,145,956) between 2000 and 2010, with an average annual growth rate of nearly 2.5%. Growth in central Florida has been occurring and is projected to continue to occur at a faster rate than the Florida state average. Research conducted for the Orlando Growth Management Plan (City of Orlando Planning and Development, 01 Feb 2005) projects Orange County annual population growth to be 2.06% annually between 2000 and 2030. The table presented below (Table 2-8) is a compilation of growth projections for Orlando. These growth projections provide strong indication of continued growth in construction and petroleum related products and other commodities moving through Port Canaveral.

**Table 2-8**  
**Projected Growth for City of Orlando 2004 - 2030**

<b>Item</b>	<b>Units</b>	<b>2004</b>	<b>2030</b>	<b>Increase</b>	<b>% Increase</b>
Single Family	units	35,275	48,359	13,084	37.1%
Multi Family	units	67,078	97,072	29,994	44.7%
Office Space	Sq ft	31,294,507	54,048,319	22,753,812	72.7%
Retail Space	Sq ft	27,549,806	40,563,707	13,013,901	47.2%
Industrial Space	Sq ft	35,183,626	53,888,668	18,705,042	53.2%
Hospital Space	Sq ft	5,018,761	7,382,021	2,363,260	47.1%
Gov/Civic Space	Sq ft	16,096,413	26,019,805	9,923,392	61.7%
<b>Total</b>	<b>Sq ft</b>	<b>115,143,113</b>	<b>181,902,520</b>	<b>66,759,407</b>	<b>57.9%</b>
Hotel Rooms	rooms	19,604	36,252	16,648	84.9%
Employment	employees	223,038	361,941	138,903	62.3%

Source: Orlando Growth Management Plan, 01Feb05

## 2.4 Port Hinterland

The cargo terminals at Port Canaveral typically service the central Florida region. Some commodities handled at Port Canaveral are distributed throughout the state and beyond, such as newsprint and food products (personal communication Jeff Allen, formerly of Mid-Florida Freezer). A significant proportion of construction related materials are concentrated in the central Florida region, which is roughly defined as the area from Daytona Beach (Volusia County) south to Ft. Pierce (St. Lucie County) extending west to Orlando (Orange County). Delivery of as much as 50% of aggregate material is concentrated in the Orlando region, with the remainder going to central and south Florida (personal communication Brian Hubert, Ambassador Services, Inc.). There are no major aggregate material import terminals on the east coast of Florida, other than Jacksonville and Port Canaveral. The cement terminals at Port Canaveral predominantly service the central Florida region, with southeastern Florida being serviced from terminals in Port Everglades. A large proportion of building materials (60%) goes to The Home Depot and Lowes distribution centers in central and south eastern Florida (City of Frostproof; Polk County and Pompano Beach; Broward County).

## 2.5 Port Canaveral Historical and Current Cruise Ship Operations

Cruise ship operations at Port Canaveral are integrated with Caribbean cruise ship operations and are increasingly becoming integrated with European and West Coast cruise ship operations as cruise lines expand into these markets. Vessel deployment to the Caribbean has historically been based out of three Florida ports: Miami, Port Everglades and Port Canaveral, the three busiest cruise ports in the world (in that order). New developments in the cruise industry include the

expansion of the Caribbean services to include other U.S. ports, increased cruise ship operations out of west coast ports, and the sharing of vessels between the Caribbean and European market.

Table 2-9 provides an example of these developments. Since their introduction as the world's largest cruise ships in 2000, RCI's Voyager Class vessels have been deployed in the Caribbean service. With the single exception of the *Adventurer of the Seas*, which has always been homeported in San Juan, PR, Voyager Class vessels have been homeported in the major south Florida ports:

- *Voyager of the Seas*: Miami;
- *Explorer of the Seas*: Miami;
- *Mariner of the Seas*: Miami and Port Canaveral; and
- *Navigator of the Seas*: Miami and Port Everglades.

As newer, larger cruise ships have entered the world fleet they have historically been homeported at one of the three main Florida ports, displacing the smaller vessels which then have relocated to alternative U.S. West Coast ports or to the European market (Table 2-9). In 2009, when RCI's Freedom Class vessels entered the fleet, RCI broke from the historic trend of deploying the newest and largest ships solely in the Caribbean service. RCI's *Independence of the Seas* was and continues to be deployed in the European market from Southampton, England. RCI's *Freedom of the Seas* entered service in May 2009 and is homeported in Port Canaveral, cruising to the Eastern and Western Caribbean. This Freedom Class vessel replaced the smaller Voyager Class *Mariner of the Seas*, which then relocated from Port Canaveral to the Port of Los Angeles, and is now the largest cruise vessel in service on the U.S. West Coast.

RCI's Oasis Class vessels (previously called the Genesis Class), are currently the world's largest cruise ships. The first vessel in this class, *Oasis of the Seas*, left the shipyard in November 2009 and began regular service out of its inaugural home port at Port Everglades on December 1, 2009. The second vessel, *Allure of the Seas*, was launched in November 2010. Both Oasis Class vessels are homeported in Port Everglades at least through 2014 (their initial contract period). Both vessels are in the Caribbean service. In a letter dated July 2008, RCI has initiated correspondence with the Canaveral Port Authority concerning potential terminal and berth modifications that would be required to accommodate the *Allure of the Seas* at Port Canaveral. However, Oasis class vessels are not projected to be homeported at Port Canaveral in either the without-project or with-project condition and are not included in channel design or benefits calculations.

**Table 2-9**  
**RCI Voyager, Freedom, and Oasis Class Vessel Deployment Schedules**

Voyager Class		Freedom Class		Oasis Class	
Vessel	Homeport	Vessel	Homeport	Vessel	Homeport
<i>Voyager</i>	Galveston – Winter Barcelona - Summer	<i>Freedom</i>	Port Canaveral	<i>Oasis</i>	Port Everglades
<i>Mariner</i>	Los Angeles	<i>Independence</i>	Southampton, England	<i>Allure</i>	Port Everglades
<i>Navigator</i>	Miami/PE – Winter Spain - Summer	<i>Liberty</i>	Miami		
<i>Adventurer</i>	San Juan				
<i>Explorer</i>	Bayonne, NJ				

Source: royalcaribbean.com

### 2.5.1 Florida's Cruise Ship Industry

Florida's east coast ports are by far the nation's (and the world's) busiest cruise ports. Table 2-10 presents the volume of North American multi-day cruise passengers by departure port for 2003 – 2010. In 2010, Port Canaveral cruise passengers accounted for 12.2% of all North American cruise passengers (MARAD, 2011), ranking it as the 3<sup>rd</sup> busiest cruise port with more than twice as many passengers as the 4<sup>th</sup> busiest cruise port, New York. The market dominance of east coast Florida cruise ports is due to the Caribbean's prominence and allure as a cruise destination and Florida's proximity to it. Caribbean cruise destinations, including the Bahamas and Bermuda, accounted for more than 72% of all North American passenger volume in 2010 (Table 2-11). It is important to note that total multi-day cruise passenger counts and Port Canaveral Passenger counts have remained steady in recent years despite the economic recession and continued economic difficulties.

**Table 2-10**  
**North American Multi-Day Cruise Passengers by Selected Departure Ports (000's)**

<b>Port</b>	<b>2003</b>	<b>2004</b>	<b>2005</b>	<b>2006</b>	<b>2007</b>	<b>2008</b>	<b>2009</b>	<b>2010</b>
Miami	1,867	1,683	1,771	1,890	1,890	2,099	2,044	2,151
Ft. Lauderdale	1,100	1,237	1,199	1,145	1,289	1,187	1,277	1,759
Port Canaveral	1,114	1,230	1,234	1,396	1,298	1,226	1,189	1,299
New York	432	548	370	536	575	435	403	556
San Juan	579	677	581	555	534	521	507	522
Seattle	165	291	337	382	386	435	430	469
Galveston	377	433	531	616	529	403	386	429
Tampa	419	399	408	461	368	393	401	425
Long Beach	171	401	363	380	370	365	415	414
Los Angeles	516	434	615	583	624	607	412	374
<b>Total (all ports)</b>	<b>8,349</b>	<b>9,418</b>	<b>9,747</b>	<b>9,971</b>	<b>10,289</b>	<b>9,915</b>	<b>9,858</b>	<b>10,609</b>

Source: MARAD, 2009 & 2011

**Table 2-11**  
**North American Cruise Passengers By Destination (000's)**

<b>Destination</b>	<b>2003</b>	<b>2004</b>	<b>2005</b>	<b>2006</b>	<b>2007</b>	<b>2008</b>	<b>2009</b>	<b>2010</b>
Western Caribbean	2,924	3,094	3,142	3,151	3,107	2,817	2,828	3,264
Bahamas	1,292	1,431	1,390	1,541	1,442	1,448	1,741	1,970
Eastern Caribbean	1,037	1,215	1,315	1,386	1,409	1,407	1,249	1,661
Mexico (Pacific)	731	964	1,130	1,075	1,215	1,265	1,095	875
Alaska	776	880	930	939	1,014	1,015	1,011	872
Southern Caribbean	749	895	788	749	805	859	801	815
Hawaii	222	232	307	402	495	251	193	188
Bermuda	212	195	226	234	211	224	264	269
Canada/New England	173	214	179	165	189	231	226	265
Transatlantic	76	96	146	138	162	168	158	157
Trans-Panama Canal	95	108	112	91	117	102	146	166
Pacific Coast	25	48	56	60	59	58	63	44
South America	12	10	7	18	14	14	35	19
South Pacific/Far East	7	8	9	12	19	27	29	25
Nowhere	17	29	9	9	31	29	18	17
<b>Total</b>	<b>8,349</b>	<b>9,418</b>	<b>9,747</b>	<b>9,971</b>	<b>10,289</b>	<b>9,915</b>	<b>9,858</b>	<b>10,609</b>
Caribbean Sub Total	4,710	5,204	5,245	5,286	5,321	5,083	4,879	5,742
Percent of Total	56.4%	55.3%	53.8%	53.0%	51.7%	51.3%	49.5%	54.1%
Caribbean/Bahamas/ Bermuda Sub Total	6,215	6,830	6,861	7,061	6,774	6,755	6,620	7,712
Percent of Total	74.4%	72.5%	70.4%	70.8%	67.8%	68.1%	67.2%	72.7%

Source: MARAD, 2009 & 2011

There are 30 new cruise ships scheduled for delivery into the North American market between 2008 and 2012 (Cruise Industry News Annual Report, 2008). Seventeen of these new vessels are larger than 110,000 gross registered tons with passenger capacities of approximately 3,000 or more. The largest of the new vessels (Oasis Class) has a beam in excess of 154 feet and a length overall of nearly 1,200 feet. Four of the largest new vessel classes are the:

- Disney Cruise Lines (two ships at 128,000 tons, 1,115 feet length overall (LOA), and 2,500 passengers, both vessels homeported at Port Canaveral);
- Royal Caribbean International Freedom Class (three ships at 158,000 tons, 1,112 feet length overall (LOA), and 3,600 passengers, one vessel homeported at Port Canaveral);
- Norwegian Cruise Lines Epic (one ship at 150,000 tons, 1,068 feet LOA, and 4,200 passengers, homeported at Miami and Barcelona, Spain); and
- Royal Caribbean International Oasis Class (two ships at 220,000 tons, 1,118 feet LOA, and 5,400 passengers, both vessels homeported at Port Everglades)

Of the 30 new cruise ships scheduled for delivery into the North American fleet between 2008 and 2012, 16 are destined for service in the Caribbean (eight of which are also slated to share service in the European market), eight are slated for world-wide service, and six do not have a service destination identified.

## 2.5.2 Port Canaveral's Cruise Ship Industry

Port Canaveral has historically been a preferred port for the largest, newest cruise ships and, along with Miami and Port Everglades, a first homeport for new vessels. In 2003, Royal Caribbean International placed one of its new Voyager Class vessels (*Mariner of the Seas*) at Port Canaveral. Disney Cruise Line placed its first two vessels (*Disney Wonder* and *Disney Magic*) at Port Canaveral directly from the ship yard. Royal Caribbean International replaced the *Mariner of the Seas* at Port Canaveral, with the new, larger Freedom Class vessel (the *Freedom of the Seas*) in 2009. Similarly, in November 2009 Carnival Cruise Lines replaced the *Carnival Glory*, previously homeported at Port Canaveral, with the *Carnival Dream*, its newest, largest cruise ship. Most recently, in January 2011 Disney Cruise Lines placed its newest ship, the *Disney Dream* into service at Port Canaveral, replacing the *Disney Wonder*, which has now been redeployed to the West Coast. The *Disney Fantasy* (same dimensions as the *Disney Dream*) will be homeported at Port Canaveral when it enters service in March 2012.

The cruise ships<sup>1</sup> homeported at Port Canaveral in 2011 include:

- *Carnival Dream* (3,646 normal capacity; 4,631 maximum capacity<sup>2</sup>)
- *Carnival Sensation* (2,052 norm; 2,634 max);
- *Disney Magic* (1,754 norm; 2,713 max);
- *Disney Dream* (2,500 norm; 4,000 max);
- *RCI Monarch of the Seas* (2,345 norm; 2,744 max); and
- *RCI Freedom of the Seas* (3,634 norm; 4,375 max).

In addition, the port is also a port-of-call for other cruise ships, which in 2011 included: *Carnival Pride*, *Norwegian Sun*, *Norwegian Gem*, *Norwegian Jewel*, *Royal Caribbean Enchantment of the Seas*, and others. In the CPA fiscal year 2011 (01 Oct - 30 Sept) the port was either the homeport or a port of call for 587 multi-day voyages (Table 2-12). There are currently 579

<sup>1</sup> Only multi-day cruise ships are included. Gaming vessels have also historically offered partial day cruises from Port Canaveral.

<sup>2</sup> Normal capacity is based on two occupants per stateroom, maximum capacity includes total number of berths – source MARAD Cruise Passenger Statistics Data

homeport or a port of call multi-day voyages scheduled for Port Canaveral in 2012, including the *Disney Fantasy*, which will enter service and be homeported at Port Canaveral in March 2012. The number of calls includes typical 7-day and 4/5-day cruise itineraries for homeported vessels, port-of-call arrivals, and other scheduled itineraries.

**Table 2-12**  
**Port Canaveral Multi-day Cruise Ship Operations FY2011 & FY2012**

2011 - Actual			2012 - Scheduled		
Berth	Vessel	Calls	Berth	Vessel	Calls
CT 5	Carnival Sensation (H)	104	CT 5	Carnival Sensation (H)	104
CT 5	Carnival Pride	36	CT 5	Carnival Pride	36
CT 5	Carnival Dream (H)	52	CT 5	Carnival Dream (H)	52
CT 5	Norwegian Gem	20	CT 5	Norwegian Gem	37
CT 5	Norwegian Jewel	38	CT 5	Norwegian Jewel	28
CT5	Norwegian Sun	28	CT5	Norwegian Sun	28
CT 8	Disney Magic (H)	33	CT 8	Disney Magic (H)	29
CT 8	Disney Wonder (H)	26	CT 8	Disney Fantasy (H)	32
CT8	Disney Dream	72	CT8	Disney Dream	94
CT 10	Monarch of the Seas (H)	103	CT 10	Monarch of the Seas (H)	62
CT 10	Freedom of the Seas (H)	53	CT 10	Freedom of the Seas (H)	52
CT10	Enchantment of the Seas	10	CT10	Enchantment of the Seas	9
CT 10	Other	12	CT 10	Other	16

Note: (H) after vessel name designates vessels homeported at Port Canaveral. All other vessels are port-of-call.

Port Canaveral has experienced a 4.1% average annual growth in multi-day cruise passengers between 2000 and 2011, which includes the effects of the recent economic downturn. Day trip cruise (gaming vessel) passenger volumes grew between 2000 and 2004, but then have fallen



since then. Table 2-13 presents Port Canaveral revenue passenger volumes for fiscal years 2000 – 2011.

**Table 2-13**  
**Port Canaveral Revenue Passengers (Fiscal Years)**

Fiscal Year	Multi-Day	Day Trip	Total
2000	1,995,619	1,793,002	3,788,621
2001	1,798,366	1,795,058	3,593,424
2002	1,951,196	1,873,044	3,824,240
2003	2,168,450	1,941,020	4,109,470
2004	2,631,320	1,954,910	4,586,230
2005	2,529,743	1,859,108	4,388,851
2006	2,782,712	1,759,344	4,542,056
2007	2,718,416	1,557,506	4,275,922
2008	2,484,504	1,089,456	3,573,960
2009	2,468,439	782,336	3,250,775
2010	2,722,751	80,200	2,802,951
2011	3,100,199	44,469	3,144,668

Source: CPA

Another important reason for Port Canaveral's major role in the cruise ship industry is the port's high vessel utilization rate, making it an extremely attractive and profitable homeport for the cruise industry. Cruise ship utilization is measured in two ways. A vessel's normal capacity is the comparison between the actual number of passengers and the vessel's capacity assuming two passengers per room. The vessel's maximum capacity compares the actual number of passengers to the total number of berths on-board the vessel, recognizing that many rooms, especially those occupied by families, house more than 2 persons per trip. Port Canaveral consistently displays higher utilization rates than Miami or Port Everglades (Table 2-14). CPA attributes the port's high utilization rates to a higher proportion of families with children traveling together, and to the many nearby landside family attractions, which are available at Port Canaveral but are not available at other Florida ports, such as Walt Disney World, Universal Studios, Sea World, and the Kennedy Space Center.

**Table 2-14**  
**Comparative Normal Capacity Utilization (2004 – 2011)**

	Port Canaveral	Miami	Port Everglades
2004	122.6%	110.1%	100.8%
2005	123.5%	110.9%	102.5%
2006	121.9%	110.6%	103.7%
2007	122.2%	110.7%	104.2%
2008	123.4%	110.7%	104.2%
2009	123.3%	111.7%	103.6%
2010	120.3%	111.4%	104.7%
2011*	122.3%	110.8%	104.9%

Source: MARAD 2011; \*2011 data for  
01Jan11 through 30June2011

Cruise ship utilization has consistently been high at Port Canaveral and has not been appreciably reduced during to the economic downturn experienced in 2007 and 2008. It is important to note that the addition of the *Mariner of the Seas* to Port Canaveral's homeport fleet in 2004 did not reduce vessel utilization on the *Sovereign of the Seas* (Table 2-15). The immediately high utilization rate at Port Canaveral for the *Mariner of the Seas* and the *Freedom of the Seas* indicates that shifting the vessel from Miami to Port Canaveral did not reduce its utilization rate at Port Canaveral.

**Table 2-15**  
**Port Canaveral Cruise Ship Capacity Utilization (2003 – 2011)**

	Average Passengers Per Call							
	Normal Capacity	2005	2006	2007	2008	2009	2010	2011*
Sovereign of the Seas	2,276	2,553	2,557	2,574	2,591	---	---	---
Mariner of the Seas	3,114	3,486	3,489	3,476	3,466	---	---	---
Freedom of the Seas	3,634	---	---	---	---	4,088	4,005	3,905
Disney Dream	2,500	---	---	---	---	---	---	3,649
Disney Magic	1,754	2,610	2,575	2,571	2,544	2,533	2,545	2,628
Disney Wonder	1,754	2,651	2,540	2,622	2,618	2,627	2,624	
Carnival Dream	3,646	---	---	---	---	---	4,212	4,346
Carnival Glory	2,758	3,331	3,331	3,291	3,341	3,323	---	---

	Normal Capacity Utilization							
	Normal Capacity	2005	2006	2007	2008	2009	2010	2011*
Sovereign of the Seas	2,276	112%	112%	113%	114%	---	---	---
Mariner of the Seas	3,114	112%	112%	112%	111%	---	---	---
Freedom of the Seas	3,634	---	---	---	---	112%	110%	107%
Disney Dream	2,500	---	---	---	---	---	---	146%
Disney Magic	1,754	149%	147%	147%	145%	144%	145%	150%
Disney Wonder	1,754	151%	145%	149%	149%	150%	150%	---
Carnival Dream	3,646	---	---	---	---	---	116%	119%
Carnival Glory	2,758	121%	121%	119%	121%	120%	---	---

\*Data for 2011 for 01 Jan through 30 June; Source: MARAD 2011

### 2.5.3 Port Canaveral Cruise Ship Operations

This section discusses the operations of the large multi-day cruise ships which use Port Canaveral. These vessels are all berthed in the West Basin. Day-trip cruise ships, which are substantially smaller than multi-day cruise ships, operate out of cruise berths on the south shore of the port. The day-trip cruise ships are not constrained by existing channel conditions.

Existing constraints on the large multi-day cruise ships berthed in the West Basin are explained in the following paragraphs.

Large cruise ship operations in the port are constrained by existing channel width and by the close proximity to moored cargo ships, naval vessels, and the day-trip ships that berth at the south side cruise terminals. The Port Canaveral Pilots will only allow small day-trip size cruise ships to moor at the south side cruise terminals because of the narrow channel. The narrowness of the channel and the close proximity to moored vessels results in a “surge effect” when large cruise ships transit the channel at speeds in excess of 6 knots, which may occur during windy conditions (cross-winds greater than 15 knots). These surge effects have caused some incidents of parted lines, minor vessel connection damage, and some personnel injuries over the years.

Port Canaveral’s standard operating procedures require loading and unloading of cargo vessels to cease during the transit of large cruise ships during high wind conditions (cross-winds greater than 25 knots). The standard operating procedure also recommends that mooring lines be attended during large cruise ship transits. Port Canaveral operations personnel, port tenants, and the Canaveral Pilots Association all work to minimize the effects associated with surges, however minor delays in vessel loading and unloading along the south side docks regularly occur. In addition, tugs are used to keep moored vessels alongside the piers to offset surge effects, which pull vessels away from their moorings (see Section 1-9 Canaveral Harbor Surge Effects and Modeling of the Engineering Appendix). Tugs are typically used at North Cargo Piers 1, 2, and 4, at the Poseidon Wharf, and in the Trident Basin.

Cruise ships currently transit Port Canaveral channels twice daily on regular schedules—inbound to the West Turning Basin from early to mid-a.m. hours and outbound from the West Turning Basin during approximately mid-p.m. hours. Often, as many as three cruise ships arrive or depart in 20 minute intervals during the port’s busy days. Port Canaveral’s largest homeport vessels, as well as various regularly scheduled port-of-call vessels, sail to and from the West Turning Basin in winds of up to 35 knots. These large vessels must travel at relatively slow speeds to minimize surge at critical locations in the west access and inner channels but are greatly affected by channel cross-winds at those speeds due to the vessel’s large amount of sail area.

Cruise ships typically do not use assisting tugboats because they are maneuvered through the use of rudder, conventional fixed or azimuthing pod propeller, and bow and stern thrusters. However, tug assist is required under windy conditions. The larger ships have three or four thrusters forward and three or four thrusters aft. Those ships without stern thrusters generally have two or three azimuthing and/or fixed position pods aft. The fixed pod is on the centerline of the ship at the stern. Azimuthing pods are on either side of the centerline at the stern. The pods are positioned to optimize underway propulsion and have an override maneuvering power mode for use in port. However, the two Disney ships currently homeported at Port Canaveral and the new Disney vessel currently under construction, which is scheduled to be homeported at Port Canaveral, have traditional propulsion systems.

The size of cruise ships and cargo vessels entering Port Canaveral is currently constrained by the federally authorized 400-foot channel width. The narrow channel constrains the maximum length and beam of cruise and cargo vessels that can use the port and affects the operation of cruise and cargo vessels using the port. Wind conditions during large cruise ship transits and proximity to moored vessels along the Port’s main channel compound the operational impacts

imposed by the channel's narrow width. Safe navigation inside the harbor with minimal surge effects to moored vessels requires a balance between vessel speed and good ship handling capability to manage the yaw of the vessel or "crab angle" as it moves through the waterway under the influence of moderate to high wind conditions.

A vessel's "crab angle", also known as drift angle, is defined as the difference between a ship's heading and the actual course made good. Cruise ships transiting the channels at Port Canaveral are susceptible to "crabbing" because of their large superstructure which acts as a sail in the wind and the moderate speeds which must be maintained so as to avoid surge impacts on moored vessels and to maintain braking control of the vessel. The wider the "crab angle", the larger the effective beam of the vessel.

The effective beam is a critical parameter for very large cruise ships such as the *Mariner of the Seas*, which has a length of 1,021 feet and a beam of 127 feet. For two vessels traveling with the same "crab angle" the longer vessel would have the larger effective beam. The extreme length of the *Mariner of the Seas* means that the vessel's effective beam approaches the limits of acceptable safe passage through the current configuration of Port Canaveral's channels.

The *Mariner of the Seas* effective beam was discussed in a letter from the Canaveral Pilot's Association to CPA in December 2002. This letter was written in anticipation of the arrival of *Mariner of the Seas* in 2003 and the need for dredging of certain locations within the harbor, but outside and adjacent to the existing authorized 400-foot channel boundaries. The pilots requested these key areas of dredging to improve the safety of navigation for this new larger cruise ship.

A Port Canaveral Berth Access Simulation Study was conducted in May 2003 to evaluate *Mariner of the Seas* navigation through Port Canaveral in various configurations including the existing channel, the existing channel plus areas requested to be dredged by the pilots adjacent to but outside the authorized channel, and then for a 500-foot channel width. The Canaveral Pilots and RCCL ship captains participated in the simulations at the Simulation, Training, Assessment & Research (STAR) Center, located in Dania Beach, FL.

The simulation was based on the 400-foot channel width as it existed in 2003. Voyager Class vessel speeds were on the order of 6 to 10 knots between the Port entrance and the Navy's Poseidon Wharf in the MTB. Between the Poseidon Wharf and the entrance to the WTB, ship speeds were generally 6 knots or less. The study reported that for Voyager Class vessel speed of 6 knots, crab angles of 2.5 to 3 degrees were observed for 15-knot cross winds. The crab angle increased to approximately 4.5 degrees for 25-knot cross winds. Also noted were minimal clearances to berthed vessels that likely would have resulted in undesirable surge effects on those moored ships and associated operations. For the configuration that included the dredge areas requested by the pilots and for 30-knot cross winds, crab angles of 7 to 8 degrees were observed for transit speeds of 6 knots or less. For 30-knot winds, a more comfortable vessel speed of 6.2 knots limited the crab angle to about 6 degrees.

Prior to the arrival of the Voyager Class vessel, *Mariner of the Seas*, in 2003, and at the request of the Canaveral Harbor Pilots (also with confirmation by simulations at the STAR Center), CPA executed dredging at five locations adjacent to, but outside the federally authorized channel that were considered to be key navigation areas and/or restricted channel areas critical to the safe navigation of this cruise vessel. Those dredge areas effectively provided 50 feet of additional channel width north of the channel at either end of the Inner Reach and 80 feet of additional

channel width south of the channel along both cuts of the West Access Channel. In essence, since November 2003, with the pilot's recommended dredging, the channel width at certain key areas is effectively on the order of 450 feet. CPA dredging outside the federally authorized channel is included in the without-project condition.

The arrival of the *Freedom of the Seas* in 2009, which is nearly 100 feet longer than *Mariner of the Seas*, required the CPA to again dredge beyond the limits of the federal channel based on requests from the Canaveral Harbor Pilots and confirmed by simulations at the STAR Center. This additional dredging included expanding the southeast corner of the present entrance to the West Turning Basin to enable access by a Freedom Class vessel. CPA's widening of the West Turning Basin entrance, referred to as the Corner Cut-Off, was completed in 2011. The navigation effects of CPA dredging outside the federally authorized channel at the entrance to the West Turning Basin are included in the without-project condition.

Despite the narrow channel conditions at Port Canaveral, cruise ship arrival and departure delays are not common because of the importance of schedules to passengers and potential expenses to the cruise lines. Normal high wind conditions (20 - 35 miles per hour) may induce excessive "crabbing" as the vessel transits Port Canaveral's narrow channel. Normal high wind conditions typically do not delay cruise ship arrivals and departures because the cruise lines will use tug assist to transit the channel under normal high wind conditions. Wind direction, as well as speed, influences the Pilot's decision to use tug assist. Winds that are abeam of the vessel as it transits through the Port, i.e., winds from northerly and southerly directions, have a greater impact on the vessel's sail area and are more likely to result in tug assist. Tug assist typically consists of one or two tugs, depending on the strength and direction of the wind and other factors, such as vessel size, propulsion equipment, and size of vessels at cargo berths. Table 2-16 presents annual summations of the number of wind-related occurrences of tug assistance for cruise ships. Tug assist occurrences due to equipment failure or berth shifting are not included in the summation calculations. Discussions with representatives of the Canaveral Pilots Association indicate that tug assistance has continued and may be exacerbated by the arrival of the new larger cruise ships at Port Canaveral.<sup>3</sup> Attachment I to this Economics Appendix includes the itemized list of cruise ship tug assist occurrences as compiled by the Port Canaveral Pilots.

**Table 2-16**  
**Port Canaveral Historical Wind-Related Cruise Ship Tug Assist Occurrences**

	2006	2007	2008	2009
One Tug	10	20	7	16
Two Tugs	4	7	4	1
<b>Total</b>	<b>14</b>	<b>27</b>	<b>11</b>	<b>17</b>

Source: Port Canaveral Pilots

<sup>3</sup> Personal communication with Ben Borgie, Canaveral Pilots Association

### 2.6 Port Canaveral Historical and Current Cargo

Bulk cargo has been moving through Port Canaveral since the Port opened in 1955. During the early years of the port, petroleum products emerged as the dominant commodity along with the commercial fishing industry. Construction materials such as cement and food goods such as orange juice and citrus were also major commodities. Over time, construction materials and petroleum products remained the largest commodities at the port, by volume. Chart 1 presents total annual cargo tonnage at Port Canaveral since 1966. Table 2-17 presents historical tonnage volumes at the port since 1982.

**Chart 2-1**  
**Annual Port Canaveral Total Cargo Tonnage (1966 – 2011)**

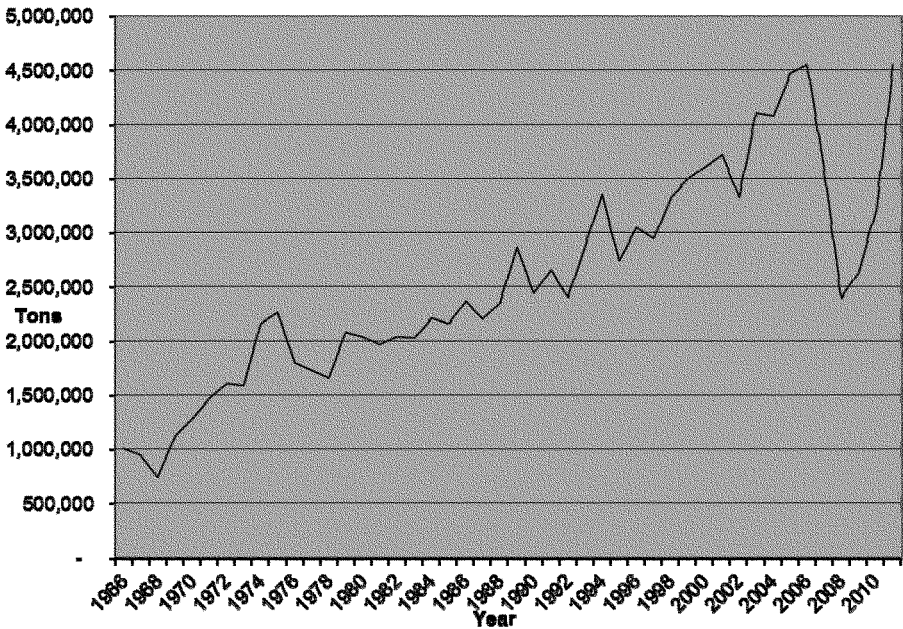

Source: CPA

**Table 2-17**  
**Port Canaveral Historical Total Annual Tonnage (short tons)**

Fiscal Year	Total Tonnage	Fiscal Year	Total Tonnage
1982	2,036,007	1997	2,862,036
1983	2,027,979	1998	3,234,148
1984	2,206,558	1999	3,410,448
1985	2,156,186	2000	3,490,242
1986	2,322,729	2001	3,596,664
1987	2,102,427	2002	3,160,064
1988	2,291,477	2003	3,867,724
1989	2,468,168	2004	4,083,528
1990	2,314,933	2005	4,467,088
1991	2,521,901	2006	4,553,756
1992	2,285,888	2007	3,572,206
1993	2,722,268	2008	2,395,779
1994	3,232,476	2009	2,626,795
1995	2,647,861	2010	3,218,144
1996	2,940,868	2011	4,547,724

Source: CPA

Note: data is for fiscal years (01 Oct – 30 Sep), excludes potable water

Port Canaveral has experienced a steady and slightly accelerating growth trend in bulk cargo during the years from 1986 through 2006. The port's total FY 2006 tonnage was nearly double its FY 1986 total tonnage. In the ten years from FY 1996 through FY 2006, total tonnage increased by 55%. Table 2-18 presents long term average annual growth rates for Port Canaveral's total tonnage calculated through FY 2011. The recent economic downturn has had a dramatic impact on cargo tonnage at Port Canaveral, especially in FY 2008, however tonnage totals rebounded by 2011, due in large part to Seaport Canaveral activity. Historically, the majority of bulk cargo commodities at Port Canaveral have been building and construction materials. These commodities have been especially hard hit by the downturn in residential and commercial construction in southeastern and central Florida, which began in 2007. Therefore, recovery of this sector of the economy is expected to be a necessary precondition to recovery in Port Canaveral construction-related commodity tonnage to pre-downturn levels. Fuel terminal operations at Seaport Canaveral and resumption of residential, commercial, and municipal



infrastructure construction are projected to increase without-project condition total commodity tonnage at Port Canaveral to greater than historical levels.

**Table 2-18**  
**Port Canaveral Total Annual Tonnage Long Term Growth Rates**

Fiscal Years	Average Annual Growth Rate	Fiscal Years	Average Annual Growth Rate
1972 – 2010	2.71%	1992 – 2011	3.41%
1982 - 2011	2.81%	2002 - 2011	3.53%

Source: CPA

### 2.6.1 Existing Cargo Traffic Characterization

The growth experienced in central and south Florida population and housing through mid-2007 drove the growth and dominance of construction and energy related commodities at Port Canaveral. The amount of construction-related materials (stone products, cement, lumber, and slag) at Port Canaveral increased from 29% of total tonnage in 2000 to more than 58% of all tonnage in 2006<sup>4</sup>. Construction and energy related commodities combined for 88% of all goods moving through Port Canaveral in 2006 and 91% in 2011. Seaport Canaveral operations, which began in 2010, brought 857,207 tons of petroleum products through the port in 2010 and 2,490,926 tons in 2011. Table 2-19 presents a summary of commodities handled at Port Canaveral between 2001 and 2011.

During 2001 – 2006, although the port demonstrated an overall growth in cargo, only one commodity type, lumber, experienced constant growth from year to year (slag has only been imported to Port Canaveral since 2003). In 2011, only three major commodities: petroleum products, aggregate stone, and limestone, are above their 2006 tonnages. One of Port Canaveral's advantages, apart from proximity to Central Florida, is that it has the real estate – the physical space – available for large volume storage of liquid bulk and dry bulk commodities, such as stone products and petroleum products. The availability of physical space to store commodities is a major reason why two new dry bulk facilities are currently under construction at the Port.

The recent downturn in real estate and housing construction experienced throughout the nation has severely impacted construction-related commodity tonnage at Port Canaveral. For fiscal year 2011 construction-related commodity tonnage is down by 73% from 2006, although total tonnage is nearly equivalent. However, the impact to construction commodities has not been uniform. Cement import tonnage has fallen from 1.3 million tons in 2006 to zero tonnage during the past three years. Imported cement is used to augment domestic supply to meet the national demand. In 2006, the national consumption of cement was 127.7 million tons, of which 25% was met through imports. In 2010, national consumption has fallen to 69.5 million tons and the percentage of consumption met by imports had fallen to 9% (USGS Mineral Commodity Summaries, Jan. 2011). Alternatively, imports of stone commodities at the port (aggregate, granite, and limestone) in 2011 are 38% higher than the 2006 level of imports.

<sup>4</sup> Data reported in Port Canaveral fiscal years (01Oct – 30Sep)

Port tenants are flexible in their ability to accommodate shifts in cargo volumes and types. For example, in response to reductions in lumber imports, warehouse construction on the north side cargo area has been deferred temporarily and the area has been paved over to accommodate car and truck imports and exports. Fiscal year 2011 tonnage for cars and trucks is greater than fiscal year 2006 tonnage by 26%.

Non-Seaport Canaveral petroleum deliveries have fallen by 33% from 2006 to 2011, largely because Florida Power and Light has totally ceased deliveries. The Cape Canaveral Power Plant is currently undergoing conversion to a gas-fired facility.

**Table 2-19**  
**Port Canaveral Commodity Tonnage FY 2001 – FY 2011 (Short Tons)**

	2001	2002	2003	2004	2005	2006	2007	2008	2009	2010	2011
Petroleum	2,060,158	1,491,295	1,867,608	1,598,098	1,587,742	1,359,576	1,251,171	920,585	990,594	1,892,632	3,399,958
Cement	781,754	774,581	950,864	1,036,173	1,098,129	1,292,208	536,471	34,667	0	0	0
Steel Scrap	24,584	13	0	0	0	0	0	0	0	0	0
Salt	166,336	189,908	169,333	193,058	201,050	198,000	192,000	204,100	210,900	192,050	227,708
Newsprint	217,394	179,008	190,914	178,915	104,863	108,952	105,689	71,381	65,377	42,404	0
Juice Con.	47,566	55,973	53,531	56,206	49,550	50,883	50,739	39,427	46,448	37,539	50,972
Juice	86,535	57,456	40,355	64,111	70,206	59,655	34,264	42,580	66,432	41,191	35,492
Lumber	22,551	156,650	180,518	269,845	445,231	582,541	211,805	113,601	30,733	9,297	7,533
Plywood	0	0	11,394	18,845	30,599	17,435	0	0	0	0	0
Citrus	60,286	40,415	44,289	53,044	0	0	11,921	15,007	8,512	16,261	10,159
Fertilizer	0	0	0	0	24,590	0	0	0	0	9,320	55,914
Agg. Stone	34,513	101,221	205,878	350,662	308,750	246,236	306,769	147,170	672,191	545,684	300,701
Rebars	37,523	25,887	2,225	7,593	0	5,931	0	0	0	0	0
Limestone	0	0	0	0	144,515	97,864	476,177	433,468	263,373	65,694	175,732
Pumice	0	44,813	85,964	49,017	0	51,758	28,687	0	8,818	0	0
Sand	7,278	24,406	5,200	6,000	0	0	58,779	4,417	25,000	0	0
Slag	0	0	0	184,108	297,497	398,432	207,458	227,705	137,169	296,064	235,856
Cars	7,040	7,072	6,108	6,232	10,264	10,147	15,428	19,147	9,763	6,057	4,638
Trucks	352	424	1,310	4,023	8,937	8,352	9,059	12,777	11,352	18,405	18,599
Other	11,702	10,942	52,233	7,598	85,365	67,786	75,789	109,747	80,133	45,546	24,462
<b>Total</b>	<b>3,565,592</b>	<b>3,160,064</b>	<b>3,867,724</b>	<b>4,083,528</b>	<b>4,467,088</b>	<b>4,563,756</b>	<b>3,572,206</b>	<b>2,395,779</b>	<b>2,626,795</b>	<b>3,218,144</b>	<b>4,547,724</b>

Notes: Source – Canaveral Port Authority  
 Excludes potable water and bunkering fuel; Agg. Stone includes rock aggregate and granite

## **2.6.2 Existing Cargo Fleet**

The cargo fleet calling at Port Canaveral can be characterized by the type of service the carrier is providing. Cargo services at Port Canaveral are generally either point-to-point services, which deliver a full vessel load, or multi-point services, which call at multiple ports delivering a partial load to each port. Lumber and Transmontaigne's petroleum products are examples of multi-point services, which typically deliver partial loads. Lumber vessels arriving from the Baltic region and call at New London, CT, Wilmington, NC, and Savannah, GA before reaching Port Canaveral. Transmontaigne-bound tankers typically call at Port Everglades prior to calling at Port Canaveral. Seaport Canaveral receives a mix of multi-point and point-to-point deliveries. Seaport Canaveral's multi-point deliveries are typically on smaller vessels with drafts less than 30 feet, which would not benefit from channel improvements. Multi-point services usually arrive at Port Canaveral with sailing drafts which are unconstrained by existing channel depths. In 2006 – 2008, cement imports, which previously were nearly always point-to-point deliveries, have included multi-point deliveries. This switch to multi-point cement deliveries was due to the reduced demand for cement during the economic downturn no longer requiring a full vessel load to be delivered to Port Canaveral.

Point-to-point services typically arrive at Port Canaveral more fully loaded and offload the entire cargo at the port. Cargo vessels on point-to-point services arrive at Port Canaveral with the deepest drafts of all vessels using the port. Examples of point-to-point service dry bulk cargo include cement, slag, limestone, and rock products (aggregate and granite). Tables 2-20 through 2-23 provide details for the deepest draft point-to-point dry bulk cargo vessels calls from January 2006<sup>5</sup> through September 2009. Seaport Canaveral also receives point-to-point liquid bulk deliveries and generates point-to-point liquid bulk shipments to other ports. Table 2-20 presents Seaport Canaveral point-to-point vessel calls for the 12 months between August 2010 and July 2011. It is important to note that point-to-point vessel calls at Seaport Canaveral are projected to benefit from channel improvements, but multi-port vessel calls at Seaport Canaveral are not projected to benefit from channel improvements.

---

<sup>5</sup> There is a gap in available data as the result of a change in data reporting at the port

**Table 2-20**  
**Cement Imports – 36 Feet or Greater Arrival Draft (Jan 2006 – Sep 2009)**

<b>2006</b>						
<b>Date</b>	<b>Vessel</b>	<b>DWT</b>	<b>Origin</b>	<b>Berth</b>	<b>Tonnage</b>	<b>Draft</b>
11Jan	Nordtide	45,406	Sweden	SCP4	33,347	37.00
16Jan	Spar Sirius	45,402	Taiwan	SCP4	22,102	37.72
30Jan	Talisman	56,019	Thailand	NCP4	45,171	36.00
23Feb	Bled	34,947	Columbia	NCP4	35,910	35.88
18Mar	Ancash Queen	46,673	China	NCP4	46,141	36.00
19Apr	Genco Glory	41,061	Egypt	NCP4	40,254	35.75
16Jul	Fany	43,598	Taiwan	SCP4	34,425	36.56
<b>2007</b>						
<b>Date</b>	<b>Vessel</b>	<b>DWT</b>	<b>Origin</b>	<b>Berth</b>	<b>Tonnage</b>	<b>Draft</b>
05Feb	North Star	42,219	Taiwan	SCP4	27,117	*
17Feb	Tassos N	41,343	Taiwan	NCP4	41,761	36.00
21Feb	Winterset	23,500	Colombia	SCP4	6,437	*
15Mar	Asian Glory	45,194	Brazil	NCP4	26,698	*
26Mar	Maritime Diamond	47,574	Taiwan	SCP4	30,669	*
06Apr	Ince Atlantic	45,608	Taiwan	NCP4	25,850	*
07May	Flag Adrienne	18,289	Columbia	SCP4	13,314	*
31May	New Power	43,665	Brazil	NCP4	19,995	*
31May	BMS Tourloti	37,662	Taiwan	SCP4	22,129	*
23Jun	Flag Adrienne	18,289	Columbia	SCP4	13,403	*
22Jul	Angelina The Great	40,763	Sweden	SCP4	9,915	*
03Aug	Flag Adrienne	18,289	Columbia	SCP4	13,297	*
17Aug	Pontomedon	37,596	Brazil	NCP4	35,549	33.83
16Sep	Flag Adrienne	18,289	Columbia	SCP4	13,602	*
08Oct	KCL Barracuda	17,722	Columbia	SCP4	13,917	*
<b>2008</b>						
<b>Date</b>	<b>Vessel</b>	<b>DWT</b>	<b>Origin</b>	<b>Berth</b>	<b>Tonnage</b>	<b>Draft</b>
30Jan	Jia Quing	47,324	Colombia	SCP4	13,917	36.75
<b>2009</b>						
<b>Date</b>	<b>Vessel</b>	<b>DWT</b>	<b>Origin</b>	<b>Berth</b>	<b>Tonnage</b>	<b>Draft</b>
None						

Source: CPA and Canaveral Pilots Association

Note: \* indicates draft 33 feet or less

**Table 2-21**  
**Aggregate Rock/Granite Imports – 36 Feet or Greater Arrival Draft (Jan 2006 – Sep 2009)**

<b>2006</b>						
<b>Date</b>	<b>Vessel</b>	<b>DWT</b>	<b>Origin</b>	<b>Berth</b>	<b>Tonnage</b>	<b>Draft</b>
10Jan	Tsuru	38,678	Canada	SCP5	39,683	37.50
10Feb	Olga Topic	45,483	Canada	SCP5	47,511	37.00
18May	Dove	38,631	Canada	SCP5	40,765	37.88
25Jun	Bernardo Quintano	67,044	Mexico	SCP4	60,611	39.5
16Aug	Falcon	50,296	Canada	SCP5	41,106	38.5
12Oct	Gdynia	65,738	Canada	SCP5	63,015	39.5
<b>2007</b>						
<b>Date</b>	<b>Vessel</b>	<b>DWT</b>	<b>Origin</b>	<b>Berth</b>	<b>Tonnage</b>	<b>Draft</b>
14Jan	Gdynia	65,738	Canada	SCP5	59,931	37.92
29Jun	Bauta	41,756	Canada	SCP5	43,563	37.25
03Sep	CSL Argosy	74,423	Canada	SCP4	68,333	39.50
<b>2008</b>						
<b>Date</b>	<b>Vessel</b>	<b>DWT</b>	<b>Origin</b>	<b>Berth</b>	<b>Tonnage</b>	<b>Draft</b>
24Apr	Balder	48,184	Canada	SCP4	51,180	38.25
26Jun	Harmen Oldendorff	66,188	Canada	SCP4	58,399	39.50
02Sep	CSL Spirit	70,018	Canada	SCP4	28,967	39.50
03Oct	CSL Spirit	70,018	Canada	SCP4	28,634	39.50
21Oct	CSL Metis		Canada	SCP4	62,893	39.50
16Nov	Top Rich		Canada	SCP5	47,066	37.75
12Dec	Nord Vision		Canada	SCP5	54,844	39.50
20Dec	Stella Maris		Canada	SCP5	54,802	39.25
<b>2009</b>						
<b>Date</b>	<b>Vessel</b>	<b>DWT</b>	<b>Origin</b>	<b>Berth</b>	<b>Tonnage</b>	<b>Draft</b>
10Jan	CSL Metis		Canada	SCP4	62,920	39.50
08Mar	CSL Metis		Canada	SCP4	62,915	39.42
10May	Eastern Power		Canada	SCP4	65,215	39.50
13Jul	Ince Atlantic		Canada	SCP4	48,358	39.17
02Aug	KT Venture		Canada	SCP4	52,943	38.67

Source: CPA and Canaveral Pilots Association

Note: \* indicates shallow draft

**Table 2-22**  
**Limestone Imports – 36 Feet or Greater Arrival Draft (Jan 2006 – Sep 2009)**

<b>2006</b>						
<b>Date</b>	<b>Vessel</b>	<b>DWT</b>	<b>Origin</b>	<b>Berth</b>	<b>Tonnage</b>	<b>Draft</b>
08Jul	Swan	34,291	Bahamas	SCP5	37,529	36.00
21Sep	Bernardo Quintana	67,044	Mexico	SCP4	60,335	39.50
<b>2007</b>						
<b>Date</b>	<b>Vessel</b>	<b>DWT</b>	<b>Origin</b>	<b>Berth</b>	<b>Tonnage</b>	<b>Draft</b>
13Feb	Balder	51,180	Bahamas	SCP5	49,835	38.58
21Feb	Borc	28,106	Bahamas	SCP5	28,794	34.58
07Apr	Borc	28,106	Bahamas	SCP5	28,874	34.50
10Apr	WH Blount	65,402	Mexico	SCP4	58,950	39.50
10Apr	Bahama Spirit	46,606	Bahamas	SCP5	47,675	37.25
23May	Bahama Spirit	46,606	Bahamas	SCP5	46,848	36.00
14Jun	Bahama Spirit	46,606	Bahamas	SCP5	47,805	37.25
23Aug	Balder	51,180	Bahamas	SCP4	46,985	36.33
14Sep	Ha Skelnar	unk	Mexico	SCP4	15,659	*
26Sep	Bahama Spirit	46,606	Bahamas	SCP4	48,040	37.25
04Nov	Bahama Spirit	46,606	Bahamas	SCP4	47,739	37.25
22Dec	Shelia Ann	70,037	Bahamas	SCP4	50,689	36.00
<b>2008</b>						
<b>Date</b>	<b>Vessel</b>	<b>DWT</b>	<b>Origin</b>	<b>Berth</b>	<b>Tonnage</b>	<b>Draft</b>
25Jan	Bahama Spirit	46,606	Bahamas	SCP4	47,854	37.25
05Feb	WH Blount	65,402	Mexico	SCP4	56,000	38.00
06Mar	Bahama Spirit	46,606	Bahamas	SCP4	47,533	37.25
07Apr	Bahama Spirit	46,606	Bahamas	SCP4	47,339	37.25
17Apr	Ballangen	41,630	Bahamas	SCP5	43,036	36.67
19May	Bahama Spirit	46,606	Bahamas	SCP4	47,558	37.25
29Jun	Bahama Spirit	46,606	Bahamas	SCP4	45,700	37.25
04Nov	WH Blount	65,402	Mexico	SCP4	57,820	39.50
<b>2009</b>						
<b>Date</b>	<b>Vessel</b>	<b>DWT</b>	<b>Origin</b>	<b>Berth</b>	<b>Tonnage</b>	<b>Draft</b>
17Feb	Ha Skelnar	unk	Mexico	SCP4	65,814	39.42
21Apr	Bahama Spirit	46,606	Bahamas	SCP4	47,759	37.25
26Jul	Bernardo Quintana	67,044	Mexico	SCP4	22,442	38.75

Source: CPA and Canaveral Pilots Association

Note: \* indicates shallow draft

**Table 2-23**  
**Slag Imports – 36 Feet or Greater Arrival Draft (Jan 2006 – Sep 2009)**

2006						
Date	Vessel	DWT	Origin	Berth	Tonnage	Draft
29Jan	Nikkei Phoenix	45,635	France	NCP2	48,759	37.75
04Apr	Nikkei Tiger	45,363	Japan	NCP2	48,060	37.16
2007						
Date	Vessel	DWT	Origin	Berth	Tonnage	Draft
21Feb	Medi Dubai	52,523	Japan	NCP2	45,749	34.08
18Mar	Condor	50,296	Japan	NCP2	45,392	34.58
21May	Ace Bulker	28,498	Japan	NCP2	29,840	32.00
25Sep	Griffon	46,635	Japan	NCP2	43,181	34.42
18Dec	Nikkei Phoenix	45,635	Japan	NCP2	48,562	37.58
2008						
Date	Vessel	DWT	Origin	Berth	Tonnage	Draft
13Jan	Spring Hawk	46,570	Japan	NCP2	42,594	35.00
13Apr	Kang Kong	55,589	Japan	NCP2	46,603	34.33
14Jul	Ocean Prince	52,475	Japan	NCP2	46,685	34.75
2009						
Date	Vessel	DWT	Origin	Berth	Tonnage	Draft
01Jan	Nikkei Phoenix	45,635	Japan	NCP2	48,791	37.67

Source: CPA and Canaveral Pilots Association

Note: \* indicates shallow draft

### 2.6.3 Existing Cargo Fleet Operations and Tidal Advantage

Large bulk cargo vessels calling at Port Canaveral must operate under a combination of constraints that affect the vessel's potential use of tidal advantage, including channel depth and channel transit schedules. The deepest operating draft approved by the Canaveral Pilots Association is 39.5 feet, which requires special coordination so that the vessel arrives at peak high water. Any vessel arriving with a sailing draft of 36 feet or deeper must coordinate arrival with the rising tide, i.e., use tidal advantage. The channel transit schedule constraint is based on the priority given to cruise ship and submarine transits. When cruise ships and submarines are arriving or departing the port, all other vessel traffic must stand-by. Daily cruise ship morning arrival and evening departure times can effectively close the port to cargo vessel transits for an hour or more. Historically, some vessels awaiting tidal advantage have missed the tidal window because it occurred concurrently with cruise ship or submarine transits. Therefore, using tidal advantage at Port Canaveral includes the additional risk of missing a tidal cycle (and potentially two tidal cycles) due to conflicts with transits by cruise ships or submarines.



Vessel arrival draft data for the years prior to the recent economic recession (Table 2-24 and Chart 2-2) indicate that vessels were typically loaded to avoid reliance on a rising tide, which is consistent with discussions with the pilots and port personnel. Although most large cargo vessels are typically loaded to avoid channel depth constraints and the additional operational difficulties that would follow, some vessels and cargo types do consistently use tidal advantage. For example, dry bulk carriers delivering aggregates, slag, and cement - which are high volume, low value commodities that are stockpiled at the port - consistently arrive at Port Canaveral with drafts that require tidal advantage (Tables 2-20 through 2-23). These vessels typically take a few days to unload and their cargo may spend days or weeks stockpiled at the terminal facility prior to delivery to an end-user.

**Table 2-24**  
**Port Canaveral Deep Draft Vessel Arrival Drafts 2002 - 2006**

Arrival Draft	2002	2003	2004	2005	2006	Total
33	12	13	17	16	12	70
34	31	29	39	24	22	145
35	9	6	18	16	17	66
36	4	15	13	30	17	79
37	2	3	2	13	9	29
38	4	6	5	7	10	32
39	4	3	3	2	2	14
40	0	0	0	4	4	8

Source: USACE, Waterborne Commerce Statistics 2002 - 2006

**Chart 2-2**  
**Port Canaveral Deep Draft Vessel Arrival Drafts (2002-2006)**

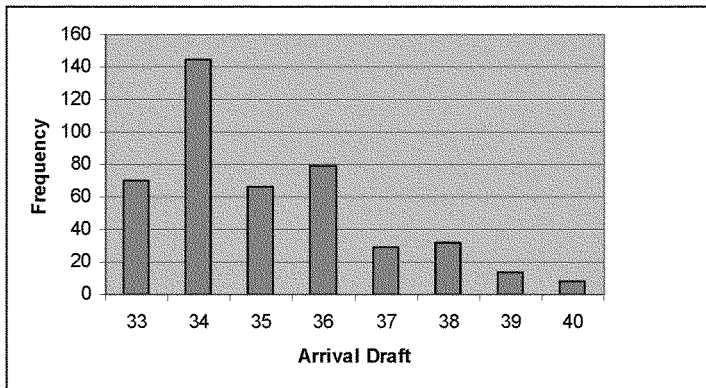

Source: USACE Waterborne Commerce Statistics 2002 – 2006

Large vessel point-to-point calls at Seaport Canaveral typically avoid requiring tidal advantage (Table 2-25 and Chart 2-3) because Seaport Canaveral's vessel operations are closely

coordinated with landside infrastructure availability, landside transport, and end-user delivery schedules. Between February 2010, when Seaport Canaveral began operations, and mid-July 2011 only two vessels have arrived with drafts deeper than 36.0 feet: one at 36.8 feet (Aug 2010) and one at 38.5 feet (Jun 2010). Avoidance of needing tidal advantage not only affects the vessels operating draft, but also affects the overall size of the vessel. Seaport Canaveral vessels tend to be in a narrow size range (Table 2-25 and Chart 2-4) because this is the vessel size that can efficiently operate within the operating draft constraint. Under improved conditions including a deeper channel, efficient vessel size would increase as the operating draft increases. Regardless of potential channel improvements, large vessel point-to-point calls at Seaport Canaveral will continue to avoid requiring tidal advantage due to the additional operational additional risk of missing a tidal cycle (and potentially two tidal cycles) due to transits by cruise ships or submarines.

**Table 2-25**  
**Seaport Canaveral Point-to-Point Vessel Sailing Drafts Aug 2010 – July 2011**

Date	Vessel	LOA	Origin	Tonnage		Sailing
				Inbound	Outbound	Draft
13-Aug-10	Piltene	640	Latvia	47,162		32
23-Aug-10	Haruna Express	590	Canada	50,408		36.8
11-Dec-10	Atlantic Grace	601	US	46,709		35
19-Jan-11	Politisa Lady	599	Venezuela	40,285		32
31-Jan-11	Athiri	752	India	66,497		32
10-Feb-11	Citron	600	Algeria	53,388		35
14-Feb-11	Oriental Ruby	620	Venezuela	40,244	39,490	35
24-Feb-11	Cartagena	601	Netherlands	40,246	40,345	34
27-Feb-11	Arendal	601	Venezuela	40,276		34
5-Mar-11	Lichtenstein	601	Canada		41,111	34
9-Mar-11	Box	601	US	40,310		35
2-Apr-11	Ajax	614	Venezuela	40,238	40,245	35
29-Apr-11	United Ambassador	750	Canada	50,211		35
2-May-11	Kate Maersk	601	Venezuela	40,213	39,472	35
6-May-11	Nordic Hanne	600	Venezuela	36,351	40,203	34.6
21-May-11	Marvea	578	Aruba	34,649		35
22-May-11	Amphitrite	600	Venezuela	40,299		31
9-Jun-11	Nordic Hanne	600	Venezuela	40,392		34.6
29-Jun-11	Nordic Agnetha	602	Venezuela	40,250	39,361	34
3-Jul-11	Eskden	600	Venezuela	40,223	307	33
13-Jul-11	Overseas Kythnos	600	United Kingdom	51,394		34.5
23-Jul-11	Mount Hope	597	US	40,223	38,122	26.3
25-Jul-11	Atlantic Queen	601	Aruba	34,002		35.6

Source: CPA

**Chart 2-3**  
**Seaport Canaveral Point-to-Point Vessel Sailing Drafts August 2010 – July 2011**

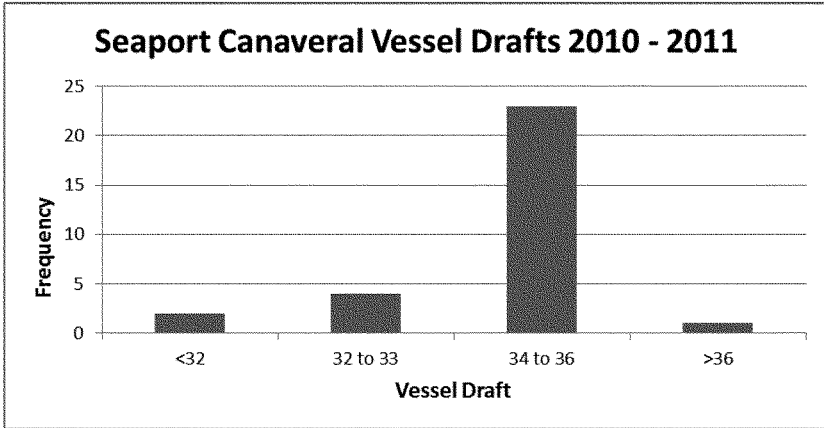

**Chart 2-4**  
**Seaport Canaveral Point-to-Point Vessel Length Overall August 2010 – July 2011**

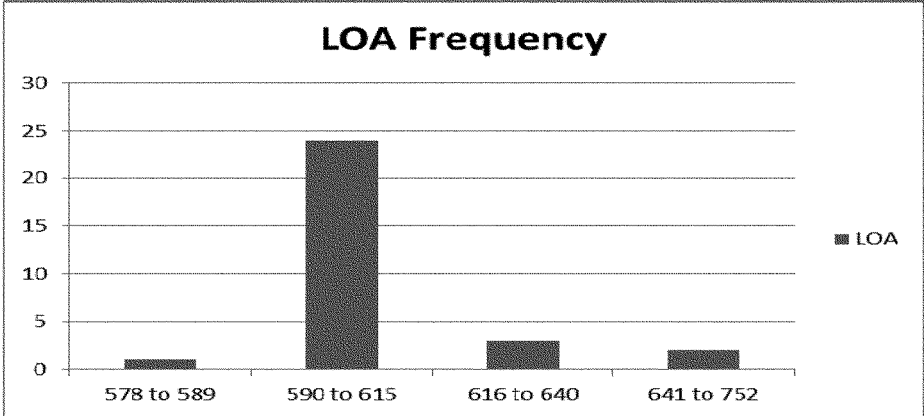

### 3 Without-Project Conditions

Most general conditions relating to climate, winds, waves, and current are expected to be similar to existing conditions. Water quality conditions will continue to be monitored and any necessary corrective actions would be taken. One major change to general conditions will be the projected widening of State Road 528 (Beachline Expressway) which runs between Orlando and Port Canaveral. Currently the road is a four lane (two lanes in each direction) toll road designed in 1960. A Project Development and Environment (PD&E) study was completed by the Florida Department of Transportation in August 2006 recommending a six lane widening project as the selected alternative. In May 2007, Florida's Turnpike Enterprise began Phase I of a project to widen the Beachline West. It encompasses the reconstruction of the mainline toll plaza located near Milepost 5, which is now complete. Ultimate roadway improvements will include four travel lanes in each direction, but due to construction costs, the improvements will be stage-constructed, with the interim improvements including three lanes in each direction. In June 2008, a project began to widen the Beachline from the Turnpike to McCoy Road. Improvements include widening the existing bridge structures at US 441, Landstreet Road, CSX Taft Yard, Orange Avenue and McCoy Road. A new bridge will also be constructed for the access ramp over CSX. The final phase, between Interstate 4 and the Turnpike, has been pushed out due to rising construction costs and expected traffic projections. That project is not included in the Turnpike's current five-year work program.

#### 3.1 Navigation Features

##### 3.1.1 Canaveral Ocean Dredged Material Disposal Site (ODMDS)

Under without-project conditions, maintenance dredging is projected to continue with volumes similar to recent historical volumes. Material samples from more than 300 borings indicate that project and future maintenance material will be similar in quality to recent historical dredged material and therefore suitable for disposal at the Canaveral ODMDS. Long-term monitoring of the ODMDS will continue as outlined in the Canaveral ODMDS Long Term Management Plan. Offshore disposal at the Canaveral ODMDS will continue to be the long term disposal plan for port users (CPA, USACE, USN) and is the most cost-effective disposal alternative, consistent with engineering and environmental criteria. Disposal alternatives for dredged material, other than the ODMDS, consist of very expensive and restrictive upland placement alternatives. Use of the Canaveral ODMDS is not expected to cause significant adverse impacts to Essential Fish Habitat. The disposal site is clear of any coral, coral reef, live / hard bottom or artificial reef habitat. The disposal site's 3 million cubic yard annual capacity limit is sufficient for both maintenance and new project dredging (Table 27, Engineering Appendix).

A draft revised ODMDS Site Monitoring and Management Plan (SMMP) has been released for public comment in January 2012 and is projected to be made final in March 2012. Although the current SMMP limits the use of the ODMDS to 3 million cubic yards of dredged material per year, the revised draft SMMP does not identify an annual volume limit. Additionally, overall planning for the revised SMMP specifically accounts for all construction and maintenance dredging volumes associated with this project. This project requires no changes to the Canaveral ODMDS Long Term Management Plan.

### 3.1.2 Channel Conditions

Royal Caribbean International (RCI) homeported a new Freedom Class vessel at Port Canaveral in 2009, the *Freedom of the Seas*. The Freedom Class is an additional 91 feet longer than the previous Voyager Class vessel, *Mariner of the Seas*, which was homeported at Port Canaveral (Nov. 2003 – Jan. 2009) prior to the arrival of the *Freedom of the Seas*. Other dimensions are similar to the Voyager Class. As discussed in Section 2.3.3 Existing Port Canaveral Cruise Ship Operations, limited dredging outside of authorized project limits was conducted in order for the *Mariner of the Seas* (Voyager Class) to operate safely within Port Canaveral.

Prior to bringing a Freedom Class vessel to Port Canaveral, additional limited dredging beyond existing authorized channel and turning basin dimensions, as recommended by the Pilots and RCI, was conducted. This additional dredging included expanding the southeast corner of the present entrance to the West Turning Basin to enable access by a Freedom Class vessel. The immediate widening of the West Turning Basin entrance is referred to as the Interim Corner Cut-Off (ICCO). The Pilots have stated their willingness to transit a Freedom Class vessel through Port Canaveral under this interim channel modification, but only under the condition that further improvements (including full length channel widening) would be forthcoming. The Pilots have stated that interim channel modifications are not a long term solution to the restrictions on navigation of a Freedom Class vessel at Port Canaveral. Additional discussion of without-project condition vessel operations is contained in Section 3.4 Port Canaveral Operations.

## 3.2 Terminal Facilities

### 3.2.1 Cargo Terminals

Recently completed construction projects include extending SCP4 and widening SCP1. The largest difference between existing and without-project conditions for Port Canaveral's cargo terminal facilities will be the completion of Seaport Canaveral's (formerly Vitol) 36 acre, 2.8 million barrel petroleum product storage facility. This fuel terminal is located on the port's North Cargo Area adjacent to the Middle Turning Basin (North Cargo Piers 1-2). Initial construction, which was completed in December 2009, includes 24 storage tanks with a combined capacity of 2.8 million barrels. Initial construction cost was \$45 million. Seaport Canaveral Terminal capacity is more than three times the existing capacity at Transmontaigne's facility (formerly Coastal Fuels). Seaport Canaveral has delivery contracts in place and the first delivery occurred in February 2010. As of September 2011, 3.3 million tons of petroleum products have been delivered to the facility. The facility currently has 24 storage tanks with a capacity of 2.84 million barrels and a six lane truck rack. At full build-out, whenever that might occur, Seaport Canaveral will have 31 storage tanks with a capacity of 3.79 million barrels. Additional development at the facility may also include a pipeline to the Orlando International Airport and potentially a biodiesel production plant. Full build-out, jet fuel pipeline, and the biodiesel plant are all potential developments at Seaport Canaveral, which have not been included as elements that affect project benefits because of their speculative nature.

The Canaveral Port Authority is currently in the design and construction stages for three new cargo berths in the West Basin, North Cargo Berths (NCB) 5, 6 & 8. These projects (including improvements to CT 6 being performed concurrently with NCB 8) are currently estimated to cost between \$45 and \$65 million.

### 3.2.2 Cruise Terminals

Under without-project conditions, the Canaveral Port Authority has undertaken a \$32 million effort to upgrade and expand Cruise Terminal (CT) 8 to accommodate the new, larger Disney vessels. The first of these new, larger vessels, the *Disney Dream*, entered service at Port Canaveral in January 2011. The second of two new Disney cruise ships, the *Disney Fantasy*, is currently under construction, with expected delivery in February 2012. These vessels are 128,000 Gross Registered Tonnage (GRT), with a draft of 27 feet, length overall of 1,115 feet, and a beam at the waterline of 121 feet. The older Disney ships are 83,000 GRT (with 965 ft LOA, 106 ft beam, and 25 ft draft), so the new vessels are considerably longer and wider, although they will employ traditional propulsion systems. Completed modifications to CT 8 to accommodate the new larger Disney cruise ships include berth extension and additional mooring features without compromising the safety of navigation for cruise vessel traffic to and from adjacent CT 10. The passenger terminal was also substantially upgraded, and additional plans are being drawn up better accommodate up to 4,000 passengers.

CT 10 was modified in 2009 to accommodate RCI's new Freedom Class vessel. Prior to modifications CT 10 was capable of berthing a vessel with a maximum length of 1,020 feet. The new Freedom Class vessels are 1,112 feet LOA. Completed modifications to CT 10 include the construction of a mooring dolphin to the east of the existing pier and additional pier extension, which satisfy the requirements of the larger vessel. The passenger terminal was also enlarged to accommodate up to 3,500 passengers.

### 3.3 Economic Conditions in the Project Hinterland

Even throughout the recent severe economic downturn, the population of the six-county region encompassing the project area continued to grow at a significant rate. For example, the population of Brevard County grew 14.1% from 2000 to 2010 (see Section 2.2.4). Under a medium growth scenario generated by the Bureau of Economic and Business Research (BEBR)<sup>6</sup> at the University of Florida, the six-county port hinterland region is projected to increase population by 43% (1.4 million people) between 2010 and 2035, an average annual growth rate of 1.45%. This projected regional population growth is proportionately greater than projected statewide growth, which is projected to increase by 33%, an average annual rate of 1.1%. Table 3-1 presents the BEBR population growth estimates for the port's six-county hinterland region.

---

<sup>6</sup> BEBR, 2010

**Table 3-1**  
**Six-County Regional Population Projections (2010 – 2035)**

County	2010	2035	Population Increase	Percent Increase	Average Annual Growth Rate
Brevard	554,900	727,200	172,300	31.1%	1.1%
Lake	293,500	487,700	194,200	66.2%	2.1%
Orange	1,111,000	1,623,200	512,200	46.1%	1.5%
Osceola	273,300	506,400	233,100	85.3%	2.5%
Seminole	423,700	548,900	125,200	29.5%	1.0%
Volusia	506,500	636,600	130,100	25.7%	0.9%
<b>Region Total</b>	<b>3,162,900</b>	<b>4,530,000</b>	<b>1,367,100</b>	<b>43.2%</b>	<b>1.45%</b>
<b>Florida</b>	<b>18,773,400</b>	<b>24,970,700</b>	<b>6,197,300</b>	<b>33.0%</b>	<b>1.15%</b>

Source: Bureau of Economic and Business Research, University of Florida; Publication 156; March 2010

In addition to the projected population growth within the port's hinterland which will grow demand for Port cargo, commencement of full operations at the new Seaport Canaveral fuel terminal will expand the area historically serviced by fuel terminals at Port Canaveral. Transmontaigne (previously the only fuel terminal facility operating at Port Canaveral) cannot expand or substantially change its operation due to permit and zoning constraints within the City of Cape Canaveral. Transmontaigne's facility is off port property and surrounded by residential development, drastically limiting its growth potential. Seaport Canaveral's business plan and physical plant design do not suffer from the same limitations and are aimed at expanding the existing hinterland for fuel beyond the area serviced by Transmontaigne to include the Orlando area and the Orlando International Airport.

The Florida 2006 Energy Plan states that 90% of the state's waterborne deliveries of fuel oil are handled by three principal ports: Tampa, Jacksonville, and Port Everglades. On Florida's east coast, there is only a very small volume handled at Fort Pierce, apart from Jacksonville, Port Everglades, and Port Canaveral. The hurricane seasons of 2004 and 2005 created severe disruptions of fuel distribution within Florida, which prompted the state to assess its need for expanded distribution and storage infrastructure improvements and contingency planning. The Florida 2006 Energy Plan's first recommendation for transportation fuels was to "facilitate diverse petroleum supply and distribution mechanisms into and within Florida". The new Seaport Canaveral Terminal adds significant additional capacity at a strategic location in central Florida, because of its proximity to Orlando and its mid-coast location between major delivery ports at Jacksonville and Port Everglades.

The Annual Energy Outlook 2011 projects that the South Atlantic region will increase its share of the nation's gasoline consumption from 39.6% in 2010 to 44.3% in 2035 (Table 3-2). Similarly, the South Atlantic region's distillate fuel consumption is expected to increase from 32.7% to 35.1% of national consumption. Overall, gasoline consumption in the South Atlantic region is projected to increase by 15.4% during 2010 through 2035, an annual rate of 0.6%. Distillate fuel consumption in the South Atlantic region is projected to increase by 40.2% from 2010 through 2035, an annual rate of 1.4%. The South Atlantic region's ethanol consumption in

gasoline is projected to increase by 86.3% over the same period, an annual growth rate of 2.5%. National ethanol net imports are projected to increase by a factor of more than 300 from less than 1,000 barrels per day in 2010 to more than 250,000 barrels per day by 2035.

**Table 3-2**  
**Fuel Consumption Projections in Millions of Barrels per Day (2010 – 2035)**

Fuel	2010	2035	Consumption Increase	Percentage Increase	Average Annual Growth Rate
<b>National</b>					
Gasoline	9.02	9.31	0.29	3.2%	0.1%
Distillate	3.73	4.87	1.14	30.6%	1.1%
Ethanol Imports	0.0008	0.2562	0.2554	32,534%	---
<b>South Atlantic</b>					
Gasoline	3.57	4.12	0.55	15.4%	0.6%
Distillate	1.22	1.71	0.49	40.2%	1.4%
Ethanol in Gasoline	0.248	0.462	0.214	86.3%	2.5%

Source: Annual Energy Outlook 2011; South Atlantic Supplemental Regional Table (Table 5)

### 3.4 Port Canaveral Operations

#### 3.4.1 Commodity Projections

The without-project condition commodity forecast for Port Canaveral is based on recent historical commodity volumes and growth at the port, projected demographic and economic growth in the port's hinterland (see Section 3.3 Economic Conditions), and on existing port development. The base year of the analysis is 2014; however, commodity forecasts use FY11 CPA data as the baseline. As discussed in Section 2.4, growth in overall commodity tonnage at Port Canaveral has been growing steadily over the past 40 years, although volumes of specific commodities have fluctuated significantly. Commodities with the most consistent historical growth have been construction-related commodities such as lumber, cement, and stone products and petroleum products (see Sections 2.4.1 and 2.4.2).

The effects of the recent recession were first seen in a total tonnage reduction from 2006 to 2007. By 2008, total tonnage had been reduced to 53% of 2006 levels. Since 2008, total tonnage at Port Canaveral has risen, though not yet to pre-recession levels. Total tonnage for 2009 was 9.64% greater than total 2008 tonnage, and 2010 total tonnage was 22.5% greater than total 2009 tonnage. By 2011, the Port's total tonnage was 99.9% of 2006 tonnage (Table 2-19). The effects of the recession have not impacted all commodities equally. Tonnage for lumber and cement has substantially reduced, but petroleum products and stone products have increased. Overall, residual tonnage impacts due to the recession are expected to be short-lived.

The commodity forecast used in this analysis focuses only on the four categories of bulk commodities that are carried on vessels large enough to potentially benefit from navigation improvements at Port Canaveral: fuel, rock, slag, and cement. Other commodities handled at



Port Canaveral, such as lumber, salt, food products, etc., will continue to be carried on vessels which are too small to require navigation improvements at Port Canaveral. Therefore, these other commodity groups are excluded from further analysis.

#### **3.4.1.1 Rock Forecast**

Rock (aggregate, limestone, and granite) forecasts were provided by the CPA based on term sheets for the two major bulk handling firms operating at the port. The term sheet is a planning document used by both the operator and the CPA to allocate resources and terminal area. The term sheet provides a revenue stream estimate for the CPA and is used to establish minimum guarantee fees. As a consequence of the guarantee fees, the projections contained in the term sheets are both conservative and as accurate as possible. The term sheets for both firms provide commodity projections from 2011 through 2035. In this analysis, there is no further growth projected for these commodities beyond growth identified in the term sheets, due to forecast uncertainty.

Port Canaveral is uniquely situated as the only deep water port on Florida's central east coast with the ability to handle and store the amount of rock products identified in the term sheets. The commercial importance of Port Canaveral's location, as explained by the operators, is that continued infrastructure development along the Orlando/Interstate 4 corridor requires more rock products than can be supplied through existing and historical local sources. The fixed location of rail infrastructure and the inability to develop potential sources within the Everglades due to land use constraints increase the need for imported rock products. At the same time, vessels carrying international rock products are increasing in size, lowering per unit transportation costs and increasing their cost competitiveness in the central Florida market. For example CSL, one of the world's major bulk carriers which calls regularly at Port Canaveral, will have a new fleet of Panamax bulk vessels in service by 2012 with draft capabilities of 44 feet.

#### **3.4.1.2 Fuel Forecast**

Seaport Canaveral began operation in February 2010. From February 2010 through September 2011, Seaport Canaveral has handled 3.3 million tons of petroleum products. A detailed analysis of individual point-to-point shipments from the twelve month period from August 2010 through July 2011 was used to inform the Seaport Canaveral forecast (Table 2-25). The Transmontaigne facility, which also handles petroleum products, operates in a very different way than the Seaport Canaveral facility, due to its use as one of three Transmontaigne east Florida facilities which share deliveries and coordinate operations. The Transmontaigne facility, which cannot expand due to its proximity to residential development, does not provide a reference for future operations at Seaport Canaveral.

In early 2010, a short-term (2011 – 2013) forecast for Seaport Canaveral, based on current contracts, was provided by the terminal operator. This forecast, which projected an approximate 50% utilization of the Seaport Canaveral facility, included the recessionary impact of existing and near-term economic conditions. Actual Seaport Canaveral tonnage for point-to-point vessels during the 12 month period from August 2010 through July 2011 was 1,272,625 tons, which is 15.87% larger than the projection provided in 2010 (1,098, 334 tons). The actual 1,272,625 tons was used in place of the 2011 forecast and the remaining two short-term forecast years (1.4 million tons in 2012 and 1.9 million tons in 2013) were increased by 15.87% to 1.65 million tons in 2012 and 2.21 million tons in 2013. The long-term forecast (2014 – 2064) is based on the

South Atlantic annual growth rates for gasoline (0.6%) and distillate fuel (1.4%) consumption, as presented in the Annual Energy Outlook 2011. These growth rates are proportionally applied to the short-term 2013 forecast (2.21 million tons; 1.78 million tons gasoline and 0.44 million tons distillate fuel) to generate the long-term (2014 – 2064) forecast.

### 3.4.1.3 Cement Forecast

The cement forecast is based on observed recent growth and includes the substantial impact that the recent recession had on cement imports. Domestic cement production is historically supplemented with imported cement. During the period from 1997 through 2007, cement imports, on average, accounted for 20.6% (23.6 million tons) of national cement consumption<sup>7</sup>. In 2009, cement import tonnage had fallen to 6.2 million tons and domestic consumption had fallen to a level equivalent to consumption in 1991. There have been no cement imports to Port Canaveral in 2009 – 2011. Nonetheless, the two cement terminal facilities at Port Canaveral, even though they have recently been idle, are being constantly maintained in operating condition on a monthly basis by Continental Cement (south side terminal) and CEMEX (north side terminal). These terminals have not been closed and the cement industry projects a strong recovery in cement imports due to pent up demand, environmental regulations restricting domestic cement production, and the permanent closure of domestic cement production plants that have not weathered the current economic downturn.

The Portland Cement Association (PCA) produced an analysis of projected future industry characteristics in 2011 titled “Overview Impact of Existing and Proposed Regulatory Standards on Domestic Cement Capacity”. The PCA analysis projects domestic cement consumption, production, and imports through 2025 under two regulatory scenarios. One regulatory scenario includes the effects of five currently enacted environmental regulations and two proposed regulations (the with-current emissions policy condition). The second regulatory scenario excludes these existing and proposed regulatory standards (the without-current emissions policy condition). The implications of these two policy scenarios is that imports are expected to increase more rapidly as a percentage of total cement usage under current emissions policy due to regulatory impacts on the level and cost of domestic production.

Under the with-current emissions policy scenario, the most likely condition for USACE planning purposes, U.S. cement consumption is projected by the PCA to increase from observed 2010 levels (68.9 million tons) to 170.8 million tons in 2025, an annual growth rate of 6.2%. Cement imports under the with-current emissions policy scenario are projected to increase from observed 2010 levels (5.9 million tons) to 82.0 million tons in 2025, an annual growth rate of 19.2%. This reflects an increasing share of imports versus domestic production over this period.

Even under the without-current emissions policy scenario, which favors domestic production over imports, the PCA projects that cement imports are projected to grow at an annual rate of 15.0%, achieving 48.0 million tons in 2025. Under the without-current emissions policy scenario, the PCA projects that cement imports at the national level will more than double between 2010 and 2015. One important contributing factor to the PCA import projections under both policy scenarios is that domestic production is expected to level off beginning in 2015. Under the without-current emissions policy scenario, domestic production levels off at a greater tonnage than under the with-current emissions policy scenario.

---

<sup>7</sup> USGS Cement Statistics, last modification: December 13, 2010

The cement forecast uses the Port's 2007 level of imports (536,000 tons) as the cement tonnage projected to be achieved in 2015, which represents a much slower return of consumption levels than projected by the Portland Cement Association. This 2007 level of imports is 42% of the peak level (1.3 million tons) achieved in 2006. The projected growth rate for cement imports through Port Canaveral is based on the observed relationship between historical population growth in the port's six-county hinterland and growth in cement imports. This relationship is based on the assumption that increases in population require increases in infrastructure, such as buildings and roads, which are cement intensive structures. During the years from 2000 to 2006, the six-county population grew at an average annual rate of 2.96% and cement imports at Port Canaveral increased at a rate of 5.73%. BEBR population projections indicate an average annual population increase of 1.45% from 2010 through 2035 for the six-county region. Based on the observed proportional relationship between population growth and cement imports during the years from 2000 through 2006, the projected average annual increase in cement imports for a 1.45% population growth rate would be 2.81%  $[(1.45\%/2.96) * 5.73\% = 2.81\%]$ .

Note that the cement import tonnage growth assumptions used in this Economics Appendix (no resumption of cement imports at Port Canaveral until 2015 with a subsequent growth rate of 2.8% thereafter) are considerably lower than the cement industry's projections. The impact of alternative cement forecasts on project benefits are assessed in Section 5.6 Risk and Uncertainty.

#### 3.4.1.4 Slag Forecast

Ground granulated blast furnace slag is a by-product of iron and steel production that is an input into concrete production and a substitute for Portland cement. Unground blast furnace slag is the import commodity, which is typically ground at and distributed from marine terminal facilities such as the Hanson plant and terminal at Port Canaveral. The forecast for slag is based on observed 2011 tonnage. The annual growth rate for slag is the same growth rate used for cement. The slag facility at Port Canaveral does not have the consistent historical use, due to ownership changes, that would allow for a separate growth rate to be developed in a manner similar to the cement growth rate.

Fly ash, which is a residual product of coal combustion, is also a substitute for Portland cement and an alternative product to slag. Fly ash and slag compete as low cost replacements for Portland cement in concrete production. The USGS reports<sup>8</sup> that USEPA regulations, which reclassify fly ash as a hazardous waste, will likely result in increased sales and market share of slag as a substitute for fly ash as an input into concrete production. The USGS states that long-term growth in the supply of slag is likely to rely primarily on imports because of environmental restrictions on domestic production<sup>9</sup>. A sensitivity analysis for the slag forecast is presented in Section 5.6 Risk and Uncertainty.

Domestic slag consumption has not fallen as much as domestic cement consumption has fallen during the recent recession. This is because the market share of slag as an input to concrete production has been increasing relative to Portland cement as more concrete design specifications are written to include slag as a component of concrete mix. The net reliance on imported slag, as compared to domestically produced slag, has also increased from 2006 to 2010

<sup>8</sup> U S Geological Survey, Mineral Commodities Summaries, Iron and Steel Slag, January 2011.

<sup>9</sup> US Geological Survey, Mineral Commodities Summary, Iron and Steel Slag, January 2011

from 8% to 10% of domestic consumption. The slag facility at Port Canaveral has an annual capacity of 600,000 tons, which is projected to be achieved in this forecast by 2045. Projected growth for slag is discontinued after 2045. Slag is the only commodity at Port Canaveral that reaches a capacity constraint before the end of the evaluation period.

#### **3.4.1.5 Commodity Forecast Summary**

The forecasted commodity tonnages for each of the potentially benefitting commodities are presented in Table 3-3. One important perspective on these forecasts is that they do not include the effects of potential future development at the Port. Because its cruise business has not been negatively affected by the recent economic downturn, the port has had the financial resources to continue to improve and expand its infrastructure even during the recessionary period, increasing its competitiveness relative to other ports for new business once the recessionary period is over. For example, the forecasts do not include any new commodity shipments through North Cargo Berths 5, 6 & 8, which are currently under development by Port Canaveral and should be completed within the next several years. The CPA is aggressively looking for opportunities to increase trade opportunities, such as containerized shipping; and has undeveloped, or underdeveloped real estate available for future port expansion. Additionally, these forecasts do not attempt to account for any future effects of the Panama Canal Expansion on Port trade.

**Table 3-3  
Base Case Commodity Forecast – Selected Years (Tons)**

	2011	2012	2013	2014	2015	2016	2017	2018	2019	2020	2030	2040	2050	2060
Aggregate	400,000	500,000	600,000	700,000	800,000	800,000	800,000	800,000	800,000	800,000	800,000	800,000	800,000	800,000
Cement	---	---	---	---	536,471	551,542	567,036	582,965	599,342	616,178	812,881	1,072,376	1,414,710	1,414,710
Limestone	600,000	720,000	840,000	960,000	1,080,000	960,000	960,000	960,000	960,000	960,000	960,000	960,000	960,000	960,000
Granite	400,000	480,000	560,000	640,000	720,000	840,000	840,000	840,000	840,000	840,000	840,000	840,000	840,000	840,000
Slog	235,856	242,482	249,294	256,297	263,497	270,899	278,509	286,333	294,377	302,646	399,260	526,715	604,973	604,973
Cassoline <sup>1</sup>	874,905	1,278,912	1,775,252	1,785,903	1,796,619	1,807,398	1,818,243	1,829,152	1,840,127	1,851,168	1,965,285	2,086,438	2,215,059	2,351,609
Distillate Fuel <sup>1</sup>	223,429	373,016	435,439	441,535	447,717	453,965	460,341	466,785	473,320	479,947	551,534	633,800	728,336	836,973

Note: 2011 data based on observed FY 2011 tonnage reported by CPA

<sup>1</sup> Includes only Seaport Canaveral point-to-point tonnage

### 3.4.2 Cargo Fleet Forecast

Channel depths at Port Canaveral will be the same under existing and without-project conditions. Large bulk carriers and tankers are constrained by existing channel depths as described in Section 2.4.3, and will continue to be constrained under without-project conditions. Cargo vessels affected by this constraint include vessels carrying stone products (aggregate, limestone, and granite), cement, slag, and petroleum products.

The vessels of the future without-project fleet are based on the vessels observed at the port in from 2006 through 2009<sup>10</sup>, with the exception of Seaport Canaveral Terminal tankers, which are instead based on Seaport Canaveral point-to-point vessels which arrived during August 2010 – July 2011. For the other three commodity groups, the number of future vessel calls for each commodity is based on the projected commodity level divided by the average delivered tonnage per vessel call observed in a detailed analysis of 2006 vessel calls. Future without-project fleet operations at the port are expected to exhibit the same characteristics and patterns that were observed in 2006. For example, cement vessels delivered both full and partial loads in 2006, and are projected to deliver similar sized loads under future without-project conditions. The distribution of cargo to vessels of different sizes is also based on the observed 2006 distribution. For example, granite and limestone vessels were sorted into two categories based on average length overall (LOA) and arrival draft. Based on this categorization, 38% of granite and limestone was delivered on vessels with an average LOA of 597 feet and an arrival draft of 36.0 feet, and 62% was delivered on vessels with an average LOA of 753 feet and an arrival draft of 39.5 feet. These proportions and vessel sizes are used in the without-project condition fleet projections. Table 3-4 presents the projected number of vessel calls for the commodities that could potentially benefit from navigation improvements at Port Canaveral.

**Table 3-4**  
**Without-Project Condition Projected Cargo Vessel Calls**

	2020	2030	2040	2050	2060
Aggregate	5	5	5	5	5
Cement	10	14	20	26	35
Limestone	16	16	16	16	16
Granite	16	16	16	16	16
Slag	7	9	12	14	14
Gasoline <sup>1</sup>	44	47	50	53	56
Distillate Fuel <sup>1</sup>	11	13	15	17	20

<sup>1</sup> Includes only Seaport Canaveral point-to-point vessels

<sup>10</sup> The 2010 and 2011 operating characteristics of these vessels has not changed since the period of detailed analysis

### 3.4.3 Projected Cruise Ship Operations

The overall industry demand for cruise ship services is projected to continue to exhibit strong growth in the near-term. Of the 30 new cruise ships currently scheduled for delivery into the North American fleet between 2008 and 2012, 16 are destined for service in the Caribbean, and 8 are slated for world-wide service. All but three of these new vessels are larger than 110,000 gross registered tons with passenger capacities of approximately 2,500 or more. The largest new vessel classes, RCI's Freedom Class, RCI's Oasis Class, the two new Disney vessels, and the Norwegian Cruise Lines Epic (previously Project F3) Class, all have vessels scheduled to be deployed in Caribbean service, as does Carnival's new Dream Class vessels, which are similar in size to RCI's Voyager Class.

The demand for cruise ship services at Port Canaveral is projected to remain strong. The consistently high cruise ship utilization levels at Port Canaveral (Table 2-21) have not been reduced during the recent economic downturn. Discussions with port personnel indicate that cruise lines are marketing their cruise packages as a relatively low cost family vacation and that more passengers are driving to the port in order to reduce total vacation costs. The most recent cruise ship utilization data available for the port indicates that overall multi-day cruise ship utilization levels for 2010 and the first half of 2011 are relatively unchanged from utilization levels during 2005 through 2009.

Cruise ship operations at Port Canaveral under without-project conditions will be very similar to operations under existing conditions, which includes the interim channel modifications that allow temporary use of the channel by the *Freedom of the Seas*. As of January 2011, Port Canaveral is the home port for three new vessels: RCI's *Freedom of the Seas*, the *Disney Dream* and Carnival Cruise Line's *Carnival Dream* (Table 2-15). In spring 2012, a second new Disney vessel, *Disney Fantasy*, will be homeported at Port Canaveral and the last of the smaller Disney vessels currently homeported at Port Canaveral will be re-deployed.

The *Freedom of the Seas* is the largest cruise ship projected to use Canaveral Harbor's Federal channel system in the near-term (Table 3-5). Under without-project conditions, regularly scheduled use of Port Canaveral by the *Freedom of the Seas* is projected to be restricted by wind conditions. The Port Canaveral Pilots consider the Freedom Class vessels to be too large for regularly scheduled unassisted passage through Port Canaveral's existing channels, based on the vessel's length and effective beam under normal high wind conditions. The Interim Corner Cutoff (ICCO) modification to the West Turning Basin was conducted to provide a temporary solution to allow these vessels to call at the Port until a permanent improvement to the navigation project can be implemented. Until that time, the Freedom Class vessels exceed design constraints of the Federal navigation channel and will continue to require tug assist under normal high wind conditions.

The new Disney cruise ships are narrower, but longer than the Freedom Class vessels. The Port Canaveral Pilots project that these vessels will be operated under more restrictive wind condition criteria than the current Disney fleet because, although they are larger than the existing Disney vessels, they will have traditional propulsion equipment. The new Disney vessels also are projected to require tug assist under normal high wind conditions. The new Norwegian F3 Class vessel, *Epic*, is also projected to use Port Canaveral as a port of call.

RCI has been in contact with the CPA concerning Oasis Class vessels using Port Canaveral as a potential port of call and as a port of refuge during emergency conditions. Under without-project

conditions, including interim channel modifications, Oasis Class vessels are too large to operate in Canaveral Harbor's Federal channels on a regularly scheduled basis. Simulation-based evaluations conducted for the Oasis Class indicate an Oasis Class vessel could potentially operate in Port Canaveral in a limited fashion under with-project conditions, however; Oasis Class vessels are not projected to use Port Canaveral and the benefits calculations do not include any benefits related to Oasis Class vessels.

**Table 3-5**  
**Present and Future Large Cruise Ships and Classes**

<b>Cruise Ship or Class</b>	<b>Design Draft (ft)</b>	<b>Length Overall (ft)</b>	<b>Beam at Waterline (ft)</b>	<b>Disp. At Design Draft (m. tons)</b>	<b>Side Wind Sail Area</b>	<b>GRT</b>
Disney <i>Dream &amp; Fantasy</i> Homeport 2011 & 2012	27	1,115	121	62,414	132,181	128,000
CCL <i>Dream</i> Homeport 2009	27	1,004	122	58,262	126,404	130,000
RCI Voyager Class Homeport 2003 - 2009	28	1,021	127	62,716	119,523	138,000
NCL <i>Epic</i> Port of Call	29	1,081	133	73,761	144,959	150,000
Cunard <i>Queen Mary 2</i> Potential Port of Call	33	1,131	135	79,827	139,716	150,000
RCI <i>Freedom of the Seas</i> Homeport 2009	28	1,112	127	71,019	140,092	158,000
RCI Oasis Class Potential Port of Call	30	1,187	154	106,000	168,664	220,000

With the exception of Miami and Port Everglades, other Florida ports have structural constraints that preclude calls by these new larger cruise vessels. New, larger cruise ships have air drafts in excess of 200 feet. Freedom Class vessels have an air draft of 210 feet, as do Voyager Class vessels. Oasis Class vessels have an air draft of 230 feet. Cruise ship activity at the ports of Tampa and Jacksonville are constrained by bridge heights:

- Tampa: Sunshine Skyway Bridge 175 feet vertical clearance (Tampa Bay Pilots Port Guide 2004); and
- Jacksonville: Dames Point Bridge 169 feet vertical clearance (St. Johns Bar Pilots Association).

Other alternative ports for embarkation to Caribbean cruise destinations include Charleston, SC, Galveston, TX and San Juan, PR. However, each of these ports has constraints which would not allow them to homeport the largest new cruise ships. Charleston is limited by berth space availability. The largest cruise ships cannot fit into Charleston's limited berth space (300 linear feet plus 150 feet provided by a mooring dolphin), although adjacent cargo berth space is occasionally used. Galveston's passenger volumes have shown strong growth up to 2006 (620,000 passengers) but have dropped off to 440,000 passengers in 2010 and are approximately one-third of Port Canaveral's levels. Continued strong passenger growth at Galveston is



constrained by berth availability: only 2 cruise ship berths comprising 2,000 linear feet. San Juan is a limited alternative because of significantly higher air travel costs.

## 4 Problems Addressed by the Economic Analysis

Five major problems have been identified based on the analysis of existing and without-project conditions at Port Canaveral. These problems are summarized below and discussed in the following paragraphs. The five major problems are:

1. Channel and turning basin dimensions at Port Canaveral limit the size of cruise ships that are able to call at the Port and impact large cruise ship operations within the Port.
2. Channel dimensions and depths at Port Canaveral limit the size and efficient utilization and movement of cargo vessels that call at the Port.
3. Surges occur at cargo piers due to the passage of large cruise ships through the narrow ship channel. Surge effects can cause damages to vessels, such as parted lines and minor connection damage, personnel injuries, and result in cargo ships having to stop loading and unloading activities while the cruise ships pass. Surges due to cruise ship passage may also require the use of tugs to hold vessels alongside cargo piers. Surge effects are increased when cruise ships speed up to maintain steerage during high winds.
4. Congestion at cargo berths is expected (future without project conditions) to result in vessel delays and additional transportation costs.
5. Channel and turning basin dimensions are restricting the port's ability to develop new cargo and cruise terminals needed to accommodate growing demand and larger vessels.

### 4.1 Cruise Ship Size Limitations

Current and future cruise ships calling and expected to call at Port Canaveral are constrained by channel widths and the dimensions of the West Turning Basin.

#### 4.1.1 Channel Widths

The existing channels and turning basins were sized for much smaller vessels than are currently calling at Port Canaveral. The navigation project improvements authorized in 1992 (WRDA 1992) and completed in 1995 justified widening and deepening the project to its current dimensions based on a composite design vessel (a 67,000 Dead Weight Tonnage (DWT) tanker and a 45,000 DWT bulk cement carrier) with an average length of 750 feet, a beam of 100 feet, and maximum draft of 40 feet. Cruise ships calling at the Port at that time were not large enough to be constrained by channel dimensions.

Since the time of the 1992 authorization, the cruise ships calling at Port Canaveral have increased substantially in Gross Registered Tonnage (GRT), length, beam, draft, and passenger capacity. As the third busiest cruise port in the world, in terms of number of passengers, serving the world's largest cruise destination (the Caribbean), Port Canaveral attracts among the largest cruise vessels currently afloat.

The largest cruise vessel currently homeported at Port Canaveral is the Royal Caribbean International (RCI) Freedom Class vessel, *Freedom of the Seas*. The *Freedom of the Seas* has the following dimensions: 160,000 GRT; length 1,112 feet; beam 127 feet; draft 28 feet; and

passenger capacity 3,634. This vessel replaced the *Mariner of the Seas* at Port Canaveral, a Voyager Class 138,000 GRT vessel, with a length of 1,020 feet, a beam of 127 feet (at the waterline), a draft of 29 feet, and a capacity of 3,114 passengers.

There are currently two Freedom Class vessels in the RCI fleet, *Liberty of the Seas* and *Freedom of the Seas*. The *Liberty of the Seas* is currently homeported in Miami.

The *Mariner of the Seas*, the smaller Voyager Class vessel that was at the time the largest cruise ship at Port Canaveral, had difficulty during adverse weather conditions navigating the current 400 foot wide channel, maneuvering the channel bends, and operating within the 1,400 foot turning circle in the West Turning Basin. Given its larger size (nearly 100 feet longer), the Freedom Class *Freedom of the Seas* faces even greater difficulties. The wind and wave climate at Canaveral Harbor influence the transit conditions for cruise vessel traffic (Engineering Appendix: section 1.3 Site Environmental Conditions). The wind, in particular, influences cruise ship transits due to the very large freeboard area of these vessels. Safe navigation inside the harbor requires a balance between vessel speed and good ship handling capability to manage the yaw of the vessel or “crab angle” as it moves through the waterway under the influence of moderate to high wind conditions.

A vessel’s “crab angle” is defined as the difference between the ship heading and the actual course made good, sometimes also called the “drift angle”. Cruise ships transiting the channels at Port Canaveral are susceptible to “crabbing” because their large superstructure acts as a sail in the wind and moderate speeds must be maintained to avoid surge impacts on moored vessels and to maintain control of the vessel. The wider the “crab angle”, the larger the effective beam of the vessel.

The newest, largest cruise ships operating at Port Canaveral are designed with propulsion systems intended to allow them to transit ports without tug assists. However, under high wind conditions and considering the narrow channels and turns at Port Canaveral, these vessels sometimes require tug assist to conduct channel transits under extremely high wind conditions. In addition, during cruise ship transits under high wind conditions, tug assist is required for moored vessels to counter the surge effect and keep the moored vessel alongside the pier when cruise ships increase speed to minimize “crab angle”.

#### 4.1.2 Turning Basins

As previously stated, the dimensions of the West Turning Basin (WTB) are inadequate for existing vessels homeported at Port Canaveral and cannot safely accommodate future cruise ships projected to call at Port Canaveral. The WTB is currently 1,400 feet in diameter, Federally authorized to -31 feet, and maintained at -35 feet by CPA. Corps design guidelines for turning basins are contained in EM 1110-2-1613 (excerpt below).

9-2. Turning Basins. c. Size. (1) The size of the turning basin should provide a minimum turning diameter of at least 1.2 times the length of the design ship where prevailing currents are 0.5 knot or less. Recent ERDC/WES simulator studies have shown that turning basins should provide minimum turning diameters of 1.5 times the length of the design setup where tidal currents are less than 1.5 knots. The turning basin should be elongated along the prevailing current direction when currents are greater than 1.5 knots and designed according to tests conducted on a ship simulator. **Turning operations with tankers in ballast condition or other ships with high sail areas**

*and design wind speeds of greater than 25 knots will require a special design study using a ship simulator [emphasis added].*

The WTB diameter is considered by the Pilots to be inadequate for the Freedom Class vessels (1.26 times vessel LOA). The minimum acceptable WTB diameter for the Freedom Class vessel, as determined in STAR Center simulations conducted on the *Freedom of the Seas* in 2009, was 1,675 feet. The design cruise ship (*Freedom of the Seas*) is well powered and highly maneuverable. However, the wind sail area of these classes of ultra-large cruise ships is extremely significant and results in large applied forces in the moderate to high (30 knot) design winds experienced at Port Canaveral. Therefore, in consideration of safety and vessel operations under high wind conditions, the minimum effective WTB diameter is 1,725 feet (1.55 times LOA).

The West Turning Basin is federally authorized to -31 feet and maintained at -35 feet by CPA. The authorized depth of -31 feet was justified based on the maximum operating draft of the smaller cargo and cruise vessels using the West Turning Basin at the time of the 1992 authorization. The Voyager, Freedom and Disney cruise ships have operating drafts of 28 to 30 feet and cannot use tidal advantage because of their rigid sailing schedules. In addition, the azimuth steering equipment of these ultra-large modern cruise ships, which allow them to navigate into ports without tug assist under normal weather conditions, also require a significant amount of clearance (typically 1-2 meters) between the vessel and channel bottom in order to function correctly. For these reasons, the authorized depth of -31 feet is not considered adequate for safe navigation of the current cruise ship fleet, which is why CPA currently maintains the WTB to -35 feet. The minimum required depth in the WTB is now considered to be -35 feet and the incremental maintenance costs to maintain the WTB to this depth is included in all with project condition alternatives.

## **4.2 Cargo Vessel Size Limitations**

Current and future cargo vessels calling at Port Canaveral are constrained by channel and turning basin depths.

As stated in the last section, the existing channels and turning basins were sized for smaller cargo vessels than those currently calling at Port Canaveral. The design vessel used for the previous deepening and widening project was a composite design vessel (a 67,000 DWT tanker and a 45,000 DWT bulk cement carrier) with an average length of 750 feet, a beam of 100 feet, and maximum operating draft of 40 feet.

The largest cargo vessels currently calling at Port Canaveral (and those projected to call in the without-project condition), are vessels carrying stone products, slag, cement, and petroleum products. Table 4-1 presents the largest vessels which called at Port Canaveral in 2006. The two dry bulk vessels, the *Gdynia* (65,738 DWT, 738' LOA, 105.6' beam, 42.4' design draft) and the *Bernardo Quintana A* (67,044 DWT, 753' LOA, 105.6' beam, 43.3' design draft) each arrived at Port Canaveral depth limited, with a 39.5-foot operating draft. The only other vessel to arrive with a 39.5-foot operating draft in 2006 was the tanker *Falcon* (dimensions unknown), which delivered power plant fuel oil.

**Table 4-1**  
**Largest Cargo Vessels to Call at Port Canaveral in 2006**

Ship	Maximum Draft (ft)	Length Overall (ft)	Beam at Waterline (ft)	Deadweight Tonnage (m. tons)
Gdynia (Dry Bulk-Aggregate)	42.4	738	105.6	65,738
Bernardo Quintana A (Dry Bulk-Limestone)	43.3	753	105.6	67,044
Bregen (Liquid Bulk-Gasoline)	44.7	797	105.6	68,159

The tanker, *Bregen* (68,159 DWT, 797' LOA, 105.6' beam, 44.7' design draft), delivered fuel oil to Transmontaigne (formerly Coastal Fuels), arriving with only a 26-foot sailing draft. Vessels delivering fuel oil to Transmontaigne often arrive at drafts less than the port's operating maximum draft and also less than the vessel's maximum operating draft. The reason these vessels arrive less than fully loaded is that Port Canaveral is one of several ports of call for these vessels and they often arrive at Port Canaveral partially offloaded after already having delivered fuel oil to other east coast ports during their in-bound voyage.

Under without-project conditions, the commodities projected to demonstrate the most growth, with the exception of lumber, are the same commodities which use the largest cargo vessels calling at the port: i.e., stone products, cement, slag, and petroleum products (see Section 3.4.2). Bulk vessels carrying these commodities to Port Canaveral generally range in size from 60,000 Dead Weight Tons (DWT) to 80,000 DWT. A statistical description of dimensions for vessels ranging from 60,000 DWT and 100,000 DWT is presented in Table 4-2. Tankers currently calling at Seaport Canaveral Terminal are generally in the same dead weight tonnage class as dry bulk carriers; however, Seaport Canaveral is capable of servicing much larger vessels with sizes up to 100,000 DWT or more. A statistical analysis of vessel dimensions in the appropriate DWT range, as opposed to the dimensions of a specific vessel, is presented because, based on the historic record of cargo vessel calls at the Port, no single specific large bulk vessel is likely to make regular repeated calls at Port Canaveral. A discussion of the characteristics of the world fleet in the appropriate DWT range is a better representation of the characteristics of vessels that are likely to use the Port under future without and with project conditions.

**Table 4-2**  
**Characteristics of Cargo Vessels from the World Fleet Currently Using and**  
**Projected to Use Port Canaveral**

CATEGORY	Statistic Dimension	Maximum Draft (ft)	Length Overall (ft)	Beam at Waterline (ft)
60,000 to 70,000 DWT BULK CARRIER (464 vessels)	Maximum	45.8	834	125
	Minimum	32.7	679	104
	Average	42.7	742	106
	90 <sup>th</sup> Percentile	43.7	751	106
70,001 to 80,000 DWT BULK CARRIER (925 vessels)	Maximum	48.8	837	121
	Minimum	37.2	713	105
	Average	45.5	742	106
	90 <sup>th</sup> Percentile	46.8	750	106
80,001 to 100,000 DWT BULK CARRIER (213 vessels)	Maximum	49.3	850	141
	Minimum	37.7	689	106
	Average	45.1	761	118
	90 <sup>th</sup> Percentile	47.3	798	141
60,000 to 70,000 DWT OIL PRODUCTS CARRIER (175 vessels)	Maximum	46.2	800	131
	Minimum	36.5	600	105
	Average	42.7	739	108
	90 <sup>th</sup> Percentile	44.7	791	118
70,001 to 80,000 DWT OIL PRODUCTS CARRIER (244 vessels)	Maximum	49.3	810	138
	Minimum	37.6	700	105
	Average	45.0	749	107
	90 <sup>th</sup> Percentile	47.6	750	106
80,001 to 100,000 DWT OIL PRODUCTS CARRIER (293 vessels)	Maximum	52.8	894	158
	Minimum	38	691	106
	Average	45	792	134.5
	90 <sup>th</sup> Percentile	48.8	814	141

The maximum operational draft allowed at Port Canaveral, as stated in the *Port Canaveral Operational Guidelines*, is currently 39.5 feet. Vessels arriving with an operating draft of 39.5 feet must time their arrival at the port with high water. Vessels arriving with operational drafts greater than 36 feet must arrive with a rising tide. The effects of channel depth constraints on cargo vessels at Port Canaveral were presented previously in Sections 2.4.2 and 2.4.3. These sections show that large cargo vessels typically arrive at the port with operating drafts just less than the 36-foot restriction on unconstrained operations imposed by the port's operational guidelines.

Projected operating drafts for the future large cargo vessel fleet calling at Port Canaveral are expected to be depth constrained in the same manner as under existing conditions, including point-to-point petroleum product vessels calling at the Seaport Canaveral fuel terminal. The point-to-point vessels calling at Seaport Canaveral Terminal are projected to avoid the need for tidal advantage in the same manner as observed under existing conditions. The tug/barges and multi-port delivery vessels arriving at Seaport Canaveral Terminal do not require tidal advantage and are not anticipated to benefit from any project improvements.

Large cargo vessels in the fleet currently calling at the Port and projected to use the Port in the future without-project condition cannot load to their most efficient potential due to channel depth constraints. As shown in Table 4-2, the design drafts of the majority of these vessels are in excess of the channel constraint and the vessels could be filled more deeply if not for the Port's channel restrictions. Because of the 39.5 foot channel restriction, these vessels must lightload in order to transit the navigation channel. Channel depth constraints directly impact Port Canaveral cargo terminal operators and carriers. Port Canaveral's cargo terminal facilities are capable of handling larger vessel loads for each of the following impacted commodities: stone products, cement, slag, and petroleum products. The channel depth constraint reduces the effectiveness and efficiency of cargo terminal operations by restricting the size of individual vessel loads, which causes equipment to be under-utilized. Carriers are similarly operating at less than optimum efficiency when vessels are light-loaded and more trips are required to deliver the same quantity of cargo.

### 4.3 Surge Effects

Under existing and without-project conditions, cruise ships transiting the channel generate water surges due to the speeds required to maintain headway and reduce crab angles during high winds to provide safe bank clearance in the existing 400 foot wide channel. These surges result from the piston-effect of the large cruise ships transiting the narrow channel, which pushes water into (and then pulls water out of) the Trident Basin and Middle Turning Basin and also pulls vessels away from the multi-use berths adjacent to the channel, primarily at NCP 1 & 2, NCP 3 & 4 and CT3<sup>11</sup>. A hydrodynamic surge study was conducted for this investigation and preliminary results are contained in the Engineering Appendix. Ship passage induced surges have caused damage to cargo and naval vessels, damage to connecting equipment, and have also resulted in several injuries. The port's standard operating procedures include distribution of a Surge Warning Letter to all port users, which recommends appropriate attention to mooring lines and cessation of

---

<sup>11</sup> Passing ship forces on vessels moored parallel to the channel and perpendicular to the channel are discussed in greater detail in the Engineering Appendix.

loading and unloading activities during cruise ship passage under moderate and more severe wind conditions.

Surge effects directly impact port tenants who must stop loading and unloading activities during cruise ship transits. Cessation of loading and unloading activities causes inefficiencies at the dock and adds to the total time that the vessel must spend in port. Surge effects may be offset by the placement of a tug, which helps hold the vessel against the dock as the cruise ship passes through the channel. Under historical conditions, prior to the new larger cruise ships currently homeported at Port Canaveral and prior to operations at Seaport Canaveral, the use of an assisting tug to offset surge forces has occurred, although infrequently. Under existing and future without-project conditions, which include the substantially larger cruise ships and tankers moored at the vulnerable piers NCP 1 & 2, tug assist is projected to occur more frequently.

#### **4.4 Future Berth Congestion**

Berth congestion resulting in vessel delays may become a problem in the future without-project condition. Port facilities are already highly utilized and under without-project conditions will become increasingly congested. The mid-range commodity growth scenario predicts berth usage as high as 80% for the north cargo berths shared by Seaport Canaveral tankers, salt, slag, and lumber products. The frequency and duration of tanker calls at NCP 1 and 2 will likely cause some traffic to shift to other berths as available. South cargo berths are currently shared by petroleum products, stone products, cement, perishable items, newsprint and lumber. Congestion at cargo berths reduces the effectiveness and efficiency of cargo vessels and landside facilities. Vessel delays due to berth congestion have historically occurred sporadically at the multi-purpose berths along the south cargo piers. Projected growth in commodity movements at Port Canaveral will result in a larger number of cargo vessels that will have to wait offshore for a berth to become available.

#### **4.5 Limitations on New Cargo and Cruise Terminals**

Channel and turning basin dimensions are restricting the port's ability to develop new cargo and cruise terminals needed to accommodate growing demand. Because existing large vessels are operating at or above channel design dimensions, there is little or no opportunity to develop new berths and terminals to accommodate future growth in cargo and cruise services. Given the current levels of growth, the Port will need to develop new landside facilities and infrastructure to keep pace with demand. However, inadequately sized channels and turning basins are already beginning to impinge on vessel handling facilities which lie immediately adjacent to the navigation channel and turning basins. Absent expansion of the channels and turning basins, there are limited opportunities to develop new facilities.

### **5 Alternative Plan Evaluation**

Detailed alternative plan evaluation was prepared in accordance with Corps' guidance on formulation and evaluation of deep draft navigation projects as described in:

- The Planning Guidance Notebook, ER 1105-2-100 (22 April 2000)
- National Economic Development Procedures Manual: Deep Draft Navigation, IWR Report 91-R-13 (Nov 1991)

- Digest of Water Resource Policy and Authorities, EP 1165-2-1 (30 July 99)
- Planning Guidance Letter #97-06, Cruise Ships and Benefits to Navigation (07 Jul 97).

## **5.1 Detailed Alternative Plan Description**

### **5.1.1 Without-Project Condition Channel Description**

The without-project condition includes continuation of the CPA dredging and maintenance of areas outside the current federally authorized channel. These CPA actions include:

- Maintenance of the West Turning Basin to a depth of -35;
- Spot dredging outside of the federally authorized channel in areas recommended by the Canaveral Pilots; and
- Maintenance of the area in the West Turning Basin outside of the federally authorized channel, which the CPA opened to navigation by constructing the Interim Corner Cut Off.

### **5.1.2 Alternative With-Project Condition Channel Descriptions**

The alternative with-project conditions carried forward for detailed economic analysis include:

- Channel widening in two 50-foot increments from 400 to 500 feet: Widening Plan 1 (450 feet) and Widening Plan 2 (500 feet). Both channel widening alternatives extend from the sea to the West Turning Basin and include placement of an outbound range as an aid to navigation, repositioning of the existing inbound range, and extending an existing turn widener at the entrance from the sea; and
- Channel deepening from the sea to the West Access Channel and Middle Turning Basin, in three increments. The name of each increment is based on the channel depth at the Inner Reach, which is the first reach from the sea that is not affected by wave action (Table 5-1). The without-project depth of the Inner reach is -40 feet. The first increment is a two-foot increment (Deepening Plan 1; -42 feet) and each successive increment is a one-foot increment (Deepening Plan 2; -43 feet and Deepening Plan 3; -44 feet). Each depth increment includes any necessary associated berth deepening (non-federal responsibility).

The Canaveral Port Authority is not interested in partnering in a project deeper than the -44-foot plan (Deepening Plan 3) at this time, due to high associated costs (port infrastructure upgrades) which would be required by channel depths deeper than the -44-foot plan. Likewise, CPA is not interested in any widening alternatives greater than 500 feet (Widening Plan 2) because they would involve extensive and extremely expensive relocation and reconstruction of berthing facilities at the South Cargo Piers, as well as at NCP 1 & 2.

### **5.1.3 Identification of Alternative Plan Increments**

The formulation of alternative plans addressed channel widening and channel deepening as separable elements subject to incremental analysis. Each is discussed separately below.



### 5.1.3.1 Channel Widening Plans

Widening Plans 1 and 2, which are independent of any alternative to deepen channels below existing project depths, include the following components:

- Turn Widener:
  - Widening Plan 1 dimensions are -41' project depth X 22.14 acres (irregular shaped area) bounded to the north and northeast by the civil turn widener and Cut 1 of the outer reach;
  - Widening Plan 2 would provide dimensions of -41' project depth X 11.14 acres (irregular shaped area) bounded to the north and northeast by the civil turn widener and Cut 1 of the outer reach
- Middle Reach: The middle reach extends from the apex of the channel turn westward to the western boundary of the Trident Access Channel. Existing dimensions are -44' project depth X 400' wide X 5,658' long.
  - Widening Plan 1 would increase the project width from 400' to 450', providing a 50' widener of 2,282' in length along the north side of the channel for the portion of the middle reach that is inside of the north jetty. The eastern terminus of the 50' widener transitions from the existing to the new northern channel boundary over a plan distance of 500'
  - Widening Plan 2 would increase the project width to 500', providing a 100' widener of 2,282' in length along the north side of the channel for the portion of the middle reach that is inside of the north jetty. The eastern terminus of the 100' widener transitions from the existing to the new northern channel boundary over a plan distance of 500';
- Trident Access Channel: At the southern boundary of the existing Trident Access channel,
  - Widening Plan 1 will overlay 50' of the Trident Access Channel
  - Widening Plan 2 will overlay a total of 100' of the Trident Access Channel;
- Inner Reach, Cut 2 and Cut 3: Existing dimensions are -40' project depth X 400' wide X 3,344' long.
  - Widening Plan 1 would provide a 50' widener along the entire length of the reach on the north side of the channel. The rip-rap protected shoreline and berm between the Middle and Trident Basins will be relocated northward to accommodate the 50' north side channel widener
  - Widening Plan 2 would increase the project width to 500', providing a 100' widener along the entire length of the reach on the north side of the channel. The rip-rap protected shoreline and berm between the Middle and Trident Basins will be relocated northward to accommodate the 100' north side channel widener
- West Access Channel (east of Station 260+00): Existing dimensions are -39' project depth X 400' wide X 1,840' long.

- Widening Plan 1 provides 50' of widening along the entire length of the channel by redefining the northern channel boundary 12' north of the existing northern boundary, and widening the channel by 38' along the south side and into the barge canal
- Widening Plan 2 would increase the project width to 500', providing 100' of widening along the entire length of the channel by redefining the northern channel boundary 12' north of the existing northern boundary, and widening the channel by 88' along the south side and into the barge canal
- West Turning Basin and West Access Channel, Cut A (west of Station 260+00): The existing federally authorized turning basin and Cut A of the west access channel take up 78.6 acres with a federally authorized project depth of -31' and a current depth of -35' as maintained by the CPA. The existing federal project basin provides a turning circle diameter of 1,400'. Since the mid-1980's and as recently as 2003, the CPA also maintains additional areas adjacent to the northeast shoreline at the entrance to the West Turning Basin to -35' at the request of the pilots for cruise ship navigation access. In 2009, in order to be able to homeport RCI's *Freedom of the Seas*, CPA executed the Interim Corner Cut Off (ICCO) new work dredging in advance of project authorization, shifting the -35' CPA maintained dredge boundary further to the northeast. As of 2009, the CPA maintains a depth of -35' at 18.5 acres of navigation area that lie beyond the existing federal project limits at the entrance to West Basin. The ICCO was intended to be an interim measure for cruise navigation, not anticipated to support access in the full range of conditions encountered at Port Canaveral. The construction costs of the ICCO are not included as project costs in this analysis, as this project element was completed in advance of project authorization and cost sharing agreement. It is the CPA's intention to request that project authorization specifies that this in-kind construction work be credited against the sponsor's share of total project costs. Therefore, for the purposes of this decision document, the ICCO is included as part of the without-project condition in both widening and deepening plan evaluations.
  - Channel Widening Plans 1 and 2 include identical expansion of the federal project limits in the northern and western portions of the West Turning Basin to enlarge the entrance to the west basin providing a turning circle diameter of 1725'. The turning circle and entrance widening will be created by dredging beyond the present federal and CPA project boundaries to the northeast and to the south within the barge canal. Approximately 18.5 acres of existing bank, shoreline, and uplands adjacent to the CPA -35' project boundary and 6.9 acres within the existing barge canal will be dredged to the currently maintained depth of -35'.

### 5.1.3.2 Channel Deepening Plans

Channel deepening increments are identified in a manner typical of Corps deep draft navigation feasibility studies, i.e., the first increment of deepening evaluated is a two-foot increment and successive increments are one-foot in depth. Existing channel depths and potential with-project depths vary among the multiple sections of the channel from the entrance-from-the-sea to each of the turning basins. Essentially, the Port Canaveral project is a stepped channel, deepest at the ocean entrance and becoming progressively shallower as it moves inland. The design vessel used in the alternatives analysis of channel depths is an Aframax Tanker displacing 94,000 tons

partially loaded with an operational draft in Port Canaveral of 39.5 feet, which is the projected maximum unrestricted operational draft allowed in Port Canaveral. The design analysis assumes vessel transit at 0.0 MLLW tide height.

Water depth requirements in channel sections vary based on vessel speed, wave motions, and safety clearance (Engineering Appendix: section 1.0 Engineering Design). The water depths required in any section of the channel is the sum of wave motion, squat, and safety clearance. The derivation of the 2.5-foot safety clearance is based on the actual practice of the Port Canaveral Pilots Association, which has established a minimum under keel clearance requirement of 2.5 ft for all ships underway, in all channel reaches and basins, and for all stages of the tide (MLLW to MHHW). This is similar to the USACE design guidance that suggests a safety clearance of at least 2 ft between the bottom of the ship and the design channel bottom. The pilots require at least 6 inches of clearance under the keel at berth for all tides and stages of unloading or loading operations.

In order to achieve the 2.5-foot safety clearance during typical vessel operations, the impacts of vessel squat and wave motion must be taken into consideration. Adequate clearance in the innermost channel section (the West Access Channel) which is well within the harbor and therefore has less squat and wave motion, requires that the channel be 3.5 feet deeper than the 39.5-foot sailing draft of the design vessel. As the channel progresses towards the open ocean, channel depth requirements increase because the effects of squat and wave action are greater. At the Outer Reach of the Entrance Channel, which is the closest to the open ocean, the 39.5-foot design vessel sailing draft requires that the channel be 6.6 feet deeper than the vessel's sailing draft to provide adequate safety clearance during typical operations. Future vessels calling at Port Canaveral may arrive at operating drafts greater than 39.5 feet under advantageous tide conditions.

Table 5-1 presents the design depth requirements for large cargo vessels arriving at Port Canaveral with an unrestricted operating draft of 39.5 feet. Figures 5-1 through 5-3 present drawings of the two widening alternatives used in the ship simulations. Note that the plan naming convention used for the ship simulation analysis is slightly different than the naming convention used throughout this Economics Appendix. The Widening 1 plan, which is a 450-foot channel, is identified in the simulation modeling as Plan B. The Widening 2 plan, which is a 500-foot channel, is identified as Plan A. The channel depths and widths associated with each alternative plan are presented in Table 5-2. Note that the Port Canaveral terminal facilities are in the Middle Turning Basin, West Access Channel, and West Turning Basin.

**Table 5-1**  
**Channel Depth Design Requirements (feet below MLLW)**

Parameter	WAC	MTB	INNER CHANNEL			ENTRANCE CHANNEL		
			INNER REACH Cut 2 (CT3) Sta 200+00	Cut 2 (TTB) Sta 185+00	MIDDLE REACH Cut 2 (Jetties) Sta 165+00	OUTER REACH Cut 1 Sta 85+00	OUTER REACH Cut 1 (B7/8) Sta 55+00	Cut 1A/1B
Vessel Speed (knots)	4.5	5	6	7	8	8	9	10
Draft (ft)	39.5	39.5	39.5	39.5	39.5	39.5	39.5	39.5
Salinity & Temp Corr (ft)	--	--	--	--	--	--	--	--
Wave Motions (ft)	--	--	--	1.4	1.4	1.4	1.4	1.4
Squat (ft)	1.0	1.3	1.7	2.0	2.0	2.0	2.2	2.7
Safety Clearance (ft)	2.5	2.5	2.5	2.5	2.5	2.5	2.5	2.5
Total Required Water Depth (ft)	43	43.3	43.7	44	45.4	45.4	45.4	46.1
Existing Authorized Depth (ft)	39	39	40	44	44	44	44	44
Proposed Project Depth (ft, MLLW)	43	43	44	44	46	46	46	46

**Table 5-2**  
**Alternative Plan Channel Depths and Widths (feet below MLLW)**

	Existing Authorized Depth			Deepen Plan 1		Deepen Plan 2		Deepen Plan 3	
	Existing Authorized Depth	Deepen Plan 1	Deepen Plan 2	Deepen Plan 1	Deepen Plan 2	Deepen Plan 1	Deepen Plan 2	Deepen Plan 1	Deepen Plan 2
Outer Reach	41	44	45	45	46	46	46	46	46
Middle Reach	41	44	45	45	46	46	46	46	46
Inner Reach	40	42	43	43	44	44	44	44	44
Middle Turning Basin	39	41	42	42	43	43	43	43	43
West Access Channel	39	41	42	42	43	43	43	43	43
West Turning Basin	31*	35	35	35	35	35	35	35	35
Channel Width	Existing Authorized Width 400 feet			Widen Plan 1 450 feet		Widen Plan 2 500 feet			

\*Maintained by CPA to 35

Figure 5-1  
Alternative Plans: Sheet 1

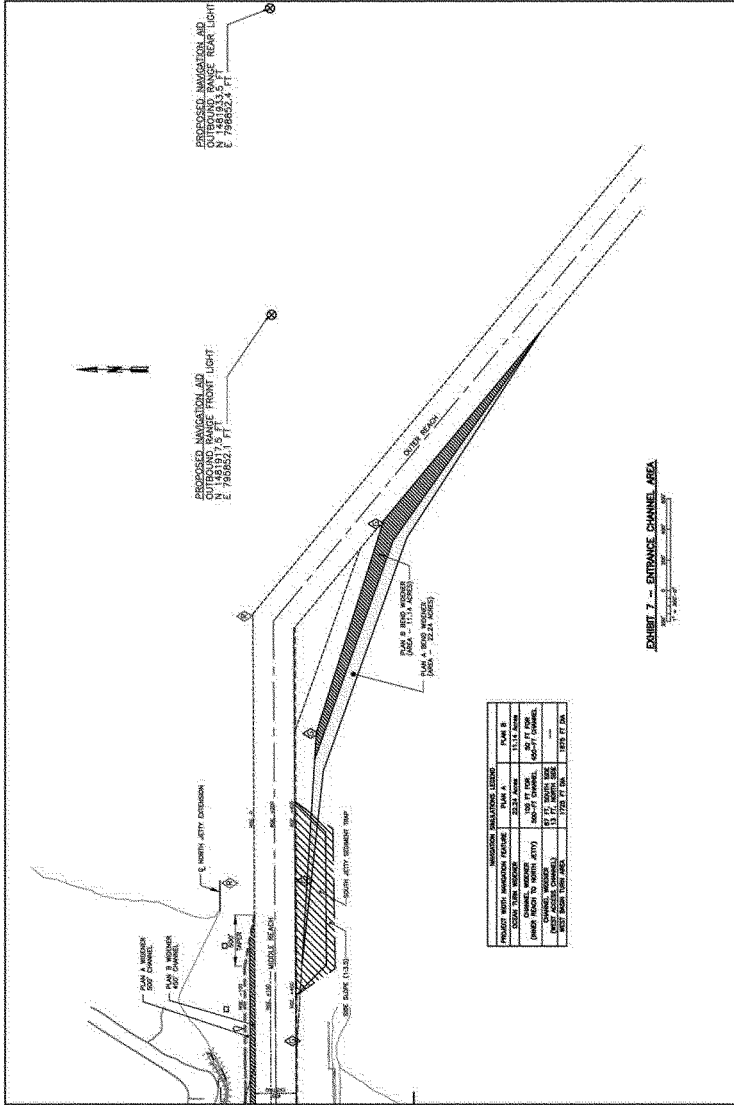





## **5.2 Alternative Plan Costs**

Potential project costs include construction costs, real estate costs, financial costs (interest during construction), engineering and design, supervision and administration, and operation and maintenance costs (Engineering Appendix: Section 10 Cost Estimates). Project costs also include any non-financial (i.e., non-cost shared) associated non-Federal costs, such as berth deepening, landside infrastructure, or other modifications that must be performed in order for project benefits to be realized. A Cost Risk Analysis was conducted, which resulted in a project cost contingency of 20.97% (see Engineering Appendix). All total project costs used in this analysis (not based on actual costs for CPA work already performed), include 20.97% contingency. All costs are calculated using FY 2012 dollars, a 50-year project life, and all discounting is conducted at the current FY 2012 Federal discount rate (4.00%). The following sub-sections provide detailed cost information for the alternative plans.

### **5.2.1 Construction and Investment Costs**

Project elements which compose the construction cost for the widening alternatives, including West Turning Basin improvements include:

- Dredging and disposal or reuse: channel widening, turn widener, and turning basin extension;
- Upland excavation with materials relocation, disposal, and reuse: along north side of inner reach, western end of middle reach and at eastern end of West Turning Basin;
- Aids to Navigation: two inbound and two outbound range structures;
- Rip rap revetment: construct revetment along north side of inner reach;
- Real estate costs: upland area (8.0 acres) along north side of inner reach;
- Interest during construction: fourteen month construction duration;
- Engineering and design (E&D) and supervision and administration (S&A);
- Relocation costs; mooring dolphin, submarine sail, fence, tower guy, warning sign, Grouper Road and utility corridor; and
- Seawall construction to protect existing Air Force structures.

In addition to the construction first costs listed above, a contingency factor of 20.97% was determined through a cost and schedule risk analysis as the appropriate level of contingency for this project (Engineering Appendix Attachment M: Cost and Schedule Risk Analysis). Interest during construction was calculated on a monthly basis to reflect the opportunity cost of funds allocated to the project. Work conducted in advance by the CPA (Interim Corner Cutoff), including engineering, design, supervision, and administration, is included in project cost calculations at the actual cost expended. Contingencies and interest during construction are not added to the actual costs expended by the CPA. Table 5-3 presents construction costs for the widening alternatives, which includes widening the channel only to existing depths. There is no channel deepening included in the widening alternatives and therefore Table 5-3 does not include deepening costs.



**Table 5-3**  
**Construction Costs: Widening Alternatives\***

<b>Cost Category</b>	<b>Widening Plan 1 (450 feet)</b>	<b>Widening Plan 2 (500 feet)</b>
Real Estate	\$822,623	\$1,645,245
Upland Excavation	\$2,186,521	\$4,588,251
Revetment	\$2,890,370	\$2,890,370
Fence	\$100,758	\$100,758
Tower Guy	\$17,267	\$17,267
Warning Sign Replacement	\$90,301	\$90,301
Retaining Wall	\$1,189,696	\$1,189,696
Submarine Sail Relocation	\$43,888	\$43,888
Aids to Navigation	\$1,975,000	\$1,975,000
Mooring Dolphin Demolition and Replace	\$190,000	\$190,000
Dredging (w/disposal, mob, & de-mob)	\$5,105,230	\$7,679,180
S&A and E&D (7.5% each)	\$2,454,447	\$2,814,707
Interest During Construction	\$357,840	\$518,637
<b>Sub-Total</b>	<b>\$17,423,940</b>	<b>\$23,743,299</b>
Contingency (20.97%) <sup>12</sup>	\$3,653,800	\$4,978,970
<b>Total Widening Plan Construction Costs</b>	<b>\$21,077,740</b>	<b>\$28,722,269</b>

\*Widening to existing depths only – no channel deepening

Construction costs for the channel deepening alternatives include dredging and disposal costs and a small amount of associated costs required for some berth deepening. Dredge material volumes and costs are based on existing conditions and reflect the various existing channel depths presented in Table 5-2. There are no utility relocations associated with the channel deepening alternatives. Table 5-4 presents the construction costs for deepening the channel at the existing 400-foot authorized channel width (excludes any channel widening). Construction

<sup>12</sup> The appropriate contingency level was identified by the Cost and Schedule Risk Analysis (Engineering Appendix Attachment M: Cost and Schedule Risk Analysis Report

costs for combined widening and deepening alternatives are presented in Table 5-5 (Widening Plan 1 plus deepening alternatives) and Table 5-6 (Widening Plan 2 plus deepening alternatives).

**Table 5-4**  
**Construction Costs: Channel Deepening Alternatives\***

<b>Cost Category</b>	<b>-42 feet</b>	<b>-43 feet</b>	<b>-44 feet</b>
Unrestricted Operating Draft	38 feet	39 feet	40 feet
Channel Dredging (w/disposal, mob, & de-mob)	\$2,287,271	\$5,891,577	\$10,021,292
Berth Dredging (100% non-Federal cost)	\$126,750	\$190,125	\$253,500
S&A and E&D (7.5% each)	\$343,091	\$883,737	\$1,503,194
Interest During Construction	\$47,791	\$74,072	\$84,737
<b>Sub-Total</b>	<b>\$2,804,903</b>	<b>\$7,039,510</b>	<b>\$11,862,723</b>
Contingency (20.97%) <sup>13</sup>	\$588,188	\$1,476,185	\$2,487,613
<b>Total Deepening Only Construction Costs</b>	<b>\$3,393,091</b>	<b>\$8,515,695</b>	<b>\$14,350,336</b>

\*Excludes channel widening – deepening at existing widths only

<sup>13</sup> The appropriate contingency level was identified by the Cost and Schedule Risk Analysis (Engineering Appendix Attachment M: Cost and Schedule Risk Analysis Report)

**Table 5-5**  
**Construction Costs: Widening Plan 1 (450 feet) and Channel Deepening**

Cost Category	-42 feet	-43 feet	-44 feet
Unrestricted Operating Draft	38 feet	39 feet	40 feet
Real Estate	\$822,623	\$822,623	\$822,623
Upland Excavation	\$2,186,521	\$2,186,521	\$2,186,521
Revetment	\$2,890,370	\$2,890,370	\$2,890,370
Fence	\$100,758	\$100,758	\$100,758
Tower Guy	\$17,267	\$17,267	\$17,267
Warning Sign Replacement	\$90,301	\$90,301	\$90,301
Retaining Wall	\$1,189,696	\$1,189,696	\$1,189,696
Submarine Sail Relocation	\$43,888	\$43,888	\$43,888
Aids to Navigation	\$1,975,000	\$1,975,000	\$1,975,000
Mooring Dolphin Demolition and Replace	\$190,000	\$190,000	\$190,000
Dredging (w/disposal, mob, & de-mob)	\$6,327,537	\$10,274,373	\$14,749,236
Berth Dredging	\$126,750	\$190,125	\$253,500
S&A and E&D (7.5% each)	\$2,074,942	\$2,622,481	\$3,242,001
Interest During Construction	\$371,200	\$434,170	\$444,263
<b>Sub-Total</b>	<b>\$18,406,852</b>	<b>\$23,027,572</b>	<b>\$28,195,424</b>
Contingency (20.97%) <sup>14</sup>	\$3,859,917	\$4,828,882	\$5,912,580
<b>Total Widening 1 Plus Deepening Plan Construction Costs</b>	<b>\$22,266,769</b>	<b>\$27,856,454</b>	<b>\$34,108,004</b>

<sup>14</sup> The appropriate contingency level was identified by the Cost and Schedule Risk Analysis (Engineering Appendix Attachment M: Cost and Schedule Risk Analysis Report)

**Table 5-6**  
**Construction Costs: Widening Plan 2 (500 feet) and Channel Deepening**

Cost Category	-42 feet	-43 feet	-44 feet
Unrestricted Operating Draft	38 feet	39 feet	40 feet
Real Estate	\$1,645,245	\$1,645,245	\$1,645,245
Upland Excavation	\$4,588,251	\$4,588,251	\$4,588,251
Revetment	\$2,890,370	\$2,890,370	\$2,890,370
Fence	\$100,758	\$100,758	\$100,758
Tower Guy	\$17,267	\$17,267	\$17,267
Warning Sign Replacement	\$90,301	\$90,301	\$90,301
Retaining Wall	\$1,189,696	\$1,189,696	\$1,189,696
Submarine Sail Relocation	\$43,888	\$43,888	\$43,888
Aids to Navigation	\$1,975,000	\$1,975,000	\$1,975,000
Mooring Dolphin Demolition and Replace	\$190,000	\$190,000	\$190,000
Berth Dredging	\$126,750	\$190,125	\$253,500
Dredging (w/disposal, mob, & de-mob)	\$9,590,087	\$13,849,784	\$18,637,509
S&A and E&D (7.5% each)	\$3,120,355	\$3,768,816	\$4,496,481
Interest During Construction	\$563,586	\$617,672	\$629,839
<b>Sub-Total</b>	<b>\$26,131,554</b>	<b>\$31,157,174</b>	<b>\$36,748,105</b>
Contingency (20.97%)	\$5,479,787	\$6,533,659	\$7,706,078
<b>Total Widening 2 Plus Deepening Plan Construction Costs</b>	<b>\$31,611,341</b>	<b>\$37,690,833</b>	<b>\$44,454,182</b>

## 5.2.2 Operations and Maintenance Costs

Operation and maintenance costs generated by the project are defined as additional incremental operations and maintenance costs, over and above what is required to operate and maintain the existing Federal navigation project. The operations and maintenance costs of the alternative plans are based on increased maintenance dredging volumes due to the widening of the existing channels. Analysis of historical maintenance dredging patterns and the hydrodynamic analysis of without and with-project conditions indicate that very minor changes in hydraulic conditions due to channel deepening would result in no additional maintenance dredging volumes due to the

deepening alternatives. Therefore, no additional operations and maintenance costs are allocated to the channel deepening only alternatives.

The estimated annual volume of additional maintenance dredging material generated by the Widening 1 alternative is 52,125 cubic yards. The resulting additional Widening 1 alternative plan-related maintenance dredging cost is \$467,561 (\$8.97/CY). The estimated annual volume of additional maintenance dredging material generated by the Widening 2 alternative is 69,500 cubic yards. The resulting additional Widening 2 alternative plan-related maintenance dredging cost is \$623,415 (\$8.97/CY).

### 5.2.3 Total Average Annual Equivalent Costs

Tables 5-7 through 5-10 present the total average annual equivalent (AAEQ) project costs for each alternative plan and the incremental AAEQ cost for each successive plan increment. For tables presenting the combined widening and deepening project AAEQ cost information (Tables 5-9 and 5-10), the first project increment is channel widening. Channel widening is the appropriate first increment because channel widening is the only type of improvement that benefits both the cargo and cruise industries operating at the Port (Section 5.3 With-Project Benefits). The succeeding increments are channel deepening starting with a two-foot increment followed by successive one-foot increments, where necessary to achieve the required depths identified in Tables 5-1 (rounded up to the nearest full foot) and 5-2. All average annual equivalent costs are calculated at the FY 2012 discount rate (4.00%) over a period of 50 years and with prices at the FY 2012 price level.

**Table 5-7**  
**Average Annual Equivalent (AAEQ) Project Costs: Channel Widening**

Alternative Plan	Total First Costs	Total AAEQ First Costs	Annual Maintenance Costs	Total AAEQ Costs	Incremental AAEQ Costs
Widening Plan 1 (450 feet)	\$21,077,740	\$981,173	\$467,561	\$1,448,734	\$1,448,734
Widening Plan 2 (500 feet)	\$28,722,269	\$1,337,027	\$623,415	\$1,960,442	\$511,708

Note: Discount rate = 4.00%, period 50 years

**Table 5-8**  
**Average Annual Equivalent (AAEQ) Project Costs: Channel Deepening**

Alternative Plan	Total First Costs	Total AAEQ First Costs	Annual Maintenance Costs	Total AAEQ Costs	Incremental AAEQ Costs
-42-foot Plan	\$3,393,091	\$157,949	\$0	\$157,949	\$157,884
-43-foot Plan	\$8,515,695	\$396,407	\$0	\$396,407	\$238,458
-44-foot Plan	\$14,350,336	\$668,011	\$0	\$668,011	\$271,604

Note: Discount rate = 4.00%, period 50 years

**Table 5-9**  
**Average Annual Equivalent (AAEQ) Project Costs: Widening Plan 1 (450 feet) and Channel Deepening**

Alternative Plan	Total First Costs	Total AAEQ First Costs	Annual Maintenance Costs	Total AAEQ Costs	Incremental AAEQ Costs
450-foot widening (W1) only	\$21,077,740	\$981,173	\$467,561	\$1,448,734	\$1,448,734
W1 and -42-foot deepening	\$22,266,769	\$1,036,523	\$467,561	\$1,504,084	\$55,350
W1 and -43-foot deepening	\$27,856,454	\$1,296,724	\$467,561	\$1,764,285	\$260,201
W1 and -44-foot deepening	\$34,108,004	\$1,587,734	\$467,561	\$2,055,296	\$291,011

Note: Discount rate = 4.00%, period 50 years

**Table 5-10**  
**Average Annual Equivalent (AAEQ) Project Costs: Widening Plan 2 (500 feet) and Channel Deepening**

Alternative Plan	Total First Costs	Total AAEQ First Costs	Annual Maintenance Costs	Total AAEQ Costs	Incremental AAEQ Costs
500-foot widening (W2) only	\$28,722,269	\$1,337,027	\$623,415	\$1,960,442	\$1,960,442
W2 and -42-foot deepening	\$31,611,341	\$1,471,514	\$623,415	\$2,094,929	\$134,487
W2 and -43-foot deepening	\$37,690,833	\$1,754,516	\$623,415	\$2,377,931	\$283,002
W2 and -44-foot deepening	\$44,454,182	\$2,069,351	\$623,415	\$2,692,766	\$314,835

Note: Discount rate = 4.00%, period 50 years

### 5.3 With-Project Condition Benefits

The NED Procedures Manual Deep Draft Navigation (IWR Report 91-R-13) presents three general examples of NED navigation project benefits, which are based on the conceptual basis for navigation benefits identified in the Principles and Guidelines (1983). The NED Procedures Manual states as an example of navigation benefits (page 11):

*“Reduced cost of transportation through use of vessels (modal shift), through safer or more efficient operation of vessels and/or use of larger more efficient vessels (channel enlargement), and through use of new or alternative vessel routes (new channels or port shift).”*

The with-project condition transportation cost savings calculated in this analysis fully coincide with this example presented in the NED Procedures Manual. With-project condition cargo vessel transportation cost savings are based on safer, more efficient operation of cargo vessels and use of larger, more efficient cargo vessels. With-project condition cruise ship transportation cost savings are based on safer, more efficient cruise ship operations at the port and on reduced cruise ship impacts to cargo operations within the port.

The following sub-sections describe the NED benefit estimation processes and present the NED benefits for with-project channel widening and channel deepening conditions. Channel widening, with associated aids to navigation and turning basin extension, generate cargo ship and cruise ship-related NED benefits. Channel deepening generates cargo ship-related NED benefits. There are no cruise ship related benefits from channel deepening.

In addition to transportation cost savings generated by the project, the channel widening and deepening reduces surge effects in the Middle Turning Basin, Trident Basin, and at berths NCP3 & 4. The direct benefits to the Navy and Air Force vessels using the Middle and Trident Turning Basins due to reduced surge effect, such as damage reduction or line handling cost reductions, has not been quantified in monetary terms; however, the tug assist cost savings for Trident Basin vessels under with-project conditions has been included in the benefits calculations (Section 5.3.1.2 Port Operations Analysis).

### 5.3.1 Channel Widening Benefits

Channel Widening Plans 1 & 2, including associated aids to navigation and turning basin extension components, are stand-alone alternative plans. The two channel widening alternative plans do not require a channel deepening component to generate transportation cost savings. A wider channel would beneficially affect cruise ship operations in the Port, reduce the incidence and severity of surge effects on moored cargo vessels during cruise ship passage through the Port, and would allow larger, although not deeper draft, tankers to navigate the channel to and from the Seaport Canaveral Terminal. Transportation cost savings would be generated by fewer incidences of tug assist during cruise ship passage through the Port, by fewer incidences of tug assist for cargo vessels in the Port, and by efficiencies gained through the use of larger (longer) tankers at the Seaport Canaveral Terminal.

There are two components to the beneficial effects of the alternative channel widening plans. One component is that a wider channel would allow longer (greater Length Overall [LOA]) tankers to call at Seaport Canaveral Terminal. At the request of Seaport Canaveral, the Canaveral Pilots Association has made determinations concerning maximum vessel LOA for Seaport Canaveral tankers. Under without-project conditions, the maximum LOA for Seaport Canaveral tankers is 800 feet. Under Channel Widening Plans 1 and 2, the maximum LOA for Seaport Canaveral tankers increases to 850 feet and 900 feet, respectively.

The second component of alternative widening plan beneficial effects is directly related to wind conditions at the Port. Under perfectly calm conditions (winds ranging from 0 to 5 knots) the existing channel is adequate for most vessel operations. As wind speeds increase, safe navigation within the channel becomes more challenging. At relatively high winds, additional tug assistance is required to maintain navigation safety within the channel and to provide stabilizing force to offset surge effects on vessels moored at vulnerable piers within the Port. Wind-related beneficial effects on port operations projected to result from the alternative widening plans, which are assessed in this analysis include:

- Reduction in the frequency of tug assistance for the largest cruise ships under strong wind conditions;
- Reduction in the frequency of tug assistance for the largest Seaport Canaveral tankers (tankers 800 feet LOA and larger); and
- Reduction in the frequency of tug assistance to offset surge impacts for vessels moored at:
  - Trident Basin
  - North Cargo Piers 1 and 2
  - North Cargo Piers 3 and 4.

#### 5.3.1.1 Wind Analysis

An analysis of wind conditions at the Port was conducted to project the effects of winds on large cruise ship operations within the Port. Wind speed, direction, and duration data were obtained from the following sources:

- NASA Space Shuttle Landing Facility: March 1978 – August 2009;
- Patrick Air Force Base: March 1945 – December 2004;



- Trident Submarine Basin (NOAA Station TRDF1): April 2005 – December 2008; and,
- NOAA Sea Buoy Station 41009: January 1988 – August 2008.

Wind data recorded during cruise ship transit times (4 – 8 am and 3 – 7 pm) were sorted from the overall wind data and were exclusively used in the analysis. Wind data was adjusted for elevation differences between recording station and cruise ship instrumentation. Wind direction was also taken into account by reducing the effect of winds that are not directly abeam of a vessel transiting the channel within the Port (winds from due north or due south). Wind effectiveness ranges from 100% for winds from the north and south (directly abeam of vessels transiting the channel) to 0% for winds coming directly from the east or west. The wind speeds used in this analysis represent an “effective wind speed” which discounts the effects of winds that are not directly abeam of the vessel during channel transit within the Port. This adjustment reduces the frequency of effect of winds on vessels approaching the Port and in the turn at the entrance to the Port. However, the intent of the wind analysis is to assess the effects of winds on large cruise ship operations within the Port, not in the approaching channels.

A comparison of wind data was conducted to identify an appropriate data set to represent wind conditions at the Port. Although the Trident Submarine Station wind recording device is within the Port and closest to the channel, the recording device is located in a protected area and regularly records substantially less velocity than all other recording stations. The Patrick Air Force Base is the farthest from the port, approximately 20 miles to the south. Therefore, an average of NASA Space Shuttle Landing Facility and NOAA Sea Buoy Station 41009 was used in the analysis as representative of wind conditions in the channel and at the Port. The combined data set includes more than 50 years of data. A detailed analysis of all wind data is provided in the Engineering Appendix, Section 1.3.3 Wind and Wave Climate.

The lowest maximum wind speed for a continuous three hour period was calculated for cruise ship transit times (morning and afternoon) for Summer (April – October) and Winter (November – March) for NASA Space Shuttle Landing Facility and NOAA Sea Buoy Station 41009 wind records. The lowest maximum wind speed for a continuous three hour period indicates that winds of at least a certain speed were experienced during those three hours. Using this measure of wind speed and duration avoids having the analysis unduly influenced by peak wind speeds and gusts. Lowest maximum wind speed calculations were conducted in 5 knot increments: 10 to 15 knots, 15 to 20 knots, 20 to 25 knots, etc. The number of occurrences for each wind speed increment during cruise ship transit time periods was divided by the total number of cruise ship transit time periods to calculate the probability for each wind speed increment during cruise ship transit time periods. The probability for each wind speed increment was multiplied by the probability that a large cruise ship would transit the channel (50 days per year for weekly cruises and 100 days per year for bi-weekly cruises) to obtain a joint probability for each wind speed increment during a large cruise ship transit. The resulting joint probabilities (Table 5-11) are used to estimate the number of vessel transits that would be affected by wind conditions. Note that the probabilities for Seaport Canaveral tanker tug assists very annually because the number of calls varies; therefore the Seaport Canaveral tanker joint probabilities are not presented in the table.

For example, the raw probability that the lowest maximum wind speed during a continuous three hour period in the Summer during the afternoon cruise ship transit time period (3 – 7 pm) would range from 20 to 25 knots is 4.80%. The probability that a cruise ship on a weekly schedule is

transiting the channel on any given day is 13.7% ( $50/365 = .1370$ ). The joint probability for sustained Summer afternoon wind speeds ranging from 20 to 25 knots during a cruise ship transit is 0.66% ( $4.8\% * 13.7\% = 0.658\%$ ). The appropriate cell is highlighted in Table 5-11.

Similar calculations were conducted to obtain the joint probabilities of potential wind-related effects on other port operations (Table 5-11). The joint probability for wind speed increments and large Seaport Canaveral tanker transits was calculated by multiplying the raw wind speed increment probability by the probability of the tanker transiting the channel. The joint probability for vessels moored at surge vulnerable piers was calculated by multiplying the joint probability for cruise ship transit by the probability that a vessel would be moored at the vulnerable pier (berth utilization rates). These berth utilization rates are based on the mid-level cargo forecast and a very conservative assumption concerning berth utilization at the Trident Basin. Berth utilization rates indicate that at least one vessel will be at the affected pier: North Cargo Piers 1 and 2 - 79%; North Cargo Piers 3 and 4 - 50%, Trident Basin – 10%.

**Table 5-11**  
**Joint Probability of Occurrence (Sustained Winds and Vessel Transits)**

	Sustained* Wind Speeds (Knots)					
	10-15	15-20	20-25	25-30	30-35	35-40
<b>Cruise Ship Tug Assist</b>						
Summer Morning Weekly schedule	-	1.26%	0.49%	0.20%	0.07%	0.01%
Summer Morning Bi-weekly schedule	-	2.52%	0.97%	0.40%	0.14%	0.03%
Summer Afternoon Weekly schedule	-	1.33%	0.66%	0.27%	0.12%	0.05%
Summer Afternoon Bi-weekly schedule	-	2.66%	1.32%	0.53%	0.25%	0.10%
Winter Morning Weekly schedule	-	1.99%	1.03%	0.62%	0.39%	0.13%
Winter Morning Bi-weekly schedule	-	3.97%	2.07%	1.23%	0.78%	0.26%
Winter Afternoon Weekly schedule	-	1.32%	0.99%	0.59%	0.31%	0.12%
Winter Afternoon Bi-weekly schedule	-	2.64%	1.97%	1.18%	0.62%	0.23%
<b>Cargo Vessel Tug Assist NCP 1&amp;2</b>						
Summer Morning Weekly schedule	-	1.00%	0.38%	0.16%	0.05%	0.02%
Summer Morning Bi-weekly schedule	-	1.99%	0.77%	0.31%	0.11%	0.03%
Summer Afternoon Weekly schedule	-	1.05%	0.52%	0.21%	0.10%	0.04%
Summer Afternoon Bi-weekly schedule	-	2.10%	1.04%	0.42%	0.19%	0.08%
Winter Morning Weekly schedule	-	1.57%	0.82%	0.49%	0.31%	0.10%
Winter Morning Bi-weekly schedule	-	3.14%	1.63%	0.97%	0.62%	0.21%
Winter Afternoon Weekly schedule	-	1.04%	0.78%	0.47%	0.24%	0.09%
Winter Afternoon Bi-weekly schedule	-	2.09%	1.56%	0.93%	0.49%	0.18%
<b>Cargo Vessel Tug Assist NCP 3&amp;4</b>						
Summer Morning Weekly schedule	-	0.63%	0.24%	0.10%	0.03%	0.01%
Summer Morning Bi-weekly schedule	-	1.26%	0.49%	0.20%	0.07%	0.02%
Summer Afternoon Weekly schedule	-	0.66%	0.33%	0.13%	0.06%	0.02%
Summer Afternoon Bi-weekly schedule	-	1.33%	0.66%	0.27%	0.12%	0.05%
Winter Morning Weekly schedule	-	0.99%	0.52%	0.31%	0.20%	0.07%
Winter Morning Bi-weekly schedule	-	1.99%	1.03%	0.62%	0.39%	0.13%
Winter Afternoon Weekly schedule	-	0.66%	0.49%	0.29%	0.15%	0.06%
Winter Afternoon Bi-weekly schedule	-	1.32%	0.99%	0.59%	0.31%	0.12%
<b>Trident Basin Tug Assist</b>						
Summer Morning Weekly schedule	-	0.13%	0.05%	0.02%	0.01%	0.00%
Summer Morning Bi-weekly schedule	-	0.25%	0.10%	0.04%	0.01%	0.00%
Summer Afternoon Weekly schedule	-	0.13%	0.07%	0.03%	0.01%	0.00%
Summer Afternoon Bi-weekly schedule	-	0.27%	0.13%	0.05%	0.02%	0.01%
Winter Morning Weekly schedule	-	0.20%	0.10%	0.06%	0.04%	0.01%
Winter Morning Bi-weekly schedule	-	0.40%	0.21%	0.12%	0.08%	0.03%
Winter Afternoon Weekly schedule	-	0.13%	0.10%	0.06%	0.03%	0.01%
Winter Afternoon Bi-weekly schedule	-	0.26%	0.20%	0.12%	0.06%	0.02%

\* Lowest maximum wind speed during a consecutive three hour period

### 5.3.1.2 Port Operations Analysis

An Operations Matrix was developed by CPA's consulting engineers in consultation with the Canaveral Pilots Association and the operations personnel at the Canaveral Port Authority (Tables 5-12 and 5-13). The Operations Matrix identifies the amount of tug assistance required under various wind speeds under without and with-project conditions. The Operations Matrix also identifies other port operation activities which may be required under various wind conditions, such as relocation of cargo vessels from docks that are vulnerable to surge from passing vessels and the maximum wind speed for entering and exiting the Port. The beneficial effects of channel widening on these other port operation activities were not assessed in this analysis. The Operations Matrix was developed by two senior pilots and then reviewed and approved by the Canaveral Pilots Association at one of their monthly membership meetings as accurately reflecting actual operating conditions and projected future operating conditions.

**Table 5-12**  
**Operations Matrix: Widening Plan 1 (Number of Tugs)**

	Sustained* Wind Speeds (Knots)					
	10-15	15-20	20-25	25-30	30-35	35-40
<b>Cruise Ship Tug Assist</b>						
Without-project	0	0	0	1	2	2
With-Project	0	0	0	0	1	2
<b>Cargo Vessel Tug Assist NCP 1&amp;2</b>						
Without-project	0	0	0	1	1	1
With-Project	0	0	0	0	1	1
<b>Cargo Vessel Tug Assist NCP 3&amp;4</b>						
Without-project	0	0	1	1	1	1
With-Project	0	0	0	1	1	1
<b>Trident Basin Tug Assist</b>						
Without-project	0	0	0	1	1	1
With-Project	0	0	0	0	1	1
<b>Largest Tanker Additional Tug</b>						
Without-project	0	1	1	1	1	1
With-Project	0	0	1	1	1	1

\* Lowest maximum wind speed during a consecutive three hour period

**Table 5-13**  
**Operations Matrix: Widening Plan 2 (Number of Tugs)**

	Sustained* Wind Speeds (Knots)					
	10-15	15-20	20-25	25-30	30-35	35-40
<b>Cruise Ship Tug Assist</b>						
Without-project	0	0	0	1	2	2
With-Project	0	0	0	0	1	1
<b>Cargo Vessel Tug Assist NCP 1&amp;2</b>						
Without-project	0	0	0	1	1	1
With-Project	0	0	0	0	0	1
<b>Cargo vessel Tug Assist NCP 3&amp;4</b>						
Without-project	0	0	1	1	1	1
With-Project	0	0	0	0	1	1
<b>Trident Basin Tug Assist</b>						
Without-project	0	0	0	1	2	2
With-Project	0	0	0	0	1	1
<b>Largest Tanker Additional Tug</b>						
Without-project	0	1	1	1	1	1
With-Project	0	0	0	0	1	1

\* Lowest maximum wind speed during a consecutive three hour period

### 5.3.1.3 Widening Plan Benefit Calculations – Tug Assistance Reductions

Alternative Widening Plan benefits (Table 5-16) were calculated for the two widening-only plans using the same assumptions for each widening plan concerning cruise ship schedules, tug operations, and tug costs. By 2012, three of the world's largest cruise ships are projected to work out of Port Canaveral on a weekly schedule (*Freedom of the Seas*, *Carnival Dream*, and *Disney Dream*) and one of four largest cruise ships (*Disney Fantasy*) is projected to work on a bi-weekly schedule. Three of these vessels, the *Freedom of the Seas*, *The Disney Dream* and the *Carnival Dream*, are currently homeported at the Port. The *Disney Fantasy* is expected to be homeported at Port Canaveral upon its entry into service in March 2012.

Cruise ship related benefits are calculated based on the operations of these four vessels only. The three weekly scheduled ships are projected to all arrive and depart on the same day of the week (similar to existing weekly schedule operations). For the base case analysis, it is assumed that a single tug would be sufficient for each wind event. For example, under without-project conditions and a 25-30 knot wind event on a day when the three large cruise ships are entering or exiting the Port, the base case analysis assumes that the same tug would be able to service all three cruise ships at the cost of a single tug call plus stand-by charges for two of the cruise ships. Tug costs are based on the current rates charged by the two tug companies operating in the Port. Table 5-14 presents a sample tug cost calculation for the *Freedom of the Seas*.

**Table 5-14**  
**Sample Tug Cost Calculation: Freedom of the Seas (160,000 GRT)**

1) Base Fee up to 25,000 GRT	\$1,504
2) <i>Freedom of the Seas</i> additional GRT fee (note below)	\$7,560
3) Total GRT based fee = (1 + 2)	\$9,064
4) Time of day surcharge (before 8:00 AM and after 4:00 PM) @ 35% of #3	\$3,172
5) Weekend and Holiday surcharge @ 35% of #3	\$3,172
6) Fuel surcharge @ 37 % of #3	\$3,354
<b>Total Cost = (3 + 4 + 5 + 6)</b>	<b>\$18,762</b>

Note: Calculated at \$56 per each 1,000 GRT above 25,000

Tug assist costs for each tug assist event were also calculated for two sizes of tankers (79,000 and 110,000 DWT) needing assistance to enter the Seaport Canaveral Terminal, three sizes of tankers needing alongside assistance at North Cargo Piers 1 and 2 (45,000; 79,000; and 110,000 DWT), one size of bulker needing alongside assistance at North Cargo Piers 3 and 4 (45,000 DWT), and three sizes of cruise ships (128,000; 130,000; and 160,000 DWT). Tug assist costs for the Trident Basin were calculated using the weighted average size cruise ship (139,000 DWT). Weighted average tug costs (Table 5-15) account for weekday and weekend calls and for a 37% fuel surcharge (as reported by the tug firms). Cruise ship tug assist costs for the *Freedom of the Seas* include the costs of a single working tug and two standby tugs for each tug assist event.

**Table 5-15**  
**Weighted Average Tug Assist Costs\***

Tug Assist Event Type	Weighted Average DWT	Weighted Average Cost
Seaport Canaveral Tanker Movement	90,625	\$7,613
Trident Basin Alongside Assist	139,333	\$14,766
North Cargo Piers 3&4 Alongside Assist	45,000	\$4,901
North Cargo Piers 1&2 Alongside Assist	78,000	\$8,352
Cruise Ship Movement	139,333	\$22,149

\*Costs per each tug assist event

**Table 5-16**  
**Alternative Widening Plan Annual Benefits – Tug Assistance Reductions: 2020**

	<u>Tug Assist Events</u>		<u>Tug Assist Costs</u>		<u>Transportation Cost Savings</u>
	<u>Without Project</u>	<u>With Project</u>	<u>Without Project</u>	<u>With Project</u>	
<b>Channel Widening Plan 1 (450 feet)</b>					
Seaport Canaveral Tankers	10	4	\$49,125	\$23,924	\$25,201
Trident Basin Tug Assist	2	1	\$20,418	\$8,411	\$12,007
North Cargo Piers 3 & 4 Tug Assist	17	8	\$144,787	\$70,628	\$74,159
North Cargo Piers 1 & 2 Tug Assist	13	6	\$111,592	\$49,709	\$61,883
Cruise Ship Tug Assist	24	10	\$754,663	\$310,883	\$443,780
<b>Total</b>					<b>\$617,030</b>
<b>Channel Widening Plan 2 (500 feet)</b>					
Seaport Canaveral Tankers	10	0.5	\$49,125	\$4,689	\$44,436
Trident Basin Tug Assist	2	1	\$20,418	\$6,934	\$13,484
North Cargo Piers 3 & 4 Tug Assist	17	4	\$144,787	\$31,462	\$113,326
North Cargo Piers 1 & 2 Tug Assist	13	2	\$111,592	\$16,739	\$94,853
Cruise Ship Tug Assist	24	8	\$754,663	\$256,301	\$498,362
<b>Total</b>					<b>\$764,461</b>

Avoided trip costs for tankers (Table 5-18) are calculated using the most recent Corps of Engineers vessel operating costs for the appropriate vessel size and for an estimated trip one-way distance. Point to point tankers are assumed to arrive at the Port's maximum unconstrained operating draft (36.0 feet) under without-project and alternative with-project (widening only) conditions. Seaport Canaveral purchases spot cargoes rather than maintain multiple deliverable contracts with refineries. The terminal does not maintain time-charter relationships with carriers or long-term contracts with individual refiners that would constrain their selection of vessels. Under these "spot market" operations, vessels and imported cargo may reasonably come from any of the countries that export petroleum products to the U.S. on the most efficient vessel that can be chartered to deliver the product.

Actual Seaport Canaveral point-to-point distance data mostly includes imports but also includes some domestic movements to Seaport Canaveral and some export movements which have been observed between February 2010 and July 2011. Houston, Texas was the only specifically identified domestic origin and was therefore also used as a proxy domestic port for shipments which identified the origin only as the United States (no port identified).

One-way travel distance per trip (2,014 miles) was calculated as a weighted average of the distances from the actual ports of origin or destination for all Seaport Canaveral point-to-point tanker calls observed between February 2010 and July 2011 (Table 5-17). The weights are based on the proportion of the origin's or destination's total Seaport Canaveral point-to-point tanker tonnage for February 2010 through July 2011.

Tables 5-18 and 5-19 provide an example from one year during the period of analysis (2020) how costs per trip increase with the use of larger vessels under with-project conditions, but total annual costs decrease due to the fewer number of trips. Total annual cost savings (Table 5-18) for point-to point vessels calling at Seaport Canaveral are due to the economies of scale associated with larger vessels taking fewer trips to deliver the same annual amount of cargo.

**Table 5-17**  
**Actual Seaport Canaveral Point-to-Point Distances Feb2010 – July2011\***

Country	Port	Tonnage Percentage	Actual Distance	Weighted Distance
Algeria	Algiers	2.4%	4157	98.94
Argentina	Rosario	0.9%	5864	50.32
Aruba	Oranjestad	3.4%	1225	42.15
Bahamas	Freeport	2.9%	152	4.45
Belgium	Antwerp	0.3%	4035	12.11
Brazil	Fortaleza	0.4%	3116	11.42
Canada	Point Tupper	12.2%	1417	173.52
India	Chennai	3.0%	9713	287.94
Latvia	Lielupe	2.1%	4751	99.89
Netherlands	Rotterdam	6.2%	4030	250.46
Nigeria	Lagos	1.7%	5076	86.60
Spain	Algeciras	1.4%	3767	51.41
United Kingdom	Glasgow	2.3%	3733	85.53
US & Texas	Houston	19.7%	1119	220.09
Venezuela	Maracaibo	40.1%	1319	528.71
Virgin islands	San Juan	1.1%	1001	10.85
<b>Total</b>		<b>100.0%</b>	<b>Weighted Average</b>	<b>2014.41</b>

Source: CPA and [www.sea-distances.com](http://www.sea-distances.com)

\*Distances in nautical miles



**Table 5-18**  
**Alternative Channel Widening Transportation Costs – Large Tankers: 2020**

	Without Project (400 feet)	Widening Plan 1 (450 feet)	Widening Plan 2 (500 feet)
Vessel LOA	600 feet	850 feet	900 feet
Vessel DWT	50,000	70,000	90,000
Arrival Draft	36 feet	36 feet	36 feet
Tons per trip	41,323	57,852	74,381
Number of trips	55	39	30
One-way Transportation Cost per Trip	\$135,744	\$156,421	\$172,801
In Port Costs per Trip	\$20,799	\$34,229	\$48,658
Total Cost per Trip	\$156,543	\$190,650	\$221,459

**Table 5-19**  
**Alternative Channel Widening Plan Annual Benefits – Large Tankers: 2020**

	Without Project (400 feet)	Widening Plan 1 (450 feet)	Widening Plan 2 (500 feet)
Vessel LOA	600 feet	850 feet	900 feet
Arrival Draft	36 feet	36 feet	36 feet
Tons per trip	41,323	57,852	74,381
Number of trips	55	39	30
Total Annual Cost	\$8,639,226	\$7,479,649	\$6,708,974
<b>Transportation Cost Savings</b>	---	<b>\$1,159,577</b>	<b>\$1,930,252</b>

Note: Trips reported in the table are rounded. Total annual costs include fractional trips.

Total annual channel widening plan benefits are the sum of the benefits due to reduced tug assistance and avoided tanker import trips (Table 5-20). It is important to note that the without-project condition includes the navigation effects of the CPA's widening beyond the federal channel, which includes the Interim Corner Cut Off and channel notching as described in Section 3: Without-Project Conditions.

**Table 5-20**  
***AAEQ Total Annual Channel Widening Benefits***

<b>Total Benefits</b>	
<b>Channel Widening Plan 1 (450 feet)</b>	
Reduced Tug Assist	\$606,126
Avoided Tanker Trips	\$1,277,842
<b>Total</b>	<b>\$1,883,968</b>
<b>Channel Widening Plan 2 (500 feet)</b>	
Reduced Tug Assist	\$745,426
Avoided Tanker Trips	\$2,084,322
<b>Total</b>	<b>\$2,829,748</b>

### 5.3.2 Channel Deepening Benefits

With-project condition channel deepening benefits will result from cargo vessels arriving at Port Canaveral with deeper drafts and larger loads than under without-project conditions. Larger loads and deeper drafts allow vessels to operate more efficiently. This efficiency gain is calculated as the difference in operating costs for vessels delivering the projected commodity tonnage under without and with-project conditions. In the assessment of alternative plans, the annual projected tonnage is the same under without and with-project conditions, but the number of trips required and annual operating costs (ocean voyage costs plus landside costs) will decrease due to deeper with-project channel depths.

Identification of the commodities and vessel fleet that will benefit from deeper channel depths is based on observed historical (fiscal years 2000 – 2009) commodity movements, and calendar year 2006 vessel operations and loading data. Only four commodity types (rock, cement, slag, and fuel oil) are delivered in large quantities on cargo vessels of sufficient size to potentially take advantage of a deeper channel. For future fuel oil deliveries to the Seaport Canaveral Fuel Terminal, the projected fleet and projected volumes are based on their first 18 months of operational data, Seaport Canaveral's operational projections as presented to the CPA, and discussions with port planning and operations personnel.

Table 5-21 presents the calendar year 2006 vessel and load characteristics (with the exception of projected Seaport Canaveral Fuel Terminal vessel calls) used to project with-project condition drafts and loads. Vessel type classifications were used to differentiate between different size vessels carrying the same commodity, and to differentiate among vessels carrying the same commodity to different terminals at Port Canaveral. Vessel type classifications are based on a detailed analysis of vessel origins and loading patterns observed in the 2006 data. For example, vessels carrying cement to NCP 4 and cement to SCP 5 are designated as different vessel types because, in 2006, cement vessels calling NCP4 consistently loaded more deeply and had

different origins than cement vessels calling at SCP5. The allocation of commodity tonnage to each vessel type is based on the observed 2006 proportion of the commodity carried on that vessel type. For example, a 60,000 DWT vessel delivering aggregate carried 41% (171,137) of the total 412,598 tons of aggregate delivered to Port Canaveral in calendar year 2006.

Vessel and load characteristics for vessels projected to call at the Seaport Canaveral Fuel Terminal are based on their first 18 months of operational data, discussions with CPA personnel and the projections provided to the CPA by Seaport Canaveral. Point-to-point calls at Seaport Canaveral accounted for 44% of all petroleum products moved through the facility from February 2010 through July 2011.

Under without-project conditions, Seaport Canaveral point-to-point fuel oil tanker length is based on observations presented in Section 2.6.3 Existing Cargo Fleet Operations and Tidal Advantage. Although 800 feet LOA is the longest cargo vessel the Canaveral Pilots will bring into the harbor, at the existing unconstrained operating draft (36 feet) large tankers are required to light load to the extent that they are less efficient than a smaller tanker, which can be more fully loaded when operating with a draft of 36 feet. Because Seaport Canaveral point-to-point tankers do not use tidal advantage, they are regularly 600 feet LOA, which allows more efficient operations under the without-project depth constraint. Under channel widening and deepening conditions, Seaport Canaveral point-to-point tankers are projected to increase in length and operate at deeper drafts, which allow the longer vessels to operate efficiently.

- without-channel widening conditions (800 feet LOA maximum);
- with-project Widening Plan 1 (850 feet LOA maximum); and
- with-project Widening Plan 2 (900 feet LOA maximum).

Vessel arrival draft is based on the without-project condition unrestricted maximum vessel operating draft (no tidal advantage required; 36.0 feet).

**Table 5-21**  
**Large Cargo Vessel Characteristics**

2006 Observed Averages					
Commodity	DWT	Length	Arrival Draft	Tonnage per call	Percent of Commodity Total
Aggregate	60,000	700	38.7	57,046	41%
Cement	35,000	589	33.3	34,117	16%
Cement	35,000	609	33.5	39,295	47%
Cement	40,000	634	34.5	23,155	7%
Limestone	35,000	597	36.0	37,529	38%
Granite	60,000	753	39.5	60,335	62%
Slag	35,000	599	34.8	41,882	100%
Fuel Oil w/o*	50,000	600	36.0	41,323	44%
Fuel Oil Wide Plan 1	70,000	850	36.0	57,852	44%
Fuel Oil Wide Plan 2	90,000	900	36.0	74,381	44%

Source: CPA data

\*Note: Fuel oil vessels based on actual (without-project) and projected with-project Seaport Canaveral Terminal fleet characteristics

Table 5-22 presents the without and with-project condition operating drafts and tonnages-per-call for selected large cargo vessels. Operating drafts under future with-project conditions are estimated based on observed 2006 operating drafts. Large deep draft cargo vessels arriving at Port Canaveral typically arrive with loads just less than the 36-foot constraint in order to avoid tide and priority traffic delays (see discussion in Section 2.4.3 Existing Cargo Fleet Operations). In 2006, 51 vessels arrived with drafts between 33 and 36 feet and only 19 vessels arrived at drafts greater than 36 feet. Projected with-project operating drafts maintain the observed relationship between a vessel's arrival draft and the port's maximum unconstrained arrival draft. In this way the carrier's observed reliance on tidal advantage, or conversely, the carrier's observed reluctance to use the tide is mirrored in how they are expected to operate in the alternative depth scenarios under with-project conditions. For example, in 2006 slag vessels arrived, on average, with an operating draft of 34.8 feet, which is 1.2 feet less than the 36-foot maximum unconstrained arrival draft. Under with-project conditions, slag vessel operating drafts are constrained to maintain that 1.2-foot differential, so that under a two-foot deepening with-project condition the maximum unconstrained arrival draft increases to 38 feet and slag vessels are then projected to arrive at 36.8 feet ( $38 - 1.2 = 36.8$ ).

With-project unconstrained vessel operating drafts are truncated at 39.5 feet. Port terminal operators and the pilots have identified 39.5 feet as the limit on unconstrained maximum

operating draft for existing and future vessels. Currently, vessels arriving with drafts greater than 36 feet are constrained by channel depth conditions. Most port terminal operators do not project that future vessels will regularly arrive at operating drafts greater than 39.5 feet, although occasional vessels may arrive with deeper drafts. The reason for this unconstrained maximum operating draft (39.5 feet) is that 40 feet of depth at the port's berths is considered approximately the maximum depth that can be achieved without the need for major reconstruction at some berths. A depth of 40 feet at the berth provides the required minimum one-half foot of underkeel clearance for vessels berthed with a draft of 39.5 feet. For these reasons, the deepest future unconstrained operating draft at the port would be no greater than 39.5 feet in accordance with the limitations of the port's existing berths and the dimensions of the projected fleet. No benefits are associated with channel depths greater than the design requirements identified in Table 5-1.

**Table 5-22**  
**Without and With-project Operating Drafts and Tons per Call**

Operating Drafts					
Commodity	DWT	Without Project (-40 feet)	-42 feet	-43 feet	-44 feet
Aggregate	60,000	38.7	39.5	39.5	39.5
Cement	35,000	33.3	35.3	36.3	37.3
Cement	35,000	33.5	35.5	36.5	37.5
Cement	40,000	34.5	36.5	37.5	38.5
Limestone	35,000	36.0	38.0	39.0	39.5
Granite	60,000	39.5	39.5	39.5	39.5
Slag	35,000	34.8	36.8	37.8	38.8
Fuel Oil w/o	50,000	36.0	38.0	39.0	39.5
Fuel Oil Wide Plan 1	70,000	36.0	38.0	39.0	39.5
Fuel Oil Wide Plan 2	90,000	36.0	38.0	39.0	39.5
Tons per Call					
Commodity	DWT	Without Project (-40 feet)	-42 feet	-43 feet	-44 feet
Aggregate	60,000	57,046	57,174	57,174	57,174
Cement	35,000	34,117	36,749	38,066	39,382
Cement	35,000	39,295	41,928	43,245	44,561
Cement	40,000	23,155	26,015	27,446	28,876
Limestone	35,000	37,529	40,162	41,478	42,136
Granite	60,000	60,335	60,335	60,335	60,335
Slag	35,000	41,882	44,515	45,832	47,148
Fuel Oil w/o	50,000	41,323	44,717	46,414	47,263
Fuel Oil Wide Plan 1	70,000	57,852	62,061	64,165	65,217
Fuel Oil Wide Plan 2	90,000	74,381	79,323	81,794	83,030

The number of projected cargo vessel calls for the mid-level (base case) commodity forecast is presented in Table 3-9. Only a sub-set of Port Canaveral commodities and vessels would benefit from channel deepening as discussed above. Table 5-23 presents the total number of vessel calls

for benefiting commodities for the base case commodity forecast at alternative plan depths without channel widening. Forecast year 2020 is presented in Table 5-23 as an example.

**Table 5-23**  
**Projected Benefiting Cargo Vessel Calls (without widening): 2020**

	Without Project (-40 feet)	-42 feet	-43 feet	-44 feet
Aggregate	5	5	5	5
Cement	10	9	9	9
Limestone	16	15	14	14
Granite	16	15	14	14
Slag	6	6	6	6
Gasoline <sup>1</sup>	44	41	39	39
Distillate Fuel <sup>1</sup>	11	10	10	10
<b>Totals</b>	<b>108</b>	<b>101</b>	<b>97</b>	<b>97</b>

<sup>1</sup> Seaport Canaveral point-to-point tankers only

Channel deepening allows the use of larger vessels and/or allows existing vessels to load more efficiently. More efficient vessel use results in fewer vessel calls for the projected volume of cargo (Table 5-23). Channel widening has a similar effect on gasoline and distillate fuel vessels calling at Seaport Canaveral because longer vessels are able to use the channel under widening conditions. The use of larger vessels and the more efficient use of existing vessels reduce transportation costs. Table 5-24 provides an example (2020) of the transportation costs for benefitting cargo under without-project conditions and alternative deepening and widening conditions.

Total and incremental average annual equivalent transportation costs for large cargo vessels under without and with-project conditions are presented in Table 5-24. Benefits are calculated with and without alternative widening plans in effect. Channel widening impacts deepening benefits because the projected tanker fleet (gasoline and distillate fuel oil vessels only) calling at Seaport Canaveral Terminal will shift to larger vessels under Widening Plans 1 and 2. Channel deepening benefits decline slightly with widening plans in effect because without-deepening project transportation costs are less due to the use of larger tankers resulting in fewer tanker calls. Projected benefits exhibit diminishing returns to channel deepening in that incremental benefits decline at successively deeper project depths.

**Table 5-24**  
**Projected Benefiting Cargo Vessels Transportation Costs: 2020**

	No Deepening	-42 feet	-43 feet	-44 feet
Aggregate	\$780,715	\$780,715	\$780,715	\$780,715
Cement	\$5,966,563	\$5,478,117	\$5,478,117	\$5,478,117
Granite	\$968,030	\$926,885	\$885,741	\$885,741
Limestone	\$1,424,103	\$1,374,220	\$1,324,337	\$1,324,337
Slag	\$3,525,773	\$3,059,702	\$3,059,702	\$3,059,702
Gasoline (no widening)	\$6,904,473	\$6,497,242	\$6,225,755	\$6,225,755
Distillate Fuel (no widening)	\$1,734,753	\$1,599,009	\$1,599,009	\$1,599,009
<b>Total (no widening)</b>	<b>\$21,304,409</b>	<b>\$19,715,890</b>	<b>\$19,353,376</b>	<b>\$19,353,376</b>
Gasoline (Widening Plan1)	\$5,944,315	\$5,631,474	\$5,475,053	\$5,475,053
Distillate Fuel (Widening Plan1)	\$1,535,334	\$1,378,913	\$1,378,913	\$1,378,913
<b>Total (Widening Plan1)</b>	<b>\$20,144,832</b>	<b>\$18,630,026</b>	<b>\$18,382,578</b>	<b>\$18,382,578</b>
Gasoline (Widening Plan2)	\$5,358,201	\$5,185,400	\$5,012,599	\$5,012,599
Distillate Fuel (Widening Plan2)	\$1,350,772	\$1,350,772	\$1,177,971	\$1,177,971
<b>Total (Widening Plan2)</b>	<b>\$19,374,156</b>	<b>\$18,155,811</b>	<b>\$17,719,182</b>	<b>\$17,719,182</b>



**Table 5-25**  
**Average Annual Equivalent Transportation Cost Savings: Deepening Alternatives**

<b>Plan</b>	<b>Total Transportation Cost</b>	<b>Total Transportation Cost Savings</b>	<b>Incremental Cost Savings</b>
<b>Without Channel Widening</b>			
Without-deepening	\$26,708,104		
-42 feet	\$25,074,989	\$1,633,114	\$1,633,114
-43 feet	\$24,345,037	\$2,363,067	\$729,953
-44 feet	\$23,767,018	\$2,941,086	\$578,019
<b>With Widening Plan 1 (450 feet)</b>			
Without-deepening	\$25,430,262		
-42 feet	\$23,976,241	\$1,454,021	\$1,454,021
-43 feet	\$23,306,902	\$2,123,360	\$669,339
-44 feet	\$22,755,178	\$2,675,084	\$551,724
<b>With Widening Plan 2 (500 feet)</b>			
Without-deepening	\$24,623,781		
-42 feet	\$23,231,700	\$1,392,081	\$1,392,081
-43 feet	\$22,621,773	\$2,002,008	\$609,927
-44 feet	\$22,092,217	\$2,531,564	\$529,556

Tables 5-20 and 5-25, above, separately present the benefits of alternative widening and deepening plans. Projects that employ widening and deepening plans would generate the cumulative benefits of both types of improvement. For example, a project that combines Widening Plan 1 (450-foot channel width) with a -42-foot channel depth would generate \$1,883,968 in widening plan benefits (Table 5-20) and \$1,454,021 in deepening plan benefits (Table 5-25) for a total average annual project benefit of \$3,337,989. Table 5-26 presents a matrix of total project benefits which would be generated by combining Widening Plan 1 (450 feet) or Widening Plan 2 (500 feet) with incremental deepening from -42 feet to -44 feet.

**Table 5-26**  
**Total Project AAEQ Benefits: Widening and Deepening Plan Combinations**

	No Deepening	-42 feet	-43 feet	-44 feet
No Widening	-	\$1,633,114	\$2,363,067	\$2,941,086
Widening Plan 1 (450 feet)	\$1,883,968	\$3,337,989	\$4,007,328	\$4,559,051
Widening Plan 2 (500 feet)	\$2,829,748	\$4,221,830	\$4,831,756	\$5,361,312

### 5.4 Net Benefits of Alternative Plans

The alternative plan net benefits presented in Tables 5-27 through 5-30 are calculated as the difference between the total annual average equivalent costs and benefits of each alternative. The incremental net benefits of the alternative plans are decreasing with successive plan increments, but remain positive overall, which indicates that the incremental benefits of each successive alternative are greater than the incremental costs. The incremental plan providing the greatest net benefits is the plan that includes both widening increments and all three deepening increments. This plan is identified as W2 and -44-foot deepening in Table 5-30.

**Table 5-27**  
**Cost – Benefit Analysis: Channel Widening Only**

Alternative Plan	Total AAEQ Costs	Total AAEQ Benefits	Total Net Benefits	Incremental Net Benefits	B/C Ratio
Widening Plan 1 (450 feet)	\$1,448,734	\$1,883,968	\$435,233	\$435,233	1.3
Widening Plan 2 (500 feet)	\$1,960,442	\$2,829,748	\$869,306	\$434,073	1.4

Note: Discount rate = 4.00%, period 50 years

**Table 5-28**  
**Cost – Benefit Analysis: Channel Deepening Only**

Alternative Plan	Total AAEQ Costs	Total AAEQ Benefits	Total Net Benefits	Incremental Net Benefits	B/C Ratio
-42 feet	\$157,949	\$1,633,114	\$1,475,165	\$1,475,165	10.3
-43 feet	\$396,407	\$2,363,067	\$1,966,660	\$491,494	6.0
-44 feet	\$668,011	\$2,941,086	\$2,273,075	\$306,415	4.4

Note: Discount rate = 4.00%, period 50 years

**Table 5-29**  
**Cost – Benefit Analysis: Widening Plan 1 (450 feet) and Channel Deepening**

Alternative Plan	Total AAEQ Costs	Total AAEQ Benefits	Total Net Benefits	Incremental Net Benefits	B/C Ratio
450-foot widening (W1) only	\$1,448,734	\$1,883,968	\$435,233	\$435,233	1.3
W1 and -42-foot deepening	\$1,504,084	\$3,337,988	\$1,833,905	\$1,398,671	2.2
W1 and -43-foot deepening	\$1,764,285	\$4,007,328	\$2,243,043	\$409,138	2.3
W1 and -44-foot deepening	\$2,055,296	\$4,559,051	\$2,503,756	\$260,713	2.2

Note: Discount rate = 4.00%, period 50 years

**Table 5-30**  
**Cost – Benefit Analysis: Widening Plan 2 (500 feet) and Channel Deepening**

Alternative Plan	Total AAEQ Costs	Total AAEQ Benefits	Total Net Benefits	Incremental Net Benefits	B/C Ratio
500-foot widening (W2) only	\$1,960,442	\$2,829,748	\$869,306	\$869,306	1.4
W2 and -42-foot deepening	\$2,094,929	\$4,221,830	\$2,126,900	\$1,257,594	2.0
W2 and -43-foot deepening	\$2,377,931	\$4,831,756	\$2,453,826	\$326,925	2.0
W2 and -44-foot deepening	\$2,692,766	\$5,361,312	\$2,668,546	\$214,721	2.0

Note: Discount rate = 4.00%, period 50 years

## 5.5 Summary of Accounts

The National Environmental Quality (EQ) account impacts of alternative plans are described in detail in Section 7: Environmental Consequences of the Section 203 Study. Contributions to the Regional Economic Development (RED) account are presented here, based on the Canaveral Port Authority FY 2009 Economic Impact Study (September, 2010). The alternative plans are not projected to affect total cargo volume at the port. Cargo is projected to be delivered more efficiently on more deeply laden vessels, but growth in the overall volume will not be influenced by the project. Table 5-31 presents Port Canaveral's estimated economic impact on business revenues, employment, and wages.

**Table 5-31**  
**Port Canaveral Economic Impacts**

<b>Port Canaveral Business Line</b>	<b>Business Revenues</b>	<b>Employment</b>	<b>Wages</b>
Cruise	\$916,011,000	8,908	\$392,195,000
Cargo	\$126,187,000	2,389	\$178,393,000
Other	\$98,711,000	1,796	\$78,179,000
<b>Total</b>	<b>\$1,140,910,000</b>	<b>13,093</b>	<b>\$648,767,000</b>

Source: The 2009 Economic Impact of Port Canaveral, Martin Associates, September 2010.

Alternative plan contributions to the Other Social Effects (OSE) account are limited by the nature of with-project beneficial effects, which are reduced transportation costs for some commodities and cruise ships. Transportation cost reductions at the Port would improve the relative efficiency and competitive advantage of Port Canaveral as compared to other ports. Improved competition at Port Canaveral would support job, income, and revenue stability at the Port. Improved local economic stability, although not measured or assessed in this analysis, would be considered a positive contribution to the OSE account.

## 5.6 Risk and Uncertainty

The Engineering Appendix Attachment M: Cost and Schedule Risk Analysis addresses risk and uncertainty on the cost side of the project's economic analysis. The Cost and Schedule Risk Analysis identified 20.97% as the appropriate contingency level for the proposed project. On the benefit side of the economic analysis, sensitivity analyses are conducted on parameters that affect cargo and cruise ship related benefits:

- Commodity forecast uncertainty is addressed by ranking base-case commodity projections from most certain to least certain and assessing the benefit to cost ratio at alternative levels of certainty (Table 5-32);
- Reduced cruise ship schedule and lower commodity forecast as compared to the base case;
- Higher commodity projection as compared to the base case;

- Alternative Seaport Canaveral point-to-point vessel origins and destinations; and
- Alternative tonnage forecasts for:
  - Seaport Canaveral point-to-point vessels;
  - Cement;
  - Slag; and
  - Aggregate materials.

### 5.6.1 Commodity Forecast Uncertainty Ranking

An additional assessment of the impact of commodity forecast uncertainty is developed by ranking commodity projections based on perceived levels of certainty, from the most confident forecast to the least confident. Benefits based on commodities with the highest level of certainty (fuel) are presented as Scenario 1. Using fuel oil alone, as the single benefitting commodity, results in a benefit to cost ratio of 1.3 for the recommended plan. The addition of construction-related commodities (Scenario 2) increases the benefit to cost ratio up to the base case level (2.0) for the recommended plan. This assessment of uncertainty indicates that each alternative plan is economically justified using the most confident forecast assumptions. Therefore, the risk of recommending too large a plan is acceptable because the recommended plan is justified under the most restrictive commodity forecast.

**Table 5-32**  
**Port Canaveral Commodity Forecast Uncertainty Ranking**

<b>Scenario 1 Tug and Fuel Vessels Only (Most Certain)</b>				
	500-foot widening only (W2)	W 2 and -42-foot deepening	W 2 and -43-foot deepening	W 2 and -44-foot deepening
Tugs	\$745,426	\$745,426	\$745,426	\$745,426
Fuel Vessels	\$2,084,322	\$2,476,427	\$2,637,048	\$2,719,182
Total Benefits	\$2,829,748	\$3,221,853	\$3,382,474	\$3,464,608
Costs	\$1,960,442	\$2,094,929	\$2,377,931	\$2,692,766
Net benefits	\$869,306	\$1,126,924	\$1,004,543	\$771,842
BCR	1.4	1.5	1.4	1.3
<b>Scenario 2 Tug, Fuel Vessels, &amp; Other Commodities (Less Certain)</b>				
	500-foot widening only (W2)	W 2 and -42-foot deepening	W 2 and -43-foot deepening	W 2 and -44-foot deepening
Tugs	\$745,426	\$745,426	\$745,426	\$745,426
Fuel Vessels	\$2,084,322	\$2,476,427	\$2,637,048	\$2,719,182
Other Commodities	\$ -	\$999,976	\$1,449,282	\$1,896,704
Total Benefits	\$2,829,748	\$4,221,830	\$4,831,756	\$5,361,312
Costs	\$1,960,442	\$2,094,929	\$2,377,931	\$2,692,766
Net benefits	\$869,306	\$2,126,900	\$2,453,826	\$2,668,546
BCR	1.4	2.0	2.0	2.0

### 5.6.2 Reduced Cargo Forecast and Cruise Schedule

The first sensitivity analysis evaluates the effects of using the low cargo growth scenario and a reduced cruise ship schedule. The low growth scenario extends the impacts resulting from the recent economic down turn, such that rock products remain at one-half their projected 2012 through 2020, at which time they return to the base case forecast levels. Under this low growth sensitivity analysis Seaport Canaveral gasoline and distillate fuel imports remain at projected 2013 levels through 2020, at which time growth begins using the base case growth rates. This sensitivity analysis also reduces large cruise ship calls by 25%. Table 5-33 presents the cost-benefit analysis of the low forecast scenario for incremental increases in the project, from Widening Plan 1 to Widening Plan 2 with the -44-foot deepening.

**Table 5-33**  
**Cost – Benefit Analysis: Low Forecast Scenario**

Alternative Plan	Total AAEQ Costs	Total AAEQ Benefits	Total Net Benefits	Incremental Net Benefits	B/C Ratio
450-foot widening (W1) only	\$1,448,734	\$1,823,291	\$374,557	\$374,557	1.3
500-foot widening (W2) only	\$1,960,442	\$2,760,320	\$799,878	\$425,321	1.4
W2 and -42-foot deepening	\$2,094,929	\$4,087,131	\$1,992,202	\$1,192,324	2.0
W2 and -43-foot deepening	\$2,377,931	\$4,673,059	\$2,295,128	\$302,926	2.0
W2 and -44-foot deepening	\$2,692,766	\$5,177,039	\$2,484,273	\$189,145	1.9

Note: Discount rate = 4.00%, period 50 years

### 5.6.3 Increased Cargo Forecast

The most substantial differences between the high commodity forecast and the base case commodity forecast concerning Seaport Canaveral tanker and cement shipments to the Port. Under the high forecast Seaport Canaveral terminal grows at a faster short-term rate so that the facility achieves approximately 75% capacity by 2015, which is a 25% increase over the base case. The high commodity forecast for cement has cement imports returning to 2007 levels by 2012 instead of 2015. In addition, a third rock product terminal comes into operation by 2020. This higher estimate of projected calls increases channel widening benefits and channel deepening benefits, as presented in Table 5-34.

**Table 5-34**  
**Cost – Benefit Analysis: High Forecast Scenario**

Alternative Plan	Total AAEQ Costs	Total AAEQ Benefits	Total Net Benefits	Incremental Net Benefits	B/C Ratio
450-foot widening (W1) only	\$1,448,734	\$2,212,348	\$763,614	\$763,614	1.5
500-foot widening (W2) only	\$1,960,442	\$3,365,043	\$1,404,601	\$640,987	1.7
W2 and -42-foot deepening	\$2,094,929	\$4,990,449	\$2,895,520	\$1,490,919	2.4
W2 and -43-foot deepening	\$2,377,931	\$5,680,659	\$3,302,728	\$407,208	2.4
W2 and -44-foot deepening	\$2,692,766	\$6,238,321	\$3,545,555	\$242,827	2.3

Note: Discount rate = 4.00%, period 50 years

#### 5.6.4 Increased Seaport Canaveral Forecast

Alternative Seaport Canaveral forecasts used as a sensitivity analysis include forecasts ranging from 80% of the base case forecast to 120% of the base case forecast (Table 5-35). The sensitivity analysis indicates proportionately similar impacts to net benefits for the higher and lower alternatives. The highest alternative (120% of the base case forecast) increases the net benefits of Widening Plan 2 (500 feet) with the -44-foot deepening by 19.95%. The lowest alternative (80% of the base case forecast) decreases net benefits by 19.97%. Total AAEQ net benefits for Widening Plan 2 (500 feet) with the -44-foot deepening range from \$2,847,125 for the higher forecast to \$1,899,611 for the lower forecast. The benefit/cost ratio similarly ranges from 2.2 to 1.8.

**Table 5-35**  
**Cost – Benefit Analysis: Alternative Seaport Canaveral Forecasts**

Alternative Forecast	Total Net Benefits	Impact to Net benefits	B/C Ratio
120%	\$3,205,840	\$537,294	2.2
110%	\$2,918,011	\$249,464	2.1
105%	\$2,802,391	\$133,845	2.0
<b>Base Case</b>	<b>\$2,668,546</b>	<b>- - -</b>	<b>2.0</b>
95%	\$2,516,379	-\$152,167	1.9
90%	\$2,393,951	-\$274,595	1.9
80%	\$2,101,632	-\$566,923	1.8

Note: Discount rate = 4.00%, period 50 years

### 5.6.5 Alternative Seaport Canaveral Vessel Origins

The actual origin distance data (Table 5-17) shows that Maracaibo, Venezuela is the import origin with the highest proportion of total tonnage (40.1%). Three sensitivity analyses were conducted by assigning the next two highest volume alternative ports as having 40.1% of import tonnage and with Maracaibo, Venezuela assuming the actual tonnage proportion of the alternative port (Table 5-36). Point Tupper, Canada was selected as an alternative major port because it has the next highest proportion of tonnage after Venezuela and because Canada is known to be expanding its oil production capabilities. Fortaleza, Brazil was selected as alternative port, rather than Rotterdam, Netherlands (the next largest proportion of tonnage), because Brazil is expanding production capabilities based on the discovery of the Tupi Field in 2007 and is projected to be one of the leading non-OPEC contributors (along with Canada and the United States) to world liquid fuel production growth<sup>15</sup>. Houston, Texas was selected as an alternative domestic origin based on potential increased US production.

**Table 5-36: Weighted Average Distances (nautical miles)**

	Major Port	Country	Weighted Average
Actual Origins	Venezuela	Maracaibo	2,014
Sensitivity 1	Point Tupper	Canada	1,945
Sensitivity 2	Houston	U.S. (Texas)	1,939
Sensitivity 3	Fortaleza	Brazil	2,728

The results of the sensitivity analyses (Table 5-37) using the actual weighted average origin distance indicates that there are very small differences between the deepening benefits cited in the Economics Appendix presented for the AFB and the benefits using actual weighted average origin distance (change of less than 1%). Similarly, there are only very small differences for sensitivity analyses that shift the major import location to Canada (Sensitivity 1) and Texas (Sensitivity 2). The largest change in benefits would occur with a shift to Brazil as a major origin for Seaport Canaveral imports (Sensitivity 3). A shift to Brazil would increase deepening benefits in a range of 12% to 14%. The revised Economics Appendix will use the actual weighted average distance in the benefits calculation as the most likely representation of future conditions.

<sup>15</sup> International Energy Outlook 2011, Analysis and Projections, U.S. Energy Information Administration, 19Sp11



**Table 5-37: Seaport Canaveral Origins Sensitivity Analyses Average Annual Equivalent Transportation Cost Savings: Channel Deepening Only**

Deepening Plan	Actual Origins (Base Case)											
	Sensitivity 1			Sensitivity 2			Sensitivity 3					
	Total Benefits	% Change from Base Case	Total Benefits	% Change from Base Case	Total Benefits	% Change from Base Case	Total Benefits	% Change from Base Case	Total Benefits	% Change from Base Case	Total Benefits	% Change from Base Case
-42 feet	\$1,475,165	0.00%	\$1,460,870	-0.97%	\$1,459,627	-1.05%	\$1,623,086	10.03%	\$1,946,360	-1.03%	\$2,159,917	9.63%
-43 feet	\$1,966,660	0.00%	\$1,947,984	-0.95%	\$2,251,746	-0.94%	\$2,476,128	8.93%				
-44 feet	\$2,273,075	0.00%	\$2,253,452	-0.86%								

### **5.6.6 Alternative Cement Forecasts**

The Portland Cement Association (PCA) produced an analysis of projected future industry characteristics in 2011 titled “Overview Impact of Existing and Proposed Regulatory Standards on Domestic Cement Capacity”. The PCA analysis projects domestic cement consumption, production, and imports through 2025 under two regulatory conditions. One regulatory condition includes the effects of five currently enacted environmental regulations and two proposed regulations (the with-current emissions policy condition) and the second regulatory condition excludes these existing and proposed regulatory standards (the without-current emissions policy condition). The implications of these two policy conditions is that imports are expected to increase more rapidly as a percentage of total cement usage under current emissions policy due to regulatory impacts on the level and cost of domestic production.

Under the with-current emissions policy condition, the most likely condition for USACE planning purposes, U.S. cement consumption is projected to increase from observed 2010 levels (68.9 million tons) to 170.8 million tons in 2025, an annual growth rate of 6.2%. Cement imports under the with-current emissions policy condition are projected to increase from observed 2010 levels (5.9 million tons) to 82.0 million tons in 2025, an annual growth rate of 19.2%. This reflects an increasing share of imports versus domestic production over this period.

Even under the without-current emissions policy condition, which favors domestic production over imports, cement imports are still projected to grow at an annual rate of 15.0%, achieving 48.0 million tons in 2025. Under the without-current emissions policy condition cement imports at the national level are projected to more than double between 2010 and 2015. Note again that the Economics Appendix very conservatively assumes no resumption of cement imports at Port Canaveral until 2015 with a subsequent growth rate of 2.8% thereafter.

One important contributing factor to the PCA import projections under both policy conditions is that domestic production is expected to level off beginning in 2015. Under the without-current emissions policy condition, domestic production levels off at a greater tonnage than under the with-current emissions policy condition.

Three sensitivity analyses were conducted using information contained in the PCA report:

- PCA 1 - On average, from 2000 through 2007, Port Canaveral cement imports were equivalent to 3.7% of all US cement imports. Starting in 2015, this sensitivity analysis calculates that Port Canaveral imports will resume and will equal 3.7% of the PCA without-current emissions policy condition cement import projection. After 2025, an annual growth rate of 2.81% (the base case cement imports growth rate) is used to forecast years 2026 – 2063.
- PCA 2 - Starting in 2015, this sensitivity analysis calculates Port Canaveral imports will resume and will equal 3.7% of the PCA with-current emissions policy condition cement import projection. After 2025, an annual growth rate of 2.81% (the base case cement imports growth rate) is used to forecast years 2026 – 2063.
- PCA 3 – In 2007, Port Canaveral cement imports were only 2.5% of all US cement imports, which is the lowest percentage of imports at Port Canaveral from 2000 through

2007. This sensitivity analysis calculates Port Canaveral imports as 2.5% of the PCA without-current emissions policy condition cement import projection (the lower of the two PCA import projection conditions). This analysis projects no Port Canaveral cement imports will resume until 2.5% of US imports is equivalent to the observed 2007 Port Canaveral cement import level. Under this scenario, imports are projected to begin in 2018 (539,450 tons) and continue to grow at PCA without-condition levels through 2025. After 2025, an annual growth rate of 2.81% (the base case cement imports growth rate) is used to forecast years 2026 – 2063.

Table 5-38 presents the base-case channel deepening benefits and deepening benefits under the four sensitivity analyses: 2007 Port Canaveral cement import levels not achieved until 2020 with a 2.81% growth rate thereafter and the three PCA-based scenarios. Note that cement vessels benefit from channel deepening and are not expected to contribute to channel widening benefits. The most restrictive 2020 commencement of cement benefits scenario produces fewer transportation cost savings than the base-case, as anticipated. Each of the three sensitivity analyses based on the PCA projections actually generated greater benefits than the base-case used for the calculation of benefits in the Economics Appendix. Sensitivity Analysis PCA 2, which estimates transportation cost savings using PCA import projections based on current emissions policies, and based on Port Canaveral's historical share of US cement imports, may be a more reasonable base case scenario than is currently identified in the Economics Appendix and would generate greater benefits for the project.

**Table 5-38  
Port Canaveral Cement Import Projection Sensitivity Analyses (Transportation Cost Savings)**

Deepening Plan	Base Case		2020 Start with 2.81%		PCA 1		PCA 2		PCA 3	
	Total	Incremental	Total	Incremental	Total	Incremental	Total	Incremental	Total	Incremental
-42 feet	\$1,475,165	\$1,475,165	\$1,325,531	\$1,325,531	\$2,389,712	\$2,389,712	\$3,433,052	\$3,433,052	\$1,831,940	\$1,831,940
-43 feet	\$1,966,660	\$491,494	\$1,763,284	\$437,753	\$3,148,064	\$758,352	\$4,641,872	\$1,208,821	\$2,399,917	\$567,977
-44 feet	\$2,273,075	\$308,415	\$2,024,649	\$251,984	\$3,593,670	\$445,606	\$5,401,929	\$760,057	\$2,776,762	\$376,845

### 5.6.7 Alternative Slag Forecasts

The impact of the new EPA regulations on fly ash use and the limits on domestic production of slag are both strong indicators that slag imports will likely increase substantially in the near future, even in the absence of a robustly rebounding construction industry. As an example, if only half of projected fly ash use is replaced by slag (even though it is less expensive than Portland cement), then domestic slag consumption would increase to 30 million tons by 2025. Also, if net import reliance increases from 10% to 15% (which is highly likely given domestic production regulatory changes), then total imports would be 4.5 million tons. Under this scenario, the projected 2025 import tonnage (4.5 million tons) would be three times the 2010 level of imports (1.5 million tons), which implies an average annual growth rate of 7.6%. The base case scenario for the Port Canaveral Section 203 Study uses a growth rate of less than half of this: 2.81%. This growth rate is based on projected population growth, to project future slag and cement import tonnages and does not account for the competitive advantages cited previously.

Table 5-39 presents slag projections using:

- the base case growth rate (2.81%),
- one-half the base case growth rate (1.4%) and
- the growth rate based on the fly ash replacement and import versus domestic production assumptions presented above (7.6%).

Note that plant annual capacity is approximately 600,000 tons and is used as a cap on all projections, and also that the starting point for all scenario projections are based on the observed 2010 tonnage.

**Table 5-39**  
**Sensitivity Analysis: Alternative Slag Import Forecasts**

	2011*	2020	2030	2040	2050	2060
Base case (2.81%)	235,856	302,646	399,260	526,715	604,973	604,973
Low estimate (1.4%)	235,856	267,294	307,162	352,378	405,627	466,130
Fly Ash Replacement (7.6%)	235,856	455,992	611,233	611,233	611,233	611,233

\*Actual observed data

Lowering the slag import growth rate by 50% (Projection #2) pushes the year at which the Hanson plant capacity is achieved to beyond the end of the study period (2064). Alternatively, the forecast based on the impact of the new fly ash regulations (Projection #3) causes the Hanson plant capacity to be achieved 20 years earlier than the base case.

The impact of alternative growth rate projections on project benefits (Table 5-40) is less substantial for the low projections than for the higher projection. As shown in Table 5-39, a reduction of 50% in the projected growth rate only reduces slag benefits by 10-16% (depending

on the channel deepening scenario analyzed); whereas the higher Projection 3 results in a doubling of benefits under all channel deepening scenarios. The cargo forecast presenting the effects of the new fly ash regulations (Projection #3) is considered to be a better indication of future growth than the base-case forecast, since it is based on industry-specific competitive conditions rather than a general trend among the observed relationship between cement import growth and population growth. Certainly it is a more likely scenario than Projection #1, since there is no independent analysis which plausibly suggests that currently published population projections for Florida are likely to be 100% too high.

**Table 5-40**  
**Port Canaveral Slag Import Projection Sensitivity Analyses**

Deepening Plan	Base Case (2.81% annual growth rate)		Low Forecast (one-half base-case projection = 1.4% annual growth rate)		Fly Ash Regulation & Domestic Slag Production Impact (7.6% annual growth rate)	
	Total Benefits	% Change from Base Case	Total Benefits	% Change from Base Case	Total Benefits	% Change from Base Case
-42 feet	\$ 1,475,165	n/a	\$1,381,352	-6.36%	\$1,565,566	6.13%
-43 feet	\$ 1,966,660	n/a	\$1,889,091	-3.94%	\$2,032,853	3.37%
-44 feet	\$ 2,273,075	n/a	\$2,116,430	-6.89%	\$2,454,136	7.97%

### **5.6.8 Alternative Aggregate Materials Forecast**

Rock (aggregate, limestone, and granite) forecasts were provided by the CPA based on term sheets for the two major bulk handling firms operating at the port. The term sheet is a planning document used by the operator and the CPA to allocate resources and terminal area. The term sheet provides a revenue stream estimate for the CPA and is used to establish minimum guarantee fees. The term sheets for both firms provide commodity projections from 2011 through 2035. In this analysis, there is no further growth projected for these commodities beyond growth identified in the term sheets, due to forecast uncertainty.

Port Canaveral is uniquely situated as the only deep water port on Florida's central east coast with the ability to handle and store the amount of rock products identified in the term sheets. The importance of Port Canaveral's location, as explained by the operators, is that continued infrastructure development along the Orlando/Interstate 4 corridor requires more rock products than can be supplied through existing and historical local sources. The fixed location of rail infrastructure and the inability to develop potential sources within the Everglades due to land use constraints increase the need for imported rock products. At the same time, vessels carrying international rock products are increasing in size, lowering per unit transportation costs and increasing their cost competitiveness in the central Florida market. For example CSL, one of the world's major bulk carriers which also calls regularly at Port Canaveral, will have a new fleet of Panamax bulk vessels in service by 2012 with draft capabilities of 44 feet.

An update on the status of the two new bulk terminal operators at Port Canaveral indicates that both facilities are currently under construction and are approximately one year behind schedule due to permitting issues. The permitting issues have been resolved, terminal construction is underway, and both facilities will be in operation in 2012. In addition, a third bulk terminal operator is investigating a long-term lease at Port Canaveral, which would include new bulk terminal facility on the north side of the port complex. This potential third bulk operation would be similar in capacity and handle similar commodity types as the two facilities currently under construction.

Three sensitivity analyses were developed to assess the impact of changes in the aggregate materials forecast on project benefits. The first sensitivity analysis identifies the impacts of a two year delay in commencing operations at the port for both facilities. The second sensitivity analysis includes a two year delay for both facilities but also includes a new third facility entering operations in the same year as the existing facilities. The third sensitivity analysis presents the impact of cutting the forecast for each of the two facilities by 50%.

These bulk vessels are not projected to benefit from a wider channel; therefore, the transportation cost savings presented in Table 5-41 are channel deepening benefits only. The sensitivity analysis changes in bulk commodity forecasts generate relatively small changes in overall deepening benefits largely because these bulk commodities generally have lower transportation costs than cement or slag due to import origins in the Caribbean and Canada.



**Table 5-41  
Port Canaveral Aggregate Import Projection Sensitivity Analyses**

Deepening Plan	Base Case		Two Year Delay		Two Year Delay with Third Facility		Commodity Forecast at 50% of Base-case	
	Total	Incremental	Total	Incremental	Total	Incremental	Total	Incremental
-42 feet	\$1,475,165	\$1,475,165	\$1,462,600	\$1,462,600	\$1,540,218	\$1,540,218	\$1,471,272	\$1,471,272
-43 feet	\$1,966,660	\$491,494	\$1,946,977	\$484,377	\$2,018,915	\$478,697	\$1,873,276	\$402,004
-44 feet	\$2,273,075	\$306,415	\$2,255,070	\$308,093	\$2,320,876	\$301,961	\$2,187,651	\$314,375

**CANAVERAL HARBOR, FLORIDA**  
**Integrated Section 203 Navigation Study Report**  
**&**  
**Final Environmental Assessment**

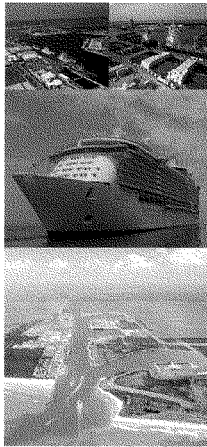

**Real Estate Plan**  
(sub-part of Volume 3)

**December 2012**  
(last revised September 2012)



**US Army Corps**  
**of Engineers** ®



**Port Canaveral Section 203 Feasibility Study**

**Real Estate Appendix**

**Real Estate Plan (REP)**

Revision: September 12, 2012

## Table of Contents

1.0	Purpose.....	1
2.0	Lands, Easement and Rights-of-Way (LER) .....	2
2.1	Existing Ownership of Lands and Estates .....	2
2.2	Real Estate Interests and Impacts .....	3
2.2.1	Navigation Servitude .....	3
2.2.2	USAF Permit Modification and Impacts to USAF .....	4
2.2.4	Dredged and Excavated Material Disposal.....	4
2.2.5	Miscellaneous Real Property Issues.....	7
2.3	Capability Assessment of Non-Federal Sponsor .....	7
3.0	Baseline Cost Estimate for Real Estate.....	7
3.1	Land Value.....	8
3.2	Administrative Cost .....	8
3.3	Summary of Costs.....	8
4.0	Schedule.....	8

## List of Tables

Table 1:	Summary of Required Lands Beyond the Existing Federal Project Limits.....	1
Table 2:	Existing Real Property Rights .....	3
Table 3:	Summary of Dredged and Excavated Material Disposal.....	7
Table 4:	Summary of LER Costs (2011 Dollars).....	8

## List of Attachments

The following list of attachments augments the discussion of the feasibility study engineering appendix. Please refer to these technical attachments for further information.

### A – Real Estate Exhibits 1-4

- Real Estate Exhibit 1: Property Boundaries (West)
- Real Estate Exhibit 2: Property Boundaries (East)
- Real Estate Exhibit 3: Preliminary Acquisition Map (3 sheets)
- Real Estate Exhibit 4: Excavated and Dredged Material Disposal Areas

### B – Existing USAF Permit No. SPCCAN-2-99-0005 to USACE for Channel Improvement Works

### C – Existing USAF Lease DACA 17-4-83-1 to USACE for Upland Disposal Site

### D – USAF Memorandum and Meeting Minutes

### E – Sponsor Capability Checklist

## 1.0 Purpose

In support of the Port Canaveral Section 203 Feasibility Study for navigation improvements to the existing Federal Canaveral Harbor, the Real Estate Plan (REP) identifies and describes lands, easements, and rights-of-way (LER) required for the construction, operation and maintenance of the proposed cost-shared project, including those required for dredged and excavated material disposal. The REP also identifies impacts to lands that are necessary to implement the project. LER values, costs, and schedule are also included. USACE publication *ER 405-1-12, Real Estate Handbook*, was consulted for plan preparation. This plan is tentative in nature and is subject to change.

The Canaveral Port Authority (CPA) is the non-federal sponsor of the existing Federal navigation project at Port Canaveral and of this project to improve the navigational improvements. CPA has prepared the feasibility study under the authority granted by Section 203 of the Water Resources Development Act (WRDA) of 1986.

The recommended plan consists of widening the main channel from 400 feet to 500 feet, expanding the West Turning Basin turning radius from 1,400 feet to 1,725 feet, and deepening several channel segments. Details of the recommended plan are located in Section 6 of the Main Report and in the Engineering Appendix.

Other than the lands previously provided for the existing Federal project, the lands required for construction, operation and maintenance of this project are the lands required for the widening of the federal navigation channel. Navigation servitude will be exercised to use, control, and regulate the needed lands below the mean high water line of lands owned by CPA and the State of Florida under the Trustees of the Internal Improvement Trust Fund (TIITF). A modification to the existing USACE permit with the USAF will be executed for the needed uplands owned by the USAF. Since all uplands are already in Federal ownership, there are no real estate costs other than administrative costs associated with negotiating and obtaining the necessary permit modifications. The following table summarizes required lands beyond the limits of the existing Federal project. These items are discussed further in the subsequent Sections.

**Table 1: Summary of Required Lands Beyond the Existing Federal Project Limits**

Project Purpose	Acreage	Estate	Number of Affected Tracts	Tract Ownership	Value
Widening	22	Navigation Servitude	1	State of Florida, TIITF	\$ 0
Widening	50	Navigation Servitude	3	CPA	\$ 0
Widening	19	Permit	2	USAF	\$ 0
Excavated Material Disposal	28	Permit	2	USAF	\$ 0

## **2.0 Lands, Easement and Rights-of-Way (LER)**

### **2.1 Existing Ownership of Lands and Estates**

The lands along and adjacent to the Canaveral Harbor and Entrance Channel are all publicly owned by the Canaveral Port Authority (CPA), the State of Florida (under the Trustees of the Internal Improvement Trust Fund (TIITF)), and the United States (USA). The lands include uplands and submerged lands as shown in *Real Estate Exhibits 1 & 2: Property Boundaries in Attachment A*. The lands are color-coordinated based on agency ownership.

The deed or agreement dates, parcel owners, and rights for easements, permits, and leases are shown on the Exhibits. Legal descriptions were obtained from Official Records of Brevard County, Canaveral Port Authority Agreements, the United States Air Force (USAF), and the United States Army Corps of Engineers (USACE). The legal descriptions are available upon request.

The majority of the uplands and submerged lands are owned by the project sponsor, CPA. The limits of the CPA parcels acquired by four deeds and one condemnation are illustrated with the green hatching. The CPA then conveyed the rights required for the Federal project from these parcels to the USA via seven perpetual easement agreements for the construction and maintenance of the federal navigable waters. Historically, perpetual easements were utilized to convey rights from existing manmade lands and shallow non-navigable waters of the Banana River to the USA for the Federal project. Today, those areas of the existing Federal project are now navigable tidal waters and therefore navigation servitude will be asserted as required for the changes to the Federal project.

As detailed in the Engineering Appendix, the widening of the entrance to the West Basin is referred to as the West Turning Basin Corner Cut-Off (CCO). CPA completed this work in 2011 in advance of the Section 203 project authorization. CPA seeks no compensation for CPA lands provided for the CCO, since it was completed in advance of project authorization without a prior agreement with the Secretary of the Army and is treated in the Feasibility Report as part of the without project condition. With construction of the CCO these lands are now submerged and navigation servitude can be asserted as required for project improvements to the West Turning Basin.

The State owns the submerged lands east of the Harbor entrance and has granted a perpetual easement to the CPA for the improvement and subsequent maintenance of the Canaveral Harbor. Thereafter the CPA granted a perpetual easement for these submerged lands to the USA for the federal project. The State also owns the submerged lands where the ocean dredged material disposal site (ODMDS) is located. The State provides a perpetual easement to CPA for the purpose of depositing material which may be dredged from the Canaveral Harbor, the Atlantic Ocean, and the Banana River. Thereafter the CPA granted a perpetual easement to the USA for the same rights. The State lands held by the TIITF are illustrated in blue. There are no known reasons for why the perpetual easements for ocean bottomlands were issued in the past as navigation servitude should also have applied at that time.

The USA owns the lands north of the Inner Channel in the middle of the project; these lands are utilized for the USAF at Cape Canaveral Air Force Station (CCAFS) and a Navy NOTU Command and Trident Submarine Base. These lands are illustrated with yellow hatching. In

1998, in conjunction with the last channel widening, the USAF issued Permit No. SPCCAN-2-99-0004 to the USACE for indefinite use of the described lands for the purpose of construction, operation, and maintenance of channel improvement works. This permit is provided in *Attachment B* and illustrated in pink on *Exhibits 1&2 of Attachment A*.

USAF Lease DACA 17-4-83-1 allows the USACE to utilize two upland disposal areas on CCAFS. The two areas include approximately 19 acres of land between the Middle and Trident Turning Basins and approximately 150 acres east of the Trident Turning Basin. Since 1982, these existing sites have been maintained and operated by the USACE for use of periodic maintenance dredging of the Navy Trident Basin and the Port Canaveral access channel. The permit has typically been renewed on a five-year term. The current amendment, number 5, is set to expire December 15, 2012. This lease is provided in *Attachment C* and illustrated in pink on *Exhibits 1&2 of Attachment A*.

In order of executed date, the following table summarizes the documents related to the ownership, perpetual easements, lease, and permit associated with the channel improvement project as illustrated in *Exhibits 1 & 2*.

**Table 2: Existing Real Property Rights**

<b>Real Property Rights</b>	<b>Parcel I.D. Numbers</b>
CPA Owned	I-4, A-39, I-10, 16, and I-95
CPA Owned, Perpetual Easement to USA	117, A-61, A-59, A-12, A-23, I-114, and 262
TIITF State of Florida Owned, Perpetual Easement to CPA	I-98, A-1
TIITF Owned, Perpetual Easement from CPA to USA	A-16, I-100
USA Owned (USAF)	A-51, Tract No. 945
Lease or Permit from USAF to USACE	Lease, Permit

Deeds for Parcels I-95, I-98, I-114, and 262 are located within the Brevard County Official Record Books. Deeds for Parcels I-4, A-39, A-10, 16, and 117 are within the Brevard County Deed Books. All other documents have no recorded file on record with the County.

## **2.2 Real Estate Interests and Impacts**

Based on the recommended channel improvements, real estate owned by the CPA, the State, and the USA will be impacted. Navigation servitude will be exercised to use, control, and regulate the necessary submerged lands from CPA and the State for the channel widening. Real property rights for approximately 8 acres of USAF uplands required for the channel widening, approximately 11 acres of USAF uplands associated with land damages due to the channel widening, and approximately 28 acres for disposal excavated upland (above -13 MLLW) material will be sought via a modification of the existing permit. These interests and estates are detailed

below and illustrated on *Real Estate Exhibit 3: Preliminary Acquisition Map (3 pages)* in *Attachment A*.

### **2.2.1 Navigation Servitude**

As defined in *ER 405-1-12*, navigation servitude is the dominant right of the Government under the Commerce Clause of the U.S. Constitution to use, control, and regulate the navigable waters of the United States and the submerged lands thereunder for various commerce-related purposes including navigation and flood control. Because the submerged lands needed for the recommended project will aid commerce by improving navigation and is located below the mean high water mark of a tidal navigable watercourse, navigation servitude is available to exercise in this project.

As stated in *ER 405-1-12*, as a general rule, the Government does not acquire interests in real property that it already possesses or over which its use or control is or can be legally exercised and it is the policy of the USACE to utilize the navigation servitude in all situations where available.

Navigation servitude will be exercised to use, control, and regulate (1.) the CPA submerged lands adjacent to the West Turning Basin and north of the Inner and Middle Reaches for the channel widening and (2.) the TIITF State submerged lands for the Bend Widener southwest of the intersection of the Middle and Outer Reaches. The 72.4 acres associated with servitude are illustrated in brown on *Exhibit 3 of Attachment A*. The limits of these areas are from the Recommended Plan as presented in the Engineering Appendix.

### **2.2.2 USAF Permit Modification and Impacts to USAF**

The attitude of the USAF towards the project is positive. A preliminary meeting between the Canaveral Port Authority and United States Air Force representatives was held November 22, 2005, to discuss the potential land impacts. At that time, USAF representatives indicated that ownership in the land would not be transferred but an easement would likely be granted as was done in past Federal projects along the harbor channel. Subsequent meetings between CPA and the USAF have recently been held in July, August, and December 2011. The existing lease and permit documents were obtained at these later meetings. Current USAF personnel agree that the land would not be transferred and that interests could be sought via a permit modification. A June 28, 2012, memorandum from the 45<sup>th</sup> Space Wing of the USAF to the USACE-Jacksonville District as well as meeting minutes is included in *Attachment D*. The letter provides comment from the USAF Commander acknowledging working closely with the team to work project issues and offering a continued partnership as the channel widening project moves forward. The next meeting is set for late September 2012.

For the proposed waterway improvements known as the Inner Reach Widener or the North Side Channel Widener, permanent use of approximately 8 acres of the southern strip of Parcel A-51 of the USA lands is required between the Middle Turning Basin and the Trident Turning Basin. This area, part of the yellow highlighted area on *Sheet 2 of Exhibit 3*, is needed for the reconstruction of the rock revetment along the channel slope due to the 100-foot widening of the channel and the additional 14-foot approximate width related to deepening the channel 4-feet in this area. These uplands will basically be shifted approximately 114 feet landward. Refer to the cross-section on *Exhibit 3*. Real estate interests in these lands will be sought by the USACE



through a modification to the existing USAF issued Permit No. SPCCAN-2-99-0004 to the USACE. The permit was originally issued for indefinite use of the described lands for the purpose of construction, operation, and maintenance of channel improvement works. Those described lands of the existing permit are illustrated in pink on *Exhibit 3* and described in the permit located in *Attachment B*. The modification would expand the area under the permit to include the 8 acres needed for widening the channel from 400-feet to 500-feet.

The permit modification would also include the approximately 11 acres of uplands north of reconstructed revetments. This area is also part of the yellow highlighted area on *Exhibit 3*. *Section 5, Repair of Damage*, within the existing Permit states “the Grantee shall promptly correct, repair or replace to the satisfaction of the Commander any property under the control of the Air Force that is interfered with, damaged or destroyed by the Grantee incident to the exercise of the privileges granted under this permit.” Due to the North Side Channel Widener, the unimproved perimeter maintenance/security roadway, security fencing, signage, and the spoil containment dike on the USAF uplands between the Middle Turning Basin and the Trident Turning Basin will need to be reconstructed northward approximately 114 feet. An abandoned boresight tower guy foundation (concrete pile tripod) and an existing mooring dolphin (fixed structure to which a vessel may be secured) east of the U.S. Navy Poseidon Wharf will need to be removed. A new monopile dolphin (type of mooring dolphin) positioned near the new shoreline will need to be constructed. The widening also impacts the USAF property such that a new bulkhead retaining wall is required to provide the shoreline setback required by USAF regulations to the existing Bldg 1064. This bulkhead wall will also be configured to stabilize the existing boat ramp used by military security patrol boats. The USN submarine sail which is partially buried in the ground as a monument will need to be repositioned. Upon completion of the construction, the USAF will resume operation and maintenance of the items.

The permit modification would also include the 28 acres north of the spoil containment dike and south of the existing leased disposal area. This area, also part of the yellow highlighted area of *Exhibit 3*, will be utilized for the disposal of excavated materials above elevation -13 feet MLLW. The volume of excavation in this area above elevation -13 feet MLLW is estimated to be 454,069 cy. Approximately 100,000 cy of this volume is material from the existing revetment that will be reused as a component of the revetment reconstruction 114 feet landward from its current location. The remaining 354,069 cy of upland material will be transported to these 28 acres. Reuse of upland excavated material is considered likely, since the excavated material is expected to be of a quality suitable for construction fill material. The material would be stockpiled at an agreeable location on the containment site for later reuse pending formal Air Force approval for use of that area for material placement.

Air Force approval for use of the site for material placement would be based on an evaluation of competing interests and on test results of the composition of the spoils to be placed. The Sponsor is well aware that Brevard County has a beach restoration project that intends to use the USAF disposal area to stockpile beach quality sand. The beach quality sand will be hydraulically dredged from just offshore of the USAF coastline and will therefore require a competent dike system to contain the fluid spoil. The existing USAF containment dike, however, is in poor condition and will need to be restored, and possibly raised in elevation, and a new intermediate dike constructed to subdivide the containment area. Based on the previous channel widening and the Sponsor’s experience with recent dredging, the project upland material above elevation -13 feet will be construction grade fill material recovered using excavation methods. This material

will be suitable for the dike modifications and the new intermediate dike needed for the Brevard County project. CPA is currently coordinating with USAF and Brevard County to insure that the one-time placement of the recovered spoil will complement the Brevard County project. Use of the recovered stockpiled material to reconstruct and improve the containment dike system would not reduce the area available for spoil.

In the unlikely event that the USAF should not approve placing the excavated material on their site, other options for reuse of the upland excavated material can be further developed, including off-site placement or existing disposal area dike upgrades requiring suitable fill. If the USAF wishes to retain ownership of the upland material (since the material is being excavated from their property), then the Sponsor could truck the material to a different site on CCAFS as designated by the USAF. These alternatives would be slightly more expensive than the recommended upland disposal plan due to additional haul distances, but would be expected to remain within the contingency allowance for upland material disposal costs estimated in this report.

#### **2.2.4 Dredged and Excavated Material Disposal**

Dredge material below -13 feet MLLW generally consists of silts and clays, and are not suitable for reuse. As stated in 6.7.3.1 of the main report, these silts and clays will be disposed in the Canaveral Offshore Dredged Material Disposal Site (ODMDS) located approximately 10 miles south of Canaveral Harbor. Approximately 3.1 million cy of dredged material below elevation -13 feet MLLW will be tested, and assuming approval, permitted for disposal at the ODMDS.

It is the responsibility of the U.S. Environmental Protection Agency (EPA) and the U.S. Army Corps of Engineers (USACE) to under the Marine Protection, Research, and Sanctuaries Act (MPRSA) of 1972 to manage and monitor each of the Offshore Dredged Material Disposal Sites designed by the EPA pursuant to Section 102 of the MPRSA. Section 102(c)(3) of the MPRSA required the development of a Site Management and Monitoring Plan (SMMP) for each ODMDS and review and revise the SMMP not less frequently than every 10 years. The present management plan for the Canaveral Harbor ODMDS is the February 2012 SMMP. The plan is discussed further in 6.7.3.1 of the main report and is included in the Engineering Appendix as *Attachment P*.

As discussed above, the volume of excavated material above elevation -13 feet MLLW that requires disposal is 354,069 cy. The material will be placed on the USAF property as described in paragraph 2.2.2.

The disposal sites and project areas generating the material are indicated on *Exhibit 4 of Attachment A*. The material is summarized below.

**Table 3: Summary of Dredged and Excavated Material Disposal**

<b>Material Type</b>	<b>Current Location</b>	<b>Future Location</b>	<b>Quantity</b>
Dredged (below -13 feet MLLW)	Federal project to be deepened and widened, State and CPA land	ODMDS	3.1 million CY
Excavated (above -13 feet MLLW)	Existing rock revetment along Inner Reach, USAF Land	Future rock revetment along Inner Reach, USAF Land	100,000 CY
Excavated (above -13 feet MLLW)	USAF property impacted by the North Side Widener	USAF property north of the containment berm	354,069 CY

The operation and maintenance of the Recommended Plan is nearly identical to operation and maintenance of the existing Canaveral Harbor project, with the exception of an additional 69,000 cubic yards of annual maintenance dredging that is expected to occur mostly in the vicinity of the extended turn widener in the entrance channel. Material from this area has historically been suitable for placement at the ODMDS. This small volume of additional maintenance material is not projected to have a substantial impact on ODMDS capacity.

This additional maintenance volume in combination with the construction material, plus all other projected volumes as listed in the SMMP, exceed half of the remaining site capacity and will therefore require an assessment of the proposed action's impacts upon the ODMDS' capacity requirements prior to the next 10-year renewal cycle of EPA's Site Management and Monitoring Plan (SMMP). At that time, impacts on the ODMDS site capacity would be assessed through some combination of management alternatives, evaluation of capacity based on bathymetric surveys, or through an assessment using the USACE MDFATE or MPFATE modeling. At this time, it is anticipated that the ODMDS, which is the least cost dredge material disposal site, will continue to be available throughout the project life, subject to decennial development and approval of SMMPs

### **2.2.5 Miscellaneous Real Property Issues**

No induced flooding, zoning issues, mineral interests or known contamination issues exist. The 2007 Hazardous, Toxic, and Radioactive Waste (HTRW) Assessment which is located as Attachment K of the Engineering Appendix states that no HTRW materials were located within the limits of the Recommended Plan. There are no displacements that are within the study area, hence no relocation assistance benefits are required by the project. There are no facility or utility relocations as defined by *ER 405-1-12*. As described in Section 6.3 of the Engineering Appendix, the existing communications, gas, electrical, and CPA CCTV utility crossings under the channel are at sufficient depths and will not be impacted by the project.

### **2.3 Capability Assessment of Non-Federal Sponsor**

The Canaveral Port Authority is the governing authority of the Canaveral Port District, a political subdivision of the State of Florida. Per Section I of Article IV, General Grant of Powers, of

Chapter 2003-335 of Laws of Florida Special Acts of 1953, “The Canaveral Harbor Port District,” the Canaveral Port Authority has the power “to acquire by grant, purchase, gift, devise, condemnation, or in any other manner, all property, real or personal, or any estate or interest therein, within said Canaveral Port District.” An “Assessment of Non-Federal Sponsor’s Real Estate Acquisition Capability for Canaveral Port Authority” is provided as *Attachment E*.

### 3.0 Baseline Cost Estimate for Real Estate

#### 3.1 Land Value

It is anticipated that there are no costs associated with the land value of estates to be sought from the USAF. There are only administrative costs. There are no costs associated with navigation servitude related to the submerged lands from the CPA and State of Florida.

#### 3.2 Administrative Cost

The administrative cost associated for real estate components is \$99,500 as summarized in Table 6-35 of the Main Report. The cost includes review of acquisition, permitting, and any other real estate issues.

#### 3.3 Summary of Costs

The costs associated with lands, easements, and right-of-ways are summarized below.

**Table 4: Summary of LER Costs (2011 Dollars)**

Description of LER	Acres	Cost \$	Term
Land to be added to USA Permit SPCCAN-2-99-004 for channel widening, including land with property damage to repair and upland disposal site	47	0	Indefinite
Navigational Servitude related to submerged lands from CPA and TIITF	-	0	Indefinite
Administrative Costs	-	\$99,500	-
TOTAL		\$99,500	

### 4.0 Schedule

Steps to secure real estate interests are outlined below.

- CPA submitted the Real Estate Plan to the USAF for comment.
- A Public Meeting was conducted on May 14, 2012.
- USAF Comments on the REP were received on June 28, 2012.
- USACE South Atlantic Division approval in September 2012; PED begins.
- Local USAF and CPA to meet again to discuss the real estate process and issues.

- Based on boundary surveys and preliminary design associated with the impacts to USAF property conducted during PED, draft legal descriptions will be prepared by CPA and submitted to the USAF and USACE for review. USAF comments will be incorporated.
- Expected project approval from the Assistant Secretary of the Army is April 2013.
- USACE will review the legal descriptions. CPA will incorporate their comments.
- A Project Partnership Agreement (PPA) will be negotiated and signed.
- Negotiations between the USACE and the USAF over permit modification language, signature, and recording of the legal documents will occur.
- The Certification of Availability of Real Estate for Solicitation of Construction Contracts will then be obtained from the COE District Chief of Real Estate. Construction is expected to commence July 2013 on the areas outside of USAF properties.
- Construction will commence on the areas within USAF properties upon LER certification.

**Port Canaveral Section 203 Feasibility Study  
Real Estate Appendix**

Attachment A

Real Estate Exhibits 1-4

Rev Date: September 12, 2012



**EXISTING PERPETUAL CHANNEL IMPROVEMENT EASEMENTS**

DATE	OWNER	PERPETUAL EASEMENT TO L.D. #	PARCEL L.D. #	BREVARD COUNTY RECORDS
2/7/75	CPA	USA	117	DEED BOOK 235, PAGE 242
3/28/72	CPA	USA	4-61	PL. RECORDED COPY ON FILE
3/27/63	CPA	USA	A-59	NO RECORDED COPY ON FILE
1/21/84	UIFP	CPA	I-88	089 132, PAGE 502, P.E. TO CPA
1/21/84	UIFP	CPA	I-100	BOOK 472, PAGE 384
3/25/84	CPA	USA	A-12	NO RECORDED COPY ON FILE
3/25/84	CPA	USA	A-16	P.E. TO USA
3/25/84	CPA	USA	A-1	NO RECORDED COPY ON FILE
3/9/85	CPA	USA	A-23	NO RECORDED COPY ON FILE
1/14/88	CPL	USA	I-114	P.E. TO CPA
12/17/73	CPL	USA	202	089 145, PAGE 191

**EXISTING LEASE AND PERMIT**

DATE	GRANTOR	GRANTEE	L.D. #	DESCRIPTION
1/19/78	DEPARTMENT OF THE AIR FORCE	DEPARTMENT OF THE ARMY		PERMIT TO CONSTRUCT AND OPERATE AIRCRAFT TAXIWAY AND RUNWAY FOR CONSTRUCTION, OPERATION AND MAINTENANCE OF CHANNEL IMPROVEMENT PROJECT
8/11/88	DEPARTMENT OF THE AIR FORCE	CORPS OF ENGINEERS		5-YEAR RENEWABLE LEASE (SAC 17-1431-1) FOR CONSTRUCTION AND OPERATION OF CANALS, FACILITIES WHICH ARE BEING USED TO IMPROVE NAVIGATION OF THE CANALS. THIS LEASE INCLUDES ALL NECESSARY PERMITS AND APPROVALS FROM THE U.S. NAVY, PORTLAND BEACON AND PORT CHANNEL ACCESS CHANNELS.

**REAL ESTATE OWNERSHIP SUMMARY**

DATE	OWNER	DESCRIPTION	PARCEL L.D. #	BREVARD COUNTY RECORDS
1/17/75	USA	DEED	1-1	DEED BOOK 235, PAGE 237
1/17/75	CPL	WARRANTY DEED	A-39	DEED BOOK 301, PAGE 432
8/28/79	CPL	CONDEMNATION	18	DEED BOOK 324, PAGE 435
11/17/75	USA/CP	PURCHASE OPTION	A-51	NO RECORDED COPY ON FILE
-	USA/CP	PURCHASE OPTION	TRACT NO. 245	NO RECORDED COPY ON FILE
1/15/84	CPL	DEED	1-185	DEED BOOK 359, PAGE 187
1/15/84	CPL	DEED	1-185	NO RECORDED COPY

**LEGEND**

- RED LIGHTED BODY
- GREEN LIGHTED BODY
- LIGHTED REGION
- EXISTING RANGE STRUCTURE
- SONAR STRUCTURE
- REB DATUM/STATION

**REAL ESTATE LEGEND**

- UNITED STATES AIR FORCE LAND
- CPA LAND
- TRF LAND
- PARCEL L.D.
- PERMIT BOUNDARY
- LEASE AND POINT BOUNDARY
- EASEMENT BOUNDARY
- EXISTING FEDERAL PROJECT
- RECOMMENDED FEDERAL PROJECT

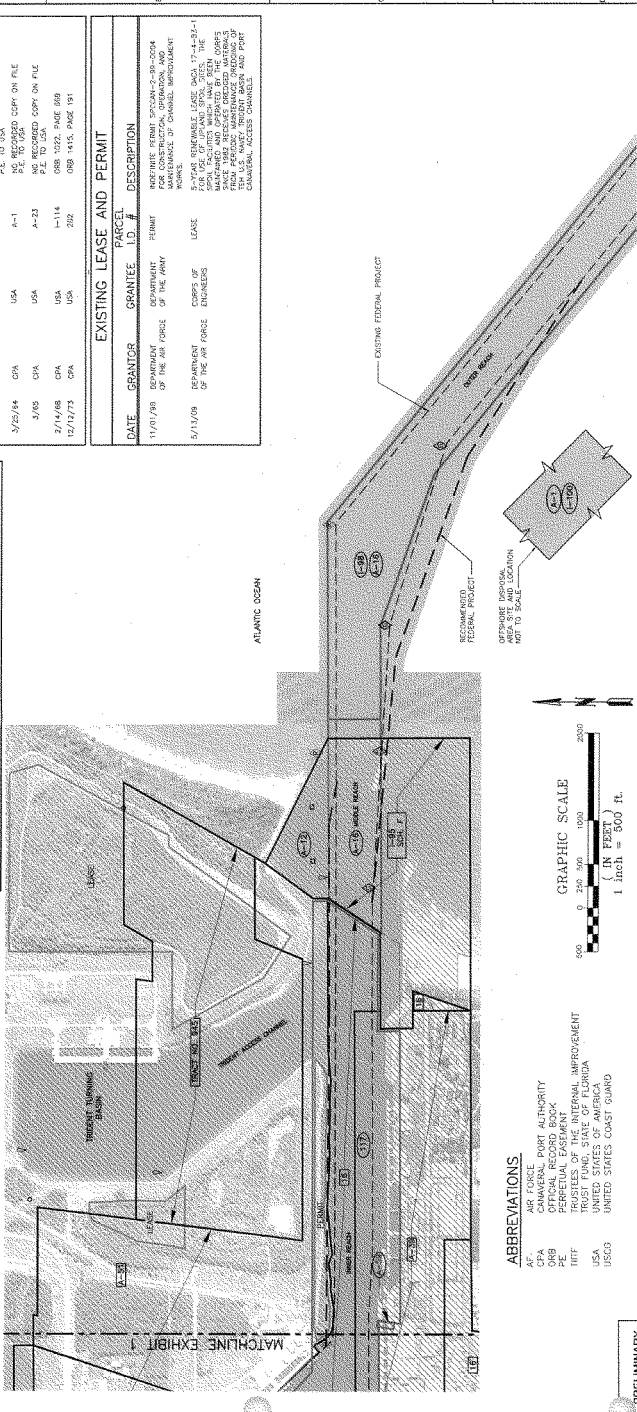

**ABBREVIATIONS**

- AF - AIR FORCE
- CPA - CANAL PORT AUTHORITY
- CRB - CANAL RECORD BOOK
- PE - PERPETUAL EASEMENT
- UIFP - UNITED STATES FEDERAL PROJECT IMPROVEMENT
- USA - UNITED STATES OF AMERICA
- USCG - UNITED STATES COAST GUARD

PRELIMINARY  
NOT FOR CONSTRUCTION

**CH2MHILL**  
 1000 UNIVERSITY AVENUE, SUITE 200  
 CANAL PORT AUTHORITY  
 18 FORTWORTH AVENUE  
 FT. WORTH, TX 76102

VERIFY SCALE  
 1" = 500 FT.  
 1" = 1000 FT.  
 1" = 2000 FT.  
 1" = 4000 FT.  
 1" = 8000 FT.  
 1" = 16000 FT.

SHEET 2  
 ROW RE EX-2  
 DATE 11/07  
 JOB 20081

CANAL PORT AUTHORITY  
 NAVIGATION IMPROVEMENTS  
 SECTION 203 FEASIBILITY STUDY  
 REAL ESTATE EXHIBIT 2: PROPERTY BOUNDARIES (EAST)

FILE NO. 20081



**REAL ESTATE ACQUISITION MAP**

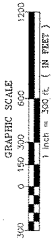

NOTE: ACRES, SQUARE FEET AND APPROXIMATE FINAL AREAS WILL BE DETERMINED DURING THE DESIGN PHASE.

**REAL ESTATE LEGEND**

- AREA OF UPLANDS SERVICE RELATED TO SUBMERGED LANDS: 77.4 ACRES
- APPROXIMATE LIMITS OF USMF LANDS TO BE ACQUIRED FOR THE PROJECT: 141.2 ACRES
- APPROXIMATE LIMITS OF USMF LANDS TO BE ACQUIRED FOR THE PROJECT: 47 ACRES

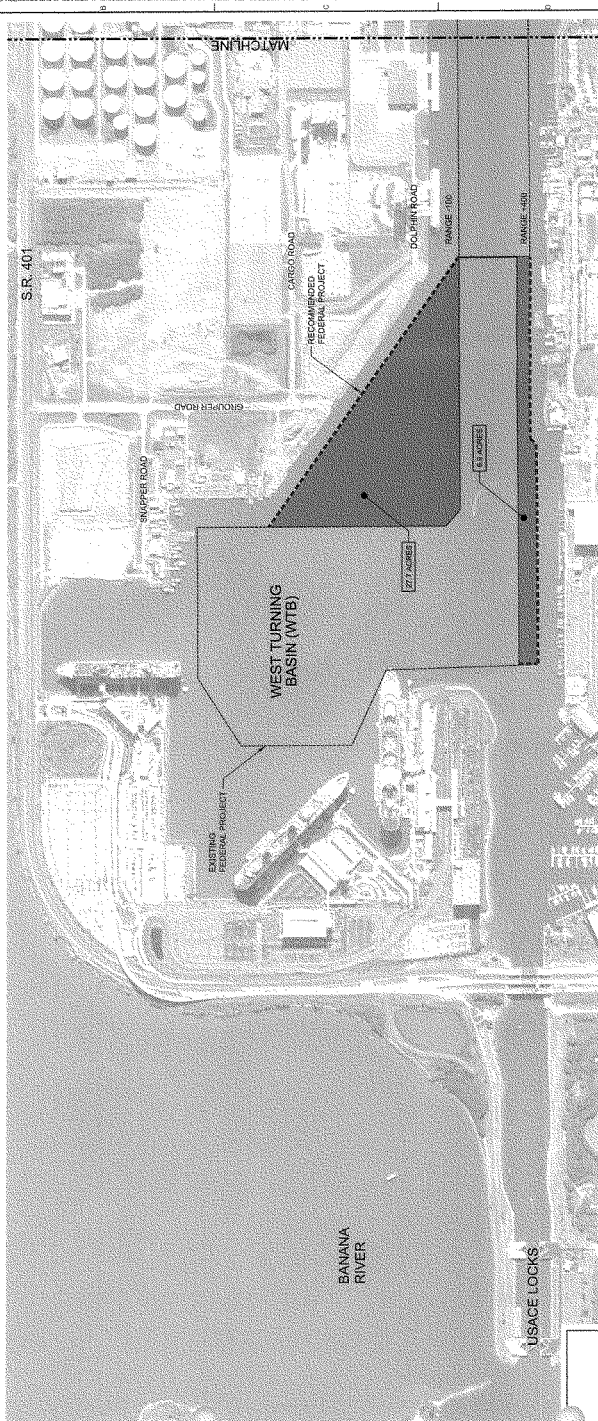

PRELIMINARY INT FOR CONSTRUCTION	SHEET NO. 1545	DATE: 08/20/2023	CH2M HILL 1400 CHALMERS RD., SUITE 200 HOUSTON, TX 77056 P.O. BOX 241000 HOUSTON, TX 77224	ORIGINAL PORT AUTHORITY MAPS SECTION 203 FEASIBILITY STUDY REAL ESTATE EXHIBIT 3: PRELIMINARY ACQUISITION MAP	PROJECT NO. 1545
	DRAWN BY: [Name]	CHECKED BY: [Name]			



**CH2M HILL**

1400 CHALMERS RD., SUITE 200  
HOUSTON, TX 77056  
P.O. BOX 241000  
HOUSTON, TX 77224

SECTION 203 FEASIBILITY STUDY  
REAL ESTATE EXHIBIT 3: PRELIMINARY ACQUISITION MAP

PROJECT NO. 1545

DATE: 08/20/2023

1545





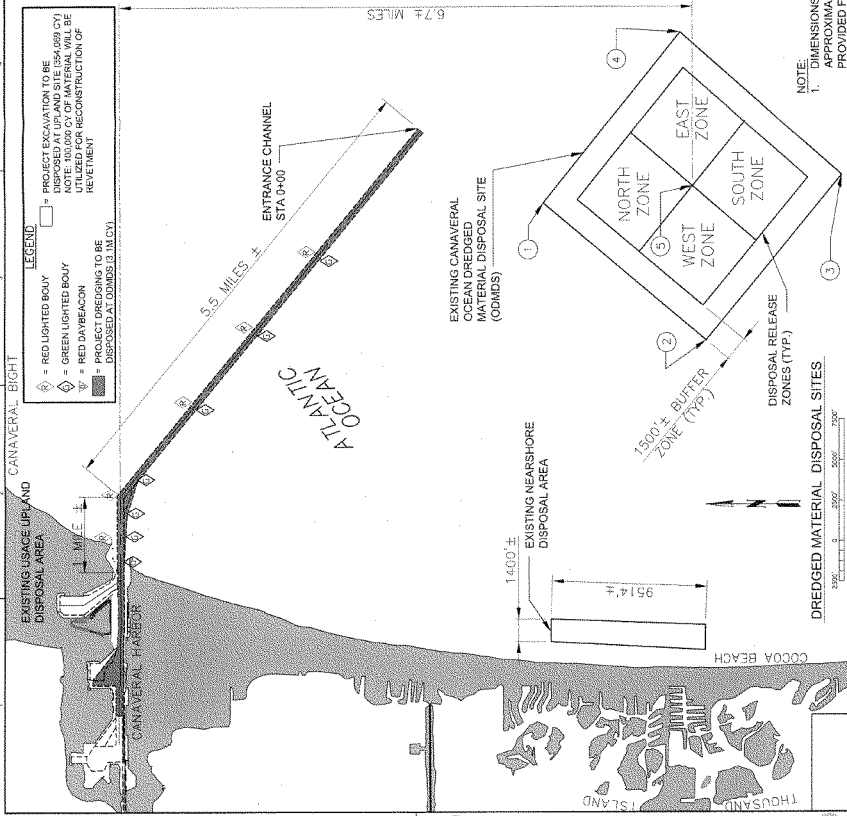
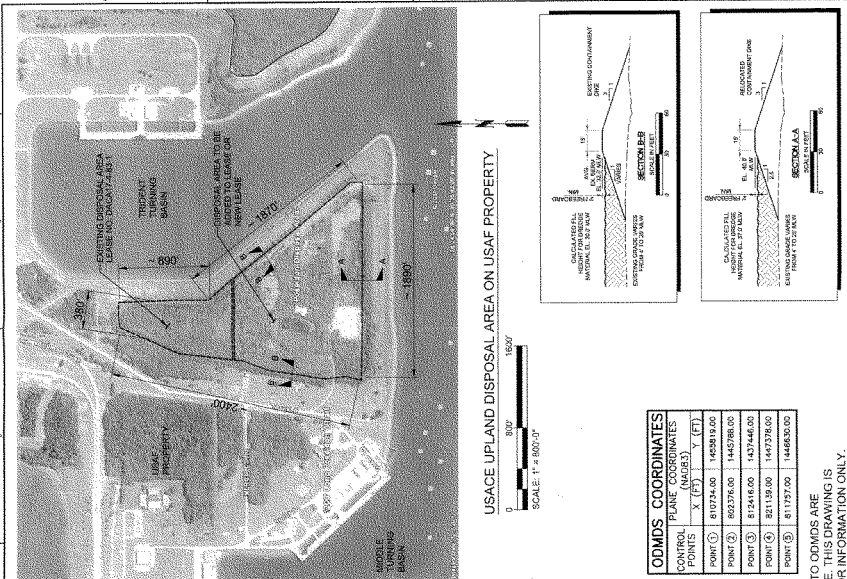

6.74 MILES

**LEGEND**

- ◻ = PROJECT EXCAVATION TO BE DISPOSED AT UPLAND SITE (S&A 059 CY)
- ◻ = GREEN LIGHTED BODY UTILIZED FOR RECONSTRUCTION OF REVENUE
- ◻ = RED DAMBACON
- ◻ = PROJECT DREDGING TO BE DISPOSED AT ODMDS (3.1M CY)

**ODMDS COORDINATES**

GENERAL POINTS	PLANE COORDINATES (NAD83)	X (FT)	Y (FT)
POINT ①	810724.00	1463919.00	
POINT ②	812416.00	1471746.00	
POINT ③	821139.00	1473736.00	
POINT ④	811927.00	1446630.00	

**NOTE:**  
1. DIMENSIONS TO ODMDS ARE APPROXIMATE. THIS DRAWING IS PROVIDED FOR INFORMATION ONLY.

**USACE UPLAND DISPOSAL AREA ON USAF PROPERTY**

**DREDGED MATERIAL DISPOSAL SITES**

**EXISTING CANAVERAL OCEAN DREDGED MATERIAL DISPOSAL SITE (ODMDS)**

**EXISTING NEARSHORE DISPOSAL AREA**

**DISPOSAL RELEASE ZONES (TYP.)**

CANAVERAL BIGHT

EXISTING USACE UPLAND DISPOSAL AREA

CANAVERAL HARBOR

ATLANTIC OCEAN

1500'± BUFFER ZONE (TYP.)

DISPOSAL RELEASE ZONES (TYP.)

DREDGED MATERIAL DISPOSAL SITES

EXISTING CANAVERAL OCEAN DREDGED MATERIAL DISPOSAL SITE (ODMDS)

EXISTING NEARSHORE DISPOSAL AREA

COCOA BEACH

THOUSAND ISLAND

1 MILE

5.5 MILES ±

ENTRANCE CHANNEL STA 0+00

380'

630'

1970'

1890'

SHOLE TRAINING BASIN

TROUT TRAINING BASIN

DISPOSAL AREA TO BE RECONSTRUCTED ON NEW LEASE

USAF PROPERTY

SCALE 1" = 300'-0"

0 300' 600' 900'

N

SECTION A-A

SECTION B-B

SECTION C-C

SECTION D-D

SECTION E-E

SECTION F-F

SECTION G-G

SECTION H-H

SECTION I-I

SECTION J-J

SECTION K-K

SECTION L-L

SECTION M-M

SECTION N-N

SECTION O-O

SECTION P-P

SECTION Q-Q

SECTION R-R

SECTION S-S

SECTION T-T

SECTION U-U

SECTION V-V

SECTION W-W

SECTION X-X

SECTION Y-Y

SECTION Z-Z

SECTION AA-AA

SECTION BB-BB

SECTION CC-CC

SECTION DD-DD

SECTION EE-EE

1:1874

1:1874

1:1874

1:1874

1:1874

1:1874

1:1874

1:1874

1:1874

1:1874

1:1874

1:1874

1:1874

1:1874

1:1874

1:1874

1:1874

1:1874

1:1874

1:1874

1:1874

1:1874

1:1874

1:1874

1:1874

1:1874

1:1874

1:1874

1:1874

1:1874

1:1874

1:1874

1:1874

1:1874

1:1874

1:1874

1:1874

1:1874

1:1874

1:1874

1:1874

1:1874

1:1874

1:1874

1:1874

1:1874

1:1874

1:1874

1:1874

1:1874

1:1874

1:1874

1:1874

1:1874

1:1874

1:1874

1:1874

1:1874

1:1874

1:1874

1:1874

1:1874

1:1874

1:1874

1:1874

1:1874

1:1874

1:1874

1:1874

1:1874

1:1874

1:1874

1:1874

1:1874

1:1874

1:1874

1:1874

1:1874

1:1874

1:1874

1:1874

1:1874

1:1874

1:1874

1:1874

1:1874

1:1874

1:1874

1:1874

1:1874

1:1874

1:1874

1:1874

1:1874

1:1874

1:1874

1:1874

1:1874

1:1874

1:1874

1:1874

1:1874

1:1874

1:1874

1:1874

1:1874

1:1874

1:1874

1:1874

1:1874

1:1874

1:1874

1:1874

1:1874

1:1874

1:1874

1:1874

1:1874

1:1874

1:1874

1:1874

1:1874

1:1874

1:1874

1:1874

1:1874

1:1874

1:1874

1:1874

1:1874

1:1874

1:1874

1:1874

1:1874

1:1874

1:1874

1:1874

1:1874

1:1874

1:1874

1:1874

1:1874

1:1874

1:1874

1:1874

1:1874

1:1874

1:1874

1:1874

1:1874

1:1874

1:1874

1:1874

1:1874

1:1874

1:1874

1:1874

1:1874

1:1874

1:1874

1:1874

1:1874

1:1874

1:1874

1:1874

1:1874

1:1874

1:1874

1:1874

1:1874

1:1874

1:1874

1:1874

1:1874

1:1874

1:1874

1:1874

1:1874

1:1874

1:1874

1:1874

1:1874

1:1874

1:1874

1:1874

1:1874

1:1874

1:1874

1:1874

1:1874

1:1874

1:1874

1:1874

1:1874

1:1874

1:1874

1:1874

1:1874

1:1874

1:1874

1:1874

1:1874

1:1874

**Port Canaveral Section 203 Feasibility Study  
Real Estate Appendix**

Attachment B

Existing USAF Permit No. SPCCAN-2-99-0004  
to COE for Channel Improvement Works

Rev Date: October 2011

1550



DEPARTMENT OF THE AIR FORCE  
HEADQUARTERS AIR FORCE SPACE COMMAND

2

04 DEC 1998

MEMORANDUM FOR ARMY CORPS OF ENGINEERS  
Jacksonville District/CESAJ-RE-A  
P.O. Box 4970  
Jacksonville FL 32232-0019

FROM: HQ AFSPC/CEPR  
150 Vandenberg Street, Suite 1105  
Peterson AFB CO 80914-4150

SUBJECT: Permit for Channel Improvement Works, Cape Canaveral AS FL

The attached Permit No. SPCCAN-2-99-0004 has been executed by the Air Force, and a copy is forwarded for your files. Our POC is Ms. Sandi Brown, DSN 692-5241.

A handwritten signature in cursive script that reads "David Winkler".

DAVID R. WINKLER, Major, USAF  
Chief, Resources Branch

Attachment:  
Permit No. SPCCAN-2-99-0004

cc:  
AFREA/DR  
~~45 CES/CELO~~

PERMIT NO. SPCCAN-2-99-0004

DEPARTMENT OF THE AIR FORCE  
PERMIT TO OTHER FEDERAL DEPARTMENT OR AGENCY  
TO USE PROPERTY ON  
CAPE CANAVERAL AIR STATION, BREVARD COUNTY, FLORIDA

The SECRETARY OF THE AIR FORCE ("Grantor") hereby grants to the DEPARTMENT OF THE ARMY, acting by and through the United States Army Engineer District Jacksonville ("Grantee"), a permit for an indefinite term beginning November 1, 1998, for the purpose of construction, operation and maintenance of channel improvement works on, over and across the land identified and described on Exhibits A and B ("Permitted Premises") and for such other purposes as may be required in connection therewith. Both exhibits are attached hereto and made a part of this Permit.

THIS PERMIT is granted subject to the following conditions:

1. General Supervision. The use, occupation and maintenance of the Permitted Premises and exercise of the privileges hereby granted shall be without cost or expense to the Department of the Air Force ("Air Force") and shall be subject to the general supervision and control of the Commander, 45 SW, Patrick Air Force Base, Florida ("Commander"), and such reasonable rules and regulations as

the Commander may prescribe from time to time. Any reference to "Commander" shall include the Commander's duly appointed successors and authorized representatives.

2. Authorized Activities. The Permitted Premises shall be used only for the purpose of conducting activities related to construction, operation and maintenance of the channel improvement works, and for such other purposes as may be required in connection therewith, including the right to clear, cut, fell, remove and dispose of any and all timber, trees, underbrush, buildings, improvements and/or other obstructions therefrom and to excavate, dredge, cut away, and remove any or all of the land and to place thereon dredge or disposal material.

3. Condition of the Permitted Premises. The Grantee has inspected and knows the condition of the Permitted Premises. It is understood that they are permitted in an "as is," "where is" condition and without any representation or obligation on the part of the Air Force to make any alterations, repairs, or improvements.

4. Protection and Maintenance. The Grantee shall, at all times, protect, repair and maintain the Permitted Premises in good order and condition (including erosion prevention and repair) at its expense and without cost or expense to the Air Force. The Grantee shall exercise due



diligence in protecting the Permitted Premises against damage or destruction by fire, vandalism, theft, weather, or other causes.

5. Repair of Damage. The Grantee shall promptly correct, repair or replace to the satisfaction of the Commander any property under the control of the Air Force that is interfered with, damaged or destroyed by the Grantee incident to the exercise of the privileges granted under this Permit.

6. Utilities and Services.

a. The Grantee shall pay the cost, as determined by the Commander, of producing and/or supplying any utilities and other services furnished by the Air Force or through Air Force facilities for the use of the Grantee. Such costs shall include the Grantee's proportionate share of the operation and maintenance cost of the Air Force facilities.

b. If for any reason The Air Force shall deem it necessary or expedient for the Air Force to perform any functions and/or render any services which are the responsibility of the Grantee, the Commander may, in lieu of reimbursement, require the Grantee to furnish the personnel and/or materials required for the performance of the

functions and/or the rendering of the services. In addition to furnishing personnel and/or materials, the Grantee shall reimburse the Air Force for any costs it incurs in connection with performance of functions and/or rendering of services. Selection of such personnel will be subject to the approval of the Commander.

7. Additions and Alterations. No additions or improvements to or alterations of the Permitted Premises shall be constructed or made without the prior written consent of the Commander. All costs of any additions, improvements or alterations shall be funded by the Grantee.

8. Compliance with Applicable Laws.

a. The Grantee shall at all times during the existence of this Permit, promptly observe and comply, at its sole cost and expense, with the provisions of all applicable Federal, state and local laws, rules, regulations, orders, ordinances, and other governmental standards, and in particular those provisions concerning the protection of the environment, occupational safety and health, pollution control and abatement, safe drinking water, and solid and hazardous waste.

b. Responsibility for compliance with such laws, rules, regulations, orders, ordinances and standards rests

exclusively with the Grantee. The Air Force assumes no enforcement or supervisory responsibility except for matters committed to its jurisdiction. The Grantee shall assume responsibility for and pay all costs required to comply with applicable laws, rules, regulations, orders, ordinances and other governmental standards, or associated with compliance, defense of enforcement actions or suits, payment of fines, penalties, or other sanctions and remedial costs.

9. Environmental Protection and Natural Resources.

a. The Grantee will be solely responsible for compliance with all applicable environmental laws and other legal requirements in conjunction with its exercise of the privileges granted under this Permit, including any taxes, fees, permits, fines, penalties, or other costs associated with any environmental compliance or violations related to its activities and operations under the Permit. This does not affect the Grantee's right to contest their validity or applicability.

b. The Grantee shall promptly take all steps necessary to clean up, abate, remove, or remediate any contamination for which it is responsible, including proper notification to regulatory authorities, and shall promptly notify the Commander of such events.

c. The Grantee shall be solely responsible for and obtain at its cost and expense and without any cost or expense to the Government any environmental permits required for its activities and operations under the Permit, independent of any existing Cape Canaveral Air Station permits. All contact with Federal, state and local regulatory agencies shall be coordinated with and approved by the Commander.

d. The Grantee shall not remove or disturb, or cause or permit to be removed or disturbed, any historical, archeological, architectural or other cultural artifacts, relics, vestiges, remains or objects of antiquity. In the event such items are discovered on the Permitted Premises, the Grantee shall immediately notify the Commander and protect the site and the material from further disturbance until the Commander gives written clearance to proceed.

e. The Grantee shall comply with the Cape Canaveral Air Station spill prevention control and countermeasure plan and hazardous materials/wastes plan, or in the alternative, its own such plans for activities and operations on the Permitted Premises, provided the plans have been approved by the appropriate regulatory authorities and are acceptable to the Commander.

f. The Grantee will use all reasonable means

available to protect the environment and natural resources. Where damage to natural resources nonetheless occurs from activities of the Grantee, the Grantee shall be solely liable therefor (including any requirement to restore the damaged resources).

g. The Grantee shall strictly comply with the hazardous waste permit requirements under the Resource Conservation and Recovery Act, or its Florida equivalent. Any hazardous waste permit shall be limited to generation and transportation. Storage and/or disposal of toxic or hazardous materials/wastes within the Permitted Premises are specifically prohibited. The Grantee must provide at its own expense such hazardous waste management facilities, complying with all laws and regulations. Air Force hazardous waste management facilities will not be available to the Grantee.

#### 10. Termination.

a. This Permit may be terminated by the Grantor upon on hundred twenty (120) days' written notice to the Grantee in the event of a formal, written determination by the Air Force that the land covered by the Permit is excess to the needs of the Air Force. The Grantor's right to terminate this Permit may be exercised only at the level of Deputy Assistant Secretary of the Air Force (Installations)

or higher.

b. This Permit will terminate automatically, subject to paragraphs 9 and 11, in the event the Canaveral Harbor Project, Florida, is deauthorized by an Act of Congress.

11. Vacation of Permitted Premises. On or before the date of any termination of this Permit pursuant to paragraph 10a above, the Grantee shall vacate the Permitted Premises, remove its personal property therefrom, and restore the Permitted Premises to a condition satisfactory to the Commander, ordinary wear and tear and damage beyond the control of the Grantee excepted. If this Permit terminates automatically pursuant to paragraph 10b above, the Grantee shall vacate the Permitted Premises, remove its personal property therefrom, and restore the Permitted Premises to the aforesaid condition within ninety (90) days, or such longer time as the Commander may designate.

12. Liability. The Air Force shall not be responsible for damages to property or injuries to persons which may arise from or be attributable or incident to the condition or state of repair of the Permitted Premises, or its use and occupation or conduct of activities by the Grantee. The Grantee agrees to assume all risks of loss or damage to property and injury or death to persons by reason of or

incident to the possession and/or use of the Permitted Premises, or the activities conducted under this Permit. The Grantee shall, at its expense, settle and pay any claims arising out of the use and occupancy of the Permitted Premises.

13. Notices. No notice, order, direction, determination, requirement, consent or approval under this Permit shall be of any effect unless it is in writing. Written communications shall be addressed, if to the Air Force to: Commander, 45 SW, 1201 Edward H. White II Street, MS 7100, Patrick Air Force Base, Florida 32925-3299; and if to the Grantee, to: United States Army Engineer District Jacksonville, Attn: CESAJ-RE-A, P.O. Box 4970, Jacksonville, Florida 32232-0019; or at such other address or addresses as the Air Force or the Grantee may from time to time designate. Notice shall be deemed to have been duly given if and when enclosed in a properly sealed envelope or wrapper addressed as aforesaid, and deposited, postage prepaid, in a post office regularly maintained by the United States Postal Service.

14. This Permit may not be transferred or assigned.

15. This Permit may only be modified or amended by mutual agreement of the parties in writing.

16. This Permit is not subject to Title 10, United States Code, Section 2662.

IN WITNESS WHEREOF, I have hereunto set my hand by authority of the Secretary of the Air Force this 30<sup>th</sup> day of November, 1998.

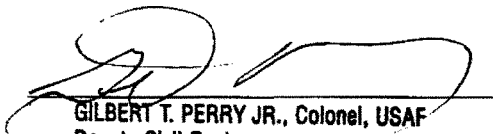
  
GILBERT T. PERRY JR., Colonel, USAF  
Deputy Civil Engineer

THIS PERMIT, together with all terms and conditions thereof, is hereby accepted and executed by the Grantee this 16<sup>th</sup> day of November, 1998.

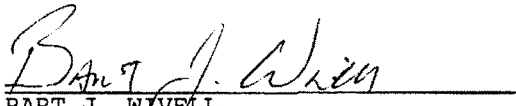
  
BART J. WIVELL  
CHIEF, REAL ESTATE DIVISION  
UNITED STATES ARMY ENGINEER  
DISTRICT JACKSONVILLE



**DESCRIPTION:**

ALL THAT PROTION OF SECTION 11, TOWNSHIP 24 SOUTH, RANGE 37 EAST, BREVARD COUNTY, FLORIDA, AT CAPE CANAVERAL AIR FORCE BASE, AND BEING MORE PARTICULARLY DESCRIBED AS FOLLOWS:

FOR A POINT OF REFERENCE COMMENCE AT THE INTERSECTION OF THE CENTERLINE OF STATE ROAD NO. 401 (HAVING A 60 FOOT RIGHT-OF-WAY AS NOW EXISTS) AND THE WESTERLY LINE OF SECTION 11, TOWNSHIP 24 SOUTH, RANGE 37 EAST; THENCE RUN S 00°29'00" E, ALONG SAID WESTERLY LINE OF SAID SECTION 11, A DISTANCE OF 1247.81 FEET TO A POINT; THENCE RUN N 89°41'32" E, A DISTANCE OF 157.58 FEET TO A POINT; THENCE RUN N 38°11'48" E, A DISTANCE OF 100.64 FEET TO A POINT; THENCE RUN N 89°38'55" E, A DISTANCE OF 445.16 FEET TO A POINT; THENCE RUN S 00°19'02" E, A DISTANCE OF 73.88 FEET TO A POINT; THENCE RUN S 46°38'07" W, A DISTANCE OF 132.71 FEET TO A POINT; THENCE RUN S 43°26'14" E, A DISTANCE OF 1188.58 FEET TO A POINT; THENCE RUN N 47°01'45" E, A DISTANCE OF 124.62 FEET TO A POINT; THENCE RUN S 87°16'39" E, A DISTANCE OF 223.08 FEET TO THE POINT OF BEGINNING, SAID POINT ON THE PERMANENT NORTHERN RIGHT-OF-WAY LINE OF THE NEW CHANNEL; THENCE RUN N 89°52'05" E, ALONG SAID PERMANENT NORTHERN RIGHT-OF-WAY LINE OF THE NEW CHANNEL, A DISTANCE OF 3049 FEET, MORE OR LESS, TO A POINT ON THE BANK OF THE OLD CHANNEL; THENCE LEAVING SAID PERMANENT NORTHERN RIGHT-OF-WAY OF THE NEW CHANNEL, AND MEANDERING IN A SOUTHERLY DIRECTION ALONG THE BANK OF THE NEW CHANNEL A DISTANCE OF 3434 FEET, MORE OR LESS, TO A POINT ON SAID PERMANENT NORTHERN RIGHT-OF-WAY OF THE NEW CHANNEL; THENCE RUN N 76°14'32" E, ALONG SAID PERMANENT NORTHERN RIGHT-OF-WAY OF THE NEW CHANNEL, A DISTANCE OF 176 FEET, MORE OR LESS, TO THE POINT OF BEGINNING. SAID LANDS CONTAINING 8.40 ACRES, MORE OR LESS.

*Exhibit B'*

PROJECT: Canaveral Harbor Turning Basin  
 North Bank Boundary Survey  
 LOCATION: Cape Canaveral, Florida  
 TRACT NO: A Portion of Tract 4  
 ACREAGE: 5.82

DESCRIPTIONS:

All that portion of section 11, Township 24 South, Range 37 East, Brevard County, Florida, at Cape Canaveral Air Force Base, and being More particularly described as follows:

For a point of Reference, Commence at the Intersection of the centerline of state road no. 401 having a 60 foot right-of-way as now exists) and the westerly line of section 11, Township 24 South, Range 37 East;

thence, run S 00°29'00" E, along said Westerly line of said section 11, a distance of 1247.81 feet to a point;

Thence, run N 89°41'32" E, a distance of 157.58 feet to a point;

Thence, run N 38°11'48" E, a distance of 100.64 feet to a point;

Thence, run N 89°38'55" E, a distance of 445.16 feet to a point;

Thence, run S 00°19'02" E, a distance of 763.88 feet to a point;

Thence, run S 46°38'07" W, a distance of 132.71 feet to a point;

Thence, run S 43°26'14" E, a distance of 1188.58 feet to a point;

Thence, run N 47°01'45" E, a distance of 124.61 feet to a point;

Thence, run S 87°16'39" E, a distance of 223.08' to a Corps of Engineers Monument with a disk stamped CCAFS67 (1995), said Monument being on the permanent Northern right of way line of the channel;

Thence, S 78°00'02" W 167.53 feet to a point on the Northeast corner of a bulk head, this being the point of beginning;

Thence, Southwesterly along the bulk head 43 feet, more or less, to where it meets the top of the new bank of the channel;

Thence, Southeasterly along the Meanders of the new bank of the channel 3,434 feet, more or less, to a point on a bulk head;

Thence, along the bulk head in a northerly direction 25 feet, more or less, to a point on the end of the bulk head;

Thence, in a Southeasterly direction and along the bulk head 90 feet, more or less, to a point where the bulk head and the old top of bank meet;

Thence, meandering in a Southwesterly direction along the old bank 3,436 feet, more or less, to a point on a bulk head;

Thence, in a Northeasterly direction and along the bulk head to the point of beginning;

The above described parcel contains 5.82 acres, more or less, and is a portion of Tract #4 of the Canaveral Air Force Station Project.

Exhibit B<sup>2</sup>

**Port Canaveral Section 203 Feasibility Study**  
**Real Estate Appendix**

Attachment C

Existing USAF Lease DACA 17-4-83-1 to COE for Upland Disposal Site

Rev Date: October 2011

REQUEST FOR ENVIRONMENTAL IMPACT ANALYSIS		FOR ENVIRONMENTAL PLANNING USE ONLY	
REQUEST		DATE	
1. TO: (Departmental Planning Function)		AUG 11 1994	
2. FROM: (Organization and Office Symbol)		3. CONTROL NUMBER	
45th CES/CEV		WON 80316	
3. PROJECT (Name, Office Symbol and Phone No.)		4. ESTIMATED COMPLETION DATE	
Dull, CESAJ-RE-N (904) 232-1174			
5. TYPE OF ANALYSIS NEEDED			
<input checked="" type="checkbox"/> PRELIMINARY ENVIRONMENTAL SURVEY <input type="checkbox"/> ENVIRONMENTAL ASSESSMENT <input type="checkbox"/> ENVIRONMENTAL IMPACT STATEMENT			
6. TITLE OF PROPOSED ACTION			
RENEWAL OF LEASE DACA 17-4-83-1, CAPE CANAVERAL AFS			
7. PURPOSE OF AND NEED FOR ACTION (Continued on <u>      </u> Sheets)			
<p>PURPOSE: The purpose of the proposed action is to extend Air Force Lease DACA 17-4-83-1 for a five-year period to expire on 15 December 1997. This outgrant permits the U.S. Army Corps of Engineers (COE) to utilize two upland spoil disposal areas on CCAFS.</p> <p>NEED: The existing upland spoil sites on CCAFS have been maintained and operated by the COE since 1982. These spoil facilities receive dredged materials from periodic maintenance dredging of the U.S. Navy Trident Basin and Port Canaveral access channels. The existing disposal facilities or surrounding environment; nor will additional Air Force lands be required for outgrant extension.</p> <p>ALTERNATIVES: No Action. The only feasible alternative to the proposed action is to do nothing. No action will result in expiration of lease DACA 17-4-83-1 on December 15, 1991. Consequently, lease expiration could delay future COE dredging operations within the Trident basin and possibly impact the CCAFS mission.</p>			
8. DESCRIPTION OF PROPOSED ACTION AND ALTERNATIVES (Continued on <u>      </u> Sheets)			
<p>DESCRIPTION OF THE PROPOSED ACTION AND ALTERNATIVES: The proposed action consists of extending existing Air Force Lease DACA 17-4-83-1 for a period of five years, to expire on 15 December 1992. This outgrant includes two upland spoil disposal facilities totaling ± 169 ac located at the southern terminus of CCAFS. The existing spoil disposal facilities will continue to be managed by the COE and will support periodic maintenance dredging of the CCAFS Trident basin. The proposed action will not require alteration of the existing disposal facilities or surrounding environment; nor will additional Air Force lands be required for outgrant extension.</p>			
9. ORGANIZATIONAL APPROVAL (Name and Grade of Commander)		SIGNATURE	
Mr George Rodriguez 45CES/CECR		<i>George Rodriguez</i>	
		DATE	
		AUG 12 1994	
10. ENVIRONMENTAL PLANNING RESPONSE			
<input type="checkbox"/> Preliminary Environmental survey (AF Form 814) attached <input type="checkbox"/> Proposed action qualified for Catex (Appropriate Documentation attached) <input type="checkbox"/> Proposed action does not qualify for Catex, assessment required			
11. REMARKS			
<p>Considering that the proposed action supports a continuation of existing operations without significant alteration of the environment, a Categorical Exclusion (CATEX) in accordance with AFR 19-2 (Attachment 7, Class Action 2.r) applies.</p> <p>Additional environmental comments are provided on the attached AF Form 814.</p> <p>Attached drawing applies.</p>			
12. ENVIRONMENTAL PLANNER CERTIFICATION (Name and Grade)		SIGNATURE	
Virginia J. Crawford GS-12		<i>V. J. Crawford</i>	
		DATE	
		AUG 12 1994	
13. ENVIRONMENTAL PROTECTION COMMITTEE APPROVAL (Name and Grade)		SIGNATURE	
Olin C. Miller GM-14		<i>Olin C. Miller</i>	
		DATE	
		8/23/94	

813.11.8 - Continued...

Contract is due to expire on 15 December 1992. Continued maintenance dredging operations and subsequent spoil disposal will be required throughout the life of these facilities. Consequently, renewal of AF lease DACA 17-4-83-1 is essential. As this is a lease renewal with no significant changes as Environmental Baseline Survey is not required.

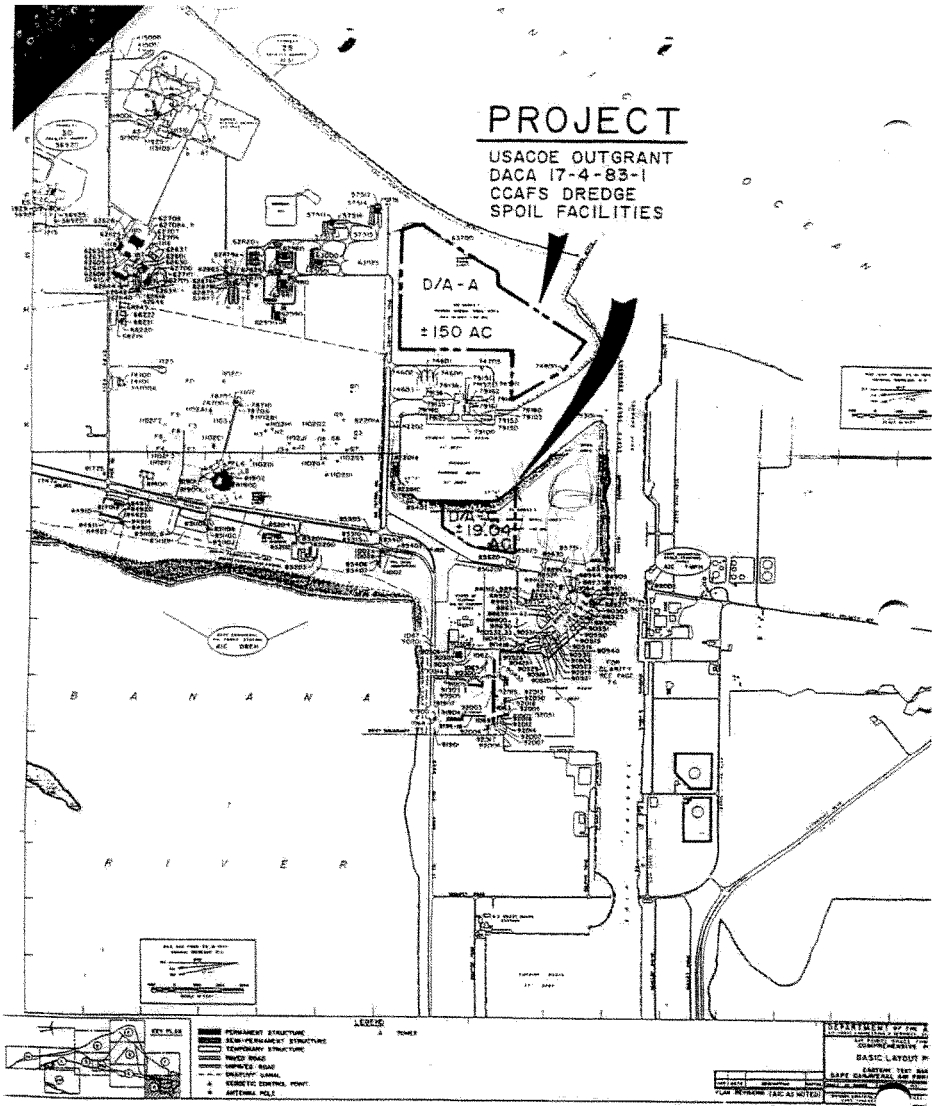

Figure 1 SITE PLAN

Amendment No. 2  
Department of the Air Force  
Permit No. DACA17-4-83-1  
Cape Canaveral Air Force Station,  
Brevard County, Florida

WHEREAS, by authority of the Secretary of the Air Force, the Department of the Army was granted Permit No. DACA17-4-83-1, beginning 2 December 1982 and ending 15 December 1987, but revocable at will by the Secretary of the Air Force, to use and occupy certain land at Cape Canaveral Air Force Station, Brevard County, Florida, as more particularly described in the said permit; and

WHEREAS, by Amendment No. 1, dated 8 March 1988, the term of the said permit was extended to 15 December 1992.

WHEREAS, the permittee has a requirement for the continued use of the permitted property and the appropriate authority has approved the further extension of the said permit for another five (5) years, and

NOW THEREFORE, effective as of 15 December 1987, Department of the Air Force Permit No. DACA17-4-83-1, as amended, is hereby further amended as follows: CJH

The term of the permit is extended to 15 December 1997.

Except as herein provided, all other terms and conditions of the said permit shall remain unchanged.

This amendment is not subject to Title 10, United States Code, Section 2662.

IN WITNESS WHEREOF, I have hereunto set my hand by authority of the Secretary of the Air Force this 19 day of April 1995.

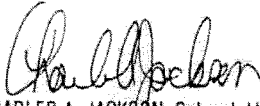
  
CHARLES A. JACKSON, Colonel, USAF  
Assistant to The Civil Engineer

Amendment No. 3  
Department of the Air Force  
Permit No. DACA17-4-83-1  
Cape Canaveral Air Force Station,  
Brevard County, Florida

WHEREAS, by authority of the Secretary of the Air Force, the Department of the Army was granted Permit No. DACA17-4-83-1, beginning 2 December 1982 and ending 15 December 1987, but revocable at will by the Secretary of the Air Force, to use and occupy certain land at Cape Canaveral Air Force Station, Brevard County, Florida, as more particularly described in the said permit; and

WHEREAS, by Amendment No. 1, dated 8 March 1988, the term of the said permit was extended to 15 December 1992, and

WHEREAS, by Amendment No. 2, dated 19 April 1995, the term of said permit was extended to 15 December 1997, and

WHEREAS, the permittee has a requirement for the continued use of the permitted property and the appropriate authority has approved the further extension of the said permit for another five (5) years.

NOW THEREFORE, Department of the Air Force Permit No. DACA17-4-83-1, as amended, is hereby further amended as follows:

The term of the permit is extended to 15 December 2002.

Except as herein provided, all other terms and conditions of the said permit shall remain unchanged.

This amendment is not subject to Title 10, United States Code, Section 2662.

IN WITNESS WHEREOF, I have hereunto set my hand by authority of the Secretary of the Air Force this 5th day of January 1998.



CHARLES A. JACKSON, Colonel, USAF  
Deputy Civil Engineer



AMENDMENT NO. 4  
DEPARTMENT OF THE AIR FORCE  
PERMIT NO. DACA17-4-83-1  
Cape Canaveral Air Force Station  
Brevard County, Florida

ORIGINAL

WHEREAS, by authority of the Secretary of the Air Force, the Department of the Army was granted Permit No. DACA17-4-83-1, beginning 15 December 1982 and ending 15 December 1987, but revocable at will by the Secretary of the Air Force, to use and occupy certain land at Cape Canaveral Air Force Station, Brevard County, Florida, as more particularly described in said permit; and

WHEREAS, by Amendment No. 1 dated 8 March 1988, the permit was amended to extend the term for an additional five (5) years to 15 December 1992; and

WHEREAS, by Amendment No. 2 dated 19 April 1995, the permit was amended to extend the term for an additional five (5) years to 15 December 1997; and

WHEREAS, by Amendment No. 3 dated 5 January 1998, the permit was amended to extend the term for an additional five (5) years to 15 December 2002; and

WHEREAS, the permittee has a requirement for the continued use of the permitted property and the appropriate authority has approved the further extension of the said permit for another five (5) years.

NOW THEREFORE, Department of the Air Force Permit No. DACA17-4-83-1 as amended, is hereby further amended as follows:

The term of the permit is extended to 15 December 2007.

Except as herein provided, all other terms and conditions of the said permit shall remain unchanged.

This amendment is not subject to Title 10, United States Code, Section 2652.

IN WITNESS WHEREOF I have hereunto set my hand by authority of the Secretary of the Air Force this 13 day of FEBRUARY, 2004

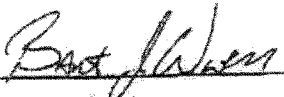

Bart J. Wivall  
Chief, Real Estate Division  
U.S. Army Corps of Engineers  
Jacksonville, Florida District  
On behalf of the permittee  
Date 5/19/2007



Willie L. Patterson  
Chief, Real Estate Division  
U.S. Army Corps of Engineers  
Mobile, Alabama District  
on behalf of the Department of  
The Air Force.

**AMENDMENT NO. 5**

**DEPARTMENT OF THE AIR FORCE  
PERMIT NO. DACA17-4-83-1  
Cape Canaveral Air Force Station  
Brevard County, Florida**

**WHEREAS, by authority of the Secretary of the Air Force, the Department of the Army was granted Permit No. DACA17-4-83-1, beginning 16 December 1982 and ending 15 December 1987, but revocable at will by the Secretary of the Air Force, to use and occupy certain land at Cape Canaveral Air Force Station, Brevard County, Florida, as more particularly described in said permit; and**

**WHEREAS, by Amendments No. 1, 2, 3 and 4, the permit was amended to extend the term for additional periods of five (5) years each to 15 December 2007; and**

**WHEREAS, the permittee has a requirement for the continued use of the permitted property and the appropriate authority has approved the further extension of the said permit for another five (5) years.**

**NOW THEREFORE, Department of the Air Force Permit No. DACA17-4-83-1, as amended, is hereby further amended as follows:**

**The term of the permit is extended to 15 December 2012.**

**Except as herein provided, all other terms and conditions of the said permit shall remain unchanged.**

**This amendment is not subject to Title 10, United States Code, Section 2662.**

**IN WITNESS WHEREOF I have hereunto set my hand by authority of the Secretary of the Air Force this 13<sup>th</sup> day of May, 2009.**

**Date 5/13/09**

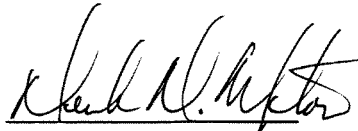

**Derrick D. Moton  
Chief, Military Branch  
Real Estate Division**

**Port Canaveral Section 203 Feasibility Study  
Real Estate Appendix**

Attachment D

USAF Memorandum and Meeting Minutes

Date: July 2012



**DEPARTMENT OF THE AIR FORCE**  
45<sup>th</sup> SPACE WING (AFSPC)

JUN 28 2012

MEMORANDUM FOR US ARMY CORPS OF ENGINEERS, JACKSONVILLE DISTRICT  
ATTN: MR. JASON SPINNING (CESAJ-PD-EC)

FROM: 45 SW/CC  
1201 Edward H. White II St.  
Patrick AFB FL 32925-3299

SUBJECT: Review of Integrated Section 203 Report/EA (your memo, 10 Apr 12)

1. We appreciate the opportunity to formally review the Integrated Section 203 Report and Draft Environmental Assessment (EA) on improvements to the existing Federal Navigation Project at Port Canaveral, FL. Since last summer, we have been working closely with the Canaveral Port Authority (CPA) and your representatives to work issues, initiate government approval processes and provide informal comments relating to this project. Attached are the 45th Space Wing's formal comments to the current 203 Report/EA.

2. We look forward to our continued partnership as this channel widening project moves ahead. Our point of contact for any questions is Mr. Scott Cook, 45 SW/XPE, DSN 854-2377, Scott.Cook@patrick.af.mil.

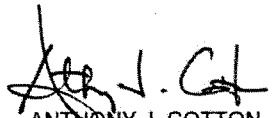
  
ANTHONY J. COTTON  
Brigadier General, USAF  
Commander

Attachment:  
45 SW Comments

cc:  
45 MSG/CC  
45 SW/XP  
Canaveral Port Authority

Attachment -- 45<sup>th</sup> Space Wing Comments -- 203 Study for Channel Widening Project

ORG	Page #	Para #	Line #	Comments
45 SW	General			<p><b>Comment:</b> Add in the appropriate location, "A plan will be created by the CPA and/or US Army Corps of Engineers to address how vessel movements in and out of the middle turning basin will be achieved during construction. The 45 SW will request Explosive Site Plan (ESP) approval from the Department of Defense Explosives Safety Board (DDESB) as required to account for any changes in configuration to the channel adjacent to Air Force Property."</p> <p><b>Rationale:</b> Safety and ensuring no impacts to DoD ops</p>
45 SW	General			<p><b>Comment:</b> We are still finalizing a new property boundary survey so the acreage calculations in the report may not be accurate but that can be worked/updated as part of the formal request for use of AF property after funding for the project has been approved.</p>
45 SW	Main Report, p 6-51 Real Estate Plan, p. 4	Para 6.7.3.2. Para 2.2.3		<p><b>Rationale:</b> Current surveys will drive update to report</p> <p><b>Comment:</b> Modify the study/EA language to indicate that "while the USACE upland containment site on the USAF property may be the preferred site for spoil disposal, the USAF has not agreed to use of that area for that purpose and would have to further evaluate that option in light of other competing interests for that same disposal area as well as test results on the composition of the spoil to be disposed of."</p>
45 SW	Engineering Annex; pgs. 56-57	Para 1.8.2. Middle Turning Basin sub-para		<p><b>Rationale:</b> Clarification--caveat</p> <p><b>Comment:</b> Add the following to end of the paragraph, "Work performed near under-channel communications lines, and related communications manholes will require careful coordination with the 45th Space Wing and AT&amp;T to avoid service interruptions. This channel widening project will bear the cost to mitigate, replace, or relocate any impacted federal structure, utilities, or communications infrastructure.</p>
45 SW	Engineering Annex; pgs. 56-57	Para 1.8.2. Middle Turning Basin sub-para		<p><b>Rationale:</b> Wing won't be responsible for bearing cost of funding impacts due to project</p> <p><b>Comment:</b> This same portion of the report does mention the need to comply with the shoreline setback distance required by USAF regulations to the existing Bldg 1064 and the CPA previously produced site sketch showing how that setback distance could be achieved. Since then our regulations have been changed and now require an 86 foot set-back (versus 85 feet as shown in the previous CPA-provided site sketch), measured from the building to the mean high-water mark</p>
				<p><b>Rationale:</b> Updated requirement</p>

ENVIRONMENTAL ASSESSMENT-SPECIFIC COMMENTS				
ORG	Page #	Para #	Line #	Comments
45 SW	1-10	Sec 1.5		<p><b>Comment:</b> The NEPA specific sections are noted with an asterisk. Recommend Chap 5 "Formulation and Evaluation of Alternative Plans" and Chap 8 "Public Involvement, Review, and Consultation" be marked with asterisks as well.</p> <p><b>Rationale:</b> These sections contain NEPA specific information by providing the rationale for selection of alternatives and compliance with public scoping/consultation requirements.</p> <p><b>Comment:</b> The referenced figures are duplicative.</p> <p><b>Rationale:</b> Edit</p> <p><b>Comment:</b> The water quality discussion is based on information that is now 6 yrs old, although the section reports that ongoing water quality monitoring is being performed. Recommend updating section to reflect current condition, particularly since that information is presumably available.</p> <p><b>Rationale:</b> NEPA analysis should utilize current available data.</p> <p><b>Comment:</b> There is a statement in this section, "Concentrations of metals in the samples were typical of coastal waters, although some concentrations were above those of reference stations (Anamar 2005)". Please indicate the significance of this statement: for example, that regulatory standards were exceeded.</p> <p><b>Rationale:</b> Clarification of statement</p> <p><b>Comment:</b> Planning Objectives and Plan Formulation Criteria are presented in the referenced sections. Which criteria were used to select the preferred alternative?</p> <p><b>Rationale:</b> Clarification</p> <p><b>Comment:</b> The legend identifying the alternatives on the figures do not match the names of the alternatives in the text. Recommend not using terms "Plan A" or "Plan B" because the text refers to Plan 1 and Plan 2. Please rectify on the figures which widening plan is Plan 1 and which is Plan 2.</p> <p><b>Rationale:</b> Clarification and edit</p> <p><b>Comment:</b> Recommend providing an explanation that the "Recommended Plan" referred to in Sec 6 is equivalent to the "Preferred Alternative" in Sec 7. This provides a link between the formulation of alternatives in Sec 6 and the final alternatives selected to be carried forward for analysis in Sec 7.</p> <p><b>Rationale:</b> Clarification</p>
45 SW	Chap 1 & 2	Fig 1-1/2-1 and Fig 1-2/ 2-2		
45 SW	2-4	Sec 2.1.5		
45 SW	2-47	Sec 2.6.1		
45 SW	Chap 5	Sec 5.1.3 and 5.2		
45 SW	6-5+	Fig 6-1 to 6-3		
45 SW	6-43	Sec 6.7.1		

45 SW	7-7 and 7-12	Sec 7.2.8.2 and 7.2.14.2	<p><b>Comment:</b> Mitigation measures are generally referred to in the text for potential effects to sea turtle hatchlings and to offset turbidity. Please specify the specific mitigation measures.</p> <p><b>Rationale:</b> Clarification</p> <p><b>Comment:</b> There is a statement in this section, "Brevard County is <i>not</i> classified by EPA as an attainment/maintenance area..." Should this read "Brevard County is classified by EPA as an attainment/maintenance area..."</p> <p><b>Rationale:</b> Correction</p> <p><b>Comment:</b> There is a reference to "Section 10 consultation" having been initiated in accordance with the NHPA. Shouldn't this be Sec 106?</p> <p><b>Rationale:</b> Edit</p> <p><b>Comment:</b> Recommend chart or table listing permits, licenses, and authorizations that need to be obtained to accomplish the project to ensure compliance with 40 CFR 1502.25</p> <p><b>Rationale:</b> Clarification</p> <p><b>Comment:</b> Occupational safety and health impacts have not been assessed in accordance with 32 CFR 989.27</p> <p><b>Rationale:</b> Completeness</p> <p><b>Comment:</b> Please delete references in the document to the US Air Force being a cooperating agency.</p> <p><b>Rationale:</b> The US Air Force intends to participate in this planning process as a stakeholder.</p> <p><b>Comment:</b> The Proposed Action is not specifically defined in the FONSI. Please define the proposed action.</p> <p><b>Rationale:</b> Clarification</p>
45 SW	7-13	Sec 7.2.16.1	
45 SW	7-24	Sec 7.2.35.4	
45 SW	General		
45 SW	General		
45 SW	General		
45 SW	FONSI		

## Port Canaveral 203 Feasibility Study: Real Estate Meeting

**ATTENDEES:** David Stone, 45 SW/XPE  
 Cecil O'Bryan, 45 CES  
 Miccich Amick, 45 CES  
 Robert Fowler, 45 CES/CEAO

Scott Cook, 45 SW/XP  
 John Walsh, CPA  
 Linda Batz, CH2M HILL

**PREPARED BY:** Linda Batz

**DATE:** July 24, 2012

**PROJECT NUMBER:** 424368

The USAF representatives had received and reviewed the October 2011 Real Estate Plan Appendix to the Canaveral Harbor Integrated Section 203 Navigation Study Report and Draft Environmental Assessment.

All agreed that either the existing permit SPCCAN-2-99-005 could be modified or an easement could be issued to the USACE for the required land for the widening. The attached sketch was provided by the USAF as their understanding of the project. The sketch essentially simplifies Exhibit 3.

The primary issue at this time is defining the existing property line between the USAF and the CPA. Some discrepancies in the legal descriptions of Tract No. 945, the legal from the permit, and the legal description from the July 22, 2005 survey by Land and Sea Surveying commissioned by the USAF were discussed. USAF stated that it appeared some land interests across the Trident Basin may need to be also conveyed. CH2M HILL agreed and stated that when the final legal descriptions are developed during the PED phase that will need to be addressed. USAF also stated that when more accurate survey is available, it will need to be provided in order to update the Explosive Site Plans.

### USAF Contact Information:

David Stone, 45 SW/XPE	<a href="mailto:David.Stone@patrick.af.mil">David.Stone@patrick.af.mil</a>	321-494-7402-
Cecil O'Bryan, 45 CES	<a href="mailto:Cecil.Obryan@patrick.af.mil">Cecil.Obryan@patrick.af.mil</a>	321-853-5445
Miccich Amick, 45 CES	<a href="mailto:Miccich.Amick@patrick.af.mil">Miccich.Amick@patrick.af.mil</a>	321-853-5449
Robert Fowler, 45 CES/CEAO	<a href="mailto:Robert.Fowler@patrick.af.mil">Robert.Fowler@patrick.af.mil</a>	321-853-0917
Scott Cook, 45 SW/XP	<a href="mailto:Scott.Cook8@us.af.mil">Scott.Cook8@us.af.mil</a>	321-494-2377



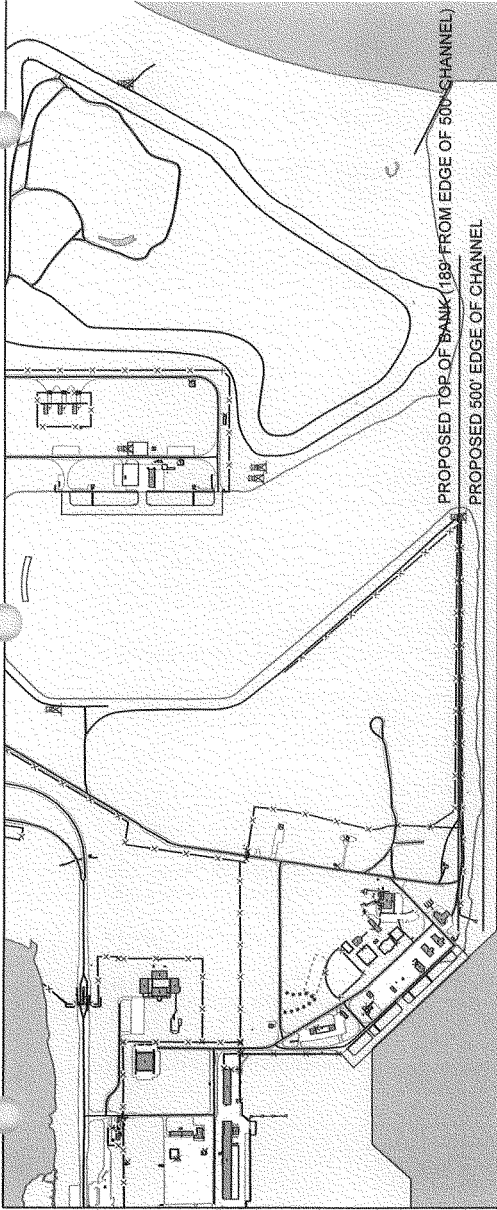

Cape Canaveral AFS

From USAF  
12-10-11

**Minutes of Section 203 Environmental Meeting  
8-25-11 at 11:00 am  
Canaveral Port Authority Commission Room  
(prepared by C.S. Noble 8-25-11)**

- Attendee list attached.
- Agenda attached.
- John Walsh opened the meeting a few minutes after 11:00 am and welcomed everyone. No prior minutes were reviewed since this is the first environmental related meeting. The next surge study follow-up meeting is schedule for Weds. Sept. 7 at 9:30.
- Lee Swain of Dial Cordy gave an overview of the Section 203 environmental sections. He indicated that the NEPA portions are included in the Feasibility study as one integrated document. The descriptions and alternatives are included in the report. Comments were received from the AFB in April 2011 from the Corps offices, which are being finalized into the draft EA, along with any additional comments received at this meeting. The updated draft is anticipated for late Sept. This is the draft that, after Corps approval, will be released to the public.
- Dave Stone indicated that the USAF will have schedule input mid- to late next week.
- John Walsh indicated that, if possible, he would like to have it before the next Corps. vertical meeting (Weds)
- Lee Swain asked that any comments for revision to the report be sent in written memo format
- Don George initiated a discussion about whether the AF is going to be considered as a cooperating agency. Considering that there is real estate involved, who is to sign the FONSI
- Oz indicated that the Corps will be signing the FONSI. The Corps is reviewing the issue of the AF as a cooperating agency and anticipated to make a decision next week.
- Lee Swain asked, who from the AF will sign off on the FONSI, if they are a cooperating agency and the AF replied that it would be Space Command
- Don asked if the Corps is doing a FONPA (Finding of no practical alternative)
- The Corps indicated they will look into it further that it is not typically done
- AF reps indicated that it's an AF requirement for the land transfer
- Oz indicated there was an existing easement
- Dave indicated he had information on the '98 easement.
- The AF indicated that an environmental baseline survey (similar to a Phase 1) must be addressed as part of real property transfer and that it is a stand-alone document. The EA in the report is used for the NEPA
- Aubree indicated that there are 2 types of cooperating agencies, one without jurisdiction and one with jurisdiction. Without jurisdiction means they provide guidance but no agency action. With jurisdiction means they would provide agency action separate from the Corps.
- The AF discussed that, in this circumstance, the USAF may sign FONSI and have NONPA done at the same time.
- Mike indicated they would check with HQ and get back with us by Weds.
- John introduced a consultant sketch that shows the (-)13 and up elevation disposal plan going landside in the SE of the corner of the middle basin and that includes the berm movement for upland disposal, which could have potential for spoil reuse
- Lt. Maples indicated concern that the capacities may not allow enough for the mid-reach project
- Jim indicated that depending on the capacity requirements, the berms could be raised to increase the storage capacity

- Lt. Maples asked for the review to address when this may be done and with which project (Section 203 or mid-reach)
- Dave Stone brought up there is approx. 14 acres in permitted area-why not use that area
- Jim says the drawing showed a likely, practical location but would like to have that location also considered and Dave indicated they will provide that location and permit to JW and CH2
- The Corps also recommended looking on the east side
- John would like consideration of hydraulic dredge for harbor work
- Lt. Maples said he did not want to digress too much from the subject, but the Corps is expected to send a MOA about the mid-reach project-will this project impact that letter
- Oz indicated that the letter is in review by consultant Kevin Bodge, who is addressing some additional AF coordination and letter is expected to go out early next week.
- Lt. Maples recalled that the mid-reach disposal capacity was greater than 600k CY and it seems that the capacity may not cover both projects. Should the letter address the capacity impact?
- Oz indicated that the Corp just found out about the CPA upland disposal yesterday and will be addressing this
- Don asked if the survey can include Trident storage area to determine what capacity is there-that there is a large borrow area available from what was removed for LC37.
- AF indicated that the environmental baseline will also need to cover the disposal area and the disposal area needs to be permitted
- Mike also indicated that the capacity for the maintenance dredging of Trident needs to be considered
- John indicated that hydraulic dredging should be considered
- Dave asked about the access right of entry timeframe and John responded soonest.
- Dave and Don brought up that scrub jay or eagles are non issues (no habitat) and will be removed from AF consideration for this area.
- Lee indicated they will remain in the Corps report to cover the Corps reporting requirements, although subsequent to the document, eagles have been removed from the endangered list
- Dave and Don indicated that Tom Penders, AF Archeologist, considers cultural issues a non-issue at the disposal areas
- Don indicated that the environmental baseline would be a draft staff review, then final going to 45SW for review and signature. He indicated that he will assist / meet on site with the biologist after they get the visitor badges.

#### ACTION ITEMS

- USAF will review the protocol for the FONSI/FONPA for this and provide answer by Weds.
- Dave will provide a copy of Poseidon permit to JW and CH2
- Dave indicated they will be providing a memo to John for timelines/review
- USAF will expedite the access for the Poseidon storage survey and consider expansions for Trident area
- Corps will provide input on the USAF as cooperating agency, i.e. what type (with or without jurisdictional action)
- Oz will check on the easements prior to '98
- CPA will review disposal options

SECTION 203 NAVIGATION IMPROVEMENTS, PORT CANAVERAL, FL

**Environmental Study Discussions**

MEETING AGENDA

August 25, 11:00

1. Review Draft of Minutes from prior
2. Overview and reminder on what the section 203 study is. and its role. This is an economic feasibility study and not a construction document.
3. Update that Modeling Final Plan Under way and updates will be discussed again 9/7/11 at 9:30 am at the next surge meeting
4. Dial Cordy update on Environmental reports completed
5. Open and environmental reports still to be completed
6. Any added Mission Partner input on AF property environmental impacts reviewed
7. Other items:
8. Next meeting 9/7 9:30 am on Surge follow up 9/21/11 for any environmental issues need follow up.



MEETING SIGN-IN SHEET							
PROJECT:		MEETING DATE:		MEETING TIME:			
SECTION 203 ENVIRONMENTAL		3/26/2011		11:00 AM			
FACILITATOR:		PLACE/ROOM:		COMMISSION ROOM			
Canaveral Port Authority							
Initials (For Attendance)	Name	Company	Title	Phone	Fax	Cell	E-Mail
	LaPrade, Michael	NOTU	CDR (XO)				Michael.LaPrade@ssp.navy.mil
	McDonald, Kimberly	NOTU					Kimberly.McDonald@ssp.navy.mil
	James Kuzma	NOTU					James.kuzma@ssp.navy.mil
	Ben Borgie	Pilot	Co-Chairman	321-223-8766			benborgie@aol.com
	Mark Bontrager	Space Florida					mbontrager@spaceflorida.gov
	Murphy, Jerry T	USACE					Jerry.T.Murphy@usace.army.mil
<i>telep</i>	Oswaldo Rodriguez	USACE					Oswaldo.Rodriguez@usace.army.mil
<i>[Signature]</i>	Don George	USAF	Nat. Resources	321-853-6823			Donald.George@patrick.af.mil
	Joven Williams	USAF	PM	321-730-6328			Joven.Williams@patrick.af.mil
	Dale Hawkins	USAF					Dale.Hawkins@patrick.af.mil
	Jones, Lance M	USAF					Lance.Jones@patrick.af.mil
	Shauna Folio	USAF	LtCol				shauna.folio@patrick.af.mil
	Trump, William	USAF					William.Trump@patrick.af.mil
	Donn Sardella	USAF/SSLS	Env Eng	321-730-6312			Donn.Sardella.cfr@patrick.af.mil
	Robinson, Danilo	USARMY					danilo.robinson@us.army.mil
	Michael J. Lesinski	USCG	CE Planner	305-278-6748			Michael.J.Lesinski@uscg.mil
	Cliff Harder	USCG	Supervisor	321-784-6781			Cliff.J.Harder@uscg.mil
	Marie Byrd	USCG	Sector Jax PDA				Marie.B.Byrd@uscg.mil
	Robert S. Butts	USCG	Sector Jax	904-564-7563		904-561-7254	Robert.s.butts@uscg.mil
	Ed See	USCG	LT	321-784-0797			Edward.G.See@uscg.mil
	Andy Blomme	USCG	Capt				Carlyle.A.Blomme@uscg.mil
	Eddy Pauley	USCG					eddy.pauley@aol.com
<i>APC</i>	<i>Cook, Scott</i>	<i>45 SW XP</i>	<i>Civ</i>	<i>321-494-2874</i>			
	<i>LEE SWAIN</i>	<i>DIAL CONOY</i>	<i>V.P.</i>	<i>904-241-8821</i>			
<i>Folk</i>	<i>APrice Hershorn</i>	<i>Corps</i>	<i>Bio</i>	<i>904-232-9736</i>			<i>APrice.G.Hershorn@usace.army.mil</i>

Section 203 Navigation Improvements, Port Canaveral, Florida  
 Vessel Surge Study Meeting  
 July 13, 2011

---

## Attendees:

Sandra Rice	Halcrow	srice@sdrmaritime.com
Gary Ledford	Halcrow	ledfordg@halcrow.com
Michael Lesinski	U.S. Coast Guard	michael.j.lesinski@uscg.mil
Dave Stone	45th Space Wing	david.stone@patrick.af.mil
Jim Westermeyer	NOTU	james.westermeyer@ssp.navy.mil
Dave Dahl	Navy Reg SE	david.a.dahl@navy.mil
Linda Batz	CH2M Hill	linda.batz@ch2m.com
Jim Moore	CH2M Hill	jim.moore@ch2m.com
Doug Mutter	Canaveral Port Authority	dmutter@portcanaveral.com
Lt. Cliff Harder	U.S. Coast Guard	cliff.j.harder@uscg.mil
Doug Brown	Canaveral Pilots	captlima@aol.com
Don George	45 CES/CEAN	donald.george@patrick.af.mil
Dale Hawkins	45 CES/CEAN	dale.hawkins@patrick.af.mil
Matthew Maples	NOTU	lt.matthew.maples@ssp.navy.mil
Capt. James Kuzma	NOTU CO	james.kuzma@ssp.navy.mil
Kimberly McDonald	NOTU	kimberly.mcdonald@ssp.navy.mil
Joe Hellebrand	Canaveral Port Authority	jhellebrand@portcanaveral.com
Robert LaBranche	Congressman Posey	robert.labranche@mail.house.gov
Patrick Gavin	Congressman Posey	patrick.gavin@mail.house.gov
Eddy Pauley	Pauley Management	eddypauley@aol.com
John Walsh	Canaveral Port Authority	jwalsh@portcanaveral.com
William Trump	USAF 45RMS/RMRA	william.trump@patrick.af.mil

## Via teleconference:

Paul Kopp	NSWC Carderock	paul.kopp@navy.mil
Frank Cole	NAVFAC	frank.cole@navy.mil
John McCoy	NAVFAC SE	john.d.mccoy@navy.mil
Jerry Diamantides	David Miller & Associates	jdiamantides@dma-us.com

***John Walsh of the Canaveral Port Authority called the meeting to order at 10:04 a.m.***

***Mr. Robert LaBranche, Community Relations Director***, spoke on behalf of Congressman Posey's office. Mr. LaBranche conveyed the importance of this project to the local economy and noted that Congressman Posey would like everyone involved to work together to see it happen.

***Ms. Sandra Rice, with the use of visual aids, began her presentation.***

***Sandra Rice*** - My name Sandy Rice and I am representing the engineering portion of the navigation project Feasibility theme today and we're going to talk about, as John mentioned, the Surge Study

modeling and what we plan to do there, as well as a few slides at the end about the impact on the Air Force side property, issues, and what not.

For those of you that maybe aren't as familiar with the project our overall 203 navigation project purpose is to increase the safety and efficiency of cargo vessel, commercial ship operations, and to accommodate the larger vessels that are now using the federal navigation project to Port Canaveral.

The purpose of the Surge Study is to demonstrate that the recommended navigation project and the present and foreseeable future ship traffic will not adversely impact any of the operations at middle basin or trident basin.

Our Canaveral harbor has a main southeast to northwest ocean approach channel and a main east/west channel through Canaveral Harbor that has three basins to the north side; Trident, Middle and West Basin and the Cape Canaveral Air Force Station borders the north side of the Port, the northeast side.

As far as the Port facilities on the north side, those Port facilities that are part of the Cape Canaveral Air Force Station are located within the Trident Basin and the Middle Basin, we have identified those as the Trident Wharf, Poseidon Wharf, the Boeing EELD Berth and the Air Force Berth.

As far as the surge modeling a lot of technical information was provided and supporting technical papers and what not were provided with the meeting announcement and that certainly can convey in a lot more detail the approach that we are using as far as a numerical model approach to looking at surge effects in the basins. This is going to be a study by Coast and Harbor Engineering using their time domain models that predict harbor dynamics, water surface level changes and current velocity changes, as well as the effects of passing vessel loads on vessels that are at berths of interest. The long wave unstudied model calculates those water level, the basic harbor dynamic response, in terms of water levels and current velocities as a vessel moves through the channel.

***Jerry Diamantides joined the meeting via teleconference***

Ms. Rice continued, so the transmission of those velocities not only around the vessel and the pressure effects as it moves through the water but those velocities transfer out to the entire aquatic domain of the harbor, so the modeling will capture all of that. There could be points of interest that are not only at berth, for example, it could also be at a certain location in the basin, it doesn't necessarily have to be at a berth. The long wave load model then basically takes...it predicts a segment forces on a haul or it could be a structure basically an object that's taking up space in the water and it comes up with the forces on that and a certain format and those are converted into what become the time history of loads on the moored vessel in terms of the surge, the sway and the all rotation. The surge is in the direction along the berth, the sway is on or off the berth and the all rotation direction forces the starboard to that vessel.

The modeling has been validated in different manners. There have been field measurements of water level draw downs and water level fluctuations at various locations. That's been tested. Then there is also tank model testing on moored vessels where the passing ship forces have been determined, and that part has been used to validate that part of the model. Coast and Harbor continually looks for opportunities to validate and verify their modeling technique but everything I know about it, it is a very good technique it's being used widely now. It has been used in support of a few federal navigation projects as well, in this case out in California.



So input to the modeling includes vessel hull grid models, 3-D models, of the hull basically from the water surface down. The modeling is terrific because it can handle very complex boundary conditions. It can model odd geometries of the basins and the orientation of the basins relative to the channel. It can model the presence of the bulkhead, the flat surface, the shoal and the banks. It takes all that into consideration in the transmission of these forces and how the water levels and velocities change.

Then the passing vessel can modeled. We have a passing vessel scenario basically that has to be developed that we would work on; that was with the pilots, taking let's say a cruise ship, for example, based on a certain settling wind conditions that cruise ship may translate down the channel in a certain manner, in a certain position, with a certain attitude, with a certain speed plan. That is what we would capture in the model. It would set-up some different plans, it would have do with some possibly high wind and normal wind, varying those kind of things.

So the vessel model input would look something like this. The cruise ship is on the left here. That's what it's model might look like. This happens to be the Grandeur of the Seas, not one of the ships that is here, but certainly representative. We have a submarine hull grid model here on the right and we have the computer generated view of what the water contours look like, the contours below the hull.

As far as the hydrodynamic modeling this top left figure basically shows you the domain boundary conditions, how the model is set-up for those boundary conditions. The different colors represent the deepwater versus the shoals or where there is solid areas where its blue right up to the bulkhead. There are various output figures, graphics, plots, information that can be provided. A couple of examples here on the lower left, we have a velocity color condor plot that represents a particular time step in the simulation period where the colors will denote what the current velocities are in the water and how they are moving and changing with the vessel depending on what the time step is selected to look at.

The one on left here is showing the water surface elevations, in this case it's an outbound vessel and you can see the bow wave there is a little bit of a higher water surface elevation in front of the vessel. There is some draw down towards the stern of the vessel and more or less, still water levels further to the stern and what not. The other kind of plots that can be generated if there is a particular point of interest in a basin we can do a whole time series plot for the entire simulation how the water level changes or how the current velocity, depth average to current velocity changes in that location over time for the whole course of simulation.

This is an example of an animation with the passing vessel coming through and coming adjacent to. . . as you can see the colors will change water surface elevations as the ship moves through and we can pick up passing vessel load affects, time histories on any vessels moored at any location that we select. In this particular position and the moored ship here along the bank that's one of its worst surge positions, for surge loading on that particular vessel.

**Question** - Does that show that the moored ship would be pulled down because there is low water there?

**Sandra Rice** - Yes, exactly. There would be a drop in water level.

This is an example of what the passing vessel time history looks like that we would output for any particular simulation were on FX, FY and the moment there, that's surge sway and the all direction. We have taken all and divided it by the length of the ship to get it in the force form instead of the moment form.

So what we are looking for today is, we would like to hear from you what your expectations are of the modeling effort, what outcomes you are looking for, and can you identify for us the points of interest that we should be focusing on, what vessels should be at what berth, is it all four of the berths that are of concern, two of the berths, certain ships, certain submarines, and we would need whatever information you would give we would like to have IGES 3-D models for the vessel. We have the capability of scaling some models that we have, commercial type vessels, submarine of course would be inaudible the cruise ship models we can come up with those for the passing vessel information but whatever ship you might select for Poseidon Wharf we'll look at, we are hoping you can provide us with those models. As far as the passing vessels and scenarios based on the information you give us about the models and what you want to see then we can put together a draft matrix of passing vessel scenarios. inaudible

What we are planning for the execution of the study as far as the schedule is we would like to between now and the end of the month try and coordinate the information that was input in this modeling effort, which means coordinating our effort with you to get the information we need and deciding having to buy in on the simulation runs inaudible if we can do that then we ought to be able to present the results of this to you by the end of next month.

That concludes my part about the surge modeling. I think Gary Ledford would like to go over a few slides.

***Mr. Gary Ledford, with the use of visual aids, began his presentation.***

Gary Ledford with Halcrow. I'm just going to go over some of the impacts on the north side. To give you a little bit of history, I was with Gee & Jenson back in the mid 90's when we worked on the impacts for the first channel widening. I was responsible for moving that Navy dolphin back to where it is today and also replacing the Air Force communications duct. We made it deeper and wide enough to allow for future widening such as this project and it's interesting watching the Air Force suddenly have to advance themselves from nineteenth century cooper to twenty-first century fiber.

***Question*** - Gary what was that project?

***Gary Ledford*** - That was the first channel widening from 300 to 400 feet.

***Question*** - What year was that?

***Gary Ledford*** - That was probably 1994 or 1995, I think.

***Gary Ledford*** - And we basically modeled the expansion of this project as that project was done by just advancing the north side another 100 feet to the north and basically duplicating what was done back then by moving the north channel embankment at a 3 1/2 to 1 slope to the north and then replicating and moving everything to the north to the existing dike, patrol road, fences, those sort of things. We have identified some of the items in the study and also some have been recently added. We realize that there is an impact on the boat ramp, Building 1064, the mooring dolphin again, the

submarine sail, which wasn't there back when we started this, and of course the rip rap embankment, the cable crossing sign, the security signage as I mentioned the security fence, patrol boat and all those things. And like the other channel widening project we would look for an easement to be able to utilize that part of the property and also there would be a temporary easement, during the construction, primarily to get the dike moved.

Some of the items that were recently brought to our attention, of course the boat ramp, which we were aware of, the dolphin, but we did not know about Building 1064. We understand the Air Force has a requirement for an 85 foot setback to the high water line. In this case one solution would be to put a section of bulkhead wall and give you hard structure, I think it might be more comfortable for 85 foot and then we would just meld in the new embankment to that wall, providing 100 feet to the high water mark. Now according to the NOAA site, in fact they measured there in the Trident Basin, high water is like +3.7 or something, I just rounded it up to 4 feet and worked from there. But again we can make adjustments depending on what you really want to see.

We are showing a new dolphin moved back along that wall and we have what I call a cut-off wall to maintain existing boat ramp as it is today and we can then widen the top of that wall and make it into a catwalk so that you have access to the dolphin. We probably will use a *inaudible* dolphin, which is typically how we do things around these.

We do need to talk about the fact that we may have an issue with offshore disposal of some of the clays, materials. EPA actually manages the offshore disposal site via the MDS. They are in the process of revising or taking a new look at managing that site and if our project time table is such that we cannot wait for them to come up with their new management plan, then there is possibility that we may be looking for improving the existing dike and using that area for dredged disposal. We are hoping we do not have to do that but we just wanted to bring it out on the table and make you all aware of that.

**Comment** - And that was brought up previously. The issue was whether or not, what's the impact or the potential happen to some of the entrance to the Trident Basin based on the study.

**Gary Ledford** - The Surge Study will tell us a lot about the entrance.

**Comment** - I believe there is another activity *inaudible*

**Comment** - The Army Corps has been talking to the County about the possibility of using that area for beach sand storage.

**Gary Ledford** - So what we really need to stay on schedule is July 22nd and 29th dates we need to get information back on the vessels, points interest and those sorts of things and the 3-D models of the vessels if possible. We need coordinate basically all the simulation scenarios that we come to agreement that we want to see run. It is a pretty tight time table but we have to keep the project moving and with that we are going to open it up for discussion.

**Jerry Diamantides** - From the perspective of one of the guys that is pulling together the entire study, if you will, and of course this is a Feasibility Study for partnered projects between the Corps of Engineers and the Port Authority, we have a draft document that has been through Corps of Engineers review and is getting through as a draft one of the major hurdles of the Corps of Engineers review process and the plan is to have this document go out for public review, as a draft, in the next

month. One of the things that we are hoping for is that the group that is assembled today and the agreements and the understandings that we get to today will allow us to have that draft go out to the public without show stopping comments relative to these issues coming up during that time. Again this is a Feasibility Study so we are only talking a 35% design, if you will, so we do not need to finalize all the details on all the items and this is only a draft, this is not the final, the final won't be for months yet but we are hoping that by this kind of coordination we won't be hitting a speed bump in the road in moving the draft through and getting it out to the public without some major open ended items with this group. That's our hope, that's what we would like to accomplish in part with this meeting and with whatever resolutions that we come up with and a path forward. I just wanted to lay that out there from kind of the 30,000 foot perspective, I'm not the engineer and I'm not in any of the decisions that you folks are making around the table but I just wanted you to see some of the larger picture of where we are.

**Captain Kuzma** - I'm a little confused by that, only from the fact that at the executive level meeting with Stan Payne, myself, Capt. Bloom as well as General Wilson, we talked about putting a master schedule together so everybody could understand what the process was. This seems to be a part of that process but I don't know what part of that process it is. I'm obviously probably one of the guys that is not experienced with this whole process but it seems that if we are putting something out that includes data from the study that appears to be a little ahead of some schedule and I still have not seen a draft of the schedule as to how we are going to get to the 26th. This is the first time I have seen this particular schedule of the 26th of August and I have committed to Stan Payne as well as Representative Posey and General Wilson to make sure the Navy folks will be involved. I'm glad we have a schedule to talk about I just cannot commit for the folks who are on the other end because they have other jobs to do too. I'm a little concerned but I'm going to ask Stan, "Where is the schedule?", "Tell us what the targets are so we can insure the resources we need to apply to this to make sure it's efficient and effective to go through."

**Jerry Diamantides** - I understand that, and that's one of the reasons we are having this discussion today. We need to firm up that schedule and make sure that it is something that everyone can work with. I concur.

**Captain Kuzma** - I have a couple questions. The information that is going to be discussed will actually be available so people can actually look at that and have effective, efficient discussions, especially when you are looking for a decision or an input by a certain date. The first Feasibility Study was rushed for folks to take a look at on the government side of the house. Is there going to be some sort of formal minutes that can be reviewed and to document the action items taken by folks or to make sure we are all on the same page, or how does that plan on working?

**John Walsh** - Noted that minutes will be taken for today's meeting and sent out and before we leave today we will set another meeting date so that we have regular periods and we want to make all stakeholders have communication and know what the expectations are from today forward.

**Captain Kuzma** - The beginning of this is to talk about increase safety and efficiency, both for the present and foreseeable future and the ship impacts. One of the items that is in the 203 Study talks about an option for one Genesis cruise ships into 500-550 foot channel. As I brought up with the executive level group we have the horsepower to go through and do the right thing and take a long term view. I'm not very good a crystal ball, but an expansion and making sure the Port is competitive and that we hit that safety margin is great. At the first meeting the pilots talked about basically a zero safety margin now and with the 500 foot channel if the bigger cruise ships came here we would be

back down to a zero safety margin. In talking with Representative Posey's office it would be very bad to come back in 3-4 years and say we now have to expand the channel again and not have used the horse power that is in the room and dedicated to study to look at all the options for a 15-20 year view. If someone can guarantee whether it is a CO NOUTU is the emissary for region southeast that the larger cruise ships are not coming here and we are not going to get into this situation again, I would certainly like to get that documented in some minutes, as well as whether or not a 550 foot option won't be investigated for some period of time.

**David Dahl** - Our organization does the facility support for Captain Kuzma at NOTU. Back to the schedule. Is there a written process chart or written flow chart with dates and actions on it, somewhere written down because I'm confused. For instance on the public comment issue that we spoke of 5 minutes ago, that was a public comment on the draft plan for the study, not on the study but on the plan for the study, is that correct?

**Jerry Diamantides** - The schedule is being revised because we are in the process of responding to some Corps of Engineers headquarters comments and when we do respond to those comments and Corps of Engineers headquarters is satisfied with those responses, the next step is to have the document, which is not just the plan but the entire Feasibility Study be available for public comment and public comment includes other government agencies as well federal and state local. That schedule is being revised at the moment, so I do not have an updated schedule that I can provide today but we were looking at a trying to keep this project moving and to trying to, to the best that we can, solidify the plan that we have and stop that plan from changing while we are in the approval process. Again this not plans an specs, we are not identifying exactly what will be built. For the civil works part of the Corps of the Engineers we are looking at getting approval to proceed with plans and specs from something that is approximately 35% designed and there is a 20% cost lead way allowed in there as well. So we want to move this Feasibility Study through the public review process as a draft, move it through a final process where we have the final NEPA document and the final Feasibility Study, which then can get authorized by Congress at which point we can do the plans and specs that are the final detailed plan for the project. That is the way we are looking to move this through and we were looking on a schedule that would move this through in the next few months but that is going to change slightly and I do not have an updated schedule at the moment. Once we do we will certainly share that information.

**Sandra Rice** - I can make a couple statements about the schedule that we have regarding the Surge Modeling Component. We can certainly be more flexible on the dates noted if they do not work. We would just like to accomplish it in a timely a manner as possible in the next few months. We will be looking at a Genesis class vessel only in the proposed future recommended plan, we are not evaluating that in the existing plan as we do not see that ever as being a vessel that will commonly operate here in the existing conditions. It would be evaluated in the future conditions. That is not say it couldn't come in here on some emergency basis or there's a big hurricane down in South Florida and they need to go somewhere and we have an opportunity to bring it in here for a day to get people off the ship.

**Inaudible conversation**

**Captain Kuzma** - In Section 5.4 of the Feasibility Study it talks about extended channel 550 was eliminated from analysis because of consideration for existing land use on both sides of the channel, particularly talking about the Air Force, it's typically vacant, minimized by usage lands for navigation purposes preferred. The channel extension to 550 was excluded from analysis because of the

potential impacts and minimizing encroachment on Air Force property. There is no discussion as to whether or not the rest of the study talks about future growth, which clearly includes Genesis classes, as well as that discussion of 550 feet and that's my concern is that it appears to have not been looked at because of potential impact. This current study has a potential impact, current mission, today and you would go through the same thing I would assume if we were looking to make another incremental widening. That is my concern, so I'm not looking at any of my documents but the actual Feasibility Study and that's the concern.

**Jerry Diamantides** - I very much understand your concern. It is quite a reasonable concern and one that is not necessarily a problem but it is certainly one of the criterion that we need to address here when we are doing the planning, is what is the most likely future condition. As we have been discussing with the Corp of Engineers at a regional level and at a headquarters level we got a lot of push back for having the a larger Genesis class vessel being without project condition, meaning that the most likely foreseeable future would be the Genesis class coming to Port Canaveral on a regular basis. We got a lot of push back from the Corps of Engineers Headquarters and their economists and their planning folks saying that we can not substantiate that as a study team as the most likely future without project condition and therefore we were looking at vessels the next class size down from the Genesis in order to design the channel and we have been through this ship simulation to show that the vessels that we do identify as being within our project condition can effectively use the channel. I agree with you that it does not address the potential for the larger vessels which could someday in the near future want to come to Port Canaveral but the Corps of Engineers at the regional and the headquarters level doesn't feel that is the likely future with our project conditions, so we have not designed for the Genesis class vessel as the design vessel. Let me add thought that is an excellent comment and one that I believe you are not alone in putting forward.

**Sandra Rice** - We are open to discussing this in a little more detail now or however you would like to proceed from here.

**John McCoy** - I provided NOTU with some comments on my thoughts on the study and I have a couple more to add if I could. In the study you did not talk about changing water levels, mean low water and behind water levels, are you going to look at those as well?

**Sandra Rice** - Typically when I have worked on these studies I've looked at everything just at mean low/low water, which would be conservative.

**John McCoy** - My concern is Poseidon Wharf the utility trench right there is at or near B high water and I do not know if you can get a couple beta points along that utility trench?

**Sandra Rice** - Sure.

**John McCoy** - For the Surge Study you are just going to look at vessel surge at the Poseidon and Trident sway are you going to do anymore inline arrangements looking at tensions or anything like that or is that going to be somebody else's responsibility?

**Sandra Rice** - Certainly once all the *inaudible* vessel loads are figured out for a particular ship of interest at a berth of interest whether operations would take that information and evaluate it on the Navy or Air Force side or you guys want us to do it, it can be done many ways. We are going to be providing those histories in a form that provide the direct comparison between the existing condition channel versus the recommended planned channel that is deepened and widened. So that is going

to provide some level of . . . a good indication right there of what the results will be, but yes on taking it to the mooring analysis level then specifically operations at those berths of interest can be looked at as well.

We definitely need to prioritize and focus on things that are our biggest concern for the Surge Study to put our dollars to the most effective use. Same thing at the Air Force wharf I haven't heard that there are issues necessarily.

**Dave Stone** - Certainly the Delta Mariner Pier is an area of interest for us and I think we would be interested in knowing and having the Surge Study characterize differences that would be experienced at that location between what's happening now and the kind of surge that might be experienced in the future so they can evaluate that against their offloading tolerances and those kind of things. I will be working with our launch squadron folks to try to get that hull data that your needing for the study, so that will be one thing that I will be tracking.

And just to piggyback on some of the earlier comments I certainly would like to echo Capt. Kuzma's comments about the need for an integrated master schedule, that is one thing that our senior leadership is very interested in because there is a lot of dates that get thrown out for discussion and I think we need to see it on paper and understand all of the touch points for the Air Force and all the other parties involved so we understand where we have inputs and when those are needed so that we can muster the resources that are needed to make sure that we keep everything on schedule because our intent is to certainly not be a road block in that regard.

With respect to comments on the impacts on the land and facilities I'm very pleased to see that you have already taken a look at that setback line for Building 1064 and come up with some mitigating options, that is really good and also just the fact that there is a general awareness if not a personal past involvement on your part Gary for the com line that goes under the water and we also have com manholes and utilities in that same general area that would need to be looked at closely to make sure that their not disturbed as well or if there is any mitigations needed. We'll keep you connected as we move forward.

**Bill Trump** - I would like to get with Gary Ledford to find out a little bit of his involvement in the 1994 or 1995 timeframe of the widening and what he believes is going to be the effect on our current cable under the Port. Further, one of the comments that I had made to Dave was that back in 1994 AT&T are the owners of the cable under the Port and at some point we need to engage AT&T and the fact that their termination point. . .

**Gary Ledford** - I have the as-built profile of the directional drill that I did under the channel.

**Bill Trump** - It appeared to me that the manhole 604, I believe it was, is right near the area that is being demo.

**Gary Ledford** - Right, they need to take a look at that.

**Dave Stone** - For general awareness there are some explosive safety plans that Poseidon and Trident areas that project out onto the channel and just as a matter of update and approval required by our defense department explosive safety board once the channel width limits are established and we have the GIS data to allow us to project those accurately on plans that can move forward we would have a need to go forward and update those plans to of course to reflect the any new

configurations there. I do not see that as any kind of show stopper but it's an update item that would be on a master schedule that we would need to complete.

Don George - Who is doing the NEPA documentation and when would we get an opportunity to review that prior to it going final?

**Jerry Diamantides** - The NEPA documentation is being done by the study team there is the **inaudible** and David Miller & Associates and Dial Cordy. As it stands right now we are looking at an environment assessment and a finding of no significant impact at this point. That draft will be available for you in the upcoming month or so, or months, weeks the draft document goes out for public review.

**Don George** - I understand that in the not so distant future we'll get a crack at the draft NEPA document because there were a few things on there that we had concerns about when we saw it before with regards to wildlife and potential impacts certainly with moving the dike back in the spoil area and all and I know that US Fish, FWCC and all those folks have concerns with regards to the rock revetment and things like that, so we want make sure all that was addressed appropriately.

Is there going to be a plan developed for the Surge Study that we can review before it actually takes place?

**Jerry Diamantides** - Before Sandy addresses the Surge Study let me say we would be happy to take your comments now, we will take those comments now and we will address the comments and fold them into the draft that will be coming out for public review. If you can make them available. You can send those to us through John Walsh at the Port.

**Sandra Rice** - We would have the written plan that basically contain the things that we have agreed to as far as what vessels we want to model, what are the points of interest at berths, what results we are looking at each location, what the passing vessels are, what the passing scenarios are, so yes we need your information to coordinate exactly what we are putting in the plan and make sure it is what everybody wants.

**Don George** - On the west side of the Army out-port bulkhead we've got some serious erosion around behind that bulkhead, that would be site we would want to have as a point of interest down the road. Also, undermining some of the rock revetments that we got over there. We've noticed a lot of destabilization in some of that, that actually moves those granite boulders out and that has been a concern of the Port's back during the previous widening that actually some of those sloughed off. I assume they are going to do some monitoring, ground truthing of their model.

**Sandra Rice** - I do not know. I'll have to ask them about that. They do some quality assurance review on the model.

**Don George** - I didn't know if they were going to be putting out some instrumentation, doing some measurements of what's happening right now and bounce that off what their model projects for the future and that kind of thing.

**Sandra Rice** - No there will be no plans to do that. Actually, at the beginning of the 203 Study we did a hydraulic type study where we actually put out current meters and we did truth, if you will, the existing conditions and the current meter. We used that to build **inaudible** model, a Corps of the Engineers type software, and then with the larger, recommended project we evaluated what the



affects would be of that widening and deepening as far as changing any current speeds or flows and what not through the Port. That is already documented in the 203 Report, if you want to look at that. The surge modeling is really intended to capture the passing ship effects. I wouldn't expect if there is a high degree of erosion at a certain spot I wouldn't expect that to be possibly more associated with tug thruster, ship thruster or stern compulsion then something to do with the surge modeling.

**Don George** - This is on the west side of the whole thing there is a little bit of sandy area of there on that west side where NOTU had a pavilion and everything. We moved facilities out of the way because of that, really not a lot of ship movement or anything going on in there and I'm just wondering how if that is directly related to the current ship surge that we experience.

**Sandra Rice** - We can certainly use that as a point of interest. We look to see what happens when a ship goes by.

**Don George** - You mentioned that they look for opportunities to check the . . .

**Sandra Rice** - We can do that but there will not be any equipment placed at that location to try to verify that the models are giving us the same numbers. This is strictly on numerical modeling and the validation of the modeling has come from many other sources and many other projects as of data.

**Don George** - I hope they would do something to validate here to and that would be a good point of interest to look at, especially with the Delta Mariner pulling in there the way it backs up to that thing and it could be doing one of these kind of deals. I know they had looked at some of the that with regards to opening and closing the locks and the hydrology. . .you know. . . the movement of the water through there, eroding bulkheads and things like that. So I was just kind of hoping that they would toss that into their modeling too.

**Sandra Rice** - We can talk about that. If there is a way to some how easily incorporate something like that, we'd be happy to do it.

**Lt. Cliff Harder** - I'm the supervisor of the Coast Guard Marine Safety Detachment here in Port Canaveral. I have a copy technical questions regarding the capabilities of the Surge Study, I will follow that with some specific expectations from the Coast Guard regarding the capabilities of the Surge Study and points of interest that you have asked for and also I will restate what the Coast Guard's position is on the overall 203 project in general.

First off regarding the technical questions. I'm curious on whether or not the modeling will be able to include multiple ship transits or ship transits that are made one right after the other, in particular, Port Canaveral being a cruise ship port we have several cruise ships that leave one right after another and will the modeling be able to basically calculate and account for this compounded effect created by one ship leaving directly after the other?

**Sandra Rice** - I believe the answer to that is, no but I will ask that question.

**Lt. Cliff Harder** - I bring that point up one because I am curious but it is definitely going to be a concern with the particular project because that is a reality here in Port Canaveral. I will mention to the group that a few weeks ago we had an incident at NCP-2 we had two cruise ships outbound Port Canaveral the last one being the Freedom of the Seas, one of our larger cruise ships, there was a loaded tank ship transferring cargo at Seaport Canaveral at NCP-2 and that ship was surged 11

minutes after the last cruise ship left or passed by the NCP. It surged approximately 40 feet and it parted several lines including wire rope cables that were used to attach the vessel to the pier. So that particular scenario is going to be very concerning to us. We like to make sure that we understand that and that is part of the modeling study.

The second question I have is sort of related to the first one regarding the technical capabilities. Based on what I have seen here today that the passing, the event, and the water levels, and the movement of water and velocities will be captured in the immediate vicinity of the vessel but will the modeling be able to capture the holistic effect of the water movement out of the Port and into the Port prior to and after a significant time after the ships have already transit out of the Port, well out of the Jetty area as water starts to flow back into the Port especially during outbound transits. Will the model be able to capture that?

**Sandra Rice** - I believe it will, I shall pose that question exactly as you have asked it to the modeling folks.

**Lt. Cliff Harder** - I think the last point I would like to make is to the validation comment that was made earlier I think is also valid. I think it will be important in some way to validate the results of the study and how that gets accomplished, there are probably several ways to do that and I'm certainly not the person to propose it but I think it will be important to validate that.

**Sandra Rice** - I will ask that question.

**Lt. Cliff Harder** - As far as expectations go regarding the study at points of interest. You know the Coast Guard is interested in the Port as a whole and our specific points of interest include all the commercial deep draft berths here in the Port. We need to understand what the effects will be at all these deep draft berths, so we do not exclude any of those deep draft berths and although the Department of Defense, Navy and Air Force they are well represented here and their representing their interests we are interested in all commercial deep draft berths being looking at and being a part of this study and the mooring analysis that you mention regarding the strains on the lines and the impacts on the mooring lines are an important part of that to us as well and I would it would be to the Port also. To that end, we do not have any of the 3-D modeling data that you are asking for, for those deep draft berths. I would see that this would need to be a collaborative effort between the Port and its commercial partners that are bringing the ships to those berths to develop those models with the current commercial vessels that are coming to each one of those berths and the expectation would be that the modeling also not just include the vessels that are currently calling on Port Canaveral at those commercial berths but also any expected future vessels that the Port includes in having here call into the Port whether it be Genesis class cruise ships or larger tankers to Seaport Canaveral or otherwise.

**Sandra Rice** - Understood. John do you want to address the commercial interest in this.

**John Walsh** - We are interested. We have reached out to each of the major cruise lines that sends ships here to get their whole data. We have reached out to Seaport Canaveral for each of their cargo vessels that will be calling on them as well as new carriers, like Bluewater and ASI to get as many different pieces as possible. As you are aware we are going to be temporarily berthing the Carnival Ecstasy as CT-3, which could have a potential high impact in its temporary home but as well on NCP-3 and NCP-4 are of particular concern and some of the south cargo piers as well as just mentioned. We plan to take advantage of making this as comprehensive a study as we can throughout the Port

so we are committed to knowing which areas are safe, which areas can accommodate larger vessels as well as the proposed North Cargo Berth 5 and 6 as they come out. Probably less effect in that West Turning Basin with still some effect in those new areas we plan to construct.

**Lt. Cliff Harder** - Will there be a baseline study utilizing the current conditions of the channel and the current traffic, and the current commercial vessels at the deep draft berths to provide a comparison to, so there will be a baseline and then a future state?

**Sandra Rice** - Yes, it would be two boundary condition models built, if you will, one reflecting the existing conditions as they are today, and the other will reflect the future recommended planned conditions and the same runs would be performed in both runs.

**Lt. Cliff Harder** - I just want to kind of restate the scope of today's meeting to be basically the Surge Study and it appears to be more also to include the actual 203 project and particularly the movement with the public comments. We concur with the Air Force and the Navy's comments regarding the master schedule. It was our understanding that a master schedule would be produced to basically demonstrate how we were going to proceed so that we would have a timeline and expectations so our resources could understand what was happening and when and when they would need to be providing input.

Aside from the Surge Study the Coast Guard currently has a letter in routing that will be provided to document the concerns that were mentioned at the original 203 Feasibility Study meeting and they include other concerns regarding the impact of the new West Turning Basin on the federal channel and there is a number of factors that go into that. We are looking forward to a collaborative effort to study the impacts there and understand how frequently the ships will be turning in there. How long the obstructions and impacts will be of the federal channel, the effects of prop wash, propeller thruster wash and things like that will have on the small vessel traffic community as well as the marinas located on the south side of the channel as well.

We also have some aids in navigation matters that the Coast Guard will be responsible for in relation to this project and that also will be documented in the letter.

With the widening of the channel we mentioned at the last meeting that the generally I think that one could conclude that deeper channel and wider channel would generally translate to safer vessel traffic transits. The other side to that is that it will allow the vessels that are transiting the channel, large vessels, passenger vessels, cruise ships, tankers laden with dangerous cargos it will physically put them closer to the other vessels that are moored at the north and south side or the Poseidon Wharf and those are one of the areas that we want to make sure that we fully understand.

And again we are looking forward to collaborative effort there with the Port and all the stakeholders that are affected by that to ensure that we understand we have the safety margin that is needed to insure that although we are creating more and deeper areas to navigate vessels in and out of the channel but we are not having a counter effect in that we are putting vessels closer to each other and having potential collisions and elisions as a result of that.

In general, the Coast Guard supports the deepening and widening of the channel. We think that we can work through these issues collaboratively with the rest of the stakeholders and as I have said our official letter will be forthcoming.

I do have a representative from the Coast Guard Civil Engineering Unit in Miami, one of the issues that was also represented in that letter deals with the relocation of the Coast Guard and the Coast Guard assets potentially to the south side of the channel and what I would like to do is turn that over to Mr. Michael Lesinski so he can speak specifically to that particular issue.

**Michael Lesinski** - The Coast Guard is ready to discuss with the Port any options for relocating Station Port Canaveral. I believe you have our requirements and anything that satisfies those operational requirements the Coast Guard will be happy to work with you. At this time I don't think we have any specific proposals so I don't think there is any specific points of interest to be looked at under the Surge Study. Just one other question, who should our input be addressed to?

**John Walsh** - Ideally, directly to Sandra Rice and copy John Walsh.

**Kimberly McDonald** - Your information on the vessels. Sandy did I hear you correctly at the beginning that you do not have the modeling for the submarines or did I miss that in translation?

**Sandra Rice** - No, we are looking for a 3-D model, which is called IGES file format it's a CAD compatible type format that can be. . . it is the language that is needed to go into the numerical levels.

**Kimberly McDonald** - Is this something that Carderock would have because I know they do a lot of developmental testing on submarines?

**Sandra Rice** - I would think that they could provide it, or the shipyards, it would come from the shipyards maybe.

**Kimberly McDonald** - Is that something you are expecting NOTU to run to ground or do you already have points of contact for that.

**Sandra Rice** - The only point of contact or resource I would use to try to get that would be Bill Sealy.

**Kimberly McDonald** - I may have his e-mail and I'll see if I can get a hold of him but I was just interested in that.

**Paul Kopp** - We probably do have some format of submarine hull definitions that could be used. Either in Rhino 3-D, we most certainly have the Ohio, I don't know if we would have the Vanguard class. I could also probably come up with sort of generic commercial ships that could be used if you have problems getting the geometry for some of those other commercial deep draft ships.

**Sandra Rice** - We just need for the Navy folks to decide what is the primary ships of interest. We don't have the capability to evaluate every ship, we need to pare this down to a manageable level to what we can evaluate and select things that are representative of the operations.

**Captain Kuzma** - Sandy do you have a catalog of existing models that you have used in other Navy Port?

**Sandra Rice** - No, I have not had the opportunity. I have commercial.

**Captain Kuzma** - We will identify the ships and provide the information and look at what we can.

**Sandra Rice** - We are looking to you to try and decide what your primary operations **inaudible**

**Captain Kuzma** - I was just looking if you already had something we wouldn't have to go find those.

**Paul Kopp** - The channel widening back in the mid 90's did that include a deepening of the channel at the time?

**Gary Ledford** - Yes, it did include deepening all the back out to just a little bit west of North Cargo Pier 4.

**Paul Kopp** - So, that was set to the 46 Foot project depth at that time?

**Sandra Rice** - No. Right now I don't know what particular area you are interested in but right now the outer reach, the approach channel and the first second of the east/west channel is at **inaudible** as is the Trident area, and then moving in from there the inner reach is 40 foot project depth, middle basin area and west access channel is a 39 foot project depth, so now this deepening is fairly significant, we would be going to a 46 foot in the approach channel in the first section of the east/west channel and the inner reach would go from 40 to 44 foot and then in the area of Middle Basin all of that would be changing from 39 to 43 foot and back in the West Basin area, in the project that remains unchanged, however, I think John is looking at whether or not will be leaving that for cargo and commercial vessels that are coming that the berths are being built for.

**John Walsh** - Correct.

**Paul Kopp** - And then there is on top of that the more or less standard 2 foot over dredge. With the study that was done back in the mid 90's was there a surge or wake wash study that was performed at that point?

**Gary Ledford** - No, in fact we were warned by the Corps specifically not to use that Feasibility Study as a model.

**Paul Kopp** - I was more interested in if there was any sort of validation from the results of that study.

**Sandra Rice** - No this would be. . . I have done some desk top type parallel passing ship studies at some of the commercial berths, NCP 3 and 4 and south side berths the Cruise Terminals there and that is in the 203 Study, that using empirical modals and their more geared for open water situations which we really don't have here. . . it gives you an indication of what those. . . a ballpark order of magnitude of what the forces are it's not as nearly as accurate at this modeling would be. It takes into account all the real boundary conditions.

**Paul Kopp** - The NOAA tide gauge that is installed at the Trident Pier. . . there is probably not going to be any impact on the operation of that, however, that sensor might be able to provide some information that could be used to sort of qualitatively validate the model for the existing configuration.

**Sandra Rice** - Yes, it certainly could. That was in the other Hydraulic Study that I mentioned that was done. . . that was sort of a look to see how normal currents in the Port may change and what not. That information was utilized and validated in that modeling along with the current measurements that were taken at the point and time. That was back in 2006 or 2007. That data is great to have and that certainly will get real time access to that and that will be utilized as necessary for the modeling.

**Kim McDonald** - The drawings that were provided that show the changes at the Poseidon Wharf have those been developed also to show the changes at the opening to the Trident? A picture speaks a thousand words and we would like to kind of see what the impacts are going to be at the mouth of the Trident as far as changes. . . so that you know. . . we can look at. . .you know. . if we see any impacts to it.

**Gary Ledford** - We can certainly do that. The problem with the Feasibility Study is where do you stop? We're not into full blow design at this point. Just looking at it briefly we didn't see any impact but we can certainly do that.

**Kim McDonald** - John also brought up going back to the plans around the Poseidon. He has a concern that the wave action at the southern bridge at the Poseidon might create a problem at the sheet pile under the bridge, right there at that corner, and he wanted to know if there are going to be any consideration to providing more rip rap at that area right there underneath the southern bridge at the concrete wall in the modifications that you have proposed here.

**Gary Ledford** - Again another design detail, but we can certainly look at that. The concept that we have come up with so far of putting that, what we call a cut-off wall on the east side of the boat ramp may in turn mitigate that. We wanted to get some primary buy in from you folks, or comments, etc. on what we are showing there because that would be put into the surge model as part of the boundary conditions. So if you totally don't like that or if you want to see something else now is the time to tell us.

**Kim McDonald** - Ok, that is why I am asking the question. The concern would be at that wall and we would like to. . .John's suggestion would be to provide rip rap under that. . .at the bulkhead wall underneath the wharf.

**Gary Ledford** - It's been a couple years since I have been over there, and incidentally we are the ones who designed those panels where the Yokohama or seaward fenders are on there but anyway, it's kind of shoaled in back there, if I remember. Are we talking about the right. . .right next to the. . .

**Kim McDonald** - Where the end bridge, the east bridge crosses the land transitions to the bridge. . .I believe the area that he is talking about is that concrete sheet pile wall there that is part of the structure of the wharf itself. I know it's shoaled or sanded. . .my nautical terms are lacking.

**Gary Ledford** - If I remember correctly that wall is designed for zero depth anyway. That is what we call shallow wall. It's been a long time since I have looked at drawings but definitely it needs to be looked at.

**Kim McDonald** - Ok, that would probably be one of the key points that we would identify. I just wanted to throw that out there.

He also actually wanted to bring the point up that while we have this cut-off wall and we have the boat ramp there the impacts that are going to be to the floating ramp there and basically the impact maybe with the surge and the waves that may not be usable anymore, so that will need to be addressed in the modifications as to whether or not we can keep the floating pier at boat ramp. Perhaps that would be one of those key points. . .when I came here today I wasn't sure what we were looking for, nor th

schedule, so certainly we can go back and revisit that and identify it in the key points. It is just some of the questions that he put out there.

**Sandra Rice** - Right. We can consider that as points of interest.

**Kim McDonald** - Currently, that is our only boat ramp.

**Sandra Rice** - Yes.

**Kim McDonald** - The Navy agrees with the 45 Space Wing and the Coast Guard about the validation of the model. There is interest on our part in knowing how the model is going to be validated.

**Sandra Rice** - Specifically at the Port Canaveral site.

**Kim McDonald** - Yes.

**Doug Mutter** - To go back to the commercial side of it. On this study I assume the studies are the vessels going by at 5-5 1/2 knots. Is that correct?

**Sandra Rice** - We would probably look at what we would say the condition is associated with normal conditions and then maybe a high wind event. We are primarily talking about outbound cruise ship transits. We don't expect and have been made aware of any issues with tug assisted displacement vessel transits either inbound or outbound to have being detrimental in any way or cause surge issues.

**Doug Mutter** - The reality of it is not all the time is it normal conditions. Probably half the time we have high wind events, and you are trying to keep a cruise ship on its normal schedule, as the Pilots can attest too, that they have to speed up in the channel in order to maintain their position to keep from getting out of shape.

**Sandra Rice** - We would be looking at those more extreme type. . .

**Doug Mutter** - And the other thing with the timing like Lt. Harder said once that vessel was passed it was 11 minutes after it passed when that ship got surged. Right now there is supposed to be 30 minutes between ships transiting the channel. That does not always happen to try and keep cruise ships on track. The usually are 15 minutes behind each other. Once it barely calms down you have another one that goes by and creates another surge. This is just my view of the reality of it. It is not always a normal condition. Take for today, we are going to have two ships at north one and north two both large vessels, one overhanging north two kind of the same way the surge happened a couple weeks ago and we will have a couple cruise ships transiting right by those. Just saying if you keep that in some of scenarios instead of it being 5 1/2 knots it maybe it maybe 7 knots.

**Sandra Rice** - Again we will be working with the Pilots to establish what we are going to call normal versus higher level wind condition *inaudible*. I certainly am very interested in the talking to Coast and Harbor about this idea that. . the close transit. . .that is something we can accommodate. I'll just have to report back on that.

**Jave Dahl** - I have a couple questions about the minutes. Who is going to keep the minutes for this meeting? With the contractor?

**John Walsh** - No, with the Port, so the Port will be issuing minutes for each of the meetings. I would like to suggest John that when the meetings come out we get a drop on the draft so that we can validate all the points and make sure all the issues, for instance the Coast Guard had some outstanding points today that should absolutely be in the minutes as did the Port.

**John Walsh** - I agree. One of the items we put in, obviously the meeting is taped so we are able to go back through, so we will be able to go back and pick up each point. I've made notes as we have gone through but we will be able to do a full transcript of everything that everyone brought up today. Those calling in as well as those individuals that are here, so I don't think we will miss any key items but we always do a draft ahead of time so this is as we have seen it, but if there are some items, and occasionally people want to also add a few items they forgot but are important to distribute in a process like this.

**Dave Dahl** - That's outstanding. Thank you sir. Is there a master schedule somewhere?

**John Walsh** - There has been a master schedule prepared with David Miller & Associates going through but the whole surge piece is a new impact of that. Originally the surge was something that in prior command, in prior discussions, was prior to my time coming to the Port, that is was not something that was going to need to be done, so it has had an impact. I have heard the message loud and clear today. I come from a construction background so schedules how much and when are the two aspects that I live by, so you can expect that by mid next week there will be a master schedule submitted to everyone, prior to our next meeting, people will have opportunity to review minutes as well as the master schedule as we see it today, understanding that there are certain impacts that we may not anticipate but at least when those impacts then come we can show what the impact is on the schedule and we will try to build in all the anticipated delays, so we will do an idea, and show where there is float in particular items off the idea. . .

**Dave Dahl** - A place to start and we modify as we go.

**John Walsh** - Correct.

**Captain Kuzma** - The one thing that the master schedule with talking to Mr. Payne and Coast Guard was the authorities don't necessarily reside with myself from a Navy point of view and some of that was to allow us to make sure that we could get the information to our respected chain of commands through the authoritative decision makers to do that. It was meant to allow us to really make sure our processes did not stand in the long term discussions of the project.

**John Walsh** - Ok. We appreciate that.

**Dave Dahl** - The ship models. . .from the little bit I know about this whole project we have commercial vessels, we have Coast Guard vessels, we have Army vessels, we have Air Force vessels, we have Navy vessels, and we have a variety of the big commercials and seemed like Sandy said that what we are going to do was take a look at that universe of potential vessels in the Port and identify the ones that would be the high interest items and model those. Is that correct?

**Sandra Rice** - Yes, in the interest of making this a study that we can manage and get through. . .

**Dave Dahl** - Right, you have to pare down to a certain number.



**Sandra Rice** - Right.

**Dave Dahl** - Are we going to have a meeting to do that or are you going to propose a group that we will model or how exactly is that process going to happen?

**Sandra Rice** - I think that we would first need to see from you what you think your universal high interest vessels looks like.

**Dave Dahl** - Ok. So we would submit those to you and copy the Port?

**John Walsh** - Yes we would like to be copied so we are aware of that.

**Dave Dahl** - Is that the universe there? There are Army ships that use the Port commercial, the cruise ships, the Navy ships and then there are some Air Force vessels as well, correct? I'm not trying to make it unmanageable I heard you loud and clear that we have to pare it down, but I'm just wondering how we are going to get to the ones we want to model because it be sad to miss some we really wanted to model.

**Sandra Rice** - And by looking at the list we can possibly decide that this one is more important than this one.

**Dave Dahl** - Perfect. Public Comment on the draft review, I'm not sure I understood that.

**John Walsh** - That is a process of the Army Corps of Engineers and they have several of those, but essentially the draft is then distributed as general public comments as the draft goes out or the draft is posted on David Miller's site so that people can download that, review the draft and then all stakeholders of the Port, local government agencies, other municipal functions, US Fish and Wildlife, FDEP, Florida Fish and Wildlife, so any and all stakeholders, Propeller Club, groups that may use the Port for recreational boating or fishing, so it allows everyone that would like to have an input, to bring input there are public meetings that would be a part of that as well.

**Dave Dahl** - That draft is a draft of our proposed study. . .

**John Walsh** - The entire study, so. . . the surge is a part this pile here is essentially the draft as it sits today of the Section 203 Study, so it is allowing people to look at this document, as it exists, which will eventually will go up to the Atlanta office of the Corps to have approvals at that level and then move from Atlanta to Washington.

**Dave Dahl** - So the surge is a subset of that?

**John Walsh** - The surge is a subset that will become another binder to go in this set of information that is the economic analysis, the engineering analysis, the environmental analysis, being done by Dial Cordy.

**Dave Dahl** - Thanks Mr. Walsh.

Kim McDonald - I hate to go back to schedule again, but so essentially the data that we are talking about, the ship data, the key points of interest, you need those all within 9 days. Correct?

**Sandra Rice** - I had to put something on paper.

**John Walsh** - Ideally, yes, if I could speak for Mr. Payne it would be 3 days but. . .

**Kim McDonald** - Since I have the engineer side, when we are talking key points how many are you looking for? Like the ship thing, we can provide thousands points or do you want ten points. Never mind that didn't filter down to me.

So basically you are looking for in a week to a little over a week to get that information to dial into the next process to get to that 35%.

**John Walsh** - This is correct.

**Sandra Rice** - Right, we just want to move, collecting the information and processing the information to get a plan together that everyone is in agreement with. . .

**Kim McDonald** - And then that's the 35% review that everyone. . . that is where you lost me, because by August we are supposed to have a 35% design level completed, or they will. . .

**Sandra Rice** - My focus is on the surge model I'm not. . .

**John Walsh** - Yes, there is concurrency David Miller & Associates is working on the overall Section 203, when we say 35% it's 35% design drawings that the Corps requires at that point but the Port is committed to saying if we can identify points that we know are a problem now one of the things I was going to bring up is obviously there are specifics as we talk about the communication utilities, we would like to engage a surveyor and coordinate with the Air Force and the base to bring a surveyor in and lets specifically pinpoint those. They're going to be part of moving to the 60%, moving to the 100% drawings, so if we start collecting that data now concurrently we don't necessarily need to wait to a 35% point to collect data that we know we are going to need in the future, so we would like to expedite some of those steps, they will actually help us pinpoint potential areas of conflict, take a look at the grades in the angles in those areas that will help Gary look at potential solutions and if the Surge Study brings back that there is a particular impact then we will be asking him to look from a marine structural engineering standpoint to say, "How can we mitigate this effect, if we build this particular structure or seawall or whatever is necessary?", would that mitigate then an effect that the study says could be impacted. We are hopeful, but the study will show that the widening and deepening that there would be already a lesser impact, it doesn't mean that we can cure everything that currently exists out there, but it may be the opportunity to make incremental improvements to say not only will the widening and deepening make things less of a problem we can also take that opportunity if we have to change a particular structure to do it in the most prudent way we can to reduce the impact even as it exists today lower than it is on the particular vessel, on top of the standards that have been used, with getting notices out, proper linehandling and proper seamanship techniques, which will always be first and foremost one of the things that we as a Port and various stakeholders at the Port need to make very real every day. That is the number one effect. The ship that came away, the Captain admitted that it was old lines and that it was tied up at high tide and they weren't tending those properly, so that is a simple effort that we can all do as stakeholders to make sure that it doesn't happen on a regular basis.

**Dave Stone** - Sandy could you provide information on the specific format that you want the whole data in, so that I can effectively pass that to the Delta Mariner folks in a way that you need it. I

understand that you are trying to collect that whole data by the 22nd of July, so I'm wondering what is the 29th date for, once you get that whole data what will happen on the 29th?

**Sandra Rice** - First we have to know the vessels and the points of interest and then from that we can determine what are reasonable passing scenarios. . . after the hulls are figured out what vessels we want to put where, we will be able to develop good passing scenarios.

**Dave Stone** - So the 29th is to look at passing scenarios?

**Sandra Rice** - Well, yes, if we got the information say on the 22nd then between the 22nd and 29th we can work to put together the draft passing scenarios and provide them to you as draft report. . .to change something, add something.

**Dave Stone** - When this goes out, the Feasibility Study goes out for public and federal review, how do the federal entities get notified that it is available for their review?

**John Walsh** - There are a group of stakeholders, David Miller has already but it is broad notice but there also will be newspaper publication, Federal Register is where a lot of the agencies will. .

**Dave Stone** - I guess that is what I was getting at, do you have to watch the Federal Register and that's your opportunity. . .

**John Walsh** - We will reach out to as many individuals and groups that we know have continued interest in the Port. It will be announced at Port meetings, as well put onto our website, as well as probably ads in local publications as well, so that local constituents and groups know to look for that data, but in general a reach out in e-mail attempt of all of those groups that we know have a stake or a interest here in the Port. The Army Corps has a regular cast as well as they go through any of these studies that they know that they need to locate, we're working obviously with the Jacksonville Army Corps office and they work very closely on these throughout the country, throughout our region on those studies.

**Dave Stone** - Just one last point, I know when we were looking at the draft Feasibility Study it was sometimes very difficult to access servers from a .mil site to get them. It may be a good idea to have those available via CDs that we could pick-up as well. We eventually got to that, but sometimes with some of our computer firewalls it's hard to get to them.

**John Walsh** - Ok, we will do that.

**Sandra Rice** - After today I can e-mail people the more specific information, vessel particulars, possibly a picture, whatever. If there is a certain point of contact within each group, so I am not broadcasting to everybody, I don't know if I can pare down who would be good points of contact in each group to get this information.

**Captain Kuzma** - I would like to thank everybody for lots of discussion and great work. When the leadership talked we talked about the kind of process that over higher view is kind of study impact and then mitigation, so we all have kind of talked about that in different terms of whatever. The Navy, like the Coast Guard, were looking for growth compatible with the current mission understanding that here is probably some discussion down the line. I would ask that if there is something that comes out that the group wants someone to look at to really push it directly to the respective points of

contact. We are really looking forward to step through this but we do have concerns and we have responsibilities on our side of the mission as we move forward. I don't think my team has any further comments.

**John Walsh** - Anyone else? On behalf of the Port the one item we did want to go over today is to keep this on a regular basis. Do we want to decide today to do an every two week or every three week rotation, so as this data moves forward it gives people the opportunity we would not have to have all stakeholders but if each group had at least representative, or their particular concerns. . .we found in the past that if we don't set those regular meetings and deadlines then things can slip very quickly. Every two weeks? The 27th?

**Captain Kuzma** - I would recommend that you set that as a starting pointing and if there is an issue then when the folks get back. . .certainly there will be different people.

**John Walsh** - Ok, we will set that today for the 27th at 10:00 and then that if there are particulars or if people have additional questions after leaving today at least we have that platform to address them and bring them forward and keep things moving on a very pressured point forward, and we do appreciate the input that we have received today. We know this has an impact on groups and we are looking for it to be a very successful project for all stakeholders and we do appreciate your time coming today and through the process. Thank you.

The meeting was adjourned at a 11:52 a.m.

Tara Carroll  
Recording Secretary  
July 26, 2011

## Port Canaveral Channel Widening, Section 203 Feasibility Study

### Real Estate Issues – Meeting at CPA Offices

**ATTENDEES:** Bob Fowler, USAF Real Property  
853-0917,  
Robert.Fowler@patrick.af.mil

Jeannen Baker, USAF Real  
Property, 853-0967  
Jeannen.Baker@patrick.af.mil

Jeannie Adame, CPA Director of  
Environmental Plans &  
Programs, Project Manager, 783-  
7831x256  
JAdame@PortCanaveral.org

Susan Cossey, Director of Tenant  
Development and FTZ 136,  
783-7831x257  
SCossey@PortCanaveral.org

Suzie Norris, CH2M Hill,  
Project Engineer, 799-1236x222  
Suzanna.Norris@CH2M.com

Linda Batz, CH2M Hill,  
Project Engineer, 799-1236x211  
Linda.Batz@CH2M.com

**FROM:** Linda Batz

**DATE:** November 22, 2005 (1400)

**CC:** Attendees, Sandy Rice, and Gary Ledford

Jeannie and Linda introduced the channel widening project and study process. The widening will affect the USAF uplands adjacent to the harbor between the Middle Turning Basin and the Trident Turning Basin. Bob was aware of the project and remembered a meeting approximately 4-5 years ago that Gary Ledford had attended.

A task in the first phase of the study is to identify all property owners and adjacent property owners and to verify ownership of those lands. Bob provided a copy of the legal description of the USAF parcel named "Tract No. 945." This parcel is 198.50 acres and is identified under the G.T. Gwathmey, Et Al Schedule "A" document. It appears this parcel is north of the parcel identified in Contract DA-08-123-eng-2257 (GJ ID#A-51) and includes uplands between the Middle Turning Basin and the Trident Turning Basin. Bob had a preliminary property map prepared by Land & Sea Survey that the USAF had commissioned. Once the map is final, a copy could be provided to CPA.

Another task in the first phase of the study is to determine the optimal width of the widening based on economic and engineering analyses. Once the width is determined and the impact to the USAF land is known, Jeannie will submit a letter explaining the proposed impact to Jack Gibson, Deputy Commander, 45 CES/CD with a copy to CES/CEL.

Jeannen and Bob noted that the USAF would probably not give up interest (ownership) in the land, but would probably grant the easement to the COE. The procedure utilized in the last widening should be researched. /end

**Port Canaveral Section 203 Feasibility Study  
Real Estate Appendix**

Attachment E

Sponsor Capability Checklist

Date: July 2012

ASSESSMENT OF NON-FEDERAL SPONSOR'S REAL ESTATE ACQUISITION  
CAPABILITY FOR CANAVERAL PORT AUTHORITY

I. Legal Authority:

- a. Does the sponsor have legal authority to acquire and hold title to real property for project purposes? *Yes.*
- b. Does the sponsor have the power of eminent domain for this project? *Yes.*
- c. Does the sponsor have "quick take" authority for this project? *Yes.*
- d. Are any of the lands/interests in land required for the project located outside the sponsor's political boundary? *No, but portions for the widening are on the Air Force property.*
- e. Are any of the lands/interests in land required for the project owned by an entity whose property the sponsor cannot condemn? *Yes, United States of America, 45<sup>th</sup> Space Wing.*

II. Human Resource Requirements:

- a. Will the sponsor's in house staff require technical training to become familiar with the real estate requirements of Federal projects including P.L. 91-646, as amended? *Yes.*
- b. If the answer to II.a is "yes", has a reasonable plan been developed to provide such training? *In process now in conjunction with USACE.*
- c. Does the sponsor's in-house staff have sufficient real estate acquisition experience to meet its responsibilities for the project? *Yes.*
- d. Is the sponsor's projected in-house staffing level sufficient considering its other work load, if any, and the project schedule? *Yes.*
- e. Can the sponsor obtain contractor support, if required in a timely fashion? *Yes.*
- f. Will the sponsor likely request USACE assistance in acquiring real estate? *Yes.*

III. Other Project Variables:

- a. Will the sponsor's staff be located within reasonable proximity to the project site? *Yes.*
- b. Has the sponsor approved the project/real estate schedule/milestones? *Yes.*

IV. Overall Assessment:

- a. Has the sponsor performed satisfactorily on other USACE projects? *Yes.*
- b. With regard to this project, the sponsor is anticipated to be: highly capable/fully capable/moderately capable/marginally capable/insufficiently capable. *highly capable*

V. Coordination:

- a. Has this assessment been coordinated with the sponsor? Yes.
- b. Does the sponsor concur with this assessment? Yes.

Date: 12/15/11

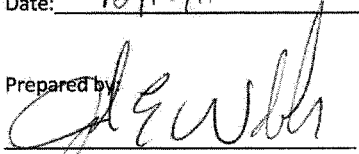
Prepared by 

John E. Walsh  
Deputy Executive Director, Infrastructure  
Canaveral Port Authority

Reviewed and approved by:



J. Stanley Payne  
Chief Executive Officer  
Canaveral Port Authority